

**Agilent B1505A  
Power Device Analyzer/  
Curve Tracer**

**User's Guide**



**Agilent Technologies**

# Notices

© Agilent Technologies, Inc. 2009, 2010, 2011, 2012, 2013

No part of this manual may be reproduced in any form or by any means (including electronic storage and retrieval or translation into a foreign language) without prior agreement and written consent from Agilent Technologies, Inc. as governed by United States and international copyright laws.

## Manual Part Number

B1505-90000

## Edition

Edition 1, June 2009  
Edition 2, November 2009  
Edition 3, June 2010  
Edition 4, August 2010  
Edition 5, June 2011  
Edition 6, June 2012  
Edition 7, September 2012  
Edition 8, November 2012  
Edition 9, October 2013

Agilent Technologies, Inc.  
5301 Stevens Creek Blvd  
Santa Clara, CA 95051 USA

## Warranty

**The material contained in this document is provided “as is,” and is subject to being changed, without notice, in future editions. Further, to the maximum extent permitted by applicable law, Agilent disclaims all warranties, either express or implied, with regard to this manual and any information contained herein, including but not limited to the implied warranties of merchantability and fitness for a particular purpose. Agilent shall not be liable for errors or for incidental or consequential damages in connection with the furnishing, use, or performance of this document or of any information contained herein. Should Agilent and the user have a separate written agreement with warranty terms covering the material in this document that conflict with these terms, the warranty terms in the separate agreement shall control.**

## Technology Licenses

The hardware and/or software described in this document are furnished under a license and may be used or copied only in accordance with the terms of such license.

## Restricted Rights Legend

If software is for use in the performance of a U.S. Government prime contract or subcontract, Software is delivered and licensed as “Commercial computer software” as defined in DFAR 252.227-7014 (June 1995), or as a “commercial item” as defined in FAR 2.101(a) or as “Restricted computer software” as defined in FAR 52.227-19 (June 1987) or any equivalent agency regulation or contract clause. Use, duplication or disclosure of Software is subject to Agilent Technologies’ standard commercial license terms, and non-DOD Departments and Agencies of the U.S. Government will

receive no greater than Restricted Rights as defined in FAR 52.227-19(c)(1-2) (June 1987). U.S. Government users will receive no greater than Limited Rights as defined in FAR 52.227-14 (June 1987) or DFAR 252.227-7015 (b)(2) (November 1995), as applicable in any technical data.

## Declaration of Conformity

To get the latest version of the declaration of conformity, go to <http://regulations.corporate.agilent.com/DoC/search.htm> and type in the product number in the Search field.

## Latest Information

To get the latest firmware/software/electronic manuals/support information, go to [www.agilent.com](http://www.agilent.com) and type in the product number in the Search field at the top of the page.



**Agilent Technologies**

**DECLARATION OF CONFORMITY**  
According to EN ISO/IEC 17050-1:2004



**Manufacturer's Name:** Agilent Technologies Singapore (International) Pte. Ltd.  
**Manufacturer's Address:** No. 1 Yishun Ave 7  
SINGAPORE 768923  
Singapore

**Declares under sole responsibility that the product as originally delivered**

**Product Name:** Power Device Analyzer/Curve Tracer  
High Power Source/Monitor Unit Module,  
Medium Power Source/Monitor Unit Module,  
High Current Source/Monitor Unit Module,  
High Voltage Source/Monitor Unit Module,  
Medium Current Source/Monitor Unit Module  
Multi Frequency Capacitance Measurement Unit Module  
**Model Number:** Agilent B1505A  
Agilent B1510A, Agilent B1511A, Agilent B1512A, Agilent B1513A/B,  
Agilent B1514A, Agilent B1520A  
**Product Options:** This declaration covers all related options of the above product(s)

**complies with the essential requirements of the following applicable European Directives, and carries the CE marking accordingly:**

Low Voltage Directive (2006/95/EC)  
EMC Directive (2004/108/EC)

**and conforms with the following product standards**

<b>EMC</b>	<b>Standard</b>	<b>Limit</b>
	IEC 61326-1:2005 / EN 61326-1:2006	
	CISPR 11:2003 / EN55011:1998+A1:1999+A2 :2002	Group 1 Class A
	IEC 61000-4-2:2001 / EN 61000-4-2:1995+A1:1998+A2:2001	4 kV CD, 8 kV AD
	IEC 61000-4-3:2002+A1:2002/EN 61000-4-3:2002+A1:2002	3 V/m / 80 MHz-1 GHz / 1.4-2 GHz, 1 V/m / 2-2.7 GHz
	IEC 61000-4-4:2004 / EN 61000-4-4:2004	0.5 kV signal lines, 1 kV power lines
	IEC 61000-4-5:2001/EN 61000-4-5:1995+A1:2001	0.5 kV line-line, 1 kV line-ground
	IEC 61000-4-6:2003 / EN 61000-4-6:1996+A1:2001	3 V, 0.15-80 MHz
	IEC 61000-4-11:2004 / EN 61000-4-11:2004	Voltage Dip: 0 % for 1/0.5 cycle, 70 % for 25/30 cycles Short Interruptions: 0 % for 250/300 cycles
	Canada: ICES/NMB-001:2004	
	Australia/New Zealand: AS/NZS CISPR 11:2004	

**Safety** IEC 61010-1:2001 / EN 61010-1:2001  
Canada: CAN/CSA-C22.2 No. 61010-1-04, C/US

**Supplementary Information:**

The product was tested in a typical configuration with Agilent Technologies test systems.

This DoC applies to above-listed products placed on the EU market after:  
Year of the CE marking '09

**June 22, 2012**  
Date

川路利行

**Toshiyuki Kawaji**

QA Manager  
Agilent Technologies Hachioji  
Semiconductor Test Division

For further information, please contact your local Agilent Technologies sales office, agent or distributor,  
or Agilent Technologies Deutschland GmbH, Herrenberger Straße 130, 71034 Böblingen, Germany.



**Agilent Technologies**

**DECLARATION OF CONFORMITY**  
According to EN ISO/IEC 17050-1:2004



**Manufacturer's Name:** Agilent Technologies Singapore (International) Pte. Ltd.  
**Manufacturer's Address:** No. 1 Yishun Ave 7  
SINGAPORE 768923  
Singapore

**Declares under sole responsibility that the product as originally delivered**

**Product Name:** Module Selector

**Model Number:** Agilent N1258A

**Product Options:** This declaration covers all related options of the above product(s)

**complies with the essential requirements of the following applicable European Directives, and carries the CE marking accordingly:**

Low Voltage Directive (2006/95/EC)  
EMC Directive (2004/108/EC)

**and conforms with the following product standards**

**EMC Standard**

IEC 61326-1:2005 / EN 61326-1:2006  
CISPR 11:2003 / EN55011:1998+A1:1999+A2 :2002  
IEC 61000-4-2:2001 /EN 61000-4-2:1995+A1:1998+A2:2001  
IEC 61000-4-3:2002+A1:2002/EN 61000-4-3:2002+A1:2002  
IEC 61000-4-4:2004 / EN 61000-4-4:2004  
IEC 61000-4-5:2001/EN 61000-4-5:1995+A1:2001  
IEC 61000-4-6:2003 / EN 61000-4-6:1996+A1:2001  
IEC 61000-4-11:2004 / EN 61000-4-11:2004

Canada: ICES/NMB-001:2004  
Australia/New Zealand: AS/NZS CISPR 11:2004

**Limit**

Group 1 Class A  
4 kV CD, 8 kV AD  
3 V/m / 80 MHz-1 GHz / 1.4-2 GHz, 1 V/m / 2-2.7 GHz  
0.5 kV signal lines, 1 kV power lines  
0.5 kV line-line, 1 kV line-ground  
3 V, 0.15-80 MHz  
Voltage Dip: 0 % for 1/0.5 cycle, 70 % for 25/30 cycles  
Short Interruptions: 0 % for 250/300 cycles

**Safety** IEC 61010-1:2001 / EN 61010-1:2001  
Canada: CAN/CSA-C22.2 No. 61010-1-04, C/US

**Supplementary Information:**

The product was tested in a typical configuration with Agilent Technologies test systems.

This DoC applies to above-listed products placed on the EU market after:  
Year of the CE marking '09

**July 20, 2012**

Date

川路利行

Toshiyuki Kawaji

QA Manager  
Agilent Technologies Hachioji  
Semiconductor Test Division

For further information, please contact your local Agilent Technologies sales office, agent or distributor, or Agilent Technologies Deutschland GmbH, Herrenberger Straße 130, 71034 Böblingen, Germany.



**Agilent Technologies**

**DECLARATION OF CONFORMITY**  
According to EN ISO/IEC 17050-1:2004



**Manufacturer's Name:** Agilent Technologies Singapore (International) Pte. Ltd.  
**Manufacturer's Address:** No. 1 Yishun Ave 7  
SINGAPORE 768923  
Singapore

**Declares under sole responsibility that the product as originally delivered**

**Product Name:** Test Fixture  
**Model Number:** Agilent N1259A  
**Product Options:** This declaration covers all options of the above product(s)

**complies with the essential requirements of the following applicable European Directives, and carries the CE marking accordingly:**

Low Voltage Directive (2006/95/EC)  
EMC Directive (2004/108/EC)

**and conforms with the following product standards**

<b>EMC</b>	<b>Standard</b>	<b>Limit</b>
	IEC 61326-1:2005 / EN 61326-1:2006	
	CISPR 11:2003 / EN55011:1998+A1:1999+A2 :2002	Group 1 Class A
	IEC 61000-4-2:2001 / EN 61000-4-2:1995+A1:1998+A2:2001	4 kV CD, 8 kV AD
	IEC 61000-4-3:2002+A1:2002/EN 61000-4-3:2002+A1:2002	3 V/m / 80 MHz-1 GHz / 1.4-2 GHz, 1 V/m / 2-2.7 GHz
	IEC 61000-4-4:2004 / EN 61000-4-4:2004	0.5 kV signal lines, 1 kV power lines
	IEC 61000-4-5:2001/EN 61000-4-5:1995+A1:2001	0.5 kV line-line, 1 kV line-ground
	IEC 61000-4-6:2003 / EN 61000-4-6:1996+A1:2001	3 V, 0.15-80 MHz
	IEC 61000-4-11:2004 / EN 61000-4-11:2004	0 % for 1/0.5 cycle, 0 % for 250/300 cycles, 70 % for 25/30 cycles
	Canada: ICES/NMB-001:2004	
	Australia/New Zealand: AS/NZS CISPR 11:2004	

**Safety** IEC 61010-1:2001 / EN 61010-1:2001  
Canada: CAN/CSA-C22.2 No. 61010-1-04, C/US

**Supplementary Information:**

The product was tested in a typical configuration with Agilent Technologies test systems.

This DoC applies to above-listed products placed on the EU market after:

March 20, 2010  
Date

川路 利行

**Toshiyuki Kawaji**  
QA Manager  
Agilent Technologies

For further information, please contact your local Agilent Technologies sales office, agent or distributor, or Agilent Technologies Deutschland GmbH, Herrenberger Straße 130, 71034 Böblingen, Germany.



**Agilent Technologies**

**DECLARATION OF CONFORMITY**  
According to EN ISO/IEC 17050-1:2004



**Manufacturer's Name:** Agilent Technologies Singapore (International) Pte. Ltd.  
**Manufacturer's Address:** No. 1 Yishun Ave 7  
SINGAPORE 768923  
Singapore

**Declares under sole responsibility that the product as originally delivered**

**Product Name:** Ultra High Current Expander / Fixture

**Model Number:** Agilent N1265A

**Product Options:** This declaration covers all related options of the above product(s)

**complies with the essential requirements of the following applicable European Directives, and carries the CE marking accordingly:**

Low Voltage Directive (2006/95/EC)  
EMC Directive (2004/108/EC)

**and conforms with the following product standards**

<b>EMC</b>	<b>Standard</b>	<b>Limit</b>
	IEC 61326-1:2005 / EN 61326-1:2006	
	CISPR 11:2003 / EN55011:1998+A1:1999+A2 :2002	Group 1 Class A
	IEC 61000-4-2:2001 / EN 61000-4-2:1995+A1:1998+A2:2001	4 kV CD, 8 kV AD
	IEC 61000-4-3:2002+A1:2002/EN 61000-4-3:2002+A1:2002	3 V/m / 80 MHz-1 GHz / 1.4-2 GHz, 1 V/m / 2-2.7 GHz
	IEC 61000-4-4:2004 / EN 61000-4-4:2004	0.5 kV signal lines, 1 kV power lines
	IEC 61000-4-5:2001/EN 61000-4-5:1995+A1:2001	0.5 kV line-line, 1 kV line-ground
	IEC 61000-4-6:2003 / EN 61000-4-6:1996+A1:2001	3 V, 0.15-80 MHz
	IEC 61000-4-11:2004 / EN 61000-4-11:2004	Voltage Dip: 0 % for 1/0.5 cycle, 70 % for 25/30 cycles Short Interruptions: 0 % for 250/300 cycles
	Canada: ICES/NMB-001:2004	
	Australia/New Zealand: AS/NZS CISPR 11:2004	
<b>Safety</b>	IEC 61010-1:2001 / EN 61010-1:2001	
	Canada: CAN/CSA-C22.2 No. 61010-1-04, C/US	

**Supplementary Information:**

The product was tested in a typical configuration with Agilent Technologies test systems.

This DoC applies to above-listed products placed on the EU market after:  
Year of the CE marking '12

**June 22, 2012**

Date

川路利行

Toshiyuki Kawaji

QA Manager  
Agilent Technologies Hachioji  
Semiconductor Test Division

For further information, please contact your local Agilent Technologies sales office, agent or distributor,  
or Agilent Technologies Deutschland GmbH, Herrenberger Straße 130, 71034 Böblingen, Germany.



**Agilent Technologies**

**DECLARATION OF CONFORMITY**  
According to EN ISO/IEC 17050-1:2004



**Manufacturer's Name:** Agilent Technologies Singapore (International) Pte. Ltd.  
**Manufacturer's Address:** No. 1 Yishun Ave 7  
SINGAPORE 768923  
Singapore

**Declares under sole responsibility that the product as originally delivered**

**Product Name:** High Voltage Source Monitor Unit Current Expander  
High Voltage Source Monitor Unit / High Current Source Monitor Unit  
Fast Switch  
**Model Number:** Agilent N1266A  
Agilent N1267A  
**Product Options:** This declaration covers all related options of the above product(s)

**complies with the essential requirements of the following applicable European Directives, and carries the CE marking accordingly:**

Low Voltage Directive (2006/95/EC)  
EMC Directive (2004/108/EC)

**and conforms with the following product standards**

EMC	Standard	Limit
	IEC 61326-1:2005 / EN 61326-1:2006	
	CISPR 11:2003 / EN55011:1998+A1:1999+A2 :2002	Group 1 Class A
	IEC 61000-4-2:2001 /EN 61000-4-2:1995+A1:1998+A2:2001	4 kV CD, 8 kV AD
	IEC 61000-4-3:2002+A1:2002/EN 61000-4-3:2002+A1:2002	3 V/m / 80 MHz-1 GHz / 1.4-2 GHz, 1 V/m / 2-2.7 GHz
	IEC 61000-4-4:2004 / EN 61000-4-4:2004	0.5 kV signal lines, 1 kV power lines
	IEC 61000-4-5:2001/EN 61000-4-5:1995+A1:2001	0.5 kV line-line, 1 kV line-ground
	IEC 61000-4-6:2003 / EN 61000-4-6:1996+A1:2001	3 V, 0.15-80 MHz
	IEC 61000-4-11:2004 / EN 61000-4-11:2004	Voltage Dip: 0 % for 1/0.5 cycle, 70 % for 25/30 cycles Short Interruptions: 0 % for 250/300 cycles
	Canada: ICES/NMB-001:2004	
	Australia/New Zealand: AS/NZS CISPR 11:2004	

**Safety** IEC 61010-1:2001 / EN 61010-1:2001  
Canada: CAN/CSA-C22.2 No. 61010-1-04, C/US

**Supplementary Information:**

The product was tested in a typical configuration with Agilent Technologies test systems.

This DoC applies to above-listed products placed on the EU market after:  
Year of the CE marking '12

**June 22, 2012**

Date

川路 利行

**Toshiyuki Kawaji**

QA Manager  
Agilent Technologies Hachioji  
Semiconductor Test Division

For further information, please contact your local Agilent Technologies sales office, agent or distributor,  
or Agilent Technologies Deutschland GmbH, Herrenberger Straße 130, 71034 Böblingen, Germany.



**Agilent Technologies**

**SUPPLIER'S DECLARATION OF CONFORMITY**

According to ISO/IEC 17050-1:2004

**Supplier's Name:** Agilent Technologies Singapore (International) Pte. Ltd.  
**Supplier's Address:** No. 1 Yishun Ave 7  
SINGAPORE 768923  
Singapore

**Object of declaration:**

**Brand Name:** Agilent Technologies  
**Product Name:** Ultra High Voltage Expander  
**Model Number:** Agilent N1268A  
**Product Options:** Options of the above product covered

**complies with the essential requirements of the following applicable European Directives, and carries the CE marking accordingly:**

**Low Voltage Directive (2006/95/EC)**  
**EMC Directive (2004/108/EC)**

**The object of declaration described above is in conformity with the requirements of the following documents:**

*Above declares model is equivalent to Manufacture's Declaration of Conformity:*

*Model: HEOPT-10B10-LC-AG1*

*Description: High Voltage Power Supply*

**Supplementary Information:**

The product was tested in a typical configuration with Agilent Technologies test systems.

This DoC applies to above-listed products placed on the EU market after:

Year of the CE marking '12

**November 13, 2012**

Date of issue

川路 利行

**Toshiyuki Kawaji**

QA Manager  
Agilent Technologies Hachioji  
Semiconductor Test Division



## **COMPLIANCE WITH GERMAN NOISE REQUIREMENTS**

This is to declare that this product is in conformance with the German Regulation on Noise Declaration for Machines (Lärmangabe nach der Maschinenlärminformation-Verordnung -3.GSGV Deutschland).

- **Herstellerbescheinigung**

GERÄUSCHEMISSION

Lpa < 70 dB

am Arbeitsplatz

normaler Betrieb

nach DIN 45635 T. 19

- **Manufacturer's Declaration**

ACOUSTIC NOISE EMISSION

Lpa < 70dB

operator position

normal operation

per ISO 7779

### **South Korean Class A EMC declaration**

This equipment is Class A suitable for professional use and is for use in electromagnetic environments outside of the home.

A급 기기

(업무용 방송통신기자재)

이 기기는 업무용(A급) 전자파적합기기로서 판매자 또는 사용자는 이 점을 주의하시기 바라며, 가정외의 지역에서 사용하는 것을 목적으로 합니다.

The KCC (Korea Communications Commission), the EMC/RF/Telecom authority, has been changed to MSIP (Ministry of Science, ICT & Future Planning) since February 2013. The existing certificate/registration number "KCC-REM-ATi-1H-ParaINSTR" has the same effect as the new number "MSIP-REM-ATi-1H-ParaINSTR".

## WARNING



### High Voltage

is used in the operation of this equipment.

### LETHAL VOLTAGE on CONTACT

may be present at measurement terminals,  
if you fail to take in all safety precautions!

- When the RED indicator lights, lethal voltage ( $\pm 10$  kV dc/pulse) may appear at measurement terminals.
- **Usually use the interlock function.**
- Do not operate the instrument unless another person is around the work space who is familiar with instrument operation and hazards or administering first aid.
- Potentials less than  $\pm 500$  V may cause death under certain conditions. Therefore, adequate preventive measures must be taken at all times!

### FIRST AID FOR ELECTRIC SHOCK

#### *SPECIAL ATTENTION TO RESCUE IN SAFETY*

- Never rush into an accidental situation.
- Take special attention to the following notices to prevent second accident.
  - Do NOT touch the CASUALTY or conductive surface with your hands unprotected.
  - Shut off high voltage at once.
  - Disconnect AC mains.
- If it is unsure to make safe, the following procedure will help to protect your lives during the CASUALTY is rescued.
  - Stand on a dry insulating material; use a dry wooden or plastic implement to free the CASUALTY from contact with hazardous electrical source.

- Ground the circuit to de-energize.
- Free the CASUALTY from the LIVE conductor

**CALL EMERGENCY**

- Call your local Emergency number immediately, if any of signs or symptoms shown in the following table will be found.

[http://en.wikipedia.org/wiki/Emergency\\_telephone\\_number#Emergency\\_numbers](http://en.wikipedia.org/wiki/Emergency_telephone_number#Emergency_numbers)

**DELAYED SYMPTOMS**

- In some cases, electric shock can cause injuries that are not evident and symptoms may be delayed.
- Burns to the CASUALTY may be greater than they appear on the surface.
- For these reasons, all electric shock CASUALTY should be taken to hospital for advanced observation.

<i>English</i>	<i>Deutsch</i>	<i>French</i>	<i>Japanese</i>	<i>Korean</i>	<i>Simplified Chinese</i>	<i>Traditional Chinese</i>
<b>Symptoms</b>	<b>Symptome</b>	<b>Symptômes</b>	<b>兆候</b>	<b>징후</b>	<b>征候</b>	<b>徵候</b>
Cardiac arrest	Herz-Kreislauf-Stillstand	Arestation cardiopulmonaire	心肺停止	심폐 정지	心肺停止	心肺停止
Abnormal cardiac rhythm	Arrhythmia	Arythmie	不整脈	부정맥	脉律不齐	脈律不齊
Respiratory failure (difficult or absent breathing)	Respiratorischer Mißerfolg	Échec respiratoire	呼吸不全	호흡 부전	呼吸不全	呼吸不全
Muscle pain and contractions	Muskelschmerz und Zusammenziehungen	Douleur du muscle et contractions	筋肉痛 / 痙攣	근육통 / 수축	肌肉痛 / 痙攣	肌肉痛 / 痙攣
Seizures (heart beat stopped)	Herzlähmung	Paralyse cardiaque	心臟麻痺	심장 마비	心脏麻痹	心臟麻痺
Numbness and tingling	Eine Taubheit / Stachel	Un engourdissement / Une épine	痺れ / 刺痛	저리다 / 가시痛	发麻 / 刺痛	發麻 / 刺痛
Unconsciousness	Bewusstlosigkeit	Évanouissement	意識不明	의식 불명	意识不明	意識不明
Entrance and exit wound burns	Eine elektrische Schockspur	Une trace du choc électrique	感電跡	감전 자국	触电痕迹	觸電痕跡

## First Aid for Electric Shock Procedure

Do not give compression-only CPR to infants and children — all infants and children who have a sudden cardiac arrest need conventional CPR. Also should not be used for adults whose cardiac arrest is from respiratory causes, or for an unwitnessed cardiac arrest.

D	Danger	Check for DANGER, make SAFE first to YOU, Others, and the CASUALTY.	
R	Response	Check for a RESPONSE.	
		Leave on back. If not conscious, <ol style="list-style-type: none"> <li>1. Ask others to emergency CALL for an ambulance immediately.</li> <li>2. HELP to bring AED, ASAP.</li> <li>3. Start CPR by YOU.</li> </ol>	
C	CPR for ADULT only	Start the center of chest compressions (>100 compressions per minute) without stopping until emergency medical services arrive.	
		One of the most famous chest compression-only CPR is AHA Hands-Only CPR which is without mouth-to-mouth rescue breaths. <a href="http://handsonlycpr.org/">http://handsonlycpr.org/</a> <a href="http://www.youtube.com/watch?v=zuJkRpJ7Fyg">http://www.youtube.com/watch?v=zuJkRpJ7Fyg</a>	
		Rhythm of chest compression: <a href="http://www.heart.org/HEARTORG/CPRAndECC/CommunityTraining/CommunityPrograms/CPR-Week_UCM_427219_SubHomePage.jsp">http://www.heart.org/HEARTORG/CPRAndECC/CommunityTraining/CommunityPrograms/CPR-Week_UCM_427219_SubHomePage.jsp</a> <a href="http://www.youtube.com/watch?v=n5hP4DIBCEE&amp;feature=player_detailpage">http://www.youtube.com/watch?v=n5hP4DIBCEE&amp;feature=player_detailpage</a>	
		Continue CPR until <ul style="list-style-type: none"> <li>● Signs of life return.</li> <li>● AED is ready to use.</li> <li>● Medical services arrive and take over.</li> </ul>	
If YOU have a trained rescue skill, should apply the following step. If not, only keep chest compression until others help.			
A	Airway	<b>No foreign material</b> Leave on back, open airway.	<b>Foreign material</b> Place in the recovery position, clear of objects.
B	Breathing	30 compress & 2 breaths	
D	Defibrillator 	Apply AED with following voice prompts. If no AED available, continue CPR until qualified personnel arrives.	

- ※AED: Automated External Defibrillator
- ※CPR: Cardio Pulmonary Resuscitation
- ※AHA: American Heart Association, Inc.

## Reference

- AHA CPR & Emergency Cardiovascular Care (ECC)  
([http://www.heart.org/HEARTORG/CPRAAndECC/CPR\\_UCM\\_001118\\_SubHomePage.jsp](http://www.heart.org/HEARTORG/CPRAAndECC/CPR_UCM_001118_SubHomePage.jsp))
- AHA Hands-only CPR (<http://handsonlycpr.org/>)
- Save a Life  
([http://www.heart.org/HEARTORG/CPRAAndECC/CommunityTraining/CommunityPrograms/CPR-Week\\_UCM\\_427219\\_SubHomePage.jsp](http://www.heart.org/HEARTORG/CPRAAndECC/CommunityTraining/CommunityPrograms/CPR-Week_UCM_427219_SubHomePage.jsp))
- AHA CPR Translated Website  
([http://www.heart.org/HEARTORG/CPRAAndECC/International/TranslatedWebsites/Translated-Websites\\_UCM\\_303149\\_SubHomePage.jsp](http://www.heart.org/HEARTORG/CPRAAndECC/International/TranslatedWebsites/Translated-Websites_UCM_303149_SubHomePage.jsp))  
Deutsch (<http://www.american-heart.de/startseite>)  
Japanese (<http://eccjapan.heart.org/>) available as of March, 2012))
- Chain of Survival  
([http://www.heart.org/HEARTORG/CPRAAndECC/WhatisCPR/ECCIntro/Chain-of-Survival\\_UCM\\_307516\\_Article.jsp](http://www.heart.org/HEARTORG/CPRAAndECC/WhatisCPR/ECCIntro/Chain-of-Survival_UCM_307516_Article.jsp))
- ECC Guidelines Highlights 2010  
English ([http://eccjapanheart.org/pdf/ECC\\_Guidelines\\_Highlights\\_2010.pdf](http://eccjapanheart.org/pdf/ECC_Guidelines_Highlights_2010.pdf))  
Japanese ([http://eccjapanheart.org/pdf/ECC\\_Guidelines\\_Highlights\\_2010JP.pdf](http://eccjapanheart.org/pdf/ECC_Guidelines_Highlights_2010JP.pdf))  
Deutsch ([http://www.american-heart.at/fileadmin/downloads/Guidelines2010-Highlights\\_D/Guidelines2010-Highlights\\_D.pdf](http://www.american-heart.at/fileadmin/downloads/Guidelines2010-Highlights_D/Guidelines2010-Highlights_D.pdf))

## International

- ILCOR (<http://www.ilcor.org/en/home/>)
- ILCOR CoSTR 2010 Consensus  
(<http://www.ilcor.org/en/consensus-2010/costr-2010-documents/>)

## Europe

- ERC (<https://www.erc.edu/>)
- ERC Guidelines 2010 (<http://www.cprguidelines.eu/2010/>)  
Local language translation  
(<https://www.erc.edu/index.php/doclibrary/en/185/1/>)

## America

- AHA (<http://www.americanheart.org/>)
- AHA Guidelines 2010 (<http://guidelines.ecc.org/2010-guidelines-for-cpr.html>)
- A.C.T.N.T. Hands-only Webcast  
([http://www.actnt.com/My%20Videos/Hands\\_Only-Webcast.wmv](http://www.actnt.com/My%20Videos/Hands_Only-Webcast.wmv))

---

## Safety Summary

The following general safety precautions must be observed during all phases of operation, service, and repair of this instrument. Failure to comply with these precautions or with specific warnings elsewhere in this manual may impair the protections provided by the instrument. In addition, it violates safety standards of design, manufacture, and intended use of the instrument. Agilent Technologies, Inc. assumes no liability for customer's failure to comply with these requirements.

Product manuals may be provided on CD-ROM or in printed form. Printed manuals are an option for many products. Manuals may also be available on the Web. Go to [www.agilent.com](http://www.agilent.com) and type the product model number in the Search field at the top of the page.

---

### NOTE

Do not use this instrument in any manner not specified by the manufacturer. The protective features of this instrument may be impaired if it is used in a manner not specified in the operation instructions.

This instrument is an INDOOR USE product.

This instrument complies with INSTALLATION CATEGORY II for mains input and INSTALLATION CATEGORY I for measurement input terminals, and POLLUTION DEGREE 2 defined in IEC 61010-1.

If an instrument is marked CAT I (IEC Measurement Category I), or it is not marked with a measurement category, its inputs must not be connected to line-voltage mains.

---

- *DANGEROUS PROCEDURE WARNINGS*

Warnings, such as example below, shall be complied. Procedures throughout in this manual prevent you from potentially hazard. Their instructions contained in the warnings must be followed.

---

### WARNING

**Hazardous voltage, instrument maximum output voltage may appear at the measurement terminals (High, Force, Guard, and Sense) if Interlock terminal is closed. Open the Interlock terminal when the measurement terminals are accessible. Voltage applied to the terminals will be limited up to  $\pm 40$  V or  $\pm 42$  V.**

---

- *BEFORE APPLYING POWER*

Verify that all safety precautions are taken. Make all connections to the instrument before applying power. Note the instrument's external markings described under "Safety Symbols".

- *GROUND THE INSTRUMENT*

This is Safety Class I instrument. To minimize shock hazard, the instrument chassis and cabinet must be connected to an electrical ground. The power terminal and the power cable must meet International Electrotechnical Commission (IEC) safety standards.

- *DO NOT OPERATE IN AN EXPLOSIVE ATMOSPHERE*

Do not operate the instrument in the presence of flammable gases or fumes. Operation of any electrical instrument in such an environment constitutes a definite safety hazard.

- *DO NOT REMOVE COVERS*

No operator serviceable parts inside. Refer servicing to qualified personnel. To prevent electrical shock do not remove covers.

- *IN CASE OF DAMAGE*

Instruments that appear damaged or defective should be made inoperative and secured against unintended operation until they can be repaired by qualified service personnel. Return the instrument to a Agilent Technologies sales or service office for services and repair to ensure that safety features are maintained.

- *USE ONLY THE SPECIFIC ACCESSORIES*

Specific accessories satisfy the requirements for specific characteristics for using the instrument. Use the specific accessories, cables, adapters, and so on for safety reasons.

---

## Safety Symbols

The general definitions of safety symbols used on equipment or in manuals are listed below.

 Direct current.

 Alternating current.

 Earth ground terminal.

 Protective conductor terminal. For protection against electrical shock in case of a fault. Used with field wiring terminals to indicate the terminal which must be connected to ground before operating equipment.

 Frame or chassis terminal. A connection to the frame (chassis) of the equipment which normally includes all exposed metal structures.

 Grounded terminal which indicates the earth potential.

 On supply.

 Off supply.

 Standby supply. The equipment will be marked with this symbol is not completely disconnected from AC mains when power switch is in the standby position.

 In position of a bi-stable push switch.

 Out position of a bi-stable push switch.

 Hazardous voltage and potential for electrical shock. Do not touch terminals that have this symbol when the equipment is on.

 Hot surface. Avoid contact. Surfaces are hot and may cause personal injury if touched.

 Instruction manual symbol. The equipment will be marked with this symbol when it is necessary for the user to refer to the instruction manual.

---

### WARNING

**The warning sign denotes a hazard. It calls attention to a procedure, practice, condition or the like, which, if not correctly performed or adhered to, could result in injury or death to personal.**

---

### CAUTION

The caution sign denotes a hazard. It calls attention to an operating procedure, practice, condition or the like, which, if not correctly performed or adhered to, could result in damage to or destruction of part or all of the equipment.

---



CAT I IEC Measurement Category I



The CE mark shows that the product complies with all applicable European Directives.



The CSA mark is a registered trademark of the Canadian Standards Association.



The C-Tick mark is a registered trademark of the Australian Communications Authority. This signifies compliance with the Australian EMC Framework Regulations under the terms of the Radio communications Act.

**ICES/NMB-001**

This ISM device complies with Canadian ICES-001.  
Cet appareil ISM est conforme à la norme NMB-001 du Canada.

**ISM** GROUP 1  
CLASS A

This is the symbol for an Industrial, Scientific and Medical, Group 1 Class A product. (CISPR 11)



Korea's safety and EMC mark



China RoHS - Environmentally Green Product Label



China RoHS - Product with Toxic Substance 40 yr EPUP



The Chinese mark for paper-based packaging materials; Paperboard and Corrugated Fiberboard

CFB



Plastic Material Coding Identification

---

## Power Supply and Measurement Safety

- Power Supply Safety

This instrument can output high currents and voltages. Make sure that the load or device under test can safely handle the output current and voltage. Also, make sure that the connection leads can safely withstand the expected currents and are insulated for the expected voltages.

The instrument outputs may be connected so as to float relative to earth ground. Isolation or floating voltage ratings are indicated on the instrument, near the output terminal or the Circuit Common terminal.

- Voltage/Current Measurement Safety

Multimeters and other instruments capable of measuring high voltages and currents are subject to specific safety concerns because of the circuits to which they may be connected. To safely use these instruments, you need to understand the markings on the instrument near the input terminals, which include the Protection Limits and the IEC Measurement Category.

- Protection Limits

Agilent multimeters and other voltage measurement instruments provide protection circuitry to prevent damage to the instrument and to protect against the danger of electric shock, provided the Protection Limits are not exceeded. To ensure safe operation of the instrument, do not exceed the Protection Limits shown on the input terminals.

- Source/Monitor Terminals

Source/monitor unit, SMU, can simultaneously perform DC voltage or current output and measurement. Typical SMU has the Force, Guard, Sense, and Circuit Common terminals as shown below. Normally the Force, Guard, and Sense terminals are the same potential. Voltage marked around the terminals indicates the Protection Limits.

Force and Sense must be connected to a terminal of a device under test for the Kelvin connection which is effective for high current measurement and low resistance measurement. For the non-Kelvin connection to ease the connections, connect Force only. Do not connect Sense. It must be opened.

Guard should be extended to around the device terminal for reducing leakage current caused by a coaxial cable used. Guard must be never connected to anything at the device side.

Circuit Common should be connected to shielding of the coaxial cable used.

The following image is the Kelvin triaxial connector of High Power SMU.

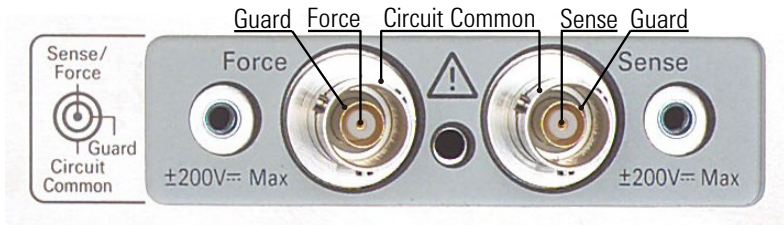

- To Avoid Risk of Residual Charge

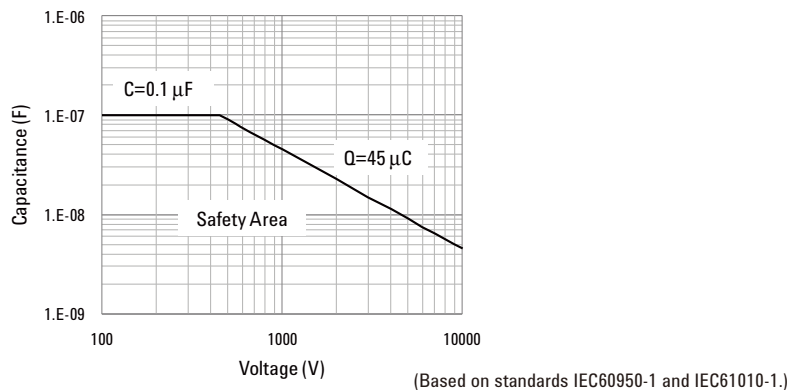

This graph shows the load capacitance vs voltage characteristics generally considered as safety. Use the instrument within the safety area up to 0.1  $\mu\text{F}$  or 45  $\mu\text{C}$  according to the voltage. Also do not connect the capacitive load over the maximum load capacitance specified for the instrument, for example 10 nF for HVSMU and 5 nF for UHVU.

Before touching the measurement terminal, confirm that it has been discharged enough. For that, ground and discharge the terminals over 10 seconds after stopping the high voltage output, and confirm that they have been safety voltage by using another volt meter.

If abnormal end of measurement, breaking of cable, or device damage occurs, do not touch the terminals until they are discharged enough.

Also if a series resistor such as N1262A-020, N1262A-021, and N1262A-023 is connected, do not touch the terminal until it is discharged enough.

## High Voltage Shock Hazard

Agilent B1505A can force dangerous voltages ( $\pm 10$  kVdc for UHVU,  $\pm 3000$  Vdc for HVSMU,  $\pm 2200$  Vpulse for HVMCU,  $\pm 200$  Vdc for HPSMU, and  $\pm 100$  Vdc for MPSMU) at the High, Force, Guard, and Sense terminals. To prevent electric shock hazard, the following safety precautions must be observed during the use of Agilent B1505A.

- Use a three-conductor AC power cable to appliance coupler (inlet) and the instrument to an electric ground (safety ground).
- Prepare shielding box which covers interface to a device under test and equipped with interlock circuit that opens when the door is opened.
- Before performing measurement, connect the interlock circuit to the Interlock terminal of this instrument.
- Confirm periodically that the interlock function works normally.
- Before touching the connections of the High, Force, Guard, and Sense terminals, turn the instrument off and discharge any capacitors of the measurement path. If you do not turn the instrument off, complete “all” of the following items, regardless of any instrument settings.
  - Terminate measurement by pressing the Stop key, confirm that the Measurement status indicator is not lit.
  - Confirm that the High Voltage indicator is not lit.
  - Open the shielding box access door (open the Interlock terminal).
  - Discharge any capacitors if the capacitance is connected to an SMU.
- Warn workers in the vicinity of the instrument about hazardous conditions.

## **Gefahr durch Hochspannung**

Von den Geräten Agilent B1505A können Spannungen an den Anschlüssen “High”, “Force”, “Guard” und “Sense” von bis zu 10 kV ausgehen. Um elektrischem Schlag vorzubeugen, ist bei der Benützung der Geräte Agilent B1505A folgendes zu beachten.

- Verwenden Sie ein dreiphasiges AC-Stromkabel für die Gerätsteckvorrichtung (Eingang) und schließen Sie das Instrument an eine Erdung an (Sicherheitserdung).
- Bereiten Sie das Abschirmungsgehäuse vor, dass die Oberfläche eines zu testenden Geräts abdeckt und mit einem Verriegelungsstromkreis ausgestattet ist, der bei geöffneter Tür unterbrochen wird.
- Vor der Messung verbinden Sie den Verriegelungsstromkreis mit dem Interlock-Anschluss dieses Instruments.
- Prüfen Sie in regelmäßigen Abständen, dass die Verriegelungsfunktion ordnungsgemäß funktioniert.
- Bevor Sie die Verbindungen zu den Anschlüssen “High”, “Force”, “Guard” und “Sense” berühren, schalten Sie das Instrument aus und entladen alle Kondensatoren des Messwegs. Wenn Sie das Instrument nicht ausschalten, führen Sie, unabhängig von den Instrumenteinstellungen, alle folgenden Schritte durch.
  - Beenden Sie die Messung, indem Sie auf die Taste “Stop” drücken. Stellen Sie sicher, dass die Statusanzeige “Measurement” nicht leuchtet.
  - Stellen Sie sicher, dass die Anzeige “High Voltage” nicht leuchtet.
  - Öffnen Sie die Tür des Abschirmungsgehäuses (öffnen des Interlock-Anschlusses).
  - Entladen Sie alle Kondensatoren, wenn die Kapazität mit einer SMU verbunden ist.
- Warnen Sie Mitarbeiter in der Umgebung des Instruments vor den Gefahren.

## **Danger de choc dû à une haute tension**

Une tension dangereuse (max.  $\pm$  pour UHVU; 10 kVdc, max.  $\pm$  pour HVSMU; 3000 Vdc, max.  $\pm$  pour HVMCU; 2200 Vpulse, max.  $\pm$  pour HPSMU; 200 Vdc, max.  $\pm$  pour MPSMU; 100 Vdc) émanant du dispositif Agilent B1505A peut être sortie aux bornes High, Force, Guard et Sense. Les précautions suivantes doivent être observées contre commotion électrique accidentelle.

- Utilisez un câble d'alimentation CA à trois conducteurs vers le coupleur secteur (entrée) et branchez l'instrument sur une mise électrique à la terre (prise de terre de sécurité).
- Préparez le boîtier de protection qui couvre l'interface avec le dispositif à tester et équipez-le d'un circuit de sécurité qui s'ouvre lors de l'ouverture d'une porte.
- Avant de procéder aux mesures, connectez le circuit de sécurité à la borne Interlock de l'instrument.
- Vérifiez régulièrement le bon fonctionnement de la fonction de sécurité.
- Avant de toucher les connexions des bornes High, Force, Guard et Sense, mettez l'instrument hors tension et déchargez tout condensateur du chemin de mesure. Si vous ne mettez pas l'instrument hors tension, effectuez « toutes » les opérations ci-dessous, quels que soient les paramètres de l'instrument.
  - Terminez les mesures en appuyant sur la touche Stop ; vérifiez que l'indicateur d'état Measurement est éteint.
  - Vérifiez que le témoin High Voltage est éteint.
  - Ouvrez la trappe d'accès au boîtier de protection (ouvrez la borne Interlock).
  - Déchargez les éventuels condensateurs si la capacité est connectée à une unité SMU.
- Informez les personnes travaillant à proximité de l'instrument des conditions.

## 高電圧感電注意

Agilent B1505A の High、Force、Guard、Sense 端子には、危険電圧が出力されることがあります（UHVU の場合は最大  $\pm 10$  kVdc、HVSMU の場合は最大  $\pm 3000$  Vdc、HVMCU の場合は最大  $\pm 2200$  Vpulse、HPSMU の場合は最大  $\pm 200$  Vdc、MPSMU の場合は最大  $\pm 100$  Vdc）。感電事故防止のため、Agilent B1505A の使用時には必ず以下の事柄を守ってください。

- 3 極電源ケーブルを使用して本器を接地してください。
- ドアを開くことによって開放されるインターロック回路を装備し、被測定デバイスとのインタフェースを覆うことのできるシールド・ボックスを用意してください。
- 測定を開始する前にはインターロック回路を本器の Interlock 端子に接続してください。
- インターロック機能が正常であることを定期的に確認してください。
- High、Force、Guard、Sense 端子に繋がる接続部に触れる前には、本器の電源を切断してください。また、測定系のキャパシタを放電してください。電源を切らない場合は、以下の事項を全て実施してください。
  - Stop キーを押して Measurement インジケータが消灯したことを確認してください。
  - 高電圧警告 (High Voltage) インジケータが消灯していることを確認してください。
  - シールド・ボックスのドアを開けてください (Interlock 端子を開放してください)。
  - キャパシタが SMU に接続されているならば、キャパシタを放電してください。
- 周囲のほかの作業者に対しても、高電圧危険に対する注意を徹底してください。

---

## Product Stewardship



- Waste Electrical and Electronic Equipment (WEEE) Directive 2002/96/EC

This product complies with the WEEE Directive (2002/96/EC) marking requirements. The affixed label indicates that you must not discard this electrical/electronic product in domestic household waste.

Product Category: With reference to the equipment types in the WEEE directive Annex 1, this product is classified as a "Monitoring and Control instrumentation" product.

Do not dispose in domestic household waste.

To return unwanted products, contact your local Agilent office or visit the following website for more information.

[www.agilent.com/environment/product/](http://www.agilent.com/environment/product/)

- LCD Fluorescent Lamp

Certain products sold by Agilent contain a liquid crystal display (LCD); backlighting for the LCD is provided by a fluorescent lamp which contains mercury, and must be managed, recycled, and/or disposed in accordance with all applicable laws, ordinances and regulations.

For information on how to recycle or dispose of the fluorescent lamp contained in your own product, visit the following website.

<http://www.agilent.com/environment/mercury.shtml>

If you live in the U.S., also visit the following websites.

<http://www.lamprecycle.org>

<http://www.eiae.org>

If you have additional questions, please visit the following website.

<http://www.agilent.com/go/contactus>

- Perchlorate Information

Perchlorate Material - special handling may apply. Visit the following website.

<http://www.dtsc.ca.gov/hazardouswaste/perchlorate/>

Equipment's real-time clock battery or coin cell battery may contain perchlorate and may require special handling when recycled or disposed of in California.



---

## Precautionary Statement

Agilent B1505A Power Device Analyzer/Curve Tracer operates in the Microsoft Windows environment. Agilent B1505A requires Agilent EasyEXPERT software, a specially-designed Windows application program.

- About guarantee and support for Agilent B1505A

Agilent Technologies guarantees and supports the performance of Agilent B1505A for the same condition as the preload condition when shipped from the factory.

- About updating Agilent EasyEXPERT and the Windows Update

Agilent Technologies confirms the operation of Agilent EasyEXPERT patch programs and important Windows security patches, and provides recommended update information. Visit Agilent B1505A support site, download the patches, and perform the software update.

- About Windows application programs and peripherals (including driver)

Using commercial products on Agilent B1505A is your responsibility. Agilent Technologies cannot provide compatibility information for commercial products. If problems arise, perform Agilent B1505A system recovery.

- About servicing

Bench repair service is available at your nearest Agilent Technologies service center. Be aware that the B1505A configuration might be updated to the latest one without notice because of support issues.

The internal hard disk drive (HDD) might be initialized during servicing. If peripherals are connected, they will be removed.

When Agilent B1505A is returned, the internal HDD might be initialized. Peripherals will be returned separately.

- Other notes

- Back up the internal HDD to prevent loss of data by accident or failure.
- Protect Agilent B1505A from computer viruses.
- If you connect Agilent B1505A to the network, take care to protect it from computer virus.

---

## Working in Comfort

To optimize your comfort and productivity, it is important that you set up your work area correctly and use your instrument properly. With that in mind, we have developed some set-up and use recommendations for you to follow based on established ergonomic principles. Improper and prolonged use of keyboards and input devices are among those tasks that have been associated with repetitive strain injury (RSI) to soft tissues in the hands and arms. If you experience discomfort or pain while using the instrument, discontinue use immediately and consult your physician as soon as possible. For more information on RSI you may wish to consult the *About Repetitive Strain Injury* section. Please study the recommendations described below. Included there are references to relevant parts of international standards, regulations and guidelines, such as ISO 9241 and the European Community Display Screen Equipment directive. You may also wish to consult your employer's human resources department or other relevant departments for guidance specific to your company.

### **About Repetitive Strain Injury**

Because your comfort and safety are our primary concern, we strongly recommend that you use the instrument in accordance with established ergonomic principles and recommendations. Scientific literature suggests that there may be a relationship between injury to soft tissues -especially in the hands and arms- and prolonged improper use of keyboards or other equipment requiring repeated motions of the hands and forearms. This literature also suggests that there are many other risk factors that may increase the chance of such injury, commonly called Repetitive Strain Injury.

#### *What is RSI?*

Repetitive Strain Injury (RSI -also known as cumulative trauma disorder or repetitive motion injury) is a type of injury where soft tissues in the body, such as muscles, nerves, or tendons, become irritated or inflamed. RSI has been a reported problem for those who perform repetitive tasks such as assembly line work, meatpacking, sewing, playing musical instruments, and computer work. RSI also has been observed in those who frequently engage in activities such as carpentry, knitting, housework, gardening, tennis, windsurfing and lifting children.

#### *What causes RSI?*

The specific causes of RSI have not been established. Nevertheless, the incidence of RSI has been associated with a variety of risk factors, including:

- Too many uninterrupted repetitions of an activity or motion.

- Performing an activity in an awkward or unnatural posture.
- Maintaining static posture for prolonged periods.
- Failing to take frequent short breaks.
- Other environmental and psychosocial factors.

In addition, there have been reports associating the occurrence of RSI with the use of keyboards, mice, and other input devices. Also, certain medical conditions, such as rheumatoid arthritis, obesity and diabetes, may predispose some people to this type of injury.

*What if I experience discomfort?*

If you are experiencing any discomfort, seek professional medical advice immediately. Typically, the earlier a problem is diagnosed and treated, the easier it is to resolve.

### **Mice and Other Input Devices**

Various aspects of using mice and other input devices may increase your risk of discomfort or injury. Observing the following recommendations may reduce that risk.

- Try to keep your hand, wrist, and forearm in a neutral position while using your mouse or other input device.
- If you use your thumb to rotate the ball on a trackball or spaceball, keep it in a relaxed, natural shape, and maintain a neutral posture in your hand, wrist, and forearm.
- Hold the mouse gently by draping your fingers over it. Keep your hand relaxed and fingers loose. Do not grip the mouse tightly.
- It takes very little pressure or force from your fingers to activate the buttons or scroll wheel on your mouse, scrolling mouse, trackball, or other input device. Using too much force can place unnecessary stress on the tendons and muscles in your hands, wrists, and forearms.
- If you are using a scrolling mouse, be sure to keep your fingers and hand in a relaxed, neutral position when activating the scroll wheel. Also, this type of mouse features software that can minimize the number of mouse movements or button clicks.
- When using a mouse, trackball, or other input device, position it as close to the keyboard as possible, and keep it at the same level as you do not have to stretch while using it.
- Be sure to keep your mouse and trackball clean. Regular removal of accumulated dust and dirt helps ensure proper tracking and reduces unnecessary hand and wrist motions.

---

## **In This Manual**

This manual describes the product overview and installation information of Agilent Technologies B1505A. This manual consists of the following chapters:

- Chapter 1, “Getting Started”  
This chapter describes basic operations of Agilent B1505A.
- Chapter 2, “Introduction”  
This chapter describes basic features of Agilent B1505A.
- Chapter 3, “Accessories”  
This chapter describes accessories available for Agilent B1505A.
- Chapter 4, “Installation”  
This chapter describes installation and maintenance.
- Chapter 5, “Specifications and Options”  
This chapter describes specifications and options of Agilent B1505A.





---

# Contents

## 1. Getting Started

To Turn On/Off B1505A .....	1-3
To Turn B1505A On .....	1-4
To Turn B1505A Off .....	1-4
To Launch EasyEXPERT .....	1-6
If Only One Workspace Exists .....	1-7
To Create Workspace .....	1-8
To Select Workspace .....	1-9
To Use Tracer Test Mode .....	1-10
To Use Application Test Mode .....	1-12
To Use Classic Test Mode .....	1-14
To Perform Measurement .....	1-16
To Use Test Result Editor .....	1-17
To Use Analysis Tools .....	1-18

## 2. Introduction













Overview .....	2-3
Agilent EasyEXPERT Software .....	2-6
Front View .....	2-8
Rear View .....	2-11
 .....	2-12
 .....	2-13
 .....	2-14
 .....	2-15
Measurement Resources .....	2-16
GNDU - Ground Unit .....	2-16
About SMU .....	2-17
HPSMU - High Power SMU .....	2-18

---

# Contents













HCSMU - High Current SMU .....	2-21
HVSMU - High Voltage SMU .....	2-23
MPSMU - Medium Power SMU .....	2-25
MCSMU - Medium Current SMU .....	2-28
HVMCU - High Voltage Medium Current Unit .....	2-30
UHCU - Ultra High Current Unit .....	2-32
UHVU - Ultra High Voltage Unit .....	2-34
MFCMU - Multi Frequency CMU .....	2-36

## 3. Accessories

N1258A Module Selector .....	3-3
 .....	3-3
 .....	3-5
 .....	3-6
N1259A Test Fixture .....	3-7
 .....	3-7
 .....	3-8
 .....	3-9
 .....	3-12
 .....	3-13
 .....	3-14
 .....	3-16
N1260A High Voltage Bias-Tee .....	3-19
N1261A Protection Adapter .....	3-20
N1262A Resistor Box .....	3-21
16493S-010/011 HCSMU Adapter .....	3-23
16493S-020/021 Dual HCSMU Adapter .....	3-24
N1265A Ultra High Current Expander/Fixture .....	3-26
 .....	3-27
 .....	3-28
 .....	3-29

---

# Contents

	.....	3-30
	.....	3-31
	.....	3-32
	.....	3-33
	.....	3-35
	.....	3-37
	.....	3-41
	.....	3-42
N1266A HVSMU Current Expander	.....	3-43
	.....	3-44
N1267A HVSMU/HCSMU Fast Switch	.....	3-46
	.....	3-46
N1268A Ultra High Voltage Expander	.....	3-55
	.....	3-55
	.....	3-56
	.....	3-57
N1269A Ultra High Voltage Connection Adapter	.....	3-58

## 4. Installation

	.....	4-3
Requirements	.....	4-4
Power Requirements	.....	4-4
Operating Environment	.....	4-4
Storaging/Shipping Environment	.....	4-4
Installation Requirements	.....	4-5
Power Cable	.....	4-5
Inspection and Installation	.....	4-7
To Inspect B1505A and Accessories	.....	4-7
To Perform Initial Setup	.....	4-8
To Change Windows Logon Setting	.....	4-9
To Change GPIB Address	.....	4-10

---

# Contents

To Enable System Controller .....	4-11
Maintenance .....	4-12
Cleaning .....	4-12
Self-test and Diagnosis .....	4-12
⚠ .....	4-13
Calibration .....	4-13
About Plug-in Modules .....	4-14
<b>5. Specifications and Options</b>	
Specifications .....	5-3
Specification Conditions .....	5-4
Mainframe .....	5-5
HPSMU .....	5-7
MPSMU .....	5-10
HCSMU .....	5-13
MCSMU .....	5-15
HVSMU .....	5-17
SMU Common Specifications .....	5-19
SMU Supplemental Characteristics .....	5-22
MFCMU .....	5-26
UHC (Ultra High Current) Expander / Fixture (N1265A) .....	5-31
HVSMU Current Expander (N1266A) .....	5-35
UHV (Ultra High Voltage) Expander (N1268A) .....	5-38
Accessories .....	5-40
EasyEXPERT Software .....	5-53
Program and interface capabilities .....	5-60
Furnished Software .....	5-60
General Specifications .....	5-61
Accessories and Options .....	5-63



---

**1**

**Getting Started**

---

## Getting Started

This chapter describes the basic operations of Agilent B1505A. Before learning the product details, let's try to use the B1505A briefly. The operations need the B1505A, power cable, and USB keyboard only (USB mouse and stylus pen are optional). Agilent B1505A also requires Agilent EasyEXPERT software as its graphical user interface.

During the operations, you will not connect device under test. Open all measurement terminal.

This chapter consists of the following sections.

- “To Turn On/Off B1505A”
- “To Launch EasyEXPERT”
- “To Use Tracer Test Mode”
- “To Use Application Test Mode”
- “To Use Classic Test Mode”
- “To Perform Measurement”
- “To Use Analysis Tools”

---

### NOTE

#### If you use the B1505A at the first time

If this is the first time to turn Agilent B1505A on after the delivery, you need to perform the initial setup of the B1505A. See “Inspection and Installation” on page 4-7. After the initial setup and if no users are added, you can automatically logon as “Agilent B1500 User” account without password.

---

---

## To Turn On/Off B1505A

---

### NOTE

#### When turning the B1505A on

Open the measurement terminals at the device side when turning the B1505A on. Also disconnect the device from the measurement terminals and open the measurement terminals after the test. If you leave the connection with the device, the device may be damaged by unexpected operations or charge-up of measurement cables.

---

### NOTE

#### If Start EasyEXPERT button is not displayed

Select All Programs > Start EasyEXPERT from the Start menu. The Start EasyEXPERT button will be displayed.

---

### NOTE

#### Automatic start function

If the automatic start function is on, EasyEXPERT is launched within the B1505A boot up process. If the function is off, EasyEXPERT is not launched and the Start EasyEXPERT button is displayed.

To turn the automatic start function off, use the Start EasyEXPERT window displayed by the File > Exit menu on the EasyEXPERT main screen. And remove the check from the Option > Auto Start of EasyEXPERT menu.

---

### NOTE

#### If EasyEXPERT does not run

Launch “Agilent Connection Expert” by using the icon on Windows taskbar. And check the USB0 connection status displayed in “Instrument I/O on this PC” area.

USB0 connection status display example:

```
USB0
+ B1500A(USB0::2391::1::0001::0::INSTR)
+ agb1500a
+ UsbDevice1
```

If “agb1500A” and “UsbDevice1” are not listed, add them by using “Add VISA Alias” in the right-button-menu on “B1500A (USB0:: . . :INSTR)”. If the problem still remains, perform Agilent B1500 system recovery. To perform recovery, see Agilent EasyEXPERT *User’s Guide*.

## Getting Started

### To Turn On/Off B1505A

## To Turn B1505A On

1. Connect the power cable from Agilent B1505A to an AC power outlet.
2. Connect the USB keyboard to the B1505A. Optionally, connect the USB mouse to the B1505A.
3. Press the Standby switch (lower right corner of the front panel). Windows, measurement module initialization, and self-calibration will start. For the Windows logon screen, log on Windows.

After logging on, the Start EasyEXPERT button will be displayed on the screen, or EasyEXPERT will be launched if the automatic start function is on.

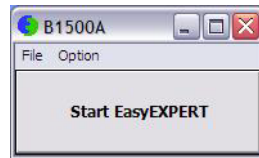

## To Turn B1505A Off

Press the Standby switch (lower right corner of the front panel). Windows will be shutdown and the B1505A will become the standby state.

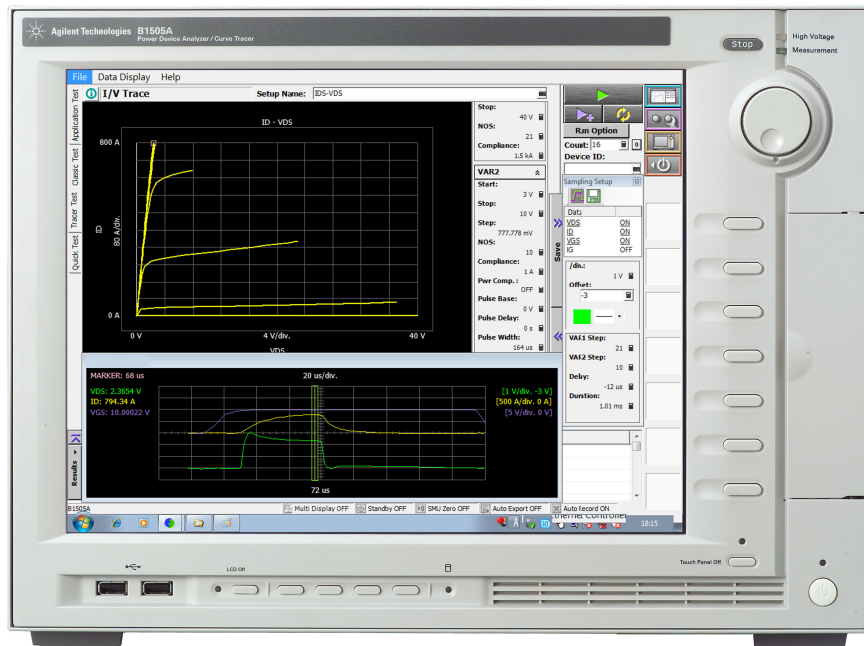

---

**NOTE**

Agilent B1505A has the following front panel user interface.

- **Stop**  
Stops the present measurement or source output immediately.
- **Rotary knob**  
Rotating the knob moves the marker on the graph window, or increases/decreases/changes the value in the active entry field.  
Pressing the knob sets or enters the value.
- **Softkeys**  
Seven softkeys are available. Used to select one for the entry field specified or the dialog box. They are also used to recall the test definitions (pre-defined test setups).
- **Touch Panel Off**  
Enables or disables the touch screen operation.
- **Standby switch**  
Turns the B1505A on. Pressing the button in the ON state makes the B1505A in the standby state.
- **LCD Off**  
Enables or disables the LCD panel. LED lights when the LCD is disabled.
- **+, -, Set, Cancel**  
Four keys are available for adjusting brightness. Use + and - to adjust it and then press *Set* to fix it. Pressing *Cancel* instead of *Set* cancels the adjustment.

Agilent B1505A also requires Agilent EasyEXPERT software as its graphical user interface. You can operate Agilent EasyEXPERT by using the touch panel. Use your fingers, stylus pen, and so on for the touch panel operation. The USB keyboard and the USB mouse are also available for operating the EasyEXPERT.

To remove USB devices from the B1505A, use “Safely Remove Hardware” on Windows taskbar. If it is not used, the B1505A may cause the internal USB communication error. If the error occurs, turn the B1505A off and disconnect the power cable from the B1505A. Leave it about 30 seconds before rebooting the B1505A, and connect the power cable again, and then turn the B1505A on.

---

## To Launch EasyEXPERT

1. If the automatic start function is off, the Start EasyEXPERT button is displayed. Click the button and wait until the EasyEXPERT main screen or workspace selection screen is displayed.

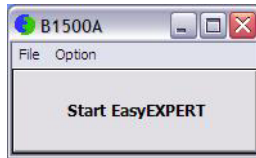

---

### NOTE

Workspace is the space created in Agilent B1505A's internal hard disk drive, and is used to store the test setup, test result data, and so on. The workspace can be created and allocated for each user.

2. If this is the first time to start the EasyEXPERT, or if no workspace exists, a workspace will be created automatically.  
Skip to "To Use Tracer Test Mode" on page 1-10, "To Use Application Test Mode" on page 1-12, or "To Use Classic Test Mode" on page 1-14.
3. If only one workspace exists, the B1505A displays the screen as shown in Figure 1-1.  
Skip to "If Only One Workspace Exists" on page 1-7.
4. If two or more workspaces exist, the B1505A displays the screen as shown in Figure 1-3.  
Skip to "To Select Workspace" on page 1-9.

## If Only One Workspace Exists

For the screen as shown in Figure 1-1, perform the following steps.

- If you do not want to create a workspace, select the *Yes* radio button and click OK. Skip to “To Use Tracer Test Mode” on page 1-10, “To Use Application Test Mode” on page 1-12, or “To Use Classic Test Mode” on page 1-14.
- If you want to create a workspace, select the *No, I want to start a new session.* radio button and click Next. The B1500A displays the screen as shown in Figure 1-2. Skip to “To Create Workspace” on page 1-8.
- If you want to manage workspaces, select the *No, I want to manage Workspaces.* radio button and click Next. The B1500A displays the screen as shown in Figure 1-3. Skip to “To Select Workspace” on page 1-9.

Figure 1-1

### If Only One Workspace Exists

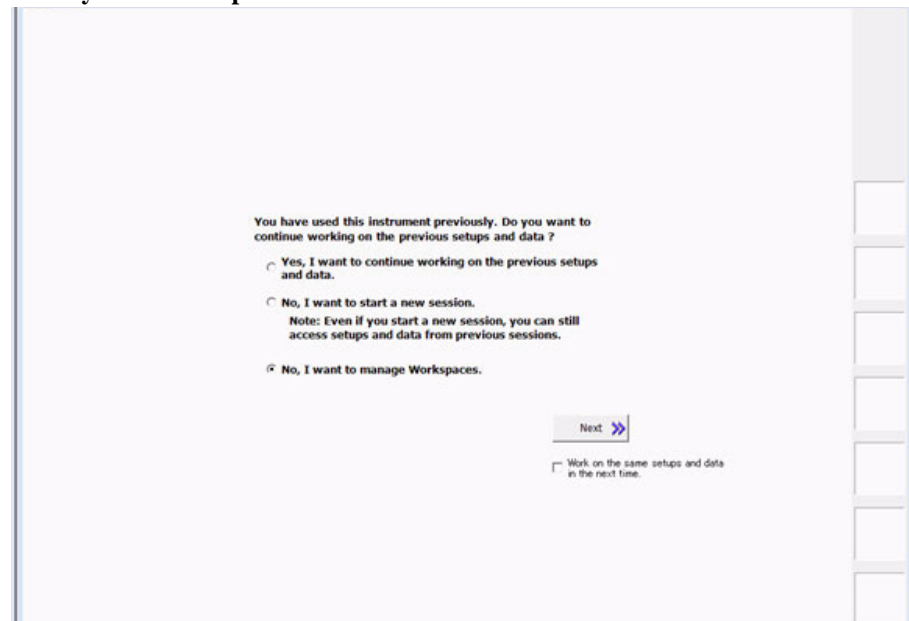

---

#### NOTE

#### Work on the same setups and data in the next time

If this check box is checked, the workspace selection screen will be skipped at the next startup and EasyEXPERT will be launched with the workspace used at the last operation. To perform this setup again, click the File > Close Workspace menu on the EasyEXPERT main screen.

## To Create Workspace

For the screen as shown in Figure 1-2, perform the following steps. To cancel creating workspace, click Prev.

1. Enter the name of the new workspace into the above-entry field.  
Check *Allow other users to access this workspace* box if you want to create a public workspace that is opened for all users.
2. If you are the owner of the existing workspace, you can change the name of the existing workspace.  
If you want to rename the existing workspace, enter the name into the below-entry field.  
Check *Allow other users to access this workspace* box if you want to set it to a public workspace that is opened for all users.
3. Click OK.

Skip to “To Use Tracer Test Mode” on page 1-10, “To Use Application Test Mode” on page 1-12, or “To Use Classic Test Mode” on page 1-14.

Figure 1-2

### To Create Workspace

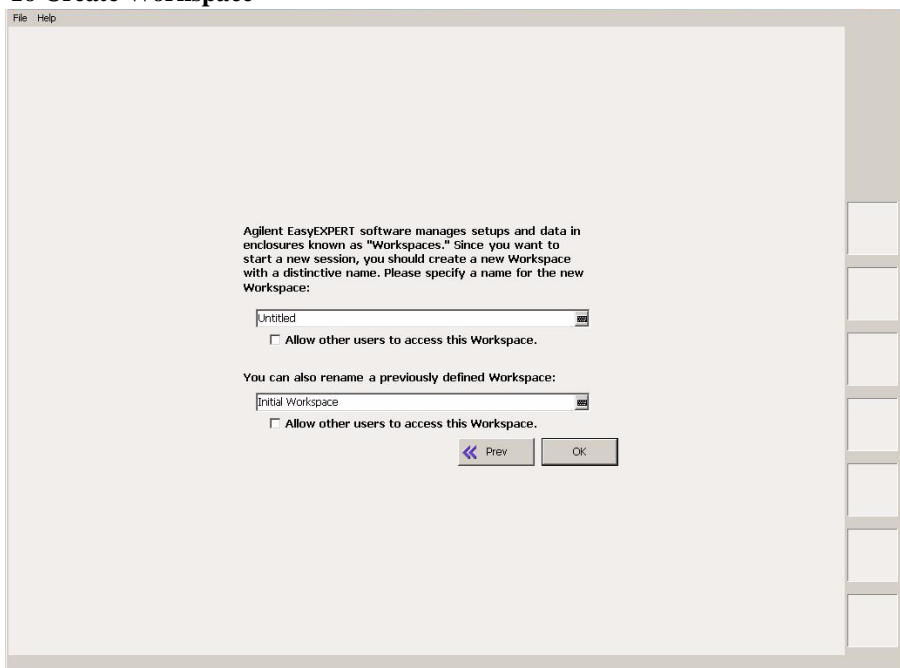



## To Select Workspace

For the screen as shown in Figure 1-3, perform the following steps. This example selects the workspace named as *test* that is a private workspace.

1. Select *Your Workspaces* radio button.
2. Select *test* and click Continue.

Skip to “To Use Tracer Test Mode” on page 1-10, “To Use Application Test Mode” on page 1-12, or “To Use Classic Test Mode” on page 1-14.

If you want to manage workspaces, click the *Manage Workspaces* button. See *Agilent EasyEXPERT User’s Guide*.

Figure 1-3

### To Select Workspace

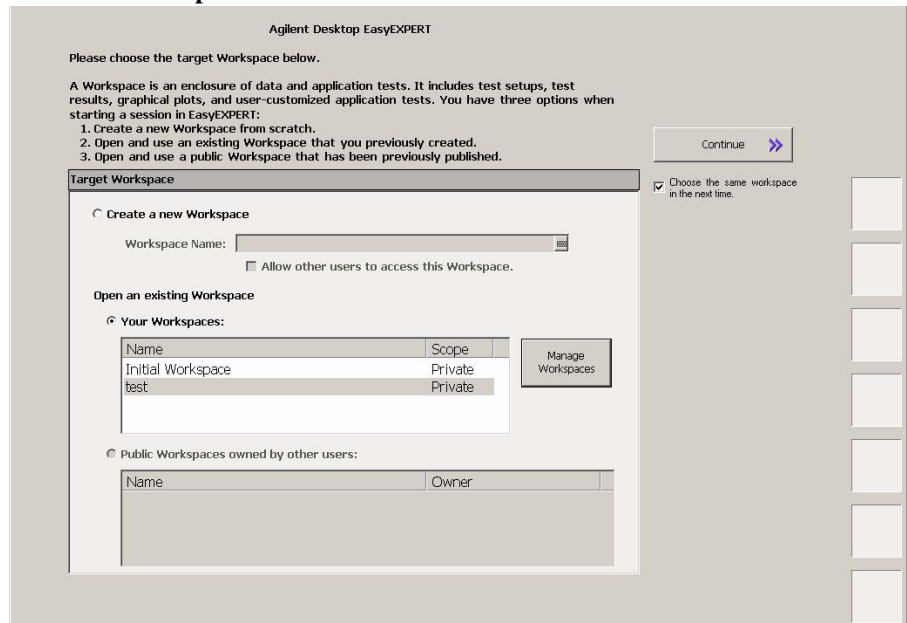

---

#### NOTE

#### Choose the same Workspace in the next time



If this check box is checked, the workspace selection screen will be skipped at the next startup and EasyEXPERT will be launched with the workspace used at the last operation. To perform this setup again, click the File > Close Workspace menu on the EasyEXPERT main screen.

## To Use Tracer Test Mode

The following procedure performs the tracer test setup.

1. Click the Tracer Test tab on the main screen. The tab is in the leftmost column on the screen. The I/V Trace screen is displayed. See Figure 1-4.
2. Set the channels at the field below the graph as shown in Table 1-1.
3. Set the measurement condition at the right field of the graph as shown in Table 1-3.
4. Set the graph display condition at the field below the graph as shown in Table 1-2.

To enter the value, use the USB keyboard or the screen/numeric keyboard opened by clicking the right button of the entry field.

To start measurement, click  for the single measurement or  for the repeat measurement.

If the Stop field is highlighted, the range of measurement and graph display can be changed by using the rotary knob during the repeat measurement.

**Table 1-1**

**I/V Trace Channel Setup**

Unit	V Name	I Name	Mode <sup>a</sup>	Function
SMU1	V1	I1	V	VAR1
SMU2	V2	I2	V	CONST

- a. Channel output mode. Set I or IPULSE for the current output and voltage measurement. Set V or VPULSE for the voltage output and current measurement.

**Table 1-2**

**I/V Trace Graph Setup**

	Name	Scale			Name	Scale	
<b>Y</b> ↑	I1	LIN	±	→ <b>X</b>	V1	LIN	±

Table 1-3 I/V Trace Measurement Setup

VAR1		CONST	
Mode	LIN-SGL	Unit	SMU2
Start	0 V	Source	0 V
Stop	1 V	Compliance	5 mA
Step	10 mV		
NOS	101		
Interlacing	1		
Compliance	5 mA		
Pwr Comp.	OFF	Meas. Time	2 $\mu$ s
Dual Polarity	ON	Step Time	500 $\mu$ s

Figure 1-4 Display Example of I/V Trace Screen

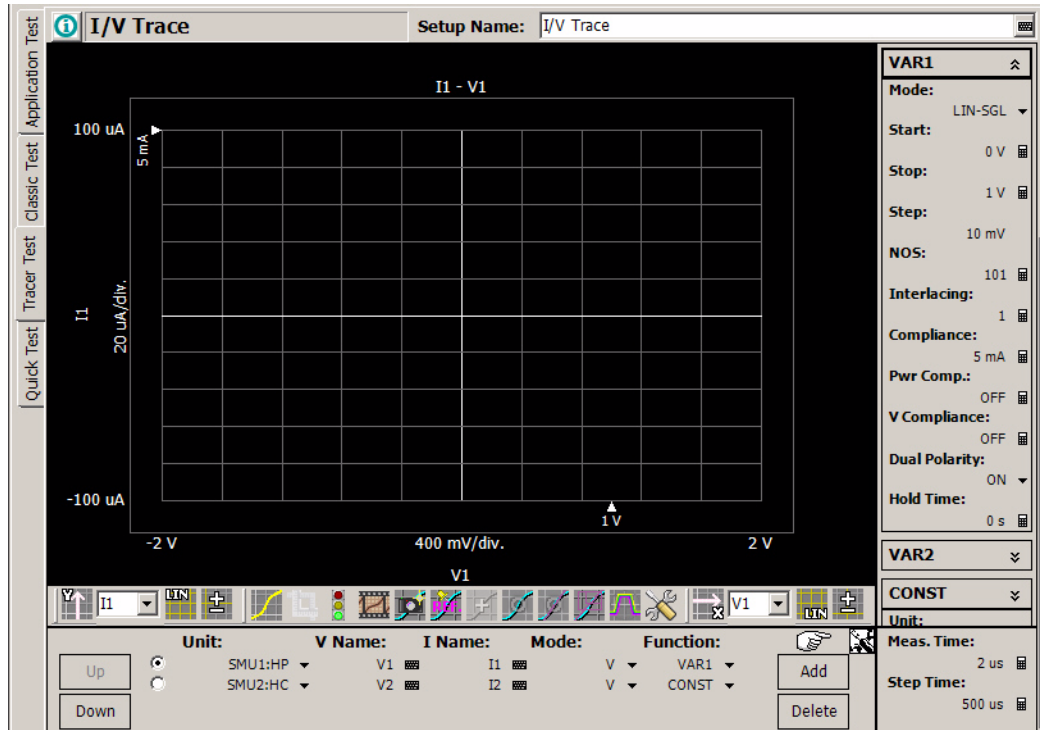

---

## To Use Application Test Mode

For the screen as shown in Figure 1-5, perform the following procedure.

Figure 1-5

### Display Example of EasyEXPERT Main Screen

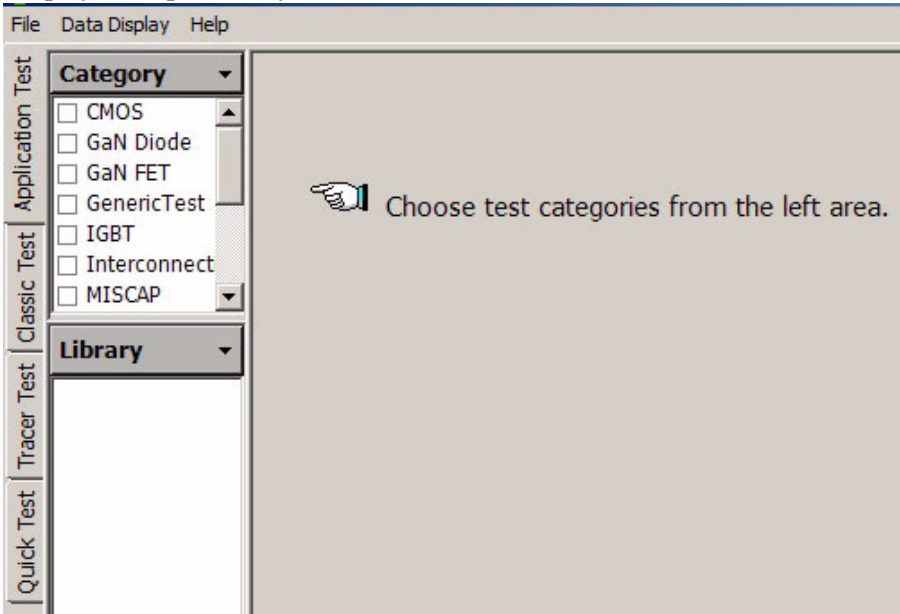

1. Click the Application Test tab on the main screen. The tab is in the leftmost column on the screen.
2. Set the Category field. For example, check the PowerMOSFET only. The Library field lists the test definitions.
3. Select a test definition at the Library field. For example, click the *Id-Vgs* and *Select* button sequentially. The screen changes the display as shown in Figure 1-6.
4. Change the measurement conditions at the Test Parameters field.  
The following example changes the voltage sweep output.
  - a. Set VgStop to 5.0 V.
  - b. Set VdStart and VdStop to 5.0 V.

To enter the value, use the USB keyboard or the screen/numeric keyboard opened by clicking the right button of the entry field.

See “To Perform Measurement” on page 1-16 to start measurement.

**NOTE**

**Test Definitions**

Test definitions are the built-in test setups that have been defined and stored in the EasyEXPERT as the application library. The EasyEXPERT contains more than forty test definitions. You can execute the test without modifications. Also you can create your own test setup/definition by making any changes. All furnished test definitions are just sample. Agilent Technologies is NOT LIABLE for any damages caused by the samples.

**Figure 1-6** Display Example of Application Test Setup Screen

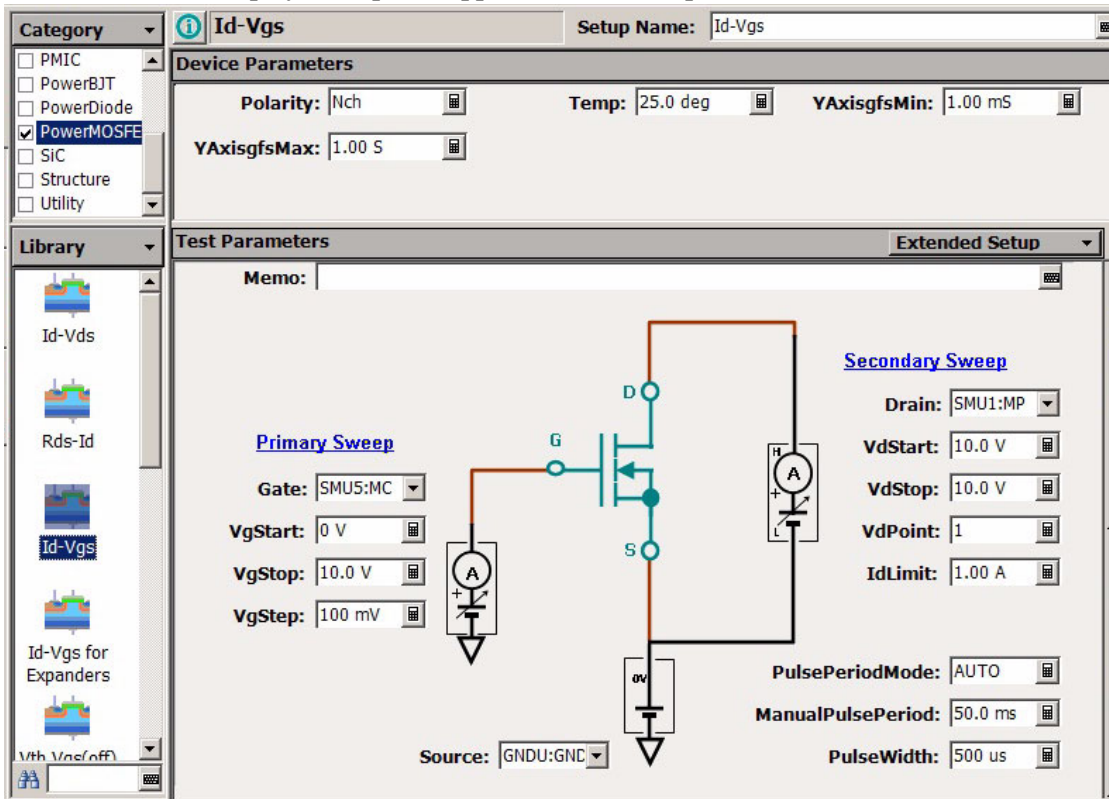

## To Use Classic Test Mode

The following procedure performs the I/V Sweep classic test setup.

1. Click the Classic Test tab on the main screen. The tab is in the leftmost column on the screen.
2. Click I/V Sweep and Select button sequentially. The I/V Sweep Channel Setup screen is displayed. See Figure 1-7.
3. Set the Channel Setup parameters as shown in Table 1-4.
4. Click the Measurement Setup tab and set the parameters as shown in Table 1-5.
5. Click the Display Setup tab and set the parameters as shown in Table 1-6.

To enter the value, use the USB keyboard or the screen/numeric keyboard opened by clicking the right button of the entry field.

Figure 1-7

### Display Example of I/V Sweep Channel Setup Screen

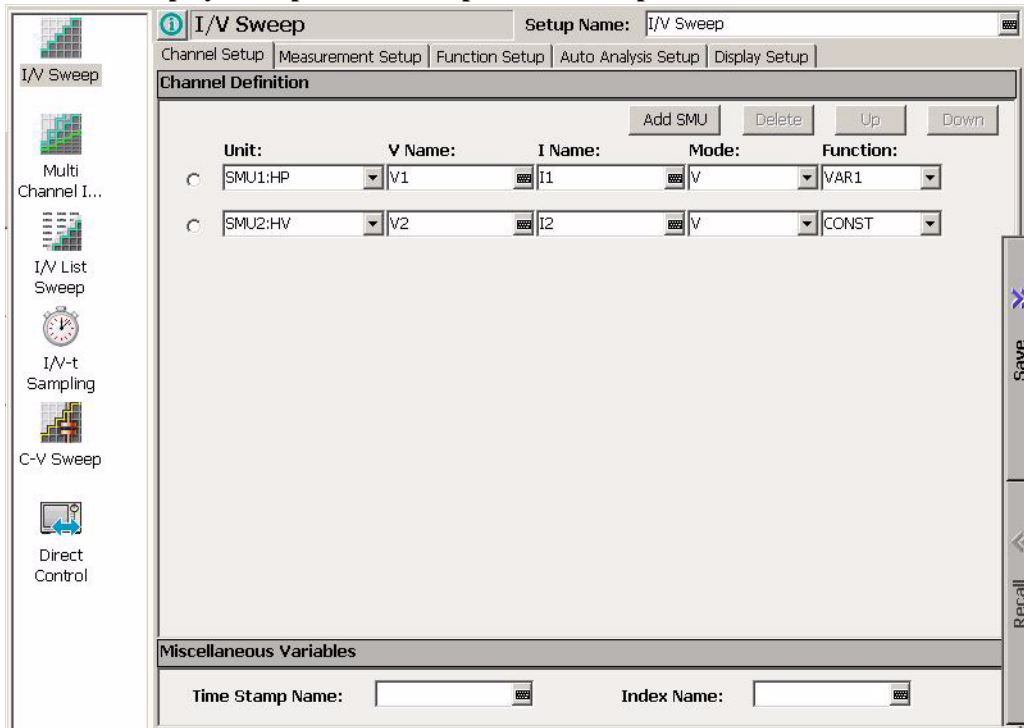

See “To Perform Measurement” on page 1-16 to start measurement.

**Table 1-4 I/V Sweep Channel Setup**

Unit	V Name	I Name	Mode <sup>a</sup>	Function
SMU1	V1	I1	V	VAR1
SMU2	V2	I2	V	CONST

a. Channel output mode. Set I or IPULSE for the current output and voltage measurement. Set V, VPULSE, or COMMON for the voltage output and current measurement.

**Table 1-5 I/V Sweep Measurement Setup**

VAR1		Timing		Constants	
Unit	SMU1	Hold	0 s	Unit	SMU2
Name	V1	Delay	0 s	V Name	V2
Direction	Single			I Name	I2
Linear/Log	LINEAR			Mode	V
Start	0 V			Source	0 V
Stop	1 V			Compliance	5 mA
Step	10 mV				
No of Step	101				
Compliance	5 mA				
Pwr Comp	OFF	Sweep	CONTINUE AT ANY	status	

**Table 1-6 I/V Sweep Display Setup**

	Name	Sharing	Scale	Min	Max
X	V1	(None)	Linear	0 V	1 V
Y1	I1	(None)	Linear	-5 mA	5 mA

## To Perform Measurement

1. Click the Single button (upper right on the main screen) to start measurement. This opens the Data Display window and starts a single sweep measurement.



After the measurement, the measurement data is displayed on the Data Display window. For the measurement after performing “To Use Classic Test Mode” on page 1-14, you will have the test result as shown in Figure 1-8. This is the leakage current measurement result because all measurement terminal is opened for performing the procedures described in this chapter.

2. If the automatic data record function has been set to ON (Auto Record ON), Test Result Editor appears on the lower area of the screen when the measurement is completed. See “To Use Test Result Editor” on page 1-17.

Figure 1-8 Display Example of Data Display Window

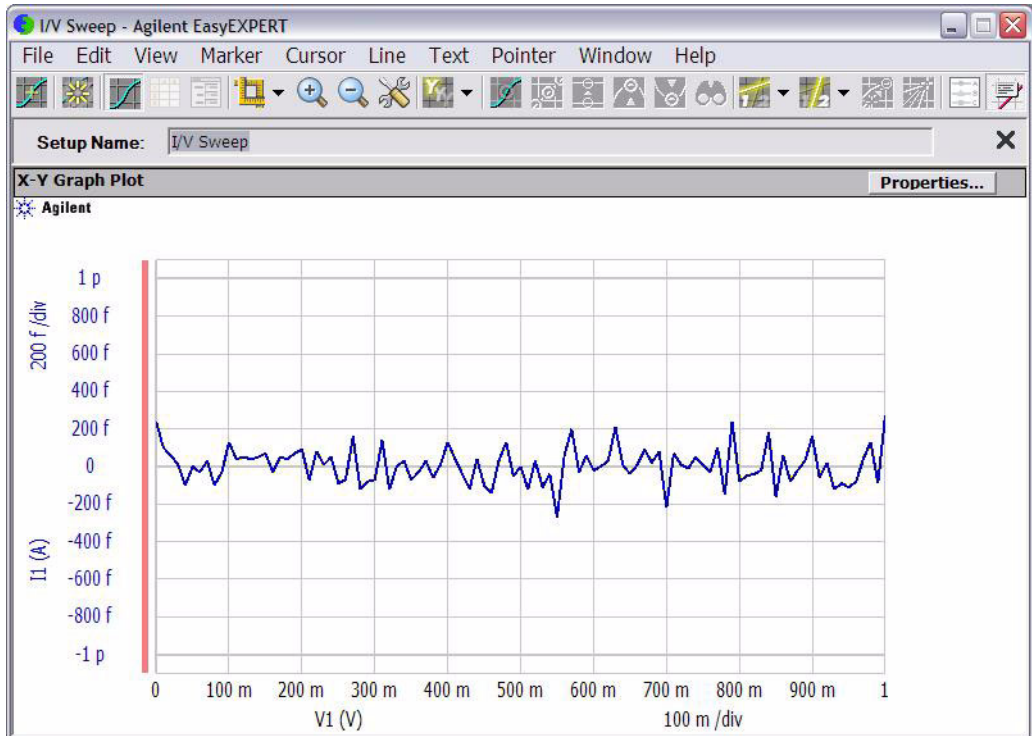



## To Use Test Result Editor

The Test Result Editor provides the following GUI to set a flag and remarks to the test result record.

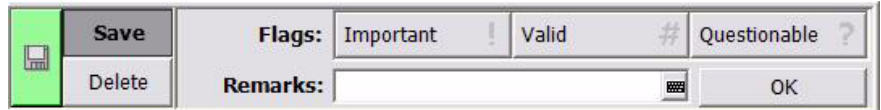

- Save button and Delete button  
Divides test records into groups, Save and Delete.  
Test records in Save-group are always listed in the lower area of the EasyEXPERT main screen.  
Test records in Delete-group can be listed when Results > Filter > Show Deleted Data is checked.
- Flags buttons  
The following buttons are available. You can set one of the following flags.
  - Important ! button  
Sets the important flag (!) to the test result record.
  - Valid # button  
Sets the valid flag (#) to the test result record.
  - Questionable ? button  
Sets the questionable flag (?) to the test result record.
- Remarks field  
You can enter characters into this field. The characters will be recorded as the Remarks value of the test result record.
- OK button  
Applies the setup on the Test Result Editor, and closes this dialog box.

## To Use Analysis Tools

The Data Display window provides several analysis functions.

- View menu: used to adjust the graph scale.
- Marker menu: used to display and control the marker.
- Cursor menu: used to display and control the cursor.
- Line menu: used to display and control the lines.

When the marker, cursor, and lines are effective, their parameters are also displayed on the X-Y Graph Plot area.

Figure 1-9 is an example displaying marker, tangent line, and regression line on the test result graph shown in Figure 1-8. You can read position of the marker and the active cursor, and intercept and gradient of the active line.

Figure 1-9 Display Example of Analysis Tools

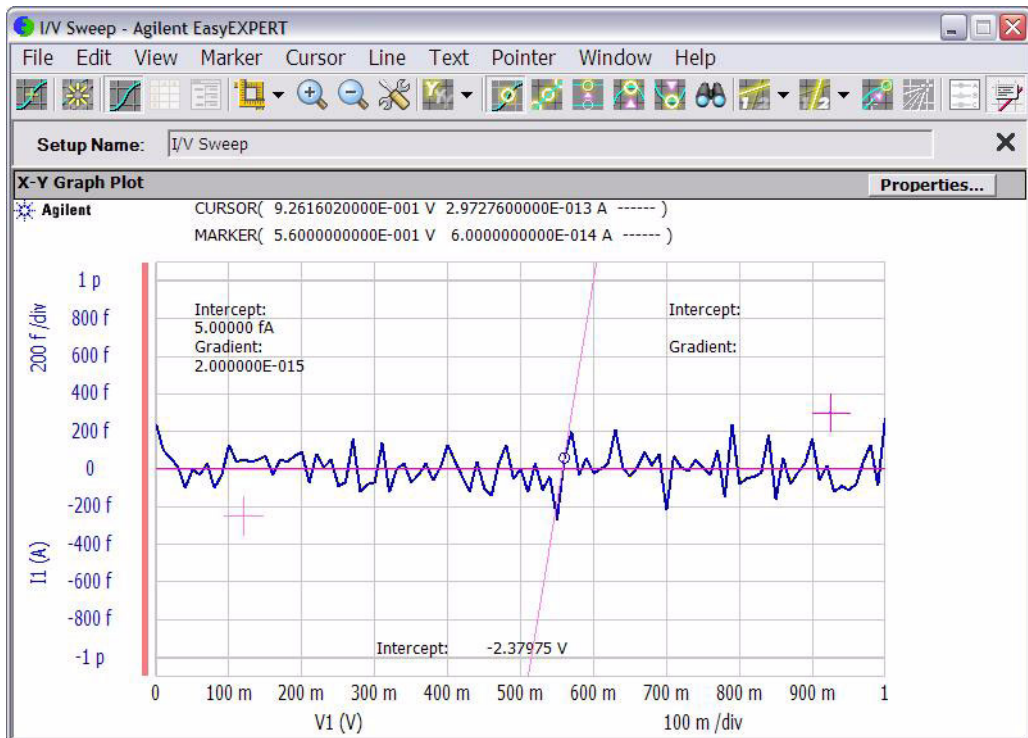



## Introduction

This chapter describes the basic functions and features of Agilent B1505A Power Device Analyzer/Curve Tracer, and consists of the following sections:

- “Overview”
- “Front View”
- “Rear View”
- “Measurement Resources”

---

### NOTE

#### Application Library

Agilent B1505A has installed Agilent EasyEXPERT software as the user interface. The EasyEXPERT contains an application library that is a set of test definitions. The application test can be performed by selecting a test definition and setting the test condition for the actual DUT (device under test).

All test definitions are just sample. If the samples damage your devices, Agilent Technologies is NOT LIABLE for the damage.

---

### NOTE

#### Furnished Sample Programs (Utility)

The following sample programs are stored in the following folder.

- <program folder>\Agilent\B1500\EasyEXPERT\Utilities\  
Prober control programs  
sleep.exe program
- <program folder>\Agilent\B1500\EasyEXPERT\415xC\Conversion\  
4155/4156 setup file converter
- <program folder>\Agilent\B1500\EasyEXPERT\IC-CAP Support\MDM\  
MDM file converter for IC-CAP users

Where, <program folder> is as follows. Then, <system drive> is the drive the EasyEXPERT has been installed.

For Windows 7 64 bit version, <system drive>:\Program Files (x86)

For Windows 7 32 bit version, Vista, or XP, <system drive>:\Program Files

For more details of programs, see Agilent EasyEXPERT User’s Guide.

---

---

## Overview

Agilent B1505A Power Device Analyzer/Curve Tracer is the parameter analyzer supporting ultra high voltage and ultra high current and is the one box solution for the power device DC parametric measurement and analysis application. Agilent B1505A provides the DC voltage/current output capability, DC voltage/current measurement capability, and impedance measurement capability. So you can perform a current-voltage sweep measurement and a capacitance-voltage sweep measurement for example by one instrument.

Agilent B1505A also provides an intuitive graphical user interface, touch screen LCD panel, keyboard, and mouse for easy and effective measurement and analysis on the Windows environment. You can analyze a measurement result characteristics graph for example by using several tools such as markers, cursors, and lines.

Also, in the GPIB remote control mode, you can control the B1505A from an external computer by using Agilent FLEX command set that is the common language for Agilent semiconductor DC measurement instruments. So you can reuse the measurement program created for Agilent 4155/4156/B1500/E5260/E5270.

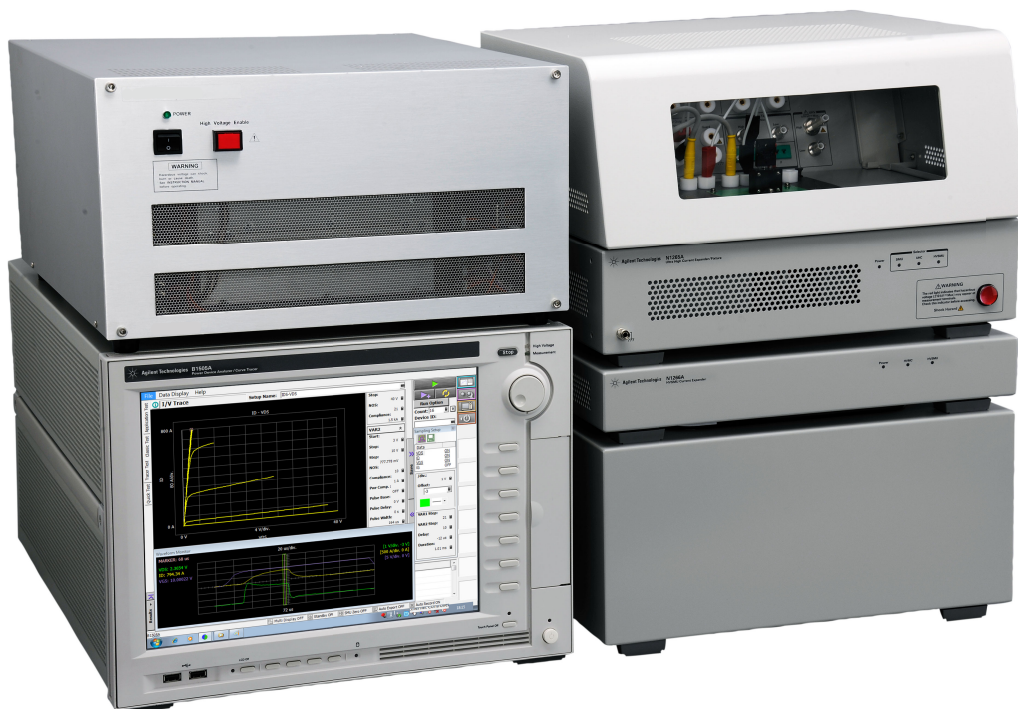

## Introduction

### Overview

- Agilent B1505A Power Device Analyzer/Curve Tracer

Mainframe that provides the ground unit (GNDU) and ten empty slots for the measurement facilities, and Agilent EasyEXPERT software for the operating environment. The EasyEXPERT is the GUI based measurement control and analysis software runs on the Windows.

This instrument is equipped with the 15 inch LCD with touch panel, hard disk drive, DVD drive, and USB/LAN/GP-IB interfaces. This instrument is also furnished with the USB keyboard, the USB mouse, and the stylus pen.

- HPSMU module

High power source/monitor unit module. Occupies two slots.

- HCSMU module

High current source/monitor unit module. Occupies two slots.

- HVSMU module

High voltage source/monitor unit module. Occupies two slots.

- MPSMU module

Medium power source/monitor unit module. Occupies one slot.

- MCSMU module

Medium current source/monitor unit module. Occupies one slot.

- MFCMU module

Multi frequency capacitance measurement unit module. Occupies one slot.

- Agilent N1258A Module selector

Selector box to switch the measurement resource connected to the device under test (DUT). The measurement resource will be HPSMU/MPSMU, HCSMU/DHCSMU (dual HCSMU), or HVSMU/HVMCU (high voltage medium current unit, configured by N1266A).

- Agilent N1259A Test fixture

Test fixture for measurements of packaged devices. Can install the module selector for switching the measurement resource connected to the DUT, the high voltage resistor box for reducing the risk of device breakdown, and the high voltage bias-tee for performing the high voltage capacitance measurement. Protection adapters are initially installed.

Cannot be used with the N1265A or N1268A expander.

- Agilent N1260A High voltage bias-tee  
Bias-tee for performing the high voltage capacitance measurement of up to 3000 Vdc.
- Agilent N1261A Protection adapter  
Adapter box for protecting GNDU, HPSMU, or MPSMU from high voltage.
- Agilent N1262A High voltage resistor box  
Resistor box for reducing the risk of device breakdown or preventing SMU from oscillation. 1 k $\Omega$  ( $\pm$  200 Vdc), 100 k $\Omega$  ( $\pm$  3000 Vdc), or 1 M $\Omega$  ( $\pm$  3000 Vdc). Blank box is also available for installing your desired resistor.
- Agilent N1265A Ultra high current expander/fixture  
Current expander to enable 500 A or 1500 A (option N1265A-015) output and measurement. Configures ultra high current unit (UHCU) with two HC/MCSMU modules.  
  
Can be the test fixture for measurements of packaged devices. The N1265A-035 universal resistor box is required for making your desired resistor box. The N1265A-040 protection adapter is required for protecting SMU from ultra high voltage by the N1268A. The N1265A-041 thermocouple is required for performing temperature measurement. The N1260A bias-tee is required for performing the high voltage capacitance measurement of up to 3000 Vdc.  
  
Selector is initially installed for switching the measurement resource connected to the DUT. The measurement resource will be the UHCU, HP/MPSMU, or HVSMU/HVMCU.  
  
The N1254A-524 ultra high current prober system cable is required for extending the selector output to your prober station.
- Agilent N1266A HVSMU current expander  
Current expander for HVSMU. Maximum current is expanded up to 2.5 A. Configures high voltage medium current unit (HVMCU) with the HVSMU module and two HC/MCSMU modules.  
  
Selector is initially installed for switching the HVSMU or the HVMCU connected to the DUT.
- Agilent N1267A HVSMU/HCSMU fast switch  
Selector box to switch the measurement resource connected to the DUT. The measurement resource will be HCSMU or HVSMU. One MCSMU module is required to control switching.

## Introduction

### Overview

- Agilent N1268A Ultra high voltage expander  
Voltage expander to enable 10 kV output and measurement. Configures ultra high voltage unit (UHVU) with two HC/MCSMU modules.
- Agilent N1269A Ultra high voltage connection adapter  
Adapter box to connect the N1268A expander Low terminal and the MCSMU modules to the DUT gate and source terminals and the prober chuck. Protection adapters for MCSMU are initially installed.

## Agilent EasyEXPERT Software

Agilent EasyEXPERT software is a specially-designed Windows application program for controlling Agilent B1500 series. The EasyEXPERT provides the easy and effective measurement and analysis environment with intuitive graphical user interface (GUI), touch screen LCD panel, keyboard, and mouse. Some of the functions are listed below.

- Single measurement, repeat measurement, and append measurement
- Module selector control
- Measurement/setup data management by workspace
- Graph display and analysis with markers, cursors, and lines; and auto analysis
- Data import/export capability, data output by CSV/XML format, and graph output by EMF/BMP/GIF/PNG format
- Maintenance; self-test and self-calibration
- Remote control function from an external computer

The EasyEXPERT has the following measurement execution environments.

- Application test
- Classic test
- Tracer test
- Quick test

### Application Test

The EasyEXPERT contains an application library that supports typical measurements for IGBT, PMIC, power MOSFET, power BJT, power diode, and so on. The application library includes more than forty test definitions.



You can perform measurements by choosing the best one for your device under test (DUT) from the application libraries, and modifying and executing it. Modification is really simple. For example, it will be completed by changing the output voltage only to DUT terminals. And the setup with your modifications can be saved and recalled as your setup (*My Favorite Setup*).

### Classic Test

You can perform measurements by using the user interface similar to the semiconductor parameter analyzers such as Agilent 4156C. The setup can be made by entering values into the setup tables used for the measurement resource control. And it can be saved and recalled as your setup (*My Favorite Setup*). This measurement environment provides the following functions.

- I/V Sweep
- Multi Channel I/V Sweep
- I/V List Sweep
- I/V-t Sampling
- C-V Sweep
- SPGU Control
- Switching Matrix Control
- Direct Control

The Direct Control test mode is used to control the measurement resources directly by using the B1505A GPIB control commands and perform measurement. For the control commands, see *Programming Guide*.

### Tracer Test

Curve tracer test mode. This test allows you to perform the high speed I-V measurement on one screen. The Tracer Test screen provides GUI for selecting the used channels, setting the sweep output, and displaying the measurement result (tracing the I-V curve). Range of the sweep output and measurement can be changed by the rotary knob on the front panel.

Tracer test also provides the oscilloscope view to display the pulse current or voltage output waveform of the HCSMU, DHCSMU, MCSMU, HVSMU, HVMCU, UHCU, or UHVU. You can verify output waveform over the I-V curve.

### Quick Test

You can execute the test setups saved in a preset group (*My Favorite Setup*) sequentially.

## Front View

This section describes the front view of Agilent B1505A.

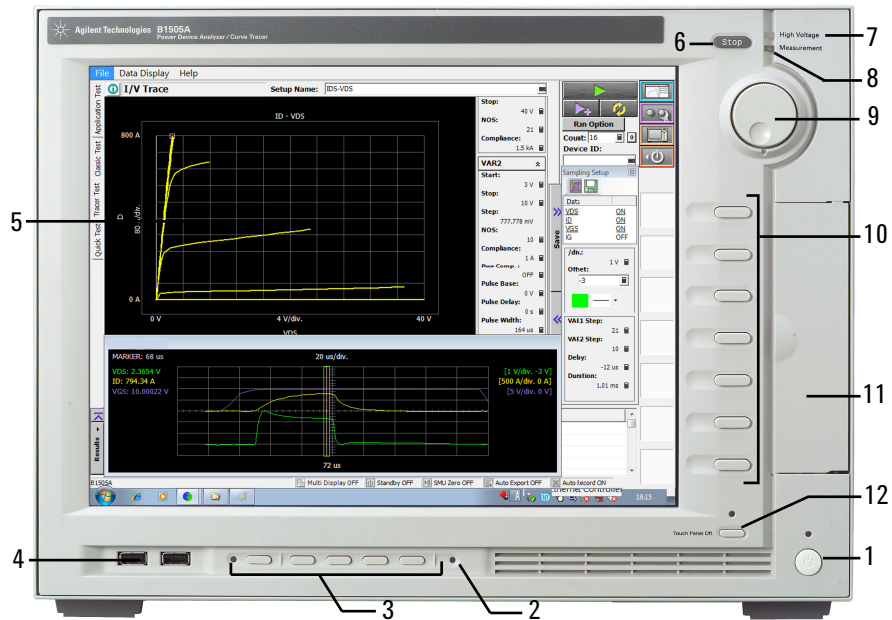

### 1. Standby switch

Turns the instrument on. Pressing the button in the ON state makes it in the standby state. The green LED lights when it is in the ON state.

## NOTE

### When turning the B1505A on

Open the measurement terminals at the device side when turning the B1505A on. Also disconnect the device from the measurement terminals and open the measurement terminals after the measurement. If you leave the connection with the device, the device may be damaged by unexpected operations or charge-up of measurement cables.

### 2. HDD access indicator

This green LED lights in the access status of HDD or DVD drive. Do not turn the instrument off during this LED lights.

### 3. LCD adjustment keys

LCD Off enables or disables the LCD panel. The green LED lights when the LCD is disabled.

Four keys are available for adjusting brightness. Use + and - to adjust it and then press *Set* to fix it. Pressing *Cancel* instead of *Set* cancels the adjustment.

### 4. USB interfaces

USB, 2 ports. For keyboard, mouse, and so on.

To remove USB devices from the instrument, use “Safely Remove Hardware” on Windows taskbar. If it is not used, the instrument may cause the internal USB communication error. If the error occurs, turn the instrument off and disconnect the power cable from it. Leave it about 30 seconds before rebooting it, and connect the power cable again, and then turn the instrument on.

### 5. LCD panel

15 inch TFT XGA display, 1024 × 768 resolution. Displays the Windows screen, Agilent EasyEXPERT software window, and so on. Touch screen operation is available when the Touch Panel Off indicator does not light.

To adjust the touch panel, use Microchip TSHARC Control Panel which is opened by selecting *Microchip TSHARC Control Panel* from the Start menu.

### 6. Stop key

Stops the present measurement or source output immediately.

### 7. High voltage status indicator

This red LED lights when a source channel applies dangerous voltage.

### 8. Measurement status indicator

This green LED lights when a measurement channel performs measurement.

### 9. Rotary knob

Works on Agilent EasyEXPERT environment. Rotating the knob moves the marker on the graph window, or increases/decreases/changes the value in the active entry field. Pressing the knob sets or enters the value.

### 10. Softkeys

Seven softkeys are available for Agilent EasyEXPERT environment. Used to select an alternative for the entry field specified or the dialog box.

## Introduction

### Front View

#### 11. DVD-R drive

For data backup, software update, and so on. With the option DR1, the drive is changed to the DVD-ROM drive.

#### 12. Touch Panel Off key

Works on the execution environment of EasyEXPERT software. Enables or disables the touch screen operation. The green LED lights when the touch screen is disabled.

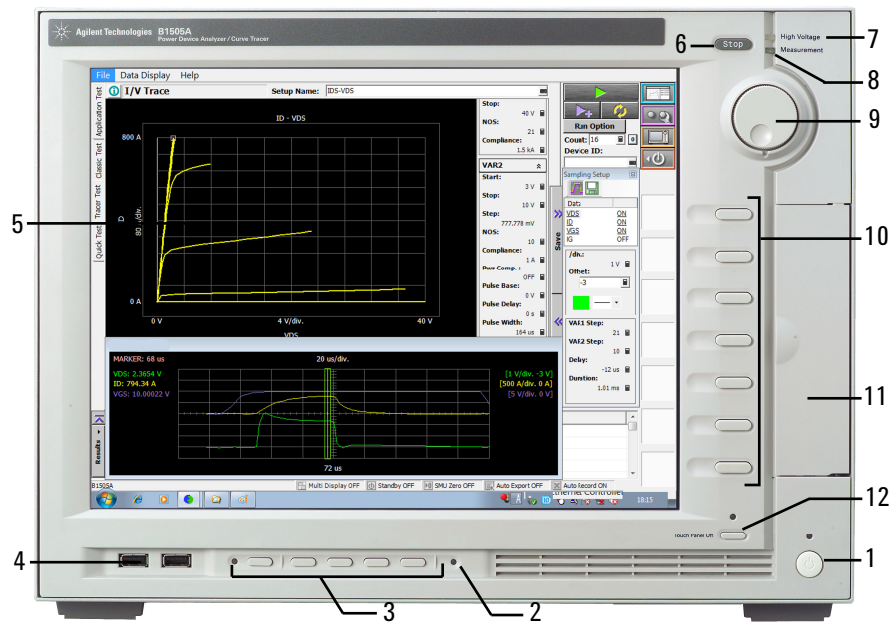

## Rear View

This section describes the rear view of Agilent B1505A.

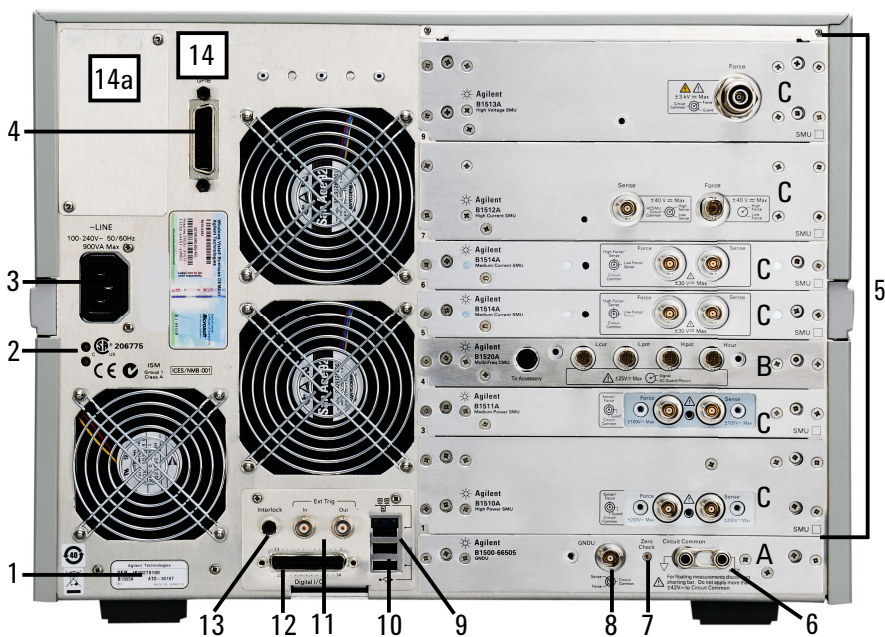

### 1. Serial number

You need this *serial number* when using Agilent Technologies telephone assistance program.

### 2. LED status indicator

For troubleshooting. Followings are some examples.

- Both LEDs turn off:  
The instrument is in the standby state and Standby switch is OFF position.
- One LED turns green:  
Power supply works normally.
- Both LEDs turn orange:  
The instrument is in the standby state and Standby switch is ON position.

3. LINE input receptacle



AC power cable is connected to this receptacle.

4. GPIB interface

Use an Agilent 82357A USB/GPIB interface or Agilent 10833A/B/C/D GPIB cable to connect to an external computer or equipment.

5. Module slot

Ten slots are available for installing the modules. Several kinds of module can be installed in the B1505A. However, the allowable number to install is different by the module type. See “Measurement Resources” on page 2-16. Also, there is a rule for the installation order by the module type. See Chapter 4, “Installation.”

 6. Circuit Common () and frame ground () terminals

Normally, connect the terminals together by using the shorting bar. For floating measurement, remove the shorting bar.

---

**WARNING**

**If the Circuit Common terminal is *not* connected to the frame ground terminal (for floating measurement), a potential shock hazard may present. Do not touch any of measurement circuit at any time while a floating measurement is in progress.**

---

---

**CAUTION**

For floating measurement, do not apply dangerous voltage to the Circuit Common terminal. Failure to heed this caution may result in damage to the instrument.

---

7. Zero Check terminal

Ground reference point of the instrument.

---

**CAUTION**

The Zero Check terminal can be used for the service purpose only. For the normal operation, leave this terminal open and do not connect anything to this terminal. Connecting anything can damage the instrument.

---

8. GNDU terminal

0 V constant voltage source. Used for the reference of measurement ground. Triaxial connector.

9. LAN interface

RJ45 connector.

#### 10. USB interfaces

USB, 2 ports. For keyboard, mouse, or peripherals.

To remove USB devices from the instrument, use “Safely Remove Hardware” on Windows taskbar. If it is not used, the instrument may cause the internal USB communication error. If the error occurs, turn the instrument off and disconnect the power cable from it. Leave it about 30 seconds before rebooting it, and connect the power cable again, and then turn the instrument on.

#### 11. Ext Trig terminals

Two BNC connectors, one for trigger input, and one for trigger output. For details about the trigger function, see *Programming Guide*.

#### 12. Digital I/O terminal

DSUB 25 pin connector. Can be used for the trigger input/output terminals or an interface to control an external relay circuit and so on. For details, see *Programming Guide*. This connector is also used to connect module selector, test fixture, or expander.



#### 13. Interlock terminal

Used in conjunction with the interlock function of the instrument. If the Interlock terminal is open, maximum SMU output is limited to  $\pm 42$  V and UHVU output is disabled. Be sure to connect this terminal to the interlock circuit of the test fixture or the prober station before performing measurement.

To verify the interlock function, perform the interlock open/close test on the Main Frame tab screen of the EasyEXPERT Configuration window.

---

**WARNING**

---

**Dangerous voltage, instrument maximum output voltage may appear at High, Force, Guard, and Sense terminals if the Interlock terminal is closed.**

#### 14. Video output terminal

VGA connector. For an external display. Signal to the built-in LCD is also applied to this terminal.

For the B1505A manufactured before the video output terminal is supported, it is mounted on the position “14a” by upgrading the mainframe.

 A. GNDU/ADC

Ground unit and A/D converter module. Always installed in the B1505A.

 B. MFCMU module

The multi frequency capacitance measurement unit (MFCMU) has four coaxial connectors, Lcur, Lpot, Hpot, and Hcur, for the four-terminal pair connection. The Hcur and Hpot have to be connected together at a terminal of the device under test (DUT). Also the Lcur and Lpot have to be connected together at the other terminal of the DUT. Then, the guard lines of four-terminal pair must be connected together.

---

**CAUTION**

---

Do not apply voltage more than  $\pm 25$  V to the MFCMU input terminals. Failure to heed this caution may result in damage to the module.

 C. HPSMU, HCSMU, HVSMU, MPSMU, MCSMU module

The high power source/monitor unit (HPSMU) has two triaxial connectors, force and sense, for the Kelvin connections.

The high current source/monitor unit (HCSMU) has the force coaxial connector and the sense triaxial connector, for the Kelvin connections.

The high voltage source/monitor unit (HVSMU) has the force connector.

The medium power source/monitor unit (MPSMU) has two triaxial connectors, force and sense, for the Kelvin connections.

The medium current source/monitor unit (MCSMU) has two triaxial connectors, force and sense, for the Kelvin connections.

In the EasyEXPERT operation mode, the SMUs can be specified by the SMU number. SMU1 is assigned to the SMU at the lowest position. And the following SMU numbers are assigned to the upper SMUs in sequence. Use the SMU number label furnished with the B1505A or equivalent to identify the SMU number.

---

**WARNING**

---

**To avoid electrical shock and instrument damage, turn the all instruments off before connecting or disconnecting measurement cable.**



---

**WARNING**

There are potentially hazardous voltages ( $\pm 10$  kVdc for UHVU,  $\pm 3000$  Vdc for HVSMU,  $\pm 2200$  V pulse for HVMCU,  $\pm 200$  Vdc for HPSMU, and  $\pm 100$  Vdc for MPSMU) present at the High, Force, Guard, and Sense terminals of the instruments. To prevent electrical shock, the following safety precautions must be observed during the use of instruments.

- Use three-conductor AC power cable to connect the instrument to an electrical ground (safety ground).

For both the N1265A and the N1268A, also connect a wire from an electrical ground (safety ground) to the earthing terminal.

- If you use prober and such instead of the test fixture, you must install and connect an interlock circuit that opens the circuit when the shielding box access door is open.
  - If you change the DUT interface, test fixture, prober, and such, connect an interlock cable to the one actually used.
  - If the N1268A is used, connect an interlock cable between the B1505A and the N1268A's Interlock Input, and connect an extra interlock cable between the N1268A's Interlock Output and the test fixture or the shielding box.
  - Confirm periodically that the interlock function works normally.
  - Before touching the connections on the High, Force, Guard, and Sense terminals in the test fixture or the shielding box, turn the instruments off and discharge any capacitors. If you do *not* turn the instruments off, complete *all* of the following items, regardless of the instrument settings.
    - Press the front panel Stop key to set the module output off.
    - Confirm that the front panel High Voltage indicator is not lit.
    - If the N1268A is used, press the High Voltage Enable switch to disable the high voltage output. And confirm that this red switch is not lit.
    - Open the Interlock terminal (open the access door).
    - Discharge any capacitors connected to a measurement resource.
  - Warn persons working around the instruments about dangerous conditions.
-

---

## Measurement Resources

Agilent B1505A can be equipped with the following measurement resources.

- “GNDU - Ground Unit”
- “HPSMU - High Power SMU”
- “HCSMU - High Current SMU”
- “HVSMU - High Voltage SMU”
- “MPSMU - Medium Power SMU”
- “MCSMU - Medium Current SMU”
- “HVMCU - High Voltage Medium Current Unit”
- “UHCU - Ultra High Current Unit”
- “UHVU - Ultra High Voltage Unit”
- “MFCMU - Multi Frequency CMU”

See Agilent EasyEXPERT *User’s Guide* for the functions available for Agilent EasyEXPERT software. See *Programming Guide* for the functions available for the GPIB remote mode.

### GNDU - Ground Unit

The B1505A is equipped with the ground unit (GNDU). The GNDU is a 0 V constant voltage source, and used for the reference of measurement ground. Also the GNDU can sink up to  $\pm 4.2$  A, so it is effective for using the HPSMU, MPSMU, and HVSMU. When the HCSMU, MCSMU, HVMCU, or UHCU is used, the GNDU must be connected to the Low side to apply the reference zero voltage. The GNDU is not used with the UHVU. Figure 2-1 is a simplified circuit diagram of GNDU.

Figure 2-1

#### Simplified GNDU Circuit Diagram

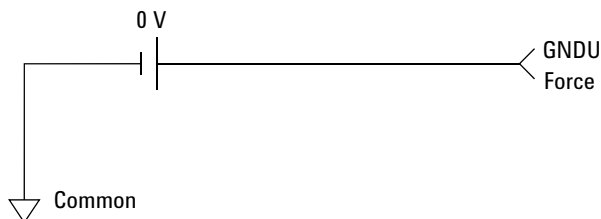

## About SMU

Source/monitor unit (SMU) can apply DC voltage or current, and can measure DC current or voltage. Figure 2-2 is a simplified SMU circuit diagram.

The HPSMU and MPSMU can perform the following operations:

- Apply voltage and measures current or voltage
- Apply current and measures current or voltage

The HCSMU, MCSMU, and HVSMU can perform the following operations:

- Apply voltage and measures current and/or voltage
- Apply current and measures current and/or voltage

---

**NOTE**

---

To select the SMU operation mode in the GPIB remote condition, enter the CMM command.

**Figure 2-2** Simplified SMU Circuit Diagram

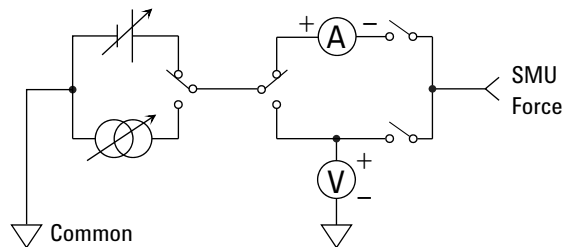

## Compliance

The SMU has a compliance feature that limits output voltage or current to prevent damage to the device under test. When the SMU applies voltage, you can specify current compliance. When the SMU applies current, you can specify voltage compliance. For details about the compliance, see *Agilent EasyEXPERT User's Guide*.

## HPSMU - High Power SMU

This section describes typical specification of the high power source/monitor unit (HPSMU). Maximum four modules can be installed in one mainframe. The total number of installed HPSMU and HCSMU modules can not exceed 4.

- Maximum voltage, current, output power:  $\pm 200$  V,  $\pm 1$  A, 20 W
- Minimum range: 2 V, 1 nA
- Output/measurement value and resolution: see Table 2-1 to Table 2-4.

Figure 2-3

HPSMU Output and Measurement Ranges

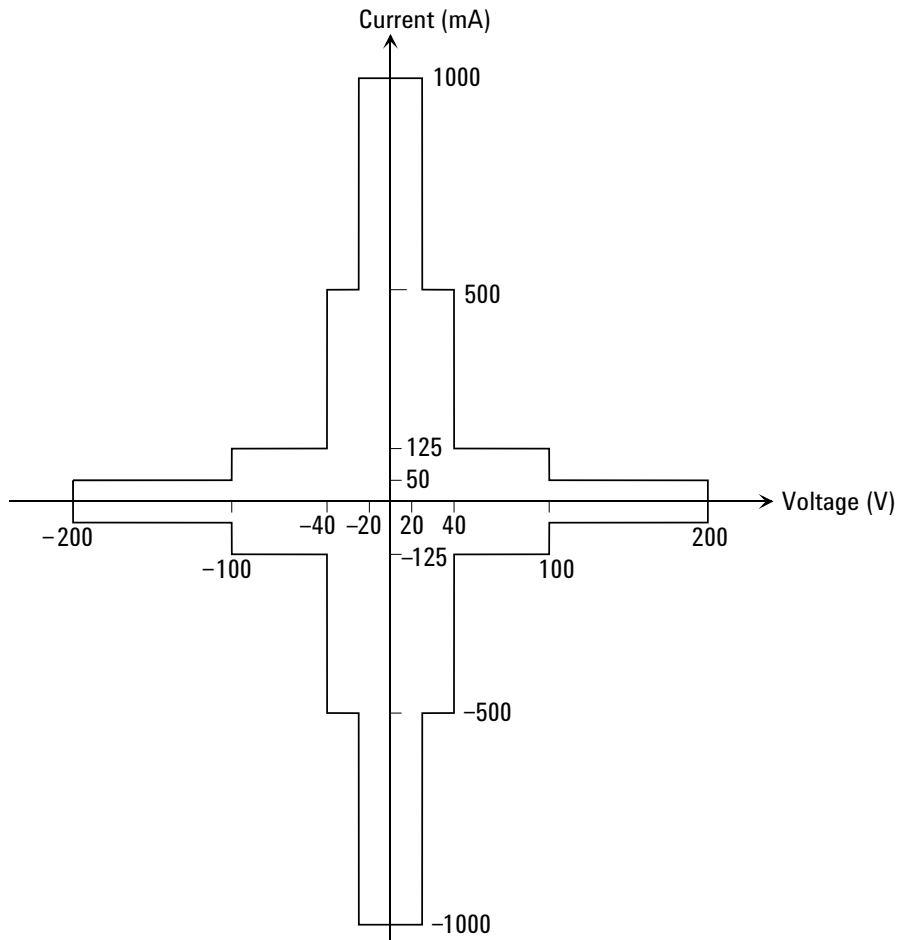

**Table 2-1 HPSMU Output Voltage Ranges and Resolutions**

Range	Output Value	Setting Resolution	Maximum Current
2 V	$0 \leq  V  \leq 2 \text{ V}$	100 $\mu\text{V}$	$\pm 1000 \text{ mA}$
20 V	$0 \leq  V  \leq 20 \text{ V}$	1 mV	$\pm 1000 \text{ mA}$
40 V	$0 \leq  V  \leq 40 \text{ V}$	2 mV	$\pm 500 \text{ mA}$
100 V	$0 \leq  V  \leq 100 \text{ V}$	5 mV	$\pm 125 \text{ mA}$
200 V	$0 \leq  V  \leq 200 \text{ V}$	10 mV	$\pm 50 \text{ mA}$

**Table 2-2 HPSMU Output Current Ranges and Resolutions**

Range	Output Value	Setting Resolution	Maximum Voltage
1 nA	$0 \leq  I  \leq 1.15 \text{ nA}$	50 fA	$\pm 200 \text{ V}$
10 nA	$0 \leq  I  \leq 11.5 \text{ nA}$	500 fA	$\pm 200 \text{ V}$
100 nA	$0 \leq  I  \leq 115 \text{ nA}$	5 pA	$\pm 200 \text{ V}$
1 $\mu\text{A}$	$0 \leq  I  \leq 1.15 \mu\text{A}$	50 pA	$\pm 200 \text{ V}$
10 $\mu\text{A}$	$0 \leq  I  \leq 11.5 \mu\text{A}$	500 pA	$\pm 200 \text{ V}$
100 $\mu\text{A}$	$0 \leq  I  \leq 115 \mu\text{A}$	5 nA	$\pm 200 \text{ V}$
1 mA	$0 \leq  I  \leq 1.15 \text{ mA}$	50 nA	$\pm 200 \text{ V}$
10 mA	$0 \leq  I  \leq 11.5 \text{ mA}$	500 nA	$\pm 200 \text{ V}$
100 mA	$0 \leq  I  \leq 50 \text{ mA}$	5 $\mu\text{A}$	$\pm 200 \text{ V}$
	$50 \text{ mA} <  I  \leq 115 \text{ mA}$	5 $\mu\text{A}$	$\pm 100 \text{ V}$
1 A	$0 \leq  I  \leq 50 \text{ mA}$	50 $\mu\text{A}$	$\pm 200 \text{ V}$
	$50 \text{ mA} <  I  \leq 125 \text{ mA}$	50 $\mu\text{A}$	$\pm 100 \text{ V}$
	$125 \text{ mA} <  I  \leq 500 \text{ mA}$	50 $\mu\text{A}$	$\pm 40 \text{ V}$
	$500 \text{ mA} <  I  \leq 1 \text{ A}$	50 $\mu\text{A}$	$\pm 20 \text{ V}$

**Table 2-3 HPSMU Measurement Voltage Values and Resolutions**

Range	Measurement Value <sup>a</sup>	Measurement Resolutions	
		High Speed ADC	High Resolution ADC
2 V	$0 \leq  V  \leq 2.2 \text{ V}$	100 $\mu\text{V}$	2 $\mu\text{V}$
20 V	$0 \leq  V  \leq 22 \text{ V}$	1 mV	20 $\mu\text{V}$
40 V	$0 \leq  V  \leq 44 \text{ V}$	2 mV	40 $\mu\text{V}$
100 V	$0 \leq  V  \leq 110 \text{ V}$	5 mV	100 $\mu\text{V}$
200 V	$0 \leq  V  \leq 200 \text{ V}$	10 mV	200 $\mu\text{V}$

**Table 2-4 HPSMU Measurement Current Values and Resolutions**

Range	Measurement Value <sup>a</sup>	Measurement Resolutions	
		High Speed ADC	High Resolution ADC
1 nA	$0 \leq  I  \leq 1.15 \text{ nA}$	50 fA	10 fA
10 nA	$0 \leq  I  \leq 11.5 \text{ nA}$	500 fA	10 fA
100 nA	$0 \leq  I  \leq 115 \text{ nA}$	5 pA	100 fA
1 $\mu\text{A}$	$0 \leq  I  \leq 1.15 \text{ }\mu\text{A}$	50 pA	1 pA
10 $\mu\text{A}$	$0 \leq  I  \leq 11.5 \text{ }\mu\text{A}$	500 pA	10 pA
100 $\mu\text{A}$	$0 \leq  I  \leq 115 \text{ }\mu\text{A}$	5 nA	100 pA
1 mA	$0 \leq  I  \leq 1.15 \text{ mA}$	50 nA	1 nA
10 mA	$0 \leq  I  \leq 11.5 \text{ mA}$	500 nA	10 nA
100 mA	$0 \leq  I  \leq 115 \text{ mA}$	5 $\mu\text{A}$	100 nA
1 A	$0 \leq  I  \leq 1 \text{ A}$	50 $\mu\text{A}$	1 $\mu\text{A}$

a. This column is applied to the auto ranging or the limited auto ranging. For fixed ranging, maximum measurement value is **Range** column value.

## HCSMU - High Current SMU

This section describes typical specification of the high current source/monitor unit (HCSMU). Maximum two modules can be installed in one mainframe. Using two modules (DHCSMU, dual HCSMU) can expand the maximum current up to  $\pm 40$  A (pulse),  $\pm 2$  A (DC). The total number of installed HPSMU and HCSMU modules can not exceed 4.

- Maximum current by one module:  $\pm 20$  A (pulse),  $\pm 1$  A (DC)
- Maximum voltage by one module:  $\pm 40$  V,  $\pm 20$  V only for the pulse over  $\pm 1$  A
- Maximum output power by one module: 40 W
- Minimum range: 0.2 V, 10  $\mu$ A
- Minimum pulse width: 50  $\mu$ s
- Output/measurement value and resolution: see Table 2-5 and Table 2-6.

---

### NOTE

Do not put any conductor on the HCSMU Low Force and Low Sense terminals, outer conductor of the coaxial connectors. Putting conductor of circuit common, chassis ground, or any potential on causes the measurement error.

---

Figure 2-4

### HCSMU Output and Measurement Ranges by One Module

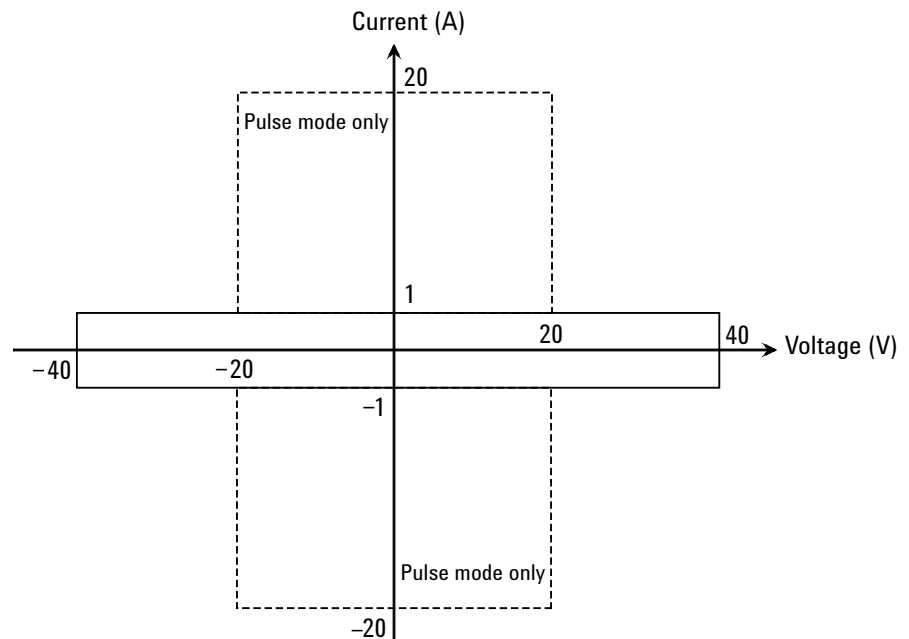

**Table 2-5 HCSMU Voltage Ranges and Resolutions (HCSMU / DHCSMU)**

Range	Output Value and Measurement Value	Setting/Measurement Resolution	Maximum Current	Maximum Pulse Base Value
0.2 V	$0 \leq  V  \leq 0.2 \text{ V}$	200 nV	$\pm 20 \text{ A} / \pm 40 \text{ A}$	$\pm 0.2 \text{ V}$
2 V	$0 \leq  V  \leq 2 \text{ V}$	2 $\mu\text{V}$	$\pm 20 \text{ A} / \pm 40 \text{ A}$	$\pm 2 \text{ V}$
20 V	$0 \leq  V  \leq 20 \text{ V}$	20 $\mu\text{V}$	$\pm 20 \text{ A} / \pm 40 \text{ A}$	$\pm 20 \text{ V}$
40 V	$0 \leq  V  \leq 40 \text{ V}$	40 $\mu\text{V}$	$\pm 1 \text{ A} / \pm 2 \text{ A}$	$\pm 40 \text{ V}$

**Table 2-6 HCSMU Current Ranges and Resolutions**

Range	Output Value and Measurement Value	Setting/Measurement Resolution	Maximum Voltage	Maximum Pulse Base Value
10 $\mu\text{A}$	$0 \leq  I  \leq 11.5 \mu\text{A}$	10 pA	$\pm 40 \text{ V}$	$\pm 10 \mu\text{A}$
100 $\mu\text{A}$	$0 \leq  I  \leq 115 \mu\text{A}$	100 pA	$\pm 40 \text{ V}$	$\pm 100 \mu\text{A}$
1 mA	$0 \leq  I  \leq 1.15 \text{ mA}$	1 nA	$\pm 40 \text{ V}$	$\pm 1 \text{ mA}$
10 mA	$0 \leq  I  \leq 11.5 \text{ mA}$	10 nA	$\pm 40 \text{ V}$	$\pm 10 \text{ mA}$
100 mA	$0 \leq  I  \leq 115 \text{ mA}$	100 nA	$\pm 40 \text{ V}$	$\pm 100 \text{ mA}$
1 A	$0 \leq  I  \leq 1.15 \text{ A}^{\text{a}}$	1 $\mu\text{A}$	$\pm 40 \text{ V}$	$\pm 1 \text{ A}$
2 A	$0 \leq  I  \leq 2.02 \text{ A}^{\text{b}}$	2 $\mu\text{A}$	$\pm 40 \text{ V}$	$\pm 2 \text{ A}$
20 A	$0 \leq  I  \leq 20 \text{ A}$	20 $\mu\text{A}$	$\pm 20 \text{ V}$	$\pm 100 \text{ mA}$
40 A	$0 \leq  I  \leq 40 \text{ A}$	40 $\mu\text{A}$	$\pm 20 \text{ V}$	$\pm 200 \text{ mA}$

a. Maximum value is 1 A for DC output or measurement by HCSMU.

b. Maximum value is 2 A for DC output or measurement.

**NOTE**

**40 A range and 2 A range**

The 40 A range and the 2 A range are available when two HCSMU modules are installed in the B1505A and connected to the 16493S-020 Dual HCSMU Kelvin combination adapter or the 16493S-021 Dual HCSMU combination adapter. Two HCSMU modules can be the DHCSMU which supports  $\pm 40 \text{ A}$  (pulse),  $\pm 2 \text{ A}$  (DC). Then the 20 A range is not supported.

When the compliance value is set to  $> 1 \text{ A}$  or  $< -1 \text{ A}$ , the current measurement range is fixed to the compliance range.



## HVSMU - High Voltage SMU

This section describes typical specification of the high voltage source/monitor unit (HVSMU). Only one module can be installed in one mainframe.

- Maximum voltage/current: 3000 V/4 mA, -3000 V/-4 mA, 1500 V/8 mA, or -1500 V/-8 mA
- Maximum output power: 12 W
- Minimum range: 200 V, 1 nA
- Output/measurement value and resolution: see Table 2-7 and Table 2-8.

---

### CAUTION

---

Never connect the HVSMU Force and Guard terminals to any output, including circuit common, chassis ground, or any other measurement resource such as SMU. Connecting other measurement resource may damage the connected one.

Figure 2-5

HVSMU Output and Measurement Ranges

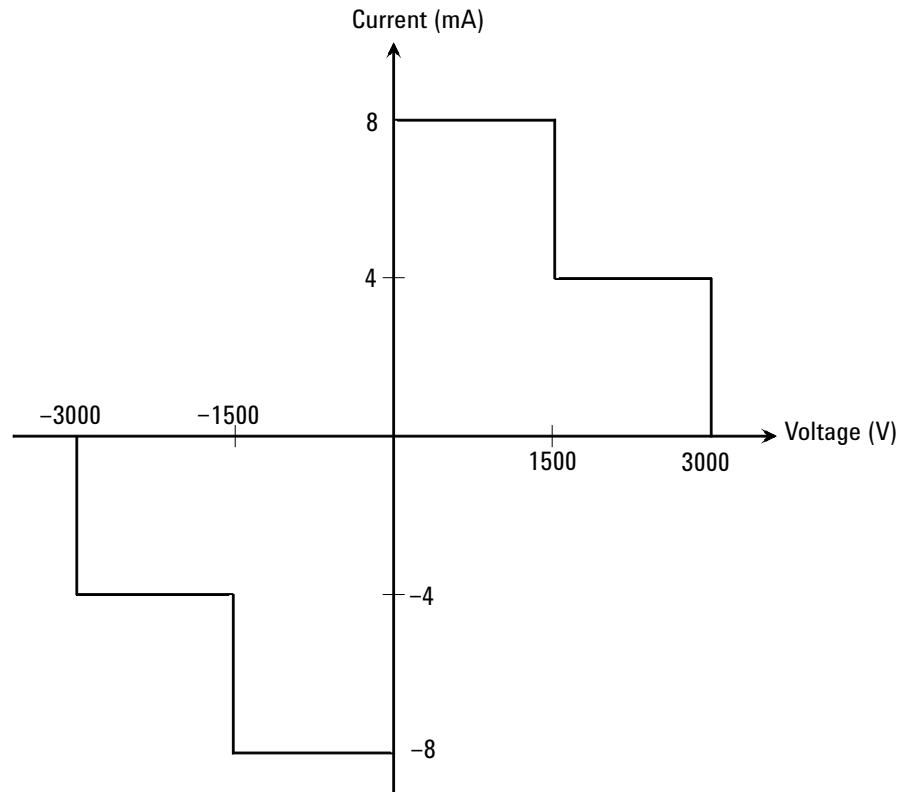

**Table 2-7 HVSMU Voltage Ranges and Resolutions**

Range	Output Value and Measurement Value	Setting/ Measurement Resolution	Maximum Current  Imax
200 V	$0 \leq  V  \leq 200 \text{ V}$	200 $\mu\text{V}$	8 mA
500 V	$0 \leq  V  \leq 500 \text{ V}$	500 $\mu\text{V}$	8 mA
1500 V	$0 \leq  V  \leq 1500 \text{ V}$	1.5 mV	8 mA
3000 V	$0 \leq  V  \leq 3000 \text{ V}$	3 mV	4 mA

**Table 2-8 HVSMU Current Ranges and Resolutions**

Range	Output Value and Measurement Value	Setting/ Measurement Resolution	Maximum Voltage  Vmax
1 nA <sup>a</sup>	$0 \leq  I  \leq 1.15 \text{ nA}$	10 fA	3000 V
10 nA	$0 \leq  I  \leq 11.5 \text{ nA}$	100 fA	3000 V
100 nA	$0 \leq  I  \leq 115 \text{ nA}$	100 fA	3000 V
1 $\mu\text{A}$	$0 \leq  I  \leq 1.15 \text{ } \mu\text{A}$	1 pA	3000 V
10 $\mu\text{A}$	$0 \leq  I  \leq 11.5 \text{ } \mu\text{A}$	10 pA	3000 V
100 $\mu\text{A}$	$0 \leq  I  \leq 115 \text{ } \mu\text{A}$	100 pA	3000 V
1 mA	$0 \leq  I  \leq 1.15 \text{ mA}$	1 nA	3000 V
10 mA	$0 \leq  I  \leq 8 \text{ mA}$	10 nA	1500 V
	$0 \leq  I  \leq 4 \text{ mA}$		3000 V

a. DC only

## MPSMU - Medium Power SMU

This section describes typical specification of the medium power source/monitor unit (MPSMU). There is no restriction for the number of modules installed in one mainframe.

- Maximum voltage, current, output power:  $\pm 100$  V,  $\pm 100$  mA, 2 W
- Minimum range: 0.5 V, 1 nA
- Output/measurement value and resolution: see Table 2-9 to Table 2-12.

**Figure 2-6** MPSMU Output and Measurement Ranges

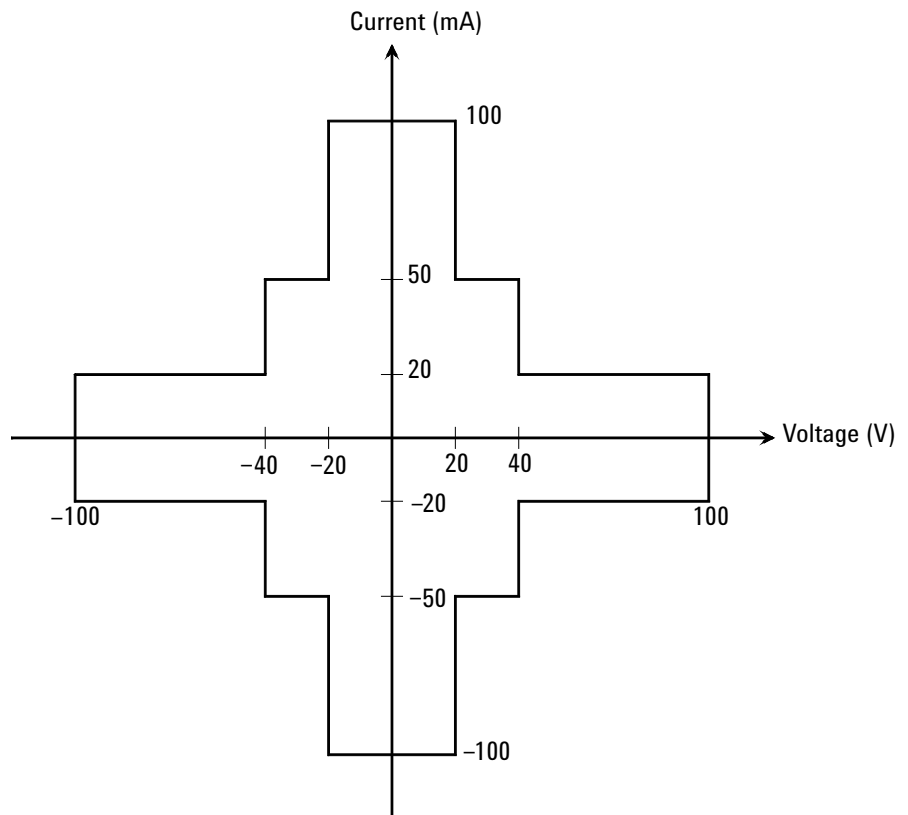

**Table 2-9** **MPSMU Output Voltage Ranges and Resolutions**

Range	Output Value	Setting Resolution	Maximum Current
0.5 V	$0 \leq  V  \leq 0.5 \text{ V}$	25 $\mu\text{V}$	$\pm 100 \text{ mA}$
2 V	$0 \leq  V  \leq 2 \text{ V}$	100 $\mu\text{V}$	$\pm 100 \text{ mA}$
5 V	$0 \leq  V  \leq 5 \text{ V}$	250 $\mu\text{V}$	$\pm 100 \text{ mA}$
20 V	$0 \leq  V  \leq 20 \text{ V}$	1 mV	$\pm 100 \text{ mA}$
40 V	$0 \leq  V  \leq 20 \text{ V}$	2 mV	$\pm 100 \text{ mA}$
	$20 \text{ V} <  V  \leq 40 \text{ V}$	2 mV	$\pm 50 \text{ mA}$
100 V	$0 \leq  V  \leq 20 \text{ V}$	5 mV	$\pm 100 \text{ mA}$
	$20 \text{ V} <  V  \leq 40 \text{ V}$	5 mV	$\pm 50 \text{ mA}$
	$40 \text{ V} <  V  \leq 100 \text{ V}$	5 mV	$\pm 20 \text{ mA}$

**Table 2-10** **MPSMU Output Current Ranges and Resolutions**

Range	Output Value	Setting Resolution	Maximum Voltage
1 nA	$0 \leq  I  \leq 1.15 \text{ nA}$	50 fA	$\pm 100 \text{ V}$
10 nA	$0 \leq  I  \leq 11.5 \text{ nA}$	500 fA	$\pm 100 \text{ V}$
100 nA	$0 \leq  I  \leq 115 \text{ nA}$	5 pA	$\pm 100 \text{ V}$
1 $\mu\text{A}$	$0 \leq  I  \leq 1.15 \mu\text{A}$	50 pA	$\pm 100 \text{ V}$
10 $\mu\text{A}$	$0 \leq  I  \leq 11.5 \mu\text{A}$	500 pA	$\pm 100 \text{ V}$
100 $\mu\text{A}$	$0 \leq  I  \leq 115 \mu\text{A}$	5 nA	$\pm 100 \text{ V}$
1 mA	$0 \leq  I  \leq 1.15 \text{ mA}$	50 nA	$\pm 100 \text{ V}$
10 mA	$0 \leq  I  \leq 11.5 \text{ mA}$	500 nA	$\pm 100 \text{ V}$
100 mA	$0 \leq  I  \leq 20 \text{ mA}$	5 $\mu\text{A}$	$\pm 100 \text{ V}$
	$20 \text{ mA} <  I  \leq 50 \text{ mA}$	5 $\mu\text{A}$	$\pm 40 \text{ V}$
	$50 \text{ mA} <  I  \leq 100 \text{ mA}$	5 $\mu\text{A}$	$\pm 20 \text{ V}$

**Table 2-11**                      **MPSMU Measurement Voltage Values and Resolutions**

Range	Measurement Value <sup>a</sup>	Measurement Resolutions	
		High Speed ADC	High Resolution ADC
0.5 V	$0 \leq  V  \leq 0.55 \text{ V}$	25 $\mu\text{V}$	0.5 $\mu\text{V}$
2 V	$0 \leq  V  \leq 2.2 \text{ V}$	100 $\mu\text{V}$	2 $\mu\text{V}$
5 V	$0 \leq  V  \leq 5.5 \text{ V}$	250 $\mu\text{V}$	5 $\mu\text{V}$
20 V	$0 \leq  V  \leq 22 \text{ V}$	1 mV	20 $\mu\text{V}$
40 V	$0 \leq  V  \leq 44 \text{ V}$	2 mV	40 $\mu\text{V}$
100 V	$0 \leq  V  \leq 100 \text{ V}$	5 mV	100 $\mu\text{V}$

**Table 2-12**                      **MPSMU Measurement Current Values and Resolutions**

Range	Measurement Value <sup>a</sup>	Measurement Resolutions	
		High Speed ADC	High Resolution ADC
1 nA	$0 \leq  I  \leq 1.15 \text{ nA}$	50 fA	10 fA
10 nA	$0 \leq  I  \leq 11.5 \text{ nA}$	500 fA	10 fA
100 nA	$0 \leq  I  \leq 115 \text{ nA}$	5 pA	100 fA
1 $\mu\text{A}$	$0 \leq  I  \leq 1.15 \text{ } \mu\text{A}$	50 pA	1 pA
10 $\mu\text{A}$	$0 \leq  I  \leq 11.5 \text{ } \mu\text{A}$	500 pA	10 pA
100 $\mu\text{A}$	$0 \leq  I  \leq 115 \text{ } \mu\text{A}$	5 nA	100 pA
1 mA	$0 \leq  I  \leq 1.15 \text{ mA}$	50 nA	1 nA
10 mA	$0 \leq  I  \leq 11.5 \text{ mA}$	500 nA	10 nA
100 mA	$0 \leq  I  \leq 100 \text{ mA}$	5 $\mu\text{A}$	100 nA

a. This column is applied to the auto ranging or the limited auto ranging.  
For fixed ranging, maximum measurement value is **Range** column value.

## MCSMU - Medium Current SMU

This section describes typical specification of the medium current source/monitor unit (MCSMU). Maximum six modules can be installed in one mainframe.

- Maximum current:  $\pm 1$  A (pulse),  $\pm 0.1$  A (DC)
- Maximum voltage:  $\pm 30$  V
- Maximum output power: 30 W (pulse), 3 W (DC)
- Minimum range: 0.2 V, 10  $\mu$ A
- Minimum pulse width: 10  $\mu$ s
- Output/measurement value and resolution: see Table 2-13 and Table 2-14.

Figure 2-7

### MCSMU Output and Measurement Ranges

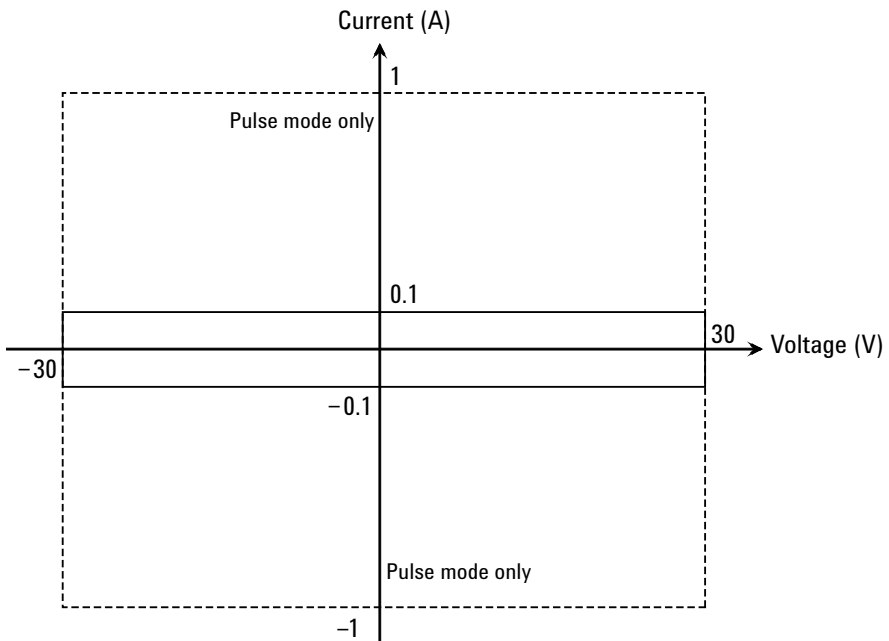

**Table 2-13** MCSMU Voltage Ranges and Resolutions

Range	Output Value and Measurement Value	Setting/ Measurement Resolution	Maximum Current	Maximum Pulse Base Value
0.2 V	$0 \leq  V  \leq 0.2 \text{ V}$	200 nV	100 mA, 1 A <sup>a</sup>	$\pm 0.2 \text{ V}$
2 V	$0 \leq  V  \leq 2 \text{ V}$	2 $\mu\text{V}$		$\pm 2 \text{ V}$
20 V	$0 \leq  V  \leq 20 \text{ V}$	20 $\mu\text{V}$		$\pm 20 \text{ V}$
40 V	$0 \leq  V  \leq 30 \text{ V}$	40 $\mu\text{V}$		$\pm 30 \text{ V}$

a. For pulse.

**Table 2-14** MCSMU Current Ranges and Resolutions

Range	Output Value and Measurement Value	Setting/ Measurement Resolution	Maximum Voltage	Maximum Pulse Base Value
10 $\mu\text{A}$	$0 \leq  I  \leq 11.5 \mu\text{A}$	10 pA	$\pm 30 \text{ V}$	$\pm 10 \mu\text{A}$
100 $\mu\text{A}$	$0 \leq  I  \leq 115 \mu\text{A}$	100 pA		$\pm 100 \mu\text{A}$
1 mA	$0 \leq  I  \leq 1.15 \text{ mA}$	1 nA		$\pm 1 \text{ mA}$
10 mA	$0 \leq  I  \leq 11.5 \text{ mA}$	10 nA		$\pm 10 \text{ mA}$
100 mA	$0 \leq  I  \leq 100 \text{ mA}$ , $0 \leq  I  \leq 115 \text{ mA}$ <sup>a</sup>	100 nA		$\pm 100 \text{ mA}$
1 A <sup>b</sup>	$0 \leq  I  \leq 1 \text{ A}$	1 $\mu\text{A}$		$\pm 50 \text{ mA}$

a. For pulse.

b. For pulse. Maximum pulse width and duty cycle are 100 ms and 5 % respectively.

## HVMCU - High Voltage Medium Current Unit

The high voltage medium current unit (HVMCU) is configured by the Agilent N1266A HVSMU current expander, the HVSMU module, and two MCSMU/HCSMU modules. Typical specifications of the HVMCU are shown below.

- Output: voltage pulse
- Measurement: current or voltage
- Maximum voltage:  $\pm 2200$  V, or  $\pm 1500$  V for 2 A compliance range
- Minimum pulse width: 10  $\mu$ s
- Minimum pulse period: 5 ms
- Output/measurement value and resolution: see Table 2-15 and Table 2-16.

---

**CAUTION**

---

Never connect the HVMCU High terminal to any output, including circuit common, chassis ground, or any other measurement resource such as SMU. Connecting other measurement resource may damage the connected one.

Figure 2-8 HVMCU Output and Measurement Ranges

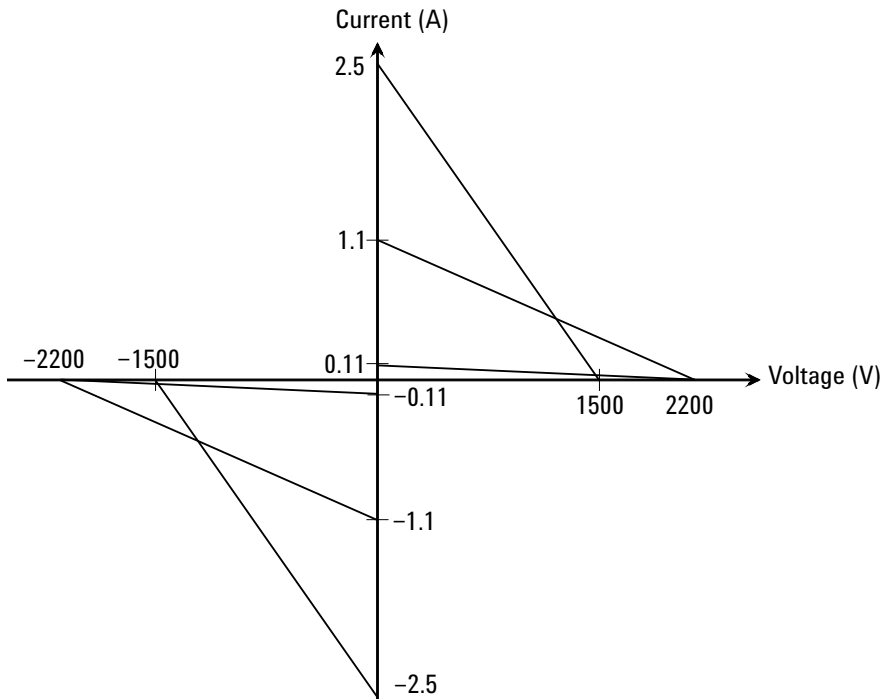



**Table 2-15 HVMCU Voltage Ranges and Resolutions**

Range	Output Value <sup>a</sup>	Measurement Value <sup>b</sup>	Setting/ Measurement Resolution	Compliance Range	Maximum Current
1500 V	$0 \leq  V  \leq 1500 \text{ V}$	$0 \leq  V  \leq 2200 \text{ V}$	1.5 mV/3 mV <sup>b</sup>	2 A	$\pm 2.5 \text{ A}$
3000 V	$0 \leq  V  \leq 2200 \text{ V}$		3 mV/3 mV	1 A	$\pm 1.1 \text{ A}$
				100 mA	$\pm 110 \text{ mA}$

a. Pulse base value is always 0 V.

b. Measurement is performed by the 3000 V measurement range.

**Table 2-16 HVMCU Current Ranges and Resolutions**

Range	Output Value	Measurement Value	Setting Resolution	Measurement Resolution	Maximum Voltage
100 mA	—	$0 \leq  I  \leq 0.11 \text{ A}$	—	200 nA	$\pm 2200 \text{ V}$
2 A	—	$0 \leq  I  \leq 1.1 \text{ A}$	—	4 $\mu\text{A}$	$\pm 2200 \text{ V}$
	—	$0 \leq  I  \leq 2.5 \text{ A}$	—	4 $\mu\text{A}$	$\pm 1500 \text{ V}$

## UHCU - Ultra High Current Unit

The ultra high current unit (UHCU) is configured by the Agilent N1265A ultra high current expander/fixture and two MCSMU/HCSMU modules. Typical specifications of the UHCU are shown below.

- Output: voltage pulse or current pulse
- Measurement: current or voltage
- Maximum current:  $\pm 500$  A, or  $\pm 1500$  A for the option N1265A-015
- Maximum voltage:  $\pm 60$  V
- Maximum power: 7.5 kW for 500 A range, or 22.5 kW for 2000 A range
- Minimum pulse width: 10  $\mu$ s
- Maximum pulse duty: 0.4 % for 500 A range, or 0.1 % for 2000 A range
- Output/measurement value and resolution: see Table 2-17 and Table 2-18.

Figure 2-9

### UHCU Output and Measurement Ranges

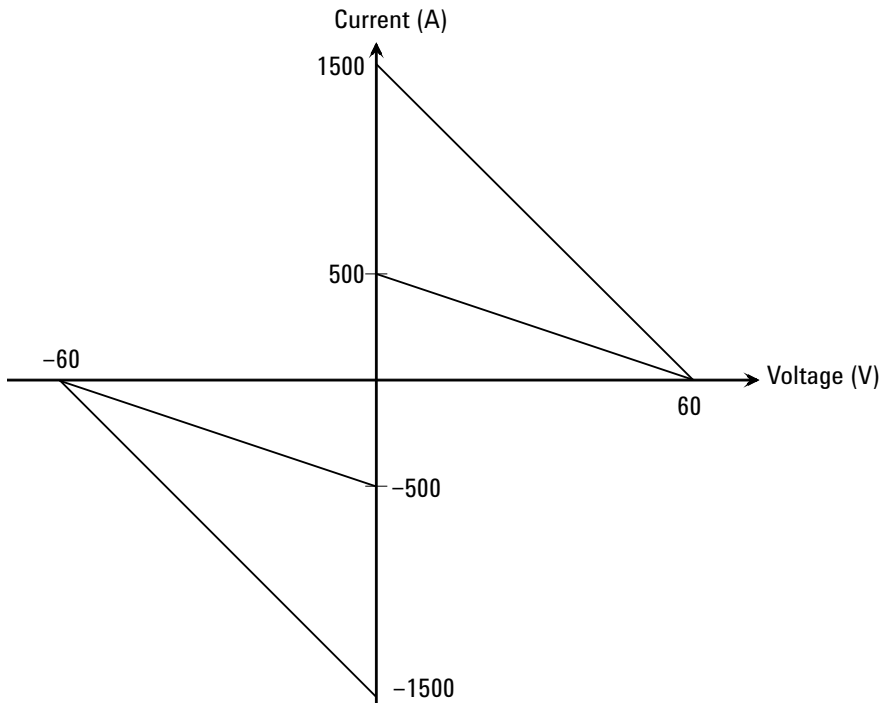

**Table 2-17 UHCU Voltage Ranges and Resolutions**

Range	Output Value	Measurement Value	Setting Resolution	Measurement Resolution	Maximum Current
100 V	$0 \leq  V  \leq 60 \text{ V}^a$	$0 \leq  V  \leq 60 \text{ V}$	200 $\mu\text{V}$	100 $\mu\text{V}$	$\pm 500 \text{ A}$ , $\pm 1500 \text{ A}^b$

a. Pulse base value is always 0 V.

b. Only for the N1265A-015.

**Table 2-18 UHCU Current Ranges and Resolutions**

Range	Output Value	Measurement Value	Setting Resolution	Measurement Resolution	Maximum Voltage
500 A	$0 \leq  I  \leq 500 \text{ A}^a$	$0 \leq  I  \leq 500 \text{ A}$	1 mA	500 $\mu\text{A}$	$\pm 63 \text{ V}^b$
2000 A <sup>c</sup>	$0 \leq  I  \leq 1500 \text{ A}$	$0 \leq  I  \leq 1500 \text{ A}$	4 mA	2 mA	

a. Pulse base value is always 0 A.

b. This is the maximum voltage compliance value.

c. Only for the N1265A-015. Pulse base value is always 0 A.

## UHVU - Ultra High Voltage Unit

The ultra high voltage unit (UHVU) is configured by the Agilent N1268A ultra high voltage expander and two MCSMU modules or a combination of a MCSMU and a HCSMU. Typical specifications of the UHVU are shown below.

- Output: DC voltage or voltage pulse
- Measurement: current or voltage
- Maximum voltage/current: 10 kV/10 mA, -10 kV/-10 mA, 10 kV/20 mA, or -10 kV/-20 mA  
Pulse width must be 1 ms or less for the current over  $\pm 10$  mA.
- Minimum pulse width: 100  $\mu$ s
- Minimum pulse period: 10 ms
- Output/measurement value and resolution: see Table 2-19 and Table 2-20.

Figure 2-10

UHVU Output and Measurement Ranges

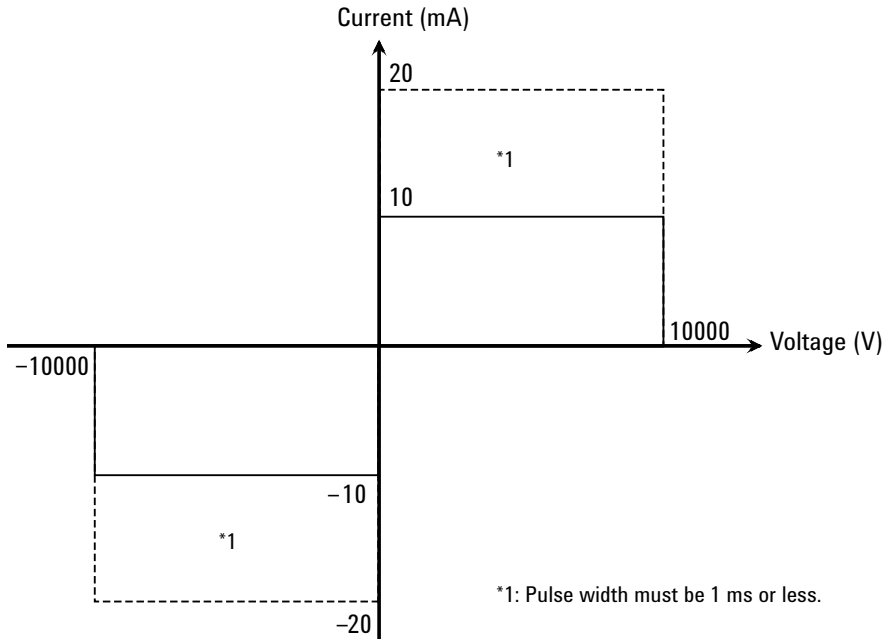

**Table 2-19 UHVU Voltage Ranges and Resolutions**

Range	Output Value	Measurement Value	Setting Resolution	Measurement Resolution	Maximum Current
10 kV	$0 \leq  V  \leq 10 \text{ kV}^a$	$0 \leq  V  \leq 10 \text{ kV}$	10 mV	10 mV	$\pm 10 \text{ mA}$ , $\pm 20 \text{ mA}^b$

a. Pulse base and peak values must be the same polarity.

b. Only for the pulse of maximum 1 ms pulse width.

**Table 2-20 UHVU Current Ranges and Resolutions**

Range	Output Value	Measurement Value	Setting Resolution	Measurement Resolution	Maximum Voltage
10 $\mu\text{A}$	—	$0 \leq  I  \leq 11.5 \mu\text{A}$	—	10 pA	$\pm 10 \text{ kV}$
100 $\mu\text{A}$	—	$0 \leq  I  \leq 115 \mu\text{A}$	—	100 pA	
1 mA	—	$0 \leq  I  \leq 1.15 \text{ mA}$	—	1 nA	
10 mA	—	$0 \leq  I  \leq 10 \text{ mA}$ , $0 \leq  I  \leq 11.5 \text{ mA}^a$	—	10 nA	
100 mA <sup>a</sup>	—	$0 \leq  I  \leq 20 \text{ mA}$	—	100 nA	

a. Only for the pulse of maximum 1 ms pulse width.

---

**CAUTION**

---

Never connect the UHVU High terminal to any output, including circuit common, chassis ground, or any other measurement resource such as SMU. Connecting other measurement resource may damage the connected one.

---

**CAUTION**

---

Never connect the UHVU Low terminal to any other measurement resource except for the N1269A or N1265A-040 adapter. Connecting other measurement resource may damage the connected one.

## MFCMU - Multi Frequency CMU

This section describes typical specification of the multi frequency capacitance measurement unit (CMU). The CMU performs the impedance measurement and returns the specified measurement data such as Cp-G. Only one module can be installed in one mainframe.

- Measurement parameters: See Table 2-21.
- AC signal, output frequency:  
1 kHz to 5 MHz  
Setting resolution: 1 mHz (1 kHz to), 10 mHz (10 kHz to), 0.1 Hz (100 kHz to), or 1 Hz (1 MHz to 5 MHz)
- AC signal, output level:  
10 mVrms to 250 mVrms, 1 mV resolution
- DC bias:  
0 to  $\pm 25$  V, using MFCMU internal DC bias  
0 to  $\pm 3000$  V, using HVSMU and high voltage bias-tee
- Measurement range:  
For the fixed ranging mode, measurement range (impedance range) must be specified to perform measurement. Table 2-22 shows the available measurement ranges and the corresponding impedance value. And Figure 2-11 shows the calculation example of the impedance vs frequency characteristics of a capacitive load. Use these information to decide the measurement range.

Impedance  $Z$  is calculated by the following formula.

$$Z = 1 / (2\pi f C)$$

where  $f$  is frequency (Hz) and  $C$  is capacitance (F).

**Table 2-21 Measurement Parameters**

<b>Primary Parameter</b>	<b>Secondary Parameter</b>
R (resistance, $\Omega$ )	X (reactance, $\Omega$ )
G (conductance, S)	B (susceptance, S)
Z (impedance, $\Omega$ )	$\theta$ (phase, radian)
Z (impedance, $\Omega$ )	$\theta$ (phase, degree)
Y (admittance, S)	$\theta$ (phase, radian)
Y (admittance, S)	$\theta$ (phase, degree)
Cp (parallel capacitance, F)	G (conductance, S)
Cp (parallel capacitance, F)	D (dissipation factor)
Cp (parallel capacitance, F)	Q (quality factor)
Cp (parallel capacitance, F)	Rp (parallel resistance, $\Omega$ )
Cs (series capacitance, F)	Rs (series resistance, $\Omega$ )
Cs (series capacitance, F)	D (dissipation factor)
Cs (series capacitance, F)	Q (quality factor)
Lp (parallel inductance, H)	G (conductance, S)
Lp (parallel inductance, H)	D (dissipation factor)
Lp (parallel inductance, H)	Q (quality factor)
Lp (parallel inductance, H)	Rp (parallel resistance, $\Omega$ )
Ls (series inductance, H)	Rs (series resistance, $\Omega$ )
Ls (series inductance, H)	D (dissipation factor)
Ls (series inductance, H)	Q (quality factor)

Table 2-22 Measurement Range for Fixed Ranging Mode

Impedance Z	Measurement range (impedance range)		
	1 kHz ≤ f ≤ 200 kHz	200 kHz < f ≤ 2 MHz	2 MHz < f ≤ 5 MHz
0 ≤ Z < 100 Ω	50 Ω	50 Ω	50 Ω
100 Ω ≤ Z < 300 Ω	100 Ω	100 Ω	100 Ω
300 Ω ≤ Z < 1 kΩ	300 Ω	300 Ω	300 Ω
1 kΩ ≤ Z < 3 kΩ	1 kΩ	1 kΩ	1 kΩ
3 kΩ ≤ Z < 10 kΩ	3 kΩ	3 kΩ	3 kΩ
10 kΩ ≤ Z < 30 kΩ	10 kΩ	10 kΩ	
30 kΩ ≤ Z < 100 kΩ	30 kΩ	30 kΩ	
100 kΩ ≤ Z < 300 kΩ	100 kΩ		
300 kΩ ≤ Z	300 kΩ		

Figure 2-11 Impedance vs Frequency Characteristics of Capacitive Load, Calculation Example

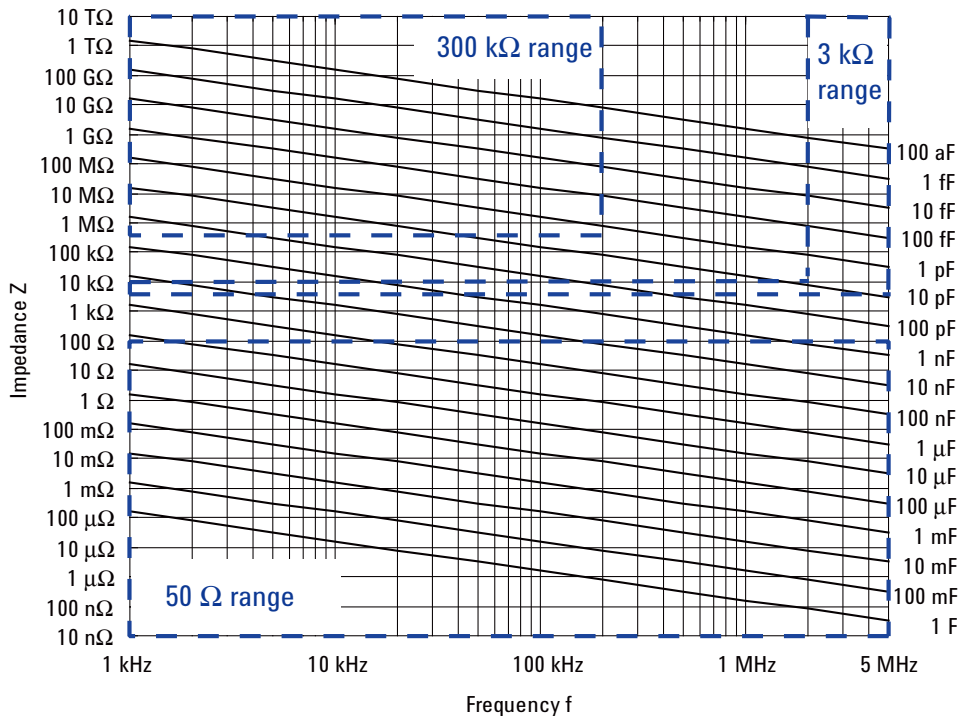



---

**3**

**Accessories**

---

## Accessories

This chapter explains the following accessories available for Agilent B1505A.

- “N1258A Module Selector”
- “N1259A Test Fixture”
- “N1260A High Voltage Bias-Tee”
- “N1261A Protection Adapter”
- “N1262A Resistor Box”
- “16493S-010/011 HCSMU Adapter”
- “16493S-020/021 Dual HCSMU Adapter”
- “N1265A Ultra High Current Expander/Fixture”
- “N1266A HVSMU Current Expander”
- “N1267A HVSMU/HCSMU Fast Switch”
- “N1268A Ultra High Voltage Expander”
- “N1269A Ultra High Voltage Connection Adapter”

---

**WARNING**

---

To avoid electrical shock and instrument damage, turn the all instruments off before connecting or disconnecting measurement cable.

---

**WARNING**

---

The B1505A, the N1265A ultra high current expander/fixture, and the N1268A ultra high voltage expander are heavy and require a two person lift.

---

**CAUTION**

---

Do not grab the fixture cover when lifting the N1259A or N1265A test fixture.

---

**NOTE**

---

### Using Universal resistor box and Universal Socket Module

The universal resistor box and the universal socket module are the do-it-yourself kit for installing a resistor you want or mounting a socket you want.

You need to prepare the hexlobe (torx type) screwdriver T-10 to remove the cover.

After installing a resistor or mounting a socket, reattach the cover. Do not use the universal resistor box and the universal socket module under the condition that the cover is removed.

---

## N1258A Module Selector

Module selector is used to switch the measurement resource connected to the device under test (DUT) automatically. The measurement resource will be GNDU, HPSMU/MPSMU, HCSMU/DHCSMU (Dual HCSMU), or HVSMU/HVMCU. One selector provides one switching channel. Also the selector installs the GNDU protection adapter and the HPSMU protection adapter. The N1258A is used with a DUT interface such as your own test fixture and prober station, not the N1259A/N1265A.

### Front Panel

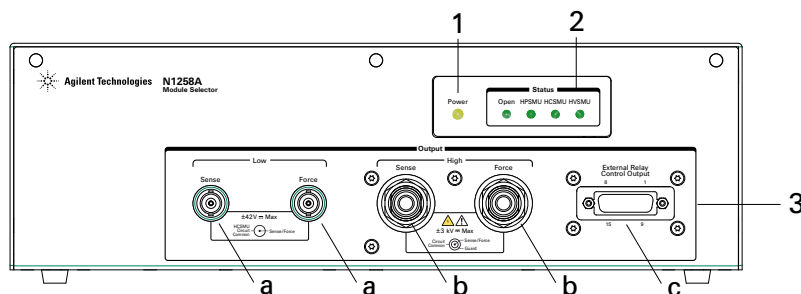

#### 1. Power indicator

This LED turns yellow when the AC power is applied to the module selector.

This LED turns green when the module selector is ready to use.

#### 2. Status indicator

A green LED lights to indicate the present connection path of the module selector.

See Figure 3-2 and Table 3-1 for the status indicator and the connection path.

#### 3. Output

##### a. Low Force and Sense output connectors

BNC connectors. Force and Sense must be extended to and connected together at a low terminal of a device under test (DUT). Then use high current cable with BNC(m) connector for Force, normal cable with BNC(m) connector for Sense, manipulators, and such.



##### b. High Force and Sense output connectors

HV(jack) connectors. Force and Sense must be extended to and connected together at a high terminal of the DUT.

## Accessories

Then use high current and high voltage cable with HV(plug) connector for Force, high voltage cable with HV(plug) connector for Sense, manipulators, and such.

Guard must be opened but should be extended as close as possible to the device terminal for reducing the leakage current of the extension cable.

### c. External Relay Control Output connector

D-sub 15 pin connector. See Figure 3-1 for pin assignment. Relay control 1 to 6 are used to control an external relay and controlled by using the FLEX command. See *Programming Guide* for the FLEX command.

Relay control signal level: 0 V or 12 V, normally 0 V (circuit common)

**Figure 3-1 External Relay Control Output Connector**

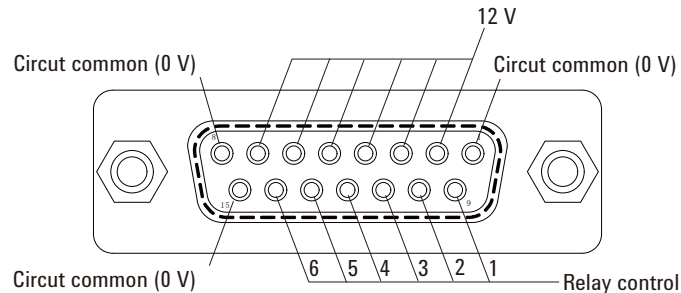

**Table 3-1 N1258A Status Indicator and Connection Path**

Status indicator	N1258A output connectors			
	Low Sense	Low Force	High Sense	High Force
Open	HCSMU Low Sense + GNDU Force + GNDU Sense	HCSMU Low Force	Open	Open
HPSMU			HPSMU Sense	HPSMU Force
HCSMU			HCSMU High Sense	HCSMU High Force
HVSMU			HVSMU Force	Open
	HVSMU Force + Series resistor			

Figure 3-2 Module Selector Simplified Internal Connections

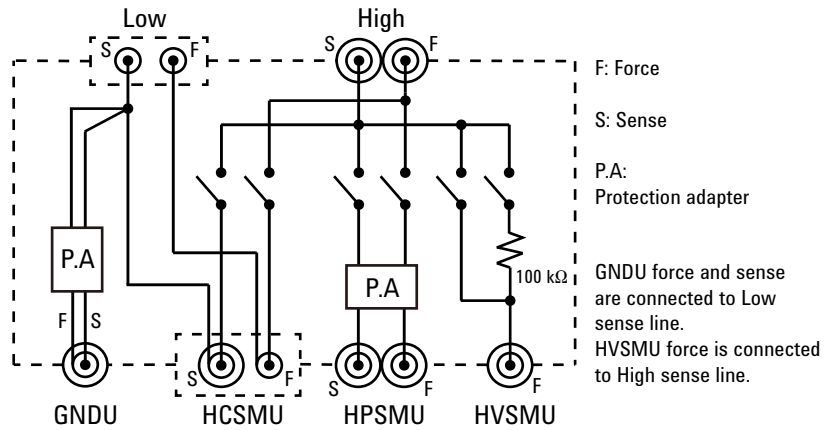

Rear Panel

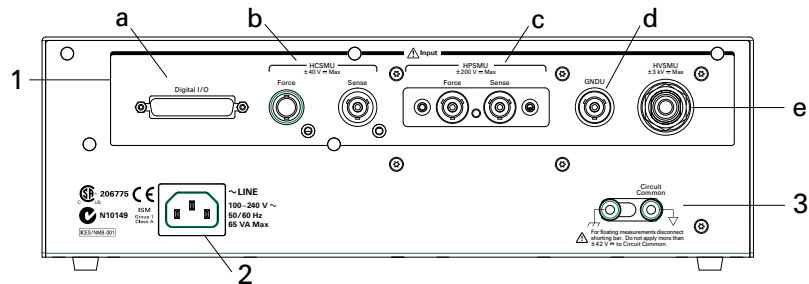

⚠ 1. Input

**WARNING**

The connector cap must be connected to the unused input connectors.

**NOTE**

Do not put any conductor on the HCSMU Low Force and Low Sense terminals, outer conductor of the coaxial connectors. Putting conductor of circuit common, chassis ground, or any potential on causes the measurement error.

a. Digital I/O connector

For connecting 16493G cable from the Digital I/O connector of B1505A or N1266A expander.

b. HCSMU input connectors

## Accessories

Force BNC connector and Sense triaxial connector. For connecting 16493S HCSMU cable or 16493S-021 Dual HCSMU combination adapter from the HCSMU. Maximum current must be  $\pm 30$  A to prevent the module selector from performance degradation and failure.

c. HPSMU input connectors

Force and Sense triaxial connectors. For connecting 16493K Kelvin triaxial cable or 16494A triaxial cable from the HP/MPSMU.

d. GNDU input connector

GNDU triaxial connector. For connecting 16493L GNDU cable from the GNDU or the HVMCU Low.



e. HVSMU input connector

HV(jack) connector. For connecting 16493T HVSMU cable from the HVSMU or the HVMCU High.

2. LINE input receptacle

AC power cable is connected to this receptacle.



3. Circuit Common () and frame ground () terminals

Normally, connect the terminals together by using the shorting bar.

Removing the shorting bar may be effective for reducing external noise caused by the ground loop. Then do not break the connection between the B1505A's Circuit Common and the prober station's frame ground.

---

**WARNING**

If the Circuit Common terminal is *not* connected to the frame ground terminal (for floating measurement), a potential shock hazard may present. Do not touch any of measurement circuit at any time while a floating measurement is in progress.

---

**CAUTION**

For floating measurement, do not apply dangerous voltage to the Circuit Common terminal. Failure to heed this caution may result in damage to the N1258A.

---

**NOTE**

Module selector may emit a noise sound during operation. However it is not abnormal status.

## N1259A Test Fixture

The N1259A is used for measurements of packaged devices. The N1259A can be connected to GNDU, MFCMU, HPSMU/MPSMU, HVSMU/HVMCU, and HCSMU/MCSMU/DHCSMU (Dual HCSMU). And the fixture initially installs the GNDU protection adapter and the HPSMU protection adapter. Also the fixture can install the module selector for switching the measurement resource connected to the DUT, the high voltage resistor box for reducing the risk of device breakdown, and the high voltage bias-tee for performing the high voltage capacitance measurement.

### Front Panel

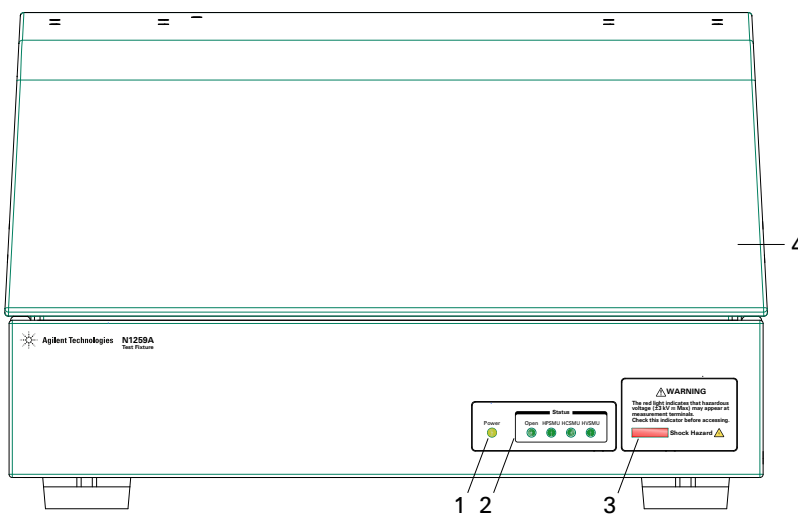

1. Power indicator (N1259A-300)

This LED turns yellow when the AC power is applied to the test fixture.

This LED turns green when the test fixture is ready to use.

2. Status indicator (N1259A-300)

A green LED lights to indicate the present connection path of the module selector. See Figure 3-2 and Table 3-2 for the status indicator and the connection path.

 3. Hazardous voltage status indicator

This red LED lights when a source channel applies dangerous voltage. This indicator is connected to the B1505A via the Interlock connector and works with the High Voltage indicator on the B1505A's front panel.

Warning labels written in French, German, and Japanese are furnished. Attach the label to the front panel of the fixture if you need.

**WARNING**

The red light indicates that hazardous voltage (maximum  $\pm 3000$  Vdc) may appear at measurement terminals. Check this indicator before accessing.

4. Fixture cover

The fixture cover should be closed to avoid electrical shock by touching measurement terminals and to prevent a device under test from external noise.

When the fixture cover is open, maximum SMU output is limited to  $\pm 42$  V.

**WARNING**

Hazardous voltage, instrument maximum output voltage may appear at the Force, Guard, and Sense terminals if the fixture cover is closed.

**WARNING**

Make sure that the cover is closed properly before starting measurement. Do not perform the measurement when a wire is protruding from the fixture cover.

**Rear Panel**

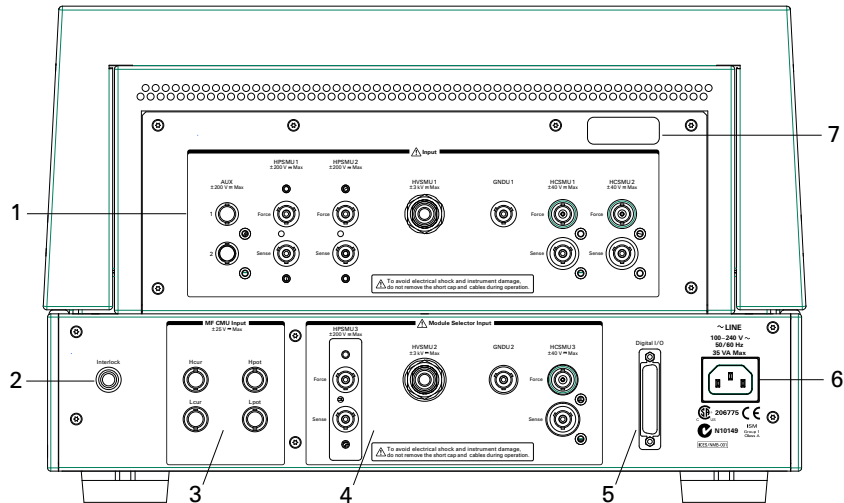

**WARNING**

The connector cap must be connected to the unused input connectors.



1. Input

- AUX1 and AUX2 input connectors

BNC connectors. For connecting MFCMU or external instruments.



- HPSMU1 and HPSMU2 input connectors  
Force and Sense triaxial connectors. For connecting 16493K Kelvin triaxial cable or 16494A triaxial cable from the HP/MPSMU.
  - HVSMU1 input connector  
HV(jack) connector. For connecting 16493T HVSMU cable from the HVSMU or the HVMCU High.
  - GNDU1 input connector  
GNDU triaxial connector. For connecting 16493L GNDU cable from the GNDU or the HVMCU Low.
  - HCSMU1 and HCSMU2 input connectors  
Force BNC connector and Sense triaxial connector. For connecting 16493S HCSMU cable or 16493S-021 Dual HCSMU combination adapter from the HCSMU. MCSMU can be used. Then use 16494A triaxial cables and N1254A-104 adapter.
2. Interlock connector  
Interlock connector. For connecting 16493J interlock cable from B1505A.
  3. MF CMU Input connectors Hcur, Hpot, Lpot, and Lcur (N1259A-020)  
BNC connectors. For connecting N1300A cable from the MFCMU.
  -  4. Module Selector Input (N1259A-300)
    - HPSMU3 input connectors  
Force and Sense triaxial connectors. For connecting 16493K Kelvin triaxial cable or 16494A triaxial cable from the HP/MPSMU.
    - HVSMU2 input connector  
HV(jack) connector. For connecting 16493T HVSMU cable from the HVSMU or the HVMCU High.
    - GNDU2 input connector  
GNDU triaxial connector. For connecting 16493L GNDU cable from the GNDU or the HVMCU Low.
    - HCSMU3 input connectors

Force BNC connector and Sense triaxial connector. For connecting 16493S HCSMU cable or 16493S-021 Dual HCSMU combination adapter from the HCSMU. Maximum current must be  $\pm 30$  A to prevent the module selector from performance degradation and failure.

**NOTE**

Do not put any conductor on the HCSMU Low Force and Low Sense terminals, outer conductor of the coaxial connectors. Putting conductor of circuit common, chassis ground, or any potential on causes the measurement error.

5. Digital I/O connector (N1259A-300)

For connecting 16493G cable from the Digital I/O connector of B1505A or N1266A expander.

6. LINE input receptacle (N1259A-300)

AC power cable is connected to this receptacle.

7. Serial number

You need this *serial number* when using Agilent Technologies telephone assistance program.

**Table 3-2 N1259A Status Indicator and Module Selector Connection Path**

Status indicator	Module Selector Output terminals			
	Low Sense	Low Force	High Sense	High Force
Open	HCSMU3 Low Sense + GNDU2 Force + GNDU2 Sense	HCSMU3 Low Force	Open	Open
HPSMU			HPSMU3 Sense	HPSMU3 Force
HCSMU			HCSMU3 High Sense	HCSMU3 High Force
HVSMU			HVSMU2 Force	Open
	HVSMU2 Force + Series resistor			

## Output Terminal Panel

### WARNING

Set the instrument output off before connecting or disconnecting connection wire.

Press the B1505A front panel Stop key to set the output off. And confirm that the B1505A front panel High Voltage indicator is not lit.

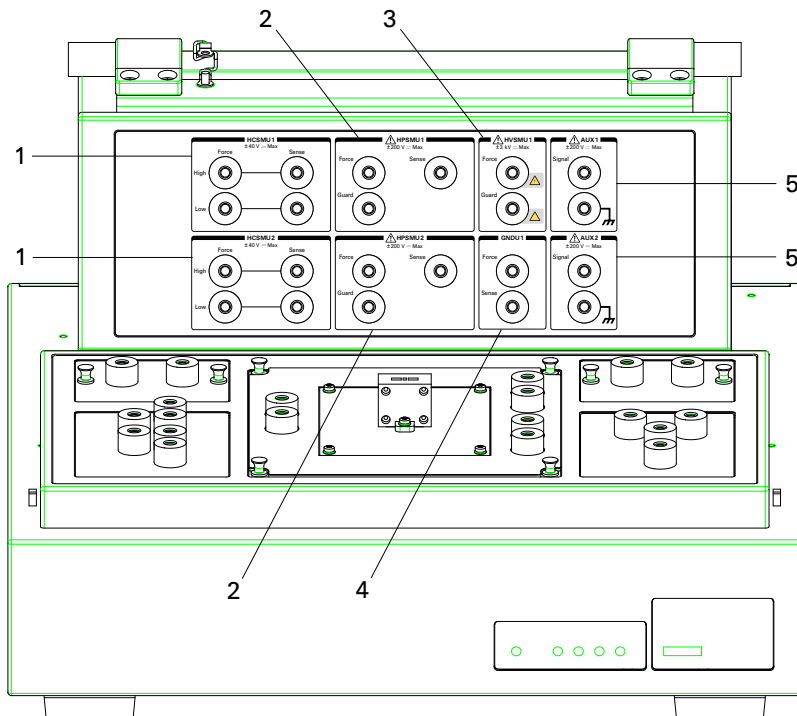

#### 1. HCSMU1 and HCSMU2

Output terminals internally connected to the HCSMU1 and HCSMU2 input connectors. High Force and Sense terminals and Low Force and Sense terminals for each HC/MC/DHCSMU.

High Force and Sense must be connected to the high terminal of a device under test (DUT).

Low Force and GNDU Force must be connected to the same terminal, and Low Sense and GNDU Sense must be connected to the same terminal. And they must be connected to the low terminal of the DUT.

 2. HPSMU1 and HPSMU2

Output terminals internally connected to the HPSMU1 and HPSMU2 input connectors. Force, Sense, and Guard terminals for each HP/MPSMU.

Force must be connected to a terminal of a DUT. And Guard must be opened. You may extend it as close as possible to the DUT terminal for reducing the leakage current of the extension cable. Also Force and Sense should be connected together at the device end for making the Kelvin connection effective for low resistance and high current measurements.

 3. HVSMU1

Output terminals internally connected to the HVSMU1 input connector. Force and Guard terminals for HVSMU/HVMCU High.

Force must be connected to a terminal of a DUT. And Guard must be opened. You may extend it as close as possible to the DUT terminal for reducing the leakage current of the extension cable.

---

**CAUTION**

---

Never connect the HVSMU1 Force and Guard terminals to any output, including circuit common, chassis ground, or any other measurement resource such as SMU. Connecting other measurement resource may damage the connected one.

4. GNDU1

Output terminals internally connected to the GNDU1 input connector. Force and Sense terminals for GNDU or HVMCU Low. Force and Sense must be connected together at the device end.

For using the HCSMU, the GNDU1 Force and Sense terminals and the HCSMU1 or HCSMU2 Low Force and Sense terminals must be connected together at the device end.

 5. AUX1 and AUX2

Output terminals internally connected to the AUX1 and AUX2 input connectors. Signal and frame ground terminals for each AUX. Signal must be connected to a terminal of a DUT.

Frame ground may be connected to the ground terminal of the DUT.

## Socket Panel

### WARNING

Set the instrument output off before connecting or disconnecting connection wire.

Press the B1505A front panel Stop key to set the output off. And confirm that the B1505A front panel High Voltage indicator is not lit.

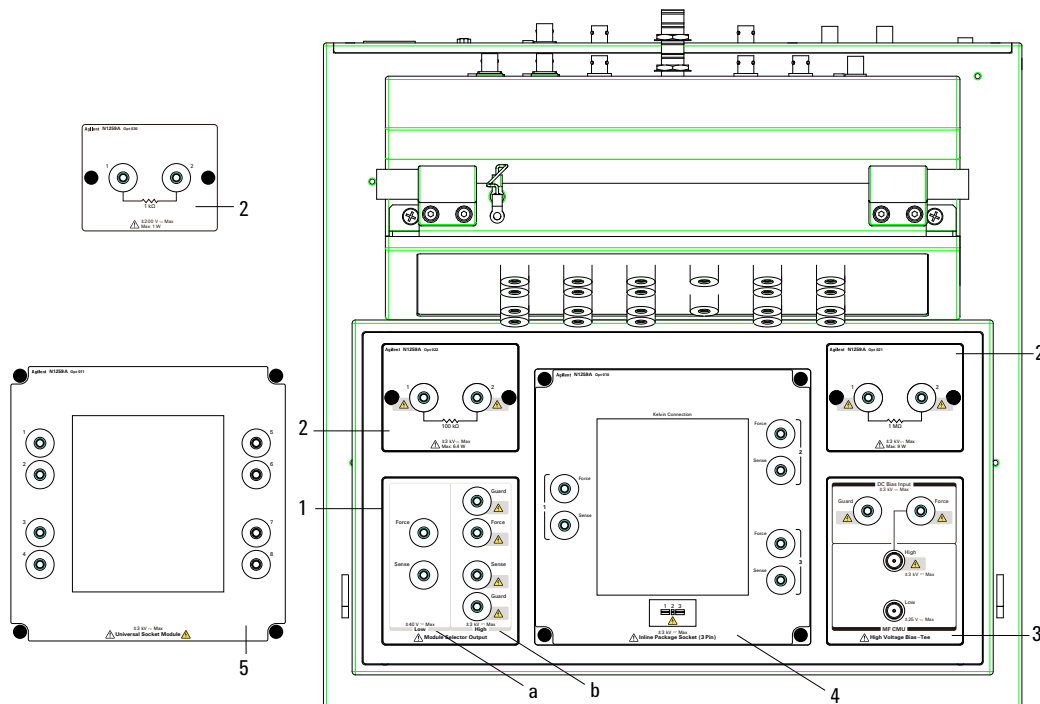

#### ⚠ 1. Module Selector Output (N1259A-300)

See Figure 3-2 and Table 3-2 for the status indicator and the connection path.

##### a. Low Force and Sense output terminals

Force and Sense must be connected together at the low terminal of a DUT.

##### b. High Force, Sense, and Guard output terminals

Force and Sense must be connected together at the high terminal of a DUT. And Guard must be opened. You may extend it as close as possible to the DUT terminal for reducing the leakage current of the extension cable.

---

**NOTE**

---

Module selector may emit a noise sound during operation. However it is not abnormal status.

-  2. 100 k $\Omega$  series resistor (N1259A-022)  
1 M $\Omega$  series resistor (N1259A-021)  
1 k $\Omega$  series resistor (N1259A-030)  
Universal resistor box (N1259A-035)

For reducing damage of DUT or preventing SMU from oscillation. The resistor is internally connected between the terminals 1 and 2. Connect the resistor between a source output terminal and a terminal of the DUT.

N1259A-021 or 022 should be connected to the drain/collector terminal.

N1259A-030 should be connected to the gate/base terminal.

N1259A-035 is kind of a do-it-yourself kit for installing a resistor. You can install your desired resistor to this box.

-  3. High Voltage Bias-Tee (N1259A-020)

MF CMU High and Low terminals are internally connected to the MF CMU Input connectors. High and Low must be connected to the high and low terminals of a DUT respectively. Use SHV(plug)-SHV(plug) cable (N1254A-512) and SHV(jack)-banana adapter (N1254A-513) for connection.

To get DC bias, connect the DC Bias Input Force and Guard terminals to the Force and Guard terminals of HVSMU, HPSMU, or MPSMU. Use connection wire (N1254A-508 or 509) for connection.

---

**NOTE**

---

SMU is used for the DC bias source. MFCMU built-in DC bias source cannot be used.

-  4. Inline Package Socket Module (N1259A-010)

This module provides a socket used for connecting three-terminal inline packaged device and three couples of the Force and Sense terminals. Socket module internal connection is shown in Figure 3-3.

Short bar is furnished with the module. It is used for performing the short correction before the impedance measurement. Set the short bar before the short correction and remove it after the correction.

To use this module, see the following simple instruction.

- a. Attach the socket module to the test fixture.
- b. Connect wires (N1254A-508 or 509) between the socket module terminals and the fixture output terminals.

For making the Kelvin connection, Force and Sense must be connected to Force and Sense of the socket module respectively.

If MCSMU, HCSMU, or DHCSMU is used, High Force and Sense must be connected to Force and Sense used for the high terminal of a device under test (DUT), respectively. Low Force and GNDU Force must be connected to Force used for the low terminal of the DUT, and Low Sense and GNDU Sense must be connected to Sense used for the low terminal of the DUT.

- c. Set the DUT on the socket.
- d. Close the fixture cover and perform measurement.

---

**CAUTION**

---

Do not apply voltage/current over the maximum limit of the socket module.

**Figure 3-3**      **Inline Package Socket Module**

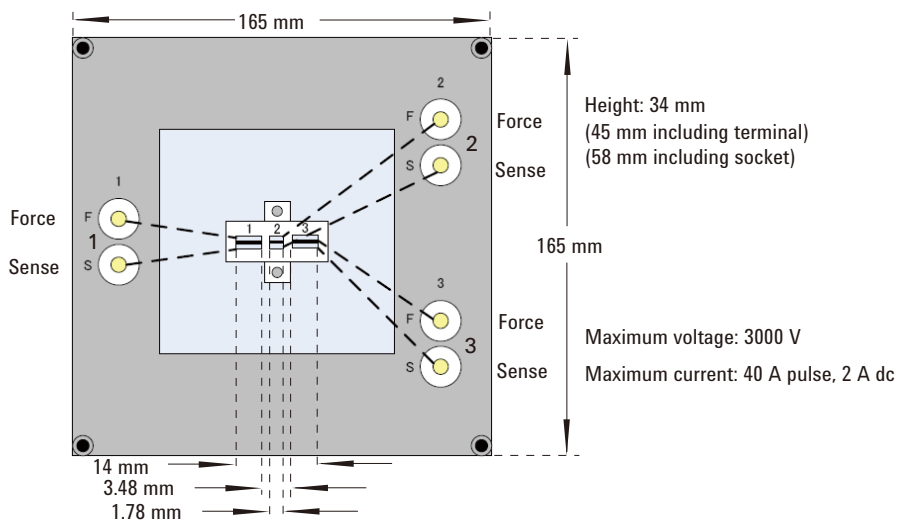

⚠ 5. Universal Socket Module (N1259A-011)

This is a blank module, kind of a do-it-yourself kit for supporting variety of packaged devices. This module can be used by mounting your desired socket or packaged device and making connections same as the N1259A-010 Inline Package Socket Module.

To use this module, see the following simple instruction. For the component locations and dimensions, see Figure 3-4. Also see “Inline Package Socket Module (N1259A-010)” on page 3-14 to perform measurement.

**Figure 3-4 Universal Socket Module**

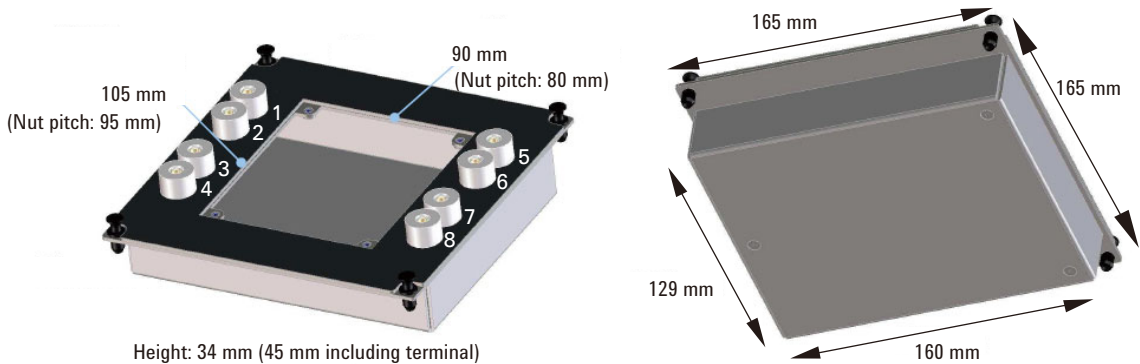

- a. Prepare the following parts.
  - blank board suitable for mounting the socket or packaged device
  - screw M3, 4 ea., for fixing the blank board on the socket module
  - wire, adequate length and quantity, for making connections
  - hexlobe (torx type) screwdriver T-10
  - socket, if you use, and packaged device under test (DUT)
- b. Cut the blank board in 104 mm × 89 mm square.
- c. Make four screw holes on the board. The holes should be 4.5 mm inside from the edge.
- d. Fix the board to the blank module.
- e. Remove the cover bottom of the blank module.
- f. Mount the socket or DUT on the board and solder wire between its terminals and the blank module terminals 1 to 8.



Make enough space between the socket/DUT terminal and the shield/chassis, for example, about 1 mm for maximum 200 V output and 6 mm for 3000 V, to prevent discharge and any accident.

- g. Reattach the cover.
- 6. Blank PTFE Board (N1259A-012)

This is an insulation board used for placing a DUT.

To use this board, see the following simple instruction.

**Figure 3-5**

**Blank PTFE Board**

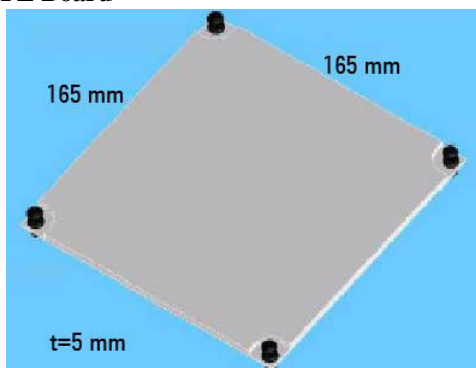

- a. Prepare a DUT, wire (N1254A-508 or 509), and dolphin clip adapter (N1254A-510) or cable lag adapter (N1254A-511).
- b. Attach the blank PTFE board to the test fixture.
- c. Connect adapters directly to the DUT and put it on the blank PTFE board.
- d. Connect wires between the adapters and the fixture output terminals.

For making the Kelvin connection, Force and Sense must be connected together at the device terminal.

If MCSMU, HCSMU, or DHCSMU is used, High Force and Sense must be connected to the high terminal of a device under test (DUT). Low Force, Low Sense, GNDU Force, and GNDU Sense must be connected to the low terminal of the DUT.

- e. Make sure the DUT location. The DUT must be placed on the blank PTFE board properly.

Make enough space between the High-Low adapters, also between the high side adapter and the shield/chassis, for example, about 1 mm for maximum 200 V output and 6 mm for 3000 V, to prevent discharge and any accident.

## Accessories

f. Close the fixture cover and perform measurement.

### 7. Curve Tracer Test Adapter Socket Module (N1259A-013)

This module provides a socket available for connecting a test adapter designed for connecting to Tektronix 370B/371B curve tracers. Socket module internal connection is shown in Figure 3-6.

To use this module, see the following simple instruction.

- Attach the socket module to the test fixture.
- Connect your test adapter to the socket.
- Connect wires (N1254A-508 or 509) between the socket module terminals and the fixture output terminals.

For making the Kelvin connection, Force and Sense must be connected to Force and Sense of the socket module respectively.

If MCSMU, HCSMU, or DHCSMU is used, High Force and Sense must be connected to Force and Sense used for the high terminal of a device under test (DUT), respectively. Low Force and GNDU Force must be connected to Force used for the low terminal of the DUT, and Low Sense and GNDU Sense must be connected to Sense used for the low terminal of the DUT.

- Set the DUT on your test adapter.
- Close the fixture cover and perform measurement.

### CAUTION

Do not apply voltage/current over the maximum limit of the socket module.

**Figure 3-6** Curve Tracer Test Adapter Socket Module

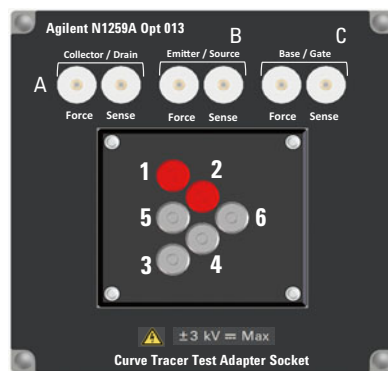

Internal connection

- Collector/Drain Force
- Collector/Drain Source
- Emitter/Source Force
- Emitter/Source Source
- Base/Gate Force
- Base/Gate Source

Maximum voltage: 3000 V

Maximum current:

A-Force: 500 A pulse, 39 A dc

A-Sense: 40 A pulse, 2 A dc

B-Force: 500 A pulse, 39 A dc

B-Sense: 40 A pulse, 2 A dc

C-Force: 40 A pulse, 2 A dc

C-Sense: 40 A pulse, 2 A dc

## N1260A High Voltage Bias-Tee

High voltage bias-tee is used to perform the high voltage C-V measurement. The C-V measurement of up to 3000 Vdc can be realized by using the bias-tee, MFCMU, and HVSMU. The N1260A is used with the N1265A test fixture or a DUT interface such as your own test fixture and prober station.

---

**NOTE**

---

HVSMU is used for the DC bias source. MFCMU built-in DC bias source cannot be used.

- From HVSMU  
HV(jack) connector. For connecting 16493T HVSMU cable from the HVSMU.
- From MFCMU Hcur, Hpot, Lpot, and Lcur  
BNC connectors. For connecting N1300A cable from the MFCMU.
- Output Low and High  
SHV(jack) connector. Low and High must be extended to the low and high terminals of a DUT respectively. Use N1254A-518 SHV cable to connect N1265A test fixture. To connect other DUT interface, use high voltage cable with SHV(plug) connector, manipulators, and such.
- AC Guard  
SHV(jack) connector. Provides the AC guard (circuit common) signal of MFCMU. For the 3-terminal device measurement, the AC Guard must be extended to the device terminal which is not connected to Low or High. For making the connection, use cable with SHV(plug) connector, manipulator, and such.  
  
To use N1265A test fixture, open this connector.

---

**CAUTION**

---

Never connect the HVSMU Force and Guard terminals to any output, including circuit common, chassis ground, or any other measurement resource such as SMU. Connecting other measurement resource may damage the connected one.

## N1261A Protection Adapter

Adapter for protecting GNDU or HP/MPSMU module from high voltage. The N1261A is used with the N1265A test fixture or a DUT interface such as your own test fixture and prober station.

N1261A-001: HPSMU protection adapter, Triaxial(f)-Triaxial(f)

N1261A-002: GNDU protection adapter, Triaxial(f)-BNC(f)

N1261A-003: HPSMU protection adapter, Triaxial(f)-HV(jack)

N1261A-004: GNDU protection adapter, Triaxial(f)-SHV(jack)

- From HPSMU of N1261A-001 and 003

Force and Sense triaxial connectors. For connecting 16493K Kelvin triaxial cable or 16494A triaxial cable from the HP/MPSMU.

- Output of N1261A-001

Triaxial connectors. Force must be extended to a terminal of a DUT. Guard must be opened but should be extended as close as possible to the device terminal for reducing the leakage current of the extension cable. Use 16494A triaxial cable to connect N1265A test fixture. To connect other DUT interface, use high voltage cable with Triaxial(m) connector, manipulators, and such.

Sense should be also extended to the DUT terminal. And Force and Sense should be connected together at the device end for making the Kelvin connection effective for low resistance and high current measurements.

- Output of N1261A-003

HV(jack) connectors. Force must be extended to a terminal of a DUT. Guard must be opened but should be extended as close as possible to the device terminal for reducing the leakage current of the extension cable. For making the connection, use high voltage cable with HV(plug) connector, manipulators, and such.

Sense should be also extended to the DUT terminal. And Force and Sense should be connected together at the device end for making the Kelvin connection effective for low resistance and high current measurements.

- From GNDU of N1261A-002 and 004

GNDU triaxial connector. For connecting 16493L GNDU cable from the GNDU.

- Output of N1261A-002  
BNC connectors. Force and Sense must be extended to a terminal of a DUT. And they must be connected together at the device end. For making the connection, use high voltage cable with BNC(m) connector, manipulators, and such.
- Output of N1261A-004  
SHV(jack) connectors. Force and Sense must be extended to a terminal of a DUT. And they must be connected together at the device end. For making the connection, use high voltage cable with SHV(plug) connector, manipulators, and such.

## N1262A Resistor Box

Resistor box for reducing the risk of device breakdown or preventing SMU from oscillation. 1 k $\Omega$  ( $\pm$  200 Vdc), 1 k $\Omega$  ( $\pm$  3000 Vdc), 100 k $\Omega$  ( $\pm$  3000 Vdc), or 1 M $\Omega$  ( $\pm$  3000 Vdc). The N1262A is used with a DUT interface such as your own test fixture and prober station, not the N1259A/N1265A test fixture.

N1262A-001: 1 M $\Omega$  ( $\pm$  3000 Vdc) resistor, HV(jack)-SHV(jack)

N1262A-002: 100 k $\Omega$  ( $\pm$  3000 Vdc) resistor, HV(jack)-SHV(jack)

N1262A-010: 1 k $\Omega$  ( $\pm$  200 Vdc) resistor, Triaxial(f)-Triaxial(f)

N1262A-011: 1 k $\Omega$  ( $\pm$  3000 Vdc) resistor, HV(jack)-SHV(jack)

N1262A-020: Universal resistor box, Triaxial(f)-Triaxial(f)

N1262A-021: Universal resistor box, HV(jack)-SHV(jack)

N1262A-023: Universal resistor box, UHV(jack)-UHV(jack)

N1262A-036: 50  $\Omega$  termination adapter

Universal resistor box is kind of a do-it-yourself kit for installing a resistor you want.

50  $\Omega$  termination adapter is a BNC(f)-BNC(m) adapter which contains 50  $\Omega$  resistor between signal line and shield. If a SMU is used as the gate drive for the measurement using HVMCU, UHVU, or UHCU, the SMU may cause oscillation. Then this adapter should be connected between the gate drive output and a DUT terminal. This will be effective for preventing oscillation.

## Accessories

- From HVSMU of N1262A-001 and 002  
HV(jack) connector. For connecting 16493T HVSMU cable from the HVSMU or HVMCU.
- From SMU of N1262A-010 and 020  
Triaxial connector. For connecting 16494A triaxial cable from the Force connector of the HP/MPSMU directly or via the N1261A-001 protection adapter.
- From SMU of N1262A-011 and 021  
HV(jack) connector. For connecting 16493T HVSMU cable from the N1261A-003 protection adapter connected to the HP/MPSMU.
- From UHV of N1262A-023  
UHV(jack) connector. For connecting UHV cable from the N1268A ultra high voltage expander.
- Output of N1262A-001, 002, 011, and 021  
SHV(jack) connector. Signal must be extended to a terminal of a DUT. For making the connection, use high voltage cable with SHV(plug) connector, manipulators, and such.
- Output of N1262A-010 and 020  
Triaxial connector. Signal must be extended to a terminal of a DUT. For making the connection, use cable with Triaxial(m) connector, manipulators, and such.
- Output of N1262A-023  
UHV(jack) connector. Signal must be extended to a terminal of a DUT. For making the connection, use ultra high voltage cable with UHV(plug) connector, manipulators, and such.

## 16493S-010/011 HCSMU Adapter

Adapters for HCSMU. The adapters are used with a DUT interface such as your own test fixture and prober station, not the N1259A/N1265A test fixture.

16493S-010: Adapter for making the Kelvin connection of HCSMU path

16493S-011: Adapter for making the non-Kelvin connection of HCSMU path

- From HCSMU
  - Triaxial connector (Sense) and BNC connector (Force). For connecting 16493S HCSMU cable from the HCSMU.
- Output of 16493S-010
  - High Force/Sense
    - BNC connectors. Force and Sense must be extended to and connected together at the high terminal of a DUT. For making the connection, use high voltage cable with BNC(m) connector, manipulators, and such.
  - Low Force/Sense
    - BNC connectors. Force and Sense must be extended to and connected together at the low terminal of a DUT. For making the connection, use high voltage cable with BNC(m) connector, manipulators, and such.
    - The DUT's low terminal must be also connected to Force and Sense of the GNDU. Use the N1261A-002/004 GNDU protection adapter.
- Output of 16493S-011
  - BNC connectors. High Force must be extended to the high terminal of a DUT. Low Force must be extended to the low terminal of the DUT. For making the connection, use high voltage cable with BNC(m) connector, manipulators, etc.
  - The DUT's low terminal must be also connected to Force and Sense of the GNDU. Use the N1261A-002/004 GNDU protection adapter.

---

### NOTE

---

Do not put any conductor on the HCSMU Low Force and Low Sense terminals, outer conductor of the coaxial connectors. Putting conductor of circuit common, chassis ground, or any potential on causes the measurement error.

## 16493S-020/021 Dual HCSMU Adapter

Adapters for Dual HCSMU operation. The adapters are used to connect two HCSMU modules installed in one B1505A. Using two modules can expand the B1505A maximum current up to  $\pm 40$  A (pulse),  $\pm 2$  A (DC).

16493S-020: Dual HCSMU Kelvin combination adapter

This adapter is used with a DUT interface such as your own test fixture and prober station, not the N1259A/N1265A test fixture. The N1258A module selector cannot be used.

16493S-021: Dual HCSMU combination adapter

This adapter is used with the N1259A/N1265A test fixture, the N1258A module selector, or the 16493S-010/011 HCSMU adapter.

---

### CAUTION

---

If DHCSMU (Dual HCSMU) is used with the N1258A or N1259A-300 module selector, the maximum current must be  $\pm 30$  A to prevent the module selector from performance degradation and failure.

- Output of 16493S-020
  - High Force/Sense

HV(jack) connectors. Force and Sense must be extended to the high terminal of a DUT and they must be connected together at the device end. For making the connection, use high voltage cable with HV(plug) connector, manipulators, and such.
  - Low Force/Sense

BNC connectors. Force and Sense must be extended to the low terminal of the DUT and they must be connected together at the device end. For making the connection, use high voltage cable with BNC(m) connector, manipulators, and such.
- Output of 16493S-021

Triaxial connector (Sense) and BNC connector (Force). For connecting the dedicated cable, 30 cm, furnished, or 16493S HCSMU cable to the HCSMU input connectors of the N1259A/N1265A test fixture, the N1258A module selector, or the 16493S-010/011 HCSMU adapter.



- Input HCSMU (16493S-020) or From HCSMU (16493A-021)  
Triaxial connector (Sense) and BNC connector (Force). For connecting 16493S HCSMU cable from the HCSMU.
  - Master Force/Sense  
Must be connected to Force/Sense of HCSMU used as the master.
  - Slave Force/Sense  
Must be connected to Force/Sense of HCSMU used as the slave.
- Input GNDU (16493S-020)  
GNDU triaxial connector. For connecting 16493L GNDU cable from the GNDU.

---

**NOTE**

---

Do not put any conductor on the HCSMU Low Force and Low Sense terminals, outer conductor of the coaxial connectors. Putting conductor of circuit common, chassis ground, or any potential on causes the measurement error.

## N1265A Ultra High Current Expander/Fixture

Test fixture which contains the current expander to enable 500 A or 1500 A (option N1265A-015) output and measurement, and contains the selector to switch the measurement resource connected to the DUT.

The current expander is used to configure ultra high current unit (UHCU) as described in “Ultra High Current Unit”.

The selector is used to switch the measurement resource connected to the DUT. The measurement resource will be the UHCU, HVSMU/HVMCU, or HP/MPSMU. The selector output can be extended to your prober station by using the N1254A-524 ultra high current prober system cable.

The N1265A also provides the connection paths for UHVU, MFCMU via bias-tee, and HP/MP/HC/MC/DHCSMU.

### Ultra High Current Unit

The ultra high current unit (UHCU) can be configured by using the N1265A and two MC/HCSMU modules as shown in Figure 3-7. The UHCU output can appear on the Selector Output by controlling the built-in selector.

Figure 3-7

#### To Configure UHCU

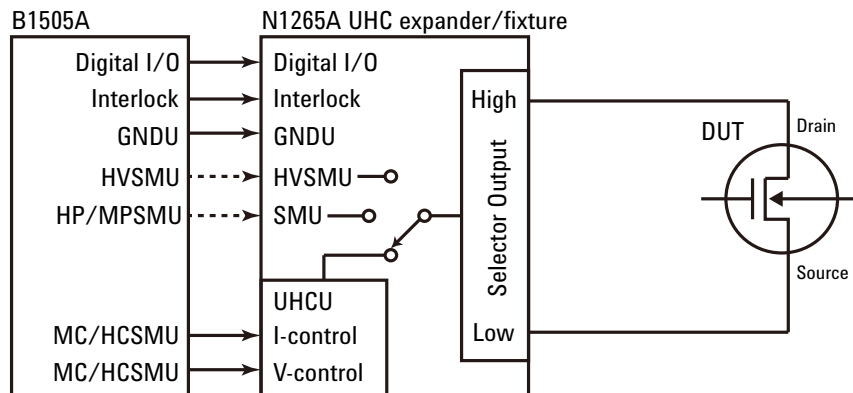

#### NOTE

For the Gate terminal of DUT, use MCSMU or HCSMU. HPSMU is substitutable but a HPSMU protection adapter and a GNDU protection adapter are additionally required. And then, the GNDU must be connected to one of the SMU input terminals of the N1265A. Do not use the GNDU input terminal of the N1265A.

## Front Panel

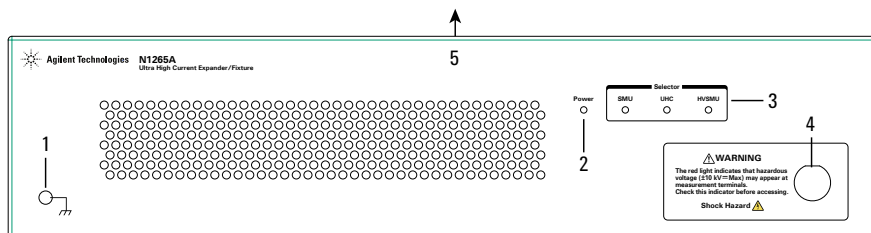

1. Terminal for connecting wrist strap

2. Power indicator

This LED turns yellow when the AC power is applied to the test fixture.

This LED turns green when the test fixture is ready to use.

3. Status indicator

A green LED lights to indicate the present connection path of the selector. See Figure 3-8 and Table 3-5 for the status indicator and the connection path.

 4. Hazardous voltage status indicator

This red LED lights when a measurement resource applies dangerous voltage.

This indicator is connected to the B1505A via the Interlock connector and works with the High Voltage indicator on the B1505A's front panel.

Warning labels written in French, German, and Japanese are furnished. Attach the label to the front panel of the fixture if you need.

---

### WARNING

---

**The red light indicates that hazardous voltage (maximum  $\pm 10$  kVdc) may appear at measurement terminals. Check this indicator before accessing.**

5. Fixture cover

The fixture cover should be closed to avoid electrical shock by touching measurement terminals and to prevent a device under test from external noise.

When the fixture cover is open, maximum SMU output is limited to  $\pm 42$  V and UHVU output is disabled.

---

### WARNING

---

**Hazardous voltage, instrument maximum output voltage may appear at the High, Force, Guard, and Sense terminals if the fixture cover is closed.**

---

### WARNING

---

**Make sure that the cover is closed properly before starting measurement. Do not perform the measurement when a wire is protruding from the fixture cover.**

**⚠ Rear Panel**

**WARNING**

Connect a wire from an electrical ground (safety ground) to this terminal.

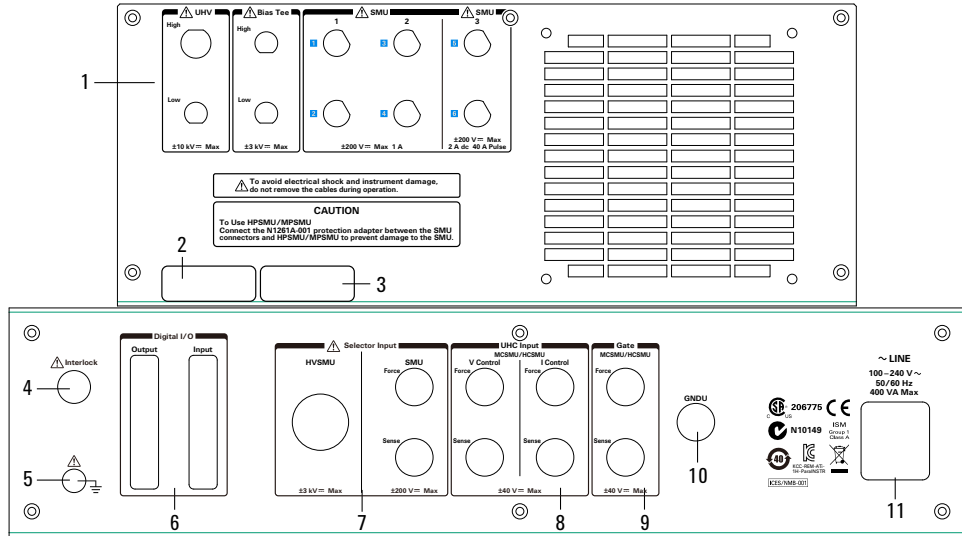

Table 3-3

SMU Input Connectors and Signals by SMU Type

Connected SMU	1 or 2		3	
	[1] or [3]	[2] or [4]	[5]	[6]
HP/MPSMU (non-Kelvin)	Force	Force	Force	Force
HP/MPSMU (Kelvin)	Force	Sense	Force	Sense
MCSMU	Force	Sense	Force	Sense
HCSMU or DHCSMU	NA		Force	Sense

**⚠ 1. Input**

- UHV High and Low connectors

UHV(jack) connector for High and SHV(jack) connector for Low. For connecting 16493V UHV cable from N1268A UHV expander.

- Bias Tee High and Low connectors

SHV(jack) connectors. For connecting N1254A-518 SHV cables from N1260A high voltage bias-tee connected to MFCMU.

- SMU 1 to 3 ([1] to [6]) connectors

Triaxial connectors. For connecting HP/MP/MCSMU. The SMU 3 ([5] and [6]) connectors can be also used to connect HCSMU or DHCSMU (Dual HCSMU). See Table 3-3.

The connector [1]/[3]/[5] is for connecting Force, and the connector [2]/[4]/[6] is for connecting Sense of the measurement resource connected to the connector [1]/[3]/[5] respectively.

For connecting HP/MPSMU, the connector [2]/[4]/[6] can be also used to connect Force of other SMU if Kelvin connection is not made.

To connect HP/MPSMU, use N1261A-001 protection adapter and 16494A triaxial cables.

To connect MCSMU, use 16494A triaxial cables.

To connect HCSMU, use 16493S HCSMU cable, N1254A-103 adapter for Force, and N1254A-517 adapter for Sense.

To connect DHCSMU, use 16493S-021 adapter, 16493S HCSMU cables, N1254A-103 adapter for Force, and N1254A-517 adapter for Sense.

2. Serial number label

You need this *serial number* when using Agilent Technologies telephone assistance program.

3. Option number label



4. Interlock connector

Interlock connector. For connecting 16493J interlock cable from B1505A.

---

## WARNING

---

**Potentially hazardous voltage may be present at the High, Force, Sense, and Guard terminals when the interlock terminals are shorted on test fixture, probe station, and such.**



5. Earth terminal

Screw terminal for earthing.

6. Digital I/O connector

## Accessories

Input connector is for connecting 16493G cable from the Digital I/O connector of B1505A.

Output connector is for connecting 16493G cable to the Digital I/O connector of N1266A, N1268A expander or any accessory.



### 7. Selector Input connectors

- HVSMU connector

HV(jack) connector. For connecting 16493T HVSMU cable from the HVSMU or the HVMCU High.

- SMU connectors

Force and Sense triaxial connectors. For connecting 16494A triaxial cable from the HP/MPSMU.

### 8. UHC Input connectors

Triaxial connectors. For connecting 16494A triaxial cables from Force and Sense connectors of the MCSMU. HCSMU is substitutable. Then use 16493S HCSMU cable, N1254A-103 adapter for Force, and N1254A-517 adapter for Sense.

### 9. Gate connectors

Triaxial connectors. For connecting 16494A triaxial cables from Force and Sense connectors of the MCSMU. HCSMU is substitutable. Then use 16493S HCSMU cable, N1254A-103 adapter for Force, and N1254A-517 adapter for Sense. Do not apply the current over 1 A to this port if the HCSMU is used. Maximum current is 1 A.

### 10. GNDU connector

GNDU triaxial connector. For connecting 16493L GNDU cable from the GNDU or the HVMCU Low.

### 11. LINE input receptacle and power switch

AC power cable is connected to this receptacle. Power switch turns on/off the N1265A. Paths other than the Selector Output do not need AC power.

## ⚠ Output Terminal Panel

### WARNING

Set the instrument output off before connecting or disconnecting connection wire.

Press the B1505A front panel Stop key to set the module output off. And confirm that the B1505A front panel High Voltage indicator is not lit.

If the N1268A is used, press the High Voltage Enable switch to disable the high voltage output. And confirm that this red switch is not lit.

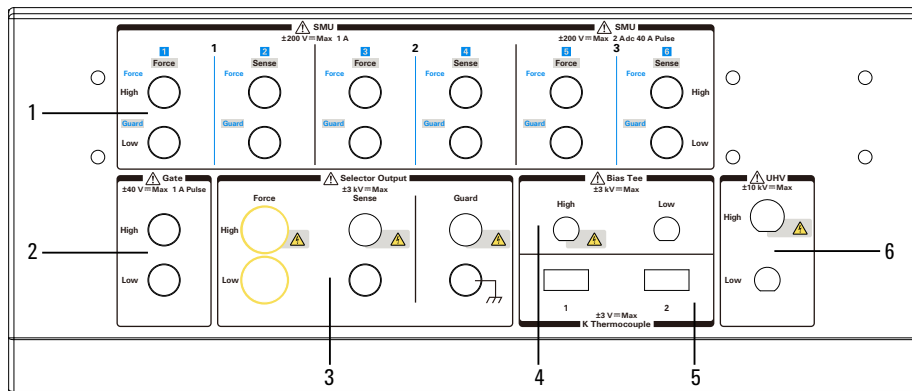

Table 3-4 SMU Terminals and Signals by SMU Type

Connected SMU	1 or 2		3		Designation on panel
	[1] or [3]	[2] or [4]	[5]	[6]	
HP/MPSMU (non-Kelvin)	Force	Force	Force	Force	Blue letters
	Guard	Guard	Guard	Guard	
HP/MPSMU (Kelvin)	Force	Sense	Force	Sense	Letters in white square
	Guard	Guard	Guard	Guard	
MCSMU	High Force	High Sense	High Force	High Sense	Black letters
	Low Force	Low Sense	Low Force	Low Sense	
HCSMU or DHCSMU	NA		High Force	High Sense	
	NA		Low Force	Low Sense	

### 1. SMU 1 to 3 ([1] to [6]) terminals

Output terminals internally connected to the SMU input connectors on the rear panel. Force, Sense, and Guard terminals for HP/MPSMU. High Force, Low Force, High Sense, and Low Sense for HC/MC/DHCSMU. See Table 3-4.

For using HP/MPSMU, Force must be connected to a terminal of a DUT. And Guard must be opened. You may extend it as close as possible to the DUT terminal for reducing the leakage current of the extension cable. Also, Force and Sense should be connected together at the device end for making the Kelvin connection effective for low resistance and high current measurements.

For using HC/MC/DHCSMU, High Force and High Sense must be connected together at the high terminal of a DUT. And Low Force and Low Sense must be connected together at the low terminal of the DUT. Also, Selector Output Low Force and Sense must be connected to the low terminal for connecting GNDU.

For the active device measurement using UHVU, use MCSMU and N1265A-040 protection adapter for the gate/base terminal and the chuck terminal. The adapter is required to protect MCSMU from ultra high voltage.

### 2. Gate High and Low terminals

Output terminals internally connected to the Gate input connectors on the rear panel. High and Low terminals used for the gate drive.

Gate terminals are designed for using with the Selector Output terminals. See Figure 3-8. High should be connected to the gate or base terminal of a DUT. Low should be connected to the source or emitter terminal of the DUT.

---

**CAUTION**

---

Open the Gate terminals for the ultra high voltage measurement using UHVU.

### 3. Selector Output

See Figure 3-8 and Table 3-5 for the status indicator and the connection path. For connecting a probe station, use the N1254A-524 system cable.

---

**CAUTION**

---

Open the terminals for the ultra high voltage measurement using UHVU.

#### a. Low Force and Low Sense output terminals

Force and Sense must be connected together at the low terminal of a DUT. Use the banana-banana wire (N1254A-522) for performing the ultra high current measurement using UHCU.

#### b. High Force and High Sense output terminals



Force and Sense must be connected together at the high terminal of a DUT. Use the banana-banana wire (N1254A-522) for performing the ultra high current measurement using UHCU.

c. Guard terminal

Guard (high level) must be opened. You may extend it as close as possible to a DUT terminal for reducing the leakage current of the extension cable.

d. Chassis common terminal

Use for grounding or shielding.

---

**NOTE**

---

Selector may emit a noise sound during operation. However it is not abnormal status.



4. Bias Tee High and Low terminals

Output terminals internally connected to the Bias Tee High and Low input connectors on the rear panel.

High and Low must be connected to the high and low terminals of a DUT respectively. Use SHV(plug)-SHV(plug) cable (N1254A-512) and SHV(jack)-banana adapter (N1254A-513) for connection.

---

**CAUTION**

---

Open the Bias Tee terminals for the ultra high voltage measurement using UHVU.

5. K Thermocouple 1 and 2 terminals

For connecting thermocouple (N1265A-041) to measure temperature around a DUT. Maximum temperature is approximately 180 °C.



6. UHV High and Low terminals

Output terminals internally connected to the UHV High and Low input connectors on the rear panel.

High and Low must be connected to the high and low terminals of a DUT respectively. Use the blank silicon plate and the UHV/SHV to no connector cables (N1254A-520) for connection. Also see “Blank Silicon Plate” on page 3-40.

---

**CAUTION**

---

Open the Gate terminals, the Selector Output terminals, and the Bias Tee terminals for the ultra high voltage measurement using the UHVU.

Figure 3-8

N1265A Built-in Selector Simplified Internal Connections

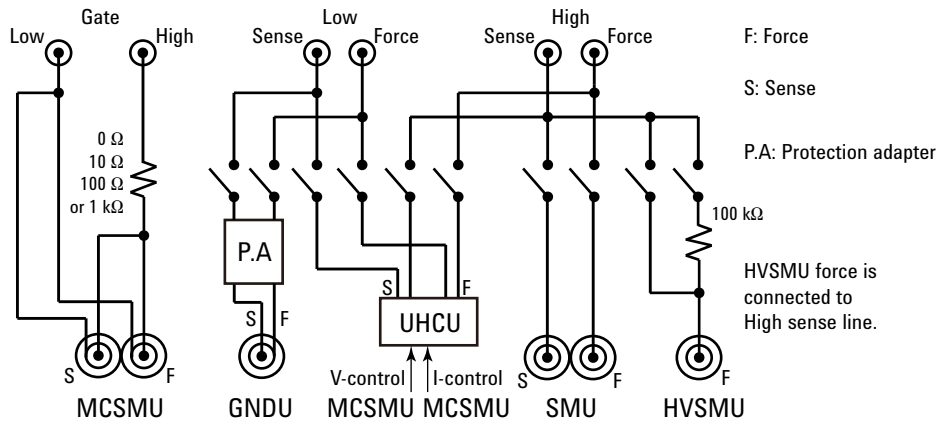

Table 3-5

N1265A Status Indicator and Selector Connection Path

Status indicator	Selector Output terminals			
	Low Sense	Low Force	High Sense	High Force
(off)	Open	Open	Open	Open
	GNDU Sense	GNDU Force	Open	Open
SMU	GNDU Sense	GNDU Force	SMU Sense	SMU Force
UHC	UHCU Low Sense	UHCU Low Force	UHCU High Sense	UHCU High Force
HVSMU	GNDU Sense	GNDU Force	HVSMU Force	Open
	GNDU Sense	GNDU Force	HVSMU Force + Series resistor	Open

**CAUTION**

Never connect the UHVU High terminal to any output, including circuit common, chassis ground, or any other measurement resource such as SMU. Connecting other measurement resource may damage the connected one.

**CAUTION**

For the ultra high voltage measurement of active device, connect the UHVU High terminal to the drain/collector terminal of a DUT. And for connecting the gate/base terminal and the chuck terminal, use two SMU output terminals which are connected to MCSMU and are attaching the N1265A-040 protection adapter. Then

connect a High terminal to the gate/base terminal, and the another High terminal to the chuck terminal. And connect all three Low terminals to the source/emitter terminal.

For the other cases, never connect any other measurement resource to the UHVU Low terminal or the DUT terminal connected to it. Connecting other measurement resource may damage the connected one.

---

## WARNING

**Before touching the DUT after the ultra high voltage measurement using the UHVU, confirm that it has been discharged enough. For that, use right hand, ground and discharge the terminals over 10 seconds after stopping the high voltage output, and confirm that they have been safety voltage by using another volt meter.**

**Especially, it is dangerous if a capacitive load or a long cable is connected. When a large load capacitance is connected, the terminals may not have been discharged until the safety voltage below  $\pm 42$  V.**

---

## Socket Modules, Blank Plate, and Adapters

---

## WARNING

**Set the instrument output off before connecting or disconnecting connection wire.**

**Press the B1505A front panel Stop key to set the module output off. And confirm that the B1505A front panel High Voltage indicator is not lit.**

**If the N1268A is used, press the High Voltage Enable switch to disable the high voltage output. And confirm that this red switch is not lit.**



- Inline Package Socket Module (N1265A-010)

This module provides a socket used for connecting three-terminal inline packaged device and three couples of the Force and Sense terminals. Socket module internal connection is shown in Figure 3-9.

Short bar is furnished with the module. It is used for performing the short correction before the impedance measurement. Set the short bar before the short correction and remove it after the correction.

To use this module, see the following simple instruction.

1. Attach the socket module to the test fixture.
2. Connect wires between the socket module terminals and the fixture output terminals. Then use the following wire (furnished with the N1265A-010).

## Accessories

- 180 mm length wire (yellow) for Selector Output High/Low Force
- 180 mm length wire for Selector Output High/Low Sense
- 250 mm length wire for Gate, SMU, or chassis

For making the Kelvin connection, Force and Sense must be connected to Force and Sense of the socket module respectively.

For the high voltage capacitance measurement, use SHV(plug)-SHV(plug) cable (N1254A-512) and SHV(jack)-banana adapter (N1254A-513) for connection.

Selector Output and Gate should be connected as follows.

- Selector Output High to DUT high (ex. Collector/Drain)
- Selector Output Low to DUT low (ex. Emitter/Source)
- Gate High to DUT drive (ex. Base/Gate Force)
- Gate Low to DUT low (ex. Emitter/Source Force)

HC/MC/DHCSMU via SMU 3 terminals should be connected as follows.

- SMU 3 High Force and Sense to DUT high
- SMU 3 Low Force and Sense to DUT low
- GNDU Force and Sense to DUT low

The GNDU signals will appear at the Selector Output Low terminals as shown in Table 3-5.

3. Set the DUT on the socket.
4. Close the fixture cover and perform measurement.

---

**CAUTION**

---

Do not apply voltage/current over the maximum limit of the socket module.

**Figure 3-9 Inline Package Socket Module**

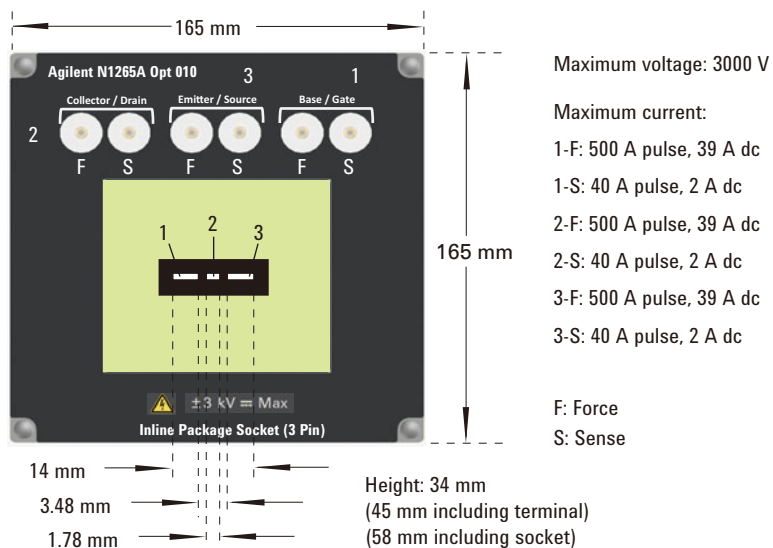

**⚠ • Universal Socket Module (N1265A-011)**

This is a blank module, kind of a do-it-yourself kit for supporting variety of packaged devices. This module can be used by mounting your desired socket or packaged device and making connections same as the N1265A-010 Inline Package Socket Module.

To use this module, see the following simple instruction. For the component locations and dimensions, see Figure 3-10. Also see “Inline Package Socket Module (N1265A-010)” on page 3-35 to perform measurement.

**Figure 3-10 Universal Socket Module**

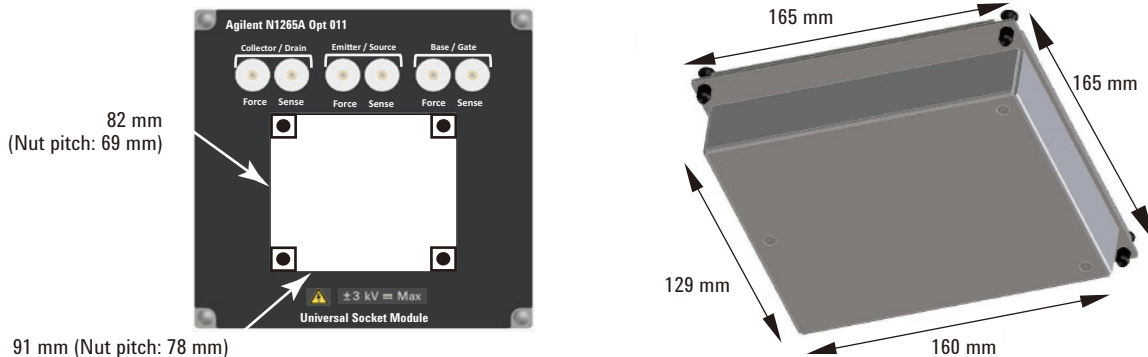

## Accessories

1. Prepare the following parts.
  - blank board suitable for mounting the socket or packaged device
  - screw M3, 4 ea., for fixing the blank board on the socket module
  - wire, adequate length and quantity, for making connections
  - hexlobe (torx type) screwdriver T-10
  - socket, if you use, and packaged device under test (DUT)
2. Cut the blank board in 90 mm × 81 mm square.
3. Make four screw holes on the board. The holes should be 6 mm inside from the edge.
4. Fix the board to the blank module.
5. Remove the cover bottom of the blank module.
6. Mount the socket or DUT on the board and solder wire between its terminals and the blank module terminals.

Make enough space between the socket/DUT terminal and the shield/chassis, for example, about 1 mm for maximum 200 V output and 6 mm for 3000 V, to prevent discharge and any accident.

7. Reattach the cover.
- Curve Tracer Test Adapter Socket Module (N1265A-013)

This module provides a socket available for connecting a test adapter designed for connecting to Tektronix 370B/371B curve tracers. Socket module internal connection is shown in Figure 3-11.

To use this module, see the following simple instruction.

**Figure 3-11**      **Curve Tracer Test Adapter Socket Module**

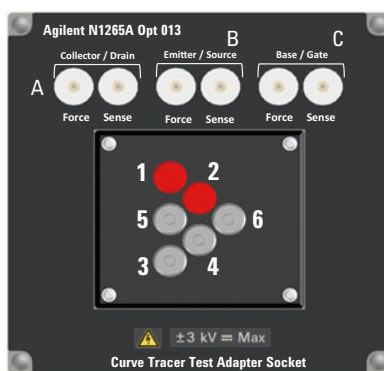

**Internal connection**

- 1: Collector/Drain Force
- 2: Collector/Drain Source
- 3: Emitter/Source Force
- 4: Emitter/Source Source
- 5: Base/Gate Force
- 6: Base/Gate Source

Maximum voltage: 3000 V

Maximum current:

A-Force: 500 A pulse, 39 A dc

A-Sense: 40 A pulse, 2 A dc

B-Force: 500 A pulse, 39 A dc

B-Sense: 40 A pulse, 2 A dc

C-Force: 40 A pulse, 2 A dc

C-Sense: 40 A pulse, 2 A dc

1. Attach the socket module to the test fixture.
2. Connect your test adapter to the socket.
3. Connect wires between the socket module terminals and the fixture output terminals. Then use the following wire.
  - N1254A-522 wire (yellow) for Selector Output High/Low Force
  - N1254A-508 or 509 wire for Selector Output High/Low Sense, Gate, SMU, or chassis

For making the Kelvin connection, Force and Sense must be connected to Force and Sense of the socket module respectively.

For the high voltage capacitance measurement, use SHV(plug)-SHV(plug) cable (N1254A-512) and SHV(jack)-banana adapter (N1254A-513) for connection.

**CAUTION**

Do not apply voltage/current over the maximum limit of the socket module.

Selector Output and Gate should be connected as follows.

- Selector Output High to DUT high (ex. Collector/Drain)
- Selector Output Low to DUT low (ex. Emitter/Source)
- Gate High to DUT drive (ex. Base/Gate Force)
- Gate Low to DUT low (ex. Emitter/Source Force)

HC/MC/DHCSMU via SMU 3 terminals should be connected as follows.

## Accessories

- SMU 3 High Force and Sense to DUT high
- SMU 3 Low Force and Sense to DUT low
- GNDU Force and Sense to DUT low

The GNDU signals will appear at the Selector Output Low terminals as shown in Table 3-5.

4. Set the DUT on your test adapter.
5. Close the fixture cover and perform measurement.

- Blank Silicon Plate

This is an insulation board used for placing a DUT. To use this board, see the following simple instruction.

1. Prepare a DUT and cable or wire, adequate length and quantity, for making connections. The following accessories are available.
  - N1254A-520 UHV/SHV to no connector cables for UHV High/Low
  - N1254A-522 banana-banana wire (yellow) or N1254A-523 banana to no connector wire (yellow) for Selector Output High/Low Force
  - N1254A-508 or 509 connection wire for Selector Output High/Low Sense, Gate, SMU, and chassis
  - N1254A-512 SHV cable and N1254A-513 adapter for capacitance measurement (Bias Tee terminals)
  - N1254A-510 dolphin clip adapter or N1254A-511 cable lag adapter
2. Attach the blank silicon plate to the test fixture.
3. Connect cable/wire between the DUT and the fixture output terminals.

For making the Kelvin connection, Force and Sense must be connected to Force and Sense of the socket module respectively.

Selector Output and Gate should be connected as follows.

- Selector Output High to DUT high (ex. Collector/Drain)
- Selector Output Low to DUT low (ex. Emitter/Source)
- Gate High to DUT drive (ex. Base/Gate Force)
- Gate Low to DUT low (ex. Emitter/Source Force)

HC/MC/DHCSMU via SMU 3 terminals should be connected as follows.



- SMU 3 High Force and Sense to DUT high
- SMU 3 Low Force and Sense to DUT low
- GNDU Force and Sense to DUT low

The GNDU signals will appear at the Selector Output Low terminals as shown in Table 3-5.

4. Make sure the DUT location. The DUT must be placed on the blank silicon plate properly.

Make enough space between the High-Low cable ends, also between the high side cable end and the shield/chassis, for example, about 1 mm for maximum 200 V output, 6 mm for 3000 V, and 32 mm for 10 kV, to prevent discharge and any accident. Also the creepage distance must be more than 100 mm for 10 kV.

5. Close the fixture cover before starting measurement.

**Figure 3-12**

**Space around Cable End**

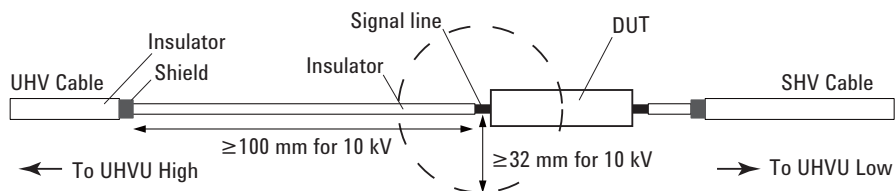

- ⚠ • Universal resistor Box (N1265A-035)

This is a blank box, kind of a do-it-yourself kit for installing a resistor you want. Generally, inserting a resistor between SMU and DUT is effective for reducing damage of DUT or preventing SMU from oscillation. You can insert your desired resistor by using this box. This box is designed for using the MCSMU.

- ⚠ • Protection Adapter (N1265A-040)

This is the adapter for protecting MCSMU from ultra high voltage. For active device measurement using UHVU, use MCSMU and this adapter for the gate/base and chuck terminals. This adapter must be attached to the SMU terminals for preventing MCSMU from damage.

## Accessories

- Container (N1265A-045)

This container can accommodate protection adapters and bias-tee which are used with the N1265A to make the measurement environment clean and safe.

Maximum superimposed load is 50 kg. The N1265A and the N1266A can be put on the top of the container.



- Prober System Cable (N1254A-524)

This is the cable for extending the N1265A's Selector Output and Gate terminals to a prober station. Cable length is 1.8 m. Prober side connector type and the maximum voltage/current are shown in Table 3-6.

This cable internally connects Selector Output Low Sense and Gate Low.

**Table 3-6 Prober Side Connectors and Maximum Voltage/Current of N1254A-524**

Connector label	Connector type	N1265A output terminals to extend	Maximum voltage	Maximum current
High Force	Banana(jack)	Selector Output High Force	3000 V	39 A dc
Low Force	Banana(jack)	Selector Output Low Force	200 V	
High Sense	HV(jack)	Selector Output High Sense	3000 V	1 A dc, 20 A pulse
Low Sense	BNC(f)	Selector Output Low Sense	200 V	
		Gate Low		
Gate	BNC(f)	Gate High	200 V	

### **WARNING**

**For using the prober system cable safely**

**Never connect the interlock cable to the N1265A.**

**Never remove the clear plastic plates from the N1265A's fixture cover.**

### **CAUTION**

Do not apply voltage/current over the maximum limit of the cable.

## N1266A HVSMU Current Expander

Current expander for HVSMU. The N1266A is used to configure the high voltage medium current unit (HVMCU) with the HVSMU module and two MC/HCSMU modules as shown in Figure 3-13. The output can be selected from the HVSMU or HVMCU.

Figure 3-13

### To Configure HVMCU

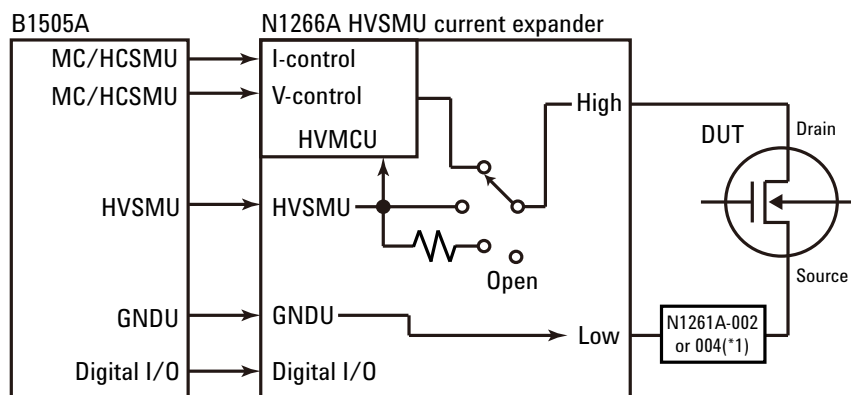

\*1: N1261A-002/004 protection adapter is required for connecting prober.  
Not required for connecting N1258A, N1259A, N1259A-300, or N1265A.

Table 3-7

### N1266A Status Indicator and Input-to-Output Connection Path

Status indicator	Input-to-output connection of output terminals	
	Low	High
(off)	GNDU Force and Sense	Open
HVMCU		HVMCU High
HVSMU		HVSMU Force
		HVSMU Force + Series resistor

**NOTE**

For the Gate terminal of DUT, use MCSMU or HCSMU. HPSMU is substitutable but a HPSMU protection adapter and a GNDU protection adapter are additionally required. And then, if the N1265A fixture is used, the GNDU must be connected to one of the SMU input terminals. Do not use the GNDU input terminal.

## Accessories

- Power indicator

This LED turns yellow when the AC power is applied to the N1266A.

This LED turns green when the N1266A is ready to use.

- Status indicator

A green LED lights to indicate the measurement resource ready to use.

**HVMC** High voltage medium current unit (HVMCU)

**HVSMU** High voltage source/monitor unit (HVSMU)



- Output High

HV(jack) connector. Force must be extended to a terminal of a DUT. Guard must be opened but should be extended as close as possible to the device terminal for reducing the leakage current of the extension cable. Use 16493T HVSMU cable to connect test fixture or adapter.

To connect prober, use high voltage triaxial cable with HV(plug) connector, manipulator, and such.

---

### CAUTION

---

Never connect the HVMCU High terminal to any output, including circuit common, chassis ground, or any other measurement resource such as SMU. Connecting other measurement resource may damage the connected one.

- Output Low

Triaxial connector. Force and sense must be extended to a terminal of a DUT and connected together at the device end. Use 16493L GNDU cable to connect test fixture or adapter.

To connect prober, use N1261A-002/004 protection adapter and a cable with BNC(m) or SHV(plug) connector, manipulator, and such.



- Input HVSMU

HV(jack) connector. For connecting 16493T HVSMU cable from the HVSMU.

- Input GNDU

Triaxial connector. For connecting 16493L GNDU cable from the GNDU.

- Input V Control Force and Sense

Triaxial connectors. For connecting 16494A triaxial cables from Force and Sense connectors of the MCSMU. HCSMU is substitutable. Then use 16493S HCSMU cable, N1254A-103 adapter for Force, and N1254A-517 adapter for Sense.

- **Input I Control Force and Sense**  
Triaxial connectors. For connecting 16494A triaxial cables from Force and Sense connectors of the MCSMU. HCSMU is substitutable. Then use 16493S HCSMU cable, N1254A-103 adapter for Force, and N1254A-517 adapter for Sense.
- **Digital I/O connector Output**  
For connecting 16493G cable to the Digital I/O connector of N1268A expander, module selector, or any accessory.
- **Digital I/O connector Input**  
For connecting 16493G cable from the Digital I/O connector of B1505A or N1265A fixture.
- **LINE input receptacle and power switch**  
AC power cable is connected to this receptacle. Power switch turns on/off the N1266A.

## N1267A HVSMU/HCSMU Fast Switch

The N1267A is used to switch quickly and automatically the measurement resource, HVSMU or HCSMU, connected to the DUT. This is effective for the current collapse measurement of GaN power devices. One MCSMU module is required to control switching.

**Figure 3-14** N1267A Simplified Internal Connections

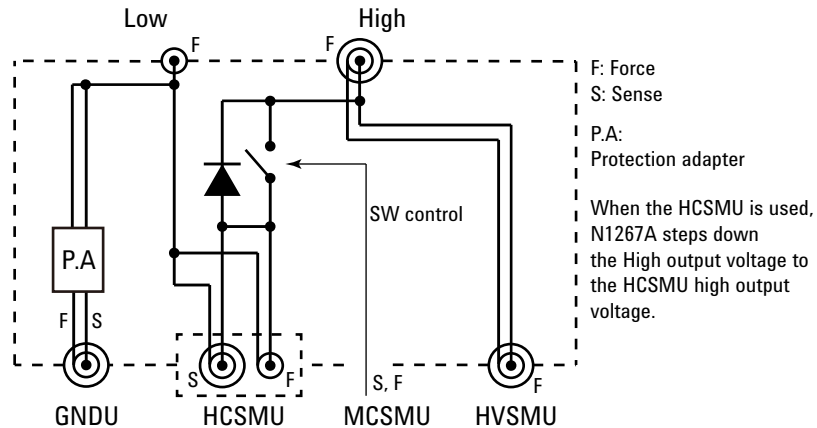

### NOTE

For the Gate terminal of DUT, use MCSMU or HCSMU. See Figure 3-15.

- Output Low Force

BNC connector.

Force must be extended to a low terminal of a device under test (DUT). Then use a cable with BNC(m) connector, manipulator, and such.



- Output High Force

HV(jack) connector.

Force must be extended to a high terminal of the DUT. Then use a cable with HV(plug) connector, manipulator, and such.

Guard must be opened.

### CAUTION

Never connect the output High Force and Guard terminals to any output, including circuit common, chassis ground, or any other measurement resource such as SMU. Connecting other measurement resource may damage the connected one.

- Input GNDU  
GNDU triaxial connector. For connecting 16493L GNDU cable from the GNDU.
- Input HCSMU  
Force BNC connector and Sense triaxial connector. For connecting 16493S HCSMU cable from the HCSMU.
- Input MCSMU  
Triaxial connectors. For connecting 16494A triaxial cables from Force and Sense connectors of the MCSMU.
- Input HVSMU  
HV(jack) connector. For connecting 16493T HVSMU cable from the HVSMU.

## GaN Current Collapse Measurement

The GaN current collapse measurement can be performed by using the N1267A and the B1505A installed with HVSMU, HCSMU, MCSMU, and GNDU. These measurement resources must be connected as shown in Figure 3-15. For making the Kelvin connection, the GNDU protection adapter is also required. Then HVSMU and GNDU must be connected to the device under test (DUT) without passing through the N1267A. If the DUT is a diode, ignore *MCSMU for Gate* in Figure 3-15.

The B1505A provides the following tracer test setup using the N1267A.

- GaN FET (N1267A):
  - Id-Vds static characteristics measurement
  - Id(Off)-Vds static characteristics measurement
  - Id-Vds current collapse measurement
  - FET current collapse measurement, oscilloscope view
- GaN Diode (N1267A):
  - If-Vf static characteristics measurement
  - Ir-Vr static characteristics measurement
  - If-Vf current collapse measurement
  - Diode current collapse measurement, oscilloscope view

The B1505A also provides the following application test definitions.

- GaN FET:
  - FET current collapse measurement, IV-t sampling
  - FET current collapse measurement, signal monitor
- GaN Diode:
  - Diode current collapse measurement, IV-t sampling
  - Diode current collapse measurement, signal monitor

**Figure 3-15 Connections for GaN Current Collapse Measurement**

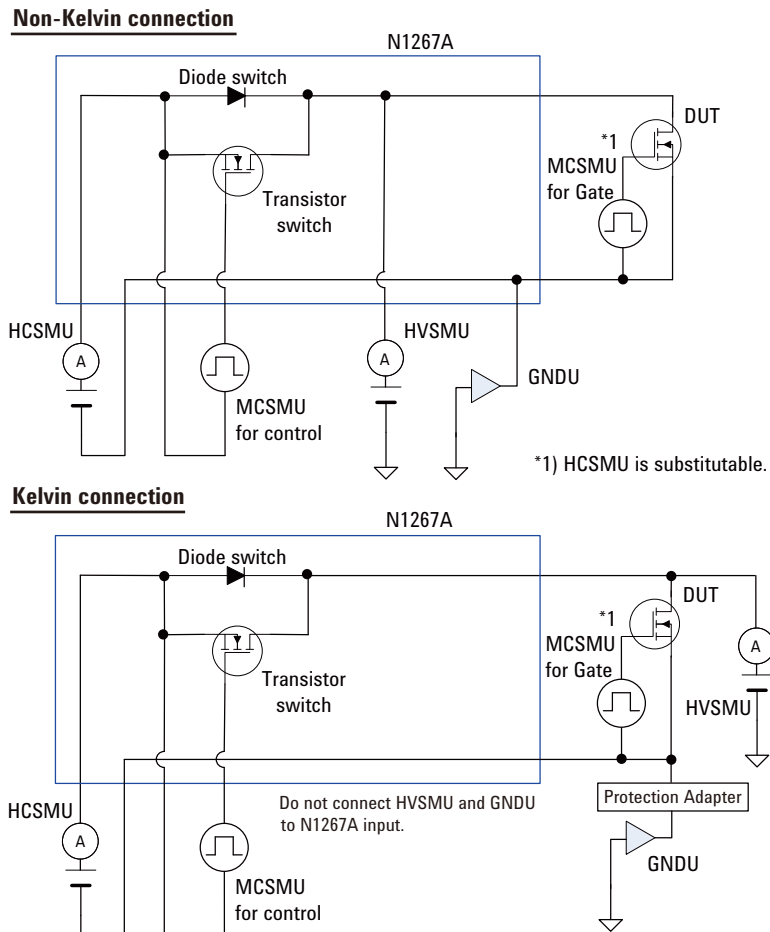



## Voltage/Current Source and Measurement Range

Source and measurement range using HVSMU and HCSMU with the N1267A is shown in Figure 3-16.

Figure 3-16

### Source and Measurement Range

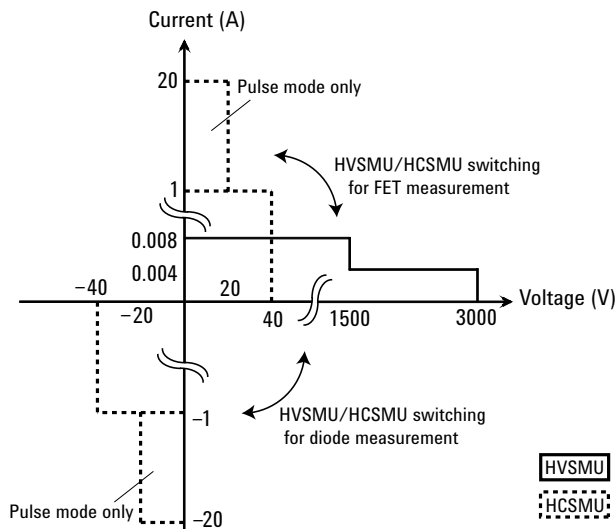

For the GaN current collapse measurement, HVSMU applies high voltage stress to the device under test (DUT) when it is in the OFF state. After that, HVSMU performs voltage measurement and HCSMU performs I-V measurement to monitor the ON state characteristics which is given by the voltage measured by HVSMU and the total current measured by HCSMU and HVSMU.

Source setting values available for HVSMU and HCSMU are shown in Tables 3-8 and 3-9. And measurement ranges are shown in Tables 3-10 and 3-11.

Table 3-8

### HVSMU Source Setting Range for OFF State

Range	Setting value <sup>a</sup>	Resolution	Compliance
200 V	1 V to 200 V	200 $\mu$ V	8 mA
500 V	1 V to 500 V	500 $\mu$ V	
1500 V	1 V to 1500 V	1.5 mV	
3000 V	1 V to 3000 V	3 mV	4 mA

a. Setting value must be the ON state voltage plus 1 V or more.

**Table 3-9 HCSMU Source Setting Range for ON State**

Range	Setting value <sup>a</sup>	Resolution	Compliance
2 V	0 V to 2 V	2 $\mu$ V	20 mA to 1 A DC, or 20 mA to 20 A pulse
20 V	0 V to 20 V	20 $\mu$ V	
40 V	0 V to 40 V	40 $\mu$ V	20 mA to 1 A DC

a. Voltage actually applied to the device under test (DUT) is the setting value minus the voltage drop of the switch.

**Table 3-10 HVSMU Voltage Measurement Range**

Range <sup>a</sup>	Measurement value	Resolution
200 V	0 V to 200 V	200 $\mu$ V
500 V	0 V to 500 V	500 $\mu$ V
1500 V	0 V to 1500 V	1.5 mV
3000 V	0 V to 3000 V	3 mV

a. Range depends on the HVSMU source setting for the device OFF state.

**Table 3-11 Current Measurement Range**

HCSMU		HVSMU	
Range <sup>a</sup>	Resolution	Range	Resolution
100 mA	100 nA	10 mA	10 nA
1 A	1 $\mu$ A		
20 A (pulse)	20 $\mu$ A		

a. Range depends on the HCSMU source setting for the device ON state.

Following tables are for the ON state static characteristics measurements. The N1267A keeps switch ON status. HCSMU performs I-V measurement. HVSMU applies 0 V with 1  $\mu\text{A}$  compliance and measures  $V_{\text{ds}}$  or  $V_{\text{f}}$ .  $I_{\text{d}}$  or  $I_{\text{f}}$  is given by the total current measured by HCSMU and HVSMU.

**Table 3-12 Source Setting Range for  $I_{\text{d}}-V_{\text{ds}}$ ,  $I_{\text{f}}-V_{\text{f}}$  Measurement**

HCSMU source setting				HVSMU source setting
Range	Setting value	Resolution	Compliance	
2 V	0 V to 2 V	2 $\mu\text{V}$	10 $\mu\text{A}$ to 1 A DC, or 10 $\mu\text{A}$ to 20 A pulse	0V output with 1 $\mu\text{A}$ compliance
20 V	0 V to 20 V	20 $\mu\text{V}$		
40 V	0 V to 40 V	40 $\mu\text{V}$	10 $\mu\text{A}$ to 1 A DC	

**Table 3-13 HVSMU Voltage Measurement Range for  $I_{\text{d}}-V_{\text{ds}}$ ,  $I_{\text{f}}-V_{\text{f}}$  Measurement**

Range	Measurement value	Resolution
200 V	0 V to 200 V	200 $\mu\text{V}$

**Table 3-14 Current Measurement Range for  $I_{\text{d}}-V_{\text{ds}}$ ,  $I_{\text{f}}-V_{\text{f}}$  Measurement**

HCSMU		HVSMU	
Range	Resolution	Range	Resolution
10 $\mu\text{A}$	10 pA	1 $\mu\text{A}$	10 nA
100 $\mu\text{A}$	100 pA		
1 mA	1 nA		
10 mA	10 nA		
100 mA	100 nA		
1 A	1 $\mu\text{A}$		
20 A (pulse)	20 $\mu\text{A}$		

Offset error for the  $I_{\text{d}}-V_{\text{ds}}$ ,  $I_{\text{f}}-V_{\text{f}}$  measurement is typical 1  $\mu\text{A}$ .

Following tables are for the OFF state static characteristics measurements. The N1267A keeps switch OFF status. HCSMU applies 0 V. HVSMU performs I-V measurement and measures Vds or Vr. Id(Off) or Ir is given by the total current measured by HCSMU and HVSMU.

**Table 3-15 Source Setting Range for Id(Off)-Vds, Ir-Vr Measurement**

HVSMU source setting				HCSMU source setting
Range	Setting value	Resolution	Compliance	
200 V	0 V to 200 V	200 $\mu$ V	10 $\mu$ A to 8 mA	0V output with compliance more than HVSMU compliance
500 V	0 V to 500 V	500 $\mu$ V		
1500 V	0 V to 1500 V	1.5 mV		
3000 V	0 V to 3000 V	3 mV	10 $\mu$ A to 4 mA	

**Table 3-16 HVSMU Voltage Measurement Range for Id(Off)-Vds, Ir-Vr Measurement**

Range	Measurement value	Resolution
200 V	0 V to 200 V	200 $\mu$ V
500 V	0 V to 500 V	500 $\mu$ V
1500 V	0 V to 1500 V	1.5 mV
3000 V	0 V to 3000 V	3 mV

**Table 3-17 Current Measurement Range for Id(Off)-Vds, Ir-Vr Measurement**

HVSMU		HCSMU	
Range	Resolution	Range	Resolution
10 $\mu$ A	10 pA	10 $\mu$ A	10 pA
100 $\mu$ A	100 pA	100 $\mu$ A	100 pA
1 mA	1 nA	1 mA	1 nA
10 mA	10 nA	10 mA	10 nA

Leak error for the Id(Off)-Vds, Ir-Vr measurement is typical 2 nA.

## Switch Control Terminals

The N1267A has the Switch Control (MCSMU Force and Sense) terminals for controlling the N1267A ON/OFF status. Requirements for the terminals are listed below.

- Control voltage to set the N1267A OFF status: 0 V
- Control voltage to set the N1267A ON status: 15 V
- Current compliance: 100 mA
- Input voltage: 0 V to +18 V
- Voltage limit (input protection): -0.6 V to +20 V

## Duration and Sampling Settings

For current collapse measurement (tracer test):

- OFF state duration: 10 ms to 655.35 s, in 10 ms resolution

For current collapse measurement, oscilloscope view or signal monitor:

- OFF state duration: 10 ms to 655.35 s, in 10 ms resolution
- ON state duration for 20 A range: 50  $\mu$ s to 1 ms, in 2  $\mu$ s resolution
- ON state duration for 1 A range and below: 50  $\mu$ s to 2 s, in 2  $\mu$ s resolution
- Sampling duration: maximum 24 ms
- Sampling rate: 6  $\mu$ s for voltage, 2  $\mu$ s to 12  $\mu$ s for current

For current collapse measurement, IV-t sampling:

- OFF state duration: 10 ms to 655.35 s, in 10 ms resolution
- Minimum sampling interval, linear sampling: 200  $\mu$ s
- Maximum number of samples, linear sampling: 100,001/(number of measurement parameters)
- Sampling mode: linear or log

## Transient Response

The N1267A has the transient response as shown in Figure 3-17 due to the internal circuit of HVSMU. After the N1267A switch status is changed from OFF to ON, HVSMU current is limited by the internal circuit, and voltage goes down. Finally it causes the current shift of *Current limit change* after *Current limit period* elapsed.

Figure 3-17

**Transient Response**

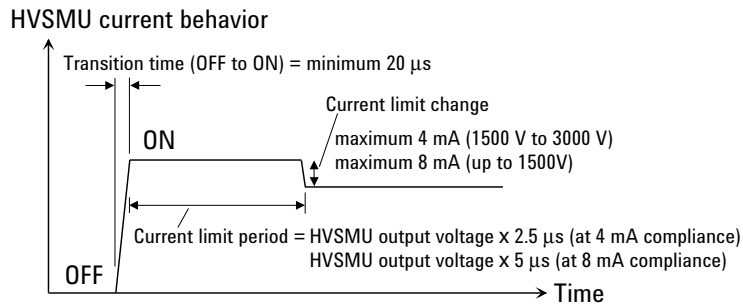

**I-V Characteristics of N1267A**

The N1267A has the I-V characteristics due to the internal semiconductor switches shown in Figure 3-15. When the device ON state characteristics is monitored, the voltage actually applied to the DUT will be the HCSMU setting voltage minus the voltage drop shown below. The voltage drop value varies by the current.

Figure 3-18

**HCSMU Output Current vs Voltage Drop**

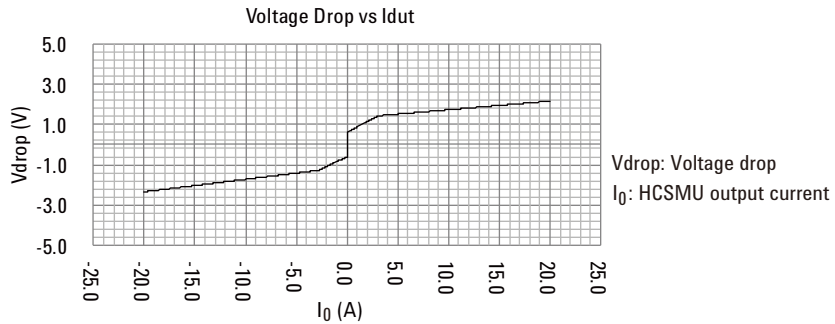

Table 3-18

**Voltage Drop**

Transistor measurement		Diode measurement	
Voltage drop	Current $I_0^a$	Voltage drop	Current $I_0^a$
$20 \times I_0$	$ I_0  \leq 30 \text{ mA}$	$58 \times I_0$	$ I_0  \leq 10 \text{ mA}$
$0.6 + 0.27 \times I_0$	$30 \text{ mA} <  I_0  \leq 3 \text{ A}$	$0.6 + 0.24 \times I_0$	$10 \text{ mA} <  I_0  \leq 3 \text{ A}$
$1.3 + 0.043 \times I_0$	$3 \text{ A} <  I_0  \leq 20 \text{ A}$	$1.1 + 0.062 \times I_0$	$3 \text{ A} <  I_0  \leq 20 \text{ A}$

a.  $I_0$ : HCSMU output current (A)

## N1268A Ultra High Voltage Expander

Voltage expander to enable 10 kV output and measurement. The N1268A is used to configure the ultra high voltage unit (UHVU) with two MC/HCSMU modules as shown in Figure 3-19.

---

### WARNING

Do not put anything on the N1268A Ultra High Voltage Expander.

---

### WARNING

Connect a wire from an electrical ground (safety ground) to the earth terminal.

---

### WARNING

Before touching the DUT after the ultra high voltage measurement using the UHVU, confirm that it has been discharged enough. For that, use right hand, ground and discharge the terminals over 10 seconds after stopping the high voltage output, and confirm that they have been safety voltage by using another volt meter.

Especially, it is dangerous if a capacitive load or a long cable is connected. When a large load capacitance is connected, the terminals may not have been discharged until the safety voltage below  $\pm 42$  V.

---

Figure 3-19

To Configure UHVU

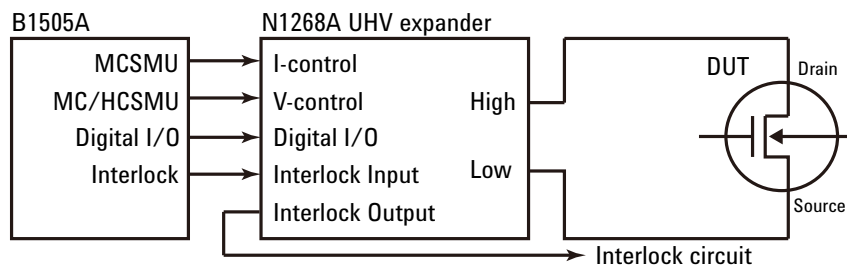

---

### NOTE

For the Gate terminal of DUT, use MCSMU. Another module cannot be used.



- Earth terminal  
Screw terminal for earthing.
- LINE input receptacle  
AC power cable is connected to this receptacle.
- POWER indicator  
This green LED lights when the N1268A is turned on.

## Accessories

- Power switch  
Turns on/off the N1268A.



- High Voltage Enable switch  
Enables/disables high voltage output. This red switch lights when the N1268A is in the high voltage output enable status.

If the Power switch is set to the on position while this switch is in the on position, the high voltage output is not enabled. Then press this switch to set it to the off position, and press the switch again to enable the high voltage output.

---

### WARNING

---

**The red light indicates that hazardous voltage (maximum  $\pm 10$  kVdc) may appear at the High terminal.**



- Interlock Input and Output  
Interlock connector. Input connector is for connecting 16493J interlock cable from B1505A. And Output connector is for connecting 16493J interlock cable from test fixture, prober station, and such.

---

### WARNING

---

**Potentially hazardous voltage may be present at the High terminal when the interlock terminals are shorted on test fixture, prober station, and such.**

- Digital I/O connector  
For connecting 16493G cable from the Digital I/O connector of B1505A, N1265A test fixture, or N1266A current expander.
- MCSMU/HCSMU V Control Force and Sense  
Triaxial connectors. For connecting 16494A triaxial cables from Force and Sense connectors of the MCSMU. HCSMU is substitutable. Then use 16493S HCSMU cable, N1254A-103 adapter for Force, and N1254A-517 adapter for Sense.
- MCSMU I Control Force and Sense  
Triaxial connectors. For connecting 16494A triaxial cables from Force and Sense connectors of the MCSMU. HCSMU is *NOT* substitutable.
- Output Low  
SHV(jack) connector. Use SHV(plug)-SHV(plug) cable of 16493V to connect N1265A test fixture.



To connect prober, use N1269A adapter and SHV(plug)-SHV(plug) cable of 16493V. See “N1269A Ultra High Voltage Connection Adapter” on page 3-58 for connecting a prober.



• Output High

UHV(jack) connector. Use UHV(plug)-UHV(plug) cable of 16493V to connect N1265A test fixture.

To connect prober, use ultra high voltage cable with UHV(plug) connector, manipulator, and such.

---

**CAUTION**

---

Never connect the UHVU High terminal to any output, including circuit common, chassis ground, or any other measurement resource such as SMU. Connecting other measurement resource may damage the connected one.

## N1269A Ultra High Voltage Connection Adapter

The N1269A is used to connect the N1268A UHV expander and the MCSMU modules to DUT. See Figure 3-20 for connection example. Protection adapters for MCSMU are initially installed. The N1269A is used with a DUT interface such as your own test fixture and prober station, not the N1259A/N1265A.

Figure 3-20

### To Use N1269A Adapter

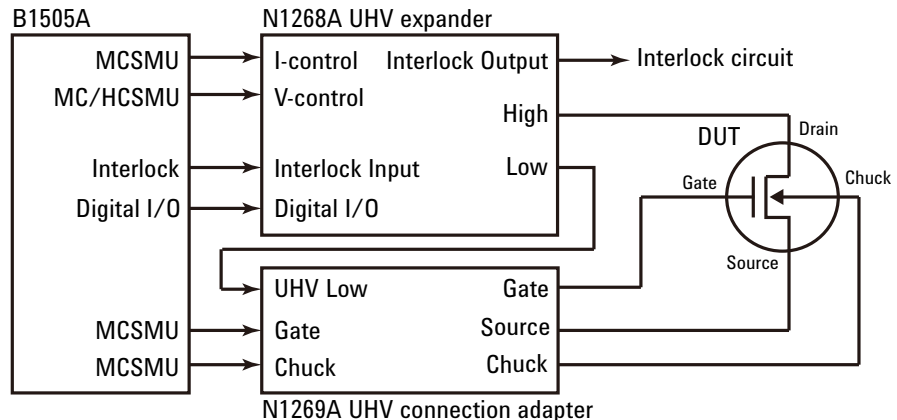

- UHV Low  
SHV(jack) connector. Use SHV(plug)-SHV(plug) cable of 16493V to connect the Low terminal of the N1268A UHV expander.
- Gate MCSMU Force and Sense  
Triaxial connectors. For connecting 16494A triaxial cables from Force and Sense connectors of the MCSMU. HCSMU is *NOT* substitutable.
- Chuck MCSMU Force and Sense  
Triaxial connectors. For connecting 16494A triaxial cables from Force and Sense connectors of the MCSMU. HCSMU is *NOT* substitutable.
- Gate, Source, Chuck  
SHV(jack) connectors. To connect prober, use cables with SHV(plug) connector, manipulators, and such.

---

**4**

**Installation**

---

## Installation

This chapter describes how to install Agilent B1505A and accessories.

- “Requirements”
- “Inspection and Installation”
- “Maintenance”
- “About Plug-in Modules”

To change the GPIB address of the B1505A, see “To Change GPIB Address” on page 4-10.

To control external GPIB devices from the B1505A/EasyEXPERT, see “To Enable System Controller” on page 4-11.

---

**WARNING**

---

**To avoid electrical shock and instrument damage, turn the all instruments off before connecting or disconnecting measurement cable.**

---

**WARNING**

---

**The B1505A, the N1265A ultra high current expander/fixture, and the N1268A ultra high voltage expander are heavy and require a two person lift.**

---

**CAUTION**

---

Do not grab the fixture cover when lifting the N1259A or N1265A test fixture.

---

**WARNING**

There are potentially hazardous voltages ( $\pm 10$  kVdc for UHVU,  $\pm 3000$  Vdc for HVSMU,  $\pm 2200$  V pulse for HVMCU,  $\pm 200$  Vdc for HPSMU, and  $\pm 100$  Vdc for MPSMU) present at the High, Force, Guard, and Sense terminals of the instruments. To prevent electrical shock, the following safety precautions must be observed during the use of instruments.

- Use three-conductor AC power cable to connect the instrument to an electrical ground (safety ground).

For both the N1265A and the N1268A, also connect a wire from an electrical ground (safety ground) to the earthing terminal.

- If you use prober and such instead of the test fixture, you must install and connect an interlock circuit that opens the circuit when the shielding box access door is open.
- If you change the DUT interface, test fixture, prober, and such, connect an interlock cable to the one actually used.
- If the N1268A is used, connect an interlock cable between the B1505A and the N1268A's Interlock Input, and connect an extra interlock cable between the N1268A's Interlock Output and the test fixture or the shielding box.
- Confirm periodically that the interlock function works normally.
- Before touching the connections on the High, Force, Guard, and Sense terminals in the test fixture or the shielding box, turn the instruments off and discharge any capacitors. If you do *not* turn the instruments off, complete *all* of the following items, regardless of the instrument settings.
  - Press the front panel Stop key to set the module output off.
  - Confirm that the front panel High Voltage indicator is not lit.
  - If the N1268A is used, press the High Voltage Enable switch to disable the high voltage output. And confirm that this red switch is not lit.
  - Open the Interlock terminal (open the access door).
  - Discharge any capacitors connected to a measurement resource.
- Warn persons working around the instruments about dangerous conditions.

## Requirements

This section contains information on:

- “Power Requirements”
- “Operating Environment”
- “Storing/Shipping Environment”
- “Installation Requirements”
- “Power Cable”

### Power Requirements

This instrument can operate from any single-phase AC power source supplying 100-240 V ( $\pm 10\%$ ) at 50/60 Hz. The maximum power consumption is 900 VA.

### Operating Environment

This instrument is specified to operate within the following environmental conditions:

<b>Temperature:</b>	5 °C to 40 °C
<b>Humidity:</b>	20 % to 70 % RH, non-condensing
<b>Altitude:</b>	0 to 2,000 m (6,561 ft.)

### Storing/Shipping Environment

This instrument is specified to store/ship within the following environmental conditions:

<b>Temperature:</b>	-20 °C to 60 °C
<b>Humidity:</b>	10 % to 90 % RH, non-condensing 20 % to 80 % RH, non-condensing, for using N1268A
<b>Altitude:</b>	0 to 4,600 m (15,092 ft.) 0 to 2,000 m (6,561 ft.), for using N1268A

## Installation Requirements

---

**WARNING**

---

**Do not operate the instrument in dusty environment, or in the presence of flammable gasses, corrosive gasses, or fumes.**

- Environmental conditions for this instrument are documented in “General Specifications” on page 5-61. In principle, this instrument should only be operated indoors in a controlled environment.
- Install the instrument horizontal place then face the roof up.
- The dimensions of this instrument are also given in “General Specifications”. Fan cools the instrument by drawing air through the sides and exhausting it out the back. The instrument must be installed in a location that allows sufficient space at the sides and back of the instrument for adequate air circulation.

If the airflow is restricted, the internal operating temperature will be higher. This may reduce the instrument’s reliability, or cause the thermal-protection circuits to turn the instrument off.

- Make sure that there is enough space for connecting/disconnecting the power cable easily.

---

**WARNING**

---

**Do not put on the N1268A Ultra High Voltage Expander.**

### Power Cable

---

**WARNING**

---

**FIRE HAZARD: Use only the power cable supplied with your instrument. Using other types of power cable may cause overheating of the power cable, resulting in fire.**

**SHOCK HAZARD: The power cable provides the chassis ground through a third conductor. Be sure to connect to a three-conductor type power outlet with the correct pin grounded.**

---

**NOTE**













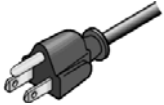

---

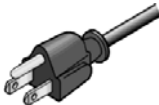
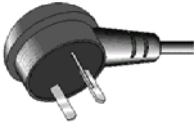
The detachable power cable may be used as an emergency disconnecting device. Removing the power cable will disconnect AC input power to the instrument.

Connect the power cable to the IEC 320 connector on the rear of the instrument. If the wrong power cable was shipped with your instrument, contact your nearest Agilent Sales and Support Office.

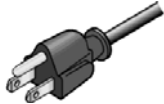
The AC input on the back of your instrument is a universal AC input. It accepts nominal line voltages in the range of 100 to 240 VAC.

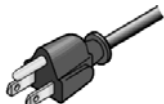
**Installation  
Requirements**

<p>Option 900</p>  <ul style="list-style-type: none"> <li>• Plug: BS 1363/A, 250 V, 10 A</li> <li>• PN: 8120-4420</li> </ul>	<p>Option 901</p>  <ul style="list-style-type: none"> <li>• Plug: AS/NZS 3112, 250 V, 10 A</li> <li>• PN: 8120-4419</li> </ul>	<p>Option 902</p>  <ul style="list-style-type: none"> <li>• Plug: IEC 60277-1, 250 V, 10 A</li> <li>• PN: 8121-1226</li> </ul>	<p>Option 903</p>  <ul style="list-style-type: none"> <li>• Plug: NEMA 5-15P, 125 V, 10 A</li> <li>• PN: 8120-6825</li> </ul>
<p>Option 904</p>  <ul style="list-style-type: none"> <li>• Plug: NEMA 6-15P, 250 V, 10 A</li> <li>• PN: 8120-3996</li> </ul>	<p>Option 906</p>  <ul style="list-style-type: none"> <li>• Plug: SEV 1011, 250 V, 10 A</li> <li>• PN: 8120-4416</li> </ul>	<p>Option 912</p>  <ul style="list-style-type: none"> <li>• Plug: SB 107-2-D1, 250 V, 10 A</li> <li>• PN: 8121-1655</li> </ul>	<p>Option 917</p>  <ul style="list-style-type: none"> <li>• Plug: IS 1293 and IS 6538, 250 V, 10 A</li> <li>• PN: 8121-1690</li> </ul>
<p>Option 918</p>  <ul style="list-style-type: none"> <li>• Plug: JIS C 8303, 125 V, 12 A</li> <li>• PN: 8121-0743</li> </ul>	<p>Option 919</p>  <ul style="list-style-type: none"> <li>• Plug: Israel SI 32, 250 V, 10 A</li> <li>• PN: 8121-0724</li> </ul>	<p>Option 920</p>  <ul style="list-style-type: none"> <li>• Plug: IRAM 2073, 250 V, 10 A</li> <li>• PN: 8121-0725</li> </ul>	<p>Option 921</p>  <ul style="list-style-type: none"> <li>• Plug: CEI 23-16, 250 V, 10 A</li> <li>• PN: 8121-0722</li> </ul>
<p>Option 922</p>  <ul style="list-style-type: none"> <li>• Plug: GB 1002 figure 3, 250 V, 10 A</li> <li>• PN: 8120-8376</li> </ul>	<p>Option 923</p>  <ul style="list-style-type: none"> <li>• Plug: SANS 164-1, 250 V, 10 A</li> <li>• PN: 8121-0564</li> </ul>	<p>Option 927</p>  <ul style="list-style-type: none"> <li>• Plug: NEMA WD-6, 250 V, 10 A</li> <li>• PN: 8120-0674</li> </ul>	<p>Option 930</p>  <ul style="list-style-type: none"> <li>• Plug: NBR 14136, 250 V, 10 A</li> <li>• PN: 8121-1809</li> </ul>
<p>Option 931</p>  <ul style="list-style-type: none"> <li>• Plug: CNS 10917-2, 125 V, 10 A</li> <li>• PN: 8121-1635</li> </ul>	<p>Option 932</p>  <ul style="list-style-type: none"> <li>• Plug: CS 0017, 250 V, 10 A</li> <li>• PN: 8121-1638</li> </ul>		



---

## Inspection and Installation

This section describes what to do when you receive the instrument and accessories.

1. Inspect the shipment. See “To Inspect B1505A and Accessories”.
2. Verify the instrument operation and perform initial setup. See “To Perform Initial Setup”.
3. Install the instrument in the appropriate place. See “Requirements” on page 4-4.

To use the instrument briefly, see “Getting Started” on page 1-1.

To change the Windows logon setting, see “To Change Windows Logon Setting” on page 4-9.

To change the GPIB address of the instrument, see “To Change GPIB Address” on page 4-10.

To allow the B1505A/EasyEXPERT to control external GPIB devices, see “To Enable System Controller” on page 4-11.

### To Inspect B1505A and Accessories

Perform the following inspections when the instrument and accessories arrive at your site.

1. Before unpacking any components, inspect all boxes for any signs of damage that might have occurred during shipment, such as:
  - dents
  - scratches
  - cuts
  - water marks

If you suspect any damage, notify your local Agilent Technologies sales or service office.

2. When you open the boxes that contain the instrument and accessories, check the components against the contents lists attached to the boxes.

If anything is missing, notify your local Agilent Technologies sales or service office.

## To Perform Initial Setup

After you receive the instrument, perform the following setup.

For the users available just after the initial setup, see Table 4-1.

1. Make sure that the Standby switch is set to off.
2. On the instrument rear panel, connect the Circuit Common terminal to the frame ground terminal by using a shorting-bar.
3. If you use Agilent 16444A-001 USB keyboard and/or the 16444A-002 USB mouse, connect it to an USB port of the instrument.
4. Connect the power cable from the instrument to an AC power outlet.
5. Open the measurement terminals and press the Standby switch to turn on the instrument.

If the instrument is operating correctly, the power-on self-test is automatically performed. If problems arise, see Agilent EasyEXPERT *User's Guide*.

6. Follow the Windows setup wizard and complete the initial setup.
  - a. Set the system display language to English. The language must be English. If you set another language, you must perform the system recovery of the B1505A. See Agilent EasyEXPERT *User's Guide* for the system recovery.
  - b. Set Country or region, Time and currency, and Keyboard layout.  
If you use the 16444A-001 USB keyboard, the Keyboard layout must be US.
  - c. Accept the End User License Agreement.
  - d. Set Time zone, date and time.

If the instrument has been already connected to your site LAN, you can proceed the network connection setup.

---

### NOTE

#### Other Windows setup

You can set other setup of Windows after the initial setup. It is your responsibility.

If you connect the instrument to the network, take care to protect it from computer virus.

**Table 4-1**                      **Users Available Just After the Initial Setup**

User Account	Description
Agilent B1500 User	Account for automatic logon. Password is not set to this account.
AgilentOnly	Account for Agilent service personnel. Do not delete this account. This account is password protected.
Administrator	Administrator. Password is not set to this account.

You can add users after the initial setup. Add users as you need.

---

**NOTE**

Agilent Technologies cannot guarantee the performance and provide compatibility information for all B1505As under several conditions. If problems arise, perform Agilent B1505A system recovery.

To perform recovery, see Agilent EasyEXPERT *User's Guide*.

---

### To Change Windows Logon Setting

Agilent B1505A initially enables Windows automatic logon. If you want to change this setting, select *All Programs > Control Auto Logon* from the Start menu. Control Auto Logon is displayed on the browser. Then click one of the following buttons on the browser and follow the setup script.

- Enable Auto Logon
- Disable Auto Logon

---

**NOTE**

If you set a password for the user account *Agilent B1500 User*, disable the automatic logon.

## To Change GPIB Address

When this instrument is shipped from the factory, the GPIB address is set to 17. To change the GPIB address, perform the following procedure.

1. If the EasyEXPERT software is running, terminate it as shown below:
  - a. Select the menu function *File > Exit* on the EasyEXPERT main screen.
  - b. Click [x] at the upper right corner of the Start EasyEXPERT button.
2. Select *All Programs > Agilent IO Libraries Suite > Agilent Connection Expert* from the Start menu. Agilent Connection Expert window appears.
3. At the *Instrument I/O on this PC* area, select GPIB0, and click the *Change Properties...* button. Agilent 82350 PCI GPIB Interface - GPIB0 window appears.
4. Change the GPIB Address value.
5. Remove the check from the *Auto-discover instruments connected to this interface* box.
6. Click the OK button on Agilent 82350 PCI GPIB Interface - GPIB0 window.
7. On the Reboot Required dialog box, click the Reboot Now button, and reboot the instrument.

## To Enable System Controller

To allow Agilent B1505A/EasyEXPERT to control external GPIB devices, perform the following procedure.

1. If the EasyEXPERT software is running, terminate it as shown below:
  - a. Select the menu function *File > Exit* on the EasyEXPERT main screen.
  - b. Click [x] at the upper right corner of the Start EasyEXPERT button.
2. Select *All Programs > Agilent IO Libraries Suite > Agilent Connection Expert* from the Start menu. Agilent Connection Expert window appears.
3. At the *Instrument I/O on this PC* area, select GPIB0, and click the *Change Properties...* button. Agilent 82350 PCI GPIB Interface - GPIB0 window appears.
4. Set the GPIB Address value to 21 that is the typical address number for the system controller.
5. Check the *System Controller* box.
6. Remove the check from the *Auto-discover instruments connected to this interface* box.

This disables the automatic device detection. So the Connection Expert cannot detect the instruments connected to the GPIB interface by itself.
7. Click the OK button on Agilent 82350 PCI GPIB Interface - GPIB0 window.
8. On the Reboot Required dialog box, click the Reboot Now button, and reboot the instrument.

---

### NOTE

#### To Disable System Controller

If the B1505A is the system controller, you cannot control the B1505A by using an external computer. To disable the system controller, change the steps 4 and 5 for setting the GPIB Address value to *not* 21 and removing the check from the *System Controller* box, and perform the procedure to the step 8.

---

## Maintenance

Maintenance should be performed periodically to keep the instrument in good condition.

## Cleaning

Before performing cleaning, turn off the instrument, and disconnect power cable from the rear panel. Use a dry cloth to clean the external case parts.

To prevent electrical shock, do not perform cleaning when the instrument is turned on, and do not use a wet cloth.

## Self-test and Diagnosis

This instrument provides the following functions to check the operation. Perform the following functions as necessary. Open the measurement terminals to perform self-test, self-calibration, or diagnosis.

- Self-test
- Self-calibration
- Diagnosis

If problems arise, contact Agilent Technologies. For details, see Agilent EasyEXPERT *User's Guide*.

---

### NOTE

#### Before performing the diagnosis of N1265A UHC Expander / Fixture

When the diagnosis of the N1265A is performed, the N1266A HVSMU Current Expander must not be connected to the N1265A.

If the N1266A is connected between the N1265A and the HVSMU, disconnect the cables from the following connectors.

- Selector Input HVSMU connector of the N1265A
- Input HVSMU connector of the N1266A

And connect the cable between the Selector Input HVSMU connector of the N1265A and the HVSMU before performing the diagnosis of the N1265A.

---

---

**NOTE**



**Interlock Open/Close test and High Voltage LED test**

Interlock function limits the maximum output voltage to  $\pm 42$  V when the measurement terminal is touchable. For safety, this function must be checked before using the B1505A after power on at least once a day by performing the diagnosis.

---

## Calibration

Calibration and adjustments must be performed periodically so that the instruments satisfy the specifications, and keep a good condition. It is recommended to perform the calibration once a year at least. For the calibration and adjustments, contact Agilent Technologies. Trained service personnel will perform the calibration and adjustments. Also see Agilent EasyEXPERT *User's Guide*.

---

## About Plug-in Modules

Module locations when the B1505A is shipped from the factory are shown in Table 4-2. This table shows the relative locations by the module types. The same type of modules must be installed in the contiguous slots.

For example, if the module configuration is two HPSMU, one MFCMU, one HCSCMU, and one HVSMU, the B1505A will be shipped with the HPSMU of the slots 1 to 4, the MFCMU of the slot 5, the HCSCMU of the slots 6 to 7, the HVSMU of the slots 8 to 9, and the blank panel of the slot 10.

Module installation must be carried out at an Agilent Technologies service center. Contact Agilent Technologies for the module installation. Then send the following equipment and accessories to Agilent Technologies.

- B1505A
- Plug-in modules to be installed

---

### WARNING

**To prevent electrical shock, turn the instrument off and remove the power cable before removing the connection cables.**

---

### NOTE

#### Module locations after servicing

After the module installation, upgrade, and so on, the B1505A will be returned with the module configuration decided by the rule shown in Table 4-2. If you want to change the module locations, consult the service personnel before servicing.

---

Table 4-2

Module Installation Rule

Slot Number and Location		Module Type
10	top	B1513B High Voltage SMU (HVSMU)
:	:	B1512A High Current SMU (HCSCMU)
:	:	B1514A Medium Current SMU (MCSCMU)
:	:	B1520A Multi Frequency CMU (MFCMU)
:	:	B1511A Medium Power SMU (MPSMU)
1	:	B1510A High Power SMU (HPSMU)
0	bottom	GNDU/ADC (always installed)





## Specifications and Options

This chapter describes the specifications and the options of Agilent B1505A Power Device Analyzer/Curve Tracer.

- “Specifications”
- “Accessories and Options”

---

## Specifications

This section lists specifications and supplemental characteristics for the B1505A and its associated modules. The specifications are the standards against which the B1505A and its associated modules are tested. When the B1505A or any of its associated modules are shipped from the factory, they meet the specifications. The “supplemental” characteristics described in the following specifications are not guaranteed, but provide useful information about the functions and performance of the instrument.

---

### NOTE

Module installation must be carried out at an Agilent Technologies service center. Contact your nearest Agilent Technologies to install and calibrate the B1505A modules.

- “Specification Conditions”
- “Mainframe”
- “HPSMU”
- “MPSMU”
- “HCSMU”
- “MCSMU”
- “HVSMU”
- “SMU Common Specifications”
- “SMU Supplemental Characteristics”
- “MFCMU”
- “UHC (Ultra High Current) Expander / Fixture (N1265A)”
- “HVSMU Current Expander (N1266A)”
- “UHV (Ultra High Voltage) Expander (N1268A)”
- “Accessories”
- “EasyEXPERT Software”
- “Furnished Software”
- “General Specifications”

## Specification Conditions

The measurement and output accuracy are specified under the conditions listed below. Note: The SMU measurement and output accuracies are specified at the SMU connector terminals, using the Zero Check terminal as a reference.

1. Temperature:  $23\text{ }^{\circ}\text{C} \pm 5\text{ }^{\circ}\text{C}$
2. Humidity: 20 % to 70 %
3. Self-calibration after a 40 minute warm-up is required.
4. Ambient temperature change less than  $\pm 1\text{ }^{\circ}\text{C}$  after self-calibration execution. (Note: This does not apply to the MFCMU).
5. Measurement made within one hour after self-calibration execution. (Note: This does not apply to the MFCMU).
6. Calibration period: 1 year
7. SMU integration time setting: 1 PLC (1 nA to 1 A range, voltage range), 200  $\mu\text{s}$  (20 A range)  
Averaging of high-speed ADC: 128 samples per 1 PLC
8. SMU filter: ON (for HPSMU and MPSMU)
9. SMU measurement terminal connection: Kelvin connection (for HPSMU, MPSMU, HCSMU, and MCSMU), non-Kelvin connection (for HVSMU)

## Mainframe

- Supported plug-in modules

The B1505A supports ten slots for plug-in modules. See Table 5-1.

- Maximum module configuration

The total power consumption of all modules cannot exceed 84 W. Under this rule, the B1505A can contain any combination of the following SMUs:

- Up to 4 dual-slot HPSMUs<sup>1</sup>
- Up to 10 single-slot MPSMUs
- Up to 2 dual-slot HCSMUs<sup>1</sup>
- Up to 6 single-slot MCSMUs
- 1 dual-slot HVSMU

In addition, up to 1 single-slot MFCMU can be installed per B1505A mainframe for any of the above listed SMU configurations.

The installation order of the modules is: HPSMU, MPSMU, MFCMU, MCSMU, HCSMU, and HVSMU starting from the bottom of the B1505A mainframe.

- Maximum voltage between common and ground

$\leq \pm 42 \text{ V}$

- Ground unit (GNDU) specifications

The GNDU is furnished with the mainframe.

- Output voltage:  $0 \text{ V} \pm 100 \mu\text{V}$
- Maximum sink current:  $\pm 4.2 \text{ A}$
- Output terminal/connection: Triaxial connector, Kelvin (remote sensing)

---

1. The total number of installed HPSMU and HCSMU modules cannot exceed 4.

Specifications and Options  
Specifications

- GNDU supplemental characteristics
    - Load capacitance: 1  $\mu$ F
    - Cable resistance:
      - For  $I_s \leq 1.6$  A: Force line  $R < 1 \Omega$
      - For  $1.6$  A  $< I_s \leq 2.0$  A: Force line  $R < 0.7 \Omega$
      - For  $2.0$  A  $< I_s \leq 4.2$  A: Force line  $R < 0.35 \Omega$
      - For all cases: Sense line  $R \leq 10 \Omega$
- where  $I_s$  is the current being sunk by the GNDU.

**Table 5-1 Supported plug-in modules**

Module	Slots <sup>a</sup>	Range of operation	Measurement resolution
B1510A HPSMU High power source/monitor unit	2	-200 V to 200 V, -1 A to 1 A	2 $\mu$ V, 10 fA
B1511A MPSMU Medium power source/monitor unit	1	-100 V to 100 V, -100 mA to 100 mA	0.5 $\mu$ V, 10 fA
B1512A HCSMU High current source/monitor unit	2	-40 V to 40 V, -1 A to 1 A -20 V to 20 V, -20 A to 20 A (Pulse only)	200 nV, 10 pA
B1513B HVSMU High voltage source/monitor unit	2	-3000 V to 3000 V, -4 mA to 4 mA -1500 V to 1500 V, -8 mA to 8 mA	200 $\mu$ V, 10 fA
B1514A MCSMU Medium current source/monitor unit	1	-30 V to 30 V, -100 mA to 100 mA -30 V to 30 V, -1 A to 1 A (Pulse only)	200 nV, 10 pA
B1520A MFCMU Multi frequency capacitance measurement unit <sup>b</sup>	1	1 kHz to 5 MHz	0.035 fFrms <sup>c</sup>

- a. Number of slots the module occupies.
- b. N1300A-100 SMU CMU Unify Unit (SCUU) is not supported for the B1505A.
- c. Valid when connecting a 10 pF capacitor to the measurement terminals under the following measurement conditions: a frequency of 1 MHz, a signal level of 250 mV AC, and a measurement time of 1 PLC. The display resolution is 0.000001 fF at 1 fF order by 6 digits display.

## HPSMU

High Power Source/Monitor Unit

- Voltage range, resolution, and accuracy  
See Table 5-4 for high resolution ADC and Table 5-6 for high speed ADC.
- Current range, resolution, and accuracy  
See Table 5-5 for high resolution ADC and Table 5-7 for high speed ADC.
- Power consumption  
See Table 5-2 for voltage source mode and Table 5-3 for current source mode.

**Table 5-2 HPSMU power consumption in voltage source mode**

Voltage range (V)	Power <sup>a</sup> (W)
2	$I_c \times 20$
20	$I_c \times 20$
40	$I_c \times 40$
100	$I_c \times 100$
200	$I_c \times 200$

a.  $I_c$  is the current compliance setting.

**Table 5-3 HPSMU power consumption in current source mode**

Voltage compliance <sup>a</sup> (V)	Power <sup>b</sup> (W)
$V_c \leq 20$	$I_o \times 20$
$20 < V_c \leq 40$	$I_o \times 40$
$40 < V_c \leq 100$	$I_o \times 100$
$100 < V_c \leq 200$	$I_o \times 200$

a.  $V_c$  is the voltage compliance setting.

b.  $I_o$  is the output current.

Specifications and Options  
Specifications

**Table 5-4 HPSMU voltage range, resolution, and accuracy (high resolution ADC)**

Range	Force resolution	Measurement resolution	Force accuracy $\pm(\%+mV)^a$	Measurement accuracy $\pm(\%+mV)^a$	Maximum current
$\pm 2$ V	100 $\mu$ V	2 $\mu$ V	$\pm(0.018 + 0.4)$	$\pm(0.01 + 0.14)$	1 A
$\pm 20$ V	1 mV	20 $\mu$ V	$\pm(0.018 + 3)$	$\pm(0.009 + 0.9)$	1 A
$\pm 40$ V	2 mV	40 $\mu$ V	$\pm(0.018 + 6)$	$\pm(0.01 + 1)$	500 mA
$\pm 100$ V	5 mV	100 $\mu$ V	$\pm(0.018 + 15)$	$\pm(0.012 + 2.5)$	125 mA
$\pm 200$ V	10 mV	200 $\mu$ V	$\pm(0.018 + 30)$	$\pm(0.014 + 2.8)$	50 mA

a.  $\pm(\%$  of output/measured value + fixed offset)

**Table 5-5 HPSMU current range, resolution, and accuracy (high resolution ADC)**

Range	Force resolution	Measurement resolution	Force accuracy $\pm(\%+A+A)^a$	Measurement accuracy $\pm(\%+A+A)^a$	Maximum voltage
$\pm 1$ nA	50 fA	10 fA	$\pm(0.1+3E-13+V_o \times 1E-15)$	$\pm(0.1+2E-13+V_o \times 1E-15)$	200 V
$\pm 10$ nA	500 fA	10 fA	$\pm(0.1+3E-12+V_o \times 1E-14)$	$\pm(0.1+1E-12+V_o \times 1E-14)$	200 V
$\pm 100$ nA	5 pA	100 fA	$\pm(0.05+3E-11+V_o \times 1E-13)$	$\pm(0.05+2E-11+V_o \times 1E-13)$	200 V
$\pm 1$ $\mu$ A	50 pA	1 pA	$\pm(0.05+3E-10+V_o \times 1E-12)$	$\pm(0.05+1E-10+V_o \times 1E-12)$	200 V
$\pm 10$ $\mu$ A	500 pA	10 pA	$\pm(0.05+3E-9+V_o \times 1E-11)$	$\pm(0.04+2E-9+V_o \times 1E-11)$	200 V
$\pm 100$ $\mu$ A	5 nA	100 pA	$\pm(0.035+15E-9+V_o \times 1E-10)$	$\pm(0.03+3E-9+V_o \times 1E-10)$	200 V
$\pm 1$ mA	50 nA	1 nA	$\pm(0.04+15E-8+V_o \times 1E-9)$	$\pm(0.03+6E-8+V_o \times 1E-9)$	200 V
$\pm 10$ mA	500 nA	10 nA	$\pm(0.04+15E-7+V_o \times 1E-8)$	$\pm(0.03+2E-7+V_o \times 1E-8)$	200 V
$\pm 100$ mA	5 $\mu$ A	100 nA	$\pm(0.045+15E-6+V_o \times 1E-7)$	$\pm(0.04+6E-6+V_o \times 1E-7)$	b
$\pm 1$ A	50 $\mu$ A	1 $\mu$ A	$\pm(0.4+3E-4+V_o \times 1E-6)$	$\pm(0.4+15E-5+V_o \times 1E-6)$	

a.  $\pm(\%$  of output/measured value + fixed offset + proportional offset),  $V_o$  is the output voltage in V.

b. 200 V ( $I_o \leq 50$  mA), 100 V ( $50$  mA  $< I_o \leq 125$  mA), 40 V ( $125$  mA  $< I_o \leq 500$  mA), 20 V ( $500$  mA  $< I_o \leq 1$  A),  $I_o$  is the output current.



**Table 5-6 HPSMU voltage range, resolution, and accuracy (high speed ADC)**

Range	Force resolution	Measurement resolution	Force accuracy $\pm(\%+mV)^a$	Measurement accuracy $\pm(\%+mV)^a$	Maximum current
$\pm 2$ V	100 $\mu$ V	100 $\mu$ V	$\pm(0.018 + 0.4)$	$\pm(0.01 + 0.7)$	1 A
$\pm 20$ V	1 mV	1 mV	$\pm(0.018 + 3)$	$\pm(0.01 + 4)$	1 A
$\pm 40$ V	2 mV	2 mV	$\pm(0.018 + 6)$	$\pm(0.015 + 8)$	500 mA
$\pm 100$ V	5 mV	5 mV	$\pm(0.018 + 15)$	$\pm(0.02 + 20)$	125 mA
$\pm 200$ V	10 mV	10 mV	$\pm(0.018 + 30)$	$\pm(0.035 + 40)$	50 mA

a.  $\pm(\%$  of output/measured value + fixed offset)

**Table 5-7 HPSMU current range, resolution, and accuracy (high speed ADC)**

Range	Force resolution	Measurement resolution	Force accuracy $\pm(\%+A+A)^a$	Measurement accuracy $\pm(\%+A+A)^a$	Maximum voltage
$\pm 1$ nA	50 fA	50 fA	$\pm(0.1+3E-13+V_o \times 1E-15)$	$\pm(0.25+3E-13+V_o \times 1E-15)$	200 V
$\pm 10$ nA	500 fA	500 fA	$\pm(0.1+3E-12+V_o \times 1E-14)$	$\pm(0.25+2E-12+V_o \times 1E-14)$	200 V
$\pm 100$ nA	5 pA	5 pA	$\pm(0.05+3E-11+V_o \times 1E-13)$	$\pm(0.1+2E-11+V_o \times 1E-13)$	200 V
$\pm 1$ $\mu$ A	50 pA	50 pA	$\pm(0.05+3E-10+V_o \times 1E-12)$	$\pm(0.1+2E-10+V_o \times 1E-12)$	200 V
$\pm 10$ $\mu$ A	500 pA	500 pA	$\pm(0.05+3E-9+V_o \times 1E-11)$	$\pm(0.05+2E-9+V_o \times 1E-11)$	200 V
$\pm 100$ $\mu$ A	5 nA	5 nA	$\pm(0.035+15E-9+V_o \times 1E-10)$	$\pm(0.05+2E-8+V_o \times 1E-10)$	200 V
$\pm 1$ mA	50 nA	50 nA	$\pm(0.04+15E-8+V_o \times 1E-9)$	$\pm(0.04+2E-7+V_o \times 1E-9)$	200 V
$\pm 10$ mA	500 nA	500 nA	$\pm(0.04+15E-7+V_o \times 1E-8)$	$\pm(0.04+2E-6+V_o \times 1E-8)$	200 V
$\pm 100$ mA	5 $\mu$ A	5 $\mu$ A	$\pm(0.045+15E-6+V_o \times 1E-7)$	$\pm(0.1+2E-5+V_o \times 1E-7)$	b
$\pm 1$ A	50 $\mu$ A	50 $\mu$ A	$\pm(0.4+3E-4+V_o \times 1E-6)$	$\pm(0.5+3E-4+V_o \times 1E-6)$	

a.  $\pm(\%$  of output/measured value + fixed offset + proportional offset),  $V_o$  is the output voltage in V.

b. 200 V ( $I_o \leq 50$  mA), 100 V ( $50$  mA  $< I_o \leq 125$  mA), 40 V ( $125$  mA  $< I_o \leq 500$  mA), 20 V ( $500$  mA  $< I_o \leq 1$  A),  $I_o$  is the output current.

## MPSMU

Medium Power Source/Monitor Unit

- Voltage range, resolution, and accuracy  
See Table 5-10 for high resolution ADC and Table 5-12 for high speed ADC.
- Current range, resolution, and accuracy  
See Table 5-11 for high resolution ADC and Table 5-13 for high speed ADC.
- Power consumption  
See Table 5-8 for voltage source mode and Table 5-9 for current source mode.

**Table 5-8 MPSMU power consumption in voltage source mode**

Voltage range (V)	Power <sup>a</sup> (W)
0.5	$I_c \times 20$
2	$I_c \times 20$
5	$I_c \times 20$
20	$I_c \times 20$
40	$I_c \times 40$
100	$I_c \times 100$

a.  $I_c$  is the current compliance setting.

**Table 5-9 MPSMU power consumption in current source mode**

Voltage compliance <sup>a</sup> (V)	Power <sup>b</sup> (W)
$V_c \leq 20$	$I_o \times 20$
$20 < V_c \leq 40$	$I_o \times 40$
$40 < V_c \leq 100$	$I_o \times 100$

a.  $V_c$  is the voltage compliance setting.

b.  $I_o$  is the output current.

**Table 5-10 Voltage range, resolution, and accuracy (high resolution ADC)**

Range	Force resolution	Measurement resolution	Force accuracy $\pm(\%+mV)^a$	Measurement accuracy $\pm(\%+mV)^a$	Maximum current
$\pm 0.5$ V	25 $\mu$ V	0.5 $\mu$ V	$\pm(0.018 + 0.15)$	$\pm(0.01 + 0.12)$	100 mA
$\pm 2$ V	100 $\mu$ V	2 $\mu$ V	$\pm(0.018 + 0.4)$	$\pm(0.01 + 0.14)$	100 mA
$\pm 5$ V	250 $\mu$ V	5 $\mu$ V	$\pm(0.018 + 0.75)$	$\pm(0.009 + 0.25)$	100 mA
$\pm 20$ V	1 mV	20 $\mu$ V	$\pm(0.018 + 3)$	$\pm(0.009 + 0.9)$	100 mA
$\pm 40$ V	2 mV	40 $\mu$ V	$\pm(0.018 + 6)$	$\pm(0.01 + 1)$	b
$\pm 100$ V	5 mV	100 $\mu$ V	$\pm(0.018 + 15)$	$\pm(0.012 + 2.5)$	

a.  $\pm$ (% of output/measured value + fixed offset)

b. 100 mA ( $V_o \leq 20$  V), 50 mA ( $20$  V  $< V_o \leq 40$  V), 20 mA ( $40$  V  $< V_o$ ),  $V_o$  is the output voltage.

**Table 5-11 Current range, resolution, and accuracy (high resolution ADC)**

Range	Force resolution	Measurement resolution	Force accuracy $\pm(\%+A+A)^a$	Measurement accuracy $\pm(\%+A+A)^a$	Maximum voltage
$\pm 1$ nA	50 fA	10 fA	$\pm(0.1+3E-13+V_o \times 1E-15)$	$\pm(0.1+2E-13+V_o \times 1E-15)$	100 V
$\pm 10$ nA	500 fA	10 fA	$\pm(0.1+3E-12+V_o \times 1E-14)$	$\pm(0.1+1E-12+V_o \times 1E-14)$	100 V
$\pm 100$ nA	5 pA	100 fA	$\pm(0.05+3E-11+V_o \times 1E-13)$	$\pm(0.05+2E-11+V_o \times 1E-13)$	100 V
$\pm 1$ $\mu$ A	50 pA	1 pA	$\pm(0.05+3E-10+V_o \times 1E-12)$	$\pm(0.05+1E-10+V_o \times 1E-12)$	100 V
$\pm 10$ $\mu$ A	500 pA	10 pA	$\pm(0.05+3E-9+V_o \times 1E-11)$	$\pm(0.04+2E-9+V_o \times 1E-11)$	100 V
$\pm 100$ $\mu$ A	5 nA	100 pA	$\pm(0.035+15E-9+V_o \times 1E-10)$	$\pm(0.03+3E-9+V_o \times 1E-10)$	100 V
$\pm 1$ mA	50 nA	1 nA	$\pm(0.04+15E-8+V_o \times 1E-9)$	$\pm(0.03+6E-8+V_o \times 1E-9)$	100 V
$\pm 10$ mA	500 nA	10 nA	$\pm(0.04+15E-7+V_o \times 1E-8)$	$\pm(0.03+2E-7+V_o \times 1E-8)$	100 V
$\pm 100$ mA	5 $\mu$ A	100 nA	$\pm(0.045+15E-6+V_o \times 1E-7)$	$\pm(0.04+6E-6+V_o \times 1E-7)$	b

a.  $\pm$ (% of output/measured value + fixed offset + proportional offset),  $V_o$  is the output voltage in V.

b. 100 V ( $I_o \leq 20$  mA), 40 V ( $20$  mA  $< I_o \leq 50$  mA), 20 V ( $50$  mA  $< I_o$ ),  $I_o$  is the output current.

Specifications and Options  
Specifications

**Table 5-12 Voltage range, resolution, and accuracy (high speed ADC)**

Range	Force resolution	Measurement resolution	Force accuracy $\pm(\%+mV)^a$	Measurement accuracy $\pm(\%+mV)^a$	Maximum current
$\pm 0.5$ V	25 $\mu$ V	25 $\mu$ V	$\pm(0.018 + 0.15)$	$\pm(0.01 + 0.25)$	100 mA
$\pm 2$ V	100 $\mu$ V	100 $\mu$ V	$\pm(0.018 + 0.4)$	$\pm(0.01 + 0.7)$	100 mA
$\pm 5$ V	250 $\mu$ V	250 $\mu$ V	$\pm(0.018 + 0.75)$	$\pm(0.01 + 2)$	100 mA
$\pm 20$ V	1 mV	1 mV	$\pm(0.018 + 3)$	$\pm(0.01 + 4)$	100 mA
$\pm 40$ V	2 mV	2 mV	$\pm(0.018 + 6)$	$\pm(0.015 + 8)$	b
$\pm 100$ V	5 mV	5 mV	$\pm(0.018 + 15)$	$\pm(0.02 + 20)$	

a.  $\pm(\%$  of output/measured value + fixed offset)

b. 100 mA ( $V_o \leq 20$  V), 50 mA ( $20$  V <  $V_o \leq 40$  V), 20 mA ( $40$  V <  $V_o$ ),  $V_o$  is the output voltage.

**Table 5-13 Current range, resolution, and accuracy (high speed ADC)**

Range	Force resolution	Measurement resolution	Force accuracy $\pm(\%+A+A)^a$	Measurement accuracy $\pm(\%+A+A)^a$	Maximum voltage
$\pm 1$ nA	50 fA	50 fA	$\pm(0.1+3E-13+V_o \times 1E-15)$	$\pm(0.25+3E-13+V_o \times 1E-15)$	100 V
$\pm 10$ nA	500 fA	500 fA	$\pm(0.1+3E-12+V_o \times 1E-14)$	$\pm(0.25+2E-12+V_o \times 1E-14)$	100 V
$\pm 100$ nA	5 pA	5 pA	$\pm(0.05+3E-11+V_o \times 1E-13)$	$\pm(0.1+2E-11+V_o \times 1E-13)$	100 V
$\pm 1$ $\mu$ A	50 pA	50 pA	$\pm(0.05+3E-10+V_o \times 1E-12)$	$\pm(0.1+2E-10+V_o \times 1E-12)$	100 V
$\pm 10$ $\mu$ A	500 pA	500 pA	$\pm(0.05+3E-9+V_o \times 1E-11)$	$\pm(0.05+2E-9+V_o \times 1E-11)$	100 V
$\pm 100$ $\mu$ A	5 nA	5 nA	$\pm(0.035+15E-9+V_o \times 1E-10)$	$\pm(0.05+2E-8+V_o \times 1E-10)$	100 V
$\pm 1$ mA	50 nA	50 nA	$\pm(0.04+15E-8+V_o \times 1E-9)$	$\pm(0.04+2E-7+V_o \times 1E-9)$	100 V
$\pm 10$ mA	500 nA	500 nA	$\pm(0.04+15E-7+V_o \times 1E-8)$	$\pm(0.04+2E-6+V_o \times 1E-8)$	100 V
$\pm 100$ mA	5 $\mu$ A	5 $\mu$ A	$\pm(0.045+15E-6+V_o \times 1E-7)$	$\pm(0.1+2E-5+V_o \times 1E-7)$	b

a.  $\pm(\%$  of output/measured value + fixed offset + proportional offset),  $V_o$  is the output voltage in V.

b. 100 V ( $I_o \leq 20$  mA), 40 V ( $20$  mA <  $I_o \leq 50$  mA), 20 V ( $50$  mA <  $I_o$ ),  $I_o$  is the output current.

## HCSMU

### High Current Source/Monitor Unit

- Voltage range, resolution, and accuracy  
See Table 5-16.
- Current range, resolution, and accuracy  
See Table 5-17.
- Power consumption  
See Table 5-14 for voltage source mode and Table 5-15 for current source mode.
- Maximum current sourcing/measurement range

Dual HCSMU (DHCSMU) configuration is available if two HCSMU modules are installed in one B1505A and connected to the 16493S-020 Dual HCSMU Kelvin combination adapter or the 16493S-021 Dual HCSMU combination adapter. This configuration expands the maximum current up to  $\pm 40$  A (pulse),  $\pm 2$  A (DC).

**Table 5-14**

#### HCSMU power consumption in voltage source mode

Voltage range (V)	Power <sup>a</sup> (W)
0.2	$I_c \times 40$
2	$I_c \times 40$
40	$I_c \times 40$

a.  $I_c$  is the current compliance setting. For pulse,  $I_c = \text{duty} \times I_{\text{pulse}}$

**Table 5-15**

#### HCSMU power consumption in current source mode

Voltage compliance <sup>a</sup> (V)	Power <sup>b</sup> (W)
$V_c \leq 0.2$	$I_o \times 40$
$0.2 < V_c \leq 2$	$I_o \times 40$
$2 < V_c \leq 40$	$I_o \times 40$

a.  $V_c$  is the voltage compliance setting.

b.  $I_o$  is the output current. For pulse,  $I_o = \text{duty} \times I_{\text{pulse}}$

Specifications and Options  
Specifications

**Table 5-16 HCSMU voltage range, resolution, and accuracy**

Range	Force resolution	Measurement resolution	Force accuracy $\pm(\%+mV+mV)^a$	Measurement accuracy $\pm(\%+mV+mV)^a$	Maximum current
$\pm 0.2$ V	200 nV	200 nV	$\pm(0.06+0.14+I_o \times 0.05)$	$\pm(0.06+0.14+I_o \times 0.05)$	20 A
$\pm 2$ V	2 $\mu$ V	2 $\mu$ V	$\pm(0.06+0.6+I_o \times 0.5)$	$\pm(0.06+0.6+I_o \times 0.5)$	20 A
$\pm 20$ V	20 $\mu$ V	20 $\mu$ V	$\pm(0.06+3+I_o \times 5)$	$\pm(0.06+3+I_o \times 5)$	20 A
$\pm 40$ V	40 $\mu$ V	40 $\mu$ V	$\pm(0.06+3+I_o \times 10)$	$\pm(0.06+3+I_o \times 10)$	1 A

a.  $\pm(\%$  of output/measured value + fixed offset + proportional offset),  $I_o$  is the output current in A.

**Table 5-17 HCSMU current range, resolution, and accuracy**

Range	Force resolution	Measurement resolution	Force accuracy $\pm(\%+A+A)^a$	Measurement accuracy $\pm(\%+A+A)^a$	Maximum voltage
$\pm 10$ $\mu$ A	10 pA	10 pA	$\pm(0.06+2E-9+V_o \times 1E-10)$	$\pm(0.06+2E-9+V_o \times 1E-10)$	40 V
$\pm 100$ $\mu$ A	100 pA	100 pA	$\pm(0.06+2E-8+V_o \times 1E-9)$	$\pm(0.06+2E-8+V_o \times 1E-9)$	40 V
$\pm 1$ mA	1 nA	1 nA	$\pm(0.06+2E-7+V_o \times 1E-8)$	$\pm(0.06+2E-7+V_o \times 1E-8)$	40 V
$\pm 10$ mA	10 nA	10 nA	$\pm(0.06+2E-6+V_o \times 1E-7)$	$\pm(0.06+2E-6+V_o \times 1E-7)$	40 V
$\pm 100$ mA	100 nA	100 nA	$\pm(0.06+2E-5+V_o \times 1E-6)$	$\pm(0.06+2E-5+V_o \times 1E-6)$	40 V
$\pm 1$ A	1 $\mu$ A	1 $\mu$ A	$\pm(0.4+2E-4+V_o \times 1E-5)$	$\pm(0.4+2E-4+V_o \times 1E-5)$	40 V
$\pm 20$ A <sup>b</sup>	20 $\mu$ A	20 $\mu$ A	$\pm(0.4+2E-3+V_o \times 1E-4)$	$\pm(0.4+2E-3+V_o \times 1E-4)$	20 V

a.  $\pm(\%$  of output/measured value + fixed offset + proportional offset),  $V_o$  is the output voltage in V.

b. Pulse mode only.

## MCSMU

Medium Current Source/Monitor Unit

- Voltage range, resolution, and accuracy  
See Table 5-20.
- Current range, resolution, and accuracy  
See Table 5-21.
- Power consumption  
See Table 5-18 for voltage source mode and Table 5-19 for current source mode.

**Table 5-18**

**MCSMU power consumption in voltage source mode**

Voltage range (V)	Power <sup>a</sup> (W)
0.2	$I_c \times 40$
2	$I_c \times 40$
40	$I_c \times 40$

a.  $I_c$  is the current compliance setting.

**Table 5-19**

**MCSMU power consumption in current source mode**

Voltage compliance <sup>a</sup> (V)	Power <sup>b</sup> (W)
$V_c \leq 0.2$	$I_o \times 40$
$0.2 < V_c \leq 2$	$I_o \times 40$
$2 < V_c \leq 40$	$I_o \times 40$

a.  $V_c$  is the voltage compliance setting.

b.  $I_o$  is the output current.

Specifications and Options  
Specifications

**Table 5-20 MCSMU voltage range, resolution, and accuracy**

Range	Force resolution	Measurement resolution	Force accuracy $\pm(\%+mV)^a$	Measurement accuracy $\pm(\%+mV+mV)^a$	Maximum current
$\pm 0.2$ V	200 nV	200 nV	$\pm(0.06+0.14)$	$\pm(0.06+0.14+I_o \times 0.05)$	1 A
$\pm 2$ V	2 $\mu$ V	2 $\mu$ V	$\pm(0.06+0.6)$	$\pm(0.06+0.6+I_o \times 0.5)$	1 A
$\pm 20$ V	20 $\mu$ V	20 $\mu$ V	$\pm(0.06+3)$	$\pm(0.06+3+I_o \times 5)$	1 A
$\pm 40$ V <sup>b</sup>	40 $\mu$ V	40 $\mu$ V	$\pm(0.06+3)$	$\pm(0.06+3+I_o \times 10)$	1 A

- a.  $\pm$ (% of output/measured value + fixed offset + proportional offset),  $I_o$  is the output current in A.  
b. Maximum output voltage is 30 V.

**Table 5-21 MCSMU current range, resolution, and accuracy**

Range	Force resolution	Measurement resolution	Force accuracy $\pm(\%+A+A)^a$	Measurement accuracy $\pm(\%+A+A)^a$	Maximum voltage
$\pm 10$ $\mu$ A	10 pA	10 pA	$\pm(0.06+2E-9+V_o \times 1E-10)$	$\pm(0.06+2E-9+V_o \times 1E-10)$	30 V
$\pm 100$ $\mu$ A	100 pA	100 pA	$\pm(0.06+2E-8+V_o \times 1E-9)$	$\pm(0.06+2E-8+V_o \times 1E-9)$	30 V
$\pm 1$ mA	1 nA	1 nA	$\pm(0.06+2E-7+V_o \times 1E-8)$	$\pm(0.06+2E-7+V_o \times 1E-8)$	30 V
$\pm 10$ mA	10 nA	10 nA	$\pm(0.06+2E-6+V_o \times 1E-7)$	$\pm(0.06+2E-6+V_o \times 1E-7)$	30 V
$\pm 100$ mA	100 nA	100 nA	$\pm(0.06+2E-5+V_o \times 1E-6)$	$\pm(0.06+2E-5+V_o \times 1E-6)$	30 V
$\pm 1$ A <sup>b</sup>	1 $\mu$ A	1 $\mu$ A	$\pm(0.4+2E-4+V_o \times 1E-5)$	$\pm(0.4+2E-4+V_o \times 1E-5)$	30 V

- a.  $\pm$ (% of output/measured value + fixed offset + proportional offset),  $V_o$  is the output voltage in V.  
b. Pulse mode only.



## HVSMU

High Voltage Source/Monitor Unit

- Voltage range, resolution, and accuracy  
See Table 5-24.
- Current range, resolution, and accuracy  
See Table 5-25.
- Power consumption  
See Table 5-22 for voltage source mode and Table 5-23 for current source mode.

**Table 5-22**

**HVSMU power consumption in voltage source mode**

Current compliance <sup>a</sup> (A)	Power (W)
$I_c \leq 0.004$	$I_c \times 3000$
$0.004 < I_c \leq 0.008$	$I_c \times 1500$

a.  $I_c$  is the current compliance setting.

**Table 5-23**

**HVSMU power consumption in current source mode**

Voltage compliance <sup>a</sup> (V)	Power <sup>b</sup> (W)
$V_c \leq 1500$	$I_o \times 1500$
$1500 < V_c \leq 3000$	$I_o \times 3000$

a.  $V_c$  is the voltage compliance setting.

b.  $I_o$  is the output current.

Specifications and Options  
Specifications

**Table 5-24 HVSMU voltage range, resolution, and accuracy**

Range	Force resolution	Measurement resolution	Force accuracy $\pm(\%+mV)^a$	Measurement accuracy $\pm(\%+mV)^a$	Maximum current
$\pm 200$ V	200 $\mu$ V	200 $\mu$ V	$\pm(0.03+40)$	$\pm(0.03+40)$	8 mA
$\pm 500$ V	500 $\mu$ V	500 $\mu$ V	$\pm(0.03+100)$	$\pm(0.03+100)$	8 mA
$\pm 1500$ V	1.5 mV	1.5 mV	$\pm(0.03+300)$	$\pm(0.03+300)$	8 mA
$\pm 3000$ V	3 mV	3 mV	$\pm(0.03+600)$	$\pm(0.03+600)$	4 mA

a.  $\pm(\%$  of output/measured value + fixed offset)

**Table 5-25 HVSMU current range, resolution, and accuracy**

Range	Force and measurement resolution	Force accuracy $\pm(\%+A+A)^a$	Measurement accuracy $\pm(\%+A+A)^a$	Maximum voltage	Minimum setting current <sup>b</sup>
$\pm 1$ nA	10 fA	$\pm(0.1+6E-13+V_o \times 1E-15)$	$\pm(0.1+6E-13+V_o \times 1E-15)$	3000 V	1 pA
$\pm 10$ nA	100 fA	$\pm(0.1+25E-13+V_o \times 1E-15)$	$\pm(0.1+25E-13+V_o \times 1E-15)$	3000 V	1 pA
$\pm 100$ nA	100 fA	$\pm(0.05+25E-12+V_o \times 1E-13)$	$\pm(0.05+25E-12+V_o \times 1E-13)$	3000 V	100 pA
$\pm 1$ $\mu$ A	1 pA	$\pm(0.05+1E-10+V_o \times 1E-13)$	$\pm(0.05+1E-10+V_o \times 1E-13)$	3000 V	100 pA
$\pm 10$ $\mu$ A	10 pA	$\pm(0.04+2E-9+V_o \times 1E-11)$	$\pm(0.04+2E-9+V_o \times 1E-11)$	3000 V	10 nA
$\pm 100$ $\mu$ A	100 pA	$\pm(0.03+3E-9+V_o \times 1E-11)$	$\pm(0.03+3E-9+V_o \times 1E-11)$	3000 V	10 nA
$\pm 1$ mA	1 nA	$\pm(0.03+6E-8+V_o \times 1E-10)$	$\pm(0.03+6E-8+V_o \times 1E-10)$	3000 V	100 nA
$\pm 10$ mA	10 nA	$\pm(0.03+2E-7+V_o \times 1E-9)$	$\pm(0.03+2E-7+V_o \times 1E-9)$	1500 V	1 $\mu$ A

a.  $\pm(\%$  of output/measured value + fixed offset + proportional offset),  $V_o$  is the output voltage in V.

b. Output current needs to be set more than current shown in the table.

## SMU Common Specifications

- SMU source measurement mode
  - For HPSMU and MPSMU: VFIM, IFVM
  - For HCSMU, MCSMU, and HVSMU: VFIM, VFVM, IFVM, IFIM
- Output terminal/connection
  - For HPSMU and MPSMU: Dual triaxial connector, Kelvin (remote sensing)
  - For HCSMU: Triaxial connector (for Sense) and coaxial connector (for Force), Kelvin (remote sensing)
  - For MCSMU: Dual triaxial connector, Kelvin (remote sensing)
  - For HVSMU: HV (high voltage) triaxial connector, non-Kelvin
- Voltage/current compliance (limiting)

The SMU can limit output voltage or current to prevent damaging the device under test.

  - Voltage compliance:
    - 0 V to  $\pm 200$  V (HPSMU)
    - 0 V to  $\pm 100$  V (MPSMU)
    - 0 V to  $\pm 40$  V (HCSMU)
    - 0 V to  $\pm 30$  V (MCSMU)
    - 0 V to  $\pm 3000$  V (HVSMU)
  - Current compliance:
    - $\pm 1$  pA to  $\pm 1$  A (HPSMU)
    - $\pm 1$  pA to  $\pm 100$  mA (MPSMU)
    - $\pm 10$  nA to  $\pm 20$  A (HCSMU)
    - $\pm 10$  nA to  $\pm 1$  A (MCSMU)
    - $\pm 1$  pA to  $\pm 8$  mA (HVSMU)
  - Compliance accuracy:

Same as the current or voltage setting accuracy.
- Power compliance
  - For HPSMU: 0.001 to 20 W, 0.001 W resolution

## Specifications and Options

### Specifications

For MPSMU: 0.001 to 2 W, 0.001 W resolution

For HCSMU: 0.001 to 40 W (DC), 0.001 to 400 W (pulse), 0.001 W resolution

For MCSMU: 0.001 to 3 W (DC), 0.001 to 30 W (pulse), 0.001 W resolution

For HVSMU: No power compliance

- SMU pulse measurement

For HPSMU and MPSMU:

- Pulse width: 500  $\mu$ s to 2 s, 100  $\mu$ s resolution
- Pulse period: 5 ms to 5 s, 100  $\mu$ s resolution  
Period  $\geq A + 2$  ms (when  $A \leq 100$  ms), where  $A = \text{delay} + \text{width}$   
Period  $\geq A + 10$  ms (when  $A > 100$  ms), where  $A = \text{delay} + \text{width}$
- Pulse delay: 0 s

For HCSMU:

- Pulse width: 50  $\mu$ s to 1 ms (20 A range), 50  $\mu$ s to 2 s (10  $\mu$ A to 1 A ranges), 2  $\mu$ s resolution
- Pulse period: 5 ms to 5 s, 100  $\mu$ s resolution
- Pulse duty:  
For 20 A range:  $\leq 1\%$   
For 10  $\mu$ A to 1 A ranges:  
Period  $\geq A + 2$  ms (when  $A \leq 100$  ms), where  $A = \text{delay} + \text{width}$   
Period  $\geq A + 10$  ms (when  $A > 100$  ms), where  $A = \text{delay} + \text{width}$
- Pulse delay: 0 s to (period-width) s, 2  $\mu$ s resolution

For MCSMU:

- Pulse width: 10  $\mu$ s to 100 ms (1 A range), 10  $\mu$ s to 2 s (10  $\mu$ A to 100 mA ranges), 2  $\mu$ s resolution
- Pulse period: 5 ms to 5 s, 100  $\mu$ s resolution
- Pulse duty:  
For 1 A range:  $\leq 5\%$   
For 10  $\mu$ A to 100 mA ranges:  
Period  $\geq A + 2$  ms (when  $A \leq 100$  ms), where  $A = \text{delay} + \text{width}$

Period  $\geq A + 10$  ms (when  $A > 100$  ms), where  $A = \text{delay} + \text{width}$

- Pulse delay: 0 s to (period–width) s, 2  $\mu\text{s}$  resolution

For HVSMU:

- Pulse width: 500  $\mu\text{s}$  to 2 s, 2  $\mu\text{s}$  resolution
- Pulse period: 5 ms to 5 s, 100  $\mu\text{s}$  resolution

Period  $\geq A + 2$  ms (when  $A \leq 100$  ms), where  $A = \text{delay} + \text{width}$

Period  $\geq A + 10$  ms (when  $A > 100$  ms), where  $A = \text{delay} + \text{width}$

- Pulse delay: 0 s to (period–width) s, 2  $\mu\text{s}$  resolution
- Pulse output limitation:

When the pulse voltage is more than 1500 volts, the peak and base of pulse should be same polarities.

- Pulse measurement delay:

2  $\mu\text{s}$  to (period–pulse measurement time–0.002) s, 2  $\mu\text{s}$  resolution

- About measurement accuracy

- RF electromagnetic field and SMU measurement accuracy

Voltage and current measurement accuracy may be affected by RF electromagnetic field of strength over 3 V/m at frequencies 80 MHz to 1 GHz and 1.4 GHz to 2.0 GHz, and 1 V/m at frequencies 2.0 GHz to 2.7 GHz. The extent of this effect depends upon how the instrument is positioned and shielded.

- Induced RF field noise and SMU measurement accuracy

Voltage and current measurement accuracy can be affected by induced RF field noise strengths greater than 3V<sub>rms</sub> in the frequency range of 150 kHz to 80 MHz. The extent of this effect depends upon how the instrument is positioned and shielded.

## SMU Supplemental Characteristics

- Current compliance setting accuracy (for opposite polarity)  
For HPSMU and MPSMU:
  - For 1 pA to 10 nA ranges:  $\pm$  (setting accuracy + 12 % of range)
  - For 100 nA to 1 A ranges:  $\pm$  (setting accuracy + 2.5 % of range)For HCSMU and MCSMU:
  - For 10  $\mu$ A to 1 A ranges:  $\pm$  (setting accuracy + 2.5 % of range)
  - For 20 A range (HCSMU):  $\pm$  (setting accuracy + 0.6 % of range)For HVSMU:
  - For 1 nA to 10 nA ranges:  $\pm$  (setting accuracy + 12 % of range)
  - For 100 nA to 10 mA ranges:  $\pm$  (setting accuracy + 2.5 % of range)
- SMU pulse setting accuracy (fixed measurement range)  
For HPSMU and MPSMU:
  - Width:  $\pm$ (0.5 % + 50  $\mu$ s)
  - Period:  $\pm$ (0.5 % + 100  $\mu$ s)For HCSMU and MCSMU:
  - Width:  $\pm$ (0.1 % + 2  $\mu$ s)
  - Period:  $\pm$ (0.1 % + 100  $\mu$ s)For HVSMU:
  - Width:  $\pm$ (0.1 % + 2  $\mu$ s)
  - Period:  $\pm$ (0.5 % + 100  $\mu$ s)
- Minimum pulse measurement time  
16  $\mu$ s (HPSMU and MPSMU)  
2  $\mu$ s (HCSMU and MCSMU)  
6  $\mu$ s (HVSMU)
- Voltage source output resistance (Force line, non-Kelvin connection)  
0.2  $\Omega$  (HPSMU)

0.3  $\Omega$  (MPSMU)

3  $\Omega$  (HVSMU, at 10 mA range)

- Voltage measurement input resistance
  - $\geq 10^{13} \Omega$  (HPSMU and MPSMU)
  - $\geq 10^9 \Omega$  (HCSMU and MCSMU,  $\leq 1$  A), 80 k $\Omega$  (HCSMU, 20 A)
  - $\geq 10^{12} \Omega$  (HVSMU)
- Current source output resistance
  - $\geq 10^{13} \Omega$  (HPSMU and MPSMU)
  - $\geq 10^9 \Omega$  (HCSMU and MCSMU,  $\leq 1$  A), 80 k $\Omega$  (HCSMU, 20 A)
  - $\geq 10^{12} \Omega$  (HVSMU, at 10 nA range)
- Maximum allowable cable resistance (Kelvin connection)
  - For HPSMU and MPSMU:
    - Sense: 10  $\Omega$
    - Force: 10  $\Omega$  ( $\leq 100$  mA), 1.5  $\Omega$  ( $> 100$  mA)
  - For HCSMU:
    - Sense: 10  $\Omega$
    - Force: 0.6  $\Omega$  (between High and Low)
  - For MCSMU:
    - Sense: 10  $\Omega$
    - Force: 1  $\Omega$  (between High and Low)
- Maximum allowable inductance
  - For HCSMU and MCSMU:
    - Force: 3  $\mu$ H (with Low Force as shield)
- Maximum load capacitance
  - For HPSMU and MPSMU:
    - For 1 pA to 10 nA ranges: 1000 pF
    - For 100 nA to 10 mA ranges: 10 nF
    - For 100 mA and 1 A ranges: 100  $\mu$ F

## Specifications and Options

### Specifications

For HCSMU:

- For 10  $\mu$ A to 10 mA ranges: 12 nF
- For 100 mA to 20 A ranges: 100  $\mu$ F

For MCSMU:

- For 10  $\mu$ A to 10 mA ranges: 12 nF
- For 100 mA to 1 A ranges: 100  $\mu$ F

For HVSMU:

- For 1 nA to 1  $\mu$ A ranges: 1000 pF
- For 10  $\mu$ A to 10 mA ranges: 10 nF
- Maximum guard capacitance  
900 pF (HPSMU and MPSMU)  
1500 pF (HVSMU)
- Maximum shield capacitance  
5000 pF (HPSMU, MPSMU, and HVSMU)
- Noise characteristics  
For HPSMU (filter ON), MPSMU (filter ON), and HVSMU:
  - Voltage source: 0.01 % of V range (rms.)
  - Current source: 0.1 % of I range (rms.)

For HCSMU:

- Voltage/current source: 100 mV (0 to peak) max

For MCSMU:

- Voltage/current source: 200 mV (0 to peak) max
- Overshoot (filter ON)

For HPSMU and MPSMU:

- Voltage source: 0.03 % of V range
- Current source: 1 % of I range

For HCSMU and MCSMU:



- Voltage/current source: 10 % of range

For HVSMU:

- Voltage source: 1 V (resistive load)
- Current source: 1 % of I range

- Range switching transient noise

For HPSMU and MPSMU: (filter ON)

- Voltage ranging: 250 mV
- Current ranging: 70 mV

For HCSMU and MCSMU, 10  $\mu$ A to 1 A ranges:

- Voltage ranging: 250 mV
- Current ranging: 70 mV

For HCSMU, 20 A range:

- Voltage ranging: 5 V max

For HVSMU:

- Voltage ranging: 300 mV
- Current ranging: 300 mV

- Maximum guard offset voltage

$\pm 1$  mV (HPSMU)

$\pm 3$  mV (MPSMU)

$\pm 5$  mV (HVSMU)

- Maximum slew rate

0.2 V/ $\mu$ s (HPSMU and MPSMU)

1 V/ $\mu$ s (HCSMU and MCSMU)

0.4 V/ $\mu$ s (HVSMU)

- Output settling time

For HVSMU: 500  $\mu$ s to reach  $\pm 0.01$  % of setting value

Conditions: 100 V step, 8 mA compliance, 1000 pF load capacitance

## MFCMU

### Multi Frequency Capacitance Measurement Unit

- Measurement functions
  - Measurement parameters: Cp-G, Cp-D, Cp-Q, Cp-Rp, Cs-Rs, Cs-D, Cs-Q, Lp-G, Lp-D, Lp-Q, Lp-Rp, Ls-Rs, Ls-D, Ls-Q, R-X, G-B, Z- $\theta$ , Y- $\theta$
  - Ranging: Auto or fixed
  - Measurement terminal: Four-terminal pair configuration, four BNC (female) connectors
  - Cable length: 1.5 m or 3 m, automatic identification of accessories
- Test signal
  - Frequency  
Range: 1 kHz to 5 MHz  
Resolution: 1 mHz (minimum)  
Accuracy:  $\pm 0.008\%$
  - Output signal level  
Range: 10 mVrms to 250 mVrms  
Resolution: 1 mVrms  
Accuracy:  
 $\pm (10.0\% + 1 \text{ mVrms})$  at the measurement port of the MFCMU  
 $\pm (15.0\% + 1 \text{ mVrms})$  at the measurement port of the MFCMU cable (1.5 m or 3.0 m)
  - Output impedance: 50  $\Omega$ , typical
  - Signal level monitor  
Range: 10 mVrms to 250 mVrms  
Accuracy (open load):  
 $\pm (10.0\% \text{ of reading} + 1 \text{ mVrms})$  at the measurement port of the MFCMU  
 $\pm (15.0\% \text{ of reading} + 1 \text{ mVrms})$  at the measurement port of the MFCMU cable (1.5 m or 3.0 m)

- DC bias function

- DC bias

Range: 0 to  $\pm 25$  V

Resolution: 1 mV

Accuracy:  $\pm (0.5 \% + 5.0 \text{ mV})$  at the measurement port of the MFCMU or the MFCMU cable (1.5 m or 3.0 m)

- Maximum DC bias current, supplemental characteristics

Impedance range ( $\Omega$ )	Maximum DC bias current (A)
50	$10 \times 10^{-3}$
100	$10 \times 10^{-3}$
300	$10 \times 10^{-3}$
$1 \times 10^3$	$1 \times 10^{-3}$
$3 \times 10^3$	$1 \times 10^{-3}$
$10 \times 10^3$	$100 \times 10^{-6}$
$30 \times 10^3$	$100 \times 10^{-6}$
$100 \times 10^3$	$10 \times 10^{-6}$
$300 \times 10^3$	$10 \times 10^{-6}$

- Output impedance: 50  $\Omega$ , typical

- DC bias monitor

Range: 0 to  $\pm 25$  V

Accuracy (open load):  $\pm (0.2 \% \text{ of reading} + 10 \text{ mV})$  at the measurement port of the MFCMU or the MFCMU cable (1.5 m or 3.0 m)

- Sweep characteristics

- Available sweep parameters: DC bias voltage, oscillator level, frequency
    - Sweep type: linear, log
    - Sweep mode: single, double
    - Sweep direction: up, down
    - Number of measurement points: maximum 1001

## Specifications and Options

### Specifications

- Measurement accuracy

Measurement accuracy at the measurement port of the MFCMU or the MFCMU cable (1.5 m or 3.0 m)

- $|Z|$  accuracy:  $\pm E$  (%)
- $\theta$  accuracy:  $\pm E/100$  (radian)
- C accuracy:  
 $\pm E$  (%) at  $Dx \leq 0.1$   
 $\pm E \times (1 + Dx^2)^{1/2}$  (%) at  $Dx > 0.1$
- D accuracy:  
 $\pm E/100$  at  $Dx \leq 0.1$   
 $\pm E \times (1 + Dx)/100$  at  $Dx > 0.1$
- G accuracy:  
 $\pm E/Dx$  (%) at  $Dx \leq 0.1$   
 $\pm E \times (1 + Dx^2)^{1/2}/Dx$  (%) at  $Dx > 0.1$

where,

$Zx$ : Impedance measurement value ( $\Omega$ )

$Dx$ : Measurement value of D

$$E = E_P' + (Z_S' / |Zx| + Y_O' \times |Zx|) \times 100 \text{ (%)}$$

$$E_P' = E_{PL} + E_{POSC} + E_P \text{ (%)}$$

$$Y_O' = Y_{OL} + Y_{OSC} + Y_O \text{ (S)}$$

$$Z_S' = Z_{SL} + Z_{OSC} + Z_S \text{ (\Omega)}$$

For the parameter value, see Table 5-26 to Table 5-28. Calculation example of the measurement accuracy is also shown in Table 5-29.

Specification conditions:

- Temperature:  $23 \text{ }^\circ\text{C} \pm 5 \text{ }^\circ\text{C}$
- Integration time: 1 PLC or 16 PLC

**Table 5-26** Parameters  $E_{POSC}$ ,  $Z_{OSC}$

Oscillator level $V_{osc}$ mV	$E_{POSC}$ %	$Z_{OSC}$ m $\Omega$
$125 < V_{osc} \leq 250$	$0.03 \times (250/V_{osc} - 1)$	$5 \times (250/V_{osc} - 1)$
$64 < V_{osc} \leq 125$	$0.03 \times (125/V_{osc} - 1)$	$5 \times (125/V_{osc} - 1)$
$32 < V_{osc} \leq 64$	$0.03 \times (64/V_{osc} - 1)$	$5 \times (64/V_{osc} - 1)$
$V_{osc} \leq 32$	$0.03 \times (32/V_{osc} - 1)$	$5 \times (64/V_{osc} - 1)$

$V_{osc}$  is oscillator level in mV.

**Table 5-27** Parameters  $E_{PL}$ ,  $Y_{OL}$ ,  $Z_{SL}$

Cable length	$E_{PL}$ %	$Y_{OL}$ nS	$Z_{SL}$ m $\Omega$
1.5 m	$0.02 + 3 \times f / 100$	$750 \times f / 100$	5.0
3 m	$0.02 + 5 \times f / 100$	$1500 \times f / 100$	5.0

f is frequency in MHz. If measurement cable is extended, open compensation, short compensation, and load compensation must be performed.

**Table 5-28** Parameters  $Y_{OSC}$ ,  $Y_O$ ,  $E_P$ ,  $Z_S$

Frequency f Hz	$Y_{OSC}$ nS	$Y_O$ nS	$E_P$ %	$Z_S$ m $\Omega$
$1k \leq f \leq 200k$	$1 \times (125/V_{osc} - 0.5)$	1.5	0.095	5.0
$200k < f \leq 1M$	$2 \times (125/V_{osc} - 0.5)$	3.0	0.095	5.0
$1M < f \leq 2M$	$2 \times (125/V_{osc} - 0.5)$	3.0	0.28	5.0
$2M < f$	$20 \times (125/V_{osc} - 0.5)$	30.0	0.28	5.0

$V_{osc}$  is oscillator level in mV.

**Table 5-29 Example of calculated C/G measurement accuracy**

Frequency	Measured Capacitance	C Accuracy <sup>a</sup>	Measured Conductance	G Accuracy <sup>a</sup>
5 MHz	1 pF	± 0.61 %	≤ 3 μS	± 192 nS
	10 pF	± 0.32 %	≤ 31 μS	± 990 nS
	100 pF	± 0.29 %	≤ 314 μS	± 9 μS
	1 nF	± 0.32 %	≤ 3 mS	± 99 μS
1 MHz	1 pF	± 0.26 %	≤ 628 nS	± 16 nS
	10 pF	± 0.11 %	≤ 6 μS	± 71 nS
	100 pF	± 0.10 %	≤ 63 μS	± 624 nS
	1 nF	± 0.10 %	≤ 628 μS	± 7 μS
100 kHz	10 pF	± 0.18 %	≤ 628 nS	± 11 nS
	100 pF	± 0.11 %	≤ 6 μS	± 66 nS
	1 nF	± 0.10 %	≤ 63 μS	± 619 nS
	10 nF	± 0.10 %	≤ 628 μS	± 7 μS
10 kHz	100 pF	± 0.18 %	≤ 628 nS	± 11 nS
	1 nF	± 0.11 %	≤ 6 μS	± 66 nS
	10 nF	± 0.10 %	≤ 63 μS	± 619 nS
	100 nF	± 0.10 %	≤ 628 μS	± 7 μS
1 kHz	100 pF	± 0.92 %	≤ 63 nS	± 6 nS
	1 nF	± 0.18 %	≤ 628 nS	± 11 nS
	10 nF	± 0.11 %	≤ 6 μS	± 66 nS
	100 nF	± 0.10 %	≤ 63 μS	± 619 nS

a. The calculation examples are specified under the conditions  $D_x = 0.1$ , 1 PLC integration time, 30 mVrms test signal level, and at four-terminal pair port of the MFCMU.

## UHC (Ultra High Current) Expander / Fixture (N1265A)

- Functions
  - Fixture capability
  - Current expander capability
 

Expands the B1505A's current capability up to 1500 A. The N1265A configures the Ultra High Current Unit (UHCU) by using two MCSMU/HCSMU installed in the B1505A.
  - Selector capability
 

Switches the measurement resource to be connected to the selector output. The measurement resource will be the UHCU, the HVSMU/HVMCU, or the HPSMU/MPSMU.
- Channels
 

See Table 5-30.

**Table 5-30 N1265A Input-Output Channels**

Channel	Quantity	Input	Output
SMU	6 <sup>a</sup>	Triaxial <sup>b</sup>	Banana
UHV	1	UHV coaxial (High), SHV (Low)	UHV coaxial (High), SHV (Low)
Bias Tee	1	SHV × 2 (High, Low)	SHV × 2 (High, Low)
Gate	1	Triaxial × 2 (Force, Sense)	Banana × 2 (High, Low)
Selector	1 <sup>c</sup>	HV triaxial × 1 Triaxial × 2 (Force, Sense)	Banana × 6 (High Force/Sense, Low Force/Sense, Guard, Chassis)

- a. Maximum 6 non-Kelvin connections. Maximum 3 Kelvin connections can be made.
- b. Either the HCSMU or the Dual HCSMU can be connected to the SMU port 3.
- c. The UHCU or any measurement resource connected to one of the Selector Input terminals can be connected to the Selector Output terminal.

## Specifications and Options

### Specifications

- Maximum output for selector channel
  - HVSMU output:  $\pm 3000\text{ V} / 4\text{ mA}$ ,  $\pm 1500\text{ V} / 8\text{ mA}$
  - HVMCU output:  $\pm 2200\text{ V} / 1.1\text{ A}$ ,  $\pm 1500\text{ V} / 2.5\text{ A}$
  - HPSMU output:  $\pm 200\text{ V} / 1\text{ A}$
  - MPSMU output:  $\pm 100\text{ V} / 100\text{ mA}$
  - UHCU output:  $\pm 60\text{ V} / 1500\text{ A}$  or  $500\text{ A}$Refer to each module specification.
- Gate control channel
  - Non-Kelvin connection
  - Maximum Voltage:  $\pm 40\text{ V}$
  - Maximum Current:  $\pm 1\text{ A}$  (pulse),  $100\text{ mA}$  (DC)
  - Output Resistance:  $0\ \Omega / 10\ \Omega / 100\ \Omega / 1000\ \Omega$  (nominal value)
- UHCU
  - Output peak power
    - $7.5\text{ kW}$  ( $\pm 500\text{ A}$  range)
    - $22.5\text{ kW}$  ( $\pm 1500\text{ A}$  range)
  - Voltage range, resolution, and accuracy
    - See Table 5-31.
  - Current range, resolution, and accuracy
    - See Table 5-32.
  - Pulse width, resolution, and period
    - See Table 5-33.
- Other functionality
  - Filter
    - Filter can be used for UHC output in current mode at  $500\text{ A}$  range.
  - Thermocouple input: 2ea.
    - 2 K-type thermocouple inputs
    - Temperature range:  $-50\text{ }^\circ\text{C}$  to  $+300\text{ }^\circ\text{C}$



- Other terminals/indicators
  - Digital I/O input: 1ea.
  - Digital I/O output: 1 ea.
  - Power indicator: 1ea.
  - High voltage indicator: 1ea.
  - Selector indicator: 1ea.
  - Interlock terminal: 1ea.
  - Earth terminal: 1ea.
  - Wrist strap terminal: 1ea.

**Table 5-31 UHCU voltage range, resolution, and accuracy**

Range	Setting resolution	Measurement resolution	Setting and measurement accuracy $\pm(\%+mV)^{a b c}$
$\pm 60 V$	200 $\mu V$	100 $\mu V$	$\pm(0.2+10)$

- a.  $\pm(\%$  of output/measured value + fixed offset)
- b. Setting accuracy is defined at open load.
- c. Accuracy is defined with the pulse width 1 ms at 500 A range or 500  $\mu s$  at 1500 A range.

**Table 5-32 UHCU current range, resolution, and accuracy**

Range	Setting resolution	Measurement resolution	Setting and measurement accuracy $\pm(\%+A+A)^{a b c d}$
$\pm 500 A$	1 mA	500 $\mu A$	$\pm(0.6+0.3+0.01 \times V_o)$
$\pm 1500 A$	4 mA	2 mA	$\pm(0.8+0.9+0.02 \times V_o)$

- a.  $\pm(\%$  of output/measured value + fixed offset + proportional offset),  $V_o$  is the output voltage in V.
- b. Maximum voltage compliance in current pulse mode is 63 V.
- c. Accuracy is defined with the pulse width 1 ms at 500 A range or 500  $\mu s$  at 1500 A range.
- d. Over 400 A at 500 A range and over 1200 A at 1500 A range are supplemental characteristics.

Table 5-33

**UHCU pulse width, resolution, and period**

Range	Voltage pulse width	Current pulse width	Resolution	Pulse period <sup>a</sup>
500 A	10 $\mu$ s to 1 ms	10 $\mu$ s to 1 ms	2 $\mu$ s	Duty $\leq$ 0.4 %
1500 A	10 $\mu$ s to 500 $\mu$ s	10 $\mu$ s to 500 $\mu$ s	2 $\mu$ s	Duty $\leq$ 0.1 %

a. At continuous maximum current output, the output current may be reduced due to insufficient charging time.

### Supplemental Characteristics

- UHCU output resistance (nominal value)
  - 120 m $\Omega$  (500 A output range)
  - 40 m $\Omega$  (1500 A output range)
- Leakage
  - Selector channel:
    - High Sense: less than 1 nA, when HVSMU/HVMCU is connected
    - High Force: less than 10 nA, when HPSMU/MPSMU is connected
  - UHVU channel: less than 1 nA
  - SMU channel: less than 1 nA
- Thermocouple reading accuracy
  - $\pm$  2  $^{\circ}$ C (0  $^{\circ}$ C  $\leq$  T < +100  $^{\circ}$ C)
  - $\pm$  5  $^{\circ}$ C (+100  $^{\circ}$ C  $\leq$  T)
  - $\pm$  5  $^{\circ}$ C (T < 0  $^{\circ}$ C)

## HVSMU Current Expander (N1266A)

- Functions
  - Current expander capability

Expands HVSMU current up to 2.5 A. The N1266A configures the High Voltage Medium Current Unit (HVMCU) by using the HVSMU and two MCSMU/HCSMU installed in the B1505A.
  - Selector capability

Switches the measurement resource to be connected to the selector output. The measurement resource will be the HVMCU, the HVSMU, or the HVSMU through a 100 k $\Omega$  series resistor.
- Output terminals

High: HV triaxial  
Low: BNC
- Maximum output

HVSMU:  $\pm 3000$  V / 4 mA,  $\pm 1500$  V / 8 mA  
HVMCU: Refer to HVMCU specification.
- HVMCU
  - Output peak power

600 W ( $\pm 2200$  V range)  
900 W ( $\pm 1500$  V range)
  - Voltage range, resolution, and accuracy

See Table 5-34.
  - Current range, resolution, and accuracy

See Table 5-35.
  - Pulse width and resolution

See Table 5-36.

Specifications and Options  
Specifications

- Other terminals/indicators  
Digital I/O input: 1ea.  
Digital I/O output: 1 ea.  
Power indicator: 1ea.  
Selector indicator: 1ea.

**Table 5-34 HVMCU voltage range, resolution, and accuracy**

Range	Setting resolution	Measurement resolution	Setting accuracy $\pm(\%+V)^{a b c}$	Measurement accuracy $\pm(\%+V)^{a b}$
$\pm 2200$ V	3 mV	3 mV	$\pm(5+20)$	$\pm(0.8+1.8)$
$\pm 1500$ V	1.5 mV	3 mV	$\pm(5+20)$	$\pm(0.8+1.8)$

- a.  $\pm(\%$  of output/measured value + fixed offset)  
b. Setting accuracy is defined at open load.  
c. Accuracy is defined with the pulse width 100  $\mu$ s at 1.1 A range and 2.5 A range, or 1 ms at 100 mA range.

**Table 5-35 HVMCU current range, resolution, and accuracy**

Range	Measurement resolution	Measurement accuracy $\pm(\%+A+A)^{a b}$
$\pm 2.5$ A	4 $\mu$ A	$\pm(0.9+4E-3+V_o \times 3E-7)$
$\pm 1.1$ A	4 $\mu$ A	$\pm(0.9+4E-3+V_o \times 3E-7)$
$\pm 110$ mA	200 nA	$\pm(0.9+2E-4+V_o \times 3E-7)$

- a.  $\pm(\%$  of measured value + fixed offset + proportional offset),  $V_o$  is the output voltage in V.  
b. Supplemental characteristics over 1.1 A. Applicable condition: 20 averaging samples.

**Table 5-36**

**HVMCU pulse width and resolution**

Range	Pulse width	Resolution
1500 V / 2.5 A	10 $\mu$ s to 100 $\mu$ s	2 $\mu$ s
2200 V / 1.1 A	10 $\mu$ s to 100 $\mu$ s	2 $\mu$ s
2200 V / 110 mA	10 $\mu$ s to 1 ms	2 $\mu$ s

### Supplemental Characteristics

- HVMCU charged capacitance: 0.22  $\mu$ F
- Output resistance (nominal value)
  - 2000  $\Omega$  (1500 V / 2.5 A output range)
  - 20000  $\Omega$  (2200 V / 1.1 A output range)
  - 600  $\Omega$  (2200 V / 110 mA output range)
- Leakage
  - Selector output:
    - HVSMU: less than 80 pA

## UHV (Ultra High Voltage) Expander (N1268A)

- Functions

Expands the B1505A's voltage capability up to 10 kV. The N1268A configures the Ultra High Voltage Unit (UHVU) by using two MCSMU or a couple of MCSMU and HCSMU installed in the B1505A.

- UHVU

- Voltage range, resolution, and accuracy

See Table 5-37.

- Current range, resolution, and accuracy

See Table 5-38.

- Pulse width, resolution, and period

See Table 5-39.

- Output terminals

High: UHV coaxial

Low: SHV

- Other terminals/indicators

Digital I/O terminal: 1ea.

Power indicator: 1ea.

High voltage indicator: 1ea.

Interlock input: 1ea.

Interlock output: 1ea.

Earth terminal: 1ea.

Table 5-37

UHVU voltage range, resolution, and accuracy

Range	Setting and measurement resolution	Setting and measurement accuracy $\pm(\%+V)^a$ b
$\pm 10$ kV	10 mV	$\pm(1.2+42)$

a.  $\pm(\%$  of output/measured value + fixed offset)

b. Setting accuracy is defined at open load.

**Table 5-38 UHVU current range, resolution, and accuracy**

Range	Measurement resolution	Measurement accuracy $\pm(\%+A+A)^a$
$\pm 10 \mu\text{A}$	10 pA	$\pm(0.06+2\text{E}-9+1\text{E}-9)$
$\pm 100 \mu\text{A}$	100 pA	$\pm(0.06+2\text{E}-8+1\text{E}-9)$
$\pm 1 \text{mA}$	1 nA	$\pm(0.06+2\text{E}-7+1\text{E}-9)$
$\pm 10 \text{mA}$	10 nA	$\pm(0.06+2\text{E}-6+1\text{E}-9)$
$\pm 100 \text{mA}^b$	100 nA	$\pm(0.06+20\text{E}-6+1\text{E}-9)$

- a.  $\pm$ (% of measured value + fixed offset)
- b. Pulsed mode only (maximum pulse width is 1 ms). The maximum current is 20 mA.

**Table 5-39 UHVU pulse width, resolution, and period**

Range	Pulse width	Resolution	Pulse period
100 mA	100 $\mu\text{s}$ to 1 ms	2 $\mu\text{s}$	10 ms to 5 s
$\leq 10 \text{mA}$	100 $\mu\text{s}$ to 2 s	2 $\mu\text{s}$	10 ms to 5 s

### Supplemental Characteristics

- Output resistance (nominal value)
  - 10000  $\Omega$  (High)
  - 1000  $\Omega$  (Low)
- Other AC characteristics
  - Slew rate: 100 V/ $\mu\text{s}$  (with 1 m cable)
  - Overshoot:  $\pm 1 \%$  of setting voltage
  - Ripple: 3 Vp-p
  - Maximum load capacitance: 5 nF
  - Maximum load inductance: 5  $\mu\text{H}$

## Accessories

### N1258A module selector

- Input
  - HPSMU port 1 ea., Triaxial for HPSMU/MPSMU Force and Sense
  - HCSMU port 1 ea., BNC for Force and Triaxial for Sense
  - HVSMU port 1 ea., HV triaxial for HVSMU Force or HVMCU High
  - GNDU port 1 ea., Triaxial
  - Digital I/O port 1 ea., D-sub 25 pin
  - AC power line connector 1 ea.
- Output
  - High port 1 ea., HV triaxial for Force and Sense
  - Low port 1 ea., BNC for Force and Sense
  - External relay control output 1 ea., D-sub 25 pin
- Protection
  - HPSMU, GNDU, and HCSMU Low Force
- Power indicator
  - LED turns yellow when AC power is applied and turns green the module selector is ready to use.
- Status indicator
  - Green LED lights to indicate the present connection path of module selector; Open, HCSMU, HPSMU, or HVSMU.
- Maximum voltage/current
  - HPSMU port:  $\pm 200\text{ V} / 1\text{ A}$
  - HCSMU port:  $\pm 40\text{ V} / 2\text{ A}$ ,  $\pm 20\text{ V} / 30\text{ A}$  (Pulse width 1 ms, duty 1 %)
  - HVSMU port:  $\pm 3000\text{ V} / 4\text{ mA}$ ,  $\pm 2200\text{ V} / 1.1\text{ A}$ ,  $\pm 1500\text{ V} / 2.5\text{ A}$
- Leakage current, supplemental characteristics
  - HPSMU port: 10 pA at 200 V
  - HCSMU port: 100 pA at 10 V (High Force to Low Force, High Sense to Low Sense)



HVSMU port: 10 pA at 1500 V (humidity range: 20 % to 70 % RH),  
20 pA at 3000 V (humidity range: 20 % to 50 % RH)

## N1259A test fixture

- Input

HPSMU port 2 ea., Triaxial for HPSMU/MPSMU Force and Sense

HCSMU port 2 ea., BNC for Force and Triaxial for Sense

HVSMU port 1 ea., HV triaxial for HVSMU Force or HVMCU High

GNDU port 1 ea., Triaxial

AUX port 2 ea., BNC

Interlock port 1 ea.

- Protection

HPSMU, GNDU, and HCSMU Low Force

- High voltage indicator

LED turns red when output voltage is  $\geq 42$  V or specified value.

- Maximum voltage/current

HPSMU port: Force:  $\pm 200$  V / 1 A, Sense:  $\pm 200$  V

HCSMU port:

High Force:  $\pm 40$  V / 2 A,  $\pm 20$  V / 40 A (Pulse width 1 ms, duty 1 %)

Low Force:  $\pm 40$  V / 2 A,  $\pm 20$  V / 40 A (Pulse width 1 ms, duty 1 %)

High Sense:  $\pm 40$  V

Low Sense:  $\pm 40$  V

HVSMU port:  $\pm 3000$  V / 4 mA,  $\pm 2200$  V / 1.1 A,  $\pm 1500$  V / 2.5 A

**Note:** The total power consumption of all modules cannot exceed 50 W when using the N1259A under the condition that operating temperature is  $> 35$  °C.

- Leakage current, supplemental characteristics

HPSMU port (Force, Sense): 10 pA at 200 V

HCSMU port (High Force, High Sense): 100 pA at 10 V

HVSMU port (Force): 10 pA at 1500 V (humidity range: 20 % to 70 % RH),  
20 pA at 3000 V (humidity range: 20 % to 50 % RH)

### **N1259A-010 inline package socket module (3 pin)**

- Number of terminals: 6 ea.,  $\varnothing$ 4 mm jack (banana)
- DUT interface: Inline package socket (3-pin)
- Maximum voltage for terminals: 3000 Vdc

### **N1259A-011 universal socket module**

- Number of terminals: 8 ea.,  $\varnothing$ 4 mm jack (banana)
- Maximum voltage for terminals: 3000 Vdc

### **N1259A-013 curve tracer test adapter socket module**

- Number of terminals: 6 ea.,  $\varnothing$ 4 mm jack (banana)
- Test adapter interface<sup>1</sup>: 6 ea.,  $\varnothing$ 4 mm jack (banana)
- Maximum voltage for terminals: 3000 Vdc
- Maximum current for terminals:  
Collector/Drain Force and Emitter/Source Force: 39 A (DC), 500 A (pulse)  
Others: 1A (DC), 20 A (pulse)

### **N1259A-020 high voltage bias-tee**

- Input  
DC Bias Input port 1 ea.,  $\varnothing$ 4 mm jack (banana) for Force and Guard  
MFCMU Input port 1 ea., BNC for Hcur, Hpot, Lcur, and Lpot on the rear panel
- Output  
MFCMU port 1 ea., SHV for High and Low
- External DC bias voltage:  $\pm$  3000 V
- Frequency: 10 kHz to 1 MHz (150  $\Omega$  at 10 kHz)
- Series capacitance: 110 nF  $\pm$  5 %
- Input resistance: 100 k $\Omega$   $\pm$  1 %

---

1. A test adapter for Tektronix curve tracers (370B/371B) can be connected to this interface.

### **N1259A-021 1 M $\Omega$ resistor box**

- Input/output: 1 ea.,  $\varnothing$ 4 mm jack (banana)
- Resistance: 1 M $\Omega$   $\pm$  5 %
- Maximum voltage:  $\pm$  3000 V
- Power rating: 9 W
- Leakage current, supplemental characteristics: 10 pA at 100 V

### **N1259A-022 100 k $\Omega$ resistor box**

- Input/output: 1 ea.,  $\varnothing$ 4 mm jack (banana)
- Resistance: 100 k $\Omega$   $\pm$  5 %
- Maximum voltage:  $\pm$  3000 V
- Power rating: 6.4 W
- Leakage current, supplemental characteristics: 10 pA at 100 V

### **N1259A-030 1 k $\Omega$ resistor box for gate**

- Input/output: 1 ea.,  $\varnothing$ 4 mm jack (banana)
- Resistance: 1 k $\Omega$   $\pm$  10 %
- Maximum voltage:  $\pm$  200 V
- Power rating: 1 W
- Leakage current, supplemental characteristics: 10 pA at 100 V

### **N1259A-035 universal resistor box**

- Input/output: 1 ea.,  $\varnothing$ 4 mm jack (banana)
- Resistance: Installed by user
- Maximum voltage for terminals:  $\pm$  3000 V

## N1259A-300 module selector for test fixture

- Input
  - HPSMU port 1 ea., Triaxial for HPSMU/MPSMU Force and Sense
  - HCSMU port 1 ea., BNC for Force and Triaxial for Sense
  - HVSMU port 1 ea., HV triaxial for HVSMU Force or HVMCU High
  - GNDU port 1 ea., Triaxial
  - Digital I/O port 1 ea., D-sub 25 pin
  - AC power line connector 1 ea.
- Output
  - High port 1 ea.,  $\varnothing$ 4 mm jack (banana) for Force and Guard, and Sense and Guard
  - Low port 1 ea.,  $\varnothing$ 4 mm jack (banana) for Force and Sense
- Protection
  - HPSMU, GNDU, and HCSMU Low Force
- Power indicator
  - LED turns yellow when AC power is applied and turns green the module selector is ready to use.
- Status indicator
  - Green LED lights to indicate the present connection path of module selector; Open, HCSMU, HPSMU, or HVSMU.
- Maximum voltage/current
  - HPSMU port:  $\pm 200$  V / 1 A
  - HCSMU port:  $\pm 40$  V / 2 A,  $\pm 20$  V / 30 A (Pulse width 1 ms, duty 1 %)
  - HVSMU port:  $\pm 3000$  V / 4 mA,  $\pm 2200$  V / 1.1 A,  $\pm 1500$  V / 2.5 A
- Leakage current, supplemental characteristics
  - HPSMU port: 10 pA at 200 V
  - HCSMU port: 100 pA at 10 V (High Force to Low Force, High Sense to Low Sense)
  - HVSMU port: 10 pA at 1500 V (humidity range: 20 % to 70 % RH),  
30 pA at 3000 V (humidity range: 20 % to 50 % RH)

### **N1260A high voltage bias-tee**

- Input  
HVSMU port 1 ea., HV triaxial  
MFCMU port 1 ea., BNC for Hcur, Hpot, Lcur, and Lpot
- Output  
Output port: 1 ea., SHV for High, Low, and AC Guard
- External DC bias voltage:  $\pm 3000$  V
- Frequency: 10 kHz to 1 MHz (150  $\Omega$  at 10 kHz)
- Series capacitance: 110 nF  $\pm 5$  %
- Input resistance: 100 k $\Omega$   $\pm 1$  %

### **N1261A-001 protection adapter for HPSMU (triaxial output)**

- Input: Triaxial for HPSMU or MPSMU Force and Sense
- Output: Triaxial for Force and Sense
- Leakage current, supplemental characteristics: 10 pA at 200 V

### **N1261A-002 protection adapter for GNDU (BNC output)**

- Input: Triaxial for GNDU
- Output: BNC for Force and Sense

### **N1261A-003 protection adapter for HPSMU (HV triaxial output)**

- Input: Triaxial for HPSMU or MPSMU Force and Sense
- Output: HV triaxial for Force and Sense
- Leakage current, supplemental characteristics: 10 pA at 200 V

### **N1261A-004 protection adapter for GNDU (SHV output)**

- Input: Triaxial for GNDU
- Output: SHV for Force and Sense

### **N1262A-001 1 M $\Omega$ resistor box**

- Input: HV triaxial for HVSMU or HVMCU

## Specifications and Options

### Specifications

- Output: SHV
- Resistance:  $1\text{ M}\Omega \pm 5\%$
- Maximum voltage:  $\pm 3000\text{ V}$
- Power rating: 9 W
- Leakage current, supplemental characteristics: 10 pA at 100 V

### **N1262A-002 100 k $\Omega$ resistor box**

- Input: HV triaxial for HVSMU or HVMCU
- Output: SHV
- Resistance:  $100\text{ k}\Omega \pm 5\%$
- Maximum voltage:  $\pm 3000\text{ V}$
- Power rating: 6.4 W
- Leakage current, supplemental characteristics: 10 pA at 100 V

### **N1262A-010 1 k $\Omega$ resistor box for gate (triaxial output)**

- Input: Triaxial for SMU Force
- Output: Triaxial
- Resistance:  $1\text{ k}\Omega \pm 10\%$
- Maximum voltage:  $\pm 200\text{ V}$
- Power rating: 1 W
- Leakage current, supplemental characteristics: 10 pA at 100 V

### **N1262A-011 1 k $\Omega$ resistor box for gate (SHV output)**

- Input: HV triaxial for SMU Force
- Output: SHV
- Resistance:  $1\text{ k}\Omega \pm 10\%$
- Maximum voltage:  $\pm 3000\text{ V}$
- Power rating: 1 W
- Leakage current, supplemental characteristics: 10 pA at 100 V

### **N1262A-020 universal resistor box, triaxial**

- Input: Triaxial, 1 ea.
- Output: Triaxial, 1 ea.
- Resistance: Installed by user
- Maximum voltage for terminals:  $\pm 200$  V

### **N1262A-021 universal resistor box, HV triaxial to SHV**

- Input: HV triaxial, 1 ea.
- Output: SHV, 1 ea.
- Resistance: Installed by user
- Maximum voltage for terminals:  $\pm 3000$  V

### **N1262A-023 universal resistor box for ultra high voltage**

- Input: UHV coaxial, 1 ea.
- Output: UHV coaxial, 1 ea.
- Resistance: Installed by user
- Maximum voltage for terminals:  $\pm 10$  kV

### **N1262A-036 50 $\Omega$ termination adapter**

- Input: BNC, 1 ea.
- Output: BNC, 1 ea.
- Maximum power: 1 W

### **N1254A-524 ultra high current prober system cable**

- Input:  $\varnothing 4$  mm jack (banana), 8 ea.  
Selector output (High Force, High Sense, Low Force, Low Sense, and Guard)  
Gate output (High Force and Low Force)  
Chassis
- Output:  
 $\varnothing 4$  mm jack (banana), 2 ea. for High Force and Low Force

## Specifications and Options

### Specifications

HV triaxial, 1 ea. for High Sense

BNC, 2 ea. for Low Sense and Gate

- Maximum voltage/current:

For High Force:  $\pm 3000$  V / 39 A (DC)

For Low Force:  $\pm 200$  V / 39 A (DC)

For High Sense:  $\pm 3000$  V / 1 A

For Low Sense and Gate:  $\pm 200$  V / 1 A

### **N1265A-010 500 A ultra high current 3-pin inline package socket module**

- Number of terminals: 6 ea.,  $\varnothing 4$  mm jack (banana)
- DUT interface: Inline package socket (3-pin)
- Maximum voltage for terminals: 3000 Vdc
- Maximum current for terminals:  
Force: 39 A (DC), 500 A (pulse)  
Sense: 1 A (DC), 20 A (pulse)

### **N1265A-011 universal socket module**

- Number of terminals: 6 ea.,  $\varnothing 4$  mm jack (banana)
- Maximum voltage for terminals: 3000 Vdc
- Universal blank area: 90 mm W  $\times$  81 mm D

### **N1265A-013 curve tracer test adapter socket module**

- Number of terminals: 6 ea.,  $\varnothing 4$  mm jack (banana)
- Test adapter interface<sup>1</sup>: 6 ea.,  $\varnothing 4$  mm jack (banana)
- Maximum voltage for terminals: 3000 Vdc
- Maximum current for terminals:  
Collector/Drain Force and Emitter/Source Force: 39 A (DC), 500 A (pulse)

---

1. A test adapter for Tektronix curve tracers (370B/371B) can be connected to this interface.



Others: 1 A (DC), 20 A (pulse)

### **N1265A-035 universal resistor box for N1265A**

- Input: 4 ea. for High Force, High Sense, Low Force, and Low Sense,  $\varnothing$ 4 mm jack (banana)
- Output: 2 ea. for High and Low,  $\varnothing$ 4 mm jack (banana)
- Resistance: Installed by user
- Maximum voltage for terminals:  $\pm$  200 V

### **N1265A-040 10 kV ultra high voltage gate protection adapter**

- Input: 4 ea. for High Force, High Sense, Low Force, and Low Sense,  $\varnothing$ 4 mm jack (banana)
- Output: 2 ea. for High and Low,  $\varnothing$ 4 mm jack (banana)
- Maximum voltage:  $\pm$  200 V
- Maximum surge voltage:  $\pm$  10 kV

### **N1265A-041 thermocouple, type K, 2 ea**

N1265A-041 can be connected to Thermocouple terminal inside the N1265A and enables B1505A to read out temperature at the top of the thermocouple.

- Connector: Type K plug
- Length: 3000 mm
- Temperature range:  $-50$  °C to  $+180$  °C

### **N1265A-045 container for protection adapter and bias-tee**

N1265A-045 can accommodate protection adapters and bias-tee which are used with N1265A to make the measurement environment clean and safe.

- Dimension: 420 mm W  $\times$  193 mm H  $\times$  565 mm D
- Weight: 15 kg
- Maximum superimposed load: 50 kg

## **N1267A HVSMU/HCSMU fast switch**

To change connection between HVSMU and HCSMU for Gallium Nitride current collapse measurement. Switch is controlled by a MCSMU. Note: N1267A supports the B1513B; and does not support the B1513A. Note: N1267A does not support two HCSMU (40 A) configuration and the N1265A test fixture.

- Input:
  - HVSMU port, 1ea., HV triaxial
  - HCSMU port, 1ea., Force: BNC, Sense: Triaxial
  - MCSMU port, 1ea., Force/Sense: Triaxial
  - GND port, 1ea., Triaxial
- Output:
  - High: HV triaxial
  - Low: BNC
- Maximum current: 20 A, see Figure 3-16.
- Maximum voltage: 3000 V, see Figure 3-16.
- Measurement mode:
  - GaN current collapse measurement mode
    - I-V time domain measurement
    - I-V trace measurement
  - Static characteristic measurement mode
    - Id-Vds, If-Vf measurement
    - Id(Off)-Vds, Ir-Vr measurement
- Current applied to DUT: HCSMU measurement/output current plus HVSMU measurement/output current
- GaN current collapse measurement mode:
  - Module used for the device OFF state: HVSMU. See Table 5-40 for the source setting range.
  - Module used for the device ON state: HCSMU. See Table 5-41 for the source setting range.
  - Voltage measurement resolution (HVSMU): minimum 200  $\mu$ V

Current measurement resolution (HCSMU): minimum 100 nA

Resolution depends on the measurement range setting.

Transition time (switch OFF to ON): minimum 20  $\mu$ s

Setting time for the device OFF state: 10 ms to 655.35 s, maximum value can be extended by creating a program.

Setting time for the device ON state: minimum 50  $\mu$ s

Setting of pulse or DC sampling: Based on the SMU timing specifications

**Table 5-40**

**HVSMU Source Setting Range for GaN Current Collapse Measurement**

Voltage setting value <sup>a</sup>	Current compliance value
+1 V to + 3000 V	8 mA ( $\leq$ 1500 V) or 4 mA ( $>$ 1500 V)

a. Setting value must be the ON state voltage plus 1 V or more.

**Table 5-41**

**HCSMU Source Setting Range for GaN Current Collapse Measurement**

Voltage setting value <sup>a</sup>	Current compliance value
0 V to $\pm$ 40 V	20 mA to 20 A pulse ( $\leq$ 20 V) or 20 mA to 1 A DC

a. Voltage actually applied to the device under test (DUT) is the setting value minus the voltage drop of the switch.

- Static characteristics measurement mode:

Module used for the Id-Vds, If-Vf measurement: HCSMU. See Table 5-42 for the source setting range.

Offset error for the Id-Vds, If-Vf measurement: 1  $\mu$ A (typical)

Module used for the Id(Off)-Vds, Ir-Vr measurement: HVSMU. See Table 5-43 for the source setting range.

Leak error for the Id(Off)-Vds, Ir-Vr measurement: 2 nA (typical)

Voltage measurement resolution (HVSMU): minimum 200  $\mu$ V

Current measurement resolution (HCSMU): minimum 10 pA

Resolution depends on the measurement range setting.

**Table 5-42 HCSMU Source Setting Range for Id-Vds, If-Vf Measurement**

Voltage setting value	Current compliance value
0 V to $\pm 40$ V	10 $\mu$ A to 20 A pulse ( $\leq 20$ V) or 10 $\mu$ A to 1 A DC

**Table 5-43 HVSMU Source Setting Range for Id(Off)-Vds, Ir-Vr Measurement**

Voltage setting value	Current compliance value
0 V to + 3000 V	10 $\mu$ A to 8 mA ( $\leq 1500$ V) or 10 $\mu$ A to 4 mA ( $> 1500$ V)

### **N1269A ultra high voltage connection adapter**

To make the connection simple and to protect measurement resources from unexpected surge when connecting UHVU to wafer prober.

- Input:
  - Gate MCSMU Force, 1ea., Triaxial
  - Gate MCSMU Sense, 1ea., Triaxial
  - Chuck MCSMU Force, 1ea., Triaxial
  - Chuck MCSMU Sense, 1ea., Triaxial
  - UHV Low, 1ea., HV triaxial
- Output: 3 ea. for Gate, Chuck, and Source, SHV
- Maximum voltage:  $\pm 200$  V
- Maximum surge voltage:  $\pm 10$  kV

## EasyEXPERT Software

### Operation mode

- Application test mode  
Realizes application oriented point-and-click test setup and execution. You can select a test definition from library by device type and measurement item, and execute the test after changing setup parameter values as needed. Also see “Application library”.
- Classic test mode  
Realizes function oriented test setup and execution with the same look, feel, and terminology of Agilent 4155/4156 user interface. In addition, it improves the user interface by taking full advantage of EasyEXPERT’s GUI features.
- Tracer test mode (Curve tracer mode)  
Realizes intuitive and interactive sweep control by using a rotary knob, similar to a curve tracer. Just like an analog curve tracer, you can sweep in only one direction (useful for R&D device analysis) or in both positive and negative directions (useful in failure analysis applications). Test setups can be saved, and used in the classic test mode for further detailed measurement and analysis. Also see “Oscilloscope view”.
- Quick test mode  
A GUI-based quick test mode enables you to perform test sequencing without programming. You can select, copy, rearrange, and cut-and-paste any test setups with a few simple mouse clicks. Once you have selected and arranged your tests, simply click on the measurement button to begin running an automated test sequence.

### Application library

Contains over 40 application test definitions conveniently organized by device type, application, and technology. You can easily edit and customize the furnished application tests to fit your specific needs.

The following table shows a part of tests included in the library. They are subject to change without notice.

## Specifications and Options

### Specifications

Category	Test items
PowerMOSFET (Si, GaN)	Id-Vds, Rds-Id, Id-Vgs, Vth, Cgs, Cds, Cgd, QSCV, current collapse, breakdown, etc.
IGBT	Ic-Vce, Ic-Vge, Vth, Cge, Cce, Cgc, breakdown, etc.
SiC	Id-Vds, Rds-Id, Id-Vgs, Vth, Cgs, Cds, Cgd, QSCV, breakdown, etc.
PowerBJT	Ic-Vce, Vce(sat), Ic-Vcbo, Ic-Vceo, Ie-Vbeo, etc.
PowerDiode	If-Vf, Ir-Vr, Cj-Vr, etc.
MISCAP	C-V, Ileak-V, TDDB, breakdown, etc.

### Oscilloscope view

Available for the tracer test using HCSMU, MCSMU, HVSMU, UHCU, HVMCU, or UHVU. The oscilloscope view displays current or voltage measurement data versus time. The pulsed measurement waveforms appear in a separate window for easy verification of the measurement timings. This function is useful for verifying waveform timings and debugging pulsed measurements. It is available when a tracer test has at least one channel used in pulsed mode. The oscilloscope view can display the pulse waveform at any (user specified) sweep step of the sweep output.

- Sampling interval: 2  $\mu$ s (HCSMU/MCSMU/UHCU/HVMCU/UHVU) or 6  $\mu$ s (HVSMU)
- Sampling points: 2000 Sa (HCSMU/MCSMU/UHCU/HVMCU/UHVU) or 4000 Sa (HVSMU)
- Marker function
  - Data read-out for each channel
  - Resolution: 2  $\mu$ s
- Data saving
  - Numeric: TXT/CSV/XMLSS
  - Image: EMF/BMP/JPG/PNG

## Measurement modes

Supports the following measurement modes.

- IV measurement
  - Spot
  - Staircase sweep
  - Pulsed spot
  - Pulsed sweep
  - Staircase sweep with pulsed bias
  - Sampling
  - Multi-channel sweep
  - Multi-channel pulsed sweep
  - List sweep
  - Linear search<sup>(\*1)</sup>
  - Binary search<sup>(\*1)</sup>
- C measurement
  - Spot C
  - CV (DC bias) sweep
  - Pulsed spot C<sup>(\*1)</sup>
  - Pulsed sweep CV<sup>(\*1)</sup>
  - C-t sampling<sup>(\*1)</sup>
  - C-f sweep<sup>(\*1)</sup>
  - CV (AC level) sweep<sup>(\*1)</sup>
  - Quasi-static CV (QSCV)<sup>(\*1)</sup>

<sup>(\*1)</sup> Direct Control classic test is used.

## Sweep measurement

Number of steps: 1 to 10001 (SMU), 1 to 1001 (CMU)

Sweep mode: linear or logarithmic (log)

Sweep direction: single or double

Hold time: 0 to 655.35 s, 10 ms resolution

Delay time: 0 to 65.535 s or 655.35 s for CV (AC level) sweep and C-f sweep, 100  $\mu$ s resolution

## Specifications and Options

### Specifications

Step delay time: 0 to 1 s, 100  $\mu$ s resolution

Step output trigger delay time: 0 to (delay time) s, 100  $\mu$ s resolution

Step measurement trigger delay time: 0 to 65.535 s, 100  $\mu$ s resolution

### **Sampling (time domain) measurement**

Performs the voltage/current measurement in the specified time interval and plots the measured data versus time.

Sampling channels: up to 10

Sampling mode: linear or logarithmic (log)

Sampling points: 1 to 100001/(number of channels) for linear sampling, 1 to 1 + (number of data for 11 decades) for log sampling

Sampling interval range: 100  $\mu$ s + 20  $\mu$ s  $\times$  (number of channels - 1) to 2 ms in 10  $\mu$ s resolution for linear sampling, or 2 ms to 65.535 s in 1 ms resolution for both linear and log sampling

Hold time, bias hold time: -90 ms to -100  $\mu$ s in 100  $\mu$ s resolution, 0 to 655.35 s in 10 ms resolution

Measurement time resolution: 100  $\mu$ s

### **Other measurement characteristics**

- Measurement control:  
Single, repeat, append, and stop
- SMU setting capabilities:  
Limited auto ranging, voltage/current compliance, power compliance, automatic sweep abort functions, self-test, and self-calibration
- Standby mode  
If the standby mode is ON, only the standby channels remain programmed to their specified output value in the non-measurement status.
- Bias hold function  
This function allows you to keep a source active between measurements. The source module will apply the specified bias between measurements when running classic tests inside an application test, in quick test mode, or during a repeated measurement. The function ceases as soon as these conditions end or when a measurement that does not use this function is started.



- Current offset cancel

This function subtracts the offset current from the current measurement raw data, and returns the result as the measurement data. This function is used to compensate the error factor (offset current) caused by the measurement path such as the measurement cables, manipulators, or probe card.

- Time stamp

Time stamp function utilizing an internal quartz clock. Resolution: 100  $\mu$ s

## Data display

- X-Y graph plot

X-axis and up to eight Y-axes. Linear and log scale. Real time graph plotting.

X-Y graph plot can be printed or stored as image data to clip board or mass storage device. The formats BMP, GIF, PNG, and EMF are supported.

- Scale

Auto scale and zoom

- Marker

Marker to min/max, interpolation, direct marker, and marker skip

- Cursor

Direct cursor

- Line

Two lines, normal mode, grad mode, tangent mode, and regression mode

- Overlay graph comparison

Graphical plots can be overlaid for comparison.

- List display

Measurement data and calculated user function data are listed in conjunction with sweep step number or time domain sampling step number. Up to 20 data sets can be displayed.

- Data variable display

Up to 20 user-defined parameters can be displayed.

## Automatic analysis function

On a graphics plot, the markers and lines can be automatically located using the auto analysis setup. Parameters can be automatically determined using automatic analysis, user function, and read out functions.

- Analysis functions  
Up to 20 user-defined analysis functions can be defined using arithmetic expressions.  
Measured data, pre-defined variables, and read out functions can be used in the computation. The results can be displayed on the LCD.
- Read out functions  
Built-in functions for reading various values related to the marker, cursor, or line

## Arithmetic functions

- User functions  
Up to 20 user-defined functions can be defined using arithmetic expressions.  
Measured data and pre-defined variables can be used in the computation. The results can be displayed on the LCD.
- Arithmetic operators  
+, -, \*, /, ^, abs (absolute value), at (arc tangent), avg (averaging), cond (conditional evaluation), delta, diff (differential), exp (exponent), integ (integration), lgt (logarithm, base 10), log (logarithm, base e), mavg (moving average), max, min, sqrt, trigonometric function, inverse trigonometric function, and so on
- Physical constants assigned to the keys
  - q: Electron charge, 1.602177E-19 C
  - k: Boltzmann constant, 1.380658E-23 J/K
  - $\epsilon$  (e): Dielectric constant of vacuum, 8.854188E-12 F/m
- Numeric constants assigned to the keys  
a ( $10^{-18}$ ), f ( $10^{-15}$ ), p ( $10^{-12}$ ), n ( $10^{-9}$ ), u or  $\mu$  ( $10^{-6}$ ), m ( $10^{-3}$ ), k ( $10^3$ ), M ( $10^6$ ), G ( $10^9$ ), T ( $10^{12}$ ), P ( $10^{15}$ )

## Workspace and data management

- Workspace

Separate work environment for EasyEXPERT. Every workspace supports the following features.

- Measurement setup and execution
- Save/Recall My Favorite (preset group) setup
- Save/Recall measurement data and settings
- Import/Export device definition, measurement settings, My Favorite setup, measurement data, and application library
- Test result data management
- Access authority (private/public) setting

- Data auto record / auto export

EasyEXPERT has the ability to automatically store the measurement setup and data within a workspace. It can also export measurement data in real time. You can save data to any storage device connected to the PC.

- Import/export files

File type: EasyEXPERT format, XML-SS format, CSV format

- Workspace management

EasyEXPERT has the ability to import/export a workspace for back-up and portability.

## External instrument control

- External instruments supported by application tests

Agilent 4284A/E4980A, 81110A, and 3458A

- Wafer prober control

Scripts to perform chuck move/up/down and subsite move for major semi-automatic probers are furnished. The wafer prober control can be performed in the repeat measurement process.

## Program and interface capabilities

- Data storage  
Hard disk drive, DVD-R drive
- Interfaces  
GPIB, interlock, USB (USB 2.0, 2 ea. on front, 2 ea. on rear),  
LAN (1000BASE-T/100BASE-TX/10BASE-T), trigger in/out, digital I/O,  
VGA video output
- Remote control capabilities  
FLEX commands (GPIB)  
EasyEXPERT remote control function (LAN)
- Trigger I/O  
Only available using GPIB FLEX commands.  
  
Trigger in/out synchronization pulses before and after setting and measuring DC voltage and current. Arbitrary trigger events can be masked or activated independently.

## Furnished Software

- Prober control scripts
- Desktop EasyEXPERT software
- 4155/56 setup file converter  
Converts the measurement setup file (extension MES or DAT) for Agilent 4155 and 4156 into the equivalent setup file for EasyEXPERT classic test mode.
- MDM file converter  
Converts the EasyEXPERT test result data file (extension XTR or ZTR) to Agilent IC-CAP MDM file. Supports the data of the following classic tests.
  - I/V Sweep
  - Multi Channel I/V Sweep
  - C-V Sweep

---

**NOTE**

---

For the latest system requirements, go to [www.agilent.com](http://www.agilent.com) and type in B1505A in the Search field at the top of the page.

## General Specifications

- Temperature range  
Operating: +5 °C to +40 °C  
Storage: -20 °C to +60 °C
- Humidity <sup>1</sup>  
Operating: 20 % to 70 % RH, non-condensing  
Storage: 10 % to 90 % RH or 20 % to 80 % RH for using N1268A, non-condensing
- Altitude  
Operating: 0 to 2,000 m (6,561 ft.)  
Storage: 0 to 4,600 m (15,092 ft.) or 0 to 2,000 m (6,561 ft.) for using N1268A
- Power requirement  
100-240 V (±10 %), 50/60 Hz
- Maximum volt-amps (VA)  
B1505A: 900 VA  
N1258A: 65 VA  
N1259A-300: 35 VA  
N1265A: 400 VA  
N1266A: 60 VA  
N1268A: 350 VA

---

1. In case of some supplemental characteristics, humidity range is defined as 20 % to 50 % RH.

## Specifications and Options

### Specifications

- Regulatory compliance
  - EMC
    - IEC 61326-1 / EN 61326-1
    - ICES/NMB-001
    - AS/NZS CISPR 11
    - KC: RRA Notification amending Radio Waves Act Article 58-2
  - Safety
    - IEC 61010-1 / EN 61010-1
    - CAN/CSA-C22.2 No. 61010-1
- Dimensions
  - B1505A: 420 mm (W) × 330 mm (H) × 575 mm (D)
  - N1258A: 330 mm (W) × 120 mm (H) × 410 mm (D)
  - N1259A: 420 mm (W) × 272 mm (H) × 410 mm (D)
  - N1260A: 164 mm (W) × 53 mm (H) × 125 mm (D)
  - N1261A-001: 80 mm (W) × 40 mm (H) × 110 mm (D)
  - N1261A-002: 80 mm (W) × 40 mm (H) × 110 mm (D)
  - N1261A-003: 90 mm (W) × 40 mm (H) × 140 mm (D)
  - N1261A-004: 80 mm (W) × 40 mm (H) × 125 mm (D)
  - N1262A: 50 mm (W) × 40 mm (H) × 125 mm (D)
  - N1265A: 420 mm (W) × 285 mm (H) × 575 mm (D)
  - N1266A: 420 mm (W) × 75 mm (H) × 575 mm (D)
  - N1267A: 202 mm (W) × 56 mm (H) × 175 mm (D)
  - N1268A: 420 mm (W) × 222 mm (H) × 482 mm (D)
  - N1269A: 134 mm (W) × 56 mm (H) × 150 mm (D)
- Weight
  - B1505A (empty): 20 kg, B1510A: 2.0 kg, B1511A: 1.1 kg, B1512A: 2.1 kg, B1513B: 2.0 kg, B1514A: 1.3 kg, B1520A: 1.3 kg, N1258A: 5.0 kg, N1259A: 12.0 kg, N1260A: 0.6 kg, N1261A: 0.3 kg, N1262A: 0.3 kg, N1265A: 30 kg, N1266A: 10 kg, N1267A: 0.8 kg, N1268A: 18 kg, N1269A: 0.4 kg

## Accessories and Options

Furnished accessories and the available options and accessories for Agilent B1505A are listed in Table 5-44 and Table 5-45.

**Table 5-44**      **Furnished Accessories**

Description	Quantity
16444A-001 USB keyboard	1
16444A-002 USB mouse	1
16444A-003 Stylus pen	1
16493J Interlock cable	1
16493L GNDU cable	1
16494A Triaxial cable, for the B1505A installed with HPSMU/MPSMU/MCSMU	2/module
16493S HCSMU cable, for the B1505A installed with HCSMU	1/module
16493S-010 HCSMU Kelvin adapter, for the B1505A installed with HCSMU	1/module
16493T HVSMU cable, for the B1505A installed with HVSMU	1
N1300A CMU cable, for the B1505A installed with MFCMU	1
16493G Digital I/O cable, furnished with the N1258A, N1259A-300, N1265A, N1266A, or N1268A	1
Extra interlock cable (16493J), furnished with the N1268A	1
SMU number label, for the B1505A installed with SMU	1
Power cable	1
Disk set for Agilent 4155B/4155C/4156B/4156C firmware update	1
Desktop EasyEXPERT CD	1
License-to-use for EasyEXPERT and Desktop EasyEXPERT	

Specifications and Options  
Accessories and Options

**Table 5-45 Options and Accessories**

Model Number	Option Item	Description
B1505A		Power Device Analyzer/Curve Tracer
	B1505A-015	1.5 m cable length
	B1505A-030	3 m cable length
	B1505A-050	50 Hz power line frequency
	B1505A-060	60 Hz power line frequency
	B1505A-A6J	ANSI Z540 compliant calibration
	B1505A-UK6	Commercial calibration certificate with test data
	B1505A-ABA	Paper manual set, English
	B1505A-ABJ	Paper manual set, Japanese
	B1505A-DR1	Changing DVD-R drive to DVD-ROM drive
	B1505A-1CM	Rack mount kit
B1510A		High Power Source/Monitor Unit module (HPSMU)
B1511A		Medium Power Source/Monitor Unit module (MPSMU)
B1512A		High Current Source/Monitor Unit module (HCSMU)
B1513B		High Voltage Source/Monitor Unit module (HVSMU)
B1514A		Medium Current Source/Monitor Unit module (MCSMU)
B1520A		Multi Frequency Capacitance Measurement Unit module (MFCMU)
N1253A		Accessories for Digital I/O
	N1253A-100	Digital I/O T-cable
	N1253A-200	Digital I/O BNC box
N1254A		Accessories
	N1254A-100	GNDU Kelvin adapter, 1 ea.
	N1254A-103	Triax(m)-BNC(f) adapter, triaxial shield open, 1 ea.
	N1254A-500	HV(jack) connector, panel mount, for soldering, 1 ea.
	N1254A-501	HV(jack)-HV(jack) adapter, panel mount, 1 ea.
	N1254A-502	HV(plug) connector, panel mount, for soldering, 1 ea.
	N1254A-503	BNC(m) to no connector coaxial cable, 1.5 m, 1 ea.
	N1254A-504	HV(jack) to no connector coaxial cable, 1.5 m, 1 ea.
	N1254A-505	HV(plug) to no connector triaxial cable, 1.5 m, 1 ea.
		N1254A-506



Model Number	Option Item	Description
N1254A	N1254A-507	HV(plug)-HV(plug) coaxial cable, 1.5 m, 1 ea.
	N1254A-508	Connection wire, banana-to-banana, red 1 ea.
	N1254A-509	Connection wire, banana-to-banana, black 1 ea
	N1254A-510	Dolphin clip adapter, black 1 ea. and red 1ea.
	N1254A-511	Cable lag adapter, black 1 ea. and red 1ea.
	N1254A-512	SHV(plug)-SHV(plug) cable, 1 ea.
	N1254A-513	SHV(jack)-banana adapter, 1 ea.
	N1254A-514	BNC(m)-BNC(m) adapter, 1 ea.
	N1254A-515	BNC(f)-BNC(m)-BNC(f) adapter, 1 ea.
	N1254A-516	BNC(f)-BNC(f)-BNC(f) adapter, 1 ea.
	N1254A-517	Triax(f)-Triax(m) adapter, shield separated, 1 ea.
	N1254A-518	SHV(plug)-SHV(plug) coaxial cable, 1.5 m, 1 ea.
	N1254A-520	UHV(plug) to no connector cable, 1 m, 1 ea. and SHV(plug) to no connector cable, 1 m, 1 ea.
	N1254A-521	UHV(jack)-UHV(jack) adapter, 1 ea. and SHV(jack)-SHV(jack) adapter, 1 ea.
	N1254A-522	Connection wire, banana-to-banana, maximum 1500 A, 2 ea.
	N1254A-523	Banana to no connector wire, maximum 1500 A, 1 m, 2 ea.
	N1254A-524	System cable for prober, 1.8 m, 1 ea.
N1258A		Module Selector
N1259A		Test Fixture
	N1259A-001	Test fixture, built-in HPSMU protection adapter, built-in GNDU protection adapter, four black connection wire, and six red connection wire, and N1259A-010, 1 ea.
	N1259A-010	Kelvin socket module for inline package device
	N1259A-011	Universal socket module for power device
	N1259A-012	Blank PTFE board
	N1259A-013	Curve tracer test adapter socket module
	N1259A-020	Built-in high voltage bias-tee (furnished with two SHV-SHV cables and two SHV-banana adapters)
	N1259A-021	1 M $\Omega$ resistor box
	N1259A-022	100 k $\Omega$ resistor box

Specifications and Options  
Accessories and Options

Model Number	Option Item	Description
N1259A	N1259A-030	1 k $\Omega$ resistor box
	N1259A-035	Universal resistor box
	N1259A-300	Built-in module selector
N1260A		High voltage bias-tee
N1261A		Protection Adapter
	N1261A-001	HPSMU protection adapter, Triax(f)
	N1261A-002	GNDU protection adapter, BNC(f)
	N1261A-003	HPSMU protection adapter, HV(jack)
	N1261A-004	GNDU protection adapter, SHV(jack)
N1262A		High voltage resistor box
	N1262A-001	1 M $\Omega$ resistor box, SHV(jack)
	N1262A-002	100 k $\Omega$ resistor box, SHV(jack)
	N1262A-010	1 k $\Omega$ resistor box, Triax(f)
	N1262A-011	1 k $\Omega$ resistor box, SHV(jack)
	N1262A-020	Universal resistor box, Triax(f)
	N1262A-021	Universal resistor box, SHV(jack)
	N1262A-023	Universal resistor box, UHV(jack), with UHV(plug)-UHV(plug) cable, 1.5 m
	N1262A-036	50 $\Omega$ termination adapter
N1265A		Ultra High Current Expander/Fixture
	N1265A-001	Test fixture, built-in 500 A ultra high current expander, built-in module selector, four black connection wire, and four red connection wire, N1265A-002, 1 ea. and N1265A-010, 1 ea.
	N1265A-002	Blank silicon plate
	N1265A-010	Kelvin socket module for inline package device, maximum 500 A (furnished with two high current connection wire (18 cm), two sense connection wire (18 cm), and two gate connection wire (25 cm))
	N1265A-011	Universal socket module for power device, maximum 1500 A
	N1265A-013	Curve tracer test adapter socket module
	N1265A-015	Built-in 1500 A ultra high current expander (replaced with built-in 500 A ultra high current expander)
	N1265A-035	Universal resistor box
	N1265A-040	Protection adapter for Gate/SMU

Model Number	Option Item	Description
N1265A	N1265A-041	Thermocouple, Type K, 2 ea.
	N1265A-045	Container for protection adapter and bias-tee
	N1265A-A6J	ANSI Z540 compliant calibration
	N1265A-UK6	Commercial calibration certificate with test data
N1266A		HVSMU Current Expander
N1267A		HVSMU/HCSMU Fast Switch
N1268A		Ultra High Voltage Expander
N1269A		Ultra High Voltage Connection Adapter
N1300A		CMU cable
	N1300A-001	1.5 m length
	N1300A-002	3 m length
16444A		Accessories for B1500 series
	16444A-001	USB keyboard
	16444A-002	USB mouse
	16444A-003	Stylus pen
16493G		Digital I/O connection cable
	16493G-001	1.5 m length
	16493G-002	3 m length
16493J		Interlock cable
	16493J-001	1.5 m length
	16493J-002	3 m length
	16493J-003	5 m length
16493K		HPSMU Kelvin triaxial cable
	16493K-001	1.5 m length
	16493K-002	3 m length
16493L		GNDU cable
	16493L-001	1.5 m length
	16493L-002	3 m length
	16493L-003	5 m length

Specifications and Options  
Accessories and Options

Model Number	Option Item	Description
16493S		Accessories for HCSMU
	16493S-001	HCSMU cable, Triax(m)-Triax(m) and BNC(m)-BNC(m), 1.5 m length
	16493S-002	HCSMU cable, Triax(m)-Triax(m) and BNC(m)-BNC(m), 3 m length
	16493S-010	HCSMU Kelvin adapter
	16493S-011	HCSMU non-Kelvin adapter
	16493S-020	Dual HCSMU Kelvin combination adapter (Adapter, 40 A, when connecting to wafer prober directly without N1258A selector)
	16493S-021	Dual HCSMU combination adapter (Adapter, 40 A, when not connecting to wafer prober directly)
16493T		HVSMU cable, HV(plug)-HV(plug) triaxial cable
	16493T-001	1.5 m length
	16493T-002	3 m length
16493U		High current coaxial cable, BNC(m)-BNC(m)
	16493U-001	1.5 m length
	16493U-002	3 m length
16493V		UHVU cable set, UHV(plug)-UHV(plug) and SHV(plug)-SHV(plug)
	16493V-001	1.5 m length
	16493V-002	3 m length
16494A		Triaxial cable
	16494A-001	1.5 m length
	16494A-002	3 m length
	16494A-003	80 cm length
	16494A-004	40 cm length
	16494A-005	4 m length