

Agilent N6467A BroadR-Reach Compliance Test Application

Methods of Implementation



Agilent Technologies

Notices

© Agilent Technologies, Inc. 2013

No part of this manual may be reproduced in any form or by any means (including electronic storage and retrieval or translation into a foreign language) without prior agreement and written consent from Agilent Technologies, Inc. as governed by United States and international copyright laws.

Manual Part Number

Version 01.01.0000 or greater

Edition

July 23, 2013

Available in electronic format only

Agilent Technologies, Inc.
1900 Garden of the Gods Road
Colorado Springs, CO 80907 USA

Warranty

The material contained in this document is provided “as is,” and is subject to being changed, without notice, in future editions. Further, to the maximum extent permitted by applicable law, Agilent disclaims all warranties, either express or implied, with regard to this manual and any information contained herein, including but not limited to the implied warranties of merchantability and fitness for a particular purpose. Agilent shall not be liable for errors or for incidental or consequential damages in connection with the furnishing, use, or performance of this document or of any information contained herein. Should Agilent and the user have a separate written agreement with warranty terms covering the material in this document that conflict with these terms, the warranty terms in the separate agreement shall control.

Technology Licenses

The hardware and/or software described in this document are furnished under a license and may be used or copied only in accordance with the terms of such license.

Restricted Rights Legend

If software is for use in the performance of a U.S. Government prime contract or sub-contract, Software is delivered and licensed as “Commercial computer software” as defined in DFAR 252.227-7014 (June 1995), or as a “commercial item” as defined in FAR 2.101(a) or as “Restricted computer software” as defined in FAR 52.227-19 (June 1987) or any equivalent

agency regulation or contract clause. Use, duplication or disclosure of Software is subject to Agilent Technologies’ standard commercial license terms, and non-DOD Departments and Agencies of the U.S. Government will receive no greater than Restricted Rights as defined in FAR 52.227-19(c)(1-2) (June 1987). U.S. Government users will receive no greater than Limited Rights as defined in FAR 52.227-14 (June 1987) or DFAR 252.227-7015 (b)(2) (November 1995), as applicable in any technical data.

Safety Notices

CAUTION

A **CAUTION** notice denotes a hazard. It calls attention to an operating procedure, practice, or the like that, if not correctly performed or adhered to, could result in damage to the product or loss of important data. Do not proceed beyond a **CAUTION** notice until the indicated conditions are fully understood and met.

WARNING

A **WARNING** notice denotes a hazard. It calls attention to an operating procedure, practice, or the like that, if not correctly performed or adhered to, could result in personal injury or death. Do not proceed beyond a **WARNING** notice until the indicated conditions are fully understood and met.

BroadR-Reach Compliance Test Application—At a Glance

Testing the Broad-R Reach PHY's transmitter is accomplished through the use of various test modes that are defined in the Broad-R Reach specification.

There are five test modes that are used for the testing of the transmitter waveform, transmitter distortion, transmitted jitter, and transmitter droop. The test modes shall only change the data symbols provided to the transmitter circuitry and not alter the electrical and jitter characteristics of the transmitter and receiver from those of normal operation. These modes shall be enabled by setting a 3-bit control register.

Table 1 List of Test Modes and Relevant Tests

Test Mode	Description
1	Transmit droop test mode
2	Transmit jitter test in MASTER mode
3	Transmit jitter test in SLAVE mode
4	Transmitter distortion test
5	Normal operation at full power. This is for the PSD mask and power level test.

The tests in the N6467A Broad-R Reach Test Application are grouped according to the test mode required to run the test.

The N6467A BroadR-Reach Compliance Test Application:

- Lets you select individual or multiple test to run.
- Lets you identify the device being tested and its configuration.
- Shows you how to make oscilloscope connections to the device under test.
- Automatically checks for proper oscilloscope configuration.
- Automatically sets up the oscilloscope for each test.
- Allows you to determine the number of trials for each test.
- Provides detailed information of each test that has been run. The result of maximum 64 worst trials can be displayed at any one time.
- Creates a printable HTML report of the tests that have been run. This report includes pass/fail limits, margin analysis, and screen shots.

Contents

BroadR-Reach Compliance Test Application—At a Glance	3
1 Installing the BroadR-Reach Compliance Test Application	
Installing the Software	8
Installing the License Key	9
2 Preparing to Take Measurements	
Calibrating the Oscilloscope	12
Setting Up DUT Connections	13
Requirements	13
General Test Setup	13
Transmitter Distortion Test Setup	14
Transmitter Power Spectral Density (PSD) Test Setup	15
Starting the BroadR-Reach Compliance Test Application	17
3 Test Mode 1 Tests	
Transmitter Output Droop Positive	20
Transmitter Output Droop Negative	21
4 Test Mode 2 Tests	
Transmit Clock Frequency (MASTER)	24
MASTER TxOut Jitter	25
5 Test Mode 3 Tests	
Transmit Clock Frequency (SLAVE)	28
Slave TX_TCLK Jitter	29
6 Test Mode 4 Tests	
Transmitter Distortion	32
7 Test Mode 5 Tests	
Transmitter Power Spectral Density (PSD)	34

A Calibrating the Infiniium Oscilloscope and Probe

Oscilloscope Internal Calibration	36
Required Equipment for Oscilloscope Calibration	36
Running the Oscilloscope Internal Calibration	36
Probe Calibration	40
Required Equipment for Probe Calibration	40
Connecting the Probe for Calibration	40
Verifying the Connection	42
Running the Probe Calibration and Deskew	44
Verifying the Probe Calibration	46

Index

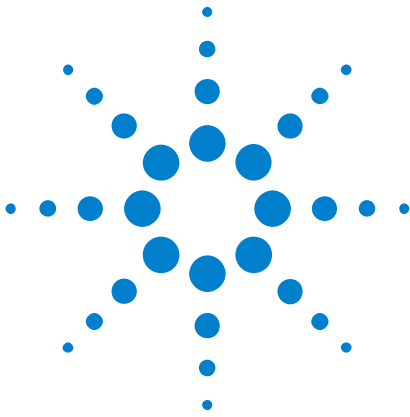

1 Installing the BroadR-Reach Compliance Test Application

Installing the Software 8

Installing the License Key 9

If you purchased the N6467A BroadR-Reach Compliance Test Application separate from your Infiniium oscilloscope, you need to install the software and license key.



Installing the Software

- 1 Make sure you have the minimum version of Infiniium oscilloscope software (see the N6467A release notes) by choosing **Help > About Infiniium...** from the main menu.
- 2 To obtain the BroadR-Reach Compliance Test Application, go to Agilent website: "<http://www.agilent.com/find/N6467A>"
- 3 The link for BroadR-Reach Compliance Test Application will appear. Double-click on it and follow the instructions to download and install the application software.

Installing the License Key

- 1 Request a license code from Agilent by following the instructions on the Entitlement Certificate.

You will need the oscilloscope's "Option ID Number", which you can find in the **Help > About Infiniium...** dialog.
- 2 After you receive your license code from Agilent, choose **Utilities > Install Option License...**
- 3 In the Install Option License dialog, enter your license code and click **Install License**.
- 4 Click **OK** in the dialog that tells you to restart the Infiniium oscilloscope application software to complete the license installation.
- 5 Click **Close** to close the Install Option License dialog.
- 6 Choose **File > Exit**.
- 7 Restart the Infiniium oscilloscope application software to complete the license installation.

1 Installing the BroadR-Reach Compliance Test Application

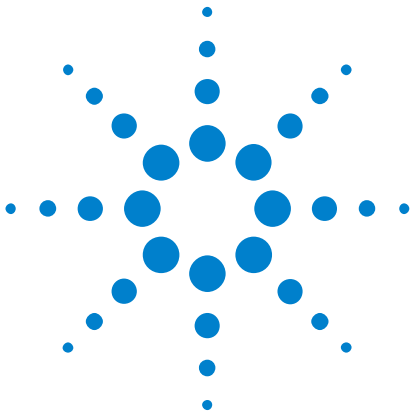

2 Preparing to Take Measurements

Calibrating the Oscilloscope 12

Setting Up DUT Connections 13

Starting the BroadR-Reach Compliance Test Application 17

Before running the BroadR-Reach automated tests, you should calibrate the oscilloscope and probe. After the oscilloscope and probe have been calibrated, you are ready to start the BroadR-Reach Compliance Test Application and perform the measurements.



Calibrating the Oscilloscope

If you haven't already calibrated the oscilloscope, see [Appendix A](#), “Calibrating the Infiniium Oscilloscope and Probe,” starting on page 35.

NOTE

If the ambient temperature changes more than 5 degrees Celsius from the calibration temperature, internal calibration should be performed again. The delta between the calibration temperature and the present operating temperature is shown in the **Utilities > Calibration** menu.

NOTE

If you switch cables between channels or other oscilloscopes, it is necessary to perform cable and probe calibration again. Agilent recommends that, once calibration is performed, you label the cables with the channel on which they were calibrated.

Setting Up DUT Connections

Requirements

The N5395B/N5395C Ethernet Fixture is recommended for some of the tests. A different, comparable fixture may be used, but is not guaranteed to produce an exact result.

Table 2 List of Tests Supported by the N5395B/N5395C Ethernet Electrical Compliance Test Board

Section	Tests
10	Power Spectral Density Using Spectrum Analyzer
11	Transmitter Distortion Test

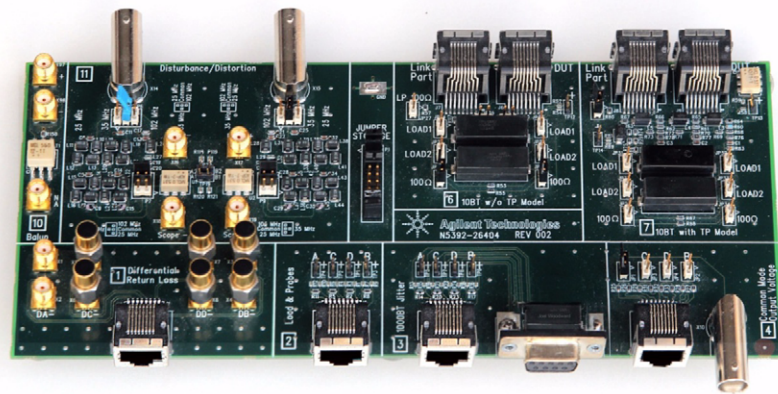

Figure 1 N5395B/N5395C Ethernet Electrical Compliance Test Board

General Test Setup

The signal supplied to the oscilloscope can either be a differential signal, or single ended signal. The type of connection accepted can be selected in the **Configure** tab of the app.

This connection is used for all the tests unless stated otherwise.

- Differential connection to oscilloscope:

Two SMA cables are needed to connect the output of the transmitter to the oscilloscope. The specific channel used can be selected in the **Configure** tab of the app.

An optional TX_TCLK may be supplied to the oscilloscope to run the tests.

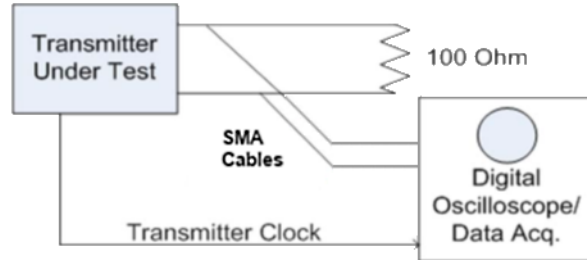

Figure 2 Connection to the Oscilloscope Using a Pair of SMA Cables

- Single-ended connection to oscilloscope:

A differential probe is used to connect the output of the transmitter to the oscilloscope. The specific channel used can be selected in the **Configure** tab of the app.

An optional TX_TCLK may be supplied to the oscilloscope to run the tests.

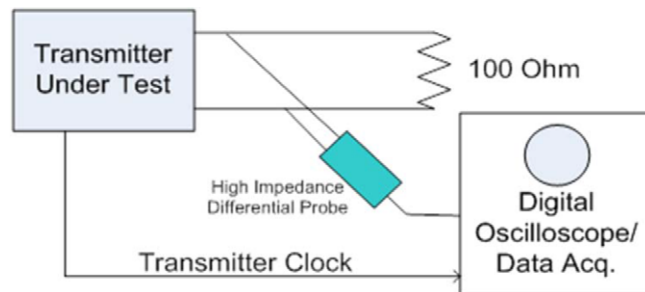

Figure 3 Connection to the Oscilloscope using a Differential Probe

Transmitter Distortion Test Setup

Section 11 of the N5395B/N5395C Ethernet Test Fixture is required for this test.

A disturbing signal source is required to test for compliance. There is an option to test without a disturbing signal source, but the test result is not applicable for compliance.

The test only accepts a differential signal.

When using a supported function generator, there will be an automatic calibration process to calibrate the function generators. If an unsupported model is used, the user will have to manually calibrate the function generators.

Table 3 List of Supported Function Generators

Function Generator	Number Required
Agilent 33250A	2
Agilent 81150A	1

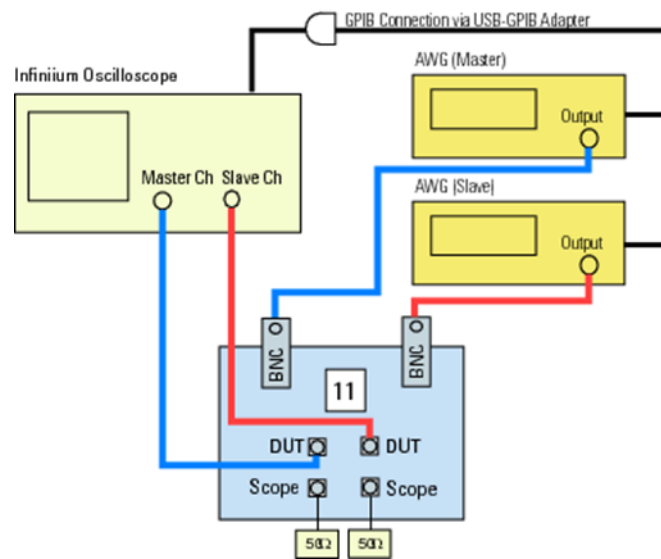

Figure 4 Connection for Transmitter Distortion Test Using Agilent 33250A Function Generators

Transmitter Power Spectral Density (PSD) Test Setup

The Power Spectral Density (PSD) Test can be run using either a spectrum analyzer or an oscilloscope.

For the connection using a spectrum analyzer, the differential output will need to be converted to a single-ended output using a balun.

2 Preparing to Take Measurements

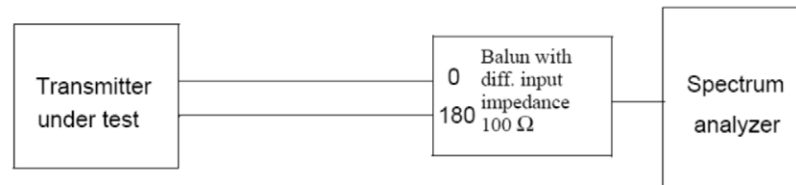

Starting the BroadR-Reach Compliance Test Application

- 1 Ensure that the BroadR-Reach Device Under Test (DUT) is operating and set to desired test modes.
- 2 To start the BroadR-Reach Compliance Test Application: From the Infiniium oscilloscope's main menu, choose **Analyze > Automated Test Apps > N6467A BroadR-Reach Test App**.

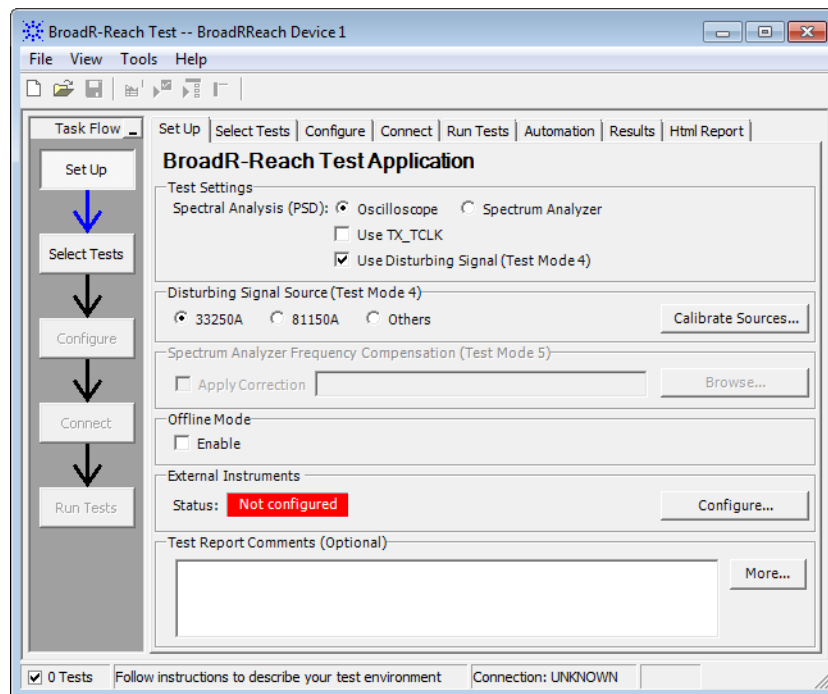

Figure 5 BroadR-Reach Compliance Test Application Main Window

The task flow pane, and the tabs in the main pane, show the steps you take in running the automated tests:

Set Up	Lets you identify and set up the test environment.
Select Tests	Lets you select the tests you want to run. The tests are organized hierarchically so you can select all tests in a group. After tests are run, status indicators show which tests have passed, failed, or not been run, and there are indicators for the test groups.
Configure	Lets you configure test parameters (for example, channels used in test, number of averages, etc.).
Connect	Shows you how to connect the oscilloscope to the device under test for the tests that are to be run.

2 Preparing to Take Measurements

Run Tests	Starts the automated tests. If the connections to the device under test need to be changed while multiple tests are running, the tests pause, show you how to change the connection, and wait for you to confirm that the connections have been changed before continuing.
Automation	Lets you construct scripts of commands that drive execution of the application.
Results	Contains more detailed information about the tests that have been run. You can change the thresholds at which marginal or critical warnings appear.
HTML Report	Shows a compliance test report that can be printed.



3 Test Mode 1 Tests

Transmitter Output Droop Positive 20

Transmitter Output Droop Negative 21

Transmitter Output Droop Positive

This test measures the positive output droop of the transmitter.

References [1] BroadR-Reach Physical Layer Transceiver Specification, v1.2, Section 5.4.1.

Algorithm Discussion Reference [1] specifies the positive output droop of a compliant PHY. The positive droop measured with respect to the initial peak value after the zero crossing and the value 500 ns after the initial peak, shall be less than 45%.

The app triggers the Test Mode 1 signal on the rising edge and determines the time the positive peak occurred and the voltage at that specific instance. The app then measures the voltage 500 ns after the peak. The Droop is calculated as:

$$\text{Droop} = 100 \times (V_d/V_{pk}) \%$$

Where:

- V_d is the magnitude of the droop.
- V_{pk} is the initial peak after the zero crossing.

Setup This test may be run using either a differential output or single-ended output from the transmitter (MDI). Refer to "[General Test Setup](#)" on page 13 for connection details.

Transmitter Output Droop Negative

This test measures the negative output droop of the transmitter.

References [1] BroadR-Reach Physical Layer Transceiver Specification, v1.2, Section 5.4.1.

Algorithm Discussion Reference [1] specifies the negative output droop of a compliant PHY. The negative droop measured with respect to the initial peak value after the zero crossing and the value 500 ns after the initial peak, shall be less than 45%.

The app triggers the Test Mode 1 signal on the falling edge and determines the time the negative peak occurred and the voltage at that specific instance. The app then measures the voltage 500 ns after the peak. The Droop is calculated as:

$$\text{Droop} = 100 \times (V_d/V_{pk}) \%$$

Where:

- V_d is the magnitude of the droop.
- V_{pk} is the initial peak after the zero crossing.

Setup This test may be run using either a differential output or single-ended output from the transmitter (MDI). Refer to "[General Test Setup](#)" on page 13 for connection details.

3 Test Mode 1 Tests



4 Test Mode 2 Tests

Transmit Clock Frequency (MASTER) 24

MASTER TxOut Jitter 25

Transmit Clock Frequency (MASTER)

This test measures the frequency of the transmitter clock when the PHY is operating in MASTER mode.

References [1] BroadR-Reach Physical Layer Transceiver Specification, v1.2, Section 5.4.5.

[2] BroadR-Reach Physical Layer Transceiver Specification, v1.2, Section 5.2.

Algorithm Discussion Reference [1] specifies the symbol transmission rate of a compliant PHY. The symbol transmission rate of the MASTER PHY shall be within the range of $66 \frac{2}{3} \text{ MHz} \pm 100 \text{ ppm}$.

The Reference [2] specifies that Test Mode 2 shall transmit the data symbol sequence $\{+1, -1\}$ repeatedly on the channel. The transmitter shall time the transmitted symbols from a symbol rate clock in the MASTER timing mode.

The measured data rate of the Test Mode 2 signal is thus equal to the MASTER Transmit Clock Frequency of the PHY.

Setup This test may be run using either a differential output or single-ended output from the transmitter (MDI). Refer to "[General Test Setup](#)" on page 13 for connection details.

MASTER TxOut Jitter

References [1] BroadR-Reach Physical Layer Transceiver Specification, v1.2, Section 5.4.3.

Algorithm Discussion Reference[1] specifies that when in test mode 2, the RMS (Root Mean Square) value of the MDI output jitter, J_{TXOUT} , relative to an unjittered reference shall be less than 50 ps.

This test measures the data time interval error of the test mode 2 signal at the MDI. The ideal reference data rate is selected automatically by the oscilloscope and compared to the original signal to determine the data time interval error.

Setup This test may be run using either a differential output or single-ended output from the transmitter (MDI). Refer to "[General Test Setup](#)" on page 13 for connection details.

4 Test Mode 2 Tests



5 Test Mode 3 Tests

Transmit Clock Frequency (SLAVE) 28

Slave TX_TCLK Jitter 29

Transmit Clock Frequency (SLAVE)

References [1] BroadR-Reach Physical Layer Transceiver Specification, v1.2, Section 5.4.5.

[2] BroadR-Reach Physical Layer Transceiver Specification, v1.2, Section 5.2.

Algorithm Reference [1] specifies the symbol transmission rate of a compliant PHY.

Discussion The symbol transmission rate of the MASTER PHY shall be within the range of $66 \frac{2}{3} \text{ MHz} \pm 100 \text{ ppm}$.

The specification does not specify the conformance limit for a PHY that is operating in SLAVE mode, but the SLAVE is supposed to have a symbol clock rate that is equal to the MASTER PHY. Reference [2] specifies that Test Mode 3 shall transmit the data symbol sequence $\{+1, -1\}$ repeatedly on the channel. The transmitter shall time the transmitted symbols from a symbol rate clock in the SLAVE timing mode.

Alternatively, an exposed TX_TCLK could be used to measure the frequency.

Setup This test may be run using either a differential output or single-ended output from the transmitter (MDI). Alternatively, this test can also be run using the TX_TCLK. Refer to "General Test Setup" on page 13 for connection details.

Slave TX_TCLK Jitter

References [1] BroadR-Reach Physical Layer Transceiver Specification, v1.2, Section 5.4.3.

Algorithm Discussion Reference[1] specifies that the RMS value of the SLAVE TX_TCLK jitter relative to an unjittered reference shall be less than 0.01 UI (Unit Interval) after the receiver is properly receiving the data.

This test measures the data time interval error at the MDI. The ideal reference data rate is selected automatically by the oscilloscope and compared to the original signal to determine the data time interval error.

Alternatively, an exposed TX_TCLK could be used to measure the jitter.

Setup This test may be run using either a differential output or single-ended output from the transmitter (MDI). Alternatively, this test can also be run using the TX_TCLK. Refer to "[General Test Setup](#)" on page 13 for connection details.



6 Test Mode 4 Tests

Transmitter Distortion 32

Transmitter Distortion

References [1] BroadR-Reach Physical Layer Transceiver Specification, v1.2, Section 5.4.2.

Algorithm Discussion When operating in Test Mode 4 and capturing the waveform using the Section 11 of the fixture, the peak distortion shall be less than 15 mV.

Reference [1] specifies that the peak distortion is determined by sampling the differential signal output with the symbol rate clock at an arbitrary phase and processing a block of any 2047 consecutive samples with MATLAB code in reference [1].

A software high pass filter is applied to the sampled signal before post-processing.

Alternatively, this test can also be run without the disturbing signal, but the result cannot be used to determine compliance.

Setup This test can only be run using a differential output from the transmitter (MDI). Refer to "[Transmitter Distortion Test Setup](#)" on page 14 for connection details.



7 Test Mode 5 Tests

Transmitter Power Spectral Density (PSD) 34

Transmitter Power Spectral Density (PSD)

References [1] BroadR-Reach Physical Layer Transceiver Specification, v1.2, Section 5.4.4.

Algorithm Discussion Reference [1] specifies that in Test Mode 5, the power spectral density (PSD) of the transmitter, shall be between the upper and lower bounds specified in the table below.

Frequency	PSD Upper Bound (dBm) *	PSD Lower Bound (dBm) *
@1 MHz	-23.3	-30.7
@20 MHz	-24.8	-35.6
@40 MHz	-28.5	-49.0
57 MHz-200 MHz	-36.5	-
* Settings: RBW=10 kHz, VBW=30 kHz, sweep time >1 min, RMS detector, sweep time 3.275 seconds.		

The upper and lower limits are piece-wise linear masks connecting points given in the table above. A lower PSD mask is provided to ensure the tolerances.

This test could be run using an external spectrum analyzer or the oscilloscope.

Setup Refer to "[General Test Setup](#)" on page 13 for testing using oscilloscope.

Refer to "[Transmitter Power Spectral Density \(PSD\) Test Setup](#)" on page 15 for testing using spectrum analyzer.

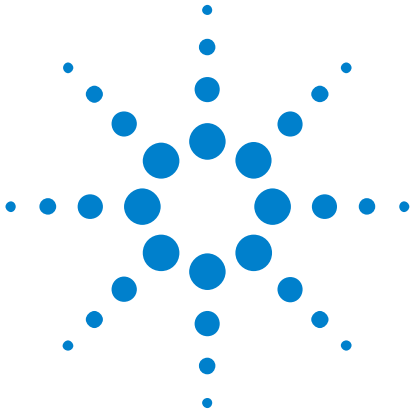

A Calibrating the Infiniium Oscilloscope and Probe

Oscilloscope Internal Calibration 36

Probe Calibration 40

This section describes the Agilent Infiniium digital storage oscilloscope calibration procedures.



Oscilloscope Internal Calibration

This will perform an internal diagnostic and calibration cycle for the oscilloscope. For the Agilent oscilloscope, this is referred to as Calibration.

Required Equipment for Oscilloscope Calibration

To calibrate the Infiniium oscilloscope in preparation for running the BroadR-Reach automated tests, you need the following equipment:

- Keyboard, qty = 1, (provided with the Agilent Infiniium oscilloscope).
- Mouse, qty = 1, (provided with the Agilent Infiniium oscilloscope).
- Precision 3.5 mm BNC to SMA male adapter, Agilent p/n 54855-67604, qty = 2 (provided with the Agilent Infiniium oscilloscope).
- Calibration cable (provided with Agilent Infiniium oscilloscopes). Use a good quality 50 Ω BNC cable.
- BNC shorting cap.

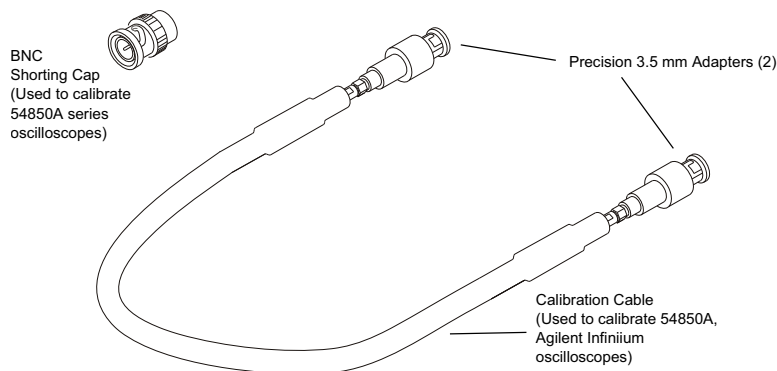

Figure 6 Accessories Provided with the Agilent Infiniium Oscilloscope

Running the Oscilloscope Internal Calibration

This Calibration will take about 20 minutes. Perform the following steps:

- 1 Set up the oscilloscope with the following steps:
 - a Connect the keyboard, mouse, and power cord to the rear of the oscilloscope.
 - b Plug in the power cord.
 - c Turn on the oscilloscope by pressing the power button located on the lower left of the front panel.
 - d Allow the oscilloscope to warm up at least 30 minutes prior to starting the calibration procedure in step 3 below.

- 2 Locate and prepare the accessories that will be required for the internal calibration:
 - a Locate the BNC shorting cap.
 - b Locate the calibration cable.
 - c Locate the two Agilent precision SMA/BNC adapters.
 - d Attach one SMA adapter to the other end of the calibration cable - hand tighten snugly.
 - e Attach another SMA adapter to the other end of the calibration cable - hand tighten snugly.
- 3 Referring to the following figure, perform the following steps:
 - a Click the **Utilities > Calibration...** menu to open the Calibration dialog box.

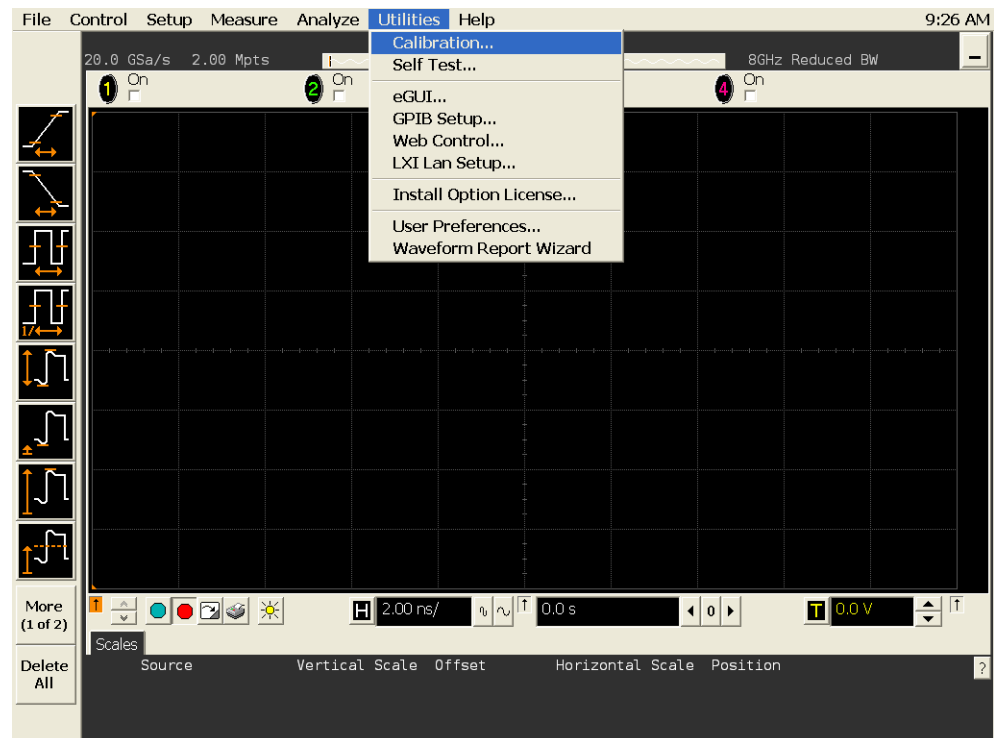

Figure 7 Accessing the Calibration Menu

- 4 Referring to the following figure, perform the following steps to start the calibration:

A Calibrating the Infiniium Oscilloscope and Probe

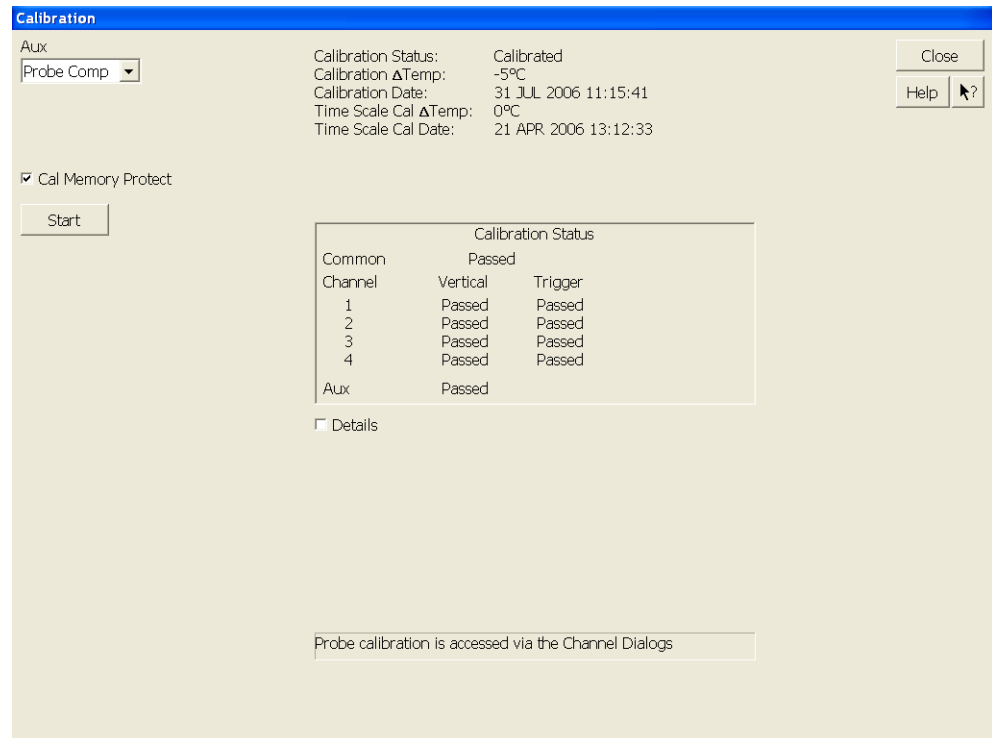

Figure 8 Oscilloscope Calibration Window

- a Uncheck the **Cal Memory Protect** checkbox.
- b Click the **Start** button to begin the calibration.
- c During the calibration of channel 1, if you are prompted to perform a **Time Scale Calibration**, as shown in the following figure, click the **Std+Dflt** button to continue the calibration, using the Factory default calibration factors.

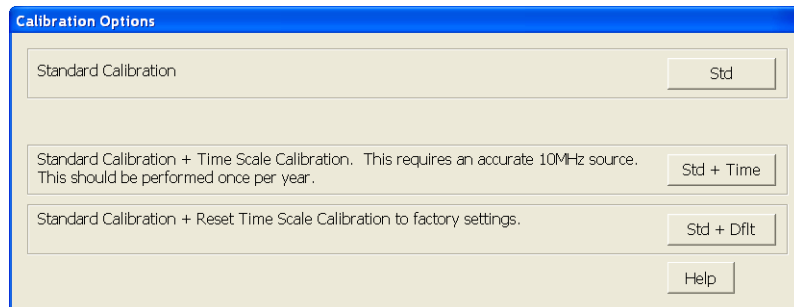

Figure 9 Time Scale Calibration Dialog Box

- d** When the calibration procedure is complete, you will be prompted with a Calibration Complete message window. Click the **OK** button to close this window.
- e** Confirm that the Vertical and Trigger Calibration Status for all Channels passed.
- f** Click the **Close** button to close the calibration window.
- g** The internal calibration is completed.

NOTE

These steps do not need to be performed every time a test is run. However, if the ambient temperature changes more than 5 degrees Celsius from the calibration temperature, this calibration should be performed again. The delta between the calibration temperature and the present operating temperature is shown in the **Utilities > Calibration...** menu.

Probe Calibration

Before performing BroadR-Reach tests, you should calibrate the probes. Calibration of the solder-in probe heads consist of a vertical calibration and a skew calibration. The vertical calibration should be performed before the skew calibration. Both calibrations should be performed for best probe measurement performance.

Required Equipment for Probe Calibration

The calibration procedure requires the following parts.

- BNC (male) to SMA (male) adapter.
- Deskew fixture.
- 50 Ω SMA terminator.

Connecting the Probe for Calibration

For the following procedure, refer to the following figure.

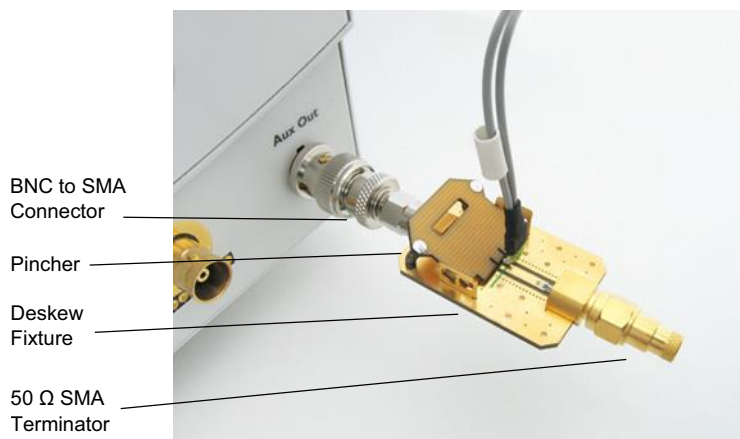

Figure 10 Solder-in Probe Head Calibration Connection Example

- 1 Connect BNC (male) to SMA (male) adapter to the deskew fixture on the connector closest to the yellow pincher.
- 2 Connect the 50 Ω SMA terminator to the connector farthest from yellow pincher.
- 3 Connect the BNC side of the deskew fixture to the Aux Out BNC of the Infiniium oscilloscope.
- 4 Connect the probe to an oscilloscope channel.
- 5 To minimize the wear and tear on the probe head, it should be placed on a support to relieve the strain on the probe head cables.
- 6 Push down the back side of the yellow pincher. Insert the probe head resistor lead underneath the center of the yellow pincher and over the center conductor of the deskew fixture. The negative probe head

A Calibrating the Infiniium Oscilloscope and Probe

resistor lead or ground lead must be underneath the yellow pincher and over one of the outside copper conductors (ground) of the deskew fixture. Make sure that the probe head is approximately perpendicular to the deskew fixture.

- 7 Release the yellow pincher.

Verifying the Connection

- 1 On the Infiniium oscilloscope, press the **[Auto Scale]** key on the front panel.
- 2 Set the volts per division to **100 mV/div**.
- 3 Set the horizontal scale to **1.00 ns/div**.
- 4 Set the horizontal position to approximately **3 ns**. You should see a waveform similar to that in the following figure.

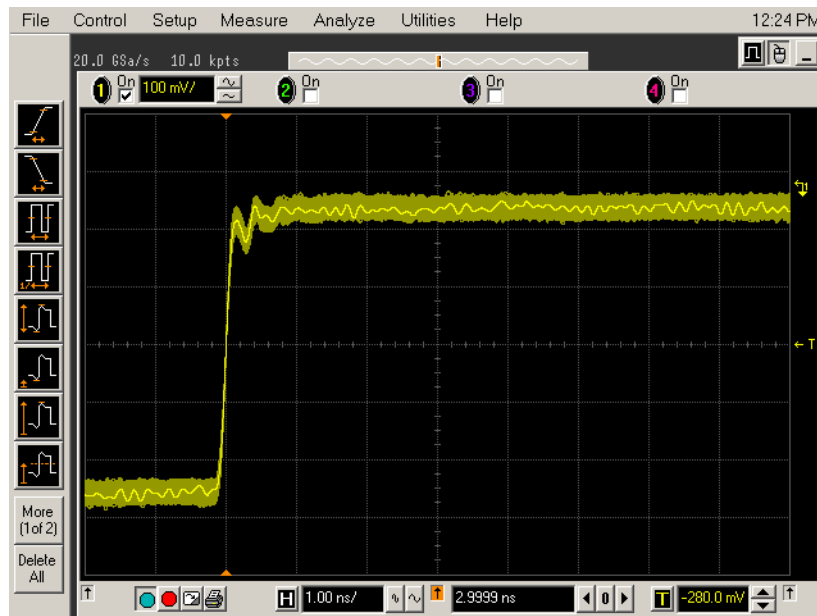

Figure 11 Good Connection Waveform Example

If you see a waveform similar to that of the following figure, then you have a bad connection and should check all of your probe connections.

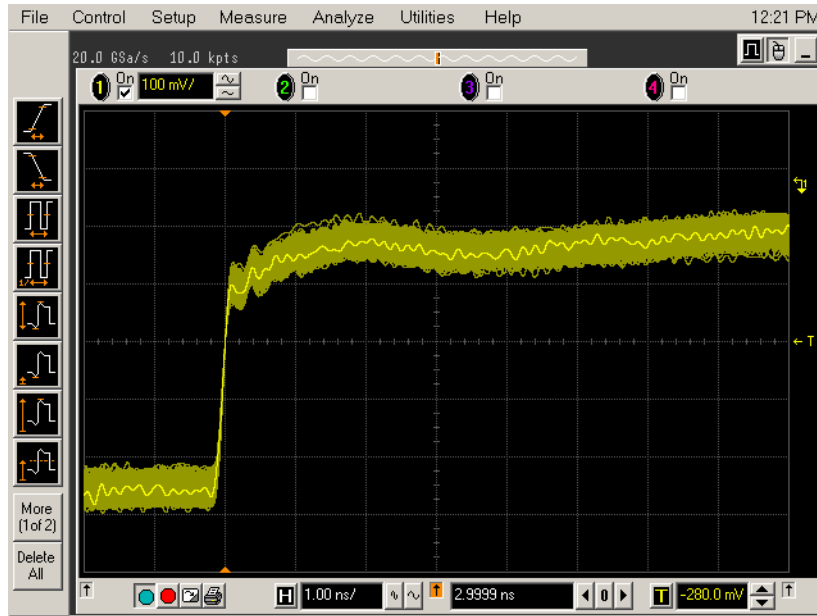

Figure 12 Bad Connection Waveform Example

Running the Probe Calibration and Deskew

- 1 On the Infiniium oscilloscope in the **Setup** menu, select the channel connected to the probe, as shown in the following figure.

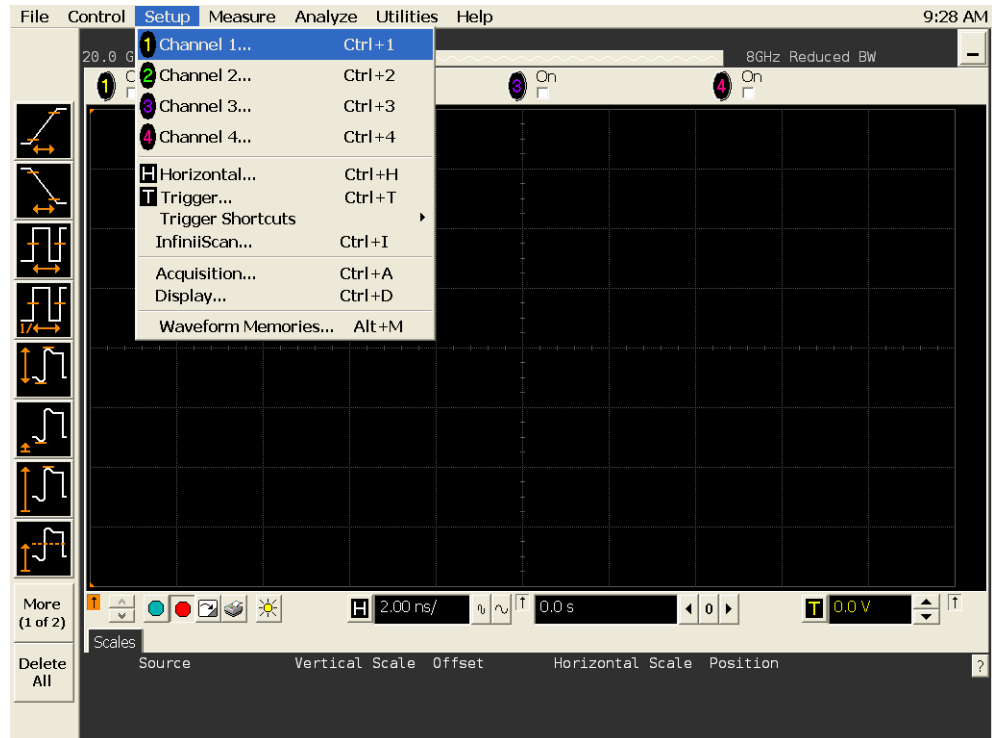

Figure 13 Channel Setup Window

- 2 In the Channel Setup dialog box, select the **Probes...** button, as shown in the following figure.

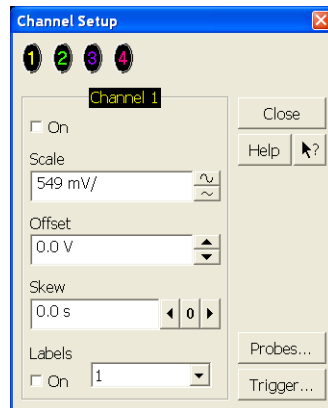

Figure 14 Channel Dialog Box

- In the Probe Setup dialog box, select the **Calibrate Probe...** button.

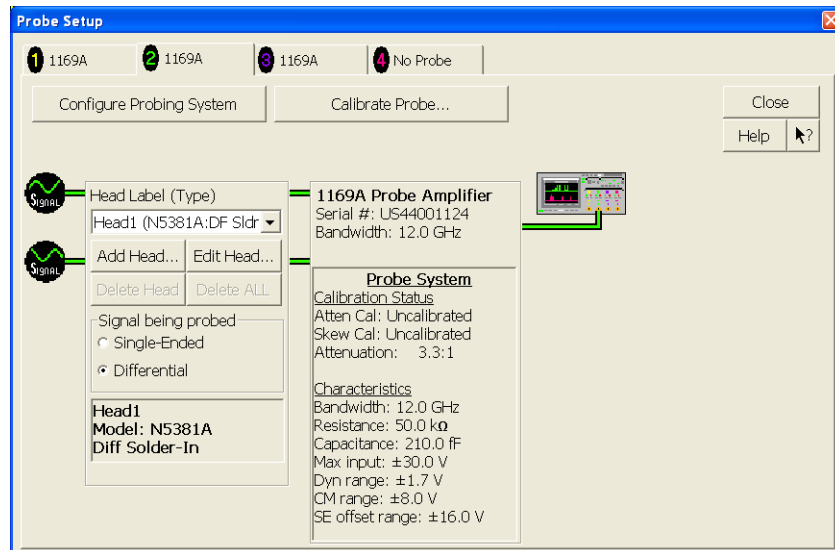

Figure 15 Probe Setup Window

- In the Probe Calibration dialog box, select the **Calibrated Atten/Offset** radio button.
- Select the **Start Atten/Offset Calibration...** button and follow the on-screen instructions for the vertical calibration procedure.

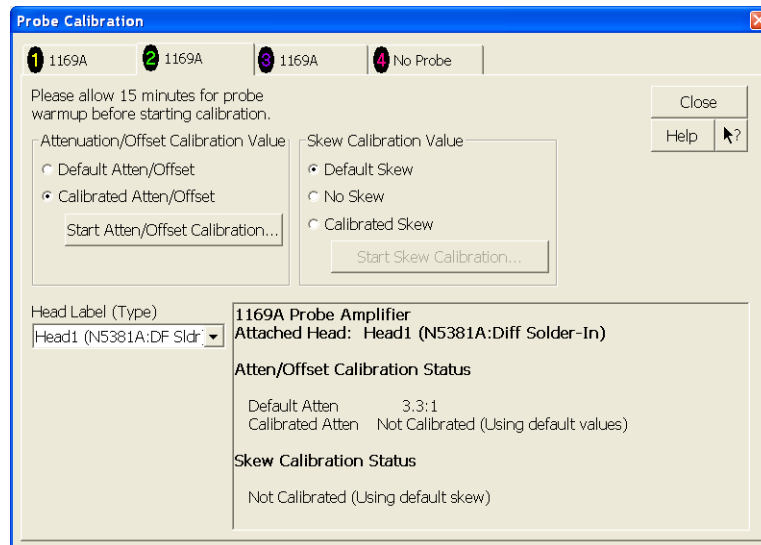

Figure 16 Probe Calibration Window

- 6 Once the vertical calibration has successfully completed, select the **Calibrated Skew...** button.
- 7 Select the **Start Skew Calibration...** button and follow the on-screen instructions for the skew calibration.

At the end of each calibration, the oscilloscope will prompt you if the calibration was or was not successful.

Verifying the Probe Calibration

If you have successfully calibrated the probe, it is not necessary to perform this verification. However, if you want to verify that the probe was properly calibrated, the following procedure will help you verify the calibration.

The calibration procedure requires the following parts:

- BNC (male) to SMA (male) adapter.
- SMA (male) to BNC (female) adapter.
- BNC (male) to BNC (male) 12 inch cable such as the Agilent 8120-1838.
- Agilent 54855-61620 calibration cable (Infiniium oscilloscopes with bandwidths of 6 GHz and greater only).
- Agilent 54855-67604 precision 3.5 mm adapters (Infiniium oscilloscopes with bandwidths of 6 GHz and greater only).
- Deskew fixture.

For the following procedure, refer to the following figure.

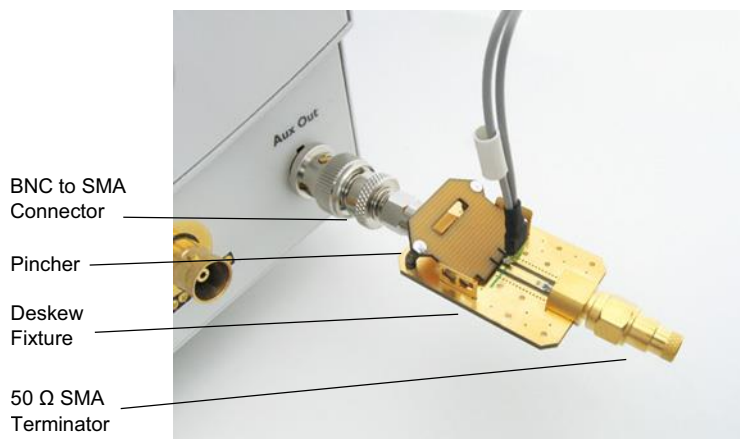

Figure 17 Probe Calibration Verification Connection Example

- 1 Connect BNC (male) to SMA (male) adapter to the deskew fixture on the connector closest to the yellow pincher.
- 2 Connect the SMA (male) to BNC (female) to the connector farthest from the yellow pincher.
- 3 Connect the BNC (male) to BNC (male) cable to the BNC connector on the deskew fixture to one of the unused oscilloscope channels. For infiniium oscilloscopes with bandwidths of 6 GHz and greater, use the 54855-61620 calibration cable and the two 54855-64604 precision 3.5 mm adapters.
- 4 Connect the BNC side of the deskew fixture to the Aux Out BNC of the Infiniium oscilloscope.
- 5 Connect the probe to an oscilloscope channel.

- 6 To minimize the wear and tear on the probe head, it should be placed on a support to relieve the strain on the probe head cables.
- 7 Push down on the back side of the yellow pincher. Insert the probe head resistor lead underneath the center of the yellow pincher and over the center conductor of the deskew fixture. The negative probe head resistor lead or ground lead must be underneath the yellow pincher and over one of the outside copper conductors (ground) of the deskew fixture. Make sure that the probe head is approximately perpendicular to the deskew fixture.
- 8 Release the yellow pincher.
- 9 On the oscilloscope, press the autoscale button on the front panel.
- 10 Select Setup menu and choose the channel connected to the BNC cable from the pull-down menu.
- 11 Select the **Probes...** button.
- 12 Select the **Configure Probe System** button.
- 13 Select **User Defined Probe** from the pull-down menu.
- 14 Select the **Calibrate Probe...** button.
- 15 Select the **Calibrated Skew** radio button.
- 16 Once the skew calibration is completed, close all dialog boxes.
- 17 Select the **Start Skew Calibration...** button and follow the on-screen instructions.
- 18 Set the vertical scale for the displayed channels to **100 mV/div**.
- 19 Set the horizontal range to **1.00 ns/div**.
- 20 Set the horizontal position to approximately **3 ns**.
- 21 Change the vertical position knobs of both channels until the waveforms overlap each other.
- 22 Select the Setup menu choose **Acquisition...** from the pull-down menu.
- 23 In the Acquisition Setup dialog box enable averaging. When you close the dialog box, you should see waveforms similar to that in the following figure.

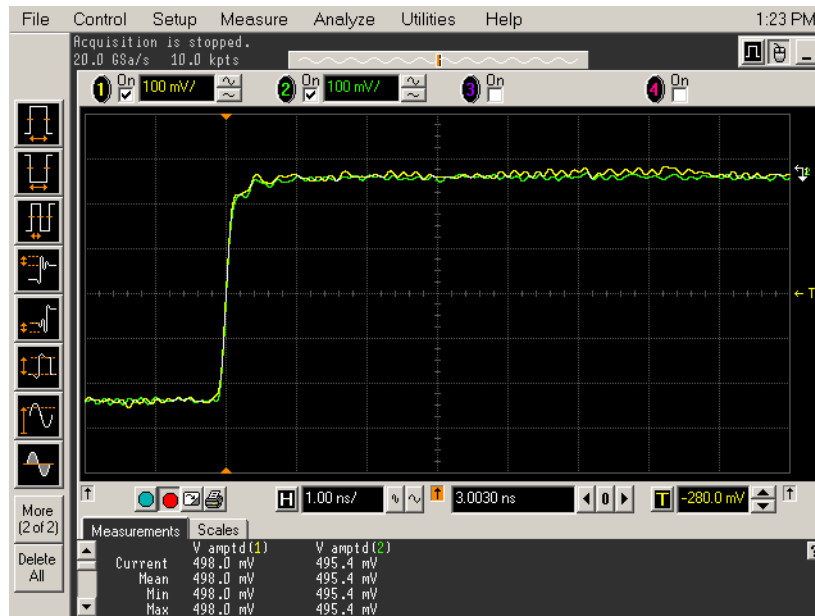

Figure 18 Calibration Probe Waveform Example

NOTE

Each probe is calibrated with the oscilloscope channel to which it is connected. Do not switch probes between channels or other oscilloscopes, or it will be necessary to calibrate them again. It is recommended that the probes be labeled with the channel on which they were calibrated.

A Calibrating the Infiniium Oscilloscope and Probe

Index

A

application software, installing, [8](#)
application software, starting, [17](#)
Automation tab, [18](#)

B

BNC shorting cap, [36](#)
BNC to SMA male adapter, [36](#)
BroadR-Reach compliance test application, [3](#)

C

calibrating the oscilloscope, [12](#), [35](#)
calibration cable, [36](#)
Configure tab, [17](#)
Connect tab, [17](#)

D

deskew and probe calibration, running, [44](#)

E

equipment required for calibration, [36](#)
equipment required for probe calibration, [40](#)

H

HTML Report tab, [18](#)

I

installation, [7](#)

K

keyboard, [36](#)

L

license key, installing, [9](#)

M

master TxOut jitter, [25](#)
measurements, preparing, [11](#)
mouse, [36](#)

N

N5395B/N5395C Ethernet Fixture, [13](#), [14](#)
notices, [3](#)

O

oscilloscope calibration, [12](#)
oscilloscope internal calibration, [36](#)
oscilloscope internal calibration, running, [36](#)

P

precision 3.5 mm BNC to SMA male
adapter, [36](#)
probe calibration, [40](#)
probe calibration and deskew, running, [44](#)
probe calibration connection, verifying, [42](#)
probe calibration, connecting, [40](#)
probe calibration, verifying, [46](#)

R

requirements, [13](#)
Results tab, [18](#)
Run Tests tab, [18](#)

S

Select Tests tab, [17](#)
Set Up tab, [17](#)
slave TX_TCLK jitter, [29](#)

T

Test Mode 1 tests, [19](#)
Test Mode 2 tests, [23](#)
Test Mode 3 tests, [27](#)
Test Mode 4 tests, [31](#)
Test Mode 5 tests, [33](#)
test setup, general, [13](#)
test setup, transmitter distortion, [14](#)
test setup, transmitter power spectral
density, [15](#)
transmit clock frequency (master), [24](#)
transmit clock frequency (slave), [28](#)
transmitter distortion, [32](#)
transmitter output droop negative, [21](#)
transmitter output droop positive, [20](#)
transmitter power spectral density (PSD), [34](#)

