

Solutions for Cost Savings in Creating Realistic Multi-Emitter Signal Scenarios

Application Brief

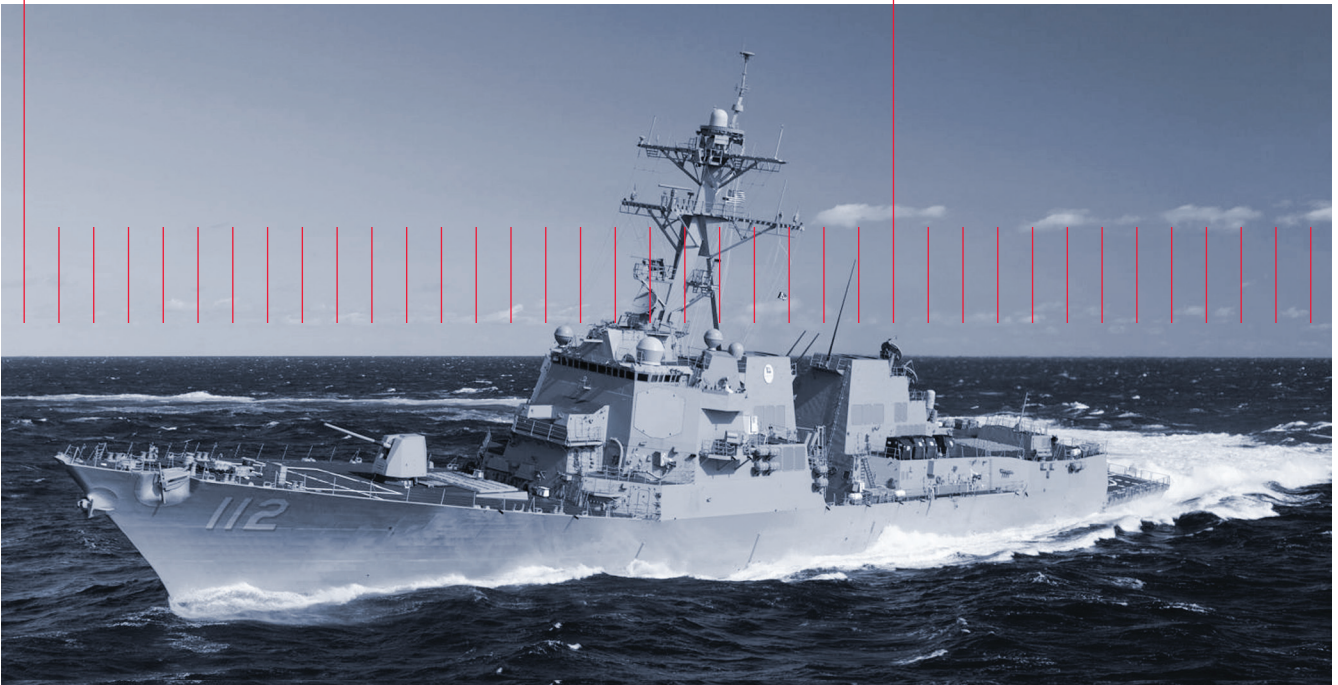



Introduction

Today's radar and electronic warfare (EW) systems face an increasingly cluttered spectral environment. As an example, the airwaves in an urban setting may include countless RF and microwave emitters—and therefore potential interferers—such as wireless communications infrastructure, wireless networking systems and civilian radars. Evaluating radar/EW hardware under a variety of highly realistic scenarios can help characterize system performance in the presence of multiple interference signals.

To test hardware in the lab environment, one option is to capture actual waveforms in the field and play them back in the lab environment. Another option is to create highly realistic multi-emitter test signals. Better yet, combine both to provide flexible test spectrums consisting of both real world signals as well as simulated formats.

Custom hardware and software to create these test signals can be costly. The design, development and testing of custom systems takes time, money and resources. This brief describes a commercial, off-the-shelf (COTS) solution for signal generation and analysis, and presents two example scenarios. Highlights include creation of multi-emitter test signals, the capture of real world signals, and combining these to create highly flexible test scenarios.

Problem: Today's spectral environment becoming increasingly crowded with many sources of potential interferers

Simulation sources have generally been used in electronic systems level (ESL) or electronic design automation (EDA) environments to design RF systems and circuits. Until recently, these have been used to design for a single format within categories such as wireless communications, wireless connectivity or radar. Modern environments include multiple categories of potential interference signals, highlighting the need for more capable and flexible test systems.

Creating new test systems to provide realistic spectrum emulation for component and system level testing need to take into account today's complex spectral environment. Differences in frequency and modulation types impose a challenge in capturing and recreating real world signals. In addition, combining the real

world spectrum with simulated signals makes the effort even more complex.

In the past, a single emitter simulation could be used to create a test signal with an arbitrary waveform generator (AWG). In such cases the simulation time-step or sample rate is set to match the specific signal format of interest. For example, in an LTE simulation the sample rate might be set to oversample the LTE signal by a factor of two or four.

In simulation, using a single sample rate for a single emitter signal is a relatively straightforward process; however, today's real-world signal scenarios are much more complex. With most EDA or ESL tools, it can be quite challenging to combine multiple signal types that utilize different sample rates. As an example,

imagine combining radar, LTE and 802.11ac wireless LAN (WLAN) signals. Achieving a common sample rate requires the cumbersome process of finding suitable up-sampling or down-sampling factors for each signal. This level of complexity presents a significant barrier to the creation of realistic scenarios that contain multiple emitters.

Capital investment in test equipment is often balanced against long-term usefulness. Flexibility to address emerging scenarios and applications are also needed. Custom-built test equipment typically falls short in these areas as they are designed for a specific application and often need additional development and redesign for continued usefulness.

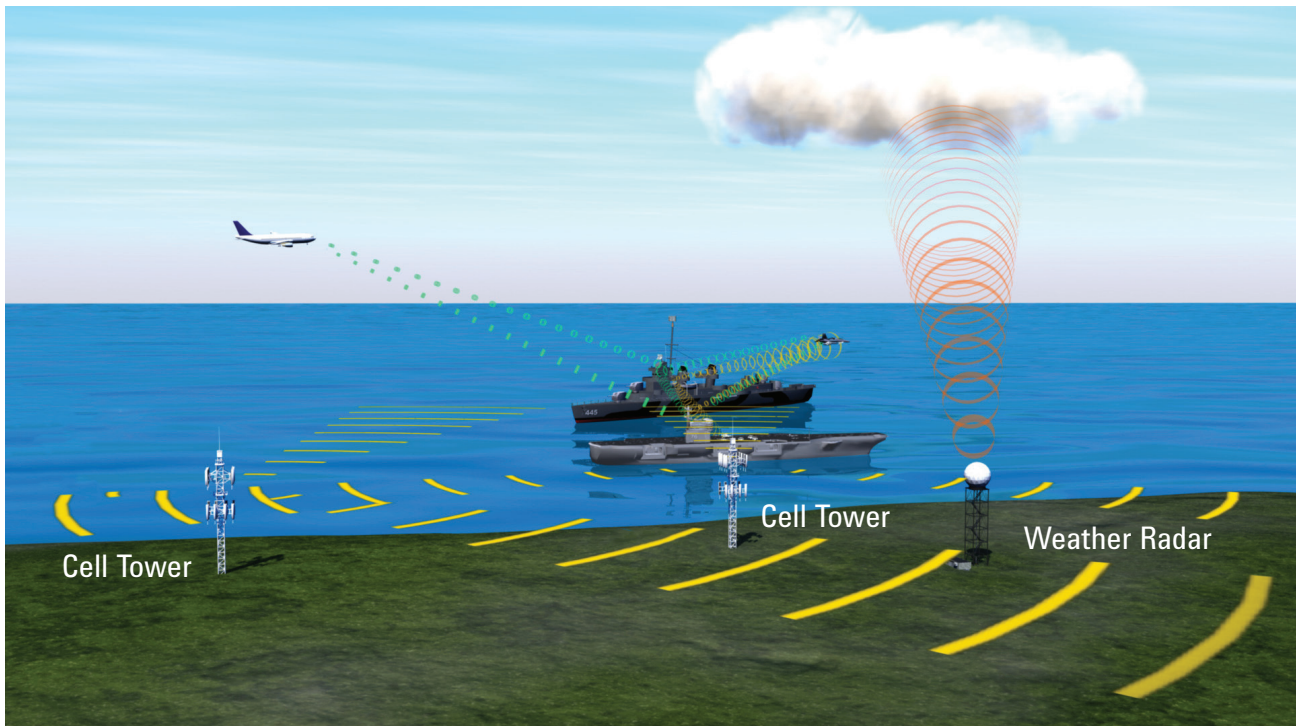

Figure 1. Today's cluttered spectral environment.

Solution: A COTS configuration creating multi-emitter waveforms with simulation and high-performance AWGs

Keysight Technologies has developed a simulation-based SignalCombiner element which is capable of re-sampling and combining of multiple signals that have different bandwidths and signal types. In addition, when used with Keysight test equipment, it can combine real-world signals that have been captured and combine them with library-based signals to create composite output spectrums.

The flexibility of this solution is provided by Keysight EEs of ESL SystemVue software. In SystemVue, the SignalCombiner element enables the creation and combination of multi-emitter signals within the simulation environment. Through resampling, multiple emitters are combined into a single waveform that can be downloaded to a high-precision AWG such as the Keysight M8190A

for playback (Figure 2). Because the M8190A delivers high resolution and wide bandwidth simultaneously, it is well suited to applications that require playback of complex, high fidelity signals.

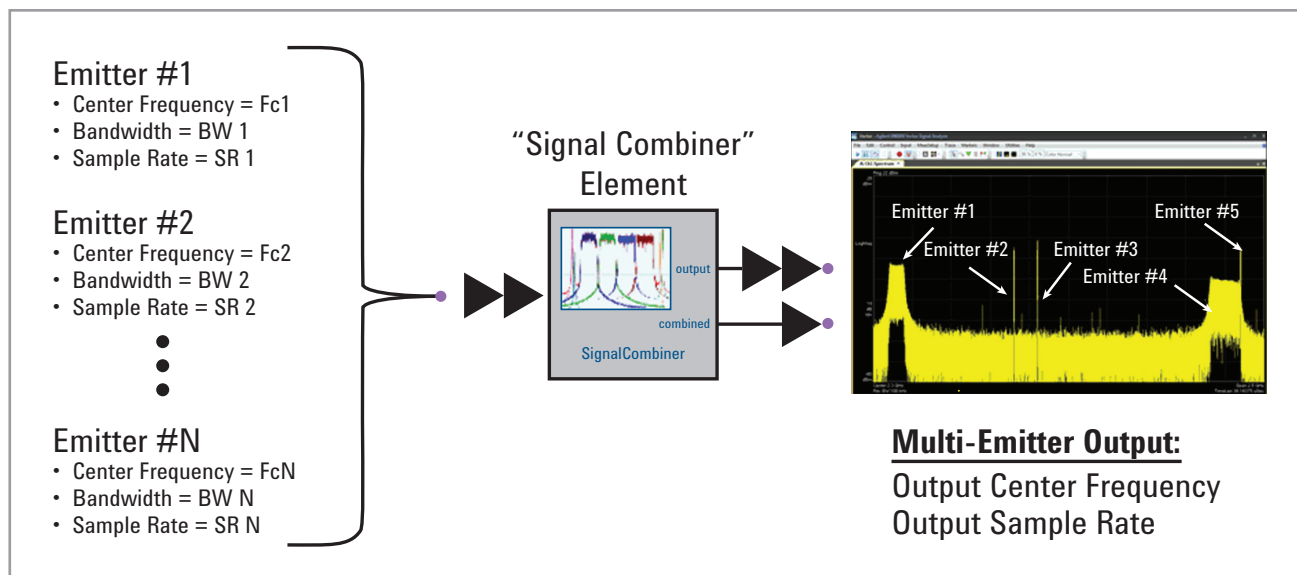

Figure 2. SignalCombiner resamples multiple emitters and produces a single signal that can be used as a stimulus in device testing.

A complete software and hardware configuration, as shown in Figure 3, contains the following elements:

- **W1461 BP** SystemVue Comms Architect and W1905EP Radar Library: System-level simulation design software which can be used to simulate and combine emitters.
- **M8190A**: The AWG provides 12-bit resolution at 12 GSa/s and 14-bit resolution at 8 GSa/s. Its two output channels can be used to drive the wideband I and Q inputs of an E8267D PSG vector signal generator.
- **E8267D** with Option 016: The PSG vector signal generator can be used to modulate and upconvert I and Q baseband signals produced by the AWG. The maximum carrier frequency is 44 GHz.
- **DSAX96204Q**: This high-performance Infiniium oscilloscope provides 63 GHz bandwidth for analysis of ultra-wideband (UWB) signals and provides direct time domain view of signals with frequencies beyond Ka-band and into V-band.
- **PXA**: The signal analyzer provides frequency coverage from 3 Hz to 50 GHz with industry leading displayed average noise level (DANL).
- **89600**: Keysight's industry-leading vector signal analysis (VSA) software supports more than 70 signal standards and modulation types. It provides analysis capabilities in the time, frequency and modulation domains. The 89600 VSA software can be used with simulation as well as with test equipment.

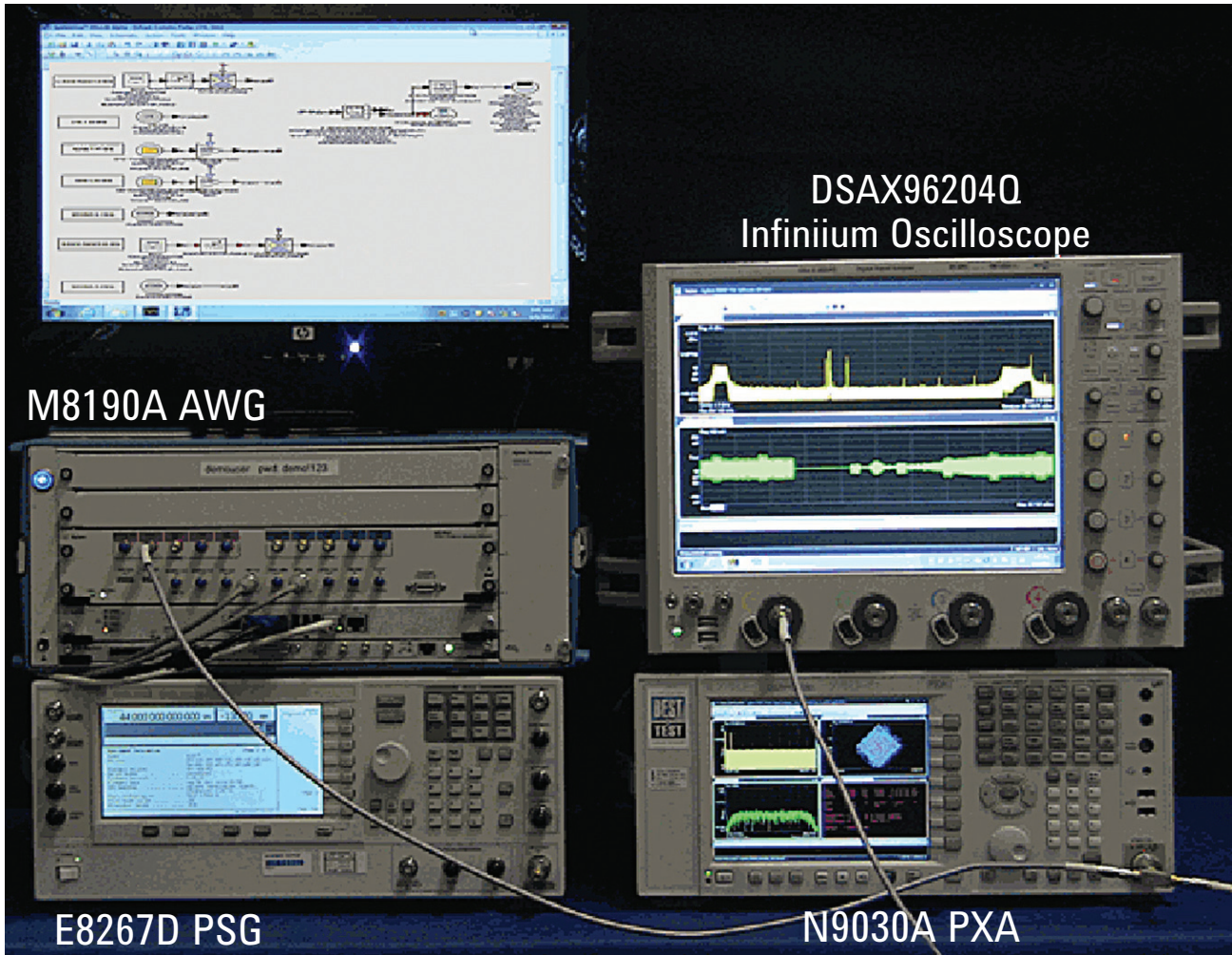

Figure 3. This combination of COTS hardware and software enables cost-effective creation and analysis of multi-emitter signal scenarios.

In the example configuration, the SystemVue ESL software is running on the AWG's embedded controller. The 89600 VSA software, which provides demodulation capabilities, is running inside the oscilloscope but could also run inside the PXA.

Unlike expensive multi-bay test systems that produce signal scenarios in real time, the example configuration produces

multi-emitter signals using simulation. Signal creation can be time consuming, depending on the complexity, sample rate and total playback time. However, simulations can be performed "off-line" to create .bin files, which can later easily be downloaded to the M8190A AWG using the M8190A soft front panel software.

When compared to real-time systems, the configuration shown here may

provide a subset of the capability, but may still cover a significant number of the likely use cases for testing in R&D applications. In addition, the relatively low cost of a COTS solution may make it possible to equip multiple labs or teams with individual systems, facilitating analysis of various scenarios prior to system-level testing hardware with the real-time system.

Results, part 1: Creating realistic multi-emitter radar and comms test signals

The goal of any test system stimulus is to provide realistic test inputs to the device under test (DUT) to verify design requirements compliance. Contemporary radar and EW systems face a continuously increasing spectrum of RF and Microwave signals that vary in format and quantity. Achieving these goals with the broadest application and lowest cost

using COTS software and hardware is demonstrated by the Keysight solution shown below.

Figure 4 shows the basic flow of creating complex test spectrums using this approach. SystemVue has a rich set of libraries which can be used to create emitters, including standards-based wireless

libraries and a radar library. These can be combined together to create complex spectrums. The resulting multi-emitter signal can then be downloaded to an AWG to playback the resulting multi-emitter test signal. A vector PSG can be used to modulate I/Q signals on an RF/microwave carrier for higher frequency modulated test signals.

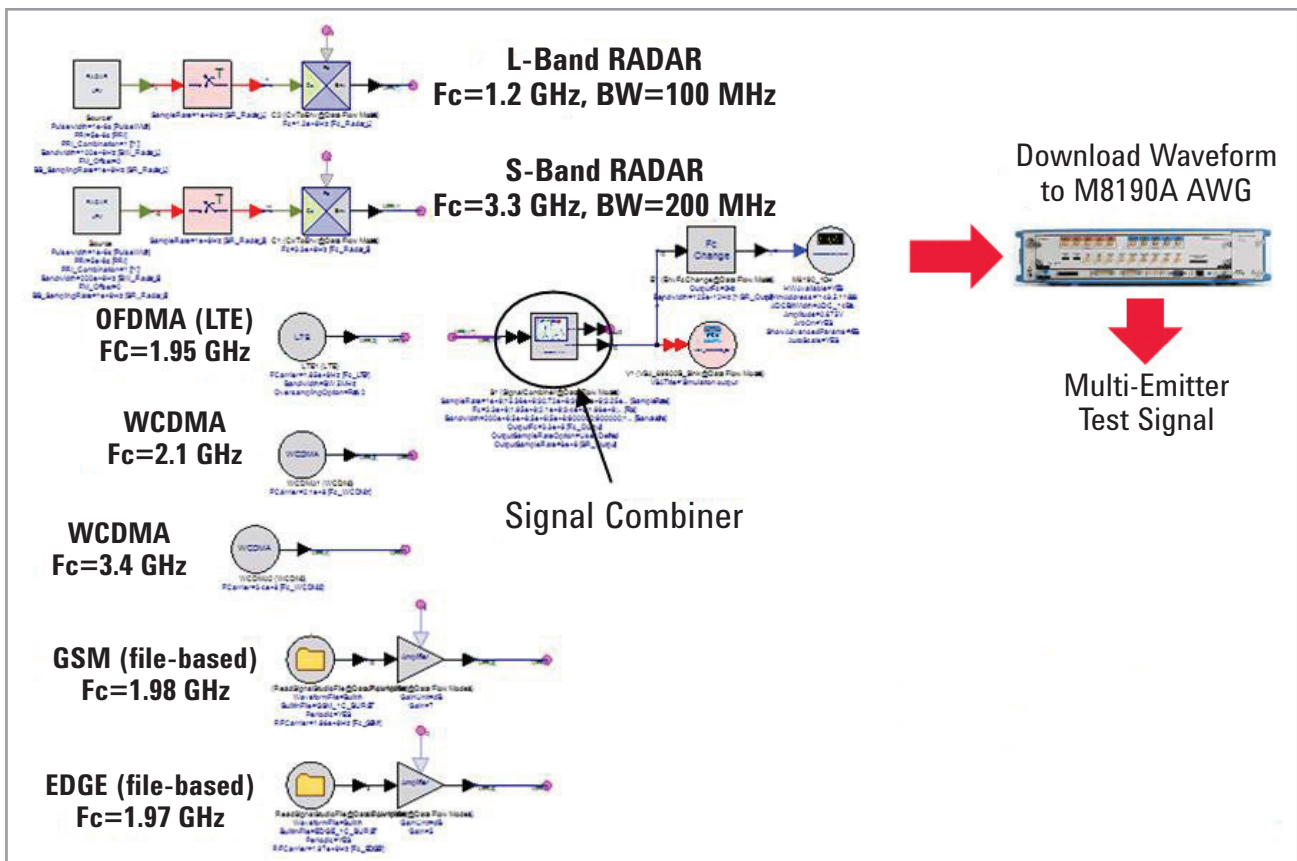

Figure 4. Multi-emitter signal creation with SystemVue

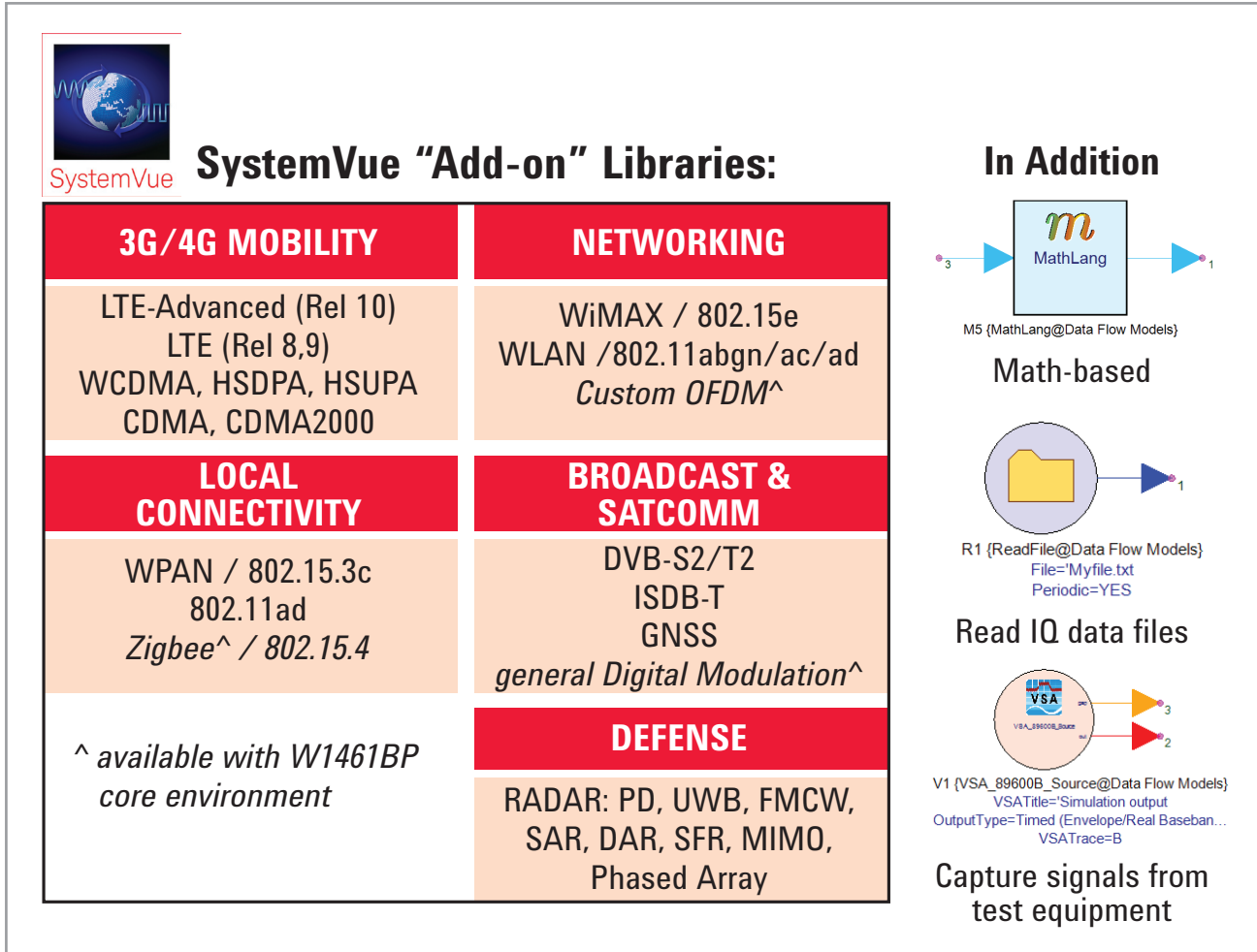

Figure 5. Creating waveforms in SystemVue

Figure 5 shows the rich set of add-on libraries available with SystemVue, including LTE, W-CDMA, custom OFDM, and wireless networking libraries. In addition, SystemVue supports math-based modeling (Mathlang) and signals can be read in as ascii I/Q data files or by capturing and recording them into an .sdf file using the 89600 VSA software with Keysight test equipment.

Figure 4 shown earlier is the SystemVue workspace that is used to simulate the multi-emitter environment. Two radar

waveforms are simulated, one at L-band with a center frequency of 1.2 GHz and LFM chirp bandwidth of 100 MHz, and one at S-band with a center frequency of 3.3 GHz and an LFM chirp bandwidth of 200 MHz. Several wireless emitters are also simulated: an LTE OFDMA signal at 1.95 GHz, two W-CDMA signals (one at 2.1 GHz and one at 3.4 GHz), a GSM signal at 1.98 GHz, and an EDGE signal at 1.97 GHz.

Figure 6 shows the measured multi-emitter environment on the oscilloscope

using the VSA software. The L-band radar signal is on the far left. The LTE, EDGE, GSM, and W-CDMA signals are near the middle of the spectrum, and the S-band radar signal is on the far right. One of the W-CDMA signals falls within the S-band radar's bandwidth.

Figure 7 shows how we can zoom into the L-band radar spectrum. The main time display (green trace on lower left) shows the linear frequency chirp. The chirped phase and frequency are shown on the right.

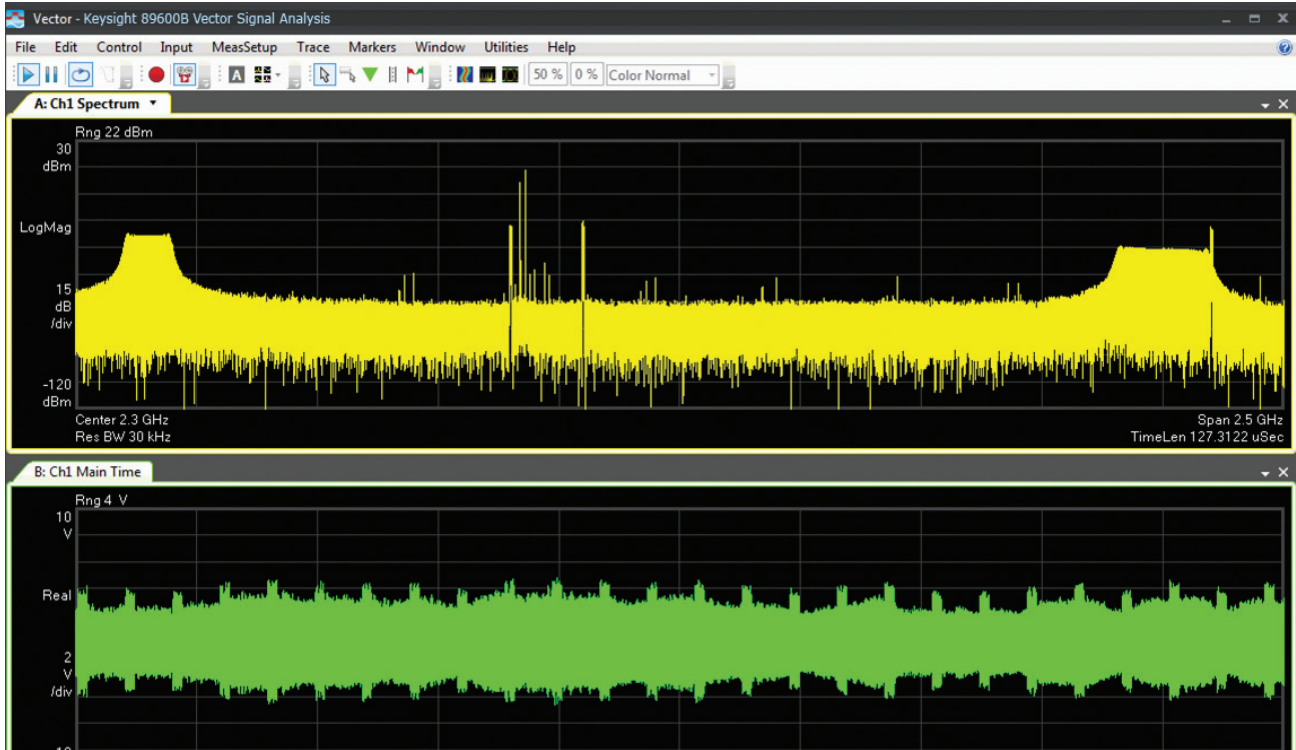

Figure 6. Measured waveform on DSA 91304A high performance oscilloscope and VSA

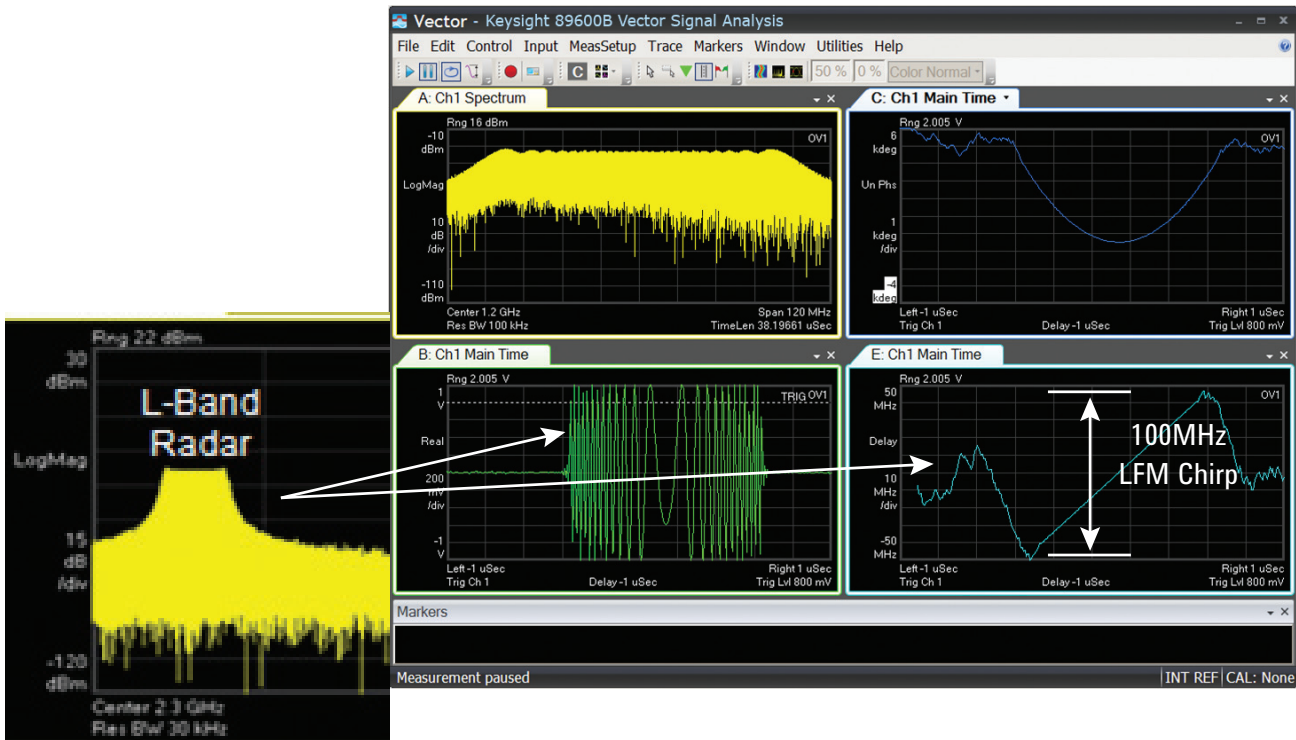

Figure 7. Close-Up: S-band radar emitter

Results, part 2: Creating a multi-emitter environment using captured real-world signals and simulated emitter signals

Today's cluttered spectral environment may contain many potential sources of interference such as wireless signals, signals from military assets, radars, EW, etc. Capturing these offending signals in the actual environment, storing the information and playing back the spectrums during testing allows for great flexibility.

In addition to capturing offending signals, it may be useful to generate mixed radar and communications test signals to evaluate hardware under different scenarios. This enables the ability to create "worse case" scenarios to evaluate the performance of the DUT.

Advantages:

- Generate realistic radar and communication test signals at a fraction of the cost using COTS
- Address emerging signal and threat scenarios using a flexible combination of captured recordings and simulated radar and communication emitters
- Reduce the need for multiple racks using a high precision, wide bandwidth AWG to turn simulated signals into highly realistic signals

The Keysight hardware and software that performs multi-channel signal capture are the M9703A digitizer and 89600 VSA

software. Combined with an RF down-converter, or PXAs used in a wideband downconversion mode, broad spectrums of real world signals can be captured and stored for testing.

The M9703A digitizer is a multiple-channel phase-coherent digitizer which can digitize up to 8 IF channels per blade. Once the signals have been digitized, they can be identified and analyzed using the 89600 VSA software. Recorded signals can then be combined with other radar and communications emitters using SystemVue and downloaded to the M8190A AWG to create multi-emitter test signals.

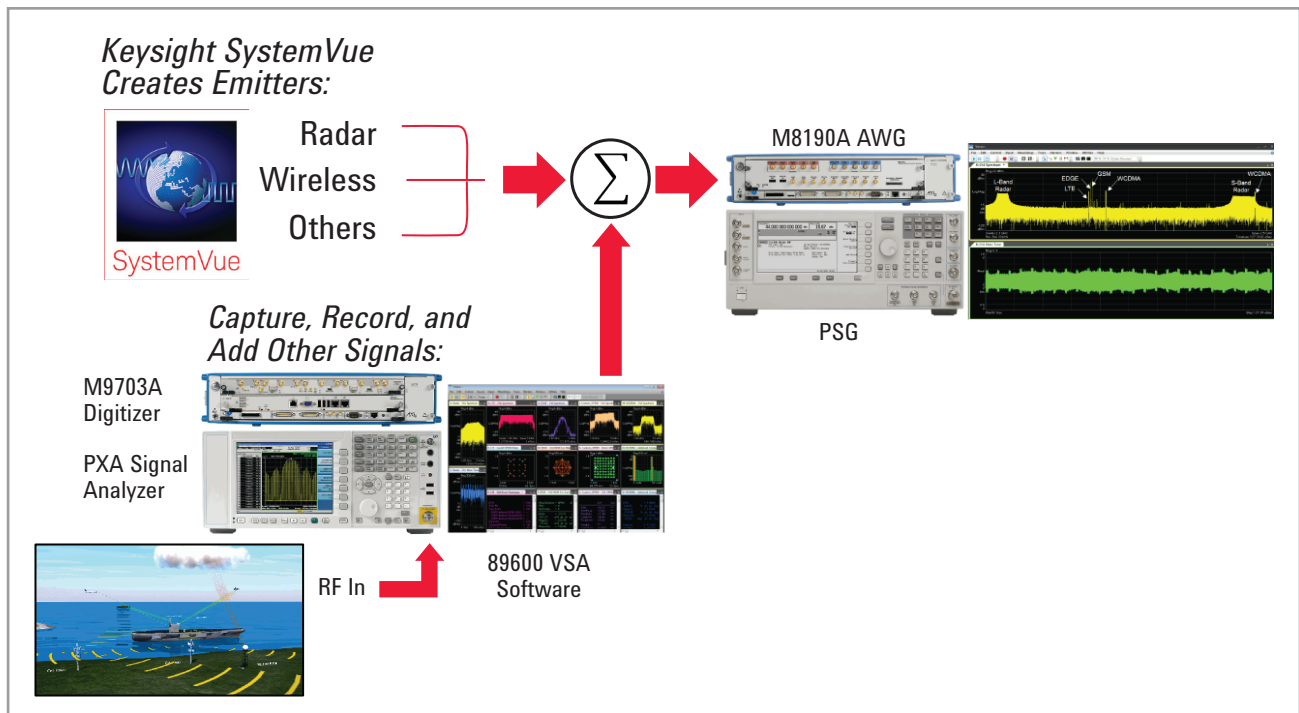

Figure 8. Creating multi-emitter waveforms with digitizers, simulation, and high-performance AWGs

The M9703A FPGAs feature an optional real-time digital downconverter (DDC), allowing tuning and zooming on the analyzed signal. The DDC improves the dynamic range, reduces the noise floor, and extends the capture time for an accelerated measurement speed. The DDC can be utilized with the 89600 VSA software for advanced measurement analysis.

An additional option for capturing signals is using a wideband real-time digital oscilloscope such as Keysight Infiniium Q-Series oscilloscopes, to directly digitize a signal up to 62 GHz for analysis with the 89600 VSA software.

Figure 9 shows five IF signals captured and digitized with the M9703A digitizer,

using a PXA as a wideband downconverter. A radar signal centered at 1.85 GHz is shown on the upper left, an LTE signal centered at 1.95 GHz on the lower left, and EDGE signal centered at 1.97 GHz on the upper middle, a W-CDMA signal centered at 1.98 GHz on the lower middle, and a custom OFDM signal centered at 1.9 GHz on the upper right.

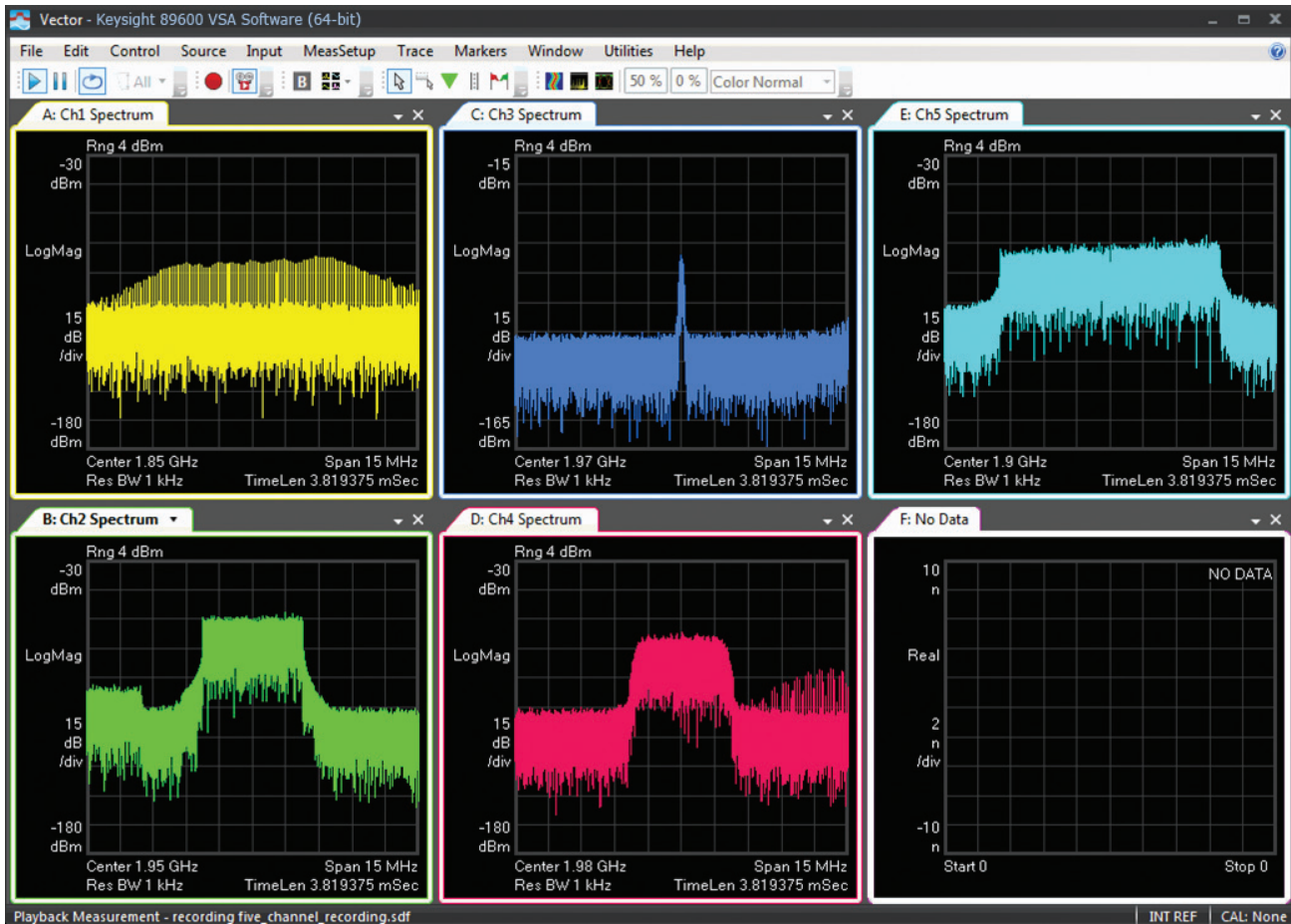

Figure 9. 5 Channel IF signal captured with M9703A

Each digitized channel is analyzed simultaneously at different frequencies using the 89600 VSA software with the M9703A digitizer and DDC as shown in Figure 10. The radar signal is shown on the left, followed by the LTE demodulation, EDGE demodulation, custom OFDM demodulation, and W-CDMA demodulation.

Each channel of the recorded .sdf file is read into SystemVue using the 89600 VSA simulation signal source. The

recorded signals are re-sampled and combined into one waveform, which is downloaded as an IF signal to channel 1 on the M8190A AWG.

Additional radar and W-CDMA are re-sampled and combined, then downloaded as an IF signal to channel 2 on the M8190A AWG.

Figure 11 shows Channels 1 and 2 on the M8190A AWG being combined together

with a splitter to create a composite test signal comprised of the recorded signals and additional emitters added in SystemVue. The resulting spectrum, as measured on the PXA signal analyzer, is shown in Figure 11.

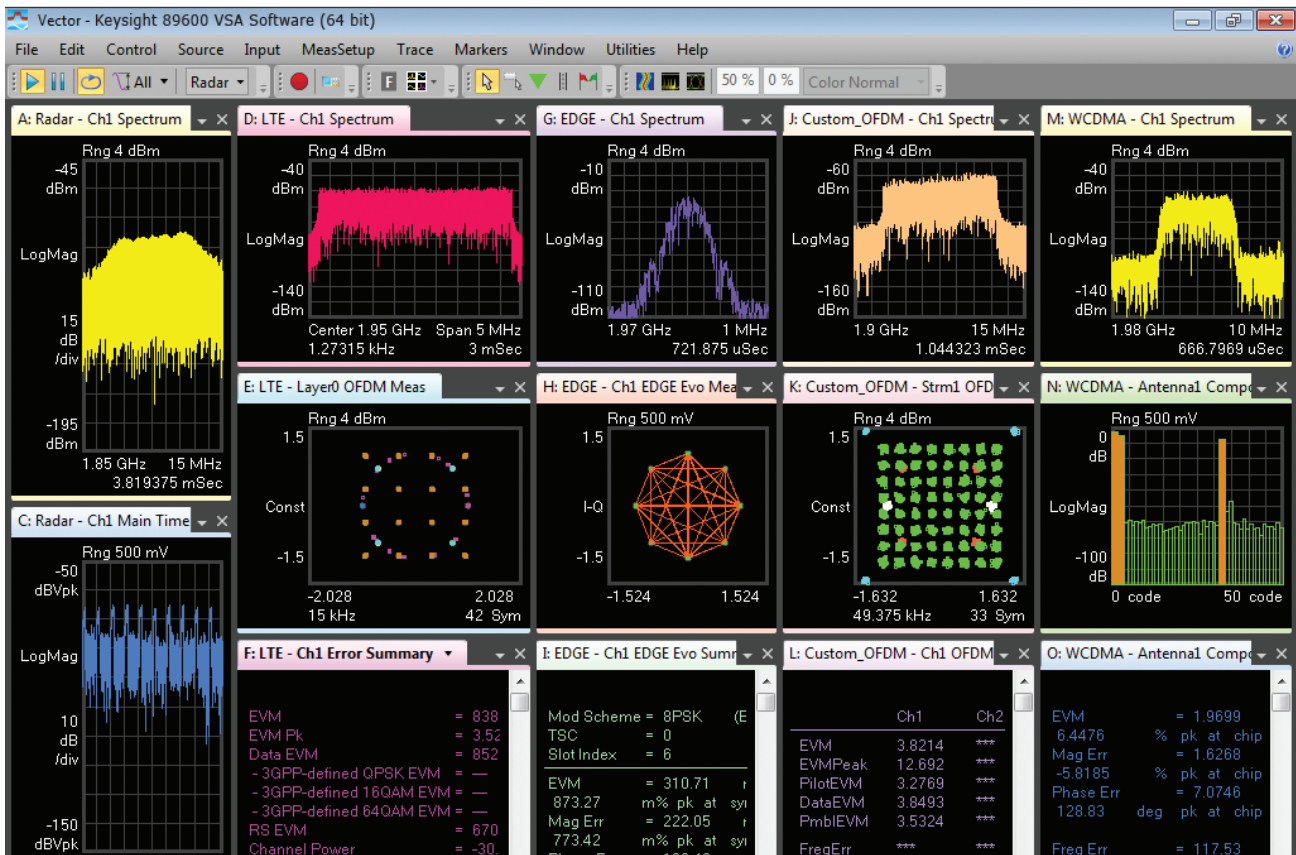

Figure 10. 5 Simultaneous Demodulation of the Signals at Different Frequencies using the 89600 VSA Software with M9703A DDC

Conclusion

Today's systems operate in increasingly cluttered RF and microwave spectral environments. These environments may consist of many different types of emitters including radar, wireless communications, wireless networking, and other potential interference sources. Evaluating hardware under a variety of emitter test signal scenarios helps to determine the system performance in the presence of potential interference. Co-existence between radar and wireless systems can be a significant issue.

Capturing actual waveforms in the field and playing them back in the lab environment has utility in creating a realistic spectral environment for hardware Device-Under-Test (DUT) evaluation. In addition, however, it may also be useful to modify a captured spectral environment with additional emitters to evaluate hardware in the lab environment over a number of different signal scenarios.

The Keysight COTS approach can be used to create multi-emitter test signals with COTS ESL software, a wideband AWG and a vector signal generator with wideband I/Q inputs. Keysight's advances in simulation arbitrary resampling technology—when combined with the signal fidelity provided by recent advances in AWG technology—simplify the generation of wideband multi-emitter signals. The flexibility of this approach enables detailed examination of emitter co-existence using the same test equipment.

Keysight COTS solution provides a cost effective method to achieve these test goals. The flexibility and applicability of this solution provides the user with the ability to adapt to changing conditions, evolving real world spectrums and emerging signal scenario requirements. Advantages include:

- Generate realistic radar and communication test signals at a fraction of the cost using COTS
- Address emerging signal scenarios using a flexible combination of captured recordings and simulated radar and communication emitters
- Reduce the need for multiple racks using a high precision, wide bandwidth AWG to turn simulated signals into highly realistic signals
- Flexibility for testing from components level through system level

Although this is not a real-time capability, the flexibility gained by combining design simulation with COTS wideband test equipment is an efficient way to address emerging multi-emitter signal scenarios. With a modest set of test equipment, the COTS system provides a cost-effective test solution for present and future multi-emitter R&D test applications.

Related literature

- Technical overview, *Keysight EEsof EDA SystemVue 2012*, publication 5990-4731EN
- Note: The technical overview includes information about a variety of waveform libraries including radar (W1905), LTE (W1912), WLAN (W1917) and LTE-Advanced (W1918)
- Product brochure, *89600 VSA Software*, publication 5990-6553EN
- Product data sheet, *M8190A Arbitrary Waveform Generator*, publication 5990-7516EN
- Product data sheet, *E8267D PSG Vector Signal Generator*, publication 5989-0697EN
- Product brochure, *PSG Signal Generators*, publication 5989-1324EN
- Product data sheet, *Infiniium 90000 Q-Series Oscilloscopes*, publication 5990-9712EN
- Product data sheet, *Infiniium 90000 X-Series Oscilloscopes*, publication 5990-5271EN
- Product brochure, *N9030A PXA X-Series Signal Analyzer*, publication 5990-3951EN
- Product brochure, *X-Series Signal Analysis*, publication 5990-7998EN

myKeysight

myKeysight

www.keysight.com/find/mykeysight

A personalized view into the information most relevant to you.

Three-Year Warranty

www.keysight.com/find/ThreeYearWarranty

Keysight's commitment to superior product quality and lower total cost of ownership. The only test and measurement company with three-year warranty standard on all instruments, worldwide.



Keysight Assurance Plans

www.keysight.com/find/AssurancePlans

Up to five years of protection and no budgetary surprises to ensure your instruments are operating to specification so you can rely on accurate measurements.



Keysight Channel Partners

www.keysight.com/find/channelpartners

Get the best of both worlds: Keysight's measurement expertise and product breadth, combined with channel partner convenience.

www.keysight.com/find/ad

For more information on Keysight Technologies' products, applications or services, please contact your local Keysight office. The complete list is available at: www.keysight.com/find/contactus

Americas

Canada	(877) 894 4414
Brazil	55 11 3351 7010
Mexico	001 800 254 2440
United States	(800) 829 4444

Asia Pacific

Australia	1 800 629 485
China	800 810 0189
Hong Kong	800 938 693
India	1 800 112 929
Japan	0120 (421) 345
Korea	080 769 0800
Malaysia	1 800 888 848
Singapore	1 800 375 8100
Taiwan	0800 047 866
Other AP Countries	(65) 6375 8100

Europe & Middle East

Austria	0800 001122
Belgium	0800 58580
Finland	0800 523252
France	0805 980333
Germany	0800 6270999
Ireland	1800 832700
Israel	1 809 343051
Italy	800 599100
Luxembourg	+32 800 58580
Netherlands	0800 0233200
Russia	8800 5009286
Spain	0800 000154
Sweden	0200 882255
Switzerland	0800 805353
	Opt. 1 (DE)
	Opt. 2 (FR)
	Opt. 3 (IT)
United Kingdom	0800 0260637

For other unlisted countries:
www.keysight.com/find/contactus
 (BP-07-10-14)