

Keysight E3633A and E3634A DC Power Supplies

NOTICE: This document contains references to Agilent Technologies. Agilent's former Test and Measurement business has become Keysight Technologies. For more information, go to www.keysight.com.



The Keysight E3633A and Keysight E3634A are high performance 200 watt single-output dual range programmable DC power supplies with both GPIB and RS-232 interfaces. The combination of bench-top and system features in these power supplies provides versatile solutions for your design and test requirements.

Convenient bench-top features

- Single-output dual range
- Easy-to-use knob control settings
- Highly visible vacuum-fluorescent display meters
- High accuracy and high resolution
- Remote voltage sensing
- Overvoltage and overcurrent protection
- Output on/off
- Excellent load and line regulation and low ripple and noise
- Operating states storage
- Portable, ruggedized case with non-skid feet
- Front and Rear output terminals
- Retrieving/Scrolling error messages on the display

Flexible system features

- GPIB (IEEE-488) and RS-232 interfaces are standard
- SCPI (Standard Commands for Programmable Instruments) compatibility
- I/O setup easily done from front-panel
- Software calibration, no internal adjustments required

Keysight E3633A and E3634A DC Power Supplies

The Front Panel at a Glance

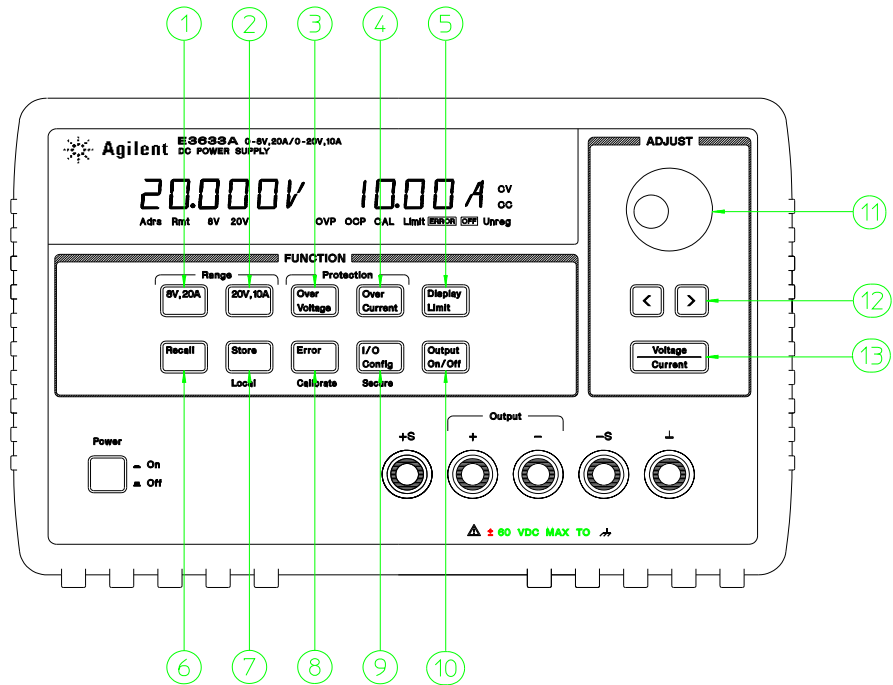

- | | |
|---|---|
| 1 8V/20A range selection key (E3633A)
25V/7A range selection key (E3634A) | 7 Store operating state/Local key |
| 2 20V/10A range selection key (E3633A)
50V/4A range selection key (E3634A) | 8 Error/Calibrate key |
| 3 Overvoltage protection key | 9 I/O Configuration/Secure key |
| 4 Overcurrent protection key | 10 Output On/Off key |
| 5 Display limit key | 11 Control knob |
| 6 Recall operating state key | 12 Resolution selection keys |
| | 13 Voltage/current adjust selection key |

- 1 8V/20A* or 25V/7A** range selection key** Selects the 8V/20A or 25V/7A range and allows the full rated output to 8V/20A or 25V/7A.
- 2 20V/10A* or 50V/4A** range selection key** Selects the 20V/10A or 50V/4A range and allows the full rated output to 20V/10A or 50V/4A.
- 3 Overvoltage protection key** Enables or disables the overvoltage protection function, sets trip voltage level, and clears the overvoltage condition.
- 4 Overcurrent protection key** Enables or disables the overcurrent protection function, sets trip current level, and clears the overcurrent condition.
- 5 Display limit key** Shows voltage and current limit values on the display and allows knob adjustment for setting limit values.
- 6 Recall operating state key** Recalls a previously stored operating state from location “1”, “2”, or “3”.
- 7 Store operating state / Local key¹** Stores an operating state in location “1”, “2”, or “3” / or returns the power supply to local mode from remote interface mode.
- 8 Error / Calibrate key²** Displays error codes generated during operation, self-test and calibration / or enables calibration mode (the power supply must be unsecured before performing calibration). See *Service Guide* for more details on calibration.
- 9 I/O Configuration / Secure key³** Configures the power supply for remote interfaces / or secure or unsecure the power supply for calibration. See *Service Guide* for more details on how to secure or unsecure the power supply.
- 10 Output On/Off key** Enables or disables the power supply output. This key toggles between on and off.
- 11 Control knob** Increases or decreases the value of the blinking digit by turning clockwise or counter clockwise.
- 12 Resolution selection keys** Move the blinking digit to the right or left.
- 13 Voltage/current adjust selection key** Selects the knob control function for voltage or current adjustment.

¹The key can be used as the “**Local**” key when the power supply is in the remote interface mode.

²You can enable the “calibration mode” by holding down this key when you turn on the power supply.

³You can use it as the “**Secure**” or “**Unsecure**” key when the power supply is in the calibration mode.

*For Keysight E3633A Model **For Keysight E3634A Model

Front-Panel Voltage and Current Limit Settings

You can set the voltage and current limit values from the front panel using the following method.

Use the voltage/current adjust selection key, the resolution selection keys, and the control knob to change the voltage and current limit values.

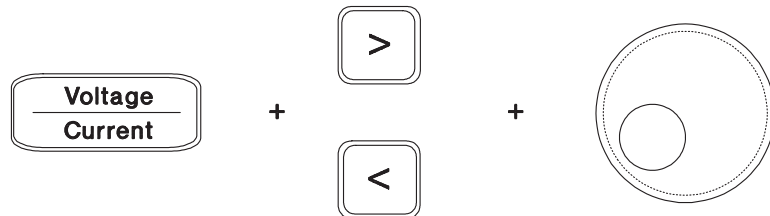

- 1 Select the desired range using the range selection keys after turning on the power supply.
- 2 Press the **Display Limit** key to show the limit values on the display.
- 3 Move the blinking digit to the appropriate position using the resolution selection keys and change the blinking digit value to the desired voltage limit by turning the control knob. If the display limit times out, press the **Display Limit** key again.
- 4 Set the knob to current control mode by pressing the **Voltage Current** key.
- 5 Move the blinking digit to the appropriate position using the resolution selection keys and change the blinking digit value to the desired current limit by turning the control knob.
- 6 Press the **Output On/Off** key to enable the output. After about 5 seconds, the display will go to output monitoring mode automatically to display the voltage and current at the output or the display will go to output monitoring mode immediately by pressing the **Display Limit** key again.

Note

All front panel keys and controls can be disabled with remote interface commands. The Keysight E3633A and Keysight E3634A must be in "Local" mode for the front panel keys and controls to function.

Display Annunciators

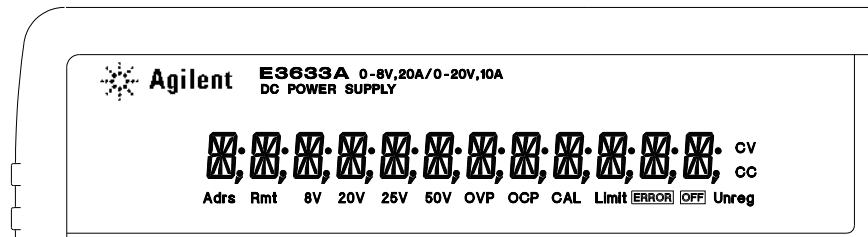

Adrs	Power supply is addressed to listen or talk over a remote interface.
Rmt	Power supply is in remote interface mode.
8V	Shows the 8V/20A range is selected. (Keysight E3633A model)
20V	Shows the 20V/10A range is selected. (Keysight E3633A model)
25V	Shows the 25V/7A range is selected. (Keysight E3634A model)
50V	Shows the 50V/4A range is selected. (Keysight E3634A model)
OVP	The overvoltage protection function is enabled when the annunciator turns on or the overvoltage protection circuit has caused the power supply to shutdown when the annunciator blinks.
OCP	The overcurrent protection function is enabled when the annunciator turns on or the overcurrent protection circuit has caused the power supply to shutdown when the annunciator blinks.
CAL	The power supply is in calibration mode.
Limit	The display shows the limit values of voltage and current.
ERROR	Hardware or remote interface command errors are detected and the error bit has not been cleared.
OFF	The output of the power supply is disabled (For more information, see page 52 in the User's Guide).
Unreg	The output of the power supply is unregulated (output is neither CV nor CC).
CV	The power supply is in constant voltage mode.
CC	The power supply is in constant current mode.

To review the display annunciators, hold down  key as you turn on the power supply.

The Rear Panel at a Glance

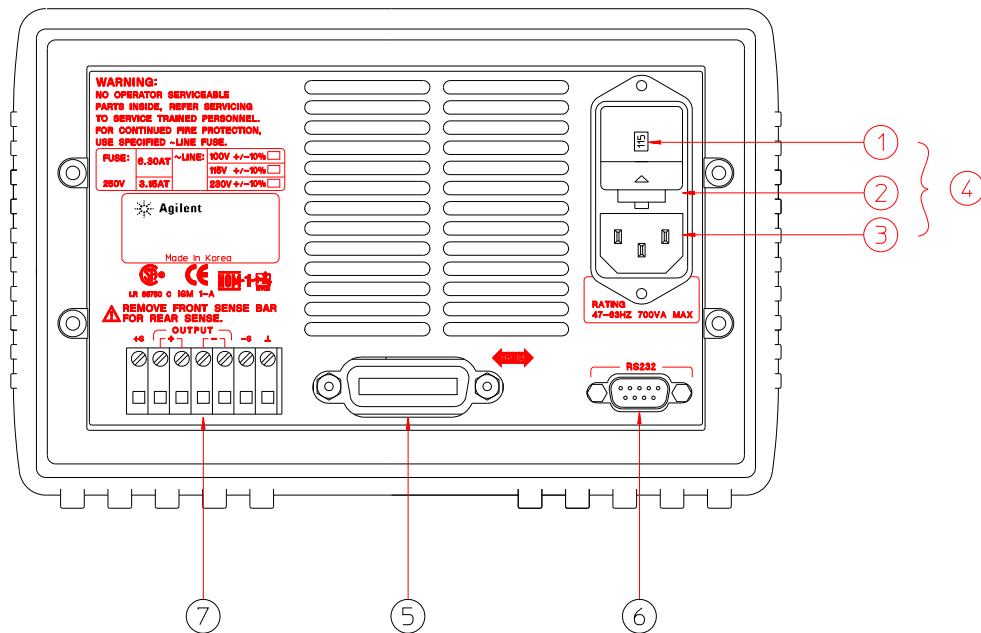

-
- | | |
|-----------------------------------|---------------------------------------|
| 1 Power-line voltage setting | 5 GPIB (IEEE-488) interface connector |
| 2 Power-line fuse-holder assembly | 6 RS-232 interface connector |
| 3 AC inlet | 7 Rear output terminals |
| 4 Power-line module | |

Use the front-panel key to:

- Select the GPIB or RS-232 interface (see chapter 3 in User's Guide).
- Set the GPIB bus address (see chapter 3 in User's Guide).
- Set the RS-232 baud rate and parity (see chapter 3 in User's Guide).

In This Book

This is the Service Guide for your Keysight E3633A and E3634A DC power supplies. Unless otherwise stated, the information in this manual applies to both two models.

Specifications Chapter 1 lists the power supply's specifications and describes how to interpret these specifications.

Quick Start Chapter 2 prepares the power supply for use and helps you get familiar with the front panel features.

Calibration Procedures Chapter 3 provides performance verification and calibration procedures.

Theory of Operation Chapter 4 describes block and circuit level theory related to the operation of the power supply.

Service Chapter 5 provides guidelines for returning your power supply to Keysight Technologies for servicing, or for servicing it yourself.

Component Drawings Chapter 6 contains the power supply's component locator drawings.

*If you have questions relating to the operation of the power supply, call **1-800-829-4444** in the United States, or contact your nearest Keysight Technologies Sales Office.*

*If your Keysight E3633A or Keysight E3634A fails within 3 years of purchase, Keysight will repair or replace it free of charge. Call **1-800-258-5165** ("**Express Exchange**") in the United States, or contact your nearest Keysight Technologies Sales Office.*

Contents

Chapter 1 Specifications

Performance Specifications - - - - -	15
Supplemental Characteristics - - - - -	17

Chapter 2 Quick Start

To Prepare the Power Supply for Use - - - - -	23
To Check the Rated Voltages of the Power Supply - - - - -	25
To Check the Rated Currents of the Power Supply - - - - -	26
To Use the Power Supply in Constant Voltage Mode - - - - -	28
To Use the Power Supply in Constant Current Mode - - - - -	30
To Store and Recall the Instrument State - - - - -	32
To Program Overvoltage Protection - - - - -	34
Setting the OVP Level and Enable the OVP Circuit - - - - -	34
Checking OVP Operation - - - - -	35
Clearing the Overvoltage Condition - - - - -	35
To Program Overcurrent Protection - - - - -	37
Setting the OCP Level and Enable the OCP Circuit - - - - -	37
Checking OCP Operation - - - - -	38
Clearing the Overcurrent Condition - - - - -	38
To Rack Mount the Power Supply - - - - -	40

Chapter 3 Calibration Procedures

Keysight Technologies Calibration Services - - - - -	45
Calibration Interval - - - - -	45
Automating Calibration Procedures - - - - -	45
Test Considerations - - - - -	46
Recommended Test Equipment - - - - -	47
Performance Verification Tests - - - - -	48
Self-Test - - - - -	48
Performance Verification Tests - - - - -	48
Measurement Techniques - - - - -	49
Setup for Most Tests - - - - -	49
Electronic Load - - - - -	49
General Measurement Techniques - - - - -	50
Current-Monitoring Resistor - - - - -	50
Programming - - - - -	50
Constant Voltage (CV) Verifications - - - - -	51
Constant Voltage Test Setup - - - - -	51
Voltage Programming and Readback Accuracy - - - - -	51

CV Load Effect (Load Regulation) - - - - -	52
CV Source effect (Line Regulation) - - - - -	53
CV PARD (Ripple and Noise) - - - - -	54
Load Transient Response Time- - - - -	55
Constant Current (CC) Verifications- - - - -	56
Constant Current Test Setup- - - - -	56
Current Programming and Readback Accuracy - - - - -	56
CC Load Effect (Load Regulation) - - - - -	57
CC Source Effect (Line Regulation) - - - - -	58
CC PARD (Ripple and Noise) - - - - -	58
Common Mode Current Noise- - - - -	59
Performance Test Record for Keysight E3633A and E3634A - - - - -	60
CV Performance Test Record- - - - -	60
CC Performance Test Record- - - - -	60
Calibration Security Code- - - - -	61
To Unsecure the Power Supply for Calibration - - - - -	62
<i>To Unsecure the Power Supply Without the Security Code</i> - - - - -	63
<i>Calibration Count</i> - - - - -	64
<i>Calibration Message</i> - - - - -	64
General Calibration/Adjustment Procedure - - - - -	65
Front Panel Voltage and Current Calibration- - - - -	66
Aborting a Calibration in Progress - - - - -	71
Calibration Record for Keysight E3633A/E3634A - - - - -	72
Error Messages - - - - -	73
An Example program of Excel 97 for Calibration - - - - -	76
 Chapter 4 Theory of Operation	
Block Diagram Overview - - - - -	87
AC Input and Bias Supplies - - - - -	89
Floating Logic - - - - -	90
D-to-A Converter - - - - -	92
A-to-D Converter - - - - -	93
Power Mesh and Control - - - - -	94
Earth-Referenced Logic - - - - -	96
Front Panel- - - - -	96
 Chapter 5 Service	
Operating Checklist - - - - -	99
Is the Power Supply Inoperative? - - - - -	99
Does the Power Supply Fail Self-Test? - - - - -	99
Types of Service Available - - - - -	100
Standard Repair Service (worldwide) - - - - -	100

Express Exchange (U.S.A. only) - - - - -	100
Repacking for Shipment - - - - -	101
Electrostatic Discharge (ESD) Precautions- - - - -	102
Surface Mount Repair - - - - -	102
To Replace the Power-Line Fuse - - - - -	102
To Disconnect the Output Using an External Relay- - - - -	103
Installation Procedure - - - - -	103
Troubleshooting Hints - - - - -	104
Unit is Inoperative - - - - -	104
Unit Reports Errors 740 to 750 - - - - -	104
Unit Fails Self-Test- - - - -	104
Bias Supplies Problems - - - - -	105
Self-Test Procedures - - - - -	106
Power-On Self-Test - - - - -	106
Complete Self-Test - - - - -	106

Chapter 6 Component Drawings

E3633-60002/E3634-60002 Component locator for the main board	111
E3633-60003 Component locator for the front panel - - - - -	112
E3633-60019/E3634-60019 Component locator for the main board (serial MY53xx6xxx)	113
Component locator for the front panel (serial MY53xx6xxx) - - - -	114

THIS PAGE HAS BEEN INTENTIONALLY LEFT BLANK.

Specifications

Specifications

The *performance* specifications are listed in the following pages. Specifications are warranted in the temperature range of 0 to 40°C with a resistive load. *Supplemental* characteristics, which are not warranted but are descriptions of performance determined either by design or testing. Chapter 3 “Calibration Procedures” contains procedures for verifying the performance specifications.

Performance Specifications

Table 1-1. Performance Specifications

Parameter		Keysight E3633A	Keysight E3634A
Output Ratings (@ 0 °C - 40 °C)	Low Range	0 to +8 V/0 to 20 A	0 to +25 V/0 to 7 A
	High Range	0 to +20 V/0 to 10 A	0 to +50V/0 to 4 A
Programming Accuracy ^[1] 12 months (@ 25 °C ± 5 °C), ±(% of output + offset)	Voltage	0.05% + 10 mV	
	Current	0.2% + 10 mA	
Readback Accuracy ^{[1] [2]} 12 months (over GPIB and RS-232 or front panel with respect to actual output @ 25 °C ± 5 °C), ±(% of output + offset)	Voltage	0.05% + 5 mV	
	Current	0.15% + 5 mA	
Ripple and Noise (with outputs ungrounded, or with either output terminal grounded, 20 Hz to 20 MHz)	Normal mode voltage	<0.35 mV rms and 3 mV p-p	<0.5 mV rms and 3 mV p-p
	Normal mode current	<2 mA rms	
	Common mode current	<1.5 uA rms	
Load Regulation , ±(% of output + offset)	Voltage	<0.01% + 2 mV	
	Current	<0.01% + 250 uA	
Line Regulation , ±(% of output + offset)	Voltage	<0.01% + 2 mV	
	Current	<0.01% + 250 uA	
Programming Resolution	Voltage	1 mV	3 mV
	Current	1 mA	0.5 mA
Readback Resolution	Voltage	0.5 mV	1.5 mV
	Current	1 mA	0.5 mA
Front Panel Resolution	Voltage	1 mV	
	Current	1 mA (< 10A), 10mA (≥ 10A)	

^[1]Accuracy specifications are after an 1-hour warm-up with no load and calibration at 25 °C.

^[2]This specification may degrade when the unit is subjected to an RF field >= 3V/meter.

Transient Response Time

Less than 50 μ sec for output to recover to within 15 mV following a change in output current from full load to half load or vice versa

Command Processing Time

Average time for output voltage to begin to change after receipt of digital data when the power supply is connected directly to the GPIB or RS-232 is less than 100 msec

OVP and OCP Accuracy, \pm (% of output + offset)

OVP 0.5% + 0.5 V

OCP 0.5% + 0.5 A

Activation time : Average time for output to start to drop after OVP or OCP condition occurs.

OVP <1.5 msec when the trip voltage is equal or greater than 3 V
 <10 msec when the trip voltage is less than 3 V

OCP <10 msec

Supplemental Characteristics

Table 1-2. Supplemental Characteristics

Parameter		Keysight E3633A		Keysight E3634A	
Output Programming Range (maximum programmable values)	Low Range	0 to +8.24 V/ 0 to 20.6 A		0 to +25.75 V/ 0 to 7.21 A	
	High Range	0 to +20.6 V/ 0 to 10.3 A		0 to +51.5V/ 0 to 4.12 A	
	OVP	1 V to 22 V		1 V to 55 V	
	OCP	0 A to 22 A		0 A to 7.5 A	
Voltage Programming Speed: Maximum time required for output voltage to settle within 1% of its total excursion (for resistive load). Excludes command processing time.		Full Load	No Load	Full Load	No Load
	Up	95 msec	45 msec	80 msec	100 msec
	Down	30 msec	450 msec	30 msec	450 msec

Remote Sensing Capability

Voltage drop	Up to 0.7 V per each lead
Load regulation	Add 5 mV to spec for each 1-volt change in the + output lead due to load current changes.
Load voltage	Subtract voltage drop in load leads from specified output voltage rating.

Temperature Coefficient, \pm (% of output + offset)

Maximum change in output/readback per °C after a 30-minute warm-up

Voltage	0.01% + 3 mV
Current	0.02% + 3 mA

Stability, \pm (% of output + offset)

Following a 30-minute warm-up, with the output in the ON state according to the operating mode (CC with load or CV), and with a change in the output over 8 hours under constant load, line, and ambient temperature

Voltage	0.02% + 1 mV
Current	0.1% + 1 mA

Output Voltage Overshoot

During turn-on or turn-off of ac power, output plus overshoot will not exceed 1 V if the output control is set to less than 1 V. If the output control is set to 1 V or higher, there is no overshoot.

Programming Language

SCPI (Standard Commands for Programmable Instruments)

State Storage Memory

Three (3) user-configurable stored states

Recommended Calibration Interval

1 year

Output Terminal Isolation (maximum, from chassis ground)

± 60 Vdc when connecting shorting conductors without insulation to the (+) output to the (+) sense and the (-) output and the (-) sense terminals.

± 240 Vdc when connecting insulated shorting conductors to the (+) output to the (+) sense and the (-) output and the (-) sense terminals.

AC Input Ratings (selectable via rear panel selector)

std 115 Vac \pm 10%, 47 to 63 Hz

opt 0E3 230 Vac \pm 10%, 47 to 63 Hz

opt 0E9 100 Vac \pm 10%, 47 to 63 Hz

Maximum Input Power

700 VA with full load

Cooling

Fan cooled

Operating Temperature

0 to 40 °C for full rated output. At higher temperatures, the output current is derated linearly to 50% at 55 °C maximum temperature.

Storage Temperature

-20 to 70 °C for storage environment.

Environmental Conditions

Designed for indoor use in an installation category II, pollution degree 2 environment.
Designed to operate at a maximum relative humidity of 95 %
and at altitudes of up to 2000 meters.

Dimensions*

213 mmW x 133 mmH x 348 mmD (8.4 x 5.2 x 13.7 in)

*See below for detailed information.

Weight

Net	9.5 kg (21 lb)
Shipping	12 kg (26 lb)

Weight (MY53xx6xxx)

Net	11.4 kg (E3633A)
	10.9 kg (E3634A)
Shipping	13.9 kg (E3633A)
	13.4 kg (E3634A)

Chapter 1 Specifications
Supplemental Characteristics

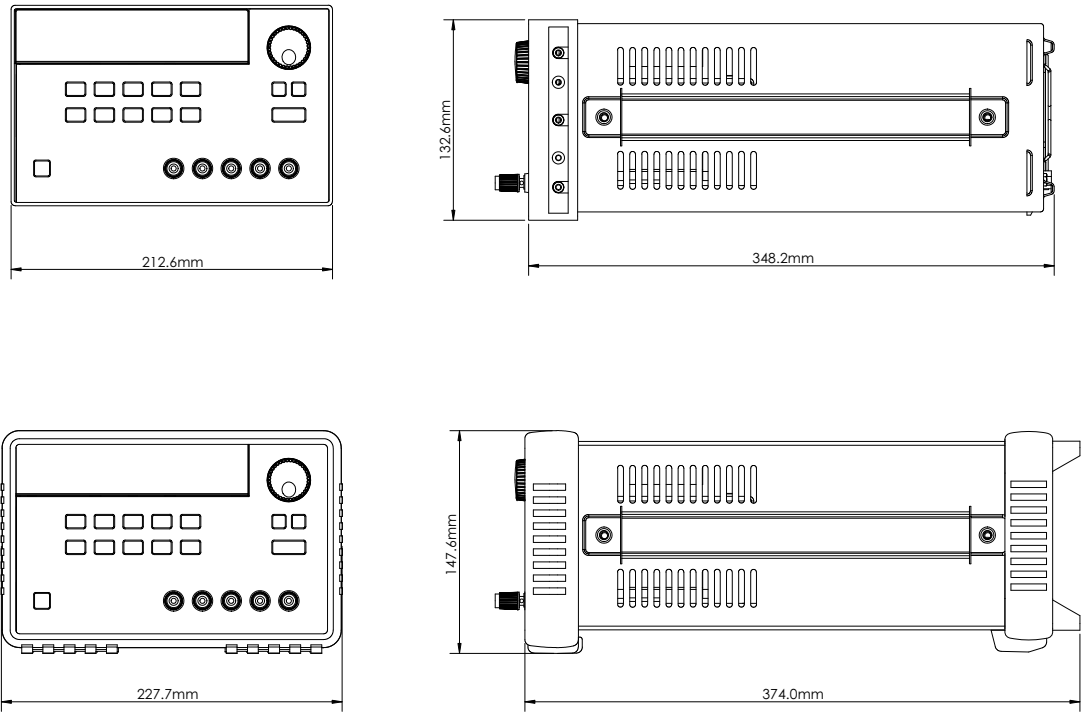





Figure 8-1. Dimensions of Keysight E3633A and E3634A Power Supplies

Quick Start

Quick Start

One of the first things you will want to do with your power supply is to become acquainted with its front panel. Written procedures in this chapter prepare the power supply for use and familiarize you with most front-panel operations.

- The power supply is shipped from the factory configured in the front-panel operation mode. At power-on, the power supply is automatically set to operate in the front-panel operation mode. When in this mode, the front-panel keys can be used. When the power supply is in *remote* operation mode, you can return to front-panel operation mode at any time by pressing the  (**Local**) key if you did not previously send the front-panel lockout command. A change between front-panel and remote operation modes will *not* result in a change in the output parameters.
- The power supply has two output ranges. This feature allows more voltage at a lower current or more current at a lower voltage. The desired output range is selected from the front panel or over the remote interfaces. The **8V** or **20V** for the E3633A and **25V** or **50V** for the E3634A annunciator indicates the presently selected range.
- When you press  key (the **Limit** annunciator flashes), the display of the power supply goes to the *limit* mode and the present limit values will be displayed. In this mode, you can also observe the change of the limit values when adjusting the knob. If you press the  key again or let the display time-out after several seconds, the power supply will return the display to the *meter* mode (the **Limit** annunciator turns off). In this mode, the actual output voltage and current will be displayed.
- The output of the power supply can be enabled or disabled from the front panel by pressing  key. When the output is off, the **OFF** annunciator turns on and the output is disabled.
- The display provides the present operating status of the power supply with annunciators and also informs the user of error codes. For example, the power supply is operating in CV mode in the 8V/20A* or 25V/7A** range and controlled from the front panel, then the **CV** and **8V*** or **25V**** annunciators will turn on. If, however, the power supply is remotely controlled, the **Rmt** annunciator will also turn on, and when the power supply is being addressed over GPIB interface, the **Adrs** annunciator will turn on. See “*Display Annunciators*” on page 5 for more information.

*For Keysight E3633A Model **For Keysight E3634A Model

To Prepare the Power Supply for Use

The following steps help you verify that the power supply is ready for use.

1 Check the list of supplied items.

Verify that you have received the following items with your power supply. If anything is missing, contact your nearest Keysight Technologies Sales Office.

- One power cord for your location.
- One *User's Guide*.
- This *Service Guide*.
- Certificate of Calibration.

2 Verify that the correct power-line voltage setting is selected and that the correct power-line fuse is installed.

The line voltage is set to 100, 115 or 230 Vac from the factory according to the input power option selected when you ordered the power supply. Change the voltage setting if it is not correct for your location (see the next page for detailed information). For 100 or 115 Vac operation, the correct fuse is 6.3 AT (Keysight part number 2110-1030) and for 230 Vac operation, the correct fuse is 3.15 AT (Keysight part number 2110-1031).



3 Connect the power cord and turn on the power supply.

A *power-on self-test* occurs automatically when you turn on the power supply. The front-panel display will light up while the power supply performs its power-on self-test. After performing the self-test, the power supply will go into the *power-on / reset* state; the output is disabled (the **OFF** annunciator turns on); the 8V/20A* or 25V/7A** range is selected (the **8V*** or **25V**** annunciator turns on); the knob is selected for voltage control.

Notice that the **OVP** and **OCP** annunciators also turn on.



4 Enable the outputs.

Press  key to enable the outputs. The **OFF** annunciator turns off and the **8V*** or **25V****, **OVP**, **OCP**, and **CV** annunciators are lit. The *flashing* digit can be adjusted by turning the knob. Notice that the display is in the meter mode. “Meter mode” means that the display shows the actual output voltage and current.

*For Keysight E3633A Model **For Keysight E3634A Model

Chapter 2 Quick Start
To Prepare the Power Supply for Use

1 Remove the power cord. Remove the fuse-holder assembly with a flat-blade screwdriver from the rear panel.

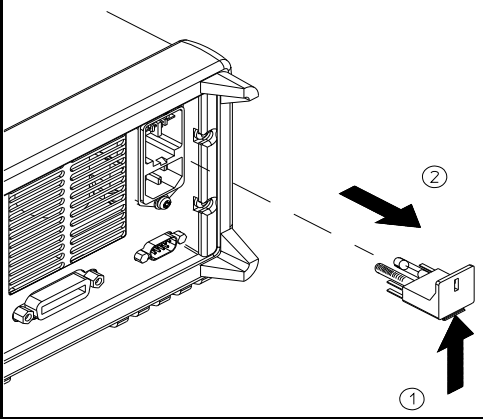

2 Install the correct line fuse. Remove the power-line voltage selector from the power-line module.

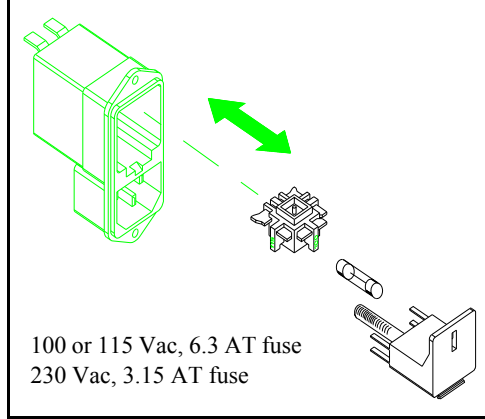

100 or 115 Vac, 6.3 AT fuse
230 Vac, 3.15 AT fuse

3 Rotate the power-line voltage selector until the correct voltage appears.

4 Replace the power-line voltage selector and the fuse-holder assembly in the rear panel.

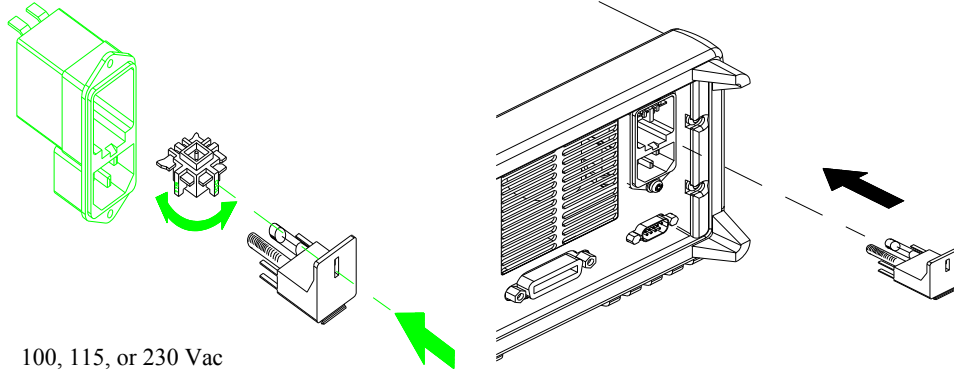

100, 115, or 230 Vac

Install the correct fuse and verify that the correct line voltage appears in the window.

To Check the Rated Voltages of the Power Supply

The following procedures check to ensure that the power supply produces its rated voltage output with no load and properly responds to operation from the front panel.

For each step, use the keys shown on the left margins.



1 Turn on the power supply.

The power supply will go into the *power-on / reset* state; the output is disabled (the **OFF** annunciator turns on); the 8V/20A* or 25V/7A** range is selected (the **8V*** or **25V**** annunciator turns on); and the knob is selected for *voltage* control.



2 Enable the outputs.

The **OFF** annunciator turns off and the **8V*** or **25V****, **OVP**, **OCP**, and **CV** annunciators are lit. The flashing digit can be adjusted by turning the knob. Notice that the display is in the meter mode. “Meter mode” means that the display shows the actual output voltage and current.



3 Check that the front-panel voltmeter properly responds to knob control.

Turn the knob clockwise or counter clockwise to check that the voltmeter responds to knob control and the ammeter indicates nearly zero.



4 Ensure that the voltage can be adjusted from zero to the maximum rated value.

Adjust the knob until the voltmeter indicates 0 volts and then adjust the knob until the voltmeter indicates “8.0 volts”* or “25.0 volts”**.

¹You can use the resolution selection keys to move the flashing digit to the right or left when setting the voltage.

*For Keysight E3633A Model **For Keysight E3634A Model

To Check the Rated Currents of the Power Supply

The following procedures check to ensure that the power supply produces its rated current outputs with a short and properly responds to operation from the front panel. For each step, use the keys shown on the left margins.



1 Turn on the power supply.

The power supply will go into the *power-on / reset* state; the output is disabled (the **OFF** annunciator turns on); the 8V/20A* or 25V/7A** range is selected (the **8V*** or **25V**** annunciator turns on); and the knob is selected for voltage control.



2 Connect a short across (+) and (-) output terminals with an insulated test lead.

3 Enable the outputs.

The **OFF** annunciator turns off and the **8V*** or **25V****, **OVP**, and **OCP** annunciators turn on. The **CV** or **CC** annunciator is lit depending on the resistance of the test lead. The *flashing* digit can be adjusted by turning the knob. Notice that the display is in the meter mode. “Meter mode” means that the display shows the actual output voltage and current.



4 Adjust the voltage limit value to 1.0 volt.

Set the display to the *limit* mode (the **Limit** annunciator will be flashing). Adjust the voltage limit to 1.0 volt to assure CC operation. The **CC** annunciator will light.



5 Check that the front-panel ammeter properly responds to knob control.

Set the knob to the *current* control, and turn the knob clockwise or counter clockwise when the display is in the meter mode (the **Limit** annunciator is off). Check that the ammeter responds to knob control and the voltmeter indicates nearly zero (actually, the voltmeter will show the voltage drop caused by the test lead).

*For Keysight E3633A Model **For Keysight E3634A Model



6 Ensure that the current can be adjusted from zero to the maximum rated value.

Adjust the knob until the ammeter indicates 0 amps and then until the ammeter indicates “20.0 amps”^{*} or “7.0 amps”^{**}.

2

Note

*If an error has been detected during the output checkout procedures, the **ERROR** annunciator will turn on. See “Error Messages” for more information, starting on page 123 in chapter 5 of the User’s Guide.*

¹You can use the resolution selection keys to move the flashing digit to the right or left when setting the voltage.

^{*}For Keysight E3633A Model ^{**}For Keysight E3634A Model

To Use the Power Supply in Constant Voltage Mode

To set up the power supply for constant voltage (CV) operation, proceed as follows.
For each step, use the keys shown on the left margin.



1 Connect a load to the desired output terminals.

With power-off, connect a load to the desired output terminals.

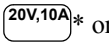

2 Turn on the power supply.

The power supply will go into the *power-on / reset* state; the output is disabled (the **OFF** annunciator turns on); the 8V/20A* or 25V/7A** range is selected (the **8V*** or **25V**** annunciator turns on); and the knob is selected for *voltage* control.

Press * or ** key to operate the power supply in the 20V/10A* or 50V/4A** range before proceeding to the next step. The **20V*** or **50V**** annunciator turns on.



3 Set the display to the limit mode.

Notice that the **Limit** annunciator flashes, indicating that the display is in the limit mode. When the display is in the *limit* mode, you can see the voltage and current limit values of the power supply.

In constant voltage mode, the voltage values between the meter and limit modes are the same, but the current values are not. Moreover, if the display is in the meter mode, you cannot see the change of current limit value when adjusting the knob. We recommend that you should set the display to “limit” mode to see the change of current limit value in the constant voltage mode whenever adjusting the knob.



4 Adjust the knob for the desired current limit.

Check that the **Limit** annunciator still flashes. Set the knob for *current* control. The second digit of the ammeter will be flashing. The flashing digit can be changed using the resolution selection keys and the flashing digit can be adjusted by turning the knob. Adjust the knob to the desired current limit.

¹You can use the resolution selection keys to move the flashing digit to the right or left when setting current.

*For Keysight E3633A Model **For Keysight E3634A Model



5 Adjust the knob for the desired output voltage.

Check that the **Limit** annunciator still flashes. Set the knob for *voltage* control. The second digit of the voltmeter will be *flashing*. Change the flashing digit using the resolution selection keys and adjust the knob to the desired output voltage.



6 Return to the meter mode.

Press  key or let the display time-out after several seconds to return to the meter mode. Notice that the **Limit** annunciator turns off and the display shows “OUTPUT OFF” message.



7 Enable the output.

The **OFF** annunciator turns off and the **8V*** (or **25V****) or **20V*** (or **50V****), **OVP**, **OCF** and **CV** annunciators are lit. Notice that the display is in the *meter* mode. In the meter mode, the display shows the actual output voltage and current.

8 Verify that the power supply is in the constant voltage mode.

If you operate the power supply in the constant voltage (CV) mode, verify that the **CV** annunciator is lit. If the **CC** annunciator is lit, choose a higher current limit.

Note

During actual CV operation, if a load change causes the current limit to be exceeded, the power supply will automatically crossover to the constant current mode at the preset current limit and the output voltage will drop proportionately.

¹You can use the resolution selection keys to move the flashing digit to the right or left when setting the current.

*For Keysight E3633A Model **For Keysight E3634A Model

To Use the Power Supply in Constant Current Mode

To set up the power supply for constant current (CC) operation, proceed as follows.



1 Connect a load to the output terminals.

With power-off, connect a load to the (+) and (-) output terminals.

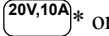

2 Turn on the power supply.

The power supply will go into the *power-on / reset* state; the output is disabled (the **OFF** annunciator turns on); the 8V/20A* or 25V/7A** range is selected (the **8V*** or **25V**** annunciator turns on); and the knob is selected for *voltage* control.

Press * or ** key to operate the power supply in the 20V/10A* or 50V/4A** range before proceeding to the next step. The **20V*** or **50V**** annunciator turns on.



3 Set the display to the limit mode.

Notice that the **Limit** annunciator flashes, indicating that the display is in the limit mode. When the display is in the *limit* mode, you can see the voltage and current limit values of the selected supply.

In constant current mode, the current values between the meter mode and limit mode are the same, but the voltage values are not. Moreover, if the display is in the meter mode, you cannot see the change of voltage limit value when adjusting the knob. We recommend that you should set the display to “limit” mode to see the change of voltage limit value in the constant current mode whenever adjusting the knob.



4 Adjust the knob for the desired voltage limit.

Check that the **Limit** annunciator still flashes and the second digit of voltmeter flashes to indicate the knob is selected for voltage control. The flashing digit can be changed using the resolution keys and the flashing digit can be adjusted by turning the knob. Adjust the knob for the desired voltage limit.

¹You can use the resolution selection keys to move the flashing digit to the right or left when setting the voltage.

*For Keysight E3633A Model **For Keysight E3634A Model



5 Adjust the knob for the desired output current.

Check that the **Limit** annunciator still flashes. Set the knob for *current* control. The second digit of the ammeter will be flashing. Change the flashing digit using the resolution selection keys and adjust the knob to the desired output current.



6 Return to the meter mode.

Press  key or let the display time-out after several seconds to return to the meter mode. Notice that the **Limit** annunciator turns off and the display shows “OUTPUT OFF” message.



7 Enable the output.

The **OFF** annunciator turns off and the **8V*** (or **25V****) or **20V*** (or **50V****), **OVP**, **OCF** and **CC** annunciators are lit. Notice that the display is in the meter mode. In the *meter* mode, the display shows the actual output voltage and current.

8 Verify that the power supply is in the constant current mode.

If you operate the power supply in the constant current (CC) mode, verify that the **CC** annunciator is lit. If the **CV** annunciator is lit, choose a higher voltage limit.

Note

During actual CC operation, if a load change causes the voltage limit to be exceeded, the power supply will automatically crossover to constant voltage mode at the preset voltage limit and the output current will drop proportionately.

¹You can use the resolution selection keys to move the flashing digit to the right or left when setting the voltage.

*For Keysight E3633A Model **For Keysight E3634A Model

To Store and Recall the Instrument State

You can store up to three different operating states in *non-volatile* memory. This also enables you to recall the entire instrument configuration with just a few key presses from the front panel.

The memory locations are supplied with the reset states from the factory for front-panel operation. Refer to the description of *RST command, starting on page 96 in the User's Guide for more information.

The following steps show you how to store and recall an operating state.

1 Set up the power supply for the desired operating state.

The storage feature “remembers” output range selection, the limit value settings of voltage and current, output on/off state, OVP and OCP on/off state, and OVP and OCP trip levels.

A small rectangular button with rounded corners and the word "Store" written inside.

2 Turn on the storage mode.

Three memory locations (numbered 1, 2 and 3) are available to store the operating states. The operating states are stored in *non-volatile* memory and are remembered when being recalled.

A rectangular display box with a thick black border containing the text "STORE 1".

This message appears on the display for approximately 3 seconds.



3 Store the operating state in memory location “3”.

Turn the knob to the right to specify the memory location 3.

A rectangular display box with a thick black border containing the text "STORE 3".

To cancel the store operation, let the display time-out after about 3 seconds or press any other function key except the  key. The power supply returns to the normal operating mode and to the function pressed.

Store

4 Save the operating state.

The operating state is now stored. To recall the stored state, go to the following steps.

DONE

2

Recall

5 Turn on the recall mode.

Memory location “1” will be displayed in the recall mode.

RECALL 1

This message appears on the display for approximately 3 seconds.



6 Recall the stored operating state.

Turn the knob to the right to change the displayed storage location to 3.

RECALL 3

If this setting is not followed within 3 seconds with **Recall** key stroke, the power supply returns to normal operating mode and will not recall the instrument state 3 from memory.

Recall

7 Restore the operating state.

The power supply should now be configured in the same state as when you stored the state on the previous steps.

DONE

This message appears on the display for approximately 1 second.

To Program Overvoltage Protection

Overvoltage protection guards the load against output voltages that reach a specified value greater than the programmed protection level. It is accomplished by shorting the output via an internal SCR when the trip level is set to equal or greater than 3 volts, or by programming the output to 1 volt when the trip level is set to less than 3 volts.

The following steps show how to set the OVP trip level, how to check OVP operation, and how to clear overvoltage condition.

Setting the OVP Level and Enable the OVP Circuit



1 Turn on the power supply.

The power supply will go into the *power-on / reset* state; the output is disabled (the **OFF** annunciator turns on); the 8V/20A* or 25V/7A** range is selected (the **8V*** or **25V**** annunciator turns on); and the knob is selected for *voltage* control.



2 Enable the output.

The **OFF** annunciator turns off and the display will go to the meter mode.



3 Enter the OVP menu and set the trip level.

LEVEL 22.0 V (E3633A)

LEVEL 55.0 V (E3634A)

You will see the above message on the display when you enter the OVP menu. Adjust the control knob for the desired OVP trip level.

Note that you cannot set the trip levels to lower than 1.0 volt.



4 Enable the OVP circuit.

OVP ON

You will see the above message after pressing  key.

*For Keysight E3633A Model **For Keysight E3634A Model

Over
Voltage

5 Exit the OVP menu.

CHANGED

The “CHANGED” message is highlighted for a second to show that the new OVP trip level is now in effect. If the OVP settings are not changed, “NO CHANGE” will be displayed. The power supply will exit the OVP menu and the display will return to the meter mode. Check that the **OVP** annunciator turns on.

2

Checking OVP Operation

To check OVP operation, raise the output voltage to near the trip point. Then very gradually increase the output by turning the knob until the OVP circuit trips. This will cause the power supply output to drop to near zero, the **OVP** annunciator to blink, and the **CC** annunciator to turn on. The “OVP TRIPPED” message also appears on the display.

Clearing the Overvoltage Condition

When the OVP condition occurs (the “OVP TRIPPED” message is shown on the display), the **OVP** annunciator flashes. When it was caused by an external voltage source such as a battery, disconnect it first. Clear the overvoltage condition by adjusting output voltage level or by adjusting OVP trip level.

The following steps show how to clear the overvoltage condition and get back to normal mode operation. In the following steps, the display will go back to “OVP TRIPPED” if you let the display time out after about several seconds.

- *Adjust output voltage level*

Display
Limit



1 Lower the output voltage level.

Lower the output voltage level below the OVP trip point after pressing **Display Limit** key. The **OVP** and **Limit** annunciators are blinking.

Over
Voltage



2 Move to the clear mode.

OVP CLEAR

Press **Over Voltage** key twice to move to the OVP CLEAR mode. The “OVP ON” message appears on the display. Turn the knob to the right until the above message appears on the display.



3 Clear the overvoltage condition and exit this menu.

Now, when you press  key again, the “DONE” message is displayed for a second and the **OVP** annunciator will not blink any more. The output will return to meter mode.

• *Adjust OVP trip level*



1 Raise the OVP trip level.

Press  key and turn the knob to raise the OVP trip level.



2 Move to the OVP CLEAR mode.

OVP CLEAR

Press  key to move to the OVP CLEAR mode. The “OVP ON” message appears on the display. Turn the knob to the right until the above message appears on the display.



3 Clear the overvoltage condition and exit this menu.

Now, when you press  key again, the “DONE” message is displayed for a second and the **OVP** annunciator will not blink any more. The output will return to the meter mode.

To Program Overcurrent Protection

Overcurrent protection guards the load against output currents that reach a specified value greater than the programmed protection level. It is accomplished by programming the output current to zero.

The following steps show how to set the overcurrent protection trip level, how to check OCP operation and how to clear overcurrent condition.

Setting the OCP Level and Enable the OCP Circuit



1 Turn on the power supply.

The power supply will go into the *power-on / reset* state; the output is disabled (the **OFF** annunciator turns on); the 8V/20A* or 25V/7A** range is selected (the **8V*** or **25V**** annunciator turns on); and the knob is selected for *voltage* control.



2 Enable the output.

The **OFF** annunciator turns off and the display will go to the meter mode.



3 Enter the OCP menu and set the trip level.

LEVEL 22.0 A (E3633A)

LEVEL 7.5 A (E3634A)

You will see the above message on the display when you enter the OCP menu. Adjust the knob for the desired OCP trip level.



4 Enable the OCP circuit.

OCP ON

You will see the above message after pressing the  key.

*For Keysight E3633A Model **For Keysight E3634A Model



5 Exit the OCP menu.

CHANGED

The “CHANGED” message is displayed for a second to show that the new OCP trip level is now in effect. If the OCP settings are not changed, “NO CHANGE” will be displayed. The power supply will exit the OCP menu and the display will return to the meter mode. Check that the **OCP** annunciator turns on.

Checking OCP Operation

To check OCP operation, raise the output current to near the trip point. Then very gradually increase the output by turning the knob until the OCP circuit trips. This will cause the power supply’s output current to drop to zero and the **OCP** annunciator to blink. The “OCP TRIPPED” message also appears on the display.

Clearing the Overcurrent Condition



When the OCP condition occurs (the “OCP TRIPPED” message is shown on the display), the **OCP** annunciator flashes. When it was caused by external voltage sources such as a battery, disconnect it first. Clear the overcurrent condition by adjusting output current level or by adjusting OCP trip level.

The following steps show how to clear the overcurrent condition and get back to normal mode operation. In the following steps, the display will go back to “OCP TRIPPED” if you let the display time out after about several seconds.

- *Adjust output current level*



1 Lower the output current level.

Press  key and set the knob for *current* control by pressing  key, then lower the output current level below the OCP trip point.



2 Move to the clear mode.

OCP CLEAR

Press  key twice to move to the OCP CLEAR mode. The “OCP ON” message appears on the display. Turn the knob to the right until the above message appears on the display.



3 Clear the overcurrent condition and exit this menu.

Now, when you press  key again, the “DONE” message is displayed for a second and the **OC**P annunciator will not blink any more. The output will return to meter mode. The knob is selected for *current* control.

Notice that the power supply is operated in the constant current (CC) mode.

• **Adjust OCP trip level**

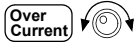

1 Raise the OCP trip level.

Press  key and turn the knob to raise the OCP trip level.



2 Move to the OCP CLEAR mode.



Press the  key to move to the OCP CLEAR mode. The “OCP ON” message appears on the display. Turn the knob to the right until the above message appears on the display.



3 Clear the overcurrent condition and exit this menu.

Now, when you press  key again, the “DONE” message is displayed for a second and the OCP annunciator will not blink any more. The output will return to the meter mode.

To Rack Mount the Power Supply

The power supply can be mounted in a standard 19-inch rack cabinet using one of three optional kits available. A rack-mounting kit for a single instrument is available as Option 1CM (P/N 5063-9243). Installation instructions and hardware are included with each rack-mounting kit. Any Keysight System II instrument of the same size can be rack-mounted beside the Keysight E3633A or E3634A DC power supply.

Remove the front and rear bumpers before rack-mounting the power supply.

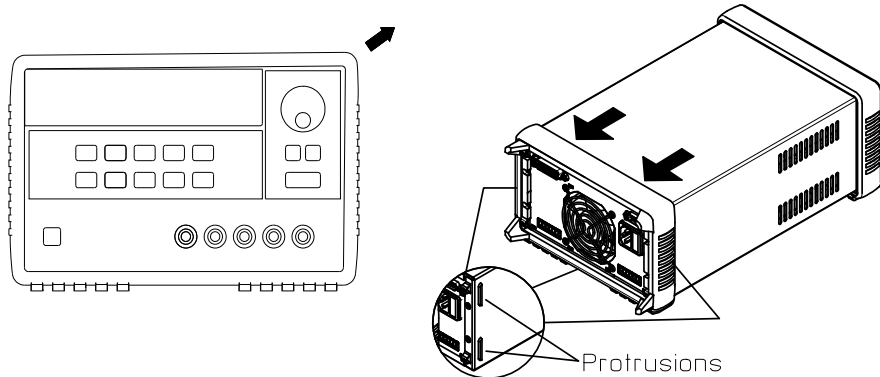

To remove the rubber bumper, pull the bumper off from the top as there are protrusions on the sides and bottom of the cover.

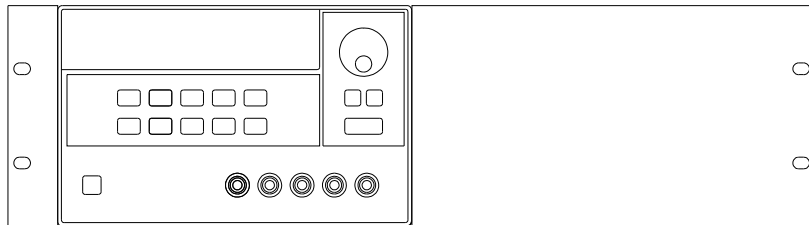

To rack mount a single instrument, order adapter kit 5063-9243.

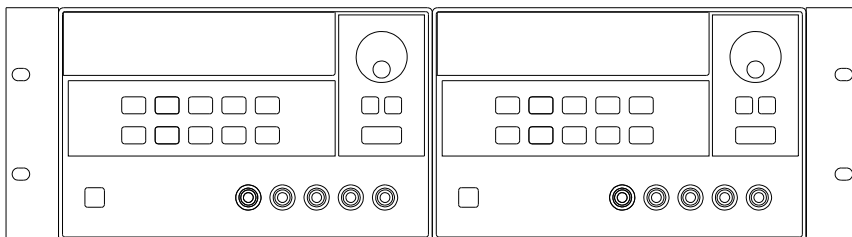

To rack mount two instruments of the same depth side-by-side, order lock-link kit 5061-9694 and flange kit 5063-9214.

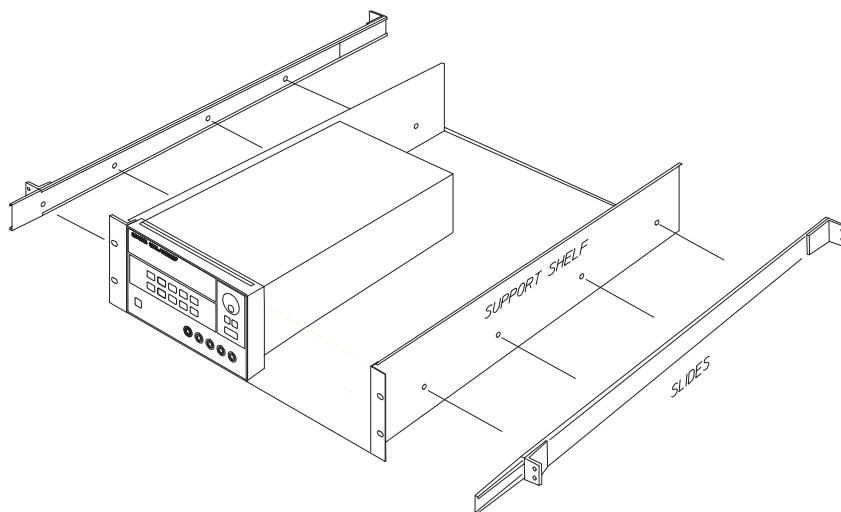

To install two instruments in a sliding support shelf, order support shelf 5063-9256, and slide kit 1494-0015.

THIS PAGE HAS BEEN INTENTIONALLY LEFT BLANK.

Calibration Procedures

Calibration Procedures

This chapter contains procedures for verification of the power supply's performance and calibration (adjustment). The chapter is divided into the following sections:

- Keysight Technologies Calibration Services, on page 45
- Calibration Interval, on page 45
- Automating Calibration Procedures, on page 46
- Test Considerations, on page 46
- Recommended Test Equipment, on page 47
- Performance Verification Tests, on page 48
- Measurement Techniques, starting on page 49
- Constant Voltage (CV) Verifications, starting on page 51
- Constant Current (CC) Verifications, starting on page 56
- Common Mode Current Noise, on page 59
- Performance Test Record for Keysight E3633A/E3634A, on page 60
- Calibration Security Code, starting on page 61
- Calibration Count, on page 64
- Calibration Message, on page 64
- General Calibration/Adjustment Procedure, starting on page 65
- Aborting a Calibration in Progress, on page 71
- Calibration Record for Keysight E3633A/E3634A, on page 72
- Error Messages, starting on page 73
- An Example Program of Excel 97 for Calibration, starting on page 75

The performance verification tests for constant voltage (CV) and constant current (CC) operations use the power supply's specifications listed in chapter 1, "Specifications," starting on page 13.

Note

*If you calibrate the power supply over the remote interface, you must send the *RST command to the power supply or turn the power supply off and on again after performing a calibration to ensure proper power supply operation.*

Closed-Case Electronic Calibration The power supply features closed-case electronic calibration since no internal mechanical adjustments are required for normal calibration. The power supply calculates correction factors based upon the input reference value you enter. The new correction factors are stored in non-volatile memory until the next calibration adjustment is performed. (*Non-volatile* memory does not change when power has been off or after a remote interface reset.)

3

Keysight Technologies Calibration Services

When your power supply is due for calibration, contact your local Keysight Technologies Service Center for a low-cost calibration. The Keysight E3633A and E3634A power supplies are supported on calibration processes which allow Keysight Technologies to provide this service at competitive prices.

Calibration Interval

The power supply should be calibrated on a regular interval determined by the accuracy requirements of your application. A 1-year interval is adequate for most applications. Keysight Technologies does not recommend extending calibration intervals beyond 1 year for any application. Keysight Technologies recommends that complete re-adjustment should always be performed at the calibration interval. This will increase your confidence that the Keysight E3633A and E3634A will remain within specification for the next calibration interval. This criteria for re-adjustment provides the best long-term stability.

Automating Calibration Procedures

You can automate the complete verification procedures outlined in this chapter if you have access to programmable test equipment. You can program the instrument configurations specified for each test over the remote interface. You can then enter readback verification data into a test program and compare the results to the appropriate test limit values.

You can also enter calibration constants from the remote interface. Remote operation is similar to the local front-panel procedure. You can use a computer to perform the adjustment by first selecting the required setup. The calibration value is sent to the power supply and then the calibration is initiated over the remote interface. The power supply must be unsecured prior to initiating the calibration procedure. An example program of Excel 97 for calibration over the GPIB interface is listed at the end of this chapter.

For further details on programming the power supply, see chapters 3 and 4 in the *Keysight E3633A and E3634A User's Guide*.

Test Considerations

To ensure proper instrument operation, verify that you have selected the correct power-line voltage prior to attempting any test procedure in this chapter. See page 24 in chapter 2 for more information.

Ensure that all connections of terminals (both front panel and rear panel) are removed while the power supply internal self-test is being performed.

For optimum performance verification, all test procedures should comply with the following recommendations:

- Assure that the calibration ambient temperature is stable and between 20°C and 30°C.
- Assure ambient relative humidity is less than 80%.
- Allow a 1-hour warm-up period before verification or calibration.
- Use short cables to connect test set-ups.

Caution

The tests should be performed by qualified personnel. During performance verification tests, hazardous voltages may be present at the outputs of the power supply.

Recommended Test Equipment

The test equipment recommended for the performance verification and adjustment procedures is listed below. If the exact instrument is not available, use the accuracy requirements shown to select substitute calibration standards. If you use equipment other than that recommended in Table 3-1, you must recalculate the measurement uncertainties for the actual equipment used.

Table 3-1. Recommended Test Equipment

Instrument	Requirements	Recommended Model	Use
GPIB controller	Full GPIB or RS-232 capabilities	Keysight 82341C interface card	Programming and readback accuracy
Oscilloscope	100 MHz with 20 MHz bandwidth	Keysight 54602B	Display transient response and ripple & noise waveform
RMS Voltmeter	20 Hz to 20 MHz		Measure rms ripple & noise
Coaxial cable		Keysight 10502A	Measure rms ripple & noise
BNC female to banana plug adapter		Keysight 1251-2277	Measure rms ripple & noise
Digital Voltmeter	Resolution: 0.1 mV Accuracy: 0.01%	Keysight 34401A	Measure dc voltages
Electronic Load	Voltage Range: 60 Vdc Current Range: 60 Adc Open and Short Switches Transient On/Off	Keysight 60502B	Measure load and line regulations and transient response time.
Resistive Loads (R _L)	(0.4 Ω, 300 W/2.0 Ω, 300 W)* (3.5 Ω, 300 W/12.5 Ω, 300 W)**		Measure ripple and noise
Current monitoring Resistor (Shunt)	(0.01 Ω, 0.1%) ^[1]	ISOTEK Co. Model: A-H	Constant current test setup

^[1] It is recommended to use a current monitoring resistor after calibration to find the accurate resistance.

*For Keysight E3633A Model **For Keysight E3634A Model

Performance Verification Tests

The performance verification tests use the power supply's specifications listed in chapter 1, "Specifications", starting on page 13.

You can perform two different levels of performance verification tests:

- **Self-Test** A series of internal verification tests that provide high confidence that the power supply is operational.
- **Performance Verification Tests** These tests are used to verify that the power supply is operating as specified in the performance specifications.

Self-Test

A *power-on* self-test occurs automatically when you turn on the power supply. This limited test assures you that the power supply is operational.

The *complete* self-test is enabled by holding down **Recall** key (actually any front panel keys except **Error** key) as you turn on the power supply and *hold down* the key *until you hear a long beep*. The self-test will begin when you release the key following the beep. The complete self-test takes approximately two seconds to execute.

You can also perform a self-test from the remote interface (*see chapter 3 in the Keysight E3633A and E3634A User's Guide*).

- If the self-test is successful, "PASS" is displayed on the front panel.
- If the self-test fails, "FAIL" is displayed and the **ERROR** annunciator turns on. If repair is required, see chapter 5, "Service", for further details.
- If self-test passes, you have a high confidence that the power supply is operational.

Performance Verification Tests

These tests should be used to verify the power supply's specifications following repairs to specific circuits. The following sections explain all verification procedures in detail. All of the performance test limits are shown in each test.

Measurement Techniques

Setup for Most Tests

Most tests are performed at the front terminals as shown in the following figure. Measure the dc voltage directly at the (+) and (-) terminals on the front panel.

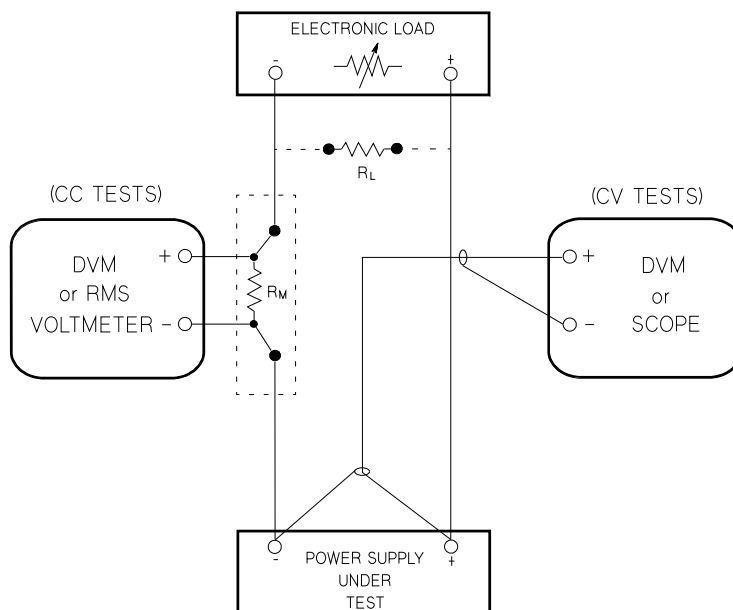

Figure 3-1. Performance Verification Test Setup

Electronic Load

Many of the test procedures require the use of a variable load resistor capable of dissipating the required power. Using a variable load resistor requires that switches should be used to connect, disconnect, and short the load resistor. An electronic load, if available, can be used in place of a variable load resistor and switches. The electronic load is considerably easier to use than load resistors. It eliminates the need for connecting resistors or rheostats in parallel to handle power, it is much more stable than carbon-pile load, and it makes easy work of switching between load conditions as is required for the load regulation and load response tests. Substitution of the electronic load requires minor changes to the test procedures in this chapter.

General Measurement Techniques

To achieve best results when measuring load regulation, peak to peak voltage, and transient response time of the power supply, measuring devices must be connected through the hole in the neck of the binding post at (A) while the load resistor is plugged into the front of the output terminals at (B). A measurement made across the load includes the impedance of the leads to the load. The impedance of the load leads can easily be several orders of the magnitude greater than the power supply impedance and thus invalidate the measurement. To avoid mutual coupling effects, each measuring device must be connected directly to the output terminals by separate pairs of leads.

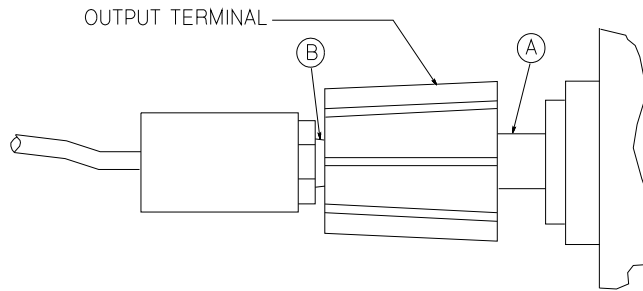

Figure 3-2. Front Panel Terminal Connections (Side View)

Current-Monitoring Resistor

To eliminate output current measurement error caused by the voltage drops in the leads and connections, connect the current monitoring resistor between the (-) output terminal and the load as a four-terminal device. Connect the current-monitoring leads inside the load-lead connections directly at the monitoring points on the resistor element (see R_M in Figure 3-1).

Programming

Most performance tests can be performed from the front panel. However, an GPIB or RS-232 controller is required to perform the voltage and current programming accuracy and readback accuracy tests.

The test procedures are written assuming that you know how to program the power supply either from the front panel or from an GPIB or RS-232 controller. Complete instructions on front panel and remote programming are given in the *Keysight E3633A and E3634A User's Guide*.

Constant Voltage (CV) Verifications

Constant Voltage Test Setup

If more than one meter or if a meter and an oscilloscope are used, connect each to the (+) and (-) terminals by a separate pair of leads to avoid mutual coupling effects. Use coaxial cable or shielded 2-wire cable to avoid noise pick-up on the test leads.

Voltage Programming and Readback Accuracy

This test verifies that the voltage programming and GPIB or RS-232 readback functions are within specifications. Note that the readback values over the remote interface should be identical to those displayed on the front panel.

You should program the power supply over the remote interface for this test to avoid round off errors.

- 1 Turn off the power supply and connect a digital voltmeter between the (+) and (-) terminals of the output to be tested as shown in Figure 3-1.
- 2 Turn on the power supply. Select the 20V/10A* or 50V/4A** range and enable the output by sending the commands:

```
VOLT:RANG P20V (E3633A)
```

```
VOLT:RANG P50V (E3634A)
```

```
OUTP ON
```

- 3 Program the output voltage to zero volt and current to full rated value (10.0 A)* or (4.0 A)** by sending the commands:

```
VOLT 0
```

```
CURR 10 (E3633A)
```

```
CURR 4 (E3634A)
```

- 4 Record the output voltage reading on the digital voltmeter (DVM). The reading should be within the limit of $(0\text{ V} \pm 10\text{ mV})$. Also, note that the **CV**, **Adrs**, **Limit**, and **Rmt** annunciators are on.
- 5 Readback the output voltage over the remote interface by sending the command:

```
MEAS:VOLT?
```
- 6 Record the value displayed on the controller. This value should be within the limit of $(\text{DVM} \pm 5\text{ mV})$.

*For Keysight E3633A Model **For Keysight E3634A Model

Chapter 3 Calibration Procedures

Constant Voltage (CV) Verifications

- 7 Program the output voltage to full rated value (20.0 V)* or (50.0 V)** by sending the command:

```
VOLT 20.0 (E3633A)
```

```
VOLT 50.0 (E3634A)
```

- 8 Record the output voltage reading on the digital voltmeter (DVM). The reading should be within the limit of (20 V \pm 20 mV)* or (50 V \pm 35mV)**.
- 9 Readback the output voltage over the remote interface by sending the command:

```
MEAS : VOLT?
```

- 10 Record the value displayed on the controller. This value should be within the limit of (DVM \pm 15 mV)* or (DVM \pm 30 mV)**.

CV Load Effect (Load Regulation)

This test measures the immediate change in the output voltage resulting from a change in the output current from full to no load.

- 1 Turn off the power supply and connect a digital voltmeter between the (+) and (-) terminals of the output as shown in Figure 3-1.
- 2 Turn on the power supply. Select the 20V/10A* or 50V/4A** range, enable the output, and set the display to the limit mode. When the display is in the limit mode, program the output current to the maximum programmable value and the voltage to the full rated value (20.0 V)* or (50.0 V)**.
- 3 Operate the electronic load in constant current mode and set its current to (10.0 A)* or (4.0 A)**. Check that the front panel **CV** annunciator remains lit. If not lit, adjust the load so that the output current drops slightly until the **CV** annunciator lights. Record the output voltage reading on the digital voltmeter.
- 4 Operate the electronic load in open mode (input off). Record the output voltage reading on the digital voltmeter immediately. The difference between the digital voltmeter readings in steps (3) and (4) is the CV load regulation. The difference of the readings during the immediate change should be within the limit of (4 mV)* or (7 mV)**.

*For Keysight E3633A Model **For Keysight E3634A Model

CV Source effect (Line Regulation)

This test measures the immediate change in output voltage that results from a change in ac line voltage from the minimum value (10% below the nominal input voltage) to maximum value (10% above the nominal input voltage).

- 1 Turn off the power supply and connect a digital voltmeter between the (+) and (-) terminals of the output to be tested as shown in Figure 3-1.
- 2 Connect the ac power line through a variable voltage transformer.
- 3 Turn on the power supply. Select the 20V/10A* or 50V/4A** range, enable the output, and set the display to the limit mode. When the display is in the limit mode, program the current to the maximum programmable value and the voltage to full rated value (20.0 V)* or (50.0 V)**.
- 4 Operate the electronic load in constant current mode and set its current to (10.0 A)* or (4.0 A)**. Check that the **CV** annunciator remains lit. If not lit, adjust the load so that the output current drops slightly until the **CV** annunciator lights.
- 5 Adjust the transformer to low line voltage limit (104 Vac for nominal 115 Vac, 90 Vac for nominal 100 Vac, or 207 Vac for nominal 230 Vac). Record the output reading on the digital voltmeter.
- 6 Adjust the transformer to high line voltage (127 Vac for nominal 115 Vac, 110 Vac for nominal 100 Vac, or 253 Vac for nominal 230 Vac). Record the voltage reading on the digital voltmeter immediately. The difference between the digital voltmeter readings in steps (5) and (6) is the CV line regulation. The difference of the readings during the immediate change should be within the limit of (4 mV)* or (7 mV)**.

*For Keysight E3633A Model **For Keysight E3634A Model

CV PARD (Ripple and Noise)

Periodic and random deviations (PARD) in the output (ripple and noise) combine to produce a residual ac voltage superimposed on the dc output voltage. CV PARD is specified as the rms or peak-to-peak output voltage in the frequency range from 20 Hz to 20 Mhz.

- **VRMS measurement techniques:**

When measuring Vrms ripple and noise, the monitoring device should be plugged into the front of the terminals at (B) in Figure 3-2. Use the coaxial cable and BNC female to banana plug adapter to connect the monitor device to the power supply. To reduce the measurement error caused by common mode noise, it is recommended that you use a common mode choke between the cable and the BNC adapter. The common mode choke is constructed by inserting coaxial cable into Ferrite Toroidal core. The load resistor should be connected to the terminal at (A) in Figure 3-2. Twisted leads between the load resistor and the power supply helps reduce noise pickup for these measurements.

- 1 Turn off the power supply and connect the output to be tested as shown in Figure 3-1 to an oscilloscope (ac coupled) between (+) and (-) terminals. Set the oscilloscope to AC mode and bandwidth limit to 20 MHz. Connect a resistive load (2.0 Ω)* or (12.5 Ω)** to the terminal at (A) in Figure 3-2.
- 2 Turn on the power supply. Select the 20V/10A* or 50V/4A** range, enable the output, and set the display to the limit mode. When the display is in the limit mode, program the current to the full rated value (10.0 A)* or (4.0 A)** and the voltage to the full rated value (20.0 V)* or (50.0 V)**.
- 3 Check that the front panel **CV** annunciator remains lit. If not lit, adjust the load down slightly.
- 4 Note that the waveform on the oscilloscope does not exceed the peak-to-peak limit of 3 mV.
- 5 Disconnect the oscilloscope and connect the ac rms voltmeter in its place according to the VRMS measurement techniques above. The rms voltage reading does not exceed the rms limit of 0.35 mV* or 0.5 mV**.

*For Keysight E3633A Model **For Keysight E3634A Model

Load Transient Response Time

This test measures the time for the output voltage to recover to within 15 mV of nominal output voltage following a load change from full load to half load, or half load to full load.

- 1 Turn off the power supply and connect the output to be tested as shown in Figure 3-1 with an oscilloscope. Operate the electronic load in constant current mode.
- 2 Turn on the power supply. Select 20V/10A* or 50V/4A** range, enable the output, and set the display to the limit mode. When the display is in the limit mode, program the current to the full rated value (10.0 A)* or (4.0 A)** and the voltage to the full rated value (20.0 V)* or (50.0 V)**.
- 3 Set the electronic load to transient operation mode between one half of the output's full rated value and the output's full rated value at a 1 kHz rate with 50% duty cycle.
- 4 Set the oscilloscope for ac coupling, internal sync, and lock on either the positive or negative load transient.
- 5 Adjust the oscilloscope to display transients as shown in Figure 3-3. Note that the pulse width ($t_2 - t_1$) of the transients at 15 mV from the base line is no more than 50 μ sec for the output.

3

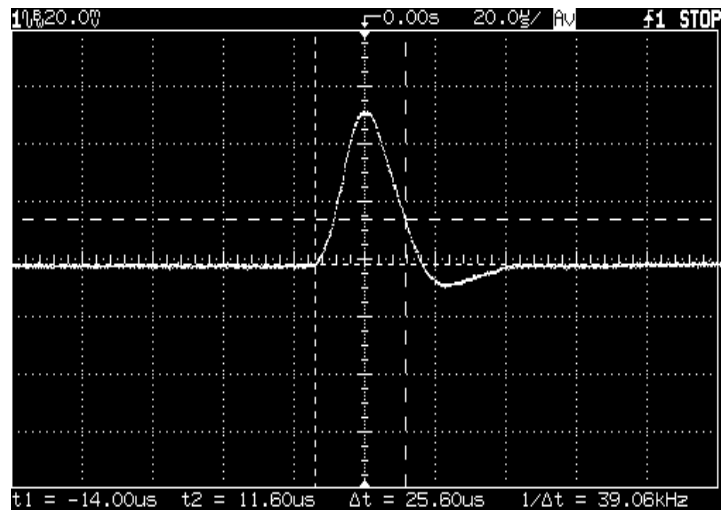

Figure 3-3. Transient Response Time

*For Keysight E3633A Model **For Keysight E3634A Model

Constant Current (CC) Verifications

Constant Current Test Setup

Follow the general setup instructions in the “Measurement Techniques” section, starting on page 50 and the specific instructions will be given in the following paragraphs.

Current Programming and Readback Accuracy

This test verifies that the current programming and GPIB or RS-232 readback functions are within specifications. Note that the readback values over the remote interface should be identical to those displayed on the front panel. The accuracy of the current monitoring resistor must be 0.01% or better.

You should program the power supply over the remote interface for this test to avoid round off errors.

- 1 Turn off the power supply and connect a 0.01 Ω current monitoring resistor (R_M) across the output to be tested and a digital voltmeter across the current monitoring resistor (R_M).
- 2 Turn on the power supply. Select the 8V/20A* or 25V/7A** range and enable the output by sending the commands:
VOLT:RANG P8V (E3633A)
VOLT:RANG P25V (E3634A)
OUTP ON
- 3 Program the output voltage to full rated voltage (8.0 V)* or (25.0 V)** and output current to zero amps by sending the commands:
VOLT 8 (E3633A)
VOLT 25 (E3634A)
CURR 0
- 4 Divide the voltage drop (DVM reading) across the current monitoring resistor (R_M) by its resistance to convert to amps and record this value (I_O). This value should be within the limit of (0 A \pm 10 mA). Also, note that the **CC**, **Adrs**, **Limit**, and **Rmt** annunciators are on.
- 5 Readback the output current over the remote interface by sending the command:
MEAS:CURR?
- 6 Record the value displayed on the controller. This value should be within the limit of ($I_O \pm 5$ mA).
*For Keysight E3633A Model **For Keysight E3634A Model

- 7 Program the output current to the full rated value (20.0 A)* or (7.0 A)** by sending the command:

```
CURR 20.0 (E3633A)
```

```
CURR 7.0 (E3634A)
```

- 8 Divide the voltage drop (DVM reading) across the current monitoring resistor (R_M) by its resistance to convert to amps and record this value (I_O). This value should be within the limit of (20 A \pm 50 mA)* or (7A \pm 24 mA)**.
- 9 Readback the output current over the remote interface by sending the command:
MEAS : CURR ?
- 10 Record the value displayed on the controller. This value should be within the limit of ($I_O \pm 35$ mA)* or ($I_O \pm 15.5$ mA)**.

CC Load Effect (Load Regulation)

This test measures the immediate change in output current resulting from a change in the load from full rated output voltage to short circuit.

- 1 Turn off the power supply and connect the output to be tested as shown in Figure 3-1 with the digital voltmeter connected across the 0.01 Ω current monitoring resistor (R_M).
- 2 Turn on the power supply. Select the 8V/20A* or 25V/7A** range, enable the output, and set the display to the limit mode. When the display is in the limit mode, program the output voltage to the maximum programmable value and the output current to the full rated value (20.0 A)* or (7.0 A)**.
- 3 Set the voltage of the electronic load to (6.0 V)* or (23.0 V)** to operate it in constant voltage mode since a voltage drop occurs on the load wires when (20.0 A)* or (7.0 A)** flows on the load wires. Check that the **CC** annunciator is on. If it is not, adjust the load so that the output voltage drops slightly. Record the current reading by dividing the voltage reading on the digital voltmeter by the resistance of the current monitoring resistor.
- 4 Operate the electronic load in short (input short) mode. Record the current reading immediately by dividing the voltage reading on the digital voltmeter by the resistance of the current monitoring resistor. The difference between the current readings in step (3) and (4) is the load regulation current. The difference of the readings during the immediate change should be within the limit of (2.25 mA)* or (0.95 mA)**.

*For Keysight E3633A Model **For Keysight E3634A Model

CC Source Effect (Line Regulation)

This test measures the immediate change in output current that results from a change in ac line voltage from the minimum value (10% below the nominal input voltage) to the maximum value (10% above nominal voltage).

- 1 Turn off the power supply and connect the output to be tested as shown in Figure 3-1 with the digital voltmeter connected across the current monitoring resistor (R_M).
- 2 Connect the ac power line through a variable voltage transformer.
- 3 Turn on the power supply. Select the 8V/20A* or 25V/7A** range, enable the output, and set the display to the limit mode. When the display is in the limit mode, program the voltage to the full rated value (8.0 V)* or (25.0 V)** and the current to the full rated value (20.0 A)* or (7.0 A)**.
- 4 Operate the electronic load in constant voltage mode and set its voltage to (8.0 V)* or (25.0 V)**. Check that the **CC** annunciator remains lit. If not lit, adjust the load so that the output voltage drops slightly until the **CC** annunciator lights.
- 5 Adjust the transformer to low line voltage limit (104 Vac for nominal 115 Vac, 90 Vac for nominal 100 Vac, or 207 Vac for nominal 230 Vac). Record the output current reading by dividing the voltage reading on the digital voltmeter by the resistance of the current monitoring resistor.
- 6 Adjust the transformer to 10% above the nominal line voltage (127 Vac for a 115 Vac nominal input, 110 Vac for a 100 Vac nominal input or 253 Vac for a 230 Vac nominal input). Record the current reading again immediately by dividing the voltage reading on the digital voltmeter by the resistance of the current monitoring resistor. The difference between the current readings in step (5) and (6) is the load regulation current. The difference of the readings during the immediate change should be within the limit of (2.25 mA)* or (0.95 mA)**.

CC PARD (Ripple and Noise)

Periodic and random deviations (PARD) in the output (ripple and noise) combine to produce a residual ac current, as well as an ac voltage superimposed on the dc output. CC PARD is specified as the rms output current in a frequency range 20 Hz to 20 MHz with the power supply in constant current operation.

- 1 Turn off the power supply and connect the output to be tested as shown in Figure 3-1 with a load resistor (0.4 Ω)* or (3.5 Ω)** across output terminals. Connect a rms voltmeter across the load resistor. Use only a resistive load for this test.
- 2 Turn on the power supply. Select the 8V/20A* or 25V/7A** range, enable the output, and set the display to the limit mode. When the display is in the limit mode, program the current to full rated value (20.0 A)* or (7.0 A)** and the voltage to the full rated value (8.0 V)* or (25.0 V)**.

*For Keysight E3633A Model **For Keysight E3634A Model

- 3 The output current should be at the full rated rating with the CC annunciator on. If not lit, adjust the load so that the output voltage drops slightly until the **CC** annunciator lights.
- 4 Divide the reading on the rms voltmeter by the load resistance to obtain rms current. The readings should be within the limit of 2 mA.

Common Mode Current Noise

The common mode current is that ac current component which exists between the output or output lines and chassis ground. Common mode noise can be a problem for very sensitive circuitry that is referenced to earth ground. When a circuit is referenced to earth ground, a low level line-related ac current will flow from the output terminals to earth ground. Any impedance to earth ground will create a voltage drop equal to the output current flow multiplied by the impedance.

- 1 Turn off the power supply and connect a 100 k Ω resistor (R_S) and a 2200 pF capacitor in parallel between the (-) terminal and chassis ground.
- 2 Connect a digital voltmeter across R_S .
- 3 Turn on the power supply. Select the 8V/20A* or 25V/7A** range, enable the output, and set the display to the limit mode. When the display is in the limit mode, program the output to the full rated value (8.0 V and 20.0 A)* or (25.0 V and 7.0 A)**.
- 4 Record the voltage across R_S and convert it to current by dividing by the resistance (DVM reading/100 k Ω). Note that the current is less than 1.5 μ A.

*For Keysight E3633A Model **For Keysight E3634A Model

Performance Test Record for Keysight E3633A and E3634A

CV Performance Test Record

Test Description	Models	Actual Result	Specifications	
			Upper Limit	Lower Limit
CV Programming Accuracy @ 0 volts (DVM reading)	both		+0.0100 V	-0.0100 V
CV Readback Accuracy @ 0 volts	both		DVM + 0.0050 V	DVM - 0.0050 V
CV Programming Accuracy @ Full Scale (DVM reading)	(E3633A)		+20.0200 V	19.9800 V
	(E3634A)		+50.0350 V	49.9650 V
CV Readback Accuracy @ Full Scale	(E3633A)		DVM + 0.0150 V	DVM - 0.0150 V
	(E3634A)		DVM + 0.0300 V	DVM - 0.0300 V
CV Load Effect (Load Regulation)			Maximum change: < (4 mV)* or (7 mV)**	
CV Source Effect (Line Regulation)			Maximum change: < (4 mV)* or (7 mV)**	
CV PARD (Normal mode)			< 3 mV p-p, (350 μ V)* or (500 μ V)** rms	
Load Transient Response Time	both		< 50 μ sec	

CC Performance Test Record

Test Description	Models	Actual Result	Specifications	
			Upper Limit	Lower Limit
CC Programming Accuracy @ 0 amps (I_O)	both		+0.0100 A	-0.0100 A
CC Readback Accuracy @ 0 amps	both		$I_O + 0.0050$ A	$I_O - 0.0050$ A
CC Programming Accuracy @ Full Scale (I_O)	(E3633A)		20.0500 A	19.9500 A
	(E3634A)		7.0230 A	6.9770 A
CC Readback Accuracy @ Full Scale	(E3633A)		$I_O + 0.0350$ A	$I_O - 0.0350$ A
	(E3634A)		$I_O + 0.0155$ A	$I_O - 0.0155$ A
CC Load Effect (Load Regulation)			Maximum change: < (2.25 mA)* or (0.95 mA)**	
CC Source Effect (Line Regulation)			Maximum change: < (2.25 mA)* or (0.95 mA)**	
CC PARD (Normal mode)	both		< 2 mA rms	
CC PARD (Common mode)	both		< 1.5 μ A rms	

*For Keysight E3633A Model **For Keysight E3634A Model

Calibration Security Code

This feature allows you to enter a security code (electronic key) to prevent accidental or unauthorized calibrations of the power supply. When you first receive your power supply, it is secured. Before you can calibrate the power supply, you must unsecure it by entering the correct security code. A procedure to unsecure the power supply is given on the following page.

- The security code is set to “HP003633”^{*} or “HP003634”^{**} when the power supply is shipped from the factory. The security code is stored in *non-volatile* memory, and does not change when power has been off or after a remote interface reset.
- To secure the power supply from the remote interface, the security code may contain up to 12 alphanumeric characters as shown below. The first character must be a letter, but the remaining characters can be letters or numbers. You do not have to use all 12 characters but the first character must always be a letter.

A _ _ _ _ _ _ _ _ _ _ _ _ (12 characters)

- To secure the power supply from the remote interface so that it can be unsecured from the front panel, use the eight-character format shown below. The first two characters must be “H P” and the remaining characters must be numbers. Only the last six characters are recognized from the front panel, but all eight characters are required. *To unsecure the power supply from the front panel, omit the “HP” and enter the remaining numbers as shown on the following pages.*

HP _ _ _ _ _ _ (8 characters)

- If you forget your security code, you can disable the security feature by adding a jumper inside the power supply, and then entering a new code. *See the procedure on page 63.*



^{*}For Keysight E3633A Model ^{**}For Keysight E3634A Model

To Unsecure the Power Supply for Calibration

The power supply can use a calibration security code to prevent unauthorized or accidental calibration. This procedure shows you how to unsecure the power supply for calibration from the front panel.



1 Turn on the front-panel calibration mode.

SECURED

Turn on the calibration mode by holding down  (Calibrate) key as you turn on the power supply and hold down the key until you hear a long beep.

If the power supply is secured, you will see the above message from the front panel for approximately one second. The “CAL MODE” message is then displayed on the front panel.



2 Move to the security code by pressing (Secure) key.

000000 CODE

3 Enter the security code using the knob and resolution selection keys.

003633 CODE (E3633A)

003634 CODE (E3634A)

The security code is set to “HP003633”* or “HP003634”** when the power supply is shipped from the factory. The security code is stored in non-volatile memory and does not change when the power has been off or after a remote interface reset.

- To enter the security code from the *front panel*, enter *only the last six digits*.
- To enter the security code from the remote interface, you may enter up to 12 characters.

Use the resolution selection keys to move left or right between digits. Use the knob to change the digits. Notice that the security code may be different if the security code has been changed from the default setting.

*For Keysight E3633A Model **For Keysight E3634A Model



4 Unsecure the power supply.

UNSECURED

The power supply is unsecured when you press  (Secure) key. You will see the above message from the front panel for one second. The “CAL MODE” message is displayed on the front panel after above message.



5 Turn off the calibration mode.

Turn off the power supply to exit the calibration mode.

To re-secure the power supply (following calibration), perform this procedure again.

3

To Unsecure the Power Supply Without the Security Code

To unsecure the power supply without the correct security code (when you forget the security code), follow the steps below. See “Electrostatic Discharge (ESD) Precautions” in chapter 5 before beginning this procedure.

- 1 Disconnect the power cord and all load connections from the power supply.
- 2 Remove the instrument cover.
- 3 Connect the power cord and turn on the calibration mode by holding down  (Calibrate) key as you turn on the power supply and *hold down* the key until you hear a long beep. Be careful not to touch the power line connections.
- 4 Apply a short between the two exposed metal pads on JP5^[1] (located near U13). The JP5 is outlined with a circle on the component locator drawing on [page 111](#).
- 5 While maintaining the short, move to the security code and enter any unsecure code in the calibration mode. The power supply is now unsecured.
- 6 Remove the short at JP5^[2]. (An error occurs if not removed.)
- 7 Turn off and reassemble the power supply.

Now you can enter a new security code. Be sure you take note of the new security code.

[1]For serial MY53xx6xxx, apply a short between the two exposed metal pads on JP102 (located near U103). The JP102 is outlined with a circle on the component locator drawing on [page 113](#).

[2]For serial MY53xx6xxx, remove the short at JP102.

Calibration Count

The calibration count feature provides an independent “serialization” of your calibrations. You can determine the number of times that your power supply has been calibrated. By monitoring the calibration count, you can determine whether an unauthorized calibration has been performed. Since the value increments by one for each calibration parameter (see Table 3-2 on the next page), a complete calibration increases the value by 5 counts.

- The calibration count is stored in *non-volatile* memory and does not change when power has been off or after a remote interface reset. Your power supply was calibrated before it left the factory. When you receive the power supply, read the calibration count to determine its value.
- The calibration count increments up to a maximum of 32,767 after which it wraps around to 0. No way is provided to program or reset the calibration count.

Calibration Message

You can use the calibration message feature to record calibration information about your power supply. For example, you can store such information as the last calibration date, the next calibration due date, the power supply’s serial number, or even the name and phone number of the person to contact for a new calibration.

You can record and read information in the calibration message from the remote interface only.

- The calibration message may contain up to 40 characters.
- The calibration message is stored in *non-volatile* memory and does not change when power has been off or after a remote interface reset.
- Remote Interface Operation

CAL:SEC:STAT {OFF|ON}, <code> *Secure or unsecure the power supply*

CAL:SEC:CODE <new code> *Change the security code*

CAL:STR <quoted string> *Store the calibration message*

CAL:STR? *Query the calibration information*

See “*Calibration Overview*”, starting on page 68 in chapter 3 of the *User’s Guide* for more details.

General Calibration/Adjustment Procedure

The calibration procedures from the front panel are described in this section. For voltage calibration, *disconnect* all loads from the power supply and connect a DVM across the output terminals. For current calibration, disconnect all loads from the power supply, connect an appropriate current monitoring resistor 0.01 Ω across the output terminals, and connect a DVM across the terminals of the monitoring resistor.

Note that the power supply should be calibrated after 1-hour warm-up with no load connected.

The following table shows calibration parameters and points which should be used to calibrate the output voltage and current.

Table 3-2. Parameters for Calibration

Calibration Parameter	Voltage/ Current	Calibration Point mnemonic
CAL SETUP 1	Voltage	V LO
		V MI
		V HI
CAL SETUP 2	OVP	None
CAL SETUP 3	Current	I LO
		I MI
		I HI
CAL SETUP 4	OCP	None

Note *You can terminate any **CAL SETUP** without changing its calibration constants by turning off power.*

Note *Perform the voltage calibration prior to the **OVP** calibration and the current calibration prior to the **OCP** calibration.*

Front Panel Voltage and Current Calibration

1 Unsecure the power supply.

To calibrate the voltage and current, you must unsecure the power supply according to the procedure given on page 62.

2 Disconnect all loads from the power supply and connect a DVM across output terminals.



3 Turn on the calibration mode.

CAL MODE

Turn on the calibration mode by holding down  (Calibrate) key as you turn on the power supply and hold down the key until you hear a long beep. Make sure that the power supply is in “CV” mode. If the power supply is not in “CV” mode, an error occurs.

Voltage and OVP Calibration



4 Move down a level to the voltage calibration mode.

CAL SETUP 1

The display shows the above message to indicate that the power supply is ready for voltage calibration.



5 Calibrate DAC and select the low voltage calibration point.

30 LEFT

The “START BITCAL” message is displayed for about 3 seconds to indicate that the power supply is ready for DAC calibration. Then it counts down numbers from 30 to 0.

V LO 0.5000 V

Then, the display shows the low voltage calibration point.

6 Read the DVM and change the low voltage value on the display to match the measured voltage.

For example, if the DVM reading is 0.4500 V, adjust the voltage to 0.4500 V using the knob and resolution selection keys.

V LO 0.4500 V

Error
Calibrate

7 Pressing  (Calibrate) key saves the change and selects the middle voltage calibration point. (“V MI 25.000 V” - E3634A model)

V MI 10.000 V (E3633A)

If the entered number is within an acceptable range, an “ENTERED” message appears for one second. If the entered number is not correct, an “MIN VALUE” or “MAX VALUE” message appears for one second and the display shows the low voltage calibration point again. The display now shows the middle voltage calibration point.

8 Read the DVM and change the middle voltage value on the display to match the measured voltage.

For example, if the DVM reads 10.001 V, adjust the voltage to 10.001 V using the knob and arrow keys.

V MI 10.001 V

Error
Calibrate

9 Pressing  (Calibrate) key saves the changes and selects the high voltage calibration point. (“V HI 49.500 V” - E3634A model)

V HI 19.500 V (E3633A)

If the entered number is within an acceptable range, an “ENTERED” message appears for one second. If the entered number is not correct, an “MIN VALUE” or “MAX VALUE” message appears for one second and the display shows the middle voltage calibration point again. The display now shows the high voltage calibration point.

- 10 Read the DVM and change the high voltage value on the display to match the measured voltage.**

For example, if the DVM reads 19.495 V, adjust the voltage to 19.495 V using the knob and arrow keys.

V HI 19.495 V



- 11 Pressing  (Calibrate) key saves the new voltage calibration constants, and goes to the OVP calibration mode.**

CAL SETUP 2

A “CALIBRATING” message appears for one second to indicate that the voltage calibration is progressing and new voltage calibration constants of “SETUP 1” are stored. Then, the display shows above message to indicate that the power supply is ready for the OVP calibration.

If the calibration fails, a “DAC CAL FAIL” or “ADC CAL FAIL” message appears for one second and the display shows the “CAL SETUP 1” for voltage calibration again.

Current and OCP Calibration



- 12 Pressing  (Calibrate) key saves the new calibration constants for OVP circuit and goes to the current calibration mode.**

CAL SETUP 3

A “CALIBRATING” message appears for about several seconds to indicate that the OVP calibration is progressing and new calibration constants of “SETUP 2” are stored. Then, the display shows the above message to indicate that the power supply is ready for the current calibration.

Connect an appropriate shunt 0.01 Ω across the output terminals, and connect a digital voltmeter across the shunt resistor for the current calibration.

If the calibration fails, a “OVP CAL FAIL” message appears for one second and the display shows the “CAL SETUP 2” for OVP calibration again.

Error
Calibrate

- 13 Select the low current calibration point.**
(“I LO 0.2000 A” - E3634A model)

I LO 0.5000 A (E3633A)

The display shows the low current calibration point.

- 14 Read the DVM and change the low current value on the display to match the computed current (DVM reading ÷ by shunt resistance).**

For example, if the computed value is 0.4990 A, adjust the current to 0.4990 A using the knob and arrow keys.

Notice that you should wait for the DVM reading to stabilize for accurate calibration.

I LO 0.4990 A

Error
Calibrate

- 15 Pressing the “Calibrate” key saves the change and selects the middle current calibration point.** (“I MI 3.5000 A” - E3634A model)

I MI 10.000 A (E3633A)

If the entered number is within an acceptable range, an “ENTERED” message appears for one second. If the entered number is not correct, an “MIN VALUE” or “MAX VALUE” message appears for one second and the display shows the low current calibration point again. The display now shows the middle current calibration point.

- 16 Read the DVM and change the middle current value on the display to match the computed current (DVM reading ÷ by shunt resistance).**

For example, if the computed value is 9.999 A, adjust the current to 9.999 A using the knob and arrow keys.

Notice that you should wait for the DVM reading to stabilize for accurate calibration.

I MI 09.999 A

Error
Calibrate

- 17 Pressing the “Calibrate” key saves the change and selects the high current calibration point. (“I HI 6.9000 A” - E3634A model)**

I HI 19.500 A (E3633A)

If the entered number is within an acceptable range, an “ENTERED” message appears for one second. If the entered number is not correct, an “MIN VALUE” or “MAX VALUE” message appears for one second and the display shows the middle current calibration point again. The display now shows the high current calibration point

- 18 Read the DVM and change the high current value on the display to match the computed current (DVM reading , by shunt resistance).**

For example, if the computed value is 19.499 A, adjust the current to 19.499 A using the knob and arrow keys.

Notice that you should wait for the DVM reading to stabilize for accurate calibration.

I HI 19.499 A

Error
Calibrate

- 19 Pressing the “Calibrate” key saves the new calibration constants for the output current and goes to the OCP calibration mode.**

CAL SETUP 4

A “CALIBRATING” message appears for one second to indicate that the current calibration is progressing and new calibration constants of “SETUP 3” are stored. Then, the display shows the above message to indicate that the power supply is ready for the OCP calibration.

If the calibration fails, an “DAC CAL FAIL” or “ADC CAL FAIL” message appears for one second and the display shows the “CAL SETUP 3” for current calibration again.



- 20 Pressing the “Calibrate” key saves the new OCP calibration constants and return to the calibration mode.**

CAL MODE

A “CALIBRATING” message appears for several seconds to indicate that the OCP calibration is progressing and new OCP calibration constants of “SETUP 4” are stored. Then the display will return to the calibration mode.

If the calibration fails, a “OCP CAL FAIL” message appears for one second and the display shows the “CAL SETUP 4” for OCP calibration again.



Turn off the power supply to exit the calibration mode.

3

Aborting a Calibration in Progress

Sometimes it may be necessary to abort a calibration after the procedure has already been initiated. You can abort a calibration at any time by turning the power supply off from the front panel. When performing a calibration from the remote interface, you can abort a calibration by issuing a remote interface device clear message or by pressing the front-panel “Local” key.

Calibration Record for Keysight E3633A/E3634A

Step	Calibration Description	Measurement Mode (DVM)	Supply Being Adjusted
1	Unsecure the power supply (see page 62).		
2	Turn on "CAL MODE" (hold down "Calibrate" and "Power" keys as you turn on the power supply until you hear a long beep).		
3	Move down menu to "CAL SETUP 1" (press "Calibrate" key).		Voltage Calibration
4	Calibrate DAC and select the low point for voltage calibration; "START BITCAL" appears for about 3 seconds and the display counts down numbers from 30 to 0. Then, "V LO 0.5000 V" appears on the display (press "Calibrate" key and wait about 30 seconds; then change the display to match the DVM reading).	V	DAC and low voltage point calibration
5	"V MI 10.000 V"* or "V MI 25.000 V"*** appears on the display (press "Calibrate" key; then change the display to match the DVM reading).	V	Middle voltage point calibration
6	"V HI 19.500 V"* or "V HI 49.500 V"*** appears on the display (press "Calibrate" key; then change the display to match the DVM reading).	V	High voltage point calibration
7	"CAL SETUP 2" now appears on the display (press "Calibrate" key).	V	OVP calibration
8	"CAL SETUP 3" now appears on the display (press "Calibrate" key; then connect 0.01 Ω resistor across the output terminals).		Current calibration
9	"I LO 0.5000 A"* or "I LO 0.2000 A"*** appears on the display (press "Calibrate" key; then change the display to match the computed current through the resistor).	A	Low current point calibration
10	"I MI 10.000 A"* or "I MI 3.5000 A"*** appears on the display (press "Calibrate" key; then change the display to match the computed current through the resistor).	A	Middle current point calibration
11	"I HI 19.500 A"* or "I HI 6.9000 A"*** appears on the display (press "Calibrate" key; then change the display to match the computed current through the resistor).	A	High current point calibration
12	"CAL SETUP 4" now appears on the display (press "Calibrate" key).	A	OCP calibration
13	Press "Calibrate" key, then press "Power" switch.		Exit CAL MODE

*For Keysight E3633A Model **For Keysight E3634A Model

Error Messages

The following tables are abbreviated lists of error messages for the E3633A and E3634A. The errors listed are the most likely errors to be encountered during calibration and adjustment. A more complete list of error messages and descriptions is contained in chapter 5 of the E3633A and E3634A User's Guide.

System Error Messages

Error	Error Messages
-330	Self-test failed
-350	Queue overflow
501	Isolator UART framing error
502	Isolator UART overrun error
503 ^[1]	SPI data error
511	RS-232 framing error
512	RS-232 overrun error
513	RS-232 parity error
514	Command allowed only with RS-232
521	Input buffer overflow
522	Output buffer overflow
550	Command not allowed in local

[1] This error message is only applicable for serial MY53xx6xxx.

Self-Test Error Messages

Error	Error Messages
601	Front panel does not respond
602	RAM read/write failed
603	A/D sync stuck
604	A/D slope convergence failed
605	Cannot calibrate rundown gain
606	Rundown gain out of range
607	Rundown too noisy
608	Serial configuration readback failed
609 ^[1]	System ADC test failed
624	Unable to sense line frequency
625	I/O processor does not respond
626	I/O processor failed self-test
630	Fan test failed
631	System DAC test failed
632	Hardware test failed

[1]This error message is only applicable for serial MY53xx6xxx.

Calibration Error Messages

Error	Error Messages
701	Cal security disabled by jumper
702	Cal secured
703	Invalid secure code
704	Secure code too long
705	Cal aborted
708	Cal output disabled
712	Bad DAC cal data
713	Bad readback cal data
714	Bad OVP cal data
715	Bad OCP cal data
716	Bad DAC DNL error correction data
717	Cal OVP or OCP status enabled
718	Gain out of range for gain error correction
740	Cal checksum failed, secure state
741	Cal checksum failed, string data
742	Cal checksum failed, store/recall data in location 0
743	Cal checksum failed, store/recall data in location 1
744	Cal checksum failed, store/recall data in location 2
745	Cal checksum failed, store/recall data in location 3
746	Cal checksum failed, DAC cal constants
747	Cal checksum failed, readback cal constants
748	Cal checksum failed, GPIB address
749	Cal checksum failed, internal data
750	Cal checksum failed, DAC DNL error correction data



Continued on next page

An Example program of Excel 97 for Calibration

This section contains an Excel Macros (Visual Basic[®] for Applications) program for calibration over the GPIB interface. This program makes software adjustments to the E3633A power supply using a current shunt and a digital multimeter which is connected to the controller. In this program a 0.001 ohm current shunt is used. Be sure to change the value of the variable “shunt” to the value of the current shunt used and the GPIB address for the power supply and the digital voltmeter.

```
*****  
'This program was written on a PC with Excel Macros (Visual Basic® for Applications)  
'for Windows 95 or Windows NT 4.0. It will make software adjustments to the E3633A  
'Power Supply on the GPIB bus using a Keysight 34401A Digital Multimeter and a current  
'shunt. In the program a 0.001 ohm current shunt is used to measure current. Be sure to  
'change the value of the variable 'shunt' to the value of the current shunt used.  
*****  
Global id_power As Long  
Global id_DMM As Long  
Global power As Long  
Global DMM As Long  
Global Const VI_SUCCESS = &H0&  
Global Const VoltageMin = 0  
Global Const VoltageMid = 1  
Global Const VoltageMax = 2  
Global Const CurrentMin = 3  
Global Const CurrentMid = 4  
Global Const CurrentMax = 5  
  
Sub Calibration_Click()  
    Dim shunt As Single 'Current shunt value in Ohms  
    Dim UserAnswer      'User response  
    Range("B4:B6").ClearContents  
  
    If OpenPort = False Then  
        ClosePort  
        Exit Sub  
    End If  
    InitializeDevice  
    EnableOVPandOCP False  
    If CheckSecurity = False Then  
        ClosePort  
        Exit Sub  
    End If
```

Continued on next page

Chapter 3 Calibration Procedures

An Example program of Excel 97 for Calibration

```
If DacErrorCorrection = False Then
    ClosePort
    Exit Sub
End If

shunt = 0.001 'Change the current shunt value

UserAnswer = MsgBox("Voltage & OVP calibration. Connect the output to the DMM",
vbYesNo + vbQuestion, "E3633A Calibration")

If UserAnswer = vbNo Then
    ClosePort
    Exit Sub
End If

Range("B4").Select
ActiveCell.Value = "Begin Voltage Calibration"
StartCalibration VoltageMin, True, shunt 'Set output to minimum voltage cal
ActiveCell.Value = "End Minimum Voltage Calibration"
StartCalibration VoltageMid, True, shunt 'Set output to middle voltage cal
ActiveCell.Value = "End Middle Voltage Calibration"
StartCalibration VoltageMax, True, shunt 'Set output to maximum voltage cal
ActiveCell.Value = "End Maximum Voltage Calibration"
Message = SendSCPI(power, "Syst:Err?")
If InStr(Message, "0") Then
    ActiveCell.Value = "Voltage Calibration Complete"
Else
    ActiveCell.Value = Message
    ClosePort
    Exit Sub
End If

OVPandOCPCalibration True
UserAnswer = MsgBox("Connect the Current shunt to the DMM input to measure a current.
Connect the output to the shunt.", vbYesNo + vbQuestion, "E3633A Calibration")
If UserAnswer = vbNo Then
    ClosePort
    Exit Sub
End If

ActiveCell.Value = "Begin Current Calibration"
StartCalibration CurrentMin, False, shunt 'Set output to minimum current cal
ActiveCell.Value = "End Minimum Current Calibration"
StartCalibration CurrentMid, False, shunt 'Set output to middle current cal
```

Continued on next page

Chapter 3 Calibration Procedures

An Example program of Excel 97 for Calibration

```
ActiveCell.Value = "End Middle Current Calibration"
StartCalibration CurrentMax, False, shunt 'Set output to maximum current cal
ActiveCell.Value = "End Maximum Current Calibration"
OVPandOCPCalibration False
Message = SendSCPI(power, "Syst:Err?")
If InStr(Message, "0") Then
    ActiveCell.Value = "Current Calibration Complete"
Else
    ActiveCell.Value = Message
    ClosePort
    Exit Sub
End If
EnableOVPandOCP True
SaveDate
ActiveCell.Value = "Calibration Complete"
Message = SendSCPI(power, "*RST")
ClosePort
End Sub

Private Function OpenPort() As Boolean 'Open communications on GPIB
    Dim Power_Address As String
    Dim DMM_Address As String
    Dim Error As Long

    Power_Address = "5" 'Select power supply GPIB address between 0 to 30
    DMM_Address = "22" 'Select DMM GPIB address between 0 to 30
    Error = viOpenDefaultRM(id_power) 'Open the power supply VISA session
    If OpenPort = CheckError(Error, "Open ID Error to Power Supply") Then
        Exit Function
    End If
    Error = viOpenDefaultRM(id_DMM) 'Open the DMM VISA session
    If OpenPort = CheckError(Error, "Open ID Error to Digital Multi Meter") Then
        Exit Function
    End If
    Error = viOpen(id_power, "GPIB0::" & Power_Address & "::INSTR", 0, 1000, power)
    If OpenPort = CheckError(Error, "Unable Open to Power Supply") Then
        Exit Function
    End If
    Error = viOpen(id_DMM, "GPIB0::" & DMM_Address & "::INSTR", 0, 1000, DMM)
    If OpenPort = CheckError(Error, "Unable Open to Digital Multi Meter") Then
        Exit Function
    End If
    OpenPort = True
End Function
```

Continued on next page

Chapter 3 Calibration Procedures

An Example program of Excel 97 for Calibration

```
Private Function InitializeDevice()  
    SendSCPI power, "*Cls"  
    SendSCPI DMM, "*Rst" 'Set power-on condition for DMM  
    SendSCPI power, "*Rst" 'Set power-on condition for power supply  
End Function  
  
Private Function CheckError(Error As Long, Message As String) As Boolean  
    If Error < VI_SUCCESS Then  
        ActiveCell.Value = Message  
        CheckError = False 'Exit Calibration  
    Else  
        CheckError = True  
    End If  
End Function  
  
Private Function ClosePort()  
    Dim Error As Long  
    Error = viClose(power)  
    Error = viClose(id_power)  
    Error = viClose(DMM)  
    Error = viClose(id_DMM)  
End Function  
  
Private Function EnableOVPandOCP(bEnable As Boolean)  
    If bEnable Then  
        SendSCPI power, "Volt:Prot:Stat On"  
        SendSCPI power, "Curr:Prot:Stat On"  
    Else  
        SendSCPI power, "Volt:Prot:Stat Off"  
        SendSCPI power, "Curr:Prot:Stat Off"  
    End If  
End Function  
  
'This routine send a SCPI command string to the GPIB port.  
'If the command contains a question mark, the response is read, and returned  
  
Private Function SendSCPI(device As Long, command As String) As String  
    Dim commandString As String  
    Dim ReturnString As String  
    Dim crlfpos As Integer  
    Dim ReadBuffer As String * 512  
    Dim actual As Long  
    Dim Error As Long  
    commandString = command & Chr$(10)
```

Continued on next page

Chapter 3 Calibration Procedures

An Example program of Excel 97 for Calibration

```
Error = viWrite(device, ByVal commandString, Len(commandString), actual)
If InStr(commandString, "?") Then
    Error = viRead(device, ByVal ReadBuffer, 512, actual)
    ReturnString = ReadBuffer
    crlfpos = InStr(ReturnString, Chr$(0))
    If crlfpos Then
        ReturnString = Left(ReturnString, crlfpos - 2)
    End If
    SendSCPI = ReturnString
End If
End Function

Private Function delay(delay_time As Single) 'This routine is used to create delays
    Dim Finish As Single
    Finish = Timer + delay_time
    Do
        Loop Until Finish <= Timer
    End Function

Private Function CheckSecurity() As Boolean
    Dim Message As String
    Dim SecurityCode As String
    Message = SendSCPI(power, "Cal:Str?")
    Range("B5").Select
    ActiveCell.Value = Message
    Message = SendSCPI(power, "Cal:Count?")
    Range("B6").Select
    ActiveCell.Value = Message
    Range("B4").Select
    SecurityCode = "HP003633"
    SendSCPI power, "Cal:Sec:Stat Off," & SecurityCode
    Message = SendSCPI(power, "Cal:Sec:Stat?")

    If InStr(Message, "1") Then
        ActiveCell.Value = "Unable to Unsecure the Power Supply"
        CheckSecurity = False
    Else
        Message = SendSCPI(power, "Syst:Err?")
        If InStr(Message, "0") Then
            CheckSecurity = True
        Else
            ActiveCell.Value = Message
            CheckSecurity = False
        End If
    End If
End Function
```

Continued on next page

Chapter 3 Calibration Procedures

An Example program of Excel 97 for Calibration

```
Private Function DacErrorCorrection() As Boolean
    Dim Message As String
    SendSCPI power, "Output On"      'Turn on the power supply output
    SendSCPI power, "Cal:Dac:Error"
    For I = 1 To 27
        delay 1
        ActiveCell.Value = "Waitting for " & Str$(27 - I) & "secs"
    Next I
    SendSCPI power, "Output Off"     'Turn off the power supply output
    Message = SendSCPI(power, "Syst:Err?")
    If InStr(Message, "0") Then
        ActiveCell.Value = "DAC DNL Error Correction completed for power supply"
        DacErrorCorrection = True
    Else
        ActiveCell.Value = Message
        DacErrorCorrection = False
    End If
End Function

Private Function StartCalibration(mode As Integer, bVolt As Boolean, shunt As Single)
    Dim DMMdata As Single

    SendSCPI power, "Output On" 'Turn on the power supply output
    Select Case mode
        Case VoltageMin
            SendSCPI power, "Cal:Volt:Level Min" 'Set output to minimum cal value
        Case VoltageMid
            SendSCPI power, "Cal:Volt:Level Mid" 'Set output to middle cal value
        Case VoltageMax
            SendSCPI power, "Cal:Volt:Level Max" 'Set output to maximum cal value
        Case CurrentMin
            SendSCPI power, "Cal:Curr:Level Min" 'Set output to minimum cal value
        Case CurrentMid
            SendSCPI power, "Cal:Curr:Level Mid" 'Set output to middle cal value
        Case CurrentMax
            SendSCPI power, "Cal:Curr:Level Max" 'Set output to maximum cal value
    End Select

    delay 4
    DMMdata = SendSCPI(DMM, "Meas:Volt:DC?") 'measure output
```

Chapter 3 Calibration Procedures

An Example program of Excel 97 for Calibration

```
If bVolt Then
    'Send the measured voltage value to the power supply
    SendSCPI power, "Cal:Volt:Data " & Str(DMMdata)
Else
    'Send the measured current value to the power supply
    SendSCPI power, "Cal:Curr:Data " & Str(DMMdata / shunt)
End If
SendSCPI power, "Output Off"    'Turn off the power supply output
End Function

Private Function OVPandOCPCalibration(bVolt As Boolean)
    SendSCPI power, "Output On" 'Turn on the power supply output
    If bVolt Then
        ActiveCell.Value = " Begin OVP Calibration"
        SendSCPI power, "Cal:Volt:Prot" 'Perform OVP circuit calibration
    Else
        ActiveCell.Value = " Begin OCP Calibration"
        SendSCPI power, "Cal:Curr:Prot" 'Perform OCP circuit calibration
    End If
    delay 9
    SendSCPI power, "Output Off"    'Turn off the power supply output
End Function

Private Function SaveDate()
    Dim Message As String
    'calibration string enclosed in quotes
    Message = "Cal:Str " & Chr(34) & Date & Chr(34)
    SendSCPI power, Message
    Message = SendSCPI(power, "Cal:Str?")
    Range("B5").Select
    ActiveCell.Value = Message
    Message = SendSCPI(power, "Cal:Count?")
    Range("B6").Select
    ActiveCell.Value = Message

    Range("B4").Select

End Function
```

End of Program

Chapter 3 Calibration Procedures

An Example program of Excel 97 for Calibration

Declaration for Windows 95/NT 4.0

```
Declare Function viOpenDefaultRM Lib "visa32.dll" (instrumentHandle As Long) As Long
```

```
Declare Function viOpen Lib "visa32.dll" (ByVal instrumentHandle As Long, _  
    ByVal viDesc As String, ByVal mode As Long, ByVal timeout As Long, _  
    vi As Long) As Long
```

```
Declare Function viClose Lib "visa32.dll" (ByVal vi As Long) As Long
```

```
Declare Function viWrite Lib "visa32.dll" (ByVal vi As Long, ByVal Buffer As String,  
    ByVal count As Long, retCount As Long) As Long
```

```
Declare Function viRead Lib "visa32.dll" (ByVal vi As Long, ByVal Buffer As String, _  
    ByVal count As Long, retCount As Long) As Long
```

3

THIS PAGE HAS BEEN INTENTIONALLY LEFT BLANK.

Theory of Operation

Theory of Operation

This chapter provides block diagram level descriptions of the power supply. The descriptions provide a basic understanding of circuit operation and are intended as an aid in troubleshooting. It is assumed in the following discussions that you are familiar with the operating and programming instructions presented in the E3633A and E3634A User's Guide. Subjects covered include the following:

- Block Diagram Overview, starting on page 85
- AC Input and Bias Supplies, on page 87
- Floating Logic, starting on page 88
- D-to-A Converter, on page 90
- A-to-D Converter, on page 91
- Power Mesh and Control, starting on page 92
- Earth-Referenced Logic, on page 94
- Front Panel, on page 94

Block Diagram Overview

This discussion pertains to the block diagram on the next page. The power supply's circuitry is divided into two major blocks: the floating circuitry and the earth referenced circuitry. All power mesh and control circuits, display circuit, and digital circuits are contained in the floating circuitry. This circuitry also contains the power supply's main controller. The earth referenced circuitry provides the interface between the user and the power supply.

The floating circuitry can be viewed in four pieces; the DAC system, the digital logic section (floating logic), the power mesh and control section, and the front panel (display and keyboard) section.

The floating logic receives digital signals from the earth-referenced logic and the DAC converts them to analog signals which are sent to the power control circuits in order to program the power supply's output voltage and current. The power supply can also be commanded to send measurement and status data back to the remote interface controller and/or the VFD (vacuum fluorescent display) display on the front panel. The data is processed and sent back via the floating logic and earth-referenced logic.

The power mesh and control circuits contains voltage and current control circuits which allows the power supply to operate in either the constant voltage (CV) or constant current (CC) mode. The control circuits compare the power supply's output voltage or current with the programmed value and generates a control signal which varies the conduction of the series pass transistor to raise or lower the output as required.

The front panel circuits consist of VFD control, display high voltage drivers, and keyboard scanning. Communication between the front panel and floating logic circuits is accomplished through a 4-wire bi-directional serial interface.

The earth referenced circuitry uses a controller configured as a slave to the main controller. This controller establishes external I/O communication with the main controller through a bi-directional, optically isolated, serial communications link. The earth referenced controller controls low-level GPIB (IEEE-488) and RS-232 interface operation.

Separate reference and bias supplies are provided for the floating and ground reference circuitry. The front panel operates from the floating circuitry with its logic common different from the main controller logic common.

Block Diagram

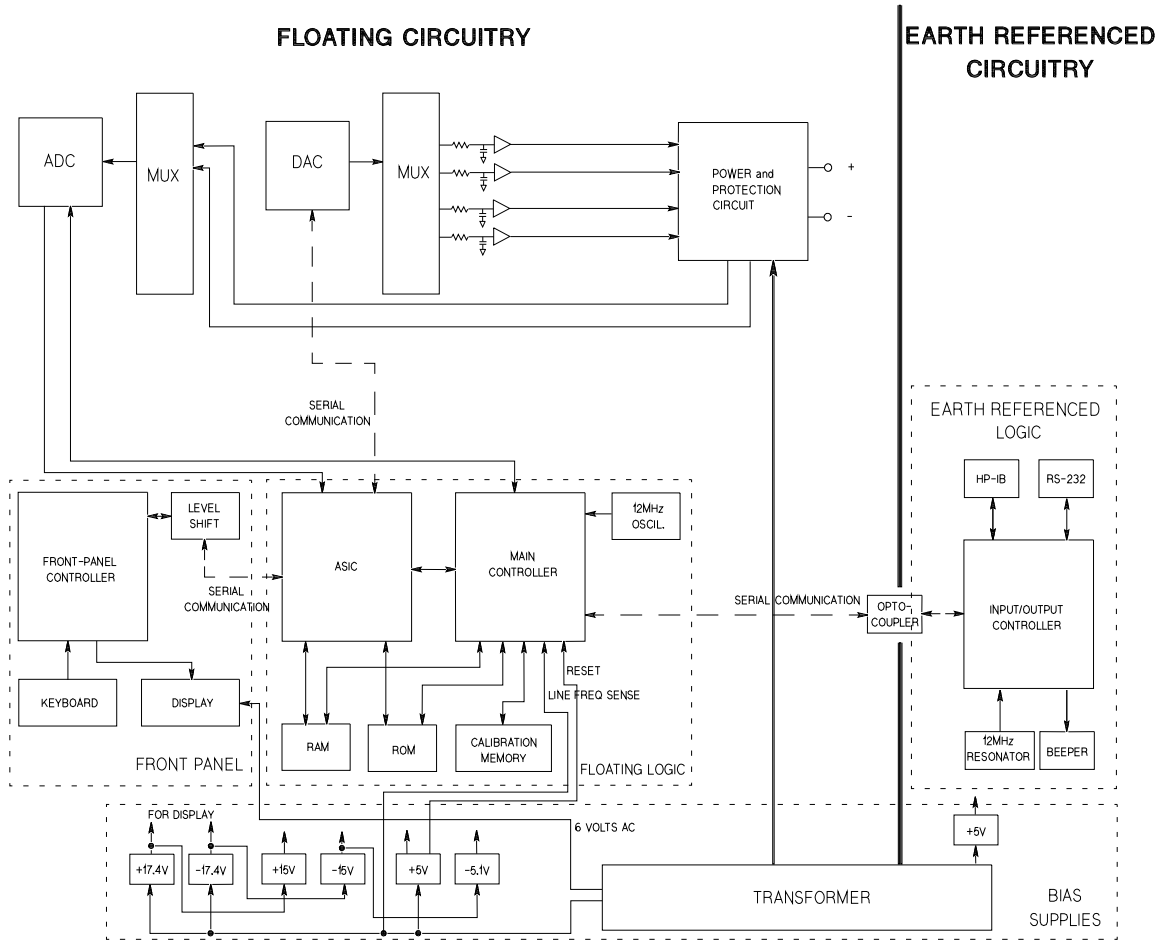

AC Input and Bias Supplies

The ac mains are connected by a fused power module. This module incorporates the functions of mains connection, fusing, and line voltage selection (100/115/230 Vac). The line voltage selection function of the module selects which primary winding of power transformer is energized. The transformer secondary windings are connected to the main pc board through connectors.

The bias supplies are consists of three sections; +5 Vdc and -5.1 Vdc for the power circuits and floating logic; ± 17.4 Vdc for the display; and +5 Vdc for the earth referenced logic. Power-on reset signals are provided by the +5 Vdc supply of the floating logic.

The ± 17.4 Vdc for the display circuits are produced by rectifier CR8, filter capacitors C18 and C19, and voltage regulators U12 and U16. A separate winding of transformer provides a center tapped 6 Vrms filament supply for the display.

The floating +5 Vdc is produced from the separate winding of transformer. The +5_REF signal is derived from +15 Vdc supply and the TURN_ON RESET signal is derived from +5 Vdc supply. The FAN FAIL signal is asserted when the fan current through R20 is not detected. The TURN_ON RESET signal holds the main controller and other logic in a reset state until the +5 Vdc logic power is fully operational. This signal is generally active only following application of line power to the instrument.

The +5V dc earth referenced supply is produced by rectifier CR4, filter capacitor C23, and regulator U9. The GPIB (IEEE-488) and RS-232 computer interfaces are powered from this supply.

Floating Logic

The floating common logic controls operation of the entire instrument. All output functions and bus command interpretation is performed in the main controller U19. The front panel and the earth referenced logic operate as slaves to U19. The floating common logic is comprised of the main controller U19, custom gate array U20, the program ROM U13, RAM U14, calibration EEPROM U15, and the 12 MHz clock oscillator. Non-volatile EEPROM U15 stores calibration constants, calibration secure code, calibration count, and store/recall variables. Power-on reset is provided to the main controller by the voltage regulator U10.

The main controller U19 is a 16-bit micro controller. It controls such features as receive and transmit serial port, timer/counter ports, and selectable input 10-bit successive approximation A-to-D converter ports.

A conventional address/data bus is used to transfer data between the main controller and external ROM and RAM. When the address latch enable (ALE) signal goes high, address data is present on the address/data bus. ASIC U20 latches the address data and decodes the correct chip enable (low true) for external ROM and RAM accesses and for read/write accesses to the internal registers of U20. The system memory map is shown below.

0000 _H - 1FF7 _H	U14	32k x 8 RAM
1FF8 _H - 1FFF _H	U20	Gate Array
2000 _H - FFFF _H	U13	Program ROM

Program ROM U13 contains four 64k x 8 data banks of data. Banks are selected by controlling A16 and A17 ROM address bits directly from the main controller port bits. Custom gate array U20 performs address latching and memory map decoding functions as discussed above. In addition, U20 contains a variety of internal read/write registers. The read (XRD) and write (XWR) signals transfer data out of and into U20 when it is addressed. There are four internal registers in U20: an internal configuration register, an 8 bit counter register, a serial transmit/receive register, and an internal status register.

The counter register is used to capture the ADC slope count at the COMP input. The COMP input functions as both a clocked comparator and the slope counter input for the ADC. In both cases the counter register captures the lower 8 bits of a 24-bit counter. The upper 16 bits of the count are captured by the SYNC input to U19.

The serial register is used to send and receive serial data bytes from the main controller to the DAC system, or to communicate with the front panel controller. The serial register is multiplexed to these two circuits. The transmission rate is selected to 1.5

M bits/second for the DAC system and 93.75 k bits/second for communication with the front panel controller. The general serial interface is a 3-bit interface as shown below.

U20 Internal Signal	Configuration Signals	Front Panel Signals
Serial Clock	SERCK	XFPSK
Data OUT (send)	SERDAT	FPDI
Data IN (receive)	SERRBK	FPDO

Serial data is received simultaneously as serial data is clocked out. Front panel data is exchanged in both directions whenever a byte is sent from U20. The input data of DAC is strobed to outputs by U19 signal SERSTB. Interrupts from the front panel are detected by U20 and signaled to the CHINT. The main controller FPINT signals the front panel controller that U20 has data to send.

The power supply's calibration data are stored in a 256 x 16 bit non-volatile electrically erasable ROM U15. This non-volatile ROM read/write data is accessed by a 4-bit serial protocol controlled by U19.

The main controller has an on-chip 10-bit successive approximation ADC. The FLASH input is used to sample the residual charge on the main integrating ADC output of U25.

Port bits are also configured to measure the input power line frequency (LSENSE). Frequencies from 55 Hz to 66 Hz are measured as 60 Hz. All other line input frequencies are assumed to be 50 Hz.

The main controller communicates with the earth referenced controller U1 through an optically isolated (U2 and U5) asynchronous serial link. Data is sent in an 11-bit frame at a rate of 187.5 k bits/ second. When the RS-232 interface is selected, data is sent across the isolated link at 93.75 k bits/second. The 11-bit data frame is configured for one start bit, eight data bits, one control bit, and one stop bit.

D-to-A Converter

All reference voltages of power circuits are derived from the internal voltage reference of system DAC U22. The system DAC track/hold amplifier outputs are used to provide controllable reference voltages to power circuits. The system DAC is programmed and responds to the main controller via internal 3-wire serial data bus SERCLK, SERRBK, and SERSTB. The system DAC is multiplexed to 6 track/hold amplifiers through U26. Each track/hold amplifier is refreshed approximately every 1 msec to maintain its output setting. Changes to track/hold amplifier outputs are accomplished by dwelling on that position for an extended period.

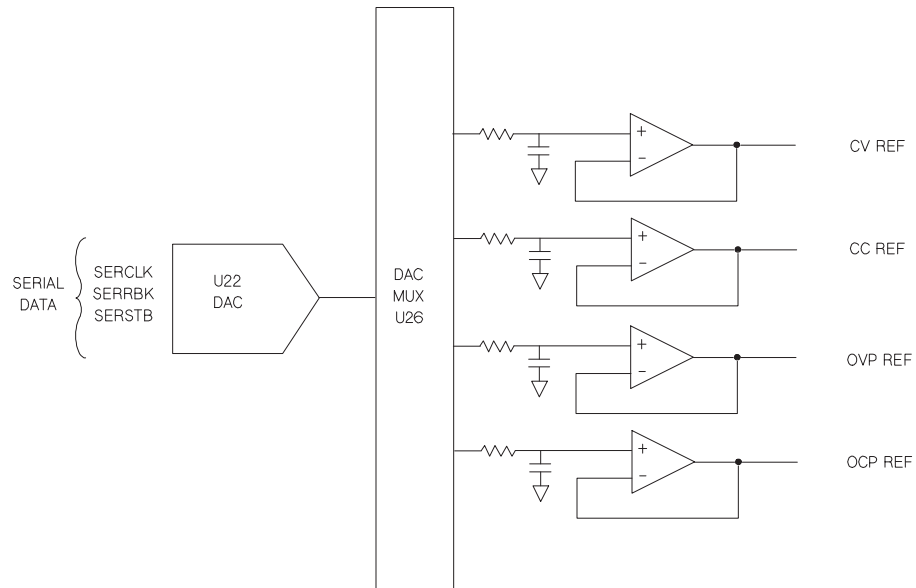

A-to-D Converter

The analog-to-digital converter (ADC) is used to change dc voltages into digital information. The circuitry consists of an integrator amplifier (U25 and U28), current steering switch U32, resistors (R72, R73, and R98), voltage reference U31, ADC controller U20, and residue ADC in U19.

The ADC method used by the power supply is called *multislope III*. Multislope III is a charge balancing continuously integrating analog-to-digital converter. The input voltage continuously forces charge onto the integrator capacitors C50 and C52 through R73.

Switch U32 steers fixed positive or negative reference currents onto the integrator capacitors to cancel, or balance the accumulated input charge. The level shifted (R99 and R100) output of the integrator is checked every 2.66 msec by the U20 COMP input. Logic state machines in U20 control the U32 current steering to continuously seek an approximate 2.5 V level on the integrator amplifier output, FLASH. If the ADC input voltage is between ± 15 V, the integrator output (FLASH) will remain within the 0 V to 5 V range of the U19 on-chip ADC. The U19 ADC input (FLASH) is clamped to 0 V or 5 V by R47 and CR14 to protect U19.

The integrator amplifier is formed by U25 and U28. Resistors R60 and R61 affect the amplifier stability. Amplifier oscillation may occur if their values are incorrect. Amplifier U28 improves the offset voltage characteristics of integrator amplifier U25. Each analog-to-digital conversion occurs continuously. The ADC starts by clearing the integrator slope count in U20. At the end of the integration period, the slope count is latched. The slope count provides the most significant bits of the input voltage conversion. The least significant bits are converted by the on-chip ADC of U19.

U40 provides a stable +5 V reference voltage for ADC. U31A amplifies the voltage reference to +10 V while amplifier U31B inverts the +10 V reference to -10 V. The reference voltage forces precision slope currents for the integrating ADC through R72 and R98.

Power Mesh and Control

For the power mesh and control circuit, the preregulator which is controlled by the phase control circuits is added ahead of the series pass transistor to minimize the power dissipated at the series pass transistor by controlling the dc level across the input filter capacitor, depending on the output voltage.

For the dual range of output, a controlled transformer tap switching is used. It is accomplished by two SCR and one bridge diode and the SCR control circuit in the power circuit; CR17, CR19, and CR44. By turning on or off the SCR, these circuits allow the input capacitors (C39, C46, and C74) to charge to one of two discrete voltage levels, depending on the output voltage required. When all SCR's are not fired, the bridge diode conducts and the lowest voltage of two discrete voltage levels is developed across the input filter capacitors.

The SCR control circuit determines whether SCR is to be fired by monitoring the output voltage and comparing this value against internally derived reference levels.

The series pass transistor is part of the feedback loop which consists of the driver and the Constant Voltage/Constant Current error amplifier. This feedback loop provides "fine and fast" regulation of the output while the feedback loop which is controlled by transformer tap switching handles large, relatively slow, and regulation demands.

The series pass transistor is made to alter its conduction to maintain a constant output voltage or current. The voltage developed across the current sampling resistors is the input to the constant current error amplifier. The constant voltage error amplifier obtains its input from differential amplifier which senses the output voltage. Any changes in output voltage or current are detected and amplified by the constant voltage or constant current error circuit and applied to the series pass transistor in the correct phase and amplitude to counteract the change in output voltage or current.

Two error amplifiers are included in a CV/CC supply, one for controlling output voltage, the other for controlling output current. Since the constant voltage amplifier tends to achieve zero output impedance and alters the output current whenever the load resistance changes, while the constant current amplifier causes the output impedance to be infinite and changes the output voltage in response to any load resistance change, it is obvious that the two amplifiers cannot operate simultaneously. For any given value of load resistance, the power supply must act either as a constant voltage source or as a constant current source - it cannot be both; transfer between these two modes is accomplished at a value of load resistance equal to the ratio of the output voltage control setting to the output current control setting.

Full protection against any overload condition is inherent in the Constant Voltage/Constant Current design principle since there is not any load condition that can cause an output which lies outside the operating region. For either constant voltage or constant current operation, the proper choice of front panel voltage and current limit settings insures optimum protection for the load device as well as full protection for the power supply.

The diodes connected across the output terminals in reverse polarity protect the output electrolytic capacitor and the series pass transistors from the effects of a reverse voltage applied across the output terminals.

Earth-Referenced Logic

Microprocessor U1 handles GPIB (IEEE-488) control through bus interface chip U6 and bus receiver/driver chips U3 and U11. The RS-232 interface is also controlled through microprocessor U1. RS-232 transceiver chip U19 provides the required level shifting to approximate ± 9 volt logic levels through on-chip charge-pump power supplies using C3 and C9. Communication between the earth referenced logic interface circuits and the floating logic is accomplished through an optically-isolated bi-directional serial interface. Isolator U5 couples data from U1 to processor U19. Isolator U2 couples data from U19 to microprocessor U1.

Front Panel

T

he front panel circuits consist of vacuum fluorescent display control, display high voltage drivers, and keyboard scanning. Communication between the front panel and floating logic circuits is accomplished through a 4-wire bi-directional serial interface. The main controller U19 can cause a hardware reset to front-panel controller by signal IGFPRES. The front panel logic operates from -12.4 volts (logic 1) and -17.4 volts (logic 0). The front panel logic high supply (-12.4 volts) is produced by the -17.4 volts bias supply and the voltage regulator U2 on the front panel board. The four serial communication signals are level shifted by the comparator U8 from the floating logic 0 V to 5 V levels to the -17.4 V to -12.4 V levels present on the front panel assembly. U2 acts as the serial shift register interface for the front-panel controller U5 on the front panel board.

Display anode and grid voltages are +17.4 volts for an ‘on’ segment and -17.4 volts for an ‘off’ segment. The -11.2 V cathode bias for the display is provided by filament winding center tap bias circuit VR1, R18, and C25 on the main board. Keyboard scanning is accomplished through a conventional scanned row-column key matrix. Keys are scanned by outputting data at front-panel controller U5 port pins P0.0 through P0.3 to poll each key column for a key press. Column read-back data are read by the microprocessor at port pins P1.0 through P1.3 for decoding and communication to the floating logic circuits.

Service

Service

This chapter discusses the procedures involved for returning a failed power supply to Keysight for service or repair. Subjects covered include the following:

- Operating Checklist, on page 97
- Types of Service Available, starting on page 98
- Repacking for shipment, on page 99
- Electrostatic Discharge (ESD) Precautions, on page 100
- Surface Mount Repair, on page 100
- To Replace the Power-Line Fuse, on page 100
- To Disconnect the Output Using an External Relay, on page 101
- Troubleshooting Hints, starting on page 102
- Self-Test Procedures, starting on page 104

Operating Checklist

Before returning your power supply to Keysight for service or repair check the following items:

Is the Power Supply Inoperative?

- Verify that the ac power cord is connected to the power supply.
- Verify that the front-panel power switch is depressed.
- Verify that the power-line fuse is installed:
 - Use the 6.3 AT, 250 V fuse for 100 or 115 Vac operation.*
 - Use the 3.15 AT, 250 V fuse for 230 Vac operation.*
- Verify the power-line voltage setting.
 - See “To prepare the power supply for use” on page 23.*

Does the Power Supply Fail Self-Test?

- Verify that the correct power-line voltage is selected.
 - See “To prepare the power supply for use” on page 23.*
- Remove all load connections to the power supply.
 - Ensure that all terminal connections are removed while the self-test is performed.*

Types of Service Available

If your power supply fails within 3 years of original purchase, Keysight Technologies will repair or replace it free of charge. If your unit fails after your 3-year warranty expires, Keysight will repair or replace it at a very competitive price. Keysight will make the decision locally whether to repair or replace your unit.

Standard Repair Service (worldwide)

Contact your nearest Keysight Service Center. They will arrange to have your power supply repaired or replaced.

Express Exchange (U.S.A. only)

You can receive a replacement Keysight E3633A or E3634A via overnight shipment for low downtime.

1 Call 1-800-258-5165 and ask for “Express Exchange.”

- You will be asked for your shipping address and a credit card number to guarantee return of your failed power supply.
- If you do not return your failed power supply within 45 days, your credit card will be billed for a new Keysight E3633A or E3634A.
- If you choose not to supply a credit card number, you will be asked to send your failed unit to a designated Keysight Service Center. After the failed unit is received, Keysight will send your replacement unit.

2 Keysight will immediately send a replacement Keysight E3633A or E3634A to you via overnight shipment.

- The replacement unit will have a different serial number than your failed unit.
- If you cannot accept a new serial number for the replacement unit, use the Standard Repair Service option described above.
- If your failed unit was "in-warranty", your replacement unit continues the original 3-year warranty period. You will not be billed for the replacement unit as long as the failed unit is received by Keysight.
- If your 3-year warranty has expired, Keysight will bill you for the Keysight E3633A or E3634A exchange price - less than a new unit price. Keysight warrants exchange units against defects for 90 days.

Repacking for Shipment

For the Express Exchange Service described on the previous page, return your failed Keysight E3633A or E3634A to the designated Keysight Service Center using the shipping carton of the exchange unit. A shipping label will be supplied. Keysight will notify you when your failed unit has been received.

If the instrument is to be shipped to Keysight for service or repair, be sure to:

- Attach a tag to the power supply identifying the owner and indicating the required service or repair. Include the instrument model number and full serial number.
- Place the power supply in its original container with appropriate packaging material.
- Secure the container with strong tape or metal bands.

If the original shipping container is not available, place your unit in a container which will ensure at least 4 inches of compressible packaging material around all sides for the power supply. Use static-free packaging materials to avoid additional damage to your unit.

Keysight Technologies recommends that you always insure shipments.

Electrostatic Discharge (ESD) Precautions

Almost all electrical components can be damaged by electrostatic discharge (ESD) during handling. Component damage can occur at electrostatic discharge voltages as low as 50 volts.

The following guidelines will help prevent ESD damage when serving the power supply or any electronic device.

- Disassemble instruments only in a static-free work area.
- Use a conductive work area to dissipate static charge.
- Use a conductive wrist strap to dissipate static charge accumulation.
- Minimize handling.
- Keep replacement parts in original static-free packaging.
- Remove all plastic, styrofoam, vinyl, paper, and other static-generating materials from the immediate work area.
- Use only anti-static solder suckers.

Surface Mount Repair

Surface mount components should only be removed using soldering irons or desoldering stations expressly designed for surface mount components.

Use of conventional solder removal equipment will almost always result in permanent damage to the printed circuit board and will void your Keysight Technologies factory warranty.

To Replace the Power-Line Fuse

The power-line fuse is located within the power supply's fuse-holder assembly on the rear panel (see page 24). For 100 or 115 Vac operation, you must use a 6.3 A slow-blow fuse (HP part number 2110-1030). For 230 Vac operation, you must use a 3.15 A slow-blow fuse (HP part number 2110-1031).

To Disconnect the Output Using an External Relay

When the output of the power supply is turned off, it is implemented by setting the output to 0 volts and 0.02 amps. This gives a zero output voltage without actually disconnecting the output. To disconnect the output, an external relay must be connected between the output and the load. A TTL signal of either low true or high true is provided to control an external relay. This signal can only be controlled with the remote command `OUTPut :RELAy {OFF|ON}`. The TTL output is available on the RS-232 connector pin 1 and pin 9.

When the `OUTPut :RELAy` state is “ON”, the TTL output of pin 1 is high (4.5 V) and pin 9 is low (0.5 V). The levels are reversed when the `OUTPut :RELAy` state is “OFF”.

Note *TTL output of pin 1 or pin 9 of the RS-232 connector is available only after installing two jumpers inside the power supply. See below for more information.*

Note *Do not use the RS-232 interface if you have configured the power supply to output relay control signals. Internal components on the RS-232 circuitry may be damaged.*

Installation Procedure

The assembly drawings are located in chapter 6, “Component Drawings”.

- 1 Remove the front and rear bumpers and take off the cover .
- 2 Install JP3^[1] and JP4 located adjacent to the connector P5 (the JP3 and JP4 are outlined with a circle in the component locator diagram on [page 111](#)).
A bare wire may be used.
- 3 Reassemble the power supply.

[1]For serial MY53xx6xxx, install JP001 and JP002 located adjacent to the connector CN001 (the JP001 and JP002 are outlined with a circle in the component locator diagram on [page 113](#)).

Troubleshooting Hints

This section provides a brief check list of common failures. Before troubleshooting or repairing the power supply, make sure that the failure is in the instrument rather than any external connections. Also make sure that the instrument is accurately calibrated. The power supply's circuits allow troubleshooting and repair with basic equipment such as a digital multimeter and a 100 MHz oscilloscope.

Caution

This instrument contains CMOS integrated circuits which are susceptible to failure due to electrostatic discharge. Refer to the "Electrostatic Discharge (ESD) Precautions" section earlier in this chapter for further handling precautions.

Unit is Inoperative

- Verify that the ac power cord is connected to the power supply.
- Verify that the front-panel power switch is depressed.
- Verify that the power-line fuse is installed:
 - Use the 6.3 AT, 250 V fuse for 100 or 115 Vac operation.
 - Use the 3.15 AT, 250 V fuse for 230 Vac operation.
- Verify the power-line voltage setting.
 - See "To prepare the power supply for use" on page 23.

Unit Reports Errors 740 to 750

These errors may be produced if you accidentally turn off power of the unit during a calibration or while changing a non-volatile state of the instrument. Recalibration or resetting the state should clear the error. If the error persists, a hardware failure may have occurred.

Unit Fails Self-Test

Verify that the correct power-line voltage setting is selected. Also, ensure that all terminal connections are removed while the self-test is performed. Failure of the DAC U22^[1] on the PC board will cause many self-test failures.

[1]For serial MY53xx6xxx, failure of the DAC U104 on the PC board will cause many self-test failures.

Bias Supplies Problems

Check that the input to the voltage regulators of the bias supplies is at least 1 V greater than their output.

Circuit failures can cause heavy loads of the bias supplies which may pull down the regulator output voltages.

Check the voltages of bias supplies as tabulated below.

Table 5-1. Bias Supplies Voltages

Bias Supply	Minimum	Maximum	Check At
+5 V Floating	+4.75 V	+5.25 V	U10 pin 2
-5.1 V Floating	-4.75 V	-5.25 V	Anode of CR6
+15 V Floating	+14.25 V	+15.75 V	Anode of CR9
-15 V Floating	-14.25 V	-15.75 V	Cathode of CR10

Table 5-2. Bias Supplies Voltages (MY53xx6xxx)

Bias Supply	Minimum	Maximum	Check At
+3.3 V Floating	+3.135 V	+3.465 V	U203 pin 3
+15 V Floating	+14.25 V	+15.75 V	Anode of CR202
-15 V Floating	-14.25 V	-15.75 V	Cathode of CR203

Some circuits produce their own local bias supplies from the main bias supplies. Be sure to check that these local bias supplies are active. In particular, the ADC (analog-to-digital converter), ac input, and front panel sections have local bias supplies. Always check that the power supplies are free of ac oscillations using an oscilloscope. Failure of bias supplies will cause many self-test failures.

Self-Test Procedures

Power-On Self-Test

Each time the power supply is powered on, a set of self-tests are performed. These tests check that the minimum set of logic and measurement hardware are functioning properly. The power-on self-test performs checks 601 through 604 and 624 through 632. For serial MY53xx6xxx, the power-on self-test utilizes the complete self-test, which covers error codes 601 through 632.

Complete Self-Test

Hold any front panel key except the “Error” key for more than 5 seconds while turning on the power to perform a complete self-test. The power supply beeps when the test starts. The tests are performed in the order shown below.

- 601** **Front Panel Does not respond** The main controller U19 (U101 for serial MY53xx6xxx) attempts to establish serial communications with the front panel controller U1 (U602 for serial MY53xx6xxx) on the front panel board. During this test, the U1 (U602 for serial MY53xx6xxx) turns on all display segments. Communication must function in both directions for this test to pass. If this error is detected during power-on self-test, the power supply will beep twice. This error is only readable from the remote interface.
- 602** **RAM read/write failed** This test writes and reads a 55h and AAh checker board pattern to each address of ram U14 (on-chip RAM for serial MY53xx6xxx). Any incorrect readback will cause a test failure. This error is only readable from the remote interface.
- 603** **A/D sync stuck** The main controller issues an A/D sync pulse to U19 and U20 to latch the value in the ADC slope counters. A failure is detected when a sync interrupt is not recognized and subsequent time-out occurs.
- 604** **A/D slope convergence failed** The input amplifier is configured to the measure zero (MZ) state in the 10 V range. This test checks whether the ADC integrator produces nominally the same number of positive and negative slope decisions ($\pm 10\%$) during a 20 ms interval.
- 605** **Cannot calibrate rundown gain** This test checks the nominal gain between integrating ADC and the U19 on-chip ADC. This error is reported if the procedure cannot run to completion due to a hardware failure.

- 606** **Rundown gain out of range** This test checks the nominal gain between the integrating ADC and the U19 on-chip ADC. The nominal gain is checked to $\pm 10\%$ tolerance.
- 607** **Rundown too noisy** This test checks the gain repeatability between the integrating ADC and the U19 on-chip ADC. The gain test (606) is performed eight times. Gain noise must be less than ± 64 lsb's of the U19 on-chip ADC.
- 608** **Serial configuration readback failed** This test re-sends the last 3 byte serial configuration data to all the serial path (SERDAT, SERBCK, SERCLK). The data is then clocked back into U20 and compared against the original 3 bytes sent. A failure occurs if the data do not match. This tests checks the serial data path through U23.
- 609** **System ADC test failed** This test checks if the ADC hardware is functional. The main controller U101 establishes communication with the ADC and checks if there are any error bits set for the ADC's status reporting.
- 624** **Unable to sense line frequency** This test checks that the LSENCE logic input U19 is toggling. If no logic input detected, the power supply will assume a 50 Hz line operation for all future measurements.
- 625** **I/O processor did not respond** This test checks that communications can be established between U19 (U101 for serial MY53xx6xxx) and U1 (U802 for serial MY53xx6xxx) through the isolated (U2 and U5) (U801 for serial MY53xx6xxx) serial data link. Failure to establish communication in either direction will generate an error. If this condition is detected at power-on self-test, the power supply will beep and the error annunciator will be on.
- 626** **I/O processor failed self-test** This test causes the earth referenced processor U1 (U802 for serial MY53xx6xxx) to execute an internal, ram test. Failure will generate an error.
- 630** **Fan test failed** This test checks if the fan current is flowing. If the current is not detected at power-on self-test, the power supply will beep and the error annunciator will be on. Fan test fail could likely induce overtemperature condition in the power supply.
- 631** **System DAC test failed** This test checks if the DAC hardware is functional. The main controller U19 (U101 for serial MY53xx6xxx) sends a reference voltage data to DAC and converts the DAC output to digital data to see if the digital data is within a valid range.

632

Hardware test failed This test checks the status of voltage and current error amplifiers for the power circuit. If both amplifiers are not operational, the power supply will beep and the error annunciator will be on.

Component Drawings

Component Drawings

This chapter contains component locator drawings for the power supply. The block diagram is also shown in chapter 4.

- E3633-60002/E3634-60002 Component locator for the main board, on [page 111](#)
- E3633-60003 Component locator for the front panel, on [page 112](#)
- E3633-60019/E3634-60019 Component locator for the main board (serial MY53xx6xxx), on [page 113](#)
- Component locator for the front panel (serial MY53xx6xxx), on [page 114](#)

E3633-60002/E3634-60002 Component locator for the main board

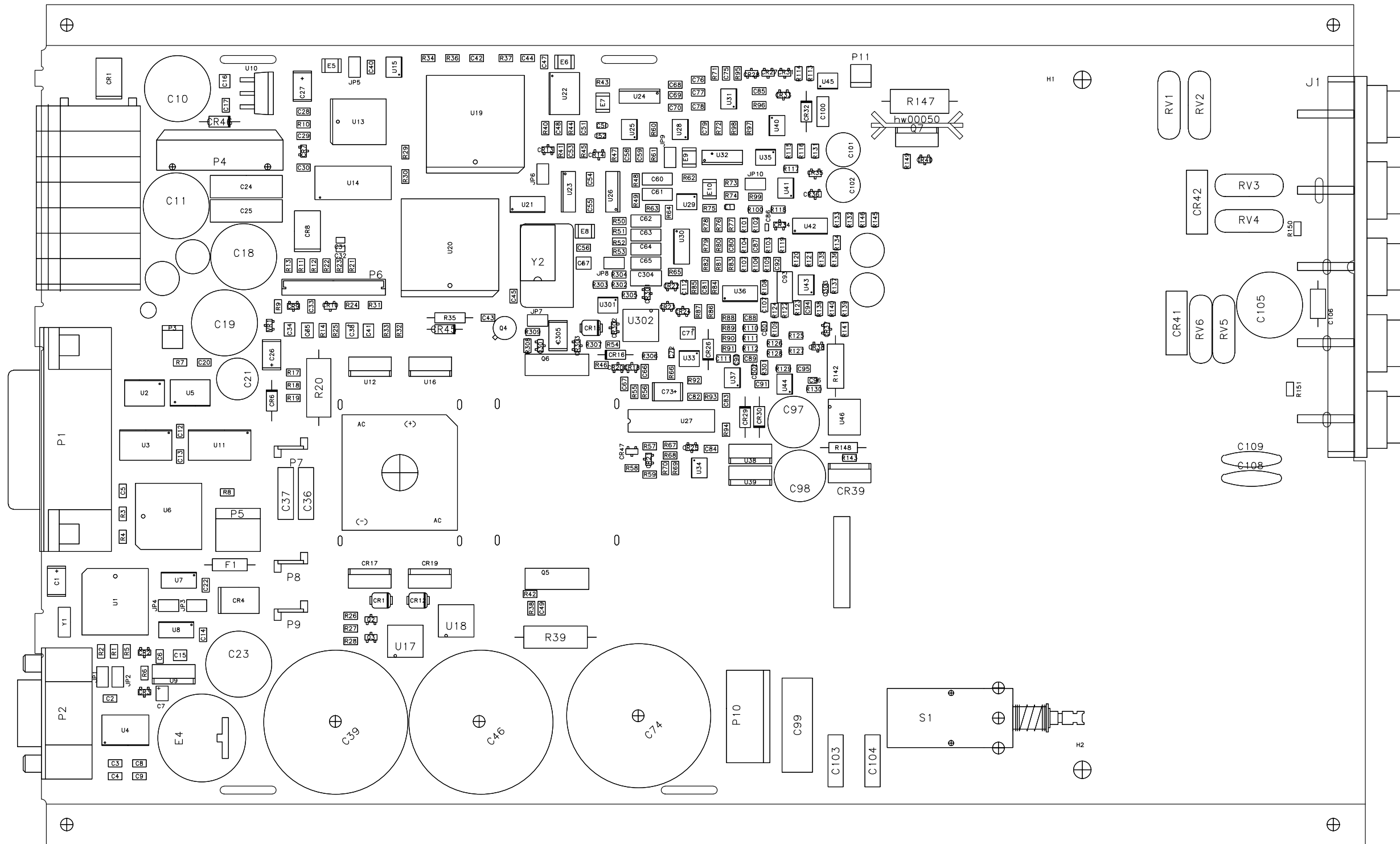

E3633-60003 Component locator for the front panel

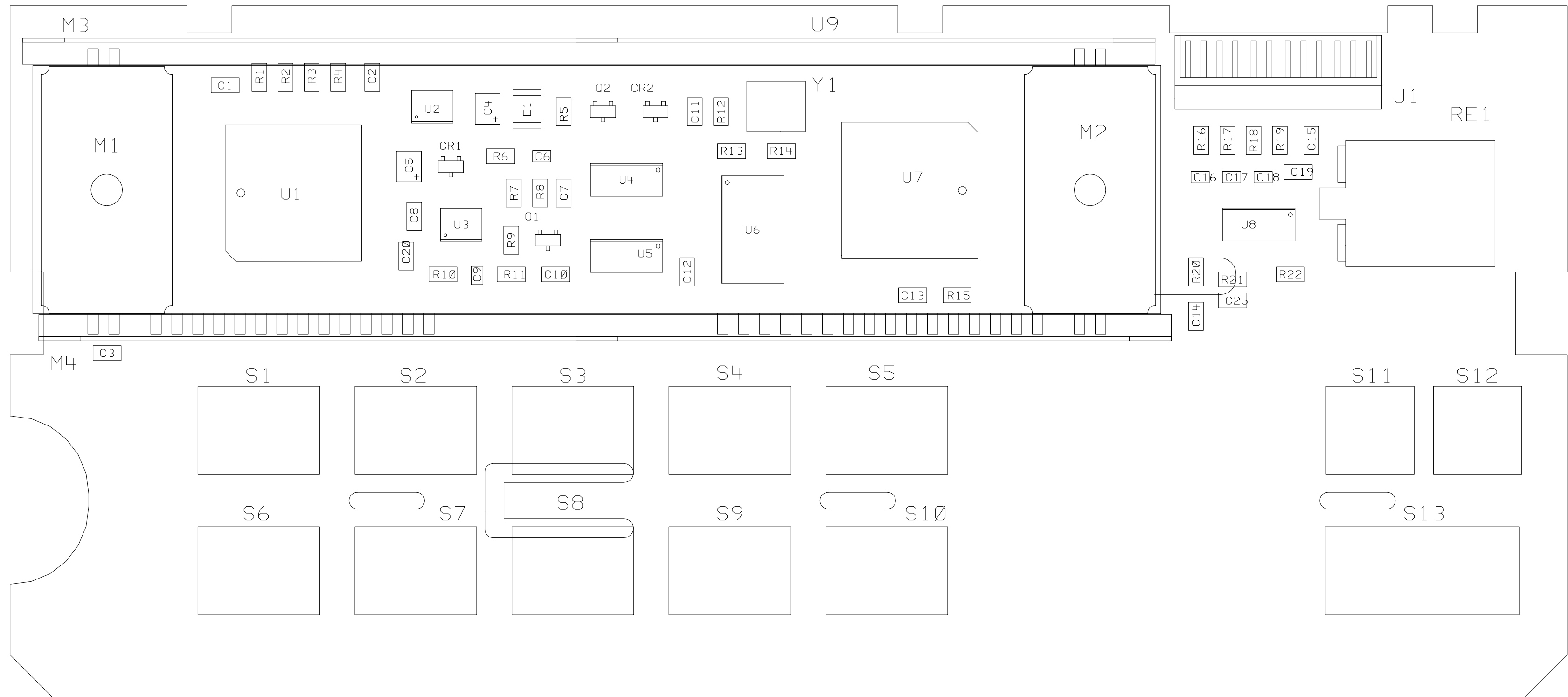

Component locator for the front panel (serial MY53xx6xxx)

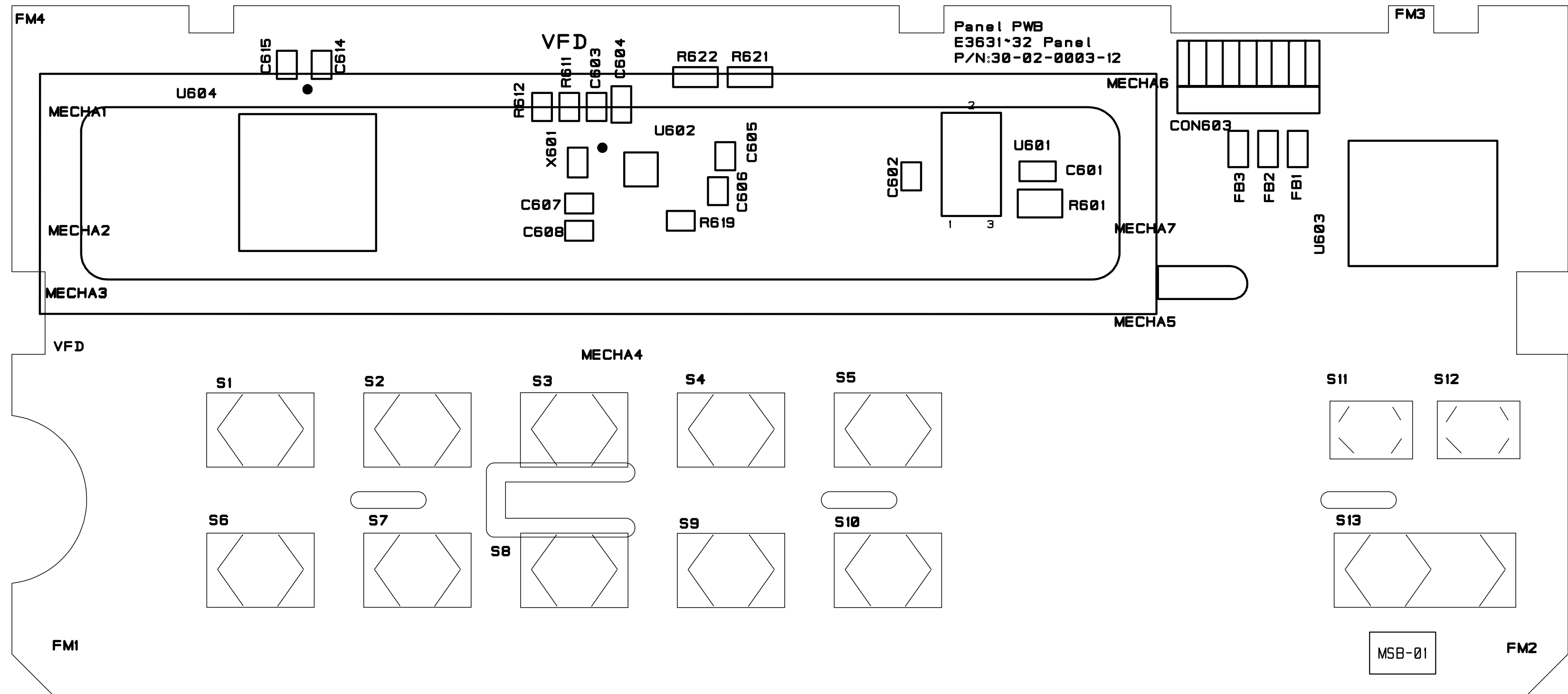

Printing History
Edition 8, November 2014

New editions are complete revisions of the manual. Update packages, which are issued between editions, may contain additional information and replacement pages which you merge into the manual. The dates on this page change only when a new edition is published.

Certification

Keysight Technologies certifies that this product met its published specifications at the time of shipment. Keysight further certifies that its calibration measurements are traceable to the United States National Institute of Standards and Technology (formerly National Bureau of Standards), to the extent allowed by that organization's calibration facilities, and to the calibration facilities of other International Standards Organization members.

Warranty

This Keysight product is warranted against defects in materials and workmanship for a period of 3 years from date of shipment. Duration and conditions of warranty for this product may be superseded when the product is integrated into (becomes a part of) other Keysight products. During the warranty period, Keysight will, at its option, either repair or replace products which prove to be defective. The warranty period begins on the date of delivery or on the date of installation if installed by Keysight.

Warranty Service

For warranty service or repair, this product must be returned to a service facility designated by Keysight.

For products returned to Keysight for warranty service, the Buyer shall prepay shipping charges to Keysight and Keysight shall pay shipping charges to return the product to the Buyer. However, the Buyer

shall pay all shipping charges, duties, and taxes for products returned to Keysight from another country.

Limitation of Warranty

The foregoing warranty shall not apply to defects resulting from improper or inadequate maintenance by the Buyer, Buyer-supplied products or interfacing, unauthorized modification or misuse, operation outside of the environmental specifications for the product, or improper site preparation or maintenance.

The design and implementation of any circuit on this product is the sole responsibility of the Buyer. Keysight does not warrant the Buyer's circuitry or malfunctions of Keysight products that result from the Buyer's circuitry. In addition, Keysight does not warrant any damage that occurs as a result of the Buyer's circuit or any defects that result from Buyer-supplied products.

To the extent allowed by local law, Keysight makes no other warranty, expressed or implied, whether written or oral with respect to this product and specifically disclaims any implied warranty or condition of merchantability, fitness for a particular purpose or satisfactory quality.

For transactions in Australia and New Zealand: The warranty terms contained in this statement, except to the extent lawfully permitted, do not exclude, restrict, or modify and are in addition to the mandatory statutory rights applicable to the sale of this product.

Exclusive Remedies

To the extent allowed by local law, the remedies provided herein are the Buyer's sole and exclusive remedies. Keysight shall not be liable for any direct, indirect, special, incidental, or consequential damages (including lost profit or data), whether based on warranty, contract, tort, or any other legal theory.

Notice

The information contained in this document is subject to change without notice.

To the extent allowed by local law, Keysight makes no warranty of any kind with regard to this material, including, but not limited to, the implied warranties of merchantability and fitness for a particular purpose.

To the extent allowed by local law, Keysight shall not be liable for errors contained herein or for incidental or consequential damages in connection with the furnishing, performance, or use of this material. No part of this document may be photocopied, reproduced, or translated to another language without the prior written consent of Keysight.

Restricted Rights

The Software and Documentation have been developed entirely at private expense. They are delivered and licensed as "commercial computer software" as defined in DFARS 252.227-7013 (Oct 1988), DFARS 252.211-7015 (May 1991), or DFARS 252.227-7014 (Jun 1995), as a "commercial item" as defined in FAR 2.101(a), or as "restricted computer software" as defined in FAR 52.227-19 (Jun 1987) (or any equivalent agency regulation or contract clause), whichever is applicable. You have only those rights provided for such Software and Documentation by the applicable FAR or DFARS clause or the Keysight standard software agreement for the product involved.

Safety Information

Do not install substitute parts or perform any unauthorized modification to the product. Return the product to an HP Sales and Service Office for service and repair to ensure that safety features are maintained.

Safety Symbols

Warning

Calls attention to a procedure, practice, or condition, that could possibly cause bodily injury or death.

Caution

Calls attention to a procedure, practice, or condition that could possibly cause damage to equipment or permanent loss of data.

Warning

No operator serviceable parts inside. Refer servicing to service-trained personnel.

Warning

For continued protection against fire, replace the line fuse only with a fuse of the specified type and rating.



Earth ground symbol.



Chassis ground symbol.



Caution, risk of danger (refer to this manual for specific Warning or Caution information to avoid personal injury or equipment damage. Hazardous voltages may be present.)



Direct current (DC)



Alternating current (AC)



Protective conductor terminal



Out position of a bi-stable push control



In position of a bi-stable push control



Positive binding post



Negative binding post

Regulatory Markings



ISM 1-A

The CE marking is a legal compliance marking of the European Community. This CE marking shows that the product complies with all the relevant European Legal Directives.



This symbol indicates the time period during which no hazardous or toxic substance elements are expected to leak or deteriorate during normal use. Forty years is the expected useful life of the product.



N10149

The C-tick mark is a registered trademark of the Spectrum Management Agency of Australia. This signifies compliance with the Australia EMC Framework regulations under the terms of the Radio Communication Act of 1992.



This symbol is a South Korean Class A EMC Declaration. This is a Class A instrument suitable for professional use and in electromagnetic environment outside of the home.

ICES/NMB-001

ICES/NMB-001 indicates that this ISM device complies with the Canadian ICES-001. Cet appareil ISM est conforme a la norme NMB-001 du Canada.



This instrument complies with the WEEE Directive (2002/96/EC) marking requirement. This affixed product label indicates that you must not discard this electrical or electronic product in domestic household waste.



The CSA mark is a registered trademark of the Canadian Standards Association.

www.keysight.com

Contact us

To obtain service, warranty, or technical assistance, contact us at the following phone or fax numbers:

United States:

(tel) 800 829 4444 (fax) 800 829 4433

Canada:

(tel) 877 894 4414 (fax) 800 746 4866

China:

(tel) 800 810 0189 (fax) 800 820 2816

Europe:

(tel) 31 20 547 2111

Japan:

(tel) 0120 (421) 345 (fax) 0120 (421) 678

Korea:

(tel) (080) 769 0800 (fax) (080) 769 0900

Latin America:

(tel) (305) 269 7500

Taiwan:

(tel) 0800 047 866 (fax) 0800 286 331

Other Asia Pacific Countries:

(tel) (65) 6375 8100 (fax) (65) 6755 0042

Or visit the Keysight World Wide Web at:

www.keysight.com/find/assist

Product specifications and descriptions in this document are subject to change without notice. Always refer to the Keysight Web site for the latest revision.

This information is subject to change without notice.

© Keysight Technologies 1998-2014

Edition 8, November 2014



E3634-90010
www.keysight.com