



Agilent X-Series Wireless Communications Test Set

This manual provides documentation
for the following test sets:

EXT Test Set E6607A/B/C

**U9060A IQ Analyzer
Measurement Application:
User's and Programmer's
Reference**



Agilent Technologies

Notices

© Agilent Technologies, Inc.
2010-2013

No part of this manual may be reproduced in any form or by any means (including electronic storage and retrieval or translation into a foreign language) without prior agreement and written consent from Agilent Technologies, Inc. as governed by United States and international copyright laws.

Trademark Acknowledgements

Microsoft® is a U.S. registered trademark of Microsoft Corporation.

Windows® and MS Windows® are U.S. registered trademarks of Microsoft Corporation.

Adobe Acrobat® and Reader® are U.S. registered trademarks of Adobe Systems Incorporated.

Java™ is a U.S. trademark of Sun Microsystems, Inc.

MATLAB® is a U.S. registered trademark of Math Works, Inc.

Norton Ghost™ is a U.S. trademark of Symantec Corporation.

Wikipedia® is a registered trademark of the Wikimedia Foundation.

Manual Part Number

U9060-90009

Supersedes: U9060-90003 and U9060-90006

Print Date

February 2013

Supersedes: N/A

Printed in USA

Agilent Technologies Inc.
1400 Fountaingrove Parkway
Santa Rosa, CA 95403

Warranty

The material contained in this document is provided “as is,” and is subject to being changed, without notice, in future editions. Further, to the maximum extent permitted by applicable law, Agilent disclaims all warranties, either express or implied, with regard to this manual and any information contained herein, including but not limited to the implied warranties of merchantability and fitness for a particular purpose. Agilent shall not be liable for errors or for incidental or consequential damages in connection with the furnishing, use, or performance of this document or of any information contained herein. Should Agilent and the user have a separate written agreement with warranty terms covering the material in this document that conflict with these terms, the warranty terms in the separate agreement shall control.

Technology Licenses

The hardware and/or software described in this document are furnished under a license and may be used or copied only in accordance with the terms of such license.

Restricted Rights Legend

If software is for use in the performance of a U.S. Government

prime contract or subcontract, Software is delivered and licensed as “Commercial computer software” as defined in DFAR 252.227-7014 (June 1995), or as a “commercial item” as defined in FAR 2.101(a) or as “Restricted computer software” as defined in FAR 52.227-19 (June 1987) or any equivalent agency regulation or contract clause. Use, duplication or disclosure of Software is subject to Agilent Technologies’ standard commercial license terms, and non-DOD Departments and Agencies of the U.S. Government will receive no greater than Restricted Rights as defined in FAR 52.227-19(c)(1-2) (June 1987). U.S. Government users will receive no greater than Limited Rights as defined in FAR 52.227-14 (June 1987) or DFAR 252.227-7015 (b)(2) (November 1995), as applicable in any technical data.

Safety Notices

CAUTION

A **CAUTION** notice denotes a hazard. It calls attention to an operating procedure, practice, or the like that, if not correctly performed or adhered to, could result in damage to the product or loss of important data. Do not proceed beyond a CAUTION notice until the indicated conditions are fully understood and met.

WARNING

A **WARNING** notice denotes a hazard. It calls attention to an operating procedure, practice, or the like that, if not correctly performed or adhered to, could result in personal injury or death. Do not proceed beyond a WARNING notice until the indicated conditions are fully understood and met.

Warranty

This Agilent technologies instrument product is warranted against defects in material and workmanship for a period of one year from the date of shipment. During the warranty period, Agilent Technologies will, at its option, either repair or replace products that prove to be defective.

For warranty service or repair, this product must be returned to a service facility designated by Agilent Technologies. Buyer shall prepay shipping charges to Agilent Technologies, and Agilent Technologies shall pay shipping charges to return the product to Buyer. For products returned to Agilent Technologies from another country, Buyer shall pay all shipping charges, duties, and taxes.

Where to Find the Latest Information

Documentation is updated periodically. For the latest information about these products, including instrument software upgrades, application information, and product information, browse to one of the following URLs, according to the name of your product:

<http://www.agilent.com/find/ext>

To receive the latest updates by email, subscribe to Agilent Email Updates at the following URL:

<http://www.agilent.com/find/emailupdates>

Information on preventing test set damage can be found at:

<http://www.agilent.com/find/tips>

Is your product software up-to-date?

Periodically, Agilent releases software updates to fix known defects and incorporate product enhancements. To search for software updates for your product, go to the Agilent Technical Support website at:

<http://www.agilent.com/find/techsupport>

Contents

1. Using Help

How Help is Organized.....	58
Front Panel Keys used by the Help System	61
Navigating the Help Files	63
Basic Help Window Operations	64
Navigating Help with a Mouse	65
Navigating Help Without a Mouse	66
Definition of Terms.....	71
Viewing Help Files on a separate Computer.....	73
Other Help Resources	75
Context Sensitive Help not Available.....	77

2. About the Test Set

How the Test Set Is Used	80
Receiver Testing	80
Transmitter Testing	80
Hardware Elements of the Test Set.....	81
Software Elements of the Test Set.....	86
Methods of Operating the Source	89
Waveform Segment Files	89
Methods of Operating the Analyzer	89
Creating Sequences.....	89
Executing Sequences.....	90
Installing Application Software	91
Viewing a license key	91
Obtaining and installing a license key	91
Missing and old Measurement application software.....	92
X-Series options and accessories	93
Front-Panel Features (E6607A/B)	94
Overview of key types.....	96
Front-Panel Features (E6607C)	101
Overview of key types	103
Display Annotations	107
Test Set Display Indicators	109
Rear-Panel Features	110
Window Control Keys	112
Multi-Window.....	112
Zoom.....	112
Next Window	113
Mouse and Keyboard Control.....	115
Right-Click	115
Virtual Front Panel	117
PC Keyboard.....	118
Instrument Security & Memory Volatility	122

3. About the IQ Analyzer Measurement Application

Using the Electronic Attenuator Hardware (Option EA3)	124
--	-----

Contents

Using the Wideband Analysis Hardware (Option B25).....	125
4. Programming the Test Set	
What Programming Information is Available?.....	128
IEEE Common GPIB Commands	129
Calibration Query	129
Clear Status	129
Standard Event Status Enable	129
Standard Event Status Register Query	130
Identification Query	130
Instrument Model Number	131
Operation Complete	131
Query Instrument Options	132
Recall Instrument State	132
Save Instrument State	133
Service Request Enable	133
Status Byte Query	134
Trigger	134
Self Test Query	134
Wait-to-Continue	135
5. System Functions	
File	138
File Explorer	138
Page Setup	139
Print	140
Maximize/Restore Down	140
Minimize	141
Exit	141
Mode Preset	142
Restore Mode Defaults	144
Meas Preset	145
Preset Type (Remote Command Only)	145
*RST (Remote Command Only)	146
Print	147
Quick Save	148
Recall	150
State	151
Trace (+State)	156
Sequences	159
Data (Import)	161
Save	163
State	163
Trace (+State)	168
Sequences	170
Data (Export)	172
Screen Image	174

Mass Storage Catalog (Remote Command Only)	178
Mass Storage Change Directory (Remote Command Only).	178
Mass Storage Copy (Remote Command Only).	178
Mass Storage Delete (Remote Command Only).	179
Mass Storage Data (Remote Command Only)	179
Mass Storage Make Directory (Remote Command Only).	180
Mass Storage Move (Remote Command Only)	180
Mass Storage Remove Directory (Remote Command Only)	180
System.	182
Show	182
Power On.	189
Alignments	199
I/O Config	241
Restore Defaults	250
Control Panel.	255
Licensing.	255
Security	258
Diagnostics	258
Service.	270
Internet Explorer.	270
System Remote Commands (Remote Commands Only)	270
User Preset	274
User Preset.	274
User Preset All Modes.	275
Save User Preset	276

6. Complex Spectrum Measurement

AMPTD Y Scale	281
Ref Value	281
Attenuation	282
Range (for RF Input).	283
Range.	283
Scale/Div (Spectrum)	284
Scale/Div (I/Q Waveform)	284
Internal Preamp	285
Ref Position	285
Auto Scaling	286
Auto Couple	288
BW	289
Res BW	289
Cont.	291
FREQ Channel	292
Input/Output	293
Marker.	294
Select Marker	294
Marker Type	294
Marker X Axis Value (Remote Command Only)	295
Marker X Axis Position (Remote Command Only)	295
Marker Y Axis Value (Remote Command Only)	296

Contents

Properties	297
Couple Markers	299
All Markers Off	299
Backward Compatibility SCPI Commands	300
Marker Function	301
Select Marker	301
Marker Function Type	301
Band Adjust	302
Marker To	305
Mkr -> CF	305
Mkr -> Ref Lvl	305
Meas	307
Meas Setup	308
Avg/Hold Num	308
Avg Mode	308
Avg Type	309
HW Averaging	310
Time Avg Num	310
PhNoise Opt	311
Auto	312
Best Close-in P Noise	312
Best Wide-offset P Noise	313
Fast Tuning	313
Meas Preset	314
Advanced	314
IF Gain State	326
IF Gain Offset	327
Mode	328
Mode Setup	329
Peak Search	330
Next Peak	330
Next Pk Right	331
Next Pk Left	331
Marker Delta	332
Mkr->CF	332
Mkr->Ref Lvl	332
Peak Criteria	333
“Peak Search” Criteria	333
“Next Peak” Criteria	334
Continuous Peak Search	338
Pk-Pk Search	339
Min Search	340
Recall	341
Restart	342
Save	343
Single	344
Source (Internal)	345
Span X Scale	346
Span (Spectrum View)	346

Ref Value (Waveform View)	347
Scale/Div (Waveform View)	348
Ref Position (Waveform View)	348
Auto Scaling (Waveform View)	349
Sweep/Control	350
Pause/Resume	350
Trace/Detector	351
Trigger	352
View/Display	353
Measurement Results View	353
Display	355

7. Waveform Measurement

AMPTD Y Scale	359
Ref Value	359
Attenuation	360
Range (for RF Input)	361
Scale/Div	361
Internal Preamp	363
Ref Position	363
Auto Scaling	365
Auto Couple	366
BW	367
Digital IF BW	367
Filter Type	368
Filter Type Bwcc	369
Filter BW	378
Channel Filter Bandwidth Bwcc (Remote Command Only)	378
Filter Alpha	379
Cont.	381
FREQ Channel	382
Input/Output	383
Marker	384
Select Marker	384
Marker Type	384
Marker X Axis Value (Remote Command Only)	385
Marker X Axis Position (Remote Command Only)	386
Marker Y Axis Value (Remote Command Only)	387
Properties	387
Couple Markers	389
All Markers Off	390
Backward Compatibility SCPI Commands	390
Marker Function	392
Select Marker	392
Marker Function Type	392
Band Adjust	393
Marker To	396
Meas	397
Meas Setup	398

Contents

Average/Hold Num	398
Avg Mode	399
Avg Type	399
HW Averaging	400
Time Avg Num	400
Sample Rate	401
Sample Period (Aperture) Setting (Remote Command Only)	401
Meas Time.	402
PhNoise Opt	402
Advanced	405
Meas Preset	409
Mode	411
Mode Setup	412
Peak Search	413
Next Peak	413
Min Search	413
Recall	415
Restart.	416
Save	417
Single	418
Source (Internal).	419
Span X Scale.	420
Ref Value.	420
Scale/Div.	421
Ref Position	421
Auto Scaling	422
Sweep/Control	423
Pause and Resume	423
Trace/Detector	424
Trigger	425
View/Display	426
Display	427
RF Envelope	427
I/Q Waveform	428

8. Common Measurement Functions

AMPTD Y Scale.	433
Reference Level	433
Attenuation	434
Range	446
Scale / Div.	452
Scale Type.	453
Presel Center.	453
Preselector Adjust	455
Y Axis Unit.	456
Reference Level Offset.	463
μ W Path Control	464
Internal Preamp.	469
Auto Couple	473

Contents

Mode	475
Application Mode Number Selection (Remote Command Only)	477
Application Mode Catalog Query (Remote Command Only)	478
Application Identification (Remote Commands Only)	479
Application Identification Catalog (Remote Commands Only)	480
Detailed List of Modes	482
Global Settings	486
BW	489
Res BW	489
Video BW	491
VBW:3dB RBW	492
Span:3dB RBW	494
RBW Control	495
Cont (Continuous Measurement/Sweep)	501
FREQ Channel	503
Center Frequency	503
Input/Output	507
RF Input	509
RF Calibrator	512
External Gain	514
Restore Input/Output Defaults	518
Data Source	518
Corrections	520
Freq Ref In	533
RF Output & Test Set Config	536
Output Config	570
Marker	581
Select Marker	584
Normal	584
Delta	585
Fixed	585
Off	586
Properties	587
Marker Table	594
Marker Count	594
Couple Markers	598
All Markers Off	599
Marker Function	601
Select Marker	602
Marker Noise	602
Band/Interval Power	604
Band/Interval Density	604
Marker Function Off	606
Band Adjust	606
Measure at Marker	610
Marker To	621
Mkr->CF	621
Mkr->CF Step	622
Mkr->Start	622

Contents

Mkr->Stop	623
Mkr Δ ->Span	623
Mkr Δ ->CF	624
Mkr->Ref Lvl	624
Meas	627
Remote Measurement Functions	627
Meas Setup	643
Average/Hold Number	643
Average Type	644
Limits	647
N dB Points	669
PhNoise Opt	672
ADC Dither	675
Swept IF Gain	677
FFT IF Gain	679
Analog Demod Tune & Listen	681
Mode Setup	689
IF Path	689
IF Path Auto	690
Restore Mode Defaults	690
Peak Search	693
Next Peak	693
Next Pk Right	694
Next Pk Left	694
Marker Delta	695
Mkr->CF	695
Mkr->Ref Lvl	695
Peak Criteria	696
Peak Table	700
Continuous Peak Search On/Off	704
Pk-Pk Search	705
Min Search	706
Recall	707
Amplitude Correction	707
Restart	713
Save	715
Amplitude Correction	715
Single (Single Measurement/Sweep)	723
Source (Internal)	725
RF Output	725
Amplitude	726
Modulation	731
Frequency	731
Modulation Setup	764
Multiport Adapter Output Port Amplitude Correction Configuration Validation (Remote Command Only)	814
List Sequencer	814
Source Preset	858
Source Self Test	859

Contents

Recall.....	859
Save.....	859
Signal Studio Commands.....	859
Sequence Studio Commands.....	861
Span.....	863
Span.....	863
Full Span.....	864
Zero Span.....	865
Last Span.....	866
Sweep/Control.....	867
Sweep Time.....	867
Sweep Setup.....	869
Pause/Resume.....	880
Gate.....	881
Points.....	896
Zoom Points.....	898
Abort (Remote Command Only).....	899
Trace/Detector.....	901
Trigger.....	903
Free Run.....	911
Video (IF Envelope).....	912
Line.....	916
External 1.....	918
External 2.....	921
RF Burst.....	924
Periodic Timer (Frame Trigger).....	930
Baseband I/Q.....	938
TV.....	949
Auto/Holdoff.....	955
View/Display.....	959
Display.....	959
Full Screen.....	968
Display Enable (Remote Command Only).....	968

List of Commands

This list includes every SCPI command described in this document. To find a command in the list, search according to its first alphanumeric character, ignoring any leading "*", ":" or "[" characters.

:ABORt.	899
*CAL?	208
:CALCulate:BWIDth BANDwidth:NDB <rel_ampl>.....	669
:CALCulate:BWIDth BANDwidth:NDB?	669
:CALCulate:BWIDth BANDwidth:RESult?	670
:CALCulate:BWIDth BANDwidth[:STATe] OFF ON 0 1	669
:CALCulate:BWIDth BANDwidth[:STATe]?	669
:CALCulate:CLIMits:FAIL?	632
:CALCulate:DATA<n>:COMPRESS? BLOCK CFIT MAXimum MINimum MEAN DMEan RMS RM- SCubed SAMPLE SDEVIation PPHase [,<soffset>[,<length>[,<roffset>[,<rlimit>]]]]	633
:CALCulate:DATA[1] 2 3 4 5 6:PEAKs? <threshold>,<excursion>[,AMPLitude FREQuency TIME]	638
:CALCulate:DATA[n]?	632
:CALCulate:LIMit[1] 2 3 4 5 6:CLEar	667
:CALCulate:LIMit[1] 2 3 4 5 6:CONTrol[:DATA] <x>,<x>	665
:CALCulate:LIMit[1] 2 3 4 5 6:CONTrol[:DATA]?	665
:CALCulate:LIMit[1] 2 3 4 5 6:CONTrol:POINts?	665
:CALCulate:LIMit[1] 2 3 4 5 6:FAIL?	667
:CALCulate:LIMit[1] 2 3 4 5 6:LOWer[:DATA] <ampl>	666
:CALCulate:LIMit[1] 2 3 4 5 6:LOWer[:DATA]?	666
:CALCulate:LIMit[1] 2 3 4 5 6:LOWer:POINts?	666
:CALCulate:LIMit[1] 2 3 4 5 6:STATe ON OFF 0 1	664
:CALCulate:LIMit[1] 2 3 4 5 6:STATe?	664
:CALCulate:LIMit[1] 2 3 4 5 6:UPPer[:DATA] <ampl>,<ampl>	666
:CALCulate:LIMit[1] 2 3 4 5 6:UPPer[:DATA]?	666
:CALCulate:LIMit[1] 2 3 4 5 6:UPPer:POINts?	666
:CALCulate:LLINe[1] 2 3 4 5 6:AMPLitude:CMODE:RELative ON OFF 1 0	654

List of Commands

:CALCulate:LLINE[1] 2 3 4 5 6:AMPLitude:CMODE:RELative?	654
:CALCulate:LLINE[1] 2 3 4 5 6:AMPLitude:INTerpolate:TYPE LOGarithmic LINear.	652
:CALCulate:LLINE[1] 2 3 4 5 6:AMPLitude:INTerpolate:TYPE?	652
:CALCulate:LLINE[1] 2 3 4 5 6:BUILd TRACE1 TRACE2 TRACE3 TRACE4 TRACE5 TRACE6.	658
:CALCulate:LLINE[1] 2 3 4 5 6:COMMeNt "text".	655
:CALCulate:LLINE[1] 2 3 4 5 6:COMMeNt?	655
:CALCulate:LLINE[1] 2 3 4 5 6:CONTRol:INTerpolate:TYPE LOGarithmic LINear.	652
:CALCulate:LLINE[1] 2 3 4 5 6:CONTRol:INTerpolate:TYPE?	652
:CALCulate:LLINE[1] 2 3 4 5 6:COpy LLINE1 LLINE2 LLINE3 LLINE4 LLINE5 LLINE6.	658
:CALCulate:LLINE[1] 2 3 4 5 6:DATA <x>,<ampl>,<connect>.	663
:CALCulate:LLINE[1] 2 3 4 5 6:DATA?	663
:CALCulate:LLINE[1] 2 3 4 5 6:DATA:MERGe <x-axis>,<ampl>,<connected>.	668
:CALCulate:LLINE[1] 2 3 4 5 6:DELete	661
:CALCulate:LLINE[1] 2 3 4 5 6:DESCRiption "Description"	654
:CALCulate:LLINE[1] 2 3 4 5 6:DESCRiption?	654
:CALCulate:LLINE[1] 2 3 4 5 6:DISPlay OFF ON 0 1	649
:CALCulate:LLINE[1] 2 3 4 5 6:DISPlay?	649
:CALCulate:LLINE[1] 2 3 4 5 6:FAIL?	664
:CALCulate:LLINE[1] 2 3 4 5 6:FREQuency:CMODE:RELative ON OFF 1 0.	653
:CALCulate:LLINE[1] 2 3 4 5 6:FREQuency:CMODE:RELative?	653
:CALCulate:LLINE[1] 2 3 4 5 6:MARGin <rel_ampl>.	655
:CALCulate:LLINE[1] 2 3 4 5 6:MARGin?	655
:CALCulate:LLINE[1] 2 3 4 5 6:MARGin:STATe OFF ON 0 1.	655
:CALCulate:LLINE[1] 2 3 4 5 6:MARGin:STATe?	655
:CALCulate:LLINE[1] 2 3 4 5 6:OFFSet:UPDate	660
:CALCulate:LLINE[1] 2 3 4 5 6:OFFSet:X <value>.	659
:CALCulate:LLINE[1] 2 3 4 5 6:OFFSet:X?	659
:CALCulate:LLINE[1] 2 3 4 5 6:OFFSet:Y <rel_ampl>.	660
:CALCulate:LLINE[1] 2 3 4 5 6:OFFSet:Y?	660
:CALCulate:LLINE[1] 2 3 4 5 6:TRACe 1 2 3 4 5 6.	650
:CALCulate:LLINE[1] 2 3 4 5 6:TRACe?	650

List of Commands

:CALCulate:LLINe[1] 2 3 4 5 6:TYPE UPPer LOWer.	651
:CALCulate:LLINe[1] 2 3 4 5 6:TYPE?.	651
:CALCulate:LLINe:ALL:DELeTe	663
:CALCulate:LLINe:CMODe FIXEd RELAtive	668
:CALCulate:LLINe:CMODe?.	668
:CALCulate:LLINe:CONTRol:DOMain FREQUency TIME	662
:CALCulate:LLINe:CONTRol:DOMain?.	662
:CALCulate:LLINe:TEST OFF ON 0 1	662
:CALCulate:LLINe:TEST?.	662
:CALCulate:MAMarker:COUPling ON OFF 1 0.	619
:CALCulate:MAMarker:COUPling?.	619
:CALCulate:MAMarker:DETEctor[1] 2 3 OFF NORMAl AVERAge POSitive SAMPle NEGative QPEak EAVER- age RAverage	615
:CALCulate:MAMarker:DETEctor[1] 2 3?.	615
:CALCulate:MAMarker:DETEctor[1] 2 3:DWELl <dwelL time>	615
:CALCulate:MAMarker:DETEctor[1] 2 3:DWELl?.	615
:CALCulate:MAMarker:PCENter ON OFF 1 0.	620
:CALCulate:MAMarker:PCENter?.	620
:CALCulate:MARKer[1] 2 3 4 5 6 7 8 9 10 11 12:CPSeArch[:STATe] ON OFF 1 0.	704
:CALCulate:MARKer[1] 2 3 4 5 6 7 8 9 10 11 12:CPSeArch[:STATe]?	704
:CALCulate:MARKer[1] 2 3 4 5 6 7 8 9 10 11 12:FCOunt:GATetime <time>.	598
:CALCulate:MARKer[1] 2 3 4 5 6 7 8 9 10 11 12:FCOunt:GATetime?	598
:CALCulate:MARKer[1] 2 3 4 5 6 7 8 9 10 11 12:FCOunt:GATetime:AUTO OFF ON 0 1.	598
:CALCulate:MARKer[1] 2 3 4 5 6 7 8 9 10 11 12:FCOunt:GATetime:AUTO?	598
:CALCulate:MARKer[1] 2 3 4 5 6 7 8 9 10 11 12:FCOunt[:STATe] OFF ON 0 1	595
:CALCulate:MARKer[1] 2 3 4 5 6 7 8 9 10 11 12:FCOunt[:STATe]?	595
:CALCulate:MARKer[1] 2 3 4 5 6 7 8 9 10 11 12:FCOunt:X?.	596
:CALCulate:MARKer[1] 2 3 4 5 6 7 8 9 10 11 12:FUNCTion NOISe BPOWer BDENsity OFF	601
:CALCulate:MARKer[1] 2 3 4 5 6 7 8 9 10 11 12:FUNCTion?.	601
:CALCulate:MARKer[1] 2 3 4 5 6 7 8 9 10 11 12:FUNCTion:BAND:LEFT <freq>	608
:CALCulate:MARKer[1] 2 3 4 5 6 7 8 9 10 11 12:FUNCTion:BAND:LEFT?	608

List of Commands

:CALCulate:MARKer[1] 2 3 4 5 6 7 8 9 10 11 12:FUNction:BAND:RIGHt <freq>	609
:CALCulate:MARKer[1] 2 3 4 5 6 7 8 9 10 11 12:FUNction:BAND:RIGHt?	609
:CALCulate:MARKer[1] 2 3 4 5 6 7 8 9 10 11 12:FUNction:BAND:SPAN <freq>	607
:CALCulate:MARKer[1] 2 3 4 5 6 7 8 9 10 11 12:FUNction:BAND:SPAN?	607
:CALCulate:MARKer[1] 2 3 4 5 6 7 8 9 10 11 12:FUNction:MAMarker?	610
:CALCulate:MARKer[1] 2 3 4 5 6 7 8 9 10 11 12:LINes[:STATe] OFF ON 0 1	593
:CALCulate:MARKer[1] 2 3 4 5 6 7 8 9 10 11 12:LINes[:STATe]?	593
:CALCulate:MARKer[1] 2 3 4 5 6 7 8 9 10 11 12:MAXimum	693
:CALCulate:MARKer[1] 2 3 4 5 6 7 8 9 10 11 12:MAXimum:LEFT	694
:CALCulate:MARKer[1] 2 3 4 5 6 7 8 9 10 11 12:MAXimum:NEXT	694
:CALCulate:MARKer[1] 2 3 4 5 6 7 8 9 10 11 12:MAXimum:RIGHt	694
:CALCulate:MARKer[1] 2 3 4 5 6 7 8 9 10 11 12:MINimum	706
:CALCulate:MARKer[1] 2 3 4 5 6 7 8 9 10 11 12:MODE POSition DELTA FIXed OFF	581
:CALCulate:MARKer[1] 2 3 4 5 6 7 8 9 10 11 12:MODE?	581
:CALCulate:MARKer[1] 2 3 4 5 6 7 8 9 10 11 12:PTPeak	706
:CALCulate:MARKer[1] 2 3 4 5 6 7 8 9 10 11 12:REFerence <integer>	587
:CALCulate:MARKer[1] 2 3 4 5 6 7 8 9 10 11 12:REFerence?	587
:CALCulate:MARKer[1] 2 3 4 5 6 7 8 9 10 11 12[:SET]:CENTer	621
:CALCulate:MARKer[1] 2 3 4 5 6 7 8 9 10 11 12[:SET]:DELTA:CENTer	624
:CALCulate:MARKer[1] 2 3 4 5 6 7 8 9 10 11 12[:SET]:DELTA:SPAN	623
:CALCulate:MARKer[1] 2 3 4 5 6 7 8 9 10 11 12[:SET]:RLEVel	625
:CALCulate:MARKer[1] 2 3 4 5 6 7 8 9 10 11 12[:SET]:START	622
:CALCulate:MARKer[1] 2 3 4 5 6 7 8 9 10 11 12[:SET]:STEP	622
:CALCulate:MARKer[1] 2 3 4 5 6 7 8 9 10 11 12[:SET]:STOP	623
:CALCulate:MARKer[1] 2 3 4 5 6 7 8 9 10 11 12:TRACe 1 2 3 4 5 6	592
:CALCulate:MARKer[1] 2 3 4 5 6 7 8 9 10 11 12:TRACe?	592
:CALCulate:MARKer[1] 2 3 4 5 6 7 8 9 10 11 12:TRACe:AUTO OFF ON 0 1	593
:CALCulate:MARKer[1] 2 3 4 5 6 7 8 9 10 11 12:TRACe:AUTO?	593
:CALCulate:MARKer[1] 2 3 4 5 6 7 8 9 10 11 12:X <freq>	582
:CALCulate:MARKer[1] 2 3 4 5 6 7 8 9 10 11 12:X?	582
:CALCulate:MARKer[1] 2 3 4 5 6 7 8 9 10 11 12:X:POSition <real>	583

List of Commands

:CALCulate:MARKer[1] 2 3 4 5 6 7 8 9 10 11 12:X:POSition?	583
:CALCulate:MARKer[1] 2 3 4 5 6 7 8 9 10 11 12:X:READout FREQuency TIME ITIME PERiod	589
:CALCulate:MARKer[1] 2 3 4 5 6 7 8 9 10 11 12:X:READout?	589
:CALCulate:MARKer[1] 2 3 4 5 6 7 8 9 10 11 12:X:READout:AUTO ON OFF 1 0	589
:CALCulate:MARKer[1] 2 3 4 5 6 7 8 9 10 11 12:X:READout:AUTO?	589
:CALCulate:MARKer[1] 2 3 4 5 6 7 8 9 10 11 12:Y <real>	584
:CALCulate:MARKer[1] 2 3 4 5 6 7 8 9 10 11 12:Y?	584
:CALCulate:MARKer:AOFF	599
:CALCulate:MARKer:COUPle[:STATe] OFF ON 0 1	598
:CALCulate:MARKer:COUPle[:STATe]?	598
:CALCulate:MARKer:PEAK:EXCursion <rel_ampl>	698
:CALCulate:MARKer:PEAK:EXCursion?	698
:CALCulate:MARKer:PEAK:EXCursion:STATe OFF ON 0 1	698
:CALCulate:MARKer:PEAK:EXCursion:STATe?	698
:CALCulate:MARKer:PEAK:SEARch:MODE MAXimum PARameter	696
:CALCulate:MARKer:PEAK:SEARch:MODE?	696
:CALCulate:MARKer:PEAK:SORT FREQuency AMPLitude	701
:CALCulate:MARKer:PEAK:SORT?	701
:CALCulate:MARKer:PEAK:TABLE:READout ALL GTDLine LTDLine	702
:CALCulate:MARKer:PEAK:TABLE:READout?	702
:CALCulate:MARKer:PEAK:TABLE:STATe OFF ON 0 1	701
:CALCulate:MARKer:PEAK:TABLE:STATe?	701
:CALCulate:MARKer:PEAK:THReshold <ampl>	699
:CALCulate:MARKer:PEAK:THReshold?	699
:CALCulate:MARKer:PEAK:THReshold:STATe OFF ON 0 1	699
:CALCulate:MARKer:PEAK:THReshold:STATe?	699
:CALCulate:MARKer:TABLE[:STATe] OFF ON 0 1	594
:CALCulate:MARKer:TABLE[:STATe]?	594
:CALCulate:SPECTrum:MARKer[1] 2 3 4 5 6 7 8 9 10 11 12:CPSeArch[:STATe] ON OFF 1 0	338
:CALCulate:SPECTrum:MARKer[1] 2 3 4 5 6 7 8 9 10 11 12:CPSeArch[:STATe]?	338
:CALCulate:SPECTrum:MARKer[1] 2 3 4 5 6 7 8 9 10 11 12:FUNCTion NOISe BPOWer BDENsity OFF	301

List of Commands

:CALCulate:SPECtrum:MARKer[1] 2 3 4 5 6 7 8 9 10 11 12:FUNCtion?	301
:CALCulate:SPECtrum:MARKer[1] 2 3 4 5 6 7 8 9 10 11 12:FUNCtion:BAND:LEFT <freq>	303
:CALCulate:SPECtrum:MARKer[1] 2 3 4 5 6 7 8 9 10 11 12:FUNCtion:BAND:LEFT?	303
:CALCulate:SPECtrum:MARKer[1] 2 3 4 5 6 7 8 9 10 11 12:FUNCtion:BAND:RIGHT <freq>	303
:CALCulate:SPECtrum:MARKer[1] 2 3 4 5 6 7 8 9 10 11 12:FUNCtion:BAND:RIGHT?	303
:CALCulate:SPECtrum:MARKer[1] 2 3 4 5 6 7 8 9 10 11 12:FUNCtion:BAND:SPAN <freq>	302
:CALCulate:SPECtrum:MARKer[1] 2 3 4 5 6 7 8 9 10 11 12:FUNCtion:BAND:SPAN?	302
:CALCulate:SPECtrum:MARKer[1] 2 3 4 5 6 7 8 9 10 11 12:MAXimum	330
:CALCulate:SPECtrum:MARKer[1] 2 3 4 5 6 7 8 9 10 11 12:MAXimum:LEFT	331
:CALCulate:SPECtrum:MARKer[1] 2 3 4 5 6 7 8 9 10 11 12:MAXimum:NEXT	331
:CALCulate:SPECtrum:MARKer[1] 2 3 4 5 6 7 8 9 10 11 12:MAXimum:RIGHT	331
:CALCulate:SPECtrum:MARKer[1] 2 3 4 5 6 7 8 9 10 11 12:MINimum	340
:CALCulate:SPECtrum:MARKer[1] 2 3 4 5 6 7 8 9 10 11 12:MODE POSition DELTA OFF	294
:CALCulate:SPECtrum:MARKer[1] 2 3 4 5 6 7 8 9 10 11 12:MODE?	294
:CALCulate:SPECtrum:MARKer[1] 2 3 4 5 6 7 8 9 10 11 12:PTPeak	339
:CALCulate:SPECtrum:MARKer[1] 2 3 4 5 6 7 8 9 10 11 12:REFerence <integer>	298
:CALCulate:SPECtrum:MARKer[1] 2 3 4 5 6 7 8 9 10 11 12:REFerence?	298
:CALCulate:SPECtrum:MARKer[1] 2 3 4 5 6 7 8 9 10 11 12[:SET]:CENTer	305
:CALCulate:SPECtrum:MARKer[1] 2 3 4 5 6 7 8 9 10 11 12[:SET]:RLEVel	305
:CALCulate:SPECtrum:MARKer[1] 2 3 4 5 6 7 8 9 10 11 12:STATe OFF ON 0 1	300
:CALCulate:SPECtrum:MARKer[1] 2 3 4 5 6 7 8 9 10 11 12:STATe?	300
:CALCulate:SPECtrum:MARKer[1] 2 3 4 5 6 7 8 9 10 11 12:TRACe SPECTrum ASPECTrum IQ IQ.	298
:CALCulate:SPECtrum:MARKer[1] 2 3 4 5 6 7 8 9 10 11 12:TRACe?	298
:CALCulate:SPECtrum:MARKer[1] 2 3 4 5 6 7 8 9 10 11 12:X <freq>	295
:CALCulate:SPECtrum:MARKer[1] 2 3 4 5 6 7 8 9 10 11 12:X?	295
:CALCulate:SPECtrum:MARKer[1] 2 3 4 5 6 7 8 9 10 11 12:X:POSition <freq>	296
:CALCulate:SPECtrum:MARKer[1] 2 3 4 5 6 7 8 9 10 11 12:X:POSition?	296
:CALCulate:SPECtrum:MARKer[1] 2 3 4 5 6 7 8 9 10 11 12:Y?	296
:CALCulate:SPECtrum:MARKer:AOFF	300
:CALCulate:SPECtrum:MARKer:COUPl[e[:STATe] ON OFF 1 0	299
:CALCulate:SPECtrum:MARKer:COUPl[e[:STATe]?	299

List of Commands

:CALCulate:SPECTrum:MARKer:PEAK:EXCursion <rel_ampl>	335
:CALCulate:SPECTrum:MARKer:PEAK:EXCursion?	335
:CALCulate:SPECTrum:MARKer:PEAK:EXCursion:STATe OFF ON 0 1	335
:CALCulate:SPECTrum:MARKer:PEAK:EXCursion:STATe?	335
:CALCulate:SPECTrum:MARKer:PEAK:SEARch:MODE MAXimum PARAmeter	333
:CALCulate:SPECTrum:MARKer:PEAK:SEARch:MODE?	333
:CALCulate:SPECTrum:MARKer:PEAK:THReshold <ampl>	336
:CALCulate:SPECTrum:MARKer:PEAK:THReshold?	336
:CALCulate:SPECTrum:MARKer:PEAK:THReshold:STATe OFF ON 0 1	336
:CALCulate:SPECTrum:MARKer:PEAK:THReshold:STATe?	336
:CALCulate:TRACe[1] 2 3 4 5 6:FAIL?	667
:CALCulate:WAVeform:MARKer[1] 2 3 4 5 6 7 8 9 10 11 12:FUNCTion BPOWER BDENsity OFF	392
:CALCulate:WAVeform:MARKer[1] 2 3 4 5 6 7 8 9 10 11 12:FUNCTion?	392
:CALCulate:WAVeform:MARKer[1] 2 3 4 5 6 7 8 9 10 11 12:FUNCTion:BAND:LEFT <time>	394
:CALCulate:WAVeform:MARKer[1] 2 3 4 5 6 7 8 9 10 11 12:FUNCTion:BAND:LEFT?	394
:CALCulate:WAVeform:MARKer[1] 2 3 4 5 6 7 8 9 10 11 12:FUNCTion:BAND:RIGHT <time>	395
:CALCulate:WAVeform:MARKer[1] 2 3 4 5 6 7 8 9 10 11 12:FUNCTion:BAND:RIGHT?	395
:CALCulate:WAVeform:MARKer[1] 2 3 4 5 6 7 8 9 10 11 12:FUNCTion:BAND:SPAN <time>	393
:CALCulate:WAVeform:MARKer[1] 2 3 4 5 6 7 8 9 10 11 12:FUNCTion:BAND:SPAN?	393
:CALCulate:WAVeform:MARKer[1] 2 3 4 5 6 7 8 9 10 11 12:MAXimum	413
:CALCulate:WAVeform:MARKer[1] 2 3 4 5 6 7 8 9 10 11 12:MAXimum:NEXT	413
:CALCulate:WAVeform:MARKer[1] 2 3 4 5 6 7 8 9 10 11 12:MINimum	414
:CALCulate:WAVeform:MARKer[1] 2 3 4 5 6 7 8 9 10 11 12:MODE POSition DELTA OFF	384
:CALCulate:WAVeform:MARKer[1] 2 3 4 5 6 7 8 9 10 11 12:MODE?	384
:CALCulate:WAVeform:MARKer[1] 2 3 4 5 6 7 8 9 10 11 12:REFerence <integer>	388
:CALCulate:WAVeform:MARKer[1] 2 3 4 5 6 7 8 9 10 11 12:REFerence?	388
:CALCulate:WAVeform:MARKer[1] 2 3 4 5 6 7 8 9 10 11 12:STATe OFF ON 0 1	390
:CALCulate:WAVeform:MARKer[1] 2 3 4 5 6 7 8 9 10 11 12:STATe?	390
:CALCulate:WAVeform:MARKer[1] 2 3 4 5 6 7 8 9 10 11 12:TRACe RFENvelope I Q IQ	389
:CALCulate:WAVeform:MARKer[1] 2 3 4 5 6 7 8 9 10 11 12:TRACe?	389
:CALCulate:WAVeform:MARKer[1] 2 3 4 5 6 7 8 9 10 11 12:X <time>	385

List of Commands

:CALCulate:WAVEform:MARKer[1] 2 3 4 5 6 7 8 9 10 11 12:X?	385
:CALCulate:WAVEform:MARKer[1] 2 3 4 5 6 7 8 9 10 11 12:X:POSition <real>	386
:CALCulate:WAVEform:MARKer[1] 2 3 4 5 6 7 8 9 10 11 12:X:POSition?	386
:CALCulate:WAVEform:MARKer[1] 2 3 4 5 6 7 8 9 10 11 12:Y?	387
:CALCulate:WAVEform:MARKer:AOFF	390
:CALCulate:WAVEform:MARKer:COUPle[:STATe] ON OFF 1 0	389
:CALCulate:WAVEform:MARKer:COUPle[:STATe]?	389
:CALibration[:ALL]?	207
:CALibration[:ALL]	207
:CALibration:AUTO ON PARTial OFF	199
:CALibration:AUTO?	199
:CALibration:AUTO:ALERt TTEMperature DAY WEEK NONE	203
:CALibration:AUTO:ALERt?	203
:CALibration:AUTO:MODE ALL NRF	202
:CALibration:AUTO:MODE?	202
:CALibration:AUTO:TIME:OFF?	217
:CALibration:DATA:BACKup <filename>	226
:CALibration:DATA:DEFault	220
:CALibration:DATA:REStore <filename>	226
:CALibration:EMIXer?	211
:CALibration:EMIXer	211
:CALibration:EXPIred?	206
:CALibration:FREQuency:REFerence:COARse <integer>	231
:CALibration:FREQuency:REFerence:COARse?	231
:CALibration:FREQuency:REFerence:FINE <integer>	231
:CALibration:FREQuency:REFerence:FINE?	231
:CALibration:FREQuency:REFerence:MODE CALibrated USER	230
:CALibration:FREQuency:REFerence:MODE?	230
:CALibration:INTernal:SOURce[:ALL]?	212
:CALibration:INTernal:SOURce[:ALL]	212
:CALibration:MPADapter:CABLEs:TEST	269

List of Commands

:CALibration:MPADapter:GAIN?	229
:CALibration:MPADapter:GAIN	229
:CALibration:NRF?	209
:CALibration:NRF	209
:CALibration:RF?	210
:CALibration:RFPSelector:ALERt ON OFF 0 1	236
:CALibration:RFPSelector:ALERt?	236
:CALibration:RFPSelector:CONDucted?	232
:CALibration:RFPSelector:CONDucted	232
:CALibration:RFPSelector:FULL?	235
:CALibration:RFPSelector:FULL	235
:CALibration:RFPSelector:RADiated?	234
:CALibration:RFPSelector:RADiated	234
:CALibration:RFPSelector:SCHeduler:RECurrence DAY WEEK OFF	239
:CALibration:RFPSelector:SCHeduler:RECurrence?	239
:CALibration:RFPSelector:SCHeduler:RECurrence:DAY SUN MON TUE WED THU FRI SAT	240
:CALibration:RFPSelector:SCHeduler:RECurrence:DAY?	240
:CALibration:RFPSelector:SCHeduler:RECurrence:WEEK <integer>	240
:CALibration:RFPSelector:SCHeduler:RECurrence:WEEK?	240
:CALibration:RFPSelector:SCHeduler:STATe ON OFF 0 1	241
:CALibration:RFPSelector:SCHeduler:STATe?	241
:CALibration:RFPSelector:SCHeduler:TASK T1 T2 T3	237
:CALibration:RFPSelector:SCHeduler:TASK?	237
:CALibration:RFPSelector:SCHeduler:TIME:NEXT?	218
:CALibration:RFPSelector:SCHeduler:TIME:STARt "date","time"	237
:CALibration:RFPSelector:SCHeduler:TIME:STARt?	237
:CALibration:RF	210
:CALibration:SOURce:STATe OFF ON 0 1	513
:CALibration:SOURce:STATe?	513
:CALibration:TEMPerature:CURRent?	214
:CALibration:TEMPerature:LALL?	214

List of Commands

:CALibration:TEMPerature:LPReselector?	216
:CALibration:TEMPerature:LRF?	215
:CALibration:TEMPerature:RFPSelector:LCONducted?	217
:CALibration:TEMPerature:RFPSelector:LRADiated?	218
:CALibration:TEMPerature:SOURce: LALL?	216
:CALibration:TIME:LALL?	214
:CALibration:TIME:LPReselector?	216
:CALibration:TIME:LRF?	215
:CALibration:TIME:RFPSelector:LCONducted?	217
:CALibration:TIME:RFPSelector:LRADiated?	217
:CALibration:TIME:SOURce:LALL?	215
:CALibration:YTF?	227
:CALibration:YTF	227
*CLS	129
:CONFigure:<Measurement>	145
:CONFigure?	632
:CONFigure:SPECTrum	314
:CONFigure:SPECTrum:NDEFault	277
:CONFigure:SPECTrum	277
:CONFigure:WAVEform	409
:CONFigure:WAVEform:NDEFault	357
:CONFigure:WAVEform	357
:COUple ALL NONE	473
:DISPlay:<measurement>:ANNotation:TITLe:DATA <string>	963
:DISPlay:<measurement>:ANNotation:TITLe:DATA?	963
:DISPlay:ACTivefunc[:STATe] ON OFF 1 0	962
:DISPlay:ACTivefunc[:STATe]?	962
:DISPlay:ANNotation:MBAR[:STATe] OFF ON 0 1	960
:DISPlay:ANNotation:MBAR[:STATe]?	960
:DISPlay:ANNotation:SCReen[:STATe] OFF ON 0 1	961
:DISPlay:ANNotation:SCReen[:STATe]?	961

List of Commands

:DISPlay:ANNotation:TRACe[:STATe] ON OFF 1 0	961
:DISPlay:ANNotation:TRACe[:STATe]?	961
:DISPlay:BACKlight ON OFF	967
:DISPlay:BACKlight?	967
:DISPlay:BACKlight:INTensity <integer>	967
:DISPlay:BACKlight:INTensity?	967
:DISPlay:ENABle OFF ON 0 1	969
:DISPlay:ENABle?	969
:DISPlay:FSCReen[:STATe] OFF ON 0 1	968
:DISPlay:FSCReen[:STATe]?	968
:DISPlay:SPECtrum:VIEW[1]:WINDow[1]:2:TRACe:Y[:SCALe]:COUPlE ON OFF 1 0	287
:DISPlay:SPECtrum:VIEW[1]:WINDow[1]:2:TRACe:Y[:SCALe]:COUPlE?	287
:DISPlay:SPECtrum:VIEW[1]:WINDow[1]:TRACe:Y[:SCALe]:PDIVision <rel_ampl>	284
:DISPlay:SPECtrum:VIEW[1]:WINDow[1]:TRACe:Y[:SCALe]:PDIVision?	284
:DISPlay:SPECtrum:VIEW[1]:WINDow[1]:TRACe:Y[:SCALe]:RLEVel <ampl>	281
:DISPlay:SPECtrum:VIEW[1]:WINDow[1]:TRACe:Y[:SCALe]:RLEVel?	281
:DISPlay:SPECtrum:VIEW[1]:WINDow[1]:TRACe:Y[:SCALe]:RPOSition TOP CENTer BOTTom	285
:DISPlay:SPECtrum:VIEW[1]:WINDow[1]:TRACe:Y[:SCALe]:RPOSition?	285
:DISPlay:SPECtrum:VIEW[1]:WINDow2:TRACe:X[:SCALe]:COUPlE 0 1 OFF ON	349
:DISPlay:SPECtrum:VIEW[1]:WINDow2:TRACe:X[:SCALe]:COUPlE	349
:DISPlay:SPECtrum:VIEW[1]:WINDow2:TRACe:X[:SCALe]:PDIVision <time>	348
:DISPlay:SPECtrum:VIEW[1]:WINDow2:TRACe:X[:SCALe]:PDIVision?	348
:DISPlay:SPECtrum:VIEW[1]:WINDow2:TRACe:X[:SCALe]:RLEVel <time>	347
:DISPlay:SPECtrum:VIEW[1]:WINDow2:TRACe:X[:SCALe]:RLEVel?	347
:DISPlay:SPECtrum:VIEW[1]:WINDow2:TRACe:X[:SCALe]:RPOSition LEFT CENTer RIGHT	348
:DISPlay:SPECtrum:VIEW[1]:WINDow2:TRACe:X[:SCALe]:RPOSition?	348
:DISPlay:SPECtrum:VIEW[1]:WINDow2:TRACe:Y[:SCALe]:PDIVision <voltage>	284
:DISPlay:SPECtrum:VIEW[1]:WINDow2:TRACe:Y[:SCALe]:PDIVision?	284
:DISPlay:SPECtrum:VIEW[1]:WINDow2:TRACe:Y[:SCALe]:RLEVel <voltage>	282
:DISPlay:SPECtrum:VIEW[1]:WINDow2:TRACe:Y[:SCALe]:RLEVel?	282
:DISPlay:SPECtrum:VIEW[1]:WINDow2:TRACe:Y[:SCALe]:RPOSition TOP CENTer BOTTom	286

List of Commands

:DISPlay:SPEctrum:VIEW[1]:WINDow2:TRACe:Y[:SCALe]:RPOSition?	286
:DISPlay:THEME TDColor TDMonochrome FCOLor FMONochrome	966
:DISPlay:THEME?	966
:DISPlay:WAVEform:VIEW[1]2:WINDow[1]:TRACe:X[:SCALe]:COUple 0 1 OFF ON	422
:DISPlay:WAVEform:VIEW[1]2:WINDow[1]:TRACe:X[:SCALe]:COUple?	422
:DISPlay:WAVEform:VIEW[1]2:WINDow[1]:TRACe:X[:SCALe]:PDIVision <time>	421
:DISPlay:WAVEform:VIEW[1]2:WINDow[1]:TRACe:X[:SCALe]:PDIVision?	421
:DISPlay:WAVEform:VIEW[1]2:WINDow[1]:TRACe:X[:SCALe]:RLEVel <time>	420
:DISPlay:WAVEform:VIEW[1]2:WINDow[1]:TRACe:X[:SCALe]:RLEVel?	420
:DISPlay:WAVEform:VIEW[1]2:WINDow[1]:TRACe:X[:SCALe]:RPOSition LEFT CENTer RIGHT	421
:DISPlay:WAVEform:VIEW[1]2:WINDow[1]:TRACe:X[:SCALe]:RPOSition?	421
:DISPlay:WAVEform:VIEW[1]2:WINDow[1]:TRACe:Y[:SCALe]:COUple 0 1 OFF ON	365
:DISPlay:WAVEform:VIEW[1]2:WINDow[1]:TRACe:Y[:SCALe]:COUple?	365
:DISPlay:WAVEform:VIEW[1]:WINDow[1]:TRACe:Y[:SCALe]:PDIVision <rel_ampl>	362
:DISPlay:WAVEform:VIEW[1]:WINDow[1]:TRACe:Y[:SCALe]:PDIVision?	362
:DISPlay:WAVEform:VIEW[1]:WINDow[1]:TRACe:Y[:SCALe]:RLEVel <ampl>	359
:DISPlay:WAVEform:VIEW[1]:WINDow[1]:TRACe:Y[:SCALe]:RLEVel?	359
:DISPlay:WAVEform:VIEW[1]:WINDow[1]:TRACe:Y[:SCALe]:RPOSition TOP CENTer BOTTom	364
:DISPlay:WAVEform:VIEW[1]:WINDow[1]:TRACe:Y[:SCALe]:RPOSition?	364
:DISPlay:WAVEform:VIEW2:WINDow[1]:TRACe:Y[:SCALe]:PDIVision <voltage>	362
:DISPlay:WAVEform:VIEW2:WINDow[1]:TRACe:Y[:SCALe]:PDIVision?	362
:DISPlay:WAVEform:VIEW2:WINDow[1]:TRACe:Y[:SCALe]:RLEVel <voltage>	360
:DISPlay:WAVEform:VIEW2:WINDow[1]:TRACe:Y[:SCALe]:RLEVel?	360
:DISPlay:WAVEform:VIEW2:WINDow[1]:TRACe:Y[:SCALe]:RPOSition TOP CENTer BOTTom	364
:DISPlay:WAVEform:VIEW2:WINDow[1]:TRACe:Y[:SCALe]:RPOSition?	364
:DISPlay:WAVEform:VIEW:NSElect <integer>	426
:DISPlay:WAVEform:VIEW:NSElect?	426
:DISPlay:WAVEform:VIEW[:SElect] RFENvelope IQ	426
:DISPlay:WAVEform:VIEW[:SElect]?	426
:DISPlay:WINDow[1]:ANNotation[:ALL] OFF ON 0 1	966
:DISPlay:WINDow[1]:ANNotation[:ALL]?	966

List of Commands

:DISPlay:WINDow[1]:TRACe:GRATICule:GRID[:STATe] OFF ON 0 1	964
:DISPlay:WINDow[1]:TRACe:GRATICule:GRID[:STATe]?	964
:DISPlay:WINDow[1]:TRACe:Y:DLINe <ampl>	965
:DISPlay:WINDow[1]:TRACe:Y:DLINe?	965
:DISPlay:WINDow[1]:TRACe:Y:DLINe:STATe OFF ON 0 1	965
:DISPlay:WINDow[1]:TRACe:Y:DLINe:STATe?	965
:DISPlay:WINDow[1]:TRACe:Y[:SCALe]:PDIVision <rel_ampl>	452
:DISPlay:WINDow[1]:TRACe:Y[:SCALe]:PDIVision?	452
:DISPlay:WINDow[1]:TRACe:Y[:SCALe]:RLEVel <real>	433
:DISPlay:WINDow[1]:TRACe:Y[:SCALe]:RLEVel?	433
:DISPlay:WINDow[1]:TRACe:Y[:SCALe]:RLEVel:OFFSet <rel_ampl>	463
:DISPlay:WINDow[1]:TRACe:Y[:SCALe]:RLEVel:OFFSet?	463
:DISPlay:WINDow[1]:TRACe:Y[:SCALe]:SPACing LINear LOGarithmic	453
:DISPlay:WINDow[1]:TRACe:Y[:SCALe]:SPACing?	453
:DISPlay:WINDow:FORMat:TILE	113
:DISPlay:WINDow:FORMat:ZOOM	113
:DISPlay:WINDow:MAMarker:POSition LEFT RIGHT	614
:DISPlay:WINDow:MAMarker:POSition?	614
:DISPlay:WINDow:MAMarker[:STATe] ON OFF 1 0	614
:DISPlay:WINDow:MAMarker[:STATe]?	614
:DISPlay:WINDow[:SElect] <number>	113
:DISPlay:WINDow[:SElect]?	113
*ESE <integer>	130
*ESE?	130
*ESR?	130
:FEED:RF:PORT:OUTP RFIO1	537
:FETCh:SPECtrum[n]?	277
:FETCh:WAVEform[n]	357
:FORMat:BORDER NORMal SWAPped	641
:FORMat:BORDER?	641
:FORMat[:TRACe][:DATA] ASCii INTEger,32 REAL,32 REAL,64	639

List of Commands

:FORMat[:TRACe][:DATA]?	639
:GLOBal:FREQUency:CENTer[:STATe] 1 0 ON OFF	487
:GLOBal:FREQUency:CENTer[:STATe]?	487
:HCOPy:ABORt	147
:HCOPy[:IMMediate]	147
*IDN?	131
:INIT	90
:INITiate:CONTInuous OFF ON 0 1	501
:INITiate:CONTInuous?	501
:INITiate[:IMMediate]	713
:INITiate:PAUSE	880
:INITiate:REStart	713
:INITiate:RESume	880
:INITiate:SPECtrum	277
:INITiate:WAVEform	357
:INPut:MIXer EXTernal INTernal	508
:INPut:MIXer?	508
:INSTrument:CATalog?	478
:INSTrument:COUPle:DEFault	487
:INSTrument:COUPle:FREQUency:CENTer ALL NONE	487
:INSTrument:COUPle:FREQUency:CENTer?	487
:INSTrument:DEFault	144
:INSTrument:NSElect <integer>	478
:INSTrument:NSElect?	478
:INSTrument[:SElect] SEQAN BASIC WCDMA EDGE GSM WIMAX OFDMA ADEMOD BTooth TDSCDMA CDMA2K CDMA1XEV LTE LTETDD	475
:INSTrument[:SElect]?	475
:MEASure:SPECtrum[n]?	277
:MEASure:WAVEform[n]	357
:MEMMory:RDIRectory <directory_name>	180
:MEMMory[:SOURce]	860

List of Commands

:MEMory[:SOURce]:DATA <file_name>, <data>	861
:MEMory[:SOURce]:DATA:APPend <file_name>, <data>	861
:MMEMory:CATalog? [<directory_name>]	178
:MMEMory:CDIRectory [<directory_name>]	178
:MMEMory:CDIRectory?	178
:MMEMory:COpy <string>,<string>[,<string>,<string>]	178
:MMEMory:DATA <file_name>, <data>	179
:MMEMory:DATA? <file_name>	179
:MMEMory:DELeTe <file_name>[,<directory_name>]	179
:MMEMory:HEADer:ID? “<file name>”	808
:MMEMory:LOAD:CORRection 1 2 3 4 5 6, <filename>	707
:MMEMory:LOAD:MPADapter:CORRection 1 2 3 4 5 6 7 8 9 10 11 12 13 14 15 16, <filename>.	709
:MMEMory:LOAD:SEQuences: SLISt ALISt SAALISt "MySequence.txt"	159
:MMEMory:LOAD:STATe <filename>	151
:MMEMory:LOAD:TRACe TRACE1 TRACE2 TRACE3 TRACE4 TRACE5 TRACE6,<filename>	157
:MMEMory:LOAD:TRACe:REGISter TRACE1 TRACE2 TRACE3 TRACE4 TRACE5 TRACE6,<integer> .	157
:MMEMory:MDIRectory <directory_name>	180
:MMEMory:MOVE <string>,<string>[,<string>,<string>]	180
:MMEMory:REGISter:STATe:LAbel <reg number>,"label"	166
:MMEMory:REGISter:STATe:LAbel? <reg number>	166
:MMEMory:STORe:CORRection 1 2 3 4 5 6, <filename>	715
:MMEMory:STORe:MPADapter:CORRection 1 2 3 4 5 6 7 8 9 10 11 12 13 14 15 16, <filename>	718
:MMEMory:STORe:SCReen <filename>	175
:MMEMory:STORe:SCReen:THEMe TDCOLOR TDMonochrome FCOLOR FMONochrome	175
:MMEMory:STORe:SCReen:THEMe?	175
:MMEMory:STORe:STATe <filename>	163
:MMEMory:STORe:TRACe TRACE1 TRACE2 TRACE3 TRACE4 TRACE5 TRACE6 ALL,<filename> ...	168
:MMEMory:STORe:TRACe:REGISter TRACE1 TRACE2 TRACE3 TRACE4 TRACE5 TRACE6 ALL,<integer>	168
:MMEM:STOR:SEQuences: SLISt ALISt SAALISt SSTep "MySequence.txt"	170
:MPAD:PORT:INP RFIO1	540

List of Commands

*OPC?	131
*OPC	131
*OPT?	132
:OUTPut:ANALog OFF SVIDeo LOGVideo LINVideo DAUDio	575
:OUTPut:ANALog?	575
:OUTPut:ANALog:AUTO OFF ON 0 1	576
:OUTPut:ANALog:AUTO?	576
:OUTPut[:EXTernal][:STATe] ON OFF 1 0	725
:OUTPut[:EXTernal][:STATe]?	725
:OUTPut:MODulation[:STATe] ON OFF 1 0	731
:OUTPut:MODulation[:STATe]?	731
*RCL <register #>	133
:READ:SPECTrum[n]?	277
:READ:WAVEform[n]	357
*RST	146
*SAV <register #>	133
[:SENSe]:<measurement>:TRIGger:SOURce IF	904
[:SENSe]:<measurement>:TRIGger:SOURce	904
[:SENSe]:ADC:DITHer:AUTO[:STATe] OFF ON 0 1	676
[:SENSe]:ADC:DITHer:AUTO[:STATe]?	676
[:SENSe]:ADC:DITHer[:STATe] OFF ON HIGH	675
[:SENSe]:ADC:DITHer[:STATe]?	675
[:SENSe]:AVERage:CLEar	644
[:SENSe]:AVERage:COUNT <integer>	643
[:SENSe]:AVERage:COUNT?	643
[:SENSe]:AVERage:TYPE RMS LOG SCALar [:SENSe]:AVERage:TYPE?	645
[:SENSe]:AVERage:TYPE:AUTO OFF ON 0 1	644
[:SENSe]:AVERage:TYPE:AUTO?	644
[:SENSe]:BANDwidth BWIDth[:RESolution] <freq>	489
[:SENSe]:BANDwidth BWIDth[:RESolution]?	489
[:SENSe]:BANDwidth BWIDth[:RESolution]:AUTO OFF ON 0 1	489

List of Commands

[[:SENSe]:BANDwidth BWIDth[:RESolution]:AUTO?	489
[[:SENSe]:BANDwidth BWIDth:SHAPE GAUSSian FLATtop	495
[[:SENSe]:BANDwidth BWIDth:SHAPE?	495
[[:SENSe]:BANDwidth BWIDth:TYPE DB3 DB6 IMPulse NOISe	498
[[:SENSe]:BANDwidth BWIDth:TYPE?	498
[[:SENSe]:BANDwidth BWIDth:VIDeo <freq>	491
[[:SENSe]:BANDwidth BWIDth:VIDeo?	491
[[:SENSe]:BANDwidth BWIDth:VIDeo:AUTO OFF ON 0 1	491
[[:SENSe]:BANDwidth BWIDth:VIDeo:AUTO?	491
[[:SENSe]:BANDwidth BWIDth:VIDeo:RATio <real>	492
[[:SENSe]:BANDwidth BWIDth:VIDeo:RATio?	492
[[:SENSe]:BANDwidth BWIDth:VIDeo:RATio:AUTO OFF ON 0 1	492
[[:SENSe]:BANDwidth BWIDth:VIDeo:RATio:AUTO?	492
[[:SENSe]:CORRection:BTS[:RF]:GAIN <rel_ampl>	517
[[:SENSe]:CORRection:BTS[:RF]:GAIN?	517
[[:SENSe]:CORRection:BTS[:RF]:LOSS <rel_ampl>	517
[[:SENSe]:CORRection:BTS[:RF]:LOSS?	517
[[:SENSe]:CORRection:CSET[1] 2 3 4 5 6:COMMeNt "text"	525
[[:SENSe]:CORRection:CSET[1] 2 3 4 5 6:COMMeNt?	525
[[:SENSe]:CORRection:CSET[1] 2 3 4 5 6:DATA <freq>, <ampl>,	532
[[:SENSe]:CORRection:CSET[1] 2 3 4 5 6:DATA?	532
[[:SENSe]:CORRection:CSET[1] 2 3 4 5 6:DATA:MERGe <freq>, <ampl>,	533
[[:SENSe]:CORRection:CSET[1] 2 3 4 5 6:DELeTe	531
[[:SENSe]:CORRection:CSET[1] 2 3 4 5 6:DESCRiption "text"	525
[[:SENSe]:CORRection:CSET[1] 2 3 4 5 6:DESCRiption?	525
[[:SENSe]:CORRection:CSET[1] 2 3 4 5 6:RF:PORT RFIN RFIO1 RFIO2 RFOut.	526
[[:SENSe]:CORRection:CSET[1] 2 3 4 5 6:RF:PORT?	526
[[:SENSe]:CORRection:CSET[1] 2 3 4 5 6:RF:PORT:RFIO1 SOURce ANALyzer BOTH.	527
[[:SENSe]:CORRection:CSET[1] 2 3 4 5 6:RF:PORT:RFIO1?	527
[[:SENSe]:CORRection:CSET[1] 2 3 4 5 6:RF:PORT:RFIO2 SOURce ANALyzer BOTH.	528
[[:SENSe]:CORRection:CSET[1] 2 3 4 5 6:RF:PORT:RFIO2?	528

List of Commands

[[:SENSe]:CORRection:CSET[1] 2 3 4 5 6[:STATe] ON OFF 1 0	521
[[:SENSe]:CORRection:CSET[1] 2 3 4 5 6[:STATe]?.	521
[[:SENSe]:CORRection:CSET[1] 2 3 4 5 6:X:SPACing LINear LOGarithmic	523
[[:SENSe]:CORRection:CSET[1] 2 3 4 5 6:X:SPACing?	523
[[:SENSe]:CORRection:CSET:ALL:DELeTe	532
[[:SENSe]:CORRection:CSET:ALL[:STATe] ON OFF 1 0	531
[[:SENSe]:CORRection:CSET:ALL[:STATe]?.	531
[[:SENSe]:CORRection:IMPedance[:INPut][:MAGNitude] 50 75	510
[[:SENSe]:CORRection:IMPedance[:INPut][:MAGNitude]?	510
[[:SENSe]:CORRection:MS[:RF]:GAIN <rel_ampl>	515
[[:SENSe]:CORRection:MS[:RF]:GAIN?	515
[[:SENSe]:CORRection:MS[:RF]:LOSS <rel_ampl>	516
[[:SENSe]:CORRection:MS[:RF]:LOSS?	516
[[:SENSe]:CORRection:SA[:RF]:GAIN <rel_ampl>.	515
[[:SENSe]:CORRection:SA[:RF]:GAIN?.	515
[[:SENSe]:DEMod AM FM PM OFF	681
[[:SENSe]:DEMod?.	681
[[:SENSe]:DEMod:AM:BANDwidth:CHANnel <freq>	682
[[:SENSe]:DEMod:AM:BANDwidth:CHANnel?	682
[[:SENSe]:DEMod:FM:BANDwidth:CHANnel <freq>.	683
[[:SENSe]:DEMod:FM:BANDwidth:CHANnel?.	683
[[:SENSe]:DEMod:FM:DEEMphasis OFF US25 US50 US75 US750.	684
[[:SENSe]:DEMod:FM:DEEMphasis?.	684
[[:SENSe]:DEMod:PM:BANDwidth:CHANnel <freq>.	686
[[:SENSe]:DEMod:PM:BANDwidth:CHANnel?.	686
[[:SENSe]:DEMod:STATe OFF ON 0 1	687
[[:SENSe]:DEMod:STATe?.	687
[[:SENSe]:DEMod:TIME <time>.	687
[[:SENSe]:DEMod:TIME?	687
[[:SENSe]:FEED RF AIQ EMIXer	507
[[:SENSe]:FEED?.	507

List of Commands

[[:SENSe]:FEED:AREFERENCE REF50 REF4800 OFF	512
[[:SENSe]:FEED:AREFERENCE?	512
[[:SENSe]:FEED:DATA INPut STORed	518
[[:SENSe]:FEED:DATA?	518
[[:SENSe]:FEED:DATA:STORe	520
[[:SENSe]:FEED:RF:PORT[:INPut] RFIN RFIN2 RFIO1 RFIO2	511
[[:SENSe]:FEED:RF:PORT[:INPut]?	511
[[:SENSe]:FEED:RF:PORT:OUTPut RFOut RFIO1 RFIO2	537
[[:SENSe]:FEED:RF:PORT:OUTPut?	537
[[:SENSe]:FREQUENCY:CENTer <freq>	504
[[:SENSe]:FREQUENCY:CENTer?	504
[[:SENSe]:FREQUENCY:RF:CENTer <freq>	505
[[:SENSe]:FREQUENCY:RF:CENTer?	505
[[:SENSe]:FREQUENCY:SPAN <freq>	863
[[:SENSe]:FREQUENCY:SPAN?	863
[[:SENSe]:FREQUENCY:SPAN:BANDwidth[:RESolution]:RATio <integer>	494
[[:SENSe]:FREQUENCY:SPAN:BANDwidth[:RESolution]:RATio?	494
[[:SENSe]:FREQUENCY:SPAN:BANDwidth[:RESolution]:RATio:AUTO OFF ON 0 1	494
[[:SENSe]:FREQUENCY:SPAN:BANDwidth[:RESolution]:RATio:AUTO?	494
[[:SENSe]:FREQUENCY:SPAN:FULL	865
[[:SENSe]:FREQUENCY:SPAN:PREVious	866
[[:SENSe]:FREQUENCY:SYNThesis:AUTO[:STATe] OFF ON 0 1	674
[[:SENSe]:FREQUENCY:SYNThesis:AUTO[:STATe]?	674
[[:SENSe]:FREQUENCY:SYNThesis[:STATe] 1 2 3	672
[[:SENSe]:FREQUENCY:SYNThesis[:STATe]?	672
[[:SENSe]:IF:GAIN:FFT:AUTO[:STATe] OFF ON 0 1	680
[[:SENSe]:IF:GAIN:FFT:AUTO[:STATe]?	680
[[:SENSe]:IF:GAIN:FFT[:STATe] AUTOOrange LOW HIGH	679
[[:SENSe]:IF:GAIN:FFT[:STATe]?	679
[[:SENSe]:IF:GAIN:SWEPT:AUTO[:STATe] OFF ON 0 1	678
[[:SENSe]:IF:GAIN:SWEPT:AUTO[:STATe]?	678

List of Commands

[[:SENSe]:IF:GAIN:SWEPT[:STATe] OFF ON 0 1	677
[[:SENSe]:IF:GAIN:SWEPT[:STATe]?	677
[[:SENSe]:IFPath B10M B25M B40M B140M B160M	689
[[:SENSe]:IFPath?	689
[[:SENSe]:IFPath:AUTO ON OFF 1 0	690
[[:SENSe]:IFPath:AUTO?	690
[[:SENSe]:MPADapter:CORRection:CSET[1] 2 3 4 5 6 7 8 9 10 11 12 13 14 15 16:ANTenna[:UNIT] GAUSs PTES- la UVM UAM NOConversion	550
[[:SENSe]:MPADapter:CORRection:CSET[1] 2 3 4 5 6 7 8 9 10 11 12 13 14 15 16:ANTenna[:UNIT]?	550
[[:SENSe]:MPADapter:CORRection:CSET[1] 2 3 4 5 6 7 8 9 10 11 12 13 14 15 16:COMMeNT "text"	554
[[:SENSe]:MPADapter:CORRection:CSET[1] 2 3 4 5 6 7 8 9 10 11 12 13 14 15 16:COMMeNT?	554
[[:SENSe]:MPADapter:CORRection:CSET[1] 2 3 4 5 6 7 8 9 10 11 12 13 14 15 16:DATA <freq>, <ampl>,	569
[[:SENSe]:MPADapter:CORRection:CSET[1] 2 3 4 5 6 7 8 9 10 11 12 13 14 15 16:DATA?	569
[[:SENSe]:MPADapter:CORRection:CSET[1] 2 3 4 5 6 7 8 9 10 11 12 13 14 15 16:DATA:MERGe <freq>, <ampl>,	570
[[:SENSe]:MPADapter:CORRection:CSET[1] 2 3 4 5 6 7 8 9 10 11 12 13 14 15 16:DELeTe	568
[[:SENSe]:MPADapter:CORRection:CSET[1] 2 3 4 5 6 7 8 9 10 11 12 13 14 15 16:DESCription "text"	553
[[:SENSe]:MPADapter:CORRection:CSET[1] 2 3 4 5 6 7 8 9 10 11 12 13 14 15 16:DESCription?	553
[[:SENSe]:MPADapter:CORRection:CSET[1] 2 3 4 5 6 7 8 9 10 11 12 13 14 15 16:RF:PORT RFIO RFIO1 RFIO2 RFIO3 RFIO4 RFIO5 RFIO6 RFIO7	554
[[:SENSe]:MPADapter:CORRection:CSET[1] 2 3 4 5 6 7 8 9 10 11 12 13 14 15 16:RF:PORT?	554
[[:SENSe]:MPADapter:CORRection:CSET[1] 2 3 4 5 6 7 8 9 10 11 12 13 14 15 16:RF:PORT:RFIO0 SOURce AN- ALyzer BOTH	555
[[:SENSe]:MPADapter:CORRection:CSET[1] 2 3 4 5 6 7 8 9 10 11 12 13 14 15 16:RF:PORT:RFIO0?	555
[[:SENSe]:MPADapter:CORRection:CSET[1] 2 3 4 5 6 7 8 9 10 11 12 13 14 15 16:RF:PORT:RFIO1 SOURce AN- ALyzer BOTH	556
[[:SENSe]:MPADapter:CORRection:CSET[1] 2 3 4 5 6 7 8 9 10 11 12 13 14 15 16:RF:PORT:RFIO1?	556
[[:SENSe]:MPADapter:CORRection:CSET[1] 2 3 4 5 6 7 8 9 10 11 12 13 14 15 16:RF:PORT:RFIO2 SOURce AN- ALyzer BOTH	557
[[:SENSe]:MPADapter:CORRection:CSET[1] 2 3 4 5 6 7 8 9 10 11 12 13 14 15 16:RF:PORT:RFIO2?	557
[[:SENSe]:MPADapter:CORRection:CSET[1] 2 3 4 5 6 7 8 9 10 11 12 13 14 15 16:RF:PORT:RFIO3 SOURce AN- ALyzer BOTH	559
[[:SENSe]:MPADapter:CORRection:CSET[1] 2 3 4 5 6 7 8 9 10 11 12 13 14 15 16:RF:PORT:RFIO3?	559
[[:SENSe]:MPADapter:CORRection:CSET[1] 2 3 4 5 6 7 8 9 10 11 12 13 14 15 16:RF:PORT:RFIO4 SOURce AN-	

List of Commands

ALyzer BOTH	560
[[:SENSe]:MPADapter:CORRection:CSET[1] 2 3 4 5 6 7 8 9 10 11 12 13 14 15 16:RF:PORT:RFIO4?	560
[[:SENSe]:MPADapter:CORRection:CSET[1] 2 3 4 5 6 7 8 9 10 11 12 13 14 15 16:RF:PORT:RFIO5 SOURce AN-ALyzer BOTH	561
[[:SENSe]:MPADapter:CORRection:CSET[1] 2 3 4 5 6 7 8 9 10 11 12 13 14 15 16:RF:PORT:RFIO5?	561
[[:SENSe]:MPADapter:CORRection:CSET[1] 2 3 4 5 6 7 8 9 10 11 12 13 14 15 16:RF:PORT:RFIO6 SOURce AN-ALyzer BOTH	563
[[:SENSe]:MPADapter:CORRection:CSET[1] 2 3 4 5 6 7 8 9 10 11 12 13 14 15 16:RF:PORT:RFIO6?	563
[[:SENSe]:MPADapter:CORRection:CSET[1] 2 3 4 5 6 7 8 9 10 11 12 13 14 15 16:RF:PORT:RFIO7 SOURce AN-ALyzer BOTH	564
[[:SENSe]:MPADapter:CORRection:CSET[1] 2 3 4 5 6 7 8 9 10 11 12 13 14 15 16:RF:PORT:RFIO7?	564
[[:SENSe]:MPADapter:CORRection:CSET[1] 2 3 4 5 6 7 8 9 10 11 12 13 14 15 16[:STATe] ON OFF 1 0	548
[[:SENSe]:MPADapter:CORRection:CSET[1] 2 3 4 5 6 7 8 9 10 11 12 13 14 15 16[:STATe]?	548
[[:SENSe]:MPADapter:CORRection:CSET[1] 2 3 4 5 6 7 8 9 10 11 12 13 14 15 16:X:SPACing LINear LOGarithmic	552
[[:SENSe]:MPADapter:CORRection:CSET[1] 2 3 4 5 6 7 8 9 10 11 12 13 14 15 16:X:SPACing?	552
[[:SENSe]:MPADapter:CORRection:CSET:ALL:DELeTe	569
[[:SENSe]:MPADapter:CORRection:CSET:ALL[:STATe] ON OFF 1 0	568
[[:SENSe]:MPADapter:CORRection:CSET:ALL[:STATe]?	568
[[:SENSe]:MPADapter:GAIN[:STATe] ON OFF 1 0	546
[[:SENSe]:MPADapter:GAIN[:STATe]?	546
[[:SENSe]:MPADapter:PORT:INPut OFF	541
[[:SENSe]:MPADapter:PORT:INPut OFF RFIO0 RFIO1 RFIO2 RFIO3 RFIO4 RFIO5 RFIO6 RFIO7	540
[[:SENSe]:MPADapter:PORT:INPut RFIO0	541
[[:SENSe]:MPADapter:PORT:INPut?	540
[[:SENSe]:MPADapter:PORT:OUTPut:BITMap <integer>	543
[[:SENSe]:MPADapter:PORT:OUTPut:BITMap?	543
[[:SENSe]:MPADapter[:STATe] ON OFF 1 0	540
[[:SENSe]:MPADapter[:STATe]?	540
[[:SENSe]:POWer:IQ[:I]:RANGe[:UPPer] <ampl>	448
[[:SENSe]:POWer:IQ[:I]:RANGe[:UPPer]?	448
[[:SENSe]:POWer:IQ:Q:RANGe[:UPPer] <ampl>	451

List of Commands

[[:SENSe]:POWer:IQ:Q:RANGe[:UPPer]?	451
[[:SENSe]:POWer:IQ:RANGe:AUTO OFF ON 0 1	448
[[:SENSe]:POWer:IQ:RANGe:AUTO?	448
[[:SENSe]:POWer[:RF]:ATTenuation <rel_ampl>	437
[[:SENSe]:POWer[:RF]:ATTenuation?	437
[[:SENSe]:POWer[:RF]:ATTenuation:AUTO OFF ON 0 1	437
[[:SENSe]:POWer[:RF]:ATTenuation:AUTO?	437
[[:SENSe]:POWer[:RF]:ATTenuation:STEP[:INCRement] 10 dB 2 dB	445
[[:SENSe]:POWer[:RF]:ATTenuation:STEP[:INCRement]?	445
[[:SENSe]:POWer[:RF]:EATTenuation <rel_ampl>	442
[[:SENSe]:POWer[:RF]:EATTenuation?	442
[[:SENSe]:POWer[:RF]:EATTenuation:STATe OFF ON 0 1	439
[[:SENSe]:POWer[:RF]:EATTenuation:STATe?	439
[[:SENSe]:POWer[:RF]:GAIN:BAND LOW FULL	470
[[:SENSe]:POWer[:RF]:GAIN:BAND?	470
[[:SENSe]:POWer[:RF]:GAIN[:STATe] OFF ON 0 1	469
[[:SENSe]:POWer[:RF]:GAIN[:STATe]?	469
[[:SENSe]:POWer[:RF]:MIXer:RANGe[:UPPer] <real>	446
[[:SENSe]:POWer[:RF]:MIXer:RANGe[:UPPer]?	446
[[:SENSe]:POWer[:RF]:MW:PATH STD LNPath MPBypass FULL	465
[[:SENSe]:POWer[:RF]:MW:PATH?	465
[[:SENSe]:POWer[:RF]:MW:PRESelector[:STATe] ON OFF 0 1	469
[[:SENSe]:POWer[:RF]:MW:PRESelector[:STATe]?	469
[[:SENSe]:POWer[:RF]:PADJust <freq>	455
[[:SENSe]:POWer[:RF]:PADJust?	455
[[:SENSe]:POWer[:RF]:PADJust:PRESelector MWAVE MMWave EXTernal	456
[[:SENSe]:POWer[:RF]:PADJust:PRESelector?	456
[[:SENSe]:POWer[:RF]:PCENter	454
:SENSe:POWer:RF:RANGe <real>	361
:SENSe:POWer:RF:RANGe <real>	361
:SENSe:POWer:RF:RANGe <real>	283

List of Commands

:SENSe:POWer:RF:RANGe?	283
:SENSe:POWer:RF:RANGe?	361
:SENSe:POWer:RF:RANGe?	361
[:SENSe]:POWer[:RF]:RANGe:AUTO ON OFF 1 0	444
[:SENSe]:POWer[:RF]:RANGe:AUTO?	444
[:SENSe]:POWer[:RF]:RANGe:OPTimize IMMEDIATE	443
[:SENSe]:POWer[:RF]:RANGe:OPTimize:ATTenuation OFF ELECTrical COMBined	443
[:SENSe]:POWer[:RF]:RANGe:OPTimize:ATTenuation?	443
[:SENSe]:ROSCillator:EXTernal:FREQuency <freq>	536
[:SENSe]:ROSCillator:EXTernal:FREQuency?	536
[:SENSe]:ROSCillator:SOURce INTernal EXTernal	534
[:SENSe]:ROSCillator:SOURce?	534
[:SENSe]:ROSCillator:SOURce:TYPE INTernal EXTernal SENSe	534
[:SENSe]:ROSCillator:SOURce:TYPE?	534
[:SENSe]:SPECTrum:ADC:DITHer:AUTO[:STATe] ON OFF 1 0	324
[:SENSe]:SPECTrum:ADC:DITHer:AUTO[:STATe]?	324
[:SENSe]:SPECTrum:ADC:DITHer[:STATe] ON OFF 1 0	324
[:SENSe]:SPECTrum:ADC:DITHer[:STATe]?	324
[:SENSe]:SPECTrum:AVERage:COUNt <integer>	308
[:SENSe]:SPECTrum:AVERage:COUNt?	308
[:SENSe]:SPECTrum:AVERage[:STATe] ON OFF 1 0	308
[:SENSe]:SPECTrum:AVERage[:STATe]?	308
[:SENSe]:SPECTrum:AVERage:TACount <integer>	310
[:SENSe]:SPECTrum:AVERage:TACount?	310
[:SENSe]:SPECTrum:AVERage:TCONtrol EXPonential REPeat	309
[:SENSe]:SPECTrum:AVERage:TCONtrol?	309
[:SENSe]:SPECTrum:AVERage:TYPE RMS LOG SCALar MAXimum MINimum 	309
[:SENSe]:SPECTrum:AVERage:TYPE?	309
[:SENSe]:SPECTrum:BANDwidth[:RESolution] <bandwidth>	289
[:SENSe]:SPECTrum:BANDwidth[:RESolution]?	289
[:SENSe]:SPECTrum:BANDwidth[:RESolution]:AUTO ON OFF 1 0	289

List of Commands

[[:SENSe]:SPECTrum:BANDwidth[:RESolution]:AUTO?	289
[[:SENSe]:SPECTrum:DIF:BANDwidth <freq>.....	316
[[:SENSe]:SPECTrum:DIF:BANDwidth?	316
[[:SENSe]:SPECTrum:DIF:BANDwidth:AUTO ON OFF 1 0	316
[[:SENSe]:SPECTrum:DIF:BANDwidth:AUTO?	316
[[:SENSe]:SPECTrum:DIF:FILTer:ALPHa <real>	320
[[:SENSe]:SPECTrum:DIF:FILTer:ALPHa?	320
[[:SENSe]:SPECTrum:DIF:FILTer:BANDwidth <freq>.....	319
[[:SENSe]:SPECTrum:DIF:FILTer:BANDwidth?	319
[[:SENSe]:SPECTrum:DIF:FILTer:BANDwidth:AUTO ON OFF 1 0	319
[[:SENSe]:SPECTrum:DIF:FILTer:BANDwidth:AUTO?	319
[[:SENSe]:SPECTrum:DIF:FILTer:TYPE?	315
[[:SENSe]:SPECTrum:DIF:FILTer:TYPE	315
[[:SENSe]:SPECTrum:FFT:LENGth <integer>.....	323
[[:SENSe]:SPECTrum:FFT:LENGth?	323
[[:SENSe]:SPECTrum:FFT:LENGth:AUTO ON OFF 1 0.....	321
[[:SENSe]:SPECTrum:FFT:LENGth:AUTO?	321
[[:SENSe]:SPECTrum:FFT:RBWPoints <real>.....	322
[[:SENSe]:SPECTrum:FFT:RBWPoints?	322
[[:SENSe]:SPECTrum:FFT:WINDow:LENGth <integer>	322
[[:SENSe]:SPECTrum:FFT:WINDow:LENGth?	322
[[:SENSe]:SPECTrum:FFT:WINDow[:TYPE] FLATtop UNIForm HANNing HAMMING GAUSSian BLACK- man BH4Tap KB70 KB90 KB110	321
[[:SENSe]:SPECTrum:FFT:WINDow[:TYPE]?	321
[[:SENSe]:SPECTrum:FREQuency:SPAN <freq>	346
[[:SENSe]:SPECTrum:FREQuency:SPAN?	346
[[:SENSe]:SPECTrum:FREQuency:SYNThesis:AUTO[:STATe] OFF ON 0 1.....	312
[[:SENSe]:SPECTrum:FREQuency:SYNThesis:AUTO[:STATe]?	312
[[:SENSe]:SPECTrum:FREQuency:SYNThesis[:STATe] 1 2 3.....	311
[[:SENSe]:SPECTrum:FREQuency:SYNThesis[:STATe]?	311
[[:SENSe]:SPECTrum:IF:GAIN:AUTO[:STATe] ON OFF 1 0.....	325

List of Commands

[[:SENSe]:SPEctrum:IF:GAIN:AUTO[:STATe]?	325
[[:SENSe]:SPEctrum:IF:GAIN:OFFSet <rel_ampl>	327
[[:SENSe]:SPEctrum:IF:GAIN:OFFSet?	327
[[:SENSe]:SPEctrum:IF:GAIN[:STATe] AUTOrangeLOW HIGH	326
[[:SENSe]:SPEctrum:IF:GAIN[:STATe]?	326
[[:SENSe]:SPEctrum:SRATe?	318
[[:SENSe]:SPEctrum:WBIF:FILTer:BANDwidth <real>	319
[[:SENSe]:SPEctrum:WBIF:FILTer:BANDwidth?	319
[[:SENSe]:SPEctrum:WBIF:FILTer[:TYPE]?	315
[[:SENSe]:SPEctrum:WBIF:FILTer[:TYPE]	315
[[:SENSe]:SWEep:EGATe:CONTRol EDGE LEVel	891
[[:SENSe]:SWEep:EGATe:CONTRol?	891
[[:SENSe]:SWEep:EGATe:DELay <time>	887
[[:SENSe]:SWEep:EGATe:DELay?	887
[[:SENSe]:SWEep:EGATe:DELay:COMPensation:TYPE OFF SETTled GDELay	893
[[:SENSe]:SWEep:EGATe:DELay:COMPensation:TYPE?	893
[[:SENSe]:SWEep:EGATe:EXTernal[1] 2:LEVel <voltage>	896
[[:SENSe]:SWEep:EGATe:EXTernal[1] 2:LEVel?	896
[[:SENSe]:SWEep:EGATe:HOLDoff <time>	892
[[:SENSe]:SWEep:EGATe:HOLDoff?	892
[[:SENSe]:SWEep:EGATe:HOLDoff:AUTO OFF ON 0 1	892
[[:SENSe]:SWEep:EGATe:HOLDoff:AUTO?	892
[[:SENSe]:SWEep:EGATe:LENGth <time>	887
[[:SENSe]:SWEep:EGATe:LENGth?	887
[[:SENSe]:SWEep:EGATe:METHod LO VIDeo FFT	888
[[:SENSe]:SWEep:EGATe:METHod?	888
[[:SENSe]:SWEep:EGATe:MINFast?	895
[[:SENSe]:SWEep:EGATe:POLarity NEGative POSitive	896
[[:SENSe]:SWEep:EGATe:POLarity?	896
[[:SENSe]:SWEep:EGATe:SOURce EXTernal1 EXTernal2 LINE FRAME RFBurst	890
[[:SENSe]:SWEep:EGATe:SOURce?	890

List of Commands

[[:SENSe]:SWEep:EGATe[:STATe] OFF ON 0 1	881
[[:SENSe]:SWEep:EGATe[:STATe]?	881
[[:SENSe]:SWEep:EGATe:TIME <time>.	886
[[:SENSe]:SWEep:EGATe:TIME?	886
[[:SENSe]:SWEep:EGATe:VIEW ON OFF 1 0	883
[[:SENSe]:SWEep:EGATe:VIEW?	883
[[:SENSe]:SWEep:EGATe:VIEW:STARt <time>	886
[[:SENSe]:SWEep:EGATe:VIEW:STARt?	886
[[:SENSe]:SWEep:FFT:WIDTh <real>	877
[[:SENSe]:SWEep:FFT:WIDTh?	877
[[:SENSe]:SWEep:FFT:WIDTh:AUTO OFF ON 0 1	878
[[:SENSe]:SWEep:FFT:WIDTh:AUTO?	878
[[:SENSe]:SWEep:POINts <integer>	897
[[:SENSe]:SWEep:POINts?	897
[[:SENSe]:SWEep:TIME <time>	868
[[:SENSe]:SWEep:TIME?	868
[[:SENSe]:SWEep:TIME:AUTO OFF ON 0 1	868
[[:SENSe]:SWEep:TIME:AUTO?	868
[[:SENSe]:SWEep:TIME:AUTO:RULes NORMAl ACCuracy SRESponse	870
[[:SENSe]:SWEep:TIME:AUTO:RULes?	870
[[:SENSe]:SWEep:TIME:AUTO:RULes:AUTO[:STATe] ON OFF 1 0	871
[[:SENSe]:SWEep:TIME:AUTO:RULes:AUTO[:STATe]?	871
[[:SENSe]:SWEep:TIME:GATE:LEVel HIGH LOW	896
[[:SENSe]:SWEep:TIME:GATE:LEVel?	896
[[:SENSe]:SWEep:TYPE FFT SWEep	873
[[:SENSe]:SWEep:TYPE?	873
[[:SENSe]:SWEep:TYPE:AUTO OFF ON 0 1	874
[[:SENSe]:SWEep:TYPE:AUTO?	874
[[:SENSe]:SWEep:TYPE:AUTO:RULes SPEEd DRANge	875
[[:SENSe]:SWEep:TYPE:AUTO:RULes?	875
[[:SENSe]:SWEep:TYPE:AUTO:RULes:AUTO[:STATe] OFF ON 0 1	876

List of Commands

[[:SENSe]:SWEep:TYPE:AUTO:RULEs:AUTO[:STATe]?	876
[[:SENSe]:SWEep:TZOom:POINts <integer>	899
[[:SENSe]:SWEep:TZOom:POINts?	899
[[:SENSe]:VOLTage POWER:IQ:MIRROred OFF ON 0 1	449
[[:SENSe]:VOLTage POWER:IQ:MIRROred?	449
[[:SENSe]:VOLTage:IQ[:I]:RANGe[:UPPer] <voltage>	448
[[:SENSe]:VOLTage:IQ[:I]:RANGe[:UPPer]?	448
[[:SENSe]:VOLTage:IQ:Q:RANGe[:UPPer] <voltage>	450
[[:SENSe]:VOLTage:IQ:Q:RANGe[:UPPer]?	450
[[:SENSe]:VOLTage:IQ:RANGe:AUTO OFF ON 0 1	447
[[:SENSe]:VOLTage:IQ:RANGe:AUTO?	447
[[:SENSe]:WAVEform:ADC:DITHer:AUTO[:STATe] OFF ON 0 1	406
[[:SENSe]:WAVEform:ADC:DITHer:AUTO[:STATe]?	406
[[:SENSe]:WAVEform:ADC:DITHer[:STATe] OFF ON 0 1	406
[[:SENSe]:WAVEform:ADC:DITHer[:STATe]?	406
[[:SENSe]:WAVEform:APERture?	401
[[:SENSe]:WAVEform:AVERage:COUNt <integer>	398
[[:SENSe]:WAVEform:AVERage:COUNt?	398
[[:SENSe]:WAVEform:AVERage[:STATe] OFF ON 0 1	398
[[:SENSe]:WAVEform:AVERage[:STATe]?	398
[[:SENSe]:WAVEform:AVERage:TACount <integer>	400
[[:SENSe]:WAVEform:AVERage:TACount?	400
[[:SENSe]:WAVEform:AVERage:TCONtrol EXPOnential REPeat	399
[[:SENSe]:WAVEform:AVERage:TCONtrol?	399
[[:SENSe]:WAVEform:AVERage:TYPE LOG MAXimum MINimum RMS SCALar	399
[[:SENSe]:WAVEform:AVERage:TYPE?	399
[[:SENSe]:WAVEform:BANDwidth[:RESolution]	368
[[:SENSe]:WAVEform:DIF:BANDwidth <freq>	367
[[:SENSe]:WAVEform:DIF:BANDwidth?	367
[[:SENSe]:WAVEform:DIF:FILTer:ALPHa <real>	379
[[:SENSe]:WAVEform:DIF:FILTer:ALPHa?	379

List of Commands

[:SENSe]:WAVeform:DIF:FILTer:BANDwidth <freq>	378
[:SENSe]:WAVeform:DIF:FILTer:BANDwidth?	378
[:SENSe]:WAVeform:DIF:FILTer:BANDwidth:AUTO ON OFF 1 0	378
[:SENSe]:WAVeform:DIF:FILTer:BANDwidth:AUTO?	378
[:SENSe]:WAVeform:DIF:FILTer:TYPE GAUSSian FLATtop SNYQuist RSNYquist RCOSine RRCosine	369
[:SENSe]:WAVeform:DIF:FILTer:TYPE GAUSSian FLATtop	369
[:SENSe]:WAVeform:DIF:FILTer:TYPE?	369
[:SENSe]:WAVeform:DIF:FILTer:TYPE?	369
[:SENSe]:WAVeform:FREQuency:SYNThesis:AUTO[:STATe] OFF ON 0 1	404
[:SENSe]:WAVeform:FREQuency:SYNThesis:AUTO[:STATe]?	404
[:SENSe]:WAVeform:FREQuency:SYNThesis[:STATe] 1 2 3	403
[:SENSe]:WAVeform:FREQuency:SYNThesis[:STATe]?	403
[:SENSe]:WAVeform:IF:GAIN:AUTO[:STATe] ON OFF 1 0	407
[:SENSe]:WAVeform:IF:GAIN:AUTO[:STATe]?	407
[:SENSe]:WAVeform:IF:GAIN:OFFSet <rel_ampl >	409
[:SENSe]:WAVeform:IF:GAIN:OFFSet?	409
[:SENSe]:WAVeform:IF:GAIN[:STATe] AUTOOrange LOW HIGH	408
[:SENSe]:WAVeform:IF:GAIN[:STATe]?	408
[:SENSe]:WAVeform:SRATe <freq>	401
[:SENSe]:WAVeform:SRATe?	401
[:SENSe]:WAVeform:SWEep:TIME <time>	402
[:SENSe]:WAVeform:SWEep:TIME?	402
[:SENSe]:WAVeform:WBIF:FILTer:BANDwidth <real>	379
[:SENSe]:WAVeform:WBIF:FILTer:BANDwidth?	379
[:SENSe]:WAVeform:WBIF:FILTer[:TYPE] GAUSSian NONE NYQuist RNYQuist RCOSine RRCosine	369
[:SENSe]:WAVeform:WBIF:FILTer[:TYPE]?	369
:SERVice[:PRoDuction]:SIQuery:SCPI:LIST?	862
:SOURce:AM[:DEPT]h[:LINear]?	810
:SOURce:AM[:DEPT]h[:LINear]	810
:SOURce:AM:INTernal:FREQuency?	811
:SOURce:AM:INTernal:FREQuency	811

List of Commands

:SOURce:AM:STATe?	810
:SOURce:AM:STATe	810
:SOURce:FM[:DEViation]?	812
:SOURce:FM[:DEViation]	812
:SOURce:FM:INTernal:FREQuency?	812
:SOURce:FM:INTernal:FREQuency	812
:SOURce:FM:STATe?	811
:SOURce:FM:STATe	811
:SOURce:FREQuency:CHANnels:BAND NONE PGSM EGSM RGSM DCS1800 PCS1900 TGSM810 GSM450 GSM480 GSM700 GSM850 BANDI BAND DII BANDIII BANDIV BANDV BANDVI BANDVII BANDVIII BANDIX BANDX BANDXI BANDXII BAND XIII BANDXIV USCELL USPCS JAPAN KOREAN NMT IMT2K UPPER SECOND PAMR400 PAMR800 IMT EXT PCS1DOT9G AWS US2DOT5G PUBLIC LOWER BAND1 BAND2 BAND3 BAND4 BAND5 BAND6 BA ND7 BAND8 BAND10 BAND11 BAND12 BAND13 BAND14 BAND17 BAND18 BAND19 BAND20 BAND21 BAND24 BAND25 BAND33 BAND34 BAND35 BAND36 BAND37 BAND38 BAND39 BAND40 BAND41 B AND42 BAND43 BANDA BANDB BANDC BANDD BANDE BANDF	743
:SOURce:FREQuency:CHANnels:BAND?	743
:SOURce:FREQuency:CHANnels:NUMBer <int>	732
:SOURce:FREQuency:CHANnels:NUMBer?	732
:SOURce:FREQuency[:CW] <freq>	732
:SOURce:FREQuency[:CW]?	732
:SOURce:FREQuency:OFFSet <freq>	764
:SOURce:FREQuency:OFFSet?	764
:SOURce:FREQuency:REFerence <freq>	763
:SOURce:FREQuency:REFerence?	763
:SOURce:FREQuency:REFerence:SET	762
:SOURce:FREQuency:REFerence:STATe OFF ON 0 1	763
:SOURce:FREQuency:REFerence:STATe?	763
:SOURce:LIST:INITiation:ARMed?	858
:SOURce:LIST:MPADapter:CORRection:ERRor?	857
:SOURce:LIST:MPADapter:PORT:OUTPut:BITMap:MODE LIST FIXed	857
:SOURce:LIST:MPADapter:PORT:OUTPut:BITMap:MODE?	857
:SOURce:LIST:NUMBer:STEPs <integer>	816
:SOURce:LIST:NUMBer:STEPs?	816

List of Commands

:SOURce:LIST:SETup:AMPLitude <ampl>, <ampl>, <ampl>,	853
:SOURce:LIST:SETup:AMPLitude?	853
:SOURce:LIST:SETup:CLear	856
:SOURce:LIST:SETup:CNFRequency <double>, <double>, <double>,	852
:SOURce:LIST:SETup:CNFRequency?	852
:SOURce:LIST:SETup:DURation:TYPE <enum>, <enum>, <enum>,	854
:SOURce:LIST:SETup:DURation:TYPE?	854
:SOURce:LIST:SETup:INPut:TRIGger <enum>, <enum>, <enum>,	850
:SOURce:LIST:SETup:INPut:TRIGger?	850
:SOURce:LIST:SETup:OUTPut:TRIGger <bool>, <bool>, <bool>,	856
:SOURce:LIST:SETup:OUTPut:TRIGger ?	856
:SOURce:LIST:SETup:RADio:BAND <enum>, <enum>, <enum>,	851
:SOURce:LIST:SETup:RADio:BAND?	851
:SOURce:LIST:SETup:RADio:BAND:LINK <enum>, <enum>, <enum>,	852
:SOURce:LIST:SETup:RADio:BAND:LINK?	852
:SOURce:LIST:SETup:TOCount <time/int>, <time/int>, <time/int>,	855
:SOURce:LIST:SETup:TOCount?	855
:SOURce:LIST:SETup:TRANSition:TIME <time>, <time>, <time>,	850
:SOURce:LIST:SETup:TRANSition:TIME?	850
:SOURce:LIST:SETup:WAVeform <string>, <string>, <string>,	854
:SOURce:LIST:SETup:WAVeform?	854
:SOURce:LIST[:STATe] ON OFF 1 0	815
:SOURce:LIST[:STATe]?	815
:SOURce:LIST:STEP[1] 2 3 4..1000:SETup IMMEDIATE INTERNAL KEY BUS EXTERNAL2, <time>, NONE PGSM EGSM RGSM DCS1800 PCS1900 TGSM810 GSM450 GSM480 GSM700 GSM850 BANDI BANDII BANDIII BANDIV BANDV BANDVI BANDVII BANDVIII BANDIX BANDX BANDXI BANDXII BANDXIII BANDXIV USCELL USPCS JAPAN KOREAN NMT IMT2K UPPER SECOND PAMR400 PAMR800 IMT EXT PCS1DOT9G AWS US2DOT5G PUBLIC LOWER NONE BAND1 BAND2 BAND3 BAND4 BAND5 BAND6 BAND7 BAND8 BAND10 BAND11 BAND12 BAND13 BAND14 BAND17 BAND18 BAND19 BAND20 BAND21 BAND24 BAND25 BAND33 BAND34 BAND35 BAND36 BAND37 BAND38 BAND39 BAND40 BAND41 BAND42 BAND43 BANDA BANDB BANDC BANDD BANDE BANDF, DOWN UP, <freq>, <ampl>, <string>, TIME COUNt CONTinuous, <time>, ON OFF 1 0, [<int>],	848
:SOURce:LIST:STEP[1] 2 3 4..1000:SETup?	848
:SOURce:LIST:STEP[1] 2 3...1000:SETup: RADio:BAND?	821

List of Commands

:SOURce:LIST:STEP[1] 2 3...1000:SETup:AMPLitude <double>	841
:SOURce:LIST:STEP[1] 2 3...1000:SETup:AMPLitude?	841
:SOURce:LIST:STEP[1] 2 3...1000:SETup:CNFRequency <double>	839
:SOURce:LIST:STEP[1] 2 3...1000:SETup:CNFRequency <double>	840
:SOURce:LIST:STEP[1] 2 3...1000:SETup:CNFRequency?	839
:SOURce:LIST:STEP[1] 2 3...1000:SETup:CNFRequency?	840
:SOURce:LIST:STEP[1] 2 3...1000:SETup:DURation:TCOut <double>	846
:SOURce:LIST:STEP[1] 2 3...1000:SETup:DURation:TCOut <double>	847
:SOURce:LIST:STEP[1] 2 3...1000:SETup:DURation:TCOut?	846
:SOURce:LIST:STEP[1] 2 3...1000:SETup:DURation:TCOut?	847
:SOURce:LIST:STEP[1] 2 3...1000:SETup:DURation:TYPE TIME COUNt CONTinuous	845
:SOURce:LIST:STEP[1] 2 3...1000:SETup:DURation:TYPE?	845
:SOURce:LIST:STEP[1] 2 3...1000:SETup:INPut:TRIGger IMMEDIATE INTernal EXTernal2 KEY BUS	818
:SOURce:LIST:STEP[1] 2 3...1000:SETup:INPut:TRIGger?	818
:SOURce:LIST:STEP[1] 2 3...1000:SETup:OUTPut:TRIGger ON OFF 1 0	847
:SOURce:LIST:STEP[1] 2 3...1000:SETup:OUTPut:TRIGger	847
:SOURce:LIST:STEP[1] 2 3...1000:SETup:RADio:BAND NONE PGSM EGSM RGSM DCS1800 PCS1900 TGSM810 GSM450 GSM480 GSM700 GSM850 BANDI BAN DII BANDIII BANDIV BANDV BANDVI BANDVII BANDVIII BANDIX BANDX BANDXI BANDXII BAND XIII BANDXIV USCELL USPCS JAPAN KOREAN NMT IMT2K UPPER SECOND PAMR400 PAMR800 IMT EXT PCS1DOT9G AWS US2DOT5G PUBLIC LOWER NONE BAND1 BAND2 BAND3 BAND4 BAND5 BAN D6 BAND7 BAND8 BAND10 BAND11 BAND12 BAND13 BAND14 BAND17 BAND18 BAND19 BAND20 B AND21 BAND24 BAND25 BAND33 BAND34 BAND35 BAND36 BAND37 BAND38 BAND39 BAND40 BAN D41 BAND42 BAND43 BANDA BANDB BANDC BANDD BANDE BANDF	821
:SOURce:LIST:STEP[1] 2 3...1000:SETup:RADio:BAND:LINK DOWN UP	839
:SOURce:LIST:STEP[1] 2 3...1000:SETup:RADio:BAND:LINK?	839
:SOURce:LIST:STEP[1] 2 3...1000:SETup:TRANSition:TIME <time>	821
:SOURce:LIST:STEP[1] 2 3...1000:SETup:TRANSition:TIME?	821
:SOURce:LIST:STEP[1] 2 3...1000:SETup:WAVEform <string>	842
:SOURce:LIST:STEP[1] 2 3...1000:SETup:WAVEform?	842
:SOURce:LIST:TRIG	90
:SOURce:LIST:TRIGger[:IMMEDIATE]	815
:SOURce:LIST:TRIGger:INITiate[:IMMEDIATE]	816
:SOURce:PM[:DEViation]?	813

List of Commands

:SOURce:PM[:DEVIation].	813
:SOURce:PM:INternal:FREQuency?	813
:SOURce:PM:INternal:FREQuency	813
:SOURce:PM:STATe?	813
:SOURce:PM:STATe	813
:SOURce:POWer:ALC[:STATe] ON OFF 1 0	730
:SOURce:POWer:ALC[:STATe]?	730
:SOURce:POWer[:LEVel][:IMMediate][:AMPLitude] <ampl>	726
:SOURce:POWer[:LEVel][:IMMediate][:AMPLitude]?	726
:SOURce:POWer[:LEVel][:IMMediate]:OFFSet <rel_ampl>.	730
:SOURce:POWer[:LEVel][:IMMediate]:OFFSet?	730
:SOURce:POWer:REFeRence <ampl>	729
:SOURce:POWer:REFeRence?	729
:SOURce:POWer:REFeRence:STATe OFF ON 0 1	729
:SOURce:POWer:REFeRence:STATe?	729
:SOURce:PRESet.	858
:SOURce:RADio:ARB: DEFault:DIRectory?	769
:SOURce:RADio:ARB:BASeband:FREQuency:OFFSet <freq>	773
:SOURce:RADio:ARB:BASeband:FREQuency:OFFSet?	773
:SOURce:RADio:ARB:CATalog?	771
:SOURce:RADio:ARB:DEFault:DIRectory <string>	769
:SOURce:RADio:ARB:DELeTe <string>	769
:SOURce:RADio:ARB:DELeTe:ALL	770
:SOURce:RADio:ARB:FCATalog?	771
:SOURce:RADio:ARB:HEADer:CLear	807
:SOURce:RADio:ARB:HEADer:INformation?	809
:SOURce:RADio:ARB:HEADer:SAVE	808
:SOURce:RADio:ARB:LOAD <string>	767
:SOURce:RADio:ARB:LOAD:ALL <string>.	768
:SOURce:RADio:ARB:MDEStination:ALCHold NONE M1 M2 M3 M4	806
:SOURce:RADio:ARB:MDEStination:ALCHold?	806

List of Commands

:SOURce:RADio:ARB:MDEStination:PULSe NONE M1 M2 M3 M4	804
:SOURce:RADio:ARB:MDEStination:PULSe?	804
:SOURce:RADio:ARB:MPLicensed:NAME:LOCKed?	801
:SOURce:RADio:ARB:MPLicensed:UID:LOCKed?	801
:SOURce:RADio:ARB:MPOLarity:MARKer1 POSitive NEGative.	802
:SOURce:RADio:ARB:MPOLarity:MARKer1?	802
:SOURce:RADio:ARB:MPOLarity:MARKer2 POSitive NEGative.	802
:SOURce:RADio:ARB:MPOLarity:MARKer2?	802
:SOURce:RADio:ARB:MPOLarity:MARKer3 POSitive NEGative.	803
:SOURce:RADio:ARB:MPOLarity:MARKer3?	803
:SOURce:RADio:ARB:MPOLarity:MARKer4 POSitive NEGative.	803
:SOURce:RADio:ARB:MPOLarity:MARKer4?	803
:SOURce:RADio:ARB:RETRigger ON OFF IMMediate	775
:SOURce:RADio:ARB:RETRigger?	775
:SOURce:RADio:ARB:RSCaling <real>	772
:SOURce:RADio:ARB:RSCaling?	772
:SOURce:RADio:ARB:SCLock:RATE <freq>	772
:SOURce:RADio:ARB:SCLock:RATE?	772
:SOURce:RADio:ARB:SEQuence[:MWAVeform] <filename>, <waveform1>, <reps>, NONE M1 M2 M3 M4 M1M2 M1M3 M1M4 M2M3 M2M4 M3M4 M1M2M3 M1M2M4 M1M3M4 M2M3M4 M1M2M3M4 ALL, {<waveform2>, <reps>, NONE M1 M2 M3 M4 M1M2 M1M3 M1M4 M2M3 M2M4 M3M4 M1M2M3 M1M2M4 M1M3M4 M2M3M4 M1M2M3M4 ALL, }	784
:SOURce:RADio:ARB:SEQuence[:MWAVeform]? <filename>	784
:SOURce:RADio:ARB[:STATe] ON OFF 1 0	765
:SOURce:RADio:ARB[:STATe]?	765
:SOURce:RADio:ARB:TRIGger:INITiate	810
:SOURce:RADio:ARB:TRIGger[:SOURce] KEY BUS EXTernal2	777
:SOURce:RADio:ARB:TRIGger[:SOURce]?	777
:SOURce:RADio:ARB:TRIGger:TYPE CONTInuous SINGLE SADVance GATE.	774
:SOURce:RADio:ARB:TRIGger:TYPE?	774
:SOURce:RADio:ARB:TRIGger:TYPE:CONTInuous[:TYPE] FREE TRIGger RESet.	774

List of Commands

:SOURce:RADio:ARB:TRIGger:TYPE:CONTInuous[:TYPE]?	774
:SOURce:RADio:ARB:TRIGger:TYPE:SADVance[:TYPE] SINGLE CONTInuous	777
:SOURce:RADio:ARB:TRIGger:TYPE:SADVance[:TYPE]?	777
:SOURce:RADio:ARB:WAVEform <string>	766
:SOURce:RADio:ARB:WAVEform?	766
:SOURce:RADio:BAND:LINK DOWN UP	761
:SOURce:RADio:BAND:LINK?	761
:SOURce:RADio:MPADapter:CORRection:ERRor?	814
:SOURce:SELF:TEST[:ALL]	859
*SRE <integer>	133
*SRE?	133
*STB?	134
:SYSTem:APPLication:CATalog[:NAME]?	481
:SYSTem:APPLication:CATalog[:NAME]:COUNt?	480
:SYSTem:APPLication:CATalog:OPTion? <model>	481
:SYSTem:APPLication:CATalog:REVision? <model>	481
:SYSTem:APPLication[:CURRent][:NAME]?	479
:SYSTem:APPLication[:CURRent]:OPTion?	480
:SYSTem:APPLication[:CURRent]:REVision?	479
:SYSTem:COMMunicate:GPIB[1][:SELF]:ADDRes <integer>	241
:SYSTem:COMMunicate:GPIB[1][:SELF]:ADDRes?	241
:SYSTem:COMMunicate:GPIB[1][:SELF]:CONTRoller[:ENABle] ON OFF 0 1	242
:SYSTem:COMMunicate:GPIB[1][:SELF]:CONTRoller[:ENABle]?	242
:SYSTem:COMMunicate:LAN:SCPI:HISLip:ENABle OFF ON 0 1	245
:SYSTem:COMMunicate:LAN:SCPI:HISLip:ENABle?	245
:SYSTem:COMMunicate:LAN:SCPI:SICL:ENABle OFF ON 0 1	245
:SYSTem:COMMunicate:LAN:SCPI:SICL:ENABle?	245
:SYSTem:COMMunicate:LAN:SCPI:SOCKet:CONTRol?	246
:SYSTem:COMMunicate:LAN:SCPI:SOCKet:ENABle OFF ON 0 1	244
:SYSTem:COMMunicate:LAN:SCPI:SOCKet:ENABle?	244
:SYSTem:COMMunicate:LAN:SCPI:TELNet:ENABle OFF ON 0 1	243

List of Commands

:SYSTem:COMMunicate:LAN:SCPI:TELNet:ENABle?	243
:SYSTem:COMMunicate:USB:CONNection?	248
:SYSTem:COMMunicate:USB:PACKets?	250
:SYSTem:COMMunicate:USB:STATus?	249
:SYSTem:CONFiGure[:SYSTem]?	188
:SYSTem:CSYStem?	188
:SYSTem:DATE “<year>,<month>,<day>”	273
:SYSTem:DATE?	273
:SYSTem:DEFault [ALL] ALIGn INPut MISC MODEs PON	250
:SYSTem:ERRor[:NEXT]?	183
:SYSTem:ERRor:OVERload[:STATe] 0 1 OFF ON	186
:SYSTem:ERRor:VERBoSe OFF ON 0 1	185
:SYSTem:ERRor:VERBoSe?	185
:SYSTem:HELP:HEADers?	272
:SYSTem:HID?	258
:SYSTem:IDN <string>	247
:SYSTem:IDN?	247
:SYSTem:KLOCK OFF ON 0 1	272
:SYSTem:KLOCK?	272
:SYSTem:LIcense:EXTernal:LIST?	860
:SYSTem:LIcense[:FPACK]:WAVEform:ADD <string>	794
:SYSTem:LIcense[:FPACK]:WAVEform:CLEAr <int>	797
:SYSTem:LIcense[:FPACK]:WAVEform:FREE?	799
:SYSTem:LIcense[:FPACK]:WAVEform:LOCK <int>	798
:SYSTem:LIcense[:FPACK]:WAVEform:NAME? <int>	800
:SYSTem:LIcense[:FPACK]:WAVEform:REPLace <int>, <string>	796
:SYSTem:LIcense[:FPACK]:WAVEform:STATus? <int>	798
:SYSTem:LIcense[:FPACK]:WAVEform:UID? <int>	800
:SYSTem:LIcense[:FPACK]:WAVEform:USED?	799
:SYSTem:LIcense:LIST:DETail?	860
:SYSTem:LKEY <”OptionInfo”>, <”LicenseInfo”>	256

List of Commands

:SYSTem:LKEY? <"OptionInfo">	257
:SYSTem:LKEY:DELeTe <"OptionInfo">,<"LicenseInfo">	256
:SYSTem:LKEY:LIST?	257
:SYSTem:LKEY:WAVeform:ADD <string>	794
:SYSTem:LKEY:WAVeform:CLEAr <int>	797
:SYSTem:LKEY:WAVeform:FREE?	799
:SYSTem:LKEY:WAVeform:LOCK <int>	798
:SYSTem:LKEY:WAVeform:NAME? <int>	800
:SYSTem:LKEY:WAVeform:REPLace <int>,<string>	796
:SYSTem:LKEY:WAVeform:STATus? <int>	798
:SYSTem:LKEY:WAVeform:UID? <int>	800
:SYSTem:LKEY:WAVeform:USED?	799
:SYSTem:MRELay:COUNT?	260
:SYSTem:OPTions?	271
:SYSTem:PDOWn [NORMal FORCe]	271
:SYSTem:PON:APPLication:LLISt <string of INSTrument:SELeCt names>	197
:SYSTem:PON:APPLication:LLISt?	197
:SYSTem:PON:APPLication:VMEMory[:AVAIlable]?	197
:SYSTem:PON:APPLication:VMEMory:TOTal?	197
:SYSTem:PON:APPLication:VMEMory:USED?	198
:SYSTem:PON:APPLication:VMEMory:USED:NAME? <INSTrument:SELeCt name>	198
:SYSTem:PON:ETIME?	261
:SYSTem:PON:MODE SA BASIC ADEMOD NFIGURE PNOISE CDMA2K TDSCD- MA VSA VSA89601 WCDMA WIMAXOFDMA	192
:SYSTem:PON:MODE?	192
:SYSTem:PON:TIME?	214
:SYSTem:PON:TYPE MODE USER LAST	190
:SYSTem:PON:TYPE?	190
:SYSTem:PRESet	142
:SYSTem:PRESet:TYPE FACTory MODE USER	145
:SYSTem:PRESet:TYPE?	145

List of Commands

:SYSTem:PRESet:USER	275
:SYSTem:PRESet:USER:ALL	276
:SYSTem:PRESet:USER:SAVE	276
:SYSTem:PRINt:THEMe TDColor TDMonochrome FCOLor FMONochrome	140
:SYSTem:PRINt:THEMe?	140
:SYSTem:PUP:PROcEss	195
:SYSTem:SHOW OFF ERRor SYSTem HARDware LXI HWStatistIcs ALIGnment SOFTware CAPPLIcation	182
:SYSTem:SHOW?	182
:SYSTem:TEMPerature:HEXTreme?	261
:SYSTem:TEMPerature:LEXtreme?	260
:SYSTem:TEST:WCTS:[ALL]	262
:SYSTem:TEST:WCTS:FEC	264
:SYSTem:TEST:WCTS:FEC:RESult?	268
:SYSTem:TEST:WCTS:MPADapter	263
:SYSTem:TEST:WCTS:MPADapter:RESult?	267
:SYSTem:TEST:WCTS:SHOW:RESult FEC	267
:SYSTem:TEST:WCTS:SHOW:RESult MPADapter	266
:SYSTem:TEST:WCTS:SHOW:RESult SOURce	264
:SYSTem:TEST:WCTS:SOURce	263
:SYSTem:TEST:WCTS:SOURce:RESult?	265
:SYSTem:TIME "<hour>,<minute>,<second>"	273
:SYSTem:TIME?	273
:SYSTem:VERSion?	272
:TRACe:SPECTrum:STRace[:STATe] OFF ON 0 1	351
:TRACe:SPECTrum:STRace[:STATe]?	351
*TRG	134
:TRIGger:<measurement>[:SEQuence]:IQ:SOURce EXTernal1 EXTernal2 IMMedIate IQMag IDEMod QDE-Mod IINPut QINPut AIQMag	909
:TRIGger:<measurement>[:SEQuence]:IQ:SOURce?	909
:TRIGger:<measurement>[:SEQuence]:RF:SOURce EXTernal1 EXTernal2 IMMedIate LINE FRAMe RF-Burst VIDeo IF ALARm LAN TV	908
:TRIGger:<measurement>[:SEQuence]:RF:SOURce?	908

List of Commands

:TRIGger:<measurement>[:SEquence]:SOURce EXTernal1 EXTernal2 IMMediate LINE FRAME RFBurst VIDeo IF ALARm LAN IQMag IDEMod QDEMod IINPut QINPut AIQMag TV	903
:TRIGger:<measurement>[:SEquence]:SOURce?	903
:TRIGger TRIGger1 TRIGger2[:SEquence]:OUTPut HSWP MEASuring MAIN GATE GTRigger OEV-en SPOint SSWeep SSETtled S1Marker S2Marker S3Marker S4Marker OFF	570
:TRIGger TRIGger1 TRIGger2[:SEquence]:OUTPut?	570
:TRIGger TRIGger1 TRIGger2[:SEquence]:OUTPut:POLarity POSitive NEGative	571
:TRIGger TRIGger1 TRIGger2[:SEquence]:OUTPut:POLarity?	571
:TRIGger[:SEquence]:AIQMag:BANDwidth <freq>	949
:TRIGger[:SEquence]:AIQMag:BANDwidth?	949
:TRIGger[:SEquence]:AIQMag:CENTer <freq>	948
:TRIGger[:SEquence]:AIQMag:CENTer?	948
:TRIGger[:SEquence]:AIQMag:DELay <time>	948
:TRIGger[:SEquence]:AIQMag:DELay?	948
:TRIGger[:SEquence]:AIQMag:DELay:STATe OFF ON 0 1	948
:TRIGger[:SEquence]:AIQMag:DELay:STATe?	948
:TRIGger[:SEquence]:AIQMag:LEVel <ampl >	947
:TRIGger[:SEquence]:AIQMag:LEVel?	947
:TRIGger[:SEquence]:AIQMag:SLOPe POSitive NEGative	947
:TRIGger[:SEquence]:AIQMag:SLOPe?	947
:TRIGger[:SEquence]:ATRigger <time>	956
:TRIGger[:SEquence]:ATRigger?	956
:TRIGger[:SEquence]:ATRigger:STATe OFF ON 0 1	956
:TRIGger[:SEquence]:ATRigger:STATe?	956
:TRIGger[:SEquence]:DELay <time>	915
:TRIGger[:SEquence]:DELay?	915
:TRIGger[:SEquence]:DELay:STATe OFF ON 0 1	915
:TRIGger[:SEquence]:DELay:STATe?	915
:TRIGger[:SEquence]:EXTernal1:DELay <time>	920
:TRIGger[:SEquence]:EXTernal1:DELay?	920
:TRIGger[:SEquence]:EXTernal1:DELay:COMPensation OFF ON 0 1	921
:TRIGger[:SEquence]:EXTernal1:DELay:COMPensation?	921

List of Commands

:TRIGger[:SEquence]:EXTernal1:DElay:STATe OFF ON 0 1	920
:TRIGger[:SEquence]:EXTernal1:DElay:STATe?	920
:TRIGger[:SEquence]:EXTernal1:LEVel <level>	919
:TRIGger[:SEquence]:EXTernal1:LEVel?	919
:TRIGger[:SEquence]:EXTernal1:SLOPe POSitive NEGative	919
:TRIGger[:SEquence]:EXTernal1:SLOPe?	919
:TRIGger[:SEquence]:EXTernal2:DElay <time>	923
:TRIGger[:SEquence]:EXTernal2:DElay?	923
:TRIGger[:SEquence]:EXTernal2:DElay:COMPensation OFF ON 0 1	924
:TRIGger[:SEquence]:EXTernal2:DElay:COMPensation?	924
:TRIGger[:SEquence]:EXTernal2:DElay:STATe OFF ON 0 1	923
:TRIGger[:SEquence]:EXTernal2:DElay:STATe?	923
:TRIGger[:SEquence]:EXTernal2:LEVel	922
:TRIGger[:SEquence]:EXTernal2:LEVel?	922
:TRIGger[:SEquence]:EXTernal2:SLOPe POSitive NEGative	923
:TRIGger[:SEquence]:EXTernal2:SLOPe?	923
:TRIGger[:SEquence]:FRAME:ADJust <time>	933
:TRIGger[:SEquence]:FRAME:DElay <time>	937
:TRIGger[:SEquence]:FRAME:DElay?	937
:TRIGger[:SEquence]:FRAME:DElay:STATe OFF ON 0 1	937
:TRIGger[:SEquence]:FRAME:DElay:STATe?	937
:TRIGger[:SEquence]:FRAME:OFFSet <time>	932
:TRIGger[:SEquence]:FRAME:OFFSet?	932
:TRIGger[:SEquence]:FRAME:OFFSet:DISPlay:RESet	934
:TRIGger[:SEquence]:FRAME:PERiod <time>	931
:TRIGger[:SEquence]:FRAME:PERiod?	931
:TRIGger[:SEquence]:FRAME:SYNC EXTernal1 EXTernal2 RFBurst OFF	934
:TRIGger[:SEquence]:FRAME:SYNC?	934
:TRIGger[:SEquence]:FRAME:SYNC:HOLDoff <time>	938
:TRIGger[:SEquence]:FRAME:SYNC:HOLDoff?	938
:TRIGger[:SEquence]:FRAME:SYNC:HOLDoff:STATe OFF ON 0 1	938

List of Commands

:TRIGger[:SEQuence]:FRAMe:SYNC:HOLDoff:STATe?	938
:TRIGger[:SEQuence]:HOLDoff <time>	957
:TRIGger[:SEQuence]:HOLDoff?	957
:TRIGger[:SEQuence]:HOLDoff:STATe OFF ON 0 1	957
:TRIGger[:SEQuence]:HOLDoff:STATe?	957
:TRIGger[:SEQuence]:HOLDoff:TYPE NORMAl ABOVe BELow	958
:TRIGger[:SEQuence]:HOLDoff:TYPE?	958
:TRIGger[:SEQuence]:IDEMod:DELay <time>	941
:TRIGger[:SEQuence]:IDEMod:DELay?	941
:TRIGger[:SEQuence]:IDEMod:DELay:STATe OFF ON 0 1	941
:TRIGger[:SEQuence]:IDEMod:DELay:STATe?	941
:TRIGger[:SEQuence]:IDEMod:LEVel <voltage>	940
:TRIGger[:SEQuence]:IDEMod:LEVel?	940
:TRIGger[:SEQuence]:IDEMod:SLOPe POSitive NEGative	941
:TRIGger[:SEQuence]:IDEMod:SLOPe?	941
:TRIGger[:SEQuence]:IINPut:DELay <time>	944
:TRIGger[:SEQuence]:IINPut:DELay?	944
:TRIGger[:SEQuence]:IINPut:DELay:STATe OFF ON 0 1	944
:TRIGger[:SEQuence]:IINPut:DELay:STATe?	944
:TRIGger[:SEQuence]:IINPut:LEVel <voltage>	944
:TRIGger[:SEQuence]:IINPut:LEVel?	944
:TRIGger[:SEQuence]:IINPut:SLOPe POSitive NEGative	944
:TRIGger[:SEQuence]:IINPut:SLOPe?	944
:TRIGger[:SEQuence]:IQMag:DELay <time>	940
:TRIGger[:SEQuence]:IQMag:DELay?	940
:TRIGger[:SEQuence]:IQMag:DELay:STATe OFF ON 0 1	940
:TRIGger[:SEQuence]:IQMag:DELay:STATe?	940
:TRIGger[:SEQuence]:IQMag:LEVel <ampl >	939
:TRIGger[:SEQuence]:IQMag:LEVel?	939
:TRIGger[:SEQuence]:IQMag:SLOPe POSitive NEGative	939
:TRIGger[:SEQuence]:IQMag:SLOPe?	939

List of Commands

:TRIGger[:SEquence]:LINE:DELay <time>	918
:TRIGger[:SEquence]:LINE:DELay?	918
:TRIGger[:SEquence]:LINE:DELay:STATe OFF ON 0 1	918
:TRIGger[:SEquence]:LINE:DELay:STATe?	918
:TRIGger[:SEquence]:LINE:SLOPe POSitive NEGative	917
:TRIGger[:SEquence]:LINE:SLOPe?	917
:TRIGger[:SEquence]:OFFSet <time>	916
:TRIGger[:SEquence]:OFFSet?	916
:TRIGger[:SEquence]:OFFSet:STATe OFF ON 0 1	916
:TRIGger[:SEquence]:OFFSet:STATe?	916
:TRIGger[:SEquence]:QDEMod:DELay <time>	943
:TRIGger[:SEquence]:QDEMod:DELay?	943
:TRIGger[:SEquence]:QDEMod:DELay:STATe OFF ON 0 1	943
:TRIGger[:SEquence]:QDEMod:DELay:STATe?	943
:TRIGger[:SEquence]:QDEMod:LEVel <voltage>	942
:TRIGger[:SEquence]:QDEMod:LEVel?	942
:TRIGger[:SEquence]:QDEMod:SLOPe POSitive NEGative	942
:TRIGger[:SEquence]:QDEMod:SLOPe?	942
:TRIGger[:SEquence]:QINPut:DELay <time>	946
:TRIGger[:SEquence]:QINPut:DELay?	946
:TRIGger[:SEquence]:QINPut:DELay:STATe OFF ON 0 1	946
:TRIGger[:SEquence]:QINPut:DELay:STATe?	946
:TRIGger[:SEquence]:QINPut:LEVel <voltage>	945
:TRIGger[:SEquence]:QINPut:LEVel?	945
:TRIGger[:SEquence]:QINPut:SLOPe POSitive NEGative	946
:TRIGger[:SEquence]:QINPut:SLOPe?	946
:TRIGger[:SEquence]:RFBurst:DELay <time>	928
:TRIGger[:SEquence]:RFBurst:DELay?	928
:TRIGger[:SEquence]:RFBurst:DELay:COMPensation OFF ON 0 1	929
:TRIGger[:SEquence]:RFBurst:DELay:COMPensation?	929
:TRIGger[:SEquence]:RFBurst:DELay:STATe OFF ON 0 1	928

List of Commands

:TRIGger[:SEQuence]:RFBurst:DELay:STATe?	928
:TRIGger[:SEQuence]:RFBurst:LEVel:ABSolute <ampl>	925
:TRIGger[:SEQuence]:RFBurst:LEVel:ABSolute?	925
:TRIGger[:SEQuence]:RFBurst:LEVel:RELAtive <rel_ampl>	927
:TRIGger[:SEQuence]:RFBurst:LEVel:RELAtive?	927
:TRIGger[:SEQuence]:RFBurst:LEVel:TYPE ABSolute RELAtive	926
:TRIGger[:SEQuence]:RFBurst:LEVel:TYPE?	926
:TRIGger[:SEQuence]:RFBurst:SLOPe POSitive NEGAtive	928
:TRIGger[:SEQuence]:RFBurst:SLOPe?	928
:TRIGger[:SEQuence]:SLOPe POSitive NEGAtive	914
:TRIGger[:SEQuence]:SLOPe?	914
:TRIGger[:SEQuence]:TV:FMODE ENTire ODD EVEN	951
:TRIGger[:SEQuence]:TV:FMODE?	951
:TRIGger[:SEQuence]:TV:LINE <integer>	950
:TRIGger[:SEQuence]:TV:LINE?	950
:TRIGger[:SEQuence]:TV:STANdard MNTSc JNTSc NTSC443 MPAL BPAL NPAL CPAL PAL60 LSEC	953
:TRIGger[:SEQuence]:TV:STANdard?	953
:TRIGger[:SEQuence]:VIDeo:DELay <time>	915
:TRIGger[:SEQuence]:VIDeo:DELay?	915
:TRIGger[:SEQuence]:VIDeo:DELay:STATe OFF ON 0 1	915
:TRIGger[:SEQuence]:VIDeo:DELay:STATe?	915
:TRIGger[:SEQuence]:VIDeo:LEVel <ampl>	913
:TRIGger[:SEQuence]:VIDeo:LEVel?	913
:TRIGger[:SEQuence]:VIDeo:SLOPe POSitive NEGAtive	914
:TRIGger[:SEQuence]:VIDeo:SLOPe?	914
*TST?	135
:UNIT:POWEr DBM DBMV DBMA V W A DBUV DBUA DBPW DBUVM DBUAM DBPT DBG	457
:UNIT:POWEr?	457
*WAI	135

1 Using Help

The online Help system is "context-sensitive", which means that the information displayed when you invoke the Help system depends on the selected instrument Mode, Measurement and key.

NOTE The instructions for using help are applicable to the instrument front-panel as well as a virtual front panel.

TIP To view help for any front-panel key or menu key, press that key while this Help Window is open.

To scroll any page vertically, press the **Down Arrow** or **Up Arrow** front-panel keys. To locate these keys, see [“Front Panel Keys used by the Help System” on page 61](#).

NOTE **E6607C:** When using the E6607C there is no instrument front-panel. Therefore, the PC mouse and monitor are required for instrument control through a virtual front panel (VFP). For ease in using the VFP, the PC keyboard is recommended.

Structure of Help

See [“How Help is Organized” on page 58](#).

Navigating Help

- If the instrument has an attached mouse, see [“Navigating Help with a Mouse” on page 65](#).
- If the instrument does not have an attached mouse, see [“Navigating Help Without a Mouse” on page 66](#).
For specific details of how to navigate to topics, see [“Finding a Topic” on page 70](#).
- You can also copy the Help files to a separate computer and view them there. For details, see [“Viewing Help Files on a separate Computer” on page 73](#).

Locating Other Documentation

See [“Other Help Resources” on page 75](#).

Key Path	Front-panel key
Help Map ID	1001

How Help is Organized

This topic includes:

- “Help Contents Listing” on page 58
- “Key Descriptions for Each Measurement” on page 59
- “Key Information for Softkeys” on page 59
- “Common Measurement Functions” on page 60

Help Contents Listing

The listing under the Contents tab in the Help Window includes a topic for each Front-panel key and each softkey, for each available measurement.

The Contents listing is split into several major sections, as shown below for the HTML Help version of the document. The structure of the PDF version is similar.



Help information is split between these sections as follows:

1. Using Help

This section.

2. Additional Documentation

Describes available documents for the test set, with links to allow you to download or open the files.

3. About the Analyzer

Provides general information about the instrument.

4. About this Mode or Measurement Application

Provides an overview of the currently-selected Measurement Application

5. Programming the Test Set

Provides an overview of available programming information. Includes a list of all SCPI commands for the currently-selected Measurement Application.

6. System Functions

This section contains information for the following front-panel keys, which are listed in alphabetical order: **File, Preset, Print, Quick Save, Recall, Save, System, User Preset.**

The functions of these keys do not vary between measurements: they operate the same way, irrespective of which instrument measurement you have selected.

The sections for **Recall** and **Save** contain only cross-references to the respective sections in “[Common Measurement Functions](#)” on page 60, and are included here for convenience.

7. Measurement Functions

See “[Key Descriptions for Each Measurement](#)” on page 59 below.

8. Common Measurement Functions

See “[Common Measurement Functions](#)” on page 60 below.

[Back to Top](#)

Key Descriptions for Each Measurement

The Contents section for each Measurement is sub-divided into topics for each front-panel key, in alphabetical order, as shown below.

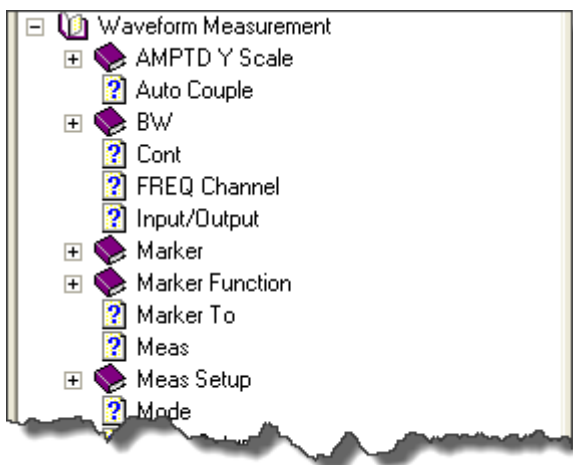

When you expand any front-panel key section, you will see a listing of softkeys in the menu for that front-panel key (if there is a menu), plus any SCPI Remote Commands associated with the functionality, as described in “[Key Information for Softkeys](#)” on page 59 below.

If you don't see a topic for a front-panel key in the Measurement-specific section, then it is located in the System Functions section.

[Back to Top](#)

Key Information for Softkeys

Information for each softkey that appears when you press a front-panel key (or a softkey with a submenu) is listed under the entry for each key.

Using Help
How Help is Organized

The example below shows the submenu under the **SPAN X Scale** Front-panel key in the "Waveform" Measurement, alongside the actual softkeys for that menu.

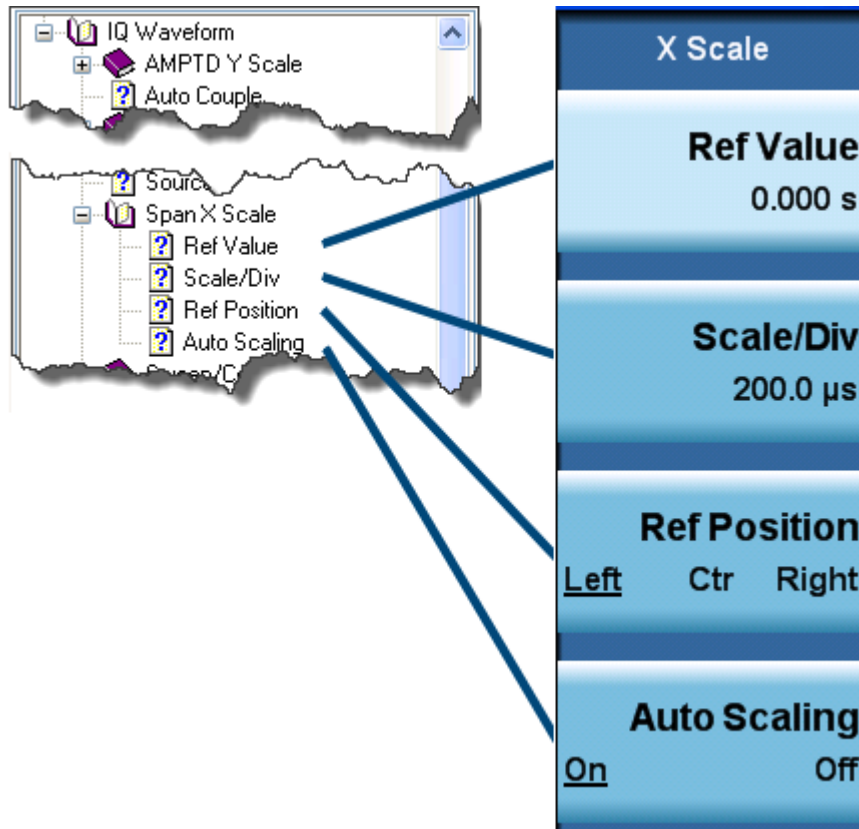

In these subsections, all softkeys are listed in the order they appear in their menu (that is, **not** in alphabetical order).

[Back to Top](#)

Common Measurement Functions

This section groups together function and key information that is shared between measurements. However, there is a listing for every front-panel key and subkey in the [Key Descriptions for Each Measurement](#), so you will generally not need to refer to this section.

The key subsections are listed alphabetically.

NOTE The presence of a key or command description in this section indicates that it is available in more than one measurement. Its presence does **not** indicate that the functionality is necessarily available in all measurements.

[Back to Top](#)

Front Panel Keys used by the Help System

The interactive Help system uses the front-panel keys shown below.

E6607A/B



E6607C

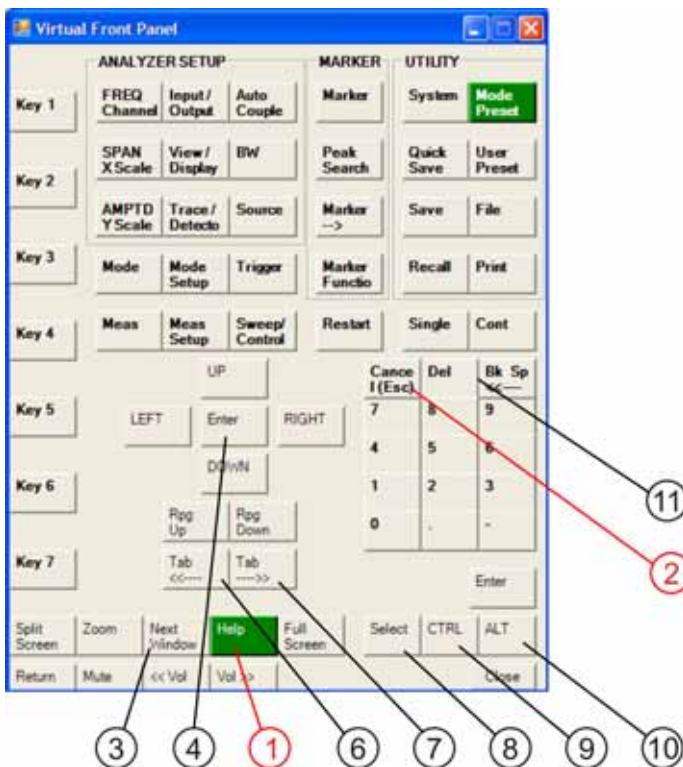

Using Help

Front Panel Keys used by the Help System

Item		Description
#	Name	
1	Help Key	Opens Help (displaying the topic for the last key pressed).
2	Cancel (Esc) Key	Exits Help.
3	Next Window Key	Changes the current window pane selection.
4	Arrow / Enter Keys	A central Enter key, surrounded by four directional arrow keys. Navigates within the Help system.
5	Knob	For future use.
6	Backward Tab Key	Moves between controls in the Help display.
7	Forward Tab Key	Moves between controls in the Help display.
8	Select / Space Key	Navigates within the Help system, in conjunction with other keys.
9	Ctrl Key	Navigates within the Help system, in conjunction with other keys. See “Navigating the Help Files” on page 63 .
10	Alt Key	Navigates within the Help system, in conjunction with other keys. See “Navigating the Help Files” on page 63 .
11	Bk Sp (Backspace) Key	Acts as a "Back" key when navigating the pages of the Help system.

[Back to Top](#)

Navigating the Help Files

This topic includes:

- “Help Window Components” on page 63
- “Basic Help Window Operations” on page 64
- “Navigating Help with a Mouse” on page 65

Help Window Components

The Help Window appears on top of, and to the left of, the measurement display. When Help is open, the instrument’s display appears as below.



1. Application Title Bar

The instrument retains its current Mode and Measurement when Help is open, as shown in the Title Bar.

2. Help Button Bar

These buttons provide shortcuts to frequently-used help functions, including printing.

3. Help Navigation Pane Tabs

Click one of these tabs to display either the Table of Contents, Index, Search, or Favorites controls.

4. Help Navigation Pane

5. Help Topic Pane

6. Previous Page and Next Page Buttons

Use these buttons to move to the previous or next page in the Help file.

7. Application Softkey Menu

You can still see and use the current softkey menu when Help is open.

When Help is open, pressing a softkey displays Help for that softkey, but does **not** execute the softkey’s function.

[Back to Top](#)

Basic Help Window Operations

This topic includes:

- “Opening Help” on page 64
- “Getting Help for a Specific Key” on page 64
- “Closing Help” on page 64
- “Viewing Help on Using Help” on page 65

For more Help window operations, see “Navigating Help Without a Mouse” on page 66.

To locate the keys mentioned in this section, see “Front Panel Keys used by the Help System” on page 61.

Opening Help

To access the Help system, press the green **Help** key below the front panel display while an Agilent application is running.



Note that the softkey menu remains visible when Help is open.

Getting Help for a Specific Key

- If Help **is** already open, press the desired key. The relevant Help topic appears.
The function normally invoked by the key is **not** executed when the key is pressed with Help open.
If you want to execute the key’s function, first close Help by pressing the **Cancel (Esc)** key (as described in “Closing Help” on page 64), then press the key, before opening Help again (if required).
- If Help is **not** already open, press the desired key (which executes the key’s function), then press the **Help** key to display the relevant Help page. Help is available for all softkeys, and for all the front-panel keys listed under the "System Functions" and "Measurement" sections.

For details of how to navigate within the panes of the Help window, see “Navigating the Help Files” on page 63.

[Back to Top](#)

Closing Help

To close Help, and return to the measurement application, press the **Cancel (Esc)** key (depicted below).



[Back to Top](#)

Viewing Help on Using Help

With the Help window open, press the green **Help** key a second time.

The "Using Help" page appears.

To exit Help on Using Help, press the **Bk Sp** key, or see [“Topic Pane Operations” on page 68](#) for equivalent methods.



[Back to Top](#)

Navigating Help with a Mouse

When Help is open, you can point-and-click to navigate, as you would when using Help for any Microsoft Windows computer application.

If you also have a keyboard attached to the instrument, you can use the Help system's full-text search feature to locate help for any topic, by typing in a key name, a topic name, or any other desired text. See [“Searching for a Help Topic” on page 66](#).

Selecting a Topic from the Contents Listing

To select and display a topic, do the following:

- If necessary, press the green **Help** key on the Front Panel, as described in [“Opening Help” on page 64](#), to open Help.
- Choose the desired topic from the list under the Contents Tab of the Navigation Pane, then click on the topic title to display the first page of the topic.
- To expand the tree and display a listing of subtopics (if any), click on the + icon to the left of the topic's book icon, as shown below.

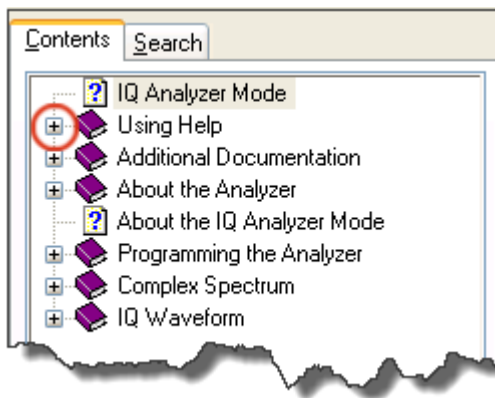

- To move to the next or previous page within a topic, click the **Next Page** or **Previous Page** keys (at the top right of the **Topic Pane**), as shown below.



[Back to Top](#)

Searching for a Help Topic

Select the "Search" tab of the Help Navigation Pane, then use the following procedure:

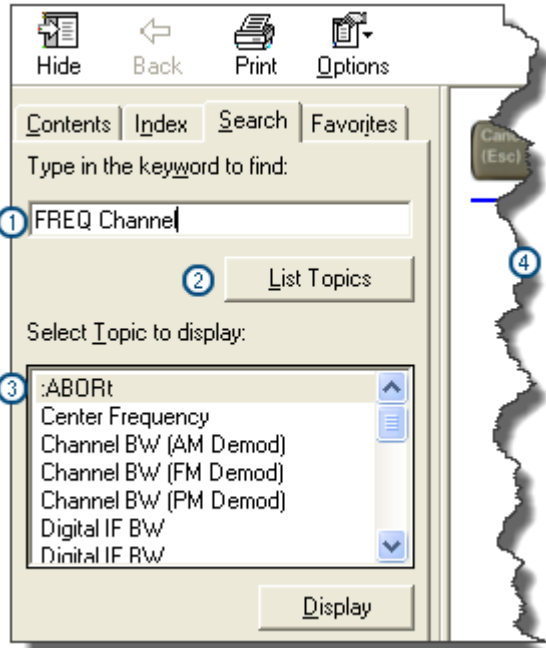

1. Type the desired topic text into the Search edit box. Note that the text search is **not** case-sensitive.
2. Click on the **List Topics** button.
3. **Either:**
Double-click on the desired topic in the list,
Or:
Click on the desired topic to select it, then click the **Display** button beneath the list.
4. The topic is displayed in the Topic Pane.

[Back to Top](#)

Navigating Help Without a Mouse

Most features of the Help system can be accessed and navigated without attaching a mouse or keyboard to the instrument.

There are a few exceptions, as noted in [“Functions that cannot be used without a Mouse and Keyboard” on page 70](#).

This topic includes:

- [“Next Window Key” on page 67](#)
- [“Contents Tab \(Navigation Pane\) Operations” on page 67](#)

- “Topic Pane Operations” on page 68
- “Selecting a Hyperlink” on page 69
- “Finding a Topic” on page 70

To locate all the keys mentioned in this section, see “Front Panel Keys used by the Help System” on page 61.

Next Window Key

- To toggle the focus between the Navigation Pane and the Topic Pane, press the **Next Window** key.



Contents Tab (Navigation Pane) Operations

- To switch the active tab, hold down the **Ctrl** key, then press either the **Forward Tab** or **Backward Tab** key.



- To scroll **horizontally**, hold down the **Ctrl** key, then press either the **Left Arrow** or **Right Arrow** keys.

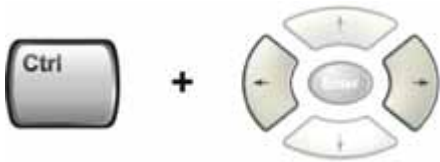

- To scroll **vertically**, hold down the **Ctrl** key, then press either the **Up Arrow** or **Down Arrow** keys.

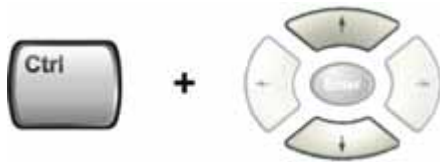

- To scroll up or down the list of topics, press the **Up Arrow** or **Down Arrow** keys.



Using Help

Navigating the Help Files

- To display a selected topic in the Topic Pane, select it in the Contents listing, then press the **Enter** key.

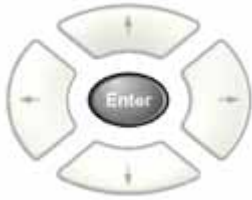

- To expand or collapse a selected topic, press the **Right Arrow** or **Left Arrow** key.

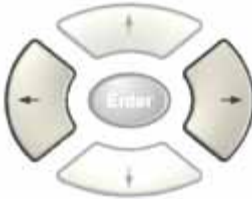

Back to Top

Topic Pane Operations

- To scroll up or down within a topic, press either the **Up Arrow** key or **Down Arrow** key.



- To go **back**
(that is, to display the previously-viewed topic), **either**:
Hold down the **Alt** key, then press the **Left Arrow** key.

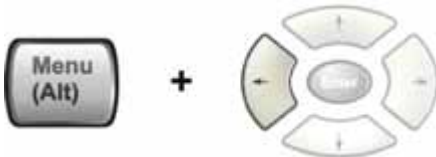

Or:

Press the **Bk Sp** key.



- To go **forward**, hold down the **Alt** key, then press the **Right Arrow** key.

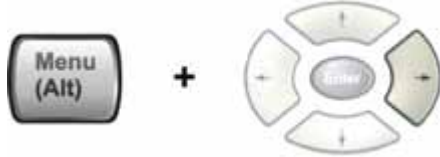

(The "Forward" operation has no effect unless there have been previous "Back" operations.)

- To go to the next or previous page, use the **Forward Tab** or **Backward Tab** keys



to select the **Next Page** or **Previous Page** key



then press **Enter**.

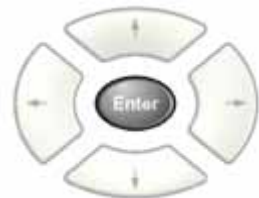

- To print the currently displayed, topic, press the Front-panel **Print** key



[Back to Top](#)

Selecting a Hyperlink

To select and follow a hyperlink on a Help page:.

1. Ensure that the focus is in the **Topic Pane**.

(If necessary, toggle the focus between the Navigation Pane and the Topic Pane by pressing the [Next Window Key](#).)

2. Move from link to link in the Topic Pane by pressing the **Forward Tab** and **Backward Tab** keys.



Links become highlighted upon selection.

Using Help

Navigating the Help Files

3. When you have selected the desired link, activate it by pressing the **Enter** key.



[Back to Top](#)

Finding a Topic

To display a different Help topic by selecting it from the Contents tab of the Navigation Pane:

1. Ensure that the focus is in the Contents tab of the Navigation Pane.
(If necessary, toggle the focus between the Navigation Pane and the Topic Pane, by pressing the [Next Window Key](#). Then press **Ctrl + Forward Tab** or **Backward Tab** to select the Contents tab.)
2. Move up or down the Contents list, by pressing the **Up Arrow** or **Down Arrow** keys.

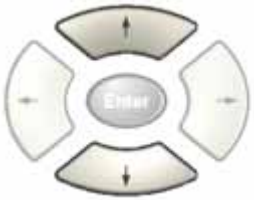

Topics become highlighted upon selection.

3. Display the selected topic, by pressing the **Enter** key.



[Back to Top](#)

Functions that cannot be used without a Mouse and Keyboard

The following parts of the HTML Help System **cannot** easily be used without attaching a mouse and keyboard to the instrument.

- The buttons in the Help Button Bar, consisting of: **Hide**, **Back**, **Print** and **Options**.
- The functionality of the Search Tab of the Navigation Pane.
- The functionality of the Favorites Tab of the Navigation Pane.

[Back to Top](#)

Definition of Terms

Many special terms are used throughout this documentation. The table below provides brief definitions of commonly-used terms. Please refer to the "Getting Started Guide" for detailed explanations.

Term	Meaning
Default Unit	The default measurement unit of the setting.
Default Terminator	Indicates the units that will be attached to the numeric value that you have entered. This default will be used from the front panel, when you terminate your entry by pressing the Enter key, rather than selecting a units key. This default will be used remotely when you send the command without specifying any units after your value(s).
Dependencies/ Couplings	Some commands may be unavailable when other parameters are set in certain ways. If applicable, any such limitations are described here.
Example	Provides command examples using the indicated remote command syntax.
Factory Preset	Describes the function settings after a Factory Preset .
Key Path	The sequence of Front-panel keys that accesses the function or setting.
Knob Increment/Decrement	The numeric value of the minimum increment or decrement that is applied when turning the thumb wheel knob.
Max	The Maximum numerical value that the setting can take.
Min	The Minimum numerical value that the setting can take.
Meas Global	The functionality described is the same in all measurements.
Meas Local	The functionality described is only true for the measurement selected.
Mode Global	The functionality described is the same for all modes.
Preset	In some cases, a Preset operation changes the status of a parameter. If the operation of the key specified is modified by a Preset operation, the effect is described here.
Range	Describes the range of the smallest to largest values to which the function can be set. If you try to set a value below the minimum value, the instrument defaults to the minimum value. If you try to set a value above the maximum value, the instrument defaults to the maximum value.
Remote Command	Shows the syntax requirements for each SCPI command.
Remote Command Notes	Additional notes regarding Remote Commands.
Resolution	Specifies the smallest change that can be made to the numeric value of a parameter.
SCPI Status Bits/ OPC Dependencies	Pressing certain keys may affect one or more status bits. If applicable, details are given here.

[Using Help](#)
Definition of Terms

Term

State Saved

Meaning

Indicates what happens to a particular function when the instrument state is saved (either to an external memory device or the internal D: drive). It also indicates whether the current settings of the function are maintained if the instrument is powered on or preset using **Power On Last State** or **User Preset**.

[Back to Top](#)

Viewing Help Files on a separate Computer

You may want to view the help pages **without** having them appear on top of the instrument's screen.

Two separate Help files are available for each instrument Mode (or Measurement Application). The two files contain all the same help pages in different formats:

1. HTML Help (CHM) format.

These files are installed on the instrument's hard disk. To copy these files to another computer, see [“Copying the HTML Help \(CHM\) Files” on page 74](#) below.

2. Adobe Acrobat (PDF) format.

These files are called "Users & Programmers References". They are included on the Documentation CD supplied with the instrument, or may be downloaded from the Agilent web site.

For details of the names and locations of these files, see [“Additional Documentation” on page 67](#).

For details of how to navigate PDF files, see [“Navigating Acrobat \(PDF\) Files” on page 75](#).

You can copy any of the CHM or PDF files to another computer, then open and view the help pages in the file on that computer.

Your choice of which file to copy and view may depend on what you want to do with the file (for example, whether you want to print it and read the paper copy, or view it on the computer).

The table below compares the relative advantages of the two formats:

Format Type	HTML Help Format (CHM Files)	Acrobat Format (PDF Files)
File Extension	CHM	PDF
Software Required to view file	Microsoft Windows operating system only, with Microsoft Internet Explorer installed.	Free Adobe Reader software can be downloaded for many operating systems, including: Microsoft Windows, Macintosh, Linux, Solaris.
Full Text Search?	Yes	Yes
Printable?	Yes, but with limited control.	Yes. Full print control. See “Printing Acrobat Files” on page 76 .
Printable Table of Contents?	No	Yes
Navigable without a Mouse and Keyboard?	Yes, but with some loss of functionality.	No
Has Page Numbers?	No	Yes
Context-Sensitive Display?	Yes, when viewed using the X-Series Analyzer application window.	No
Indexed?	Yes	No

Active Hyperlinks? Yes

Yes

[Back to Top](#)

Copying the HTML Help (CHM) Files

You can find the HTML Help (.chm) files:

- **Either**, on the documentation CD that came with the instrument,
- **Or**, in a special directory on the instrument's hard disk. The directory path is:
C:\Program Files\Agilent\SignalAnalysis\Infrastructure\Help

NOTE You can open and view the HTML Help files only on a computer that has Microsoft Windows and Microsoft Internet Explorer installed.

[Back to Top](#)

Other Help Resources

- All available documentation is present either on the test set hard disk, either as HTML Help or Acrobat PDF files, or may be downloaded from the Agilent web site.
- To view a list of links to other documentation, see “Additional Documentation” on page 67, or click the item “Additional Documentation” in the Contents tab of the Help Navigation Pane.
- Many of the supporting documents use the Adobe Acrobat (PDF) file format. You can view PDF files using the pre-installed Adobe Reader software.

The Adobe Reader user interface differs from the Windows Help interface. For full details, see “Navigating Acrobat (PDF) Files” on page 75 and “Printing Acrobat Files” on page 76.

Navigating Acrobat (PDF) Files

IMPORTANT To navigate PDF files effectively, you must attach a mouse and keyboard to the instrument. If it is not possible to attach a mouse and keyboard to the instrument, you should transfer the PDF file to a separate computer, then open it on that computer.

Acrobat Reader Window

When a PDF file is open and being viewed, the instrument’s display shows the Adobe Acrobat Reader Window, which has the following features.

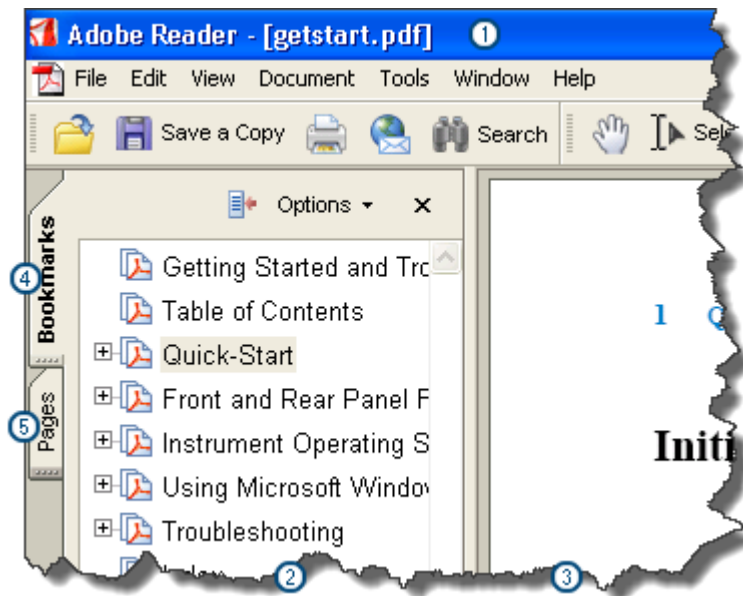

1. Adobe Acrobat Reader Window title bar
2. Navigation Pane
3. Document Pane

4. Navigation Pane: Bookmarks tab

5. Navigation Pane: Pages tab

The Navigation Pane also has tabs labeled Attachments and Comments, but, typically, PDF files for Agilent X-Series Analyzers contain useful content only under the Bookmarks and Pages Tabs.

Unlike the HTML Help Window, the Acrobat Reader Window is **not** embedded in the instrument's Application window, but can be resized, moved and closed independently of the Application window.

[Back to Top](#)

Printing Acrobat Files

NOTE The driver for the appropriate printer must be installed on the instrument's hard disk before any file can be printed. For driver installation instructions, see the printer manufacturer's documentation.

To print all or part of an open Acrobat file from the instrument, do the following.

1. **Either,**
 - a. click on the Print icon in the Acrobat Reader toolbar,
The image shows a standard printer icon with a sheet of paper coming out of the tray, set against a light background with a subtle drop shadow.
 - b. **or,** select File > Print from the menu.
2. The Acrobat Reader Print dialog opens.
3. Choose the desired options within the Print dialog, then click OK to print (or click Cancel to cancel printing).

NOTE Clicking the Properties button within the Print dialog opens a window containing controls that are specific to the printer model installed. Check the printer manufacturer's documentation for details of these capabilities.

[Back to Top](#)

Context Sensitive Help not Available

There is currently no context-sensitive help for the function you selected. However, this does not necessarily mean that no help is available for the function.

To find related information:

- If your instrument has an attached Mouse and Keyboard, see “Searching for a Help Topic” on page 66.
- If your instrument does **not** have an attached Mouse and Keyboard, see “Finding a Topic” on page 70.
- To learn how to select on-page links **without** a Mouse attached to your instrument, see “Selecting a Hyperlink” on page 69.

TIP To understand the organization of Help, see “How Help is Organized” on page 58.

Help Map ID	1002
-------------	------

Using Help
Context Sensitive Help not Available

2

About the Test Set

The EXT Wireless Communication Test Set is a one-box tester, combining a vector signal analyzer with a vector signal source in a single instrument. The analyzer and source are each provided with a dedicated list sequencer, for rapid execution of a series of stimulus or measurement steps. The test set is optimized for production testing (including calibration and verification) of wireless mobile devices.

E6607A/B



E6607C

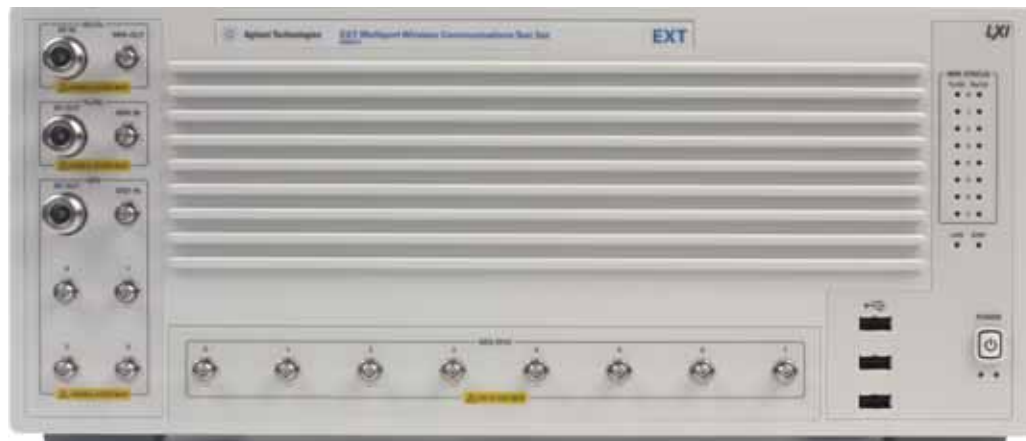

How the Test Set Is Used

The E6607A/B/C Wireless Communication Test Set is typically used in a production test environment where mobile devices are being calibrated and verified in a “non-signalling” mode (that is, in a mode of operation which does not involve call processing, and which relies instead on test functions which are built into the device under test).

The test controller communicates with both the DUT and the test set to coordinate Rx and Tx test operations and to collect test results. However, both the DUT and the test set perform their own independent operations during the process (for example, internal test routines run by the DUT, and sequences run by the test set).

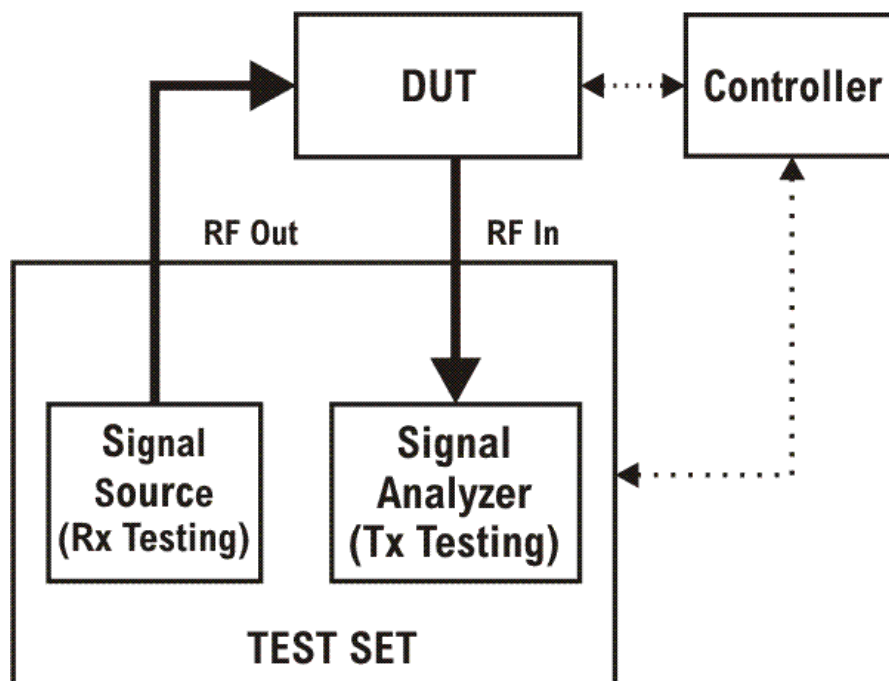

Receiver Testing

The source within the test set can supply test signals to the DUT for the purpose of receiver testing. Typically the source plays a waveform which has been downloaded to the test set (for example, a .wfm file generated using Agilent Signal Studio or some other application). In receiver testing, the test set is providing the necessary stimulus for measurements which are performed by the DUT itself, using its built-in self-test capabilities. The test results (bit error rate, for example) come back to the controller from the DUT rather than from the test set.

Transmitter Testing

The signal analyzer within the test set receives and measures signals from the DUT for the purpose of transmitter testing. Because the DUT is not being operated in a call-processing mode, the measurements

made by the analyzer pertain to signal quality (power, modulation accuracy, and so on) rather than to the data content of the transmitted signal. In transmitter testing, the measurement results come back to the controller from the test set rather than the DUT.

Hardware Elements of the Test Set

The test set includes a source and analyzer, which operate independently. You can control either of them directly (using front panel keys, the virtual front panel, or remote commands) or indirectly (by running a sequence, in which case the source and analyzer are operated by their list sequencers).

The source list sequencer and analyzer list sequencer function independently; however, you can coordinate their actions by setting them up to exchange trigger signals.

E6607A/B

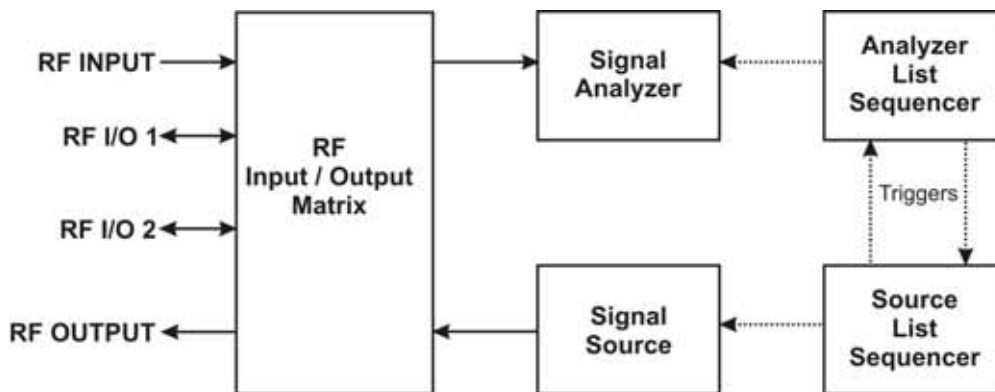

E6607C

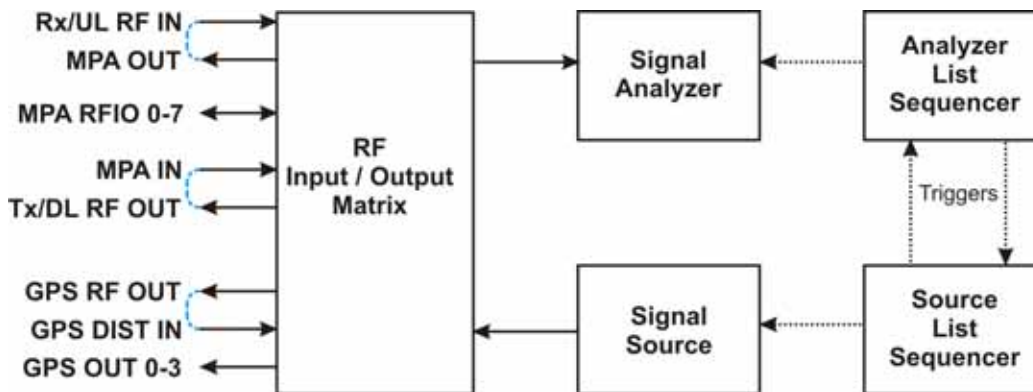

E6607A/B

The source and analyzer communicate with the device under test through an RF input/output matrix with four ports. Two of the ports have a fixed direction: an RF Output port which can be connected only to the source, and an RF Input port which can be connected only to the analyzer.

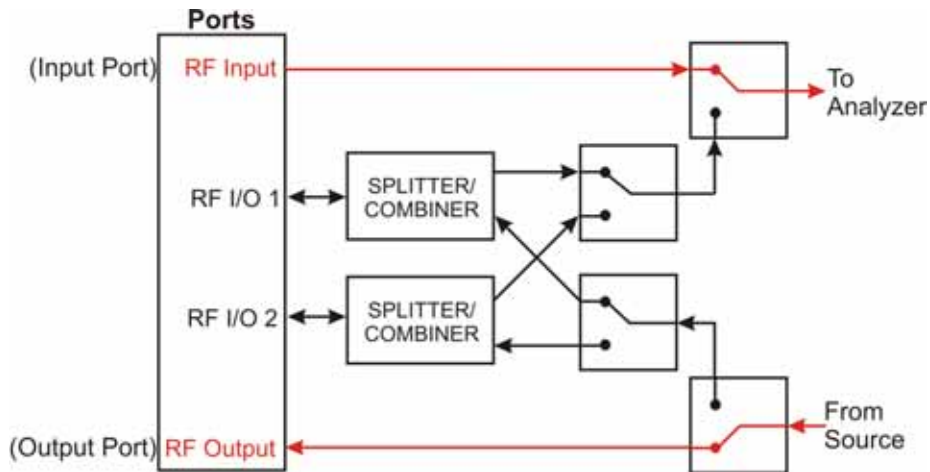

E6607C

The source and analyzer communicate with the device under test through an RF input/output matrix with multiple ports. Two of the ports have a fixed direction: an Tx/DL RF Out port which can be connected only to the source, and an Rx/UL RF In port which can be connected only to the analyzer.

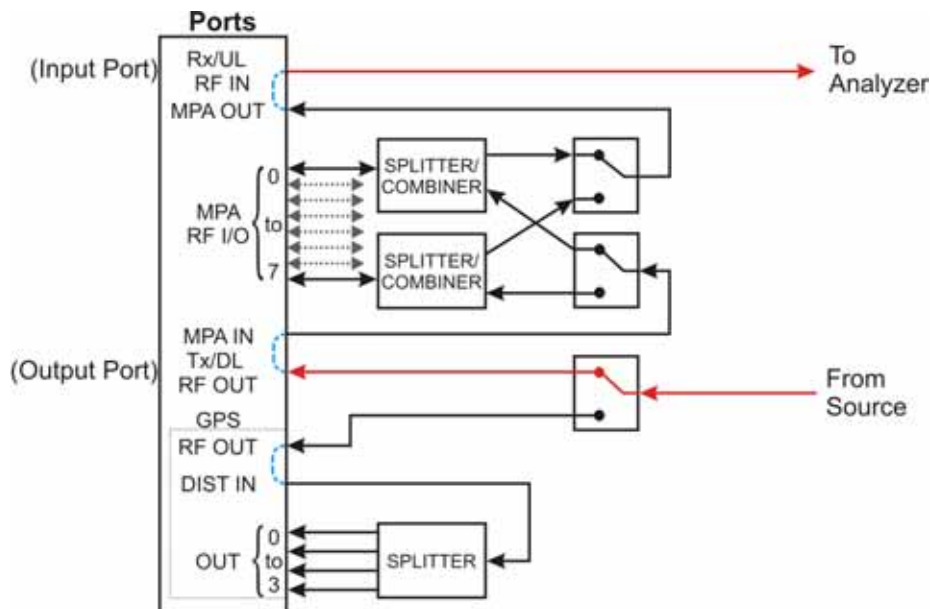

E6607A/B

The remaining two ports (the RF I/O ports) have bi-directional capability; they can be connected (through a splitter/combiner) to the source, to the analyzer, or to both at once. For example, in testing a mobile phone, both the source and the analyzer might be set up to interface with the device through the RF I/O 1 port, employing different frequencies for the transmit and receive signals.

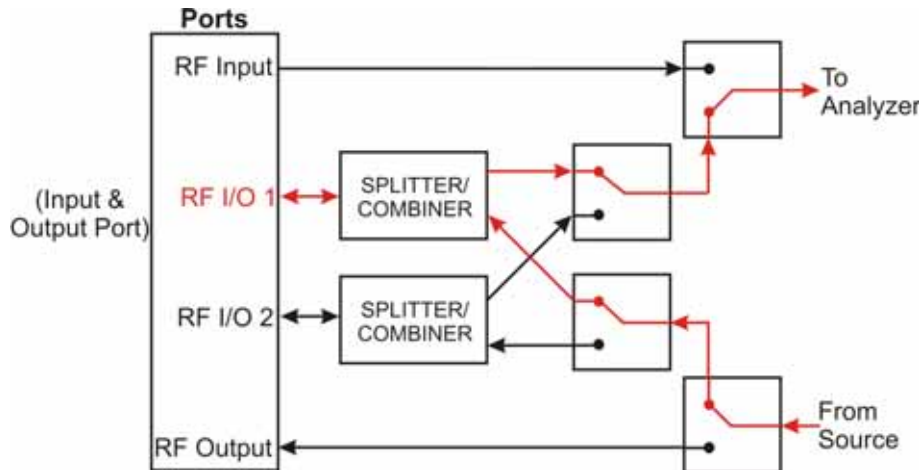

E6607C

The eight MPA RFIO ports have bi-directional capability; they can be connected (through internal splitter/combiners) to the source, to the analyzer, or to both at once. For example, in testing a mobile phone, both the source and the analyzer might be set up to interface with the device through the MPA RFIO 0 port, employing different frequencies for the transmit and receive signals.

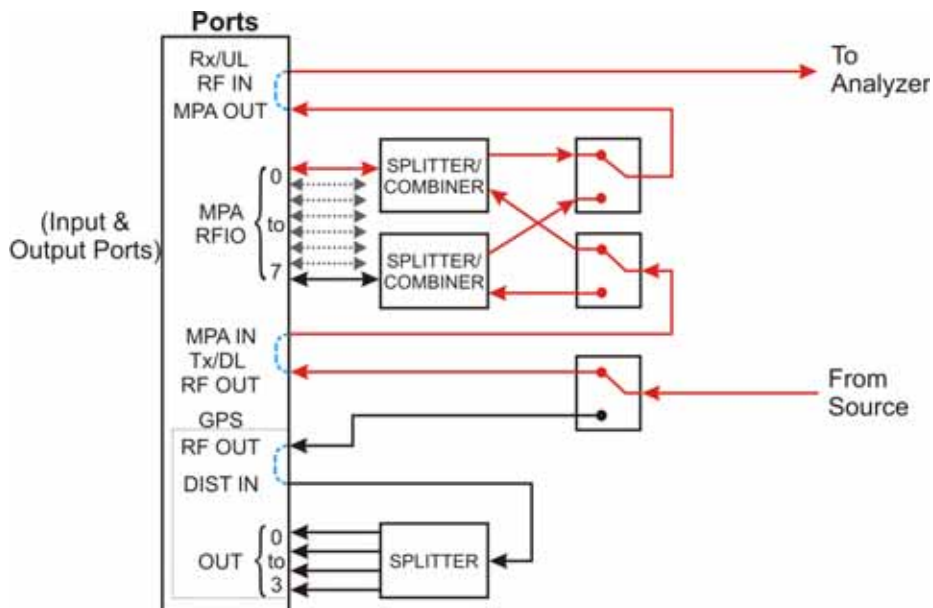

E6607A/B

The RF I/O ports can also be used in a single direction, as in the case illustrated below, where RF I/O 1 serves as the input port, and RF Output serves as the output port.

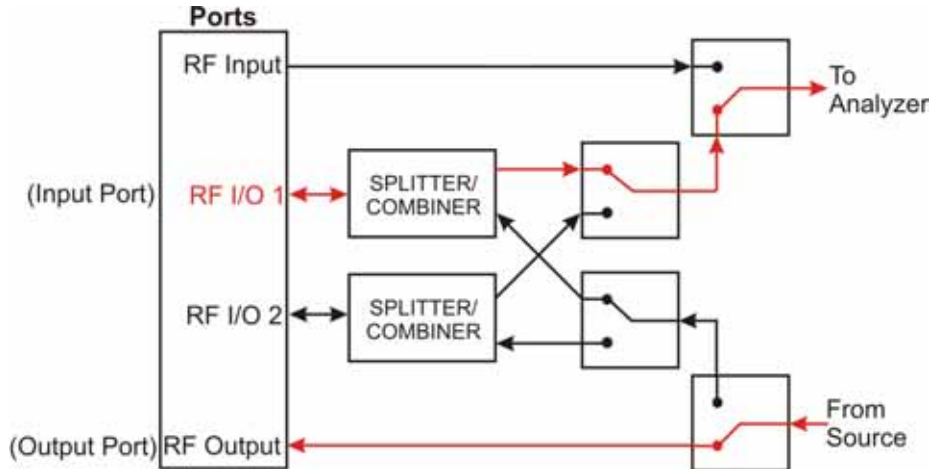

E6607C

The MPA RFIO ports can also be used in a single direction, as in the case illustrated below. In this case, the MPA RFIO 0-7 ports are paired and each pair is connected to a single DUT. In each pair, one serves as the input port and the other serves as the output port. This provides for a total of 4 DUTs connected to a single test set at the same time.

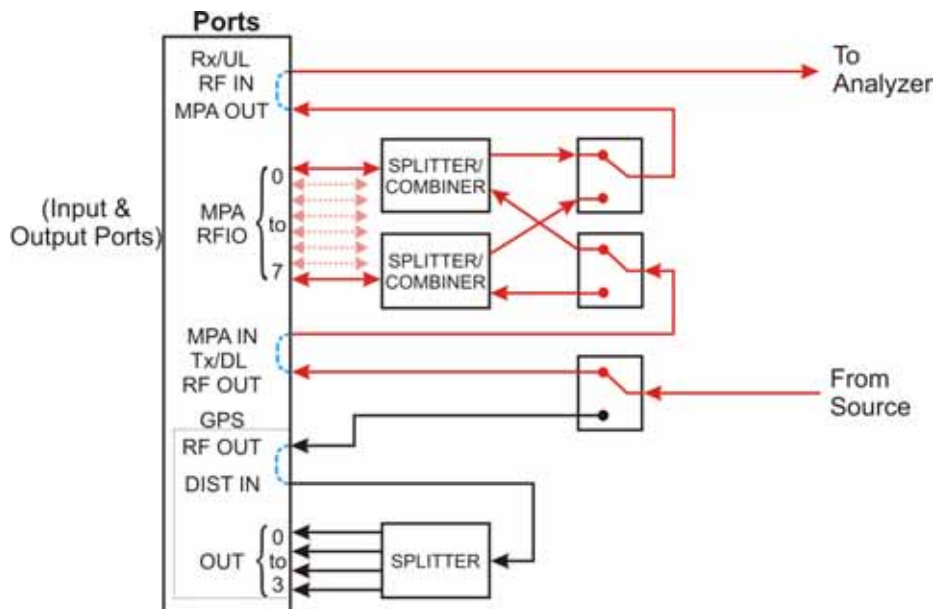

E6607C

When making GPS tests, the GPS OUT ports are fixed direction and are connected only to the source, as in the case illustrated below. In this case, four of the MPA RFIO 0-7 ports are paired with the four GPS OUT ports and each pair is connected to a single DUT. In each pair, the MPA RFIO port serves as the input port and the GPS OUT port serves as the output port. This provides for a total of 4 DUTs connected to a single test set at the same time.

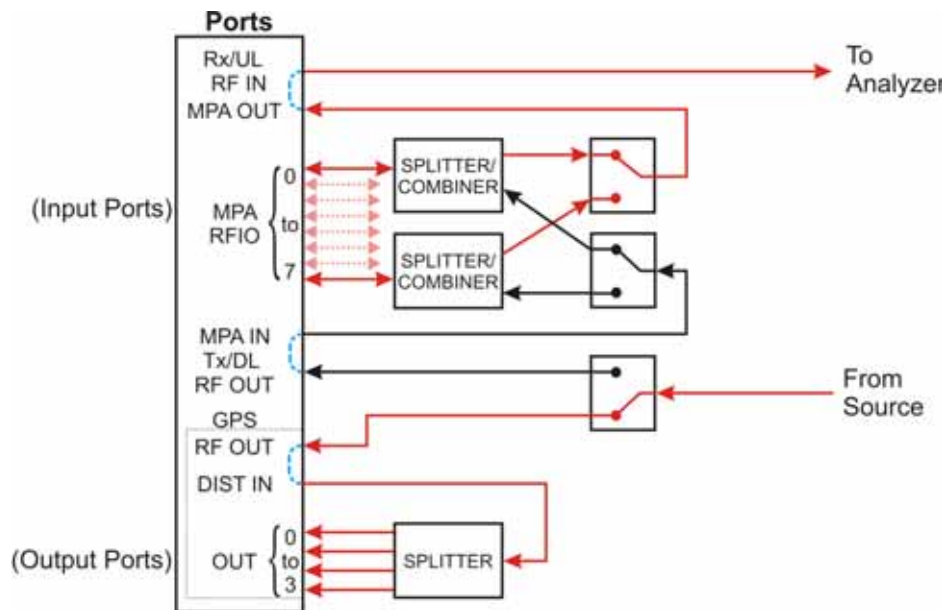

E6607A/B

For any sequence that the test set runs, a single port must be designated the input port, and a single port must be designated the output port. These port assignments cannot be changed during a sequence. The rules for port assignments are:

- Only one port at a time can be the input port, and it must be one of the following: RF Input, RF I/O 1, or RF I/O 2.
- Only one port at a time can be the output port, and it must be one of the following: RF Output, RF I/O 1, or RF I/O 2.
- RF I/O 1 can serve as both the input port and the output port simultaneously, but in that case it must be the only port in use.
- RF I/O 2 can serve as both the input port and the output port simultaneously, but in that case it must be the only port in use.

Although the two RF I/O ports cannot both be used bi-directionally at the same time, having two bi-directional ports offers practical advantages in reducing the impact of fixturing delays. For example, you can set up two sequences which are exactly alike, except that one of them designates RF I/O 1 as the input and output port, while the other sequence uses RF I/O 2 in the same way. During testing, the two sequences are run alternatively; a DUT is tested on one port while the next DUT is being fixtured on the other port.

E6607C

For any sequence that the test set runs using the MPA RFIO or GPS OUT ports, a single MPA RFIO port must be designated the input port. For the output signal to the DUT, any of the MPA RFIO ports can be designated as output ports. Up to eight of the MPA RFIO ports can provide an output signal at one time. (However, if the MPA RFIO ports are used in input/output pairs, this will limit the number of available output ports to four.) These port assignments cannot be changed during a sequence. The rules for port assignments are:

- Only one port at a time can be the input port, and it must be one of the following: Rx/UL RF IN or any one of MPA RFIO 0-7.
- MPA RFIO 0-7 serve as both input ports or output ports when the MPA RF OUT is connected to the MPA IN.
- GPS 0-3 serve as output ports simultaneously when the GPS OUT is connected to the Dist .

Software Elements of the Test Set

The test set firmware, which runs within the Windows XP Pro operating system, controls the source and analyzer, and provides access to a variety of licensed measurement applications which are available to be installed on the test set.

The basic test set includes licenses for two applications: the IQ Analyzer Mode (U9060A) and the Sequence Analyzer Mode (U9065A). Several other applications are available for installation. Many of the measurements which are included in these applications can be run from within the Sequence Analyzer mode, and not just in the native mode of the measurement. The table below shows all the available applications, and the measurements they include. Measurements which can be run from within the Sequence Analyzer mode are marked “available to sequencer” in the table.

Table 2-1 Applications and Measurements in the Test Set

Application	Measurement
IQ Analyzer Mode (U9060A)	<ul style="list-style-type: none"> • IQ Waveform • Complex Spectrum
Analog Demodulation Mode (U9063A)	<ul style="list-style-type: none"> • Amplitude Modulation • Frequency Modulation • Phase Modulation
Sequence Analyzer Mode (U9065A)	<ul style="list-style-type: none"> • Basic measurements: Power, Phase & Frequency, Discrete PAVT, IQ Data • List Sequencer • All application-specific measurements listed below that are marked “available to sequencer”.

Table 2-1 Applications and Measurements in the Test Set

Application	Measurement
GSM/EDGE Mode (U9071A)	<ul style="list-style-type: none"> • Transmit Power, also known as Burst Power • Power Vs. Time, GSM & Edge versions (available to sequencer) • GMSK Phase & Frequency (available to sequencer) • Output RF Spectrum, GMSK & EDGE versions (available to sequencer) • EDGE Error Vector Magnitude (available to sequencer)
cdma2000 Mode (U9072A)	<ul style="list-style-type: none"> • Channel Power • Code Domain • ACP (available to sequencer) • Spectrum Emission Mask (available to sequencer) • Occupied Bandwidth (available to sequencer) • Modulation Accuracy (available to sequencer) • QPSK Error Vector Magnitude (available to sequencer)
W-CDMA/HSPA Mode (U9073A)	<ul style="list-style-type: none"> • Channel Power • Adjacent Channel Power (available to sequencer) • Spectrum Emission Mask (available to sequencer) • Occupied Bandwidth (available to sequencer) • Code Domain (available to sequencer) • Modulation Accuracy (available to sequencer) • QPSK Error Vector Magnitude (available to sequencer) • Power Control (available to sequencer)
“WiMAX” Mode (802.16 OFDMA, U9075A)	<ul style="list-style-type: none"> • Channel Power • Adjacent Channel Power • Spectrum Emission Mask • Modulation Analysis
1xEVDO Mode (U9076A)	<ul style="list-style-type: none"> • Channel Power • Reverse-Link Code Domain • Adjacent Channel Power (available to sequencer) • Spectrum Emission Mask (available to sequencer) • Occupied Bandwidth (available to sequencer) • Reverse-Link Modulation Accuracy (available to sequencer)

Table 2-1 Applications and Measurements in the Test Set

Application	Measurement
TD-SCDMA with HSPA/8PSK (U9079A)	<ul style="list-style-type: none"> • Burst Power (Transmit Power) • Power vs Time • ACP (available to sequencer) • Spectrum Emission Mask (available to sequencer) • Occupied Bandwidth (available to sequencer) • Code Domain Power (available to sequencer) • Conformance Error Vector Magnitude (available to sequencer)
LTE Mode (U9080A)	<ul style="list-style-type: none"> • Channel Power • Modulation Analysis (available to sequencer) • Occupied Bandwidth (available to sequencer) • ACP (available to sequencer) • Spectrum Emission Mask (available to sequencer) • Conformance Error Vector Magnitude (available to sequencer)
Bluetooth (U9081A)	<ul style="list-style-type: none"> • ACP • LE In-band Emissions • EDR In-band Spurious Emissions • Occupied Bandwidth • Transmit Analysis
LTE TDD Mode (U9082A)	<ul style="list-style-type: none"> • Channel Power • Occupied Bandwidth (available to sequencer) • ACP (available to sequencer) • Spectrum Emission Mask (available to sequencer) • Transmit On/Off Power (available to sequencer) • LTE Modulation Analysis (available to sequencer) • Conformance Error Vector Magnitude (available to sequencer)

NOTE Some measurements which are not marked “available to sequencer” can be replaced by a basic measurement function which is available in the Sequence Analyzer mode. For example, it is possible to use the basic Power measurement in Sequence Analyzer mode as a substitute for a Channel Power measurement from one of the other modes. Some measurements are not currently supported by the analyzer list sequencer, and therefore can be run only in the native mode of the measurement.

Methods of Operating the Source

Regardless of which measurement mode is currently selected, the source can be operated using front panel keys, the virtual front panel, or remote commands, or by initiating the source list sequencer (which executes a predefined series of signal-generation steps).

The RF output of the source can be modulated by its internal arbitrary waveform generator, which runs waveform segment files that have been downloaded to the test set and loaded into ARB memory. (If a source sequence refers to a number of different waveform segments, all of these segments need to be loaded into ARB memory before the sequence can execute.)

In addition to playing back waveform segments in ARB memory, the source provides basic modulation functions (AM, FM, and PM).

Waveform Segment Files

A waveform segment can be defined in a set of binary files (an I/Q data file with its supporting header and marker files) or in a .wfm file (a combined file format which is produced by Agilent Signal Studio). Playback of .wfm segments requires installation of a Signal Studio license on the test set.

Where the segment is represented by separate binary files, the files need to be placed in the same directory, and need to follow a naming convention which enables the test set to recognize them: if the I/Q data file is called "testWaveform.bin", then the header file needs to be called "testWaveform_hdr.bin" and the marker file needs to be called "testWaveform_mkr.bin". The I/Q data file is the one that is loaded to ARB memory and is referenced by name in source sequences.

Methods of Operating the Analyzer

When a measurement mode other than Sequence Analyzer mode is selected, the analyzer can be operated using front panel keys, the virtual front panel, or remote commands. When the analyzer is used in this way, measurements are made in their native measurement mode (for example, GSM measurements in GSM/EDGE mode).

In Sequence Analyzer mode, initiating the analyzer list sequencer causes it to execute a predefined series of acquisitions and measurements. As described in [“Software Elements of the Test Set” on page 86](#) Sequence Analyzer mode incorporates many measurements from other modes; that is, measurements such as EDGE EVM in GSM/EDGE mode can also be included in a sequence, so that the measurements are made when the analyzer list sequencer is initiated. The Sequence Analyzer mode also includes four basic measurements (power, frequency, phase, and I/Q data).

Creating Sequences

A sequence is a set of parameters which defines a series of signals to be generated, or acquisitions to be analyzed, or both. The parameters can be saved to a text file and later recalled. Initiating the sequencers causes the source and/or analyzer to execute all steps defined in the sequence. (A series of SCPI commands can also be used for the same purpose.)

Although it is possible to create and save a simple sequence using front panel keys, the complexity of the format makes it preferable to use a spreadsheet template or other tool to create a sequence (which is saved to a text file).

The easiest method is to use Agilent Sequence Studio, a PC application designed specifically to generate

sequences for the EXT Wireless Communication Test Set. Sequence Studio is able to load waveform traces directly from the test set, so that the analysis intervals in the sequence can be aligned with the waveform, using an interactive graph display; this method of creating sequences is much more efficient than typing in numerical values.

Executing Sequences

Sequences are executed by initiating the source list sequencer, the analyzer list sequencer, or both.

The source list sequencer can be initiated (in any measurement mode) by using the **[Source], List Sequencer, Initiate Sequence** key, or by sending the `:SOURCE:LIST:TRIG` command.

The analyzer list sequencer can be initiated (in the Sequence Analyzer mode) by using the **[Restart]** key, or by sending the `:INIT` command.

When both list sequencers are used together, initiation of the sequencers must be carefully coordinated. It is not possible for both sequencers to be initiated absolutely simultaneously. When both are used, the source list sequencer should always be initiated first. There are two ways to coordinate the sequencers so that they are initiated in the proper order:

- Enable **Meas Setup, Include Source in Sequence**. When this selection is made, both of the list sequencers are initiated automatically, in the correct order, when you use a command or key to initiate the analyzer sequence (in this case, the source sequence cannot be initiated independently of the analyzer sequence).
- If “Include Source in Sequence” is disabled, then the source and analyzer must be initiated independently, and the source must be initiated first.

In addition to the initiating the sequencers, it is also necessary to trigger them. Output and input triggering for the two sequencers (as defined in the sequences they are executing) must be set up to coordinate the timing of their operations. Typically, the analyzer list sequencer generates a trigger input to the source list sequencer, so that the source begins generating a signal once the analyzer is ready to receive and analyze it.

Installing Application Software

When you want to install a measurement application after your initial hardware purchase, you only need to license it. All of the available applications are loaded in your test set at the time of purchase.

When you purchase an application, you receive an entitlement certificate that is used to obtain a license key for that particular measurement application. Enter the license key that you obtain into the EXT test set to activate the new measurement application.

For the latest information on Agilent X-series measurement applications and upgrade kits, visit the following internet URL: <http://www.agilent.com/find/ext>

Viewing a license key

Measurement personalities purchased with your test set have been installed and activated at the factory before shipment. The test set requires a unique **License Key** for every measurement application purchased. The license key is a hexadecimal string that is specific to your measurement application, test set model number and serial number. It enables you to install, or reactivate that particular application.

Press **System, Show, System** to display which measurement applications are currently licensed in your test set.

Go to the following location to view the license keys for the installed measurement applications:

C:\Programing Files\Agilent\Licensing

NOTE You may want to keep a copy of your license key in a secure location. You can print out a copy of the display showing the license numbers to do this. If you should lose your license key, call your nearest Agilent Technologies service or sales office for assistance.

Obtaining and installing a license key

If you purchase an additional application that requires installation, you will receive an “Entitlement Certificate” which may be redeemed for a license key for one test set. Follow the instructions that accompany the certificate to obtain your license key.

Installing a license key for the selected application can be done using a USB memory device. To do this, you put the license file on the USB memory device at the root level. Follow the instructions that come with your software installation kit.

Installing a license key can also be done manually using the license management application in the test set. It is found through the test set front panel keys at **System, Licensing...**, or internally at C:\Programming Files\Agilent\Licensing.

NOTE You can also use these procedures to reinstall a license key that has been accidentally deleted, or lost due to a memory failure.

Missing and old Measurement application software

All the software applications were loaded at the time of original test set manufacture. It is a good idea to regularly update your software with the latest available version. This assures that you get any improvements and expanded functionality that is available.

Because the software was loaded at the initial purchase, there may be additional measurement applications that are now available. If the application you are interested in licensing is not available, you will need to do a software update. (Press **System, Show, System.**)

Check the Agilent internet website for the latest software versions available for downloading:

http://www.agilent.com/find/ext_software

You must load the updated software package into the test set from a USB drive, or directly from the internet. An automatic loading program is included with the files.

X-Series options and accessories

“EXT Test Set Options” on page 93

“EXT X-series accessories” on page 93

“Advanced Measurement Application Software” on page 93

EXT Test Set Options

Product	Description
<EXT model number>	Wireless communications test set
<EXT model number>-503	Frequency range from 10 MHz to 3.6 GHz
<EXT model number>-504	Frequency range from 10 MHz to 3.8 GHz
<EXT model number>-UK6	Commercial Calibration Certificate with Test Data

EXT X-series accessories

Product	Description
<EXT model number>-EFM	USB storage device 4 GB blank
<EXT model number>-KYB	Keyboard, USB interface
<EXT model number>-HTC	Hard transit case
<EXT model number>-ICP	Rackmount kit with handles
<EXT model number>-1CN	Front handle kit
<EXT model number>-1CM	Rackmount kit
<EXT model number>-1CR	Rack slide kit

Advanced Measurement Application Software

For a current list of application software, go to the following URLs.

<http://www.agilent.com/find/ext>

Select the **Options** tab on the top of the webpage.

Front-Panel Features (E6607A/B)



Item		Description
#	Name	
1	Menu Keys	Key labels appear to the left of the menu keys to identify the current function of each key. The displayed functions are dependent on the currently selected Mode and Measurement, and are directly related to the most recent key press.
2	Measurement Keys	These keys select the Mode, and the Measurement within the mode. They also control the initiation and rate of recurrence of measurements.
3	Setup Keys	These keys set the parameters used for setting up the test set in the current Mode.
4	Marker Keys	Markers are often available for a measurement, to measure a very specific point/segment of data within the range of the current measurement data.
5	Utility Keys	These keys control system-wide functionality such as <ul style="list-style-type: none"> • test set configuration information and I/O setup, • printer setup and printing, • file management, save and recall, • test set presets.
6	Probe Power	Supplies power for external high frequency probes and accessories.
7	Headphones Output	Headphones can be used to hear any available audio output.
8	Back Space Key	Press this key to delete the previous character when entering alphanumeric information. It also works as the Back key in Help and Explorer windows.
9	USB Connectors	Standard USB 2.0 ports, Type A. Connect to external peripherals such as a mouse, keyboard, DVD drive or hard drive.

Item		Description
#	Name	
10	Delete Key	Press this key to delete files, or to perform other deletion tasks.
11	Local/Cancel/(Esc) Key	<p>If you are in remote operation the Local key</p> <ul style="list-style-type: none"> returns test set control from remote back to local (the front panel). turns the display on (if it was turned off for remote operation). can be used to clear errors. (Press the key once to return to local control, and a second time to clear error message line.) <p>If you have not already pressed the units or Enter key, Cancel exits the currently selected function without changing its value.</p> <p>Esc works the same as it does on a pc keyboard. It</p> <ul style="list-style-type: none"> exits Windows dialogs clears errors aborts printing cancels operations. <p>This key also exits the help system if it has been accessed.</p>
12	Numeric Keypad	Enters a specific numeric value for the current function. Entries appear on the upper left of the display, in the measurement information area.
13	Enter and Arrow Keys	<p>The Enter key terminates data entry when either no unit of measure is needed, or you want to use the default unit.</p> <p>The arrow keys</p> <ul style="list-style-type: none"> Increment and decrement the value of the current measurement selection. Navigate help topics. Navigate, or make selections, within Windows dialogs. Navigate within forms used for setting up measurements. Navigate within tables. <p>NOTE The arrow keys cannot be used to move a mouse pointer around on the display.</p>
14	Menu/ (Alt) Key	Alt works the same as a pc keyboard. Use it to change control focus in Windows pull-down menus.
15	Ctrl Key	Ctrl works the same as a pc keyboard. Use it to navigate in Windows applications, or to select multiple items in lists.
16	Select / Space Key	Select is also the Space key and it has typical pc functionality. For example, in Windows dialogs, it selects files, checks and unchecks check boxes, and picks radio button choices. It opens a highlighted Help topic.
17	Tab Keys	Use these keys to move between fields in Windows dialogs.
18	Knob	Increments and decrements the value of the current active function.
19	Return Key	Exits the current menu and returns to the previous menu. Has typical pc functionality.
20	Full Screen Key	Pressing this key turns off the softkeys to maximize the graticule display area.

About the Test Set
Front-Panel Features (E6607A/B)

Item		Description
#	Name	
21	Help Key	Initiates a context-sensitive help display for the current Mode. Once Help is accessed, pressing a front panel key brings up the help topic for that key function. Use the Local/Cancel/(Esc) key to exit help.
22	Speaker Control Keys	Enables you to increase or decrease the speaker volume, or mute it.
23	Window Control Keys	These keys select between single or multiple window displays. They zoom the current window to fill the data display, or change the currently selected window. They can be used to switch between the Help window navigation pane and the topic pane.
24	Power Standby/ On	Turns the test set on. A green light indicates power on. A yellow light indicates standby mode. <div style="border: 1px solid black; padding: 2px; display: inline-block; margin: 5px 0;">NOTE</div> The front-panel switch is a standby switch, not a LINE switch (disconnecting device). The test set continues to draw power even when the line switch is in standby. The main power cord can be used as the system disconnecting device. It disconnects the mains circuits from the mains supply.
25	RF I/O 1 Connector	RF Input/Output port #1 (communicates with both the source and the analyzer).
26	RF I/O 2 Connector	RF Input/Output port #2 (communicates with both the source and the analyzer).
27	RF Output	The test set's RF output port (communicates only with the source).
28	RF Input	The test set's RF input port (communicates only with the analyzer).

Overview of key types

The keys labeled **FREQ Channel**, **System**, and **Marker Functions** are all examples of front-panel keys.



Most of the dark or light gray keys access menus of functions that are displayed along the right side of the display. These displayed key labels are next to a column of keys called menu keys.

Menu keys list functions based on which front-panel key was pressed last. These functions are also dependant on the current selection of measurement application (**Mode**) and measurement (**Meas**).

If the numeric value of a menu key function can be changed, it is called an active function. The function label of the active function is highlighted after that key has been selected. For example, press **AMPTD Y Scale**. This calls up the menu of related amplitude functions. The function labeled **Ref Level** (the default selected key in the Amplitude menu) is highlighted. **Ref Level** also appears in the upper left of the display in the measurement information area. The displayed value indicates that the function is selected and its

value can now be changed using any of the data entry controls.



Some menu keys have multiple choices on their label, such as **On/Off** or **Top/Ctr/Bot** (as shown below). The different choices are selected by pressing the key multiple times. For example, the Auto/Man type of key. To select the function, press the menu key and notice that Auto is underlined and the key becomes highlighted. To change the function to manual, press the key again so that Man is underlined. If there are more than two settings on the key, keep pressing it until the desired selection is underlined.

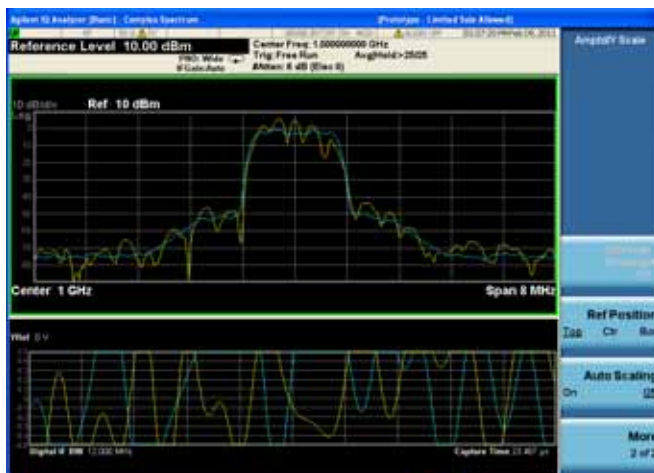

When a menu first appears, one key label is highlighted to show which key is the default selection. If you

About the Test Set Front-Panel Features (E6607A/B)

press **Marker Function**, the **Marker Function Off** key is the menu default key, and is highlighted.



Some of the menu keys are grouped together by a yellow bar running behind the keys near the left side or by a yellow border around the group of keys. When you press a key within the yellow region, such as **Marker Noise**, the highlight moves to that key to show it has been selected. The keys that are linked are related functions, and only one of them can be selected at any one time. For example, a marker can only have one marker function active on it. So if you select a different function it turns off the previous selection. If the current menu is two pages long, the yellow bar or border could include keys on the second page of keys.



In some key menus, a key label is highlighted to show which key has been selected from multiple available choices. And the menu is immediately exited when you press one of the other keys. For example, when you press the **Select Marker** key (in the **Marker** menu), it brings up its own menu of keys. The **Marker 1** key is highlighted. When you press the **marker 2** key, the highlight moves to that key and

the screen returns to the **Marker** menu.



If a displayed key label shows a small solid-black arrow tip pointing to the right, it indicates that additional key menus are available. If the arrow tip is not filled in solid then pressing the key the first time selects that function. Now the arrow is solid and pressing it again brings up an additional menu of

About the Test Set Front-Panel Features (E6607A/B)

settings.

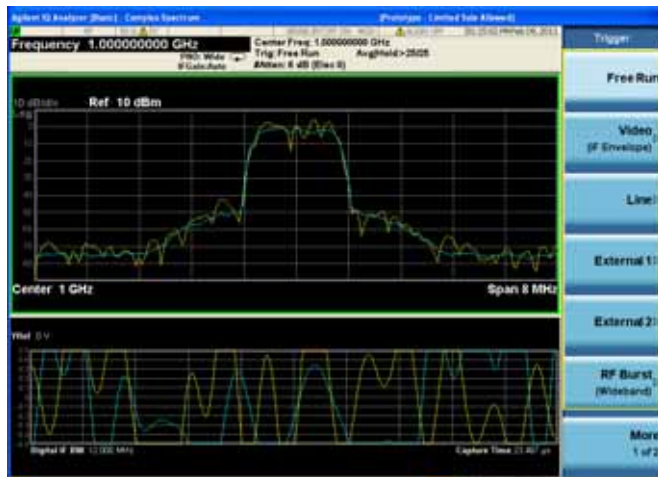

Open
Arrow Tip

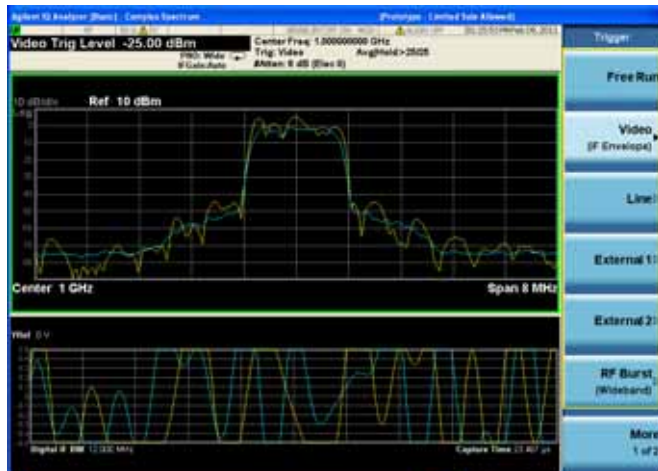

Solid
Arrow Tip

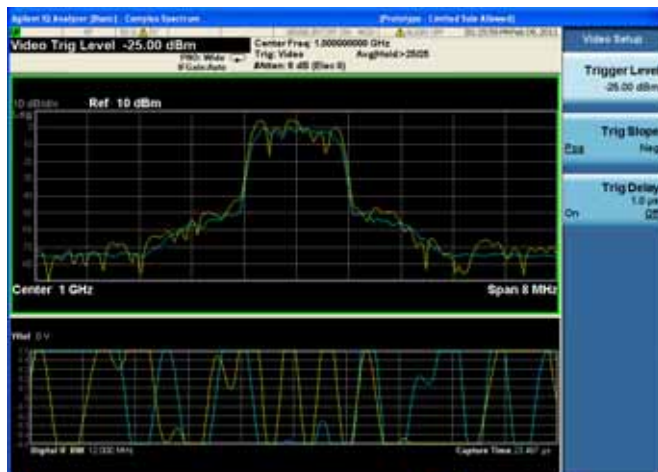
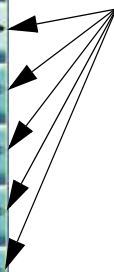

Front-Panel Features (E6607C)

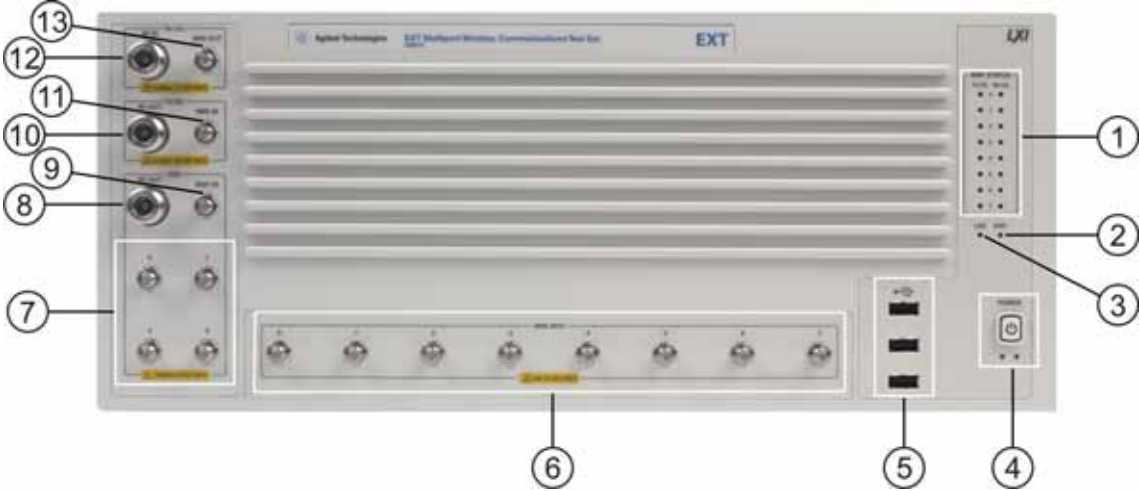

Item		Description
#	Name	
1	MPA Status	<p>MPA Status Indicator LEDs light indicating the status of the instrument:</p> <ul style="list-style-type: none"> Tx/DL 0 - 7 (these light to indicate that the related RFIO ports are being used to transmit RF outputs to the connected DUTs). Rx/UL 0 - 7 (these light to indicate that the related RFIO ports are being used to receive RF inputs from the connected DUTs). <p>NOTE There are no indicators for the GPS ports, because the ports cannot be switched on or off. Whatever RF input is provided to the GPS DIST IN port is always split and delivered to the GPS 0 - 3 ports.</p>
2	Stat	<p>SCPI Status Indicator LED lights to indicate that the instrument is ready to receive a remote SCPI command.</p>
3	LAN	<p>LAN Status Indicator LED lights to indicate that the instrument has made an active LAN connection.</p>
4	Power	<p>Power Standby/On switch and indicator LEDs. A green light indicates power on. A yellow light indicates standby mode.</p> <p>NOTE The front-panel switch is a standby switch, not a LINE switch (disconnecting device). The test set continues to draw power even when the line switch is in standby.</p> <p>The main power cord can be used as the system disconnecting device. It disconnects the mains circuits from the mains supply.</p>
5	USB Connectors	<p>Standard USB 2.0 ports, Type A. Connect to external peripherals such as a mouse, keyboard, DVD drive or hard drive.</p>

About the Test Set
Front-Panel Features (E6607C)

Item		Description
#	Name	
6	MPA RFIO, Ports 0 - 7	RF input and output connections to the DUTs (SMA connectors). The maximum safe input level at any of these ports is 2 W (+33 dBm), ± 15 Vdc.
7	GPS, Ports 0 - 3	RF input and output connections to the DUTs (SMA connectors). The maximum safe input level at any of these ports is 0.25 W (+24 dBm), 0 Vdc. Because GPS Ports 0 - 3 are the outputs of a four-way splitter, the maximum output power levels from these ports are lower than for RFIO Ports 0 - 7; see the E6607C data sheet for specifics.
8	RF OUT	GPS RF output port (communicates only with the source). The maximum safe input level at any of these ports is 0.25 W (+24 dBm), 0 Vdc.
9	DIST IN	GPS RF distribution input port (SMA connector). This port is connected to the four-way splitter that provides the signal to the 4 GPS output Ports 0 - 3. The maximum safe input level at any of these ports is 0.25 W (+24 dBm), 0 Vdc.
10	RF OUT	Tx/DL RF output port (communicates only with the source). The maximum safe input level at any of these ports is 0.25 W (+24 dBm), ± 15 Vdc.
11	MPA IN	Tx/DL MPA RF input port (SMA connector). The maximum safe input level at any of these ports is 0.25 W (+24 dBm), ± 15 Vdc.
12	RF IN	Rx/UL RF input port (communicates only with the analyzer). The maximum safe input level at any of these ports is 0.25 W (+24 dBm), ± 15 Vdc.
13	MPA OUT	Rx/UL RF MPA output port (SMA connector). The maximum safe input level at any of these ports is 0.25 W (+24 dBm), ± 15 Vdc.

Overview of key types

The keys labeled **FREQ Channel**, **System**, and **Marker Function** are all examples of front-panel keys.



Most of the dark or light gray keys access menus of functions that are displayed along the right side of the display. These displayed key labels are next to a column of keys called menu keys.

Menu keys list functions based on which front-panel key was pressed last. These functions are also dependant on the current selection of measurement application (**Mode**) and measurement (**Meas**).

If the numeric value of a menu key function can be changed, it is called an active function. The function label of the active function is highlighted after that key has been selected. For example, press **AMPTD Y Scale**. This calls up the menu of related amplitude functions. The function labeled **Ref Level** (the default selected key in the Amplitude menu) is highlighted. **Ref Level** also appears in the upper left of the display in the measurement information area. The displayed value indicates that the function is selected and its value can now be changed using any of the data entry controls.



Some menu keys have multiple choices on their label, such as **On/Off** or **Top/Ctr/Bot** (as shown below). The different choices are selected by pressing the key multiple times. For example, the Auto/Man type of key. To select the function, press the menu key and notice that Auto is underlined and the key becomes highlighted. To change the function to manual, press the key again so that Man is underlined. If there are

About the Test Set

Overview of key types

more than two settings on the key, keep pressing it until the desired selection is underlined.

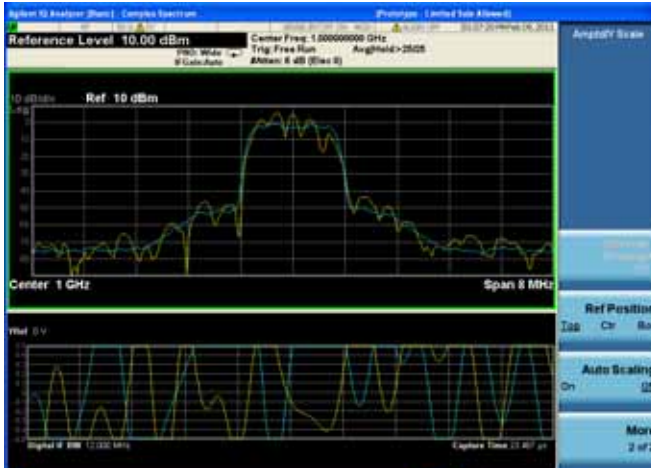

When a menu first appears, one key label is highlighted to show which key is the default selection. If you press **Marker Function**, the **Marker Function Off** key is the menu default key, and is highlighted.



Some of the menu keys are grouped together by a yellow bar running behind the keys near the left side or by a yellow border around the group of keys. When you press a key within the yellow region, such as **Marker Noise**, the highlight moves to that key to show it has been selected. The keys that are linked are related functions, and only one of them can be selected at any one time. For example, a marker can only have one marker function active on it. So if you select a different function it turns off the previous selection. If the current menu is two pages long, the yellow bar or border could include keys on the

second page of keys.



In some key menus, a key label is highlighted to show which key has been selected from multiple available choices. And the menu is immediately exited when you press one of the other keys. For example, when you press the **Select Marker** key (in the **Marker** menu), it brings up its own menu of keys. The **Marker 1** key is highlighted. When you press the **marker 2** key, the highlight moves to that key and the screen returns to the **Marker** menu.



If a displayed key label shows a small solid-black arrow tip pointing to the right, it indicates that additional key menus are available. If the arrow tip is not filled in solid then pressing the key the first time selects that function. Now the arrow is solid and pressing it again brings up an additional menu of

About the Test Set

Overview of key types

settings.

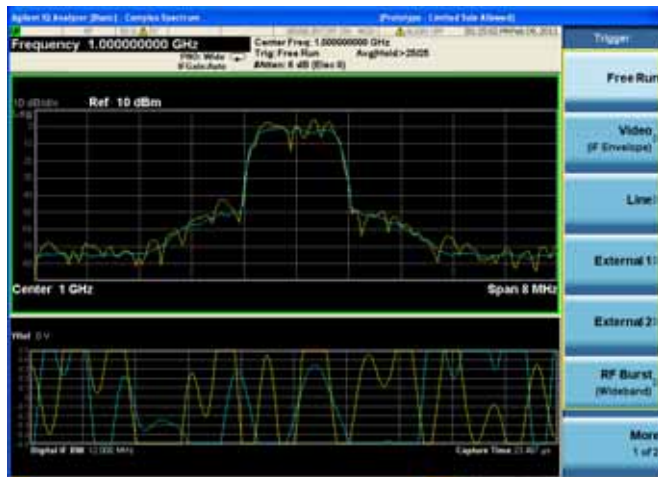

Open Arrow Tip

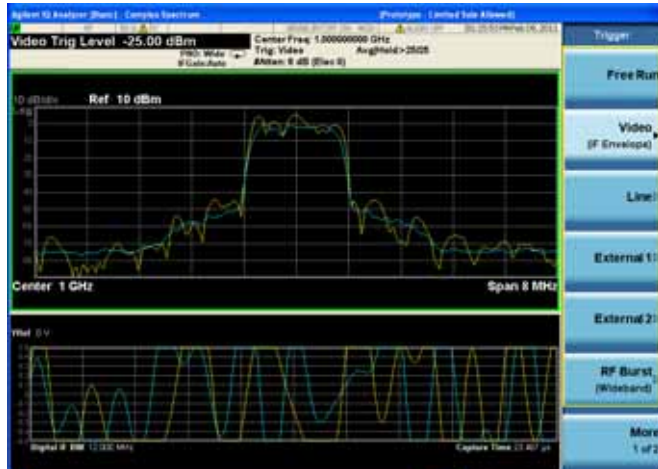
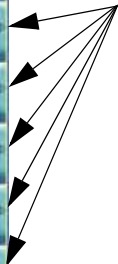

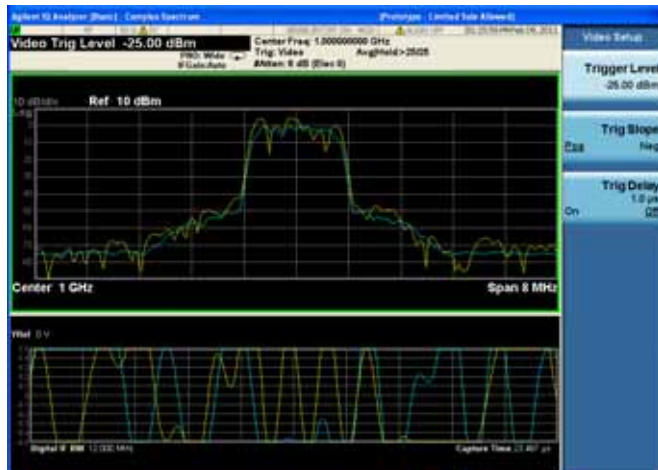
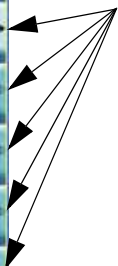

Solid Arrow Tip

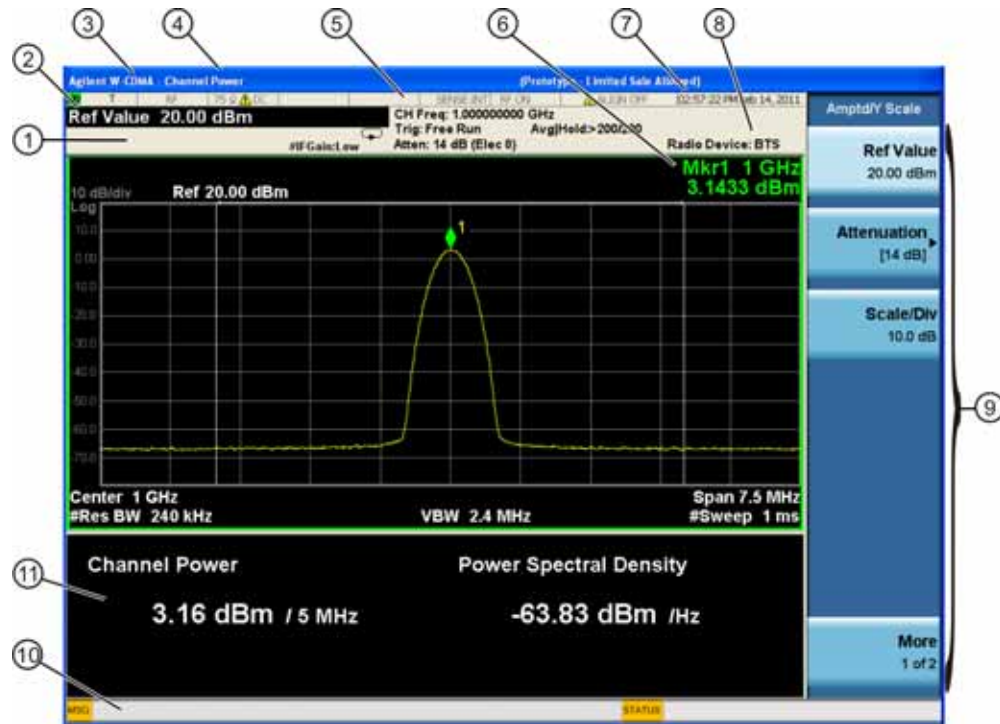

Display Annotations

This section describes the display annotation as it is on the Sequence Analyzer measurement application display. Other measurement application modes have some annotation differences.



Item	Description	Function Keys
1	Measurement bar - Shows general measurement settings and information.   Indicates single/continuous measurement. Some measurements include limits that the data is tested against. A Pass/Fail indication may be shown in the lower left of the measurement bar.	All the keys in the test set Setup part of the front panel.
2	Active Function (measurement bar) - when the current active function has a settable numeric value, it is shown here.	Currently selected front panel key.
3	Banner - shows the name of the selected application that is currently running.	Mode

About the Test Set
Display Annotations

Item	Description	Function Keys
4	Measurement title - shows title information for the current measurement, or a title that you created for the measurement.	Meas View/Display, Display, Title
5	Settings panel - displays system information that is not specific to any one application. <ul style="list-style-type: none"> • Input/Output status - RLTS indicate Remote, Listen, Talk, SRQ • Input impedance and coupling • Selection of external frequency reference • Setting of automatic internal alignment routine 	Local and System, I/O Config Input/Output, Amplitude, System and others
6	Active marker frequency, amplitude or function value	Marker
7	Settings panel - time and date display.	System, Control Panel
8	Trace and detector information	Trace/Detector, Clear Write (W) Trace Average (A) Max Hold (M) Min Hold (m) Trace/Detector, More, Detector, Average (A) Normal (N) Peak (P) Sample (S) Negative Peak (p)
9	Key labels that change based on the most recent key press.	Softkeys
10	Displays information, warning and error messages. Message area - single events, Status area - conditions	
11	Measurement settings for the data currently being displayed in the graticule area. In the example above: center frequency, resolution bandwidth, video bandwidth, frequency span, sweep time and number of sweep points.	Keys in the test set Setup part of the front panel.

Test Set Display Indicators

The display of the EXT Test Set includes, in the measurement bar, a field (highlighted in red below) which indicates the state of the internal source. When using the E6607A/B with the Multiport Adapter or when using the E6607C, this display is modified to indicate which output ports of the Multiport Adapter (if any) are supplying RF output power.



The table below illustrates the content of this field under different circumstances.

Multiport Adapter Usage	In Sequence Analyzer Mode	Not in Sequence Analyzer Mode, RF On	Not in Sequence Analyzer Mode, RF Off
Any or all of the 8 “RFIO” ports are in use.	SEQ MPA	RF ON MPA	RF OFF MPA
The 4 “GPS” ports are in use.	SEQ MPA-G	RF ON MPA-G	RF OFF MPA-G
Multiport Adapter is not in use.	SEQ	RF ON	RF OFF

Rear-Panel Features

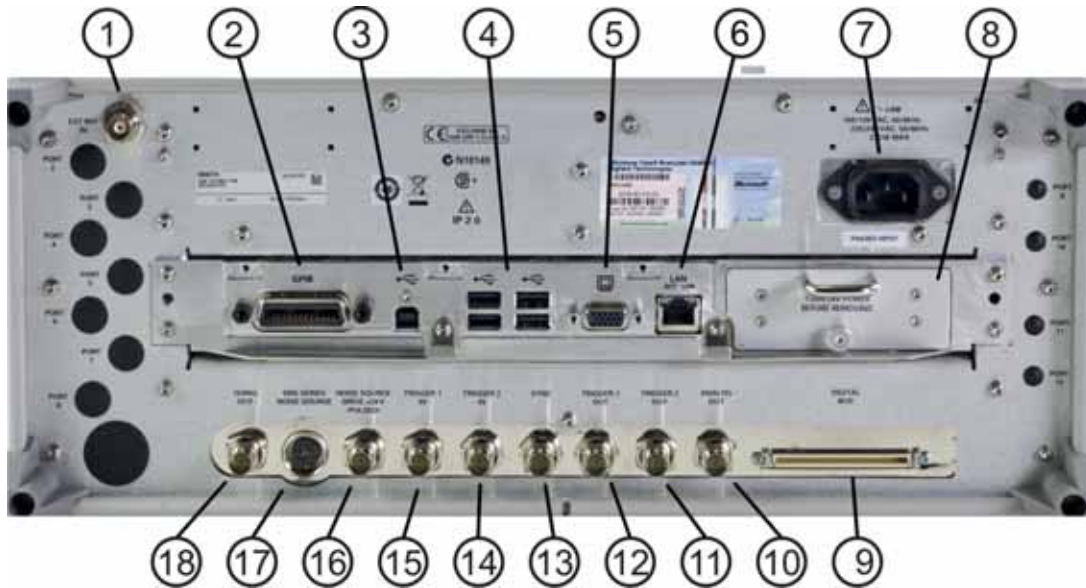

Item		Description
#	Name	
1	EXT REF IN	Input for an external frequency reference signal: 1 to 50 MHz
2	GPIB	A General Purpose Interface Bus (GPIB, IEEE 488.1) connection that can be used for remote test set operation.
3	USB Connector	USB 2.0 port, Type B. USB TMC (test and measurement class) connects to an external pc controller to control the test set and for data transfers over a 480 Mbps link.
4	USB Connectors	Standard USB 2.0 ports, Type A. Connect to external peripherals such as a mouse, keyboard, printer, DVD drive, or hard drive.
5	MONITOR	Allows connection of an external VGA monitor.
6	LAN	A TCP/IP Interface that is used for remote test set operation.
7	Line power input	The AC power connection. See the product specifications for more details.
8	Removable Hard Drive	Standard on E6607A.
9	DIGITAL BUS	Reserved for future use.
10	ANALOG OUT	Reserved for future use.
11	TRIGGER 2 OUT	A trigger output used to synchronize other test equipment with the test set. Configurable from the Input/Output keys.

Item		Description
#	Name	
12	TRIGGER 1 OUT	A trigger output used to synchronize other test equipment with the test set. Configurable from the Input/Output keys.
13	SYNC	Reserved for future use.
14	TRIGGER 2 IN	Allows external triggering of measurements.
15	TRIGGER 1 IN	Allows external triggering of measurements.
16	NOISE SOURCE DRIVE +28 V (PULSED)	Not functional in the EXT Test Set.
17	SNS SERIES NOISE SOURCE	Not functional in the EXT Test Set.
18	10 MHz OUT	An output of the test set internal 10 MHz frequency reference signal. It is used to lock the frequency reference of other test equipment to the test set.

Window Control Keys

The instrument provides three front-panel keys for controlling windows. They are Multi Window, Zoom, and Next Window. These are all “immediate action” keys.

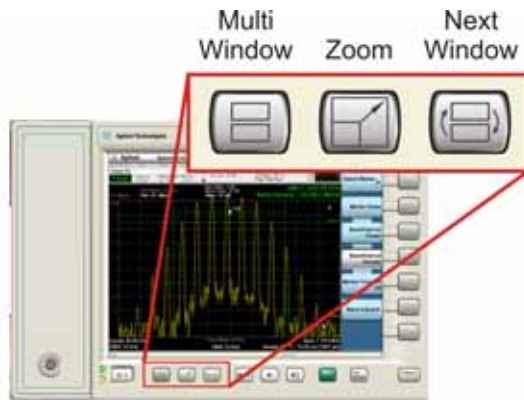

Multi-Window

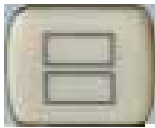

The **Multi Window** front-panel key will toggle you back and forth between the Normal View and the last Multi Window View (Zone Span, Trace Zoom or Spectrogram) that you were in, when using the Swept SA measurement of the Spectrum Analyzer Mode. It remembers which View you were in through a Preset. This “previous view” is set to Zone Span on a Restore Mode Defaults.

Key Path:	Front-panel key
Initial S/W Revision:	Prior to A.02.00
Help Map ID:	3496

Zoom

Zoom is a toggle function. Pressing this key once increases the size of the selected window; pressing the key again returns the window to the original size.

When Zoom is on for a window, that window will get the entire primary display area. The zoomed window, since it is the selected window, is outlined in green.

Zoom is local to each Measurement. Each Measurement remembers its Zoom state. The Zoom state of each Measurement is part of the Mode’s state.

NOTE Data acquisition and processing for the other windows continues while a window

is zoomed, as does all SCPI communication with the other windows.

Remote Command:	:DISPlay:WINDow:FORMat:ZOOM
Remote Command:	:DISPlay:WINDow:FORMat:TILE
Example:	:DISP:WIND:FORM:ZOOM sets zoomed :DISP:WIND:FORM:TILE sets un-zoomed
Preset:	TILE
Initial S/W Revision:	Prior to A.02.00
Help Map ID:	3497

Next Window

Selects the next window of the current view. When the Next Window key is pressed, the next window in the order of precedence becomes selected. If the selected window was zoomed, the next window will also be zoomed.

The window numbers are as follows. Note that these numbers also determine the order of precedence (that is, Next Window goes from 1 to 2, then 2 to 3, etc.):

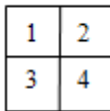

Four window display

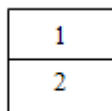

Two window display

Remote Command:	:DISPlay:WINDow[:SElect] <number> :DISPlay:WINDow[:SElect]?
Example:	:DISP:WIND 1
Preset:	1
Min:	1
Max:	If <number> is greater than the number of windows, limit to <number of windows>
Initial S/W Revision:	Prior to A.02.00
Help Map ID:	0

One and only one window is always selected. The selected window has the focus; this means that all window-specific key presses apply only to that window. You can tell which window is selected by the thick green border around it. If a window is not selected, its boundary is gray.

If a window in a multi-window display is zoomed it is still outlined in green. If there is only one window,

About the Test Set
Window Control Keys

the green outline is not used. This allows the user to distinguish between a zoomed window and a display with only one window.

The selected window is local to each Measurement. Each Measurement remembers which window is selected. The selected window for each Measurement is remembered in Mode state.

NOTE When this key is pressed in Help Mode, it toggles focus between the table of contents window and the topic pane window.

Mouse and Keyboard Control

If you do not have access to the instrument front-panel, there are several ways that a mouse and PC Keyboard can give you access to functions normally accessed using the front-panel keys.

NOTE **E6607C:** When using the E6607C there is no instrument front-panel. Therefore, the PC mouse and monitor are required for instrument control through a virtual front panel (VFP). For ease in using the VFP, the PC keyboard is recommended.

Right-Click

If you plug in a mouse and right-click on the analyzer screen, a menu will appear as below:

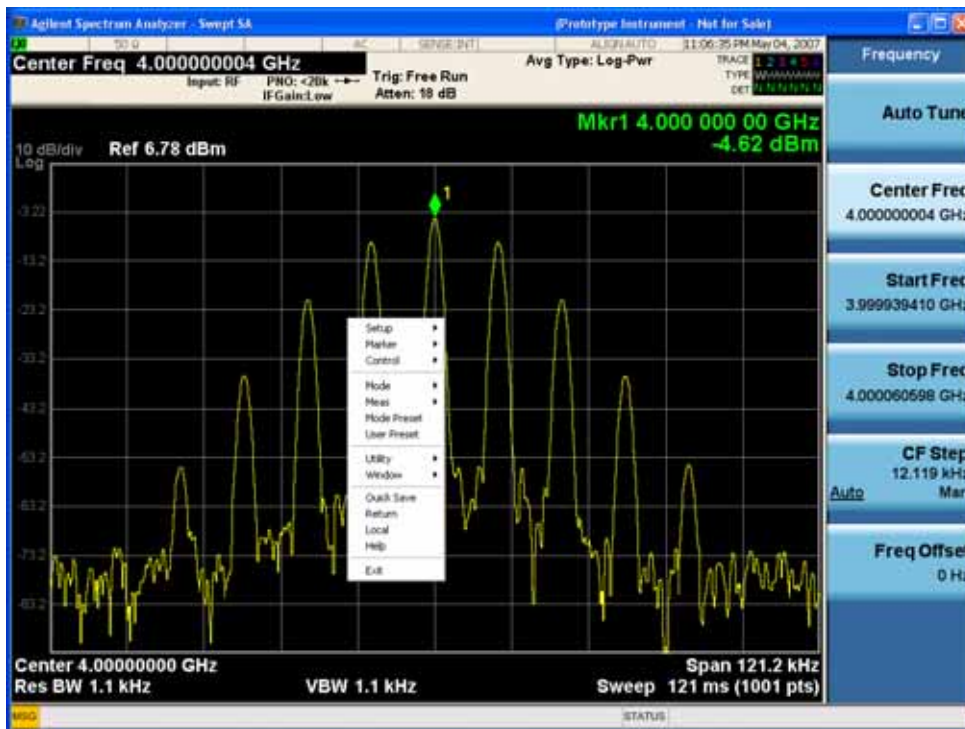

Placing the mouse on one of the rows marked with a right arrow symbol will cause that row to expand, as for example below where the mouse is hovered over the “Utility” row:

About the Test Set Mouse and Keyboard Control

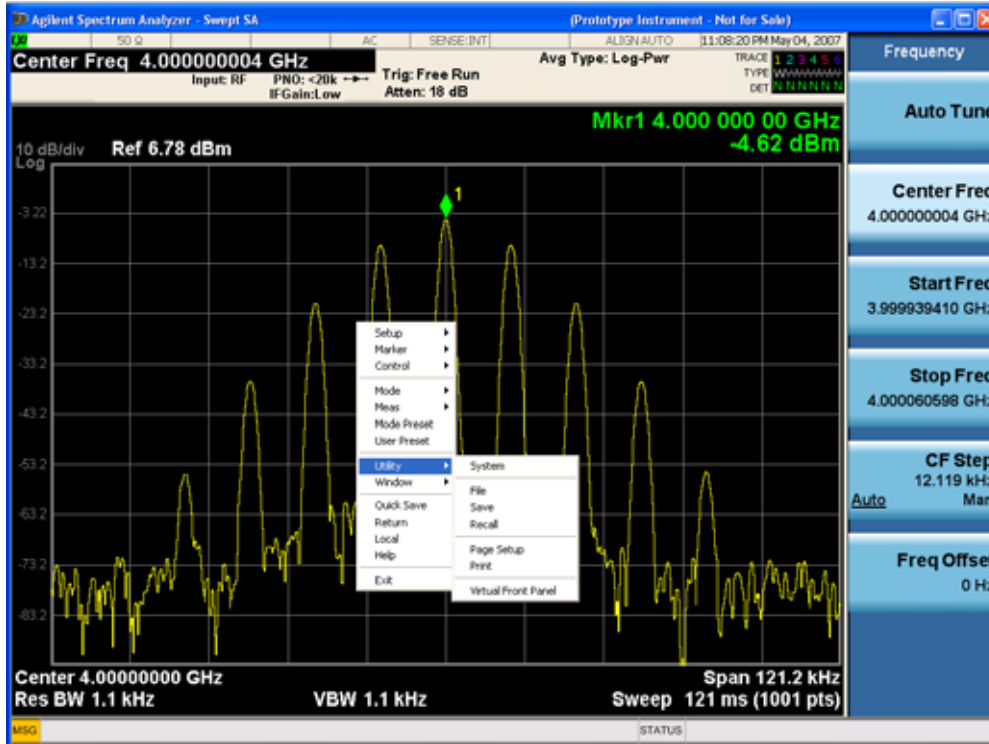

This method can be used to access any of the front-panel keys by using a mouse; as for example if you are accessing the instrument through Remote Desktop.

The array of keys thus available is shown below:

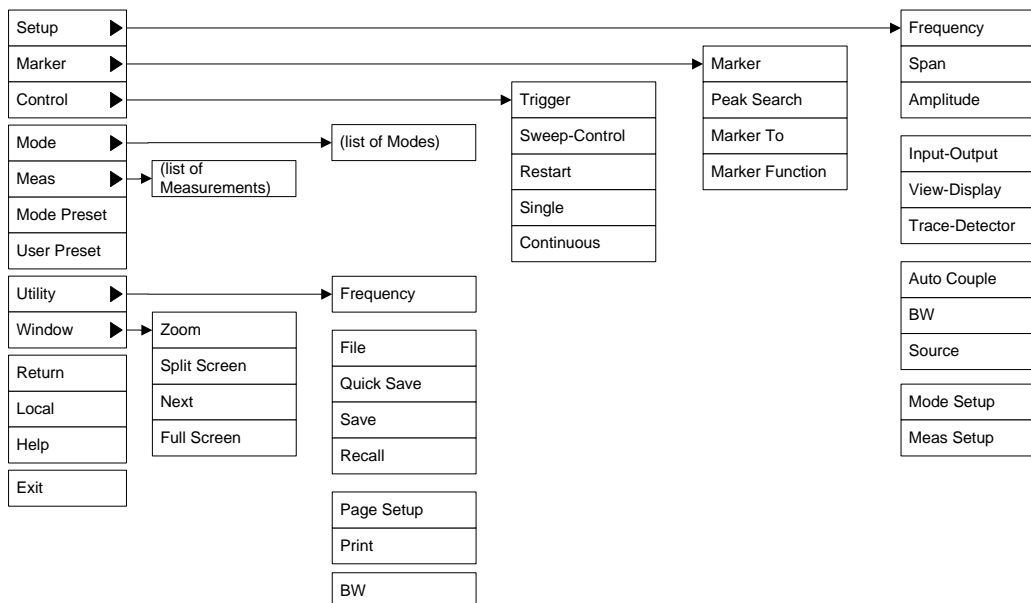

Virtual Front Panel

If you have a PC mouse, monitor, and keyboard plugged in (or through a Remote Desktop), you can navigate the front panel using the virtual front panel (VFP) shown below. Access the VFP as follows:

1. Right-click the mouse as described in [“Right-Click” on page 115](#).
2. Left-click Utility (1) in the menu, as shown below.
3. Left-click Virtual Front Panel (2) in the menu, as shown below.

NOTE The PC mouse and monitor are required when using the E6607C. For ease in using the VFP, the PC keyboard is recommended.

:

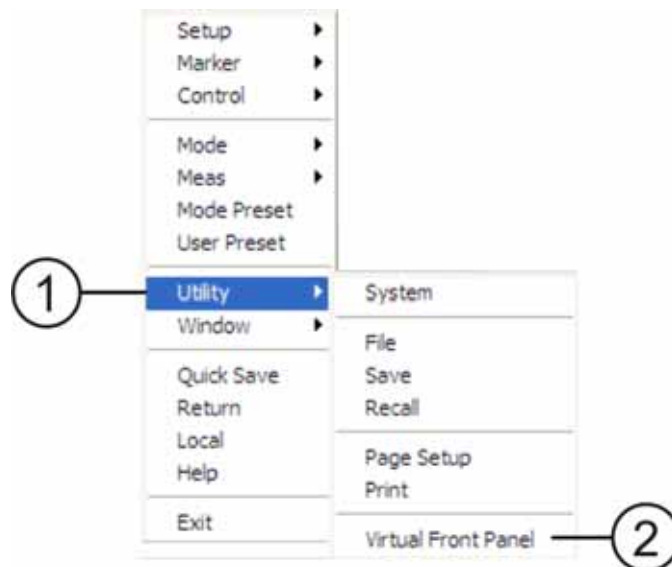

When the VFP opens, the keys behave just as the front-panel and menu keys described in [“Front-Panel Features \(E6607A/B\)” on page 94](#) and [“Overview of key types” on page 103](#). On the VFP the keys labeled "Key 1" through "Key 7" function as the menu keys. Using the mouse to click on a combination of the VFP keys and the menu keys on the display screen, you can operate the instrument just as you would using the front-panel of the E6607A/B.

About the Test Set
Mouse and Keyboard Control



PC Keyboard

If you have a PC keyboard plugged in (or via Remote Desktop), certain key codes on the PC keyboard map to front-panel keys on the GPSA front panel. These key codes are shown below:

Front-panel key	Key code
Frequency	CTRL+SHIFT+F
Span	CTRL+SHIFT+S
Amplitude	CTRL+SHIFT+A
Input/Output	CTRL+SHIFT+O
View/Display	CTRL+SHIFT+V
Trace/Detector	CTRL+ALT+T
Auto Couple	CTRL+SHIFT+C
Bandwidth	CTRL+ALT+B
Source	CTRL+ALT-U

Front-panel key	Key code
Marker	CTRL+ALT+K
Peak Search	CTRL+ALT+P
Marker To	CTRL+ALT+N
Marker Function	CTRL+ALT+F
System	CTRL+SHIFT+Y
Quick Save	CTRL+Q
Save	CTRL+S
Recall	CTRL+R
Mode Preset	CTRL+M
User Preset	CTRL+U
Print	CTRL+P
File	CTRL+SHIFT+L
Mode	CTRL+SHIFT+M
Measure	CTRL+ALT+M
Mode Setup	CTRL+SHIFT+E
Meas Setup	CTRL+ALT+E
Trigger	CTRL+SHIFT+T
Sweep/Control	CTRL+SHIFT+W
Restart	CTRL+ALT+R
Single	CTRL+ALT+S
Cont	CTRL+ALT+C
Zoom	CTRL+SHIFT+Z
Next Window	CTRL+SHIFT+N
Split Screen	CTRL+L
Full Screen	CTRL+SHIFT+B
Return	CTRL+SHIFT+R
Mute	Mute
Inc Audio	Volume Up
Dec Audio	Volume Down
Help	F1

About the Test Set
Mouse and Keyboard Control

Front-panel key	Key code
Control	CTRL
Alt	ALT
Enter	Return
Cancel	Esc
Del	Delete
Backspace	Backspace
Select	Space
Up Arrow	Up
Down Arrow	Down
Left Arrow	Left
Right Arrow	Right
Menu key 1	CTRL+SHIFT+F1
Menu key 2	CTRL+SHIFT+F2
Menu key 3	CTRL+SHIFT+F3
Menu key 4	CTRL+SHIFT+F4
Menu key 5	CTRL+SHIFT+F5
Menu key 6	CTRL+SHIFT+F6
Menu key 7	CTRL+SHIFT+F7
Backspace	BACKSPACE
Enter	ENTER
Tab	Tab
1	1
2	2
3	3
4	4
5	5
6	6
7	7
8	8
9	9

Front-panel key	Key code
0	0

This is a pictorial view of the table:

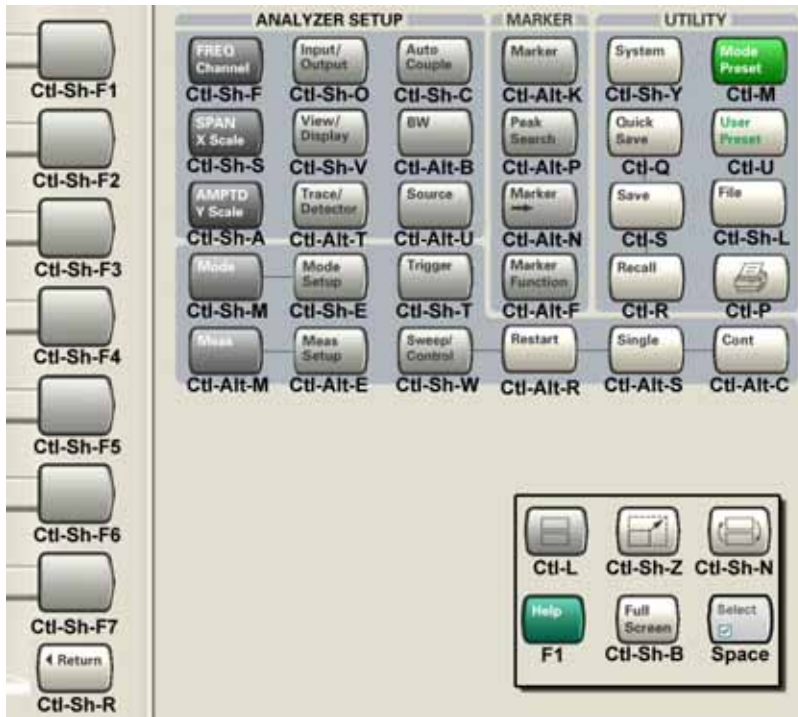

Instrument Security & Memory Volatility

If you are using the test set in a secure environment, you may need details of how to clear or sanitize its memory, in compliance with published security standards of the United States Department of Defense, or other similar authorities.

For the X Series test sets, this information is contained in the document "Security Features and Volatility". This document is **not** included in the test set's on-disk library, but it may be downloaded from Agilent's web site.

To obtain a copy of the document, click on or browse to the following URL:

<http://www.agilent.com/find/security>

To locate and download the document, select a Model Number, for example "E6607A", then click "Submit". Then, follow the on-screen instructions to download the file.

About the IQ Analyzer Measurement Application

This chapter provides information on using the IQ Analyzer Mode in your Agilent Test Set. It also documents some of the available optional hardware that can be used in this mode. This includes options such as EA3 (electronic attenuator) and preamp options (P02, P08, P13, P26). The X-Series Option B25 must be used with the measurements found in IQ Analyzer Mode since the optional wideband hardware cannot be accessed in other modes.

What Does IQ Analyzer Mode Do?

The IQ Analyzer Mode makes frequency domain and time domain measurements. These measurements often use alternate hardware signal paths when compared with a similar measurement in the Signal Analysis Mode using the Swept SA measurement. These frequency domain and time domain measurements can be used to output I/Q data results when measuring complex modulated digital signals.

- Complex Spectrum Measurement (Frequency Domain)

This measurement is comparable to a precision microwave spectrum analyzer measurement that also provides demodulated I/Q data for individual I and Q amplitude data pairs.

- I/Q Waveform Measurement (Time Domain)

This measurement is comparable to a precision vector signal analyzer measurement that also provides demodulated I/Q data for individual magnitude and phase analysis.

The following optional alternate hardware is typically used with IQ Analyzer Mode:

- **Option EA3** provides an alternate attenuator that switches electronically. It has a maximum of 40 dB in 1 dB steps. (The standard attenuator is 70 dB maximum attenuation in 2 dB steps.). This hardware may be accessed from within IQ Analyzer Mode, but only with the narrowband IF path. It cannot be used with the B25 wideband path.
- **Option B25** provides an alternate wideband digital IF signal path with a maximum bandwidth of 25 MHz. This hardware can only be accessed from within measurements in IQ analyzer mode and other demod measurements such as EVM for EDGE and 802.16 OFDMA or 89601A VSA mode.

Using the Electronic Attenuator Hardware (Option EA3)

Option EA3 is required for many of the optional measurement personalities. This optional attenuator does the fast switching necessary to accommodate the complicated multiple-sweep, averaged measurements required for digital communication systems testing. The hardware is specified for measurements up to a maximum of 3.6 GHz and works with many different measurement personalities. These additional measurement personalities are purchased separately and are accessed using the **Mode** key. See [“Installing Application Software” on page 91](#) for information about loading measurement instrument software.

Using the Wideband Analysis Hardware (Option B25)

Option B25 hardware enables up to 25 MHz of capture bandwidth. IQ Analyzer Mode is provided to access this wideband hardware.

There are couplings and interactions when using the optional hardware with other options and hardware.

- B25 access is not limited to IQ analyzer mode. We can use B25 from 89600 VSA software and modulation analysis in other modes.
- If this wideband hardware is installed, IQ Analyzer Mode always makes measurements above 3.6 GHz using the wideband path. The standard “narrowband” path is not available in IQ Analyzer Mode above 3.6 GHz.
- Option EA3 (1 dB electronic attenuator for digital communications) is not required for operation of the wideband option B25.
- If the wideband hardware is installed, but the electronic attenuator (EA3) is *not* installed, then the wideband input path is used for all measurements in IQ Analyzer Mode. Since the standard “narrowband” path is not available in IQ Analyzer Mode without Option EA3, only the Option B25 specifications apply.
- The preamp options (P03) cannot be used in IQ Analyzer Mode with Option B25.

TIP

Improved accuracy can be obtained using an external calibration. This capability is available using the Agilent 89600 Vector Signal Analysis Software.

About the IQ Analyzer Measurement Application
Using the Wideband Analysis Hardware (Option B25)

This chapter provides introductory information about the programming documentation included with your test set.

What Programming Information is Available?

The X-Series Documentation can be accessed through the Additional Documentation page in the instrument Help system and is included on the Documentation CD shipped with the instrument. It can also be found in the instrument at: C:\ProgramsFiles\Agilent\SignalAnalysis\Infrastructure\Help\otherdocs, or online at: http://www.agilent.com/find/mxa_manuals.

The following resources are available to help you create programs for automating your X-Series measurements:

Resource	Description
X-Series Programmer's Guide	<p>Provides general SCPI programming information on the following topics:</p> <ul style="list-style-type: none"> • Programming the X-Series Applications • Programming fundamentals • Programming examples <p>Note that SCPI command descriptions for measurement applications are NOT in this book, but are in the User's and Programmer's Reference.</p>
User's and Programmer's Reference manuals	<p>Describes all front-panel keys and softkeys, including SCPI commands for a measurement application. Note that:</p> <ul style="list-style-type: none"> • Each measurement application has its own User's and Programmer's Reference. • The content in this manual is duplicated in the analyzer's Help (the Help that you see for a key is identical to what you see in this manual).
Embedded Help in your instrument	<p>Describes all front-panel keys and softkeys, including SCPI commands, for a measurement application.</p> <p>Note that the content that you see in Help when you press a key is identical to what you see in the User's and Programmer's Reference.</p>
X-Series Getting Started Guide	<p>Provides valuable sections related to programming including:</p> <ul style="list-style-type: none"> • Licensing New Measurement Application Software - After Initial Purchase • Configuring instrument LAN Hostname, IP Address, and Gateway Address • Using the Windows XP Remote Desktop to connect to the instrument remotely • Using the Embedded Web Server Telnet connection to communicate SCPI <p>This printed document is shipped with the instrument.</p>
Agilent Application Notes	Printable PDF versions of pertinent application notes.
Agilent VISA User's Guide	Describes the Agilent Virtual Instrument Software Architecture (VISA) library and shows how to use it to develop I/O applications and instrument drivers on Windows PCs.

IEEE Common GPIB Commands

Numeric values for bit patterns can be entered using decimal or hexi-decimal representations. (that is,. 0 to 32767 is equivalent to #H0 to #H7FFF).

Calibration Query

*CAL? Performs a full alignment and returns a number indicating the success of the alignment. A zero is returned if the alignment is successful. A one is returned if any part of the alignment fails. The equivalent SCPI command is CALibrate[:ALL]?

See “Alignments” on page 199 for details of *CAL?.

Clear Status

Clears the status byte register. It does this by emptying the error queue and clearing all bits in all of the event registers. The status byte register summarizes the states of the other registers. It is also responsible for generating service requests.

Key Path:	No equivalent key. Related key System, Show Errors, Clear Error Queue
Remote Command:	*CLS
Example:	*CLS Clears the error queue and the Status Byte Register.
Notes:	For related commands, see the SYSTem:ERRor[:NEXT]? command. See also the STATus:PRESet command and all commands in the STATus subsystem.
Status Bits/OPC dependencies:	Resets all bits in all event registers to 0, which resets all the status byte register bits to 0 also.
Backwards Compatibility Notes:	In general the status bits used in the X-Series status system will be backwards compatible with ESA and PSA. However, note that all conditions will generate events that go into the event log, and some will also generate status bits.
Initial S/W Revision:	Prior to A.02.00
Help Map ID:	0

Standard Event Status Enable

Selects the desired bits from the standard event status enable register. This register monitors I/O errors and synchronization conditions such as operation complete, request control, query error, device dependent error, status execution error, command error, and power on. The selected bits are OR'd to become a summary bit (bit 5) in the byte register which can be queried.

The query returns the state of the standard event status enable register.

Key Path:	No equivalent key. Related key System, Show Errors, Clear Error Queue
-----------	--

Remote Command:	*ESE <integer> *ESE?
Example:	*ESE 36 Enables the Standard Event Status Register to monitor query and command errors (bits 2 and 5). *ESE? Returns a 36 indicating that the query and command status bits are enabled.
Notes:	For related commands, see the <i>STATUS</i> subsystem and <i>SYSTEM:ERROR[:NEXT]?</i> commands.
Preset:	255
State Saved:	Not saved in state.
Min:	0
Max:	255
Status Bits/OPC dependencies:	Event Enable Register of the Standard Event Status Register.
Initial S/W Revision:	Prior to A.02.00
Help Map ID:	0

Standard Event Status Register Query

Queries and clears the standard event status event register. (This is a destructive read.) The value returned is a hexadecimal number that reflects the current state (0/1) of all the bits in the register.

Remote Command:	*ESR?
Example:	*ESR? Returns a 1 if there is either a query or command error, otherwise it returns a zero.
Notes:	For related commands, see the <i>STATUS</i> subsystem commands.
Preset:	0
Min:	0
Max:	255
Status Bits/OPC dependencies:	Standard Event Status Register (bits 0 – 7).
Initial S/W Revision:	Prior to A.02.00
Help Map ID:	0

Identification Query

Returns a string of instrument identification information. The string will contain the model number, serial number, and firmware revision.

The response is organized into four fields separated by commas. The field definitions are as follows:

Manufacturer
Model
Serial number
Firmware version

Key Path:	No equivalent key. See related key System, Show System.
Remote Command:	*IDN?
Example:	*IDN? Returns instrument identification information, such as: Agilent Technologies,N9020A,US01020004,A.01.02
Initial S/W Revision:	Prior to A.02.00
Help Map ID:	0

Instrument Model Number

ID? - Returns a string of the instrument identification. The string will contain the model number.

When in Remote Language compatibility mode the query will return the model number of the emulated instrument, when in any other mode the returned model number will be that of the actual hardware.

Operation Complete

The *OPC command sets bit 0 in the standard event status register (SER) to “1” when pending operations have finished, that is when all overlapped commands are complete. It does not hold off subsequent operations. You can determine when the overlapped commands have completed either by polling the OPC bit in SER, or by setting up the status system such that a service request (SRQ) is asserted when the OPC bit is set.

The *OPC? query returns a “1” after all the current overlapped commands are complete. So it holds off subsequent commands until the "1" is returned, then the program continues. This query can be used to synchronize events of other instruments on the external bus.

Remote Command:	*OPC *OPC?
Example:	INIT:CONT 0 Selects single sweeping. INIT:IMM Initiates a sweep. *OPC? Holds off any further commands until the sweep is complete.
Status Bits/OPC dependencies:	Not global to all remote ports or front panel. *OPC only considers operation that was initiated on the same port as the *OPC command was issued from. *OPC is an overlapped command, but *OPC? is sequential.

Backwards Compatibility Notes:	<p>The ESA/PSA/VSA products do not meet all the requirements for the *OPC command specified by IEEE 488.2. This is corrected for X-Series. This will sometimes cause behavior that is not backward compatible, but it will work as customers expect.</p> <p>Commands such as, *OPC/*OPC?/*WAI/*RST used to be global. They considered front panel operation in conjunction with the GPIB functionality. Now they are evaluated on a per channel basis. That is, the various rear panel remote ports and the front panel i/o are all considered separately. Only the functionality initiated on the port where the *OPC was sent, is considered for its operation.</p> <p>*OPC used to hold off until the operation bits were cleared. Now it holds off until all overlapping commands are completed. Also, earlier instruments did not wait for completion of all processes, only the ones identified here (in the STATus:OPERation register):</p> <p>Calibrating: monitored by PSA, ESA, VSA (E4406A)</p> <p>Sweeping: monitored by PSA, ESA, VSA (E4406A)</p> <p>Waiting for Trigger: monitored by PSA, ESA, VSA (E4406A)</p> <p>Measuring: monitored by PSA and ESA (but not in all Modes).</p> <p>Paused: monitored by VSA (E4406A).</p> <p>Printing: monitored by VSA (E4406A).</p> <p>Mass memory busy: monitored by VSA (E4406A).</p>
Initial S/W Revision:	Prior to A.02.00
Help Map ID:	0

Query Instrument Options

Returns a string of all the installed instrument options. It is a comma separated list with quotes, such as: "503,P03,PFR".

To be IEEE compliant, this command should return an arbitrary ascii variable that would not begin and end with quotes. But the quotes are needed to be backward compatible with previous SA products and software. So, the actual implementation will use arbitrary ascii. But quotes will be sent as the first and last ascii characters that are sent with the comma-separated option list.

Remote Command:	*OPT?
Initial S/W Revision:	Prior to A.02.00
Help Map ID:	0

Recall Instrument State

This command recalls the instrument state from the specified instrument memory register.

If the state being loaded has a newer firmware revision than the revision of the instrument, no state is recalled and an error is reported

If the state being loaded has an equal firmware revision than the revision of the instrument, the state will be loaded.

If the state being loaded has an older firmware revision than the revision of the instrument, the instrument will only load the parts of the state that apply to the older revision.

Remote Command:	*RCL <register #>
Example:	*RCL 7 Recalls the instrument state that is currently stored in register 7.
Notes:	Registers 0 through 6 are accessible from the front panel in menu keys for Recall Registers.
Min:	0
Max:	127
Status Bits/OPC dependencies:	The command is sequential.
Initial S/W Revision:	Prior to A.02.00
Help Map ID:	0

Save Instrument State

This command saves the current instrument state and mode to the specified instrument memory register.

Remote Command:	*SAV <register #>
Example:	*SAV 9 Saves the instrument state in register 9.
Notes:	Registers 0 through 6 are accessible from the front panel in menu keys for Save Registers.
Min:	0
Max:	127
Status Bits/OPC dependencies:	The command is sequential.
Initial S/W Revision:	Prior to A.02.00
Help Map ID:	0

Service Request Enable

This command enables the desired bits of the service request enable register.

The query returns the value of the register, indicating which bits are currently enabled.

Remote Command:	*SRE <integer> *SRE?
Example:	*SRE 22 Enables bits 1, 2, and 4 in the service request enable register.

Notes:	For related commands, see the STATus subsystem and SYSTem:ERRor[:NEXT]? commands.
Preset:	0
Min:	0
Max:	255
Status Bits/OPC dependencies:	Service Request Enable Register (all bits, 0 – 7).
Initial S/W Revision:	Prior to A.02.00
Help Map ID:	0

Status Byte Query

Returns the value of the status byte register without erasing its contents.

Remote Command:	*STB?
Example:	*STB? Returns a decimal value for the bits in the status byte register. For example, if a 16 is returned, it indicates that bit 5 is set and one of the conditions monitored in the standard event status register is set.
Notes:	See related command *CLS.
Status Bits/OPC dependencies:	Status Byte Register (all bits, 0 – 7).
Initial S/W Revision:	Prior to A.02.00
Help Map ID:	0

Trigger

This command triggers the instrument. Use the :TRIGger[:SEQuence]:SOURce command to select the trigger source.

Key Path:	No equivalent key. See related keys Single and Restart.
Remote Command:	*TRG
Example:	*TRG Triggers the instrument to take a sweep or start a measurement, depending on the current instrument settings.
Notes:	See related command :INITiate:IMMediate.
Initial S/W Revision:	Prior to A.02.00
Help Map ID:	0

Self Test Query

This query performs the internal self-test routines and returns a number indicating the success of the

testing. A zero is returned if the test is successful, 1 if it fails.

Remote Command:	*TST?
Example:	*TST? Runs the self-test routines and returns 0=passed, 1=some part failed.
Initial S/W Revision:	Prior to A.02.00
Help Map ID:	0

Wait-to-Continue

This command causes the instrument to wait until all overlapped commands are completed before executing any additional commands. There is no query form for the command.

Remote Command:	*WAI
Example:	INIT:CONT OFF; INIT;*WAI Sets the instrument to single sweep. Starts a sweep and waits for its completion.
Status Bits/OPC dependencies:	Not global to all remote ports or front panel. *OPC only considers operation that was initiated on the same port as the *OPC command was issued from.
Initial S/W Revision:	Prior to A.02.00
Help Map ID:	0

File

Opens a menu that enables you to access various standard and custom Windows functions. Press any other front-panel key to exit

Key Path:	Front-panel key
Initial S/W Revision:	Prior to A.02.00
Help Map ID:	2200

File Explorer

Opens the standard Windows File Explorer. The File Explorer opens in the My Documents directory for the current user.

The File Explorer is a separate Windows application, so to return to the analyzer once you are in the File Explorer, you may either:

Exit the File Explorer by clicking on the red X in the upper right hand corner, with a mouse

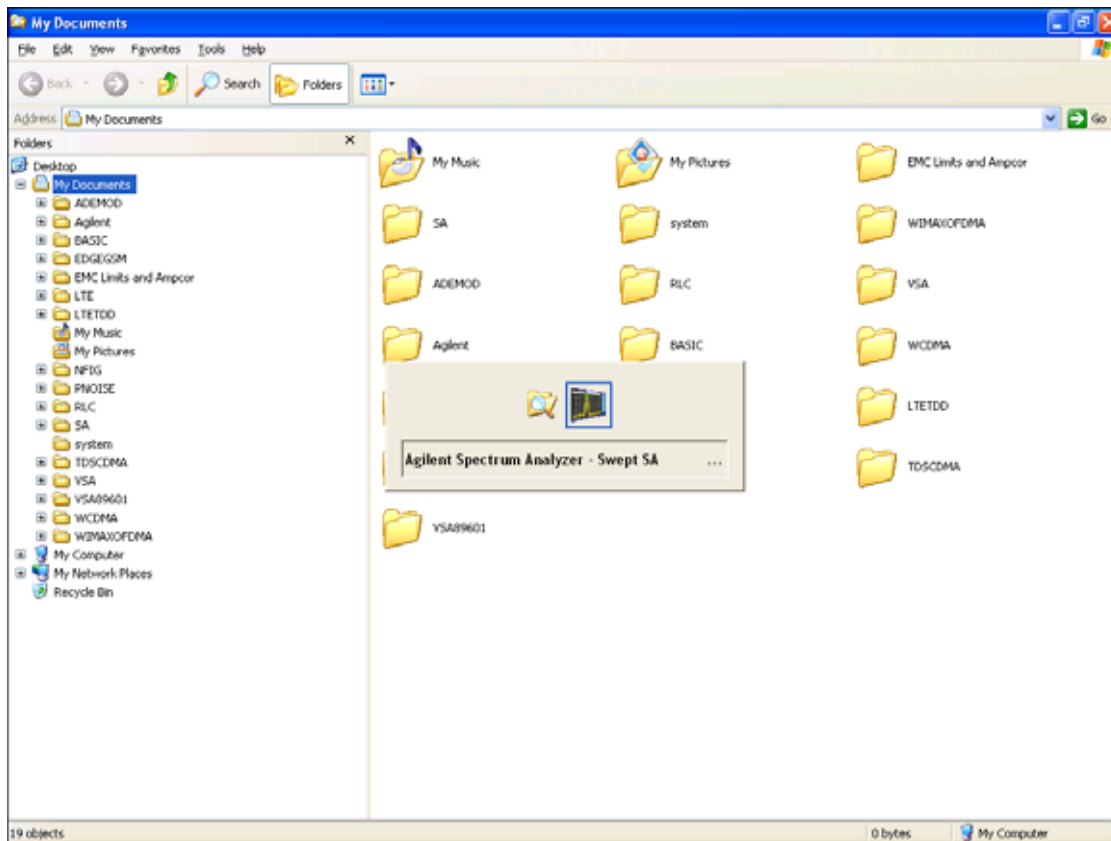

Or use Alt-Tab: press and hold the Alt key and press and release the Tab key until the Analyzer

logo is showing in the window in the center of the screen, as shown above, then release the Alt key.

Key Path:	File
Initial S/W Revision:	Prior to A.02.00
Help Map ID:	2201

Page Setup

The Page Setup key brings up a Windows Page Setup dialog that allows you to control aspects of the pages sent to the printer when the PRINT hardkey is pressed.

Key Path:	File
Initial S/W Revision:	Prior to A.02.00
Help Map ID:	3513

Paper size, the printer paper source, the page orientation and the margins are all settable. Just like any standard Windows dialog, you may navigate the dialog using the front-panel keys, or a mouse. There are no SCPI commands for controlling these parameters.

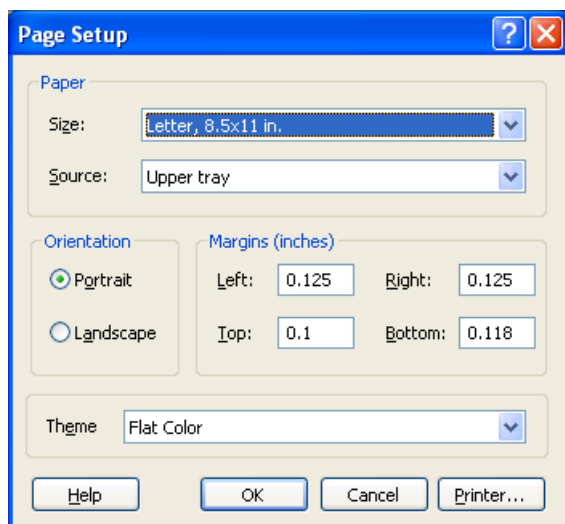

Also contained in this dialog is a drop-down control that lets you select the Theme to use when printing. For more on Themes, see information under View/Display, Display, System Display Settings, Theme. The Theme control has a corresponding SCPI command.

Parameter Name:	Print Themes
Parameter Type:	Enum
Mode:	All

Remote Command:	:SYSTem:PRINT:THEMe TDCoLor TDMonochrome FCoLoR FMONochrome :SYSTem:PRINT:THEMe?
Example:	:SYST:PRIN:THEM FCOL
Setup:	:SYSTem:DEFault MISC
Preset:	FCOL; not part of Preset, but is reset by Restore Misc Defaults or Restore System Defaults All and survives subsequent running of the modes.
State Saved:	No
Initial S/W Revision:	Prior to A.02.00
Help Map ID:	0

Print

The Print key opens a Print dialog for configured printing (for example, to the printer of your choice). Refer to your Microsoft Windows Operating System manual for more information.

Maximize/Restore Down

These keys allow the Instrument Application to be maximized and then restored to its prior state. Only one of the two keys is visible at a time. When not already maximized the Maximize Application key is visible, and when maximized, the Restore Down Application key is visible and replaces the Maximize Application key.

Maximize

This key allows you to Maximize the Instrument Application, which causes the analyzer display to fill the screen. Once the application is maximized, this key is replaced by the Restore Down key.

Key Path:	File
Mode:	All
Notes:	No equivalent remote command for this key.
State Saved:	No
Initial S/W Revision:	A.05.01
Help Map ID:	3668

Restore Down

This key allows you to Restore Down the Instrument Application and reverses the action taken by Maximize. This key is only visible when the application has been maximized, and after the Restore Down action has been completed this key is replaced by the Maximize key.

Key Path:	File
-----------	-------------

Mode:	All
Notes:	No equivalent remote command for this key.
State Saved:	No
Initial S/W Revision:	A.05.01
Help Map ID:	3669

Minimize

The Minimize key causes the analyzer display to disappear down into the task bar, allowing you to see

the Windows Desktop. You can use Alt-Tab (press and hold the Alt  key and press and release the Tab key) to restore the analyzer display.

Key Path:	File
Mode:	All
Notes:	No equivalent remote command for this key.
State Saved:	No
Initial S/W Revision:	A.05.01
Help Map ID:	3670

Exit

This key, when pressed, will exit the Instrument Application. A dialog box is used to confirm that you intended to exit the application:

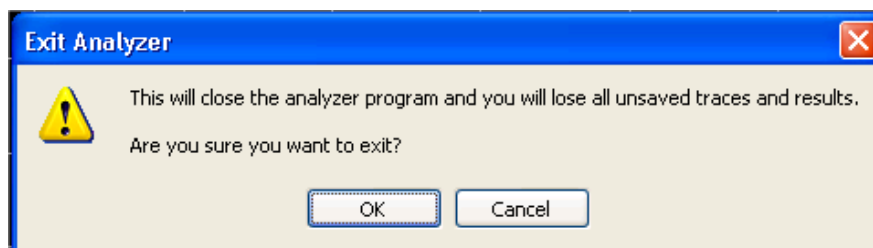

Key Path:	File
Mode:	All
Notes:	The Instrument Application will close. No further SCPI commands can be sent. Use with caution!
Initial S/W Revision:	Prior to A.02.00
Help Map ID:	2202

Mode Preset

Returns the active mode to a known state.

Mode Preset does the following for the currently active mode:

Aborts the currently running measurement.

Brings up the default menu for the mode, with no active function.

Sets measurement Global settings to their preset values for the active mode only.

Activates the default measurement.

Brings up the default menu for the mode.

Clears the input and output buffers.

Sets Status Byte to 0.

Mode Preset does not:

Cause a mode switch

Affect mode persistent settings

Affect system settings

See [“How-To Preset” on page 143](#) for more information.

Key Path:	Front-panel key
Remote Command:	:SYSTem:PRESet
Example:	:SYST:PRES
Notes:	*RST is preferred over :SYST:PRES for remote operation. *RST does a Mode Preset, as done by the :SYST:PRES command, and it sets the measurement mode to Single measurement rather than Continuous for optimal remote control throughput. Clears all pending OPC bits. The Status Byte is set to 0.
Couplings:	A Mode Preset aborts the currently running measurement, activates the default measurement, and gets the mode to a consistent state with all of the default couplings set.

Backwards Compatibility Notes:	<p>In the X-Series, the legacy “Factory Preset” has been replaced with Mode Preset, which only presets the currently active mode, not the entire instrument. In the X-Series, the way in to preset the entire instrument is by using System, Restore System Defaults All, which behaves essentially the same way as restore System Defaults does on ESA and PSA.</p> <p>There is also no “Preset Type” as there is on the PSA. There is a green Mode Preset front-panel key that does a Mode Preset and a white-with-green-letters User Preset front-panel key that does a User Preset. The old PRESet:TYPE command is ignored (without generating an error), and SYST:PRES without a parameter does a Mode Preset, which should cover most backward code compatibility issues.</p> <p>The settings and correction data under the Input/Output front-panel key (examples: Input Z Corr, Ext Amp Gain, etc.) are no longer part of any Mode, so they will not be preset by a Mode Preset. They are preset using Restore Input/Output Defaults, Restore System Defaults All. Note that because User Preset does a Recall State, and all of these settings are saved in State, they ARE recalled when using User Preset.</p>
Initial S/W Revision:	Prior to A.02.00
Help Map ID:	2300

How-To Preset

The table below shows all possible presets, their corresponding SCPI commands and front-panel access (key paths). Instrument settings depend on the current measurement context. Some settings are local to the current measurement, some are global (common) across all the measurements in the current mode, and some are global to all the available modes. In a similar way, restoring the settings to their preset state can be done within the different contexts.

Auto Couple - is a measurement local key. It sets all Auto/Man parameter couplings in the measurement to Auto. Any Auto/Man selection that is local to other measurements in the mode will not be affected.

Meas Preset - is a measurement local key. Meas Preset resets all the variables local to the current measurement except the persistent ones.

Mode Preset - resets all the current mode's measurement local and measurement global variables except the persistent ones.

Restore Mode Defaults - resets ALL the Mode variables (and all the Meas global and Meas local variables), including the persistent ones.

Type Of Preset	SCPI Command	Front Panel Access
Auto Couple	:COUPle ALL	Auto Couple front-panel key
Meas Preset	:CONFigure:<Measurement>	Meas Setup Menu
Mode Preset	:SYSTem:PRESet	Mode Preset (green key)
Restore Mode Defaults	:INSTrument:DEFault	Mode Setup Menu

System Functions
Mode Preset

Type Of Preset	SCPI Command	Front Panel Access
Restore All Mode Defaults	:SYSTem:DEFault MODEs	System Menu; Restore System Default Menu
*RST	*RST	not possible (Mode Preset with Single)
Restore Input/Output Defaults	:SYSTem:DEFault INPut	System Menu; Restore System Default Menu
Restore Power On Defaults	:SYSTem:DEFault PON	System Menu; Restore System Default Menu
Restore Alignment Defaults	:SYSTem:DEFault ALIGn	System Menu; Restore System Default Menu
Restore Miscellaneous Defaults	:SYSTem:DEFault MISC	System Menu; Restore System Default Menu
Restore All System Defaults	:SYSTem:DEFault [ALL] :SYSTem:PRESet:PERsistent	System Menu; Restore System Default Menu
User Preset	:SYSTem:PRESet:USER	User Preset Menu
User Preset All Modes	:SYSTem:PRESet:USER:ALL	User Preset Menu
Power On Mode Preset	:SYSTem:PON:TYPE MODE	System Menu
Power On User Preset	:SYSTem:PON:TYPE USER	System Menu
Power On Last State	:SYSTem:PON:TYPE LAST	System Menu

Restore Mode Defaults

Resets the state for the currently active mode by resetting the mode persistent settings to their factory default values, clearing mode data and by performing a Mode Preset. This function will never cause a mode switch. This function performs a full preset for the currently active mode; whereas, Mode Preset performs a partial preset. Restore Mode Defaults does not affect any system settings. System settings are reset by the Restore System Defaults function. This function does reset mode data; as well as settings.

Key Path:	Mode Setup
Remote Command:	:INSTrument :DEFault
Example:	:INST:DEF
Notes:	Clears all pending OPC bits. The Status Byte is set to 0. A message comes up saying: "If you are sure, press key again".
Couplings:	A Restore Mode Defaults will cause the currently running measurement to be aborted and causes the default measurement to be active. It gets the mode to a consistent state with all of the default couplings set.
Initial S/W Revision:	Prior to A.02.00

Help Map ID:	2307
--------------	------

Meas Preset

Resets the measurement local variables for the currently active measurement to their factory default values. The measurement settings that get reset are the same ones that are reset during a Mode Preset. This function keeps the instrument in the current measurement and the current mode and does not affect the settings for other measurements, but does abort the currently running measurement.

Key Path:	Meas Setup
Remote Command:	:CONFigure:<Measurement>
Example:	:CONF:ACP immediately does a Meas Preset to the ACP measurement.
Notes:	Clears the Measuring bit :CONF:<Measurement> resets the specified measurement settings to default in ESA, VSA and PSA; in GPSA it allows the addition of the NDEFault node to the command to prevent a measurement preset from occurring after a measurement switch. :MEASure:<Measurement> also restores the default values of the selected measurement, but it also initiates the specified measurement.
Initial S/W Revision:	Prior to A.02.00
Help Map ID:	2306

Preset Type (Remote Command Only)

As stated in the Backward Compatibility section, to be compatible with ESA/PSA the PRESet:TYPE command will be implemented as a no-op.

Mode:	All
Remote Command:	:SYSTem:PRESet:TYPE FACTory MODE USER :SYSTem:PRESet:TYPE?
Example:	:SYST:PRESet:TYPE FACT
Notes:	This command is supported for backward compatibility only. It is a no-op which does not change the behavior of any preset operation.
Preset:	This is unaffected by Preset but is set to Mode on a “Restore System Defaults->All”
State Saved:	No
Initial S/W Revision:	Prior to A.02.00
Help Map ID:	0

***RST (Remote Command Only)**

*RST is equivalent to :SYST:PRES;:INIT:CONT OFF, which is a Mode Preset in the Single measurement state. This remote command is preferred over Mode Preset remote command - :SYST:PRES, as optimal remote programming occurs with the instrument in the single measurement state.

Remote Command:	*RST
Example:	*RST
Notes:	Sequential Clears all pending OPC bits and the Status Byte is set to 0.
Couplings:	A *RST will cause the currently running measurement to be aborted and cause the default measurement to be active. *RST gets the mode to a consistent state with all of the default couplings set.
Backwards Compatibility Notes:	In legacy analyzers *RST did not set the analyzer to Single, but in the X-Series it does, for compliance with the IEEE 488.2 specification. In the X-Series, *RST does not do a *CLS (clear the status bits and the error queue). In legacy analyzers, *RST used to do the equivalent of SYSTem:PRESet, *CLS and INITiate:CONTinuous OFF. But to be 488.2 compliant, *RST in the X-Series does not do a *CLS.
Initial S/W Revision:	Prior to A.02.00
Help Map ID:	2301

Print

This front-panel key is equivalent to performing a File, Print, OK. It immediately performs the currently configured Print to the Default printer.

The :HCOPY command is equivalent to pressing the PRINT key. The HCOpy:ABORt command can be used to abort a print which is already in progress. Sending HCOpy:ABORt will cause the analyzer to stop sending data to the printer, although the printer may continue or even complete the print, depending on how much data was sent to the printer before the user sent the ABORt command.

Key Path:	Front-panel key
Remote Command:	:HCOPY[:IMMediate]
Initial S/W Revision:	Prior to A.02.00
Help Map ID:	3495

Key Path:	SCPI command only
Remote Command:	:HCOpy:ABORt
Initial S/W Revision:	Prior to A.02.00
Help Map ID:	0

Quick Save

The Quick Save front-panel key repeats the most recent save that was performed from the Save menu, with the following exceptions:

Register saves are not remembered as Saves for the purpose of the Quick Save function

If the current measurement does not support the last non-register save that was performed, an informational message is generated, “File type not supported for this measurement”

Quick Save repeats the last type of qualified save (that is, a save qualified by the above criteria) in the last save directory by creating a unique filename using the Auto File Naming algorithm described below.

If Quick Save is pressed after startup and before any qualified Save has been performed, the Quick Save function performs a Screen Image save using the current settings for Screen Image saves (current theme, current directory), which then becomes the “last save” for the purpose of subsequent Quick Saves.

The Auto File Naming feature automatically generates a file name for use when saving a file. The filename consists of a prefix and suffix separated by a dot, as is standard for the Windows® file system. A default prefix exists for each of the available file types:

Type	Default Prefix	Menu
State	State_	(Save/Recall)
Trace + State	State_	(Save/Recall)
Screen	Screen_	(Save/Recall)
Amplitude Corrections	Ampcor_	(Import/Export)
Traces	Trace_	(Import/Export)
Limit Lines	LLine_	(Import/Export)
Measurement Result	MeasR_	(Import/Export)
Capture Buffer	CapBuf_	(Import/Export)

A four digit number is appended to the prefix to create a unique file name. The numbering sequence starts at 0000 within each Mode for each file type and updates incrementally to 9999, then wraps to 0000 again. It remembers where it was through a Mode Preset and when leaving and returning to the Mode. It is reset by Restore Misc Defaults and Restore System Defaults and subsequent running of the instrument application. So, for example, the first auto file name generated for State files is State_0000.state. The next is State_0001, and so forth.

One of the key features of Auto File Name is that we guarantee that the Auto File Name will never conflict with an existing file. The algorithm looks for the next available number. If it gets to 9999, then it looks for holes. If it find no holes, that is no more numbers are available, it gives an error.

For example, if when we get to State_0010.state there is already a State_0010.state file in the current directory, it advances the counter to State_0011.state to ensure that no conflict will exist (and then it verifies that State_0011.state also does not exist in the current directory and advances again if it does,

and so forth).

If you enter a file name for a given file type, then the prefix becomes the filename you entered instead of the default prefix, followed by an underscore. The last four letters (the suffix) are the 4-digit number.

For example, if you save a measurement results file as “fred.csv”, then the next auto file name chosen for a measurement results save will be fred_0000.csv.

NOTE Although 0000 is used in the example above, the number that is used is actually the current number in the Meas Results sequence, that is, the number that would have been used if you had not entered your own file name.

NOTE If the filename you entered ends with _dddd, where d=any number, making it look just like an auto file name, then the next auto file name picks up where you left off with the suffix being dddd + 1.

Key Path:	Front-panel key
Notes:	No remote command for this key specifically.
Initial S/W Revision:	Prior to A.02.00
Help Map ID:	2635

Recall

The **Recall** menu lets you choose what you want to recall, and where you want to recall it from. Among the types of files you can recall are **States and Traces**. In addition, an **Import (Data)** option lets you recall a number of data types stored in CSV files (as used by Excel and other spreadsheet programs).

The default paths for Recall are data type dependent and are the same as for the Save key.

Key Path:	Front-panel key
Notes:	<p>No remote command for this key specifically, but the :MMEM:LOAD command is available for specific file types. An example is :MMEM:LOAD:STATe <filename>.</p> <p>If you try to recall a State file for a mode that is not licensed or not available in the instrument, an error message will occur and the state will not change.</p>
Backwards Compatibility Notes:	<p>In legacy analyzers, it was possible to load a state without affecting the trace data, limit lines or correction data. Similarly (since User Preset is actually loading a state), it was possible to do a User Preset without affecting the trace data, limit lines or correction data.</p> <p>In the X-Series, “state” always includes all of this data; so whenever state is loaded, all of the traces, limit lines and corrections are affected. Although this differs from previous behavior, it is desirable behavior, and should not cause adverse issues for users.</p>
Backwards Compatibility Notes:	<p>Recall for the X-Series supports backward compatibility in the sense that you can recall a state file from any X-Series model number and any version of X-Series software. If you try to recall a state file onto an instrument with less capability than what was available on the instrument during the save, the recall will ignore the state it doesn’t support and it will limit the recalled setting to what it allows.</p> <p>Example: if the saved state includes preamp ON, but the recalling instrument does not have a preamp; the preamp is limited to OFF. Conversely, if you save a state without a preamp, the preamp is OFF in the state file. When this saved file is recalled on an instrument with a licensed preamp, the preamp is changed to OFF. Another example is if the saved state has center frequency set to 20 GHz, but the instrument recalling the saved state is a different model and only supports 13.5 GHz. In this case, the center frequency is limited along with any other frequency based settings. Since the center frequency can’t be preserved in this case, the recall limiting tries to at least preserve span to keep the measurement setup as intact as possible.</p> <p>Note that there is no state file compatibility outside of the X-Series. For example, you cannot recall a state file from ESA or PSA.</p>
Initial S/W Revision:	Prior to A.02.00
Help Map ID:	2637

State

The **Recall State** menu lets you choose a register or file from which to recall the state.

The content of a state file includes all of the settings and data required to return the analyzer as closely as possible to the Mode it was in, with the exact settings that were in place, when the save occurred. The Mode settings in each state file include the settings that are affected by Mode Preset, as well as the additional settings affected by Restore Mode Defaults; all of the Mode's settings. In addition, all of the settings of the **Input/Output** system are included, even though they are outside of the Mode's state, because they are needed to restore the complete setup. Persistent System settings (for example, GPIB address) are not affected by either a Mode Preset or Restore Mode Defaults, nor are they included in a saved State file.

Since each state file is only for one Mode, the settings for other Modes are unaffected when it is loaded. **Recall State** will cause a mode switch if the state being recalled is not from the current active mode.

After the recall completes, the message "File <filename> recalled" or "Recalled State Register <register number>" is displayed.

For rapid recalls, the State menu lists 16 registers that you can choose from to recall. Pressing a Register key initiates the recall. You can also select a file from which to recall.

The default path for all State Files is:

My Documents\<<mode name>\state

where <mode name> is the parameter used to select the mode with the INST:SEL command (for example, SA for the Spectrum Analyzer).

See ["More Information" on page 152](#).

Key Path:	Recall
Mode:	All
Remote Command:	:MMEMory:LOAD:STATe <filename>
Example:	:MMEM:LOAD:STAT "myState.state" This recalls the file myState.state on the default path
Example:	MMEM:LOAD:STAT "MyStateFile.state" This loads the state file data (on the default file directory path) into the instrument state.

System Functions
Recall

Notes:	<p>When you pick a file to recall, the analyzer first verifies that the file is recallable in the current instrument by checking the software version and model number of the instrument. If everything matches, a full recall proceeds by aborting the currently running measurement, clearing any pending operations, and then loading the State from the saved state file. You can open state files from any mode, so recalling a State file switches to the mode that was active when the save occurred. After switching to the mode of the saved state file, mode settings and data (if any for the mode) are loaded with values from the saved file. The saved measurement of the mode becomes the newly active measurement and the data relevant to the measurement (if there is any) is recalled.</p> <p>If there is a mismatch between file version or model number or instrument version or model number, the recall function tries to recall as much as possible and returns a warning message. It may limit settings that differ based on model number, licensing or version number.</p> <p>After recalling the state, the Recall State function does the following:</p> <p>Makes the saved measurement for the mode the active measurement.</p> <p>Clears the input and output buffers.</p> <p>Status Byte is set to 0.</p> <p>Executes a *CLS</p> <p>If the file specified is empty an error is generated. If the specified file does not exist, another error is generated. If there is a mismatch between the file and the proper file type, an error is generated. If there is a mismatch between file version or model number or instrument version or model number, a warning is displayed. Then it returns to the State menu and File Open dialog goes away.</p> <p>After the Recall, the analyzer exits the Recall menu and returns to the previous menu.</p>
Backwards Compatibility SCPI:	<p>:MMEMory:LOAD:STATe 1,<filename></p> <p>For backwards compatibility, the above syntax is supported. The "1" is simply ignored.</p>
Initial S/W Revision:	Prior to A.02.00
Help Map ID:	2638

More Information

In measurements that support saving Traces, for example, Swept SA, the Trace data is saved along with the State in the State file. When recalling the State, the Trace data is recalled as well. Traces are recalled exactly as they were stored, including the writing mode and update and display modes. If a Trace was updating and visible when the State was saved, it will come back updating and visible, and its data will be rewritten right away. When you use State to save and recall traces, any trace whose data must be preserved should be placed in View or Blank mode before saving.

The following table describes the Trace Save and Recall possibilities:

<p>You want to recall state and one trace's data, leaving other traces unaffected.</p>	<p>Save Trace+State from 1 trace. Make sure that no other traces are updating (they should all be in View or Blank mode) when the save is performed.</p>	<p>On Recall, specify the trace you want to load the one trace's data into. This trace will load in View. All other traces' data will be unaffected, although their trace mode will be as it was when the state save was performed.</p>
<p>You want to recall all traces</p>	<p>Save Trace+State from ALL traces.</p>	<p>On Recall, all traces will come back in View (or Blank if they were in Blank or Background when saved)</p>
<p>You want all traces to load exactly as they were when saved.</p>	<p>Save State</p>	<p>On recall, all traces' mode and data will be exactly as they were when saved. Any traces that were updating will have their data immediately overwritten.</p>

From File...

When you press "From File", the analyzer brings up a Windows dialog and a menu entitled "**File Open.**" This menu allows you to navigate to the various fields in the Windows dialog without using a keyboard or mouse. The **Tab** and **Arrow** keys can also be used for dialog navigation.

System Functions

Recall

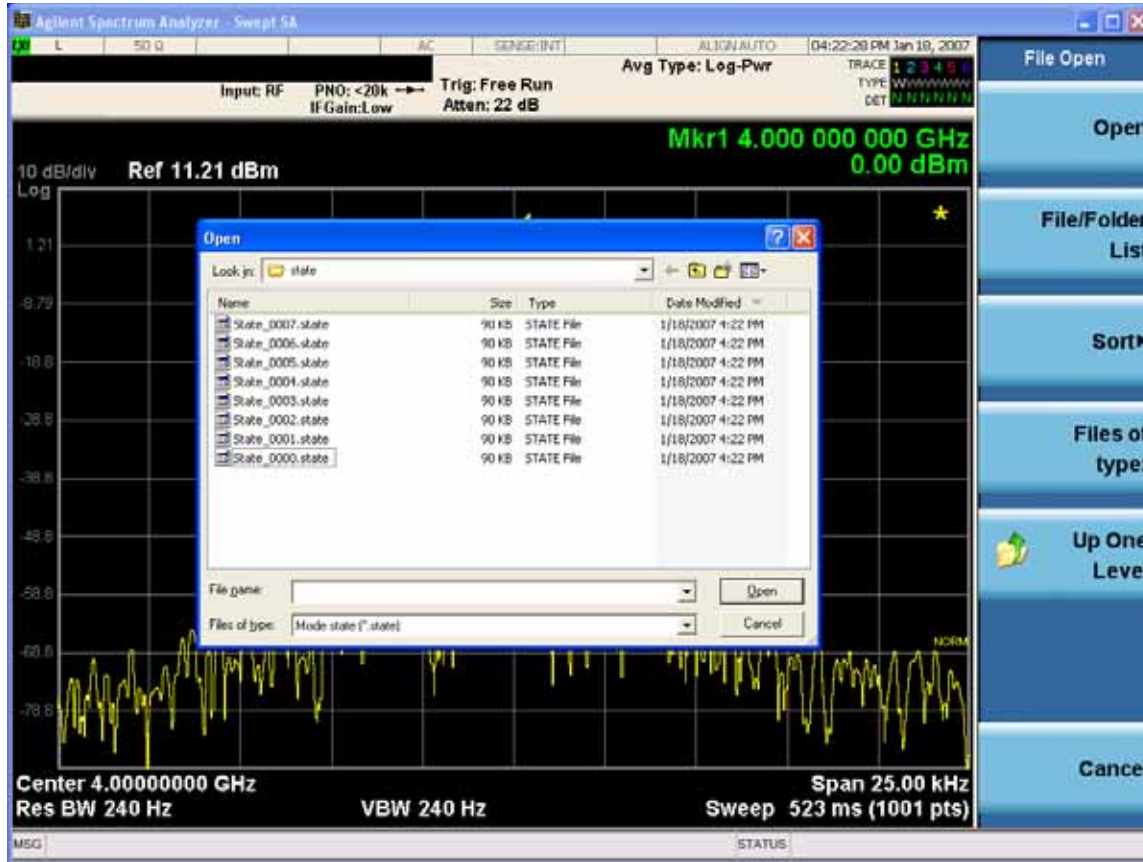

Listed below are the functions of the various fields in the dialog, and the corresponding softkeys:

Open

Performs the recall of the specified file. While the recall is being performed, the floppy icon appears briefly in the Meas bar.

File/Folder List

Enables you to navigate to the center of the dialog that contains the list of files and folders. Once here you can get information about the file and use the tab keys to navigate to the other fields in the dialog, such as Look In.

Look In

The **Look In** field shows the path from which the file will be recalled and allows you to change the path using the up and down arrow keys to navigate to other paths; the Enter key to open a directory; and the Backspace key to go back one directory. The **Look In field** first uses the last path from the Save As dialog **Save In:** path for that same file type. There is no softkey for directly navigating to the Look In field, but you can use the left tab to get here from the File/Folder List.

User specified paths are remembered when you leave and return to a Mode and are reset back to the default using **Restore Mode Defaults**.

Sort

Accesses a menu that enables you to sort the files within the File Open dialog. Only one sorting type can

be selected at a time and the sorting happens immediately. The sorting types are **By Date**, **By Name**, **By extension**, and **By Size**.

Files of Type

This field shows the file suffix for the type of file you have selected to recall. For example, if you navigated here while recalling State, "Mode state (*.state)" is in the field. If you navigated here while recalling Trace, "Mode state (*.trace)" is in the field. If you navigated here while importing a trace data file, "Trace Data (*.csv)" is in the field. For some file types, there is more than one choice in the dropdown menu, which you can select by using the up and down arrow keys and Enter.

Up One Level

This key corresponds to the icon of a folder with the up arrow that is in the tool bar of the dialog. When pressed, it causes the file and folder list to navigate up one level in the directory structure. The Backspace key does the same thing.

Cancel

This key corresponds to the **Cancel** selection in the dialog. It causes the current **Open** request to be cancelled. The ESC key does the same thing.

Key Path:	Recall, State
Notes:	Brings up the Open dialog for recalling a State Save Type
Initial S/W Revision:	Prior to A.02.00
Help Map ID:	2646

Edit Register Names

You may enter a custom name on any of the Register keys, to help you remember what you are using that state to save. To do this, press the **Edit Register Names** key, choose the register whose name you wish to edit, and then enter the desired label using the Alpha Editor or an external PC keyboard.

The maximum number of characters that can be added is 30. In most cases, 30 characters will fit on two lines of the key.

For more information and the SCPI command, see Edit Register Names under the **Save, State** function.

Key Path:	Recall, State
Mode:	All
Dependencies:	N9060A-7FP or N9060B-2FP license required to edit the register names. When the feature is not licensed, sending the SCPI command generates an error, -221, "Settings conflict;Option not available"
Initial S/W Revision:	A.11.00
Help Map ID:	50008

Register 1 thru Register 16

Selecting any one of these register keys causes the State of the mode from the specified Register to be

System Functions

Recall

recalled. Each of the register keys annotates whether it is empty or at what date and time it was last modified. In addition, you can use the **Edit Register Names** key under **Save, State** to enter custom names for each register.

Registers are shared by all modes, so recalling from any one of the registers will cause a mode switch to the mode that was active when the save to the Register occurred.

Although these 16 registers are the only registers available from the front panel, there are 128 state registers available in the instrument. Registers 17–128 are only available from the SCPI interface, using the *RCL command.

After the recall completes, the message "Register <register number> recalled" appears in the message bar. If you are in the Spectrum Analyzer Mode, and you are recalling a register that was saved in the Spectrum Analyzer Mode, then after the recall, you will still be in the Recall Register menu. If the Recall causes you to switch modes, then after the Recall, you will be in the Frequency menu.

If a requested register is empty an error is generated.

Key Path:	Recall, State
Example:	*RCL 1
Range:	1–16 from front panel, 1–128 from SCPI
Readback:	Date and time with seconds resolution are displayed on the key OR A custom name of up to 30 characters entered using the Save, State, Edit Register Names key OR “(empty)” if no prior save operation has been performed to this register.
Initial S/W Revision:	Prior to A.02.00
Modified at S/W Revision:	Prior to A.11.00
Help Map ID:	2639

Trace (+State)

The Recall Trace (+State) menu lets you choose a register or file from which to recall the Trace+State state file.

A saved state contains all of the settings and data required to return the analyzer as closely as possible to the exact setup it had when the save occurred. This includes the Input/Output settings, even though they are outside of the Mode’s state, because they are needed to restore the complete setup. A Trace+State file also includes trace data from one trace or all traces, which will load in View mode when the Trace+State file is recalled. Recall Trace (+State) will also cause a mode switch if the state being recalled is not for the current active mode.

After the recall completes, the message "File <filename> recalled" or “Recalled Trace Register <register number>” is displayed.

For rapid recalls, the Trace (+State) menu lists 5 registers to choose from to recall. Pressing a Register

key initiates the recall. You can also select a file from which to recall.

The default path for all State Files including .trace files is:

My Documents\<<mode name>\state

where <mode name> is the parameter used to select the mode with the INST:SEL command (for example, SA for the Spectrum Analyzer).

Key Path:	Recall
Mode:	SA
Remote Command:	:MMEMory:LOAD:TRACe TRACE1 TRACE2 TRACE3 TRACE4 TRACE5 TRACE6 , <filename> :MMEMory:LOAD:TRACe:REGister TRACE1 TRACE2 TRACE3 TRACE4 TRACE5 TRACE6 , <integer>
Example:	MMEM:LOAD:TRAC TRACE2,"MyTraceFile.trace" This loads the trace file data (on the default file directory path) into the specified trace; if it is a "single trace" save file, that trace is loaded to trace 2, and is set to be not updating. :MMEM:LOAD:TRAC:REG TRACE1,2 restores the trace data in register 2 to Trace 1
Notes:	When you perform the recall, the recalling Trace function must first verify the file is recallable in this instrument by checking instrument software version and model number, since it includes State. If everything matches, a full recall proceeds by aborting the currently running measurement, and loading the state from the saved state file to as close as possible to the context in which the save occurred. You can open .trace files from any mode that supports them, so recalling a Trace file switches to the mode that was active when the save occurred. After switching to the mode of the saved state file, mode settings and data (if any for the mode) are loaded with values from the saved file and the saved measurement of the mode becomes the newly active measurement, and the data relevant to the measurement (if there is any) is recalled. Once the state is loaded, the trace data must be loaded. The internal flags are consulted to see which trace to load and the "To Trace" setting to see where to load it. Trace data is always loaded with the specified trace set to View, so that the data is visible and not updating(so as not to erase the recalled data). If the file is an "all trace" file, all traces are loaded with the saved data(to the original trace the data was saved from) and set to View. Traces whose data is not loaded are restored to the update state that existed when they were saved. After the Recall the analyzer exits the Recall menu and returns to the previous menu. Some modes and measurements do not have available all 6 traces. Phase Noise mode command, for example, is: MMEMory:LOAD:TRACe TRACE1 TRACE2 TRACE3 , <filename>
Initial S/W Revision:	Prior to A.02.00
Help Map ID:	3491

Register 1 thru Register 5

Selecting any one of these register keys causes the Traces and State from the specified Register to be recalled. Each of the register keys annotates whether it is empty or at what date and time it was last modified.

Trace registers are shared by all modes, so recalling from any one of the 5 registers may cause a mode switch to the mode that was active when the save to the Register occurred.

Key Path:	Recall, Trace
Range:	1-5
Readback:	Date and time with seconds resolution of the last Save is displayed on the key, or "(empty)" if no prior save operation performed to this register.
Initial S/W Revision:	Prior to A.02.00
Help Map ID:	3593

To Trace

These menu selections let you choose the Trace where the recalled saved trace will go. Not all modes have the full 6 traces available. The default is the currently selected trace, selected in this menu or in the Trace/Detector, Export Data, Import Data, or Save Trace menus, except if you have chosen All, then it remains chosen until you specifically change it to a single trace.

If the .trace file is an "all trace" file, "**To Trace**" is ignored and the traces each go back to the trace from which they were saved.

Once selected, the key returns back to the Recall Trace menu and the selected Trace number is annotated on the key. Now you have selected exactly where the trace needs to be recalled. To trigger a recall of the selected Trace, you must select the **Open** key in the Recall Trace menu.

When you select a trace, it makes that trace the current trace, so it displays on top of all of the other traces.

Key Path:	Save, Data, Trace
Mode:	SA
Initial S/W Revision:	Prior to A.02.00
Help Map ID:	3492

From File...

When you press "From File", the analyzer brings up a Windows dialog and a menu entitled "**File Open.**" This menu allows you to navigate to the various fields in the Windows dialog without using a keyboard or mouse. The **Tab** and **Arrow** keys can also be used for dialog navigation.

See "[From File...](#)" on page 153 under Save, State for a full description of this dialog and menu.

Key Path:	Recall, Trace
-----------	----------------------

Mode:	SA
Notes:	Brings up Open dialog for recalling a Trace Save Type
Initial S/W Revision:	Prior to A.02.00
Help Map ID:	3493

Sequences

This menu and all of its submenus are only available in the EXT (E6607A).

These keys allow you to import a Tab separated or .txt file that will automatically setup all the parameters required for building a Sequence. The parameters will automatically be loaded into the Stated Sequencer.

Once selected, in order to import the selected Sequence Type you must select the Open key in the Source Sequence menu.

Key Path:	Recall, Sequences
Mode:	All
Remote Command:	:MMEMory:LOAD:SEquences: SLIS ALIS SAALIS "MySequence.txt"
Example:	:MMEM:LOAD:SEQ:SLIS "MySequence.txt"
Notes:	Available file types are: CSV (Comma delimited) (*.csv) Text (Tab delimited) (*.txt)
Initial S/W Revision:	A.05.00
Help Map ID:	3630

Source Sequence

The list of parameters, that configure steps, that makes up a sequence for the Source.

The Source sequence is a sequence of flexible configurable steps that can be set anywhere in the instruments frequency range.

Key Path:	Recall, Sequences
Example:	:MMEM:LOAD:SEQ:SLIS "MySequence.txt"
Dependencies:	Only available in XOBT
Initial S/W Revision:	A.05.00
Help Map ID:	3631

Analyzer Sequence

Only Available in: Sequence Analyzer Mode

The list of parameters, that configure steps, that makes up a sequence for the Analyzer.

The Analyzer sequence is a sequence of flexible configurable steps that can be set anywhere in the instruments frequency range for measuring the performance of a transmitters output

Key Path:	Recall,Sequences
Example:	:MMEM:LOAD:SEQ:ALIS "MySequence.txt"
Dependencies:	Only available in XOBT, Sequence Analyzer mode
Initial S/W Revision:	A.05.00
Help Map ID:	3632

Source and Analyzer Sequence

Only Available in: Sequence Analyzer Mode

The list of parameters, that configure steps, that makes up sequences for the Analyzer and the Source.

The Source and Analyzer sequence is completely configurable and can have internal triggers between the source and the analyzer to orchestrate a sequence to completely test an external transmitter and receiver's performance.

Key Path:	Recall,Sequences
Example:	:MMEM:LOAD:SEQ:SAAL "MySequence.txt"
Dependencies:	Only available in XOBT, Sequence Analyzer mode
Initial S/W Revision:	A.05.00
Help Map ID:	3633

Open...

Pressing **File Open** brings up the File Open standard Windows dialog and the File Open key menu. When the user navigates to this selection, they have already determined they are recalling a specific Data Type and now they want to specify which file to open.

When you first enter this dialog, the path is in the Look In: field in this File Open dialog depends on which import data type you navigated here from.

The only files that are visible are those specific to the file type being recalled.

Key Path:	Recall, Sequence
Notes:	The key location is mode-dependent and will vary.
Notes:	Brings up Open dialog for recalling a <sequence> Save Type
Initial S/W Revision:	A.05.00

Help Map ID:	3635
--------------	------

Data (Import)

Importing a data file loads data that was previously saved from the current measurement or from other measurements and/or modes that produce compatible data files. The Import Menu only contains Data Types that are supported by the current measurement.

Since the commonly exported data files are in .csv format, the data can be edited by the user prior to importing. This allows you to export a data file, manipulate the data in Excel (the most common PC Application for manipulating .csv files) and then import it.

Importing Data loads measurement data from the specified file into the specified or default destination, depending on the data type selected. Selecting an Import Data menu key will not actually cause the importing to occur, since the analyzer still needs to know from where to get the data. Pressing the Open key in this menu brings up the Open dialog and Open menu that provides you with the options from where to recall the data. Once a filename has been selected or entered in the Open menu, the recall occurs as soon as the Open button is pressed.

Key Path:	Recall
Mode:	All
Notes:	The menu is built from whatever data types are available for the mode. Some keys will be missing completely, so the key locations in the sub-menu will vary. No SCPI command directly controls the Data Type that this key controls. The Data Type is included in the MMEM:LOAD commands.
Dependencies:	If a file type is not used by a certain measurement, it is grayed out for that measurement. The key for a file type will not show at all if there are no measurements in the Mode that support it.
Preset:	Is not affected by Preset or shutdown, but is reset during Restore Mode Defaults
Readback:	The data type that is currently selected
Initial S/W Revision:	Prior to A.02.00
Help Map ID:	2648

Open...

When you press “Open”, the analyzer brings up a Windows dialog and a menu entitled “**File Open.**” This menu allows you to navigate to the various fields in the Windows dialog without using a keyboard or mouse. The **Tab** and **Arrow** keys can also be used for dialog navigation.

See “[From File...](#)” on page 153 in **Recall, State**, for a full description of this dialog and menu.

Key Path:	Recall, Data
-----------	---------------------

System Functions
Recall

Notes:	The key location is mode-dependent and will vary. Brings up Open dialog for recalling a <mode specific> Save Type
Initial S/W Revision:	Prior to A.02.00
Help Map ID:	2654

Save

The **Save** menu lets you choose what you want to save and where you want to save it. Among the types of files you can save are **States**, **Traces**, and **Screen Images**. In addition, an **Export (Data)** option lets you save a number of data types as CSV files for easy import into Excel and other spreadsheet programs.

Key Path:	Front-panel key
Mode:	All
Notes:	No remote command for this key specifically, but the :MMEM:STORe command is available for specific file types. An example is :MMEM:STOR:STATe <filename>.
Initial S/W Revision:	Prior to A.02.00
Help Map ID:	2600

State

The Save State menu lets you choose a register or file for saving the state.

The content of a state file includes all of the settings and data required to return the analyzer as closely as possible to the Mode it was in, with the exact settings which were in place, when the save occurred. The Mode settings in each state file include the settings that are affected by Mode Preset, as well as the additional settings affected by Restore Mode Defaults; all of the Mode's settings. In addition, all of the settings of the **Input/Output** system are included, even though they are outside of the Mode's state, because they are needed to restore the complete setup. Persistent **System** settings (for example, GPIB address) are not affected by either Mode Preset or Restore Mode Defaults, nor are they included in a saved State file.

After the save completes, the message "File <filename> saved" or "State Register <register number> saved" is displayed.

For rapid saving, the State menu lists 16 registers to save to. Pressing a Register key initiates the save. You can also select a file to save to.

The default path for all State Files is:

My Documents\<mode name>\state

where <mode name> is the parameter used to select the mode with the INST:SEL command (for example, SA for the Spectrum Analyzer).

Key Path:	Save
Mode:	All
Remote Command:	:MMEMory:STORe:STATe <filename>

System Functions
Save

Example:	MMEM:STOR:STATe "MyStateFile.state" This stores the current instrument state data in the file MyStateFile.state in the default directory.
Notes:	Both single and double quotes are supported for any filename parameter over remote. After saving to a register, that register's menu key is updated with the date the time, unless a custom label has been entered for that key. After saving to a register, you remain in the Save State menu, so that you can see the Register key update. After saving to a file, the analyzer automatically returns to the previous menu and any Save As dialog goes away.
Backwards Compatibility SCPI:	:MMEMory:STORe:STATe 1,<filename> For backwards compatibility, the above syntax is supported. The "1" is simply ignored. The command is sequential.
Initial S/W Revision:	Prior to A.02.00
Help Map ID:	2601

To File . . .

When you press "To File", the analyzer brings up a Windows dialog and a menu entitled "Save As." This menu allows you to navigate to the various fields in the Windows dialog without using a keyboard or mouse. The **Tab** and **Arrow** keys can also be used for dialog navigation.

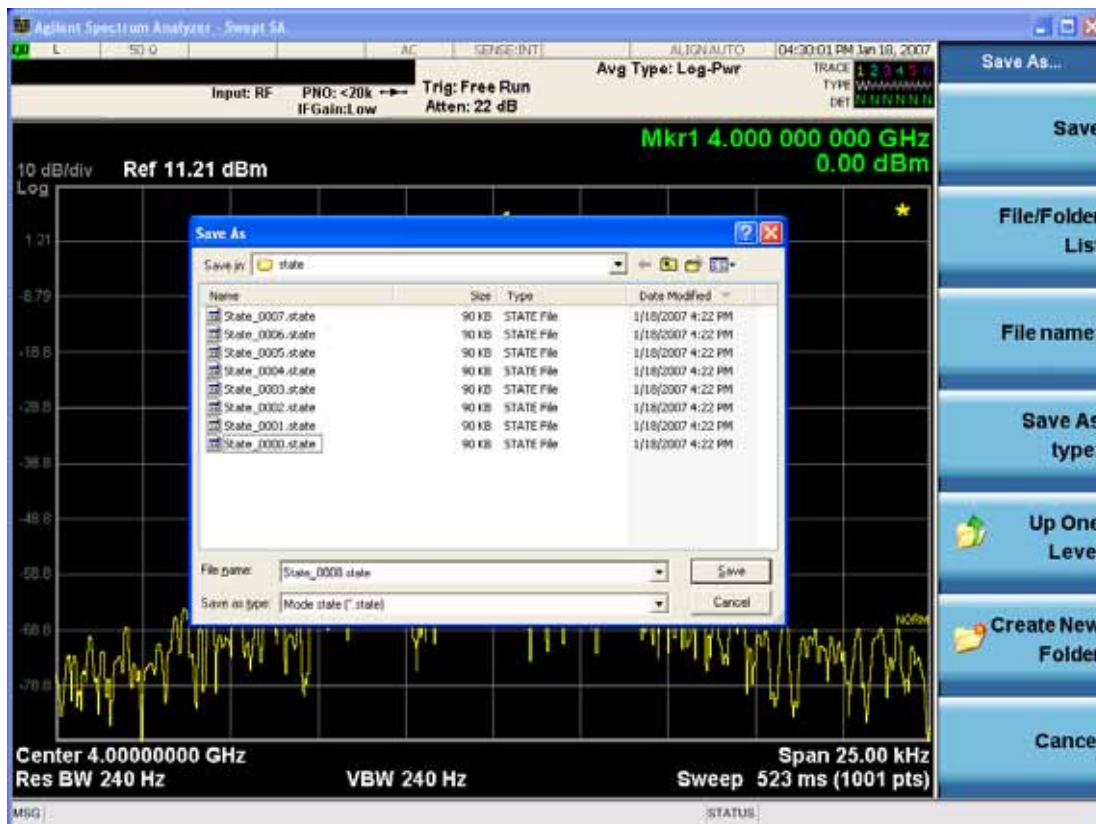

The

Listed below are the functions of the various fields in the dialog, and the corresponding softkeys:

Save

Performs the save to the specified file of the selected type. If the file already exists, a dialog will appear that allows you to replace the existing file by selecting **OK**, or you can Cancel the request. If you select **OK**, the file will be overwritten. Using the C: drive is strongly discouraged, since it runs the risk of being overwritten during an instrument software upgrade.

While the save is being performed, the floppy icon appears briefly in the Meas bar.

File/Folder List

Enables you to navigate to the center of the dialog that contains the list of files and folders. Once here you can get information about the file and use the tab keys to navigate to the other fields in the dialog, such as **Save In**.

Save In

The **Save In** field shows the path to which the file will be saved and allows you to change the path using the up and down arrow keys to navigate to other paths; the Enter key to open a directory; and the Backspace key to go back one directory. The **Save In field** defaults to the default path for this type of file and remembers the last path you used to save this type of file. There is no softkey for directly navigating to the **Save In** field but you can use left tab to get here from the File/Folder List.

User specified paths are remembered when you leave and return to a Mode and are reset back to the default using **Restore Mode Defaults**.

File Name

The **File Name** field is initially loaded with an automatically generated filename specific to the appropriate Save Type. The automatically generated filename is guaranteed not to conflict with any filename currently in the directory. You may replace or modify this filename using the File Name key. See the "[Quick Save](#)" on page 148 documentation for more on the automatic file naming algorithm.

When you press the **File Name** key the analyzer displays the Alpha Editor. Use the knob to choose the letter to add and the front-panel Enter key to add the letter to the file name. The BK character moves you back and the FW character moves you forward in the filename. The Select key on the front panel generates a space character. When you are done entering the filename press the **Done** softkey. This returns back to the **File Open** dialog and menu, but does not cause the save to occur.

Save As Type

This field shows the file suffix for the type of file you have selected to save. For example, if you navigated here while saving State, "Mode state (*.state)" is in the field. If you navigated here from saving Trace, "Mode state (*.trace)" is in the field. If you navigated here while exporting a trace data file, "Trace Data (*.csv)" is in the field. For some file types, there is more than one choice in the dropdown, which you can select by using the up and down arrow keys and Enter.

Up One Level

This key corresponds to the icon of a folder with the up arrow that is in the tool bar of the dialog. When pressed, it causes the file and folder list to navigate up one level in the directory structure. The Backspace key does the same thing.

Create New Folder

System Functions

Save

This key corresponds to the icon of a folder with the "*" that is in the tool bar of the dialog. When pressed, a new folder is created in the current directory with the name **New Folder** and you can enter a new folder name using the Alpha Editor.

Cancel

This key corresponds to the **Cancel** selection in the dialog. It causes the current **Save As** request to be cancelled. The ESC key does the same thing.

Key Path:	Save, State
Mode:	All
Notes:	Brings up Save As dialog for saving a State Save Type
Initial S/W Revision:	Prior to A.02.00
Help Map ID:	2609

Edit Register Names

You may enter a custom name on any of the Register keys, to help you remember what you are using that state to save. To do this, press the **Edit Register Names** key, choose the register whose name you wish to edit, and then enter the desired label using the Alpha Editor or an external PC keyboard.

The maximum number of characters that can be added is 30. In most cases, 30 characters will fit on two lines of the key.

See ["More Information" on page 167](#)

Key Path:	Save, State
Mode:	All
Remote Command:	:MMEMory:REGister:STATe:LABel <reg number>,"label" :MMEMory:REGister:STATe:LABel? <reg number>
Example:	:MMEM:REG:STAT:LAB 1,"my label"
Notes:	<reg number> is an integer from 1 to 16. If the SCPI specifies an invalid register number an error message is generated, -222,"Data out of range;Invalid register label number" "label" is a string from 0 to 30 characters in length. If a label exceeds 30 characters, an error message is generated, -150,"String data error;Label clipped to 30 characters" "label" of length 0 erases the custom label and restores the default (time and date) label. E.g.: :MMEM:REG:STAT:LAB 1,""
Dependencies:	N9060A-7FP or N9060B-2FP license required to edit the register names. When the feature is not licensed, sending this command generates an error, -221,"Settings conflict;Option not available"
Preset:	The names are unaffected by Preset or power cycle but are set to the default label (time and date) on a "Restore System Defaults->Misc"

Initial S/W Revision:	A.11.00
Help Map ID:	50009

More Information

When you edit one of the register names, the time and date field will be replaced by the custom name.

If you delete all the characters in the custom name, it restores the default (time and date).

The register names are stored within the state files, but they are not part of the instrument state; that is, once you have edited a register name, loading a new state will not change that register name. Another consequence of this is that the names will be persistent through a power cycle. Also, if a named state file is transferred to another analyzer, it will bring its custom name along with it.

If you try to edit the name of an empty register, the analyzer will first save the state to have a file to put the name in. If you load a named state file into an analyzer with older firmware it will ignore the metadata.

The *SAV and *RCL commands will not be affected by the custom register names, nor will the MMEM commands.

Register 1 thru Register 16

Selecting any one of these register menu keys causes the State of the currently active mode to be saved to the specified Register. The registers are provided for rapid saving and recalling, since you do not need to specify a filename or navigate to a file. Each of the register menu keys annotates whether it is empty or at what date and time it was last modified. In addition, you can use the **Edit Register Names** key to enter custom names for each register.

Although these 16 registers are the only registers available from the front panel, there are 128 state registers available in the instrument. Registers 17–128 are only available from the SCPI interface, using the *SAV command.

There is one set of 128 state registers in the instrument, not one set for each Mode. When a state is saved, the Mode it was saved from is saved with it; then when it is recalled, the instrument switches to that Mode.

After the save completes, the corresponding register menu key annotation is updated with the date and time and the message "Register <register number> saved" is displayed.

Key Path:	Save, State
Mode:	All
Example:	*SAV 1
Range:	1–16 from front panel, 1–128 from SCPI

System Functions
Save

Readback:	Date and time with seconds resolution are displayed on the key OR A custom name of up to 30 characters entered using the Edit Register Names key OR “(empty)” if no prior save operation has been performed to this register.
Initial S/W Revision:	Prior to A.02.00
Modified at S/W Revision:	A.11.00
Help Map ID:	2602

Trace (+State)

The **Save Trace (+State)** menu lets you choose a register or file specifying where to save the Trace+State state file.

A saved state contains all of the settings and data required to return the analyzer as closely as possible to the exact setup it had when the save occurred. This includes the Input/Output settings, even though they are outside of the Mode’s state, because they are needed to restore the complete setup. A Trace+State file also includes trace data from one trace or all traces, which will load in View mode when the Trace+State file is recalled.

After the save completes, the message "File <filename> saved" or "Trace Register <register number> saved" is displayed.

For rapid saves, the Trace (+State) menu lists 5 registers to save to. Pressing a Register key initiates the save. You can also select a file to save to.

The default path for all State Files including .trace files is:

My Documents\<mode name>\state

where <mode name> is the parameter used to select the mode with the INST:SEL command (for example, SA for the Spectrum Analyzer).

This key is grayed out for measurements that do not support trace saves. It is blanked for modes that do not support trace saves. Saving **Trace** is identical to saving State except a .trace extension is used on the file instead of .state, and internal flags are set in the file indicating which trace was saved. You may select to save one trace or ALL traces.

Key Path:	Save
Mode:	SA
Remote Command:	:MMEMory:STORe:TRACe TRACE1 TRACE2 TRACE3 TRACE4 TRACE5 TRACE6 ALL, <filename> > :MMEMory:STORe:TRACe:REGister TRACE1 TRACE2 TRACE3 TRACE4 TRACE5 TRACE6 ALL, <integer>

Example:	<p>:MMEM:STOR:TRAC TRACE1,“myState.trace” saves the file myState.trace on the default path and flags it as a “single trace” file with Trace 1 as the single trace (even though all of the traces are in fact stored).</p> <p>:MMEM:STOR:TRAC ALL,“myState.trace” saves the file myState.trace on the default path and flags it as an “all traces” file</p> <p>:MMEM:STOR:TRAC:REG TRACE1,2 stores trace 1 data in trace register 2</p>
Notes:	<p>This command actually performs a save state, which in the Swept SA measurement includes the trace data. However it flags it (in the file) as a “save trace” file of the specified trace (or all traces).</p> <p>Some modes and measurements do not have available all 6 traces. The Phase Noise mode command, for example, is: MMEMory:STORe:TRACe TRACE1 TRACE2 TRACE3 ALL,<filename></p> <p>The range for the register parameter is 1–5</p> <p>When you initiate a save, if the file already exists, a dialog will appear that allows you to replace the existing file by selecting OK or you can Cancel the request. If you select OK, the file will be overwritten. Using the C: drive is strongly discouraged, since it runs the risk of being overwritten during an instrument software upgrade.</p> <p>Both single and double quotes are supported for any filename parameter over remote.</p> <p>After saving to a register, that register’s menu key is updated with the date and time of the save.</p> <p>After saving to a register, you remain in the Save Trace menu, so that you can see the Register key update. After saving to a file, the analyzer automatically returns to the previous menu and any Save As dialog goes away.</p>
Initial S/W Revision:	Prior to A.02.00
Help Map ID:	3486

Register 1 thru Register 5

Selecting any one of these register menu keys causes the Trace(s) specified under From Trace, along with the state of the currently active mode, to be saved to the specified Trace Register. The registers are provided for rapid saving and recalling, since you do not need to specify a filename or navigate to a file. Each of the register menu keys annotates whether it is empty or at what date and time it was last modified.

Key Path:	Save, Trace
Mode:	SA
Range:	1–5
Readback:	Date and time with seconds resolution are displayed on the key, or "(empty)" if no prior save operation performed to this register.
Initial S/W Revision:	Prior to A.02.00

Help Map ID:	3598
--------------	------

From Trace

Accesses a menu that enables you to select the trace to be saved. Once a trace is selected, the key returns to the Save Trace menu and the selected trace number is annotated on the key. The default is the currently selected trace, selected in this menu or in the Trace/Det, Export Data, Import Data or Recall Trace menus, except if you have chosen All then it remains chosen until you specifically change it to a single trace. To save the Trace you must select the **Save As** key in the Save Trace menu.

When you select a trace, it makes that trace the current trace, so it displays on top of all of the other traces.

Key Path:	Save, Trace + State
Mode:	SA
Initial S/W Revision:	Prior to A.02.00
Help Map ID:	3505

To File . . .

When you press “To File”, the analyzer brings up a Windows dialog and a menu entitled “**Save As.**” This menu allows you to navigate to the various fields in the Windows dialog without using a keyboard or mouse. The **Tab** and **Arrow** keys can also be used for dialog navigation.

See “[To File . . .](#)” on page 164 in **Save, State** for a full description of this dialog and menu.

Key Path:	Save, Trace (+State)
Mode:	SA
Notes:	Brings up Save As dialog for saving a Trace+State Save Type
Initial S/W Revision:	Prior to A.02.00
Help Map ID:	3506

Sequences

This menu and all of its submenus are only available in the EXT (E6607A).

These keys allow you to save a Tab separated or CSV file of the setup parameters required to build a Sequence.

In order to save you must select the Save As button and choose a destination folder.

Key Path:	Save, Sequences
Mode:	All
Remote Command:	:MMEM:STOR:SEquences: SLIST ALIST SAAList SSTep "MySequence.txt"

Example:	:MMEM:STOR:SEQ:SLIS "MySequence.txt"
Notes:	Available file types are: CSV (Comma delimited) (*.csv) Text (Tab delimited) (*.txt)
Initial S/W Revision:	A.05.00
Help Map ID:	3636

Source Sequence

The list of parameters, that configure steps, that makes up a sequence for the Source.

The Source sequence is a sequence of flexible configurable steps that can be set anywhere in the instruments frequency range.

Key Path:	Save, Sequences
Example:	:MMEM:STOR:SEQ:SLIS "MySequence.txt"
Dependencies:	Only available in XOBT
Initial S/W Revision:	A.05.00
Help Map ID:	3637

Analyzer Sequence

Only Available in: Sequence Analyzer Mode

The list of parameters, that configure steps, that makes up a sequence for the Analyzer.

The Analyzer sequence is a sequence of flexible configurable steps that can be set anywhere in the instruments frequency range for measuring the performance of a transmitters output

Key Path:	Save, Sequences
Example:	:MMEM:STOR:SEQ:ALIS "MySequence.txt"
Dependencies:	Only available in XOBT, Sequence Analyzer mode
Initial S/W Revision:	A.05.00
Help Map ID:	3638

Source and Analyzer Sequence

Available in: Sequence Analyzer Mode

The list of parameters, that configure steps, that makes up a sequence for the Analyzer and the Source.

The Source and Analyzer sequence is completely configurable and can have internal triggers between the source and the analyzer to orchestrate a sequence to completely test an external transmitter and

System Functions

Save

receiver's performance.

Key Path:	Save, Sequences
Example:	:MMEM:STOR:SEQ:SAAL "MySequence.txt"
Dependencies:	Only available in XOBT, Sequence Analyzer mode
Initial S/W Revision:	A.05.00
Help Map ID:	3639

Save As . . .

This menu lets you select the location where you can save the Sequence. This menu is a standard Windows® dialog with Save As menu keys. The "File Name" field in the Save As dialog is initially loaded with an automatically generated filename specific to the appropriate Save Type. The automatically generated filename is guaranteed not to conflict with any filename currently in the directory. You may replace or modify this filename using the File Name softkey. See the Quick Save key documentation for more on the automatic file naming algorithm.

The default path for all Sequence Files is:

My Documents\Sequences

Key Path:	Save, Sequences
Mode:	All
Notes:	Brings up Save As dialog for saving a Sequence Save Type
Initial S/W Revision:	A.05.00
Help Map ID:	3641

Data (Export)

Exporting a data file stores data from the current measurement to mass storage files. The Export Menu only contains data types that are supported by the current measurement.

Since the commonly exported data files are in .csv format, the data can be edited by you prior to importing. This allows you to export a data file, manipulate the data in Excel (the most common PC Application for manipulating .csv files) and then import it.

Selecting an Export Data menu key will not actually cause the exporting to occur, since the analyzer still needs to know where you wish to save the data. Pressing the Save As key in this menu brings up the Save As dialog and Save As menu that allows you to specify the destination file and directory. Once a filename has been selected or entered in the Open menu, the export will occur as soon as the Save key is pressed.

Key Path:	Save
Mode:	All

Notes:	The menu is built from whatever data types are available for the mode. So the key locations in the sub menu will vary. No SCPI command directly controls the Data Type that this key controls. The Data Type is included in the MMEM:STORe commands.
Dependencies:	If a file type is not used by a certain measurement, that type is grayed out for that measurement. The key for a file type will not show at all if there are no measurements in the Mode that support it.
Preset:	Is not affected by a Preset or shutdown, but is reset during Restore Mode Defaults
Readback:	The data type that is currently selected
Initial S/W Revision:	Prior to A.02.00
Help Map ID:	2611

Save As . . .

When you press “Save As”, the analyzer brings up a Windows dialog and a menu entitled “**Save As.**” This menu allows you to navigate to the various fields in the Windows dialog without using a keyboard or mouse. The **Tab** and **Arrow** keys can also be used for dialog navigation.

See “[To File . . .](#)” on page 164 in **Save, State** for a full description of this dialog and menu.

The default path for saving files is:

For all of the Trace Data Files:

My Documents\<<mode name>\data\traces

For all of the Limit Data Files:

My Documents\<<mode name>\data\limits

For all of the Measurement Results Data Files:

My Documents\<<mode name>\data\<<measurement name>\results

For all of the Capture Buffer Data Files:

My Documents\<<mode name>\data\captureBuffer

Key Path:	Save, Data
Mode:	All
Notes:	The key location is mode-dependent and will vary. Brings up the Save As dialog for saving a <mode specific> Save Type. The save is performed immediately and does not wait until the measurement is complete.
Initial S/W Revision:	Prior to A.02.00
Help Map ID:	2617

Screen Image

Pressing Screen Image accesses a menu of functions that enable you to specify a format and location for the saved screen image. It brings up a menu that allows you to specify the color scheme of the Screen Image (Themes) or navigate to the Save As dialog to perform the actual save.

Screen Image files contain an exact representation of the analyzer display. They cannot be loaded back onto the analyzer, but they can be loaded into your PC for use in many popular applications.

The image to be saved is actually captured when the **Save** front panel key is pressed, and kept in temporary storage to be used if you ask for a Screen Image save. When the Screen Image key is pressed, a "thumbnail" of the captured image is displayed, as shown below:

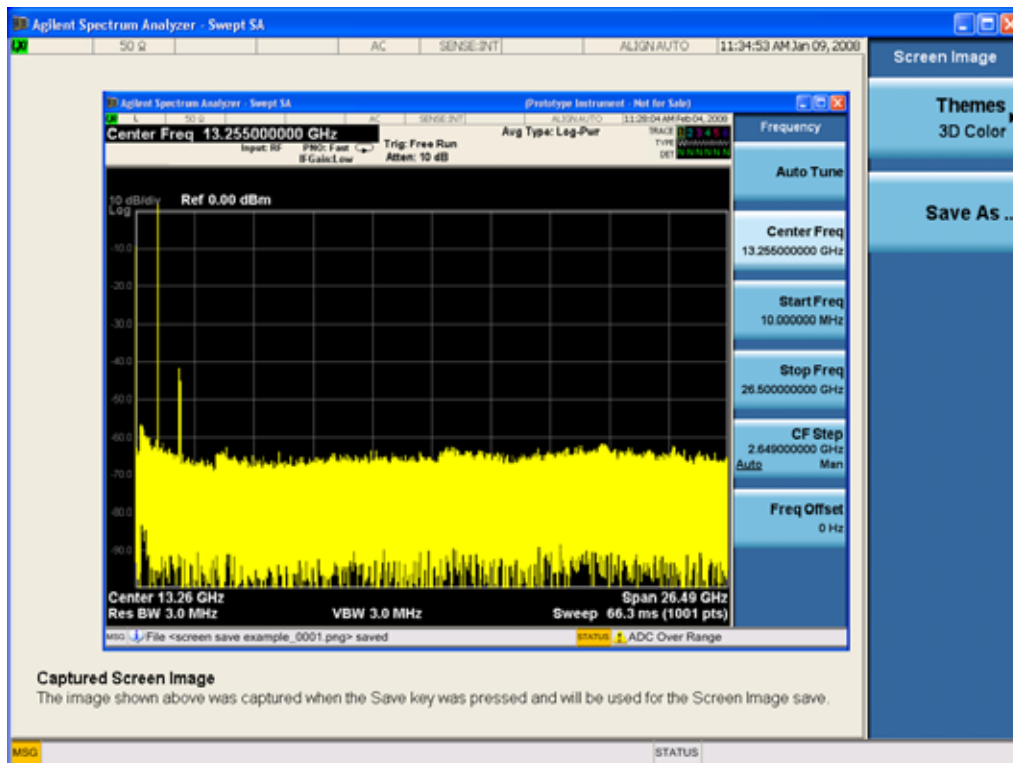

When you continue on into the **Save As** menu and complete the Screen Image save, the image depicted in the thumbnail is the one that gets saved, showing the menus that were on the screen before going into the **Save** menus. The save is performed immediately and does not wait until the measurement is complete.

After you have completed the save, the **Quick Save** front-panel key lets you quickly repeat the last save performed, using an auto-named file, with the current screen data.

NOTE For versions previous to A.01.55, if you initiate a screen image save by navigating through the Save menus, the image that is saved will contain the Save menu softkeys, not the menus and the active function that were on the screen when you first pressed the Save front panel key.

Key Path:	Save
Mode:	All
Remote Command:	:MMEMory:STORe:SCReEn <filename>
Example:	:MMEM:STOR:SCR "myScreen.png" This stores the current screen image in the file MyScreenFile.png in the default directory.
Initial S/W Revision:	Prior to A.02.00
Help Map ID:	2620

Themes

Accesses a menu of functions that enable you to choose the theme to be used when saving the screen image.

The **Themes** option is the same as the **Themes** option under the **Display** and **Page Setup** dialogs. It allows you to choose between themes to be used when saving the screen image.

Key Path:	Save, Screen Image
Remote Command:	:MMEMory:STORe:SCReEn:THEME TDCoLor TDMonochrome FCoLoR FMONochrome :MMEMory:STORe:SCReEn:THEMe?
Example:	:MMEM:STOR:SCR:THEM TDM
Preset:	3D Color; Is not part of Preset, but is reset by Restore Misc Defaults or Restore System Defaults All and survives subsequent running of the modes.
Readback:	3D Color 3D Mono Flat Color Flat Mono
Backwards Compatibility Notes:	In ESA and PSA we offer the choice of "Reverse Bitmap" or "Reverse Metafile" when saving screen images. This is much like the "Flat Color" theme available in X-Series. Also, if the user selected Reverse Bitmap AND a black&white screen image, that would be much like "Flat Monochrome". In other words, each of the X-Series themes has a similar screen image type in ESA/PSA. But they are not identical.
Initial S/W Revision:	Prior to A.02.00
Help Map ID:	2621

3D Color

Selects a standard color theme with each object filled, shaded and colored as designed.

Key Path:	Save, Screen Image, Themes
Example:	MMEM:STOR:SCR:THEM TDC

System Functions

Save

Readback:	3D Color
Initial S/W Revision:	Prior to A.02.00
Help Map ID:	2622

3D Monochrome

Selects a format that is like 3D color but shades of gray are used instead of colors.

Key Path:	Save, Screen Image, Themes
Example:	MMEM:STOR:SCR:THEM TDM
Readback:	3D Mono
Initial S/W Revision:	Prior to A.02.00
Help Map ID:	2623

Flat Color

Selects a format that is best when the screen is to be printed on an ink printer.

Key Path:	Save, Screen Image, Themes
Example:	MMEM:STOR:SCR:THEM FCOL
Readback:	Flat Color
Initial S/W Revision:	Prior to A.02.00
Help Map ID:	2624

Flat Monochrome

Selects a format that is like Flat Color. But only black is used (no colors, not even gray), and no fill.

Key Path:	Save, Screen Image, Themes
Example:	MMEM:STOR:SCR:THEM FMON
Readback:	Flat Mono
Initial S/W Revision:	Prior to A.02.00
Help Map ID:	2625

Save As...

When you press “Save As”, the analyzer brings up a Windows dialog and a menu entitled “**Save As.**” This menu allows you to navigate to the various fields in the Windows dialog without using a keyboard or mouse. The **Tab** and **Arrow** keys can also be used for dialog navigation.

See “[To File . . .](#)” on page 164 in **Save, State** for a full description of this dialog and menu.

The default path for Screen Images is

My Documents\<<mode name>\screen.

where <mode name> is the parameter used to select the mode with the INST:SEL command (for example, SA for the Spectrum Analyzer).

Key Path:	Save, Screen Image
Notes:	Brings up Save As dialog for saving a Screen Image Save Type
Initial S/W Revision:	Prior to A.02.00
Help Map ID:	2626

Mass Storage Catalog (Remote Command Only)

Remote Command:	:MMEMory:CATalog? [<directory_name>]
Notes:	<p>The string must be a valid logical path.</p> <p>Queries disk usage information (drive capacity, free space available) and obtains a list of files and directories in a specified directory in the following format:</p> <p><numeric_value>,<numeric_value>,{<file_entry>}</p> <p>It returns two numeric parameters and as many strings as there are files and directories. The first parameter indicates the total amount of storage currently used in bytes. The second parameter indicates the total amount of storage available, also in bytes. The <file_entry> is a string. Each <file_entry> indicates the name, type, and size of one file in the directory list:</p> <p><file_name>,<file_type>,<file_size></p> <p>As the windows file system has an extension that indicates file type, <file_type> is always empty. <file_size> provides the size of the file in bytes. For directories, <file_entry> is surrounded by square brackets and both <file_type> and <file_size> are empty</p>
Initial S/W Revision:	Prior to A.02.00
Help Map ID:	0

Mass Storage Change Directory (Remote Command Only)

Remote Command:	:MMEMory:CDIRectory [<directory_name>] :MMEMory:CDIRectory?
Notes:	<p>The string must be a valid logical path.</p> <p>Changes the default directory for a mass memory file system. The <directory_name> parameter is a string. If no parameter is specified, the directory is set to the *RST value.</p> <p>At *RST, this value is set to the default user data storage area, that is defined as System.Environment.SpecialFolder.Personal.</p> <p>Query returns full path of the default directory.</p>
Initial S/W Revision:	Prior to A.02.00
Help Map ID:	0

Mass Storage Copy (Remote Command Only)

Remote Command:	:MMEMory:COPY <string>,<string> [, <string>,<string>]
-----------------	---

Notes:	<p>The string must be a valid logical path.</p> <p>Copies an existing file to a new file or an existing directory to a new directory.</p> <p>Two forms of parameters are allowed. The first form has two parameters. In this form, the first parameter specifies the source, and the second parameter specifies the destination.</p> <p>The second form has four parameters. In this form, the first and third parameters specify the source. The second and fourth parameters specify the directories. The first pair of parameters specifies the source. The second pair specifies the destination. An error is generated if the source doesn't exist or the destination file already exists.</p> <p>This command will generate an "access denied" error if the destination is a restricted folder (e.g., C:\Windows) and the current user does not have Power User or Administrator privileges.</p>
Help Map ID:	0

Mass Storage Delete (Remote Command Only)

Remote Command:	:MMEMory:DELeTe <file_name> [, <directory_name>]
Notes:	<p>The string must be a valid logical path.</p> <p>Removes a file from the specified directory. The <file_name> parameter specifies the file name to be removed. This command will generate an "access denied" error if the file is in a restricted folder (e.g., C:\Windows) and the current user does not have Power User or Administrator privileges.</p>
Initial S/W Revision:	Prior to A.02.00
Help Map ID:	0

Mass Storage Data (Remote Command Only)

Creates a file containing the specified data OR queries the data from an existing file.

Remote Command:	<p>:MMEMory:DATA <file_name>, <data></p> <p>:MMEMory:DATA? <file_name></p>
Notes:	<p>The string must be a valid logical path.</p> <p>The command form is MMEMory:DATA <file_name>,<data>. It loads <data> into the file <file_name>. <data> is in 488.2 block format. <file_name> is string data.</p> <p>The query form is MMEMory:DATA? <file_name> with the response being the associated <data> in block format.</p>
Initial S/W Revision:	Prior to A.02.00
Help Map ID:	0

Mass Storage Make Directory (Remote Command Only)

Remote Command:	:MMEMory:MDIRectory <directory_name>
Notes:	<p>The string must be a valid logical path.</p> <p>Creates a new directory. The <directory_name> parameter specifies the name to be created.</p> <p>This command will generate an “access denied” error if the new directory would be in a restricted folder (e.g., C:\Windows) and the current user does not have Power User or Administrator privileges.</p>
Initial S/W Revision:	Prior to A.02.00
Help Map ID:	0

Mass Storage Move (Remote Command Only)

Remote Command:	:MMEMory:MOVE <string>, <string> [, <string>, <string>]
Notes:	<p>The string must be a valid logical path.</p> <p>Moves an existing file to a new file or an existing directory to a new directory.</p> <p>Two forms of parameters are allowed. The first form has two parameters. In this form, the first parameter specifies the source, and the second parameter specifies the destination.</p> <p>The second form has four parameters. In this form, the first and third parameters specify the source. The second and fourth parameters specify the directories. The first pair of parameters specifies the source. The second pair specifies the destination. An error is generated if the source doesn't exist or the destination file already exists.</p> <p>This command will generate an “access denied” error if the destination is a restricted folder (e.g., C:\Windows) and the current user does not have Power User or Administrator privileges.</p>
Initial S/W Revision:	Prior to A.02.00
Help Map ID:	0

Mass Storage Remove Directory (Remote Command Only)

Remote Command:	:MEMMory:RDIRectory <directory_name>
Notes:	<p>The string must be a valid logical path.</p> <p>Removes a directory. The <directory_name> parameter specifies the directory name to be removed. All files and directories under the specified directory shall also be removed.</p> <p>This command will generate an “access denied” error if the folder is a restricted folder (e.g., C:\Windows) or is in a restricted folder and the current user does not have Power User or Administrator privileges.</p>

Initial S/W Revision:	Prior to A.02.00
Help Map ID:	0

System

Opens a menu of keys that access various configuration menus and dialogs.

Key Path:	Front-panel key
Notes:	No remote command for this key specifically.
Initial S/W Revision:	Prior to A.02.00
Help Map ID:	2400

Show

Accesses a menu of choices that enable you to select the information window you want to view.

Key Path:	System
Mode:	All
Remote Command:	:SYSTem:SHOW OFF ERRor SYSTem HARDware LXI HWSTatistics ALIGNment SOFTware CAPplication :SYSTem:SHOW?
Example:	:SYST:SHOW SYST
Notes:	This command displays (or exits) the various System information screens.
Preset:	OFF
State Saved:	No
Range:	OFF ERRor SYSTem HARDware LXI HWSTatistics ALIGNment SOFTware CAPplication
Initial S/W Revision:	Prior to A.02.00
Help Map ID:	2403

Errors

There are two modes for the Errors selection, History and Status.

The list of errors displayed in the Errors screen does not automatically refresh. You must press the Refresh key or leave the screen and return to it to refresh it.

History brings up a screen displaying the event log in chronological order, with the newest event at the top. The history queue can hold up to 100 messages (if a message has a repeat count greater than 1 it only counts once against this number of 100). Note that this count bears no relation to the size of the SCPI queue. If the queue extends onto a second page, a scroll bar appears to allow scrolling with a mouse. Time is displayed to the second.

Status brings up a screen summarizing the status conditions currently in effect. Note that the time is

displayed to the second.

The fields on the Errors display are:

Type (unlabeled) - Displays the icon identifying the event or condition as an error or warning.

ID - Displays the error number.

Message - Displays the message text.

Repeat (RPT) - This field shows the number of consecutive instances of the event, uninterrupted by other events. If an event occurs 5 times with no other intervening event, the value of repeat will be 5.

If the value of Repeat is 1 the field does not display. If the value of Repeat is >1, the time and date shown are those of the most recent occurrence. If the value of repeat reaches 999,999 it stops there.

Time - Shows the most recent time (including the date) at which the event occurred.

Key Path:	System, Show
Mode:	All
Remote Command:	:SYSTem:ERRor [:NEXT] ?
Example:	:SYST:ERR?
Notes:	<p>The return string has the format: “<Error Number>,<Error>” Where <Error Number> and <Error> are those shown on the Show Errors screen</p>

Backwards Compatibility Notes:	<p>In some legacy analyzers, the Repeat field shows the number of times the message has repeated since the last time the error queue was cleared. In the X-Series, the Repeat field shows the number of times the error has repeated since the last intervening error. So the count may very well be different than in the past even for identical signal conditions</p> <p>Unlike previous analyzers, in the X-Series all errors are reported through the Message or Status lines and are logged to the event queue. They never appear as text in the graticule area (as they sometimes do in previous analyzers) and they are never displayed in the settings panel at the top of the screen (as they sometimes do, by changing color, in previous analyzers).</p> <p>As a consequence of the above, the user can only see one status condition (the most recently generated) without looking at the queue. In the past, at least in the Spectrum Analyzer, multiple status conditions might display on the right side of the graticule.</p> <p>In general, there is no backwards compatibility specified or guaranteed between the error numbers in the X-Series and those of earlier products. Error, event, and status processing code in customers' software will probably need to be rewritten to work with X-Series.</p> <p>In the legacy analyzers, some conditions report as errors and others simply turn on status bits. Conditions that report as errors often report over and over as long as the condition exists. In the X-series, all conditions report as start and stop events. Consequently, software that repeatedly queries for a condition error until it stops reporting will have to be rewritten for the X-series.</p>
Initial S/W Revision:	Prior to A.02.00
Help Map ID:	3487

Next Page

Next Page and Previous Page menu keys move you between pages of the log, if it fills more than one page. These keys are grayed out in some cases:

If on the last page of the log, the Next Page key is grayed-out

If on the first page of the log, the Previous Page key is grayed-out.

If there is only one page, both keys are grayed out.

Key Path:	System, Show, Errors
Initial S/W Revision:	Prior to A.02.00
Help Map ID:	2671

Previous Page

See [“Next Page” on page 184](#).

Key Path:	System, Show, Errors
-----------	-----------------------------

Initial S/W Revision:	Prior to A.02.00
Help Map ID:	3629

History

The History and Status keys select the Errors view. The Status key has a second line which shows a number in [square brackets]. This is the number of currently open status items.

Key Path:	System, Show, Errors
Initial S/W Revision:	Prior to A.02.00
Help Map ID:	2672

Status

See [“History” on page 185](#).

Verbose SCPI On/Off

When you turn Verbose SCPI on, additional information is returned when you send the :SYSTem:ERRor? query. The additional information consists of the characters that stimulated the error. This can aid you in debugging your test programs by indicating where in the parsing of a SCPI command the instrument encountered an invalid command or query.

Specifically, with Verbose SCPI on, the SYSTem:ERRor? query is expanded to show the SCPI data received, with the indicator <Err> at the point in the stream that the error occurred.

Verbose SCPI has no effect on the Show Errors screen or front panel Message Line; it only changes the response to the :SYST:ERR? query.

See the example below, where the invalid command “SENS:BOGUS” is sent:

Normal response to :SYST:ERR (using the Telnet window):

```
SCPI> SENS:BOGUS
```

```
SCPI> SYST:ERR?
```

```
-113,"Undefined header"
```

Now after turning on Verbose SCPI:

```
SCPI> SYST:BOGUS
```

```
SCPI> SYST:ERR?
```

```
-113,"Undefined header;SYST:BOGUS<Err>"
```

Key Path:	System, Show, Errors
Mode:	All
Remote Command:	:SYSTem:ERRor:VERBose OFF ON 0 1 :SYSTem:ERRor:VERBose?

Example:	:SYST:ERR:VERB ON
Preset:	This is unaffected by Preset but is set to OFF on a “Restore System Defaults->Misc”
State Saved:	No
Range:	On Off
Initial S/W Revision:	Prior to A.02.00
Help Map ID:	2673

Input Overload Enable (Remote Command Only)

Input Overload errors are reported using the Input Overload status bit (bit 12 in the Measurement Integrity status register). Input Overloads (for example, ADC Overload errors) can come and go with great frequency, generating many error events (for example, for signals just on the verge of overload), and so are not put into the SCPI error queue by default. Normally the status bit is the only way for detecting these errors remotely.

It is possible to enable Input Overload reporting to the SCPI queue, by issuing the :SYSTem:ERRor:OVERload ON command. To return to the default state, issue the :SYSTem:ERRor:OVERload OFF command. In either case, Input Overloads always set the status bit.

NOTE For versions of firmware before A.10.01, the Input Overload was only a Warning and so was never available in the SCPI queue, although it did set the status bit. For A.10.01 and later, the Input Overload is an error and can be enabled to the SCPI queue using this command.

Key Path:	SCPI only
Remote Command:	:SYSTem:ERRor:OVERload[:STATe] 0 1 OFF ON
Example:	:SYST:ERR:OVER 1 Enable overload errors
Preset:	Set to OFF by Restore Misc Defaults (no Overload errors go to SCPI)
State Saved:	Saved in instrument state.
Initial S/W Revision:	A.10.01
Help Map ID:	0

Refresh

When pressed, refreshes the Show Errors display.

Key Path:	System, Show, Errors
Initial S/W Revision:	Prior to A.02.00
Help Map ID:	2674

Clear Error Queue

This clears all errors in all error queues.

Note the following:

Clear Error Queue does not affect the current status conditions.

Mode Preset does not clear the error queue.

Restore System Defaults will clear all error queues.

*CLS only clears the queue if it is sent remotely and *RST does not affect any error queue.

Switching modes does not affect any error queues.

Key Path:	System, Show, Errors
Initial S/W Revision:	Prior to A.02.00
Help Map ID:	2675

System

The System screen is formatted into three groupings: product descriptive information, options tied to the hardware, and software products:

<Product Name> <Product Description>	
Product Number: N9020A	
Serial Number: US46220924	
Firmware Revision: A.01.01	
Computer Name: <hostname>	
Host ID: N9020A,US44220924	
N9020A-503	Frequency Range to 3.6 GHz
N9020A-PFR	Precision Frequency Reference
N9020A-P03	Preamp 3.6 GHz
N9060A-2FP	Spectrum Analysis Measurement Suite 1.0.0.0
N9073A-1FP	WCDMA 1.0.0.0
N9073A-2FP	WCDMA with HSDPA 1.0.0.0

The Previous Page is grayed-out if the first page of information is presently displayed. The Next Page menu key is grayed-out if the last page is information is presently displayed.

Key Path:	System, Show
Mode:	All
Example:	SYST:SHOW SYST

System Functions

System

Backwards Compatibility Notes:	The hardware statistics that are displayed in the PSA Show System screen have been moved to a dedicated Show Hardware Statistics screen in the Service Menu.
Initial S/W Revision:	Prior to A.02.00
Help Map ID:	2676

Show System contents (Remote Command Only)

A remote command is available to obtain the contents of the Show System screen (the entire contents, not just the currently displayed page).

Remote Command:	:SYSTem:CONFigure[:SYSTem]?
Example:	:SYST:CONF?
Notes:	The output is an IEEE Block format of the Show System contents. Each line is separated with a new-line character.
Initial S/W Revision:	Prior to A.02.00
Help Map ID:	0

Computer System description (Remote Command Only)

A remote command is available to obtain the Computer System description. The Computer System is the operating system and patch level as reported by operating system.

Remote Command:	:SYSTem:CSYSTem?
Example:	:SYST:CSYS?
Notes:	The return value is the Computer System name and service pack level.
Initial S/W Revision:	Prior to A.12.00
Help Map ID:	0

Hardware

The show hardware screen is used to view details of the installed hardware. This information can be used to determine versions of hardware assemblies and field programmable devices, in the advent of future upgrades or potential repair needs.

The screen is formatted into two groupings: product descriptive information and hardware information. The hardware information is listed in a table format:

Hardware Information							
MXA Signal Analyzer Product Number: N9020A Serial Number: US46220107 Firmware Revision: A.01.14							
Assembly Name	Part #	Serial #	Mat Rev	Rev	OF Rev	Hw Id	Misc
Analog IF	E441060104	78060200131	003	0	C	15	
YIG Tuned Filter	50877305	11061500550	005	0	A	11	
Digital IF	E441060105	78060100559	003	0	F	14	
Front End Controller	E441060101	78060100147	004	2	A	8	
Low Band Switch	E441060170	78060800346	005	1	A	10	
LO Synthesizer	E441060102	78060100226	003	3	G	2	
Reference	E441060108	78060300420	004	1	C	16	
Front End	E441060154	13062800820	010	2	B	9	

The Previous Page is grayed-out if the first page of information is presently displayed. The Next Page menu key is grayed-out if the last page is information is presently displayed.

Key Path:	System, Show
Mode:	All
Example:	SYST:SHOW HARD
Initial S/W Revision:	Prior to A.02.00
Help Map ID:	2677

LXI

This key shows you the product number, serial number, firmware revision, computer name, IP address, Host ID, LXI Class, LXI Version, MAC Address, and the Auto-MDIX Capability.

Key Path:	System, Show
Initial S/W Revision:	Prior to A.02.00
Help Map ID:	3499

Power On

Enables you to select how the instrument should power on. The options are: Mode and Input/Output

System Functions

System

Defaults, User Preset and Last State.

Key Path:	System
Mode:	All
Remote Command:	:SYSTem: PON: TYPE MODE USER LAST :SYSTem: PON: TYPE?
Example:	:SYST: PON: TYPE MODE
Preset:	This is unaffected by a Preset but is set to Mode on a “Restore System Defaults->All”
State Saved:	No
Backwards Compatibility SCPI:	:SYSTem: PON: TYPE PRESet the “PRESet” parameter is supported for backward compatibility only and behaves the same as MODE.
Backwards Compatibility Notes:	The Preset Type key in legacy analyzers has been removed, and the Power On toggle key has been replaced by this 1-of-N key in the System menu.
Initial S/W Revision:	Prior to A.02.00
Help Map ID:	2316

Mode and Input/Output Defaults

When the analyzer is powered on in Mode and Input/Output Defaults, it performs a Restore Mode Defaults to all modes in the instrument and also performs a Restore Input/Output Defaults.

Persistent parameters (such as Amplitude Correction tables or Limit tables) are not affected at power on, even though they are normally cleared by Restore Input/Output Defaults and/or Restore Mode Defaults.

Key Path:	System, Power On
Mode:	All
Example:	SYST: PON: TYPE MODE
Readback Text:	Defaults
Initial S/W Revision:	Prior to A.02.00
Help Map ID:	2317

User Preset

Sets **Power On** to **User Preset**. When the analyzer is powered on in User Preset, it will User Preset each mode and switch to the power-on mode. Power On User Preset will not affect any settings beyond what a normal User Preset affects.

NOTE An instrument could never power up for the first time in User Preset.

Key Path:	System, Power On
Mode:	All
Example:	SYST:PON:TYPE USER
Readback Text:	User Preset
Backwards Compatibility Notes:	Power On User Preset will cause the instrument to power up in the power-on mode, not the last mode the instrument was in prior to shut down. Also, Power On User Preset will User Preset all modes. This does not exactly match legacy behavior.
Initial S/W Revision:	Prior to A.02.00
Help Map ID:	2318

Last State

Sets **Power On** to **Last**. When the analyzer is powered on, it will put all modes in the last state they were in prior to when the analyzer was put into Power Standby and it will wake up in the mode it was last in prior to powering off the instrument. The saving of the active mode prior to shutdown happens behind the scenes when a controlled shutdown is requested by using the front panel power **Standby** key or by using the remote command `SYSTem:PDOWn`. The non-active modes are saved as they are deactivated and recalled by Power On Last State.

NOTE An instrument can never power up for the first time in Last.

If line power to the analyzer is interrupted, for example by pulling the line cord plug or by switching off power to a test rack, Power On Last State may not work properly. For proper operation, Power On Last State depends on you shutting down the instrument using the Standby key or the `SYSTem:PDOWn` SCPI command. This will ensure the last state of each mode is saved and can be recalled during a power up.

Key Path:	System, Power On
Mode:	All
Example:	SYST:PON:TYPE LAST
Notes:	Power on Last State only works if you have done a controlled shutdown prior to powering on in Last. If a controlled shutdown is not done when in Power On Last State, the instrument will power up in the last active mode, but it may not power up in the active mode's last state. If an invalid mode state is detected, a Mode Preset will occur. To control the shutdown under remote control use the <code>:SYSTem:PDOWn</code> command.
Readback Text:	Last State

Backwards Compatibility Notes:	It is no longer possible to power-up the analyzer in the last mode the analyzer was running with that mode in the preset state. (ESA/PSA SYST:PRESET:TYPE MODE with SYST:PON:PRESET) You can power-on the analyzer in the last mode the instrument was running in its last state (SYST:PON:TYPE LAST), or you can specify the mode to power-up in its preset state (SYST:PON:MODE <mode>).
Initial S/W Revision:	Prior to A.02.00
Help Map ID:	2319

Power On Application

Accesses a menu that lists the available Modes and lets you select which Mode is to be the power-on application.

This application is used for Power On Type “Mode and Input/Output Defaults” and Restore System Defaults All.

Key Path:	System, Power On
Mode:	All
Remote Command:	: SYSTem: PON: MODE SA BASIC ADEMOD NFIGURE PNOISE CDMA2K TDSCDMA VSA VSA89 601 WCDMA WIMAXOFDMA : SYSTem: PON: MODE?
Example:	SYST:PON:MODE SA
Notes:	The list of possible modes (and remote parameters) to choose from is dependent on which modes are installed in the instrument.
Preset:	This is unaffected by a Preset but is set on a “Restore System Defaults->All” to SA.
State Saved:	No
Initial S/W Revision:	Prior to A.02.00
Help Map ID:	2320

Configure Applications

The Configure Applications utility can be used to:

- select applications for preload
- determine how many applications can fit in memory at one time
- specify the order of the Modes in the Mode menu.

This utility consists of a window with instructions, a set of “Select Application” checkboxes, a “fuel bar” style memory gauge, and keys that help you set up your configuration.

For more information, see the following topics:

[“Preloading Applications” on page 193](#)

[“Access to Configure Applications utility” on page 193](#)

[“Virtual memory usage” on page 193](#)

Key Path:	System, Power On
Example:	:SYST:SHOW CAPP Displays the Config Applications screen
Initial S/W Revision:	A.02.00
Help Map ID:	3616

Preloading Applications

During runtime, if a Mode that is not preloaded is selected using the Mode menu or sending SCPI commands, there will be a pause while the Application is loaded. During this pause a message that says “Loading application, please wait ...” is displayed. Once loaded, the application stays loaded, so the next time you select it during a session, there is no delay.

Preloading enables you to “preload” at startup, to eliminate the runtime delay. Preloading an application will cause it to be loaded into the analyzer’s memory when the analyzer program starts up. If you do this, the delay will increase the time it takes to start up the analyzer program, but this may be preferable to having to wait the first time you select an application. Note that, once an application is loaded into memory, it cannot be unloaded without exiting and restarting the analyzer program.

Note that there are more applications available for the X-Series than can fit into Windows Virtual Memory. By allowing you to choose which licensed applications to load at startup, the Configure Applications utility allows you to make optimal use of your memory.

Access to Configure Applications utility

A version of the utility runs the first time you power up the analyzer after purchasing it from Agilent. The utility automatically configures preloads so that as many licensed applications as possible are preloaded while keeping the total estimated virtual memory usage below the limit. This auto-configuration only takes place at the very first run, and after analyzer software upgrades.

You may, at any time, manually call up the Configure Applications utility by pressing System, Power On, Configure Applications, to find a configuration that works best for you, and then restart the analyzer program.

The utility may also be called if, during operation of the analyzer, you attempt to load more applications than can fit in memory at once.

Virtual memory usage

There are more applications available for the X-Series than can fit into memory at any one time, so the Configure Applications utility includes a memory tracker that serves two purposes:

It will not let you preload more applications than will fit into memory at once.

You can determine how many of your favorite applications can reside in memory at one time.

The utility provides a graphical representation of the amount of memory (note that the memory in

System Functions

System

question here is Virtual memory and is a limitation imposed by the operating system, not by the amount of physical memory you have in your analyzer). You select applications to preload by checking the boxes on the left. Checked applications preload at startup. The colored fuel bar indicates the total memory required when all the checked applications are loaded (either preloaded or selected during runtime).

Here is what the fuel bar colors mean:

RED: the applications you have selected cannot all fit into the analyzer's memory. You must deselect applications until the fuel bar turns yellow.

YELLOW: the applications you have selected can all fit into the analyzer's memory, but there is less than 10% of the memory left, probably not enough to load any other applications, either via preload or by selecting a Mode while the analyzer is running..

GREEN: The indicator is green when <90% of the memory limit is consumed. This means the applications you have selected can all fit into the analyzer's memory with room to spare. You will likely be able to load one or more other applications without running out of memory.

Select All

Marks all applications in the selection list. This allows you to enable all applications licensed on the instrument for pre-loading, or is a convenience for selecting all applications in one operation and then letting you deselect individual applications.

Key Path:	System, Power On, Configure Applications
Initial S/W Revision:	A.02.00
Help Map ID:	3617

Deselect All

Clears the marks from all applications in the selection list, except the Power On application. The Power On application cannot be eliminated from the pre-load list.

Key Path:	System, Power On, Configure Applications
Initial S/W Revision:	A.02.00
Help Map ID:	3618

Move Up

The application list is the order that applications appear in the Mode Menu. This key enables you to shift the selected application up in the list, thus moving the selected application earlier in the Mode Menu.

Key Path:	System, Power On, Configure Applications
Initial S/W Revision:	A.02.00
Help Map ID:	3619

Move Down

The application list is the order that applications appear in the Mode Menu. This key enables you to shift the selected application down in the list, thus moving the selected application later in the Mode Menu.

Key Path:	System, Power On, Configure Applications
Initial S/W Revision:	A.02.00
Help Map ID:	3620

Select/Deselect

Toggles the currently highlighted application in the list.

Key Path:	System, Power On, Configure Applications
Initial S/W Revision:	A.02.00
Help Map ID:	3621

Save Changes and Exit

Applies the configuration of the applications list. The marked applications will be pre-loaded in memory the next time the instrument application is started, and the order of the applications in the list will be the order of the applications in the Mode Menu.

After saving your changes, the analyzer asks you if you would like it to restart so that your changes can take effect (see dialog box, below). If you choose not to restart, the changes will not take affect until the next time you shut down and restart the analyzer.

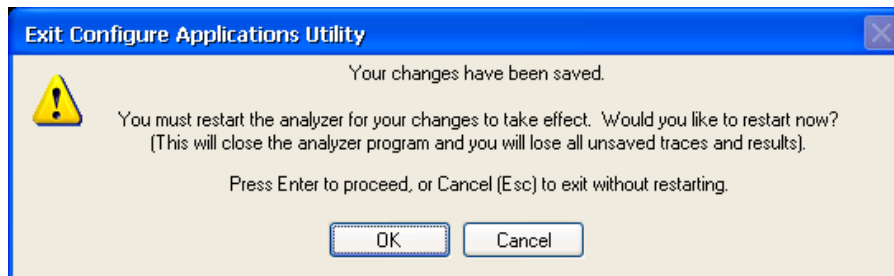

Key Path:	System, Power On, Configure Applications
Remote Command:	:SYSTem:PUP:PROcess
Example:	:SYST:PUP:PROC This is the SCPI command for restarting the analyzer. You must Wait after this command for the instrument application to restart
Notes:	The softkey will be grayed-out when the virtual memory of the selected applications exceeds 100% of the limit.

Notes:	You cannot use *WAI or *OPC? to synchronize operation after a restart. This command stops and restarts the instrument application, thus the SCPI operation is terminated and restarted. A remote program must use fixed wait time to resume sending commands to the instrument. The wait time will be dependent upon which applications are pre-loaded.
Initial S/W Revision:	A.02.00
Modified at S/W Revision:	A.04.00
Help Map ID:	3622

Exit Without Saving

Pressing this key will exit the Configure Applications utility without saving your changes.

Key Path:	System, Power On, Configure Applications
Initial S/W Revision:	A.02.00
Modified at S/W Revision:	A.04.00
Help Map ID:	3623

Configure Applications - Instrument boot-up

At start-up of the analyzer program a dialog box similar to the one under the **System, Power On, Configure Applications** key will be displayed allowing you to choose which licensed applications are to be loaded. This dialog will only be displayed if the memory required to pre-load all of the licensed applications exceeds the Virtual Memory available.

Configure Applications - Windows desktop

The Configure Applications Utility may be run from the Windows Desktop. The utility is launched by



double-clicking the icon on the desktop, which brings-up a dialog box similar to the one under the **System, Power On, Configure Applications** key, allowing you to choose which licensed applications are to be loaded when the analyzer program starts up. This dialog box has mouse buttons on it that do the job the softkeys normally do in the **System, Power On, Configure Applications** menu.

Configure Applications - Remote Commands

The following topics provide details on using remote commands to configure the list of applications you want to load into the instrument memory or query the Virtual Memory utilization for your applications.

[“Configuration list \(Remote Command Only\)” on page 197](#)

[“Configuration Memory Available \(Remote Command Only\)” on page 197](#)

[“Configuration Memory Total \(Remote Command Only\)” on page 197](#)

[“Configuration Memory Used \(Remote Command Only\)” on page 198](#)

[“Configuration Application Memory \(Remote Command Only\)” on page 198](#)

Configuration list (Remote Command Only)

This remote command is used to set or query the list of applications to be loaded in-memory.

Remote Command:	:SYSTem:PON:APPLication:LLIST <string of INSTRument:SElect names> :SYSTem:PON:APPLication:LLIST?
Example:	:SYST:PON:APPL:LLIS "SA,BASIC,WCDMA"
Notes:	<string of INSTRument:SElect names> are from the enums of the :INSTRument:SElect command. The order of the <INSTRument:SElect names> is the order that the applications are loaded into memory, and the order that they appear in the Mode Menu. Error message –225 "Out of Memory" is reported when more applications are listed than can reside in Virtual Memory. When this occurs, the existing applications load list is unchanged.
Preset:	Not affected by Preset
State Saved:	Not saved in instrument state
Initial S/W Revision:	A.02.00
Help Map ID:	0

Configuration Memory Available (Remote Command Only)

This remote command is used to query the amount of Virtual Memory remaining.

Remote Command:	:SYSTem:PON:APPLication:VMEMory[:AVAIlable]?
Example:	:SYST:PON:APPL:VMEM?
Preset:	Not affected by Preset
Initial S/W Revision:	A.02.00
Help Map ID:	0

Configuration Memory Total (Remote Command Only)

This remote command is used to query the limit of Virtual Memory allowed for applications.

Remote Command:	:SYSTem:PON:APPLication:VMEMory:TOTal?
Example:	:SYST:PON:APPL:VMEM:TOT?
Preset:	Not affected by Preset
Initial S/W Revision:	A.02.00
Help Map ID:	0

Configuration Memory Used (Remote Command Only)

This remote command is a query of the amount of Virtual Memory used by all measurement applications.

Remote Command:	:SYSTem:PON:APPLication:VMEMory:USED?
Example:	:SYST:PON:APPL:VMEM:USED?
Preset:	Not affected by Preset
Initial S/W Revision:	A.02.00
Help Map ID:	0

Configuration Application Memory (Remote Command Only)

This remote command is used to query the amount of Virtual Memory a particular application consumes.

Remote Command:	:SYSTem:PON:APPLication:VMEMory:USED:NAME? <INSTRument:SElect name>
Example:	:SYST:PON:APPL:VMEM:USED:NAME? CDMA2K
Notes:	<INSTRument:SElect name> is from the enums of the :INSTRument:SElect command Value returned will be 0 (zero) if the name provided is invalid.
Preset:	Not affected by Preset
Initial S/W Revision:	Prior to A.02.00
Help Map ID:	0

Restore Power On Defaults

This selection causes the Power On Type and Power On Application settings to be a reset to their default values. This level of Restore System Defaults does not affect any other system settings, mode settings and does not cause a mode switch. The Power On key, under the Restore System Defaults menu, causes the same action.

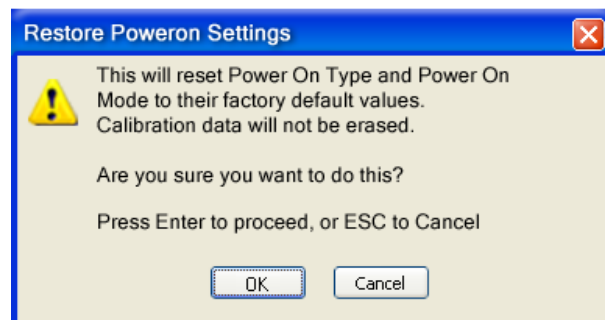

If you press any key other than OK or Enter, it is construed as a Cancel, because the only path that will

actually cause the reset to be executed is through OK or Enter.

Key Path:	System, Power On
Example:	:SYST:DEF PON
Initial S/W Revision:	Prior to A.02.00
Help Map ID:	2321

Alignments

The Alignments Menu controls and displays the automatic alignment of the instrument, and provides the ability to restore the default alignment values.

The current setting of the alignment system is displayed in the system Settings Panel along the top of the display, including a warning icon for conditions that may cause specifications to be impacted.



Key Path:	System
Initial S/W Revision:	Prior to A.02.00
Help Map ID:	2000

Auto Align

Configures the method for which the automatic background alignment is run.

Automatic background alignments are run periodically between measurement acquisitions. The instrument's software determines when alignments are to be performed to maintain warranted operation. The recommended setting for Auto Align is Normal.

An Auto Align execution cannot be aborted with the Cancel (ESC) key. To interrupt an Auto Align execution, select **Auto Align Off**.

Key Path:	System, Alignments
Mode:	All
Remote Command:	:CALibration:AUTO ON PARTial OFF :CALibration:AUTO?
Example:	:CAL:AUTO ON
Notes:	While Auto Align is executing, bit 0 of Status Operation register is set.
Couplings:	Auto Align is set to Off if Restore Align Data is invoked.
Preset:	This is unaffected by Preset but is set to ON upon a "Restore System Defaults->Align".
State Saved:	No

System Functions
System

Status Bits/OPC dependencies:	When Auto Align is executing, bit 0 in the Status Operational register is set.
Backwards Compatibility SCPI:	:CALibration:AUTO ALERt Parameter ALERt is for backward compatibility only and is mapped to PARTial
Backwards Compatibility Notes:	ESA SCPI for Auto Align is :CALibration:AUTO <Boolean>. The command for X-Series is an enumeration. Thus the parameters of “0” and “1” are not possible in X-Series. Similarly, the ESA SCPI for :CALibration:AUTO? returned the Boolean value 1 or 0, in X-Series it is an Enumeration (string). Thus, queries by customer applications into numeric variables will result in an error In PSA Auto Align OFF was not completely off, it is equivalent to PARTial in X-Series. In X-Series, OFF will be fully OFF. This means users of PSA SCPI who choose OFF may see degraded performance and should migrate their software to use PARTial.
Initial S/W Revision:	Prior to A.02.00
Help Map ID:	2001

Normal

Auto Align, Normal turns on the automatic alignment of all measurement systems. The Auto Align, Normal selection maintains the instrument in warranted operation across varying temperature and over time.

If the condition “Align Now, All required” is set, transition to Auto Align, Normal will perform the required alignments and clear the “Align Now, All required” condition and then continue with further alignments as required to maintain the instrument adequately aligned for warranted operation.

When **Auto Align, Normal** is selected the Auto Align Off time is set to zero.

When **Auto Align, Normal** is selected the Settings Panel indicates ALIGN AUTO.

Key Path:	System, Alignments, Auto Align
Mode:	All
Example:	:CAL:AUTO ON
Notes:	Alignment processing as a result of the transition to Normal will be executed sequentially. Thus, *OPC? or *WAI following CAL:AUTO ON will return when the alignment processing is complete. The presence of an external signal may interfere with the RF portion of the alignment. If so, the Error Condition message “Align skipped: 50 MHz interference” or “Align skipped: 4.8 GHz interference” is reported, and bit 11 is set in the Status Questionable Calibration register. After the interfering signal is removed, subsequent alignment of the RF will clear the condition, and clear bit 11 in the Status Questionable Calibration register.
Readback Text:	Normal

Status Bits/OPC dependencies:	An interfering user signal may prevent automatic alignment of the RF subsystem. If this occurs, the Error Condition message “Align skipped: 50 MHz interference” or “Align skipped: 4.8 GHz interference” is reported, the Status Questionable Calibration bit 11 is set, and the alignment proceeds. When a subsequent alignment of the RF subsystem succeeds, either by the next cycle of automatic alignment or from an Align Now, RF, the Error Condition and Status Questionable Calibration bit 11 are cleared.
Initial S/W Revision:	Prior to A.02.00
Help Map ID:	2002

Partial

Auto Align, Partial disables the full automatic alignment and the maintenance of warranted operation for the benefit of improved measurement throughput. Accuracy is retained for the Resolution Bandwidth filters and the IF Passband which is critical to FFT accuracy, demodulation, and many measurement applications. With Auto Align set to Partial, you are now responsible for maintaining warranted operation by updating the alignments when they expire. The Auto Align, Alert mechanism will notify you when alignments have expired. One solution to expired alignments is to perform the Align All, Now operation. Another is to return the Auto Align selection to Normal.

Auto Align, Partial is recommended for measurements where the throughput is so important that a few percent of improvement is more valued than an increase in the accuracy errors of a few tenths of a decibel. One good application of Auto Align, Partial would be an automated environment where the alignments can be called during overhead time when the device-under-test is exchanged.

When **Auto Align, Partial** is selected the elapsed time counter begins for Auto Align Off time.

When **Auto Align, Partial** is selected the Settings Panel indicates ALIGN PARTIAL with a warning icon. The warning icon is to inform the operator that they are responsible for maintaining the warranted operation of the instrument

Key Path:	System, Alignments, Auto Align
Mode:	All
Example:	:CAL:AUTO PART
Notes:	Auto Align Partial begins the elapsed time counter for Auto Align Off time.
Readback Text:	Partial
Initial S/W Revision:	Prior to A.02.00
Help Map ID:	2003

Off

Auto Align, Off disables automatic alignment and the maintenance of warranted operation, for the benefit of maximum measurement throughput. With Auto Align set to Off, you are now responsible for maintaining warranted operation by updating the alignments when they expire. The Auto Align, Alert mechanism will notify you when alignments have expired. One solution to expired alignments is to perform the Align All, Now operation. Another is to return the Auto Align selection to Normal.

System Functions

System

The Auto Align, Off setting is rarely the best choice, because Partial gives almost the same improvement in throughput while maintaining the warranted performance for a much longer time. The choice is intended for unusual circumstances such as the measurement of radar pulses where you might like the revisit time to be as consistent as possible.

When **Auto Align, Off** is selected the Auto Align Off time is initialized and the elapsed time counter begins.

When **Auto Align, Off** is selected the Settings Panel indicates ALIGN OFF with a warning icon. The warning icon is to inform the operator that they are responsible for maintaining the warranted operation of the instrument:

Key Path:	System, Alignments, Auto Align
Mode:	All
Example:	:CAL:AUTO OFF
Notes:	Auto Align Off begins the elapsed time counter for Auto Align Off time.
Couplings:	Auto Align is set to Off if Restore Align Data is invoked.
Readback Text:	Off
Initial S/W Revision:	Prior to A.02.00
Help Map ID:	2004

All but RF

Auto Align, All but RF, configures automatic alignment to include or exclude the RF subsystem. (Eliminating the automatic alignment of the RF subsystem prevents the input impedance from changing. The normal input impedance of 50 ohms can change to an open circuit when alignments are being used. Some devices under test do not behave acceptably under such circumstances, for example by showing instability.) When Auto Align, All but RF ON is selected, the operator is responsible for performing an Align Now, RF when RF-related alignments expire. The Auto Align, Alert mechanism will notify the operator to perform an Align Now, All when the combination of time and temperature variation is exceeded.

When Auto Align, All but RF ON is selected the Settings Panel indicates ALIGN AUTO/NO RF with a warning icon (warning icon is intended to inform the operator they are responsible for the maintaining the RF alignment of the instrument):

Key Path:	System, Alignments, Auto Align
Mode:	All
Remote Command:	:CALibration:AUTO:MODE ALL NRF :CALibration:AUTO:MODE?
Example:	:CAL:AUTO:MODE NRF
Preset:	This is unaffected by Preset but is set to ALL on a "Restore System Defaults->Align".

State Saved:	No
Readback Text:	RF or NRF
Initial S/W Revision:	Prior to A.02.00
Help Map ID:	2005

Alert

The instrument will signal an Alert when conditions exist such that you will need to perform a full alignment (for example, Align Now, All). The Alert can be configured in one of four settings; Time & Temperature, 24 hours, 7 days, or None. A confirmation is required when a selection other than Time & Temperature is chosen. This prevents accidental deactivation of alerts.

With Auto Align set to Normal, the configuration of Alert is not relevant because the instrument's software maintains the instrument in warranted operation.

Key Path:	System, Alignments, Auto Align
Mode:	All
Remote Command:	:CALibration:AUTO:ALERT TTEMPerature DAY WEEK NONE :CALibration:AUTO:ALERT?
Example:	:CAL:AUTO:ALER TTEM
Notes:	The alert that alignment is needed is the setting of bit 14 in the Status Questionable Calibration register.
Preset:	This is unaffected by Preset but is set to TTEMPerature on a "Restore System Defaults->Align".
State Saved:	No
Status Bits/OPC dependencies:	The alert is the Error Condition message "Align Now, All required" and bit 14 is set in the Status Questionable Calibration register.
Initial S/W Revision:	Prior to A.02.00
Help Map ID:	2006

Time & Temperature

With Auto Align Alert set to Time & Temperature the instrument will signal an alert when alignments expire due to the combination of the passage of time and changes in temperature. The alert is the Error Condition message "Align Now, All required". If this choice for Alert is selected, the absence of an alert means that the analyzer alignment is sufficiently up-to-date to maintain warranted accuracy.

Key Path:	System, Alignments, Auto Align, Alert
Mode:	All
Example:	:CAL:AUTO:ALER TTEM
Readback Text:	Time & Temp

System Functions
System

Status Bits/OPC dependencies:	Bit 14 is set in the Status Questionable Calibration register.
Initial S/W Revision:	Prior to A.02.00
Help Map ID:	2007

24 hours

With Auto Align Alert set to 24 Hours the instrument will signal an alert after a time span of 24 hours since the last successful full alignment (for example, Align Now, All or completion of a full Auto Align). You may choose this selection in an environment where the temperature is stable on a daily basis at a small risk of accuracy errors in excess of the warranted specifications. The alert is the Error Condition message “Align Now, All required”.

For front-panel operation , confirmation is required to transition into this setting of Alert. The confirmation dialog is:

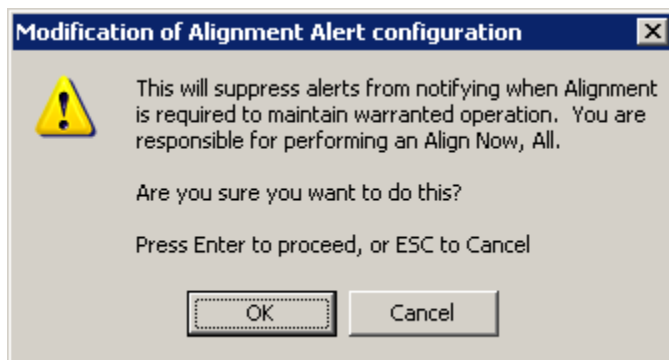

No confirmation is required when Alert is configured through a remote command.

Key Path:	System, Alignments, Auto Align, Alert
Mode:	All
Example:	:CAL:AUTO:ALER DAY
Readback Text:	24 hours
Status Bits/OPC dependencies:	Bit 14 is set in the Status Questionable Calibration register.
Initial S/W Revision:	Prior to A.02.00
Help Map ID:	2008

7 days

With Auto Align Alert is set to 7 days the instrument will signal an alert after a time span of 168 hours since the last successful full alignment (for example, Align Now, All or completion of a full Auto Align). You may choose this selection in an environment where the temperature is stable on a weekly basis, at a modest risk of accuracy degradations in excess of warranted performance. The alert is the Error Condition message “Align Now, All required”.

For front panel operation, confirmation is required for the customer to transition into this setting of Alert. The confirmation dialog is:

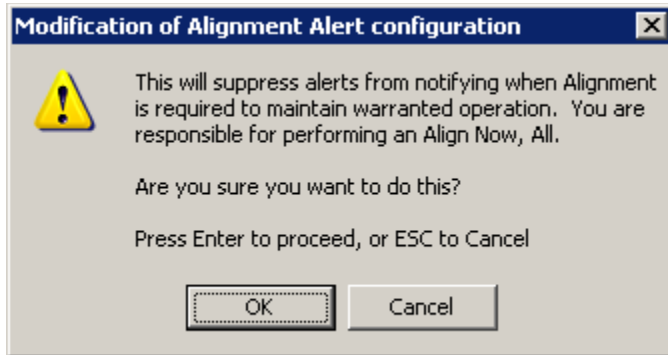

No confirmation is required when Alert is configured through a remote command.

Key Path:	System, Alignments, Auto Align, Alert
Mode:	All
Example:	:CAL:AUTO:ALER WEEK
Readback Text:	7 days
Status Bits/OPC dependencies:	Bit 14 is set in the Status Questionable Calibration register.
Initial S/W Revision:	Prior to A.02.00
Help Map ID:	2009

None

With Auto Align Alert set to None the instrument will not signal an alert. This is provided for rare occasions where you are making a long measurement which cannot tolerate Auto Align interruptions, and must have the ability to capture a screen image at the end of the measurement without an alert posted to the display. Agilent does not recommends using this selection in any other circumstances, because of the risk of accuracy performance drifting well beyond expected levels without the operator being informed.

For front panel operation, confirmation is required to transition into this setting of Alert. The confirmation dialog is:

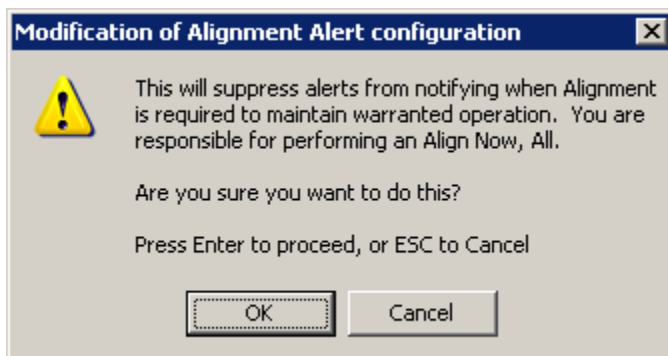

System Functions System

No confirmation is required when Alert is configured through a remote command.

Key Path:	System, Alignments, Auto Align, Alert
Mode:	All
Example:	:CAL:AUTO:ALER NONE
Initial S/W Revision:	Prior to A.02.00
Help Map ID:	2010

Execute Expired Alignments (Remote Command Only)

Alignments can be expired in the situation where Auto Align is in the state of Partial or Off. This feature runs the alignments that have expired. This is different than performing an Align All, Now operation. Align All, Now performs an alignment of all subsystems regardless of whether they are needed or not, with Execute Expired Alignments, only the individual subsystems that have become due are aligned.

Mode:	All
Remote Command:	:CALibration:EXPIred?
Example:	:CAL:EXP?
Notes:	:CALibration:EXPIred? returns 0 if successful :CALibration:EXPIred? returns 1 if failed
Initial S/W Revision:	Prior to A.02.00
Help Map ID:	0

Align Now

Accesses alignment processes that are immediate action operations. They perform complete operations and run until they are complete.

Key Path:	System, Alignments
Initial S/W Revision:	Prior to A.02.00
Help Map ID:	2011

All

Immediately executes an alignment of all subsystems. The instrument stops any measurement currently underway, performs the alignment, then restarts the measurement from the beginning (similar to pressing the **Restart** key).

If an interfering user signal is present at the RF Input, the alignment is performed on all subsystems except the RF. After completion, the Error Condition message “Align skipped: 50 MHz interference” or “Align skipped: 4.8 GHz interference” is generated. In addition the Error Condition message “Align Now, RF required” is generated, and bits 11 and 12 are set in the Status Questionable Calibration register.

The query form of the remote commands (:CALibration[:ALL]? or *CAL?) invokes the alignment of all subsystems and returns a success or failure value. An interfering user signal is not grounds for failure; if the alignment was able to succeed on all portions but unable to align the RF because of an interfering signal, the resultant will be the success value.

Successful completion of **Align Now, All** will clear the “Align Now, All required” Error Condition, and clear bit 14 in the Status Questionable Calibration register. It will also begin the elapsed time counter for Last Align Now, All Time, and capture the Last Align Now, All Temperature.

If the Align RF subsystem succeeded in aligning (no interfering signal present), the elapsed time counter begins for Last Align Now, RF Time, and the temperature is captured for the Last Align Now, RF Temperature. In addition the Error Conditions “Align skipped: 50 MHz interference” and “Align skipped: 4.8 GHz interference” are cleared, the Error Condition “Align Now, RF required” is cleared, and bits 11 and 12 are cleared in the Status Questionable Calibration register

Align Now, All can be interrupted by pressing the Cancel (ESC) front-panel key or remotely with Device Clear followed by the :ABORt SCPI command. When this occurs the Error Condition message “Align Now, All required” is generated, and bit 14 is set in the Status Questionable Condition register. This is because new alignment data may be employed for an individual subsystem, but not a cohesive set of data for all subsystems.

In many cases, you might find it more convenient to change alignments to Normal, instead of executing Align Now, All. When the Auto Align process transitions to Normal, the analyzer will immediately start to update only the alignments that have expired, thus efficiently restoring the alignment process.

In models with the RF Preselector, such as the N9038A, the Align Now All alignment will immediately execute an alignment of all subsystems in the Spectrum Analyzer and partial subsystems of the RF Preselector. The additional alignments are the System Gain, Mechanical attenuator and Electronic attenuator alignments on the RF Preselector path. The purpose of these alignments is to improve the RF Preselector path amplitude variation compared to the bypass path.

Key Path:	System, Alignments, Align Now
Mode:	All
Remote Command:	:CALibration[:ALL] :CALibration[:ALL]?
Example:	:CAL

Notes:	<p>:CALibration[:ALL]? returns 0 if successful</p> <p>:CALibration[:ALL]? returns 1 if failed</p> <p>:CALibration[:ALL]? is the same as *CAL?</p> <p>While Align Now, All is performing the alignment, bit 0 in the Status Operation register is set. Completion, or termination, will clear bit 0 in the Status Operation register.</p> <p>This command is sequential; it must complete before further SCPI commands are processed. Interrupting the alignment from remote is accomplished by invoking Device Clear followed by the :ABORt command.</p> <p>Successful completion will clear bit 14 in the Status Questionable Calibration register.</p> <p>An interfering user signal is not grounds for failure of Align Now, All. However, bits 11 and 12 are set in the Status Questionable Calibration register to indicate Align Now, RF is required.</p> <p>An interfering user supplied signal will result in the instrument requiring an Align Now, RF with the interfering signal removed.</p>
Couplings:	<p>Initializes the time for the Last Align Now, All Time.</p> <p>Records the temperature for the Last Align Now, All Temperature.</p> <p>If Align RF component succeeded, initializes the time for the Last Align Now, RF Time.</p> <p>If Align RF component succeeded, records the temperature for the Last Align Now, RF Temperature.</p>
Status Bits/OPC dependencies:	Bits 11, 12, or 14 may be set in the Status Questionable Calibration register.
Initial S/W Revision:	Prior to A.02.00
Help Map ID:	2012

Mode:	All
Remote Command:	*CAL?
Example:	*CAL?
Notes:	<p>*CAL? returns 0 if successful</p> <p>*CAL? returns 1 if failed</p> <p>:CALibration[:ALL]? is the same as *CAL?</p> <p>See additional remarks described with :CALibration[:ALL]?</p> <p>Everything about :CALibration[:ALL]? is synonymous with *CAL? including all conditions, status register bits, and couplings</p>
Initial S/W Revision:	Prior to A.02.00
Help Map ID:	0

All but RF

Immediately executes an alignment of all subsystems except the RF subsystem. The instrument will stop any measurement currently underway, perform the alignment, and then restart the measurement from the beginning (similar to pressing the Restart key). This can be used to align portions of the instrument that are not impacted by an interfering user input signal.

This operation might be chosen instead of **All** if you do not want the device under test to experience a large change in input impedance, such as a temporary open circuit at the analyzer input.

The query form of the remote commands (:CALibration:NRF?) will invoke the alignment and return a success or failure value.

Successful completion of Align Now, All but RF will clear the “Align Now, All required” Error Condition, and clear bit 14 in the Status Questionable Calibration register. If “Align Now, All required” was in effect prior to executing the All but RF, the Error Condition message “Align Now, RF required” is generated and bit 12 in the Status Questionable Calibration register is set. It will also begin the elapsed time counter for Last Align Now, All Time, and capture the Last Align Now, All Temperature.

Align Now, All but RF can be interrupted by pressing the Cancel (ESC) front-panel key or remotely with Device Clear followed by the :ABORt SCPI command. When this occurs the Error Condition message “Align Now, All required” is generated, and bit 14 is set in the Status Questionable Condition register. This is because new alignment data may be used for an individual subsystem, but not a full new set of data for all subsystems.

In models with the RF Preselector, such as the N9038A, the “All but RF” alignment will execute an alignment of all subsystems except the RF subsystem of the Spectrum Analyzer, as well as the system gain of the RF Preselector.

Key Path:	System, Alignments, Align Now
Mode:	All
Remote Command:	:CALibration:NRF :CALibration:NRF?
Example:	:CAL:NRF
Notes:	:CALibration:NRF? returns 0 if successful :CALibration:NRF? returns 1 if failed While Align Now, All but RF is performing the alignment, bit 0 in the Status Operation register is set. Completion, or termination, will clear bit 0 in the Status Operation register. This command is sequential; it must complete before further SCPI commands are processed. Interrupting the alignment from remote is accomplished by invoking Device Clear followed by the :ABORt command. Successful completion will clear bit 14 in the Status Questionable Calibration register and set bit 12 if invoked with “Align Now, All required”.
Couplings:	Initializes the time for the Last Align Now, All Time. Records the temperature for the Last Align Now, All Temperature.

System Functions
System

Status Bits/OPC dependencies:	Bits 12 or 14 may be set in the Status Questionable Calibration register.
Initial S/W Revision:	Prior to A.02.00
Help Map ID:	2013

RF

Immediately executes an alignment of the RF subsystem. The instrument stops any measurement currently underway, performs the alignment, then restarts the measurement from the beginning (similar to pressing the **Restart** key).

This operation might be desirable if the alignments had been set to not include RF alignments, or if previous RF alignments could not complete because of interference which has since been removed.

If an interfering user signal is present at the RF Input, the alignment will terminate and generate the Error Condition message “Align skipped: 50 MHz interference” or “Align skipped: 4.8 GHz interference”, and Error Condition “Align Now, RF required”. In addition, bits 11 and 12 will be set in the Status Questionable Calibration register.

The query form of the remote commands (:CALibration:RF?) will invoke the alignment of the RF subsystem and return a success or failure value. An interfering user signal is grounds for failure.

Successful completion of Align Now, RF will begin the elapsed time counter for Last Align Now, RF Time, and capture the Last Align Now, RF Temperature.

Align Now, RF can be interrupted by pressing the Cancel (ESC) front-panel key or remotely with Device Clear followed by the :ABORt SCPI command. When this occurs, the Error Condition message “Align Now, RF required” is generated, and bit 12 is set in the Status Questionable Condition register. None of the new alignment data is used.

In models with the RF Preselector, such as the N9038A, the RF alignment will execute an alignment of the RF subsystem of the Spectrum Analyzer, as well as the RF subsystem on RF Preselector path.

Key Path:	System, Alignments, Align Now
Mode:	All
Remote Command:	:CALibration:RF :CALibration:RF?
Example:	:CAL:RF

Notes:	<p>:CALibration:RF? returns 0 if successful</p> <p>:CALibration:RF? returns 1 if failed (including interfering user signal)</p> <p>While Align Now, RF is performing the alignment, bit 0 in the Status Operation register is set. Completion, or termination, will clear bit 0 in the Status Operation register.</p> <p>This command is sequential; it must complete before further SCPI commands are processed. Interrupting the alignment from remote is accomplished by invoking Device Clear followed by the :ABORt command.</p> <p>Successful completion clears the Error Conditions “Align skipped: 50 MHz interference” and “Align skipped: 4800 MHz interference” and the Error Conditions “Align RF failed” and “Align Now, RF required”, and clears bits 3, 11, and 12 in the Status Questionable Calibration register.</p> <p>A failure encountered during alignment will generate the Error Condition message “Align RF failed” and set bit 3 in the Status Questionable Calibration register.</p> <p>An interfering user signal will result in bits 11 and 12 to be set in the Status Questionable Calibration register to indicate Align Now, RF is required.</p> <p>An interfering user supplied signal will result in the instrument requiring an Align Now, RF with the interfering signal removed.</p>
Couplings:	<p>Initializes the time for the Last Align Now, RF Time.</p> <p>Records the temperature for the Last Align Now, RF Temperature.</p>
Status Bits/OPC dependencies:	Bits 11, 12, or 14 may be set in the Status Questionable Calibration register.
Initial S/W Revision:	Prior to A.02.00
Help Map ID:	2014

External Mixer

Immediately executes an alignment of the External Mixer that is plugged into the USB port. The instrument stops any measurement currently underway, performs the alignment, then restarts the measurement from the beginning (similar to pressing the Restart key). As this alignment calibrates the LO power to the mixer, this is considered an LO alignment; and failure is classified as an LO alignment failure.

The query form of the remote commands (:CALibration:EMIXer?) will invoke the alignment of the External Mixer and return a success or failure value.

Key Path:	System, Alignments, Align Now
Mode:	All
Remote Command:	:CALibration:EMIXer :CALibration:EMIXer?
Example:	:CAL:EMIX

System Functions
System

Notes:	<p>:CAL:EMIX? returns 0 if successful</p> <p>:CAL:EMIX? returns 1 if failed</p> <p>While Align Now, Ext Mix is performing the alignment, bit 0 in the Status Operation register is set. Completion, or termination, will clear bit 0 in the Status Operation register.</p> <p>This command is sequential; it must complete before further SCPI commands are processed. Interrupting the alignment from remote is accomplished by invoking Device Clear followed by the :ABORt command.</p> <p>A failure encountered during alignment will generate the Error Condition message “Align LO failed” and set bit 5 in the Status Questionable Calibration register. Successful completion will clear the “Align LO failed” message and bit 5 in the Status Questionable Calibration register.</p>
Dependencies:	This key does not appear unless option EXM is present and is grayed-out unless a USB mixer is plugged in to the USB.
Status Bits/OPC dependencies:	Bit3 may be set in the Status Questionable Calibration Extended Failure register.
Initial S/W Revision:	A.08.00
Help Map ID:	3672

Source

This menu is only available in the EXT (E6607A).

Accesses source alignment processes that are immediate action operations. They perform complete operations and run until they are complete.

Immediately executes an IQ alignment of the complete source. The instrument stops any sequence of the source, performs the alignment, then restarts the sequence from the beginning.

There is no alert available for the source alignment. The operators have the responsibility to check temperature shift since last Align Now, Source to determine if the source alignment need to be executed.

Key Path:	System, Alignments, Align Now
Mode:	All
Remote Command:	<p>:CALibration:INTernal:SOURce[:ALL]</p> <p>:CALibration:INTernal:SOURce[:ALL]?</p>
Example:	:CAL:INT:SOUR
Notes:	<p>Only available in: XOBT</p> <p>:CAL:SOUR? Initiates an Alignment and returns 0 if successful</p> <p>:CAL:SOUR? Initiates an Alignment and returns 1 if failed</p>
Couplings:	<p>Initializes the time for the Last Align Source Now, All Time.</p> <p>Records the temperature for the Last Align Source Now, All Temperature.</p>

Status Bits/OPC dependencies:	Bits TODO may be set in the Status Questionable Calibration register
Initial S/W Revision:	A.05.00
Help Map ID:	3652

Show Alignment Statistics

Shows alignment information you can use to ensure that the instrument is operating in a specific manner. The Show Alignment Statistics screen is where you can view time and temperature information.

Values which are displayed are only updated when the Show Alignment Statistics screen is invoked, they are not updated while the Show Alignment Statistics screen is being displayed. The remote commands that access this information obtain current values.

An example of the Show Alignment Statistics screen would be similar to:

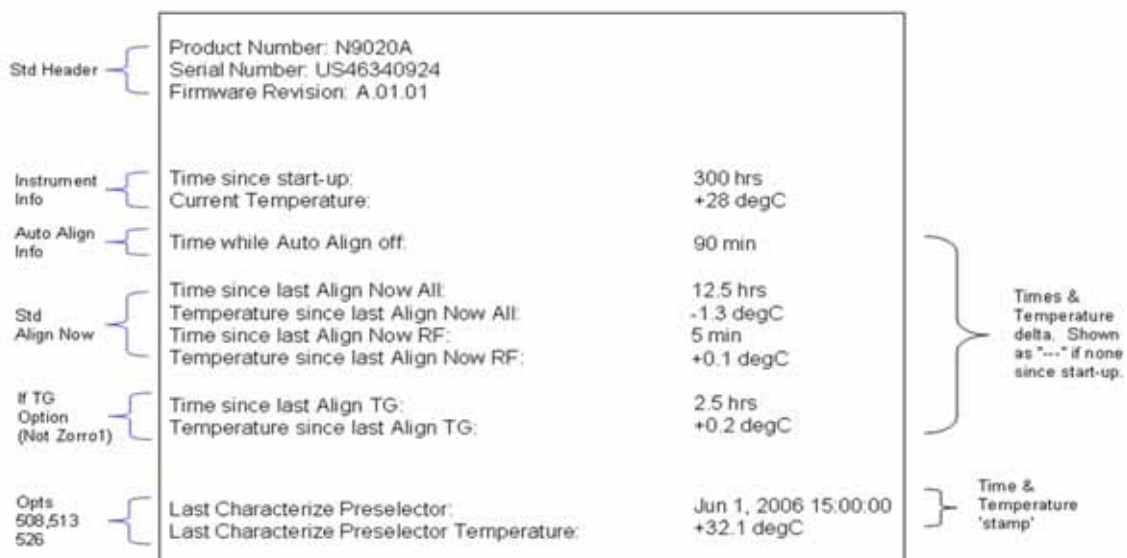

A successful Align Now, RF will set the Last Align RF temperature to the current temperature, and reset the Last Align RF time. A successful Align Now, All or Align Now, All but RF will set the Last Align Now All temperature to the current temperature, and reset the Last Align Now All time. A successful Align Now, All will also reset the Last Align RF items if the RF portion of the Align Now succeeded.

Key Path:	System, Alignments
Mode:	All
Notes:	The values displayed on the screen are only updated upon entry to the screen and not updated while the screen is being displayed.
Initial S/W Revision:	Prior to A.02.00
Help Map ID:	2018

System Functions
System

Key Path:	Visual annotation in the Show Alignment Statistics screen
Mode:	All
Remote Command:	:SYSTem:PON:TIME?
Example:	:SYST:PON:TIME?
Notes:	Value is the time since the most recent start-up in seconds.
State Saved:	No
Initial S/W Revision:	Prior to A.02.00
Help Map ID:	0

Key Path:	Visual annotation in the Show Alignment Statistics screen
Mode:	All
Remote Command:	:CALibration:TEMPerature:CURRent?
Example:	:CAL:TEMP:CURR?
Notes:	Value is in degrees Centigrade. Value is invalid if using default alignment data (Align Now, All required)
State Saved:	No
Initial S/W Revision:	Prior to A.02.00
Help Map ID:	0

Key Path:	Visual annotation in the Show Alignment Statistics screen
Mode:	All
Remote Command:	:CALibration:TIME:LALL?
Example:	:CAL:TIME:LALL?
Notes:	Value is the elapsed time, in seconds, since the last successful Align Now, All or Align Now, All but RF was executed.
State Saved:	No
Initial S/W Revision:	Prior to A.02.00
Help Map ID:	0

Key Path:	Visual annotation in the Show Alignment Statistics screen
Mode:	All
Remote Command:	:CALibration:TEMPerature:LALL?
Example:	:CAL:TEMP:LALL?

Notes:	Value is in degrees Centigrade at which the last successful Align Now, All or Align Now, All but RF was executed.
State Saved:	No
Initial S/W Revision:	Prior to A.02.00
Help Map ID:	0

Key Path:	Visual annotation in the Show Alignment Statistics screen
Mode:	All
Remote Command:	:CALibration:TIME:LRF?
Example:	:CAL:TIME:LRF?
Notes:	Value is the elapsed time, in seconds, since the last successful Align Now, RF was executed, either individually or as a component of Align Now, All.
State Saved:	No
Initial S/W Revision:	Prior to A.02.00
Help Map ID:	0

Key Path:	Visual annotation in the Show Alignment Statistics screen
Mode:	All
Remote Command:	:CALibration:TEMPerature:LRF?
Example:	:CAL:TEMP:LRF?
Notes:	Value is in degrees Centigrade at which the last successful Align Now, RF was executed, either individually or as a component of Align Now, All.
State Saved:	No
Initial S/W Revision:	Prior to A.02.00
Help Map ID:	0

Key Path:	Visual annotation in the Show Alignment Statistics screen
Mode:	All
Remote Command:	:CALibration:TIME:SOURce:LALL?
Example:	:CAL:TIME:SOUR:LALL?
Notes:	Value is the date and time of the last successful Align Now, Source was performed on the instrument.
State Saved:	No
Initial S/W Revision:	A.05.00

System Functions
System

Help Map ID:	0
--------------	---

Key Path:	Visual annotation in the Show Alignment Statistics screen
Mode:	All
Remote Command:	:CALibration:TEMPerature:SOURce: LALL?
Example:	:CAL:TEMP:SOUR:LALL?
Notes:	Value is in degrees Centigrade at which the last successful Align Now, Source was performed on the instrument.
State Saved:	No
Initial S/W Revision:	A.05.00

Help Map ID:	0
--------------	---

Key Path:	Visual annotation in the Show Alignment Statistics screen
Mode:	All
Remote Command:	:CALibration:TIME:LPreselector?
Example:	:CAL:TIME:LPR?
Notes:	Value is the date and time the last successful Characterize Preselector was executed. The date is separated from the time by a space character. Returns "" if no Characterize Preselector has ever been performed on the instrument.
Dependencies:	In models that do not include preselectors, this command is not enabled and any attempt to set or query will yield an error.
State Saved:	No
Initial S/W Revision:	Prior to A.02.00

Help Map ID:	0
--------------	---

Key Path:	Visual annotation in the Show Alignment Statistics screen
Mode:	All
Remote Command:	:CALibration:TEMPerature:LPreselector?
Example:	:CAL:TEMP:LPR?
Notes:	Value is in degrees Centigrade at which the last successful Characterize Preselector was executed.
Dependencies:	In models that do not include preselectors, this command is not enabled and any attempt to set or query will yield an error.
State Saved:	No
Initial S/W Revision:	Prior to A.02.00

Help Map ID: 0

Key Path:	Visual annotation in the Show Alignment Statistics screen
Mode:	All
Remote Command:	:CALibration:AUTO:TIME:OFF?
Example:	:CAL:AUTO:TIME:OFF?
Notes:	Value is the elapsed time, in seconds, since Auto Align has been set to Off or Off with Alert. The value is 0 if Auto Align is ALL or NORF.
State Saved:	No
Initial S/W Revision:	Prior to A.02.00
Help Map ID:	0

Key Path:	Visual annotation in the Show Alignment Statistics screen
Mode:	All
Remote Command:	:CALibration:TIME:RFPSselector:LCONducted?
Example:	:CAL:TIME:RFPS:LCON?
Notes:	Values are the date and time the last successful Align Now, 20 Hz – 30 MHz was executed. The date is separated from the time by a semi-colon character.
State Saved:	No
Help Map ID:	0

Key Path:	Visual annotation in the Show Alignment Statistics screen
Mode:	All
Remote Command:	:CALibration:TEMPerature:RFPSselector:LCONducted?
Example:	:CAL:TEMP:RFPS:LCON?
Notes:	Value is in degrees Centigrade at which the last successful Align Now, 20 Hz – 30 MHz was executed.
State Saved:	No
Help Map ID:	0

Key Path:	Visual annotation in the Show Alignment Statistics screen
Mode:	All
Remote Command:	:CALibration:TIME:RFPSselector:LRADiated?
Example:	:CAL:TIME:RFPS:LRAD?

System Functions
System

Notes:	Value is the date and time the last successful Align Now, 30 MHz – 3.6 GHz was executed. The date is separated from the time by a semi-colon character.
State Saved:	No
Help Map ID:	0

Key Path:	Visual annotation in the Show Alignment Statistics screen
Mode:	All
Remote Command:	:CALibration:TEMPerature:RFPSelector:LRADiated?
Example:	:CAL:TEMP:RFPS:LRAD?
Notes:	Value is in degrees Centigrade at which the last successful Align Now, 30 MHz – 3.6 GHz was executed.
State Saved:	No
Help Map ID:	0

Key Path:	Visual annotation in the Show Alignment Statistics screen
Mode:	All
Remote Command:	:CALibration:RFPSelector:SCHeduler:TIME:NEXT? This query returns data using the following format “YYYY/MM/DD; HH:MM:SS”
Example:	:CAL:RFPS:SCH:TIME:NEXT?
Notes:	The next run time will be updated based on the start date/time and recurrence set by the users. “date” is representation of the date the task will run in the form of “YYYY/MM/DD” where: YYYY is the four digit representation of year. (for example, 2009) MM is the two digit representation of month. (for example, 01 to 12) DD is the two digit representation of the day. (for example, 01 to 28, 29, 30 or 31 depending on the month and year) “time” is a representation of the time of day the task will run in the form of “HH:MM:SS” where: HH is the two digit representation of the hour in 24 hour format MM is the two digit representation of minute SS is the two digit representation of seconds For model N9038A only.
State Saved:	No
Help Map ID:	0

Restore Align Defaults

Initializes the alignment user interface settings, not alignment data, to the factory default values. Align Now, All must be executed if the value of the Timebase DAC results in a change.

For front panel operation, you are prompted to confirm action before setting the alignment parameters to factory defaults:

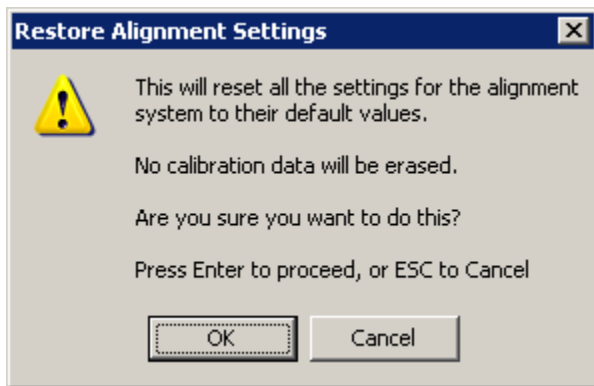

The parameters affected are:

Parameter	Setting
Timebase DAC	Calibrated
Timebase DAC setting	Calibrated value
Auto Align State	Normal (if the instrument is not operating with default alignment data, Off otherwise)
Auto Align All but RF	Off
Auto Align Alert	Time & Temperature

Key Path:	System, Alignments
Mode:	All
Example:	:SYST:DEF ALIG
Notes:	Alignment processing that results as the transition to Auto Alignment Normal will be executed sequentially; thus *OPC? or *WAI will wait until the alignment processing is complete.
Initial S/W Revision:	Prior to A.02.00
Help Map ID:	2022

Backup or Restore Align Data...

Opens the utility for backing-up or restoring the alignment data.

Alignment data for the instrument resides on the hard drive in a database. Agilent uses high quality hard drives; however it is highly recommended the alignment data be backed-up to storage outside of the

System Functions

System

instrument. Additionally, for customers who use multiple CPU Assemblies or multiple disk drives, the alignment that pertains to the instrument must be transferred to the resident hard drive after a CPU or hard drive is replaced. This utility facilitates backing-up and restoring the alignment data.

NOTE This utility allows the operator to navigate to any location of the Windows file system. It is intended that the operator use a USB memory device or Mapped Network Drive to back up the alignment data to storage outside of the instrument.

Key Path:	System, Alignments
Initial S/W Revision:	A.02.00
Help Map ID:	3624

Key Path:	System, Alignments
Mode:	All
Remote Command:	:CALibration:DATA:DEFault
Example:	:CAL:DATA:DEF
Couplings:	Sets Auto Align to Off. Sets bit 14 in the Status Questionable Calibration register. The Error Condition message "Align Now, All required" is generated.
Initial S/W Revision:	Prior to A.02.00
Help Map ID:	0

Alignment Data Wizard

The Backup or Restore Alignment Data wizard guides you through the operation of backing-up or restoring the alignment data.

The following dialogue boxes operate without a mouse or external keyboard when you use the default file names.

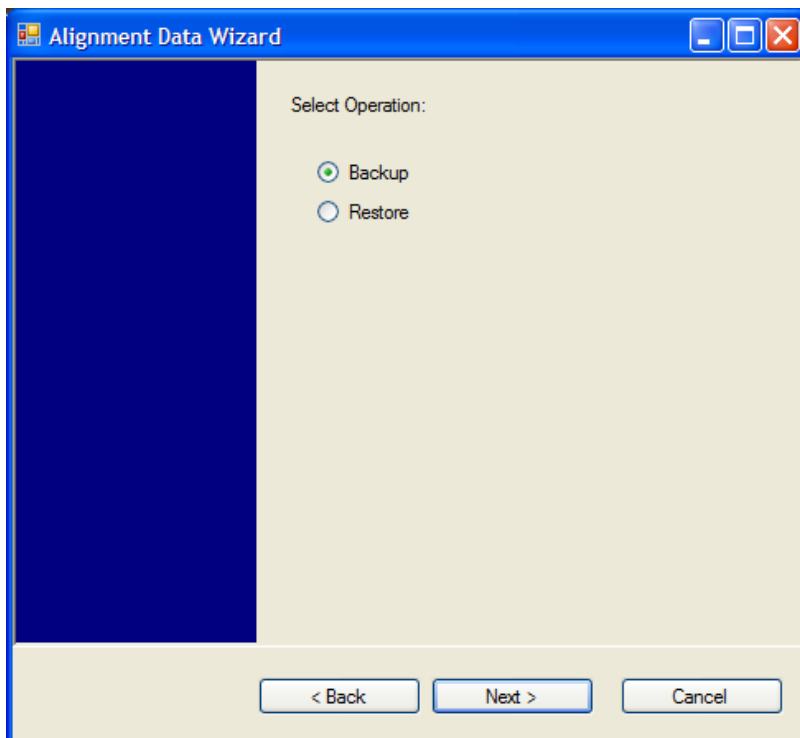
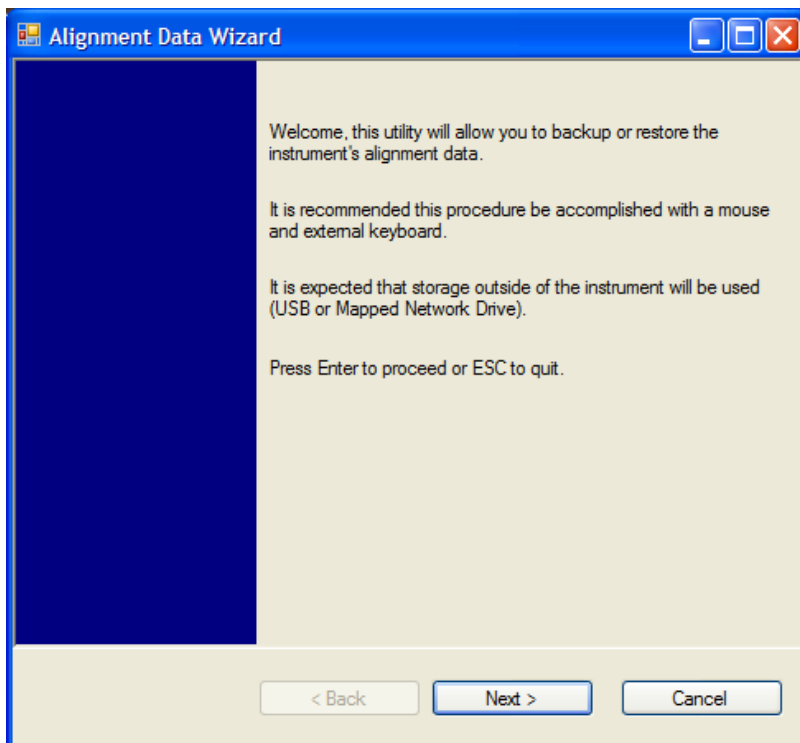

The backup screen indicates the approximate amount of space required to contain the backup file.

The default file name will be AlignDataBackup_<model number>_<serial number>_<date in YYYYMMDDHHMMSS>.bak.

System Functions

System

For the N9030A the default backup location will be the internal F: drive which is a solid-state memory device located internally on the instrument.

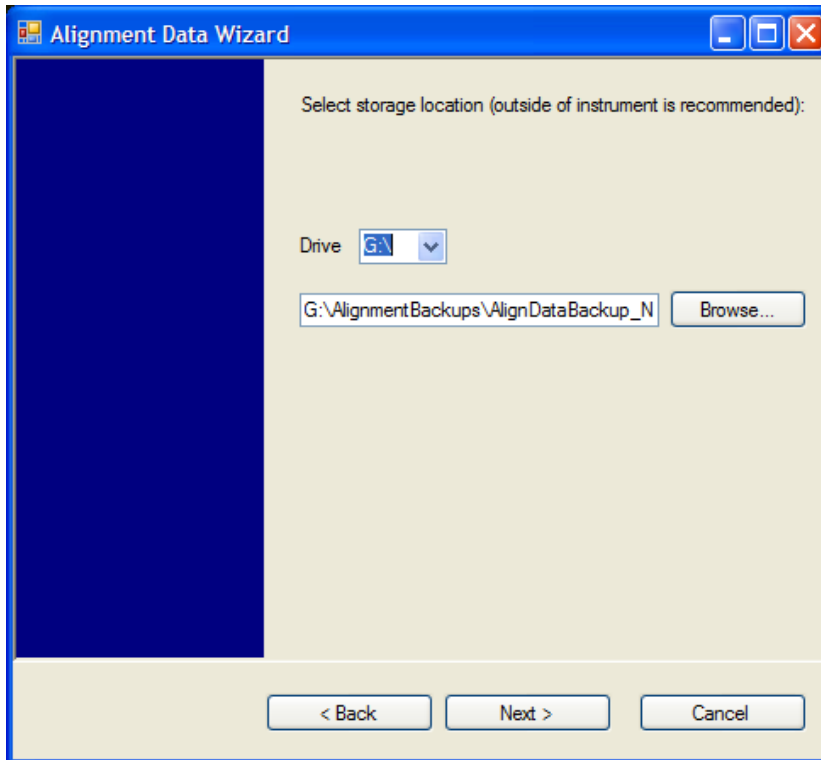

Changing the drive letter will also modify the path displayed in the box below. When this step is first loaded, the drive drop-down menu is populated with connected drives, which provide the user with write access. If there are many unreachable network drives connected to the instrument, this step can take a few seconds. If a USB drive is present, it will be selected by default. The path defaults to the AlignmentBackups folder, and a filename is automatically created in the form of AlignDataBackup_<model>_<serial number>_<date><time>. When the "Next >" button is pressed, you will be prompted to create a new folder if the chosen path does not yet exist.

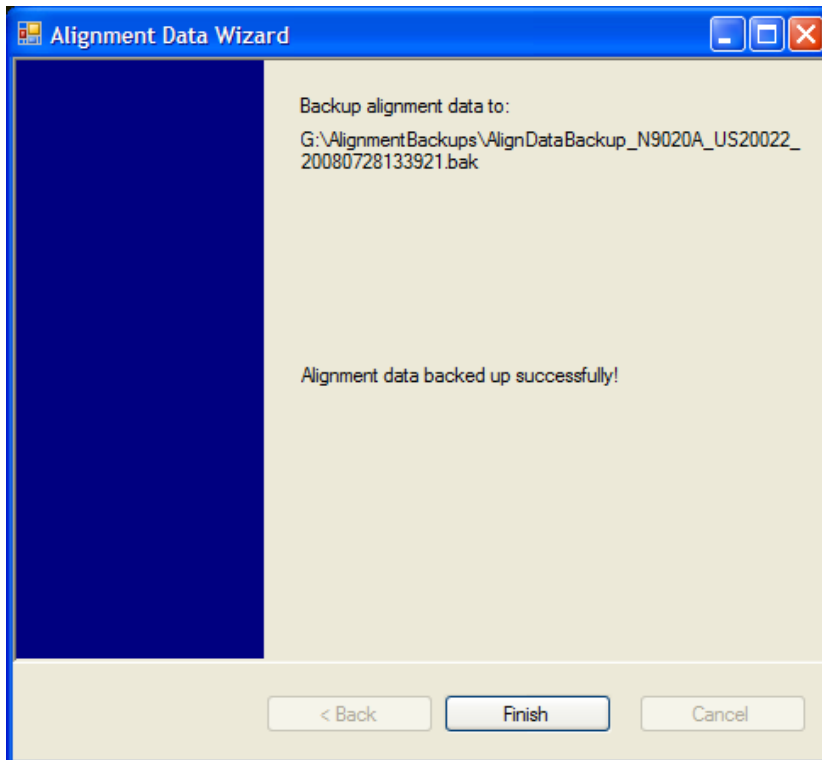
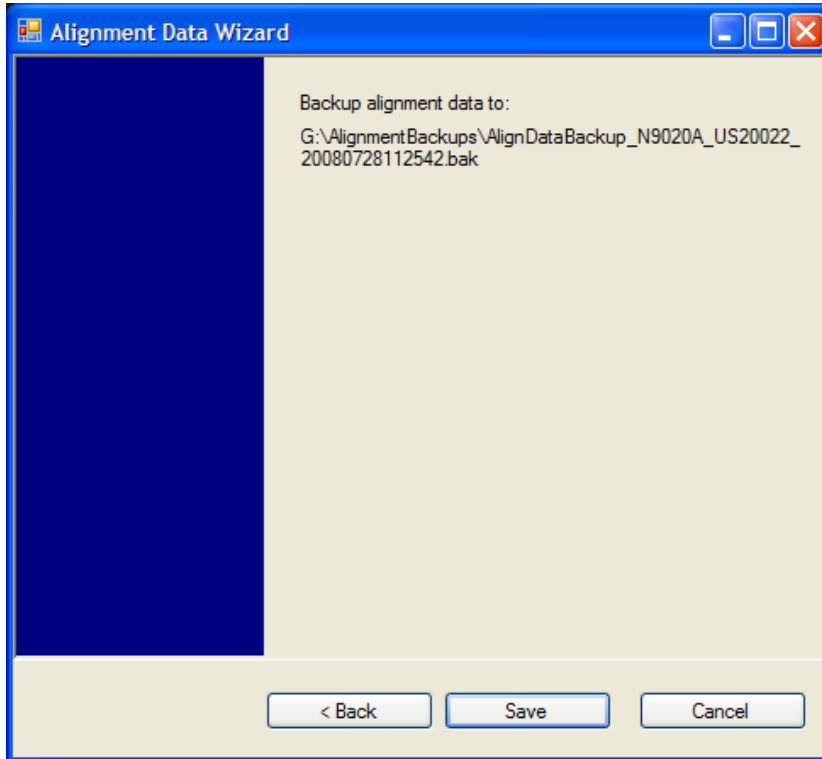

The restore operation checks the validity of the restore file using the database's built-in file validation. If the restore file is corrupt, the existing alignment data will remain in use.

If the serial number information in the backup file being restored is different from that of the instrument,

System Functions

System

the following message appears (the serial number shown are examples):

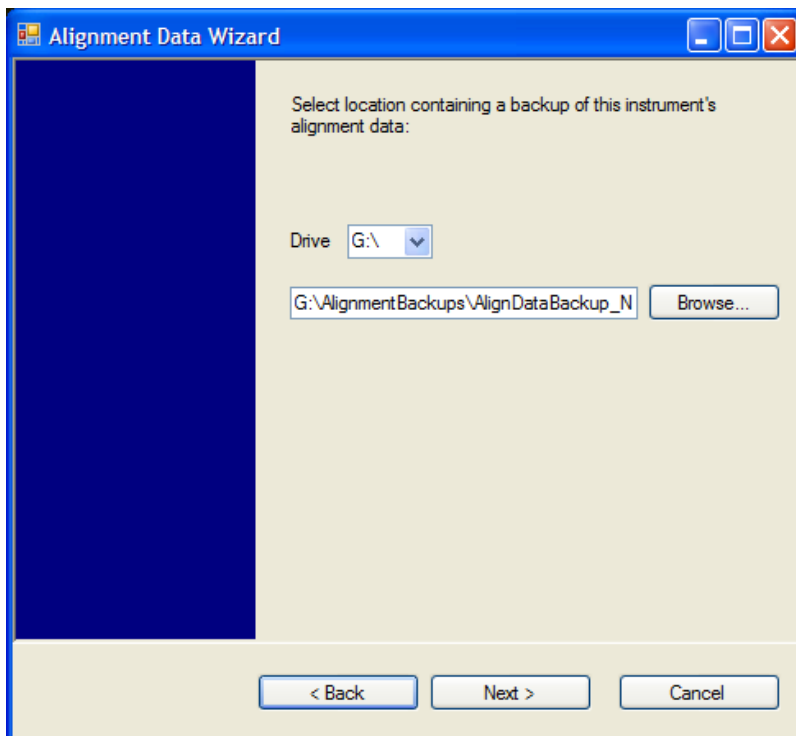
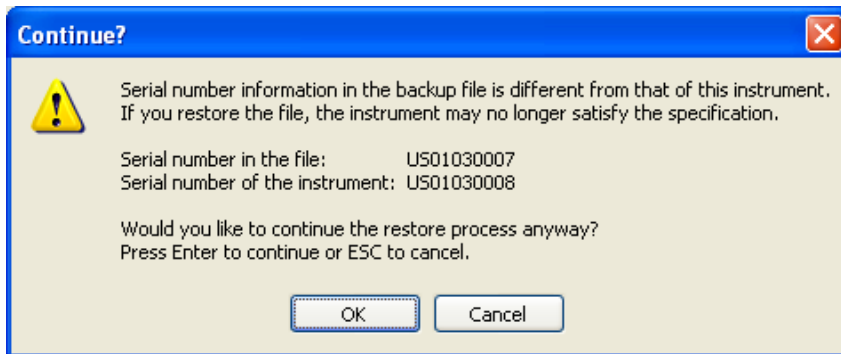

Changing the drive letter also modifies the path displayed in the box below. When this step is first loaded, the drive drop-down menu is populated with connected drives, which provide you with read access. The path defaults to the AlignBackups folder. The most recent *.bak file in the folder will also be selected by default.

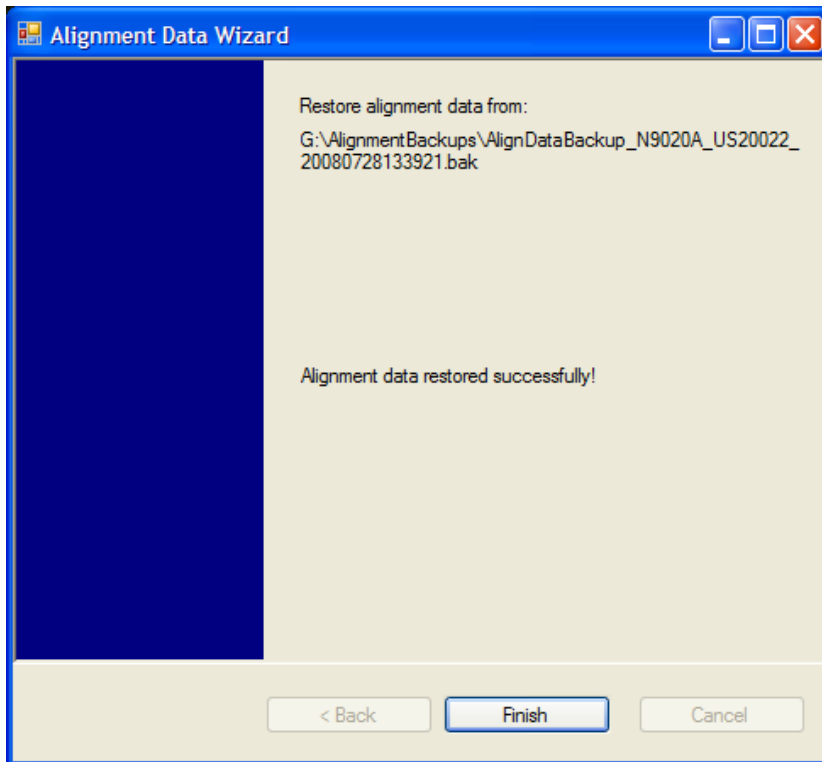
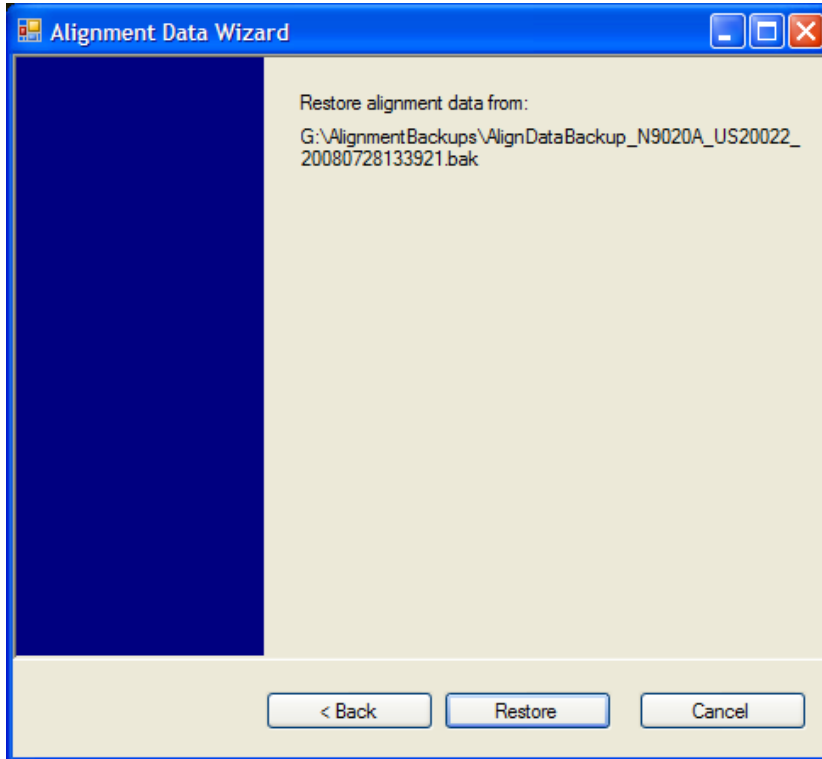

Perform Backup (Remote Command Only)

Invokes an alignment data backup operation to the provided Folder.

NOTE It is recommended that the Folder provided is outside of the instrument (USB or Mapped Network Drive).

Remote Command:	:CALibration:DATA:BACKup <filename>
Example:	:CAL:DATA:BACK "F:\AlignDataBackup_N9020A_US00000001_2008140100.bak"
Initial S/W Revision:	A.02.00
Help Map ID:	0

Perform Restore (Remote Command Only)

Invokes an alignment data restore operation from the provided filename.

Remote Command:	:CALibration:DATA:RESTore <filename>
Example:	:CAL:DATA:REST "F:\ AlignDataBackup_N9020A_US00000001_2008140100.bak "
Initial S/W Revision:	A.02.00
Help Map ID:	0

Advanced

Accesses alignment processes that are immediate action operations that perform operations that run until complete. Advanced alignments are performed on an irregular basis, or require additional operator interaction

Key Path:	System, Alignments
Initial S/W Revision:	Prior to A.02.00
Help Map ID:	2015

Characterize Preselector

The Preselector tuning curve drifts over temperature and time. Recognize that the Amplitude, Presel Center function adjusts the preselector for accurate amplitude measurements at an individual frequency. Characterize Preselector improves the amplitude accuracy by ensuring the Preselector is approximately centered at all frequencies without the use of the Amplitude, Presel Center function. Characterize Preselector can be useful in situations where absolute amplitude accuracy is not of utmost importance, and the throughput savings or convenience of not performing a Presel Center is desired. Presel Center is required prior to any measurement for best (and warranted) amplitude accuracy.

Agilent recommends that the Characterize Preselector operation be performed yearly as part of any calibration, but performing this operation every three months can be worthwhile.

Characterize Preselector immediately executes a characterization of the Preselector, which is a

YIG-tuned filter (YTF). The instrument stops any measurement currently underway, performs the characterization, then restarts the measurement from the beginning (similar to pressing the Restart key).

The query form of the remote commands (:CALibration:YTF?) will invoke the alignment of the YTF subsystem and return a success or failure value.

A failure encountered during alignment will generate the Error Condition message “Characterize Preselector failure” and set bit 3 in the STATUS:QUESTIONable:CALibration:EXTended:FAILure status register. Successful completion of Characterize Preselector will clear this Condition. It will also begin the elapsed time counter for Last Characterize Preselector Time, and capture the Last Characterize Preselector Temperature.

The last Characterize Preselector Time and Temperature survives across the power cycle as this operation is performed infrequently.

NOTE The Characterize Preselector function can be interrupted by pressing the Cancel (ESC) front-panel key or remotely with Device Clear followed by the :ABORT SCPI command. None of the new characterization data is then used. However, since the old characterization data is purged at the beginning of the characterization, you now have an uncharacterized preselector. You should re-execute this function and allow it to finish before making any further preselected measurements.

Key Path:	System, Alignments, Advanced
Mode:	All
Remote Command:	:CALibration:YTF :CALibration:YTF?
Example:	:CAL:YTF
Notes:	:CALibration:YTF? returns 0 if successful :CALibration:YTF? returns 1 if failed (including interfering user signal) While Advanced, Characterize Preselector is performing the alignment, bit 0 in the Status Operation register is set. Completion, or termination, will clear bit 0 in the Status Operation register. This command is sequential; it must complete before further SCPI commands are processed. Interrupting the alignment from remote is accomplished by invoking Device Clear followed by the :ABORT command. Successful completion will clear bit 9 in the Status Questionable Calibration register. A failure encountered during alignment will generate the Error Condition message “Characterize Preselector failed” and set bit 9 in the Status Questionable Calibration register. For Options that support frequencies > 3.6 GHz only.

Dependencies:	This key does not appear in models that do not contain preselectors. In these models the SCPI command is accepted without error but no action is taken.
Couplings:	Initializes the time for the Last Characterize Preselector Time. Records the temperature for the Last Characterize Preselector Temperature.
Initial S/W Revision:	Prior to A.02.00
Help Map ID:	2016

Characterize Multiport Adapter Preamp

A Multiport Adapter Preamp Characterization should be made when MPA and EXT are first paired, a message window is popped up as below to inform the user to take this action:

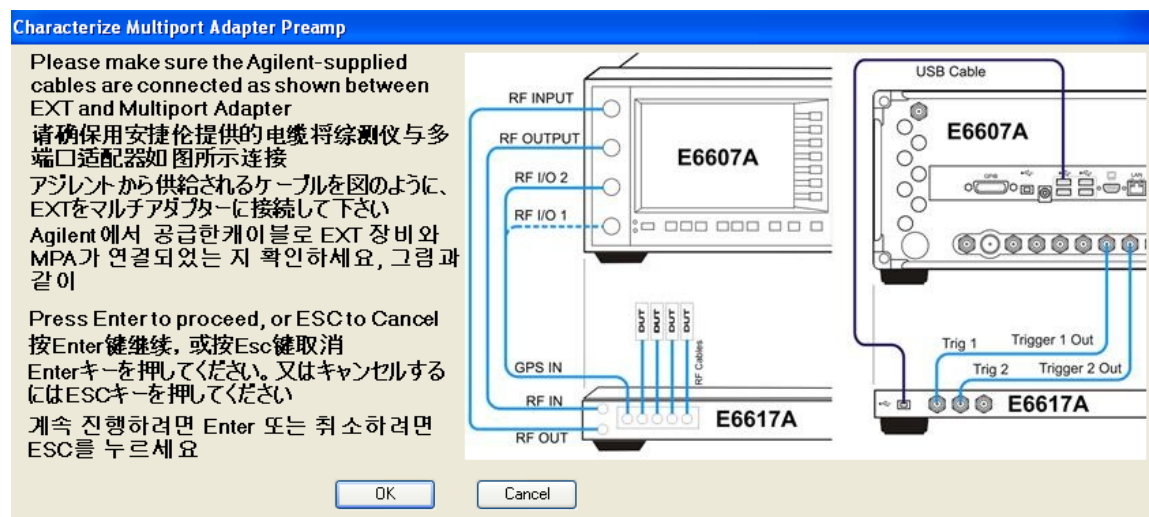

Correspondingly, bit 8 of the STATUS:QUESTIONable:CALibration:EXTended:NEEDED register (error 80) will be set for the “MPA Align required” message. Successful completion of Characterize Multiport Adapter Preamp will clear this Condition.

Users are expected to execute a characterization of the Preamp of Multiport Adapter when it is plugged into the USB port for the first time. The instrument stops any measurement currently underway, performs the characterization, then restarts the measurement from the beginning (similar to pressing the **Restart** key).

The query form of the remote command :CALibration:MPADapter:GAIN? will invoke the characterization of the Preamp of Multiport Adapter and return a success or failure value.

A failure encountered during characterization will generate the Error Condition message “MPA Align failed” and set bit 8 (error 83) in the STATUS:QUESTIONable:CALibration:EXTended:FAILure status register. Successful completion of Characterize Multiport Adapter Preamp will clear this Condition.

NOTE:

NOTE **Characterize Multiport Adapter Preamp** can be interrupted by pressing the Cancel (ESC) front-panel key or remotely with Device Clear followed by the

:ABORt SCPI command.

Key Path:	System, Alignments, Advanced
Mode:	All
Remote Command:	:CALibration:MPADapter:GAIN :CALibration:MPADapter:GAIN?
Example:	:CAL: MPAD:GAIN
Notes:	<p>:CALibration:MPADapter:GAIN? returns 0 if successful</p> <p>:CALibration:MPADapter:GAIN? returns 1 if failed</p> <p>While System, Alignments, Advanced, Characterize Multiport Adapter Preamp is performing the characterization, bit 0 in the Status Operation register is set. Completion, or termination, will clear bit 0 in the Status Operation register.</p> <p>This command is sequential, it must be completed before further SCPI commands are processed. Interrupting the alignment from remote is accomplished by invoking Device Clear followed by the :ABORt command.</p> <p>Successful completion will clear bit 8 in the Status Questionable Calibration Extended Failure register.</p> <p>A failure encountered during alignment will generate the Error Condition message “MPAdapter Preamp Charact Failure” and set bit 8 in the Status Questionable Calibration Extended Failure register.</p>
Dependencies:	This key does not appear unless a multiport adapter is plugged in to the USB. Grayout error: -221.1400; Multiport Adapter Not Available
Status Bits/OPC dependencies:	Bit8 may be set in the Status Questionable Calibration Extended Failure register.
Initial S/W Revision:	A.10.00
Help Map ID:	50010

Timebase DAC

Allows control of the internal 10 MHz reference oscillator timebase. This may be used to adjust for minor frequency alignment between the signal and the internal frequency reference. This adjustment has no effect if the instrument is operating with an External Frequency Reference.

If the value of the Timebase DAC changes (by switching to Calibrated from User with User set to a different value, or in User with a new value entered) an alignment may be necessary. The alignment system will take appropriate action; which will either invoke an alignment or cause an Alert.

Key Path:	System, Alignments
Mode:	All

System Functions
System

Remote Command:	:CALibration:FREQuency:REFErence:MODE CALibrated USER :CALibration:FREQuency:REFErence:MODE?
Example:	:CAL:FREQ:REF:MODE CAL
Notes:	If the value of the timebase is changed the alignment system automatically performs an alignment or alerts that an alignment is due. If the value of the timebase is changed the alignment system automatically performs an alignment or alerts that an alignment is due.
Preset:	This is unaffected by Preset but is set to CALibrated on a “Restore System Defaults->Align”.
State Saved:	No
Initial S/W Revision:	Prior to A.02.00
Help Map ID:	2019

Calibrated

Sets the Timebase DAC to the value established during factory or field calibration. The value displayed on the menu key is the calibrated value.

Key Path:	System, Alignments, Timebase DAC
Mode:	All
Example:	:CAL:FREQ:REF:MODE CAL
Readback Text:	[xxx] < where xxx is the calibrated value
Initial S/W Revision:	Prior to A.02.00
Help Map ID:	2020

User

Allows setting the Timebase DAC to a value other than the value established during the factory or field calibration. The value displayed on the menu key is the calibrated value.

Key Path:	System, Alignments, Timebase DAC
Mode:	All
Example:	:CAL:FREQ:REF:MODE USER
Readback Text:	xxx < where xxx is the Timebase DAC setting
Initial S/W Revision:	Prior to A.02.00
Help Map ID:	2021

Key Path:	System, Alignments, Timebase DAC
Mode:	All

Remote Command:	:CALibration:FREQuency:REFeRence:FINE <integer> :CALibration:FREQuency:REFeRence:FINE?
Example:	:CAL:FREQ:REF:FINE 8191
Notes:	If the value of the timebase is changed the alignment system automatically performs an alignment or alerts that an alignment is due.
Couplings:	Setting :CAL:FREQ:REF:FINE sets :CAL:FREQ:REF:MODE USER
Preset:	This is unaffected by Preset but is set to the factory setting on a “Restore System Defaults->Align”.
State Saved:	No
Min:	0
Max:	16383
Backwards Compatibility SCPI:	:CALibration:FREQuency:REFeRence:COARse ESA hardware contained two DAC controls for the Timebase. In X-Series the command :CALibration:FREQuency:REFeRence:FINE is the method for adjusting the timebase. The :COARse command is provided as an alias to :FINE.
Initial S/W Revision:	Prior to A.02.00
Help Map ID:	0

Remote Command:	:CALibration:FREQuency:REFeRence:COARse <integer> :CALibration:FREQuency:REFeRence:COARse?
Example:	:CAL:FREQ:REF:COAR 8191
Notes:	This is an alias for CAL:FREQ:REF:FINE any change to COARse is reflected in FINE and vice-versa. See CAL:FREQ:REF:FINE for description of functionality.
Couplings:	Setting :CAL:FREQ:REF:COAR sets :CAL:FREQ:REF:MODE USER
Initial S/W Revision:	Prior to A.02.00
Help Map ID:	0

RF Preselector

This menu and all of its submenus are only available in models with the RF Preselector, such as the N9038A.

See [“Align Now, 20 Hz to 30 MHz” on page 232](#)

See [“Align Now, 30 MHz to 3.6 GHz” on page 233](#)

See [“Align Now, 20 Hz to 3.6 GHz” on page 235](#)

See “Alert” on page 236

Key Path:	System, Alignments
Initial S/W Revision:	Prior to A.08..00
Help Map ID:	3694

Align Now, 20 Hz to 30 MHz

Immediately executes an alignment of the receiver subsystem. The receiver will stop any measurement currently underway, perform the alignment, and then restart the measurement from the beginning (similar to pressing the Restart key).

The query form of the remote commands (:CALibration:RFPSelector:CONDUCTed?) will invoke the alignment of the RF Preselector on Conducted Band and return a success or failure value. Successful completion will clear the “Align 20 Hz to 30 MHz required” Error Condition, and clear the bit 1 in the Status Questionable Calibration Extended Needed register. The elapsed time counter will begin for Last Align Now, Conducted Time, and the temperature is captured for the Last Align Now, Conducted Temperature. The alignment can be interrupted by pressing the Cancel (ESC) front-panel key or remotely with Device Clear followed by the :ABORT SCPI command. When this occurs, the Error Condition “Align 20 Hz to 30 MHz required” is set because new alignment data may be employed for an individual subsystem, but not a cohesive set of data for all subsystems.

The “Align 20 Hz to 30 MHz required” Error Condition will appear when this alignment has expired. User is now responsible to perform the Align Now, 20 Hz to 30 MHz in order to keep the receiver in warranted operation. This alignment can only be performed by user as it is not part of the Auto Align process.

Key Path:	System, Alignments, RF Preselector, Align Now
Mode:	All
Remote Command:	:CALibration:RFPSelector:CONDUCTed :CALibration:RFPSelector:CONDUCTed?
Example:	:CAL:RFPS:COND

Notes:	<p>:CALibration:RFPSelector:CONDUCTed? Return 0 if successful</p> <p>:CALibration:RFPSelector:CONDUCTed? Return 1 if failed</p> <p>When Align 20 Hz to 30 MHz is performing the alignment, bit 0 in the Status Operation register is set. Completion, or termination, will clear bit 0 in the Status Operation register.</p> <p>This command is sequential; it must complete before further SCPI commands are processed. Interrupting the alignment from remote is accomplished by invoking Device Clear followed by the :ABORt command. Successful completion will clear bit 1 in the Status Questionable Calibration Extended Needed register and bit 0 in Status Questionable Calibration Extended Failure register.</p> <p>A failure encountered during alignment will set the Error Condition “20 Hz to 30 MHz Alignment Failure” and set both bit 1 in the Status Questionable Calibration Extended Needed register and bit 9 in Status Questionable Calibration register.</p> <p>For model N9038A only.</p>
Dependencies:	This key does not appear in other than N9038A models, setting or querying the SCPI will generate an error.
Couplings:	<p>Initializes the time for the Last Align Conducted Now, Conducted Time.</p> <p>Records the temperature for the Last Align Conducted Now, Conducted Temperature.</p>
Status Bits/OPC Dependencies:	<p>Bit 8 or 9 may be set in the Status Questionable Calibration register.</p> <p>Bit 1 may be set in the Status Questionable Calibration Extended Needed register.</p> <p>Bit 0 may be set in the Status Questionable Calibration Extended Failure register.</p>
Initial S/W Revision:	A.08.00
Help Map ID:	3673

Align Now, 30 MHz to 3.6 GHz

Immediately executes an alignment of the receiver subsystem. The receiver will stop any measurement currently underway, perform the alignment, and then restart the measurement from the beginning (similar to pressing the Restart key).

The query form of the remote commands (:CALibration:RFPSelector:RADiated?) will invoke the alignment of the RF Preselector on Radiated Band and return a success or failure value. Successful completion will clear the “Align 30 MHz to 3.6 GHz required” Error Condition, and clear the bit 2 in the Status Questionable Calibration Extended Needed register. The elapsed time counter will begin for Last Align Now, Radiated Time, and the temperature is captured for the Last Align Now, Radiated Temperature. The alignment can be interrupted by pressing the Cancel (ESC) front-panel key or remotely with Device Clear followed by the :ABORt SCPI command. When this occurs, the Error Condition “Align 30 MHz to 3.6 GHz required” is set because new alignment data may be employed for an individual subsystem, but not a cohesive set of data for all subsystems.

System Functions
System

The “Align 30 MHz to 3.6 GHz required” Error Condition will appear when this alignment has expired. User is now responsible to perform the Align Now, 30 MHz to 3.6 GHz in order to keep the receiver in warranted operation. This alignment can only be performed by user as it is not part of the Auto Align process.

Key Path:	System, Alignments, RF Preselector, Align Now
Mode:	All
Remote Command:	:CALibration:RFPSelector:RADiated :CALibration:RFPSelector:RADiated?
Example:	:CAL:RFPS:RAD
Notes:	:CALibration:RFPSelector:RADiated? Return 0 if successful :CALibration:RFPSelector:RADiated? Return 1 if failed When Align 30 MHz to 3.6 GHz is performing the alignment, bit 0 in the Status Operation register is set. Completion, or termination, will clear bit 0 in the Status Operation register. This command is sequential; it must complete before further SCPI commands are processed. Interrupting the alignment from remote is accomplished by invoking Device Clear followed by the :ABORT command. Successful completion will clear bit 2 in the Status Questionable Calibration Extended Needed register and bit 1 in Status Questionable Calibration Extended Failure register. A failure encountered during alignment will set the Error Condition “30 MHz to 3.6 GHz Alignment Failure” and set both bit 2 in the Status Questionable Calibration Extended Needed register and bit 9 in Status Questionable Calibration register. For model N9038A only.
Dependencies:	This key does not appear in other than N9038A models, setting or querying the SCPI will generate an error.
Couplings:	Initializes the time for the Last Align Radiated Now, Radiated Time. Records the temperature for the Last Align Radiated Now, Radiated Temperature.
Status Bits/OPC Dependencies:	Bit 8 or 9 may be set in the Status Questionable Calibration register. Bit 2 may be set in the Status Questionable Calibration Extended Needed register. Bit 1 may be set in the Status Questionable Calibration Extended Failure register.
Initial S/W Revision:	A.08.00
Help Map ID:	3674

Align Now, 20 Hz to 3.6 GHz

Immediately executes an alignment of the receiver subsystem. The receiver will stop any measurement currently underway, perform the alignment, and then restart the measurement from the beginning (similar to pressing the Restart key).

The query form of the remote commands (:CALibration:RFPSelector:FULL?) will invoke the alignment of the RF Preselector on both Conducted and Radiated Band and return a success or failure value. Successful completion will clear the “Align 20 Hz to 3.6 GHz required” Error Condition, and clear the bit 1 and bit 2 in the Status Questionable Calibration Extended Needed register. The elapsed time counter will begin for Last Align Now, Conducted Time and Last Align Now Radiated Time and the temperature is captured for Last Align Now, Conducted Temperature and Last Align Now, Radiated Temperature. The alignment can be interrupted by pressing the Cancel (ESC) front-panel key or remotely with Device Clear followed by the :ABORt SCPI command. When this occurs, the Error Condition “Align 20 Hz to 3.6 GHz required” is set because new alignment data may be employed for an individual subsystem, but not a cohesive set of data for all subsystems.

The “Align 20 Hz to 3.6 GHz required” Error Condition will appear when this alignment has expired. User is now responsible to perform the Align Now, 20 Hz to 3.6 GHz in order to keep the receiver in warranted operation. This alignment can only be performed by user as it is not part of the Auto Align process.

Key Path:	System, Alignments, RF Preselector, Align Now
Mode:	All
Remote Command:	:CALibration:RFPSelector:FULL :CALibration:RFPSelector:FULL?
Example:	:CAL:RFPS:FULL
Notes:	:CALibration:RFPSelector:FULL? Return 0 if successful :CALibration:RFPSelector:FULL? Return 1 if failed When Align 20 Hz to 3.6 GHz is performing the alignment, bit 0 in the Status Operation register is set. Completion, or termination, will clear bit 0 in the Status Operation register. This command is sequential; it must complete before further SCPI commands are processed. Interrupting the alignment from remote is accomplished by invoking Device Clear followed by the :ABORt command. Successful completion will clear bit 1, bit 2 in the Status Questionable Calibration Extended Needed register and bit 0, bit 1 in Status Questionable Calibration Extended Failure register. A failure encountered during alignment will set the Error Condition “20 Hz to 3.6 GHz Alignment Failure” and set bit1, bit 2 in the Status Questionable Calibration Extended Needed register and bit 9 in Status Questionable Calibration register. For model N9038A only.
Dependencies:	This key does not appear in other than N9038A models, setting or querying the SCPI will generate an error.

System Functions
System

Couplings:	<p>Initializes the time for the Last Align Conducted Now, Conducted Time.</p> <p>Initializes the time for the Last Align Radiated Now, Radiated Time.</p> <p>Records the temperature for the Last Align Conducted Now, Conducted Temperature.</p> <p>Records the temperature for the Last Align Radiated Now, Radiated Temperature.</p>
Status Bits/OPC Dependencies:	<p>Bit 8 or 9 may be set in the Status Questionable Calibration register.</p> <p>Bit 1 and 2 may be set in the Status Questionable Calibration Extended Needed register.</p> <p>Bit 0 and 1 may be set in the Status Questionable Calibration Extended Failure register.</p>
Initial S/W Revision:	A.08.00
Help Map ID:	3675

Alert

Setting Alert to ON/OFF will enable/disable the display of RF Preselector alignment required message on the status line. The instrument will power up with Alert On mode.

Key Path:	System, Alignments, RF Preselector
Mode:	All
Remote Command:	:CALibration:RFPSelector:ALERT ON OFF 0 1 :CALibration:RFPSelector:ALERT?
Example:	:CAL:RFPS:ALER OFF
Notes:	<p>For model N9038A only.</p> <p>Error Condition will be generated when the alert is On and any of the RF Preselector alignments has expired.</p>
Preset:	This is unaffected by Preset, but is set to ON on a “Restore System Defaults->Align”.
State Saved:	No
Initial S/W Revision:	A.08.00
Help Map ID:	3676

Schedule Setup

Enables you to schedule a task to run automatically at the background based on the recurrence and time set in the scheduler. Make sure that the Instrument’s local time is accurate as the Scheduler relies on this information to execute the task.

Key Path:	System, Alignments, RF Preselector
-----------	---

Initial S/W Revision:	A.08.00
Help Map ID:	3677

Task

There are 3 task that can be selected for the scheduler to run.

Task 1 is the 20 Hz to 30 MHz alignment

Task 2 is the 30 MHz to 3.6 GHz alignment

Task 3 is the 20 Hz to 3.6 GHz alignment.

Key Path:	System, Alignments, RF Preselector, Schedule Setup
Mode:	All
Remote Command:	:CALibration:RFPSselector:SCHeDuler:TASK T1 T2 T3 :CALibration:RFPSselector:SCHeDuler:TASK?
Example:	:CAL:RFPS:SCH:TASK T1
Notes:	Changing the task will not reset the Scheduler time and the alignment is based on the current scheduled configuration to occur. For model N9038A only.
Preset:	This is unaffected by Preset but is set to T3 on a "Restore System Defaults->Align".
State Saved:	No
Range:	Task 1 Task 2 Task 3
Initial S/W Revision:	A.08.00
Help Map ID:	3678

Date/Time

Enables you to configure the scheduler to run a task starting from this date and time. The date and time rely on the instrument's local time to execute a scheduled task. The date is based on the format "YYYY/MM/DD" and the time is based on a 24 hour clock.

Key Path:	System, Alignments, RF Preselector, Schedule Setup
Mode:	All
Remote Command:	:CALibration:RFPSselector:SCHeDuler:TIME:STARt "date", "time" :CALibration:RFPSselector:SCHeDuler:TIME:STARt? This query returns data using the following format "YYYY/MM/DD; HH:MM:SS"
Example:	:CAL:RFPS:SCH:TIME:STAR "2009/8/20","12:00:00"

System Functions
System

Notes:	<p>“date” is representation of the date the task will run in the form of “YYYY/MM/DD” where:</p> <p>YYYY is the four digit representation of year. (for example, 2009)</p> <p>MM is the two digit representation of month. (for example, 01 to 12)</p> <p>DD is the two digit representation of the day. (for example, 01 to 28, 29, 30 or 31 depending on the month and year)</p> <p>“time” is a representation of the time of day the task will run in the form of “HH:MM:SS” where:</p> <p>HH is the two digit representation of the hour in 24 hour format</p> <p>MM is the two digit representation of minute</p> <p>SS is the two digit representation of seconds</p> <p>For model N9038A only.</p>
Preset:	This is unaffected by Preset but is set to Current date and 00:00:00 on a “Restore System Defaults->Align”.
State Saved:	No
Initial S/W Revision:	A.08.00
Help Map ID:	3679

Date

Enables you to configure the date of the scheduled task. The SCPI command to configure the date and time parameters of the scheduler is the same; however, they each have their own front-panel control.

Key Path:	System, Alignments, RF Preselector, Schedule Setup, Date/Time
Notes:	<p>See “Date/Time ” on page 237.</p> <p>For model N9038A only.</p>
Preset:	This is unaffected by Preset but is set to Current date and 00:00:00 on a “Restore System Defaults->Align”.
State Saved:	No
Initial S/W Revision:	A.08.00
Help Map ID:	3680

Time

Enables you to configure the time of the scheduled task. The SCPI command to configure the date and time parameters of the scheduler is the same; however, they each have their own front panel-control.

Key Path:	System, Alignments, RF Preselector, Schedule Setup, Date/Time
Notes:	<p>See “Date/Time ” on page 237 .</p> <p>For model N9038A only.</p>

Preset:	This is unaffected by Preset but is set to Current date and 00:00:00 on a “Restore System Defaults->Align”.
State Saved:	No
Initial S/W Revision:	A.08.00
Help Map ID:	3681

Recurrence

Enables you to configure the scheduler to run the task recurrently on a scheduled date and time. You can schedule it to run daily, weekly or alternate weeks.

Key Path:	System, Alignments, RF Preselector, Schedule Setup
Mode:	All
Remote Command:	:CALibration:RFPSelector:SCHeduler:RECurrence DAY WEEK OFF :CALibration:RFPSelector:SCHeduler:RECurrence?
Example:	:CAL:RFPS:SCH:REC DAY
Notes:	For model N9038A only.
Preset:	This is unaffected by Preset but is set to OFF on a “Restore System Defaults->Align”.
State Saved:	No
Range:	DAY WEEK OFF
Initial S/W Revision:	A.08.00
Help Map ID:	3682

Every N Weeks

Enables you to configure the scheduler to run the task on a day in every number of week’s duration.

Key Path:	System, Alignments, RF Preselector, Schedule Setup, Recurrence
Initial S/W Revision:	A.08.00
Help Map ID:	3683

N of Weeks

Enables you to set the number of weeks that the scheduler will wait to trigger a task.

Key Path:	System, Alignments, RF Preselector, Schedule Setup, Recurrence, Every N Weeks
Mode:	All

System Functions
System

Remote Command:	:CALibration:RFPSelector:Scheduler:REcurrence:WEEK <integer> :CALibration:RFPSelector:Scheduler:REcurrence:WEEK?
Example:	:CAL:RFPS:SCH:REC:WEEK 2
Notes:	New scheduled date to run the alignment task will get updated when this parameter is changed. For model N9038A only.
Preset:	This is unaffected by Preset but is set to 1 on a “Restore System Defaults->Align”.
State Saved:	No
Range:	1–52
Initial S/W Revision:	A.08.00
Help Map ID:	3684

Day

Enables you to set the Day of the Week the scheduler will run a scheduled task.

Key Path:	System, Alignments, RF Preselector, Schedule Setup, Recurrence, Every N Weeks
Mode:	All
Remote Command:	:CALibration:RFPSelector:Scheduler:REcurrence:DAY SUN MON TUE WED THU FRI SAT :CALibration:RFPSelector:Scheduler:REcurrence:DAY?
Example:	:CAL:RFPS:SCH:REC:DAY SUN
Notes:	For model N9038A only.
Preset:	This is unaffected by Preset but is set to SUN on a “Restore System Defaults->Align”.
State Saved:	No
Range:	Sunday Monday Tuesday Wednesday Thursday Friday Saturday
Initial S/W Revision:	A.08.00
Help Map ID:	3685

Scheduler

Setting the Scheduler to ON will trigger the execution of the scheduled task based on the recurrence and time set in the scheduler since the last successful of the specific alignment. A warning condition of “RF Preselector alignment scheduler is ON” will be appeared when the scheduler is set to ON. OFF will turn off the Scheduler from running any scheduled task.

Key Path:	System, Alignments, RF Preselector
-----------	---

Mode:	All
Remote Command:	:CALibration:RFPSelector:SCHeduler:STATe ON OFF 0 1 :CALibration:RFPSelector:SCHeduler:STATe?
Example:	:CAL:RFPS:SCH:STAT OFF
Notes:	For model N9038A only.
Preset:	This is unaffected by Preset but is set to OFF on a “Restore System Defaults->Align”.
State Saved:	No
Initial S/W Revision:	A.08.00
Help Map ID:	3686

I/O Config

Activates a menu for identifying and changing the I/O configuration for remote control.

Key Path:	System
Initial S/W Revision:	Prior to A.02.00
Help Map ID:	2100

GPIB

Activates a menu for configuring the GPIB I/O port.

Key Path:	System, I/O Config
Initial S/W Revision:	A.02.00
Help Map ID:	3625

GPIB Address

Select the GPIB remote address.

Key Path:	System, I/O Config, GPIB
Mode:	All
Remote Command:	:SYSTem:COMMunicate:GPIB [1] [:SELF] :ADDRess <integer> :SYSTem:COMMunicate:GPIB [1] [:SELF] :ADDRess?
Example:	:SYST:COMM:GPIB:ADDR 17
Notes:	Changing the Address on the GPIB port requires all further communication to use the new address.

Preset:	This is unaffected by Preset but is set to 18 on a “Restore System Defaults->Misc”
State Saved:	No
Range:	0 to 30
Initial S/W Revision:	Prior to A.02.00
Help Map ID:	2101

GPIB Controller

Sets the GPIB port into controller or device mode. In the normal state, GPIB controller is disabled, which allows the analyzer to be controlled by a remote computer. When GPIB Controller is enabled, the instrument can run software applications that use the instrument's computer as a GPIB controller; controlling devices connected to the instrument's GPIB port.

NOTE When GPIB Controller is enabled, the analyzer application itself cannot be controlled over GPIB. In this case it can easily be controlled via LAN or USB. The GPIB port cannot be a controller and device at the same time. Only one controller can be active on the GPIB bus at any given time. If the analyzer is the controller, an external PC cannot be a controller.

To control the instrument from the software that is performing GPIB controller operation, you can use an internal TCP/IP connection to the analyzer application. Use the address TCPIP0:localhost:inst0:INSTR to send SCPI commands to the analyzer application.

Key Path:	System, I/O Config, GPIB
Mode:	All
Scope:	Mode Global
Remote Command:	:SYSTem:COMMunicate:GPIB[1] [:SELF] :CONTroller[:ENABLE] ON OFF 0 1 :SYSTem:COMMunicate:GPIB[1] [:SELF] :CONTroller[:ENABLE]?
Example:	:SYST:COMM:GPIB:CONT ON Will set GPIB port to Controller
Notes:	When the instrument becomes the Controller bit 0 in the Standard Event Status Register is set (and when the instrument relinquishes Controller capability bit 0 is cleared in the Standard Event Status Register).
Preset:	This is unaffected by Preset but is set to OFF on a “Restore System Defaults->Misc”
State Saved:	No
Range:	Disabled Enabled
Initial S/W Revision:	A.02.00
Help Map ID:	3626

Disabled

Disables the GPIB Controller capability, this is the default (or normal) setting.

Key Path:	System, I/O Config, GPIB, GPIB Controller
Example:	:SYST:COMM:GPIB:CONT OFF Will set GPIB port to Device
Initial S/W Revision:	A.02.00
Help Map ID:	3627

Enabled

Enables the GPIB Controller capability.

Key Path:	System, I/O Config, GPIB, GPIB Controller
Example:	:SYST:COMM:GPIB:CONT ON Will set GPIB port to Controller
Initial S/W Revision:	A.02.00
Help Map ID:	3628

SCPI LAN

Activates a menu for identifying and changing the SCPI over a LAN configuration. There are a number of different ways to send SCPI remote commands to the instrument over LAN. It can be a problem to have multiple users simultaneously accessing the instrument over the LAN. These keys limit that somewhat by disabling the telnet, socket, and/or SICL capability.

Key Path:	System, I/O Config
Initial S/W Revision:	Prior to A.02.00
Help Map ID:	2102

SCPI Telnet

Turns the SCPI LAN telnet capability On or Off allowing you to limit SCPI access over LAN through telnet.

Key Path:	System, I/O Config, SCPI LAN
Mode:	All
Remote Command:	:SYSTem:COMMunicate:LAN:SCPI:TELNet:ENABle OFF ON 0 1 :SYSTem:COMMunicate:LAN:SCPI:TELNet:ENABle?
Example:	:SYST:COMM:LAN:SCPI:TELN:ENAB OFF
Preset:	This is unaffected by Preset but is set to ON with a "Restore System Defaults->Misc"
State Saved:	No

System Functions
System

Range:	On Off
Initial S/W Revision:	Prior to A.02.00
Help Map ID:	2103

SCPI Socket

Turns the capability of establishing Socket LAN sessions On or Off. This allows you to limit SCPI access over LAN through socket sessions.

Key Path:	System, I/O Config, SCPI LAN
Mode:	All
Remote Command:	:SYSTem:COMMunicate:LAN:SCPI:SOCKet:ENABle OFF ON 0 1 :SYSTem:COMMunicate:LAN:SCPI:SOCKet:ENABle?
Example:	:SYST:COMM:LAN:SCPI:SOCK:ENAB OFF
Preset:	This is unaffected by a Preset but is set to ON with a “Restore System Defaults->Misc”
State Saved:	No
Range:	On Off
Initial S/W Revision:	Prior to A.02.00
Help Map ID:	2104

SICL Server

Turns the SICL server capability On or Off, enabling you to limit SCPI access over LAN through the SICL server. (SICL IEEE 488.2 protocol.)

Parameter	Description	Setting
Maximum Connections	The maximum number of connections that can be accessed simultaneously	5
Instrument Name	The name (same as the remote SICL address) of your analyzer	inst0
Instrument Logical Unit	The unique integer assigned to your analyzer when using SICL LAN	8
Emulated GPIB Name	The name (same as the remote SICL address) of the device used when communicating with your analyzer	gpib7
Emulated GPIB Logical Unit	The unique integer assigned to your device when it is being controlled using SICL LAN	8
Emulated GPIB Address	The emulated GPIB address assigned to your transmitter tester when it is a SICL server (the same as your GPIB address)	18

Key Path:	System, I/O Config, SCPI LAN
Mode:	All
Remote Command:	:SYSTem:COMMunicate:LAN:SCPI:SIcL:ENABle OFF ON 0 1 :SYSTem:COMMunicate:LAN:SCPI:SIcL:ENABle?
Example:	:SYST:COMM:LAN:SCPI:SIcL:ENAB OFF
Preset:	This is unaffected by Preset, but is set to ON with a “Restore System Defaults->Misc”
State Saved:	No
Range:	On Off
Initial S/W Revision:	Prior to A.02.00
Help Map ID:	2106

HiSLIP Server

Turns the HiSLIP server capability On or Off, enabling you to limit SCPI access over LAN through the HiSLIP server.

HiSLIP stands for High Speed LAN Instrument Protocol and is part of the IVI-6.1 specification.

Here is an example of a VISA connection string used to connect to the HiSLIP Server on an X-Series Spectrum Analyzer:

TCPIP0::a-n9030a-93016::hislip0::INSTR

In the example above, hislip0 is the HiSLIP device name that VISA users must include in their HiSLIP VISA Address strings. Your HiSLIP device name may be different depending on your VISA settings.

Key Path:	System, I/O Config, SCPI LAN
Mode:	All
Remote Command:	:SYSTem:COMMunicate:LAN:SCPI:HISLip:ENABle OFF ON 0 1 :SYSTem:COMMunicate:LAN:SCPI:HISLip:ENABle?
Example:	:SYST:COMM:LAN:SCPI:HISL:ENAB OFF
Preset:	This is unaffected by Preset, but is set to ON with a “Restore System Defaults->Misc”
State Saved:	No
Range:	On Off
Initial S/W Revision:	A.11.00
Help Map ID:	50007

SCPI Socket Control Port (Remote Command Only)

Returns the TCP/IP port number of the control socket associated with the SCPI socket session. This

System Functions
System

query enables you to obtain the unique port number to open when a device clear is to be sent to the instrument. Every time a connection is made to the SCPI socket, the instrument creates a peer control socket. The port number for this socket is random. The user must use this command to obtain the port number of the control socket. To force a device clear on this socket, open the port and send the string “DCL ” to the instrument.

If this SCPI command is sent to a non SCPI Socket interface, then 0 is returned.

Mode:	All
Remote Command:	:SYSTem:COMMunicate:LAN:SCPI:SOCKet:CONTRol?
Example:	:SYST:COMM:LAN:SCPI:SOCK:CONT?
Preset:	This is unaffected by Preset or “Restore System Defaults->Misc”.
State Saved:	No
Range:	0 to 65534
Initial S/W Revision:	Prior to A.02.00
Help Map ID:	0

Reset Web Password

The embedded web server contains certain capability which are password protected; modifying the LAN configuration of the instrument, and access to web pages that can change the settings of the instrument. The default password from the factory is ‘agilent’ (without the quotes). The control provided here is the means to set the web password as the user desires, or to reset the password to the factory default.

Selecting Reset web password brings up a control for resetting the password as the user desires, or to the factory default. A keyboard is required to change the password from the factory default of ‘agilent’ or to set a new password that contains alphabetic characters. The control is:

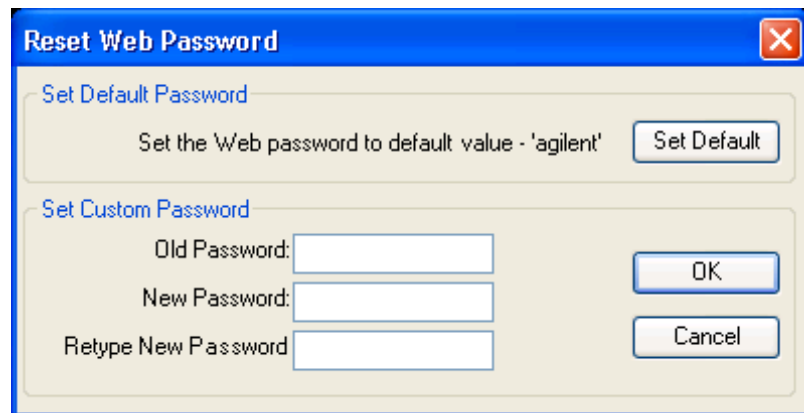

If this control is entered without an external keyboard or mouse connected, you can cancel the control by pressing the Cancel (ESC) front-panel key.

Key Path:	System, I/O Config
Mode:	All

Initial S/W Revision:	Prior to A.02.00
Help Map ID:	3600

LXI

Opens a menu that allows you to access the various LXI configuration properties.

Key Path:	System, I/O Config
Initial S/W Revision:	Prior to A.02.00
Help Map ID:	3606

LAN Reset

Resets the LAN connection.

Key Path:	System, I/O Config, LXI
Initial S/W Revision:	Prior to A.02.00
Help Map ID:	3500

System IDN Response

This key allows you to specify a response to the *IDN? query, or to return the analyzer to the Factory response if you have changed it.

To choose the factory-set response, press the **Factory** key.

To specify your own response, press the **User** key, and enter your desired response.

Key Path:	System, I/O Config
Mode:	All
Remote Command:	:SYSTem:IDN <string> :SYSTem:IDN?
Notes:	This affects the response given in all Modes of the Analyzer, unless the current Mode has also specified a custom response, in which case the current Mode's custom IDN response takes precedence over the System's, but only while that Mode is the current Mode.. It survives shutdown and restart of the software and therefore survives a power cycle Null string as parameter restores the Factory setting
Preset:	This is unaffected by Preset but is set to the original factory setting on a "Restore System Defaults->Misc"
State Saved:	No
Initial S/W Revision:	A.06.00

System Functions
System

Help Map ID:	3667
--------------	------

Factory

This key selects the factory setting, for example:

“Agilent Technologies,N9020A,MY00012345,A.05.01”

where the fields are manufacturer, model number, serial number, firmware revision.

Key Path:	System, I/O Config, IDN Response
Example:	:SYST:IDN "" null string, restores the factory setting
Initial S/W Revision:	A.06.0
Help Map ID:	3665

User

This key allows you to specify your own response to the *IDN? query. You may enter your desired response with the Alpha Editor or a plugin PC keyboard.

When you press this key, the active function becomes the current User string with the cursor at the end. This makes it easy to edit the existing string.

If you enter a null string (for example, by clearing the User String while editing and then pressing **Done**) the analyzer automatically reverts to the Factory setting.

Key Path:	System, I/O Config, IDN Response
Example:	:SYST:IDN “XYZ Corp,Model 12,012345,A.01.01” user specified response
Initial S/W Revision:	A.06.00
Help Map ID:	3666

Query USB Connection (Remote Command Only)

Enables you to determine the speed of the USB connection.

Mode:	All
Remote Command:	:SYSTem:COMMunicate:USB:CONNectioN?
Example:	:SYST:COMM:USB:CONN?

Notes:	<p>NONE – Indicates no USB connection has been made.</p> <p>LSpeed – Indicates a USB low speed connection (1.5 Mbps).</p> <p>This is reserved for future use, the T+M488 protocol is not supported on low speed connections.</p> <p>HSPeed – Indicates that a USB high speed connection (480 Mbps) has been negotiated.</p> <p>FSPeed – Indicates that a USB full speed connection (12 Mbps) has been negotiated.</p>
State Saved:	No
Range:	NONE LSpeed HSPeed FSPeed
Initial S/W Revision:	Prior to A.02.00
Help Map ID:	0

USB Connection Status (Remote Command Only)

Enables you to determine the current status of the USB connection.

Mode:	All
Remote Command:	:SYSTem:COMMunicate:USB:STATus?
Example:	:SYST:COMM:USB:STAT?
Notes:	<p>SUSPended – Indicates that the USB bus is currently in its suspended state. The bus is in the suspended state when:</p> <p>The bus is not connected to any controller</p> <p>The controller is currently powered off</p> <p>The controller has explicitly placed the USB device into the suspended state.</p> <p>When in the suspended state, no USB activity, including start of frame packets are received.</p> <p>ACTive – Indicates that the USB device is in the active state. When the device is in the active state, it is receiving periodic start of frames but it isn't necessarily receiving or transmitting data.</p>
State Saved:	No
Range:	SUSPended ACTive
Initial S/W Revision:	Prior to A.02.00
Help Map ID:	0

USB Packet Count (Remote Command Only)

Enables you to determine the number of packets received and transmitted on the USB bus.

Mode:	All
Remote Command:	:SYSTem:COMMunicate:USB:PACKets?
Example:	:SYST:COMM:USB:PACK?
Notes:	Two integers are returned. The first is the number of packets received since application invocation, the second is the number of packets transmitted since application invocation. If no packets have been received or transmitted the response is 0,0. The packet count is initialized to 0,0 when the instrument application is started.
State Saved:	No
Initial S/W Revision:	Prior to A.02.00
Help Map ID:	0

Restore Defaults

Provides incremental initialization of the system setting groups along with supporting a comprehensive reset of the entire instrument back to a factory default state. The menu selections are the groups of system settings and when one is selected, that particular group of system settings is reset back to their default values.

Key Path:	System
Mode:	All
Remote Command:	:SYSTem:DEFault [ALL] ALIGn INPut MISC MODes PON
Example:	SYST:DEF
State Saved:	No
Initial S/W Revision:	Prior to A.02.00
Help Map ID:	2308

Restore Input/Output Defaults

Causes the group of settings and data associated with Input/Output front-panel key to be a reset to their default values. This level of Restore System Defaults does not affect any other system settings, mode settings and does not cause a mode switch. .

Confirmation is required to restore the Input/Output setting. The confirmation dialog is:

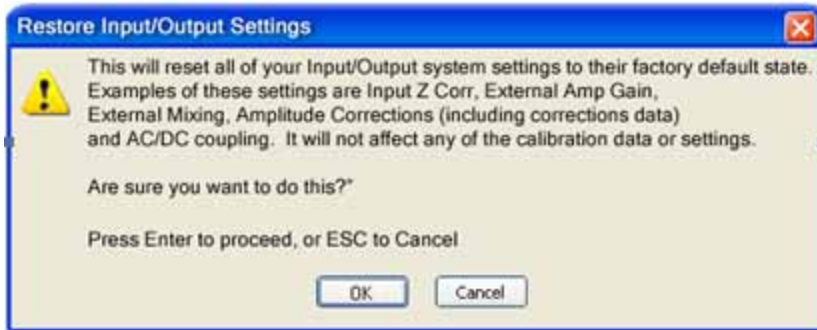

Key Path:	System, Restore System Defaults
Example:	:SYST:DEF INP
Initial S/W Revision:	Prior to A.02.00
Help Map ID:	2309

Restore Power On Defaults

This selection causes the Power On settings to be a reset to their default value. This level of Restore System Defaults does not affect any other system settings, mode settings and does not cause a mode switch. The Power On settings and their default values are Power On Type reset to Mode and Input/Output Defaults and Power On Application reset to whatever the factory set as its default value.

Confirmation is required to restore the factory default values. The confirmation dialog is:

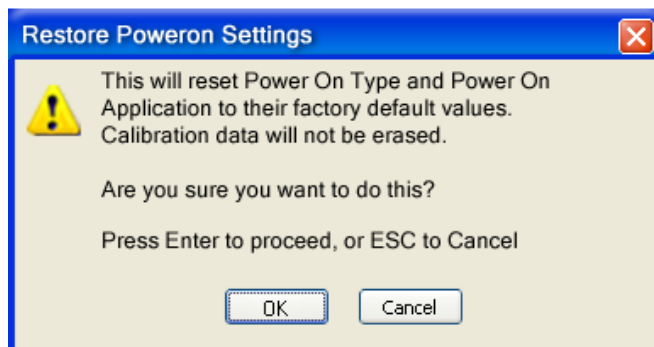

Key Path:	System, Restore System Defaults
Example:	:SYST:DEF PON
Initial S/W Revision:	Prior to A.02.00
Help Map ID:	2310

Restore Align Defaults

This selection causes the Alignment system settings to be a reset to their default values. This does not affect any Alignment data stored in the system. This level of Restore System Defaults does not affect any other system settings, mode settings and does not cause a mode switch.

System Functions

System

After performing this function, it may impact the auto-alignment time of the instrument until a new alignment baseline has been established.

Confirmation is required to restore the factory default values. The confirmation dialog is:

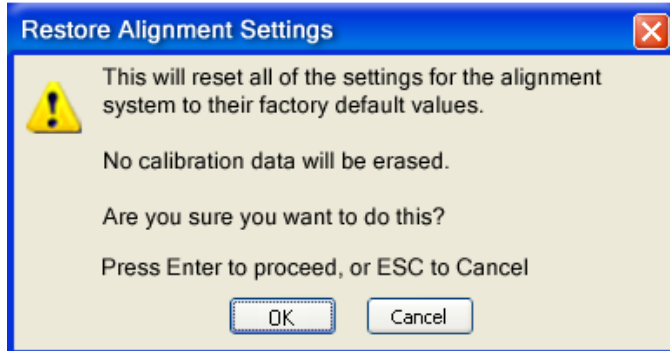

Key Path:	System, Restore System Defaults
Example:	:SYST:DEF ALIG
Initial S/W Revision:	Prior to A.02.00
Help Map ID:	2311

Restore Misc Defaults

This selection causes miscellaneous system settings to be reset to their default values. With this reset, you lose the GPIB address and it is reset to 18, so this should be used with caution. This level of Restore System Defaults does not affect any other system settings, mode settings and does not cause a mode switch. This miscellaneous group contains the rest of the settings that have not been part of the other Restore System Defaults groups. The following table is a complete list of settings associated with this group:

Miscellaneous Setting	Default Value
Verbose SCPI	Off
GPIB Address	18
Auto File Name Number	000
Save Type	State
State Save To	Register 1
Screen Save To	SCREEN000.png
DISP:ENABle	ON
Full Screen	Off
SCPI Telnet	ON
SCPI Socket	ON

Miscellaneous Setting	Default Value
SICL Server	ON
Display Intensity	100
Display Backlight	ON
Display Theme	TDColor
System Annotation	ON
The SYST:PRES:TYPE	MODE

Confirmation is required to restore the factory default values. The confirmation dialog is:

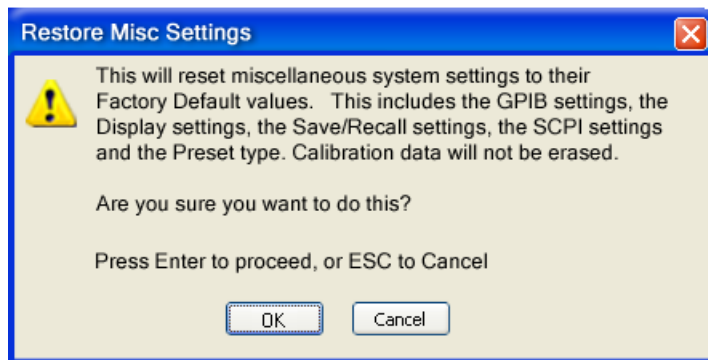

Key Path:	System, Restore System Defaults
Example:	:SYST:DEF MISC
Initial S/W Revision:	Prior to A.02.00
Help Map ID:	2312

Restore Mode Defaults (All Modes)

This selection resets all of the modes in the instrument back to their default state just as a Restore Mode Defaults does and it switches the instrument to the power-on mode and causes the default measurement for the power-on mode to be active. This level of Restore System Defaults does not affect any system settings, but it does affect the state of all modes and does cause a mode switch unless the instrument was already in the power-on mode.

Confirmation is required to restore the factory default values. The confirmation dialog is:

System Functions
System

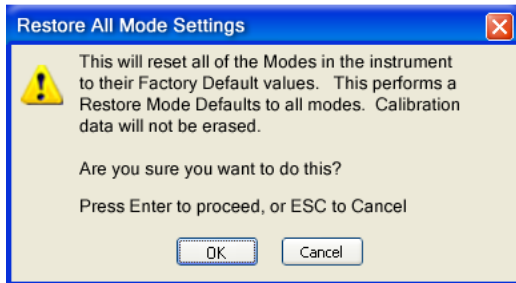

Key Path:	System, Restore System Defaults
Example:	:SYST:DEF MOD
Couplings:	An All Mode will cause the currently running measurement to be aborted, mode switch to the power-on mode and activate the default measurement for the power-on mode.. It gets the mode to a consistent state with all of the default couplings set.
Initial S/W Revision:	Prior to A.02.00
Help Map ID:	2313

All

This performs a comprehensive reset of ALL analyzer settings to their factory default values. It resets all of the system setting groups, causes a Restore Mode Defaults for all modes in the instrument, and switches back to the power-on mode. It does not affect the User Preset file or any user saved files.

Confirmation is required to restore the factory default values. The confirmation dialog is:

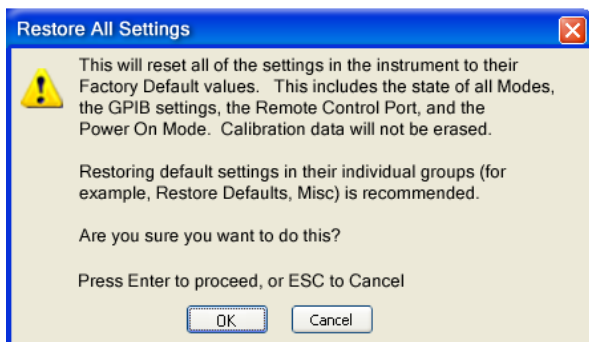

Key Path:	System, Restore System Defaults
Example:	:SYST:DEF ALL
Couplings:	An All will cause the currently running measurement to be aborted and get all modes to a consistent state, so it is unnecessary to couple any settings.
Initial S/W Revision:	Prior to A.02.00
Help Map ID:	2314

Control Panel...

Opens the Windows Control Panel. The Control Panel is used to configure certain elements of Windows that are not configured through the hardkey/softkey System menus.

The Control Panel is a separate Windows application, so to return to the analyzer once you are in the Control Panel, you may either:

Exit the Control Panel by clicking on the red X in the upper right hand corner, with a mouse

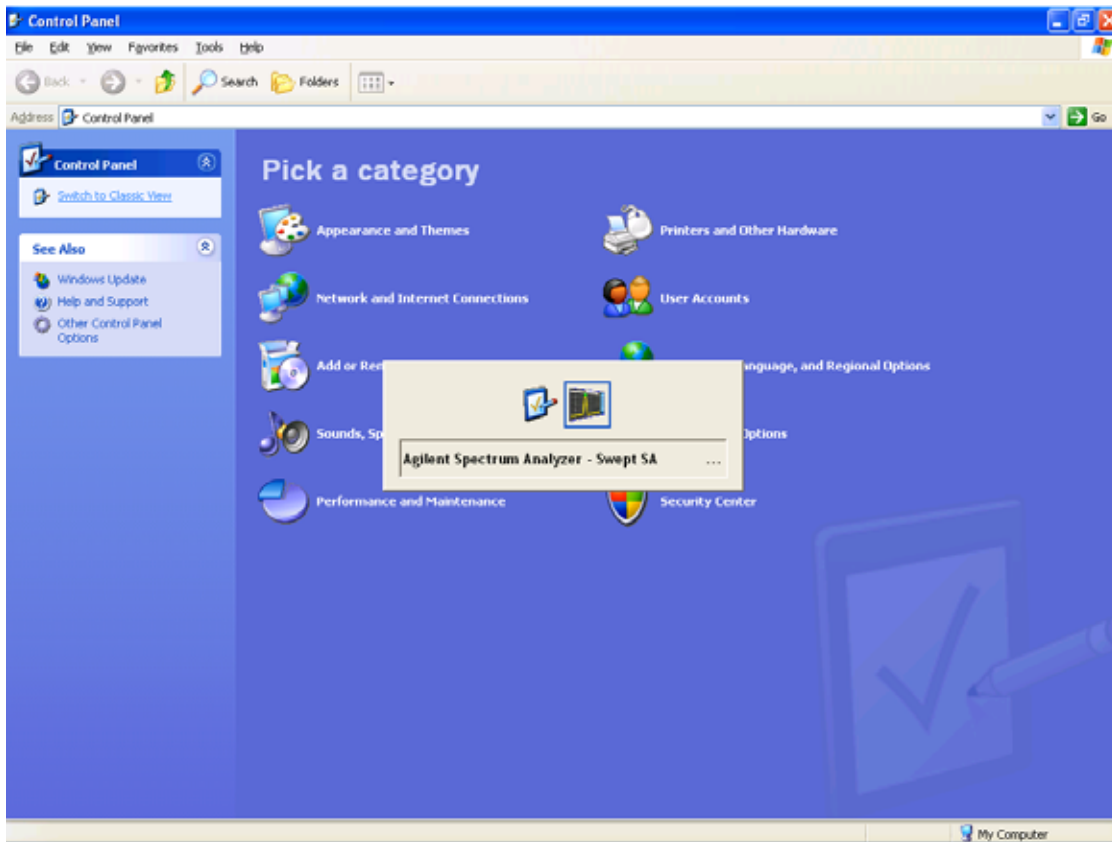

Or use Alt-Tab: press and hold the Alt  key and press and release the Tab key until the Analyzer logo is showing in the window in the center of the screen, as above, then release the Alt key.

Key Path:	System
Notes:	No remote command for this key.
Initial S/W Revision:	Prior to A.02.00
Help Map ID:	2401

Licensing...

Opens the license explorer.

System Functions
System

For Help on this key, select Help in the menu bar at the top of the license explorer window.

Key Path:	System
Notes:	No equivalent remote command for this key.
Backwards Compatibility Notes:	In ESA the SCPI command for displaying the Show Licenses screen is: :SYSTem:CONFIgure:LKEY:STATe OFF ON 0 1 :SYSTem:CONFIgure:LKEY:STATe? There are no equivalent SCPI commands in the X-Series for displaying the License Explorer.
Initial S/W Revision:	Prior to A.02.00
Help Map ID:	2402

Remote Command:	:SYSTem:LKEY <"OptionInfo">, <"LicenseInfo">
Example:	SYST:LKEY "N9073A-1FP","027253AD27F83CDA5673A9BA5F427FDA5E4F25AEB1017638211AC9F60D9C639FE539735909C551DE0A91"
Notes:	The <"OptionInfo"> contains the feature and the version. You must specify the feature but can omit the version. If you omit the version, the system regards it as the latest one, since the system knows which version is supported for each feature. The <"LicenseInfo"> contains the signature, the expiration date, and serial number for transport if transportable. You must specify the signature, but you can omit the other information. If you omit the expiration date, the system regards it as permanent. If you omit the serial number, the system regards it as non-transportable. As a result, this supports reverse compatibility.
Initial S/W Revision:	Prior to A.02.00
Help Map ID:	0

Remote Command:	:SYSTem:LKEY:DELeTe <"OptionInfo">, <"LicenseInfo">
Example:	SYST:LKEY:DEL "N9073A-1FP","027253AD27F83CDA5673A9BA5F427FDA5E4F25AEB1017638211AC9F60D9C639FE539735909C551DE0A91"
Notes:	The <"OptionInfo"> contains the feature and the version. You must specify the feature but can omit the version. If you omit the version, the system regards it as the latest one, if more than one version is installed. The <"LicenseInfo"> contains the signature, the expiration date, and whether or not be transportable. You must specify the signature, but you can omit the other information. If you omit the expiration date, the system regards it as permanent. If you omit the transportability, the system regards it as non-transportable. As a result, this supports reverse compatibility.
Initial S/W Revision:	Prior to A.02.00

Help Map ID:	0
--------------	---

Remote Command:	:SYSTem:LKEY:LIST?
Notes:	<p>Return Value:</p> <p>An <arbitrary block data> of all the installed instrument licenses.</p> <p>The format of each license is as follows.</p> <p><Feature>,<Version>,<Signature>,<Expiration Date>,<Serial Number for Transport></p> <p>Return Value Example:</p> <p>#3136</p> <p>N9073A-1FP,1.000,B043920A51CA</p> <p>N9060A-2FP,1.000,4D1D1164BE64</p> <p>N9020A-508,1.000,389BC042F920</p> <p>N9073A-1F1,1.000,5D71E9BA814C,13-aug-2005</p> <p><arbitrary block data> is:</p> <p>#NMMM<data></p> <p>Where:</p> <p>N is the number of digits that describes the number of MMM characters. For example if the data was 55 bytes, N would be 2.</p> <p>MMM would be the ASCII representation of the number of bytes. In the previous example, N would be 55.</p> <p><data> ASCII contents of the data</p>
Initial S/W Revision:	Prior to A.02.00
Help Map ID:	0

Remote Command:	:SYSTem:LKEY? <"OptionInfo" >
Example:	SYST:LKEY? "N9073A-1FP"
Notes:	<p>The <"OptionInfo"> contains the feature and the version. You must specify the feature but can omit the version. If you omit the version, the system regards it as the latest one.</p> <p>Return Value:</p> <p><"LicenseInfo"> if the license is valid, null otherwise.</p> <p><"LicenseInfo"> contains the signature, the expiration date, and serial number if transportable.</p> <p>Return Value Example:</p> <p>"B043920A51CA"</p>
Initial S/W Revision:	Prior to A.02.00

System Functions

System

Help Map ID:	0
Remote Command:	:SYSTem:HID?
Notes:	Return value is the host ID as a string
Initial S/W Revision:	Prior to A.02.00
Help Map ID:	0

Security

Accesses capabilities for operating the instrument in a security controlled environment.

Key Path:	System
Initial S/W Revision:	A.04.00
Help Map ID:	3661

USB

Read-Write

Selection for allowing full read-write access to the USB ports.

Key Path:	System, Security, USB
Example:	:SYST:SEC:USB:WPR OFF Will set USB ports to Read-Write
Initial S/W Revision:	A.04.00
Help Map ID:	3662

Read only

Selection for disabling write access to the USB ports.

Key Path:	System, Security, USB
Example:	:SYST:SEC:USB:WPR ON Will set USB ports to Read only
Initial S/W Revision:	A.04.00
Help Map ID:	3663

Diagnostics

The Diagnostics key in the System menu gives you access to basic diagnostic capabilities of the instrument.

Key Path:	System
-----------	---------------

Initial S/W Revision:	Prior to A.02.00
Help Map ID:	2445

Show Hardware Statistics

Provides a display of various hardware statistics. The statistics include the following:

Mechanical relay cycles

High and Low temperature extremes

Elapsed time that the instrument has been powered-on (odometer)

The display should appear listing the statistics, product number, serial number, and firmware revision.

Hardware Statistical Information	
Agilent MXA Signal Analyzer	
Product Number: N9020A	
Serial Number: US00061145	
Instrument S/W Revision: A.12.00	
Revision Date: 7/11/2012 12:11:10 PM	
Component Name	Value
MechAtten #1 Count Total	457304
Calibrator Switch Cycles	105953
AC/DC Switch Cycles	114240
2 dB #1 Mechanical Atten Cycles	112655
2 dB #2 Mechanical Atten Cycles	124456
MechAtten #2 Count Total	472265
6 dB Mechanical Atten Cycles	115302
10 dB Mechanical Atten Cycles	93602
20 dB Mechanical Atten Cycles	144781
30 dB Mechanical Atten Cycles	118580
Low Noise Path Switch	45668
Preselector Bypass Cycles	31133
High temperature operating extreme	45.75
Low temperature operating extreme	-23.9375
Elapsed Time (On-Time)(hours)	134164

In some CXA models this field is called "Fixed Atten"

Some CXA models omit these fields

Only shown if LNP installed

Only shown if MPB installed

The CXA models in which the AC/DC Switch field is called Fixed Atten and which omit the mech atten fields are the N9000A–503/507 models.

The data will be updated only when the Show Hardware Statistics menu key is pressed, it will not be updated while the screen is displayed.

The tabular data should be directly printable.

Key Path:	System, Diagnostics
Mode:	All

Notes:	The values displayed on the screen are only updated upon entry to the screen and not updated while the screen is being displayed.
Initial S/W Revision:	Prior to A.02.00
Help Map ID:	2446

SCPI for Show Hardware Statistics (Remote Commands Only)

Each of the hardware statistic items can be queried via SCPI.

“Query the Mechanical Relay Cycle Count” on page 260

“Query the Operating Temperature Extremes” on page 260

“Query the Elapsed Time since 1st power on” on page 261

Query the Mechanical Relay Cycle Count

Return the count of mechanical relay cycles. For N9038A model, there are additional 2 Mechanical Relays which are <N9038A Input2>, <N9038A Bypass>.

Remote Command:	:SYSTem:MRELAY:COUNT?
Example:	:SYST:MREL:COUN?
Notes:	<p>Query Only</p> <p>The return value is a comma separated list of the individual counts for each mechanical relay.</p> <p>The position of the relays in the list is:</p> <p>“<Cal Signal>,<AC/DC>,<2dB #1 Atten>,<2dB #2 Atten>,<6dB Atten>,<10dB Atten>,<20dB Atten>,<30dB Atten>,<Fixed Atten>,<Low Noise Path Switch>,<Presel Bypass>,<N9038A Input2>, <N9038A Bypass>”</p> <p>Items in the list not pertaining to your particular hardware configuration will return as -999 for those items.</p>
Dependencies:	This SCPI command is NOT supported by the E6607C model.
Initial S/W Revision:	Prior to A.02.00
Modified at S/W Revision:	A.08.00
Help Map ID:	0

Query the Operating Temperature Extremes

Returns the low operating temperature extreme value. The value survives a power-cycle and is the temperature extreme encountered since the value was reset by the factory or service center.

Mode:	All
Remote Command:	:SYSTem:TEMPerature:LEXTreme?
Example:	:SYST:TEMP:LEXT?

Notes:	Value is in degrees Celsius at which the lowest operating temperature has been recorded since 1st power-up.
State Saved:	No
Initial S/W Revision:	Prior to A.02.00
Help Map ID:	0

Mode:	All
Remote Command:	:SYSTem:TEMPerature:HEXTreme?
Example:	:SYST:TEMP:HEXT?
Notes:	Value is in degrees Celsius at which the highest operating temperature has been recorded since 1st power-up.
State Saved:	No
Initial S/W Revision:	Prior to A.02.00
Help Map ID:	0

Query the Elapsed Time since 1st power on

Returns the elapsed on-time in minutes since 1st power-on.

Remote Command:	:SYSTem:PON:ETIMe?
Example:	:SYST:PON:ETIM?
Notes:	Query Only
Initial S/W Revision:	Prior to A.02.00
Help Map ID:	0

Advanced

Accesses advanced diagnostic capabilities performed in the factory or under instructions from repair procedures. This menu key is only visible when the logged-in user is “saservice”. The first access to the Advanced Diagnostic Menu after invoking the instrument application will require an authentication, which is to enter the Service Code. Subsequent accesses to the Advanced Diagnostic Menu are unimpeded. The Authentication dialog looks like:

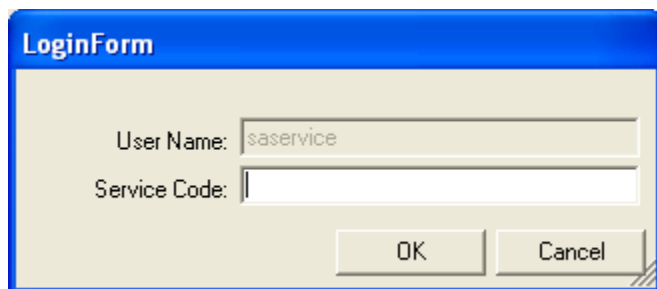

System Functions
System

“OK” is the default key thus the Enter key is used to complete the entry. If invalid Service Code is entered authentication is not granted and you are provided the following dialog:



Key Path:	System, Diagnostics
Notes:	Password is required to access this menu.
Initial S/W Revision:	Prior to A.02.00
Help Map ID:	3498

Self test

This key gives you access to diagnostic capabilities for self tests of the instrument.

Key Path:	System, Diagnostics
Initial S/W Revision:	Prior to A.10.00
Help Map ID:	50000

All Self Test

This key invokes all the self tests defined in the Diagnostics Self Test section.

Key Path:	System, Diagnostics, Self Test
Remote Command:	:SYSTem:TEST:WCTS:[ALL]
Example:	SYST:TEST:WCTS:[ALL]
Initial S/W Revision:	A.12.50
Help Map ID:	50011

Source Self Test

This key invokes the internal source self test. When operation is complete, the generated test summary file is: E:\Agilent\Instrument\CRFSSelfTestLog.txt. This test summary file can be retrieved from the instrument using the MMEM set of SCPI command, once you have the fully qualified the path and file name.

If the self test fails, the following error message will be generated:

“-330, Self-test failed, see log file E:\Agilent\Instrument\ CRFSSelfTestLog.txt”

If the self test passes, an advisory message “Source self-test completed successfully” is generated.

Key Path:	System, Diagnostics, Self Test
Remote Command:	:SYSTem:TEST:WCTS:SOURce
Example:	SYST:TEST:WCTS:SOURce
Notes:	Access log with command : MMEM:DATA? "E:\Agilent\Instrument\CRFSSelfTestLog.txt" Alias of source self test (:SOURce:SELF:TEST[:ALL])
Initial S/W Revision:	A.10.00
Help Map ID:	50001

RFIO Self Test

This key invokes the RFIO ports self test for embedded MPA, which just are available on E6607C. When operation is completed, the generated test summary information is appended to log file E:\Agilent\Instrument\RFIOTestLog.txt. This test summary file can be retrieved from the instrument using the MMEM set of SCPI command, once you have the fully qualified the path and file name.

If the self test fails, the following error message will be generated:

“-330, Self-test failed, see log file E:\Agilent\Instrument\RFIOTestLog.txt”

If the self test passes, an advisory message “RFIO self-test completed successfully” is generated.

Key Path:	System, Diagnostics, Self Test
Remote Command:	:SYSTem:TEST:WCTS:MPADapter
Example:	SYST:TEST:WCTS:MPAD
Notes:	Access log with command : MMEM:DATA? "E:\Agilent\Instrument\RFIOTestLog.txt"
Initial S/W Revision:	A.12.50
Help Map ID:	50012

NOTE This function is NOT available on EXT E6607A and E6607B models.

FEC Self Test

This key invokes the EXT E6607C froned end control self test. When operation is complete, the generated test summary information is appended to log file E:\Agilent\Instrument\FECTestLog.txt. This test summary file can be retrieved from the instrument using the MMEM set of SCPI command, once you have the fully qualified the path and file name.

If the self test fails, the following error message will be generated:

“-330, Self-test failed, see log file E:\Agilent\Instrument\FECTestLog.txt”

System Functions
System

If the self test passes, an advisory message “FEC self-test completed successfully” is generated.

Key Path:	System, Diagnostics, Self Test
Remote Command:	: SYSTem: TEST: WCTS: FEC
Example:	SYST:TEST:WCTS:FEC
Notes:	Access log with command : MMEM:DATA? "E:\ Agilent\Instrument\FECTestLog.txt"
Initial S/W Revision:	A.12.50
Help Map ID:	50013

NOTE This function is NOT available on EXT E6607A and E6607B models.

Show Result

This key gives you access to show results of the following self tests:

“[Source Self Test Results](#)” on page 264

E6607C embedded MPA self-test results - “[RFIO Self Test REsults](#)” on page 266

E6607C FEC self-test results - “[FEC Self Test REsults](#)” on page 267

Key Path:	System, Diagnostics, Self Test
Initial S/W Revision:	A.12.50
Help Map ID:	50014

Source Self Test Results

Provides a display of last source test results, the display should appear listing model number, serial number and test time at the top of display, and then list test date/time, test name, measured value, valid range and pass/fail of each source test item, the tabular data should be directly printable.

Key Path:	System, Diagnostics, Self Test, Show Results
Remote Command:	: SYSTem: TEST: WCTS: SHOW: RESult SOURce
Example:	SYST:TEST:WCTS:SHOW:RES SOUR
Initial S/W Revision:	A.12.50
Help Map ID:	50015

The example of source self test result display is as follows:

Source Self Test Results					
Produce Number: E6607B					
Serial Number: MY51380425					
Instrument S/W: 11/15/2012 2:51:19 PM					
FpgaVersionTest					
Date	Time(GMT)	Name	MeasValue	ValidRange	Result
11/23/2012	16:13:56	Analog_FPGA	16.000	>= 16.000	Pass
11/23/2012	16:13:56	Digital_FPGA	50.000	>= 46.000	Pass
11/23/2012	16:13:56	CRFS_FPGA	38.000	>= 38.000	Pass
ModulatorTest					
Date	Time(GMT)	Name	MeasValue	ValidRange	Result
11/23/2012	16:13:57	LOLevel_vs_DET_LO	-1.108	-2.200 - 2.200	Pass
11/23/2012	16:13:57	LOLevel_vs_LEVEL_DET	1.010	-1.100 - 1.100	Pass
11/23/2012	16:13:57	LOLevel_vs_LEVEL_REF	1.995	0.500 - 2.500	Pass
11/23/2012	16:13:57	QUAD_vs_DET_LO	-0.879	-1.100 - 1.100	Pass
11/23/2012	16:13:57	QUAD_vs_LEVEL_DET	0.000	-1.100 - 1.100	Pass
11/23/2012	16:13:57	QUAD_vs_LEVEL_REF	0.000	-0.300 - 0.300	Pass
11/23/2012	16:13:57	QUAD_vs_QUAD_LOOP	0.885	0.350 - 1.100	Pass
IQModulatorTest					
Date	Time(GMT)	Name	MeasValue	ValidRange	Result
11/23/2012	16:13:57	VBLO_DAC	0.154	0.000 - 0.500	Pass
11/23/2012	16:13:57	AMP_BIAS1	145.154	132.000 - 185.000	Pass
11/23/2012	16:13:57	AMP_BIAS2	145.740	132.000 - 185.000	Pass
11/23/2012	16:13:57	OFFSET_QN	0.119	0.100 - 0.125	Pass
11/23/2012	16:13:57	OFFSET_QP	0.121	0.100 - 0.125	Pass

Show Source Self Test Results contents (Remote Command Only)

A remote command is available to obtain the contents of the Show Souce Self Test Results screen (the entire contents, not just the currently displayed page).

Remote Command:	:SYSTem:TEST:WCTS:SOURce:RESult?
Example:	SYST:TEST:WCTS:SOUR:RES?

System Functions
System

Notes:	The output is an IEEE Block format of the Show Source Self Test Results contents. Each line is separated with a new-line character.
Initial S/W Revision:	A.12.50
Help Map ID:	0

RFIO Self Test Results

Provides a display of last RFIO test results for embedded MPA of E6607C, the display should appear listing model number, serial number and test time at the top of display, and then list test date/time, test name, measured value, valid range and pass/fail of each RFIO test item, the tabular data should be directly printable.

Key Path:	System, Diagnostics, Self Test, Show Results
Remote Command:	:SYSTem:TEST:WCTS:SHOW:RESult MPADapter
Example:	SYST:TEST:WCTS:SHOW:RES MPAD
Initial S/W Revision:	A.12.50
Help Map ID:	50016

NOTE This function is NOT available on EXT E6607A and E6607B models.

The example of RFIO self test result display is as following:

RFIO Self Test Results					
Produce Number: E6607C					
Serial Number: MY51380437					
Instrument S/W: 11/16/2012 2:51:19 PM					
CarrierClockTest	16:13:56				
Date	Time(GMT)	Name	MeasValue	ValidRange	Result
11/23/2012	16:13:57	Dig FPGA 100 MHz	1.000	1.000 - 1.000	Pass
11/23/2012	16:13:57	Feldspar CCLK	1.000	1.000 - 1.000	Pass
11/23/2012	16:13:57	Feldspar LVDS	1.000	1.000 - 1.000	Pass
11/23/2012	16:13:57	Dig FPGA LVDS	1.000	1.000 - 1.000	Pass
11/23/2012	16:13:57	Dig FPGA 200 MHz	1.000	1.000 - 1.000	Pass
DetectorTest					
Date	Time(GMT)	Name	MeasValue	ValidRange	Result
11/23/2012	16:13:57	ABUS_DET_SYNTH	29.879	14.400 - 100.000	Pass
11/23/2012	16:13:57	ABUS_DET_LO	18.136	9.000 - 100.000	Pass
11/23/2012	16:13:57	ABUS_DET_MOD	13.556	6.600 - 100.000	Pass

11/23/2012	16:13:57	ABUS_DET_MOD_FLT	18.000	7.800 - 100.000	Pass
FilterBankTest1					
Date	Time(GMT)	Name	MeasValue	ValidRange	Result
11/23/2012	16:13:57	Bank1_LPF_550MHz	30.357	>= 10.000	Pass
11/23/2012	16:13:57	Bank1_LPF_750MHz	29.358	>= 10.000	Pass
11/23/2012	16:13:57	Bank1_LPF_1020MHz	27.036	>= 10.000	Pass
11/23/2012	16:13:57	Bank1_LPF_1600MHz	27.594	>= 10.000	Pass
11/23/2012	16:13:57	Bank1_LPF_2400MHz	21.490	>= 10.000	Pass
11/23/2012	16:13:57	Bank1_LPF_3000MHz	18.476	>= 10.000	Pass
11/23/2012	16:13:57	OFFSET_QP	0.121	0.100 - 0.125	Pass

Show RFIO Self Test Results contents (Remote Command Only)

A remote command is available to obtain the contents of the Show RFIO Self Test Results screen (the entire contents, not just the currently displayed page).

Remote Command:	:SYSTem:TEST:WCTS:MPADapter:RESult?
Example:	SYST:TEST:WCTS:MPAD:RES?
Notes:	The output is an IEEE Block format of the Show RFIO Self Test Results contents. Each line is separated with a new-line character.
Initial S/W Revision:	A.12.50
Help Map ID:	0

FEC Self Test Results

Provides a display of last FEC test results, the display should appear listing model number, serial number and test time at the top of display, and then list test date/time, test name, measured value, valid range and pass/fail of each FEC test item, the tabular data should be directly printable.

Key Path:	System, Diagnostics, Self Test, Show Results
Remote Command:	:SYSTem:TEST:WCTS:SHOW:RESult FEC
Example:	SYST:TEST:WCTS:SHOW:RES FEC
Initial S/W Revision:	A.12.50
Help Map ID:	50017

This function is NOT available on EXT E6607A and E6607B models.

System Functions
System

The example of FEC self test result display is as follows:

FEC Self Test Results					
Produce Number: E6607C					
Serial Number: MY51380437					
Instrument S/W: 11/16/2012 2:51:19 PM					
FpgaVersionTest					
Date	Time(GMT)	Name	MeasValue	ValidRange	Result
11/23/2012	16:13:56	Analog_FPGA	16.000	>= 16.000	Pass
11/23/2012	16:13:56	Digital_FPGA	50.000	>= 46.000	Pass
11/23/2012	16:13:56	CRFS_FPGA	38.000	>= 38.000	Pass
PowerSupplyTest					
Date	Time(GMT)	Name	MeasValue	ValidRange	Result
11/23/2012	16:13:56	ABUS_+32CHK	31.904	30.900 - 32.900	Pass
11/23/2012	16:13:56	ABUS_+12CHK	12.296	10.800 - 13.200	Pass
11/23/2012	16:13:56	+10VA	9.935	9.600 - 10.200	Pass
11/23/2012	16:13:56	+5VA	4.995	4.900 - 5.100	Pass
11/23/2012	16:13:56	+3.3VA	3.299	3.200 - 3.400	Pass
11/23/2012	16:13:56	-3.3VA	-3.311	-3.400 - -3.200	Pass
11/23/2012	16:13:56	ACOM	0.00	-0.200 - 0.200	Pass
11/23/2012	16:13:56	-5VA	-5.036	-5.100 - -4.900	Pass
11/23/2012	16:13:56	-6.1VA	-5.880	-6.200 - -5.700	Pass
11/23/2012	16:13:56	-10VA	-10.116	-10.200 - -9.800	Pass
11/23/2012	16:13:56	ABUS_-2.5V_REF	-2.508	-2.520 - -2.470	Pass
11/23/2012	16:13:56	ABUS_+2.5V_REF	2.508	2.480 - 2.520	Pass
11/23/2012	16:13:56	ABUS_-10VPALC	-10.047	-10.200 - -9.800	Pass
11/23/2012	16:13:57	ABUS_DET_MOD_FLT	18.000	7.800 - 100.000	Pass

Show FEC Self Test Results contents (Remote Command Only)

A remote command is available to obtain the contents of the Show FEC Self Test Results screen (the entire contents, not just the currently displayed page).

Remote Command:	:SYSTem:TEST:WCTS:FEC:RESult?
-----------------	-------------------------------

Example:	SYST:TEST:WCTS:FEC:RES?
Notes:	The output is an IEEE Block format of the Show FEC Self Test Results contents. Each line is separated with a new-line character.
Initial S/W Revision:	A.12.50
Help Map ID:	0

Multiport Adapter Cables Test

This key gives you access to diagnostic capabilities for the RF and trigger cable connections between EXT and Multiport Adapter with this instrument, which include:

EXT RF Input <-> Multiport Adapter RF OUT

EXT RF Output <-> Multiport Adapter RF IN

EXT RF IO2 <-> Multiport Adapter GPS IN

EXT Trigger 1<-> Multiport Adapter Trigger 1

EXT Trigger 2 <-> Multiport Adapter Trigger 2

Key Path:	System, Diagnostics
Remote Command:	:CALibration:MPADapter:CABLEs:TEST
Example:	:CAL:MPAD:CABL:TEST
Notes:	If the Multiport Adapter cables are not connected correctly. It will report the proper error, for example: “-330, Self-test failed, MPA’S RF IN or RF OUT not properly connected”.
Dependencies:	This key does not appear unless a multiport adapter is plugged in to the USB. Grayout error: -221.1400; Multiport Adapter Not Available
Initial S/W Revision:	A.10.0
Help Map ID:	50018

Quick Test ...

This key gives you access to launch a Windows program for conducting a confidence check of the Agilent EXT Wireless Communications Test Set and the E6617A Multiport Adapter connected to EXT. The operator must exit Quick Test to return to the instrument application.

Key Path:	System, Diagnostics
Notes:	Operator is responsible for exiting the Quick Test and returning focus to the Instrument Application. The softkey in the menu is only displayed when the instrument is an EXT and the EXTQuickTest.exe file is present in the C:\Program Files\Agilent\EXTQuickTest folder.

System Functions
System

Initial S/W Revision:	A.09.49
Help Map ID:	50019

	Agilent Converged	PSA
IP Address	SYSTem:COMMunicate:LAN:ADDRess <string> SYSTem:COMMunicate:LAN:ADDRess?	:SYSTem:COMMunicate:LAN[:SELF]:IP <string> :SYSTem:COMMunicate:LAN[:SELF]:IP?
Gateway	SYSTem:COMMunicate:LAN:DGATeway <string> SYSTem:COMMunicate:LAN:DGATeway?	:SYSTem:COMMunicate:LAN[:SELF]:GATEway <string> :SYSTem:COMMunicate:LAN[:SELF]:GATEway?
Subnet Mask	SYSTem:COMMunicate:LAN:SMASk <string> SYSTem:COMMunicate:LAN:SMASk?	:SYSTem:COMMunicate:LAN[:SELF]:SUBNetmask <string> :SYSTem:COMMunicate:LAN[:SELF]:SUBNetmask?

Service

Accesses capabilities performed in the factory or under instructions from repair procedures. This menu key is only visible when the logged-in user is “advanceduser” or “saservice”. The first access to the Service Menu after invoking the instrument application will require an authentication Service Code.

Key Path:	System
Initial S/W Revision:	Prior to A.02.00
Help Map ID:	2500

Internet Explorer...

This key launches Microsoft Internet Explorer. A mouse and external keyboard are highly desired for using Internet Explorer. When Internet Explorer is running, close Internet Explorer to return focus to the Instrument Application (or use Alt-Tab).

Key Path:	System
Mode:	All
Notes:	No equivalent remote command for this key.
Initial S/W Revision:	A.05.01
Help Map ID:	3671

System Remote Commands (Remote Commands Only)

The commands in this section have no front-panel key equivalent.

[“System Powerdown \(Remote Command Only\)” on page 271](#)

“List installed Options (Remote Command Only)” on page 271

“Lock the Front-panel keys (Remote Command Only)” on page 271

“List SCPI Commands (Remote Command Only)” on page 272

“SCPI Version Query (Remote Command Only)” on page 272

“Date (Remote Command Only)” on page 273

“Time (Remote Command Only)” on page 273

Initial S/W Revision:	Prior to A.02.00
Help Map ID:	0

System Powerdown (Remote Command Only)

Remote Command:	:SYSTem:PDOWn [NORMal FORCe]
Notes:	Shuts down the instrument in the normal way (NORMal) or forced way (FORCe). In case there is another application with modified data pending for saving, the application prompt the user. The system waits until the user responds in the normal mode. It will go off after 20 seconds of wait in the force mode and all data will be lost.
Help Map ID:	0

List installed Options (Remote Command Only)

Lists the installed options that pertain to the instrument (signal analyzer). .

Mode:	All
Remote Command:	:SYSTem:OPTions?
Example:	:SYST:OPT?
Notes:	The return string is a comma separated list of the installed options. For example: “503,P03,PFR” :SYSTem:OPTions? and *OPT? are the same.
State Saved:	No
Initial S/W Revision:	Prior to A.02.00
Help Map ID:	0

Lock the Front-panel keys (Remote Command Only)

Disables the instrument keyboard to prevent local input when the instrument is controlled remotely. Annunciation showing a “K” for ‘Klock” (keyboard lock) alerts the local user that the keyboard is locked. Klock is similar to the GPIB Local Lockout function; namely that no front-panel keys are active with the exception of the Power Standby key. (The instrument is allowed to be turned-off if Klock is

System Functions
System

ON.) The Klock command is used in remote control situations where Local Lockout cannot be used.

Although primary intent of Klock is to lock-out the front panel, it will lock-out externally connected keyboards through USB. Klock has no effect on externally connected pointing devices (mice).

The front panel 'Local' key (Cancel/Esc) has no effect if Klock is ON.

Mode:	All
Remote Command:	:SYSTem:KLOCK OFF ON 0 1 :SYSTem:KLOCK?
Example:	:SYST:KLOC ON
Notes:	Keyboard lock remains in effect until turned-off or the instrument is power-cycled
Preset:	Initialized to OFF at startup, unaffected by Preset
State Saved:	No
Initial S/W Revision:	Prior to A.02.00
Help Map ID:	0

List SCPI Commands (Remote Command Only)

Outputs a list of the valid SCPI commands for the currently selected Mode.

Remote Command:	:SYSTem:HELP:HEADers?
Example:	:SYST:HELP:HEAD?
Notes:	The output is an IEEE Block format with each command separated with the New-Line character (hex 0x0A)
Initial S/W Revision:	Prior to A.02.00
Help Map ID:	0

SCPI Version Query (Remote Command Only)

Returns the SCPI version number with which the instrument complies. The SCPI industry standard changes regularly. This command indicates the version used when the instrument SCPI commands were defined.

Remote Command:	:SYSTem:VERSion?
Example:	:SYST:VERS?
Initial S/W Revision:	Prior to A.02.00
Help Map ID:	0

Date (Remote Command Only)

The recommended access to the Date, Time, and Time zone of the instrument is through the Windows native control (Control Panel or accessing the Task Bar). You may also access this information remotely, as shown in this command and Time (below).

Sets or queries the date in the instrument.

Mode:	All
Remote Command:	:SYSTem:DATE "<year>, <month>, <day>" :SYSTem:DATE?
Example:	:SYST:DATE "2006,05,26"
Notes:	<year> is the four digit representation of year. (for example, 2006) <month> is the two digit representation of year. (for example. 01 to 12) <day> is the two digit representation of day. (for example, 01 to 28, 29, 30, or 31) depending on the month and year Unless the current account has Power User or Administrator privileges, an error will be generated by this command and no action will be taken.
Initial S/W Revision:	Prior to A.02.00
Help Map ID:	0

Time (Remote Command Only)

Sets or queries the time in the instrument.

Mode:	All
Remote Command:	:SYSTem:TIME "<hour>, <minute>, <second>" :SYSTem:TIME?
Example:	:SYST:TIME "13,05,26"
Notes:	<hour> is the two digit representation of the hour in 24 hour format <minute> is the two digit representation of minute <second> is the two digit representation of second Unless the current account has Power User or Administrator privileges, an error will be generated by this command and no action will be taken.
Initial S/W Revision:	Prior to A.02.00
Help Map ID:	0

User Preset

Accesses a menu that gives you the following three choices:

User Preset – recalls a state previously saved using the Save User Preset function.

User Preset All Modes – presets all of the modes in the analyzer

Save User Preset – saves the current state for the current mode

Key Path:	Front-panel key
Backwards Compatibility Notes:	<p>User Preset is actually loading a state, and in legacy analyzers, it was possible to load a state without affecting the trace data, limit lines or correction data. Similarly it was possible to do a User Preset without affecting the trace data, limit lines or correction data.</p> <p>In the X-Series, “state” always includes all of this data; so whenever state is loaded, or User Preset is executed, all of the traces, limit lines and corrections are affected. Although this differs from previous behavior, it is desirable behavior, and should not cause adverse issues for users.</p> <p>On ESA and PSA, User Preset affected the entire instrument’s state. In the X-Series, User Preset only recalls the state for the active mode. There is a User Preset file for each mode. User Preset can never cause a mode switch as it can in legacy analyzers. If you want to recall all modes to their user preset file state, you will need to do a User Preset after mode switching into each mode.</p> <p>User Preset recalls mode state which can now include data like traces; whereas on ESA and PSA, User Preset did not affect data.</p>
Initial S/W Revision:	Prior to A.02.00
Help Map ID:	2024

User Preset

User Preset sets the state of the currently active mode back to the state that was previously saved for this mode using the Save User Preset menu key or the SCPI command, `SYST:PRES:USER:SAV`. It not only recalls the Mode Preset settings, but it also recalls all of the mode persistent settings, and the Input/Output system setting that existed at the time Save User Preset was executed.

If a Save User Preset has not been done at any time, User Preset recalls the default user preset file for the currently active mode. The default user preset files are created if, at power-on, a mode detects there is no user preset file. There will never be a scenario when there is no user preset file to restore. For each mode, the default user preset state is the same state that would be saved if a Save User Preset is performed in each mode right after doing a Restore Mode Default and after a Restore Input/Output Defaults.

The User Preset function does the following:

Aborts the currently running measurement.

Sets the mode State to the values defined by Save User Preset.

Makes the saved measurement for the currently running mode the active measurement.

Brings up the saved menu for the power-on mode.

Clears the input and output buffers.

Sets the Status Byte to 0.

Key Path:	User Preset
Remote Command:	:SYSTem:PRESet:USER
Example:	:SYST:PRES:USER:SAVE :SYST:PRES:USER
Notes:	:SYST:PRES:USER:SAVE is used to save the current state as the user preset state. Clears all pending OPC bits. The Status Byte is set to 0. Pressing the User Preset front-panel key while already in the User Preset menu will cause the User Preset to get executed
Couplings:	A user preset will cause the currently running measurement to be aborted and cause the saved measurement to be active. Recalling a User Preset file has the same issues that recalling a Save State file has. Some settings may need to be limited and therefore re-coupled, since the capabilities of the mode may have changes when the User Preset file was last saved.
Initial S/W Revision:	Prior to A.02.00
Help Map ID:	2302

User Preset All Modes

Recalls all of the User Preset files for each mode, switches to the power-on mode, and activates the saved measurement from the power-on mode User Preset file.

NOTE When the instrument is secured, all of the user preset files are converted back to their default user preset files.

The User Preset function does the following:

Aborts the currently running measurement.

Switches the Mode to the power-on mode.

Restores the User Preset files for each mode.

Makes the saved measurement for the power-on mode the active measurement.

Brings up the saved menu for the power-on mode.

Clears the input and output buffers.

System Functions
User Preset

Sets the Status Byte to 0.

Key Path:	User Preset
Remote Command:	:SYSTem:PRESet:USER:ALL
Example:	:SYST:PRES:USER:SAVE :SYST:PRES:USER:ALL
Notes:	Clears all pending OPC bits. The Status Byte is set to 0. :SYST:PRES:USER:SAVE is used to save the current state as the user preset state.
Couplings:	A user preset will cause the currently running measurement to be aborted, cause a mode switch to the power-on mode, and cause the saved measurement to be active in the power-on mode. Recalling a User Preset file has the same issues that recalling a Save State file has. Some settings may need to be limited and therefore re-coupled, since the capabilities of the mode may have changes when the User Preset file was last saved.
Initial S/W Revision:	Prior to A.02.00
Help Map ID:	2303

Save User Preset

Saves the currently active mode and its State. You can recall this User Preset file by pressing the User Preset menu key or sending the SYST:PRES:USER remote command. This same state is also saved by the Save State function.

Key Path:	User Preset
Remote Command:	:SYSTem:PRESet:USER:SAVE
Example:	:SYST:PRES:USER:SAVE
Notes:	:SYST:PRES:SAVE creates the same file as if the user requested a *SAV or a MMEM:STOR:STAT, except User Preset Save does not allow the user to specify the filename or the location of the file.
Initial S/W Revision:	Prior to A.02.00
Help Map ID:	2304

The complex spectrum measurement provides spectrum analysis capability for the instrument. The control of the measurement was designed to be familiar to those who are accustomed to using swept spectrum analyzers. For more details about this measurement, see the section [“Complex Spectrum Measurement Description” on page 279](#) below.

This topic contains the following sections:

[“Measurement Commands for Complex Spectrum” on page 277](#)

[“Remote Command Results for Complex Spectrum” on page 277](#)

Measurement Commands for Complex Spectrum

The general functionality of CONFigure, INITiate, FETCh, MEASure, and READ are described in the section [“Remote Measurement Functions” on page 627](#). See the SENSE subsystem commands for more measurement related commands.

:CONFigure:SPECTrum

:CONFigure:SPECTrum:NDEFault

:INITiate:SPECTrum

:FETCh:SPECTrum [n] ?

:MEASure:SPECTrum [n] ?

:READ:SPECTrum [n] ?

Remote Command Results for Complex Spectrum

The following table shows the returned results of the FETCh|MEASure|READ commands.

n	Results Returned
0	Returns unprocessed I/Q trace data, as a series of trace point values, in volts. The I values are listed first in each pair, using the 0 through even-indexed values. The Q values are the odd-indexed values.

not specified or n=1	<p>Returns the following comma-separated scalar results:</p> <ol style="list-style-type: none"> 1. FFT peak is the FFT peak amplitude. 2. FFT frequency is the FFT frequency of the peak amplitude. 3. FFT points is the Number of points in the FFT spectrum. 4. First FFT frequency is the frequency of the first FFT point of the spectrum. 5. FFT spacing is the frequency spacing between the FFT points of the spectrum. 6. Time domain points is the number of points in the time domain trace used for the FFT. The number of points doubles if the data is complex instead of real. See the time domain scalar description below. 7. First time point is the time of the first time domain point, where time zero is the trigger event. 8. Time spacing is the time spacing between the time domain points. The time spacing value doubles if the data is complex instead of real. See the time domain scaler description below. 9. Time domain returns a 1 if time domain is complex (I/Q) and complex data will be returned. It returns a 0 if the data is real. (raw ADC samples) When this value is 1 rather than 0 (complex vs. real data), the time domain points and the time spacing scalars both increase by a factor of two. 10. Scan time is the total scan time of the time domain trace used for the FFT. The total scan time = (time spacing) (time domain points 1) 11. Current average count is the current number of data measurements that have already been combined, in the averaging calculation.
2	Returns the trace data of the log-magnitude versus time. (That is, the RF envelope.)
3	Returns the I and Q trace data. It is represented by I and Q pairs (in volts) versus time.
4	Returns spectrum trace data. That is, the trace of log-magnitude versus frequency. (The trace is computed using a FFT.)
5	Returns the averaged trace data of log-magnitude versus time. (That is, the RF envelope.)
6	Not used.
7	Returns the averaged spectrum trace data. That is, the trace of the averaged log-magnitude versus frequency.
8	Not used.
9	Returns a trace containing the shape of the FFT window.
10	Returns trace data of the phase of the FFT versus frequency.
11	Returns comma-separated linear spectrum trace data in Volts RMS.
12	Returns comma-separated averaged linear spectrum trace data in Volts RMS.

13	<p>Returns the following comma-separated scalar results:</p> <ol style="list-style-type: none"> 1. I/Q Magnitude and Phase Delta Results available (0 = not available, 1 = available). Results are available when the last measurement was made with I/Q Magnitude and Phase Delta Results enabled (SPEC:IQD:ENAB ON) and the setup was valid for generating the results (invalid setup when input is I/Q, I/Q Path is I+jQ, and Center Frequency is not 0 Hz) 2. Delta magnitude and phase trace (results 14 – 17) start frequency (0 when I/Q Magnitude and Phase Delta Results not available) 3. Delta magnitude and phase trace (results 14 – 17) number of points (1 when I/Q Magnitude and Phase Delta Results not available) 4. Delta magnitude and phase trace (results 14 – 17) frequency spacing between points (0 when I/Q Magnitude and Phase Delta Results not available) 5. Current average count (1 when I/Q Magnitude and Phase Delta Results not available) 6. Frequency of the FFT trace (result 4) peak magnitude in Hz (0 when I/Q Magnitude and Phase Delta Results not available) 7. Delta magnitude at the FFT trace peak magnitude frequency in dB (–999 when I/Q Magnitude and Phase Delta Results not available) 8. Delta phase at the FFT trace peak magnitude frequency in radians (–999 when I/Q Magnitude and Phase Delta Results not available) 9. Delta phase at the FFT trace peak magnitude frequency in degrees (–999 when I/Q Magnitude and Phase Delta Results not available or invalid setup) 10. Frequency of the averaged FFT trace (result 7) peak magnitude in Hz (0 when I/Q Magnitude and Phase Delta Results not available) 11. Averaged delta magnitude at the averaged FFT trace peak magnitude frequency in dB (–999 when I/Q Magnitude and Phase Delta Results not available) 12. Averaged delta phase at the averaged FFT trace peak magnitude frequency in radians (–999 when I/Q Magnitude and Phase Delta Results not available) 13. Averaged delta phase at the averaged FFT trace peak magnitude frequency in degrees (–999 when I/Q Magnitude and Phase Delta Results not available)
14	Current delta magnitude trace in dB (–999 when I/Q Magnitude and Phase Delta Results not available)
15	Current delta phase trace in radians (–999 when I/Q Magnitude and Phase Delta Results not available)
16	Averaged delta magnitude trace in dB (–999 when I/Q Magnitude and Phase Delta Results not available)
17	Averaged delta phase trace in radians (–999 when I/Q Magnitude and Phase Delta Results not available)

Complex Spectrum Measurement Description

This measurement is FFT (Fast Fourier Transform) based. The FFT-specific parameters are located in the advanced menu. Also available under basic mode spectrum measurements is an I/Q window, which shows the I and Q signal waveforms in parameters of voltage versus time. The advantage of having an I/Q view available while in the spectrum measurement is that it allows you to view complex components

Complex Spectrum Measurement

of the same signal without changing settings or measurements.

Key Path:	Front-panel key
Initial S/W Revision:	Prior to A.02.00
Help Map ID:	10000

AMPTD Y Scale

Accesses the vertical scale parameters menu. The menu selection is dependant on the active window view.

Key Path:	Front-panel key
Initial S/W Revision:	Prior to A.02.00
Help Map ID:	10051

Ref Value

Enables you to adjust the absolute power reference value. Ref in the upper left corner of the display, indicates the current value. To change the reference level, use the front-panel step keys, knob, or numeric keypad.

Ref Value (Spectrum window)

Enables you to adjust the absolute power reference value in the spectrum view window. Ref in the upper left corner of the display, indicates the current value. To change the reference level, use the front-panel step keys, knob, or numeric keypad.

Key Path:	AMPTD Y Scale
Mode:	BASIC
Remote Command:	:DISPlay:SPECTrum:VIEW[1]:WINDow[1]:TRACe:Y[:SCALE]:RLEVel <ampl> :DISPlay:SPECTrum:VIEW[1]:WINDow[1]:TRACe:Y[:SCALE]:RLEVel?
Example:	DISP:SPEC:VIEW:WIND:TRAC:Y:RLEV 100 DISP:SPEC:VIEW:WIND:TRAC:Y:RLEV?
Notes:	You must be in the IQ Analyzer (Basic) mode to use this command. Use INSTRument:SElect to set the mode.
Couplings:	When Auto Scaling is turned on, this value is automatically determined by the measurement result. When this value is set, Auto Scaling is turned off. Attenuation is not coupled to Ref Value.
Preset:	0.00 dBm
State Saved:	Saved in instrument state.
Min:	-250 dBm
Max:	250 dBm

Complex Spectrum Measurement
AMPTD Y Scale

Initial S/W Revision:	Prior to A.02.00
Help Map ID:	I0006

Ref Value (I/Q Waveform window)

Enables you to adjust the absolute voltage reference value in the waveform view window. Ref in the upper left corner of the display, indicates the current value. To change the reference level, use the front-panel step keys, knob, or numeric keypad.

Key Path:	AMPTD Y Scale
Mode:	BASIC
Remote Command:	:DISPlay:SPECTrum:VIEW[1]:WINDow2:TRACe:Y[:SCALE]:RLEVe l <voltage> :DISPlay:SPECTrum:VIEW[1]:WINDow2:TRACe:Y[:SCALE]:RLEVe l?
Example:	DISP:SPEC:VIEW:WIND2:TRAC:Y:RLEV 120 DISP:SPEC:VIEW:WIND2:TRAC:Y:RLEV?
Notes:	You must be in the IQ Analyzer (Basic) mode to use this command. Use INSTrument:SElect to set the mode.
Couplings:	When Auto Scaling is turned on, this value is automatically determined by the measurement result. When this value is set, Auto Scaling is turned off.
Preset:	0 V
State Saved:	Saved in instrument state.
Min:	-250 V
Max:	250 V
Initial S/W Revision:	Prior to A.02.00
Help Map ID:	I0007

Attenuation

Accesses a menu that enables you to change attenuation settings. This key has a readback text that describes the total attenuator value.

In the Complex Spectrum measurement, there are no functions available for Adjust Atten for Min Clip and Pre-Adjust for Min Clip.

This is only available when the selected input is RF.

Due to available hardware, RF input, Attenuation settings are not always available. Currently in the E6607C, the Attenuation menu is replaced by the Range menu described in [“Range \(for RF Input\)”](#) on

Key Path:	AMPTD Y Scale
Initial S/W Revision:	Prior to A.02.00
Help Map ID:	10060

Range (for RF Input)

When RF Input, this menu exists in the case that the Attenuation settings are not opened to customer. At present, only in the E6607C, the Range menu replaces the Attenuation menu to realize the gain control. Accessing the Range menu to set the range value used to do the instrument gain adjustment. The range value means range target. Generally, the expected peak power of the input signal can be used.

Key Path:	AMPTD Y Scale
Mode:	BASIC
Remote Command:	:SENSe:POWer:RF:RANGe <real> :SENSe:POWer:RF:RANGe?
Example:	SENS:POW:RF:RANG 10.0 SENS:POW:RF:RANG?
Notes:	You must be in the IQ Analyzer (Basic) mode to use this command. Use INSTRument:SElect to set the mode.
Preset:	20.00 dBm
State Saved:	Saved in instrument state.
Min:	-100 dBm
Max:	100 dBm
Default Unit	dBm -dBm
Initial S/W Revision	A.12.50
Help Map ID:	10099

Range

Accesses a menu that enables you to change baseband I/Q gain settings. This key has a readback text that describes gain range value.

This is only available when the selected input is IQ.

Key Path:	AMPTD Y Scale
Initial S/W Revision:	Prior to A.02.00
Help Map ID:	10062

Scale/Div (Spectrum)

Sets the vertical scale in spectrum view by changing the amplitude value per division.

Key Path:	AMPTD Y Scale
Mode:	BASIC
Remote Command:	:DISPlay:SPECTrum:VIEW[1]:WINDow[1]:TRACe:Y[:SCALe]:PDI Vision <rel_ampl> :DISPlay:SPECTrum:VIEW[1]:WINDow[1]:TRACe:Y[:SCALe]:PDI Vision?
Example:	DISP:SPEC:VIEW:WIND:TRAC:Y:PDIV 10 DISP:SPEC:VIEW:WIND:TRAC:Y:PDIV?
Notes:	You must be in the IQ Analyzer (Basic) mode to use this command. Use INSTRument:SElect to set the mode.
Couplings:	When you set a value manually, Auto Scaling automatically changes to Off. When Auto Scaling is turned on, this value is automatically determined by the measurement result.
Preset:	10 dB
State Saved:	Saved in instrument state.
Min:	0.10 dB
Max:	20 dB
Initial S/W Revision:	Prior to A.02.00
Help Map ID:	I0008

Scale/Div (I/Q Waveform)

Sets the vertical scale in the waveform view by changing the amplitude value per division.

Key Path:	AMPTD Y Scale
Mode:	BASIC
Remote Command:	:DISPlay:SPECTrum:VIEW[1]:WINDow2:TRACe:Y[:SCALe]:PDIv sion <voltage> :DISPlay:SPECTrum:VIEW[1]:WINDow2:TRACe:Y[:SCALe]:PDIv sion?
Example:	DISP:SPEC:VIEW:WIND2:TRAC:Y:PDIV 10 DISP:SPEC:VIEW:WIND2:TRAC:Y:PDIV?
Notes:	You must be in the IQ Analyzer (Basic) mode to use this command. Use INSTRument:SElect to set the mode.

Couplings:	When you set a value manually, Auto Scaling automatically changes to Off. When Auto Scaling is turned on, this value is automatically determined by the measurement result.
Preset:	100.0 mV
State Saved:	Saved in instrument state.
Min:	1.00 nV
Max:	20.0 V
Initial S/W Revision:	Prior to A.02.00
Help Map ID:	10009

Internal Preamp

Accesses a menu of keys that control the internal preamps. Turning on the preamp gives a better noise figure, but a reduced TOI to noise floor dynamic range. You can optimize this setting for your particular measurement. The LowBand selection needs to show "(3.0 GHz)" for all versions of the N9000A and "(3.6 GHz)" for the other models.

See [“Internal Preamp” on page 469](#) for more information.

This is only available when the selected input is RF.

Due to available hardware, RF input, Internal Preamp setting is not always available. Currently in the E6607C, the Internal Preamp menu is disabled.

Key Path:	AMPTD Y Scale
Initial S/W Revision:	Prior to A.02.00
Help Map ID:	10061

Ref Position

Allows you to set the reference position to either Top, Ctr (center) or Bottom.

Ref Position (Spectrum)

Allows you to set the spectrum reference position to Top, Ctr (center) or Bottom.

Key Path:	AMPTD Y Scale
Mode:	BASIC
Remote Command:	:DISPlay:SPECTrum:VIEW[1]:WINDow[1]:TRACe:Y[:SCALE]:RPO Sition TOP CENTer BOTTom :DISPlay:SPECTrum:VIEW[1]:WINDow[1]:TRACe:Y[:SCALE]:RPO Sition?

Complex Spectrum Measurement
AMPTD Y Scale

Example:	DISP:SPEC:VIEW:WIND2:TRAC:Y:RPOS CENT DISP:SPEC:VIEW:WIND2:TRAC:Y:RPOS?
Notes:	You must be in the IQ Analyzer (Basic) mode to use this command. Use INSTRUMENT:SELEct to set the mode.
Preset:	TOP
State Saved:	Saved in instrument state.
Range:	Top Ctr Bot
Initial S/W Revision:	Prior to A.02.00
Help Map ID:	I0010

Ref Position (IQ Waveform)

Allows you to set the spectrum reference position to Top, Ctr (center) or Bottom.

Key Path:	AMPTD Y Scale
Mode:	BASIC
Remote Command:	:DISPlay:SPECTrum:VIEW[1]:WINDow2:TRACe:Y[:SCALe]:RPOSi tion TOP CENTer BOTTom :DISPlay:SPECTrum:VIEW[1]:WINDow2:TRACe:Y[:SCALe]:RPOSi tion?
Example:	DISP:SPEC:VIEW:WIND2:TRAC:Y:RPOS TOP DISP:SPEC:VIEW:WIND2:TRAC:Y:RPOS?
Notes:	You must be in the IQ Analyzer (Basic) mode to use this command. Use INSTRUMENT:SELEct to set the mode.
Preset:	CENTer
State Saved:	Saved in instrument state.
Range:	Top Ctr Bot
Initial S/W Revision:	Prior to A.02.00
Help Map ID:	I0011

Auto Scaling

Enables you to toggle the Auto Scaling function between On and Off. Upon pressing the Restart front-panel key or the Restart key under the Meas Control menu, the Auto Scaling function automatically determines the scale per division and reference values based on the measurement results.

Key Path:	AMPTD Y Scale
Mode:	BASIC

Remote Command:	:DISPlay:SPECTrum:VIEW[1]:WINDow[1] 2:TRACe:Y[:SCALe]:COUPle ON OFF 1 0 :DISPlay:SPECTrum:VIEW[1]:WINDow[1] 2:TRACe:Y[:SCALe]:COUPle?
Example:	DISP:SPEC:VIEW:WIND2:TRAC:Y:COUP 0
Notes:	You must be in the IQ Analyzer (Basic) mode to use this command. Use INSTRument:SElect to set the mode.
Couplings:	When you set a value to either Scale/Div or Ref Value manually, Auto Scaling automatically changes to Off. When this value is turned on, Ref Value and Scale/Div are automatically determined by the measurement result.
Preset:	OFF
State Saved:	Saved in instrument state.
Range:	On Off
Initial S/W Revision:	Prior to A.02.00
Help Map ID:	10012

Auto Couple

For information on this key, see [“Auto Couple” on page 473](#).

Key Path:	Front-panel key
Help Map ID:	0

BW

Opens the Bandwidth menu.

Key Path:	Front-panel key
Initial S/W Revision:	Prior to A.02.00
Help Map ID:	I0052

Res BW

Enables you to set the resolution bandwidth setting. This is the resolution bandwidth of the FFT analysis. Changing this value changes the FFT Window size, FFT length and the sweep time (measurement capture length).

If FFT Length Ctrl in the FFT Size menu under Meas Setup, Advanced is set to Manual, the Res BW key is grayed out and shows the resolution bandwidth determined by the FFT Window size.

If the function is auto-coupled, the value setting is ignored.

Key Path:	BW
Mode:	BASIC
Remote Command:	[:SENSe] :SPEctrum:BA NDwidth[:RESolution] <bandwidth> [:SENSe] :SPEctrum:BA NDwidth[:RESolution] ? [:SENSe] :SPEctrum:BA NDwidth[:RESolution] :AUTO ON OFF 1 0 [:SENSe] :SPEctrum:BA NDwidth[:RESolution] :AUTO?
Example:	SPEC:BA ND 100 SPEC:BA ND? SPEC:BA ND:AUTO OFF SPEC:BA ND:AUTO?
Notes:	You must be in the IQ Analyzer (Basic) mode to use this command. Use INSTRument:SElect to set the mode.
Preset:	160 kHz ON
State Saved:	Saved in instrument state.
Min:	0.1 Hz
Max:	3.0 MHz
Backwards Compatibility SCPI:	[:SENSe] :SPEctrum:BWIDth[:RESolution]

Complex Spectrum Measurement
BW

Initial S/W Revision:	Prior to A.02.00
Help Map ID:	I0013

Cont

For information on this key, see “[Cont \(Continuous Measurement/Sweep\)](#)” on page 501.

Key Path:	Front-panel key
Help Map ID:	0

FREQ Channel

For information on this key, see [“FREQ Channel”](#) on page 503.

Key Path:	Front-panel key
Help Map ID:	0

Input/Output

For information on this key, see [“Input/Output” on page 507](#).

Key Path:	Front-panel key
Help Map ID:	0

Marker

Accesses a menu that enables you to set the marker parameters.

Key Path:	Front-panel key
Initial S/W Revision:	Prior to A.02.00
Help Map ID:	I0056

Select Marker

Displays 12 markers available for selection.

Key Path:	Marker
Initial S/W Revision:	Prior to A.02.00
Help Map ID:	I0068

Marker Type

Sets the marker control mode as described under **Normal**, **Delta** and **Off**. All interactions and dependencies detailed under the key description are enforced when the remote command is sent.

Key Path:	Marker
Mode:	BASIC
Remote Command:	:CALCulate:SPECTrum:MARKer [1] 2 3 4 5 6 7 8 9 10 11 12 : MODE POSition DELTA OFF :CALCulate:SPECTrum:MARKer [1] 2 3 4 5 6 7 8 9 10 11 12 : MODE?
Example:	CALC:SPEC:MARK:MODE OFF CALC:SPEC:MARK:MODE?
Notes:	If the selected marker is Off, pressing Marker sets it to Normal and places it at the center of the screen on the trace determined by the Marker Trace rules. At the same time, Marker X Axis Value appears on the Active Function area. Default Active Function: the active function for the selected marker's current control mode. If the current control mode is Off, there is no active function and the active function is turned off. Active Function Display: the marker X axis value entered in the active function area displays the marker value to its full entered precision. You must be in the IQ Analyzer (Basic) mode to use this command. Use INSTrument:SElect to set the mode.
Preset:	OFF

State Saved:	Saved in instrument state.
Range:	Normal Delta Off
Initial S/W Revision:	Prior to A.02.00
Help Map ID:	10031

Marker X Axis Value (Remote Command Only)

Sets the marker X Axis value in the current marker X Axis Scale unit. It has no effect if the control mode is **Off**, but is the SCPI equivalent of entering an X value if the control mode is **Normal** or **Delta**.

Mode:	BASIC
Remote Command:	:CALCulate:SPECTrum:MARKer [1] 2 3 4 5 6 7 8 9 10 11 12 : X <freq> :CALCulate:SPECTrum:MARKer [1] 2 3 4 5 6 7 8 9 10 11 12 : X?
Example:	CALC:SPEC:MARK3:X 100 CALC:SPEC:MARK3:X?
Notes:	If no suffix is sent it uses the fundamental units for the current marker X Axis Scale. If a suffix is sent that does not match the current marker X Axis Scale unit, an error “Invalid suffix” is generated. The query returns the marker’s absolute X Axis value if the control mode is Normal , or the offset from the marker’s reference marker if the control mode is Delta . The query is returned in the fundamental units for the current marker X Axis scale: Hz for Frequency and Inverse Time , seconds for Period and Time . If the marker is Off the response is not a number. You must be in the IQ Analyzer (Basic) mode to use this command. Use INSTRument:SElect to set the mode.
Preset:	After a preset, all markers are turned OFF, so Marker X Axis Value query returns a not a number (NAN).
State Saved:	No
Range:	Depends on X axis range of selected Trace.
Initial S/W Revision:	Prior to A.02.00
Help Map ID:	0

Marker X Axis Position (Remote Command Only)

Sets the marker X position in trace points. It has no effect if the control mode is **Off**, but is the SCPI equivalent of entering a value if the control mode is **Normal** or **Delta** - except in trace points rather than X Axis Scale units. The entered value is immediately translated into the current X Axis Scale units for

Complex Spectrum Measurement
Marker

setting the value of the marker.

Mode:	BASIC
Remote Command:	:CALCulate:SPECTrum:MARKer [1] 2 3 4 5 6 7 8 9 10 11 12 : X:POSition <freq> :CALCulate:SPECTrum:MARKer [1] 2 3 4 5 6 7 8 9 10 11 12 : X:POSition?
Example:	CALC:SPEC:MARK10:X:POS 500 CALC:SPEC:MARK10:X:POS?
Notes:	The query returns the marker's absolute X Axis value in trace points if the control mode is Normal , or the offset from the marker's reference marker in trace points if the control mode is Delta . The value is returned as a real number, not an integer, corresponding to the translation from X Axis Scale units to trace points. If the marker is Off the response is not a number. You must be in the IQ Analyzer (Basic) mode to use this command. Use INSTRument:SElect to set the mode.
Preset:	After a preset, all markers are turned OFF, so Marker X Axis Value query returns a not a number (NAN).
State Saved:	No
Range:	Depends on length of selected Trace.
Initial S/W Revision:	Prior to A.02.00
Help Map ID:	0

Marker Y Axis Value (Remote Command Only)

Returns the marker Y value. Query only.

Mode:	BASIC
Remote Command:	:CALCulate:SPECTrum:MARKer [1] 2 3 4 5 6 7 8 9 10 11 12 : Y?
Example:	CALC:SPEC:MARK11:Y?

Notes:	<p>When the marker is on and MarkerTrace is set to IQ, it returns I and Q values.</p> <p>Case #1 - MarkerTrace SPEC, I or Q: returns a single double value.</p> <pre>>:CALC:SPEC:MARK1:Y? -2.402406506109E+001</pre> <p>Case #2 - MarkerTrace IQ: returns a double array of two values, the first is I, and the second is Q.</p> <pre>>:CALC: SPEC:MARK1:Y? -3.006944493834E-003,+9.9870666467354E-004</pre> <p>The IQ selection is for backward compatibility purposes. It is recommended that the users use the I and/or Q selection instead.</p> <p>You must be in a mode that includes the ComplexSpectrum measurement to use this command. Use INSTRument:SElect to set the mode.</p>
Notes:	You must be in the IQ Analyzer (Basic) mode to use this command. Use INSTRument:SElect to set the mode.
Preset:	Result dependant on markers setup and signal source
State Saved:	No
Backwards Compatibility SCPI:	:CALCulate:SPECTrum:MARKer[1] 2 3 4 5 6 7 8 9 10 11 12:FUNCTion:RESuIt?
Initial S/W Revision:	Prior to A.02.00
Help Map ID:	0

Properties

Accesses a menu used to set certain properties of the selected marker.

Key Path:	Marker
Initial S/W Revision:	Prior to A.02.00
Help Map ID:	10069

Select Marker

Displays 12 markers available for selection.

Key Path:	Marker, Properties
Initial S/W Revision:	Prior to A.02.00
Help Map ID:	Use 10068

Relative To

Selects the marker relative to its reference marker.

Key Path:	Marker, Properties
Mode:	BASIC
Remote Command:	:CALCulate:SPECTrum:MARKer [1] 2 3 4 5 6 7 8 9 10 11 12 : REFerence <integer> :CALCulate:SPECTrum:MARKer [1] 2 3 4 5 6 7 8 9 10 11 12 : REFerence?
Example:	CALC:SPEC:MARK6:REF 8 CALC:SPEC:MARK:REF?
Notes:	A marker cannot be relative to itself so that choice is grayed out, and if sent from SCPI generates error -221: "Settings conflict; marker cannot be relative to itself." When queried a single value is returned (the specified marker numbers relative marker).
Preset:	2 3 4 5 6 7 8 9 10 11 12 1
State Saved:	Saved in instrument state.
Min:	1
Max:	12
Initial S/W Revision:	Prior to A.02.00
Help Map ID:	10049

Marker Trace

Assigns the specified marker to the designated trace.

Key Path:	Marker
Mode:	BASIC
Remote Command:	:CALCulate:SPECTrum:MARKer [1] 2 3 4 5 6 7 8 9 10 11 12 : TRACe SPECTrum ASpectrum I Q IQ :CALCulate:SPECTrum:MARKer [1] 2 3 4 5 6 7 8 9 10 11 12 : TRACe?
Example:	CALC:SPEC:MARK:TRAC SPEC CALC:SPEC:MARK:TRAC?

Notes:	Assigns the specified marker to the designated trace. The IQ selection is for backward compatibility purposes. It is recommended that the users use the I and/or Q selection instead. You must be in a mode that includes the Complex Spectrum measurement to use this command. Use INSTRUMENT:SELEct to set the mode.
Preset:	SPECTrum
State Saved:	Saved in instrument state.
Range:	Spectrum Spectrum Avg I Q IQ
Initial S/W Revision:	Prior to A.02.00
Help Map ID:	I0034

Couple Markers

When this function is true, moving any marker causes an equal X Axis movement of every other marker that is not **Off**. By “equal X Axis movement” we mean that we preserve the difference between each marker’s X Axis value (in the fundamental x-axis units of the trace that marker is on) and the X Axis value of the marker being moved (in the same fundamental x-axis units).

Key Path:	Marker
Mode:	BASIC
Remote Command:	:CALCulate:SPECTrum:MARKer:COUple[:STATe] ON OFF 1 0 :CALCulate:SPECTrum:MARKer:COUple[:STATe]?
Example:	CALC:SPEC:MARK:COUP ON CALC:SPEC:MARK:COUP?
Notes:	You must be in the IQ Analyzer (Basic) mode to use this command. Use INSTRUMENT:SELEct to set the mode.
Preset:	OFF
State Saved:	Saved in instrument state.
Range:	On Off
Initial S/W Revision:	Prior to A.02.00
Help Map ID:	I0035

All Markers Off

Turns off all markers.

Key Path:	Marker
Mode:	BASIC

Remote Command:	:CALCulate:SPECTrum:MARKer:AOff
Example:	CALC:SPEC:MARK:AOff
Notes:	You must be in the IQ Analyzer (Basic) mode to use this command. Use INSTRument:SElect to set the mode.
Initial S/W Revision:	Prior to A.02.00
Help Map ID:	I0036

Backward Compatibility SCPI Commands

Sets or queries the state of a marker. Setting a marker that is OFF to state ON or 1 puts it in Normal mode and places it at the center of the screen.

Mode:	BASIC
Remote Command:	:CALCulate:SPECTrum:MARKer [1] 2 3 4 5 6 7 8 9 10 11 12 : STATE OFF ON 0 1 :CALCulate:SPECTrum:MARKer [1] 2 3 4 5 6 7 8 9 10 11 12 : STATe?
Example:	CALC:SPEC:MARK3:STAT ON CALC:SPEC:MARK3:STAT?
Notes:	You must be in the IQ Analyzer (Basic) mode to use this command. Use INSTRument:SElect to set the mode.
Preset:	OFF
State Saved:	Saved in instrument state.
Range:	On Off
Initial S/W Revision:	Prior to A.02.00
Help Map ID:	0

Marker Function

Opens the Marker Function menu.

Key Path:	Front-panel key
Initial S/W Revision:	Prior to A.02.00
Help Map ID:	10058

Select Marker

Displays 12 markers available for selection.

Key Path:	Marker Function
Initial S/W Revision:	Prior to A.02.00
Help Map ID:	Use 10068

Marker Function Type

Sets the marker control mode as described under **Normal**, **Delta** and **Off**, below. All interactions and dependencies detailed under the key description are enforced when the remote command is sent.

Key Path:	Marker Function
Mode:	BASIC
Remote Command:	:CALCulate:SPECTrum:MARKer[1] 2 3 4 5 6 7 8 9 10 11 12: FUNCTION NOISE BPOWer BDENsity OFF :CALCulate:SPECTrum:MARKer[1] 2 3 4 5 6 7 8 9 10 11 12: FUNCTION?
Example:	CALC:SPEC:MARK:FUNC NOIS CALC:SPEC:MARK:FUNC?
Notes:	You must be in the IQ Analyzer (Basic) mode to use this command. Use INSTRument:SElect to set the mode.
Preset:	OFF
State Saved:	Saved in instrument state.
Range:	Marker Noise Band/Interval Power Band Interval Density Marker Function Off
Initial S/W Revision:	Prior to A.02.00
Help Map ID:	10042

Band Adjust

Opens a menu of keys that allow you to modify the band.

Key Path:	Marker Function
Initial S/W Revision:	Prior to A.02.00
Help Map ID:	I0059

Band/Interval Span for Frequency Domain

Sets the width of the span for the selected marker.

Key Path:	Marker Function, Band Adjust
Mode:	BASIC
Remote Command:	:CALCulate:SPECTrum:MARKer [1] 2 3 4 5 6 7 8 9 10 11 12 : FUNction:BAND:SPAN <freq> :CALCulate:SPECTrum:MARKer [1] 2 3 4 5 6 7 8 9 10 11 12 : FUNction:BAND:SPAN?
Example:	CALC:SPEC:MARK12:FUNC:BAND:SPAN 20MHz CALC:SPEC:MARK12:FUNC:BAND:SPAN?
Notes:	You must be in the IQ Analyzer (Basic) mode to use this command. Use INSTrument:SElect to set the mode.
Couplings:	Changing the Band/Interval Span necessarily changes the Band/Interval Left and Band/Interval Right values
Preset:	10% of Span
State Saved:	Saved in instrument state.
Min:	0
Max:	26.5GHz
Initial S/W Revision:	Prior to A.02.00
Help Map ID:	I0043

Band/Interval Left for Frequency Domain

Sets the left edge frequency or time for the band of the selected marker.

Key Path:	Marker Function, Band Adjust
Mode:	BASIC

Remote Command:	:CALCulate:SPECTrum:MARKer [1] 2 3 4 5 6 7 8 9 10 11 12 : FUNction:BAND:LEFT <freq> :CALCulate:SPECTrum:MARKer [1] 2 3 4 5 6 7 8 9 10 11 12 : FUNction:BAND:LEFT?
Example:	CALC:SPEC:MARK12:FUNC:BAND:LEFT 20GHz CALC:SPEC:MARK12:FUNC:BAND:LEFT?
Notes:	You must be in the IQ Analyzer (Basic) mode to use this command. Use INSTRument:SElect to set the mode.
Couplings:	Changing the Band/Interval Left necessarily changes the Band/Interval Span and Band/Interval Right values
Preset:	5% of Span
State Saved:	Saved in instrument state.
Min:	0
Max:	26.5GHz
Initial S/W Revision:	Prior to A.02.00
Help Map ID:	10044

Band/Interval Right for Frequency Domain

Sets the right edge frequency or time for the band of the selected marker.

Key Path:	Marker Function, Band Adjust
Mode:	BASIC
Remote Command:	:CALCulate:SPECTrum:MARKer [1] 2 3 4 5 6 7 8 9 10 11 12 : FUNction:BAND:RIGHT <freq> :CALCulate:SPECTrum:MARKer [1] 2 3 4 5 6 7 8 9 10 11 12 : FUNction:BAND:RIGHT?
Example:	CALC:SPEC:MARK12:FUNC:BAND:RIGH 20GHz CALC:SPEC:MARK12:FUNC:BAND:RIGH?
Notes:	You must be in the IQ Analyzer (Basic) mode to use this command. Use INSTRument:SElect to set the mode.
Couplings:	Changing the Band/Interval Right necessarily changes the Band/Interval Left and Band/Interval Span values
Preset:	5% of Span
State Saved:	Saved in instrument state.
Min:	0
Max:	26.5GHz

Complex Spectrum Measurement
Marker Function

Initial S/W Revision:	Prior to A.02.00
Help Map ID:	I0045

Marker To

Accesses menu keys that can copy the current marker value into another instrument parameter (for example, Center Freq). If the currently selected marker is not on when you press this front panel key, it is turned on at the center of the screen as a normal marker.

Key Path:	Front-panel key
Initial S/W Revision:	Prior to A.02.00
Help Map ID:	10057

Mkr -> CF

Sets the center frequency to the frequency of the selected marker. The marker stays at this frequency, so it moves to the center of the display.

Key Path:	Marker ->
Mode:	BASIC
Remote Command:	:CALCulate:SPECTrum:MARKer [1] 2 3 4 5 6 7 8 9 10 11 12 [:SET] :CENTer
Example:	CALC:SPEC:MARK4:CENT
Notes:	In the delta marker mode, this function sets the center frequency to the x-axis value of the delta marker. If the currently selected marker is not on when this key is pressed, it is turned on at the center of the screen as a normal type marker. You must be in the IQ Analyzer (Basic) mode to use this command. Use INSTRument:SElect to set the mode.
Dependencies:	This key is not available (grayed out) when the selected marker is not on the spectrum trace.
Initial S/W Revision:	Prior to A.02.00
Help Map ID:	10040

Mkr -> Ref Lvl

Sets the reference level to the amplitude value of the selected marker, moving the marked point to the reference level (top line of the graticule).

Key Path:	Marker ->
Mode:	BASIC
Remote Command:	:CALCulate:SPECTrum:MARKer [1] 2 3 4 5 6 7 8 9 10 11 12 [:SET] :RLEVel

Complex Spectrum Measurement
Marker To

Example:	CALC:SPEC:MARK4:RLEV
Notes:	<p>Make the Marker Y value to the display reference value. If the currently selected marker is not on when this key is pressed, it is turned on at the center of the screen as a normal type marker, and its amplitude applied to the reference value.</p> <p>You must be in the IQ Analyzer (Basic) mode to use this command. Use INSTRument:SElect to set the mode.</p>
Initial S/W Revision:	Prior to A.02.00
Help Map ID:	10041

Meas

See “Meas” on page 627 for information on this key.

Key Path:	Front-panel key
Help Map ID:	0

Meas Setup

Opens the menu that allows you to set up the measurement parameters.

Key Path:	Front-panel key
Initial S/W Revision:	Prior to A.02.00
Help Map ID:	I0053

Avg/Hold Num

Sets the number of ‘sweeps’ that are averaged. After the specified number of ‘sweeps’ (average counts), the averaging mode (terminal control) setting determines the averaging action.

Key Path:	Meas Setup
Mode:	BASIC
Remote Command:	[:SENSe] :SPECTrum:AVERAge:COUNT <integer> [:SENSe] :SPECTrum:AVERAge:COUNT? [:SENSe] :SPECTrum:AVERAge [:STATe] ON OFF 1 0 [:SENSe] :SPECTrum:AVERAge [:STATe] ?
Example:	SPEC:AVER:COUN 10 SPEC:AVER:COUN? SPEC:AVER 0 SPEC:AVER?
Notes:	You must be in the IQ Analyzer (Basic) mode to use this command. Use INSTRument:SElect to set the mode.
Preset:	25 ON
State Saved:	Saved in instrument state.
Min:	1
Max:	20001
Initial S/W Revision:	Prior to A.02.00
Help Map ID:	I0014

Avg Mode

Selects the type of termination control used for the averaging function. This determines the averaging action after the specified number of sweeps (average count) is reached.

EXPOnential - Each successive data acquisition after the average count is reached, is exponentially weighted and combined with the existing average.

REPeat - After reaching the average count, the averaging is reset and a new average is started.

Key Path:	Meas Setup
Mode:	BASIC
Remote Command:	[:SENSE] :SPECTrum:AVERage:TCONtrol EXPOnential REPeat [:SENSE] :SPECTrum:AVERage:TCONtrol?
Example:	SPEC:AVER:TCON REP SPEC:AVER:TCON?
Notes:	You must be in the IQ Analyzer (Basic) mode to use this command. Use INSTRument:SElect to set the mode.
Preset:	EXPOnential
State Saved:	Saved in instrument state.
Range:	Exp Repeat
Initial S/W Revision:	Prior to A.02.00
Help Map ID:	I0015

Avg Type

Allows you to select the type of averaging.

- Pwr Avg (RMS) - The power is averaged, providing the rms of the voltage.LOG
- Log Pwr Avg (Video) - The log of the power is averaged.
- Voltage Avg - The voltage is averaged.
- Maximum - The maximum values are retained.
- Minimum - The minimum values are retained.

Key Path:	Meas Setup
Mode:	BASIC
Remote Command:	[:SENSE] :SPECTrum:AVERage:TYPE RMS LOG SCALar MAXimum MINimum [:SENSE] :SPECTrum:AVERage:TYPE?
Example:	SPEC:AVER:TYPE MIN SPEC:AVER:TYPE?

Notes:	You must be in the IQ Analyzer (Basic) mode to use this command. Use INSTRument:SElect to set the mode. Pwr Avg (RMS) = RMS Log Pwr Avg (Video) = LOG Voltage Avg = SCALar Maximum = MAXimum Minimum = MINimum
Preset:	LOG
State Saved:	Saved in instrument state.
Range:	Pwr Avg(RMS) Log-Pwr Avg(Video) Voltage Avg Maximum Minimum
Initial S/W Revision:	Prior to A.02.00
Help Map ID:	I0016

HW Averaging

Changes the number of time averages is to be made using hardware. This averaging is much faster than the standard averaging done in software. The hardware averaging is done on the complex voltage time trace data before any measurement application averaging is done. Both types of averaging (HW and SW) can be done on the same measurement data.

When time averaging is being done in HW, each trace update represents N fresh data acquisitions averaged together, where N is the number of averages. You cannot access the individual time data. Note that in the spectrum measurement this averaging is done prior to the standard averaging done within the application. Thus the yellow trace in this measurement shows the result of the time averaging. Subsequent averaging is orthogonal to this hardware based time averaging and its result is seen as the blue trace in this and other applications.

So it is possible to turn off the averaging within the application but still have the HW averaging set to a certain number. In another words, turning averaging off within the measurement will not affect HW averaging. If HW averaging needs to be turned off, simply set the HW Averaging parameter to 1.

Since it is time averaging, a trigger source something other than Free Run should be used to avoid cancelling out the signal to be measured. It is most useful for a periodic signal with known periods.

Time Avg Num

Sets the number of HW averages to be executed per data acquisition.

Key Path:	Meas Setup
Mode:	BASIC
Remote Command:	[:SENSE] :SPECTrum:AVERage:TACount <integer> [:SENSE] :SPECTrum:AVERage:TACount?
Example:	SPEC:AVER:TAC 10 SPEC:AVER:TAC?

Notes:	Not available when using Option B25.
Dependencies:	This feature is only available with Pxa or when Option B40 is installed.
Preset:	1
State Saved:	Saved in instrument state.
State Saved:	Saved in state
Min:	1
Max:	65535
Default Unit:	Enter
Help Map ID:	10070

PhNoise Opt

Selects the LO (local oscillator) phase noise behavior for various desired operating conditions.

Remote Command:	[:SENSe] :SPECtrum:FREQUency:SYNThesis [:STATe] 1 2 3 [:SENSe] :SPECtrum:FREQUency:SYNThesis [:STATe] ?
Example:	SPEC:FREQ:SYNT 2 Selects optimization for best wide offset phase noise
Notes:	Parameter: <ol style="list-style-type: none"> 1 optimizes phase noise for small frequency offsets from the carrier. 2 optimizes phase noise for wide frequency offsets from the carrier. 3 optimizes LO for tuning speed (In PXA, the local oscillator hardware provides for extra-low phase noise at the expense of some speed)
Dependencies:	Does not appear in all models. The key is blank in those models, but the SCPI command is accepted for compatibility (although no action is taken).
Preset:	Because this function is in Auto after preset, and because Span after preset > 400 kHz (see Auto rules, next section) the state of this function after Preset will be 2
State Saved:	Saved in instrument state.
Min:	1
Max:	3
Initial S/W Revision:	Prior to A.07.00
Modified at S/W Revision:	A.07.00
Help Map ID:	10085

Auto

Selects the LO (local oscillator) phase noise behavior to optimize dynamic range and speed for various instrument operating conditions.

The X-Series has two grades of LO; a high performance LO that gives the best phase noise performance; and a medium-performance LO that gives excellent performance.

In models with the high performance LO, Auto will choose:

	Best Close in Phase Noise	Best Wide-offset Phase Noise
Span	400 kHz	>400 kHz

In models with the medium-performance LO, Auto will choose:

	Best Close in Phase Noise	Best Wide-offset Phase Noise
Span	150 kHz	>150 kHz

Note that Fast Tuning will not be selected when in Auto.

Key Path:	Meas Setup, PhNoise Opt
Remote Command:	[:SENSe] :SPECtrum:FREQuency:SYNThesis:AUTO [:STATE] OFF ON 0 1 [:SENSe] :SPECtrum:FREQuency:SYNThesis:AUTO [:STATE] ?
Example:	SPEC:FREQ:SYNT:AUTO ON
Preset:	ON
State Saved:	Saved in instrument state.
Initial S/W Revision:	Prior to A.07.00
Help Map ID:	I0082

Best Close-in P Noise

The LO phase noise is optimized for smaller offsets from the carrier, at the expense of phase noise farther out.

Key Path:	Meas Setup, PhNoise Opt
Example:	SPEC:FREQ:SYNT 1

Couplings:	The frequency below which the phase noise is optimized is model dependent: CXA: n/a EXA: [offset 150 kHz] MXA: [offset 150 kHz] PXA: [offset 400 kHz]
Readback:	Close-in. If manually selected the “Man” will be underlined. The actual frequency offset within which noise is optimized is shown with in square brackets, as this can vary depending on the hardware set in use. For example, in some analyzers this annotation appears as [offset <140 kHz]
Initial S/W Revision:	Prior to A.07.00
Help Map ID:	10083

Best Wide-offset P Noise

The LO phase noise is optimized for wider offsets from the carrier. Closer offsets are compromised and the throughput of measurements (especially remote measurements where the center frequency is changing rapidly), is reduced.

Key Path:	Meas Setup, PhNoise Opt
Example:	SPEC:FREQ:SYNT 2
Couplings:	The frequency below which the phase noise is optimized is model dependent: CXA: n/a EXA: [offset >150 kHz] MXA: [offset >150 kHz] PXA: [offset >400 kHz]
Readback:	Wide-offset. If manually selected the “Man” will be underlined. The actual frequency offset beyond which noise is optimized is shown with in square brackets, as this can vary depending on the hardware set in use. For example, in some analyzers this annotation appears as [offset >160 kHz]
Initial S/W Revision:	Prior to A.07.00
Help Map ID:	10084

Fast Tuning

In this mode, the LO behavior compromises phase noise at many offsets from the carrier in order to allow rapid measurement throughput when changing the center frequency. The term “fast tuning” refers to the time it takes to move the local oscillator to the start frequency and begin a capture; this setting does

Complex Spectrum Measurement

Meas Setup

not impact the actual measurement time in any way.

Key Path:	Meas Setup, PhNoise Opt
Example:	SPEC:FREQ:SYNT 3
State Saved:	Saved in instrument state.
Readback:	Fast Tuning. If manually selected the “Man” will be underlined.
Initial S/W Revision:	Prior to A.07.00
Help Map ID:	I0098

Meas Preset

Returns all measurement local parameters to the factory default values.

Key Path:	Meas Setup
Mode:	BASIC
Remote Command:	:CONFigure:SPECTrum
Example:	CONF:SPEC
Notes:	You must be in the IQ Analyzer (Basic) mode to use this command. Use INSTRument:SElect to set the mode.
Initial S/W Revision:	Prior to A.02.00
Help Map ID:	I0029

Advanced

Opens a menu of advanced settings for the complex spectrum measurement.

Key Path:	Meas Setup
Initial S/W Revision:	Prior to A.02.00
Help Map ID:	I0054

Filter Type

This parameter allows you to select the type of IF filter (post ADC, digital filter) that is used. This is an advanced control that normally does not need to be changed.

Key Path:	Meas Setup, Advanced
Mode:	BASIC

Remote Command:	[:SENSE] :SPECTrum:DIF:FILTer:TYPE GAUSSian FLATtop SNYQuist RSNYquist RCOSine RRCosine [:SENSE] :SPECTrum:DIF:FILTer:TYPE?
Example:	SPEC:DIF:FILT:TYPE GAUS SPEC:DIF:FILT:TYPE?
Dependencies:	Gaussian and Flattop are available in all DIF configurations. For the other filter types, the filters are only available with Pxa or when Option B40 is installed.
Couplings:	Based on the DIF board and the IF Path Selection parameter which is described in the table above.
Preset:	FLAT
State Saved:	Saved in instrument state.
Range:	Gaussian Flattop (With Digital IF and/or Option B40 or B1X) Gaussian Flattop Short nyquist Root Short Nquist Raised Cosine Root RaisedCosine
Backwards Compatibility SCPI:	[:SENSe]:SPECTrum:BANDwidth:PPFT:TYPE [:SENSe]:SPECTrum:BWIDth:PPFT:TYPE [:SENSe]:SPECTrum:BANDwidth BWIDth:IF:SHAPE
Initial S/W Revision:	Prior to A.02.00
Help Map ID:	10017

Remote Command:	[:SENSE] :SPECTrum:WBIF:FILTer [:TYPE] GAUSSian NONE NYQuist RNYQuist RCOSine RRCosine [:SENSE] :SPECTrum:WBIF:FILTer [:TYPE] ?
Help Map ID:	0

Digital IF BW

Allows you to select the type of IF filter (post ADC, digital filter) that is used. This is an advanced control that normally does not need to be changed.

The Digital IF bandwidth is determined from the Span. The Digital IF BW and Span relation is determined by the following formula.

$$\text{Digital IF BW} = \text{Span} \times 1.5$$

This equation holds except for the case when only the value is clipped to the max value. Furthermore, when Pxa or Option B40 is installed, continuous bandwidth setting is possible. For any other configuration, only fixed bandwidth values are available and quantizing the bandwidth values becomes necessary.

Complex Spectrum Measurement

Meas Setup

()

Continuous bandwidth setting is available in this configuration. Hence the theoretical coupling equation above with span is used in all cases except when the bandwidth reaches the maximum value, which in this case, is clipped to the maximum value.

Note that if the Digital IF BW state is set to Man and not Auto, any value greater than the Span is settable.

There are coupling dependencies with the IF Path Selection parameter. The IF Path Selection determines the maximum value and maximum resolution values. For instance, even with the B40 and B1X options installed on a PXA, if the IF Path Selection is set to 25 MHz with the IF Path Auto set OFF, the maximum bandwidth value will be clipped to 25 MHz.

()

The Digital IF BW parameter directly sets the digital IF filter bandwidth, which can only be set to certain fixed discrete values. Thus, the theoretical value of the Digital IF bandwidth will be derived first. Then the closest discrete bandwidth value will be selected from the filter table.. The exception is 25 MHz where, if the theoretical value exceeds 10 MHz, the 25 MHz bandwidth will automatically be selected.

For example, if you set the Span to 2.9 MHz and 3.0 MHz, the theoretical Digital IF BW value will be as follows.

$$\text{Digital IF Bw} = (2.9 \text{ MHz}) \times 1.5 = 4.35 \text{ MHz}$$

$$\text{Digital IF Bw} = (3.0 \text{ MHz}) \times 1.5 = 4.5 \text{ MHz}$$

If you have the Flattop filter selected, only 4 MHz and 5 MHz bandwidths are available. For in-between values, the next widest possible value is selected. In this case, both 4.35 MHz and 4.5 MHz are rounded to 5 MHz.

Key Path:	Meas Setup, Advanced
Mode:	BASIC
Remote Command:	[:SENSe]:SPECTrum:DIF:BANDwidth <freq> [:SENSe]:SPECTrum:DIF:BANDwidth? [:SENSe]:SPECTrum:DIF:BANDwidth:AUTO ON OFF 1 0 [:SENSe]:SPECTrum:DIF:BANDwidth:AUTO?
Example:	SPEC:DIF:BAND 1MHz SPEC:DIF:BAND? SPEC:DIF:BAND:AUTO 0 SPEC:DIF:BAND:AUTO?
Notes:	You must be in the IQ Analyzer (Basic) mode to use this command. Use INSTRument:SElect to set the mode.

Dependencies:	<p>For applications that have the IF Path Selection menu such as the BASIC mode, if IF Path Auto is OFF, the maximum value depends on which IF Path is currently selected. If 10 MHz, 25 MHz, 40 MHz, 140 MHz or 160 MHz paths are selected, the maximum value of this parameter will be 10,25,40, 140 or 160 MHz respectively. If IF Path Auto is ON, the maximum value will be the maximum Digital IF BW available in the instrument regardless of the current IF Path Selection. For example, say that the instrument had the options B25, B40 and B1X installed. Clearly the maximum available Digital IF BW of the instrument is 140 MHz. Thus if IF Path Auto is ON and IF Path Selection is B25M, the maximum Digital IF BW is not limited to 25 MHz but is 140 MHz.</p>
Couplings:	<p>The bandwidth of the IF Filter is coupled to the span by the following equations.</p> <p>Digital IF BW = Span * 1.5</p> <p>()</p> <p>Digital IF BW = Span * 1.5</p> <p>is used as is, since continuous bandwidths are allowed.</p> <p>()</p> <p>Since the Digital IF BW can only be set to discrete values, Digital IF BW is not always set by the exact value above.</p> <p>If the HW cannot set to the exact value of the requested Digital IF BW, it uses “the next wider bandwidth value” available.</p> <p>For instance, a Digital IF BW requested to be set at 3.01 MHz is quantized to 3.1 MHz in the UI and hardware.</p>
Preset:	<p>Hardware Dependent:</p> <p>No Option = 10.0 MHz</p> <p>Option B25 = 25.0 MHz</p> <p>Option B40 and/or B1X = 12.0 MHz</p>
State Saved:	<p>Saved in instrument state.</p>
Min:	<p>10 Hz</p>

Complex Spectrum Measurement
Meas Setup

Max:	<p>Hardware Dependent:</p> <p>RF Input:</p> <p>No Option = 10 MHz</p> <p>Option B25 = 25 MHz</p> <p>Option B40 = 40.0 MHz</p> <p>Option B1X = 140.0 MHz</p> <p>Option B1Y = 160.0 MHz</p> <p>I/Q Input:</p> <p>No Option = 10 MHz per channel (20 MHz for I+jQ)</p> <p>Option B25 = 25 MHz per channel (50 MHz for I+jQ)</p> <p>Option S40 = 40 MHz per channel (80 MHz for I+jQ)</p>
Backwards Compatibility SCPI:	<p>[[:SENSE]:SPECTrum:BANDwidth:PFFT[:SIZE]</p> <p>[[:SENSE]:SPECTrum:BWIDth:PFFT[:SIZE]</p> <p>[[:SENSE]:SPECTrum:BANDwidth BWIDth:IF[:SIZE]</p>
Initial S/W Revision:	Prior to A.02.00
Help Map ID:	10018

Sample Rate (Remote Command Only)

Sample rate is not arbitrarily configurable for the Complex Spectrum measurement since everything from Span, IF BW, Window length and FFT length is affected. Thus there is no soft key menu and SCPI is query only. If you need to set an arbitrary sample rate, you will need to use the Waveform measurement.

Mode:	BASIC
Remote Command:	[[:SENSE]:SPECTrum:SRATe?
Example:	SPEC:SRAT?
Notes:	SCPI only and query only.
Dependencies:	Depends on the Digital IF BW value
State Saved:	No
Min:	12.5 Hz
Max:	<p>Default: 45 MHz</p> <p>Option B40: 50 MHz</p> <p>Option B1X: 175 MHz</p> <p>Option B1Y: 200 MHz</p>
Help Map ID:	0

Filter Bandwidth

This is only available with Pxa or when Option B40 is installed.

Key Path:	Meas Setup, Advanced
Mode:	BASIC
Remote Command:	[:SENSE] :SPECTrum:DIF:FILTer:BA NDwidth <freq> [:SENSE] :SPECTrum:DIF:FILTer:BA NDwidth? [:SENSE] :SPECTrum:DIF:FILTer:BA NDwidth:AUTO ON OFF 1 0 [:SENSE] :SPECTrum:DIF:FILTer:BA NDwidth:AUTO?
Example:	SPEC:DIF:FILT:BA ND 1MHz SPEC:DIF:FILT:BA ND? SPEC:DIF:FILT:BA ND:AUTO 0 SPEC:DIF:FILT:BA ND:AUTO?
Notes:	You must be in the IQ Analyzer (Basic) mode to use this command. Use INSTRument:SElect to set the mode.
Dependencies:	This feature is only available with Pxa or when Option B40 is installed.
Couplings:	Sets the same value as the current Digital IF BW value upon a preset or when Channel Filter Bandwidth Auto is ON.
Preset:	Same value as Digital IF Bw ON
State Saved:	Saved in instrument state.
Min:	10 Hz
Max:	Clipped to the current Digital IF Bw value.
Help Map ID:	10072

Channel Filter Bandwidth Bwcc (Remote Command Only)

This is the backward compatibility command for Filter Bandwidth.

Mode:	BASIC
Remote Command:	[:SENSE] :SPECTrum:WBIF:FILTer:BA NDwidth <real> [:SENSE] :SPECTrum:WBIF:FILTer:BA NDwidth?
Example:	SPEC:WBIF:FILT:BA ND 0.3 SPEC:WBIF:FILT:BA ND?
Notes:	You must be in the IQ Analyzer (Basic) mode to use this command. Use INSTRument:SElect to set the mode.
Dependencies:	This feature is only available with Pxa or when Option B40 is installed.

Complex Spectrum Measurement
Meas Setup

Couplings:	The value is determined by the following equation. $\text{ChannelFilterBwBwcc} = \frac{\text{ChannelFilterBw}}{(\text{DigitalIFBw} * \text{OverSampleRatio})}$
Preset:	0.8
State Saved:	Saved in instrument state.
Min:	0.01
Max:	1.0
Help Map ID:	0

Channel Filter Alpha

Sets the filter alpha for the DIF filter. This feature is only available with Pxa or when Option B40 is installed.

Key Path:	Meas Setup, Advanced
Mode:	BASIC
Remote Command:	[:SENSe] :SPECTrum:DIF:FILTer:ALPHa <real> [:SENSe] :SPECTrum:DIF:FILTer:ALPHa?
Example:	SPEC:DIF:FILT:ALPH 0.5 SPEC:DIF:FILT:ALPH?
Notes:	You must be in the IQ Analyzer (Basic) mode to use this command. Use INSTRument:SElect to set the mode.
Dependencies:	This feature is only available with Pxa or when Option B40 is installed.
Couplings:	Disabled when not using the DIF40 or WBDIF boards.
Preset:	0.2
State Saved:	Saved in instrument state.
Min:	0.01
Max:	1.00
Backwards Compatibility SCPI:	[:SENSe] :SPECTrum:WBIF:FILTer:ALPHa
Help Map ID:	I0071

FFT Window

Opens a menu that enables you to choose one of the available FFT filtering windows.

Key Path:	Meas Setup, Advanced
Mode:	BASIC

Remote Command:	[:SENSE] :SPECTrum:FFT:WINDow [:TYPE] FLATtop UNIFORM HANNing HAMMING GAUSSian BLACKman BH4Tap KB70 KB90 KB110 [:SENSE] :SPECTrum:FFT:WINDow [:TYPE] ?
Example:	SPEC:FFT:WIND KB90 SPEC:FFT:WIND?
Notes:	This selection affects the acquisition point quantity and the FFT size, based on the resolution bandwidth selected. You must be in the IQ Analyzer (Basic) mode to use this command. Use INSTRument:SElect to set the mode.
Preset:	FLATtop
State Saved:	Saved in instrument state.
Range:	Flat Top (High AmptdAcc) Uniform Hanning Hamming Gaussian (Alpha3.5) Blackman Blackman-Harris K-B 70 dB (Kaiser-Bessel) K-B 90 dB (Kaiser-Bessel) K-B 110 dB (Kaiser-Bessel)
Initial S/W Revision:	Prior to A.02.00
Help Map ID:	10019

FFT Size

Opens a menu that enables you to set the FFT or window length parameters.

Key Path:	Meas Setup, Advanced
Initial S/W Revision:	Prior to A.02.00
Help Map ID:	10055

Length Ctrl

Length Ctrl (Man) enables control of the FFT window or length settings. Press Length Ctrl (Auto) to disable the FFT window or length settings. This setting is directly coupled to the Res BW as follows: Enabling Length Ctrl disables the Res BW, while disabling Length Ctrl allows Res BW control.

Key Path:	Meas Setup, Advanced, FFT Size
Mode:	BASIC
Remote Command:	[:SENSE] :SPECTrum:FFT:LENGth:AUTO ON OFF 1 0 [:SENSE] :SPECTrum:FFT:LENGth:AUTO?
Example:	SPEC:FFT:LENG:AUTO 0 SPEC:FFT:LENG:AUTO?
Notes:	You must be in the IQ Analyzer (Basic) mode to use this command. Use INSTRument:SElect to set the mode.

Complex Spectrum Measurement
Meas Setup

Preset:	ON
State Saved:	Saved in instrument state.
Range:	Auto Man
Initial S/W Revision:	Prior to A.02.00
Help Map ID:	I0020

Min Pnts/RBW

Sets the minimum number of data points that are used inside the resolution bandwidth. The value is ignored if the length control is set to manual. This is an advanced control that normally does not need to be changed.

Key Path:	Meas Setup, Advanced, FFT Size
Mode:	BASIC
Remote Command:	[:SENSE] :SPECTrum:FFT:RBWPoints <real> [:SENSE] :SPECTrum:FFT:RBWPoints?
Example:	SPEC:FFT:RBWP 0.5 SPEC:FFT:RBWP?
Notes:	You must be in the IQ Analyzer (Basic) mode to use this command. Use INSTRument:SElect to set the mode.
Preset:	3.1
State Saved:	Saved in instrument state.
Min:	0.1
Max:	100
Initial S/W Revision:	Prior to A.02.00
Help Map ID:	I0021

Window Length

Sets the FFT window length. This value is only used if the length control is set to manual. This is an advanced control that normally does not need to be changed.

The “points” is the number of points for IQ pairs. For example, if the Window Length is set to 10, it means the window length is for 10 I and 10 Q points. Not 5 I and 5 Q points.

Key Path:	Meas Setup, Advanced, FFT Size
Mode:	BASIC
Remote Command:	[:SENSE] :SPECTrum:FFT:WINDow:LENGth <integer> [:SENSE] :SPECTrum:FFT:WINDow:LENGth?

Example:	SPEC:FFT:WIND:LENG 100 SPEC:FFT:WIND:LENG?
Notes:	You must be in the IQ Analyzer (Basic) mode to use this command. Use INSTRument:SElect to set the mode.
Dependencies:	Grayed out when Length Ctrl is set to Man.
Preset:	1694
State Saved:	Saved in instrument state.
Min:	8
Max:	1048576
Initial S/W Revision:	Prior to A.02.00
Help Map ID:	10022

FFT Length

Enables you to set the FFT length. This value is only used if the length control is set to manual. The value must be greater than or equal to the window length value. Any amount greater than the window length is implemented by zero padding. This is an advanced control that normally does not need to be changed.

The “points” is the number of points for IQ pairs. For example, if the Window Length is set to 10, it means the window length is for 10 I and 10 Q points. Not 5 I and 5 Q points.

Key Path:	Meas Setup, Advanced, FFT Size
Mode:	BASIC
Remote Command:	[:SENSe] :SPECTrum:FFT:LENGth <integer> [:SENSe] :SPECTrum:FFT:LENGth?
Example:	SPEC:FFT:LENG 566 SPEC:FFT:LENG?
Notes:	You must be in the IQ Analyzer (Basic) mode to use this command. Use INSTRument:SElect to set the mode.
Dependencies:	Grayed out when Length Ctrl is set to Man.
Preset:	2048
State Saved:	Saved in instrument state.
Min:	8
Max:	131072
Initial S/W Revision:	Prior to A.02.00
Help Map ID:	10023

ADC Dither

Opens the ADC Dither menu.

Key Path:	Meas Setup, Advanced
Initial S/W Revision:	Prior to A.02.00
Help Map ID:	10073

ADC Dither Auto

Toggles automatic ADC dither on or off.

Key Path:	Meas Setup, Advanced, ADC Dither
Mode:	BASIC
Remote Command:	[:SENSe] :SPEctrum:ADC:DITHer:AUTO [:STATe] ON OFF 1 0 [:SENSe] :SPEctrum:ADC:DITHer:AUTO [:STATe] ?
Example:	SPEC:ADC:DITH:AUTO 0 SPEC:ADC:DITH:AUTO?
Notes:	You must be in the IQ Analyzer (Basic) mode to use this command. Use INSTRUMENT:SElect to set the mode.
Preset:	ON
State Saved:	Saved in instrument state.
Range:	Auto Man
Initial S/W Revision:	Prior to A.02.00
Help Map ID:	10024

ADC Dither State

Turn the ADC dither on or off. The “ADC dither” function refers to the introduction of noise to the digitized steps of the analog-to-digital converter, to improve amplitude accuracy.

This is an advanced control that normally does not need to be changed.

Key Path:	Meas Setup, Advanced, ADC Dither
Mode:	BASIC
Remote Command:	[:SENSe] :SPEctrum:ADC:DITHer [:STATe] ON OFF 1 0 [:SENSe] :SPEctrum:ADC:DITHer [:STATe] ?
Example:	SPEC:ADC:DITH 0 SPEC:ADC:DITH?

Notes:	You must be in the IQ Analyzer (Basic) mode to use this command. Use INSTRUMENT:SELEct to set the mode.
Preset:	OFF
State Saved:	Saved in instrument state.
Range:	On (Best Log Accy) Off (Best Noise)
Initial S/W Revision:	Prior to A.02.00
Help Map ID:	10025

IF Gain

Accesses the keys to select the IF Gain settings.

When in Autorange mode, the IF checks its range once for data acquisition, to provide the best signal to noise ratio. You can specify the range for the best speed, and optimize for noise or for large signals.

When the IF Gain is set to Autorange, the IF Gain is set to High initially for each chunk of data. The data is then acquired. If the IF overloads, then the IF Gain is set to Low and the data is re-acquired. Because of this operation, the Autorange setting uses more measurement time as the instrument checks/resets its range. You can get faster measurement speed by forcing the range to either the high or low gain setting. But you must know that your measurement conditions will not overload the IF (in the high gain range) and that your signals are well above the noise floor (for the low gain range), and that the signals are not changing.

When Digital Bus Out (under the Input/Output menu) is on, the IF Gain State Autorange selection is not allowed. Thus, in this case, IF Gain State will be set to Low.

This only applies to the RF input. It does not apply to baseband I/Q input.

Key Path:	Meas Setup, Advanced
Initial S/W Revision:	Prior to A.02.00
Help Map ID:	10074

IF Gain Auto

Returns manually selected IF Gain settings to the auto (default) setting.

Key Path:	Meas Setup, Advanced, IF Gain
Mode:	BASIC
Remote Command:	[:SENSE] :SPECTrum:IF:GAIN:AUTO[:STATe] ON OFF 1 0 [:SENSE] :SPECTrum:IF:GAIN:AUTO[:STATe] ?
Example:	SPEC:IF:GAIN:AUTO ON SPEC:IF:GAIN:AUTO?

Notes:	This only applies to the RF input. It does not apply to baseband I/Q input. You must be in the IQ Analyzer (Basic) mode to use this command. Use INSTRUMENT:SELEct to set the mode.
Preset:	ON
State Saved:	Saved in instrument state.
Range:	On Off
Initial S/W Revision:	Prior to A.02.00
Help Map ID:	10026

IF Gain State

Allows you to optimize IF Gain for specific signals or signal levels.

Key Path:	Meas Setup, Advanced, IF Gain
Mode:	BASIC, PN, WCDMA, C2K, 1XEVD0, GSM
Remote Command:	[:SENSE] :SPECTrum:IF:GAIN [:STATe] AUTOrange LOW HIGH [:SENSE] :SPECTrum:IF:GAIN [:STATe] ?
Example:	SPEC:IF:GAIN HIGH SPEC:IF:GAIN?
Notes:	This only applies to the RF input. It does not apply to baseband I/Q input. You must be in the IQ Analyzer (Basic) mode to use this command. Use INSTRUMENT:SELEct to set the mode. If the user tries to select Autorange via SCPI while Digital Bus Out is ON, an error message –224, "Illegal parameter value; "IF Gain Autorange not allowed when Digital Bus Out is on" is displayed. If the user tries to select Autorange via front panel while Digital Bus Out is ON, an advisory message "IF Gain Autorange not allowed when Digital Bus Out is on" is displayed.
Couplings:	If the “Bus Out” key under the Input/Output menu is ON, then IF Gain Autorange is not allowed and is grayed out. If the current selection is Autorange when “Bus Out” turns ON, then it is forced to Low. If the current selection is either Low or High when “Bus Out” turns ON, then the selection is maintained and the Autorange key is grayed out.
Preset:	LOW
State Saved:	Saved in instrument state.
Range:	Autorange (Slower Follows Signals) Low (Best for Large Signals) High (Best Noise Level)
Readback Text:	Autorange Low High

Initial S/W Revision:	Prior to A.02.00
Help Map ID:	10027

IF Gain Offset

Sets the IF Gain offset for the 40MHz, 140MHz, 160MHz IF Paths in 2 dB step from -6 dB to +6 dB. Increasing the gain can increase the amplitude of small signals as long as you don't overdrive the hardware. Wideband gain should usually be adjusted after setting the input attenuation.

Internally, the IF Gain value will change based on the current configuration of the HW. If the user chooses to offset this value, they may do so with this parameter. Hence the value specified is not an absolute value but relative to the current internal IF Gain setting.

For example:

IF Gain Low + IF Gain Offset +4dB = Total IF Gain of +4dB ($0 + 4 = 4$)

IF Gain High + IF Gain Offset +4 dB = Total IF Gain of +14dB ($10 + 4 = 14$)

IF Gain Low + IF Gain Offset -6dB = Total IF Gain of -6dB ($0 - 6 = -6$)

IF Gain High + IF Gain Offset -6dB = Total IF Gain of +6dB ($10 - 6 = 4$)

Thus the total IF Gain range when IF Gain Offset is available is a minimum of $0 - 6 = -6$ dB and a maximum of $10 + 6 = 16$ dB. The available IF Gain depends on the IF Path and center frequency. The maximum IF Gain may not be achievable at all times depending on the configuration.

Key Path:	Meas Setup, Advanced
Remote Command:	[:SENSe] :SPECTrum:IF:GAIN:OFFSet <rel_ampl> [:SENSe] :SPECTrum:IF:GAIN:OFFSet?
Example:	SPEC:IF:GAIN:OFFS 2 Sets the IF Gain offset to 2
Preset:	0
State Saved:	Saved in instrument state
Min:	-6
Max:	+6
Default Unit:	dB
Help Map ID:	10077

Mode

See “Mode” on page 475 for information on this key.

Key Path:	Front-panel key
Help Map ID:	0

Mode Setup

See “Mode Setup” on page 689 for information on this key.

Key Path:	Front-panel key
Help Map ID:	0

Peak Search

Pressing the Peak Search key displays the Peak Search menu and places the selected marker on the trace point with the maximum y-axis value for that marker's trace. The Peak Search features allow you to define specific search criteria to determine which signals can be considered peaks, excluding unwanted signals from the search.

See [“More Information” on page 330](#)

Key Path:	Front panel key
Mode:	BASIC
Remote Command:	:CALCulate:SPECTrum:MARKer [1] 2 3 4 5 6 7 8 9 10 11 12 : MAXimum
Example:	CALC:SPEC:MARK2:MAX SYST:ERR? can be used to query the errors to determine if a peak is found. The message “No peak found” will be returned after an unsuccessful search.
Initial S/W Revision:	Prior to A.02.00
Help Map ID:	I0038

More Information

The behavior of a Peak Search is dependent on settings under the Peak Criteria softkey on the second page of the menu. If **Same as “Next Peak” Criteria** is selected, and either **Pk Excursion** or **Pk Threshold** are on, a signal must meet those criteria to be considered a peak. If no valid peak is found, a “No peak found” message is generated and the marker is not moved. When **Highest Peak** is on, or both **Pk Excursion** and **Pk Threshold** are off, the marker is always placed at the point on the trace with the maximum y-axis value, even if that point is on the very edge of the trace.

Pressing Peak Search with the selected marker off causes the selected marker to be set to **Normal** at the center of the screen, then a peak search is immediately performed.

Pressing the front panel Peak Search key always does a peak search. Occasionally, you may need to get to the Peak Search menu key functions without doing a peak search. You can do this by first accessing the Peak Search menu. Then go to the other menus that you need to access. Finally, you can get back to the Peak Search key menu by using the front panel Return key and pressing it as many times as required to navigate back through the previously accessed menus until you get back to the Peak Search menu.

Next Peak

Pressing Next Peak moves the selected marker to the peak that has the next highest amplitude less than the marker's current value. Only peaks which meet all enabled peak criteria are considered. If there is no valid peak lower than the current marker position, a “No peak found” message is generated and the marker is not moved.

If the selected marker was off, then it is turned on as a normal marker and a peak search is performed.

Key Path:	Peak Search
Mode:	BASIC
Remote Command:	:CALCulate:SPECTrum:MARKer [1] 2 3 4 5 6 7 8 9 10 11 12 : MAXimum: NEXT
Example:	CALC:SPEC:MARK:MAX:NEXT
Initial S/W Revision:	Prior to A.02.00
Help Map ID:	10063

Next Pk Right

Pressing Next Pk Right moves the selected marker to the nearest peak right of the current marker which meets all enabled peak criteria. If there is no valid peak to the right of the current marker position, a “No peak found” message is generated and the marker is not moved.

If the selected marker was off, then it is turned on as a normal marker and a peak search is performed.

Key Path:	Peak Search
Remote Command:	:CALCulate:SPECTrum:MARKer [1] 2 3 4 5 6 7 8 9 10 11 12 : MAXimum: RIGHT
Example:	CALC:SPEC:MARK2:MAX:RIGH Selects marker 2 and moves it to the next peak to the right of the current marker position.
State Saved:	Not part of saved state
Help Map ID:	10078

Next Pk Left

Pressing Next Pk Left moves the selected marker to the nearest peak left of the current marker which meets all enabled peak criteria. If there is no valid peak to the left of the current marker position, a “No peak found” message is generated and the marker is not moved.

If the selected marker was off, then it is turned on as a normal marker and a peak search is performed.

Key Path:	Peak Search
Remote Command:	:CALCulate:SPECTrum:MARKer [1] 2 3 4 5 6 7 8 9 10 11 12 : MAXimum: LEFT
Example:	CALC:SPEC:MARK2:MAX:LEFT Selects marker 2 and moves it to the next peak to the left of the current marker position.
State Saved:	Not part of saved state

Help Map ID:	10079
--------------	-------

Marker Delta

Performs the same function as the Delta 1-of-N selection key in the Marker menu. Basically, this sets the control mode for the selected marker to Delta mode. See the Marker section for details of delta markers. The key is duplicated here in the Peak Search Menu to allow you to conveniently perform a peak search and change the marker's control mode to Delta without having to access two separate menus.

Key Path:	Peak Search or Marker
Notes:	Whenever the selected marker is in Delta mode and you are in the Peak Search menu, the Marker Delta key should be highlighted and the active function for setting its delta value turned on.
Initial S/W Revision:	Prior to A.02.00
Help Map ID:	10075

Mkr->CF

Assigns the selected marker's frequency to the Center Frequency setting. See the Marker‡ section for the description of this function. The key is duplicated here in the Peak Search Menu to allow you to conveniently perform a peak search and marker to CF without having to access two separate menus.

Key Path:	Peak Search or Marker (
Dependencies:	Same as specified under Marker To
Initial S/W Revision:	Prior to A.02.00
Help Map ID:	Use 10040

Mkr->Ref Lvl

Assigns the selected marker's level to the Reference Level setting. See the Marker‡ section for the description of this function. The key is duplicated here in the Peak Search Menu to allow you to conveniently perform a peak search and marker to RL without having to access two separate menus.

Key Path:	Peak Search or Marker (
Dependencies:	Same as specified under Marker To
Initial S/W Revision:	Prior to A.09.00
Help Map ID:	Use 10041

Peak Criteria

Pressing this key opens the Peak Criteria menu and allows you to adjust the Pk Threshold and Pk Excursion parameters used for peak search functions

For a signal to be identified as a peak it must meet certain criteria. Signals in the negative frequency range and signals very close to 0 Hz are ignored. If either the peak excursion or peak threshold functions are on, then the signal must satisfy those criteria before being identified as a peak. (Note that this does not apply when the input is base band I/Q)

When peak excursion and peak threshold are both off:

Peak Search, Continuous Peak Search, and maximum part of **Pk-Pk Search** will search the trace for the point with the highest y-axis value which does not violate the LO feedthrough rules. A rising and falling slope are not required for these three peak search functions.

The remaining search functions **Next Peak, Next Pk Right**, etc. will only consider trace points which have a rising and falling slope on the left and right respectively.

Key Path:	Peak Search
Initial S/W Revision:	Prior to A.09.00
Help Map ID:	10086

“Peak Search” Criteria

This menu lets you decide what kind of search you want to do when the Peak Search key is pressed (or the equivalent SCPI command sent).

Note that there are two “types” of peak search functions. One type is the “Peak Search” type, the other type is the “Next Peak” type. “Next Peak” searches (for example, Next Peak, Next Pk Left, Next Pk Right) are always checked using the Excursion and Threshold criteria as long as these criteria are On. The “Peak Search” type of search, simply finds the highest point on the trace. However you can change the “Peak Search” type of search so that it also uses the Excursion and Threshold criteria. This allows you to find the Maximum point on the trace that also obeys the Excursion and/or Threshold criteria.

When **Highest Peak** is selected, pressing **Peak Search** simply finds the highest peak on the marker’s trace. If **Same as “Next Peak” Criteria** is selected, then the search is also forced to consider the Excursion and Threshold found under the “**Next Peak” Criteria** menu.

Key Path:	Peak Search, Peak Criteria
Remote Command:	:CALCulate:SPECTrum:MARKer:PEAK:SEARCh:MODE MAXimum PARAMeter :CALCulate:SPECTrum:MARKer:PEAK:SEARCh:MODE?

Complex Spectrum Measurement
Peak Criteria

Notes:	MAXimum corresponds to the Highest Peak setting PARAmeter corresponds to the Same as “Next Peak” Criteria setting
Preset:	MAXimum
State Saved:	Saved in instrument state.
Readback line:	Current state
Initial S/W Revision:	Prior to A.09.00
Help Map ID:	10087

Highest Peak

When this key is selected, pressing the Peak Search key or issuing the equivalent SCPI command finds the maximum point on the trace, subject to the peak-search qualifications. This also affects the Peak Search half of Pk-Pk search and the Continuous Peak Search.

Key Path:	Peak Search, Peak Criteria, “Peak Search” Criteria
Example:	CALC:SPECTrum:MARK:PEAK:SEAR:MODE MAX
Readback:	Highest Peak
Initial S/W Revision:	Prior to A.09.00
Help Map ID:	10088

Same as “Next Peak” Criteria

When this key is selected, pressing the Peak Search key or issuing the equivalent SCPI command finds the maximum point on the trace, but subject to the Excursion and Threshold set under the Next Peak Criteria menu. The search is, of course, also subject to the peak-search qualifications. This also affects the Peak Search half of Pk-Pk search and the Continuous Peak Search.

Key Path:	Peak Search, Peak Criteria, “Peak Search” Criteria
Example:	CALC:SPECTrum:MARK:PEAK:SEAR:MODE PAR
Readback:	Use Excurs & Thr
Initial S/W Revision:	Prior to A.09.00
Help Map ID:	10089

“Next Peak” Criteria

This key opens up a menu which allows you to independently set the Peak Excursion and Peak Threshold and turn them on and off.

Key Path:	Peak Search, Peak Criteria
-----------	-----------------------------------

Initial S/W Revision:	Prior to A.09.00
Help Map ID:	10090

Pk Excursion

Turns the peak excursion requirement on/off and sets the excursion value. The value defines the minimum amplitude variation (rise and fall) required for a signal to be identified as peak. For example, if a value of

6 dB is selected, peak search functions like the marker Next Pk Right function move only to peaks that rise and fall 6 dB or more.

When both Pk Excursion and Pk Threshold are on, a signal must rise above the Pk Threshold value by at least the **Peak Excursion** value and then fall back from its local maximum by at least the **Peak Excursion** value to be considered a peak.

NOTE In the event that a sequence of trace points with precisely the same values represents the maximum, the leftmost point is found.

See [“More Information” on page 336](#).

Key Path:	Peak Search, Peak Criteria, “Next Peak” Criteria
Remote Command:	:CALCulate:SPECTrum:MARKer:PEAK:EXCursion <rel_ampl> :CALCulate:SPECTrum:MARKer:PEAK:EXCursion? :CALCulate:SPECTrum:MARKer:PEAK:EXCursion:STATe OFF ON 0 1 :CALCulate:SPECTrum:MARKer:PEAK:EXCursion:STATe?
Example:	:CALC:SPECTrum:MARK:PEAK:EXC:STAT ON :CALC:SPECTrum:MARK:PEAK:EXC 30 DB sets the minimum peak excursion requirement to 30 dB
Couplings:	Whenever you adjust the value of Pk Excursion (with the knob, step keys, or by completing a numeric entry), and Peak Threshold is turned ON, the Peak Threshold Line and the Peak Excursion Region are displayed
Preset:	6.0 dB ON
Preset:	6.0 dB ON
State Saved:	Saved in instrument state
Min:	0.0 dB
Max:	100.0 dB
Initial S/W Revision:	Prior to A.09.00

Help Map ID:	10091
--------------	-------

More Information

If two signals are very close together and the peak excursion and threshold criteria are met at the outside edges of the combined signals, this function finds the highest of these two signals as a peak (or next peak). However, if a signal appears near the edge of the screen such that the full extent of either the rising or falling edge cannot be determined, and the portion that is on screen does not meet the excursion criteria, then the signal cannot be identified as a peak.

When measuring signals near the noise floor, you can reduce the excursion value even further to make these signals recognizable. To prevent the marker from identifying noise as signals, reduce the noise floor variations to a value less than the peak-excursion value by increasing the averaging count.

Pk Threshold

Turns the peak threshold requirement on/off and sets the threshold value. The peak threshold value defines the minimum signal level (or min threshold) that the peak identification algorithm uses to recognize a peak.

When both Pk Excursion and Pk Threshold are on, a signal must rise above the Pk Threshold value by at least the **Peak Excursion** value and then fall back from its local maximum by at least the **Peak Excursion** value to be considered a peak.

For example, if a threshold value of -90 dBm is selected, the peak search algorithm will only consider signals with amplitude greater than the -90 dBm threshold. If a threshold value of -90 dBm is selected, and **Peak Excursion** is **On** and set to 6 dB, the peak search algorithm will only consider signals with amplitude greater than the -90 dBm threshold which rise 6 dB above the threshold and then fall back to the threshold.

Key Path:	Peak Search, Peak Criteria, "Next Peak Criteria"
Remote Command:	:CALCulate:SPECTrum:MARKer:PEAK:THReshold <ampl> :CALCulate:SPECTrum:MARKer:PEAK:THReshold? :CALCulate:SPECTrum:MARKer:PEAK:THReshold:STATe OFF ON 0 1 :CALCulate:SPECTrum:MARKer:PEAK:THReshold:STATe?
Example:	CALC:SPECTrum:MARK:PEAK:THR:STAT ON turns on the threshold criterion. CALC:SPECTrum:MARK:PEAK:THR -60 dBm sets the threshold to -60 dBm.
Preset:	-90.0 dBm ON
State Saved:	Saved in instrument state.
Min:	The current Ref Level $- 200$ dB.
Max:	The current Ref Level.

Initial S/W Revision:	Prior to A.09.00
Help Map ID:	10092

Pk Threshold Line

Turns the peak threshold line on or off. Preset state is off. No equivalent SCPI command.

See [“More Information” on page 337](#).

Dependencies:	If Peak Threshold is Off and the Peak Threshold line is turned on, it should turn on Peak Threshold.
Initial S/W Revision:	Prior to A.09.00
Help Map ID:	10097

More Information

The Peak Threshold line is green and has the value of the peak threshold (for example, “-20.3 dBm”) written above its right side above the line itself. If Peak Excursion is ON it shows on the left side as a region above the Peak Threshold line. As with all such lines (Display Line, Trigger Level line, etc) it is drawn on top of all traces.

TODO: Replace with Complex Spectrum screen shot

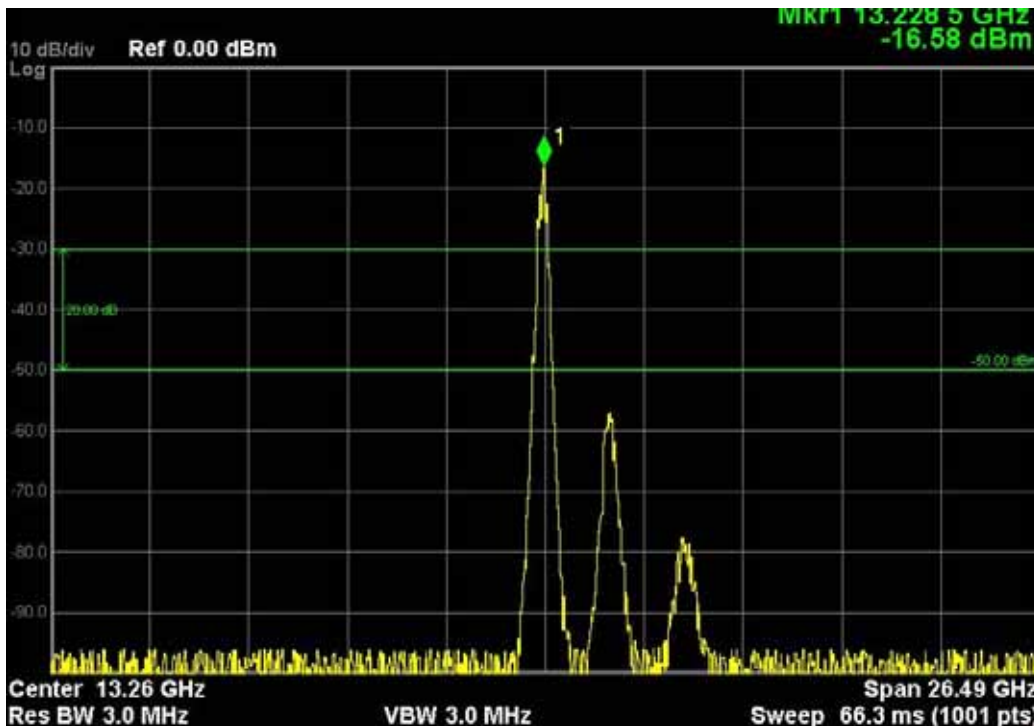

This function is automatically set to ON (thus turning on the Peak Threshold line) whenever the value of Peak Threshold or Peak Excursion becomes the active function, unless Peak Threshold is OFF. It is automatically set to OFF whenever Peak Threshold is set to OFF. Manually turning it ON automatically turns on Pk Threshold.

The Peak Excursion part is on whenever the Pk Threshold part is on, unless Peak Excursion is OFF.

Continuous Peak Search

Turns Continuous Peak Search on or off. When Continuous Peak Search is on, a peak search is automatically performed for the selected marker after each sweep. The rules for finding the peak are exactly the same as for **Peak Search** including the use of the peak criteria rules. If no valid peak is found, a “No peak found” message is generated after each sweep.

Key Path:	Peak Search
Remote Command:	:CALCulate:SPECTrum:MARKer [1] 2 3 4 5 6 7 8 9 10 11 12 : CPSearch[:STATe] ON OFF 1 0 :CALCulate:SPECTrum:MARKer [1] 2 3 4 5 6 7 8 9 10 11 12 : CPSearch[:STATe] ?
Example:	CALC:SPEC:MARK:CPS ON Turns on Continuous Peak Search.
Notes:	Sending this command selects the subopcoded marker
Preset:	Mode Preset
State Saved:	Saved in instrument state.
Status Bits/OPC dependencies:	The Measuring bit should remain set while this command is operating and should not go false until the marker position has been updated.
Initial S/W Revision:	Prior to A.09.00
Help Map ID:	I0093

More Information

When Continuous Peak Search is turned on a peak search is immediately performed and then is repeated after each sweep. If Continuous Peak Search is turned on with the selected marker off, the selected marker is set to **Normal** at the center of the screen, and then a peak search is immediately performed and subsequently repeated after each sweep.

When in Continuous Peak Search, *OPC will not return true, nor will READ or MEASURE return any data, until the sweep is complete and the marker has been re-peaked. Note further that if the analyzer is in a measurement such as averaging, and Continuous Peak Search is on, the entire measurement will be allowed to complete (i.e., all the averages taken up to the average number) before the repeak takes place, and only THEN will *OPC go true and READ or MEASURE return data.

Note that this function is not the “Continuous Peak” function found in some other instruments. That function was designed to track the signal; this function simply does a Peak Search after each sweep.

When Continuous Peak Search is turned on for a marker, a little “hat” is placed above the marker.



Pk-Pk Search

Finds and displays the amplitude and frequency (or time, if the markers are on the I or Q trace) differences between the highest and lowest y-axis value. It places the selected marker on the minimum value on its selected trace. And it places that marker's reference marker on the peak of its selected trace.

The rules for finding the maximum peak are exactly the same as for **Peak Search** including the use of the peak criteria rules. However, the minimum trace value is not required to meet any criteria other than being the minimum y-axis value in the trace.

If the selected marker is off, a delta type marker is turned on and the peak-to-peak search is done. If the selected marker is on, but it is not a delta marker, then it is changed to delta which turns on the reference marker if needed, and then it performs the peak-to-peak function.

Key Path:	Peak Search
Remote Command:	:CALCulate:SPECTrum:MARKer[1] 2 3 4 5 6 7 8 9 10 11 12:PTPeak
Example:	CALC:SPEC:MARK:PTP CALC:SPEC:MARK:Y? queries the delta amplitude value for marker 1.
Notes:	Turns on the Marker Δ active function.
Notes:	Sending this command selects the subopcoded marker.
Dependencies:	Pk-Pk Search is grayed out when Coupled Markers is on.
Couplings:	The selected marker becomes a delta marker if not already in delta mode.
State Saved:	Not part of saved state.
Initial S/W Revision:	Prior to A.09.00
Help Map ID:	10094

Min Search

Moves the selected marker to the minimum y-axis value on the current trace. Minimum (negative) peak searches do not have to meet the peak search criteria. It just looks for the lowest y-axis value. If the selected marker is Off, it is turned on before the minimum search is performed.

Key Path:	Peak Search
Remote Command:	:CALCulate:SPECTrum:MARKer [1] 2 3 4 5 6 7 8 9 10 11 12 : MINimum
Example:	CALC:SPEC:MARK:MIN selects marker 1 and moves it to the minimum amplitude value.
Notes:	Sending this command selects the subopcoded marker.
State Saved:	Not part of saved state.
Initial S/W Revision:	Prior to A.09.00
Help Map ID:	10095

Recall

See “Recall” on page 150 for information on this key.

Key Path:	Front-panel key
Help Map ID:	0

Restart

See “Restart” on page 713 for information on this key.

Key Path:	Front-panel key
Help Map ID:	0

Save

See “Save” on page 163 for information on this key.

Key Path:	Front-panel key
Help Map ID:	0

Single

See “[Single \(Single Measurement/Sweep\)](#)” on page 723 for information on this key.

Key Path:	Front-panel key
Help Map ID:	0

Source (Internal)

For information on this key, see “Source (Internal)” on page 725.[\[Proc_iFrame:35360@\]](#)

Key Path	Front-panel key
Help Map ID	0

Span X Scale

Accesses the frequency span menu when the spectrum view is active or the horizontal time menu when the waveform view is active.

Key Path:	Front-panel key
Initial S/W Revision:	Prior to A.02.00
Help Map ID:	10050

Span (Spectrum View)

This parameter allows you to modify the frequency span in spectrum view for the complex spectrum measurement. This is translated to the required Digital IF bandwidth for the FFT analysis. The analyzer's Digital IF bandwidth is always equal to or greater than this value. The maximum span is dependent upon the instrument type and the options that are installed. The maximum span is equal to the maximum bandwidths of the IF Paths.

Key Path:	SPAN X Scale
Mode:	BASIC
Remote Command:	[:SENSe] :SPECTrum:FREQuency:SPAN <freq> [:SENSe] :SPECTrum:FREQuency:SPAN?
Example:	SPEC:FREQ:SPAN 10 SPEC:FREQ:SPAN?
Notes:	You must be in the IQ Analyzer (Basic) mode to use this command. Use INSTRument:SElect to set the mode.
Couplings:	Changing the span causes the resolution bandwidth to change automatically, and affects data acquisition time.
Preset:	8 MHz
State Saved:	Saved in instrument state.
Min:	10 Hz

Max:	<p>Hardware Dependent:</p> <p>RF Input:</p> <p>No Option = 8.0 MHz</p> <p>Option B25 = 25.0 MHz</p> <p>Option B40 = 40.0 MHz</p> <p>Option B1X = 140.0 MHz</p> <p>Option B1Y = 160.0 MHz</p> <p>I/Q Input:</p> <p>No Option = 10.0 MHz per channel (20.0 MHz for I+jQ)</p> <p>Option B25 = 25 MHz per channel (50 MHz for I+jQ)</p> <p>Option S40 = 40 MHz per channel (80 MHz for I+jQ)</p>
Initial S/W Revision:	Prior to A.02.00
Help Map ID:	10001

Ref Value (Waveform View)

Sets the horizontal scale reference value in the waveform view window.

Key Path:	SPAN X Scale
Mode:	BASIC
Remote Command:	<pre>:DISPlay:SPECTrum:VIEW[1]:WINDow2:TRACe:X[:SCALe]:RLEVe l <time></pre> <pre>:DISPlay:SPECTrum:VIEW[1]:WINDow2:TRACe:X[:SCALe]:RLEVe l?</pre>
Example:	<pre>DISP:SPEC:VIEW:WIND2:TRAC:X:RLEV 10</pre> <pre>DISP:SPEC:VIEW:WIND2:TRAC:X:RLEV?</pre>
Notes:	You must be in the IQ Analyzer (Basic) mode to use this command. Use INSTRUMENT:SElect to set the mode.
Couplings:	If the Auto Scaling is set to On, this value is automatically determined by the measurement result. When you set this value manually, Auto Scaling automatically changes to Off.
Preset:	0.000 s
State Saved:	Saved in instrument state.
Min:	-1.00 s
Max:	10.00 s
Initial S/W Revision:	Prior to A.02.00
Help Map ID:	10002

Scale/Div (Waveform View)

Allows you to set the horizontal scale in the waveform view window by changing the time value per division.

Key Path:	SPAN X Scale
Mode:	BASIC
Remote Command:	:DISPlay:SPECTrum:VIEW[1]:WINDow2:TRACe:X[:SCALe]:PDIvion <time> :DISPlay:SPECTrum:VIEW[1]:WINDow2:TRACe:X[:SCALe]:PDIvion?
Example:	DISP:SPEC:VIEW:WIND2:TRAC:X:PDIV 1e-9 DISP:SPEC:VIEW:WIND2:TRAC:X:PDIV?
Notes:	You must be in the IQ Analyzer (Basic) mode to use this command. Use INSTRUMENT:SElect to set the mode.
Couplings:	If the Auto Scaling is set to On, this value is automatically determined by the measurement result. When you set this value manually, Auto Scaling automatically changes to Off.
Preset:	18.80 us
State Saved:	Saved in instrument state.
Min:	1.000 ns
Max:	1.000 s
Initial S/W Revision:	Prior to A.02.00
Help Map ID:	10003

Ref Position (Waveform View)

Allows you to set the reference position in the waveform view window to Left, Ctr (center) or Right.

Key Path:	SPAN X Scale
Mode:	BASIC
Remote Command:	:DISPlay:SPECTrum:VIEW[1]:WINDow2:TRACe:X[:SCALe]:RPOSi tion LEFT CENTer RIGHT :DISPlay:SPECTrum:VIEW[1]:WINDow2:TRACe:X[:SCALe]:RPOSi tion?
Example:	DISP:SPEC:VIEW:WIND2:TRAC:X:RPOS LEFT DISP:SPEC:VIEW:WIND2:TRAC:X:RPOS?
Notes:	You must be in the IQ Analyzer (Basic) mode to use this command. Use INSTRUMENT:SElect to set the mode.

Preset:	LEFT
State Saved:	Saved in instrument state.
Range:	Left Ctr Right
Initial S/W Revision:	Prior to A.02.00
Help Map ID:	10004

Auto Scaling (Waveform View)

Allows you to toggle the Auto Scaling function in the waveform view window between On and Off.

Key Path:	SPAN X Scale
Mode:	BASIC
Remote Command:	:DISPlay:SPECTrum:VIEW[1]:WINDow2:TRACe:X[:SCALe]:COUPl e 0 1 OFF ON :DISPlay:SPECTrum:VIEW[1]:WINDow2:TRACe:X[:SCALe]:COUPl e
Example:	DISP:SPEC:VIEW:WIND2:TRAC:X:COUP 0 DISP:SPEC:VIEW:WIND2:TRAC:X:COUP?
Notes:	You must be in the IQ Analyzer (Basic) mode to use this command. Use INSTRument:SElect to set the mode.
Couplings:	Upon pressing the Restart front-panel key, this function automatically determines the scale per division and reference values based on the measurement results. When you set a value to either Scale/Div or Ref Value manually, Auto Scaling automatically changes to Off.
Preset:	ON
State Saved:	Saved in instrument state.
Range:	On Off
Initial S/W Revision:	Prior to A.02.00
Help Map ID:	10005

Sweep/Control

Accesses the keys to control pausing/resuming the sweep or measurement.

See “Sweep/Control” on page 867 for more information.

Key Path:	Front-panel key
Help Map ID:	0

Pause/Resume

Pauses a measurement after the current data acquisition is complete. When Paused, the label on the key changes to Resume. Pressing Resume continues the paused measurement. Refer to “Pause/Resume” on page 880 for more information.

Key Path:	Sweep/Control
Initial S/W Revision:	Prior to A.02.00
Help Map ID:	10037

Trace/Detector

Toggles the instantaneous trace display between On and Off.

This is a display only feature and the actual Spectrum trace still exists even when the Spectrum Trace State is OFF. It is just invisible. Hence it is possible to set Spectrum Trace State to OFF and put a marker on Spectrum trace.

Key Path:	Front-panel key
Remote Command:	:TRACe:SPECTrum:STRace[:STATe] OFF ON 0 1 :TRACe:SPECTrum:STRace[:STATe]?
Example:	TRAC:SPEC:STR OFF TRAC:SPEC:STR?
Preset:	ON
State Saved:	Saved in instrument state.
Range:	On Off
Initial S/W Revision:	Prior to A.09.00
Help Map ID:	10096

Trigger

Displays menu keys that allow you to select and control the trigger source for the current measurement.

See “[Trigger](#)” on page 903 for more information.

Key Path:	Front-panel key
Help Map ID:	0

View/Display

This measurement has only one view, so there are no View Selection keys in this menu. For details of the measurement's view, see [“Measurement Results View” on page 353](#) View.

This menu includes a **Display** key, which accesses a menu that allows you to control certain functions related to the display of the analyzer. See [“Display” on page 959](#) for more information.

Key Path:	Front-panel key
Initial S/W Revision:	Prior to A.02.00
Help Map ID:	10067

Measurement Results View

The figure below shows an example of the view for the Complex Spectrum Measurement.

- The upper Spectrum Window shows the trace of the signal and its average in the frequency domain. For details, see [“Spectrum Window” on page 355](#).
- The lower I/Q Spectrum Window shows the traces of the I and Q of the input signal. For details, see [“I/Q Waveform Window” on page 355](#) Waveform Window.
- The measured values for the mean power and peak-to-mean power are shown in the text window.

Complex Spectrum Measurement

View/Display



Trace Results

There are two trace views: Spectrum and I/Q Spectrum.

Spectrum Window

Marker Trace	Yes
Corresponding Trace	Returns spectrum trace data. That is, the trace of log-magnitude versus frequency. (The trace is computed using a FFT.) (n=4)
Corresponding Trace	Returns the averaged trace data of log-magnitude versus time. (That is, the RF envelope.) (n=5)

I/Q Waveform Window

Marker Trace	Yes
Corresponding Trace	Returns the I and Q trace data. It is represented by I and Q pairs (in volts) versus time. (n=3)

Display

Invokes the Display menu and allows you to control certain functions related to the display of the analyzer.

See “Display” on page 959 for more information.

Key Path:	View/Display
Initial S/W Revision:	Prior to A.02.00
Help Map ID:	Use 3440

The waveform measurement is a generic measurement for viewing the input signal waveforms in the time domain. This measurement represents how the instrument performs the zero span functionality found in traditional spectrum analyzers. For more details, see [“Waveform Measurement Description” on page 358](#) below.

This topic contains the following sections:

[“Measurement Commands for Waveform” on page 357](#)

[“Remote Command Results for Waveform Measurement” on page 357](#)

Measurement Commands for Waveform

The general functionality of CONFigure, INITiate, FETCh, MEASure, and READ are described at this section.

:CONFigure:WAVEform

:CONFigure:WAVEform:NDEFault

:INITiate:WAVEform

:FETCh:WAVEform [n]

:MEASure:WAVEform [n]

:READ:WAVEform [n]

For more measurement related commands, see the SENSE subsystem, and the section [“Remote Measurement Functions” on page 627](#).

Remote Command Results for Waveform Measurement

The following table denotes the returned results from the FETCh|MEASure|READ commands:

n	Results Returned
0	Returns unprocessed I/Q trace data, as a series of trace point values, in volts. The I values are listed first in each pair, using the 0 through even-indexed values. The Q values are the odd-indexed values.

n	Results Returned
1	<p>Returns the following scalar results:</p> <ol style="list-style-type: none"> 1. Sample Time is a floating point number representing the time between samples when using the trace queries (n=0, 2, and so forth). 2. Mean Power is the mean power (in dBm). This is the power across the entire trace. If averaging is on, the power is for the latest acquisition. 3. Mean Power Averaged is the power (in dBm) for N averages, if averaging is on. This is the power across the entire trace. If averaging is on, the power is for the latest acquisition. If averaging is off, the value of the mean power averaged is the same as the value of the mean power. 4. Number of samples is the number of data points in the captured signal. This number is useful when performing a query on the signal (i.e. when n=0,2,etc.). 5. Peak-to-mean ratio has units of dB. This is the ratio of the maximum signal level to the mean power. Valid values are only obtained with averaging turned off. If averaging is on, the peak-to-mean ratio is calculated using the highest peak value, rather than the displayed average peak value. 6. Maximum value is the maximum of the most recently acquired data (in dBm). 7. Minimum value is the minimum of the most recently acquired data (in dBm).
2	<p>Returns trace point values of the entire captured signal envelope trace data. These data points are floating point numbers representing the power of the signal (in dBm). There are N data points, where N is the number of samples. The period between the samples is defined by the sample time.</p>

Waveform Measurement Description

Also available under the basic Waveform measurement is an I/Q window, which shows the I and Q signal waveforms in parameters of voltage versus time to disclose the voltages that comprise the complex modulated waveform of a digital signal.

The waveform measurement can also be used to perform general purpose power measurements to a high degree of accuracy.

Key Path	Front-panel key
Initial S/W Revision	Prior to A.02.00
Help Map ID	9500

AMPTD Y Scale

Accesses a menu of functions that enable you to set the vertical scale parameters.

Key Path	Front-panel key
Initial S/W Revision	Prior to A.02.00
Help Map ID	9506

Ref Value

Sets the absolute power reference value. However, since Auto Scaling is defaulted to On, this value is automatically determined by the measurement result. When you set a value manually, Auto Scaling automatically changes to Off.

Ref Value (RF Envelope View)

Sets the Y Scale reference value (in dBm) when the RF Envelope View is active. By default, the measurement determines the reference value with Auto Scaling. Entering a reference value manually turns Auto Scaling off.

Key Path	AMPTD Y Scale
Mode	BASIC, PN, WCDMA, C2K, GSM, WIMAX OFDMA, TD-SCDMA, 1xEV-DO, DVB-T/H, DTMB, ISDB-T, CMMB, LTE, LTETDD, WLAN, WLAN
Remote Command	:DISPlay:WAVEform:VIEW[1]:WINDow[1]:TRACe:Y[:SCALe]:RLEVel <ampl> :DISPlay:WAVEform:VIEW[1]:WINDow[1]:TRACe:Y[:SCALe]:RLEVel?
Example	DISP:WAV:VIEW:WIND:TRAC:Y:RLEV -50 dBm DISP:WAV:VIEW:WIND:TRAC:Y:RLEV?
Notes	You must be in the mode that includes Waveform measurement to use this command. Use INSTRument:SElect to set the mode.
Couplings	When Auto Scaling is On, this value is automatically determined by the measurement result. When you set a value manually, Auto Scaling automatically changes to Off.
Preset	10.00 dBm
State Saved	Saved in instrument state.
Range	-250.00 dBm to 250.00 dBm
Initial S/W Revision	Prior to A.02.00
Modified at S/W Revision	A.03.00

Help Map ID	9507
-------------	------

Ref Value (I/Q Waveform View)

Sets the Y Scale reference value (in volts) when the I/Q Waveform View is active. By default, the measurement determines the reference value with Auto Scaling. Entering a reference value manually turns Auto Scaling off.

Key Path	AMPTD Y Scale
Mode	BASIC, PN, WCDMA, C2K, GSM, WIMAX OFDMA, TD-SCDMA, 1xEV-DO, DVB-T/H, DTMB, ISDB-T, CMMB, LTE, LTETDD, WLAN, WLAN
Remote Command	:DISPlay:WAVeform:VIEW2:WINDow[1]:TRACe:Y[:SCALe]:RLEVe l <voltage> :DISPlay:WAVeform:VIEW2:WINDow[1]:TRACe:Y[:SCALe]:RLEVe l?
Example	DISP:WAV:VIEW2:WIND:TRAC:Y:RLEV 25 V DISP:WAV:VIEW2:WIND:TRAC:Y:RLEV?
Notes	You must be in a mode that includes the Waveform measurement to use this command. Use INSTRument:SELEct to set the mode.
Couplings	When Auto Scaling is On, this value is automatically determined by the measurement result. When you set a value manually, Auto Scaling automatically changes to Off.
Preset	0 V
State Saved	Saved in instrument state.
Min	-250 V
Max	250 V
Initial S/W Revision	Prior to A.02.00
Modified at S/W Revision	A.03.00
Help Map ID	9508

Attenuation

Accesses a menu of functions that enable you to change the attenuation settings. This key has a readback text that describes total attenuator value

This is only available when the selected input is RF.

For more information on this key, see [“Attenuation” on page 434](#).

Due to available hardware, RF input, Attenuation settings are not always available. Currently in the E6607C, the Attenuation menu is replaced by the Range menu described in [“Range \(for RF Input\)” on](#)

page 361.

Key Path	AMPTD Y Scale
Initial S/W Revision	Prior to A.02.00
Help Map ID	9566

Range (for RF Input)

Due to available hardware, RF input, Attenuation settings are not always available. At present, only in the E6607C, the Range menu replaces the Attenuation menu to realize the gain control. Accessing the Range menu to set the range value used to do the instrument gain adjustment. The range value means range target. Generally, the expected peak power of the input signal can be used.

Key Path	AMPTD Y Scale
Mode	BASIC
Remote Command	:SENSe:POWer:RF:RANGe <real> :SENSe:POWer:RF:RANGe?
Example	:SENSe:POWer:RF:RANGe <real> :SENSe:POWer:RF:RANGe?
Notes	You must be in the IQ Analyzer (Basic) mode to use this command. Use INSTRument:SElect to set the mode.
Couplings	When Auto Scaling is On, this value is automatically determined by the measurement result. When you set a value manually, Auto Scaling automatically changes to Off.
Preset	20.00 dBm
State Saved	Saved in instrument state.
Min	-100 dBm
Max	100 dBm
Default Unit	dBm -dBm
Initial S/W Revision	A.12.50
Help Map ID	9531

Scale/Div

Sets the units per division of vertical scale in the logarithmic display. However, since Auto Scaling is defaulted to On, this value is automatically determined by the measurement result. When you set a value manually, Auto Scaling automatically changes to Off.

Waveform Measurement
AMPTD Y Scale

Scale/Div (RF Envelope View)

Sets the scale per division for the RF Envelope result waveform (time domain) measurements in the graph window.

Key Path	AMPTD Y Scale
Mode	BASIC, PN, WCDMA, C2K, GSM, WIMAX OFDMA, TD-SCDMA, 1xEV-DO, DVB-T/H, DTMB, ISDB-T, CMMB, LTE, LTETDD, WLAN
Remote Command	:DISPlay:WAVeform:VIEW[1]:WINDow[1]:TRACe:Y[:SCALE]:PDI Vision <rel_ampl> :DISPlay:WAVeform:VIEW[1]:WINDow[1]:TRACe:Y[:SCALE]:PDI Vision?
Example	DISP:WAV:VIEW:WIND:TRAC:Y:PDIV 5 DISP:WAV:VIEW:WIND:TRAC:Y:PDIV?
Notes	You must be in a mode that includes the Waveform measurement to use this command. Use INSTRument:SELEct to set the mode.
Couplings	When Auto Scaling is On, this value is automatically determined by the measurement result. When you set a value manually, Auto Scaling automatically changes to Off.
Preset	10.00 dB
State Saved	Saved in instrument state.
Range	0.10 dB to 20.00 dB
Initial S/W Revision	Prior to A.02.00
Modified at S/W Revision	A.03.00
Help Map ID	9509

Scale/Div (I/Q Waveform View)

Sets the scale per division for the I/Q signal waveform graph.

Key Path	AMPTD Y Scale
Mode	BASIC, PN, WCDMA, C2K, GSM, WIMAX OFDMA, TD-SCDMA, 1xEV-DO, DVB-T/H, DTMB, ISDB-T, CMMB, LTE, LTETDD, WLAN
Remote Command	:DISPlay:WAVeform:VIEW2:WINDow[1]:TRACe:Y[:SCALE]:PDI vision <voltage> :DISPlay:WAVeform:VIEW2:WINDow[1]:TRACe:Y[:SCALE]:PDI vision?
Example	DISP:WAV:VIEW2:WIND:TRAC:Y:PDIV 25mV DISP:WAV:VIEW2:WIND:TRAC:Y:PDIV?

Notes	You must be in a mode that includes the Waveform measurement to use this command. Use INSTRument:SElect to set the mode.
Couplings	When Auto Scaling is On, this value is automatically determined by the measurement result. When you set a value manually, Auto Scaling automatically changes to Off.
Preset	100.0 mV
State Saved	Saved in instrument state.
Min	1.0 nV
Max	20 V
Initial S/W Revision	Prior to A.02.00
Modified at S/W Revision	A.03.00
Help Map ID	9510

Internal Preamp

Accesses keys that control the internal preamps. Turning on the preamp gives a better noise figure, but a reduced TOI to noise floor dynamic range. You can optimize this setting for your particular measurement. The LowBand selection needs to show "(3.0 GHz)" for all versions of N9000A and "(3.6 GHz)" for the other models.

See “[Internal Preamp](#)” on page 469 for more information.

This key is only available when the selected input is RF.

Due to available hardware, RF input, Internal Preamp settings are not always available. Currently in the E6607C, the Internal Preamp menu is disabled.

Key Path	AMPTD Y Scale
Initial S/W Revision	Prior to A.02.00
Help Map ID	9551

Ref Position

Positions the reference level at the top, center or bottom of the Y Scale display. Changing the reference position does not change the reference level value.

Ref Position (RF Envelope View)

Positions the reference level at the top, center or bottom of the Y Scale display. Changing the reference position does not change the reference level value.

Key Path	AMPTD Y Scale
----------	----------------------

Waveform Measurement
AMPTD Y Scale

Mode	BASIC, PN, WCDMA, C2K, GSM, WIMAX OFDMA, TD-SCDMA, 1xEV-DO, DVB-T/H, DTMB, ISDB-T, CMMB, LTE, LTETDD, WLAN
Remote Command	:DISPlay:WAVeform:VIEW[1]:WINDow[1]:TRACe:Y[:SCALe]:RPO Sition TOP CENTer BOTTom :DISPlay:WAVeform:VIEW[1]:WINDow[1]:TRACe:Y[:SCALe]:RPO Sition?
Example	DISP:WAV:VIEW:WIND:TRAC:Y:RPOS CENT DISP:WAV:VIEW:WIND:TRAC:Y:RPOS?
Notes	You must be in a mode that includes the Waveform measurement to use this command. Use INSTRument:SElect to set the mode.
Preset	TOP
State Saved	Saved in instrument state.
Range	Top Ctr Bot
Initial S/W Revision	Prior to A.02.00
Modified at S/W Revision	A.03.00
Help Map ID	9511

Ref Position (I/Q Waveform View)

Positions the reference level at the top, center or bottom of the Y Scale display. Changing the reference position does not change the reference level value.

Key Path	AMPTD Y Scale
Mode	BASIC, PN, WCDMA, C2K, GSM, WIMAX OFDMA, TD-SCDMA, 1xEV-DO, DVB-T/H, DTMB, ISDB-T, CMMB, LTE, LTETDD, WLAN
Remote Command	:DISPlay:WAVeform:VIEW2:WINDow[1]:TRACe:Y[:SCALe]:RPO Sition TOP CENTer BOTTom :DISPlay:WAVeform:VIEW2:WINDow[1]:TRACe:Y[:SCALe]:RPO Sition?
Example	DISP:WAV:VIEW2:WIND:TRAC:Y:RPOS CENT DISP:WAV:VIEW2:WIND:TRAC:Y:RPOS?
Notes	You must be in a mode that includes the Waveform measurement to use this command. Use INSTRument:SElect to set the mode.
Preset	CENT
State Saved	Saved in instrument state.
Range	Top Ctr Bot
Initial S/W Revision	Prior to A.02.00
Modified at S/W Revision	A.03.00

Help Map ID	9512
-------------	------

Auto Scaling

Toggles the Auto Scaling function between On and Off. When the **Restart** front-panel key is pressed, this function automatically determines the scale per division and reference values based on the measurement results.

Key Path	AMPTD Y Scale
Mode	BASIC, PN, WCDMA, C2K, GSM, WIMAX OFDMA, TD-SCDMA, 1xEV-DO, DVB-T/H, DTMB, ISDB-T, CMMB, LTE, LTETDD, WLAN
Remote Command	:DISPlay:WAVEform:VIEW [1] 2 :WINDow [1] :TRACe:Y[:SCALE] :COUPle 0 1 OFF ON :DISPlay:WAVEform:VIEW [1] 2 :WINDow [1] :TRACe:Y[:SCALE] :COUPle?
Example	DISP:WAV:VIEW:WIND:TRAC:Y:COUP OFF DISP:WAV:VIEW:WIND:TRAC:Y:COUP?
Notes	You must be in a mode that includes the Waveform measurement to use this command. Use INSTRUMENT:SElect to set the mode.
Couplings	When Auto Scaling is On, upon pressing the Restart front-panel key, this function automatically switches the scale per division and reference values into the defaults. When you set a value to either Scale/Div or Ref Value manually, Auto Scaling automatically changes to Off.
Preset	OFF
State Saved	Saved in instrument state.
Range	On Off
Initial S/W Revision	Prior to A.02.00
Modified at S/W Revision	A.03.00
Help Map ID	9513

Auto Couple

For details on this key, see “Auto Couple” on page 473.[\[Proc_iFrame:3041@\]](#)

Key Path	Front-panel key
Help Map ID	0

BW

Accesses a menu that enables you to control the information bandwidth functions of the instrument. You can also select the filter type for the measurement.

Key Path	Front-panel key
Initial S/W Revision	Prior to A.02.00
Help Map ID	9514

Digital IF BW

Enables you to set the Digital IF (formerly Info BW) bandwidth of the instrument.

Key Path	BW
Mode	BASIC, PN, WCDMA, C2K, GSM, WIMAX OFDMA, TD-SCDMA, 1xEV-DO, DVB-T/H, DTMB, ISDB-T, CMMB, LTE, LTETDD, WLAN
Remote Command	[:SENSe] :WAVeform:DIF:BANDwidth <freq> [:SENSe] :WAVeform:DIF:BANDwidth?
Example	WAV:DIF:BAND 1kHz WAV:DIF:BAND?
Notes	Max value depends on the IF Path Selection
Notes	You must be in a mode that includes the Waveform measurements to use this command. Use INSTRument:SElect to set the mode.
Dependencies	For applications that have the IF Path Selection menu such as the BASIC mode, if IF Path Auto is OFF, the maximum value depends on which IF Path is currently selected. If 10 MHz, 25 MHz, 40 MHz, or 140 MHz paths are selected, the maximum value of this parameter will be 10, 25, 40 or 140 MHz, respectively. If IF Path Auto is ON, the maximum value will be the maximum Digital IF BW available in the instrument regardless of the current IF Path Selection. For example, say that the instrument had the options B25, B40 and B1X installed. The maximum available Digital IF BW of the instrument is 140 MHz. Thus, if IF Path Auto is ON and IF Path Selection is 25 MHz, the maximum Digital IF BW is not limited to 25 MHz but is 140 MHz.

Preset	All except the following list: 100 kHz Basic: 1 MHz GSM/EDGE: 510 kHz TDSCDMA: 1.3 MHz 1xEVDO: 1.3 MHz DVB-T/H: 8.0 MHz DTMB: 8.0 MHz ISDB-T: 6.0 MHz CMMB: 8.0 MHz WLAN: Hardware Dependent
State Saved	Saved in instrument state.
Min	10 Hz
Max	Hardware Dependent: RF Input: No Option = 10 MHz Option B25 = 25 MHz Option B40 = 40 MHz I/Q Input: No Option = 10 MHz per channel (20 MHz for I+jQ) Option B25 = 25 MHz per channel (50 MHz for I+jQ) Option S40 = 40 MHz per channel (80 MHz for I+jQ)
Backwards Compatibility SCPI	[:SENSe] :WAVeform:BAWdwidth [:RESolution] [:SENSe]:WAVeform:BWIDth[:RESolution]
Initial S/W Revision	Prior to A.02.00
Modified at S/W Revision	A.03.00
Help Map ID	9515

Filter Type

Selects the type of bandwidth filter that is used.

Besides the Gaussian filter shape, a variety of other filter types are available with variable alpha settings for maximum control over the filter shape.

Key Path	BW
Mode	BASIC, PN, WCDMA, C2K, GSM, WIMAX OFDMA, TD-SCDMA, 1xEV-DO, DVB-T/H, DTMB, ISDB-T, CMMB, LTE, LTETDD, WLAN

Remote Command	[:SENSe]:WAVeform:DIF:FILTer:TYPE GAUSSian FLATtop [:SENSe]:WAVeform:DIF:FILTer:TYPE? (With DIF40 and/or WBDIF) [:SENSe]:WAVeform:DIF:FILTer:TYPE GAUSSian FLATtop SNYQuist RSNYquist RCOSine RRCosine [:SENSe]:WAVeform:DIF:FILTer:TYPE?
Example	WAV:DIF:FILT:TYPE GAUS WAV:DIF:FILT:TYPE?
Remote Command Notes	You must be in a mode that includes the Waveform measurements to use this command. Use INSTRument:SElect to set the mode.
Dependencies	Gaussian and Flattop are available in all DIF configurations. For the other filter types, the filters are only available with PXA or when Option B40 is installed.
Preset	BASIC with B40 or B1X: FLATtop All other apps: GAUSSian
State Saved	Saved in instrument state.
Range	Gaussian FlatTop (With Digital IF and/or Option B40 or B1X) Gaussian Flattop Short nyquist Root Short Nquist Raised Cosine Root RaisedCosine
Backwards Compatibility SCPI	[:SENSe]:WAVeform:BANDwidth:SHAPE [:SENSe]:WAVeform:BWIDth:SHAPE [:SENSe]:WAVeform:BANDwidth BWIDth[:RESolution]:TYPE
Initial S/W Revision	Prior to A.02.00
Modified at S/W Revision	A.03.00
Help Map ID	9516

Filter Type Bwcc

This parameter is strictly for Bwcc purposes.

Remote Command:	[:SENSe]:WAVeform:WBIF:FILTer[:TYPE] GAUSSian NONE NYQuist RNYQuist RCOSine RRCosine [:SENSe]:WAVeform:WBIF:FILTer[:TYPE]?
Preset:	BASIC with B40 or B1X: FLATtop All other apps: GAUSSian
Help Map ID:	0

Gaussian

With a PXA or Option B40, the capability for arbitrary Digital IF bandwidths is available. However, for instruments without the Digital IF or the Option B40 or B1X board, the selectable Gaussian filter bandwidths are predetermined in the following list. There are 160 Info BWs (RBWs). They are arranged in a 24-per-decade sequence from 1 Hz through 3 MHz, plus the 4, 5, 6 and 8 MHz settings.

The table in the section [“Gaussian filters” on page 371](#) lists all 160 Gaussian filter types.

Gaussian filters

Normal (-3 dB)	-6 dB	Noise	Impulse
1.0 Hz	1.41 Hz	1.06 Hz	1.49 Hz
1.1 Hz	1.55 Hz	1.16 Hz	1.63 Hz
1.2 Hz	1.69 Hz	1.27 Hz	1.77 Hz
1.3 Hz	1.83 Hz	1.37 Hz	1.92 Hz
1.5 Hz	2.11 Hz	1.59 Hz	2.22 Hz
1.6 Hz	2.25 Hz	1.69 Hz	2.37 Hz
1.8 Hz	2.53 Hz	1.90 Hz	2.66 Hz
2.0 Hz	2.81 Hz	2.12 Hz	2.96 Hz
2.2 Hz	3.09 Hz	2.33 Hz	3.25 Hz
2.4 Hz	3.38 Hz	2.54 Hz	3.55 Hz
2.7 Hz	3.80 Hz	2.86 Hz	3.99 Hz
3.0 Hz	4.22 Hz	3.17 Hz	4.44 Hz
3.3 Hz	4.64 Hz	3.49 Hz	4.88 Hz
3.6 Hz	5.06 Hz	3.81 Hz	5.32 Hz
3.9 Hz	5.49 Hz	4.12 Hz	5.77 Hz
4.3 Hz	6.05 Hz	4.55 Hz	6.36 Hz
4.7 Hz	6.61 Hz	4.97 Hz	6.95 Hz
5.1 Hz	7.17 Hz	5.39 Hz	7.54 Hz
5.6 Hz	7.87 Hz	5.92 Hz	8.27 Hz
6.2 Hz	8.72 Hz	6.56 Hz	9.17 Hz
6.8 Hz	9.55 Hz	7.18 Hz	10.0 Hz
7.5 Hz	10.5 Hz	7.93 Hz	11.1 Hz
8.2 Hz	11.5 Hz	8.66 Hz	12.1 Hz
9.1 Hz	12.8 Hz	9.64 Hz	13.5 Hz
10 Hz	14.0 Hz	10.6 Hz	14.8 Hz
11 Hz	15.4 Hz	11.6 Hz	16.2 Hz
12 Hz	16.9 Hz	12.7 Hz	17.7 Hz
13 Hz	18.3 Hz	13.7 Hz	19.2 Hz
15 Hz	21.1 Hz	15.9 Hz	22.2 Hz

Normal (-3 dB)	-6 dB	Noise	Impulse
16 Hz	22.5 Hz	16.9 Hz	23.7 Hz
18 Hz	25.3 Hz	19.1 Hz	26.6 Hz
20 Hz	28.1 Hz	21.1 Hz	29.5 Hz
22 Hz	30.9 Hz	23.2 Hz	32.5 Hz
24 Hz	33.8 Hz	25.4 Hz	35.5 Hz
27 Hz	38.0 Hz	28.6 Hz	40.0 Hz
30 Hz	42.3 Hz	31.8 Hz	44.5 Hz
33 Hz	46.3 Hz	34.8 Hz	48.7 Hz
36 Hz	50.7 Hz	38.1 Hz	53.3 Hz
39 Hz	54.9 Hz	41.3 Hz	57.7 Hz
43 Hz	60.5 Hz	45.5 Hz	63.6 Hz
47 Hz	66.1 Hz	49.7 Hz	69.5 Hz
51 Hz	71.7 Hz	53.9 Hz	75.3 Hz
56 Hz	78.9 Hz	59.3 Hz	83.0 Hz
62 Hz	87.3 Hz	65.6 Hz	91.7 Hz
68 Hz	95.5 Hz	71.8 Hz	100 Hz
75 Hz	106 Hz	79.4 Hz	111 Hz
82 Hz	115 Hz	86.8 Hz	121 Hz
91 Hz	128 Hz	96.4 Hz	135 Hz
100 Hz	141 Hz	106 Hz	148 Hz
110 Hz	154 Hz	116 Hz	162 Hz
120 Hz	169 Hz	127 Hz	178 Hz
130 Hz	183 Hz	137 Hz	192 Hz
150 Hz	211 Hz	159 Hz	222 Hz
160 Hz	225 Hz	169 Hz	237 Hz
180 Hz	253 Hz	190 Hz	266 Hz
200 Hz	281 Hz	211 Hz	295 Hz
220 Hz	309 Hz	232 Hz	325 Hz
240 Hz	337 Hz	254 Hz	355 Hz
270 Hz	380 Hz	286 Hz	400 Hz

Normal (-3 dB)	-6 dB	Noise	Impulse
300 Hz	422 Hz	317 Hz	444 Hz
330 Hz	463 Hz	348 Hz	487 Hz
360 Hz	507 Hz	381 Hz	533 Hz
390 Hz	550 Hz	413 Hz	578 Hz
430 Hz	605 Hz	455 Hz	636 Hz
470 Hz	662 Hz	498 Hz	696 Hz
510 Hz	718 Hz	540 Hz	755 Hz
560 Hz	789 Hz	593 Hz	829 Hz
620 Hz	872 Hz	655 Hz	916 Hz
680 Hz	958 Hz	720 Hz	1.01 kHz
750 Hz	1.06 kHz	794 Hz	1.11 kHz
820 Hz	1.15 kHz	866 Hz	1.21 kHz
910 Hz	1.28 kHz	964 Hz	1.35 kHz
1.0 kHz	1.41 kHz	1.06 kHz	1.48 kHz
1.1 kHz	1.55 kHz	1.17 kHz	1.63 kHz
1.2 kHz	1.69 kHz	1.27 kHz	1.78 kHz
1.3 kHz	1.83 kHz	1.38 kHz	1.93 kHz
1.5 kHz	2.11 kHz	1.59 kHz	2.22 kHz
1.6 kHz	2.26 kHz	1.70 kHz	2.37 kHz
1.8 kHz	2.54 kHz	1.91 kHz	2.67 kHz
2.0 kHz	2.82 kHz	2.12 kHz	2.96 kHz
2.2 kHz	3.10 kHz	2.33 kHz	3.26 kHz
2.4 kHz	3.38 kHz	2.54 kHz	3.56 kHz
2.7 kHz	3.80 kHz	2.86 kHz	4.00 kHz
3.0 kHz	4.23 kHz	3.18 kHz	4.44 kHz
3.3 kHz	4.65 kHz	3.49 kHz	4.89 kHz
3.6 kHz	5.06 kHz	3.81 kHz	5.32 kHz
3.9 kHz	5.48 kHz	4.12 kHz	5.76 kHz
4.3 kHz	6.07 kHz	4.56 kHz	6.38 kHz
4.7 kHz	6.62 kHz	4.98 kHz	6.96 kHz

Normal (-3 dB)	-6 dB	Noise	Impulse
5.1 kHz	7.16 kHz	5.38 kHz	7.53 kHz
5.6 kHz	7.87 kHz	5.92 kHz	8.27 kHz
6.2 kHz	8.74 kHz	6.57 kHz	9.18 kHz
6.8 kHz	9.58 kHz	7.20 kHz	10.1 kHz
7.5 kHz	10.5 kHz	7.92 kHz	11.1 kHz
8.2 kHz	11.5 kHz	8.66 kHz	12.1 kHz
9.1 kHz	12.8 kHz	9.64 kHz	13.5 kHz
10 kHz	14.1 kHz	10.6 kHz	14.8 kHz
11 kHz	15.4 kHz	11.6 kHz	16.2 kHz
12 kHz	16.9 kHz	12.7 kHz	17.8 kHz
13 kHz	18.3 kHz	13.7 kHz	19.2 kHz
15 kHz	21.2 kHz	15.9 kHz	22.3 kHz
16 kHz	22.4 kHz	16.8 kHz	23.5 kHz
18 kHz	25.2 kHz	19.0 kHz	26.5 kHz
20 kHz	28.4 kHz	21.3 kHz	29.8 kHz
22 kHz	31.2 kHz	23.4 kHz	32.8 kHz
24 kHz	33.8 kHz	25.4 kHz	35.6 kHz
27 kHz	38.1 kHz	28.7 kHz	40.1 kHz
30 kHz	42.1 kHz	31.7 kHz	44.3 kHz
33 kHz	46.8 kHz	35.2 kHz	49.2 kHz
36 kHz	50.1 kHz	37.7 kHz	52.7 kHz
39 kHz	54.8 kHz	41.2 kHz	57.6 kHz
43 kHz	61.1 kHz	46.0 kHz	64.3 kHz
47 kHz	66.2 kHz	49.8 kHz	69.6 kHz
51 kHz	72.3 kHz	54.3 kHz	76.0 kHz
56 kHz	79.5 kHz	59.8 kHz	83.6 kHz
62 kHz	86.3 kHz	64.9 kHz	90.8 kHz
68 kHz	96.5 kHz	72.6 kHz	101 kHz
75 kHz	106 kHz	79.7 kHz	111 kHz
82 kHz	114 kHz	86.0 kHz	120 kHz

Normal (-3 dB)	-6 dB	Noise	Impulse
91 kHz	129 kHz	97.3 kHz	136 kHz
100 kHz	140 kHz	105 kHz	147 kHz
110 kHz	154 kHz	116 kHz	162 kHz
120 kHz	169 kHz	127 kHz	178 kHz
130 kHz	182 kHz	137 kHz	192 kHz
150 kHz	210 kHz	158 kHz	221 kHz
160 kHz	223 kHz	168 kHz	235 kHz
180 kHz	253 kHz	190 kHz	266 kHz
200 kHz	280 kHz	211 kHz	295 kHz
220 kHz	308 kHz	232 kHz	324 kHz
240 kHz	336 kHz	253 kHz	353 kHz
270 kHz	380 kHz	286 kHz	400 kHz
300 kHz	420 kHz	316 kHz	441 kHz
330 kHz	467 kHz	352 kHz	491 kHz
360 kHz	506 kHz	380 kHz	532 kHz
390 kHz	550 kHz	414 kHz	578 kHz
430 kHz	599 kHz	451 kHz	629 kHz
470 kHz	660 kHz	497 kHz	693 kHz
510 kHz	715 kHz	538 kHz	750 kHz
560 kHz	786 kHz	592 kHz	826 kHz
620 kHz	867 kHz	653 kHz	912 kHz
680 kHz	952 kHz	717 kHz	1.00 MHz
750 kHz	1.05 MHz	791 kHz	1.10 MHz
820 kHz	1.14 MHz	859 kHz	1.19 MHz
910 kHz	1.27 MHz	960 kHz	1.34 MHz
1.0 MHz	1.40 MHz	1.06 MHz	1.47 MHz
1.1 MHz	1.53 MHz	1.15 MHz	1.61 MHz
1.2 MHz	1.66 MHz	1.26 MHz	1.75 MHz
1.3 MHz	1.80 MHz	1.36 MHz	1.89 MHz
1.5 MHz	2.06 MHz	1.56 MHz	2.17 MHz

Normal (-3 dB)	-6 dB	Noise	Impulse
1.6 MHz	2.19 MHz	1.66 MHz	2.29 MHz
1.8 MHz	2.51 MHz	1.91 MHz	2.63 MHz
2.0 MHz	2.75 MHz	2.10 MHz	2.88 MHz
2.2 MHz	3.00 MHz	2.30 MHz	3.14 MHz
2.4 MHz	3.30 MHz	2.54 MHz	3.45 MHz
2.7 MHz	3.63 MHz	2.81 MHz	3.78 MHz
3.0 MHz	4.09 MHz	3.18 MHz	4.22 MHz
4 MHz	5.30 MHz	4.23 MHz	5.30 MHz
5 MHz	5.78 MHz	4.81 MHz	5.41 MHz
6 MHz	6.31 MHz	5.50 MHz	5.82 MHz
8 MHz	8.07 MHz	7.21 MHz	6.90 MHz

Flattop

With a PXA or Option B40, the capability for arbitrary Digital IF bandwidths is available. However, for instruments without the Digital IF or the Option B40 or B1X board, the selectable Flattop filter bandwidths are predefined in the following table. There are 134 Digital IF BWs (RBWs).

The table in the section [“Flattop Filters” on page 377](#) lists all 134 Flattop filter types.

Flattop Filters

3.0 Hz	3.3 Hz	3.6 Hz	3.9 Hz
4.3 Hz	4.7 Hz	5.1 Hz	5.6 Hz
6.2 Hz	6.8 Hz	7.5 Hz	8.2 Hz
9.1 Hz	10 Hz	11 Hz	12 Hz
13 Hz	15 Hz	16 Hz	18 Hz
20 Hz	22 Hz	24 Hz	27 Hz
30 Hz	33 Hz	36 Hz	39 Hz
43 Hz	47 Hz	51 Hz	56 Hz
62 Hz	68 Hz	75 Hz	82 Hz
91 Hz	100 Hz	110 Hz	120 Hz
130 Hz	150 Hz	160 Hz	180 Hz
200 Hz	220 Hz	240 Hz	270 Hz
300 Hz	330 Hz	360 Hz	390 Hz
430 Hz	470 Hz	510 Hz	560 Hz
620 Hz	680 Hz	750 Hz	820 Hz
910 Hz	1.0 kHz	1.1 kHz	1.2 kHz
1.3 kHz	1.5 kHz	1.6 kHz	1.8 kHz
2.0 kHz	2.2 kHz	2.4 kHz	2.7 kHz
3.0 kHz	3.3 kHz	3.6 kHz	3.9 kHz
4.3 kHz	4.7 kHz	5.1 kHz	5.6 kHz
6.2 kHz	6.8 kHz	7.5 kHz	8.2 kHz
9.1 kHz	10 kHz	11 kHz	12 kHz
13 kHz	15 kHz	16 kHz	18 kHz
20 kHz	22 kHz	24 kHz	27 kHz
30 kHz	33 kHz	36 kHz	39 kHz
43 kHz	47 kHz	51 kHz	56 kHz
62 kHz	68 kHz	75 kHz	82 kHz
91 kHz	100 kHz	110 kHz	120 kHz
130 kHz	150 kHz	160 kHz	180 kHz
200 kHz	220 kHz	240 kHz	270 kHz

Waveform Measurement
BW

300 kHz	330 kHz	390 kHz	430 kHz
510 kHz	620 kHz	750 kHz	1.0 MHz
1.5 MHz	3.0 MHz	4 MHz	5 MHz
6 MHz	8 MHz		

Filter BW

This feature is only available with PXA or when Option B40 is installed.

Key Path	BW
Mode	BASIC
Remote Command	[:SENSe]:WAVeform:DIF:FILTer:BANDwidth <freq> [:SENSe]:WAVeform:DIF:FILTer:BANDwidth? [:SENSe]:WAVeform:DIF:FILTer:BANDwidth:AUTO ON OFF 1 0 [:SENSe]:WAVeform:DIF:FILTer:BANDwidth:AUTO?
Example	WAV:DIF:FILT:BAND 1MHz WAV:DIF:FILT:BAND? WAV:DIF:FILT:BAND:AUTO 0 WAV:DIF:FILT:BAND:AUTO?
Notes	You must be in the IQ Analyzer (Basic) mode to use this command. Use INSTRument:SElect to set the mode.
Dependencies	This feature is only available with PXA or when Option B40 is installed.
Couplings	Sets the same value as the current Digital IF BW value upon a preset or when Channel Filter Bandwidth Auto is ON.
Preset	Same value as Digital IF BW ON
State Saved	Saved in instrument state.
Min	10 Hz
Max	Clipped to the current Digital IF BW value.
Initial S/W Revision	A.04.00
Help Map ID	9569

Channel Filter Bandwidth Bwcc (Remote Command Only)

This is the backward compatibility command for Channel Filter Bandwidth.

Mode	BASIC
------	-------

Remote Command	[:SENSE] :WAVEform:WBIF:FILTer:BANDwidth <real> [:SENSE] :WAVEform:WBIF:FILTer:BANDwidth?
Example	WAV:WBIF:FILT:BAND 0.3 WAV:WBIF:FILT:BAND?
Notes	You must be in the IQ Analyzer (Basic) mode to use this command. Use INSTRument:SElect to set the mode.
Dependencies	This feature is only available with PXA or when Option B40 is installed.
Couplings	The value is determined by the following equation. ChannelFilterBwBwcc = (ChannelFilterBw/(DigitalIFBw*OverSampleRatio))
Preset	0.8
State Saved	Saved in instrument state.
Min	0.01
Max	1.0
Initial S/W Revision	A.04.00
Help Map ID	0

Filter Alpha

Sets the filter alpha for the DIF filter. This feature is only available with PXA or when Option B40 is installed.

Key Path	BW
Mode	BASIC
Remote Command	[:SENSE] :WAVEform:DIF:FILTer:ALPHa <real> [:SENSE] :WAVEform:DIF:FILTer:ALPHa?
Example	WAV:DIF:FILT:ALPH 0.5 WAV:DIF:FILT:ALPH?
Notes	You must be in the IQ Analyzer (Basic) mode to use this command. Use INSTRument:SElect to set the mode.
Dependencies	This feature is only available with PXA or when Option B40 is installed.
Preset	0.2
State Saved	Saved in instrument state.
Min	0.01
Max	1.00

Waveform Measurement
BW

Backwards Compatibility SCPI	[:SENSe]:WAVEform:WBIF:FILTer:ALPHa
Help Map ID	9570

Cont

For details on this key, see “Cont (Continuous Measurement/Sweep)” on page 501.[\[Proc_iFrame:3309@\]](#)

Key Path	Front-panel key
Help Map ID	0

FREQ Channel

For details on this key, see [“FREQ Channel”](#) on page 503.

Key Path	Front-panel key
Help Map ID	0

Input/Output

For details on this key, see “Input/Output” on page 507.[\[Proc_iFrame:3065@\]](#)

Key Path	Front-panel key
Help Map ID	0

Marker

Accesses a menu that enables you to select, set up and control the markers for the current measurement.

For more information, see [“Marker” on page 581](#).

Key Path	Front-panel key
Initial S/W Revision	Prior to A.02.00
Help Map ID	9533

Select Marker

Displays 12 markers available for selection.

See [“Select Marker” on page 584](#) for more information.

Key Path	Marker
Initial S/W Revision	Prior to A.02.00
Help Map ID	9561

Marker Type

Sets the marker control mode to **Normal**, **Delta**, **Fixed** or **Off**. All interactions and dependencies detailed under the key description are enforced when the remote command is sent. If the selected marker is Off, pressing Marker sets it to Normal and places it at the center of the screen on the trace determined by the **Marker Trace** rules. At the same time, the Marker X Axis Value appears on the Active Function area.

The default active function is the active function for the currently selected marker control mode. If the current control mode is Off, there is no active function and the active function is turned off.

Key Path	Marker
Mode	BASIC, PN, WCDMA, C2K, GSM, WIMAX OFDMA, TD-SCDMA, 1xEV-DO, DVB-T/H, DTMB, ISDB-T, CMMB, LTE, LTETDD, WLAN
Remote Command	:CALCulate:WAVeform:MARKer [1] 2 3 4 5 6 7 8 9 10 11 12 : MODE POSition DELTA OFF :CALCulate:WAVeform:MARKer [1] 2 3 4 5 6 7 8 9 10 11 12 : MODE?
Example	CALC:WAV:MARK:MODE OFF CALC:WAV:MARK:MODE?

Notes	<p>If the selected marker is Off, pressing Marker sets it to Normal and places it at the center of the screen on the trace determined by the Marker Trace rules. At the same time, Marker X Axis Value appears on the Active Function area.</p> <p>Default Active Function: the active function for the selected marker's current control mode. If the current control mode is Off, there is no active function and the active function is turned off.</p> <p>Active Function Display: the marker X axis value entered in the active function area displays the marker value to its full entered precision.</p> <p>You must be in a mode that includes the Waveform measurement to use this command. Use INSTRument:SElect to set the mode.</p>
Preset	OFF
State Saved	Saved in instrument state.
Range	Normal Delta Off
Initial S/W Revision	Prior to A.02.00
Modified at S/W Revision	A.03.00
Help Map ID	9534

Marker X Axis Value (Remote Command Only)

Sets the marker X Axis value in the current marker X Axis Scale unit. It has no effect if the control mode is **Off**, but is the SCPI equivalent of entering an X value if the control mode is **Normal** or **Delta**.

Mode	BASIC, PN, WCDMA, C2K, GSM, WIMAX OFDMA, TD-SCDMA, 1xEV-DO, DVB-T/H, DTMB, ISDB-T, CMMB, LTE, LTETDD, WLAN
Remote Command	<pre>:CALCulate:WAVEform:MARKer [1] 2 3 4 5 6 7 8 9 10 11 12 : X <time></pre> <pre>:CALCulate:WAVEform:MARKer [1] 2 3 4 5 6 7 8 9 10 11 12 : X?</pre>
Example	<pre>CALC:WAV:MARK:X 50 ms</pre> <pre>CALC:WAV:MARK:X?</pre>
Notes	<p>If no suffix is sent, uses the fundamental units for the current marker X Axis Scale. If a suffix is sent that does not match the current marker X Axis Scale unit, an error "Invalid suffix" is generated. If the specified marker is Fixed and a Marker Function is on, error -221 "Settings conflict; cannot adjust Fixed marker while Marker Function is on" is generated.</p> <p>The query returns the marker's absolute X Axis value if the control mode is Normal, or the offset from the marker's reference marker if the control mode is Delta. The query is returned in the fundamental units for the current marker X Axis scale: Hz for Frequency and Inverse Time, seconds for Period and Time. If the marker is Off the response is not a number.</p> <p>You must be in a mode that includes the Waveform measurement to use this command. Use INSTRument:SElect to set the mode.</p>

Preset	0
Preset	After a preset, all markers are turned OFF, so Marker X Axis Value query returns a not a number (NAN).
State Saved	No
Min	-9.9E+37
Max	9.9E+37
Initial S/W Revision	Prior to A.02.00
Modified at S/W Revision	A.03.00
Help Map ID	0

Marker X Axis Position (Remote Command Only)

Sets the marker X position in trace points. It has no effect if the control mode is **Off**, but is the SCPI equivalent of entering a value if the control mode is **Normal** or **Delta**. The entered value is immediately translated into the current X Axis Scale units for setting the value of the marker.

Mode	BASIC, PN, WCDMA, C2K, GSM, WIMAX OFDMA, TD-SCDMA, 1xEV-DO, DVB-T/H, DTMB, ISDB-T, CMMB, LTE, LTETDD, WLAN
Remote Command	:CALCulate:WAVEform:MARKer [1] 2 3 4 5 6 7 8 9 10 11 12 : X:POSition <real> :CALCulate:WAVEform:MARKer [1] 2 3 4 5 6 7 8 9 10 11 12 : X:POSition?
Example	CALC:WAV:MARK:X:POS 500 CALC:WAV:MARK:X:POS?
Notes	The query returns the marker's absolute X Axis value in trace points if the control mode is Normal or the offset from the marker's reference marker in trace points if the control mode is Delta . The value is returned as a real number, not an integer, corresponding to the translation from X Axis Scale units to trace points. You must be in a mode that includes the Waveform measurement to use this command. Use INSTRument:SELEct to set the mode.
Preset	0
Preset	After a preset, all markers are turned OFF, so Marker X Axis Value query returns not a number (NAN).
State Saved	No
Min	-9.9E+37
Max	9.9E+37
Initial S/W Revision	Prior to A.02.00

Modified at S/W Revision	A.03.00
Help Map ID	0

Marker Y Axis Value (Remote Command Only)

Queries the marker Y Axis value in the current marker Y Axis unit.

Mode	BASIC, PN, WCDMA, C2K, GSM, WIMAX OFDMA, TD-SCDMA, 1xEV-DO, DVB-T/H, DTMB, ISDB-T, CMMB, LTE, LTETDD, WLAN
Remote Command	:CALCulate:WAVeform:MARKer [1] 2 3 4 5 6 7 8 9 10 11 12 : Y?
Example	CALC:WAV:MARK11:Y?
Notes	<p>When the marker is on, IQ waveform returns I and Q values.</p> <p>Case #1 - Trace RF, I or Q: returns a single double value.</p> <p>>:CALC:WAV:MARK1:Y?</p> <p>-2.402406506109E+001</p> <p>Case #2 - Trace IQ: returns a double array of two values, the first is I, and the second is Q.</p> <p>>:CALC:WAV:MARK1:Y?</p> <p>-3.006944493834E-003,+9.9870666467354E-004</p> <p>The IQ selection is for backward compatibility purposes. It is recommended that the users use the I and/or Q selection instead.</p> <p>You must be in a mode that includes the Waveform measurement to use this command. Use INSTRument:SElect to set the mode.</p>
Preset	Result dependant on the marker setup and signal source.
State Saved	No
Backwards Compatibility SCPI	:CALCulate:WAVeform:MARKer[1] 2 3 4 5 6 7 8 9 10 11 12:FUNCTion:RESuIt?
Initial S/W Revision	Prior to A.02.00
Modified at S/W Revision	A.03.00
Help Map ID	0

Properties

Accesses the marker properties menu.

Key Path	Marker
Initial S/W Revision	Prior to A.02.00

Waveform Measurement
Marker

Help Map ID	9562
-------------	------

Select Marker

Displays 12 markers available for selection.

Key Path	Marker
Initial S/W Revision	Prior to A.02.00
Help Map ID	9563

Relative To

Selects the marker that the selected marker is relative to (its reference marker).

Key Path	Marker, Properties
Mode	BASIC, PN, WCDMA, C2K, GSM, WIMAX OFDMA, TD-SCDMA, 1xEV-DO, DVB-T/H, DTMB, ISDB-T, CMMB, LTE, LTETDD, WLAN
Remote Command	:CALCulate:WAVEform:MARKer [1] 2 3 4 5 6 7 8 9 10 11 12 : REFerence <integer> :CALCulate:WAVEform:MARKer [1] 2 3 4 5 6 7 8 9 10 11 12 : REFerence?
Example	CALC:WAV:MARK:REF 8 CALC:WAV:MARK:REF?
Notes	A marker cannot be relative to itself so that choice is grayed out, and if sent from SCPI generates error -221: "Settings conflict; marker cannot be relative to itself." When queried a single value is returned (the specified marker numbers relative marker). You must be in a mode that includes the Waveform measurement to use this command. Use INSTRument:SElect to set the mode.
Preset	2 3 4 5 6 7 8 9 10 11 12 1
State Saved	Saved in instrument state.
Min	1
Max	12
Initial S/W Revision	Prior to A.02.00
Modified at S/W Revision	A.03.00
Help Map ID	9538

Marker Trace

Assigns the specified marker to the designated trace.

Key Path	Marker
Mode	BASIC, PN, WCDMA, C2K, GSM, WIMAX OFDMA, TD-SCDMA, 1xEV-DO, DVB-T/H, DTMB, ISDB-T, CMMB, LTE, LTETDD, WLAN
Remote Command	:CALCulate:WAVEform:MARKer [1] 2 3 4 5 6 7 8 9 10 11 12 : TRACe RFENvelope I Q IQ :CALCulate:WAVEform:MARKer [1] 2 3 4 5 6 7 8 9 10 11 12 : TRACe?
Example	CALC:WAV:MARK:TRAC RFEN CALC:WAV:MARK:TRAC?
Notes	Assigns the specified marker to the designated trace. The IQ selection is for backward compatibility purposes. It is recommended that the users use the I and/or Q selection instead. You must be in a mode that includes the Waveform measurement to use this command. Use INSTRument:SElect to set the mode.
Preset	RFEN
State Saved	Saved in instrument state.
Range	RF Envelope I Q IQ
Initial S/W Revision	Prior to A.02.00
Modified at S/W Revision	A.03.00
Help Map ID	9539

Couple Markers

Toggles the state of the markers to be coupled On or Off. When this function is true (On), moving any marker causes an equal X-axis movement of every other marker which is not **Off**. “Equal X-axis movement” refers to the difference between each marker’s X-Axis value (in the fundamental x-axis units of the trace that marker is on) and the X-Axis value of the marker being moved (in the same fundamental x-axis units) are preserved.

Key Path	Marker
Mode	BASIC, PN, WCDMA, C2K, GSM, WIMAX OFDMA, TD-SCDMA, 1xEV-DO, DVB-T/H, DTMB, ISDB-T, CMMB, LTE, LTETDD, WLAN
Remote Command	:CALCulate:WAVEform:MARKer:COUple [:STATe] ON OFF 1 0 :CALCulate:WAVEform:MARKer:COUple [:STATe] ?
Example	CALC:WAV:MARK:COUP ON CALC:WAV:MARK:COUP ON

Waveform Measurement
Marker

Notes	You must be in a mode that includes the Waveform measurement to use this command. Use INSTRument:SElect to set the mode.
Preset	OFF
State Saved	Saved in instrument state.
Range	On Off
Initial S/W Revision	Prior to A.02.00
Modified at S/W Revision	A.03.00
Help Map ID	9540

All Markers Off

Turns off all markers.

Key Path	Marker
Mode	BASIC, PN, WCDMA, C2K, GSM, WIMAX OFDMA, TD-SCDMA, 1xEV-DO, DVB-T/H, DTMB, ISDB-T, CMMB, LTE, LTETDD, WLAN
Remote Command	:CALCulate:WAVEform:MARKer:AOFF
Example	CALC:WAV:MARK:AOFF
Notes	You must be in a mode that includes the Waveform measurement to use this command. Use INSTRument:SElect to set the mode.
Initial S/W Revision	Prior to A.02.00
Modified at S/W Revision	A.03.00
Help Map ID	9541

Backward Compatibility SCPI Commands

Sets or queries the state of a marker. Setting a marker which is OFF to state ON or 1 puts it in Normal mode and places it at the center of the screen.

Mode	BASIC, PN, WCDMA, C2K, GSM, WIMAX OFDMA, TD-SCDMA, 1xEV-DO, DVB-T/H, DTMB, ISDB-T, CMMB, LTE, LTETDD, WLAN
Remote Command	:CALCulate:WAVEform:MARKer [1] 2 3 4 5 6 7 8 9 10 11 12 : STATE OFF ON 0 1 :CALCulate:WAVEform:MARKer [1] 2 3 4 5 6 7 8 9 10 11 12 : STATE?
Example	CALC:WAV:MARK:STAT ON CALC:WAV:MARK:STAT?
Notes	You must be in a mode that includes the Waveform measurement to use this command. Use INSTRument:SElect to set the mode.

Preset	OFF
State Saved	Saved in instrument state.
Range	On Off
Initial S/W Revision	Prior to A.02.00
Modified at S/W Revision	A.03.00
Help Map ID	9542

Marker Function

Accesses a menu of marker functions that perform post-processing operations on markers based on the measurement specifications. Marker functions are distinct from measurement functions, which automatically perform complex sequences of setup, data acquisition, and display operations in order to measure specified signal characteristics. Marker Functions are specified for each individual marker and may be turned on individually for each marker.

The **Marker Function** menu controls which marker functions are turned on and allows you to adjust the setup parameters for each function. These parameters include the following, but only one parameter can be assigned to a given marker:

- **Marker Noise**
- **Band/Interval Power**
- **Band/Interval Density**
- **Marker Function Off**

Key Path	Front-panel key
Initial S/W Revision	Prior to A.02.00
Help Map ID	9546

Select Marker

Displays 12 markers available for selection.

Key Path	Marker
Initial S/W Revision	Prior to A.02.00
Help Map ID	9565

Marker Function Type

Sets the marker control function type to, Marker Noise, Band/Interval Power, Band Interval Density, or Marker Function Off

Key Path	Marker Function
Mode	BASIC, PN, WCDMA, C2K, GSM, WIMAX OFDMA, TD-SCDMA, 1xEV-DO, DVB-T/H, DTMB, ISDB-T, CMMB, LTE, LTETDD, WLAN
Remote Command	:CALCulate:WAVEform:MARKer [1] 2 3 4 5 6 7 8 9 10 11 12 : FUNction BPOwer BDENSity OFF :CALCulate:WAVEform:MARKer [1] 2 3 4 5 6 7 8 9 10 11 12 : FUNction?

Example	CALC:WAV:MARK:FUNC BPOW CALC:WAV:MARK:FUNC?
Notes	You must be in a mode that includes the Waveform measurement to use this command. Use INSTRUMENT:SElect to set the mode.
Preset	OFF
State Saved	Saved in instrument state.
Range	Band/Interval Power Band Interval Density Marker Function Off
Initial S/W Revision	Prior to A.02.00
Modified at S/W Revision	A.03.00
Help Map ID	9547

Band Adjust

Accesses a menu that enables you to set the frequency span width and the left and right edge, or time values, for the band or interval of the selected marker.

Key Path	Marker Function
Initial S/W Revision	Prior to A.02.00
Help Map ID	9556

Band/Interval Span for Time Domain

Sets the width of the frequency span for the selected marker.

Key Path	Marker Function
Mode	BASIC, PN, WCDMA, C2K, GSM, WIMAX OFDMA, TD-SCDMA, 1xEV-DO, DVB-T/H, DTMB, ISDB-T, CMMB, LTE, LTETDD, WLAN
Remote Command	:CALCulate:WAVEform:MARKer [1] 2 3 4 5 6 7 8 9 10 11 12 : FUNCTION: BAND: SPAN <time> :CALCulate:WAVEform:MARKer [1] 2 3 4 5 6 7 8 9 10 11 12 : FUNCTION: BAND: SPAN?
Example	CALC:WAV:MARK:FUNC: BAND: SPAN 20 ms CALC:WAV:MARK:FUNC: BAND: SPAN?
Notes	You must be in a mode that includes the Waveform measurement to use this command. Use INSTRUMENT:SElect to set the mode.
Couplings	Changing the Band/Interval Span necessarily changes the Band/Interval Left and Band/Interval Right values
Preset	0
Preset	10% of Meas Time

Waveform Measurement
Marker Function

State Saved	Saved in instrument state.
Min	0
Max	100s
Backwards Compatibility SCPI	:CALCulate:WAVEform:MARKer[1] 2 3 4:X:SPAN
Initial S/W Revision	Prior to A.02.00
Modified at S/W Revision	A.03.00
Help Map ID	9548

Band/Interval Left for Time Domain

Sets the left edge frequency or time value for the band of the selected marker.

Key Path	Marker Function
Mode	BASIC, PN, WCDMA, C2K, GSM, WIMAX OFDMA, TD-SCDMA, 1xEV-DO, DVB-T/H, DTMB, ISDB-T, CMMB, LTE, LTETDD, WLAN
Remote Command	:CALCulate:WAVEform:MARKer [1] 2 3 4 5 6 7 8 9 10 11 12 : FUNction:BAND:LEFT <time> :CALCulate:WAVEform:MARKer [1] 2 3 4 5 6 7 8 9 10 11 12 : FUNction:BAND:LEFT?
Example	CALC:WAV:MARK12:FUNc:BAND:LEFT 1 s CALC:WAV:MARK12:FUNc:BAND:LEFT?
Notes	You must be in a mode that includes the Waveform measurement to use this command. Use INSTRument:SElect to set the mode.
Couplings	Changing the Band/Interval Left necessarily changes the Band/Interval Span and Band/Interval Right values
Preset	0
Preset	5% of Meas Time
State Saved	Saved in instrument state.
Min	0
Max	100 s
Initial S/W Revision	Prior to A.02.00
Modified at S/W Revision	A.03.00
Help Map ID	9549

Band/Interval Right for Time Domain

Sets the right edge frequency or time value for the band of the selected marker.

Key Path	Marker Function
Mode	BASIC, PN, WCDMA, C2K, GSM, WIMAX OFDMA, TD-SCDMA, 1xEV-DO, DVB-T/H, DTMB, ISDB-T, CMMB, LTE, LTETDD, WLAN
Remote Command	:CALCulate:WAVEform:MARKer[1] 2 3 4 5 6 7 8 9 10 11 12:FUNCTION:BAND:RIGHT <time> :CALCulate:WAVEform:MARKer[1] 2 3 4 5 6 7 8 9 10 11 12:FUNCTION:BAND:RIGHT?
Example	CALC:WAV:MARK12:FUNC:BAND:RIGHT 1 s CALC:WAV:MARK12:FUNC:BAND:RIGHT?
Notes	You must be in a mode that includes the Waveform measurement to use this command. Use INSTRUMENT:SElect to set the mode.
Couplings	Changing the Band/Interval Left necessarily changes the Band/Interval Span and Band/Interval Right values
Preset	0
Preset	5% of Meas Time
State Saved	Saved in instrument state.
Min	0
Max	100 s
Initial S/W Revision	Prior to A.02.00
Modified at S/W Revision	A.03.00
Help Map ID	9550

Marker To

There is no 'Marker To' functionality supported in Waveform measurements. The front-panel key displays a blank menu when pressed.

Key Path	Front-panel key
Initial S/W Revision	Prior to A.02.00
Help Map ID	9564

Meas

For details on this key, see “Meas” on page 627.[\[Proc_iFrame:4008@\]](#)

Key Path	Front-panel key
Help Map ID	0

Meas Setup

Displays the setup menu keys that enable you to control the parameters for the current measurement.

Key Path	Front-panel key
Initial S/W Revision	Prior to A.02.00
Help Map ID	9521

Average/Hold Num

Sets the number of sweeps (average counts) that are averaged. After the specified number of sweeps, the averaging mode (terminal control) setting determines the averaging action.

Key Path	Meas Setup
Mode	BASIC, PN, WCDMA, C2K, GSM, WIMAX OFDMA, TD-SCDMA, 1xEV-DO, DVB-T/H, DTMB, ISDB-T, CMMB, LTE, LTETDD, WLAN
Remote Command	[:SENSe] :WAVeform:AVERAge:COUNT <integer> [:SENSe] :WAVeform:AVERAge:COUNT? [:SENSe] :WAVeform:AVERAge [:STATe] OFF ON 0 1 [:SENSe] :WAVeform:AVERAge [:STATe] ?
Example	WAV:AVER:COUN 1001 WAV:AVER:COUN? WAV:AVER ON WAV:AVER?
Notes	You must be in a mode that includes the Waveform measurement to use this command. Use INSTRument:SElect to set the mode.
Preset	10 OFF
State Saved	Saved in instrument state.
Min	1
Max	20001
Initial S/W Revision	Prior to A.02.00
Modified at S/W Revision	A.03.00
Help Map ID	9522

Avg Mode

Enables you to set the averaging mode.

When set to Exponential (Exp) the measurement averaging continues using the specified number of averages to compute each averaged value. The average is displayed at the end of each sweep.

When set to Repeat, the measurement resets the average counter each time the specified number of averages is reached.

Key Path	Meas Setup
Mode	BASIC, PN, WCDMA, C2K, GSM, WIMAX OFDMA, TD-SCDMA, 1xEV-DO, DVB-T/H, DTMB, ISDB-T, CMMB, LTE, LTETDD, WLAN
Remote Command	[:SENSE] :WAVeform:AVERage:TCONtrol EXPonential REPeat [:SENSe] :WAVeform:AVERage:TCONtrol?
Example	WAV:AVER:TCON REP WAV:AVER:TCON?
Notes	You must be in a mode that includes the Waveform measurement to use this command. Use INSTRument:SElect to set the mode.
Preset	EXPonential
State Saved	Saved in instrument state.
Range	Exp Repeat
Initial S/W Revision	Prior to A.02.00
Modified at S/W Revision	A.03.00
Help Map ID	9523

Avg Type

Selects the type of averaging.

Key Path	Meas Setup
Mode	BASIC, PN, WCDMA, C2K, GSM, WIMAX OFDMA, TD-SCDMA, 1xEV-DO, DVB-T/H, DTMB, ISDB-T, CMMB, LTE, LTETDD, WLAN
Remote Command	[:SENSe] :WAVeform:AVERage:TYPE LOG MAXimum MINimum RMS SCALar [:SENSe] :WAVeform:AVERage:TYPE?
Example	WAV:AVER:TYPE MAX WAV:AVER:TYPE?

Notes	The SCPI selection of MAX and MIN are kept for BWCC, but they are removed from the front panel access because they are not an Average function. You must be in a mode that includes the Waveform measurement to use this command. Use INSTRument:SElect to set the mode.
Preset	RMS
State Saved	Saved in instrument state.
Range	Pwr Avg(RMS) Log-Pwr Avg(Video) Voltage Avg
Initial S/W Revision	Prior to A.02.00
Modified at S/W Revision	A.03.00
Help Map ID	9524

HW Averaging

Changes the number of time averages is to be made using hardware. This averaging is much faster than the standard averaging done in software. The hardware averaging is done on the complex voltage time trace data before any measurement application averaging is done. Both types of averaging (HW and SW) can be done on the same measurement data.

When time averaging is being done in HW, each trace update represents N fresh data acquisitions averaged together, where N is the number of averages. You cannot access the individual time data. Note that in the spectrum measurement this averaging is done prior to the standard averaging done within the application. Thus the yellow trace in this measurement shows the result of the time averaging. Subsequent averaging is orthogonal to this hardware based time averaging and its result is seen as the blue trace in this and other applications.

So it is possible to turn off the averaging within the application but still have the HW averaging set to a certain number. In other words, turning averaging off within the measurement will not affect HW averaging. If HW averaging needs to be turned off, simply set the HW Averaging parameter to 1.

Since it is time averaging, a trigger source something other than FreeRun should be used to avoid cancelling out the signal to be measured. It is most useful for a periodic signal with known periods.

Time Avg Num

Sets the number of HW averages to be executed per each data acquisition.

Key Path	Meas Setup
Mode	BASIC
Remote Command	[:SENSE] :WAVEform:AVERage:TACount <integer> [:SENSE] :WAVEform:AVERage:TACount?
Example	WAV:AVER:TAC 10 WAV:AVER:TAC?

Notes	This feature is only available with PXA or when Option B40 is installed.
Preset	1
State Saved	Saved in instrument state.
Min	1
Max	65535
Help Map ID	9571

Sample Rate

Enables you to set an arbitrary sample rate for the acquired data to be processed.

Key Path	Meas Setup
Mode	BASIC
Remote Command	[:SENSe] :WAVeform:SRATe <freq> [:SENSe] :WAVeform:SRATe?
Example	WAV:SRAT 1.3636 MHz
Notes	Command and query available with PXA or when Option B40 is installed. For other configurations, only the query is available.
Couplings	The coupling between Sample Rate and IF BW depends on Physics implementation.
Preset	125.0 kHz
Min	12.5 Hz
Max	Option B25 10 MHz path: 15 MHz Option B25 25MHz path: 45 MHz Digital IF 10 MHz path: 12.5 MHz Digital IF 25 MHz path: 31.25 MHz Digital IF0 40 MHz path: 50 MHz Option B40 140 MHz path: 175 MHz
Help Map ID	9574

Sample Period (Aperture) Setting (Remote Command Only)

Returns the time between samples (sample period or aperture).

Mode	BASIC
Remote Command	[:SENSe] :WAVeform:APERture?
Example	WAV:APER?

Waveform Measurement
Meas Setup

Notes	Query only.
Couplings	Coupled to Sample Rate by the following equation. Sample Period = 1/(Sample Rate)
Preset	1/(Sample Rate Default)
Min	1/(Max Sample Rate)
Max	1/(Min Sample Rate)
Help Map ID	0

Meas Time

Sets how long the measurement is performed. X Scale only changes the representation of the display.

Key Path	Meas Setup
Mode	BASIC, PN, WCDMA, C2K, GSM, WIMAX OFDMA, TD-SCDMA, 1xEV-DO, DVB-T/H, DTMB, ISDB-T, CMMB, LTE, LTETDD, WLAN
Remote Command	[:SENSe] :WAVeform:SWEep:TIME <time> [:SENSe] :WAVeform:SWEep:TIME?
Example	WAV:SWE:TIME 50 ms WAV:SWE:TIME?
Notes	Specifies and returns how long the measurement is performed. It is the time record length of the measurement waveform. The Max time may be reduced when the sample frequency is high due to the memory limitation. You must be in a mode that includes the Waveform measurement to use this command. Use INSTRument:SElect to set the mode.
Preset	2.000000 ms
State Saved	Saved in instrument state.
Range	1.000 (s to 100.00 s)
Initial S/W Revision	Prior to A.02.00
Modified at S/W Revision	A.03.00
Help Map ID	9525

PhNoise Opt

Selects the LO (local oscillator) phase noise behavior for various desired operating conditions.

Key Path	Meas Setup
----------	------------

Remote Command	[:SENSe] :WAVeform:FREQUency:SYNTHeSis [:STATe] 1 2 3 [:SENSe] :WAVeform:FREQUency:SYNTHeSis [:STATe] ?
Example	WAV:FREQ:SYNT 2 Selects optimization for best wide offset phase noise
Notes	Parameter: 1. 1 optimizes phase noise for small frequency offsets from the carrier. 2. 2 optimizes phase noise for wide frequency offsets from the carrier. 3. 3 optimizes LO for tuning speed (In PXA, the local oscillator hardware provides for extra-low phase noise at the expense of some speed)
Dependencies	Does not appear in all models. The key is blank in those models, but the SCPI command is accepted for compatibility (although no action is taken).
Preset	Because this function is in Auto after preset, and because Digital IF BW after preset < 150 kHz for MXA/EXA and > 400 kHz for PXA the state of this function after Preset will be 1 for MXA/EXA and 2 for PXA.
State Saved	Saved in instrument state.
Min	1
Min	1
Max	3
Initial S/W Revision	Prior to A.07.00
Modified at S/W Revision	A.07.00
Help Map ID	9578

Auto

Selects the LO (local oscillator) phase noise behavior to optimize dynamic range and speed for various instrument operating conditions.

The X-Series has two grades of LO; a high performance LO that gives the best phase noise performance; and a medium-performance LO that gives excellent performance.

In models with the high performance LO, Auto will choose:

	Best Close in Phase Noise	Best Wide-offset Phase Noise
Filter BW	≤400 kHz	> 400 kHz

Waveform Measurement
Meas Setup

In models with the medium-performance LO, Auto will choose:

	Best Close in Phase Noise	Best Wide-offset Phase Noise
Filter BW	≤150 kHz	>150 kHz

Note that Fast Tuning will not be selected when in Auto.

Key Path	Meas Setup, PhNoise Opt
Remote Command	[:SENSe] :WAVeform:FREQUency:SYNTHeSis:AUTO [:STATe] OFF ON 0 1 [:SENSe] :WAVeform:FREQUency:SYNTHeSis:AUTO [:STATe] ?
Example	WAV:FREQ:SYNT:AUTO ON
Preset	ON
State Saved	Saved in instrument state.
Initial S/W Revision	Prior to A.07.00
Help Map ID	9575

Best Close-in P Noise

The LO phase noise is optimized for smaller offsets from the carrier, at the expense of phase noise farther out.

Key Path	Meas Setup, PhNoise Opt
Example	WAV:FREQ:SYNT 1
Couplings	The frequency below which the phase noise is optimized is model dependent: CXA: n/a EXA: [offset 150 kHz] MXA: [offset 150 kHz] PXA: [offset 400 kHz]
Readback	Close-in. If manually selected, “Man” will be underlined. The actual frequency offset within which noise is optimized is shown with in square brackets, as this can vary depending on the hardware set in use. For example, in some analyzers this annotation appears as [offset <150 kHz]
Initial S/W Revision	Prior to A.07.00
Help Map ID	9576

Best Wide-offset P Noise

The LO phase noise is optimized for wider offsets from the carrier. Closer offsets are compromised and

the throughput of measurements (especially remote measurements where the center frequency is changing rapidly), is reduced.

Key Path	Meas Setup, PhNoise Opt
Example	WAV:FREQ:SYNT 2
Couplings	The frequency below which the phase noise is optimized is model dependent: CXA: n/a EXA: [offset >150 kHz] MXA: [offset >150 kHz] PXA: [offset >400 kHz]
Readback	Wide-offset. If manually selected, “Man” will be underlined. The actual frequency offset beyond which noise is optimized is shown with in square brackets, as this can vary depending on the hardware set in use. For example, in some analyzers this annotation appears as [offset >150 kHz]
Initial S/W Revision	Prior to A.07.00
Help Map ID	9577

Advanced

Accesses a menu of advanced functions that are used for specific applications. These settings should not be changed for most measurements.

Key Path	Meas Setup
Initial S/W Revision	Prior to A.02.00
Help Map ID	9557

ADC Dither

Accesses the ADC Dither control menu.

Key Path	Meas Setup, Advanced
Initial S/W Revision	Prior to A.02.00
Help Map ID	9558

ADC Dither Auto

Sets ADC dithering to automatically select whether dithering is needed.

Key Path	Meas Setup, Advanced, ADC Dither
----------	---

Waveform Measurement
Meas Setup

Mode	BASIC, PN, WCDMA, C2K, GSM, WIMAX OFDMA, TD-SCDMA, 1xEV-DO, DVB-T/H, DTMB, ISDB-T, CMMB, LTE, LTETDD, WLAN
Remote Command	[:SENSe] :WAVeform:ADC:DITHer:AUTO [:STATe] OFF ON 0 1 [:SENSe] :WAVeform:ADC:DITHer:AUTO [:STATe] ?
Example	WAV:ADC:DITH:AUTO ON WAV:ADC:DITH:AUTO?
Notes	The dither function improves linearity for low level signals, at the expense of a higher noise floor. You must be in a mode that includes the Waveform measurement to use this command. Use INSTRument:SElect to set the mode.
Preset	OFF
State Saved	Saved in instrument state.
Range	On Off
Initial S/W Revision	Prior to A.02.00
Modified at S/W Revision	A.03.00
Help Map ID	9527

ADC Dither

Toggles the dither function On and Off. The dither function improves linearity for low level signals, at the expense of a higher noise floor.

The reduced clipping-to-noise ratio results in higher noise, because the clipping level of the ADC relative to the front terminals remains unchanged with the introduction of dither. The enhanced linearity is mostly improved scale fidelity.

With dither on, the third-order distortions are usually invisible for mixer levels below -35 dBm. With dither off, these distortions can be visible, with typical power levels of -110 dBm referred to the mixer. Detection nonlinearity can reach 1 dB for dither off at mixer levels around -70 dBm and lower, while the specified nonlinearity is many times smaller with dither on.

Key Path	Meas Setup, Advanced, ADC Dither
Mode	BASIC, PN, WCDMA, C2K, GSM, WIMAX OFDMA, TD-SCDMA, 1xEV-DO, DVB-T/H, DTMB, ISDB-T, CMMB, LTE, LTETDD, WLAN
Remote Command	[:SENSe] :WAVeform:ADC:DITHer [:STATe] OFF ON 0 1 [:SENSe] :WAVeform:ADC:DITHer [:STATe] ?
Example	WAV:ADC:DITH ON WAV:ADC:DITH?

Notes	The dither function improves linearity for low level signals, at the expense of a higher noise floor. You must be in a mode that includes the Waveform measurement to use this command. Use INSTRument:SElect to set the mode.
Preset	OFF
State Saved	Saved in instrument state.
Range	Auto Man
Backwards Compatibility SCPI	[:SENSe]:WAVeform:WBIF:ADC:DITHer [:SENSe]:WAVeform:PDITHer
Initial S/W Revision	Prior to A.02.00
Modified at S/W Revision	A.03.00
Help Map ID	9526

IF Gain

Sets the IF Gain function to Auto, Low Gain or High Gain. These settings affect sensitivity and IF overloads.

This only applies to the RF input. It does not apply to baseband I/Q input.

Key Path	Meas Setup, Advanced
Initial S/W Revision	Prior to A.02.00
Help Map ID	9554

IF Gain Auto

Activates the auto rules for IF Gain.

Key Path	Meas Setup, Advanced, IF Gain
Mode	BASIC, PN, WCDMA, C2K, GSM, WIMAX OFDMA, TD-SCDMA, 1xEV-DO, DVB-T/H, DTMB, ISDB-T, CMMB, LTE, LTETDD, WLAN
Remote Command	[:SENSe]:WAVeform:IF:GAIN:AUTO[:STATe] ON OFF 1 0 [:SENSe]:WAVeform:IF:GAIN:AUTO[:STATe]?
Example	WAV:IF:GAIN:AUTO ON WAV:IF:GAIN:AUTO?
Notes	This only applies to the RF input. It does not apply to baseband I/Q input. You must be in a mode that includes the Waveform measurement to use this command. Use INSTRument:SElect to set the mode.
Preset	ON

Waveform Measurement
Meas Setup

State Saved	Saved in instrument state.
Range	On Off
Initial S/W Revision	Prior to A.02.00
Modified at S/W Revision	A.03.00
Help Map ID	9528

IF Gain State

Selects the range of IF gain.

Key Path	Meas Setup, Advanced, IF Gain
Mode	BASIC, PN, WCDMA, C2K, GSM, WIMAX OFDMA, TD-SCDMA, 1xEV-DO, DVB-T/H, DTMB, ISDB-T, CMMB, LTE, LTETDD, WLAN
Remote Command	[:SENSE] :WAVEform:IF:GAIN [:STATE] AUTOrange LOW HIGH [:SENSE] :WAVEform:IF:GAIN [:STATE] ?
Example	WAV:IF:GAIN HIGH WAV:IF:GAIN?
Notes	This only applies to the RF input and does not apply to baseband I/Q input. You must be in a mode that includes the Waveform measurement to use this command. Use INSTRument:SElect to set the mode.
Preset	AUTO
State Saved	Saved in instrument state.
Range	Autorange (Slower Follows Signals) Low (Best for Large Signals) High (Best Noise Level)
Readback Text	Autorange Low High
Initial S/W Revision	Prior to A.02.00
Modified at S/W Revision	A.03.00
Help Map ID	9529

IF Gain Offset

Sets the IF Gain offset for the 40 MHz and 140 MHz IF Paths in 2 dB step from -6 dB to +6 dB. Increasing the gain can increase the amplitude of small signals as long as you do not overdrive the hardware. Wideband gain should usually be adjusted after setting the input attenuation.

The IF Gain key is enabled for all IF Path selections, but the IF Gain Offset is not activated when the IF Path Selection is Narrow and IF Path Selection Narrow is either 10 MHz or 25 MHz.

Internally, the IF Gain value will change based on the current configuration of the hardware. If you choose to offset this value, you may do so with this parameter. The value specified is not an absolute value but relative to the current internal IF Gain setting.

For example:

IF Gain Low + IF Gain Offset +4 dB = Total IF Gain of +4 dB (0 + 4 = 4)

IF Gain High + IF Gain Offset +4 dB = Total IF Gain of +14 dB (10 + 4 = 14)

IF Gain Low + IF Gain Offset -6 dB = Total IF Gain of -6 dB (0 - 6 = -6)

IF Gain High + IF Gain Offset -6 dB = Total IF Gain of +6 dB (10 - 6 = 4)

The total IF Gain range when IF Gain Offset is available is a minimum of 0 - 6 = -6 dB and a maximum of 10 + 6 = 16 dB. The available IF Gain depends on the IF Path and center frequency. The maximum IF Gain may not be achievable at all times depending on the configuration.

Key Path	Meas Setup, Advanced
Remote Command	[:SENSe] :WAVeform:IF:GAIN:OFFSet <rel_ampl > [:SENSe] :WAVeform:IF:GAIN:OFFSet?
Example	WAV:IF:GAIN:OFFS 2 Sets the IF Gain offset to 2
Couplings	If the IF Path Selection is 10 MHz or 25 MHz, then this feature is not available and is grayed out.
Preset	0
State Saved	Saved in instrument state.
Min	-6
Max	+6
Default Unit	dB
Help Map ID	9572

Meas Preset

Restores all the measurement parameters to their default values.

Key Path	Meas Setup
Mode	BASIC, PN, WCDMA, C2K, GSM, WIMAX OFDMA, TD-SCDMA, 1xEV-DO, DVB-T/H, DTMB, ISDB-T, CMMB, LTE, LTETDD, WLAN
Remote Command	:CONFigure:WAVeform
Example	CONF:WAV
Notes	Restore default values of all parameters. You must be in a mode that includes the Waveform measurement to use this command. Use INSTRument:SElect to set the mode.
Initial S/W Revision	Prior to A.02.00

Waveform Measurement
Meas Setup

Modified at S/W Revision	A.03.00
Help Map ID	9530

Mode

For details on this key, see “Mode” on page 475 [Proc_iFrame:2670@]

Key Path	Front-panel key
Help Map ID	0

Mode Setup

For details on this key, see [“Mode Setup”](#) on page 689.

Key Path	Front-panel key
Help Map ID	0

Peak Search

Places the selected marker on the trace point with the maximum y-axis value for that marker's trace and accesses a menu that enables you to select to do a next peak or minimum peak search.

Key Path	Front-panel key
Mode	BASIC, PN, WCDMA, C2K, GSM, WIMAX OFDMA, TD-SCDMA, 1xEV-DO, DVB-T/H, DTMB, ISDB-T, CMMB, LTE, LTETDD, WLAN
Remote Command	:CALCulate:WAVEform:MARKer [1] 2 3 4 5 6 7 8 9 10 11 12 : MAXimum
Example	CALC:WAV:MARK2:MAX
Notes	You must be in a mode that includes the Waveform measurement to use this command. Use INSTRUMENT:SElect to set the mode.
Initial S/W Revision	Prior to A.02.00
Modified at S/W Revision	A.03.00
Help Map ID	9544

Next Peak

Moves the selected marker to the next highest local maximum with a value less than the current marker's.

Key Path	Peak Search
Mode	BASIC, PN, WCDMA, C2K, GSM, WIMAX OFDMA, TD-SCDMA, 1xEV-DO, DVB-T/H, DTMB, ISDB-T, CMMB, LTE, LTETDD, WLAN
Remote Command	:CALCulate:WAVEform:MARKer [1] 2 3 4 5 6 7 8 9 10 11 12 : MAXimum:NEXT
Example	CALC:WAV:MARK:MAX:NEXT
Notes	You must be in a mode that includes the Waveform measurement to use this command. Use INSTRUMENT:SElect to set the mode.
Initial S/W Revision	Prior to A.02.00
Modified at S/W Revision	A.03.00
Help Map ID	9543

Min Search

Moves the selected marker to the minimum y-axis value on the current trace.

Key Path	Peak Search
----------	-------------

Waveform Measurement
Peak Search

Mode	BASIC, PN, WCDMA, C2K, GSM, WIMAX OFDMA, TD-SCDMA, 1xEV-DO, DVB-T/H, DTMB, ISDB-T, CMMB, LTE, LTETDD, WLAN
Remote Command	:CALCulate:WAVEform:MARKer [1] 2 3 4 5 6 7 8 9 10 11 12 : MINimum
Example	CALC:WAV:MARK:MIN
Notes	You must be in a mode that includes the Waveform measurement to use this command. Use INSTRument:SElect to set the mode.
Initial S/W Revision	Prior to A.02.00
Modified at S/W Revision	A.03.00
Help Map ID	9545

Recall

For details on this key, see [“Recall” on page 150](#).

Key Path	Front-panel key
Help Map ID	0

Restart

For details on this key, see “Restart” on page 713.[\[Proc_iFrame:3307@\]](#)

Key Path	Front-panel key
Help Map ID	0

Save

For details on this key, see “Save” on page 163.

Key Path	Front-panel key
Help Map ID	0

Single

For details on this key, see “[Single \(Single Measurement/Sweep\)](#)” on page 723.[\[Proc_iFrame:3515@\]](#)

Key Path	Front-panel key
Help Map ID	0

Source (Internal)

For details on this key, see “Source (Internal)” on page 725.[\[Proc_iFrame:35360@\]](#)

Key Path	Front-panel key
Help Map ID	0

Span X Scale

Accesses a menu of functions that enable you to set the horizontal scale parameters.

Key Path	Front-panel key
Initial S/W Revision	Prior to A.02.00
Help Map ID	9501

Ref Value

Sets the reference value for time on the horizontal axis. When Auto Scaling is set to On, the displayed plots use a Scale/Div value determined by the test set, based on the measurement result.

Key Path	SPAN X Scale
Mode	BASIC, PN, WCDMA, C2K, GSM, WIMAX OFDMA, TD-SCDMA, 1xEV-DO, DVB-T/H, DTMB, ISDB-T, CMMB, LTE, LTETDD, WLAN
Remote Command	:DISPlay:WAVeform:VIEW[1] 2:WINDow[1]:TRACe:X[:SCALe]:RLEVel <time> :DISPlay:WAVeform:VIEW[1] 2:WINDow[1]:TRACe:X[:SCALe]:RLEVel?
Example	DISP:WAV:VIEW:WIND:TRAC:X:RLEV 10 ms DISP:WAV:VIEW:WIND:TRAC:X:RLEV?
Notes	You must be in a mode that includes the Waveform measurement to use this command. Use INSTRument:SElect to set the mode.
Couplings	If Auto Scaling is set to On, this value is automatically determined by the measurement result. When you set this value manually, Auto Scaling automatically changes to Off.
Preset	0.00 s
State Saved	Saved in instrument state.
Min	-1.000 s
Max	10.00 s
Initial S/W Revision	Prior to A.02.00
Modified at S/W Revision	A.03.00
Help Map ID	9502

Scale/Div

Sets the horizontal scale by changing a time value per division.

Key Path	SPAN X Scale
Mode	BASIC, PN, WCDMA, C2K, GSM, WIMAX OFDMA, TD-SCDMA, 1xEV-DO, DVB-T/H, DTMB, ISDB-T, CMMB, LTE, LTETDD, WLAN
Remote Command	:DISPlay:WAVEform:VIEW[1] 2:WINDow[1]:TRACe:X[:SCALe]:P DIVision <time> :DISPlay:WAVEform:VIEW[1] 2:WINDow[1]:TRACe:X[:SCALe]:P DIVision?
Example	DISP:WAV:VIEW:WIND:TRAC:X:PDIV 500 us DISP:WAV:VIEW:WIND:TRAC:X:PDIV?
Notes	You must be in a mode that includes the Waveform measurement to use this command. Use INSTRument:SElect to set the mode.
Couplings	If Auto Scaling is set to On, this value is automatically determined by the measurement result. When you set this value manually, Auto Scaling automatically changes to Off.
Preset	200.0 us
State Saved	Saved in instrument state.
Min	1.000 ns
Max	1.000 s
Initial S/W Revision	Prior to A.02.00
Modified at S/W Revision	A.03.00
Help Map ID	9503

Ref Position

Sets the reference position for the X axis to Left, Center or Right.

Key Path	SPAN X Scale
Mode	BASIC, PN, WCDMA, C2K, GSM, WIMAX OFDMA, TD-SCDMA, 1xEV-DO, DVB-T/H, DTMB, ISDB-T, CMMB, LTE, LTETDD, WLAN
Remote Command	:DISPlay:WAVEform:VIEW[1] 2:WINDow[1]:TRACe:X[:SCALe]:R POSition LEFT CENTer RIGHT :DISPlay:WAVEform:VIEW[1] 2:WINDow[1]:TRACe:X[:SCALe]:R POSition?
Example	DISP:WAV:VIEW:WIND:TRAC:X:RPOS LEFT DISP:WAV:VIEW:WIND:TRAC:X:RPOS?

Waveform Measurement
Span X Scale

Notes	Allows you to set the reference position to Left, Ctr (center) or Right. You must be in a mode that includes the Waveform measurement to use this command. Use INSTRument:SElect to set the mode.
Preset	LEFT
State Saved	Saved in instrument state.
Range	Left Ctr Right
Initial S/W Revision	Prior to A.02.00
Modified at S/W Revision	A.03.00
Help Map ID	9504

Auto Scaling

Toggles the scale coupling function between On and Off.

Key Path	SPAN X Scale
Mode	BASIC, PN, WCDMA, C2K, GSM, WIMAX OFDMA, TD-SCDMA, 1xEV-DO, DVB-T/H, DTMB, ISDB-T, CMMB, LTE, LTETDD, WLAN
Remote Command	:DISPlay:WAVeform:VIEW[1] 2:WINDow[1]:TRACe:X[:SCALe]:COUPle 0 1 OFF ON :DISPlay:WAVeform:VIEW[1] 2:WINDow[1]:TRACe:X[:SCALe]:COUPle?
Example	DISP:WAV:VIEW:WIND:TRAC:X:COUP ON DISP:WAV:VIEW:WIND:TRAC:X:COUP?
Notes	You must be in a mode that includes the Waveform measurement to use this command. Use INSTRument:SElect to set the mode.
Couplings	When Auto Scaling is On and the Restart front-panel key is pressed, this function automatically determines the scale per division and reference values based on the measurement results. When you set a value to either Scale/Div or Ref Value manually, Auto Scaling automatically changes to Off.
Preset	1
State Saved	Saved in instrument state.
Range	On Off
Initial S/W Revision	Prior to A.02.00
Modified at S/W Revision	A.03.00
Help Map ID	9505

Sweep/Control

Accesses the Sweep menu that allows you to pause and restart the measurement.

For more information, see [“Sweep/Control” on page 867](#).

Key Path	Front-panel key
Initial S/W Revision	Prior to A.02.00
Help Map ID	9517

Pause and Resume

Pauses a measurement after the current data acquisition is complete. When Paused, the label on the key changes to Resume. Pressing the Resume key resumes the measurement at the point it was at when paused.

For more information, see [“Pause/Resume” on page 880](#).

Key Path	Sweep/Control
Initial S/W Revision	Prior to A.02.00
Help Map ID	9555

Trace/Detector

There is no Trace/Detector functionality supported in the Waveform measurement. The front-panel key displays a blank menu when pressed.

Key Path	Front-panel key
Initial S/W Revision	Prior to A.02.00
Help Map ID	9560

Trigger

Accesses a menu of functions that enable you to select and control the trigger source for the current measurement

For more information, see [“Trigger” on page 903](#).

Key Path	Front-panel key
Initial S/W Revision	Prior to A.02.00
Help Map ID	Use 3371

View/Display

Accesses a menu of functions that enable you to set up and control the display parameters for the current measurement.

This topic contains the following sections:

[“View Selection by name \(Remote Command Only\)” on page 426](#)

[“View Selection by number \(Remote Command Only\)” on page 426](#)

View Selection by name (Remote Command Only)

Selects the results view.

Key Path	View/Display
Mode	BASIC, PN, WCDMA, C2K, GSM, WIMAX OFDMA, TD-SCDMA, 1xEV-DO, DVB-T/H, DTMB, ISDB-T, CMMB, LTE, LTETDD, WLAN
Remote Command	:DISPlay:WAVeform:VIEW[:SElect] RFENvelope IQ :DISPlay:WAVeform:VIEW[:SElect]?
Example	DISP:WAV:VIEW RFEN DISP:WAV:VIEW?
Notes	You must be in a mode that includes the Waveform measurement to use this command. Use INSTRument:SElect to set the mode.
Preset	RFENveloper
State Saved	Saved in instrument state.
Range	RF Envelope IQ Waveform
Initial S/W Revision	Prior to A.02.00
Modified at S/W Revision	A.03.00
Help Map ID	0

View Selection by number (Remote Command Only)

Displays the numeric values of the measurement results.

Mode	BASIC, PN, WCDMA, C2K, GSM, WIMAX OFDMA, TD-SCDMA, 1xEV-DO, DVB-T/H, DTMB, ISDB-T, CMMB, LTE, LTETDD, WLAN
Remote Command	:DISPlay:WAVeform:VIEW:NSElect <integer> :DISPlay:WAVeform:VIEW:NSElect?
Example	DISP:WAV:VIEW:NSEL 1 DISP:WAV:VIEW:NSEL?

Notes	You must be in a mode that includes the Waveform measurement to use this command. Use INSTRument:SElect to set the mode.
Preset	1
State Saved	Saved in instrument state.
Min	1
Max	2
Initial S/W Revision	Prior to A.02.00
Modified at S/W Revision	A.03.00
Help Map ID	0

Key Path	Front-panel key
Initial S/W Revision	Prior to A.02.00
Help Map ID	9518

Display

Accesses a menu of functions that enable you to set the display parameters.

For more information, see [“Display” on page 959](#).

Key Path	View/Display
Initial S/W Revision	Prior to A.02.00
Help Map ID	9552

RF Envelope

This view shows an example of the RF Envelope result for the waveform (time domain) measurements in the graph window. The measured values for the mean power and peak-to-mean power are shown in the text window.

Waveform Measurement
View/Display

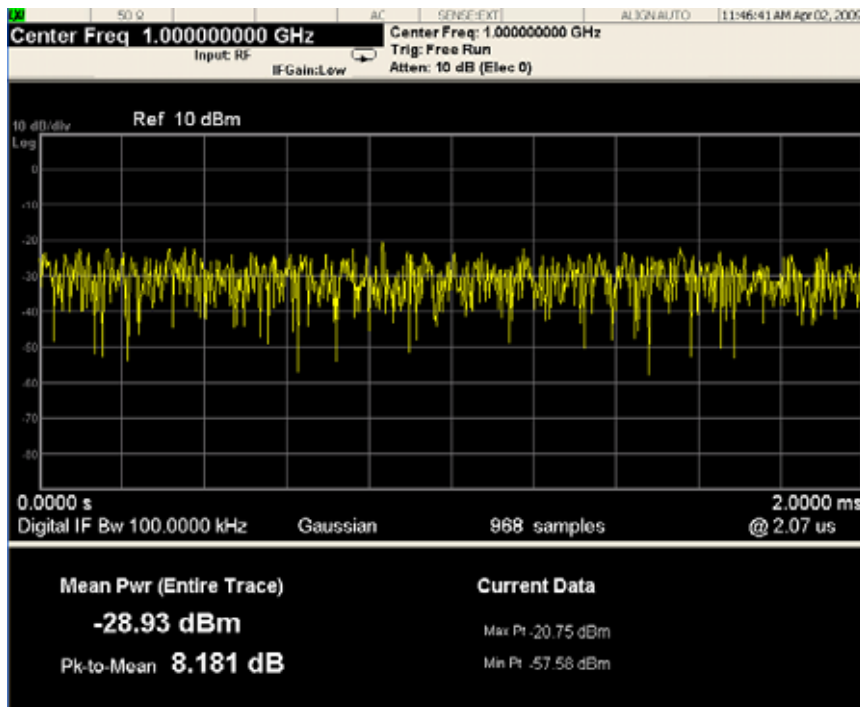

Numeric Results

Name	Type	Description	Unit	Format
Mean Pwr	Float64	The mean power (dBm). This is either the power across the entire trace, or the power between markers if the markers are enabled.	dBm	XX.XX dBm
Pk-to-Mean	Float64	This is the ratio of the maximum signal level to the mean power.	dB	XX.XX dB
Max Pt	Float64	The maximum of the most recently acquired data.	dBm	XX.XX dBm
Min Pt	Float64	The minimum of the most recently acquired data.	dBm	XX.XX dBm

Key Path	View/Display
Initial S/W Revision	Prior to A.02.00
Help Map ID	9519

I/Q Waveform

This view shows the I and Q signal waveforms in parameters of voltage versus time.

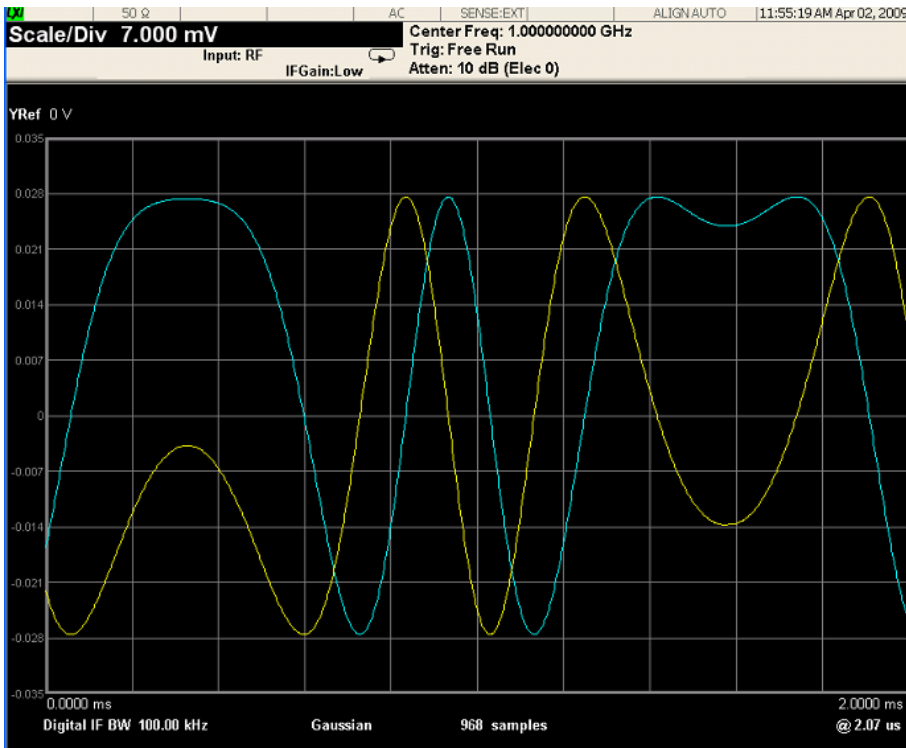

Key Path	View/Display
Initial S/W Revision	Prior to A.02.00
Help Map ID	9520

The key and command descriptions in this section describe functions that operate the same in multiple measurements and/or modes. This section is a library of functions that is referenced by many measurements and modes

To find the exact description and parameters for functions in a specific measurement, always look in the measurement section of this documentation. Pressing the front-panel key or key and then pressing the green Help key also provides the correct information.

NOTE

If you want to print the documentation, select this section and the measurement of interest to ensure that you have all the information you need. See [“Printing Acrobat Files” on page 76](#) for further instructions about printing.

AMPTD Y Scale

The Amplitude front-panel key activates the Amplitude menu and selects Reference Level or Reference Value (depending on the measurement) as the active function.

Some features in the Amplitude menu apply to multiple measurements; others apply only to specific measurements. Keys that only apply to some measurements are blanked or grayed out in measurements that are not supported.

Key Path:	Front-panel key
Initial S/W Revision:	Prior to A.02.00
Help Map ID:	3001

Reference Level

The Reference Level specifies the amplitude represented by the topmost graticule line.

Changing the reference level does not restart a measurement, because it is a display function only; instead it vertically ‘pans’ all displayed traces and markers to the new value. If a change to the reference level changes the attenuation value (e.g. through an auto coupling), then the measurement will be restarted.

See [“Amplitude Representations” on page 434](#)

Key Path:	AMPTD Y Scale
Remote Command:	:DISPlay:WINDow[1]:TRACe:Y[:SCALe]:RLEVel <real> :DISPlay:WINDow[1]:TRACe:Y[:SCALe]:RLEVel?
Example:	DISP:WIND:TRAC:Y:RLEV 20 dBm Sets the reference level to 20 dBm, which displays in the current Y axis unit. For example, if the Y axis unit is dBμV, then 126.99 dBμV will be displayed.
Couplings:	If you reduce the attenuation, the analyzer may have to lower the reference level to keep it below its allowed maximum. This allowed maximum level is specified in the “Max” row, below, along with other variables which affect it. When you increase attenuation, the reference level does not change.
Preset:	0 dBm
State Saved:	Saved in instrument state
Min:	RefLevelMin = -170 dBm + RefLevelOffset - ExtGain.

AMPTD Y Scale

Max:	<p>The maximum Ref Level is typically:</p> <p>+30 dBm + RL Offset – External Gain (for MXA and PXA)</p> <p>+23 dBm + RL Offset – External Gain (for EXA and CXA)</p> <p>This maximum value is determined by the maximum power that can be safely applied to the input circuitry. The actual maximum value at any given time may be even less than this, depending on other values including Mech Atten, Int Preamp Gain, Swept IF Gain, FFT IF Gain, Max Mixer Level, and the total attenuation currently available.</p> <p>Note that the maximum reference level is unaffected by the input choice of external mixing.</p>
Default Unit:	Depends on the current selected Y axis unit
Backwards Compatibility Notes:	<ol style="list-style-type: none"> 1. In PSA, there was a restriction on Ref Level Max which was that it could not exceed 0 dBm when the preamp was on. This restriction does not apply to X-Series. 2. Ref Level – Ref Level is a display function, not a measurement control function, so a change in the setting does not start a new sweep (unless attenuation changes). This behavior differs from that of legacy analyzers
Initial S/W Revision:	Prior to A.02.00
Help Map ID:	3002

Amplitude Representations

The following is an illustration of the reference level and Y Axis scales under various conditions:

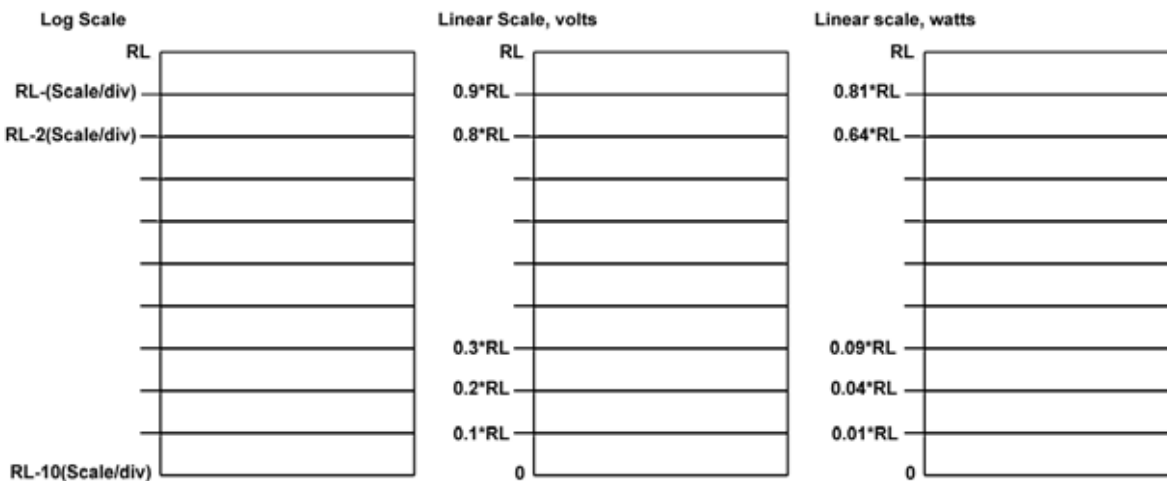

Attenuation

This menu controls the attenuator functions and interactions between the attenuation system components.

There are two attenuator configurations in the X-Series. One is a dual attenuator configuration

consisting of a mechanical attenuator and an optional electronic attenuator. The other configuration uses a single attenuator with combined mechanical and electronic sections that controls all the attenuation functions. Different models in the X-Series come with different configurations.

See “Dual Attenuator Configurations” on page 435.

See “Single Attenuator Configuration:” on page 436

Most Attenuation settings are the same for all measurements – they do not change as you change measurements. Settings like these are called “Meas Global” and are unaffected by Meas Preset.

Key Path:	AMPTD Y Scale
Scope:	Meas Global
Dependencies:	In measurements that support the I/Q inputs, this key is unavailable when I/Q is the selected input, and is replaced by the Range key in that case. Attenuator controls and settings are not available on the E6607C. If any attenuator commands are sent to the E6607C the following error will be generated: -241;Hardware missing; not available for this model number
Readback Line:	Contains a summary in [] brackets of the current total attenuation. See the descriptions of the “(Mech) Atten ” on page 436, “Enable Elec Atten” on page 439, and “Elec Atten” on page 442 keys for more detail on the contributors to the total attenuation. Note that when "Pre-Adjust for Min Clip" is on, this value can change at the start of every measurement.
Initial S/W Revision:	Prior to A.02.00
Modified at S/W Revision:	A.03.00
Help Map ID:	3003

Dual Attenuator Configurations

Configuration 1: Mechanical attenuator + optional electronic attenuator

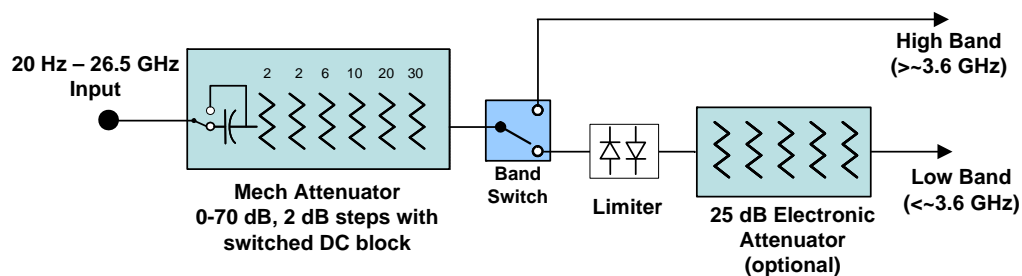

Configuration 2: Mechanical attenuator, no optional electronic attenuator

AMPTD Y Scale

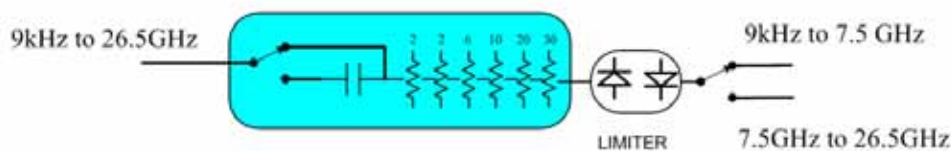

(note that Configuration 2 is not strictly speaking a dual-section attenuator, since there is no electronic section available. However, it behaves exactly like Configuration 1 without the Electronic Attenuator option EA3, therefore for the sake of this document it is grouped into the “Dual Attenuator” configuration)

Single Attenuator Configuration:

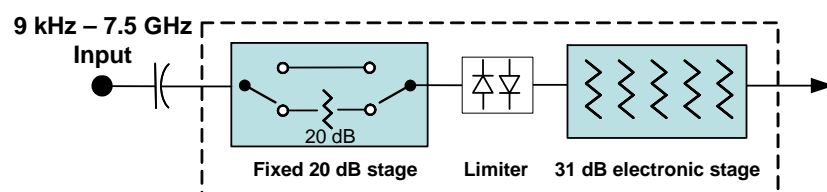

You can tell which attenuator configuration you have by pressing the Attenuation key, which (in most Modes) opens the Attenuation menu. If the first key in the Attenuation menu says **Mech Atten** you have the dual attenuator configuration. If the first key says **Atten** you have the single attenuator configuration.

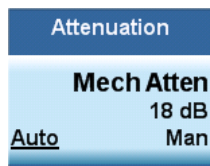

Dual Attenuator



Single Attenuator

In the single attenuator configuration, you control the attenuation with a single control, as the fixed stage has only two states. In the dual attenuator configuration, both stages have significant range so you are given separate control of the mechanical and electronic attenuator stages.

When you have the dual attenuator configuration, you may still have only a single attenuator, because unless option EA3 (the Electronic Attenuator option) is available, and you purchase it, you will have only the mechanical attenuator.

(Mech) Atten

This key is labeled **Mech Atten** in dual attenuator models and **Atten** in single attenuator models. In the dual attenuator configuration, this key only affects the mechanical attenuator.

This key lets you modify the attenuation applied to the RF input signal path. This value is normally auto coupled to the Ref Level, the Internal Preamp Gain, any External Gain that is entered, and the Max Mixer Level, as described in the table below.

See “Attenuator Configurations and Auto/Man” on page 438

Key Path:	AMPTD Y Scale, Attenuation
Remote Command:	<pre>[:SENSe] :POWer [:RF] :ATTenuation <rel_ampl> [:SENSe] :POWer [:RF] :ATTenuation? [:SENSe] :POWer [:RF] :ATTenuation:AUTO OFF ON 0 1 [:SENSe] :POWer [:RF] :ATTenuation:AUTO?</pre>
Example:	<p>POW:ATT 20</p> <p>Dual attenuator configuration: sets the mechanical attenuator to 20 dB</p> <p>Single attenuator mode: sets the main attenuation to 20 dB (see below for definition of “main” attenuation).</p> <p>If the attenuator was in Auto, it sets it to Manual.</p>
Dependencies:	<p>Some measurements do not support the Auto setting of (Mech) Atten. In these measurements, the Auto/Man selection is not available, and the Auto/Man line on the key disappears.</p> <p>In dual attenuator configurations, when the electronic attenuator is enabled, the mechanical attenuator has no auto setting and the Auto/Man line on the key disappears. The state of Auto/Man is remembered and restored when the electronic attenuator is once again disabled. This is described in more detail in the “Enable Elec Atten” on page 439 key description.</p> <p>See “Attenuator Configurations and Auto/Man” on page 438 for more information on the Auto/Man functionality of Attenuation.</p>
Couplings:	<p>When (Mech) Atten is in Auto, it uses the following algorithm to determine a value:</p> $\text{Atten} = \text{ReferenceLevel} + \text{PreAmpGain} + \text{ExternalGain} - \text{RefLevelOffset} - \text{MaxMixerLevel} + \text{IF Gain}.$ <p>Limit this value to be between 6 dB and the Max value. No value below 6 dB can ever be chosen by Auto.</p> <p>The resulting value is rounded up to the largest value possible given the attenuation step setting. That is, 50.01 dB would change to 60 dB (for a 10 dB attenuation step).</p> <p>The “IF Gain” term in the equation above is either 0 dB or +10 dB, depending on the settings of FFT IF Gain, Swept IF Gain, max Ref Level and the Auto/Man setting of Mech Atten.</p> <p>In External Mixing and BBIQ, where the Attenuator is not in the signal path, the Attenuator setting changes as described above when (Mech) Atten is in Auto, but no changes are made to the actual attenuator hardware setting until the input is changed back to the RF Input.</p>

AMPTD Y Scale

Preset:	The preset for Mech Attenuation is “Auto.” The Auto value of attenuation is: CXA, EXA, MXA and PXA: 10 dB EXT: 6dB
State Saved:	Saved in instrument state
Min:	0 dB The attenuation set by this key cannot be decreased below 6 dB with the knob or step keys. To get to a value below 6 dB it has to be directly entered from the keypad or via SCPI. This protects from adjusting the attenuation to a dangerously small value which can put the instrument at risk of damage to input circuitry. However, if the current mechanical attenuation is below 6 dB it can be increased with the knob and step keys, but not decreased.
Max:	CXA N9000A–503/507: 50 dB CXA N9000A–513/526: 70dB EXA: 60 dB MXA and PXA: 70 dB EXT: 70 dB In the single attenuator configuration, the total of ATT and EATT cannot exceed 50 dB, so if the EATT is set to 24 dB first, the main attenuation cannot be greater than 26 dB and will be reduced accordingly; if the main attenuator is set to 40 dB first, EATT cannot be greater than 10 dB.
Initial S/W Revision:	Prior to A.02.00
Modified at S/W Revision:	A.03.00
Help Map ID:	3004

Attenuator Configurations and Auto/Man

As described in the Attenuation key description, there are two distinct attenuator configurations available in the X-Series, the single attenuator and dual attenuator configurations. In dual attenuator configurations, we have the mechanical attenuation and the electronic attenuation, and the current total attenuation is the sum of the electronic + mechanical attenuation. In single attenuator configurations, we refer to the attenuation set using the **(Mech) Atten** key (or POW:ATT SCPI) as the “main” attenuation; and the attenuation that is set by the SCPI command POW:EATT as the “soft” attenuation (the POW:EATT command is honored even in the single attenuator configuration, for compatibility purposes). Then the current total attenuation is the sum of the main + soft attenuation. See the **Elec Atten** key description for more on “soft” attenuation.

In the dual attenuator configuration, when the electronic attenuator is enabled, there is no Auto/Man functionality for the mechanical attenuator, and the third line of the key label (the Auto/Man line) disappears:

<p>Mech Atten 0 dB <u>Auto</u> Man</p>

<p>Mech Atten 0 dB</p>

<p>Mech Atten when elec atten disabled</p>
--

<p>Mech Atten when elec atten enabled</p>

vsd05

Enable Elec Atten

Enables the Electronic Attenuator.

The electronic attenuator offers finer steps than the mechanical attenuator, has no acoustical noise, is faster, and is less subject to wear. These advantages primarily aid in remote operation and are negligible for front panel use. See [“Using the Electronic Attenuator: Pros and Cons” on page 441](#) for a detailed discussion of the pros and cons of using the electronic attenuator.

For the single attenuator configuration, for SCPI backwards compatibility, the “soft” attenuation feature replaces the dual attenuator configuration’s electronic attenuator. All the same couplings and limitations apply. See [“Attenuator Configurations and Auto/Man” on page 438](#)

See [“More Information” on page 440](#)

Key Path:	AMPTD Y Scale, Attenuation
Remote Command:	[:SENSe] :POWer [:RF] :EATTenuation:STATe OFF ON 0 1 [:SENSe] :POWer [:RF] :EATTenuation:STATe?
Example:	POW:EATT:STAT ON

Dependencies:	<p>This key only appears in Dual Attenuator models with an Electronic Attenuator installed. It does not appear in models with the Single Attenuator configuration, as in the single attenuator configuration there is no “electronic attenuator” there is only a single integrated attenuator (which has both a mechanical and electronic stage). However, in the single attenuator configuration, EATT SCPI commands are accepted for compatibility with other X-series instruments and set a “soft” attenuation as described in “Attenuator Configurations and Auto/Man” on page 438</p> <p>The electronic attenuator (and the “soft” attenuation function provided in single attenuator configurations) is unavailable above 3.6 GHz. Therefore, if the Stop Frequency of the analyzer is > 3.6 GHz then the Enable Elec Atten key will be OFF and grayed out.</p> <p>If the Internal Preamp is on, meaning it is set to Low Band or Full, the electronic attenuator (and the “soft” attenuation function provided in single attenuator configurations) is unavailable. In this case the Enable Elec Atten key will be OFF and grayed out.</p> <p>If either of the above is true, if the SCPI command is sent, an error indicating that the electronic attenuator is unavailable will be sent.</p> <p>If the electronic/soft Attenuator is enabled, then the Stop Freq of the analyzer is limited to 3.6 GHz and the Internal Preamp is unavailable.</p> <p>The SCPI-only “soft” electronic attenuation for the single-attenuator configuration is not available in all measurements; in particular, it is not available in the Swept SA measurement.</p>
Couplings:	Enabling and disabling the Electronic Attenuator affects the setting of the Mechanical Attenuator (in dual attenuator configurations). This is described in more detail below this table.
Preset:	OFF for Swept SA measurement; ON for all other measurements that support the electronic attenuator
State Saved:	Saved in instrument state
Initial S/W Revision:	Prior to A.02.00
Modified at S/W Revision:	A.03.00
Help Map ID:	3005

More Information

Mechanical Attenuator Transition Rules

When the Electronic Attenuator is enabled, the Mechanical Attenuator transitions to a state that has no Auto function. Below are the rules for transitioning the Mechanical Attenuator. NOTE that the information below ONLY applies to the dual attenuator configurations, and ONLY when the Electronic Attenuator is installed:

When the Electronic Attenuation is enabled from a disabled state:

- The Mechanical Attenuator is initialized to 10 dB (this is its optimal performance setting). You can then set it as desired with SCPI, numeric keypad, step keys, or knob, and it behaves as it normally

would in manual mode

- The Auto/Man state of (Mech) Atten is saved
- The Auto/Man line on the (Mech) Atten key disappears and the auto rules are disabled
- The Electronic Attenuator is set to 10 dB less than the previous value of the Mechanical Attenuator, within the limitation that it must stay within the range of 0 to 24 dB of attenuation.

Examples in the dual attenuator configuration:

- Mech Atten at 20 dB. Elec Atten enabled, Mech Atten set to 10 dB, and Elec Atten set to 10 dB. New total attenuation equals the value before Elec Atten enabled.
- Mech Atten at 0 dB. Elec Atten enabled, Mech Atten set to 10 dB, and Elec Atten set to 0 dB. New total attenuation does not equal the value before Elec Atten enabled.
- Mech Atten at 40 dB. Elec Atten enabled, Mech Atten set to 10 dB, and Elec Atten set to 24 dB. New total attenuation does not equal the value before Elec Atten enabled.

When the Electronic Attenuation is disabled from an enabled state:

- The Elec Atten key is grayed out
- The Auto/Man state of (Mech) Atten is restored
- If now in Auto, (Mech) Atten recouples
- If now in Man, (Mech) Atten is set to the value of total attenuation that existed before the Elec Atten was disabled. The resulting value is rounded up to the smallest value possible given the (Mech) Atten Step setting - (That is, 57 dB changes to 58 dB when (Mech) Atten Step is 2 dB.)

Using the Electronic Attenuator: Pros and Cons

The electronic attenuator offers finer steps than the mechanical attenuator, has no acoustical noise, is faster, and is less subject to wear.

The “finer steps” advantage of the electronic attenuator is beneficial in optimizing the alignment of the analyzer dynamic range to the signal power in the front panel as well as remote use. Thus, you can achieve improved relative signal measurement accuracy. Compared to a mechanical attenuator with 2 dB steps, the 1 dB resolution of the electronic attenuator only gives better resolution when the odd-decibel steps are used. Those odd-decibel steps are less accurately calibrated than the even-decibel steps, so one tradeoff for this superior relative accuracy is reduced absolute amplitude accuracy.

Another disadvantage of the electronic attenuator is that the spectrum analyzer loses its “Auto” setting, making operation less convenient.

Also, the relationship between the dynamic range specifications (TOI, SHI, compression and noise) and instrument performance are less well-known with the electrical attenuator. With the mechanical attenuator, TOI, SHI and compression threshold levels increase dB-for-dB with increasing attenuation, and the noise floor does as well. With the electronic attenuator, there is an excess attenuation of about 1 to 3 dB between 0 and 3.6 GHz, making the effective TOI, SHI, and so forth, less well known. Excess attenuation is the actual attenuation relative to stated attenuation. Excess attenuation is accounted for in the analyzer calibration

AMPTD Y Scale

Elec Atten

Controls the Electronic Attenuator in dual attenuator configurations. This key does not appear in single attenuator configurations, as the control of both the mechanical and electronic stages of the single attenuator is integrated into the single **Atten** key.

Key Path:	AMPTD Y Scale, Attenuation
Remote Command:	<code>[:SENSE] :POWER [:RF] :EATTenuation <rel_ampl></code> <code>[:SENSE] :POWER [:RF] :EATTenuation?</code>
Notes:	Electronic Attenuation's specification is defined only when Mechanical Attenuation is 6 dB.
Dependencies:	This key only appears in Dual Attenuator models with an Electronic Attenuator installed. It does not appear in models with the Single Attenuator configuration, as in the single attenuator configuration there is no "electronic attenuator" there is only a single integrated attenuator (which has both a mechanical and electronic stage). However, in the single attenuator configuration, EATT SCPI commands are accepted for compatibility with other X-series instruments and set a "soft" attenuation as described in "Attenuator Configurations and Auto/Man" on page 438 . The "soft" attenuation is treated as an addition to the "main" attenuation value set by the Atten softkey or the POW:ATT SCPI command and affects the total attenuation displayed on the Attenuation key and the Meas Bar. When Enable Elec Atten is off or grayed out, the Elec Atten key is grayed out.
Preset:	0 dB
State Saved:	Saved in instrument state
Min:	0 dB
Max:	Dual attenuator configuration: 24 dB Single attenuator configuration: the total of ATT and EATT cannot exceed 50 dB, so if the EATT is set to 24 dB first, the main attenuation cannot be greater than 26 dB and will be reduced accordingly; if the main attenuator is set to 40 dB first, EATT cannot be greater than 10 dB
Initial S/W Revision:	Prior to A.02.00
Modified at S/W Revision:	A.03.00
Help Map ID:	3006

Adjust Atten for Min Clip

Sets the combination of mechanical and electronic attenuation based on the current measured signal level so that clipping will be at a minimum.

This is an "immediate action" function, that is, it executes once, when the key is pressed.

This key is grayed out in measurements that do not support this functionality. The spectrum analyzer

measurement, Swept SA, does not support this functionality.

Key Path:	AMPTD Y Scale, Attenuation
Remote Command:	[:SENSE] :POWER [:RF] :RANGE:OPTimize IMMEDIATE
Initial S/W Revision:	Prior to A.02.00
Modified at S/W Revision:	A.03.00
Help Map ID:	3007

Pre-Adjust for Min Clip

If this function is on, it does the adjustment described under “Adjust Atten for Min Clip” on page 442 each time a measurement restarts. Therefore, in Continuous measurement mode, it only executes before the first measurement.

In dual attenuator models, you can set **Elec+Mech Atten**, in which case both attenuators participate in the autoranging, or **Elec Atten Only**, in which case the mechanical attenuator does not participate in the autoranging. This latter case results in less wear on the mechanical attenuator and is usually faster.

This key is grayed out in measurements that do not support this functionality. The spectrum analyzer measurement, Swept SA, does not support this functionality.

Key Path:	AMPTD Y Scale, Attenuation
Remote Command:	[:SENSE] :POWER [:RF] :RANGE:OPTimize:ATTenuation OFF ELECTrical COMBined [:SENSE] :POWER [:RF] :RANGE:OPTimize:ATTenuation?
Notes:	The SCPI parameter ELECTrical sets this function to On in single attenuator models. The SCPI parameter COMBined is mapped to ELECTrical in single attenuator models; if you send COMBined, it sets the function to On and returns ELEC to a query.
Dependencies:	This key only appears in Dual Attenuator models with an Electronic Attenuator installed. It does not appear in models with the Single Attenuator configuration, as in the single attenuator configuration there is no “electronic attenuator” there is only a single integrated attenuator (which has both a mechanical and electronic stage). When Enable Elec Atten is off or grayed out, the Pre-Adjust for Min Clip key is grayed out.
Preset:	OFF for Swept SA measurement; ON for all other measurements that support Pre-Adjust for Min Clip
State Saved:	Saved in instrument state
Range:	Dual attenuator models: Off Elec Atten Only Mech + Elec Atten Single attenuator models: Off On

AMPTD Y Scale

Initial S/W Revision:	Prior to A.02.00
Modified at S/W Revision:	A.03.00
Help Map ID:	3008

Remote Command:	[:SENSe] :POWer [:RF] :RANGe:AUTO ON OFF 1 0 [:SENSe] :POWer [:RF] :RANGe:AUTO?
Notes:	ON aliases to "Elec Atten Only" (:POW:RANG:OPT:ATT ELEC) OFF aliases to "Off" (:POW:RANG:OPT:ATT OFF) The query :POW:RANG:AUTO? returns true if :POW:RANG:OPT:ATT is not "Off"
Initial S/W Revision:	Prior to A.02.00
Help Map ID:	0

Off

Turns **Pre-Adjust for Min Clip** off. This is the default setting.

This key is grayed out in measurements that do not support this functionality. The spectrum analyzer measurement, Swept SA, does not support this functionality.

Key Path:	AMPTD Y Scale, Attenuation, Pre-Adjust for Min Clip
Example:	:POW:RANGe:OPT:ATT OFF
Initial S/W Revision:	Prior to A.02.00
Help Map ID:	3010

Elec Atten Only

Selects only the electric attenuator to participate in auto ranging. This offers less wear on the mechanical attenuator and is usually faster.

This key is grayed out in measurements that do not support this functionality. The spectrum analyzer measurement, Swept SA, does not support this functionality.

Key Path:	AMPTD Y Scale, Attenuation, Pre-Adjust for Min Clip
Example:	:POW:RANGe:OPT:ATT ELEC
Initial S/W Revision:	Prior to A.02.00
Help Map ID:	3011

Mech + Elec Atten

In dual attenuator models, this selects both attenuators participate in the autoranging.

This key is grayed out in measurements that do not support this functionality. The spectrum analyzer

measurement, Swept SA, does not support this functionality.

Key Path:	AMPTD Y Scale, Attenuation, Pre-Adjust for Min Clip
Example:	:POW:RANGe:OPT:ATT COMB
Initial S/W Revision:	Prior to A.02.00
Help Map ID:	3012

(Mech) Atten Step

This controls the step size used when making adjustments to the input attenuation.

This key is labeled **Mech Atten Step** in dual attenuator models and **Atten Step** in single attenuator models. In the dual attenuator configuration, this key only affects the step size of the mechanical attenuator.

Key Path:	AMPTD Y Scale, Attenuation
Remote Command:	[:SENSe] :POWer [:RF] :ATTenuation:STEP [:INCRement] 10 dB 2 dB [:SENSe] :POWer [:RF] :ATTenuation:STEP [:INCRement] ?
Example:	POW:ATT:STEP 2
Notes:	Note this feature works like a 1-N choice from the front panel, but it takes a specific value (in dB) when used remotely. The only valid values are 2 and 10.
Dependencies:	Blanked in CXA and EXA if option FSA (2 dB steps) is not present. If blanked, attempts to set it via SCPI will yield an error.
Couplings:	When the attenuation step size changes, the current mechanical attenuation value is adjusted (if necessary) to be quantized to the new step size. That is, if step is set to 10 dB, mech atten is increased if necessary so it is a multiple of 10 dB
Preset:	PXA and MXA: 2 dB EXA and CXA: 10 dB (2 dB with option FSA) EXT: 2 dB
State Saved:	Saved in instrument state
Initial S/W Revision:	Prior to A.02.00
Modified at S/W Revision:	A.03.00
Help Map ID:	3013

Max Mixer Level

Controls the limitation on the Ref Level for a given attenuation setting, and therefore also interacts with

AMPTD Y Scale

the Auto rules for selecting the attenuation as a coupling from the reference level.

Key Path:	AMPTD Y Scale, Attenuation
Remote Command:	[:SENSe] :POWer [:RF] :MIXer :RANGe [:UPPer] <real> [:SENSe] :POWer [:RF] :MIXer :RANGe [:UPPer] ?
Example:	POW:MIX:RANG -15 dBm
Preset:	-10 dBm
State Saved:	Saved in instrument state
Min:	-50 dBm
Max:	-10 dBm
Default Unit:	Depends on the current selected Y axis unit, see Swept SA discussion of Y Axis Unit
Initial S/W Revision:	Prior to A.02.00
Help Map ID:	3014

Range

This key is only available when I/Q is the selected input. It replaces the Attenuation key in that case.

Each input channel (I and Q) has four internal gain ranges. The maximum allowed voltage in each gain range is slightly more than the nominal value, so the break point between ranges is a couple of millivolts higher than the nominal (setting a peak voltage of 0.502 mV will still map to the 0.5 V Peak range).

Gain Setting	Volts RMS	Volts Peak	Volts Peak - Peak	dBm (50W)	Break Point
0 dB	0.7071	1.0	2.0	10	n/a
6 dB	0.3536	0.5	1.0	4	0.502 V Peak
12 dB	0.1768	0.25	0.5	-2	0.252 V Peak
18 dB	0.0884	0.125	0.25	-8	0.127 V Peak

Key Path:	AMPTD Y Scale
Notes:	Visible only when the selected input is I/Q.
State Saved:	No

Readback Text:	When Range is Auto, "[Auto]" When Range is Man and I & Q are the same, "[<range value>]" When Range is Man and I & Q are different: "[I: <I range value> Q: <Q range value>]" See I Range and Q Range for the <range value> enumeration definition.
Initial S/W Revision:	Prior to A.02.00
Help Map ID:	29880

Range Auto/Man

The Auto setting for Range causes the range to be set based on the Y Scale settings. When Range is “Auto”, the I & Q Range are set based on the top of the Y Scale when the Y scale is in dB units (for example, power), or to the max(abs(top), abs(bottom)) when the Y scale reference is not at the top of the screen.

Not all measurements support Range Auto/Man. If Auto is not supported in the current measurement, this key is grayed out and shows “Man” and MAN is returned to a SCPI query, but this does NOT change the Auto/Man setting for Range. When you go to a measurement that supports Auto, it goes back to Auto if it was previously in Auto mode.

Key Path:	AMPTD Y Scale, Range
Scope:	Meas Global
Remote Command:	[:SENSe] :VOLTage :IQ :RANGe :AUTO OFF ON 0 1 [:SENSe] :VOLTage :IQ :RANGe :AUTO?
Example:	Put the I Range and Q Range in manual. VOLT:IQ:RANG:AUTO OFF
Dependencies:	If Auto is not supported, sending the SCPI command will generate an error.
Couplings:	When in Auto, both I Range and Q Range are set to the same value, computed as follows: Maximum absolute value is computed for the Y Scale. The top and bottom of the graph are computed based on Ref Value, Scale/Div, and Ref Position. Formula: YMax = max(abs(top), abs(bottom)). The I Range and Q Range are then set to YMax.
Preset:	ON
State Saved:	Saved in instrument state
Range:	Auto Man
Initial S/W Revision:	Prior to A.02.00
Help Map ID:	29881

AMPTD Y Scale

Remote Command:	[:SENSE] :POWER:IQ:RANGE:AUTO OFF ON 0 1 [:SENSE] :POWER:IQ:RANGE:AUTO?
Example:	Put the I Range and Q Range in manual. POW:IQ:RANG:AUTO OFF
Notes:	The POW:IQ:RANG:AUTO is an alternate form of the VOLT:IQ:RANG:AUTO command. This is to maintain consistency with I Range and Q Range, which support both the POWER and VOLTage forms of the command.
Preset:	ON
Range:	Auto Man
Initial S/W Revision:	Prior to A.02.00
Help Map ID:	0

I Range

This is the internal gain range for the I channel when Input Path is I Only or I and I/Q, and it is used for both the I and Q channels when the Input Path is I+jQ. See [“I/Q Gain Ranges” on page 451](#).

Key Path:	AMPTD Y Scale, Range
Remote Command:	[:SENSE] :VOLTage:IQ[:I]:RANGE[:UPPER] <voltage> [:SENSE] :VOLTage:IQ[:I]:RANGE[:UPPER] ?
Example:	Set the I Range to 0.5 V Peak VOLT:IQ:RANG 0.5 V
Notes:	The numeric entries are mapped to the smallest gain range whose break point is greater than or equal to the value, or 1 V Peak if the value is greater than 1 V.
Couplings:	When Q Same as I is On, the I Range value will be copied to the Q Range. Changing the value will also set Range = Man.
Preset:	1 V Peak
State Saved:	Saved in instrument state
Range:	1 V Peak 0.5 V Peak 0.25 V Peak 0.125 V Peak
Initial S/W Revision:	Prior to A.02.00
Help Map ID:	29883

Remote Command:	[:SENSE] :POWER:IQ[:I]:RANGE[:UPPER] <ampl> [:SENSE] :POWER:IQ[:I]:RANGE[:UPPER] ?
------------------------	---

Example:	Set the I Range to 0.5 V Peak when Reference Z is 50Ω, and to 1.0 V Peak when Reference Z is 75Ω POW:IQ:RANG 4 dBm
Notes:	The POWER form of the command is provided for convenience. It maps to the same underlying gain range parameter as the VOLTage form of the command. The Reference Z (not the I channel Input Z) is used to convert the power to peak voltage, which is then used to set the I Range as with the VOLTage form of the command. The power values of the 4 range states (1V Peak, 0.5V Peak, 0.25V Peak, and 0.125V Peak) will vary with Reference Z. Here are some examples: 50Ω: 10, 4, -2, -8 75Ω: 8.2, 2.2, -3.8, -9.8 600Ω: -0.8, -6.8, -12.8, -18.9
Preset:	10.0 dBm
Range:	-20 dBm to 10 dBm
Min:	-20 dBm
Max:	10 dBm
Initial S/W Revision:	Prior to A.02.00
Help Map ID:	0

Q Range

Accesses the Q Range menu.

Key Path:	AMPTD Y Scale, Range
Readback Text:	Q Same as I 1 V Peak 0.5 V Peak 0.25 V Peak 0.125 V Peak When Q Same as I is On, the readback is "Q Same as I", otherwise it is the Q Range value.
Initial S/W Revision:	Prior to A.02.00
Help Map ID:	29884

Q Same as I

Many, but not all, usages require the I and Q channels to have an identical setup. To simplify channel setup, the Q Same as I will cause the Q channel range to be mirrored from the I channel. That way you only need to set up one channel (the I channel). The I channel values are copied to the Q channel, so at the time Q Same as I is Off, the I and Q channel setups will be identical.

Key Path:	AMPTD Y Scale, Range, Q Range
Remote Command:	[:SENSE] :VOLTage POWer: IQ: MIRROred OFF ON 0 1 [:SENSE] :VOLTage POWer: IQ: MIRROred?

AMPTD Y Scale

Example:	Turn off the mirroring of I Range to Q Range. VOLT:IQ:MIRR OFF POW:IQ:MIRR OFF
Couplings:	When On, the I Range value is mirrored (copied) to the Q Range.
Preset:	On
State Saved:	Saved in instrument state.
Range:	On Off
Readback Text:	"Q Same as I" when On, otherwise none.
Initial S/W Revision:	Prior to A.02.00
Help Map ID:	29885

Q Range Value

This is the internal gain range for the Q channel. See [“I/Q Gain Ranges” on page 451](#). The Q Range only applies to Input Path Q Only and Ind I/Q. For input I+jQ the I Range determines both I and Q channel range settings.

Key Path:	AMPTD Y Scale, Range
Remote Command:	[:SENSe] :VOLTage :IQ :Q :RANGe [:UPPer] <voltage> [:SENSe] :VOLTage :IQ :Q :RANGe [:UPPer] ?
Example:	Set the Q Range to 0.5 V Peak VOLT:IQ:Q:RANG 0.5 V
Notes:	The numeric entries are mapped to the smallest gain range whose break point is greater than or equal to the value, or 1 V Peak if the value is greater than 1 V. The Q Range is only used for Input Path Q Only and Ind I/Q. For input I+jQ the I Range determines both I and Q channel range settings.
Couplings:	When Q Same as I is On, the I Range value will be copied to the Q Range and the range value keys are disabled. Changing the value will also set Range = Man.
Preset:	1 V Peak
State Saved:	Saved in instrument state
Range:	1 V Peak 0.5 V Peak 0.25 V Peak 0.125 V Peak
Initial S/W Revision:	Prior to A.02.00
Help Map ID:	29886

Remote Command:	[:SENSE] :POWER:IQ:Q:RANGE[:UPPER] <ampl> [:SENSE] :POWER:IQ:Q:RANGE[:UPPER] ?
Example:	Will set the Q Range to 0.5 V Peak when Reference Z is 50Ω, and to 1.0 V Peak when Reference Z is 75Ω POW:IQ:Q:RANG 4 dBm
Notes:	The POWER form of the command is provided for convenience. It maps to the same underlying gain range parameter as the VOLTage form of the command. The Reference Z (not the Q channel Input Z) is used to convert the power to peak voltage, which is then used to set the Q Range as with the VOLTage form of the command. The power values of the 4 range states (1V Peak, 0.5V Peak, 0.25V Peak, and 0.125V Peak) will vary with Reference Z. Here are some examples: 50Ω: 10, 4, -2, -8 75Ω: 8.2, 2.2, -3.8, -9.8 600Ω: -0.8, -6.8, -12.8, -18.9
Preset:	10.0 dBm
Range:	-20 dBm to 10 dBm
Min:	-20 dBm
Max:	10 dBm
Initial S/W Revision:	Prior to A.02.00
Help Map ID:	0

I/Q Gain Ranges

See the following sections:

1 V Peak

[“0.5 V Peak” on page 452](#)

[“0.25 V Peak” on page 452](#)

[“0.125 V Peak” on page 452](#)

1 V Peak

Set the channel gain state to 1 Volt Peak.

Key Path:	AMPTD Y Scale, I Range Q Range
Initial S/W Revision:	Prior to A.02.00
Help Map ID:	29887

AMPTD Y Scale

0.5 V Peak

Set the channel gain state to 0.5 Volt Peak.

Key Path:	AMPTD Y Scale, I Range Q Range
Initial S/W Revision:	Prior to A.02.00
Help Map ID:	29888

0.25 V Peak

Set the channel gain state to 0.25 Volt Peak.

Key Path:	AMPTD Y Scale, I Range Q Range
Initial S/W Revision:	Prior to A.02.00
Help Map ID:	29889

0.125 V Peak

Set the channel gain state to 0.125 Volt Peak.

Key Path:	AMPTD Y Scale, I Range Q Range
Initial S/W Revision:	Prior to A.02.00
Help Map ID:	29890

Scale / Div

Sets the units per vertical graticule division on the display. This function is only available when Scale Type (Log) is selected and the vertical scale is power. When Scale Type (Lin) is selected, Scale/Div is grayed out.

Key Path:	AMPTD Y Scale
Remote Command:	<code>:DISPlay:WINDow[1]:TRACe:Y[:SCALe]:PDIVision <rel_amp1></code> <code>:DISPlay:WINDow[1]:TRACe:Y[:SCALe]:PDIVision?</code>
Example:	DISP:WIND:TRAC:Y:PDIV 5 DB
Dependencies:	Scale/Div is grayed out in linear Y scale. Sending the equivalent SCPI command does change the Scale/Div, though it has no affect while in Lin.
Preset:	10.00 dB / Div
State Saved:	Saved in instrument state
Min:	0.10 dB
Max:	20 dB
Initial S/W Revision:	Prior to A.02.00

Help Map ID:

3015

Scale Type

Chooses a linear or logarithmic vertical scale for the display and for remote data readout.

When Scale Type (Log) is selected, the vertical graticule divisions are scaled in logarithmic units. The top line of the graticule is the Reference Level and uses the scaling per division Scale/Div to assign values to the other locations on the graticule.

When Scale Type (Lin) is selected, the vertical graticule divisions are linearly scaled with the reference level value at the top of the display and zero volts at the bottom. Each vertical division of the graticule represents one-tenth of the Reference Level.

NOTE The Y Axis Unit used for each type of display is set by pressing Y Axis Unit. The analyzer remembers separate Y Axis Unit settings for both Log and Lin.

Key Path:	AMPTD Y Scale
Remote Command:	:DISPlay:WINDow[1]:TRACe:Y[:SCALe]:SPACing LINear LOGarithmic :DISPlay:WINDow[1]:TRACe:Y[:SCALe]:SPACing?
Example:	DISP:WIND:TRAC:Y:SPAC LOG DISP:WIND:TRAC:Y:SPAC?
Dependencies:	If Normalize is on, Scale Type forced to Log and is grayed out.
Couplings:	Changing the Scale Type always sets the Y Axis unit to the last unit specified for the current amplitude scale. In other words, we restore the Y Axis unit setting appropriate per log/lin.
Preset:	LOG
State Saved:	Saved in instrument state
Initial S/W Revision:	Prior to A.02.00
Help Map ID:	3016

Presel Center

When this key is pressed, the centering of the preselector filter is adjusted to optimize the amplitude accuracy at the frequency of the selected marker. If the selected marker is not on when Presel Center is pressed, the analyzer will turn on the selected marker, perform a peak search, and then perform centering on the marker's center frequency. If the selected marker is already on and between the start and stop frequencies of the analyzer, the analyzer performs the preselector calibration on that marker's frequency. If the selected marker is already on, but outside the frequency range between Start Freq and Stop Freq, the analyzer will first perform a peak search, and then perform centering on the marker's center frequency.

AMPTD Y Scale

The value displayed on the **Presel Adjust** key will change to reflect the new preselector tuning (see **Presel Adjust**).

A number of considerations should be observed to ensure proper operation. See “[Proper Preselector Operation](#)” on page 454.

Key Path:	AMPTD Y Scale
Remote Command:	[:SENSE] :POWER [:RF] :PCENter
Example:	POW:PCEN
Notes:	Note that the rules outlined above under the key description apply for the remote command as well as the key. The result of the command is dependent on marker position, and so forth. Any message shown by the key press is also shown in response to the remote command.
Dependencies:	<ul style="list-style-type: none"> • Grayed out if the microwave preselector is off.) • If the selected marker’s frequency is below Band 1, advisory message 0.5001 is generated and no action is taken. • Grayed out if entirely in Band 0. • Blank in models that do not include a preselector, such as option 503. If the SCPI is sent in these instruments, it is accepted without error, and the query always returns 0. • Grayed out in the Spectrogram View.
Couplings:	The active marker position determines where the centering will be attempted. If the analyzer s in a measurement such as averaging when centering is initiated, the act of centering the preselector will restart averaging but the first average trace will not be taken until the centering is completed.
Status Bits/OPC dependencies:	<p>When centering the preselector, *OPC will not return true until the process is complete and a subsequent measurement has completed, nor will results be returned to a READ or MEASure command.</p> <p>The Measuring bit should remain set while this command is operating and should not go false until the subsequent sweep/measurement has completed.</p>
Initial S/W Revision:	Prior to A.02.00
Modified at S/W Revision:	A.03.00
Help Map ID:	3017

Proper Preselector Operation

A number of considerations should be observed to ensure proper operation:

1. If the selected marker is off, the analyzer will turn on a marker, perform a peak search, and adjust the preselector using the selected marker's frequency. It uses the "highest peak" peak search method unqualified by threshold or excursion, so that there is no chance of a 'no peak found' error. It continues with that peak, even if it is the peak of just noise. Therefore, for this operation to work properly, there should be a signal on screen in a preselected range for the peak search to find.
2. If the selected marker is already on, the analyzer will attempt the centering at that marker's frequency. There is no preselector for signals below about 3.6 GHz, therefore if the marker is on a signal below 3.6 GHz, no centering will be attempted and an advisory message generated
3. In some models, the preselector can be bypassed. If it is bypassed, no centering will be attempted in that range and a message will be generated.

Preselector Adjust

Allows you to manually adjust the preselector filter frequency to optimize its response to the signal of interest. This function is only available when "Presel Center" on page 453 is available.

For general purpose signal analysis, using Presel Center is recommended. Centering the filter minimizes the impact of long-term preselector drift. Presel Adjust can be used instead to manually optimize the preselector. One application of manual optimization would be to peak the preselector response, which both optimizes the signal-to-noise ratio and minimizes amplitude variations due to small (short-term) preselector drifting.

Key Path:	AMPTD Y Scale
Scope:	Meas Global
Remote Command:	[:SENSE] :POWER [:RF] :PADJust <freq> [:SENSe] :POWER [:RF] :PADJust?
Example:	POW:PADJ 100KHz POW:PADJ?
Notes:	The value on the key reads out to 0.1 MHz resolution.
Dependencies:	<ul style="list-style-type: none"> • Grayed out if microwave preselector is off.) • Grayed out if entirely in Band 0. • Blank in models that do not include a preselector, such as option 503. If the SCPI is sent in these instruments, it is accepted without error, and the query always returns 0. • Grayed out in the Spectrogram View.
Preset:	0 MHz

AMPTD Y Scale

State Saved:	The Presel Adjust value set by Presel Center , or by manually adjusting Presel Adjust , is not saved in instrument state, and does not survive a Preset or power cycle.
Min:	-500 MHz
Max:	500 MHz
Default Unit:	Hz
Backwards Compatibility SCPI:	[:SENSE] :POWER [:RF] :MW :PADJust [:SENSE] :POWER [:RF] :MMW :PADJust PSA had multiple preselectors, but the X-Series has only one. These commands simply alias to [:SENSE]:POWER[:RF]:PADJust
Initial S/W Revision:	Prior to A.02.00
Modified at S/W Revision:	A.03.00
Help Map ID:	3020

Remote Command:	[:SENSE] :POWER [:RF] :PADJust :PRESelector MWAVE MMWave EXTERNAL [:SENSE] :POWER [:RF] :PADJust :PRESelector?
Notes:	PSA had multiple preselectors, and you could select which preselector to adjust. Since the X-Series has only one mm/uW preselector, the preselector selection softkey is no longer available. However, to provide backward compatibility, we accept the legacy remote commands. The command form has no effect, the query always returns MWAVE
Initial S/W Revision:	Prior to A.02.00
Help Map ID:	0

Y Axis Unit

Displays the menu keys that enable you to change the vertical (Y) axis amplitude unit. The analyzer retains the entered Y Axis Unit separately for both Log and Lin amplitude scale types. For example, if Scale Type has been set to Log, and you set Y Axis Unit to dBm, pressing Scale Type (Log) sets the Y Axis Unit to dBm. If Scale Type has been set to Lin and you set Y Axis Unit to V, pressing Scale Type (Lin) sets the Y Axis Unit to V. Pressing Scale Type (Log) again sets the Y axis unit back to dBm.

NOTE

The units of current (A, dBmA, dBuA) are calculated based on 50 ohms input impedance.

All four of the EMI units (dBuA/m, dBuV/m, dBG, dBpT) are treated by the instrument exactly as though they were dBuV. The user must load an appropriate correction factor using Amplitude Corrections for accurate and meaningful results.

If a SCPI command is sent to the analyzer that uses one of the EMI units as a terminator, the analyzer treats it as though DBUV had been sent as the terminator.

Key Path:	AMPTD Y Scale
Mode:	SA
Scope:	Meas Global
Remote Command:	:UNIT:POWer DBM DBMV DBMA V W A DBUV DBUA DBPW DBUVM DBUAM DBPT DBG :UNIT:POWer?
Example:	UNIT:POW dBmV UNIT:POW?
Notes:	The Y axis unit has either logarithmic or linear characteristics. The set of units that is logarithmic consists of dBm, dBmV, dBmA, dBμV, dBμA, dBμV/m, dBμA/m, dBpT, and dBG. The set of units that are linear consists of V, W, and A. The chosen unit will determine how the reference level and all the amplitude-related outputs like trace data, marker data, etc. read out.
Notes:	The settings of Y Axis Unit and Scale Type, affect how the data is read over the remote interface. When using the remote interface no unit is returned, so you must know what the Y axis unit is to interpret the results: Example 1, set the following: Scale Type (Log) Y Axis Unit, dBm Scale/Div, 1 dB Ref Level, 10 dBm This sets the top line to 10 dBm with each vertical division representing 1 dB. Thus, if a point on trace 1 is on the fifth graticule line from the top, it represents 5 dBm and will read out remotely as 5. Example 2, set the following: Scale Type (Lin) Y Axis Unit, Volts Ref Level, 100 mV (10 mV/div) This sets the top line to 100 mV and the bottom line to 0 V, so each vertical division represents 10 mV. Thus, if a point on trace 1 is on the fifth graticule line from the top, it represents 50 mV and will read out remotely as 50.

AMPTD Y Scale

Dependencies:	<p>If an amplitude correction with an Antenna Unit other than None is applied and enabled, then that antenna unit is forced and the key with that unit is the only Y Axis Unit available. All other Y Axis Unit keys are grayed out.</p> <p>If an amplitude correction with an Antenna Unit other than None is applied and enabled, and you then turn off that correction or set Apply Corrections to No, the Y Axis Unit that existed before the Antenna Unit was applied is restored.</p>
Couplings:	The analyzer retains the entered Y Axis Unit separately for both Log and Lin amplitude scale types
Preset:	dBm for log scale, V for linear. The true 'preset' value is dBm, since at preset the Y Scale type is set to logarithmic.
State Saved:	Saved in instrument state
Readback line:	1-of-N selection
Initial S/W Revision:	Prior to A.02.00
Modified at S/W Revision:	A.02.00, A.04.00, A.11.00
Help Map ID:	3021

dBm

Sets the amplitude unit for the selected amplitude scale (log/lin) to dBm.

Key Path:	AMPTD Y Scale, Y Axis Unit
Example:	UNIT:POW DBM
Dependencies:	Grayed out if an Amplitude Correction with an Antenna Unit is ON.
Readback:	dBm
Initial S/W Revision:	Prior to A.02.00
Modified at S/W Revision:	A.02.00
Help Map ID:	3022

dBmV

Sets the amplitude unit for the selected amplitude scale (log/lin) to dBmV.

Key Path:	AMPTD Y Scale, Y Axis Unit
Example:	UNIT:POW DBMV
Dependencies:	Grayed out if an Amplitude Correction with an Antenna Unit is ON.
Readback:	dBmV
Initial S/W Revision:	Prior to A.02.00
Modified at S/W Revision:	A.02.00

Help Map ID:	3023
--------------	------

dBmA

Sets the amplitude unit for the selected amplitude scale (log/lin) to dBmA.

Key Path:	AMPTD Y Scale, Y Axis Unit
Example:	UNIT:POW DBMA
Dependencies:	Grayed out if an Amplitude Correction with an Antenna Unit is ON.
Readback:	dBmA
Initial S/W Revision:	Prior to A.02.00
Modified at S/W Revision:	A.02.00
Help Map ID:	3024

W

Sets the amplitude unit for the selected amplitude scale (log/lin) to watt.

Key Path:	AMPTD Y Scale, Y Axis Unit
Example:	UNIT:POW W
Dependencies:	Grayed out if an Amplitude Correction with an Antenna Unit is ON.
Readback:	W
Initial S/W Revision:	Prior to A.02.00
Modified at S/W Revision:	A.02.00
Help Map ID:	3025

V

Sets the amplitude unit for the selected amplitude scale (log/lin) to volt.

Key Path:	AMPTD Y Scale, Y Axis Unit
Example:	UNIT:POW V
Dependencies:	Grayed out if an Amplitude Correction with an Antenna Unit is ON.
Readback:	V
Initial S/W Revision:	Prior to A.02.00
Modified at S/W Revision:	A.02.00
Help Map ID:	3026

AMPTD Y Scale

A

Sets the amplitude unit for the selected amplitude scale (log/lin) to Ampere.

Key Path:	AMPTD Y Scale, Y Axis Unit
Example:	UNIT:POW A
Dependencies:	Grayed out if an Amplitude Correction with an Antenna Unit is ON.
Readback:	A
Initial S/W Revision:	Prior to A.02.00
Modified at S/W Revision:	A.02.00
Help Map ID:	3027

dBmV

Sets the amplitude unit for the selected amplitude scale (log/lin) to dB μ V.

Key Path:	AMPTD Y Scale, Y Axis Unit
Example:	UNIT:POW DBUV
Dependencies:	Grayed out if an Amplitude Correction with an Antenna Unit is ON.
Readback:	dB μ V
Initial S/W Revision:	Prior to A.02.00
Modified at S/W Revision:	A.02.00
Help Map ID:	3028

dBmA

Sets the amplitude unit for the selected amplitude scale (log/lin) to dB μ A.

NOTE

The unit dBuA can also appear as an Antenna Unit. This will be used by customers using current probes, because current probes are often supplied with conversion tables that provide the transducer factors. When dBuA is used as an Antenna Unit the normal conversion from power to amps for dBuA (based on the analyzer input impedance) is not done, but instead the conversion is based solely on the Correction that contains the transducer factors. This is what distinguishes dBuA as a normal unit from dBuA as an antenna unit. When querying the Y-Axis unit, you can query the Antenna Unit to distinguish between regular dBuA and the dBuA antenna unit. If :CORR:CSET:ANT? returns NOC (for No Conversion), you are using a normal Y Axis dBuA. If it returns UA you are using an Antenna Unit dBuA.

Key Path:	AMPTD Y Scale, Y Axis Unit
-----------	-----------------------------------

Example:	UNIT:POW DBUA
Dependencies:	Grayed out if an Amplitude Correction with an Antenna Unit is ON.
Readback:	dB μ A
Initial S/W Revision:	Prior to A.02.00
Modified at S/W Revision:	A.02.00
Help Map ID:	3029

dBpW

Sets the amplitude unit for the selected amplitude scale (log/lin) to dBpW.

Key Path:	AMPTD Y Scale, Y Axis Unit
Example:	UNIT:POW DBPW
Dependencies:	Grayed out if an Amplitude Correction with an Antenna Unit is ON.
Readback:	dB μ A
Initial S/W Revision:	A.11.00
Help Map ID:	4044

Antenna Unit

When a Correction is turned on that uses an Antenna Unit, the Y Axis Unit changes to that Antenna Unit. All of the keys in the Y-Axis Unit menu are then greyed out, except the Antenna Unit key. The unit being used is shown on this key and is shown as selected in the submenu.

Key Path:	AMPTD Y Scale, Y Axis Unit
Dependencies:	Grayed out if no Amplitude Correction with an Antenna Unit is on.
Readback line:	Currently selected unit
Initial S/W Revision:	A.11.00
Help Map ID:	4004

dBmV/m

Sets the amplitude unit for the selected amplitude scale (log/lin) to dB μ V/m. This is an antenna unit, and this key is grayed out unless a Correction with this Antenna Unit selected is ON. If this is the case, all of the other Antenna Units are grayed out.

Key Path:	AMPTD Y Scale, Y Axis Unit, Antenna Unit
Example:	UNIT:POW DBUVM
Dependencies:	Grayed out if no Amplitude Correction with an Antenna Unit is on.
Readback:	dB μ V/m

AMPTD Y Scale

Initial S/W Revision:	A.02.00
Help Map ID:	3030

dBmA/m

Sets the amplitude unit for the selected amplitude scale (log/lin) to dB μ A/m. This is an antenna unit, and this key is grayed out unless a Correction with this Antenna Unit selected is ON. If this is the case, all of the other Antenna Units are grayed out.

Key Path:	AMPTD Y Scale, Y Axis Unit, Antenna Unit
Example:	UNIT:POW DBUAM
Dependencies:	Grayed out if no Amplitude Correction with an Antenna Unit is on.
Readback:	dB μ A/m
Initial S/W Revision:	A.02.00
Help Map ID:	3031

dBmA

Sets the amplitude unit for the selected amplitude scale (log/lin) to dB μ A. This is an antenna unit, and this key is grayed out unless a Correction with this Antenna Unit selected is ON. If this is the case, all of the other Antenna Units are grayed out.

Key Path:	AMPTD Y Scale, Y Axis Unit, Antenna Unit
Example:	UNIT:POW DBUAM
Dependencies:	Grayed out if no Amplitude Correction with an Antenna Unit is on.
Readback:	dB μ A
Initial S/W Revision:	A.11.00
Help Map ID:	4045

dBpT

Sets the amplitude unit for the selected amplitude scale (log/lin) to dBpT. This is an antenna unit, and this key is grayed out unless a Correction with this Antenna Unit selected is ON. If this is the case, all of the other Antenna Units are grayed out.

Key Path:	AMPTD Y Scale, Y Axis Unit, Antenna Unit
Example:	UNIT:POW DBPT
Dependencies:	Grayed out if no Amplitude Correction with an Antenna Unit is on.
Readback:	dBpT
Initial S/W Revision:	A.02.00

Help Map ID:	3032
--------------	------

dBG

Sets the amplitude unit for the selected amplitude scale (log/lin) to dBG. This is an antenna unit, and this key is grayed out unless a Correction with this Antenna Unit selected is ON. If this is the case, all of the other Antenna Units are grayed out.

Key Path:	AMPTD Y Scale, Y Axis Unit, Antenna Unit
Example:	UNIT:POW DBG
Dependencies:	Grayed out if no Amplitude Correction with an Antenna Unit is on.
Readback:	dBG
Initial S/W Revision:	A.02.00
Help Map ID:	3033

None

This is selected if no Antenna Unit is currently on, however you cannot actually set this value, since it is always grayed out. The key is included simply to provide an indication on the Readback line of the Antenna Unit key when there is no Antenna Unit selected.

Key Path:	AMPTD Y Scale, Y Axis Unit, Antenna Unit
Readback:	“None”
Initial S/W Revision:	A.11.00
Help Map ID:	4046

Reference Level Offset

Adds an offset value to the displayed reference level. The reference level is the absolute amplitude represented by the top graticule line on the display.

See [“More Information” on page 464](#)

Key Path:	AMPTD Y Scale
Mode:	SA
Scope:	Meas Global
Remote Command:	:DISPlay:WINDow[1]:TRACe:Y[:SCALE]:RLEVel:OFFSet <rel_ampl> :DISPlay:WINDow[1]:TRACe:Y[:SCALE]:RLEVel:OFFSet?
Example:	DISP:WIND:TRAC:Y:RLEV:OFFS 12.7 Sets the Ref Level Offset to 12.7 dB. The only valid suffix is dB. If no suffix is sent, dB will be assumed.

AMPTD Y Scale

Preset:	0 dBm
State Saved:	Saved in instrument state
Min:	The range for Ref Lvl Offset is variable. It is limited to values that keep the reference level within the range of –327.6 dB to 327.6 dB.
Max:	327.6 dB
Backwards Compatibility Notes:	<ol style="list-style-type: none">1. In pre-X-Series instruments, Ref Level Offset could not be adjusted by the knob or step keys. That is no longer the case.2. In ESA and PSA, Ref Level Offset was applied to the data as it was acquired; thus if the Offset changed the new offset was not applied until new trace data was taken. In X-Series, the offset is applied as the data is displayed/queried, so if you change the offset, it will change the data immediately.
Initial S/W Revision:	Prior to A.02.00
Modified at S/W Revision:	A.04.00
Help Map ID:	3034

More Information

Offsets are used when gain or loss occurs between a device under test and the analyzer input. Thus, the signal level measured by the analyzer may be thought of as the level at the input of an external amplitude conversion device. Entering an offset does not affect the trace position or attenuation value, just the value of the top line of the display and the values represented by the trace data. Thus, the values of exported trace data, queried trace data, marker amplitudes, trace data used in calculations such as N dB points, trace math, peak threshold, and so forth, are all affected by Ref Level Offset.

NOTE Changing the offset causes the analyzer to immediately stop the current sweep and prepare to begin a new sweep, but the data will not change until the trace data updates, because the offset is applied to the data as it is taken. If a trace is exported with a nonzero Ref Level Offset, the exported data will contain the trace data with the offset applied.

The maximum reference level available is dependent on the reference level offset. That is, Ref Level - Ref Level Offset must be in the range –170 to +30 dBm. For example, the reference level value range can be initially set to values from –170 dBm to 30 dBm with no reference level offset. If the reference level is first set to –20 dBm, then the reference level offset can be set to values of –150 to +50 dB.

If the reference level offset is first set to –30 dB, then the reference level can be set to values of –200 dBm to 0 dBm. In this case, the reference level is “clamped” at 0 dBm because the maximum limit of +30 dBm is reached with a reference level setting of 0 dBm with an offset of –30 dB. If instead, the reference level offset is first set to 30 dB, then the reference level can be set to values of –140 to +60 dBm.

μW Path Control

The **μW Path Control** functions include the **μW Preselector Bypass** (Option MPB) and **Low Noise**

Path (Option LNP) controls in the High Band path circuits.

When the μ W Preselector is bypassed, the user has better flatness, but will be subject to spurs from out of band interfering signals. When the Low Noise Path is enabled, the analyzer automatically switches around certain circuitry in the high frequency bands which can contribute to noise, when it is appropriate based on other analyzer settings.

For most applications, the preset state is Standard Path, which gives the best remote-control throughput, minimizes acoustic noise from switching and minimizes the risk of wear out in the hardware switches. For applications that utilize the wideband IF paths, the preset state is the μ W Preselector Bypass path, if option MPB is present. This is because, when using a wideband IF such as the 140 MHz IF, the μ W Preselector's bandwidth can be narrower than the available IF bandwidth, causing degraded amplitude flatness and phase linearity, so it is desirable to bypass the preselector in the default case.

Users may choose Low Noise Path Enable. It gives a lower noise floor, especially in the 21–26.5 GHz region, though without improving many measures of dynamic range, and without giving the best possible noise floor. The preamp, if purchased and used, gives better noise floor than does the Low Noise Path, however its compression threshold and third-order intercept are much poorer than that of the non-preamp Low Noise Path. There are some applications, typically for signals around 30 dBm, for which the third-order dynamic range of the standard path is good enough, but the noise floor is not low enough even with 0 dB input attenuation. When the third-order dynamic range of the preamp path is too little and the noise floor of the standard path is too high, the Low Noise Path can provide the best dynamic range.

Key Path:	AMPTD Y Scale
Mode:	SA, BASIC, PNOISE, VSA , LTE, LTETDD
Scope:	Meas Global
Remote Command:	[:SENSE] :POWER [:RF] :MW:PATH STD LNPPath MPBypass FULL [:SENSE] :POWER [:RF] :MW:PATH?
Example:	:POW:MW:PATH LNP Enables the Low Noise path
Notes:	<p>If a Presel Center is performed, the analyzer will momentarily switch to the Standard Path, regardless of the setting of μW Path Control</p> <p>The DC Block will always be switched in when the low noise path is switched in, to protect succeeding circuitry from DC. Note that this does not mean “when the low noise path is enabled” but when, based on the Low Noise Path rules, the path is actually switched in. This can happen when the selection is Low Noise Path Enable . In the case where the DC Block is switched in the analyzer is now AC coupled. However, if the user has selected DC coupling, the UI will still behave as though it were DC coupled, including all annunciation, warnings, status bits, and responses to SCPI queries. This is because, based on other settings, the analyzer could switch out the low noise path at any time and hence go back to being DC coupled.</p> <p>Alignment switching ignores the settings in this menu, and restores them when finished.</p>
Dependencies:	Unavailable in BBIQ and External Mixing

AMPTD Y Scale

Preset:	All modes other than IQ Analyzer mode and VXA: STD IQ Analyzer, VXA and WLAN mode: MPB option present and licensed: MPB MPB option not present and licensed: STD
State Saved:	Save in instrument state
Readback:	Value selected in the submenu
Initial S/W Revision:	A.04.00
Modified at S/W Revision:	A.10.00
Help Map ID:	4027

Standard Path

This path gives the best remote-control throughput, minimizes acoustic noise from switching and minimizes the risk of wear in the hardware switches, particularly in remote test scenarios where both low band and high band setups will follow in rapid succession.

In this path, the bypass of the low band/high band switch and microwave preamp is never activated, which can cause some noise degradation but preserves the life of the bypass switch.

Key Path:	AMPTD Y Scale, μW Path Control
Example:	:POW:MW:PATH STD
Readback Text:	Standard Path
Initial S/W Revision:	A.04.00
Help Map ID:	4028

Low Noise Path Enable

You may choose Low Noise Path Enable, which gives a lower noise floor under some circumstances, particularly when operating in the 21–26.5 GHz region. With the Low Noise Path enabled, the low band/high band switch and microwave preamp are bypassed whenever all of the following are true:

- The analyzer is not in the Low Band, meaning:
 - the start frequency is above 3.5 GHz and
 - the stop frequency is above 3.6 GHz.
- the internal preamp is not installed or (if installed) is set to **Off** or **Low Band**

Note that this means that, when any part of a sweep is done in Low Band, the Low Noise Path is not used, whether or not the **Low Noise Path Enable** is selected in the user interface. Also, if the preamp is turned on, the Low Noise Path is not used, whether or not the **Low Noise Path Enable** is selected in the user interface. The only time the Low Noise Path is used is when **Low Noise Path Enable** is selected, the sweep is completely in High Band (> 3.6 GHz) and no preamp is in use.

See “More Information” on page 467

Key Path:	AMPTD Y Scale, μW Path Control
Measurement:	Swept SA
Example:	:POW:MW:PATH LNP
Notes:	<p>For measurements that use IQ acquisition, the low noise path is used when the Center Frequency is in High Band (> 3.6 GHz) and no preamp is in use.</p> <p>In other words, the rules above are modified to use only the center frequency to qualify which path to switch in.</p> <p>This is not the case for FFT's in the Swept SA measurement; they use the same rules as swept measurements.</p>
Dependencies:	<p>Key is blanked if current mode does not support it.</p> <p>Key is grayed out if mode supports it but current measurement does not support it.</p> <p>Unless Option LNP is present and licensed, key is blank and if SCPI command sent, error -241, "Hardware missing; Option not installed" is generated.</p>
Readback Text:	Low Noise Path Enable
Initial S/W Revision:	A.04.00
Help Map ID:	4029

More Information

The user should understand that the Low Noise Path, while giving improved DANL, has the disadvantage of decreased TOI performance and decreased gain compression performance relative to the standard path.

The user should also understand that the bypass switch is a mechanical switch and has finite life, so if the **Low Noise Path** is enabled, it is possible to cause frequent cycling of this switch by frequently changing analyzer settings such that the above conditions hold true only some of the time. A user making tests of this nature should consider opting for the **Standard Path**, which will never throw the bypass switch, at the expense of some degraded noise performance.

The low noise path is useful for situations where the signal level is so low that the analyzer performance is dominated by noise even with 0 dB attenuation, but still high enough that the preamp option would have excessive third-order intermodulation or compression. The preamp, if purchased and used, gives better noise floor than does the “Low Noise Path.” However, its compression threshold and third-order intercept are much poorer than that of the non-preamp path. There are some applications, typically for signals around 30 dBm, for which the third-order dynamic range of the standard path is good enough, but the noise floor is not low enough even with 0 dB input attenuation. When the third-order dynamic range of the preamp path is too little and the noise floor of the standard path is too high, the Low Noise Path can provide the best dynamic range

The graph below illustrates the concept. It shows, in red, the performance of an analyzer at different attenuation settings, both with the preamp on and off, in a measurement that is affected by both analyzer

AMPTD Y Scale

noise and analyzer TOI. The green shows the best available dynamic range, offset by 0.5 dB for clarity. The blue shows how the best available dynamic range improves for moderate signal levels with the low noise path switched in. In this illustration, the preamp improves the noise floor by 15 dB while degrading the third-order intercept by 30 dB, and the low noise path reduces loss by 8 dB. The attenuator step size is 2 dB.

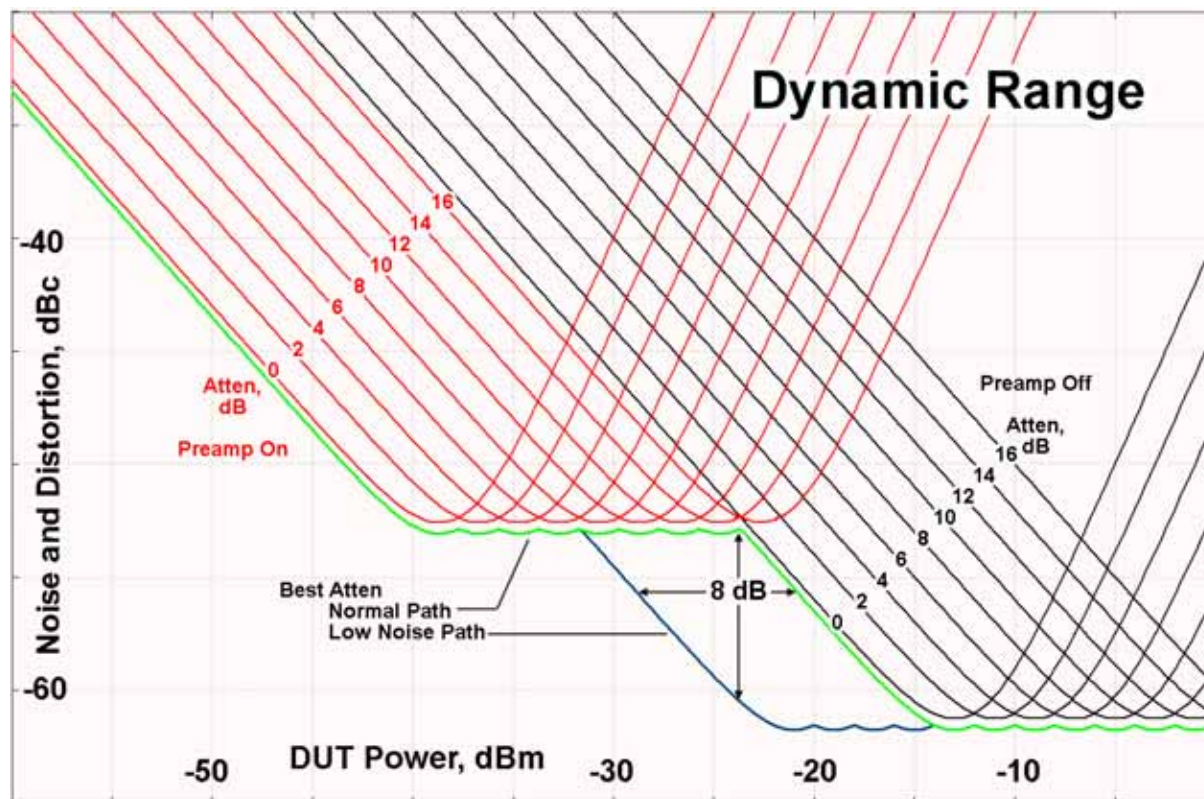

There are other times where selecting the low noise path improves performance, too. Compression-limited measurements such as finding the nulls in a pulsed-RF spectrum can profit from the low noise path in a way similar to the TOI-limited measurement illustrated. Accuracy can be improved when the low noise path allows the optimum attenuation to increase from a small amount like 0, 2 or 4 dB to a larger amount, giving better return loss at the analyzer input. Harmonic measurements, such as second and third harmonic levels, are much improved using the low noise path because of the superiority of that path for harmonic (though not intermodulation) distortion performance.

μ W Preselector Bypass

This key toggles the preselector bypass switch for band 1 and higher. When the microwave preselector is on, the signal path is preselected. When the microwave preselector is off, the signal path is not preselected. The preselected path is the normal path for the analyzer.

The preselector is a tunable bandpass filter which prevents signals away from the frequency of interest from combining in the mixer to generate in-band spurious signals (images). The consequences of using a preselector filter are its limited bandwidth, the amplitude and phase ripple in its passband, and any amplitude and phase instability due to center frequency drift.

Option MPB or pre-selector bypass provides an unpreselected input mixer path for certain X-Series signal analyzers with frequency ranges above 3.6 GHz. This signal path allows a wider bandwidth and

less amplitude variability, which is an advantage when doing modulation analysis and broadband signal analysis. The disadvantage is that, without the preselector, image signals will be displayed. Another disadvantage of bypassing the preselector is increased LO emission levels at the front panel input port.

Key Path:	AMPTD Y Scale, μW Path Control
Example:	:POW:MW:PATH MPB
Dependencies:	Key is blanked if current mode does not support it. Key is grayed out if mode supports it but current measurement does not support it. Key is blank unless Option MPB is present and licensed. If SCPI command sent when MPB not present, error -241, "Hardware missing; Option not installed" is generated.
Readback Text:	μ W Preselector Bypass
Initial S/W Revision:	A.04.00
Help Map ID:	4030

Remote Command:	[:SENSE] :POWER [:RF] :MW:PRESelector [:STATE] ON OFF 0 1 [:SENSE] :POWER [:RF] :MW:PRESelector [:STATE] ?
Example:	:POW:MW:PRES OFF Bypasses the microwave preselector
Notes:	The ON parameter sets the STD path (:POW:MW:PATH STD) The OFF parameter sets path MPB (:POW:MW:PATH MPB)
Preset:	ON
Help Map ID:	0

Internal Preamp

Accesses a menu of keys that control the internal preamps. Turning on the preamp gives a better noise figure, but a poorer TOI to noise floor dynamic range. You can optimize this setting for your particular measurement.

The instrument takes the preamp gain into account as it sweeps. If you sweep outside of the range of the preamp the instrument will also account for that. The displayed result will always reflect the correct gain.

Key Path:	AMPTD Y Scale
Scope:	Meas Global
Remote Command:	[:SENSE] :POWER [:RF] :GAIN [:STATE] OFF ON 0 1 [:SENSE] :POWER [:RF] :GAIN [:STATE] ?

AMPTD Y Scale

Dependencies:	Preamp is not available on all hardware platforms. If the preamp is not present or is unlicensed, the key is not shown. The preamp is not available when the electronic/soft attenuator is enabled. Preamp controls and settings are not available on the E6607C. If any preamp commands are sent to the E6607C the following error will be generated: -241;Hardware missing; not available for this model number
Preset:	OFF
State Saved:	Saved in instrument state
Initial S/W Revision:	Prior to A.02.00
Help Map ID:	3036

Key Path:	AMPTD Y Scale, Internal Preamp
Scope:	Meas Global
Remote Command:	[:SENSE] :POWER [:RF] :GAIN:BAND LOW FULL [:SENSE] :POWER [:RF] :GAIN:BAND?
Dependencies:	Preamp is not available on all hardware platforms. If the preamp is not present or is unlicensed, the key is not shown. If a POW:GAIN:BAND FULL command is sent when a low band preamp is available, the preamp band parameter is to LOW instead of FULL, and an "Option not installed" message is generated.
Preset:	LOW
State Saved:	Saved in instrument state
Initial S/W Revision:	Prior to A.02.00
Help Map ID:	0

Off

Turns the internal preamp off

Key Path:	AMPTD Y Scale, Internal Preamp
Example:	:POW:GAIN OFF
Readback:	Off
Initial S/W Revision:	Prior to A.02.00
Help Map ID:	3038

Low Band

Sets the internal preamp to use only the low band.

The frequency range of the installed (optional) low-band preamp is displayed in square brackets on the

Low Band key label.

Key Path:	AMPTD Y Scale, Internal Preamp
Example:	:POW:GAIN ON :POW:GAIN:BAND LOW
Readback:	Low Band
Initial S/W Revision:	Prior to A.02.00
Help Map ID:	3039

Full Range

Sets the internal preamp to use its full range. The low band (0–3.6 GHz or 0–3GHz, depending on the model) is supplied by the low band preamp and the frequencies above low band are supplied by the high band preamp.

The frequency range of the installed (optional) preamp is displayed in square brackets on the **Full Range** key label. If the high band option is not installed the Full Range key does not appear.

Key Path:	AMPTD Y Scale, Internal Preamp
Example:	:POW:GAIN ON :POW:GAIN:BAND FULL
Readback:	Full Range
Initial S/W Revision:	Prior to A.02.00
Help Map ID:	3040

AMPTD Y Scale

Auto Couple

The Auto Couple feature provides a quick and convenient way to automatically couple multiple instrument settings. This helps ensure accurate measurements and optimum dynamic range. When the Auto Couple feature is activated, either from the front panel or remotely, all parameters of the current measurement that have an Auto/Manual mode are set to Auto mode and all measurement settings dependent on (or coupled to) the Auto/Man parameters are automatically adjusted for optimal performance.

However, the Auto Couple key actions are confined to the current measurement only. It does not affect other measurements in the mode, and it does not affect markers, marker functions, or trace or display attributes.

See [“More Information” on page 473](#)

Key Path:	Front-panel key
Remote Command:	:COUPle ALL NONE
Example:	:COUP ALL
Notes:	:COUPle ALL puts all Auto/Man parameters in Auto mode (equivalent to pressing the Auto Couple key). :COUPLE NONE puts all Auto/Man parameters in manual mode. It decouples all the coupled instrument parameters and is not recommended for making measurements.
Initial S/W Revision:	Prior to A.02.00
Help Map ID:	3041

More Information

There are two types of functions that have Auto/Manual modes.

Auto/Man Active Function keys

An Auto/Man toggle key controls the binary state associated with an instrument parameter by toggling between **Auto** (where the parameter is automatically coupled to the other parameters it is dependent upon) and **Man** (where the parameter is controlled independent of the other parameters), as well as making the parameter the active function. The current mode is indicated on the softkey with either **Auto** or **Man** underlined as illustrated below.

Sweep Time
66.24 ms
<u>Auto</u> Man

vsd07

Auto/Man 1-of-N keys

An Auto/Man 1-of-N key allows you to manually pick from a list of parameter values, or place the function in Auto, in which case the value is automatically selected (and indicated) as shown below. If in

Auto Couple

Auto, Auto is underlined on the calling key. If in manual operation, manual is indicated on the calling key. But the calling key does not actually toggle the function, it simply opens the menu.

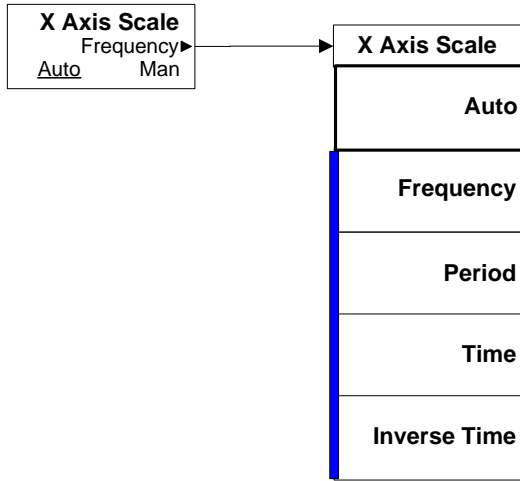

vsd08

Mode

The Mode key allows you to select the available measurement applications or “Modes”. Modes are a collection of measurement capabilities packaged together to provide an instrument personality that is specific to your measurement needs. Each application software product is ordered separately by Model Number and must be licensed to be available. Once an instrument mode is selected, only the commands that are valid for that mode can be executed.

NOTE Key operation can be different between modes. The information displayed in Help is about the current mode.

To access Help for a different Mode you must first exit Help (by pressing the Cancel (Esc) key). Then select the desired mode and re-access Help.

For more information on Modes, preloading Modes, and memory requirements for Modes, see [“More Information” on page 476](#)

Key Path:	Front-panel key
Remote Command:	:INSTrument [:SElect] SEQAN BASIC WCDMA EDGEgSM WIMAXOFDMA ADEMOD BT00th TDSC DMA CDMA2K CDMA1XEV LTE LTETDD :INSTrument [:SElect] ?
Example:	INST SEQAN
Notes:	The available parameters are dependent upon installed and licensed applications resident in the instrument. Parameters given here are an example, specific parameters are in the individual Application. A list of the valid mode choices is returned with the INST:CAT? Query.
Preset:	Not affected by Preset. In the EXT, the mode set by Restore System Defaults is the Sequence Analyzer mode.
State Saved:	Saved in instrument state
Backwards Compatibility SCPI:	:INSTrument[:SElect] GSM provided for backwards compatibility. Mapped to EDGEgSM.
Backwards Compatibility SCPI:	:INSTrument[:SElect] SANalyzer provided for ESU compatibility. When this command is received, the analyzer aliases it to the following: INST:SEL SCPI LC This results in the analyzer being placed in SCPI Language Compatibility Mode, in order to emulate the ESU Spectrum Analyzer Mode.

Mode

Backwards Compatibility SCPI:	:INSTrument[:SElect] RECEiver provided for ESU compatibility. When this command is received, the analyzer aliases it to the following: :INST:SEL EMI :CONF FSC This results in the analyzer being placed in the EMI Receiver Mode, running the Frequency Scan measurement, in order to emulate the ESU Receiver Mode.
Initial S/W Revision:	Prior to A.02.00
Modified at S/W Revision:	A.10.01
Help Map ID:	2670

Example:	INST 'SEQAN'?
Notes:	The query is not a quoted string. It is an enumeration as indicated in the Instrument Select table above. The command must be sequential: i.e. continued parsing of commands cannot proceed until the instrument select is complete and the resultant SCPI trees are available.
Backwards Compatibility SCPI:	:INSTrument[:SElect] 'GSM' 'BASIC'
Initial S/W Revision:	Prior to A.02.00
Help Map ID:	0

More Information

It is possible to specify the order in which the Modes appear in the Mode menu, using the Configure Applications utility (**System, Power On, Configure Applications**). It is also possible, using the same utility, to specify a subset of the available applications to load into memory at startup time, which can significantly decrease the startup time of the test set. During runtime, if an application that is not loaded into memory is selected (by either pressing that applications Mode key or sending that applications :INST:SEL command over SCPI), there will be a pause while the Application is loaded. During this pause a message box that says "Loading application, please wait..." is displayed.

Each application (Mode) that runs in the X-Series test set consumes virtual memory. The various applications consume varying amounts of virtual memory, and as more applications run, the memory consumption increases. Once an application is run, some of its memory remains allocated even when it is not running, and is not released until the test set program (xSA.exe) is shut down.

Agilent characterizes each Mode and assigns a memory usage quantity based on a conservative estimate. There is a limited amount of virtual memory available to applications (note that this is virtual memory and is independent of how much physical RAM is in the instrument). The instrument keeps track of how much memory is being used by all loaded applications – which includes those that preloaded at startup, and all of those that have been run since startup.

When you request a Mode that is not currently loaded, the instrument looks up the memory estimate for that Mode, and adds it to the residual total for all currently loaded Modes. If there is not enough virtual

memory to load the Mode, a dialog box and menu will appear that gives you four options:

Close and restart the test set program without changing your configured preloads. This may free up enough memory to load the requested Mode, depending on your configured preloads

Clear out all preloads and close and restart the test set program with only the requested application preloaded, and with that application running. This choice is guaranteed to allow you to run the requested application; but you will lose your previously configured preloads. In addition, there may be little or no room for other applications, depending on the size of the requested application.

Bring up the Configure Applications utility in order to reconfigure the preloaded apps to make room for the applications you want to run (this will then require restarting the test set program with your new configuration). This is the recommended choice because it gives you full flexibility to select exactly what you want.

Exit the dialog box without doing anything, which means you will be unable to load the application you requested.

In each case except 4, this will cause the test set software to close, and you will lose all unsaved traces and results.

If you attempt to load a mode via SCPI that will exceed memory capacity, the Mode does not load and an error message is returned:

```
-225, "Out of memory;Insufficient resources to load Mode (mode name) "
```

where “mode name” is the SCPI parameter for the Mode in question, for example, BASIC for IQ Analyzer Mode.

Application Mode Number Selection (Remote Command Only)

Select the measurement mode by its mode number. The actual available choices depend upon which applications are installed in your instrument. The modes appear in this table in the same order they appear in the Mode menu (if the order is not changed by the Configure Applications utility found in the **System, Power On** menu). See [“Detailed List of Modes” on page 482](#) for Mode details.

The Mode Number is the parameter for use with the :INSTrument:NSElect command. The Mode Parameter is the parameter for use with the :INSTrument[:SElect] command.

Mode	Mode Number	Mode Parameter
Sequence Analyzer	400	SEQAN
I/Q Analyzer (Basic)	8	BASIC
WCDMA with HSPA+	9	WCDMA
GSM/EDGE/EDGE Evo	13	EDGE GSM
802.16 OFDMA (WiMAX/WiBro)	75	WIMAXOFDMA
Analog Demod	234	ADEMOD
Bluetooth	228	BTtooth

Mode

Mode	Mode Number	Mode Parameter
TD-SCDMA with HSPA/8PSK	211	TDSCDMA
cdma2000	10	CDMA2K
1xEV-DO	15	CDMA1XEV
LTE	102	LTE
LTE TDD	105	LTETDD

Remote Command:	:INSTRument:NSElect <integer> :INSTRument:NSElect?
Example:	:INST:NSEL 1
Notes:	The command must be sequential: i.e. continued parsing of commands cannot proceed until the instrument select is complete and the resultant SCPI trees are available.
Preset:	Not affected by Preset. Set to default mode following Restore System Defaults.
State Saved:	Saved in instrument state
Initial S/W Revision:	Prior to A.02.00
Help Map ID:	0

Application Mode Catalog Query (Remote Command Only)

Returns a string containing a comma separated list of names of all the installed and licensed measurement modes (applications). These names can only be used with the :INSTRument[:SElect] command.

Remote Command:	:INSTRument:CATalog?
Example:	:INST:CAT?
Notes:	Query returns a quoted string of the installed and licensed modes separated with a comma. Example: "BASIC,EDGE GSM,CDMA"
Backwards Compatibility Notes:	VSA (E4406A) :INSTRument:CATalog? returned a list of installed INSTRument:SELECT items as a comma separated list of string values: "BASIC","GSM","EDGE GSM","CDMA","NADC","PDC","WCDMA","CDMA2K","CDMA1XEV","IDEN","WIDEN","WLAN","SERVICE" X-Series uses the ESA/PSA compatible query of a string contain comma separated values: "BASIC,CDMA,CDMA2K,WCDMA,CDMA1XEV,EDGE GSM,GSM,TDS CDMA,DMODULATION,WLAN"

Initial S/W Revision:	Prior to A.02.00
Help Map ID:	0

Application Identification (Remote Commands Only)

Each entry in the Mode Menu will have a Model Number and associated information: Version, and Options.

This information is displayed in the Show System screen. The corresponding SCPI remote commands are defined here.

[“Current Application Model ” on page 479](#)

[“Current Application Revision” on page 479](#)

[“Current Application Options” on page 480](#)

Current Application Model

Returns a string that is the Model Number of the currently selected application (mode).

Remote Command:	:SYSTem:APPLication[:CURRent] [:NAME] ?
Example:	:SYST:APPL?
Notes:	Query returns a quoted string that is the Model Number of the currently selected application (Mode). Example: "N9060A" String length is 6 characters.
Preset:	Not affected by Preset
State Saved:	Not saved in state, the value will be the selected application when a Save is done.
Initial S/W Revision:	Prior to A.02.00
Help Map ID:	0

Current Application Revision

Returns a string that is the Revision of the currently selected application (mode).

Remote Command:	:SYSTem:APPLication[:CURRent] :REVersion?
Example:	:SYST:APPL:REV?
Notes:	Query returns a quoted string that is the Revision of the currently selected application (Mode). Example: "1.0.0.0" String length is a maximum of 23 characters. (each numeral can be an integer + 3 decimal points)

Mode

Preset:	Not affected by a Preset
State Saved:	Not saved in state, the value will be the selected application when a Save is done.
Initial S/W Revision:	Prior to A.02.00
Help Map ID:	0

Current Application Options

Returns a string that is the Options list of the currently selected application (Mode).

Remote Command:	:SYSTem:APPLication[:CURRent]:OPTion?
Example:	:SYST:APPL:OPT?
Notes:	Query returns a quoted string that is the Option list of the currently selected application (Mode). The format is the name as the *OPT? or SYSTem:OPTion command: a comma separated list of option identifiers. Example: "1FP,2FP" String length is a maximum of 255 characters.
Preset:	Not affected by a Preset
State Saved:	Not saved in state per se, the value will be the selected application when a Save is invoked.
Initial S/W Revision:	Prior to A.02.00
Help Map ID:	0

Application Identification Catalog (Remote Commands Only)

A catalog of the installed and licensed applications (Modes) can be queried for their identification.

[“Application Catalog Number of Entries” on page 480](#)

[“Application Catalog Revision” on page 481](#)

[“Application Catalog Options” on page 481](#)

Application Catalog Number of Entries

Returns the number of installed and licensed applications (Modes).

Remote Command:	:SYSTem:APPLication:CATalog[:NAME]:COUNt?
Example:	:SYST:APPL:CAT:COUN?
Preset:	Not affected by Preset
State Saved:	Not saved in instrument state.
Initial S/W Revision:	Prior to A.02.00

Help Map ID:	0
--------------	---

Application Catalog Model Numbers

Returns a list of Model Numbers for the installed and licensed applications (Modes).

Remote Command:	:SYSTem:APPLication:CATalog[:NAME]?
Example:	:SYST:APPL:CAT?
Notes:	Returned value is a quoted string of a comma separated list of Model Numbers. Example, if SAMS and Phase Noise are installed and licensed: "N9060A,N9068A" String length is COUNT * 7 - 1. (7 = Model Number length + 1 for comma. -1 = no comma for the 1st entry.)
Preset:	Not affected by a Preset
State Saved:	Not saved in instrument state.
Initial S/W Revision:	Prior to A.02.00
Help Map ID:	0

Application Catalog Revision

Returns the Revision of the provided Model Number.

Remote Command:	:SYSTem:APPLication:CATalog:REVisIon? <model>
Example:	:SYST:APPL:CAT:REV? 'N9060A'
Notes:	Returned value is a quoted string of revision for the provided Model Number. The revision will be a null-string ("") if the provided Model Number is not installed and licensed. Example, if SAMS is installed and licensed: "1.0.0.0"
Preset:	Not affected by a Preset.
State Saved:	Not saved in instrument state.
Initial S/W Revision:	Prior to A.02.00
Help Map ID:	0

Application Catalog Options

Returns a list of Options for the provided Model Number

Remote Command:	:SYSTem:APPLication:CATalog:OPTion? <model>
Example:	:SYST:APPL:CAT:OPT? 'N9060A'

Mode

Notes:	Returned value is a quoted string of a comma separated list of Options, in the same format as *OPT? or :SYSTem:OPTion?. If the provided Model Number is not installed and licensed a null-string ("") will be returned. Example, if SAMS is installed and licensed: "2FP" String length is a maximum of 255 characters.
Preset:	Not affected by a Preset
State Saved:	Not saved in instrument state.
Initial S/W Revision:	Prior to A.02.00
Help Map ID:	0

Detailed List of Modes

This section contains an alphabetical list of Modes available in the X-Series, along with a brief description of each Mode.

Note that with the exception of the 89601 VSA, only licensed applications appear in the Mode menu. The 89601 will always appear, because it's licensing is handled differently.

1xEV-DO

Selects the 1xEV-DO mode for general purpose measurements of signals following this standard. There are several measurements available in this mode.

If you are using the Help feature, this mode must be currently active to access its detailed information. If it is not active, exit the Help feature (Esc key), select the mode, and re-access Help.

Key Path:	Mode
Example:	INST:SEL CDMA1XEV INST:NSEL 15
Initial S/W Revision:	Prior to A.02.00
Help Map ID:	3566

802.16 OFDMA (WiMAX/WiBro)

Selects the OFDMA mode for general purpose measurements of WiMAX signals. There are several measurements available in this mode.

If you are using the Help feature, this mode must be currently active to access its detailed information. If it is not active, exit the Help feature (Esc key), select the mode, and re-access Help.

Key Path:	Mode
Example:	INST:SEL WIMAXOFDMA INST:NSEL 75

Initial S/W Revision:	Prior to A.02.00
Help Map ID:	3531

Analog Demod

Selects the Analog Demod mode for making measurements of AM, FM and phase modulated signals.

If you are using the Help feature, this mode must be currently active to access its detailed information. If it is not active, exit the Help feature (Esc key), select the mode, and re-access Help.

Key Path:	Mode
Example:	INST:SEL ADEMOM INST:NSEL 234
Initial S/W Revision:	Prior to A.02.00
Help Map ID:	3529

Bluetooth

Selects the Bluetooth mode for Bluetooth specific measurements. There are several measurements available in this mode.

If you are using the Help feature, this mode must be currently active to access its detailed information. If it is not active, exit the Help feature (Esc key), select the mode, and re-access Help.

Key Path:	Mode
Example:	INST:SEL BT INST:NSEL 228
Initial S/W Revision:	A.06.01
Help Map ID:	30035

cdma2000

Selects the cdma2000 mode for general purpose measurements of signals following this standard. There are several measurements available in this mode.

If you are using the Help feature, this mode must be currently active to access its detailed information. If it is not active, exit the Help feature (Esc key), select the mode, and re-access Help.

Key Path:	Mode
Example:	INST:SEL CDMA2K INST:NSEL 10
Initial S/W Revision:	Prior to A.02.00
Help Map ID:	3533

Mode

GSM/EDGE/EDGE Evo

Selects the GSM with EDGE mode for general purpose measurements of signals following this standard. There are several measurements available in this mode.

If you are using the Help feature, this mode must be currently active to access its detailed information. If it is not active, exit the Help feature (Esc key), select the mode, and re-access Help.

Key Path:	Mode
Example:	INST:SEL EDGEGSM INST:NSEL 13
Initial S/W Revision:	Prior to A.02.00
Modified at S/W Revision:	A.02.00
Help Map ID:	3532

IQ Analyzer (Basic)

The IQ Analyzer Mode makes general purpose frequency domain and time domain measurements. These measurements often use alternate hardware signal paths. These frequency domain and time domain measurements can be used to output I/Q data results when measuring complex modulated digital signals.

If you are using the Help feature, this mode must be currently active to access its detailed information. If it is not active, exit the Help feature (Esc key), select the mode, and re-access Help.

Key Path:	Mode
Example:	INST:SEL BASIC INST:NSEL 8
Initial S/W Revision:	Prior to A.02.00
Help Map ID:	3526

LTE

Selects the LTE mode for general purpose measurements of signals following the LTE FDD standard. There are several measurements available in this mode.

If you are using the Help feature, this mode must be currently active to access its detailed information. If it is not active, exit the Help feature (Esc key), select the mode, and re-access Help.

Key Path:	Mode
Example:	INST:SEL LTE INST:NSEL 102
Initial S/W Revision:	Prior to A.02.00
Help Map ID:	3586

LTE TDD

Selects the LTE TDD mode for general purpose measurements of signals following the LTE TDD standard. There are several measurements available in this mode.

If you are using the Help feature, this mode must be currently active to access its detailed information. If it is not active, exit the Help feature (Esc key), select the mode, and re-access Help.

Key Path:	Mode
Example:	INST:SEL LTETDD INST:NSEL 105
Initial S/W Revision:	A.03.00
Help Map ID:	44220

Sequence Analyzer

Selects the Sequence Analyzer mode for sequenced measurements. Depending on licensed applications there may be a number of different measurements available in this mode. These measurements are all done on IQ captured data and can be set up to calculated on any part of the capture.

If you are using the Help feature, this mode must be currently active to access its detailed information. If it is not active, exit the Help feature (Esc key), select the mode, and re-access Help.

Key Path:	Mode
Example:	INST:SEL SEQAN INST:NSEL 400
Initial S/W Revision:	A.05.01
Help Map ID:	30033

TD-SCDMA with HSPA/8PSK

Selects the TD-SCDMA mode for general purpose measurements of signals following this standard. There are several measurements available in this mode.

If you are using the Help feature, this mode must be currently active to access its detailed information. If it is not active, exit the Help feature (Esc key), select the mode, and re-access Help.

Key Path:	Mode
Example:	INST:SEL TDSCDMA INST:NSEL 211
Initial S/W Revision:	Prior to A.02.00
Help Map ID:	3534

Mode

W-CDMA with HSPA+

Selects the W-CDMA with HSPA+ mode for general purpose measurements of signals following this standard. There are several measurements available in this mode.

If you are using the Help feature, this mode must be currently active to access its detailed information. If it is not active, exit the Help feature (Esc key), select the mode, and re-access Help.

Key Path:	Mode
Example:	INST:SEL WCDMA INST:NSEL 9
Initial S/W Revision:	Prior to A.02.00
Help Map ID:	3530

Global Settings

Opens up a menu that allows you to switch certain Meas Global parameters to a Mode Global state. These switches apply to all Modes that support global settings. No matter what Mode you are in when you set the “Global Center Frequency” switch to on, it applies to all Modes that support Global Settings.

Key Path:	Front Panel Key
Initial S/W Revision:	Prior to A.02.00
Help Map ID:	4003

Global Center Freq

The software maintains a Mode Global value called “Global Center Freq”.

When the **Global Center Freq** key is switched to **On** in any mode, the current mode’s center frequency is copied into the Global Center Frequency, and from then on all modes which support global settings use the Global Center Frequency. So you can switch between any of these modes and the Center Freq will remain unchanged.

Adjusting the Center Freq of any mode which supports Global Settings, while **Global Center Freq** is **On**, will modify the Global Center Frequency.

When **Global Center Freq** is turned **Off**, the Center Freq of the current mode is unchanged, but now the Center Freq of each mode is once again independent.

When **Mode Preset** is pressed while **Global Center Freq** is **On**, the Global Center Freq is preset to the preset Center Freq of the current mode.

This function is reset to Off when the Restore Defaults key is pressed in the Global Settings menu, or when **System, Restore Defaults, All Modes** is pressed.

Key Path:	Mode Setup, Global Settings
Scope:	Mode Global

Remote Command:	: INStRument : COUPle : FREQuency : CENTer ALL NONE : INStRument : COUPle : FREQuency : CENTer?
Example:	INST:COUP:FREQ:CENT ALL INST:COUP:FREQ:CENT?
Preset:	Set to Off on Global Settings, Restore Defaults and System, Restore Defaults, All Modes
Range:	On Off
Initial S/W Revision:	Prior to A.02.00
Help Map ID:	4009

Remote Command:	: GLOBal : FREQuency : CENTer [: STATe] 1 0 ON OFF : GLOBal : FREQuency : CENTer [: STATe] ?
Preset:	Off
Initial S/W Revision:	Prior to A.02.00
Help Map ID:	0

Restore Defaults

This key resets all of the functions in the Global Settings menu to Off. This also occurs when **System, Restore Defaults, All Modes** is pressed.

Key Path:	Mode Setup, Global Settings
Remote Command:	: INStRument : COUPle : DEFault
Example:	INST:COUP:DEF
Backwards Compatibility SCPI:	: GLOBal : DEFault
Initial S/W Revision:	Prior to A.02.00
Help Map ID:	4010

Mode

BW

The BW key opens the bandwidth menu, which contains keys to control the Resolution Bandwidth and Video Bandwidth functions of the test set.

The Res BW functions control filter bandwidth and filter type. There are two filter types, Gaussian and Flattop. The Gaussian filters have a response curve that is parabolic on a log scale. The Flattop filter shape is a close approximation of a rectangular filter.

NOTE The AVERAGE functions are found in the Trace menu and the Meas Setup menu. In the Trace menu, you may turn Trace Averaging on or off for the desired traces (rather than globally as in the past); and in the Meas Setup menu you may configure Averaging, by setting the Average Number and the Average Type.

Key Path	Front-panel key
Initial S/W Revision	Prior to A.02.00
Help Map ID	3042

Res BW

Activates the resolution bandwidth active function, which allows you to manually set the resolution bandwidth (RBW) of the test set. Normally, **Res BW** (Auto) selects automatic coupling of the Res BW to **Span** using the ratio set by the Span:3dB RBW key. To decouple the resolution bandwidth, press Res BW until Man is underlined, or simply enter a different value for **Res BW**.

See [“More Information” on page 490](#)

Key Path	BW
Remote Command	[:SENSE]:BANDwidth BWIDth[:RESolution] <freq> [:SENSE]:BANDwidth BWIDth[:RESolution]? [:SENSE]:BANDwidth BWIDth[:RESolution]:AUTO OFF ON 0 1 [:SENSE]:BANDwidth BWIDth[:RESolution]:AUTO?
Example	BAND 1 KHZ BAND? BWID:AUTO ON BWID:AUTO?
Notes	For numeric entries, all RBW Types choose the nearest (arithmetically, on a linear scale, rounding up) available RBW to the value entered.
Notes	The setting and querying of values depends on the current bandwidth type.

BW

Dependencies	When in Zero Span with no EMI Standard selected, there is no Auto setting for Res BW. The Auto/Man line on the Res BW key disappears in this case, and if the SCPI command [:SENSe]:BWID[:RESolution]:AUTO ON is sent, it generates an error.
Couplings	Res BW is normally coupled to Span; if Res BW is set to Auto, as the Span decreases, so will the Res BW. Normally, in Zero Span, this coupling is turned off and Res BW has no Auto setting. When a CISPR or MIL EMI Standard is in use, the Res BW is coupled to Center Frequency and not to Span, and this is true even in Zero Span. Sweep time is coupled to RBW when in a non-zero span. If Sweep Time is set to Auto, then the sweep time is changed as the RBW changes, to maintain amplitude calibration. Video bandwidth (VBW) is normally coupled to RBW. If VBW is set to Auto, then the VBW is changed as the RBW changes, to maintain the ratio set by VBW:3dB RBW. See the ““ VBW:3dB RBW ” on page 492” key description.
Preset	3 MHz ON
State Saved	Saved in Instrument State
Min	1 Hz
Max	8 MHz is the max equivalent –3 dB RBW, which means that the named RBW (the one shown on the key) can actually exceed 8 MHz if using a filter other than –3 dB Gaussian
Default Unit	Hz
Initial S/W Revision	Prior to A.02.00
Help Map ID	3043

More Information

When the **Res BW** is manually selected, it may be returned to the coupled state by pressing the **Res BW** key until **Auto** is underlined. This may also be done by pressing Auto Couple or by performing a **Preset**.

When **Res BW** is set to **Auto**, the bandwidth selected depends on the Filter Type (see “Filter Type” below).

Only certain discrete resolution bandwidths are available. The available bandwidths are dependent on the **Filter Type** or the **EMC Standard**. If an unavailable bandwidth is entered with the numeric keypad, the closest available bandwidth is selected.

The zero-span case deserves some mention, because RBW is coupled to Span when in a swept (non-zero) span and in zero span there is normally no meaningful RBW coupling in Zero Span. However, when a MIL or CISPR EMC Standard is selected, there IS a meaningful coupling for RBW in Zero Span – in fact, it is coupled to Center Frequency, in order to make measurements according to the EMI specifications.

The annotation under RBW in the bottom left of the screen shows the type of filter or bandwidth that is being used. The following examples illustrate this:

-3 dB (Normal) filter BW:Res BW 300 Hz
 -6 dB filter BW: Res BW (-6 dB) 422 Hz
 Noise filter BW: Res BW (Noise) 317 Hz
 Impulse filter BW: Res BW (Impulse) 444 Hz
 CISPR filter BW:Res BW (CISPR) 200 Hz
 MIL filter BW:Res BW (MIL) 1 kHz
 Flattop filter type:Res BW (Flattop) 300 Hz

Video BW

Lets you change the test set post-detection filter (VBW) from 1 Hz to 8 MHz in approximately 10% steps. In addition, a wide-open video filter bandwidth may be chosen by selecting 50 MHz.

Normally, Video BW (Auto) selects automatic coupling of the Video BW filter to the resolution bandwidth filter using the ratio set by the VBW:3dB RBW key. To decouple the video bandwidth, press Video BW until Man is underlined, or simply enter a new value.

When the **Video BW** is manually selected, it may be returned to the coupled state by pressing the **Video BW** key until **Auto** is underlined. This may also be done by pressing Auto Couple or by performing a **Preset**.

Key Path	BW
Remote Command	[:SENSe] :BANDwidth BWIDth:VIDeo <freq> [:SENSe] :BANDwidth BWIDth:VIDeo? [:SENSe] :BANDwidth BWIDth:VIDeo:AUTO OFF ON 0 1 [:SENSe] :BANDwidth BWIDth:VIDeo:AUTO?
Example	BAND:VID 1 KHZ BAND:VID? BWID:VID:AUTO ON BWID:VID:AUTO?
Notes	For numeric entries, the test set chooses the nearest (arithmetically, on a linear scale, rounding up) available VBW to the value entered. The 50 MHz VBW is defined to mean “wide open”.
Notes	The values shown in this table reflect the conditions after a Mode Preset.

Dependencies	<p>Sometimes the displayed Video BW is not actually used to process the trace data:</p> <ul style="list-style-type: none"> • When the Average Detector is selected and Sweep Type is set to Swept, the video bandwidth filter cannot be used, because it uses the same hardware as the Average Detector. • When the Quasi-Peak, EMI Average or RMS Average detector is selected the VBW is implemented by the digital IF as part of the detector <p>When this is the case, the VBW still acts to change the Sweep Time, if Sweep Time is in Auto, and still affects the data on other traces for which this is not the case.</p>
Preset	3 MHz ON
State Saved	Saved in Instrument State
Min	1 Hz
Max	50 MHz
Default Unit	Hz
Initial S/W Revision	Prior to A.02.00
Modified at S/W Revision	A.02.00
Help Map ID	3044

VBW:3dB RBW

Selects the ratio between the video bandwidth and the equivalent 3 dB resolution bandwidth to be used for setting VBW when VBW is in Auto.

VBW:3dB RBW (Auto) selects automatic coupling of the VBW:3 dB RBW ratio to **Detector**. See [“Coupling Auto Rules:” on page 493](#) for more information. To decouple the ratio, press VBW:3 dB RBW until Man is underlined, or simply enter a new value.

When the VBW:3dB RBW is manually selected, it may be returned to the coupled state by pressing the VBW:3 dB RBW key until **Auto** is underlined. This may also be done by pressing Auto Couple or by performing a **Preset**.

Key Path	BW
Remote Command	<pre>[:SENSE] :BANDwidth BWIDth:VIDeo:RATio <real> [:SENSE] :BANDwidth BWIDth:VIDeo:RATio? [:SENSE] :BANDwidth BWIDth:VIDeo:RATio:AUTO OFF ON 0 1 [:SENSE] :BANDwidth BWIDth:VIDeo:RATio:AUTO?</pre>

Example	BAND:VID:RAT 2 BAND:VID:RAT? BAND:VID:RAT:AUTO 0 BAND:VID:RAT:AUTO?
Notes	The values shown in this table reflect the conditions after a Mode Preset.
Couplings	See “Coupling Auto Rules:” on page 493
Preset	1 ON
State Saved	Saved in Instrument State
Min	0.00001
Max	3000000
Initial S/W Revision	Prior to A.02.00
Modified at S/W Revision	A.02.00
Help Map ID	3045

Coupling Auto Rules:

The Auto Rules for the **VBW:3dB RBW** function are as follows:

First, we go through the following list and find the lowest numbered detector being used on any active traces (traces for which Update is On):

- Peak
- Normal
- Average
- Sample
- Negative Peak
- EMI Average
- Quasi Peak
- RMS Average

Use that detector to pick the ratio based on the following criteria:

1. If the detector is Peak and the EMC Standard is set to either CISPR or MIL, use 10.0 (we use wide VBWs to capture peak levels accurately).
2. Otherwise, if the detector is **Negative Peak**, use 1.0 (in the Negative Peak case, there are no known significant use models so we use a medium ratio).
3. Otherwise, if the detector is **Normal**, use 1.0.
4. Otherwise, if the detector is **Average**, and the span is nonzero, use 0.1. The use of a small ratio in

BW

Average detection is desirable because of its effect on the sweep time equations. The VBW filter is not actually in-circuit when the average detector is on. If the detector is Average, and the span is zero, use 10.0, which gives optimal behavior for Interval Markers in zero span.

5. Otherwise, if the detector is EMI Average, Quasi Peak or CISPR RMS, use 1.0. In fact this is a “don’t care” since no VBW is used for these detectors, as noted under “Dependencies” for the VBW key.
6. Otherwise, the detector is simply **Peak** or **Sample**. These two detectors can use the same rules. In these cases, if any active trace is in max hold or min hold, use 10.0, because Max and Min Hold operations are usually intended to capture peaks and pits without smoothing from the VBW filter; otherwise, use 1.0 as a compromise, because you have not set the test set in a way that implies that you are measuring noise, pulsed-RF or CW signals.

Note that because the above couplings depend on which traces are active, they are re-examined whenever any trace goes active or inactive, except when this leaves no traces active. Transitioning to the state where no traces are active should not affect the couplings; in that way, the annotation will always reflect the state of the last trace which was active.

Span:3dB RBW

Selects the ratio between span and resolution bandwidth.

Normally, Span:3dB RBW (Auto) selects a Span:3dB RBW ratio of 106:1. If you manually enter the ratio, Man becomes underlined, which enables you to manually select ratios more suitable for certain measurements.

When the Span:3dB RBW is manually selected, it may be returned to the coupled state by pressing the Span:3dB RBW key until **Auto** is underlined. This may also be done by pressing Auto Couple or by performing a **Preset**.

Key Path	BW
Remote Command	<pre>[:SENSe] :FREQuency:SPAN:BANDwidth[:RESolution]:RATio<integer> [:SENSe] :FREQuency:SPAN:BANDwidth[:RESolution]:RATio? [:SENSe] :FREQuency:SPAN:BANDwidth[:RESolution]:RATio:AUTO OFF ON 0 1 [:SENSe] :FREQuency:SPAN:BANDwidth[:RESolution]:RATio:AUTO?</pre>
Example	<pre>FREQ:SPAN:BAND:RAT 200 sets a ratio of 200:1, and turns off the auto coupling. FREQ:SPAN:BAND:RAT:AUTO ON FREQ:SPAN:BAND:RAT?</pre>
Notes	The values shown in this table reflect the conditions after a Mode Preset.

Dependencies	Grayed out when the EMC Standard is set to CISPR or MIL, since RBW is coupled to Center Frequency rather than Span in this case. If the grayed out key is pressed, an advisory message is generated. If the equivalent SCPI command is sent, the command is acted upon, but it doesn't affect the current measurement.
Preset	106 ON
State Saved	Saved in Instrument State
Min	2
Max	10000
Initial S/W Revision	Prior to A.02.00
Help Map ID	3046

RBW Control

Selects the type/shape for the resolution bandwidth filters. Historically, the Res BW filters in Agilent Test Sets were Gaussian filters, specified using the –3 dB bandwidth of the filter. That is, a 10 MHz Res BW filter was a Gaussian shape with its –3 dB points 10 MHz apart. In the X-Series you can, using the **Filter BW** key, specify bandwidths other than the –3 dB bandwidth (–6 dB, Noise, Impulse) for the width of the Gaussian filters. Furthermore, the **Filter BW** menu lets you choose between a Gaussian and Flat Top filter shape, for varying measurement conditions.

Key Path	BW
Dependencies]The RBW Control key is grayed out if the EMC Standard is set to CISPR or MIL . In this case the Filter Type is always Gaussian; the Filter BW is chosen as appropriate for the filter and the standard.
Readback line	[<filter type>] or, if Filter Type is Gaussian, [Gaussian,<filter BW>]
Initial S/W Revision	Prior to A.02.00
Modified at S/W Revision	A.02.00
Help Map ID	3047

Filter Type

Besides the familiar Gaussian filter shape, there are certain special filter types, such as Flat Top, that are desirable under certain conditions. The **Filter Type** menu gives you control over these types.

See [“More Information” on page 496](#)

Key Path	BW, RBW Control
Remote Command	[:SENSE] :BANDwidth BWIDth :SHAPE GAUSSian FLATtop [:SENSE] :BANDwidth BWIDth :SHAPE ?

Example	BAND:SHAP GAUS
Notes	GAUSSian= Gaussian FLATtop = Flattop
Dependencies	When EMC Standard is set to CISPR or MIL , the Filter Type is always Gaussian
Preset	Auto Couple chooses the preset value
State Saved	Saved in State
Readback line	1-of-N selection
Initial S/W Revision	Prior to A.02.00
Modified at S/W Revision	A.02.00
Help Map ID	3048

More Information

Gaussian filters

When the Gaussian filter type is chosen, a set of 160 RBW filters are available whose shape is approximately Gaussian. The actual bandwidths used to realize the X-Series’s Gaussian filters are chosen to come as close as possible to a 24 step per decade series, within the limitations of the digital IF.

For Gaussian filters, the annotation at the bottom of the screen shows the filter bandwidth type (unless it is Normal). This is shown parenthetically between the words “Res BW” and the value, for example

Res BW 10.0 Hz (Normal bandwidth)

Res BW (Impulse) 14.8 Hz (Impulse bandwidth)

Flattop filters

When the Flattop filter type is chosen, a new set of 134 RBW hardware settings are available. These settings realize filters that are approximately rectangular in shape. When this shape is chosen the filter bandwidth options are irrelevant and therefore unavailable.

The annotation at the bottom of the screen will show that the Flattop shape is being used, for example:

Res BW (Flattop) 10 Hz

Gaussian

Selects the Gaussian filter type. There are 160 of these RBWs. They are arranged in a 24-per-decade sequence from 1 Hz through 3 MHz, plus the 4, 5, 6 and 8 MHz settings.

Key Path	BW, RBW Control, Filter Type
Example	BAND:SHAP GAUS
Notes	Parameter is GAUSSian. See remote command in section “Filter Type” on page 495 .
Readback	Gaussian

Initial S/W Revision	Prior to A.02.00
Help Map ID	3049

Flattop

Selects the flat top filter type

Key Path	BW, RBW Control, Filter Type
Example	BAND:SHAP FLAT
Readback	Flattop
Initial S/W Revision	Prior to A.02.00
Help Map ID	3050

Filter BW

When using the Gaussian filters for certain types of applications it can be useful to be able to specify the filter width using points other than the -3 dB points. The Filter BW function allows you to pick the filter based on its -3 dB (Normal) bandwidth, its -6 dB bandwidth, its Noise bandwidth, or its Impulse bandwidth. Note that in all four cases the -3 dB bandwidth is the same. The filter does not change, but the way you specify it changes.

BW

See “More Information” on page 498

Key Path	BW, RBW Control
Remote Command	[:SENSe] :BANDwidth BWIDth :TYPE DB3 DB6 IMPulse NOISe [:SENSe] :BANDwidth BWIDth :TYPE?
Example	BAND:TYPE NOIS
Notes	DB3 = -3 dB (Normal) DB6 = -6 dB IMPulse = Impulse NOISe = Noise
Dependencies	Grayed out if the Flattop filter type is selected. When EMC Standard is set to CISPR or MIL , the Filter BW is chosen as appropriate for the filter and the standard.
Preset	Auto Couple chooses the preset value
State Saved	Saved in State
Readback line	1-of-N selection
Initial S/W Revision	Prior to A.02.00
Modified at S/W Revision	A.02.00
Help Map ID	3052

More Information

The test set provides four ways of specifying the bandwidth of a Gaussian filter:

The -3 dB bandwidth of the filter

The -6 dB bandwidth of the filter

The equivalent Noise bandwidth of the filter, which is defined as the bandwidth of a rectangular filter with the same peak gain which would pass the same power for noise signals.

The equivalent Impulse bandwidth of the filter, which is defined as the bandwidth of a rectangular filter with the same peak gain which would pass the same power for impulsive (narrow pulsed) signals.

The figure below shows the relationships of the various filter bandwidths for filters with the X-Series' shape factor (shape factor is defined as the ratio of the -60 dB bandwidth to the -3 dB bandwidth):

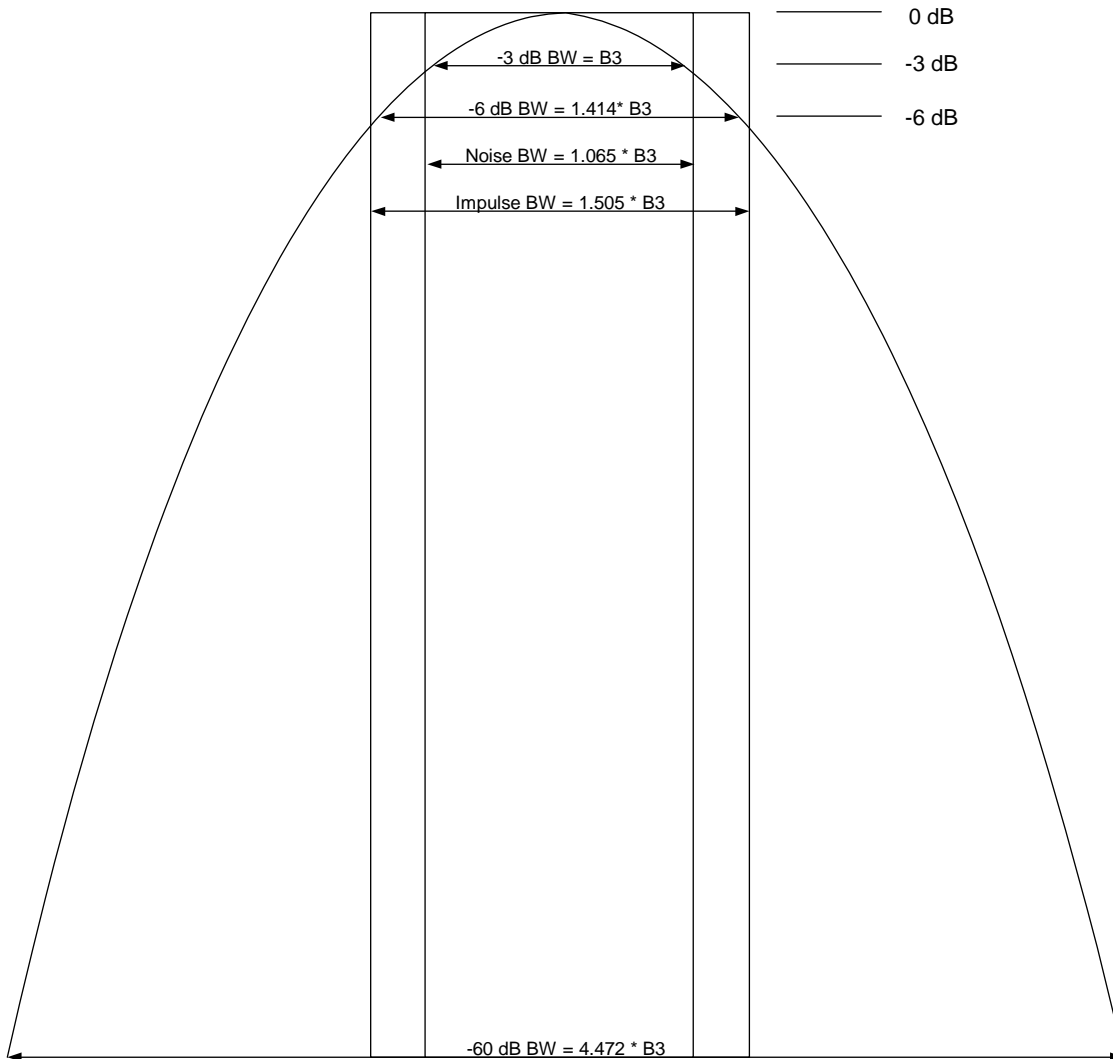

The Filter Type menu lets you choose the filter bandwidth (–3 dB, –6 dB, Noise or Impulse) that is used when specifying the width of the filter. Note that for a given Gaussian filter, changing the filter bandwidth specification does not affect the filter width at all but only the means of specifying it. For example, the filter whose –3 dB bandwidth is 1.0 kHz is the same as the filter whose –6 dB bandwidth is 1.41 kHz, whose Noise bandwidth is 1.06 kHz, and whose Impulse bandwidth is 1.48 kHz. As you cycle through these various filter bandwidths the filter does not change, but the way the filter is annotated and the value which appears in the active function area and on the key does.

–3 dB (Normal)

Selects the normal gaussian-shaped bandwidths that are defined by their –3 dB bandwidths.

Key Path	BW, RBW Control, Filter BW
Example	BAND:TYPE DB3
Readback	–3 dB
Initial S/W Revision	Prior to A.02.00

BW

Help Map ID	3053
-------------	------

-6 dB

Selects the filter bandwidths where the bandwidth is defined at the -6 dB points. This uses the normal RBW filters, but the value displayed on the key, active function line and screen annotation changes to reflect the -6 dB bandwidth instead of the -3 dB bandwidth.

Key Path	BW, RBW Control, Filter BW
Example	BAND:TYPE DB6
Readback	-6 dB
Initial S/W Revision	Prior to A.02.00
Help Map ID	3054

Noise

Selects the noise filter bandwidths. This uses the normal RBW filters, but the value displayed on the key, active function line and screen annotation changes to reflect the equivalent noise bandwidth, instead of the -3 dB bandwidth.

Key Path	BW, RBW Control, Filter BW
Example	BAND:TYPE NOIS
Readback	Noise
Initial S/W Revision	Prior to A.02.00
Help Map ID	3055

Impulse

Selects the impulse bandwidths. This uses the normal RBW filters, but the value displayed on the key, active function line and screen annotation changes to reflect the equivalent impulse bandwidth instead of the -3 dB bandwidth.

Key Path	BW, RBW Control, Filter BW
Example	BAND:TYPE IMP
Readback	Impulse
Initial S/W Revision	Prior to A.02.00
Help Map ID	3056

Cont (Continuous Measurement/Sweep)

Sets the test set for Continuous measurement operation. The single/continuous state is Meas Global so the setting will affect all measurements. If you are Paused, pressing **Cont** does a Resume.

Key Path:	Front-panel key
Remote Command:	:INITiate:CONTinuous OFF ON 0 1 :INITiate:CONTinuous?
Example:	:INIT:CONT 0 puts the test set in Single measurement operation. :INIT:CONT 1 puts the test set in Continuous measurement operation
Preset:	ON (Note that SYST:PRESet sets INIT:CONT to ON but *RST sets INIT:CONT to OFF)
State Saved:	Saved in instrument state
Backwards Compatibility Notes:	For Spectrum Analysis mode in ESA and PSA, there is no Cont hardkey, instead there is a Sweep Single/Cont key. In these analyzers, switching the Sweep Single/Cont key from Single to Cont restarts averages (displayed average count reset to 1), but does not restart Max Hold and Min Hold . The X-Series has Single and Cont hardkeys in place of the Sweep Single Cont softkey. In the X-Series, if in single measurement, the Cont hardkey (and INIT:CONT ON) switches to continuous measurement, but never restarts a measurement and never resets a sweep.
Initial S/W Revision:	Prior to A.02.00
Help Map ID:	3309

With **Avg/Hold Num** (in the **Meas Setup** menu) set to **Off** or set to **On** with a value of 1, a sweep is taken after the trigger condition is met; and the test set continues to take new sweeps after the current sweep has completed and the trigger condition is again met. However, with **Avg/Hold Num** set to On with a value >1, multiple sweeps (data acquisitions) are taken for the measurement. The trigger condition must be met prior to each sweep. The sweep is not stopped when the average count k equals the number N set for Avg/Hold Num is reached, but the number k stops incrementing. A measurement average usually applies to all traces, marker results, and numeric results. But sometimes it only applies to the numeric results.

If the test set is in Single measurement, pressing the **Cont** key does not change k and does not cause the sweep to be reset; the only action is to put the test set into Continuous measurement operation.

If it is already in continuous sweep:

the INIT:CONT 1 command has no effect

the INIT:CONT 0 command will place the test set in Single Sweep but will have no effect on the current sequence until k = N, at which point the current sequence will stop and the instrument will go to the idle

Cont (Continuous Measurement/Sweep)

state.

FREQ Channel

Opens a menu that enables you to control the Center Frequency of the instrument.

Key Path	Front-panel key
Instrument S/W Revision	Prior to A.02.00
Help Map ID	5009

Center Frequency

Sets the frequency that corresponds to the horizontal center of the graticule (for the normal setup where Frequency Scale Type is set to linear). While adjusting the Center Frequency the Span is held constant, this means that both Start Frequency and Stop Frequency will change.

Center Freq also sets the frequency entry mode to Center/Span. In Center/Span mode, the center frequency and span values are displayed below the graticule, and the default active function in the Frequency menu is **Center Freq**.

The **Center Frequency** setting is the same for all measurements within a **Mode**. Some modes are also able to share a global **Center Frequency** value; if this is the case, the **Mode** will have a **Global Settings** key in its **Mode Setup** menu.

If your test set has multiple inputs, the Center Freq function sets (and queries) the Center Frequency for the currently selected input. If you select another input, the Center Freq changes to the value for that input. SCPI commands are available to directly set the Center Freq for a specific input.

FREQ Channel

See [“RF Center Freq” on page 505](#)

See [“Center Frequency Presets” on page 505](#)

Remote Command	[:SENSe]:FREQuency:CENTer <freq> [:SENSe]:FREQuency:CENTer?
Default Unit	Hz
Dependencies/Couplings	When operating in “swept span”, any value of the Center Frequency or Span that is within the frequency range of the analyzer is allowed when the value is being set through the front panel numeric key pad or the SCPI command. The other parameter is forced to a different value if needed, to keep the Start and the Stop Frequencies within the analyzer’s frequency range The Center Frequency can be limited by Start or Stop Freq limits, if the Span is so large that Start or Stop hit their limit.
Example	FREQ:CENT 50 MHz FREQ:CENT UP changes the center frequency to 150 MHz if you use FREQ:CENT:STEP 100 MHz to set the center frequency step size to 100 MHz FREQ:CENT?
Key Path	FREQ Channel
Mode	BASIC, GSM, WIMAXOFDMA, WCDMA
Scope	Meas Global
Notes	For RF input it is equivalent to FREQ:RF:CENT Preset and Max values are dependant on Hardware Options ()
Preset	Depends on instrument maximum frequency, mode, measurement, and selected input. See “RF Center Freq” on page 505 and “Center Frequency Presets” on page 505 .
State Saved	Saved in State
Min	Depends on instrument maximum frequency, mode, measurement, and selected input. See “RF Center Freq” on page 505 and “Center Frequency Presets” on page 505 .
Max	Depends on instrument maximum frequency, mode, measurement, and selected input. See “RF Center Freq” on page 505 and “Center Frequency Presets” on page 505 .
Status Bits/OPC Dependencies	non-overlapped
Instrument S/W Revision	Prior to A.02.00

Help Map ID

3059

Center Frequency Presets

The following table provides the Center Frequency Presets for the various modes.

Freq Option	CF after Mode Preset	Stop Freq after Mode Preset	Max Freq (can't tune above)

RF Center Freq

SCPI command for specifying the RF Center Frequency. This will always access the RF value, even when the selected input is not RF. The front panel always uses the Freq Center (Selected Input).

Remote Command	[:SENSe] :FREQuency:RF:CENTer <freq> [:SENSe] :FREQuency:RF:CENTer?
Dependencies/Couplings	If the electrical attenuator is enabled, any attempt to set Center Frequency such that the Stop Frequency would be >3.6 GHz results in an advisory message. If the equivalent SCPI command is sent, this same message is generated as part of a “-221, Settings conflict” warning.
Example	FREQ:RF:CENT 30 MHz
Mode	All
Scope	Meas Global
Notes	This command is the same in all modes, but the parameter is Measurement Global. So the value is independent in each mode and common across all the measurements in the mode.
Preset	See table above
State Saved	Saved in instrument state.
Min	-79.999995 MHz
Max	See table above. Basically instrument maximum frequency – 10 Hz minimum span. If the knob or step keys are being used, depends on the value of the other three interdependent parameters
Instrument S/W Revision	Prior to A.02.00
Help Map ID	0

FREQ Channel

Input/Output

The Input/Output features are common across multiple Modes and Measurements. These common features are described in this section. See the Measurement description for information on features that are unique.

The Input/Output key accesses the softkeys that control the Input/Output parameters of the instrument. In general, these are functions associated with external connections to the test set, either to the inputs or the outputs. Since these connections tend to be fairly stable within a given setup, in general, the input/output settings do not change when you Preset the test set.

Other functions related to the input/output connections, but which tend to change on a measurement by measurement basis, can be found under the **Trigger** and **AMPTD Y Scale** keys. In addition, some of the digital I/O bus configurations can be found under the **System** key.

NOTE The functions in the Input/Output menu are "global" (common) to all Modes (applications). But individual Input/Output functions only appear in a Mode if they apply to that Mode. Functions that apply to a Mode but not to all measurements in the Mode may be grayed-out in some measurements.

[“Input/Output variables - Preset behavior” on page 509](#)

The Input Port selection is the first menu under the **Input/Output** key:

Key Path:	Front-panel key
Remote Command:	[:SENSe] :FEED RF AIQ EMIXer [:SENSe] :FEED?
Example:	:FEED RF :FEED?
Couplings:	The [:SENSe]:FEED RF command turns the calibrator OFF
Preset:	This setting is unaffected by a Preset or power cycle. It survives a Mode Preset and mode changes. It is set to RF on a "Restore Input/Output Defaults" or "Restore System Defaults->All"
State Saved:	Saved in instrument state

Input/Output

<p>Backwards Compatibility SCPI:</p>	<p><code>[:SENSe]:FEED AREFERENCE</code></p> <p>In the PSA the calibrator was one of the inputs and selected using the AREF parameter to the same :FEED command that switched the inputs. In the X-Series it is controlled in a separate menu and overrides the input selection. For code compatibility the <code>[:SENSe]:FEED AREFERENCE</code> command is provided, and is aliased to <code>[SENSe]:FEED:AREF REF50</code>, which causes the input to be switched to the 50 MHz calibrator. The <code>[:SENSe]:FEED RF</code> command switches the input back to the RF port and turns the calibrator OFF, thus providing full compatibility with the PSA calibrator function.</p> <p>Note that after sending this, the query <code>[:SENSe]:FEED?</code> will NOT return "AREF" but instead the currently selected input.</p>
<p>Backwards Compatibility SCPI:</p>	<p><code>[:SENSe]:FEED IQ IONLy QONLy</code></p> <p><code>[:SENSe]:FEED?</code></p> <p>The parameters <code>IQ IONLy QONLy</code> are supported for backwards compatibility with the E44406A.</p> <p><code>[:SENSe]:FEED IQ</code> aliases to <code>[:SENSe]:FEED:IQ:TYPE IQ</code></p> <p><code>[:SENSe]:FEED IONLy</code> aliases to <code>[:SENSe]:FEED:IQ:TYPE IONLy</code></p> <p><code>[:SENSe]:FEED QONLy</code> aliases to <code>[:SENSe]:FEED:IQ:TYPE QONLy</code></p> <p>The query <code>[:SENSe]:FEED?</code> will always returns AIQ whatever the type of legacy parameters <code>IQ IONLy QONLy</code> has been used.</p>
<p>Backwards Compatibility Notes:</p>	<p>Most of the settings in the X-Series Input/Output system, including External Gain, Amplitude Corrections settings and data, etc., are shared by all modes and are not changed by a mode switch. Furthermore, most variables in the Input/Output system key are not affected by Mode Preset. Both of these behaviors represent a departure from legacy behavior.</p> <p>In the X-Series. Input/Output settings are reset by using the "Restore Input/Output Defaults" function. They can also be reset to their default values through the System->Restore System Defaults-> In/Out Config key or through the System ->Restore System Defaults -> All key (and corresponding SCPI).</p> <p>While this matches most use cases better, it does create some code compatibility issues. For example, Amplitude Corrections are no longer turned off by a Mode Preset, but instead by using the "Restore Input/Output Defaults" key/SCPI.</p> <p>Although Input/Output settings are not part of each Mode's State, they are saved in the Save State files, so that all of the instrument settings can be recalled with Recall State, as in legacy instruments.</p>
<p>Initial S/W Revision:</p>	<p>Prior to A.02.00</p>
<p>Help Map ID:</p>	<p>3065</p>
<p>Remote Command:</p>	<p><code>:INPut :MIXer EXTernal INTernal</code></p> <p><code>:INPut :MIXer?</code></p>

Example:	INP:MIX INT INP:MIX?
Notes:	<p>1. In legacy analyzers you choose between the Internal mixer or an External Mixer. In the X-Series, the External Mixer is one of the choices for the Input and hence is selected using the FEED command (:SENSe:FEED EXTMixer).</p> <p>For compatibility, the INPut:MIXer EXTernal INTernal legacy command is mapped as follows:</p> <ol style="list-style-type: none"> 1. When INPut:MIXer EXTernal is received, SENSe:FEED EMIXer is executed. 2. When INPut:MIXer INTernal is received, SENSe:FEED RF is executed. 3. When INPut:MIXer? is received, the response will be INT if any input other than the external mixer is selected and EXT if the external mixer is selected
Preset:	INT
Backwards Compatibility Notes:	<p>1. PSA supports the following SCPI Command :</p> <pre>:INPut:MIXer:TYPE PRESelected UNPReselect</pre> <pre>:INPut:MIXer:TYPE?</pre> <p>PXA does not support the :INPut:MIXer:TYPE command.</p>
Initial S/W Revision:	A.08.01
Help Map ID:	0

Input/Output variables - Preset behavior

Virtually all the input/output settings are NOT a part of mode preset. They can be set to their default value by one of the three ways - by using the Restore Input/Output Defaults key on the first page of the input/output menu, by using the System->Restore System Defaults->Input/Output Settings or by using the System -> Restore System Defaults->All. Also, they survive a Preset and a Power cycle.

A very few of the Input/Output settings do respond to a Mode Preset; for example, if the Calibrator is on it turns off on a Preset, and if DC coupling is in effect it switches to AC on a Preset. These exceptions are made in the interest of reliability and usability, which overrides the need for absolute consistency. Exceptions are noted in the SCPI table for the excepted functions.

RF Input

Selects the front-panel RF input port to be the test set signal input. If RF is already selected, pressing this key accesses the RF input setup functions.

Key Path:	Input/Output
Example:	[:SENSe]:FEED RF

Input/Output

Readback:	The RF input port, RF coupling, and current input impedance settings appear on this key as: "XX, YY, ZZ" where XX is RF, RF2, RFIO1, RFIO2, depending on what input is selected (only appears on test sets with multiple RF inputs) YY is AC or DC ZZ is 50 or 75
Initial S/W Revision:	Prior to A.02.00
Help Map ID:	3068

Input Z Correction

Sets the input impedance for unit conversions. This affects the results when the y-axis unit is voltage or current units (dBmV, dB μ V, dB μ A, V, A), but not when it is power units (dBm, W). The impedance you select is for computational purposes only, since the actual impedance is set by internal hardware to 50 ohms. Setting the computational input impedance to 75 ohms is useful when using a 75 ohm to 50 ohm adapter to measure a 75 ohm device on an test set with a 50 ohm input impedance.

There are a variety ways to make 50 to 75 ohm transitions, such as impedance transformers or minimum loss pads. The choice of the solution that is best for your measurement situation requires balancing the amount of loss that you can tolerate with the amount of measurement frequency range that you need. If you are using one of these pads/adaptors with the **Input Z Corr** function, you might also want to use the **Ext Gain** key. This function is used to set a correction value to compensate for the gain (loss) through your pad. This correction factor is applied to the displayed measurement values.

Key Path:	Input/Output, RF Input
Remote Command:	[:SENSe] :CORRection:IMPedance [:INPut] [:MAGNitude] 50 75 [:SENSe] :CORRection:IMPedance [:INPut] [:MAGNitude] ?
Example:	CORR:IMP 75 sets the input impedance correction to 75 ohms. CORR:IMP?
Couplings:	When the main RF Input is selected, the Input Z Correction will automatically change to 50 ohms. You may then change it to whatever is desired.
Preset:	This is unaffected by a Preset but is set to 50 ohms on a "Restore Input/Output Defaults" or "Restore System Defaults->All" Some instruments/options may have 75 ohms available.
State Saved:	Saved in instrument state
Readback:	50 Ω or 75 Ω Current setting reads back to the RF key.
Initial S/W Revision:	Prior to A.02.00

Help Map ID:	3069
--------------	------

RF Input Port

Specifies the RF input port used. The RF Input Port key only appears on units with multiple inputs, and lets you switch between the two inputs.

Switching from the RF input port to one of the RFIO ports, on units which have them, changes the receiver performance of the instrument.

Key Path:	Input/Output, RF Input
Remote Command:	[:SENSe] :FEED:RF:PORT [:INPut] RFIN RFIN2 RFIO1 RFIO2 [:SENSe] :FEED:RF:PORT [:INPut] ?
Example:	:FEED:RF:PORT RFIN
Dependencies:	This key only appears in models that support multiple inputs. If the SCPI command is sent with unsupported parameters in any other model, an error is generated, -221.1900, "Settings conflict;option not installed" When any input is selected in a measurement that does not support it, the "No result; Meas invalid with this input" error condition occurs, and the measurement returns invalid data when queried.
Preset:	This is unaffected by Mode Preset but is set to RF on a "Restore Input/Output Defaults" or "Restore System Defaults -> All"
State Saved:	Saved in State
Readback:	The current RF Input Port selected is read back to this key
Backwards Compatibility SCPI:	INPut<1 2>:TYPE INPUT1 INPUT2 INPut<1 2>:TYPE? included for R&S ESU compatibility. In the MXE, the INPUT1 parameter is aliased to RFIN and the INPUT2 parameter is aliased to RFIN2
Initial S/W Revision:	A.05.01
Help Map ID:	29997

RF Input

Specifies using the main RF port for the current measurement

Key Path:	Input/Output, RF Input, RF Input Port
Example:	:FEED:RF:PORT RFIN
ReadBack:	RF Input
Initial S/W Revision:	A.05.01
Help Map ID:	29998

Input/Output

RFIO1

Specifies using the RFIO 1 port, if supported, for the current measurement

Key Path:	Input/Output, RF Input, RF Input Port
Example:	:FEED:RF:PORT RFIO1
Dependencies:	Only available in EXT. If Multiport Adapter is ON, Select RF Input to RFIO1, an error message is generated: “-221, Settings conflict; RFIO1 or RFIO2 Port unavailable when Multiport Adapter is ON”.
ReadBack:	RFIO 1
Initial S/W Revision:	A.05.01
Help Map ID:	29999

RFIO2

Specifies using the RFIO 2 port, if supported, for the current measurement

Key Path:	Input/Output, RF Input, RF Input Port
Example:	:FEED:RF:PORT RFIO2
Dependencies:	Only available in EXT. If Multiport Adapter is ON, Select RF Input to RFIO1, an error message is generated: “-221, Settings conflict; RFIO1 or RFIO2 Port unavailable when Multiport Adapter is ON”.
ReadBack:	RFIO 2
Initial S/W Revision:	A.05.01
Help Map ID:	30000

RF Calibrator

Lets you choose a calibrator signal to look at or turns the calibrator "off".

Key Path:	Input/Output
Remote Command:	[:SENSE] :FEED:AREFERENCE REF50 REF4800 OFF [:SENSE] :FEED:AREFERENCE?
Example:	FEED:AREF REF50 selects the 50 MHz amplitude reference as the signal input. FEED:AREF REF4800 selects the 4.8 GHz amplitude reference as the signal input FEED:AREF OFF turns the calibrator "off" (switches back to the selected input – RF or I/Q)

Dependencies:	<p>Selecting an input (RF or I/Q) turns the Calibrator OFF. This is true whether the input is selected by the keys or with the [:SENSe]:FEED command.</p> <p>The 4.8 GHz internal reference is only available in some models and frequency range options. If the 4.8 GHz reference is not present, the 4.8 GHz softkey will be blanked, and if the REF4800 parameter is sent, the test set will generate an error.</p>
Couplings:	When one of the calibrator signals is selected, the test set routes that signal (an internal amplitude reference) to the test set, and changes the main input selection to RF so the calibrator signal can be seen. When you turn the calibrator off it does not switch back to the previously selected input.
Preset:	OFF
State Saved:	Saved in instrument state
Readback:	Off, 50 MHz, 4.8 GHz
Initial S/W Revision:	Prior to A.02.00
Help Map ID:	3086

Remote Command:	<pre>:CALibration:SOURce:STATe OFF ON 0 1 :CALibration:SOURce:STATe?</pre>
Notes:	<p>For ESA backwards compatibility.</p> <p>In the ESA the calibrator was a separate output which you connected to the input and switched on with this command.</p> <p>In the X-Series, the ON parameter is aliased to the [:SENSe]:FEED:AREF REF50 command and the OFF parameter is aliased to [:SENSe]:FEED:AREF OFF.</p> <p>When CALibration:SOURce:STATe? is received, 1 will be returned if any of the references is selected and 0 if the Calibrator is "Off"</p>
Preset:	OFF
Initial S/W Revision:	Prior to A.02.00
Help Map ID:	0

50 MHz

Selects the 50 MHz internal reference as the input signal.

Key Path:	Input/Output, RF Calibrator
Example:	:FEED:AREF REF50
Readback:	50 MHz
Initial S/W Revision:	Prior to A.02.00
Help Map ID:	3087

Input/Output

Off

Switches the input back to the selected input (RF or I/Q)

Key Path:	Input/Output, RF Calibrator
Example:	:FEED:AREF OFF
Readback:	Off
Initial S/W Revision:	Prior to A.02.00
Help Map ID:	3085

External Gain

Compensates for gain or loss in the measurement system outside the test set. The External Gain is subtracted from the amplitude readout (or the loss is added to the amplitude readout). So, the displayed signal level represents the signal level at the output of the device-under-test, which can be the input of an external device that provides gain or loss.

Entering an External Gain value does not affect the Reference Level, therefore the trace position on screen changes, as do all of values represented by the trace data. Thus, the values of exported trace data, queried trace data, marker amplitudes, trace data used in calculations such as N dB points, trace math, peak threshold, etc., are all affected by External Gain. Changing the External Gain, even on a trace which is not updating, will immediately change all of the above, without new data needing to be taken.

NOTE Changing the External Gain causes the test set to immediately stop the current sweep and prepare to begin a new sweep. The data will not change until the trace data updates because the offset is applied to the data as it is taken. If a trace is exported with a nonzero External Gain, the exported data will contain the trace data with the offset applied.

Key Path:	Input/Output
Couplings:	The Ext Preamp, MS, and BS keys may be grayed out depending on which measurement is currently selected. If any of the grayed out keys are pressed, or the equivalent SCPI command is sent, an advisory message is generated.
Readback:	1-of-N selection [variable]
Initial S/W Revision:	Prior to A.02.00
Help Map ID:	3090

Ext Preamp

This function is similar to the reference level offset function. Both affect the displayed signal level. Ref Lvl Offset is a mathematical offset only, no test set configuration is affected. Ext Preamp gain is used when determining the auto-coupled value of the Attenuator. The External Gain value and the Maximum Mixer Level settings are both part of the automatic setting equation for the RF attenuation setting. (10 dB of Attenuation is added for every 10 dB of External Gain.)

Note that the Ref Lvl Offset and Maximum Mixer Level are described in the Amplitude section. They are reset by the instrument Preset. The External Preamp Gain is reset by the "Restore Input/Output Defaults" or "Restore System Defaults->All functions. . The External Gain is subtracted from the amplitude readout so that the displayed signal level represents the signal level at the output of the device-under-test, which is the input of the external device that is providing gain or loss.

Key Path:	Input/Output, External Gain
Remote Command:	[:SENSe] :CORRection:SA[:RF] :GAIN <rel_amp1> [:SENSe] :CORRection:SA[:RF] :GAIN?
Example:	CORR:SA:GAIN 10 sets the Ext Gain value to 10 dB CORR:SA:GAIN -10 sets the Ext Gain value to -10 dB (that is, an attenuation of 10 dB)
Notes:	Does not auto return.
Dependencies:	The reference level limits are determined in part by the External Gain/Atten, Max Mixer Level, and RF Atten. This key is grayed out in Modes that do not support External Gain
Preset:	This is unaffected by Preset but is set to 0 dB on a "Restore Input/Output Defaults" or "Restore System Defaults->All"
State Saved:	Saved in instrument state
Min:	-120 dB
Max:	120 dB
Readback:	Preamp Gain, <Ext Gain value> dB
Backwards Compatibility SCPI:	[:SENSe]:CORRection:OFFSet[:MAGNitude] The legacy "Ext Preamp Gain" key is now called "Ext Gain" and the sub-menu has choices of Ext Preamp MS BTS for backwards compatibility.
Initial S/W Revision:	Prior to A.02.00
Help Map ID:	3091

MS

Sets an external gain/attenuation value for MS (Mobile Station) tests.

Key Path:	Input/Output, External Gain
Remote Command:	[:SENSe] :CORRection:MS[:RF] :GAIN <rel_amp1> [:SENSe] :CORRection:MS[:RF] :GAIN?

Input/Output

Example:	CORR:MS:GAIN 10 sets the Ext Gain value to 10 dB CORR:MS:GAIN -10 sets the Ext Gain value to -10 dB (that is, a loss of 10 dB.)
Notes:	Does not auto return.
Dependencies:	The reference level limits are determined in part by the External Gain, Max Mixer Level, RF Atten This key is grayed out in modes that do not support MS.
Preset:	This is unaffected by a Preset but is set to 0 dB on a "Restore Input/Output Defaults" or "Restore System Defaults->All"
State Saved:	Saved in instrument state.
Min:	-100 dB
Max:	100 dB
Readback:	MS, <Ext Gain value> dB
Initial S/W Revision:	Prior to A.02.00
Help Map ID:	3092

Remote Command:	[:SENSE] :CORRection:MS [:RF] :LOSS <rel_ampl> [:SENSE] :CORRection:MS [:RF] :LOSS?
Example:	CORR:MS:LOSS 10 sets the Ext Gain value to -10 dB, and subsequently querying :LOSS will give 10 dB CORR:MS:LOSS -10 sets the Ext Gain value to 10 dB, and subsequently querying :LOSS will give -10 dB
Notes:	A positive value of <rel_ampl> in the above command means a loss and a negative value indicates a gain. Anytime :LOSS is set it sets :GAIN to the negative value of the parameter sent. Anytime :LOSS is queried it gives the negative of :GAIN
Preset:	This is unaffected by a Preset but is set to 0 dB on a "Restore Input/Output Defaults" or "Restore System Defaults->All"
Min:	100 dB
Max:	-100 dB
Initial S/W Revision:	Prior to A.02.00
Help Map ID:	0

BTS

Sets an external attenuation value for BTS (Base Transceiver Station) tests.

Key Path:	Input/Output, External Gain
Remote Command:	[:SENSe] :CORRection:BTS [:RF] :GAIN <rel_ampl> [:SENSe] :CORRection:BTS [:RF] :GAIN?
Example:	CORR:BTS:GAIN 10 sets the Ext Gain value to 10 dB CORR:BTS:GAIN -10 sets the Ext Gain value to -10 dB (that is, a loss of 10 dB.)
Notes:	Does not auto return.
Dependencies:	The reference level limits are determined in part by the External Gain, Max Mixer Level, RF Atten This key is grayed out in modes that do not support BTS.
Preset:	This is unaffected by a Preset but is set to 0 dB on a "Restore Input/Output Defaults" or "Restore System Defaults->All"
State Saved:	Saved in instrument state.
Min:	-100 dB
Max:	100 dB
Readback:	BTS, <Ext Gain value> dB
Initial S/W Revision:	Prior to A.02.00
Help Map ID:	3093

Remote Command:	[:SENSe] :CORRection:BTS [:RF] :LOSS <rel_ampl> [:SENSe] :CORRection:BTS [:RF] :LOSS?
Example:	CORR:BTS:LOSS 10 sets the Ext Gain value to -10 dB, and subsequently querying :LOSS will give 10 dB CORR:BTS:LOSS -10 sets the Ext Gain value to 10 dB, and subsequently querying :LOSS will give -10 dB
Notes:	A positive value of <rel_ampl> in the above command means a loss and a negative value indicates a gain. Anytime :LOSS is set it sets :GAIN to the negative value of the parameter sent. Anytime :LOSS is queried it gives the negative of :GAIN
Preset:	This is unaffected by a Preset but is set to 0 dB on a "Restore Input/Output Defaults" or "Restore System Defaults->All"
Min:	100 dB

Input/Output

Max:	-100 dB
Initial S/W Revision:	Prior to A.02.00
Help Map ID:	0

Restore Input/Output Defaults

This selection causes the group of settings and data associated with the **Input/Output** key to be a reset to their default values. In addition, when a Source is installed, licensed and selected, Restore Input/Output defaults will initiate a Source Preset.

This level of Restore System Defaults does not affect any other system settings or mode settings and does not cause a mode switch. All the features described in this section are reset using this key, including Input Corrections and Data (described in the Corrections section).

Key Path:	Input/Output
Example:	:SYST:DEF INP presets all the Input/Output variables to their factory default values.
Notes:	Refer to the Utility Functions for information about Restore System Defaults and the complete description of the :SYSTem:DEFault INPut: command.
Initial S/W Revision:	Prior to A.02.00
Help Map ID:	3094

Data Source

Gives you the choice of either using a hardware input signal as the input or raw data stored in a data storage buffer from an earlier acquisition. You can also share raw data across certain measurements that support this feature. The measurements must be capable of storing raw data. There are three choices under this menu. You can select "Inputs" which is the same as selecting one of the inputs from the input port, for example RF, AREF, I/Q, or IFALign. Selecting "Capture Buffer" allows you to use data that has been stored earlier in the same measurement or from a previous measurement using the "Current Meas -> Capture Buffer" feature. Selecting "Recorded Data" allows you to playback long data capture records stored in the record buffer.

Key Path:	Input/Output
Remote Command:	[:SENSe] :FEED:DATA INPut STORed [:SENSe] :FEED:DATA?
Example:	FEED:DATA STOR FEED:DATA?
Notes:	INPutS = Inputs STORed = Capture Buffer

Dependencies:	Not all inputs are available in all modes. Unavailable keys are grayed out.
Preset:	This is unaffected by Preset but is set to INPut on a "Restore Input/Output Defaults" or "Restore System Defaults->All"
State Saved:	Saved in instrument state
Readback:	Variable
Backwards Compatibility SCPI:	[:SENSe]:FEED:SOURce INPut STORed [:SENSe]:FEED:SOURce?
Initial S/W Revision:	Prior to A.02.00
Help Map ID:	3095

Inputs

Sets the measurement to use the input selections (RF, AREF, I/Q)

Key Path:	Input/Output, Data Source
Example:	FEED:DATA INP causes the measurement to look at the input selection
Notes:	Does not auto return.
Readback:	Inputs
Initial S/W Revision:	Prior to A.02.00
Help Map ID:	3096

Capture Buffer

Some WCDMA and demod measurements support this feature. This allows sharing of the raw data across certain measurements. If you want to make another measurement on the same signal, you would store that raw data using the "Current Meas -> Capture Buffer" key. Then the data is available for the next measurement to use. You must have raw data stored in the instrument memory before the Capture Buffer choice is available for use.

Key Path:	Input/Output, Data Source
Example:	FEED:DATA STOR causes stored measurement data to be used with a different measurement that supports this.
Notes:	Does not auto return. This key is grayed out when you switch to a measurement that does not support this feature.
Dependencies:	If you switch to a measurement that does not support this feature, then the instrument switches to use "Inputs" and grays out this key. If the grayed out key is pressed, it generates a message.
Readback:	Stored Data
Initial S/W Revision:	Prior to A.02.00

Input/Output

Help Map ID:	3097
--------------	------

Current Meas -> Capture Buffer

Pressing this key stores the raw data of one measurement in the internal memory of the instrument where it can then be used by a different measurement by pressing "Stored Data". When raw data is stored, then the data source selection switch automatically changes to "Stored Data". Stored raw data cannot be directly accessed by a user. There is no save/recall function to save the raw data in an external media. However if you want to get the stored raw data, you must first perform a measurement using the stored raw data. Now you can access the used raw data, which is the same as stored raw data, using the FETCh or READ commands.

Key Path:	Input/Output, Data Source
Remote Command:	[:SENSE] :FEED:DATA:STORE
Example:	FEED:DATA:STOR stores recorded data
Notes:	This is command only, there is no query
Backwards Compatibility SCPI:	[:SENSE] :FEED:SOURce:STORE
Initial S/W Revision:	Prior to A.02.00
Help Map ID:	3099

Corrections

This key accesses the Amplitude Corrections menu.

Amplitude Corrections arrays can be entered, sent over SCPI, or loaded from a file. They allow you to correct the response of the test set for various use cases. The X-series supports four separate Corrections arrays, each of which can contain up to 2000 points. They can be turned on and off individually and any or all can be on at the same time.

Trace data is in absolute units and corrections data is in relative units, but we want to be able to display trace data at the same time as corrections data. Therefore we establish a reference line to be used while building or editing a Corrections table. The reference line is halfway up the display and represents 0 dB of correction. It is labeled "0 dB CORREC". It is drawn in blue.

Corrections data is always in dB. Whatever dB value appears in the correction table represents the correction to be applied to that trace at that frequency. So if a table entry shows 30 dB that means we ADD 30 dB to each trace to correct it before displaying it.

In zero span, where the frequency is always the center frequency of the test set, we apply the (interpolated) correction for the center frequency to all points in the trace. In the event where there are two correction amplitudes at the center frequency, we apply the first one in the table.

Note that the corrections are applied as the data is taken; therefore, a trace in **View** (Update Off) will not be affected by changes made to the corrections table after the trace is put in **View**.

Instruments that have multiple Input/Output RF ports can have different corrections applied to the different ports. There are 4 sets of corrections that can be applied to the RF ports; ports cannot share the same set of corrections but a single port can have multiple corrections applied to it. The correction data

is applied to incoming signals as well as transmitted signals and is in the form of a list of spot frequencies and amplitude correction levels.

Key Path:	Input/Output, Corrections
Mode:	SEQAN, TDSCDMA
Dependencies:	<p>This key will only appear if you have the proper option installed in your instrument.</p> <p>Amplitude correction may not be available in all modes; if a mode does not support amplitude correction, the Corrections key should be blanked while in that mode. If an application supports corrections but the current measurement does not, then the key should be grayed out in that measurement.</p> <p>This menu selection does not have any effect when Input/Output, RF Output & Test Set Config, Multiport Adapter, Multiport Adapter is set to the On state and Input/Output, RF Output & Test Set Config, RF Output is RF Output.</p>
Preset:	Corrections arrays are reset (deleted) by Restore Input/Output Defaults. They survive shutdown and restarting of the test set application, which means they will survive a power cycle.
Initial S/W Revision:	A.02.00
Help Map ID:	3101

Correction On/Off

Turning the Selected Correction on allows the values in it to be applied to the data. This also automatically turns on "Apply Corrections" (sets it to ON), otherwise the correction would not take effect.

A new sweep is initiated if an amplitude correction is switched on or off. Note that changing, sending or loading corrections data does NOT directly initiate a sweep, however in general these operations will turn corrections on, which DOES initiate a sweep.

Key Path:	Input/Output, Corrections
Remote Command:	<pre>[:SENSE] :CORRection:CSET [1] 2 3 4 5 6 [:STATe] ON OFF 1 0 [:SENSe] :CORRection:CSET [1] 2 3 4 5 6 [:STATe] ?</pre>
Example:	SENS:CORR:CSET1 ON

Input/Output

Dependencies:	<p>Turning this on automatically turns on "Apply Corrections"</p> <p>Only the first correction array (Correction 1) supports antenna units. When this array is turned on, and it contains an Antenna Unit other than "None", the Y Axis Unit of the test set is forced to that Antenna Unit. All other Y Axis Unit choices are grayed out.</p> <p>Note that this means that a correction file with an Antenna Unit can only be loaded into the Corrections 1 register. Consequently only for Correction 1 does the dropdown in the Recall dialog include .ant, and if an attempt is made to load a correction file into any other Correction register which DOES contain an antenna unit, a Mass Storage error is generated.</p> <p>This command will generate an "Option not available" error unless you have the proper option installed in your instrument.</p>
Preset:	Not affected by a Preset. Set to OFF by Restore Input/Output Defaults
State Saved:	Saved in instrument state.
Backwards Compatibility Notes:	Unlike legacy analyzers, Preset does not turn Corrections off (Restore Input/Output Defaults does).
Initial S/W Revision:	A.02.00
Help Map ID:	3104

Properties

Accesses a menu that lets you set the properties of the selected correction.

Key Path:	Input/Output, Corrections
Initial S/W Revision:	A.02.00
Help Map ID:	3105

Select Correction

Specifies the selected correction. The term "selected correction" is used throughout this document to specify which correction will be affected by the functions.

Key Path:	Input/Output, Corrections, Properties
Notes:	The selected correction is remembered even when not in the correction menu.
Preset:	Set to Correction 1 by Restore Input/Output Defaults.
Readback:	Correction 1 Correction 2 Correction 3 Correction 4 Correction 5 Correction 6
Initial S/W Revision:	A.02.00
Help Map ID:	Use 3557

Frequency Interpolation

This setting controls how the correction values per-bucket are calculated. We interpolate between frequencies in either the logarithmic or linear scale.

This setting is handled and stored individually per correction set.

See “Interpolation” on page 523

Key Path:	Input/Output, Corrections, Properties
Remote Command:	[:SENSE] :CORRection:CSET [1] 2 3 4 5 6 :X:SPACing LINear LOGarithmic [:SENSE] :CORRection:CSET [1] 2 3 4 5 6 :X:SPACing?
Example:	CORR:CSET:X:SPAC LIN
Preset:	Unaffected by a Preset. Set to Linear by Restore Input/Output Defaults.
State Saved:	Saved in instrument state.
Initial S/W Revision:	A.02.00
Help Map ID:	3108

Interpolation

For each bucket processed by the application, all of the correction factors at the frequency of interest (center frequency of each bucket) are summed and added to the amplitude. All trace operations and post processing treat this post-summation value as the true signal to use.

To effect this correction, the goal, for any particular start and stop frequency, is to build a correction trace, whose number of points matches the current Sweep Points setting of the instrument, which will be used to apply corrections on a bucket by bucket basis to the data traces.

For amplitudes that lie between two user specified frequency points, we interpolate to determine the amplitude value. You may select either linear or logarithmic interpolation between the frequencies.

If we interpolate on a log scale, we assume that the line between the two points is a straight line on the log scale. For example, let’s say the two points are (2,4) and (20,1). A straight line between them on a log scale looks like:

Input/Output

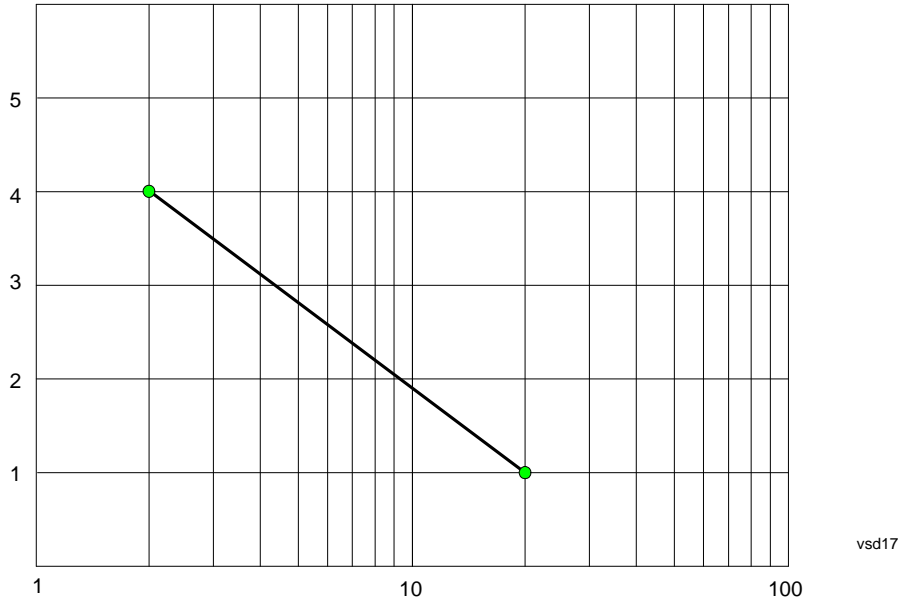

On a linear scale (like that of the test set), this translates to:



If we interpolate on a linear scale, we assume that the two points are connected by a straight line on the linear scale, as below:

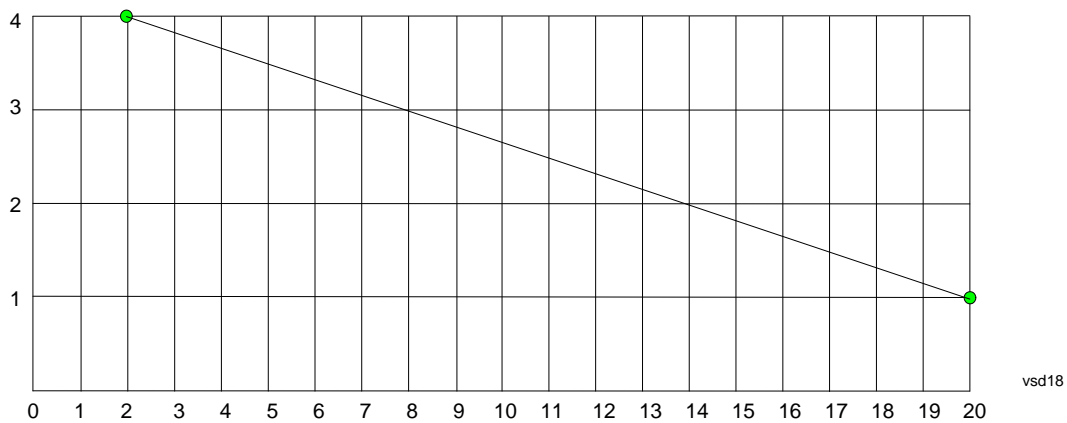

The correction to be used for each bucket is taken from the interpolated correction curve at the center of the bucket.

Description

Sets an ASCII description field which will be stored in an exported file. Can be displayed in the active function area by selecting as the active function, if desired to be in a screen dump.

Key Path:	Input/Output, Corrections, Properties
Remote Command:	[:SENSE] :CORRection:CSET [1] 2 3 4 5 6 :DESCription "text" [:SENSE] :CORRection:CSET [1] 2 3 4 5 6 :DESCription?
Example:	:CORR:CSET1:DESC "11941A Antenna correction"
Notes:	45 chars max; may not fit on display if max chars used
Preset:	Unaffected by a Preset. Set to empty by Restore Input/Output Defaults
State Saved:	Saved in instrument state.
Initial S/W Revision:	A.02.00
Help Map ID:	3106

Comment

Sets an ASCII comment field which will be stored in an exported file. Can be displayed in the active function area by selecting as the active function, if desired to be in a screen dump.

Key Path:	Input/Output, Corrections, Properties
Remote Command:	[:SENSE] :CORRection:CSET [1] 2 3 4 5 6 :COMMent "text" [:SENSE] :CORRection:CSET [1] 2 3 4 5 6 :COMMent?
Example:	:CORR:CSET1:COMM "this is a comment"
Notes:	60 chars max; may not fit on display if max chars used
Preset:	Unaffected by Preset. Set to empty by Restore Input/Output Defaults
State Saved:	Saved in instrument state
Initial S/W Revision:	A.02.00
Help Map ID:	3107

RF Port

This menu and all of its submenus are only available in the EXT.

Maps one of the sets of corrections to one of the IO ports.

Key Path:	Input/Output, Corrections, Properties
-----------	--

Input/Output

Mode:	SEQAN
Remote Command:	[[:SENSe]:CORRection:CSET [1] 2 3 4 5 6:RF:PORT RFIN RFIO1 RFIO2 RFOut [:SENSe]:CORRection:CSET [1] 2 3 4 5 6:RF:PORT?
Example:	:CORR:CSET:RF:PORT RFIN
Remote Command Notes:	
Dependencies:	Only available in EXT
Couplings:	
Preset:	Unaffected by Preset. Set to RF by Restore Input/Output Defaults
State Saved:	Saved in State
Initial S/W Revision:	A.05.01
Help Map ID:	30001

RF Input

The port that the current corrections will be applied to.

Key Path:	Input/Output, Corrections, Properties, RF Port
Example:	:CORR:CSET:RF:PORT RFIN
Dependencies:	Only available in EXT
ReadBack:	RF IN
Initial S/W Revision:	A.05.01
Help Map ID:	30002

RFOut

The port that the current corrections will be applied to.

Key Path:	Input/Output, Corrections, Properties, RF Port
Example:	:CORR:CSET:RF:PORT RFO
Dependencies:	Only available in EXT
ReadBack:	RFOut
Initial S/W Revision:	A.05.01
Help Map ID:	30003

RFIO1

The port that the current corrections will be applied to. Pressing this key again allows the user access to the menu

for specifying which internal device the corrections for RFIO 1 will be applied to.

Key Path:	Input/Output, Corrections, Properties, RF Port
Remote Command:	[:SENSe] :CORRection:CSET [1] 2 3 4 5 6 :RF:PORT:RFIO1 SOURce ANALyzer BOTH [:SENSe] :CORRection:CSET [1] 2 3 4 5 6 :RF:PORT:RFIO1?
Example:	:CORR:CSET:RF:PORT:RFIO1 BOTH
Preset:	Both
State Saved:	Saved in State
Help Map ID:	30004

Correct Source

Sets the corrections for the RFIO1 port to be applied to the source.

Key Path:	Input/Output, Corrections, Properties, RF Port
Example:	:CORR:CSET:RF:PORT:RFIO1 SOUR
Readback:	"Correct Source"
Help Map ID:	30005

Correct Analyzer

Sets the corrections for the RFIO1 port to be applied to the test set.

Key Path:	Input/Output, Corrections, Properties, RF Port
Example:	:CORR:CSET:RF:PORT:RFIO1 ANAL
Readback:	"Correct Analyzer"
Help Map ID:	30006

Correct Source and Analyzer

Sets the corrections for the RFIO1 port to be applied to both the source and the test set.

Key Path:	Input/Output, Corrections, Properties, RF Port
Example:	:CORR:CSET:RF:PORT:RFIO1 BOTH
Readback:	"Correct Source and Analyzer"
Help Map ID:	30007

Input/Output

RFIO2

The port that the current corrections will be applied to. Pressing this key again allows the user access to the menu for specifying which internal device the corrections for RFIO 2 will be applied to.

Key Path:	Input/Output, Corrections, Properties, RF Port
Remote Command:	[:SENSe] :CORRection:CSET [1] 2 3 4 5 6 :RF:PORT:RFIO2 SOURce ANALyzer BOTH [:SENSe] :CORRection:CSET [1] 2 3 4 5 6 :RF:PORT:RFIO2?
Example:	:CORR:CSET:RF:PORT:RFIO2 BOTH
Preset:	Both
State Saved:	Saved in State
Help Map ID:	30008

Correct Source

Sets the corrections for the RFIO2 port to be applied to the source.

Key Path:	Input/Output, Corrections, Properties, RF Port
Example:	:CORR:CSET:RF:PORT:RFIO2 SOUR
Readback:	"Correct Source"
Help Map ID:	30009

Correct Analyzer

Sets the corrections for the RFIO2 port to be applied to the test set.

Key Path:	Input/Output, Corrections, Properties, RF Port
Example:	:CORR:CSET:RF:PORT:RFIO2 ANAL
Readback:	"Correct Analyzer"
Help Map ID:	30010

Correct Source and Analyzer

Sets the corrections for the RFIO2 port to be applied to both the source and the test set.

Key Path:	Input/Output, Corrections, Properties, RF Port
Example:	:CORR:CSET:RF:PORT:RFIO2 BOTH
Readback:	"Correct Source and Analyzer"
Help Map ID:	30011

Edit

Invokes the integrated editing facility for this correction set.

When entering the menu, the editor window turns on, the selected correction is turned **On**, **Apply Corrections** is set to **On**, the amplitude scale is set to **Log**, and the Amplitude Correction (“Ampcor”) trace is displayed. The actual, interpolated correction trace is shown in green for the selected correction. Note that since the actual interpolated correction is shown, the correction trace may have some curvature to it. This trace represents only the correction currently being edited, rather than the total, accumulated amplitude correction for all amplitude corrections which are currently on, although the total, accumulated correction for all corrections which are turned on is still applied to the data traces.

Because corrections data is always in dB, but the Y-axis of the test set is in absolute units, it is necessary to establish a reference line for display of the Corrections data. The reference line is halfway up the display and represents 0 dB of correction. It is labeled “0 dB CORREC”. It is drawn in blue.

Corrections data is always in dB. Whatever dB value appears in the correction table represents the correction to be applied to that trace at that frequency. So if a table entry shows 30 dB that means we ADD 30 dB to each trace to correct it before displaying it. By definition all points are connected. If a gap is desired for corrections data, enter 0 dB.

Note that a well-designed Corrections array should start at 0 dB and end at 0 dB. This is because whatever the high end point is will be extended to the top frequency of the instrument, and whatever the low end point is will be extended down to 0 Hz. So for a Corrections array to have no effect outside its range, you should start and end the array at 0 dB.

NOTE The table editor will only operate properly if the test set is sweeping, because its updates are tied to the sweep system. Thus, you should not try to use the editor in single sweep, and it will be sluggish during compute-intensive operations like narrow-span FFT sweeps.

When exiting the edit menu (by using the **Return** key or by pressing an instrument front-panel key), the editor window turns off and the Ampcor trace is no longer displayed; however, **Apply Corrections** remains **On**, any correction that was on while in the editor remains on, and the amplitude scale returns to its previous setting.

Corrections arrays are not affected by a Preset, because they are in the Input/Output system. They also survive shutdown and restarting of the test set application, which means they will survive a power cycle.

Key Path:	Input/Output, Corrections
Initial S/W Revision:	A.02.00
Help Map ID:	29983

Navigate

Lets you move through the table to edit the desired point.

Key Path:	Input/Output, Corrections, Edit
Notes:	There is no value readback on the key

Input/Output

Min:	1
Max:	2000
Initial S/W Revision:	A.02.00
Help Map ID:	3545

Frequency

Lets you edit the frequency of the current row.

Key Path:	Input/Output, Corrections, Edit
Notes:	There is no value readback on the key.
Min:	0
Max:	1 THz
Initial S/W Revision:	A.02.00
Help Map ID:	3572

Amplitude

Lets you edit the Amplitude of the current row.

Key Path:	Input/Output, Corrections, Edit
Notes:	There is no value readback on the key.
Min:	-1000 dB
Max:	1000 dB
Initial S/W Revision:	A.02.00
Help Map ID:	3574

Insert Point Below

Inserts a point below the current point. The new point is a copy of the current point and becomes the current point. The new point is not yet entered into the underlying table, and the data in the row is displayed in light gray.

Key Path:	Input/Output, Corrections, Edit
Initial S/W Revision:	A.02.00
Help Map ID:	3576

Delete Point

Deletes the currently-selected point, whether or not that point is being edited, and selects the Navigate functionality. The point following the currently-selected point (or the point preceding if there is none)

will be selected.

Key Path:	Input/Output, Corrections, Edit
Initial S/W Revision:	A.02.00
Help Map ID:	3581

Delete Correction

Deletes the correction values for this set. When this key is pressed a prompt is placed on the screen that says “Please press Enter or OK key to delete correction. Press ESC or Cancel to close this dialog.” The deletion is only performed if you press OK or Enter.

Key Path:	Input/Output, Corrections
Remote Command:	[:SENSE] :CORRection:CSET [1] 2 3 4 5 6 :DELete
Example:	CORR:CSET:DEL CORR:CSET1:DEL CORR:CSET4:DEL
Notes:	Pressing this key when no corrections are present is accepted without error.
Initial S/W Revision:	A.02.00
Help Map ID:	3115

Apply Corrections

Applies amplitude corrections which are marked as ON to the measured data. If this is set to OFF, then no amplitude correction sets will be used, regardless of their individual on/off settings. If set to ON, the corrections that are marked as ON (see “[Correction On/Off](#)” on page 521) are used.

Key Path:	Input/Output, Corrections
Remote Command:	[:SENSE] :CORRection:CSET:ALL [:STATe] ON OFF 1 0 [:SENSE] :CORRection:CSET:ALL [:STATe] ?
Example:	SENS:CORR:CSET:ALL OFF This command makes sure that no amplitude corrections are applied, regardless of their individual on/off settings.
Preset:	Not affected by Preset. Set to OFF by Restore Input/Output Defaults
State Saved:	Saved in instrument state.
Initial S/W Revision:	A.02.00
Help Map ID:	3102

Delete All Corrections

Erases all correction values for all 4 Amplitude Correction sets.

Input/Output

When this key is pressed a prompt is placed on the screen that says “Please press Enter or OK key to delete all corrections. Press ESC or Cancel to close this dialog.” The deletion is only performed if you press OK or Enter.

Key Path:	Input/Output, Corrections
Remote Command:	<code>[:SENSE] :CORRection:CSET:ALL:DELeTe</code>
Example:	<code>CORR:CSET:ALL:DEL</code>
Initial S/W Revision:	A.02.00
Help Map ID:	3119

Remote Correction Data Set Commands

Set (Replace) Data (Remote Command Only)

The command takes an ASCII series of alternating frequency and amplitude points, each value separated by commas.

The values sent in the command will totally replace all existing correction points in the specified set.

An Ampcor array can contain 2000 points maximum.

Remote Command:	<code>[:SENSE] :CORRection:CSET [1] 2 3 4 5 6 :DATA <freq>, <ampl>, . . .</code> <code>[:SENSE] :CORRection:CSET [1] 2 3 4 5 6 :DATA?</code>
Example:	<code>CORR:CSET1:DATA 10000000,-1.0,20000000,1.0</code> This defines two correction points at (10 MHz, -1.0 dB) and (20 MHz, 1.0 dB) for correction set 1.
Preset:	Empty after Restore Input/Output Defaults. Survives a shutdown or restart of test set application (including a power cycle).
State Saved:	Saved in instrument state.
Min:	Freq: 0 Hz Amptd: -1000 dBm
Max:	Freq: 1 THz Amptd: +1000 dBm
Initial S/W Revision:	A.02.00
Help Map ID:	0

Merge Correction Data (Remote Command Only)

The command takes an ASCII series of alternating frequency and amplitude points, each value separated by commas. The difference between this command and Set Data is that this merges new correction points into an existing set.

Any new point with the same frequency as an existing correction point will replace the existing point's

amplitude with that of the new point.

An Ampcor array can contain 2000 total points, maximum.

Remote Command:	[:SENSe] :CORRection:CSET [1 2 3 4 5 6 :DATA:MERGe <freq>, <ampl>, ...
Example:	CORR:CSET1:DATA:MERGE 15000000,-5.0,25000000,5.0 This adds two correction points at (15 MHz, -5.0 dB) and (25 MHz, 5.0 dB) to whatever values already exist in correction set 1.
Preset:	Empty after Restore Input/Output Defaults. Survives shutdown/restart of test set application (including power cycle)
Min:	Freq: 0 Hz Amptd: -1000 dBm
Max:	Freq: 1 THz Amptd: +1000 dBm
Initial S/W Revision:	A.02.00
Help Map ID:	0

Freq Ref In

Specifies the frequency reference as being the internal reference, external reference or sensing the presence of an external reference.

When the frequency reference is set to internal, the internal 10 MHz reference is used even if an external reference is connected.

When the frequency reference is set to external, the instrument will use the external reference. However, if there is no external signal present, or it is not within the proper amplitude range, a condition error message is generated. When the external signal becomes valid, the error is cleared.

If Sense is selected, the instrument checks whether a signal is present at the external reference connector and will automatically switch to the external reference when a signal is detected. When no signal is present, it automatically switches to the internal reference. No message is generated as the reference switches between external and internal. The monitoring of the external reference occurs approximately on 1 millisecond intervals, and never occurs in the middle of a measurement acquisition, only at the end of the measurement (end of the request).

If for any reason the instrument's frequency reference is not able to obtain lock, Status bit 2 in the Questionable Frequency register will be true and a condition error message is generated. When lock is regained, Status bit 2 in the Questionable Frequency register will be cleared and the condition error will be cleared.

If an external frequency reference is being used, you must enter the frequency of the external reference if it is not exactly 10 MHz. The External Ref Freq key is provided for this purpose.

Key Path:	Input/Output
-----------	--------------

Input/Output

Remote Command:	<code>[:SENSe] :ROSCillator :SOURce :TYPE</code> <code>INTernal EXTernal SENSe</code> <code>[:SENSe] :ROSCillator :SOURce :TYPE?</code>
Preset:	This is unaffected by a Preset but is set to SENSe on a "Restore Input/Output Defaults" or "Restore System Defaults->All".
State Saved:	Saved in instrument state.
Status Bits/OPC dependencies:	STATus:QUEStionable:FREQuency bit 2 set if unlocked.
Backwards Compatibility Notes:	1. Freq Ref In was not saved in state in the legacy instruments. It is a part of state in the X-Series.
Initial S/W Revision:	Prior to A.02.00
Help Map ID:	3124

Remote Command:	<code>[:SENSe] :ROSCillator :SOURce?</code>
Notes:	The query <code>[SENSe]:ROSCillator:SOURce?</code> returns the current switch setting. This means: <ol style="list-style-type: none"> 1. If it was set to SENSe but there is no external reference so the instrument is actually using the internal reference, then this query returns INTernal and not SENSe. 2. If it was set to SENSe and there is an external reference present, the query returns EXTernal and not SENSe. 3. If it was set to EXTernal, then the query returns "EXTernal" 4. If it was set to INTernal, then the query returns "INTernal"
Preset:	SENSe
Backwards Compatibility Notes:	The query <code>[:SENSe] :ROSCillator :SOURce?</code> was a query-only command in ESA which always returned whichever reference the instrument was using. The instrument automatically switched to the ext ref if it was present. In PSA (which had no sensing) the command <code>[:SENSe] :ROSCillator :SOURce</code> set the reference (INT or EXT), so again its query returned the actual routing. Thus the query form of this command is 100% backwards compatible with both instruments.
Initial S/W Revision:	Prior to A.02.00
Help Map ID:	0

Remote Command:	<code>[:SENSe] :ROSCillator :SOURce INTernal EXTernal</code>
Notes:	For PSA compatibility the command form is provided and is directly mapped to <code>[:SENSe] :ROSCillator :SOURce :TYPE</code>
Initial S/W Revision:	Prior to A.02.00
Help Map ID:	0

Sense

The external reference is used if a valid signal is sensed at the Ext Ref input. Otherwise the internal reference is used.

Key Path:	Input/Output, Freq Ref In
Example:	:ROSC:SOUR:TYPE SENS
Readback:	Sense
Initial S/W Revision:	Prior to A.02.00
Help Map ID:	3127

Internal

The internal reference is used.

Key Path:	Input/Output, Freq Ref In
Example:	:ROSC:SOUR:TYPE INT
Readback:	Internal
Initial S/W Revision:	Prior to A.02.00
Help Map ID:	3128

External

The external reference is used.

Key Path:	Input/Output, Freq Ref In
Example:	:ROSC:SOUR:TYPE EXT
Readback:	External
Initial S/W Revision:	Prior to A.02.00
Help Map ID:	3129

Ext Ref Freq

This key tells the test set the frequency of the external reference. When the external reference is in use (either because the reference has been switched to External or because the Reference has been switched to Sense and there is a valid external reference present) this information is used by the test set to determine the internal settings needed to lock to that particular external reference signal.

For the instrument to stay locked, the value entered must be within 5 ppm of the actual external reference frequency. So it is important to get it close, or you risk an unlock condition.

Note that this value only affects the instrument's ability to lock. It does not affect any calculations or measurement results. See "Freq Offset" in the Frequency section for information on how to offset

Input/Output

frequency values.

Key Path:	Input/Output, Freq Ref In
Remote Command:	[:SENSe] :ROSCillator :EXTernal :FREQuency <freq> [:SENSe] :ROSCillator :EXTernal :FREQuency?
Example:	ROSC:EXT:FREQ 20 MHz sets the external reference frequency to 20 MHz, but does not select the external reference. ROSC:SOUR:TYPE EXT selects the external reference.
Notes:	Still available with Internal selected, to allow setup for when External is in use.
Preset:	This is unaffected by a Preset but is set to 10 MHz on a "Restore Input/Output Defaults" or "Restore System Defaults->All"
Min:	CXA: 10 MHz EXA: 10 MHz or 13 MHz, depending on whether N9010A-R13 is licensed MXA: 1 MHz PXA: 1 MHz 1 MHz
Max:	CXA: 10 MHz EXA: 10 MHz MXA: 50 MHz PXA: 50 MHz 50 MHz
Default Unit:	Hz
Initial S/W Revision:	Prior to A.02.00
Help Map ID:	3130

RF Output & Test Set Config

This menu and all of its submenus are only available in the EXT (E6607A/B/C).

Access the menu to select the front-panel RF output port to be the test set signal output. If RF is already selected, pressing this key accesses the RF output setup functions.

EXT (E6607A/B)

The RF Output & Test Set Config key allows you to set the RF Output Port and multipoint adapter unit which is connected to the EXT by USB for download of calibration data and additional control.

EXT (E6607C)

The RF Output & Test Set Config key allows you to set the RF Output Port and MPA settings.

Key Path:	Input/Output
Dependencies:	Only available in EXT
Preset:	All settings under this key are returned to their default state when Restore Input/Output Defaults is pressed.
State Saved:	Saved in State
Initial S/W Revision:	A.10.00
Help Map ID:	30017

RF Output

Specifies the RF Output Port used.

Switching from the RF Output port to one of the RFIO ports changes the transmitter performance of the instrument.

Key Path:	Input/Output, RF Output & Test Set Config
Remote Command:	[:SENSE] :FEED:RF:PORT:OUTPut RFOut RFIO1 RFIO2 [:SENSE] :FEED:RF:PORT:OUTPut?
Example:	:FEED:RF:PORT:OUTP RFIO1
Dependencies:	Only available in EXT
Preset:	This is unaffected by Mode Preset but is set to RFOut on a "Restore Input/Output Defaults" or "Restore System Defaults -> All"
State Saved:	Saved in State
Readback Text:	The current RF Output Port selected is read back to this key
Initial S/W Revision:	A.05.01
Help Map ID:	30013

RF Out

The RF port that will be used for the current output

Key Path:	Input/Output, RF Output & Test Set Config, RF Output
Example:	:FEED:RF:PORT:OUTP RFO
Dependencies:	Only available in EXT
ReadBack:	RF Output
Initial S/W Revision:	A.05.01

Input/Output

Help Map ID:	30014
--------------	-------

RFIO1

The RF port that will be used for the current output

Key Path:	Input/Output, RF Output & Test Set Config, RF Output
Example:	:FEED:RF:PORT:OUTP RFIO1
Dependencies:	Only available in EXT.
ReadBack:	RFIO1
Initial S/W Revision:	A.05.01
Help Map ID:	30015

RFIO2

The RF port that will be used for the current output

Key Path:	Input/Output, RF Output & Test Set Config, RF Output
Example:	:FEED:RF:PORT:OUTP RFIO2
Dependencies:	Only available in EXT.
ReadBack:	RFIO2
Initial S/W Revision:	A.05.01
Help Map ID:	30016

Multiport Adapter

The Multiport Adapter key allows you to set the multiport adapter unit which is connected to the EXT by USB for download of calibration data and additional control.

Multiport Adapter is only available in the EXT (E6607A/B/C), and is blanked for other models.

EXT (E6607A/B)

The Multiport Adapter key will not be displayed if the multiport adapter unit is not connected to the EXT by USB.

EXT (E6607C)

The MPA is integrated into the instrument; therefore, the Multiport Adapter key is always displayed.

See [“More Information” on page 539](#)

Key Path:	Input/Output, RF Output & Test Set Config
-----------	--

Dependencies:	Multiport adapter is only available for EXT (E6607A/B) model, and is blanked for other models. Multiport adapter unit is connected to EXT by USB for download of calibration data and additional control.
Preset:	All settings under this key are returned to their default state when Restore Input/Output Defaults is pressed.
State Saved:	All settings under this key, are remembered when you unplugged the multiport adapter unit USB connection, so that when multiport adapter unit USB is connected again, all the multiport adapter functions will retain their previous settings, with the exception of Multiport Adapter which is set to OFF.
Initial S/W Revision:	A.10.00
Help Map ID:	0

More Information

Multiport adapter in the EXT (E6607A/B) supports the Agilent E6617A, which provides a USB connection for download of calibration data and additional control.

The connection diagram for Agilent E6617A switch unit is:

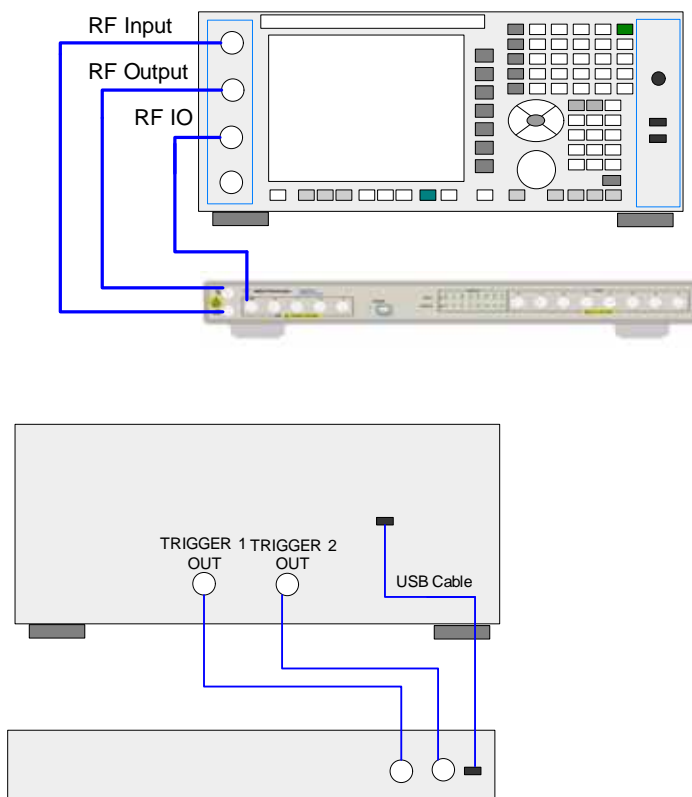

Multiport Adapter On/Off

Turning the Multiport Adapter On means that the multiport adapter unit is connected and it will be used for the measurements or source.

Input/Output

Turning the Multiport Adapter Off means that the multiport adapter unit will not be used for the analyzer or source.

Key Path:	Input/Output, RF Output & Test Set Config, Multiport Adapter
Remote Command:	[:SENSE] :MPADapter [:STATE] ON OFF 1 0 [:SENSE] :MPADapter [:STATE] ?
Example:	:MPAD ON
Dependencies:	Only when the multiport adapter unit is connected to the EXT by USB, it is appeared. Otherwise, it will not be displayed and set to OFF. If the current RF Input port is not RF Input, turn Multiport Adapter to On , an error message is generated: “-221, Settings conflict; RFIO1 or RFIO2 Port unavailable when Multiport Adapter is ON”.
Preset:	This is unaffected by Mode Preset but is set to OFF on a "Restore Input/Output Defaults" or "Restore System Defaults -> All"
Initial S/W Revision:	A.10.00
Help Map ID:	0

Input Port

Specifies the multiport adapter unit input port used.

Key Path:	Input/Output, RF Output & Test Set Config, Multiport Adapter
Remote Command:	[:SENSE] :MPADapter :PORT :INPut OFF RFIO0 RFIO1 RFIO2 RFIO3 RFIO4 RFIO5 RFIO6 RFIO7 [:SENSE] :MPADapter :PORT :INPut ?
Example:	:MPAD :PORT :INP RFIO1
Dependencies:	This menu selection does not have any effect unless Input/Output, More, RF Output & Test Set Config, Multiport Adapter is set to the On state.
Preset:	This is unaffected by Mode Preset but is set to RFIO0 on a "Restore Input/Output Defaults" or "Restore System Defaults -> All"
State Saved:	Saved in State
Readback Text:	The current Multiport Adapter Input Port selected is read back to this key
Backwards Compatibility SCPI Notes:	The commands above are included for ESU compatibility
Initial S/W Revision:	A.10.00
Help Map ID:	0

OFF

Specifies using the multiport adapter input port OFF.

Key Path:	Input/Output, RF Output & Test Set Config, Multiport Adapter, Input Port
Example:	[:SENSe] :MPADapter:PORT:INPut OFF
ReadBack:	OFF
Initial S/W Revision:	A.10.00
Help Map ID:	0

RFIO0

Specifies using the multiport adapter input port RFIO 0.

Key Path:	Input/Output, RF Output & Test Set Config, Multiport Adapter, Input Port
Example:	[:SENSe] :MPADapter:PORT:INPut RFIO0
ReadBack:	RFIO 0
Initial S/W Revision:	A.10.00
Help Map ID:	0

RFIO1

Specifies using the multiport adapter input port RFIO 1.

Key Path:	Input/Output, RF Output & Test Set Config, Multiport Adapter, Input Port
Example:	[:SENSe]:MPADapter:PORT:INPut RFIO1
ReadBack:	RFIO 1
Initial S/W Revision:	A.10.00
Help Map ID:	0

RFIO2

Specifies using the multiport adapter Input port RFIO 2.

Key Path:	Input/Output, RF Output & Test Set Config, Multiport Adapter, Input Port
Example:	[:SENSe]:MPADapter:PORT:INPut RFIO2
ReadBack:	RFIO 2
Initial S/W Revision:	A.10.00
Help Map ID:	0

Input/Output

RFIO3

Specifies using the multiport adapter input port RFIO 3.

Key Path:	Input/Output, RF Output & Test Set Config, Multiport Adapter, Input Port
Example:	[:SENSe]:MPADapter:PORT:INPut RFIO3
ReadBack:	RFIO 3
Initial S/W Revision:	A.10.00
Help Map ID:	0

RFIO4

Specifies using the multiport adapter input port RFIO 4.

Key Path:	Input/Output, RF Output & Test Set Config, Multiport Adapter, Input Port
Example:	[:SENSe]:MPADapter:PORT:INPut RFIO4
ReadBack:	RFIO 4
Initial S/W Revision:	A.10.00
Help Map ID:	0

RFIO5

Specifies using the multiport adapter input port RFIO 5.

Key Path:	Input/Output, RF Output & Test Set Config, Multiport Adapter, Input Port, Page 2
Example:	[:SENSe]:MPADapter:PORT:INPut RFIO5
ReadBack:	RFIO 5
Initial S/W Revision:	A.10.00
Help Map ID:	0

RFIO6

Specifies using the multiport adapter input port RFIO 6.

Key Path:	Input/Output, RF Output & Test Set Config, Multiport Adapter, Input Port, Page 2
Example:	[:SENSe]:MPADapter:PORT:INPut RFIO6
ReadBack:	RFIO 6
Initial S/W Revision:	A.10.00
Help Map ID:	0

RFIO7

Specifies using the multiport adapter input port RFIO 7.

Key Path:	Input/Output, RF Output & Test Set Config, Multiport Adapter, Input Port, Page 2
Example:	[:SENSe]:MPADapter:PORT:INPut RFIO7
ReadBack:	RFIO 7
Initial S/W Revision:	A.10.00
Help Map ID:	0

Output Port

Specifies the multiport adapter unit output ports used. The Output Port key lets you set eight outputs ON/OFF. See the table below for bitmapping.

Multiport Adapter Output Port	Bit
RFIO0	0
RFIO1	1
RFIO2	2
RFIO3	3
RFIO4	4
RFIO5	5
RFIO6	6
RFIO7	7

Key Path:	Input/Output, RF Output & Test Set Config, Multiport Adapter
Remote Command:	[:SENSe]:MPADapter:PORT:OUTPut:BITMap <integer> [:SENSe]:MPADapter:PORT:OUTPut:BITMap?
Example:	:MPAD:PORT:OUTPut:BITMap 1
Notes:	<p>Each bit is associated with a multiport adapter output port; as shown in the bitmap table above. The value of a bit is '0' if the corresponding multiport adapter output port is not selected, and '1' if it is. (For example, to select multiport adapter RFIO7 output port , set Bit 7 to '1'.)</p> <p>The field requires a decimal entry. For example, if multiport adapter selects the RFIO 7 output port and RFIO 0 output port, the Bit Mask for this combination is 10000001, and the value of this parameter is the decimal number '129'.</p>

Input/Output

Dependencies:	This menu selection does not have any effect unless Input/Output, RF Output & Test Set Config, Multiport Adapter, Multiport Adapter is set to the On state and Input/Output, RF Output & Test Set Config, RF Output is RF Output port. When Input/Output, RF Output & Test Set Config, Multiport Adapter, Multiport Adapter is set to the On state and Input/Output, RF Output & Test Set Config, RF Output is set to RFIO1 or RFIO2 port, the Multiport Adapter GPS Output Port will be used.
Preset:	This is unaffected by Mode Preset but is set to "1" on a "Restore Input/Output Defaults" or "Restore System Defaults -> All"
State Saved:	Saved in State
Backwards Compatibility SCPI Notes:	The commands above are included for ESU compatibility
Initial S/W Revision:	A.10.00
Help Map ID:	0

RFIO0

Turn on or off the multiport adapter RFIO0 output port.

Key Path:	Input/Output, RF Output & Test Set Config, Multiport Adapter, Output Port
Preset:	Not affected by a Preset. Set to ON pressing System > Restore Defaults > Input/Output Settings or System > Restore Defaults > All.
State Saved:	Saved in instrument state.
Initial S/W Revision:	A.10.0
Help Map ID:	0

RFIO1

Turn on or off the multiport adapter RFIO1 output port.

Key Path:	Input/Output, RF Output & Test Set Config, Multiport Adapter, Output Port
Preset:	Not affected by a Preset. Set to OFF by pressing System > Restore Defaults > Input/Output Settings or System > Restore Defaults > All.
State Saved:	Saved in instrument state.
Initial S/W Revision:	A.10.0
Help Map ID:	0

RFIO2

Turn on or off the multiport adapter RFIO2 output port.

Key Path:	Input/Output, RF Output & Test Set Config, Multiport Adapter, Output Port
-----------	--

Preset:	Not affected by a Preset. Set to OFF by pressing System > Restore Defaults > Input/Output Settings or System > Restore Defaults > All.
State Saved:	Saved in instrument state.
Initial S/W Revision:	A.10.0
Help Map ID:	0

RFIO3

Turn on or off the multiport adapter RFIO3 output port.

Key Path:	Input/Output, RF Output & Test Set Config, Multiport Adapter, Output Port
Preset:	Not affected by a Preset. Set to OFF by pressing System > Restore Defaults > Input/Output Settings or System > Restore Defaults > All.
State Saved:	Saved in instrument state.
Initial S/W Revision:	A.10.0
Help Map ID:	0

RFIO4

Turn on or off the multiport adapter RFIO4 output port.

Key Path:	Input/Output, RF Output & Test Set Config, Multiport Adapter, Output Port
Preset:	Not affected by a Preset. Set to OFF by pressing System > Restore Defaults > Input/Output Settings or System > Restore Defaults > All.
State Saved:	Saved in instrument state.
Initial S/W Revision:	A.10.0
Help Map ID:	0

RFIO5

Turn on or off the multiport adapter RFIO5 output port.

Key Path:	Input/Output, RF Output & Test Set Config, Multiport Adapter, Output Port
Preset:	Not affected by a Preset. Set to OFF by pressing System > Restore Defaults > Input/Output Settings or System > Restore Defaults > All.
State Saved:	Saved in instrument state.
Initial S/W Revision:	A.10.0
Help Map ID:	0

Input/Output

RFIO6

Turn on or off the multiport adapter RFIO6 output port.

Key Path:	Input/Output, RF Output & Test Set Config, Multiport Adapter, Output Port, Page 2
Preset:	Not affected by a Preset. Set to OFF by pressing System > Restore Defaults > Input/Output Settings or System > Restore Defaults > All.
State Saved:	Saved in instrument state.
Initial S/W Revision:	A.10.0
Help Map ID:	0

RFIO7

Turn on or off the multiport adapter RFIO7 output port.

Key Path:	Input/Output, RF Output & Test Set Config, Multiport Adapter, Output Port, Page 2
Preset:	Not affected by a Preset. Set to OFF by pressing System > Restore Defaults > Input/Output Settings or System > Restore Defaults > All.
State Saved:	Saved in instrument state.
Initial S/W Revision:	A.10.0
Help Map ID:	0

Preamp On/Off

Turn on or off the preamplifier of the multiport adapter input path. It will provide one fix gain for the multiport adapter input path.

Key Path:	Input/Output, RF Output & Test Set Config, Multiport Adapter
Remote Command:	[:SENSE] :MPADapter:GAIN [:STATE] ON OFF 1 0 [:SENSE] :MPADapter:GAIN [:STATE] ?
Example:	:MPAD:GAIN ON
Dependencies:	This menu selection does not have any effect unless Input/Output, More, RF Output & Test Set Config, Multiport Adapter, Multiport Adapter is set to the On state.
Preset:	This is unaffected by Mode Preset but is set to OFF on a "Restore Input/Output Defaults" or "Restore System Defaults -> All"
State Saved:	Saved in instrument state.
Initial S/W Revision:	A.10.0
Help Map ID:	0

Amplitude Corrections

Corrections

Multiport Adapter Amplitude Corrections arrays can be entered by the user, sent over SCPI, or loaded from a file. The Multiport Adapter correction supports 16 separate Corrections arrays, each of which can contain up to 2000 points. They can be turned on and off individually and any or all can be on at the same time. Multiport Adapter has multiple Input/Output RF ports can have different corrections applied to the different ports. The correction data is applied to incoming signals as well as transmitted signals and is in the form of a list of spot frequencies and amplitude correction levels.

See section “[Amplitude Corrections](#)” on page 547 for more information on Corrections.

Key Path:	Input/Output, RF Output & Test Set Config, Multiport Adapter
Mode:	Sequence Analyzer, I/Q Analyzer
Dependencies:	<p>This key will only appear if you have the proper option installed in your instrument.</p> <p>Multiport Adapter Amplitude correction may not be available in all modes; if a mode does not support amplitude correction, the Correction On/Off and Apply Corrections On/Off keys should be grayed and un-accessible.</p> <p>This menu selection does not have any effect unless Input/Output, More, RF Output & Test Set Config, Multiport Adapter, Multiport Adapter is set to the On state.</p>
Preset:	Multiport Adapter Corrections arrays are reset (deleted) by Restore Input/Output Defaults. They survive shutdown and restarting of the analyzer application, which means they will survive a power cycle.
Initial S/W Revision:	A.10.00
Help Map ID:	0

Select Correction

Specifies the selected correction. The term "selected correction" is used throughout this document to specify which correction will be affected by the functions.

Key Path:	Input/Output, RF Output & Test Set Config, Multiport adapter, Corrections
Mode:	Sequence Analyzer, I/Q Analyzer
Notes:	The selected correction is remembered even when not in the correction menu
Dependencies:	This menu selection does not have any effect unless Input/Output, More, RF Output & Test Set Config, Multiport Adapter, Multiport Adapter is set to the On state.
Preset:	Set to Correction 1 by Restore Input/Output Defaults

Input/Output

Readback:	Correction 1 Correction 2 Correction 3 Correction 4 Correction 5 Correction 6 Correction 7 Correction 9 Correction 9 Correction 10 Correction 11 Correction 12
Initial S/W Revision:	A.10.00
Help Map ID:	0

Correction On/Off

Turning the Selected Correction on allows the values in it to be applied to the data. This also automatically turns on "Apply Corrections" (sets it to ON), otherwise the correction would not take effect.

A new sweep is initiated if an amplitude correction is switched on or off. Note that changing, sending or loading corrections data does NOT directly initiate a sweep, however in general these operations will turn corrections on, which DOES initiate a sweep.

Key Path:	Input/Output, RF Output & Test Set Config, Multiport Adapter, Corrections
Remote Command:	[:SENSe] :MPADapter:CORRection:CSET [1] 2 3 4 5 6 7 8 9 10 11 12 13 14 15 16 [:STATe] ON OFF 1 0 [:SENSe] :MPADapter:CORRection:CSET [1] 2 3 4 5 6 7 8 9 10 11 12 13 14 15 16 [:STATe] ?
Example:	SENS:MPAD:CORR:CSET ON
Dependencies:	This menu selection does not have any effect unless Input/Output, More, RF Output & Test Set Config, Multiport Adapter, Multiport Adapter is set to the On state. This menu selection is hidden if the currently active measurement or mode does not support amplitude correction. Turning this on automatically turns on "Apply Corrections" Only the first correction array (Correction 1) supports antenna units. When this array is turned on, and it contains an Antenna Unit other than "None", the Y Axis Unit of the analyzer is forced to that Antenna Unit. All other Y Axis Unit choices are grayed out. Note that this means that a correction file with an Antenna Unit can only be loaded into the Corrections 1 register. Consequently only for Correction 1 does the dropdown in the Recall dialog include.ant, and if an attempt is made to load a correction file into any other Correction register which DOES contain an antenna unit, a Mass Storage error is generated. This command will generate an "Option not available" error unless you have the proper option installed in your instrument.
Preset:	Not affected by a Preset. Set to OFF by Restore Input/Output Defaults
State Saved:	Saved in instrument state.
Initial S/W Revision:	A.10.00
Help Map ID:	0

Properties

Accesses a menu that lets you set the properties of the selected correction.

Key Path:	Input/Output, RF Output & Test Set Config, Multiport Adapter, Corrections
Dependencies:	This menu selection does not have any effect unless Input/Output, RF Output & Test Set Config, Multiport Adapter, Multiport Adapter is set to the On state. This menu selection is hidden if the currently active measurement or mode does not support amplitude correction.
Initial S/W Revision:	A.10.00
Help Map ID:	0

Select Correction

Specifies the selected correction. The term "selected correction" is used throughout this document to specify which correction will be affected by the functions.

Key Path:	Input/Output, RF Output & Test Set Config, Multiport Adapter, Corrections, Properties
Notes:	The selected correction is remembered even when not in the correction menu
Dependencies:	This menu selection does not have any effect unless Input/Output, RF Output & Test Set Config, Multiport Adapter, Multiport Adapter is set to the On state
Preset:	Set to Correction 1 by Restore Input/Output Defaults.
Readback:	Correction 1 Correction 2 Correction 3 Correction 4 Correction 5 Correction 6 Correction 7 Correction 9 Correction 9 Correction 10 Correction 11 Correction 12 Correction 13 Correction 14 Correction 15 Correction 16
Initial S/W Revision:	A.10.00
Help Map ID:	0

Antenna Unit

For devices (like antennae) which make measurements of field strength or flux density, the correction array should contain within its values the appropriate conversion factors such that, when the data on the analyzer is presented in dB μ V, the display is calibrated in the appropriate units. The "Antenna Unit" used for the conversion is contained within the corrections array database. It may be specified by the user or loaded in from an external file or SCPI.

When an array with an Antenna Unit other than "None" is turned on, the Y Axis Unit of the analyzer is forced to that unit. When this array is turned on, and it contains an Antenna Unit other than "None", the Y Axis Unit of the analyzer is forced to that Antenna Unit., and all other Y Axis Unit choices are grayed out.

Antenna Unit does not appear in all Modes that support Corrections. Only the modes listed in the Mode row of the table below support Antenna Units.

Key Path:	Input/Output, RF Output & Test Set Config, Multiport Adapter, Corrections, Properties
Mode:	SA

Input/Output

Remote Command:	[:SENSe]:MPADapter:CORRection:CSET[1] 2 3 4 5 6 7 8 9 10 11 12 13 14 15 16:ANTenna[:UNIT] GAUSS PTESLa UVM UAM NOConversion [:SENSe]:MPADapter:CORRection:CSET[1] 2 3 4 5 6 7 8 9 10 11 12 13 14 15 16:ANTenna[:UNIT]?
Example:	:MPAD:CORR:CSET:ANT GAUS
Dependencies:	Only the first correction array (Correction 1) supports antenna units. Note that this means that a correction file with an Antenna Unit can only be loaded into the Corrections 1 register. Consequently only for Correction 1 does the dropdown in the Recall dialog include.ant, and if an attempt is made to load a correction file into any other Correction register which DOES contain an antenna unit, a Mass Storage error is generated. Forceful message -250.3004
Preset:	Unaffected by Preset. Set to NOC by Restore Input/Output Defaults
State Saved:	Saved in State
Initial S/W Revision:	A.10.00
Help Map ID:	0

dB μ V/m

Sets the antenna unit to dB μ V/m. If this correction is turned on, and Apply Corrections is on, the Y Axis Unit will then be forced to dB μ V/m and all other Y Axis Unit selections will be grayed out.

Key Path:	Input/Output, RF Output & Test Set Config, Multiport Adapter, Corrections, Properties, Antenna Unit
Example:	:MPAD:CORR:CSET2:ANT UVM
Readback:	"dB μ V/m"
Initial S/W Revision:	A.10.00
Help Map ID:	0

dB μ A/m

Sets the antenna unit to dB μ A/m. If this correction is turned on, and Apply Corrections is on, the Y Axis Unit will then be forced to dB μ A/m and all other Y Axis Unit selections will be grayed out.

Key Path:	Input/Output, RF Output & Test Set Config, Multiport Adapter, Corrections, Properties, Antenna Unit
Example:	:MPAD:CORR:CSET2:ANT UVA
Readback:	" dB μ A/m"
Initial S/W Revision:	A.10.00
Help Map ID:	0

dBpT

Sets the antenna unit to dBpT. If this correction is turned on, and Apply Corrections is on, the Y Axis Unit will then be forced to dBpT and all other Y Axis Unit selections will be grayed out.

Key Path:	Input/Output, RF Output & Test Set Config, Multiport Adapter, Corrections, Properties, Antenna Unit
Example:	:MPAD:CORR:CSET3:ANT PTES
Readback:	"dBpT"
Initial S/W Revision:	A.10.00
Help Map ID:	0

dBG

Sets the antenna unit to dBG. If this correction is turned on, and Apply Corrections is on, the Y Axis Unit will then be forced to dBG and all other Y Axis Unit selections will be grayed out.

Key Path:	Input/Output, RF Output & Test Set Config, Multiport Adapter, Corrections, Properties, Antenna Unit
Example:	:MPAD:CORR:CSET:ANT GAUS
Readback:	" dBG"
Initial S/W Revision:	A.10.00
Help Map ID:	0

None

Selects no antenna unit for this Correction set. Thus no Y Axis unit will be forced.

Key Path:	Input/Output, RF Output & Test Set Config, Multiport Adapter, Corrections, Properties, Antenna Unit
Example:	:MPAD:CORR:CSET4:ANT NOC
Readback:	"None"
Initial S/W Revision:	A.10.00
Help Map ID:	0

Frequency Interpolation

This setting controls how the correction values per-bucket are calculated. We interpolate between frequencies in either the logarithmic or linear scale.

This setting is handled and stored individually per correction set.

See [“Interpolation” on page 552](#)

Key Path:	Input/Output, RF Output & Test Set Config, Multiport Adapter, Corrections, Properties
-----------	--

Input/Output

Remote Command:	[:SENSe]:MPADapter:CORRection:CSET[1] 2 3 4 5 6 7 8 9 10 11 12 13 14 15 16:X:SPACing LINear LOGarithmic [:SENSe]:MPADapter:CORRection:CSET[1] 2 3 4 5 6 7 8 9 10 11 12 13 14 15 16:X:SPACing?
Example:	:MPAD:CORR:CSET:X:SPAC LIN
Dependencies:	This menu selection does not have any effect unless Input/Output, More, RF Output & Test Set Config, Multiport Adapter, Multiport Adapter is set to the On state.
Preset:	Unaffected by a Preset. Set to Linear by Restore Input/Output Defaults.
State Saved:	Saved in instrument state.
Initial S/W Revision:	A.10.00
Help Map ID:	0

Interpolation

For each bucket processed by the application, all of the correction factors at the frequency of interest (center frequency of each bucket) are summed and added to the amplitude. All trace operations and post processing treat this post-summation value as the true signal to use.

To effect this correction, the goal, for any particular start and stop frequency, is to build a correction trace, whose number of points matches the current Sweep Points setting of the instrument, which will be used to apply corrections on a bucket by bucket basis to the data traces.

For amplitudes that lie between two user specified frequency points, we interpolate to determine the amplitude value. You may select either linear or logarithmic interpolation between the frequencies.

If we interpolate on a log scale, we assume that the line between the two points is a straight line on the log scale. For example, let's say the two points are (2,4) and (20,1). A straight line between them on a log scale looks like:

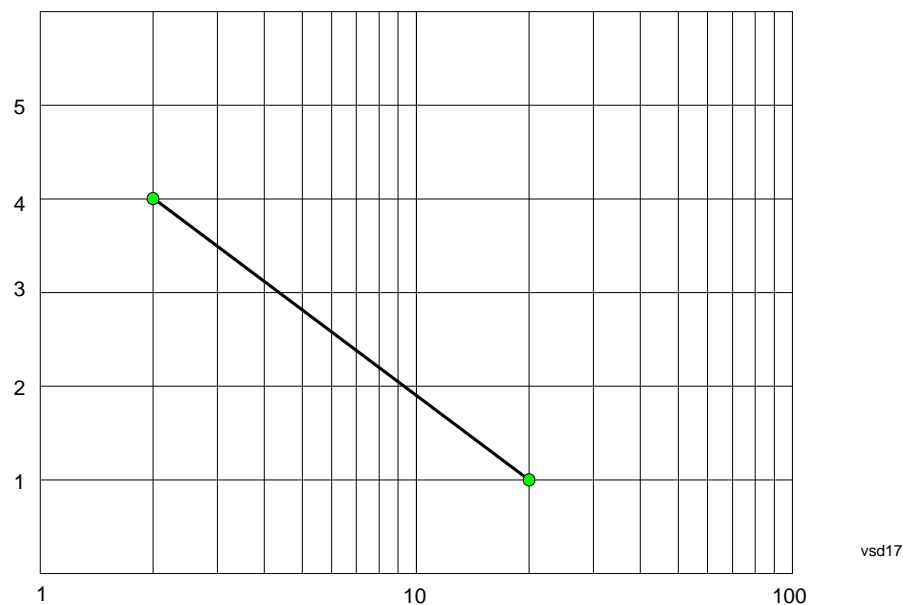

On a linear scale (like that of the spectrum analyzer), this translates to:

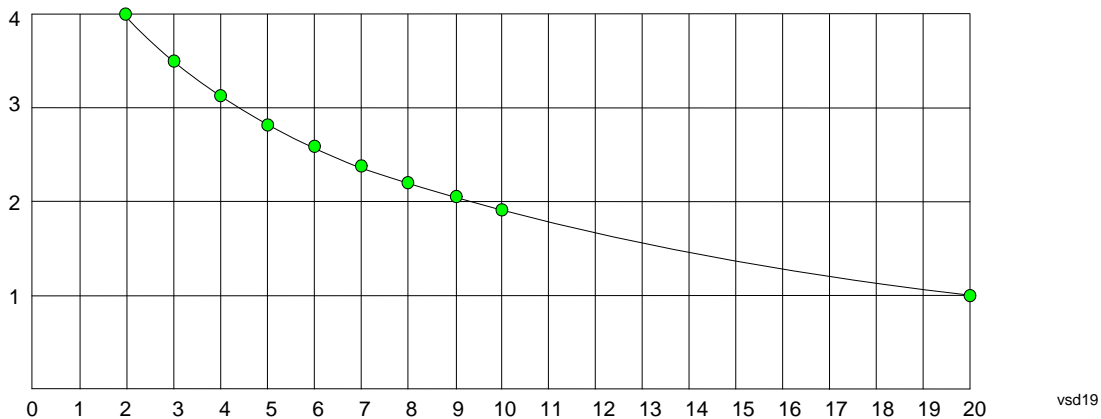

On the other hand, if we interpolate on a linear scale, we assume that the two points are connected by a straight line on the linear scale, as below:

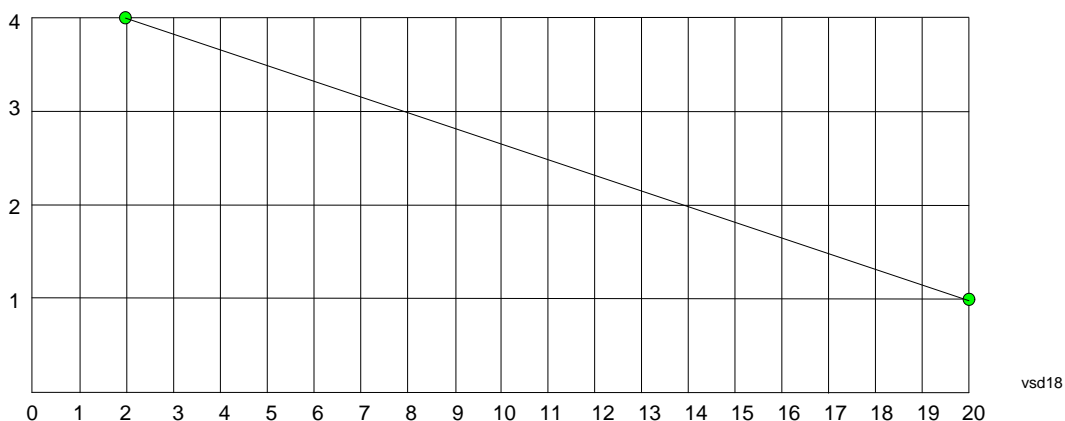

The correction to be used for each bucket is taken from the interpolated correction curve at the center of the bucket.

Description

Sets an ASCII description field which will be stored in an exported file. Can be displayed in the active function area by selecting as the active function, if desired to be in a screen dump.

Key Path:	Input/Output, RF Output & Test Set Config, Multiport Adapter, Corrections, Properties
Remote Command:	[:SENSe]:MPADapter:CORRection:CSET[1] 2 3 4 5 6 7 8 9 10 11 12 13 14 15 16:DESCription "text" [:SENSe]:MPADapter:CORRection:CSET[1] 2 3 4 5 6 7 8 9 10 11 12 13 14 15 16:DESCription?
Example:	:MPAD:CORR:CSET:DESC "11941A Antenna correction"
Notes:	45 chars max; may not fit on display if max chars used
Dependencies:	This menu selection does not have any effect unless Input/Output, More, RF Output & Test Set Config, Multiport Adapter, Multiport Adapter is set to the On state.

Input/Output

Preset:	Unaffected by a Preset. Set to empty by Restore Input/Output Defaults
State Saved:	Saved in instrument state.
Initial S/W Revision:	A.10.00
Help Map ID:	0

Comment

Sets an ASCII comment field which will be stored in an exported file. Can be displayed in the active function area by selecting as the active function, if desired to be in a screen dump.

Key Path:	Input/Output, RF Output & Test Set Config, Multiport Adapter, Corrections, Properties
Remote Command:	[:SENSe] :MPADapter:CORRection:CSET [1] 2 3 4 5 6 7 8 9 10 11 12 13 14 15 16 :COMMENT "text" [:SENSe] :MPADapter:CORRection:CSET [1] 2 3 4 5 6 7 8 9 10 11 12 13 14 15 16 :COMMENT?
Example:	:MPAD:CORR:CSET:COMM "this is a comment"
Notes:	45 chars max; may not fit on display if max chars used
Preset:	Unaffected by Preset. Set to empty by Restore Input/Output Defaults
State Saved:	Saved in instrument state
Initial S/W Revision:	A.10.00
Help Map ID:	0

RF Port

Maps one of the sets of corrections to one of the IO ports.

Key Path:	Input/Output, RF Output & Test Set Config, Multiport Adapter, Corrections, Properties
Mode:	SEQAN
Remote Command:	[:SENSe] :MPADapter:CORRection:CSET [1] 2 3 4 5 6 7 8 9 10 11 12 13 14 15 16 :RF:PORT RFIO RFIO1 RFIO2 RFIO3 RFIO4 RFIO5 RFIO6 RFIO7 [:SENSe] :MPADapter:CORRection:CSET [1] 2 3 4 5 6 7 8 9 10 11 12 13 14 15 16 :RF:PORT?
Example:	:MPAD:CORR:CSET:RF:PORT RFIO0
Notes:	
Dependencies:	Only available in EXT
Couplings:	
Preset:	Unaffected by Preset. Set to RF by Restore Input/Output Defaults

State Saved:	Saved in State
Backwards Compatibility SCPI:	
Initial S/W Revision:	A.10.00
Help Map ID:	0

RFIO0

The port to which the current corrections are applied. Pressing this key again allows the user access to the menu for specifying to which internal device and multiport adapter RF path the corrections for multiport adapter RFIO 0 are applied.

Key Path:	Input/Output, RF Output & Test Set Config, Multiport Adapter, Corrections, Properties, RF Port
Remote Command:	[:SENSE] :MPADapter:CORRection:CSET [1] 2 3 4 5 6 7 8 9 10 11 12 13 14 15 16 :RF:PORT:RFIO0 SOURce ANALyzer BOTH [:SENSE] :MPADapter:CORRection:CSET [1] 2 3 4 5 6 7 8 9 10 11 12 13 14 15 16 :RF:PORT:RFIO0?
Example:	:MPAD:CORR:CSET:RF:PORT:RFIO0 BOTH
Preset:	Both
State Saved:	Saved in State
Initial S/W Revision:	A.10.0
Help Map ID:	0

Correct Source

Sets the corrections for the multiport adapter RFIO 0 port to be applied to the source.

Key Path:	Input/Output, RF Output & Test Set Config, Multiport Adapter, Corrections, Properties, RF Port, RFIO 0
Example:	:MPAD:CORR:CSET[1] 2 3 4 5 6 7 8 9 10 11 12 13 14 15 16:RF:PORT:RFIO0 SOUR
Readback:	"Correct Source"
Initial S/W Revision:	A.10.0
Help Map ID:	0

Correct Analyzer

Sets the corrections for the multiport adapter RFIO 0 port to be applied to the analyzer.

Key Path:	Input/Output, RF Output & Test Set Config, Multiport Adapter, Corrections, Properties, RF Port, RFIO 0
Example:	:MPAD:CORR:CSET[1] 2 3 4 5 6 7 8 9 10 11 12 13 14 15 16:RF:PORT:RFIO0 ANAL

Input/Output

Readback:	"Correct Analyzer"
Initial S/W Revision:	A.10.0
Help Map ID:	0

Correct Source and Analyzer

Sets the corrections for the multiport adapter RFIO 0 port to be applied to both the source and the analyzer.

Key Path:	Input/Output, RF Output & Test Set Config, Multiport Adapter, Corrections, Properties, RF Port, RFIO 0
Example:	:MPAD:CORR:CSET[1] 2 3 4 5 6 7 8 9 10 11 12 13 14 15 16:RF:PORT:RFIO0 BOTH
Readback:	"Correct Source and Analyzer"
Initial S/W Revision:	A.10.0
Help Map ID:	0

RFIO1

The port to which the current corrections will be applied. Pressing this key again allows the user access to the menu for specifying to which internal device and multiport adapter RF path the corrections for multiport adapter RFIO 1 are applied.

Key Path:	Input/Output, RF Output & Test Set Config, Multiport Adapter, Corrections, Properties, RF Port
Remote Command:	[:SENSe] :MPADapter :CORRection :CSET [1] 2 3 4 5 6 7 8 9 10 11 12 13 14 15 16 :RF :PORT :RFIO1 SOURce ANALyzer BOTH [:SENSe] :MPADapter :CORRection :CSET [1] 2 3 4 5 6 7 8 9 10 11 12 13 14 15 16 :RF :PORT :RFIO1?
Example:	:MPAD:CORR:CSET:RF:PORT:RFIO1 BOTH
Preset:	Both
State Saved:	Saved in State
Initial S/W Revision:	A.10.0
Help Map ID:	0

Correct Source

Sets the corrections for the multiport adapter RFIO 1 port to be applied to the source.

Key Path:	Input/Output, RF Output & Test Set Config, Multiport Adapter, Corrections, Properties, RF Port, RFIO 1
Example:	:MPAD:CORR:CSET[1] 2 3 4 5 6 7 8 9 10 11 12 13 14 15 16:RF:PORT:RFIO1 SOUR
Readback:	"Correct Source"

Initial S/W Revision:	A.10.0
Help Map ID:	0

Correct Analyzer

Sets the corrections for the multiport adapter RFIO 1 port to be applied to the analyzer.

Key Path:	Input/Output, RF Output & Test Set Config, Multiport Adapter, Corrections, Properties, RF Port, RFIO 1
Example:	:MPAD:CORR:CSET[1] 2 3 4 5 6 7 8 9 10 11 12 13 14 15 16:RF:PORT:RFIO1 ANAL
Readback:	"Correct Analyzer"
Initial S/W Revision:	A.10.0
Help Map ID:	0

Correct Source and Analyzer

Sets the corrections for the multiport adapter RFIO 1 port to be applied to both the source and the analyzer.

Key Path:	Input/Output, RF Output & Test Set Config, Multiport Adapter, Corrections, Properties, RF Port, RFIO 1
Example:	:MPAD:CORR:CSET[1] 2 3 4 5 6 7 8 9 10 11 12 13 14 15 16:RF:PORT:RFIO1 BOTH
Readback:	"Correct Source and Analyzer"
Initial S/W Revision:	A.10.0
Help Map ID:	0

RFIO2

The port to which the current corrections are applied. Pressing this key again allows the user access to the menu for specifying to which internal device and multiport adapter RF path the corrections for multiport adapter RFIO 2 are applied.

Key Path:	Input/Output, RF Output & Test Set Config, Multiport Adapter, Corrections, Properties, RF Port
Remote Command:	[:SENSE] :MPADapter:CORRection:CSET [1] 2 3 4 5 6 7 8 9 10 11 12 13 14 15 16 :RF:PORT:RFIO2 SOURCE ANALyzer BOTH [:SENSE] :MPADapter:CORRection:CSET [1] 2 3 4 5 6 7 8 9 10 11 12 13 14 15 16 :RF:PORT:RFIO2?
Example:	:MPAD:CORR:CSET:RF:PORT:RFIO2 BOTH
Preset:	Both
State Saved:	Saved in State
Initial S/W Revision:	A.10.0

Input/Output

Help Map ID:	0
--------------	---

Correct Source

Sets the corrections for the multiport adapter RFIO 2 port to be applied to the source.

Key Path:	Input/Output, RF Output & Test Set Config, Multiport Adapter, Corrections, Properties, RF Port, RFIO 2
Example:	:MPAD:CORR:CSET[1] 2 3 4 5 6 7 8 9 10 11 12 13 14 15 16:RF:PORT:RFIO2 SOUR
Readback:	"Correct Source"
Initial S/W Revision:	A.10.0
Help Map ID:	0

Correct Analyzer

Sets the corrections for the multiport adapter RFIO 2 port to be applied to the analyzer.

Key Path:	Input/Output, RF Output & Test Set Config, Multiport Adapter, Corrections, Properties, RF Port, RFIO 2
Example:	:MPAD:CORR:CSET[1] 2 3 4 5 6 7 8 9 10 11 12 13 14 15 16:RF:PORT:RFIO2 ANAL
Readback:	"Correct Analyzer"
Initial S/W Revision:	A.10.0
Help Map ID:	0

Correct Source and Analyzer

Sets the corrections for the multiport adapter RFIO 2 port to be applied to both the source and the analyzer.

Key Path:	Input/Output, RF Output & Test Set Config, Multiport Adapter, Corrections, Properties, RF Port, RFIO 2
Example:	:MPAD:CORR:CSET[1] 2 3 4 5 6 7 8 9 10 11 12 13 14 15 16:RF:PORT:RFIO2 BOTH
Readback:	"Correct Source and Analyzer"
Initial S/W Revision:	A.10.0
Help Map ID:	0

RFIO3

The port to which the current corrections will be applied. Pressing this key again allows the user access to the menu for specifying to which internal device and multiport adapter RF path the corrections for multiport adapter

RFIO 3 are applied.

Key Path:	Input/Output, RF Output & Test Set Config, Multiport Adapter, Corrections, Properties, RF Port
Remote Command:	[:SENSE] :MPADapter:CORRection:CSET [1] 2 3 4 5 6 7 8 9 10 11 12 13 14 15 16 :RF:PORT:RFIO3 SOURce ANALyzer BOTH [:SENSe] :MPADapter:CORRection:CSET [1] 2 3 4 5 6 7 8 9 10 11 12 13 14 15 16 :RF:PORT:RFIO3?
Example:	:MPAD:CORR:CSET:RF:PORT:RFIO3 BOTH
Preset:	Both
State Saved:	Saved in State
Initial S/W Revision:	A.10.0
Help Map ID:	0

Correct Source

Sets the corrections for the multiport adapter RFIO 3 port to be applied to the source.

Key Path:	Input/Output, RF Output & Test Set Config, Multiport Adapter, Corrections, Properties, RF Port, RFIO 3
Example:	:MPAD:CORR:CSET[1] 2 3 4 5 6 7 8 9 10 11 12 13 14 15 16:RF:PORT:RFIO3 SOUR
Readback:	"Correct Source"
Initial S/W Revision:	A.10.0
Help Map ID:	0

Correct Analyzer

Sets the corrections for the multiport adapter RFIO 3 port to be applied to the analyzer.

Key Path:	Input/Output, RF Output & Test Set Config, Multiport Adapter, Corrections, Properties, RF Port, RFIO 3
Example:	:MPAD:CORR:CSET[1] 2 3 4 5 6 7 8 9 10 11 12 13 14 15 16:RF:PORT:RFIO3 ANAL
Readback:	"Correct Analyzer"
Initial S/W Revision:	A.10.0
Help Map ID:	0

Input/Output

Correct Source and Analyzer

Sets the corrections for the multiport adapter RFIO 3 port to be applied to both the source and the analyzer.

Key Path:	Input/Output, RF Output & Test Set Config, Multiport Adapter, Corrections, Properties, RF Port, RFIO 3
Example:	:MPAD:CORR:CSET[1] 2 3 4 5 6 7 8 9 10 11 12 13 14 15 16:RF:PORT:RFIO3 BOTH
Readback:	"Correct Source and Analyzer"
Initial S/W Revision:	A.10.0
Help Map ID:	0

RFIO4

The port to which the current corrections are applied. Pressing this key again allows the user access to the menu for specifying to which internal device and multiport adapter RF path the corrections for multiport adapter RFIO 4 are applied.

Key Path:	Input/Output, RF Output & Test Set Config, Multiport Adapter, Corrections, Properties, RF Port
Remote Command:	[:SENSe] :MPADapter:CORRection:CSET [1] 2 3 4 5 6 7 8 9 10 11 12 13 14 15 16 :RF:PORT:RFIO4 SOURce ANALyzer BOTH [:SENSe] :MPADapter:CORRection:CSET [1] 2 3 4 5 6 7 8 9 10 11 12 13 14 15 16 :RF:PORT:RFIO4?
Example:	:MPAD:CORR:CSET:RF:PORT:RFIO4 BOTH
Preset:	Both
State Saved:	Saved in State
Initial S/W Revision:	A.10.0
Help Map ID:	0

Correct Source

Sets the corrections for the multiport adapter RFIO 4 port to be applied to the source.

Key Path:	Input/Output, RF Output & Test Set Config, Multiport Adapter, Corrections, Properties, RF Port, RFIO 4
Example:	:MPAD:CORR:CSET[1] 2 3 4 5 6 7 8 9 10 11 12 13 14 15 16:RF:PORT:RFIO4 SOUR
Readback:	"Correct Source"
Initial S/W Revision:	A.10.0
Help Map ID:	0

Correct Analyzer

Sets the corrections for the multiport adapter RFIO 4 port to be applied to the analyzer.

Key Path:	Input/Output, RF Output & Test Set Config, Multiport Adapter, Corrections, Properties, RF Port, RFIO 4
Example:	:MPAD:CORR:CSET[1] 2 3 4 5 6 7 8 9 10 11 12 13 14 15 16:RF:PORT:RFIO4 ANAL
Readback:	"Correct Analyzer"
Initial S/W Revision:	A.10.0
Help Map ID:	0

Correct Source and Analyzer

Sets the corrections for the multiport adapter RFIO 4 port to be applied to both the source and the analyzer.

Key Path:	Input/Output, RF Output & Test Set Config, Multiport Adapter, Corrections, Properties, RF Port, RFIO 4
Example:	:MPAD:CORR:CSET[1] 2 3 4 5 6 7 8 9 10 11 12 13 14 15 16:RF:PORT:RFIO4 BOTH
Readback:	"Correct Source and Analyzer"
Initial S/W Revision:	A.10.0
Help Map ID:	0

RFIO5

The port to which the current corrections are applied. Pressing this key again allows the user access to the menu for specifying to which internal device and multiport adapter RF path the corrections for multiport adapter RFIO 5 are applied.

Key Path:	Input/Output, RF Output & Test Set Config, Multiport Adapter, Corrections, Properties, RF Port
Remote Command:	[:SENSE] :MPADapter:CORREction:CSET [1] 2 3 4 5 6 7 8 9 10 11 12 13 14 15 16 :RF:PORT:RFIO5 SOURCE ANALyzer BOTH [:SENSE] :MPADapter:CORREction:CSET [1] 2 3 4 5 6 7 8 9 10 11 12 13 14 15 16 :RF:PORT:RFIO5?
Example:	:MPAD:CORR:CSET:RF:PORT:RFIO5 BOTH
Preset:	Both
State Saved:	Saved in State
Initial S/W Revision:	A.10.0
Help Map ID:	0

Input/Output

Correct Source

Sets the corrections for the multiport adapter RFIO 5 port to be applied to the source.

Key Path:	Input/Output, RF Output & Test Set Config, Multiport Adapter, Corrections, Properties, RF Port, RFIO 5
Example:	:MPAD:CORR:CSET[1] 2 3 4 5 6 7 8 9 10 11 12 13 14 15 16:RF:PORT:RFIO5 SOUR
Readback:	"Correct Source"
Initial S/W Revision:	A.10.0
Help Map ID:	0

Correct Analyzer

Sets the corrections for the multiport adapter RFIO 5 port to be applied to the analyzer.

Key Path:	Input/Output, RF Output & Test Set Config, Multiport Adapter, Corrections, Properties, RF Port, RFIO 5
Example:	:MPAD:CORR:CSET[1] 2 3 4 5 6 7 8 9 10 11 12 13 14 15 16:RF:PORT:RFIO5 ANAL
Readback:	"Correct Analyzer"
Initial S/W Revision:	A.10.0
Help Map ID:	0

Correct Source and Analyzer

Sets the corrections for the multiport adapter RFIO 5 port to be applied to both the source and the analyzer.

Key Path:	Input/Output, RF Output & Test Set Config, Multiport Adapter, Corrections, Properties, RF Port, RFIO 5
Example:	:MPAD:CORR:CSET[1] 2 3 4 5 6 7 8 9 10 11 12 13 14 15 16:RF:PORT:RFIO5 BOTH
Readback:	"Correct Source and Analyzer"
Initial S/W Revision:	A.10.0
Help Map ID:	0

RFIO6

The port to which the current corrections are applied. Pressing this key again allows the user access to the menu for specifying to which internal device and multiport adapter RF path the corrections for multiport adapter RFIO 6 are applied.

Key Path:	Input/Output, RF Output & Test Set Config, Multiport Adapter, Corrections, Properties, RF Port, Page 2
-----------	---

Remote Command:	[:SENSE] :MPADapter:CORRection:CSET [1] 2 3 4 5 6 7 8 9 10 11 12 13 14 15 16 :RF:PORT:RFIO6 SOURce ANALyzer BOTH [:SENSe] :MPADapter:CORRection:CSET [1] 2 3 4 5 6 7 8 9 10 11 12 13 14 15 16 :RF:PORT:RFIO6?
Example:	:MPAD:CORR:CSET:RF:PORT:RFIO6 BOTH
Preset:	Both
State Saved:	Saved in State
Initial S/W Revision:	A.10.0
Help Map ID:	0

Correct Source

Sets the corrections for the multiport adapter RFIO 6 port to be applied to the source.

Key Path:	Input/Output, RF Output & Test Set Config, Multiport Adapter, Corrections, Properties, RF Port, RFIO 6
Example:	:MPAD:CORR:CSET[1] 2 3 4 5 6 7 8 9 10 11 12 13 14 15 16:RF:PORT:RFIO6 SOUR
Readback:	"Correct Source"
Initial S/W Revision:	A.10.0
Help Map ID:	0

Correct Analyzer

Sets the corrections for the multiport adapter RFIO 6 port to be applied to the analyzer.

Key Path:	Input/Output, RF Output & Test Set Config, Multiport Adapter, Corrections, Properties, RF Port, RFIO 6
Example:	:MPAD:CORR:CSET[1] 2 3 4 5 6 7 8 9 10 11 12 13 14 15 16:RF:PORT:RFIO6 ANAL
Readback:	"Correct Analyzer"
Initial S/W Revision:	A.10.0
Help Map ID:	0

Correct Source and Analyzer

Sets the corrections for the multiport adapter RFIO 6 port to be applied to both the source and the analyzer.

Key Path:	Input/Output, RF Output & Test Set Config, Multiport Adapter, Corrections, Properties, RF Port, RFIO 6
Example:	:MPAD:CORR:CSET[1] 2 3 4 5 6 7 8 9 10 11 12 13 14 15 16:RF:PORT:RFIO6 BOTH

Input/Output

Readback:	"Correct Source and Analyzer"
Initial S/W Revision:	A.10.0
Help Map ID:	0

RFIO7

The port to which the current corrections are applied. Pressing this key again allows the user access to the menu for specifying to which internal device and multiport adapter RF path the corrections for multiport adapter RFIO 7 are applied.

Key Path:	Input/Output, RF Output & Test Set Config, Multiport Adapter, Corrections, Properties, RF Port, Page 2
Remote Command:	[:SENSe] :MPADapter:CORRection:CSET [1] 2 3 4 5 6 7 8 9 10 11 12 13 14 15 16 :RF:PORT:RFIO7 SOURce ANALyzer BOTH [:SENSe] :MPADapter:CORRection:CSET [1] 2 3 4 5 6 7 8 9 10 11 12 13 14 15 16 :RF:PORT:RFIO7?
Example:	:MPAD:CORR:CSET:RF:PORT:RFIO7 BOTH
Preset:	Both
State Saved:	Saved in State
Initial S/W Revision:	A.10.0
Help Map ID:	0

Correct Source

Sets the corrections for the multiport adapter RFIO 7 port to be applied to the source.

Key Path:	Input/Output, RF Output & Test Set Config, Multiport Adapter, Corrections, Properties, RF Port, RFIO 7
Example:	:MPAD:CORR:CSET[1] 2 3 4 5 6 7 8 9 10 11 12 13 14 15 16:RF:PORT:RFIO7 SOUR
Readback:	"Correct Source"
Initial S/W Revision:	A.10.0
Help Map ID:	0

Correct Analyzer

Sets the corrections for the multiport adapter RFIO 7 port to be applied to the analyzer.

Key Path:	Input/Output, RF Output & Test Set Config, Multiport Adapter, Corrections, Properties, RF Port, RFIO 7
Example:	:MPAD:CORR:CSET[1] 2 3 4 5 6 7 8 9 10 11 12 13 14 15 16:RF:PORT:RFIO7 ANAL
Readback:	"Correct Analyzer"

Initial S/W Revision:	A.10.0
Help Map ID:	0

Correct Source and Analyzer

Sets the corrections for the multiport adapter RFIO 7 port to be applied to both the source and the analyzer.

Key Path:	Input/Output, RF Output & Test Set Config, Multiport Adapter, Corrections, Properties, RF Port, RFIO 7
Example:	:MPAD:CORR:CSET[1] 2 3 4 5 6 7 8 9 10 11 12 13 14 15 16:RF:PORT:RFIO7 BOTH
Readback:	"Correct Source and Analyzer"
Initial S/W Revision:	A.10.0
Help Map ID:	0

Table Editor

Edit

Invokes the integrated editing facility for this correction set. See description in section [“Table Editor” on page 565](#).

When entering the menu, the editor window turns on, the selected correction is turned **On**, **Apply Corrections** is set to **On**, the amplitude scale is set to **Log**, and the Amplitude Correction (“Ampcor”) trace is displayed. The actual, interpolated correction trace is shown in green for the selected correction. Note that since the actual interpolated correction is shown, the correction trace may have some curvature to it. This trace represents only the correction currently being edited, rather than the total, accumulated amplitude correction for all amplitude corrections which are currently on, although the total, accumulated correction for all corrections which are turned on is still applied to the data traces.

Because corrections data is always in dB, but the Y-axis of the analyzer is in absolute units, it is necessary to establish a reference line for display of the Corrections data. The reference line is halfway up the display and represents 0 dB of correction. It is labeled “0 dB CORREC”. It is drawn in blue. (0,0,255) and is three pixels high. The green correction trace is drawn after all other traces and this reference blue line, so it sits “on top” of them.

Corrections data is always in dB. Whatever dB value appears in the correction table represents the correction to be applied to that trace at that frequency. So if a table entry shows 30 dB that means we ADD 30 dB to each trace to correct it before displaying it. By definition all points are connected. If a gap is desired for corrections data, enter 0 dB.

Note that a well-designed Corrections array should start at 0 dB and end at 0 dB. This is because whatever the high end point is will be extended to the top frequency of the instrument, and whatever the low end point is will be extended down to 0 Hz. So for a Corrections array to have no effect outside its range, you should start and end the array at 0 dB.

NOTE The table editor will only operate properly if the analyzer is sweeping, because its updates are tied to the sweep system. Thus, you should not try to use the editor in single sweep, and it will be sluggish during compute-intensive operations like narrow-span FFT sweeps.

When exiting the edit menu (by using the **Return** key or by pressing an instrument front-panel key), the editor

Input/Output

window turns off and the Ampcor trace is no longer displayed; however, **Apply Corrections** remains **On**, any correction that was on while in the editor remains on, and the amplitude scale returns to its previous setting.

Corrections arrays are not affected by a Preset, because they are in the Input/Output system. They also survive shutdown and restarting of the analyzer application, which means they will survive a power cycle.

When editing a correction, the editor remembers which correction and which element in the correction array you were editing, and returns you to that correction and that element when you return to the editor after leaving it.

Key Path:	Input/Output, RF Output & Test Set Config, Multiport Adapter, Corrections
Initial S/W Revision:	A.10.00
Help Map ID:	0

Navigate

Lets you move through the table to edit the desired point.

Key Path:	Input/Output, RF Output & Test Set Config, Multiport Adapter, Corrections, Edit
Notes:	There is no value readback on the key
Min:	1
Max:	2000
Initial S/W Revision:	A.10.00
Help Map ID:	0

Frequency

Lets you edit the frequency of the current row.

Key Path:	Input/Output, RF Output & Test Set Config, Multiport Adapter, Corrections, Edit
Notes:	There is no value readback on the key.
Min:	0
Max:	1 THz
Initial S/W Revision:	A.10.00
Help Map ID:	0

Amplitude

Lets you edit the Amplitude of the current row.

Key Path:	Input/Output, RF Output & Test Set Config, Multiport Adapter, Corrections, Edit
-----------	--

Notes:	There is no value readback on the key.
Min:	-1000 dB
Max:	1000 dB
Initial S/W Revision:	A.10.00
Help Map ID:	0

Insert Point Below

Inserts a point below the current point. The new point is a copy of the current point and becomes the current point. The new point is not yet entered into the underlying table, and the data in the row is displayed in light gray.

Key Path:	Input/Output, RF Output & Test Set Config, Multiport Adapter, Corrections, Edit
Initial S/W Revision:	A.10.00
Help Map ID:	0

Delete Point

Deletes the currently-selected point, whether or not that point is being edited, and selects the Navigate functionality. The point following the currently-selected point (or the point preceding if there is none) will be selected.

Key Path:	Input/Output, RF Output & Test Set Config, Multiport Adapter, Corrections, Edit
Initial S/W Revision:	A.10.00
Help Map ID:	0

Scale X Axis

Matches the X Axis to the selected Correction, as well as possible. Sets the Start and Stop Frequency to contain the minimum and maximum Frequency of the selected Correction. The range between Start Frequency and Stop Frequency is 12.5% above the range between the minimum and maximum Frequency, so that span exceeds this range by one graticule division on either side. If in zero-span, or there is no data in the Ampcor table, or the frequency range represented by the table is zero, no action is taken. Standard clipping rules apply if the value in the table is outside the allowable range for the X axis.

Key Path:	Input/Output, RF Output & Test Set Config, Multiport Adapter, Corrections, Edit
Dependencies:	If either the first or last point in the array is outside the frequency range of the current input, an error message is generated: “-221. Settings conflict; Start or Stop Freq out of range for current input settings”
Initial S/W Revision:	A.10.00
Help Map ID:	0

Input/Output

Delete Correction

Deletes the correction values for this set. When this key is pressed a prompt is placed on the screen that says “Please press Enter or OK key to delete correction. Press ESC or Cancel to close this dialog.” The deletion is only performed if you press OK or Enter.

Key Path:	Input/Output, RF Output & Test Set Config, Multiport Adapter, Corrections
Remote Command:	[:SENSe] :MPADapter:CORRection:CSET [1 2 3 4 5 6 7 8 9 10 11 12 13 14 15 16 :DELete
Example:	MPAD:CORR:CSET:DEL MPAD:CORR:CSET1:DEL MPAD:CORR:CSET4:DEL
Notes:	Pressing this key when no corrections are present is accepted without error.
Initial S/W Revision:	A.10.00
Help Map ID:	0

Correction On/Off

Apply Corrections

Applies amplitude corrections which are marked as ON to the measured data. If this is set to OFF, then no amplitude correction sets will be used, regardless of their individual on/off settings. If set to ON, the corrections that are marked as ON (see “[Correction On/Off](#)” on page 548) are used.

Key Path:	Input/Output, RF Output & Test Set Config, Multiport Adapter, Corrections
Remote Command:	[:SENSe] :MPADapter:CORRection:CSET:ALL [:STATe] ON OFF 1 0 [:SENSe] :MPADapter:CORRection:CSET:ALL [:STATe] ?
Example:	SENS:MPAD:CORR:CSET:ALL OFF This command makes sure that no amplitude corrections are applied, regardless of their individual on/off settings.
Preset:	Not affected by Preset. Set to OFF by Restore Input/Output Defaults
State Saved:	Saved in instrument state.
Initial S/W Revision:	A.10.00
Help Map ID:	0

Delete All Corrections

Erases all correction values for all 16 Amplitude Correction sets.

When this key is pressed a prompt is placed on the screen that says “Please press Enter or OK key to delete all

corrections. Press ESC or Cancel to close this dialog.” The deletion is only performed if you press OK or Enter.

Key Path:	Input/Output, RF Output & Test Set Config, Multiport Adapter, Corrections
Remote Command:	[:SENSE] :MPADapter:CORRection:CSET:ALL:DELeTe
Example:	MPAD:CORR:CSET:ALL:DEL
Initial S/W Revision:	A.10.00
Help Map ID:	0

Set (Replace) Data (Remote Command Only)

The command takes an ASCII series of alternating frequency and amplitude points, each value separated by commas.

The values sent in the command will totally replace all existing correction points in the specified set.

An Ampcor array can contain 2000 points maximum.

Remote Command:	[:SENSE] :MPADapter:CORRection:CSET [1] 2 3 4 5 6 7 8 9 10 11 12 13 14 15 16 :DATA <freq>, <ampl>, . . . [:SENSE] :MPADapter:CORRection:CSET [1] 2 3 4 5 6 7 8 9 10 11 12 13 14 15 16 :DATA?
Example:	MPAD:CORR:CSET[1] 2 3 4 5 6 7 8 9 10 11 12 13 14 15 16:DATA 10000000,-1.0,20000000,1.0 This defines two correction points at (10 MHz, -1.0 dB) and (20 MHz, 1.0 dB) for correction set 1.
Preset:	Empty after Restore Input/Output Defaults. Survives a shutdown or restart of analyzer application (including a power cycle).
State Saved:	Saved in instrument state.
Min:	Freq: 0 Hz Amptd: -1000 dBm
Max:	Freq: 1 THz Amptd: +1000 dBm
Initial S/W Revision:	A.10.00
Help Map ID:	0

Merge Correction Data (Remote Command Only)

The command takes an ASCII series of alternating frequency and amplitude points, each value separated by commas. The difference between this command and Set Data is that this merges new correction points into an existing set.

Any new point with the same frequency as an existing correction point will replace the existing point's amplitude with that of the new point.

Input/Output

An Ampcor array can contain 2000 total points, maximum.

Remote Command:	[:SENSe] :MPADapter:CORRection:CSET [1] 2 3 4 5 6 7 8 9 10 11 12 13 14 15 16 :DATA:MERGe <freq>, <ampl>, ...
Example:	MPAD:CORR:CSET[1]2 3 4 5 6 7 8 9 10 11 12 13 14 15 16:DATA:MERGE 15000000,-5.0,25000000,5.0 This adds two correction points at (15 MHz, -5.0 dB) and (25 MHz, 5.0 dB) to whatever values already exist in correction set 1.
Preset:	Empty after Restore Input/Output Defaults. Survives shutdown/restart of analyzer application (including power cycle)
Min:	Freq: 0 Hz Amptd: -1000 dBm
Max:	Freq: 1 THz Amptd: +1000 dBm
Initial S/W Revision:	A.10.00
Help Map ID:	0

Output Config

Accesses keys that configure various output settings, like the frequency reference output, trigger output and analog output.

Key Path:	Input/Output
Backwards Compatibility Notes:	1. In ESA there was not a user interface to enable the Video Output (Analog Output), Trigger Output, or Gate Output. In the X-Series each of these physical connectors requires configuration, thus the user interface has been added for X-Series, along with the potential for an output you think is always on to be switched off.
Initial S/W Revision:	Prior to A.02.00
Help Map ID:	3133

Trig Out (1 and 2)

Select the type of output signal that will be output from the rear panel Trig 1 Out or Trig 2 Out connectors.

Key Path:	Input/Output, Output Config
Remote Command:	:TRIGger TRIGger1 TRIGger2 [:SEQuence] :OUTPut HSWP MEASuring MAIN GATE GTRigger OEVen SPOint SSweep SETtled S1Marker S2Marker S3Marker S4Marker OFF :TRIGger TRIGger1 TRIGger2 [:SEQuence] :OUTPut?

Example:	TRIG:OUTP HSWP TRIG2:OUTP GATE
Dependencies:	The second Trigger output (Trig 2 Out) does not appear in all models; in models that do not support it, the Trig 2 Out key is blanked, and sending the SCPI command for this output generates an error, "Hardware missing; Not available for this model number" In models that do not support the Trigger 2 output, this error is returned if trying to set Trig 2 Out and a query of Trig 2 Out returns OFF.
Dependencies:	SSweep SSETtled S1Marker S2Marker S3Marker S4Marker are only available for the source in the EXT.
Preset:	Trigger 1: Sweeping (HSWP) Trigger 2: Gate This is unaffected by a Preset but is preset to the above values on a "Restore Input/Output Defaults" or "Restore System Defaults->All"
State Saved:	Saved in instrument state
Initial S/W Revision:	Prior to A.02.00
Help Map ID:	3135

Off

Selects no signal to be output to the Trig 1 Out or Trig 2 Out connector.

Key Path:	Input/Output, Output Config, Trig 1/2 Output
Example:	TRIG1:OUTP OFF
Readback:	Off
Initial S/W Revision:	Prior to A.02.00
Help Map ID:	3141

Polarity

Sets the output to the Trig 1 Out or Trig 2 Out connector to trigger on either the positive or negative polarity.

Key Path:	Input/Output, Output Config, Trig 1/2 Output
Remote Command:	:TRIGger TRIGger1 TRIGger2[:SEquence]:OUTPut:POLarity POSitive NEGative :TRIGger TRIGger1 TRIGger2[:SEquence]:OUTPut:POLarity?
Example:	TRIG1:OUTP:POL POS
Preset:	This is unaffected by a Preset but is set to POSitive on a "Restore Input/Output Defaults" or "Restore System Defaults->All"

Input/Output

State Saved:	Saved in instrument state
Initial S/W Revision:	Prior to A.02.00
Help Map ID:	3142

Sweeping (HSWP)

Selects the Sweeping Trigger signal to be output to the Trig 1 Out or Trig 2 Out connector when a measurement is made. This signal has historically been known as "HSWP" (High = Sweeping), and is 5 V TTL level with 50 ohm output impedance."

Key Path:	Input/Output, Output Config, Trig 1/2 Output
Example:	TRIG1:OUTP HSWP
Readback:	Sweeping
Initial S/W Revision:	Prior to A.02.00
Help Map ID:	3136

Measuring

Selects the Measuring trigger signal to be output to the Trig 1 Out or Trig 2 Out connector. This signal is true while the Measuring status bit is true.

Key Path:	Input/Output, Output Config, Trig 1/2 Output
Example:	TRIG1:OUTP MEAS
Readback:	Measuring
Initial S/W Revision:	Prior to A.02.00
Help Map ID:	3137

Main Trigger

Selects the current instrument trigger signal to be output to the Trig 1 Out or Trig 2 Out connector.

Key Path:	Input/Output, Output Config, Trig 1/2 Output
Example:	TRIG1:OUTP MAIN
Readback:	Main Trigger
Initial S/W Revision:	Prior to A.02.00
Help Map ID:	3200

Gate Trigger

Selects the gate trigger signal to be output to the Trig 1 Out or Trig 2 Out connector. This is the source of

the gate timing, not the actual gate signal.

Key Path:	Input/Output, Output Config, Trig 1/2 Output
Example:	TRIG1:OUTP GTR
Readback:	Gate Trigger
Initial S/W Revision:	Prior to A.02.00
Help Map ID:	3138

Gate

Selects the gate signal to be output to the Trig 1 Out or Trig 2 Out connector. The gate signal has been delayed and its length determined by delay and length settings. When the polarity is positive, a high on the Trig 1 Out or Trig 2 Out represents the time the gate is configured to pass the signal.

Key Path:	Input/Output, Output Config, Trig 1/2 Output
Example:	TRIG1:OUTP GATE
Readback:	Gate
Initial S/W Revision:	Prior to A.02.00
Help Map ID:	3139

Odd/Even Trace Point

Selects either the odd or even trace points as the signal to be output to the Trig 1 Out or Trig 2 Out connector when performing swept spectrum analysis. When the polarity is positive, this output goes high during the time the test set is sweeping past the first point (Point 0) and every other following trace point. The opposite is true if the polarity is negative.

Key Path:	Input/Output, Output Config, Trig 1/2 Output
Example:	TRIG1:OUTP OEV
Readback:	Odd/Even
Initial S/W Revision:	Prior to A.02.00
Help Map ID:	3140

Source Point Trigger

Selects the gate signal to be output to the Trig 1 Out or Trig 2 Out connector for use as the Point Trigger when operating an external source in Tracking mode. When Ext Trigger 1 is selected as the Point Trigger under Source, the Source Point Trigger under Trig1 Out automatically gets selected. Similarly, when Ext Trigger 2 is selected as the Point Trigger under Source, the Source Point Trigger key under Trig2 Out automatically gets selected

Key Path:	Input/Output, Output Config, Trig 1/2 Output
-----------	---

Input/Output

Example:	TRIG1:OUTP SPO
Readback:	Source Point
Initial S/W Revision:	Prior to A.02.00
Help Map ID:	3178

Source Marker 1

This key is only available in the EXT.

Trigger output at marker 1 in current playing Waveform file.

Key Path:	Input/Output, Output Config, Trig 1/2 Output
Example:	:TRIG1:OUTP S1M
ReadBack:	Marker 1
Initial S/W Revision:	A.05.01
Help Map ID:	30019

Source Marker 2

This key is only available in the EXT.

Trigger output at marker 2 in current playing Waveform file.

Key Path:	Input/Output, Output Config, Trig 1/2 Output
Example:	:TRIG1:OUTP S2M
ReadBack:	Marker 2
Initial S/W Revision:	A.05.01
Help Map ID:	30020

Source Marker 3

This key is only available in the EXT.

Trigger output at marker 3 in current playing Waveform file.

Key Path:	Input/Output, Output Config, Trig 1/2 Output
Example:	:TRIG1:OUTP S3M
ReadBack:	Marker 3
Initial S/W Revision:	A.05.01
Help Map ID:	30021

Source Marker 4

This key is only available in the EXT.

Trigger output at marker 4 in current playing Waveform file.

Key Path:	Input/Output, Output Config, Trig 1/2 Output
Example:	:TRIG1:OUTP S4M
ReadBack:	Marker 4
Initial S/W Revision:	A.05.01
Help Map ID:	30022

Analog Out

This menu lets you control which signal is fed to the “Analog Out” connector on the test set rear panel.

See [“More Information” on page 576](#)

Key Path:	Input/Output, Output Config
Remote Command:	:OUTPut :ANALog OFF SVIDeo LOGVideO LINVideO DAUDio :OUTPut :ANALog?
Example:	OUTP:ANAL SVIDeo ! causes the analog output type to be Screen Video
Preset:	OFF
Preset:	This is unaffected by Preset but is set to DAUDio on a "Restore Input/Output Defaults" or "Restore System Defaults->All
State Saved:	Saved in Input/Output State
Readback line:	1-of-N selection [variable]
Backwards Compatibility Notes:	Prior to A.04.00, OFF was the default functionality except when in the Analog Demod application or with Tune and Listen, in which case it was DAUDio, and there was no selection menu. So for backwards compatibility with earlier X-Series firmware versions, Auto (:OUTP:ANAL:AUTO ON) will duplicate the prior behavior. The DNWB and SANalyzer parameters, which were legal in PSA but perform no function in the X-Series, are accepted without error.
Initial S/W Revision:	A.04.00
Help Map ID:	3143

Input/Output

More Information

The table below gives the range for each output.

Analog Out	Nominal Range exc. (10% overrange)	Scale Factor	Notes
Off	0 V		
Screen Video	0 – 1 V open circuit	10%/division	8566 compatible
Log Video	0 – 1 V terminated	1/(192.66 dB/V)	dB referenced to mixer level, 1V out for –10 dBm at the mixer.
Linear Video	0 – 1 V terminated	100%/V	Linear referenced to Ref Level, 1 V out for RF envelope at the Ref Level.
Demod Audio	(varies with test set setting)		

Auto

Selects the Auto state for the Analog Output menu. In this state, the Analog Output will automatically be set to the most sensible setting for the current mode or measurement.

If you make a selection manually from the Analog Out menu, this selection will remain in force until you change it (or re-select Auto), even if you go to a mode or measurement for which the selected output does not apply.

Key Path:	Input/Output, Output Config, Analog Out
Remote Command:	:OUTPut:ANALog:AUTO OFF ON 0 1 :OUTPut:ANALog:AUTO?
Example:	OUTP:ANAL:AUTO ON
Preset:	ON
State Saved:	Saved in Input/Output State
Initial S/W Revision:	A.04.00
Help Map ID:	29995

Off

Turns off the analog output.

Key Path:	Input/Output, Output Config, Analog Out
Example:	OUTP:ANAL OFF ! causes the analog output to be off
Readback Text:	Off
Initial S/W Revision:	A.04.00
Help Map ID:	3144

Log Video (RF Envelope, Ref=Mixer Level)

Selects the analog output to be the log of the video signal. In this mode, the pre-detector data is output to the Analog Out connector with a Log scaling. The output is referenced to the current level at the mixer, does not depend on display settings like Reference Level or dB per division, and it is not influenced by the selected detector or any digital flatness corrections or trace post-processing (like Trace Averaging), but does change with input attenuation.

The output is designed so that full scale (1 V) corresponds to -10 dBm at the mixer. The full range (0–1 V) covers 192.66 dB ; thus, 0 V corresponds to -202.66 dBm at the mixer.

Key Path:	Input/Output, Output Config, Analog Out
Example:	OUTP:ANAL LOGV
Dependencies:	<p>Because the Log Video output uses one of the two IF processing channels, only one detector is available while Screen Video is selected. All active traces will change to use the same detector as the selected trace when Log Video is activated.</p> <p>Log Video output is not available while any EMI Detector is selected (Quasi Peak, RMS Average or EMI Average), because these detectors use both IF processing channels. Consequently, if the user chooses an EMI Detector, there will be no Log Video output.</p> <p>The output holds at its last value during an alignment, during a marker count, and during retrace (after a sweep and before the next sweep starts).</p> <p>This function depends on optional capability. The key will be blanked and the command will generate an “Option not available” error unless you have Option YAV licensed in your instrument.</p>
Couplings:	Log Video output changes while in FFT Sweeps, so for measurements that use exclusively FFT Sweeps, or if the user manually chooses FFT Sweeps, the Log Video output will look different than it does in swept mode.
Readback Text:	Log Video
Initial S/W Revision:	A.04.00
Help Map ID:	3146

Linear Video (RF Envelope, Ref=Ref Level)

Selects the analog output to be the envelope signal on a linear (voltage) scale. In this mode, the pre-detector data is output to the Analog Out connector with a Linear scaling. The output is based on the current Reference Level, and is not influenced by the selected detector or any digital flatness corrections or trace post-processing (like Trace Averaging).

The scaling is set so that 1 V output occurs with an instantaneous video level equal to the reference level, and 0 V occurs at the bottom of the graticule. This scaling gives you the ability to control the gain without having another setup control for the key. But it requires you to control the look of the display (the reference level) in order to control the analog output.

This mode is ideal for looking at Amplitude Modulated signals, as the linear envelope effectively

Input/Output

demodulates the signal.

Key Path:	Input/Output, Output Config, Analog Out
Example:	OUTP:ANAL LINV
Dependencies:	<p>Because the Linear Video output uses one of the two IF processing channels, only one detector is available while Linear Video is selected. All active traces will change to use the same detector as the selected trace when Log Video is activated.</p> <p>Linear Video output is not available while any EMI Detector is selected (Quasi Peak, RMS Average or EMI Average), because these detectors use both IF processing channels. Consequently, if the user chooses an EMI Detector, there will be no Linear Video output.</p> <p>The output holds at its last value during an alignment and during a marker count and during retrace (after a sweep and before the next sweep starts).</p> <p>This function depends on optional capability; the key will be blanked and the command will generate an “Option not available” error unless you have Option YAV licensed in your instrument.</p>
Couplings:	Linear Video output changes while in FFT Sweeps, so for measurements that use exclusively FFT Sweeps, or if the user manually chooses FFT Sweeps, the Linear Video output will look different than it does in swept mode.
Readback Text:	Linear Video
Initial S/W Revision:	A.04.00
Help Map ID:	3147

Demod Audio

Selects the analog output to be the demodulation of the video signal.

When Demod Audio is selected, the demodulated audio signal appears at this output whenever the Analog Demod application is demodulating a signal.

When Analog Out is in the Auto state, this output is auto-selected when in the Analog Demod mode.

If any other Analog Output is manually selected when in the Analog Demod mode, a condition warning message appears.

Key Path:	Input/Output, Output Config, Analog Out
Example:	OUTP:ANAL DAUD

Dependencies:	<p>This key only appears if the Analog Demod application (N9063A), the N6141A or W6141A application, or Option EMC is installed and licensed, otherwise the key will be blanked and the command will generate an “Option not available” error.</p> <p>The output holds at its last value during an alignment and during a marker count. It is not held between sweeps, in order for Tune and Listen to work properly.</p> <p>When Demod Audio is the selected Analog Output:</p> <ul style="list-style-type: none"> • all active traces are forced to use the same detector. • CISPR detectors (QPD, EMI Avg, RMS Avg) are unavailable
Readback Text:	Demod Audio
Initial S/W Revision:	Prior to A.02.00 (this was the default functionality, and there was no selection)
Modified at S/W Revision:	A.04.00
Help Map ID:	3148

Digital Bus

This menu allows you to configure the LVDS connector located on the rear panel of the instrument. It is a unidirectional link of real time data at a 90 MSa/s rate. The ADC is sampling a 22.5 MHz IF.

The data that appears on this port is raw, uncorrected ADC samples, unless you have option RTL. With option RTL, you get fully corrected I/Q data.

This connector will only be active when the Narrowband IF Path is currently in use.

Key Path:	Input/Output, Output Config, Digital Out
Initial S/W Revision:	A.04.00
Help Map ID:	3559

Marker

See “Marker Control Mode” on page 581.

See “Setting the Marker X-axis Value” on page 581.

See “Setting the Marker X Position in Trace Points” on page 582.

See “Setting the Marker Y-axis Value” on page 583.

The Marker key accesses the Marker menu. A marker can be placed on a trace to allow the value of the trace at the marker point to be determined precisely. The functions in this menu include a 1-of-N selection of the control mode Normal, Delta, Fixed, or Off for the selected marker. If the selected marker is Off, pressing Marker sets it to Normal and places it at the center of the screen on the trace determined by the Marker Trace rules.

Markers may also be used in pairs to read the difference (or delta) between two data points. They can be used in Marker Functions to do advanced data processing, or to specify operating points in functions like Signal Track and N dB Points.

The SCPI command in the table below selects the marker and sets the marker control mode as described under **Normal**, **Delta**, **Fixed** and **Off**, below. All interactions and dependencies detailed under the key description are enforced when the remote command is sent.

Remote Command:	:CALCulate:MARKer [1] 2 3 4 5 6 7 8 9 10 11 12 :MODE POSITION DELTA FIXED OFF :CALCulate:MARKer [1] 2 3 4 5 6 7 8 9 10 11 12 :MODE?
Preset:	OFF (all markers)
State Saved:	The marker control mode is saved in instrument state
Backwards Compatibility SCPI:	:CALCulate:MARKer[1] 2 3 4 5 6 7 8 9 10 11 12:MODE SPAN BAND These parameters are aliased to POSition if sent. A query does not reflect them.
Initial S/W Revision:	Prior to A.02.00
Help Map ID:	3149

Marker Control Mode

Setting the Marker X-axis Value

The command below sets the marker X-axis value in the current marker X-axis scale unit. In each case the marker that is addressed becomes the selected marker. It has no effect (other than to cause the marker to become selected) if the control mode is **Off**, **but** it is the SCPI equivalent of entering an X value if the

Marker

control mode is **Normal**, **Delta**, or **Fixed**.

Remote Command:	:CALCulate:MARKer [1] 2 3 4 5 6 7 8 9 10 11 12 :X <freq> :CALCulate:MARKer [1] 2 3 4 5 6 7 8 9 10 11 12 :X?
Notes:	<p>If no suffix is sent it will use the fundamental units for the current marker X-axis scale. If a suffix is sent that does not match the current marker X-axis scale unit, an invalid suffix error is generated.</p> <p>If the specified marker is Fixed and a Marker Function is on, a message is generated. If the key is pressed, an advisory message is generated. If the equivalent SCPI command is sent, this same message is generated as part of a “-221, Settings conflict” warning.</p> <p>The query returns the marker’s absolute X-axis value if the control mode is Normal or Fixed. It returns the offset from the marker’s reference marker if the control mode is Delta. The query is returned in the fundamental units for the current marker X-axis scale: Hz for Frequency and Inverse Time, seconds for Period and Time. If the marker is Off the response is not a number.</p>
Preset:	After a preset, if X is queried with no value sent first, the center of screen value is returned.
Min:	- ∞ (minus infinity)
Max:	+ ∞ (plus infinity). X-Series marker values are not limited and do not clip
Default Unit:	Determined by X-axis scale
Backwards Compatibility SCPI:	:CALCulate:MARKer[1] 2 3 4:X:CENTer
Initial S/W Revision:	Prior to A.02.00
Help Map ID:	3150

Setting the Marker X Position in Trace Points

The command below sets the marker X position in trace points. It has no effect if the marker control mode is **Off**. But it is the SCPI equivalent of entering a value if the control mode is **Normal** or **Delta** or **Fixed** – except the setting is in trace points rather than X-axis scale units.

NOTE The entered value in Trace Points is immediately translated into the current X-axis scale units for setting the value of the marker. The marker’s value in X-axis scale Units, NOT trace points, are preserved if a change is made to the X-axis scale settings. Thus, if you use this command to place a marker on bucket 500, which happens at that time to correspond to 13 GHz, and then you change the Start Frequency so that bucket 500 is no longer 13 GHz, the marker will stay at 13 GHz, NOT at bucket 500.

Remote Command:	:CALCulate:MARKer [1] 2 3 4 5 6 7 8 9 10 11 12 :X:POSition <real> :CALCulate:MARKer [1] 2 3 4 5 6 7 8 9 10 11 12 :X:POSition?
Notes:	If the specified marker is Fixed and a Marker Function is on, a message is generated. If the key is pressed, an advisory message is generated. If the equivalent SCPI command is sent, this same message is generated as part of a “-221, Settings conflict” warning. The query returns the marker’s absolute X-axis value in trace points if the control mode is Normal or Fixed . It returns the offset from the marker’s reference marker in trace points if the control mode is Delta . The value is returned as a real number, not an integer, corresponding to the translation from X-axis scale units to trace points
Preset:	After a preset, if X is queried with no value sent first, the center of screen value is returned. So if per default, the number of Trace points is 1001, the center value is 500.
Min:	0
Max:	Number of trace points – 1
Default Unit:	unitless
Backwards Compatibility SCPI:	:CALCulate:MARKer[1] 2 3 4:X:POSition:CENTer
Backwards Compatibility SCPI:	The legacy command, :CALCulate:MARKer[n]:X:POSition:CENTer <param> was used to control the center point between the Delta and Reference marker in trace points (buckets) in Span Pair mode. In the new system, this is equivalent to simply setting the marker position in trace points. So this command is aliased to the command :CALCulate:MARKer[n]:X:POSition <param> <hr/> NOTE The UP/DOWN parameters will increment/decrement by one bucket. This will require a conversion to buckets and back. <hr/>
Initial S/W Revision:	Prior to A.02.00
Help Map ID:	3151

Setting the Marker Y-axis Value

The command below selects the marker and sets the marker Y-axis value; the default unit is the current

Marker

Y-axis unit. It has no effect (other than selecting the marker) unless the marker control mode is **Fixed**.

Remote Command:	:CALCulate:MARKer [1] 2 3 4 5 6 7 8 9 10 11 12 :Y <real> :CALCulate:MARKer [1] 2 3 4 5 6 7 8 9 10 11 12 :Y?
Example:	CALC:MARK2:MODE POS turns on marker 2 as a normal marker. CALC:MARK2:X 20 GHZ moves marker 2 to 20 GHz if X-axis scale is Frequency. If X-axis scale is Time, the -131 invalid suffix error is generated.
Preset:	Trace value at center of screen. There is no way to predict what this will be after a preset.
Min:	- ∞ (minus infinity)
Max:	+ ∞ (plus infinity)
Initial S/W Revision:	Prior to A.02.00
Help Map ID:	3152

Select Marker

Specifies the selected marker. The term “selected marker” is used throughout this document to specify which marker is affected by the functions.

Key Path	Marker
Notes	The selected marker is remembered even when not in the Marker menu and is used if a Search is done or a Band Function is turned on or for Signal Track or Continuous Peak.
Preset	Marker 1
State Saved	The number of the selected marker is saved in instrument state.
Initial S/W Revision	Prior to A.02.00
Help Map ID	3153

Normal

Sets the control mode for the selected marker to **Normal** and turns on the active function for setting its value. If the selected marker was **Off**, it is placed at the center of the screen on the trace specified by the marker’s Trace attribute.

A Normal mode (POSition type) marker can be moved to any point on the X-axis by specifying its X-axis value. Its absolute Y-axis value is then the value of the trace point at that X-axis value.

Key Path	Marker
Example	:CALC:MARK:MODE POS sets Marker 1 to Normal.
Notes	See the description under the “Marker” key, above.

Couplings	<ul style="list-style-type: none"> The marker addressed by this command becomes the selected marker on the front panel.
State Saved	The marker control mode (Normal, Delta, Fixed, Off) and X-axis value are saved in instrument state.
Initial S/W Revision	Prior to A.02.00
Help Map ID	3154

Delta

Sets the control mode for the selected marker to Delta and turns on the active function for setting its delta value. If the selected marker was **Off**, it is placed at the center of the screen on the trace specified by the marker's Trace attribute.

In Delta mode the marker result shows the relative result between the selected (Delta) marker and its reference marker. A delta marker can be moved to any point on the X-axis by specifying its X-axis offset from a reference marker. Its absolute Y-axis value is then the value of the trace point at that X-axis value.

Key Path	Marker
Example	:CALC:MARK:MODE DELT sets marker 1 to Delta.
Notes	See the description under the "Marker" key, above.
State Saved	The marker control mode (Normal, Delta, Fixed, Off) and X-axis value are saved in instrument state
Initial S/W Revision	Prior to A.02.00
Help Map ID	3155

Fixed

See ["Fixed Marker X-axis Value"](#) on page 586.

See ["Fixed Marker Y-axis Value"](#) on page 586.

Sets the control mode for the selected marker to Fixed. A fixed marker is fixed in the sense that it stays where you place it. It can be directly moved in both X and Y. It can be moved with a Peak Search. It can also be indirectly moved by re-zeroing the delta if it is a relative marker. If it is moved, it again becomes fixed at the X-axis point it moved to and it has a Y-axis result that it took on when it moved there. If a Normal or Delta marker is changed to Fixed it becomes fixed at the X-axis point it was at, and with the Y-axis result it had when it was set to Fixed.

In Fixed mode the marker result shows:

- If no Marker Function is on, the absolute X-axis and Y axis value of the marker
- If a Marker Function is on, the X-axis value and the Y-axis function result the marker had when it became fixed.

Marker

Fixed Marker X-axis Value

Key Path	Marker, Fixed
Example	:CALC:MARK:MODE FIX sets Marker 1 to Fixed.
Notes	See the description under the “Marker” key, above.
Dependencies	<p>You cannot directly set the X or Y value of a Fixed marker which has a marker function turned on. If an attempt is made to actually adjust it while a Marker Function is on, a message is generated. If the key is pressed, an advisory message is generated. If the equivalent SCPI command is sent, this same message is generated as part of a “–221, Settings conflict” warning.</p> <p>you cannot directly set the Y value of a Fixed marker while Normalize is turned on. If an attempt is made to do so while Normalize is on, a message is generated. If the key is pressed, an advisory message is generated. If the equivalent SCPI command is sent, this same message is generated as part of a “–221, Settings conflict” warning.</p>
State Saved	The marker control mode (Normal, Delta, Fixed, Off) and X and Y-axis values are saved in instrument state
Initial S/W Revision	Prior to A.02.00
Help Map ID	3489

Fixed Marker Y-axis Value

Key Path	Marker, Fixed
Example	:CALC:MARK:MODE FIX sets Marker 1 to Fixed.
Notes	See the description under the Marker key, above.
Dependencies	<p>you cannot directly set the X or Y value of a Fixed marker which has a marker function turned on. If an attempt is made to actually adjust it while a Marker Function is on, a message is generated. If the key is pressed, an advisory message is generated. If the equivalent SCPI command is sent, this same message is generated as part of a “–221, Settings conflict” warning.</p>
State Saved	The marker control mode (Normal, Delta, Fixed, Off) and X and Y-axis values are saved in instrument state
Default Unit	depends on the current selected Y axis unit
Initial S/W Revision	Prior to A.02.00
Help Map ID	3157

Off

Turns off the selected marker and its marker function setting, if any. However, Off does not affect which

marker is selected.

Key Path	Marker
Example	:CALC:MARK:MODE OFF sets Marker 1 to Off.
Notes	See the description under the “Marker” key, above.
State Saved	The marker control mode (Normal, Delta, Fixed, Off) is saved in instrument state
Initial S/W Revision	Prior to A.02.00
Help Map ID	3158

Properties

Opens a menu used to set certain properties of the selected marker.

Key Path	Marker
Initial S/W Revision	Prior to A.02.00
Help Map ID	3159

Select Marker

Duplicate of the **Select Marker** key under **Marker**. Selecting a marker here causes the same marker to be selected under **Marker**. (That is, there is only one “selected marker”.)

Relative To

Selects the marker that the selected marker is relative to (its reference marker).

Every marker has another marker to which it is relative. This marker is referred to as the “reference marker” for that marker. This attribute is set by the **Marker, Properties, Relative To** key. The marker must be a **Delta** marker to make this attribute relevant. If it is a **Delta** marker, the reference marker determines how the marker is controlled and how its value is displayed. A marker cannot be relative to itself.

Key Path	Marker, Properties
Remote Command	:CALCulate:MARKer [1] 2 3 4 5 6 7 8 9 10 11 12 :REFerence <integer> :CALCulate:MARKer [1] 2 3 4 5 6 7 8 9 10 11 12 :REFerence ?
Example	CALC:MARK1:REF 2 sets the marker 1 reference marker to 2 and turns marker 1 on as a delta marker.

Marker

Notes	A marker cannot be relative to itself so that choice is grayed out. If the grayed out key is pressed, an advisory message is generated. If the equivalent SCPI command is sent, this same message is generated as part of a “–221, Settings conflict” warning. See error –221.2200 in Master Error Messages: X-Series document for exact error text.
Notes	This command causes the marker specified with the subopcode to become selected. Range (for SCPI command): 1 to 12. If the range is exceeded the value is clipped.
Couplings	The act of specifying the selected marker’s reference marker makes the selected marker a Delta marker. If the reference marker is off it is turned on in Fixed mode at the delta marker location.
Preset	The preset default “Relative To” marker (reference marker) is the next higher numbered marker (current marker +1). For example, if marker 2 is selected, then it’s default reference marker is marker 3. The exception is marker 12, which has a default reference of marker 1. Set to the defaults by using Restore Mode Defaults . This is not reset by Marker Off , All Markers Off , or Preset .
State Saved	Saved in instrument state. Not affected by Marker Off and hence not affected by Preset or power cycle.
Min	1
Max	12
Status Bits/OPC dependencies	none Default (selected when Restore Mode Defaults is pressed): next higher numbered marker or 1 if marker 12.
Initial S/W Revision	Prior to A.02.00
Help Map ID	3160

X-axis scale (formerly Readout)

Accesses a menu that enables you to affect how the X-axis information for the selected marker is displayed in the marker area (top-right of display) and the active function area of the display, and how the marker is controlled. The available settings for the X-axis scale are Frequency, Period, Time, and Inverse Time.

See “[More Information](#)” on page 589.

Key Path	Marker, Properties
----------	---------------------------

Remote Command	:CALCulate:MARKer [1] 2 3 4 5 6 7 8 9 10 11 12 :X:READout FREQUency TIME ITIME PERiod :CALCulate:MARKer [1] 2 3 4 5 6 7 8 9 10 11 12 :X:READout ? :CALCulate:MARKer [1] 2 3 4 5 6 7 8 9 10 11 12 :X:READout :AUTO ON OFF 1 0 :CALCulate:MARKer [1] 2 3 4 5 6 7 8 9 10 11 12 :X:READout :AUTO?
Example	CALC:MARK3:X:READ TIME sets the marker 3 X-axis scale to Time.
Notes	This command causes the specified marker to become selected.
Notes	This command causes the specified marker to become selected.
Preset	AUTO Marker Preset (selected when a marker is turned Off): Auto (see below). In most measurements the Auto settings results in Frequency being the preset readout.
State Saved	Saved in instrument state
Initial S/W Revision	Prior to A.02.00
Help Map ID	3161

More Information

The **X-axis scale** of a marker is the scale of its X-axis value. This affects the units displayed in the Marker Result block and used to specify the marker's X-axis location. The X-axis scale is specified using the **Marker, Properties, X-axis scale** key.

All markers in swept spans have both a time and frequency value. Which of these is used for the result display, and for positioning the marker, depends on the **X-axis scale** setting. The **X-axis scale** setting can be **Frequency** or **Time**, as well as the reciprocal of either (**Period** or **Inverse Time**). There is also an **Auto** setting - when in **Auto**, a marker's **X-axis scale** changes whenever the domain of the trace, upon which it set, changes. All choices for **X-axis scale** are allowed.

Auto

When in Auto, the X-Axis Scale is **Frequency** if the Marker Trace is a frequency domain trace, **Time** if the Marker Trace is a time domain trace. When in Auto, if the marker changes traces, or the domain of the trace the marker is on changes, the auto result is re-evaluated. If the X-axis scale is chosen manually, that Scale is used regardless of the domain of the trace.

Key Path	Marker, Properties, X-axis scale
Example	CALC:MARK2:X:READ:AUTO ON sets the marker 2 X-axis scaling to automatically select the most appropriate units.
Initial S/W Revision	Prior to A.02.00
Help Map ID	3066

Marker

Frequency

Sets the marker X-axis scale to Frequency, displaying the absolute frequency of a normal marker or the frequency of the delta marker relative to the reference marker. Frequency is the auto setting for frequency domain traces.

If Frequency is selected for a time domain trace, all of the points in the trace will show the same value. Attempting to use the knob or step keys to adjust the X-axis value of the marker or entering an X-axis value from the numeric keypad or remotely will have no effect but will generate no error.

Key Path	Marker, Properties, X-axis Scale
Example	CALC:MARK2:X:READ FREQ sets the marker 2 X-axis scale to Frequency.
Notes	1-of-N readback is Frequency
State Saved	The X-axis scale setting is saved in instrument state.
Initial S/W Revision	Prior to A.02.00
Help Map ID	3162

Period

Sets the marker X-axis scale to Period, displaying the reciprocal of the frequency of the marker, or the reciprocal of the frequency separation of the two markers in a delta-marker mode. The units are those of time (sec, msec, et cetera). If the markers are at the same frequency in a delta marker mode, the result is the reciprocal of 0, which is infinitely large. The display will show “---” and a SCPI query will return infinity.

If Period is selected for a time domain trace, all of the points in the trace will show the same value. Attempting to use the knob or step keys to adjust the X-axis value of the marker or entering an X-axis value from the numeric keypad or remotely will have no effect but will generate no error.

Key Path	Marker, Properties, X-axis Scale
Example	CALC:MARK2:X:READ PER sets the marker 2 X-axis scale to Period.
Notes	1-of-N readback is Period
State Saved	The X-axis scale setting is saved in instrument state.
Initial S/W Revision	Prior to A.02.00
Help Map ID	3163

Time

Sets the marker X-axis scale to Time, displaying the time interval between a normal marker and the start of a sweep or the time of the delta marker relative to the reference marker. Time is the auto setting for time domain traces. In a delta-marker mode it is the (sweep) time interval between the two markers.

Key Path	Marker, Properties, X Axis Scale
Example	CALC:MARK2:X:READ TIME sets the marker 2 X-axis scale to Time.

Notes	1-of-N readback is Time
Couplings	Frequency domain traces taken in FFT mode have no valid time data. Therefore when Time is selected for markers on such traces, the X-axis value is taken as the appropriate percentage of the displayed sweep time, which is a calculated estimate.
State Saved	The X-axis scale setting is saved in instrument state
Initial S/W Revision	Prior to A.02.00
Help Map ID	3164

Inverse Time

Sets the marker X-axis scale to Inverse Time, displaying the reciprocal time. It is useful in a delta mode to show the reciprocal of (sweep) time between two markers. This function is only meaningful when on a time domain trace and in the **Delta** control mode. If the markers are at the same X-axis value, the time between them is 0, so the reciprocal of sweep time is infinitely large. The display will show “---” and a SCPI query will return infinity.

Key Path	Marker, Properties, X Axis Scale
Example	:CALC:MARK2:X:READ ITIM sets the marker 2 X-axis scale to Inverse Time.
Notes	1-of-N readback is Inverse Time
Couplings	Frequency domain traces taken in FFT mode have no valid time data. Therefore when Inverse Time is selected for markers on such traces, the X-axis value is undefined, shows as “---” and returns not a number to a query.
State Saved	The X-axis scale setting is saved in instrument state
Initial S/W Revision	Prior to A.02.00
Help Map ID	3165

Marker Trace

Selects the trace that you want your marker to be placed on. A marker is associated with one and only one trace. This trace is used to determine the placement, result, and X-axis scale of the marker. All markers have an associated trace, even **Fixed** markers; it is from that trace that they determine their attributes and behaviors, and it is to that trace that they go when they become Normal or Delta markers.

See [“Auto Init On” on page 592](#).

See [“Auto Init Rules Flowchart” on page 593](#).

See [“Auto Init OFF” on page 593](#).

Key Path	Marker, Properties
----------	---------------------------

Marker

Remote Command	:CALCulate:MARKer [1] 2 3 4 5 6 7 8 9 10 11 12 :TRACe 1 2 3 4 5 6 :CALCulate:MARKer [1] 2 3 4 5 6 7 8 9 10 11 12 :TRACe?
Example	CALC:MARK1:TRAC 2 places marker 1 on trace 2.
Notes	A marker may be placed on a blanked and/or inactive trace, even though the trace is not visible and/or updating. An application may register a trace name to be displayed on the key instead of a trace number.
Couplings	The state of Marker Trace is not affected by the Auto Couple key. If a Marker Trace is chosen manually, Auto Init goes to Off for that marker. Sending the remote command causes the addressed marker to become selected.
Preset	Presets on Preset or All Markers Off
State Saved	The Marker Trace and state of Auto Init for each marker is saved in instrument state.
Min	1
Max	6
Readback line	[TraceN, Auto Init] or [TraceN, Manual] where N is the trace number to which the marker is currently assigned.
Initial S/W Revision	Prior to A.02.00
Help Map ID	3166

Auto Init On

When **Auto Init** is true, the marker's trace attribute is re-determined automatically by the test set whenever the marker turns on (Normal, Delta or Fixed) from an Off state. (The trace attribute is also determined for all markers that are on, whenever **Auto Init** is turned on).

When the marker moves between traces the marker's X position in trace points is retained as it moves. For moving between active traces this generally means the x-axis value of the marker will not change. But for moving to or from an inactive trace, the x-axis value will take on that of the new trace at the bucket the marker was on the old trace (and is still on, on the new trace, since the bucket doesn't change).

Note this is true even if the marker is off screen. Thus, a marker that is at the center of the screen on the old trace stays at the center of the screen on the new trace. A marker that is off screen one whole screen to the left on the old trace remains off screen one whole screen to the left on the new trace – even if this means it is at negative time.

Marker Trace is set to 1, and Auto Init is set to On, on a Preset or All Markers Off.

Auto Init Rules Flowchart

Auto Init OFF

This command associates the marker with the specified trace and turns Marker Trace, Auto Init OFF for that marker. If the marker is not **Off** it moves the marker from the trace it was on to the new trace. If the marker is **Off** it stays off but is now associated with the specified trace.

The query returns the number of the trace on which the marker is currently placed, even if that marker is in Auto mode.

Remote Command:	:CALCulate:MARKer [1] 2 3 4 5 6 7 8 9 10 11 12 :TRACe:AUTO OFF ON 0 1 :CALCulate:MARKer [1] 2 3 4 5 6 7 8 9 10 11 12 :TRACe:AUTO?
Notes:	Turning Marker Trace Auto Init off has no effect on the trace on which the marker is currently placed. The response to the query is 0 if OFF, 1 if ON.
Couplings:	The state of Auto Init is not affected by the Auto Couple key. Auto Init is set to True on a Preset or All Markers Off. If Auto Init is set to On for a marker and that marker is on, that marker's Marker Trace is immediately set according to the above flowchart. Sending the remote command causes the addressed marker to become selected.
Preset:	ON
Initial S/W Revision:	Prior to A.02.00
Help Map ID:	3167

Lines

When on, displays a vertical line of graticule height and a horizontal line of graticule width, intersecting at the indicator point of the marker (that is, the center of the X or the bottom tip of the diamond. The lines are blue in color.

If the marker is off screen the lines should be extended from the marker so that they go thru the screen area if possible. This is really useful for off screen Fixed markers as it lets you see their amplitude even though they are off the X-axis.

Key Path	Marker, Properties
Remote Command	:CALCulate:MARKer [1] 2 3 4 5 6 7 8 9 10 11 12 :LINES [:STATe] OFF ON 0 1 :CALCulate:MARKer [1] 2 3 4 5 6 7 8 9 10 11 12 :LINES [:STATe] ?
Example	:CALC:MARK2:LIN:ON turns Lines on for marker 2.

Marker

Couplings	Sending the remote command causes the addressed marker to become selected.
Preset	OFF
State Saved	Saved in State
Initial S/W Revision	Prior to A.02.00
Help Map ID	3168

Marker Table

When set to On the display is split into a measurement window and a marker data display window. For each marker which is on, information is displayed in the data display window, which includes the marker number, control mode, trace number, X axis scale, X axis value, and the Y-axis result. Additional information is shown for markers which have marker functions turned on.

Turning the Marker Table on turns the Peak Table off and vice versa.

Key Path	Marker
Remote Command	:CALCulate:MARKer:TABLE[:STATe] OFF ON 0 1 :CALCulate:MARKer:TABLE[:STATe] ?
Example	CALC:MARK:TABL ON turns on the marker table.
Preset	OFF
State Saved	Whether the marker table is on is saved in instrument state
Initial S/W Revision	Prior to A.02.00
Help Map ID	3169

Marker Count

Accesses the marker count menu.

Key Path	Marker
Readback line	[On] if count on for the selected marker, [Off] if it is off.
Initial S/W Revision	Prior to A.02.00
Help Map ID	3170

Counter On/Off

Turns the marker frequency counter on and off. The selected marker is counted, and if the selected marker is a delta marker and its reference marker is not fixed, the reference marker is counted as well.

See [“Understanding the Marker Counter”](#) on page 596.

See “Query Count Value” on page 596.

Key Path	Marker Function, Marker Count
Remote Command	:CALCulate:MARKer [1] 2 3 4 5 6 7 8 9 10 11 12 :FCOunt [:S TATe] OFF ON 0 1 :CALCulate:MARKer [1] 2 3 4 5 6 7 8 9 10 11 12 :FCOunt [:S TATe] ?
Example	CALC:MARK2:FCO ON selects marker 2, turns it on, and turns on the counter CALC:MARK2:FCO:X? returns the counted frequency.
Notes	<p>Fixed markers are not counted, but a Fixed marker will have a count stored in it if it is selected or is the reference marker for the selected marker. The count already in the marker is stored when the marker becomes fixed and if there is none or the marker moves (for example, Pk Search) it is counted and stored after the next sweep.</p> <p>If a Fixed marker has a count stored in it, that count is displayed when the marker is selected, and used as the reference count when that marker is a reference marker.</p> <p>If a Fixed marker has a count stored in it, that count is deleted if the marker X is adjusted.</p> <p>If a Fixed marker has a count stored in it, and a Search function is performed using the Fixed marker, while the counter is on, the count stored in the marker is updated.</p> <p>If a Fixed marker has a count stored in it, and is a reference marker, and the reference is moved to a valid trace point by re-zeroing the delta (by pressing Delta again or sending the DELTA SCPI command), while the counter is on, the count stored in the marker is updated.</p>
Notes	This command causes the specified marker to become selected.
Dependencies	Marker Count is unavailable (grayed out and Off) if the Gate function is on.
Couplings	<p>If the selected marker is Off when the counter is turned on, the selected marker is set to Normal and placed at center of screen on the trace determined by the Marker Trace rules.</p> <p>If a marker which is OFF is selected while the counter is on, the counter remains on, but since the marker is off, the count is undefined. In this case, the test set returns "not a number" to a SCPI count query.</p> <p>The counter is turned OFF when the selected marker is turned OFF.</p>
Preset	OFF
State Saved	The state of the counter (on/off) is saved in instrument state. In the case of Fixed markers, the count stored in the marker is saved in instrument state.
Initial S/W Revision	Prior to A.02.00
Help Map ID	3171

Marker

Query Count Value

Queries the frequency count. The query returns the absolute count unless the specified marker is in Delta mode, then it returns the relative count. If the marker is off, or the marker is on but the counter is off, the test set will return "not a number" to a SCPI count query. A marker with no stored count, or a non-**Fixed** marker on a stored trace, will also return not a number to a SCPI count query. Note this result may simply mean that the first sweep after the counter turned on has not yet completed.

Remote Command:	:CALCulate:MARKer [1] 2 3 4 5 6 7 8 9 10 11 12 :FCOUNT :X?
Notes:	This query does NOT cause the specified marker to become selected.
Initial S/W Revision:	Prior to A.02.00
Help Map ID:	0

Understanding the Marker Counter

See [“Counting Off-screen Markers”](#) on page 596.

See [“Delta Marker”](#) on page 596.

See [“Fixed Markers”](#) on page 597.

See [“More Information on "Counter"”](#) on page 597.

Using the internal counter we can count the frequency of a marker, but we cannot count while we are actually sweeping. So, once we are done with a sweep, we move to the selected marker frequency and count that frequency. Then, if the marker is a Delta marker, the count is also taken for its reference marker. The count is actually performed by moving the LO to the frequency (or frequencies in the case of a delta marker) we wish to count. The count is executed on a marker by marker basis and no further count is taken until after the next sweep (even if the marker moves before another sweep has completed).

The Marker Count is taken by tuning the test set to the frequency of the marker and counting the IF, with the test set not sweeping. The count is adjusted for display by adding or subtracting it (as appropriate) from the LO frequency, so that you see a count that represents the signal frequency. This is true even if External Mixing is on. Since all this happens between sweeps, you never see the test set retuning to do the counts.

If you wish to see the entered frequency of a counted marker it will appear in the active function area when that marker is selected (for Fixed markers, you have to press the Marker, Fixed key to select Fixed markers and then press it a second time to view or adjust the x or y marker values).

Counting Off-screen Markers

If the selected marker is off the X-axis the test set can still be tuned to the marker (unless it is outside the range of the test set), so the count can still be displayed. This means you can see a count for an off-screen marker even though there may be no valid Y-value for the marker. If the marker frequency is outside the range of the test set, the display will show three dashes in the count block (---), and not a number is returned to a SCPI count query.

Delta Marker

When a Delta Marker is selected while Marker Count is on:

If the reference marker is not a fixed marker, the display shows the difference between the count of the selected marker and the count of the reference marker

If the reference marker is a fixed marker and there is a count stored in the marker (because Marker Count was on when the marker became a fixed marker), the display shows the difference between the count at the marker and the count stored in the reference marker.

Marker Count works in zero span as well as in Swept analysis. The test set tunes to the frequency of the selected marker, which, for active zero span traces, is simply the center frequency of the test set.

Fixed Markers

Fixed markers have a count stored in them that is generally kept fixed and not updated. If a fixed marker is selected, or used as a reference, the signal at the marker frequency is not counted; rather the stored count is seen or used as the reference. The count is stored, if Count is on, when the marker becomes fixed or when, while fixed, the marker is moved by re-zeroing the reference (if it is the reference marker) or via a peak search (since both of these, by definition, use valid trace data). The count stored in a Fixed marker is lost if the counter is turned off, if the marker is moved to an inactive trace, or if the marker is moved by adjusting its x-value.

More Information on "Counter"

When the counter is on, the count (or the delta count) for the selected marker is displayed.

The invalid data indicator (*) will turn on until the completion of the first count.

Marker Count frequency readings are corrected using the **Freq Offset** function. Note however that Marker Delta readings are not corrected, as any offset would be applied to both.

In zero span on active traces the counter continues to function, counting any signal near the center frequency of the test set.

NOTE	No signal farther from the marker frequency than the Res BW is seen by the counter.
-------------	---

The above command turns on or off the frequency counter. If the specified marker number in the command is not the selected marker, it becomes the selected marker. If the specified marker number is not on, FCOunt ON sets it to Normal and places it at center of screen on the trace determined by the Marker Trace rules. Once the marker count is on, it is on for any selected marker, not just for the one used in the command. A 1 is returned to the state query only if marker count is on and the specified number is the selected marker. The invalid data indicator (*) will turn on until the completion of the first count but this does not keep a value from being returned.

Gate Time Auto/Man

Controls the length of time during which the frequency counter measures the signal frequency. Longer gate times allow for greater averaging of signals whose frequency is “noisy”, though the measurement takes longer. If the gate time is an integer multiple of the length of a power-line cycle (20 ms for 50 Hz power, 16.67 ms for 60 Hz power), the counter rejects incidental modulation at the power line rate. The shortest gate time that rejects both 50 and 60 Hz modulation is 100 ms, which is the value chosen in Auto, or on Preset or when Auto Couple is pressed.

Marker

The start time of the Gate Time of the counter must be controlled by the same trigger parameters as controls the sweep. Thus, if the Trigger is not in Free Run, the counter gate must not start until after the trigger is received and delayed.

Key Path	Marker Function, Marker Count
Remote Command	:CALCulate:MARKer [1] 2 3 4 5 6 7 8 9 10 11 12 :FCOunt :GATetime <time> :CALCulate:MARKer [1] 2 3 4 5 6 7 8 9 10 11 12 :FCOunt :GATetime? :CALCulate:MARKer [1] 2 3 4 5 6 7 8 9 10 11 12 :FCOunt :GATetime:AUTO OFF ON 0 1 :CALCulate:MARKer [1] 2 3 4 5 6 7 8 9 10 11 12 :FCOunt :GATetime:AUTO?
Example	:CALC:MARK2:FCO:GAT 1e-2 sets the gate time for Marker 2 to $10^{(-2)}$ s = 10 ms.
Notes	When Auto Couple is pressed, Gate Time is set to 100 ms.
Notes	This command causes the specified marker to become selected.
Preset	100 ms ON
State Saved	Saved in instrument state.
Min	1 us
Max	500 ms
Initial S/W Revision	Prior to A.02.00
Help Map ID	3173

Couple Markers

When this function is true, moving any marker causes an equal X-axis movement of every other marker which is not Fixed or Off. By “equal X-axis movement” we mean that we preserve the difference between each marker’s X-axis value (in the fundamental x-axis units of the trace that marker is on) and the X-axis value of the marker being moved (in the same fundamental x-axis units).

Note that Fixed markers do not couple. They stay where they were while all the other markers move. Of course, if a Fixed marker is being moved, all the non-fixed markers do move with it.

This may result in markers going off screen.

Key Path	Marker
Remote Command	:CALCulate:MARKer:COUPle [:STATe] OFF ON 0 1 :CALCulate:MARKer:COUPle [:STATe] ?
Example	:CALC:MARK:COUP ON sets Couple Markers on.

Preset	Off, presets on Mode Preset and All Markers Off
State Saved	Saved in State
Initial S/W Revision	Prior to A.02.00
Help Map ID	3174

All Markers Off

Turns off all markers. See Marker, “Off” on page 586.

Key Path	Marker
Remote Command	:CALCulate:MARKer:AOff
Example	CALC:MARK:AOff turns off all markers.
Couplings	sets the selected marker to 1.
Preset	n/a.
Initial S/W Revision	Prior to A.02.00
Help Map ID	3175

Marker

Marker Function

The Marker Function key opens up a menu of softkeys that allow you to control the Marker Functions of the instrument. Marker Functions perform post-processing operations on marker data. Band Functions are Marker Functions that allow you to define a band of frequencies around the marker. The band defines the region of data used for the numerical calculations. These marker functions also allow you to perform mathematical calculations on trace and marker data and report the results of these calculations in place of the normal marker result.

NOTE Unlike regular markers, marker function markers are not placed directly on the trace. They are placed at a location which is relative to the result of the function calculation.

See [“More Information”](#) on page 601.

See [“Fixed marker functions”](#) on page 602.

See [“Interval Markers”](#) on page 602.

Remote Command	:CALCulate:MARKer [1] 2 3 4 5 6 7 8 9 10 11 12 :FUNCTION NOISE BPOWER BDENSITY OFF :CALCulate:MARKer [1] 2 3 4 5 6 7 8 9 10 11 12 :FUNCTION?
Notes	Sending this command selects the subcoded marker The marker function result is queried in the same fashion as the Marker Result, as outlined in the Marker section, with the CALC:MARK:Y? command.
Dependencies	Fixed markers: It is not possible to change the Band Function for a Fixed marker; so all of the Band Function keys are grayed out for a Fixed marker. If a marker function was already on when the marker became Fixed then the selected Band Function is shown but cannot be changed. Therefore, you cannot directly set the X or Y value of a Fixed marker which has a marker function turned on. To turn off the function, turn off the marker.
Preset	OFF
State Saved	The band function for each marker is saved in Instrument State
Initial S/W Revision	Prior to A.02.00
Help Map ID	3180

More Information

The units to be used for displaying Marker Function results in Delta mode vary depending on what is the reference marker and what it is referenced to.

Marker Functions are different from Measurements, which automatically perform complex sequences of

Marker Function

setup, data acquisition, and display operations in order to measure specified signal characteristics. Marker Functions are specified for each individual marker and may be turned on individually for each marker.

The **Marker Fctn** menu controls which marker functions are turned on and allows you to adjust setup parameters for each function. The Marker Functions are **Marker Noise**, **Band/Interval Power**, and **Band/Interval Density**, only one of which can be on for a given marker.

If the selected marker is off, pressing Marker Fctn sets it to Normal and places it at the center of the display on the trace determined by the Marker Trace rules. However, if the selected marker was **Off**, **Marker Function Off** had to be the selected function, and it remains so even after the marker is thus turned on, although you may then change it.

Fixed marker functions

In the case of a fixed marker, it is not possible to turn on or change a band function. This is because a Fixed marker holds the value it had when it became fixed; the trace it was on may keep on changing, so the function value, which depends on trace data, could not be calculated on an ongoing basis.

It is possible to have a Marker Function on for a Fixed marker, in the case where a function was already on when the marker became Fixed. In this case the function value will be retained in the marker. It is also possible to have a Marker Function on for a Fixed marker in the case when the marker was off and was turned on as **Fixed** because **Delta** was pressed to create a reference marker - in which case the marker function, marker function width, Y Axis value and marker function result that the **Delta** marker had when **Delta** was pressed are copied into the Fixed marker. If **Delta** is pressed again, causing the fixed reference marker to move to the delta marker's position, the marker function, marker function width, Y Axis value and marker function result that the **Delta** marker had when **Delta** was pressed are again copied into the fixed reference marker.

If a Marker Function is on for a Fixed marker, the marker's reported value is derived by the function. Therefore you cannot directly set the X or Y value of a Fixed marker which has a marker function turned on. Indirect setting as detailed above or when a Peak Search is performed is allowed, as the Fixed marker is always placed on a trace and can derive its function value from the trace at the moment when it is placed.

Interval Markers

What is an interval marker? The band power marker computes the total power within a span in a nonzero span. The results computation must include the RBW. The interval power marker measures the average power across some time interval in zero span.

Interval Density is defined to be Interval Power divided by Bn. Bn is the noise bandwidth of the RBW filter, as noted and used within the Band Power computation.

Select Marker

See ["Select Marker" on page 584](#).

Marker Noise

Turns on the Marker Noise function for the selected marker, making it a noise marker. If the selected marker is off, it is turned on in **Normal** mode and located at the center of the screen.

When **Marker Noise** is selected while in the **Marker Function Off** state, the **Band Span** or **Interval Span** is initialized to 5% of the screen width.

When **Marker Noise** is on, the marker's Y Axis Result is the average noise level, normalized to a 1 Hz noise power bandwidth, in the band specified under the **Band Adjust** key.

See [“More Information” on page 603](#).

See [“Off-trace Markers” on page 603](#).

Key Path	Marker Function
Example	<p>CALC:MARK:FUNC NOIS turns on marker 1 as a noise marker.</p> <p>CALC:MARK:FUNC? returns the current marker function for the marker specified. In this case it returns the string: NOIS.</p> <p>CALC:MARK:Y? returns the y-axis value of the Marker Noise function for marker 1 (if Marker Noise is ON for marker 1). Note that the delta value when the Y axis unit is Watt is the square of the delta value when the Y axis unit is Volt. For example, when the percent ratio with Y axis unit in Volt is 0.2, the percent ratio with Y axis unit in Watt will be $0.2^2 = 0.04$. When you read the value out remotely you have to know whether your Y Axis Unit is log (dB), linear (V or A), or power (W).</p>
Notes	See the description under the ““Marker Function” on page 601” key.
Dependencies	Fixed markers: It is not possible to change the Band Function for a Fixed marker; so all of the Band Function keys are grayed out for a Fixed marker.
Couplings	<p>Average detector and Power Averaging auto selected when Marker Noise on</p> <p>If the selected (specified) marker is off, selecting Marker Noise via front panel or SCPI will turn the marker on.</p>
Initial S/W Revision	Prior to A.02.00
Help Map ID	3181

More Information

To guarantee accurate data for noise-like signals, a correction for equivalent noise bandwidth is made by the test set. The **Marker Noise** function accuracy is best when the detector is set to Average or Sample, because neither of these detectors will peak-bias the noise. The trade off between sweep time and variance of the result is best when Average Type is set to Power Averaging. Therefore, Auto coupling chooses the Average detector and Power Averaging when Marker Noise is on. Though the Marker Noise function works with all settings of detector and Average Type, using the positive or negative peak detector gives less accurate measurement results.

Off-trace Markers

If a **Normal** or **Delta** noise marker is so near to the left or right edge of the trace that some of the band is off the trace, then it uses only that subset of the Band Width that is on-trace. If the marker itself is off-trace, its value becomes undefined.

Neither band/interval power nor band/interval density markers are defined if any part of the band is

Marker Function

off-trace (unless they are Fixed with a stored function value in them), except that when the edges of the bandwidth are trivially off-screen, due to mathematical limitations in the test set or in the controlling computer, the result will still be considered valid.

Band/Interval Power

Turns on the Band/Interval Power function for the selected marker. If the selected marker is off it is turned on in **Normal** marker and located at the center of the screen.

When **Band/Interval Power** is selected while in the **Marker Function Off** state, the **Band Span** or **Interval Span** is initialized to 5% of the screen width.

If the detector mode for the detector on the marker's trace is set to Auto, the average detector is selected. If the Average type is set to Auto, Power Averaging is selected. Other choices for the detector or Average type will usually cause measurement inaccuracy.

Key Path	Marker Function
Example	<p>CALC:MARK:FUNC BPOW turns on marker 1 as a band power marker.</p> <p>CALC:MARK2:FUNC? returns the current setting of marker function for marker 2. In this case it returns the string: BPOW.</p> <p>CALC:MARK:Y? returns the y-axis value of the Band Power function for marker 1. Note that the delta value when the Y axis unit is Watt is the square of the delta value when the Y axis unit is Volt. For example, when the percent ratio with Y axis unit in Volt is 0.2, the percent ratio with Y axis unit in Watt will be $0.2^2 = 0.04$. When you read the value out remotely you have to know whether your Y Axis Unit is log (dB), linear (V or A), or power (W).</p>
Notes	See the description under the ““Marker Function” on page 601” key, above.
Dependencies	Fixed markers: It is not possible to change the Band Function for a Fixed marker; so all of the Band Function keys are grayed out for a Fixed marker.
Couplings	<p>If the detector mode for the detector on the marker's trace is set to Auto, the average detector is selected. If the Average type is set to Auto, Power Averaging is selected.</p> <p>If the selected (specified) marker is off, selecting Band Power via front panel or SCPI will turn the marker on.</p>
Initial S/W Revision	Prior to A.02.00
Help Map ID	3182

Band/Interval Density

Turns on the Band/Interval Density function for the selected marker. If the selected marker is off it is turned on in **Normal** marker mode and located at the center of the screen.

When **Band/Interval Density** is selected while in the **Marker Function Off** state, the **Band Span** or **Interval Span** is initialized to 5% of the screen width.

See [“More Information” on page 605](#).

See “What is band/interval density?” on page 605

Key Path	Marker Function
Example	<p>CALC:MARK:FUNC BDEN turns on marker 1 as a band density marker.</p> <p>CALC:MARK:FUNC? returns the current setting of band function for the marker specified. In this case it returns the string: BDEN.</p> <p>CALC:MARK:Y? returns the y-axis value of the Band Density function for marker 1. Note that the delta value when the Y axis unit is Watt is the square of the delta value when the Y axis unit is Volt. For example, when the percent ratio with Y axis unit in Volt is 0.2, the percent ratio with Y axis unit in Watt will be $0.2^2 = 0.04$. When you read the value out remotely you have to know whether your Y Axis Unit is log (dB), linear (V or A), or power (W).</p>
Notes	<p>The zero-width case is treated as one bucket wide although it shows a width of 0.</p> <p>When the trace the marker is on crosses domains, the width crosses domains as well, to remain the same percentage of the trace</p>
Notes	See the description under the ““Marker Function” on page 601” key, above.
Dependencies	Fixed markers: It is not possible to change the Band Function for a Fixed marker; so all of the Band Function keys are grayed out for a Fixed marker.
Couplings	<p>If the detector mode for the detector on the marker’s trace is set to Auto, the average detector is selected. If the Average type is set to Auto, Power Averaging is selected.</p> <p>If the selected (specified) marker is off, selecting Band Density via front panel or SCPI will turn the marker on.</p>
State Saved	n/a.
Initial S/W Revision	Prior to A.02.00
Help Map ID	3183

More Information

It may seem like the band density marker function is exactly like a function of a noise marker with variable width. But they are somewhat different. The Noise markers assume that the signal to be measured is noise-like. Based on this assumption, we can actually make reasonable measurements under very nonideal conditions: any detector may be used, any averaging type, any VBW. In contrast, the Band Power and Band Density markers make no assumption about the statistics of the signal.

If the detector mode for the detector on the marker’s trace is set to Auto, the average detector is selected. If the Average type is set to Auto, Power Averaging is selected. Other choices for the detector or Average type will usually cause measurement inaccuracy.

What is band/interval density?

On frequency domain traces, the average density across a band is the total band power divided by the bandwidth over which it is measured.

Marker Function

On time domain traces, interval density is the average power in the interval divided by the noise bandwidth of the RBW of the trace.

Marker Function Off

Turns off band functions for the selected marker.

Key Path	Marker Function
Example	:CALC:MARK:FUNC OFF turns off marker functions for marker 1
Notes	See the description under the “Marker” on page 581 key, above.
Dependencies	Fixed markers: It is not possible to change the Band Function for a Fixed marker; so all of the Band Function keys are grayed out for a Fixed marker, including Off
Couplings	Turning off the marker function has no effect on the band span nor does it turn the marker off.
Initial S/W Revision	Prior to A.02.00
Help Map ID	3184

Band Adjust

Opens a menu that lets you set the width or left or right edges of the band.

It is legal to change the width of the band even if there is no marker function on. Generally this can only happen by sending the SCPI command since access to the menu is restricted if no marker function is on.

Key Path	Marker Function
Dependencies	If the marker is Fixed, Band Adjust is grayed out. If the marker function is Off, Band Adjust is grayed out.
Couplings	If any of the Band Adjust functions are the active function, the wings and arms of the selected marker display in green; otherwise they display in white.
Initial S/W Revision	Prior to A.02.00
Help Map ID	3185

Band/Interval Span

Sets the width of the span for the selected marker.

It is legal to change the width of the band even if there is no marker function on. Generally this can only happen by sending the SCPI command since access to the menu is restricted if no marker function is on.

In the table below, $\text{sweep_width} = \max(1, \text{sweep_points} - 1)$ and sweep_points is the number of sweep points, set in the **Sweep** menu.

Key Path	Marker Function, Band Adjust
----------	-------------------------------------

Remote Command	:CALCulate:MARKer [1] 2 3 4 5 6 7 8 9 10 11 12 :FUNction: BAND:SPAN <freq> :CALCulate:MARKer [1] 2 3 4 5 6 7 8 9 10 11 12 :FUNction: BAND:SPAN?
Example	:CALC:MARK12:FUNC:BAND:SPAN 20 MHz sets the band span of marker 12 to 20 MHz :CALC:MARK:FUNC:BAND:SPAN? queries the band span of Marker 1
Notes	Units are those of the trace's domain, Hz for frequency domain, s for time domain.
Notes	Sending this command selects the subcoded marker The unit of the parameter must match the current domain of the trace the selected marker is on, or an invalid suffix error will be generated. If no unit is sent the fundamental unit for the trace domain will be used (Hz for freq domain traces, s for time domain traces). Note that all the values provided in this table are only valid for frequency domain traces. If the current domain of the trace is time domain, values and unit will be different. In frequency domain, the Preset value is dependant on the frequency range of the instrument. The default value 1.3245 GHz is appropriate only if the instrument is a 26.5 GHz instrument (Option 526). In a 26.5 GHz Instrument, the default span is 26.49 GHz, so 5% of the span corresponds to 1.3245 GHz.
Couplings	Changing the Band/Interval Span necessarily changes the Band/Interval Left and Band/Interval Right values Band/Interval Span is set to 0 when the marker is turned off Band/Interval Span is set to 5% of span when any marker function is turned on if and only if it is zero at that time
Preset	If 0, set to 5% of span, when a marker function is turned on
State Saved	Saved in Instrument State
Min	0 Hz
Max	Infinity. Unlike legacy analyzers, where the markers were forced to be on screen, X-Series marker values are not limited and do not clip
Backwards Compatibility SCPI	:CALCulate:MARKer[1] 2 3 4:X:SPAN
Initial S/W Revision	Prior to A.02.00
Help Map ID	3186

Band/Interval Left

Sets the left edge frequency or time for the band of the selected marker. The right edge is unaffected.

It is legal to change the width of the band even if there is no marker function on. Generally this can only happen by sending the SCPI command since access to the menu is restricted if no marker function is on.

In the table below, sweep_width = max(1,sweep_points-1) and sweep_points is the number of sweep

Marker Function

points, set in the **Sweep** menu.

Key Path	Marker Function, Band Adjust
Remote Command	:CALCulate:MARKer [1] 2 3 4 5 6 7 8 9 10 11 12 :FUNction: BAND:LEFT <freq> :CALCulate:MARKer [1] 2 3 4 5 6 7 8 9 10 11 12 :FUNction: BAND:LEFT?
Example	:CALC:MARK12:FUNC:BAND:LEFT 20 GHz sets the left edge of the band span of marker 12 to 20 GHz :CALC:MARK:FUNC:BAND:LEFT? queries the band span of Marker 1
Notes	Units are those of the trace's domain, Hz for frequency domain, s for time domain. When the left edge is moved, the right edge stays anchored; thus, the marker's frequency will change.
Notes	Sending this command selects the subcoded marker The unit of the parameter must match the current domain of the trace the selected marker is on, or an invalid suffix error will be generated. If no unit is sent the fundamental unit for the trace domain will be used (Hz for freq domain traces, s for time domain traces). Note that all the values provided in this table are only valid for frequency domain traces. If the current domain of the trace is time domain, values and unit will be different. In frequency domain, the Preset value is dependant on the frequency range of the instrument. The default value 1.3245 GHz is appropriate only if the instrument is a 26.5 GHz instrument (Option 526). In a 26.5 GHz Instrument, the default span is 26.49 GHz, so 5% of the span corresponds to 1.3245 GHz.
Couplings	Changing the Band/Interval Left necessarily changes the Band/Interval Span and Band/Interval Center values Band/Interval Span is set to 0 when the marker is turned off so that means Band/Interval Left is set to the center value at this time Band/Interval Span is set to 5% of span when any marker function is turned on if and only if it is zero at that time
Preset	If 0, Band/Interval Span is set to 5% of span, when a marker function is turned on, which affects Band/Interval Left
State Saved	Saved in Instrument State
Min	0 Hz
Max	Infinity. Unlike legacy analyzers, where the markers were forced to be on screen, X-Series marker values are not limited and do not clip
Backwards Compatibility SCPI	:CALCulate:MARKer[1] 2 3 4:X:STARt (This legacy command was used to control the Reference marker in Delta Pair/Band Pair mode, and is aliased to the new command.)
Initial S/W Revision	Prior to A.02.00

Help Map ID

3188

Band/Interval Right

Sets the right edge frequency or time for the band of the selected marker. The left edge is unaffected

In the table below, $\text{sweep_width} = \max(1, \text{sweep_points} - 1)$ and sweep_points is the number of sweep points, set in the **Sweep** menu.

It is legal to change the width of the band even if there is no marker function on. Generally this can only happen by sending the SCPI command since access to the menu is restricted if no marker function is on.

Key Path	Marker Function, Band Adjust
Remote Command	:CALCulate:MARKer [1] 2 3 4 5 6 7 8 9 10 11 12 :FUNction: BAND:RIGHT <freq> :CALCulate:MARKer [1] 2 3 4 5 6 7 8 9 10 11 12 :FUNction: BAND:RIGHT?
Example	:CALC:MARK12:FUNC:BAND:RIGHT 20 GHz sets the right edge of the band span of marker 12 to 20 GHz :CALC:MARK:FUNC:BAND:RIGHT? queries the band span of Marker 1
Notes	Units are those of the trace's domain, Hz for frequency domain, s for time domain. When the right edge is moved, the left edge stays anchored; thus, the marker's frequency will change.
Notes	Sending this command selects the subcoded marker The unit of the parameter must match the current domain of the trace the selected marker is on, or an invalid suffix error will be generated. If no unit is sent the fundamental unit for the trace domain will be used (Hz for freq domain traces, s for time domain traces). Note that all the values provided in this table are only valid for frequency domain traces. If the current domain of the trace is time domain, values and unit will be different. In frequency domain, the Preset value is dependant on the frequency range of the instrument. The default value 1.3245 GHz is appropriate only if the instrument is a 26.5 GHz instrument (Option 526). In a 26.5 GHz Instrument, the default span is 26.49 GHz, so 5% of the span corresponds to 1.3245 GHz.
Couplings	Changing the Band/Interval Right necessarily changes the Band/Interval Span and Band/Interval Center values Band/Interval Span is set to 5% of span when any marker function is turned on if and only if it is zero at that time
Preset	If 0, Band/Interval Span is set to 5% of span, when a marker function is turned on, which affects Band/Interval Right
State Saved	Saved in Instrument State
Min	0 Hz

Marker Function

Max	Infinity. Unlike legacy analyzers, where the markers were forced to be on screen, X-Series marker values are not limited and do not clip
Backwards Compatibility SCPI	:CALCulate:MARKer[1] 2 3 4:X:STOP (This legacy command was used to control the Delta marker in Delta Pair/Band Pair mode, and is aliased to the new command. For compatibility. Note that if you were using the old command for Band Power measurements it will work just fine.)
Initial S/W Revision	Prior to A.02.00
Help Map ID	3190

Measure at Marker

This key and all the keys in this menu only appear with the N6141A or W6141A application or Option EMC installed and licensed.

Key Path	Marker Function
Dependencies	The Measure at Marker menu is not available in Spectrogram.
Initial S/W Revision	A.02.00
Help Map ID	3816

Measure at Marker

When this key is pressed, the test set executes one Measure at Marker function and then returns. Measure at Marker goes to the frequency of the selected marker and takes a reading with each of the three detectors selected in the Detectors menu, using the dwell times specified there, then displays the readings in a window on the display, using the current Y-Axis Unit.

When the Measure at Marker is complete, the test set restores all settings to their pre-Measure-at-Marker values and normal sweeps resume.

Key Path	Marker Function, Measure at Marker
Remote Command	:CALCulate:MARKer[1] 2 3 4 5 6 7 8 9 10 11 12:FUNCTION:MAMarker?
Example	:CALC:MARK2:FUNC:MAM? Performs a Measure at Marker function at Marker 2's current frequency and, when completed, returns the results of the measure at marker window in a query

Notes	<p>This query command returns comma separated values for the 3 specified detectors and the frequency value of the marker. If a Detector is off or if no measurement has yet completed, -999.0 will be returned. This can happen, for example, if you are operating with too large a value of (span/sweep points) and the Measure at Marker function does not execute but instead puts up the advisory message, “Span per point too large, narrow span or increase RBW or number of points” (see below).</p> <p>The size of the return data array is fixed at 4. The elements are:</p> <ol style="list-style-type: none"> 1. Detector 1 value (if off, -999.0 for backwards compatibility) 2. Detector 2 value (if off, -999.0 for backwards compatibility) 3. Detector 3 value (if off, -999.0 for backwards compatibility) 4. Frequency of Marker <p>If a sweep is in process when this function executes it aborts, and restarts after the function is complete.</p> <p>This command is not backwards compatible with the E7400 and PSA option 239 so the Backwards Compatibility command is included.</p>
Dependencies	<p>If BW & Avg Type is in Autocoupled state, the (up to three) measurements taken by Measure at Marker are taken with Auto Coupled settings for the functions in the BW menu, even if those functions are in manual.</p>
Couplings	<p>If the specified Marker is not on, the test set turns it on at center of screen and does a peak search before performing the function.</p>
Status Bits/OPC dependencies	<p>OPC goes true when the measurement is complete</p>
Backwards Compatibility SCPI	<p>:MEASure:EMI:MARKer[1] 2 3 4 5 6 7 8 9 10 11 12?</p> <p>(Performs a Measure at Marker function at specified marker’s current frequency and returns the results)</p>
Initial S/W Revision	<p>A.02.00</p>
Help Map ID	<p>3817</p>

Measure at Marker presents its information in a separate window which normally appears in the upper right of the display but can be repositioned to the upper left.

Marker Function

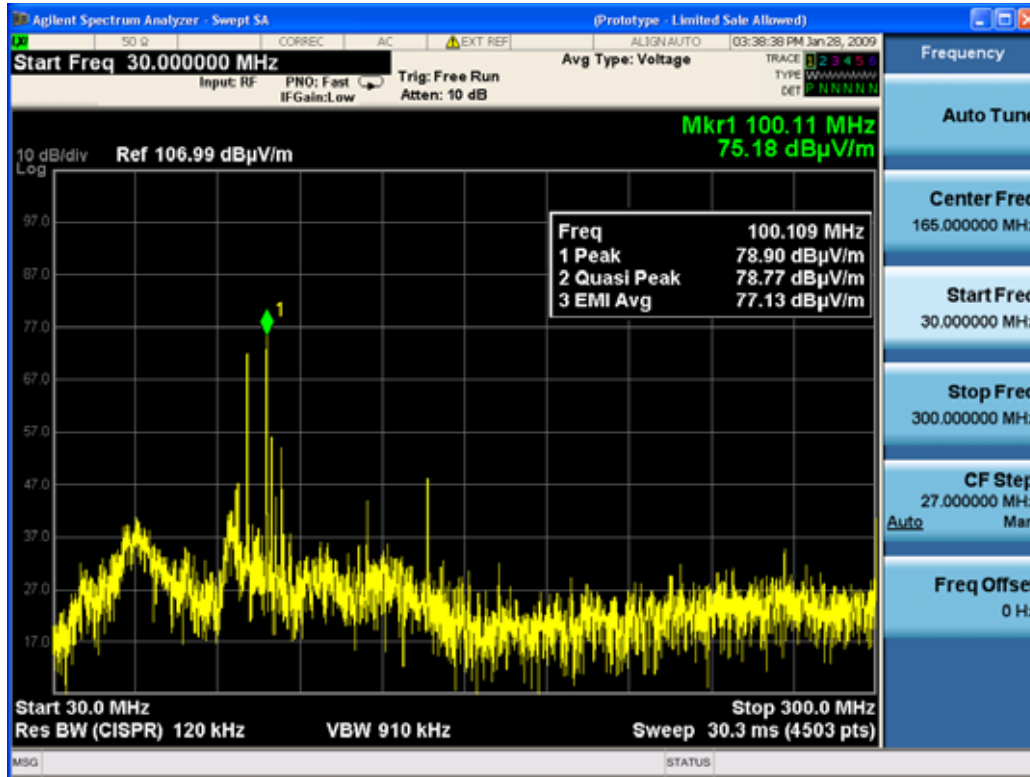

The Measure at Marker box shows the detector name for the selected detectors and “Off” for those not selected. The names used are:

Name	Detector
Normal	Normal
Peak	Peak
Sample	Sample
Neg Peak	Negative Peak
RMS	Average detector with Power Average (RMS)
Log Avg	Average detector with Log-Pwr Average
VoltageAvg	Average detector with Voltage Average
Quasi Peak	Quasi Peak
EMI Avg	EMI Average
RMS Avg	RMS Average

The marker frequency is shown in the “Freq” field. The measured value is shown for all detectors except those that are “Off.” For these, --- is displayed. The current Y-Axis unit is used, and the precision that is used for the detector value displays is exactly the same as for the Marker. The precision used for the Frequency display is six significant digits.

The sequence of steps in the measurement is as follows:

- Any sweep in progress is aborted.
- If in Zero Span, the Center Frequency is used as the frequency at which to take the reading, since in Zero Span, all markers are by definition at the Center Frequency
- If not in Zero Span:
 - If the selected marker is Off, it is first turned on in the center of the screen and a peak search performed.
 - If the selected marker is on, but offscreen, it is first moved to the center of the screen and a peak search performed.
 - A frequency “zoom” function is performed to determine the frequency of the selected marker to the required precision. If you are operating with too large a value of (span/sweep points) then the Measure at Marker window will not display, but instead an advisory message, “Span per point too large, narrow span or increase RBW or number of points”. This means you have chosen a combination of RBW, span and sweep points that makes each trace point much wider than the RBW, so that the trace point in which the signal appears is an inadequately precise measure of its frequency—for example, with a 30 MHz to 1000 MHz span, 601 trace points and 120 kHz RBW, each trace point is 13 times as wide as the RBW. In this case, a SCPI query of the results will yield -999 dBm for each detector.
 - If the zoom is successful, the test set goes to zero span at this frequency
- Each detector is then read in successive single-point zero span sweeps, using a sweep time equal to the specified dwell time. The value displayed by Measure at Marker represents the maximum value output by the detector during the dwell time Autocoupled bandwidth and average type settings are used for each detector unless the **BW & Avg Type** key is set to **As Set**, in which case the current bandwidth and average type settings are used.
- Each result is then displayed in the measure at marker window as it becomes available.
- The test set returns to its pre-Measure at Marker span and settings after executing a Measure at Marker function, including Bandwidth, Avg Type, and EMC Std - regardless of the setting of **BW & Avg Type**
- Finally, if the sweep had to be aborted, the aborted sweep is restarted.

While the function is executing, all the fields except Freq show --- for their values until the measurement is complete for that detector. As each detector is read, an informational message is displayed in the status line, for example,

Measuring with detector 1 (Peak) with RBW=120 kHz

After the last detector, the status line is cleared.

Meas at Marker Window

This key opens a menu which controls the Measure at Marker window.

Key Path	Marker Function, Measure at Marker
----------	---

Marker Function

Readback	In square brackets, the state of the window then the window position, separated by commas, as [On, Left]
Initial S/W Revision	A.02.00
Help Map ID	3818

Window

This key turns the Measure at Marker window on and off. It turns on automatically when Measure at Marker is initiated and turns off on a Preset. If the Window is turned on without a Measure at Marker result, --- is displayed for each result for which the detector is not “Off”.

Key Path	Marker Function, Measure at Marker, Meas at Marker Window
Remote Command	:DISPlay:WINDow:MAMarker[:STATE] ON OFF 1 0 :DISPlay:WINDow:MAMarker[:STATE]?
Example	:DISP:WIND:MAM ON
Couplings	The window turns on automatically when Measure at Marker is initiated and turns off on a Preset.
Preset	Off
State Saved	Saved in instrument state
Readback Text	On Off
Initial S/W Revision	A.02.00
Help Map ID	3819

Position

This key controls the placement of the Measure at Marker window on the display.

Key Path	Marker Function, Measure at Marker, Meas at Marker Window
Remote Command	:DISPlay:WINDow:MAMarker:POSition LEFT RIGHT :DISPlay:WINDow:MAMarker:POSition?
Example	:DISP:WIND:MAM:POS RIGH
Preset	Right
State Saved	Saved in instrument state
Readback Text	Left Right
Initial S/W Revision	A.02.00
Help Map ID	3820

Detectors

This key opens up a menu that allows you to configure the detectors to be used for the Measure at Marker reading. Any of the test set detectors can be used for each of the three detectors, or any of the three can be turned off. The dwell time for each detector is also settable.

When performing a Meas at Marker, the dwell time settings that you select will depend on the characteristics of the emission you are measuring. The default dwell time (200 ms) should work well for typical EUT emissions, but sometimes you will encounter emissions for which the defaults are not optimal. This is especially the case for emissions that vary slowly over time or have a slow repetition rate. By lengthening the dwell times you can increase the likelihood of accurately measuring these low repetition rate signals.

When Measure at marker is activated, the receiver makes a zero span measurement for each of the (up to) three detectors selected, using the Dwell Time set for each detector. If the signal's repetition period is greater than 200 ms (the default setting), the dwell time should be increased to capture at least two and preferably more repetitions of the signal. Additionally, if you do not need or do not wish to use a detector to make a measurement, that specific detector may be turned off.

If the Measure at Marker window is being displayed, and one of the detectors is changed, any value being displayed for that detector changes to “---“ until the next successful reading from that detector.

Key Path	Marker Function, Measure at Marker,
Remote Command	:CALCulate:MAMarker:DETECTOR[1] 2 3 OFF NORMAl AVERAge POSitive SAMPlE NEGative QPEak EAVERage RAVERage :CALCulate:MAMarker:DETECTOR[1] 2 3?
Example	:CALC:MAM:DET2 QPE Sets the detector for measure at marker detector 2 to Quasi peak :CALC:MAM:DET OFF Sets the detector for measure at marker detector 1 to Off
State Saved	Saved in instrument state
Initial S/W Revision	A.02.00
Help Map ID	3821

Key Path	Marker Function, Measure at Marker,
Remote Command	:CALCulate:MAMarker:DETECTOR[1] 2 3:DWELl <dwell time> :CALCulate:MAMarker:DETECTOR[1] 2 3:DWELl?
Example	:CALC:MAM:DET2:DWEL 500 ms Sets the detector for measure at marker detector 2 to dwell for 500 ms
State Saved	Saved in instrument state

Marker Function

Backwards Compatibility SCPI	[:SENSE]:EMI:MEASure:DETEctor:DWELl <dwel time> Sets all of the detectors dwell time to the specified amount
Initial S/W Revision	A.02.00
Help Map ID	0

Detector 1

This menu lets you select the detector to be used for Detector 1, or turn Detector 1 off. This is a 1-of-N menu that shows the normal list of detectors, but with the “Auto” key replaced by “Off”.

Key Path	Marker Function, Measure at Marker, Detectors
Remote Command	See “ Detectors ” on page 615.
Example	:CALC:MAM:DET QPE Sets the detector for measure at marker detector 1 to Quasi peak :CALC:MAM:DET OFF Sets the detector for measure at marker detector 1 to Off
Preset	Peak
State Saved	Saved in instrument state
Readback Text	Detector name
Initial S/W Revision	A.02.00
Help Map ID	3822

Detector 2

This menu lets you select the detector to be used for Detector 2, or turn Detector 2 off. This is a 1-of-N menu that shows the normal list of detectors, but with the “Auto” key replaced by “Off”.

Key Path	Marker Function, Measure at Marker, Detectors
Remote Command	See “ Detectors ” on page 615.
Example	:CALC:MAM:DET2 QPE Sets the detector for measure at marker detector 2 to Quasi peak :CALC:MAM:DET2 OFF Sets the detector for measure at marker detector 2 to Off
Preset	Quasi Peak
State Saved	Saved in instrument state
Readback Text	Detector name

Backwards Compatibility SCPI	[:SENSe]:EMI:MEASure:DETEctor:QPEak[:STATe] OFF ON 0 1 If sent with On as a parameter, sets detector 2 to Quasi Peak If sent with Off as a parameter, sets detector 2 to Off
Initial S/W Revision	A.02.00
Help Map ID	3823

Detector 3

This menu lets you select the detector to be used for Detector 3, or turn Detector 3 off. This is a 1-of-N menu that shows the normal list of detectors, but with the “Auto” key replaced by “Off”.

Key Path	Marker Function, Measure at Marker, Detectors
Remote Command	See “ Detectors ” on page 615.
Example	:CALC:MAM:DET3 QPE Sets the detector for measure at marker detector 1 to Quasi peak :CALC:MAM:DET3 OFF Sets the detector for measure at marker detector 1 to Off
Preset	EMI Average
State Saved	Saved in instrument state
Readback Text	Detector name
Backwards Compatibility SCPI	[:SENSe]:EMI:MEASure:DETEctor:AVERage[:STATe] OFF ON 0 1 If sent with On as a parameter, sets detector 3 to EMI Average If sent with Off as a parameter, sets detector 3 to Off
Initial S/W Revision	A.02.00
Help Map ID	3824

Detector 1 Dwell Time

This is the time specified by the user to dwell while taking the measurement for detector 1. The minimum allowed dwell time is based on the current detector. If “Off” is selected for detector 1, this key is grayed out and shows 200 ms.

Key Path	Marker Function, Measure at Marker, Detectors
Remote Command	See “ Detectors ” on page 615.
Example	:CALC:MAM:DET:DWEL 400 ms Sets the dwell time for detector 1 to 400 ms
Preset	200 ms
State Saved	Saved in instrument state

Marker Function

Min	1 ms
Max	60 s
Initial S/W Revision	A.02.00
Default Unit	s
Help Map ID	3825

Detector 2 Dwell Time

This is the time specified by the user to dwell while taking the measurement for detector 2. The minimum allowed dwell time is based on the current detector. If “Off” is selected for detector 2, this key is grayed out and shows 200 ms.

Key Path	Marker Function, Measure at Marker, Detectors
Remote Command	See “ Detectors ” on page 615.
Example	:CALC:MAM:DET2:DWEL 400 ms Sets the dwell time for detector 2 to 400 ms
Preset	200 ms
State Saved	Saved in instrument state
Min	1 ms
Max	60 s
Initial S/W Revision	A.02.00
Default Unit	s
Help Map ID	3826

Detector 3 Dwell Time

This is the time specified by the user to dwell while taking the measurement for detector 3. The minimum allowed dwell time is based on the current detector. If “Off” is selected for detector 3, this key is grayed out and shows 200 ms.

Key Path	Marker Function, Measure at Marker, Detectors
Remote Command	See “ Detectors ” on page 615.
Example	:CALC:MAM:DET3:DWEL 400 ms Sets the dwell time for detector 1 to 400 ms
Preset	200 ms
State Saved	Saved in instrument state
Min	1 ms
Max	60 s

Initial S/W Revision	A.02.00
Default Unit	s
Help Map ID	3827

BW & Avg Type

This key controls the type of bandwidth and average type coupling used in Measure at Marker.

If set to “Autocoupled”, then the RBW and Average Type are selected by the instrument during the Measure at Marker function, according to the normal Autocouple rules, regardless of whether RBW and Average Type are currently in Auto. If set to “As Set”, then the current value for RBW and Average Type are used (which of course, could also be “Auto”).

Here are the details of the two modes:

If **BW & Avg Type** is set to **Autocoupled**, **Measure at Marker** behaves as follows:

1. The **EMC Std** changes to CISPR if any of the CISPR detectors (EMI Avg, RMS Avg, QPD) becomes selected; for all other detectors, the value of **EMC Std** that existed before Measure at Marker is used.
2. **RBW** autocouples throughout Measure at Marker, even if **RBW** is set to **Manual**. The autocouple rules are based on whatever the instantaneous setting of EMC Std, Span, and Center Freq are.

If **BW & Avg Type** is set to **As Set**, **Measure at Marker** behaves as follows:

1. The **EMC Std** never changes; so if it is set to **None** it stays at **None** throughout, even if one of the CISPR detectors is selected.
2. If **RBW** is set to **Auto**, then **RBW** autocouples throughout Measure at Marker. The autocouple rules are based on whatever the setting of EMC Std, Span, and Center Freq are.
3. If **RBW** is set to **Manual**, the RBW never changes at all throughout Measure at Marker, it stays at the value to which it was set before Measure at Marker began.

The test set returns to its pre-Measure at Marker span and settings after executing a Measure at Marker function, including Bandwidth, Avg Type, and EMC Std.

It is important to note that, when RBW is coupled to Frequency, as it is when **EMC Std** is anything but “None”, for all EMI measurements, the frequency it is coupled to for Measure at Marker is the MARKER frequency, not the Center Frequency.

Key Path	Marker Function, Measure at Marker
Remote Command	:CALCulate:MAMarker:COUpling ON OFF 1 0 :CALCulate:MAMarker:COUpling?
Example	:CALC:MAM:COUP ON
Preset	Autocoupled
State Saved	Saved in instrument state
Readback Text	Autocoupled As Set
Initial S/W Revision	A.02.00

Marker Function

Help Map ID	3828
-------------	------

Center Presel On/Off

This key controls the automatic centering of the preselector for the Measure at Marker function.

When Center Presel is On, the first step in performing the Measure at Marker function is to perform a Presel Center. This is not performed if the microwave preselector is off, or the selected marker's frequency is below Band 1. If the function is not performed, no message is generated.

Key Path	Marker Function, Measure at Marker
Remote Command	:CALCulate:MAMarker:PCENter ON OFF 1 0 :CALCulate:MAMarker:PCENter?
Example	:CALC:MAM:PCEN ON
Dependencies	Blank in models that do not include a preselector, such as option 503. If the SCPI is sent in these instruments, it is accepted without error, and the query always returns 0.
Preset	On
Backwards Compatibility SCPI	[:SENSe]:EMI:MEASure:PCENter[:STATe] OFF ON 0 1 [:SENSe]:EMI:MEASure:PCENter[:STATe]?
Initial S/W Revision	A.02.00
Help Map ID	3829

Marker To

The Marker -> key accesses menu keys that can copy the current marker value into other test set parameters (for example, Center Freq). The currently selected marker is made the active function on entry to this menu (if the currently selected marker is not on when you press this front-panel key, it is turned on at the center of the screen as a normal type marker and then made the active function).

The **Marker ->** (or Marker To) feature is used to quickly assign a marker's x- or y-axis value to another parameter. For example, if a marker's x-axis value is 500 MHz and y-axis value is -20 dBm, pressing **Mkr -> CF** would assign 500 MHz to **Center Freq** and pressing **Mkr ->Ref Lvl** would assign -20 dBm to **Ref Level**.

Notes	All Marker To functions executed from the front panel use the selected marker's values, while all Marker To remote commands specify in the command which marker's value to use. Consistent with other remote marker commands, sending a Marker To remote command will never change which marker is selected.
Initial S/W Revision	Prior to A.02.00
Help Map ID	3192

Mkr->CF

Sets the center frequency of the test set to the frequency of the selected marker. The marker stays at this frequency, so it moves to the center of the display. In delta marker mode, this function sets the center frequency to the x-axis value of the delta marker. When the frequency scale is in log mode, the center frequency is not at the center of the display.

If the currently selected marker is not on when this key is pressed, it is turned on at the center of the screen as a normal type marker.

Key Path	Marker ->
Remote Command	:CALCulate:MARKer [1] 2 3 4 5 6 7 8 9 10 11 12 [:SET] :CENTer
Example	CALC:MARK2:CENT sets the CF of the test set to the value of marker 2.
Notes	Sending this command selects the subopcoded marker If specified marker is off, this command will turn it on at the center of the screen as a normal type marker.
Dependencies	This function is not available (key is grayed out) when x-axis is the time domain
Couplings	All the usual couplings associated with setting Center Frequency apply (see the Frequency Section).
Initial S/W Revision	Prior to A.02.00

Marker To

Help Map ID	3193
-------------	------

Mkr->CF Step

Sets the center frequency (CF) step size of the test set to the marker frequency, or in a delta-marker mode, to the frequency difference between the delta and reference markers.

If the currently selected marker is not on when this key is pressed, it is turned on at the center of the screen as a normal type marker.

Key Path	Marker ->
Remote Command	:CALCulate:MARKer [1] 2 3 4 5 6 7 8 9 10 11 12 [:SET] :STEP
Example	CALC:MARK1:STEP sets the CF step to the value (or delta value) of marker 1.
Notes	Sending this command selects the subcoded marker If specified marker is off, this command will turn it on at the center of the screen as a normal type marker.
Dependencies	This function is not available (key is grayed out) when x-axis is the time domain
Couplings	All the usual couplings associated with setting CF Step apply (see the Frequency Section).
Initial S/W Revision	Prior to A.02.00
Help Map ID	3194

Mkr->Start

Changes the start frequency to the frequency of the selected marker. The marker stays at this frequency, so it moves to the left edge of the display. In delta marker mode, this function sets the start frequency to the x-axis value of the delta marker.

If the currently selected marker is not on when this key is pressed, it is turned on at the center of the screen as a normal type marker.

Key Path	Marker ->
Remote Command	:CALCulate:MARKer [1] 2 3 4 5 6 7 8 9 10 11 12 [:SET] :START
Example	CALC:MARK1:STAR sets the start frequency to the value (or delta value) of marker 1.
Notes	Sending this command selects the subcoded marker If specified marker is off, this command will turn it on at the center of the screen as a normal type marker.

Dependencies	This function is not available (key is grayed out) when x-axis is the time domain
Couplings	All the usual couplings associated with setting Start Frequency apply (see the Frequency Section).
Initial S/W Revision	Prior to A.02.00
Help Map ID	3195

Mkr->Stop

Changes the stop frequency to the frequency of the selected marker. The marker stays at this frequency, so it moves to the right edge of the display. In delta marker mode, this function sets the stop frequency to the x-axis value of the delta marker.

If the currently selected marker is not on when this key is pressed, it is turned on at the center of the screen as a normal type marker.

Key Path	Marker ->
Remote Command	:CALCulate:MARKer [1] 2 3 4 5 6 7 8 9 10 11 12 [:SET] :STOP
Example	CALC:MARK3:STOP sets the stop frequency to the value (or delta value) of marker 3.
Notes	Sending this command selects the subopcoded marker If specified marker is off, this command will turn it on at the center of the screen as a normal type marker.
Dependencies	This function is not available (key is grayed out) when x-axis is the time domain
Couplings	All the usual couplings associated with setting Stop Frequency apply (see the Frequency Section).
Initial S/W Revision	Prior to A.02.00
Help Map ID	3196

MkrΔ->Span

Sets the start and stop frequencies to the values of the delta markers. That is, it moves the lower of the two marker frequencies to the start frequency and the higher of the two marker frequencies to the stop frequency. The marker mode is unchanged and the two markers (delta and reference) end up on opposite edges of the display.

Key Path	Marker ->
Remote Command	:CALCulate:MARKer [1] 2 3 4 5 6 7 8 9 10 11 12 [:SET] :DELTA:SPAN

Marker To

Example	CALC:MARK2:DELT:SPAN sets the start and stop frequencies to the values of marker 2 and its reference marker.
Notes	Sending this command selects the subcoded marker
Dependencies	This function is only available when the selected marker is a delta marker. Otherwise the key is grayed out. In addition, this function is not available when x-axis is the time domain
Couplings	All the usual couplings associated with setting Span apply (see the Section ““Span” on page 863”).
Backwards Compatibility SCPI	:CALCulate:MARKer[1] 2 3 4 5 6 7 8 9 10 11 12[:SET]:SPAN
Initial S/W Revision	Prior to A.02.00
Help Map ID	3197

MkrΔ->CF

Sets the center frequency to the frequency difference between the selected marker and its reference marker. The marker is then changed to a Normal marker and placed at the center of span.

Key Path	Marker ->
Remote Command	:CALCulate:MARKer [1] 2 3 4 5 6 7 8 9 10 11 12 [:SET] :DEL Ta:CENTer
Example	CALC:MARK2:CENT sets the CF of the test set to the value of marker 2.
Notes	Sending this command selects the subcoded marker
Dependencies	This function is only available when the selected marker is a delta marker. Otherwise the key is grayed out. In addition, this function is not available when x-axis is the time domain
Initial S/W Revision	Prior to A.02.00
Help Map ID	3198

Mkr->Ref Lvl

Sets the reference level to the amplitude value of the selected marker, moving the marked point to the reference level (top line of the graticule). The marker’s mode (Normal, Delta, Fixed) doesn’t matter in this case. For example, given a delta marker, if the delta marker is the selected marker, its amplitude is applied to the reference level. If the reference marker is selected, its amplitude is applied to the reference level.

If the currently selected marker is not on when this key is pressed, it is turned on at the center of the screen as a normal type marker, and its amplitude applied to the reference level.

Key Path	Marker ->
----------	---------------------

Remote Command	:CALCulate:MARKer [1] 2 3 4 5 6 7 8 9 10 11 12 [:SET] :RLEVel
Example	CALC:MARK2:RLEV sets the reference level of the test set to the amplitude of marker 2.
Notes	Sending this command selects the subopcoded marker If specified marker is off, this command will turn it on at the center of the screen as a normal type marker.
Couplings	All the usual couplings associated with setting Reference Level apply.
Initial S/W Revision	Prior to A.02.00
Help Map ID	3199

Marker To

Meas

The information in this section is common to all measurements. For key and remote command information for a specific measurement, refer to the section that describes the measurement of interest.

Measurements available under the Meas key are specific to the current Mode.

When viewing Help for measurements, note the following:

NOTE Operation for some keys differs between measurements. The information displayed in Help pertains to the current measurement. To see how a key operates in a different measurement, exit Help (press the Cancel Esc key), select the measurement, then reenter Help (press the Help key) and press that key.

Key Path:	Front-panel key
Initial S/W Revision:	Prior to A.02.00
Help Map ID:	4008

Remote Measurement Functions

This section contains the following topics:

[“Measurement Group of Commands” on page 628](#)

[“Current Measurement Query \(Remote Command Only\) ” on page 632](#)

[“Limit Test Current Results \(Remote Command Only\)” on page 632](#)

[“Data Query \(Remote Command Only\)” on page 632](#)

[“Calculate/Compress Trace Data Query \(Remote Command Only\)” on page 632](#)

[“Calculate Peaks of Trace Data \(Remote Command Only\)” on page 637](#)

[“Format Data: Numeric Data \(Remote Command Only\)” on page 639](#)

[“Format Data: Byte Order \(Remote Command Only\)” on page 641](#)

Initial S/W Revision:	Prior to A.02.00
Help Map ID:	29978

Meas

Measurement Group of Commands

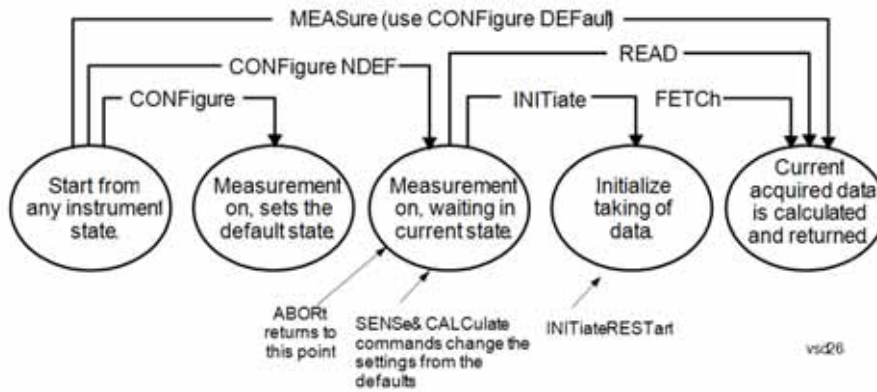

Measure Commands:**:MEASure:<measurement>[n]?**

This is a fast single-command way to make a measurement using the factory default instrument settings. These are the settings and units that conform to the Mode Setup settings (e.g. radio standard) that you have currently selected.

- Stops the current measurement (if any) and sets up the instrument for the specified measurement using the factory defaults
- Initiates the data acquisition for the measurement
- Blocks other SCPI communication, waiting until the measurement is complete before returning results.
- If the function does averaging, it is turned on and the number of averages is set to 10.
- After the data is valid it returns the scalar results, or the trace data, for the specified measurement. The type of data returned may be defined by an [n] value that is sent with the command.

The scalar measurement results will be returned if the optional [n] value is not included, or is set to 1. If the [n] value is set to a value other than 1, the selected trace data results will be returned. See each command for details of what types of scalar results or trace data results are available.

ASCII is the default format for the data output. (Older versions of Spectrum Analysis and Phase Noise mode measurements only use ASCII.) The binary data formats should be used for handling large blocks of data since they are smaller and faster than the ASCII format. Refer to the FORMat:DATA command for more information.

If you need to change some of the measurement parameters from the factory default settings you can set up the measurement with the CONFigure command. Use the commands in the SENSE:<measurement> and CALCulate:<measurement> subsystems to change the settings. Then you can use the READ? command to initiate the measurement and query the results.

If you need to repeatedly make a given measurement with settings other than the factory defaults, you can use the commands in the SENSE:<measurement> and CALCulate:<measurement> subsystems to set up the measurement. Then use the READ? command to initiate the measurement and query results.

Measurement settings persist if you initiate a different measurement and then return to a previous one. Use READ:<measurement>? if you want to use those persistent settings. If you want to go back to the default settings, use MEASure:<measurement>?.

Configure Commands:**:CONFigure:<measurement>**

This command stops the current measurement (if any) and sets up the instrument for the specified measurement using the factory default instrument settings. It does not initiate the taking of measurement data unless INIT:CONTinuous is ON. If you change any measurement settings after using the CONFigure command, the READ command can be used to initiate a measurement without changing the settings back to their defaults.

:CONFigure:NDEFault<measurement> stops the current measurement and changes to the specified measurement. It does not change the settings to the defaults. It does not initiate the taking of measurement data unless INIT:CONTinuous is ON.

The **CONFigure?** query returns the current measurement name.

The **CONFigure:CATalog?** query returns a quoted string of all licensed measurement names in the current mode. For example, "SAN, CHP, OBW, ACP, PST, TXP, SPUR, SEM, LIST".

Fetch Commands:**:FETCh:<measurement>[n]?**

This command puts selected data from the most recent measurement into the output buffer. Use FETCh if you have already made a good measurement and you want to return several types of data (different [n] values, for example, both scalars and trace data) from a single measurement. FETCh saves you the time of re-making the measurement. You can only FETCh results from the measurement that is currently active, it will not change to a different measurement. An error message is reported if a measurement other than the current one is specified.

If you need to get new measurement data, use the READ command, which is equivalent to an INITiate followed by a FETCh.

The scalar measurement results will be returned if the optional [n] value is not included, or is set to 1. If the [n] value is set to a value other than 1, the selected trace data results will be returned. See each command for details of what types of scalar results or trace data results are available. The binary data formats should be used for handling large blocks of data since they are smaller and transfer faster than the ASCII format. (FORMat:DATA)

FETCh may be used to return results other than those specified with the original READ or MEASure command that you sent.

INITiate Commands:**:INITiate:<measurement>**

This command is not available for measurements in all the instrument modes:

- Initiates a trigger cycle for the specified measurement, but does not output any data. You must then use the FETCh<meas> command to return data. If a measurement other than the current one is specified, the instrument will switch to that measurement and then initiate it.
- For example, suppose you have previously initiated the ACP measurement, but now you are running the channel power measurement. If you send INIT:ACP? it will change from channel power to ACP and will initiate an ACP measurement.
- Does not change any of the measurement settings. For example, if you have previously started the ACP measurement and you send INIT:ACP? it will initiate a new ACP measurement using the same instrument settings as the last time ACP was run.
- If your selected measurement is currently active (in the idle state) it triggers the measurement, assuming the trigger conditions are met. Then it completes one trigger cycle. Depending upon the measurement and the number of averages, there may be multiple data acquisitions, with multiple trigger events, for one full trigger cycle. It also holds off additional commands on GPIB until the acquisition is complete.

READ Commands:**:READ:<measurement>[n]?**

- Does not preset the measurement to the factory default settings. For example, if you have previously initiated the ACP measurement and you send READ:ACP? it will initiate a new measurement using the same instrument settings.
- Initiates the measurement and puts valid data into the output buffer. If a measurement other than the current one is specified, the instrument will switch to that measurement before it initiates the measurement and returns results.

For example, suppose you have previously initiated the ACP measurement, but now you are running the channel power measurement. Then you send READ:ACP? It will change from channel power back to ACP and, using the previous ACP settings, will initiate the measurement and return results.

- Blocks other SCPI communication, waiting until the measurement is complete before returning the results

If the optional [n] value is not included, or is set to 1, the scalar measurement results will be returned. If the [n] value is set to a value other than 1, the selected trace data results will be returned. See each command for details of what types of scalar results or trace data results are available. The binary data formats should be used when handling large blocks of data since they are smaller and faster than the ASCII format.
(FORMat:DATA)

Initial S/W Revision:

Prior to A.02.00

Help Map ID:

0

Meas

Current Measurement Query (Remote Command Only)

This command returns the name of the measurement that is currently running.

Remote Command:	:CONFigure?
Example:	CONF?
Initial S/W Revision:	Prior to A.02.00
Help Map ID:	0

Limit Test Current Results (Remote Command Only)

Queries the status of the current measurement limit testing. It returns a 0 if the measured results pass when compared with the current limits. It returns a 1 if the measured results fail any limit tests.

Remote Command:	:CALCulate:CLIMits:FAIL?
Example:	CALC:CLIM:FAIL? queries the current measurement to see if it fails the defined limits. Returns a 0 or 1: 0 it passes, 1 it fails.
Initial S/W Revision:	Prior to A.02.00
Help Map ID:	0

Data Query (Remote Command Only)

Returns the designated measurement data for the currently selected measurement and subopcode.

n = any valid subopcode for the current measurement. See the measurement command results table for your current measurement, for information about what data is returned for the subopcodes.

This command uses the data setting specified by the FORMat:BORDER and FORMat:DATA commands and can return real or ASCII data. (See the format command descriptions under Input/Output in the Analyzer Setup section.)

Remote Command:	:CALCulate:DATA [n] ?
Notes:	The return trace depends on the measurement. In CALCulate:<meas>:DATA[n], n is any valid subopcode for the current measurement. It returns the same data as the FETCh:<measurement>? query where <measurement> is the current measurement.
Initial S/W Revision:	Prior to A.02.00
Help Map ID:	0

Calculate/Compress Trace Data Query (Remote Command Only)

Returns compressed data for the currently selected measurement and sub-opcode [n].

n = any valid sub-opcode for that measurement. See the MEASure:<measurement>? command description of your specific measurement for information on the data that can be returned.

The data is returned in the current Y Axis Unit of the test set. The command is used with a sub-opcode <n> (default=1) to specify the trace. With trace queries, it is best if the test set is not sweeping during the query. Therefore, it is generally advisable to be in Single Sweep, or Update=Off.

This command is used to compress or decimate a long trace to extract and return only the desired data. A typical example would be to acquire N frames of GSM data and return the mean power of the first burst in each frame. The command can also be used to identify the best curve fit for the data.

Remote Command:	:CALCulate:DATA<n>:COMPRESS? BLOCK CFIT MAXimum MINimum MEAN DMEan RMS RMSCubed SAMPLE SDEVIation PPHase [,<soffset>[,<length>[,<roffset>[,<rlimit>]]]]
Example:	To query the mean power of a set of GSM bursts: Supply a signal that is a set of GSM bursts. Select the IQ Waveform measurement (in IQ Analyzer Mode). Set the sweep time to acquire at least one burst. Set the triggers such that acquisition happens at a known position relative to a burst. Then query the mean burst levels using, CALC:DATA2:COMP? MEAN,24e-6,526e-6 (These parameter values correspond to GSM signals, where 526e-6 is the length of the burst in the slot and you just want 1 burst.)
Notes:	The command supports 5 parameters. Note that the last 4 (<soffset>,<length>,<roffset>,<rlimit>) are optional. But these optional parameters must be entered in the specified order. For example, if you want to specify <length>, then you must also specify <soffset>. See details below for a definition of each of these parameters. This command uses the data in the format specified by FORMat:DATA, returning either binary or ASCII data.
Initial S/W Revision:	Prior to A.02.00
Help Map ID:	0

- BLOCk or block data - returns all the data points from the region of the trace data that you specify. For example, it could be used to return the data points of an input signal over several timeslots, excluding the portions of the trace data that you do not want. (This is x,y pairs for trace data and I,Q pairs for complex data.)
- CFIT or curve fit - applies curve fitting routines to the data. <soffset> and <length> are required to define the data that you want. <roffset> is an optional parameter for the desired order of the curve equation. The query will return the following values: the x-offset (in seconds) and the curve coefficients ((order + 1) values).

MIN, MAX, MEAN, DME, RMS, RMSC, SAMP, SDEV and PPH return one data value for each specified region (or <length>) of trace data, for as many regions as possible until you run out of trace data (using <roffset> to specify regions). Or they return the number of regions you specify (using <rlimit>) ignoring any data beyond that.

- MINimum - returns the minimum data point (y value) for the specified region(s) of trace data. For I/Q

Meas

trace data, the minimum magnitude of the I/Q pairs is returned.

- **MAXimum** - returns the maximum data point (y value) for the specified region(s) of trace data. For I/Q trace data, the maximum magnitude of the I/Q pairs is returned.
- **MEAN** - returns a single value that is the arithmetic mean of the data point values (in dB/ dBm) for the specified region(s) of trace data. For I/Q trace data, the mean of the magnitudes of the I/Q pairs is returned. See the following equations.

NOTE If the original trace data is in dB, this function returns the arithmetic mean of those log values, not log of the mean power which is a more useful value. The mean of the log is the better measurement technique when measuring CW signals in the presence of noise. The mean of the power, expressed in dB, is useful in power measurements such as Channel Power. To achieve the mean of the power, use the RMS option.

Equation 1 Mean Value of Data Points for Specified Region(s)

$$\text{MEAN} = \frac{1}{n} \sum_{X_i \in \text{region}(s)} X_i \quad \text{vsd27-1}$$

where X_i is a data point value, and n is the number of data points in the specified region(s).

Equation 2 Mean Value of I/Q Data Pairs for Specified Region(s)

$$\text{MEAN} = \frac{1}{n} \sum_{X_i \in \text{region}(s)} |X_i| \quad \text{vsd27-2}$$

where $|X_i|$ is the magnitude of an I/Q pair, and n is the number of I/Q pairs in the specified region(s).

- **DMEan** - returns a single value that is the mean power (in dB/ dBm) of the data point values for the specified region(s) of trace data. See the following equation:

Equation 3 DMEan Value of Data Points for Specified Region(s)

$$\text{DME} = 10 \times \log_{10} \left(\frac{1}{n} \sum_{X_i \in \text{region}(s)} 10^{\frac{X_i}{10}} \right) \quad \text{vsd27-3}$$

- **RMS** - returns a single value that is the average power on a root-mean-squared voltage scale (arithmetic rms) of the data point values for the specified region(s) of trace data. See the following equation.

NOTE For I/Q trace data, the rms of the magnitudes of the I/Q pairs is returned. See the following equation.

This function is very useful for I/Q trace data. However, if the original trace data is in dB, this function returns the rms of the log values which is not usually needed.

Equation 4
RMS Value of Data Points for Specified Region(s)

$$\text{RMS} = \sqrt{\frac{1}{n} \sum_{X_i \in \text{region}(s)} X_i^2} \quad \text{vsd27-4}$$

where X_i is a data point value, and n is the number of data points in the specified region(s).

Equation 5
RMS Value of I/Q Data Pairs for Specified Region(s)

$$\text{RMS} = \sqrt{\frac{1}{n} \sum_{X_i \in \text{region}(s)} X_i X_i^*} \quad \text{vsd27-5}$$

where X_i is the complex value representation of an I/Q pair, X_i^* its conjugate complex number, and n is the number of I/Q pairs in the specified region(s).

Once you have the rms value for a region of trace data (linear or I/Q), you may want to calculate the mean power. You must convert this rms value (peak volts) to power in dBm:

$$10 \times \log[10 \times (\text{rms value})^2]$$

- **SAMPLE** - returns the first data value (x,y pair) for the specified region(s) of trace data. For I/Q trace data, the first I/Q pair is returned.
- **SDEViation** - returns a single value that is the arithmetic standard deviation for the data point values for the specified region(s) of trace data. See the following equation.

For I/Q trace data, the standard deviation of the magnitudes of the I/Q pairs is returned. See the following equation.

Equation 6
Standard Deviation of Data Point Values for Specified Region(s)

$$\text{SDEV} = \sqrt{\frac{1}{n} \sum_{X_i \in \text{region}(s)} (X_i - \bar{X})^2} \quad \text{vsd27-7}$$

where X_i is a data point value, \bar{X} is the arithmetic mean of the data point values for the specified region(s), and n is the number of data points in the specified region(s).

Meas

$$\text{SDEV} = \sqrt{\frac{1}{n} \sum_{X_i \in \text{region}(s)} (|X_i| - \bar{X})^2}$$

vsd27-8

where $|X_i|$ is the magnitude of an I/Q pair, \bar{X} is the mean of the magnitudes for the specified region(s), and n is the number of data points in the specified region(s).

- PPHase - returns the x,y pairs of both rms power (dBm) and arithmetic mean phase (radian) for every specified region and frequency offset (Hz). The number of pairs is defined by the specified number of regions. This parameter can be used for I/Q vector ($n=0$) in Waveform (time domain) measurement and all parameters are specified by data point in PPHase.

The rms power of the specified region may be expressed as:

$$\text{Power} = 10 \times \log [10 \times (\text{RMS I/Q value})] + 10.$$

The RMS I/Q value (peak volts) is:

$$\sqrt{\frac{1}{n} \sum_{X_i \in \text{region}} X_i X_i^*}$$

vsd27-9

where X_i is the complex value representation of an I/Q pair, X_i^* its conjugate complex number, and n is the number of I/Q pairs in the specified region.

The arithmetic mean phase of the specified region may be expressed as:

$$\frac{1}{n} \sum_{Y_i \in \text{region}} Y_i$$

vsd27-10

where Y_i is the unwrapped phase of I/Q pair with applying frequency correction and n is the number of I/Q pairs in the specified region.

The frequency correction is made by the frequency offset calculated by the arithmetic mean of every specified region's frequency offset. Each frequency offset is calculated by the least square method against the unwrapped phase of I/Q pair.

Sample Trace Data - Constant Envelope

(See below for explanation of variables.)

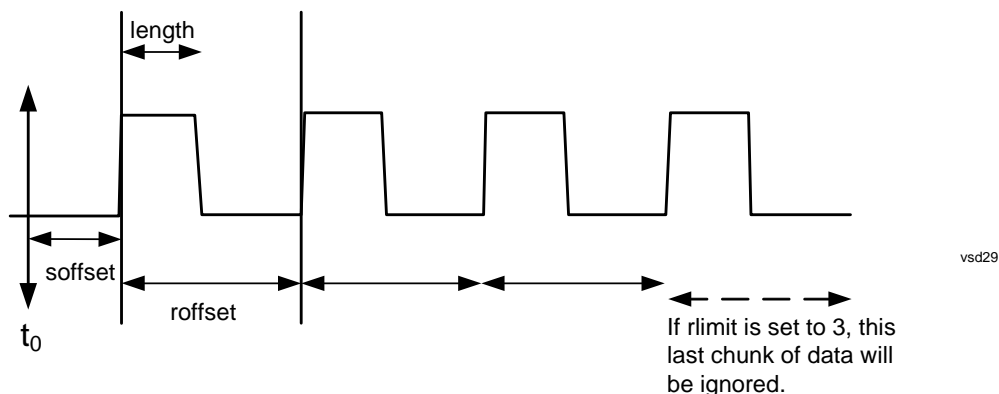

Sample Trace Data - Not Constant Envelope

(See below for explanation of variables.)

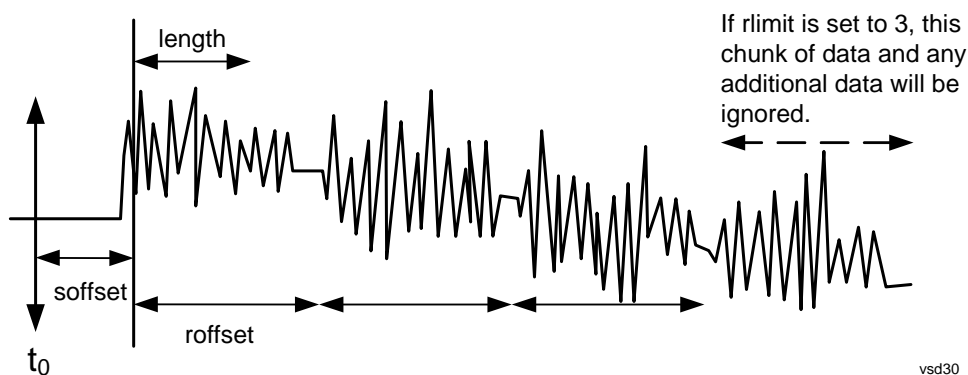

<soffset> - start offset is an optional real number. (It is in seconds for time-domain traces, and is a dimensionless index 0 to Npoints - 1, for frequency-domain traces). It specifies the amount of data at the beginning of the trace that will be ignored before the decimation process starts. It is the time or frequency change from the start of the trace to the point where you want to start using the data. The default value is zero.

<length> - is an optional real number. (It is in seconds for time-domain traces, and is a dimensionless index 0 to Npoints - 1, for frequency-domain traces). It defines how much data will be compressed into one value. This parameter has a default value equal to the current trace length.

<roffset> - repeat offset is an optional real number. (It is in seconds for time-domain traces, and is a dimensionless index 0 to Npoints - 1, for frequency-domain traces). It defines the beginning of the next field of trace elements to be compressed. This is relative to the beginning of the previous field. This parameter has a default value equal to the <length> variable. Note that this parameter is used for a completely different purpose when curve fitting (see CFIT above).

<rlimit> - repeat limit is an optional integer. It specifies the number of data items that you want returned. It will ignore any additional items beyond that number. You can use the Start offset and the Repeat limit to pick out exactly what part of the data you want to use. The default value is all the data.

Calculate Peaks of Trace Data (Remote Command Only)

Returns a list of all the peaks for the currently selected measurement and sub-opcode [n]. The peaks must

Meas

meet the requirements of the peak threshold and excursion values.

n = any valid sub-opcode for the current measurement. See the MEASure:<measurement> command description of your specific measurement for information on the data that can be returned.

The command can only be used with specific sub-opcodes with measurement results that are trace data. Both real and complex traces can be searched, but complex traces are converted to magnitude in dBm. In many measurements the sub-opcode n=0, is the raw trace data which cannot be searched for peaks. And Sub-opcode n=1, is often calculated results values which also cannot be searched for peaks.

This command uses the data setting specified by the FORMat:BORDER and FORMat:DATA commands and can return real or ASCII data. If the format is set to INT,32, it returns REAL,32 data.

The command has four types of parameters:

- Threshold (in dBm)
- Excursion (in dB)
- Sorting order (amplitude, frequency, time)
- Optional in some measurements: Display line use (all, > display line, < display line)

Remote Command:	<code>:CALCulate:DATA[1] 2 3 4 5 6 :PEAKs?</code> <code><threshold>, <excursion> [, AMPLitude FREQuency TIME]</code>
Example:	<p><code>CALC:DATA4:PEAK? -40,10,FREQ,GTDL</code> This will identify the peaks of trace 4 that are above -40 dBm, with excursions of at least 10 dB. The peaks are returned in order of increasing frequency, starting with the lowest frequency. Only the peaks that are above the display line are returned.</p> <p>Query Results 1:</p> <p>With FORMat:DATA REAL,32 selected, it returns a list of floating-point numbers. The first value in the list is the number of peak points that are in the following list. A peak point consists of two values: a peak amplitude followed by its corresponding frequency (or time).</p> <p>If no peaks are found the peak list will consist of only the number of peaks, (0).</p>

<p>Notes:</p>	<p><n> - is the trace that will be used</p> <p><threshold> - is the level below which trace data peaks are ignored. Note that the threshold value is required and is always used as a peak criterion. To effectively disable the threshold criterion for this command, provide a substantially low threshold value such as -200 dBm. Also note that the threshold value used in this command is independent of and has no effect on the threshold value stored under the Peak Criteria menu.</p> <p><excursion> - is the minimum amplitude variation (rise and fall) required for a signal to be identified as peak. Note that the excursion value is required and is always used as a peak criterion. To effectively disable the excursion criterion for this command, provide the minimum value of 0.0 dB. Also note that the excursion value used in this command is independent of and has no effect on the excursion value stored under the Peak Criteria menu.</p> <p>Values must be provided for threshold and excursion. The sorting and display line parameters are optional (defaults are AMPLitude and ALL).</p> <p>Note that there is always a Y-axis value for the display line, regardless of whether the display line state is on or off. It is the current Y-axis value of the display line which is used by this command to determine whether a peak should be reported</p> <p>Sorting order:</p> <p>AMPLitude - lists the peaks in order of descending amplitude, with the highest peak first (default if optional parameter not sent)</p> <p>FREQuency - lists the peaks in order of occurrence, left to right across the x-axis.</p> <p>TIME - lists the peaks in order of occurrence, left to right across the x-axis.</p> <p>Peaks vs. Display Line:</p> <p>ALL - lists all of the peaks found (default if optional parameter not sent).</p> <p>GTDLine (greater than display line) - lists all of the peaks found above the display line.</p> <p>LTDLine (less than display line) - lists all of the peaks found below the display line.</p>
<p>Initial S/W Revision:</p>	<p>Prior to A.02.00</p>
<p>Help Map ID:</p>	<p>0</p>

Format Data: Numeric Data (Remote Command Only)

This command specifies the format of the trace data input and output. It specifies the formats used for trace data during data transfer across any remote port. It affects only the data format for setting and querying trace data for the :TRACe[:DATA], TRACe[:DATA]?, :CALCulate:DATA[n]? and FETCh:SANalyzer[n]? commands and queries.

<p>Remote Command:</p>	<p>:FORMat [:TRACe] [:DATA] ASCii INTEger, 32 REAL, 32 REAL, 64</p> <p>:FORMat [:TRACe] [:DATA] ?</p>
-------------------------------	---

Meas

Notes:	<p>The query response is:</p> <p>ASCii: ASC,8</p> <p>REAL,32: REAL,32</p> <p>REAL,64: REAL,64</p> <p>INTeger,32: INT,32</p> <p>When the numeric data format is REAL or ASCii, data is output in the current Y Axis unit. When the data format is INTeger, data is output in units of m dBm (.001 dBm).</p> <p>The INT,32 format returns binary 32-bit integer values in internal units (m dBm), in a definite length block.</p>
Dependencies:	<p>Sending a data format spec with an invalid number (for example, INT,48) generates no error. The test set simply uses the default (8 for ASCii, 32 for INTeger, 32 for REAL).</p> <p>Sending data to the test set which does not conform to the current FORMat specified, results in an error. Sending ASCII data when a definite block is expected generates message -161 "Invalid Block Data" and sending a definite block when ASCII data is expected generates message -121 "Invalid Character in Number".</p>
Preset:	ASCii
Backwards Compatibility Notes:	Note that the INT,32 format is only applicable to the command, TRACe:DATA. For all other commands/queries which honor FORMat:DATA, if INT,32 is sent the analyzer will behave as though it were set to REAL,32.
Initial S/W Revision:	Prior to A.02.00
Help Map ID:	0

The specs for each output type follow:

ASCii - Amplitude values are in ASCII, in the current Y Axis Unit, one ASCII character per digit, values separated by commas, each value in the form:

SX.YYYYYEsZZ

Where:

S = sign (+ or -)

X = one digit to left of decimal point

Y = 5 digits to right of decimal point

E = E, exponent header

s = sign of exponent (+ or -)

ZZ = two digit exponent

REAL,32 - Binary 32-bit real values in the current Y Axis Unit, in a definite length block.

REAL,64 - Binary 64-bit real values in the current Y Axis Unit, in a definite length block.

Format Data: Byte Order (Remote Command Only)

This command selects the binary data byte order for data transfer and other queries. It controls whether binary data is transferred in normal or swapped mode. This command affects only the byte order for setting and querying trace data for the :TRACe[:DATA], TRACe[:DATA]? , :CALCulate:DATA[n]? and FETCh:SANalyzer[n]? commands and queries.

By definition any command that says it uses FORMat:DATA uses any format supported by FORMat:DATA.

The NORMal order is a byte sequence that begins with the most significant byte (MSB) first, and ends with the least significant byte (LSB) last in the sequence: 1|2|3|4. SWAPped order is when the byte sequence begins with the LSB first, and ends with the MSB last in the sequence: 4|3|2|1.

Remote Command:	:FORMat:BORDER NORMAL SWAPped :FORMat:BORDER?
Preset:	NORMal
Initial S/W Revision:	Prior to A.02.00
Help Map ID:	0

Meas

Meas Setup

The Meas Setup key opens up a menu of keys that allow you to control the most important parameters for the current measurement.

NOTE In the Meas Setup menu you may configure Averaging, by setting the Average Number and the Average Type.

Key Path	Front-panel key
Initial S/W Revision	Prior to A.02.00
Help Map ID	3202

Average/Hold Number

Sets the terminal count number N for **Average**, **Max Hold** and **Min Hold** trace types. This number is an integral part of how the average trace is calculated. Basically, increasing N results in a smoother average trace.

See [“More Information” on page 644](#).

See [“AVER:CLE command” on page 644](#).

Key Path	Meas Setup
Remote Command	[:SENSe] :AVERage:COUNT <integer> [:SENSe] :AVERage:COUNT?
Couplings	Restarting any of these functions (Average , Max Hold or Min Hold) restarts all of them, as there is only one count.
Preset	100
State Saved	Saved in Instrument State
Min	1
Max	10000
Status Bits/OPC dependencies	See the Section “Sweep/Control” on page 867 for a discussion of the Sweeping, Measuring, Settling and OPC bits, and the Hi Sweep line. All are affected when a sequence is reset.
Initial S/W Revision	Prior to A.02.00
Help Map ID	3203

Meas Setup

More Information

AVER:CLE command

The AVER:CLE command (below) resets the average/hold count and does an INIT:IMM, which begins another set of sweeps when trigger conditions are satisfied. It only does this if an active trace is in Average or Hold type.

Remote Command:	[:SENSe] :AVERage :CLEar
Example:	AVER:COUN 100 AVER:CLE sets the current count (k and K) to 1 and restarts the averaging process.
Notes:	When the test set receives this command it performs an INIT:IMM, if and only if there is an active trace in Max Hold, Min Hold, or Average type.
Default Unit:	Enter
Initial S/W Revision:	Prior to A.02.00
Help Map ID:	3204

Average Type

Lets you control the way averaging is done by choosing one of the following averaging scales: log-power (video), power (RMS), or voltage averaging. Also lets you choose Auto Average Type (default).

When performing Trace Averaging, the equation that is used to calculate the averaged trace depends on the average type. See the descriptions for the keys which select each Average Type (“[Log-Pwr Avg \(Video\)](#)” on page 646 (Video), “[Pwr Avg \(RMS\)](#)” on page 646 (RMS), or “[Voltage Avg](#)” on page 647) for details on these equations.

See “[More Information](#)” on page 645.

Key Path	Meas Setup
Remote Command	[:SENSe] :AVERage :TYPE :AUTO OFF ON 0 1 [:SENSe] :AVERage :TYPE :AUTO?
Preset	ON
State Saved	Saved in Instrument State
Readback line	1-of-N selection as Log-Pwr (Video) for Log-Pwr (Video) Avg Pwr (RMS) for Power Avg Voltagefor Voltage
Initial S/W Revision	Prior to A.02.00
Help Map ID	3205

Remote Command:	[:SENSe] :AVERAge:TYPE RMS LOG SCALAr [:SENSe] :AVERAge:TYPE?
Notes:	Parameters map to avg types as: RMS = Pwr (RMS) Avg LOG = Log-Pwr (Video) Avg SCALAr = Voltage Avg
Preset:	LOG
Backwards Compatibility SCPI:	[:SENSe]:AVERAge:TYPE LINear sets Scalar averaging [:SENSe]:AVERAge:TYPE VOLTage sets Scalar averaging [:SENSe]:AVERAge:TYPE VIDEo sets Log-Power averaging [:SENSe]:AVERAge:TYPE LPOWer sets Log-Power averaging [:SENSe]:AVERAge:TYPE POWEr sets RMS averaging
Initial S/W Revision:	Prior to A.02.00
Help Map ID:	3206

More Information

When you select log-power averaging, the measurement results are the average of the signal level in logarithmic units (decibels). When you select power average (RMS), all measured results are converted into power units before averaging and filtering operations, and converted back to decibels for displaying. Remember: there can be significant differences between the average of the log of power and the log of the average power.

These are the averaging processes within the test set and all of them are affected by this setting:

Trace averaging (see Section [“Trace Average” on page 1008](#)) averages signal amplitudes on a trace-to-trace basis. The average type applies to all traces in Trace Average (it is not set on a trace-by-trace basis).

Average detector (see Section [“Detector” on page 1014](#)) averages signal amplitudes during the time or frequency interval represented by a particular measurement point.

VBW filtering (see Section [“BW” on page 489](#)) adds video filtering which is a form of averaging of the video signal.

When **Auto** is selected, the test set chooses the type of averaging (see below). When one of the average types is selected manually, the test set uses that type regardless of other test set settings, and shows Man on the **Average Type** key.

Auto

Chooses the optimum type of averaging for the current test set measurement settings.

Key Path	Meas setup, Average Type
Example	AVER:TYPE:AUTO ON

Meas Setup

Notes	See Average Type , above
Couplings	Here are the auto-select rules for Average Type : Auto selects Voltage Averaging if the Detector for any active trace is EMI Average or QPD or RMS Average ; otherwise it selects Power (RMS) Averaging if a Marker Function (Marker Noise, Band/Intvl Power) is on, or Detector is set to Man and Average ; otherwise if Amplitude, Scale Type is set to Lin it selects Voltage Averaging ; otherwise, if the EMC Standard is set to CISPR, it selects Voltage; otherwise Auto selects Log-Power Average . Note that these rules are only applied to active traces. Traces which are not updating do not impact the auto-selection of Average Type.
State Saved	Saved in Instrument State
Readback	The type auto-selected is displayed in the readback line on the Average Type key
Initial S/W Revision	Prior to A.02.00
Help Map ID	3207

Log-Pwr Avg (Video)

Selects the logarithmic (decibel) scale for all filtering and averaging processes. This scale is sometimes called “Video” because it is the most common display and analysis scale for the video signal within the test set. This scale is excellent for finding CW signals near noise, but its response to noise-like signals is 2.506 dB lower than the average power of those noise signals. This is compensated for in the Marker Noise function.

The equation for trace averaging on the log-pwr scale is shown below, where K is the number of averages accumulated. (In continuous sweep mode, once K has reached the Average/Hold Number, K stays at that value, providing a continuous running average.)

$$\text{New avg} = ((K-1)\text{Old avg} + \text{New data})/K$$

Assumes all values in decibel scale.

Key Path	Meas setup, Average Type
Example	AVER:TYPE LOG
Notes	See ““Average Type” on page 644”
Couplings	See ““Auto” on page 645”
Readback	Log-Pwr (Video)
Initial S/W Revision	Prior to A.02.00
Help Map ID	3208

Pwr Avg (RMS)

In this average type, all filtering and averaging processes work on the power (the square of the magnitude) of the signal, instead of its log or envelope voltage. This scale is best for measuring the true

time average power of complex signals. This scale is sometimes called RMS because the resulting voltage is proportional to the square root of the mean of the square of the voltage.

In the equation for averaging on this scale (below), K is the number of averages accumulated. (In continuous sweep mode, once K has reached the Average/Hold Number, K stays at that value, providing a running average.)

$$\text{New avg} = 10 \log \left(\frac{1}{K} \left((K-1)(10\text{Old avg}/10) + 10\text{New data}/10 \right) \right)$$

Equation assumes all values are in the decibel scale.

Key Path	Meas setup, Average Type
Example	AVER:TYPE RMS
Notes	See “Average Type” on page 644
Couplings	See “Auto” on page 645
Readback	Pwr (RMS)
Initial S/W Revision	Prior to A.02.00
Help Map ID	3209

Voltage Avg

In this Average type, all filtering and averaging processes work on the voltage of the envelope of the signal. This scale is good for observing rise and fall behavior of AM or pulse-modulated signals such as radar and TDMA transmitters, but its response to noise-like signals is 1.049 dB lower than the average power of those noise signals. This is compensated for in the **Marker Noise** function.

In the equation for averaging on this scale (below), K is the number of averages accumulated. (In continuous sweep mode, once K has reached the Average/Hold Number, K stays at that value.)

$$\text{New avg} = 20 \log \left(\frac{1}{K} \left((K-1)(10\text{Old avg}/20) + 10\text{New data}/20 \right) \right)$$

Equation assumes all values are in the decibel scale.

Key Path	Meas setup, Average Type
Example	AVER:TYPE SCAL
Notes	See “Average Type” on page 644
Couplings	See “Auto” on page 645
Readback	Pwr (RMS)
Initial S/W Revision	Prior to A.02.00
Help Map ID	3210

Limits

The limits key opens up a menu of keys to control the limits for the current measurement. Limits arrays

Meas Setup

can be entered by the user, sent over SCPI, or loaded from a file.

Initial S/W Revision	A.02.00
Key Path	Meas Setup
Dependencies	This key will only appear if you have the proper option installed in your test set.
Preset	Limits are turned off by a Preset, but the Limits arrays (data) are only reset (deleted) by Restore Mode Defaults. They survive shutdown and restarting of the test set application, which means they will survive a power cycle.
Help Map ID	3832

Select Limit

Specifies the selected limit. The term “selected limit” is used throughout this document to specify which limit is affected by the functions.

Key Path	Meas Setup, Limits
Notes	The selected limit is remembered even when not in the Limit Menu.
Preset	Limit 1, not affected by Mode Preset, preset by Restore Mode Defaults.
State Saved	Saved in State.
Initial S/W Revision	A.02.00
Help Map ID	3833

Limit On/Off

Selects whether the limit and margin are displayed. If Test Limits is on, this also determines whether the test trace (see “[Test Trace](#)” on page 650) is tested against the limit. If **Limit On/Off** is **On**, the following occurs:

- The limit line is displayed, in the same color as the limited trace, but paler. Portions of traces which fail the limits are displayed in red.
- The margin line is displayed if Margin is on and the Margin Value is non-zero (see “[Margin](#)” on page 655). The margin line is displayed in the same color as the limit line, but paler still and dashed. Portions of traces which pass the limits but fail the margin is displayed in amber.
- The trace is tested for the purpose of the “Trace Pass/Fail” indication in the graticule if, in addition to **Limit On/Off** being **On**, the trace is displayed and **Test Limits (All Limits)** is on (see “[Test Limits](#)” on page 661). If the trace is not tested, no report of the trace passing or failing is seen on the graticule. Note that the SCPI queries of Limit Pass/Fail are independent of these conditions; the test is always performed when queried over SCPI.

The PASS/FAIL box in the corner of the Meas Bar is only displayed if there is at least one “Trace Pass/Fail” indication displayed in the graticule.

Note that the red and amber coloring of traces which fail the limits and/or margins only applies to traces whose X-axis corresponds to the current test set X-axis. Traces which are not updating (in View, for

example) will not change color if the test set X-axis settings (for example, start and stop frequency) do not match those of the trace, for example if they have been changed since the trace stopped updating. In this case, the Invalid Data indicator (*) will appear in the upper right hand corner.

When the limits are frequency limits but the trace is a zero-span trace, the limit trace is drawn at the limit amplitude of the center frequency. When the limits are time limits but the trace is a frequency domain trace, the limit trace is drawn according to the current time axis, with the left of the screen being 0 and the right being equal to sweep time.

Key Path	Meas Setup, Limits
Remote Command	:CALCulate:LLINe [1] 2 3 4 5 6 :DISPlay OFF ON 0 1 :CALCulate:LLINe [1] 2 3 4 5 6 :DISPlay?
Example	:CALC:LLIN2:DISP ON turns on the display for limit line 2.
Dependencies	This command will generate an “Option not available” error unless you have the proper option installed in your test set.
Couplings	Limit display ON selects the limit. Testing is done on all displayed limits if Test Limits (All Limits) is ON. Entering the limit menu from the GUI turns on the selected limit.
Preset	OFF
State Saved	Saved in State.
Backwards Compatibility SCPI	:CALCulate:LLINe[1] 2:STATe OFF ON 0 1 (In the past you had to send the DISP command as well as the STATe command in order to get a limit on and testing. Now, the DISP command is sufficient, but we accept the state command and do nothing with it)
Initial S/W Revision	A.02.00
Help Map ID	3834

Properties

Accesses a menu which lets you set the properties of the selected limit.

Key Path	Meas Setup, Limits
Initial S/W Revision	A.02.00
Help Map ID	3835

Select Limit

Specifies the selected limit. The term “selected limit” is used throughout this document to specify which limit is affected by the functions.

Key Path	Meas Setup, Limits, Properties
----------	--------------------------------

Meas Setup

Notes	The selected limit is remembered even when not in the Limit Menu.
Preset	Limit 1, not affected by Mode Preset, preset by Restore Mode Defaults.
State Saved	Saved in State.
Initial S/W Revision	A.02.00
Help Map ID	3836

Test Trace

Selects the trace you want the limit to test. A limit is applied to one and only one trace; each trace can have both an upper and a lower limit. When executing Limit Test, the limit is applied only to the specified trace.

A trace can have multiple limit lines simultaneously; in that case, only one upper and one lower limit line will affect the color of the trace. Other limit lines are displayed, and affect the pass/fail status, but the trace does not turn red if it crosses a secondary limit line.

Key Path	Meas Setup, Limits, Properties
Remote Command	:CALCulate:LLINe [1] 2 3 4 5 6 :TRACe 1 2 3 4 5 6 :CALCulate:LLINe [1] 2 3 4 5 6 :TRACe?
Example	:CALC:LLIN3:TRAC 2 applies limit 3 to trace 2.
Notes	When the trace display is off, the trace is not tested. The trace is tested only when the trace display is on and Test Limits (see “Test Limits” on page 661) is on.
Couplings	This matters when testing a trace or limit line for failure, via :CALC:LLIN3:FAIL? or :CALC:TRAC2:FAIL?
Preset	Limits 1 and 2 preset to 1, Limits 3 and 4 preset to 2, Limits 5 and 6 preset to 3 Not affected by Mode Preset, preset by Restore Mode Defaults.
State Saved	Saved in State.
Min	1
Max	6
Readback	Trace 1 2 3 4 5 6
Initial S/W Revision	A.02.00
Help Map ID	3837

Type

Selects whether the limit you are editing is an upper or lower limit. An upper limit fails if the trace exceeds the limit. A lower limit fails if the trace falls below the limit.

Key Path	Meas Setup, Limits, Properties
----------	---------------------------------------

Remote Command	:CALCulate:LLINE [1] 2 3 4 5 6 :TYPE UPPER LOWER :CALCulate:LLINE [1] 2 3 4 5 6 :TYPE?
Example	:CALC:LLIN2:TYPE LOW sets limit line 2 to act as a lower limit.
Couplings	If a margin has already been set for this limit line, and this key is used to change the limit type, then the margin value will reverse sign.
Preset	Upper for Line 1, 3, and 5; Lower for Line 2, 4, 6. Not affected by Mode Preset, preset by Restore Mode Defaults.
State Saved	Saved in State.
Initial S/W Revision	A.02.00
Help Map ID	3838

Interpolation

Accesses a menu which lets you set the frequency and amplitude interpolation of the selected limit.

Key Path	Meas Setup, Limits, Properties
Readback	[Lin Log Frequency, Lin Log Amplitude]
Initial S/W Revision	A.02.00
Help Map ID	3839

Frequency Interpolation

This key is grayed out if Time is the selected X-axis units. Sets the interpolation between frequency points, allowing you to determine how limit trace values are computed between points in a limit table. The available interpolation modes are linear and logarithmic. If frequency interpolation is logarithmic (Log), frequency values between limit points are computed by first taking the logarithm of both the table values and the intermediate value. A linear interpolation is then performed in this logarithmic frequency space. An exactly analogous manipulation is done for logarithmic amplitude interpolation.

Note that the native representation of amplitude is in dB.

For linear amplitude interpolation and linear frequency interpolation, the interpolation is computed as:

$$y = 20 \log\left(\frac{10^{\frac{y_{i+1}}{20}} - 10^{\frac{y_i}{20}}}{f_{i+1} - f_i} (f - f_i) + 10^{\frac{y_i}{20}}\right)$$

For linear amplitude interpolation and log frequency interpolation, the interpolation is computed as:

$$y = 20 \log\left(\frac{10^{\frac{y_{i+1}}{20}} - 10^{\frac{y_i}{20}}}{\log f_{i+1} - \log f_i} (\log f - \log f_i) + 10^{\frac{y_i}{20}}\right)$$

For log amplitude interpolation and linear frequency interpolation, the interpolation is computed as:

Meas Setup

$$y = \frac{y_{i+1} - y_i}{f_{i+1} - f_i} (f - f_i) + y_i$$

For log amplitude interpolation and log frequency interpolation, the interpolation is computed as:

$$y = \frac{y_{i+1} - y_i}{\log f_{i+1} - \log f_i} (\log f - \log f_i) + y_i$$

NOTE Interpolation modes determine how limit values are computed between points in the limit table. The appearance of a limit trace is also affected by the amplitude scale, which may be linear or logarithmic.

Key Path	Meas Setup, Limits, Properties, Interpolation
Remote Command	:CALCulate:LLINE [1] 2 3 4 5 6 :CONTRol:INTerpolate:TYPE LOGarithmic LINear :CALCulate:LLINE [1] 2 3 4 5 6 :CONTRol:INTerpolate:TYPE?
Example	:CALC:LLIN:CONT:INT:TYPE LIN sets limit line 1 frequency interpolation to linear.
Preset	Linear, not affected by Mode Preset, preset by Restore Mode Defaults.
State Saved	Saved in instrument state.
Initial S/W Revision	A.02.00
Help Map ID	3840

Amplitude Interpolation

Sets the interpolation to linear or logarithmic for the specified limiting points set, allowing you to determine how limit trace values are computed between points in a limit table. See Frequency Interpolation for the equations used to calculate limit values between points.

Key Path	Meas Setup, Limits, Properties, Interpolation
Remote Command	:CALCulate:LLINE [1] 2 3 4 5 6 :AMPLitude:INTerpolate:TYPE LOGarithmic LINear :CALCulate:LLINE [1] 2 3 4 5 6 :AMPLitude:INTerpolate:TYPE?
Example	:CALC:LLIN:AMPL:INT:TYPE LIN sets limit line 1 amplitude interpolation to linear.
Preset	Logarithmic, not affected by Mode Preset, preset by Restore Mode Defaults.
State Saved	Saved in instrument state.
Initial S/W Revision	A.02.00
Help Map ID	3841

Fixed / Relative

Opens a menu which will allow you to specify that the selected limit is relative to either Center Frequency or Reference level.

Key Path	Meas Setup, Limits, Properties
Readback	Fixed Rel to CF Rel to RL Rel to CF + RL (square brackets)
Initial S/W Revision	A.02.00
Help Map ID	3842

Relative to CF

Chooses whether the limit line frequency points are coupled to the test set center frequency, and whether the frequency points are expressed as an offset from the test set center frequency. If the limit lines are specified with time, this has no effect. The limit table must in this case support negative frequencies.

For example, assume you have a frequency limit line, and the test set center frequency is at 1 GHz. If Relative to CF is “Off”, entering a limit line segment with a frequency coordinate of 300 MHz displays the limit line segment at 300 MHz, and the limit line segment will not change frequency if the center frequency changes. If Relative to CF is “On”, entering a limit line segment with a frequency coordinate of 300 MHz displays the limit line segment at CF + 300 MHz, or 1.3 GHz. Furthermore, if the center frequency changes to 2 GHz, the limit line segment is displayed at CF + 300 MHz, or 2.3 GHz.

It is possible to change this setting after a limit line has been entered. When changing from On to Off or vice-versa, the frequency values in the limit line table change so that the limit line remains in the same position for the current frequency settings of the test set.

Pressing this button makes Center Frequency the active function.

Key Path	Meas Setup, Limits, Properties, Fixed/Relative
Remote Command	:CALCulate:LLINe [1] 2 3 4 5 6 :FREQUENCY:CMODE:RELative ON OFF 1 0 :CALCulate:LLINe [1] 2 3 4 5 6 :FREQUENCY:CMODE:RELative?
Example	:CALC:LLIN:FREQ:CMOD:REL ON makes limit line 1 relative to the center frequency.
Notes	If the Trace Domain is changed to Time (:CALCulate:LLINe:CONTRol:DOMain TIME), the SCPI command :CALCulate:LLINe[1] 2 3 4 5 6:FREQUENCY:CMODE:RELative ON OFF 1 0 will have no effect.
Couplings	Pressing this button makes Center Frequency the active function.
Preset	Off, not affected by Mode Preset, preset by Restore Mode Defaults.
State Saved	Saved in instrument state.
Initial S/W Revision	A.02.00
Help Map ID	3843

Meas Setup

Relative to RL

Chooses whether the limit line amplitude points are coupled to the test set reference level, and whether the amplitude points are expressed as an offset from the test set reference level.

For example, assume you have a limit line, and the reference level at -10 dBm. If Relative to RL is “Off”, entering a limit line segment with an amplitude coordinate of -20 dB displays the limit line segment at -20 dBm, and the limit line segment will not change amplitude if the reference level amplitude changes. If Relative to RL is “On”, entering a limit line segment with an amplitude coordinate of -20 dB displays the limit line segment at $RL - 20$ dB, or -30 dBm. Furthermore, if the reference level amplitude changes to -30 dBm, the limit line segment is displayed at $RL - 20$ dB, or -50 dBm.

It is possible to change this setting after a limit line has been entered. When changing from On to Off or vice-versa, the amplitude values in the limit line table change so that the limit line remains in the same position for the current reference level settings of the test set.

Key Path	Meas Setup, Limits, Properties, Fixed/Relative
Remote Command	:CALCulate:LLINe [1] 2 3 4 5 6 :AMPLitude:CMODE:RELative ON OFF 1 0 :CALCulate:LLINe [1] 2 3 4 5 6 :AMPLitude:CMODE:RELative?
Example	:CALC:LLIN:AMPL:CMOD:REL ON makes limit line 1 relative to the reference level amplitude.
Couplings	Pressing this button makes Reference level the active function.
Preset	Off, not affected by Mode Preset, preset by Restore Mode Defaults.
State Saved	Saved in instrument state.
Initial S/W Revision	A.02.00
Help Map ID	3844

Description

Provides a description of up to 60 characters by which the operator can easily identify the limit. It is stored in the exported file. Can be displayed in the active function area by selecting as the active function, if desired to be in a screen dump.

Key Path	Meas Setup, Limits, Properties
Remote Command	:CALCulate:LLINe [1] 2 3 4 5 6 :DESCRiption "Description" :CALCulate:LLINe [1] 2 3 4 5 6 :DESCRiption?
Example	:CALC:LLIN:DESC "European Emissions"
Preset	"" (null String), not affected by Mode Preset, preset by Restore Mode Defaults.
State Saved	Saved in instrument state
Readback	As much of the description will fit on one line of the key, followed by “...” if some of the description will not fit on one line of the key.
Initial S/W Revision	A.02.00

Help Map ID	3845
-------------	------

Comment

Sets an ASCII comment field which is stored in an exported file. Can be displayed in the active function area by selecting as the active function, if desired to be in a screen dump. The Limits .csv file supports this field.

Key Path	Meas Setup, Limits, Properties
Remote Command	:CALCulate:LLINe [1] 2 3 4 5 6 :COMMeNt "text" :CALCulate:LLINe [1] 2 3 4 5 6 :COMMeNt?
Example	:CALC:LLIN1:COMM "this is a comment"
Preset	"" (null String), not affected by Mode Preset, preset by Restore Mode Defaults.
State Saved	Saved in instrument state.
Readback	As much of the description will fit on one line of the key, followed by "..." if some of the description will not fit on one line of the key.
Initial S/W Revision	A.02.00
Help Map ID	3846

Margin

Selects a margin for this limit, which will cause a trace to Fail Margin when the trace is between the limit line and the margin line. Portions of the traces which pass the limit but fail the margin are displayed in an amber color.

A margin is always specified in dB relative to a limit – an upper limit always has a negative margin, and a lower limit always has a positive margin. If a value is entered with the incorrect sign, the system automatically takes the negative of the entered value.

If the limit type is switched from lower to upper while margin is present, the margin reverses sign.

When the Margin is selected, it may be turned off by pressing the Margin key until Off is underlined. This may also be done by performing a preset. Margin is the default active function whenever the margin is on, and it is not the active function whenever the margin is off.

The margin lines are displayed in the same color as limit lines, but paler. If the limited trace is blanked then the limit line and the margin line is blanked as well.

Key Path	Meas Setup, Limits
Remote Command	:CALCulate:LLINe [1] 2 3 4 5 6 :MARGIn <rel_amp1> :CALCulate:LLINe [1] 2 3 4 5 6 :MARGIn? :CALCulate:LLINe [1] 2 3 4 5 6 :MARGIn:STATe OFF ON 0 1 :CALCulate:LLINe [1] 2 3 4 5 6 :MARGIn:STATe?

Meas Setup

Example	<p>:CALC:LLIN1:MARG -2dB sets limit line 1's margin to -2 dB (Limit Line 1 is by default an upper limit).</p> <p>:CALC:LLIN2:MARG 1dB sets limit line 2's margin to 1 dB (Limit Line 2 is by default a lower limit).</p> <p>:CALC:LLIN2:MARG:STAT OFF turns off the margin for limit line 2 and removes any tests associated with that margin line.</p>
Notes	The queries "Limit Line Fail?" (:CALCulate:LLINe[1] 2 3 4 5 6:FAIL?) and "Trace Fail?" (:CALCulate:TRACe[1] 2 3 4 5 6:FAIL?) will return 1 if the margin fails.
Couplings	This will affect :CALC:LLIN3:FAIL or :CALC:TRAC2:FAIL?
Preset	not affected by Mode Preset, set to 0 dB for all Limits by Restore Mode Defaults.
State Saved	Saved in instrument state.
Min	-40 dB (Upper); 0 dB (Lower)
Max	0 dB (Upper); 40 dB (Lower);
Default Unit	dB
Initial S/W Revision	A.02.00
Help Map ID	3847

Edit

Opens the Table Editor for the selected limit line.

When entering the menu, the editor window (with the limit table) turns on, the selected Limit is turned **On** and the amplitude scale is set to **Log**. The display of the trace to which the selected limit applies is turned on (thus, traces in Blank are set to View and traces in Background are set to On). Turning on the Limit means it's display is on, and it's testing mode is on as well; you should turn off any other limits that are on if they interfere with the editing of the selected limit.

NOTE The table editor will only operate properly if the test set is sweeping, because its updates are tied to the sweep system. Thus, you should not try to use the editor in single sweep, and it will be slow during computer-intensive operations like narrow-span FFT sweeps.

When exiting the edit menu (by using the Return key or by pressing a test set front panel key), the editor window turns off, however the Limit is still on and displayed, and the amplitude scale remains **Log**.

Limits are turned off by a Preset, but the Limits arrays (data) are only reset (deleted) by Restore Mode Defaults. They survive shutdown and restarting of the test set application, which means they will survive a power cycle.

Key Path	Meas Setup, Limits
----------	---------------------------

Couplings	Turns the Limit Peaks table off. A remote user can enter or access limit line data via :CALCulate:LLINe[1] 2 3 4 5 6:DATA
Initial S/W Revision	A.02.00
Help Map ID	3848

Navigate

Lets you move through the table to edit the desired point

Key Path	Meas Setup, Limits, Edit
Notes	There is no value readback on the key
Initial S/W Revision	A.02.00
Help Map ID	3849

Frequency

Lets you edit the frequency of the current row.

Key Path	Meas Setup, Limits, Edit
Notes	There is no value readback on the key
Initial S/W Revision	A.02.00
Help Map ID	3850

Amplitude

Lets you edit the Amplitude of the current row.

Key Path	Meas Setup, Limits, Edit
Notes	There is no value readback on the key
Min	-1000 dBm
Max	1000 dBm
Initial S/W Revision	A.02.00
Help Map ID	3851

Insert Point Below

Pressing this key inserts a point below the current point. The new point is a copy of the current point and becomes the current point. The new point is not yet entered into the underlying table, and the data in the row is displayed in light gray.

Key Path	Meas Setup, Limits, Edit
----------	---------------------------------

Meas Setup

Initial S/W Revision	A.02.00
Help Map ID	3852

Delete Point

This is an immediate action key. It will immediately delete the currently-selected point, whether or not that point is being edited, and select Navigate. The point following the currently-selected point (or the point preceding if there is none) is selected.

Key Path	Meas Setup, Limits, Edit
Initial S/W Revision	A.02.00
Help Map ID	3853

Copy from Limit

Copies an existing limit into the current limit, including all secondary parameters (Description, Associated Trace, Type, Margin, Interpolation, Relative to CF/RL).

Remote Command:	:CALCulate:LLINE [1] 2 3 4 5 6 :COPY LLINE1 LLINE2 LLINE3 LLINE4 LLINE5 LLINE6
Example:	:CALC:LLINE2:COPY LLINE1 copies the data from line 1 into line 2.
Notes:	Auto return to the Edit menu.
Initial S/W Revision:	A.02.00
Help Map ID:	3874

Build from Trace

Builds a limit using an existing trace. This command will overwrite all data in the limit. Since a straight copy would typically have hundreds or thousands of segments, the data is approximated to better represent a limit line; small excursions whose width is less than 10 trace buckets will sometimes not be captured. Secondary parameters which are not associated with traces (Description, Associated Trace, Type, Margin, Interpolation, Relative to CF/RL) are unchanged.

When taking a trace in order to build a limit, it will often work well to take the trace with a resolution bandwidth wider than the expected measurement, a video bandwidth lower than the expected measurement, and with the detector set to Max Hold or Min Hold.

Note that an upper limit is built above the trace, while a lower limit is built below the trace. If the trace is constant, the limit should pass after being built.

Remote Command:	:CALCulate:LLINE [1] 2 3 4 5 6 :BUILd TRACE1 TRACE2 TRACE3 TRACE4 TRACE5 TRACE6
Example:	:CALC:LLIN2:BUIL TRACE1 builds limit line 2 based on the data in trace 1. This will overwrite the data in the table editor.
Notes:	Auto return to Edit menu.

Initial S/W Revision:	A.02.00
Help Map ID:	3873

Offset

Enters a menu which allows you to offset the limit trace by a specified frequency, time, or amplitude. The offsets are immediately applied to the limit trace for display and failure calculation; the offset can also be applied to the points in the limit line.

Key Path	Meas Setup, Limits, Edit
Initial S/W Revision	A.02.00
Help Map ID	3870

X Offset

Offsets the limit trace by some specified frequency (for Frequency-based limit lines) or a time (for time-based limit lines).

Key Path	Meas Setup, Limits, Edit, Offset
Remote Command	:CALCulate:LLINe [1] 2 3 4 5 6 :OFFSet:X <value> :CALCulate:LLINe [1] 2 3 4 5 6 :OFFSet:X? <value> = <freq> if Limit X-Axis Unit is Frequency, <value> = <time> if Limit X-Axis Unit is Time
Example	:CALC:LLIN:OFFS:X -50MHZ sets the X axis offset to -50 MHz. :CALC:LLIN:OFFS:UPD will apply the X axis offset to all points in the limit line, then reset the X axis offset to zero.
Preset	0 Hz if Limit X-Axis Unit is Frequency 0 S if Limit X-Axis Unit is Time
State Saved	Saved in State, survives Preset
Min	-500 GHz
Max	500 GHz
Default Unit	Determined by X axis scale.
Initial S/W Revision	A.02.00
Help Map ID	3871

Y Offset

Offsets all segments in the limit line by some specified amplitude.

Key Path	Meas Setup, Limits, Edit, Offset
----------	---

Meas Setup

Remote Command	:CALCulate:LLINe [1] 2 3 4 5 6 :OFFSet:Y <rel ampl> :CALCulate:LLINe [1] 2 3 4 5 6 :OFFSet:Y?
Example	:CALC:LLIN:OFFS:Y -3 dB sets the Y axis offset to -3 dB. :CALC:LLIN:OFFSet:UPD will apply the Y axis offset to all points in the limit line, then reset the Y axis offset to zero.
Preset	0 dB
State Saved	Saved in instrument state.
Min	-Infinity
Max	+Infinity
Default Unit	dB
Initial S/W Revision	A.02.00
Help Map ID	3872

Apply Offsets to Limit Table

Adds the X and Y offsets to each point in the limit table, then resets the X and Y offset values to zero. This has no effect on the position of the limit trace.

For example, if the X offset is -10 MHz and the Y offset is 1 dB, the values in the limit table are updated as follows: 10 MHz is subtracted from each X value, 1 dB is added to each Y value. The offset values are then reset to zero. The limit trace is not moved and the limit table is updated to accurately reflect the currently-displayed limit trace.

Key Path	Meas Setup, Limits, Edit, Offset
Remote Command	:CALCulate:LLINe [1] 2 3 4 5 6 :OFFSet:UPDate
Example	:CALC:LLIN:OFFS:UPD sets updates the limit table to reflect the X and Y offsets, then resets the offsets to zero.
State Saved	No state
Initial S/W Revision	A.02.00
Help Map ID	3866

Scale X Axis

Matches the X-axis to the selected Limit, as well as possible.

For frequency limits and a frequency-domain X-axis, sets the Start and Stop Frequency to contain the minimum and maximum Frequency of the selected Limit. The range between Start Frequency and Stop Frequency is 12.5% above the range between the minimum and maximum Frequency so that span exceeds this range by one graticule division on either side.

For time limits and a time-domain X-axis, sets the sweep time to match the maximum Time of the selected Limit.

If the domain of the selected limit does not match the domain of the X-axis, no action is taken. Standard

clipping rules apply, if the value in the table is outside the allowable range for the X axis.

Key Path	Meas Setup, Limits, Edit
Initial S/W Revision	A.02.00
Help Map ID	3867

Delete Limit

Deletes the currently selected limit line. Pressing Delete Limit purges the data from the limit line tables.

Limit data – including secondary parameters such as description, margin value, et cetera - are cleared and returned to factory preset settings.

When this key is pressed a prompt is placed on the screen that says “Please press Enter or OK key to delete limit. Press ESC or Cancel to close this dialog.” The deletion is only performed if you press OK or Enter; if so, after the deletion, the informational message “Limit deleted” appears in the MSG line.

Key Path	Meas Setup, Limits
Remote Command	:CALCulate:LLINe [1] 2 3 4 5 6 :DELeTe
Example	:CALC:LLIN2:DEL deletes all data for limit line 2.
Initial S/W Revision	A.02.00
Help Map ID	3854

Test Limits

Selects whether displayed traces are tested against displayed limits (i.e. those for which Limit On/Off is set to On).

For each displayed trace for which a Limit is turned on, a message is displayed in the upper-left corner of the graticule to notify whether the trace passes or fails the limits.

If the trace is at or within the bounds of all applicable limits and margins, the text “Trace x Pass” is displayed in green, where x is the trace number. A separate line is used for each reported trace.

If the trace is at or within the bounds of all applicable limits, but outside the bounds of some applicable margin, the text “Trace x Fail Margin” is displayed in amber, where x is the trace number. A separate line is used for each reported trace.

If the trace is outside the bounds of some applicable limits, the text “Trace x Fail” is displayed in red, where x is the trace number. A separate line is used for each reported trace.

If the trace has no enabled limits, or the trace itself is not displayed, no message is displayed for that trace.

The PASS/FAIL box in the corner of the Meas Bar is only displayed if there is at least one “Trace Pass/Fail” indication displayed in the graticule.

If two amplitude values are entered for the same frequency, a single vertical line is the result. In this case, if an upper line is chosen, the lesser amplitude is tested. If a lower line is chosen, the greater amplitude is tested.

Meas Setup

This command only affects the display, and has no impact on remote behavior. Limit queries over SCPI test the trace against the limit regardless of whether the trace or the limit is turned on (exception: the query `:CALCulate:TRACe[1]|2|3|4|5|6:FAIL?` tests only the limits that are turned on for that trace).

Key Path	Meas Setup, Limits
Remote Command	<code>:CALCulate:LLINe:TEST OFF ON 0 1</code> <code>:CALCulate:LLINe:TEST?</code>
Example	<code>:CALC:LLIN:TEST ON</code> turns on testing, and displays the results in the upper left corner.
Preset	On, not affected by Mode Preset, preset by Restore Mode Defaults.
State Saved	Saved in instrument state.
Initial S/W Revision	A.02.00
Help Map ID	3855

X-Axis Unit

Selects how the limit-line segments are defined. Pressing X-axis unit selects whether the limit lines are entered using frequency (Freq) or sweep time (Time) to define the segments. They can be specified as a table of limit-line segments of amplitude versus frequency, or of amplitude versus time. When the X-Axis Unit is set to Time, a time value of zero corresponds to the start of the sweep, which is at the left edge of the graticule, and the column and key in the Limit Table Editor will read Time instead of Frequency

Switching the limit-line definition between Freq and Time will erase all of the current limit lines. When you do this from the front panel, a warning dialog will pop up letting you know that you are about to erase all the limit lines, and prompting you to hit “OK” if you are sure.

Changing the X-axis unit will erase all your limit lines. Are you sure you want to do this? Press **Enter** or **OK** to proceed, or **Cancel (Esc)** to cancel.

Key Path	Meas Setup, Limits
Remote Command	<code>:CALCulate:LLINe:CONTRol:DOMain FREQuency TIME</code> <code>:CALCulate:LLINe:CONTRol:DOMain?</code>
Example	<code>:CALC:LLIN:CONT:DOM FREQ</code> deletes all currently existing limit lines, then sets all limit lines to be specified in terms of frequency.
Couplings	This affects all limit lines simultaneously, and resets all limit line data except the .wav file and email address stored in the Actions.
Preset	Freq, not affected by Mode Preset, preset by Restore Mode Defaults.
State Saved	Saved in instrument state.
Initial S/W Revision	A.02.00
Help Map ID	3856

Delete All Limits

Deletes all limit lines. Pressing Delete All Limits purges the data from all limit line tables.

All limit data are cleared and returned to factory preset settings.

When this key is pressed a prompt is placed on the screen that says “Please press Enter or OK key to delete all limits. Press ESC or Cancel to close this dialog.” The deletion is only performed if you press OK or Enter; if so, after the deletion, the informational message “All Limits deleted” appears in the MSG line.

Key Path	Meas Setup, Limits
Remote Command	:CALCulate:LLINe:ALL:DELeTe
Example	:CALC:LLIN:ALL:DEL deletes all data for all limit lines.
Initial S/W Revision	A.02.00
Help Map ID	3857

Limit Line Data (Remote Command Only, Backwards Compatibility)

Defines the limit line values, and destroys all existing data. Up to 200 points may be defined for each limit using the following parameters.

<x>Frequency or time values as specified by :Calculate:LLINe:CONTrol:DOMain. Units default to Hz (for frequency) and seconds (for time).

Range: –30 Gs to +30 Gs for time limits, –3 kHz to +350 GHz for frequency limits.

<ampl>Amplitude values units default to dBm. Up to two amplitude values can be provided for each x-axis value, by repeating <x-axis> in the data list.

Range: –1000 dBm to +1000 dBm

<connect> connect values are either "0" or "1." A "1" means this point is connected to the previously defined point to define the limit line. A "0" means that it is a point of discontinuity and is not connected to the preceding point. The connect value is ignored for the first point.

Remote Command:	:CALCulate:LLINe [1] 2 3 4 5 6 :DATA <x>, <ampl>, <connect> :CALCulate:LLINe [1] 2 3 4 5 6 :DATA?
Example:	:CALC:LLIN3:DATA 1E9,-20,0,2E9,-20,1,2E9,-10,1,3E9,-10,1 describes a stair-stepped limit line.
Preset:	Limit line data is cleared by Restore Mode Defaults. However, it survives shutdown/restart of the test set application (including power cycle)
State Saved:	Saved in instrument state.
Initial S/W Revision:	A.02.00

Meas Setup

Help Map ID:	0
--------------	---

Limit Line Fail? (Remote Command Only)

Tests a limit line against its associated trace. Returns a 0 if the trace is within the limit and margin, a 1 if the trace exceeds either the limit or the margin.

Note that this command only tests one limit line – other limit lines are not tested when executing this command. To see whether a trace passed all limits, use :CALCulate:TRACe:FAIL?.

Note this command performs the test regardless of whether the trace or the limit is turned on on the display.

Remote Command:	:CALCulate:LLINe [1] 2 3 4 5 6 :FAIL?
Example:	:CALC:LLIN:FAIL? returns a zero if limit line 1's associated trace has no failure, 1 if there is a margin or limit failure.
Initial S/W Revision:	A.02.00
Help Map ID:	0

Limit State (Remote Command Only, SCPI standard compatibility)

Sets or queries whether the limit line is tested. This command is identical to :CALC:LLIN[1]|2|3|4|5|6:DISP.

Remote Command:	:CALCulate:LIMit [1] 2 3 4 5 6 :STATe ON OFF 0 1 :CALCulate:LIMit [1] 2 3 4 5 6 :STATe?
Example:	:CALC:LIM:STAT ON turns on limit line 1
Couplings:	This command is identical to :CALC:LLIN:DISP Testing is done on all displayed limits if “Test All Limits” is ON.
Preset:	Off (all limits)
State Saved:	Saved in State.
Initial S/W Revision:	A.02.00
Help Map ID:	0

Limit Line Control (Remote Command Only, SCPI standard compatibility)

Defines a list of limit line control (frequency or time) values for a given limit line. Up to 2000 points may be defined for each limit using the following parameters.

<x>Frequency or time values as specified by :Calculate:LLINe:CONTrol:DOMain. Units default to Hz (for frequency) and seconds (for time).

Range: –30 Gs to +30 Gs for time limits, –3 kHz to +1200 GHz for frequency limits.

Note that X values may be repeated if a vertical step in the limit line is desired.

The points query returns the number of points in the control. It should match the number of points in the amplitude, that is, the number of values for the CONTROL axis and for the corresponding UPPER and/or LOWER limit lines must be identical. If one array is larger than the other, the limit trace is built using only as much data as is contained in the smaller array.

An empty array returns not a number (9.91e+37 to a data query), 0 to a POINTs query.

Remote Command:	:CALCulate:LIMit [1] 2 3 4 5 6 :CONTRol [:DATA] <x>, <x>, ... :CALCulate:LIMit [1] 2 3 4 5 6 :CONTRol [:DATA] ?
Example:	:CALC:LIM:CONT 1GHz,2GHz,2GHz,3GHz describes the X values of a stair-stepped limit line.
Preset:	Limit line data is cleared by Restore Mode Defaults.
State Saved:	Saved in instrument state.
Initial S/W Revision:	A.02.00
Help Map ID:	0

Remote Command:	:CALCulate:LIMit [1] 2 3 4 5 6 :CONTRol :POINTs?
Example:	:CALC:LIM:CONT:POIN? returns the number of points in the limit line.
Preset:	Limit line data is cleared by Restore Mode Defaults.
State Saved:	Saved in instrument state.
Initial S/W Revision:	A.02.00
Help Map ID:	0

Limit Line Upper / Lower (Remote Command Only, SCPI standard compatibility)

Defines a list of amplitude values for a given limit line. Changing the number of elements in the list spectrum will automatically turn the limit line off. Using the “UPP” syntax defines an upper limit line, using the “LOW” syntax defines a lower limit line. Note that a line may not be simultaneously both upper and lower; the type of the limit line will automatically be changed as appropriate. Up to 200 points may be defined for each limit using the following parameters.

<ampl>Amplitude values units default to dBm.

Range: -200 dBm to +100 dBm

The points query returns the number of points in the amplitude list. It will not be possible to turn on the limit line unless the number of points in the control matches the number of points in the amplitude.

The points query returns the number of points in the amplitude list. It should match the number of points in the control, that is, the number of values for the CONTROL axis and for the corresponding UPPER and/or LOWER limit lines must be identical. If one array is larger than the other, the limit trace is built using only as much data as is contained in the smaller array.

Meas Setup

An empty array returns the system error “list is empty” to a data query, 0 to a POINTs query.

Remote Command:	:CALCulate:LIMit [1] 2 3 4 5 6 :UPPer [:DATA] <ampl>, <ampl>, ... :CALCulate:LIMit [1] 2 3 4 5 6 :UPPer [:DATA] ?
Example:	:CALC:LIM:UPP -10, -10, -20, -20 describes the amplitude values of an upper limit line
Preset:	Limit line data is cleared by Restore Mode Defaults.
State Saved:	Saved in instrument state.
Initial S/W Revision:	A.02.00
Help Map ID:	0

Remote Command:	:CALCulate:LIMit [1] 2 3 4 5 6 :UPPer :POINTs?
Example:	:CALC:LIM:UPP:POIN? returns the number of points in the upper limit line.
Preset:	Upper Limit line data/points is cleared by Restore Mode Defaults.
State Saved:	Saved in instrument state.
Initial S/W Revision:	A.02.00
Help Map ID:	0

Remote Command:	:CALCulate:LIMit [1] 2 3 4 5 6 :LOWer [:DATA] <ampl>, ... :CALCulate:LIMit [1] 2 3 4 5 6 :LOWer [:DATA] ?
Example:	:CALC:LIM:LOW -10, -10, -20, -20 describes the amplitude values of an lower limit line
Preset:	Limit line data is cleared by Restore Mode Defaults.
State Saved:	Saved in instrument state.
Initial S/W Revision:	A.02.00
Help Map ID:	0

Remote Command:	:CALCulate:LIMit [1] 2 3 4 5 6 :LOWer :POINTs?
Example:	:CALC:LIM:UPP:POIN? returns the number of points in the lower limit line.
Preset:	Limit line data/points is cleared by Restore Mode Defaults.
State Saved:	Saved in instrument state.
Initial S/W Revision:	A.02.00
Help Map ID:	0

Limit Fail? (Remote Command Only, SCPI standard Compatibility)

Tests a limit line against its associated trace. Returns a 0 if the trace is within the limit and margin, a 1 if the trace exceeds either the limit or the margin. This command is identical to “:CALC:LLIN:FAIL?”

Note that this command only tests one limit line – other limit lines are not tested when executing this command. To see whether a trace passed all limits, use :CALCulate:TRACe:FAIL?.

Note this command performs the test regardless of whether the trace or the limit is turned on on the display.

Remote Command:	:CALCulate:LIMit [1] 2 3 4 5 6 : FAIL?
Example:	:CALC:LIM:FAIL? returns a zero if limit line 1’s associated trace has no failure, 1 if there is a margin or limit failure.
Couplings:	This command is identical to :CALC:LLIN:FAIL?
Initial S/W Revision:	A.02.00
Help Map ID:	0

Limit Clear (Remote Command Only, SCPI standard Compatibility)

Clears a limit line, and all associated data. This command is identical to “:CALC:LLIN:DEL”

Remote Command:	:CALCulate:LIMit [1] 2 3 4 5 6 : CLear
Example:	:CALC:LIM2:CLE deletes all data for limit line 2.
Couplings:	This command is identical to :CALC:LLIN:DEL
Initial S/W Revision:	A.02.00
Help Map ID:	0

Trace Fail? (Remote Command Only)

Tests a trace against all associated limit lines. Returns a 0 if the trace is within all limits and margins, a 1 if the trace exceed either the limit or the margin. If no limits apply to the selected trace, this will automatically return a 0.

Only applies to limits that are turned on, if a Limit is off it will not be tested. If a Trace is not displaying it will still be tested, and if **Test Limits (All Limits)** is off the Trace will still be tested.

This command ignores limit lines that are assigned to other traces.

Remote Command:	:CALCulate:TRACe [1] 2 3 4 5 6 : FAIL?
Example:	:CALC:TRAC3:FAIL? returns a zero if there is no failure, 1 if the trace exceeds either the limit or the margin.
Initial S/W Revision:	A.02.00
Help Map ID:	0

Meas Setup

Fixed / Relative Limit (Remote Command Only, Backwards Compatibility)

This command sets both Relative to CF and Relative to RL simultaneously for all limits. If queried, it returns whether Limit Line 1 is set Relative to CF, and ignores all other fixed/relative data.

Remote Command:	:CALCulate:LLINe:CMODE FIXed RELative :CALCulate:LLINe:CMODE?
Example:	:CALC:LLIN:CMOD REL makes all limit lines relative to the center frequency and reference level.
Notes:	<p>This SCPI command is only supported for Backwards Compatibility.</p> <p>On the X-Series, this functionality is provided by a key which is specific to each limit line, and which provides a sub-menu with 2 keys (Relative to CF / Relative to RL).</p> <p>In order to be consistent with the implementation of the following new commands:</p> <pre>:CALCulate:LLINe[1] 2 3 4 5 6:FREQuency:CMODE:RELative ON OFF 1 0</pre> <pre>:CALCulate:LLINe[1] 2 3 4 5 6:FREQuency:CMODE:RELative?</pre> <p>and</p> <pre>:CALCulate:LLINe[1] 2 3 4 5 6:AMPLitude:CMODE:RELative ON OFF 1 0</pre> <pre>:CALCulate:LLINe[1] 2 3 4 5 6:AMPLitude:CMODE:RELative?</pre> <p>The :CALCulate:LLINe:CMODE? Query will returns 1 if Limit Line 1 is set Relative to CF, and returns 0 otherwise.</p>
Preset:	Fixed
Initial S/W Revision:	A.02.00
Help Map ID:	0

Merge Limit Line Data

Adds the points with the specified values to the current limit line, allowing you to merge limit line data. Up to two amplitude values are allowed for each X value. If more than 200 points are entered to be merged, the first 200 points are merged, then an error 'too many DATA entries' is reported.

Remote Command:	:CALCulate:LLINe [1] 2 3 4 5 6 :DATA:MERGe <x-axis>, <ampl>, <connected>
Example:	:CALC:LLIN1:DATA:MERG 1000000000,-20,0,2000000000,-30,1 merges the 10 GHz segment and the 20 GHz segment into limit line 1. Note that the 20 GHz segment is connected to the next lower point, which may or may not be the 10 GHz point.
Notes:	This SCPI command is only supported for Backwards Compatibility.
Preset:	Fixed
Initial S/W Revision:	A.02.00

Help Map ID:

0

N dB Points

Turns N dB points on and off and allows you to set the N dB value. N dB uses the selected marker. If the selected marker is not on when N dB is turned on, the selected marker turns on, as a Normal marker, at center screen, and is used by N dB.

See “N dB Points Results Query” on page 670.

See “More Information” on page 670.

Key Path	Meas Setup
Remote Command	:CALCulate:BWIDth BANDwidth:NDB <rel_ampl> :CALCulate:BWIDth BANDwidth:NDB? :CALCulate:BWIDth BANDwidth[:STATE] OFF ON 0 1 :CALCulate:BWIDth BANDwidth[:STATE]?
Notes	If the selected marker is turned Off it turns off N dB Points. N DB Points is unaffected by Auto Couple
Preset	Off, 3.01 dB OFF
Preset	Off, 3.01 dB OFF
State Saved	The on/off status and the offset value are both saved in instrument state.
Min	-140 dB
Max	-0.01 dB
Initial S/W Revision	Prior to A.02.00
Help Map ID	3211

Meas Setup

N dB Points Results Query

Remote Command:	:CALCulate:BWIDth BANDwidth:RESult?
Example:	:CALC:MARK:AOFF set selected marker to 1 :CALC:MARK:MAX put marker 1 on peak :CALC:BWID ON turn on N dB for the selected marker (1) :CALC:BWID:NDB-3.01 set the offset to -3.01 dB :CALC:BWID:RES? Query the result
Notes:	-100 returned if invalid reading
Initial S/W Revision:	Prior to A.02.00
Help Map ID:	3212

More Information

A marker should be placed on the peak of interest before turning on N dB points. The N dB points function looks for the two points on the marker's trace closest to the marker's X-axis value that are N dB below the marker's amplitude, one above and the other below the marker's X-axis value. (That is, one point is to the right and one is to the left of the selected marker.) The selected N dB value is called the offset. The function reports the frequency difference (for frequency domain traces) or time difference (for time domain traces) between those two points.

Each point is identified by a horizontal arrow pointing towards the marker, next to the trace. The arrows used by the N dB Points function is as shown in the figure below (where each square represents one pixel). They point in, horizontally, at the trace below a peak, on either side of its skirts. There is one pixel between the arrow and the trace

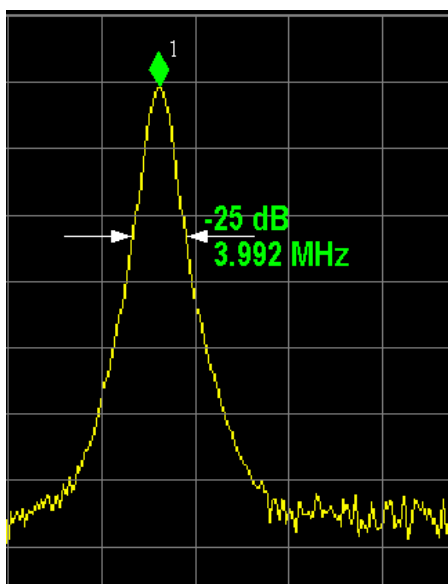

N dB Points can be used to measure the bandwidth of a signal; it is commonly used in conjunction with a tracking generator to measure filter bandwidths.

In one of the common use cases, the marker is placed on a peak, and the arrows are displayed N dB down the skirt from the marker on either side of the peak. The N dB value and the frequency difference between the two arrows is displayed around the arrow as shown in the figure above. Normally this displays on the right hand arrow, but if this would place any part of the text off screen to the right then it displays on the left arrow.

If the test set is unable to find data that is N dB below the marker on either side of the marker, the arrows are displayed at the indicator point of the marker, no value (---) is displayed as the result and -100 Hz returned remotely (see figure below):



Some sample N dB scenarios are shown below, to illustrate how the function works in various cases. In each case, the two-headed blue arrow represents N dB of amplitude.

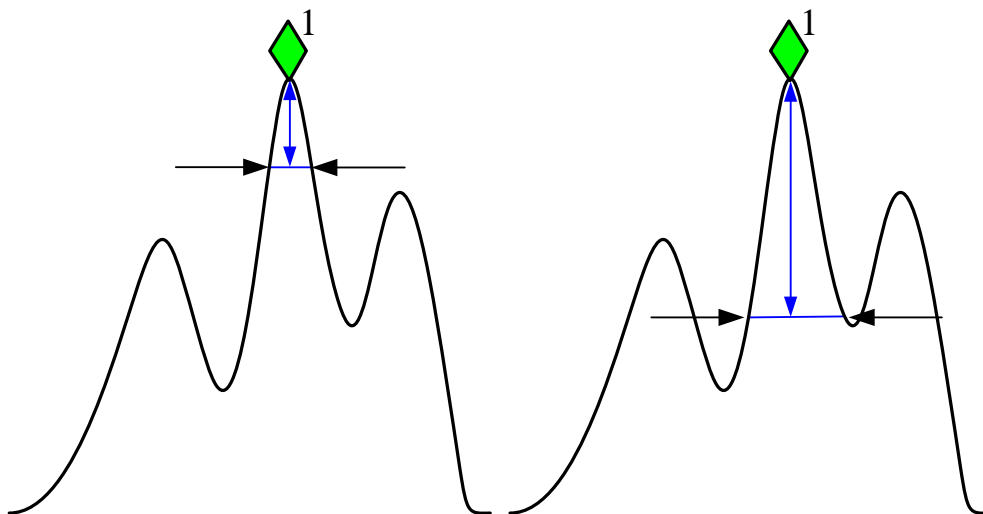

Meas Setup

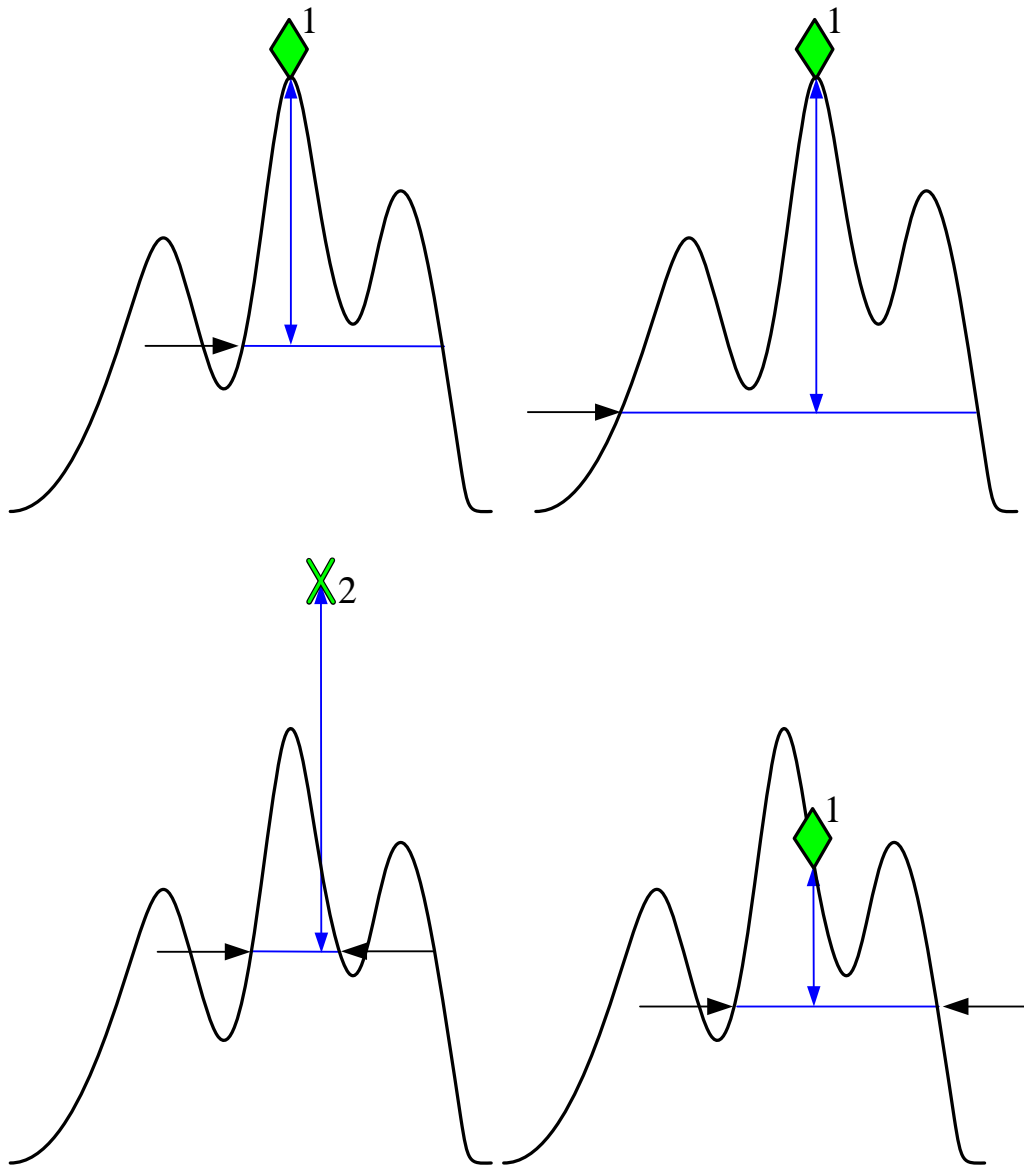

PhNoise Opt

Selects the LO (local oscillator) phase noise behavior for various desired operating conditions.

Remote Command:	<code>[:SENSe] :FREQuency:SYNTHeSis [:STATe] 1 2 3</code> <code>[:SENSe] :FREQuency:SYNTHeSis [:STATe] ?</code>
Example:	<code>FREQ:SYNT 2</code> selects optimization for best wide offset phase noise

Notes:	Parameter: 1 - optimizes phase noise for small frequency offsets from the carrier. 2 - optimizes phase noise for wide frequency offsets from the carrier. 3 - optimizes LO for tuning speed
Preset:	Because this function is in Auto after preset, and because Span after preset > 314.16 kHz (see Auto rules, next section) the state of this function after Preset is 2.
Dependencies:	Does not appear in all models. The key is blank in those models, but the SCPI command is accepted for compatibility (although no action is taken).
Initial S/W Revision:	Prior to A.02.00
Modified at S/W Revision:	A.02.00
Help Map ID:	3213

Auto

Selects the LO (local oscillator) phase noise behavior to optimize dynamic range and speed for various test set operating conditions.

The X-Series has two grades of LO; a high performance LO that gives the best phase noise performance; and a medium-performance LO that gives excellent performance.

In models with the high performance LO, Auto will choose:

Fast Tuning whenever Span > 44.44 MHz or RBW > 1.9 MHz

otherwise, if center frequency is < 195 kHz OR ALL of the following are true:

CF 1 MHz AND Span 1.3 MHz AND RBW 75 kHz

then Best Close in Phase Noise;

otherwise, Best Wide-offset Phase Noise

In models with the medium-performance LO, Auto will choose:

Fast Tuning whenever Span > 12.34 MHz or RBW > 250 kHz

otherwise, if center frequency is < 25 kHz OR ALL of the following are true:

CF >= 1 MHz AND Span <= 141.4 kHz AND RBW <= 5 kHz

then **Best Close in Phase Noise**;

otherwise, **Best Wide-offset Phase Noise**

In units whose hardware does not provide for an extra-fast tuning option, the settings for Fast Tuning are the same as Best Close-in, so in those models you will see no difference between these settings.

These rules apply whether in swept spans, zero span, or FFT spans.

Key Path	Meas Setup, PhNoise Opt
----------	-------------------------

Meas Setup

Remote Command	<code>[:SENSe] :FREQuency:SYNThesis:AUTO [:STATe] OFF ON 0 1</code> <code>[:SENSe] :FREQuency:SYNThesis:AUTO [:STATe] ?</code>
Example	FREQ:SYNT:AUTO ON
Preset	ON
State Saved	Saved in instrument state.
Initial S/W Revision	Prior to A.02.00
Help Map ID	3215

Best Close-in P Noise

The LO phase noise is optimized for smaller offsets from the carrier, at the expense of phase noise farther out.

Key Path	Meas Setup, PhNoise Opt
Example	FREQ:SYNT 1
Couplings	offset <20 kHz
Readback	Close-in. If manually selected the “Man” is underlined. The actual frequency offset within which noise is optimized is shown with in square brackets, as this can vary depending on the hardware set in use. For example, in some test sets this annotation appears as [offset <20 kHz]
Initial S/W Revision	Prior to A.02.00
Help Map ID	3216

Best Wide-offset Noise

The LO phase noise is optimized for wider offsets from the carrier. Optimization is especially improved for offsets from 70 kHz to 300 kHz. Closer offsets are compromised and the throughput of measurements (especially remote measurements where the center frequency is changing rapidly), is reduced.

Key Path	Meas Setup, PhNoise Opt
Example	FREQ:SYNT 2
Couplings	offset >30 kHz
Readback	Wide-offset. If manually selected the “Man” is underlined. The actual frequency offset beyond which noise is optimized is shown with in square brackets, as this can vary depending on the hardware set in use. For example, in some test sets this annotation appears as [offset >30 kHz]
Initial S/W Revision	Prior to A.02.00
Help Map ID	3217

Fast Tuning

In this mode, the LO behavior compromises phase noise at many offsets from the carrier in order to allow rapid measurement throughput when changing the center frequency or span. The term “fast tuning” refers to the time it takes to move the local oscillator to the start frequency and begin a sweep; this setting does not impact the actual sweep time in any way.

Key Path	Meas Setup, PhNoise Opt
Example	FREQ:SYNT 3
State Saved	Saved in instrument state.
Readback	Fast Tuning. Also, the “Man” must be underlined.
Initial S/W Revision	Prior to A.02.00
Help Map ID	3218

ADC Dither

Accesses the menu to control the ADC Dither function. The dither function enhances linearity for low level signals at the expense of reduced clipping-to-noise ratio. The reduced clipping-to-noise ratio results in higher noise, because we work to ensure that the clipping level of the ADC relative to the front terminals remains unchanged with the introduction of dither, and this results in reduced ADC dynamic range. So making measurements with ADC dither gives you better amplitude linearity, but turning ADC dither off gives you a lower noise floor (better sensitivity).

With dither on, the third-order distortions are usually invisible for mixer levels below -35 dBm. With dither off, these distortions can be visible, with typical power levels of -110 dBm referred to the mixer. Detection nonlinearity can reach 1 dB for dither off at mixer levels around -70 dBm and lower, while the specified nonlinearity is many times smaller with dither on.

When ADC Dither is on, the linearity of low-level signals is improved. The enhanced linearity is mostly improved scale fidelity. The linearity improvements of dither are most significant for RBWs of 3.9 kHz and less in swept mode, and FFT widths of 4 kHz and less in FFT mode.

The increased noise due to turning dither on is most significant in low band (0 to 3.6 GHz) with IF Gain set to Low, where it can be about 0.2 dB.

Key Path	Meas Setup
Example	ADC:DITH:HIGH Sets the ADC dither setting to High ADC:DITH ON Sets the ADC dither setting to Medium
Remote Command	[:SENSE] :ADC:DITHer [:STATE] OFF ON HIGH [:SENSE] :ADC:DITHer [:STATE] ?
Dependencies	
Preset	AUTO

Meas Setup

Backwards Compatibility SCPI	The old command [:SENSe]:ADC:DITHer AUTO is aliased to [:SENSe]:ADC:DITHer:AUTO[:STATe] ON; because of this, the [:SENSe]:ADC:DITHer function cannot be a true Boolean, so the query, [:SENSe]:ADC:DITHer? returns OFF or ON (not 1 or 0 like a true Boolean)
Initial S/W Revision	Prior to A.02.00
Modified at S/W Revision	A.02.00
Help Map ID	3219

Auto

Sets the ADC dither to automatic. The test set then chooses the dither level according to which is most likely to be the best selection, based on other settings within the digital IF.

When in Auto, the test set sets the dither to Medium whenever the effective IF Gain is Low by this definition of IF Gain = Low:

- When Sweep Type = Swept, IF Gain = Low whenever Swept IF Gain is set to Low Gain, whether by auto coupling or manual selection.
- When Sweep Type = FFT, IF Gain = Low whenever FFT IF Gain is set to "Low Gain," which cannot happen by auto coupling.

Whenever the IF Gain is not low by this definition, Auto sets the dither to Off.

Key Path	Meas Setup, ADC Dither
Remote Command	[:SENSe]:ADC:DITHer:AUTO[:STATe] OFF ON 0 1 [:SENSe]:ADC:DITHer:AUTO[:STATe]?
Example	ADC:DITH:AUTO ON
Preset	ON
State Saved	Saved in instrument state
Readback	The "Auto" is underlined, and the readback value is whatever setting is auto-selected
Initial S/W Revision	Prior to A.02.00
Help Map ID	3220

High (Best Log Accy)

When ADC dither is set to High, the scale fidelity is especially good, most notably the relative scale fidelity. The trade off is that there is a modest loss of noise floor performance, up to about a decibel.

Key Path	Meas setup, ADC Dither
Example	ADC:DITH:HIGH
Readback	If manually selected, the readback is High, with the "Man" underlined

Initial S/W Revision	A.02.00
Help Map ID	3869

Medium (Log Accy)

The Medium setting of ADC Dither (known as “On” in earlier versions of the test set software) improves the linearity of low-level signals at the expense of some noise degradation.

Key Path	Meas setup, ADC Dither
Example	ADC:DITH:ON
Readback	If manually selected, the readback is Medium, with the “Man” underlined
Initial S/W Revision	Prior to A.02.00
Modified at S/W Revision	A.02.00
Help Map ID	3221

Off (Best Noise)

When ADC Dither is Off, the test set noise floor is improved, because without the need to make room for the dither, you get a lower noise floor and better sensitivity.

Key Path	Meas setup, ADC Dither
Example	ADC:DITH:OFF
Readback	If manually selected, the readback is Off, with the “Man” underlined.
Initial S/W Revision	Prior to A.02.00
Help Map ID	3222

Swept IF Gain

To take full advantage of the RF dynamic range of the test set, there is an added switched IF amplifier with approximately 10 dB of gain. When you can turn it on without overloading the test set, the dynamic range is always better with it on than off. The **Swept IF Gain** key can be used to set the IF Gain function to Auto, or to High Gain (the extra 10 dB), or to Low Gain. These settings affect sensitivity and IF overloads.

This function is only active when in Swept sweeps. In FFT sweeps, the FFT IF Gain function is used instead.

Key Path	Meas Setup
Remote Command	[:SENSe] :IF:GAIN:SWEPT [:STATe] OFF ON 0 1 [:SENSe] :IF:GAIN:SWEPT [:STATe] ?
Example	IF:GAIN:SWEP ON

Meas Setup

Notes	where ON = high gain OFF = low gain
Couplings	<p>The 'auto' rules for Swept IF Gain depend on attenuation, preamp state, start and stop frequency and the setting of FFT IF Gain. Set the Swept IF Gain to High (On) when the total input attenuation is 0 dB, the preamp is off, the start frequency is 10 MHz or more, and the FFT IF Gain is auto coupled, or manually set to Autorange, or manually set to High. Also set the Swept IF Gain to High (On) when the total input attenuation is 2 dB or less, the preamp is on, the start frequency is 10 MHz or more, and the stop frequency is 3.6 GHz or less and the FFT IF Gain is auto coupled, or manually set to Uttering, or manually set to High. Under all other circumstances, set the Swept IF Gain to Low (Off).</p> <p>If the sweep type is Swept, the start frequency of the test set is less than 10 MHz, and you put Swept IF Gain in Manual On, a warning condition is generated and remains in effect as long as this condition exists. The warning message is about a possible IF overload.</p> <p>As with most parameters with an AUTO state, AUTO COUPLE sets it to Auto, and setting any specific value (for example on or off) will set the AUTO state to false.</p>
Preset	Auto after a Preset which yields Off unless the Preamp is on. Auto and Off after Meas Preset.
State Saved	Saved in instrument state.
Readback Line	High Gain or Low Gain
Initial S/W Revision	Prior to A.02.00
Help Map ID	3223

Auto

Activates the auto rules for Swept IF Gain

Key Path	Meas setup
Remote Command	[:SENSE] : IF : GAIN : SWEPT : AUTO [: STATE] OFF ON 0 1 [:SENSE] : IF : GAIN : SWEPT : AUTO [: STATE] ?
Example	IF:GAIN:SWEP:AUTO ON
Preset	ON
Initial S/W Revision	Prior to A.02.00
Help Map ID	3224

Low Gain (Best for Large Signals)

Forces Swept IF Gain to be off.

Key Path	Meas setup, ADC Ranging
Example	IF:GAIN:SWEP OFF
State Saved	Saved in instrument state.
Readback	Low Gain
Initial S/W Revision	Prior to A.02.00
Help Map ID	3225

High Gain (Best Noise Level)

Forces Swept IF Gain to be on.

Key Path	Meas setup, ADC Ranging
Example	IF:GAIN:SWEP ON
Dependencies	The High setting for Swept IF Gain is grayed out when FFT IF Gain is manually set to Low (not when Low is chosen by the auto-rules).
State Saved	Saved in instrument state.
Readback	High Gain
Initial S/W Revision	Prior to A.02.00
Help Map ID	3226

FFT IF Gain

Accesses the keys to set the ranging in the digital IF when doing FFT sweeps. When in Autorange mode, the IF checks its range once for every FFT chunk, to provide the best signal to noise ratio. You can specify the range for the best FFT speed, and optimize for noise or for large signals.

When the sweep type is FFT and this function is in Autorange, the IF Gain is set ON initially for each chunk of data. The data is then acquired. If the IF overloads, then the IF Gain is set OFF and the data is re-acquired. Because of this operation, the Auto setting uses more measurement time as the test set checks/resets its range. You can get faster measurement speed by forcing the range to either the high or low gain setting. But you must know that your measurement conditions will not overload the IF (in the high gain range) and that your signals are well above the noise floor (for the low gain range), and that the signals are not changing.

Key Path	Meas Setup
Remote Command	[:SENSe] : IF:GAIN:FFT [:STATe] AUTOrange LOW HIGH [:SENSe] : IF:GAIN:FFT [:STATe] ?

Meas Setup

Couplings	As with most parameters with an AUTO state, AUTO COUPLE sets it to Auto, which then picks Autorange, and setting any specific value (AUTOrange, LOW or HIGH) will set the AUTO state to false.
Preset	AUTOrange
State Saved	Saved in instrument state.
Readback Line	Autorange, High Gain or Low Gain
Initial S/W Revision	Prior to A.02.00
Help Map ID	3227

Auto

Allows the test set to pick the FFT IF Gain method as appropriate. This “Auto” state is set by the Auto Couple key, and it puts it in Autorange.

Key Path	Meas setup
Remote Command	[:SENSE] : IF : GAIN : FFT : AUTO [: STATE] OFF ON 0 1 [: SENSE] : IF : GAIN : FFT : AUTO [: STATE] ?
Example	IF:GAIN:FFT:AUTO ON
Preset	ON
State Saved	Saved in instrument state.
Backwards Compatibility SCPI	DISPlay:WINDow[1]:TRACe:Y[:SCALe]:LOG:RANGe:AUTO
Initial S/W Revision	Prior to A.02.00
Help Map ID	3228

Autorange (Slower – Follows Signals)

Turns the ADC ranging to automatic which provides the best signal to noise ratio. Autorange is usually preferred over the manual range choices.

Key Path	Meas setup, FFT IF Gain
Example	IF:GAIN:FFT AUTOrange
State Saved	Saved in instrument state.
Readback	Autorange
Initial S/W Revision	Prior to A.02.00
Help Map ID	3229

Low Gain (Best for Large Signals)

Forces FFT IF Gain to be off.

Key Path	Meas setup, FFT IF Gain
Example	IF:GAIN:FFT LOW
State Saved	Saved in instrument state.
Readback	Low Gain
Initial S/W Revision	Prior to A.02.00
Help Map ID	3230

High Gain (Best Noise Level)

Forces FFT IF Gain to be on.

Key Path	Meas setup, FFT IF Gain
Example	IF:GAIN:FFT HIGH
Dependencies	The High setting for FFT IF Gain is grayed out when Swept IF Gain is manually set to Low (not when Low is chosen by the auto-rules).
State Saved	Saved in instrument state.
Readback	High Gain
Initial S/W Revision	Prior to A.02.00
Help Map ID	3231

Analog Demod Tune & Listen

The Analog Demod Tune & Listen key opens the Analog Demod menu which contains keys to turn the demod function on and off and select modulation type. This key only appears if the U9063A Analog Demod personality is installed and licensed.

When the function is on (set to AM, FM, or PM), the demodulated signal is fed to the test set's speaker. Muting and volume control functions are done through the standard Windows speaker volume control interface.

Key Path	Meas Setup
Remote Command	[:SENSe] :DEMod AM FM PM OFF [:SENSe] :DEMod?
Example	DEM AM turns amplitude demodulation function ON

Meas Setup

Dependencies	When Tune & Listen is turned on, all active traces are forced to use the same detector. CISPR detectors (QPD, EMI Avg, RMS Avg) and Tune & Listen are mutually exclusive. No sound output is heard if one of these detectors is selected.
Preset	OFF
State Saved	Saved in instrument state.
Initial S/W Revision	Prior to A.02.00
Modified at S/W Revision	A.02.00
Help Map ID	3800

AM

Pressing this key, when it is not selected, selects and activates the AM demodulation function. Pressing it a second time branches to the AM Demod menu where AM demodulation settings can be adjusted.

Key Path	Meas Setup, Analog Demod Tune&Listen
State Saved	Saved in instrument state.
Initial S/W Revision	Prior to A.02.00
Help Map ID	3801

Channel BW (AM Demod)

Sets the RBW setting used by the hardware during the demodulation period in nonzero spans. Note that this is a separate parameter only for the demodulation function and does not affect the RBW setting in the BW menu which is used during the normal sweep. The flat top filter type must be used during the demodulation period. A 5 kHz Video Bandwidth filter is used.

In Zero Span, the test set's RBW & VBW filters are used for the demodulation; thus, the Channel BW (and RBW filter type) will match those of the test set. This allows gap-free listening. The Channel BW key is grayed out and the value displayed on the key matches the current RBW of the test set. Upon leaving zero span, the non-zero-span setting of Channel BW is restored as well as the flattop filter type.

Key Path	Meas Setup, Analog Demod Tune&Listen, AM
Remote Command	[:SENSE] :DEMod:AM:BANDwidth:CHANnel <freq> [:SENSE] :DEMod:AM:BANDwidth:CHANnel?
Example	DEM:AM:BAND:CHAN 200 kHz
Notes	This key/command is grayed out in zero span.
Dependencies	Unavailable in zero span.
Couplings	In zero span only, the value is set equal to the test set's current RBW value and it displays that value on the key, but the key is grayed out.

Preset	30 kHz
State Saved	Saved in instrument state.
Min	390 Hz
Max	8 MHz
Default Unit	Hz
Initial S/W Revision	Prior to A.02.00
Help Map ID	3802

FM

Pressing this key, when it is not selected, selects and activates the FM demodulation function. Pressing it a second time branches to the FM Demod menu where FM demodulation settings can be adjusted.

Key Path	Meas Setup, Analog Demod Tune&Listen
Example	DEM FM turns frequency demodulation function ON
State Saved	Saved in instrument state.
Initial S/W Revision	Prior to A.02.00
Help Map ID	3803

Channel BW (FM Demod)

Sets the RBW setting used by the hardware during the demodulation period in nonzero spans. Note that this is a separate parameter only for the demodulation function and does not affect the RBW setting in the BW menu which is used during the normal sweep. The flat top filter type must be used during the demodulation period. A 5 kHz Video Bandwidth filter is used.

In Zero Span, the test set's RBW & VBW filters are used for the demodulation; thus, the Channel BW (and RBW filter type) will match those of the test set. This allows gap-free listening. The Channel BW key is grayed out and the value displayed on the key matches the current RBW of the test set. Upon leaving zero span, the previous setting of Channel BW and the flattop filter type are restored.

Key Path	Meas Setup, Analog Demod Tune&Listen, FM
Remote Command	[:SENSE] :DEMod:FM:BANDwidth:CHANnel <freq> [:SENSE] :DEMod:FM:BANDwidth:CHANnel?
Example	DEM:FM:BAND:CHAN 200 MHz
Notes	This key / command is grayed out in zero span
Dependencies	Unavailable in zero span.
Couplings	In zero span only, the value is set equal to the test set's current RBW value and it displays that value on the key, but the key is grayed out.

Meas Setup

Preset	150 kHz
State Saved	Saved in instrument state.
Min	390 Hz
Max	8 MHz
Default Unit	Hz
Initial S/W Revision	Prior to A.02.00
Help Map ID	3804

De-emphasis (FM Demod only)

The De-emphasis setting controls a single-pole filter (6 dB/octave roll off), usually to counter intentional pre-emphasis in the transmitter. When De-emphasis state is OFF the hardware digital filter is bypassed, otherwise the setting is applied

The De-emphasis key is only available when FM is the demod selected. It is grayed out for AM and PM.

Key Path	Meas Setup, Analog Demod Tune & Listen, FM
Remote Command	[:SENSe] :DEMod:FM:DEEMphasis OFF US25 US50 US75 US750 [:SENSe] :DEMod:FM:DEEMphasis?
Example	DEM:FM:DEEM US75 DEM:FM:DEEM?
Dependencies	Only available in FM. Grayed out for AM and PM.
Preset	US75 (recommended for US commercial FM 75 μ s pre-emphasis)
State Saved	Saved in instrument state.
Readback line	1-of-N selection
Initial S/W Revision	Prior to A.02.00
Help Map ID	3805

Off

This setting bypasses the De-emphasis filter.

Key Path	Meas Setup, Analog Demod Tune&Listen, FM, De-emphasis
Example	DEM:FM:DEEM OFF
Readback	Off
Initial S/W Revision	Prior to A.02.00
Help Map ID	3858

25 μ s

Sets the De-emphasis time constant to 25 μ s.

Key Path	Meas Setup, Analog Demod Tune&Listen, FM, De-emphasis
Example	DEM:FM:DEEM US25
Readback	25 μ s
Initial S/W Revision	Prior to A.02.00
Help Map ID	3859

50 μ s

Sets the De-emphasis time constant to 50 μ s.

Key Path	Meas Setup, Analog Demod Tune&Listen, FM, De-emphasis
Example	DEM:FM:DEEM US50
Readback	50 μ s
Initial S/W Revision	Prior to A.02.00
Help Map ID	3860

75 μ s

Sets the De-emphasis time constant to 75 μ s.

Key Path	Meas Setup, Analog Demod Tune&Listen, FM, De-emphasis
Example	DEM:FM:DEEM US75
Readback	75 μ s
Initial S/W Revision	Prior to A.02.00
Help Map ID	3861

750 μ s

Sets the De-emphasis time constant to 750 μ sec.

Key Path	Meas Setup, Analog Demod Tune&Listen, FM, De-emphasis
Example	DEM:FM:DEEM US750
Readback	750 μ s
Initial S/W Revision	Prior to A.02.00
Help Map ID	3862

Meas Setup

PM

Pressing this key, when it is not selected, selects and activates the PM demodulation function. Pressing it a second time branches to the PM Demod menu where PM demodulation settings can be adjusted.

Key Path	Meas Setup, Analog Demod Tune&Listen
Example	DEM PM turns Phase demodulation function ON
State Saved	Saved in instrument state.
Initial S/W Revision	Prior to A.02.00
Help Map ID	3806

Channel BW (PM Demod)

Sets the RBW setting used by the hardware during the demodulation period in nonzero spans. Note that this is a separate parameter only for the demodulation function and does not affect the RBW setting in the BW menu which is used during the normal sweep. The flat top filter type must be used during the demodulation period. A 5 kHz Video Bandwidth filter is used.

In Zero Span, the test set's RBW & VBW filters are used for the demodulation; thus, the Channel BW (and RBW filter type) will match those of the test set. This allows gap-free listening. The Channel BW key is grayed out and the value displayed on the key matches the current RBW of the test set. Upon leaving zero span, the previous setting of Channel BW and the flattop filter type are restored.

Key Path	Meas Setup, Analog Demod Tune&Listen, M
Remote Command	[:SENSE] :DEMod:PM:BANDwidth:CHANnel <freq> [:SENSE] :DEMod:PM:BANDwidth:CHANnel?
Example	DEM:PM:BAND:CHAN 200 MHz
Notes	This key / command is grayed out in zero span
Dependencies	Unavailable in zero span.
Couplings	In zero span only, the value is set equal to the test set's current RBW value and it displays that value on the key, but the key is grayed out.
Preset	100 kHz
State Saved	Saved in instrument state.
Min	390 Hz
Max	8 MHz
Default Unit	Hz
Initial S/W Revision	Prior to A.02.00
Help Map ID	3807

Off

Pressing this key, turns the demodulation function off.

Key Path	Meas Setup, Analog Demod Tune&Listen
Example	DEM OFF turns the demodulation function OFF
State Saved	Saved in instrument state.
Initial S/W Revision	Prior to A.02.00
Help Map ID	3808

Demod Time

Sets the amount of time the test set demodulates the signal after each sweep. The demodulated signal can be heard through the speaker during demodulation. In zero span, demodulation can be performed continuously, making this parameter not applicable, hence it is grayed out in zero span.

Key Path	Meas Setup, Analog Demod Tune&Listen
Remote Command	[:SENSe] :DEMod:TIME <time> [:SENSe] :DEMod:TIME?
Example	DEM:TIME 500 ms DEM:TIME?
Notes	This key / command is grayed out in zero span
Dependencies	Unavailable in zero span.
Preset	500 ms
State Saved	Saved in instrument state.
Min	2 ms
Max	100 s
Initial S/W Revision	Prior to A.02.00
Help Map ID	3809

Demod State (Remote Command Only)

Sets or queries the state of the Analog Demod Tune and Listen function. Setting the state to ON with this command will select AM demodulation by default and activate it (turn it on).

The response to the query is determined by the current setting of [:SENSe] :DEMod AM|FM|PM|OFF. The response is 1 if AM, FM, PM are selected, or 0 if OFF is selected.

Remote Command:	[:SENSe] :DEMod:STATe OFF ON 0 1 [:SENSe] :DEMod:STATe?
------------------------	--

Meas Setup

Preset:	OFF
Initial S/W Revision:	Prior to A.02.00
Help Map ID:	0

Mode Setup

Opens a menu that enables you to select Mode Setup parameters.

Key Path	Front-panel key
Initial S/W Revision	Prior to A.02.00
Help Map ID	5005

IF Path

Enables you to select different IF Paths for the AIF/DIF boards.

The selections are 10 MHz, 25 MHz, and 40 MHz paths. However, depending on the model or option, some of these paths might not be available.

Key Path	Mode Setup
Mode	BASIC
Remote Command	[:SENSe] :IFPath B10M B25M B40M B140M B160M [:SENSe] :IFPath?
Example	IFP B25M IFP?
Notes	You must be in the IQ Analyzer (Basic) mode to use this command. Use INSTRument:SElect to set the mode. B10M = 10 MHz B25M = 25 MHz B40M = 40 MHz In cases where the path is not available but is selected from SCPI, it generates an error -241, "Hardware missing; Option not installed."
Dependencies	If Option B25, B40 is not installed, the 25 MHz path is not available. If Option B40 is not installed, the 40 MHz path is not available. The preset value depends on the Digital IF BW setting of the default measurement.
Preset	If the 25 MHz path is not available, it presets to 10 MHz.
State Saved	Saved in instrument state.
Range	B10M B25M B40M
Readback text	Currently selected IF Path selection.
Initial S/W Revision	A.04.00

Help Map ID	5006
-------------	------

IF Path Auto

Automatically selects between the IF Paths based on the current measurements Digital IF Bandwidth setting.

When IF Path Auto is set to ON and the measurement tries to set a Digital IF Bandwidth between 10 and 25 MHz, the IF Path parameter automatically switches from 10 MHz to 25 MHz. When the measurement sets the Digital IF Bandwidth back to a value narrower than 10 MHz, then the IF Path automatically switches from 25 MHz to 10 MHz. This is the same for the other paths as well.

When reducing the Digital IF Bandwidth, the selected IF Path is the narrowest possible path applicable. For example, an instrument with B25 and B40 installed and the user currently has IF Path Auto set to ON and the Digital IF Bandwidth is 50 MHz, the IF Path selection will be 140 MHz. If the bandwidth decreases and the value is 40 MHz or narrower (but above 25 MHz), the IF Path will automatically change to 40 MHz. Similarly, for bandwidths equal to or narrower than 25 MHz (but above 10 MHz), the 25 MHz path is selected. For bandwidths equal to or narrower than 10 MHz, the 10 MHz path is selected.

These rules apply even for DIF configurations of Swept DIF + WBDIF.

Key Path	Mode Setup, IF Path
Mode	BASIC
Remote Command	[:SENSE] :IFPath:AUTO ON OFF 1 0 [:SENSE] :IFPath:AUTO?
Example	IFP:AUTO ON IFP:AUTO?
Notes	You must be in the IQ Analyzer (Basic) mode to use this command. Use INSTRUMENT:SElect to set the mode.
Dependencies	This feature automatically selects between the IF Paths available. If option B25 or B40 are not installed, it will always select 10 MHz.
Preset	ON
State Saved	Saved in instrument state.
Range	On Off
Initial S/W Revision	A.04.00
Help Map ID	5007

Restore Mode Defaults

Restore Mode Defaults resets the state for the currently active mode by resetting the mode persistent settings to their factory default values, clearing mode data and by performing a Mode Preset.

For more information, see “Restore Mode Defaults” on page 144.[Proc_iFrame:2307@]

Key Path	Mode setup
Initial S/W Revision	Prior to A.02.00
Help Map ID	0

Mode Setup

Peak Search

Pressing the Peak Search key displays the Peak Search menu and places the selected marker on the trace point with the maximum y-axis value for that marker's trace. The Peak Search features allow you to define specific search criteria to determine which signals can be considered peaks, excluding unwanted signals from the search.

See [“More Information” on page 693](#).

Remote Command:	:CALCulate:MARKer [1] 2 3 4 5 6 7 8 9 10 11 12:MAXimum
Example:	<p>CALC:MARK2:MAX performs a peak search using marker 2.</p> <p>CALC:MARK2:Y? queries the marker amplitude (Y-axis) value for marker 2.</p> <p>CALC:MARK2:X? queries the marker frequency or time (X-axis) value for marker 2.</p> <p>SYST:ERR? can be used to query the errors to determine if a peak is found. The error -200 is returned after an unsuccessful search.</p>
Notes:	Sending this command selects the subcoded marker.
Initial S/W Revision:	Prior to A.02.00
Help Map ID:	3233

More Information

If **Same as “Next Peak” Criteria** is selected, and either **Pk Excursion** or **Pk Threshold** are on, a signal must meet those criteria. If no valid peak is found, a message is generated. And then the marker is not moved. When **Highest Peak** is on, or both **Pk Excursion** and **Pk Threshold** are off, the marker is always placed at the point on the trace with the maximum y-axis value, even if that point is on the very edge of the trace (exception: negative frequencies and signals close to the LO are not searched at all).

Pressing Peak Search with the selected marker off causes the selected marker to be set to **Normal** at the center of the screen, then a peak search is immediately performed.

Pressing the front panel Peak Search key always does a peak search. Occasionally, you may need to get to the Peak Search menu key functions without doing a peak search. You can do this by first accessing the Peak Search menu. Then go to the other menus that you need to access. Finally, you can get back to the Peak Search key menu by using the front panel Return key and pressing it as many times as required to navigate back through the previously accessed menus until you get back to the Peak Search menu.

Next Peak

Pressing Next Peak moves the selected marker to the peak that has the next highest amplitude less than the marker's current value. Only peaks which meet all enabled peak criteria are considered. If there is no valid peak lower than the current marker position, an error is generated and the marker is not moved.

Peak Search

If the selected marker was off, then it is turned on as a normal marker and a peak search is performed.

Key Path	Peak Search
Remote Command	:CALCulate:MARKer [1] 2 3 4 5 6 7 8 9 10 11 12 :MAXimum:NEXT
Example	CALC:MARK2:MAX:NEXT Selects marker 2 and moves it to the peak that is closest in amplitude to the current peak, but the next lower value.
Notes	Sending this command selects the subcoded marker.
State Saved	Not part of saved state.
Initial S/W Revision	Prior to A.02.00
Help Map ID	3234

Next Pk Right

Pressing Next Pk Right moves the selected marker to the nearest peak right of the current marker which meets all enabled peak criteria. If there is no valid peak to the right of the current marker position, an error is generated and the marker is not moved.

If the selected marker was off, then it is turned on as a normal marker and a peak search is performed.

Key Path	Peak Search
Remote Command	:CALCulate:MARKer [1] 2 3 4 5 6 7 8 9 10 11 12 :MAXimum:RIGHT
Example	CALC:MARK2:MAX:RIGHT Selects marker 2 and moves it to the next peak to the right of the current marker position.
Notes	Sending this command selects the subcoded marker.
State Saved	Not part of saved state.
Initial S/W Revision	Prior to A.02.00
Help Map ID	3235

Next Pk Left

Pressing Next Pk Left moves the selected marker to the nearest peak left of the current marker which meets all enabled peak criteria. If there is no valid peak to the left of the current marker position, an error is generated and the marker is not moved.

If the selected marker was off, then it is turned on as a normal marker and a peak search is performed.

Key Path	Peak Search
Remote Command	:CALCulate:MARKer [1] 2 3 4 5 6 7 8 9 10 11 12 :MAXimum:LEFT

Example	CALC:MARK2:MAX:LEFT selects marker 2 and moves it to the next peak to the left of the current marker position.
State Saved	Not part of saved state.
Initial S/W Revision	Prior to A.02.00
Help Map ID	3236

Marker Delta

Performs the same function as the Delta 1-of-N selection key in the Marker menu. Basically this sets the control mode for the selected marker to Delta mode. See the “[Marker](#)” on page 581 for the complete description of this function. The key is duplicated here in the Peak Search Menu to allow you to conveniently perform a peak search and change the marker’s control mode to Delta without having to access two separate menus.

Initial S/W Revision	Prior to A.02.00
Key Path	Peak Search or Marker
Notes	Whenever the selected marker is in Delta mode and you are in the Peak Search menu, the Marker Delta key should be highlighted and the active function for setting its delta value turned on.
Help Map ID	3237

Mkr->CF

Assigns the selected marker’s frequency to the Center Frequency setting. See “[Marker To](#)” on page 621 for the description of this function. The key is duplicated here in the Peak Search Menu to allow you to conveniently perform a peak search and marker to CF without having to access two separate menus.

Key Path	Peak Search or Marker->
Dependencies	Same as specified under Marker To
Initial S/W Revision	Prior to A.02.00
Help Map ID	3238

Mkr->Ref Lvl

Assigns the selected marker’s level to the Reference Level setting. See “[Marker To](#)” on page 621 for the description of this function. The key is duplicated here in the Peak Search Menu to allow you to conveniently perform a peak search and marker to RL without having to access two separate menus.

Key Path	Peak Search or Marker ->
Dependencies	Same as specified under Marker To
Initial S/W Revision	Prior to A.02.00

Peak Search

Help Map ID	3239
-------------	------

Peak Criteria

Pressing this key opens the Peak Criteria menu and allows you to adjust the Pk Threshold and Pk Excursion parameters used for peak search functions.

For a signal to be identified as a peak it must meet certain criteria. Signals in the negative frequency range and signals very close to 0 Hz are ignored. If either the peak excursion or peak threshold functions are on, then the signal must satisfy those criteria before being identified as a peak.

When peak excursion and peak threshold are both off:

Peak Search, **Continuous Peak Search**, and maximum part of **Pk-Pk Search** will search the trace for the point with the highest y-axis value which does not violate the LO feed through rules. A rising and falling slope are not required for these three peak search functions.

The remaining search functions **Next Peak**, **Next Pk Right**, et cetera will only consider trace points which have a rising and falling slope on the left and right respectively.

Key Path	Peak Search
Initial S/W Revision	Prior to A.02.00
Help Map ID	3240

“Peak Search” Criteria

This menu lets you decide what kind of search you want to do when the Peak Search key is pressed (or the equivalent SCPI command sent).

Note that there are two “types” of peak search functions. One type is the “Peak Search” type, the other type is the “Next Peak” type. “Next Peak” searches (for example, Next Peak, Next Pk Left, Next Pk Right) are always checked using the Excursion and Threshold criteria as long as these criteria are On. The “Peak Search” type of search, simply finds the highest point on the trace. However you can change the “Peak Search” type of search so that it also uses the Excursion and Threshold criteria. This allows you to find the Maximum point on the trace that also obeys the Excursion and/or Threshold criteria.

When **Highest Peak** is selected, pressing **Peak Search** simply finds the highest peak on the marker’s trace. If **Same as “Next Peak” Criteria** is selected, then the search is also forced to consider the Excursion and Threshold found under the **“Next Peak” Criteria** menu.

Key Path	Peak Search, Peak Criteria
Remote Command	:CALCulate:MARKer:PEAK:SEARch:MODE MAXimum PARAMeter :CALCulate:MARKer:PEAK:SEARch:MODE?
Notes	MAXimum corresponds to the Highest Peak setting PARAMeter corresponds to the Same as “Next Peak” Criteria setting
Preset	MAXimum

State Saved	Saved in instrument state.
Readback line	Current state
Initial S/W Revision	Prior to A.02.00
Help Map ID	3241

Highest Peak

When this key is selected, pressing the Peak Search key or issuing the equivalent SCPI command finds the maximum point on the trace, subject to the peak-search qualifications. This also affects the Peak Search half of Pk-Pk search and the Continuous Peak Search.

Key Path	Peak Search, Peak Criteria, “Peak Search” Criteria
Example	CALC:MARK:PEAK:SEAR:MODE MAX
Readback	Highest Peak
Initial S/W Revision	Prior to A.02.00
Help Map ID	3242

Same as “Next Peak” Criteria

When this key is selected, pressing the Peak Search key or issuing the equivalent SCPI command finds the maximum point on the trace, but subject to the Excursion and Threshold set under the Next Peak Criteria menu. The search is, of course, also subject to the peak-search qualifications. This also affects the Peak Search half of Pk-Pk search and the Continuous Peak Search.

Key Path	Peak Search, Peak Criteria, “Peak Search” Criteria
Example	CALC:MARK:PEAK:SEAR:MODE PAR
Readback	Use Excurs & Thr
Initial S/W Revision	Prior to A.02.00
Help Map ID	3243

“Next Peak” Criteria

This key opens up a menu which allows you to independently set the Peak Excursion and Peak Threshold and turn them on and off.

Key Path	Peak Search, Peak Criteria
Initial S/W Revision	Prior to A.02.00
Help Map ID	3244

Pk Excursion On/Off

Turns the peak excursion requirement on/off and sets the excursion value. The value defines the

Peak Search

minimum amplitude variation (rise and fall) required for a signal to be identified as peak. For example, if a value of 6 dB is selected, peak search functions like the marker Next Pk Right function move only to peaks that rise and fall 6 dB or more.

When both Pk Excursion and Pk Threshold are on, a signal must rise above the Pk Threshold value by at least the **Peak Excursion** value and then fall back from its local maximum by at least the **Peak Excursion** value to be considered a peak.

NOTE In the event that a sequence of trace points with precisely the same values represents the maximum, the leftmost point is found.

See “[More Information](#)” on page 698.

Key Path	Peak Search, Peak Criteria, “Next Peak” Criteria
Remote Command	:CALCulate:MARKer:PEAK:EXCursion <rel_ampl> :CALCulate:MARKer:PEAK:EXCursion? :CALCulate:MARKer:PEAK:EXCursion:STATE OFF ON 0 1 :CALCulate:MARKer:PEAK:EXCursion:STATE?
Example	:CALC:MARK:PEAK:EXC:STAT ON :CALC:MARK:PEAK:EXC 30 DB sets the minimum peak excursion requirement to 30 dB
Dependencies	Available only when Y axis unit is amplitude units, otherwise grayed out.
Couplings	Whenever you adjust the value of Pk Excursion (with the knob, step keys, or by completing a numeric entry), and Peak Threshold is turned ON, the Peak Threshold Line and the Peak Excursion Region are displayed.
Preset	6.0 dB ON
Preset	6.0 dB ON
State Saved	Saved in State
Min	0.0 dB
Max	100.0 dB
Initial S/W Revision	Prior to A.02.00
Help Map ID	3245

More Information

If two signals are very close together and the peak excursion and threshold criteria are met at the outside edges of the combined signals, this function finds the highest of these two signals as a peak (or next peak). However, if a signal appears near the edge of the screen such that the full extent of either the

rising or falling edge cannot be determined, and the portion that is on screen does not meet the excursion criteria, then the signal cannot be identified as a peak.

When measuring signals near the noise floor, you can reduce the excursion value even further to make these signals recognizable. To prevent the marker from identifying noise as signals, reduce the noise floor variations to a value less than the peak-excursion value by reducing the video bandwidth or by using trace averaging.

Pk Threshold On/Off

Turns the peak threshold requirement on/off and sets the threshold value. The peak threshold value defines the minimum signal level (or min threshold) that the peak identification algorithm uses to recognize a peak.

When both Pk Excursion and Pk Threshold are on, a signal must rise above the Pk Threshold value by at least the **Peak Excursion** value and then fall back from its local maximum by at least the **Peak Excursion** value to be considered a peak.

For example, if a threshold value of -90 dBm is selected, the peak search algorithm will only consider signals with amplitude greater than the -90 dBm threshold. If a threshold value of -90 dBm is selected, and **Peak Excursion** is **On** and set to 6 dB, the peak search algorithm will only consider signals with amplitude greater than the -90 dBm threshold which rise 6 dB above the threshold and then fall back to the threshold.

Key Path	Peak Search, Peak Criteria, "Next Peak Criteria"
Remote Command	:CALCulate:MARKer:PEAK:THReshold <ampl> :CALCulate:MARKer:PEAK:THReshold? :CALCulate:MARKer:PEAK:THReshold:STATe OFF ON 0 1 :CALCulate:MARKer:PEAK:THReshold:STATe?
Example	CALC:MARK:PEAK:THR:STAT ON turns on the threshold criterion. CALC:MARK:PEAK:THR -60 dBm sets the threshold to -60 dBm.
Dependencies	When Ref Level Offset changes, Peak Threshold must change by the same amount.
Preset	-90.0 dBm ON
State Saved	Saved in instrument state.
Min	The current displayed Ref Level $- 200$ dB. The current displayed Ref Level is the current Ref Level, offset by the Ref Level Offset.
Max	The current displayed Ref Level. This means the current Ref Level, offset by the Ref Level Offset.
Default Unit	depends on the current selected Y axis unit
Initial S/W Revision	Prior to A.02.00
Help Map ID	3246

Peak Search

Pk Threshold Line On/Off

Turns the peak threshold line on or off. Preset state is off. No equivalent SCPI command.

See “More Information” on page 700.

Dependencies	If Peak Threshold is Off and the Peak Threshold line is turned on, it should turn on Peak Threshold.
Initial S/W Revision	Prior to A.02.00
Help Map ID	3814

More Information

The Peak Threshold line is green and has the value of the peak threshold (for example, “-20.3 dBm”) written above its right side, above the line itself. If Peak Excursion is ON it shows on the left side as a region above the Peak Threshold line. As with all such lines (Display Line, Trigger Level line, et cetera) it is drawn on top of all traces.

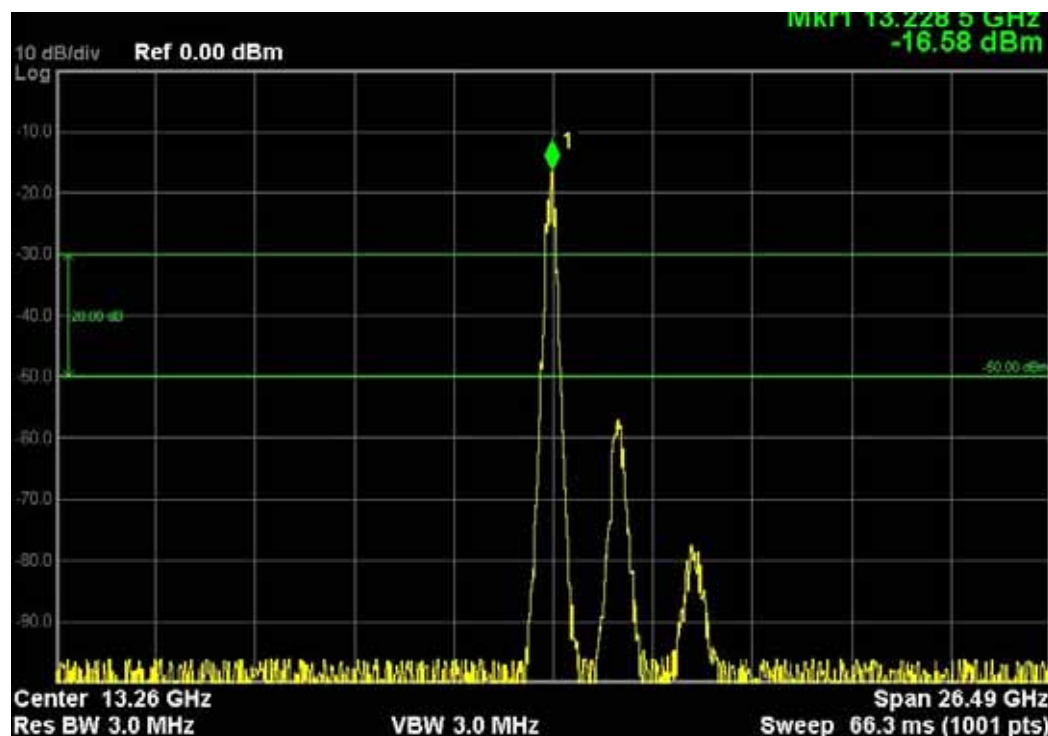

This function is automatically set to ON (thus turning on the Peak Threshold line) whenever the value of Peak Threshold or Peak Excursion becomes the active function, unless Peak Threshold is OFF. It is automatically set to OFF whenever Peak Threshold is set to OFF. Manually turning it ON automatically turns on Pk Threshold.

The Peak Excursion part is on whenever the Pk Threshold part is on, unless Peak Excursion is OFF.

Peak Table

Opens the Peak Table menu.

The Peak Table provides a displayed list of up to 20 signal peaks from the selected trace. If more than one trace window is displayed, the selected trace in the selected window is used. If there are more than 20 signals which meet the peak search criteria, only the 20 highest peaks are listed.

The Peak Table is updated after each sweep. The list of peaks in the Peak Table can be ordered either by ascending frequency or by descending amplitude. In either case, the entire trace is first evaluated and the 20 highest peaks are selected for inclusion in the list. After the peaks are selected, they are then sorted and displayed according to the Peak Sort setting.

Key Path	Peak Search
Initial S/W Revision	Prior to A.02.00
Help Map ID	3247

Peak Table On/Off

Turns Peak Table on/off. When turned on, the display is split into a measurement window and a peak table display window.

Turning the Peak Table on turns the Marker Table off and vice versa.

Key Path	Peak Search, Peak Table
Remote Command	:CALCulate:MARKer:PEAK:TABLE:STATE OFF ON 0 1 :CALCulate:MARKer:PEAK:TABLE:STATE?
Example	CALC:MARK:PEAK:TABL:STAT ON Turns on and displays the peak table.
Dependencies	When the Peak Table turns on, if Peak Threshold is On then it becomes the active function.
Preset	OFF
State Saved	Saved in instrument state.
Initial S/W Revision	Prior to A.02.00
Help Map ID	3248

Peak Sort

Sets the peak table sorting routine to list the peaks in order of descending amplitude or ascending frequency. The remote command can also be used to sort the peaks found using the :CALCulate:DATA:PEAKs command.

Key Path	Peak Search, Peak Table
Remote Command	:CALCulate:MARKer:PEAK:SORT FREQuency AMPLitude :CALCulate:MARKer:PEAK:SORT?
Example	CALC:MARK:PEAK:SORT AMPL Sets sorting routine to list peaks in order of descending amplitude. CALC:MARK:PEAK:SORT?

Peak Search

Preset	AMPLitude
Preset	AMPLitude
State Saved	Saved in instrument state.
Backwards Compatibility SCPI	:TRACe:MATH:PEAK:SORT
Backwards Compatibility SCPI	The old TRAC:MATH:PEAK:SORT command/query used in ESA is still supported for backward compatibility.
Initial S/W Revision	Prior to A.02.00
Help Map ID	3249

Peak Readout

Shows up to twenty signal peaks as defined by the setting:

All (ALL) - lists all the peaks defined by the peak criteria, in the current sort setting.

Above Display Line (GTDLine) - lists the peaks that are greater than the defined display line, and that meet the peak criteria. They are listed in the current sort order.

Below Display Line (LTDLine) - lists the peaks that are less than the defined display line, and that meet the peak criteria. They are listed in the current sort order.

If the peak threshold is defined and turned on, then the peaks must meet this peak criteria in addition to the display line requirements.

See [“More Information” on page 702](#).

Key Path	Peak Search, Peak Table
Remote Command	:CALCulate:MARKer:PEAK:TABLE:READout ALL GTDLine LTDLine :CALCulate:MARKer:PEAK:TABLE:READout?
Example	CALC:MARK:PEAK:TABL:READ GTDL
Dependencies	Turning Display Line off forces Readout to ALL
Preset	All
Preset	All
State Saved	Saved in instrument state.
Readback line	1-of-N selection
Initial S/W Revision	Prior to A.02.00
Help Map ID	3250

More Information

If the Display Line (see the Section “View/Display”) is turned on, the Peak Table can be selected to include all peaks, only those above the Display Line, or only those below the Display Line. See Figures

1-2 and 1-3 to understand what happens if both Display Line and Pk Threshold are turned on.

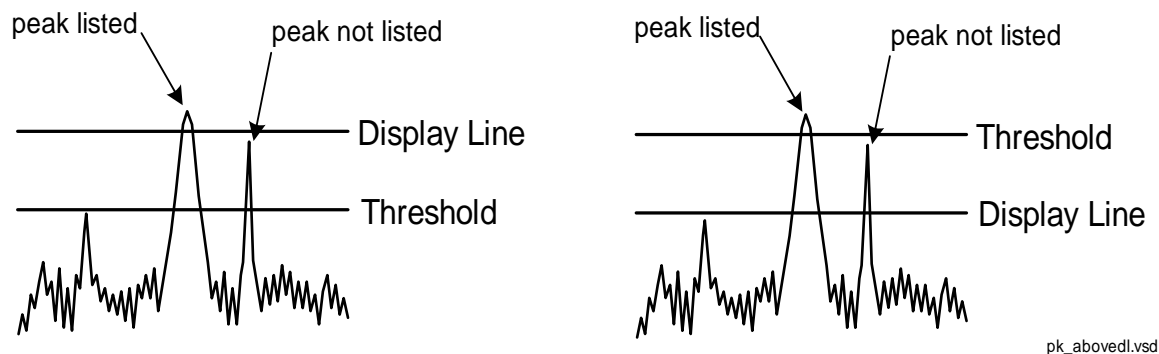

Figure 1- 2Above Display Line Peak Identification

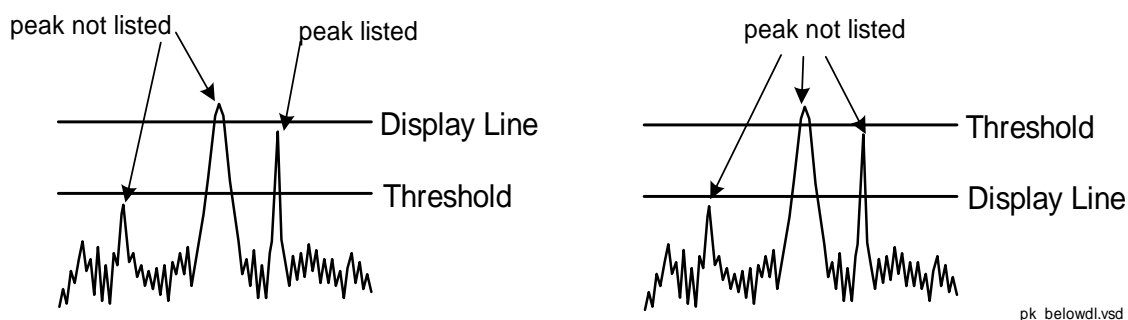

Figure 1- 3Below Display Line Peak Identification

All

Sets the peak table to display the 20 highest peaks in the order specified by the current Peak Sort setting. If the Peak Criteria are turned on, then only peaks that meet the defined Pk Excursion and Pk Threshold values are found.

Key Path	Peak Search, Peak Table, Peak Readout
Example	CALC:MARK:PEAK:TABL:READ ALL
Notes	Auto return after pressed
Readback	All
Initial S/W Revision	Prior to A.02.00
Help Map ID	3251

Above Display Line

Sets the peak table to display only the 20 highest peaks above the display line in the order specified by the current Sort setting. If the Peak Criteria are turned on, then only peaks that meet the defined criteria are found. If the display line is not already on, it is turned on (it has to be on or it cannot be used to

Peak Search

exclude peaks).

Key Path	Peak Search, Peak Table, Peak Readout
Example	CALC:MARK:PEAK:TABL:READ GTDL
Notes	Auto return after pressed
Dependencies	When Above Display Line is selected, Display Line is turned on and becomes the active function.
Readback	Above DL
Initial S/W Revision	Prior to A.02.00
Help Map ID	3252

Below Display Line

Sets the peak table to display only the 20 highest peaks below the display line as defined by the peak in the order specified by the current Sort setting. If the Peak Criteria are turned on, then only peaks that meet the defined criteria are found. If the display line is not already on, it is turned on (it has to be on or it cannot be used to exclude peaks).

Key Path	Peak Search, Peak Table, Peak Readout
Example	CALC:MARK:PEAK:TABL:READ LTDL
Notes	Auto return after pressed
Dependencies	When Below Display Line is selected, Display Line is turned on and becomes the active function.
Readback	Below DL
Initial S/W Revision	Prior to A.02.00
Help Map ID	3253

Continuous Peak Search On/Off

Turns Continuous Peak Search on or off. When Continuous Peak Search is on, a peak search is automatically performed for the selected marker after each sweep. The rules for finding the peak are exactly the same as for **Peak Search**, including the use of the peak criteria rules. If no valid peak is found, a warning is generated after each sweep.

See “[More Information](#)” on page 705.

Key Path	Peak Search
Remote Command	:CALCulate:MARKer [1] 2 3 4 5 6 7 8 9 10 11 12 : CPSearch [: STATE] ON OFF 1 0 :CALCulate:MARKer [1] 2 3 4 5 6 7 8 9 10 11 12 : CPSearch [: STATE] ?

Example	CALC:MARK:CPS ON Turns on Continuous Peak Search.
Notes	Sending this command selects the subcoded marker
Couplings	The Continuous Peak Search key is grayed out when the selected marker is a Fixed marker. Also, if Continuous Peak Search is on and the selected marker becomes a fixed marker, then Continuous Peak Search is turned off and the key grayed out. Signal Track and Continuous Peak Search are mutually exclusive so if Signal Track is on, Continuous Peak Search is grayed out and vice versa.
Preset	Mode Preset
State Saved	Saved in instrument state.
Status Bits/OPC dependencies	The Measuring bit should remain set while this command is operating and should not go false until the marker position has been updated.
Initial S/W Revision	Prior to A.02.00
Help Map ID	3254

More Information

When Continuous Peak Search is turned on a peak search is immediately performed and then is repeated after each sweep. If Continuous Peak Search is turned on with the selected marker off, the selected marker is set to **Normal** at the center of the screen, and then a peak search is immediately performed and subsequently repeated after each sweep.

When in Continuous Peak Search, *OPC will not return true, nor will READ or MEASURE return any data, until the sweep is complete and the marker has been re-peaked. Note further that if the test set is in a measurement such as averaging, and Continuous Peak Search is on, the entire measurement is allowed to complete (i.e., all the averages taken up to the average number) before the repeak takes place, and only THEN will *OPC go true and READ or MEASURE return data.

When Continuous Peak Search is turned on for a marker, a little “hat” is placed above the marker.

Pk-Pk Search

Finds and displays the amplitude and frequency (or time, if in zero span) differences between the highest and lowest y-axis value. It places the selected marker on the minimum value on its selected trace. And it places that marker’s reference marker on the peak of its selected trace. This function turns on the reference marker and sets its mode to **Fixed** if it is not already on. (These markers may be on two different traces.)

The rules for finding the maximum peak are exactly the same as for **Peak Search**, including the use of the peak criteria rules. However, the minimum trace value is not required to meet any criteria other than being the minimum y-axis value in the trace.

When Pk-Pk Search is successful, a message is displayed on the message line.

If the selected marker is off, a delta type marker is turned on and the peak-to-peak search is done. If the selected marker is on, but it is not a delta marker, then it is changed to delta which turns on the reference

Peak Search

marker if needed, and then it performs the peak-to-peak function.

Key Path	Peak Search
Remote Command	:CALCulate:MARKer [1] 2 3 4 5 6 7 8 9 10 11 12 :PTPeak
Example	CALC:MARK:PTP CALC:MARK:Y? queries the delta amplitude value for marker 1.
Notes	Turns on the Marker Δ active function.
Notes	Sending this command selects the subopcoded marker.
Dependencies	Pk-Pk Search is grayed out when Coupled Markers is on.
Couplings	The selected marker becomes a delta marker if not already in delta mode.
State Saved	Not part of saved state.
Initial S/W Revision	Prior to A.02.00
Help Map ID	3255

Min Search

Moves the selected marker to the minimum y-axis value on the current trace. Minimum (negative) peak searches do not have to meet the peak search criteria. It just looks for the lowest y-axis value. If the selected marker is Off, it is turned on before the minimum search is performed.

Key Path	Peak Search
Remote Command	:CALCulate:MARKer [1] 2 3 4 5 6 7 8 9 10 11 12 :MINimum
Example	CALC:MARK:MIN selects marker 1 and moves it to the minimum amplitude value.
Notes	Sending this command selects the subopcoded marker.
State Saved	Not part of saved state.
Initial S/W Revision	Prior to A.02.00
Help Map ID	3256

Recall

Most of the functions under this key work the same way in many measurements, so they are documented in “Recall” on page 150.[Proc_iFrame:2637@]

The Amplitude Correction Import Data function under Recall is documented here.

Amplitude Correction

This key selects the Amplitude Corrections as the data type to be imported. When pressed a second time, it brings up the Select Menu, which lets you select the Correction into which the data will be imported.

Amplitude Corrections are fully discussed in the documentation of the Input/Output key, under the Corrections softkey.

A set of preloaded Corrections files can be found in the directory

/My Documents/ EMC Limits and Ampcor.

Under this directory, the directory called Ampcor (Legacy Naming) contains a set of legacy corrections files, generally the same files that were supplied with older Agilent EMI analyzers, that use the legacy suffixes .ant, .oth, .usr, and .cbl, and the old 8-character file names. In the directory called Ampcor, the same files can be found, with the same suffixes, but with longer, more descriptive filenames.

When the Amplitude Correction is an Antenna correction and the Antenna Unit in the file is not **None**, the Y Axis Unit setting will change to match the Antenna Unit in the file.

Key Path:	Recall
Mode:	EDGE GSM
Remote Command:	:MMEMory:LOAD:CORRection 1 2 3 4 5 6, <filename>
Example:	:MMEM:LOAD:CORR 2 "myAmpcor.csv" recalls the Amplitude Correction data from the file myAmpcor.csv in the current directory to the 2nd Amplitude Correction table, and turns on Correction 2. The default path is My Documents\amplitudeCorrections.

Recall

Dependencies:	<p>Only the first correction array (Correction 1) supports antenna units. This means that a correction file with an Antenna Unit can only be loaded into the Corrections 1 register. Consequently only for Correction 1 does the dropdown in the Recall dialog include .ant, and if an attempt is made to load a correction file into any other Correction register which DOES contain an antenna unit, a Mass Storage error is generated.</p> <p>Corrections are not supported by all Measurements. If in a Mode in which some Measurements support it, this key will be grayed out in measurements that do not. The key will not show at all if no measurements in the Mode support it.</p> <p>Errors are reported if the file is empty or missing, or if the file type does not match, or if there is a mismatch between the file type and the destination data type. If any of these occur during manual operation, the test set returns to the Import Data menu and the File Open dialog goes away.</p> <p>This key does not appear unless you have the proper option installed in your instrument.</p> <p>This command will generate an “Option not available” error unless you have the proper option installed in your instrument.</p>
Couplings:	When a correction file is loaded from mass storage, it is automatically turned on (Correction ON) and Apply Corrections is set to On. This allows the user to see its effect, thus confirming the load.
Readback:	selected Correction
Backwards Compatibility SCPI:	<p>:MMEMory:LOAD:CORRection ANTenna CABLe OTHer USER, <filename></p> <p>For backwards compatibility, ANTenna maps to 1, CABLe maps to 2, OTHer maps to 3 and USER maps to 4</p>
Initial S/W Revision:	A.02.00
Help Map ID:	2649

Amplitude Correction

These keys let you select which Correction to import the data into. Once selected, the key returns back to the Import Data menu and the selected Correction number is annotated on the key. The next step is to select the Open key in the Import Data menu.

Antenna corrections are a particular kind of Amplitude Corrections – they are distinguished in the corrections file by having the Antenna Unit set to a value other than None. Only Correction 1 supports Antenna Units.

Key Path:	Recall, Data, Amplitude Correction
Notes:	auto return
Dependencies:	Only Correction 1 may be used to load a Correction that contains an Antenna Unit other than None
Preset:	Not part of Preset, but is reset to Correction 1 by Restore Input/Output Defaults; survives shutdown.

State Saved:	The current Correction number is saved in instrument state
Initial S/W Revision:	A.02.00
Help Map ID:	2650

Multiport Adapter Amplitude Correction

This key selects the Multiport Adapter Amplitude Corrections as the data type to be imported. When pressed a second time, it brings up the Select Menu, which lets you select the Correction into which the data will be imported.

Amplitude Corrections are fully discussed in the documentation of the Input/Output key, under the Corrections softkey.

A set of preloaded Corrections files can be found in the directory

/My Documents/ EMC Limits and Ampcor.

Under this directory, the directory called Ampcor (Legacy Naming) contains a set of legacy corrections files, generally the same files that were supplied with older Agilent EMI analyzers, that use the legacy suffixes .ant, .oth, .usr, and .cbl, and the old 8-character file names. In the directory called Ampcor, the same files can be found, with the same suffixes, but with longer, more descriptive filenames.

When the Amplitude Correction is an Antenna correction and the Antenna Unit in the file is not **None**, the Y Axis Unit setting will change to match the Antenna Unit in the file.

Key Path:	Recall, Data, Amplitude Correction
Mode:	SA EDGE GSM PN
Remote Command:	:MMEMory:LOAD:MPADapter:CORRection 1 2 3 4 5 6 7 8 9 10 11 12 13 14 15 16, <filename>.
Example:	:MMEM:LOAD:MPAD:CORR 2 "myAmpcor.csv" recalls the Multiport Adapter Amplitude Correction data from the file myAmpcor.csv in the current directory to the 2nd Multiport Adapter Amplitude Correction table, and turns on MPA Correction 2. The default path is My Documents\amplitudeCorrections.

Recall

Dependencies:	<p>Only the first correction array (Correction 1) supports antenna units. This means that a correction file with an Antenna Unit can only be loaded into the Corrections 1 register. Consequently only for Correction 1 does the dropdown in the Recall dialog include .ant, and if an attempt is made to load a correction file into any other Correction register which DOES contain an antenna unit, a Mass Storage error is generated.</p> <p>Corrections are not supported by all Measurements. If in a Mode in which some Measurements support it, this key will be grayed out in measurements that do not. The key will not show at all if no measurements in the Mode support it.</p> <p>Errors are reported if the file is empty or missing, or if the file type does not match, or if there is a mismatch between the file type and the destination data type. If any of these occur during manual operation, the analyzer returns to the Import Data menu and the File Open dialog goes away.</p> <p>This key does not appear unless you have the proper option installed in your instrument.</p> <p>This command will generate an “Option not available” error unless you have the proper option installed in your instrument.</p> <p>If the file is empty, message –250.3005 is reported. If the file does not exist message –256 is reported. If there is a mismatch between the file and the destination data type, an message is reported. –250.3003. See error list in the X-series Messaging document for the exact error text.</p>
Couplings:	When a correction file is loaded from mass storage, it is automatically turned on (Correction ON) and Apply Corrections is set to On. This allows the user to see its effect, thus confirming the load.
Readback:	selected Correction
Backwards Compatibility SCPI:	<p>For backwards compatibility, the following parameters syntax is supported:</p> <pre>:MMEMory:LOAD:MPADapter:CORRection ANTenna CABLe OTHer USER, <filename></pre> <p>ANTenna maps to 1, CABLe maps to 2, OTHer maps to 3 and USER maps to 4</p>
Initial S/W Revision:	A.10.00
Help Map ID:	0

Multiport Adapter Amplitude Correction 1,2,3,4,5,6,7,8,9,10,11,~,15,16

These keys let you select which Correction to import the data into. Once selected, the key returns back to the Import Data menu and the selected Correction number is annotated on the key. The next step is to select the Open key in the Import Data menu.

Antenna corrections are a particular kind of Multiport Adapter Amplitude Corrections – they are distinguished in the corrections file by having the Antenna Unit set to a value other than None. Only Correction 1 supports Antenna Units.

Key Path:	Recall, Data, Amplitude Correction, Multiport Adptr Correction
Notes:	auto return

Dependencies:	Only Multiport Adapter Correction 1 may be used to load a Correction that contains an Antenna Unit other than None
Preset:	not part of Preset, but is reset to Correction 1 by Restore Input/Output Defaults; survives shutdown
State Saved:	The current Correction number is saved in instrument state
Initial S/W Revision:	A.10.00
Help Map ID:	0

Recall

Restart

The Restart function restarts the current sweep, or measurement, or set of averaged/held sweeps or measurements. If you are Paused, pressing Restart does a Resume.

The Restart function is accessed in several ways:

- Pressing the Restart key
- Sending the remote command INIT:IMMEDIATE
- Sending the remote command INIT:RESTART

Key Path:	Front-panel key
Remote Command:	:INITiate[:IMMEDIATE] :INITiate:RESTART
Example:	:INIT:IMM :INIT:REST
Notes:	:INITiate:RESTART and :INITiate:IMMEDIATE perform exactly the same function.
Couplings:	Resets average/hold count k. For the first sweep overwrites all active (update=on) traces with new current data. For application modes, it resets other parameters as required by the measurement.
Status Bits/OPC dependencies:	This is an Overlapped command. The STATUS:OPERation register bits 0 through 8 are cleared. The STATUS:QUESTionable register bit 9 (INTEgrity sum) is cleared. The SWEEPING bit is set. The MEASURING bit is set.
Backwards Compatibility Notes:	For Spectrum Analysis mode in ESA and PSA, the Restart hardkey and the INITiate:RESTART command restart trace averages (displayed average count reset to 1) for a trace in Clear Write , but did not restart Max Hold and Min Hold . In the X-Series, the Restart hardkey and the INITiate:RESTART command restart not only Trace Average , but Max Hold and Min Hold traces as well. For wireless comms modes in ESA and PSA, the Restart hardkey and the INITiate:RESTART command restart every measurement, which includes all traces and numeric results. There is no change to this operation.
Initial S/W Revision:	Prior to A.02.00
Help Map ID:	3307

The **Restart** function first aborts the current sweep/measurement as quickly as possible. It then resets the sweep and trigger systems, sets up the measurement and initiates a new data measurement sequence with

Restart

a new data acquisition (sweep) taken once the trigger condition is met.

If the test set is in the process of aligning when **Restart** is executed, the alignment finishes before the restart function is performed.

Even when set for Single operation, multiple sweeps may be taken when Restart is pressed (for example, when averaging/holding is on). Thus when we say that **Restart** "restarts a measurement," we may mean:

- It restarts the current sweep
- It restarts the current measurement
- It restarts the current set of sweeps if any trace is in Trace Average, Max Hold or Min Hold
- It restarts the current set of measurements if Averaging, or Max Hold, or Min Hold is on for the measurement
- depending on the current settings.

With **Average/Hold Number** (in **Meas Setup** menu) set to 1, or Averaging off, or no trace in Trace Average or Hold, a single sweep is equivalent to a single measurement. A single sweep is taken after the trigger condition is met; and the test set stops sweeping once that sweep has completed. However, with **Average/Hold Number** >1 and at least one trace set to **Trace Average, Max Hold, or Averaging on (most other measurements)**, multiple sweeps/data acquisitions are taken for a single measurement. The trigger condition must be met prior to each sweep. The sweep is stopped when the average count k equals the number N set for **Average/Hold Number**. A measurement average usually applies to all traces, marker results, and numeric results; but sometimes it only applies to the numeric results.

Once the full set of sweeps has been taken, the test set will go to idle state. To take one more sweep without resetting the average count, increment the average count by 1, by pressing the step up key while **Average/Hold Number** is the active function, or sending the remote command CALC:AVER:TCON UP.

Save

Most of the functions under this key work the same way in many measurements, so they are documented in “Save” on page 163.[Proc_iFrame:2600@]

The Amplitude Correction function under Save is documented here.

Amplitude Correction

Pressing this key selects **Amplitude Corrections** as the data type to be exported. Pressing this key again brings up the Select Menu, which allows the user to select which **Amplitude Correction** to save.

Amplitude Corrections are fully discussed in the documentation of the Input/Output key, under the Corrections softkey.

Key Path:	Save
Remote Command:	:MMEMory:STORe:CORRection 1 2 3 4 5 6, <filename>
Example:	:MMEM:STOR:CORR 2 "myAmpcor.csv" saves Correction 2 to the file myAmpcor.csv on the current path. The default path is My Documents\amplitudeCorrections.
Notes:	If the save is initiated via SCPI, and the file already exists, the file will be overwritten. Using the C: drive is strongly discouraged, since it runs the risk of being overwritten during an instrument software upgrade. Both single and double quotes are supported for any filename parameter over SCPI.
Dependencies:	Corrections are not supported by all Measurements. If in a Mode in which some Measurements support it, this key will be grayed out in measurements that do not. The key will not show at all if no measurements in the Mode support it. This key will not appear unless you have the proper option installed in your instrument.
Readback:	Selected Correction
Backwards Compatibility SCPI:	:MMEMory:STORe:CORRection ANTenna CABLe OTHer USER, <filename> For backwards compatibility, ANTenna maps to 1, CABLe maps to 2, OTHer maps to 3 and USER maps to 4
Initial S/W Revision:	A.02.00
Help Map ID:	2612

Correction Data File

A Corrections Data File contains a copy of one of the test set correction tables. Corrections provide a

Save

way to adjust the trace display for predetermined gain curves (such as for cable loss).

Corrections files are text files in .csv (comma separated values) form, to make them importable into Excel or other spreadsheet programs. The format for Corrections files is as follows.

Line #	Type of field	Example	Notes
1	File type, must be "Amplitude Correction"	Amplitude Correction	May not be omitted
2	File Description (in quotes)	"Correction Factors for 11966E"	60 characters max; may be empty but may not be omitted. If exceeds 60 characters, error -233 Too much data reported
3	Comment (in quotes)	"Class B Radiated"	60 characters max; may be empty but may not be omitted. . If exceeds 60 characters, error -233 Too much data reported
4	Instrument Version, Model #	A.02.06,N9020A	May be empty but may not be omitted
5	Option List, File Format Version	K03 LFE EXM ,01	May be empty but may not be omitted
6	Freq Unit to be used for all frequency values in the file	Frequency Unit,MHz	assumed to be Hz if omitted
7	Antenna Unit	Antenna Unit,None	If omitted leaves the Antenna unit unchanged. The amplitude unit in the Antenna Unit field is a conversion factor that is used to adjust the Y Axis Units of the current mode, if the mode supports Antenna Units. For more details on antenna correction data, refer to the Input/Output,Corrections key description. Allowable values: dBuv/m, dBuA/m, dBG, dBpT, None
8	Freq Interpolation	Frequency Interpolation,Linear	if omitted leaves the Freq Interpolation unchanged. Allowable values: Linear, Logarithmic
9	Bias value in mA	Bias,0.00	If omitted leaves the Bias value unchanged (added as of A.08.50)
10	Bias State	Bias State,On	If omitted leaves the Bias State unchanged. Allowable values: On, Off (added as of A.08.50)
11	Overlap, two values, Freq1 and Freq2, separated by commas.	Overlap,33500,40000	Uses Freq Unit from line 6. Thus, in this example Freq1=33.5 GHz, Freq2=40.0 GHz (see note below). If omitted leaves the overlap unchanged (added as of A.08.50)

Line #	Type of field	Example	Notes
12	DATA marker	DATA	Corrections data begins in the next line

Lines 2 through 5 can be empty but must appear in the file. Lines 6 through 11 are optional, the lines can be left out of the file altogether.

The Overlap row and the two Bias rows apply only to external mixing. Both are read-only, they are never written by the test set. The only way to insert or modify these rows is to edit the file with a text editor or a spreadsheet editor. These rows are intended for use by mixer manufacturers, as they allow the manufacturer to insert data about how the mixer corrections were generated and how they should be applied. The Bias rows allow you to specify whether to turn Bias on or off when the Correction is turned on and to specify a Bias value (turning off the Correction does not change the Bias, but turning it back on again sets it to the value specified in the file). The Overlap row allows you to specify an overlap region in which two different corrections may be applied. It is expected that in the corrections data itself, there will be TWO corrections values exactly at Max Freq, otherwise Overlap is ignored. The way the overlap is processed is as follows: if at any given time the current test set Start Freq is greater than Freq 1 and lower than Freq 2, and the current Stop Freq is greater than Freq 2, extend the first correction point at or above Freq 2 down to Freq 1, rather than using the correction data between Freq1 and Freq2.

The Antenna Unit row can only be used in Correction register 1, because there can only be one setting for Antenna Unit at any given time. If a Correction whose Antenna Unit is set to anything but None is loaded into any Correction register but 1, an error is generated (Mass storage error; Can only load an Antenna Unit into Correction 1). When a correction file is saved from any Correction register but 1, Antenna Unit is always written as None.

Similarly, the Bias rows can only be used in Correction register 1, because there can only be one setting for Bias at any given time. If a Correction file with a Bias or Bias State row is loaded into any Correction register but 1, an error is generated: Mass storage error; Can only load Bias Settings into Correction 1

The data follows the DATA row, as comma separated X, Y pairs; one pair per line.

For example, suppose you have an Antenna to correct for on an N9020A version A.02.06 and the correction data is:

- 0 dB at 200 MHz
- 17 dB at 210 MHz
- 14.8 dB at 225 MHz

Then the file will look like:

- Amplitude Correction
- "Correction Factors for 11966E"
- "Class B Radiated"
- A.02.06,N9020A
- P13 EA3 UK6,01
- Frequency Unit,MHz
- Antenna Unit,dBuV/m

Save

- Frequency Interpolation,Linear
- DATA
- 200.000000,0.00
- 210.000000,17.00
- 225.000000,14.80

The choices for the 1 of N fields in the metadata are as follows:

- Frequency Unit: Hz, kHz, MHz, GHz
- Antenna Unit: dBuv/m, dBuA/m, dBG, dBpT, None
- Frequency Interpolation: Logarithmic, Linear

Multiport Adapter Amplitude Correction

Pressing this key selects **Multiport Adapter Amplitude Corrections** as the data type to be exported. Pressing this key again brings up the Select Menu, which allows the user to select which **Multiport Adapter Amplitude Correction** to save.

Amplitude Corrections are fully discussed in the documentation of the Input/Output key, under the Corrections softkey.

Key Path:	Save, Data, Amplitude Correction
Remote Command:	:MMEMory:STORe:MPADapter:CORRection 1 2 3 4 5 6 7 8 9 10 11 12 13 14 15 16, <filename>
Example:	:MMEM:STOR:MPAD:CORR 2 "myAmpcor.csv" saves Multiport Adapter Correction 2 to the file myAmpcor.csv on the current path. The default path is My Documents\amplitudeCorrections.
Notes:	If the save is initiated via SCPI, and the file already exists, the file will be overwritten. Using the C: drive is strongly discouraged, since it runs the risk of being overwritten during an instrument software upgrade. Both single and double quotes are supported for any filename parameter over SCPI.
Dependencies:	Corrections are not supported by all Measurements. If in a Mode in which some Measurements support it, this key will be grayed out in measurements that do not. The key will not show at all if no measurements in the Mode support it. This key will not appear unless you have the proper option installed in your instrument.
Readback:	Selected Correction

Backwards Compatibility SCPI:	For backwards compatibility only, the following parameters syntax is supported: :MMEMory:STORe:MPADapter:CORRection ANTenna CABLe OTHer USER, <filename> ANTenna maps to 1, CABLe maps to 2, OTHer maps to 3 and USER maps to 4
Initial S/W Revision:	A.10.00
Help Map ID:	0

Correction Data File

A Corrections Data File contains a copy of one of the analyzer correction tables. Corrections provide a way to adjust the trace display for predetermined gain curves (such as for cable loss).

Corrections files are text files in .csv (comma separated values) form, to make them importable into Excel or other spreadsheet programs. The format for Corrections files is as follows.

Line #	Type of field	Example	Notes
1	File type, must be "Amplitude Correction"	Amplitude Correction	May not be omitted
2	File Description (in quotes)	"Correction Factors for 11966E"	45 characters max; may be empty but may not be omitted. If exceeds 45 characters, error -233 Too much data reported
3	Comment (in quotes)	"Class B Radiated"	45 characters max; may be empty but may not be omitted. . If exceeds 45 characters, error -233 Too much data reported
4	Instrument Version, Model #	A.02.06,N9020A	May be empty but may not be omitted
5	Option List, File Format Version	K03 LFE EXM ,01	May be empty but may not be omitted
6	Freq Unit to be used for all frequency values in the file	Frequency Unit,MHz	assumed to be Hz if omitted
7	Antenna Unit,	Antenna Unit,None	If omitted leaves the Antenna unit unchanged. The amplitude unit in the Antenna Unit field is a conversion factor that is used to adjust the Y Axis Units of the current mode, if the mode supports Antenna Units. For more details on antenna correction data, refer to the Input/Output,Corrections key description. Allowable values: dBuv/m, dBuA/m, dBG, dBpT, None

Save

8	Freq Interpolation	Frequency Interpolation,Linear	if omitted leaves the Freq Interpolation unchanged. Allowable values: Linear, Logarithmic
9	Bias value in mA	Bias,0.00	If omitted leaves the Bias value unchanged (added as of A.08.50)
10	Bias State	Bias State,On	If omitted leaves the Bias State unchanged. Allowable values: On, Off (added as of A.08.50)
11	Overlap, two values, Freq1 and Freq2, separated by commas.	Overlap,33500,40000	Uses Freq Unit from line 6. Thus, in this example Freq1=33.5 GHz, Freq2=40.0 GHz (see note below). If omitted leaves the overlap unchanged (added as of A.08.50)
12	DATA marker	DATA	Corrections data begins in the next line

Lines 2 through 5 can be empty but must appear in the file. Lines 6 through 11 are optional, the lines can be left out of the file altogether.

The Overlap row and the two Bias rows apply only to external mixing. Both are read-only, they are never written by the analyzer. The only way to insert or modify these rows is to edit the file with a text editor or a spreadsheet editor. These rows are intended for use by mixer manufacturers, as they allow the manufacturer to insert data about how the mixer corrections were generated and how they should be applied. The Bias rows allow you to specify whether to turn Bias on or off when the Correction is turned on and to specify a Bias value (turning off the Correction does not change the Bias, but turning it back on again sets it to the value specified in the file). The Overlap row allows you to specify an overlap region in which two different corrections may be applied. It is expected that in the corrections data itself, there will be TWO corrections values exactly at Max Freq, otherwise Overlap is ignored. The way the overlap is processed is as follows: if at any given time the current analyzer Start Freq is greater than Freq 1 and lower than Freq 2, and the current Stop Freq is greater than Freq 2, extend the first correction point at or above Freq 2 down to Freq 1, rather than using the correction data between Freq1 and Freq2.

The Antenna Unit row can only be used in Correction register 1, because there can only be one setting for Antenna Unit at any given time. If a Correction whose Antenna Unit is set to anything but None is loaded into any Correction register but 1, an error is generated (Mass storage error; Can only load an Antenna Unit into Correction 1). When a correction file is saved from any Correction register but 1, Antenna Unit is always written as None.

Similarly, the Bias rows can only be used in Correction register 1, because there can only be one setting for Bias at any given time. If a Correction file with a Bias or Bias State row is loaded into any Correction register but 1, an error is generated: Mass storage error; Can only load Bias Settings into Correction 1

The data follows the DATA row, as comma separated X, Y pairs; one pair per line.

For example, suppose you have an Antenna to correct for on an N9020A version A.02.06 and the correction data is:

- 0 dB at 200 MHz
- 17 dB at 210 MHz
- 14.8 dB at 225 MHz

Then the file will look like:

- Amplitude Correction
- "Correction Factors for 11966E"
- "Class B Radiated"
- A.02.06,N9020A
- P13 EA3 UK6,01
- Frequency Unit,MHz
- Antenna Unit,dBuV/m
- Frequency Interpolation,Linear
- DATA
- 200.000000,0.00
- 210.000000,17.00
- 225.000000,14.80

The choices for the 1 of N fields in the metadata are as follows:

- Frequency Unit: Hz, kHz, MHz, GHz
- Antenna Unit: dBuv/m, dBuA/m, dBG, dBpT, None
- Frequency Interpolation: Logarithmic, Linear

Multiport Adapter Amplitude Correction 1,2,3,4,5,6,7,8,9,10,11,~,15,16

These keys let you pick which Correction to save. Once selected, the key returns back to the Export Data menu and the selected Correction number is annotated on the key.

The next step in the Save process is to select the Save As key in the Export Data menu.

Key Path:	Save, Data, Amplitude Correction, Multiport Adptr Correction
Preset:	Not part of a Preset, but is reset to Correction 1 by Restore Input/Output Defaults. Survives a shutdown.
Readback:	1
Initial S/W Revision:	A.10.00
Help Map ID:	0

Save

Single (Single Measurement/Sweep)

Sets the test set for Single measurement operation. The single/continuous state is Meas Global, so the setting will affect all the measurements. If you are Paused, pressing **Single** does a Resume.

Key Path:	Front-panel key
Example:	:INIT:CONT OFF
Notes:	See Cont key description.
Backwards Compatibility Notes:	<p>For Spectrum Analysis mode in ESA and PSA, the Single hardkey and the INITiate:IMM switched from continuous measurement to single measurement and restarted sweeps and averages (displayed average count reset to 1), but did not restart Max Hold and Min Hold. In the X-Series, the Single hardkey and the INITiate:IMM command initiate a sweep/ measurement/ average sequence/hold sequence including Max Hold and Min Hold.</p> <p>For Spectrum Analysis mode in ESA and PSA, the Single hardkey restarted the sweep regardless of whether or not you were in an active sweep or sweep sequence. In the X-Series, Restart does this but Single only restarts the sweep or sweep sequence if you are in the idle state.</p>
Initial S/W Revision:	Prior to A.02.00
Help Map ID:	3515

Single (Single Measurement/Sweep)

Source (Internal)

Opens a menu of keys that access various source configuration menus and settings. In the test set, pressing this key also causes the central view area to change and display the Source Control Main view.

Key Path:	Front-panel key
Help Map ID:	35360

RF Output

This parameter sets the source RF power output state.

Key Path:	Source
Remote Command:	:OUTPut [:EXTErnal] [:STATe] ON OFF 1 0 :OUTPut [:EXTErnal] [:STATe] ?
Example:	OUTP OFF OUTP?
Notes:	<p>The EXTErnal node is shown in RD text so the SCPI remains the same between internal and external source control. However, for EXT we do not wish to document this node to the customer since we are controlling the internal source rather than the external source.</p> <p>This setting is for the independent mode and has no effect on the “List Sequencer” on page 814. If the “Sequencer” on page 815 is set to ON, the list sequencer controls the source output and this key will be grayed-out. And this setting will be none-forceful grey out on front panel to indicate out-of-scope. Non-forceful means user still can change this setting by SCPI but cannot change on front panel. When set to OFF will make source leave list sequencer and this setting will be black out and take effect immediately.</p> <p>When the RF Output is ON, an “RF” annunciator is displayed in the system settings panel. When the RF Output is turned Off, the RF annunciator is cleared. If the “Sequencer” on page 815 is set to ON, the “RF” annunciator will be replaced by “SEQ” in the system settings panel, indicating that the output is controlled by the list sequencer.</p>
Preset:	Off
Range:	On Off
Initial S/W Revision:	A.05.00
Help Map ID:	35361

Source (Internal)

Amplitude

Allows you to access the Amplitude sub-menu.

Key Path:	Source
Notes:	The sub-menu under this button is for independent mode and has no effect on “List Sequencer” on page 814 . If the “Sequencer” on page 815 is set to ON, the list sequencer controls the source output and this key will be grayed-out on front panel to indicate out-of-scope. When you set “Sequencer” on page 815 to Off will make source leave list sequencer and this button will be black out.
Initial S/W Revision:	A.05.00
Help Map ID:	35362

RF Power

Allows you to adjust the power level of the source using the numeric keypad, step keys, or RPG. Pressing any digit, 0 through 9, on the numeric keypad brings up the unit terminator.

Please refer to the [“RF Power Range ” on page 728](#) table below for the valid ranges.

Key Path:	Source, Amplitude
Remote Command:	:SOURce:POWer[:LEVel] [:IMMediate] [:AMPLitude] <ampl> :SOURce:POWer[:LEVel] [:IMMediate] [:AMPLitude] ?
Example:	SOUR:POW -100 dBm

Notes:	<p>Amplitude corrections can be specified for use with the source. In the event of amplitude corrections being applied, the valid ranges for the RF power do not change dependant on the current amplitude correction setting. If the combination of RF power + amplitude correction is higher or lower than the source output range, the Source Unleveled bit is set and the “Source Unleveled” indicator will appear on status panel to indicate that the source cannot maintain the output power that has been requested.</p> <p>When signal generator is unable to maintain the requested output level, the “Source Unleveled” indicator will appear on status panel. When the source output setting is restored to the normal range, the “Source Unleveled” is removed from status panel.</p> <p>Internal source has list sequence mode, which comprises of several steps which contain separate output power, frequency and waveform etc. When the source list sequence playing is complete, the last step keeps playing, and user can use this command to change the list sequence last step’s output power.</p> <p>{A.12.50} The multiport adapter RFIO TX ports and GPS ports cannot ensure power accuracy when power setting is lower than -130dBm, this power setting value is defined by the sum of RF Power setting and related amplitude correction value. But user settable value could be lower than this limit. When application detected there exists power setting lower than -130dBm on MPA RFIO TX ports, then popup warning message. When application detected there exists power setting lower than -130dBm on MPA GPS ports, then popup warning message. This is only warning message, and check is performed when RF is ON.</p>
Notes:	The Min and Max value here defined UI settable amplitude range. This range is larger than actual amplitude range with level accuracy defined in spec.
Dependencies:	The RF power is dependent on the RF output port and frequency, such that the current frequency and selected output port determine the valid range of power values.
Preset:	-100 dBm
Min:	The range of values depends on the current frequency and selected RF output port. Please refer to the “RF Power Range ” on page 728 table below for the valid ranges.
Max:	The range of values depends on the current frequency and selected RF output port. Please refer to the “RF Power Range ” on page 728 table below for the valid ranges.
Initial S/W Revision:	A.05.00
Help Map ID:	35363

Source (Internal)

RF Power Range

RF Output Port	Frequency Range	Min Output Power	Max Output Power
High Power RF Out	$10 \text{ MHz} \leq f \leq 6 \text{ GHz}$	-130 dBm	20 dBm
RFIO 1 & RFIO 2	$10 \text{ MHz} \leq f \leq 6 \text{ GHz}$	-130 dBm	0 dBm

Set Reference Power

This key allows you to set the power reference. Pressing this key turns the power reference state to ON, sets the reference power value to the current RF output power, maintains this power at the RF output, and sets the displayed power to 0.00 dB. All subsequent RF power values entered under Source>Amplitude>RF Power are interpreted as being relative to this reference power.

When you use a power reference, the signal generator outputs an RF power that is set relative to the reference power by the value entered under Source>Amplitude>RF Power as follows:

Output power = reference power entered power

Where:

reference power equals the original RF Power entered under Source>Amplitude>RF Power and set as the reference power

entered power equals a new value entered under Source>Amplitude>Amptd Offset

In addition, the displayed power value is the same as a new value entered under Source>Amplitude>RF Power.

NOTE	If Power Ref is set to ON with a reference value set, entering a value under Source>Amplitude>RF Power and pressing Set Reference Power will add that value to the existing Power Ref value. If you wish to change the reference power value to a new value entered under Source>Amplitude>RF Power, first you must set Power Ref to OFF and then press Set Reference Power.
-------------	---

Key Path:	Source, Amplitude
Dependencies:	This key is unavailable, and is grayed out when the “List Sequencer” on page 814 is turned ON.
Initial S/W Revision:	A.05.00
Help Map ID:	35364

Power Ref

This key allows you to toggle the state of the power reference.

When you use a power reference, the signal generator outputs an RF power that is set relative to the reference power by the value entered under Source>Amplitude>RF Power as follows:

Output power = reference power + entered power

Where:

reference power equals the original RF Power entered under Source>Amplitude>RF Power and set as the reference power

entered power equals a new value entered under Source>Amplitude>Amptd Offset

For more information on Reference Frequency refer to [“Set Reference Power” on page 728](#)

Key Path:	Source, Amplitude
Remote Command:	:SOURce:POWer:REFerence <ampl> :SOURce:POWer:REFerence? :SOURce:POWer:REFerence:STATe OFF ON 0 1 :SOURce:POWer:REFerence:STATe?
Example:	SOUR:POW:REF 0.00 dBm SOUR:POW:REF:STATe ON
Dependencies:	This setting is unavailable and is grayed out when the “List Sequencer” on page 814 is turned ON.
Couplings:	This value is coupled to the “Set Reference Power” on page 728 key such that pressing the Set Reference Power key updates the reference power with the current output power.
Preset:	0.00 dBm OFF
Min:	-125.00 dBm
Max:	10.00 dBm
Initial S/W Revision:	A.05.00
Help Map ID:	35365

Amptd Offset

Allows you to specify the RF output power offset value.

When the amplitude offset is set to zero (0) and you set a new offset value (positive or negative), the displayed amplitude value will change as follows and the RF output power will not change:

Displayed value = output power + offset value

Where:

output power equals the original RF Power entered under Source>Amplitude>RF Power

offset value equals the value entered under Source>Amplitude>Amptd Offset

When the amplitude offset is set to a value other than zero (0) and you enter a new RF power value under Source>Amplitude>RF Power, the displayed power will be the same as the value entered and the RF

Source (Internal)

output power will be equal to the value entered minus the offset value as follows:

Output power = entered power – offset power

Displayed Power = output power + offset power

Displayed power = entered power

Where:

entered power equals the amplitude entered under Source>Amplitude>RF Power

offset power equals the value previously entered and set under Source>Amplitude>Amptd Offset

Key Path:	Source, Amplitude
Remote Command:	:SOURce:POWer[:LEVel][:IMMediate]:OFFSet <rel_ampl> :SOURce:POWer[:LEVel][:IMMediate]:OFFSet?
Example:	SOUR:POW:OFFS 0.00 dB
Dependencies:	This setting is unavailable, and is grayed out when the List Sequencer is turned ON.
Preset:	0.00 dB
Min:	-200.00 dB
Max:	200.00 dB
Initial S/W Revision:	A.05.00
Help Map ID:	35366

ALC

Allows you to enable or disable the automatic leveling control (ALC) circuit.

The purpose of the ALC circuit is to hold output power at a desired level by adjusting the source's power circuits to compensate for power drift. Power drift occurs over time and changes in temperature.

Turning the ALC off disables the ALC circuitry, enabling you to measure the output at a specific point in a test setup and adjust as required for the desired power level at that point. Turning the ALC off is useful when the modulation consists of very narrow pulses that are below the pulse width specification of the ALC, or when the modulation consists of slow amplitude variations that the automatic leveling would remove.

Key Path:	Source, Amplitude
Remote Command:	:SOURce:POWer:ALC[:STATe] ON OFF 1 0 :SOURce:POWer:ALC[:STATe] ?
Example:	SOUR:POW:ALC OFF SOUR:POW:ALC?
Preset:	On

Range:	On Off
Initial S/W Revision:	A.05.00
Help Map ID:	35367

Modulation

Allows you to toggle the state of the modulation.

Key Path:	Source
Remote Command:	:OUTPut:MODulation[:STATe] ON OFF 1 0 :OUTPut:MODulation[:STATe]?
Example:	:OUTP:MOD OFF
Notes:	This setting is for independent mode and has no effect on “List Sequencer” on page 814 . If the “Sequencer” on page 815 is set to ON, the list sequencer controls the source output and this key will be grayed-out. And this setting will be none-forceful grey out on front panel to indicate out-of-scope. Non-forceful means user still can change this setting by SCPI but cannot change manually on front panel. When set to Off will make source leave list sequencer and this setting will be black out and take effect immediately. When the Modulation is ON, the “MOD” annunciator is displayed in the system settings panel. When the Modulation is turned Off, the “MOD” annunciator is cleared. If the “Sequencer” on page 815 is set to ON, the “MOD” annunciator will be replaced by “SEQ” in the system settings panel indicating that the output is controlled by list sequencer.
Preset:	Off
Range:	On Off
Initial S/W Revision:	A.05.00
Help Map ID:	35373

Frequency

Allows you to access the Frequency sub-menu.

Key Path:	Source
Notes:	The sub-menu under this button is for independent mode and has no effect on “List Sequencer” on page 814 . If the “Sequencer” on page 815 is set to ON, the list sequencer controls the source output and this key will be grayed-out. And this button will be grey out on front panel to indicate out-of-scope. When set to Off will make source leave list sequencer and this button will be black out.
Initial S/W Revision:	A.05.00
Help Map ID:	35374

Source (Internal)

Frequency

Allows you to set the RF Output Frequency. You can adjust the frequency of the source using the numeric keypad, step keys, or RPG. Pressing any digit, 0 through 9, on the numeric keypad brings up the unit terminator.

Key Path:	Source, Frequency
Remote Command:	:SOURce:FREQUENCY[:CW] <freq> :SOURce:FREQUENCY[:CW]?
Example:	SOUR:FREQ 1.00 GHz
Notes:	Internal source has list sequence mode, which comprises of several steps which contain separate output power, frequency and waveform etc. When the source list sequence playing is complete, the last step keeps playing, and user can use this command to change the list sequence last step's output frequency.
Couplings:	The frequency value is coupled to the current channel band and number, such that updates to the band and number will update the frequency value to the corresponding absolute frequency.
Preset:	1.00 GHz
Min:	10.00 MHz
Max:	Hardware Dependant: Option 503 = 3.6 GHz Option 504 = 3.8 GHz
Initial S/W Revision:	A.05.00
Help Map ID:	35375

Channel

The frequency of the source can be specified by a channel number of a given frequency band. This key allows you to specify the current channel number. For the appropriate range of channel numbers for a given frequency band, refer to the following tables: [“GSM/EDGE Channel Number Ranges” on page 734](#), [“W-CDMA Channel Number Ranges” on page 734](#), [“CDMA 2000 / 1xEVDO Channel Number Ranges” on page 737](#), [“LTE FDD Channel Number Ranges” on page 739](#), [“LTE TDD Channel Number Ranges” on page 740](#), and [“TDSCDMA Channel Number Ranges” on page 741](#).

Key Path:	Source, Frequency
Remote Command:	:SOURce:FREQUENCY:CHANnels:NUMBer <int> :SOURce:FREQUENCY:CHANnels:NUMBer?
Example:	SOUR:FREQ:CHAN:NUMB 1
Notes:	This key is grayed out when the “Radio Standard” on page 742 is set to NONE.

Dependencies:	This key is grayed out when the “Radio Standard” on page 742 is set to NONE.
Couplings:	The channel number is coupled to the frequency value when the “Radio Standard” on page 742 is not set to NONE. When the frequency value is changed, the channel number will increase or decrease to match the new frequency. If the frequency is not at an exact match for a channel number, the nearest channel number is displayed along with a greater than or less than sign to indicate the frequency is above or below the channel number.
Preset:	1
Min:	Please refer to the tables below for the valid ranges.
Max:	Please refer to the tables below for the valid ranges.
Initial S/W Revision:	A.05.00
Help Map ID:	35376

GSM/EDGE Channel Number Ranges

Band	Link (Device)	Range	Frequency (MHz)
P-GSM	Uplink (MS)	$1 \leq n \leq 124$	$890.0 + 0.2*n$
	Downlink (BS)	$1 \leq n \leq 124$	$935.0 + 0.2*n$
E-GSM	Uplink (MS)	$0 \leq n \leq 124$	$890.0 + 0.2*n$
		$975 \leq n \leq 1023$	$890.0 + 0.2*(n-1024)$
	Downlink (BS)	$0 \leq n \leq 124$	$935.0 + 0.2*n$
		$975 \leq n \leq 1023$	$935.0 + 0.2*(n-1024)$
DCS 1800	Uplink (MS)	$512 \leq n \leq 885$	$1710.200 + 0.20*(n-512)$
	Downlink (BS)	$512 \leq n \leq 885$	$1805.200 + 0.20*(n-512)$
PCS 1900	Uplink (MS)	$512 \leq n \leq 810$	$1850.200 + 0.2*(n-512)$
	Downlink (BS)	$512 \leq n \leq 810$	$1930.200 + 0.2*(n-512)$
R-GSM	Uplink (MS)	$0 \leq n \leq 124$	$890.0 + 0.2*n$
		$955 \leq n \leq 1023$	$890.0 + 0.2*(n-1024)$
	Downlink (BS)	$0 \leq n \leq 124$	$935.0 + 0.2*n$
		$955 \leq n \leq 1023$	$935.0 + 0.2*(n-1024)$
GSM 450	Uplink (MS)	$256 \leq n \leq 293$	$450.6 + 0.2*(n-259)$
	Downlink (BS)	$256 \leq n \leq 293$	$460.6 + 0.2*(n-259)$
GSM 480	Uplink (MS)	$306 \leq n \leq 340$	$479.000 + 0.20*(n-306)$
	Downlink (BS)	$306 \leq n \leq 340$	$489.000 + 0.20*(n-306)$
GSM 850	Uplink (MS)	$128 \leq n \leq 251$	$824.200 + 0.20*(n-128)$
	Downlink (BS)	$128 \leq n \leq 251$	$869.200 + 0.20*(n-128)$
GSM 700	Uplink (MS)	$438 \leq n \leq 516$	$777.200 + 0.20*(n-438)$
	Downlink (BS)	$438 \leq n \leq 516$	$747.200 + 0.20*(n-438)$
T-GSM810	Uplink (MS)	$350 \leq n \leq 425$	$806.0 + 0.20*(n-350)$
	Downlink (BS)	$350 \leq n \leq 425$	$851.0 + 0.20*(n-350)$

W-CDMA Channel Number Ranges

Band	Link (Device)	Range	Frequency (MHz)
Band I	Downlink	$10562 \leq n \leq 10838$	$n \div 5$
	Uplink	$9612 \leq n \leq 9888$	$n \div 5$

Band	Link (Device)	Range	Frequency (MHz)
Band II	Downlink	$412 \leq n \leq 687$ $9662 \leq n \leq 9938$	$n+5 + 1850.1$ $n+5$
	Uplink	$12 \leq n \leq 287$ $350 \leq n \leq 425$	$n+5 + 1850.1$ $n+5$
Band III	Downlink	$1162 \leq n \leq 1513$	$n+5 + 1575$
	Uplink	$937 \leq n \leq 1288$	$n+5 + 1525$
Band IV	Downlink	$537 \leq n \leq 1738$ $1887 \leq n \leq 2087$	$n+5 + 1805$ $n+5 + 1735.1$
	Uplink	$1312 \leq n \leq 1513$ $1662 \leq n \leq 1862$	$n+5 + 1450$ $n+5 + 1380.1$
Band V	Downlink	$1007 \leq n \leq 1087$ $4357 \leq n \leq 4458$	$n+5 + 670.1$ $n+5$
	Uplink	$782 \leq n \leq 862$ $4132 \leq n \leq 4233$	$n+5 + 670.1$ $n+5$
Band VI	Downlink	$1037 \leq n \leq 1062$ $4387 \leq n \leq 4413$	$n+5 + 670.1$ $n+5$
	Uplink	$812 \leq n \leq 837$ $4162 \leq n \leq 4188$	$n+5 + 670.1$ $n+5$
Band VII	Downlink	$2237 \leq n \leq 2563$ $2587 \leq n \leq 2912$	$n+5 + 2175$ $n+5 + 2105.1$
	Uplink	$2012 \leq n \leq 2338$ $2362 \leq n \leq 2687$	$n+5 + 2100$ $n+5 + 2030.1$
Band VIII	Downlink	$2937 \leq n \leq 3088$	$n+5 + 340$
	Uplink	$2712 \leq n \leq 2863$	$n+5 + 340$
Band IX	Downlink	$9237 \leq n \leq 9387$	$n+5$
	Uplink	$8762 \leq n \leq 8912$	$n+5$
Band X	Downlink	$3112 \leq n \leq 3388$ $3412 \leq n \leq 3687$	$n+5 + 1490$ $n+5 + 1430.1$
	Uplink	$2887 \leq n \leq 3163$ $3187 \leq n \leq 3462$	$n+5 + 1135$ $n+5 + 1075.1$

Source (Internal)

Band	Link (Device)	Range	Frequency (MHz)
Band XI	Downlink	$3712 \leq n \leq 3812$	$n+5 + 736$
	Uplink	$3487 \leq n \leq 3587$	$n+5 + 733$
Band XII	Downlink	$3837 \leq n \leq 3903$	$n+5 - 37$
		$3927 \leq n \leq 3992$	$n+5 - 54.9$
	Uplink	$3612 \leq n \leq 3678$	$n+5 - 22$
		$3702 \leq n \leq 3767$	$n+5 - 39.9$
Band XIII	Downlink	$4017 \leq n \leq 4043$	$n+5 - 55$
		$4067 \leq n \leq 4092$	$n+5 - 64.9$
	Uplink	$3792 \leq n \leq 3818$	$n+5 + 21$
		$3702 \leq n \leq 3767$	$n+5 - 39.9$
Band XIV	Downlink	$4117 \leq n \leq 4143$	$n+5 - 63$
		$4167 \leq n \leq 4192$	$n+5 - 72.9$
	Uplink	$3892 \leq n \leq 3918$	$n+5 + 12$
		$3942 \leq n \leq 3967$	$n+5 + 2.1$

CDMA 2000 / 1xEVDO Channel Number Ranges

Band	Link (Device)	Range	Frequency (MHz)
US Cellular	Uplink (MS, reverse link)	$1 \leq N \leq 799$ $991 \leq N \leq 1023$ $1024 \leq N \leq 1323$	$0.030 \times N + 825.000$ $0.030 \times (N - 1023) + 825.000$ $0.030 \times (N - 1024) + 815.040$
	Downlink (BS, forward link)	$1 \leq N \leq 799$ $991 \leq N \leq 1023$ $1024 \leq N \leq 1323$	$0.030 \times N + 870.000$ $0.030 \times (N - 1023) + 870.000$ $0.030 \times (N - 1024) + 860.040$
US PCS	Uplink (MS, reverse link)	$0 \leq N \leq 1199$	$1850.000 + 0.050 \times N$
	Downlink (BS, forward link)	$0 \leq N \leq 1199$	$1930.000 + 0.050 \times N$
Japan Cellular Band	Uplink (MS, reverse link)	$1 \leq N \leq 799$ $801 \leq N \leq 1039$ $1041 \leq N \leq 1199$ $1201 \leq N \leq 1600$	$0.0125 \times (N + 915.000)$ $0.0125 \times (N - 800) + 898.000$ $0.0125 \times (N - 1040) + 887.000$ $0.0125 \times (N - 1200) + 893.000$
	Downlink (BS, forward link)	$1 \leq N \leq 799$ $801 \leq N \leq 1039$ $1041 \leq N \leq 1199$ $1201 \leq N \leq 1600$	$0.0125 \times (N + 860.000)$ $0.0125 \times (N - 800) + 843.000$ $0.0125 \times (N - 1040) + 832.000$ $0.0125 \times (N - 1200) + 838.000$
Korean PCS Band	Uplink (MS, reverse link)	$0 \leq N \leq 599$	$0.050 \times N + 1750.000$
	Downlink (BS, forward link)	$0 \leq N \leq 599$	$0.050 \times N + 1840.000$
NMT-450 Band	Uplink (MS, reverse link)	$1 \leq N \leq 400$ $472 \leq N \leq 871$ $1039 \leq N \leq 1473$ $1536 \leq N \leq 1715$ $1792 \leq N \leq 2016$	$0.025 \times (N - 1) + 450.000$ $0.025 \times (N - 472) + 410.000$ $0.020 \times (N - 1024) + 451.010$ $0.025 \times (N - 1536) + 479.000$ $0.020 \times (N - 1792) + 479.000$
	Downlink (BS, forward link)	$1 \leq N \leq 400$ $472 \leq N \leq 871$ $1039 \leq N \leq 1473$ $1536 \leq N \leq 1715$ $1792 \leq N \leq 2016$	$0.025 \times (N - 1) + 460.000$ $0.025 \times (N - 472) + 420.000$ $0.020 \times (N - 1024) + 461.010$ $0.025 \times (N - 1536) + 489.000$ $0.020 \times (N - 1792) + 489.000$

Source (Internal)

Band	Link (Device)	Range	Frequency (MHz)
IMT-2000 Band	Uplink (MS, reverse link)	$0 \leq N \leq 1199$	$1920.000 + 0.050 \times N$
	Downlink (BS, forward link)	$0 \leq N \leq 1199$	$2100.000 + 0.050 \times N$
Upper 700 MHz Band	Uplink (MS, reverse link)	$0 \leq N \leq 240$	$776.000 + 0.050 \times N$
	Downlink (BS, forward link)	$0 \leq N \leq 240$	$746.000 + 0.050 \times N$
Secondary 800 MHz Band	Uplink (MS, reverse link)	$0 \leq N \leq 719$ $720 \leq N \leq 919$	$0.025 \times N + 806.000$ $0.025 \times (N - 720) + 896.000$
	Downlink (BS, forward link)	$0 \leq N \leq 719$ $720 \leq N \leq 919$	$0.025 \times N + 851.000$ $0.025 \times (N - 720) + 935.000$
2.5 GHz IMT Extension	Uplink (MS, reverse link)	$0 \leq N \leq 1399$	$2500.000 + 0.050 \times N$
	Downlink (BS, forward link)	$0 \leq N \leq 1399$	$2620.000 + 0.050 \times N$
US PCS 1.9 GHz	Uplink (MS, reverse link)	$0 \leq N \leq 1299$	$1850.000 + 0.050 \times N$
	Downlink (BS, forward link)	$0 \leq N \leq 1299$	$1930.000 + 0.050 \times N$
AWS	Uplink (MS, reverse link)	$0 \leq N \leq 899$	$1710.000 + 0.050 \times N$
	Downlink (BS, forward link)	$0 \leq N \leq 899$	$2100.000 + 0.050 \times N$
US 2.5 GHz	Uplink (MS, reverse link)	$140 \leq N \leq 1459$	$2495.000 + 0.050 \times N$
	Downlink (BS, forward link)	$140 \leq N \leq 1459$	$2617.000 + 0.050 \times N$
700 Public Safety	Uplink (MS, reverse link)	$0 \leq N \leq 240$	$787.000 + 0.050 \times N$
	Downlink (BS, forward link)	$0 \leq N \leq 240$	$757.000 + 0.050 \times N$
C2K Lower 700	Uplink (MS, reverse link)	$0 \leq N \leq 360$	$698.000 + 0.050 \times N$
	Downlink (BS, forward link)	$0 \leq N \leq 360$	$728.000 + 0.050 \times N$

Band	Link (Device)	Range	Frequency (MHz)
400 Euro PAMR	Uplink (MS, reverse link)	$1 \leq N \leq 400$	$0.025 \times (N-1) + 450.000$
		$472 \leq N \leq 871$	$0.025 \times (N-472) + 410.000$
		$1536 \leq N \leq 1715$	$0.025 \times (N-1536) + 479.000$
	Downlink (BS, forward link)	$1 \leq N \leq 400$	$0.025 \times (N-1) + 460.000$
		$472 \leq N \leq 871$	$0.025 \times (N-472) + 420.000$
		$1536 \leq N \leq 1715$	$0.025 \times (N-1536) + 489.000$
800 PAMR	Uplink (MS, reverse link)	$0 \leq N \leq 239$	$870.0125 + 0.025 \times N$
	Downlink (BS, forward link)	$0 \leq N \leq 239$	$915.0125 + 0.025 \times N$

LTE FDD Channel Number Ranges

The carrier frequency in the uplink and downlink is designated by the E-UTRA Absolute Radio Frequency Channel Number (EARFCN) in the range 0 – 65535. The relation between EARFCN and the carrier frequency in MHz for the downlink is given by the following equation, where F_{DL_low} and $N_{Offs-DL}$ are given in table 5.4.4–1 and N_{DL} is the downlink EARFCN.

$$F_{DL} = F_{DL_low} + 0.1(N_{DL} - N_{Offs-DL})$$

The relation between EARFCN and the carrier frequency in MHz for the uplink is given by the following equation where F_{UL_low} and $N_{Offs-UL}$ are given in table 5.4.4–1 and N_{UL} is the uplink EARFCN.

$$F_{UL} = F_{UL_low} + 0.1(N_{UL} - N_{Offs-UL})$$

Band	Downlink			Uplink		
	F_{DL_low} (MHz)	$N_{Offs-DL}$	Range of N_{DL}	F_{UL_low} (MHz)	$N_{Offs-UL}$	Range of N_{UL}
1	2110	0	0 – 599	1920	18000	18000 – 18599
2	1930	600	600 - 1199	1850	18600	18600 – 19199
3	1805	1200	1200 – 1949	1710	19200	19200 – 19949
4	2110	1950	1950 – 2399	1710	19950	19950 – 20399
5	869	2400	2400 – 2649	824	20400	20400 – 20649
6	875	2650	2650 – 2749	830	20650	20650 – 20749

Source (Internal)

7	2620	2750	2750 – 3449	2500	20750	20750 – 20449
8	925	3450	3450 – 3799	880	21450	21450 – 21799
9	1844.9	3800	3800 – 4149	1749.9	21800	21800 – 22149
10	2110	4150	4150 – 4749	1710	22150	22150 – 22749
11	1475.9	4750	4750 – 4949	1427.9	22750	22750 – 22949
12	729	5010	5010 – 5179	699	23010	23010 – 23179
13	746	5180	5180 – 5279	777	23180	23180 – 23279
14	758	5280	5280 – 5379	788	23280	23280 – 23379
...						
17	734	5730	5730 – 5849	704	23730	23730 – 23849
18	860	5850	5850 – 5999	815	23850	23850 – 23999
19	875	6000	6000 – 6149	830	24000	24000 – 24149
20	791	6150	6150 – 6449	832	24150	24150 – 24449
21	1495.9	6450	6450 – 6599	1447.9	24450	24450 – 24599
...						
24	1525	7700	7700 – 8039	1626.5	25700	25700 – 26039
25	1930	8040	8040 – 8689	1850	26040	26040 – 26689
...						

Note: The channel numbers that designate carrier frequencies so close to the operating band edges that the carrier extends beyond the operating band edge shall not be used. This implies that the first 7, 15, 25, 50, 75 and 100 channel numbers at the lower operating band edge and the last 6, 14, 24, 49, 74 and 99 channel numbers at the upper operating band edge shall not be used for channel bandwidths of 1.4, 3, 5, 10, 15 and 20 MHz respectively.

LTE TDD Channel Number Ranges

The carrier frequency in the uplink and downlink is designated by the E-UTRA Absolute Radio Frequency Channel Number (EARFCN) in the range 0 – 65535. The relation between EARFCN and the carrier frequency in MHz for the downlink is given by the following equation, where F_{DL_low} and $N_{Offs-DL}$ are given in table 5.4.4–1 and N_{DL} is the downlink EARFCN.

$$F_{DL} = F_{DL_low} + 0.1(N_{DL} - N_{Offs-DL})$$

The relation between EARFCN and the carrier frequency in MHz for the uplink is given by the following equation where F_{UL_low} and $N_{Offs-UL}$ are given in table 5.4.4–1 and N_{UL} is the uplink EARFCN.

$$F_{UL} = F_{UL_low} + 0.1(N_{UL} - N_{Offs-UL})$$

Band	Downlink			Uplink		
	F _{DL_low} (MHz)	N _{Offs-DL}	Range of N _{DL}	F _{UL_low} (MHz)	N _{Offs-UL}	Range of N _{UL}
33	1900	36000	36000 – 36199	1900	36000	36000 – 36199
34	2010	36200	36200 – 36349	2010	36200	36200 – 36349
35	1850	36350	36350 – 36949	1850	36350	36350 – 36949
36	1930	36950	36950 – 37549	1930	36950	36950 – 37549
37	1910	37550	37550 – 37749	1910	37550	37550 – 37749
38	2570	37750	37750 – 38249	2570	37750	37750 – 38249
39	1880	38250	38250 – 38649	1880	38250	38250 – 38649
40	2300	38650	38650 – 39649	2300	38650	38650 – 39649
41	2496	39650	39650 – 41589	2496	39650	39650 – 41589
42	3400	41590	41590 – 43589	3400	41590	41590 – 43589
43	3600	43590	43590 – 45589	3600	43590	43590 – 45589

Note: The channel numbers that designate carrier frequencies so close to the operating band edges that the carrier extends beyond the operating band edge shall not be used. This implies that the first 7, 15, 25, 50, 75 and 100 channel numbers at the lower operating band edge and the last 6, 14, 24, 49, 74 and 99 channel numbers at the upper operating band edge shall not be used for channel bandwidths of 1.4, 3, 5, 10, 15 and 20 MHz respectively.

TDSCDMA Channel Number Ranges

1.28 Mcps TDD Option

No TX-RX frequency separation is required as Time Division Duplex (TDD) is employed. Each subframe consists of 7 main timeslots where all main timeslots (at least the first one) before the single switching point are allocated DL and all main timeslots (at least the last one) after the single switching point are allocated UL.

The nominal channel spacing is 1.6 MHz, but this can be adjusted to optimise performance in a particular deployment scenario.

The carrier frequency is designated by the UTRA absolute radio frequency channel number (UARFCN). The value of the UARFCN in the IMT2000 band is defined in the general case as follows:

$$N_t = 5 * F \quad 0.0 \text{ MHz} \leq F \leq 3276.6 \text{ MHz}$$

where F is the carrier frequency in MHz

Additional channels applicable to operation in the frequency band defined in sub-clause 5.2(d) are defined via the following UARFCN definition:

$$N_t = 5 * (F - 2150.1 \text{ MHz}) \quad 2572.5 \text{ MHz} \leq F \leq 2617.5 \text{ MHz}$$

Source (Internal)

UARFCN

1.28 Mcps TDD Option

The following UARFCN range shall be supported for each band:

Table: UTRA Absolute Radio Frequency Channel Number 1.28 Mcps TDD Option

Frequency Band	Frequency Range	UARFCN Uplink and Downlink transmission
For operation in frequency band as defined in subclause 5.2 (a)	1900–1920 MHz	9504 to 9596
	2010–2025 MHz	10054 to 10121
For operation in frequency band as defined in subclause 5.2 (b)	1850–1910 MHz	9254 to 9546
	1930–1990 MHz	9654 to 9946
For operation in frequency band as defined in subclause 5.2 (c)	1910–1930 MHz	9554 to 9646
For operation in frequency band as defined in subclause 5.2 (d)	2570–2620 MHz	12854 to 13096
For operation in frequency band as defined in subclause 5.2 (e)	2300–2400 MHz	11504 to 11996
For operation in frequency band as defined in subclause 5.2 (f)	1880–1920 MHz	9404 to 9596

Radio Setup

Allows access to the sub-menus for selecting the radio standard and associated radio band. You can also set a frequency reference and offset.

Key Path:	Source, Frequency
Initial S/W Revision:	A.05.00
Help Map ID:	35377

Radio Standard

Allows access to the channel band sub-menus to select the desired radio standard. When you have selected the radio standard, you can then set an active channel band. The radio standard and the active channel band allow you to use channel numbers to set frequency automatically.

Key Path:	Source, Frequency, Radio Setup
-----------	---------------------------------------

Remote Command:	:SOURce:FREQuency:CHANnels: BAND NONE PGSM EGSM RGSM DCS1800 PCS1900 TGSM810 GSM450 GSM480 GSM700 GSM850 BANDI BANDII BANDIII BANDIV BANDV BANDVI BANDVII BANDVIII BANDIX BANDX BANDXI BANDXII BANDXIII BANDXIV USCELL USPCS JAPAN KOREAN NMT IMT2K UPPER SECOND PAMR400 PAMR800 IMTEXT PCS1DOT9G AWS US2DOT5G PUBLIC LOWER BAND1 BAND2 BAND3 BAND4 BAND5 BAND6 BAND7 BAND8 BAND10 BAND11 BAND12 BAND13 BAND14 BAND17 BAND18 BAND19 BAND20 BAND21 BAND24 BAND25 BAND33 BAND34 BAND35 BAND36 BAND37 BAND38 BAND39 BAND40 BAND41 BAND42 BAND43 BAND4A BANDB BANDC BANDD BANDE BANDF :SOURce:FREQuency:CHANnels: BAND?
Example:	SOUR:FREQ:CHAN:BAND PGSM
Notes:	Set this setting to “NONE” will grey out “Channel” on page 732 Channel
Initial S/W Revision:	A.05.00
Help Map ID:	35378

None

Selects no radio standard for use. When you have selected the radio standard to NONE, you cannot use channel numbers to set frequency automatically. You will need to set the frequency manually.

Key Path:	Source, Frequency, Radio Setup, Radio Standard
Initial S/W Revision:	A.05.00
Help Map ID:	35678

GSM/EDGE

Sets GSM/EDGE as the radio standard for use and accesses the GSM/EDGE specific channel band sub-menus.

Key Path:	Source, Frequency, Radio Setup, Radio Standard
Initial S/W Revision:	A.05.00
Help Map ID:	35379

P-GSM

Selects P-GSM as the active channel band.

Key Path:	Source, Frequency, Radio Setup, Radio Standard, GSM/EDGE
Example:	SOUR:FREQ:CHAN:BAND PGSM
Initial S/W Revision:	A.05.00
Help Map ID:	35380

Source (Internal)

E-GSM

Selects E-GSM as the active channel band.

Key Path:	Source, Frequency, Radio Setup, Radio Standard, GSM/EDGE
Example:	SOUR:FREQ:CHAN:BAND EGSM
Initial S/W Revision:	A.05.00
Help Map ID:	35381

R-GSM

Selects R-GSM as the active channel band.

Key Path:	Source, Frequency, Radio Setup, Radio Standard, GSM/EDGE
Example:	SOUR:FREQ:CHAN:BAND RGSM
Initial S/W Revision:	A.05.00
Help Map ID:	35382

DCS 1800

Selects DCS 1800 as the active channel band.

Key Path:	Source, Frequency, Radio Setup, Radio Standard, GSM/EDGE
Example:	SOUR:FREQ:CHAN:BAND DCS1800
Initial S/W Revision:	A.05.00
Help Map ID:	35383

PCS 1900

Selects PCS 1900 as the active channel band.

Key Path:	Source, Frequency, Radio Setup, Radio Standard, GSM/EDGE
Example:	SOUR:FREQ:CHAN:BAND PCS1900
Initial S/W Revision:	A.05.00
Help Map ID:	35384

GSM 450

Selects GSM 450 as the active channel band.

Key Path:	Source, Frequency, Radio Setup, Radio Standard, GSM/EDGE
Example:	SOUR:FREQ:CHAN:BAND GSM450
Initial S/W Revision:	A.05.00

Help Map ID:	35386
--------------	-------

GSM 480

Selects GSM 480 as the active channel band.

Key Path:	Source, Frequency, Radio Setup, Radio Standard, GSM/EDGE
Example:	SOUR:FREQ:CHAN:BAND GSM480
Initial S/W Revision:	A.05.00
Help Map ID:	35387

GSM 850

Selects GSM 850 as the active channel band.

Key Path:	Source, Frequency, Radio Setup, Radio Standard, GSM/EDGE
Example:	SOUR:FREQ:CHAN:BAND GSM850
Initial S/W Revision:	A.05.00
Help Map ID:	35389

GSM 700

Selects GSM 700 as the active channel band.

Key Path:	Source, Frequency, Radio Setup, Radio Standard, GSM/EDGE
Example:	SOUR:FREQ:CHAN:BAND GSM700
Initial S/W Revision:	A.05.00
Help Map ID:	35388

T-GSM 810

Selects T-GSM 810 as the active channel band.

Key Path:	Source, Frequency, Radio Setup, Radio Standard, GSM/EDGE
Example:	SOUR:FREQ:CHAN:BAND T-GSM810
Initial S/W Revision:	A.05.00
Help Map ID:	35385

WCDMA

Sets WCDMA as the radio standard for use and accesses the W-CDMA specific channel band sub-menus.

Key Path:	Source, Frequency, Radio Setup, Radio Standard
-----------	---

Source (Internal)

Initial S/W Revision:	A.05.00
Help Map ID:	35390

Band I

Selects Band I as the active channel band.

Key Path:	Source, Frequency, Radio Setup, Radio Standard, WCDMA
Example:	SOUR:FREQ:CHAN:BAND BANDI
Initial S/W Revision:	A.05.00
Help Map ID:	35391

Band II

Selects Band II as the active channel band.

Key Path:	Source, Frequency, Radio Setup, Radio Standard, WCDMA
Example:	SOUR:FREQ:CHAN:BAND BANDII
Initial S/W Revision:	A.05.00
Help Map ID:	35392

Band III

Selects Band III as the active channel band.

Key Path:	Source, Frequency, Radio Setup, Radio Standard, WCDMA
Example:	SOUR:FREQ:CHAN:BAND BANDIII
Initial S/W Revision:	A.05.00
Help Map ID:	35393

Band IV

Selects Band IV as the active channel band.

Key Path:	Source, Frequency, Radio Setup, Radio Standard, WCDMA
Example:	SOUR:FREQ:CHAN:BAND BANDIV
Initial S/W Revision:	A.05.00
Help Map ID:	35394

Band V

Selects Band V as the active channel band.

Key Path:	Source, Frequency, Radio Setup, Radio Standard, WCDMA
Example:	SOUR:FREQ:CHAN:BAND BANDV
Initial S/W Revision:	A.05.00
Help Map ID:	35395

Band VI

Selects Band VI as the active channel band.

Key Path:	Source, Frequency, Radio Setup, Radio Standard, WCDMA
Example:	SOUR:FREQ:CHAN:BAND BANDVI
Initial S/W Revision:	A.05.00
Help Map ID:	35396

Band VII

Selects Band VII as the active channel band.

Key Path:	Source, Frequency, Radio Setup, Radio Standard, WCDMA
Example:	SOUR:FREQ:CHAN:BAND BANDVII
Initial S/W Revision:	A.05.00
Help Map ID:	35397

Band VIII

Selects Band VIII as the active channel band.

Key Path:	Source, Frequency, Radio Setup, Radio Standard, WCDMA
Example:	SOUR:FREQ:CHAN:BAND BANDVIII
Initial S/W Revision:	A.05.00
Help Map ID:	35398

Band IX

Selects Band IX as the active channel band.

Key Path:	Source, Frequency, Radio Setup, Radio Standard, WCDMA
Example:	SOUR:FREQ:CHAN:BAND BANDIX
Initial S/W Revision:	A.05.00

Source (Internal)

Help Map ID:	35399
--------------	-------

Band X

Selects Band X as the active channel band.

Key Path:	Source, Frequency, Radio Setup, Radio Standard, WCDMA
Example:	SOUR:FREQ:CHAN:BAND BANDX
Initial S/W Revision:	A.05.00
Help Map ID:	35400

Band XI

Selects Band XI as the active channel band.

Key Path:	Source, Frequency, Radio Setup, Radio Standard, WCDMA
Example:	SOUR:FREQ:CHAN:BAND BANDXI
Initial S/W Revision:	A.05.00
Help Map ID:	35401

Band XII

Selects Band XII as the active channel band.

Key Path:	Source, Frequency, Radio Setup, Radio Standard, WCDMA
Example:	SOUR:FREQ:CHAN:BAND BANDXII
Initial S/W Revision:	A.05.00
Help Map ID:	35402

Band XIII

Selects band XIII as the active channel band.

Key Path:	Source, Frequency, Radio Setup, Radio Standard, WCDMA
Example:	SOUR:FREQ:CHAN:BAND BANDXIII
Initial S/W Revision:	A.05.00
Help Map ID:	35403

Band XIV

Selects Band XIV as the active channel band.

Key Path:	Source, Frequency, Radio Setup, Radio Standard, WCDMA
-----------	--

Example:	SOUR:FREQ:CHAN:BAND BANDXIV
Initial S/W Revision:	A.05.00
Help Map ID:	35404

CDMA 2000 / 1xEVDO

Sets CDMA 2000 / 1xEVDO as the radio standard for use and accesses the CDMA 2000/1xEVDO specific channel band sub-menus.

Key Path:	Source, Frequency, Radio Setup, Radio Standard
Initial S/W Revision:	A.05.00
Help Map ID:	35405

US CELL

Selects US Cell as the active channel band.

Key Path:	Source, Frequency, Radio Setup, Radio Standard, CDMA 2000 / 1xEVDO
Example:	SOUR:FREQ:CHAN:BAND USCELL
Initial S/W Revision:	A.05.00
Help Map ID:	35406

US PCS

Selects US PCS as the active channel band.

Key Path:	Source, Frequency, Radio Setup, Radio Standard, CDMA 2000 / 1xEVDO
Example:	SOUR:FREQ:CHAN:BAND PCS
Initial S/W Revision:	A.05.00
Help Map ID:	35407

Japan Cell

Selects Japan Cell as the active channel band.

Key Path:	Source, Frequency, Radio Setup, Radio Standard, CDMA 2000 / 1xEVDO
Example:	SOUR:FREQ:CHAN:BAND JAPAN
Initial S/W Revision:	A.05.00
Help Map ID:	35408

Source (Internal)

Korean PCS

Selects Korean PCS as the active channel band.

Key Path:	Source, Frequency, Radio Setup, Radio Standard, CDMA 2000 / 1xEVDO
Example:	SOUR:FREQ:CHAN:BAND KOREAN
Initial S/W Revision:	A.05.00
Help Map ID:	35409

NMT 450

Selects NMT 450 as the active channel band.

Key Path:	Source, Frequency, Radio Setup, Radio Standard, CDMA 2000 / 1xEVDO
Example:	SOUR:FREQ:CHAN:BAND NMT
Initial S/W Revision:	A.05.00
Help Map ID:	35410

IMT 2000

Selects IMT 2000 as the active channel band.

Key Path:	Source, Frequency, Radio Setup, Radio Standard, CDMA 2000 / 1xEVDO
Example:	SOUR:FREQ:CHAN:BAND IMT2K
Initial S/W Revision:	A.05.00
Help Map ID:	35411

Upper 700

Selects Upper 700 as the active channel band.

Key Path:	Source, Frequency, Radio Setup, Radio Standard, CDMA 2000 / 1xEVDO
Example:	SOUR:FREQ:CHAN:BAND UPPER
Initial S/W Revision:	A.05.00
Help Map ID:	35412

Secondary 800

Selects Secondary 800 as the active channel band.

Key Path:	Source, Frequency, Radio Setup, Radio Standard, CDMA 2000 / 1xEVDO
Example:	SOUR:FREQ:CHAN:BAND SECOND
Initial S/W Revision:	A.05.00

Help Map ID:	35413
--------------	-------

400 Euro PAMR

Selects 400 Euro PAMR as the active channel band.

Key Path:	Source, Frequency, Radio Setup, Radio Standard, CDMA 2000 / 1xEVDO
Example:	SOUR:FREQ:CHAN:BAND PAMR400
Initial S/W Revision:	A.05.00
Help Map ID:	35414

800 PAMR

Selects 800 PAMR as the active channel band.

Key Path:	Source, Frequency, Radio Setup, Radio Standard, CDMA 2000 / 1xEVDO
Example:	SOUR:FREQ:CHAN:BAND PAMR800
Initial S/W Revision:	A.05.00
Help Map ID:	35415

2.5GHz IMT EXT

Selects 2.5 GHz IMT EXT as the active channel band.

Key Path:	Source, Frequency, Radio Setup, Radio Standard, CDMA 2000 / 1xEVDO
Example:	SOUR:FREQ:CHAN:BAND IMTEXT
Initial S/W Revision:	A.05.00
Help Map ID:	35416

US PCS 1.9GHz

Selects US PCS 1.9 GHz as the active channel band.

Key Path:	Source, Frequency, Radio Setup, Radio Standard, CDMA 2000 / 1xEVDO
Example:	SOUR:FREQ:CHAN:BAND PCS1DOT9G
Initial S/W Revision:	A.05.00
Help Map ID:	35417

AWS

Selects AWS as the active channel band.

Key Path:	Source, Frequency, Radio Setup, Radio Standard, CDMA 2000 / 1xEVDO
-----------	---

Source (Internal)

Example:	SOUR:FREQ:CHAN:BAND AWS
Initial S/W Revision:	A.05.00
Help Map ID:	35418

US 2.5GHz

Selects US 2.5 GHz as the active channel band.

Key Path:	Source, Frequency, Radio Setup, Radio Standard, CDMA 2000 / 1xEVDO
Example:	SOUR:FREQ:CHAN:BAND US2DOT5G
Initial S/W Revision:	A.05.00
Help Map ID:	35419

700 Public Safety

Selects 700 Public Safety as the active channel band.

Key Path:	Source, Frequency, Radio Setup, Radio Standard, CDMA 2000 / 1xEVDO
Example:	SOUR:FREQ:CHAN:BAND PUBLIC
Initial S/W Revision:	A.05.00
Help Map ID:	35420

C2K Lower 700

Selects C2K Lower 700 as the active channel band.

Key Path:	Source, Frequency, Radio Setup, Radio Standard, CDMA 2000 / 1xEVDO
Example:	SOUR:FREQ:CHAN:BAND LOWER
Initial S/W Revision:	A.05.00
Help Map ID:	35421

LTE

Sets LTE FDD as the radio standard for use and accesses the LTE FDD specific channel band sub-menus..

Key Path:	Source, Frequency, Radio Setup, Radio Standard
Initial S/W Revision:	A.09.50
Help Map ID:	35701

BAND 1

Selects BAND 1 as the band for the current step.

Key Path:	Source, Frequency, Radio Setup, Radio Standard, LTE
Example:	SOUR:FREQ:CHAN:BAND BAND1
Initial S/W Revision:	A.09.50
Help Map ID:	35702

BAND 2

Selects BAND 2 as the band for the current step.

Key Path:	Source, Frequency, Radio Setup, Radio Standard, LTE
Example:	SOUR:FREQ:CHAN:BAND BAND2
Initial S/W Revision:	A.09.50
Help Map ID:	35703

BAND 3

Selects BAND 3 as the band for the current step.

Key Path:	Source, Frequency, Radio Setup, Radio Standard, LTE
Example:	SOUR:FREQ:CHAN:BAND BAND3
Initial S/W Revision:	A.09.50
Help Map ID:	35704

BAND 4

Selects BAND 4 as the band for the current step.

Key Path:	Source, Frequency, Radio Setup, Radio Standard, LTE
Example:	SOUR:FREQ:CHAN:BAND BAND4
Initial S/W Revision:	A.09.50
Help Map ID:	35705

BAND 5

Selects BAND 5 as the band for the current step.

Key Path:	Source, Frequency, Radio Setup, Radio Standard, LTE
Example:	SOUR:FREQ:CHAN:BAND BAND5
Initial S/W Revision:	A.09.50

Source (Internal)

Help Map ID:	35706
--------------	-------

BAND 6

Selects BAND 6 as the band for the current step.

Key Path:	Source, Frequency, Radio Setup, Radio Standard, LTE
Example:	SOUR:FREQ:CHAN:BAND BAND6
Initial S/W Revision:	A.09.50
Help Map ID:	35707

BAND 7

Selects BAND 7 as the band for the current step.

Key Path:	Source, Frequency, Radio Setup, Radio Standard, LTE
Example:	SOUR:FREQ:CHAN:BAND BAND7
Initial S/W Revision:	A.09.50
Help Map ID:	35708

BAND 8

Selects BAND 8 as the band for the current step.

Key Path:	Source, Frequency, Radio Setup, Radio Standard, LTE
Example:	SOUR:FREQ:CHAN:BAND BAND8
Initial S/W Revision:	A.09.50
Help Map ID:	35709

BAND 9

Selects BAND 9 as the band for the current step.

Key Path:	Source, Frequency, Radio Setup, Radio Standard, LTE
Example:	SOUR:FREQ:CHAN:BAND BAND9
Initial S/W Revision:	A.09.50
Help Map ID:	35710

BAND 10

Selects BAND 10 as the band for the current step.

Key Path:	Source, Frequency, Radio Setup, Radio Standard, LTE
-----------	--

Example:	SOUR:FREQ:CHAN:BAND BAND10
Initial S/W Revision:	A.09.50
Help Map ID:	35711

BAND 11

Selects BAND 11 as the band for the current step.

Key Path:	Source, Frequency, Radio Setup, Radio Standard, LTE
Example:	SOUR:FREQ:CHAN:BAND BAND11
Initial S/W Revision:	A.09.50
Help Map ID:	35712

BAND 12

Selects BAND 12 as the band for the current step.

Key Path:	Source, Frequency, Radio Setup, Radio Standard, LTE
Example:	SOUR:FREQ:CHAN:BAND BAND12
Initial S/W Revision:	A.09.50
Help Map ID:	35713

BAND 13

Selects BAND 13 as the band for the current step.

Key Path:	Source, Frequency, Radio Setup, Radio Standard, LTE
Example:	SOUR:FREQ:CHAN:BAND BAND13
Initial S/W Revision:	A.09.50
Help Map ID:	35714

BAND 14

Selects BAND 14 as the band for the current step.

Key Path:	Source, Frequency, Radio Setup, Radio Standard, LTE
Example:	SOUR:FREQ:CHAN:BAND BAND14
Initial S/W Revision:	A.09.50
Help Map ID:	35715

Source (Internal)

BAND 17

Selects BAND 17 as the band for the current step.

Key Path:	Source, Frequency, Radio Setup, Radio Standard, LTE
Example:	SOUR:FREQ:CHAN:BAND BAND17
Initial S/W Revision:	A.09.50
Help Map ID:	35716

BAND 18

Selects BAND 18 as the band for the current step.

Key Path:	Source, Frequency, Radio Setup, Radio Standard, LTE
Example:	SOUR:FREQ:CHAN:BAND BAND18
Initial S/W Revision:	A.09.50
Help Map ID:	35717

BAND 19

Selects BAND 19 as the band for the current step.

Key Path:	Source, Frequency, Radio Setup, Radio Standard, LTE
Example:	SOUR:FREQ:CHAN:BAND BAND19
Initial S/W Revision:	A.09.50
Help Map ID:	35718

BAND 20

Selects BAND 20 as the band for the current step.

Key Path:	Source, Frequency, Radio Setup, Radio Standard, LTE
Example:	SOUR:FREQ:CHAN:BAND BAND20
Initial S/W Revision:	A.09.50
Help Map ID:	35719

BAND 21

Selects BAND 21 as the band for the current step.

Key Path:	Source, Frequency, Radio Setup, Radio Standard, LTE
Example:	SOUR:FREQ:CHAN:BAND BAND21
Initial S/W Revision:	A.09.50

Help Map ID:	35720
--------------	-------

BAND 24

Selects BAND 24 as the band for the current step.

Key Path:	Source, Frequency, Radio Setup, Radio Standard, LTE
Example:	SOUR:FREQ:CHAN:BAND BAND24
Initial S/W Revision:	A.09.50
Help Map ID:	35721

BAND 25

Selects BAND 25 as the band for the current step.

Key Path:	Source, Frequency, Radio Setup, Radio Standard, LTE
Example:	SOUR:FREQ:CHAN:BAND BAND25
Initial S/W Revision:	A.09.50
Help Map ID:	35722

LTE TDD

Sets LTE TDD as the radio standard for use and accesses the LTE TDD specific channel band sub-menus..

Key Path:	Source, Frequency, Radio Setup, Radio Standard
Initial S/W Revision:	A.11.50
Help Map ID:	35766

BAND 33

Selects BAND 33 as the band for the current step.

Key Path:	Source, Frequency, Radio Setup, Radio Standard, LTE TDD
Example:	SOUR:FREQ:CHAN:BAND BAND33
Initial S/W Revision:	A.11.50
Help Map ID:	35767

BAND 34

Selects BAND 34 as the band for the current step.

Key Path:	Source, Frequency, Radio Setup, Radio Standard, LTE TDD
Example:	SOUR:FREQ:CHAN:BAND BAND34

Source (Internal)

Initial S/W Revision:	A.11.50
Help Map ID:	35768

BAND 35

Selects BAND 35 as the band for the current step.

Key Path:	Source, Frequency, Radio Setup, Radio Standard, LTE TDD
Example:	SOUR:FREQ:CHAN:BAND BAND35
Initial S/W Revision:	A.11.50
Help Map ID:	35769

BAND 36

Selects BAND 36 as the band for the current step.

Key Path:	Source, Frequency, Radio Setup, Radio Standard, LTE TDD
Example:	SOUR:FREQ:CHAN:BAND BAND36
Initial S/W Revision:	A.11.50
Help Map ID:	35770

BAND 37

Selects BAND 37 as the band for the current step.

Key Path:	Source, Frequency, Radio Setup, Radio Standard, LTE TDD
Example:	SOUR:FREQ:CHAN:BAND BAND37
Initial S/W Revision:	A.11.50
Help Map ID:	35771

BAND 38

Selects BAND 38 as the band for the current step.

Key Path:	Source, Frequency, Radio Setup, Radio Standard, LTE TDD
Example:	SOUR:FREQ:CHAN:BAND BAND38
Initial S/W Revision:	A.11.50
Help Map ID:	35772

BAND 39

Selects BAND 39 as the band for the current step.

Key Path:	Source, Frequency, Radio Setup, Radio Standard, LTE TDD
Example:	SOUR:FREQ:CHAN:BAND BAND39
Initial S/W Revision:	A.11.50
Help Map ID:	35773

BAND 40

Selects BAND 40 as the band for the current step.

Key Path:	Source, Frequency, Radio Setup, Radio Standard, LTE TDD
Example:	SOUR:FREQ:CHAN:BAND BAND40
Initial S/W Revision:	A.11.50
Help Map ID:	35774

BAND 41

Selects BAND 41 as the band for the current step.

Key Path:	Source, Frequency, Radio Setup, Radio Standard, LTE TDD
Example:	SOUR:FREQ:CHAN:BAND BAND41
Initial S/W Revision:	A.11.50
Help Map ID:	35775

BAND 42

Selects BAND 42 as the band for the current step.

Key Path:	Source, Frequency, Radio Setup, Radio Standard, LTE TDD
Example:	SOUR:FREQ:CHAN:BAND BAND42
Initial S/W Revision:	A.11.50
Help Map ID:	35776

BAND 43

Selects BAND 43 as the band for the current step.

Key Path:	Source, Frequency, Radio Setup, Radio Standard, LTE TDD
Example:	SOUR:FREQ:CHAN:BAND BAND43
Initial S/W Revision:	A.11.50

Source (Internal)

Help Map ID:	35777
--------------	-------

TDSCDMA

Sets TDSCDMA as the radio standard for use and accesses the TDSCDMA specific channel band sub-menus..

Key Path:	Source, Frequency, Radio Setup, Radio Standard
Initial S/W Revision:	A.11.50
Help Map ID:	35778

BAND A

Selects BAND A as the band for the current step.

Key Path:	Source, Frequency, Radio Setup, Radio Standard, TDSCDMA
Example:	SOUR:FREQ:CHAN:BAND BANDA
Initial S/W Revision:	A.11.50
Help Map ID:	35779

BAND B

Selects BAND B as the band for the current step.

Key Path:	Source, Frequency, Radio Setup, Radio Standard, TDSCDMA
Example:	SOUR:FREQ:CHAN:BAND BANDB
Initial S/W Revision:	A.11.50
Help Map ID:	35780

BAND C

Selects BAND C as the band for the current step.

Key Path:	Source, Frequency, Radio Setup, Radio Standard, TDSCDMA
Example:	SOUR:FREQ:CHAN:BAND BANDC
Initial S/W Revision:	A.11.50
Help Map ID:	35781

BAND D

Selects BAND D as the band for the current step.

Key Path:	Source, Frequency, Radio Setup, Radio Standard, TDSCDMA
Example:	SOUR:FREQ:CHAN:BAND BANDD

Initial S/W Revision:	A.11.50
Help Map ID:	35782

BAND E

Selects BAND E as the band for the current step.

Key Path:	Source, Frequency, Radio Setup, Radio Standard, TDSCDMA
Example:	SOUR:FREQ:CHAN:BAND BANDE
Initial S/W Revision:	A.11.50
Help Map ID:	35783

BAND F

Selects BAND F as the band for the current step.

Key Path:	Source, Frequency, Radio Setup, Radio Standard, TDSCDMA
Example:	SOUR:FREQ:CHAN:BAND BANDF
Initial S/W Revision:	A.11.50
Help Map ID:	35784

Radio Band Link

Allows you to specify the channel band type as either uplink or downlink link direction. This value is used in conjunction with the channel band and channel number to determine the absolute frequency output by the source. When set to “Uplink”, the source will calculate the uplink frequency using an uplink formula together with the selected channel band and channel number . When set to “Downlink”, the source will calculate the downlink frequency using a downlink formula together with the selected channel band and channel number.

Key Path:	Source, Frequency, Radio Setup
Remote Command:	:SOURce:RADio:BAND:LINK DOWN UP :SOURce:RADio:BAND:LINK?
Example:	SOUR:RAD:BAND:LINK UP
Preset:	DOWN
Range:	DOWN UP
Backwards Compatibility SCPI:	:SOURce:RADio:DEvice BTS MS :SOURce:RADio:DEvice?
Backwards Compatibility Notes:	BTS maps to the Downlink frequency MS maps to the Uplink frequency
Initial S/W Revision:	A.05.00

Help Map ID:	35422
--------------	-------

Set Reference Frequency

This key allows you to set the frequency reference. Pressing this key turns the frequency reference state to ON, sets the reference frequency value to the current frequency, maintains this frequency at the RF output, and sets the displayed frequency to 0.00 Hz. All subsequent frequencies entered under Source>Frequency>Frequency are interpreted as being relative to this reference frequency.

When you use a frequency reference, the signal generator outputs a frequency that is set relative to the reference frequency by the value entered under Source>Frequency>Frequency as follows:

$$\text{Output frequency} = \text{reference frequency} - \text{entered frequency}$$

Where:

reference frequency equals the original RF frequency entered under Source>Frequency>Frequency and set as the reference frequency

entered frequency equals a new value entered under Source>Frequency>Frequency

In addition, the displayed frequency value will be the same as the value entered under Source>Frequency>Frequency.

NOTE If Freq Reference is set to ON with a reference value set, entering a value under Source>Frequency>Frequency and pressing Set Frequency Reference will add that value to the existing Freq Reference value.
If you wish to change the reference frequency value to the new value entered under Source>Frequency>Frequency, first you must set Freq Reference to OFF and then press Set Frequency Reference.

Key Path:	Source, Frequency
Remote Command:	: SOURce : FREQuency : REFerence : SET
Example:	SOUR:FREQ:REF:SET
Dependencies:	This setting is unavailable, and is grayed out when the List Sequencer is turned ON.
Initial S/W Revision:	A.05.00
Help Map ID:	35423

Freq Reference

This key allows you to toggle the state of the frequency reference. When the frequency reference state is ON, an annunciator is displayed on the main source view to indicate this state to the user.

When you use a frequency reference, the signal generator outputs a frequency that is set relative to the reference frequency by the value entered under Source>Frequency>Frequency as follows:

Output frequency = reference frequency + entered frequency

Where:

reference frequency equals the original RF frequency entered under Source>Frequency>Frequency and set as the reference frequency

entered frequency equals a new value entered under Source>Frequency>Frequency

For more information on Reference Frequency refer to [“Set Reference Frequency” on page 762](#)

Key Path:	Source, Frequency
Remote Command:	:SOURce:FREQuency:REFerence <freq> :SOURce:FREQuency:REFerence? :SOURce:FREQuency:REFerence:STATe OFF ON 0 1 :SOURce:FREQuency:REFerence:STATe?
Example:	SOUR:FREQ:REF 0.00 Hz SOUR:FREQ:REF:STATe ON
Dependencies:	This setting is unavailable, and is grayed out when the List Sequencer is turned ON.
Couplings:	The frequency reference state is coupled to the frequency reference set immediate action. When the reference set immediate action key is pressed, or the SCPI command issued, it turns the frequency reference state ON.
Preset:	0.00 Hz OFF
Min:	0.00 Hz
Max:	Hardware Dependant: Option 503 = 3.6 GHz Option 504 = 3.8 GHz
Initial S/W Revision:	A.05.00
Help Map ID:	35424

Freq Offset

Allows you to specify the frequency offset value. When the frequency offset state is ON, an annunciator is displayed on the main source view to indicate this state to the user.

When the frequency offset is set to zero (0) and you set a new offset value, the displayed frequency value will change as follows and the RF output frequency will not change:

Displayed value = output frequency + offset value

Where:

output frequency equals the original frequency entered under Source>Frequency>Frequency

Source (Internal)

offset value equals the value entered under Source>Frequency>Freq Offset

When the frequency offset is set to a value other than zero (0) and you enter a new frequency value under Source>Frequency>Frequency, the displayed frequency will be the same as the value entered and the RF output frequency will be equal to the value entered minus the offset value as follows:

Output frequency = entered frequency – offset frequency

Displayed frequency = output frequency + offset frequency

Displayed frequency = entered frequency

Where:

entered frequency equals the frequency entered under Source>Frequency>Frequency

offset frequency equals the value previously entered and set under Source>Frequency>Freq Offset

Key Path:	Source, Frequency
Remote Command:	:SOURce:FREQuency:OFFSet <freq> :SOURce:FREQuency:OFFSet?
Example:	SOUR:FREQ:OFFS 0 Hz
Dependencies:	This setting is unavailable, and is grayed out when the List Sequencer is turned ON.
Preset:	0 Hz
Min:	-100.00 GHz
Max:	100.00 GHz
Initial S/W Revision:	A.05.00
Help Map ID:	35425

Modulation Setup

Allows access to the menus for setting up the available modulation types: “ARB” on page 764, “AM” on page 810, “FM” on page 811, and “PM” on page 812.

Key Path:	Source
Initial S/W Revision:	A.05.00
Help Map ID:	35428

ARB

Allows you access to the ARB sub-menus.

Key Path:	Source, Modulation Setup
Initial S/W Revision:	A.05.00

Help Map ID:	35429
--------------	-------

ARB

Allows you to toggle the state of the ARB function. When the ARB is On, a “MOD” annunciator is displayed in the system settings panel. When the ARB is turned Off, the MOD annunciator is cleared

Key Path:	Source, Modulation Setup, ARB
Remote Command:	:SOURce:RADio:ARB[:STATe] ON OFF 1 0 :SOURce:RADio:ARB[:STATe]?
Example:	SOUR:RAD:ARB OFF SOUR:RAD:ARB?
Notes:	If the ARB is ON, a user then loads or deletes another file to ARB memory, the playing waveform segment may not keep phase continuity during the ARB memory operation. The waveform will be replayed after the ARB operation is finished.
Dependencies:	This setting is for independent mode and has no effect on 3.3.8 list sequencer mode. Setting 7.1Sequencer to On will put source enter list sequencer mode, and even if ARB state is On, the ARB file will not be played. Setting 7.1Sequencer to Off will make source leave list sequencer mode, and this setting will take effect immediately. The ARB can only be turned on when there is a waveform file selected for playback. On the GUI If no waveform is selected, this key is grayed out. If you send the SCPI command to turn the ARB on with no waveform selected for playback, the ARB state remains OFF and an error is generated. “- When you try to recall a certain set of states in which the selected waveform is not in ARB memory and the ARB state is On, errors are reported
Preset:	Off
Range:	On Off
Initial S/W Revision:	A.05.00
Help Map ID:	35430

Select Waveform

Allows you to access to the waveform selection sub-menus.

Pressing this key changes the central view area to show the Waveform File Selection view.

Key Path:	Source, Modulation Setup, ARB
Initial S/W Revision:	A.05.00
Help Map ID:	35431

Source (Internal)

Select Waveform

Allows you to select a waveform sequence or segment for the dual ARB to play.

Key Path:	Source, Modulation Setup, ARB, Select Waveform
Remote Command:	:SOURce:RADio:ARB:WAVEform <string> :SOURce:RADio:ARB:WAVEform?
Example:	SOUR:RAD:ARB:WAV "test_waveform.bin"
Notes:	<p><string> - specifies the name of the waveform segment or waveform sequence to be played by the ARB.</p> <p>When in Sequence Analyzer mode, and Include Source is Yes, if the you attempt to play a waveform sequence but not all the required waveform segments are in the ARB playback memory, the application will reject the loading operation with an error is generated .</p> <p>When Include Source is No, if you attempt to play a waveform sequence but not all the required waveform segments are contained in the ARB playback memory, the application will attempt to load the required segments from either the default directory of the current directory. If the ARB memory does not have enough space for all the waveform segments to be loaded, an error is generated and none of the waveform segments is loaded.</p> <p>If the ARB is ON, and you attempt to play a waveform sequence but not all the waveform segments within the sequence could be found to be loaded into ARB memory, an error is generated. The selected waveform keeps the previous value and ARB state remains On.</p> <p>If you specify a waveform segment over SCPI but the waveform segment is not present within ARB playback memory and cannot be found for auto loading within the current directory or the default directory, an error is generated and the file selection remains unchanged.</p> <p>If you select a waveform for playback and the waveform requires a license that is not installed on the instrument, an error is generated. error is generated.</p> <p>If the ARB is ON and you load a file to ARB memory or delete a file from ARB memory, the playing waveform segment may not keep phase continuity during the ARB memory operation. The waveform will be replayed after the ARB operation is finished.</p>
Initial S/W Revision:	A.05.00
Help Map ID:	35432

Segments on Hard Disk

Allows you access to the sub-menus for loading waveform segments from the hard disk into ARB memory. The default directory is: D:\nvarb.

Pressing this key changes the current view to the Waveform Management View.

Key Path:	Source, Modulation Setup, ARB, Select Waveform
Initial S/W Revision:	A.05.00

Help Map ID:

35433

Load Segment To ARB Memory

Allows you to load the selected file into ARB memory. On the front panel you select the file for loading to the ARB memory by highlighting the desired file in the list. Using the SCPI command, you specify the file name on the HDD.

“NVWFM” (none-volatile storage) MSUS (Mass Storage Unit Specifier) is supported in the memory subsystem because the ARB memory cannot be accessed directly. Therefore, files must be downloaded to the instrument hard disk and then loaded into the ARB memory. “NVWFM” MSUS will be mapped to the default directory D:\NVARB. The SCPI command supports using either “NVWFM” MSUS or specifying a full path. For more information, see [“Memory Subsystem \(Remote Command Only\)” on page 860](#).

If a file of the same name already exists within ARB memory, it is overwritten. If you wish to load two segments of the same name, you must rename one of the segments before loading it into ARB memory. To rename a segment, you can either use Windows File Explorer, or the :MMEMory:COPI command.

Key Path:	Source, Modulation Setup, ARB, Select Waveform, Segments on Hard Disk
Remote Command:	:SOURce:RADio:ARB:LOAD <string>
Example:	SOUR:RAD:ARB:LOAD “D:\NVARB\testwaveform.bin” or SOUR:RAD:ARB:LOAD “NVWFM:testwaveform.bin”
Notes:	<p><string> - specifies the path name of the file to load from the HDD into ARB memory. It could be a <full path + filename>, or <“NVWFM” MSUS + colon + filename>.</p> <p>When in Sequence Analyzer mode, and Include Source is Yes, an attempt to load a file to ARB memory will be rejected with an error.</p> <p>When Include Source is No and if there is insufficient free ARB memory to load the selected waveform, an error is generated. .</p> <p>If you specify a file over SCPI, but the file is not at the specified location, an error is generated.</p> <p>If you try to load a waveform file but the file contains less than 500 IQ samples, an error is generated.</p> <p>If you try to load a Signal Studio waveform “*.wfm” which contains invalid waveform header, an error is generated.</p> <p>If the ARB is ON when you load a file to ARB memory or delete a file from ARB memory, the playing waveform segment may not keep phase continuity during the ARB memory operation. The waveform will be replayed after the ARB operation is finished.</p> <p>ARB can be loaded into ARB memory even required licenses do not present on the instrument. In this case, a GUI only warning message -800, “Operation complete; Loaded <filename> successfully, but no license <required licenses> installed”. User can install required licenses according to <required licenses> string to license it, or multi-pack license it.</p>

Source (Internal)

Initial S/W Revision:	A.05.00
Help Map ID:	35434

Load All To ARB Memory

Allows you to load all the segment files within the currently selected directory into ARB memory. If a file of the same name already exists within ARB memory, it is overwritten. If you wish to load two segments of the same name, you must rename one of the segments before loading it into ARB memory. To rename a segment, you can either use Windows File Explorer, or the :MEMory:COPI command.

Key Path:	Source, Modulation Setup, ARB, Select Waveform, Segments on Hard Disk
Remote Command:	:SOURce:RADio:ARB:LOAD:ALL <string>
Example:	SOUR:RAD:ARB:LOAD:ALL "D:\nvarb"
Notes:	<string> - specifies the directory on the HDD to load the files into ARB memory from. When in Sequence Analyzer mode, and Include Source is Yes, an attempt to load all files from a directory to ARB memory is rejected with an error. When Include Source is No and there is insufficient free ARB memory to load all the waveforms, when the ARB memory is full, the copy ceases, and an error is generated. If you specify a directory over SCPI, but the directory does not exist, an error is generated. If the ARB is ON, a user then loads or deletes file to ARB memory, the playing waveform segment may not keep phase continuity during the ARB memory operation. The waveform will be replayed after the ARB operation is finished.
Initial S/W Revision:	A.05.00
Help Map ID:	35435

Change Directory...

Allows you to change the currently selected directory on the hard disk. Pressing this key opens a standard windows change directory dialog allowing you to select the new directory of interest.

The current directory is used for manually loading waveform segments into ARB memory for playback, and as a search location for waveform segments that are required to be loaded into ARB memory for playback of a waveform sequence or a list sequence.

Key Path:	Source, Modulation Setup, ARB, Select Waveform, Segments on Hard Disk
Notes:	No remote command, SCPIfront panel only.
Initial S/W Revision:	A.05.00
Help Map ID:	35436

Default Directory...

Allows you to change the default directory. It is used as a search location for waveform segments that are required to be loaded into ARB memory for playback of a waveform sequence, and as a search location for selecting waveforms using SCPI.

Key Path:	Source, Modulation Setup, ARB, Select Waveform, Segments on Hard Disk
Remote Command:	:SOURce:RADio:ARB:DEFault:DIRectory <string> :SOURce:RADio:ARB: DEFault:DIRectory?
Example:	SOUR:RAD:ARB:DEF:DIR "D:\ArbFiles" SOUR:RAD:ARB:DEF:DIR?
State Saved:	Persistent, survives a power cycle and a preset but not saved in the instrument state
Initial S/W Revision:	A.05.00
Help Map ID:	35437

Segments in ARB Memory

Allows you access to the sub-menus for managing the files within ARB memory.

Key Path:	Source, Modulation Setup, ARB, Select Waveform
Initial S/W Revision:	A.05.00
Help Map ID:	35438

Delete Segment From ARB Mem

Allows you to remove a segment from ARB playback memory.

Key Path:	Source, Modulation Setup, ARB, Select Waveform, Segments in ARB Memory
Remote Command:	:SOURce:RADio:ARB:DELete <string>
Example:	SOUR:RAD:ARB:DEL "testwaveform.bin"

Source (Internal)

Notes:	<p><string> - specifies the waveform to be deleted from the ARB playback memory.</p> <p>When in Sequence Analyzer mode and Include Source is Yes, an attempt to delete a file from ARB memory is rejected with an error.</p> <p>When Include Source is No and you specify a file that does not exist within ARB memory, an error is generated.</p> <p>It is possible to delete files from within the ARB memory when the ARB is ON. However, if you attempt to delete the file that is currently playing an error is generated.</p> <p>It is possible to delete a file from within the ARB memory when the sequencer state is ON and the file is not being used by the List Sequencer. If you attempt to delete a file which is being used by the list sequencer, an error is generated.</p> <p>When sequencer state is On, even if ARB state is On, the selected waveform will not be played. In this case, if the selected waveform is not used in List Sequence, it can be deleted and the ARB state is turned Off.</p> <p>If the ARB is ON and you load a file to ARB memory or delete a file from ARB memory, the playing waveform segment may not keep phase continuity during the ARB memory operation. The waveform will be replayed after the ARB operation is finished.</p>
Initial S/W Revision:	A.05.00
Help Map ID:	35439

Delete All From ARB Memory

Allows you to remove all segments from ARB playback memory.

Key Path:	Source, Modulation Setup, ARB, Select Waveform, Segments in ARB Memory
Remote Command:	:SOURce:RADio:ARB:DELeTe:ALL
Example:	SOUR:RAD:ARB:DELeTe:ALL
Notes:	<p>When in Sequence Analyzer mode and Include Source is Yes, an attempt to delete all files from ARB memory is rejected with an error.</p> <p>When Include Source is No and you attempt to delete all files from ARB memory when the ARB is currently playing a file, all files except the one playing are deleted and an error is generated.</p> <p>If you attempt to delete all files from ARB memory when there are waveform files used in “List Sequencer” on page 814 and “Sequencer” on page 815 state is ON, all files except the files currently being used in list sequencer are deleted, and an error is generated.</p> <p>If the ARB is ON and you load a file to ARB memory or delete a file from ARB memory, the playing waveform segment may not keep phase continuity during the ARB memory operation. The waveform will be replayed after the ARB operation is finished.</p>
Initial S/W Revision:	A.05.00

Help Map ID:	35440
--------------	-------

Query ARB Memory File List (Remote Command Only)

Queries the test set for the list of waveform segments in the ARB memory.

NOTE This command returns a string for waveform segment names in ARB memory. If you want a string list of waveform segments in the ARB memory, use [“Query ARB Memory Full File List \(Remote Command Only\)”](#) on page 771.

Remote Command:	:SOURce:RADio:ARB:CATalog?
Example:	SOUR:RAD:ARB:CATalog?
Notes:	The return data is in the following format: <integer> - memory used <integer> - memory free <string> ... - comma separated list of waveform segments within ARB memory
Initial S/W Revision:	A.05.00
Help Map ID:	35686

Query ARB Memory Full File List (Remote Command Only)

Queries the test set for the string list of waveform segments in the ARB memory. It returns a string list for waveform segment names in the ARB memory.

Remote Command:	:SOURce:RADio:ARB:FCATalog?
Example:	SOUR:RAD:ARB:FCATalog?
Notes:	The return data is in the following format: <integer> - memory used <integer> - memory free <integer> - file count in ARB memory <string>,<string>, ... <string> - comma separated string list of waveform segments within ARB memory Example: SOUR:RAD:ARB:FCAT? EXT returns: 27499,2069653,3,"c2k.wfm","gsm.wfm","wcdma.wfm"
Initial S/W Revision:	A.09.00
Help Map ID:	0

Source (Internal)

ARB Setup

Allows access to the ARB setup sub-menus.

Key Path:	Source, Modulation Setup, ARB
Initial S/W Revision:	A.05.00
Help Map ID:	35441

Sample Rate

Allows you to set the ARB waveform playback sample rate.

Key Path:	Source, Modulation Setup, ARB, ARB Setup
Remote Command:	:SOURce:RADio:ARB:SCLock:RATE <freq> :SOURce:RADio:ARB:SCLock:RATE?
Example:	SOUR:RAD:ARB:SCL:RATE 48.00 MHz
Dependencies:	When a new waveform is selected for playback the settings contained within the associated waveform header file are applied to the ARB. The sample rate is one of the values stored within the header file. If the newly selected waveform file has an associated header file, the sample rate is updated with the value from the header file. The sample rate will remain unchanged if the newly selected waveform does not have an associated header file.
Preset:	125.00 MHz
Min:	1.00 kHz
Max:	125.00 MHz
Initial S/W Revision:	A.05.00
Help Map ID:	35442

Run-Time Scaling

Allows you to adjust the run-time scaling value. The run-time scaling value is applied in real-time while the waveform is playing.

Key Path:	Source, Modulation Setup, ARB, ARB Setup
Remote Command:	:SOURce:RADio:ARB:RSCaling <real> :SOURce:RADio:ARB:RSCaling?
Example:	SOUR:RAD:ARB:RSC 100.00

Dependencies:	When a new waveform is selected for playback the settings contained within the associated waveform header file are applied to the ARB. The run-time scaling is one of the values stored within the header file. If the newly selected waveform file has an associated header file, the run-time scaling is updated with the value from the header file. The run-time scaling will remain unchanged if the newly selected waveform does not have an associated header file.
Preset:	70.00 %
Min:	1.00 %
Max:	100.00 %
Initial S/W Revision:	A.05.00
Help Map ID:	35443

Baseband Freq Offset

Allows you to adjust the value by which the baseband frequency is offset relative to the carrier.

Key Path:	Source, Modulation Setup, ARB, ARB Setup
Remote Command:	:SOURce:RADio:ARB:BASEband:FREQuency:OFFSet <freq> :SOURce:RADio:ARB:BASEband:FREQuency:OFFSet?
Example:	SOUR:RAD:ARB:BAS:FREQ:OFFS 0.00 Hz
Dependencies:	When a new waveform is selected for playback the settings contained within the associated waveform header file are applied to the ARB. The baseband frequency offset is one of the values stored within the header file. If the newly selected waveform file has an associated header file, the baseband frequency offset is updated with the value from the header file. The baseband frequency offset will remain unchanged if the newly selected waveform does not have an associated header file.
Preset:	0.00 Hz
Min:	-50.00 MHz
Max:	50.00 MHz
Initial S/W Revision:	A.05.00
Help Map ID:	35444

Trigger Type

Allows access to the trigger type sub-menus. The setting for trigger type determines the behavior of the waveform when it plays.

Key Path:	Source, Modulation Setup, ARB
-----------	--------------------------------------

Source (Internal)

Remote Command:	:SOURce:RADio:ARB:TRIGger:TYPE CONTInuous SINGLE SADVance GATE :SOURce:RADio:ARB:TRIGger:TYPE?
Example:	SOUR:RAD:ARB:TRIG:TYPE CONT SOUR:RAD:ARB:TRIG:TYPE?
Notes:	Gated trigger type will be implemented at a later release
Preset:	CONTInuous
Range:	Continuous Single Seg Adv Gated
Initial S/W Revision:	A.05.00
Help Map ID:	35454

Continuous

Sets the active trigger type to Continuous. If Continuous is already selected as the active trigger type, pressing this key allows access to the continuous trigger type setup menu. In Continuous trigger mode, the waveform repeats continuously.

Key Path:	Source, Modulation Setup, ARB, Trigger Type
Remote Command:	:SOURce:RADio:ARB:TRIGger:TYPE:CONTInuous [:TYPE] FREE TRIGger RESet :SOURce:RADio:ARB:TRIGger:TYPE:CONTInuous [:TYPE] ?
Example:	SOUR:RAD:ARB:TRIG:TYPE:CONT FREE
Preset:	FREE
Range:	Free Run Trigger + Run Reset + Run
Initial S/W Revision:	A.05.00
Help Map ID:	35455

Free Run

Selects Free Run as the trigger response for the continuous trigger type. Free Run sets the waveform generator to play a waveform sequence or segment continuously, without waiting for a trigger. In this mode, the waveform generator does not respond to triggers.

Key Path:	Source, Modulation Setup, ARB, Trigger Type, Continuous
Example:	SOUR:RAD:ARB:TRIG:TYPE:CONT FREE
Initial S/W Revision:	A.05.00
Help Map ID:	35456

Trigger + Run

Sets Trigger and Run as the trigger response for the continuous trigger type. Trigger and Run sets the waveform

generator to play a waveform sequence or segment continuously when the first trigger is received, and to ignore any subsequent triggers.

Key Path:	Source, Modulation Setup, ARB, Trigger Type, Continuous
Example:	SOUR:RAD:ARB:TRIG:TYPE:CONT TRIG
Initial S/W Revision:	A.05.00
Help Map ID:	35457

Reset + Run

Sets Reset and Run as the trigger response for the continuous trigger type. Reset and Run sets the waveform generator to play a waveform sequence or segment continuously when the first trigger is received. Subsequent triggers reset the waveform sequence or segment to the start, and then play it continuously.

Key Path:	Source, Modulation Setup, ARB, Trigger Type, Continuous
Example:	SOUR:RAD:ARB:TRIG:TYPE:CONT RES
Initial S/W Revision:	A.05.00
Help Map ID:	35458

Single

Sets the active trigger type to Single. If Single is already selected as the active trigger type, pressing this key allows access to the single trigger type setup menu. In Single trigger mode, the waveform plays once.

Key Path:	Source, Modulation Setup, ARB, Trigger Type
Remote Command:	:SOURCE:RADio:ARB:RETRigger ON OFF IMMEDIATE :SOURCE:RADio:ARB:RETRigger?
Example:	SOUR:RAD:ARB:RETR OFF
Notes:	ON: Buffered Trigger OFF: No Retrigger Immediate: Restart on Trigger This is defined as an enumerated SCPI command, with ON/OFF being considered as enumerated types rather than Boolean. This means the query will return OFF instead of 0, and ON instead of 1.
Preset:	ON
Range:	No Retrigger Buffered Trigger Restart on Trigger
Initial S/W Revision:	A.05.00
Help Map ID:	35459

No Retrigger

Selects No Retrigger as the trigger response for single trigger type. No Retrigger sets the waveform generator to

Source (Internal)

play a waveform sequence or segment once when a trigger is received. Any triggers then received during playback are ignored.

Key Path:	Source, Modulation Setup, ARB, Trigger Type, Single
Example:	SOUR:RAD:ARB:RETR OFF
Initial S/W Revision:	A.05.00
Help Map ID:	35460

Buffered Trigger

Selects Buffered Trigger as the trigger response for single trigger type. Buffered Trigger sets the waveform generator to play a waveform sequence or segment once when a trigger is received. If a trigger is received during playback, the waveform generator plays the sequence or segment to the end, then plays the sequence or segment once more.

Key Path:	Source, Modulation Setup, ARB, Trigger Type, Single
Example:	SOUR:RAD:ARB:RETR ON
Initial S/W Revision:	A.05.00
Help Map ID:	35461

Restart on Trigger

Selects Restart on Trigger as the trigger response for single trigger type. Restart on Trigger sets the waveform generator to play a waveform sequence or segment once when a trigger is received. If a trigger is received during playback, the waveform generator resets and plays the sequence or segment from the start.

Key Path:	Source, Modulation Setup, ARB, Trigger Type, Single
Example:	SOUR:RAD:ARB:RETR IMM
Initial S/W Revision:	A.05.00
Help Map ID:	35462

Segment Advance

Sets the active trigger type to Segment Advance. If Segment Advance is already selected as the active trigger type, pressing this key allows access to the segment advance trigger type setup menu.

Segment Advance triggering allows you to control the playback of waveform segments within a waveform sequence. When a trigger is received the ARB advances to the next waveform segment within the waveform sequence. This type of triggering ignores the repetition count for the waveform segment within the waveform sequence. For example, if a waveform segment has a repetition count of 10 and you select single segment advance triggering mode, the waveform segment will only play once.

Segment Advance triggering can also be used for waveform segments only. In this situation the same waveform segment is played again when a trigger is received.

Key Path:	Source, Modulation Setup, ARB, Trigger Type
-----------	--

Remote Command:	:SOURce:RADio:ARB:TRIGger:TYPE:SADVance[:TYPE] SINGLE CONTInuous :SOURce:RADio:ARB:TRIGger:TYPE:SADVance[:TYPE]?
Example:	SOUR:RAD:ARB:TRIG:TYPE:SADV SING
Preset:	CONTInuous
Range:	Single Continuous
Initial S/W Revision:	A.05.00
Help Map ID:	35463

Single

Selects Single as the trigger response for Segment Advance trigger type. With single selected, once a trigger is received a segment is played once. If a trigger is received during playback of a segment, the segment plays to completion and the next segment is played once.

Key Path:	Source, Modulation Setup, ARB, Trigger Type, Segment Advance
Example:	SOUR:RAD:ARB:TRIG:TYPE:SADV SING
Initial S/W Revision:	A.05.00
Help Map ID:	35464

Continuous

Selects Continuous as the trigger response for Segment Advance trigger type. With continuous selected, once a trigger is received a segment is played continuously. When subsequent triggers are received, the currently playing segment plays to completion and then the next segment is played continuously.

Key Path:	Source, Modulation Setup, ARB, Trigger Type, Segment Advance
Example:	SOUR:RAD:ARB:TRIG:TYPE:SADV CONT
Initial S/W Revision:	A.05.00
Help Map ID:	35465

Trigger Source

Allows access to the trigger source sub-menus. The trigger source setting determines how the source receives the trigger that starts the waveform playing. Therefore, this key is grayed out if the trigger type is free run, since free run triggers immediately with no trigger source required.

Key Path:	Source, Modulation Setup, ARB
Remote Command:	:SOURce:RADio:ARB:TRIGger[:SOURce] KEY BUS EXTErnal2 :SOURce:RADio:ARB:TRIGger[:SOURce]?
Example:	SOUR:RAD:ARB:TRIGger KEY

Source (Internal)

Dependencies:	This key is grayed out if the current trigger type is Continuous, Free Run.
Preset:	EXTernal2
Range:	Trigger Key Bus External 2
Initial S/W Revision:	A.05.00
Help Map ID:	35469

Trigger Key

Sets the current trigger source to the front panel Trigger key. When Trigger Key is selected, the waveform is triggered when you press the front panel Trigger key.

Key Path:	Source, Modulation Setup, ARB, Trigger Source
Example:	SOUR:RAD:ARB:TRIGger KEY
Initial S/W Revision:	A.05.00
Help Map ID:	35470

Bus

Sets the current trigger source to Bus. Selecting Bus trigger source enables triggering over GPIB, LAN, or USB using the :SOURce:RADio:ARB:TRIGger:INITiate command.

Key Path:	Source, Modulation Setup, ARB, Trigger Source
Example:	SOUR:RAD:ARB:TRIGger BUS
Initial S/W Revision:	A.05.00
Help Map ID:	35471

External 2

Sets the current trigger source to External 2. Selecting External 2 enables triggering a waveform by an externally applied signal.

Key Path:	Source, Modulation Setup, ARB, Trigger Source
Example:	SOUR:RAD:ARB:TRIGger EXT2
Initial S/W Revision:	A.05.00
Help Map ID:	35472

Trigger Initiate

Used to initiate an immediate trigger event if the trigger source is set to Trigger Key.

Key Path:	Source, Modulation Setup, ARB
Notes:	No remote command, SCPI front panel only.

Initial S/W Revision:	A.05.00
Help Map ID:	35475

Waveform Sequences

Allows access to the waveform sequence sub-menus. Pressing this key changes the central view area to display the Waveform Sequence List view.

Key Path:	Source, Modulation Setup, ARB
Notes:	No remote command, SCPI front panel only.
Initial S/W Revision:	A.05.00
Help Map ID:	35476

Build New Sequence

Allows access to the sub-menus for creating a new waveform sequence. Pressing this key changes the central view area to display the Waveform Sequence Creation and Editing view.

Key Path:	Source, Modulation Setup, ARB, Waveform Sequences
Notes:	No remote command, SCPI front panel only.
Initial S/W Revision:	A.05.00
Help Map ID:	35477

Current Segment

Specifies the selected sequence segment that will be affected by the menu functions.

Key Path:	Source, Modulation Setup, ARB, Waveform Sequences, Build New Sequence
Notes:	No remote command, SCPI front panel only. This key is grayed out and unavailable if the sequence is currently empty.
Initial S/W Revision:	A.05.00
Help Map ID:	35478

Insert New Waveform

Allows you access to the sub-menu for inserting a new waveform segment or sequence. Pressing this key also changes the central display to show the Waveform File Selection View.

Key Path:	Source, Modulation Setup, ARB, Waveform Sequences, Build New Sequence
-----------	--

Source (Internal)

Notes:	No remote command, SCPIfront panel only. Waveform segment name string length upper limit is 128 chars. Please do NOT insert waveform which name string exceeds 128 chars.
Initial S/W Revision:	A.05.00
Help Map ID:	35479

Insert Waveform

Inserts the currently highlighted waveform to the end of the waveform sequence. Pressing this key also returns you to the menus for creating or editing a sequence, and returns the central view to the sequence creation view.

Key Path:	Source, Modulation Setup, ARB, Waveform Sequences, Build New Sequence, Insert New Waveform
Notes:	No remote command, SCPIfront panel only. Waveform segment NAME string length upper limit is 128 chars. Please do NOT insert waveform which name string exceeds 128 chars.
Initial S/W Revision:	A.05.00
Help Map ID:	35480

Segments on Hard Disk

This key functions the same as [“Segments on Hard Disk” on page 766](#).

Key Path:	Source, Modulation Setup, ARB, Waveform Sequences, Build New Sequence, Insert New Waveform
Initial S/W Revision:	Prior to A.09.00
Help Map ID:	0

Load Segment To ARB Memory

This key functions the same as [“Load Segment To ARB Memory” on page 767](#).

Key Path:	Source, Modulation Setup, ARB, Waveform Sequences, Build New Sequence, Insert New Waveform, Segment on Hard Drive
Initial S/W Revision:	Prior to A.09.00
Help Map ID:	0

Load All To ARB Memory

This key functions the same as [“Load All To ARB Memory” on page 768](#).

Key Path:	Source, Modulation Setup, ARB, Waveform Sequences, Build New Sequence, Insert New Waveform, Segment on Hard Drive
Initial S/W Revision:	Prior to A.09.00

Help Map ID:	0
--------------	---

Change Directory ...

This key functions the same as [“Change Directory...”](#) on page 768.

Key Path:	Source, Modulation Setup, ARB, Waveform Sequences, Build New Sequence, Insert New Waveform, Segment on Hard Drive
Initial S/W Revision:	Prior to A.09.00
Help Map ID:	0

Default Directory ...

This key functions the same as [“Default Directory...”](#) on page 769

Key Path:	Source, Modulation Setup, ARB, Waveform Sequences, Build New Sequence, Insert New Waveform, Segment on Hard Drive
Initial S/W Revision:	Prior to A.09.00
Help Map ID:	0

Segments in ARB Memory

This key functions the same as [“Segments in ARB Memory”](#) on page 769.

Key Path:	Source, Modulation Setup, ARB, Waveform Sequences, Build New Sequence, Insert New Waveform
Initial S/W Revision:	Prior to A.09.00
Help Map ID:	0

Delete Segment From ARB Memory

This key functions the same as [“Delete Segment From ARB Mem”](#) on page 769.

Key Path:	Source, Modulation Setup, ARB, Waveform Sequences, Build New Sequence, Insert New Waveform, Segment in ARB Memory
Initial S/W Revision:	Prior to A.09.00
Help Map ID:	0

Delete All From ARB Memory

This key functions the same as [“Delete All From ARB Memory”](#) on page 770.

Key Path:	Source, Modulation Setup, ARB, Waveform Sequences, Build New Sequence, Insert New Waveform, Segment in ARB Memory
Initial S/W Revision:	Prior to A.09.00
Help Map ID:	0

Source (Internal)

Query ARB Memory File List (Remote Command Only)

This command functions the same as “Query ARB Memory File List (Remote Command Only)” on page 771.

Initial S/W Revision:	Prior to A.09.00
Help Map ID:	0

Edit Selected Waveform

Allows access to the sub-menus for editing the details of the currently selected waveform segment.

Key Path:	Source, Modulation Setup, ARB, Waveform Sequences, Build New Sequence
Notes:	No remote command, front panel only.
Initial S/W Revision:	A.05.00
Help Map ID:	35481

Repetitions

Allows you to specify the number of times the currently selected waveform is played within the sequence.

Key Path:	Source, Modulation Setup, ARB, Waveform Sequences, Build New Sequence, Edit Selected Waveform
Notes:	No remote command, SCPI front panel only.
Preset:	1
Min:	1
Max:	65535
Initial S/W Revision:	A.05.00
Help Map ID:	35482

Marker 1

Allows you to enable or disable marker 1 for the currently selected waveform. For a waveform sequence, you can enable and disable markers on a per-segment basis, allowing you to output markers from some waveform segments within the sequence, but not for others.

Key Path:	Source, Modulation Setup, ARB, Waveform Sequences, Build New Sequence, Edit Selected Waveform
Notes:	No remote command, front panel only.
Preset:	Enabled
Range:	Enabled Disabled
Initial S/W Revision:	A.05.00
Help Map ID:	35483

Marker 2

Allows you to enable or disable marker 2 for the currently selected waveform. For a waveform sequence, you can enable and disable markers on a per-segment basis, allowing you to output markers from some waveform segments within the sequence, but not for others.

Key Path:	Source, Modulation Setup, ARB, Waveform Sequences, Build New Sequence, Edit Selected Waveform
Notes:	No remote command, front panel only.
Preset:	Enabled
Range:	Enabled Disabled
Initial S/W Revision:	A.05.00
Help Map ID:	35484

Marker 3

Allows you to enable or disable marker 3 for the currently selected waveform. For a waveform sequence, you can enable and disable markers on a per-segment basis, allowing you to output markers from some waveform segments within the sequence, but not for others.

Key Path:	Source, Modulation Setup, ARB, Waveform Sequences, Build New Sequence, Edit Selected Waveform
Notes:	No remote command, front panel only.
Preset:	Enabled
Range:	Enabled Disabled
Initial S/W Revision:	A.05.00
Help Map ID:	35485

Marker 4

Allows you to enable or disable marker 4 for the currently selected waveform. For a waveform sequence, you can enable and disable markers on a per-segment basis, allowing you to output markers from some waveform segments within the sequence, but not for others.

Key Path:	Source, Modulation Setup, ARB, Waveform Sequences, Build New Sequence, Edit Selected Waveform
Notes:	No remote command, front panel only.
Preset:	Enabled
Range:	Enabled Disabled
Initial S/W Revision:	A.05.00
Help Map ID:	35486

Source (Internal)

Delete Segment

Allows you to delete the selected segment from the waveform sequence.

Key Path:	Source, Modulation Setup, ARB, Waveform Sequences, Build New Sequence
Notes:	No remote command, front panel only.
Initial S/W Revision:	A.05.00
Help Map ID:	35487

Save Sequence...

Pressing this key displays the “Save As” dialog. The sequence name is passed to the save as dialog to use as the filename for saving, and the directory the save as dialog will open into is the default waveform directory.

Key Path:	Source, Modulation Setup, ARB, Waveform Sequences, Build New Sequence
Initial S/W Revision:	A.05.00
Help Map ID:	35488

Build New Sequence (Remote Command Only)

This command is the SCPI equivalent of the waveform sequence creation features described in [“Build New Sequence” on page 779](#).

This command writes a waveform sequence file to the hard disk. You must specify the waveform sequence file path and filename which will be saved on the hard disk, and the waveform segment file path and name which will be nested into the waveform sequence file. You can utilize mass storage unit specifier (MSUS) “NVWFM” or use a real full path representation. See the example below. MSUS “NVWFM” is mapped to D:\NVARB directory on test set hard disk.

Any number of segments, up to a segment count limit of 64, can be used to create a sequence. Repeated segments are included in the count limit.

Each waveform segment name string length upper limit is 128 chars. Please do NOT insert waveform which name string exceeds 128 chars.

The internal source does not support nesting one waveform sequence file into another waveform sequence file.

Remote Command:	<pre>:SOURce:RADio:ARB:SEquence[:MWAVeform] <filename>, <waveform1>, <reps>, NONE M1 M2 M3 M4 M1M2 M1M3 M1M4 M2M3 M2M4 M3M4 M1M2M3 M 1M2M4 M1M3M4 M2M3M4 M1M2M3M4 ALL, {<waveform2>, <reps>, NONE M1 M2 M3 M4 M1M2 M1M3 M1M4 M2M3 M2M4 M3M4 M1M2M3 M 1M2M4 M1M3M4 M2M3M4 M1M2M3M4 ALL, } ...</pre> <p>(For additional description of each item, see Notes below “For Setup SCPI” on page 786“For Setup SCPI”).</p> <pre>:SOURce:RADio:ARB:SEquence[:MWAVeform]? <filename></pre> <p>(For additional description of each item, see Notes “For Query SCPI” on page 787 below.)</p>
------------------------	--

Example:	<p>For setup:</p> <pre>SOUR:RAD:ARB:SEQ "NVWFM:testSeq1.seq", "NVWFM:wfmSegment1.wfm",10, M2M3M4, "NVWFM:wfmSegment2.wfm", 20, M1M3</pre> <p>Or</p> <pre>SOUR:RAD:ARB:SEQ "D:\NVARB\testSeq1.seq", " D:\NVARB\wfmSegment1.wfm",10, M2M3M4, " D:\NVARB\wfmSegment2.wfm", 20, M1M3</pre> <p>For query, must specify which waveform sequence file to query.</p> <pre>SOUR:RAD:ARB:SEQ? "NVWFM:testSeq1.seq"</pre> <p>Or</p> <pre>SOUR:RAD:ARB:SEQ? "D:\NVARB\testSeq1.seq",</pre>
----------	--

<p>Notes:</p>	<p>For Setup SCPI</p> <p>For the Setup SCPI command, the parameters are:</p> <p><filename> - String Type</p> <p>This variable specifies the path and name for the waveform sequence file. The path supports MSUS (NVWFM) or a real full path representation. See example.</p> <p><waveform1> - String Type</p> <p>This variable specifies the path and name of the first existing waveform segment. The path supports MSUS (NVWFM) or a real full path representation. See example.</p> <p>The segment file must reside within ARB playback memory before it can be played by the ARB player.</p> <p><reps> - Integer Type</p> <p>This variable specifies the number of times a segment or sequence plays before moving on to the next segment or sequence.</p> <p><marker> - Enum Type</p> <p>NONE – This choice disables all four markers for the waveform. Disabling markers means that the waveform sequence ignores the segments or sequence marker settings.</p> <p>M1, M2, M3, M4 – these choices, either individually or a combination of them, enable the markers for the waveform segment or sequence. Markers not specified are ignored for that segment or sequence.</p> <p>ALL – This choice enables all four markers in the waveform segment or sequence.</p> <p><waveform2> - String type.</p> <p>This variable specifies the name of a second existing waveform segment. The path supports MSUS (NVWFM) and real full path representation both. See example.</p> <p>The segment file must reside within ARB playback memory before it can be played by the ARB player.</p> <p><reps> same as above, for the 2nd waveform segment.</p> <p><marker> same as above, for the 2nd waveform segment.</p> <p>You can insert several waveform segments into a waveform sequence file. Just repeat inserting waveform segments as described above.</p> <p>Error Checks for Setup SCPI command:</p> <p>If you do not specify a filename, or you use an unsupported MSUS (that is, not NVWFM), or have an error in the waveform sequence file path, an error is generated.</p>
---------------	--

Notes:	<p>Error Checks for Query SCPI command: (Continued)</p> <p>If the specified waveform sequence file name suffix is not “.seq”, error is generated.</p> <p>If you use an unsupported MSUS (that is, not NVWFM), or have an error in the waveform segment file path, an error is generated.</p> <p>If the first specified waveform file cannot be found, an error is generated.</p> <p>If you nest one waveform sequence file into another waveform sequence file, an error is generated.</p> <p>If the specified repetition value is larger than 65535 or smaller than 1, an error is generated.</p> <p>If the specified marker type is unrecognized, an error is generated.</p> <p>For Query SCPI</p> <p>For the Query the parameters are:</p> <p><filename> - String type.</p> <p>This variable specifies the path and name of the waveform sequence file being queried. The path supports MSUS (NVWFM) or a real full path representation. See example.</p> <p>The return value is a <string>, which includes each waveform segment file name, repetitions, and marker type. For example:</p> <p>SOUR:RAD:ARB:SEQ? “NVWFM:testSeq1.seq”,</p> <p><“wfmSegment1. wfm, 10, ALL, wfmSegment2.wfm, 20, M1M3”</p> <p>Error Checks for Query SCPI command:</p> <p>If you do not specify a filename, an error is generated.</p> <p>If the waveform sequence file name is empty, an error is generated.</p> <p>If the specified waveform sequence file cannot be found, an error is generated.</p>
Initial S/W Revision:	A.05.00
Help Map ID:	35687

Edit Selected Sequence

Allows access to the sub-menus for editing the sequence currently selected within the Waveform Sequence List view. Pressing this key changes the central view area to display the Waveform Sequence Creation and Editing view.

Key Path:	Source, Modulation Setup, ARB, Waveform Sequences
Notes:	No remote command, front panel only.
Initial S/W Revision:	A.05.00
Help Map ID:	35489

Source (Internal)

Current Segment

Specifies the selected sequence segment that will be affected by the menu functions.

Key Path:	Source, Modulation Setup, ARB, Waveform Sequences, Edit Selected Sequence
Notes:	No remote command, front panel only. This key is grayed out and unavailable if the sequence is currently empty.
Initial S/W Revision:	A.05.00
Help Map ID:	35490

Insert New Waveform

Allows you access to the sub-menu for inserting a new waveform segment or sequence. Pressing this key also changes the central display to show the Waveform File Selection View.

Key Path:	Source, Modulation Setup, ARB, Waveform Sequences, Edit Selected Sequence
Notes:	No remote command, front panel only.
Initial S/W Revision:	A.05.00
Help Map ID:	35491

Insert Waveform

Inserts the currently highlighted waveform to the end of the waveform sequence. Pressing this key also returns you to the menus for creating or editing a sequence, and returns the central view to the sequence creation view.

Key Path:	Source, Modulation Setup, ARB, Waveform Sequences, Edit Selected Sequence, Insert New Waveform
Notes:	No remote command, front panel only.
Initial S/W Revision:	A.05.00
Help Map ID:	35492

Segments on Hard Disk

This key functions the same as section [“Segments on Hard Disk” on page 766.](#)[\[Proc_iFrame:35433@\]](#)

Key Path:	Source, Modulation Setup, ARB, Waveform Sequences, Edit Selected Sequence, Insert New Waveform
Initial S/W Revision:	Prior to A.09.00
Help Map ID:	0

Load Segment To ARB Memory

This key functions the same as section [“Load Segment To ARB Memory” on page 767.](#)[\[Proc_iFrame:35434@\]](#)

Key Path:	Source, Modulation Setup, ARB, Waveform Sequences, Edit Selected Sequence, Insert New Waveform, Segments on Hard Disk
Initial S/W Revision:	Prior to A.09.00
Help Map ID:	0

Load All To ARB Memory

This key functions the same as section [“Load All To ARB Memory” on page 768.](#)[\[Proc_iFrame:35435@\]](#)

Key Path:	Source, Modulation Setup, ARB, Waveform Sequences, Edit Selected Sequence, Insert New Waveform, Segments on Hard Disk
Initial S/W Revision:	Prior to A.09.00
Help Map ID:	0

Change Directory ...

This key functions the same as section [“Change Directory...” on page 768](#)[\[Proc_iFrame:35436@\]](#)

Key Path:	Source, Modulation Setup, ARB, Waveform Sequences, Edit Selected Sequence, Insert New Waveform, Segments on Hard Disk
Initial S/W Revision:	Prior to A.09.00
Help Map ID:	0

Default Directory ...

This key functions the same as section [“Default Directory...” on page 769](#)[\[Proc_iFrame:35437@\]](#)

Key Path:	Source, Modulation Setup, ARB, Waveform Sequences, Edit Selected Sequence, Insert New Waveform, Segments on Hard Disk
Initial S/W Revision:	Prior to A.09.00
Help Map ID:	0

Segments in ARB Memory

This key functions the same as section [“Segments in ARB Memory” on page 769.](#) [\[Proc_iFrame:35438@\]](#)

Key Path:	Source, Modulation Setup, ARB, Waveform Sequences, Edit Selected Sequence, Insert New Waveform
Initial S/W Revision:	Prior to A.09.00
Help Map ID:	0

Source (Internal)

Delete Segment From ARB Memory

This key functions the same as section [“Delete Segment From ARB Mem”](#) on page 769.[Proc_iFrame:35439@]

Key Path:	Source, Modulation Setup, ARB, Waveform Sequences, Edit Selected Sequence, Insert New Waveform, Segments in ARB Memory
Initial S/W Revision:	Prior to A.09.00
Help Map ID:	0

Delete All From ARB Memory

This key functions the same as section [“Delete All From ARB Memory”](#) on page 770.[Proc_iFrame:35440@]

Key Path:	Source, Modulation Setup, ARB, Waveform Sequences, Edit Selected Sequence, Insert New Waveform, Segments in ARB Memory
Initial S/W Revision:	Prior to A.09.00
Help Map ID:	0

Query ARB Memory File List (Remote Command Only)

This key functions the same as section [Query “Query ARB Memory File List \(Remote Command Only\)”](#) on page 771[Proc_iFrame:35686@]

Key Path:	Source, Modulation Setup, ARB, Waveform Sequences, Edit Selected Sequence, Insert New Waveform, Segments in ARB Memory
Initial S/W Revision:	Prior to A.09.00
Help Map ID:	0

Edit Selected Waveform

Allows access to the sub-menus for editing the details of the currently selected waveform segment.

Key Path:	Source, Modulation Setup, ARB, Waveform Sequences, Edit Selected Sequence
Notes:	No remote command, front panel only.
Initial S/W Revision:	A.05.00
Help Map ID:	35493

Repetitions

Allows you to specify the number of times the currently selected waveform is played within the sequence.

Key Path:	Source, Modulation Setup, ARB, Waveform Sequences, Edit Selected Sequence, Edit Selected Waveform
Notes:	No remote command, front panel only.
Preset:	1

Min:	1
Max:	TBD
Initial S/W Revision:	A.05.00
Help Map ID:	35494

Marker 1

Allows you to enable or disable marker 1 for the currently selected waveform. For a waveform sequence, you can enable and disable markers on a per-segment basis, allowing you to output markers from some waveform segments within the sequence but not for others.

Key Path:	Source, Modulation Setup, ARB, Waveform Sequences, Edit Selected Sequence, Edit Selected Waveform
Notes:	No remote command, front panel only.
Preset:	Enabled
Range:	Enabled Disabled
Initial S/W Revision:	A.05.00
Help Map ID:	35495

Marker 2

Allows you to enable or disable marker 2 for the currently selected waveform. For a waveform sequence, you can enable and disable markers on a per-segment basis, allowing you to output markers from some waveform segments within the sequence but not for others.

Key Path:	Source, Modulation Setup, ARB, Waveform Sequences, Edit Selected Sequence, Edit Selected Waveform
Notes:	No remote command, front panel only.
Preset:	Enabled
Range:	Enabled Disabled
Initial S/W Revision:	A.05.00
Help Map ID:	35496

Marker 3

Allows you to enable or disable marker 3 for the currently selected waveform. For a waveform sequence, you can enable and disable markers on a per-segment basis, allowing you to output markers from some waveform segments within the sequence but not for others.

Key Path:	Source, Modulation Setup, ARB, Waveform Sequences, Edit Selected Sequence, Edit Selected Waveform
Notes:	No remote command, front panel only.
Preset:	Enabled

Source (Internal)

Range:	Enabled Disabled
Initial S/W Revision:	A.05.00
Help Map ID:	35497

Marker 4

Allows you to enable or disable marker 4 for the currently selected waveform. For a waveform sequence, you can enable and disable markers on a per-segment basis, allowing you to output markers from some waveform segments within the sequence but not for others.

Key Path:	Source, Modulation Setup, ARB, Waveform Sequences, Edit Selected Sequence, Edit Selected Waveform
Notes:	No remote command, front panel only.
Preset:	Enabled
Range:	Enabled Disabled
Initial S/W Revision:	A.05.00
Help Map ID:	35498

Delete Segment

Allows you to delete the current segment from the waveform sequence.

Key Path:	Source, Modulation Setup, ARB, Waveform Sequences, Edit Selected Sequence
Notes:	No remote command, front panel only.
Initial S/W Revision:	A.05.00
Help Map ID:	35499

Save Sequence...

Pressing this key displays the “Save As” dialog box. The sequence name is passed to the save as dialog to use as the filename for saving, and the directory the save as dialog opens into is the default waveform directory.

Key Path:	Source, Modulation Setup, ARB, Waveform Sequences, Edit Selected Sequence
Notes:	No remote command, front panel only.
Initial S/W Revision:	A.05.00
Help Map ID:	35500

Current Directory...

Allows you to change the currently selected directory on the hard disk. Pressing this key opens a standard windows

change directory dialog and allows you to select the new directory of interest.

Key Path:	Source, Modulation Setup, ARB, Waveform Sequences
Notes:	No remote command, front panel only.
Initial S/W Revision:	A.05.00
Help Map ID:	35501

Waveform Utilities

Allows you access to the waveform utilities sub-menus.

Key Path:	Source, Modulation Setup, ARB
Initial S/W Revision:	A.05.00
Help Map ID:	35502

Multi-Pack Licenses

Allows you access to the Multi - Pack License sub-menus. Pressing this key also changes the central view area to display the Multi -Pack License Management view.

Key Path:	Source, Modulation Setup, ARB, Waveform Utilities
Dependencies:	This key is only available if there is at least one Multi-pack license installed on the instrument.
Initial S/W Revision:	A.05.00
Help Map ID:	35503

Add Waveform

Pressing this key accesses the Add Waveform sub-menu. It also changes the central display area to display the Multi-Pack License Waveform Add view.

Key Path:	Source, Modulation Setup, ARB, Waveform Utilities, Multi-Pack Licenses
Dependencies:	This key is only available if there is at least one slot available within at least one multi-pack license.
Initial S/W Revision:	A.05.00
Help Map ID:	35504

Add Waveform

Allows you to add the currently selected waveform segment to a multi-pack license. The new waveform is added to the next available slot regardless of which slot was selected on the Multi-Pack License Management view.

Key Path:	Source, Modulation Setup, ARB, Waveform Utilities, Multi-Pack Licenses, Add Waveform
-----------	---

Source (Internal)

Remote Command:	:SYSTem:LKEY:WAVeform:ADD <string> or :SYSTem:LIcense[:FPACK]:WAVeform:ADD <string>
Example:	SYST:LKEY:WAV:ADD "mywaveform.wfm" or SYST:LIC:WAV:ADD "mywaveform.wfm"
Notes:	The second SCPI :SYSTem:LIcense[:FPACK]:WAVeform:ADD is provided to be consistent with the style of Agilent signal sources. You can use either one of them. Since adding a waveform segment to a Multi-Pack license causes the license slot to enter the trial period of only 48 hours, pressing this key causes a confirmation dialog to be displayed to ensure you do want to add the waveform segment to the Multi-Pack. If you attempt to license a waveform that is already licensed using another slot an error is generated.
Dependencies:	This key is only available if the currently selected file is a secure waveform requiring a license, and there is at least one slot available within at least one multi-pack license. If the waveform highlighted is a secure waveform, but is already licensed, this key will be unavailable.
Initial S/W Revision:	A.05.00
Help Map ID:	35659

Segments on Hard Disk

This key functions the same as [“Segments on Hard Disk”](#) on page 766.

Key Path:	Source, Modulation Setup, ARB, Waveform Utilities, Multi-Pack Licenses, Add Waveform
Initial S/W Revision:	Prior to A.09.00
Help Map ID:	0

Load Segment To ARB Memory

This key functions the same as [“Load Segment To ARB Memory”](#) on page 767.

Key Path:	Source, Modulation Setup, ARB, Waveform Utilities, Multi-Pack Licenses, Add Waveform, Segment on Hard Drive
Initial S/W Revision:	Prior to A.09.00
Help Map ID:	0

Load All To ARB Memory

This key functions the same as [“Load All To ARB Memory”](#) on page 768.

Key Path:	Source, Modulation Setup, ARB, Waveform Utilities, Multi-Pack Licenses, Add Waveform, Segment on Hard Drive
Initial S/W Revision:	Prior to A.09.00
Help Map ID:	0

Change Directory ...

This key functions the same as [“Change Directory...”](#) on page 768.

Key Path:	Source, Modulation Setup, ARB, Waveform Utilities, Multi-Pack Licenses, Add Waveform, Segment on Hard Drive
Initial S/W Revision:	Prior to A.09.00
Help Map ID:	0

Default Directory ...

This key functions the same as [“Default Directory...”](#) on page 769

Key Path:	Source, Modulation Setup, ARB, Waveform Utilities, Multi-Pack Licenses, Add Waveform, Segment on Hard Drive
Initial S/W Revision:	Prior to A.09.00
Help Map ID:	0

Replace Waveform

Pressing this key accesses the Replace Waveform submenu. It also changes the central display area to display the Multi-Pack License Waveform Add view.

Key Path:	Source, Modulation Setup, ARB, Waveform Utilities, Multi-Pack Licenses
Dependencies:	This key is only available if the currently selected slot is in the trial state.
Initial S/W Revision:	A.05.00
Help Map ID:	35661

Replace Waveform

Allows you to replace the waveform in the currently selected slot with the waveform currently selected in the Multi-Pack License Waveform Add view.

Key Path:	Source, Modulation Setup, ARB, Waveform Utilities, Multi-Pack Licenses, Replace Waveform
-----------	---

Source (Internal)

Remote Command:	:SYSTem:LKEY:WAVEform:REPLace <int>, <string> or :SYSTem:LIcense[:FPACK]:WAVEform:REPLace <int>,<string>
Example:	SYST:LKEY:WAV:REPL 1, "myotherwaveform.wfm" or :SYST:LIC:WAV:REPL 1, "myotherwaveform.wfm"
Notes:	The second SCPI :SYSTem:LIcense[:FPACK]:WAVEform:REPLace is provided to be consistent with the style of Agilent signal sources. You can use either one of them. If you attempt to license a waveform that is already licensed using another slot an error is generated. Waveform slot number <int> is positive. If you attempt to input a slot number less than or equals 0, an error is generated. "-220 Parameter error; License slot <n> is illegal, slot number must be positive"
Initial S/W Revision:	A.05.00
Help Map ID:	35662

Segments on Hard Disk

This key functions the same as ["Segments on Hard Disk" on page 766](#).

Key Path:	Source, Modulation Setup, ARB, Waveform Utilities, Multi-Pack Licenses, Replace Waveform
Initial S/W Revision:	Prior to A.09.00
Help Map ID:	0

Load Segment To ARB Memory

This key functions the same as ["Load Segment To ARB Memory" on page 767](#).

Key Path:	Source, Modulation Setup, ARB, Waveform Utilities, Multi-Pack Licenses, Replace Waveform, Segment on Hard Drive
Initial S/W Revision:	Prior to A.09.00
Help Map ID:	0

Load All To ARB Memory

This key functions the same as ["Load All To ARB Memory" on page 768](#).

Key Path:	Source, Modulation Setup, ARB, Waveform Utilities, Multi-Pack Licenses, Replace Waveform, Segment on Hard Drive
Initial S/W Revision:	Prior to A.09.00

Help Map ID:	0
--------------	---

Change Directory ...

This key functions the same as [“Change Directory...”](#) on page 768.

Key Path:	Source, Modulation Setup, ARB, Waveform Utilities, Multi-Pack Licenses, Replace Waveform, Segment on Hard Drive
Initial S/W Revision:	Prior to A.09.00
Help Map ID:	0

Default Directory ...

This key functions the same as [“Default Directory...”](#) on page 769

Key Path:	Source, Modulation Setup, ARB, Waveform Utilities, Multi-Pack Licenses, Replace Waveform, Segment on Hard Drive
Initial S/W Revision:	Prior to A.09.00
Help Map ID:	0

Clear Waveform from Slot

Allows you to clear the waveform from the selected slot.

Key Path:	Source, Modulation Setup, ARB, Waveform Utilities, Multi-Pack Licenses
Remote Command:	:SYSTem:LKEY:WAVEform:CLEar <int> or :SYSTem:LICense[:FPACK]:WAVEform:CLEar <int>
Example:	SYST:LKEY:WAV:CLE 1 or :SYST:LIC:WAV:CLE 1
Notes:	The second SCPI :SYSTem:LICense[:FPACK]:WAVEform:CLEar is provided to be consistent with the style of Agilent signal sources. You can use either one of them. Waveform slot number <int> is positive. If you attempt to input a slot number less than or equals 0, an error is generated. "-220 Parameter error; License slot <n> is illegal, slot number must be positive"
Dependencies:	This key is only available if the currently selected slot is in the trial state.
Initial S/W Revision:	A.05.00
Help Map ID:	35664

Lock Waveform in Slot

If the selected slot is in the trial state or the lock required state, the waveform that occupies the slot is locked and

Source (Internal)

permanently licensed.

Key Path:	Source, Modulation Setup, ARB, Waveform Utilities, Multi-Pack Licenses
Remote Command:	:SYSTem:LKEY:WAVeform:LOCK <int> or :SYSTem:LIcense[:FPACK]:WAVeform:LOCK <int>
Example:	SYST:LKEY:WAV:LOCK 1 or SYST:LIC:WAV:LOCK 1
Notes:	The second SCPI :SYSTem:LIcense[:FPACK]:WAVeform:LOCK is provided to be consistent with the style of Agilent signal sources. You can use either one of them. Waveform slot number <int> is positive. If you attempt to input a slot number less than or equals 0, an error is generated. "-220 Parameter error; License slot <n> is illegal, slot number must be positive"
Dependencies:	This key is only available if the currently selected slot is in the trial state or the lock required state.
Initial S/W Revision:	A.05.00
Help Map ID:	35665

Slot Status Query (Remote Command Only)

Returns the status of the specified slot.

Remote Command:	:SYSTem:LKEY:WAVeform:STATus? <int> or :SYSTem:LIcense[:FPACK]:WAVeform:STATus? <int>
Example:	:SYST:LKEY:WAV:STAT? 1 <"Locked" or :SYST:LIC:WAV:STAT? 1 <"Locked"
Notes:	The second SCPI :SYSTem:LIcense[:FPACK]:WAVeform:STATus is provided to be consistent with the style of Agilent signal sources. You can use either one of them. Waveform slot number <int> is positive. If you attempt to input a slot number less than or equals 0, an error is generated. "-220 Parameter error; License slot <n> is illegal, slot number must be positive" Result type is string. If input slot number exceeds total available slot number, "Nonexistent" is returned.

Range:	"Locked" "Available" "Trail" "LockRequired" "Nonexistent"
Initial S/W Revision:	A.05.00
Help Map ID:	35688

Slots Free Query (Remote Command Only)

Returns the number of license slots free.

Remote Command:	:SYSTem:LKEY:WAVeform:FREE? or :SYSTem:LICense[:FPACK]:WAVeform:FREE?
Example:	:SYST:LKEY:WAV:FREE? or :SYST:LIC:WAV:FREE?
Notes:	The second SCPI :SYSTem:LICense[:FPACK]:WAVeform:FREE is provided to be consistent with the style of Agilent signal sources. You can use either one of them.
Initial S/W Revision:	A.05.00
Help Map ID:	35689

Slot Used Query (Remote Command Only)

Returns the number of license slots used.

Remote Command:	:SYSTem:LKEY:WAVeform:USED? or :SYSTem:LICense[:FPACK]:WAVeform:USED?
Example:	:SYST:LKEY:WAV:USED? or :SYST:LIC:WAV:USED?
Notes:	The second SCPI :SYSTem:LICense[:FPACK]:WAVeform:USED is provided to be consistent with the style of Agilent signal sources. You can use either one of them.
Initial S/W Revision:	A.05.00
Help Map ID:	35690

Source (Internal)

Slot Waveform Name Query (Remote Command Only)

Returns the waveform name of the specified slot

Remote Command:	:SYSTem:LKEY:WAVEform:NAME? <int> or :SYSTem:LIcense[:FPACK]:WAVEform:NAME? <int>
Example:	:SYST:LKEY:WAV:NAME? 1 <"CDMA2K_22.wfm" or :SYST:LIC:WAV:NAME? 1 <"CDMA2K_22.wfm"
Notes:	Waveform slot number <int> is positive. If you attempt to input a slot number less than or equals 0, an error is generated. "-220 Parameter error; License slot <n> is illegal, slot number must be positive". Result type is string. If input slot number exceeds total available slot number, "Nonexistent" is returned. If no waveform stored in the specified slot, then empty string is returned.
Initial S/W Revision:	A.12.00
Help Map ID:	0

Slot Waveform Unique ID Query (Remote Command Only)

Returns the waveform unique ID of the specified slot.

Remote Command:	:SYSTem:LKEY:WAVEform:UID? <int> or :SYSTem:LIcense[:FPACK]:WAVEform:UID? <int>
Example:	:SYST:LKEY:WAV:UID? 2 <"1346752140" or :SYST:LIC:WAV:UID? 2 <"1346752140"
Notes:	Waveform slot number <int> is positive. If you attempt to input a slot number less than or equals 0, an error is generated. "-220 Parameter error; License slot <n> is illegal, slot number must be positive". Result type is string. If input slot number exceeds total available slot number, "Nonexistent" is returned. Only Signal Studio waveform has unique ID, which is a positive number. (User generated waveform has no unique ID). If no waveform stored in the specified slot, then "0" is returned

Initial S/W Revision:	A.12.00
Help Map ID:	0

Locked Waveform Name List Query (Remote Command Only)

Returns the waveform name list of locked.

Remote Command:	:SOURce:RADio:ARB:MPLicensed:NAME:LOCKed?
Example:	SOUR:RAD:ARB:MPL:NAME:LOCKed? <"CDMA2K_27.wfm","GSM_MCS1.WFM","c2kWfm.wfm"
Initial S/W Revision:	A.11.00
Help Map ID:	0

Locked Waveform Unique ID List Query (Remote Command Only)

Returns the waveform unique id list of locked.

Remote Command:	:SOURce:RADio:ARB:MPLicensed:UID:LOCKed?
Example:	SOUR:RAD:ARB:MPL:UID:LOCKed? <"2996927136","3812603511","3710986266"
Notes:	Each Signal Studio waveform has a unique id recorded in header. So if the unique ids are same, that means they are same one waveform. So besides SCPI to query locked waveform name list, also provide a SCPI to query locked waveform unique id list
Initial S/W Revision:	A.11.00
Help Map ID:	0

Marker Utilities

Allows access to the marker utilities sub-menus.

Key Path:	Source, Modulation Setup, ARB
Initial S/W Revision:	A.05.00
Help Map ID:	35505

Marker Polarity

Allows access to the marker polarity sub-menu, which allows you to specify the polarity for the four markers. For a positive polarity, the marker signal is high during the marker points. For a negative marker polarity, the marker signal is high during the period of no marker points.

Key Path:	Source, Modulation Setup, ARB, Marker Utilities
Initial S/W Revision:	A.05.00

Source (Internal)

Help Map ID:	35506
--------------	-------

Mkr 1 Polarity

Allows you to set the polarity of marker 1.

Key Path:	Source, Modulation Setup, ARB, Marker Utilities, Marker Polarity
Remote Command:	:SOURce:RADio:ARB:MPOLarity:MARKer1 POSitive NEGative :SOURce:RADio:ARB:MPOLarity:MARKer1?
Example:	SOUR:RAD:ARB:MPOL:MARK1 NEG
Dependencies:	When a new waveform is selected for playback the settings contained within the associated waveform header file are applied to the ARB. The marker polarity is one of the values stored within the header file. If the newly selected waveform file has an associated header file, the marker polarity is updated with the value from the header file. The marker polarity will remain unchanged if the newly selected waveform does not have an associated header file.
Preset:	Pos
Range:	Neg Pos
Initial S/W Revision:	A.05.00
Help Map ID:	35507

Mkr 2 Polarity

Allows you to set the polarity of marker 2.

Key Path:	Source, Modulation Setup, ARB, Marker Utilities, Marker Polarity
Remote Command:	:SOURce:RADio:ARB:MPOLarity:MARKer2 POSitive NEGative :SOURce:RADio:ARB:MPOLarity:MARKer2?
Example:	SOUR:RAD:ARB:MPOL:MARK2 NEG
Dependencies:	When a new waveform is selected for playback the settings contained within the associated waveform header file are applied to the ARB. The marker polarity is one of the values stored within the header file. If the newly selected waveform file has an associated header file, the marker polarity is updated with the value from the header file. The marker polarity will remain unchanged if the newly selected waveform does not have an associated header file.
Preset:	Pos
Range:	Neg Pos
Initial S/W Revision:	A.05.00
Help Map ID:	35508

Mkr 3 Polarity

Allows you to set the polarity of marker 3.

Key Path:	Source, Modulation Setup, ARB, Marker Utilities, Marker Polarity
Remote Command:	:SOURce:RADio:ARB:MPOLarity:MARKer3 POSitive NEGative :SOURce:RADio:ARB:MPOLarity:MARKer3?
Example:	SOUR:RAD:ARB:MPOL:MARK3 NEG
Dependencies:	When a new waveform is selected for playback the settings contained within the associated waveform header file are applied to the ARB. The marker polarity is one of the values stored within the header file. If the newly selected waveform file has an associated header file, the marker polarity is updated with the value from the header file. The marker polarity will remain unchanged if the newly selected waveform does not have an associated header file.
Preset:	Pos
Range:	Neg Pos
Initial S/W Revision:	A.05.00
Help Map ID:	35509

Mkr 4 Polarity

Allows you to set the polarity of marker 4.

Key Path:	Source, Modulation Setup, ARB, Marker Utilities, Marker Polarity
Remote Command:	:SOURce:RADio:ARB:MPOLarity:MARKer4 POSitive NEGative :SOURce:RADio:ARB:MPOLarity:MARKer4?
Example:	SOUR:RAD:ARB:MPOL:MARK4 NEG
Dependencies:	When a new waveform is selected for playback the settings contained within the associated waveform header file are applied to the ARB. The marker polarity is one of the values stored within the header file. If the newly selected waveform file has an associated header file, the marker polarity is updated with the value from the header file. The marker polarity will remain unchanged if the newly selected waveform does not have an associated header file.
Preset:	Pos
Range:	Neg Pos
Initial S/W Revision:	A.05.00
Help Map ID:	35510

Marker Routing

Allows access to the marker routing sub-menus, which allow you to specify where the marker events are routed. It

Source (Internal)

should be noted that the markers can also be routed to Trigger 1 Out and Trigger 2 Out, however this must be set up using the menus accessed by pressing the “Trigger” hard key.

Key Path:	Source, Modulation Setup, ARB, Marker Utilities
Initial S/W Revision:	A.05.00
Help Map ID:	35511

Pulse/RF Blank

Allows you to select which marker is used for the pulse/RF blanking function. The pulse/RF blanking function blanks the RF when the marker signal goes low. The marker polarity determines when the marker signal is high. For a positive polarity, this is during the marker points. For a negative polarity, this is when there are no marker points.

Marker points should be set before using this function. Enabling this function without setting maker points may create a continuous low or high signal, dependant on the marker polarity. This causes either no RF output, or a continuous RF output.

Key Path:	Source, Modulation Setup, ARB, Marker Utilities, Marker Routing
Remote Command:	:SOURce:RADio:ARB:MDEStination:PULSe NONE M1 M2 M3 M4 :SOURce:RADio:ARB:MDEStination:PULSe?
Example:	SOUR:RAD:ARB:MDES:PULS NONE
Dependencies:	When a new waveform is selected for playback the settings contained within the associated waveform header file are applied to the ARB. The pulse/RF blanking setting is one of the values stored within the header file. If the newly selected waveform file has an associated header file, the pulse/RF blanking setting is updated with the value from the header file. The pulse/RF blanking setting will remain unchanged if the newly selected waveform does not have an associated header file.
Range:	None M1 M2 M3 M4
Initial S/W Revision:	A.05.00
Help Map ID:	35512

None

Sets no marker to be used for the pulse/RF blanking function, essentially turning the RF blanking function off.

Key Path:	Source, Modulation Setup, ARB, Marker Utilities, Marker Routing, Pulse/RF Blank
Example:	SOUR:RAD:ARB:MDES:PULS NONE
Initial S/W Revision:	A.05.00
Help Map ID:	35513

Marker 1

Sets marker 1 to be used for the pulse/RF blanking function.

Key Path:	Source, Modulation Setup, ARB, Marker Utilities, Marker Routing, Pulse/RF Blank
Example:	SOUR:RAD:ARB:MDES:PULS M1
Initial S/W Revision:	A.05.00
Help Map ID:	35514

Marker 2

Sets marker 2 to be used for the pulse/RF blanking function.

Key Path:	Source, Modulation Setup, ARB, Marker Utilities, Marker Routing, Pulse/RF Blank
Example:	SOUR:RAD:ARB:MDES:PULS M2
Initial S/W Revision:	A.05.00
Help Map ID:	35515

Marker 3

Sets marker 3 to be used for the pulse/RF blanking function.

Key Path:	Source, Modulation Setup, ARB, Marker Utilities, Marker Routing, Pulse/RF Blank
Example:	SOUR:RAD:ARB:MDES:PULS M3
Initial S/W Revision:	A.05.00
Help Map ID:	35516

Marker 4

Sets marker 4 to be used for the pulse/RF blanking function.

Key Path:	Source, Modulation Setup, ARB, Marker Utilities, Marker Routing, Pulse/RF Blank
Example:	SOUR:RAD:ARB:MDES:PULS M4
Initial S/W Revision:	A.05.00
Help Map ID:	35517

ALC Hold

Allows you to specify which marker is routed for use within the ALC hold function. The ALC hold marker function holds the ALC circuitry at the average value of the sample points set by the marker.

The ALC hold function operates during the low periods of the marker signal. The marker polarity determines when

Source (Internal)

the marker signal is high. For positive polarity, this is during the marker points. For a negative polarity, this is when there are no marker points.

Key Path:	Source, Modulation Setup, ARB, Marker Utilities, Marker Routing
Remote Command:	:SOURce:RADio:ARB:MDEStination:ALCHold NONE M1 M2 M3 M4 :SOURce:RADio:ARB:MDEStination:ALCHold?
Example:	SOUR:RAD:ARB:MDES:ALCH NONE
Dependencies:	When a new waveform is selected for playback the settings contained within the associated waveform header file are applied to the ARB. The ALC hold setting is one of the values stored within the header file. If the newly selected waveform file has an associated header file, the ALC hold setting is updated with the value from the header file. The ALC hold setting will remain unchanged if the newly selected waveform does not have an associated header file.
Range:	None M1 M2 M3 M4
Initial S/W Revision:	A.05.00
Help Map ID:	35518

None

Sets no marker to be used for the ALC hold function, essentially turning the ALC hold function off.

Key Path:	Source, Modulation Setup, ARB, Marker Utilities, Marker Routing, ALC Hold
Example:	SOUR:RAD:ARB:MDES:PULS NONE
Initial S/W Revision:	A.05.00
Help Map ID:	35519

Marker 1

Sets marker 1 to be used for the ALC hold function.

Key Path:	Source, Modulation Setup, ARB, Marker Utilities, Marker Routing, ALC Hold
Example:	SOUR:RAD:ARB:MDES:PULS M1
Initial S/W Revision:	A.05.00
Help Map ID:	35520

Marker 2

Sets marker 2 to be used for the ALC hold function.

Key Path:	Source, Modulation Setup, ARB, Marker Utilities, Marker Routing, ALC Hold
-----------	--

Example:	SOUR:RAD:ARB:MDES:PULS M2
Initial S/W Revision:	A.05.00
Help Map ID:	35521

Marker 3

Sets marker 3 to be used for the ALC hold function.

Key Path:	Source, Modulation Setup, ARB, Marker Utilities, Marker Routing, ALC Hold
Example:	SOUR:RAD:ARB:MDES:PULS M3
Initial S/W Revision:	A.05.00
Help Map ID:	35522

Marker 4

Sets marker 4 to be used for the ALC hold function.

Key Path:	Source, Modulation Setup, ARB, Marker Utilities, Marker Routing, ALC Hold
Example:	SOUR:RAD:ARB:MDES:PULS M4
Initial S/W Revision:	A.05.00
Help Map ID:	35523

Header Utilities

Allows access to the header utilities sub-menu. Pressing this key also causes the central display area to change to display the File Header Information view.

Key Path:	Source, Modulation Setup, ARB
Dependencies:	This key is only available if there is currently a waveform selected for playback. If no waveform is selected, the key is grayed out.
Initial S/W Revision:	A.05.00
Help Map ID:	35536

Clear Header

Allows you to clear the header information from the file header associated with the currently selected waveform.

Key Path:	Source, Modulation Setup, ARB, Header Utilities
Remote Command:	:SOURce:RADio:ARB:HEADer:CLEar
Example:	SOUR:RAD:ARB:HEAD:CLE

Source (Internal)

Notes:	Attempting to clear the header details via SCPI when no waveform was selected for playback will generate an error.
Initial S/W Revision:	A.05.00
Help Map ID:	35537

Save Setup To Header

Allows you to save new file header information details to the file.

Key Path:	Source, Modulation Setup, ARB, Header Utilities
Remote Command:	:SOURce:RADio:ARB:HEADer:SAVE
Example:	SOUR:RAD:ARB:HEAD:SAVE
Notes:	Attempting to save the header details via SCPI when no waveform was selected for playback will generate an error.
Initial S/W Revision:	A.05.00
Help Map ID:	35538

Query Waveform Unique ID (Remote Command Only)

Each Signal Studio waveform contains a unique waveform ID, which recorded in the header. This command allows you to query the unique waveform ID from the header. This is a SCPI only command.

Remote Command:	:MMEMory:HEADer:ID? "<file name>"
Example:	:MMEM:HEAD:ID? "test.wfm" (query the waveform already loaded into the ARB memory) :MMEM:HEAD:ID? "D:\NVARB\test.wfm" (query the waveform on the hard disk by absolute path) :MMEM:HEAD:ID? "NVWFM:test.wfm" (query the waveform on the hard disk by MSUS)
Notes:	SCPI query only. The queried waveform file can be in ARB memory, or on hard disk. If want to query ARB in ARB memory, then give out the file name directly. If want to query ARB on the hard disk, then absolute file path or MSUS should be given along with the file name. The valid MSUS is "NVWFM" which is mapped to D:\NVARB on hard disk. If the file cannot be found in ARB memory or on hard disk, an error is generated and value -1 is returned
Initial S/W Revision:	A.09.00
Help Map ID:	0

Query Selected Waveform Header info (Remote Command Only)

This query provides a listing of the current selected ARB header info. If no ARB selected, then empty string is returned..

Remote Command:	:SOURce:RADio:ARB:HEADer:INFormation?
Example:	SOUR:RAD:ARB:HEAD:INF?
Notes:	<p>Query only</p> <p>After each colon of field title string, related header info string will be appended.</p> <p>The field title string in "Range" part cannot change, for Sequence Studio needs to accurately match those string character to know which header info field it is.</p> <p>Below are related abbreviation description:</p> <p>"DESC" - Description</p> <p>"SR" - Sample Rate</p> <p>"RTS" - Run Time Scaling</p> <p>"RMS" - Root Mean Square</p> <p>"M1P" - Marker 1 Polarity</p> <p>"M2P" - Marker 2 Polarity</p> <p>"M3P" - Marker 3 Polarity</p> <p>"M4P" - Marker 4 Polarity</p> <p>"ALCHR" - ALC Hold Routing</p> <p>"RFBR" - RF Blank Routing</p> <p>"FOFF" - Frequency Offset</p> <p>"AWGNST" - AWGN State</p> <p>"AWGNCN" - AWGN C/N Ratio</p> <p>"AWGNCBW" - AWGN Carrier Bandwidth</p> <p>"AWGNNBW" - AWGN Noise Bandwidth</p> <p>"AWGNCRMS" - AWGN Carrier RMS</p> <p>"ORP" - DAC Over Range Protection</p> <p>"UID" - Unique ID</p> <p>"LICSTS" - License Status</p>
Range:	"DESC:", "SR:", "RTS:", "RMS:", "M1P:", "M2P:", "M3P:", "M4P:", "ALCHR:", "RFBR:", "FOFF:", "AWGNST:", "AWGNCN:", "AWGNCBW:", "AWGNNBW:", "AWGNCRMS:", "ORP:", "UID:", "LICSTS"
Initial S/W Revision:	A.12.00

Source (Internal)

Help Map ID:	0
--------------	---

Bus Trigger Command (Remote Command Only)

Used to initiate an immediate trigger event if the trigger source is set to Bus.

Remote Command:	:SOURce:RADio:ARB:TRIGger:INITiate
Example:	SOUR:RAD:ARB:TRIG:INIT
Initial S/W Revision:	A.05.00
Help Map ID:	35691

AM

Allows access to the menu for configuring the Amplitude Modulation.

Key Path:	Source, Modulation Setup
Initial S/W Revision:	A.05.00
Help Map ID:	35539

AM

Enables or disables the amplitude modulation.

Turning AM on when another modulation format is already on results in the previous modulation format being turned off and the generation of an error.

Key Path:	Source, Modulation Setup, AM
Remote Command:	:SOURce:AM:STATe :SOURce:AM:STATe?
Example:	SOUR:AM:STAT OFF
Preset:	Off
Range:	On Off
Initial S/W Revision:	A.05.00
Help Map ID:	35540

AM Depth

Allows you to set the amplitude modulation depth in percent.

Key Path:	Source, Modulation Setup, AM
Remote Command:	:SOURce:AM[:DEPTh] [:LINear] :SOURce:AM[:DEPTh] [:LINear] ?

Example:	SOUR:AM 0.1
Preset:	0.1 %
Min:	0.1 %
Max:	95.0 %
Initial S/W Revision:	A.05.00
Help Map ID:	35541

AM Rate

Allows you to set the internal amplitude modulation rate.

Key Path:	Source, Modulation Setup, AM
Remote Command:	:SOURce:AM:INTernal:FREQuency :SOURce:AM:INTernal:FREQuency?
Example:	SOUR:AM:INT:FREQ 40.0 Hz
Preset:	400.0 Hz
Min:	10 Hz
Max:	40 kHz
Initial S/W Revision:	A.05.00
Help Map ID:	35542

FM

Allows access to the menu for configuring the frequency modulation.

Key Path:	Source, Modulation Setup
Initial S/W Revision:	A.05.00
Help Map ID:	35543

FM

Enables or disables the frequency modulation.

Turning FM on when another modulation format is already on results in the previous modulation format being turned off and the generation of an error.

Key Path:	Source, Modulation Setup, FM
Remote Command:	:SOURce:FM:STATe :SOURce:FM:STATe?
Example:	SOUR:FM:STAT OFF

Source (Internal)

Preset:	Off
Range:	On Off
Initial S/W Revision:	A.05.00
Help Map ID:	35544

FM Deviation

Allows you to set the frequency modulation deviation.

Key Path:	Source, Modulation Setup, FM
Remote Command:	:SOURce:FM[:DEVIation] :SOURce:FM[:DEVIation]?
Example:	SOUR:FM 1.00 kHz
Preset:	1.00 Hz
Min:	1.00 Hz
Max:	100.00 kHz
Initial S/W Revision:	A.05.00
Help Map ID:	35545

FM Rate

Allows you to set the internal frequency modulation rate.

Key Path:	Source, Modulation Setup, FM
Remote Command:	:SOURce:FM:INTernal:FREQuency :SOURce:FM:INTernal:FREQuency?
Example:	SOUR:FM:INT:FREQ 40.0 Hz
Preset:	400.0 Hz
Min:	10 Hz
Max:	40 kHz
Initial S/W Revision:	A.05.00
Help Map ID:	35546

PM

Allows access to the menu for configuring the phase modulation.

Key Path:	Source, Modulation Setup
-----------	---------------------------------

Initial S/W Revision:	A.05.00
Help Map ID:	35547

PM

Enables or disables the phase modulation.

Turning PM on when another modulation format is already on results in the previous modulation format being turned off and the generation of an error.

Key Path:	Source, Modulation Setup, PM
Remote Command:	:SOURce:PM:STATe :SOURce:PM:STATe?
Example:	SOUR:PM:STAT OFF
Preset:	Off
Range:	On Off
Initial S/W Revision:	A.05.00
Help Map ID:	35548

PM Deviation

Allows you to set the phase modulation deviation.

Key Path:	Source, Modulation Setup, PM
Remote Command:	:SOURce:PM[:DEViation] :SOURce:PM[:DEViation]?
Example:	SOUR:PM 1.00 rad
Preset:	0.1 rad
Min:	0.1 rad
Max:	20.0 rad
Initial S/W Revision:	A.05.00
Help Map ID:	35549

PM Rate

Allows you to set the internal phase modulation rate.

Key Path:	Source, Modulation Setup, PM
Remote Command:	:SOURce:PM:INTernal:FREQuency :SOURce:PM:INTernal:FREQuency?

Source (Internal)

Example:	SOUR:PM:INT:FREQ 40.0 Hz
Preset:	400.0 Hz
Min:	10 Hz
Max:	40 kHz
Initial S/W Revision:	A.05.00
Help Map ID:	35550

Multiport Adapter Output Port Amplitude Correction Configuration Validation (Remote Command Only)

This command is used to validate MPA TX port amplitude correction for Source MXG Mode.

Key Path:	Remote Command Only
Remote Command:	:SOURce:RADio:MPADapter:CORRection:ERRor?
Example:	SOUR:RAD:MPAD:CORR:ERR?
Note	Query Only SCPI Remote command only If detected invalid configuration, popup error message "-221 Settings conflict; MPA TX port<n> amplitude correction value <n>dB is out of range. The valid range is <n> ~ <n>dB" Or "-221 Settings conflict; MPA TX port<n> amplitude correction delta exceeds <n>dB between port<n> and port<n>" to report the first detected conflict.
Range:	"No error" Error info of the first found conflic
Initial S/W Revision:	A.12.00
Help Map ID:	0

List Sequencer

Allows you access to the sub-menus for configuring the list sequencer.

List sequences allows you to enter frequencies and amplitudes at unequal intervals in nonlinear ascending, descending or random order. Each step within the list can also include its own waveform file for playback, step duration, trigger event and trigger output.

The complexities involved in configuring the list sequencer do not lend itself to manual configuration; hence the manual configuration for this feature is limited. For easier configuration of the list sequencer, it is recommended that you use either SCPI or load a tab delimited file containing the setup parameters in a tabular form. The details of the SCPI for configuring the list sequencer can be found in ["Step](#)

Configuration (Remote Command Only)” on page 848.

Once the List Sequencer has been configured using the front panel, SCPI, or loading in a tab delimited file, the sequence must be initiated using the front panel Initiate Sequence key or the corresponding SCPI command.

Key Path:	Source
Initial S/W Revision:	A.05.00
Help Map ID:	35551

Sequencer

Allows you to set the state of the list sequencer. When the list sequencer is on, the source is outputting the sequence defined by the sequencer. When the list sequencer is off, the source outputs a single waveform segment or sequence (independent mode) at a single frequency and amplitude.

Key Path:	Source, List Sequencer
Remote Command:	:SOURce:LIST[:STATe] ON OFF 1 0 :SOURce:LIST[:STATe] ?
Example:	SOUR:LIST OFF
Notes:	When the sequencer is set to ON, the list sequencer controls the output of the source.
Couplings:	When in Sequence Analyzer mode and the list sequencer state is Off, Include Source is forced to No, and the Include Source key is grayed out. When in Sequence Analyzer mode and the list sequencer state is On, Include Source is available to set. And, an ARB memory related operation, like load or delete will be rejected.
Preset:	Off
Range:	On Off
Initial S/W Revision:	A.05.00
Help Map ID:	35552

Initiate Sequence

Pressing this key arms the sequence for single execution. Once the sequence is armed the source begins the sequence as soon as the trigger is received. If the trigger is set to Free Run, the sequence starts immediately.

Key Path:	Source, List Sequencer
Remote Command:	:SOURce:LIST:TRIGger[:IMMediate]
Example:	SOUR:LIST:TRIG

Source (Internal)

Notes:	<p>When in Sequence Analyzer mode and Include Source is Yes, the Initiate list sequencer operation is rejected, and the key is grayed out, since source list sequence request is sent to physics via Parallel batch by sequence analyzer.</p> <p>If the file needed by the sequencer is not already in ARB memory, the sequence cannot be initiated and an error will be generated.</p> <p>There is a blocking SCPI query which can be used to query if source list sequence being initiated successfully or not. (see “Query List Sequence Initiation Armed Status (Remote Command Only)” on page 858 Query Source List Sequence Armed Status)</p>
Dependencies:	Under the Sequence Analyzer Mode, if Meas Setup->Include Source is set to YES, Source->List Sequencer->Initiate Sequence is disabled.
Initial S/W Revision:	A.05.00
Help Map ID:	35554

Remote Software Trigger (Remote command Only)

During execution of a list sequence, the sequence will halt and wait at any step that has Step Trigger set to “Bus”. Sending this command will trigger the step and continue the sequence.

Remote Command:	:SOURce:LIST:TRIGger:INITiate[:IMMediate]
Example:	SOUR:LIST:TRIG:INIT
Initial S/W Revision:	A.05.00
Help Map ID:	35679

List Sequencer Setup

Allows you access to the list sequencer setup menus.

Key Path:	Source, List Sequencer
Help Map ID:	35555

Number of Steps

Allows you to specify the number of steps within the list sequence.

Key Path:	Source, List Sequencer, List Sequencer Setup
Remote Command:	:SOURce:LIST:NUMBer:STEPs <integer> :SOURce:LIST:NUMBer:STEPs?
Example:	SOUR:LIST:NUMB:STEP 1

Notes:	Increasing the number of steps creates additional steps at the end of the list, with all the settings within the steps set to their default values. Decreasing the number of steps removes steps from the end of the list. The settings within the removed steps are not reset. This means that increasing the number of steps again would allow you to retrieve these steps.
Dependencies:	The Step Count parameter is increased or decreased when you insert or delete a point from within the GUI interface to the sequencer.
Preset:	1
Min:	1
Max:	1000
Initial S/W Revision:	A.05.00
Help Map ID:	35556

Current Step

Allows you to select the step number you wish to view or edit.

Key Path:	Source, List Sequencer, List Sequencer Setup
Notes:	No remote command, front panel only.
Preset:	1
Min:	1
Max:	Step Count
Initial S/W Revision:	A.05.00
Help Map ID:	35557

Insert Step Before

Allows you to insert a new step, containing default values, before the currently selected step. Inserting a step will automatically increase the Step Count parameter by 1. If sequence already reaches upper limit of 1000 steps, then insert more step will be rejected and popup error -221, "Setting Conflict; Cannot insert more steps, maximum number of steps reached"

Key Path:	Source, List Sequencer, List Sequencer Setup
Notes:	No remote command, front panel only. If the list already contains the maximum limit of 1000 steps, no operation will be made after pressing this key.
Initial S/W Revision:	A.05.00
Help Map ID:	35558

Source (Internal)

Delete Step

Allows you to delete the current step. Deleting a step will automatically decrease the Step Count parameter by 1. If sequence only has one step left, delete step will be rejected and popup error –221, “Setting conflict; Cannot delete current step, minimum number of steps reached”

Key Path:	Source, List Sequencer, List Sequencer Setup
Notes:	No remote command, Front Panel key only. If the list already contains the minimum limit of 1 step, no operation will be made after pressing this key
Initial S/W Revision:	A.05.00
Help Map ID:	35559

Clear List

Allows you to clear the list. Clearing the list sets the number of steps to the default value of 1 and sets the parameters for the only step to their default values.

Key Path:	Source, List Sequencer, List Sequencer Setup
Initial S/W Revision:	A.05.00
Help Map ID:	35560

Step Trigger

Allows access to the sub-menu for selecting the trigger input for the current step.

Key Path:	Source, List Sequencer, List Sequencer Setup
Remote Command:	:SOURce:LIST:STEP[1] 2 3...1000:SETup:INPut:TRIGger IMMediate INTernal EXTernal2 KEY BUS :SOURce:LIST:STEP[1] 2 3...1000:SETup:INPut:TRIGger?
Example:	SOUR:LIST:STEP2:SET:INP:TRIG BUS SOUR:LIST:STEP2:SET:INP:TRIG?
Notes:	SCPI is supported after A.09.40
Preset:	Free Run
Range:	Free Run Internal Manual (Trigger Key) Bus External 2
Initial S/W Revision:	A.05.00
Help Map ID:	35561

Free Run

Sets the trigger input for the current step to Free Run.

Key Path:	Source, List Sequencer, List Sequencer Setup, Step Trigger
Example:	SOUR:LIST:STEP2:SET:INP:TRIG IMM
Notes:	SCPI is supported after A.09.40
Initial S/W Revision:	A.05.00
Help Map ID:	35562

Internal

Sets the trigger input for the current step to Internal.

Key Path:	Source, List Sequencer, List Sequencer Setup, Step Trigger
Example:	SOUR:LIST:STEP2:SET:INP:TRIG INT
Notes:	SCPI is supported after A.09.40
Initial S/W Revision:	A.05.00
Help Map ID:	35563

Manual (Trigger Key)

Sets the trigger input for the current step to Manual (Trigger Key). Any step in the sequence set to Manual will cause the sequence execution to stop until the manual trigger key is pressed. Sending the Bus Trigger SCPI command will have no effect. At any point in the sequence where the list sequencer is paused waiting for a software trigger, a pop up dialog is displayed until the trigger event occurs.

Key Path:	Source, List Sequencer, List Sequencer Setup, Step Trigger
Example:	SOUR:LIST:STEP2:SET:INP:TRIG KEY
Notes:	SCPI is supported after A.09.40
Initial S/W Revision:	A.05.00
Help Map ID:	35680

Bus

Sets the trigger input for the current step to Bus. Any step in the sequence set to Bus will cause the sequence execution to stop until the Bus Trigger SCPI command is sent. Pressing the manual trigger key has no effect. At any point in the sequence where the list sequencer is paused waiting for a software trigger, a pop up dialog is displayed until the trigger event occurs.

Key Path:	Source, List Sequencer, List Sequencer Setup, Step Trigger
Example:	SOUR:LIST:STEP2:SET:INP:TRIG BUS
Notes:	SCPI is supported after A.09.40

Source (Internal)

Initial S/W Revision:	A.05.00
Help Map ID:	35681

External 2

Sets the trigger input for the current step to External 2.

Key Path:	Source, List Sequencer, List Sequencer Setup, Step Trigger
Example:	SOUR:LIST:STEP2:SET:INP:TRIG EXT2
Notes:	SCPI is supported after A.09.40
Initial S/W Revision:	A.05.00
Help Map ID:	35564

Transition Time

Allows you to specify the transition time for the current step.

The transition time is the amount of time allowed for the source to settle at the current frequency or amplitude value.

Transition Time should not be taken as additional time before or inside the Step Duration. You can set a value for the settling time to allow the source output frequency or amplitude to become stable. Make sure that during this period of time, you do not use the source output signal.

The following table lists recommended values for appropriate settling times to allow for changes within the source.

Value Changed	Recommended Transition Time
Frequency	Switching within same frequency band: 300 μ s Switching across frequency bands: 1 ms The band ranges are: Frequency Band 1: -0.08 GHz to 0.6075 GHz Frequency Band 2: 0.5075 GHz to 2.1775 GHz Frequency Band 3: 2.0775 GHz to 3.6 GHz
Amplitude	500 μ s

If the Transition Time value is shorter than the time necessary for the hardware to settle and a List Sequence is initiated, a **warning** is generated.

If the Transition Time value is longer than the Step Duration, an error is generated when initiating a source list sequence. For source list sequence, transition time is included in the step duration length. If the Transition Time value is longer than the Step Duration Time, the real step duration length is extended to equal the transition time and cause a timing shift.

Key Path:	Source, List Sequencer, List Sequencer Setup
-----------	---

Remote Command:	:SOURCE:LIST:STEP [1] 2 3...1000:SETup:TRANSition:TIME <time> :SOURCE:LIST:STEP [1] 2 3...1000:SETup:TRANSition:TIME?
Example:	SOUR:LIST:STEP2:SET:TRAN:TIME 1ms SOUR:LIST:STEP2:SET:TRAN:TIME?
Notes:	SCPI is supported after A.09.40
Preset:	1.0 ms
Min:	0.0 ms
Max:	4.0 ks
Initial S/W Revision:	A.05.00
Help Map ID:	35571

Radio Setup

Allows you access to the sub-menus for setting up the radio standard, band, and radio band link direction for the current step.

Key Path:	Source, List Sequencer, List Sequencer Setup
Notes:	No remote command, front panel only.
Initial S/W Revision:	A.05.00
Help Map ID:	35572

Radio Standard

Allows access to the sub-menus for selecting the radio standard and the associated radio band for use in the current step.

Key Path:	Source, List Sequencer, List Sequencer Setup, Radio Setup
Remote Command:	:SOURCE:LIST:STEP [1] 2 3...1000:SETup:RADio:BAND NONE PGSM EGSM RGSM DCS1800 PCS1900 TGSM810 GSM450 GSM4 80 GSM700 GSM850 BANDI BANDII BANDIII BANDIV BANDV BAND VI BANDVII BANDVIII BANDIX BANDX BANDXI BANDXII BANDXII I BANDXIV USCELL USPCS JAPAN KOREAN NMT IMT2K UPPER SEC OND PAMR400 PAMR800 IMTEXT PCS1DOT9G AWS US2DOT5G PUBLI C LOWER NONE BAND1 BAND2 BAND3 BAND4 BAND5 BAND6 BAND7 BAND8 BAND10 BAND11 BAND12 BAND13 BAND14 BAND17 BAND18 BAND19 BAND20 BAND21 BAND24 BAND25 BAND33 BAND34 BAND35 BAND36 BAND37 BAND38 BAND39 BAND40 BAND41 BAND42 BAND4 3 BANDA BANDB BANDC BANDD BANDE BANDF :SOURCE:LIST:STEP [1] 2 3...1000:SETup: RADio:BAND?
Example:	SOUR:LIST:STEP2:SET:RAD:BAND PGSM SOUR:LIST:STEP2:SET:RAD:BAND?

Source (Internal)

Notes:	SCPI is supported after A.09.40
Initial S/W Revision:	A.05.00
Help Map ID:	35573

None

Selects no radio standard for use on the current step.

Key Path:	Source, List Sequencer, List Sequencer Setup, Radio Setup, Radio Standard
Example:	SOUR:LIST:STEP2:SET:RAD:BAND NONE
Notes:	SCPI is supported after A.09.40
Initial S/W Revision:	A.05.00
Help Map ID:	35574

GSM/EDGE

Pressing this key once selects GSM/EDGE as the radio standard and the current GSM/EDGE band as the active channel band. Pressing this key again allows access to the sub-menus for selecting a different GSM/EDGE band.

Key Path:	Source, List Sequencer, List Sequencer Setup, Radio Setup, Radio Standard
Initial S/W Revision:	A.05.00
Help Map ID:	35575

P-GSM

Selects P-GSM as the band for the current step.

Key Path:	Source, List Sequencer, List Sequencer Setup, Radio Setup, Radio Standard, GSM/EDGE
Initial S/W Revision:	A.05.00
Help Map ID:	35576

E-GSM

Selects E-GSM as the band for the current step.

Key Path:	Source, List Sequencer, List Sequencer Setup, Radio Setup, Radio Standard, GSM/EDGE
Initial S/W Revision:	A.05.00
Help Map ID:	35577

R-GSM

Selects R-GSM as the band for the current step.

Key Path:	Source, List Sequencer, List Sequencer Setup, Radio Setup, Radio Standard, GSM/EDGE
Initial S/W Revision:	A.05.00
Help Map ID:	35578

DCS 1800

Selects DCS 1800 as the band for the current step.

Key Path:	Source, List Sequencer, List Sequencer Setup, Radio Setup, Radio Standard, GSM/EDGE
Initial S/W Revision:	A.05.00
Help Map ID:	35579

PCS 1900

Selects PCS 1900 as the band for the current step.

Key Path:	Source, List Sequencer, List Sequencer Setup, Radio Setup, Radio Standard, GSM/EDGE
Initial S/W Revision:	A.05.00
Help Map ID:	35580

GSM 450

Selects GSM 450 as the band for the current step.

Key Path:	Source, List Sequencer, List Sequencer Setup, Radio Setup, Radio Standard, GSM/EDGE
Initial S/W Revision:	A.05.00
Help Map ID:	35582

GSM 480

Selects GSM 480 as the band for the current step.

Key Path:	Source, List Sequencer, List Sequencer Setup, Radio Setup, Radio Standard, GSM/EDGE
Initial S/W Revision:	A.05.00
Help Map ID:	35583

Source (Internal)

GSM 850

Selects GSM 850 as the band for the current step.

Key Path:	Source, List Sequencer, List Sequencer Setup, Radio Setup, Radio Standard, GSM/EDGE
Initial S/W Revision:	A.05.00
Help Map ID:	35585

GSM 700

Selects GSM 700 as the band for the current step.

Key Path:	Source, List Sequencer, List Sequencer Setup, Radio Setup, Radio Standard, GSM/EDGE
Initial S/W Revision:	A.05.00
Help Map ID:	35584

T-GSM 810

Selects T-GSM 810 as the band for the current step.

Key Path:	Source, List Sequencer, List Sequencer Setup, Radio Setup, Radio Standard, GSM/EDGE
Initial S/W Revision:	A.05.00
Help Map ID:	35581

WCDMA

Pressing this key once selects WCDMA as the radio standard and the current WCDMA band as the active channel band. Pressing this key again allows access to the sub-menus for selecting a different WCDMA band.

Key Path:	Source, List Sequencer, List Sequencer Setup, Radio Setup, Radio Standard
Initial S/W Revision:	A.05.00
Help Map ID:	35586

Band I

Selects Band I as the band for the current step.

Key Path:	Source, List Sequencer, List Sequencer Setup, Radio Setup, Radio Standard, WCDMA
Initial S/W Revision:	A.05.00
Help Map ID:	35587

Band II

Selects Band II as the band for the current step.

Key Path:	Source, List Sequencer, List Sequencer Setup, Radio Setup, Radio Standard, WCDMA
Initial S/W Revision:	A.05.00
Help Map ID:	35588

Band III

Selects Band III as the band for the current step.

Key Path:	Source, List Sequencer, List Sequencer Setup, Radio Setup, Radio Standard, WCDMA
Initial S/W Revision:	A.05.00
Help Map ID:	35589

Band IV

Selects Band IV as the band for the current step.

Key Path:	Source, List Sequencer, List Sequencer Setup, Radio Setup, Radio Standard, WCDMA
Initial S/W Revision:	A.05.00
Help Map ID:	35590

Band V

Selects Band V as the band for the current step.

Key Path:	Source, List Sequencer, List Sequencer Setup, Radio Setup, Radio Standard, WCDMA
Initial S/W Revision:	A.05.00
Help Map ID:	35591

Band VI

Selects Band VI as the band for the current step.

Key Path:	Source, List Sequencer, List Sequencer Setup, Radio Setup, Radio Standard, WCDMA
Initial S/W Revision:	A.05.00
Help Map ID:	35592

Source (Internal)

Band VII

Selects Band VII as the band for the current step.

Key Path:	Source, List Sequencer, List Sequencer Setup, Radio Setup, Radio Standard, WCDMA
Initial S/W Revision:	A.05.00
Help Map ID:	35593

Band VIII

Selects Band VIII as the band for the current step.

Key Path:	Source, List Sequencer, List Sequencer Setup, Radio Setup, Radio Standard, WCDMA
Initial S/W Revision:	A.05.00
Help Map ID:	35594

Band IX

Selects Band IX as the band for the current step.

Key Path:	Source, List Sequencer, List Sequencer Setup, Radio Setup, Radio Standard, WCDMA
Initial S/W Revision:	A.05.00
Help Map ID:	35595

Band X

Selects Band X as the band for the current step.

Key Path:	Source, List Sequencer, List Sequencer Setup, Radio Setup, Radio Standard, WCDMA
Initial S/W Revision:	A.05.00
Help Map ID:	35596

Band XI

Selects Band XI as the band for the current step.

Key Path:	Source, List Sequencer, List Sequencer Setup, Radio Setup, Radio Standard, WCDMA
Initial S/W Revision:	A.05.00
Help Map ID:	35597

Band XII

Selects Band XII as the band for the current step.

Key Path:	Source, List Sequencer, List Sequencer Setup, Radio Setup, Radio Standard, WCDMA
Initial S/W Revision:	A.05.00
Help Map ID:	35598

Band XIII

Selects Band XIII as the band for the current step.

Key Path:	Source, List Sequencer, List Sequencer Setup, Radio Setup, Radio Standard, WCDMA
Initial S/W Revision:	A.05.00
Help Map ID:	35599

Band XIV

Selects Band XIV as the band for the current step.

Key Path:	Source, List Sequencer, List Sequencer Setup, Radio Setup, Radio Standard, WCDMA
Initial S/W Revision:	A.05.00
Help Map ID:	35600

CDMA 2000 / 1xEVDO

Pressing this key once selects CDMA 2000/1xEVDO as the radio standard and the current CDMA 2000/1xEVDO band as the active channel band. Pressing this key again allows access to the sub-menus for selecting a different CDMA 2000/1xEVDO band.

Key Path:	Source, List Sequencer, List Sequencer Setup, Radio Setup, Radio Standard
Initial S/W Revision:	A.05.00
Help Map ID:	35601

US CELL

Selects US Cell as the band for the current step.

Key Path:	Source, List Sequencer, List Sequencer Setup, Radio Setup, Radio Standard, CDMA 2000 / 1xEVDO
Initial S/W Revision:	A.05.00
Help Map ID:	35602

Source (Internal)

US PCS

Selects US PCS as the band for the current step.

Key Path:	Source, List Sequencer, List Sequencer Setup, Radio Setup, Radio Standard, CDMA 2000 / 1xEVDO
Initial S/W Revision:	A.05.00
Help Map ID:	35603

Japan Cell

Selects Japan Cell as the band for the current step.

Key Path:	Source, List Sequencer, List Sequencer Setup, Radio Setup, Radio Standard, CDMA 2000 / 1xEVDO
Initial S/W Revision:	A.05.00
Help Map ID:	35604

Korean PCS

Selects Korean PCS as the band for the current step.

Key Path:	Source, List Sequencer, List Sequencer Setup, Radio Setup, Radio Standard, CDMA 2000 / 1xEVDO
Initial S/W Revision:	A.05.00
Help Map ID:	35605

NMT 450

Selects NMT 450 as the band for the current step.

Key Path:	Source, List Sequencer, List Sequencer Setup, Radio Setup, Radio Standard, CDMA 2000 / 1xEVDO
Initial S/W Revision:	A.05.00
Help Map ID:	35606

IMT 2000

Selects IMT 2000 as the band for the current step.

Key Path:	Source, List Sequencer, List Sequencer Setup, Radio Setup, Radio Standard, CDMA 2000 / 1xEVDO
Initial S/W Revision:	A.05.00
Help Map ID:	35607

Upper 700

Selects Upper 700 as the band for the current step.

Key Path:	Source, List Sequencer, List Sequencer Setup, Radio Setup, Radio Standard, CDMA 2000 / 1xEVDO
Initial S/W Revision:	A.05.00
Help Map ID:	35608

Secondary 800

Selects Secondary 800 as the band for the current step.

Key Path:	Source, List Sequencer, List Sequencer Setup, Radio Setup, Radio Standard, CDMA 2000 / 1xEVDO
Initial S/W Revision:	A.05.00
Help Map ID:	35609

400 Euro PAMR

Selects 400 Euro PAMR as the band for the current step.

Key Path:	Source, List Sequencer, List Sequencer Setup, Radio Setup, Radio Standard, CDMA 2000 / 1xEVDO
Initial S/W Revision:	A.05.00
Help Map ID:	35610

800 PAMR

Selects 800 PAMR as the band for the current step.

Key Path:	Source, List Sequencer, List Sequencer Setup, Radio Setup, Radio Standard, CDMA 2000 / 1xEVDO
Initial S/W Revision:	A.05.00
Help Map ID:	35611

2.5GHz IMT EXT

Selects 2.5 GHz IMT EXT as the band for the current step.

Key Path:	Source, List Sequencer, List Sequencer Setup, Radio Setup, Radio Standard, CDMA 2000 / 1xEVDO
Initial S/W Revision:	A.05.00
Help Map ID:	35612

Source (Internal)

US PCS 1.9GHz

Selects US PCS 1.9 GHz as the band for the current step.

Key Path:	Source, List Sequencer, List Sequencer Setup, Radio Setup, Radio Standard, CDMA 2000 / 1xEVDO
Initial S/W Revision:	A.05.00
Help Map ID:	35613

AWS

Selects AWS as the band for the current step.

Key Path:	Source, List Sequencer, List Sequencer Setup, Radio Setup, Radio Standard, CDMA 2000 / 1xEVDO
Initial S/W Revision:	A.05.00
Help Map ID:	35614

US 2.5GHz

Selects US 2.5 GHz as the band for the current step.

Key Path:	Source, List Sequencer, List Sequencer Setup, Radio Setup, Radio Standard, CDMA 2000 / 1xEVDO
Initial S/W Revision:	A.05.00
Help Map ID:	35615

700 Public Safety

Selects 700 Public Safety as the band for the current step.

Key Path:	Source, List Sequencer, List Sequencer Setup, Radio Setup, Radio Standard, CDMA 2000 / 1xEVDO
Initial S/W Revision:	A.05.00
Help Map ID:	35616

C2K Lower 700

Selects C2K Lower 700 as the band for the current step.

Key Path:	Source, List Sequencer, List Sequencer Setup, Radio Setup, Radio Standard, CDMA 2000 / 1xEVDO
Initial S/W Revision:	A.05.00
Help Map ID:	35617

LTE

Pressing this key once selects LTE FDD as the radio standard and the current LTE FDD band as the active channel band. Pressing this key again allows access to the sub-menus for selecting a different LTE FDD band.

Key Path:	Source, List Sequencer, List Sequencer Setup, Radio Setup, Radio Standard
Initial S/W Revision:	A.09.50
Help Map ID:	35723

BAND 1

Selects BAND 1 as the band for the current step.

Key Path:	Source, List Sequencer, List Sequencer Setup, Radio Setup, Radio Standard, LTE
Initial S/W Revision:	A.09.50
Help Map ID:	35724

BAND 2

Selects BAND 2 as the band for the current step.

Key Path:	Source, List Sequencer, List Sequencer Setup, Radio Setup, Radio Standard, LTE
Initial S/W Revision:	A.09.50
Help Map ID:	35725

BAND 3

Selects BAND 3 as the band for the current step.

Key Path:	Source, List Sequencer, List Sequencer Setup, Radio Setup, Radio Standard, LTE
Initial S/W Revision:	A.09.50
Help Map ID:	35726

BAND 4

Selects BAND 4 as the band for the current step.

Key Path:	Source, List Sequencer, List Sequencer Setup, Radio Setup, Radio Standard, LTE
Initial S/W Revision:	A.09.50
Help Map ID:	35727

Source (Internal)

BAND 5

Selects BAND 5 as the band for the current step.

Key Path:	Source, List Sequencer, List Sequencer Setup, Radio Setup, Radio Standard, LTE
Initial S/W Revision:	A.09.50
Help Map ID:	35728

BAND 6

Selects BAND 6 as the band for the current step.

Key Path:	Source, List Sequencer, List Sequencer Setup, Radio Setup, Radio Standard, LTE
Initial S/W Revision:	A.09.50
Help Map ID:	35729

BAND 7

Selects BAND 7 as the band for the current step.

Key Path:	Source, List Sequencer, List Sequencer Setup, Radio Setup, Radio Standard, LTE
Initial S/W Revision:	A.09.50
Help Map ID:	35730

BAND 8

Selects BAND 8 as the band for the current step.

Key Path:	Source, List Sequencer, List Sequencer Setup, Radio Setup, Radio Standard, LTE
Initial S/W Revision:	A.09.50
Help Map ID:	35731

BAND 9

Selects BAND 9 as the band for the current step.

Key Path:	Source, List Sequencer, List Sequencer Setup, Radio Setup, Radio Standard, LTE
Initial S/W Revision:	A.09.50
Help Map ID:	35732

BAND 10

Selects BAND 10 as the band for the current step.

Key Path:	Source, List Sequencer, List Sequencer Setup, Radio Setup, Radio Standard, LTE
Initial S/W Revision:	A.09.50
Help Map ID:	35733

BAND 11

Selects BAND 11 as the band for the current step.

Key Path:	Source, List Sequencer, List Sequencer Setup, Radio Setup, Radio Standard, LTE
Initial S/W Revision:	A.09.50
Help Map ID:	35734

BAND 12

Selects BAND 12 as the band for the current step.

Key Path:	Source, List Sequencer, List Sequencer Setup, Radio Setup, Radio Standard, LTE
Initial S/W Revision:	A.09.50
Help Map ID:	35735

BAND 13

Selects BAND 13 as the band for the current step.

Key Path:	Source, List Sequencer, List Sequencer Setup, Radio Setup, Radio Standard, LTE
Initial S/W Revision:	A.09.50
Help Map ID:	35736

BAND 14

Selects BAND 14 as the band for the current step.

Key Path:	Source, List Sequencer, List Sequencer Setup, Radio Setup, Radio Standard, LTE
Initial S/W Revision:	A.09.50
Help Map ID:	35737

Source (Internal)

BAND 17

Selects BAND 17 as the band for the current step.

Key Path:	Source, List Sequencer, List Sequencer Setup, Radio Setup, Radio Standard, LTE
Initial S/W Revision:	A.09.50
Help Map ID:	35738

BAND 18

Selects BAND 18 as the band for the current step.

Key Path:	Source, List Sequencer, List Sequencer Setup, Radio Setup, Radio Standard, LTE
Initial S/W Revision:	A.09.50
Help Map ID:	35739

BAND 19

Selects BAND 19 as the band for the current step.

Key Path:	Source, List Sequencer, List Sequencer Setup, Radio Setup, Radio Standard, LTE
Initial S/W Revision:	A.09.50
Help Map ID:	35740

BAND 20

Selects BAND 20 as the band for the current step.

Key Path:	Source, List Sequencer, List Sequencer Setup, Radio Setup, Radio Standard, LTE
Initial S/W Revision:	A.09.50
Help Map ID:	35741

BAND 21

Selects BAND 21 as the band for the current step.

Key Path:	Source, List Sequencer, List Sequencer Setup, Radio Setup, Radio Standard, LTE
Initial S/W Revision:	A.09.50
Help Map ID:	35742

BAND 24

Selects BAND 24 as the band for the current step.

Key Path:	Source, List Sequencer, List Sequencer Setup, Radio Setup, Radio Standard, LTE
Initial S/W Revision:	A.09.50
Help Map ID:	35743

BAND 25

Selects BAND 25 as the band for the current step.

Key Path:	Source, List Sequencer, List Sequencer Setup, Radio Setup, Radio Standard, LTE
Initial S/W Revision:	A.09.50
Help Map ID:	35744

LTE TDD

Pressing this key once selects LTE TDD as the radio standard and the current LTE TDD band as the active channel band. Pressing this key again allows access to the sub-menus for selecting a different LTE TDD band

Key Path:	Source, List Sequencer, List Sequencer Setup, Radio Setup, Radio Standard
Initial S/W Revision:	A.11.50
Help Map ID:	35785

BAND 33

Selects BAND 33 as the band for the current step.

Key Path:	Source, List Sequencer, List Sequencer Setup, Radio Setup, Radio Standard, LTE TDD
Initial S/W Revision:	A.11.50
Help Map ID:	35786

BAND 34

Selects BAND 34 as the band for the current step.

Key Path:	Source, List Sequencer, List Sequencer Setup, Radio Setup, Radio Standard, LTE TDD
Initial S/W Revision:	A.11.50
Help Map ID:	35787

Source (Internal)

BAND 35

Selects BAND 35 as the band for the current step.

Key Path:	Source, List Sequencer, List Sequencer Setup, Radio Setup, Radio Standard, LTE TDD
Initial S/W Revision:	A.11.50
Help Map ID:	35788

BAND 36

Selects BAND 36 as the band for the current step.

Key Path:	Source, List Sequencer, List Sequencer Setup, Radio Setup, Radio Standard, LTE TDD
Initial S/W Revision:	A.11.50
Help Map ID:	35789

BAND 37

Selects BAND 37 as the band for the current step.

Key Path:	Source, List Sequencer, List Sequencer Setup, Radio Setup, Radio Standard, LTE TDD
Initial S/W Revision:	A.11.50
Help Map ID:	35790

BAND 38

Selects BAND 38 as the band for the current step.

Key Path:	Source, List Sequencer, List Sequencer Setup, Radio Setup, Radio Standard, LTE TDD
Initial S/W Revision:	A.11.50
Help Map ID:	35791

BAND 39

Selects BAND 39 as the band for the current step.

Key Path:	Source, List Sequencer, List Sequencer Setup, Radio Setup, Radio Standard, LTE TDD
Initial S/W Revision:	A.11.50
Help Map ID:	35792

BAND 40

Selects BAND 40 as the band for the current step.

Key Path:	Source, List Sequencer, List Sequencer Setup, Radio Setup, Radio Standard, LTE TDD
Initial S/W Revision:	A.11.50
Help Map ID:	35793

BAND 41

Selects BAND 41 as the band for the current step.

Key Path:	Source, List Sequencer, List Sequencer Setup, Radio Setup, Radio Standard, LTE TDD
Initial S/W Revision:	A.11.50
Help Map ID:	35794

BAND 42

Selects BAND 42 as the band for the current step.

Key Path:	Source, List Sequencer, List Sequencer Setup, Radio Setup, Radio Standard, LTE TDD
Initial S/W Revision:	A.11.50
Help Map ID:	35795

BAND 43

Selects BAND 43 as the band for the current step.

Key Path:	Source, List Sequencer, List Sequencer Setup, Radio Setup, Radio Standard, LTE TDD
Initial S/W Revision:	A.11.50
Help Map ID:	35796

TDSCDMA

Pressing this key once selects TDSCDMA as the radio standard and the current TDSCDMA band as the active channel band. Pressing this key again allows access to the sub-menus for selecting a different TDSCDMA band

Key Path:	Source, List Sequencer, List Sequencer Setup, Radio Setup, Radio Standard
Initial S/W Revision:	A.11.50
Help Map ID:	35797

Source (Internal)

BAND A

Selects BAND A as the band for the current step.

Key Path:	Source, List Sequencer, List Sequencer Setup, Radio Setup, Radio Standard, TDSCDMA
Initial S/W Revision:	A.11.50
Help Map ID:	35798

BAND B

Selects BAND B as the band for the current step.

Key Path:	Source, List Sequencer, List Sequencer Setup, Radio Setup, Radio Standard, TDSCDMA
Initial S/W Revision:	A.11.50
Help Map ID:	35799

BAND C

Selects BAND C as the band for the current step.

Key Path:	Source, List Sequencer, List Sequencer Setup, Radio Setup, Radio Standard, TDSCDMA
Initial S/W Revision:	A.11.50
Help Map ID:	35800

BAND D

Selects BAND D as the band for the current step.

Key Path:	Source, List Sequencer, List Sequencer Setup, Radio Setup, Radio Standard, TDSCDMA
Initial S/W Revision:	A.11.50
Help Map ID:	35801

BAND E

Selects BAND E as the band for the current step.

Key Path:	Source, List Sequencer, List Sequencer Setup, Radio Setup, Radio Standard, TDSCDMA
Initial S/W Revision:	A.11.50
Help Map ID:	35802

BAND F

Selects BAND F as the band for the current step.

Key Path:	Source, List Sequencer, List Sequencer Setup, Radio Setup, Radio Standard, TDSCDMA
Initial S/W Revision:	A.11.50
Help Map ID:	35803

Radio Band Link

Allows you to specify the radio band link direction for the steps within the list sequence. The link is used in conjunction with the channel band and channel number to determine the output frequency.

When set to “Uplink”, the source will calculate the uplink frequency according to an uplink formula together with selected channel band and channel number. When set to “Downlink”, the source will calculate the downlink frequency according to a downlink formula together with selected channel band and channel number.

Key Path:	Source, List Sequencer, List Sequencer Setup, Radio Setup
Remote Command:	:SOURCE:LIST:STEP [1] 2 3...1000:SETup:RADio:BAND:LINK DOWN UP :SOURCE:LIST:STEP [1] 2 3...1000:SETup:RADio:BAND:LINK?
Example:	SOUR:LIST:STEP2:SET:RAD:BAND:LINK UP SOUR:LIST:STEP2:SET:RAD:BAND:LINK?
Notes:	SCPI is supported after A.09.40
Preset:	DOWN
Range:	DOWN UP
Initial S/W Revision:	A.05.00
Help Map ID:	35685

Channel

Allows you to specify the frequency of the current step via a channel number.

Key Path:	Source, List Sequencer, List Sequencer Setup
Remote Command:	:SOURCE:LIST:STEP [1] 2 3...1000:SETup:CNFRequency <double> :SOURCE:LIST:STEP [1] 2 3...1000:SETup:CNFRequency?
Example:	SOUR:LIST:STEP2:SET:CNFR 124 SOUR:LIST:STEP2:SET:CNFR?

Source (Internal)

Notes:	SCPI is supported after A.09.40. This SCPI is used to setup channel number or frequency setting, according to current Radio Band setting. If Radio Band is “NONE”, then it’s frequency. If Radio Band is not “NONE”, then it’s channel number.
Couplings:	The channel number is coupled to the step frequency value. When the step frequency value is changed, the channel number will increase or decrease to match the new step frequency. If the step frequency is not at an exact match for a channel number, the nearest channel number is displayed, along with a greater than, or less than sign to indicate the frequency is above or below the channel number.
Preset:	1
Min:	0 (Please refer to for valid ranges.)
Max:	10838 (Please refer to for valid ranges.)
Initial S/W Revision:	A.05.00
Help Map ID:	35619

Frequency

Allows you to specify a frequency value for the current step.

Key Path:	Source, List Sequencer, List Sequencer Setup
Remote Command:	:SOURce:LIST:STEP [1] 2 3...1000 :SETup:CNFRfrequency <double> :SOURce:LIST:STEP [1] 2 3...1000 :SETup:CNFRfrequency?
Example:	SOUR:LIST:STEP2:SET:CNFR 1GHz SOUR:LIST:STEP2:SET:CNFR?
Notes:	SCPI is supported after A.09.40. This SCPI is used to setup channel number or frequency setting, according to current Radio Band setting. If Radio Band is “NONE”, then it’s frequency. If Radio Band is not “NONE”, then it’s channel number.
Couplings:	The frequency value is coupled to the channel band and number for the step, such that updates to the radio band and channel number will update the frequency value to the corresponding absolute frequency. The reverse is also true, changing the frequency value causes the value of the channel number to be updated.
Preset:	1.00 GHz
Min:	10.00 MHz
Max:	Hardware Dependant: Option 503 = 3.6 GHz Option 504 = 3.8 GHz

Initial S/W Revision:	A.05.00
Help Map ID:	35620

Power

Allows you to specify a power value for the current step.

Key Path:	Source, List Sequencer, List Sequencer Setup
Remote Command:	:SOURce:LIST:STEP [1] 2 3...1000:SETup:AMPLitude <double> :SOURce:LIST:STEP [1] 2 3...1000:SETup:AMPLitude?
Example:	SOUR:LIST:STEP2:SET:AMPL -50dBm SOUR:LIST:STEP2:SET:AMPL?
Notes:	SCPI is supported after A.09.40
Notes:	Amplitude corrections can be specified for use with the source. In the event of amplitude corrections being applied, the valid ranges for the RF power do not change dependant on the current amplitude correction setting. Instead, if the combination of RF power + amplitude correction is higher or lower than the source output range, the Source Unleveled bit is set and the “Source Unleveled” indicator will appear on status panel to indicate that the source cannot maintain the output power that has been requested.
Notes:	The Min and Max value here defined UI settable amplitude range. This range is larger than actual amplitude range with level accuracy defined in spec.
Dependencies:	The RF power is dependent on the RF output port and frequency, such that the current frequency and selected output port determine the valid range of power values.
Preset:	-100 dBm
Min:	The range of values depends on the current frequency and selected RF output port. Please refer to “RF Power” on page 726 and the table RF Power Range for the valid ranges.
Max:	The range of values depends on the current frequency and selected RF output port. Please refer to “RF Power” on page 726 and the table RF Power Range for the valid ranges.
Initial S/W Revision:	A.05.00
Help Map ID:	35621

Waveform

Allows you access to the sub-menus for selecting the waveform to be played back during the current step. Pressing this key also changes the central display area to show the Waveform File Selection view.

Key Path:	Source, List Sequencer, List Sequencer Setup
-----------	---

Source (Internal)

Remote Command:	:SOURce:LIST:STEP[1] 2 3...1000:SETup:WAVEform <string> :SOURce:LIST:STEP[1] 2 3...1000:SETup:WAVEform?
Example:	SOUR:LIST:STEP2:SET:WAV "CW" SOUR:LIST:STEP2:SET:WAV?
Notes:	SCPI is supported after A.09.40
Remote Command Notes:	String type, takes "Off" "CW" "Cont" "waveform name"
Preset:	CW
Range:	Waveform Continue Previous CW Off
Initial S/W Revision:	A.05.00
Help Map ID:	35622

CW

Sets the current step to output a CW tone.

Key Path:	Source, List Sequencer, List Sequencer Setup, Waveform
Example:	SOUR:LIST:STEP2:SET:WAV "CW"
Notes:	SCPI is supported after A.09.40
Initial S/W Revision:	A.05.00
Help Map ID:	35625

Selected Waveform

Inserts the currently selected waveform in the waveform selection view as the waveform for playback during the current step.

Key Path:	Source, List Sequencer, List Sequencer Setup, Waveform
Example:	SOUR:LIST:STEP2:SET:WAV "waveform name"
Notes:	SCPI is supported after A.09.40 If the selected waveform contains header (which contains ARB play parameters), source list sequence will automatically apply header settings of the selected waveform in that step.
Initial S/W Revision:	A.05.00
Help Map ID:	35623

Continue Previous

Sets the current step to continue with playback of the waveform from the previous step. When continuing the previous waveform, the ARB playback will not pause while the source retunes to the new frequency or amplitude

that may be defined for the new step.

Key Path:	Source, List Sequencer, List Sequencer Setup, Waveform
Example:	SOUR:LIST:STEP2:SET:WAV "Cont"
Notes:	SCPI is supported after A.09.40
Initial S/W Revision:	A.05.00
Help Map ID:	35624

Off

Disable RF output of the current step.

Key Path:	Source, List Sequencer, List Sequencer Setup, Waveform
Example:	SOUR:LIST:STEP2:SET:WAV "Off"
Notes:	SCPI is supported after A.09.40
Initial S/W Revision:	A.05.00
Help Map ID:	35683

Segments on Hard Disk

This key functions the same as ["Segments on Hard Disk"](#) on page 766.

Key Path:	Source, List Sequencer, List Sequencer Setup, Waveform
Initial S/W Revision:	Prior to A.09.00
Help Map ID:	0

Load Segment To ARB Memory

This key functions the same as ["Load Segment To ARB Memory"](#) on page 767.

Key Path:	Source, List Sequencer, List Sequencer Setup, Waveform, Segment on Hard Drive
Initial S/W Revision:	Prior to A.09.00
Help Map ID:	0

Load All To ARB Memory

This key functions the same as ["Load All To ARB Memory"](#) on page 768.

Key Path:	Source, List Sequencer, List Sequencer Setup, Waveform, Segment on Hard Drive
Initial S/W Revision:	Prior to A.09.00
Help Map ID:	0

Source (Internal)

Change Directory ...

This key functions the same as [“Change Directory...”](#) on page 768.

Key Path:	Source, List Sequencer, List Sequencer Setup, Waveform, Segment on Hard Drive
Initial S/W Revision:	Prior to A.09.00
Help Map ID:	0

Default Directory ...

This key functions the same as [“Default Directory...”](#) on page 769

Key Path:	Source, List Sequencer, List Sequencer Setup, Waveform, Segment on Hard Drive
Initial S/W Revision:	Prior to A.09.00
Help Map ID:	0

Segments in ARB Memory

This key functions the same as [“Segments in ARB Memory”](#) on page 769.

Key Path:	Source, List Sequencer, List Sequencer Setup, Waveform, Segments in ARB Memory
Initial S/W Revision:	Prior to A.09.00
Help Map ID:	0

Delete Segment From ARB Memory

This key functions the same as [“Delete Segment From ARB Mem”](#) on page 769.

Key Path:	Source, List Sequencer, List Sequencer Setup, Waveform, Segments in ARB Memory, Segment in ARB Memory
Initial S/W Revision:	Prior to A.09.00
Help Map ID:	0

Delete All From ARB Memory

This key functions the same as [“Delete All From ARB Memory”](#) on page 770.

Key Path:	Source, List Sequencer, List Sequencer Setup, Waveform, Segments in ARB Memory, Segment in ARB Memory
Initial S/W Revision:	Prior to A.09.00
Help Map ID:	0

Step Duration

Allows access to the sub-menus for setting up the duration of play for the current step.

The duration can be set to be either the number of times for the ARB file associated with the sequence to play, or a specific time value, or continuous. If the step is set to play a CW tone, the step duration cannot be set to a play count.

Key Path:	Source, List Sequencer, List Sequencer Setup
Remote Command:	:SOURce:LIST:STEP [1] 2 3...1000:SETup:DURation:TYPE TIME COUNT CONTInuous :SOURce:LIST:STEP [1] 2 3...1000:SETup:DURation:TYPE?
Example:	SOUR:LIST:STEP2:SET:DUR:TYPE TIME SOUR:LIST:STEP2:SET:DUR:TYPE?
Notes:	SCPI is supported after A.09.40
Notes:	If “Step Duration” is set to “Time” or “Play Count” for the last step, the last step of ARB keeps playing as if set to “Continuous”, until the set “Time” has expired or until the “Play Count” setting is reached.
Range:	Time Play Count Continuous
Initial S/W Revision:	A.05.00
Help Map ID:	35626

Time

Sets the duration of the current step to be a time value for the length of time the step will play. Pressing this key again opens another menu which allows you to set the time value for the step duration.

Key Path:	Source, List Sequencer, List Sequencer Setup, Step Duration
Example:	SOUR:LIST:STEP2:SET:DUR:TYPE TIME
Notes:	SCPI is supported after A.09.40
Initial S/W Revision:	A.05.00
Help Map ID:	35627

Duration Time

Allows you to specify the length of time the current step will play.

If the Transition Time value is longer than the Step Duration Time, an error is generated when initiating a source list sequence. For source list sequence, transition time is included in the step duration length. If the Transition Time value is longer than the Step Duration Time, the real step duration length is extended to equal the transition time and cause a timing shift.

Key Path:	Source, List Sequencer, List Sequencer Setup, Step Duration, Time
-----------	--

Source (Internal)

Remote Command:	:SOURce:LIST:STEP [1] 2 3...1000:SETup:DURation:TCOUNT <double> :SOURce:LIST:STEP [1] 2 3...1000:SETup:DURation:TCOUNT?
Example:	SOUR:LIST:STEP2:SET:DUR:TCO 1s SOUR:LIST:STEP2:SET:DUR:TCO?
Notes:	SCPI is supported after A.09.40 This SCPI is reused by “Play Count” and “Duration Time” according to current Duration Type setting if “Play Count” or “Duration Time”. If current “Duration Type” is “Continuous”, then popup error -221, "Settings conflict; Cannot accept time or count input when step duration type is Continuous on step #"
Notes:	If “Duration Time” is set for the last step, the last step of ARB keeps playing as if set to “Continuous” after set time expires. However, you can query Source Sweeping Condition Message (:STAT:OPER:COND?) to find out if the current list sequence is complete or not.
Preset:	1.00 ms
Min:	100 µs
Max:	1800 s
Initial S/W Revision:	A.05.00
Help Map ID:	35628

Play Count

Sets the duration of the current step to be an integer value for the number of times (play count) the ARB file is selected for playback during this step. For example, a 5 second ARB will be set to play 5 times during the step.

Key Path:	Source, List Sequencer, List Sequencer Setup, Step Duration
Example:	SOUR:LIST:STEP2:SET:DUR:TYPE COUN
Notes:	SCPI is supported after A.09.40 This key is unavailable and is grayed out if the current step is configured to CW tone rather than an ARB waveform.
Initial S/W Revision:	A.05.00
Help Map ID:	35684

Play Count

Allows you to specify the number of times the current ARB waveform file will play during a step.

Key Path:	Source, List Sequencer, List Sequencer Setup, Step Duration, Time, Play Count
-----------	--

Remote Command:	:SOURCE:LIST:STEP [1] 2 3...1000:SETup:DURation:TCOunt <double> :SOURCE:LIST:STEP [1] 2 3...1000:SETup:DURation:TCOunt?
Example:	SOUR:LIST:STEP2:SET:DUR:TCO 10 SOUR:LIST:STEP2:SET:DUR:TCO?
Notes:	SCPI is supported after A.09.40 This SCPI is reused by “Play Count” and “Duration Time” according to current Duration Type setting if “Play Count” or “Duraton Time”. If current “Duration Type” is “Continuous”, then popup error –221, "Settings conflict;Cannot accept time or count input when step duration type is Continuous on step #"
Notes:	If “Play Count” is set for the last step, the last step of ARB keeps playing as if set to “Continuous” after play count setting is reached.
Preset:	1
Min:	1
Max:	65536
Initial S/W Revision:	A.05.00
Help Map ID:	35629

Continuous

Sets the current step to be played continuously until the next step starts.

Key Path:	Source, List Sequencer, List Sequencer Setup, Step Duration
Example:	SOUR:LIST:STEP2:SET:DUR:TYPE CONT
Notes:	SCPI is supported after A.09.40
Initial S/W Revision:	A.05.00
Help Map ID:	35630

Output Trigger

Allows you to specify the trigger output for the current step. The trigger output signal is sent at the start of the step.

When select “On”, trigger event will occur on both Internal and External2 paths. Select “Off” will turn off trigger output.

Key Path:	Source, List Sequencer, List Sequencer Setup
Remote Command:	:SOURCE:LIST:STEP [1] 2 3...1000:SETup:OUTPut:TRIGger ON OFF 1 0 :SOURCE:LIST:STEP [1] 2 3...1000:SETup:OUTPut:TRIGger

Source (Internal)

Example:	SOUR:LIST:STEP2:SET:OUTP:TRIG ON SOUR:LIST:STEP2:SET:OUTP:TRIG?
Notes:	SCPI is supported after A.09.40
Preset:	Off
Range:	On Off
Initial S/W Revision:	A.05.00
Help Map ID:	35633

Step Configuration (Remote Command Only)

This SCPI command is used to configure the List Sequencer and is detailed in the table below. The command is defined such that you send one command per step, with the step number being specified as a subopcode of the SCPI command. Each command includes all the parameter settings for the step. As a step is setup, the values entered are run through several levels of validation.

Remote Command:	:SOURce:LIST:STEP[1] 2 3 4..1000:SETup IMMediate INTernal KEY BUS EXTernal2, <time>, NONE PGSM EGSM RGSM DCS1800 PCS1900 TGSM810 GSM450 GSM4 80 GSM700 GSM850 BANDI BANDII BANDIII BANDIV BANDV BAND VI BANDVII BANDVIII BANDIX BANDX BANDXI BANDXII BANDXII I BANDXIV USCELL USPCS JAPAN KOREAN NMT IMT2K UPPER SEC OND PAMR400 PAMR800 IMTEXT PCS1DOT9G AWS US2DOT5G PUBLI C LOWER NONE BAND1 BAND2 BAND3 BAND4 BAND5 BAND6 BAND7 BAND8 BAND10 BAND11 BAND12 BAND13 BAND14 BAND17 BAND18 BAND19 BAND20 BAND21 BAND24 BAND25 BAND33 BAND34 BAND35 BAND36 BAND37 BAND38 BAND39 BAND40 BAND41 BAND42 BAND4 3 BANDA BANDB BANDC BANDD BANDE BANDF, DOWN UP, <freq>, <ampl>, <string>, TIME COUNT CONTinuous, <time>, ON OFF 1 0, [<int>], :SOURce:LIST:STEP[1] 2 3 4..1000:SETup?
Example:	SOUR:LIST:STEP1:SET INT, 1ms, PGSM, DOWN, 10, -25 dBm, "GSM_Test1.bin", TIME, 10ms, OFF, 255

Notes:	<p>The parameters are: (There is a total of 11 items in each step, the following is a list of the items in the order they must appear in the remote command.)</p> <ol style="list-style-type: none"> 1. Step Trigger <enum> - specifies the input trigger for the step. For details of the valid types of step trigger see “Step Trigger” on page 818. 2. Transition Time <time> - specifies the transition time for the step in seconds. For details of the valid ranges for the transition time see “Transition Time” on page 820. 3. Radio Band <enum> - specifies the radio band for the step. For details of the valid radio bands see “Radio Setup” on page 821. 4. Radio Band Link <enum> - specifies the radio band link direction for the step. For details of the valid link types, see “Radio Band Link” on page 839. 5. Frequency/Channel Number <freq>/<chan num> - specifies the frequency in Hz or the channel number for the step. The channel number and frequency are combined as one parameter that represents the frequency or channel number depending on the radio band setting. If the radio band is set to NONE, this value is interpreted as a frequency value in Hz. If the radio band is set to a valid band, this value is interpreted as a channel number. For details of the valid ranges for frequency and channel numbers, see “Channel” on page 839 and “Frequency” on page 840. 6. Power <ampl> - specifies the output power for the step in dBm. For details of the valid ranges see “Power” on page 841. 7. Waveform <string> - specifies the waveform for playback during the step. The step can output either a new ARB waveform, continue playback of the previous waveform, or output a CW tone. The options for specifying these are: <ul style="list-style-type: none"> <filename> - plays the specified waveform from the start. The filename value is the name of the file within ARB playback memory, it does not include the windows path to the file on the HDD. If you enter a filename for a waveform that does not reside within ARB playback memory, an error is generated. CONT – continues playback of the ARB file from the previous step CW – outputs a CW tone OFF – disable RF output 8. Step Duration <enum> - specifies the duration of the step. The duration can be specified to be either time, or play count of the ARB file associated with the step, or continuous. If Waveform is set to “CW”, this value cannot be set to Play Count and an error will be generated. If continuous is selected, the following Time or Count value is ignored. For further details of this setting, see “Step Duration” on page 845. 9. Time or Count <time/int> - specifies time duration in seconds or play count of the ARB file associated with the step. For further details of this setting, including the valid ranges for the time or play count setting, “Time” on page 845 and “Play Count” on page 846. 10. Output Trigger <Boolean> - specifies the output trigger for the step. For details of the ranges for this setting see “Output Trigger” on page 847.
--------	--

Source (Internal)

Dependencies:	The range of subopcode values is 1 to 1000 and the value you enter is determined by the number of steps you have configured. For details see “Number of Steps” on page 816 . If you attempt to remotely set or query a subopcode that is out of range, an error is generated.
Initial S/W Revision:	A.05.00
Help Map ID:	35692

Step Configuration of Step Trigger parameter list (Remote Command Only)

This SCPI command is to configure “Step Trigger” parameter array of the whole List Sequencer at one time. The number of array is same as step number defined in [“Number of Steps” on page 816](#) Number of Steps. As a step is setup, the value entered run through several levels of validation.

Remote Command:	:SOURce:LIST:SETup:INPut:TRIGger <enum>, <enum>, <enum>, ... :SOURce:LIST:SETup:INPut:TRIGger?
Example:	SOUR:LIST:SET:INP:TRIG IMM,INT,EXT2 SOUR:LIST:SET:INP:TRIG?
Notes:	The command is to setup below parameter array of whole list sequence. Step Trigger <enum> - specifies the input trigger for the step. For details of the valid types of step trigger see “Step Trigger” on page 818 . If input parameter number exceeds the step number defined by Number of Steps then generate error ", and only those parametes whose index number falls in number of steps will be updated.
Remote Command Notes:	IMMEDIATE INTERNAL KEY BUS EXTERNAL2
Dependencies:	The range is 1 to 1000 which is determined by the number of steps you have configured. For details see “Number of Steps” on page 816 .
Initial S/W Revision:	A.09.40
Help Map ID:	0

Step Configuration of Transition Time parameter list (Remote Command Only)

This SCPI command is to configure “Transition Time” parameter array of the whole List Sequencer at one time. The number of array is same as step number defined in [“Number of Steps” on page 816](#) Number of Steps. As a step is setup, the value entered run through several levels of validation.

Remote Command:	:SOURce:LIST:SETup:TRANSition:TIME <time>, <time>, <time>, ... :SOURce:LIST:SETup:TRANSition:TIME?
Example:	SOUR:LIST:SET:TRAN:TIME 1ms,1ms,1ms SOUR:LIST:SET:TRAN:TIME?

Notes:	The command is to setup below parameter array of whole list sequence. Transition Time <time> - specifies the transition time for the step in seconds. For details of the valid ranges for the transition time see “Transition Time” on page 820 If input parameter number exceeds the step number defined by Number of Steps then generate error ", and only those parameters whose index number falls in number of steps will be updated.
Dependencies:	The range is 1 to 1000 which is determined by the number of steps you have configured. For details see “Number of Steps” on page 816 .
Initial S/W Revision:	A.09.40
Help Map ID:	0

Step Configuration of Radio Band parameter list (Remote Command Only)

This SCPI command is to configure “Radio Band” parameter array of the whole List Sequencer at one time. The number of array is same as step number defined in [“Number of Steps” on page 816](#) Number of Steps. As a step is setup, the value entered run through several levels of validation.

Remote Command:	:SOURCE:LIST:SETup:RADio:BAND <enum>, <enum>, <enum>, ... :SOURCE:LIST:SETup:RADio:BAND?
Example:	SOUR:LIST:SET:RAD:BAND PGSM, EGSM, RGSM SOUR:LIST:SET:RAD:BAND?
Notes:	The command is to setup below parameter array of whole list sequence. Radio Band <enum> - specifies the radio band for the step. For details of the valid radio bands see “Radio Setup” on page 821 . If input parameter number exceeds the step number defined by Number of Steps then generate error ", and only those parameters whose index number falls in number of steps will be updated.
Remote Command Notes:	NONE PGSM EGSM RGSM DCS1800 PCS1900 TGSM810 GSM450 GSM480 GSM700 GSM850 BANDI BANDII BANDIII BANDIV BANDV BANDVI BANDVII BANDVIII BANDIX BANDX BANDXI BANDXII BANDXIII BANDXIV USCELL USPCS JAPAN KOREAN NMT IMT2K UPPER SECOND PAMR400 PAMR800 IMTEXT PCS1DOT9G AWS US2DOT5G PUBLIC LOWER NONE BAND1 BAND2 BAND3 BAND4 BAND5 BAND6 BAND7 BAND8 BAND10 BAND11 BAND12 BAND13 BAND14 BAND17 BAND18 BAND19 BAND20 BAND21 BAND24 BAND25
Dependencies:	The range is 1 to 1000 which is determined by the number of steps you have configured. For details see “Number of Steps” on page 816 .
Initial S/W Revision:	A.09.40
Help Map ID:	0

Step Configuration of Radio Band Link parameter list (Remote Command Only)

This SCPI command is to configure “Radio Band Link” parameter array of the whole List Sequencer at one time.

Source (Internal)

The number of array is same as step number defined in “Number of Steps” on page 816 Number of Steps. As a step is setup, the value entered run through several levels of validation.

Remote Command:	:SOURce:LIST:SETup:RADio:BAND:LINK <enum>, <enum>, <enum>, ... :SOURce:LIST:SETup:RADio:BAND:LINK?
Example:	SOUR:LIST:SET:RAD:BAND:LINK DOWN,UP,UP SOUR:LIST:SET:RAD:BAND:LINK?
Notes:	The command is to setup below parameter array of whole list sequence. Radio Band Link <enum> - specifies the radio band link direction for the step. For details of the valid link types, see “Radio Band Link” on page 839. If input parameter number exceeds the step number defined by Number of Steps then generate error ", and only those parametes whose index number falls in number of steps will be updated.
Remote Command Notes:	DOWN UP
Dependencies:	The range is 1 to 1000 which is determined by the number of steps you have configured. For details see “Number of Steps” on page 816.
Initial S/W Revision:	A.09.40
Help Map ID:	0

Step Configuration of Frequency/Channel Number parameter list (Remote Command Only)

This SCPI command is to configure “Frequency” or “Channel Number” parameter array of the whole List Sequencer at one time. The number of array is same as step number defined in “Number of Steps” on page 816 Number of Steps. As a step is setup, the value entered run through several levels of validation.

Remote Command:	:SOURce:LIST:SETup:CNFRrequency <double>, <double>, <double>, ... :SOURce:LIST:SETup:CNFRrequency?
Example:	SOUR:LIST:SET:CNFR 1GHz,100MHz,100MHz SOUR:LIST:SET:CNFR? SOUR:LIST:SET:CNFR 124,124,124 SOUR:LIST:SET:CNFR?

Notes:	<p>The command is to setup below parameter array of whole list sequence.</p> <p>Frequency/Channel Number <freq>/<chan num> - specifies the frequency in Hz or the channel number for the step. The channel number and frequency are combined as one parameter that represents the frequency or channel number depending on the radio band setting. If the radio band is set to NONE, this value is interpreted as a frequency value in Hz. If the radio band is set to a valid band, this value is interpreted as a channel number. For details of the valid ranges for frequency and channel numbers, see “Channel” on page 839 and “Frequency” on page 840</p> <p>This SCPI is used to setup/query channel number or frequency setting, according to current Radio Band setting of that step. If Radio Band is “NONE”, then it’s frequency. If Radio Band is not “NONE”, then it’s channel number</p> <p>If input parameter number exceeds the step number defined by Number of Steps then generate error ", and only those parametes whose index number falls in legal step number will be updated.</p>
Dependencies:	The range is 1 to 1000 which is determined by the number of steps you have configured. For details see “Number of Steps” on page 816 .
Initial S/W Revision:	A.09.40
Help Map ID:	0

Step Configuration of Power parameter list (Remote Command Only)

This SCPI command is to configure “Power” parameter array of the whole List Sequencer at one time. The number of array is same as step number defined in [“Number of Steps” on page 816](#) Number of Steps. As a step is setup, the value entered run through several levels of validation.

Remote Command:	<pre>:SOURce:LIST:SETup:AMPLitude <ampl>, <ampl>, <ampl>, ... :SOURce:LIST:SETup:AMPLitude?</pre>
Example:	<pre>SOUR:LIST:SET:AMPL -50dBm,-40dBm,-30dBm SOUR:LIST:SET:AMPL?</pre>
Notes:	<p>The command is to setup below parameter array of whole list sequence.</p> <p>Power <ampl> - specifies the output power for the step in dBm. For details of the valid ranges see “Power” on page 841.</p> <p>If input parameter number exceeds the step number defined by Number of Steps then generate error ", and only those parametes whose index number falls in legal step number will be updated.</p>
Dependencies:	The range is 1 to 1000 which is determined by the number of steps you have configured. For details see “Number of Steps” on page 816 .
Initial S/W Revision:	A.09.40
Help Map ID:	0

Source (Internal)

Step Configuration of Waveform parameter list (Remote Command Only)

This SCPI command is to configure “Waveform” parameter array of the whole List Sequencer at one time. The number of array is same as step number defined in “[Number of Steps](#)” on page 816 Number of Steps. As a step is setup, the value entered run through several levels of validation.

Remote Command:	:SOURce:LIST:SETup:WAVEform <string>, <string>, <string>, ... :SOURce:LIST:SETup:WAVEform?
Example:	SOUR:LIST:SET:WAV “CW”,”Off”,”CONT” SOUR:LIST:SET:WAV?
Notes:	The command is to setup below parameter array of whole list sequence. Waveform <string> - specifies the waveform for playback during the step. The step can output either a new ARB waveform, continue playback of the previous waveform, or output a CW tone. The options for specifying these are: <filename> - plays the specified waveform from the start. The filename value is the name of the file within ARB playback memory, it is does not include the windows path to the file on the HDD. If you enter a filename for a waveform that does not reside within ARB playback memory, an error is generated. CONT – continues playback of the ARB file from the previous step CW – outputs a CW tone OFF – disable RF output If input parameter number exceeds the step number defined by Number of Steps then generate error “”, and only those parametes whose index number falls in number of steps will be updated.
Dependencies:	The range is 1 to 1000 which is determined by the number of steps you have configured. For details see “ Number of Steps ” on page 816.
Range:	”filename” “CW” “Off” “CONT”
Initial S/W Revision:	A.09.40
Help Map ID:	0

Step Configuration of Step Duration parameter list (Remote Command Only)

This SCPI command is to configure “Step Duration” parameter array of the whole List Sequencer at one time. The number of array is same as step number defined in “[Number of Steps](#)” on page 816 Number of Steps. As a step is setup, the value entered run through several levels of validation.

Remote Command:	:SOURce:LIST:SETup:DURation:TYPE <enum>, <enum>, <enum>, ... :SOURce:LIST:SETup:DURation:TYPE?
Example:	SOUR:LIST:SET:DUR:TYPE COUN,TIME,CONT SOUR:LIST:SET:DUR:TYPE?

Notes:	<p>The command is to setup below parameter array of whole list sequence.</p> <p>Step Duration <enum> - specifies the duration of the step. The duration can be specified to be either time, or play count of the ARB file associated with the step, or continuous. If Waveform is set to "CW", this value cannot be set to Play Count and an error will be generated. If continuous is selected, the following Time or Count value is ignored. For further details of this setting, see "Step Duration" on page 845.</p> <p>If input parameter number exceeds the step number defined by Number of Steps then generate error ", and only those parametes whose index number falls in number of steps will be updated.</p>
Remote Command Notes:	TIME COUNT CONTInuous
Dependencies:	The range is 1 to 1000 which is determined by the number of steps you have configured. For details see "Number of Steps" on page 816 .
Initial S/W Revision:	A.09.40
Help Map ID:	0

Step Configuration of Duration Time or Play Count parameter list (Remote Command Only)

This SCPI command is to configure "Duration Time" or "Play Count" parameter array of the whole List Sequencer at one time. The number of array is same as step number defined in ["Number of Steps" on page 816](#) Number of Steps. As a step is setup, the value entered run through several levels of validation.

Remote Command:	<pre>:SOURCE:LIST:SETup:TOCount <time/int>, <time/int>, <time/int>, ... :SOURCE:LIST:SETup:TOCount?</pre>
Example:	<pre>SOUR:LIST:SET:TOC 1s,2s,3s SOUR:LIST:SET:TOC? SOUR:LIST:SET:TOC 5,6,7 SOUR:LIST:SET:TOC?</pre>
Notes:	<p>The command is to setup below parameter array of whole list sequence.</p> <p>Time or Count <time/int> - specifies time duration in seconds or play count of the ARB file associated with the step. For further details of this setting, including the valid ranges for the time or play count setting, "Time" on page 845 and "Play Count" on page 846.</p> <p>If input parameter number exceeds the step number defined by Number of Steps then generate error ", and only those parametes whose index number falls in number of steps will be updated.</p> <p>If current "Step Duration" on page 845 is "Continuous", then generate error -221,"Settings conflict;Cannot accept time or count input when step duration type is Continuous on step #"</p>
Dependencies:	The range is 1 to 1000 which is determined by the number of steps you have configured. For details see "Number of Steps" on page 816 .

Source (Internal)

Initial S/W Revision:	A.09.40
Help Map ID:	0

Step Configuration of Output Trigger parameter list (Remote Command Only)

This SCPI command is to configure “Output Trigger” parameter array of the whole List Sequencer at one time. The number of array is same as step number defined in “[Number of Steps](#)” on page 816 Number of Steps. As a step is setup, the value entered run through several levels of validation.

Remote Command:	:SOURce:LIST:SETup:OUTPut:TRIGger <bool>, <bool>, <bool>, ... :SOURce:LIST:SETup:OUTPut:TRIGger ?
Example:	SOUR:LIST:SET:OUTP:TRIG ON,OFF,ON SOUR:LIST:SET:OUTP:TRIG?
Notes:	The command is to setup below parameter array of whole list sequence. Output Trigger <Boolean> - specifies the output trigger for the step. For details of the ranges for this setting see “ Output Trigger ” on page 847. If input parameter number exceeds the step number defined by Number of Steps then generate error ", and only those parametes whose index number falls in legal step number will be updated.
Remote Command Notes:	ON OFF 1 0
Dependencies:	The range is 1 to 1000 which is determined by the number of steps you have configured. For details see “ Number of Steps ” on page 816.
Initial S/W Revision:	A.09.40
Help Map ID:	0

Clear List (Remote Command Only)

This command is the SCPI equivalent of the Clear List UI feature described in.

Remote Command:	:SOURce:LIST:SETup:CLEar
Example:	SOUR:LIST:SETup:CLE
Initial S/W Revision:	A.05.00
Help Map ID:	35693

Multiport Adapter Output Port Bitmap Mode

When this setting is set to LIST, it will allow you to select the multiport adapter output path of each step. When this setting is set to FIXed, source list sequence multiport adapter output path on each step is controlled by global multiport adapter output port bitmap setting (same as source independent mode). Under this situation, source list sequence will ignore local multiport adapter output port bitmap setting

defined in each step, they are still there and can be queried out, but take no effect.

Key Path:	Source, List Sequencer
Remote Command:	:SOURce:LIST:MPADapter:PORT:OUTPut:BITMap:MODE LIST FIXed :SOURce:LIST:MPADapter:PORT:OUTPut:BITMap:MODE?
Example:	SOUR:LIST:MPAD:PORT:OUTP:BITM:MODE LIST SOUR:LIST:MPAD:PORT:OUTP:BITM:MODE?
Preset:	FIXed
Range:	LIST FIXed
State Saved:	Yes
Initial S/W Revision:	A.09.40
Help Map ID:	35760

Multiport Adapter Output Port Amplitude Correction Configuration Validation for List Sequencer (Remote Command Only)

This command is used to validate MPA TX port amplitude correction for Source List Sequencer.

Key Path:	Source, List Sequencer
Remote Command:	:SOURce:LIST:MPADapter:CORRection:ERRor?
Example:	SOUR:LIST:MPAD:CORR:ERR?
Notes:	Query Only SCPI Remote command only If detected invalid configuration, popup error message: "-221 Settings conflict; Source List Step<n> MPA TX port<n> amplitude correction value <n>dB is out of range. The valid range is <n> ~ <n>dB" Or "-221 Settings conflict; Source List Step<n> MPA TX port<n> amplitude correction delta exceeds <n>dB between port<n> and port<n>" to report the first detected conflict.
Range:	"No error" Error info of the first found conflict
State Saved:	Yes
Initial S/W Revision:	A.12.00
Help Map ID:	0

Source (Internal)

Manual Trigger Now

Pressing this key provides a software trigger event to the list sequencer. During execution of sequence, if the sequencer is halted on any step that has been configured with a “Manual” step trigger, then this key press will cause the sequencer to continue and execute the step.

Key Path:	Source, List Sequencer
Remote Command:	No remote command, front panel only.
Initial S/W Revision:	A.05.00
Help Map ID:	35682

Query List Sequence Initiation Armed Status (Remote Command Only)

This is a blocking SCPI query to determine if source list sequence being initiated successfully or not.

Remote Command:	:SOURce:LIST:INITiation:ARMed?
Example:	SOUR:LIST:INIT:ARMed?
Notes:	The return data is in the following format: Integer
Notes:	Query only SCPI. Returning “1” if list sequence has been initiated successfully, returning “0” if not. Once get “0”, you can use :SYST:ERR? to query what error happened. Just like “*OPC?”, this command can be blocked until event/status “IsSourceSweeping” happens, and then returns. Doing so can help user’s script query armed status only once during the time interval of the initiation. As an ancillary SCPI of existing SCPI “:SOUR:LIST:TRIGger[:IMMediate]” (see “Initiate Sequence” on page 815 Initiate Sequence), the right usage of this command is to use it after “:SOUR:LIST:TRIG”. If not, this command will return “1” immediately.
Notes:	There is an alias SCPI “:SOURce:LIST:TRIGger:INITiation:ARMed?”.
Initial S/W Revision:	A.09.40
Help Map ID:	35761

Source Preset

Allows you to preset the source settings to their default values.

Key Path:	Source
Remote Command:	:SOURce:PRESet
Example:	SOUR:PRES
Help Map ID:	35656

Source Self Test

Internal Source

This key in the System, Diagnostics menu gives you access to diagnostic capabilities of Internal Source of the instrument.

Key Path:	System, Diagnostics
Initial S/W Revision:	Prior to A.09.20
Help Map ID:	35762

Source Self Test

This key invokes internal source self test. When operation is complete, the generated test summary file is: E:\Agilent\Instrument\CRFSSelfTestLog.txt. This test summary file can be retrieved from the instrument using the MMEM set of SCPI command, once you have the fully qualified path and file name.

If self test fails, error message “-330, Self-test failed, see log file E:\Agilent\Instrument\CRFSSelfTestLog.txt” is generated. If self test passes, an advisory message “Source self-test completed successfully” is generated.

Key Path:	System, Diagnostics, Internal Source, Self Test
Remote Command:	:SOURce:SELF:TEST[:ALL]
Example:	SOUR:SELF:TEST
Notes:	MMEM:DATA? "E:\ Agilent\Instrument\CRFSSelfTestLog.txt"
Initial S/W Revision:	A.09.20
Help Map ID:	35763

Recall

Most of the functions under this key work the same way in many measurements, so they are documented in the System Functions section. For details about this key, see [“Recall” on page 150](#)[\[Proc_iFrame:2637@\]](#)

Save

Most of the functions under this key work the same way in many measurements, so they are documented in the Utility Functions section. For details about this key, see [“Save” on page 163](#)[\[Proc_iFrame:2600@\]](#)

Signal Studio Commands

Overview

EXT supports connectivity with Signal Studio. To achieve this, the SCPI commands described in this chapter enable you to connect Signal Studio to the EXT test set and to download waveform into the hard

Source (Internal)

disk. They are SCPI only, no menu

Initial S/W Revision:	A.05.00
Help Map ID:	35694

Query License List (Remote Command Only)

This query provides a listing of the current licenses for external software installed for the test set internal source.

Remote Command:	:SYSTem:LIcense:EXTeRnal:LIST?
Example:	SYST:LIC:EXT:LIST?
Notes:	Query only.
Initial S/W Revision:	A.05.00
Help Map ID:	35695

Query License List Detail (Remote Command Only)

This is an obsolete command for Signal Studio. However, it has not been removed from Signal Studio to prevent a Signal Studio connectivity time out. Using this command returns a null string and does not affect Signal Studio.

Remote Command:	:SYSTem:LIcense:LIST:DETAil?
Example:	SYST:LIC:LIST:DET?
Notes:	Query only. Always returns a null string "".
Initial S/W Revision:	A.05.00
Help Map ID:	35696

Memory Subsystem (Remote Command Only)

To be compatible with other Signal Generator products, the EXT test set internal source provides a memory subsystem for Signal Studio to download waveform file into the instrument.

“NVWFM” (none-volatile storage) MSUS (Mass Storage Unit Specifier) is supported in the memory subsystem because the ARB memory cannot be accessed directly. Therefore, files must be downloaded to the instrument hard disk and then loaded into the ARB memory. “NVWFM” MSUS will be mapped to the default directory D:\NVARB.

In addition, you can load a waveform file from the hard disk to the ARB memory, using the [“Load Segment To ARB Memory” on page 767](#) remote command :SOURce:RADio:ARB:LOAD, which also supports using either “NVWFM” MSUS or specifying a full path.

Remote Command:	:MEMory [:SOURce]
------------------------	--------------------

Example:	MEM
Initial S/W Revision:	A.05.00
Help Map ID:	35697

:DATA (Remote Command Only)

This command loads data into the EXT test set hard disk using the <data> parameter and saves the data to a file designated by the <file_name> variable. For downloads to non-volatile waveform memory, use the path “NVWFM:<file_name>”.

Remote Command:	:MEMory[:SOURce]:DATA <file_name>, <data>
Example:	MEM:DATA “NVWFM:test.wfm”, #1212 or MEM:DATA “D:\NVARB\test.wfm”, #1212
Notes:	Data is in 488.2 block format. If a file already exists with same name, the file will be overwritten without warning.
Initial S/W Revision:	A.05.00
Help Map ID:	35698

:DATA:APPend (Remote Command Only)

This command appends data to an existing file stored in hard disk using the <data> parameter and saves the data to a file designated by the <file_name> variable. For downloads to non-volatile waveform memory, use the path “NVWFM:<file_name>”.

Remote Command:	:MEMory[:SOURce]:DATA:APPend <file_name>, <data>
Example:	MEM:DATA:APP “NVWFM:test.wfm”, #14Y9oL or MEM:DATA:APP “D:\NVARB\test.wfm”, #14Y9oL
Notes:	Data is in 488.2 block format. If no file exists with the name designated in the command, a file will be created the first time this command is used with that designated name.
Initial S/W Revision:	A.05.00
Help Map ID:	35699

Sequence Studio Commands**Overview**

EXT supports connectivity with Sequence Studio. The SCPI commands described in this chapter are

Source (Internal)

used to support connectivity from Sequence Studio to the EXT test set. These are only intended for Sequence Studio, so provided as service commands, and SCPI only, no menu

Initial S/W Revision	A.12.00
Help Map ID	0

Query Supportable System Information Query SCPI List (Remote Command Only)

This query provides a listing of the current EXT supportable list of query SCPI which is used to query EXT HW/SW information. It returns string result and parsed by Sequence Studio.

Sequence Studio needs to query some EXT system information like capability etc. when connecting. With more and more new SCPIs added in EXT FW, each time when Sequence Studio try to connect to an old version FW without those new SCPI commands, VISA timeout in Sequence Studio will occur and just make Sequence Studio looks dead. To avoid that, this SCPI is provided to give a list of current supportable information-query SCPI list.

Remote Command	:SERvice[:PRODUCTION]:SIQuery:SCPI:LIST?
Example	SERV:SIQ:SCPI:LIST?
Notes	Query only The string in “Range” part cannot change, for Sequence Studio needs to accurately match those string character. If “SEQ Ver Info” string presents, then means “:SERvice[:PRODUCTION]:LSEQuencer:ANALyzer:FILE:VERSion?” and “:SERvice[:PRODUCTION]:LSEQuencer:SOURce:FILE:VERSion?” query SCPIs are supported in current version. If “ARB Header Info” string presents, that means “Query Selected Waveform Header info (Remote Command Only)” on page 809 query SCPI is supported in current version.
Range	“HW Capability Info”, “SEQ Ver Info”, “ARB Header Info”
Initial S/W Revision	A.12.00
Help Map ID	0

Span

Activates the Span function and displays a menu of span functions.

Initial S/W Revision:	Prior to A.02.00
Help Map ID:	3260

Span

Changes the displayed frequency range symmetrically about the center frequency. While adjusting the Span the Center Frequency is held constant, which means that both Start Frequency and Stop Frequency will change.

Span also sets the frequency entry mode to Center/Span. In Center/Span mode, the center frequency and span values are displayed below the graticule, and the default active function in the Frequency menu is **Center Freq**.

While discussing the Span function we make the distinction between “swept spans” and “zero span”. We use the term “swept spans” to mean spans other than zero; recognizing that, because of this terminology, the user can be in what we call a “swept span” even while performing an FFT “sweep”.

While in swept spans, setting the span to 0 Hz through SCPI or the front panel numeric key pad puts the test set into zero span. However, using the Step keys and the RPG in swept spans, the Span can only go as far down as 10 Hz and cannot be set to zero.

While in zero span, setting the Span to a non-zero value through SCPI or the front panel puts the test set in swept spans.

If the Span is set to a value greater than the maximum allowable span of the test set, an error is generated indicating the data is out of range and was clipped to upper limit.

Key Path	SPAN X Scale
Remote Command	[:SENSe] :FREQuency:SPAN <freq> [:SENSe] :FREQuency:SPAN?
Example	FREQ:SPAN 2GHz sets the span to 2 GHz FREQ:SPAN 0 Hz sets the span to 0 Hz and puts the test set in Zero Span
Notes	Preset and Max values depend on the Hardware Options
Dependencies	If the electrical attenuator is enabled, any attempt to set Span such that the Stop Frequency would be >3.6 GHz results in an error. If the key is pressed, an advisory message is generated. If the equivalent SCPI command is sent, this same message is generated as part of a “-221, Settings conflict” warning.

Span

Couplings	Span affects RBW, sweep time, FFT & Sweep choice (including FFT Width, Phase Noise Optimization and ADC Dither auto couplings.) When operating in “swept span”: <ul style="list-style-type: none"> Any value of the Center Frequency or Span that is within the frequency range of the test set is allowed when the value is being set through the front panel numeric key pad or the SCPI command. The other parameter is forced to a different value if needed, to keep the Start and the Stop Frequencies within the test set’s frequency range When using the knob or the step up/down keys or the UP DOWN keywords in SCPI, the value that is being changed i.e. the Center Frequency or Span, is limited so that the other parameter is not forced to a new value The Span cannot be set to Zero by setting Start Frequency = Stop Frequency. The value of the last setting is changed to maintain a minimum value of 10 Hz for the difference between start and stop frequencies.
Preset	Depends on test set maximum frequency: Option 503 (3.6 GHz models): 3.59 GHz Option 504 (3.8 GHz models): 3.8 GHz
State Saved	Saved in State
Min	10 Hz unless entered directly, then 0 Hz is allowed, but nothing between 0 and 10 is ever allowed.
Max	Option 503 (3.6 GHz models): 3.7 GHz Option 504 (3.8 GHz models): 3.9 GHz If the knob or step keys are being used, depends on the value of the other three interdependent parameters Center Frequency, Start Frequency, Stop Frequency
Default Unit	Hz
Status Bits/OPC dependencies	Overlapped if Signal Track is on (OPC shouldn’t return or clear until the zooming has completed for the new span)
Initial S/W Revision	Prior to A.02.00
Help Map ID	3261

Full Span

Changes the frequency span of the test set to the Preset frequency span of the test set and sets the Frequency entry mode to Center/Span.

The span is dependent on the currently selected Input (see the Section “Input/Output”).

Pressing this key while in zero span puts the test set back in swept span.

Key Path	SPAN X Scale
----------	---------------------

Remote Command	[:SENSe] :FREQuency:SPAN:FULL
Example	FREQ:SPAN:FULL sets the span to full frequency range of the test set
Notes	n /a
Couplings	Turns off signal tracking (span zoom). It does NOT turn off the markers, nor the current active function.
Initial S/W Revision	Prior to A.02.00
Help Map ID	3263

Zero Span

Changes the displayed frequency span to 0 Hz. The horizontal axis changes to time rather than frequency. The amplitude displayed is the input signal level at the current center frequency. This is a time-domain mode that changes several measurement functions and couplings. The test set behavior is similar to an oscilloscope with a frequency selective detector installed in front of the oscilloscope. See Application Note 150 for more information on how to use zero span.

You can enter Zero Span in several ways:

Press the Zero Span key in Span

Set Span = 0 Hz

Press last Span if the last span was 0

You cannot go to Zero Span by setting start freq = stop freq, or rolling span down with the RPG, that will limit you to 10 Hz

You can go back to Swept Span by setting Span to a nonzero value or pressing Last Span, assuming the last span was not also zero span.

Pressing Zero Span places the test set in Center/Span frequency entry mode.

The following table summarizes the differences between Zero Span and Swept Spans:

Zero Span	Swept Spans
X axis is time	X axis is frequency
There is no auto-RBW selection unless the EMC Standard is CISPR or MIL	RBW coupled to Span when RBW in auto
There is no auto sweep time	Sweep time coupled to RBW when sweep time in auto
Interval Power calculated in Mkr Function	Band Power calculated in Mkr Function
Can only define time limits when in zero span	Can only define frequency limits when in swept spectrum analysis
Marker Count counts at the center frequency	Marker Count counts at the marker frequency
CF Step Size set to RBW value	CF Step auto couples to 10% of Span

Span

Some “Marker ->” commands not available.	Other “Marker ->” commands not available
Freq entry mode always Center/Span	Freq entry mode can be Center/Span or Start/Stop
N dB points reports a time difference.	N dB points reports a frequency difference.

Key Path	SPAN X Scale
Example	FREQ:SPAN 0 Hz sets the span to zero, switches to Zero Span Sending FREQ:SPAN 1 MHz while in Zero Span, switches to Swept span
Notes	Setting the Span to 0 Hz will change to Zero Span and setting the span to a non-zero value will select a swept span
Notes	n /a
Dependencies	Zero Span key is unavailable (grayed out) if the following is true: Frequency scale type is LOG (for example, Log Sweep is On)
Couplings	Pressing Zero Span key (switching to Zero Span): Turns off signal track function (span zoom). Turns off the auto-coupling of RBW and sweep time.
Initial S/W Revision	Prior to A.02.00
Help Map ID	3264

Last Span

Changes the displayed frequency span to the previous span setting. If it is pressed immediately after Signal Track is turned off, then the span setting returns to the span that was in effect before Signal Track was turned on.

If this key is pressed while in a nonzero span, and the previous value of span was 0, it will put the test set back in Zero Span. And if it is pressed while in zero span, it will set the test set back to its last nonzero span.

Pressing Last Span places the test set in Center/Span frequency entry mode.

Key Path	SPAN X Scale
Remote Command	[:SENSE] :FREQuency:SPAN:PREVious
Example	FREQ:SPAN:PREV sets the span to the previous value
Notes	n /a
Initial S/W Revision	Prior to A.02.00
Help Map ID	3265

Sweep/Control

Accesses a menu that enables you to configure the Sweep and Control functions of the analyzer, such as Sweep Time and Gating.

Key Path:	Front-panel key
Initial S/W Revision:	Prior to A.02.00
Help Map ID:	3273

Sweep Time

Controls the time the analyzer takes to sweep the current frequency span when the Sweep Type is Swept, and displays the equivalent Sweep Time when the Sweep Type is FFT.

When Sweep Time is in Auto, the analyzer computes a sweep time which will give accurate measurements based on other settings of the analyzer, such as RBW and VBW.

NOTE

Significantly faster sweep times are available for the Swept SA measurement with Option FS1.

The Meas Uncal (measurement uncalibrated) warning is given in the Status Bar in the lower right corner of the screen when the manual sweep time entered is faster than the sweep time computed by the analyzer's sweep time equations, that is, the Auto Sweep Time. The analyzer's computed sweep time will give accurate measurements; if you sweep faster than this your measurements may be inaccurate. A Meas Uncal condition may be corrected by returning the Sweep Time to Auto; by entering a longer Sweep Time; or by choosing a wider RBW and/or VBW

On occasion other factors such as the Tracking Generator's maximum sweep rate, the YTF sweep rate (in high band) or the LO's capability (in low band) can cause a Meas Uncal condition. The most reliable way to correct it is to return the Sweep Time to Auto.

If the analyzer calculates that the Auto Sweep Time would be greater than 4000s (which is beyond its range), the warning message "Settings Alert;Sweep Rate Unavailable" is displayed. In this case increase the RBW or reduce the span.

If the analyzer's estimated sweep time in an FFT sweep is greater than 4000s, the warning message "Settings Alert;Span:RBW Ratio too big" is displayed. In this case reduce the span or increase the RBW and/or FFT Width.

When Sweep Type is FFT, you cannot control the sweep time, it is simply reported by the analyzer to give you an idea of how long the measurement is taking.

Note that although some overhead time is required by the analyzer to complete a sweep cycle, the sweep time reported when Sweep Type is Swept does not include the overhead time, just the time to sweep the LO over the current Span. When Sweep Type is FFT, however, the reported Sweep Time takes into

Sweep/Control

account both the data acquisition time and the processing time, in order to report an equivalent Sweep Time for a meaningful comparison to the Swept case.

Because there is no “Auto Sweep Time” when in zero span, the Auto/Man line on this key disappears when in Zero Span. The Auto/Man line also disappears when in an FFT sweep. In this case the key is grayed out as shown below.



NOTE When using a Tracking Source (**Source, Source Mode** set to “**Tracking**”), the sweep time shown includes an estimate of the source’s settling time. This estimate may contain inaccuracies, particularly when software triggering is used for the source. This can result in the reported sweep time being shorter than the actual sweep time.

Key Path:	Sweep/Control
Remote Command:	<pre>[:SENSe] :SWEep:TIME <time> [:SENSe] :SWEep:TIME? [:SENSe] :SWEep:TIME:AUTO OFF ON 0 1 [:SENSe] :SWEep:TIME:AUTO?</pre>
Example:	<pre>SWE:TIME 500 ms SWE:TIME:AUTO OFF</pre>
Notes:	The values shown in this table reflect the “swept spans” conditions which are the default settings after a preset. See “Couplings” for values in the zero span domain.
Dependencies:	<p>The third line of the softkey (Auto/Man) disappears in Zero Span. The SCPI command SWEep:TIME:AUTO ON if sent in Zero Span generates an error message.</p> <p>Softkey grayed out and third line of the softkey (Auto/Man) disappears in FFT sweeps. Pressing the key or sending the SCPI for sweep time while the instrument is in FFT sweep generates a –221, “Settings Conflict;” error. F</p> <p>The SCPI command :SWEep:TIME:AUTO ON if sent in FFT sweeps generates an error.</p> <p>Grayed out while in Gate View, to avoid confusing those who want to set GATE VIEW Sweep Time.</p> <p>Key is grayed out in Measurements that do not support swept mode.</p> <p>Key is blanked in Modes that do not support swept mode.</p> <p>Set to Auto when Auto Couple is pressed or sent remotely</p>

Couplings:	<p>Sweep Time is coupled primarily to Span and RBW. Center Frequency, VBW, and the number of sweep points also can have an effect. So changing these parameters may change the sweep time.</p> <p>The Sweep Time used upon entry to Zero Span is the same as the Sweep Time that was in effect before entering Zero Span. The Sweep Time can be changed while in Zero Span. Upon leaving Zero Span, the Auto/Man state of Sweep Time that existed before entering Zero Span is restored.</p> <p>If Sweep Time was in Auto before entering Zero Span, or if it is set to Auto while in zero span (which can happen via remote command or if Auto Couple is pressed) it returns to Auto and recouples when returning to non-zero spans.</p> <p>If Sweep Time was in Man before entering Zero Span, it returns to Man when returning to non-zero spans, and any changes to Sweep Time that were made while in Zero Span are retained in the non-zero span (except where constrained by minimum limits, which are different in and out of zero span).</p>
Preset:	The preset Sweep Time value is hardware dependent since Sweep Time presets to "Auto".
State Saved:	Saved in instrument state
Min:	<p>in zero span: 1 μs</p> <p>in swept spans: 1 ms</p> <p>in Stepped Tracking (as with option ESC): same as auto sweep time</p> <p>(in Swept Tracking, with Tracking Generator option T03 or T06, the minimum sweep time is 1 ms, but the Meas Uncal indicator is turned on for sweep times faster than 50 ms)</p>
Max:	<p>in zero span: 6000 s</p> <p>in swept spans: 4000 s</p>
Status Bits/OPC dependencies:	Meas Uncal is Bit 0 in the STATUS:QUESTionable:INTEgrity:UNCalibrated register
Initial S/W Revision:	Prior to A.02.00
Help Map ID:	3274

Sweep Setup

Lets you set the sweep functions that control features such as sweep type and time.

Key Path:	Sweep/Control
Dependencies:	<p>The whole Sweep Setup menu is grayed out in Zero Span, however, the settings in the menus under Sweep Setup can be changed remotely with no error indication.</p> <p>Grayed out in measurements that do not support swept mode.</p> <p>Blanked in modes that do not support swept mode</p>
Initial S/W Revision:	Prior to A.02.00

Help Map ID:	3275
--------------	------

Sweep Time Rules

Allows the choice of three distinct sets of sweep time rules. These are the rules that are used to set the sweep time when **Sweep Time** is in Auto mode. Note that these rules only apply when in the Swept **Sweep Type** (either manually or automatically chosen) and not when in FFT sweeps.

See [“More Information” on page 871](#).

Key Path:	Sweep/Control, Sweep Setup
Remote Command:	[:SENSE] :SWEep:TIME:AUTO:RULEs NORMAl ACCuracy SRESponse [:SENSE] :SWEep:TIME:AUTO:RULEs?
Example:	SWE:TIME:AUTO:RUL ACC
Dependencies:	In Zero Span, this key is irrelevant and cannot be accessed (because the whole Sweep Setup menu is grayed out in Zero Span), however its settings can be changed remotely with no error indication. Grayed out in FFT sweeps. Pressing the key while the instrument is in FFT sweep generates an advisory message. The SCPI is acted upon if sent, but has no effect other than to change the readout on the key, as long as the analyzer is in an FFT sweep.
Couplings:	Set to Auto on Auto Couple
Preset:	AUTO
State Saved:	Saved in instrument state
Backwards Compatibility SCPI:	:SWEep:TIME:AUTO:MODE SRESponse This legacy command is aliased to :SWEep:TIME:AUTO:RULEs SRESponse
Backwards Compatibility SCPI:	:SWEep:TIME:AUTO:MODE SANalyzer This legacy command is aliased to :SWEep:TIME:AUTO:RULEs NORMAl
Backwards Compatibility SCPI:	:SWEep:TIME:AUTO:MODE? This legacy query is aliased to :SWEep:TIME:RULEs?, so it will match for SRESponse but not for SANalyzer
Backwards Compatibility Notes:	The old Auto Sweep Time command was the same [:SENSE]:SWEep:TIME:AUTO:RULEs NORMAl ACCuracy so it still works although it now has a third parameter (SRESponse). The old Sweep Coupling command was [:SENSE]:SWEep:TIME:AUTO:MODE SRESponse SANalyzer and it is aliased as below:
Initial S/W Revision:	Prior to A.02.00

Help Map ID:

3276

More Information

The first set of rules is called **SA – Normal. Sweep Time Rules** is set to **SA-Normal** on a **Preset** or **Auto Couple**. These rules give optimal sweep times at a loss of accuracy. Note that this means that in the Preset or Auto Coupled state, instrument amplitude accuracy specifications do not apply.

Setting **Sweep Time Rules** to **SA-Accuracy** will result in slower sweep times than **SA-Normal**, usually about three times as long, but with better amplitude accuracy for CW signals. The instrument absolute amplitude accuracy specifications only apply when **Sweep Time** is set to **Auto**, and **Sweep Time Rules** are set to **SA-Accuracy**. Additional amplitude errors which occur when **Sweep Time Rules** are set to **SA-Normal** are usually well under 0.1 dB, though this is not guaranteed. Because of the faster sweep times and still low errors, **SA-Normal** is the preferred setting of **Sweep Time Rules**.

The third set of sweep time rules is called **Stimulus/Response** and is automatically selected when an integrated source is turned on, such as a Tracking Generator or a synchronized external source. The sweep times for this set of rules are usually much faster for swept-response measurements. Stimulus-response auto-coupled sweep times are typically valid in stimulus-response measurements when the system's frequency span is less than 20 times the bandwidth of the device under test. You can select these rules manually (even if not making Stimulus-Response measurements) which will allow you to sweep faster before the "Meas Uncal" warning comes on, but you are then not protected from the over-sweep condition and may end up with uncalibrated results. However, it is commonplace in measuring non-CW signals such as noise to be able to get excellent measurement accuracy at sweep rates higher than those required for CW signal accuracy, so this is a valid measurement technique.

Auto

Sets the analyzer to automatically choose the Sweep Time Rules for the measurement.

Key Path:	Sweep/Control, Sweep Setup, Sweep Time Rules
Remote Command:	[:SENSE] :SWEep:TIME:AUTO:RULEs:AUTO[:STATe] ON OFF 1 0 [:SENSE] :SWEep:TIME:AUTO:RULEs:AUTO[:STATe] ?
Example:	:SWE:TIME:AUTO:RUL:AUTO ON
Couplings:	Set on Preset or Auto Couple
Preset:	ON
Initial S/W Revision:	Prior to A.02.00
Help Map ID:	3277

SA - Normal

Chooses Sweep Time Auto Rules for optimal speed and generally sufficient accuracy.

Key Path:	Sweep/Control, Sweep Setup, Sweep Time Rules
Example:	:SWE:TIME:AUTO:RUL NORM

Sweep/Control

Dependencies:	Not available (grayed out) when Source Mode=Tracking.
Couplings:	Automatically selected unless Source is on If directly selected, sets AUTO to Off
Readback:	SA - Normal
Initial S/W Revision:	Prior to A.02.00
Help Map ID:	3278

SA - Accuracy

Chooses Sweep Time Auto Rules for specified absolute amplitude accuracy.

NOTE For specified accuracy, do not allow sweep time to fall below 20 ms when in SA - Accuracy

Key Path:	Sweep/Control, Sweep Setup, Sweep Time Rules
Example:	:SWE:TIME:AUTO:RUL ACC
Dependencies:	Not available (grayed out) when Source Mode=Tracking.
Couplings:	If directly selected, sets AUTO to Off
Readback:	SA - Accuracy
Initial S/W Revision:	Prior to A.02.00
Help Map ID:	3279

Stimulus/Response

The Stimulus-Response setting for sweep time rules provides different sweep time settings, for the case where the analyzer is sweeping in concert with a source. These modified rules take two forms:

1. Sweeping along with a swept source, which allows faster sweeps than the normal case because the RBW and VBW filters do not directly interact with the Span. We call this “Swept Tracking”
2. Sweeping along with a stepped source, which usually slows the sweep down because it is necessary to wait for the stepped source and the analyzer to settle at each point. We call this “Stepped Tracking”

The analyzer chooses one of these methods based on what kind of a source is connected or installed; it picks Swept Tracking if there is no source in use.

As always, when the X-series analyzer is in Auto Sweep Time, the sweep time is estimated and displayed in the Sweep/Control menu as well as in the annotation at the bottom of the displayed measurement; of course, since this can be dependent on variables outside the analyzer’s control, the actual sweep time may vary slightly from this estimate.

You can always choose a shorter sweep time to improve the measurement throughput, (with some potential unspecified accuracy reduction), but the Meas Uncal indicator will come on if the sweep time

you set is less than the calculated Auto Sweep time. You can also select a longer sweep time, which can be useful (for example) for obtaining accurate insertion loss measurements on very narrowband filters. The number of measurement points can also be reduced to speed the measurement (at the expense of frequency resolution).

Key Path:	Sweep/Control, Sweep Setup, Sweep Time Rules
Example:	:SWE:TIME:AUTO:RUL SRES
Couplings:	Automatically selected when the Source is on (Source Mode not set to OFF). If directly selected sets AUTO to Off
Readback:	SR
Initial S/W Revision:	Prior to A.02.00
Help Map ID:	3280

Sweep Type

Chooses between the FFT and Sweep types of sweep.

Sweep Type refers to whether or not the instrument is in Swept or FFT analysis. When in Auto, the selection of sweep type is governed by two different sets of rules, depending on whether you want to optimize for dynamic range or for speed.

FFT “sweeps” should not be used when making EMI measurements; therefore, when a CISPR detector (Quasi Peak, EMI Average, RMS Average) is selected for any active trace (one for which Update is on), the FFT key in the Sweep Type menu is grayed out, and the Auto Rules only choose Swept. If Sweep Type is manually selected to be FFT, the CISPR detectors are all grayed out.

FFT sweeps will never be auto-selected when Screen Video, Log Video or Linear Video are the selected Analog Output.

Key Path:	Sweep/Control, Sweep Setup
Remote Command:	[:SENSe] :SWEep:TYPE FFT SWEep [:SENSe] :SWEep:TYPE?
Dependencies:	In Zero Span, this key is irrelevant and cannot be accessed (because the whole Sweep Setup menu is grayed out in Zero Span), however its settings can be changed remotely with no error indication. When Gate is on, Gate Method selection affects Sweep Type: Method FFT&Sweep menu FFT - Swept grayed out and rules choose FFT Video - FFT grayed out and rules choose Swept LO - FFT grayed out and rules choose Swept
Preset:	AUTO

Sweep/Control

Backwards Compatibility SCPI:	[:SENSe]:SWEep:TYPE AUTO sets sweep type Auto to On but the query will return either FFT or SWE depending on the auto setting. [:SENSe]:SWEep:TYPE SWP selects sweep type Swept but will return SWE on a query
Initial S/W Revision:	Prior to A.02.00
Help Map ID:	3281

Auto

When in Auto, the selection of sweep type is governed by two different sets of rules, depending on whether you want to optimize for dynamic range or for speed. These rules are chosen under the **Sweep Type Rules** key.

Key Path:	Sweep/Control, Sweep Setup, Sweep Type
Remote Command:	[:SENSe] :SWEep:TYPE: AUTO OFF ON 0 1 [:SENSe] :SWEep:TYPE: AUTO?
Example:	:SWE:TYPE:AUTO ON
Couplings:	Pressing Auto Couple always sets Sweep Type to Auto. Swept is always chosen whenever any form of Signal ID is on, or the Source Mode is set to Tracking, or any EMI detector is selected, or the RF Preselector is ON.
Preset:	ON
State Saved:	Saved in instrument state
Initial S/W Revision:	Prior to A.02.00
Help Map ID:	3282

Swept

Manually selects swept analysis, so it cannot change automatically to FFT.

Key Path:	Sweep/Control, Sweep Setup, Sweep Type
Example:	SWE:TYPE SWE
Dependencies:	Grayed out while in Gated FFT (meaning Gate is ON and Gate Method is FFT). If this key is selected, the gate method Gated FFT is grayed out.
Couplings:	This selection is chosen automatically if any of the CISPR detectors is chosen for any active trace, in which case the FFT Sweep Type selection is also grayed out.
State Saved:	Saved in instrument state

Readback:	Swept
Initial S/W Revision:	Prior to A.02.00
Modified at S/W Revision:	A.02.00
Help Map ID:	3283

FFT

Manually selects FFT analysis, so it cannot change automatically to Swept.

Key Path:	Sweep/Control, Sweep Setup, Sweep Type
Example:	SWE:TYPE FFT
Dependencies:	<p>When a CISPR detector (Quasi Peak, EMI Average, RMS Average) is selected for any active trace, the FFT key is grayed out.</p> <p>When the RF Preselector is on, the FFT key is grayed out.</p> <p>When Source Mode is set to Tracking, Manual FFT is grayed out.</p> <p>When Signal ID is on, Manual FFT is grayed out.</p> <p>Grayed out while in Gated LO (meaning Gate is ON and Gate Method is LO).</p> <p>Grayed out while in Gated Video (meaning Gate is ON and Gate Method is Video).</p>
State Saved:	Saved in instrument state
Readback:	FFT
Initial S/W Revision:	Prior to A.02.00
Help Map ID:	3284

Sweep Type Rules

Selects which set of rules will be used for automatically choosing the Sweep Type when Sweep Type is in Auto.

Key Path:	Sweep/Control, Sweep Setup
Remote Command:	<pre>[:SENSE] :SWEep:TYPE:AUTO:RULEs SPEed DRANge [:SENSE] :SWEep:TYPE:AUTO:RULEs?</pre>
Dependencies:	In Zero Span, this key is irrelevant and cannot be accessed (because the whole Sweep Setup menu is grayed out in Zero Span), however its settings can be changed remotely with no error indication.
Preset:	DRANge
State Saved:	Saved in instrument state
Backwards Compatibility Notes:	The legacy parameter DYNamicrange is unsupported
Initial S/W Revision:	Prior to A.02.00

Sweep/Control

Help Map ID:	3285
--------------	------

Auto

This selection is automatically chosen when Auto Couple is pressed. When in Auto, the Sweep Type Rules are set to Best Dynamic Range. It seems like a very simple Auto function but the use of this construct allows a consistent statement about what the Auto Couple key does.

Key Path:	Sweep/Control, Sweep Setup, Sweep Type Rules
Remote Command:	[:SENSe] :SWEp:TYPE:AUTO:RULEs:AUTO[:STATe] OFF ON 0 1 [:SENSe] :SWEp:TYPE:AUTO:RULEs:AUTO[:STATe] ?
Example:	:SWE:TYPE:AUTO:RUL:AUTO ON
Couplings:	Pressing Auto Couple always sets Sweep Type Rules to Auto.
Preset:	ON
State Saved:	Saved in instrument state
Initial S/W Revision:	Prior to A.02.00
Help Map ID:	3286

Best Dynamic Range

This selection tells the analyzer to choose between swept and FFT analysis with the primary goal of optimizing dynamic range. If the dynamic range is very close between swept and FFT, then it chooses the faster one. This auto selection also depends on RBW Type.

In determining the Swept or FFT setting, the auto rules use the following approach:

- If the RBW Filter Type is Gaussian use the RBW for the Normal Filter BW and if that RBW > 210 Hz, use swept; for RBW ≤ 210 Hz, use FFT
- If the RBW Filter Type is Flat Top, use the same algorithm but use 420 Hz instead of 210 Hz for the transition point between Swept and FFT
- If any of the CISPR detectors is chosen for any active trace, always use Swept.

Key Path:	Sweep/Control, Sweep Setup, Sweep Type Rules
Example:	SWE:TYPE:AUTO:RUL DRAN sets the auto rules to dynamic range.
Couplings:	Directly selecting this setting sets AUTO to OFF.
Readback:	Dynamic Range
Initial S/W Revision:	Prior to A.02.00
Help Map ID:	3287

Best Speed

This selection tells the analyzer to choose between FFT or swept analysis based on the fastest analyzer

speed.

Key Path:	Sweep/Control, Sweep Setup, Sweep Type Rules
Example:	SWE:TYPE:AUTO:RUL SPE sets the rules for the auto mode to speed
Couplings:	Directly selecting this setting sets AUTO to OFF.
Readback:	Speed.
Initial S/W Revision:	Prior to A.02.00
Help Map ID:	3288

FFT Width

This menu displays and controls the width of the FFT's performed while in FFT mode. The "FFT width" is the range of frequencies being looked at by the FFT, sometimes referred to as the "chunk width" -- it is not the resolution bandwidth used when performing the FFT.

It is important to understand that this function does not directly set the FFT width, it sets the limit on the FFT Width. The actual FFT width used is determined by several other factors including the Span you have set. Usually the instrument picks the optimal FFT Width based on the current setup; but on occasion you may wish to limit the FFT Width to be narrower than that which the instrument would have set.

NOTE This function does not allow you to widen the FFT Width beyond that which the instrument might have set; it only allows you to narrow it. You might do this to improve the dynamic range of the measurement or eliminate nearby spurs from your measurement.

Note that the **FFT Width** setting will have no effect unless in an FFT sweep.

See "[More Information](#)" on page 879

Key Path:	Sweep/Control, Sweep Setup
Remote Command:	[:SENSe] :SWEep:FFT:WIDTh <real> [:SENSe] :SWEep:FFT:WIDTh?
Example:	SWE:FFT:WIDTh 167 kHz sets this function to "<167.4 kHz"
Notes:	The parameter is in units of frequency. For values sent from SCPI, the analyzer chooses the smallest value that is at least as great as the requested value. Examples: Parameter 3.99 kHz is sent over SCPI. Analyzer chooses 4.01 kHz Parameter 4.02 kHz is sent over SCPI. Analyzer chooses 28.81 kHz Parameter 8 MHz is sent over SCPI. Analyzer chooses 10 MHz

Sweep/Control

Dependencies:	<p>In some models, the analog prefilters are not provided. In these models the FFT Width function is always in Auto. The FFT Width key is blanked in these models, and the SCPI commands are accepted without error but have no effect.</p> <p>In Zero Span, this key is irrelevant and cannot be accessed (because the whole Sweep Setup menu is grayed out in Zero Span). However, its settings can be changed remotely with no error indication.</p>
Couplings:	The FFT Width affects the ADC Dither function (see Meas Setup key) and the point at which the instrument switches from Swept to FFT acquisition.
Preset:	The Preset is Auto, but Preset will also pick Best Dynamic Range and hence this function will be set to ~Maximum
State Saved:	Saved in instrument state
Min:	4.01 kHz
Max:	<p>The maximum available FFT width is dependent on the IF Bandwidth option. The maximum available width is:</p> <p>Option B10, 10 MHz;</p> <p>Option B25, 25 MHz,</p> <p>Option B40, 40 MHz.</p>
Backwards Compatibility SCPI:	<p>[:SENSe]:SWEep:FFT:SPAN:RATio <integer></p> <p>[:SENSe]:SWEep:FFT:SPAN:RATio?</p> <p>This is the legacy “FFTs per Span” command, because in the PSA, this is what you set rather than the FFT Width. The behavior of the analyzer when it receives this command is to compute the “intended segment width” by dividing the Span by the FFTs/Span parameter, then converting this intended width to an actual width by using the largest available FFT Width that is still less than the intended segment width. The “Span” used in this computation is whatever the Span is currently set to, whether a sweep has been taken at that Span or not.</p>
Initial S/W Revision:	Prior to A.02.00
Modified at S/W Revision:	A.04.00
Help Map ID:	3289

Key Path:	Sweep/Control, Sweep Setup
Remote Command:	<p>[:SENSe]:SWEep:FFT:WIDTh:AUTO OFF ON 0 1</p> <p>[:SENSe]:SWEep:FFT:WIDTh:AUTO?</p>
Example:	:SWE:FFT:WIDT:AUTO ON
Couplings:	Pressing Auto Couple always sets FFT Width to Auto.
Preset:	ON
State Saved:	Saved in instrument state

Initial S/W Revision:	Prior to A.02.00
Help Map ID:	0

More Information

An FFT measurement can only be performed over a limited span known as the “FFT segment”. Several segments may need to be combined to measure the entire span. For advanced FFT control in the X-Series, you have direct control over the segment width using the **FFT Width** control. Generally, in automatic operation, the X-Series sets the segment width to be as wide as possible, as this results in the fastest measurements.

However, in order to increase dynamic range, most X-series models provide a set of analog prefilters that precede the ADC. Unlike swept measurements, which pass the signal through a bandpass before the ADC, FFT measurements present the full signal bandwidth to the ADC, making them more susceptible to overload, and requiring a lower signal level. The prefilters act to alleviate this phenomenon - they allow the signal level at the ADC to be higher while still avoiding an ADC overload, by eliminating signal power outside the bandwidth of interest, which in turn improves dynamic range.

Although narrowing the segment width can allow higher dynamic ranges some cases, this comes at the expense of losing some of the speed advantages of the FFT, because narrower segments require more acquisitions and proportionately more processing overhead.

However, the advantages of narrow segments can be significant. For example, in pulsed-RF measurements such as radar, it is often possible to make high dynamic range measurements with signal levels approaching the compression threshold of the analyzer in swept spans (well over 0 dBm), while resolving the spectral components to levels below the maximum IF drive level (about -8 dBm at the input mixer). But FFT processing experiences overloads at the maximum IF drive level even if the RBW is small enough that no single spectral component exceeds the maximum IF drive level. If you reduce the width of an FFT, an analog filter is placed before the ADC that is about 1.3 times as wide as the FFT segment width. This spreads out the pulsed RF in time and reduces the maximum signal level seen by the ADC. Therefore, the input attenuation can be reduced and the dynamic range increased without overloading the ADC.

Further improvement in dynamic range is possible by changing the **FFT IF Gain** (in the **Meas Setup** menu of many measurements). If the segments are reduced in width, **FFT IF Gain** can be set to High, improving dynamic range.

Depending on what IF Bandwidth option you have ordered, there can be up to three different IF paths available in FFT sweeps, as seen in the diagram below:

Sweep/Control

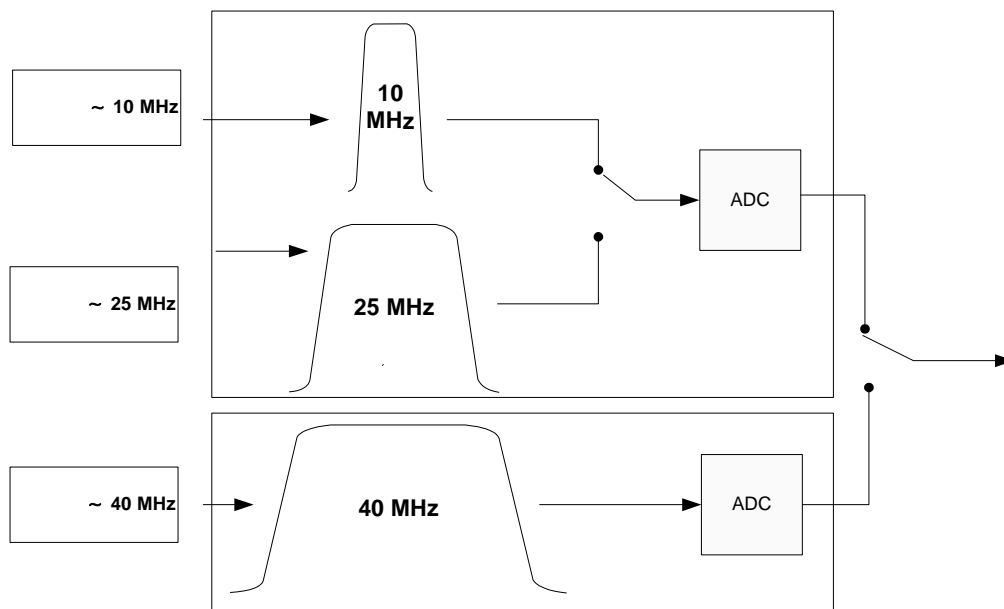

The 10 MHz path is always used for Swept sweeps. It is always used for FFT sweeps as well, unless the user specifies ~25 MHz in which case the 25 MHz path will be used for FFT sweeps, or ~40 MHz, in which case the 40 MHz path will be used for FFT sweeps. Note that, although each of these keys picks the specified path, the analyzer may choose an FFT width less than the full IF width, in order to optimize speed, trading off acquisition time versus processing time.

Pause/Resume

Pauses a measurement after the current data acquisition is complete.

When Paused, the label on the key changes to Resume. Pressing Resume un-pauses the measurement.

When you are Paused, pressing **Restart**, **Single** or **Cont** does a Resume.

Key Path:	Sweep/Control
Remote Command:	:INITiate:PAUSE
Dependencies:	Grayed out in Measurements that do not support Pausing. Blanked in Modes that do not support Pausing.
Initial S/W Revision:	Prior to A.02.00
Help Map ID:	3290

Key Path:	Sweep/Control
Remote Command:	:INITiate:RESume
Dependencies:	Grayed out in Measurements that do not support Pausing. Blanked in Modes that do not support Pausing.

Initial S/W Revision:	Prior to A.02.00
Help Map ID:	0

Gate

Accesses a menu that enables you to control the gating function. The Gate functionality is used to view signals best viewed by qualifying them with other events.

Gate setup parameters are the same for all measurements – they do not change as you change measurements. Settings like these are called “Meas Global” and are unaffected by Meas Preset.

Note that Sweep Time autocoupling rules and annotation are changed by Gate being on.

Key Path:	Sweep/Control
Scope:	Meas Global
Readback:	The state and method of Gate, as [Off, LO] or [On, Video]. Note that for measurements that only support gated LO, the method is nonetheless read back, but always as LO.
Initial S/W Revision:	Prior to A.02.00
Help Map ID:	3292

Gate On/Off

Turns the gate function on and off.

When the Gate Function is on, the selected Gate Method is used along with the gate settings and the signal at the gate source to control the sweep and video system with the gate signal. Not all measurements allow every type of Gate Methods.

When Gate is on, the annunciation in the measurement bar reflects that it is on and what method is used, as seen in the following "Gate: LO" annunciator graphic.



Key Path:	Sweep/Control, Gate
Remote Command:	[:SENSe] :SWEep:EGATe [:STATe] OFF ON 0 1 [:SENSe] :SWEep:EGATe [:STATe] ?
Example:	SWE:EGAT ON SWE:EGAT?

Sweep/Control

Dependencies:	<p>The function is unavailable (grayed out) and Off when:</p> <ul style="list-style-type: none"> • Gate Method is LO or Video and FFT Sweep Type is manually selected. • Gate Method is FFT and Swept Sweep Type is manually selected. • Marker Count is ON. <p>The following are unavailable whenever Gate is on:</p> <ul style="list-style-type: none"> • FFT under Sweep Type when Method=LO or Video or Swept under Sweep Type when Method=FFT • Marker Count <p>While Gate is on, the Auto Rules for Sweep Type are modified so that the choice agrees with the Gate Method: i.e., FFT for Method = FFT and Swept for Method = LO or Video.</p> <p>The Gate softkey and all SCPI under the [:SENSe]:SWEep:EGATe SCPI node are grayed out when Source Mode is Tracking with an external source. This is because the Gate circuitry is used to sync the external source. If the Tracking Source is turned on, the Gate is turned off.</p> <p>When in the ACP measurement:</p> <ul style="list-style-type: none"> • When Meas Method is RBW or FAST, this function is unavailable and the key is grayed out. • Whenever Gate is on, Meas Method, RBW or FAST is unavailable and keys for those are grayed out. • When Gate is on, Offset Res BW and Offset Video BW are ignored (if you set these values) and the measurement works as if all Offset Res BW and all Offset Video BW are coupled with the Res BW and the Video BW under the BW menu. When Gate is on, the Offset BW key in the Offset/Limit menu is grayed out.
Preset:	Off
State Saved:	Saved in instrument state
Range:	On Off
Backwards Compatibility SCPI:	[:SENSe]:SWEep:TIME:GATE[:STATe] ESA compatibility
Backwards Compatibility Notes:	In ESA, Trig Delay (On) and Gate (On) could not be active at the same time.. This dependency does not exist in PSA or in the X-Series.
Initial S/W Revision:	Prior to A.02.00
Help Map ID:	3293

Gate View On/Off

Turning on Gate View in the Swept SA measurement provides a single-window gate view display..

Turning on Gate View in other measurements shows the split-screen Gate View. In these measurements, when the Gate View is on, the regular view of the current measurement traces and results are reduced vertically to about 70% of the regular height. The Zero Span window, showing the positions of the Gate, is shown between the Measurement Bar and the reduced measurement window. By reducing the height

of the measurement window, some of the annotation on the Data Display may not fit and is not shown.

Key Path:	Sweep/Control, Gate
Remote Command:	[:SENSe] :SWEep:EGATe:VIEW ON OFF 1 0 [:SENSe] :SWEep:EGATe:VIEW?
Example:	SWE:EGAT:VIEW ON turns on the gate view.
Dependencies:	In the Swept SA measurement: In Gate View, the regular Sweep Time key is grayed out . When pressed, the grayed out key puts up the informational message "Use Gate View Sweep Time in the Gate menu." In the other measurements: When you turn Gate View on, the lower window takes on the current state of the instrument. Upon leaving Gate View, the instrument takes on the state of the lower window. When you turn Gate View on, the upper window Sweep Time is set to the gate view sweep time.
Couplings:	These couplings apply to the Swept SA measurement: <ul style="list-style-type: none"> • When Gate View is turned on, the instrument is set to Zero Span. • Gate View automatically turns off whenever a Span other than Zero is selected. • Gate View automatically turns off if you press the Last Span key while in Gate View, and the instrument returns to the Span it was in before entering Gate View (even if that is Zero Span). • When Gate View is turned on, the sweep time used is the gate view sweep time. This is set according to the rules in section "Gate View Setup" on page 885 • When Gate View is turned off, Sweep Time is set to the normal Swept SA measurement sweep time. • If Gate View is on and Gate is off, then turning on Gate turns off Gate View.
Preset:	OFF
State Saved:	Saved in instrument state
Range:	On Off
Initial S/W Revision:	Prior to A.02.00
Help Map ID:	3810

A sample of the Gate View screen in the Swept SA measurement is shown in the following graphic :

Sweep/Control



A sample of the Gate View screen in other measurements is shown in the following graphic . This example is for the ACP measurement:



Turning Gate View off returns the analyzer to the Normal measurement view.

In the Swept SA, the normal measurement view is the single-window Swept SA view. When returning to this view, the Swept SA measurement returns to the Span it was in before entering **Gate View** (even if that is Zero Span).

The **Gate View** window is triggered from the Gate Source, with zero trigger delay. Also, when updating the **Gate View** window, the Gate itself must not operate. So it is internally shut off while the gate view window is being updated. For the Swept SA measurement, this means that the Gate is internally shut off whenever the gate view window is displayed. The measurement bar and softkeys continue to show the Trigger source for the main sweep window and give no indication that the Gate is shut off or that the Gate View window is triggered from the Gate Source.

When in **Gate View**, vertical lines are displayed in the Gate View window as follows:

- Green lines are displayed at the gate edges as follows: in Edge Gate, a line is shown for Delay and one for the end of the Gate period (defined by Length, even in FFT. In Level Gate a line is shown only for Delay. You can adjust the position of the green lines by adjusting the gate length and the gate delay. These lines update in the Gate View window as the active function changes, even if the window is not being updated. In Gated LO and Gated Video, these lines are positioned relative to the delay reference line (not relative to 0 time). In Gated FFT, their location is relative to the left edge of the screen.
- A blue line is displayed showing the delay reference, that is, the reference point for the Gate Delay within the Zero Span window. The blue line represents where (in time) the effective location of the gate start would be if the gate were programmed to zero delay.
- The second blue line is labeled "MIN FAST" as shown in the figure above because it represents the minimum Gate Delay for fast Gated LO operation. This line is only displayed in Gated LO. You cannot scroll (knob) or decrement (down key) the Gate Delay to less than that represented by the position of this line, it can only be set below this position manually, although once there it can be moved freely with the knob while below the line.
- A yellow line in the Gated Video case only, is displayed at B_{length} , where B_{length} is the display point (bucket) length for the swept trace, which is given by the sweep time for that trace divided by number of Points – 1. So it is referenced to 0 time, not to the delay reference. This line is labeled NEXT PT (it is not shown in the figure above because the figure above is for Gated LO). The yellow line represents the edge of a display point (bucket). Normally in Gated Video, the bucket length must be selected so that it exceeds the off time of the burst. There is another way to use the analyzer in Gated Video measurements, and that is to set the bucket width much shorter than the off time of the burst. Then use the Max Hold trace function to fill in "missing" buckets more slowly. This allows you to see some of the patterns of the Gated Video results earlier, though seeing a completely filled-in spectrum later.

Gate View Setup

Accesses a menu that enables you to setup parameters relevant to the Gate View

Key Path:	Sweep/Control, Gate
Scope:	Meas Global
Initial S/W Revision:	A.10.00

Sweep/Control

Help Map ID: 4038

Gate View Sweep Time

Controls the sweep time in the Gate View window. To provide an optimal view of the gate signal, the analyzer initializes Gate View Sweep Time based on the current settings of Gate Delay and Gate Length.

Key Path:	Sweep/Control, Gate, Gate View Setup
Remote Command:	[:SENSE] :SWEep:EGATe:TIME <time> [:SENSE] :SWEep:EGATe:TIME?
Example:	SWE:EGAT:TIME 500 ms
Dependencies:	Gate View Sweep Time is initialized: <ul style="list-style-type: none">• On Preset (after initializing delay and length).• Every time the Gate Method is set/changed. Additionally, in the Swept SA measurement, whenever you do a Preset, or leave Gate View, the analyzer remembers the Gate Delay and Gate Length settings. Then, when returning to Gate View, if the current Gate Delay and/or Gate Length do not match the remembered values Gate View Sweep Time is re-initialized. <ol style="list-style-type: none">1. Compute the location of the "gate stop" line, which you know is at time $t = t_{\min} + \text{GateDelay} + \text{GateLength}$.
Preset:	519.3 μ s WiMAX OFDMA: 5 ms GSM/EDGE: 1 ms
State Saved:	Saved in instrument state
Min:	1 μ s
Max:	6000 s
Initial S/W Revision:	Prior to A.02.00
Help Map ID:	3305

Gate View Start Time

Controls the time at the left edge of the Gate View.

Key Path:	Sweep/Control, Gate, Gate View Setup
Remote Command:	[:SENSE] :SWEep:EGATe:VIEW:START <time> [:SENSE] :SWEep:EGATe:VIEW:START?
Example:	SWE:EGAT:VIEW:STAR 10ms

Notes:	Units of time are required or no units; otherwise an invalid suffix error message will be generated. See error –131.
Preset:	0 ms
State Saved:	Saved in instrument state
Min:	0
Max:	500 ms
Initial S/W Revision:	A.10.00
Help Map ID:	4039

Gate Delay

Controls the length of time from the time the gate condition goes True until the gate is turned on.

Key Path:	Sweep/Control, Gate
Remote Command:	[:SENSE] :SWEep:EGATe:DELay <time> [:SENSE] :SWEep:EGATe:DELay?
Example:	SWE:EGAT:DELay 500ms SWE:EGAT:DELay?
Notes:	Units of time are required or no units; otherwise an invalid suffix error message will be generated.
Preset:	57.7 us WiMAX OFDMA: 71 us GSM/EDGE: 600 us
State Saved:	Saved in instrument state
Min:	0.0 us
Max:	100 s
Backwards Compatibility SCPI:	[:SENSe] :SWEep:TIME:GATE:DELay ESA compatibility
Initial S/W Revision:	Prior to A.02.00
Help Map ID:	3298

Gate Length

Controls the length of time that the gate is on after it opens.

Key Path:	Sweep/Control, Gate
Remote Command:	[:SENSE] :SWEep:EGATe:LENGth <time> [:SENSE] :SWEep:EGATe:LENGth?

Sweep/Control

Example:	SWE:EGAT:LENG 1 SWE:EGAT:LENG?
Notes:	Units of time are required or no units; otherwise an invalid suffix error message will be generated.
Dependencies:	<p>Grayed out when Gate Method is set to FFT in which case the label changes to that shown below.</p> <div style="border: 1px solid black; padding: 5px; display: inline-block;"> <p>Gate Length (=1.83/RBW) 2.8 ms</p> </div> <p style="margin-left: 20px;">vsd 39-1</p> <p>The key is also grayed out if Gate Control = Level.</p>
Preset:	461.6 us WiMAX OFDMA: 50 us GSM/EDGE: 200 us
State Saved:	Saved in instrument state
Min:	100 ns
Max:	5 s
Backwards Compatibility SCPI:	[:SENSE]:SWEep:TIME:GATE:LENGth ESA compatibility
Initial S/W Revision:	Prior to A.02.00
Help Map ID:	3299

Method

This lets you choose one of the three different types of gating.

Not all types of gating are available for all measurements.

Key Path:	Sweep/Control, Gate
Remote Command:	[:SENSe]:SWEep:EGATe:METhod LO VIDeo FFT [:SENSe]:SWEep:EGATe:METhod?
Example:	SWE:EGAT:METH FFT
Preset:	LO
State Saved:	Saved in instrument state
Initial S/W Revision:	Prior to A.02.00
Help Map ID:	3300

LO

When Gate is set to On, the LO sweeps whenever the gate conditions as specified in the Gate menu are satisfied by the signal at the Gate Source.

This form of gating is more sophisticated, and results in faster measurements. With Gated LO, the analyzer only sweeps while the gate conditions are satisfied. This means that a sweep could take place over several gate events. It would start when the gate signal goes true and stop when it goes false, and then continue when it goes true again. But since the LO is sweeping as long as the gate conditions are satisfied, the sweep typically finishes much more quickly than with Gated Video.

When in zero span, there is no actual sweep performed. But data is only taken while the gate conditions are satisfied. So even though there is no sweep, the gate settings will impact when data is acquired.

Key Path:	Sweep/Control, Gate, Method
Dependencies:	Key is unavailable when Gate is On and FFT Sweep Type manually selected. When selected, Sweep Type is forced to Swept and the FFT key in Sweep Type is grayed out.
Readback:	LO
Initial S/W Revision:	Prior to A.02.00
Help Map ID:	3301

Video

When Gate is set to On, the video signal is allowed to pass through whenever the gate conditions as specified in the Gate menu are satisfied by the signal at the Gate Source.

This form of gating may be thought of as a simple switch, which connects the signal to the input of the spectrum analyzer. When the gate conditions are satisfied, the switch is closed, and when the gate conditions are not satisfied, the switch is open. So we only look at the signal while the gate conditions are satisfied.

With this type of gating, you usually set the analyzer to sweep very slowly. In fact, a general rule is to sweep slowly enough that the gate is guaranteed to be closed at least once per data measurement interval (bucket). Then if the peak detector is used, each bucket will represent the peak signal as it looks with the gate closed.

Key Path:	Sweep/Control, Gate, Method
Dependencies:	Key is unavailable when Gate is On and FFT Sweep Type manually selected. When selected, Sweep Type is forced to Swept and the FFT key in Sweep Type is grayed out
Readback:	Video
Initial S/W Revision:	Prior to A.02.00
Help Map ID:	3302

FFT

When Gate is set to On, an FFT is performed whenever the gate conditions as specified in the Gate menu are satisfied by the signal at the Gate Source. This is an FFT measurement which begins when the gate conditions are satisfied. Since the time period of an FFT is approximately $1.83/\text{RBW}$, you get a measurement that starts under predefined conditions and takes place over a predefined period. So, in

Sweep/Control

essence, this is a gated measurement. You have limited control over the gate length but it works in FFT sweeps, which the other two methods do not.

Gated FFT cannot be done in zero span since the instrument is not sweeping. So in zero span the Gated LO method is used. Data is still only taken while the gate conditions are satisfied, so the gate settings do impact when data is acquired.

The Gate Length will be 1.83/RBW.

This is a convenient way to make a triggered FFT measurement under control of an external gating signal.

Key Path:	Sweep/Control, Gate
Dependencies:	Key is unavailable when Gate is On and Swept Sweep Type is manually selected. Key is unavailable when gate Control is set to Level. When selected, Sweep Type is forced to FFT and the Swept key in Sweep Type is grayed out Forces Gate Length to 1.83/RBW
Readback:	FFT
Initial S/W Revision:	Prior to A.02.00
Help Map ID:	3303

Gate Source

The menus under the **Gate Source** key are the same as those under the **Trigger key**, with the exception that neither **Free Run** nor **Video** are available as Gate Source selections. However, a different SCPI command is used to select the Gate Source (see table below) because you may independently set the Gate Source and the Trigger Source.

Any changes to the settings in the setup menus under each **Gate Source** selection key (for example: **Trigger Level, Trigger Delay, etc**) also affect the corresponding settings under the **Trigger** menu keys. The SCPI commands used for these are the same for Trigger and Gate, since there is only one setting which affects both Gate and Trigger. Example: to set the Trigger Level for External 1 you use the command :TRIG:EXT1:LEV regardless of whether you are using External 1 as a Trigger Source or a Gate Source.

Key Path:	Sweep/Control, Gate
Remote Command:	[:SENSE] :SWEep:EGATE:SOURce EXTernal1 EXTernal2 LINE FRAME RFBurst [:SENSE] :SWEep:EGATE:SOURce?
Dependencies:	In some models, there is no second External input. In these models, the External 2 key is blanked and the EXTernal2 parameter will generate a "Hardware missing; Not available for this model number" error.

Preset:	EXTernal 1 GSM/EDGE: FRAMe
Backwards Compatibility Notes:	In ESA, there is a single Gate input port. In PSA, the Gate Source may be taken from one of two specified input ports. In the X-Series, any Trigger Source can be a Gate Source.
Initial S/W Revision:	Prior to A.02.00
Modified at S/W Revision:	A.03.00
Help Map ID:	3304

Control Edge/Level

Sets the method of controlling the gating function from the gating signal.

Edge

In Edge triggering, the gate opens (after the Delay) on the selected edge (for example, positive) of the gate signal and closes on the alternate edge (for example, negative).

Level

In Level triggering, the gate opens (after the Delay) when the gate signal has achieved a certain level and stays open as long as that level is maintained.

Key Path:	Sweep/Control, Gate
Remote Command:	[:SENSe] :SWEep:EGATe:CONTRol EDGE LEVEl [:SENSe] :SWEep:EGATe:CONTRol?
Example:	SWE:EGAT:CONT EDGE
Dependencies:	If the Gate Method is FFT the Control key is grayed out and Edge is selected. If the Gate Source is TV, Frame or Line, the Control key is grayed out and Edge is selected.
Preset:	EDGE
State Saved:	Saved in instrument state
Backwards Compatibility SCPI:	[:SENSe]:SWEep:TIME:GATE:TYPE ESA Compatibility
Initial S/W Revision:	Prior to A.02.00
Help Map ID:	3295

Gate Holdoff

Lets you increase or decrease the wait time after a gate event ends before the analyzer will respond to the next gate signal.

After any Gate event finishes, the analyzer must wait for the sweep system to settle before it can respond to another Gate signal. The analyzer calculates a "wait time," taking into account a number of factors, including RBW and Phase Noise Optimization settings. The goal is to achieve the same accuracy when

Sweep/Control

gated as in ungated operation. The figure below illustrates this concept:

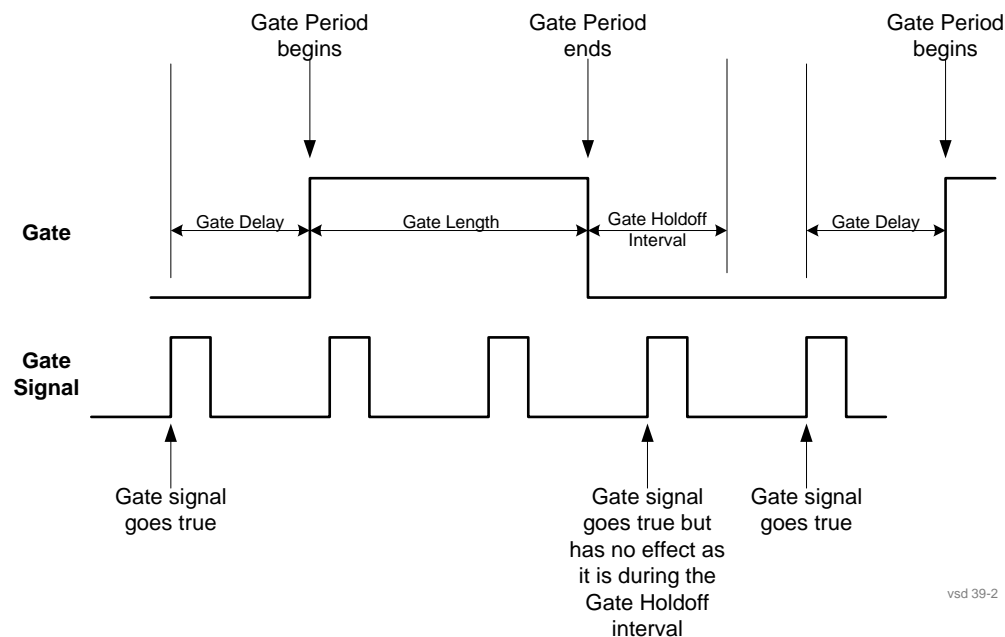

When Gate Holdoff is in Auto, the wait time calculated by the analyzer is used. When Gate Time is in Manual, the user may adjust the wait time, usually decreasing it in order to achieve greater speed, but at the risk of decreasing accuracy.

When the **Method** key is set to **Video** or **FFT**, the **Gate Holdoff** function has no effect.

In measurements that do not support Auto, the value shown when Auto is selected is “---” and the manually set holdoff is returned to a query.

Key Path:	Sweep/Control, Gate
Remote Command:	<pre>[:SENSe] :SWEep:EGATe:HOLDoff <time> [:SENSe] :SWEep:EGATe:HOLDoff? [:SENSe] :SWEep:EGATe:HOLDoff:AUTO OFF ON 0 1 [:SENSe] :SWEep:EGATe:HOLDoff:AUTO?</pre>
Example:	<pre>SWE:EGAT:HOLD 0.0002 SWE:EGAT:HOLD? SWE:EGAT:HOLD:AUTO ON SWE:EGAT:HOLD:AUTO?</pre>

Couplings:	<p>When Gate Holdoff is Auto, the Gate Holdoff key shows the value calculated by the analyzer for the wait time.</p> <p>Pressing the Gate Holdoff key while it is in Auto and not selected, causes the key to become selected and allows the user to adjust the value. If the value is adjusted, the setting changes to Man.</p> <p>Pressing the Gate Holdoff key, while it is in Auto and selected, does not change the value of Gate Holdoff, but causes the setting to change to Man. Now the user can adjust the value.</p> <p>Pressing the key while it is in Man and selected, cause the value to change back to Auto.</p> <p>Pressing the key while it is in Man and not selected, causes the key to become selected and allows the user to adjust the value.</p> <p>When Method is set to Video or FFT, the Gate Holdoff function has no effect.</p>
Preset:	Auto Auto/On
State Saved:	Saved in instrument state
Min:	1 μ sec
Max:	1 sec
Initial S/W Revision:	Prior to A.02.00
Help Map ID:	3567

Gate Delay Compensation

This function allows you to select an RBW-dependent value by which to adjust the gate delay, to compensate for changes in the delay caused by RBW effects.

You can select between uncompensated operation and two types of compensation, **Delay Until RBW Settled** and **Compensate for RBW Group Delay**.

See [“More Information” on page 894](#)

Key Path:	Sweep/Control, Gate
Scope:	Meas Global
Remote Command:	<pre>[:SENSE] :SWEep:EGATe:DElay:COMPensation:TYPE OFF SETTled GDElay [:SENSE] :SWEep:EGATe:DElay:COMPensation:TYPE?</pre>
Example:	<pre>SWE:EGAT:DEL:COMP:TYPE SETT SWE:EGAT:DEL:COMP:TYPE?</pre>

Sweep/Control

Notes:	<p>Although this function is Meas Global, there are some measurements that do not support this function. In those measurements the operation will be Uncompensated. Going into one of those measurements will not change the Meas Global selection; it will simply display the grayed-out menu key with “Uncompensated” showing as the selection. This is a non-forceful grayout, so the SCPI command is still accepted.</p> <p>If Gate Delay Compensation is not supported at all within a particular mode, the key is not displayed, and if the SCPI command is sent while in a measurement within that mode, an “Undefined Header” message is generated.</p> <p>Measurements that do not support this function include:</p> <p>Swept SA</p>
Preset:	<p>TD-SCDMA mode: Compensate for RBW Group Delay</p> <p>All other modes: Delay Until RBW Settled</p>
State Saved:	Saved in instrument state
Range:	Uncompensated Delay Until RBW Settled Compensate for RBW Group Delay
Readback text:	Uncompensated Settled Group Delay
Initial S/W Revision:	Prior to A.02.00
Modified at S/W Revision:	A.11.0
Help Map ID:	29882

More Information

Selecting **Uncompensated** means that the actual gate delay is as you sets it.

Selecting **Delay Until RBW Settled** causes the gate delay to be increased above the user setting by an amount equal to $3.06/\text{RBW}$. This compensated delay causes the GATE START and GATE STOP lines on the display to move by the compensation amount, and the actual hardware gate delay to be increased by the same amount. All the other gate lines (for example, MIN FAST) are unaffected. If the RBW subsequently changes, the compensation is readjusted for the new RBW. The value shown on the **Gate Delay** key does NOT change.

Delay Until RBW Settled allows excellent measurements of gated signals, by allowing the IF to settle following any transient that affects the burst. Excellent measurements also require that the analysis region not extend into the region affected by the falling edge of the burst. Thus, excellent measurements can only be made over a width that declines with narrowing RBWs, which is achieved by decreasing the gate length below the user setting by an amount equal to $2.53/\text{RBW}$. Therefore, for general purpose compensation, you will still want to change the gate length with changes in RBW even if the gate delay is compensated. The compensated Gate Length is limited by the analyzer so that it will never go below 10% of the value shown on the Gate Length key, as otherwise the sweep times could get very long. Anytime the **Gate Length and RBW** values combine in such a way that this limiting takes place, a warning is displayed. For measurements which contain multiple sweeps with different RBW like SEM and SPUR, the smallest RBW is used for this limiting.

Selecting **Compensate for RBW Group Delay** causes the gate delay to be increased above the user

setting by an amount equal to $1.81/\text{RBW}$. This compensated delay causes the GATE START, GATE STOP lines on the display to move by the compensation amount, and the actual hardware gate delay to be increased by the same amount. All the other gate lines (for example, MIN FAST) are unaffected. If the RBW subsequently changes, the compensation is readjusted for the new RBW. The value shown on the **Gate Delay** key does NOT change. **Compensate for RBW Group Delay** also includes gate length compensation; the gate length itself is adjusted as necessary to attempt to compensate for delay effects imposed by the RBW.

Compensate for RBW Group Delay is similar to **Delay Until RBW Settled**, but compensates for the group delay of the RBW filter, rather than the filter settling time. As the RBW gets narrow, this can allow the settling tail of the RBW to affect the beginning part of the gated measurement, and allow the beginning of the RBW settling transient to affect the end of the gated measurement. These two effects are symmetric because the RBW response is symmetric. Because the gate length is not automatically compensated, some users might find this compensation to be more intuitive than compensation for RBW settling.

Min Fast Position Query (Remote Command Only)

This command queries the position of the MIN FAST line, relative to the delay reference (REF) line. See section “[Gate View On/Off](#)” on page 882. If this query is sent while not in gate view, the MinFast calculation is performed based on the current values of the appropriate parameters and the result is returned. Knowing this value lets you set an optimal gate delay value for the current measurement setup.

Remote Command:	[:SENSE] :SWEep:EGATe:MINFast?
Example:	SWE:EGAT:MIN?
Initial S/W Revision:	Prior to A.02.00
Help Map ID:	0

Gate Preset (Remote Command Only)

Presets the time-gated spectrum analysis capability.

This command sets gate parameter values to the ESA preset values, as follows:

Gate trigger type = edge

Gate polarity = positive

Gate delay = 1 us

Gate length = 1 us

Remote Command:	[:SENSE]:SWEep:TIME:GATE:PRESet ESA Compatibility
Initial S/W Revision:	Prior to A.02.00
Help Map ID:	0

Gate Level (Remote Command Only)

Sets the gate input transition point level for the external TRIGGER inputs on the front and rear panel. This is a legacy command for PSA compatibility. It is simply an alias to the equivalent trigger level

Sweep/Control

command.

Remote Command:	<code>[:SENSe] :SWEep:EGATe:EXTeRnal [1] 2:LEVe1 <voltage></code> <code>[:SENSe] :SWEep:EGATe:EXTeRnal [1] 2:LEVe1?</code>
Notes:	This command is simply an alias to <code>:TRIGger[:SEQuence]:EXTeRnal[1] 2:LEVe1</code> For details refer
Initial S/W Revision:	Prior to A.02.00
Help Map ID:	0

Gate Polarity (Remote Command Only)

Sets the polarity for the gate signal. This setup is now done using the gate trigger's slope setting.

When Positive (Pos) is selected, a positive-going edge (Edge) or a high voltage (Level) will satisfy the gate condition, after the delay set with the Gate Delay key. When Negative (Neg) is selected, a negative-going edge (Edge) or a low voltage (Level) will satisfy the gate condition after the delay.

Remote Command:	<code>[:SENSe] :SWEep:EGATe:POLarity NEGative POSitive</code> <code>[:SENSe] :SWEep:EGATe:POLarity?</code>
Example:	<code>SWE:EGAT:POL NEG</code> <code>SWE:EGAT:POL?</code>
Preset:	POSitive
State Saved:	Saved in instrument state
Backwards Compatibility SCPI:	<code>[:SENSe] :SWEep:TIME:GATE:POLarity</code> ESA compatibility
Initial S/W Revision:	Prior to A.02.00
Help Map ID:	0

Remote Command:	<code>[:SENSe] :SWEep:TIME:GATE:LEVe1 HIGH LOW</code> <code>[:SENSe] :SWEep:TIME:GATE:LEVe1?</code> ESA compatibility
Preset:	HIGH
Initial S/W Revision:	Prior to A.02.00
Help Map ID:	0

Points

Sets the number of points taken per sweep, and displayed in the traces. The current value of points is displayed parenthetically, next to the sweep time in the lower-right corner of the display. Using more

points provides greater resolution. Using fewer points compacts the data and decreases the time required to access a trace over the remote interface.

Increasing the number of points does not increase the sweep time; however, it can slightly impact the trace processing time and therefore the overall measurement speed. Decreasing the number of points does not decrease the sweep time, but it may speed up the measurement, depending on the other sweep settings (for example, in FFT sweeps). Fewer points will always speed up the I/O.

Due to minimum sweep rate limitations of the hardware, the minimum sweep time available to the user will increase above its normal value of 1 ms as the number of sweep points increases above 15001.

Changing the number of sweep points has several effects on the analyzer. The sweep time resolution will change. Trace data for all the traces will be cleared and, if Sweep is in Cont, a new trace taken. If any trace is in average or hold, the averaging starts over.

When in a split screen display each window may have its own value for points.

When sweep points is changed, an informational message is displayed, "Sweep points changed, all traces cleared."

Key Path:	Sweep/Control
Remote Command:	[:SENSe] :SWEep:POINts <integer> [:SENSe] :SWEep:POINts?
Example:	SWE:POIN 5001 SWE:POIN?
Dependencies:	<ul style="list-style-type: none"> • This function is not available when signal identification is set to On in External Mixing • Neither the knob nor the step keys can be used to change this value. If it is tried, a warning is given. • Clipped to 1001 whenever you are in the Spectrogram View in all models but MXE, clipped to 20001 whenever you are in the Spectrogram View in MXE • Grayed out in measurements that do not support swept. Forceful message -221.3200 • Blanked in modes that do not support Swept • Grayed out if Normalize is on; you can't change the number of sweep points with Normalize on, as it will erase the reference trace.

Sweep/Control

Couplings:	<ul style="list-style-type: none">When Source Mode is set to Tracking, and Stepped Tracking is used (as with option ESC), 201 source steps are used to achieve optimal speed. The number of sweep points in the analyzer is then set to match the number of steps in the source. When Source Mode is set to Off, the previous number of points (the value that existed when Source Mode was Off previously) is restored, even if the user has changed the Points value while the Source Mode was set to Tracking.Whenever the number of sweep points change:<ul style="list-style-type: none">All trace data is erasedAny traces with Update Off will also go to Display Off (like going from View to Blank in the older analyzers)Sweep time is re-quantizedAny limit lines that are on will be updatedIf averaging/hold is on, averaging/hold starts over
Preset:	1001
State Saved:	Saved in instrument state
Min:	Normally the minimum is 1, but in Tracking Source Mode, the minimum value of Points is 101. If you go into Tracking Source Mode with fewer points than 101, it sets Points to 101.
Max:	40001 when not in Tracking Source mode In Tracking Source mode: <ul style="list-style-type: none">in Stepped Tracking (e.g., External Source), 1601 or the maximum number of points supported by the source, whichever is lessin Swept Tracking (e.g., Tracking Generator), 10000
Backwards Compatibility Notes:	<ol style="list-style-type: none">In ESA and PSA, Sweep Points was adjustable with the knob and step keys. This caused the sweep time to increase whenever Points was adjusted (either up or down), due to excessive application of the quantization rules. In the X-Series the value of Sweep Points must be entered manually, which avoids this anomalyIn ESA the preset value of Sweep Points is 401, in PSA it is 601. In X-Series it is 1001.
Initial S/W Revision:	Prior to A.02.00
Modified at S/W Revision:	A.11.00
Help Map ID:	3306

Zoom Points

In the Trace Zoom View of the Swept SA measurement, the Points key changes to Zoom Points whenever the focus (thick green border) is on the bottom window. Zoom Points controls how many

points are displayed in the Zoom Window and hence indirectly controls the Zoom Span.

Key Path:	Sweep/Control
Remote Command:	[:SENSE] :SWEep:TZOom:POINts <integer> [:SENSe] :SWEep:TZOom:POINts?
Example:	SWE:TZO:POIN 5001
Dependencies:	Only appears in the Trace Zoom View of the Swept SA measurement. If the SCPI command is sent in other Views, gives an error.
Couplings:	Zoom Points is coupled to Zoom Span and Sweep Points; if Zoom Span changes, Zoom Points will change but Sweep Points will not; if Sweep Points changes, Zoom Points will change but Zoom Span will not. Zoom Span is directly coupled to Zoom Points; if Zoom Points changes, Zoom Span will change but Sweep Points will not.
Preset:	On entry to Trace Zoom, 10% of the number of points in the upper window.
State Saved:	Saved in instrument state
Min:	1
Max:	Number of points in top window
Initial S/W Revision:	A.07.01
Help Map ID:	4035

Abort (Remote Command Only)

This command is used to stop the current measurement. It aborts the current measurement as quickly as possible, resets the sweep and trigger systems, and puts the measurement into an "idle" state. If the analyzer is in the process of aligning when ABORt is sent, the alignment finishes before the abort function is performed. So ABORt does not abort an alignment.

If the analyzer is set for Continuous measurement, it sets up the measurement and initiates a new data measurement sequence with a new data acquisition (sweep) taken once the trigger condition is met.

If the analyzer is set for Single measurement, it remains in the "idle" state until an :INIT:IMM command is received.

Remote Command:	:ABORt
Example:	:ABOR
Notes:	If :INITiate:CONTinuous is ON, then a new continuous measurement will start immediately; with sweep (data acquisition) occurring once the trigger condition has been met. If :INITiate:CONTinuous is OFF, then :INITiate:IMMEDIATE is used to start a single measurement; with sweep (data acquisition) occurring once the trigger condition has been met.

Sweep/Control

Dependencies:	For continuous measurement, ABORt is equivalent to the Restart key. Not all measurements support the abort command.
Status Bits/OPC dependencies:	The STATus:OPERation register bits 0 through 8 are cleared. The STATus:QUEStionable register bit 9 (INTEgrity sum) is cleared. Since all the bits that feed into OPC are cleared by the ABORt, the ABORt will cause the *OPC query to return true.
Initial S/W Revision:	Prior to A.02.00
Help Map ID:	0

Trace/Detector

There are no Trace/Detector functions for IQ Analyzer (Basic) mode.

Key Path	Front-panel key
Initial S/W Revision	Prior to A.02.00
Help Map ID	5001

Trigger

Accesses a menu of keys to control the selection of the trigger source and the setup of each of the trigger sources. The analyzer is designed to allow triggering from a number of different sources, for example, Free Run, Video, External, RF Burst, and so forth.

The TRIG:SOURCe command (below) will specify the trigger source for the currently selected input (RF or I/Q). If you change inputs, the new input remembers the trigger source it was last programmed to for the current measurement, and uses that trigger source. You can directly set the trigger source for each input using the TRIGger:RF:SOURce and TRIGger:IQ:SOURce commands (later in this section). When in External Mixing, the analyzer uses the RF trigger source.

Note the inclusion of the <measurement> parameter in the command below. Because each measurement remembers its own Trigger Source, the command must be qualified with the measurement name. Note that for the Swept SA measurement this is not the case; for backwards compatibility, no <measurement> parameter is used when setting the Trigger Source for the Swept SA measurement.

See [“Trigger Source Presets” on page 905](#)

See [“RF Trigger Source” on page 908](#)

See [“I/Q Trigger Source” on page 909](#)

See [“More Information” on page 910](#)

Key Path:	Front-panel key
Remote Command:	<pre>:TRIGger:<measurement>[:SEquence]:SOURce EXTErnal1 EXTErnal2 IMMediate LINE FRAMe RFBurst VIDeo IF ALARm LAN IQMag IDEMod QDEMod IINPut QINPut AIQMag T V :TRIGger:<measurement>[:SEquence]:SOURce? where <measurement> is the measurement for which you wish to set the Source (blank for the Swept SA measurement)</pre>
Example:	<pre>TRIG:ACP:SOUR EXT1 Selects the external 1 trigger input for the ACP measurement and the selected input TRIG:SOUR VID Selects video triggering for the Swept SA (SANalyzer) measurement in the Spectrum Analyzer mode. For SAN, do not use the <measurement> keyword. Only send this form in the Spectrum Analyzer mode or you will get an Undefined Header error</pre>

Trigger

Notes:	<p>Not all measurements have all the trigger sources available to them. Check the trigger source documentation for your specific measurement to see what sources are available.</p> <p>Not all trigger sources are available for each input. See the “RF Trigger Source” on page 908 and “I/Q Trigger Source” on page 909 commands for detailed information on which trigger sources are available for each input.</p> <p>Other trigger-related commands are found in the INITiate and ABORt SCPI command subsystems.</p> <p>*OPC should be used after requesting data. This will hold off any subsequent changes to the selected trigger source, until after the sweep is completed and the data is returned.</p> <p>Available ranges and presets can vary from mode to mode.</p>
Dependencies:	In some models, there is no second External input. In these models, the External 2 key is blanked and the EXTernal2 parameter will generate a “Hardware missing; Not available for this model number” message.
Preset:	See table below
Status Bits/OPC dependencies:	The Status Operation Register bit 5 "Waiting for Trigger" is set at the same time as the Sweeping or Measuring bit is set. It is cleared when the trigger actually occurs (that is, after the trigger event occurs and all the applicable trigger criteria have been met). A corresponding pop-up message ("Waiting for trigger") is generated if no trigger signal appears after approximately 2 sec. This message goes away when a trigger signal appears.
Backwards Compatibility SCPI:	:TRIGger[:SEQuence]:SOURCe EXTernal For backward compatibility, the parameter EXTernal is mapped to EXTernal1
Backwards Compatibility SCPI:	[:SENSe] : <measurement> : TRIGger : SOURce This backwards compatibility alias command is provided for ESA/PSA compatibility This backwards compatibility command does not apply to the Swept SA measurement, for that just use :TRIGger:SOURCe This backwards compatibility command does not apply to the monitor spectrum, log plot and spot frequency measurements
Backwards Compatibility SCPI:	[:SENSe] : <measurement> : TRIGger : SOURce IF In earlier instruments, the parameter IF was used by apps for the video trigger, so using the IF parameter selects VIDEo triggering. Sending IF in the command causes VID to be returned to a query.
Backwards Compatibility SCPI:	[:SENSe] : ACPr : TRIGger : SOURce This backwards Compatibility SCPI command is provided to support the same functionality as [:SENSe] : ACPr : TRIGger : SOURce (PSA W-CDMA, PSA cdma2000 and PSA 1xEVDO) due to the fact that the ACPr node conflicts with the ACPower node.
Initial S/W Revision:	Prior to A.02.00

Modified at S/W Revision:	A.03.00
Help Map ID:	3371

Trigger Source Presets

Here are the Trigger Source Presets for the various measurements:

Meas	Mode	Preset for RF	Preset for IQ	Notes
Swept SA	SA	IMM	IQ not supported	
CHP	SA, WCDMA, C2K, WIMAX OFDMA, 1xEVDO, DVB-T/H, DTMB, LTE, LTETDD, CMMB, ISDB-T, Digital Cable TV, MSR	IMM	IQ not supported	
OBW	SA, WCDMA, C2K, WIMAX OFDMA, TD-SCDMA, 1xEVDO, LTE, LTETDD, CMMB, ISDB-T, MSR	1xEVDO: EXT1 others: IMM	IQ not supported	For 1xEVDO mode, the trigger source is coupled with the gate state, as well as the gate source. When the trigger source changes to RFBurst, External1 or External2, the gate state is set to on, and the gate source is set identically with the trigger source. When the trigger source changes to IMMEDIATE, VIDEO, LINE, FRAME or IF, the gate state is set to off.
CCDF	SA, WCDMA, C2K, WIMAXOFDMA, TD-SCDMA, 1xEV-DO, DVB-T/H, DTMB, LTE, LTETDD, CMMB, ISDB-T, Digital Cable TV, MSR	WIMAXOFDMA : RFBurst LTETDD: BTS: External 1 MS: Periodic Timer TD-SCDMA and 1xEV-DO: BTS: External 1 MS: RFBurst SA, WCDMA, C2K, LTE, CMMB, ISDB-T, DVB-T/H, DTMB, Digital Cable TV, MSR: IMMEDIATE	TD-SCDMA and 1xEV-DO: BTS: External 1 MS: IQMag LTETDD: BTS: External 1 MS: Periodic Timer Others: IMM	For TD-SCDMA: Trigger source is coupled with radio device. When radio device changes to BTS, trigger source will be changed to EXTERNAL1. When radio device changes to MS, trigger source will be set as RFBurst for RF or IQ Mag for BBIQ. When TriggerSource is RFBurst or IQ Mag, Measure Interval is grayed out.

Trigger

Meas	Mode	Preset for RF	Preset for IQ	Notes
ACP	SA, WCDMA, C2K, WIMAX OFDMA, TD-SCDMA, 1xEVDO, DVB-T/H, DTMB, LTE, LTETDD, CMMB, ISDB-T, Digital Cable TV, MSR	IMM	IQ not supported	
Tx Power	SA, GSM, TD-SCDMA	SA, GSM: RFBurst TD-SCDMA: EXternal	IMM	TD-SCDMA doesn't support the Line and Periodic Timer parameters. When the mode is TD-SCDMA, if the Radio Device is switched to BTS, the value will be changed to External 1 and if the Radio device is switched to MS, the value will be changed to RFBurst
SPUR	SA, WCDMA, C2K, WIMAX OFDMA, TD-SCDMA, 1xEVDO, DVB-T/H, LTE, LTETDD, MSR	IMM	IQ not supported	
SEM	SA, WCDMA, C2K, WIMAX OFDMA, TD-SCDMA, 1xEVDO, DVB-T/H, DTMB, LTE, LTETDD, CMMB, ISDB-T, Digital Cable TV, MSR	1xEVDO(BTS): EXternal1 All others: IMMEDIATE	IQ not supported	
CDP	WCDMA	IMM	IMM	
RHO	WCDMA	IMM	IMM	
PCON	WCDMA	IMM	IMM	
QPSK	WCDMA, C2K, 1xEVDO	All except CDMA1xEVDO: IMMEDIATE CDMA1xEVDO: EXT1	IMM	

Meas	Mode	Preset for RF	Preset for IQ	Notes
MON	All except SA and BASIC	IMM	IQ not supported	
WAV		LTETDD: BTS: External 1 MS: Periodic Timer GSM/EDGE: RFBurst All others: IMMediate	LTETDD: BTS: External 1 MS: Periodic Timer GSM/EDGE: IQMag All others: IMMMediate	
PVT	WIMAXOFDMA	RFB	IMM	
EVM	WIMAXOFDMA , DVB-T/H, DTMB, LTE, LTETDD, CMMB, ISDB-T, Digital Cable TV	All but CMMB: IMM CMMB: Periodic Timer	All but CMMB: IMM CMMB: External 1	LTE, LTETDD supports Free Run, Video and External 1 only.
SPEC	BASIC	IMM	IMM	
LOG Plot	PN	IMM	IQ not supported	
Spot Freq	PN	IMM	IQ not supported	
GMSK PVT	EDGE/GSM	RFB	IMM	
GMSK PFER	EDGE/GSM	RFB	IQMag	
GMSK ORFS	EDGE/GSM	RF Burst	IQ not supported	
EDGE PVT	EDGE/GSM	RFB	IMM	
EDGE EVM	EDGE/GSM	RFB	IQMag	
EDGE ORFS	EDGE/GSM	Periodic Timer	IQ not supported	
Combined WCDMA	WCDMA	IMM	IQ not supported	
Combined GSM	EDGE/GSM	RFB	IQ not supported	

Trigger

Meas	Mode	Preset for RF	Preset for IQ	Notes
List Power Step	WCDMA, EDGE/GSM	IMM	IQ not supported	
Transmit On/Off Power	LTETDD	LTETDD: BTS: External 1 MS: Periodic Timer	LTETDD: BTS: External 1 MS: Periodic Timer	
Transmit Analysis	BLUETOOTH	RFB	IQ not supported	
Adjacent Channel Power	BLUETOOTH	IMM	IQ not supported	
LE In-band Emissions	BLUETOOTH	IMM	IQ not supported	
EDR In-band Spurious Emissions	BLUETOOTH	Periodic Timer	IQ not supported	
Conformance EVM	LTE, LTETDD, MSR	IMM	IMM	

RF Trigger Source

The **RF Trigger Source** command selects the trigger to be used for the specified measurement when RF is the selected input. The RF trigger source can be queried and changed even while another input is selected, but it is inactive until RF becomes the selected input.

Note the inclusion of the <measurement> parameter in the command below. Because each measurement remembers its own Trigger Source, the command must be qualified with the measurement name. Note that for the Swept SA measurement this is not the case; for backwards compatibility, no <measurement> parameter is used when setting the Trigger Source for the Swept SA measurement.

Remote Command:	:TRIGger:<measurement>[:SEQuence]:RF:SOURce EXTernal1 EXTernal2 IMMediate LINE FRAMe RFBurst VIDeo IF ALARm LAN TV :TRIGger:<measurement>[:SEQuence]:RF:SOURce?
Example:	TRIG:ACP:RF:SOUR EXT1 Selects the external 1 trigger input for the ACP measurement and the RF input TRIG:RF:SOUR VID Selects video triggering for the SANalyzer measurement and the RF input. For SAN, do not use the <measurement> keyword.

Notes:	<p>Not all measurements have all the trigger sources available to them. Check the trigger source documentation for your specific measurement to see what sources are available.</p> <p>Not all trigger sources are available for each input. For the RF Trigger Source, the following trigger sources are available:</p> <ul style="list-style-type: none"> — IMMEDIATE - free run triggering — VIDEO - triggers on the video signal level — LINE - triggers on the power line signal — EXTERNAL1 (or EXTERNAL) - triggers on an externally connected trigger source marked "Trigger 1 In" on the rear panel — EXTERNAL2 - triggers on an externally connected trigger source marked "Trigger 2 In" on the front panel. In some models, there is no second External input. In these models, the External 2 key is blanked and the EXTERNAL2 parameter will generate a "Hardware missing; Not available for this model number" message — RFBURST - triggers on the bursted frame — FRAME - triggers on the periodic timer — IF (video) - same as video, for backwards compatibility only <p>*OPC should be used after requesting data. This will hold off any subsequent changes to the selected trigger source, until after the sweep is completed and the data is returned.</p> <p>Available ranges, and presets can vary from mode to mode.</p>
Status Bits/OPC dependencies:	<p>The Status Operation Register bit 5 "Waiting for Trigger" is set at the same time as the Sweeping or Measuring bit is set. It is cleared when the trigger actually occurs (that is, after the trigger event occurs and all the applicable trigger criteria have been met). A corresponding pop-up message ("Waiting for trigger") is generated if no trigger signal appears after approximately 2 sec. This message goes away when a trigger signal appears.</p>
Initial S/W Revision:	Prior to A.02.00
Help Map ID:	0

I/Q Trigger Source

This command selects the trigger to be used for the specified measurement when I/Q (which requires option BBA) is the selected input. The I/Q trigger source can be queried and changed even while another input is selected, but it is inactive until I/Q becomes the selected input.

Remote Command:	<pre>:TRIGger:<measurement>[:SEquence]:IQ:SOURce EXTERNAL1 EXTERNAL2 IMMEDIATE IQMag IDEMod QDEMod IINPut QINPut AIQMag :TRIGger:<measurement>[:SEquence]:IQ:SOURce?</pre>
------------------------	--

Trigger

Example:	TRIG:WAVeform:SOUR IQM Selects I/Q magnitude triggering for the IQ Waveform measurement and the I/Q input
Notes:	<p>Not all measurements have all the trigger sources available to them. Check the trigger source documentation for your specific measurement to see what sources are available.</p> <p>Not all trigger sources are available for each input. For the I/Q Trigger Source, the following trigger sources are available:</p> <ul style="list-style-type: none"> — IMMEDIATE - free run triggering — EXTERNAL1 (or EXTERNAL) - triggers on an externally connected trigger source on the rear panel — EXTERNAL2 - triggers on an externally connected trigger source on the front panel — IQMAG - triggers on the magnitude of the I/Q signal — IDEMOD - triggers on the I/Q signal's demodulated I voltage — QDEMOD - triggers on the I/Q signal's demodulated Q voltage — IINPUT - triggers on the I channel's ADC voltage — QINPUT - triggers on the Q channel's ADC voltage — AIQMAG - triggers on the magnitude of the auxiliary receiver channel I/Q signal <p>*OPC should be used after requesting data. This will hold off any subsequent changes to the selected trigger source, until after the sweep is completed and the data is returned.</p> <p>Available ranges, and from mode to mode presets can vary</p>
Status Bits/OPC dependencies:	The Status Operation Register bit 5 "Waiting for Trigger" is set at the same time as the Sweeping or Measuring bit is set. It is cleared when the trigger actually occurs (that is, after the trigger event occurs and all the applicable trigger criteria have been met). A corresponding pop-up message ("Waiting for trigger") is generated if no trigger signal appears after approximately 2 sec. This message goes away when a trigger signal appears.
Initial S/W Revision:	Prior to A.02.00
Help Map ID:	0

More Information

The trigger menus let you select the trigger source and trigger settings for a sweep or measurement. In triggered operation (basically, any trigger source other than Free Run), the analyzer will begin a sweep or measurement only with the selected trigger conditions are met, generally when your trigger source signal meets the specified trigger level and polarity requirements. (In FFT measurements, the trigger controls when the data acquisition begins for FFT conversion.)

For each of the trigger sources, you may define a set of operational parameters or settings which will be applied when that source is selected as the current trigger source. Examples of these settings are Trigger

Level, Trigger Delay, and Trigger Slope. You may apply different settings for each source; so, for example, you could have a Trigger Level of 1v for External 1 trigger and -10 dBm for Video trigger.

Once you have established the settings for a given trigger source, they generally will remain unchanged for that trigger source as you go from measurement to measurement within a Mode (although the settings do change as you go from Mode to Mode). Furthermore, the trigger settings within a Mode are the same for the **Trigger** menu, the **Gate Source** menu, and the **Sync Source** menu that is part of the **Periodic Timer Trigger Setup** menu. That is, if **Ext1** trigger level is set to 1v in the **Trigger** menu, it will appear as 1v in both the **Gate Source** and the **Sync Source** menus. For these reasons the trigger settings commands are not qualified with the measurement name, the way the trigger source commands are.

The settings setup menu can be accessed by pressing the key for the current trigger source a second time. For example, one press of Video selects the Video trigger as the source. The Video key becomes highlighted and the hollow arrow on the key turns black. Now a second press of the key takes you into the Video Trigger Setup menu.

Trigger Setup Parameters:

The following examples show trigger setup parameters using an external trigger source.

Example 1 illustrates the trigger conditions with negative slope and no trigger occurs during trigger Holdoff time.

Example 2 illustrates the trigger conditions with positive slope, trigger delay, and auto trigger time.

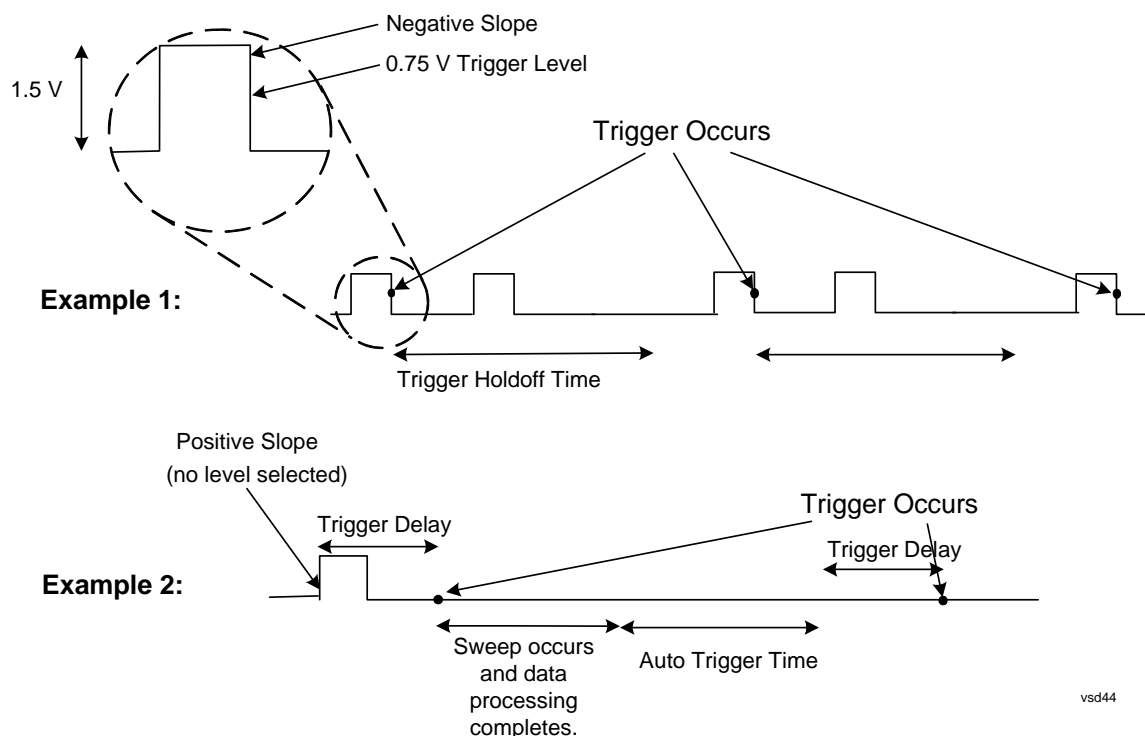

Free Run

Pressing this key, when it is not selected, selects free-run triggering. Free run triggering occurs

Trigger

immediately after the sweep/measurement is initiated.

Key Path:	Trigger
Example:	TRIG:SOUR IMM Swept SA measurement TRIG:<meas>:SOUR IMM Measurements other than Swept SA
State Saved:	Saved in instrument state
Status Bits/OPC dependencies:	The Status Operation Register bit 5 "Waiting for Trigger" is set at the same time as the Sweeping or Measuring bit is set. It is cleared when the trigger actually occurs (that is, after the trigger event occurs and all the applicable trigger criteria have been met). A corresponding pop-up message ("Waiting for trigger") is generated if no trigger signal appears after approximately 2 sec. This message goes away when a trigger signal appears.
Initial S/W Revision:	Prior to A.02.00
Help Map ID:	3373

Video (IF Envelope)

Pressing this key, when it is not selected, selects the video signal as the trigger. The Video trigger condition is met when the video signal (the filtered and detected version of the input signal, including both RBW and VBW filtering) crosses the video trigger level.

NOTE When the detector selected for all active traces is the average detector, the video signal for triggering does not include any VBW filtering.

The video trigger level is shown as a labeled line on the display. The line is displayed as long as video is the selected trigger source.

Pressing this key, when it is already selected, accesses the video trigger setup functions.

Key Path:	Trigger
Example:	TRIG:SOUR VID Swept SA measurement TRIG:<meas>:SOUR VID Measurements other than Swept SA
Notes:	Log Plot and Spot Frequency measurements do not support Video Trigger
Dependencies:	Video trigger is allowed in average detector mode.
State Saved:	Saved in instrument state
Status Bits/OPC dependencies:	The Status Operation Register bit 5 "Waiting for Trigger" is set at the same time as the Sweeping or Measuring bit is set. It is cleared when the trigger actually occurs (that is, after the trigger event occurs and all the applicable trigger criteria have been met). A corresponding pop-up message ("Waiting for trigger") is generated if no trigger signal appears after approximately 2 sec. This message goes away when a trigger signal appears.

Backwards Compatibility Notes:	1. In the past, the Average detector was not available when Video triggering was on, and consequently, functions that set the detector to average (such as Marker Noise or Band/Intvl Power) were not available when the video trigger was on. Similarly, Video triggering was not available when the detector was Average. In the X-Series, these restrictions are removed.
Initial S/W Revision:	Prior to A.02.00
Help Map ID:	3374

Trigger Level

Sets a level for the video signal trigger. When the video signal crosses this level, with the chosen slope, the trigger occurs. This level is displayed with a horizontal line only if **Video** is the selected trigger source.

Key Path:	Trigger, Video
Remote Command:	:TRIGger[:SEquence]:VIDeo:LEVel <ampl> :TRIGger[:SEquence]:VIDeo:LEVel?
Example:	TRIG:VID:LEV -40 dBm
Notes:	<p>When sweep type = FFT, the video trigger uses the amplitude envelope in a bandwidth wider than the FFT width as a trigger source. This might often be useful, but does not have the same relationship between the displayed trace and the trigger level as in swept triggering.</p> <p>Amplitude Corrections are not taken into account by the Video Trig Level. For example, if you have given yourself effective gain with an amplitude correction factor, the Video Trigger will not fire until you have dropped the trigger line that far below the displayed signal level, rather than simply dropping it down to the displayed signal level.</p> <p>Note that other corrections, specifically External Gain and Ref Level Offset, modify the actual trace data as it is taken and therefore ARE taken into account by Trig Level.</p>
Couplings:	This same level is used for the Video trigger source in the Trigger menu and for the Video selection in the Gate Source menu.
Preset:	Set the Video Trigger Level -25 dBm on Preset. When the Video Trigger Level becomes the active function, if the value is off screen, set it to either the top or bottom of screen, depending on which direction off screen it was.
State Saved:	Saved in instrument state
Min:	-170 dBm
Max:	+30 dBm
Default Unit:	Depends on the current selected Y axis unit
Backwards Compatibility SCPI:	:TRIGger[:SEquence]:IF:LEVel :TRIGger[:SEquence]:IF:LEVel?

Trigger

Backwards Compatibility Notes:	This alias is provided for backward compatibility with VSA/PSA comms apps.
Initial S/W Revision:	Prior to A.02.00
Help Map ID:	3375

Trig Slope

Controls the trigger polarity. It is set positive to trigger on a rising edge and negative to trigger on a falling edge.

Key Path:	Trigger, Video
Remote Command:	:TRIGger[:SEquence]:VIDeo:SLOPe POSitive NEGative :TRIGger[:SEquence]:VIDeo:SLOPe?
Example:	TRIG:VID:SLOP NEG
Preset:	POSitive
State Saved:	Saved in instrument state
Backwards Compatibility SCPI:	:TRIGger[:SEquence]:IF:SLOPe NEGative POSitive :TRIGger[:SEquence]:IF:SLOPe? For backward compatibility with VSA/PSA comms apps
Backwards Compatibility Notes:	The legacy :TRIGger[:SEquence]:SLOPe command affects the slopes for the VID, LINE, EXT1, EXT2, and RFB triggers.
Initial S/W Revision:	Prior to A.02.00
Help Map ID:	3377

Remote Command:	:TRIGger[:SEquence]:SLOPe POSitive NEGative :TRIGger[:SEquence]:SLOPe?
Example:	TRIG:SLOP NEG
Preset:	POSitive
State Saved:	Saved in instrument state
Backwards Compatibility Notes:	In ESA/PSA, the Trigger Slope was global to all triggers. In the X-Series, the slope can be set individually for each Trigger Source. For backward compatibility, the global SLOPe command updates all instances of trigger slope (VID, LINE, EXT1, EXT2, TV, RFB). The query returns the trigger slope setting of the currently selected trigger source.
Initial S/W Revision:	Prior to A.02.00
Help Map ID:	0

Trig Delay

Controls a time delay during that the analyzer will wait to begin a sweep after meeting the trigger criteria. You can use negative delay to pre-trigger the instrument in the time domain or FFT, but not in swept spans.

Key Path:	Trigger, Video
Remote Command:	:TRIGger[:SEQuence]:VIDeo:DELAy <time> :TRIGger[:SEQuence]:VIDeo:DELAy? :TRIGger[:SEQuence]:VIDeo:DELAy:STATe OFF ON 0 1 :TRIGger[:SEQuence]:VIDeo:DELAy:STATe?
Example:	TRIG:VID:DEL:STAT ON TRIG:VID:DEL 100 ms
Notes:	Video trigger delay may be set to negative values, in time domain, FFT and even swept. It makes intuitive sense in time domain and works well in FFT mode where the bandwidth of the filter before the video trigger is about 1.25 span. In swept spans, negative settings of Trig Delay are treated as a zero setting within the internal hardware and the advisory message "Neg. Trig Delay unavailable in Swept Mode, zero delay used." is generated when such a delay is set.
Preset:	Off, 1 us
State Saved:	Saved in instrument state
Min:	-150 ms
Max:	+500 ms
Default Unit:	s
Backwards Compatibility Notes:	! For backward compatibility with VSA/PSA comms apps :TRIGger[:SEQuence]:IF:DELAy :TRIGger[:SEQuence]:DELAy The legacy :TRIGger[:SEQuence]:DELAy command affects the delay for the VID, LINE, EXT1, EXT2, and RFB triggers.
Initial S/W Revision:	Prior to A.02.00
Help Map ID:	3378

Remote Command:	:TRIGger[:SEQuence]:DELAy <time> :TRIGger[:SEQuence]:DELAy? :TRIGger[:SEQuence]:DELAy:STATe OFF ON 0 1 :TRIGger[:SEQuence]:DELAy:STATe?
Example:	TRIG:DEL 1 ms

Trigger

Preset:	1 us
State Saved:	Saved in instrument state
Backwards Compatibility Notes:	In ESA/PSA, the Trigger Delay was global to all triggers. In the X-Series, the delay can be set individually for each Trigger Source. For backward compatibility, the global DELAY command updates all instances of trigger slope (VID, LINE, EXT1, EXT2) except TV and RFBurst. The query returns the trigger delay setting of the currently selected trigger source.
Initial S/W Revision:	Prior to A.02.00
Help Map ID:	0

Remote Command:	:TRIGger[:SEquence]:OFFSet <time> :TRIGger[:SEquence]:OFFSet? :TRIGger[:SEquence]:OFFSet:STATe OFF ON 0 1 :TRIGger[:SEquence]:OFFSet:STATe?
Example:	TRIG:OFFS ON TRIG:OFFS -100 ms
Notes:	These are ESA commands for trigger offset that allowed you to use a positive or negative delay when in zero span and in a Res BW >= 1 kHz. For ESA compatibility, X-series analyzers keep track of this offset and adds it to the Trigger Delay for VIDEO, LINE, EXTERNAL1 or EXTERNAL2 whenever the value is sent to the hardware, if in Zero Span and RBW >= 1 kHz.
Preset:	Off, 0 s
State Saved:	Saved in instrument state
Min:	-11 s
Max:	+11 s
Initial S/W Revision:	Prior to A.02.00
Help Map ID:	0

Line

Pressing this key, when it is not selected, selects the line signal as the trigger. A new sweep/measurement will start synchronized with the next cycle of the line voltage. Pressing this key, when it is already selected, access the line trigger setup menu.

Key Path:	Trigger
Example:	TRIG:SOUR LINE Swept SA measurement TRIG:<meas>:SOUR LINE Measurements other than Swept SA

Dependencies:	Line trigger is not available when operating from a "dc power source", for example, when the instrument is powered from batteries.
State Saved:	Saved in instrument state
Status Bits/OPC dependencies:	The Status Operation Register bit 5 "Waiting for Trigger" is set at the same time as the Sweeping or Measuring bit is set. It is cleared when the trigger actually occurs (that is, after the trigger event occurs and all the applicable trigger criteria have been met). A corresponding pop-up message ("Waiting for trigger") is generated if no trigger signal appears after approximately 2 sec. This message goes away when a trigger signal appears.
Initial S/W Revision:	Prior to A.02.00
Help Map ID:	3379

Trig Slope

Controls the trigger polarity. It is set positive to trigger on a rising edge and negative to trigger on a falling edge.

Key Path:	Trigger, Line
Remote Command:	:TRIGger[:SEQuence]:LINE:SLOPe POSitive NEGative :TRIGger[:SEQuence]:LINE:SLOPe?
Example:	TRIG:LINE:SLOP NEG
Preset:	POSitive
State Saved:	Saved in instrument state
Backwards Compatibility Notes:	The legacy :TRIGger[:SEQuence]:SLOPe command affects the slopes for the VID, LINE, EXT1, EXT2, and RFB triggers.
Initial S/W Revision:	Prior to A.02.00
Help Map ID:	3380

Trig Delay

Controls a time delay during which the analyzer will wait to begin a sweep after meeting the trigger criteria. You can use negative delay to pre-trigger the instrument in time domain or FFT, but not in swept spans.

Key Path:	Trigger, Line
-----------	----------------------

Trigger

Remote Command:	:TRIGger[:SEQuence]:LINE:DELay <time> :TRIGger[:SEQuence]:LINE:DELay? :TRIGger[:SEQuence]:LINE:DELay:STATe OFF ON 0 1 :TRIGger[:SEQuence]:LINE:DELay:STATe?
Example:	TRIG:LINE:DEL:STAT ON TRIG:LINE:DEL 100 ms
Notes:	Video trigger delay may be set to negative values, in time domain, FFT and even swept. It makes intuitive sense in time domain and works well in FFT mode where the bandwidth of the filter before the video trigger is about 1.25 span. In swept spans, negative settings of Trig Delay are treated as a zero setting within the internal hardware and the advisory message "Neg. Trig Delay unavailable in Swept Mode, zero delay used." is generated when such a delay is set.
Preset:	Off, 1.000 us
State Saved:	Saved in instrument state
Min:	-150 ms
Max:	500 ms
Default Unit:	S
Backwards Compatibility Notes:	The legacy :TRIGger[:SEQuence]:DELay command affects the delay for the VID, LINE, EXT1, EXT2, and RFB triggers. The legacy :TRIGger[:SEQuence]:OFFSet command is supported for the VIDEo, LINE, EXT1, and EXT2 triggers.
Initial S/W Revision:	Prior to A.02.00
Help Map ID:	3381

External 1

Pressing this key, when it is not selected, selects an external input signal as the trigger. A new sweep/measurement will start when the external trigger condition is met using the external 1 input connector on the rear panel.

Pressing this key, when it is already selected, accesses the external 1 trigger setup menu.

Key Path:	Trigger
Example:	TRIG:SOUR EXT1 Swept SA measurement TRIG:<meas>:SOUR EXT1 Measurements other than Swept SA
Dependencies:	Grayed out if in use by Point Trigger in the Source Setup menu. Forced to Free Run if already selected and Point Trigger is set to External 1.
State Saved:	Saved in instrument state

Status Bits/OPC dependencies:	The Status Operation Register bit 5 "Waiting for Trigger" is set at the same time as the Sweeping or Measuring bit is set. It is cleared when the trigger actually occurs (that is, after the trigger event occurs and all the applicable trigger criteria have been met). A corresponding pop-up message ("Waiting for trigger") is generated if no trigger signal appears after approximately 2 sec. This message goes away when a trigger signal appears.
Initial S/W Revision:	Prior to A.02.00
Help Map ID:	3382

Trigger Level

Sets the value where the external 1 trigger input will trigger a new sweep/measurement.

Key Path:	Trigger, External 1
Remote Command:	:TRIGger[:SEquence]:EXTernal1:LEVel <level> :TRIGger[:SEquence]:EXTernal1:LEVel?
Example:	TRIG:EXT1:LEV 0.4 V
Couplings:	This same level is used for the Ext1 trigger source in the Trigger menu, for the Ext1 selection in the Periodic Timer sync source (in the Trigger menu and in the Gate Source menu), and also for the Ext1 selection in the Gate Source menu.
Preset:	1.2 V
State Saved:	Saved in instrument state
Min:	-5 V
Max:	5 V
Default Unit:	V
Backwards Compatibility SCPI:	:TRIGger[:SEquence]:EXTernal:LEVel For backward compatibility, the parameter EXTernal is mapped to EXTernal1
Backwards Compatibility SCPI:	:TRIGger[:SEquence]:FRAME:EXTernal1:LEVel
Initial S/W Revision:	Prior to A.02.00
Help Map ID:	3383

Trig Slope

Controls the trigger polarity. It is set positive to trigger on a rising edge and negative to trigger on a falling edge.

Key Path:	Trigger, External 1
Remote Command:	:TRIGger[:SEquence]:EXTernal1:SLOPe POSitive NEGative :TRIGger[:SEquence]:EXTernal1:SLOPe?

Trigger

Example:	TRIG:EXT1:SLOP NEG
Couplings:	This same slope is used in the Ext1 selection for the trigger source in the Trigger menu and for the period timer sync source (in the Trigger menu and in the Gate Source menu).
Preset:	POSitive
State Saved:	Saved in instrument state
Backwards Compatibility SCPI:	:TRIGger[:SEQuence]:EXTernal:SLOPe For backward compatibility, the parameter EXTernal is mapped to EXTernal1
Backwards Compatibility SCPI:	:TRIGger[:SEQuence]:FRAMe:EXTernal1:SLOPe
Backwards Compatibility Notes:	The legacy :TRIGger[:SEQuence]:SLOPe command affects the slopes for the VID, LINE, EXT1, EXT2, and RFB triggers.
Initial S/W Revision:	Prior to A.02.00
Help Map ID:	3384

Trig Delay

Controls a time delay during which the analyzer will wait to begin a sweep after meeting the trigger criteria. You can use negative delay to pre-trigger the instrument in time domain or FFT, but not in swept spans.

Key Path:	Trigger, External 1
Remote Command:	:TRIGger[:SEQuence]:EXTernal1:DElAY <time> :TRIGger[:SEQuence]:EXTernal1:DElAY? :TRIGger[:SEQuence]:EXTernal1:DElAY:STATe OFF ON 0 1 :TRIGger[:SEQuence]:EXTernal1:DElAY:STATe?
Example:	TRIG:EXT1:DEL:STAT ON TRIG:EXT1:DEL 100 ms
Notes:	Video trigger delay may be set to negative values, in time domain, FFT and even swept. It makes intuitive sense in time domain and works well in FFT mode where the bandwidth of the filter before the video trigger is about 1.25 span. In swept spans, negative settings of Trig Delay are treated as a zero setting within the internal hardware and the advisory message "Neg. Trig Delay unavailable in Swept Mode, zero delay used." is generated when such a delay is set.
Preset:	Off, 1.000 us
State Saved:	Saved in instrument state
Min:	-150 ms
Max:	+500 ms
Default Unit:	s

Backwards Compatibility SCPI:	:TRIGger[:SEQuence]:EXTernal:DELay For backward compatibility, the parameter EXTernal is mapped to EXTernal1
Backwards Compatibility Notes:	The legacy :TRIGger[:SEQuence]:DELay command affects the delay for the VID, LINE, EXT1, EXT2, and RFB triggers. The legacy :TRIGger[:SEQuence]:OFFSet command is supported for the VIDEo, LINE, EXT1, and EXT2 triggers.
Initial S/W Revision:	Prior to A.02.00
Help Map ID:	3385

Zero Span Delay Comp On/Off

In zero span, there is a natural delay in the signal path, which comes from the RBW filter. This is usually desirable, as it allows you to trigger on events and also see those events, because the signal is delayed from the trigger event. However, in some cases it is desirable to eliminate this delay, so that trigger events line up exactly with the zero time point in zero span. You can use the **Zero Span Delay Comp On/Off** feature to enable or disable zero span delay compensation.

Key Path:	Trigger, External 1
Remote Command:	:TRIGger[:SEQuence]:EXTernal1:DELay:COMPensation OFF ON 0 1 :TRIGger[:SEQuence]:EXTernal1:DELay:COMPensation?
Example:	TRIG:EXT1:DEL:COMP ON
Dependencies:	No effect except in zero-span, but not locked out in nonzero spans. Blanked in modes that do not support zero-span measurements. If the SCPI command is sent when the key is blanked, an error is returned: -221, “Settings conflict; Feature not supported for this measurement” In analyzers shipping N9060A, this feature requires N9060A-7FP.
Preset:	OFF
State Saved:	Saved in instrument state
Initial S/W Revision:	A.11.00
Help Map ID:	4041

External 2

Pressing this key, when it is not selected, selects an external input signal as the trigger. A new sweep/measurement will start when the external trigger condition is met using the external 2 input connector. The external trigger 2 input connector is on the rear panel.

Pressing this key, when it is already selected, accesses the external 2 trigger setup menu.

Key Path:	Trigger
-----------	----------------

Trigger

Example:	TRIG:SOUR EXT2 Swept SA measurement TRIG:<meas>:SOUR EXT2 Measurements other than Swept SA
Dependencies:	In some models, there is no second External input. In these models, the External 2 key is blanked and the EXternal2 parameter will generate a "Hardware missing; Not available for this model number" message. Grayed out if in use by Point Trigger in the Source Setup menu. Forced to Free Run if already selected and Point Trigger is set to External 2.
State Saved:	Saved in instrument state
Status Bits/OPC dependencies:	The Status Operation Register bit 5 "Waiting for Trigger" is set at the same time as the Sweeping or Measuring bit is set. It is cleared when the trigger actually occurs (that is, after the trigger event occurs and all the applicable trigger criteria have been met). A corresponding pop-up message ("Waiting for trigger") is generated if no trigger signal appears after approximately 2 sec. This message goes away when a trigger signal appears.
Initial S/W Revision:	Prior to A.02.00
Modified at S/W Revision:	A.03.00
Help Map ID:	3386

Trigger Level

Sets the value where the external 2 trigger input will trigger a new sweep/measurement.

Key Path:	Trigger, External 2
Remote Command:	:TRIGger[:SEquence]:EXTernal2:LEVel :TRIGger[:SEquence]:EXTernal2:LEVel?
Example:	TRIG:EXT2:LEV 1.1 V
Couplings:	This same level is used for the Ext2 trigger source in the Trigger menu, for the Ext2 selection in the Periodic Timer sync source (in the Trigger menu and in the Gate Source menu), and also for the Ext2 selection in the Gate Source menu.
Preset:	1.2 V
State Saved:	Saved in instrument state
Min:	-5 V
Max:	5 V
Default Unit:	V
Backwards Compatibility SCPI:	:TRIGger[:SEquence]:FRAME:EXTernal2:LEVel
Initial S/W Revision:	Prior to A.02.00
Help Map ID:	3387

Trig Slope

Controls the trigger polarity. It is set positive to trigger on a rising edge and negative to trigger on a falling edge.

Key Path:	Trigger, External 2
Remote Command:	:TRIGger[:SEquence]:EXTErnal2:SLOPe POSitive NEGative :TRIGger[:SEquence]:EXTErnal2:SLOPe?
Example:	TRIG:EXT2:SLOP NEG
Couplings:	This same slope is used in the Ext2 selection for the trigger source in the Trigger menu and for the period timer sync source (in the Trigger menu and in the Gate Source menu).
Preset:	POSitive
State Saved:	Saved in instrument state
Backwards Compatibility SCPI:	:TRIGger[:SEquence]:FRAME:EXTErnal2:SLOPe
Backwards Compatibility Notes:	The legacy :TRIGger[:SEquence]:SLOPe command affects the slopes for the VID, LINE, EXT1, EXT2, and RFB triggers.
Initial S/W Revision:	Prior to A.02.00
Help Map ID:	3388

Trig Delay

Controls a time delay during which the analyzer will wait to begin a sweep after meeting the trigger criteria. You can use negative delay to pre-trigger the instrument in time domain or FFT, but not in swept spans.

Key Path:	Trigger, External 2
Remote Command:	:TRIGger[:SEquence]:EXTErnal2:DELAy <time> :TRIGger[:SEquence]:EXTErnal2:DELAy? :TRIGger[:SEquence]:EXTErnal2:DELAy:STATe OFF ON 0 1 :TRIGger[:SEquence]:EXTErnal2:DELAy:STATe?
Example:	TRIG:EXT2:DEL:STAT ON TRIG:EXT2:DEL 100 ms
Notes:	Video trigger delay may be set to negative values, in time domain, FFT and even swept. It makes intuitive sense in time domain and works well in FFT mode where the bandwidth of the filter before the video trigger is about 1.25 span. In swept spans, negative settings of Trig Delay are treated as a zero setting within the internal hardware and the advisory message "Neg. Trig Delay unavailable in Swept Mode, zero delay used." is generated when such a delay is set.
Preset:	Off, 1.000 us

Trigger

State Saved:	Saved in instrument state
Min:	-150 ms
Max:	500 ms
Default Unit:	s
Backwards Compatibility Notes:	The legacy :TRIGger[:SEQuence]:DELay command affects the delay for the VID, LINE, EXT1, EXT2, and RFB triggers. The legacy :TRIGger[:SEQuence]:OFFSet command is supported for the VIDEO, LINE, EXT1, and EXT2 triggers.
Initial S/W Revision:	Prior to A.02.00
Help Map ID:	3389

Zero Span Delay Comp On/Off

In zero span, there is a natural delay in the signal path, which comes from the RBW filter. This is usually desirable, as it allows you to trigger on events and also see those events, because the signal is delayed from the trigger event. However, in some cases it is desirable to eliminate this delay, so that trigger events line up exactly with the zero time point in zero span. You can use the **Zero Span Delay Comp On/Off** feature to enable or disable zero span delay compensation.

Key Path:	Trigger, External 2
Remote Command:	:TRIGger[:SEQuence]:EXTernal2:DELay:COMPensation OFF ON 0 1 :TRIGger[:SEQuence]:EXTernal2:DELay:COMPensation?
Example:	TRIG:EXT2:DEL:COMP ON
Dependencies:	No effect except in zero-span, but not locked out in nonzero spans. Blanked in modes that do not support zero-span measurements. If the SCPI command is sent when the key is blanked, an error is returned: -221, "Settings conflict; Feature not supported for this measurement" In analyzers shipping N9060A, this feature requires N9060A-7FP.
Preset:	OFF
State Saved:	Saved in instrument state
Initial S/W Revision:	A.11.00
Help Map ID:	4042

RF Burst

Pressing this key, when it is not selected, selects the RF Burst as the trigger. A new sweep/measurement will start when an RF burst envelope signal is identified from the signal at the RF Input connector. Pressing this key, when it is already selected, accesses the RF Burst trigger setup menu.

In some models, a variety of burst trigger circuitry is available, resulting in various available burst

trigger bandwidths. The analyzer automatically chooses the appropriate trigger path based on the hardware configuration and other settings of the analyzer.

Key Path:	Trigger
Example:	TRIG:SOUR RFB Swept SA measurement TRIG:<meas>:SOUR RFB Measurements other than Swept SA
State Saved:	Saved in instrument state
Status Bits/OPC dependencies:	The Status Operation Register bit 5 "Waiting for Trigger" is set at the same time as the Sweeping or Measuring bit is set. It is cleared when the trigger actually occurs (that is, after the trigger event occurs and all the applicable trigger criteria have been met). A corresponding pop-up message ("Waiting for trigger") is generated if no trigger signal appears after approximately 2 sec. This message goes away when a trigger signal appears.
Backwards Compatibility Notes:	The legacy command: :TRIGger[:SEquence]:RFBurst:FSElectivity[:STATe] OFF ON 0 1 is not supported in the X-Series, as the hardware to do Frequency Selective burst triggers does not exist in X-Series.
Initial S/W Revision:	Prior to A.02.00
Modified at S/W Revision:	A.04.00
Help Map ID:	3390

Absolute Trigger Level

Sets the absolute trigger level for the RF burst envelope.

NOTE When using the External Mixing path, the Absolute Trigger Level is uncalibrated because the factory default was set to accommodate the expected IF levels for the RF path.

Key Path:	Trigger, RF Burst
Scope:	Meas Global
Remote Command:	:TRIGger[:SEquence]:RFBurst:LEVel:ABSolute <ampl> :TRIGger[:SEquence]:RFBurst:LEVel:ABSolute?
Example:	TRIG:RFB:LEV:ABS 10 dBm sets the trigger level of the RF burst envelope signal to the absolute level of 10 dBm

Trigger

Notes:	<p>Sending this command does not switch the setting from relative to absolute; to switch it you need to send the :TRIGger[:SEQuence]:RFBurst:LEVel:TYPE command, below.</p> <p>Amplitude Corrections are not taken into account by the Absolute Trigger Level. For example, if you have given yourself effective gain with an amplitude correction factor, the Absolute Trigger will not fire until you have set the trigger level that far below the displayed signal level, rather than simply to the displayed signal level. This is only true for Amplitude Corrections, not External Gain or Ref Level Offset functions.</p> <p>If mode is Bluetooth, the default value is -50 dBm.</p>
Couplings:	This same level is used for the RF Burst trigger source in the Trigger menu, for the RF Burst selection in the Periodic Timer sync source (in the Trigger menu and in the Gate Source menu), and also for the RF Burst selection in the Gate Source menu
Preset:	-20 dBm
State Saved:	Saved in instrument state
Min:	-200 dBm
Max:	100 dBm
Default Unit:	depends on the current selected Y-Axis unit
Backwards Compatibility SCPI:	:TRIGger[:SEQuence]:FRAME:RFBurst:LEVel:ABSolute
Initial S/W Revision:	Prior to A.02.00
Modified at S/W Revision:	A.04.00
Help Map ID:	3391

Key Path:	Trigger, RF Burst
Remote Command:	:TRIGger[:SEQuence]:RFBurst:LEVel:TYPE ABSolute RELative :TRIGger[:SEQuence]:RFBurst:LEVel:TYPE?
Example:	TRIG:RFB:LEV:TYPE REL sets the trigger level type of the RF burst trigger to Relative.
Preset:	ABSolute
State Saved:	Saved in instrument state
Initial S/W Revision:	Prior to A.02.00
Modified at S/W Revision:	A.04.00
Help Map ID:	0

Relative Trigger Level

Sets the relative trigger level for the RF burst envelope.

In some models, the relative burst trigger function is implemented in hardware. In other models, without the advanced triggering hardware required, the relative burst trigger function is implemented in software in some measurements, and is unavailable in other measurements.

When implemented in software, the relative RF Burst trigger function is implemented as follows:

1. The measurement starts with the absolute RF Burst trigger setting. If it cannot get a trigger with that level, auto trigger fires and the acquisition starts anyway. After the acquisition, the measurement searches for the peak in the acquired waveform and saves it.
2. Now, in the next cycle of the measurement, the measurement determines a new absolute RF Burst level based on the peak value from the first measurement and the Relative RF Burst Trigger Level (always 0 or negative dB) set by the user. The following formula is used:

$$\text{absolute RF Burst level} = \text{peak level of the previous acquisition} + \text{relative RF Burst level}$$

3. If the new absolute RF Burst level differs from the previous by more than 0.5 dB, the new level is sent to the hardware; otherwise it is not updated (to avoid slowing down the acquisition)

Steps 2 and 3 repeat for subsequent measurements.

Key Path:	Trigger, RF Burst
Scope:	Meas Global
Remote Command:	:TRIGger[:SEquence]:RFBurst:LEVel:RELative <rel_amp1> :TRIGger[:SEquence]:RFBurst:LEVel:RELative?
Example:	TRIG:RFB:LEV:REL -10 dB sets the trigger level of the RF burst envelope signal to the relative level of -10 dB
Notes:	Sending this command does not switch the setting from absolute to relative; to switch it you need to send the :TRIGger[:SEquence]:RFBurst:LEVel:TYPE command, above. The relative trigger level is not available in some measurements. In those measurements the RELative parameter, and the :TRIGger[:SEquence]:RFBurst:LEVel:TYPE command (above), will generate an error if sent.
Dependencies:	This key is grayed out and Absolute Trigger Level selected if the required hardware is not present in your analyzer and the current measurement does not support Relative triggering.
Preset:	-6 dB GSM: -25 dB
State Saved:	Saved in instrument state
Min:	-45 dB
Max:	0 dB
Default Unit:	dB or dBc

Trigger

Backwards Compatibility SCPI:	:TRIGger[:SEQuence]:RFBurst:LEVel This legacy command is aliased to :TRIGger[:SEQuence]:RFBurst:LEVel:RELative because the PSA had ONLY relative burst triggering
Initial S/W Revision:	Prior to A.02.00
Modified at S/W Revision:	A.04.00
Help Map ID:	4034

Trigger Slope

It is set positive to trigger on a rising edge and negative to trigger on a falling edge.

Key Path:	Trigger, RF Burst
Remote Command:	:TRIGger[:SEQuence]:RFBurst:SLOPe POSitive NEGative :TRIGger[:SEQuence]:RFBurst:SLOPe?
Example:	TRIG:RFB:SLOP NEG
Couplings:	This same slope is used in the RF Burst selection for the trigger source in the Trigger menu and for the period timer sync source (in the Trigger menu and in the Gate Source menu).
Preset:	POSitive
State Saved:	Saved in instrument state
Backwards Compatibility SCPI:	:TRIGger[:SEQuence]:FRAME:RFBurst:SLOPe
Backwards Compatibility Notes:	The legacy :TRIGger[:SEQuence]:SLOPe command affects the slopes for the VID, LINE, EXT1, EXT2, and RFB triggers.
Initial S/W Revision:	Prior to A.02.00
Help Map ID:	3394

Trig Delay

Controls a time delay during which the analyzer will wait to begin a sweep after meeting the trigger criteria. You can use negative delay to pre-trigger the instrument in time domain or FFT, but not in swept spans.

Key Path:	Trigger, RF Burst
Remote Command:	:TRIGger[:SEQuence]:RFBurst:DELay <time> :TRIGger[:SEQuence]:RFBurst:DELay? :TRIGger[:SEQuence]:RFBurst:DELay:STATE OFF ON 0 1 :TRIGger[:SEQuence]:RFBurst:DELay:STATE?

Example:	TRIG:RFB:DEL:STAT ON TRIG:RFB:DEL 100 ms
Notes:	Video trigger delay may be set to negative values, in time domain, FFT and even swept. It makes intuitive sense in time domain and works well in FFT mode where the bandwidth of the filter before the video trigger is about 1.25 span. In swept spans, negative settings of Trig Delay are treated as a zero setting within the internal hardware and the advisory message "Neg. Trig Delay unavailable in Swept Mode, zero delay used." is generated when such a delay is set.
Preset:	Off, 1.000 us
State Saved:	Saved in instrument state
Min:	-150 ms
Max:	500 ms
Default Unit:	s
Backwards Compatibility Notes:	The legacy :TRIGger[:SEQuence]:DELay command affects the delay for the VID, LINE, EXT1, EXT2, and RFB triggers.
Initial S/W Revision:	Prior to A.02.00
Help Map ID:	3395

Zero Span Delay Comp On/Off

In zero span, there is a natural delay in the signal path, which comes from the RBW filter. This is usually desirable, as it allows you to trigger on events and also see those events, because the signal is delayed from the trigger event. However, in some cases it is desirable to eliminate this delay, so that trigger events line up exactly with the zero time point in zero span. You can use the **Zero Span Delay Comp On/Off** feature to enable or disable zero span delay compensation.

Key Path:	Trigger, RF Burst
Remote Command:	:TRIGger[:SEQuence]:RFBurst:DELay:COMPensation OFF ON 0 1 :TRIGger[:SEQuence]:RFBurst:DELay:COMPensation?
Example:	TRIG:RFB:DEL:COMP ON
Dependencies:	No effect except in zero-span, but not locked out in nonzero spans. Blanked in modes that do not support zero-span measurements. If the SCPI command is sent when the key is blanked, an error is returned: -221, "Settings conflict; Feature not supported for this measurement" In analyzers shipping N9060A, this feature requires N9060A-7FP.
Preset:	OFF
State Saved:	Saved in instrument state
Initial S/W Revision:	A.11.00

Trigger

Help Map ID:	4043
--------------	------

Periodic Timer (Frame Trigger)

Pressing this key, when it is not selected, selects the internal periodic timer signal as the trigger. Triggering occurrences are set by the **Period** parameter, which is modified by the **Sync Source** and **Offset**. Pressing this key, when it is already selected, accesses the periodic timer trigger setup functions.

If you do not have a sync source selected (it is Off), then the internal timer will not be synchronized with any external timing events.

Key Path:	Trigger
Example:	TRIG:SOUR FRAM Swept SA measurement TRIG:<meas>:SOUR FRAM Measurements other than Swept SA
State Saved:	Saved in instrument state
Readback:	[Sync: <value of Sync Source>], for example, [Sync: External 1]
Status Bits/OPC dependencies:	The Status Operation Register bit 5 "Waiting for Trigger" is set at the same time as the Sweeping or Measuring bit is set. It is cleared when the trigger actually occurs (that is, after the trigger event occurs and all the applicable trigger criteria have been met). A corresponding pop-up message ("Waiting for trigger") is generated if no trigger signal appears after approximately 2 sec. This message goes away when a trigger signal appears.
Initial S/W Revision:	Prior to A.02.00
Help Map ID:	3397

Periodic Timer Triggering:

This feature selects the internal periodic timer signal as the trigger. Trigger occurrences are set by the **Periodic Timer** parameter, which is modified by the **Sync Source** and **Offset**.

The figure below shows the action of the periodic timer trigger. Before reviewing the figure, we'll explain some uses for the periodic trigger.

A common application is measuring periodic burst RF signals for which a trigger signal is not easily available. For example, we might be measuring a TDMA radio which bursts every 20 ms. Let's assume that the 20 ms period is very consistent. Let's also assume that we do not have an external trigger source available that is synchronized with the period, and that the signal-to-noise ratio of the signal is not high enough to provide a clean RF burst trigger at all of the analysis frequencies. For example, we might want to measure spurious transmissions at an offset from the carrier that is larger than the bandwidth of the RF burst trigger. In this application, we can set the Periodic Timer to a 20.00 ms period and adjust the offset from that timer to position our trigger just where we want it. If we find that the 20.00 ms is not exactly right, we can adjust the period slightly to minimize the drift between the period timer and the signal to be measured.

A second way to use this feature would be to use **Sync Source** temporarily, instead of **Offset**. In this case, we might tune to the signal in a narrow span and use the RF Burst trigger to synchronize the periodic timer. Then we would turn the sync source off so that it would not mis-trigger. Mis-triggering

can occur when we are tuned so far away from the RF burst trigger that it is no longer reliable.

A third example would be to synchronize to a signal that has a reference time element of much longer period than the period of interest. In some CDMA applications, it is useful to look at signals with a short periodicity, by synchronizing that periodicity to the "even-second clock" edge that happens every two seconds. Thus, we could connect the even-second clock trigger to Ext1 and use then Ext1 as the sync source for the periodic timer.

The figure below illustrates this third example. The top trace represents the even-second clock. It causes the periodic timer to synchronize with the leading edge shown. The analyzer trigger occurs at a time delayed by the accumulated offset from the period trigger event. The periodic timer continues to run, and triggers continue to occur, with a periodicity determined by the analyzer time base. The timer output (labeled "late event") will drift away from its ideal time due to imperfect matching between the time base of the signal being measured and the time base of the analyzer, and also because of imperfect setting of the period parameter. But the synchronization is restored on the next even-second clock event. ("Accumulated offset" is described in the in the **Offset** function section.)

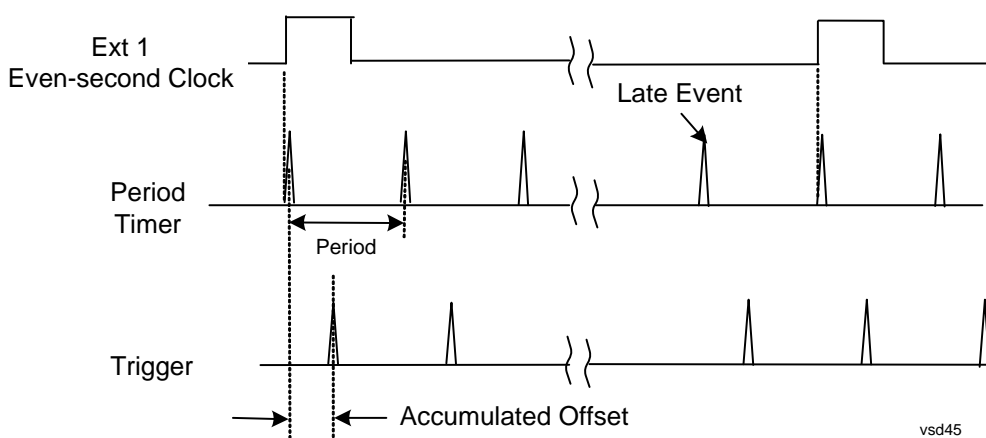

Period

Sets the period of the internal periodic timer clock. For digital communications signals, this is usually set to the frame period of your current input signal. In the case that sync source is not set to OFF, and the external sync source rate is changed for some reason, the periodic timer is synchronized at the every external synchronization pulse by resetting the internal state of the timer circuit.

Key Path:	Trigger, Periodic Timer
Remote Command:	:TRIGger[:SEquence]:FRAM:PERiod <time> :TRIGger[:SEquence]:FRAM:PERiod?
Example:	TRIG:FRAM:PER 100 ms
Dependencies:	The invalid data indicator turns on when the period is changed, until the next sweep/measurement completes.
Couplings:	The same period is used in the Gate Source selection of the period timer.
Preset:	20 ms GSM: 4.615383

Trigger

State Saved:	Saved in instrument state
Min:	100.000 ns
Max:	559.0000 ms
Default Unit:	S
Initial S/W Revision:	Prior to A.02.00
Help Map ID:	3398

Offset

Adjusts the accumulated offset between the periodic timer events and the trigger event. Adjusting the accumulated offset is different than setting an offset, and requires explanation.

The periodic timer is usually not synchronized with any external events, so the timing of its output events has no absolute meaning. Since the timing relative to external events (RF signals) is important, you need to be able to adjust (offset) it. However, you have no direct way to see when the periodic timer events occur. All that you can see is the trigger timing. When you want to adjust the trigger timing, you will be changing the internal offset between the periodic timer events and the trigger event. Because the absolute value of that internal offset is unknown, we will just call that the accumulated offset. Whenever the Offset parameter is changed, you are changing that accumulated offset. You can reset the displayed offset using Reset Offset Display. Changing the display does not change the value of the accumulated offset, and you can still make additional changes to accumulated offset.

To avoid ambiguity, we define that an increase in the "offset" parameter, either from the knob or the SCPI adjust command, serves to delay the timing of the trigger event.

Key Path:	Trigger, Periodic Timer
Remote Command:	:TRIGger[:SEquence]:FRAMe:OFFSet <time> :TRIGger[:SEquence]:FRAMe:OFFSet?
Example:	TRIG:FRAM:OFFS 1.2 ms
Notes:	<p>The front panel interface (for example, the knob), and this command, adjust the accumulated offset, which is shown on the active function display. However, the actual amount sent to the hardware each time the offset is updated is the delta value, that is, the current accumulated offset value minus the previous accumulated offset value. Note that the accumulated offset value is essentially arbitrary; it represents the accumulated offset from the last time the offset was zeroed (with the Reset Offset Display key).</p> <p>Note that this command does not change the period of the trigger waveform. Note also that Offset is used only when the sync source is set to OFF, otherwise delay is used, see section “Trig Delay” on page 937.</p> <p>An increase in the "offset" parameter, either from the knob or the SCPI adjust command, serves to delay the timing of the trigger event.</p>

Notes:	When the SCPI command is sent the value shown on the key (and the Active Function, if this happens to be the active function) is updated with the new value. However, the actual amount sent to the hardware is the delta value, that is, the current accumulated offset value minus the previous accumulated offset value. The SCPI query simply returns the value currently showing on the key.
Dependencies:	The invalid data indicator turns on when the offset is changed, until the next sweep/measurement completes.
Couplings:	The same offset is used in the Gate Source selection of the period timer.
Preset:	0 s
State Saved:	Saved in instrument state
Min:	-10.000 s
Max:	10.000 s
Default Unit:	S
Initial S/W Revision:	Prior to A.02.00
Help Map ID:	3399

Offset Adjust (Remote Command Only)

This remote command does not work at all like the related front panel keys. This command lets you advance the phase of the frame trigger by the amount you specify.

It does not change the period of the trigger waveform. If the command is sent multiple times, it advances the phase of the frame trigger an additional amount each time it is sent. Negative numbers are permitted.

Remote Command:	:TRIGger[:SEquence]:FRAMe:ADJust <time>
Example:	TRIG:FRAM:ADJ 1.2 ms
Notes:	Note also that Offset is used only when the sync source is set to OFF, otherwise delay is used, see section “Trig Delay” on page 937 An increase in the "offset" parameter, either from the knob or the SCPI adjust command, serves to delay the timing of the trigger event.
Notes:	The front panel interface (for example, the knob) and the :TRIG:FRAM:OFFS command adjust the accumulated offset, which is shown on the active function display. However, the actual amount sent to the hardware is the delta value, that is, the current offset value minus the previous offset value. When the SCPI command is sent the value shown on the key (and the Active Function, if this happens to be the active function) is updated by increasing it (or decreasing it if the value sent is negative) by the amount specified in the SCPI command. This is a "command only" SCPI command, with no query.
Dependencies:	The invalid data indicator turns on when the offset is changed, until the next sweep/measurement completes.

Trigger

Couplings:	The same offset is used in the Gate Source selection of the period timer.
Preset:	0 s
State Saved:	Saved in instrument state
Min:	-10.000 s
Max:	10.000 s
Default Unit:	S
Initial S/W Revision:	Prior to A.02.00
Help Map ID:	0

Reset Offset Display

Resets the value of the periodic trigger offset display setting to 0.0 seconds. The current displayed trigger location may include an offset value defined with the **Offset** key. Pressing this key redefines the currently displayed trigger location as the new trigger point that is 0.0 s offset. The **Offset** key can then be used to add offset relative to this new timing.

Key Path:	Trigger, Periodic Timer
Remote Command:	:TRIGger[:SEquence]:FRAMe:OFFSet:DISPlay:RESet
Example:	TRIG:FRAM:OFFS:DISP:RES
Initial S/W Revision:	Prior to A.02.00
Help Map ID:	3400

Sync Source

Selects a signal source for you to synchronize your periodic timer trigger to, otherwise you are triggering at some arbitrary location in the frame. Synchronization reduces the precision requirements on the setting of the period.

For convenience you may adjust the level and slope of the selected sync source in a conditional branch setup menu accessed from the Sync Source menu. Note that these settings match those in the **Trigger** and **Gate Source** menus; that is, each trigger source has only one value of level and slope, regardless of which menu it is accessed from.

Key Path:	Trigger, Periodic Timer
Remote Command:	:TRIGger[:SEquence]:FRAMe:SYNC EXTernal1 EXTernal2 RFBurst OFF :TRIGger[:SEquence]:FRAMe:SYNC?
Example:	TRIG:FRAM:SYNC EXT2

Dependencies:	In some models, there is no second External input. In these models, the External 2 key is blanked and the EXTERNAL2 parameter will generate a “Hardware missing; Not available for this model number” message.
Preset:	Off GSM/EDGE: RFBurst
State Saved:	Saved in instrument state
Readback:	The current setting is read back to this key and it is also Readback to the previous Periodic Timer trigger key.
Backwards Compatibility SCPI:	:TRIGger[:SEQUENCE]:FRAMe:SYNC EXTERNAL For backward compatibility, the parameter EXTERNAL is mapped to EXTERNAL1
Initial S/W Revision:	Prior to A.02.00
Modified at S/W Revision:	A.03.00
Help Map ID:	3402

Off

Turns off the sync source for your periodic trigger. With the sync source off, the timing will drift unless the signal source frequency is locked to the analyzer frequency reference.

Key Path:	Trigger, Periodic Timer, Sync Source
Example:	TRIG:FRAM:SYNC OFF
Readback:	Off
Initial S/W Revision:	Prior to A.02.00
Help Map ID:	3403

External 1

Pressing this key, when it is not selected, selects the external input port that you will use for the periodic trigger synchronization. Pressing this key, when it is already selected, accesses the external 1 sync source setup menu.

Key Path:	Trigger, Periodic Timer, Sync Source
Example:	TRIG:FRAM:SYNC EXT
Couplings:	Same as External 1 trigger source.
Readback:	External 1
Initial S/W Revision:	Prior to A.02.00
Help Map ID:	3404

Trigger

Trigger Level

Sets the value where the signal at the external 1 trigger input will synchronize with the periodic timer trigger. This same level is used in the Ext1 trigger source in the Trigger menu. See section “[Trigger Level](#)” on page 919 for information on this key and the SCPI command.

Trig Slope

Controls the trigger polarity. It is set positive to trigger on a rising edge and negative to trigger on a falling edge. This same value is used in the Ext1 trigger source in the Trigger menu. See section “[Trig Slope](#)” on page 919 for information on this key and the SCPI command

External 2

Pressing this key, when it is not selected, selects the external input port that you will use for the periodic frame trigger synchronization.

Pressing this key, when it is already selected, accesses the external 2 sync source setup menu.

Key Path:	Trigger, Periodic Timer, Sync Source
Example:	TRIG:FRAM:SYNC EXT2
Dependencies:	In some models, there is no second External input. In these models, the External 2 key is blanked and the EXternal2 parameter will generate a “Hardware missing; Not available for this model number” message.
Couplings:	Same as External 2 trigger source.
Readback:	External 2
Initial S/W Revision:	Prior to A.02.00
Modified at S/W Revision:	A.03.00
Help Map ID:	3407

Trigger Level

Sets the value where the signal at the external 2 trigger input will synchronize with the periodic timer trigger. This same level is used in the Ext2 trigger source in the Trigger menu. See section “[Trigger Level](#)” on page 922 for information on this key and the SCPI command.

Trig Slope

Controls the trigger polarity. It is set positive to trigger on a rising edge and negative to trigger on a falling edge. This same value is used in the Ext2 trigger source in the Trigger menu. See section “[Trig Slope](#)” on page 923 for information on this key and the SCPI command

RF Burst

Pressing the key once selects the RF burst envelope signal to be used for the periodic timer trigger synchronization.

Press the key a second time to access the RF burst sync source setup menu.

Key Path:	Trigger, Periodic Timer, Sync Source
-----------	---

Example:	TRIG:FRAM:SYNC RFB
Couplings:	Same as RF Burst trigger source.
Readback:	RF Burst
Initial S/W Revision:	Prior to A.02.00
Help Map ID:	3410

Trigger Level

Sets the trigger level to be used for the RF Burst trigger. This same level is used in the RF Burst trigger source in the Trigger menu. See section “[Absolute Trigger Level](#)” on page 925 for information on this key and the SCPI command.

Trig Slope

Controls the RF Burst trigger polarity. It is set positive to trigger on a rising edge and negative to trigger on a falling edge. This same value is used in the RF Burst trigger source in the Trigger menu. See section “[Trigger Slope](#)” on page 928 for information on this key and the SCPI command

Trig Delay

This setting delays the measurement timing relative to the Periodic Timer.

Key Path:	Trigger, Periodic Timer
Remote Command:	:TRIGger[:SEQuence]:FRAMe:DELay <time> :TRIGger[:SEQuence]:FRAMe:DELay? :TRIGger[:SEQuence]:FRAMe:DELay:STATe OFF ON 0 1 :TRIGger[:SEQuence]:FRAMe:DELay:STATe?
Notes:	Note that delay is used when the sync source is not set to OFF. If the sync source is set to OFF, offset is used.
Preset:	Off, 1.000 us
State Saved:	Saved in instrument state
Min:	-150 ms
Max:	+500 ms
Default Unit:	s
Initial S/W Revision:	Prior to A.02.00
Help Map ID:	3401

Sync Holdoff

Sync Holdoff specifies the duration that the sync source signal must be kept false before the transition to true to be recognized as the sync timing. The periodic timer phase is aligned when the sync source signal becomes true, after the Holdoff time is satisfied.

Trigger

A holdoff of 2 ms will work with most WiMAX signals, but there may be cases where the burst off duration is less than 1 ms and this value will need to be changed.

Key Path:	Trigger, Periodic Timer
Remote Command:	:TRIGger [:SEQuence] :FRAMe:SYNC:HOLDoff <time> :TRIGger [:SEQuence] :FRAMe:SYNC:HOLDoff? :TRIGger [:SEQuence] :FRAMe:SYNC:HOLDoff:STATe OFF ON 0 1 :TRIGger [:SEQuence] :FRAMe:SYNC:HOLDoff:STATe?
Preset:	On, 1.000 ms
State Saved:	Saved in instrument state
Min:	0 ms
Max:	+500 ms
Default Unit:	s
Initial S/W Revision:	Prior to A.02.00
Help Map ID:	3518

Baseband I/Q

Pressing this key when it is not selected selects Baseband I/Q as the trigger. Pressing the key when it is already selected accesses the Baseband I/Q trigger type selection menu. The key is annotated to display which of the Baseband I/Q trigger types is currently selected.

Key Path:	Trigger
State Saved:	Saved in instrument state
Readback:	The Baseband I/Q trigger source that becomes active when this key is selected is displayed. The possible values are "I/Q Mag", "I", "Q", "Input I", "Input Q", and "Aux I/Q Mag".
Initial S/W Revision:	Prior to A.02.00
Help Map ID:	29986

I/Q Mag

Pressing this key, when it is not selected, selects the I/Q magnitude signal as the trigger. The I/Q Magnitude trigger condition is met when the I/Q magnitude crosses the I/Q magnitude trigger level. The magnitude is measured at the output of the main I/Q digital receiver.

Key Path:	Trigger, Baseband I/Q
Example:	TRIG:<meas>:SOUR IQM
Readback Text:	I/Q Mag

Initial S/W Revision:	Prior to A.02.00
Help Map ID:	29952

Trigger Level

Sets a level for the I/Q magnitude trigger. When the signal crosses this level, with the chosen slope, the trigger occurs. If the specific Measurement displays the signal from the chosen sampling point a green line will be displayed to indicate the trigger level.

Key Path:	Trigger, Baseband I/Q, I/Q Mag
Remote Command:	:TRIGger[:SEquence]:IQMag:LEVel <ampl > :TRIGger[:SEquence]:IQMag:LEVel?
Example:	TRIG:IQM:LEV -30 dBm
Notes:	The I/Q reference impedance is used for converting between power and voltage.
Preset:	-25 dBm
State Saved:	Saved in instrument state
Range:	-200 dBm to 100 dBm
Readback Text:	<level> dBm
Initial S/W Revision:	Prior to A.02.00
Help Map ID:	29953

Trig Slope

Controls the trigger polarity. It is set positive to trigger on a rising edge and negative to trigger on a falling edge.

Key Path:	Trigger, Baseband I/Q, I/Q Mag
Remote Command:	:TRIGger[:SEquence]:IQMag:SLOPe POSitive NEGative :TRIGger[:SEquence]:IQMag:SLOPe?
Example:	TRIG:IQM:SLOP POS
Preset:	POSitive
State Saved:	Saved in instrument state
Initial S/W Revision:	Prior to A.02.00
Help Map ID:	29954

Trig Delay

Controls a time delay during which the analyzer will wait to begin a sweep after meeting the trigger

Trigger

criteria. You can use negative delay to pre-trigger the instrument in time domain or FFT.

Key Path:	Trigger, Baseband I/Q, I/Q Mag
Remote Command:	:TRIGger[:SEquence]:IQMag:DElay <time> :TRIGger[:SEquence]:IQMag:DElay? :TRIGger[:SEquence]:IQMag:DElay:STATe OFF ON 0 1 :TRIGger[:SEquence]:IQMag:DElay:STATe?
Example:	TRIG:IQM:DEL 10 ms TRIG:IQM:DEL:STAT ON
Preset:	1 us OFF
State Saved:	Saved in instrument state
Range:	-2.5 s to +10 s
Initial S/W Revision:	Prior to A.02.00
Help Map ID:	29955

I (Demodulated)

Pressing this key, when it is not selected, selects the main receiver's output I voltage as the trigger. The I (Demodulated) trigger condition is met when the I voltage crosses the I voltage trigger level.

Key Path:	Trigger, Baseband I/Q
Example:	TRIG:<meas>:SOUR IDEM
Readback Text:	I
Initial S/W Revision:	Prior to A.02.00
Help Map ID:	29956

Trigger Level

Sets a level for the I (Demodulated) trigger. When the signal crosses this level, with the chosen slope, the trigger occurs. If the specific Measurement displays the signal from the chosen sampling point a green line will be displayed to indicate the trigger level.

Key Path:	Trigger, Baseband I/Q, I (Demodulated)
Remote Command:	:TRIGger[:SEquence]:IDEMod:LEVel <voltage> :TRIGger[:SEquence]:IDEMod:LEVel?
Example:	TRIG:IDEM:LEV 0.5 V
Preset:	0.25 V

State Saved:	Saved in instrument state
Range:	-1 to 1 V
Readback Text:	0.1 of displayed unit (V, mV, etc.)
Initial S/W Revision:	Prior to A.02.00
Help Map ID:	29957

Trig Slope

Controls the trigger polarity. It is set positive to trigger on a rising edge and negative to trigger on a falling edge.

Key Path:	Trigger, Baseband I/Q, I (Demodulated)
Remote Command:	:TRIGger[:SEquence]:IDEMod:SLOPe POSitive NEGative :TRIGger[:SEquence]:IDEMod:SLOPe?
Example:	TRIG:IDEM:SLOP POS
Preset:	POSitive
State Saved:	Saved in instrument state
Initial S/W Revision:	Prior to A.02.00
Help Map ID:	29958

Trig Delay

Controls a time delay during which the analyzer will wait to begin a sweep after meeting the trigger criteria. You can use negative delay to pre-trigger the instrument in time domain or FFT.

Key Path:	Trigger, Baseband I/Q, I (Demodulated)
Remote Command:	:TRIGger[:SEquence]:IDEMod:DELay <time> :TRIGger[:SEquence]:IDEMod:DELay? :TRIGger[:SEquence]:IDEMod:DELay:STATe OFF ON 0 1 :TRIGger[:SEquence]:IDEMod:DELay:STATe?
Example:	TRIG:IDEM:DEL 10 ms TRIG:IDEM:DEL:STAT ON
Preset:	1 us OFF
State Saved:	Saved in instrument state
Range:	-2.5 s to +10 s
Initial S/W Revision:	Prior to A.02.00

Trigger

Help Map ID:	29959
--------------	-------

Q (Demodulated)

Pressing this key, when it is not selected, selects the main receiver's output Q voltage as the trigger. The Q (Demodulated) trigger condition is met when the Q voltage crosses the Q voltage trigger level.

Key Path:	Trigger, Baseband I/Q
Example:	TRIG:<meas>:SOUR QDEM
Readback Text:	Q
Initial S/W Revision:	Prior to A.02.00
Help Map ID:	29987

Trigger Level

Sets a level for the Q (Demodulated) trigger. When the signal crosses this level, with the chosen slope, the trigger occurs. If the specific Measurement displays the signal from the chosen sampling point a green line will be displayed to indicate the trigger level.

Key Path:	Trigger, Baseband I/Q, Q (Demodulated)
Remote Command:	:TRIGger [:SEquence] :QDEMod:LEVEl <voltage> :TRIGger [:SEquence] :QDEMod:LEVEl?
Example:	TRIG:QDEM:LEV 0.5 V
Preset:	0.25 V
State Saved:	Saved in instrument state
Range:	-1 to 1 V
Readback Text:	0.1 of displayed unit (V, mV, etc.)
Initial S/W Revision:	Prior to A.02.00
Help Map ID:	29960

Trig Slope

Controls the trigger polarity. It is set positive to trigger on a rising edge and negative to trigger on a falling edge.

Key Path:	Trigger, Baseband I/Q, Q (Demodulated)
Remote Command:	:TRIGger [:SEquence] :QDEMod:SLOPe POSitive NEGative :TRIGger [:SEquence] :QDEMod:SLOPe?
Example:	TRIG:QDEM:SLOP POS
Preset:	POSitive

State Saved:	Saved in instrument state
Initial S/W Revision:	Prior to A.02.00
Help Map ID:	29961

Trig Delay

Controls a time delay during which the analyzer will wait to begin a sweep after meeting the trigger criteria. You can use negative delay to pre-trigger the instrument in time domain or FFT.

Key Path:	Trigger, Baseband I/Q, Q (Demodulated)
Remote Command:	:TRIGger [:SEquence] :QDEMod:DELay <time> :TRIGger [:SEquence] :QDEMod:DELay? :TRIGger [:SEquence] :QDEMod:DELay:STATe OFF ON 0 1 :TRIGger [:SEquence] :QDEMod:DELay:STATe?
Example:	TRIG:QDEM:DEL 10 ms TRIG:QDEM:DEL:STAT ON
Preset:	1 us OFF
State Saved:	Saved in instrument state
Range:	-2.5 s to +10 s
Initial S/W Revision:	Prior to A.02.00
Help Map ID:	29962

Input I

Pressing this key, when it is not selected, selects the I channel's ADC voltage as the trigger. The Input I trigger condition is met when the voltage crosses the trigger level.

Key Path:	Trigger, Baseband I/Q
Example:	TRIG:<meas>:SOUR IINP
Readback Text:	Input I
Initial S/W Revision:	Prior to A.02.00
Help Map ID:	29963

Trigger Level

Sets a level for the Input I trigger. When the signal crosses this level, with the chosen slope, the trigger occurs.

Key Path:	Trigger, Baseband I/Q, Input I
-----------	---------------------------------------

Trigger

Remote Command:	:TRIGger[:SEQuence]:IINPut:LEVel <voltage> :TRIGger[:SEQuence]:IINPut:LEVel?
Example:	TRIG:IINP:LEV 0.5 V
Preset:	0.25 V
State Saved:	Saved in instrument state
Range:	-1 to 1 V
Readback Text:	0.1 of displayed unit (V, mV, etc.)
Initial S/W Revision:	Prior to A.02.00
Help Map ID:	29964

Trig Slope

Controls the trigger polarity. It is set positive to trigger on a rising edge and negative to trigger on a falling edge.

Key Path:	Trigger, Baseband I/Q, Input I
Remote Command:	:TRIGger[:SEQuence]:IINPut:SLOPe POSitive NEGative :TRIGger[:SEQuence]:IINPut:SLOPe?
Example:	TRIG:IINP:SLOP POS
Preset:	POSitive
State Saved:	Saved in instrument state
Initial S/W Revision:	Prior to A.02.00
Help Map ID:	29965

Trig Delay

Controls a time delay during which the analyzer will wait to begin a sweep after meeting the trigger criteria. You can use negative delay to pre-trigger the instrument in time domain or FFT.

Key Path:	Trigger, Baseband I/Q, Input I
Remote Command:	:TRIGger[:SEQuence]:IINPut:DELay <time> :TRIGger[:SEQuence]:IINPut:DELay? :TRIGger[:SEQuence]:IINPut:DELay:STATe OFF ON 0 1 :TRIGger[:SEQuence]:IINPut:DELay:STATe?
Example:	TRIG:IINP:DEL 10 ms TRIG:IINP:DEL:STAT ON

Preset:	1 us OFF
State Saved:	Saved in instrument state
Range:	-2.5 s to +10 s
Initial S/W Revision:	Prior to A.02.00
Help Map ID:	29966

Input Q

Pressing this key, when it is not selected, selects the Q channel's ADC voltage as the trigger. The Input Q trigger condition is met when the voltage crosses the trigger level.

Key Path:	Trigger, Baseband I/Q
Example:	TRIG:<meas>:SOUR QINP
Readback Text:	Input Q
Initial S/W Revision:	Prior to A.02.00
Help Map ID:	29967

Trigger Level

Sets a level for the Input Q trigger. When the signal crosses this level, with the chosen slope, the trigger occurs.

Key Path:	Trigger, Baseband I/Q, Input Q
Remote Command:	:TRIGger [:SEquence] :QINPut:LEVel <voltage> :TRIGger [:SEquence] :QINPut:LEVel?
Example:	TRIG:QINP:LEV 0.5 V
Preset:	0.25 V
State Saved:	Saved in instrument state
Range:	-1 to 1 V
Readback Text:	0.1 of displayed unit (V, mV, etc.)
Initial S/W Revision:	Prior to A.02.00
Help Map ID:	29968

Trig Slope

Controls the trigger polarity. It is set positive to trigger on a rising edge and negative to trigger on a

Trigger

falling edge.

Key Path:	Trigger, Baseband I/Q, Input Q
Remote Command:	:TRIGger[:SEQuence]:QINPut:SLOPe POSitive NEGative :TRIGger[:SEQuence]:QINPut:SLOPe?
Example:	TRIG:QINP:SLOP POS
Preset:	POSitive
State Saved:	Saved in instrument state
Initial S/W Revision:	Prior to A.02.00
Help Map ID:	29969

Trig Delay

Controls a time delay during which the analyzer will wait to begin a sweep after meeting the trigger criteria. You can use negative delay to pre-trigger the instrument in time domain or FFT.

Key Path:	Trigger, Baseband I/Q, Input Q
Remote Command:	:TRIGger[:SEQuence]:QINPut:DELay <time> :TRIGger[:SEQuence]:QINPut:DELay? :TRIGger[:SEQuence]:QINPut:DELay:STATe OFF ON 0 1 :TRIGger[:SEQuence]:QINPut:DELay:STATe?
Example:	TRIG:QINP:DEL 10 ms TRIG:QINP:DEL:STAT ON
Preset:	1 us OFF
State Saved:	Saved in instrument state
Range:	-2.5 s to +10 s
Initial S/W Revision:	Prior to A.02.00
Help Map ID:	29970

Auxiliary Channel I/Q Mag

Pressing this key, when it is not selected, selects the Auxiliary Channel I/Q magnitude signal as the trigger. The Auxiliary Channel I/Q Magnitude trigger condition is met when the auxiliary receiver's I/Q magnitude output crosses the Auxiliary I/Q magnitude trigger level.

Key Path:	Trigger, Baseband I/Q
Example:	TRIG:<meas>:SOUR AIQM

Readback Text:	Aux I/Q Mag
Initial S/W Revision:	Prior to A.02.00
Help Map ID:	29971

Trigger Level

Sets a level for the I/Q magnitude trigger. When the signal crosses this level, with the chosen slope, the trigger occurs.

Key Path:	Trigger, Baseband I/Q, Aux Channel I/Q Mag
Remote Command:	:TRIGger[:SEquence]:AIQMag:LEVel <ampl > :TRIGger[:SEquence]:AIQMag:LEVel?
Example:	TRIG:AIQM:LEV -30 dBm
Notes:	The I/Q reference impedance is used for converting between power and voltage.
Preset:	-25 dBm
State Saved:	Saved in instrument state
Range:	-200 dBm to 100 dBm
Readback Text:	<level> dBm
Initial S/W Revision:	Prior to A.02.00
Help Map ID:	29972

Trig Slope

Controls the trigger polarity. It is set positive to trigger on a rising edge and negative to trigger on a falling edge.

Key Path:	Trigger, Baseband I/Q, Aux Channel I/Q Mag
Remote Command:	:TRIGger[:SEquence]:AIQMag:SLOPe POSitive NEGative :TRIGger[:SEquence]:AIQMag:SLOPe?
Example:	TRIG:AIQM:SLOP POS
Preset:	POSitive
State Saved:	Saved in instrument state
Initial S/W Revision:	Prior to A.02.00
Help Map ID:	29973

Trig Delay

Controls a time delay during which the analyzer will wait to begin a sweep after meeting the trigger

Trigger

criteria. You can use negative delay to pre-trigger the instrument in time domain or FFT.

Key Path:	Trigger, Baseband I/Q, Aux Channel I/Q Mag
Remote Command:	:TRIGger [:SEquence] :AIQMag:DELay <time> :TRIGger [:SEquence] :AIQMag:DELay? :TRIGger [:SEquence] :AIQMag:DELay:STATe OFF ON 0 1 :TRIGger [:SEquence] :AIQMag:DELay:STATe?
Example:	TRIG:AIQM:DEL 10 ms TRIG:AIQM:DEL:STAT ON
Preset:	1 us OFF
State Saved:	Saved in instrument state
Range:	-2.5 s to +10 s
Initial S/W Revision:	Prior to A.02.00
Help Map ID:	29974

Trigger Center Frequency

This key sets the center frequency to be used by the auxiliary receiver.

Key Path:	Trigger, Baseband I/Q, Aux Channel I/Q Mag
Remote Command:	:TRIGger [:SEquence] :AIQMag:CENTer <freq> :TRIGger [:SEquence] :AIQMag:CENTer?
Example:	:TRIG:AIQM:CENT 10 MHz
Notes:	Trigger CF + 1/2 Trigger BW < Max Trigger CF - 1/2 Trigger BW > Min
Preset:	0 Hz
State Saved:	Saved in instrument state
Range:	-40 MHz to 40 MHz
Initial S/W Revision:	Prior to A.02.00
Help Map ID:	29975

Trigger Bandwidth

This key sets the information bandwidth used by the auxiliary receiver for the Auxiliary Channel I/Q Magnitude trigger.

Key Path:	Trigger, Baseband I/Q, Aux Channel I/Q Mag
-----------	---

Remote Command:	:TRIGger[:SEquence]:AIQMag:BANDwidth <freq> :TRIGger[:SEquence]:AIQMag:BANDwidth?
Example:	:TRIG:AIQM:BAND 8 MHz
Notes:	The combined sample rate for the main and auxiliary receivers cannot exceed 100 MSa/sec. The bandwidth available to the Trigger BW is limited to what is available after the main receiver's bandwidth (Info BW, sometimes pre-FFT BW) is set. Because of this limitation, the Max is not always achievable. The combination of Trigger Center Freq and Trigger BW is also limited: Trigger CF + 1/2 Trigger BW < Max Trigger CF – 1/2 Trigger BW > Min
Preset:	Bandwidth option dependent: No Opt: 10 MHz Opt B25: 25 MHz Opt S40: 40 MHz
State Saved:	Saved in instrument state
Range:	10 Hz to Maximum
Initial S/W Revision:	Prior to A.02.00
Help Map ID:	29976

TV

Pressing this key, when it is not selected, selects the TV input signal as the trigger. A new sweep/measurement will start synchronized with the next occurrence of the synchronizing pulse of the selected TV line number.

Pressing this key, when it is already selected, opens a menu of TV Trigger setup functions. The default active function in this menu is the TV line number on which you want to trigger.

The Frame and Field options enable you to determine how the fields of the TV picture signal will be affected by the trigger system. One complete TV image consists of one frame of 525 or 625 horizontal lines depending on the TV standard being used. Each frame is composed of two fields of interlacing lines, each consisting of 262 1/2 lines (or 312 1/2 lines). The fields are called Field One and Field Two. Field One is viewed as having 263 lines (or 313 lines) and Field Two is viewed as having 262 lines (or 312 lines).

For the 525 line NTSC video standard, we refer to TV lines as follows (these are the Field Modes):

Entire Frame, lines 1 to 525

Field One, lines 1 to 263

Field Two, lines 1 to 262 (note that this really refers to "actual" lines 264 to 525)

For the 625 line PAL and SECAM video standards, we refer to TV lines as follows:

Entire Frame, lines 1 to 625

Trigger

Field One, lines 1 to 313

Field Two, lines 314 to 625

As the Field is changed, the appropriate value for Line is chosen to keep triggering on the same line as before, or if this is not possible, the corresponding line in the new Field. For example, suppose line 264 is selected while in the NTSC-M standard and the Entire Frame mode. This is the first line in Field Two. If Field Two is then selected, the Line number changes to Line 1, the same actual line in the TV signal. If Field One is then selected, the line number stays at 1, but now we are triggering in the first line in Field One. The only exception to this is if we are on the last line of Field One and change to Field Two. In this case, we go to the last line in Field Two.

Key Path:	Trigger
Example:	TRIG:SOUR TV Swept SA measurement TRIG:<meas>:SOUR TV Measurements other than Swept SA
Dependencies:	This key only appears in Modes which support TV Trigger, otherwise the key is blanked. If the SCPI command is sent while the key is blanked, an error is returned.
Readback:	This key displays the value read back from TV Line
Status Bits/OPC dependencies:	The Status Operation Register bit 5 "Waiting for Trigger" is set at the same time as the Sweeping or Measuring bit is set. It is cleared when the trigger actually occurs (that is, after the trigger event occurs and all the applicable trigger criteria have been met). A corresponding pop-up message ("Waiting for trigger") is generated if no trigger signal appears after approximately 2 sec. This message goes away when a trigger signal appears.
Initial S/W Revision:	Prior to A.02.00
Help Map ID:	3416

TV Line

Selects the TV line number to trigger on. Line number range is dependent on the settings of the **Standard** and **Field** menus within the TV trigger setup functions. When the line number is incremented beyond the upper limit, the value will change to the lower limit and continue incrementing from there. When the line number is decremented below the lower limit, the value will change to the upper limit and continue decrementing from there.

Key Path:	Trigger, TV
Remote Command:	:TRIGger[:SEquence]:TV:LINE <integer> :TRIGger[:SEquence]:TV:LINE?
Example:	TRIG:TV:LINE 20 TRIG:TV:LINE?
Notes:	The range of the TV line number is dependent on the settings of the Standard and Field menus within the TV trigger setup functions.
Preset:	17

State Saved:	Saved in instrument state
Min:	The minimum value is the minimum line, and rolls over to the maximum value. The minimum line number depends on which Field and standard are selected.
Max:	The maximum value is the maximum line, and rolls over to the minimum value. The maximum line number depends on which Field and standard are selected.
Initial S/W Revision:	Prior to A.02.00
Help Map ID:	3417

Field

Accesses the menu to select the field.

Key Path:	Trigger, TV
Remote Command:	:TRIGger[:SEquence]:TV:FMODE ENTire ODD EVEN :TRIGger[:SEquence]:TV:FMODE?
Example:	TRIG:TV:FMODE EVEN
Notes:	ODD is Field 1 EVEN is Field 2
Dependencies:	This command is available only when Option B7B (TV trigger) is installed.
Preset:	ENTire
Readback:	Displays the Readback value
Initial S/W Revision:	Prior to A.02.00
Help Map ID:	3418

Entire Frame

When you select Entire Frame it causes the selected line number to be viewed as an offset into the entire frame starting with line 1, the first line in Field One.

Key Path:	Trigger, TV, Field
Example:	TRIG:TV:FMODE ENT
Min:	1, for all formats.
Max:	525, for formats NTSC-M, NTSC-Japan, NTSC-4.43, PAL-M and PAL-60 625, for formats PAL-B, D, G, H, I, PAL-N, PAL-N Combin, and SECAM-L.
Readback:	Entire Frame
Initial S/W Revision:	Prior to A.02.00

Trigger

Help Map ID:	3419
--------------	------

Field One

When you select Field One it causes the selected line number to be viewed as an offset into the first field starting with Line 1, the first line in Field One.

Key Path:	Trigger, TV, Field
Example:	TRIG:TV:FMODE ODD
Min:	Field 1 (ODD) The minimum line is 1
Max:	Field 1 (ODD) Maximum line is 263 for formats NTSC-M, NTSC-Japan, NTSC-4.43, PAL-M and PAL-60 Maximum line is 313 for formats PAL-B, D, G, H, I, PAL-N, PAL-N Combin, and SECAM-L.
Readback:	Field 1
Initial S/W Revision:	Prior to A.02.00
Help Map ID:	3420

Field Two

When you select Field Two it causes the selected line number to be viewed as an offset into the second field. If Line 1 is selected, it is the 264th line of the frame (NTSC-M, NTSC-Japan, NTSC-4.43, PAL-M, PAL-60) or the 314th line of the frame (PAL-B,D,G,H,I, PAL-N, PAL-N-Combin, SECAM-L).

Key Path:	Trigger, TV, Field
Example:	TRIG:TV:FMODE EVEN
Min:	Field 2 (EVEN) The minimum line is 1
Max:	Field 2 (EVEN) The maximum line 262 for formats NTSC-M, NTSC-Japan, NTSC-4.43, PAL-M and PAL-60 The maximum line is 312 for formats PAL-B, D, G, H, I, PAL-N, PAL-N Combin, and SECAM-L
Readback:	Field 2
Initial S/W Revision:	Prior to A.02.00
Help Map ID:	3421

Standard

Accesses the Standard menu keys which select from the following TV standards: **NTSC-M, NTSC-Japan, NTSC-4.43, PAL-M, PAL-B,D,G,H,I , PAL-N, PAL-N-Combin, PAL-60, SECAM-L.**

As the TV standard is changed, the current line value is clipped as necessary to keep it valid for the chosen standard and field mode. For example, line 600 is selected in Entire Frame mode in PAL-N; if NTSC-M is selected, the line number is clipped to 525. Or, if line 313 is selected in Field 1 mode in PAL-N and NTSC-M is selected, the line number is clipped to 263. Changing back to the PAL-N standard will leave the line number at 263.

Key Path:	Trigger, TV
Remote Command:	:TRIGger [:SEquence] :TV:STANdard MNTSc JNTSc NTSC443 MPAL BPAL NPAL CPAL PAL60 LSEC :TRIGger [:SEquence] :TV:STANdard?
Example:	TRIG:TV:STAN MPAL TRIG:TV:STAN?
Preset:	MNTS
State Saved:	Saved in instrument state
Readback:	Displays Readback value
Initial S/W Revision:	Prior to A.02.00
Help Map ID:	3423

NTSC-M

Sets the TV standard to **NTSC-M**.

Key Path:	Trigger, TV, Standard
Example:	TRIG:TV:STAN MNTS
Readback:	NTSC-M
Initial S/W Revision:	Prior to A.02.00
Help Map ID:	3424

NTSC-Japan

Sets the TV standard to **NTSC-Japan**.

Key Path:	Trigger, TV, Standard
Example:	TRIG:TV:STAN JNTS
Readback:	NTSC-Japan

Trigger

Initial S/W Revision:	Prior to A.02.00
Help Map ID:	3425

NTSC-4.43

Sets the TV standard to **NTSC-4.43**.

Key Path:	Trigger, TV, Standard
Example:	TRIG:TV:STAN NTSC443
Readback:	NTSC-Japan
Initial S/W Revision:	Prior to A.02.00
Help Map ID:	3426

PAL-M

Sets the TV standard to **PAL-M**.

Key Path:	Trigger, TV, Standard
Example:	TRIG:TV:STAN MPAL
Readback:	PAL-M
Initial S/W Revision:	Prior to A.02.00
Help Map ID:	3427

PAL-N

Sets the TV standard to **PAL-N**.

Key Path:	Trigger, TV, Standard
Example:	TRIG:TV:STAN NPAL
Readback:	PAL-N
Initial S/W Revision:	Prior to A.02.00
Help Map ID:	3428

PAL-N-Combin

Sets the TV standard to **PAL-N-Combin**.

Key Path:	Trigger, TV, Standard
Example:	TRIG:TV:STAN CPAL
Readback:	PAL-N-C

Initial S/W Revision:	Prior to A.02.00
Help Map ID:	3429

PAL-B,D,G,H,I

Sets the TV standard to **PAL-B,D,G,H,I**

Key Path:	Trigger, TV, Standard
Example:	TRIG:TV:STAN BPAL
Readback:	PAL-B
Initial S/W Revision:	Prior to A.02.00
Help Map ID:	3430

PAL-60

Sets the TV standard to **PAL-60**.

Key Path:	Trigger, TV, Standard
Example:	TRIG:TV:STAN PAL60
Readback:	PAL-N
Initial S/W Revision:	Prior to A.02.00
Help Map ID:	3431

SECAM-L

Sets the TV standard to **SECAM-L**.

Key Path:	Trigger, TV, Standard
Example:	TRIG:TV:STAN LSEC
Readback:	SECAM-L
Initial S/W Revision:	Prior to A.02.00
Help Map ID:	3432

Auto/Holdoff

Opens up a menu that lets you adjust Auto Trigger and Trigger Holdoff parameters

Key Path:	Trigger
-----------	----------------

Trigger

Readback line:	Displays a summary of the Auto Trig and Holdoff settings, in square brackets First line: Auto Off or Auto On Second Line: "Hldf" followed by: <ul style="list-style-type: none"> • If Holdoff is Off, readback Off • If Holdoff On and Type = Normal, readback value • If Holdoff On and Type = Above, readback value followed by AL • If Holdoff On and Type = Below, readback value followed by BL • If Holdoff Type selection is not supported by the current measurement, Holdoff Type is always Normal
Initial S/W Revision:	A.02.00
Help Map ID:	29989

Auto Trig

Sets the time that the analyzer will wait for the trigger conditions to be met. If they are not met after that much time, then the analyzer is triggered anyway.

Key Path:	Trigger, Auto/Holdoff
Remote Command:	:TRIGger[:SEQuence]:ATRigger <time> :TRIGger[:SEQuence]:ATRigger? :TRIGger[:SEQuence]:ATRigger:STATe OFF ON 0 1 :TRIGger[:SEQuence]:ATRigger:STATe?
Example:	TRIG:ATR:STAT ON TRIG:ATR 100 ms
Notes:	The "time that the analyzer will wait" starts when the analyzer is ready for a trigger, which may be hundreds of ms after the data acquisition for a sweep is done. The "time" ends when the trigger condition is satisfied, not when the delay ends.
Preset:	Off, 100 ms
State Saved:	Saved in instrument state
Min:	1 ms
Max:	100 s
Default Unit:	s
Initial S/W Revision:	Prior to A.02.00
Help Map ID:	3436

Trig Holdoff

Sets the holdoff time between triggers. When the trigger condition is satisfied, the trigger occurs, the delay begins, and the holdoff time begins. New trigger conditions will be ignored until the holdoff time expires. For a free-running trigger, the holdoff value is the minimum time between triggers.

Key Path:	Trigger, Auto/Holdoff
Remote Command:	:TRIGger [:SEQuence] :HOLDoff <time> :TRIGger [:SEQuence] :HOLDoff? :TRIGger [:SEQuence] :HOLDoff:STATe OFF ON 0 1 :TRIGger [:SEQuence] :HOLDoff:STATe?
Example:	TRIG:HOLD:STAT ON TRIG:HOLD 100 ms
Dependencies:	Unavailable if the selected Input is BBIQ. If this is the case, the key is grayed out if it is pressed the informational message “Feature not supported for this Input” is displayed. If the SCPI command is sent, the error “Settings conflict; Feature not supported for this Input” is generated.
Preset:	Off, 100 ms
State Saved:	Saved in instrument state
Min:	0 s
Max:	0.5 s
Default Unit:	s
Initial S/W Revision:	Prior to A.02.00
Help Map ID:	3437

Holdoff Type

Lets you set the Trigger Holdoff Type.

NOTE Holdoff Type is not supported by all measurements. If the current measurement does not support it, this key will be blank and the Holdoff Type will be Normal. If the Holdoff Type SCPI is sent while in such a measurement, the SCPI will be accepted and the setting remembered, but it will have no effect until a measurement is in force that supports Holdoff Type.

Trigger Holdoff Type functionality:

- **NORMal**
This is the “oscilloscope” type of trigger holdoff, and is the setting when the Holdoff Type key does not appear. In this type of holdoff, no new trigger will be accepted until the holdoff interval has expired after the previous trigger.
- **ABOVe**

Trigger

If the trigger slope is positive, a trigger event is generated only if the signal characteristic of interest crosses the trigger threshold (with positive slope) and then remains above the threshold for at least the holdoff time. For negative slope, the trigger event is generated if the signal characteristic crosses the threshold (with negative slope) after having been above the threshold for at least the holdoff time. In either case, the trigger event is associated with the time the level was crossed.

- **BELow**

If the trigger slope is positive, a trigger event is generated only if the signal characteristic of interest crosses the trigger threshold (with positive slope) after having been below the threshold for at least the holdoff time. For negative slope, the trigger event is generated if the signal characteristic crosses the threshold (with negative slope) and then remains below the threshold for at least the holdoff time. In either case, the trigger event is associated with the time the level was crossed.

Key Path:	Trigger, Auto/Holdoff
Remote Command:	:TRIGger [:SEQuence] :HOLDoff :TYPE NORMal ABOVE BELow :TRIGger [:SEQuence] :HOLDoff :TYPE?
Example:	TRIG:HOLD:TYPE NORM
Preset:	All modes but GSM/EDGE: Normal GSM/EDGE: Below
State Saved:	Saved in instrument state
Initial S/W Revision:	A.02.00
Help Map ID:	29990

View/Display

This section describes the Display key, which is the key in the View/Display menu that is common to multiple Modes and Measurements. See the Measurement descriptions for information on the View functions of each measurement.

Display

The **Display** menu is common to most measurements, and is used for configuring items on the display. Some **Display** menu settings apply to all the measurements in a mode, and some only to the current measurement. Those under the **System Display Settings** key apply to all measurements in all modes.

Key Path:	Display
Key Path:	View/Display
Initial S/W Revision:	Prior to A.02.00
Help Map ID:	3440

Annotation

Turns on and off various parts of the display annotation. The annotation is divided up into four categories:

1. **Meas Bar:** This is the measurement bar at the top of the screen. It does not include the settings panel or the Active Function. Turning off the Meas Bar turns off the settings panel and the Active Function. When the Meas Bar is off, the graticule area expands to fill the area formerly occupied by the Meas Bar.
2. **Screen Annotation:** this is the annotation and annunciation around the graticule, including any annotation on lines (such as the display line, the threshold line, etc.) This does NOT include the marker number or the N dB result. When off, the graticule expands to fill the entire graticule area.
3. **Trace annotation:** these are the labels on the traces, showing their detector (or their math mode).
4. **Active Function annotation:** this is the active function display in the meas bar, and all of the active function values displayed on softkeys.

See the figure below. Each type of annotation can be turned on and off individually.

View/Display

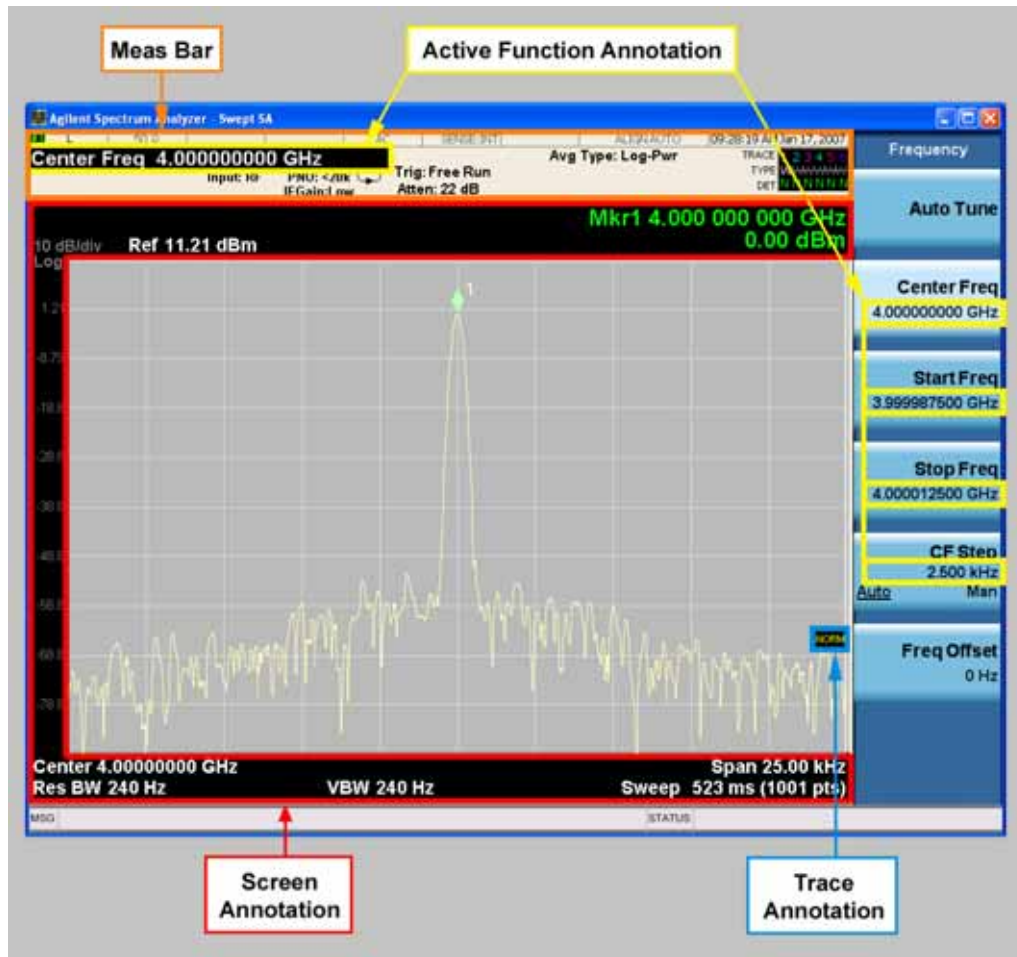

Key Path:	View/Display, Display
Initial S/W Revision:	Prior to A.02.00
Help Map ID:	3441

Meas Bar On/Off

This function turns the Measurement Bar on and off, including the settings panel. When off, the graticule area expands to fill the area formerly occupied by the Measurement Bar.

Key Path:	View/Display, Display, Annotation
Remote Command:	:DISPlay:ANNotation:MBAR[:STATe] OFF ON 0 1 :DISPlay:ANNotation:MBAR[:STATe]?
Example:	DISP:ANN:MBAR OFF
Dependencies:	Grayed out and forced to OFF when System Display Settings, Annotation is set to Off.

Preset:	On This should remain Off through a Preset when System Display Settings, Annotation is set to Off.
State Saved:	Saved in instrument state.
Initial S/W Revision:	Prior to A.02.00
Help Map ID:	3443

Screen

This controls the display of the annunciation and annotation around the graticule, including any annotation on lines (such as the display line, the threshold line, etc.) and the y-axis annotation. This does NOT include marker annotation (or the N dB result). When off, the graticule expands to fill the entire graticule area, leaving only the 1.5% gap above the graticule as described in the Trace/Detector chapter.

Key Path:	View/Display, Display, Annotation
Remote Command:	:DISPlay:ANNotation:SCReen[:STATe] OFF ON 0 1 :DISPlay:ANNotation:SCReen[:STATe] ?
Example:	DISP:ANN:SCR OFF
Dependencies:	Grayed-out and forced to OFF when System Display Settings, Annotation is set to Off.
Preset:	On This should remain Off through a Preset when System Display Settings, Annotation is set to Off
State Saved:	Saved in instrument state.
Initial S/W Revision:	Prior to A.02.00
Help Map ID:	3442

Trace

Turns on and off the labels on the traces, showing their detector (or their math mode) as described in the Trace/Detector section.

If trace math is being performed with a trace, then the trace math annotation will replace the detector annotation.

Key Path:	View/Display, Display, Annotation
Remote Command:	:DISPlay:ANNotation:TRACe[:STATe] ON OFF 1 0 :DISPlay:ANNotation:TRACe[:STATe] ?
Example:	DISP:ANN:TRAC OFF
Preset:	Off

View/Display

State Saved:	Saved in instrument state.
Initial S/W Revision:	Prior to A.02.00
Help Map ID:	3444

Active Function Values On/Off

Turns on and off the active function display in the Meas Bar, and all of the active function values displayed on the softkeys.

Note that all of the softkeys that have active functions have these numeric values blanked when this function is on. This is a security feature..

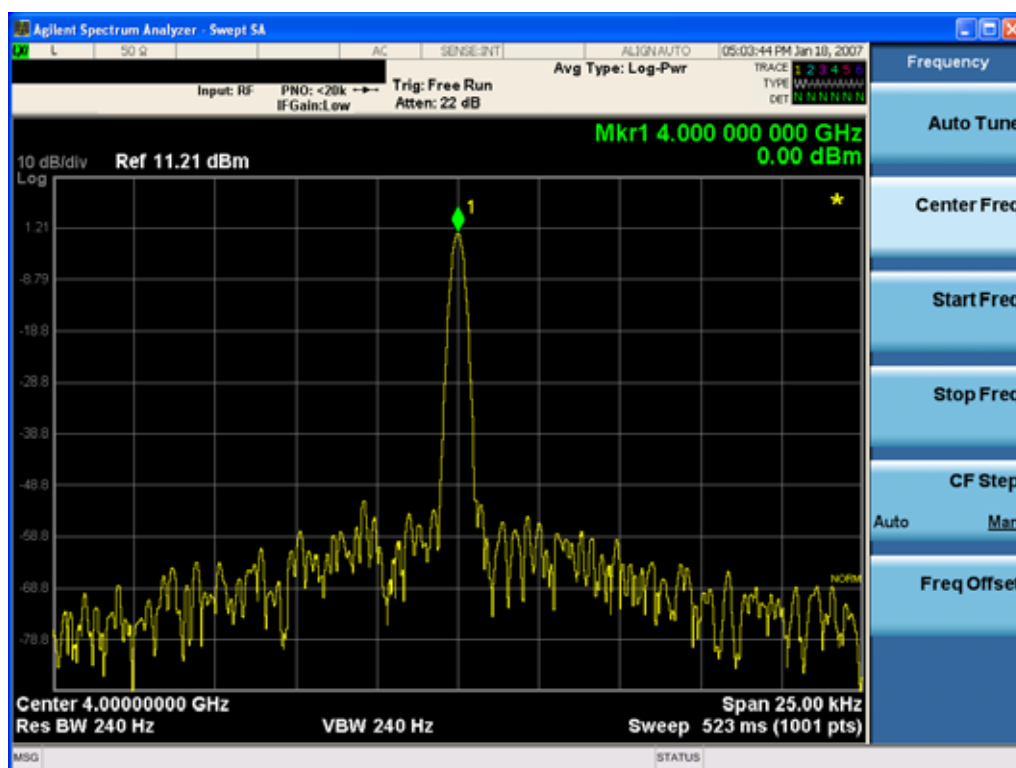

Key Path:	View/Display, Display, Annotation
Remote Command:	:DISPlay:ACTivefunc[:STATE] ON OFF 1 0 :DISPlay:ACTivefunc[:STATE]?
Example:	DISP:ACT OFF
Dependencies:	Grayed out and forced to OFF when System Display Settings, Annotation is set to Off.
Preset:	On This should remain Off through a Preset when System Display Settings, Annotation is set to Off

State Saved:	Saved in instrument state.
Initial S/W Revision:	Prior to A.02.00
Help Map ID:	3445

Title

Displays menu keys that enable you to change or clear a title on your display.

Key Path:	View/Display, Display
Initial S/W Revision:	Prior to A.02.00
Help Map ID:	3446

Change Title

Writes a title into the "measurement name" field in the banner, for example, "Channel Power".

Press **Change Title** to enter a new title through the alpha editor. Press **Enter** or **Return** to complete the entry. Press **Cancel (Esc)** to cancel the entry and preserve your existing title.

The display title will replace the measurement name. It remains for this measurement until you press **Change Title** again, or you recall a state, or a Preset is performed. A title can also be cleared by pressing **Title, Clear Title**.

NOTE Notice the inclusion of the <measurement> parameter in the command below. Because each measurement remembers the Display Title, the command must be qualified with the measurement name.

Key Path:	View/Display, Display, Title
Mode:	All
Remote Command:	:DISPlay:<measurement>:ANNotation:TITLe:DATA <string> :DISPlay:<measurement>:ANNotation:TITLe:DATA?
Example:	DISP:ACP:ANN:TITL:DATA "This Is My Title" This example sets the title to: This Is My Title
Notes:	Pressing this key cancels any active function. When a title is edited the previous title remains intact (it is not cleared) and the cursor goes at the end so that characters can be added or BKSP can be used to go back over previous characters.
Preset:	No title (measurement name instead)
State Saved:	Saved in instrument state.
Initial S/W Revision:	Prior to A.02.00
Modified at S/W Revision:	A.02.00, A.03.00

View/Display

Help Map ID:	3447
--------------	------

Clear Title

Clears a title from the front-panel display. Once cleared, the title cannot be retrieved. After the title is cleared, the current Measurement Name replaces it in the title bar.

Key Path:	View/Display, Display, Title
Example:	The following commands clear the title and restore the measurement's original title: DISP:ACP:ANN:TITL:DATA "" This example is for ACP; the measurement name is required.
Notes:	Uses the :DISPlay:<measurement>:ANNotation:TITLe:DATA <string> command with an empty string.
Preset:	Performed on Preset.
Initial S/W Revision:	Prior to A.02.00
Help Map ID:	3448

Graticule

Pressing Graticule turns the display graticule On or Off. It also turns the graticule y-axis annotation on and off.

Key Path:	View/Display, Display
Remote Command:	:DISPlay:WINDow[1]:TRACe:GRATicule:GRID[:STATe] OFF ON 0 1 :DISPlay:WINDow[1]:TRACe:GRATicule:GRID[:STATe]?
Example:	DISP:WIND:TRAC:GRAT:GRID OFF
Notes:	The graticule is the set of horizontal and vertical lines that make up the grid/divisions for the x-axis and y-axis.
Preset:	On
State Saved:	saved in instrument state
Initial S/W Revision:	Prior to A.02.00
Help Map ID:	3449

Display Line

Activates an adjustable horizontal line that is used as a visual reference line. The line's vertical position corresponds to its amplitude value. The value of the display line (for example, "-20.3 dBm") appears above the line itself on the right side of the display in the appropriate font.

The display line can be adjusted using the step keys, knob, or numeric keypad. The unit of the Display

Line is determined by the **Y axis unit** setting under **Amplitude**. If more than one window has a display line, the display line of the selected window is controlled.

If the display line is off the screen, it shows as a line at the top/bottom of the screen with an arrow pointing up or down. As with all such lines (Pk Thresh, Trigger Level, etc.) it is drawn on top of all traces.

The display line is unaffected by Auto Couple.

Key Path:	View/Display, Display
Remote Command:	:DISPlay:WINDow [1] :TRACe:Y:DLINe <ampl> :DISPlay:WINDow [1] :TRACe:Y:DLINe? :DISPlay:WINDow [1] :TRACe:Y:DLINe:STATe OFF ON 0 1 :DISPlay:WINDow [1] :TRACe:Y:DLINe:STATe?
Example:	DISP:WIND:TRAC:Y:DLIN:STAT ON DISP:WIND:TRAC:Y:DLIN:STAT -32 dBm
Preset:	Set the Display Line to Off and -25 dBm on Preset. When the Display Line goes from Off to On, if it is off screen, set it to either the top or bottom of screen, depending on which direction off screen it was. The Display Line's value does not change when it is turned off.
State Saved:	Saved in instrument state.
Min:	-∞ (minus infinity) in current units
Max:	+∞ (plus infinity) in current units
Default Unit:	Depends on the current selected Y axis unit
Initial S/W Revision:	Prior to A.02.00
Help Map ID:	3450

System Display Settings

These settings are "Mode Global" – they affect all modes and measurements and are reset only by **Restore Misc Defaults** or **Restore System Defaults** under System.

Key Path:	View/Display, Display
Initial S/W Revision:	Prior to A.02.00
Help Map ID:	3488

Annotation Local Settings

This is a Mode Global override of the meas local annotation settings. When it is **All Off**, it forces **Screen Annotation, Meas Bar, Trace, and Active Function Values** settings to be **OFF** for all measurements in all modes. This provides the security based "annotation off" function of previous test sets; hence it uses the legacy SCPI command.

View/Display

When it is **All Off**, the **Screen, Meas Bar, Trace, and Active Function Values** keys under the **Display, Annotation** menu are grayed out and forced to **Off**. When **Local Settings** is selected, you are able to set the local annotation settings on a measurement by measurement basis.

Key Path:	View/Display, Display, System Display Settings
Remote Command:	:DISPlay:WINDow[1]:ANNotation[:ALL] OFF ON 0 1 :DISPlay:WINDow[1]:ANNotation[:ALL]?
Example:	:DISP:WIND:ANN OFF
Preset:	On (Set by Restore Misc Defaults)
State Saved:	Not saved in instrument state.
Backwards Compatibility Notes:	The WINDow parameter and optional subopcode is included for backwards compatibility but ignored – all windows are equally affected.
Initial S/W Revision:	Prior to A.02.00
Help Map ID:	3451

Theme

This key allows you to change the Display theme. This is similar to the Themes selection under Page Setup and Save Screen Image. The four themes are detailed below.

Key Path:	View/Display, Display, System Display Settings
Remote Command:	:DISPlay:THEMe TDColor TDMonochrome FCOLor FMONochrome :DISPlay:THEMe?
Example:	DISP:THEM TDM sets the display theme to 3D Monochrome.
Notes:	TDColor – 3D is the standard color theme with filling and shading TDMonochrome – is similar to 3D color, but only black is used FCOLor – flat color is intended for inkjet printers to conserve ink. It uses a white background instead of black. FMONochrome – is like flat color, but only black is used
Preset:	TDColor (Set by Restore Misc Defaults)
State Saved:	Not saved in instrument state.
Initial S/W Revision:	Prior to A.02.00
Help Map ID:	3452

Backlight

Accesses the display backlight on/off keys. This setting may interact with settings under the Windows "Power" menu.

When the backlight is off, pressing ESC, TAB, SPACE, ENTER, UP, DOWN, LEFT, RIGHT, DEL,

BKSP, CTRL, or ALT turns the backlight on without affecting the application. Pressing any other key will turn backlight on and could potentially perform the action as well.

Key Path:	View/Display, Display, System Display Settings
Remote Command:	:DISPlay:BACKlight ON OFF :DISPlay:BACKlight?
Preset:	ON (Set by Restore Misc Defaults)
Initial S/W Revision:	Prior to A.02.00
Help Map ID:	3453

On

Turns the display backlight on.

Key Path:	View/Display, Display, System Display Settings, Backlight
Example:	DISP:BACK ON
Readback:	On
Initial S/W Revision:	Prior to A.02.00
Help Map ID:	3516

Off

Turns the display backlight off.

Key Path:	View/Display, Display, System Display Settings, Backlight
Example:	DISP:BACK OFF
Readback:	Off
Initial S/W Revision:	Prior to A.02.00
Help Map ID:	3517

Backlight Intensity

An active function used to set the backlight intensity. It goes from 0 to 100 where 100 is full on and 0 is off. This value is independent of the values set under the Backlight on/off key.

Key Path:	View/Display, Display, System Display Settings
Remote Command:	:DISPlay:BACKlight:INTensity <integer> :DISPlay:BACKlight:INTensity?
Example:	DISP:BACK:INT 50
Preset:	100 (Set by Restore Misc Defaults)

View/Display

Min:	0
Max:	100
Initial S/W Revision:	Prior to A.02.00
Help Map ID:	3454

Full Screen

When **Full Screen** is pressed the measurement window expands horizontally over the entire instrument display. The screen graticule area expands to fill the available display area.

It turns off the display of the softkey labels, however the menus and active functions still work. (Though it would obviously be very hard to navigate without the key labels displayed.) Pressing **Full Screen** again while Full Screen is in effect cancels Full Screen.

Note that the banner and status lines are unaffected. You can get even more screen area for your data display by turning off the Meas Bar (in the Display menu) which also turns off the settings panel.

Full Screen is a Meas Global function. Therefore it is cancelled by the **Preset** key.

Key Path:	Display
Remote Command:	:DISPlay:FSCreen[:STATe] OFF ON 0 1 :DISPlay:FSCreen[:STATe] ?
Preset:	Off
State Saved:	Not saved in instrument state.
Backwards Compatibility SCPI:	:DISPlay:MENU[:STATe] OFF ON 0 1 This emulates ESA full screen functionality, which is the same as the FSCreen command in PSA except that the sense of on/off is reversed (that is, OFF means the menus are OFF, so Fullscreen is ON) and the default is ON (meaning Fullscreen is OFF).
Backwards Compatibility Notes:	1. In ESA/PSA, Full Screen was turned on with a softkey, so pressing any other key turned Full Screen off. In the X-Series, because a hardkey is provided to turn this function on and off, pressing any other key no longer turns off Full Screen
Initial S/W Revision:	Prior to A.02.00
Help Map ID:	3464

Display Enable (Remote Command Only)

Turns the display on/off, including the display drive circuitry. The backlight stays lit so you can tell that the instrument is on. The display enable setting is mode global. The reasons for turning the display off are three:

- To increase speed as much as possible by freeing the instrument from having to update the display

- To reduce emissions from the display, drive circuitry
- For security purposes

If you have turned off the display:

- and you are in local operation, the display can be turned back on by pressing any key or by sending the SYSTem:DEFaults MISC command or the DISPlay:ENABle ON (neither *RST nor SYSTem:PRESet enable the display.)
- and you are in remote operation, the display can be turned back on by pressing the **Local** or **Esc** keys or by sending the SYSTem:DEFaults MISC command or the DISPlay:ENABle ON (neither *RST nor SYSTem:PRESet enable the display.)

and you are using either the SYSTem:KLOCK command or GPIB local lockout, then no front-panel key press will turn the display back on. You must turn it back on remotely.

Remote Command:	:DISPlay:ENABle OFF ON 0 1 :DISPlay:ENABle?
Example:	DISP:ENAB OFF
Couplings:	DISP:ENAB OFF turns Backlight OFF and DISP:ENAB ON turns Backlight ON. However, settings of Backlight do not change the state of DISP:ENAB
Preset:	On Set by SYST:DEF MISC, but Not affected by *RST or SYSTem:PRESet.
State Saved:	Not saved in instrument state.
Backwards Compatibility Notes:	1. SYST:PRES no longer turns on DISPlay:ENABle as it did in legacy analyzers
Initial S/W Revision:	Prior to A.02.00
Help Map ID:	0