



Agilent X-Series Wireless Communications Test Set

This manual provides documentation
for the following test sets:

EXT Test Set E6607A/B/C

**U9072A cdma-2000
Measurement Application:
User's and Programmer's
Reference**



Agilent Technologies

Notices

© Agilent Technologies, Inc.
2010-2013

No part of this manual may be reproduced in any form or by any means (including electronic storage and retrieval or translation into a foreign language) without prior agreement and written consent from Agilent Technologies, Inc. as governed by United States and international copyright laws.

Trademark Acknowledgements

Microsoft® is a U.S. registered trademark of Microsoft Corporation.

Windows® and MS Windows® are U.S. registered trademarks of Microsoft Corporation.

Adobe Acrobat® and Reader® are U.S. registered trademarks of Adobe Systems Incorporated.

Java™ is a U.S. trademark of Sun Microsystems, Inc.

MATLAB® is a U.S. registered trademark of Math Works, Inc.

Norton Ghost™ is a U.S. trademark of Symantec Corporation.

Wikipedia® is a registered trademark of the Wikimedia Foundation.

Manual Part Number

U9072-90008

Supersedes: U9072-90004 and U9072-90006

Print Date

February 2013

Supersedes: N/A

Printed in USA

Agilent Technologies Inc.
1400 Fountaingrove Parkway
Santa Rosa, CA 95403

Warranty

The material contained in this document is provided “as is,” and is subject to being changed, without notice, in future editions. Further, to the maximum extent permitted by applicable law, Agilent disclaims all warranties, either express or implied, with regard to this manual and any information contained herein, including but not limited to the implied warranties of merchantability and fitness for a particular purpose. Agilent shall not be liable for errors or for incidental or consequential damages in connection with the furnishing, use, or performance of this document or of any information contained herein. Should Agilent and the user have a separate written agreement with warranty terms covering the material in this document that conflict with these terms, the warranty terms in the separate agreement shall control.

Technology Licenses

The hardware and/or software described in this document are furnished under a license and may be used or copied only in accordance with the terms of such license.

Restricted Rights Legend

If software is for use in the performance of a U.S. Government

prime contract or subcontract, Software is delivered and licensed as “Commercial computer software” as defined in DFAR 252.227-7014 (June 1995), or as a “commercial item” as defined in FAR 2.101(a) or as “Restricted computer software” as defined in FAR 52.227-19 (June 1987) or any equivalent agency regulation or contract clause. Use, duplication or disclosure of Software is subject to Agilent Technologies’ standard commercial license terms, and non-DOD Departments and Agencies of the U.S. Government will receive no greater than Restricted Rights as defined in FAR 52.227-19(c)(1-2) (June 1987). U.S. Government users will receive no greater than Limited Rights as defined in FAR 52.227-14 (June 1987) or DFAR 252.227-7015 (b)(2) (November 1995), as applicable in any technical data.

Safety Notices

CAUTION

A **CAUTION** notice denotes a hazard. It calls attention to an operating procedure, practice, or the like that, if not correctly performed or adhered to, could result in damage to the product or loss of important data. Do not proceed beyond a CAUTION notice until the indicated conditions are fully understood and met.

WARNING

A **WARNING** notice denotes a hazard. It calls attention to an operating procedure, practice, or the like that, if not correctly performed or adhered to, could result in personal injury or death. Do not proceed beyond a WARNING notice until the indicated conditions are fully understood and met.

Warranty

This Agilent technologies instrument product is warranted against defects in material and workmanship for a period of one year from the date of shipment. During the warranty period, Agilent Technologies will, at its option, either repair or replace products that prove to be defective.

For warranty service or repair, this product must be returned to a service facility designated by Agilent Technologies. Buyer shall prepay shipping charges to Agilent Technologies, and Agilent Technologies shall pay shipping charges to return the product to Buyer. For products returned to Agilent Technologies from another country, Buyer shall pay all shipping charges, duties, and taxes.

Where to Find the Latest Information

Documentation is updated periodically. For the latest information about these products, including instrument software upgrades, application information, and product information, browse to one of the following URLs, according to the name of your product:

<http://www.agilent.com/find/ext>

To receive the latest updates by email, subscribe to Agilent Email Updates at the following URL:

<http://www.agilent.com/find/emailupdates>

Information on preventing test set damage can be found at:

<http://www.agilent.com/find/tips>

Is your product software up-to-date?

Periodically, Agilent releases software updates to fix known defects and incorporate product enhancements. To search for software updates for your product, go to the Agilent Technical Support website at:

<http://www.agilent.com/find/techsupport>

1. Using Help

How Help is Organized.....	102
Front Panel Keys used by the Help System	105
Navigating the Help Files	107
Basic Help Window Operations	108
Navigating Help with a Mouse	109
Navigating Help Without a Mouse	110
Definition of Terms.....	115
Viewing Help Files on a separate Computer.....	117
Other Help Resources.....	119

2. About the Test Set

How the Test Set Is Used	122
Receiver Testing	122
Transmitter Testing	122
Hardware Elements of the Test Set.....	123
Software Elements of the Test Set.....	128
Methods of Operating the Source	131
Waveform Segment Files	131
Methods of Operating the Analyzer	131
Creating Sequences.....	131
Executing Sequences.....	132
Installing Application Software	133
Viewing a license key	133
Obtaining and installing a license key	133
Missing and old Measurement application software.....	134
X-Series options and accessories	135
Front-Panel Features (E6607A/B)	136
Overview of key types.....	138
Front-Panel Features (E6607C)	143
Overview of key types	145
Display Annotations	149
Test Set Display Indicators	151
Rear-Panel Features	152
Window Control Keys	154
Multi-Window.....	154
Zoom.....	154
Next Window	155
Mouse and Keyboard Control.....	157
Right-Click	157
Virtual Front Panel	159
PC Keyboard.....	160
Instrument Security & Memory Volatility	164

3. About the cdma2000 Measurement Application

What does the cdma2000 application do?	166
Installing Application Software	167
Viewing a License Key	167

Contents

Obtaining and Installing a License Key	167
Missing and Old Measurement Application Software	168
4. Programming the Test Set	
What Programming Information is Available?	170
IEEE Common GPIB Commands	171
Calibration Query	171
Clear Status	171
Standard Event Status Enable	171
Standard Event Status Register Query	172
Identification Query	172
Instrument Model Number	173
Operation Complete	173
Query Instrument Options	174
Recall Instrument State	174
Save Instrument State	175
Service Request Enable	175
Status Byte Query	176
Trigger	176
Self Test Query	176
Wait-to-Continue	176
5. System Functions	
File	180
File Explorer	180
Page Setup	181
Print	182
Maximize/Restore Down	182
Maximize	182
Restore Down	182
Minimize	183
Exit	183
Mode Preset	184
Restore Mode Defaults	186
Meas Preset	187
Preset Type (Remote Command Only)	187
*RST (Remote Command Only)	187
Print	189
Quick Save	190
Recall	192
State	192
From File	195
Edit Register Names	197
Register 1 thru Register 16	197
Trace (+State)	198
Register 1 thru Register 5	199
To Trace	200
From File	200

Contents

Sequences	200
Source Sequence	201
Analyzer Sequence	201
Source and Analyzer Sequence	202
Open...	202
Data (Import).	202
Open...	203
Save.	204
State.	204
To File	205
Edit Register Names	207
Register 1 thru Register 16	208
Trace (+State)	208
Register 1 thru Register 5	210
From Trace	210
To File	211
Sequences	211
Source Sequence	211
Analyzer Sequence	212
Source and Analyzer Sequence	212
Save As	212
Data (Export).	213
Save As	213
Screen Image.	214
Themes	216
Save As...	217
Mass Storage Catalog (Remote Command Only)	218
Mass Storage Change Directory (Remote Command Only).	218
Mass Storage Copy (Remote Command Only).	218
Mass Storage Delete (Remote Command Only).	219
Mass Storage Data (Remote Command Only)	219
Mass Storage Make Directory (Remote Command Only).	220
Mass Storage Move (Remote Command Only)	220
Mass Storage Remove Directory (Remote Command Only)	220
System.	221
Show	221
Errors	221
System	225
Hardware	226
LXI	227
Power On.	227
Mode and Input/Output Defaults.	228
User Preset.	228
Last State.	229
Power On Application	230
Configure Applications	230
Configure Applications - Instrument boot-up	233
Configure Applications - Windows desktop	234
Configure Applications - Remote Commands	234

Restore Power On Defaults	236
Alignments	236
Auto Align	236
Align Now	243
Show Alignment Statistics	249
Restore Align Defaults	254
Backup or Restore Align Data...	255
Advanced	262
Timebase DAC	265
RF Preselector	267
I/O Config	276
GPIB	276
SCPI LAN	278
Reset Web Password	281
LXI	282
System IDN Response	282
Query USB Connection (Remote Command Only)	283
USB Connection Status (Remote Command Only)	284
USB Packet Count (Remote Command Only)	284
Restore Defaults	285
Restore Input/Output Defaults	285
Restore Power On Defaults	285
Restore Align Defaults	286
Restore Misc Defaults	286
Restore Mode Defaults (All Modes)	288
All	288
Control Panel...	289
Licensing.....	290
Security	292
USB	292
Diagnostics	292
Show Hardware Statistics	292
Advanced	295
Self test	295
Multiport Adapter Cables Test	302
Quick Test	302
Service	303
Internet Explorer.....	303
System Remote Commands (Remote Commands Only)	303
System Powerdown (Remote Command Only)	304
List installed Options (Remote Command Only)	304
Lock the Front-panel keys (Remote Command Only)	304
List SCPI Commands (Remote Command Only)	305
SCPI Version Query (Remote Command Only)	305
Date (Remote Command Only)	305
Time (Remote Command Only)	306
User Preset	307
User Preset	307
User Preset All Modes	308

Save User Preset	309
6. Channel Power Measurement	
AMPTD Y Scale	314
Ref Value	314
Attenuation	314
Scale/Div	315
Y Axis Unit	315
Internal Preamp	316
Ref Position	316
Auto Scaling	316
Auto Couple	318
BW	319
Res BW	319
Video BW	320
Filter Type	321
Cont.	323
FREQ Channel	324
Input/Output	325
Marker	326
Select Marker	326
Marker Type	326
Marker X Axis Value (Remote Command Only)	327
Marker X Axis Position (Remote Command Only)	327
Marker Y Axis Value (Remote Command only)	328
Properties	328
Select Marker	328
Relative To	329
Couple Markers	329
All Markers Off	330
Backward Compatibility SCPI Commands	330
Marker Function	331
Marker To	332
Meas	333
Meas Setup	334
Avg/Hold Num	334
Avg Mode	335
Integ BW	336
PhNoise Opt	337
PhNoise Opt Auto	337
PhNoise Opt State	338
IF Gain	338
IF Gain Auto	338
IF Gain State	339
Method	340
Integ BW	340
RRC Weighted	341
Limits	342
Power Limit	342

Contents

Power Limit Fail (remote command only)	344
PSD Limit	344
PSD Limit Fail (remote command only)	345
PSD Unit	346
Meas Preset	346
Mode	347
Mode Setup	348
Peak Search	349
Recall	350
Restart	351
Save	352
Data	352
Measurement Results	352
Single	356
Source (Internal)	357
Span X Scale	358
Span	358
Full Span	359
Last Span	360
Sweep/Control	361
Sweep Time	361
Sweep Setup	362
Auto Sweep Time Rules	362
Pause	363
Gate	363
Points	363
Trace/Detector	365
Trace Type	365
Detector	365
Detector Selection	366
Auto	367
Trigger	368
View/Display	369
Display	372
Bar Graph	372

7. ACP Measurement

AMPTD Y Scale	382
Ref Value	382
Attenuation	382
Scale/Div	383
Y Axis Unit	383
Internal Preamp	384
Ref Position	384
Auto Scaling	384
Auto Couple	386
BW	387
Res BW	387
Video BW	388

RBW Control	389
Filter Type	389
Filter BW	390
Cont.	391
FREQ Channel	392
Input/Output	393
Marker	394
Select Marker	394
Marker Type	394
Marker X Axis Value (Remote Command Only)	395
Marker X Axis Position (Remote Command Only)	396
Marker Y Axis Value (Remote Command Only)	396
Properties	397
Select Marker	397
Relative To	397
Marker Trace	398
Couple Markers	399
Marker All Off	399
Backward Compatibility Remote Commands	400
Marker Function	401
Marker To	402
Meas	403
Meas Setup	404
Average/Hold Number	404
Avg Mode	405
Carrier Setup	405
Carriers	405
Ref Carrier	406
Ref Car Freq	407
Power Ref	408
Configure Carriers	410
Offset/Limits	416
Select Offset	416
Offset Freq	416
Integ BW	418
Offset BW	420
Limits	423
Offset Side	429
Method for Offset	429
Offset Frequency Define	431
Carrier Result	431
PhNoise Opt	432
PhNoise Opt Auto	432
PhNoise Opt State	433
Meas Method	433
Meas Type	435
PSD Ref	435
Limit Test	436
Noise Correction	437

Meas Preset	437
Offset RRC Weighting (Backward Compatibility SCPI)	439
Offset Filter Alpha (Backward Compatibility SCPI)	439
Method for Carrier (Backward Compatibility SCPI)	440
Mode	442
Mode Setup	443
Peak Search	444
Peak Search	444
Next Peak	444
Next Pk Right	444
Next Pk Left	445
Marker Delta	445
Pk-Pk Search	445
Min Search	446
Recall	447
Restart	448
Save	449
Single	450
Source (Internal)	451
SPAN X Scale	452
Span	452
Full Span	453
Last Span	453
Sweep/Control	454
Sweep Time	454
Sweep Setup	455
Auto Sweep Time Rules	455
Pause	456
Gate	456
Points	456
Trace/Detector	458
Select Trace (Front-panel Only)	458
Trace Type	458
View / Blank	460
Detector	461
Auto	462
Detector Selection	462
Trigger	464
View/Display	465
Display	467
Bar Graph	467

8. Spectrum Emission Mask Measurement

AMPTD Y Scale	487
Ref Value	487
Attenuation	487
Scale/Div	488
Y Axis Unit	488
Ref Position	489

Contents

Auto Scaling	489
Auto Couple	491
BW	492
Filter Type	492
Cont.	493
FREQ Channel	494
Input/Output	495
Marker	496
Select Marker	496
Marker Type	496
Marker X Axis Value (Remote Command Only)	497
Marker X Axis Position (Remote Command Only)	497
Marker Y Axis Value (Remote Command Only)	498
Couple Markers	499
All Markers Off	499
Marker Function	500
Marker To	501
Meas	502
Meas Setup	503
Avg/Hold Num	503
Meas Type	504
Ref Channel	504
Integ BW	504
Span	506
Sweep Time	507
Res BW	508
Video BW	509
VBW/RBW	510
Power Ref	511
Offset/Limits	514
Select Offset	514
Start Freq	514
Stop Freq	517
Sweep Time	520
Offset Side	521
Res BW	521
Meas BW	523
Video BW	524
VBW/RBW	525
Limits	527
Offset Freq Define	536
Method	539
Filter Alpha	539
Meas Preset	540
Limit State(Only for TD-SCDMA)	540
80+80 MHz Mask (Only for WLAN)	541
Mode	542
Mode Setup	542
Peak Search	542

Recall	542
Restart	543
Save	543
Data	543
Single	554
Source (Internal)	555
Span X Scale	556
Ref Value	556
Scale/Div	556
Ref Position	557
Auto Scaling	558
Sweep/Control	558
Pause	558
Gate	559
Trace/Detector	560
Trace Type	560
Chan Detector	560
Chan Detector Selection	561
Chan Detector Auto	562
Offset Detector	562
Offset Detector Selection	563
Offset Detector Auto	563
Trigger	565
View/Display	566
Display	567
Change Title	567
Abs Pwr Freq	569
Rel Pwr Freq	576
Integrated Power	583
Limit Lines	591

9. Occupied Bandwidth Measurement

AMPTD Y Scale (Amplitude/Y Scale)	595
Ref Value	595
Attenuation	596
Scale/Div	596
Y Axis Unit	596
Internal Preamp	597
Ref Position	597
Auto Scaling	598
Auto Couple	599
BW	600
Res BW	600
Video BW	601
Filter Type	602
Cont (Continuous)	604
FREQ/Channel (Frequency or Channel)	605
Input/Output	606
Marker	607

Contents

Select Marker	607
Marker X Axis Value (Remote Command Only)	607
Marker X Axis Position (Remote Command Only)	608
Marker Y Axis Value (Remote Command Only)	608
Marker Type	609
Properties.	609
Select Marker	610
Relative To	610
All Markers Off	611
Backward Compatibility SCPI Commands.	611
Marker Function	612
Marker To	613
Meas	614
Meas Setup	615
Avg/Hold Num	615
Avg Mode	616
Max Hold (Remote Command Only)	616
Occ BW % Pwr	617
x dB	618
IF Gain.	618
IF Gain Auto	619
IF Gain State	619
Limit	620
Meas Preset	621
Mode	622
Mode Setup	623
Peak Search.	624
Recall	625
Restart.	626
Save.	627
Data	627
Measurement Results	627
Single	631
Source (Internal)	632
Span X Scale.	633
Span	633
Full Span	634
Last Span.	634
Sweep/Control	636
Sweep Time	636
Sweep Setup	637
Auto Sweep Time Rules	637
Pause	638
Gate	638
Points	638
Trace/Detector.	640
Trace Type.	640
Detector	641
Detector Selection	641

Auto	642
Trigger	644
View/Display	645
Display	648

10. Code Domain

AMPTD Y Scale.....	656
Y Ref Value.....	656
Power Graph & Metrics View CDP Window Y Ref Value	656
CDP Graph & CDE Graph View CDP Window Y Ref Value	657
CDP Graph & CDE Graph View CDE Window Y Ref Value	657
I/Q Error View Mag Error Window Y Ref Value	658
I/Q Error View Phase Error Window Y Ref Value	659
I/Q Error View EVM Window Y Ref Value.....	659
Code Domain View CDP Window Y Ref Value.....	660
Code Domain View Symb Power Window Y Ref Value	660
Demod Bits View CDP Window Y Ref Value	661
Demod Bits View Symb Power Window Y Ref Value	662
Attenuation	662
Y Scale/Div	662
Power Graph & Metrics View CDP Window Y Scale/Div	662
CDP Graph & CDE Graph View CDP Window Y Scale/Div	663
CDP Graph & CDE Graph View CDE Window Y Scale/Div	664
I/Q Error View Mag Error Window Y Scale/Div	664
I/Q Error View Phase Error Window Y Scale/Div	665
I/Q Error View Evm Window Y Scale/Div	665
Code Domain View CDP Window Y Scale/Div.....	666
Code Domain View Symbol Power Window Y Scale/Div.....	666
Demod Bits View CDP Window Y Scale/Div	667
Demod Bits View Symbol Power Window Y Scale/Div	668
Internal Preamp.....	668
Y Ref Position.....	668
I/Q Error View Mag Error Window Y Ref Position.....	668
I/Q Error View Phase Error Window Y Ref Position	669
I/Q Error View Evm Window Y Ref Position	669
Code Domain View Symbol Power Window Y Ref Position.....	670
Demod Bits View Symbol Power Window Y Ref Position	670
Auto Scaling	671
I/Q Error View Mag Error Window Y Auto Scaling	671
I/Q Error View Phase Error Window Y Auto Scaling	672
I/Q Error View Evm Window Y Auto Scaling	673
Code Domain View Symbol Power Window Y Auto Scaling	673
Demod Bits View Symbol Power Window Y Auto Scaling.....	674
BW	675
Marker	676
Marker Symbol Value (Remote Command only)	676
Marker X Axis Value (Remote Command only)	677
Marker X Axis Position (Remote Command only)	677
Marker Y Axis Value (Remote Command only)	678

Contents

Marker Select	678
Marker Type	678
Properties	680
Marker Select	680
Relative To	680
Marker Trace	681
Couple Marker	681
All Markers Off	682
Backward Compatibility SCPI Commands	682
Marker Function	683
Marker To	684
Mkr -> Despread	684
Meas Setup	685
Meas Type	685
Walsh Code Length	685
Walsh Code Number	686
I/Q Branch (MS only)	686
Meas Interval	687
Meas Offset	687
PN Offset	689
Sync Type (BTS only)	689
Long Code Mask (MS only)	690
Capture Interval	690
Spectrum Inversion	690
Meas Preset	691
Advanced	691
Active Set Threshold	691
Filter Alpha	692
Chip Rate	693
Walsh Code QOF (BTS only)	693
IF Gain	693
Peak Search	696
Peak Search	696
Next Peak	696
Next Pk Right	696
Next Pk Left	696
Marker Delta	697
Continuous Peak Search	697
Pk-Pk Search	697
Min Search	698
SPAN X Scale	699
Start Code Number	699
Stop Code Number	700
X Ref Value	700
I/Q Error View Mag Error Window X Ref Value	700
I/Q Error View Phase Error Window X Ref Value	701
I/Q Error View Evm Window X Ref Value	702
Code Domain View Symb Power Window X Ref Value	702
Demod Bits View Symb Power Window X Ref Value	703

X Scale/Div	704
I/Q Error View Mag Error Window X Scale/Div	704
I/Q Error View Phase Error Window X Scale/Div	704
I/Q Error View EVM Window X Scale/Div	705
Code Domain View Symb Power Window X Scale/Div	706
Demod Bits View Symb Power Window X Scale/Div	707
Ref Position	707
I/Q Error View Mag Error Window Ref Position	708
I/Q Error View Phase Error Window Ref Position	708
I/Q Error View Evm Window Ref Position	708
Code Domain View Symb Power Window Ref Position	709
Demod Bits View Symb Power Window Ref Position	709
Auto Scaling	710
I/Q Error View Mag Error Window Auto Scaling	710
I/Q Error View Phase Error Window Auto Scaling	710
I/Q Error View Evm Window Auto Scaling	711
Code Domain View Symb Power Window Auto Scaling	711
Demod Bits View Symb Power Window Auto Scaling	712
Sweep/Control	714
Pause/Resume	714
Trace/Detector	715
Trigger	716
View/Display	717
Display	717
Annotation	717
Graticule	717
Title	717
Change Title	717
Clear Title	718
View (Remote Command only)	718
View Selection by number (SCPI Remote Command only)	719
View Settings	719
Power Graph & Metrics	719
CDP Graph and CDE Graph	721
I/Q Error (Quad View)	721
Code Domain (Quad View)	721
Demod Bits	722
11. Modulation Accuracy (Composite Rho)	
AMPTD Y Scale	728
Ref Value	728
I/Q Error View - EVM Window	728
I/Q Error View – Mag Error Window	729
I/Q Error View – Phase Error Window	729
Attenuation	730
Scale/Div	730
I/Q Error View - EVM Window	730
I/Q Error View – Mag Error Window	731
I/Q Error View – Phase Error Window	731

Contents

Internal Preamp	732
Ref Position	732
I/Q Error View - EVM Window	732
I/Q Error View – Mag Error Window	732
I/Q Error View – Phase Error Window	733
Auto Scaling	733
I/Q Error View - EVM Window	733
I/Q Error View – Mag Error Window	734
I/Q Error View – Phase Error Window	735
BW	736
Marker	737
Marker Select	737
Marker Type	737
Marker Chip Value (Remote Command only)	738
Marker X Axis Value (Remote Command only)	739
Marker X Axis Position (Remote Command only)	739
Marker Y Axis Value (Remote Command only)	740
Properties	740
Marker Select	741
Relative To	741
Marker Trace	741
Couple Markers	742
All Markers Off	742
Marker Function	743
Marker To	744
Meas Setup	745
Avg Number	745
Avg Mode	745
Limits	746
RMS EVM (Composite)	746
Peak EVM (Composite)	747
Rho (Composite)	747
Peak Code Domain Error	748
Timing Error	748
Phase Error	749
PN Offset	749
Sync Type	750
Sync Type BTS	750
Long Code Mask MS	750
Radio Config	751
Spectrum	752
Advanced	752
EVM Result I/Q Offset	753
Active Set Threshold	753
Filter Alpha	754
Chip Rate	755
Multi Channel Estimator	755
IF Gain	755
Meas Preset	757

Contents

Peak Search	758
Next Peak	758
Next Pk Right	758
Next Pk Left	758
Marker Delta	759
Pk-Pk Search	759
Min Search	759
SPAN X Scale	760
Ref Value	760
I/Q Error View - EVM Window	760
I/Q Error View - Mag Error Window	761
I/Q Error View - Phase Error Window	761
Scale/Div	762
I/Q Error View - EVM Window	762
I/Q Error View - Mag Error Window	762
I/Q Error View - Phase Error Window	763
Ref Position	764
I/Q Error View - EVM Window	764
I/Q Error View - Mag Error Window	764
I/Q Error View - Phase Error Window	765
Auto Scaling	765
I/Q Error View - EVM Window	765
I/Q Error View - Mag Error Window	766
I/Q Error View - Phase Error Window	766
Sweep/Control	768
Pause/Resume	768
Trace/Detector	769
Trigger	770
View/Display	771
Display	771
Annotation	771
Graticule	771
Title	771
View Selection (Remote Command only)	772
View Selection by number (Remote Command only)	773
View Settings	773
I/Q Polar View	773
I/Q Polar Vec/ConstIn	773
Chip Offset	774
I/Q Chips	774
+45° Rotation	775
Full Vector	775
I/Q Error	776
Power Timing and Phase View	776
Prev Page	776
Next Page	777
Scroll Up	777
Scroll Down	777
First Page	777

Last Page	777
12. QPSK EVM Measurement	
AMPTD Y Scale	782
Ref Value	782
Ref Value (Magnitude Error Window)	782
Ref Value (Phase Error Window)	783
Ref Value (EVM Window)	783
Attenuation	784
Scale/Div	784
Scale/Div (Magnitude Error Window)	784
Scale/Div (Phase Error Window)	785
Scale/Div (Evm Window)	785
Internal Preamp	786
Ref Position	786
Auto Scaling	787
Auto Couple	788
BW	789
Info BW	789
Info BW Control	789
Filter Type	790
Cont.	791
FREQ Channel	792
Input/Output	793
Marker	794
Select Marker	794
Marker Type	794
Marker X Axis Value (Remote Command Only)	795
Marker Chip Value (Remote Command Only)	796
Marker X Axis Position (Remote Command Only)	797
Marker Y Axis Value (Query Only)	798
Marker Properties	798
Select Marker	799
Relative To	799
Marker Trace	799
Couple Marker	800
All Markers Off	800
Marker Function	802
Marker To	803
Meas	804
Meas Setup	805
Avg/Hold Number	805
Avg Mode	805
Meas Interval	806
Limits	807
RMS EVM	807
Freq Error	807
Meas Offset & Interval	808
Meas Offset	808

Contents

Meas Interval	809
Spectrum	809
Advanced	810
EVM Result I/Q Offset	810
RRC Filter Control	810
Filter Alpha	811
Chip Rate	811
IF Gain	812
Meas Preset	813
Mode	814
Mode Setup	815
Peak Search	816
Next Peak	816
Next Pk Right	816
Next Pk Left	817
Marker Delta	817
Pk-Pk Search	817
Min Search	818
Recall	819
Restart	820
Save	821
Single	822
Source (Internal)	823
SPAN X Scale	824
X Ref Value	824
Ref Value (X Scale, Magnitude Error Window)	824
Ref Value (X Scale, Phase Error Window)	825
Ref Value (X Scale, EVM Window)	825
X Scale/Div	826
Scale/Div (X Scale, Magnitude Error Window)	826
Scale/Div (X Scale, Phase Error Window)	827
Scale/Div (X Scale, EVM Window)	827
X Ref Position	828
Ref Position (X Scale, Magnitude Error Window)	828
Ref Position (X Scale, Phase Error Window)	829
Ref Position (X Scale, EVM Window)	829
X Auto Scaling	830
Auto Scaling (X Scale, Magnitude Error Window)	830
Auto Scaling (X Scale, Phase Error Window)	830
Auto Scaling (X Scale, Evm Window)	831
Sweep/Control	833
Pause	833
Trace/Detector	834
Trigger	835
View/Display	836
Display	837
I/Q Measured Polar Graph	837
I/Q Polar Vec/Constln	841
Chip Offset	842

I/Q Chips	842
Interpolation	843
+45° Rotation	843
Full Vector	844
I/Q Error View	844

13. Common Measurement Functions

AMPTD Y Scale	849
Reference Level	849
Attenuation	850
(Mech) Atten	852
Enable Elec Atten	854
Elec Atten	857
Adjust Atten for Min Clip	858
Pre-Adjust for Min Clip	858
(Mech) Atten Step	860
Max Mixer Level	861
Range	861
Range Auto/Man	862
I Range	863
Q Range	864
I/Q Gain Ranges	866
Scale / Div	867
Scale Type	867
Presel Center	868
Preselector Adjust	869
Y Axis Unit	871
dBm	873
dBmV	873
dBmA	873
W	873
V	874
A	874
dBmV	874
dBmA	874
dBpW	875
Antenna Unit	875
Reference Level Offset	877
μW Path Control	879
Standard Path	880
Low Noise Path Enable	880
μW Preselector Bypass	882
Internal Preamp	883
Off	884
Low Band	884
Full Range	885
Auto Couple	887
BW	889
Res BW	889

Contents

Video BW	891
VBW:3dB RBW	892
Span:3dB RBW	894
RBW Control	895
Filter Type	895
Filter BW	897
Cont (Continuous Measurement/Sweep)	901
FREQ Channel	903
Auto Tune/Zoom Center/Zone Center	903
Auto Tune	903
Zoom Center	904
Zone Center	905
Center Freq	906
Start Freq	912
Stop Freq	914
CF Step	917
Freq Offset	918
Input/Output	921
RF Input	923
Input Z Correction	924
RF Input Port	925
RF Calibrator	926
50 MHz	927
Off	927
External Gain	928
Ext Preamp	928
MS	929
BTS	930
Restore Input/Output Defaults	931
Data Source	932
Inputs	932
Capture Buffer	933
Current Meas -> Capture Buffer	933
Corrections	933
Correction On/Off	934
Properties	935
Edit	941
Delete Correction	943
Apply Corrections	943
Delete All Corrections	944
Remote Correction Data Set Commands	944
Freq Ref In	945
Sense	947
Internal	947
External	947
Ext Ref Freq	948
RF Output & Test Set Config	948
RF Output	949
Multiport Adapter	950

Output Config	980
Trig Out (1 and 2)	980
Analog Out	984
Digital Bus	988
Marker.	989
Select Marker	992
Normal	992
Delta	992
Fixed	993
Off	994
Properties.	995
Select Marker	995
Relative To	995
X-axis scale (formerly Readout).	996
Marker Trace	999
Lines	1000
Marker Table	1001
Marker Count	1001
Counter On/Off	1002
Gate Time Auto/Man.	1005
Couple Markers	1005
All Markers Off	1006
Marker Function	1007
Select Marker	1008
Marker Noise	1008
Band/Interval Power	1010
Band/Interval Density	1010
Marker Function Off	1012
Band Adjust.	1012
Band/Interval Span	1012
Band/Interval Left	1013
Band/Interval Right	1014
Measure at Marker	1016
Measure at Marker	1016
Meas at Marker Window.	1019
Detectors	1020
BW & Avg Type	1024
Center Presel On/Off	1025
Marker To	1027
Mkr->CF	1027
Mkr->CF Step	1028
Mkr->Start.	1028
Mkr->Stop.	1029
MkrΔ->Span	1029
MkrΔ->CF.	1030
Mkr->Ref Lvl	1030
Meas	1031
Remote Measurement Functions.	1031
Measurement Group of Commands	1032

Current Measurement Query (Remote Command Only)	1035
Limit Test Current Results (Remote Command Only)	1036
Data Query (Remote Command Only)	1036
Calculate/Compress Trace Data Query (Remote Command Only)	1036
Calculate Peaks of Trace Data (Remote Command Only)	1041
Format Data: Numeric Data (Remote Command Only)	1043
Format Data: Byte Order (Remote Command Only)	1045
Meas Setup	1047
Average/Hold Number	1047
Average Type	1048
Auto	1049
Log-Pwr Avg (Video)	1050
Pwr Avg (RMS)	1050
Voltage Avg.	1051
Limits	1051
Select Limit	1052
Limit On/Off	1052
Properties	1053
Margin	1059
Edit	1060
Delete Limit	1064
Test Limits	1064
X-Axis Unit	1065
Delete All Limits	1066
Limit Line Data (Remote Command Only, Backwards Compatibility)	1066
Limit Line Fail? (Remote Command Only)	1067
Limit State (Remote Command Only, SCPI standard compatibility)	1067
Limit Line Control (Remote Command Only, SCPI standard compatibility)	1067
Limit Line Upper / Lower (Remote Command Only, SCPI standard compatibility)	1068
Limit Fail? (Remote Command Only, SCPI standard Compatibility)	1069
Limit Clear (Remote Command Only, SCPI standard Compatibility)	1070
Trace Fail? (Remote Command Only)	1070
Fixed / Relative Limit (Remote Command Only, Backwards Compatibility)	1070
Merge Limit Line Data	1071
N dB Points	1071
PhNoise Opt	1075
Auto	1075
Best Close-in P Noise	1076
Best Wide-offset Noise	1077
Fast Tuning	1077
ADC Dither	1077
Auto	1078
High (Best Log Accy)	1079
Medium (Log Accy)	1079
Off (Best Noise)	1079
Swept IF Gain	1079
Auto	1080
Low Gain (Best for Large Signals)	1081
High Gain (Best Noise Level)	1081

FFT IF Gain	1081
Auto	1082
Autorange (Slower – Follows Signals)	1082
Low Gain (Best for Large Signals)	1082
High Gain (Best Noise Level)	1083
Analog Demod Tune & Listen	1083
AM	1083
Channel BW (AM Demod)	1084
FM	1084
Channel BW (FM Demod)	1085
De-emphasis (FM Demod only)	1085
PM	1087
Channel BW (PM Demod)	1087
Off	1088
Demod Time	1088
Demod State (Remote Command Only)	1089
Mode	1091
Application Mode Number Selection (Remote Command Only)	1093
Application Mode Catalog Query (Remote Command Only)	1094
Application Identification (Remote Commands Only)	1094
Current Application Model	1095
Current Application Revision	1095
Current Application Options	1096
Application Identification Catalog (Remote Commands Only)	1096
Application Catalog Number of Entries	1096
Application Catalog Model Numbers	1096
Application Catalog Revision	1097
Application Catalog Options	1097
Detailed List of Modes	1098
1xEV-DO	1098
802.16 OFDMA (WiMAX/WiBro)	1098
Analog Demod	1098
Bluetooth	1099
cdma2000	1099
GSM/EDGE/EDGE Evo	1099
IQ Analyzer (Basic)	1099
LTE	1100
LTE TDD	1100
Sequence Analyzer	1100
TD-SCDMA with HSPA/8PSK	1101
W-CDMA with HSPA+	1101
Global Settings	1101
Global Center Freq	1101
Restore Defaults	1102
Mode Setup	1103
Radio	1103
Device	1103
Restore Mode Defaults	1103
Peak Search	1105

Next Peak	1105
Next Pk Right	1106
Next Pk Left	1106
Marker Delta	1107
Mkr->CF	1107
Mkr->Ref Lvl	1107
Peak Criteria	1107
“Peak Search” Criteria	1108
“Next Peak” Criteria	1109
Peak Table	1112
Peak Table On/Off	1112
Peak Sort	1113
Peak Readout	1113
Continuous Peak Search On/Off	1116
Pk-Pk Search	1117
Min Search	1118
Recall	1119
Amplitude Correction	1119
Amplitude Correction	1120
Restart	1125
Save	1127
Amplitude Correction	1127
Multiport Adapter Amplitude Correction	1130
Single (Single Measurement/Sweep)	1135
Source (Internal)	1137
RF Output	1137
Amplitude	1137
RF Power	1138
Set Reference Power	1139
Power Ref	1140
Amptd Offset	1141
ALC	1141
Modulation	1142
Frequency	1142
Frequency	1143
Channel	1143
Radio Setup	1153
Set Reference Frequency	1170
Freq Reference	1171
Freq Offset	1172
Modulation Setup	1172
ARB	1173
AM	1215
FM	1216
PM	1217
Multiport Adapter Output Port Amplitude Correction Configuration Validation (Remote Command Only)	1218
List Sequencer	1219
Sequencer	1219

Initiate Sequence	1220
Remote Software Trigger (Remote command Only)	1220
List Sequencer Setup	1221
Multiport Adapter Output Port Bitmap Mode	1256
Multiport Adapter Output Port Amplitude Correction Configuration Validation for List Sequencer (Remote Command Only)	1257
Manual Trigger Now	1257
Query List Sequence Initiation Armed Status (Remote Command Only)	1258
Source Preset	1258
Source Self Test	1258
Internal Source	1258
Recall	1259
Save	1259
Signal Studio Commands	1259
Overview	1259
Query License List (Remote Command Only)	1259
Query License List Detail (Remote Command Only)	1259
Memory Subsystem (Remote Command Only)	1260
Sequence Studio Commands	1261
Overview	1261
Query Supportable System Information Query SCPI List (Remote Command Only)	1261
Span	1263
Span	1263
Full Span	1264
Zero Span	1265
Last Span	1266
Sweep/Control	1267
Sweep Time	1267
Sweep Setup	1269
Sweep Time Rules	1270
Sweep Type	1273
Sweep Type Rules	1275
FFT Width	1276
Pause/Resume	1279
Gate	1280
Gate On/Off	1280
Gate View On/Off	1282
Gate View Setup	1285
Gate Delay	1286
Gate Length	1287
Method	1287
Gate Source	1289
Control Edge/Level	1290
Gate Holdoff	1291
Gate Delay Compensation	1292
Min Fast Position Query (Remote Command Only)	1294
Gate Preset (Remote Command Only)	1294
Gate Level (Remote Command Only)	1294
Gate Polarity (Remote Command Only)	1295

Points	1295
Zoom Points	1297
Abort (Remote Command Only)	1298
Trace/Detector	1301
Select Trace	1303
Clear Write	1304
Trace Average	1304
Max Hold	1305
Min Hold	1306
View/Blank	1307
Detector	1310
Auto	1313
Normal	1314
Average (Log/RMS/V)	1315
Peak	1315
Sample	1316
Negative Peak	1316
Preset Detectors	1317
All Traces Auto	1317
Peak / Average / NPeak	1318
Peak / Sample / NPeak	1318
Clear Trace	1318
Clear All Traces	1318
Math	1319
Power Diff (Op1-Op2)	1322
Power Sum (Op1+Op2)	1322
Log Offset (Op1 + Offset)	1323
Log Diff (Op1-Op2+Ref)	1323
Off	1324
Operands	1325
Normalize	1326
Copy/Exchange	1330
From Trace	1331
To Trace	1332
Copy Now	1332
Exchange Now	1332
Send/Query Trace Data (Remote Command Only)	1332
Format Data: Numeric Data (Remote Command Only)	1334
Format Data: Byte Order (Remote Command Only)	1335
Smooth Trace Data (Remote Command Only)	1336
Number of Points for Smoothing (Remote Command Only)	1336
Mean Trace Data (Remote Command Only)	1336
Trigger	1339
Free Run	1347
Video (IF Envelope)	1348
Trigger Level	1349
Trig Slope	1349
Trig Delay	1350
Line	1352

Trig Slope	1353
Trig Delay	1353
External 1	1354
Trigger Level	1354
Trig Slope	1355
Trig Delay	1355
Zero Span Delay Comp On/Off	1356
External 2	1357
Trigger Level	1357
Trig Slope	1358
Trig Delay	1358
Zero Span Delay Comp On/Off	1359
RF Burst	1360
Absolute Trigger Level	1360
Relative Trigger Level	1362
Trigger Slope	1363
Trig Delay	1363
Zero Span Delay Comp On/Off	1364
Periodic Timer (Frame Trigger)	1365
Period	1366
Offset	1367
Reset Offset Display	1369
Sync Source	1369
Trig Delay	1372
Sync Holdoff	1372
Baseband I/Q	1373
I/Q Mag	1373
I (Demodulated)	1375
Q (Demodulated)	1376
Input I	1378
Input Q	1379
Auxiliary Channel I/Q Mag	1381
TV	1383
TV Line	1384
Field	1385
Standard	1386
Auto/Holdoff	1389
Auto Trig	1389
Trig Holdoff	1390
Holdoff Type	1390
View/Display	1393
Display	1393
Annotation	1393
Title	1397
Graticule	1398
Display Line	1398
System Display Settings	1399
Full Screen	1401
Display Enable (Remote Command Only)	1402

List of Commands

This list includes every SCPI command described in this document. To find a command in the list, search according to its first alphanumeric character, ignoring any leading "*", ":" or "[" characters.

:ABORt.	1298
*CAL?	245
:CALCulate:ACPower:LIMit:STATe OFF ON 0 1.	436
:CALCulate:ACPower:LIMit:STATe?	436
:CALCulate:ACPower:MARKer[1] 2 3 4 5 6 7 8 9 10 11 12:MAXimum	444
:CALCulate:ACPower:MARKer[1] 2 3 4 5 6 7 8 9 10 11 12:MAXimum:LEFT	445
:CALCulate:ACPower:MARKer[1] 2 3 4 5 6 7 8 9 10 11 12:MAXimum:NEXT.	444
:CALCulate:ACPower:MARKer[1] 2 3 4 5 6 7 8 9 10 11 12:MAXimum:RIGHT	445
:CALCulate:ACPower:MARKer[1] 2 3 4 5 6 7 8 9 10 11 12:MINimum	446
:CALCulate:ACPower:MARKer[1] 2 3 4 5 6 7 8 9 10 11 12:MODE POSition DELTA OFF.	394
:CALCulate:ACPower:MARKer[1] 2 3 4 5 6 7 8 9 10 11 12:MODE?	394
:CALCulate:ACPower:MARKer[1] 2 3 4 5 6 7 8 9 10 11 12:PTPeak.	445
:CALCulate:ACPower:MARKer[1] 2 3 4 5 6 7 8 9 10 11 12:REFerence <integer>.	397
:CALCulate:ACPower:MARKer[1] 2 3 4 5 6 7 8 9 10 11 12:REFerence?	397
:CALCulate:ACPower:MARKer[1] 2 3 4 5 6 7 8 9 10 11 12:STATe OFF ON 0 1	400
:CALCulate:ACPower:MARKer[1] 2 3 4 5 6 7 8 9 10 11 12:STATe?	400
:CALCulate:ACPower:MARKer[1] 2 3 4 5 6 7 8 9 10 11 12:TRACe 1 2 3	398
:CALCulate:ACPower:MARKer[1] 2 3 4 5 6 7 8 9 10 11 12:TRACe?.	398
:CALCulate:ACPower:MARKer[1] 2 3 4 5 6 7 8 9 10 11 12:X <freq>	395
:CALCulate:ACPower:MARKer[1] 2 3 4 5 6 7 8 9 10 11 12:X?	395
:CALCulate:ACPower:MARKer[1] 2 3 4 5 6 7 8 9 10 11 12:X:POSition <real>.	396
:CALCulate:ACPower:MARKer[1] 2 3 4 5 6 7 8 9 10 11 12:X:POSition?.	396
:CALCulate:ACPower:MARKer[1] 2 3 4 5 6 7 8 9 10 11 12:Y?	396
:CALCulate:ACPower:MARKer:AOff	399
:CALCulate:ACPower:MARKer:COUPle[:STATe] ON OFF 1 0	399
:CALCulate:ACPower:MARKer:COUPle[:STATe]?	399

List of Commands

:CALCulate:ACPower:OFFSet:LIST:LIMit:NEGative[:UPPer]:DATA <real>, <real>, <real>, <real>, <real>, <real>.	426
:CALCulate:ACPower:OFFSet:LIST:LIMit:NEGative[:UPPer]:DATA?	426
:CALCulate:ACPower:OFFSet:LIST:LIMit:POSitive[:UPPer]:DATA <real>, <real>, <real>, <real>, <real>, <real>.	426
:CALCulate:ACPower:OFFSet:LIST:LIMit:POSitive[:UPPer]:DATA?	426
:CALCulate:BWIDth BANDwidth:NDB <rel_ampl>.	1072
:CALCulate:BWIDth BANDwidth:NDB?	1072
:CALCulate:BWIDth BANDwidth:RESult?	1072
:CALCulate:BWIDth BANDwidth[:STATe] OFF ON 0 1	1072
:CALCulate:BWIDth BANDwidth[:STATe]?	1072
:CALCulate:CDPower:ASET:THReshold <real>.	692
:CALCulate:CDPower:ASET:THReshold?	692
:CALCulate:CDPower:ASET:THReshold:AUTO OFF ON 0 1	692
:CALCulate:CDPower:ASET:THReshold:AUTO?	692
:CALCulate:CDPower:AXIS[:MS] IPH QPH IQCombined	686
:CALCulate:CDPower:AXIS[:MS]?	686
:CALCulate:CDPower:MARKer[1] 2 3 4 5 6 7 8 9 10 11 12:CPEak[:STATe] ON OFF 1 0	697
:CALCulate:CDPower:MARKer[1] 2 3 4 5 6 7 8 9 10 11 12:CPEak[:STATe]?	697
:CALCulate:CDPower:MARKer[1] 2 3 4 5 6 7 8 9 10 11 12:MAXimum	696
:CALCulate:CDPower:MARKer[1] 2 3 4 5 6 7 8 9 10 11 12:MAXimum:LEFT	697
:CALCulate:CDPower:MARKer[1] 2 3 4 5 6 7 8 9 10 11 12:MAXimum:NEXT	696
:CALCulate:CDPower:MARKer[1] 2 3 4 5 6 7 8 9 10 11 12:MAXimum:RIGHT	696
:CALCulate:CDPower:MARKer[1] 2 3 4 5 6 7 8 9 10 11 12:MINimum	698
:CALCulate:CDPower:MARKer[1] 2 3 4 5 6 7 8 9 10 11 12:MODE POSition DELTA OFF.	679
:CALCulate:CDPower:MARKer[1] 2 3 4 5 6 7 8 9 10 11 12:MODE?	679
:CALCulate:CDPower:MARKer[1] 2 3 4 5 6 7 8 9 10 11 12:PTPeak	697
:CALCulate:CDPower:MARKer[1] 2 3 4 5 6 7 8 9 10 11 12:REFerence <integer>	680
:CALCulate:CDPower:MARKer[1] 2 3 4 5 6 7 8 9 10 11 12:REFerence?	680
:CALCulate:CDPower:MARKer[1] 2 3 4 5 6 7 8 9 10 11 12[:SET]:DESPread	684
:CALCulate:CDPower:MARKer[1] 2 3 4 5 6 7 8 9 10 11 12:STATe OFF ON 0 1	682
:CALCulate:CDPower:MARKer[1] 2 3 4 5 6 7 8 9 10 11 12:STATe?	682

List of Commands

:CALCulate:CDPower:MARKer[1] 2 3 4 5 6 7 8 9 10 11 12:SYMBOL <real>	676
:CALCulate:CDPower:MARKer[1] 2 3 4 5 6 7 8 9 10 11 12:SYMBOL?	676
:CALCulate:CDPower:MARKer[1] 2 3 4 5 6 7 8 9 10 11 12:TRACe CDPower[EVM MERRor PERRor SPOW- er CPOWer CDError POLar	681
:CALCulate:CDPower:MARKer[1] 2 3 4 5 6 7 8 9 10 11 12:TRACe?	681
:CALCulate:CDPower:MARKer[1] 2 3 4 5 6 7 8 9 10 11 12:X <real>	677
:CALCulate:CDPower:MARKer[1] 2 3 4 5 6 7 8 9 10 11 12:X?	677
:CALCulate:CDPower:MARKer[1] 2 3 4 5 6 7 8 9 10 11 12:X:POSition <real>	678
:CALCulate:CDPower:MARKer[1] 2 3 4 5 6 7 8 9 10 11 12:X:POSition?	678
:CALCulate:CDPower:MARKer[1] 2 3 4 5 6 7 8 9 10 11 12:Y?	678
:CALCulate:CDPower:MARKer:AOff	682
:CALCulate:CDPower:MARKer:COUPlE[:STATe] ON OFF 1 0	681
:CALCulate:CDPower:MARKer:COUPlE[:STATe]?	681
:CALCulate:CDPower:PNOFFset <integer>	689
:CALCulate:CDPower:PNOFFset?	689
:CALCulate:CDPower:SWEep:OFFSet <integer>	688
:CALCulate:CDPower:SWEep:OFFSet?	688
:CALCulate:CDPower:SWEep:TIME <integer>	687
:CALCulate:CDPower:SWEep:TIME?	687
:CALCulate:CDPower:TYPE RELative ABSolute	685
:CALCulate:CDPower:TYPE?	685
:CALCulate:CDPower:WCODe:BASE <integer>	720
:CALCulate:CDPower:WCODe:BASE?	720
:CALCulate:CDPower:WCODe:LENGth <integer> :CALCulate:CDPower:WCODe:LENGth?	685
:CALCulate:CDPower:WCODe[:NUMBer] <integer> :CALCulate:CDPower:WCODe[:NUMBer]?	686
:CALCulate:CDPower:WCODe:ORDer HADMrD BREVerse	720
:CALCulate:CDPower:WCODe:ORDer?	720
:CALCulate:CHPower:LIMit:POWer <amp;gt;	343
:CALCulate:CHPower:LIMit:POWer?	343
:CALCulate:CHPower:LIMit:POWer:FAIL?	344

List of Commands

:CALCulate:CHPower:LIMit:POWer:STATe OFF ON 0 1	343
:CALCulate:CHPower:LIMit:POWer:STATe?	343
:CALCulate:CHPower:LIMit:PSDensity <real>	344
:CALCulate:CHPower:LIMit:PSDensity?	344
:CALCulate:CHPower:LIMit:PSDensity:STATe OFF ON 0 1	344
:CALCulate:CHPower:LIMit:PSDensity:STATe?	344
:CALCulate:CHPower:LIMit:PSD:FAIL?	345
:CALCulate:CHPower:MARKer[1] 2 3 4 5 6 7 8 9 10 11 12:MAXimum	349
:CALCulate:CHPower:MARKer[1] 2 3 4 5 6 7 8 9 10 11 12:MODE POSition DELTA OFF	326
:CALCulate:CHPower:MARKer[1] 2 3 4 5 6 7 8 9 10 11 12:MODE?	326
:CALCulate:CHPower:MARKer[1] 2 3 4 5 6 7 8 9 10 11 12:REFerence <integer>	329
:CALCulate:CHPower:MARKer[1] 2 3 4 5 6 7 8 9 10 11 12:REFerence?	329
:CALCulate:CHPower:MARKer[1] 2 3 4 5 6 7 8 9 10 11 12:STATe OFF ON 0 1	330
:CALCulate:CHPower:MARKer[1] 2 3 4 5 6 7 8 9 10 11 12:STATe?	330
:CALCulate:CHPower:MARKer[1] 2 3 4 5 6 7 8 9 10 11 12:X <real>	327
:CALCulate:CHPower:MARKer[1] 2 3 4 5 6 7 8 9 10 11 12:X?	327
:CALCulate:CHPower:MARKer[1] 2 3 4 5 6 7 8 9 10 11 12:X:POSition <real>	327
:CALCulate:CHPower:MARKer[1] 2 3 4 5 6 7 8 9 10 11 12:X:POSition?	327
:CALCulate:CHPower:MARKer[1] 2 3 4 5 6 7 8 9 10 11 12:Y?	328
:CALCulate:CHPower:MARKer:AOff	330
:CALCulate:CHPower:MARKer:COUple[:STATe] ON OFF 1 0	329
:CALCulate:CHPower:MARKer:COUple[:STATe]?	329
:CALCulate:CLIMits:FAIL?	1036
:CALCulate:DATA<n>:COMPRESS? BLOCK CFIT MAXimum MINimum MEAN DMEan RMS RM- SCubed SAMPLE SDEVIation PPHase [,<soffset>[,<length>[,<roffset>[,<rlimit>]]]]	1037
:CALCulate:DATA[1] 2 3 4 5 6:PEAKs? <threshold>,<excursion>[,<AMPLitude> FREQuency TIME]	1042
:CALCulate:DATA[n]?	1036
:CALCulate:EVMQpsk:IQOffset:INCLude OFF ON 0 1	810
:CALCulate:EVMQpsk:IQOffset:INCLude?	810
:CALCulate:EVMQpsk:LIMit:FERRor <freq>	807
:CALCulate:EVMQpsk:LIMit:FERRor?	807

List of Commands

:CALCulate:EVMQpsk:LIMit:RMS <real>	807
:CALCulate:EVMQpsk:LIMit:RMS?	807
:CALCulate:EVMQpsk:MARKer[1] 2 3 4 5 6 7 8 9 10 11 12:CHIP <real>.....	796
:CALCulate:EVMQpsk:MARKer[1] 2 3 4 5 6 7 8 9 10 11 12:CHIP?.....	796
:CALCulate:EVMQpsk:MARKer[1] 2 3 4 5 6 7 8 9 10 11 12:MAXimum.....	816
:CALCulate:EVMQpsk:MARKer[1] 2 3 4 5 6 7 8 9 10 11 12:MAXimum:LEFT	817
:CALCulate:EVMQpsk:MARKer[1] 2 3 4 5 6 7 8 9 10 11 12:MAXimum:NEXT.....	816
:CALCulate:EVMQpsk:MARKer[1] 2 3 4 5 6 7 8 9 10 11 12:MAXimum:RIGHT.....	816
:CALCulate:EVMQpsk:MARKer[1] 2 3 4 5 6 7 8 9 10 11 12:MINimum	818
:CALCulate:EVMQpsk:MARKer[1] 2 3 4 5 6 7 8 9 10 11 12:MODE POSition DELTA OFF	794
:CALCulate:EVMQpsk:MARKer[1] 2 3 4 5 6 7 8 9 10 11 12:MODE?	794
:CALCulate:EVMQpsk:MARKer[1] 2 3 4 5 6 7 8 9 10 11 12:PTPeak.....	817
:CALCulate:EVMQpsk:MARKer[1] 2 3 4 5 6 7 8 9 10 11 12:REference <integer>.....	799
:CALCulate:EVMQpsk:MARKer[1] 2 3 4 5 6 7 8 9 10 11 12:REference?	799
:CALCulate:EVMQpsk:MARKer[1] 2 3 4 5 6 7 8 9 10 11 12:TRACe POLar EVM PERRor MERRor	799
:CALCulate:EVMQpsk:MARKer[1] 2 3 4 5 6 7 8 9 10 11 12:TRACe?.....	799
:CALCulate:EVMQpsk:MARKer[1] 2 3 4 5 6 7 8 9 10 11 12:X <real>.....	795
:CALCulate:EVMQpsk:MARKer[1] 2 3 4 5 6 7 8 9 10 11 12:X?.....	795
:CALCulate:EVMQpsk:MARKer[1] 2 3 4 5 6 7 8 9 10 11 12:X:POSition <real>.....	797
:CALCulate:EVMQpsk:MARKer[1] 2 3 4 5 6 7 8 9 10 11 12:X:POSition?.....	797
:CALCulate:EVMQpsk:MARKer[1] 2 3 4 5 6 7 8 9 10 11 12:Y?.....	798
:CALCulate:EVMQpsk:MARKer:AOFF.....	800
:CALCulate:EVMQpsk:MARKer:COUPle[:STATe] ON OFF 1 0	800
:CALCulate:EVMQpsk:MARKer:COUPle[:STATe]?.....	800
:CALCulate:LIMit[1] 2 3 4 5 6:CLEar	1070
:CALCulate:LIMit[1] 2 3 4 5 6:CONTrol[:DATA] <x>, <x>,	1068
:CALCulate:LIMit[1] 2 3 4 5 6:CONTrol[:DATA]?.....	1068
:CALCulate:LIMit[1] 2 3 4 5 6:CONTrol:POINts?	1068
:CALCulate:LIMit[1] 2 3 4 5 6:FAIL?	1069
:CALCulate:LIMit[1] 2 3 4 5 6:LOWer[:DATA] <ampl>,	1069
:CALCulate:LIMit[1] 2 3 4 5 6:LOWer[:DATA]?	1069

List of Commands

:CALCulate:LIMit[1] 2 3 4 5 6:LOWer:POINts?	1069
:CALCulate:LIMit[1] 2 3 4 5 6:STATe ON OFF 0 1	1067
:CALCulate:LIMit[1] 2 3 4 5 6:STATe?	1067
:CALCulate:LIMit[1] 2 3 4 5 6:UPPer[:DATA] <ampl>, <ampl>,	1068
:CALCulate:LIMit[1] 2 3 4 5 6:UPPer[:DATA]?	1068
:CALCulate:LIMit[1] 2 3 4 5 6:UPPer:POINts?	1069
:CALCulate:LLINe[1] 2 3 4 5 6:AMPLitude:CMODE:RELative ON OFF 1 0	1057
:CALCulate:LLINe[1] 2 3 4 5 6:AMPLitude:CMODE:RELative?	1057
:CALCulate:LLINe[1] 2 3 4 5 6:AMPLitude:INTerpolate:TYPE LOGarithmic LINear	1056
:CALCulate:LLINe[1] 2 3 4 5 6:AMPLitude:INTerpolate:TYPE?	1056
:CALCulate:LLINe[1] 2 3 4 5 6:BUILd TRACE1 TRACE2 TRACE3 TRACE4 TRACE5 TRACE6	1062
:CALCulate:LLINe[1] 2 3 4 5 6:COMMeNt "text"	1058
:CALCulate:LLINe[1] 2 3 4 5 6:COMMeNt?	1058
:CALCulate:LLINe[1] 2 3 4 5 6:CONTRol:INTerpolate:TYPE LOGarithmic LINear	1056
:CALCulate:LLINe[1] 2 3 4 5 6:CONTRol:INTerpolate:TYPE?	1056
:CALCulate:LLINe[1] 2 3 4 5 6:COpy LLINE1 LLINE2 LLINE3 LLINE4 LLINE5 LLINE6	1061
:CALCulate:LLINe[1] 2 3 4 5 6:DATA <x>,<ampl>,<connect>	1066
:CALCulate:LLINe[1] 2 3 4 5 6:DATA?	1066
:CALCulate:LLINe[1] 2 3 4 5 6:DATA:MERGe <x-axis>,<ampl>,<connected>	1071
:CALCulate:LLINe[1] 2 3 4 5 6:DELete	1064
:CALCulate:LLINe[1] 2 3 4 5 6:DESCRiption "Description"	1058
:CALCulate:LLINe[1] 2 3 4 5 6:DESCRiption?	1058
:CALCulate:LLINe[1] 2 3 4 5 6:DISPlay OFF ON 0 1	1053
:CALCulate:LLINe[1] 2 3 4 5 6:DISPlay?	1053
:CALCulate:LLINe[1] 2 3 4 5 6:FAIL?	1067
:CALCulate:LLINe[1] 2 3 4 5 6:FREQuency:CMODE:RELative ON OFF 1 0	1057
:CALCulate:LLINe[1] 2 3 4 5 6:FREQuency:CMODE:RELative?	1057
:CALCulate:LLINe[1] 2 3 4 5 6:MARGin <rel_ampl>	1059
:CALCulate:LLINe[1] 2 3 4 5 6:MARGin?	1059
:CALCulate:LLINe[1] 2 3 4 5 6:MARGin:STATe OFF ON 0 1	1059
:CALCulate:LLINe[1] 2 3 4 5 6:MARGin:STATe?	1059

List of Commands

:CALCulate:LLINe[1] 2 3 4 5 6:OFFSet:UPDate.	1063
:CALCulate:LLINe[1] 2 3 4 5 6:OFFSet:X <value>	1062
:CALCulate:LLINe[1] 2 3 4 5 6:OFFSet:X?.	1062
:CALCulate:LLINe[1] 2 3 4 5 6:OFFSet:Y <rel ampl>	1063
:CALCulate:LLINe[1] 2 3 4 5 6:OFFSet:Y?.	1063
:CALCulate:LLINe[1] 2 3 4 5 6:TRACe 1 2 3 4 5 6.	1054
:CALCulate:LLINe[1] 2 3 4 5 6:TRACe?.	1054
:CALCulate:LLINe[1] 2 3 4 5 6:TYPE UPPer LOWer.	1054
:CALCulate:LLINe[1] 2 3 4 5 6:TYPE?.	1054
:CALCulate:LLINe:ALL:DELeTe	1066
:CALCulate:LLINe:CMODE FIXed RELative	1070
:CALCulate:LLINe:CMODE?	1070
:CALCulate:LLINe:CONTRol:DOMain FREQuency TIME	1065
:CALCulate:LLINe:CONTRol:DOMain?.	1065
:CALCulate:LLINe:TEST OFF ON 0 1	1065
:CALCulate:LLINe:TEST?	1065
:CALCulate:MAMarker:COUPling ON OFF 1 0.	1025
:CALCulate:MAMarker:COUPling?.	1025
:CALCulate:MAMarker:DETEctor[1] 2 3 OFF NORMal AVERage POSitive SAMPle NEGative QPEak EAverage RAverage	1021
:CALCulate:MAMarker:DETEctor[1] 2 3?.	1021
:CALCulate:MAMarker:DETEctor[1] 2 3:DWELl <dwelL time>	1021
:CALCulate:MAMarker:DETEctor[1] 2 3:DWELl?.	1021
:CALCulate:MAMarker:PCENter ON OFF 1 0.	1025
:CALCulate:MAMarker:PCENter?	1025
:CALCulate:MARKer[1] 2 3 4 5 6 7 8 9 10 11 12:CPSearch[:STATe] ON OFF 1 0.	1116
:CALCulate:MARKer[1] 2 3 4 5 6 7 8 9 10 11 12:CPSearch[:STATe]?	1116
:CALCulate:MARKer[1] 2 3 4 5 6 7 8 9 10 11 12:FCOunt:GATetime <time>.	1005
:CALCulate:MARKer[1] 2 3 4 5 6 7 8 9 10 11 12:FCOunt:GATetime?	1005
:CALCulate:MARKer[1] 2 3 4 5 6 7 8 9 10 11 12:FCOunt:GATetime:AUTO OFF ON 0 1.	1005
:CALCulate:MARKer[1] 2 3 4 5 6 7 8 9 10 11 12:FCOunt:GATetime:AUTO?	1005

List of Commands

:CALCulate:MARKer[1] 2 3 4 5 6 7 8 9 10 11 12:FCOunt[:STATe] OFF ON 0 1	1002
:CALCulate:MARKer[1] 2 3 4 5 6 7 8 9 10 11 12:FCOunt[:STATe]?	1002
:CALCulate:MARKer[1] 2 3 4 5 6 7 8 9 10 11 12:FCOunt:X?	1003
:CALCulate:MARKer[1] 2 3 4 5 6 7 8 9 10 11 12:FUNCTion NOISe BPOWer BDENsity OFF	1007
:CALCulate:MARKer[1] 2 3 4 5 6 7 8 9 10 11 12:FUNCTion?	1007
:CALCulate:MARKer[1] 2 3 4 5 6 7 8 9 10 11 12:FUNCTion:BAND:LEFT <freq>	1014
:CALCulate:MARKer[1] 2 3 4 5 6 7 8 9 10 11 12:FUNCTion:BAND:LEFT?	1014
:CALCulate:MARKer[1] 2 3 4 5 6 7 8 9 10 11 12:FUNCTion:BAND:RIGHT <freq>	1015
:CALCulate:MARKer[1] 2 3 4 5 6 7 8 9 10 11 12:FUNCTion:BAND:RIGHT?	1015
:CALCulate:MARKer[1] 2 3 4 5 6 7 8 9 10 11 12:FUNCTion:BAND:SPAN <freq>	1012
:CALCulate:MARKer[1] 2 3 4 5 6 7 8 9 10 11 12:FUNCTion:BAND:SPAN?	1012
:CALCulate:MARKer[1] 2 3 4 5 6 7 8 9 10 11 12:FUNCTion:MAMarker?	1016
:CALCulate:MARKer[1] 2 3 4 5 6 7 8 9 10 11 12:LINEs[:STATe] OFF ON 0 1	1001
:CALCulate:MARKer[1] 2 3 4 5 6 7 8 9 10 11 12:LINEs[:STATe]?	1001
:CALCulate:MARKer[1] 2 3 4 5 6 7 8 9 10 11 12:MAXimum	1105
:CALCulate:MARKer[1] 2 3 4 5 6 7 8 9 10 11 12:MAXimum:LEFT	1106
:CALCulate:MARKer[1] 2 3 4 5 6 7 8 9 10 11 12:MAXimum:NEXT	1106
:CALCulate:MARKer[1] 2 3 4 5 6 7 8 9 10 11 12:MAXimum:RIGHT	1106
:CALCulate:MARKer[1] 2 3 4 5 6 7 8 9 10 11 12:MINimum	1118
:CALCulate:MARKer[1] 2 3 4 5 6 7 8 9 10 11 12:MODE POSition DELTA FIXed OFF	989
:CALCulate:MARKer[1] 2 3 4 5 6 7 8 9 10 11 12:MODE?	989
:CALCulate:MARKer[1] 2 3 4 5 6 7 8 9 10 11 12:PTPeak	1117
:CALCulate:MARKer[1] 2 3 4 5 6 7 8 9 10 11 12:REFerence <integer>	995
:CALCulate:MARKer[1] 2 3 4 5 6 7 8 9 10 11 12:REFerence?	995
:CALCulate:MARKer[1] 2 3 4 5 6 7 8 9 10 11 12[:SET]:CENTer	1027
:CALCulate:MARKer[1] 2 3 4 5 6 7 8 9 10 11 12[:SET]:DELTA:CENTer	1030
:CALCulate:MARKer[1] 2 3 4 5 6 7 8 9 10 11 12[:SET]:DELTA:SPAN	1029
:CALCulate:MARKer[1] 2 3 4 5 6 7 8 9 10 11 12[:SET]:RLEVel	1030
:CALCulate:MARKer[1] 2 3 4 5 6 7 8 9 10 11 12[:SET]:START	1028
:CALCulate:MARKer[1] 2 3 4 5 6 7 8 9 10 11 12[:SET]:STEP	1028
:CALCulate:MARKer[1] 2 3 4 5 6 7 8 9 10 11 12[:SET]:STOP	1029

List of Commands

:CALCulate:MARKer[1] 2 3 4 5 6 7 8 9 10 11 12:TRACe 1 2 3 4 5 6	999
:CALCulate:MARKer[1] 2 3 4 5 6 7 8 9 10 11 12:TRACe?	999
:CALCulate:MARKer[1] 2 3 4 5 6 7 8 9 10 11 12:TRACe:AUTO OFF ON 0 1	1000
:CALCulate:MARKer[1] 2 3 4 5 6 7 8 9 10 11 12:TRACe:AUTO?	1000
:CALCulate:MARKer[1] 2 3 4 5 6 7 8 9 10 11 12:X <freq>	989
:CALCulate:MARKer[1] 2 3 4 5 6 7 8 9 10 11 12:X?	989
:CALCulate:MARKer[1] 2 3 4 5 6 7 8 9 10 11 12:X:POSition <real>	990
:CALCulate:MARKer[1] 2 3 4 5 6 7 8 9 10 11 12:X:POSition?	990
:CALCulate:MARKer[1] 2 3 4 5 6 7 8 9 10 11 12:X:READout FREQuency TIME ITIME PERiod	996
:CALCulate:MARKer[1] 2 3 4 5 6 7 8 9 10 11 12:X:READout?	996
:CALCulate:MARKer[1] 2 3 4 5 6 7 8 9 10 11 12:X:READout:AUTO ON OFF 1 0	996
:CALCulate:MARKer[1] 2 3 4 5 6 7 8 9 10 11 12:X:READout:AUTO?	996
:CALCulate:MARKer[1] 2 3 4 5 6 7 8 9 10 11 12:Y <real>	991
:CALCulate:MARKer[1] 2 3 4 5 6 7 8 9 10 11 12:Y?	991
:CALCulate:MARKer:AOFF	1006
:CALCulate:MARKer:COUPle[:STATe] OFF ON 0 1	1006
:CALCulate:MARKer:COUPle[:STATe]?	1006
:CALCulate:MARKer:PEAK:EXCursion <rel_ampl>	1110
:CALCulate:MARKer:PEAK:EXCursion?	1110
:CALCulate:MARKer:PEAK:EXCursion:STATe OFF ON 0 1	1110
:CALCulate:MARKer:PEAK:EXCursion:STATe?	1110
:CALCulate:MARKer:PEAK:SEARch:MODE MAXimum PARAmeter	1108
:CALCulate:MARKer:PEAK:SEARch:MODE?	1108
:CALCulate:MARKer:PEAK:SORT FREQuency AMPLitude	1113
:CALCulate:MARKer:PEAK:SORT?	1113
:CALCulate:MARKer:PEAK:TABLE:READout ALL GTDLine LTDLine	1114
:CALCulate:MARKer:PEAK:TABLE:READout?	1114
:CALCulate:MARKer:PEAK:TABLE:STATe OFF ON 0 1	1113
:CALCulate:MARKer:PEAK:TABLE:STATe?	1113
:CALCulate:MARKer:PEAK:THReshold <ampl>	1111
:CALCulate:MARKer:PEAK:THReshold?	1111

List of Commands

:CALCulate:MARKer:PEAK:THReshold:STATe OFF ON 0 1	1111
:CALCulate:MARKer:PEAK:THReshold:STATe?	1111
:CALCulate:MARKer:TABLE[:STATe] OFF ON 0 1	1001
:CALCulate:MARKer:TABLE[:STATe]?	1001
:CALCulate:MATH TRACE1 TRACE2 TRACE3 TRACE4 TRACE5 TRACE6, PDIFference PSUM LOFF- set LDIFference OFF, TRACE1 TRACE2 TRACE3 TRACE4 TRACE5 TRACE6, TRACE1 TRACE2 TRACE3 TRACE4 TRACE5 TRACE6, <real>,<real>	1319
:CALCulate:MATH? TRACE1 TRACE2 TRACE3 TRACE4 TRACE5 TRACE6	1319
:CALCulate:NTData[:STATe] OFF ON 0 1	1326
:CALCulate:NTData[:STATe]?	1326
:CALCulate:OBWidth:LIMit:FBLimit <freq>	620
:CALCulate:OBWidth:LIMit:FBLimit?	620
:CALCulate:OBWidth:LIMit[:TEST] ON OFF 1 0	620
:CALCulate:OBWidth:LIMit[:TEST]?	620
:CALCulate:OBWidth:MARKer[1] 2 3 4 5 6 7 8 9 10 11 12:MAXimum	624
:CALCulate:OBWidth:MARKer[1] 2 3 4 5 6 7 8 9 10 11 12:MODE POSition DELTA OFF	609
:CALCulate:OBWidth:MARKer[1] 2 3 4 5 6 7 8 9 10 11 12:MODE?	609
:CALCulate:OBWidth:MARKer[1] 2 3 4 5 6 7 8 9 10 11 12:REFerence <integer>	610
:CALCulate:OBWidth:MARKer[1] 2 3 4 5 6 7 8 9 10 11 12:REFerence?	610
:CALCulate:OBWidth:MARKer[1] 2 3 4 5 6 7 8 9 10 11 12:STATe OFF ON 0 1	611
:CALCulate:OBWidth:MARKer[1] 2 3 4 5 6 7 8 9 10 11 12:STATe?	611
:CALCulate:OBWidth:MARKer[1] 2 3 4 5 6 7 8 9 10 11 12:X <freq>	607
:CALCulate:OBWidth:MARKer[1] 2 3 4 5 6 7 8 9 10 11 12:X?	607
:CALCulate:OBWidth:MARKer[1] 2 3 4 5 6 7 8 9 10 11 12:X:POSition <real>	608
:CALCulate:OBWidth:MARKer[1] 2 3 4 5 6 7 8 9 10 11 12:X:POSition?	608
:CALCulate:OBWidth:MARKer[1] 2 3 4 5 6 7 8 9 10 11 12:Y?	608
:CALCulate:OBWidth:MARKer:AOFF	611
:CALCulate:RHO:ASET:THReshold <rel_amp>	753
:CALCulate:RHO:ASET:THReshold?	753
:CALCulate:RHO:ASET:THReshold:AUTO OFF ON 0 1	753
:CALCulate:RHO:ASET:THReshold:AUTO?	753
:CALCulate:RHO:IQOffset:INCLude OFF ON 0 1	753

List of Commands

:CALCulate:RHO:IQOffset:INCLude?	753
:CALCulate:RHO:LIMit:CDERror <real>	748
:CALCulate:RHO:LIMit:CDERror?	748
:CALCulate:RHO:LIMit:PEAK <real>	747
:CALCulate:RHO:LIMit:PEAK?	747
:CALCulate:RHO:LIMit:PHASe <float>	749
:CALCulate:RHO:LIMit:PHASe?	749
:CALCulate:RHO:LIMit:RHO <real>	747
:CALCulate:RHO:LIMit:RHO?	747
:CALCulate:RHO:LIMit:RMS <real>	747
:CALCulate:RHO:LIMit:RMS?	747
:CALCulate:RHO:LIMit:TIMing <float>	748
:CALCulate:RHO:LIMit:TIMing?	748
:CALCulate:RHO:MARKer[1] 2 3 4 5 6 7 8 9 10 11 12:CHIP <real>	738
:CALCulate:RHO:MARKer[1] 2 3 4 5 6 7 8 9 10 11 12:CHIP?	738
:CALCulate:RHO:MARKer[1] 2 3 4 5 6 7 8 9 10 11 12:MAXimum	758
:CALCulate:RHO:MARKer[1] 2 3 4 5 6 7 8 9 10 11 12:MAXimum:LEFT	759
:CALCulate:RHO:MARKer[1] 2 3 4 5 6 7 8 9 10 11 12:MAXimum:NEXT	758
:CALCulate:RHO:MARKer[1] 2 3 4 5 6 7 8 9 10 11 12:MAXimum:RIGHT	758
:CALCulate:RHO:MARKer[1] 2 3 4 5 6 7 8 9 10 11 12:MINimum	759
:CALCulate:RHO:MARKer[1] 2 3 4 5 6 7 8 9 10 11 12:MODE POSition DELTA OFF	737
:CALCulate:RHO:MARKer[1] 2 3 4 5 6 7 8 9 10 11 12:MODE?	737
:CALCulate:RHO:MARKer[1] 2 3 4 5 6 7 8 9 10 11 12:PTPeak	759
:CALCulate:RHO:MARKer[1] 2 3 4 5 6 7 8 9 10 11 12:REFerence <integer>	741
:CALCulate:RHO:MARKer[1] 2 3 4 5 6 7 8 9 10 11 12:REFerence?	741
:CALCulate:RHO:MARKer[1] 2 3 4 5 6 7 8 9 10 11 12:TRACe POLar EVM MERRor PERRor	741
:CALCulate:RHO:MARKer[1] 2 3 4 5 6 7 8 9 10 11 12:TRACe?	741
:CALCulate:RHO:MARKer[1] 2 3 4 5 6 7 8 9 10 11 12:X <real>	739
:CALCulate:RHO:MARKer[1] 2 3 4 5 6 7 8 9 10 11 12:X?	739
:CALCulate:RHO:MARKer[1] 2 3 4 5 6 7 8 9 10 11 12:X:POSition <real>	740
:CALCulate:RHO:MARKer[1] 2 3 4 5 6 7 8 9 10 11 12:X:POSition?	740

List of Commands

:CALCulate:RHO:MARKer[1] 2 3 4 5 6 7 8 9 10 11 12:Y?	740
:CALCulate:RHO:MARKer:AOff	742
:CALCulate:RHO:MARKer:COUple[:STATe] ON OFF 1 0	742
:CALCulate:RHO:MARKer:COUple[:STATe]?	742
:CALCulate:RHO:PNOFFset <integer>	749
:CALCulate:RHO:PNOFFset?	749
:CALCulate:SEMAsk:LLINe:STATe ON OFF 1 0	591
:CALCulate:SEMAsk:LLINe:STATe?	591
:CALCulate:SEMAsk:MARKer[1] 2 3 4 5 6 7 8 9 10 11 12:MODE POSition OFF	496
:CALCulate:SEMAsk:MARKer[1] 2 3 4 5 6 7 8 9 10 11 12:MODE?	496
:CALCulate:SEMAsk:MARKer[1] 2 3 4 5 6 7 8 9 10 11 12:X <freq>	497
:CALCulate:SEMAsk:MARKer[1] 2 3 4 5 6 7 8 9 10 11 12:X?	497
:CALCulate:SEMAsk:MARKer[1] 2 3 4 5 6 7 8 9 10 11 12:X:POSition <real>	498
:CALCulate:SEMAsk:MARKer[1] 2 3 4 5 6 7 8 9 10 11 12:X:POSition?	498
:CALCulate:SEMAsk:MARKer[1] 2 3 4 5 6 7 8 9 10 11 12:Y?	498
:CALCulate:SEMAsk:MARKer:AOff	499
:CALCulate:SEMAsk:MARKer:COUple[:STATe] ON OFF 1 0	499
:CALCulate:SEMAsk:MARKer:COUple[:STATe]?	499
:CALCulate:TRACe[1] 2 3 4 5 6:FAIL?	1070
:CALibration[:ALL]?	244
:CALibration[:ALL]	244
:CALibration:AUTO ON PARTial OFF	237
:CALibration:AUTO?	237
:CALibration:AUTO:ALERt TTEMperature DAY WEEK NONE	240
:CALibration:AUTO:ALERt?	240
:CALibration:AUTO:MODE ALL NRF	240
:CALibration:AUTO:MODE?	240
:CALibration:AUTO:TIME:OFF?	252
:CALibration:DATA:BACKup <filename>	262
:CALibration:DATA:DEFault	255
:CALibration:DATA:RESTore <filename>	262

List of Commands

:CALibration:EMIXer?	248
:CALibration:EMIXer	248
:CALibration:EXPIred?	243
:CALibration:FREQuency:REFerence:COARse <integer>.....	267
:CALibration:FREQuency:REFerence:COARse?	267
:CALibration:FREQuency:REFerence:FINE <integer>	266
:CALibration:FREQuency:REFerence:FINE?.....	266
:CALibration:FREQuency:REFerence:MODE CALibrated USER.....	265
:CALibration:FREQuency:REFerence:MODE?	265
:CALibration:INTernal:SOURce[:ALL]?	248
:CALibration:INTernal:SOURce[:ALL]	248
:CALibration:MPADapter:CABLEs:TEST	302
:CALibration:MPADapter:GAIN?	265
:CALibration:MPADapter:GAIN	265
:CALibration:NRF?	246
:CALibration:NRF	246
:CALibration:RF?.....	247
:CALibration:RFPSelector:ALERT ON OFF 0 1	272
:CALibration:RFPSelector:ALERT?.....	272
:CALibration:RFPSelector:CONDUCTed?	268
:CALibration:RFPSelector:CONDUCTed	268
:CALibration:RFPSelector:FULL?	271
:CALibration:RFPSelector:FULL	271
:CALibration:RFPSelector:RADiated?	269
:CALibration:RFPSelector:RADiated	269
:CALibration:RFPSelector:SCHeduler:RECurrence DAY WEEK OFF	274
:CALibration:RFPSelector:SCHeduler:RECurrence?	274
:CALibration:RFPSelector:SCHeduler:RECurrence:DAY SUN MON TUE WED THU FRI SAT	275
:CALibration:RFPSelector:SCHeduler:RECurrence:DAY?	275
:CALibration:RFPSelector:SCHeduler:RECurrence:WEEK <integer>	275
:CALibration:RFPSelector:SCHeduler:RECurrence:WEEK?.....	275

List of Commands

:CALibration:RFPSelector:SCHeDuler:STATe ON OFF 0 1	276
:CALibration:RFPSelector:SCHeDuler:STATe?	276
:CALibration:RFPSelector:SCHeDuler:TASK T1 T2 T3	272
:CALibration:RFPSelector:SCHeDuler:TASK?	272
:CALibration:RFPSelector:SCHeDuler:TIME:NEXT?	254
:CALibration:RFPSelector:SCHeDuler:TIME:START "date","time"	273
:CALibration:RFPSelector:SCHeDuler:TIME:START?	273
:CALibration:RF	247
:CALibration:SOURce:STATe OFF ON 0 1	927
:CALibration:SOURce:STATe?	927
:CALibration:TEMPerature:CURRent?	250
:CALibration:TEMPerature:LALL?	250
:CALibration:TEMPerature:LPRe-selector?	252
:CALibration:TEMPerature:LRF?	251
:CALibration:TEMPerature:RFPSelector:LCONducted?	253
:CALibration:TEMPerature:RFPSelector:LRADiated?	253
:CALibration:TEMPerature:SOURce:LALL?	251
:CALibration:TIME:LALL?	250
:CALibration:TIME:LPRe-selector?	252
:CALibration:TIME:LRF?	251
:CALibration:TIME:RFPSelector:LCONducted?	253
:CALibration:TIME:RFPSelector:LRADiated?	253
:CALibration:TIME:SOURce:LALL?	251
:CALibration:YTF?	263
:CALibration:YTF	263
*CLS	171
:CONFigure:<Measurement>	187
:CONFigure?	1035
:CONFigure:ACP	375
:CONFigure:ACP:NDEFault	375
:CONFigure:ACPower	437

List of Commands

:CONFigure:CDPower	691
:CONFigure:CDPower	649
:CONFigure:CHPower	346
:CONFigure:CHPower:NDEFault	311
:CONFigure:CHPower	311
:CONFigure:EVMQpsk	813
:CONFigure:EVMQpsk:NDEFault	779
:CONFigure:EVMQpsk	779
:CONFigure:OBWidth	621
:CONFigure:OBWidth:NDEFault	593
:CONFigure:OBWidth	593
:CONFigure:RHO	757
:CONFigure:RHO	725
:CONFigure:SEMask	540
:CONFigure:SEMask:NDEFault	469
:CONFigure:SEMask	469
:COUPle ALL NONE	887
:DISPlay:<measurement>:ANNotation:TITLe:DATA <string>	1397
:DISPlay:<measurement>:ANNotation:TITLe:DATA?	1397
:DISPlay:ACPower:VIEW[1]:WINDow[1]:BGRaph OFF ON 0 1	467
:DISPlay:ACPower:VIEW[1]:WINDow[1]:BGRaph?	467
:DISPlay:ACPower:VIEW[1]:WINDow[1]:TRACe:Y[:SCALe]:COUPle 0 1 OFF ON	384
:DISPlay:ACPower:VIEW[1]:WINDow[1]:TRACe:Y[:SCALe]:COUPle?	384
:DISPlay:ACPower:VIEW[1]:WINDow[1]:TRACe:Y[:SCALe]:PDIVision <rel_ampl>	383
:DISPlay:ACPower:VIEW[1]:WINDow[1]:TRACe:Y[:SCALe]:PDIVision?	383
:DISPlay:ACPower:VIEW[1]:WINDow[1]:TRACe:Y[:SCALe]:RLEVel <real>	382
:DISPlay:ACPower:VIEW[1]:WINDow[1]:TRACe:Y[:SCALe]:RLEVel?	382
:DISPlay:ACPower:VIEW[1]:WINDow[1]:TRACe:Y[:SCALe]:RPOStition TOP CENTer BOTTom	384
:DISPlay:ACPower:VIEW[1]:WINDow[1]:TRACe:Y[:SCALe]:RPOStition?	384
:DISPlay:ACTivefunc[:STATe] ON OFF 1 0	1396
:DISPlay:ACTivefunc[:STATe]?	1396

List of Commands

:DISPlay:ANNotation:MBAR[:STATe] OFF ON 0 1	1394
:DISPlay:ANNotation:MBAR[:STATe]?	1394
:DISPlay:ANNotation:SCREen[:STATe] OFF ON 0 1	1395
:DISPlay:ANNotation:SCREen[:STATe]?	1395
:DISPlay:ANNotation:TRACe[:STATe] ON OFF 1 0	1395
:DISPlay:ANNotation:TRACe[:STATe]?	1395
:DISPlay:BACKlight ON OFF	1400
:DISPlay:BACKlight?	1400
:DISPlay:BACKlight:INTensity <integer>	1401
:DISPlay:BACKlight:INTensity?	1401
:DISPlay:CDPower:ANNotation:TITLe:DATA "TITLE"	718
:DISPlay:CDPower:ANNotation:TITLe:DATA?	718
:DISPlay:CDPower:CDOMain:SPAN:STARt <integer>	699
:DISPlay:CDPower:CDOMain:SPAN:STARt?	699
:DISPlay:CDPower:CDOMain:SPAN:STOP <integer>	700
:DISPlay:CDPower:CDOMain:SPAN:STOP?	700
:DISPlay:CDPower:CPOWER[:STATe] 0 1 OFF ON	721
:DISPlay:CDPower:CPOWER[:STATe]?	721
:DISPlay:CDPower:MARKer:CONSolidated ON OFF 1 0	720
:DISPlay:CDPower:MARKer:CONSolidated?	720
:DISPlay:CDPower:VIEW[1]:WINDow[1]:TRACe:Y[:SCALe]:PDIVision <real>	663
:DISPlay:CDPower:VIEW[1]:WINDow[1]:TRACe:Y[:SCALe]:PDIVision?	663
:DISPlay:CDPower:VIEW[1]:WINDow[1]:TRACe:Y[:SCALe]:RLEVel <real>	656
:DISPlay:CDPower:VIEW[1]:WINDow[1]:TRACe:Y[:SCALe]:RLEVel?	656
:DISPlay:CDPower:VIEW2:WINDow[1]:TRACe:Y[:SCALe]:PDIVision <real>	663
:DISPlay:CDPower:VIEW2:WINDow[1]:TRACe:Y[:SCALe]:PDIVision?	663
:DISPlay:CDPower:VIEW2:WINDow[1]:TRACe:Y[:SCALe]:RLEVel <real>	657
:DISPlay:CDPower:VIEW2:WINDow[1]:TRACe:Y[:SCALe]:RLEVel?	657
:DISPlay:CDPower:VIEW2:WINDow2:TRACe:Y[:SCALe]:PDIVision <real>	664
:DISPlay:CDPower:VIEW2:WINDow2:TRACe:Y[:SCALe]:PDIVision?	664
:DISPlay:CDPower:VIEW2:WINDow2:TRACe:Y[:SCALe]:RLEVel <real>	657

List of Commands

:DISPlay:CDPower:VIEW2:WINDow2:TRACe:Y[:SCALe]:RLEVel?	657
:DISPlay:CDPower:VIEW3:WINDow[1]:TRACe:X[:SCALe]:COUPlE 0 1 OFF ON	710
:DISPlay:CDPower:VIEW3:WINDow[1]:TRACe:X[:SCALe]:COUPlE?	710
:DISPlay:CDPower:VIEW3:WINDow[1]:TRACe:X[:SCALe]:PDIVision <real>.	704
:DISPlay:CDPower:VIEW3:WINDow[1]:TRACe:X[:SCALe]:PDIVision?	704
:DISPlay:CDPower:VIEW3:WINDow[1]:TRACe:X[:SCALe]:RLEVel <real>.	701
:DISPlay:CDPower:VIEW3:WINDow[1]:TRACe:X[:SCALe]:RLEVel?	701
:DISPlay:CDPower:VIEW3:WINDow[1]:TRACe:X[:SCALe]:RPOSiTion LEFT CENTer RIGHt	708
:DISPlay:CDPower:VIEW3:WINDow[1]:TRACe:X[:SCALe]:RPOSiTion?	708
:DISPlay:CDPower:VIEW3:WINDow[1]:TRACe:Y[:SCALe]:COUPlE 0 1 OFF ON	671
:DISPlay:CDPower:VIEW3:WINDow[1]:TRACe:Y[:SCALe]:COUPlE?	671
:DISPlay:CDPower:VIEW3:WINDow[1]:TRACe:Y[:SCALe]:PDIVision <real>.	664
:DISPlay:CDPower:VIEW3:WINDow[1]:TRACe:Y[:SCALe]:PDIVision?	664
:DISPlay:CDPower:VIEW3:WINDow[1]:TRACe:Y[:SCALe]:RLEVel <real>.	658
:DISPlay:CDPower:VIEW3:WINDow[1]:TRACe:Y[:SCALe]:RLEVel?	658
:DISPlay:CDPower:VIEW3:WINDow[1]:TRACe:Y[:SCALe]:RPOSiTion TOP CENTer BOTTom.	669
:DISPlay:CDPower:VIEW3:WINDow[1]:TRACe:Y[:SCALe]:RPOSiTion?	669
:DISPlay:CDPower:VIEW3:WINDow2:TRACe:X[:SCALe]:COUPlE 0 1 OFF ON	710
:DISPlay:CDPower:VIEW3:WINDow2:TRACe:X[:SCALe]:COUPlE?	710
:DISPlay:CDPower:VIEW3:WINDow2:TRACe:X[:SCALe]:PDIVision <real>	705
:DISPlay:CDPower:VIEW3:WINDow2:TRACe:X[:SCALe]:PDIVision?	705
:DISPlay:CDPower:VIEW3:WINDow2:TRACe:X[:SCALe]:RLEVel <real>	701
:DISPlay:CDPower:VIEW3:WINDow2:TRACe:X[:SCALe]:RLEVel?	701
:DISPlay:CDPower:VIEW3:WINDow2:TRACe:X[:SCALe]:RPOSiTion LEFT CENTer RIGHt	708
:DISPlay:CDPower:VIEW3:WINDow2:TRACe:X[:SCALe]:RPOSiTion?	708
:DISPlay:CDPower:VIEW3:WINDow2:TRACe:Y[:SCALe]:COUPlE 0 1 OFF ON	672
:DISPlay:CDPower:VIEW3:WINDow2:TRACe:Y[:SCALe]:COUPlE?	672
:DISPlay:CDPower:VIEW3:WINDow2:TRACe:Y[:SCALe]:PDIVision <real>	665
:DISPlay:CDPower:VIEW3:WINDow2:TRACe:Y[:SCALe]:PDIVision?	665
:DISPlay:CDPower:VIEW3:WINDow2:TRACe:Y[:SCALe]:RLEVel <real>	659
:DISPlay:CDPower:VIEW3:WINDow2:TRACe:Y[:SCALe]:RLEVel?	659

List of Commands

:DISPlay:CDPower:VIEW3:WINDow2:TRACe:Y[:SCALe]:RPOSition TOP CENTer BOTTom	669
:DISPlay:CDPower:VIEW3:WINDow2:TRACe:Y[:SCALe]:RPOSition?	669
:DISPlay:CDPower:VIEW3:WINDow3:TRACe:X[:SCALe]:COUPle 0 1 OFF ON	711
:DISPlay:CDPower:VIEW3:WINDow3:TRACe:X[:SCALe]:COUPle?	711
:DISPlay:CDPower:VIEW3:WINDow3:TRACe:X[:SCALe]:PDIVision <real>	705
:DISPlay:CDPower:VIEW3:WINDow3:TRACe:X[:SCALe]:PDIVision?	705
:DISPlay:CDPower:VIEW3:WINDow3:TRACe:X[:SCALe]:RLEVel <real>	702
:DISPlay:CDPower:VIEW3:WINDow3:TRACe:X[:SCALe]:RLEVel?	702
:DISPlay:CDPower:VIEW3:WINDow3:TRACe:X[:SCALe]:RPOSition LEFT CENTer RIGHT	708
:DISPlay:CDPower:VIEW3:WINDow3:TRACe:X[:SCALe]:RPOSition?	708
:DISPlay:CDPower:VIEW3:WINDow3:TRACe:Y[:SCALe]:COUPle 0 1 OFF ON	673
:DISPlay:CDPower:VIEW3:WINDow3:TRACe:Y[:SCALe]:COUPle?	673
:DISPlay:CDPower:VIEW3:WINDow3:TRACe:Y[:SCALe]:PDIVision <real>	665
:DISPlay:CDPower:VIEW3:WINDow3:TRACe:Y[:SCALe]:PDIVision?	665
:DISPlay:CDPower:VIEW3:WINDow3:TRACe:Y[:SCALe]:RLEVel <real>	659
:DISPlay:CDPower:VIEW3:WINDow3:TRACe:Y[:SCALe]:RLEVel?	659
:DISPlay:CDPower:VIEW3:WINDow3:TRACe:Y[:SCALe]:RPOSition TOP CENTer BOTTom	670
:DISPlay:CDPower:VIEW3:WINDow3:TRACe:Y[:SCALe]:RPOSition?	670
:DISPlay:CDPower:VIEW4:WINDow[1]:TRACe:Y[:SCALe]:PDIVision <real>	666
:DISPlay:CDPower:VIEW4:WINDow[1]:TRACe:Y[:SCALe]:PDIVision?	666
:DISPlay:CDPower:VIEW4:WINDow[1]:TRACe:Y[:SCALe]:RLEVel <real>	660
:DISPlay:CDPower:VIEW4:WINDow[1]:TRACe:Y[:SCALe]:RLEVel?	660
:DISPlay:CDPower:VIEW4:WINDow2:TRACe:X[:SCALe]:COUPle 0 1 OFF ON	712
:DISPlay:CDPower:VIEW4:WINDow2:TRACe:X[:SCALe]:COUPle?	712
:DISPlay:CDPower:VIEW4:WINDow2:TRACe:X[:SCALe]:PDIVision <real>	706
:DISPlay:CDPower:VIEW4:WINDow2:TRACe:X[:SCALe]:PDIVision?	706
:DISPlay:CDPower:VIEW4:WINDow2:TRACe:X[:SCALe]:RLEVel <real>	702
:DISPlay:CDPower:VIEW4:WINDow2:TRACe:X[:SCALe]:RLEVel?	702
:DISPlay:CDPower:VIEW4:WINDow2:TRACe:X[:SCALe]:RPOSition LEFT CENTer RIGHT	709
:DISPlay:CDPower:VIEW4:WINDow2:TRACe:X[:SCALe]:RPOSition?	709
:DISPlay:CDPower:VIEW4:WINDow2:TRACe:Y[:SCALe]:COUPle 0 1 OFF ON	673

List of Commands

:DISPlay:CDPower:VIEW4:WINDow2:TRACe:Y[:SCALe]:COUPle?	673
:DISPlay:CDPower:VIEW4:WINDow2:TRACe:Y[:SCALe]:PDIVision <real>	667
:DISPlay:CDPower:VIEW4:WINDow2:TRACe:Y[:SCALe]:PDIVision?	667
:DISPlay:CDPower:VIEW4:WINDow2:TRACe:Y[:SCALe]:RLEVel <real>	660
:DISPlay:CDPower:VIEW4:WINDow2:TRACe:Y[:SCALe]:RLEVel?	660
:DISPlay:CDPower:VIEW4:WINDow2:TRACe:Y[:SCALe]:RPOSition TOP CENTer BOTTom	670
:DISPlay:CDPower:VIEW4:WINDow2:TRACe:Y[:SCALe]:RPOSition?	670
:DISPlay:CDPower:VIEW5:WINDow[1]:TRACe:Y[:SCALe]:PDIVision <real>	667
:DISPlay:CDPower:VIEW5:WINDow[1]:TRACe:Y[:SCALe]:PDIVision?	667
:DISPlay:CDPower:VIEW5:WINDow[1]:TRACe:Y[:SCALe]:RLEVel <real>	661
:DISPlay:CDPower:VIEW5:WINDow[1]:TRACe:Y[:SCALe]:RLEVel?	661
:DISPlay:CDPower:VIEW5:WINDow2:TRACe:X[:SCALe]:COUPle 0 1 OFF ON	712
:DISPlay:CDPower:VIEW5:WINDow2:TRACe:X[:SCALe]:COUPle?	712
:DISPlay:CDPower:VIEW5:WINDow2:TRACe:X[:SCALe]:PDIVision <real>	707
:DISPlay:CDPower:VIEW5:WINDow2:TRACe:X[:SCALe]:PDIVision?	707
:DISPlay:CDPower:VIEW5:WINDow2:TRACe:X[:SCALe]:RLEVel <real>	703
:DISPlay:CDPower:VIEW5:WINDow2:TRACe:X[:SCALe]:RLEVel?	703
:DISPlay:CDPower:VIEW5:WINDow2:TRACe:X[:SCALe]:RPOSition LEFT CENTer RIGHT	709
:DISPlay:CDPower:VIEW5:WINDow2:TRACe:X[:SCALe]:RPOSition?	709
:DISPlay:CDPower:VIEW5:WINDow2:TRACe:Y[:SCALe]:COUPle 0 1 OFF ON	674
:DISPlay:CDPower:VIEW5:WINDow2:TRACe:Y[:SCALe]:COUPle?	674
:DISPlay:CDPower:VIEW5:WINDow2:TRACe:Y[:SCALe]:PDIVision <real>	668
:DISPlay:CDPower:VIEW5:WINDow2:TRACe:Y[:SCALe]:PDIVision?	668
:DISPlay:CDPower:VIEW5:WINDow2:TRACe:Y[:SCALe]:RLEVel <real>	662
:DISPlay:CDPower:VIEW5:WINDow2:TRACe:Y[:SCALe]:RLEVel?	662
:DISPlay:CDPower:VIEW5:WINDow2:TRACe:Y[:SCALe]:RPOSition TOP CENTer BOTTom	671
:DISPlay:CDPower:VIEW5:WINDow2:TRACe:Y[:SCALe]:RPOSition?	671
:DISPlay:CDPower:VIEW:NSElect <integer>	719
:DISPlay:CDPower:VIEW:NSElect?	719
:DISPlay:CDPower:VIEW[:SElect] PGRaph CDE SEVM QUAD DBITs	718
:DISPlay:CDPower:VIEW[:SElect]?	718

List of Commands

:DISPlay:CHPower:VIEW[1]:WINDow[1]:BGRaph ON OFF 1 0	372
:DISPlay:CHPower:VIEW[1]:WINDow[1]:BGRaph?	372
:DISPlay:CHPower:VIEW[1]:WINDow[1]:TRACe:Y[:SCALe]:COUPlE 0 1 OFF ON	317
:DISPlay:CHPower:VIEW[1]:WINDow[1]:TRACe:Y[:SCALe]:COUPlE?	317
:DISPlay:CHPower:VIEW[1]:WINDow[1]:TRACe:Y[:SCALe]:PDIVisIon <rel_amp>	315
:DISPlay:CHPower:VIEW[1]:WINDow[1]:TRACe:Y[:SCALe]:PDIVisIon?	315
:DISPlay:CHPower:VIEW[1]:WINDow[1]:TRACe:Y[:SCALe]:RLEVel <real>	314
:DISPlay:CHPower:VIEW[1]:WINDow[1]:TRACe:Y[:SCALe]:RLEVel?	314
:DISPlay:CHPower:VIEW[1]:WINDow[1]:TRACe:Y[:SCALe]:RPOsItIon TOP CENTer BOTTom	316
:DISPlay:CHPower:VIEW[1]:WINDow[1]:TRACe:Y[:SCALe]:RPOsItIon?	316
:DISPlay:ENABLe OFF ON 0 1	1402
:DISPlay:ENABLe?	1402
:DISPlay:EVMQpsk:VIEW[1]:WINDow2:TRACe:COFFset <integer>	842
:DISPlay:EVMQpsk:VIEW[1]:WINDow2:TRACe:COFFset?	842
:DISPlay:EVMQpsk:VIEW[1]:WINDow2:TRACe:FVECTor[:STATe] OFF ON 0 1	844
:DISPlay:EVMQpsk:VIEW[1]:WINDow2:TRACe:FVECTor[:STATe]?	844
:DISPlay:EVMQpsk:VIEW[1]:WINDow2:TRACe:INTPolation[:STATe] OFF ON 0 1	843
:DISPlay:EVMQpsk:VIEW[1]:WINDow2:TRACe:INTPolation[:STATe]?	843
:DISPlay:EVMQpsk:VIEW[1]:WINDow2:TRACe:IQCHeads <integer>	842
:DISPlay:EVMQpsk:VIEW[1]:WINDow2:TRACe:IQCHeads?	842
:DISPlay:EVMQpsk:VIEW[1]:WINDow2:TRACe:POLar VC VECTor CONStn	841
:DISPlay:EVMQpsk:VIEW[1]:WINDow2:TRACe:POLar?	841
:DISPlay:EVMQpsk:VIEW[1]:WINDow2:TRACe:ROTQpi[:STATe] OFF ON 0 1	843
:DISPlay:EVMQpsk:VIEW[1]:WINDow2:TRACe:ROTQpi[:STATe]?	843
:DISPlay:EVMQpsk:VIEW2:WINDow[1] 2 3:TRACe:Y[:SCALe]:COUPlE ON OFF 1 0	787
:DISPlay:EVMQpsk:VIEW2:WINDow[1] 2 3:TRACe:Y[:SCALe]:COUPlE?	787
:DISPlay:EVMQpsk:VIEW2:WINDow[1] 2 3:TRACe:Y[:SCALe]:RPOsItIon TOP CENTer BOTTom	786
:DISPlay:EVMQpsk:VIEW2:WINDow[1] 2 3:TRACe:Y[:SCALe]:RPOsItIon?	786
:DISPlay:EVMQpsk:VIEW2:WINDow[1]:TRACe:X[:SCALe]:COUPlE ON OFF 0 1	830
:DISPlay:EVMQpsk:VIEW2:WINDow[1]:TRACe:X[:SCALe]:COUPlE?	830
:DISPlay:EVMQpsk:VIEW2:WINDow[1]:TRACe:X[:SCALe]:PDIVisIon <real>	826

List of Commands

:DISPlay:EVMQpsk:VIEW2:WINDow[1]:TRACe:X[:SCALe]:PDIVision?	826
:DISPlay:EVMQpsk:VIEW2:WINDow[1]:TRACe:X[:SCALe]:RLEVel <real>	824
:DISPlay:EVMQpsk:VIEW2:WINDow[1]:TRACe:X[:SCALe]:RLEVel?	824
:DISPlay:EVMQpsk:VIEW2:WINDow[1]:TRACe:X[:SCALe]:RPOSition LEFT CENTer RIGHT	828
:DISPlay:EVMQpsk:VIEW2:WINDow[1]:TRACe:X[:SCALe]:RPOSition?	828
:DISPlay:EVMQpsk:VIEW2:WINDow[1]:TRACe:Y[:SCALe]:PDIVision <real>	784
:DISPlay:EVMQpsk:VIEW2:WINDow[1]:TRACe:Y[:SCALe]:PDIVision?	784
:DISPlay:EVMQpsk:VIEW2:WINDow[1]:TRACe:Y[:SCALe]:RLEVel <real>	782
:DISPlay:EVMQpsk:VIEW2:WINDow[1]:TRACe:Y[:SCALe]:RLEVel?	782
:DISPlay:EVMQpsk:VIEW2:WINDow2:TRACe:X[:SCALe]:COUPle ON OFF 0 1	830
:DISPlay:EVMQpsk:VIEW2:WINDow2:TRACe:X[:SCALe]:COUPle?	830
:DISPlay:EVMQpsk:VIEW2:WINDow2:TRACe:X[:SCALe]:PDIVision <real>	827
:DISPlay:EVMQpsk:VIEW2:WINDow2:TRACe:X[:SCALe]:PDIVision?	827
:DISPlay:EVMQpsk:VIEW2:WINDow2:TRACe:X[:SCALe]:RLEVel <real>	825
:DISPlay:EVMQpsk:VIEW2:WINDow2:TRACe:X[:SCALe]:RLEVel?	825
:DISPlay:EVMQpsk:VIEW2:WINDow2:TRACe:X[:SCALe]:RPOSition LEFT CENTer RIGHT	829
:DISPlay:EVMQpsk:VIEW2:WINDow2:TRACe:X[:SCALe]:RPOSition?	829
:DISPlay:EVMQpsk:VIEW2:WINDow2:TRACe:Y[:SCALe]:PDIVision <real>	785
:DISPlay:EVMQpsk:VIEW2:WINDow2:TRACe:Y[:SCALe]:PDIVision?	785
:DISPlay:EVMQpsk:VIEW2:WINDow2:TRACe:Y[:SCALe]:RLEVel <real>	783
:DISPlay:EVMQpsk:VIEW2:WINDow2:TRACe:Y[:SCALe]:RLEVel?	783
:DISPlay:EVMQpsk:VIEW2:WINDow3:TRACe:X[:SCALe]:COUPle ON OFF 0 1	831
:DISPlay:EVMQpsk:VIEW2:WINDow3:TRACe:X[:SCALe]:COUPle?	831
:DISPlay:EVMQpsk:VIEW2:WINDow3:TRACe:X[:SCALe]:PDIVision <real>	827
:DISPlay:EVMQpsk:VIEW2:WINDow3:TRACe:X[:SCALe]:PDIVision?	827
:DISPlay:EVMQpsk:VIEW2:WINDow3:TRACe:X[:SCALe]:RLEVel <real>	825
:DISPlay:EVMQpsk:VIEW2:WINDow3:TRACe:X[:SCALe]:RLEVel?	825
:DISPlay:EVMQpsk:VIEW2:WINDow3:TRACe:X[:SCALe]:RPOSition LEFT CENTer RIGHT	829
:DISPlay:EVMQpsk:VIEW2:WINDow3:TRACe:X[:SCALe]:RPOSition?	829
:DISPlay:EVMQpsk:VIEW2:WINDow3:TRACe:Y[:SCALe]:PDIVision <real>	785
:DISPlay:EVMQpsk:VIEW2:WINDow3:TRACe:Y[:SCALe]:PDIVision?	785

List of Commands

:DISPlay:EVMQpsk:VIEW2:WINDow3:TRACe:Y[:SCALe]:RLEVel <real>	783
:DISPlay:EVMQpsk:VIEW2:WINDow3:TRACe:Y[:SCALe]:RLEVel?	783
:DISPlay:EVMQpsk:VIEW:NSElect <integer>	836
:DISPlay:EVMQpsk:VIEW:NSElect?	836
:DISPlay:EVMQpsk:VIEW[:SElect] POLar ERRor	836
:DISPlay:EVMQpsk:VIEW[:SElect]?	836
:DISPlay:FSCReen[:STATe] OFF ON 0 1	1402
:DISPlay:FSCReen[:STATe]?	1402
:DISPlay:OBWidth:VIEW[1]:WINDow[1]:TRACe:Y[:SCALe]:COUPle 0 1 OFF ON	598
:DISPlay:OBWidth:VIEW[1]:WINDow[1]:TRACe:Y[:SCALe]:COUPle?	598
:DISPlay:OBWidth:VIEW[1]:WINDow[1]:TRACe:Y[:SCALe]:PDIVision <rel_amp>	596
:DISPlay:OBWidth:VIEW[1]:WINDow[1]:TRACe:Y[:SCALe]:PDIVision?	596
:DISPlay:OBWidth:VIEW[1]:WINDow[1]:TRACe:Y[:SCALe]:RLEVel <real>	595
:DISPlay:OBWidth:VIEW[1]:WINDow[1]:TRACe:Y[:SCALe]:RLEVel?	595
:DISPlay:OBWidth:VIEW[1]:WINDow[1]:TRACe:Y[:SCALe]:RPOSition TOP CENTer BOTTom	597
:DISPlay:OBWidth:VIEW[1]:WINDow[1]:TRACe:Y[:SCALe]:RPOSition?	597
:DISPlay:RHO:ANNotation:TITLe:DATA <string>	772
:DISPlay:RHO:ANNotation:TITLe:DATA?	772
:DISPlay:RHO:VIEW[1]:WINDow[1]:TRACe:COFFset <integer>	774
:DISPlay:RHO:VIEW[1]:WINDow[1]:TRACe:COFFset?	774
:DISPlay:RHO:VIEW[1]:WINDow[1]:TRACe:FVECTor[:STATe] 0 1 OFF ON	775
:DISPlay:RHO:VIEW[1]:WINDow[1]:TRACe:FVECTor[:STATe]?	775
:DISPlay:RHO:VIEW[1]:WINDow[1]:TRACe:IQCHeads <integer>	774
:DISPlay:RHO:VIEW[1]:WINDow[1]:TRACe:IQCHeads?	774
:DISPlay:RHO:VIEW[1]:WINDow[1]:TRACe:POLar VC VECTor CONStn	774
:DISPlay:RHO:VIEW[1]:WINDow[1]:TRACe:POLar?	774
:DISPlay:RHO:VIEW[1]:WINDow[1]:TRACe:ROTPi[:STATe] 0 1 OFF ON	775
:DISPlay:RHO:VIEW[1]:WINDow[1]:TRACe:ROTPi[:STATe]?	775
:DISPlay:RHO:VIEW2:WINDow[1]:TRACe:X[:SCALe]:COUPle 0 1 OFF ON	765
:DISPlay:RHO:VIEW2:WINDow[1]:TRACe:X[:SCALe]:COUPle?	765
:DISPlay:RHO:VIEW2:WINDow[1]:TRACe:X[:SCALe]:PDIVision <real>	762

List of Commands

:DISPlay:RHO:VIEW2:WINDow[1]:TRACe:X[:SCALe]:PDIVision?	762
:DISPlay:RHO:VIEW2:WINDow[1]:TRACe:X[:SCALe]:RLEVel <real>	760
:DISPlay:RHO:VIEW2:WINDow[1]:TRACe:X[:SCALe]:RLEVel?	760
:DISPlay:RHO:VIEW2:WINDow[1]:TRACe:X[:SCALe]:RPOStion LEFT CENTer RIGHT.	764
:DISPlay:RHO:VIEW2:WINDow[1]:TRACe:X[:SCALe]:RPOStion?	764
:DISPlay:RHO:VIEW2:WINDow[1]:TRACe:Y[:SCALe]:COUPle 0 1 OFF ON	734
:DISPlay:RHO:VIEW2:WINDow[1]:TRACe:Y[:SCALe]:COUPle?	734
:DISPlay:RHO:VIEW2:WINDow[1]:TRACe:Y[:SCALe]:PDIVision <real>	730
:DISPlay:RHO:VIEW2:WINDow[1]:TRACe:Y[:SCALe]:PDIVision?	730
:DISPlay:RHO:VIEW2:WINDow[1]:TRACe:Y[:SCALe]:RLEVel <real>	728
:DISPlay:RHO:VIEW2:WINDow[1]:TRACe:Y[:SCALe]:RLEVel?	728
:DISPlay:RHO:VIEW2:WINDow[1]:TRACe:Y[:SCALe]:RPOStion TOP CENTer BOTTom	732
:DISPlay:RHO:VIEW2:WINDow[1]:TRACe:Y[:SCALe]:RPOStion?	732
:DISPlay:RHO:VIEW2:WINDow2:TRACe:X[:SCALe]:COUPle 0 1 OFF ON	766
:DISPlay:RHO:VIEW2:WINDow2:TRACe:X[:SCALe]:COUPle?	766
:DISPlay:RHO:VIEW2:WINDow2:TRACe:X[:SCALe]:PDIVision <real>	763
:DISPlay:RHO:VIEW2:WINDow2:TRACe:X[:SCALe]:PDIVision?	763
:DISPlay:RHO:VIEW2:WINDow2:TRACe:X[:SCALe]:RLEVel <real>	761
:DISPlay:RHO:VIEW2:WINDow2:TRACe:X[:SCALe]:RLEVel?	761
:DISPlay:RHO:VIEW2:WINDow2:TRACe:X[:SCALe]:RPOStion LEFT CENTer RIGHT	764
:DISPlay:RHO:VIEW2:WINDow2:TRACe:X[:SCALe]:RPOStion?	764
:DISPlay:RHO:VIEW2:WINDow2:TRACe:Y[:SCALe]:COUPle 0 1 OFF ON	734
:DISPlay:RHO:VIEW2:WINDow2:TRACe:Y[:SCALe]:COUPle?	734
:DISPlay:RHO:VIEW2:WINDow2:TRACe:Y[:SCALe]:PDIVision <real>	731
:DISPlay:RHO:VIEW2:WINDow2:TRACe:Y[:SCALe]:PDIVision?	731
:DISPlay:RHO:VIEW2:WINDow2:TRACe:Y[:SCALe]:RLEVel <real>	729
:DISPlay:RHO:VIEW2:WINDow2:TRACe:Y[:SCALe]:RLEVel?	729
:DISPlay:RHO:VIEW2:WINDow2:TRACe:Y[:SCALe]:RPOStion TOP CENTer BOTTom	732
:DISPlay:RHO:VIEW2:WINDow2:TRACe:Y[:SCALe]:RPOStion?	732
:DISPlay:RHO:VIEW2:WINDow3:TRACe:X[:SCALe]:COUPle 0 1 OFF ON	767
:DISPlay:RHO:VIEW2:WINDow3:TRACe:X[:SCALe]:COUPle?	767

List of Commands

:DISPlay:RHO:VIEW2:WINDow3:TRACe:X[:SCALe]:PDIVision <real>	763
:DISPlay:RHO:VIEW2:WINDow3:TRACe:X[:SCALe]:PDIVision?	763
:DISPlay:RHO:VIEW2:WINDow3:TRACe:X[:SCALe]:RLEVel <real>	761
:DISPlay:RHO:VIEW2:WINDow3:TRACe:X[:SCALe]:RLEVel?	761
:DISPlay:RHO:VIEW2:WINDow3:TRACe:X[:SCALe]:RPOSition LEFT CENTer RIGHT.....	765
:DISPlay:RHO:VIEW2:WINDow3:TRACe:X[:SCALe]:RPOSition?	765
:DISPlay:RHO:VIEW2:WINDow3:TRACe:Y[:SCALe]:COUPlE 0 1 OFF ON.....	735
:DISPlay:RHO:VIEW2:WINDow3:TRACe:Y[:SCALe]:COUPlE?	735
:DISPlay:RHO:VIEW2:WINDow3:TRACe:Y[:SCALe]:PDIVision <real>	731
:DISPlay:RHO:VIEW2:WINDow3:TRACe:Y[:SCALe]:PDIVision?	731
:DISPlay:RHO:VIEW2:WINDow3:TRACe:Y[:SCALe]:RLEVel <real>	729
:DISPlay:RHO:VIEW2:WINDow3:TRACe:Y[:SCALe]:RLEVel?	729
:DISPlay:RHO:VIEW2:WINDow3:TRACe:Y[:SCALe]:RPOSition TOP CENTer BOTTom.....	733
:DISPlay:RHO:VIEW2:WINDow3:TRACe:Y[:SCALe]:RPOSition?	733
:DISPlay:RHO:VIEW:NSElect <integer>	773
:DISPlay:RHO:VIEW:NSElect?	773
:DISPlay:RHO:VIEW[:SElect] POLar ERRor TPHase	773
:DISPlay:RHO:VIEW[:SElect]?	773
:DISPlay:SEMask:VIEW[1]:WINDow[1]:TRACe:X[:SCALe]:COUPlE 0 1 OFF ON	558
:DISPlay:SEMask:VIEW[1]:WINDow[1]:TRACe:X[:SCALe]:COUPlE?	558
:DISPlay:SEMask:VIEW[1]:WINDow[1]:TRACe:X[:SCALe]:PDIVision <freq>	557
:DISPlay:SEMask:VIEW[1]:WINDow[1]:TRACe:X[:SCALe]:PDIVision ?	557
:DISPlay:SEMask:VIEW[1]:WINDow[1]:TRACe:X[:SCALe]:RLEVel <freq>	556
:DISPlay:SEMask:VIEW[1]:WINDow[1]:TRACe:X[:SCALe]:RLEVel?	556
:DISPlay:SEMask:VIEW[1]:WINDow[1]:TRACe:X[:SCALe]:RPOSition LEFT CENTer RIGHT	557
:DISPlay:SEMask:VIEW[1]:WINDow[1]:TRACe:X[:SCALe]:RPOSition?	557
:DISPlay:SEMask:VIEW[1]:WINDow[1]:TRACe:Y[:SCALe]:COUPlE 0 1 ON OFF	489
:DISPlay:SEMask:VIEW[1]:WINDow[1]:TRACe:Y[:SCALe]:COUPlE?	489
:DISPlay:SEMask:VIEW[1]:WINDow[1]:TRACe:Y[:SCALe]:PDIVision <rel_ampl>	488
:DISPlay:SEMask:VIEW[1]:WINDow[1]:TRACe:Y[:SCALe]:PDIVision?	488
:DISPlay:SEMask:VIEW[1]:WINDow[1]:TRACe:Y[:SCALe]:RLEVel <real>	487

List of Commands

:DISPlay:SEMAsk:VIEW[1]:WINDow[1]:TRACe:Y[:SCALe]:RLEVel?	487
:DISPlay:SEMAsk:VIEW[1]:WINDow[1]:TRACe:Y[:SCALe]:RPOStion TOP CENTer BOTTom.	489
:DISPlay:SEMAsk:VIEW[1]:WINDow[1]:TRACe:Y[:SCALe]:RPOStion?	489
:DISPlay:SEMAsk:VIEW:NSElect <integer>	567
:DISPlay:SEMAsk:VIEW:NSElect?	567
:DISPlay:SEMAsk:VIEW[:SElect] APFReq RPFReq IPOWer CINFormation	566
:DISPlay:SEMAsk:VIEW[:SElect]?	566
:DISPlay:THEME TDColor TDMonochrome FCOLor FMONochrome	1400
:DISPlay:THEME?	1400
:DISPlay:WINDow[1]:ANNotation[:ALL] OFF ON 0 1	1399
:DISPlay:WINDow[1]:ANNotation[:ALL]?	1399
:DISPlay:WINDow[1]:TRACe:GRATicule:GRID[:STATe] OFF ON 0 1	1398
:DISPlay:WINDow[1]:TRACe:GRATicule:GRID[:STATe]?	1398
:DISPlay:WINDow[1]:TRACe:Y:DLINe <ampl>	1399
:DISPlay:WINDow[1]:TRACe:Y:DLINe?	1399
:DISPlay:WINDow[1]:TRACe:Y:DLINe:STATe OFF ON 0 1	1399
:DISPlay:WINDow[1]:TRACe:Y:DLINe:STATe?	1399
:DISPlay:WINDow[1]:TRACe:Y[:SCALe]:NRLevel <rel_ampl>	1329
:DISPlay:WINDow[1]:TRACe:Y[:SCALe]:NRLevel?	1329
:DISPlay:WINDow[1]:TRACe:Y[:SCALe]:NRPosition <integer>	1330
:DISPlay:WINDow[1]:TRACe:Y[:SCALe]:NRPosition?	1330
:DISPlay:WINDow[1]:TRACe:Y[:SCALe]:PDIVision <rel_ampl>	867
:DISPlay:WINDow[1]:TRACe:Y[:SCALe]:PDIVision?	867
:DISPlay:WINDow[1]:TRACe:Y[:SCALe]:RLEVel <real>	849
:DISPlay:WINDow[1]:TRACe:Y[:SCALe]:RLEVel?	849
:DISPlay:WINDow[1]:TRACe:Y[:SCALe]:RLEVel:OFFSet <rel_ampl>	877
:DISPlay:WINDow[1]:TRACe:Y[:SCALe]:RLEVel:OFFSet?	877
:DISPlay:WINDow[1]:TRACe:Y[:SCALe]:SPACing LINear LOGarithmic	868
:DISPlay:WINDow[1]:TRACe:Y[:SCALe]:SPACing?	868
:DISPlay:WINDow:FORMat:TILE	155
:DISPlay:WINDow:FORMat:ZOOM	155

List of Commands

:DISPlay:WINDow:MAMarker:POSition LEFT RIGHT	1020
:DISPlay:WINDow:MAMarker:POSition?	1020
:DISPlay:WINDow:MAMarker[:STATe] ON OFF 1 0	1020
:DISPlay:WINDow:MAMarker[:STATe]?	1020
:DISPlay:WINDow[:SElect] <number>	155
:DISPlay:WINDow[:SElect]?	155
*ESE <integer>	172
*ESE?	172
*ESR?	172
:FEED:RF:PORT:OUTP RFIO1	949
:FETCh:ACP[n]?	375
:FETCh:CDPower[n]?	649
:FETCh:CHPower:CHPower?	311
:FETCh:CHPower:DENSity?	311
:FETCh:CHPower[n]?	311
:FETCh:EVMQpsk[n]?	779
:FETCh:OBWidth:FERRor?	593
:FETCh:OBWidth[n]?	593
:FETCh:OBWidth:OBWidth?	593
:FETCh:OBWidth:XDB?	593
:FETCh:RHO[n]?	725
:FETCh:SEMask[n]?	469
:FORMat:BORDer NORMal SWAPped	1045
:FORMat:BORDer NORMal SWAPped	1335
:FORMat:BORDer?	1045
:FORMat:BORDer?	1335
:FORMat[:TRACe][:DATA] ASCii INTeger,32 REAL,32 REAL,64	1043
:FORMat[:TRACe][:DATA] ASCii INTeger,32 REAL,32 REAL,64	1334
:FORMat[:TRACe][:DATA]?	1043
:FORMat[:TRACe][:DATA]?	1334
:GLOBal:FREQuency:CENTer[:STATe] 1 0 ON OFF	1102

List of Commands

:GLOBal:FREQuency:CENTer[:STATe]?	1102
:HCOPy:ABORt	189
:HCOPy[:IMMediate].	189
*IDN?	173
:INIT	132
:INITiate:ACP	375
:INITiate:CDPower	649
:INITiate:CHPower	311
:INITiate:CONTinuous OFF ON 0 1	901
:INITiate:CONTinuous?	901
:INITiate[:IMMediate]	1125
:INITiate:OBWidth.	593
:INITiate:PAUse.	1280
:INITiate:REStart	1125
:INITiate:RESume	1280
:INITiate:SEMAsk.	469
:INPut:MIXer EXTernal INTernal	922
:INPut:MIXer?	922
:INSTrument:CATalog?	1094
:INSTrument:COUPle:DEFault	1102
:INSTrument:COUPle:FREQuency:CENTer ALL NONE	1102
:INSTrument:COUPle:FREQuency:CENTer?	1102
:INSTrument:DEFault	186
:INSTrument:NSElect <integer>	1094
:INSTrument:NSElect?	1094
:INSTrument[:SElect] SEQAN BASIC WCDMA EDGE GSM WIMAX OFDMA ADEMOD BTooth TDSCDMA CDMA2K CDMA1XEV LTE LTETDD	1091
:INSTrument[:SElect]?	1091
:MEASure:ACP[n]?	375
:MEASure:CDPower[n]?	649
:MEASure:CHPower:CHPower?	311

List of Commands

:MEASure:CHPower:DENSity?	311
:MEASure:CHPower[n]?	311
:MEASure:EVMQpsk[n]?	779
:MEASure:OBWidth:FERRor?	593
:MEASure:OBWidth[n]?	593
:MEASure:OBWidth:OBWidth?	593
:MEASure:OBWidth:XDB?	593
:MEASure:RHO[n]?	725
:MEASure:SEMask[n]?	469
:MEMMory:RDIRectory <directory_name>	220
:MEMory[:SOURce]	1260
:MEMory[:SOURce]:DATA <file_name>, <data>	1260
:MEMory[:SOURce]:DATA:APPend <file_name>, <data>	1261
:MMEMory:CATalog? [<directory_name>]	218
:MMEMory:CDIRectory [<directory_name>]	218
:MMEMory:CDIRectory?	218
:MMEMory:COpy <string>,<string>[,<string>,<string>]	218
:MMEMory:DATA <file_name>, <data>	219
:MMEMory:DATA? <file_name>	219
:MMEMory:DELeTe <file_name>[,<directory_name>]	219
:MMEMory:HEADer:ID? "<file name>"	1213
:MMEMory:LOAD:CORRection 1 2 3 4 5 6, <filename>	1119
:MMEMory:LOAD:MPADapter:CORRection 1 2 3 4 5 6 7 8 9 10 11 12 13 14 15 16, <filename>	1121
:MMEMory:LOAD:SEQuences: SLISt ALISt SAAList "MySequence.txt"	201
:MMEMory:LOAD:STATe <filename>	193
:MMEMory:LOAD:TRACe TRACE1 TRACE2 TRACE3 TRACE4 TRACE5 TRACE6,<filename>	199
:MMEMory:LOAD:TRACe:REGister TRACE1 TRACE2 TRACE3 TRACE4 TRACE5 TRACE6,<integer>	199
:MMEMory:MDIRectory <directory_name>	220
:MMEMory:MOVE <string>,<string>[,<string>,<string>]	220
:MMEMory:REGister:STATe:LAbel <reg number>,"label"	207
:MMEMory:REGister:STATe:LAbel? <reg number>	207

List of Commands

:MMEMory:STORe:CORRection 1 2 3 4 5 6, <filename>	1127
:MMEMory:STORe:MPADapter:CORRection 1 2 3 4 5 6 7 8 9 10 11 12 13 14 15 16, <filename>	1130
:MMEMory:STORe:RESults <string>.	352
:MMEMory:STORe:RESults <string>.	543
:MMEMory:STORe:RESults <string>.	627
:MMEMory:STORe:SCReen <filename>	215
:MMEMory:STORe:SCReen:THEMe TDColor TDMonochrome FCOLor FMONochrome	216
:MMEMory:STORe:SCReen:THEMe?	216
:MMEMory:STORe:STATe <filename>	204
:MMEMory:STORe:TRACe TRACE1 TRACE2 TRACE3 TRACE4 TRACE5 TRACE6 ALL,<filename>	209
:MMEMory:STORe:TRACe:REGister TRACE1 TRACE2 TRACE3 TRACE4 TRACE5 TRACE6 ALL,<integer> 209	
:MMEM:STOR:SEQuences: SLISt ALISt SAAList SSTep "MySequence.txt".	211
:MPAD:PORT:INP RFIO1	952
*OPC?	173
*OPC	173
*OPT?	174
:OUTPut:ANALog OFF SVIDeo LOGVIdIo LINVIdIo DAUDIo	984
:OUTPut:ANALog?	984
:OUTPut:ANALog:AUTO OFF ON 0 1.	985
:OUTPut:ANALog:AUTO?	985
:OUTPut[:EXTErnal][:STATe] ON OFF 1 0	1137
:OUTPut[:EXTErnal][:STATe]?	1137
:OUTPut:MODulation[:STATe] ON OFF 1 0.	1142
:OUTPut:MODulation[:STATe]?	1142
*RCL <register #>	175
:READ:ACP[n]?	375
:READ:CDPower[n]?	649
:READ:CHPower:CHPower?	311
:READ:CHPower:DENSity	311
:READ:CHPower[n]?	311

List of Commands

:READ:EVMQpsk[n]?	779
:READ:OBWidth:FERRor?	593
:READ:OBWidth[n]?	593
:READ:OBWidth:OBWidth?	593
:READ:OBWidth:XDB?	593
:READ:RHO[n]?	725
:READ:SEMask[n]?	469
*RST	188
*SAV <register #>	175
[:SENSe]:<measurement>:TRIGger:SOURce IF	1340
[:SENSe]:<measurement>:TRIGger:SOURce.	1340
[:SENSe]:ACPower:AVERage:COUNt <integer>	404
[:SENSe]:ACPower:AVERage:COUNt?	404
[:SENSe]:ACPower:AVERage[:STATe] OFF ON 0 1	404
[:SENSe]:ACPower:AVERage[:STATe]?	404
[:SENSe]:ACPower:AVERage:TCONtrol EXPonential REPeat.	405
[:SENSe]:ACPower:AVERage:TCONtrol?	405
[:SENSe]:ACPower:BANDwidth[:RESolution] <bandwidth>	387
[:SENSe]:ACPower:BANDwidth[:RESolution]?	387
[:SENSe]:ACPower:BANDwidth[:RESolution]:AUTO ON OFF 1 0.	387
[:SENSe]:ACPower:BANDwidth[:RESolution]:AUTO?	387
[:SENSe]:ACPower:BANDwidth:SHAPE GAUSSian FLATtop.	389
[:SENSe]:ACPower:BANDwidth:SHAPE?	389
[:SENSe]:ACPower:BANDwidth:TYPE DB3 DB6	390
[:SENSe]:ACPower:BANDwidth:TYPE?	390
[:SENSe]:ACPower:BANDwidth:VIDeo <freq>	388
[:SENSe]:ACPower:BANDwidth:VIDeo?	388
[:SENSe]:ACPower:BANDwidth:VIDeo:AUTO OFF ON 0 1.	388
[:SENSe]:ACPower:BANDwidth:VIDeo:AUTO?	388
[:SENSe]:ACPower:CARRier[1] 2:AUTO[:STATe] OFF ON 0 1.	409
[:SENSe]:ACPower:CARRier[1] 2:AUTO[:STATe]?	409

List of Commands

[[:SENSe]:ACPower:CARRier[1] 2:COUNT <integer>	405
[[:SENSe]:ACPower:CARRier[1] 2:COUNT?	405
[[:SENSe]:ACPower:CARRier[1] 2:CPSD <real>	410
[[:SENSe]:ACPower:CARRier[1] 2:CPSD?	410
[[:SENSe]:ACPower:CARRier[1] 2:LIST:BANDwidth[:INTegration] <freq>,	414
[[:SENSe]:ACPower:CARRier[1] 2:LIST:BANDwidth[:INTegration]?	414
[[:SENSe]:ACPower:CARRier[1] 2:LIST:COUPlE OFF ON 0 1, OFF ON 0 1, OFF ON 0 1, OFF ON 0 1, OFF ON 0 1, OFF ON 0 1	411
[[:SENSe]:ACPower:CARRier[1] 2:LIST:COUPlE?	411
[[:SENSe]:ACPower:CARRier[1] 2:LIST:FILTer:ALPHa <real>,	415
[[:SENSe]:ACPower:CARRier[1] 2:LIST:FILTer:ALPHa?	415
[[:SENSe]:ACPower:CARRier[1] 2:LIST:FILTer[:RRC][:STATe] ON OFF 1 0,	415
[[:SENSe]:ACPower:CARRier[1] 2:LIST:FILTer[:RRC][:STATe]?	415
[[:SENSe]:ACPower:CARRier[1] 2:LIST:METHod IBW RRC,	440
[[:SENSe]:ACPower:CARRier[1] 2:LIST:METHod?	440
[[:SENSe]:ACPower:CARRier[1] 2:LIST:PPResent YES NO,	412
[[:SENSe]:ACPower:CARRier[1] 2:LIST:PPResent?	412
[[:SENSe]:ACPower:CARRier[1] 2:LIST:WIDTh <bandwidth>,	413
[[:SENSe]:ACPower:CARRier[1] 2:LIST:WIDTh?	413
[[:SENSe]:ACPower:CARRier[1] 2[:POWer] <real>	409
[[:SENSe]:ACPower:CARRier[1] 2[:POWer]?	409
[[:SENSe]:ACPower:CARRier[1] 2:RCARrier <integer>	406
[[:SENSe]:ACPower:CARRier[1] 2:RCARrier?	406
[[:SENSe]:ACPower:CARRier[1] 2:RCARrier:AUTO OFF ON 0 1	406
[[:SENSe]:ACPower:CARRier[1] 2:RCARrier:AUTO?	406
[[:SENSe]:ACPower:CARRier[1] 2:RCFRequency <freq>	407
[[:SENSe]:ACPower:CARRier[1] 2:RCFRequency?	407
[[:SENSe]:ACPower:CARRier[1] 2:RCFRequency:AUTO OFF ON 0 1	407
[[:SENSe]:ACPower:CARRier[1] 2:RCFRequency:AUTO?	407
[[:SENSe]:ACPower:CORRection:NOISe[:AUTO] OFF ON 0 1	437
[[:SENSe]:ACPower:CORRection:NOISe[:AUTO]?	437

List of Commands

[:SENSe]:ACPower:DETEctor:AUTO ON OFF 1 0	462
[:SENSe]:ACPower:DETEctor:AUTO?	462
[:SENSe]:ACPower:DETEctor[:FUNction] AVERAge NEGative NORMAl POSitive SAMPle	462
[:SENSe]:ACPower:DETEctor[:FUNction]?	462
[:SENSe]:ACPower:FILTer[:RRC]:ALPHa <real>	439
[:SENSe]:ACPower:FILTer[:RRC]:ALPHa?	439
[:SENSe]:ACPower:FILTer[:RRC][:STATe] OFF ON 0 1	439
[:SENSe]:ACPower:FILTer[:RRC][:STATe]?	439
[:SENSe]:ACPower:FREQuency:SPAN <freq>	452
[:SENSe]:ACPower:FREQuency:SPAN?	452
[:SENSe]:ACPower:FREQuency:SPAN:FULL	453
[:SENSe]:ACPower:FREQuency:SPAN:PREVious	453
[:SENSe]:ACPower:FREQuency:SYNThesis:AUTO[:STATe] OFF ON 0 1	432
[:SENSe]:ACPower:FREQuency:SYNThesis:AUTO[:STATe]?	432
[:SENSe]:ACPower:FREQuency:SYNThesis[:STATe] 1 2 3	433
[:SENSe]:ACPower:FREQuency:SYNThesis[:STATe]?	433
[:SENSe]:ACPower:METHod IBW IBWRange FAST RBW	434
[:SENSe]:ACPower:METHod?	434
[:SENSe]:ACPower:OFFSet[1] 2:LIST:ABSolute <real>, <real>, <real>, <real>, <real>, <real>	424
[:SENSe]:ACPower:OFFSet[1] 2:LIST:ABSolute?	424
[:SENSe]:ACPower:OFFSet[1] 2:LIST:BANDwidth[:INTegration] <bandwidth>, <bandwidth>, <bandwidth>, <bandwidth>, <bandwidth>, <bandwidth>	419
[:SENSe]:ACPower:OFFSet[1] 2:LIST:BANDwidth[:INTegration]?	419
[:SENSe]:ACPower:OFFSet[1] 2:LIST:BANDwidth:RESolution <bandwidth>, <bandwidth>, <bandwidth>, <bandwidth>, <bandwidth>, <bandwidth>	420
[:SENSe]:ACPower:OFFSet[1] 2:LIST:BANDwidth:RESolution?	420
[:SENSe]:ACPower:OFFSet[1] 2:LIST:BANDwidth:RESolution:AUTO ON OFF 1 0, ON OFF 1 0, ON OFF 1 0, ON OFF 1 0, ON OFF 1 0, ON OFF 1 0	420
[:SENSe]:ACPower:OFFSet[1] 2:LIST:BANDwidth:RESolution:AUTO?	420
[:SENSe]:ACPower:OFFSet[1] 2:LIST:BANDwidth:SHAPE GAUSSian FLATtop, GAUSSian FLATtop, GAUSSian FLATtop, GAUSSian FLATtop, GAUSSian FLATtop	422
[:SENSe]:ACPower:OFFSet[1] 2:LIST:BANDwidth:SHAPE?	422

List of Commands

[[:SENSe]:ACPower:OFFSet[1] 2:LIST:BANDwidth:TYPE DB3 DB6, DB3 DB6, DB3 DB6, DB3 DB6, DB3 DB6, DB3 DB6, DB3 DB6, DB3 DB6	423
[[:SENSe]:ACPower:OFFSet[1] 2:LIST:BANDwidth:TYPE?	423
[[:SENSe]:ACPower:OFFSet[1] 2:LIST:BANDwidth:VIDeo <freq>, <freq>, <freq>, <freq>, <freq>, <freq>	421
[[:SENSe]:ACPower:OFFSet[1] 2:LIST:BANDwidth:VIDeo?	421
[[:SENSe]:ACPower:OFFSet[1] 2:LIST:BANDwidth:VIDeo:AUTO OFF ON 0 1, OFF ON 0 1, OFF ON 0 1, OFF ON 0 1, OFF ON 0 1, OFF ON 0 1	421
[[:SENSe]:ACPower:OFFSet[1] 2:LIST:BANDwidth:VIDeo:AUTO?	421
[[:SENSe]:ACPower:OFFSet[1] 2:LIST:FILTer:ALPHa <real>, <real>, <real>, <real>, <real>, <real>	430
[[:SENSe]:ACPower:OFFSet[1] 2:LIST:FILTer:ALPHa?	430
[[:SENSe]:ACPower:OFFSet[1] 2:LIST:FILTer[:RRC][:STATe] ON OFF 1 0, ON OFF 1 0, ON OFF 1 0, ON OFF 1 0, ON OFF 1 0, ON OFF 1 0	430
[[:SENSe]:ACPower:OFFSet[1] 2:LIST:FILTer[:RRC][:STATe]?	430
[[:SENSe]:ACPower:OFFSet[1] 2:LIST[:FREQuency] <freq>, <freq>, <freq>, <freq>, <freq>, <freq>	417
[[:SENSe]:ACPower:OFFSet[1] 2:LIST[:FREQuency]?	417
[[:SENSe]:ACPower:OFFSet[1] 2:LIST:RCARrier <real>, <real>, <real>, <real>, <real>, <real>	425
[[:SENSe]:ACPower:OFFSet[1] 2:LIST:RCARrier?	425
[[:SENSe]:ACPower:OFFSet[1] 2:LIST:RPSDensity <rel_ampl>, <rel_ampl>, <rel_ampl>, <rel_ampl>, <rel_ampl>, <rel_ampl>	427
[[:SENSe]:ACPower:OFFSet[1] 2:LIST:RPSDensity?	427
[[:SENSe]:ACPower:OFFSet[1] 2:LIST:SIDE NEGAtive BOTH POSitive, NEGAtive BOTH POSitive, NEGAtive BOTH POSitive, NEGAtive BOTH POSitive, NEGAtive BOTH POSitive, NEGAtive BOTH POSitive	429
[[:SENSe]:ACPower:OFFSet[1] 2:LIST:SIDE?	429
[[:SENSe]:ACPower:OFFSet[1] 2:LIST:STATe OFF ON 0 1, OFF ON 0 1, OFF ON 0 1, OFF ON 0 1, OFF ON 0 1, OFF ON 0 1	417
[[:SENSe]:ACPower:OFFSet[1] 2:LIST:STATe?	417
[[:SENSe]:ACPower:OFFSet[1] 2:LIST:TEST ABSolute AND OR RELative, ABSolute AND OR RELative, ABSolute AND OR RELative, ABSolute AND OR RELative, ABSolute AND OR RELative, ABSolute AND OR RELative	428
[[:SENSe]:ACPower:OFFSet[1] 2:LIST:TEST?	428
[[:SENSe]:ACPower:OFFSet[1] 2:TYPE CTOCenter CTOEdge ETOCenter ETOEdge	431
[[:SENSe]:ACPower:OFFSet[1] 2:TYPE?	431
[[:SENSe]:ACPower:SWEep:POINts <integer>	457

List of Commands

[::SENSe]:ACPower:SWEEp:POINts?	457
[::SENSe]:ACPower:SWEEp:TIME <time>	454
[::SENSe]:ACPower:SWEEp:TIME?	454
[::SENSe]:ACPower:SWEEp:TIME:AUTO OFF ON 0 1	454
[::SENSe]:ACPower:SWEEp:TIME:AUTO?	454
[::SENSe]:ACPower:SWEEp:TIME:AUTO:RULes NORMAl ACCuracy	455
[::SENSe]:ACPower:SWEEp:TIME:AUTO:RULes?	455
[::SENSe]:ACPower:TYPE TPreF PSDRef	435
[::SENSe]:ACPower:TYPE?	435
[::SENSe]:ADC:DITHer:AUTO[:STATe] OFF ON 0 1	1078
[::SENSe]:ADC:DITHer:AUTO[:STATe]?	1078
[::SENSe]:ADC:DITHer[:STATe] OFF ON HIGH	1078
[::SENSe]:ADC:DITHer[:STATe]?	1078
[::SENSe]:AVERAge:CLear	1048
[::SENSe]:AVERAge:COUNt <integer>	1047
[::SENSe]:AVERAge:COUNt?	1047
[::SENSe]:AVERAge:TYPE RMS LOG SCALar [::SENSe]:AVERAge:TYPE?	1048
[::SENSe]:AVERAge:TYPE:AUTO OFF ON 0 1	1048
[::SENSe]:AVERAge:TYPE:AUTO?	1048
[::SENSe]:BANDwidth BWIDth[:RESolution] <freq>	889
[::SENSe]:BANDwidth BWIDth[:RESolution]?	889
[::SENSe]:BANDwidth BWIDth[:RESolution]:AUTO OFF ON 0 1	889
[::SENSe]:BANDwidth BWIDth[:RESolution]:AUTO?	889
[::SENSe]:BANDwidth BWIDth:SHAPE GAUSSian FLATtop	895
[::SENSe]:BANDwidth BWIDth:SHAPE?	895
[::SENSe]:BANDwidth BWIDth:TYPE DB3 DB6 IMPulse NOISe	897
[::SENSe]:BANDwidth BWIDth:TYPE?	897
[::SENSe]:BANDwidth BWIDth:VIDeo <freq>	891
[::SENSe]:BANDwidth BWIDth:VIDeo?	891
[::SENSe]:BANDwidth BWIDth:VIDeo:AUTO OFF ON 0 1	891
[::SENSe]:BANDwidth BWIDth:VIDeo:AUTO?	891

List of Commands

[[:SENSe]:BANDwidth BWIDth:VIDeo:RATio <real>	892
[[:SENSe]:BANDwidth BWIDth:VIDeo:RATio?	892
[[:SENSe]:BANDwidth BWIDth:VIDeo:RATio:AUTO OFF ON 0 1	892
[[:SENSe]:BANDwidth BWIDth:VIDeo:RATio:AUTO?	892
[[:SENSe]:CDPower:ALPHa <real>	692
[[:SENSe]:CDPower:ALPHa?	692
[[:SENSe]:CDPower:CAPTure:TIME <integer>	690
[[:SENSe]:CDPower:CAPTure:TIME?	690
[[:SENSe]:CDPower:CRATe <freq>	693
[[:SENSe]:CDPower:CRATe?	693
[[:SENSe]:CDPower:IF:GAIN:AUTO[:STATe] OFF ON 0 1	694
[[:SENSe]:CDPower:IF:GAIN:AUTO[:STATe]?	694
[[:SENSe]:CDPower:IF:GAIN[:STATe] ON OFF 1 0	694
[[:SENSe]:CDPower:IF:GAIN[:STATe]?	694
[[:SENSe]:CDPower:QOF 0 1 2 3	693
[[:SENSe]:CDPower:QOF?	693
[[:SENSe]:CDPower:SPECtrum INVert NORMAl	691
[[:SENSe]:CDPower:SPECtrum?	691
[[:SENSe]:CDPower:SYNC[:BTS] PICH DPICH	689
[[:SENSe]:CDPower:SYNC[:BTS]?	689
[[:SENSe]:CDPower:SYNC:LCMask <integer>	690
[[:SENSe]:CDPower:SYNC:LCMask?	690
[[:SENSe]:CHPower:AVERAge:COUNT <integer>	334
[[:SENSe]:CHPower:AVERAge:COUNT?	334
[[:SENSe]:CHPower:AVERAge[:STATe] ON OFF 1 0	334
[[:SENSe]:CHPower:AVERAge[:STATe]?	334
[[:SENSe]:CHPower:AVERAge:TCONtrol EXPonential REPeat	335
[[:SENSe]:CHPower:AVERAge:TCONtrol?	335
[[:SENSe]:CHPower:BANDwidth:INTegration <bandwidth>	336
[[:SENSe]:CHPower:BANDwidth:INTegration?	336
[[:SENSe]:CHPower:BANDwidth[:RESolution] <bandwidth>	319

List of Commands

[[:SENSe]:CHPower:BANDwidth[:RESolution]?	319
[[:SENSe]:CHPower:BANDwidth[:RESolution]:AUTO ON OFF 1 0.	319
[[:SENSe]:CHPower:BANDwidth[:RESolution]:AUTO?	319
[[:SENSe]:CHPower:BANDwidth:SHAPE GAUSSian FLATtop.	322
[[:SENSe]:CHPower:BANDwidth:SHAPE?	322
[[:SENSe]:CHPower:BANDwidth:VIDeo <bandwidth>	320
[[:SENSe]:CHPower:BANDwidth:VIDeo?	320
[[:SENSe]:CHPower:BANDwidth:VIDeo:AUTO ON OFF 1 0.	320
[[:SENSe]:CHPower:BANDwidth:VIDeo:AUTO?	320
[[:SENSe]:CHPower:DETECTOR:AUTO ON OFF 1 0	367
[[:SENSe]:CHPower:DETECTOR:AUTO?	367
[[:SENSe]:CHPower:DETECTOR[:FUNCTION] NORMAL AVERAGE POSITIVE SAMPLE NEGATIVE.	366
[[:SENSe]:CHPower:DETECTOR[:FUNCTION]?	366
[[:SENSe]:CHPower:FILTer[:RRC]:ALPHA <real>.	341
[[:SENSe]:CHPower:FILTer[:RRC]:ALPHA?	341
[[:SENSe]:CHPower:FILTer[:RRC]:BANDwidth <real>.	342
[[:SENSe]:CHPower:FILTer[:RRC]:BANDwidth?	342
[[:SENSe]:CHPower:FILTer[:RRC][:STATE] OFF ON 0 1.	340
[[:SENSe]:CHPower:FILTer[:RRC][:STATE]?	340
[[:SENSe]:CHPower:FREQUency:SPAN <freq>	358
[[:SENSe]:CHPower:FREQUency:SPAN?	358
[[:SENSe]:CHPower:FREQUency:SPAN:FULL	359
[[:SENSe]:CHPower:FREQUency:SPAN:PREVIOUS	360
[[:SENSe]:CHPower:FREQUency:SYNThesis:AUTO[:STATE] OFF ON 0 1	337
[[:SENSe]:CHPower:FREQUency:SYNThesis:AUTO[:STATE]?	337
[[:SENSe]:CHPower:FREQUency:SYNThesis[:STATE] 1 2 3	338
[[:SENSe]:CHPower:FREQUency:SYNThesis[:STATE]?	338
[[:SENSe]:CHPower:IF:GAIN:AUTO[:STATE] ON OFF 1 0.	339
[[:SENSe]:CHPower:IF:GAIN:AUTO[:STATE]?	339
[[:SENSe]:CHPower:IF:GAIN[:STATE] ON OFF 1 0.	339
[[:SENSe]:CHPower:IF:GAIN[:STATE]?	339

List of Commands

[[:SENSe]:CHPower:SWEEP:POINts <integer>	363
[[:SENSe]:CHPower:SWEEP:POINts?	363
[[:SENSe]:CHPower:SWEEP:TIME <time>	361
[[:SENSe]:CHPower:SWEEP:TIME?	361
[[:SENSe]:CHPower:SWEEP:TIME:AUTO OFF ON 0 1	361
[[:SENSe]:CHPower:SWEEP:TIME:AUTO?	361
[[:SENSe]:CHPower:SWEEP:TIME:AUTO:RULEs NORMAl ACCuracy	362
[[:SENSe]:CHPower:SWEEP:TIME:AUTO:RULEs?	362
[[:SENSe]:CORRection:BTS[:RF]:GAIN <rel_ampl>	930
[[:SENSe]:CORRection:BTS[:RF]:GAIN?	930
[[:SENSe]:CORRection:BTS[:RF]:LOSS <rel_ampl>	931
[[:SENSe]:CORRection:BTS[:RF]:LOSS?	931
[[:SENSe]:CORRection:CSET[1] 2 3 4 5 6:COMMeNt "text"	938
[[:SENSe]:CORRection:CSET[1] 2 3 4 5 6:COMMeNt?	938
[[:SENSe]:CORRection:CSET[1] 2 3 4 5 6:DATA <freq>, <ampl>,	944
[[:SENSe]:CORRection:CSET[1] 2 3 4 5 6:DATA?	944
[[:SENSe]:CORRection:CSET[1] 2 3 4 5 6:DATA:MERGe <freq>, <ampl>,	945
[[:SENSe]:CORRection:CSET[1] 2 3 4 5 6:DELeTe	943
[[:SENSe]:CORRection:CSET[1] 2 3 4 5 6:DESCription "text"	938
[[:SENSe]:CORRection:CSET[1] 2 3 4 5 6:DESCription?	938
[[:SENSe]:CORRection:CSET[1] 2 3 4 5 6:RF:PORT RFIN RFIO1 RFIO2 RFOut	939
[[:SENSe]:CORRection:CSET[1] 2 3 4 5 6:RF:PORT?	939
[[:SENSe]:CORRection:CSET[1] 2 3 4 5 6:RF:PORT:RFIO1 SOURce ANALyzer BOTH	939
[[:SENSe]:CORRection:CSET[1] 2 3 4 5 6:RF:PORT:RFIO1?.	939
[[:SENSe]:CORRection:CSET[1] 2 3 4 5 6:RF:PORT:RFIO2 SOURce ANALyzer BOTH	940
[[:SENSe]:CORRection:CSET[1] 2 3 4 5 6:RF:PORT:RFIO2?.	940
[[:SENSe]:CORRection:CSET[1] 2 3 4 5 6[:STATe] ON OFF 1 0	935
[[:SENSe]:CORRection:CSET[1] 2 3 4 5 6[:STATe]?	935
[[:SENSe]:CORRection:CSET[1] 2 3 4 5 6:X:SPACing LINear LOGarithmic	936
[[:SENSe]:CORRection:CSET[1] 2 3 4 5 6:X:SPACing?	936
[[:SENSe]:CORRection:CSET:ALL:DELeTe	944

List of Commands

[:SENSe]:CORRection:CSET:ALL[:STATe] ON OFF 1 0	944
[:SENSe]:CORRection:CSET:ALL[:STATe]?	944
[:SENSe]:CORRection:IMPedance[:INPut][:MAGNitude] 50 75	924
[:SENSe]:CORRection:IMPedance[:INPut][:MAGNitude]?	924
[:SENSe]:CORRection:MS[:RF]:GAIN <rel_ampl>	929
[:SENSe]:CORRection:MS[:RF]:GAIN?	929
[:SENSe]:CORRection:MS[:RF]:LOSS <rel_ampl>	930
[:SENSe]:CORRection:MS[:RF]:LOSS?	930
[:SENSe]:CORRection:SA[:RF]:GAIN <rel_ampl>	928
[:SENSe]:CORRection:SA[:RF]:GAIN?	928
[:SENSe]:DEMod AM FM PM OFF	1083
[:SENSe]:DEMod?	1083
[:SENSe]:DEMod:AM:BANDwidth:CHANnel <freq>	1084
[:SENSe]:DEMod:AM:BANDwidth:CHANnel?	1084
[:SENSe]:DEMod:FM:BANDwidth:CHANnel <freq>	1085
[:SENSe]:DEMod:FM:BANDwidth:CHANnel?	1085
[:SENSe]:DEMod:FM:DEEMphasis OFF US25 US50 US75 US750	1085
[:SENSe]:DEMod:FM:DEEMphasis?	1085
[:SENSe]:DEMod:PM:BANDwidth:CHANnel <freq>	1087
[:SENSe]:DEMod:PM:BANDwidth:CHANnel?	1087
[:SENSe]:DEMod:STATe OFF ON 0 1	1089
[:SENSe]:DEMod:STATe?	1089
[:SENSe]:DEMod:TIME <time>	1088
[:SENSe]:DEMod:TIME?	1088
[:SENSe]:DETEctor:AUTO ON OFF 1 0	1314
[:SENSe]:DETEctor:AUTO?	1314
[:SENSe]:DETEctor[:FUNction] NORMal AVERAge POSitive SAMPlE NEGAtive QPEak EAVERage EPOSitive MPOSitive RMS	1311
[:SENSe]:DETEctor[:FUNction]?	1311
[:SENSe]:DETEctor:TRACe[1] 2 3 4 5 6 AVERAge NEGAtive NORMal POSitive SAMPlE QPEak EAVERage RAVERage	1310
[:SENSe]:DETEctor:TRACe[1] 2 3 4 5 6?	1310

List of Commands

[[:SENSe]:DETEctor:TRACe[1] 2 3 4 5 6:AUTO ON OFF 1 0	1313
[[:SENSe]:DETEctor:TRACe[1] 2 3 4 5 6:AUTO?	1313
[[:SENSe]:EVMQpsk:AVERAge:COUNT <integer>	805
[[:SENSe]:EVMQpsk:AVERAge:COUNT?	805
[[:SENSe]:EVMQpsk:AVERAge[:STATe] OFF ON 0 1	805
[[:SENSe]:EVMQpsk:AVERAge[:STATe]?	805
[[:SENSe]:EVMQpsk:AVERAge:TCONtrol EXPOnential REPeat	806
[[:SENSe]:EVMQpsk:AVERAge:TCONtrol?	806
[[:SENSe]:EVMQpsk:BANDwidth[:RESolution] <freq>	789
[[:SENSe]:EVMQpsk:BANDwidth[:RESolution]?	789
[[:SENSe]:EVMQpsk:BANDwidth:SHAPe GAUSSian FLATtop	790
[[:SENSe]:EVMQpsk:BANDwidth:SHAPe?	790
[[:SENSe]:EVMQpsk:CRATe <freq>	811
[[:SENSe]:EVMQpsk:CRATe?	811
[[:SENSe]:EVMQpsk:FILTer:ALPHa <real>	811
[[:SENSe]:EVMQpsk:FILTer:ALPHa?	811
[[:SENSe]:EVMQpsk:FILTer[:RRC][:STATe] OFF ON 0 1	810
[[:SENSe]:EVMQpsk:FILTer[:RRC][:STATe]?	810
[[:SENSe]:EVMQpsk:IF:GAIN:AUTO[:STATe] ON OFF 1 0	812
[[:SENSe]:EVMQpsk:IF:GAIN:AUTO[:STATe]?	812
[[:SENSe]:EVMQpsk:IF:GAIN[:STATe] ON OFF 1 0	813
[[:SENSe]:EVMQpsk:IF:GAIN[:STATe]?	813
[[:SENSe]:EVMQpsk:MEAS:LENGth < integer >	809
[[:SENSe]:EVMQpsk:MEAS:LENGth?	809
[[:SENSe]:EVMQpsk:MEAS:OFFSet <integer>	808
[[:SENSe]:EVMQpsk:MEAS:OFFSet?	808
[[:SENSe]:EVMQpsk:SPECTrum NORMAl INVert	809
[[:SENSe]:EVMQpsk:SPECTrum?	809
[[:SENSe]:EVMQpsk:SWEEp:POINts <integer>	806
[[:SENSe]:EVMQpsk:SWEEp:POINts?	806
[[:SENSe]:FEED RF AIQ EMIXer	921

List of Commands

[:SENSe]:FEED?	921
[:SENSe]:FEED:AREFERENCE REF50 REF4800 OFF	926
[:SENSe]:FEED:AREFERENCE?	926
[:SENSe]:FEED:DATA INPut STORed	932
[:SENSe]:FEED:DATA?	932
[:SENSe]:FEED:DATA:STORe	933
[:SENSe]:FEED:RF:PORT[:INPut] RFIN RFIN2 RFIO1 RFIO2	925
[:SENSe]:FEED:RF:PORT[:INPut]?	925
[:SENSe]:FEED:RF:PORT:OUTPut RFOut RFIO1 RFIO2	949
[:SENSe]:FEED:RF:PORT:OUTPut?	949
[:SENSe]:FREQuency:CENTer <freq>	906
[:SENSe]:FREQuency:CENTer?	906
[:SENSe]:FREQuency:CENTer:STEP:AUTO OFF ON 0 1	917
[:SENSe]:FREQuency:CENTer:STEP:AUTO?	917
[:SENSe]:FREQuency:CENTer:STEP[:INCRement] <freq>	917
[:SENSe]:FREQuency:CENTer:STEP[:INCRement]?	917
[:SENSe]:FREQuency:EMIXer:CENTer <freq>	910
[:SENSe]:FREQuency:EMIXer:CENTer?	910
[:SENSe]:FREQuency:IQ:CENTer <freq>	911
[:SENSe]:FREQuency:IQ:CENTer?	911
[:SENSe]:FREQuency:OFFSet <freq>	918
[:SENSe]:FREQuency:OFFSet?	918
[:SENSe]:FREQuency:RF:CENTer <freq>	909
[:SENSe]:FREQuency:RF:CENTer?	909
[:SENSe]:FREQuency:SPAN <freq>	1263
[:SENSe]:FREQuency:SPAN?	1263
[:SENSe]:FREQuency:SPAN:BANDwidth[:RESolution]:RATio <integer>	894
[:SENSe]:FREQuency:SPAN:BANDwidth[:RESolution]:RATio?	894
[:SENSe]:FREQuency:SPAN:BANDwidth[:RESolution]:RATio:AUTO OFF ON 0 1	894
[:SENSe]:FREQuency:SPAN:BANDwidth[:RESolution]:RATio:AUTO?	894
[:SENSe]:FREQuency:SPAN:FULL	1264

List of Commands

[::SENSe]:FREQuency:SPAN:PREVious	1266
[::SENSe]:FREQuency:STARt <freq>	912
[::SENSe]:FREQuency:STARt?	912
[::SENSe]:FREQuency:STOP <freq>.	914
[::SENSe]:FREQuency:STOP?	914
[::SENSe]:FREQuency:SYNThesis:AUTO[:STATe] OFF ON 0 1	1076
[::SENSe]:FREQuency:SYNThesis:AUTO[:STATe]?	1076
[::SENSe]:FREQuency:SYNThesis[:STATe] 1 2 3	1075
[::SENSe]:FREQuency:SYNThesis[:STATe]?	1075
[::SENSe]:FREQuency:TUNE:IMMediate	903
[::SENSe]:FREQuency:TZOom CENTer?	904
[::SENSe]:FREQuency:TZOom:CENTer <frequency>	904
[::SENSe]:FREQuency:ZSPan:CENTer <frequency>	905
[::SENSe]:FREQuency:ZSPan:CENTer?	905
[::SENSe]:IF:GAIN:FFT:AUTO[:STATe] OFF ON 0 1	1082
[::SENSe]:IF:GAIN:FFT:AUTO[:STATe]?	1082
[::SENSe]:IF:GAIN:FFT[:STATe] AUTOorange LOW HIGH.	1081
[::SENSe]:IF:GAIN:FFT[:STATe]?	1081
[::SENSe]:IF:GAIN:SWEpt:AUTO[:STATe] OFF ON 0 1	1080
[::SENSe]:IF:GAIN:SWEpt:AUTO[:STATe]?	1080
[::SENSe]:IF:GAIN:SWEpt[:STATe] OFF ON 0 1	1080
[::SENSe]:IF:GAIN:SWEpt[:STATe]?	1080
[::SENSe]:MPADapter:CORRection:CSET[1] 2 3 4 5 6 7 8 9 10 11 12 13 14 15 16:ANTenna[:UNIT] GAUSs PTES- la UVM UAM NOConversion	961
[::SENSe]:MPADapter:CORRection:CSET[1] 2 3 4 5 6 7 8 9 10 11 12 13 14 15 16:ANTenna[:UNIT]?	961
[::SENSe]:MPADapter:CORRection:CSET[1] 2 3 4 5 6 7 8 9 10 11 12 13 14 15 16:COMMeNt "text"	965
[::SENSe]:MPADapter:CORRection:CSET[1] 2 3 4 5 6 7 8 9 10 11 12 13 14 15 16:COMMeNt?	965
[::SENSe]:MPADapter:CORRection:CSET[1] 2 3 4 5 6 7 8 9 10 11 12 13 14 15 16:DATA <freq>, <ampl>,	979
[::SENSe]:MPADapter:CORRection:CSET[1] 2 3 4 5 6 7 8 9 10 11 12 13 14 15 16:DATA?	979
[::SENSe]:MPADapter:CORRection:CSET[1] 2 3 4 5 6 7 8 9 10 11 12 13 14 15 16:DATA:MERGe <freq>, <ampl>,	980
[::SENSe]:MPADapter:CORRection:CSET[1] 2 3 4 5 6 7 8 9 10 11 12 13 14 15 16:DELete	978

List of Commands

[:SENSe]:MPADapter:CORRection:CSET[1] 2 3 4 5 6 7 8 9 10 11 12 13 14 15 16:DESCription "text".	965
[:SENSe]:MPADapter:CORRection:CSET[1] 2 3 4 5 6 7 8 9 10 11 12 13 14 15 16:DESCription?.	965
[:SENSe]:MPADapter:CORRection:CSET[1] 2 3 4 5 6 7 8 9 10 11 12 13 14 15 16:RF:PORT RFIO RFIO1 RFIO2 RFIO3 RFIO4 RFIO5 RFIO6 RFIO7	966
[:SENSe]:MPADapter:CORRection:CSET[1] 2 3 4 5 6 7 8 9 10 11 12 13 14 15 16:RF:PORT?	966
[:SENSe]:MPADapter:CORRection:CSET[1] 2 3 4 5 6 7 8 9 10 11 12 13 14 15 16:RF:PORT:RFIO0 SOURce AN- ALyzer BOTH	966
[:SENSe]:MPADapter:CORRection:CSET[1] 2 3 4 5 6 7 8 9 10 11 12 13 14 15 16:RF:PORT:RFIO0?	966
[:SENSe]:MPADapter:CORRection:CSET[1] 2 3 4 5 6 7 8 9 10 11 12 13 14 15 16:RF:PORT:RFIO1 SOURce AN- ALyzer BOTH.	967
[:SENSe]:MPADapter:CORRection:CSET[1] 2 3 4 5 6 7 8 9 10 11 12 13 14 15 16:RF:PORT:RFIO1?	967
[:SENSe]:MPADapter:CORRection:CSET[1] 2 3 4 5 6 7 8 9 10 11 12 13 14 15 16:RF:PORT:RFIO2 SOURce AN- ALyzer BOTH.	969
[:SENSe]:MPADapter:CORRection:CSET[1] 2 3 4 5 6 7 8 9 10 11 12 13 14 15 16:RF:PORT:RFIO2?	969
[:SENSe]:MPADapter:CORRection:CSET[1] 2 3 4 5 6 7 8 9 10 11 12 13 14 15 16:RF:PORT:RFIO3 SOURce AN- ALyzer BOTH.	970
[:SENSe]:MPADapter:CORRection:CSET[1] 2 3 4 5 6 7 8 9 10 11 12 13 14 15 16:RF:PORT:RFIO3?	970
[:SENSe]:MPADapter:CORRection:CSET[1] 2 3 4 5 6 7 8 9 10 11 12 13 14 15 16:RF:PORT:RFIO4 SOURce AN- ALyzer BOTH.	971
[:SENSe]:MPADapter:CORRection:CSET[1] 2 3 4 5 6 7 8 9 10 11 12 13 14 15 16:RF:PORT:RFIO4?	971
[:SENSe]:MPADapter:CORRection:CSET[1] 2 3 4 5 6 7 8 9 10 11 12 13 14 15 16:RF:PORT:RFIO5 SOURce AN- ALyzer BOTH.	972
[:SENSe]:MPADapter:CORRection:CSET[1] 2 3 4 5 6 7 8 9 10 11 12 13 14 15 16:RF:PORT:RFIO5?	972
[:SENSe]:MPADapter:CORRection:CSET[1] 2 3 4 5 6 7 8 9 10 11 12 13 14 15 16:RF:PORT:RFIO6 SOURce AN- ALyzer BOTH.	973
[:SENSe]:MPADapter:CORRection:CSET[1] 2 3 4 5 6 7 8 9 10 11 12 13 14 15 16:RF:PORT:RFIO6?	973
[:SENSe]:MPADapter:CORRection:CSET[1] 2 3 4 5 6 7 8 9 10 11 12 13 14 15 16:RF:PORT:RFIO7 SOURce AN- ALyzer BOTH.	974
[:SENSe]:MPADapter:CORRection:CSET[1] 2 3 4 5 6 7 8 9 10 11 12 13 14 15 16:RF:PORT:RFIO7?	974
[:SENSe]:MPADapter:CORRection:CSET[1] 2 3 4 5 6 7 8 9 10 11 12 13 14 15 16[:STATe] ON OFF 1 0	959
[:SENSe]:MPADapter:CORRection:CSET[1] 2 3 4 5 6 7 8 9 10 11 12 13 14 15 16[:STATe]?.	959
[:SENSe]:MPADapter:CORRection:CSET[1] 2 3 4 5 6 7 8 9 10 11 12 13 14 15 16:X:SPACing LINear LOGarith- mic	963
[:SENSe]:MPADapter:CORRection:CSET[1] 2 3 4 5 6 7 8 9 10 11 12 13 14 15 16:X:SPACing?.	963
[:SENSe]:MPADapter:CORRection:CSET:ALL:DELeTe	979

List of Commands

[[:SENSe]:MPADapter:CORRection:CSET:ALL[:STATe] ON OFF 1 0	978
[[:SENSe]:MPADapter:CORRection:CSET:ALL[:STATe]?	978
[[:SENSe]:MPADapter:GAIN[:STATe] ON OFF 1 0	958
[[:SENSe]:MPADapter:GAIN[:STATe]?	958
[[:SENSe]:MPADapter:PORT:INPut OFF	952
[[:SENSe]:MPADapter:PORT:INPut OFF RFIO0 RFIO1 RFIO2 RFIO3 RFIO4 RFIO5 RFIO6 RFIO7	952
[[:SENSe]:MPADapter:PORT:INPut RFIO0	953
[[:SENSe]:MPADapter:PORT:INPut?	952
[[:SENSe]:MPADapter:PORT:OUTPut:BITMap <integer>	955
[[:SENSe]:MPADapter:PORT:OUTPut:BITMap?	955
[[:SENSe]:MPADapter[:STATe] ON OFF 1 0	952
[[:SENSe]:MPADapter[:STATe]?	952
[[:SENSe]:OBWidth:AVERAge:COUNT <integer>	615
[[:SENSe]:OBWidth:AVERAge:COUNT?	615
[[:SENSe]:OBWidth:AVERAge[:STATe] ON OFF 1 0	615
[[:SENSe]:OBWidth:AVERAge[:STATe]?	615
[[:SENSe]:OBWidth:AVERAge:TCONtrol EXPonential REPeat	616
[[:SENSe]:OBWidth:AVERAge:TCONtrol?	616
[[:SENSe]:OBWidth:BANDwidth[:RESolution] <bandwidth>	600
[[:SENSe]:OBWidth:BANDwidth[:RESolution]?	600
[[:SENSe]:OBWidth:BANDwidth[:RESolution]:AUTO ON OFF 1 0	600
[[:SENSe]:OBWidth:BANDwidth[:RESolution]:AUTO?	600
[[:SENSe]:OBWidth:BANDwidth:SHAPE GAUSSian FLATtop	603
[[:SENSe]:OBWidth:BANDwidth:SHAPE?	603
[[:SENSe]:OBWidth:BANDwidth:VIDeo <bandwidth>	601
[[:SENSe]:OBWidth:BANDwidth:VIDeo?	601
[[:SENSe]:OBWidth:BANDwidth:VIDeo:AUTO ON OFF 1 0	601
[[:SENSe]:OBWidth:BANDwidth:VIDeo:AUTO?	601
[[:SENSe]:OBWidth:DETeCTOR:AUTO ON OFF 1 0	642
[[:SENSe]:OBWidth:DETeCTOR:AUTO?	642
[[:SENSe]:OBWidth:DETeCTOR[:FUNction] NORMal AVERAge POSitive SAMPle NEGative	641

List of Commands

[:SENSe]:OBWidth:DETEctor[:FUNction]?	641
[:SENSe]:OBWidth:FREQuency:SPAN <freq>	633
[:SENSe]:OBWidth:FREQuency:SPAN?	633
[:SENSe]:OBWidth:FREQuency:SPAN:FULL	634
[:SENSe]:OBWidth:FREQuency:SPAN:PREVIOUS	634
[:SENSe]:OBWidth:IF:GAIN:AUTO[:STATe] ON OFF 1 0	619
[:SENSe]:OBWidth:IF:GAIN:AUTO[:STATe]?	619
[:SENSe]:OBWidth:IF:GAIN[:STATe] ON OFF 1 0	619
[:SENSe]:OBWidth:IF:GAIN[:STATe]?	619
[:SENSe]:OBWidth:MAXHold ON OFF 1 0	617
[:SENSe]:OBWidth:MAXHold?	617
[:SENSe]:OBWidth:PERCent <real>	617
[:SENSe]:OBWidth:PERCent?	617
[:SENSe]:OBWidth:SWEep:POINts <integer>	638
[:SENSe]:OBWidth:SWEep:POINts?	638
[:SENSe]:OBWidth:SWEep:TIME <time>	636
[:SENSe]:OBWidth:SWEep:TIME?	636
[:SENSe]:OBWidth:SWEep:TIME:AUTO OFF ON 0 1	636
[:SENSe]:OBWidth:SWEep:TIME:AUTO?	636
[:SENSe]:OBWidth:SWEep:TIME:AUTO:RULEs NORMAl ACCURacy	637
[:SENSe]:OBWidth:SWEep:TIME:AUTO:RULEs?	637
[:SENSe]:OBWidth:XDB <rel_ampl>	618
[:SENSe]:OBWidth:XDB?	618
[:SENSe]:POWer:IQ[:I]:RANGe[:UPPer] <ampl>	863
[:SENSe]:POWer:IQ[:I]:RANGe[:UPPer]?	863
[:SENSe]:POWer:IQ:Q:RANGe[:UPPer] <ampl>	865
[:SENSe]:POWer:IQ:Q:RANGe[:UPPer]?	865
[:SENSe]:POWer:IQ:RANGe:AUTO OFF ON 0 1	863
[:SENSe]:POWer:IQ:RANGe:AUTO?	863
[:SENSe]:POWer[:RF]:ATTenuation <rel_ampl>	852
[:SENSe]:POWer[:RF]:ATTenuation?	852

List of Commands

[[:SENSe]:POWer[:RF]:ATTenuation:AUTO OFF ON 0 1]	852
[[:SENSe]:POWer[:RF]:ATTenuation:AUTO?	852
[[:SENSe]:POWer[:RF]:ATTenuation:STEP[:INCRement] 10 dB 2 dB]	860
[[:SENSe]:POWer[:RF]:ATTenuation:STEP[:INCRement]?	860
[[:SENSe]:POWer[:RF]:EATTenuation <rel_amp>]	857
[[:SENSe]:POWer[:RF]:EATTenuation?	857
[[:SENSe]:POWer[:RF]:EATTenuation:STATe OFF ON 0 1]	855
[[:SENSe]:POWer[:RF]:EATTenuation:STATe?	855
[[:SENSe]:POWer[:RF]:GAIN:BAND LOW FULL]	884
[[:SENSe]:POWer[:RF]:GAIN:BAND?	884
[[:SENSe]:POWer[:RF]:GAIN[:STATe] OFF ON 0 1]	883
[[:SENSe]:POWer[:RF]:GAIN[:STATe]?	883
[[:SENSe]:POWer[:RF]:MIXer:RANGe[:UPPer] <real>]	861
[[:SENSe]:POWer[:RF]:MIXer:RANGe[:UPPer]?	861
[[:SENSe]:POWer[:RF]:MW:PATH STD LNPath MPBypass FULL]	879
[[:SENSe]:POWer[:RF]:MW:PATH?	879
[[:SENSe]:POWer[:RF]:MW:PRESelector[:STATe] ON OFF 0 1]	883
[[:SENSe]:POWer[:RF]:MW:PRESelector[:STATe]?	883
[[:SENSe]:POWer[:RF]:PADJust <freq>]	870
[[:SENSe]:POWer[:RF]:PADJust?	870
[[:SENSe]:POWer[:RF]:PADJust:PRESelector MWAVE MMWave EXternal]	871
[[:SENSe]:POWer[:RF]:PADJust:PRESelector?	871
[[:SENSe]:POWer[:RF]:PCENter]	868
[[:SENSe]:POWer[:RF]:RANGe:AUTO ON OFF 1 0]	859
[[:SENSe]:POWer[:RF]:RANGe:AUTO?	859
[[:SENSe]:POWer[:RF]:RANGe:OPTimize IMMEDIATE]	858
[[:SENSe]:POWer[:RF]:RANGe:OPTimize:ATTenuation OFF ELECTrical COMBined]	858
[[:SENSe]:POWer[:RF]:RANGe:OPTimize:ATTenuation?	858
[[:SENSe]:RADio:STANdard:DEVice BTS MS]	1103
[[:SENSe]:RADio:STANdard:DEVice?	1103
[[:SENSe]:RHO:ALPHa <real>]	754

List of Commands

[[:SENSe]:RHO:ALPHA?	754
[[:SENSe]:RHO:AVERAge:COUNt <integer>	745
[[:SENSe]:RHO:AVERAge:COUNt?	745
[[:SENSe]:RHO:AVERAge[:STATe] OFF ON 0 1	745
[[:SENSe]:RHO:AVERAge[:STATe]?	745
[[:SENSe]:RHO:AVERAge:TCONtrol EXPonential REPeat	746
[[:SENSe]:RHO:AVERAge:TCONtrol?	746
[[:SENSe]:RHO:CRATe <freq>	755
[[:SENSe]:RHO:CRATe?	755
[[:SENSe]:RHO:IF:GAIN:AUTO[:STATe] OFF ON 0 1	756
[[:SENSe]:RHO:IF:GAIN:AUTO[:STATe]?	756
[[:SENSe]:RHO:IF:GAIN[:STATe] ON OFF 1 0	756
[[:SENSe]:RHO:IF:GAIN[:STATe]?	756
[[:SENSe]:RHO:MCEStimator OFF ON 0 1	755
[[:SENSe]:RHO:MCEStimator?	755
[[:SENSe]:RHO:RCONfig cdma2000 IS95	751
[[:SENSe]:RHO:RCONfig?	751
[[:SENSe]:RHO:SPECtrum INVert NORMal	752
[[:SENSe]:RHO:SPECtrum?	752
[[:SENSe]:RHO:SYNC[:BTS] PICH DPICH	750
[[:SENSe]:RHO:SYNC[:BTS]?	750
[[:SENSe]:RHO:SYNC:LCMask <integer>	751
[[:SENSe]:RHO:SYNC:LCMask?	751
[[:SENSe]:ROSCillator:EXTernal:FREQuency <freq>	948
[[:SENSe]:ROSCillator:EXTernal:FREQuency?	948
[[:SENSe]:ROSCillator:SOURce INTernal EXTernal	947
[[:SENSe]:ROSCillator:SOURce?	946
[[:SENSe]:ROSCillator:SOURce:TYPE INTernal EXTernal SENSe	946
[[:SENSe]:ROSCillator:SOURce:TYPE?	946
[[:SENSe]:SEMAsk:AVERAge:COUNt <integer>	503
[[:SENSe]:SEMAsk:AVERAge:COUNt?	503

List of Commands

[[:SENSe]:SEMAsk:AVERage[:STATe] ON OFF 1 0	503
[[:SENSe]:SEMAsk:AVERage[:STATe]?	503
[[:SENSe]:SEMAsk:BANDwidth[1] 2:INTEGRation <bandwidth>	505
[[:SENSe]:SEMAsk:BANDwidth[1] 2:INTEGRation?	505
[[:SENSe]:SEMAsk:BANDwidth[1] 2[:RESolution] <bandwidth>	508
[[:SENSe]:SEMAsk:BANDwidth[1] 2[:RESolution]?	508
[[:SENSe]:SEMAsk:BANDwidth[1] 2[:RESolution]:AUTO OFF ON 1 0	508
[[:SENSe]:SEMAsk:BANDwidth[1] 2[:RESolution]:AUTO?	508
[[:SENSe]:SEMAsk:BANDwidth[1] 2:VIDeo <bandwidth>	509
[[:SENSe]:SEMAsk:BANDwidth[1] 2:VIDeo?	509
[[:SENSe]:SEMAsk:BANDwidth[1] 2:VIDeo:AUTO OFF ON 1 0	509
[[:SENSe]:SEMAsk:BANDwidth[1] 2:VIDeo:AUTO?	509
[[:SENSe]:SEMAsk:BANDwidth[1] 2:VIDeo:RATio <real>	510
[[:SENSe]:SEMAsk:BANDwidth[1] 2:VIDeo:RATio:AUTO OFF ON 1 0	510
[[:SENSe]:SEMAsk:BANDwidth[1] 2:VIDeo:RATio:AUTO?	510
[[:SENSe]:SEMAsk:BANDwidth[1] 2:VIDeo:RATio	510
[[:SENSe]:SEMAsk:BANDwidth:SHAPE ASENse GAUSSian FLATtop	492
[[:SENSe]:SEMAsk:BANDwidth:SHAPE?	492
[[:SENSe]:SEMAsk:CARRier:AUTO[:STATe] OFF ON 1 0	512
[[:SENSe]:SEMAsk:CARRier:AUTO[:STATe]?	512
[[:SENSe]:SEMAsk:CARRier:CPSD <real>	512
[[:SENSe]:SEMAsk:CARRier:CPSD?	512
[[:SENSe]:SEMAsk:CARRier:PEAK[:POWer] <real>	513
[[:SENSe]:SEMAsk:CARRier:PEAK[:POWer]?	513
[[:SENSe]:SEMAsk:CARRier[:POWer] <real>	512
[[:SENSe]:SEMAsk:CARRier[:POWer]?	512
[[:SENSe]:SEMAsk:DETEctor:CARRier:AUTO ON OFF 1 0	562
[[:SENSe]:SEMAsk:DETEctor:CARRier:AUTO?	562
[[:SENSe]:SEMAsk:DETEctor:CARRier[:FUNCTION] AVERage NEGative NORMal POSitive SAMPLE	561
[[:SENSe]:SEMAsk:DETEctor:CARRier[:FUNCTION]?	561
[[:SENSe]:SEMAsk:DETEctor:OFFSet:AUTO ON OFF 1 0	563

List of Commands

[[:SENSe]:SEMAsk:DETEctor:OFFSet:AUTO?	563
[[:SENSe]:SEMAsk:DETEctor:OFFSet[:FUNction] AVERAge NEGAtive NORMAl POSitive SAMPle	563
[[:SENSe]:SEMAsk:DETEctor:OFFSet[:FUNction]?	563
[[:SENSe]:SEMAsk:FILTer[:RRC]:ALPHa <real>	539
[[:SENSe]:SEMAsk:FILTer[:RRC]:ALPHa?	539
[[:SENSe]:SEMAsk:FILTer[:RRC][:STATe] OFF ON 0 1	539
[[:SENSe]:SEMAsk:FILTer[:RRC][:STATe]?	539
[[:SENSe]:SEMAsk:FREQuency[1] 2:SPAN <freq>	506
[[:SENSe]:SEMAsk:FREQuency[1] 2:SPAN?	506
[[:SENSe]:SEMAsk:LIMits STD MAN	540
[[:SENSe]:SEMAsk:LIMits?	540
[[:SENSe]:SEMAsk:OFFSet[1] 2:LIST:BANDwidth:IMULti <integer>,	524
[[:SENSe]:SEMAsk:OFFSet[1] 2:LIST:BANDwidth:IMULti?	524
[[:SENSe]:SEMAsk:OFFSet[1] 2:LIST:BANDwidth[:RESolution] <bandwidth>,	522
[[:SENSe]:SEMAsk:OFFSet[1] 2:LIST:BANDwidth[:RESolution]?	522
[[:SENSe]:SEMAsk:OFFSet[1] 2:LIST:BANDwidth[:RESolution]:AUTO OFF ON 1 0,	522
[[:SENSe]:SEMAsk:OFFSet[1] 2:LIST:BANDwidth[:RESolution]:AUTO?	522
[[:SENSe]:SEMAsk:OFFSet[1] 2:LIST:BANDwidth:VIDeo <freq>,	525
[[:SENSe]:SEMAsk:OFFSet[1] 2:LIST:BANDwidth:VIDeo?	525
[[:SENSe]:SEMAsk:OFFSet[1] 2:LIST:BANDwidth:VIDeo:AUTO OFF ON 0 1,	525
[[:SENSe]:SEMAsk:OFFSet[1] 2:LIST:BANDwidth:VIDeo:AUTO?	525
[[:SENSe]:SEMAsk:OFFSet[1] 2:LIST:BANDwidth:VIDeo:RATio <real>,	526
[[:SENSe]:SEMAsk:OFFSet[1] 2:LIST:BANDwidth:VIDeo:RATio?	526
[[:SENSe]:SEMAsk:OFFSet[1] 2:LIST:BANDwidth:VIDeo:RATio:AUTO OFF ON 0 1,	526
[[:SENSe]:SEMAsk:OFFSet[1] 2:LIST:BANDwidth:VIDeo:RATio:AUTO?	526
[[:SENSe]:SEMAsk:OFFSet[1] 2:LIST:FREQuency:STARt <freq>,	514
[[:SENSe]:SEMAsk:OFFSet[1] 2:LIST:FREQuency:STARt?	514
[[:SENSe]:SEMAsk:OFFSet[1] 2:LIST:FREQuency:STOP <freq>,	517
[[:SENSe]:SEMAsk:OFFSet[1] 2:LIST:FREQuency:STOP?	517
[[:SENSe]:SEMAsk:OFFSet[1] 2:LIST:SIDE BOTH NEGAtive POSitive,	521
[[:SENSe]:SEMAsk:OFFSet[1] 2:LIST:SIDE?	521

List of Commands

[[:SENSe]:SEMAsk:OFFSet[1]2:LIST:START:ABSolute <real>,	527
[[:SENSe]:SEMAsk:OFFSet[1]2:LIST:START:ABSolute?	527
[[:SENSe]:SEMAsk:OFFSet[1]2:LIST:START:RCARrier <rel_amp>,	531
[[:SENSe]:SEMAsk:OFFSet[1]2:LIST:START:RCARrier?	531
[[:SENSe]:SEMAsk:OFFSet[1]2:LIST:STATe ON OFF 1 0,	514
[[:SENSe]:SEMAsk:OFFSet[1]2:LIST:STATe?	514
[[:SENSe]:SEMAsk:OFFSet[1]2:LIST:STOP:ABSolute <real>,	529
[[:SENSe]:SEMAsk:OFFSet[1]2:LIST:STOP:ABSolute?	529
[[:SENSe]:SEMAsk:OFFSet[1]2:LIST:STOP:ABSolute:COUple ON OFF 1 0,	529
[[:SENSe]:SEMAsk:OFFSet[1]2:LIST:STOP:ABSolute:COUple?	529
[[:SENSe]:SEMAsk:OFFSet[1]2:LIST:STOP:RCARrier <rel_amp>,	533
[[:SENSe]:SEMAsk:OFFSet[1]2:LIST:STOP:RCARrier?	533
[[:SENSe]:SEMAsk:OFFSet[1]2:LIST:STOP:RCARrier:COUple ON OFF 1 0,	533
[[:SENSe]:SEMAsk:OFFSet[1]2:LIST:STOP:RCARrier:COUple?	533
[[:SENSe]:SEMAsk:OFFSet[1]2:LIST:SWEEp:TIME <time>,	520
[[:SENSe]:SEMAsk:OFFSet[1]2:LIST:SWEEp:TIME?	520
[[:SENSe]:SEMAsk:OFFSet[1]2:LIST:SWEEp:TIME:AUTO ON OFF 1 0,	520
[[:SENSe]:SEMAsk:OFFSet[1]2:LIST:SWEEp:TIME:AUTO?	520
[[:SENSe]:SEMAsk:OFFSet[1]2:LIST:TEST ABSolute AND OR RELative,	536
[[:SENSe]:SEMAsk:OFFSet[1]2:LIST:TEST?	536
[[:SENSe]:SEMAsk:OFFSet[1]2:TYPE CTOCenter CTOEdge ETOCenter ETOEdge	538
[[:SENSe]:SEMAsk:OFFSet[1]2:TYPE?	538
[[:SENSe]:SEMAsk:SWEEp[1]2:TIME <time>	507
[[:SENSe]:SEMAsk:SWEEp[1]2:TIME?	507
[[:SENSe]:SEMAsk:SWEEp[1]2:TIME:AUTO OFF 0 ON 1	507
[[:SENSe]:SEMAsk:SWEEp[1]2:TIME:AUTO?	507
[[:SENSe]:SEMAsk:T80Mask:AUTO ON OFF 1 0 [[:SENSe]:SEMAsk:T80Mask:AUTO?	541
[[:SENSe]:SEMAsk:TYPE ?	504
[[:SENSe]:SEMAsk:TYPE PSDRef TPRef SPRef.	504
[[:SENSe]:SWEEp:EGATe:CONTRol EDGE LEVel	1290
[[:SENSe]:SWEEp:EGATe:CONTRol?	1290

List of Commands

[:SENSe]:SWEep:EGATe:DELay <time>	1286
[:SENSe]:SWEep:EGATe:DELay?	1286
[:SENSe]:SWEep:EGATe:DELay:COMPensation:TYPE OFF SETTled GDELay	1292
[:SENSe]:SWEep:EGATe:DELay:COMPensation:TYPE?	1292
[:SENSe]:SWEep:EGATe:EXTernal[1] 2:LEVel <voltage>	1295
[:SENSe]:SWEep:EGATe:EXTernal[1] 2:LEVel?	1295
[:SENSe]:SWEep:EGATe:HOLDoff <time>	1291
[:SENSe]:SWEep:EGATe:HOLDoff?	1291
[:SENSe]:SWEep:EGATe:HOLDoff:AUTO OFF ON 0 1	1291
[:SENSe]:SWEep:EGATe:HOLDoff:AUTO?	1291
[:SENSe]:SWEep:EGATe:LENGth <time>	1287
[:SENSe]:SWEep:EGATe:LENGth?	1287
[:SENSe]:SWEep:EGATe:METHod LO VIDeo FFT	1288
[:SENSe]:SWEep:EGATe:METHod?	1288
[:SENSe]:SWEep:EGATe:MINFast?	1294
[:SENSe]:SWEep:EGATe:POLarity NEGative POSitive	1295
[:SENSe]:SWEep:EGATe:POLarity?	1295
[:SENSe]:SWEep:EGATe:SOURce EXTernal1 EXTernal2 LINE FRAME RFBurst	1290
[:SENSe]:SWEep:EGATe:SOURce?	1290
[:SENSe]:SWEep:EGATe[:STATe] OFF ON 0 1	1281
[:SENSe]:SWEep:EGATe[:STATe]?	1281
[:SENSe]:SWEep:EGATe:TIME <time>	1285
[:SENSe]:SWEep:EGATe:TIME?	1285
[:SENSe]:SWEep:EGATe:VIEW ON OFF 1 0	1282
[:SENSe]:SWEep:EGATe:VIEW?	1282
[:SENSe]:SWEep:EGATe:VIEW:STARt <time>	1286
[:SENSe]:SWEep:EGATe:VIEW:STARt?	1286
[:SENSe]:SWEep:FFT:WIDTh <real>	1277
[:SENSe]:SWEep:FFT:WIDTh?	1277
[:SENSe]:SWEep:FFT:WIDTh:AUTO OFF ON 0 1	1278
[:SENSe]:SWEep:FFT:WIDTh:AUTO?	1278

List of Commands

[[:SENSe]:SWEep:POINts <integer>	1296
[[:SENSe]:SWEep:POINts?	1296
[[:SENSe]:SWEep:TIME <time>	1268
[[:SENSe]:SWEep:TIME?	1268
[[:SENSe]:SWEep:TIME:AUTO OFF ON 0 1	1268
[[:SENSe]:SWEep:TIME:AUTO?	1268
[[:SENSe]:SWEep:TIME:AUTO:RULEs NORMAl ACCuracy SRESponse	1270
[[:SENSe]:SWEep:TIME:AUTO:RULEs?	1270
[[:SENSe]:SWEep:TIME:AUTO:RULEs:AUTO[:STATe] ON OFF 1 0	1271
[[:SENSe]:SWEep:TIME:AUTO:RULEs:AUTO[:STATe]?	1271
[[:SENSe]:SWEep:TIME:GATE:LEVEl HIGH LOW	1295
[[:SENSe]:SWEep:TIME:GATE:LEVEl?	1295
[[:SENSe]:SWEep:TYPE FFT SWEep	1273
[[:SENSe]:SWEep:TYPE?	1273
[[:SENSe]:SWEep:TYPE:AUTO OFF ON 0 1	1274
[[:SENSe]:SWEep:TYPE:AUTO?	1274
[[:SENSe]:SWEep:TYPE:AUTO:RULEs SPEEd DRANge	1275
[[:SENSe]:SWEep:TYPE:AUTO:RULEs?	1275
[[:SENSe]:SWEep:TYPE:AUTO:RULEs:AUTO[:STATe] OFF ON 0 1	1275
[[:SENSe]:SWEep:TYPE:AUTO:RULEs:AUTO[:STATe]?	1275
[[:SENSe]:SWEep:TZOom:POINts <integer>	1298
[[:SENSe]:SWEep:TZOom:POINts?	1298
[[:SENSe]:VOLTage POWER:IQ:MIRROred OFF ON 0 1	864
[[:SENSe]:VOLTage POWER:IQ:MIRROred?	864
[[:SENSe]:VOLTage:IQ[:I]:RANGe[:UPPer] <voltage>	863
[[:SENSe]:VOLTage:IQ[:I]:RANGe[:UPPer]?	863
[[:SENSe]:VOLTage:IQ:Q:RANGe[:UPPer] <voltage>	865
[[:SENSe]:VOLTage:IQ:Q:RANGe[:UPPer]?	865
[[:SENSe]:VOLTage:IQ:RANGe:AUTO OFF ON 0 1	862
[[:SENSe]:VOLTage:IQ:RANGe:AUTO?	862
:SERvice[:PRoDuction]:SIQuery:SCPI:LIST?	1261

List of Commands

:SOURce:AM[:DEPT _h][:LINear]?	1215
:SOURce:AM[:DEPT _h][:LINear]	1215
:SOURce:AM:INTernal:FREQuency?	1216
:SOURce:AM:INTernal:FREQuency	1216
:SOURce:AM:STATe?	1215
:SOURce:AM:STATe	1215
:SOURce:FM[:DEVIation]?	1216
:SOURce:FM[:DEVIation]	1216
:SOURce:FM:INTernal:FREQuency?	1217
:SOURce:FM:INTernal:FREQuency	1217
:SOURce:FM:STATe?	1216
:SOURce:FM:STATe	1216
:SOURce:FREQuency:CHANnels:BAND NONE PGSM EGSM RGSM DCS1800 PCS1900 TGSM810 GSM450 GSM480 GSM700 GSM850 BANDI BAN DII BANDIII BANDIV BANDV BANDVI BANDVII BANDVIII BANDIX BANDX BANDXI BANDXII BAND XIII BANDXIV USCELL USPCS JAPAN KOREAN NMT IMT2K UPPER SECOND PAMR400 PAMR800 IMT EXT PCS1DOT9G AWS US2DOT5G PUBLIC LOWER BAND1 BAND2 BAND3 BAND4 BAND5 BAND6 BA ND7 BAND8 BAND10 BAND11 BAND12 BAND13 BAND14 BAND17 BAND18 BAND19 BAND20 BAND21 BAND24 BAND25 BAND33 BAND34 BAND35 BAND36 BAND37 BAND38 BAND39 BAND40 BAND41 B AND42 BAND43 BANDA BANDB BANDC BANDD BANDE BANDF	1154
:SOURce:FREQuency:CHANnels:BAND?	1154
:SOURce:FREQuency:CHANnels:NUMBer <int>	1144
:SOURce:FREQuency:CHANnels:NUMBer?	1144
:SOURce:FREQuency[:CW] <freq>	1143
:SOURce:FREQuency[:CW]?	1143
:SOURce:FREQuency:OFFSet <freq>	1172
:SOURce:FREQuency:OFFSet?	1172
:SOURce:FREQuency:REFerence <freq>	1171
:SOURce:FREQuency:REFerence?	1171
:SOURce:FREQuency:REFerence:SET	1170
:SOURce:FREQuency:REFerence:STATe OFF ON 0 1	1171
:SOURce:FREQuency:REFerence:STATe?	1171
:SOURce:LIST:INITiation:ARMed?	1258
:SOURce:LIST:MPADapter:CORRection:ERRor?	1257

List of Commands

:SOURce:LIST:MPADapter:PORT:OUTPut:BITMap:MODE LIST FIXed	1256
:SOURce:LIST:MPADapter:PORT:OUTPut:BITMap:MODE?	1256
:SOURce:LIST:NUMBer:STEPs <integer>	1221
:SOURce:LIST:NUMBer:STEPs?	1221
:SOURce:LIST:SETup:AMPLitude <ampl>, <ampl>, <ampl>,	1253
:SOURce:LIST:SETup:AMPLitude?	1253
:SOURce:LIST:SETup:CLear	1256
:SOURce:LIST:SETup:CNFRequency <double>, <double>, <double>,	1252
:SOURce:LIST:SETup:CNFRequency?	1252
:SOURce:LIST:SETup:DURation:TYPE <enum>, <enum>, <enum>,	1254
:SOURce:LIST:SETup:DURation:TYPE?	1254
:SOURce:LIST:SETup:INPut:TRIGger <enum>, <enum>, <enum>,	1250
:SOURce:LIST:SETup:INPut:TRIGger?	1250
:SOURce:LIST:SETup:OUTPut:TRIGger <bool>, <bool>, <bool>,	1256
:SOURce:LIST:SETup:OUTPut:TRIGger ?	1256
:SOURce:LIST:SETup:RADio:BAND <enum>, <enum>, <enum>,	1251
:SOURce:LIST:SETup:RADio:BAND?	1251
:SOURce:LIST:SETup:RADio:BAND:LINK <enum>, <enum>, <enum>,	1252
:SOURce:LIST:SETup:RADio:BAND:LINK?	1252
:SOURce:LIST:SETup:TOCount <time/int>, <time/int>, <time/int>,	1255
:SOURce:LIST:SETup:TOCount?	1255
:SOURce:LIST:SETup:TRANsition:TIME <time>, <time>, <time>,	1250
:SOURce:LIST:SETup:TRANsition:TIME?	1250
:SOURce:LIST:SETup:WAVEform <string>, <string>, <string>,	1254
:SOURce:LIST:SETup:WAVEform?	1254
:SOURce:LIST[:STATe] ON OFF 1 0	1219
:SOURce:LIST[:STATe]?	1219
:SOURce:LIST:STEP[1] 2 3 4..1000:SETup IMMEDIATE INTernal KEY BUS EXTernal2, <time>, NONE PGSM EGSM RGSM DCS1800 PCS1900 TGSM810 GSM450 GSM480 GSM700 GSM850 BANDI BANDII BANDIII BANDIV BANDV BANDVI BANDVII BANDVIII BANDIX BANDX BANDXI BANDXII BANDXIII BANDXIV USCELL USPCS JAPAN KOREAN NMT IMT2K UPPER SECOND PAMR400 PAMR800 IMT EXT PCS1DOT9G AWS US2DOT5G PUBLIC LOWER NONE BAND1 BAND2 BAND3 BAND4 BAND5 BAND6 BAND7 BAND8 BAND10 BAND11 BAND12 BAND13 BAND14 BAND17 BAND18 BAND19 BAND20 B	

List of Commands

AND21 BAND24 BAND25 BAND33 BAND34 BAND35 BAND36 BAND37 BAND38 BAND39 BAND40 BAND41 BAND42 BAND43 BANDA BANDB BANDC BANDD BANDE BANDF, DOWN UP, <freq>, <ampl>, <string>, TIME COUNT CONTInuous, <time>, ON OFF 1 0, [<int>],	1248
:SOURce:LIST:STEP[1] 2 3 4..1000:SETup?	1248
:SOURce:LIST:STEP[1] 2 3...1000:SETup: RADio: BAND?	1225
:SOURce:LIST:STEP[1] 2 3...1000:SETup: AMPLitude <double>	1242
:SOURce:LIST:STEP[1] 2 3...1000:SETup: AMPLitude?	1242
:SOURce:LIST:STEP[1] 2 3...1000:SETup: CNFRequency <double>	1240
:SOURce:LIST:STEP[1] 2 3...1000:SETup: CNFRequency <double>	1241
:SOURce:LIST:STEP[1] 2 3...1000:SETup: CNFRequency?	1240
:SOURce:LIST:STEP[1] 2 3...1000:SETup: CNFRequency?	1241
:SOURce:LIST:STEP[1] 2 3...1000:SETup: DURation: TCOunt <double>	1246
:SOURce:LIST:STEP[1] 2 3...1000:SETup: DURation: TCOunt <double>	1247
:SOURce:LIST:STEP[1] 2 3...1000:SETup: DURation: TCOunt?.	1246
:SOURce:LIST:STEP[1] 2 3...1000:SETup: DURation: TCOunt?.	1247
:SOURce:LIST:STEP[1] 2 3...1000:SETup: DURation: TYPE TIME COUNT CONTInuous	1245
:SOURce:LIST:STEP[1] 2 3...1000:SETup: DURation: TYPE?	1245
:SOURce:LIST:STEP[1] 2 3...1000:SETup: INPut: TRIGger IMMEDIATE INTERNAL EXTERNAL2 KEY BUS	1222
:SOURce:LIST:STEP[1] 2 3...1000:SETup: INPut: TRIGger?	1222
:SOURce:LIST:STEP[1] 2 3...1000:SETup: OUTPut: TRIGger ON OFF 1 0	1248
:SOURce:LIST:STEP[1] 2 3...1000:SETup: OUTPut: TRIGger	1248
:SOURce:LIST:STEP[1] 2 3...1000:SETup: RADio: BAND NONE PGSM EGSM RGSM DCS1800 PCS1900 TGSM810 GSM450 GSM480 GSM700 GSM850 BANDI BANDII BANDIII BANDIV BANDV BANDVI BANDVII BANDVIII BANDIX BANDX BANDXI BANDXII BANDXIII BANDXIV USCELL USPCS JAPAN KOREAN NMT IMT2K UPPER SECOND PAMR400 PAMR800 IMT EXT PCS1DOT9G AWS US2DOT5G PUBLIC LOWER NONE BAND1 BAND2 BAND3 BAND4 BAND5 BAND6 BAND7 BAND8 BAND10 BAND11 BAND12 BAND13 BAND14 BAND17 BAND18 BAND19 BAND20 BAND21 BAND24 BAND25 BAND33 BAND34 BAND35 BAND36 BAND37 BAND38 BAND39 BAND40 BAND41 BAND42 BAND43 BANDA BANDB BANDC BANDD BANDE BANDF	1225
:SOURce:LIST:STEP[1] 2 3...1000:SETup: RADio: BAND: LINK DOWN UP	1240
:SOURce:LIST:STEP[1] 2 3...1000:SETup: RADio: BAND: LINK?	1240
:SOURce:LIST:STEP[1] 2 3...1000:SETup: TRANsition: TIME <time>	1224
:SOURce:LIST:STEP[1] 2 3...1000:SETup: TRANsition: TIME?.	1224
:SOURce:LIST:STEP[1] 2 3...1000:SETup: WAVEform <string>	1242

List of Commands

:SOURce:LIST:STEP[1] 2 3...1000:SETup:WAVEform?	1242
:SOURce:LIST:TRIG	132
:SOURce:LIST:TRIGger[:IMMediate]	1220
:SOURce:LIST:TRIGger:INITiate[:IMMediate]	1220
:SOURce:PM[:DEVIation]?	1218
:SOURce:PM[:DEVIation]	1218
:SOURce:PM:INTernal:FREQuency?	1218
:SOURce:PM:INTernal:FREQuency	1218
:SOURce:PM:STATe?	1217
:SOURce:PM:STATe	1217
:SOURce:POWer:ALC[:STATe] ON OFF 1 0	1142
:SOURce:POWer:ALC[:STATe]?	1142
:SOURce:POWer[:LEVel][:IMMediate][:AMPLitude] <ampl>	1138
:SOURce:POWer[:LEVel][:IMMediate][:AMPLitude]?	1138
:SOURce:POWer[:LEVel][:IMMediate]:OFFSet <rel_ampl>	1141
:SOURce:POWer[:LEVel][:IMMediate]:OFFSet?	1141
:SOURce:POWer:REFerence <ampl>	1140
:SOURce:POWer:REFerence?	1140
:SOURce:POWer:REFerence:STATe OFF ON 0 1	1140
:SOURce:POWer:REFerence:STATe?	1140
:SOURce:PRESet	1258
:SOURce:RADio:ARB: DEFault:DIRectory?	1177
:SOURce:RADio:ARB:BASeband:FREQuency:OFFSet <freq>	1181
:SOURce:RADio:ARB:BASeband:FREQuency:OFFSet?	1181
:SOURce:RADio:ARB:CATalog?	1179
:SOURce:RADio:ARB:DEFault:DIRectory <string>	1177
:SOURce:RADio:ARB:DELeTe <string>	1178
:SOURce:RADio:ARB:DELeTe:ALL	1178
:SOURce:RADio:ARB:FCATalog?	1179
:SOURce:RADio:ARB:HEADer:CLEar	1212
:SOURce:RADio:ARB:HEADer:INFOrmation?	1214

List of Commands

:SOURce:RADio:ARB:HEADer:SAVE	1212
:SOURce:RADio:ARB:LOAD <string>	1175
:SOURce:RADio:ARB:LOAD:ALL <string>.....	1176
:SOURce:RADio:ARB:MDEStination:ALCHold NONE M1 M2 M3 M4	1211
:SOURce:RADio:ARB:MDEStination:ALCHold?	1211
:SOURce:RADio:ARB:MDEStination:PULSe NONE M1 M2 M3 M4	1209
:SOURce:RADio:ARB:MDEStination:PULSe?	1209
:SOURce:RADio:ARB:MPLicensed:NAME:LOCKed?	1206
:SOURce:RADio:ARB:MPLicensed:UID:LOCKed?	1206
:SOURce:RADio:ARB:MPOLarity:MARKer1 POSitive NEGative	1207
:SOURce:RADio:ARB:MPOLarity:MARKer1?	1207
:SOURce:RADio:ARB:MPOLarity:MARKer2 POSitive NEGative	1207
:SOURce:RADio:ARB:MPOLarity:MARKer2?	1207
:SOURce:RADio:ARB:MPOLarity:MARKer3 POSitive NEGative	1208
:SOURce:RADio:ARB:MPOLarity:MARKer3?	1208
:SOURce:RADio:ARB:MPOLarity:MARKer4 POSitive NEGative	1208
:SOURce:RADio:ARB:MPOLarity:MARKer4?	1208
:SOURce:RADio:ARB:RETRigger ON OFF IMMediate	1183
:SOURce:RADio:ARB:RETRigger?	1183
:SOURce:RADio:ARB:RSCaling <real>	1181
:SOURce:RADio:ARB:RSCaling?	1181
:SOURce:RADio:ARB:SCLock:RATE <freq>.....	1180
:SOURce:RADio:ARB:SCLock:RATE?	1180
:SOURce:RADio:ARB:SEQuence[:MWAVeform] <filename>, <waveform1>, <reps>, NONE M1 M2 M3 M4 M1M2 M1M3 M1M4 M2M3 M2M4 M3M4 M1M2M3 M1M2M4 M1M3M4 M2M3M4 M 1M2M3M4 ALL, {<waveform2>, <reps>, NONE M1 M2 M3 M4 M1M2 M1M3 M1M4 M2M3 M2M4 M3M4 M1M2M3 M1M2M4 M1M3M4 M2M3M4 M 1M2M3M4 ALL, }	1191
:SOURce:RADio:ARB:SEQuence[:MWAVeform]? <filename>	1191
:SOURce:RADio:ARB[:STATe] ON OFF 1 0	1173
:SOURce:RADio:ARB[:STATe]?	1173
:SOURce:RADio:ARB:TRIGger:INITiate	1215

List of Commands

:SOURce:RADio:ARB:TRIGger[:SOURce] KEY BUS EXTErnal2	1185
:SOURce:RADio:ARB:TRIGger[:SOURce]?	1185
:SOURce:RADio:ARB:TRIGger:TYPE CONTInuous SINGle SADVance GATE	1182
:SOURce:RADio:ARB:TRIGger:TYPE?	1182
:SOURce:RADio:ARB:TRIGger:TYPE:CONTInuous[:TYPE] FREE TRIGger RESet	1182
:SOURce:RADio:ARB:TRIGger:TYPE:CONTInuous[:TYPE]?	1182
:SOURce:RADio:ARB:TRIGger:TYPE:SADVance[:TYPE] SINGle CONTInuous	1184
:SOURce:RADio:ARB:TRIGger:TYPE:SADVance[:TYPE]?	1184
:SOURce:RADio:ARB:WAVEform <string>	1174
:SOURce:RADio:ARB:WAVEform?	1174
:SOURce:RADio:BAND:LINK DOWN UP	1170
:SOURce:RADio:BAND:LINK?	1170
:SOURce:RADio:MPADapter:CORREction:ERRor?	1218
:SOURce:SELF:TEST[:ALL]	1259
*SRE <integer>	175
*SRE?	175
*STB?	176
:SYSTem:APPLIcation:CATalog[:NAME]?	1096
:SYSTem:APPLIcation:CATalog[:NAME]:COUNt?	1096
:SYSTem:APPLIcation:CATalog:OPTion? <model>	1097
:SYSTem:APPLIcation:CATalog:REVision? <model>	1097
:SYSTem:APPLIcation[:CURRent][:NAME]?	1095
:SYSTem:APPLIcation[:CURRent]:OPTion?	1096
:SYSTem:APPLIcation[:CURRent]:REVision?	1095
:SYSTem:COMMunicate:GPIB[1][:SELF]:ADDRes <integer>	277
:SYSTem:COMMunicate:GPIB[1][:SELF]:ADDRes?	277
:SYSTem:COMMunicate:GPIB[1][:SELF]:CONTRoller[:ENABle] ON OFF 0 1	277
:SYSTem:COMMunicate:GPIB[1][:SELF]:CONTRoller[:ENABle]?	277
:SYSTem:COMMunicate:LAN:SCPI:HISLip:ENABle OFF ON 0 1	280
:SYSTem:COMMunicate:LAN:SCPI:HISLip:ENABle?	280
:SYSTem:COMMunicate:LAN:SCPI:SICL:ENABle OFF ON 0 1	280

List of Commands

:SYSTem:COMMunicate:LAN:SCPI:SICL:ENABle?	280
:SYSTem:COMMunicate:LAN:SCPI:SOCKEt:CONTRol?	281
:SYSTem:COMMunicate:LAN:SCPI:SOCKEt:ENABle OFF ON 0 1	279
:SYSTem:COMMunicate:LAN:SCPI:SOCKEt:ENABle?	279
:SYSTem:COMMunicate:LAN:SCPI:TELNet:ENABle OFF ON 0 1	279
:SYSTem:COMMunicate:LAN:SCPI:TELNet:ENABle?	279
:SYSTem:COMMunicate:USB:CONNectiOn?	283
:SYSTem:COMMunicate:USB:PACKets?	284
:SYSTem:COMMunicate:USB:STATus?	284
:SYSTem:CONFigure[:SYSTem]?	226
:SYSTem:CSYStem?	226
:SYSTem:DATE "<year>,<month>,<day>"	305
:SYSTem:DATE?	305
:SYSTem:DEFault [ALL] ALIGn INPut MISC MODes PON	285
:SYSTem:ERRor[:NEXT]?	222
:SYSTem:ERRor:OVERload[:STATe] 0 1 OFF ON	224
:SYSTem:ERRor:VERBose OFF ON 0 1	224
:SYSTem:ERRor:VERBose?	224
:SYSTem:HELP:HEADers?	305
:SYSTem:HID?	291
:SYSTem:IDN <string>	282
:SYSTem:IDN?	282
:SYSTem:KLOCK OFF ON 0 1	304
:SYSTem:KLOCK?	304
:SYSTem:LiCense:EXTernal:LIST?	1259
:SYSTem:LiCense[:FPACK]:WAVEform:ADD <string>	1200
:SYSTem:LiCense[:FPACK]:WAVEform:CLear <int>	1203
:SYSTem:LiCense[:FPACK]:WAVEform:FREE?	1204
:SYSTem:LiCense[:FPACK]:WAVEform:LOCK <int>	1203
:SYSTem:LiCense[:FPACK]:WAVEform:NAME? <int>	1205
:SYSTem:LiCense[:FPACK]:WAVEform:REPLace <int>, <string>	1201

List of Commands

:SYSTem:LICense[:FPACk]:WAVeform:STATus? <int>	1204
:SYSTem:LICense[:FPACk]:WAVeform:UID? <int>	1205
:SYSTem:LICense[:FPACk]:WAVeform:USED?	1205
:SYSTem:LICense:LIST:DETail?	1260
:SYSTem:LKEY <"OptionInfo">, <"LicenseInfo">.....	290
:SYSTem:LKEY? <"OptionInfo">	291
:SYSTem:LKEY:DELeTe <"OptionInfo">,<"LicenseInfo">.....	290
:SYSTem:LKEY:LIST?	291
:SYSTem:LKEY:WAVeform:ADD <string>	1200
:SYSTem:LKEY:WAVeform:CLear <int>.....	1203
:SYSTem:LKEY:WAVeform:FREE?	1204
:SYSTem:LKEY:WAVeform:LOCK <int>.....	1203
:SYSTem:LKEY:WAVeform:NAME? <int>	1205
:SYSTem:LKEY:WAVeform:REPLace <int>, <string>.....	1201
:SYSTem:LKEY:WAVeform:STATus? <int>.....	1204
:SYSTem:LKEY:WAVeform:UID? <int>.....	1205
:SYSTem:LKEY:WAVeform:USED?.....	1205
:SYSTem:MRELay:COUNt?.....	294
:SYSTem:OPTions?	304
:SYSTem:PDOWn [NORMal FORCe]	304
:SYSTem:PON:APPLication:LLISt <string of INSTRument:SELeCt names>.....	234
:SYSTem:PON:APPLication:LLISt?.....	234
:SYSTem:PON:APPLication:VMEMory[:AVAILable]?.....	235
:SYSTem:PON:APPLication:VMEMory:TOTAL?	235
:SYSTem:PON:APPLication:VMEMory:USED?	235
:SYSTem:PON:APPLication:VMEMory:USED:NAME? <INSTRument:SELeCt name>	235
:SYSTem:PON:ETIME?.....	295
:SYSTem:PON:MODE SA BASIC ADEMOD NFIGURE PNOISE CDMA2K TDSCD- MA VSA VSA89601 WCDMA WIMAXOFDMA	230
:SYSTem:PON:MODE?.....	230
:SYSTem:PON:TIME?.....	250

List of Commands

:SYSTem:PON:TYPE MODE USER LAST	228
:SYSTem:PON:TYPE?	228
:SYSTem:PRESet	184
:SYSTem:PRESet:TYPE FACTory MODE USER	187
:SYSTem:PRESet:TYPE?	187
:SYSTem:PRESet:USER	308
:SYSTem:PRESet:USER:ALL	309
:SYSTem:PRESet:USER:SAVE	309
:SYSTem:PRINt:THEMe TDColor TDMonochrome FCOLOR FMONochrome	181
:SYSTem:PRINt:THEMe?	181
:SYSTem:PUP:PROcEss	233
:SYSTem:SHOW OFF ERRor SYSTem HARDware LXI HWStatistIcs ALIGNment SOFTware CAPPLIcation	221
:SYSTem:SHOW?	221
:SYSTem:TEMPerature:HEXTreme?	294
:SYSTem:TEMPerature:LEXtreme?	294
:SYSTem:TEST:WCTS:[ALL]	296
:SYSTem:TEST:WCTS:FEC	297
:SYSTem:TEST:WCTS:FEC:RESult?	301
:SYSTem:TEST:WCTS:MPADapter	296
:SYSTem:TEST:WCTS:MPADapter:RESult?	300
:SYSTem:TEST:WCTS:SHOW:RESult FEC	300
:SYSTem:TEST:WCTS:SHOW:RESult MPADapter	299
:SYSTem:TEST:WCTS:SHOW:RESult SOURce	298
:SYSTem:TEST:WCTS:SOURce	296
:SYSTem:TEST:WCTS:SOURce:RESult?	299
:SYSTem:TIME “<hour>,<minute>,<second>”	306
:SYSTem:TIME?	306
:SYSTem:VERSion?	305
:TRACe[1] 2 3 4 5 6:DISPlay[:STATe] ON OFF 0 1	1309
:TRACe[1] 2 3 4 5 6:DISPlay[:STATe]?	1309
:TRACe[1] 2 3 4 5 6:TYPE WRITe AVERAge MAXHold MINHold	1301

List of Commands

:TRACe[1] 2 3 4 5 6:TYPE?	1301
:TRACe[1] 2 3 4 5 6:UPDate[:STATe] ON OFF 0 1	1309
:TRACe[1] 2 3 4 5 6:UPDate[:STATe]?	1309
:TRACe[1] 2 3:ACPower:DISPlay[:STATe] ON OFF 0 1	461
:TRACe[1] 2 3:ACPower:DISPlay[:STATe]?	461
:TRACe[1] 2 3:ACPower:TYPE WRITe AVERAge MAXHold MINHold	458
:TRACe[1] 2 3:ACPower:TYPE?	458
:TRACe[1] 2 3:ACPower:UPDate[:STATe] ON OFF 0 1	460
:TRACe[1] 2 3:ACPower:UPDate[:STATe]?	460
:TRACe:CHPower:TYPE WRITe AVERAge MAXHold MINHold	365
:TRACe:CHPower:TYPE?	365
:TRACe:CLEAr TRACE1 TRACE2 TRACE3 TRACE4 TRACE5 TRACE6	1318
:TRACe:CLEAr:ALL	1318
:TRACe:COpy TRACE1 TRACE2 TRACE3 TRACE4 TRACE5 TRACE6, TRACE1 TRACE2 TRACE3 TRACE4 TRACE5 TRACE6	1331
:TRACe:COpy?	1331
:TRACe[:DATA] TRACE1 TRACE2 TRACE3 TRACE4 TRACE5 TRACE6, <data>	1332
:TRACe[:DATA]? TRACE1 TRACE2 TRACE3 TRACE4 TRACE5 TRACE6	1333
:TRACe:EXCHange TRACE1 TRACE2 TRACE3 TRACE4 TRACE5 TRACE6, TRACE1 TRACE2 TRACE3 TRACE4 TRACE5 TRACE6	1331
:TRACe:EXCHange?	1331
:TRACe:MATH:MEAN? TRACE1 TRACE2 TRACE3 TRACE4 TRACE5 TRACE6	1337
:TRACe:MATH:SMOoth TRACE1 TRACE2 TRACE3 TRACE4 TRACE5 TRACE6	1336
:TRACe:MATH:SMOoth:POINts <integer>	1336
:TRACe:MATH:SMOoth:POINts?	1336
:TRACe:OBWidth:TYPE WRITe AVERAge MAXHold MINHold	640
:TRACe:OBWidth:TYPE?	640
:TRACe:SEMask:TYPE WRITe AVERAge MAXHold MINHold	560
:TRACe:SEMask:TYPE?	560
*TRG	176
:TRIGger:<measurement>[:SEquence]:IQ:SOURce EXTernal1 EXTernal2 IMMediate IQMag IDEMod QDE- Mod IINPut QINPut AIQMag	1345

List of Commands

:TRIGger:<measurement>[:SEquence]:IQ:SOURce?	1345
:TRIGger:<measurement>[:SEquence]:RF:SOURce EXTernal1 EXTernal2 IMMediate LINE FRAME RFBurst VIDeo IF ALARm LAN TV	1344
:TRIGger:<measurement>[:SEquence]:RF:SOURce?	1344
:TRIGger:<measurement>[:SEquence]:SOURce EXTernal1 EXTernal2 IMMediate LINE FRAME RFBurst VIDeo IF ALARm LAN IQMag IDEMod QDEMod IINPut QINPut AIQMag TV	1339
:TRIGger:<measurement>[:SEquence]:SOURce?	1339
:TRIGger TRIGger1 TRIGger2[:SEquence]:OUTPut HSWP MEASuring MAIN GATE GTRigger OEVEN SPOint SSWeep SSETtled S1Marker S2Marker S3Marker S4Marker OFF	980
:TRIGger TRIGger1 TRIGger2[:SEquence]:OUTPut?	980
:TRIGger TRIGger1 TRIGger2[:SEquence]:OUTPut:POLarity POSitive NEGative	981
:TRIGger TRIGger1 TRIGger2[:SEquence]:OUTPut:POLarity?	981
:TRIGger:CDPower[:SEquence]:SOURce EXTernal[1] EXTernal2 IMMediate LINE FRAME RFBurst VIDeo IF	716
:TRIGger:CDPower[:SEquence]:SOURce?	716
:TRIGger:RHO[:SEquence]:SOURce EXTernal[1] EXTernal2 IMMediate LINE FRAME RFBurst VIDeo IF	770
:TRIGger:RHO[:SEquence]:SOURce?	770
:TRIGger[:SEquence]:AIQMag:BANDwidth <freq>	1383
:TRIGger[:SEquence]:AIQMag:BANDwidth?	1383
:TRIGger[:SEquence]:AIQMag:CENTer <freq>	1382
:TRIGger[:SEquence]:AIQMag:CENTer?	1382
:TRIGger[:SEquence]:AIQMag:DELay <time>	1382
:TRIGger[:SEquence]:AIQMag:DELay?	1382
:TRIGger[:SEquence]:AIQMag:DELay:STATe OFF ON 0 1	1382
:TRIGger[:SEquence]:AIQMag:DELay:STATe?	1382
:TRIGger[:SEquence]:AIQMag:LEVel <ampl >	1381
:TRIGger[:SEquence]:AIQMag:LEVel?	1381
:TRIGger[:SEquence]:AIQMag:SLOPe POSitive NEGative	1381
:TRIGger[:SEquence]:AIQMag:SLOPe?	1381
:TRIGger[:SEquence]:ATRigger <time>	1389
:TRIGger[:SEquence]:ATRigger?	1389
:TRIGger[:SEquence]:ATRigger:STATe OFF ON 0 1	1389

List of Commands

:TRIGger[:SEQuence]:ATRigger:STATe?	1389
:TRIGger[:SEQuence]:DELay <time>	1351
:TRIGger[:SEQuence]:DELay?	1351
:TRIGger[:SEQuence]:DELay:STATe OFF ON 0 1	1351
:TRIGger[:SEQuence]:DELay:STATe?	1351
:TRIGger[:SEQuence]:EXTernal1:DELay <time>	1356
:TRIGger[:SEQuence]:EXTernal1:DELay?	1356
:TRIGger[:SEQuence]:EXTernal1:DELay:COMPensation OFF ON 0 1	1356
:TRIGger[:SEQuence]:EXTernal1:DELay:COMPensation?	1356
:TRIGger[:SEQuence]:EXTernal1:DELay:STATe OFF ON 0 1	1356
:TRIGger[:SEQuence]:EXTernal1:DELay:STATe?	1356
:TRIGger[:SEQuence]:EXTernal1:LEVel <level>	1354
:TRIGger[:SEQuence]:EXTernal1:LEVel?	1354
:TRIGger[:SEQuence]:EXTernal1:SLOPe POSitive NEGative	1355
:TRIGger[:SEQuence]:EXTernal1:SLOPe?	1355
:TRIGger[:SEQuence]:EXTernal2:DELay <time>	1359
:TRIGger[:SEQuence]:EXTernal2:DELay?	1359
:TRIGger[:SEQuence]:EXTernal2:DELay:COMPensation OFF ON 0 1	1359
:TRIGger[:SEQuence]:EXTernal2:DELay:COMPensation?	1359
:TRIGger[:SEQuence]:EXTernal2:DELay:STATe OFF ON 0 1	1359
:TRIGger[:SEQuence]:EXTernal2:DELay:STATe?	1359
:TRIGger[:SEQuence]:EXTernal2:LEVel	1358
:TRIGger[:SEQuence]:EXTernal2:LEVel?	1358
:TRIGger[:SEQuence]:EXTernal2:SLOPe POSitive NEGative	1358
:TRIGger[:SEQuence]:EXTernal2:SLOPe?	1358
:TRIGger[:SEQuence]:FRAMe:ADJust <time>	1368
:TRIGger[:SEQuence]:FRAMe:DELay <time>	1372
:TRIGger[:SEQuence]:FRAMe:DELay?	1372
:TRIGger[:SEQuence]:FRAMe:DELay:STATe OFF ON 0 1	1372
:TRIGger[:SEQuence]:FRAMe:DELay:STATe?	1372
:TRIGger[:SEQuence]:FRAMe:OFFSet <time>	1367

List of Commands

:TRIGger[:SEQuence]:FRAMe:OFFSet?	1367
:TRIGger[:SEQuence]:FRAMe:OFFSet:DISPlay:RESet	1369
:TRIGger[:SEQuence]:FRAMe:PERiod <time>	1366
:TRIGger[:SEQuence]:FRAMe:PERiod?	1366
:TRIGger[:SEQuence]:FRAMe:SYNC EXTernal1 EXTernal2 RFBurst OFF	1370
:TRIGger[:SEQuence]:FRAMe:SYNC?	1370
:TRIGger[:SEQuence]:FRAMe:SYNC:HOLDoff <time>	1373
:TRIGger[:SEQuence]:FRAMe:SYNC:HOLDoff?	1373
:TRIGger[:SEQuence]:FRAMe:SYNC:HOLDoff:STATe OFF ON 0 1	1373
:TRIGger[:SEQuence]:FRAMe:SYNC:HOLDoff:STATe?	1373
:TRIGger[:SEQuence]:HOLDoff <time>	1390
:TRIGger[:SEQuence]:HOLDoff?	1390
:TRIGger[:SEQuence]:HOLDoff:STATe OFF ON 0 1	1390
:TRIGger[:SEQuence]:HOLDoff:STATe?	1390
:TRIGger[:SEQuence]:HOLDoff:TYPE NORMAl ABOVe BELow	1391
:TRIGger[:SEQuence]:HOLDoff:TYPE?	1391
:TRIGger[:SEQuence]:IDEMod:DELay <time>	1376
:TRIGger[:SEQuence]:IDEMod:DELay?	1376
:TRIGger[:SEQuence]:IDEMod:DELay:STATe OFF ON 0 1	1376
:TRIGger[:SEQuence]:IDEMod:DELay:STATe?	1376
:TRIGger[:SEQuence]:IDEMod:LEVel <voltage>	1375
:TRIGger[:SEQuence]:IDEMod:LEVel?	1375
:TRIGger[:SEQuence]:IDEMod:SLOPe POSitive NEGative	1376
:TRIGger[:SEQuence]:IDEMod:SLOPe?	1376
:TRIGger[:SEQuence]:IINPut:DELay <time>	1379
:TRIGger[:SEQuence]:IINPut:DELay?	1379
:TRIGger[:SEQuence]:IINPut:DELay:STATe OFF ON 0 1	1379
:TRIGger[:SEQuence]:IINPut:DELay:STATe?	1379
:TRIGger[:SEQuence]:IINPut:LEVel <voltage>	1378
:TRIGger[:SEQuence]:IINPut:LEVel?	1378
:TRIGger[:SEQuence]:IINPut:SLOPe POSitive NEGative	1378

List of Commands

:TRIGger[:SEquence]:IINPut:SLOPe?	1378
:TRIGger[:SEquence]:IQMag:DELAy <time>	1374
:TRIGger[:SEquence]:IQMag:DELAy?	1374
:TRIGger[:SEquence]:IQMag:DELAy:STATe OFF ON 0 1	1374
:TRIGger[:SEquence]:IQMag:DELAy:STATe?	1374
:TRIGger[:SEquence]:IQMag:LEVel <ampl >	1374
:TRIGger[:SEquence]:IQMag:LEVel?	1374
:TRIGger[:SEquence]:IQMag:SLOPe POSitive NEGative	1374
:TRIGger[:SEquence]:IQMag:SLOPe?	1374
:TRIGger[:SEquence]:LINE:DELAy <time>	1353
:TRIGger[:SEquence]:LINE:DELAy?	1353
:TRIGger[:SEquence]:LINE:DELAy:STATe OFF ON 0 1	1353
:TRIGger[:SEquence]:LINE:DELAy:STATe?	1353
:TRIGger[:SEquence]:LINE:SLOPe POSitive NEGative	1353
:TRIGger[:SEquence]:LINE:SLOPe?	1353
:TRIGger[:SEquence]:OFFSet <time>	1352
:TRIGger[:SEquence]:OFFSet?	1352
:TRIGger[:SEquence]:OFFSet:STATe OFF ON 0 1	1352
:TRIGger[:SEquence]:OFFSet:STATe?	1352
:TRIGger[:SEquence]:QDEMod:DELAy <time>	1377
:TRIGger[:SEquence]:QDEMod:DELAy?	1377
:TRIGger[:SEquence]:QDEMod:DELAy:STATe OFF ON 0 1	1377
:TRIGger[:SEquence]:QDEMod:DELAy:STATe?	1377
:TRIGger[:SEquence]:QDEMod:LEVel <voltage>	1377
:TRIGger[:SEquence]:QDEMod:LEVel?	1377
:TRIGger[:SEquence]:QDEMod:SLOPe POSitive NEGative	1377
:TRIGger[:SEquence]:QDEMod:SLOPe?	1377
:TRIGger[:SEquence]:QINPut:DELAy <time>	1380
:TRIGger[:SEquence]:QINPut:DELAy?	1380
:TRIGger[:SEquence]:QINPut:DELAy:STATe OFF ON 0 1	1380
:TRIGger[:SEquence]:QINPut:DELAy:STATe?	1380

List of Commands

:TRIGger[:SEQuence]:QINPut:LEVel <voltage>	1379
:TRIGger[:SEQuence]:QINPut:LEVel?	1379
:TRIGger[:SEQuence]:QINPut:SLOPe POSitive NEGative	1380
:TRIGger[:SEQuence]:QINPut:SLOPe?	1380
:TRIGger[:SEQuence]:RFBurst:DELay <time>	1364
:TRIGger[:SEQuence]:RFBurst:DELay?	1364
:TRIGger[:SEQuence]:RFBurst:DELay:COMPensation OFF ON 0 1	1364
:TRIGger[:SEQuence]:RFBurst:DELay:COMPensation?	1364
:TRIGger[:SEQuence]:RFBurst:DELay:STATe OFF ON 0 1	1364
:TRIGger[:SEQuence]:RFBurst:DELay:STATe?	1364
:TRIGger[:SEQuence]:RFBurst:LEVel:ABSolute <ampl>	1361
:TRIGger[:SEQuence]:RFBurst:LEVel:ABSolute?	1361
:TRIGger[:SEQuence]:RFBurst:LEVel:RELative <rel_ampl>	1362
:TRIGger[:SEQuence]:RFBurst:LEVel:RELative?	1362
:TRIGger[:SEQuence]:RFBurst:LEVel:TYPE ABSolute RELative	1361
:TRIGger[:SEQuence]:RFBurst:LEVel:TYPE?	1361
:TRIGger[:SEQuence]:RFBurst:SLOPe POSitive NEGative	1363
:TRIGger[:SEQuence]:RFBurst:SLOPe?	1363
:TRIGger[:SEQuence]:SLOPe POSitive NEGative	1350
:TRIGger[:SEQuence]:SLOPe?	1350
:TRIGger[:SEQuence]:TV:FMODE ENTire ODD EVEN	1385
:TRIGger[:SEQuence]:TV:FMODE?	1385
:TRIGger[:SEQuence]:TV:LINE <integer>	1384
:TRIGger[:SEQuence]:TV:LINE?	1384
:TRIGger[:SEQuence]:TV:STANdard MNTSc JNTSc NTSC443 MPAL BPAL NPAL CPAL PAL60 LSEC	1387
:TRIGger[:SEQuence]:TV:STANdard?	1387
:TRIGger[:SEQuence]:VIDeo:DELay <time>	1350
:TRIGger[:SEQuence]:VIDeo:DELay?	1350
:TRIGger[:SEQuence]:VIDeo:DELay:STATe OFF ON 0 1	1350
:TRIGger[:SEQuence]:VIDeo:DELay:STATe?	1350
:TRIGger[:SEQuence]:VIDeo:LEVel <ampl>	1349

List of Commands

:TRIGger[:SEquence]:VIDeo:LEVel?	1349
:TRIGger[:SEquence]:VIDeo:SLOPe POSitive NEGative	1350
:TRIGger[:SEquence]:VIDeo:SLOPe?	1350
*TST?	176
:UNIT:ACPower:POWer:PSD DBMHZ DBMMHZ	435
:UNIT:ACPower:POWer:PSD?	435
:UNIT:CHPower:POWer:PSD DBMHZ DBMMHZ	346
:UNIT:CHPower:POWer:PSD?	346
:UNIT:POWer DBM DBMV DBMA V W A DBUV DBUA DBPW DBUVM DBUAM DBPT DBG	871
:UNIT:POWer?	871
*WAL	177

1 Using Help

The online Help system is "context-sensitive", which means that the information displayed when you invoke the Help system depends on the selected instrument Mode, Measurement and key.

NOTE The instructions for using help are applicable to the instrument front-panel as well as a virtual front panel.

TIP To view help for any front-panel key or menu key, press that key while this Help Window is open.

To scroll any page vertically, press the **Down Arrow** or **Up Arrow** front-panel keys. To locate these keys, see [“Front Panel Keys used by the Help System” on page 105](#).

NOTE **E6607C:** When using the E6607C there is no instrument front-panel. Therefore, the PC mouse and monitor are required for instrument control through a virtual front panel (VFP). For ease in using the VFP, the PC keyboard is recommended.

Structure of Help

See [“How Help is Organized” on page 102](#).

Navigating Help

- If the instrument has an attached mouse, see [“Navigating Help with a Mouse” on page 109](#).
- If the instrument does not have an attached mouse, see [“Navigating Help Without a Mouse” on page 110](#).

For specific details of how to navigate to topics, see [“Finding a Topic” on page 114](#).

- You can also copy the Help files to a separate computer and view them there. For details, see [“Viewing Help Files on a separate Computer” on page 117](#).

Locating Other Documentation

See [“Other Help Resources” on page 119](#).

Key Path	Front-panel key
----------	-----------------

How Help is Organized

This topic includes:

- “Help Contents Listing” on page 102
- “Key Descriptions for Each Measurement” on page 103
- “Key Information for Softkeys” on page 103
- “Common Measurement Functions” on page 104

Help Contents Listing

The listing under the Contents tab in the Help Window includes a topic for each Front-panel key and each softkey, for each available measurement.

The Contents listing is split into several major sections, as shown below for the HTML Help version of the document. The structure of the PDF version is similar.



Help information is split between these sections as follows:

1. Using Help

This section.

2. Additional Documentation

Describes available documents for the test set, with links to allow you to download or open the files.

3. About the Analyzer

Provides general information about the instrument.

4. About this Mode or Measurement Application

Provides an overview of the currently-selected Measurement Application

5. Programming the Test Set

Provides an overview of available programming information. Includes a list of all SCPI commands for the currently-selected Measurement Application.

6. System Functions

This section contains information for the following front-panel keys, which are listed in alphabetical order: **File, Preset, Print, Quick Save, Recall, Save, System, User Preset**.

The functions of these keys do not vary between measurements: they operate the same way, irrespective of which instrument measurement you have selected.

The sections for **Recall** and **Save** contain only cross-references to the respective sections in “[Common Measurement Functions](#)” on page 104, and are included here for convenience.

7. Measurement Functions

See “[Key Descriptions for Each Measurement](#)” on page 103 below.

8. Common Measurement Functions

See “[Common Measurement Functions](#)” on page 104 below.

Key Descriptions for Each Measurement

The Contents section for each Measurement is sub-divided into topics for each front-panel key, in alphabetical order, as shown below.

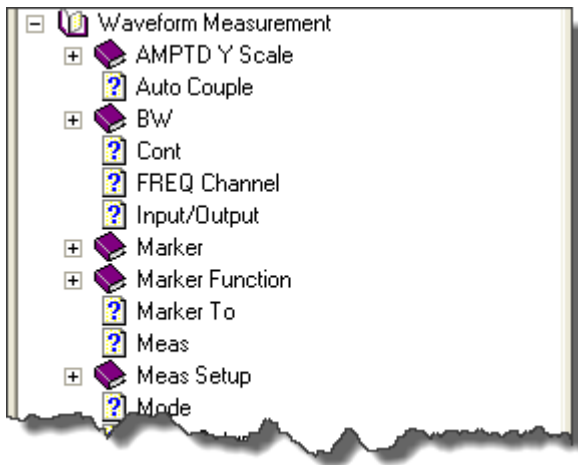

When you expand any front-panel key section, you will see a listing of softkeys in the menu for that front-panel key (if there is a menu), plus any SCPI Remote Commands associated with the functionality, as described in “[Key Information for Softkeys](#)” on page 103 below.

If you don’t see a topic for a front-panel key in the Measurement-specific section, then it is located in the System Functions section.

Key Information for Softkeys

Information for each softkey that appears when you press a front-panel key (or a softkey with a submenu) is listed under the entry for each key.

The example below shows the submenu under the **SPAN X Scale** Front-panel key in the "Waveform"

Measurement, alongside the actual softkeys for that menu.

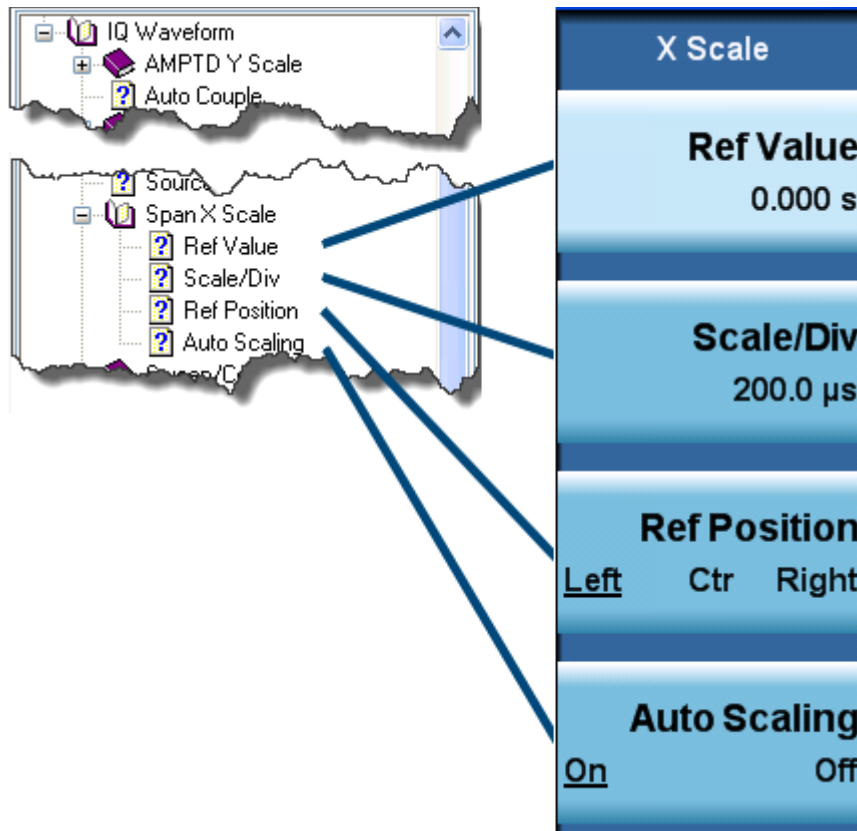

In these subsections, all softkeys are listed in the order they appear in their menu (that is, **not** in alphabetical order).

Common Measurement Functions

This section groups together function and key information that is shared between measurements. However, there is a listing for every front-panel key and subkey in the [Key Descriptions for Each Measurement](#), so you will generally not need to refer to this section.

The key subsections are listed alphabetically.

NOTE The presence of a key or command description in this section indicates that it is available in more than one measurement. Its presence does **not** indicate that the functionality is necessarily available in all measurements.

Front Panel Keys used by the Help System

The interactive Help system uses the front-panel keys shown below.

E6607A/B



E6607C

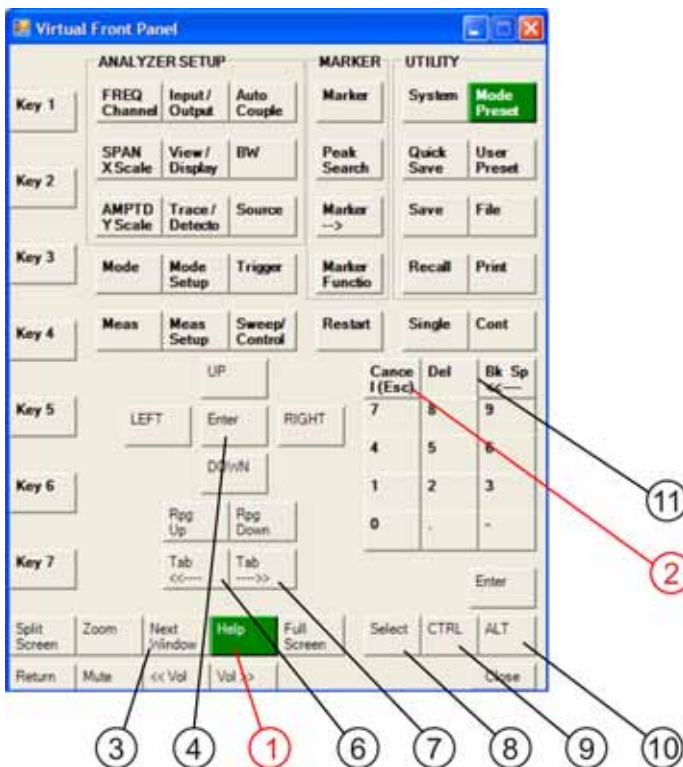

Using Help

Front Panel Keys used by the Help System

Item		Description
#	Name	
1	Help Key	Opens Help (displaying the topic for the last key pressed).
2	Cancel (Esc) Key	Exits Help.
3	Next Window Key	Changes the current window pane selection.
4	Arrow / Enter Keys	A central Enter key, surrounded by four directional arrow keys. Navigates within the Help system.
5	Knob	For future use.
6	Backward Tab Key	Moves between controls in the Help display.
7	Forward Tab Key	Moves between controls in the Help display.
8	Select / Space Key	Navigates within the Help system, in conjunction with other keys.
9	Ctrl Key	Navigates within the Help system, in conjunction with other keys. See “Navigating the Help Files” on page 107 .
10	Alt Key	Navigates within the Help system, in conjunction with other keys. See “Navigating the Help Files” on page 107 .
11	Bk Sp (Backspace) Key	Acts as a "Back" key when navigating the pages of the Help system.

Navigating the Help Files

This topic includes:

- “Help Window Components” on page 107
- “Basic Help Window Operations” on page 108
- “Navigating Help with a Mouse” on page 109

Help Window Components

The Help Window appears on top of, and to the left of, the measurement display. When Help is open, the instrument’s display appears as below.



1. Application Title Bar

The instrument retains its current Mode and Measurement when Help is open, as shown in the Title Bar.

2. Help Button Bar

These buttons provide shortcuts to frequently-used help functions, including printing.

3. Help Navigation Pane Tabs

Click one of these tabs to display either the Table of Contents, Index, Search, or Favorites controls.

4. Help Navigation Pane

5. Help Topic Pane

6. Previous Page and Next Page Buttons

Use these buttons to move to the previous or next page in the Help file.

7. Application Softkey Menu

You can still see and use the current softkey menu when Help is open.

When Help is open, pressing a softkey displays Help for that softkey, but does **not** execute the softkey’s function.

Basic Help Window Operations

This topic includes:

- “Opening Help” on page 108
- “Getting Help for a Specific Key” on page 108
- “Closing Help” on page 108
- “Viewing Help on Using Help” on page 108

For more Help window operations, see “Navigating Help Without a Mouse” on page 110.

To locate the keys mentioned in this section, see “Front Panel Keys used by the Help System” on page 105.

Opening Help

To access the Help system, press the green **Help** key below the front panel display while an Agilent application is running.



Note that the softkey menu remains visible when Help is open.

Getting Help for a Specific Key

- If Help **is** already open, press the desired key. The relevant Help topic appears.
The function normally invoked by the key is **not** executed when the key is pressed with Help open.
If you want to execute the key’s function, first close Help by pressing the **Cancel (Esc)** key (as described in “Closing Help” on page 108), then press the key, before opening Help again (if required).
- If Help is **not** already open, press the desired key (which executes the key’s function), then press the **Help** key to display the relevant Help page. Help is available for all softkeys, and for all the front-panel keys listed under the "System Functions" and "Measurement" sections.

For details of how to navigate within the panes of the Help window, see “Navigating the Help Files” on page 107.

Closing Help

To close Help, and return to the measurement application, press the **Cancel (Esc)** key (depicted below).



Viewing Help on Using Help

With the Help window open, press the green **Help** key a second time.

The "Using Help" page appears.

To exit Help on Using Help, press the **Bk Sp** key, or see [“Topic Pane Operations” on page 112](#) for equivalent methods.



Navigating Help with a Mouse

When Help is open, you can point-and-click to navigate, as you would when using Help for any Microsoft Windows computer application.

If you also have a keyboard attached to the instrument, you can use the Help system's full-text search feature to locate help for any topic, by typing in a key name, a topic name, or any other desired text. See [“Searching for a Help Topic” on page 110](#).

Selecting a Topic from the Contents Listing

To select and display a topic, do the following:

- If necessary, press the green **Help** key on the Front Panel, as described in [“Opening Help” on page 108](#), to open Help.
- Choose the desired topic from the list under the Contents Tab of the Navigation Pane, then click on the topic title to display the first page of the topic.
- To expand the tree and display a listing of subtopics (if any), click on the + icon to the left of the topic's book icon, as shown below.

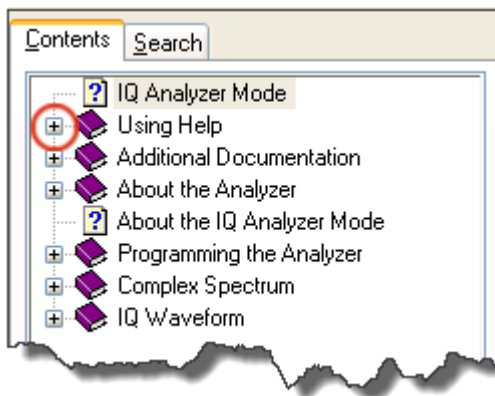

- To move to the next or previous page within a topic, click the **Next Page** or **Previous Page** keys (at the top right of the **Topic Pane**), as shown below.



Searching for a Help Topic

Select the "Search" tab of the Help Navigation Pane, then use the following procedure:

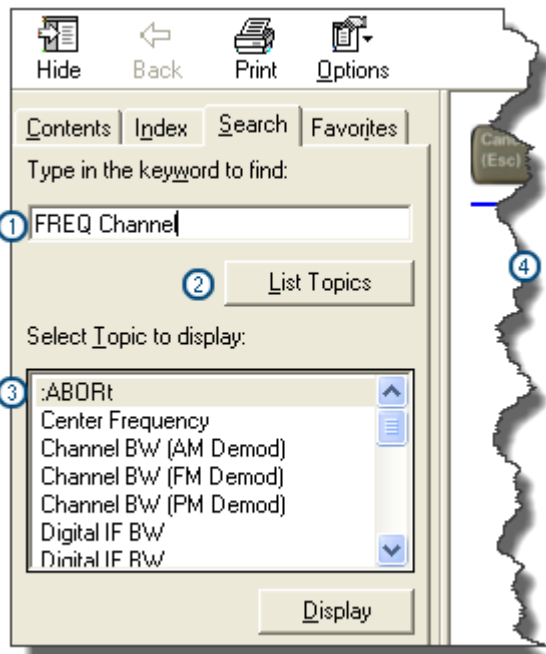

1. Type the desired topic text into the Search edit box. Note that the text search is **not** case-sensitive.
2. Click on the **List Topics** button.
3. **Either:**
 - Double-click on the desired topic in the list,
 - Or:**
 - Click on the desired topic to select it, then click the **Display** button beneath the list.
4. The topic is displayed in the Topic Pane.

Navigating Help Without a Mouse

Most features of the Help system can be accessed and navigated without attaching a mouse or keyboard to the instrument.

There are a few exceptions, as noted in [“Functions that cannot be used without a Mouse and Keyboard” on page 114.](#)

This topic includes:

- [“Next Window Key” on page 111](#)
- [“Contents Tab \(Navigation Pane\) Operations” on page 111](#)
- [“Topic Pane Operations” on page 112](#)
- [“Selecting a Hyperlink” on page 113](#)

- [“Finding a Topic” on page 114](#)

To locate all the keys mentioned in this section, see [“Front Panel Keys used by the Help System” on page 105](#).

Next Window Key

- To toggle the focus between the Navigation Pane and the Topic Pane, press the **Next Window** key.



Contents Tab (Navigation Pane) Operations

- To switch the active tab, hold down the **Ctrl** key, then press either the **Forward Tab** or **Backward Tab** key.



- To scroll **horizontally**, hold down the **Ctrl** key, then press either the **Left Arrow** or **Right Arrow** keys.

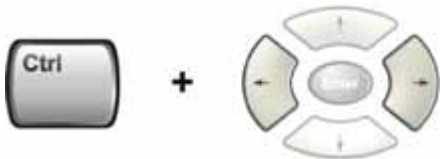

- To scroll **vertically**, hold down the **Ctrl** key, then press either the **Up Arrow** or **Down Arrow** keys.

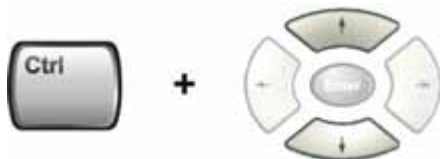

- To scroll up or down the list of topics, press the **Up Arrow** or **Down Arrow** keys.



Using Help

Navigating the Help Files

- To display a selected topic in the Topic Pane, select it in the Contents listing, then press the **Enter** key.



- To expand or collapse a selected topic, press the **Right Arrow** or **Left Arrow** key.

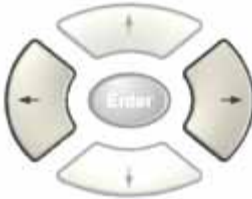

Topic Pane Operations

- To scroll up or down within a topic, press either the **Up Arrow** key or **Down Arrow** key.



- To go **back** (that is, to display the previously-viewed topic), **either**:
Hold down the **Alt** key, then press the **Left Arrow** key.

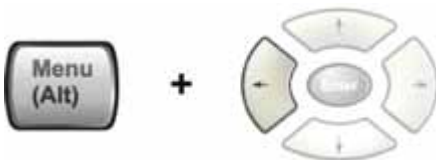

Or:

Press the **Bk Sp** key.



- To go **forward**, hold down the **Alt** key, then press the **Right Arrow** key.

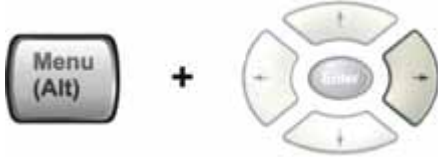

(The "Forward" operation has no effect unless there have been previous "Back" operations.)

- To go to the next or previous page, use the **Forward Tab** or **Backward Tab** keys



to select the **Next Page** or **Previous Page** key



then press **Enter**.



- To print the currently displayed, topic, press the Front-panel **Print** key



Selecting a Hyperlink

To select and follow a hyperlink on a Help page:.

1. Ensure that the focus is in the **Topic Pane**.

(If necessary, toggle the focus between the Navigation Pane and the Topic Pane by pressing the [Next Window Key](#).)

2. Move from link to link in the Topic Pane by pressing the **Forward Tab** and **Backward Tab** keys.



Links become highlighted upon selection.

Using Help

Navigating the Help Files

3. When you have selected the desired link, activate it by pressing the **Enter** key.



Finding a Topic

To display a different Help topic by selecting it from the Contents tab of the Navigation Pane:

1. Ensure that the focus is in the Contents tab of the Navigation Pane.
(If necessary, toggle the focus between the Navigation Pane and the Topic Pane, by pressing the [Next Window Key](#). Then press **Ctrl + Forward Tab** or **Backward Tab** to select the Contents tab.)
2. Move up or down the Contents list, by pressing the **Up Arrow** or **Down Arrow** keys.

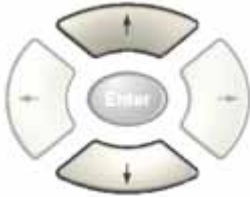

Topics become highlighted upon selection.

3. Display the selected topic, by pressing the **Enter** key.

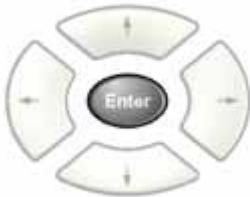

Functions that cannot be used without a Mouse and Keyboard

The following parts of the HTML Help System **cannot** easily be used without attaching a mouse and keyboard to the instrument.

- The buttons in the Help Button Bar, consisting of: **Hide**, **Back**, **Print** and **Options**.
- The functionality of the Search Tab of the Navigation Pane.
- The functionality of the Favorites Tab of the Navigation Pane.

Definition of Terms

Many special terms are used throughout this documentation. The table below provides brief definitions of commonly-used terms. Please refer to the "Getting Started Guide" for detailed explanations.

Term	Meaning
Default Unit	The default measurement unit of the setting.
Default Terminator	Indicates the units that will be attached to the numeric value that you have entered. This default will be used from the front panel, when you terminate your entry by pressing the Enter key, rather than selecting a units key. This default will be used remotely when you send the command without specifying any units after your value(s).
Dependencies/ Couplings	Some commands may be unavailable when other parameters are set in certain ways. If applicable, any such limitations are described here.
Example	Provides command examples using the indicated remote command syntax.
Factory Preset	Describes the function settings after a Factory Preset .
Key Path	The sequence of Front-panel keys that accesses the function or setting.
Knob Increment/Decrement	The numeric value of the minimum increment or decrement that is applied when turning the thumb wheel knob.
Max	The Maximum numerical value that the setting can take.
Min	The Minimum numerical value that the setting can take.
Meas Global	The functionality described is the same in all measurements.
Meas Local	The functionality described is only true for the measurement selected.
Mode Global	The functionality described is the same for all modes.
Preset	In some cases, a Preset operation changes the status of a parameter. If the operation of the key specified is modified by a Preset operation, the effect is described here.
Range	Describes the range of the smallest to largest values to which the function can be set. If you try to set a value below the minimum value, the instrument defaults to the minimum value. If you try to set a value above the maximum value, the instrument defaults to the maximum value.
Remote Command	Shows the syntax requirements for each SCPI command.
Remote Command Notes	Additional notes regarding Remote Commands.
Resolution	Specifies the smallest change that can be made to the numeric value of a parameter.
SCPI Status Bits/ OPC Dependencies	Pressing certain keys may affect one or more status bits. If applicable, details are given here.

Term	Meaning
State Saved	Indicates what happens to a particular function when the instrument state is saved (either to an external memory device or the internal D: drive). It also indicates whether the current settings of the function are maintained if the instrument is powered on or preset using Power On Last State or User Preset .

Viewing Help Files on a separate Computer

You may want to view the help pages **without** having them appear on top of the instrument's screen.

Two separate Help files are available for each instrument Mode (or Measurement Application). The two files contain all the same help pages in different formats:

1. HTML Help (CHM) format.

These files are installed on the instrument's hard disk. To copy these files to another computer, see ["Copying the HTML Help \(CHM\) Files" on page 118](#) below.

2. Adobe Acrobat (PDF) format.

These files are called "Users & Programmers References". They are included on the Documentation CD supplied with the instrument, or may be downloaded from the Agilent web site.

For details of how to navigate PDF files, see ["Navigating Acrobat \(PDF\) Files" on page 119](#).

You can copy any of the CHM or PDF files to another computer, then open and view the help pages in the file on that computer.

Your choice of which file to copy and view may depend on what you want to do with the file (for example, whether you want to print it and read the paper copy, or view it on the computer).

The table below compares the relative advantages of the two formats:

Format Type	HTML Help Format (CHM Files)	Acrobat Format (PDF Files)
File Extension	CHM	PDF
Software Required to view file	Microsoft Windows operating system only, with Microsoft Internet Explorer installed.	Free Adobe Reader software can be downloaded for many operating systems, including: Microsoft Windows, Macintosh, Linux, Solaris.
Full Text Search?	Yes	Yes
Printable?	Yes, but with limited control.	Yes. Full print control. See "Printing Acrobat Files" on page 120 .
Printable Table of Contents?	No	Yes
Navigable without a Mouse and Keyboard?	Yes, but with some loss of functionality.	No
Has Page Numbers?	No	Yes
Context-Sensitive Display?	Yes, when viewed using the X-Series Analyzer application window.	No
Indexed?	Yes	No
Active Hyperlinks?	Yes	Yes

Copying the HTML Help (CHM) Files

You can find the HTML Help (.chm) files:

- **Either**, on the documentation CD that came with the instrument,
- **Or**, in a special directory on the instrument's hard disk. The directory path is:

C:\Program Files\Agilent\SignalAnalysis\Infrastructure\Help

NOTE You can open and view the HTML Help files only on a computer that has Microsoft Windows and Microsoft Internet Explorer installed.

Other Help Resources

- All available documentation is present either on the test set hard disk, either as HTML Help or Acrobat PDF files, or may be downloaded from the Agilent web site.
- Many of the supporting documents use the Adobe Acrobat (PDF) file format. You can view PDF files using the pre-installed Adobe Reader software.

The Adobe Reader user interface differs from the Windows Help interface. For full details, see [“Navigating Acrobat \(PDF\) Files” on page 119](#) and [“Printing Acrobat Files” on page 120](#).

Navigating Acrobat (PDF) Files

IMPORTANT To navigate PDF files effectively, you must attach a mouse and keyboard to the instrument. If it is not possible to attach a mouse and keyboard to the instrument, you should transfer the PDF file to a separate computer, then open it on that computer.

Acrobat Reader Window

When a PDF file is open and being viewed, the instrument’s display shows the Adobe Acrobat Reader Window, which has the following features.

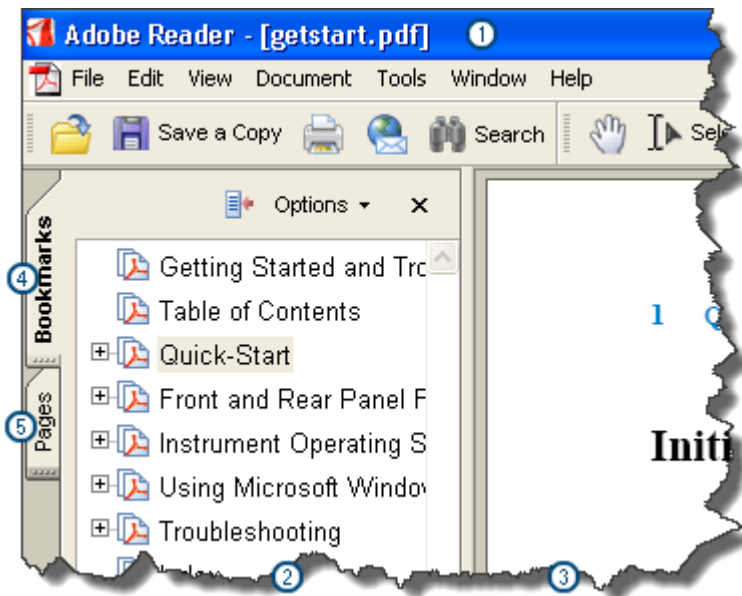

1. Adobe Acrobat Reader Window title bar
2. Navigation Pane
3. Document Pane
4. Navigation Pane: Bookmarks tab

5. Navigation Pane: Pages tab

The Navigation Pane also has tabs labeled Attachments and Comments, but, typically, PDF files for Agilent X-Series Analyzers contain useful content only under the Bookmarks and Pages Tabs.

Unlike the HTML Help Window, the Acrobat Reader Window is **not** embedded in the instrument's Application window, but can be resized, moved and closed independently of the Application window.

Printing Acrobat Files

NOTE The driver for the appropriate printer must be installed on the instrument's hard disk before any file can be printed. For driver installation instructions, see the printer manufacturer's documentation.

To print all or part of an open Acrobat file from the instrument, do the following.

1. **Either,**
 - a. click on the Print icon in the Acrobat Reader toolbar,
The image shows a standard printer icon, which is a small graphic of a printer with a sheet of paper coming out of the tray. It is rendered in a light blue and grey color scheme with a slight drop shadow.
 - b. **or,** select File > Print from the menu.
2. The Acrobat Reader Print dialog opens.
3. Choose the desired options within the Print dialog, then click OK to print (or click Cancel to cancel printing).

NOTE Clicking the Properties button within the Print dialog opens a window containing controls that are specific to the printer model installed. Check the printer manufacturer's documentation for details of these capabilities.

2

About the Test Set

The EXT Wireless Communication Test Set is a one-box tester, combining a vector signal analyzer with a vector signal source in a single instrument. The analyzer and source are each provided with a dedicated list sequencer, for rapid execution of a series of stimulus or measurement steps. The test set is optimized for production testing (including calibration and verification) of wireless mobile devices.

E6607A/B



E6607C

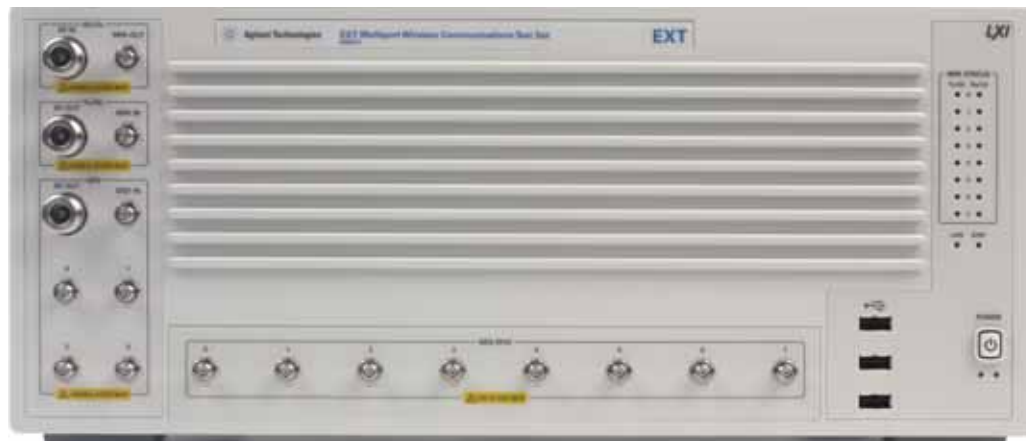

How the Test Set Is Used

The E6607A/B/C Wireless Communication Test Set is typically used in a production test environment where mobile devices are being calibrated and verified in a “non-signalling” mode (that is, in a mode of operation which does not involve call processing, and which relies instead on test functions which are built into the device under test).

The test controller communicates with both the DUT and the test set to coordinate Rx and Tx test operations and to collect test results. However, both the DUT and the test set perform their own independent operations during the process (for example, internal test routines run by the DUT, and sequences run by the test set).

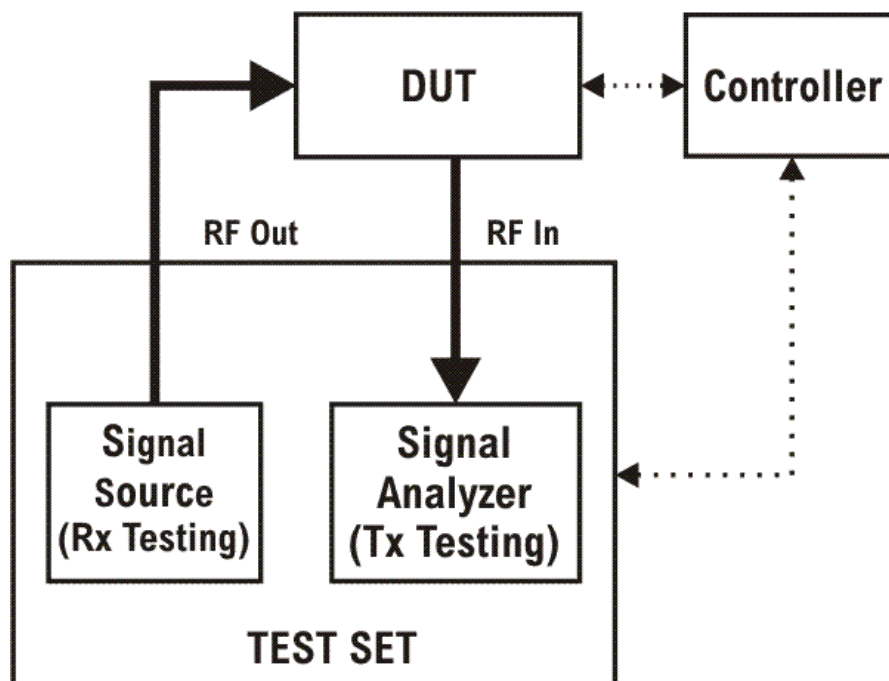

Receiver Testing

The source within the test set can supply test signals to the DUT for the purpose of receiver testing. Typically the source plays a waveform which has been downloaded to the test set (for example, a .wfm file generated using Agilent Signal Studio or some other application). In receiver testing, the test set is providing the necessary stimulus for measurements which are performed by the DUT itself, using its built-in self-test capabilities. The test results (bit error rate, for example) come back to the controller from the DUT rather than from the test set.

Transmitter Testing

The signal analyzer within the test set receives and measures signals from the DUT for the purpose of transmitter testing. Because the DUT is not being operated in a call-processing mode, the measurements

made by the analyzer pertain to signal quality (power, modulation accuracy, and so on) rather than to the data content of the transmitted signal. In transmitter testing, the measurement results come back to the controller from the test set rather than the DUT.

Hardware Elements of the Test Set

The test set includes a source and analyzer, which operate independently. You can control either of them directly (using front panel keys, the virtual front panel, or remote commands) or indirectly (by running a sequence, in which case the source and analyzer are operated by their list sequencers).

The source list sequencer and analyzer list sequencer function independently; however, you can coordinate their actions by setting them up to exchange trigger signals.

E6607A/B

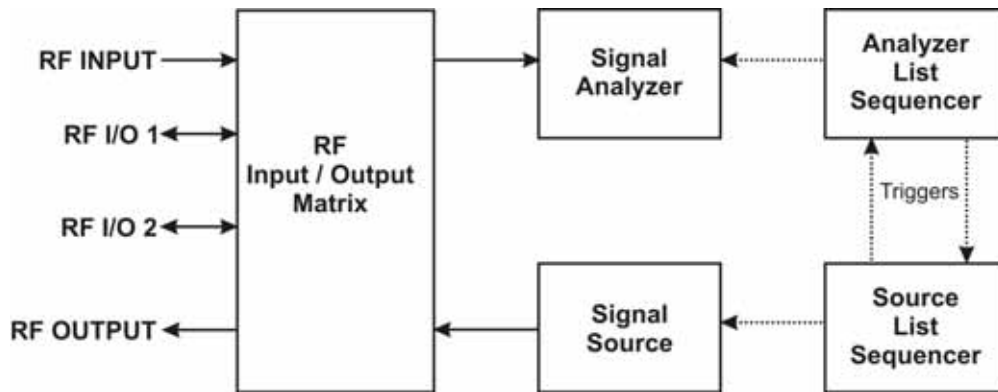

E6607C

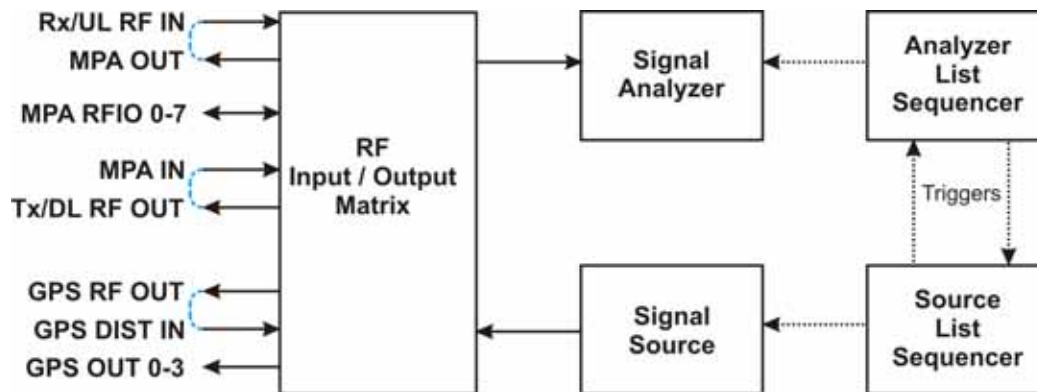

E6607A/B

The source and analyzer communicate with the device under test through an RF input/output matrix with four ports. Two of the ports have a fixed direction: an RF Output port which can be connected only to the source, and an RF Input port which can be connected only to the analyzer.

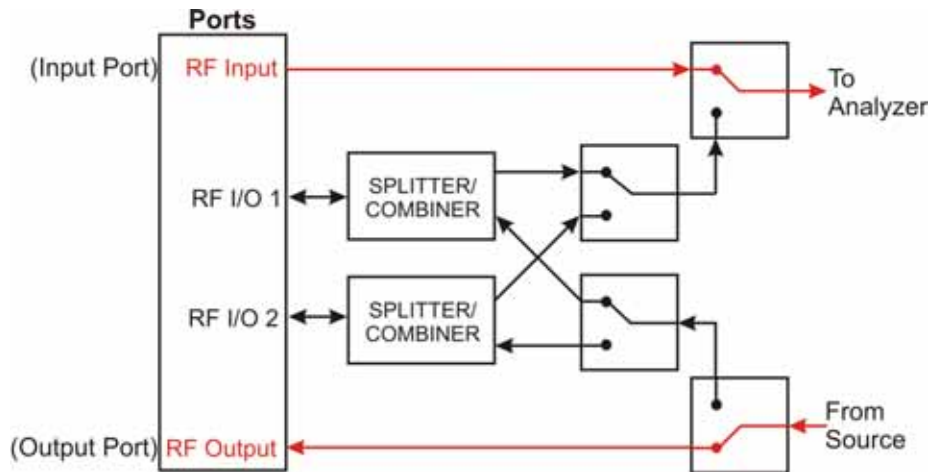

E6607C

The source and analyzer communicate with the device under test through an RF input/output matrix with multiple ports. Two of the ports have a fixed direction: an Tx/DL RF Out port which can be connected only to the source, and an Rx/UL RF In port which can be connected only to the analyzer.

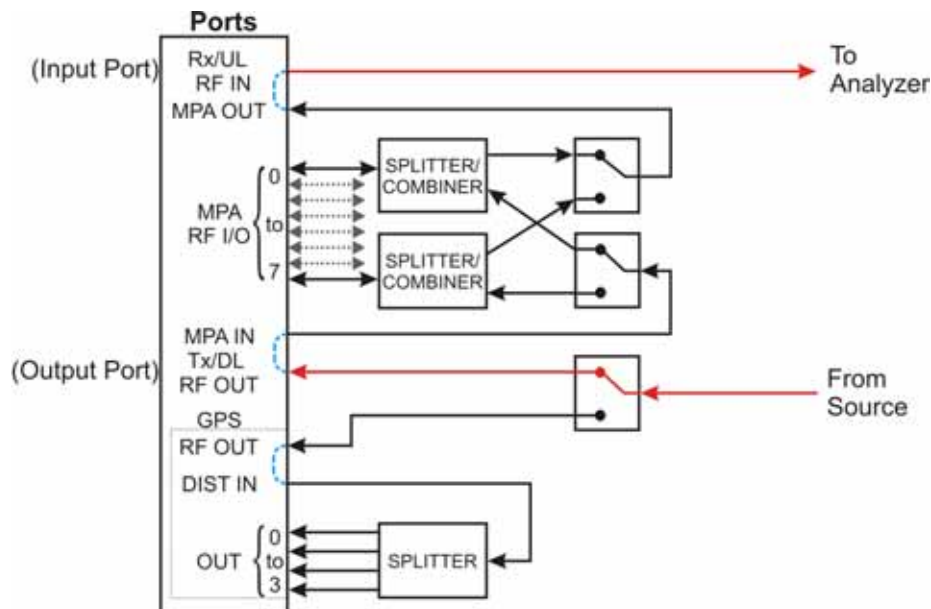

E6607A/B

The remaining two ports (the RF I/O ports) have bi-directional capability; they can be connected (through a splitter/combiner) to the source, to the analyzer, or to both at once. For example, in testing a mobile phone, both the source and the analyzer might be set up to interface with the device through the RF I/O 1 port, employing different frequencies for the transmit and receive signals.

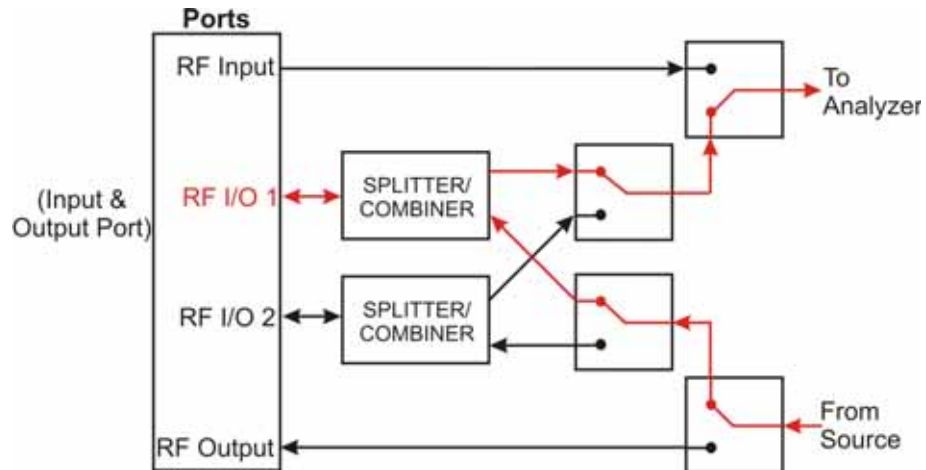

E6607C

The eight MPA RFIO ports have bi-directional capability; they can be connected (through internal splitter/combiners) to the source, to the analyzer, or to both at once. For example, in testing a mobile phone, both the source and the analyzer might be set up to interface with the device through the MPA RFIO 0 port, employing different frequencies for the transmit and receive signals.

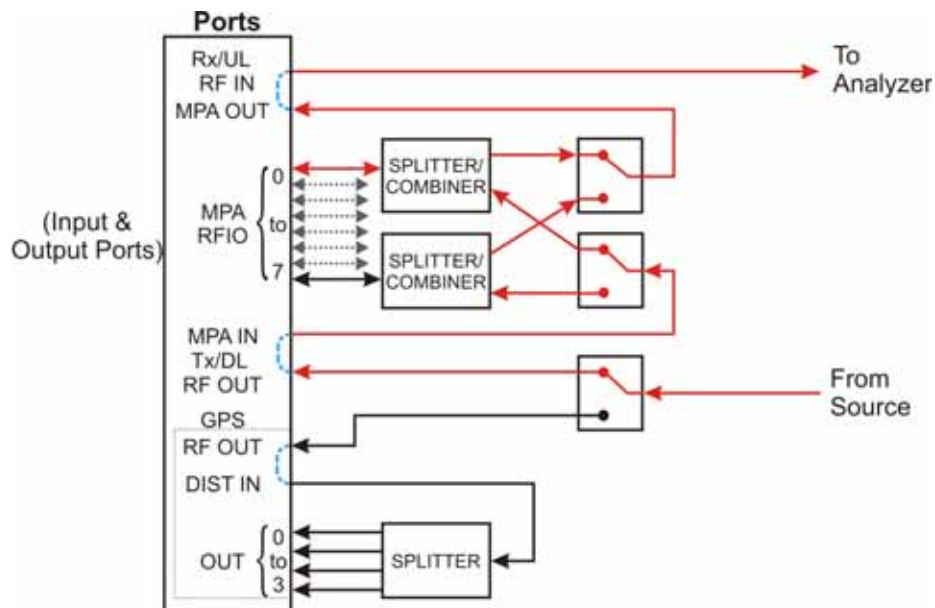

E6607A/B

The RF I/O ports can also be used in a single direction, as in the case illustrated below, where RF I/O 1 serves as the input port, and RF Output serves as the output port.

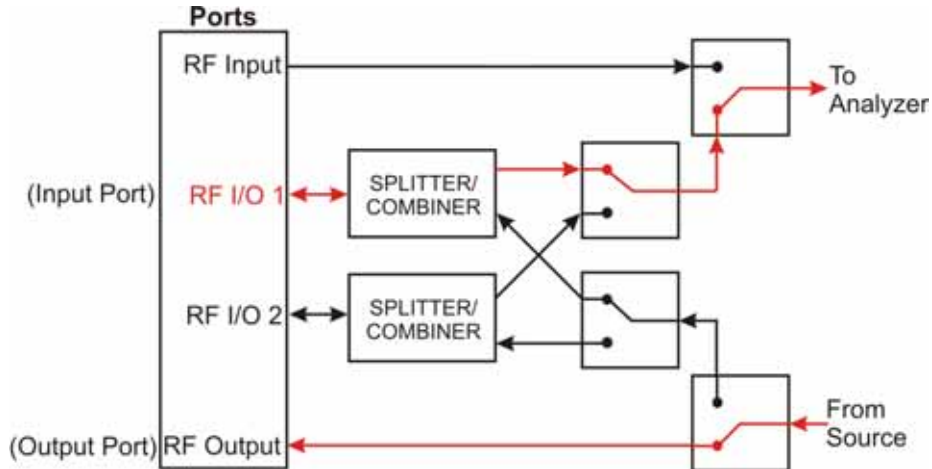

E6607C

The MPA RFIO ports can also be used in a single direction, as in the case illustrated below. In this case, the MPA RFIO 0-7 ports are paired and each pair is connected to a single DUT. In each pair, one serves as the input port and the other serves as the output port. This provides for a total of 4 DUTs connected to a single test set at the same time.

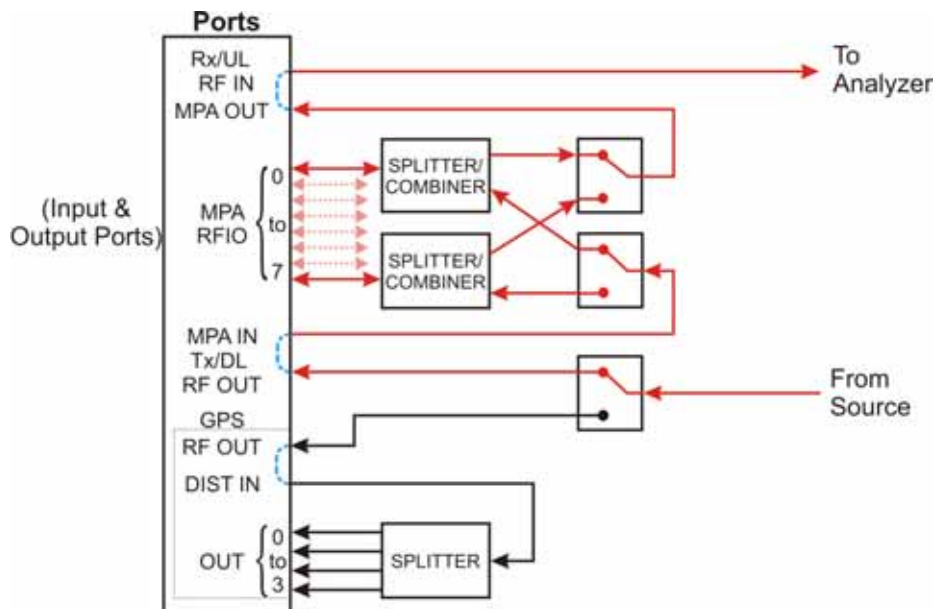

E6607C

When making GPS tests, the GPS OUT ports are fixed direction and are connected only to the source, as in the case illustrated below. In this case, four of the MPA RFIO 0-7 ports are paired with the four GPS OUT ports and each pair is connected to a single DUT. In each pair, the MPA RFIO port serves as the input port and the GPS OUT port serves as the output port. This provides for a total of 4 DUTs connected to a single test set at the same time.

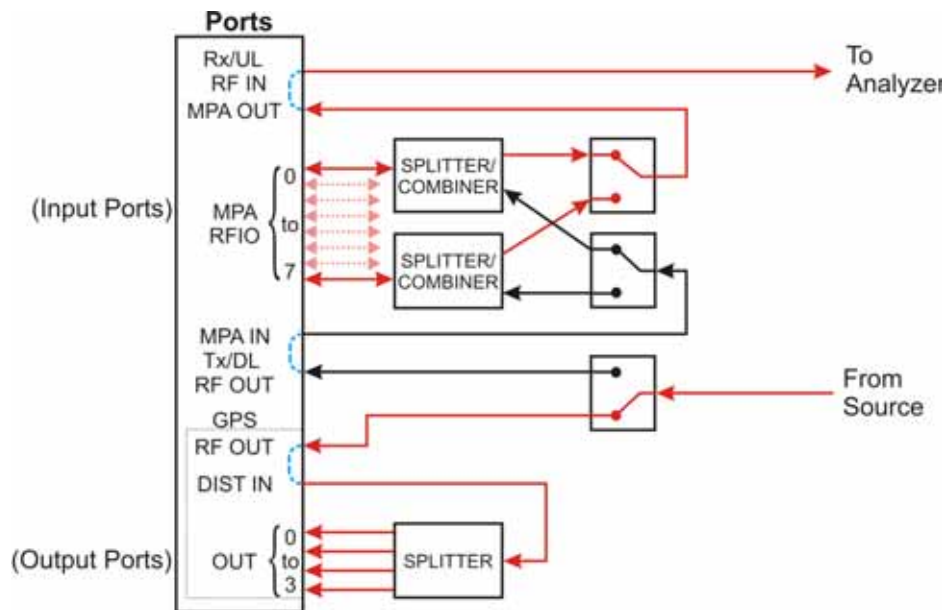

E6607A/B

For any sequence that the test set runs, a single port must be designated the input port, and a single port must be designated the output port. These port assignments cannot be changed during a sequence. The rules for port assignments are:

- Only one port at a time can be the input port, and it must be one of the following: RF Input, RF I/O 1, or RF I/O 2.
- Only one port at a time can be the output port, and it must be one of the following: RF Output, RF I/O 1, or RF I/O 2.
- RF I/O 1 can serve as both the input port and the output port simultaneously, but in that case it must be the only port in use.
- RF I/O 2 can serve as both the input port and the output port simultaneously, but in that case it must be the only port in use.

Although the two RF I/O ports cannot both be used bi-directionally at the same time, having two bi-directional ports offers practical advantages in reducing the impact of fixturing delays. For example, you can set up two sequences which are exactly alike, except that one of them designates RF I/O 1 as the input and output port, while the other sequence uses RF I/O 2 in the same way. During testing, the two sequences are run alternatively; a DUT is tested on one port while the next DUT is being fixtured on the other port.

E6607C

For any sequence that the test set runs using the MPA RFIO or GPS OUT ports, a single MPA RFIO port must be designated the input port. For the output signal to the DUT, any of the MPA RFIO ports can be designated as output ports. Up to eight of the MPA RFIO ports can provide an output signal at one time. (However, if the MPA RFIO ports are used in input/output pairs, this will limit the number of available output ports to four.) These port assignments cannot be changed during a sequence. The rules for port assignments are:

- Only one port at a time can be the input port, and it must be one of the following: Rx/UL RF IN or any one of MPA RFIO 0-7.
- MPA RFIO 0-7 serve as both input ports or output ports when the MPA RF OUT is connected to the MPA IN.
- GPS 0-3 serve as output ports simultaneously when the GPS OUT is connected to the Dist .

Software Elements of the Test Set

The test set firmware, which runs within the Windows XP Pro operating system, controls the source and analyzer, and provides access to a variety of licensed measurement applications which are available to be installed on the test set.

The basic test set includes licenses for two applications: the IQ Analyzer Mode (U9060A) and the Sequence Analyzer Mode (U9065A). Several other applications are available for installation. Many of the measurements which are included in these applications can be run from within the Sequence Analyzer mode, and not just in the native mode of the measurement. The table below shows all the available applications, and the measurements they include. Measurements which can be run from within the Sequence Analyzer mode are marked “available to sequencer” in the table.

Table 2-1 Applications and Measurements in the Test Set

Application	Measurement
IQ Analyzer Mode (U9060A)	<ul style="list-style-type: none"> • IQ Waveform • Complex Spectrum
Analog Demodulation Mode (U9063A)	<ul style="list-style-type: none"> • Amplitude Modulation • Frequency Modulation • Phase Modulation
Sequence Analyzer Mode (U9065A)	<ul style="list-style-type: none"> • Basic measurements: Power, Phase & Frequency, Discrete PAVT, IQ Data • List Sequencer • All application-specific measurements listed below that are marked “available to sequencer”.

Table 2-1 Applications and Measurements in the Test Set

Application	Measurement
GSM/EDGE Mode (U9071A)	<ul style="list-style-type: none"> • Transmit Power, also known as Burst Power • Power Vs. Time, GSM & Edge versions (available to sequencer) • GMSK Phase & Frequency (available to sequencer) • Output RF Spectrum, GMSK & EDGE versions (available to sequencer) • EDGE Error Vector Magnitude (available to sequencer)
cdma2000 Mode (U9072A)	<ul style="list-style-type: none"> • Channel Power • Code Domain • ACP (available to sequencer) • Spectrum Emission Mask (available to sequencer) • Occupied Bandwidth (available to sequencer) • Modulation Accuracy (available to sequencer) • QPSK Error Vector Magnitude (available to sequencer)
W-CDMA/HSPA Mode (U9073A)	<ul style="list-style-type: none"> • Channel Power • Adjacent Channel Power (available to sequencer) • Spectrum Emission Mask (available to sequencer) • Occupied Bandwidth (available to sequencer) • Code Domain (available to sequencer) • Modulation Accuracy (available to sequencer) • QPSK Error Vector Magnitude (available to sequencer) • Power Control (available to sequencer)
“WiMAX” Mode (802.16 OFDMA, U9075A)	<ul style="list-style-type: none"> • Channel Power • Adjacent Channel Power • Spectrum Emission Mask • Modulation Analysis
1xEVDO Mode (U9076A)	<ul style="list-style-type: none"> • Channel Power • Reverse-Link Code Domain • Adjacent Channel Power (available to sequencer) • Spectrum Emission Mask (available to sequencer) • Occupied Bandwidth (available to sequencer) • Reverse-Link Modulation Accuracy (available to sequencer)

Table 2-1 Applications and Measurements in the Test Set

Application	Measurement
TD-SCDMA with HSPA/8PSK (U9079A)	<ul style="list-style-type: none"> • Burst Power (Transmit Power) • Power vs Time • ACP (available to sequencer) • Spectrum Emission Mask (available to sequencer) • Occupied Bandwidth (available to sequencer) • Code Domain Power (available to sequencer) • Conformance Error Vector Magnitude (available to sequencer)
LTE Mode (U9080A)	<ul style="list-style-type: none"> • Channel Power • Modulation Analysis (available to sequencer) • Occupied Bandwidth (available to sequencer) • ACP (available to sequencer) • Spectrum Emission Mask (available to sequencer) • Conformance Error Vector Magnitude (available to sequencer)
Bluetooth (U9081A)	<ul style="list-style-type: none"> • ACP • LE In-band Emissions • EDR In-band Spurious Emissions • Occupied Bandwidth • Transmit Analysis
LTE TDD Mode (U9082A)	<ul style="list-style-type: none"> • Channel Power • Occupied Bandwidth (available to sequencer) • ACP (available to sequencer) • Spectrum Emission Mask (available to sequencer) • Transmit On/Off Power (available to sequencer) • LTE Modulation Analysis (available to sequencer) • Conformance Error Vector Magnitude (available to sequencer)

NOTE Some measurements which are not marked “available to sequencer” can be replaced by a basic measurement function which is available in the Sequence Analyzer mode. For example, it is possible to use the basic Power measurement in Sequence Analyzer mode as a substitute for a Channel Power measurement from one of the other modes. Some measurements are not currently supported by the analyzer list sequencer, and therefore can be run only in the native mode of the measurement.

Methods of Operating the Source

Regardless of which measurement mode is currently selected, the source can be operated using front panel keys, the virtual front panel, or remote commands, or by initiating the source list sequencer (which executes a predefined series of signal-generation steps).

The RF output of the source can be modulated by its internal arbitrary waveform generator, which runs waveform segment files that have been downloaded to the test set and loaded into ARB memory. (If a source sequence refers to a number of different waveform segments, all of these segments need to be loaded into ARB memory before the sequence can execute.)

In addition to playing back waveform segments in ARB memory, the source provides basic modulation functions (AM, FM, and PM).

Waveform Segment Files

A waveform segment can be defined in a set of binary files (an I/Q data file with its supporting header and marker files) or in a .wfm file (a combined file format which is produced by Agilent Signal Studio). Playback of .wfm segments requires installation of a Signal Studio license on the test set.

Where the segment is represented by separate binary files, the files need to be placed in the same directory, and need to follow a naming convention which enables the test set to recognize them: if the I/Q data file is called "testWaveform.bin", then the header file needs to be called "testWaveform_hdr.bin" and the marker file needs to be called "testWaveform_mkr.bin". The I/Q data file is the one that is loaded to ARB memory and is referenced by name in source sequences.

Methods of Operating the Analyzer

When a measurement mode other than Sequence Analyzer mode is selected, the analyzer can be operated using front panel keys, the virtual front panel, or remote commands. When the analyzer is used in this way, measurements are made in their native measurement mode (for example, GSM measurements in GSM/EDGE mode).

In Sequence Analyzer mode, initiating the analyzer list sequencer causes it to execute a predefined series of acquisitions and measurements. As described in [“Software Elements of the Test Set” on page 128](#) Sequence Analyzer mode incorporates many measurements from other modes; that is, measurements such as EDGE EVM in GSM/EDGE mode can also be included in a sequence, so that the measurements are made when the analyzer list sequencer is initiated. The Sequence Analyzer mode also includes four basic measurements (power, frequency, phase, and I/Q data).

Creating Sequences

A sequence is a set of parameters which defines a series of signals to be generated, or acquisitions to be analyzed, or both. The parameters can be saved to a text file and later recalled. Initiating the sequencers causes the source and/or analyzer to execute all steps defined in the sequence. (A series of SCPI commands can also be used for the same purpose.)

Although it is possible to create and save a simple sequence using front panel keys, the complexity of the format makes it preferable to use a spreadsheet template or other tool to create a sequence (which is saved to a text file).

The easiest method is to use Agilent Sequence Studio, a PC application designed specifically to generate

sequences for the EXT Wireless Communication Test Set. Sequence Studio is able to load waveform traces directly from the test set, so that the analysis intervals in the sequence can be aligned with the waveform, using an interactive graph display; this method of creating sequences is much more efficient than typing in numerical values.

Executing Sequences

Sequences are executed by initiating the source list sequencer, the analyzer list sequencer, or both.

The source list sequencer can be initiated (in any measurement mode) by using the **[Source], List Sequencer, Initiate Sequence** key, or by sending the `:SOURCE:LIST:TRIG` command.

The analyzer list sequencer can be initiated (in the Sequence Analyzer mode) by using the **[Restart]** key, or by sending the `:INIT` command.

When both list sequencers are used together, initiation of the sequencers must be carefully coordinated. It is not possible for both sequencers to be initiated absolutely simultaneously. When both are used, the source list sequencer should always be initiated first. There are two ways to coordinate the sequencers so that they are initiated in the proper order:

- Enable **Meas Setup, Include Source in Sequence**. When this selection is made, both of the list sequencers are initiated automatically, in the correct order, when you use a command or key to initiate the analyzer sequence (in this case, the source sequence cannot be initiated independently of the analyzer sequence).
- If “Include Source in Sequence” is disabled, then the source and analyzer must be initiated independently, and the source must be initiated first.

In addition to the initiating the sequencers, it is also necessary to trigger them. Output and input triggering for the two sequencers (as defined in the sequences they are executing) must be set up to coordinate the timing of their operations. Typically, the analyzer list sequencer generates a trigger input to the source list sequencer, so that the source begins generating a signal once the analyzer is ready to receive and analyze it.

Installing Application Software

When you want to install a measurement application after your initial hardware purchase, you only need to license it. All of the available applications are loaded in your test set at the time of purchase.

When you purchase an application, you receive an entitlement certificate that is used to obtain a license key for that particular measurement application. Enter the license key that you obtain into the EXT test set to activate the new measurement application.

For the latest information on Agilent X-series measurement applications and upgrade kits, visit the following internet URL: <http://www.agilent.com/find/ext>

Viewing a license key

Measurement personalities purchased with your test set have been installed and activated at the factory before shipment. The test set requires a unique **License Key** for every measurement application purchased. The license key is a hexadecimal string that is specific to your measurement application, test set model number and serial number. It enables you to install, or reactivate that particular application.

Press **System, Show, System** to display which measurement applications are currently licensed in your test set.

Go to the following location to view the license keys for the installed measurement applications:

C:\Programing Files\Agilent\Licensing

NOTE You may want to keep a copy of your license key in a secure location. You can print out a copy of the display showing the license numbers to do this. If you should lose your license key, call your nearest Agilent Technologies service or sales office for assistance.

Obtaining and installing a license key

If you purchase an additional application that requires installation, you will receive an “Entitlement Certificate” which may be redeemed for a license key for one test set. Follow the instructions that accompany the certificate to obtain your license key.

Installing a license key for the selected application can be done using a USB memory device. To do this, you put the license file on the USB memory device at the root level. Follow the instructions that come with your software installation kit.

Installing a license key can also be done manually using the license management application in the test set. It is found through the test set front panel keys at **System, Licensing...**, or internally at C:\Programming Files\Agilent\Licensing.

NOTE You can also use these procedures to reinstall a license key that has been accidentally deleted, or lost due to a memory failure.

Missing and old Measurement application software

All the software applications were loaded at the time of original test set manufacture. It is a good idea to regularly update your software with the latest available version. This assures that you get any improvements and expanded functionality that is available.

Because the software was loaded at the initial purchase, there may be additional measurement applications that are now available. If the application you are interested in licensing is not available, you will need to do a software update. (Press **System, Show, System.**)

Check the Agilent internet website for the latest software versions available for downloading:

http://www.agilent.com/find/ext_software

You must load the updated software package into the test set from a USB drive, or directly from the internet. An automatic loading program is included with the files.

X-Series options and accessories

“EXT Test Set Options” on page 135

“EXT X-series accessories” on page 135

“Advanced Measurement Application Software” on page 135

EXT Test Set Options

Product	Description
<EXT model number>	Wireless communications test set
<EXT model number>-503	Frequency range from 10 MHz to 3.6 GHz
<EXT model number>-504	Frequency range from 10 MHz to 3.8 GHz
<EXT model number>-UK6	Commercial Calibration Certificate with Test Data

EXT X-series accessories

Product	Description
<EXT model number>-EFM	USB storage device 4 GB blank
<EXT model number>-KYB	Keyboard, USB interface
<EXT model number>-HTC	Hard transit case
<EXT model number>-ICP	Rackmount kit with handles
<EXT model number>-1CN	Front handle kit
<EXT model number>-1CM	Rackmount kit
<EXT model number>-1CR	Rack slide kit

Advanced Measurement Application Software

For a current list of application software, go to the following URLs.

<http://www.agilent.com/find/ext>

Select the **Options** tab on the top of the webpage.

Front-Panel Features (E6607A/B)



Item		Description
#	Name	
1	Menu Keys	Key labels appear to the left of the menu keys to identify the current function of each key. The displayed functions are dependent on the currently selected Mode and Measurement, and are directly related to the most recent key press.
2	Measurement Keys	These keys select the Mode, and the Measurement within the mode. They also control the initiation and rate of recurrence of measurements.
3	Setup Keys	These keys set the parameters used for setting up the test set in the current Mode.
4	Marker Keys	Markers are often available for a measurement, to measure a very specific point/segment of data within the range of the current measurement data.
5	Utility Keys	These keys control system-wide functionality such as <ul style="list-style-type: none"> • test set configuration information and I/O setup, • printer setup and printing, • file management, save and recall, • test set presets.
6	Probe Power	Supplies power for external high frequency probes and accessories.
7	Headphones Output	Headphones can be used to hear any available audio output.
8	Back Space Key	Press this key to delete the previous character when entering alphanumeric information. It also works as the Back key in Help and Explorer windows.
9	USB Connectors	Standard USB 2.0 ports, Type A. Connect to external peripherals such as a mouse, keyboard, DVD drive or hard drive.

Item		Description
#	Name	
10	Delete Key	Press this key to delete files, or to perform other deletion tasks.
11	Local/Cancel/(Esc) Key	<p>If you are in remote operation the Local key</p> <ul style="list-style-type: none"> returns test set control from remote back to local (the front panel). turns the display on (if it was turned off for remote operation). can be used to clear errors. (Press the key once to return to local control, and a second time to clear error message line.) <p>If you have not already pressed the units or Enter key, Cancel exits the currently selected function without changing its value.</p> <p>Esc works the same as it does on a pc keyboard. It</p> <ul style="list-style-type: none"> exits Windows dialogs clears errors aborts printing cancels operations. <p>This key also exits the help system if it has been accessed.</p>
12	Numeric Keypad	Enters a specific numeric value for the current function. Entries appear on the upper left of the display, in the measurement information area.
13	Enter and Arrow Keys	<p>The Enter key terminates data entry when either no unit of measure is needed, or you want to use the default unit.</p> <p>The arrow keys</p> <ul style="list-style-type: none"> Increment and decrement the value of the current measurement selection. Navigate help topics. Navigate, or make selections, within Windows dialogs. Navigate within forms used for setting up measurements. Navigate within tables. <p>NOTE The arrow keys cannot be used to move a mouse pointer around on the display.</p>
14	Menu/ (Alt) Key	Alt works the same as a pc keyboard. Use it to change control focus in Windows pull-down menus.
15	Ctrl Key	Ctrl works the same as a pc keyboard. Use it to navigate in Windows applications, or to select multiple items in lists.
16	Select / Space Key	Select is also the Space key and it has typical pc functionality. For example, in Windows dialogs, it selects files, checks and unchecks check boxes, and picks radio button choices. It opens a highlighted Help topic.
17	Tab Keys	Use these keys to move between fields in Windows dialogs.
18	Knob	Increments and decrements the value of the current active function.
19	Return Key	Exits the current menu and returns to the previous menu. Has typical pc functionality.
20	Full Screen Key	Pressing this key turns off the softkeys to maximize the graticule display area.

About the Test Set
Front-Panel Features (E6607A/B)

Item		Description
#	Name	
21	Help Key	Initiates a context-sensitive help display for the current Mode. Once Help is accessed, pressing a front panel key brings up the help topic for that key function. Use the Local/Cancel/(Esc) key to exit help.
22	Speaker Control Keys	Enables you to increase or decrease the speaker volume, or mute it.
23	Window Control Keys	These keys select between single or multiple window displays. They zoom the current window to fill the data display, or change the currently selected window. They can be used to switch between the Help window navigation pane and the topic pane.
24	Power Standby/ On	Turns the test set on. A green light indicates power on. A yellow light indicates standby mode. <div style="border: 1px solid black; padding: 2px; display: inline-block; margin: 5px 0;">NOTE</div> <p style="margin-left: 20px;">The front-panel switch is a standby switch, not a LINE switch (disconnecting device). The test set continues to draw power even when the line switch is in standby.</p> <p style="margin-left: 20px;">The main power cord can be used as the system disconnecting device. It disconnects the mains circuits from the mains supply.</p>
25	RF I/O 1 Connector	RF Input/Output port #1 (communicates with both the source and the analyzer).
26	RF I/O 2 Connector	RF Input/Output port #2 (communicates with both the source and the analyzer).
27	RF Output	The test set's RF output port (communicates only with the source).
28	RF Input	The test set's RF input port (communicates only with the analyzer).

Overview of key types

The keys labeled **FREQ Channel**, **System**, and **Marker Functions** are all examples of front-panel keys.



Most of the dark or light gray keys access menus of functions that are displayed along the right side of the display. These displayed key labels are next to a column of keys called menu keys.

Menu keys list functions based on which front-panel key was pressed last. These functions are also dependant on the current selection of measurement application (**Mode**) and measurement (**Meas**).

If the numeric value of a menu key function can be changed, it is called an active function. The function label of the active function is highlighted after that key has been selected. For example, press **AMPTD Y Scale**. This calls up the menu of related amplitude functions. The function labeled **Ref Level** (the default selected key in the Amplitude menu) is highlighted. **Ref Level** also appears in the upper left of the display in the measurement information area. The displayed value indicates that the function is selected and its

value can now be changed using any of the data entry controls.



Some menu keys have multiple choices on their label, such as **On/Off** or **Top/Ctr/Bot** (as shown below). The different choices are selected by pressing the key multiple times. For example, the Auto/Man type of key. To select the function, press the menu key and notice that Auto is underlined and the key becomes highlighted. To change the function to manual, press the key again so that Man is underlined. If there are more than two settings on the key, keep pressing it until the desired selection is underlined.

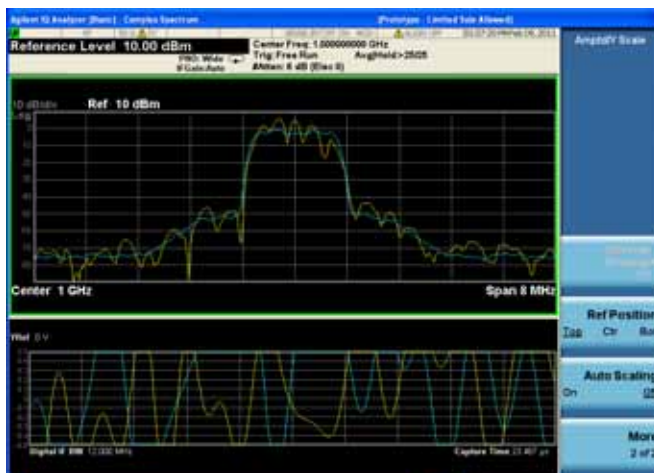

When a menu first appears, one key label is highlighted to show which key is the default selection. If you

About the Test Set Front-Panel Features (E6607A/B)

press **Marker Function**, the **Marker Function Off** key is the menu default key, and is highlighted.



Some of the menu keys are grouped together by a yellow bar running behind the keys near the left side or by a yellow border around the group of keys. When you press a key within the yellow region, such as **Marker Noise**, the highlight moves to that key to show it has been selected. The keys that are linked are related functions, and only one of them can be selected at any one time. For example, a marker can only have one marker function active on it. So if you select a different function it turns off the previous selection. If the current menu is two pages long, the yellow bar or border could include keys on the second page of keys.



In some key menus, a key label is highlighted to show which key has been selected from multiple available choices. And the menu is immediately exited when you press one of the other keys. For example, when you press the **Select Marker** key (in the **Marker** menu), it brings up its own menu of keys. The **Marker 1** key is highlighted. When you press the **marker 2** key, the highlight moves to that key and

the screen returns to the **Marker** menu.



If a displayed key label shows a small solid-black arrow tip pointing to the right, it indicates that additional key menus are available. If the arrow tip is not filled in solid then pressing the key the first time selects that function. Now the arrow is solid and pressing it again brings up an additional menu of

About the Test Set Front-Panel Features (E6607A/B)

settings.



Front-Panel Features (E6607C)

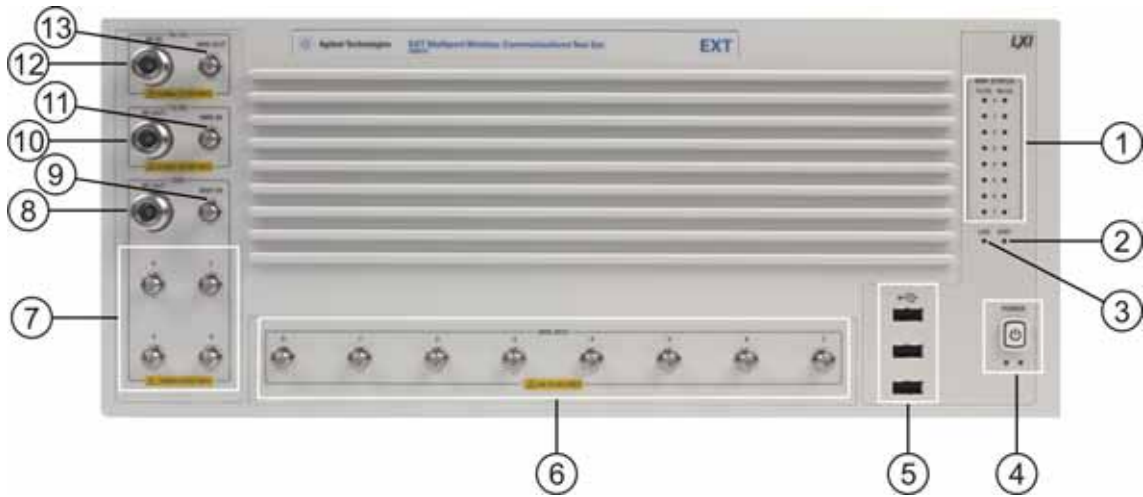

Item		Description
#	Name	
1	MPA Status	<p>MPA Status Indicator LEDs light indicating the status of the instrument:</p> <ul style="list-style-type: none"> Tx/DL 0 - 7 (these light to indicate that the related RFIO ports are being used to transmit RF outputs to the connected DUTs). Rx/UL 0 - 7 (these light to indicate that the related RFIO ports are being used to receive RF inputs from the connected DUTs). <p>NOTE There are no indicators for the GPS ports, because the ports cannot be switched on or off. Whatever RF input is provided to the GPS DIST IN port is always split and delivered to the GPS 0 - 3 ports.</p>
2	Stat	<p>SCPI Status Indicator LED lights to indicate that the instrument is ready to receive a remote SCPI command.</p>
3	LAN	<p>LAN Status Indicator LED lights to indicate that the instrument has made an active LAN connection.</p>
4	Power	<p>Power Standby/On switch and indicator LEDs. A green light indicates power on. A yellow light indicates standby mode.</p> <p>NOTE The front-panel switch is a standby switch, not a LINE switch (disconnecting device). The test set continues to draw power even when the line switch is in standby.</p> <p>The main power cord can be used as the system disconnecting device. It disconnects the mains circuits from the mains supply.</p>
5	USB Connectors	<p>Standard USB 2.0 ports, Type A. Connect to external peripherals such as a mouse, keyboard, DVD drive or hard drive.</p>

About the Test Set
Front-Panel Features (E6607C)

Item		Description
#	Name	
6	MPA RFIO, Ports 0 - 7	RF input and output connections to the DUTs (SMA connectors). The maximum safe input level at any of these ports is 2 W (+33 dBm), ± 15 Vdc.
7	GPS, Ports 0 - 3	RF input and output connections to the DUTs (SMA connectors). The maximum safe input level at any of these ports is 0.25 W (+24 dBm), 0 Vdc. Because GPS Ports 0 - 3 are the outputs of a four-way splitter, the maximum output power levels from these ports are lower than for RFIO Ports 0 - 7; see the E6607C data sheet for specifics.
8	RF OUT	GPS RF output port (communicates only with the source). The maximum safe input level at any of these ports is 0.25 W (+24 dBm), 0 Vdc.
9	DIST IN	GPS RF distribution input port (SMA connector). This port is connected to the four-way splitter that provides the signal to the 4 GPS output Ports 0 - 3. The maximum safe input level at any of these ports is 0.25 W (+24 dBm), 0 Vdc.
10	RF OUT	Tx/DL RF output port (communicates only with the source). The maximum safe input level at any of these ports is 0.25 W (+24 dBm), ± 15 Vdc.
11	MPA IN	Tx/DL MPA RF input port (SMA connector). The maximum safe input level at any of these ports is 0.25 W (+24 dBm), ± 15 Vdc.
12	RF IN	Rx/UL RF input port (communicates only with the analyzer). The maximum safe input level at any of these ports is 0.25 W (+24 dBm), ± 15 Vdc.
13	MPA OUT	Rx/UL RF MPA output port (SMA connector). The maximum safe input level at any of these ports is 0.25 W (+24 dBm), ± 15 Vdc.

Overview of key types

The keys labeled **FREQ Channel**, **System**, and **Marker Function** are all examples of front-panel keys.



Most of the dark or light gray keys access menus of functions that are displayed along the right side of the display. These displayed key labels are next to a column of keys called menu keys.

Menu keys list functions based on which front-panel key was pressed last. These functions are also dependant on the current selection of measurement application (**Mode**) and measurement (**Meas**).

If the numeric value of a menu key function can be changed, it is called an active function. The function label of the active function is highlighted after that key has been selected. For example, press **AMPTD Y Scale**. This calls up the menu of related amplitude functions. The function labeled **Ref Level** (the default selected key in the Amplitude menu) is highlighted. **Ref Level** also appears in the upper left of the display in the measurement information area. The displayed value indicates that the function is selected and its value can now be changed using any of the data entry controls.



Some menu keys have multiple choices on their label, such as **On/Off** or **Top/Ctr/Bot** (as shown below). The different choices are selected by pressing the key multiple times. For example, the Auto/Man type of key. To select the function, press the menu key and notice that Auto is underlined and the key becomes highlighted. To change the function to manual, press the key again so that Man is underlined. If there are

About the Test Set

Overview of key types

more than two settings on the key, keep pressing it until the desired selection is underlined.

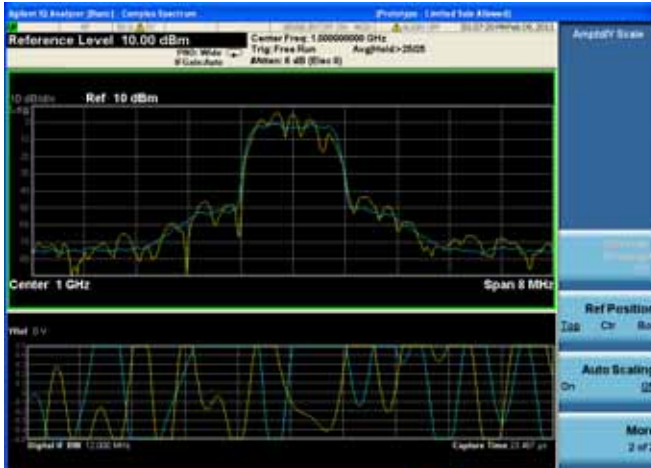

When a menu first appears, one key label is highlighted to show which key is the default selection. If you press **Marker Function**, the **Marker Function Off** key is the menu default key, and is highlighted.



Some of the menu keys are grouped together by a yellow bar running behind the keys near the left side or by a yellow border around the group of keys. When you press a key within the yellow region, such as **Marker Noise**, the highlight moves to that key to show it has been selected. The keys that are linked are related functions, and only one of them can be selected at any one time. For example, a marker can only have one marker function active on it. So if you select a different function it turns off the previous selection. If the current menu is two pages long, the yellow bar or border could include keys on the

second page of keys.



In some key menus, a key label is highlighted to show which key has been selected from multiple available choices. And the menu is immediately exited when you press one of the other keys. For example, when you press the **Select Marker** key (in the **Marker** menu), it brings up its own menu of keys. The **Marker 1** key is highlighted. When you press the **marker 2** key, the highlight moves to that key and the screen returns to the **Marker** menu.



If a displayed key label shows a small solid-black arrow tip pointing to the right, it indicates that additional key menus are available. If the arrow tip is not filled in solid then pressing the key the first time selects that function. Now the arrow is solid and pressing it again brings up an additional menu of

About the Test Set

Overview of key types

settings.

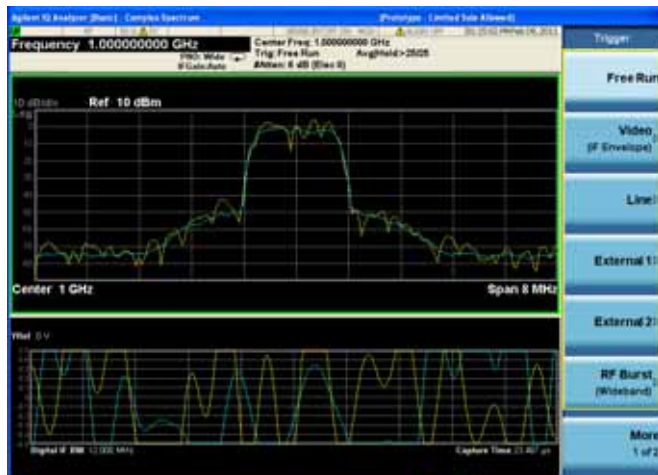

Open Arrow Tip

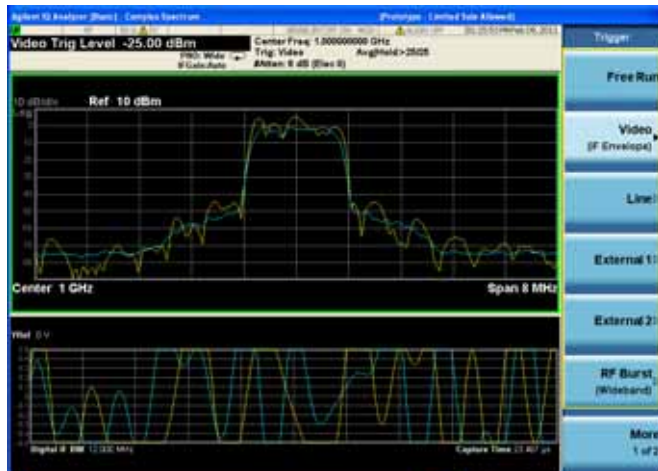

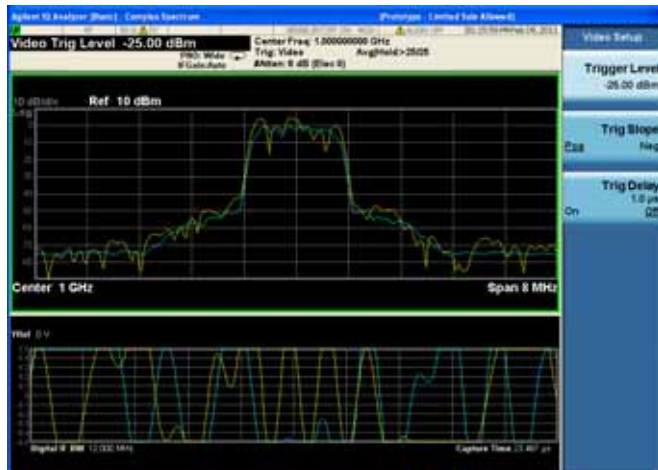
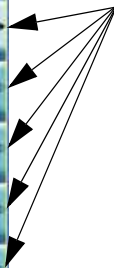

Solid Arrow Tip

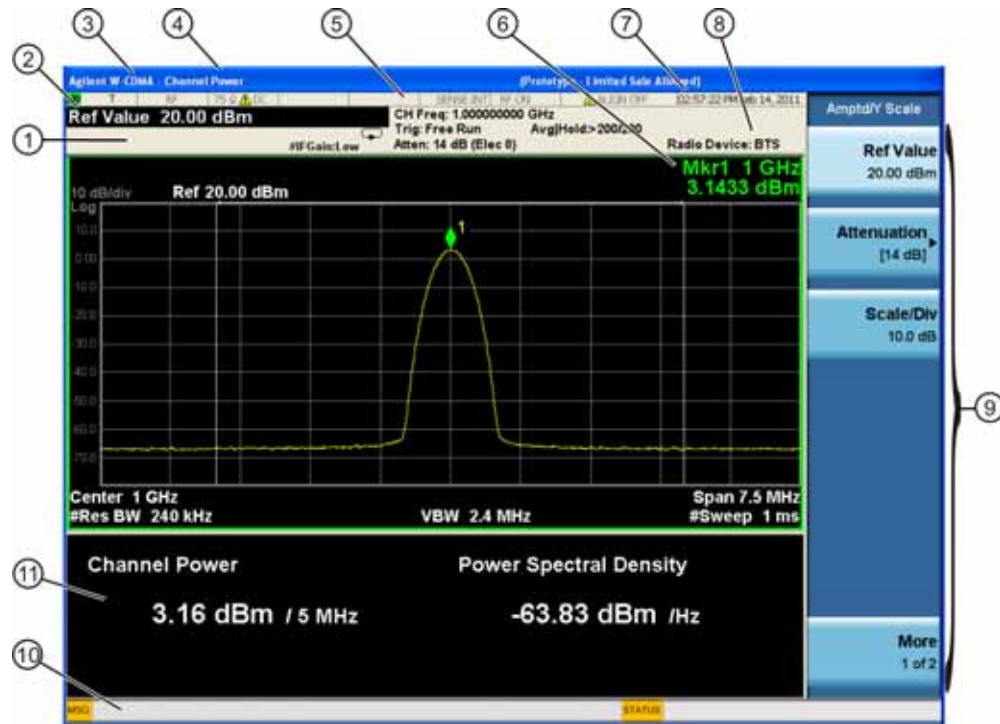

Display Annotations

This section describes the display annotation as it is on the Sequence Analyzer measurement application display. Other measurement application modes have some annotation differences.



Item	Description	Function Keys
1	<p>Measurement bar - Shows general measurement settings and information.</p> <p>  Indicates single/continuous measurement.</p> <p>Some measurements include limits that the data is tested against. A Pass/Fail indication may be shown in the lower left of the measurement bar.</p>	All the keys in the test set Setup part of the front panel.
2	Active Function (measurement bar) - when the current active function has a settable numeric value, it is shown here.	Currently selected front panel key.
3	Banner - shows the name of the selected application that is currently running.	Mode

About the Test Set
Display Annotations

Item	Description	Function Keys
4	Measurement title - shows title information for the current measurement, or a title that you created for the measurement.	Meas View/Display, Display, Title
5	Settings panel - displays system information that is not specific to any one application. <ul style="list-style-type: none"> • Input/Output status - RLTS indicate Remote, Listen, Talk, SRQ • Input impedance and coupling • Selection of external frequency reference • Setting of automatic internal alignment routine 	Local and System, I/O Config Input/Output, Amplitude, System and others
6	Active marker frequency, amplitude or function value	Marker
7	Settings panel - time and date display.	System, Control Panel
8	Trace and detector information	Trace/Detector, Clear Write (W) Trace Average (A) Max Hold (M) Min Hold (m) Trace/Detector, More, Detector, Average (A) Normal (N) Peak (P) Sample (S) Negative Peak (p)
9	Key labels that change based on the most recent key press.	Softkeys
10	Displays information, warning and error messages. Message area - single events, Status area - conditions	
11	Measurement settings for the data currently being displayed in the graticule area. In the example above: center frequency, resolution bandwidth, video bandwidth, frequency span, sweep time and number of sweep points.	Keys in the test set Setup part of the front panel.

Test Set Display Indicators

The display of the EXT Test Set includes, in the measurement bar, a field (highlighted in red below) which indicates the state of the internal source. When using the E6607A/B with the Multiport Adapter or when using the E6607C, this display is modified to indicate which output ports of the Multiport Adapter (if any) are supplying RF output power.



The table below illustrates the content of this field under different circumstances.

Multiport Adapter Usage	In Sequence Analyzer Mode	Not in Sequence Analyzer Mode, RF On	Not in Sequence Analyzer Mode, RF Off
Any or all of the 8 “RFIO” ports are in use.	SEQ MPA	RF ON MPA	RF OFF MPA
The 4 “GPS” ports are in use.	SEQ MPA-G	RF ON MPA-G	RF OFF MPA-G
Multiport Adapter is not in use.	SEQ	RF ON	RF OFF

Rear-Panel Features

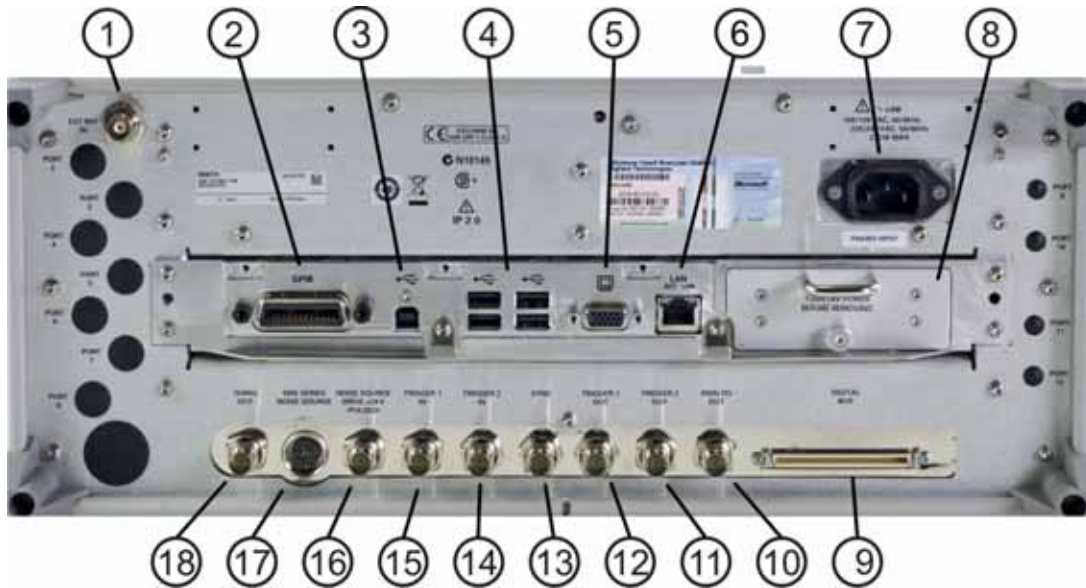

Item		Description
#	Name	
1	EXT REF IN	Input for an external frequency reference signal: 1 to 50 MHz
2	GPIB	A General Purpose Interface Bus (GPIB, IEEE 488.1) connection that can be used for remote test set operation.
3	USB Connector	USB 2.0 port, Type B. USB TMC (test and measurement class) connects to an external pc controller to control the test set and for data transfers over a 480 Mbps link.
4	USB Connectors	Standard USB 2.0 ports, Type A. Connect to external peripherals such as a mouse, keyboard, printer, DVD drive, or hard drive.
5	MONITOR	Allows connection of an external VGA monitor.
6	LAN	A TCP/IP Interface that is used for remote test set operation.
7	Line power input	The AC power connection. See the product specifications for more details.
8	Removable Hard Drive	Standard on E6607A.
9	DIGITAL BUS	Reserved for future use.
10	ANALOG OUT	Reserved for future use.
11	TRIGGER 2 OUT	A trigger output used to synchronize other test equipment with the test set. Configurable from the Input/Output keys.

Item		Description
#	Name	
12	TRIGGER 1 OUT	A trigger output used to synchronize other test equipment with the test set. Configurable from the Input/Output keys.
13	SYNC	Reserved for future use.
14	TRIGGER 2 IN	Allows external triggering of measurements.
15	TRIGGER 1 IN	Allows external triggering of measurements.
16	NOISE SOURCE DRIVE +28 V (PULSED)	Not functional in the EXT Test Set.
17	SNS SERIES NOISE SOURCE	Not functional in the EXT Test Set.
18	10 MHz OUT	An output of the test set internal 10 MHz frequency reference signal. It is used to lock the frequency reference of other test equipment to the test set.

Window Control Keys

The instrument provides three front-panel keys for controlling windows. They are Multi Window, Zoom, and Next Window. These are all “immediate action” keys.

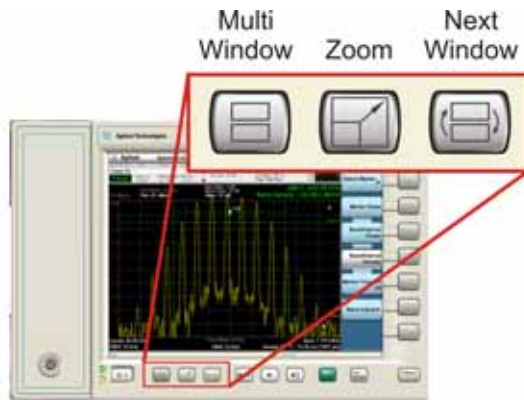

Multi-Window

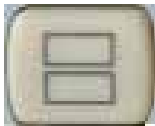

The **Multi Window** front-panel key will toggle you back and forth between the Normal View and the last Multi Window View (Zone Span, Trace Zoom or Spectrogram) that you were in, when using the Swept SA measurement of the Spectrum Analyzer Mode. It remembers which View you were in through a Preset. This “previous view” is set to Zone Span on a Restore Mode Defaults.

Key Path:	Front-panel key
Initial S/W Revision:	Prior to A.02.00

Zoom

Zoom is a toggle function. Pressing this key once increases the size of the selected window; pressing the key again returns the window to the original size.

When Zoom is on for a window, that window will get the entire primary display area. The zoomed window, since it is the selected window, is outlined in green.

Zoom is local to each Measurement. Each Measurement remembers its Zoom state. The Zoom state of each Measurement is part of the Mode’s state.

NOTE Data acquisition and processing for the other windows continues while a window is zoomed, as does all SCPI communication with the other windows.

Remote Command:	:DISPlay:WINDow:FORMat:ZOOM
Remote Command:	:DISPlay:WINDow:FORMat:TILE
Example:	:DISP:WIND:FORM:ZOOM sets zoomed :DISP:WIND:FORM:TILE sets un-zoomed
Preset:	TILE
Initial S/W Revision:	Prior to A.02.00

Next Window

Selects the next window of the current view. When the Next Window key is pressed, the next window in the order of precedence becomes selected. If the selected window was zoomed, the next window will also be zoomed.

The window numbers are as follows. Note that these numbers also determine the order of precedence (that is, Next Window goes from 1 to 2, then 2 to 3, etc.):

1	2
3	4

Four window display

1
2

Two window display

Remote Command:	:DISPlay:WINDow[:SElect] <number> :DISPlay:WINDow[:SElect] ?
Example:	:DISP:WIND 1
Preset:	1
Min:	1
Max:	If <number> is greater than the number of windows, limit to <number of windows>
Initial S/W Revision:	Prior to A.02.00

One and only one window is always selected. The selected window has the focus; this means that all window-specific key presses apply only to that window. You can tell which window is selected by the thick green border around it. If a window is not selected, its boundary is gray.

If a window in a multi-window display is zoomed it is still outlined in green. If there is only one window, the green outline is not used. This allows the user to distinguish between a zoomed window and a display with only one window.

The selected window is local to each Measurement. Each Measurement remembers which window is selected. The selected window for each Measurement is remembered in Mode state.

NOTE When this key is pressed in Help Mode, it toggles focus between the table of contents window and the topic pane window.

Mouse and Keyboard Control

If you do not have access to the instrument front-panel, there are several ways that a mouse and PC Keyboard can give you access to functions normally accessed using the front-panel keys.

NOTE **E6607C:** When using the E6607C there is no instrument front-panel. Therefore, the PC mouse and monitor are required for instrument control through a virtual front panel (VFP). For ease in using the VFP, the PC keyboard is recommended.

Right-Click

If you plug in a mouse and right-click on the analyzer screen, a menu will appear as below:

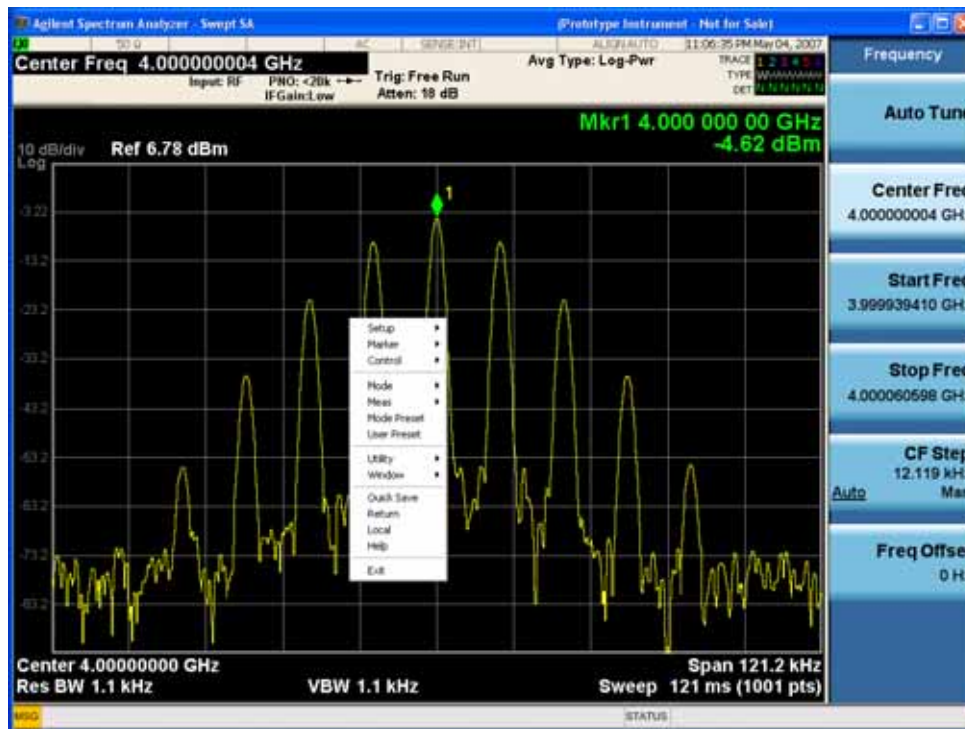

Placing the mouse on one of the rows marked with a right arrow symbol will cause that row to expand, as for example below where the mouse is hovered over the “Utility” row:

About the Test Set Mouse and Keyboard Control

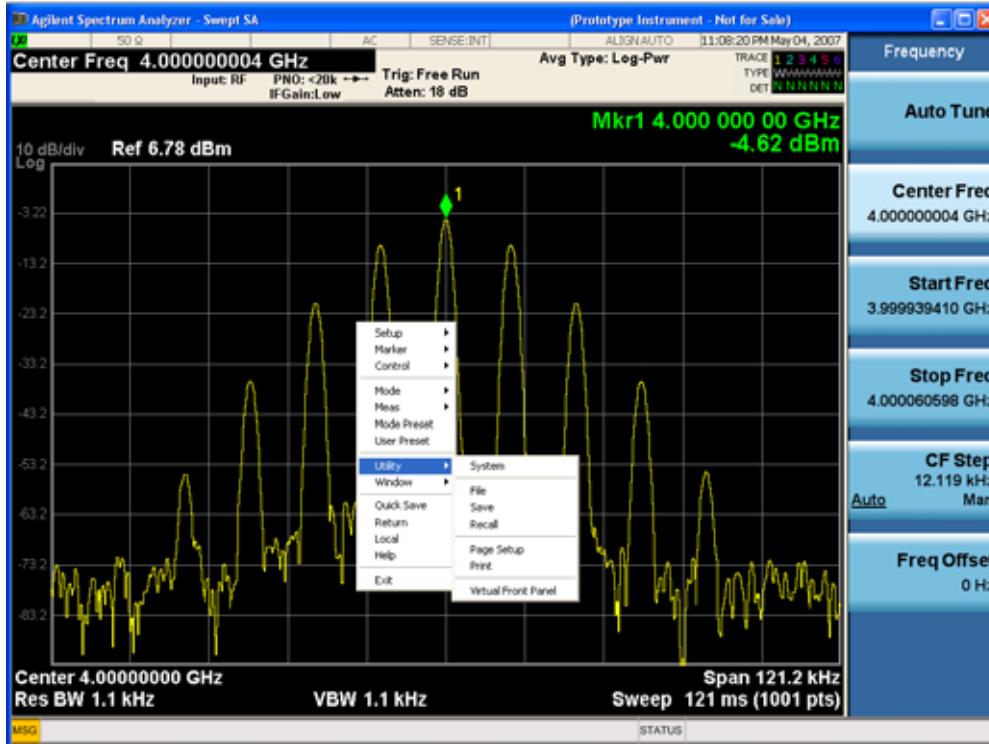

This method can be used to access any of the front-panel keys by using a mouse; as for example if you are accessing the instrument through Remote Desktop.

The array of keys thus available is shown below:

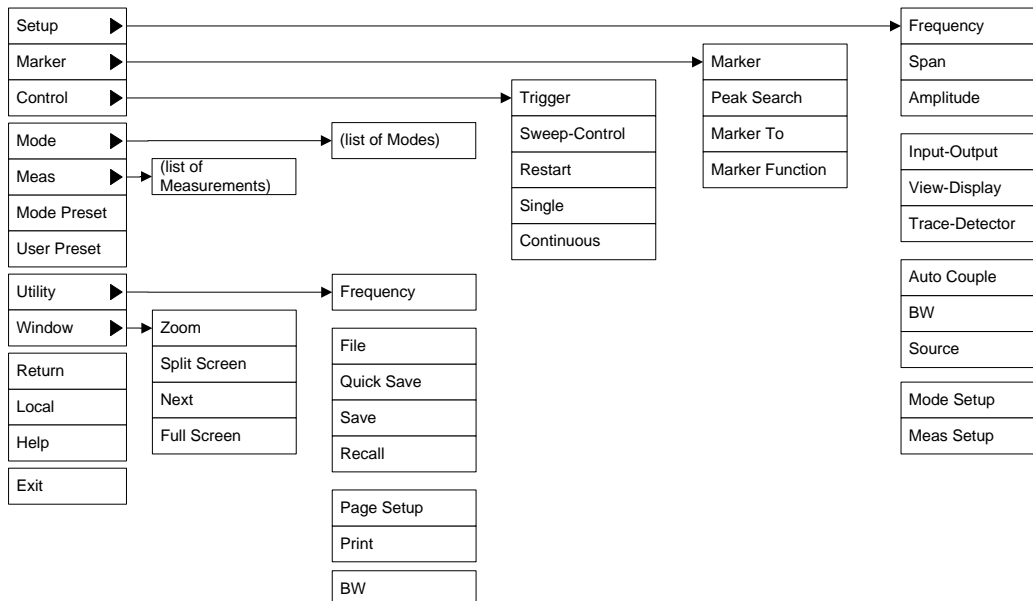

Virtual Front Panel

If you have a PC mouse, monitor, and keyboard plugged in (or through a Remote Desktop), you can navigate the front panel using the virtual front panel (VFP) shown below. Access the VFP as follows:

1. Right-click the mouse as described in [“Right-Click” on page 157](#).
2. Left-click Utility (1) in the menu, as shown below.
3. Left-click Virtual Front Panel (2) in the menu, as shown below.

NOTE The PC mouse and monitor are required when using the E6607C. For ease in using the VFP, the PC keyboard is recommended.

:

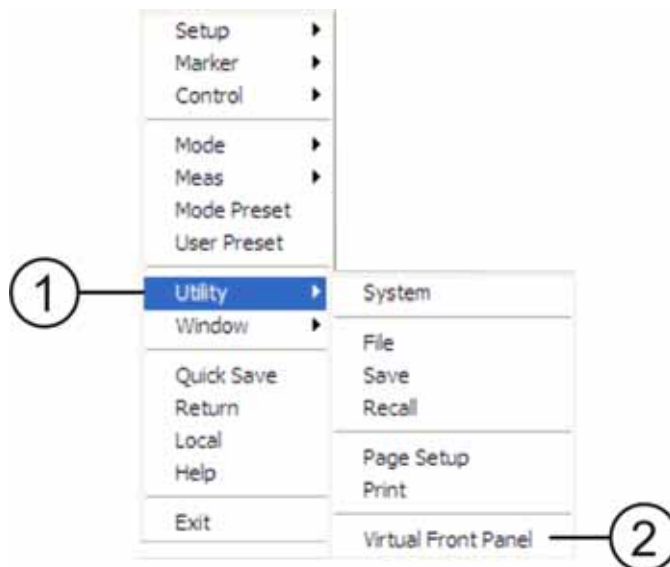

When the VFP opens, the keys behave just as the front-panel and menu keys described in [“Front-Panel Features \(E6607A/B\)” on page 136](#) and [“Overview of key types” on page 145](#). On the VFP the keys labeled "Key 1" through "Key 7" function as the menu keys. Using the mouse to click on a combination of the VFP keys and the menu keys on the display screen, you can operate the instrument just as you would using the front-panel of the E6607A/B.

About the Test Set
Mouse and Keyboard Control



PC Keyboard

If you have a PC keyboard plugged in (or via Remote Desktop), certain key codes on the PC keyboard map to front-panel keys on the GPSA front panel. These key codes are shown below:

Front-panel key	Key code
Frequency	CTRL+SHIFT+F
Span	CTRL+SHIFT+S
Amplitude	CTRL+SHIFT+A
Input/Output	CTRL+SHIFT+O
View/Display	CTRL+SHIFT+V
Trace/Detector	CTRL+ALT+T
Auto Couple	CTRL+SHIFT+C
Bandwidth	CTRL+ALT+B
Source	CTRL+ALT-U

Front-panel key	Key code
Marker	CTRL+ALT+K
Peak Search	CTRL+ALT+P
Marker To	CTRL+ALT+N
Marker Function	CTRL+ALT+F
System	CTRL+SHIFT+Y
Quick Save	CTRL+Q
Save	CTRL+S
Recall	CTRL+R
Mode Preset	CTRL+M
User Preset	CTRL+U
Print	CTRL+P
File	CTRL+SHIFT+L
Mode	CTRL+SHIFT+M
Measure	CTRL+ALT+M
Mode Setup	CTRL+SHIFT+E
Meas Setup	CTRL+ALT+E
Trigger	CTRL+SHIFT+T
Sweep/Control	CTRL+SHIFT+W
Restart	CTRL+ALT+R
Single	CTRL+ALT+S
Cont	CTRL+ALT+C
Zoom	CTRL+SHIFT+Z
Next Window	CTRL+SHIFT+N
Split Screen	CTRL+L
Full Screen	CTRL+SHIFT+B
Return	CTRL+SHIFT+R
Mute	Mute
Inc Audio	Volume Up
Dec Audio	Volume Down
Help	F1

About the Test Set
Mouse and Keyboard Control

Front-panel key	Key code
Control	CTRL
Alt	ALT
Enter	Return
Cancel	Esc
Del	Delete
Backspace	Backspace
Select	Space
Up Arrow	Up
Down Arrow	Down
Left Arrow	Left
Right Arrow	Right
Menu key 1	CTRL+SHIFT+F1
Menu key 2	CTRL+SHIFT+F2
Menu key 3	CTRL+SHIFT+F3
Menu key 4	CTRL+SHIFT+F4
Menu key 5	CTRL+SHIFT+F5
Menu key 6	CTRL+SHIFT+F6
Menu key 7	CTRL+SHIFT+F7
Backspace	BACKSPACE
Enter	ENTER
Tab	Tab
1	1
2	2
3	3
4	4
5	5
6	6
7	7
8	8
9	9

Front-panel key	Key code
0	0

This is a pictorial view of the table:

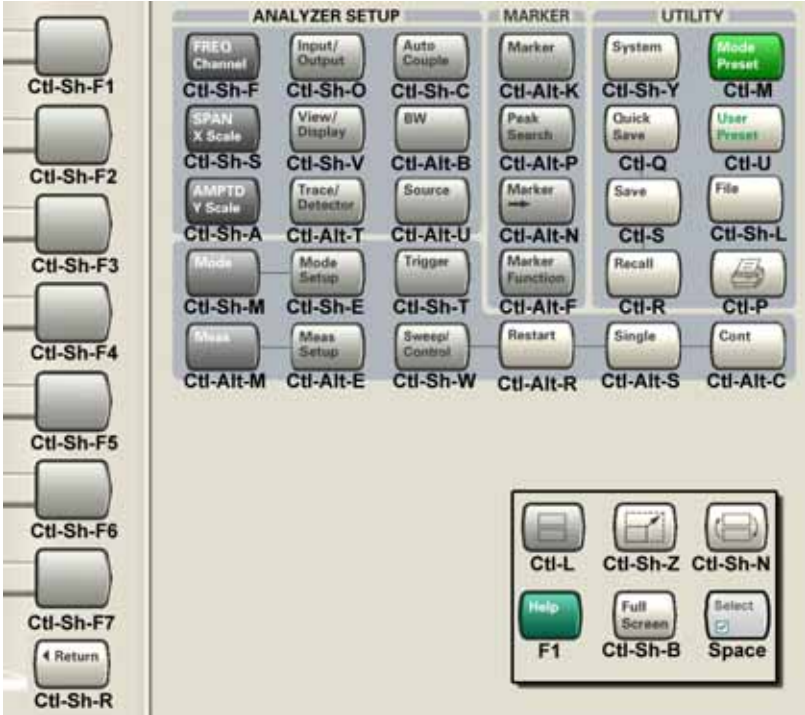

Instrument Security & Memory Volatility

If you are using the test set in a secure environment, you may need details of how to clear or sanitize its memory, in compliance with published security standards of the United States Department of Defense, or other similar authorities.

For the X Series test sets, this information is contained in the document "Security Features and Volatility". This document is **not** included in the test set's on-disk library, but it may be downloaded from Agilent's web site.

To obtain a copy of the document, click on or browse to the following URL:

<http://www.agilent.com/find/security>

To locate and download the document, select a Model Number, for example "E6607A", then click "Submit". Then, follow the on-screen instructions to download the file.

3

About the cdma2000 Measurement Application

This chapter provides overall information on cdma2000 communications systems, and describes cdma2000 measurements made by the test set.

What does the cdma2000 application do?

The cdma2000 application can be used to test a cdma2000 transmitter and IS95 signals with the Radio configuration 1 and 2. It is manufactured according to the following standards documents:

- 3GPP2 C.S0002 Physical Layer Standard for cdma2000 Spread Spectrum Systems
- 3GPP2 C. S0010 Recommended Minimum Performance Standards for cdma2000 Spread Spectrum Base Stations
- 3GPP2 C. S0011 Recommended Minimum Performance Standards for cdma2000 Spread Spectrum Mobile Stations

These documents define complex, multi-part measurements used to create and maintain an interference-free environment. For example, the documents include standardized test methods for the measurement of power in a carrier, a spectrum emission mask, and other critical measurements.

The instrument automatically makes these measurements using the measurement methods and limits defined in the documents. The detailed results displayed by the measurements enable you to analyze cdma2000 system performance. You may alter the measurement parameters for specialized analysis. For infrastructure test, the test set tests transmitters of base stations in a non-interfering manner using a coupler or power splitter.

This test set makes the following measurements of cdma2000 signals:

- Channel Power
- Adjacent Channel Power (ACP)
- Spectrum Emission Mask
- Occupied BW
- Code Domain
- Modulation Accuracy (Composite RHO)
- QPSK EVM

Installing Application Software

When you want to install a measurement application after your initial hardware purchase, you actually only need to license it. All of the available applications are loaded in your test set at the time of purchase.

So when you purchase an application, you will receive an entitlement certificate that is used to obtain a license key for that particular measurement application. Enter the license key that you obtain into the test set to activate the new measurement application. See below for more information.

For the latest information on X-series measurement applications and upgrade kits, visit the following internet URL.

http://www.agilent.com/find/sa_upgrades

Viewing a License Key

Measurement personalities purchased with your test set have been installed and activated at the factory before shipment. The test set requires a unique **License Key** for every measurement application purchased. The license key is a hexadecimal string that is specific to your measurement application, instrument model number and serial number. It enables you to install, or reactivate that particular application.

Press **System, Show, System** to display which measurement applications are currently licensed in your test set.

Press **System, More, Licensing...** to view the license keys for the installed measurement applications.

NOTE You may want to keep a copy of your license key in a secure location. You can print out a copy of the display showing the license numbers to do this. If you should lose your license key, call your nearest Agilent Technologies service or sales office for assistance.

Obtaining and Installing a License Key

If you purchase an additional application that requires installation, you will receive an “Entitlement Certificate” which may be redeemed for a license key for one test set. Follow the instructions that accompany the certificate to obtain your license key.

Installing a license key for the selected application can be done automatically using a USB memory device. To do this, you would put the license file on the USB memory device at the root level. Follow the instructions that come with your software installation kit.

Installing a license key can also be done manually using the license management application in the test set. It is found through the front panel keys at **System, Licensing...**, or internally at C:\Programming Files\Agilent\Licensing.

NOTE You can also use these procedures to reinstall a license key that has been accidentally deleted, or lost due to a memory failure.

Missing and Old Measurement Application Software

All the software applications were loaded at the time of original test set manufacture. It is a good idea to regularly update your software with the latest available version. This assures that you get any improvements and expanded functionality that is available.

Because the software was loaded at the initial purchase, there may be additional measurement applications that are now available. If the application you are interested in licensing is not available, you will need to do a software update. (Press **System, Show, System.**)

Check the Agilent internet website for the latest software versions available for downloading:

http://www.agilent.com/find/ext_software

You must load the updated software package into the test set from a USB drive, or directly from the internet. An automatic loading program is included with the files.

This chapter provides introductory information about the programming documentation included with your test set.

What Programming Information is Available?

The X-Series Documentation can be accessed through the Additional Documentation page in the instrument Help system and is included on the Documentation CD shipped with the instrument. It can also be found in the instrument at: C:\ProgramsFiles\Agilent\SignalAnalysis\Infrastructure\Help\otherdocs, or online at: http://www.agilent.com/find/mxa_manuals.

The following resources are available to help you create programs for automating your X-Series measurements:

Resource	Description
X-Series Programmer's Guide	<p>Provides general SCPI programming information on the following topics:</p> <ul style="list-style-type: none"> • Programming the X-Series Applications • Programming fundamentals • Programming examples <p>Note that SCPI command descriptions for measurement applications are NOT in this book, but are in the User's and Programmer's Reference.</p>
User's and Programmer's Reference manuals	<p>Describes all front-panel keys and softkeys, including SCPI commands for a measurement application. Note that:</p> <ul style="list-style-type: none"> • Each measurement application has its own User's and Programmer's Reference. • The content in this manual is duplicated in the analyzer's Help (the Help that you see for a key is identical to what you see in this manual).
Embedded Help in your instrument	<p>Describes all front-panel keys and softkeys, including SCPI commands, for a measurement application.</p> <p>Note that the content that you see in Help when you press a key is identical to what you see in the User's and Programmer's Reference.</p>
X-Series Getting Started Guide	<p>Provides valuable sections related to programming including:</p> <ul style="list-style-type: none"> • Licensing New Measurement Application Software - After Initial Purchase • Configuring instrument LAN Hostname, IP Address, and Gateway Address • Using the Windows XP Remote Desktop to connect to the instrument remotely • Using the Embedded Web Server Telnet connection to communicate SCPI <p>This printed document is shipped with the instrument.</p>
Agilent Application Notes	Printable PDF versions of pertinent application notes.
Agilent VISA User's Guide	Describes the Agilent Virtual Instrument Software Architecture (VISA) library and shows how to use it to develop I/O applications and instrument drivers on Windows PCs.

IEEE Common GPIB Commands

Numeric values for bit patterns can be entered using decimal or hexi-decimal representations. (that is,. 0 to 32767 is equivalent to #H0 to #H7FFF).

Calibration Query

*CAL? Performs a full alignment and returns a number indicating the success of the alignment. A zero is returned if the alignment is successful. A one is returned if any part of the alignment fails. The equivalent SCPI command is CALibrate[:ALL]?

See “Alignments” on page 236 for details of *CAL?.

Clear Status

Clears the status byte register. It does this by emptying the error queue and clearing all bits in all of the event registers. The status byte register summarizes the states of the other registers. It is also responsible for generating service requests.

Key Path:	No equivalent key. Related key System, Show Errors, Clear Error Queue
Remote Command:	*CLS
Example:	*CLS Clears the error queue and the Status Byte Register.
Notes:	For related commands, see the SYSTem:ERRor[:NEXT]? command. See also the STATus:PRESet command and all commands in the STATus subsystem.
Status Bits/OPC dependencies:	Resets all bits in all event registers to 0, which resets all the status byte register bits to 0 also.
Backwards Compatibility Notes:	In general the status bits used in the X-Series status system will be backwards compatible with ESA and PSA. However, note that all conditions will generate events that go into the event log, and some will also generate status bits.
Initial S/W Revision:	Prior to A.02.00

Standard Event Status Enable

Selects the desired bits from the standard event status enable register. This register monitors I/O errors and synchronization conditions such as operation complete, request control, query error, device dependent error, status execution error, command error, and power on. The selected bits are OR'd to become a summary bit (bit 5) in the byte register which can be queried.

The query returns the state of the standard event status enable register.

Key Path:	No equivalent key. Related key System, Show Errors, Clear Error Queue
-----------	--

Remote Command:	*ESE <integer> *ESE?
Example:	*ESE 36 Enables the Standard Event Status Register to monitor query and command errors (bits 2 and 5). *ESE? Returns a 36 indicating that the query and command status bits are enabled.
Notes:	For related commands, see the STATus subsystem and SYSTem:ERRor[:NEXT]? commands.
Preset:	255
State Saved:	Not saved in state.
Min:	0
Max:	255
Status Bits/OPC dependencies:	Event Enable Register of the Standard Event Status Register.
Initial S/W Revision:	Prior to A.02.00

Standard Event Status Register Query

Queries and clears the standard event status event register. (This is a destructive read.) The value returned is a hexadecimal number that reflects the current state (0/1) of all the bits in the register.

Remote Command:	*ESR?
Example:	*ESR? Returns a 1 if there is either a query or command error, otherwise it returns a zero.
Notes:	For related commands, see the STATus subsystem commands.
Preset:	0
Min:	0
Max:	255
Status Bits/OPC dependencies:	Standard Event Status Register (bits 0 – 7).
Initial S/W Revision:	Prior to A.02.00

Identification Query

Returns a string of instrument identification information. The string will contain the model number, serial number, and firmware revision.

The response is organized into four fields separated by commas. The field definitions are as follows:

Manufacturer

Model

Serial number

Firmware version

Key Path:	No equivalent key. See related key System, Show System.
Remote Command:	*IDN?
Example:	*IDN? Returns instrument identification information, such as: Agilent Technologies,N9020A,US01020004,A.01.02
Initial S/W Revision:	Prior to A.02.00

Instrument Model Number

ID? - Returns a string of the instrument identification. The string will contain the model number.

When in Remote Language compatibility mode the query will return the model number of the emulated instrument, when in any other mode the returned model number will be that of the actual hardware.

Operation Complete

The *OPC command sets bit 0 in the standard event status register (SER) to “1” when pending operations have finished, that is when all overlapped commands are complete. It does not hold off subsequent operations. You can determine when the overlapped commands have completed either by polling the OPC bit in SER, or by setting up the status system such that a service request (SRQ) is asserted when the OPC bit is set.

The *OPC? query returns a “1” after all the current overlapped commands are complete. So it holds off subsequent commands until the "1" is returned, then the program continues. This query can be used to synchronize events of other instruments on the external bus.

Remote Command:	*OPC *OPC?
Example:	INIT:CONT 0 Selects single sweeping. INIT:IMM Initiates a sweep. *OPC? Holds off any further commands until the sweep is complete.
Status Bits/OPC dependencies:	Not global to all remote ports or front panel. *OPC only considers operation that was initiated on the same port as the *OPC command was issued from. *OPC is an overlapped command, but *OPC? is sequential.

Backwards Compatibility Notes:	<p>The ESA/PSA/VSA products do not meet all the requirements for the *OPC command specified by IEEE 488.2. This is corrected for X-Series. This will sometimes cause behavior that is not backward compatible, but it will work as customers expect.</p> <p>Commands such as, *OPC/*OPC?/*WAI/*RST used to be global. They considered front panel operation in conjunction with the GPIB functionality. Now they are evaluated on a per channel basis. That is, the various rear panel remote ports and the front panel i/o are all considered separately. Only the functionality initiated on the port where the *OPC was sent, is considered for its operation.</p> <p>*OPC used to hold off until the operation bits were cleared. Now it holds off until all overlapping commands are completed. Also, earlier instruments did not wait for completion of all processes, only the ones identified here (in the STATus:OPERation register):</p> <p>Calibrating: monitored by PSA, ESA, VSA (E4406A)</p> <p>Sweeping: monitored by PSA, ESA, VSA (E4406A)</p> <p>Waiting for Trigger: monitored by PSA, ESA, VSA (E4406A)</p> <p>Measuring: monitored by PSA and ESA (but not in all Modes).</p> <p>Paused: monitored by VSA (E4406A).</p> <p>Printing: monitored by VSA (E4406A).</p> <p>Mass memory busy: monitored by VSA (E4406A).</p>
Initial S/W Revision:	Prior to A.02.00

Query Instrument Options

Returns a string of all the installed instrument options. It is a comma separated list with quotes, such as: "503,P03,PFR".

To be IEEE compliant, this command should return an arbitrary ascii variable that would not begin and end with quotes. But the quotes are needed to be backward compatible with previous SA products and software. So, the actual implementation will use arbitrary ascii. But quotes will be sent as the first and last ascii characters that are sent with the comma-separated option list.

Remote Command:	*OPT?
Initial S/W Revision:	Prior to A.02.00

Recall Instrument State

This command recalls the instrument state from the specified instrument memory register.

If the state being loaded has a newer firmware revision than the revision of the instrument, no state is recalled and an error is reported

If the state being loaded has an equal firmware revision than the revision of the instrument, the state will be loaded.

If the state being loaded has an older firmware revision than the revision of the instrument, the instrument will only load the parts of the state that apply to the older revision.

Remote Command:	*RCL <register #>
Example:	*RCL 7 Recalls the instrument state that is currently stored in register 7.
Notes:	Registers 0 through 6 are accessible from the front panel in menu keys for Recall Registers.
Min:	0
Max:	127
Status Bits/OPC dependencies:	The command is sequential.
Initial S/W Revision:	Prior to A.02.00

Save Instrument State

This command saves the current instrument state and mode to the specified instrument memory register.

Remote Command:	*SAV <register #>
Example:	*SAV 9 Saves the instrument state in register 9.
Notes:	Registers 0 through 6 are accessible from the front panel in menu keys for Save Registers.
Min:	0
Max:	127
Status Bits/OPC dependencies:	The command is sequential.
Initial S/W Revision:	Prior to A.02.00

Service Request Enable

This command enables the desired bits of the service request enable register.

The query returns the value of the register, indicating which bits are currently enabled.

Remote Command:	*SRE <integer> *SRE?
Example:	*SRE 22 Enables bits 1, 2, and 4 in the service request enable register.
Notes:	For related commands, see the STATus subsystem and SYSTem:ERRor[:NEXT]? commands.
Preset:	0
Min:	0
Max:	255

Status Bits/OPC dependencies:	Service Request Enable Register (all bits, 0 – 7).
Initial S/W Revision:	Prior to A.02.00

Status Byte Query

Returns the value of the status byte register without erasing its contents.

Remote Command:	*STB?
Example:	*STB? Returns a decimal value for the bits in the status byte register. For example, if a 16 is returned, it indicates that bit 5 is set and one of the conditions monitored in the standard event status register is set.
Notes:	See related command *CLS.
Status Bits/OPC dependencies:	Status Byte Register (all bits, 0 – 7).
Initial S/W Revision:	Prior to A.02.00

Trigger

This command triggers the instrument. Use the :TRIGger[:SEQuence]:SOURce command to select the trigger source.

Key Path:	No equivalent key. See related keys Single and Restart.
Remote Command:	*TRG
Example:	*TRG Triggers the instrument to take a sweep or start a measurement, depending on the current instrument settings.
Notes:	See related command :INITiate:IMMediate.
Initial S/W Revision:	Prior to A.02.00

Self Test Query

This query performs the internal self-test routines and returns a number indicating the success of the testing. A zero is returned if the test is successful, 1 if it fails.

Remote Command:	*TST?
Example:	*TST? Runs the self-test routines and returns 0=passed, 1=some part failed.
Initial S/W Revision:	Prior to A.02.00

Wait-to-Continue

This command causes the instrument to wait until all overlapped commands are completed before

executing any additional commands. There is no query form for the command.

Remote Command:	*WAI
Example:	INIT:CONT OFF; INIT;*WAI Sets the instrument to single sweep. Starts a sweep and waits for its completion.
Status Bits/OPC dependencies:	Not global to all remote ports or front panel. *OPC only considers operation that was initiated on the same port as the *OPC command was issued from.
Initial S/W Revision:	Prior to A.02.00

File

Opens a menu that enables you to access various standard and custom Windows functions. Press any other front-panel key to exit

Key Path:	Front-panel key
Initial S/W Revision:	Prior to A.02.00

File Explorer

Opens the standard Windows File Explorer. The File Explorer opens in the My Documents directory for the current user.

The File Explorer is a separate Windows application, so to return to the analyzer once you are in the File Explorer, you may either:

Exit the File Explorer by clicking on the red X in the upper right hand corner, with a mouse

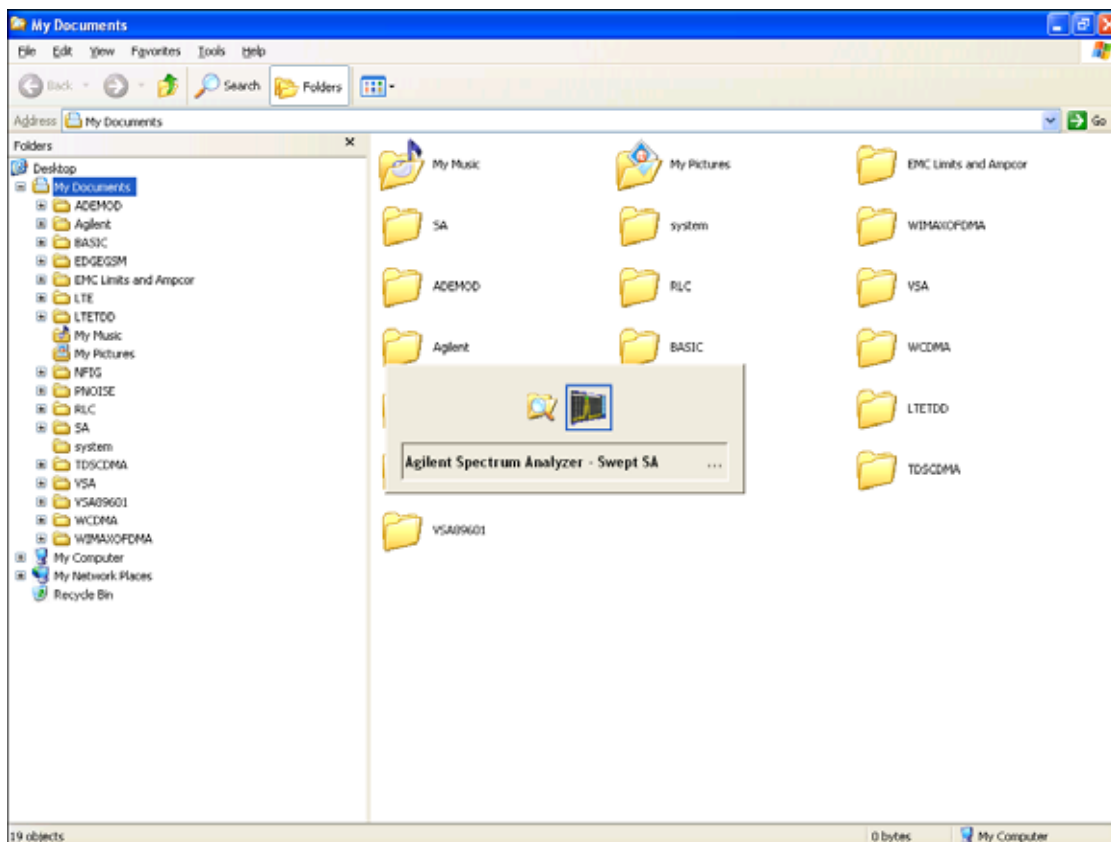

Or use Alt-Tab: press and hold the Alt  key and press and release the Tab key until the Analyzer

logo is showing in the window in the center of the screen, as shown above, then release the Alt key.

Key Path:	File
Initial S/W Revision:	Prior to A.02.00

Page Setup

The Page Setup key brings up a Windows Page Setup dialog that allows you to control aspects of the pages sent to the printer when the PRINT hardkey is pressed.

Key Path:	File
Initial S/W Revision:	Prior to A.02.00

Paper size, the printer paper source, the page orientation and the margins are all settable. Just like any standard Windows dialog, you may navigate the dialog using the front-panel keys, or a mouse. There are no SCPI commands for controlling these parameters.

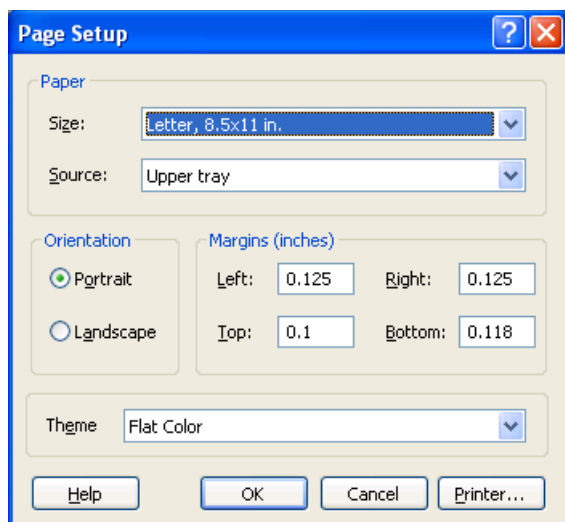

Also contained in this dialog is a drop-down control that lets you select the Theme to use when printing. For more on Themes, see information under View/Display, Display, System Display Settings, Theme. The Theme control has a corresponding SCPI command.

Parameter Name:	Print Themes
Parameter Type:	Enum
Mode:	All
Remote Command:	:SYSTem:PRINT:THEMe TDCOLOR TDMonochrome FCOLOR FMONochrome :SYSTem:PRINT:THEMe?
Example:	:SYST:PRIN:THEM FCOL

Setup:	:SYSTem:DEFault MISC
Preset:	FCOL; not part of Preset, but is reset by Restore Misc Defaults or Restore System Defaults All and survives subsequent running of the modes.
State Saved:	No
Initial S/W Revision:	Prior to A.02.00

Print

The Print key opens a Print dialog for configured printing (for example, to the printer of your choice). Refer to your Microsoft Windows Operating System manual for more information.

Maximize/Restore Down

These keys allow the Instrument Application to be maximized and then restored to its prior state. Only one of the two keys is visible at a time. When not already maximized the Maximize Application key is visible, and when maximized, the Restore Down Application key is visible and replaces the Maximize Application key.

Maximize

This key allows you to Maximize the Instrument Application, which causes the analyzer display to fill the screen. Once the application is maximized, this key is replaced by the Restore Down key.

Key Path:	File
Mode:	All
Notes:	No equivalent remote command for this key.
State Saved:	No
Initial S/W Revision:	A.05.01

Restore Down

This key allows you to Restore Down the Instrument Application and reverses the action taken by Maximize. This key is only visible when the application has been maximized, and after the Restore Down action has been completed this key is replaced by the Maximize key.

Key Path:	File
Mode:	All
Notes:	No equivalent remote command for this key.
State Saved:	No
Initial S/W Revision:	A.05.01

Minimize

The Minimize key causes the analyzer display to disappear down into the task bar, allowing you to see

the Windows Desktop. You can use Alt-Tab (press and hold the Alt  key and press and release the Tab key) to restore the analyzer display.

Key Path:	File
Mode:	All
Notes:	No equivalent remote command for this key.
State Saved:	No
Initial S/W Revision:	A.05.01

Exit

This key, when pressed, will exit the Instrument Application. A dialog box is used to confirm that you intended to exit the application:

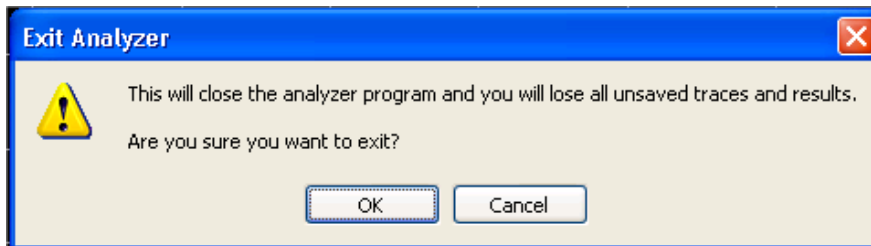

Key Path:	File
Mode:	All
Notes:	The Instrument Application will close. No further SCPI commands can be sent. Use with caution!
Initial S/W Revision:	Prior to A.02.00

Mode Preset

Returns the active mode to a known state.

Mode Preset does the following for the currently active mode:

Aborts the currently running measurement.

Brings up the default menu for the mode, with no active function.

Sets measurement Global settings to their preset values for the active mode only.

Activates the default measurement.

Brings up the default menu for the mode.

Clears the input and output buffers.

Sets Status Byte to 0.

Mode Preset does not:

Cause a mode switch

Affect mode persistent settings

Affect system settings

See [“How-To Preset” on page 185](#) for more information.

Key Path:	Front-panel key
Remote Command:	:SYSTem:PRESet
Example:	:SYST:PRES
Notes:	*RST is preferred over :SYST:PRES for remote operation. *RST does a Mode Preset, as done by the :SYST:PRES command, and it sets the measurement mode to Single measurement rather than Continuous for optimal remote control throughput. Clears all pending OPC bits. The Status Byte is set to 0.
Couplings:	A Mode Preset aborts the currently running measurement, activates the default measurement, and gets the mode to a consistent state with all of the default couplings set.

Backwards Compatibility Notes:	<p>In the X-Series, the legacy “Factory Preset” has been replaced with Mode Preset, which only presets the currently active mode, not the entire instrument. In the X-Series, the way in to preset the entire instrument is by using System, Restore System Defaults All, which behaves essentially the same way as restore System Defaults does on ESA and PSA.</p> <p>There is also no “Preset Type” as there is on the PSA. There is a green Mode Preset front-panel key that does a Mode Preset and a white-with-green-letters User Preset front-panel key that does a User Preset. The old PRESet:TYPE command is ignored (without generating an error), and SYST:PRES without a parameter does a Mode Preset, which should cover most backward code compatibility issues.</p> <p>The settings and correction data under the Input/Output front-panel key (examples: Input Z Corr, Ext Amp Gain, etc.) are no longer part of any Mode, so they will not be preset by a Mode Preset. They are preset using Restore Input/Output Defaults, Restore System Defaults All. Note that because User Preset does a Recall State, and all of these settings are saved in State, they ARE recalled when using User Preset.</p>
Initial S/W Revision:	Prior to A.02.00

How-To Preset

The table below shows all possible presets, their corresponding SCPI commands and front-panel access (key paths). Instrument settings depend on the current measurement context. Some settings are local to the current measurement, some are global (common) across all the measurements in the current mode, and some are global to all the available modes. In a similar way, restoring the settings to their preset state can be done within the different contexts.

Auto Couple - is a measurement local key. It sets all Auto/Man parameter couplings in the measurement to Auto. Any Auto/Man selection that is local to other measurements in the mode will not be affected.

Meas Preset - is a measurement local key. Meas Preset resets all the variables local to the current measurement except the persistent ones.

Mode Preset - resets all the current mode's measurement local and measurement global variables except the persistent ones.

Restore Mode Defaults - resets ALL the Mode variables (and all the Meas global and Meas local variables), including the persistent ones.

Type Of Preset	SCPI Command	Front Panel Access
Auto Couple	:COUPle ALL	Auto Couple front-panel key
Meas Preset	:CONFigure:<Measurement>	Meas Setup Menu
Mode Preset	:SYSTem:PRESet	Mode Preset (green key)
Restore Mode Defaults	:INSTrument:DEFault	Mode Setup Menu
Restore All Mode Defaults	:SYSTem:DEFault MODes	System Menu; Restore System Default Menu

System Functions
Mode Preset

Type Of Preset	SCPI Command	Front Panel Access
*RST	*RST	not possible (Mode Preset with Single)
Restore Input/Output Defaults	:SYSTem:DEFault INPut	System Menu; Restore System Default Menu
Restore Power On Defaults	:SYSTem:DEFault PON	System Menu; Restore System Default Menu
Restore Alignment Defaults	:SYSTem:DEFault ALIGn	System Menu; Restore System Default Menu
Restore Miscellaneous Defaults	:SYSTem:DEFault MISC	System Menu; Restore System Default Menu
Restore All System Defaults	:SYSTem:DEFault [ALL] :SYSTem:PRESet:PERsistent	System Menu; Restore System Default Menu
User Preset	:SYSTem:PRESet:USER	User Preset Menu
User Preset All Modes	:SYSTem:PRESet:USER:ALL	User Preset Menu
Power On Mode Preset	:SYSTem:PON:TYPE MODE	System Menu
Power On User Preset	:SYSTem:PON:TYPE USER	System Menu
Power On Last State	:SYSTem:PON:TYPE LAST	System Menu

Restore Mode Defaults

Resets the state for the currently active mode by resetting the mode persistent settings to their factory default values, clearing mode data and by performing a Mode Preset. This function will never cause a mode switch. This function performs a full preset for the currently active mode; whereas, Mode Preset performs a partial preset. Restore Mode Defaults does not affect any system settings. System settings are reset by the Restore System Defaults function. This function does reset mode data; as well as settings.

Key Path:	Mode Setup
Remote Command:	:INSTrument:DEFault
Example:	:INST:DEF
Notes:	Clears all pending OPC bits. The Status Byte is set to 0. A message comes up saying: "If you are sure, press key again".
Couplings:	A Restore Mode Defaults will cause the currently running measurement to be aborted and causes the default measurement to be active. It gets the mode to a consistent state with all of the default couplings set.
Initial S/W Revision:	Prior to A.02.00

Meas Preset

Resets the measurement local variables for the currently active measurement to their factory default values. The measurement settings that get reset are the same ones that are reset during a Mode Preset. This function keeps the instrument in the current measurement and the current mode and does not affect the settings for other measurements, but does abort the currently running measurement.

Key Path:	Meas Setup
Remote Command:	:CONFigure:<Measurement>
Example:	:CONF:ACP immediately does a Meas Preset to the ACP measurement.
Notes:	Clears the Measuring bit :CONF:<Measurement> resets the specified measurement settings to default in ESA, VSA and PSA; in GPSA it allows the addition of the NDEFault node to the command to prevent a measurement preset from occurring after a measurement switch. :MEASure:<Measurement> also restores the default values of the selected measurement, but it also initiates the specified measurement.
Initial S/W Revision:	Prior to A.02.00

Preset Type (Remote Command Only)

As stated in the Backward Compatibility section, to be compatible with ESA/PSA the PRESet:TYPE command will be implemented as a no-op.

Mode:	All
Remote Command:	:SYSTem:PRESet:TYPE FACTory MODE USER :SYSTem:PRESet:TYPE?
Example:	:SYST:PRESet:TYPE FACT
Notes:	This command is supported for backward compatibility only. It is a no-op which does not change the behavior of any preset operation.
Preset:	This is unaffected by Preset but is set to Mode on a “Restore System Defaults->All”
State Saved:	No
Initial S/W Revision:	Prior to A.02.00

*RST (Remote Command Only)

*RST is equivalent to :SYST:PRESet::INIT:CONT OFF, which is a Mode Preset in the Single measurement state. This remote command is preferred over Mode Preset remote command - :SYST:PRESet, as optimal remote programming occurs with the instrument in the single measurement

System Functions
Mode Preset

state.

Remote Command:	*RST
Example:	*RST
Notes:	Sequential Clears all pending OPC bits and the Status Byte is set to 0.
Couplings:	A *RST will cause the currently running measurement to be aborted and cause the default measurement to be active. *RST gets the mode to a consistent state with all of the default couplings set.
Backwards Compatibility Notes:	In legacy analyzers *RST did not set the analyzer to Single, but in the X-Series it does, for compliance with the IEEE 488.2 specification. In the X-Series, *RST does not do a *CLS (clear the status bits and the error queue). In legacy analyzers, *RST used to do the equivalent of SYSTem:PRESet, *CLS and INITiate:CONTinuous OFF. But to be 488.2 compliant, *RST in the X-Series does not do a *CLS.
Initial S/W Revision:	Prior to A.02.00

Print

This front-panel key is equivalent to performing a File, Print, OK. It immediately performs the currently configured Print to the Default printer.

The :HCOPY command is equivalent to pressing the PRINT key. The HCOpy:ABORt command can be used to abort a print which is already in progress. Sending HCOpy:ABORt will cause the analyzer to stop sending data to the printer, although the printer may continue or even complete the print, depending on how much data was sent to the printer before the user sent the ABORt command.

Key Path:	Front-panel key
Remote Command:	:HCOPY[:IMMediate]
Initial S/W Revision:	Prior to A.02.00

Key Path:	SCPI command only
Remote Command:	:HCOpy:ABORt
Initial S/W Revision:	Prior to A.02.00

Quick Save

The Quick Save front-panel key repeats the most recent save that was performed from the Save menu, with the following exceptions:

Register saves are not remembered as Saves for the purpose of the Quick Save function

If the current measurement does not support the last non-register save that was performed, an informational message is generated, “File type not supported for this measurement”

Quick Save repeats the last type of qualified save (that is, a save qualified by the above criteria) in the last save directory by creating a unique filename using the Auto File Naming algorithm described below.

If Quick Save is pressed after startup and before any qualified Save has been performed, the Quick Save function performs a Screen Image save using the current settings for Screen Image saves (current theme, current directory), which then becomes the “last save” for the purpose of subsequent Quick Saves.

The Auto File Naming feature automatically generates a file name for use when saving a file. The filename consists of a prefix and suffix separated by a dot, as is standard for the Windows® file system. A default prefix exists for each of the available file types:

Type	Default Prefix	Menu
State	State_	(Save/Recall)
Trace + State	State_	(Save/Recall)
Screen	Screen_	(Save/Recall)
Amplitude Corrections	Ampcor_	(Import/Export)
Traces	Trace_	(Import/Export)
Limit Lines	LLine_	(Import/Export)
Measurement Result	MeasR_	(Import/Export)
Capture Buffer	CapBuf_	(Import/Export)

A four digit number is appended to the prefix to create a unique file name. The numbering sequence starts at 0000 within each Mode for each file type and updates incrementally to 9999, then wraps to 0000 again. It remembers where it was through a Mode Preset and when leaving and returning to the Mode. It is reset by Restore Misc Defaults and Restore System Defaults and subsequent running of the instrument application. So, for example, the first auto file name generated for State files is State_0000.state. The next is State_0001, and so forth.

One of the key features of Auto File Name is that we guarantee that the Auto File Name will never conflict with an existing file. The algorithm looks for the next available number. If it gets to 9999, then it looks for holes. If it find no holes, that is no more numbers are available, it gives an error.

For example, if when we get to State_0010.state there is already a State_0010.state file in the current directory, it advances the counter to State_0011.state to ensure that no conflict will exist (and then it verifies that State_0011.state also does not exist in the current directory and advances again if it does,

and so forth).

If you enter a file name for a given file type, then the prefix becomes the filename you entered instead of the default prefix, followed by an underscore. The last four letters (the suffix) are the 4-digit number.

For example, if you save a measurement results file as “fred.csv”, then the next auto file name chosen for a measurement results save will be fred_0000.csv.

NOTE Although 0000 is used in the example above, the number that is used is actually the current number in the Meas Results sequence, that is, the number that would have been used if you had not entered your own file name.

NOTE If the filename you entered ends with _dddd, where d=any number, making it look just like an auto file name, then the next auto file name picks up where you left off with the suffix being dddd + 1.

Key Path:	Front-panel key
Notes:	No remote command for this key specifically.
Initial S/W Revision:	Prior to A.02.00

Recall

The **Recall** menu lets you choose what you want to recall, and where you want to recall it from. Among the types of files you can recall are **States and Traces**. In addition, an **Import (Data)** option lets you recall a number of data types stored in CSV files (as used by Excel and other spreadsheet programs).

The default paths for Recall are data type dependent and are the same as for the Save key.

Key Path:	Front-panel key
Notes:	<p>No remote command for this key specifically, but the :MMEM:LOAD command is available for specific file types. An example is :MMEM:LOAD:STATe <filename>.</p> <p>If you try to recall a State file for a mode that is not licensed or not available in the instrument, an error message will occur and the state will not change.</p>
Backwards Compatibility Notes:	<p>In legacy analyzers, it was possible to load a state without affecting the trace data, limit lines or correction data. Similarly (since User Preset is actually loading a state), it was possible to do a User Preset without affecting the trace data, limit lines or correction data.</p> <p>In the X-Series, “state” always includes all of this data; so whenever state is loaded, all of the traces, limit lines and corrections are affected. Although this differs from previous behavior, it is desirable behavior, and should not cause adverse issues for users.</p>
Backwards Compatibility Notes:	<p>Recall for the X-Series supports backward compatibility in the sense that you can recall a state file from any X-Series model number and any version of X-Series software. If you try to recall a state file onto an instrument with less capability than what was available on the instrument during the save, the recall will ignore the state it doesn’t support and it will limit the recalled setting to what it allows.</p> <p>Example: if the saved state includes preamp ON, but the recalling instrument does not have a preamp; the preamp is limited to OFF. Conversely, if you save a state without a preamp, the preamp is OFF in the state file. When this saved file is recalled on an instrument with a licensed preamp, the preamp is changed to OFF. Another example is if the saved state has center frequency set to 20 GHz, but the instrument recalling the saved state is a different model and only supports 13.5 GHz. In this case, the center frequency is limited along with any other frequency based settings. Since the center frequency can’t be preserved in this case, the recall limiting tries to at least preserve span to keep the measurement setup as intact as possible.</p> <p>Note that there is no state file compatibility outside of the X-Series. For example, you cannot recall a state file from ESA or PSA.</p>
Initial S/W Revision:	Prior to A.02.00

State

The **Recall State** menu lets you choose a register or file from which to recall the state.

The content of a state file includes all of the settings and data required to return the analyzer as closely as possible to the Mode it was in, with the exact settings that were in place, when the save occurred. The Mode settings in each state file include the settings that are affected by Mode Preset, as well as the additional settings affected by Restore Mode Defaults; all of the Mode's settings. In addition, all of the settings of the **Input/Output** system are included, even though they are outside of the Mode's state, because they are needed to restore the complete setup. Persistent System settings (for example, GPIB address) are not affected by either a Mode Preset or Restore Mode Defaults, nor are they included in a saved State file.

Since each state file is only for one Mode, the settings for other Modes are unaffected when it is loaded. **Recall State** will cause a mode switch if the state being recalled is not from the current active mode.

After the recall completes, the message "File <filename> recalled" or "Recalled State Register <register number>" is displayed.

For rapid recalls, the State menu lists 16 registers that you can choose from to recall. Pressing a Register key initiates the recall. You can also select a file from which to recall.

The default path for all State Files is:

My Documents\<mode name>\state

where <mode name> is the parameter used to select the mode with the INST:SEL command (for example, SA for the Spectrum Analyzer).

See ["More Information" on page 194](#).

Key Path:	Recall
Mode:	All
Remote Command:	:MMEMory:LOAD:STATe <filename>
Example:	:MMEM:LOAD:STAT "myState.state" This recalls the file myState.state on the default path
Example:	MMEM:LOAD:STAT "MyStateFile.state" This loads the state file data (on the default file directory path) into the instrument state.

System Functions
Recall

Notes:	<p>When you pick a file to recall, the analyzer first verifies that the file is recallable in the current instrument by checking the software version and model number of the instrument. If everything matches, a full recall proceeds by aborting the currently running measurement, clearing any pending operations, and then loading the State from the saved state file. You can open state files from any mode, so recalling a State file switches to the mode that was active when the save occurred. After switching to the mode of the saved state file, mode settings and data (if any for the mode) are loaded with values from the saved file. The saved measurement of the mode becomes the newly active measurement and the data relevant to the measurement (if there is any) is recalled.</p> <p>If there is a mismatch between file version or model number or instrument version or model number, the recall function tries to recall as much as possible and returns a warning message. It may limit settings that differ based on model number, licensing or version number.</p> <p>After recalling the state, the Recall State function does the following:</p> <p>Makes the saved measurement for the mode the active measurement.</p> <p>Clears the input and output buffers.</p> <p>Status Byte is set to 0.</p> <p>Executes a *CLS</p> <p>If the file specified is empty an error is generated. If the specified file does not exist, another error is generated. If there is a mismatch between the file and the proper file type, an error is generated. If there is a mismatch between file version or model number or instrument version or model number, a warning is displayed. Then it returns to the State menu and File Open dialog goes away.</p> <p>After the Recall, the analyzer exits the Recall menu and returns to the previous menu.</p>
Backwards Compatibility SCPI:	<p>:MMEMory:LOAD:STATe 1,<filename></p> <p>For backwards compatibility, the above syntax is supported. The "1" is simply ignored.</p>
Initial S/W Revision:	Prior to A.02.00

More Information

In measurements that support saving Traces, for example, Swept SA, the Trace data is saved along with the State in the State file. When recalling the State, the Trace data is recalled as well. Traces are recalled exactly as they were stored, including the writing mode and update and display modes. If a Trace was updating and visible when the State was saved, it will come back updating and visible, and its data will be rewritten right away. When you use State to save and recall traces, any trace whose data must be preserved should be placed in View or Blank mode before saving.

The following table describes the Trace Save and Recall possibilities:

<p>You want to recall state and one trace's data, leaving other traces unaffected.</p>	<p>Save Trace+State from 1 trace. Make sure that no other traces are updating (they should all be in View or Blank mode) when the save is performed.</p>	<p>On Recall, specify the trace you want to load the one trace's data into. This trace will load in View. All other traces' data will be unaffected, although their trace mode will be as it was when the state save was performed.</p>
<p>You want to recall all traces</p>	<p>Save Trace+State from ALL traces.</p>	<p>On Recall, all traces will come back in View (or Blank if they were in Blank or Background when saved)</p>
<p>You want all traces to load exactly as they were when saved.</p>	<p>Save State</p>	<p>On recall, all traces' mode and data will be exactly as they were when saved. Any traces that were updating will have their data immediately overwritten.</p>

From File...

When you press "From File", the analyzer brings up a Windows dialog and a menu entitled "**File Open.**" This menu allows you to navigate to the various fields in the Windows dialog without using a keyboard or mouse. The **Tab** and **Arrow** keys can also be used for dialog navigation.

System Functions

Recall



Listed below are the functions of the various fields in the dialog, and the corresponding softkeys:

Open

Performs the recall of the specified file. While the recall is being performed, the floppy icon appears briefly in the Meas bar.

File/Folder List

Enables you to navigate to the center of the dialog that contains the list of files and folders. Once here you can get information about the file and use the tab keys to navigate to the other fields in the dialog, such as Look In.

Look In

The **Look In** field shows the path from which the file will be recalled and allows you to change the path using the up and down arrow keys to navigate to other paths; the Enter key to open a directory; and the Backspace key to go back one directory. The **Look In field** first uses the last path from the Save As dialog **Save In:** path for that same file type. There is no softkey for directly navigating to the Look In field, but you can use the left tab to get here from the File/Folder List.

User specified paths are remembered when you leave and return to a Mode and are reset back to the default using **Restore Mode Defaults**.

Sort

Accesses a menu that enables you to sort the files within the File Open dialog. Only one sorting type can

be selected at a time and the sorting happens immediately. The sorting types are **By Date**, **By Name**, **By extension**, and **By Size**.

Files of Type

This field shows the file suffix for the type of file you have selected to recall. For example, if you navigated here while recalling State, "Mode state (*.state)" is in the field. If you navigated here while recalling Trace, "Mode state (*.trace)" is in the field. If you navigated here while importing a trace data file, "Trace Data (*.csv)" is in the field. For some file types, there is more than one choice in the dropdown menu, which you can select by using the up and down arrow keys and Enter.

Up One Level

This key corresponds to the icon of a folder with the up arrow that is in the tool bar of the dialog. When pressed, it causes the file and folder list to navigate up one level in the directory structure. The Backspace key does the same thing.

Cancel

This key corresponds to the **Cancel** selection in the dialog. It causes the current **Open** request to be cancelled. The ESC key does the same thing.

Key Path:	Recall, State
Notes:	Brings up the Open dialog for recalling a State Save Type
Initial S/W Revision:	Prior to A.02.00

Edit Register Names

You may enter a custom name on any of the Register keys, to help you remember what you are using that state to save. To do this, press the **Edit Register Names** key, choose the register whose name you wish to edit, and then enter the desired label using the Alpha Editor or an external PC keyboard.

The maximum number of characters that can be added is 30. In most cases, 30 characters will fit on two lines of the key.

For more information and the SCPI command, see Edit Register Names under the **Save, State** function.

Key Path:	Recall, State
Mode:	All
Dependencies:	N9060A-7FP or N9060B-2FP license required to edit the register names. When the feature is not licensed, sending the SCPI command generates an error, -221, "Settings conflict;Option not available"
Initial S/W Revision:	A.11.00

Register 1 thru Register 16

Selecting any one of these register keys causes the State of the mode from the specified Register to be recalled. Each of the register keys annotates whether it is empty or at what date and time it was last modified. In addition, you can use the **Edit Register Names** key under **Save, State** to enter custom names for each register.

System Functions

Recall

Registers are shared by all modes, so recalling from any one of the registers will cause a mode switch to the mode that was active when the save to the Register occurred.

Although these 16 registers are the only registers available from the front panel, there are 128 state registers available in the instrument. Registers 17–128 are only available from the SCPI interface, using the *RCL command.

After the recall completes, the message "Register <register number> recalled" appears in the message bar. If you are in the Spectrum Analyzer Mode, and you are recalling a register that was saved in the Spectrum Analyzer Mode, then after the recall, you will still be in the Recall Register menu. If the Recall causes you to switch modes, then after the Recall, you will be in the Frequency menu.

If a requested register is empty an error is generated.

Key Path:	Recall, State
Example:	*RCL 1
Range:	1–16 from front panel, 1–128 from SCPI
Readback:	Date and time with seconds resolution are displayed on the key OR A custom name of up to 30 characters entered using the Save, State, Edit Register Names key OR “(empty)” if no prior save operation has been performed to this register.
Initial S/W Revision:	Prior to A.02.00
Modified at S/W Revision:	Prior to A.11.00

Trace (+State)

The Recall Trace (+State) menu lets you choose a register or file from which to recall the Trace+State state file.

A saved state contains all of the settings and data required to return the analyzer as closely as possible to the exact setup it had when the save occurred. This includes the Input/Output settings, even though they are outside of the Mode’s state, because they are needed to restore the complete setup. A Trace+State file also includes trace data from one trace or all traces, which will load in View mode when the Trace+State file is recalled. Recall Trace (+State) will also cause a mode switch if the state being recalled is not for the current active mode.

After the recall completes, the message "File <filename> recalled" or “Recalled Trace Register <register number>” is displayed.

For rapid recalls, the Trace (+State) menu lists 5 registers to choose from to recall. Pressing a Register key initiates the recall. You can also select a file from which to recall.

The default path for all State Files including .trace files is:

My Documents\<<mode name>\state

where <mode name> is the parameter used to select the mode with the INST:SEL command (for example, SA for the Spectrum Analyzer).

Key Path:	Recall
Mode:	SA
Remote Command:	:MMEMory:LOAD:TRACe TRACE1 TRACE2 TRACE3 TRACE4 TRACE5 TRACE6 , <filename> :MMEMory:LOAD:TRACe:REGister TRACE1 TRACE2 TRACE3 TRACE4 TRACE5 TRACE6 , <integer>
Example:	MMEM:LOAD:TRAC TRACE2,"MyTraceFile.trace" This loads the trace file data (on the default file directory path) into the specified trace; if it is a "single trace" save file, that trace is loaded to trace 2, and is set to be not updating. :MMEM:LOAD:TRAC:REG TRACE1,2 restores the trace data in register 2 to Trace 1
Notes:	<p>When you perform the recall, the recalling Trace function must first verify the file is recallable in this instrument by checking instrument software version and model number, since it includes State. If everything matches, a full recall proceeds by aborting the currently running measurement, and loading the state from the saved state file to as close as possible to the context in which the save occurred. You can open .trace files from any mode that supports them, so recalling a Trace file switches to the mode that was active when the save occurred. After switching to the mode of the saved state file, mode settings and data (if any for the mode) are loaded with values from the saved file and the saved measurement of the mode becomes the newly active measurement, and the data relevant to the measurement (if there is any) is recalled.</p> <p>Once the state is loaded, the trace data must be loaded. The internal flags are consulted to see which trace to load and the "To Trace" setting to see where to load it. Trace data is always loaded with the specified trace set to View, so that the data is visible and not updating (so as not to erase the recalled data). If the file is an "all trace" file, all traces are loaded with the saved data (to the original trace the data was saved from) and set to View. Traces whose data is not loaded are restored to the update state that existed when they were saved.</p> <p>After the Recall the analyzer exits the Recall menu and returns to the previous menu.</p> <p>Some modes and measurements do not have available all 6 traces. Phase Noise mode command, for example, is: MMEMory:LOAD:TRACe TRACE1 TRACE2 TRACE3 , <filename></p>
Initial S/W Revision:	Prior to A.02.00

Register 1 thru Register 5

Selecting any one of these register keys causes the Traces and State from the specified Register to be recalled. Each of the register keys annotates whether it is empty or at what date and time it was last modified.

System Functions

Recall

Trace registers are shared by all modes, so recalling from any one of the 5 registers may cause a mode switch to the mode that was active when the save to the Register occurred.

Key Path:	Recall, Trace
Range:	1–5
Readback:	Date and time with seconds resolution of the last Save is displayed on the key, or "(empty)" if no prior save operation performed to this register.
Initial S/W Revision:	Prior to A.02.00

To Trace

These menu selections let you choose the Trace where the recalled saved trace will go. Not all modes have the full 6 traces available. The default is the currently selected trace, selected in this menu or in the Trace/Detector, Export Data, Import Data, or Save Trace menus, except if you have chosen All, then it remains chosen until you specifically change it to a single trace.

If the .trace file is an "all trace" file, "**To Trace**" is ignored and the traces each go back to the trace from which they were saved.

Once selected, the key returns back to the Recall Trace menu and the selected Trace number is annotated on the key. Now you have selected exactly where the trace needs to be recalled. To trigger a recall of the selected Trace, you must select the **Open** key in the Recall Trace menu.

When you select a trace, it makes that trace the current trace, so it displays on top of all of the other traces.

Key Path:	Save, Data, Trace
Mode:	SA
Initial S/W Revision:	Prior to A.02.00

From File...

When you press "From File", the analyzer brings up a Windows dialog and a menu entitled "**File Open.**" This menu allows you to navigate to the various fields in the Windows dialog without using a keyboard or mouse. The **Tab** and **Arrow** keys can also be used for dialog navigation.

See "[From File...](#)" on page 195 under Save, State for a full description of this dialog and menu.

Key Path:	Recall, Trace
Mode:	SA
Notes:	Brings up Open dialog for recalling a Trace Save Type
Initial S/W Revision:	Prior to A.02.00

Sequences

This menu and all of its submenus are only available in the EXT (E6607A).

These keys allow you to import a Tab separated or .txt file that will automatically setup all the parameters required for building a Sequence. The parameters will automatically be loaded into the Stated Sequencer.

Once selected, in order to import the selected Sequence Type you must select the Open key in the Source Sequence menu.

Key Path:	Recall, Sequences
Mode:	All
Remote Command:	:MMEMory:LOAD:SEQuences: SLIS ALIS SAALIS "MySequence.txt"
Example:	:MMEM:LOAD:SEQ:SLIS "MySequence.txt"
Notes:	Available file types are: CSV (Comma delimited) (*.csv) Text (Tab delimited) (*.txt)
Initial S/W Revision:	A.05.00

Source Sequence

The list of parameters, that configure steps, that makes up a sequence for the Source.

The Source sequence is a sequence of flexible configurable steps that can be set anywhere in the instruments frequency range.

Key Path:	Recall, Sequences
Example:	:MMEM:LOAD:SEQ:SLIS "MySequence.txt"
Dependencies:	Only available in XOBT
Initial S/W Revision:	A.05.00

Analyzer Sequence

Only Available in: Sequence Analyzer Mode

The list of parameters, that configure steps, that makes up a sequence for the Analyzer.

The Analyzer sequence is a sequence of flexible configurable steps that can be set anywhere in the instruments frequency range for measuring the performance of a transmitters output

Key Path:	Recall, Sequences
Example:	:MMEM:LOAD:SEQ:ALIS "MySequence.txt"
Dependencies:	Only available in XOBT, Sequence Analyzer mode
Initial S/W Revision:	A.05.00

Source and Analyzer Sequence

Only Available in: Sequence Analyzer Mode

The list of parameters, that configure steps, that makes up sequences for the Analyzer and the Source.

The Source and Analyzer sequence is completely configurable and can have internal triggers between the source and the analyzer to orchestrate a sequence to completely test an external transmitter and receiver's performance.

Key Path:	Recall, Sequences
Example:	:MMEM:LOAD:SEQ:SAAL "MySequence.txt"
Dependencies:	Only available in XOBT, Sequence Analyzer mode
Initial S/W Revision:	A.05.00

Open...

Pressing **File Open** brings up the File Open standard Windows dialog and the File Open key menu.

When the user navigates to this selection, they have already determined they are recalling a specific Data Type and now they want to specify which file to open.

When you first enter this dialog, the path is in the Look In: field in this File Open dialog depends on which import data type you navigated here from.

The only files that are visible are those specific to the file type being recalled.

Key Path:	Recall, Sequence
Notes:	The key location is mode-dependent and will vary.
Notes:	Brings up Open dialog for recalling a <sequence> Save Type
Initial S/W Revision:	A.05.00

Data (Import)

Importing a data file loads data that was previously saved from the current measurement or from other measurements and/or modes that produce compatible data files. The Import Menu only contains Data Types that are supported by the current measurement.

Since the commonly exported data files are in .csv format, the data can be edited by the user prior to importing. This allows you to export a data file, manipulate the data in Excel (the most common PC Application for manipulating .csv files) and then import it.

Importing Data loads measurement data from the specified file into the specified or default destination, depending on the data type selected. Selecting an Import Data menu key will not actually cause the importing to occur, since the analyzer still needs to know from where to get the data. Pressing the Open key in this menu brings up the Open dialog and Open menu that provides you with the options from where to recall the data. Once a filename has been selected or entered in the Open menu, the recall

occurs as soon as the Open button is pressed.

Key Path:	Recall
Mode:	All
Notes:	The menu is built from whatever data types are available for the mode. Some keys will be missing completely, so the key locations in the sub-menu will vary. No SCPI command directly controls the Data Type that this key controls. The Data Type is included in the MMEM:LOAD commands.
Dependencies:	If a file type is not used by a certain measurement, it is grayed out for that measurement. The key for a file type will not show at all if there are no measurements in the Mode that support it.
Preset:	Is not affected by Preset or shutdown, but is reset during Restore Mode Defaults
Readback:	The data type that is currently selected
Initial S/W Revision:	Prior to A.02.00

Open...

When you press “Open”, the analyzer brings up a Windows dialog and a menu entitled “**File Open.**” This menu allows you to navigate to the various fields in the Windows dialog without using a keyboard or mouse. The **Tab** and **Arrow** keys can also be used for dialog navigation.

See “[From File...](#)” on page 195 in **Recall, State**, for a full description of this dialog and menu.

Key Path:	Recall, Data
Notes:	The key location is mode-dependent and will vary. Brings up Open dialog for recalling a <mode specific> Save Type
Initial S/W Revision:	Prior to A.02.00

Save

The **Save** menu lets you choose what you want to save and where you want to save it. Among the types of files you can save are **States**, **Traces**, and **Screen Images**. In addition, an **Export (Data)** option lets you save a number of data types as CSV files for easy import into Excel and other spreadsheet programs.

Key Path:	Front-panel key
Mode:	All
Notes:	No remote command for this key specifically, but the :MMEM:STORE command is available for specific file types. An example is :MMEM:STOR:STATe <filename>.
Initial S/W Revision:	Prior to A.02.00

State

The Save State menu lets you choose a register or file for saving the state.

The content of a state file includes all of the settings and data required to return the analyzer as closely as possible to the Mode it was in, with the exact settings which were in place, when the save occurred. The Mode settings in each state file include the settings that are affected by Mode Preset, as well as the additional settings affected by Restore Mode Defaults; all of the Mode's settings. In addition, all of the settings of the **Input/Output** system are included, even though they are outside of the Mode's state, because they are needed to restore the complete setup. Persistent **System** settings (for example, GPIB address) are not affected by either Mode Preset or Restore Mode Defaults, nor are they included in a saved State file.

After the save completes, the message "File <filename> saved" or "State Register <register number> saved" is displayed.

For rapid saving, the State menu lists 16 registers to save to. Pressing a Register key initiates the save. You can also select a file to save to.

The default path for all State Files is:

My Documents\<mode name>\state

where <mode name> is the parameter used to select the mode with the INST:SEL command (for example, SA for the Spectrum Analyzer).

Key Path:	Save
Mode:	All
Remote Command:	:MMEMory:STORe:STATe <filename>
Example:	MMEM:STOR:STATe "MyStateFile.state" This stores the current instrument state data in the file MyStateFile.state in the default directory.

Notes:	<p>Both single and double quotes are supported for any filename parameter over remote.</p> <p>After saving to a register, that register's menu key is updated with the date the time, unless a custom label has been entered for that key.</p> <p>After saving to a register, you remain in the Save State menu, so that you can see the Register key update. After saving to a file, the analyzer automatically returns to the previous menu and any Save As dialog goes away.</p>
Backwards Compatibility SCPI:	<p>:MMEMory:STORe:STATe 1,<filename></p> <p>For backwards compatibility, the above syntax is supported. The "1" is simply ignored. The command is sequential.</p>
Initial S/W Revision:	Prior to A.02.00

To File . . .

When you press “To File”, the analyzer brings up a Windows dialog and a menu entitled “**Save As.**” This menu allows you to navigate to the various fields in the Windows dialog without using a keyboard or mouse. The **Tab** and **Arrow** keys can also be used for dialog navigation.

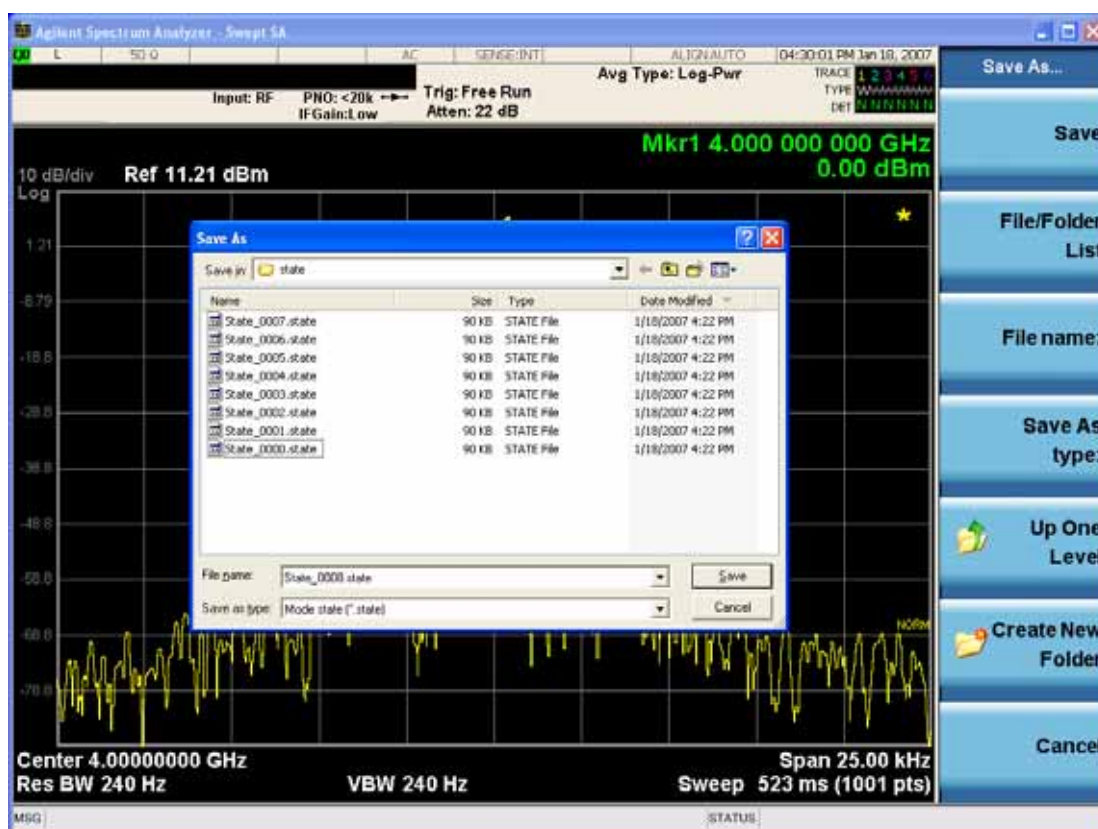

The

Listed below are the functions of the various fields in the dialog, and the corresponding softkeys:

Save

Performs the save to the specified file of the selected type. If the file already exists, a dialog will appear that allows you to replace the existing file by selecting **OK**, or you can Cancel the request. If you select

System Functions

Save

OK, the file will be overwritten. Using the C: drive is strongly discouraged, since it runs the risk of being overwritten during an instrument software upgrade.

While the save is being performed, the floppy icon appears briefly in the Meas bar.

File/Folder List

Enables you to navigate to the center of the dialog that contains the list of files and folders. Once here you can get information about the file and use the tab keys to navigate to the other fields in the dialog, such as Save In.

Save In

The Save In field shows the path to which the file will be saved and allows you to change the path using the up and down arrow keys to navigate to other paths; the Enter key to open a directory; and the Backspace key to go back one directory. The **Save In field** defaults to the default path for this type of file and remembers the last path you used to save this type of file. There is no softkey for directly navigating to the Save In field but you can use left tab to get here from the File/Folder List.

User specified paths are remembered when you leave and return to a Mode and are reset back to the default using **Restore Mode Defaults**.

File Name

The **File Name** field is initially loaded with an automatically generated filename specific to the appropriate Save Type. The automatically generated filename is guaranteed not to conflict with any filename currently in the directory. You may replace or modify this filename using the File Name key. See the "[Quick Save](#)" on page 190 documentation for more on the automatic file naming algorithm.

When you press the **File Name** key the analyzer displays the Alpha Editor. Use the knob to choose the letter to add and the front-panel Enter key to add the letter to the file name. The BK character moves you back and the FW character moves you forward in the filename. The Select key on the front panel generates a space character. When you are done entering the filename press the **Done** softkey. This returns back to the **File Open** dialog and menu, but does not cause the save to occur.

Save As Type

This field shows the file suffix for the type of file you have selected to save. For example, if you navigated here while saving State, "Mode state (*.state)" is in the field. If you navigated here from saving Trace, "Mode state (*.trace)" is in the field. If you navigated here while exporting a trace data file, "Trace Data (*.csv)" is in the field. For some file types, there is more than one choice in the dropdown, which you can select by using the up and down arrow keys and Enter.

Up One Level

This key corresponds to the icon of a folder with the up arrow that is in the tool bar of the dialog. When pressed, it causes the file and folder list to navigate up one level in the directory structure. The Backspace key does the same thing.

Create New Folder

This key corresponds to the icon of a folder with the "*" that is in the tool bar of the dialog. When pressed, a new folder is created in the current directory with the name **New Folder** and you can enter a new folder name using the Alpha Editor.

Cancel

This key corresponds to the **Cancel** selection in the dialog. It causes the current **Save As** request to be cancelled. The ESC key does the same thing.

Key Path:	Save, State
Mode:	All
Notes:	Brings up Save As dialog for saving a State Save Type
Initial S/W Revision:	Prior to A.02.00

Edit Register Names

You may enter a custom name on any of the Register keys, to help you remember what you are using that state to save. To do this, press the **Edit Register Names** key, choose the register whose name you wish to edit, and then enter the desired label using the Alpha Editor or an external PC keyboard.

The maximum number of characters that can be added is 30. In most cases, 30 characters will fit on two lines of the key.

See [“More Information” on page 207](#)

Key Path:	Save, State
Mode:	All
Remote Command:	:MMEMory:REGister:STATe:LABel <reg number>,"label" :MMEMory:REGister:STATe:LABel? <reg number>
Example:	:MMEM:REG:STAT:LAB 1,"my label"
Notes:	<reg number> is an integer from 1 to 16. If the SCPI specifies an invalid register number an error message is generated, -222,"Data out of range;Invalid register label number" "label" is a string from 0 to 30 characters in length. If a label exceeds 30 characters, an error message is generated, -150,"String data error;Label clipped to 30 characters" "label" of length 0 erases the custom label and restores the default (time and date) label. E.g.: :MMEM:REG:STAT:LAB 1,""
Dependencies:	N9060A-7FP or N9060B-2FP license required to edit the register names. When the feature is not licensed, sending this command generates an error, -221,"Settings conflict;Option not available"
Preset:	The names are unaffected by Preset or power cycle but are set to the default label (time and date) on a "Restore System Defaults->Misc"
Initial S/W Revision:	A.11.00

More Information

When you edit one of the register names, the time and date field will be replaced by the custom name.

If you delete all the characters in the custom name, it restores the default (time and date).

The register names are stored within the state files, but they are not part of the instrument state; that is, once you have edited a register name, loading a new state will not change that register name. Another consequence of this is that the names will be persistent through a power cycle. Also, if a named state file is transferred to another analyzer, it will bring its custom name along with it.

If you try to edit the name of an empty register, the analyzer will first save the state to have a file to put the name in. If you load a named state file into an analyzer with older firmware it will ignore the metadata.

The *SAV and *RCL commands will not be affected by the custom register names, nor will the MMEM commands.

Register 1 thru Register 16

Selecting any one of these register menu keys causes the State of the currently active mode to be saved to the specified Register. The registers are provided for rapid saving and recalling, since you do not need to specify a filename or navigate to a file. Each of the register menu keys annotates whether it is empty or at what date and time it was last modified. In addition, you can use the **Edit Register Names** key to enter custom names for each register.

Although these 16 registers are the only registers available from the front panel, there are 128 state registers available in the instrument. Registers 17–128 are only available from the SCPI interface, using the *SAV command.

There is one set of 128 state registers in the instrument, not one set for each Mode. When a state is saved, the Mode it was saved from is saved with it; then when it is recalled, the instrument switches to that Mode.

After the save completes, the corresponding register menu key annotation is updated with the date and time and the message "Register <register number> saved" is displayed.

Key Path:	Save, State
Mode:	All
Example:	*SAV 1
Range:	1–16 from front panel, 1–128 from SCPI
Readback:	Date and time with seconds resolution are displayed on the key OR A custom name of up to 30 characters entered using the Edit Register Names key OR “(empty)” if no prior save operation has been performed to this register.
Initial S/W Revision:	Prior to A.02.00
Modified at S/W Revision:	A.11.00

Trace (+State)

The **Save Trace (+State)** menu lets you choose a register or file specifying where to save the

Trace+State state file.

A saved state contains all of the settings and data required to return the analyzer as closely as possible to the exact setup it had when the save occurred. This includes the Input/Output settings, even though they are outside of the Mode's state, because they are needed to restore the complete setup. A Trace+State file also includes trace data from one trace or all traces, which will load in View mode when the Trace+State file is recalled.

After the save completes, the message "File <filename> saved" or "Trace Register <register number> saved" is displayed.

For rapid saves, the Trace (+State) menu lists 5 registers to save to. Pressing a Register key initiates the save. You can also select a file to save to.

The default path for all State Files including .trace files is:

My Documents\<mode name>\state

where <mode name> is the parameter used to select the mode with the INST:SEL command (for example, SA for the Spectrum Analyzer).

This key is grayed out for measurements that do not support trace saves. It is blanked for modes that do not support trace saves. Saving **Trace** is identical to saving State except a .trace extension is used on the file instead of .state, and internal flags are set in the file indicating which trace was saved. You may select to save one trace or ALL traces.

Key Path:	Save
Mode:	SA
Remote Command:	:MMEMory:STORe:TRACe TRACE1 TRACE2 TRACE3 TRACE4 TRACE5 TRACE6 ALL, <filename> > :MMEMory:STORe:TRACe:REGister TRACE1 TRACE2 TRACE3 TRACE4 TRACE5 TRACE6 ALL, <integer>
Example:	:MMEM:STOR:TRAC TRACE1, "myState.trace" saves the file myState.trace on the default path and flags it as a "single trace" file with Trace 1 as the single trace (even though all of the traces are in fact stored). :MMEM:STOR:TRAC ALL, "myState.trace" saves the file myState.trace on the default path and flags it as an "all traces" file :MMEM:STOR:TRAC:REG TRACE1,2 stores trace 1 data in trace register 2

Notes:	<p>This command actually performs a save state, which in the Swept SA measurement includes the trace data. However it flags it (in the file) as a “save trace” file of the specified trace (or all traces).</p> <p>Some modes and measurements do not have available all 6 traces. The Phase Noise mode command, for example, is: <code>MMEMory:STORE:TRACe TRACE1 TRACE2 TRACE3 ALL,<filename></code></p> <p>The range for the register parameter is 1–5</p> <p>When you initiate a save, if the file already exists, a dialog will appear that allows you to replace the existing file by selecting OK or you can Cancel the request. If you select OK, the file will be overwritten. Using the C: drive is strongly discouraged, since it runs the risk of being overwritten during an instrument software upgrade.</p> <p>Both single and double quotes are supported for any filename parameter over remote.</p> <p>After saving to a register, that register’s menu key is updated with the date and time of the save.</p> <p>After saving to a register, you remain in the Save Trace menu, so that you can see the Register key update. After saving to a file, the analyzer automatically returns to the previous menu and any Save As dialog goes away.</p>
Initial S/W Revision:	Prior to A.02.00

Register 1 thru Register 5

Selecting any one of these register menu keys causes the Trace(s) specified under From Trace, along with the state of the currently active mode, to be saved to the specified Trace Register. The registers are provided for rapid saving and recalling, since you do not need to specify a filename or navigate to a file. Each of the register menu keys annotates whether it is empty or at what date and time it was last modified.

Key Path:	Save, Trace
Mode:	SA
Range:	1–5
Readback:	Date and time with seconds resolution are displayed on the key, or "(empty)" if no prior save operation performed to this register.
Initial S/W Revision:	Prior to A.02.00

From Trace

Accesses a menu that enables you to select the trace to be saved. Once a trace is selected, the key returns to the Save Trace menu and the selected trace number is annotated on the key. The default is the currently selected trace, selected in this menu or in the Trace/Det, Export Data, Import Data or Recall Trace menus, except if you have chosen All then it remains chosen until you specifically change it to a single trace. To save the Trace you must select the **Save As** key in the Save Trace menu.

When you select a trace, it makes that trace the current trace, so it displays on top of all of the other

traces.

Key Path:	Save, Trace + State
Mode:	SA
Initial S/W Revision:	Prior to A.02.00

To File . . .

When you press “To File”, the analyzer brings up a Windows dialog and a menu entitled “**Save As.**” This menu allows you to navigate to the various fields in the Windows dialog without using a keyboard or mouse. The **Tab** and **Arrow** keys can also be used for dialog navigation.

See “To File . . .” on page 205 in **Save, State** for a full description of this dialog and menu.

Key Path:	Save, Trace (+State)
Mode:	SA
Notes:	Brings up Save As dialog for saving a Trace+State Save Type
Initial S/W Revision:	Prior to A.02.00

Sequences

This menu and all of its submenus are only available in the EXT (E6607A).

These keys allow you to save a Tab separated or CSV file of the setup parameters required to build a Sequence.

In order to save you must select the Save As button and choose a destination folder.

Key Path:	Save, Sequences
Mode:	All
Remote Command:	:MMEM:STOR:SEquences: SLISt ALISt SAALISt SSTep "MySequence.txt"
Example:	:MMEM:STOR:SEQ:SLISt "MySequence.txt"
Notes:	Available file types are: CSV (Comma delimited) (*.csv) Text (Tab delimited) (*.txt)
Initial S/W Revision:	A.05.00

Source Sequence

The list of parameters, that configure steps, that makes up a sequence for the Source.

The Source sequence is a sequence of flexible configurable steps that can be set anywhere in the

instruments frequency range.

Key Path:	Save, Sequences
Example:	:MMEM:STOR:SEQ:SLIS "MySequence.txt"
Dependencies:	Only available in XOBT
Initial S/W Revision:	A.05.00

Analyzer Sequence

Only Available in: Sequence Analyzer Mode

The list of parameters, that configure steps, that makes up a sequence for the Analyzer.

The Analyzer sequence is a sequence of flexible configurable steps that can be set anywhere in the instruments frequency range for measuring the performance of a transmitters output

Key Path:	Save, Sequences
Example:	:MMEM:STOR:SEQ:ALIS "MySequence.txt"
Dependencies:	Only available in XOBT, Sequence Analyzer mode
Initial S/W Revision:	A.05.00

Source and Analyzer Sequence

Available in: Sequence Analyzer Mode

The list of parameters, that configure steps, that makes up a sequence for the Analyzer and the Source.

The Source and Analyzer sequence is completely configurable and can have internal triggers between the source and the analyzer to orchestrate a sequence to completely test an external transmitter and receiver's performance.

Key Path:	Save, Sequences
Example:	:MMEM:STOR:SEQ:SAAL "MySequence.txt"
Dependencies:	Only available in XOBT, Sequence Analyzer mode
Initial S/W Revision:	A.05.00

Save As . . .

This menu lets you select the location where you can save the Sequence. This menu is a standard Windows® dialog with Save As menu keys. The "File Name" field in the Save As dialog is initially loaded with an automatically generated filename specific to the appropriate Save Type. The automatically generated filename is guaranteed not to conflict with any filename currently in the directory. You may replace or modify this filename using the File Name softkey. See the Quick Save key documentation for more on the automatic file naming algorithm.

The default path for all Sequence Files is:

My Documents\Sequences

Key Path:	Save, Sequences
Mode:	All
Notes:	Brings up Save As dialog for saving a Sequence Save Type
Initial S/W Revision:	A.05.00

Data (Export)

Exporting a data file stores data from the current measurement to mass storage files. The Export Menu only contains data types that are supported by the current measurement.

Since the commonly exported data files are in .csv format, the data can be edited by you prior to importing. This allows you to export a data file, manipulate the data in Excel (the most common PC Application for manipulating .csv files) and then import it.

Selecting an Export Data menu key will not actually cause the exporting to occur, since the analyzer still needs to know where you wish to save the data. Pressing the Save As key in this menu brings up the Save As dialog and Save As menu that allows you to specify the destination file and directory. Once a filename has been selected or entered in the Open menu, the export will occur as soon as the Save key is pressed.

Key Path:	Save
Mode:	All
Notes:	The menu is built from whatever data types are available for the mode. So the key locations in the sub menu will vary. No SCPI command directly controls the Data Type that this key controls. The Data Type is included in the MMEM:STOR commands.
Dependencies:	If a file type is not used by a certain measurement, that type is grayed out for that measurement. The key for a file type will not show at all if there are no measurements in the Mode that support it.
Preset:	Is not affected by a Preset or shutdown, but is reset during Restore Mode Defaults
Readback:	The data type that is currently selected
Initial S/W Revision:	Prior to A.02.00

Save As . . .

When you press “Save As”, the analyzer brings up a Windows dialog and a menu entitled “**Save As.**” This menu allows you to navigate to the various fields in the Windows dialog without using a keyboard or mouse. The **Tab** and **Arrow** keys can also be used for dialog navigation.

See “[To File . . .](#)” on page 205 in **Save, State** for a full description of this dialog and menu.

The default path for saving files is:

System Functions

Save

For all of the Trace Data Files:

My Documents\<<mode name>\data\traces

For all of the Limit Data Files:

My Documents\<<mode name>\data\limits

For all of the Measurement Results Data Files:

My Documents\<<mode name>\data\<<measurement name>\results

For all of the Capture Buffer Data Files:

My Documents\<<mode name>\data\captureBuffer

Key Path:	Save, Data
Mode:	All
Notes:	The key location is mode-dependent and will vary. Brings up the Save As dialog for saving a <mode specific> Save Type. The save is performed immediately and does not wait until the measurement is complete.
Initial S/W Revision:	Prior to A.02.00

Screen Image

Pressing Screen Image accesses a menu of functions that enable you to specify a format and location for the saved screen image. It brings up a menu that allows you to specify the color scheme of the Screen Image (Themes) or navigate to the Save As dialog to perform the actual save.

Screen Image files contain an exact representation of the analyzer display. They cannot be loaded back onto the analyzer, but they can be loaded into your PC for use in many popular applications.

The image to be saved is actually captured when the **Save** front panel key is pressed, and kept in temporary storage to be used if you ask for a Screen Image save. When the Screen Image key is pressed, a "thumbnail" of the captured image is displayed, as shown below:

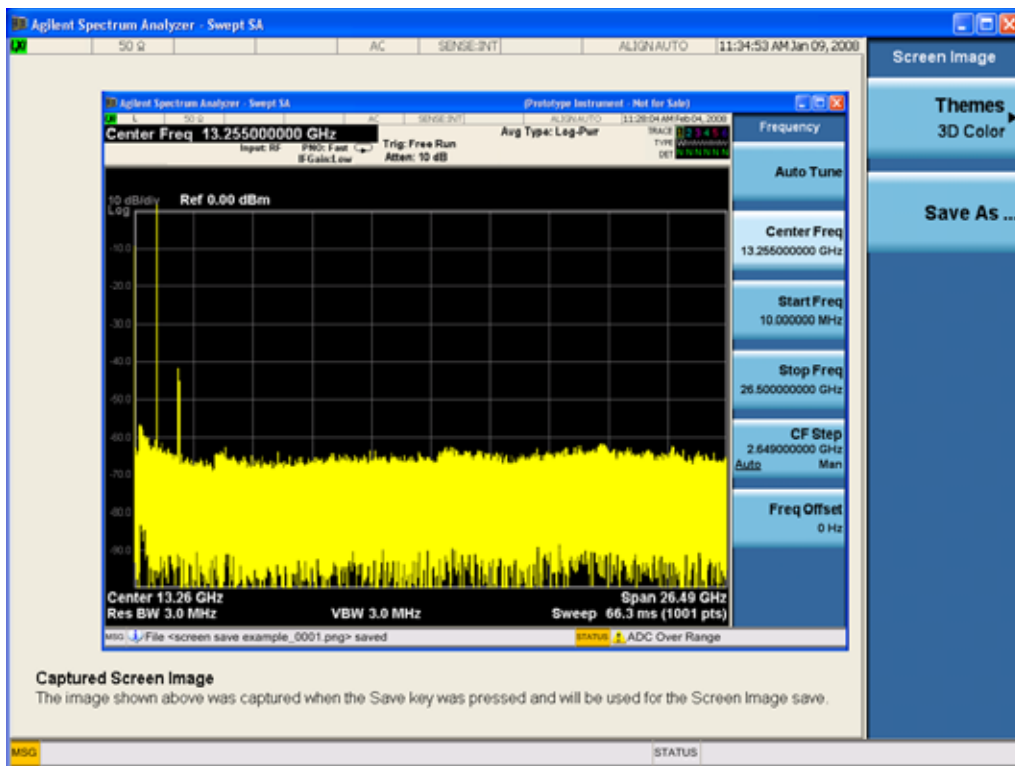

When you continue on into the **Save As** menu and complete the Screen Image save, the image depicted in the thumbnail is the one that gets saved, showing the menus that were on the screen before going into the **Save** menus. The save is performed immediately and does not wait until the measurement is complete.

After you have completed the save, the **Quick Save** front-panel key lets you quickly repeat the last save performed, using an auto-named file, with the current screen data.

NOTE For versions previous to A.01.55, if you initiate a screen image save by navigating through the Save menus, the image that is saved will contain the Save menu softkeys, not the menus and the active function that were on the screen when you first pressed the Save front panel key.

Key Path:	Save
Mode:	All
Remote Command:	:MMEMory:STORe:SCReem <filename>
Example:	:MMEM:STOR:SCR "myScreen.png" This stores the current screen image in the file MyScreenFile.png in the default directory.
Initial S/W Revision:	Prior to A.02.00

Themes

Accesses a menu of functions that enable you to choose the theme to be used when saving the screen image.

The **Themes** option is the same as the **Themes** option under the **Display** and **Page Setup** dialogs. It allows you to choose between themes to be used when saving the screen image.

Key Path:	Save, Screen Image
Remote Command:	:MMEMory:STORe:SCReen:THEMe TDCOLOR TDMonochrome FCOLOR FMONochrome :MMEMory:STORe:SCReen:THEMe?
Example:	:MMEM:STOR:SCR:THEM TDM
Preset:	3D Color; Is not part of Preset, but is reset by Restore Misc Defaults or Restore System Defaults All and survives subsequent running of the modes.
Readback:	3D Color 3D Mono Flat Color Flat Mono
Backwards Compatibility Notes:	In ESA and PSA we offer the choice of "Reverse Bitmap" or "Reverse Metafile" when saving screen images. This is much like the "Flat Color" theme available in X-Series. Also, if the user selected Reverse Bitmap AND a black&white screen image, that would be much like "Flat Monochrome". In other words, each of the X-Series themes has a similar screen image type in ESA/PSA. But they are not identical.
Initial S/W Revision:	Prior to A.02.00

3D Color

Selects a standard color theme with each object filled, shaded and colored as designed.

Key Path:	Save, Screen Image, Themes
Example:	MMEM:STOR:SCR:THEM TDC
Readback:	3D Color
Initial S/W Revision:	Prior to A.02.00

3D Monochrome

Selects a format that is like 3D color but shades of gray are used instead of colors.

Key Path:	Save, Screen Image, Themes
Example:	MMEM:STOR:SCR:THEM TDM
Readback:	3D Mono
Initial S/W Revision:	Prior to A.02.00

Flat Color

Selects a format that is best when the screen is to be printed on an ink printer.

Key Path:	Save, Screen Image, Themes
Example:	MMEM:STOR:SCR:THEM FCOL
Readback:	Flat Color
Initial S/W Revision:	Prior to A.02.00

Flat Monochrome

Selects a format that is like Flat Color. But only black is used (no colors, not even gray), and no fill.

Key Path:	Save, Screen Image, Themes
Example:	MMEM:STOR:SCR:THEM FMON
Readback:	Flat Mono
Initial S/W Revision:	Prior to A.02.00

Save As...

When you press “Save As”, the analyzer brings up a Windows dialog and a menu entitled “**Save As.**” This menu allows you to navigate to the various fields in the Windows dialog without using a keyboard or mouse. The **Tab** and **Arrow** keys can also be used for dialog navigation.

See “[To File . . .](#)” on page 205 in **Save, State** for a full description of this dialog and menu.

The default path for Screen Images is

My Documents\`<mode name>`\screen.

where `<mode name>` is the parameter used to select the mode with the INST:SEL command (for example, SA for the Spectrum Analyzer).

Key Path:	Save, Screen Image
Notes:	Brings up Save As dialog for saving a Screen Image Save Type
Initial S/W Revision:	Prior to A.02.00

Mass Storage Catalog (Remote Command Only)

Remote Command:	:MMEMory:CATalog? [<directory_name>]
Notes:	<p>The string must be a valid logical path.</p> <p>Queries disk usage information (drive capacity, free space available) and obtains a list of files and directories in a specified directory in the following format:</p> <p><numeric_value>,<numeric_value>,{<file_entry>}</p> <p>It returns two numeric parameters and as many strings as there are files and directories. The first parameter indicates the total amount of storage currently used in bytes. The second parameter indicates the total amount of storage available, also in bytes. The <file_entry> is a string. Each <file_entry> indicates the name, type, and size of one file in the directory list:</p> <p><file_name>,<file_type>,<file_size></p> <p>As the windows file system has an extension that indicates file type, <file_type> is always empty. <file_size> provides the size of the file in bytes. For directories, <file_entry> is surrounded by square brackets and both <file_type> and <file_size> are empty</p>
Initial S/W Revision:	Prior to A.02.00

Mass Storage Change Directory (Remote Command Only)

Remote Command:	:MMEMory:CDIRectory [<directory_name>] :MMEMory:CDIRectory?
Notes:	<p>The string must be a valid logical path.</p> <p>Changes the default directory for a mass memory file system. The <directory_name> parameter is a string. If no parameter is specified, the directory is set to the *RST value.</p> <p>At *RST, this value is set to the default user data storage area, that is defined as System.Environment.SpecialFolder.Personal.</p> <p>Query returns full path of the default directory.</p>
Initial S/W Revision:	Prior to A.02.00

Mass Storage Copy (Remote Command Only)

Remote Command:	:MMEMory:COPY <string>,<string>[,<string>,<string>]
-----------------	---

Notes:	<p>The string must be a valid logical path.</p> <p>Copies an existing file to a new file or an existing directory to a new directory.</p> <p>Two forms of parameters are allowed. The first form has two parameters. In this form, the first parameter specifies the source, and the second parameter specifies the destination.</p> <p>The second form has four parameters. In this form, the first and third parameters specify the source. The second and fourth parameters specify the directories. The first pair of parameters specifies the source. The second pair specifies the destination. An error is generated if the source doesn't exist or the destination file already exists.</p> <p>This command will generate an "access denied" error if the destination is a restricted folder (e.g., C:\Windows) and the current user does not have Power User or Administrator privileges.</p>
--------	--

Mass Storage Delete (Remote Command Only)

Remote Command:	:MMEMory:DELeTe <file_name>[, <directory_name>]
Notes:	<p>The string must be a valid logical path.</p> <p>Removes a file from the specified directory. The <file_name> parameter specifies the file name to be removed. This command will generate an "access denied" error if the file is in a restricted folder (e.g., C:\Windows) and the current user does not have Power User or Administrator privileges.</p>
Initial S/W Revision:	Prior to A.02.00

Mass Storage Data (Remote Command Only)

Creates a file containing the specified data OR queries the data from an existing file.

Remote Command:	:MMEMory:DATA <file_name>, <data> :MMEMory:DATA? <file_name>
Notes:	<p>The string must be a valid logical path.</p> <p>The command form is MMEMory:DATA <file_name>,<data>. It loads <data> into the file <file_name>. <data> is in 488.2 block format. <file_name> is string data.</p> <p>The query form is MMEMory:DATA? <file_name> with the response being the associated <data> in block format.</p>
Initial S/W Revision:	Prior to A.02.00

Mass Storage Make Directory (Remote Command Only)

Remote Command:	:MMEMory:MDIRectory <directory_name>
Notes:	<p>The string must be a valid logical path.</p> <p>Creates a new directory. The <directory_name> parameter specifies the name to be created.</p> <p>This command will generate an “access denied” error if the new directory would be in a restricted folder (e.g., C:\Windows) and the current user does not have Power User or Administrator privileges.</p>
Initial S/W Revision:	Prior to A.02.00

Mass Storage Move (Remote Command Only)

Remote Command:	:MMEMory:MOVE <string>, <string> [, <string>, <string>]
Notes:	<p>The string must be a valid logical path.</p> <p>Moves an existing file to a new file or an existing directory to a new directory.</p> <p>Two forms of parameters are allowed. The first form has two parameters. In this form, the first parameter specifies the source, and the second parameter specifies the destination.</p> <p>The second form has four parameters. In this form, the first and third parameters specify the source. The second and fourth parameters specify the directories. The first pair of parameters specifies the source. The second pair specifies the destination. An error is generated if the source doesn't exist or the destination file already exists.</p> <p>This command will generate an “access denied” error if the destination is a restricted folder (e.g., C:\Windows) and the current user does not have Power User or Administrator privileges.</p>
Initial S/W Revision:	Prior to A.02.00

Mass Storage Remove Directory (Remote Command Only)

Remote Command:	:MEMMory:RDIRectory <directory_name>
Notes:	<p>The string must be a valid logical path.</p> <p>Removes a directory. The <directory_name> parameter specifies the directory name to be removed. All files and directories under the specified directory shall also be removed.</p> <p>This command will generate an “access denied” error if the folder is a restricted folder (e.g., C:\Windows) or is in a restricted folder and the current user does not have Power User or Administrator privileges.</p>
Initial S/W Revision:	Prior to A.02.00

System

Opens a menu of keys that access various configuration menus and dialogs.

Key Path:	Front-panel key
Notes:	No remote command for this key specifically.
Initial S/W Revision:	Prior to A.02.00

Show

Accesses a menu of choices that enable you to select the information window you want to view.

Key Path:	System
Mode:	All
Remote Command:	:SYSTem:SHOW OFF ERRor SYSTem HARDware LXI HWSTatistics ALIGNment SOFTware CAPPLication :SYSTem:SHOW?
Example:	:SYST:SHOW SYST
Notes:	This command displays (or exits) the various System information screens.
Preset:	OFF
State Saved:	No
Range:	OFF ERRor SYSTem HARDware LXI HWSTatistics ALIGNment SOFTware CAPPLication
Initial S/W Revision:	Prior to A.02.00

Errors

There are two modes for the Errors selection, History and Status.

The list of errors displayed in the Errors screen does not automatically refresh. You must press the Refresh key or leave the screen and return to it to refresh it.

History brings up a screen displaying the event log in chronological order, with the newest event at the top. The history queue can hold up to 100 messages (if a message has a repeat count greater than 1 it only counts once against this number of 100). Note that this count bears no relation to the size of the SCPI queue. If the queue extends onto a second page, a scroll bar appears to allow scrolling with a mouse. Time is displayed to the second.

Status brings up a screen summarizing the status conditions currently in effect. Note that the time is displayed to the second.

The fields on the Errors display are:

System Functions
System

Type (unlabeled) - Displays the icon identifying the event or condition as an error or warning.

ID - Displays the error number.

Message - Displays the message text.

Repeat (RPT) - This field shows the number of consecutive instances of the event, uninterrupted by other events. If an event occurs 5 times with no other intervening event, the value of repeat will be 5.

If the value of Repeat is 1 the field does not display. If the value of Repeat is >1, the time and date shown are those of the most recent occurrence. If the value of repeat reaches 999,999 it stops there.

Time - Shows the most recent time (including the date) at which the event occurred.

Key Path:	System, Show
Mode:	All
Remote Command:	:SYSTem:ERRor [:NEXT] ?
Example:	:SYST:ERR?
Notes:	The return string has the format: “<Error Number>,<Error>” Where <Error Number> and <Error> are those shown on the Show Errors screen
Backwards Compatibility Notes:	In some legacy analyzers, the Repeat field shows the number of times the message has repeated since the last time the error queue was cleared. In the X-Series, the Repeat field shows the number of times the error has repeated since the last intervening error. So the count may very well be different than in the past even for identical signal conditions Unlike previous analyzers, in the X-Series all errors are reported through the Message or Status lines and are logged to the event queue. They never appear as text in the graticule area (as they sometimes do in previous analyzers) and they are never displayed in the settings panel at the top of the screen (as they sometimes do, by changing color, in previous analyzers). As a consequence of the above, the user can only see one status condition (the most recently generated) without looking at the queue. In the past, at least in the Spectrum Analyzer, multiple status conditions might display on the right side of the graticule. In general, there is no backwards compatibility specified or guaranteed between the error numbers in the X-Series and those of earlier products. Error, event, and status processing code in customers’ software will probably need to be rewritten to work with X-Series. In the legacy analyzers, some conditions report as errors and others simply turn on status bits. Conditions that report as errors often report over and over as long as the condition exists. In the X-series, all conditions report as start and stop events. Consequently, software that repeatedly queries for a condition error until it stops reporting will have to be rewritten for the X-series.
Initial S/W Revision:	Prior to A.02.00

Next Page

Next Page and Previous Page menu keys move you between pages of the log, if it fills more than one page. These keys are grayed out in some cases:

If on the last page of the log, the Next Page key is grayed-out

If on the first page of the log, the Previous Page key is grayed-out.

If there is only one page, both keys are grayed out.

Key Path:	System, Show, Errors
Initial S/W Revision:	Prior to A.02.00

Previous Page

See [“Next Page” on page 223](#).

Key Path:	System, Show, Errors
Initial S/W Revision:	Prior to A.02.00

History

The History and Status keys select the Errors view. The Status key has a second line which shows a number in [square brackets]. This is the number of currently open status items.

Key Path:	System, Show, Errors
Initial S/W Revision:	Prior to A.02.00

Status

See [“History” on page 223](#).

Verbose SCPI On/Off

When you turn Verbose SCPI on, additional information is returned when you send the :SYSTem:ERRor? query. The additional information consists of the characters that stimulated the error. This can aid you in debugging your test programs by indicating where in the parsing of a SCPI command the instrument encountered an invalid command or query.

Specifically, with Verbose SCPI on, the SYSTem:ERRor? query is expanded to show the SCPI data received, with the indicator <Err> at the point in the stream that the error occurred.

Verbose SCPI has no effect on the Show Errors screen or front panel Message Line; it only changes the response to the :SYST:ERR? query.

See the example below, where the invalid command “SENS:BOGUS” is sent:

Normal response to :SYST:ERR (using the Telnet window):

```
SCPI> SENS:BOGUS
```

```
SCPI> SYST:ERR?
```

System Functions
System

-113,"Undefined header"

Now after turning on Verbose SCPI:

SCPI> SYST:BOGUS

SCPI> SYST:ERR?

-113,"Undefined header;SYST:BOGUS<Err>"

Key Path:	System, Show, Errors
Mode:	All
Remote Command:	:SYSTem:ERRor:VERBoSe OFF ON 0 1 :SYSTem:ERRor:VERBoSe?
Example:	:SYST:ERR:VERB ON
Preset:	This is unaffected by Preset but is set to OFF on a "Restore System Defaults->Misc"
State Saved:	No
Range:	On Off
Initial S/W Revision:	Prior to A.02.00

Input Overload Enable (Remote Command Only)

Input Overload errors are reported using the Input Overload status bit (bit 12 in the Measurement Integrity status register). Input Overloads (for example, ADC Overload errors) can come and go with great frequency, generating many error events (for example, for signals just on the verge of overload), and so are not put into the SCPI error queue by default. Normally the status bit is the only way for detecting these errors remotely.

It is possible to enable Input Overload reporting to the SCPI queue, by issuing the :SYSTem:ERRor:OVERload ON command. To return to the default state, issue the :SYSTem:ERRor:OVERload OFF command. In either case, Input Overloads always set the status bit.

NOTE For versions of firmware before A.10.01, the Input Overload was only a Warning and so was never available in the SCPI queue, although it did set the status bit. For A.10.01 and later, the Input Overload is an error and can be enabled to the SCPI queue using this command.

Key Path:	SCPI only
Remote Command:	:SYSTem:ERRor:OVERload[:STATe] 0 1 OFF ON
Example:	:SYST:ERR:OVER 1 Enable overload errors
Preset:	Set to OFF by Restore Misc Defaults (no Overload errors go to SCPI)
State Saved:	Saved in instrument state.

Initial S/W Revision:	A.10.01
-----------------------	---------

Refresh

When pressed, refreshes the Show Errors display.

Key Path:	System, Show, Errors
Initial S/W Revision:	Prior to A.02.00

Clear Error Queue

This clears all errors in all error queues.

Note the following:

Clear Error Queue does not affect the current status conditions.

Mode Preset does not clear the error queue.

Restore System Defaults will clear all error queues.

*CLS only clears the queue if it is sent remotely and *RST does not affect any error queue.

Switching modes does not affect any error queues.

Key Path:	System, Show, Errors
Initial S/W Revision:	Prior to A.02.00

System

The System screen is formatted into three groupings: product descriptive information, options tied to the hardware, and software products:

<Product Name> <Product Description>	
Product Number: N9020A	
Serial Number: US46220924	
Firmware Revision: A.01.01	
Computer Name: <hostname>	
Host ID: N9020A,US44220924	
N9020A-503	Frequency Range to 3.6 GHz
N9020A-PFR	Precision Frequency Reference
N9020A-P03	Preamp 3.6 GHz
N9060A-2FP	Spectrum Analysis Measurement Suite 1.0.0.0
N9073A-1FP	WCDMA 1.0.0.0
N9073A-2FP	WCDMA with HSDPA 1.0.0.0

System Functions

System

The Previous Page is grayed-out if the first page of information is presently displayed. The Next Page menu key is grayed-out if the last page is information is presently displayed.

Key Path:	System, Show
Mode:	All
Example:	SYST:SHOW SYST
Backwards Compatibility Notes:	The hardware statistics that are displayed in the PSA Show System screen have been moved to a dedicated Show Hardware Statistics screen in the Service Menu.
Initial S/W Revision:	Prior to A.02.00

Show System contents (Remote Command Only)

A remote command is available to obtain the contents of the Show System screen (the entire contents, not just the currently displayed page).

Remote Command:	:SYSTem:CONFIgure [:SYSTem] ?
Example:	:SYST:CONF?
Notes:	The output is an IEEE Block format of the Show System contents. Each line is separated with a new-line character.
Initial S/W Revision:	Prior to A.02.00

Computer System description (Remote Command Only)

A remote command is available to obtain the Computer System description. The Computer System is the operating system and patch level as reported by operating system.

Remote Command:	:SYSTem:CSYSTem?
Example:	:SYST:CSYS?
Notes:	The return value is the Computer System name and service pack level.
Initial S/W Revision:	Prior to A.12.00

Hardware

The show hardware screen is used to view details of the installed hardware. This information can be used to determine versions of hardware assemblies and field programmable devices, in the advent of future upgrades or potential repair needs.

The screen is formatted into two groupings: product descriptive information and hardware information. The hardware information is listed in a table format:

Hardware Information							
MXA Signal Analyzer							
Product Number: N9020A							
Serial Number: US46220107							
Firmware Revision: A.01.14							
Assembly Name	Part #	Serial #	Mat Rev	Rev	OF Rev	Hw Id	Misc
Analog IF	E441060104	78060200131	003	0	C	15	
YIG Tuned Filter	50877305	11061500550	005	0	A	11	
Digital IF	E441060105	78060100559	003	0	F	14	
Front End Controller	E441060101	78060100147	004	2	A	8	
Low Band Switch	E441060170	78060800346	005	1	A	10	
LO Synthesizer	E441060102	78060100226	003	3	G	2	
Reference	E441060108	78060300420	004	1	C	16	
Front End	E441060154	13062800820	010	2	B	9	

The Previous Page is grayed-out if the first page of information is presently displayed. The Next Page menu key is grayed-out if the last page of information is presently displayed.

Key Path:	System, Show
Mode:	All
Example:	SYST:SHOW HARD
Initial S/W Revision:	Prior to A.02.00

LXI

This key shows you the product number, serial number, firmware revision, computer name, IP address, Host ID, LXI Class, LXI Version, MAC Address, and the Auto-MDIX Capability.

Key Path:	System, Show
Initial S/W Revision:	Prior to A.02.00

Power On

Enables you to select how the instrument should power on. The options are: Mode and Input/Output

System Functions

System

Defaults, User Preset and Last State.

Key Path:	System
Mode:	All
Remote Command:	:SYSTem: PON: TYPE MODE USER LAST :SYSTem: PON: TYPE?
Example:	:SYST: PON: TYPE MODE
Preset:	This is unaffected by a Preset but is set to Mode on a “Restore System Defaults->All”
State Saved:	No
Backwards Compatibility SCPI:	:SYSTem:PON:TYPE PRESet the “PRESet” parameter is supported for backward compatibility only and behaves the same as MODE.
Backwards Compatibility Notes:	The Preset Type key in legacy analyzers has been removed, and the Power On toggle key has been replaced by this 1-of-N key in the System menu.
Initial S/W Revision:	Prior to A.02.00

Mode and Input/Output Defaults

When the analyzer is powered on in Mode and Input/Output Defaults, it performs a Restore Mode Defaults to all modes in the instrument and also performs a Restore Input/Output Defaults.

Persistent parameters (such as Amplitude Correction tables or Limit tables) are not affected at power on, even though they are normally cleared by Restore Input/Output Defaults and/or Restore Mode Defaults.

Key Path:	System, Power On
Mode:	All
Example:	SYST:PON:TYPE MODE
Readback Text:	Defaults
Initial S/W Revision:	Prior to A.02.00

User Preset

Sets **Power On** to **User Preset**. When the analyzer is powered on in User Preset, it will User Preset each mode and switch to the power-on mode. Power On User Preset will not affect any settings beyond what a normal User Preset affects.

NOTE An instrument could never power up for the first time in User Preset.

Key Path:	System, Power On
-----------	-------------------------

Mode:	All
Example:	SYST:PON:TYPE USER
Readback Text:	User Preset
Backwards Compatibility Notes:	Power On User Preset will cause the instrument to power up in the power-on mode, not the last mode the instrument was in prior to shut down. Also, Power On User Preset will User Preset all modes. This does not exactly match legacy behavior.
Initial S/W Revision:	Prior to A.02.00

Last State

Sets **Power On to Last**. When the analyzer is powered on, it will put all modes in the last state they were in prior to when the analyzer was put into Power Standby and it will wake up in the mode it was last in prior to powering off the instrument. The saving of the active mode prior to shutdown happens behind the scenes when a controlled shutdown is requested by using the front panel power **Standby** key or by using the remote command SYSTem:PDOWn. The non-active modes are saved as they are deactivated and recalled by Power On Last State.

NOTE An instrument can never power up for the first time in Last.

If line power to the analyzer is interrupted, for example by pulling the line cord plug or by switching off power to a test rack, Power On Last State may not work properly. For proper operation, Power On Last State depends on you shutting down the instrument using the Standby key or the SYSTem:PDOWn SCPI command. This will ensure the last state of each mode is saved and can be recalled during a power up.

Key Path:	System, Power On
Mode:	All
Example:	SYST:PON:TYPE LAST
Notes:	Power on Last State only works if you have done a controlled shutdown prior to powering on in Last. If a controlled shutdown is not done when in Power On Last State, the instrument will power up in the last active mode, but it may not power up in the active mode's last state. If an invalid mode state is detected, a Mode Preset will occur. To control the shutdown under remote control use the :SYSTem:PDOWn command.
Readback Text:	Last State
Backwards Compatibility Notes:	It is no longer possible to power-up the analyzer in the last mode the analyzer was running with that mode in the preset state. (ESA/PSA SYST:PRESET:TYPE MODE with SYST:PON:PRESET) You can power-on the analyzer in the last mode the instrument was running in its last state (SYST:PON:TYPE LAST), or you can specify the mode to power-up in its preset state (SYST:PON:MODE <mode>).

System Functions
System

Initial S/W Revision:	Prior to A.02.00
-----------------------	------------------

Power On Application

Accesses a menu that lists the available Modes and lets you select which Mode is to be the power-on application.

This application is used for Power On Type “Mode and Input/Output Defaults” and Restore System Defaults All.

Key Path:	System, Power On
Mode:	All
Remote Command:	:SYSTem:PON:MODE SA BASIC ADEMOD NFIGURE PNOISE CDMA2K TDSCDMA VSA VSA89 601 WCDMA WIMAXOFDMA :SYSTem:PON:MODE?
Example:	SYST:PON:MODE SA
Notes:	The list of possible modes (and remote parameters) to choose from is dependent on which modes are installed in the instrument.
Preset:	This is unaffected by a Preset but is set on a “Restore System Defaults->All” to SA.
State Saved:	No
Initial S/W Revision:	Prior to A.02.00

Configure Applications

The Configure Applications utility can be used to:

select applications for preload

determine how many applications can fit in memory at one time

specify the order of the Modes in the Mode menu.

This utility consists of a window with instructions, a set of “Select Application” checkboxes, a “fuel bar” style memory gauge, and keys that help you set up your configuration.

For more information, see the following topics:

[“Preloading Applications” on page 231](#)

[“Access to Configure Applications utility” on page 231](#)

[“Virtual memory usage” on page 231](#)

Key Path:	System, Power On
Example:	:SYST:SHOW CAPP Displays the Config Applications screen
Initial S/W Revision:	A.02.00

Preloading Applications

During runtime, if a Mode that is not preloaded is selected using the Mode menu or sending SCPI commands, there will be a pause while the Application is loaded. During this pause a message that says “Loading application, please wait ...” is displayed. Once loaded, the application stays loaded, so the next time you select it during a session, there is no delay.

Preloading enables you to “preload” at startup, to eliminate the runtime delay. Preloading an application will cause it to be loaded into the analyzer’s memory when the analyzer program starts up. If you do this, the delay will increase the time it takes to start up the analyzer program, but this may be preferable to having to wait the first time you select an application. Note that, once an application is loaded into memory, it cannot be unloaded without exiting and restarting the analyzer program.

Note that there are more applications available for the X-Series than can fit into Windows Virtual Memory. By allowing you to choose which licensed applications to load at startup, the Configure Applications utility allows you to make optimal use of your memory.

Access to Configure Applications utility

A version of the utility runs the first time you power up the analyzer after purchasing it from Agilent. The utility automatically configures preloads so that as many licensed applications as possible are preloaded while keeping the total estimated virtual memory usage below the limit. This auto-configuration only takes place at the very first run, and after analyzer software upgrades.

You may, at any time, manually call up the Configure Applications utility by pressing System, Power On, Configure Applications, to find a configuration that works best for you, and then restart the analyzer program.

The utility may also be called if, during operation of the analyzer, you attempt to load more applications than can fit in memory at once.

Virtual memory usage

There are more applications available for the X-Series than can fit into memory at any one time, so the Configure Applications utility includes a memory tracker that serves two purposes:

It will not let you preload more applications than will fit into memory at once.

You can determine how many of your favorite applications can reside in memory at one time.

The utility provides a graphical representation of the amount of memory (note that the memory in question here is Virtual memory and is a limitation imposed by the operating system, not by the amount of physical memory you have in your analyzer). You select applications to preload by checking the boxes on the left. Checked applications preload at startup. The colored fuel bar indicates the total memory required when all the checked applications are loaded (either preloaded or selected during runtime).

Here is what the fuel bar colors mean:

RED: the applications you have selected cannot all fit into the analyzer’s memory. You must deselect applications until the fuel bar turns yellow.

YELLOW: the applications you have selected can all fit into the analyzer’s memory, but there is less than 10% of the memory left, probably not enough to load any other applications, either via preload or by selecting a Mode while the analyzer is running..

System Functions

System

GREEN: The indicator is green when <90% of the memory limit is consumed. This means the applications you have selected can all fit into the analyzer's memory with room to spare. You will likely be able to load one or more other applications without running out of memory.

Select All

Marks all applications in the selection list. This allows you to enable all applications licensed on the instrument for pre-loading, or is a convenience for selecting all applications in one operation and then letting you deselect individual applications.

Key Path:	System, Power On, Configure Applications
Initial S/W Revision:	A.02.00

Deselect All

Clears the marks from all applications in the selection list, except the Power On application. The Power On application cannot be eliminated from the pre-load list.

Key Path:	System, Power On, Configure Applications
Initial S/W Revision:	A.02.00

Move Up

The application list is the order that applications appear in the Mode Menu. This key enables you to shift the selected application up in the list, thus moving the selected application earlier in the Mode Menu.

Key Path:	System, Power On, Configure Applications
Initial S/W Revision:	A.02.00

Move Down

The application list is the order that applications appear in the Mode Menu. This key enables you to shift the selected application down in the list, thus moving the selected application later in the Mode Menu.

Key Path:	System, Power On, Configure Applications
Initial S/W Revision:	A.02.00

Select/Deselect

Toggles the currently highlighted application in the list.

Key Path:	System, Power On, Configure Applications
Initial S/W Revision:	A.02.00

Save Changes and Exit

Applies the configuration of the applications list. The marked applications will be pre-loaded in memory the next time the instrument application is started, and the order of the applications in the list will be the

order of the applications in the Mode Menu.

After saving your changes, the analyzer asks you if you would like it to restart so that your changes can take effect (see dialog box, below). If you choose not to restart, the changes will not take affect until the next time you shut down and restart the analyzer.

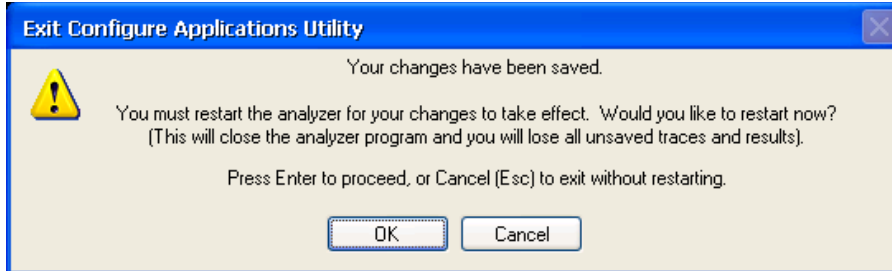

Key Path:	System, Power On, Configure Applications
Remote Command:	:SYSTem:PUP:PROcess
Example:	:SYST:PUP:PROC This is the SCPI command for restarting the analyzer. You must Wait after this command for the instrument application to restart
Notes:	The softkey will be grayed-out when the virtual memory of the selected applications exceeds 100% of the limit.
Notes:	You cannot use *WAI or *OPC? to synchronize operation after a restart. This command stops and restarts the instrument application, thus the SCPI operation is terminated and restarted. A remote program must use fixed wait time to resume sending commands to the instrument. The wait time will be dependent upon which applications are pre-loaded.
Initial S/W Revision:	A.02.00
Modified at S/W Revision:	A.04.00

Exit Without Saving

Pressing this key will exit the Configure Applications utility without saving your changes.

Key Path:	System, Power On, Configure Applications
Initial S/W Revision:	A.02.00
Modified at S/W Revision:	A.04.00

Configure Applications - Instrument boot-up

At start-up of the analyzer program a dialog box similar to the one under the **System, Power On, Configure Applications** key will be displayed allowing you to choose which licensed applications are to be loaded. This dialog will only be displayed if the memory required to pre-load all of the licensed applications exceeds the Virtual Memory available.

Configure Applications - Windows desktop

The Configure Applications Utility may be run from the Windows Desktop. The utility is launched by



double-clicking the icon on the desktop, which brings-up a dialog box similar to the one under the **System, Power On, Configure Applications** key, allowing you to choose which licensed applications are to be loaded when the analyzer program starts up. This dialog box has mouse buttons on it that do the job the softkeys normally do in the **System, Power On, Configure Applications** menu.

Configure Applications - Remote Commands

The following topics provide details on using remote commands to configure the list of applications you want to load into the instrument memory or query the Virtual Memory utilization for your applications.

[“Configuration list \(Remote Command Only\)” on page 234](#)

[“Configuration Memory Available \(Remote Command Only\)” on page 235](#)

[“Configuration Memory Total \(Remote Command Only\)” on page 235](#)

[“Configuration Memory Used \(Remote Command Only\)” on page 235](#)

[“Configuration Application Memory \(Remote Command Only\)” on page 235](#)

Configuration list (Remote Command Only)

This remote command is used to set or query the list of applications to be loaded in-memory.

Remote Command:	:SYSTem:PON:APPLication:LLISt <string of INSTRument:SELEct names> :SYSTem:PON:APPLication:LLISt?
Example:	:SYST:PON:APPL:LLIS "SA,BASIC,WCDMA"
Notes:	<string of INSTRument:SELEct names> are from the enums of the :INSTRument:SELEct command. The order of the <INSTRument:SELEct names> is the order that the applications are loaded into memory, and the order that they appear in the Mode Menu. Error message –225 "Out of Memory" is reported when more applications are listed than can reside in Virtual Memory. When this occurs, the existing applications load list is unchanged.
Preset:	Not affected by Preset
State Saved:	Not saved in instrument state
Initial S/W Revision:	A.02.00

Configuration Memory Available (Remote Command Only)

This remote command is used to query the amount of Virtual Memory remaining.

Remote Command:	:SYSTem:PON:APPLication:VMEMory[:AVAIlable]?
Example:	:SYST:PON:APPL:VMEM?
Preset:	Not affected by Preset
Initial S/W Revision:	A.02.00

Configuration Memory Total (Remote Command Only)

This remote command is used to query the limit of Virtual Memory allowed for applications.

Remote Command:	:SYSTem:PON:APPLication:VMEMory:TOTal?
Example:	:SYST:PON:APPL:VMEM:TOT?
Preset:	Not affected by Preset
Initial S/W Revision:	A.02.00

Configuration Memory Used (Remote Command Only)

This remote command is a query of the amount of Virtual Memory used by all measurement applications.

Remote Command:	:SYSTem:PON:APPLication:VMEMory:USED?
Example:	:SYST:PON:APPL:VMEM:USED?
Preset:	Not affected by Preset
Initial S/W Revision:	A.02.00

Configuration Application Memory (Remote Command Only)

This remote command is used to query the amount of Virtual Memory a particular application consumes.

Remote Command:	:SYSTem:PON:APPLication:VMEMory:USED:NAME? <INSTRument:SELEct name>
Example:	:SYST:PON:APPL:VMEM:USED:NAME? CDMA2K
Notes:	<INSTRument:SELEct name> is from the enums of the :INSTRument:SELEct command Value returned will be 0 (zero) if the name provided is invalid.
Preset:	Not affected by Preset
Initial S/W Revision:	Prior to A.02.00

Restore Power On Defaults

This selection causes the Power On Type and Power On Application settings to be a reset to their default values. This level of Restore System Defaults does not affect any other system settings, mode settings and does not cause a mode switch. The Power On key, under the Restore System Defaults menu, causes the same action.

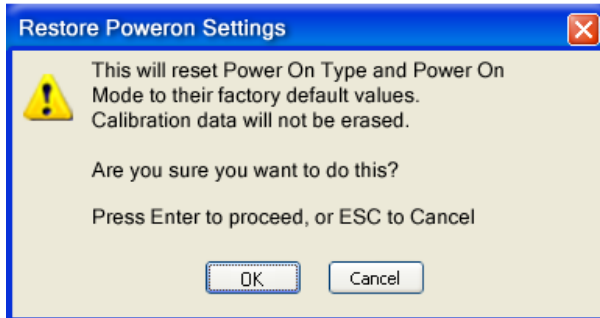

If you press any key other than OK or Enter, it is construed as a Cancel, because the only path that will actually cause the reset to be executed is through OK or Enter.

Key Path:	System, Power On
Example:	.:SYST:DEF PON
Initial S/W Revision:	Prior to A.02.00

Alignments

The Alignments Menu controls and displays the automatic alignment of the instrument, and provides the ability to restore the default alignment values.

The current setting of the alignment system is displayed in the system Settings Panel along the top of the display, including a warning icon for conditions that may cause specifications to be impacted.



Key Path:	System
Initial S/W Revision:	Prior to A.02.00

Auto Align

Configures the method for which the automatic background alignment is run.

Automatic background alignments are run periodically between measurement acquisitions. The instrument's software determines when alignments are to be performed to maintain warranted operation. The recommended setting for Auto Align is Normal.

An Auto Align execution cannot be aborted with the Cancel (ESC) key. To interrupt an Auto Align

execution, select **Auto Align Off**.

Key Path:	System, Alignments
Mode:	All
Remote Command:	:CALibration:AUTO ON PARTial OFF :CALibration:AUTO?
Example:	:CAL:AUTO ON
Notes:	While Auto Align is executing, bit 0 of Status Operation register is set.
Couplings:	Auto Align is set to Off if Restore Align Data is invoked.
Preset:	This is unaffected by Preset but is set to ON upon a “Restore System Defaults->Align”.
State Saved:	No
Status Bits/OPC dependencies:	When Auto Align is executing, bit 0 in the Status Operational register is set.
Backwards Compatibility SCPI:	:CALibration:AUTO ALERT Parameter ALERT is for backward compatibility only and is mapped to PARTial
Backwards Compatibility Notes:	ESA SCPI for Auto Align is :CALibration:AUTO <Boolean>. The command for X-Series is an enumeration. Thus the parameters of “0” and “1” are not possible in X-Series. Similarly, the ESA SCPI for :CALibration:AUTO? returned the Boolean value 1 or 0, in X-Series it is an Enumeration (string). Thus, queries by customer applications into numeric variables will result in an error In PSA Auto Align OFF was not completely off, it is equivalent to PARTial in X-Series. In X-Series, OFF will be fully OFF. This means users of PSA SCPI who choose OFF may see degraded performance and should migrate their software to use PARTial.
Initial S/W Revision:	Prior to A.02.00

Normal

Auto Align, Normal turns on the automatic alignment of all measurement systems. The Auto Align, Normal selection maintains the instrument in warranted operation across varying temperature and over time.

If the condition “Align Now, All required” is set, transition to Auto Align, Normal will perform the required alignments and clear the “Align Now, All required” condition and then continue with further alignments as required to maintain the instrument adequately aligned for warranted operation.

When **Auto Align, Normal** is selected the Auto Align Off time is set to zero.

When **Auto Align, Normal** is selected the Settings Panel indicates ALIGN AUTO.

Key Path:	System, Alignments, Auto Align
-----------	---------------------------------------

Mode:	All
Example:	:CAL:AUTO ON
Notes:	<p>Alignment processing as a result of the transition to Normal will be executed sequentially. Thus, *OPC? or *WAI following CAL:AUTO ON will return when the alignment processing is complete.</p> <p>The presence of an external signal may interfere with the RF portion of the alignment. If so, the Error Condition message “Align skipped: 50 MHz interference” or “Align skipped: 4.8 GHz interference” is reported, and bit 11 is set in the Status Questionable Calibration register. After the interfering signal is removed, subsequent alignment of the RF will clear the condition, and clear bit 11 in the Status Questionable Calibration register.</p>
Readback Text:	Normal
Status Bits/OPC dependencies:	<p>An interfering user signal may prevent automatic alignment of the RF subsystem. If this occurs, the Error Condition message “Align skipped: 50 MHz interference” or “Align skipped: 4.8 GHz interference” is reported, the Status Questionable Calibration bit 11 is set, and the alignment proceeds. When a subsequent alignment of the RF subsystem succeeds, either by the next cycle of automatic alignment or from an Align Now, RF, the Error Condition and Status Questionable Calibration bit 11 are cleared.</p>
Initial S/W Revision:	Prior to A.02.00

Partial

Auto Align, Partial disables the full automatic alignment and the maintenance of warranted operation for the benefit of improved measurement throughput. Accuracy is retained for the Resolution Bandwidth filters and the IF Passband which is critical to FFT accuracy, demodulation, and many measurement applications. With Auto Align set to Partial, you are now responsible for maintaining warranted operation by updating the alignments when they expire. The Auto Align, Alert mechanism will notify you when alignments have expired. One solution to expired alignments is to perform the Align All, Now operation. Another is to return the Auto Align selection to Normal.

Auto Align, Partial is recommended for measurements where the throughput is so important that a few percent of improvement is more valued than an increase in the accuracy errors of a few tenths of a decibel. One good application of Auto Align, Partial would be an automated environment where the alignments can be called during overhead time when the device-under-test is exchanged.

When **Auto Align, Partial** is selected the elapsed time counter begins for Auto Align Off time.

When **Auto Align, Partial** is selected the Settings Panel indicates ALIGN PARTIAL with a warning icon. The warning icon is to inform the operator that they are responsible for maintaining the warranted operation of the instrument

Key Path:	System, Alignments, Auto Align
Mode:	All
Example:	:CAL:AUTO PART
Notes:	Auto Align Partial begins the elapsed time counter for Auto Align Off time.

Readback Text:	Partial
Initial S/W Revision:	Prior to A.02.00

Off

Auto Align, Off disables automatic alignment and the maintenance of warranted operation, for the benefit of maximum measurement throughput. With Auto Align set to Off, you are now responsible for maintaining warranted operation by updating the alignments when they expire. The Auto Align, Alert mechanism will notify you when alignments have expired. One solution to expired alignments is to perform the Align All, Now operation. Another is to return the Auto Align selection to Normal.

The Auto Align, Off setting is rarely the best choice, because Partial gives almost the same improvement in throughput while maintaining the warranted performance for a much longer time. The choice is intended for unusual circumstances such as the measurement of radar pulses where you might like the revisit time to be as consistent as possible.

When **Auto Align, Off** is selected the Auto Align Off time is initialized and the elapsed time counter begins.

When **Auto Align, Off** is selected the Settings Panel indicates ALIGN OFF with a warning icon. The warning icon is to inform the operator that they are responsible for maintaining the warranted operation of the instrument:

Key Path:	System, Alignments, Auto Align
Mode:	All
Example:	:CAL:AUTO OFF
Notes:	Auto Align Off begins the elapsed time counter for Auto Align Off time.
Couplings:	Auto Align is set to Off if Restore Align Data is invoked.
Readback Text:	Off
Initial S/W Revision:	Prior to A.02.00

All but RF

Auto Align, All but RF, configures automatic alignment to include or exclude the RF subsystem. (Eliminating the automatic alignment of the RF subsystem prevents the input impedance from changing. The normal input impedance of 50 ohms can change to an open circuit when alignments are being used. Some devices under test do not behave acceptably under such circumstances, for example by showing instability.) When Auto Align, All but RF ON is selected, the operator is responsible for performing an Align Now, RF when RF-related alignments expire. The Auto Align, Alert mechanism will notify the operator to perform an Align Now, All when the combination of time and temperature variation is exceeded.

When Auto Align, All but RF ON is selected the Settings Panel indicates ALIGN AUTO/NO RF with a warning icon (warning icon is intended to inform the operator they are responsible for the maintaining the RF alignment of the instrument):

Key Path:	System, Alignments, Auto Align
-----------	---------------------------------------

System Functions

System

Mode:	All
Remote Command:	:CALibration:AUTO:MODE ALL NRF :CALibration:AUTO:MODE?
Example:	:CAL:AUTO:MODE NRF
Preset:	This is unaffected by Preset but is set to ALL on a “Restore System Defaults->Align”.
State Saved:	No
Readback Text:	RF or NRF
Initial S/W Revision:	Prior to A.02.00

Alert

The instrument will signal an Alert when conditions exist such that you will need to perform a full alignment (for example, Align Now, All). The Alert can be configured in one of four settings; Time & Temperature, 24 hours, 7 days, or None. A confirmation is required when a selection other than Time & Temperature is chosen. This prevents accidental deactivation of alerts.

With Auto Align set to Normal, the configuration of Alert is not relevant because the instrument’s software maintains the instrument in warranted operation.

Key Path:	System, Alignments, Auto Align
Mode:	All
Remote Command:	:CALibration:AUTO:ALERT TTEMPerature DAY WEEK NONE :CALibration:AUTO:ALERT?
Example:	:CAL:AUTO:ALERT TTEM
Notes:	The alert that alignment is needed is the setting of bit 14 in the Status Questionable Calibration register.
Preset:	This is unaffected by Preset but is set to TTEMPerature on a “Restore System Defaults->Align”.
State Saved:	No
Status Bits/OPC dependencies:	The alert is the Error Condition message “Align Now, All required” and bit 14 is set in the Status Questionable Calibration register.
Initial S/W Revision:	Prior to A.02.00

Time & Temperature

With Auto Align Alert set to Time & Temperature the instrument will signal an alert when alignments expire due to the combination of the passage of time and changes in temperature. The alert is the Error Condition message “Align Now, All required”. If this choice for Alert is selected, the absence of an alert means that the analyzer alignment is sufficiently up-to-date to maintain warranted accuracy.

Key Path:	System, Alignments, Auto Align, Alert
-----------	--

Mode:	All
Example:	:CAL:AUTO:ALER TTEM
Readback Text:	Time & Temp
Status Bits/OPC dependencies:	Bit 14 is set in the Status Questionable Calibration register.
Initial S/W Revision:	Prior to A.02.00

24 hours

With Auto Align Alert set to 24 Hours the instrument will signal an alert after a time span of 24 hours since the last successful full alignment (for example, Align Now, All or completion of a full Auto Align). You may choose this selection in an environment where the temperature is stable on a daily basis at a small risk of accuracy errors in excess of the warranted specifications. The alert is the Error Condition message “Align Now, All required”.

For front-panel operation , confirmation is required to transition into this setting of Alert. The confirmation dialog is:

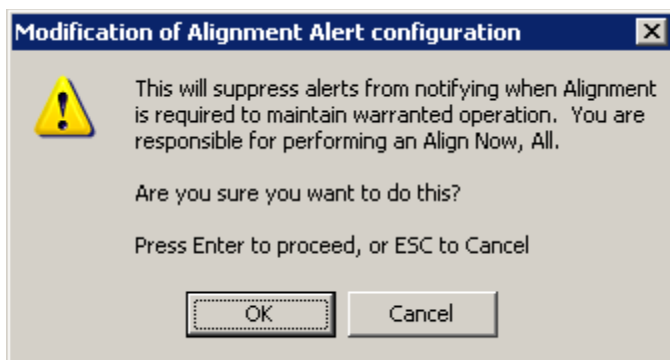

No confirmation is required when Alert is configured through a remote command.

Key Path:	System, Alignments, Auto Align, Alert
Mode:	All
Example:	:CAL:AUTO:ALER DAY
Readback Text:	24 hours
Status Bits/OPC dependencies:	Bit 14 is set in the Status Questionable Calibration register.
Initial S/W Revision:	Prior to A.02.00

7 days

With Auto Align Alert is set to 7 days the instrument will signal an alert after a time span of 168 hours since the last successful full alignment (for example, Align Now, All or completion of a full Auto Align). You may choose this selection in an environment where the temperature is stable on a weekly basis, at a modest risk of accuracy degradations in excess of warranted performance. The alert is the Error Condition message “Align Now, All required”.

For front panel operation, confirmation is required for the customer to transition into this setting of Alert. The confirmation dialog is:

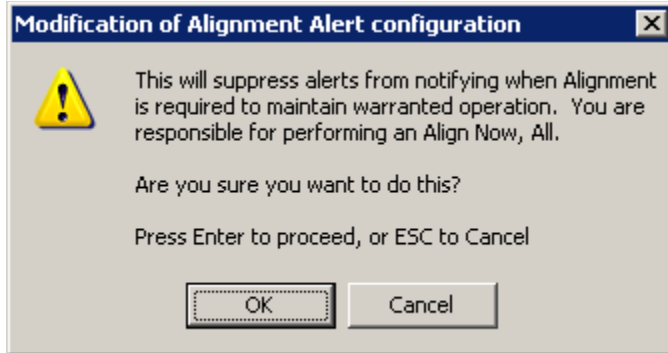

No confirmation is required when Alert is configured through a remote command.

Key Path:	System, Alignments, Auto Align, Alert
Mode:	All
Example:	:CAL:AUTO:ALER WEEK
Readback Text:	7 days
Status Bits/OPC dependencies:	Bit 14 is set in the Status Questionable Calibration register.
Initial S/W Revision:	Prior to A.02.00

None

With Auto Align Alert set to None the instrument will not signal an alert. This is provided for rare occasions where you are making a long measurement which cannot tolerate Auto Align interruptions, and must have the ability to capture a screen image at the end of the measurement without an alert posted to the display. Agilent does not recommend using this selection in any other circumstances, because of the risk of accuracy performance drifting well beyond expected levels without the operator being informed.

For front panel operation, confirmation is required to transition into this setting of Alert. The confirmation dialog is:

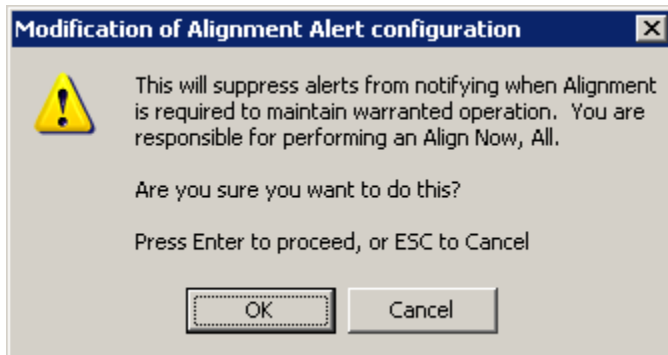

No confirmation is required when Alert is configured through a remote command.

Key Path:	System, Alignments, Auto Align, Alert
-----------	--

Mode:	All
Example:	:CAL:AUTO:ALER NONE
Initial S/W Revision:	Prior to A.02.00

Execute Expired Alignments (Remote Command Only)

Alignments can be expired in the situation where Auto Align is in the state of Partial or Off. This feature runs the alignments that have expired. This is different than performing an Align All, Now operation. Align All, Now performs an alignment of all subsystems regardless of whether they are needed or not, with Execute Expired Alignments, only the individual subsystems that have become due are aligned.

Mode:	All
Remote Command:	:CALibration:EXPIred?
Example:	:CAL:EXP?
Notes:	:CALibration:EXPIred? returns 0 if successful :CALibration:EXPIred? returns 1 if failed
Initial S/W Revision:	Prior to A.02.00

Align Now

Accesses alignment processes that are immediate action operations. They perform complete operations and run until they are complete.

Key Path:	System, Alignments
Initial S/W Revision:	Prior to A.02.00

All

Immediately executes an alignment of all subsystems. The instrument stops any measurement currently underway, performs the alignment, then restarts the measurement from the beginning (similar to pressing the **Restart** key).

If an interfering user signal is present at the RF Input, the alignment is performed on all subsystems except the RF. After completion, the Error Condition message “Align skipped: 50 MHz interference” or “Align skipped: 4.8 GHz interference” is generated. In addition the Error Condition message “Align Now, RF required” is generated, and bits 11 and 12 are set in the Status Questionable Calibration register.

The query form of the remote commands (:CALibration[:ALL]? or *CAL?) invokes the alignment of all subsystems and returns a success or failure value. An interfering user signal is not grounds for failure; if the alignment was able to succeed on all portions but unable to align the RF because of an interfering signal, the resultant will be the success value.

Successful completion of **Align Now, All** will clear the “Align Now, All required” Error Condition, and clear bit 14 in the Status Questionable Calibration register. It will also begin the elapsed time counter for Last Align Now, All Time, and capture the Last Align Now, All Temperature.

System Functions

System

If the Align RF subsystem succeeded in aligning (no interfering signal present), the elapsed time counter begins for Last Align Now, RF Time, and the temperature is captured for the Last Align Now, RF Temperature. In addition the Error Conditions “Align skipped: 50 MHz interference” and “Align skipped: 4.8 GHz interference” are cleared, the Error Condition “Align Now, RF required” is cleared, and bits 11 and 12 are cleared in the Status Questionable Calibration register

Align Now, All can be interrupted by pressing the Cancel (ESC) front-panel key or remotely with Device Clear followed by the :ABORt SCPI command. When this occurs the Error Condition message “Align Now, All required” is generated, and bit 14 is set in the Status Questionable Condition register. This is because new alignment data may be employed for an individual subsystem, but not a cohesive set of data for all subsystems.

In many cases, you might find it more convenient to change alignments to Normal, instead of executing Align Now, All. When the Auto Align process transitions to Normal, the analyzer will immediately start to update only the alignments that have expired, thus efficiently restoring the alignment process.

In models with the RF Preselector, such as the N9038A, the Align Now All alignment will immediately execute an alignment of all subsystems in the Spectrum Analyzer and partial subsystems of the RF Preselector. The additional alignments are the System Gain, Mechanical attenuator and Electronic attenuator alignments on the RF Preselector path. The purpose of these alignments is to improve the RF Preselector path amplitude variation compared to the bypass path.

Key Path:	System, Alignments, Align Now
Mode:	All
Remote Command:	:CALibration[:ALL] :CALibration[:ALL]?
Example:	:CAL
Notes:	<p>:CALibration[:ALL]? returns 0 if successful</p> <p>:CALibration[:ALL]? returns 1 if failed</p> <p>:CALibration[:ALL]? is the same as *CAL?</p> <p>While Align Now, All is performing the alignment, bit 0 in the Status Operation register is set. Completion, or termination, will clear bit 0 in the Status Operation register.</p> <p>This command is sequential; it must complete before further SCPI commands are processed. Interrupting the alignment from remote is accomplished by invoking Device Clear followed by the :ABORt command.</p> <p>Successful completion will clear bit 14 in the Status Questionable Calibration register.</p> <p>An interfering user signal is not grounds for failure of Align Now, All. However, bits 11 and 12 are set in the Status Questionable Calibration register to indicate Align Now, RF is required.</p> <p>An interfering user supplied signal will result in the instrument requiring an Align Now, RF with the interfering signal removed.</p>

Couplings:	<p>Initializes the time for the Last Align Now, All Time.</p> <p>Records the temperature for the Last Align Now, All Temperature.</p> <p>If Align RF component succeeded, initializes the time for the Last Align Now, RF Time.</p> <p>If Align RF component succeeded, records the temperature for the Last Align Now, RF Temperature.</p>
Status Bits/OPC dependencies:	Bits 11, 12, or 14 may be set in the Status Questionable Calibration register.
Initial S/W Revision:	Prior to A.02.00

Mode:	All
Remote Command:	*CAL?
Example:	*CAL?
Notes:	<p>*CAL? returns 0 if successful</p> <p>*CAL? returns 1 if failed</p> <p>:CALibration[:ALL]? is the same as *CAL?</p> <p>See additional remarks described with :CALibration[:ALL]?</p> <p>Everything about :CALibration[:ALL]? is synonymous with *CAL? including all conditions, status register bits, and couplings</p>
Initial S/W Revision:	Prior to A.02.00

All but RF

Immediately executes an alignment of all subsystems except the RF subsystem. The instrument will stop any measurement currently underway, perform the alignment, and then restart the measurement from the beginning (similar to pressing the Restart key). This can be used to align portions of the instrument that are not impacted by an interfering user input signal.

This operation might be chosen instead of **All** if you do not want the device under test to experience a large change in input impedance, such as a temporary open circuit at the analyzer input.

The query form of the remote commands (:CALibration:NRF?) will invoke the alignment and return a success or failure value.

Successful completion of Align Now, All but RF will clear the “Align Now, All required” Error Condition, and clear bit 14 in the Status Questionable Calibration register. If “Align Now, All required” was in effect prior to executing the All but RF, the Error Condition message “Align Now, RF required” is generated and bit 12 in the Status Questionable Calibration register is set. It will also begin the elapsed time counter for Last Align Now, All Time, and capture the Last Align Now, All Temperature.

Align Now, All but RF can be interrupted by pressing the Cancel (ESC) front-panel key or remotely with Device Clear followed by the :ABORt SCPI command. When this occurs the Error Condition message “Align Now, All required” is generated, and bit 14 is set in the Status Questionable Condition register. This is because new alignment data may be used for an individual subsystem, but not a full new set of data for all subsystems.

System Functions

System

In models with the RF Preselector, such as the N9038A, the “All but RF” alignment will execute an alignment of all subsystems except the RF subsystem of the Spectrum Analyzer, as well as the system gain of the RF Preselector.

Key Path:	System, Alignments, Align Now
Mode:	All
Remote Command:	:CALibration:NRF :CALibration:NRF?
Example:	:CAL:NRF
Notes:	:CALibration:NRF? returns 0 if successful :CALibration:NRF? returns 1 if failed While Align Now, All but RF is performing the alignment, bit 0 in the Status Operation register is set. Completion, or termination, will clear bit 0 in the Status Operation register. This command is sequential; it must complete before further SCPI commands are processed. Interrupting the alignment from remote is accomplished by invoking Device Clear followed by the :ABORt command. Successful completion will clear bit 14 in the Status Questionable Calibration register and set bit 12 if invoked with “Align Now, All required”.
Couplings:	Initializes the time for the Last Align Now, All Time. Records the temperature for the Last Align Now, All Temperature.
Status Bits/OPC dependencies:	Bits 12 or 14 may be set in the Status Questionable Calibration register.
Initial S/W Revision:	Prior to A.02.00

RF

Immediately executes an alignment of the RF subsystem. The instrument stops any measurement currently underway, performs the alignment, then restarts the measurement from the beginning (similar to pressing the **Restart** key).

This operation might be desirable if the alignments had been set to not include RF alignments, or if previous RF alignments could not complete because of interference which has since been removed.

If an interfering user signal is present at the RF Input, the alignment will terminate and generate the Error Condition message “Align skipped: 50 MHz interference” or “Align skipped: 4.8 GHz interference”, and Error Condition “Align Now, RF required”. In addition, bits 11 and 12 will be set in the Status Questionable Calibration register.

The query form of the remote commands (:CALibration:RF?) will invoke the alignment of the RF subsystem and return a success or failure value. An interfering user signal is grounds for failure.

Successful completion of Align Now, RF will begin the elapsed time counter for Last Align Now, RF Time, and capture the Last Align Now, RF Temperature.

Align Now, RF can be interrupted by pressing the Cancel (ESC) front-panel key or remotely with Device Clear followed by the :ABORt SCPI command. When this occurs, the Error Condition message “Align

Now, RF required” is generated, and bit 12 is set in the Status Questionable Condition register. None of the new alignment data is used.

In models with the RF Preselector, such as the N9038A, the RF alignment will execute an alignment of the RF subsystem of the Spectrum Analyzer, as well as the RF subsystem on RF Preselector path.

Key Path:	System, Alignments, Align Now
Mode:	All
Remote Command:	:CALibration:RF :CALibration:RF?
Example:	:CAL:RF
Notes:	<p>:CALibration:RF? returns 0 if successful</p> <p>:CALibration:RF? returns 1 if failed (including interfering user signal)</p> <p>While Align Now, RF is performing the alignment, bit 0 in the Status Operation register is set. Completion, or termination, will clear bit 0 in the Status Operation register.</p> <p>This command is sequential; it must complete before further SCPI commands are processed. Interrupting the alignment from remote is accomplished by invoking Device Clear followed by the :ABORt command.</p> <p>Successful completion clears the Error Conditions “Align skipped: 50 MHz interference” and “Align skipped: 4800 MHz interference” and the Error Conditions “Align RF failed” and “Align Now, RF required”, and clears bits 3, 11, and 12 in the Status Questionable Calibration register.</p> <p>A failure encountered during alignment will generate the Error Condition message “Align RF failed” and set bit 3 in the Status Questionable Calibration register.</p> <p>An interfering user signal will result in bits 11 and 12 to be set in the Status Questionable Calibration register to indicate Align Now, RF is required.</p> <p>An interfering user supplied signal will result in the instrument requiring an Align Now, RF with the interfering signal removed.</p>
Couplings:	<p>Initializes the time for the Last Align Now, RF Time.</p> <p>Records the temperature for the Last Align Now, RF Temperature.</p>
Status Bits/OPC dependencies:	Bits 11, 12, or 14 may be set in the Status Questionable Calibration register.
Initial S/W Revision:	Prior to A.02.00

External Mixer

Immediately executes an alignment of the External Mixer that is plugged into the USB port. The instrument stops any measurement currently underway, performs the alignment, then restarts the measurement from the beginning (similar to pressing the Restart key). As this alignment calibrates the LO power to the mixer, this is considered an LO alignment; and failure is classified as an LO alignment failure.

The query form of the remote commands (:CALibration:EMIXer?) will invoke the alignment of the

System Functions
System

External Mixer and return a success or failure value.

Key Path:	System, Alignments, Align Now
Mode:	All
Remote Command:	:CALibration:EMIXer :CALibration:EMIXer?
Example:	:CAL:EMIX
Notes:	:CAL:EMIX? returns 0 if successful :CAL:EMIX? returns 1 if failed While Align Now, Ext Mix is performing the alignment, bit 0 in the Status Operation register is set. Completion, or termination, will clear bit 0 in the Status Operation register. This command is sequential; it must complete before further SCPI commands are processed. Interrupting the alignment from remote is accomplished by invoking Device Clear followed by the :ABORt command. A failure encountered during alignment will generate the Error Condition message “Align LO failed” and set bit 5 in the Status Questionable Calibration register. Successful completion will clear the “Align LO failed” message and bit 5 in the Status Questionable Calibration register.
Dependencies:	This key does not appear unless option EXM is present and is grayed-out unless a USB mixer is plugged in to the USB.
Status Bits/OPC dependencies:	Bit3 may be set in the Status Questionable Calibration Extended Failure register.
Initial S/W Revision:	A.08.00

Source

This menu is only available in the EXT (E6607A).

Accesses source alignment processes that are immediate action operations. They perform complete operations and run until they are complete.

Immediately executes an IQ alignment of the complete source. The instrument stops any sequence of the source, performs the alignment, then restarts the sequence from the beginning.

There is no alert available for the source alignment. The operators have the responsibility to check temperature shift since last Align Now, Source to determine if the source alignment need to be executed.

Key Path:	System, Alignments, Align Now
Mode:	All
Remote Command:	:CALibration:INTernal:SOURce[:ALL] :CALibration:INTernal:SOURce[:ALL]?
Example:	:CAL:INT:SOUR

Notes:	Only available in: XOBT :CAL:SOUR? Initiates an Alignment and returns 0 if successful :CAL:SOUR? Initiates an Alignment and returns 1 if failed
Couplings:	Initializes the time for the Last Align Source Now, All Time. Records the temperature for the Last Align Source Now, All Temperature.
Status Bits/OPC dependencies:	Bits TODO may be set in the Status Questionable Calibration register
Initial S/W Revision:	A.05.00

Show Alignment Statistics

Shows alignment information you can use to ensure that the instrument is operating in a specific manner. The Show Alignment Statistics screen is where you can view time and temperature information.

Values which are displayed are only updated when the Show Alignment Statistics screen is invoked, they are not updated while the Show Alignment Statistics screen is being displayed. The remote commands that access this information obtain current values.

An example of the Show Alignment Statistics screen would be similar to:

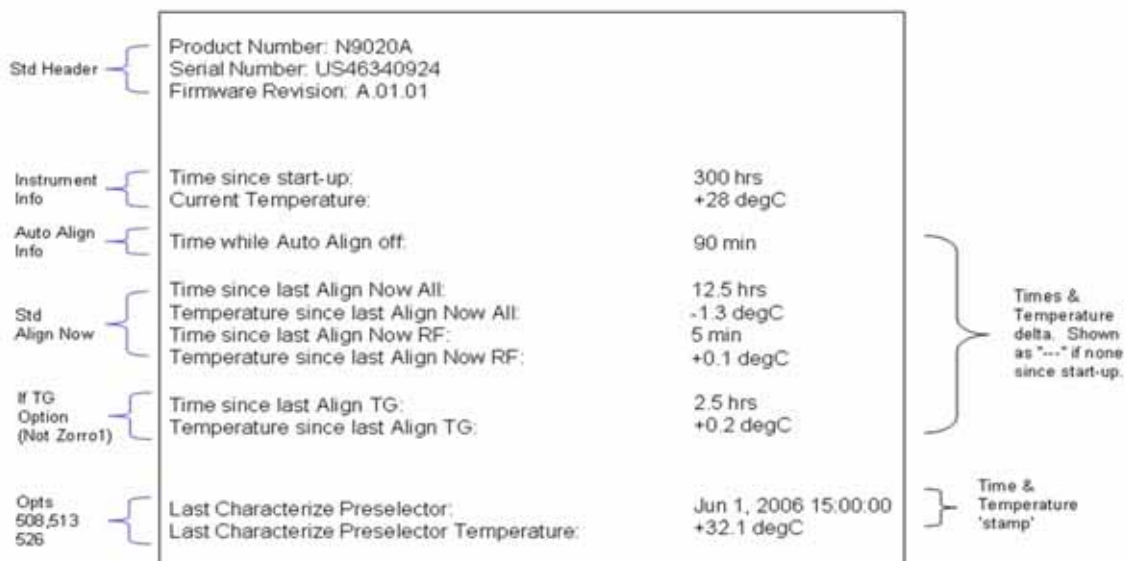

A successful Align Now, RF will set the Last Align RF temperature to the current temperature, and reset the Last Align RF time. A successful Align Now, All or Align Now, All but RF will set the Last Align Now All temperature to the current temperature, and reset the Last Align Now All time. A successful Align Now, All will also reset the Last Align RF items if the RF portion of the Align Now succeeded.

Key Path:	System, Alignments
Mode:	All

System Functions
System

Notes:	The values displayed on the screen are only updated upon entry to the screen and not updated while the screen is being displayed.
Initial S/W Revision:	Prior to A.02.00

Key Path:	Visual annotation in the Show Alignment Statistics screen
Mode:	All
Remote Command:	:SYSTem:PON:TIME?
Example:	:SYST:PON:TIME?
Notes:	Value is the time since the most recent start-up in seconds.
State Saved:	No
Initial S/W Revision:	Prior to A.02.00

Key Path:	Visual annotation in the Show Alignment Statistics screen
Mode:	All
Remote Command:	:CALibration:TEMPerature:CURRent?
Example:	:CAL:TEMP:CURR?
Notes:	Value is in degrees Centigrade. Value is invalid if using default alignment data (Align Now, All required)
State Saved:	No
Initial S/W Revision:	Prior to A.02.00

Key Path:	Visual annotation in the Show Alignment Statistics screen
Mode:	All
Remote Command:	:CALibration:TIME:LALL?
Example:	:CAL:TIME:LALL?
Notes:	Value is the elapsed time, in seconds, since the last successful Align Now, All or Align Now, All but RF was executed.
State Saved:	No
Initial S/W Revision:	Prior to A.02.00

Key Path:	Visual annotation in the Show Alignment Statistics screen
Mode:	All
Remote Command:	:CALibration:TEMPerature:LALL?
Example:	:CAL:TEMP:LALL?

Notes:	Value is in degrees Centigrade at which the last successful Align Now, All or Align Now, All but RF was executed.
State Saved:	No
Initial S/W Revision:	Prior to A.02.00

Key Path:	Visual annotation in the Show Alignment Statistics screen
Mode:	All
Remote Command:	:CALibration:TIME:LRF?
Example:	:CAL:TIME:LRF?
Notes:	Value is the elapsed time, in seconds, since the last successful Align Now, RF was executed, either individually or as a component of Align Now, All.
State Saved:	No
Initial S/W Revision:	Prior to A.02.00

Key Path:	Visual annotation in the Show Alignment Statistics screen
Mode:	All
Remote Command:	:CALibration:TEMPerature:LRF?
Example:	:CAL:TEMP:LRF?
Notes:	Value is in degrees Centigrade at which the last successful Align Now, RF was executed, either individually or as a component of Align Now, All.
State Saved:	No
Initial S/W Revision:	Prior to A.02.00

Key Path:	Visual annotation in the Show Alignment Statistics screen
Mode:	All
Remote Command:	:CALibration:TIME:SOURce:LALL?
Example:	:CAL:TIME:SOUR:LALL?
Notes:	Value is the date and time of the last successful Align Now, Source was performed on the instrument.
State Saved:	No
Initial S/W Revision:	A.05.00

Key Path:	Visual annotation in the Show Alignment Statistics screen
Mode:	All
Remote Command:	:CALibration:TEMPerature:SOURce: LALL?

System Functions
System

Example:	:CAL:TEMP:SOUR:LALL?
Notes:	Value is in degrees Centigrade at which the last successful Align Now, Source was performed on the instrument.
State Saved:	No
Initial S/W Revision:	A.05.00

Key Path:	Visual annotation in the Show Alignment Statistics screen
Mode:	All
Remote Command:	:CALibration:TIME:LPreselector?
Example:	:CAL:TIME:LPR?
Notes:	Value is the date and time the last successful Characterize Preselector was executed. The date is separated from the time by a space character. Returns "" if no Characterize Preselector has ever been performed on the instrument.
Dependencies:	In models that do not include preselectors, this command is not enabled and any attempt to set or query will yield an error.
State Saved:	No
Initial S/W Revision:	Prior to A.02.00

Key Path:	Visual annotation in the Show Alignment Statistics screen
Mode:	All
Remote Command:	:CALibration:TEMPerature:LPreselector?
Example:	:CAL:TEMP:LPR?
Notes:	Value is in degrees Centigrade at which the last successful Characterize Preselector was executed.
Dependencies:	In models that do not include preselectors, this command is not enabled and any attempt to set or query will yield an error.
State Saved:	No
Initial S/W Revision:	Prior to A.02.00

Key Path:	Visual annotation in the Show Alignment Statistics screen
Mode:	All
Remote Command:	:CALibration:AUTO:TIME:OFF?
Example:	:CAL:AUTO:TIME:OFF?
Notes:	Value is the elapsed time, in seconds, since Auto Align has been set to Off or Off with Alert. The value is 0 if Auto Align is ALL or NORF.
State Saved:	No

Initial S/W Revision:	Prior to A.02.00
-----------------------	------------------

Key Path:	Visual annotation in the Show Alignment Statistics screen
Mode:	All
Remote Command:	:CALibration:TIME:RFPSelector:LCONducted?
Example:	:CAL:TIME:RFPS:LCON?
Notes:	Values are the date and time the last successful Align Now, 20 Hz – 30 MHz was executed. The date is separated from the time by a semi-colon character.
State Saved:	No

Key Path:	Visual annotation in the Show Alignment Statistics screen
Mode:	All
Remote Command:	:CALibration:TEMPerature:RFPSelector:LCONducted?
Example:	:CAL:TEMP:RFPS:LCON?
Notes:	Value is in degrees Centigrade at which the last successful Align Now, 20 Hz – 30 MHz was executed.
State Saved:	No

Key Path:	Visual annotation in the Show Alignment Statistics screen
Mode:	All
Remote Command:	:CALibration:TIME:RFPSelector:LRADiated?
Example:	:CAL:TIME:RFPS:LRAD?
Notes:	Value is the date and time the last successful Align Now, 30 MHz – 3.6 GHz was executed. The date is separated from the time by a semi-colon character.
State Saved:	No

Key Path:	Visual annotation in the Show Alignment Statistics screen
Mode:	All
Remote Command:	:CALibration:TEMPerature:RFPSelector:LRADiated?
Example:	:CAL:TEMP:RFPS:LRAD?
Notes:	Value is in degrees Centigrade at which the last successful Align Now, 30 MHz – 3.6 GHz was executed.
State Saved:	No

Key Path:	Visual annotation in the Show Alignment Statistics screen
-----------	--

Mode:	All
Remote Command:	:CALibration:RFPSelector:SCHeduler:TIME:NEXT? This query returns data using the following format “YYYY/MM/DD; HH:MM:SS”
Example:	:CAL:RFPS:SCH:TIME:NEXT?
Notes:	The next run time will be updated based on the start date/time and recurrence set by the users. “date” is representation of the date the task will run in the form of “YYYY/MM/DD” where: YYYY is the four digit representation of year. (for example, 2009) MM is the two digit representation of month. (for example, 01 to 12) DD is the two digit representation of the day. (for example, 01 to 28, 29, 30 or 31 depending on the month and year) “time” is a representation of the time of day the task will run in the form of “HH:MM:SS” where: HH is the two digit representation of the hour in 24 hour format MM is the two digit representation of minute SS is the two digit representation of seconds For model N9038A only.
State Saved:	No

Restore Align Defaults

Initializes the alignment user interface settings, not alignment data, to the factory default values. Align Now, All must be executed if the value of the Timebase DAC results in a change.

For front panel operation, you are prompted to confirm action before setting the alignment parameters to factory defaults:

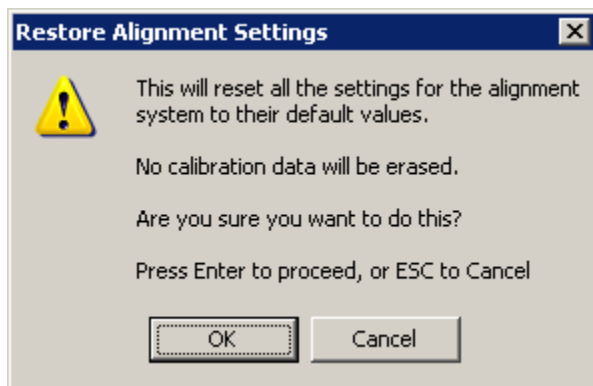

The parameters affected are:

Parameter	Setting
Timebase DAC	Calibrated
Timebase DAC setting	Calibrated value
Auto Align State	Normal (if the instrument is not operating with default alignment data, Off otherwise)
Auto Align All but RF	Off
Auto Align Alert	Time & Temperature

Key Path:	System, Alignments
Mode:	All
Example:	:SYST:DEF ALIG
Notes:	Alignment processing that results as the transition to Auto Alignment Normal will be executed sequentially; thus *OPC? or *WAI will wait until the alignment processing is complete.
Initial S/W Revision:	Prior to A.02.00

Backup or Restore Align Data...

Opens the utility for backing-up or restoring the alignment data.

Alignment data for the instrument resides on the hard drive in a database. Agilent uses high quality hard drives; however it is highly recommended the alignment data be backed-up to storage outside of the instrument. Additionally, for customers who use multiple CPU Assemblies or multiple disk drives, the alignment that pertains to the instrument must be transferred to the resident hard drive after a CPU or hard drive is replaced. This utility facilitates backing-up and restoring the alignment data.

NOTE This utility allows the operator to navigate to any location of the Windows file system. It is intended that the operator use a USB memory device or Mapped Network Drive to back up the alignment data to storage outside of the instrument.

Key Path:	System, Alignments
Initial S/W Revision:	A.02.00

Key Path:	System, Alignments
Mode:	All
Remote Command:	:CALibration:DATA:Default

System Functions

System

Example:	:CAL:DATA:DEF
Couplings:	Sets Auto Align to Off. Sets bit 14 in the Status Questionable Calibration register. The Error Condition message “Align Now, All required” is generated.
Initial S/W Revision:	Prior to A.02.00

Alignment Data Wizard

The Backup or Restore Alignment Data wizard guides you through the operation of backing-up or restoring the alignment data.

The following dialogue boxes operates without a mouse or external keyboard when you use the default file names.

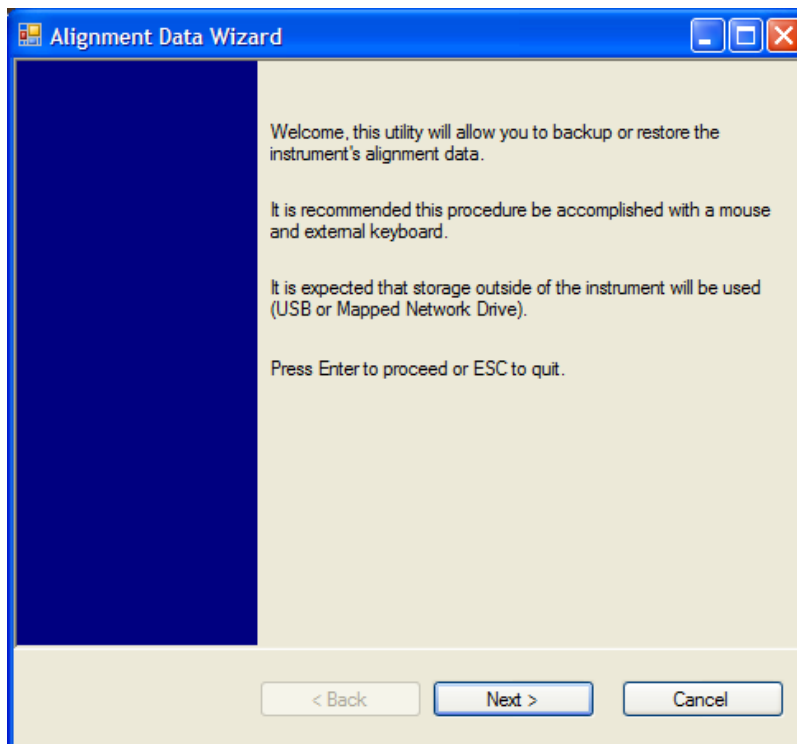

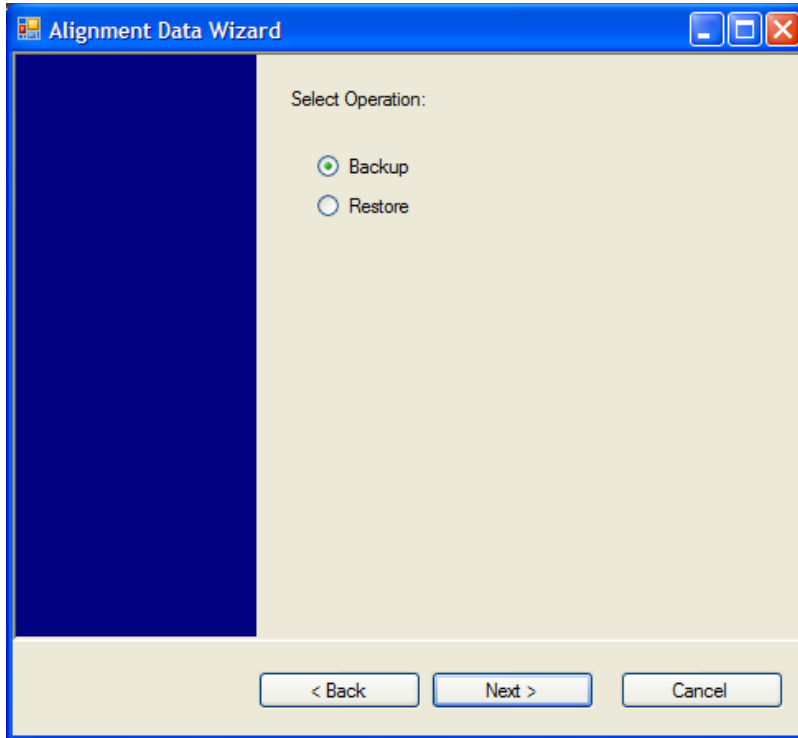

The backup screen indicates the approximate amount of space required to contain the backup file.

The default file name will be AlignDataBackup_<model number>_<serial number>_<date in YYYYMMDDHHMMSS>.bak.

For the N9030A the default backup location will be the internal F: drive which is a solid-state memory device located internally on the instrument.

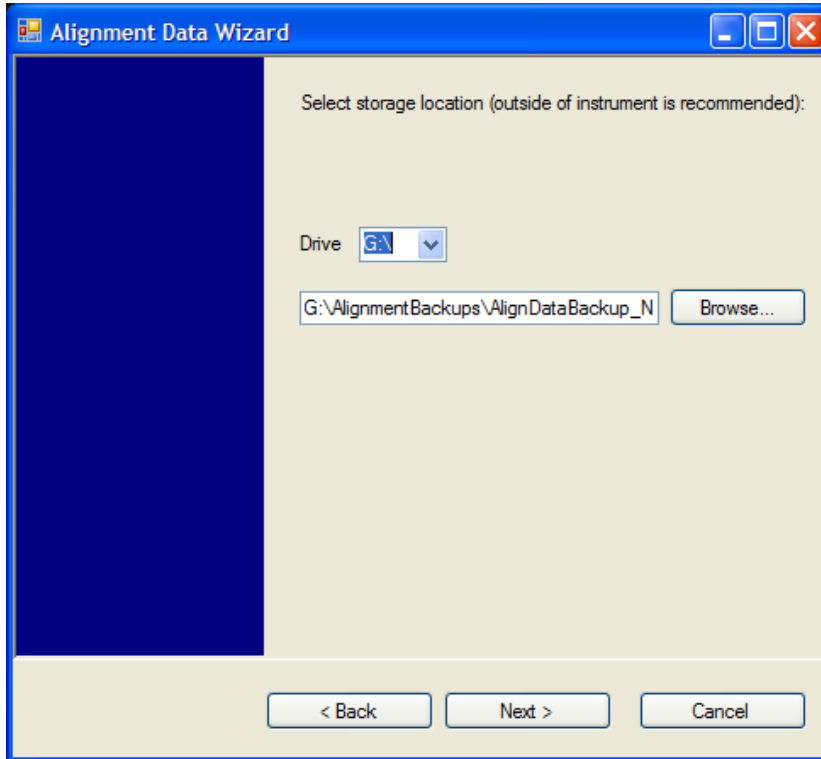

Changing the drive letter will also modify the path displayed in the box below. When this step is first loaded, the drive drop-down menu is populated with connected drives, which provide the user with write access. If there are many unreachable network drives connected to the instrument, this step can take a few seconds. If a USB drive is present, it will be selected by default. The path defaults to the AlignmentBackups folder, and a filename is automatically created in the form of AlignDataBackup_<model>_<serial number>_<date><time>. When the "Next >" button is pressed, you will be prompted to create a new folder if the chosen path does not yet exist.

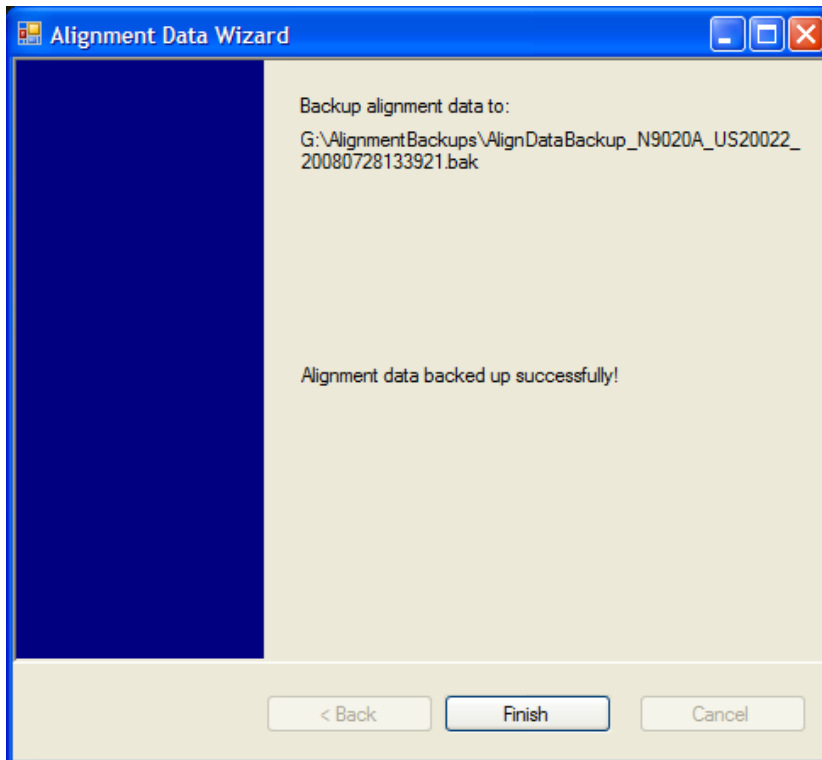
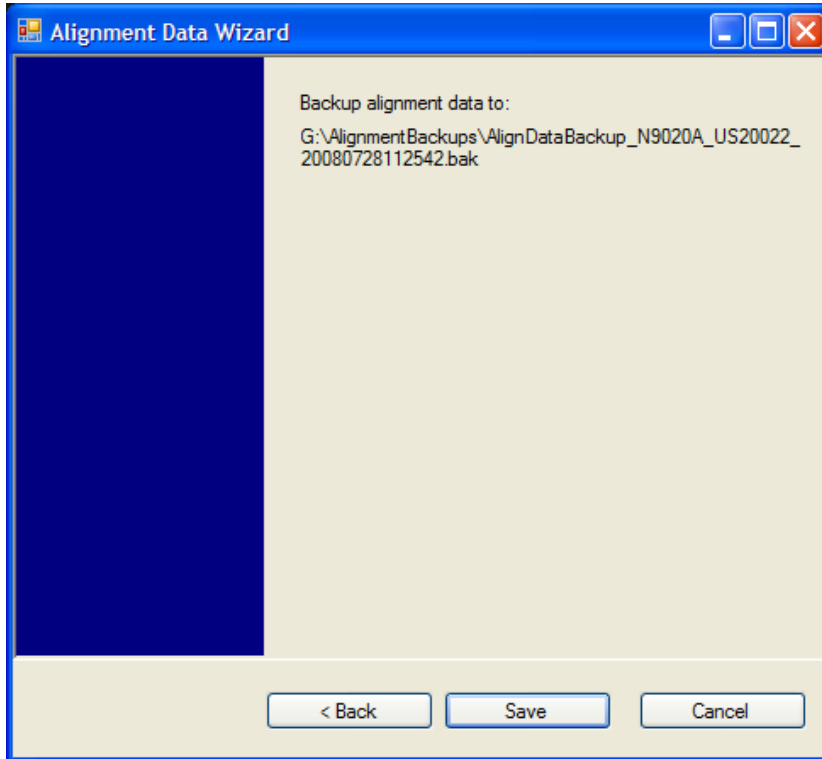

The restore operation checks the validity of the restore file using the database's built-in file validation. If the restore file is corrupt, the existing alignment data will remain in use.

If the serial number information in the backup file being restored is different from that of the instrument,

System Functions

System

the following message appears (the serial number shown are examples):

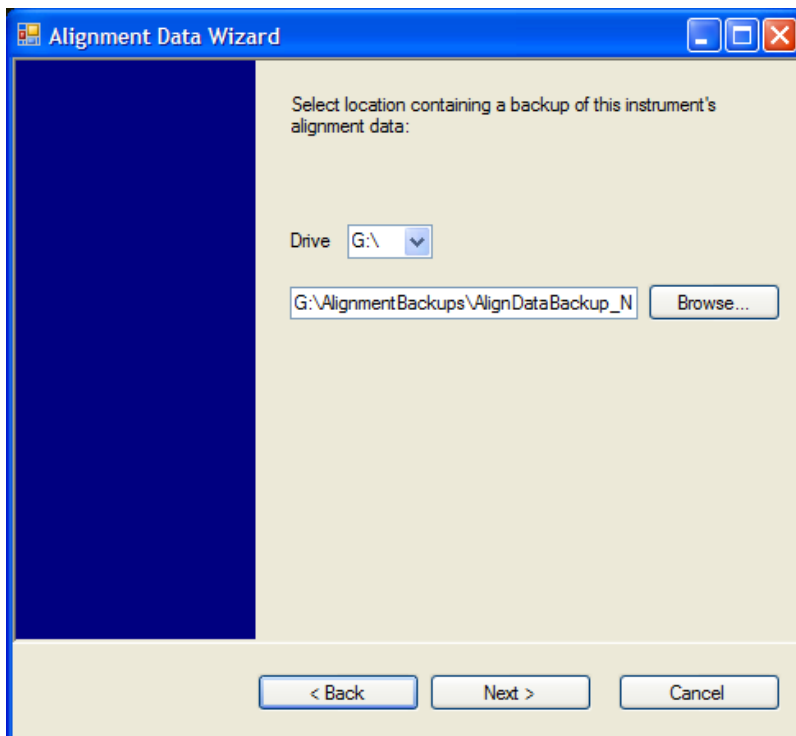
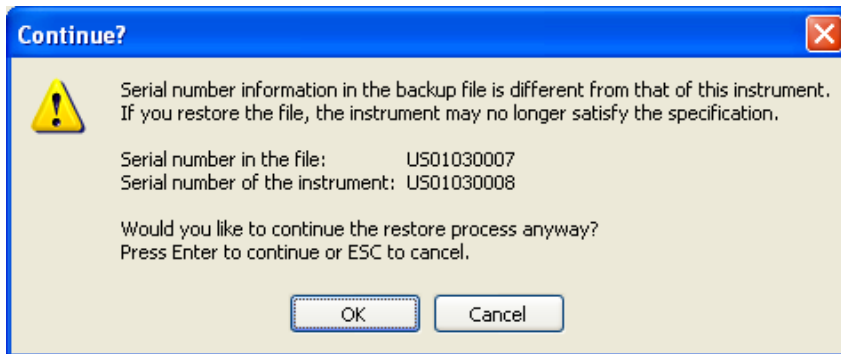

Changing the drive letter also modifies the path displayed in the box below. When this step is first loaded, the drive drop-down menu is populated with connected drives, which provide you with read access. The path defaults to the AlignBackups folder. The most recent *.bak file in the folder will also be selected by default.

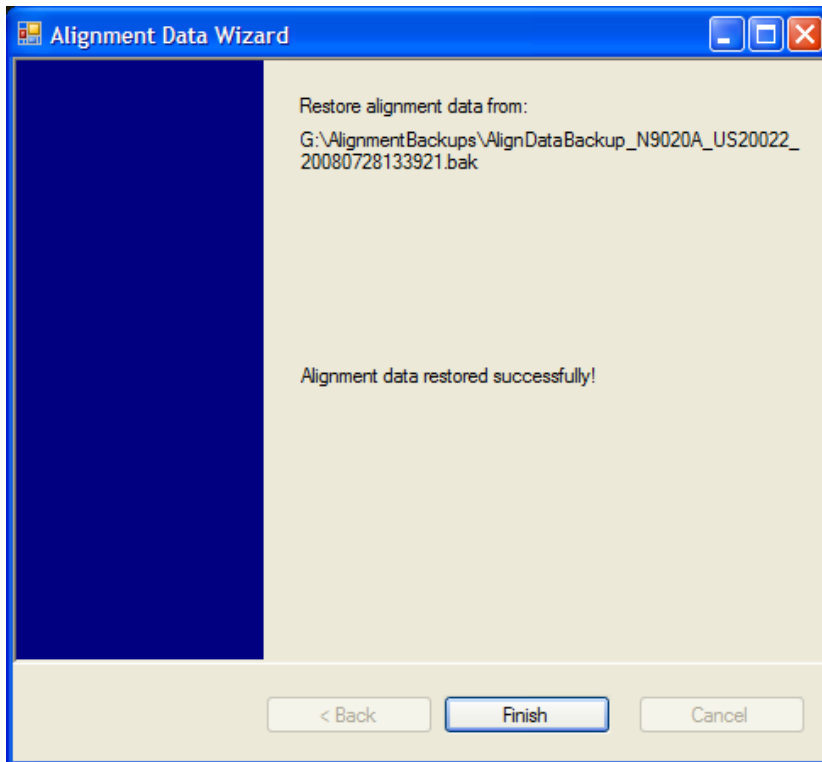
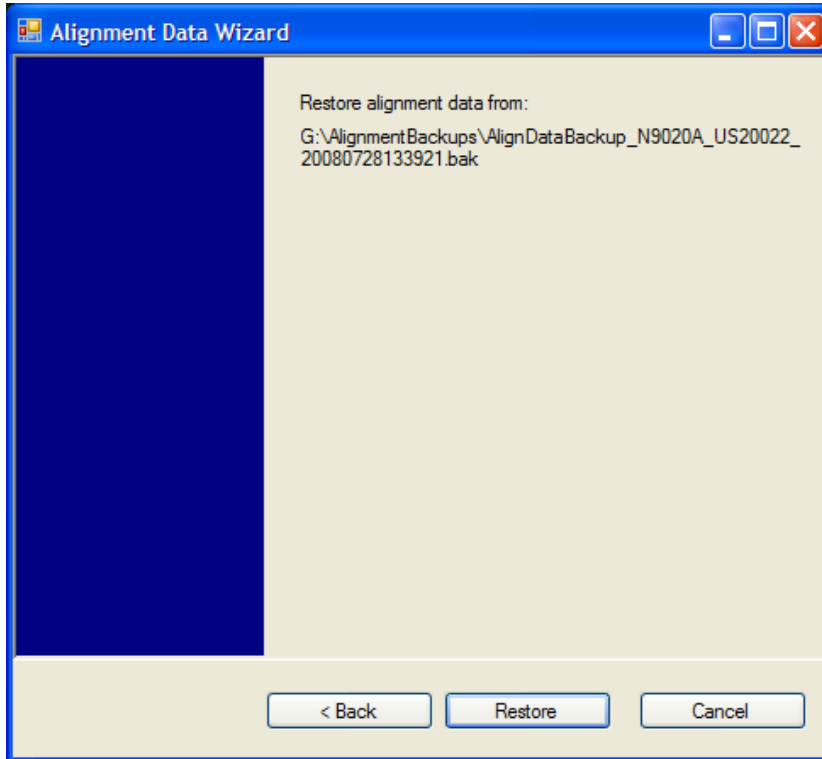

Perform Backup (Remote Command Only)

Invokes an alignment data backup operation to the provided Folder.

NOTE It is recommended that the Folder provided is outside of the instrument (USB or Mapped Network Drive).

Remote Command:	:CALibration:DATA:BACKup <filename>
Example:	:CAL:DATA:BACK "F:\AlignDataBackup_N9020A_US00000001_2008140100.bak"
Initial S/W Revision:	A.02.00

Perform Restore (Remote Command Only)

Invokes an alignment data restore operation from the provided filename.

Remote Command:	:CALibration:DATA:RESTore <filename>
Example:	:CAL:DATA:REST "F:\ AlignDataBackup_N9020A_US00000001_2008140100.bak "
Initial S/W Revision:	A.02.00

Advanced

Accesses alignment processes that are immediate action operations that perform operations that run until complete. Advanced alignments are performed on an irregular basis, or require additional operator interaction

Key Path:	System, Alignments
Initial S/W Revision:	Prior to A.02.00

Characterize Preselector

The Preselector tuning curve drifts over temperature and time. Recognize that the Amplitude, Presel Center function adjusts the preselector for accurate amplitude measurements at an individual frequency. Characterize Preselector improves the amplitude accuracy by ensuring the Preselector is approximately centered at all frequencies without the use of the Amplitude, Presel Center function. Characterize Preselector can be useful in situations where absolute amplitude accuracy is not of utmost importance, and the throughput savings or convenience of not performing a Presel Center is desired. Presel Center is required prior to any measurement for best (and warranted) amplitude accuracy.

Agilent recommends that the Characterize Preselector operation be performed yearly as part of any calibration, but performing this operation every three months can be worthwhile.

Characterize Preselector immediately executes a characterization of the Preselector, which is a YIG-tuned filter (YTF). The instrument stops any measurement currently underway, performs the characterization, then restarts the measurement from the beginning (similar to pressing the Restart key).

The query form of the remote commands (:CALibration:YTF?) will invoke the alignment of the YTF subsystem and return a success or failure value.

A failure encountered during alignment will generate the Error Condition message “Characterize Preselector failure” and set bit 3 in the STATUS:QUESTIONable:CALibration:EXTended:FAILure status register. Successful completion of Characterize Preselector will clear this Condition. It will also begin the elapsed time counter for Last Characterize Preselector Time, and capture the Last Characterize Preselector Temperature.

The last Characterize Preselector Time and Temperature survives across the power cycle as this operation is performed infrequently.

NOTE The Characterize Preselector function can be interrupted by pressing the Cancel (ESC) front-panel key or remotely with Device Clear followed by the :ABORT SCPI command. None of the new characterization data is then used. However, since the old characterization data is purged at the beginning of the characterization, you now have an uncharacterized preselector. You should re-execute this function and allow it to finish before making any further preselected measurements.

Key Path:	System, Alignments, Advanced
Mode:	All
Remote Command:	:CALibration:YTF :CALibration:YTF?
Example:	:CAL:YTF
Notes:	:CALibration:YTF? returns 0 if successful :CALibration:YTF? returns 1 if failed (including interfering user signal) While Advanced, Characterize Preselector is performing the alignment, bit 0 in the Status Operation register is set. Completion, or termination, will clear bit 0 in the Status Operation register. This command is sequential; it must complete before further SCPI commands are processed. Interrupting the alignment from remote is accomplished by invoking Device Clear followed by the :ABORT command. Successful completion will clear bit 9 in the Status Questionable Calibration register. A failure encountered during alignment will generate the Error Condition message “Characterize Preselector failed” and set bit 9 in the Status Questionable Calibration register. For Options that support frequencies > 3.6 GHz only.
Dependencies:	This key does not appear in models that do not contain preselectors. In these models the SCPI command is accepted without error but no action is taken.
Couplings:	Initializes the time for the Last Characterize Preselector Time. Records the temperature for the Last Characterize Preselector Temperature.

Initial S/W Revision:	Prior to A.02.00
-----------------------	------------------

Characterize Multiport Adapter Preamp

A Multiport Adatper Preamp Characterization should be made when MPA and EXT are first paired, a message window is popped up as below to inform the user to take this action:

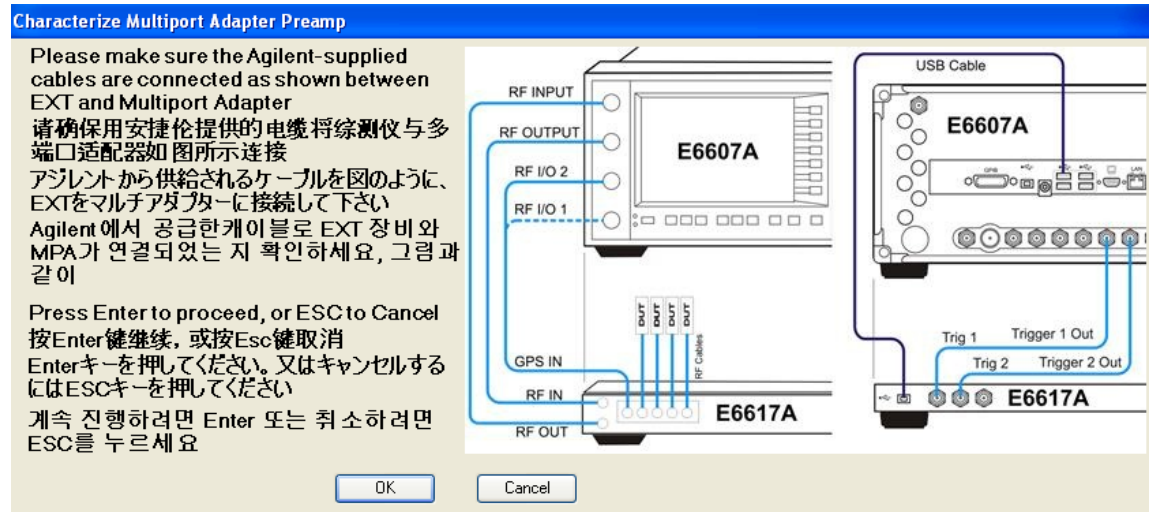

Correspondingly, bit 8 of the STATus:QUEStionable:CALibration:EXTended:NEEDED register (error 80) will be set for the “MPA Align required” message. Successful completion of Characterize Multiport Adapter Preamp will clear this Condition.

Users are expected to execute a characterization of the Preamp of Multiport Adapter when it is plugged into the USB port for the first time. The instrument stops any measurement currently underway, performs the characterization, then restarts the measurement from the beginning (similar to pressing the **Restart** key).

The query form of the remote command :CALibration:MPADapter:GAIN? will invoke the characterization of the Preamp of Multiport Adapter and return a success or failure value.

A failure encountered during characterization will generate the Error Condition message “MPA Align failed” and set bit 8 (error 83) in the STATus:QUEStionable:CALibration:EXTended:FAILure status register. Successful completion of Characterize Multiport Adapter Preamp will clear this Condition.

NOTE:

NOTE **Characterize Multiport Adapter Preamp** can be interrupted by pressing the Cancel (ESC) front-panel key or remotely with Device Clear followed by the :ABORt SCPI command.

Key Path:	System, Alignments, Advanced
Mode:	All

Remote Command:	:CALibration:MPADapter:GAIN :CALibration:MPADapter:GAIN?
Example:	:CAL:MPAD:GAIN
Notes:	:CALibration:MPADapter:GAIN? returns 0 if successful :CALibration:MPADapter:GAIN? returns 1 if failed While System, Alignments, Advanced, Characterize Multiport Adapter Preamp is performing the characterization, bit 0 in the Status Operation register is set. Completion, or termination, will clear bit 0 in the Status Operation register. This command is sequential, it must be completed before further SCPI commands are processed. Interrupting the alignment from remote is accomplished by invoking Device Clear followed by the :ABORt command. Successful completion will clear bit 8 in the Status Questionable Calibration Extended Failure register. A failure encountered during alignment will generate the Error Condition message “MPAdapter Preamp Charact Failure” and set bit 8 in the Status Questionable Calibration Extended Failure register.
Dependencies:	This key does not appear unless a multiport adapter is plugged in to the USB. Grayout error: -221.1400; Multiport Adapter Not Available
Status Bits/OPC dependencies:	Bit8 may be set in the Status Questionable Calibration Extended Failure register.
Initial S/W Revision:	A.10.00

Timebase DAC

Allows control of the internal 10 MHz reference oscillator timebase. This may be used to adjust for minor frequency alignment between the signal and the internal frequency reference. This adjustment has no effect if the instrument is operating with an External Frequency Reference.

If the value of the Timebase DAC changes (by switching to Calibrated from User with User set to a different value, or in User with a new value entered) an alignment may be necessary. The alignment system will take appropriate action; which will either invoke an alignment or cause an Alert.

Key Path:	System, Alignments
Mode:	All
Remote Command:	:CALibration:FREQuency:REFeRence:MODE CALibrated USER :CALibration:FREQuency:REFeRence:MODE?
Example:	:CAL:FREQ:REF:MODE CAL

System Functions
System

Notes:	If the value of the timebase is changed the alignment system automatically performs an alignment or alerts that an alignment is due. If the value of the timebase is changed the alignment system automatically performs an alignment or alerts that an alignment is due.
Preset:	This is unaffected by Preset but is set to CALibrated on a "Restore System Defaults->Align".
State Saved:	No
Initial S/W Revision:	Prior to A.02.00

Calibrated

Sets the Timebase DAC to the value established during factory or field calibration. The value displayed on the menu key is the calibrated value.

Key Path:	System, Alignments, Timebase DAC
Mode:	All
Example:	:CAL:FREQ:REF:MODE CAL
Readback Text:	[xxx] < where xxx is the calibrated value
Initial S/W Revision:	Prior to A.02.00

User

Allows setting the Timebase DAC to a value other than the value established during the factory or field calibration. The value displayed on the menu key is the calibrated value.

Key Path:	System, Alignments, Timebase DAC
Mode:	All
Example:	:CAL:FREQ:REF:MODE USER
Readback Text:	xxx < where xxx is the Timebase DAC setting
Initial S/W Revision:	Prior to A.02.00

Key Path:	System, Alignments, Timebase DAC
Mode:	All
Remote Command:	:CALibration:FREQuency:REFerence:FINE <integer> :CALibration:FREQuency:REFerence:FINE?
Example:	:CAL:FREQ:REF:FINE 8191
Notes:	If the value of the timebase is changed the alignment system automatically performs an alignment or alerts that an alignment is due.
Couplings:	Setting :CAL:FREQ:REF:FINE sets :CAL:FREQ:REF:MODE USER

Preset:	This is unaffected by Preset but is set to the factory setting on a “Restore System Defaults->Align”.
State Saved:	No
Min:	0
Max:	16383
Backwards Compatibility SCPI:	:CALibration:FREQuency:REFeRence:COARse ESA hardware contained two DAC controls for the Timebase. In X-Series the command :CALibration:FREQuency:REFeRence:FINE is the method for adjusting the timebase. The :COARse command is provided as an alias to :FINE.
Initial S/W Revision:	Prior to A.02.00

Remote Command:	:CALibration:FREQuency:REFeRence:COARse <integer> :CALibration:FREQuency:REFeRence:COARse?
Example:	:CAL:FREQ:REF:COAR 8191
Notes:	This is an alias for CAL:FREQ:REF:FINE any change to COARse is reflected in FINE and vice-versa. See CAL:FREQ:REF:FINE for description of functionality.
Couplings:	Setting :CAL:FREQ:REF:COAR sets :CAL:FREQ:REF:MODE USER
Initial S/W Revision:	Prior to A.02.00

RF Preselector

This menu and all of its submenus are only available in models with the RF Preselector, such as the N9038A.

See [“Align Now, 20 Hz to 30 MHz” on page 267](#)

See [“Align Now, 30 MHz to 3.6 GHz” on page 269](#)

See [“Align Now, 20 Hz to 3.6 GHz” on page 270](#)

See [“Alert” on page 272](#)

Key Path:	System, Alignments
Initial S/W Revision:	Prior to A.08..00

Align Now, 20 Hz to 30 MHz

Immediately executes an alignment of the receiver subsystem. The receiver will stop any measurement currently underway, perform the alignment, and then restart the measurement from the beginning (similar to pressing the Restart key).

The query form of the remote commands (:CALibration:RFPreselector:CONDUCTed?) will invoke the alignment of the RF Preselector on Conducted Band and return a success or failure value. Successful

System Functions
System

completion will clear the “Align 20 Hz to 30 MHz required” Error Condition, and clear the bit 1 in the Status Questionable Calibration Extended Needed register. The elapsed time counter will begin for Last Align Now, Conducted Time, and the temperature is captured for the Last Align Now, Conducted Temperature. The alignment can be interrupted by pressing the Cancel (ESC) front-panel key or remotely with Device Clear followed by the :ABORt SCPI command. When this occurs, the Error Condition “Align 20 Hz to 30 MHz required” is set because new alignment data may be employed for an individual subsystem, but not a cohesive set of data for all subsystems.

The “Align 20 Hz to 30 MHz required” Error Condition will appear when this alignment has expired. User is now responsible to perform the Align Now, 20 Hz to 30 MHz in order to keep the receiver in warranted operation. This alignment can only be performed by user as it is not part of the Auto Align process.

Key Path:	System, Alignments, RF Preselector, Align Now
Mode:	All
Remote Command:	:CALibration:RFPreselector:CONDUCTed :CALibration:RFPreselector:CONDUCTed?
Example:	:CAL:RFPS:COND
Notes:	:CALibration:RFPreselector:CONDUCTed? Return 0 if successful :CALibration:RFPreselector:CONDUCTed? Return 1 if failed When Align 20 Hz to 30 MHz is performing the alignment, bit 0 in the Status Operation register is set. Completion, or termination, will clear bit 0 in the Status Operation register. This command is sequential; it must complete before further SCPI commands are processed. Interrupting the alignment from remote is accomplished by invoking Device Clear followed by the :ABORt command. Successful completion will clear bit 1 in the Status Questionable Calibration Extended Needed register and bit 0 in Status Questionable Calibration Extended Failure register. A failure encountered during alignment will set the Error Condition “20 Hz to 30 MHz Alignment Failure” and set both bit 1 in the Status Questionable Calibration Extended Needed register and bit 9 in Status Questionable Calibration register. For model N9038A only.
Dependencies:	This key does not appear in other than N9038A models, setting or querying the SCPI will generate an error.
Couplings:	Initializes the time for the Last Align Conducted Now, Conducted Time. Records the temperature for the Last Align Conducted Now, Conducted Temperature.

Status Bits/OPC Dependencies:	<p>Bit 8 or 9 may be set in the Status Questionable Calibration register.</p> <p>Bit 1 may be set in the Status Questionable Calibration Extended Needed register.</p> <p>Bit 0 may be set in the Status Questionable Calibration Extended Failure register.</p>
Initial S/W Revision:	A.08.00

Align Now, 30 MHz to 3.6 GHz

Immediately executes an alignment of the receiver subsystem. The receiver will stop any measurement currently underway, perform the alignment, and then restart the measurement from the beginning (similar to pressing the Restart key).

The query form of the remote commands (:CALibration:RFPSelector:RADiated?) will invoke the alignment of the RF Preselector on Radiated Band and return a success or failure value. Successful completion will clear the “Align 30 MHz to 3.6 GHz required” Error Condition, and clear the bit 2 in the Status Questionable Calibration Extended Needed register. The elapsed time counter will begin for Last Align Now, Radiated Time, and the temperature is captured for the Last Align Now, Radiated Temperature. The alignment can be interrupted by pressing the Cancel (ESC) front-panel key or remotely with Device Clear followed by the :ABORt SCPI command. When this occurs, the Error Condition “Align 30 MHz to 3.6 GHz required” is set because new alignment data may be employed for an individual subsystem, but not a cohesive set of data for all subsystems.

The “Align 30 MHz to 3.6 GHz required” Error Condition will appear when this alignment has expired. User is now responsible to perform the Align Now, 30 MHz to 3.6 GHz in order to keep the receiver in warranted operation. This alignment can only be performed by user as it is not part of the Auto Align process.

Key Path:	System, Alignments, RF Preselector, Align Now
Mode:	All
Remote Command:	:CALibration:RFPSelector:RADiated :CALibration:RFPSelector:RADiated?
Example:	:CAL:RFPS:RAD

Notes:	<p>:CALibration:RFPSelector:RADiated? Return 0 if successful</p> <p>:CALibration:RFPSelector:RADiated? Return 1 if failed</p> <p>When Align 30 MHz to 3.6 GHz is performing the alignment, bit 0 in the Status Operation register is set. Completion, or termination, will clear bit 0 in the Status Operation register.</p> <p>This command is sequential; it must complete before further SCPI commands are processed. Interrupting the alignment from remote is accomplished by invoking Device Clear followed by the :ABORt command. Successful completion will clear bit 2 in the Status Questionable Calibration Extended Needed register and bit 1 in Status Questionable Calibration Extended Failure register.</p> <p>A failure encountered during alignment will set the Error Condition “30 MHz to 3.6 GHz Alignment Failure” and set both bit 2 in the Status Questionable Calibration Extended Needed register and bit 9 in Status Questionable Calibration register.</p> <p>For model N9038A only.</p>
Dependencies:	<p>This key does not appear in other than N9038A models, setting or querying the SCPI will generate an error.</p>
Couplings:	<p>Initializes the time for the Last Align Radiated Now, Radiated Time.</p> <p>Records the temperature for the Last Align Radiated Now, Radiated Temperature.</p>
Status Bits/OPC Dependencies:	<p>Bit 8 or 9 may be set in the Status Questionable Calibration register.</p> <p>Bit 2 may be set in the Status Questionable Calibration Extended Needed register.</p> <p>Bit 1 may be set in the Status Questionable Calibration Extended Failure register.</p>
Initial S/W Revision:	<p>A.08.00</p>

Align Now, 20 Hz to 3.6 GHz

Immediately executes an alignment of the receiver subsystem. The receiver will stop any measurement currently underway, perform the alignment, and then restart the measurement from the beginning (similar to pressing the Restart key).

The query form of the remote commands (:CALibration:RFPSelector:FULL?) will invoke the alignment of the RF Preselector on both Conducted and Radiated Band and return a success or failure value. Successful completion will clear the “Align 20 Hz to 3.6 GHz required” Error Condition, and clear the bit 1 and bit 2 in the Status Questionable Calibration Extended Needed register. The elapsed time counter will begin for Last Align Now, Conducted Time and Last Align Now Radiated Time and the temperature is captured for Last Align Now, Conducted Temperature and Last Align Now, Radiated Temperature. The alignment can be interrupted by pressing the Cancel (ESC) front-panel key or remotely with Device Clear followed by the :ABORt SCPI command. When this occurs, the Error Condition “Align 20 Hz to 3.6 GHz required” is set because new alignment data may be employed for an individual subsystem, but not a cohesive set of data for all subsystems.

The “Align 20 Hz to 3.6 GHz required” Error Condition will appear when this alignment has expired. User is now responsible to perform the Align Now, 20 Hz to 3.6 GHz in order to keep the receiver in warranted operation. This alignment can only be performed by user as it is not part of the Auto Align process.

Key Path:	System, Alignments, RF Preselector, Align Now
Mode:	All
Remote Command:	:CALibration:RFPSelector:FULL :CALibration:RFPSelector:FULL?
Example:	:CAL:RFPS:FULL
Notes:	:CALibration:RFPSelector:FULL? Return 0 if successful :CALibration:RFPSelector:FULL? Return 1 if failed When Align 20 Hz to 3.6 GHz is performing the alignment, bit 0 in the Status Operation register is set. Completion, or termination, will clear bit 0 in the Status Operation register. This command is sequential; it must complete before further SCPI commands are processed. Interrupting the alignment from remote is accomplished by invoking Device Clear followed by the :ABORT command. Successful completion will clear bit 1, bit 2 in the Status Questionable Calibration Extended Needed register and bit 0, bit 1 in Status Questionable Calibration Extended Failure register. A failure encountered during alignment will set the Error Condition “20 Hz to 3.6 GHz Alignment Failure” and set bit 1, bit 2 in the Status Questionable Calibration Extended Needed register and bit 9 in Status Questionable Calibration register. For model N9038A only.
Dependencies:	This key does not appear in other than N9038A models, setting or querying the SCPI will generate an error.
Couplings:	Initializes the time for the Last Align Conducted Now, Conducted Time. Initializes the time for the Last Align Radiated Now, Radiated Time. Records the temperature for the Last Align Conducted Now, Conducted Temperature. Records the temperature for the Last Align Radiated Now, Radiated Temperature.
Status Bits/OPC Dependencies:	Bit 8 or 9 may be set in the Status Questionable Calibration register. Bit 1 and 2 may be set in the Status Questionable Calibration Extended Needed register. Bit 0 and 1 may be set in the Status Questionable Calibration Extended Failure register.
Initial S/W Revision:	A.08.00

Alert

Setting Alert to ON/OFF will enable/disable the display of RF Preselector alignment required message on the status line. The instrument will power up with Alert On mode.

Key Path:	System, Alignments, RF Preselector
Mode:	All
Remote Command:	:CALibration:RFPSelector:ALERT ON OFF 0 1 :CALibration:RFPSelector:ALERT?
Example:	:CAL:RFPS:ALER OFF
Notes:	For model N9038A only. Error Condition will be generated when the alert is On and any of the RF Preselector alignments has expired.
Preset:	This is unaffected by Preset, but is set to ON on a “Restore System Defaults->Align”.
State Saved:	No
Initial S/W Revision:	A.08.00

Schedule Setup

Enables you to schedule a task to run automatically at the background based on the recurrence and time set in the scheduler. Make sure that the Instrument’s local time is accurate as the Scheduler relies on this information to execute the task.

Key Path:	System, Alignments, RF Preselector
Initial S/W Revision:	A.08.00

Task

There are 3 task that can be selected for the scheduler to run.

Task 1 is the 20 Hz to 30 MHz alignment

Task 2 is the 30 MHz to 3.6 GHz alignment

Task 3 is the 20 Hz to 3.6 GHz alignment.

Key Path:	System, Alignments, RF Preselector, Schedule Setup
Mode:	All
Remote Command:	:CALibration:RFPSelector:SCHeduler:TASK T1 T2 T3 :CALibration:RFPSelector:SCHeduler:TASK?
Example:	:CAL:RFPS:SCH:TASK T1

Notes:	Changing the task will not reset the Scheduler time and the alignment is based on the current scheduled configuration to occur. For model N9038A only.
Preset:	This is unaffected by Preset but is set to T3 on a “Restore System Defaults->Align”.
State Saved:	No
Range:	Task 1 Task 2 Task 3
Initial S/W Revision:	A.08.00

Date/Time

Enables you to configure the scheduler to run a task starting from this date and time. The date and time rely on the instrument’s local time to execute a scheduled task. The date is based on the format “YYYY/MM/DD” and the time is based on a 24 hour clock.

Key Path:	System, Alignments, RF Preselector, Schedule Setup
Mode:	All
Remote Command:	:CALibration:RFPSelector:SCHeuler:TIME:START "date", "time" :CALibration:RFPSelector:SCHeuler:TIME:START? This query returns data using the following format "YYYY/MM/DD; HH:MM:SS"
Example:	:CAL:RFPS:SCH:TIME:STAR "2009/8/20","12:00:00"
Notes:	“date” is representation of the date the task will run in the form of “YYYY/MM/DD” where: YYYY is the four digit representation of year. (for example, 2009) MM is the two digit representation of month. (for example, 01 to 12) DD is the two digit representation of the day. (for example, 01 to 28, 29, 30 or 31 depending on the month and year) “time” is a representation of the time of day the task will run in the form of “HH:MM:SS” where: HH is the two digit representation of the hour in 24 hour format MM is the two digit representation of minute SS is the two digit representation of seconds For model N9038A only.
Preset:	This is unaffected by Preset but is set to Current date and 00:00:00 on a “Restore System Defaults->Align”.
State Saved:	No
Initial S/W Revision:	A.08.00

System Functions

System

Date

Enables you to configure the date of the scheduled task. The SCPI command to configure the date and time parameters of the scheduler is the same; however, they each have their own front-panel control.

Key Path:	System, Alignments, RF Preselector, Schedule Setup, Date/Time
Notes:	See “Date/Time ” on page 273 . For model N9038A only.
Preset:	This is unaffected by Preset but is set to Current date and 00:00:00 on a “Restore System Defaults->Align”.
State Saved:	No
Initial S/W Revision:	A.08.00

Time

Enables you to configure the time of the scheduled task. The SCPI command to configure the date and time parameters of the scheduler is the same; however, they each have their own front panel-control.

Key Path:	System, Alignments, RF Preselector, Schedule Setup, Date/Time
Notes:	See “Date/Time ” on page 273 . For model N9038A only.
Preset:	This is unaffected by Preset but is set to Current date and 00:00:00 on a “Restore System Defaults->Align”.
State Saved:	No
Initial S/W Revision:	A.08.00

Recurrence

Enables you to configure the scheduler to run the task recurrently on a scheduled date and time. You can schedule it to run daily, weekly or alternate weeks.

Key Path:	System, Alignments, RF Preselector, Schedule Setup
Mode:	All
Remote Command:	:CALibration:RFPreselector:Scheduler:REcurrence DAY WEEK OFF :CALibration:RFPreselector:Scheduler:REcurrence?
Example:	:CAL:RFPS:SCH:REC DAY
Notes:	For model N9038A only.
Preset:	This is unaffected by Preset but is set to OFF on a “Restore System Defaults->Align”.
State Saved:	No

Range:	DAY WEEK OFF
Initial S/W Revision:	A.08.00

Every N Weeks

Enables you to configure the scheduler to run the task on a day in every number of week's duration.

Key Path:	System, Alignments, RF Preselector, Schedule Setup, Recurrence
Initial S/W Revision:	A.08.00

N of Weeks

Enables you to set the number of weeks that the scheduler will wait to trigger a task.

Key Path:	System, Alignments, RF Preselector, Schedule Setup, Recurrence, Every N Weeks
Mode:	All
Remote Command:	:CALibration:RFPSelector:SCHeduler:REcurrence:WEEK <integer> :CALibration:RFPSelector:SCHeduler:REcurrence:WEEK?
Example:	:CAL:RFPS:SCH:REC:WEEK 2
Notes:	New scheduled date to run the alignment task will get updated when this parameter is changed. For model N9038A only.
Preset:	This is unaffected by Preset but is set to 1 on a "Restore System Defaults->Align".
State Saved:	No
Range:	1-52
Initial S/W Revision:	A.08.00

Day

Enables you to set the Day of the Week the scheduler will run a scheduled task.

Key Path:	System, Alignments, RF Preselector, Schedule Setup, Recurrence, Every N Weeks
Mode:	All
Remote Command:	:CALibration:RFPSelector:SCHeduler:REcurrence:DAY SUN MON TUE WED THU FRI SAT :CALibration:RFPSelector:SCHeduler:REcurrence:DAY?
Example:	:CAL:RFPS:SCH:REC:DAY SUN
Notes:	For model N9038A only.

System Functions
System

Preset:	This is unaffected by Preset but is set to SUN on a “Restore System Defaults->Align”.
State Saved:	No
Range:	Sunday Monday Tuesday Wednesday Thursday Friday Saturday
Initial S/W Revision:	A.08.00

Scheduler

Setting the Scheduler to ON will trigger the execution of the scheduled task based on the recurrence and time set in the scheduler since the last successful of the specific alignment. A warning condition of “RF Preselector alignment scheduler is ON” will be appeared when the scheduler is set to ON. OFF will turn off the Scheduler from running any scheduled task.

Key Path:	System, Alignments, RF Preselector
Mode:	All
Remote Command:	:CALibration:RFPreselector:Scheduler:STATE ON OFF 0 1 :CALibration:RFPreselector:Scheduler:STATE?
Example:	:CAL:RFPS:SCH:STAT OFF
Notes:	For model N9038A only.
Preset:	This is unaffected by Preset but is set to OFF on a “Restore System Defaults->Align”.
State Saved:	No
Initial S/W Revision:	A.08.00

I/O Config

Activates a menu for identifying and changing the I/O configuration for remote control.

Key Path:	System
Initial S/W Revision:	Prior to A.02.00

GPIB

Activates a menu for configuring the GPIB I/O port.

Key Path:	System, I/O Config
Initial S/W Revision:	A.02.00

GPIB Address

Select the GPIB remote address.

Key Path:	System, I/O Config, GPIB
Mode:	All
Remote Command:	:SYSTem:COMMunicate:GPIB [1] [:SELF] :ADDRESS <integer> :SYSTem:COMMunicate:GPIB [1] [:SELF] :ADDRESS?
Example:	:SYST:COMM:GPIB:ADDR 17
Notes:	Changing the Address on the GPIB port requires all further communication to use the new address.
Preset:	This is unaffected by Preset but is set to 18 on a "Restore System Defaults->Misc"
State Saved:	No
Range:	0 to 30
Initial S/W Revision:	Prior to A.02.00

GPIB Controller

Sets the GPIB port into controller or device mode. In the normal state, GPIB controller is disabled, which allows the analyzer to be controlled by a remote computer. When GPIB Controller is enabled, the instrument can run software applications that use the instrument's computer as a GPIB controller; controlling devices connected to the instrument's GPIB port.

NOTE When GPIB Controller is enabled, the analyzer application itself cannot be controlled over GPIB. In this case it can easily be controlled via LAN or USB. The GPIB port cannot be a controller and device at the same time. Only one controller can be active on the GPIB bus at any given time. If the analyzer is the controller, an external PC cannot be a controller.

To control the instrument from the software that is performing GPIB controller operation, you can use an internal TCP/IP connection to the analyzer application. Use the address TCPIP0:localhost:inst0:INSTR to send SCPI commands to the analyzer application.

Key Path:	System, I/O Config, GPIB
Mode:	All
Scope:	Mode Global
Remote Command:	:SYSTem:COMMunicate:GPIB [1] [:SELF] :CONTroller [:ENABle] ON OFF 0 1 :SYSTem:COMMunicate:GPIB [1] [:SELF] :CONTroller [:ENABle] ?
Example:	:SYST:COMM:GPIB:CONT ON Will set GPIB port to Controller

System Functions
System

Notes:	When the instrument becomes the Controller bit 0 in the Standard Event Status Register is set (and when the instrument relinquishes Controller capability bit 0 is cleared in the Standard Event Status Register).
Preset:	This is unaffected by Preset but is set to OFF on a “Restore System Defaults->Misc”
State Saved:	No
Range:	Disabled Enabled
Initial S/W Revision:	A.02.00

Disabled

Disables the GPIB Controller capability, this is the default (or normal) setting.

Key Path:	System, I/O Config, GPIB, GPIB Controller
Example:	:SYST:COMM:GPIB:CONT OFF Will set GPIB port to Device
Initial S/W Revision:	A.02.00

Enabled

Enables the GPIB Controller capability.

Key Path:	System, I/O Config, GPIB, GPIB Controller
Example:	:SYST:COMM:GPIB:CONT ON Will set GPIB port to Controller
Initial S/W Revision:	A.02.00

SCPI LAN

Activates a menu for identifying and changing the SCPI over a LAN configuration. There are a number of different ways to send SCPI remote commands to the instrument over LAN. It can be a problem to have multiple users simultaneously accessing the instrument over the LAN. These keys limit that somewhat by disabling the telnet, socket, and/or SICL capability.

Key Path:	System, I/O Config
Initial S/W Revision:	Prior to A.02.00

SCPI Telnet

Turns the SCPI LAN telnet capability On or Off allowing you to limit SCPI access over LAN through telnet.

Key Path:	System, I/O Config, SCPI LAN
Mode:	All

Remote Command:	:SYSTem:COMMunicate:LAN:SCPI:TELNet:ENABle OFF ON 0 1 :SYSTem:COMMunicate:LAN:SCPI:TELNet:ENABle?
Example:	:SYST:COMM:LAN:SCPI:TELN:ENAB OFF
Preset:	This is unaffected by Preset but is set to ON with a “Restore System Defaults->Misc”
State Saved:	No
Range:	On Off
Initial S/W Revision:	Prior to A.02.00

SCPI Socket

Turns the capability of establishing Socket LAN sessions On or Off. This allows you to limit SCPI access over LAN through socket sessions.

Key Path:	System, I/O Config, SCPI LAN
Mode:	All
Remote Command:	:SYSTem:COMMunicate:LAN:SCPI:SOCKet:ENABle OFF ON 0 1 :SYSTem:COMMunicate:LAN:SCPI:SOCKet:ENABle?
Example:	:SYST:COMM:LAN:SCPI:SOCK:ENAB OFF
Preset:	This is unaffected by a Preset but is set to ON with a “Restore System Defaults->Misc”
State Saved:	No
Range:	On Off
Initial S/W Revision:	Prior to A.02.00

SICL Server

Turns the SICL server capability On or Off, enabling you to limit SCPI access over LAN through the SICL server. (SICL IEEE 488.2 protocol.)

Parameter	Description	Setting
Maximum Connections	The maximum number of connections that can be accessed simultaneously	5
Instrument Name	The name (same as the remote SICL address) of your analyzer	inst0
Instrument Logical Unit	The unique integer assigned to your analyzer when using SICL LAN	8
Emulated GPIB Name	The name (same as the remote SICL address) of the device used when communicating with your analyzer	gpib7

System Functions
System

Parameter	Description	Setting
Emulated GPIB Logical Unit	The unique integer assigned to your device when it is being controlled using SICL LAN	8
Emulated GPIB Address	The emulated GPIB address assigned to your transmitter tester when it is a SICL server (the same as your GPIB address)	18

Key Path:	System, I/O Config, SCPI LAN
Mode:	All
Remote Command:	:SYSTem:COMMunicate:LAN:SCPI:SICL:ENABle OFF ON 0 1 :SYSTem:COMMunicate:LAN:SCPI:SICL:ENABle?
Example:	:SYST:COMM:LAN:SCPI:SICL:ENAB OFF
Preset:	This is unaffected by Preset, but is set to ON with a “Restore System Defaults->Misc”
State Saved:	No
Range:	On Off
Initial S/W Revision:	Prior to A.02.00

HiSLIP Server

Turns the HiSLIP server capability On or Off, enabling you to limit SCPI access over LAN through the HiSLIP server.

HiSLIP stands for High Speed LAN Instrument Protocol and is part of the IVI–6.1 specification.

Here is an example of a VISA connection string used to connect to the HiSLIP Server on an X-Series Spectrum Analyzer:

TCPIP0::a-n9030a-93016::hislip0::INSTR

In the example above, hislip0 is the HiSLIP device name that VISA users must include in their HiSLIP VISA Address strings. Your HiSLIP device name may be different depending on your VISA settings.

Key Path:	System, I/O Config, SCPI LAN
Mode:	All
Remote Command:	:SYSTem:COMMunicate:LAN:SCPI:HISLip:ENABle OFF ON 0 1 :SYSTem:COMMunicate:LAN:SCPI:HISLip:ENABle?
Example:	:SYST:COMM:LAN:SCPI:HISL:ENAB OFF
Preset:	This is unaffected by Preset, but is set to ON with a “Restore System Defaults->Misc”
State Saved:	No

Range:	On Off
Initial S/W Revision:	A.11.00

SCPI Socket Control Port (Remote Command Only)

Returns the TCP/IP port number of the control socket associated with the SCPI socket session. This query enables you to obtain the unique port number to open when a device clear is to be sent to the instrument. Every time a connection is made to the SCPI socket, the instrument creates a peer control socket. The port number for this socket is random. The user must use this command to obtain the port number of the control socket. To force a device clear on this socket, open the port and send the string "DCL" to the instrument.

If this SCPI command is sent to a non SCPI Socket interface, then 0 is returned.

Mode:	All
Remote Command:	:SYSTem:COMMunicate:LAN:SCPI:SOCKet:CONTRol?
Example:	:SYST:COMM:LAN:SCPI:SOCK:CONT?
Preset:	This is unaffected by Preset or "Restore System Defaults->Misc".
State Saved:	No
Range:	0 to 65534
Initial S/W Revision:	Prior to A.02.00

Reset Web Password

The embedded web server contains certain capability which are password protected; modifying the LAN configuration of the instrument, and access to web pages that can change the settings of the instrument. The default password from the factory is 'agilent' (without the quotes). The control provided here is the means to set the web password as the user desires, or to reset the password to the factory default.

Selecting Reset web password brings up a control for resetting the password as the user desires, or to the factory default. A keyboard is required to change the password from the factory default of 'agilent' or to set a new password that contains alphabetic characters. The control is:

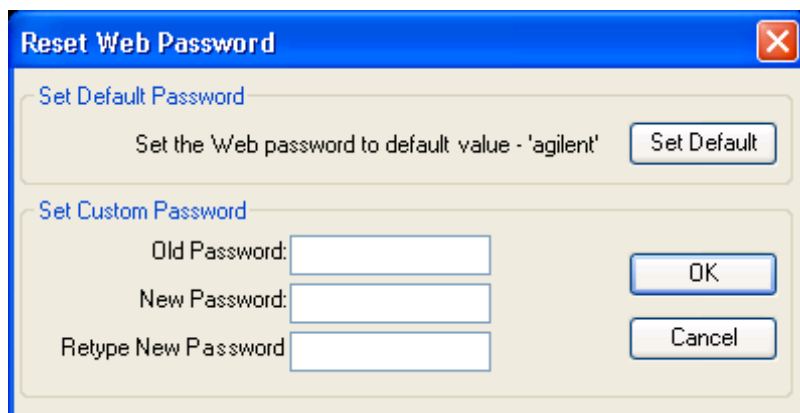

If this control is entered without an external keyboard or mouse connected, you can cancel the control by

System Functions

System

pressing the Cancel (ESC) front-panel key.

Key Path:	System, I/O Config
Mode:	All
Initial S/W Revision:	Prior to A.02.00

LXI

Opens a menu that allows you to access the various LXI configuration properties.

Key Path:	System, I/O Config
Initial S/W Revision:	Prior to A.02.00

LAN Reset

Resets the LAN connection.

Key Path:	System, I/O Config, LXI
Initial S/W Revision:	Prior to A.02.00

System IDN Response

This key allows you to specify a response to the *IDN? query, or to return the analyzer to the Factory response if you have changed it.

To choose the factory-set response, press the **Factory** key.

To specify your own response, press the **User** key, and enter your desired response.

Key Path:	System, I/O Config
Mode:	All
Remote Command:	:SYSTem:IDN <string> :SYSTem:IDN?
Notes:	This affects the response given in all Modes of the Analyzer, unless the current Mode has also specified a custom response, in which case the current Mode's custom IDN response takes precedence over the System's, but only while that Mode is the current Mode.. It survives shutdown and restart of the software and therefore survives a power cycle Null string as parameter restores the Factory setting
Preset:	This is unaffected by Preset but is set to the original factory setting on a "Restore System Defaults->Misc"
State Saved:	No
Initial S/W Revision:	A.06.00

Factory

This key selects the factory setting, for example:

“Agilent Technologies,N9020A,MY00012345,A.05.01”

where the fields are manufacturer, model number, serial number, firmware revision.

Key Path:	System, I/O Config, IDN Response
Example:	:SYST:IDN "" null string, restores the factory setting
Initial S/W Revision:	A.06.0

User

This key allows you to specify your own response to the *IDN? query. You may enter your desired response with the Alpha Editor or a plugin PC keyboard.

When you press this key, the active function becomes the current User string with the cursor at the end. This makes it easy to edit the existing string.

If you enter a null string (for example, by clearing the User String while editing and then pressing **Done**) the analyzer automatically reverts to the Factory setting.

Key Path:	System, I/O Config, IDN Response
Example:	:SYST:IDN “XYZ Corp,Model 12,012345,A.01.01” user specified response
Initial S/W Revision:	A.06.00

Query USB Connection (Remote Command Only)

Enables you to determine the speed of the USB connection.

Mode:	All
Remote Command:	:SYSTem:COMMunicate:USB:CONNectioN?
Example:	:SYST:COMM:USB:CONN?
Notes:	<p>NONE – Indicates no USB connection has been made.</p> <p>LSPeed – Indicates a USB low speed connection (1.5 Mbps).</p> <p>This is reserved for future use, the T+M488 protocol is not supported on low speed connections.</p> <p>HSPeed – Indicates that a USB high speed connection (480 Mbps) has been negotiated.</p> <p>FSPeed – Indicates that a USB full speed connection (12 Mbps) has been negotiated.</p>
State Saved:	No
Range:	NONE LSPeed HSPeed FSPeed

Initial S/W Revision:	Prior to A.02.00
-----------------------	------------------

USB Connection Status (Remote Command Only)

Enables you to determine the current status of the USB connection.

Mode:	All
Remote Command:	:SYSTem:COMMunicate:USB:STATus?
Example:	:SYST:COMM:USB:STAT?
Notes:	<p>SUSPended – Indicates that the USB bus is currently in its suspended state. The bus is in the suspended state when:</p> <ul style="list-style-type: none"> The bus is not connected to any controller The controller is currently powered off The controller has explicitly placed the USB device into the suspended state. <p>When in the suspended state, no USB activity, including start of frame packets are received.</p> <p>ACTive – Indicates that the USB device is in the active state. When the device is in the active state, it is receiving periodic start of frames but it isn't necessarily receiving or transmitting data.</p>
State Saved:	No
Range:	SUSPended ACTive
Initial S/W Revision:	Prior to A.02.00

USB Packet Count (Remote Command Only)

Enables you to determine the number of packets received and transmitted on the USB bus.

Mode:	All
Remote Command:	:SYSTem:COMMunicate:USB:PACKets?
Example:	:SYST:COMM:USB:PACK?
Notes:	<p>Two integers are returned. The first is the number of packets received since application invocation, the second is the number of packets transmitted since application invocation. If no packets have been received or transmitted the response is 0,0.</p> <p>The packet count is initialized to 0,0 when the instrument application is started.</p>
State Saved:	No
Initial S/W Revision:	Prior to A.02.00

Restore Defaults

Provides incremental initialization of the system setting groups along with supporting a comprehensive reset of the entire instrument back to a factory default state. The menu selections are the groups of system settings and when one is selected, that particular group of system settings is reset back to their default values.

Key Path:	System
Mode:	All
Remote Command:	:SYSTem:DEFault [ALL] ALIGn INPut MISC MODes PON
Example:	SYST:DEF
State Saved:	No
Initial S/W Revision:	Prior to A.02.00

Restore Input/Output Defaults

Causes the group of settings and data associated with Input/Output front-panel key to be a reset to their default values. This level of Restore System Defaults does not affect any other system settings, mode settings and does not cause a mode switch. .

Confirmation is required to restore the Input/Output setting. The confirmation dialog is:

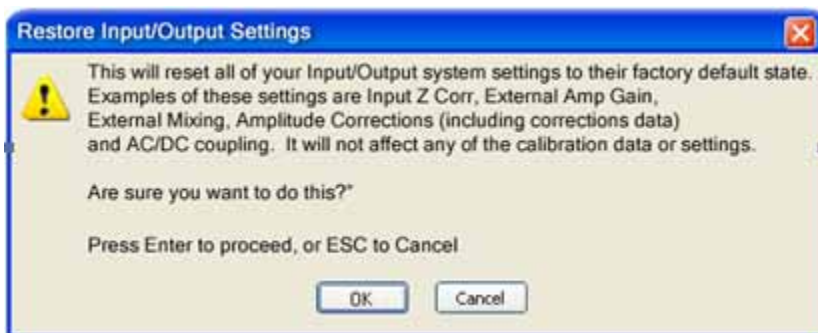

Key Path:	System, Restore System Defaults
Example:	:SYST:DEF INP
Initial S/W Revision:	Prior to A.02.00

Restore Power On Defaults

This selection causes the Power On settings to be a reset to their default value. This level of Restore System Defaults does not affect any other system settings, mode settings and does not cause a mode switch. The Power On settings and their default values are Power On Type reset to Mode and Input/Output Defaults and Power On Application reset to whatever the factory set as its default value.

Confirmation is required to restore the factory default values. The confirmation dialog is:

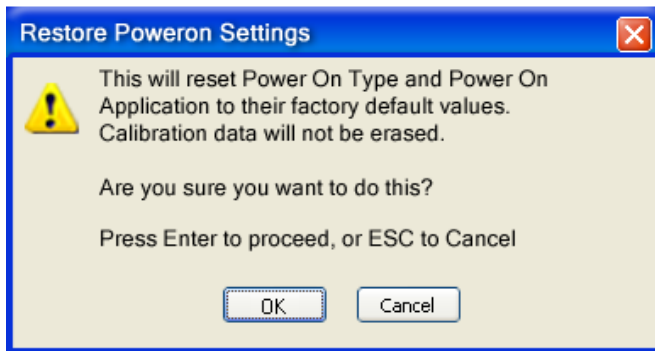

Key Path:	System, Restore System Defaults
Example:	:SYST:DEF PON
Initial S/W Revision:	Prior to A.02.00

Restore Align Defaults

This selection causes the Alignment system settings to be a reset to their default values. This does not affect any Alignment data stored in the system. This level of Restore System Defaults does not affect any other system settings, mode settings and does not cause a mode switch.

After performing this function, it may impact the auto-alignment time of the instrument until a new alignment baseline has been established.

Confirmation is required to restore the factory default values. The confirmation dialog is:

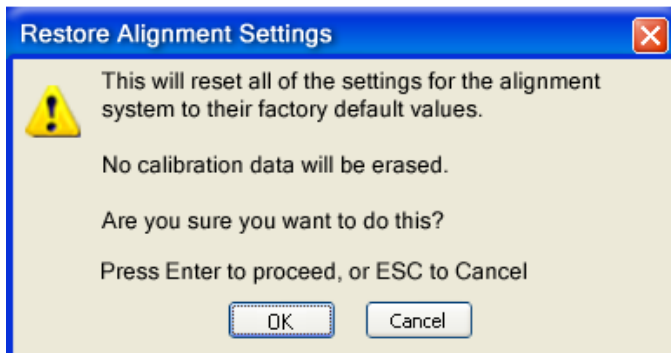

Key Path:	System, Restore System Defaults
Example:	:SYST:DEF ALIG
Initial S/W Revision:	Prior to A.02.00

Restore Misc Defaults

This selection causes miscellaneous system settings to be reset to their default values. With this reset, you lose the GPIB address and it is reset to 18, so this should be used with caution. This level of Restore System Defaults does not affect any other system settings, mode settings and does not cause a mode

switch. This miscellaneous group contains the rest of the settings that have not been part of the other Restore System Defaults groups. The following table is a complete list of settings associated with this group:

Miscellaneous Setting	Default Value
Verbose SCPI	Off
GPIB Address	18
Auto File Name Number	000
Save Type	State
State Save To	Register 1
Screen Save To	SCREEN000.png
DISP:ENABle	ON
Full Screen	Off
SCPI Telnet	ON
SCPI Socket	ON
SICL Server	ON
Display Intensity	100
Display Backlight	ON
Display Theme	TDColor
System Annotation	ON
The SYST:PRES:TYPE	MODE

Confirmation is required to restore the factory default values. The confirmation dialog is:

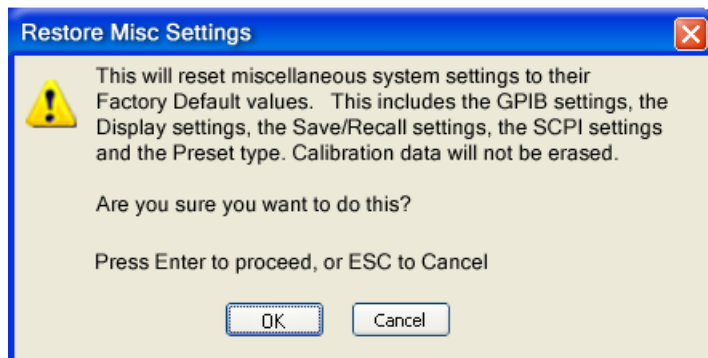

Key Path:	System, Restore System Defaults
Example:	:SYST:DEF MISC
Initial S/W Revision:	Prior to A.02.00

Restore Mode Defaults (All Modes)

This selection resets all of the modes in the instrument back to their default state just as a Restore Mode Defaults does and it switches the instrument to the power-on mode and causes the default measurement for the power-on mode to be active. This level of Restore System Defaults does not affect any system settings, but it does affect the state of all modes and does cause a mode switch unless the instrument was already in the power-on mode.

Confirmation is required to restore the factory default values. The confirmation dialog is:

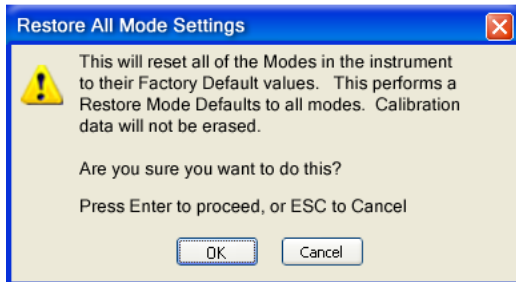

Key Path:	System, Restore System Defaults
Example:	:SYST:DEF MOD
Couplings:	An All Mode will cause the currently running measurement to be aborted, mode switch to the power-on mode and activate the default measurement for the power-on mode.. It gets the mode to a consistent state with all of the default couplings set.
Initial S/W Revision:	Prior to A.02.00

All

This performs a comprehensive reset of ALL analyzer settings to their factory default values. It resets all of the system setting groups, causes a Restore Mode Defaults for all modes in the instrument, and switches back to the power-on mode. It does not affect the User Preset file or any user saved files.

Confirmation is required to restore the factory default values. The confirmation dialog is:

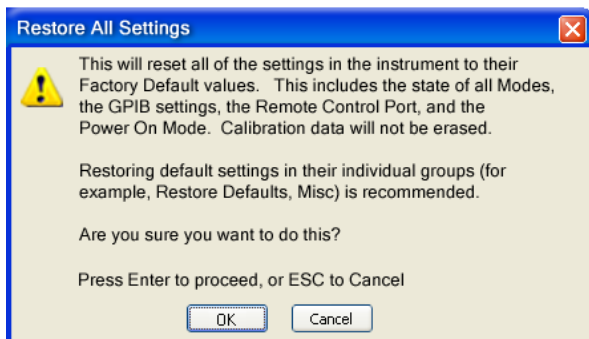

Key Path:	System, Restore System Defaults
-----------	--

Example:	:SYST:DEF ALL
Couplings:	An All will cause the currently running measurement to be aborted and get all modes to a consistent state, so it is unnecessary to couple any settings.
Initial S/W Revision:	Prior to A.02.00

Control Panel...

Opens the Windows Control Panel. The Control Panel is used to configure certain elements of Windows that are not configured through the hardkey/softkey System menus.

The Control Panel is a separate Windows application, so to return to the analyzer once you are in the Control Panel, you may either:

Exit the Control Panel by clicking on the red X in the upper right hand corner, with a mouse

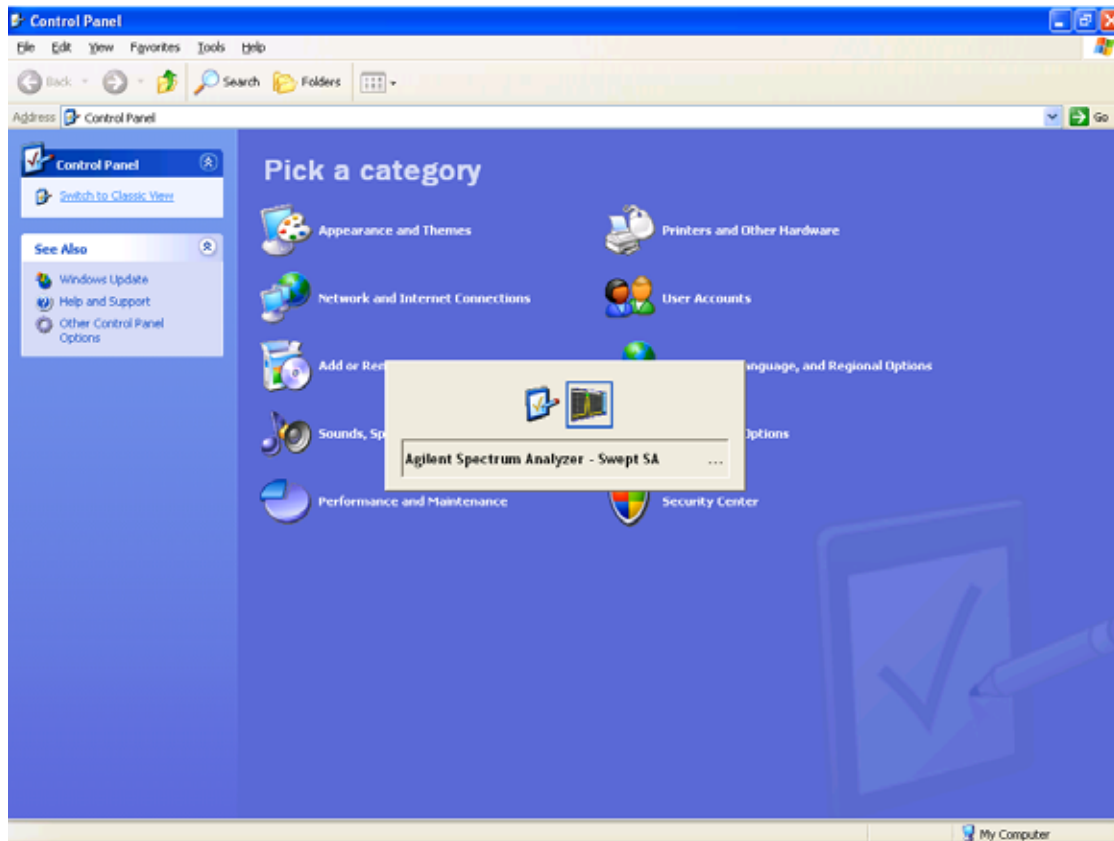

Or use Alt-Tab: press and hold the Alt  key and press and release the Tab key until the Analyzer logo is showing in the window in the center of the screen, as above, then release the Alt key.

Key Path:	System
Notes:	No remote command for this key.
Initial S/W Revision:	Prior to A.02.00

Licensing...

Opens the license explorer.

For Help on this key, select Help in the menu bar at the top of the license explorer window.

Key Path:	System
Notes:	No equivalent remote command for this key.
Backwards Compatibility Notes:	In ESA the SCPI command for displaying the Show Licenses screen is: :SYSTem:CONFIgure:LKEY:STATe OFF ON 0 1 :SYSTem:CONFIgure:LKEY:STATe? There are no equivalent SCPI commands in the X-Series for displaying the License Explorer.
Initial S/W Revision:	Prior to A.02.00

Remote Command:	:SYSTem:LKEY <"OptionInfo">, <"LicenseInfo">
Example:	SYST:LKEY "N9073A-1FP","027253AD27F83CDA5673A9BA5F427FDA5E4F25AEB1017638211AC9F60D9C639FE539735909C551DE0A91"
Notes:	The <"OptionInfo"> contains the feature and the version. You must specify the feature but can omit the version. If you omit the version, the system regards it as the latest one, since the system knows which version is supported for each feature. The <"LicenseInfo"> contains the signature, the expiration date, and serial number for transport if transportable. You must specify the signature, but you can omit the other information. If you omit the expiration date, the system regards it as permanent. If you omit the serial number, the system regards it as non-transportable. As a result, this supports reverse compatibility.
Initial S/W Revision:	Prior to A.02.00

Remote Command:	:SYSTem:LKEY:DELeTe <"OptionInfo">, <"LicenseInfo">
Example:	SYST:LKEY:DEL "N9073A-1FP","027253AD27F83CDA5673A9BA5F427FDA5E4F25AEB1017638211AC9F60D9C639FE539735909C551DE0A91"
Notes:	The <"OptionInfo"> contains the feature and the version. You must specify the feature but can omit the version. If you omit the version, the system regards it as the latest one, if more than one version is installed. The <"LicenseInfo"> contains the signature, the expiration date, and whether or not be transportable. You must specify the signature, but you can omit the other information. If you omit the expiration date, the system regards it as permanent. If you omit the transportability, the system regards it as non-transportable. As a result, this supports reverse compatibility.
Initial S/W Revision:	Prior to A.02.00

Remote Command:	:SYSTem:LKEY:LIST?
Notes:	<p>Return Value:</p> <p>An <arbitrary block data> of all the installed instrument licenses.</p> <p>The format of each license is as follows.</p> <p><Feature>,<Version>,<Signature>,<Expiration Date>,<Serial Number for Transport></p> <p>Return Value Example:</p> <p>#3136</p> <p>N9073A-1FP,1.000,B043920A51CA</p> <p>N9060A-2FP,1.000,4D1D1164BE64</p> <p>N9020A-508,1.000,389BC042F920</p> <p>N9073A-1F1,1.000,5D71E9BA814C,13-aug-2005</p> <p><arbitrary block data> is:</p> <p>#NMMM<data></p> <p>Where:</p> <p>N is the number of digits that describes the number of MMM characters. For example if the data was 55 bytes, N would be 2.</p> <p>MMM would be the ASCII representation of the number of bytes. In the previous example, N would be 55.</p> <p><data> ASCII contents of the data</p>
Initial S/W Revision:	Prior to A.02.00

Remote Command:	:SYSTem:LKEY? <"OptionInfo" >
Example:	SYST:LKEY? "N9073A-1FP"
Notes:	<p>The <"OptionInfo"> contains the feature and the version. You must specify the feature but can omit the version. If you omit the version, the system regards it as the latest one.</p> <p>Return Value:</p> <p><"LicenseInfo"> if the license is valid, null otherwise.</p> <p><"LicenseInfo"> contains the signature, the expiration date, and serial number if transportable.</p> <p>Return Value Example:</p> <p>"B043920A51CA"</p>
Initial S/W Revision:	Prior to A.02.00

Remote Command:	:SYSTem:HID?
Notes:	Return value is the host ID as a string

System Functions

System

Initial S/W Revision:	Prior to A.02.00
-----------------------	------------------

Security

Accesses capabilities for operating the instrument in a security controlled environment.

Key Path:	System
Initial S/W Revision:	A.04.00

USB

Read-Write

Selection for allowing full read-write access to the USB ports.

Key Path:	System, Security, USB
Example:	:SYST:SEC:USB:WPR OFF Will set USB ports to Read-Write
Initial S/W Revision:	A.04.00

Read only

Selection for disabling write access to the USB ports.

Key Path:	System, Security, USB
Example:	:SYST:SEC:USB:WPR ON Will set USB ports to Read only
Initial S/W Revision:	A.04.00

Diagnostics

The Diagnostics key in the System menu gives you access to basic diagnostic capabilities of the instrument.

Key Path:	System
Initial S/W Revision:	Prior to A.02.00

Show Hardware Statistics

Provides a display of various hardware statistics. The statistics include the following:

Mechanical relay cycles

High and Low temperature extremes

Elapsed time that the instrument has been powered-on (odometer)

The display should appear listing the statistics, product number, serial number, and firmware revision.

Hardware Statistical Information	
Agilent MXA Signal Analyzer	
Product Number: N9020A	
Serial Number: US00061145	
Instrument S/W Revision: A.12.00	
Revision Date: 7/11/2012 12:11:10 PM	
Component Name	Value
MechAtten #1 Count Total	457304
Calibrator Switch Cycles	105953
AC/DC Switch Cycles	114240
2 dB #1 Mechanical Atten Cycles	112655
2 dB #2 Mechanical Atten Cycles	124456
MechAtten #2 Count Total	472265
6 dB Mechanical Atten Cycles	115302
10 dB Mechanical Atten Cycles	93602
20 dB Mechanical Atten Cycles	144781
30 dB Mechanical Atten Cycles	118580
Low Noise Path Switch	45668
Preselector Bypass Cycles	31133
High temperature operating extreme	45.75
Low temperature operating extreme	-23.9375
Elapsed Time (On-Time)(hours)	134164

In some CXA models this field is called "Fixed Atten"

Some CXA models omit these fields

Only shown if LNP installed

Only shown if MPB installed

The CXA models in which the AC/DC Switch field is called Fixed Atten and which omit the mech atten fields are the N9000A–503/507 models.

The data will be updated only when the Show Hardware Statistics menu key is pressed, it will not be updated while the screen is displayed.

The tabular data should be directly printable.

Key Path:	System, Diagnostics
Mode:	All
Notes:	The values displayed on the screen are only updated upon entry to the screen and not updated while the screen is being displayed.
Initial S/W Revision:	Prior to A.02.00

SCPI for Show Hardware Statistics (Remote Commands Only)

Each of the hardware statistic items can be queried via SCPI.

“Query the Mechanical Relay Cycle Count” on page 294

“Query the Operating Temperature Extremes” on page 294

“Query the Elapsed Time since 1st power on” on page 295

Query the Mechanical Relay Cycle Count

Return the count of mechanical relay cycles. For N9038A model, there are additional 2 Mechanical Relays which are <N9038A Input2>, <N9038A Bypass>.

Remote Command:	:SYSTem:MRELay:COUNT?
Example:	:SYST:MREL:COUN?
Notes:	<p>Query Only</p> <p>The return value is a comma separated list of the individual counts for each mechanical relay.</p> <p>The position of the relays in the list is: “<Cal Signal>,<AC/DC>,<2dB #1 Atten>,<2dB #2 Atten>,<6dB Atten>,<10dB Atten>,<20dB Atten>,<30dB Atten>,<Fixed Atten>,<Low Noise Path Switch>,<Presel Bypass>,<N9038A Input2>, <N9038A Bypass>”</p> <p>Items in the list not pertaining to your particular hardware configuration will return as -999 for those items.</p>
Dependencies:	This SCPI command is NOT supported by the E6607C model.
Initial S/W Revision:	Prior to A.02.00
Modified at S/W Revision:	A.08.00

Query the Operating Temperature Extremes

Returns the low operating temperature extreme value. The value survives a power-cycle and is the temperature extreme encountered since the value was reset by the factory or service center.

Mode:	All
Remote Command:	:SYSTem:TEMPerature:LEXTreme?
Example:	:SYST:TEMP:LEXT?
Notes:	Value is in degrees Celsius at which the lowest operating temperature has been recorded since 1st power-up.
State Saved:	No
Initial S/W Revision:	Prior to A.02.00

Mode:	All
Remote Command:	:SYSTem:TEMPerature:HEXTreme?
Example:	:SYST:TEMP:HEXT?
Notes:	Value is in degrees Celsius at which the highest operating temperature has been recorded since 1st power-up.
State Saved:	No
Initial S/W Revision:	Prior to A.02.00

Query the Elapsed Time since 1st power on

Returns the elapsed on-time in minutes since 1st power-on.

Remote Command:	:SYSTem: PON: ETIMe?
Example:	:SYST:PON:ETIM?
Notes:	Query Only
Initial S/W Revision:	Prior to A.02.00

Advanced

Accesses advanced diagnostic capabilities performed in the factory or under instructions from repair procedures. This menu key is only visible when the logged-in user is “saservice”. The first access to the Advanced Diagnostic Menu after invoking the instrument application will require an authentication, which is to enter the Service Code. Subsequent accesses to the Advanced Diagnostic Menu are unimpeded. The Authentication dialog looks like:

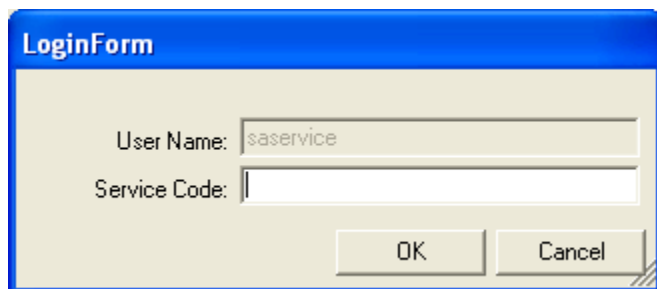

“OK” is the default key thus the Enter key is used to complete the entry. If invalid Service Code is entered authentication is not granted and you are provided the following dialog:



Key Path:	System, Diagnostics
Notes:	Password is required to access this menu.
Initial S/W Revision:	Prior to A.02.00

Self test

This key gives you access to diagnostic capabilities for self tests of the instrument.

Key Path:	System, Diagnostics
Initial S/W Revision:	Prior to A.10.00

All Self Test

This key invokes all the self tests defined in the Diagnostics Self Test section.

Key Path:	System, Diagnostics, Self Test
Remote Command:	:SYSTem:TEST:WCTS:[ALL]
Example:	SYST:TEST:WCTS:[ALL]
Initial S/W Revision:	A.12.50

Source Self Test

This key invokes the internal source self test. When operation is complete, the generated test summary file is: E:\Agilent\Instrument\CRFSSelfTestLog.txt. This test summary file can be retrieved from the instrument using the MMEM set of SCPI command, once you have the fully qualified the path and file name.

If the self test fails, the following error message will be generated:

“-330, Self-test failed, see log file E:\Agilent\Instrument\ CRFSSelfTestLog.txt”

If the self test passes, an advisory message “Source self-test completed successfully” is generated.

Key Path:	System, Diagnostics, Self Test
Remote Command:	:SYSTem:TEST:WCTS:SOURce
Example:	SYST:TEST:WCTS:SOURce
Notes:	Access log with command : MMEM:DATA? "E:\ Agilent\Instrument\CRFSSelfTestLog.txt" Alias of source self test (:SOURce:SELF:TEST[:ALL])
Initial S/W Revision:	A.10.00

RFIO Self Test

This key invokes the RFIO ports self test for embedded MPA, which just are available on E6607C. When operation is completed, the generated test summary information is appended to log file E:\Agilent\Instrument\RFIOTestLog.txt. This test summary file can be retrieved from the instrument using the MMEM set of SCPI command, once you have the fully qualified the path and file name.

If the self test fails, the following error message will be generated:

“-330, Self-test failed, see log file E:\Agilent\Instrument\RFIOTestLog.txt”

If the self test passes, an advisory message “RFIO self-test completed successfully” is generated.

Key Path:	System, Diagnostics, Self Test
Remote Command:	:SYSTem:TEST:WCTS:MPADapter
Example:	SYST:TEST:WCTS:MPAD

Notes:	Access log with command : MMEM:DATA? "E:\ Agilent\Instrument\RFIOTestLog.txt"
Initial S/W Revision:	A.12.50

NOTE This function is NOT available on EXT E6607A and E6607B models.

FEC Self Test

This key invokes the EXT E6607C froned end control self test. When operation is complete, the generated test summary information is appended to log file E:\Agilent\Instrument\FECTestLog.txt. This test summary file can be retrieved from the instrument using the MMEM set of SCPI command, once you have the fully qualified the path and file name.

If the self test fails, the following error message will be generated:

“-330, Self-test failed, see log file E:\Agilent\Instrument\FECTestLog.txt”

If the self test passes, an advisory message “FEC self-test completed successfully” is generated.

Key Path:	System, Diagnostics, Self Test
Remote Command:	:SYSTem:TEST:WCTS:FEC
Example:	SYST:TEST:WCTS:FEC
Notes:	Access log with command : MMEM:DATA? "E:\ Agilent\Instrument\FECTestLog.txt"
Initial S/W Revision:	A.12.50

NOTE This function is NOT available on EXT E6607A and E6607B models.

Show Result

This key gives you access to show results of the following self tests:

[“Source Self Test Results” on page 297](#)

E6607C embedded MPA self-test results - [“RFIO Self Test REsults” on page 299](#)

E6607C FEC self-test results - [“FEC Self Test REsults” on page 300](#)

Key Path:	System, Diagnostics, Self Test
Initial S/W Revision:	A.12.50

Source Self Test Results

Provides a display of last source test results, the display should appear listing model number, serial number and test time at the top of display, and then list test date/time, test name, measured value, valid range and pass/fail of each

System Functions
System

source test item, the tabular data should be directly printable.

Key Path:	System, Diagnostics, Self Test, Show Results
Remote Command:	:SYSTem:TEST:WCTS:SHOW:RESult SOURce
Example:	SYST:TEST:WCTS:SHOW:RES SOUR
Initial S/W Revision:	A.12.50

The example of source self test result display is as follows:

Source Self Test Results					
Produce Number: E6607B					
Serial Number: MY51380425					
Instrument S/W: 11/15/2012 2:51:19 PM					
FpgaVersionTest					
Date	Time(GMT)	Name	MeasValue	ValidRange	Result
11/23/2012	16:13:56	Analog_FPGA	16.000	>= 16.000	Pass
11/23/2012	16:13:56	Digital_FPGA	50.000	>= 46.000	Pass
11/23/2012	16:13:56	CRFS_FPGA	38.000	>= 38.000	Pass
ModulatorTest					
Date	Time(GMT)	Name	MeasValue	ValidRange	Result
11/23/2012	16:13:57	LOLevel_vs_DET_LO	-1.108	-2.200 - 2.200	Pass
11/23/2012	16:13:57	LOLevel_vs_LEVEL_DET	1.010	-1.100 - 1.100	Pass
11/23/2012	16:13:57	LOLevel_vs_LEVEL_REF	1.995	0.500 - 2.500	Pass
11/23/2012	16:13:57	QUAD_vs_DET_LO	-0.879	-1.100 - 1.100	Pass
11/23/2012	16:13:57	QUAD_vs_LEVEL_DET	0.000	-1.100 - 1.100	Pass
11/23/2012	16:13:57	QUAD_vs_LEVEL_REF	0.000	-0.300 - 0.300	Pass
11/23/2012	16:13:57	QUAD_vs_QUAD_LOOP	0.885	0.350 - 1.100	Pass
IQModulatorTest					
Date	Time(GMT)	Name	MeasValue	ValidRange	Result
11/23/2012	16:13:57	VBLO_DAC	0.154	0.000 - 0.500	Pass
11/23/2012	16:13:57	AMP_BIAS1	145.154	132.000 - 185.000	Pass
11/23/2012	16:13:57	AMP_BIAS2	145.740	132.000 - 185.000	Pass
11/23/2012	16:13:57	OFFSET_QN	0.119	0.100 - 0.125	Pass
11/23/2012	16:13:57	OFFSET_QP	0.121	0.100 - 0.125	Pass

Show Source Self Test Results contents (Remote Command Only)

A remote command is available to obtain the contents of the Show Souce Self Test Results screen (the entire contents, not just the currently displayed page).

Remote Command:	:SYSTem:TEST:WCTS:SOURce:RESult?
Example:	SYST:TEST:WCTS:SOUR:RES?
Notes:	The output is an IEEE Block format of the Show Source Self Test Results contents. Each line is separated with a new-line character.
Initial S/W Revision:	A.12.50

RFIO Self Test REsults

Provides a display of last RFIO test results for embedded MPA of E6607C, the display should appear listing model number, serial number and test time at the top of display, and then list test date/time, test name, measured value, valid range and pass/fail of each RFIO test item, the tabular data should be directly printable.

Key Path:	System, Diagnostics, Self Test, Show Results
Remote Command:	:SYSTem:TEST:WCTS:SHOW:RESult MPADapter
Example:	SYST:TEST:WCTS:SHOW:RES MPAD
Initial S/W Revision:	A.12.50

NOTE This function is NOT available on EXT E6607A and E6607B models.

The example of RFIO self test result display is as following:

RFIO Self Test Results					
Produce Number: E6607C					
Serial Number: MY51380437					
Instrument S/W: 11/16/2012 2:51:19 PM					
CarrierClockTest	16:13:56				
Date	Time(GMT)	Name	MeasValue	ValidRange	Result
11/23/2012	16:13:57	Dig FPGA 100 MHz	1.000	1.000 - 1.000	Pass
11/23/2012	16:13:57	Feldspar CCLK	1.000	1.000 - 1.000	Pass
11/23/2012	16:13:57	Feldspar LVDS	1.000	1.000 - 1.000	Pass
11/23/2012	16:13:57	Dig FPGA LVDS	1.000	1.000 - 1.000	Pass
11/23/2012	16:13:57	Dig FPGA 200 MHz	1.000	1.000 - 1.000	Pass
DetectorTest					
Date	Time(GMT)	Name	MeasValue	ValidRange	Result

System Functions
System

11/23/2012	16:13:57	ABUS_DET_SYNTH	29.879	14.400 - 100.000	Pass
11/23/2012	16:13:57	ABUS_DET_LO	18.136	9.000 - 100.000	Pass
11/23/2012	16:13:57	ABUS_DET_MOD	13.556	6.600 - 100.000	Pass
11/23/2012	16:13:57	ABUS_DET_MOD_FLT	18.000	7.800 - 100.000	Pass
FilterBankTest1					
Date	Time(GMT)	Name	MeasValue	ValidRange	Result
11/23/2012	16:13:57	Bank1_LPF_550MHz	30.357	>= 10.000	Pass
11/23/2012	16:13:57	Bank1_LPF_750MHz	29.358	>= 10.000	Pass
11/23/2012	16:13:57	Bank1_LPF_1020MHz	27.036	>= 10.000	Pass
11/23/2012	16:13:57	Bank1_LPF_1600MHz	27.594	>= 10.000	Pass
11/23/2012	16:13:57	Bank1_LPF_2400MHz	21.490	>= 10.000	Pass
11/23/2012	16:13:57	Bank1_LPF_3000MHz	18.476	>= 10.000	Pass
11/23/2012	16:13:57	OFFSET_QP	0.121	0.100 - 0.125	Pass

Show RFIO Self Test Results contents (Remote Command Only)

A remote command is available to obtain the contents of the Show RFIO Self Test Results screen (the entire contents, not just the currently displayed page).

Remote Command:	:SYSTem:TEST:WCTS:MPADapter:RESult?
Example:	SYST:TEST:WCTS:MPAD:RES?
Notes:	The output is an IEEE Block format of the Show RFIO Self Test Results contents. Each line is separated with a new-line character.
Initial S/W Revision:	A.12.50

FEC Self Test REsults

Provides a display of last FEC test results, the display should appear listing model number, serial number and test time at the top of display, and then list test date/time, test name, measured value, valid range and pass/fail of each FEC test item, the tabular data should be directly printable.

Key Path:	System, Diagnostics, Self Test, Show Results
Remote Command:	:SYSTem:TEST:WCTS:SHOW:RESult FEC
Example:	SYST:TEST:WCTS:SHOW:RES FEC
Initial S/W Revision:	A.12.50

This function is NOT available on EXT E6607A and E6607B models.

The example of FEC self test result display is as follows:

FEC Self Test Results					
Produce Number: E6607C					
Serial Number: MY51380437					
Instrument S/W: 11/16/2012 2:51:19 PM					
FpgaVersionTest					
Date	Time(GMT)	Name	MeasValue	ValidRange	Result
11/23/2012	16:13:56	Analog_FPGA	16.000	>= 16.000	Pass
11/23/2012	16:13:56	Digital_FPGA	50.000	>= 46.000	Pass
11/23/2012	16:13:56	CRFS_FPGA	38.000	>= 38.000	Pass
PowerSupplyTest					
Date	Time(GMT)	Name	MeasValue	ValidRange	Result
11/23/2012	16:13:56	ABUS_+32CHK	31.904	30.900 - 32.900	Pass
11/23/2012	16:13:56	ABUS_+12CHK	12.296	10.800 - 13.200	Pass
11/23/2012	16:13:56	+10VA	9.935	9.600 - 10.200	Pass
11/23/2012	16:13:56	+5VA	4.995	4.900 - 5.100	Pass
11/23/2012	16:13:56	+3.3VA	3.299	3.200 - 3.400	Pass
11/23/2012	16:13:56	-3.3VA	-3.311	-3.400 - -3.200	Pass
11/23/2012	16:13:56	ACOM	0.00	-0.200 - 0.200	Pass
11/23/2012	16:13:56	-5VA	-5.036	-5.100 - -4.900	Pass
11/23/2012	16:13:56	-6.1VA	-5.880	-6.200 - -5.700	Pass
11/23/2012	16:13:56	-10VA	-10.116	-10.200 - -9.800	Pass
11/23/2012	16:13:56	ABUS_-2.5V_REF	-2.508	-2.520 - -2.470	Pass
11/23/2012	16:13:56	ABUS_+2.5V_REF	2.508	2.480 - 2.520	Pass
11/23/2012	16:13:56	ABUS_-10VPALC	-10.047	-10.200 - -9.800	Pass
11/23/2012	16:13:57	ABUS_DET_MOD_FLT	18.000	7.800 - 100.000	Pass

Show FEC Self Test Results contents (Remote Command Only)

A remote command is available to obtain the contents of the Show FEC Self Test Results screen (the entire contents, not just the currently displayed page).

Remote Command:	:SYSTem:TEST:WCTS:FEC:RESUlt?
-----------------	-------------------------------

Example:	SYST:TEST:WCTS:FEC:RES?
Notes:	The output is an IEEE Block format of the Show FEC Self Test Results contents. Each line is separated with a new-line character.
Initial S/W Revision:	A.12.50

Multiport Adapter Cables Test

This key gives you access to diagnostic capabilities for the RF and trigger cable connections between EXT and Multiport Adapter with this instrument, which include:

EXT RF Input <-> Multiport Adapter RF OUT

EXT RF Output <-> Multiport Adapter RF IN

EXT RF IO2 <-> Multiport Adapter GPS IN

EXT Trigger 1<-> Multiport Adapter Trigger 1

EXT Trigger 2 <-> Multiport Adapter Trigger 2

Key Path:	System, Diagnostics
Remote Command:	:CALibration:MPADapter:CABLes:TEST
Example:	:CAL:MPAD:CABL:TEST
Notes:	If the Multiport Adapter cables are not connected correctly. It will report the proper error, for example: “-330, Self-test failed, MPA’S RF IN or RF OUT not properly connected”.
Dependencies:	This key does not appear unless a multiport adapter is plugged in to the USB. Grayout error: -221.1400; Multiport Adapter Not Available
Initial S/W Revision:	A.10.0

Quick Test ...

This key gives you access to launch a Windows program for conducting a confidence check of the Agilent EXT Wireless Communications Test Set and the E6617A Multiport Adapter connected to EXT. The operator must exit Quick Test to return to the instrument application.

Key Path:	System, Diagnostics
Notes:	Operator is responsible for exiting the Quick Test and returning focus to the Instrument Application. The softkey in the menu is only displayed when the instrument is an EXT and the EXTQuickTest.exe file is present in the C:\Program Files\Agilent\EXTQuickTest folder.
Initial S/W Revision:	A.09.49

	Agilent Converged	PSA
--	-------------------	-----

IP Address	SYSTem:COMMunicate:LAN:ADDRess <string> SYSTem:COMMunicate:LAN:ADDRess?	:SYSTem:COMMunicate:LAN[:SELF]:IP <string> :SYSTem:COMMunicate:LAN[:SELF]:IP?
Gateway	SYSTem:COMMunicate:LAN:DGATeway <string> SYSTem:COMMunicate:LAN:DGATeway?	:SYSTem:COMMunicate:LAN[:SELF]:GATEway <string> :SYSTem:COMMunicate:LAN[:SELF]:GATEway?
Subnet Mask	SYSTem:COMMunicate:LAN:SMASK <string> SYSTem:COMMunicate:LAN:SMASK?	:SYSTem:COMMunicate:LAN[:SELF]:SUBNetmask <string> :SYSTem:COMMunicate:LAN[:SELF]:SUBNetmask?

Service

Accesses capabilities performed in the factory or under instructions from repair procedures. This menu key is only visible when the logged-in user is “advanceduser” or “saservice”. The first access to the Service Menu after invoking the instrument application will require an authentication Service Code.

Key Path:	System
Initial S/W Revision:	Prior to A.02.00

Internet Explorer...

This key launches Microsoft Internet Explorer. A mouse and external keyboard are highly desired for using Internet Explorer. When Internet Explorer is running, close Internet Explorer to return focus to the Instrument Application (or use Alt-Tab).

Key Path:	System
Mode:	All
Notes:	No equivalent remote command for this key.
Initial S/W Revision:	A.05.01

System Remote Commands (Remote Commands Only)

The commands in this section have no front-panel key equivalent.

[“System Powerdown \(Remote Command Only\)” on page 304](#)

[“List installed Options \(Remote Command Only\)” on page 304](#)

[“Lock the Front-panel keys \(Remote Command Only\)” on page 304](#)

[“List SCPI Commands \(Remote Command Only\)” on page 305](#)

[“SCPI Version Query \(Remote Command Only\)” on page 305](#)

[“Date \(Remote Command Only\)” on page 305](#)

“Time (Remote Command Only)” on page 306

Initial S/W Revision:	Prior to A.02.00
-----------------------	------------------

System Powerdown (Remote Command Only)

Remote Command:	:SYSTem:PDOWn [NORMal FORCe]
Notes:	Shuts down the instrument in the normal way (NORMal) or forced way (FORCe). In case there is another application with modified data pending for saving, the application prompt the user. The system waits until the user responds in the normal mode. It will go off after 20 seconds of wait in the force mode and all data will be lost.

List installed Options (Remote Command Only)

Lists the installed options that pertain to the instrument (signal analyzer). .

Mode:	All
Remote Command:	:SYSTem:OPTions?
Example:	:SYST:OPT?
Notes:	The return string is a comma separated list of the installed options. For example: “503,P03,PFR” :SYSTem:OPTions? and *OPT? are the same.
State Saved:	No
Initial S/W Revision:	Prior to A.02.00

Lock the Front-panel keys (Remote Command Only)

Disables the instrument keyboard to prevent local input when the instrument is controlled remotely. Annunciation showing a “K” for ‘Klock’ (keyboard lock) alerts the local user that the keyboard is locked. Klock is similar to the GPIB Local Lockout function; namely that no front-panel keys are active with the exception of the Power Standby key. (The instrument is allowed to be turned-off if Klock is ON.) The Klock command is used in remote control situations where Local Lockout cannot be used.

Although primary intent of Klock is to lock-out the front panel, it will lock-out externally connected keyboards through USB. Klock has no effect on externally connected pointing devices (mice).

The front panel ‘Local’ key (Cancel/Esc) has no effect if Klock is ON.

Mode:	All
Remote Command:	:SYSTem:KLOCK OFF ON 0 1 :SYSTem:KLOCK?
Example:	:SYST:KLOC ON

Notes:	Keyboard lock remains in effect until turned-off or the instrument is power-cycled
Preset:	Initialized to OFF at startup, unaffected by Preset
State Saved:	No
Initial S/W Revision:	Prior to A.02.00

List SCPI Commands (Remote Command Only)

Outputs a list of the valid SCPI commands for the currently selected Mode.

Remote Command:	:SYSTem:HELP:HEADers?
Example:	:SYST:HELP:HEAD?
Notes:	The output is an IEEE Block format with each command separated with the New-Line character (hex 0x0A)
Initial S/W Revision:	Prior to A.02.00

SCPI Version Query (Remote Command Only)

Returns the SCPI version number with which the instrument complies. The SCPI industry standard changes regularly. This command indicates the version used when the instrument SCPI commands were defined.

Remote Command:	:SYSTem:VERSion?
Example:	:SYST:VERS?
Initial S/W Revision:	Prior to A.02.00

Date (Remote Command Only)

The recommended access to the Date, Time, and Time zone of the instrument is through the Windows native control (Control Panel or accessing the Task Bar). You may also access this information remotely, as shown in this command and Time (below).

Sets or queries the date in the instrument.

Mode:	All
Remote Command:	:SYSTem:DATE "<year>, <month>, <day>" :SYSTem:DATE?
Example:	:SYST:DATE "2006,05,26"

System Functions
System

Notes:	<p><year> is the four digit representation of year. (for example, 2006)</p> <p><month> is the two digit representation of year. (for example. 01 to 12)</p> <p><day> is the two digit representation of day. (for example, 01 to 28, 29, 30, or 31) depending on the month and year</p> <p>Unless the current account has Power User or Administrator privileges, an error will be generated by this command and no action will be taken.</p>
Initial S/W Revision:	Prior to A.02.00

Time (Remote Command Only)

Sets or queries the time in the instrument.

Mode:	All
Remote Command:	<p>:SYSTem:TIME "<hour>, <minute>, <second>"</p> <p>:SYSTem:TIME?</p>
Example:	:SYST:TIME "13,05,26"
Notes:	<p><hour> is the two digit representation of the hour in 24 hour format</p> <p><minute> is the two digit representation of minute</p> <p><second> is the two digit representation of second</p> <p>Unless the current account has Power User or Administrator privileges, an error will be generated by this command and no action will be taken.</p>
Initial S/W Revision:	Prior to A.02.00

User Preset

Accesses a menu that gives you the following three choices:

User Preset – recalls a state previously saved using the Save User Preset function.

User Preset All Modes – presets all of the modes in the analyzer

Save User Preset – saves the current state for the current mode

Key Path:	Front-panel key
Backwards Compatibility Notes:	<p>User Preset is actually loading a state, and in legacy analyzers, it was possible to load a state without affecting the trace data, limit lines or correction data. Similarly it was possible to do a User Preset without affecting the trace data, limit lines or correction data.</p> <p>In the X-Series, “state” always includes all of this data; so whenever state is loaded, or User Preset is executed, all of the traces, limit lines and corrections are affected. Although this differs from previous behavior, it is desirable behavior, and should not cause adverse issues for users.</p> <p>On ESA and PSA, User Preset affected the entire instrument’s state. In the X-Series, User Preset only recalls the state for the active mode. There is a User Preset file for each mode. User Preset can never cause a mode switch as it can in legacy analyzers. If you want to recall all modes to their user preset file state, you will need to do a User Preset after mode switching into each mode.</p> <p>User Preset recalls mode state which can now include data like traces; whereas on ESA and PSA, User Preset did not affect data.</p>
Initial S/W Revision:	Prior to A.02.00

User Preset

User Preset sets the state of the currently active mode back to the state that was previously saved for this mode using the Save User Preset menu key or the SCPI command, `SYST:PRES:USER:SAV`. It not only recalls the Mode Preset settings, but it also recalls all of the mode persistent settings, and the Input/Output system setting that existed at the time Save User Preset was executed.

If a Save User Preset has not been done at any time, User Preset recalls the default user preset file for the currently active mode. The default user preset files are created if, at power-on, a mode detects there is no user preset file. There will never be a scenario when there is no user preset file to restore. For each mode, the default user preset state is the same state that would be saved if a Save User Preset is performed in each mode right after doing a Restore Mode Default and after a Restore Input/Output Defaults.

The User Preset function does the following:

Aborts the currently running measurement.

Sets the mode State to the values defined by Save User Preset.

Makes the saved measurement for the currently running mode the active measurement.

System Functions
User Preset

Brings up the saved menu for the power-on mode.

Clears the input and output buffers.

Sets the Status Byte to 0.

Key Path:	User Preset
Remote Command:	:SYSTem:PRESet:USER
Example:	:SYST:PRES:USER:SAVE :SYST:PRES:USER
Notes:	:SYST:PRES:USER:SAVE is used to save the current state as the user preset state. Clears all pending OPC bits. The Status Byte is set to 0. Pressing the User Preset front-panel key while already in the User Preset menu will cause the User Preset to get executed
Couplings:	A user preset will cause the currently running measurement to be aborted and cause the saved measurement to be active. Recalling a User Preset file has the same issues that recalling a Save State file has. Some settings may need to be limited and therefore re-coupled, since the capabilities of the mode may have changes when the User Preset file was last saved.
Initial S/W Revision:	Prior to A.02.00

User Preset All Modes

Recalls all of the User Preset files for each mode, switches to the power-on mode, and activates the saved measurement from the power-on mode User Preset file.

NOTE When the instrument is secured, all of the user preset files are converted back to their default user preset files.

The User Preset function does the following:

Aborts the currently running measurement.

Switches the Mode to the power-on mode.

Restores the User Preset files for each mode.

Makes the saved measurement for the power-on mode the active measurement.

Brings up the saved menu for the power-on mode.

Clears the input and output buffers.

Sets the Status Byte to 0.

Key Path:	User Preset
-----------	--------------------

Remote Command:	:SYSTem:PRESet:USER:ALL
Example:	:SYST:PRES:USER:SAVE :SYST:PRES:USER:ALL
Notes:	Clears all pending OPC bits. The Status Byte is set to 0. :SYST:PRES:USER:SAVE is used to save the current state as the user preset state.
Couplings:	A user preset will cause the currently running measurement to be aborted, cause a mode switch to the power-on mode, and cause the saved measurement to be active in the power-on mode. Recalling a User Preset file has the same issues that recalling a Save State file has. Some settings may need to be limited and therefore re-coupled, since the capabilities of the mode may have changes when the User Preset file was last saved.
Initial S/W Revision:	Prior to A.02.00

Save User Preset

Saves the currently active mode and its State. You can recall this User Preset file by pressing the User Preset menu key or sending the SYST:PRES:USER remote command. This same state is also saved by the Save State function.

Key Path:	User Preset
Remote Command:	:SYSTem:PRESet:USER:SAVE
Example:	:SYST:PRES:USER:SAVE
Notes:	:SYST:PRES:SAVE creates the same file as if the user requested a *SAV or a MMEM:STOR:STAT, except User Preset Save does not allow the user to specify the filename or the location of the file.
Initial S/W Revision:	Prior to A.02.00

The Channel Power measurement is used to find the total power present in a specified bandwidth. The power spectral density (the power in the signal normalized to 1 Hz) is also reported (In WLAN mode, the peak power spectral density for 1 MHz is reported). For measurement results and views, see [“View/Display” on page 369](#).

This topic contains the following sections:

[“Measurement Commands for Channel Power” on page 311](#)

[“Remote CommandResults for Channel Power Measurement” on page 312](#)

Measurement Commands for Channel Power

These commands are used to measure the total rms power in a specified integration bandwidth.

Use :INSTrument:SELEct to set the mode.

```
:CONFigure:CHPower
:CONFigure:CHPower:NDEFault
:INITiate:CHPower
:FETCh:CHPower [n] ?
:MEASure:CHPower [n] ?
:READ:CHPower [n] ?
:FETCh:CHPower:CHPower?
:MEASure:CHPower:CHPower?
:READ:CHPower:CHPower?
:FETCh:CHPower:DENSity?
:MEASure:CHPower:DENSity?
:READ:CHPower:DENSity
```

For more measurement related commands, see the SENSE subsystem, and the section [“Remote Measurement Functions” on page 1031](#).

Remote CommandResults for Channel Power Measurement

Command	Return Value
FETCh:CHPower[n]? MEASure:CHPower[n]? READ:CHPower[n]?	Refer to the table below.
FETCh:CHPower:CHPower? MEASure:CHPower:CHPower? READ:CHPower:CHPower?	Returns the Channel Power (dBm) (BW compatibility functionality)
FETCh:CHPower:DENSity? MEASure:CHPower:DENSity? READ:CHPower:DENSity?	Returns the Power Spectral Density (dBm/Hz) (BW compatibility functionality)

n	Results Returned
n=1 (or not specified)	Returns scalar results: <ol style="list-style-type: none"> 1. Channel Power is a floating point number representing the total channel power in the specified integration bandwidth. 2. PSD (Power Spectral Density) is the power in the specified unit bandwidth. The unit bandwidth is selected by the PSD Unit parameter in either dBm/Hz or dBm/MHz.
2	Returns floating point numbers that are the captured trace data of the power (in dBm/resolution BW) of the signal. The frequency span of the captured trace data is specified by the Span key.

Remote Command Results for WLAN Channel Power Measurement

n	Results Returned
n=1 (or not specified)	<p>Returns scalar results:</p> <p>When the radio standard is NOT WLAN 802.11ac 80 + 80 MHz:</p> <ol style="list-style-type: none"> 1. Channel Power is a floating point number representing the total channel power in the specified integration bandwidth. 2. PSD (Power Spectral Density) is the power in the specified unit bandwidth. The unit bandwidth is selected by the PSD Unit parameter in either dBm/Hz or dBm/MHz. <p>When the radio standard is WLAN 802.11ac 80 + 80 MHz:</p> <ol style="list-style-type: none"> 1. Channel Power of the carrier of which the center frequency is indicated by Freq Segment 1 is a floating point number representing the total channel power of the first segment in the specified integration bandwidth. 2. PSD (Power Spectral Density) of the carrier of which the center frequency is indicated by Freq Segment 1 is the power in the specified unit bandwidth of the first segment. The unit bandwidth is selected by the PSD Unit parameter in either dBm/Hz or dBm/MHz. 3. Channel Power of the carrier of which the center frequency is indicated by Freq Segment 2 is a floating point number representing the total channel power of the second segment in the specified integration bandwidth. 4. PSD (Power Spectral Density) of the carrier of which the center frequency is indicated by Freq Segment 2 is the power in the specified unit bandwidth of the second segment. The unit bandwidth is selected by the PSD Unit parameter in either dBm/Hz or dBm/MHz.
2	Returns floating point numbers that are the captured trace data of the power (in dBm/resolution BW) of the signal. The frequency span of the captured trace data is specified by the Span key.

Key Path:	Meas
Mode:	WCDMA, C2K, WIMAX OFDMA, 1xEVDO, LTE, LTETDD, WLAN
Initial S/W Revision:	Prior to A.02.00
Modified at S/W Revision:	A.03.00

AMPTD Y Scale

Accesses a menu of functions that enable you to set the vertical scale parameters. The parameter values are measurement independent, except all Attenuation values and the Internal Preamp selection, which are the same across all measurements.

Key Path:	Front-panel key
Initial S/W Revision:	Prior to A.02.00

Ref Value

Sets the value for the absolute power reference. However, since the Auto Scaling is defaulted to On, this value is automatically determined by the measurement result. When you set a value manually, Auto Scaling automatically changes to Off.

Key Path:	AMPTD Y Scale
Mode:	WCDMA, C2K, WIMAX OFDMA, 1xEVDO, LTE, LTETDD, WLAN
Remote Command:	:DISPlay:CHPower:VIEW[1]:WINDow[1]:TRACe:Y[:SCALE]:RLEV el <real> :DISPlay:CHPower:VIEW[1]:WINDow[1]:TRACe:Y[:SCALE]:RLEV el?
Example:	DISP:CHP:VIEW:WIND:TRAC:Y:RLEV 10 dBm DISP:CHP:VIEW:WIND:TRAC:Y:RLEV?
Notes:	You must be in the W-CDMA mode, cdma2000 mode, LTD mode, LTE TDD mode, WLAN mode, 1xEVDO mode, or WIMAX OFDMA mode to use this command. Use :INSTrument:SELEct to set the mode.
Couplings:	When the Auto Scaling is On, this value is automatically determined by the measurement result. When you set a value manually, Auto Scaling automatically changes to Off.
Preset:	10.00 dBm
State Saved:	Saved in instrument state.
Min:	-250.00 dBm
Max:	250.00 dBm
Initial S/W Revision:	Prior to A.02.00
Modified at S/W Revision:	A.02.00, A.03.00

Attenuation

Accesses a menu of functions that enable you to change the attenuation settings. This key has read-back

text that describes the total attenuator value.

See AMPTD Y Scale, “Attenuation” on page 850 for more information.

Key Path:	AMPTD/Y Scale
Initial S/W Revision:	Prior to A.02.00

Scale/Div

Sets the units per division of the vertical scale in the logarithmic display. However, since the Auto Scaling is defaulted to On, this value is automatically determined by the measurement result. When you set a value manually, Auto Scaling automatically changes to Off.

Key Path:	AMPTD Y Scale
Mode:	WCDMA, C2K, WIMAX OFDMA, 1xEVDO, LTE, LTETDD, WLAN
Remote Command:	:DISPlay:CHPower:VIEW[1]:WINDow[1]:TRACe:Y[:SCALe]:PDIV ision <rel_ampl> :DISPlay:CHPower:VIEW[1]:WINDow[1]:TRACe:Y[:SCALe]:PDIV ision?
Example:	DISP:CHP:VIEW:WIND:TRAC:Y:PDIV 2 DISP:CHP:VIEW:WIND:TRAC:Y:PDIV?
Notes:	You must be in the W-CDMA mode, cdma2000 mode, LTD mode, LTE TDD mode, WLAN mode, 1xEVDO mode, or WIMAX OFDMA mode to use this command. Use :INSTrument:SElect to set the mode.
Couplings:	When the Auto Scaling is On, this value is automatically determined by the measurement result. When you set a value manually, Auto Scaling automatically changes to Off.
Preset:	10.00 dB
State Saved:	Saved in instrument state.
Min:	0.10 dB
Max:	20.00 dB
Initial S/W Revision:	Prior to A.02.00
Modified at S/W Revision:	A.02.00, A.03.00

Y Axis Unit

Allows you to change the vertical (Y) axis amplitude unit.

See “Y Axis Unit” on page 871 under AMPTD Y Scale for more information.

Key Path:	AMPTD/Y Scale
-----------	----------------------

Channel Power Measurement
AMPTD Y Scale

Initial S/W Revision:	A.04.00
-----------------------	---------

Internal Preamp

Accesses a menu of functions that enable you to control the internal preamplifiers.

See AMPTD Y Scale, “[Internal Preamp](#)” on page 883 for more information.

Key Path:	AMPTD/Y Scale
Initial S/W Revision:	Prior to A.02.00

Ref Position

Positions the reference level at the top, center, or bottom of the Y Scale display. Changing the reference position does not change the reference level value.

Key Path:	AMPTD Y Scale
Mode:	WCDMA, C2K, WIMAX OFDMA, 1xEVDO, LTE, LTETDD, WLAN
Remote Command:	:DISPlay:CHPower:VIEW[1]:WINDow[1]:TRACe:Y[:SCALe]:RPOS ition TOP CENTer BOTTom :DISPlay:CHPower:VIEW[1]:WINDow[1]:TRACe:Y[:SCALe]:RPOS ition?
Example:	DISP:CHP:VIEW:WIND:TRAC:Y:RPOS CENT DISP:CHP:VIEW:WIND:TRAC:Y:RPOS?
Notes:	You must be in the W-CDMA mode, cdma2000 mode, LTD mode, LTE TDD mode, WLAN mode, 1xEVDO mode, or WIMAX OFDMA mode to use this command. Use :INSTrument:SELEct to set the mode.
Preset:	TOP
State Saved:	Saved in instrument state.
Range:	Top Ctr Bot
Initial S/W Revision:	Prior to A.02.00
Modified at S/W Revision:	A.02.00, A.03.00

Auto Scaling

Toggles the Auto Scaling function between On and Off.

Key Path:	AMPTD Y Scale
Mode:	WCDMA, C2K, WIMAX OFDMA, 1xEVDO, LTE, LTETDD, WLAN

Remote Command:	:DISP:CHPower:VIEW[1]:WINDow[1]:TRACe:Y[:SCALe]:COUPlE 0 1 OFF ON :DISP:CHPower:VIEW[1]:WINDow[1]:TRACe:Y[:SCALe]:COUPlE?
Example:	DISP:CHP:VIEW:WIND:TRAC:Y:COUP OFF DISP:CHP:VIEW:WIND:TRAC:Y:COUP?
Couplings:	When Auto Scaling is On, and the Restart front-panel key is pressed, this function automatically sets the scale per division to 10 dB and determines the reference values based on the measurement results. When you set a value to either Scale/Div or Ref Value manually, Auto Scaling automatically changes to Off.
Preset:	1
State Saved:	Saved in instrument state.
Range:	On Off
Initial S/W Revision:	Prior to A.02.00
Modified at S/W Revision:	A.02.00, A.03.00

Auto Couple

See “[Auto Couple](#)” on page 887 for more information.

Key Path:	Front-panel key
-----------	------------------------

BW

Accesses a menu of functions that enable you to specify and control the video and resolution bandwidths. You can also select the type of filter for the measurement and set the filter bandwidth.

Key Path:	Front-panel key
Initial S/W Revision:	Prior to A.02.00

Res BW

Sets the value of the resolution bandwidth (RBW). If an unavailable bandwidth is entered with the numeric keypad, the closest available bandwidth is selected.

Key Path:	BW
Mode:	WCDMA, C2K, WIMAX OFDMA, 1xEVDO, LTE, LTETDD, WLAN
Remote Command:	[:SENSE]:CHPower:BANDwidth[:RESolution] <bandwidth> [:SENSE]:CHPower:BANDwidth[:RESolution]? [:SENSE]:CHPower:BANDwidth[:RESolution]:AUTO ON OFF 1 0 [:SENSE]:CHPower:BANDwidth[:RESolution]:AUTO?
Example:	CHP:BAND 5 MHz CHP:BAND? CHP:BAND:AUTO ON CHP:BAND:AUTO?
Notes:	You must be in the W-CDMA mode, cdma2000 mode, LTD mode, LTE TDD mode, WLAN mode, 1xEVDO mode, or WIMAX OFDMA mode to use this command. Use :INSTrument:SELEct to set the mode.
Couplings:	Sweep time is coupled to the RBW. As the RBW changes, the sweep time (if set to Auto) is changed to maintain amplitude calibration. Video bandwidth (VBW) is coupled to the RBW. As the resolution bandwidth changes, the video bandwidth (if set to Auto) changes to maintain the ratio of VBW/RBW (10:1). When the Res BW is set to Auto, the resolution bandwidth is auto-coupled to the span. The ratio of Span/RBW is approximately 106:1 when auto coupled. When Res BW is set to Man, and the bandwidths are entered manually, these bandwidths are used regardless of other analyzer settings.

Channel Power Measurement
BW

Preset:	WCDMA: 240 kHz C2K: 24 kHz WIMAX OFDMA: 100kHz 1xEVDO: 30kHz LTE: Auto LTETDD: Auto WLAN: 100 kHz WCDMA, C2K, 1xEVDO , WIMAX OFDMA, WLAN: OFF LTE, LTETDD: ON
State Saved:	Saved in instrument state.
Min:	1 Hz
Max:	8 MHz
Backwards Compatibility SCPI:	[:SENSe] :CHPower :BWIDth [:RESolution]
Initial S/W Revision:	Prior to A.02.00
Modified at S/W Revision:	A.02.00, A.03.00

Video BW

Changes the analyzer post-detection filter (VBW).

Key Path:	BW
Mode:	WCDMA, C2K, WIMAX OFDMA, 1xEVDO, LTE, LTETDD, WLAN
Remote Command:	[:SENSe] :CHPower :BANDwidth :VIDeo <bandwidth> [:SENSe] :CHPower :BANDwidth :VIDeo? [:SENSe] :CHPower :BANDwidth :VIDeo :AUTO ON OFF 1 0 [:SENSe] :CHPower :BANDwidth :VIDeo :AUTO?
Example:	CHP:BAND:VID 2.4 MHz CHP:BAND:VID? CHP:BAND:VID:AUTO OFF CHP:BAND:VID:AUTO?
Notes:	You must be in the W-CDMA mode, cdma2000 mode, LTD mode, LTE TDD mode, WLAN mode, 1xEVDO mode, or WIMAX OFDMA mode to use this command. Use :INSTrument:SELEct to set the mode.
Dependencies:	See Couplings

Couplings:	<p>Video bandwidth (VBW) is coupled to the RBW. As the resolution bandwidth changes, the video bandwidth (if set to Auto) changes to maintain the ratio set by VBW/RBW.</p> <p>Sweep Time is coupled to the Video Bandwidth (VBW). As the VBW is changed, the sweep time (when set to Auto) is changed to maintain amplitude calibration. This occurs because of common hardware between the two circuits, even though the Video BW filter is not actually “in-circuit” when the detector is set to Average. Because the purpose of the average detector and the VBW filter are the same, either can be used to reduce the variance of the result.</p> <p>Although the VBW filter is not “in-circuit” when using the average detector, the Video BW key can have an effect on (Auto) sweep time, and is not disabled. In this case, reducing the VBW setting increases the sweep time, which increases the averaging time, producing a lower-variance trace.</p> <p>When using the average detector with either Sweep Time set to Man, or in zero span, the VBW setting has no effect and is disabled (grayed out).</p> <p>When the video bandwidth is AUTO coupled, the video bandwidth value is set to: Resolution Bandwidth * Video Bandwidth to Resolution Bandwidth Ratio</p>
Preset:	<p>WCDMA: 2.4MHz C2K: 240 kHz WIMAX OFDMA: Auto 1xEVDO: 300 kHz LTE: Auto LTETDD: Auto WLAN: Auto ON</p>
State Saved:	Saved in instrument state.
Min:	1 Hz
Max:	50 MHz
Initial S/W Revision:	Prior to A.02.00
Modified at S/W Revision:	A.02.00, A.03.00

Filter Type

Selects the type of bandwidth filter that is used. The choices are Gaussian or Flat top.

Key Path:	BW
Mode:	WCDMA, C2K, WIMAX OFDMA, 1xEVDO, LTE, LTETDD, WLAN

Channel Power Measurement
BW

Remote Command:	[:SENSe] :CHPower:BAWdwidth:SHApe GAUSSian FLATtop [:SENSe] :CHPower:BAWdwidth:SHApe?
Example:	CHP:BAND:SHAP GAUS CHP:BAND:SHAP?
Preset:	GAUSSian
State Saved:	Saved in instrument state.
Range:	Gaussian Flattop
Backwards Compatibility SCPI:	[:SENSe] :CHPower:BWIDth:SHApe
Initial S/W Revision:	Prior to A.02.00
Modified at S/W Revision:	A.02.00, A.03.00

Cont

See “[Cont \(Continuous Measurement/Sweep\)](#)” on page 901 in the "Common Measurement Functions" section for more information.

Key Path:	Front-panel key
-----------	------------------------

FREQ Channel

See “[FREQ Channel](#)” on page 903 in the "Common Measurement Functions" fsection or more information.

Key Path:	Front-panel key
-----------	------------------------

Input/Output

See [“Input/Output” on page 921](#) for more information.

Key Path:	Front-panel key
-----------	------------------------

Marker

Accesses a menu that enables you to select, set up and control the markers for the current measurement.

Key Path:	Front-panel key
Initial S/W Revision:	Prior to A.02.00

Select Marker

Displays 12 markers available for selection.

Key Path:	Marker
Initial S/W Revision:	Prior to A.02.00

Marker Type

Sets the marker control mode to **Normal**, **Delta**, **Fixed** or **Off**. All interactions and dependencies detailed under the key description are enforced when the remote command is sent. If the selected marker is **Off**, pressing **Marker** sets it to **Normal** and places it at the center of the screen on the trace determined by the **Marker Trace** rules. At the same time, **Marker X Axis Value** appears on the Active Function area.

The default active function is the active function for the currently selected marker control mode. If the current control mode is **Off**, there is no active function and the active function is turned off.

Key Path:	Marker
Mode:	WCDMA, C2K, WIMAX OFDMA, 1xEVDO, LTE, LTETDD, WLAN
Remote Command:	:CALCulate:CHPower:MARKer [1] 2 3 4 5 6 7 8 9 10 11 12 :M ODE POSition DELTa OFF :CALCulate:CHPower:MARKer [1] 2 3 4 5 6 7 8 9 10 11 12 :M ODE?
Example:	CALC:CHP:MARK3:MODE POS CALC:CHP:MARK3:MODE?
Notes:	If the selected marker is Off , pressing Marker sets it to Normal and places it at the center of the screen on the trace determined by the Marker Trace rules. At the same time, Marker X Axis Value appears on the Active Function area. Default Active Function: the active function for the selected marker's current control mode. If the current control mode is Off , there is no active function and the active function is turned off. Active Function Display: the marker X axis value entered in the active function area displays the marker value to its full entered precision.
Preset:	OFF

State Saved:	Saved in instrument state.
Range:	Normal Delta Off
Initial S/W Revision:	Prior to A.02.00
Modified at S/W Revision:	A.02.00, A.03.00

Marker X Axis Value (Remote Command Only)

Sets the marker X Axis value in the current marker X Axis Scale unit. It has no effect if the control mode is **Off**, but is the SCPI equivalent of entering an X value if the control mode is **Normal**, **Delta**, or **Fixed**.

Mode:	WCDMA, C2K, WIMAX OFDMA, 1xEVDO, LTE, LTETDD, WLAN
Remote Command:	:CALCulate:CHPower:MARKer [1] 2 3 4 5 6 7 8 9 10 11 12 :X <real> :CALCulate:CHPower:MARKer [1] 2 3 4 5 6 7 8 9 10 11 12 :X ?
Example:	CALC:CHP:MARK3:X 0 CALC:CHP:MARK3:X?
Notes:	The query returns the marker's absolute X Axis value if the control mode is Normal , or the offset from the marker's reference marker if the control mode is Delta . The query is returned in the fundamental units for the current marker X Axis scale: Hz for Frequency .
Preset:	After a preset, all markers are turned OFF, so Marker X Axis Value query returns a not a number (NAN).
State Saved:	Saved in instrument state.
Min:	-9.9E+37
Max:	9.9E+37
Initial S/W Revision:	Prior to A.02.00
Modified at S/W Revision:	A.02.00, A.03.00

Marker X Axis Position (Remote Command Only)

Sets the marker X Axis Scale position in trace points. This setting has no effect if the control mode is **Off**, but is the SCPI equivalent of entering a value if the control mode is **Normal** or **Delta**. The entered value is immediately translated into the current X Axis Scale units for setting the value of the marker.

Mode:	WCDMA, C2K, WIMAX OFDMA, 1xEVDO, LTE, LTETDD, WLAN
Remote Command:	:CALCulate:CHPower:MARKer [1] 2 3 4 5 6 7 8 9 10 11 12 :X :POSition <real> :CALCulate:CHPower:MARKer [1] 2 3 4 5 6 7 8 9 10 11 12 :X :POSition?

Channel Power Measurement
Marker

Example:	CALC:CHP:MARK10:X:POS 0 CALC:CHP:MARK10:X:POS?
Notes:	The query returns the marker's absolute X Axis value in trace points if the control mode is Normal , or the offset from the marker's reference marker in trace points if the control mode is Delta .
Preset:	After a preset, all markers are turned OFF, so Marker X Axis Value query returns a not a number (NAN).
State Saved:	Saved in instrument state.
Min:	-9.9E+37
Max:	9.9E+37
Initial S/W Revision:	Prior to A.02.00
Modified at S/W Revision:	A.02.00, A.03.00

Marker Y Axis Value (Remote Command only)

Returns the marker Y Axis value in the current marker Y Axis unit.

Mode:	WCDMA, C2K, WIMAX OFDMA, 1xEVDO, LTE, LTETDD, WLAN
Remote Command:	:CALCulate:CHPower:MARKer [1] 2 3 4 5 6 7 8 9 10 11 12 : Y ?
Example:	CALC:CHP:MARK11:Y?
Preset:	Result dependent on Markers setup and signal source.
State Saved:	Saved in instrument state.
Initial S/W Revision:	Prior to A.02.00
Modified at S/W Revision:	A.02.00, A.03.00

Properties

Accesses the marker properties menu.

Key Path:	Marker
Initial S/W Revision:	Prior to A.02.00

Select Marker

Displays 12 markers available for selection.

Key Path:	Marker
Initial S/W Revision:	Prior to A.02.00

Relative To

Sets the reference marker to which the selected marker is relative.

Key Path:	Marker, Properties
Mode:	WCDMA, C2K, WIMAX OFDMA, 1xEVDO, LTE, LTETDD, WLAN
Remote Command:	:CALCulate:CHPower:MARKer [1] 2 3 4 5 6 7 8 9 10 11 12 :R EFerence <integer> :CALCulate:CHPower:MARKer [1] 2 3 4 5 6 7 8 9 10 11 12 :R EFerence?
Example:	CALC:CHP:MARK:REF 5 CALC:CHP:MARK:REF?
Notes:	A marker cannot be relative to itself so that choice is grayed out, and if sent from SCPI generates error -221: "Settings conflict; marker cannot be relative to itself." When queried, a single value is returned (the specified marker numbers relative marker).
Preset:	2 3 4 5 6 7 8 9 10 11 12 1
State Saved:	Saved in instrument state.
Min:	1
Max:	12
Initial S/W Revision:	Prior to A.02.00
Modified at S/W Revision:	A.02.00, A.03.00

Couple Markers

When this function is active, moving any marker causes an "equal X Axis movement" of every other marker that is not set to **Off**. By "equal X Axis movement" we mean that we preserve the difference between each marker's X Axis value (in the fundamental x-axis units of the trace that marker is on) and the X Axis value of the marker being moved (in the same fundamental x-axis units).

This may result in markers going off screen.

Key Path:	Marker
Mode:	WCDMA, C2K, WIMAX OFDMA, 1xEVDO, LTE, LTETDD, WLAN
Remote Command:	:CALCulate:CHPower:MARKer:COUple [:STATe] ON OFF 1 0 :CALCulate:CHPower:MARKer:COUple [:STATe] ?
Example:	CALC:CHPower:MARK:COUP ON
Preset:	OFF
State Saved:	Saved in instrument state.

Channel Power Measurement
Marker

Range:	On Off
Initial S/W Revision:	A.02.00

All Markers Off

Turns off all markers.

Key Path:	Marker
Mode:	WCDMA, C2K, WIMAX OFDMA, 1xEVDO, LTE, LTETDD, WLAN
Remote Command:	:CALCulate:CHPower:MARKer:AOFF
Example:	CALC:CHP:MARK:AOFF
Initial S/W Revision:	Prior to A.02.00
Modified at S/W Revision:	A.02.00, A.03.00

Backward Compatibility SCPI Commands

Sets or queries the state of a marker. Setting a marker which is OFF to state ON or 1 puts it in Normal mode and places it at the center of the screen.

Mode:	WCDMA, C2K, WIMAX OFDMA, 1xEVDO, LTE, LTETDD, WLAN
Remote Command:	:CALCulate:CHPower:MARKer [1] 2 3 4 5 6 7 8 9 10 11 12 :S TATe OFF ON 0 1 :CALCulate:CHPower:MARKer [1] 2 3 4 5 6 7 8 9 10 11 12 :S TATe?
Example:	CALC:CHP:MARK3:STAT ON CALC:CHP:MARK3:STAT?
Preset:	OFF
State Saved:	Saved in instrument state.
Range:	On Off
Initial S/W Revision:	Prior to A.02.00
Modified at S/W Revision:	A.02.00, A.03.00

Marker Function

There are no 'Marker Functions' supported in Channel Power, so this front-panel key displays a blank menu when pressed.

Key Path:	Front-panel key
Initial S/W Revision:	Prior to A.02.00

Marker To

There is no 'Marker To' functionality supported in Channel Power measurement, so this front-panel key displays a blank key menu when pressed.

Key Path:	Front-panel key
Initial S/W Revision:	Prior to A.02.00

Meas

See [“Meas” on page 1031](#) for more information.

Key Path:	Front-panel key
-----------	------------------------

Meas Setup

Displays the setup menu for the currently selected measurement. The parameters included in this menu are as follows.

- Averaging
- IF Gain
- Channel Power Span
- Integrated Bandwidth
- Filter Bandwidth
- Root Raised Cosine (RRC) Filter

Key Path:	Front-panel key
Initial S/W Revision:	Prior to A.02.00

Avg/Hold Num

Specifies the number of measurement averages used to calculate the measurement result. The average is displayed at the end of each sweep. After the specified number of average counts, the averaging mode (terminal control) setting determines the averaging action.

Key Path:	Meas Setup
Mode:	WCDMA, C2K, WIMAX OFDMA, 1xEVDO, LTE, LTETDD, WLAN
Remote Command:	[:SENSe]:CHPower:AVERage:COUNT <integer> [:SENSe]:CHPower:AVERage:COUNT? [:SENSe]:CHPower:AVERage[:STATe] ON OFF 1 0 [:SENSe]:CHPower:AVERage[:STATe]?
Example:	CHP:AVER:COUN 15 CHP:AVER:COUN? CHP:AVER ON CHP:AVER?
Notes:	You must be in the W-CDMA mode, cdma2000 mode, LTD mode, LTE TDD mode, WLAN mode, 1xEVDO mode, or WIMAX OFDMA mode to use this command. Use :INSTrument:SELEct to set the mode.

Preset:	WCDMA: 200 WIMAX OFDMA, LTE, LTETDD: 200 CDMA2K: 20 1xEVDO: 20 WLAN: 10 ON
State Saved:	Saved in instrument state.
Min:	1
Max:	10000
Initial S/W Revision:	Prior to A.02.00
Modified at S/W Revision:	A.02.00, A.03.00

Avg Mode

Allows you to select the type of termination control used for the averaging function. This determines the averaging action after the specified number of data acquisitions (average count) is reached.

When set to Exponential (Exp) the measurement averaging continues using the specified number of averages to compute each exponentially-weighted averaged value. The average is displayed at the end of each sweep.

When set to Repeat, the measurement resets the average counter each time the specified number of averages is reached.

Key Path:	Meas Setup
Mode:	WCDMA, C2K, WIMAX OFDMA, 1xEVDO, LTE, LTETDD, WLAN
Remote Command:	[:SENSE] :CHPower:AVERage:TCONtrol EXPonential REPEAT [:SENSE] :CHPower:AVERage:TCONtrol?
Example:	CHP:AVER:TCON EXP CHP:AVER:TCON?
Notes:	You must be in the W-CDMA mode, cdma2000 mode, LTD mode, LTE TDD mode, WLAN mode, 1xEVDO mode, or WIMAX OFDMA mode to use this command. Use :INSTrument:SElect to set the mode.
Preset:	EXP
State Saved:	Saved in instrument state.
Range:	Exp Repeat
Initial S/W Revision:	Prior to A.02.00
Modified at S/W Revision:	A.02.00, A.03.00

Integ BW

Specifies the range of integration used in calculating the power in the channel. The integration bandwidth (IBW) is displayed on the trace as two markers connected by an arrow.

Key Path:	Meas Setup
Mode:	WCDMA, C2K, WIMAX OFDMA, 1xEVDO, LTE, LTETDD, WLAN
Remote Command:	[:SENSE] :CHPower:BANDwidth:INTEgration <bandwidth> [:SENSE] :CHPower:BANDwidth:INTEgration?
Example:	CHP:BAND:INT 10MHz CHP:BAND:INT?
Notes:	You must be in the W-CDMA mode, cdma2000 mode, LTD mode, LTE TDD mode, WLAN mode, 1xEVDO mode, or WIMAX OFDMA mode to use this command. Use :INSTrument:SElect to set the mode.
Couplings:	The minimum value of the span is coupled with the integration bandwidth.
Preset:	WCDMA: 5 MHz C2K: 1.23 MHz WIMAX OFDMA: 10 MHz 1xEVDO: 1.23 MHz LTE: 5 MHz LTETDD: 5 MHz WLAN: if Radio Std is 802.11a/g(OFDM/DSSS-OFDM): 20 MHz if Radio Std is 802.11b: 25 MHz if Radio Std is 802.11n(20MHz): 20 MHz if Radio Std is 802.11n(40MHz): 40 MHz if Radio Std is 802.11ac (20 MHz): 20 MHz if Radio Std is 802.11ac (40 MHz): 40 MHz if Radio Std is 802.11ac (80 MHz): 80 MHz if Radio Std is 802.11ac (160 MHz): 160 MHz if Radio Std is 802.11ac (80 MHz + 80 MHz): 80 MHz
State Saved:	Saved in instrument state.
Min:	100 Hz
Max:	1 GHz
Max:	RF Input: 1 GHz
Initial S/W Revision:	Prior to A.02.00

Modified at S/W Revision:	A.02.00, A.03.00
---------------------------	------------------

PhNoise Opt

Selects the LO (local oscillator) phase noise behaviour for various operating conditions.

Key Path:	Meas Setup
Initial S/W Revision:	A.04.20

PhNoise Opt Auto

Selects the LO (local oscillator) phase noise behavior to optimize dynamic range and speed for various instrument operating conditions.

The X-Series has two grades of LO; a high performance LO that gives the best phase noise performance; and a medium-performance LO that gives excellent performance.

In models with the high performance LO, Auto will choose:

Fast Tuning whenever Span > 44.44 MHz or RBW > 1.9 MHz

otherwise, if center frequency is < 195 kHz OR ALL of the following are true:

CF 1 MHz AND Span 1.3 MHz AND RBW 75 kHz

then Best Close in Phase Noise;

otherwise, Best Wide-offset Phase Noise

In models with the medium-performance LO, Auto will choose:

Fast Tuning whenever Span > 12.34 MHz or RBW > 250 kHz

otherwise, if center frequency is < 25 kHz OR ALL of the following are true:

CF >= 1 MHz AND Span <= 141.4 kHz AND RBW <= 5 kHz

then **Best Close in Phase Noise;**

otherwise, **Best Wide-offset Phase Noise**

In units whose hardware does not provide for an extra-fast tuning option, the settings for Fast Tuning are the same as Best Close-in, so in those models you will see no difference between these settings.

These rules apply whether in swept spans, zero span, or FFT spans.

Key Path:	Meas Setup
Remote Command:	[:SENSe] :CHPower:FREQuency:SYNThesis:AUTO [:STATe] OFF ON 0 1 [:SENSe] :CHPower:FREQuency:SYNThesis:AUTO [:STATe] ?
Example:	CHP:FREQ:SYNT:AUTO 1 CHP:FREQ:SYNT:AUTO?

Channel Power Measurement
Meas Setup

Preset:	OFF
State Saved:	Saved in instrument state.
Range:	Auto Man
Readback Text:	“Auto” is underlined when Auto is selected, otherwise Man is underlined.
Initial S/W Revision:	A.04.20

PhNoise Opt State

Selects the LO (local oscillator) phase noise behavior for various operating conditions.

Key Path:	Meas Setup
Remote Command:	[:SENSe] :CHPower:FREQuency:SYNTHeSis [:STATe] 1 2 3 [:SENSe] :CHPower:FREQuency:SYNTHeSis [:STATe] ?
Example:	CHP:FREQ:SYNT 1 CHP:FREQ:SYNT?
Notes:	Parameter key: <ol style="list-style-type: none"> 1. optimizes phase noise for close-in from the carrier. 2. optimizes phase noise for wide-offset from the carrier. 3. optimizes LO for tuning speed.
Preset:	3
State Saved:	Saved in instrument state.
Range:	Hardware Dependent: PXA: Best Close-in Noise [offset < 140 kHz] Best Wide-offset Noise [offset > 160 kHz] Fast Tuning MXA, EXA: Best Close-in Noise [offset < 20 kHz] Best Wide-offset Noise [offset > 30 kHz] Fast Tuning
Initial S/W Revision:	A.04.20

IF Gain

Sets the IF Gain function to Auto, Low Gain or High Gain. These settings affect sensitivity and IF overloads.

Key Path:	Meas Setup
Initial S/W Revision:	Prior to A.02.00

IF Gain Auto

Activates the auto rules for IF Gain. When Auto is active, the IF Gain is set to High Gain under any of

the following conditions:

- The input attenuator is set to 0 dB
- The preamp is turned On and the frequency range is under 3.6 GHz

For other settings, Auto sets the IF Gain to Low Gain.

Key Path:	Meas Setup, IF Gain
Remote Command:	[:SENSe] :CHPower : IF : GAIN : AUTO [: STATe] ON OFF 1 0 [:SENSe] :CHPower : IF : GAIN : AUTO [: STATe] ?
Example:	CHP:IF:GAIN:AUTO ON CHP:IF:GAIN:AUTO?
Couplings:	When the auto attenuation exists (for example, with an electrical attenuator), IF Gain State differs depending on the condition. Auto sets IF Gain to High Gain under any of the following conditions: The input attenuator is set to 0 dB, or the preamp is turned on and the frequency range is under 3.6 GHz. For other conditions, Auto sets IF Gain to Low Gain.
Preset:	OFF
State Saved:	Saved in instrument state.
Range:	Off On
Initial S/W Revision:	Prior to A.02.00

IF Gain State

Selects the range of the IF Gain.

Key Path:	Meas Setup, IF Gain
Remote Command:	[:SENSe] :CHPower : IF : GAIN [: STATe] ON OFF 1 0 [:SENSe] :CHPower : IF : GAIN [: STATe] ?
Example:	CHP : IF : GAIN ON CHP : IF : GAIN?
Notes:	ON = high gain OFF = low gain
Couplings:	When the auto attenuation exists (for example, with an electrical attenuator), IF Gain State differs depending on the condition. Auto sets IF Gain to High Gain under any of the following conditions: The input attenuator is set to 0 dB, or the preamp is turned on and the frequency range is under 3.6 GHz. For other conditions, Auto sets IF Gain to Low Gain.

Channel Power Measurement
Meas Setup

Preset:	OFF
State Saved:	Saved in instrument state.
Range:	Low Gain High Gain
Initial S/W Revision:	Prior to A.02.00

Method

Turns the Root Raised Cosine (RRC) filter On or Off. The α value (roll off) for the filter is set to the value of the Filter Alpha parameter, and the RRC filter bandwidth is set to the Filter BW parameter.

Key Path:	Meas Setup
Mode:	WCDMA, C2K, WIMAX OFDMA, 1xEVDO, LTE, LTETDD, WLAN
Remote Command:	[:SENSE] :CHPower:FILTer [:RRC] [:STATe] OFF ON 0 1 [:SENSE] :CHPower:FILTer [:RRC] [:STATe] ?
Example:	CHP:FILT OFF CHP:FILT?
Notes:	This parameter is normally used when TETRA is selected as the Radio Std. You must be in the W-CDMA mode, cdma2000 mode, LTD mode, LTE TDD mode, WLAN mode, 1xEVDO mode, or WIMAX OFDMA mode to use this command. Use :INSTrument:SElect to set the mode.
Dependencies:	For CDMA2K mode, this key is blank. For 1xEVDO mode, this key is blank. For WLAN 802.11 ac (80 + 80 MHz), RRC Weighted is not supported .
Preset:	OFF
State Saved:	Saved in instrument state.
Range:	Integ BW RRC Weighted
Initial S/W Revision:	Prior to A.02.00
Modified at S/W Revision:	A.02.00, A.03.00, A.10.00

Integ BW

See “[Method](#)” on page 340for details.

Key Path:	Meas Setup
Initial S/W Revision:	Prior to A.02.00
Modified at S/W Revision:	A.02.00, A.03.00, A.10.00

RRC Weighted

See “Method” on page 340 for details.

Key Path:	Meas Setup
Initial S/W Revision:	Prior to A.02.00
Modified at S/W Revision:	A.02.00, A.03.00, A.10.00

Filter Alpha

Inputs the alpha value for the Root Raised Cosine (RRC) filter.

Key Path:	Meas Setup, Method
Mode:	WCDMA, C2K, WIMAX OFDMA, 1xEVDO, LTE, LTETDD, WLAN
Remote Command:	[:SENSE] :CHPower :FILTer [:RRC] :ALPHA <real> [:SENSE] :CHPower :FILTer [:RRC] :ALPHA?
Example:	CHP:FILT:ALPH 0.5 CHP:FILT:ALPH?
Notes:	This parameter is normally used when TETRA is selected as the Radio Std. You must be in the W-CDMA mode, cdma2000 mode, LTD mode, LTE TDD mode, WLAN mode, 1xEVDO mode, or WIMAX OFDMA mode to use this command. Use :INSTrument:SElect to set the mode.
Dependencies:	For CDMA2K mode, this key is blank. For 1xEVDO mode, this key is blank.
Preset:	WCDMA,,WIMXA OFMDA, LTE, LTETDD, WLAN: 0.22
State Saved:	Saved in instrument state.
Min:	0.01
Max:	1.00
Initial S/W Revision:	Prior to A.02.00
Modified at S/W Revision:	A.02.00, A.03.00, A.10.00

Filter BW

Inputs the Root Raised Cosine (RRC) filter bandwidth. Normally, the filter bandwidth is the same as the symbol rate of the signal.

Key Path:	Meas Setup, Method, RRC Weighted
Mode:	WCDMA, C2K, WIMAX OFDMA, 1xEVDO, LTE, LTETDD, WLAN

Channel Power Measurement Meas Setup

Remote Command:	<code>[:SENSe] :CHPower:FILTer [:RRC] :BANDwidth <real></code> <code>[:SENSe] :CHPower:FILTer [:RRC] :BANDwidth?</code>
Example:	<code>CHP:FILT:BAND 10MHz</code> <code>CHP:FILT:BAND?</code>
Notes:	This parameter is normally used when TETRA is selected as the Radio Std. You must be in the W-CDMA mode, cdma2000 mode, LTD mode, LTE TDD mode, WLAN mode, 1xEVDO mode, or WIMAX OFDMA mode to use this command. Use <code>:INSTrument:SELEct</code> to set the mode.
Dependencies:	For CDMA2K mode, this key is blank. For 1xEVDO mode, this key is blank.
Preset:	LTE, LTETDD: 3.84MHz WCDMA: 3.84MHz WIMAX OFDMA: 10MHz WLAN: if Radio Std is 802.11a/g(OFDM/DSSS-OFDM): 16.6 MHz if Radio Std is 802.11b: 22 MHz if Radio Std is 802.11n(20MHz): 17.8 MHz if Radio Std is 802.11n(40MHz): 36.6 MHz
State Saved:	Saved in instrument state.
Min:	100 Hz
Max:	100 MHz
Backwards Compatibility SCPI:	<code>[:SENSe] :CHPower:FILTer [:RRC] :BWiDth</code>
Initial S/W Revision:	Prior to A.02.00
Modified at S/W Revision:	A.02.00, A.03.00, A.10.00

Limits

Accesses the Limits menu that allows you to set up the test limit for channel power or power spectral density.

Key Path:	Meas Setup
Initial S/W Revision:	A.10.00

Power Limit

If Power Limit is on, Power Limit is used as threshold which can judge whether the real measured channel power can be passed or not. If real measured channel power exceeds Power Limit, channel power test

fails, otherwise, it passes. If Power Limit is off, channel power test is always passed.

Key Path:	Meas Setup, Limits
Mode:	WCDMA, C2K, WIMAX OFDMA, 1xEVDO, LTE, LTETDD, WLAN
Remote Command:	:CALCulate:CHPower:LIMit:POWer <ampl> :CALCulate:CHPower:LIMit:POWer? :CALCulate:CHPower:LIMit:POWer:STATe OFF ON 0 1 :CALCulate:CHPower:LIMit:POWer:STATe?
Example:	CALC:CHP:LIM:POW 16.00 CALC:CHP:LIM:POW? CALC:CHP:LIM:POW:STAT ON CALC:CHP:LIM:POW:STAT?
Notes:	This parameter and PSD Limit can determine Pass/Fail criteria. If ((power limit = On) and (PSD limit= Off)) Pass if (power test passes) Fail if (power test fails) If ((power limit = On) and (PSD limit= On)) Pass if (both power test and PSD test pass) Fail if (either of power test or PSD test fails) If ((power limit = Off) and (PSD limit= On)) Pass if (PSD test passes) Fail if (PSD test fails) If ((power limit = Off) and (PSD limit= Off)) Always Pass For WLAN 802.11ac (80 MHz + 80 MHz), the power test and the PSD test are performed to both carriers. Which means the power (or PSD) readouts of both carriers should be compared with the power (or PSD) limit individually, and the test passes only when both values are lower than the limit.
Preset:	16.00 WCDMA, C2K, WIMAX OFDMA, 1xEVDO, LTE, LTETDD: OFF WLAN: ON
State Saved:	Saved in instrument state.
Min:	-200.0
Max:	200.0
Initial S/W Revision:	A.10.00

Power Limit Fail (remote command only)

The command is query only and used to query if power test passes or fails.

Remote Command:	:CALCulate:CHPower:LIMit:POWer:FAIL?
Example:	CALC:CHP:LIM:POW:FAIL?
Notes:	This command is query only. When Power Limit is off, the returned value is always 0 (pass). When Power Limit is on, the returned value is 0(pass) while power test passes and 1(fail) while power test fails.
Initial S/W Revision:	A.10.00

PSD Limit

If PSD (power spectral density) Limit is ON, PSD Limit is used as threshold which can judge whether the real measured PSD can be passed or not. If real measured PSD exceeds PSD Limit, PSD test fails, otherwise, it passes. If PSD is off, PSD test is always passed.

Key Path:	Meas Setup, Limits
Mode:	WCDMA, C2K, WIMAX OFDMA, 1xEVDO, LTE, LTETDD, WLAN
Remote Command:	:CALCulate:CHPower:LIMit:PSDensity <real> :CALCulate:CHPower:LIMit:PSDensity? :CALCulate:CHPower:LIMit:PSDensity:STATe OFF ON 0 1 :CALCulate:CHPower:LIMit:PSDensity:STATe?
Example:	CALC:CHP:LIM:PSD 4.00 CALC:CHP:LIM:PSD? CALC:CHP:LIM:POW:STAT ON CALC:CHP:LIM:POW:STAT?

Notes:	<p>This parameter and Power Limit can determine Pass/Fail criteria.</p> <p>If ((power limit = On) and (PSD limit= Off))</p> <p style="padding-left: 40px;">Pass if (power test passes)</p> <p style="padding-left: 40px;">Fail if (power test fails)</p> <p>If ((power limit = On) and (PSD limit= On))</p> <p style="padding-left: 40px;">Pass if (both power test and PSD test pass)</p> <p style="padding-left: 40px;">Fail if (either of power test or PSD test fails)</p> <p>If ((power limit = Off) and (PSD limit= On))</p> <p style="padding-left: 40px;">Pass if (PSD test passes)</p> <p style="padding-left: 40px;">Fail if (PSD test fails)</p> <p>If ((power limit = Off) and (PSD limit= Off))</p> <p style="padding-left: 40px;">Always Pass</p> <p>For WLAN 802.11ac (80 MHz + 80 MHz), the power test and the PSD test are performed to both carriers. Which means the PSD (or power) readouts of both carriers should be compared with the PSD (or power) limit individually, and the test passes only when both values are lower than the limit.</p>
Couplings:	The value is automatically converted when PSD Unit is changed.
Preset:	<p>4.00</p> <p>WCDMA, C2K, WIMAX OFDMA, 1Xevdo, LTE, LTETDD: OFF</p> <p>WLAN: ON</p>
State Saved:	Saved in instrument state.
Min:	-200.0
Max:	200.0
Initial S/W Revision:	A.10.00

PSD Limit Fail (remote command only)

The command is query only and used to query if PSD test passes or fails.

Remote Command:	:CALCulate:CHPower:LIMit:PSD:FAIL?
Example:	CALC:CHP:LIM:PSD:FAIL?
Notes:	<p>This command is query only.</p> <p>When PSD Limit is off, the returned value is always 0 (pass).</p> <p>When PSD Limit is on, the returned value is 0(pass) while PSD test passes and 1(fail) while PSD test fails.</p>
Initial S/W Revision:	A.10.00

PSD Unit

Sets the unit bandwidth for Power Spectral Density. The available units are dBm/Hz and dBm/MHz.

Key Path:	Meas Setup
Mode:	WCDMA, C2K, WIMAX OFDMA, 1xEVDO, LTE, LTETDD, WLAN
Remote Command:	:UNIT:CHPower:POWer:PSD DBMHZ DBMMHZ :UNIT:CHPower:POWer:PSD?
Example:	UNIT:CHP:POW:PSD DBMMHZ UNIT:CHP:POW:PSD?
Couplings:	When the PSD unit is changed, the PSD result of the “MEAS READ FETCH:CHP1?” is also changed by the PSD unit basis (in either dBm/Hz or dBm/MHz).
Preset:	DBMHZ WLAN: DBMMHZ
State Saved:	Saved in instrument state.
Range:	dBm/Hz dBm/MHz
Initial S/W Revision:	Prior to A.02.00
Modified at S/W Revision:	A.02.00, A.03.00

Meas Preset

Restores all the measurement parameters to their default values.

Key Path:	Meas Setup
Mode:	WCDMA, C2K, WIMAX OFDMA, 1xEVDO, LTE, LTETDD, WLAN
Remote Command:	:CONFigure:CHPower
Example:	CONF:CHP
Initial S/W Revision:	Prior to A.02.00
Modified at S/W Revision:	A.02.00, A.03.00

Mode

See “Mode” on page 1091 for more information.

Key Path:	Front-panel key
-----------	-----------------

Mode Setup

See “[Mode Setup](#)” on page 1103 for more information.

Key Path:	Front-panel key
-----------	------------------------

Peak Search

Places the selected marker on the trace point with the maximum y-axis value. Pressing Peak Search with the selected marker Off causes the selected marker to be set to Normal, then a peak search is immediately performed.

Key Path:	Front panel key
Mode:	WCDMA, C2K, WIMAX OFDMA, 1xEVDO, LTE, LTETDD, WLAN
Remote Command:	:CALCulate:CHPower:MARKer [1] 2 3 4 5 6 7 8 9 10 11 12 :M AXimum
Example:	CALC:CHP:MARK2:MAX
Initial S/W Revision:	Prior to A.02.00
Modified at S/W Revision:	A.02.0, A.03.000

Recall

See “[Recall](#)” on page 192 for more information.

Key Path:	Front-panel key
Initial S/W Revision:	Prior to A.02.00

Restart

See [“Restart” on page 1125](#) for more information.

Key Path:	Front-panel key
-----------	-----------------

Save

See “[Save](#)” on page 204 for more information.

Key Path:	Front-panel key
-----------	------------------------

Data

See “[Data \(Export\)](#)” on page 213 for more information.

Key Path:	Front-panel key
-----------	------------------------

Measurement Results

Pressing this key selects Meas Results as the data type to be exported.

The Meas Results file contains information which describes the current state of the analyzer. It is detailed in Meas Result File Contents below.

Key Path:	Save, Data
Remote Command:	:MMEMory:STORe:RESults <string>
Example:	:MMEM:STOR:RES “MeasR_0000.csv”
Notes:	<p>If the save is initiated via SCPI and the file already exists, the file will be overwritten.</p> <p>The SCPI command exports Channel Power measurement results to the file specified as the parameter in the current path. The default path is My Documents\<current mode>\data\CHP\results.</p> <p>Using the C: drive is strongly discouraged, since it runs the risk of being overwritten during an instrument software upgrade.</p> <p>The SCPI parameter is a quoted string, which specifies the filename. Both single and double quotes are supported for any filename parameter over SCPI.</p>
Dependencies:	The current active measurement must be the Channel Power measurement to use this command.
Status Bits/OPC dependencies:	Sequential – waits for the previous measurement to complete.
Initial S/W Revision:	Prior to A.02.00

Meas Results File Contents

A Meas Results File contains measurement results with the following information.

File ID string, which is “MeasResult”

Measurement ID following Mode ID, which is “SA:CHP” for example.

Firmware rev and model number

- Option string
- Auto Sweep Time Rules
- Average Mode
- Average Number
- Average State
- Center Frequency
- Detector
- IFGain
- IFGainAuto
- Impedance
- Integ BW
- Internal Preamp
- Internal Preamp Band
- PSD Unit
- Resolution Band Width
- Resolution Bandwidth Shape
- RRC Filter Alpha
- RRC Filter BW
- RRC Filter State
- Span
- Sweep Points
- Sweep Time
- Sweep Time Auto
- TriggerSource
- Video Bandwidth
- Y Axis Unit

The file contains these data followed by MeasResult1 and MeasResult2 that flag the start of the measurement results. Each line of Measurement Results consists of two comma separated values, MeasResult1 value and MeasResult2 value. MeasResult1 contains the same results as MEAS/READ/FETCh:CHPower1; MeasResult2, MEAS/READ/FETCh:CHPower2.

Exported file is .csv file. The Meas Results file, when imported into Excel, will show the following data:

MeasResult	
------------	--

SA:CHP	
A.10.53	N9030A
B25 B40	1
Auto Sweep Time Rules	Normal
Average Mode	Exponential
Average Number	10
Average State	TRUE
Center Frequency	13255000000
Detector	Average
IFGain	FALSE
IFGainAuto	FALSE
Impedance	50
Integ BW	2000000
Internal Preamp	FALSE
Internal Preamp Band	Low
PSD Unit	DbmHz
Resolution Band Width	27000
Resolution Bandwidth Shape	Gaussian
RRC Filter Alpha	0.22
RRC Filter BW	3840000
RRC Filter State	FALSE
Span	3000000
Sweep Points	1001
Sweep Time	0.004933333
Sweep Time Auto	TRUE
TriggerSource	Free
Video Bandwidth	270000
Y Axis Unit	DecibelMilliwatt
MeasResult1	MeasResult2
-76.8141133132837	-95.29174
-139.824413269924	-94.99601
	-94.95281

	-95.17146
--	-----------

Single

See “[Single \(Single Measurement/Sweep\)](#)” on page 1135 for more information.

Key Path:	Front-panel key
-----------	------------------------

Source (Internal)

Operation of this key is identical across all measurements. For details about this key, see [“Source \(Internal\)” on page 1137](#).

Key Path:	Front-panel key
-----------	------------------------

Span X Scale

Accesses a menu of functions that enable you set the horizontal scale parameters.

Key Path:	Front-panel key
Initial S/W Revision:	Prior to A.02.00

Span

Changes the frequency range symmetrically about the center frequency.

The default (and minimum) Span is calculated using the number of carriers and the carrier width where;

$$\text{Span} = (\text{Upper Carrier Freq} + (\text{max offset IBW} * (1 + \alpha)) / 2) - (\text{Lower Carrier Freq} - (\text{max offset IBW} * (1 + \alpha)) / 2)$$

The span is increased by a factor of 1 + Filter Alpha if the RRC Filter is on.

Key Path:	Span X Scale
Mode:	WCDMA, C2K, WIMAX OFDMA, 1xEVDO, LTE, LTETDD, WLAN
Remote Command:	[:SENSe] :CHPower:FREQuency:SPAN <freq> [:SENSe] :CHPower:FREQuency:SPAN?
Example:	CHP:FREQ:SPAN 10 MHz CHP:FREQ:SPAN?
Notes:	You must be in the W-CDMA mode, cdma2000 mode, LTD mode, LTE TDD mode, WLAN mode, 1xEVDO mode, or WIMAX OFDMA mode to use this command. Use :INSTrument:SElect to set the mode.
Dependencies:	For WLAN 802.11ac (80 MHz + 80 MHz), the key is not enabled and its value is coupled with the spacing between the center frequencies of the two carriers. Span = Center Frequency 1 – Center Frequency 2 + Integ BW + 40 MHz Margin. When the calculated span is over 1 GHz, it's still coupled to its maximum value, which is 1 GHz.
Couplings:	When Res BW is set to Auto, the resolution bandwidth is auto-coupled to span. The ratio of span /RBW is approximately 106:1. When the Res BW is set to Man, bandwidths are entered by the user, and these bandwidths are used regardless of other analyzer settings. Since Span is coupled to Integ BW in the factory default condition, if you change the integration bandwidth setting, the span setting changes by a proportional amount until a limit value is reached. However, the span can be individually set. The minimum value of the span is coupled with the integration bandwidth.

Preset:	<p>WCDMA: 7.5 MHz</p> <p>C2K: 1.845 MHz</p> <p>WIMAX OFDMA: 20 MHz</p> <p>1xEVDO: 2.0MHz</p> <p>LTE: 7.5 MHz</p> <p>LTETDD: 7.5 MHz</p> <p>WLAN:</p> <p style="padding-left: 20px;">if Radio Std is 802.11a/g(OFDM/DSSS-OFDM): 30 MHz</p> <p style="padding-left: 20px;">if Radio Std is 802.11b: 37.5MHz</p> <p style="padding-left: 20px;">if Radio Std is 802.11n(20MHz): 30 MHz</p> <p style="padding-left: 20px;">if Radio Std is 802.11n(40MHz): 60 MHz</p> <p style="padding-left: 20px;">if Radio Std is 802.11ac (20 MHz): 30 MHz</p> <p style="padding-left: 20px;">if Radio Std is 802.11ac (40 MHz): 60 MHz</p> <p style="padding-left: 20px;">if Radio Std is 802.11ac (80 MHz): 120 MHz</p> <p style="padding-left: 20px;">if Radio Std is 802.11ac (160 MHz): 240 MHz</p> <p style="padding-left: 20px;">if Radio Std is 802.11ac (80 MHz + 80 MHz): 360 MHz</p>
State Saved:	Saved in instrument state.
Min:	100 Hz
Max:	1 GHz
Max:	RF Input: 1 GHz
Initial S/W Revision:	Prior to A.02.00
Modified at S/W Revision:	A.02.00, A.03.00

Full Span

Changes the span to show the full frequency range of the spectrum analyzer.

Key Path:	Span X Scale
Mode:	WCDMA, C2K, WIMAX OFDMA, 1xEVDO, LTE, LTETDD, WLAN
Remote Command:	[:SENSe] :CHPower :FREQuency :SPAN :FULL
Example:	CHP:FREQ:SPAN:FULL
Notes:	You must be in the W-CDMA mode, cdma2000 mode, LTD mode, LTE TDD mode, WLAN mode, 1xEVDO mode, or WIMAX OFDMA mode to use this command. Use :INSTrument:SElect to set the mode.
Couplings:	Selecting full span changes the measurement span value.
Initial S/W Revision:	Prior to A.02.00

Channel Power Measurement
Span X Scale

Modified at S/W Revision:	A.02.00, A.03.00
---------------------------	------------------

Last Span

Changes the span to the previous span setting. If no previous span value exists, then the span remains unchanged.

Key Path:	Span X Scale
Mode:	WCDMA, C2K, WIMAX OFDMA, 1xEVDO, LTE, LTETDD, WLAN
Remote Command:	[:SENSE] :CHPower:FREQuency:SPAN:PREVious
Example:	CHP:FREQ:SPAN:PREV
Notes:	You must be in the W-CDMA mode, cdma2000 mode, LTD mode, LTE TDD mode, WLAN mode, 1xEVDO mode, or WIMAX OFDMA mode to use this command. Use :INSTrument:SELect to set the mode.
Couplings:	Selecting last span changes the measurement span value.
Initial S/W Revision:	Prior to A.02.00
Modified at S/W Revision:	A.02.00, A.03.00

Sweep/Control

Accesses a menu of functions that enable you to set up and control the sweep time and source for the current measurement. See “Sweep/Control” on page 1267 for more information.

Key Path:	Front-panel key
Initial S/W Revision:	Prior to A.02.00

Sweep Time

Selects the length of time that the spectrum analyzer sweeps the displayed frequency span. Additional overhead time, which impacts the sweep rate, is not calculated as part of the sweep time. In fact:

- sweep rate = span/sweep time
- update rate = 1/(sweep time + overhead)
- sweep cycle time = sweep time + overhead

Sweep time is coupled to RBW and VBW, and is impacted by the number of sweep points, so changing those parameters may change the sweep time.

Key Path:	Sweep/Control
Mode:	WCDMA, C2K, WIMAX OFDMA, 1xEVDO, LTE, LTETDD, WLAN
Remote Command:	[:SENSe]:CHPower:SWEep:TIME <time> [:SENSe]:CHPower:SWEep:TIME? [:SENSe]:CHPower:SWEep:TIME:AUTO OFF ON 0 1 [:SENSe]:CHPower:SWEep:TIME:AUTO?
Example:	CHP:SWE:TIME 25ms CHP:SWE:TIME? CHP:SWE:TIME:AUTO OFF CHP:SWE:TIME:AUTO?
Preset:	WIMAX OFDMA: Automatically Calculated WCDMA: 1.0 ms CDMA2K: 9.4ms 1xEVDO: 2.66ms LTE: Automatically Calculated LTETDD: Automatically Calculated WLAN: Automatically Calculated
State Saved:	Saved in instrument state.

Min:	1 ms
Max:	4000 s
Initial S/W Revision:	Prior to A.02.00
Modified at S/W Revision:	A.02.00, A.03.00

Sweep Setup

Accesses a menu that enables you to set the sweep state for the current measurement.

Key Path:	Sweep/Control
Initial S/W Revision:	Prior to A.02.00

Auto Sweep Time Rules

Switches the analyzer between normal and accuracy sweep states.

Setting **Auto Sweep Time** to **Accy** results in slower sweep times, usually about three times as long, but yields better amplitude accuracy for CW signals. The instrument amplitude accuracy specifications only apply when **Auto Sweep Time** is set to **Accy**.

Additional amplitude errors which occur when **Auto Sweep Time** is set to **Norm** are usually well under 0.1 dB, though this is not guaranteed. Because of the faster sweep times and still low errors, **Norm** is the preferred setting of **Auto Sweep Time**. **Auto Sweep Time** is set to **Norm** on a **Preset** or **Auto Couple**. This means that in the Preset or Auto Coupled state, instrument amplitude accuracy specifications do not apply.

Key Path:	Sweep/Control, Sweep Setup
Mode:	WCDMA, C2K, WIMAX OFDMA, 1xEVDO, LTE, LTETDD, WLAN
Remote Command:	[:SENSe] :CHPower:SWEep:TIME:AUTO:RULEs NORMal ACCuracy [:SENSe] :CHPower:SWEep:TIME:AUTO:RULEs?
Example:	CHP:SWE:TIME:AUTO:RUL NORM CHP:SWE:TIME:AUTO:RUL?
Notes:	In Zero Span, this key is irrelevant and inaccessible (because the whole Sweep Setup menu is grayed out in Zero Span), however its settings can be changed remotely with no error indication. Set to Norm when Auto Couple is pressed or sent remotely
Preset:	NORMal
State Saved:	Saved in instrument state.
Range:	Norm Accy
Initial S/W Revision:	Prior to A.02.00
Modified at S/W Revision:	A.02.00, A.03.00

Pause

Pauses a measurement after the current data acquisition is complete. When Paused, the label on the key changes to Resume. Pressing the Resume key resumes the measurement at the point it was at when paused. See [“Pause/Resume” on page 1279](#) for more details.

Key Path:	Sweep/Control
Initial S/W Revision:	Prior to A.02.00

Gate

Accesses a menu that enables you to control the gating function. See [“Gate ” on page 1280](#) in "Common Measurement Functions" section for more details.

The Gate functionality is used to view signals best viewed by qualifying them with other events.

Key Path:	Sweep/Control
Initial S/W Revision:	Prior to A.02.00

Points

Sets the number of points per sweep. The resolution of setting the sweep time depends on the number of points selected. If Preset is selected, the number of points per sweep defaults to 1001. The current value of points is displayed parenthetically, next to the sweep time in the lower-right corner of the display.

Changing the number of points has several effects on the analyzer. Since markers are read at the point location, the marker reading may change. All trace data is cleared.

Key Path:	Sweep/Control
Mode:	WCDMA, C2K, WIMAX OFDMA, 1xEVDO, LTE, LTETDD, WLAN
Remote Command:	[:SENSE] :CHPower:SWEep:POINTs <integer> [:SENSE] :CHPower:SWEep:POINTs?
Example:	CHP:SWE:POIN 501 CHP:SWE:POIN?
Notes:	Whenever the number of sweep points changes: All trace data is erased Any traces with Update Off also go to Display Off (like going from View to Blank in the older analyzers) Sweep time is re-quantized Any limit lines that are on are updated If averaging/hold is on, averaging/hold starts over

Channel Power Measurement
Sweep/Control

Couplings:	Whenever the number of sweep points changes, the sweep time is re-quantized.
Preset:	Other: 1001 1xEVDO: 512
State Saved:	Saved in instrument state.
Min:	101
Max:	20001
Initial S/W Revision:	Prior to A.02.00
Modified at S/W Revision:	A.02.00, A.03.00

Trace/Detector

Accesses a menu of functions that enable you to control the detectors for the current measurement.

Key Path:	Front-panel key
Initial S/W Revision:	Prior to A.02.00

Trace Type

Allows you to select the type of trace you want to use for the current measurement. The first page of this menu contains a 1-of-N selection of the trace type (**Clear Write, Average, Max Hold, Min Hold**) for the selected trace.

Key Path:	Trace/Detector
Mode:	WCDMA, C2K, WIMAX OFDMA, 1xEVDO, LTE, LTETDD, WLAN
Remote Command:	:TRACe:CHPower:TYPE WRITe AVERAge MAXHold MINHold :TRACe:CHPower:TYPE?
Example:	TRAC:CHP:TYPE WRIT TRAC:CHP:TYPE?
Notes:	WRITe = Clear Write AVERAge = Average MAXHold = Maximum Hold MINHold = Minimum Hold
Couplings:	When Detector setting is "Auto" (:SENSe]:CHPower:DETEctor:AUTO?), Detector (:SENSe]:CHPower:DETEctor[:FUNCTion]?) switches aligning with the switch of this parameter: "NORMal" with WRITe (Clear Write), "AVERAge" with AVERAge, "POSitive (peak)" with MAXHold, and "NEGative (peak)" with MINHold.
Preset:	AVERAge
State Saved:	Saved in instrument state.
Range:	ClearWrite Average MaxHold MinHold
Initial S/W Revision:	Prior to A.02.00
Modified at S/W Revision:	A.02.00, A.03.00

Detector

Accesses a menu of functions that enable you to control the detectors for the current measurement. The following choices are available:

Channel Power Measurement

Trace/Detector

- Auto- the detector selected depends on marker functions, trace functions, average type, and the trace averaging function.
- Normal-the detector determines the peak of the CW-like signals, and it yields alternating maximums and minimums of noise-like signals. This is also referred to as Rosenfell detection.
- Average-the detector determines the average of the signal within the sweep points. The averaging method depends upon the Average Type selection (voltage, power or log scales).
- Peak-the detector determines the maximum of the signal within the sweep points.
- Sample-the detector indicates the instantaneous level of the signal at the center of the sweep points represented by each display point.
- Negative Peak-the detector determines the minimum of the signal within the sweep points.

Key Path:	Detector
Initial S/W Revision:	Prior to A.02.00

Detector Selection

Selects a detector to be used by the analyzer for the current measurement.

Key Path:	Trace/Detector
Mode:	WCDMA, C2K, WIMAX OFDMA, 1xEVDO, LTE, LTETDD, WLAN
Remote Command:	[:SENSe] :CHPower:DETEctor [:FUNction] NORMal AVERage POSitive SAMPlE NEGative [:SENSe] :CHPower:DETEctor [:FUNction] ?
Example:	CHP:DET NORM CHP:DET?
Notes:	When you manually select a detector (instead of selecting Auto), that detector is used regardless of other analyzer settings. The Normal detector determines the peak of CW-like signals, and it yields alternating maximums and minimums of noise-like signals. This method of detection is also referred to as Rosenfell detection. The Average detector determines the average of the signal within the sweep points. The averaging method is Power Average (RMS). The Peak detector determines the maximum of the signal within the sweep points. The Sample detector indicates the instantaneous level of the signal at the center of the sweep points represented by each display point. The Negative Peak detector determines the minimum of the signal within the sweep points.

Couplings:	When Detector setting is “Auto” (:SENSe]:CHPower:DETECTOR:AUTO?), Detector (:SENSe]:CHPower:DETECTOR[:FUNCTION]?) switches aligning with the switch of this parameter: “NORMal” with Clear Write, “AVERage” with AVERage, “POSitive (peak)” with MAXHold, and “NEGative (peak)” with MINHold.
Preset:	AVERage
State Saved:	Saved in instrument state.
Range:	Normal Average Peak Sample Negative Peak
Initial S/W Revision:	Prior to A.02.00
Modified at S/W Revision:	A.02.00, A.03.00

Auto

Sets the detector for the currently selected trace to Auto.

Key Path:	Trace/Detector
Mode:	WCDMA, C2K, WIMAX OFDMA, 1xEVDO, LTE, LTETDD, WLAN
Remote Command:	[:SENSe] :CHPower:DETECTOR:AUTO ON OFF 1 0 [:SENSe] :CHPower:DETECTOR:AUTO?
Example:	CHP:DET:AUTO ON CHP:DET:AUTO?
Couplings:	When Detector setting is “Auto” (:SENSe]:CHPower:DETECTOR:AUTO?), Detector (:SENSe]:CHPower:DETECTOR[:FUNCTION]?) switches aligning with the switch of this parameter: “NORMal” with Clear Write, “AVERage” with AVERage, “POSitive (peak)” with MAXHold, and “NEGative (peak)” with MINHold.
Preset:	ON
State Saved:	Saved in instrument state.
Initial S/W Revision:	Prior to A.02.00
Modified at S/W Revision:	A.02.00, A.03.00

Trigger

Accesses a menu of functions that enable you to select and control the trigger source for the current measurement.

See [“Trigger” on page 1339](#) for more information.

Key Path:	Front-panel key
Initial S/W Revision:	Prior to A.02.00

View/Display

Accesses a menu of functions that enable you to control the instrument display as well as turn the bar graph On and Off.

The results of the measurement can be displayed as a single spectrum trace view or displayed with a Bar Graph trace on the spectrum trace.

Spectrum View with Bar Graph off

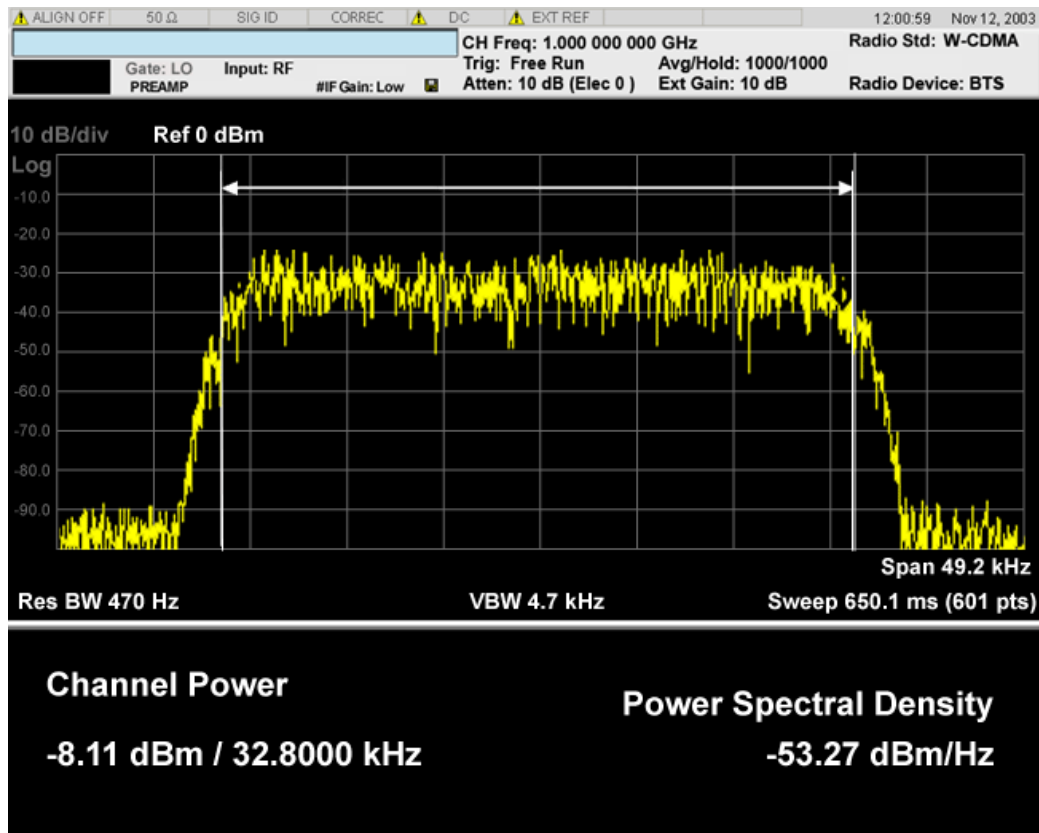

Spectrum View with Bar Graph on

This View is the same as the 'Spectrum' view, but has a blue bar between the markers that indicates the measured output power level. The bar graph is activated when the "Bar Graph" Soft Key is set to ON under the View/Display menu. The actual measured output power level is displayed on the display at the bottom of the bar.

Channel Power Measurement
View/Display

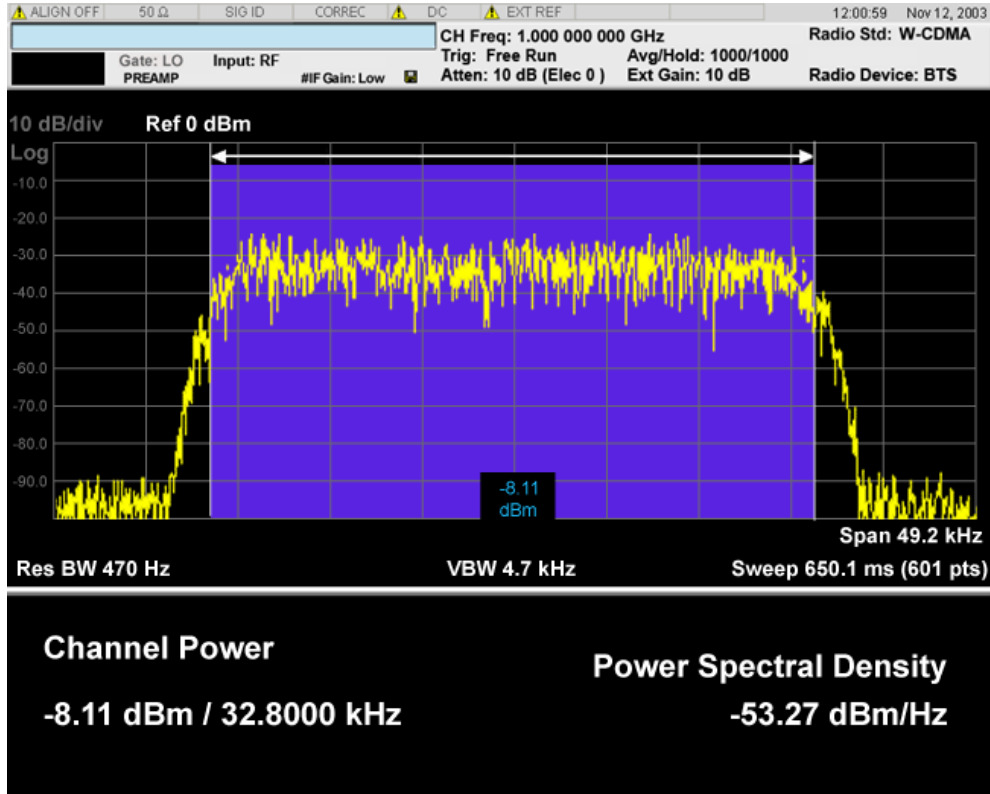

If the current mode is WLAN and the format is WLAN 802.11ac 80+80 MHz, the spectrum view is changed a little so that the results of both carrier segments can be displayed.

Spectrum View with Bar Graph off for WLAN 802.11ac (80 + 80 MHz):

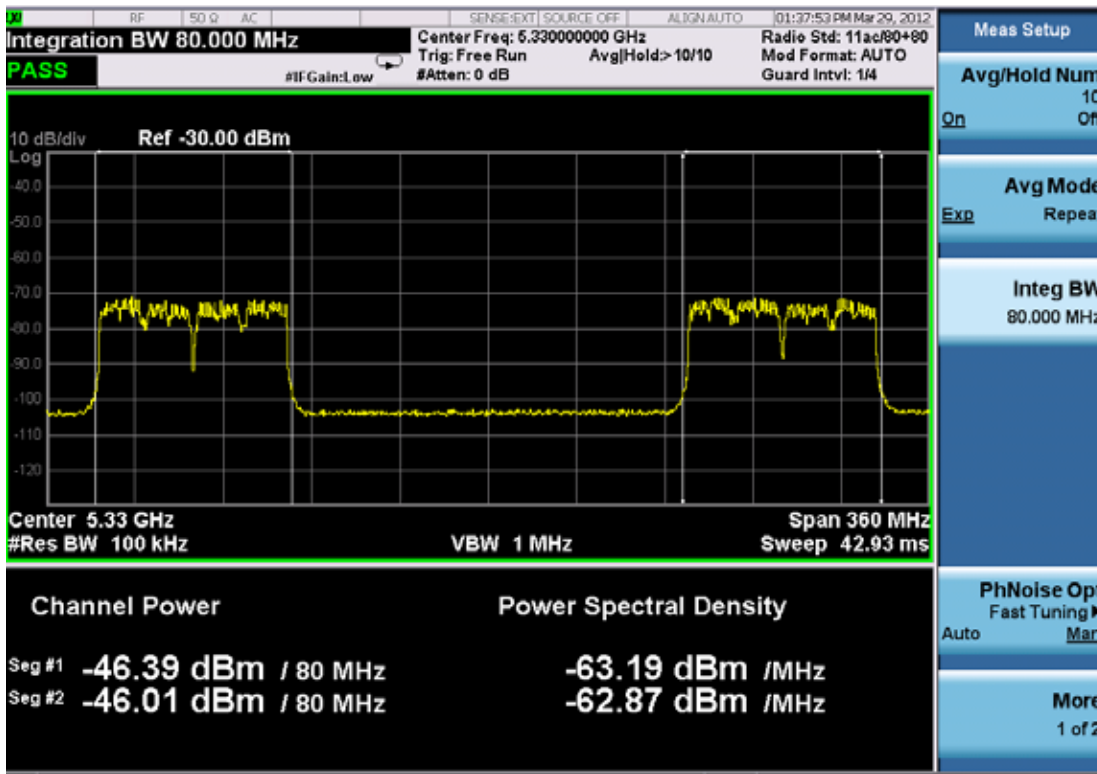

Spectrum View with Bar Graph on for WLAN 802.11ac (80 + 80 MHz):

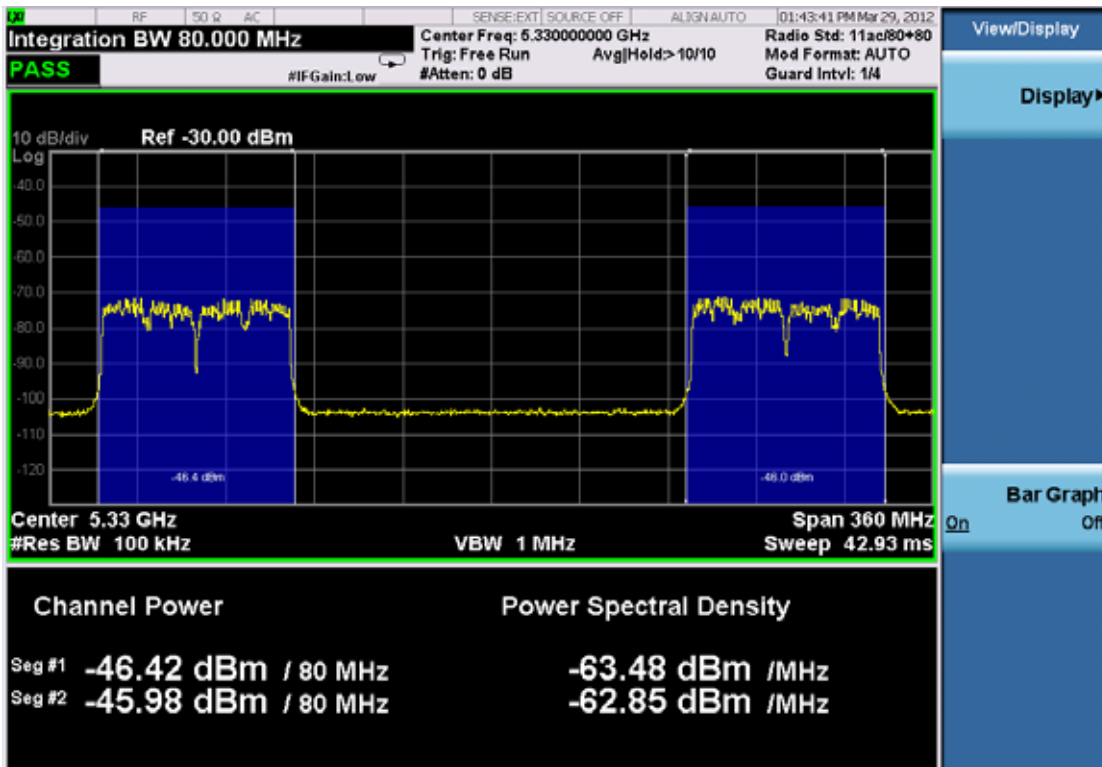

Channel Power Measurement

View/Display

Power Results:

The spectrum trace and power bars are displayed in the upper window. Total carrier power, total PSD and total format carrier power are displayed in the lower window. Total format carrier power is total power of carriers of the same Radio Format. If there is no carrier of the corresponding format, it is not displayed. Thus items in the total format power table changes depending on the carrier configuration.

Carrier Info:

The lower window of Power Results view is replaced by the carrier info table in this view. Carrier center frequency can be displayed in either offset or absolute frequency depending on Carrier Freq. The table can be scrolled by Carrier Result on Meas Setup menu or by Select Carrier on Config Carriers menu. The highlighted row changes as either Carrier Result or Select Carrier is changed. The highlighted row and these keys are not coupled.

Key Path:	Front-panel key
Initial S/W Revision:	Prior to A.02.00

Display

Accesses a menu of functions that enable you to set the display parameters.

See “[Display](#)” on page 1393 for more information.

Key Path:	View/Display
Initial S/W Revision:	Prior to A.02.00

Bar Graph

Turns the Bar Graph On and Off.

Key Path:	View/Display
Mode:	WCDMA, C2K, WIMAX OFDMA, 1xEVDO, LTE, LTETDD, WLAN
Remote Command:	:DISPlay:CHPower:VIEW[1]:WINDow[1]:BGRaph ON OFF 1 0 :DISPlay:CHPower:VIEW[1]:WINDow[1]:BGRaph?
Example:	DISP:CHP:VIEW:WIND:BGR ON DISP:CHP:VIEW:WIND:BGR?
Notes:	You must be in the W-CDMA mode, cdma2000 mode, LTD mode, LTE TDD mode, WLAN mode, 1xEVDO mode, or WIMAX OFDMA mode to use this command. Use :INSTrument:SELEct to set the mode.
Preset:	OFF
State Saved:	Saved in instrument state.
Range:	On Off
Initial S/W Revision:	Prior to A.02.00

Modified at S/W Revision:	A.02.00, A.03.00
---------------------------	------------------

ACP is a measurement of the amount of interference, or power, in an adjacent frequency channel. The results are displayed as a bar graph or as spectrum data, with measurement data at specified offsets. For measurement results and views, see [“View/Display” on page 465](#).

This topic contains the following sections:

[“Measurement Commands for ACP” on page 375](#)

[“Remote Command Results for ACP Measurement” on page 375](#)

Measurement Commands for ACP

The following commands are used to retrieve the measurement results:

:CONFigure:ACP

:CONFigure:ACP:NDEFault

:INITiate:ACP

:FETCh:ACP [n] ?

:READ:ACP [n] ?

:MEASure:ACP [n] ?

For more measurement related commands, see the SENSE subsystem, and the section [“Remote Measurement Functions” on page 1031](#).

Remote Command Results for ACP Measurement

Condition	N	Results Returned
-----------	---	------------------

<p>Meas Type = Total power reference</p>	<p>Not specified or n = 1</p>	<p>Returns 28 comma-separated scalar results, in the following order.</p> <ol style="list-style-type: none"> 1. 0.0 2. Total carrier power (dBm) 3. 0.0 4. Reference carrier power (dBm) 5. Lower offset A - relative power (dB) 6. Lower offset A - absolute power (dBm) 7. Upper offset A - relative power (dB) 8. Upper offset A - absolute power (dBm) 9. Lower offset B - relative power (dB) 10. Lower offset B - absolute power (dBm) 11. Upper offset B - relative power (dB) 12. Upper offset B - absolute power (dBm) ... 25. Lower offset F - relative power (dB) 26. Lower offset F - absolute power (dBm) 27. Upper offset F - relative power (dB) 28. Upper offset F - absolute power (dBm) <p>If the results are not available, -999.0 is returned.</p>
--	-----------------------------------	---

Meas Type = Power spectral density reference	not specified or n = 1	<p>Returns 28 comma-separated scalar results, in the following order.</p> <ol style="list-style-type: none"> 1. 0.0 2. Total carrier power (dBm/Hz or dBm/MHz) 3. 0.0 4. Reference carrier power (dBm/Hz or dBm/MHz) 5. Lower offset A - relative power (dB) 6. Lower offset A - absolute power (dBm/Hz or dBm/MHz) 7. Upper offset A - relative power (dB) 8. Upper offset A - absolute power (dBm/Hz or dBm/MHz) 9. Lower offset B - relative power (dB) 10. Lower offset B - absolute power (dBm/Hz or dBm/MHz) 11. Upper offset B - relative power (dB) 12. Upper offset B - absolute power (dBm/Hz or dBm/MHz) ... 25. Lower offset F - relative power (dB) 26. Lower offset F - absolute power (dBm/Hz or dBm/MHz) 27. Upper offset F - relative power (dB) 28. Upper offset F - absolute power (dBm/Hz or dBm/MHz) <p>If the results are not available, -999.0 is returned.</p>
Meas Method = FAST	not specified or n = 1	<p>Returns 5 comma-separated results, in the following order:</p> <ol style="list-style-type: none"> 1. Reference carrier - absolute power (dBm) 2. Lower offset A - absolute power (dBm) 3. Upper offset A - absolute power (dBm) 4. Lower offset B - absolute power (dBm) 5. Upper offset B - absolute power (dBm)

<p>Meas Type = Total power reference</p>	<p>n = 2</p>	<p>Returns 48 scalar results, in the following order:</p> <ol style="list-style-type: none"> 1. Channel (1) - relative power (dB) 2. Channel (1) - absolute power (dBm) 3. Channel (2) - relative power (dB) 4. Channel (2) - absolute power (dBm) ... 23. Channel (12) - relative power (dB) 24. Channel (12) - absolute power (dBm) 25. Lower offset A - relative power (dB) 26. Lower offset A - absolute power (dBm) 27. Upper offset A - relative power (dB) 28. Upper offset A - absolute power (dBm) 29. Lower offset B - relative power (dB) 30. Lower offset B - absolute power (dBm) 31. Upper offset B - relative power (dB) 32. Upper offset B - absolute power (dBm) ... 45. Lower offset F - relative power (dB) 46. Lower offset F - absolute power (dBm) 47. Upper offset F - relative power (dB) 48. Upper offset F - absolute power (dBm) <p>If the results are not available, -999.0 is returned.</p>
--	--------------	--

Meas Type = Power spectral density reference	n = 2	<p>Returns 48 scalar results, in the following order:</p> <ol style="list-style-type: none"> 1. Channel (1) - relative power (dB) 2. Channel (1) - absolute power (dBm/Hz or dBm/MHz) 3. Channel (2) - relative power (dB) 4. Channel (2) - absolute power (dBm/Hz or dBm/MHz) ... 23. Channel (12) - relative power (dB) 24. Channel (12) - absolute power (dBm/Hz or dBm/MHz) 25. Lower offset A - relative power (dB) 26. Lower offset A - absolute power (dBm/Hz or dBm/MHz) 27. Upper offset A - relative power (dB) 28. Upper offset A - absolute power (dBm/Hz or dBm/MHz) 29. Lower offset B - relative power (dB) 30. Lower offset B - absolute power (dBm/Hz or dBm/MHz) 31. Upper offset B - relative power (dB) 32. Upper offset B - absolute power (dBm/Hz or dBm/MHz) ... 45. Lower offset F - relative power (dB) 46. Lower offset F - absolute power (dBm/Hz or dBm/MHz) 47. Upper offset F - relative power (dB) 48. Upper offset F - absolute power (dBm/Hz or dBm/MHz) <p>If the results are not available, -999.0 is returned.</p>
---	-------	--

<p>Meas Type = Total power reference</p>	<p>n = 3</p>	<p>Returns 24 scalar values of the pass/fail (0 = passed, or 1 = failed) determined by testing the relative to the reference carrier and by testing the absolute power limit of the offset frequencies (measured as total power in dB):</p> <ol style="list-style-type: none"> 1. Lower offset A - relative limit result 2. Lower offset A - absolute limit result 3. Upper offset A - relative limit result 4. Upper offset A - absolute limit result 5. Lower offset B - relative limit result 6. Lower offset B - absolute limit result 7. Upper offset B - relative limit result 8. Upper offset B - absolute limit result ... 21 Lower offset F - relative limit result 22 Lower offset F - absolute limit result 23 Upper offset F - relative limit result 24 Upper offset F - absolute limit result
<p>Meas Type = Power spectral density reference</p>	<p>n = 3</p>	<p>Returns 24 scalar values of the pass/fail (0 = passed, or 1 = failed) determined by testing the relative to the reference carrier and by testing the absolute power limit of the offset frequencies (measured as power spectral density in dB):</p> <ol style="list-style-type: none"> 1. Lower offset A - relative limit result 2. Lower offset A - absolute limit result 3. Upper offset A - relative limit result 4. Upper offset A - absolute limit result 5. Lower offset B - relative limit result 6. Lower offset B - absolute limit result 7. Upper offset B - relative limit result 8. Upper offset B - absolute limit result ... 21 Lower offset F - relative limit result 22 Lower offset F - absolute limit result 23 Upper offset F - relative limit result 24 Upper offset F - absolute limit result
	<p>n = 4</p>	<p>Returns <Num Pts> comma-separated scalar values representing the Y values in Trace 1</p>
	<p>n = 5</p>	<p>Returns <Num Pts> comma-separated scalar values representing the Y values in Trace 2</p>

	n = 6	Returns <Num Pts> comma-separated scalar values representing the Y values in Trace 3
Meas Type = Total power reference	n = 7	<p>Returns (2 * numberOfCarriers) scalar results, in the following order:</p> <p>The numberOfCarriers is the value filled in Carriers under Carrier Setup menu. If license N9060A-5FP is enabled, max value of numberOfCarriers is 18, otherwise, max value of numberOfCarriers is 12.</p> <ol style="list-style-type: none"> 1. Channel (1) - relative power (dB) 2. Channel (1) - absolute power (dBm) 3. Channel (2) - relative power (dB) 4. Channel (2) - absolute power (dBm) <p>...</p> <p>2 * numberOfCarriers -1. Channel (numberOfCarriers) - relative power (dB)</p> <p>2 * numberOfCarriers. Channel (numberOfCarriers) - absolute power (dBm)</p> <p>If the results are not available, 9.91E+37 is returned.</p>
Meas Type = Power spectral density reference	n = 7	<p>Returns (2 * numberOfCarriers) scalar results, in the following order:</p> <p>The numberOfCarriers is the value filled in Carriers under Carrier Setup menu.</p> <p>If license N9060A-5FP is enabled, max value of numberOfCarriers is 18, otherwise, max value of numberOfCarriers is 12.</p> <ol style="list-style-type: none"> 1. Channel (1) - relative power (dB) 2. Channel (1) - absolute power (dBm/Hz or dBm/MHz) 3. Channel (2) - relative power (dB) 4. Channel (2) - absolute power (dBm/Hz or dBm/MHz) <p>...</p> <p>2 * numberOfCarriers -1. Channel (numberOfCarriers) - relative power (dB)</p> <p>2 * numberOfCarriers. Channel (numberOfCarriers) - absolute power (dBm/Hz or dBm/MHz)</p> <p>If the results are not available, 9.91E+37 is returned</p>

Key Path	Front-panel key
Initial S/W Revision	Prior to A.02.00

AMPTD Y Scale

Accesses a menu of functions that enable you to set the vertical scale parameters. The parameter values are measurement independent, except all Attenuation values and the Internal Preamp selections, which are the same across all measurements.

Key Path	Front-panel key
Initial S/W Revision	Prior to A.02.00

Ref Value

Sets the value for the absolute power reference. However, since the Auto Scaling is defaulted to On, this value is automatically determined by the measurement result. When you set a value manually, Auto Scaling automatically changes to Off.

Key Path	AMPTD Y Scale
Mode	WCDMA, C2K, WIMAX OFDMA, TD-SCDMA, 1xEVDO, LTE, LTETDD
Remote Command	:DISPlay:ACPower:VIEW[1]:WINDow[1]:TRACe:Y[:SCALE]:RLEV el <real> :DISPlay:ACPower:VIEW[1]:WINDow[1]:TRACe:Y[:SCALE]:RLEV el?
Example	DISP:ACP:VIEW:WIND:TRAC:Y:RLEV 100 DISP:ACP:VIEW:WIND:TRAC:Y:RLEV?
Notes	You must be in the mode that includes ACP measurements to use this command. Use :INSTrument:SELEct to set the mode.
Couplings	When the Auto Scaling is On, this value is automatically determined by the measurement result. When you set a value manually, Auto Scaling automatically changes to Off.
Preset	-30 dBm
State Saved	Saved in instrument state.
Min	-250.00 dBm
Max	250.00 dBm
Initial S/W Revision	Prior to A.02.00
Modified at S/W Revision	A.02.00, A.03.00

Attenuation

Accesses a menu of functions that enable you to change attenuation settings. This key has read-back text that describes the total attenuator value.

See AMPTD Y Scale, “Attenuation” on page 850 in the section for more information.

Key Path	AMPTD Y Scale
Initial S/W Revision	Prior to A.02.00

Scale/Div

Sets the units-per-division of the vertical scale in the logarithmic display. However, since the Auto Scaling is defaulted to On, this value is automatically determined by the measurement result. When you set a value manually, Auto Scaling automatically changes to Off.

Key Path	AMPTD Y Scale
Mode	WCDMA, C2K, WIMAX OFDMA, TD-SCDMA, 1xEVDO, LTE, LTETDD
Remote Command	:DISPlay:ACPower:VIEW[1]:WINDow[1]:TRACe:Y[:SCALe]:PDIVision <rel_ampl> :DISPlay:ACPower:VIEW[1]:WINDow[1]:TRACe:Y[:SCALe]:PDIVision?
Example	DISP:ACP:VIEW:WIND:TRAC:Y:PDIV 5 DISP:ACP:VIEW:WIND:TRAC:Y:PDIV?
Notes	You must be in the mode that includes ACP measurements to use this command. Use :INSTrument:SELEct to set the mode.
Couplings	When the Auto Scaling is On, this value is automatically determined by the measurement result. When you set a value manually, Auto Scaling automatically changes to Off.
Preset	10.00 dB
State Saved	Saved in instrument state.
Min	0.10 dB
Max	20.00 dB
Initial S/W Revision	Prior to A.02.00
Modified at S/W Revision	A.02.00, A.03.00

Y Axis Unit

Allows you to change the vertical (Y) axis amplitude unit.

See “Y Axis Unit” on page 871 under AMPTD Y Scale for more information.

Parameter Name	Y Axis Unit
Key Path	AMPTD/Y Scale
Initial S/W Revision	A.04.00

Internal Preamp

Accesses a menu of functions that enable you to control the internal preamplifiers.

See AMPTD Y Scale, “[Internal Preamp](#)” on page 883 for more information.

Key Path	AMPTD Y Scale
Initial S/W Revision	Prior to A.02.00

Ref Position

Positions the reference level at the top, center, or bottom of the Y- scale display. Changing the reference position does not change the reference level value.

Key Path	AMPTD Y Scale
Mode	WCDMA, C2K, WIMAX OFDMA, TD-SCDMA, 1xEVDO, LTE, LTETDD
Remote Command	:DISPlay:ACPower:VIEW[1]:WINDow[1]:TRACe:Y[:SCALe]:RPOS ition TOP CENTer BOTTom :DISPlay:ACPower:VIEW[1]:WINDow[1]:TRACe:Y[:SCALe]:RPOS ition?
Example	DISP:ACP:VIEW:WIND:TRAC:Y:RPOS CENT DISP:ACP:VIEW:WIND:TRAC:Y:RPOS?
Notes	You must be in the mode that includes ACP measurements to use this command. Use :INSTrument:SELEct to set the mode.
Preset	TOP
State Saved	Saved in instrument state.
Range	Top Ctr Bot
Initial S/W Revision	Prior to A.02.00
Modified at S/W Revision	A.02.00, A.03.00

Auto Scaling

Toggles the Auto Scaling function between On and Off.

Key Path	AMPTD Y Scale
Mode	WCDMA, C2K, WIMAX OFDMA, TD-SCDMA, 1xEVDO, LTE, LTETDD
Remote Command	:DISPlay:ACPower:VIEW[1]:WINDow[1]:TRACe:Y[:SCALe]:COUP le 0 1 OFF ON :DISPlay:ACPower:VIEW[1]:WINDow[1]:TRACe:Y[:SCALe]:COUP le?

Example	DISP:ACP:VIEW:WIND:TRAC:Y:COUP ON DISP:ACP:VIEW:WIND:TRAC:Y:COUP?
Notes	You must be in the mode that includes ACP measurements to use this command. Use :INSTrument:SELEct to set the mode.
Couplings	When Auto Scaling is On and the Restart front-panel key is pressed, this function automatically determines the scale per division and reference values based on the measurement results. When you set a value to either Scale/Div or Ref Value manually, Auto Scaling automatically changes to Off.
Preset	ON
State Saved	Saved in instrument state.
Range	On Off
Initial S/W Revision	Prior to A.02.00
Modified at S/W Revision	A.02.00, A.03.00

Auto Couple

See “[Auto Couple](#)” on page 887 for more information.

Key Path	Front-panel key
Initial S/W Revision	Prior to A.02.00

BW

Accesses a menu of functions that enable you to specify and control the video and resolution bandwidths. You can also select the type of filter for the measurement and set the filter bandwidth.

Key Path	Front-panel key
Initial S/W Revision	Prior to A.02.00

Res BW

Sets the value of the resolution bandwidth. If an unavailable bandwidth is entered with the numeric keypad, the closest available bandwidth is selected.

Key Path	BW
Mode	WCDMA, C2K, WIMAX OFDMA, TD-SCDMA, 1xEVDO, LTE, LTETDD
Remote Command	[:SENSE]:ACPower:BANDwidth[:RESolution] <bandwidth> [:SENSE]:ACPower:BANDwidth[:RESolution]? [:SENSE]:ACPower:BANDwidth[:RESolution]:AUTO ON OFF 1 0 [:SENSE]:ACPower:BANDwidth[:RESolution]:AUTO?
Example	ACP:BAND 25kHz ACP:BAND? ACP:BAND:AUTO ON ACP:BAND:AUTO?
Notes	This key is available only in IBW mode. This parameter is preset by the Meas Method selection. Preset values are as follows: IBW: 100 kHz IBWR: 27 kHz FAST (WCDMA): 390 kHz You must be in the mode that includes ACP measurements to use this command. Use :INSTRument:SElect to set the mode.
Couplings	The resolution bandwidth is coupled to the video bandwidth based on the video to resolution bandwidth ratio setting if AUTO is selected.

ACP Measurement
BW

Preset	WCDMA: 100 kHz WIMAX OFDMA: 100 kHz C2K: Method RBW: grayed out(1.2 MHz) Method IBW: 15 kHz TD-SCDMA: 30 kHz 1xEVDO: 30 kHz LTE: 100 kHz LTETDD: 100 kHz 0
State Saved	Saved in instrument state.
Min	1 Hz
Max	8 MHz
Initial S/W Revision	Prior to A.02.00
Modified at S/W Revision	A.02.00, A.03.00

Video BW

Changes the test set post-detection filter (VBW).

Key Path	BW
Mode	WCDMA, C2K, WIMAX OFDMA, TD-SCDMA, 1xEVDO, LTE, LTETDD
Remote Command	[:SENSe] :ACPower:BA NDwidth:VIDeo <freq> [:SENSe] :ACPower:BA NDwidth:VIDeo? [:SENSe] :ACPower:BA NDwidth:VIDeo:AUTO OFF ON 0 1 [:SENSe] :ACPower:BA NDwidth:VIDeo:AUTO?
Example	ACP:BA ND:VID 1kHz ACP:BA ND:VID? ACP:BWID:VID:AUTO ON ACP:BWID:VID:AUTO?
Notes	The values shown in this table reflect the conditions after a Mode Preset.

Preset	WCDMA, WIMAX OFDMA: 1 MHz C2K: Method RBW: grayed out(1.2 MHz) Method IBW: 150 kHz TD-SCDMA: 300 kHz 1xEVDO: 300 kHz LTE: 1 MHz LTETDD: 1 MHz SA: ON WCDMA: OFF WIMAX OFDMA: OFF TD-SCDMA: OFF CDMA1xEVDO: OFF LTE: ON LTETDD: ON
State Saved	Saved in instrument state.
Min	1 Hz
Max	50 MHz
Backwards Compatibility SCPI	[:SENSe]:ACPower:BWIDth:VIDeo
Initial S/W Revision	Prior to A.02.00
Modified at S/W Revision	A.02.00, A.03.00

RBW Control

Accesses a menu that enables you to select the filter bandwidth and type.

Key Path	BW
Initial S/W Revision	Prior to A.02.00

Filter Type

Selects the type of bandwidth filter that is used. The choices are Gaussian or Flat top.

Key Path	BW, RBW Control
Mode	WCDMA, C2K, WIMAX OFDMA, TD-SCDMA, 1xEVDO, LTE, LTETDD
Remote Command	[:SENSe]:ACPower:BANDwidth:SHAPE GAUSSian FLATtop [:SENSe]:ACPower:BANDwidth:SHAPE?

ACP Measurement
BW

Example	ACP:BAND:SHAP GAUS ACP:BAND:SHAP?
Preset	GAUSSian C2K: FLATtop
State Saved	Saved in instrument state.
Range	Gaussian (Normal) Flattop
Backwards Compatibility SCPI	[:SENSe]:ACPower:BWIDth:SHAPE
Initial S/W Revision	Prior to A.02.00
Modified at S/W Revision	A.02.00, A.03.00

Filter BW

Selects a Gaussian filter based on its -3 dB (Normal) bandwidth or its -6 dB bandwidth.

Key Path	BW, RBW Control
Mode	WCDMA, C2K, WIMAX OFDMA, TD-SCDMA, 1xEVDO, LTE, LTETDD
Remote Command	[:SENSe]:ACPower:BAWIDth:TYPE DB3 DB6 [:SENSe]:ACPower:BAWIDth:TYPE?
Example	ACP:BAND:TYPE DB3 ACP:BAND:TYPE?
Dependencies	When Filter Type is Flattop or Meas Method is RBW or FAST, this key is grayed out and disabled. If the key is pressed, an advisory message is generated. If the equivalent remote command is sent, a "Setting conflict" warning is generated.
Preset	DB3
State Saved	Saved in instrument state.
Range	-3 dB (Normal) -6 dB
Backwards Compatibility SCPI	[:SENSe]:ACPower:BWIDth:TYPE
Initial S/W Revision	Prior to A.02.00
Modified at S/W Revision	A.02.00, A.03.00

Cont

See “Cont (Continuous Measurement/Sweep)” on page 901 for more information.

Key Path	Front-panel key
Initial S/W Revision	Prior to A.02.00

FREQ Channel

See “[FREQ Channel](#)” on page 903 for more information.

Key Path	Front-panel key
Initial S/W Revision	Prior to A.02.00

Input/Output

See [“Input/Output” on page 921](#) for more information.

Key Path	Front-panel key
Initial S/W Revision	Prior to A.02.00

Marker

Accesses a menu that enables you to select, set up and control the markers for the current measurement. Note that this key and all sub keys are unavailable when “[Meas Method](#)” on page 433 is set to RBW

Key Path	Front-panel key
Initial S/W Revision	Prior to A.02.00

Select Marker

Displays 12 markers available for selection. Note that this key and all sub keys are unavailable when “[Meas Method](#)” on page 433 is set to RBW

Key Path	Marker
Initial S/W Revision	Prior to A.02.00

Marker Type

Sets the marker control mode to **Normal**, **Delta**, **Fixed** or **Off**. All interactions and dependencies detailed under the key description are enforced when the remote command is sent. If the selected marker is Off, pressing Marker sets it to Normal and places it at the center of the screen on the trace determined by the **Marker Trace** rules. At the same time, **Marker X Axis Value** appears on the Active Function area.

The default active function is the active function for the currently selected marker control mode. If the current control mode is Off, there is no active function and the active function is turned off.

Key Path	Marker
Mode	WCDMA, C2K, WIMAX OFDMA, TD-SCDMA, 1xEVDO, LTE, LTETDD
Remote Command	:CALCulate:ACPower:MARKer [1] 2 3 4 5 6 7 8 9 10 11 12 :M ODE POSition DELTa OFF :CALCulate:ACPower:MARKer [1] 2 3 4 5 6 7 8 9 10 11 12 :M ODE?
Example	CALC:ACP:MARK2:MODE DELT CALC:ACP:MARK2:MODE?

Notes	<p>If the selected marker is Off, pressing Marker sets it to Normal and places it at the center of the screen on the trace determined by the Marker Trace rules. At the same time, Marker X Axis Value appears on the Active Function area.</p> <p>Default Active Function: the active function for the selected marker's current control mode. If the current control mode is Off, there is no active function and the active function is turned off.</p> <p>Active Function Display: the marker X axis value entered in the active function area will display the marker value to its full entered precision.</p> <p>You must be in the mode that includes ACP measurements to use this command. Use :INSTrument:SElect to set the mode.</p>
Preset	OFF OFF OFF OFF OFF OFF OFF OFF OFF OFF OFF OFF
State Saved	Saved in instrument state.
Range	Normal Delta Off
Initial S/W Revision	Prior to A.02.00
Modified at S/W Revision	A.02.00, A.03.00

Marker X Axis Value (Remote Command Only)

Sets the marker X axis value in the current marker X Axis Scale unit. This value has no effect if the control mode is **Off**, but is the SCPI equivalent of entering an X value if the control mode is **Normal**, **Delta** or **Fixed**.

Mode	WCDMA, C2K, WIMAX OFDMA, TD-SCDMA, 1xEVDO, LTE, LTETDD
Remote Command	<pre>:CALCulate:ACPower:MARKer [1] 2 3 4 5 6 7 8 9 10 11 12 : X <freq> :CALCulate:ACPower:MARKer [1] 2 3 4 5 6 7 8 9 10 11 12 : X ?</pre>
Example	<pre>CALC:ACP:MARK3:X 0 CALC:ACP:MARK3:X?</pre>
Notes	The query returns the marker's absolute X Axis value if the control mode is Normal , or the offset from the marker's reference marker if the control mode is Delta . If the marker is Off the response is not a number.
Dependencies	Unavailable when " Meas Method " on page 433 is set to RBW.
Preset	After a preset, all Markers are turned OFF, so Marker X Axis Value query will return a not a number (NAN).
State Saved	No
Min	-9.9E+37
Max	9.9E+37
Initial S/W Revision	Prior to A.02.00

Modified at S/W Revision	A.02.00, A.03.00
--------------------------	------------------

Marker X Axis Position (Remote Command Only)

Sets the marker X position in trace points. It has no effect if the control mode is **Off**, but is the SCPI equivalent of entering a value if the control mode is **Normal**, **Delta** or **Fixed**. The entered value is immediately translated into the current X Axis Scale units for setting the value of the marker.

Mode	WCDMA, C2K, WIMAX OFDMA, TD-SCDMA, 1xEVDO, LTE, LTETDD
Remote Command	:CALCulate:ACPower:MARKer [1] 2 3 4 5 6 7 8 9 10 11 12 :X :POSition <real> :CALCulate:ACPower:MARKer [1] 2 3 4 5 6 7 8 9 10 11 12 :X :POSition?
Example	CALC:ACP:MARK10:X:POS 0 CALC:ACP:MARK10:X:POS?
Notes	The query returns the marker's absolute X Axis value in trace points if the control mode is Normal , or the offset from the marker's reference marker in trace points if the control mode is Delta . The value is returned as a real number, not an integer, corresponding to the translation from X Axis Scale units to trace points (see "Fractional Trace Points"). If the marker is Off the response is not a number. When a Marker is turned on, it is placed center of the screen on the trace. Therefore the default value depends on instrument condition, although the Preset/Default is defined as 500 (this value might be expected value when all offset is on).
Dependencies	Unavailable when " Meas Method " on page 433 is set to RBW.
Preset	After a preset, all Markers are turned OFF, so Marker X Axis Value query will return a not a number (NAN).
State Saved	No
Min	-9.9E+37
Max	9.9E+37
Initial S/W Revision	Prior to A.02.00
Modified at S/W Revision	A.02.00, A.03.00

Marker Y Axis Value (Remote Command Only)

Returns the marker Y axis value in the current marker Y axis unit.

Mode	WCDMA, C2K, WIMAX OFDMA, TD-SCDMA, 1xEVDO, LTE, LTETDD
Remote Command	:CALCulate:ACPower:MARKer [1] 2 3 4 5 6 7 8 9 10 11 12 :Y?
Example	CALC:ACP:MARK11:Y?

Notes	Since the result value is always calculated from acquisition data, the default value is arbitrary. Although the Preset/Default values are defined.
Dependencies	Unavailable when “Meas Method” on page 433 is set to RBW.
Preset	Result dependent on markers setup and signal source.
State Saved	No
Backwards Compatibility SCPI	:CALCulate:ACPower:MARKer[1] 2 3 4 5 6 7 8 9 10 11 12:FUNcTion:RESult?
Initial S/W Revision	Prior to A.02.00
Modified at S/W Revision	A.02.00, A.03.00

Properties

Accesses the marker properties menu. Note that this key is unavailable when “Meas Method” on page 433 is set to RBW.

Key Path	Marker
Initial S/W Revision	Prior to A.02.00

Select Marker

Displays 12 markers available for selection. Note that this key is unavailable when “Meas Method” on page 433 is set to RBW

Key Path	Marker
Initial S/W Revision	Prior to A.02.00

Relative To

Selects the desired marker. The selected marker will be relative to its reference marker.

Key Path	Marker, Properties
Mode	WCDMA, C2K, WIMAX OFDMA, TD-SCDMA, 1xEVDO, LTE, LTETDD
Remote Command	:CALCulate:ACPower:MARKer[1] 2 3 4 5 6 7 8 9 10 11 12:REFerence <integer> :CALCulate:ACPower:MARKer[1] 2 3 4 5 6 7 8 9 10 11 12:REFerence?
Example	CALC:ACP:MARK2:REF 6 CALC:ACP:MARK2:REF?

Notes	<p>A marker cannot be relative to itself so that choice is grayed out, and if sent from SCPI generates error –221: “Settings conflict; marker cannot be relative to itself.”</p> <p>When queried a single value will be returned (the specified marker numbers relative marker).</p> <p>You must be in the mode that includes ACP measurements to use this command. Use :INSTrument:SELEct to set the mode.</p>
Dependencies	Unavailable when “Meas Method” on page 433 is set to RBW.
Preset	2 3 4 5 6 7 8 9 10 11 12 1
State Saved	Saved in instrument state.
Min	1
Max	12
Initial S/W Revision	Prior to A.02.00
Modified at S/W Revision	A.02.00, A.03.00

Marker Trace

Selects the trace that you want your marker to be placed on. A marker is associated with one and only one trace. This trace is used to determine the placement, result, and X Axis Scale of the marker. All markers have an associated trace, even **Fixed** markers; it is from that trace that they determine their attributes and behaviors, and it is to that trace that they go when they become Normal or Delta markers.

Key Path	Marker, Properties
Mode	WCDMA, C2K, WIMAX OFDMA, TD-SCDMA, 1xEVDO, LTE, LTETDD
Remote Command	<p>:CALCulate:ACPower:MARKer [1] 2 3 4 5 6 7 8 9 10 11 12 : TRACe 1 2 3</p> <p>:CALCulate:ACPower:MARKer [1] 2 3 4 5 6 7 8 9 10 11 12 : TRACe?</p>
Example	<p>CALC:ACP:MARK2:TRAC 2</p> <p>CALC:ACP:MARK2:TRAC?</p>
Notes	<p>If the selected marker is Off, pressing Marker sets it to Normal and places it at the center of the screen on the trace determined by the Marker Trace rules. At the same time, Marker X Axis Value appears on the Active Function area.</p> <p>Default Active Function: the active function for the selected marker’s current control mode. If the current control mode is Off, there is no active function and the active function is turned off.</p> <p>Active Function Display: the marker X axis value entered in the active function area will display the marker value to its full entered precision.</p>
Dependencies	Unavailable when “Meas Method” on page 433 is set to RBW.

Couplings	This is not affected by Auto Coupling. Sending the remote command causes the addressed marker to become selected.
Preset	All Markers Off
State Saved	Saved in instrument state.
Range	1 2 3
Initial S/W Revision	Prior to A.02.00
Modified at S/W Revision	A.02.00, A.03.00

Couple Markers

When this function is On, moving any marker causes an equal X axis movement of every other marker which is not **Off**. By “equal X axis movement” we mean that we preserve the difference between each marker’s X axis value (in the fundamental x-axis units of the trace that marker is on) and the X axis value of the marker being moved (in the same fundamental x-axis units).

Key Path	Marker
Mode	WCDMA, C2K, WIMAX OFDMA, TD-SCDMA, 1xEVDO, LTE, LTETDD
Remote Command	:CALCulate:ACPower:MARKer:COUPlE[:STATe] ON OFF 1 0 :CALCulate:ACPower:MARKer:COUPlE[:STATe]?
Example	CALC:ACP:MARK:COUP ON
Dependencies	Unavailable when “ Meas Method ” on page 433 is set to RBW.
Preset	OFF
State Saved	Saved in instrument state.
Range	On Off
Initial S/W Revision	Prior to A.02.00
Modified at S/W Revision	A.02.00, A.03.00

Marker All Off

Turns all active markers off.

Key Path	Marker
Mode	WCDMA, C2K, WIMAX OFDMA, TD-SCDMA, 1xEVDO, LTE, LTETDD
Remote Command	:CALCulate:ACPower:MARKer:AOff
Example	CALC:ACP:MARK:AOff
Dependencies	Unavailable when “ Meas Method ” on page 433 is set to RBW.

Initial S/W Revision	Prior to A.02.00
Modified at S/W Revision	A.02.00, A.03.00

Backward Compatibility Remote Commands

Sets or queries the state of a marker. Setting a marker which is off to the on state or 1 puts it in Normal mode and places it at the center of the screen.

Mode	WCDMA, WIMAX OFDMA, C2K, TD-SCDMA, 1xEVDO, LTE, LTETDD
Remote Command	:CALCulate:ACPower:MARKer [1] 2 3 4 5 6 7 8 9 10 11 12 :S TATe OFF ON 0 1 :CALCulate:ACPower:MARKer [1] 2 3 4 5 6 7 8 9 10 11 12 :S TATe?
Example	CALC:ACP:MARK2:STAT ON CALC:ACP:MARK2:STAT?
Notes	This parameter is also accessed from Marker, Properties, 1 You must be in the mode that includes ACP measurements to use this command. Use :INSTrument:SELect to set the mode.
Preset	OFF OFF OFF OFF OFF OFF OFF OFF OFF OFF OFF OFF
State Saved	Saved in instrument state.
Range	On Off
Initial S/W Revision	Prior to A.02.00
Modified at S/W Revision	A.02.00, A.03.00

Marker Function

There are no Marker Functions supported in the ACP measurement. The front-panel key will display a blank menu when pressed.

Key Path	Front-panel key
Initial S/W Revision	Prior to A.02.00

Marker To

There is no Marker To functionality supported in ACP. The front-panel key will display a blank menu when pressed.

Key Path	Front-panel key
Initial S/W Revision	Prior to A.02.00

Meas

See “Meas” on page 1031 for more information.

Key Path	Front-panel key
Initial S/W Revision	Prior to A.02.00

Meas Setup

Displays the setup menu for the currently selected measurement. The functions included in the measurement setup menu include setting the parameters for the carriers, offsets, bandwidths, measurement methods and types. This menu also allows you to turn noise correction on and off.

Key Path	Front-panel key
Initial S/W Revision	Prior to A.02.00

Average/Hold Number

Specifies the number of measurement averages used to calculate the measurement result. The average will be displayed at the end of each sweep. After the specified number of average counts, the average mode (termination control) setting determines the average action.

Key Path	Meas Setup
Mode	WCDMA, C2K, WIMAX OFDMA, TD-SCDMA, 1xEVDO, LTE, LTETDD
Remote Command	[:SENSe]:ACPower:AVERage:COUNT <integer> [:SENSe]:ACPower:AVERage:COUNT? [:SENSe]:ACPower:AVERage[:STATe] OFF ON 0 1 [:SENSe]:ACPower:AVERage[:STATe]?
Example	ACP:AVER:COUN 250 ACP:AVER:COUN? ACP:AVER OFF ACP:AVER?
Notes	You must be in the mode that includes ACP measurements to use this command. Use :INSTrument:SELEct to set the mode.
Preset	10 ON
State Saved	Saved in instrument state.
Min	1
Max	1000
Backwards Compatibility SCPI	[:SENSe]:ACPR:AVERage:COUNT [:SENSe]:MCPower:AVERage:COUNT (PSA Power Suite, PSA W-CDMA, PSA cdma2000)
Initial S/W Revision	Prior to A.02.00
Modified at S/W Revision	A.02.00, A.03.00

Avg Mode

Enables you to set the averaging mode. This determines the averaging action after the specified number of data acquisitions (average count) is reached.

When set to Exponential (Exp) the measurement averaging continues using the specified number of averages to compute each averaged value. The average will be displayed at the end of each sweep.

When set to Repeat, the measurement resets the average counter each time the specified number of averages is reached.

Key Path	Meas Setup
Mode	WCDMA, C2K, WIMAX OFDMA, TD-SCDMA, 1xEVDO, LTE, LTETDD
Remote Command	[:SENSe] :ACPower:AVERage:TCONtrol EXPonential REPeat [:SENSe] :ACPower:AVERage:TCONtrol?
Example	ACP:AVER:TCON EXP ACP:AVER:TCON?
Notes	You must be in the mode that includes ACP measurements to use this command. Use :INSTrument:SELEct to set the mode.
Preset	EXPonential
State Saved	Saved in instrument state.
Range	Exp Repeat
Backwards Compatibility SCPI	[:SENSe] :ACPR:AVERage:TCONtrol
Initial S/W Revision	Prior to A.02.00
Modified at S/W Revision	A.02.00, A.03.00

Carrier Setup

Accesses a menu that contains Carriers, Ref Carrier, Ref Car Freq, Ref Car Pwr and Configure Carriers.

Key Path	Meas Setup
Initial S/W Revision	Prior to A.02.00

Carriers

Specifies the number of carriers to be measured.

Key Path	Meas Setup, Carrier Setup, Configure Carriers
Mode	WCDMA, C2K, WIMAX OFDMA, 1xEVDO, TD-SCDMA, LTE, LTETDD
Remote Command	[:SENSe] :ACPower:CARRier [1] 2:COUNT <integer> [:SENSe] :ACPower:CARRier [1] 2:COUNT?

ACP Measurement
Meas Setup

Example	ACP:CARR:COUN 1 ACP:CARR:COUN?
Notes	Carrier sub op code. 1 for BTS, 2 for MS. Default is BTS. You must be in the mode that includes ACP measurements to use this command. Use :INSTrument:SELEct to set the mode.
Dependencies	When Number of Carriers is 1, Ref Carrier is grayed out. If N9060A-5FP license is enabled, Max of Carrier is 18, otherwise, Max of Carrier is 12.
Couplings	Changing this parameter might affect to the Span.
Preset	1
State Saved	Saved in instrument state.
Min	1
Max	12
Initial S/W Revision	Prior to A.02.00
Modified at S/W Revision	A.02.00, A.03.00

Ref Carrier

Sets the reference carrier. Relative power measurements are made from the reference carrier.

If set to Auto, the measurement selects the carrier with the highest power as the reference carrier and the Ref Carrier parameter is updated. If a value is entered when Ref Carrier Mode is set to Auto, the mode changes to Man.

If set to Man, the value that you enter for the Ref Carrier is used as the reference carrier.

Key Path	Meas Setup, Carrier Setup
Mode	WCDMA, C2K, WIMAX OFDMA, 1xEVDO, TD-SCDMA, LTE, LTETDD
Remote Command	[:SENSe] :ACPpower:CARRier [1] 2:RCARrier <integer> [:SENSe] :ACPpower:CARRier [1] 2:RCARrier? [:SENSe] :ACPpower:CARRier [1] 2:RCARrier:AUTO OFF ON 0 1 [:SENSe] :ACPpower:CARRier [1] 2:RCARrier:AUTO?
Example	ACP:CARR:RCAR 1 ACP:CARR:RCAR? ACP:CARR:RCAR:AUTO OFF ACP:CARR:RCAR:AUTO?
Notes	Carrier sub op code. 1 for BTS, 2 for MS. Default is BTS. You must be in the mode that includes ACP measurements to use this command. Use :INSTrument:SELEct to set the mode.

Dependencies	If there is only one carrier, this key will be grayed out.
Couplings	If you enter a carrier value that is currently configured as having no power present, that carrier will be changed to having power present. If you enter a ref carrier this parameter will be set to manual.
Preset	Auto determined
State Saved	Saved in instrument state.
Min	1
Max	Number of available carriers
Backwards Compatibility SCPI	[:SENSe]:MCPower:RCARrier[1] 2 (PSA Power Suite)
Initial S/W Revision	Prior to A.02.00
Modified at S/W Revision	A.02.00, A.03.00

Ref Car Freq

Sets the reference carrier frequency.

Key Path	Meas Setup, Carrier Setup
Mode	WCDMA, C2K, WIMAX OFDMA, 1xEVDO, TD-SCDMA, LTE, LTETDD
Remote Command	[:SENSe]:ACPpower:CARRier[1] 2:RCFRrequency <freq> [:SENSe]:ACPpower:CARRier[1] 2:RCFRrequency? [:SENSe]:ACPpower:CARRier[1] 2:RCFRrequency:AUTO OFF ON 0 1 [:SENSe]:ACPpower:CARRier[1] 2:RCFRrequency:AUTO?
Example	ACP:CARR:RCFR 250 MHz ACP:CARR:RCFR? ACP:CARR:RCFR:AUTO OFF ACP:CARR:RCFR:AUTO?
Notes	Carrier sub op code. 1 for BTS, 2 for MS. Default is BTS. You must be in the mode that includes ACP measurements to use this command. Use :INSTrument:SELect to set the mode.

ACP Measurement
Meas Setup

Couplings	<p>Coupled to the Center Frequency.</p> <p>If the center frequency changes, the Ref Carrier Frequency is calculated using the following three steps;</p> $\text{Ref Freq1} = \text{Ctr Freq} - (\text{Total of all Carrier Widths} / 2)$ $\text{Ref Freq2} = \text{Ref Freq1} + (\text{Total of all Carrier Widths up to Ref Carrier})$ $\text{Ref Freq} = \text{Ref Freq2} + (0.5 * \text{Carrier Width of Ref Carrier})$ <p>If reference carrier frequency changes the Center Frequency is calculated using the following three steps;</p> $\text{Ctr Freq1} = \text{Ref Freq} - (0.5 * \text{Carrier Width of Ref Carrier})$ $\text{Ctr Freq2} = \text{Ctr Freq1} - (\text{Total of all Carrier Widths up to Ref Carrier})$ $\text{Ctr Freq} = \text{Ctr Freq2} + (\text{Total of all Carrier Widths} / 2)$ <p>This ensures that the carriers are always centered on the screen.</p> <p>If there is only one carrier present the Reference Carrier Frequency will be the same as the Center Frequency.</p>
Preset	Calculated based on the current Center Frequency
State Saved	Saved in instrument state.
Min	-79.999995 MHz
Max	<p>Hardware Dependent:</p> <p>Option 503 = 3.699999995 GHz</p> <p>Option 504 = 3.899999995 GHz</p>
Initial S/W Revision	Prior to A.02.00
Modified at S/W Revision	A.02.00, A.03.00

Power Ref

Sets the power reference in the carrier that will be used to compute the relative values for the offsets.

Key Path	Meas Setup, Carrier Setup
Initial S/W Revision	Prior to A.02.00
Modified at S/W Revision	A.03.00, A.04.00

Total Power

Sets the multi-carrier power reference.

When set to Auto, the carrier power result reflects the measured power value in the selected reference carrier.

When set to Man, the result is referenced to the last measured value, or you may specify the reference for the multi-carrier power measurement. Relative values are displayed, referenced to the “Power

Reference” value.

Key Path	Meas Setup, Carrier Setup, Power Ref
Mode	WCDMA, C2K, WIMAX OFDMA, TD-SCDMA, LTE, LTETDD
Remote Command	[[:SENSe]:ACPower:CARRier[1] 2[:POWER] <real> [:SENSe]:ACPower:CARRier[1] 2[:POWER]? [:SENSe]:ACPower:CARRier[1] 2:AUTO[:STAtE] OFF ON 0 1 [:SENSe]:ACPower:CARRier[1] 2:AUTO[:STAtE]?
Example	ACP:CARR 10 ACP:CARR? ACP:CARR:AUTO OFF ACP:CARR:AUTO?
Notes	Although the default value is defined, the value is recalculated by the measurement result just after measurement. Carrier sub op code. 1 for BTS, 2 for MS. Default is BTS. You must be in the mode that includes ACP measurements to use this command. Use :INSTrument:SElect to set the mode.
Dependencies	This key is available only when the Meas Type is TPreF. If the Meas Type is not TPreF, this key is grayed out.
Preset	0.0 ON
State Saved	Saved in instrument state.
Min	-200 dBm
Max	200 dBm
Backwards Compatibility SCPI	[[:SENSe]:MCPower:CARRier[1] 2[:POWER]
Initial S/W Revision	Prior to A.02.00
Modified at S/W Revision	A.02.00, A.03.00, A.04.00

PSD

Sets the power spectral density in the carrier (main channel) that is used to compute the relative power spectral density values for the offsets when Meas Type is set to PSD Ref. When the PSD Ref state is set to Auto, this will be set to the measured carrier power spectral density.

Key Path	Meas Setup, Carrier Setup, Power Ref
Mode	WCDMA, C2K, WIMAX OFDMA, TD-SCDMA, LTE, LTETDD

ACP Measurement
Meas Setup

Remote Command	<code>[:SENSe] :ACPower:CARRier [1] 2:CPsD <real></code> <code>[:SENSe] :ACPower:CARRier [1] 2:CPsD?</code>
Example	ACP:CARR:CPsD 25 ACP:CARR:CPsD?
Notes	Although the default value is defined, the value is recalculated by the measurement result just after measurement. Carrier sub op code. 1 for BTS, 2 for MS. Default is BTS. You must be in the mode that includes ACP measurements to use this command. Use :INSTrument:SElect to set the mode.
Dependencies	This key is available only when the Meas Type is PSDRef. If the Meas Type is not PSDRef, this key is grayed out.
Couplings	The value of PSD is automatically converted when PSD Unit is changed.
Preset	0.0
State Saved	Saved in instrument state.
Min	-999
Max	999
Initial S/W Revision	Prior to A.02.00
Modified at S/W Revision	A.02.00, A.03.00, A.04.00

Configure Carriers

Accesses a menu that contains Carrier, Carrier Pwr Present, Carrier Width and Carrier Integ BW parameters.

Key Path	Meas Setup, Carrier Setup
Initial S/W Revision	Prior to A.02.00

Carrier

Selects the carrier to configure for the current measurement.

Key Path	Meas Setup, Carrier Setup, Configure Carriers
Mode	WCDMA, C2K, WIMAX OFDMA, 1xEVDO, TD-SCDMA, LTE, LTETDD
Couplings	Max value is the number of available carriers, so this value might change when the number of carriers is changed.
Preset	1
State Saved	No
Min	1

Max	Number of available carriers
Initial S/W Revision	Prior to A.02.00
Modified at S/W Revision	A.02.00, A.03.00

Carrier Coupling

Couples carrier settings to carrier #1. The coupled parameters are Carrier Power Present, Carrier Spacing, Measurement Noise Bandwidth, Method, and Filter Alpha.

Key Path	Meas Setup, Carrier Setup, Configure Carriers
Mode	WCDMA, C2K, WIMAX OFDMA, 1xEVDO, TD-SCDMA, LTE, LTETDD
Remote Command	[:SENSe] :ACPower:CARRier [1] 2 :LIST:COUple OFF ON 0 1, OFF ON 0 1, OFF ON 0 1, OFF ON 0 1, OFF ON 0 1, OFF ON 0 1 [:SENSe] :ACPower:CARRier [1] 2 :LIST:COUple?
Example	ACP:CARR:LIST:COUP OFF ACP:CARR:LIST:COUP?
Notes	Carrier sub op code. 1 for BTS, 2 for MS. Default is BTS. You must be in the mode that includes ACP measurements to use this command. Use :INSTrument:SElect to set the mode.
Couplings	When Couple is selected, the carrier settings are coupled to carrier #1. Coupled parameters are Carrier Power Present, Carrier Spacing, Measurement Noise Bandwidth, Method and Filter Alpha. When a setting is changed, the couple is set to Man automatically. Carrier #1 is always set to couple and cannot be changed. Couple/Man selection on the Carrier key is not displayed when selected carrier number is #1.
Preset	ON
State Saved	Saved in instrument state.
Range	Couple Man
Initial S/W Revision	Prior to A.02.00
Modified at S/W Revision	A.02.00, A.03.00

Carrier Pwr Present

Configures the carriers for this measurement. It allows spaces to be inserted between carriers. Carriers with the power present parameter set to Yes are carriers, and those with the power present parameter set to No are spaces. Each carrier power present is set to Yes or No. The individual carriers can be set by selecting the desired carrier on the carrier menu key using the up down arrows, the knob, or numeric keypad, then toggling the carrier power present using the carrier power present menu key.

ACP Measurement Meas Setup

The query for this parameter returns the current values for all of the carriers. If a carrier is defined as having no power present, the power displayed will be relative to the reference carrier, otherwise the absolute power will be displayed.

If you change the carrier power present to no and that carrier is currently configured as the reference carrier, the next carrier to the left (or the right if there are no carriers to the left) will be assigned as the reference carrier. This also applies to the scenario where there are only two carriers configured as having power present and you configure only one carrier to have no power present.

Key Path	Meas Setup, Carrier Setup, Configure Carriers
Mode	WCDMA, C2K, WIMAX OFDMA, 1xEVDO, TD-SCDMA, LTE, LTETDD
Remote Command	[:SENSE] :ACPpower:CARRier [1] 2:LIST:PPResent YES NO, ... [:SENSE] :ACPpower:CARRier [1] 2:LIST:PPResent?
Example	ACP:CARR2:LIST:PPR YES ACP:CARR2:LIST:PPR?
Notes	Carrier sub op code. 1 for BTS, 2 for MS. Default is BTS. When setting these values remotely, the position in the list sent corresponds to the carrier. Missing values are not permitted, therefore if you want to change values 2 and 6 you must send all values up to 6. Subsequent values will remain unchanged, unless the number of values sent is greater than the number of carriers, then subsequent values will be ignored.
Dependencies	If there is only one carrier, this key will be grayed out.
Couplings	Coupled to the number of carriers. When the SCPI command is sent, the number of carriers will be set to the number of entries in the parameter list.
Preset	YES
State Saved	Saved in instrument state.
Range	Yes No
Backwards Compatibility SCPI	[:SENSE] :MCPower:CARRier [1] 2:LIST:PPResent (PSA Power Suite)
Initial S/W Revision	Prior to A.02.00
Modified at S/W Revision	A.02.00, A.03.00

Carrier Spacing

Sets the width of the carrier spacing. This will be the value applied to all the current slots, whether they are carriers or spaces.

Enter each carrier spacing value individually by selecting the desired carrier on the carrier menu key using the up down arrows, the knob, or the numeric keypad, then enter the carrier width using the carrier spacing menu key.

Key Path	Meas Setup, Carrier Setup, Configure Carriers
Mode	WCDMA, C2K, WIMAX OFDMA, 1xEVDO, TD-SCDMA, LTE, LTETDD

Remote Command	[:SENSE] :ACPower:CARRier [1] 2 :LIST:WIDTh <bandwidth>, ... [:SENSE] :ACPower:CARRier [1] 2 :LIST:WIDTh?
Example	ACP:CARR2:LIST:WIDT 25kHz ACP:CARR2:LIST:WIDT?
Notes	Carrier sub op code. 1 for BTS, 2 for MS. Default is BTS. When setting these values remotely, the position in the list sent corresponds to the carrier. Missing values are not permitted, therefore if you want to change values 2 and 6 you must send all values up to 6. Subsequent values will remain unchanged, unless the number of values sent is greater than the number of carriers, then subsequent values will be ignored. You must be in the mode that includes ACP measurements to use this command. Use :INSTrument:SElect to set the mode.
Couplings	Coupled to the number of carriers. When the SCPI command is sent, the number of carriers will be set to the number of entries in the parameter list. Changing Carrier Spacing might affect the Span.
Preset	WCDMA: 5 MHz WIMAX OFDMA: 10 MHz C2K: 1.25 MHz 1xEVDO: 1.25 MHz TD-SCDMA: 1.6 MHz LTE: 5 MHz LTETDD: 5 MHz
State Saved	Saved in instrument state.
Min	0 Hz
Max	1 GHz
Backwards Compatibility SCPI	[:SENSe]:MCPower:CARRier [1] 2 :LIST:WIDTh (PSA Power Suite)
Initial S/W Revision	Prior to A.02.00
Modified at S/W Revision	A.02.00, A.03.00

Measurement Noise Bandwidth

Specifies the Measurement Noise Bandwidth used to calculate the power in the carriers.

Each Measurement Noise Bandwidth value is entered individually by selecting the desired carrier on the carrier menu key using the up down arrows, the knob, or the numeric keypad. Then enter the measurement noise bandwidth using the measurement noise bandwidth key.

Key Path	Meas Setup, Carrier Setup, Configure Carriers
Mode	WCDMA, C2K, WIMAX OFDMA, TD-SCDMA, 1xEVDO, LTE, LTETDD

ACP Measurement
Meas Setup

Remote Command	[:SENSe]:ACPower:CARRier[1] 2:LIST:BANDwidth[:INTEgrati on] <freq>, ... [:SENSe]:ACPower:CARRier[1] 2:LIST:BANDwidth[:INTEgrati on]?
Example	ACP:CARR2:LIST:BAND 25kHz ACP:CARR2:LIST:BAND?
Notes	In the WCDMA mode, the preset/default value is defined as 3.84 MHz. But internally, 4.6848 MHz is used as the default value. Carrier sub op code. 1 for BTS, 2 for MS. Default is BTS. When setting these values remotely, the position in the list sent corresponds to the carrier. Missing values are not permitted, therefore if you want to change values 2 and 6 you must send all values up to 6. Subsequent values will remain unchanged, unless the number of values sent is greater than the number of carriers, then subsequent values will be ignored. You must be in the mode that includes ACP measurements to use this command. Use :INSTrument:SELEct to set the mode.
Couplings	Coupled to the number of carriers. When the SCPI command is sent, the number of carriers is set to the number of entries in the parameter list.
Preset	WCDMA: 3.84 MHz WIMAX OFDMA: 10 MHz C2K: 1.23 MHz TD-SCDMA: 1.28 MHz 1xEVDO: 1.23 MHz LTE, LTETDD: 4.515 MHz 4.5 MHz
State Saved	Saved in instrument state.
Min	10 Hz
Max	1 GHz
Backwards Compatibility SCPI	[:SENSe]:ACPower:BANDwidth:INTEgration [:SENSe]:ACPower:BWIDth:INTEgration [:SENSe]:ACPower:CARRier[1] 2:LIST:BWIDth[:INTEgration] [:SENSe]:MCPower:CARRier[1] 2:LIST:BANDwidth[:INTEgration] (PSA Power Suite) [:SENSe]:MCPower:CARRier[1] 2:LIST:BWIDth[:INTEgration] (PSA Power Suite)

Method for Carrier

Accesses the carrier configuration method settings.

Key Path	Meas Setup, Carrier Setup, Configure Carriers
----------	---

Mode	WCDMA, WIMAX OFDMA, TD-SCDMA, LTE, LTETDD
Remote Command	[:SENSe] :ACPower:CARRier [1] 2:LIST:FILTer [:RRC] [:STATe] ON OFF 1 0, ... [:SENSe] :ACPower:CARRier [1] 2:LIST:FILTer [:RRC] [:STATe] ?
Example	ACP:CARR:LIST:FILT 0,0,0,0 ACP:CARR:LIST:FILT?
Notes	The binary values translate as follows: 1 ON = RRC Weighted 0 OFF = Integ BW Maximum of Array length depends on the number of carriers. You must be in the mode that includes ACP measurements to use this command. Use :INSTrument:SElect to set the mode.
Preset	LTE, LTETDD: OFF WCDMA: ON WIMAX OFDMA: OFF TD-SCDMA: ON
State Saved	Saved in instrument state.
Range	IntegBW RRC Weight
Initial S/W Revision	Prior to A.02.00
Modified at S/W Revision	A.02.00, A.03.00

Filter Alpha for Carrier

Inputs the alpha value for the filter used in the current carrier configuration.

Key Path	Meas Setup, Carrier Setup, Configure Carriers, Method, RRC Weighted
Mode	WCDMA, WIMAX OFDMA, TD-SCDMA, LTE, LTETDD
Remote Command	[:SENSe] :ACPower:CARRier [1] 2:LIST:FILTer:ALPHa <real>, ... [:SENSe] :ACPower:CARRier [1] 2:LIST:FILTer:ALPHa?
Example	ACP:CARR2:LIST:FILT:ALPH 0.5 ACP:CARR2:LIST:FILT:ALPH?
Notes	You must be in the mode that includes ACP measurements to use this command. Use :INSTrument:SElect to set the mode.

ACP Measurement
Meas Setup

Preset	0.22 C2K: No DTMB: 0.05
State Saved	Saved in instrument state.
Min	0.01
Max	1.0
Initial S/W Revision	Prior to A.02.00
Modified at S/W Revision	A.02.00, A.03.00

Offset/Limits

Accesses a menu of functions that contains Offset, Offset Freq/Offset To Edge, Offset Integ BW, Upper Offset Limit and Lower Offset parameters.

Key Path	Meas Setup
Initial S/W Revision	Prior to A.02.00

Select Offset

Selects the offset to configure.

Key Path	Meas Setup, Offset/Limits, Limits
Mode	WCDMA, C2K, WIMAX OFDMA, TD-SCDMA, 1xEVDO, LTE
Preset	A
State Saved	Saved in instrument state.
Range	Offset A Offset B Offset C Offset D Offset E Offset F
Initial S/W Revision	Prior to A.02.00
Modified at S/W Revision	A.02.00, A.03.00

Offset Freq

This parameter determines the frequency difference between the center of the main channel and the center of the carrier.

Each Offset Freq state value is entered individually by selecting the desired carrier on the carrier menu key using the up down arrows, RPG or numeric keypad. Then enter the Offset Freq State using the Offset Frequency key.

The list contains up to six (6) entries, depending on the mode selected, for offset frequencies. Each offset frequency in the list corresponds to a reference bandwidth in the bandwidth list.

An offset frequency of zero turns the display of the measurement for that offset off, but the measurement is still made and reported. You can turn off (not use) specific offsets with the

[:SENSe]:ACP:OFFSet:LIST:STATe command

Turning the offset off has the same effect as setting the frequency of the offset to 0 Hz and will cause it to be removed from the results screen.

Key Path	Meas Setup, Offset/Limits
Mode	WCDMA, C2K, WIMAX OFDMA, TD-SCDMA, 1xEVDO, LTE
Remote Command	<pre>[:SENSe] :ACPpower:OFFSet [1] 2 :LIST [:FREQuency] <freq>, <freq>, <freq>, <freq>, <freq>, <freq> [:SENSe] :ACPpower:OFFSet [1] 2 :LIST [:FREQuency] ? [:SENSe] :ACPpower:OFFSet [1] 2 :LIST:STATe OFF ON 0 1, OFF ON 0 1, OFF ON 0 1, OFF ON 0 1, OFF ON 0 1, OFF ON 0 1 [:SENSe] :ACPpower:OFFSet [1] 2 :LIST:STATe?</pre>
Example	<pre>ACP:OFFS1:LIST 0,0,0,0,0,0 ACP:OFFS1:LIST? ACP:OFFS2:LIST:STAT 1,1,0,0,0,0 ACP:OFFS2:LIST:STAT?</pre>
Notes	<p>The label for this menu key will change depending on the currently selected radio standard or mode. For cdma2000 the label for the menu key will be Offset to Edge. For all other supported standards the label will be Offset Freq.</p> <p>When setting these values remotely, the position in the list sent corresponds to the offset. Missing values are not permitted, unless the number of values sent is greater than the number of carriers, then subsequent values will be ignored.</p> <p>Offset sub op code. 1 for BTS, 2 for MS. Default is BTS.</p> <p>You must be in the mode that includes ACP measurements to use this command. Use :INSTrument:SElect to set the mode.</p>
Couplings	Changing Offset Frequency might affect the Span. See the Span key section for details.

ACP Measurement
Meas Setup

Preset	<p>WCDMA: 5.0 MHz, 10.0 MHz, 0 Hz, 0 Hz, 0 Hz, 0 Hz 5.0 MHz, 10.0 MHz, 0 Hz, 0 Hz, 0 Hz, 0 Hz</p> <p>WIMAX OFDMA: 10 MHz, 20 MHz, 0 Hz, 0 Hz, 0 Hz, 0 Hz 10 MHz, 20 MHz, 0 Hz, 0 Hz, 0 Hz, 0 Hz</p> <p>C2K: 765 kHz, 1.995 MHz, 0 Hz, 0 Hz, 0 Hz, 0 Hz 900 kHz, 1.995 MHz, 0 Hz, 0 Hz, 0 Hz, 0 Hz</p> <p>TD-SCDMA: 1.6 MHz, 3.2 MHz, 0 Hz, 0 Hz, 0 Hz, 0 Hz 1.6 MHz, 3.2 MHz, 0 Hz, 0 Hz, 0 Hz, 0 Hz</p> <p>1xEVDO: 765 kHz, 1.995 MHz, 3.125 MHz, 4.000 MHz, 7.500 MHz, 7.500 MHz 765 kHz, 1.995 MHz, 3.125 MHz, 4.000 MHz, 7.500 MHz, 7.500 MHz</p> <p>LTE, LTETDD: 5 MHz, 10 MHz, 0, 0, 0, 0 5 MHz, 10 MHz, 0, 0, 0, 0</p> <p>SA: ON, OFF, OFF, OFF, OFF, OFF ON, OFF, OFF, OFF, OFF, OFF</p> <p>WCDMA: ON, ON, OFF, OFF, OFF, OFF ON, ON, OFF, OFF, OFF, OFF</p> <p>WIMAX OFDMA: ON, ON, OFF, OFF, OFF, OFF ON, ON, OFF, OFF, OFF, OFF</p> <p>TD-SCDMA: ON, ON, OFF, OFF, OFF, OFF ON, ON, OFF, OFF, OFF, OFF</p> <p>CDMA1xEVDO: ON, ON, OFF, OFF, OFF, OFF ON, ON, OFF, OFF, OFF, OFF</p> <p>LTE, LTETDD: ON, ON, OFF, OFF, OFF, OFF ON, OFF, OFF, OFF, OFF, OFF</p>
State Saved	Saved in instrument state.
Min	0 Hz
Max	500 MHz
Backwards Compatibility SCPI	[[:SENSe]:MCPower:OFFSet[1]]2:LIST[:FREQuency] (PSA Power Suite)
Initial S/W Revision	Prior to A.02.00
Modified at S/W Revision	A.02.00, A.03.00

Integ BW

Sets the Integration Bandwidth for the offsets. If there is more than one bandwidth, the list must contain six (6) entries. Each resolution bandwidth in the list corresponds to an offset frequency in the list defined by [[:SENSe]:ACP:OFFSet[n]:LIST[:FREQuency]].

Enter each value individually by selecting the desired offset on the offset menu key using the up down arrows, the knob, or the numeric keypad, then enter the Offset Integration Bandwidth using the Offset Integration Bandwidth menu key.

You can turn off (not use) specific offsets with the [[:SENSe]:ACP:OFFSet[n]:LIST:STATe command."

Key Path	Meas Setup, Offset/Limits
Mode	WCDMA, C2K, WIMAX OFDMA, TD-SCDMA, 1xEVDO, LTE, LTETDD

Remote Command	<pre>[:SENSE] :ACPower:OFFSet [1] 2 :LIST:BANDwidth[:INTEgratio n] <bandwidth>, <bandwidth>, <bandwidth>, <bandwidth>, <bandwidth>, <bandwidth> [:SENSE] :ACPower:OFFSet [1] 2 :LIST:BANDwidth[:INTEgratio n] ?</pre>
Example	<pre>ACP:OFFS2:LIST:BAND 2 MHz, 2 MHz, 2 MHz, 2 MHz, 2 MHz, 2 MHz ACP:OFFS2:LIST:BAND?</pre>
Notes	<p>When setting these values remotely, the position in the list sent corresponds to the offset. Missing values are not permitted i.e. if you want to change values 2 you must send all values up to 2. Subsequent values will remain unchanged, unless the number of values sent is greater than the number of carriers, then subsequent values will be ignored.</p> <p>Offset sub op code. 1 for BTS, 2 for MS. Default is BTS.</p> <p>You must be in the mode that includes ACP measurements to use this command. Use :INSTrument:SELEct to set the mode.</p>
Couplings	Changing Integ BW might affect to the Span. See Span section for details.
Preset	<pre>WCDMA: 3.84 MHz, 3.84 MHz, 3.84 MHz, 3.84 MHz, 3.84 MHz, 3.84 MHz 3.84 MHz, 3.84 MHz, 3.84 MHz, 3.84 MHz, 3.84 MHz, 3.84 MHz WIMAX OFDMA: 10 MHz, 10 MHz, 10 MHz, 10 MHz, 10 MHz, 10 MHz 10 MHz, 10 MHz, 10 MHz, 10 MHz, 10 MHz, 10 MHz C2K: 30 kHz, 30 kHz, 30 kHz, 30 kHz, 30 kHz, 30 kHz 30 kHz, 30 kHz, 30 kHz, 30 kHz, 30 kHz, 30 kHz TD-SCDMA: 1.28 MHz, 1.28 MHz, 1.28 MHz, 1.28 MHz, 1.28 MHz, 1.28 MHz 1xEVDO: C2K: 30 kHz, 30 kHz, 30 kHz, 30 kHz, 30 kHz, 30 kHz 30 kHz, 30 kHz, 30 kHz, 30 kHz, 30 kHz, 30 kHz LTE, LTETDD: 4.515 MHz, 4.515 MHz, 4.515 MHz, 4.515 MHz, 4.515 MHz, 4.515 MHz 4.5 MHz, 4.5 MHz, 4.5 MHz, 4.5 MHz, 4.5 MHz, 4.5 MHz</pre>
State Saved	Saved in instrument state.
Min	10 Hz
Max	1 GHz
Backwards Compatibility SCPI	<pre>[:SENSE]:ACPower:OFFSet[1] 2:LIST:BWIDth[:INTEgration] [:SENSE]:ACPR:OFFSet[1] 2:LIST:BANDwidth [:SENSE]:ACPR:OFFSet[1] 2:LIST:BWIDth [:SENSE]:MCPower:OFFSet[1] 2:LIST:BANDwidth[:INTEgration] (PSA Power Suite) [:SENSE]:MCPower:OFFSet[1] 2:LIST:BWIDth[:INTEgration] (PSA Power Suite)</pre>
Initial S/W Revision	Prior to A.02.00

ACP Measurement
Meas Setup

Modified at S/W Revision	A.02.00, A.03.00
--------------------------	------------------

Offset BW

Accesses the offset bandwidth menu.

Key Path	Meas Setup, Offset/Limits
Initial S/W Revision	Prior to A.02.00

Res BW

Sets the resolution bandwidth. If an unavailable bandwidth is entered with the numeric keypad, the closest available bandwidth is selected.

Key Path	Meas Setup, Offset/Limits
Mode	WCDMA, C2K, 1xEVDO, LTE
Remote Command	<pre>[:SENSe] :ACPower:OFFSet [1] 2:LIST:BANDwidth:RESolution <bandwidth>, <bandwidth>, <bandwidth>, <bandwidth>, <bandwidth>, <bandwidth> [:SENSe] :ACPower:OFFSet [1] 2:LIST:BANDwidth:RESolution? [:SENSe] :ACPower:OFFSet [1] 2:LIST:BANDwidth:RESolution: AUTO ON OFF 1 0, ON OFF 1 0, ON OFF 1 0, ON OFF 1 0, ON OFF 1 0, ON OFF 1 0 [:SENSe] :ACPower:OFFSet [1] 2:LIST:BANDwidth:RESolution: AUTO?</pre>
Example	<pre>ACP:OFFS2:LIST:BAND:RES 220kHz,220kHz,220kHz,220kHz,220kHz,220kHz ACP:OFFS2:LIST:BAND:RES? ACP:OFFS2:LIST:BAND:RES:AUTO 1,1,1,1,1,1 ACP:OFFS2:LIST:BAND:RES:AUTO?</pre>
Notes	<p>This key is available only in the IBW mode.</p> <p>Offset sub op code. 1 for BTS, 2 for MS. Default is BTS.</p> <p>You must be in the mode that includes ACP measurements to use this command. Use :INSTrument:SELEct to set the mode.</p>
Couplings	<p>When Res BW Mode is AUTO, this value is exactly same as Res BW under BW key. And when this value is changed by user, Res BW Mode is also changed to Man.</p>

Preset	<p>WCDMA: 100 kHz, 100 kHz, 100 kHz, 100 kHz, 100 kHz, 100 kHz</p> <p>C2K:</p> <p>Method: RBW</p> <p>30 K</p> <p>Method: IBW</p> <p>C2K: 15 kHz, 15 kHz, 15 kHz, 15 kHz, 15 kHz, 15 kHz 15 kHz, 15 kHz, 15 kHz, 15 kHz, 15 kHz</p> <p>1xEVDO: 3 kHz, 30 kHz, 30 kHz, 30 kHz, 30 kHz, 30 kHz 3 kHz, 30 kHz, 30 kHz, 30 kHz, 30 kHz, 30 kHz</p> <p>LTE: 100 kHz, 100 kHz, 100 kHz, 100 kHz, 100 kHz, 100 kHz 100 kHz, 100 kHz, 100 kHz, 100 kHz, 100 kHz</p> <p>1, 1, 1, 1, 1, 1</p>
State Saved	Saved in instrument state.
Min	1 Hz
Max	8 MHz
Backwards Compatibility SCPI	[:SENSe]:ACPower:OFFSet[1] 2:LIST:BWIDth:RESolution
Initial S/W Revision	Prior to A.02.00
Modified at S/W Revision	A.02.00, A.03.00

Video BW

Enables you to change the test set post-detection filter (VBW).

Key Path	Meas Setup, Offset/Limits, Offset BW
Mode	WCDMA, C2K, WIMAX OFDMA, TD-SCDMA, 1xEVDO, LTE, LTETDD
Remote Command	<pre>[:SENSe]:ACPower:OFFSet[1] 2:LIST:BANDwidth:VIDeo <freq>, <freq>, <freq>, <freq>, <freq>, <freq> [:SENSe]:ACPower:OFFSet[1] 2:LIST:BANDwidth:VIDeo? [:SENSe]:ACPower:OFFSet[1] 2:LIST:BANDwidth:VIDeo:AUTO OFF ON 0 1, OFF ON 0 1, OFF ON 0 1, OFF ON 0 1, OFF ON 0 1, OFF ON 0 1 [:SENSe]:ACPower:OFFSet[1] 2:LIST:BANDwidth:VIDeo:AUTO?</pre>
Example	<pre>ACP:OFFS2:LIST:BAND:VID 5 MHz, 5 MHz, 5 MHz, 5 MHz, 5 MHz, 5 MHz ACP:OFFS2:LIST:BAND:VID? ACP:OFFS2:LIST:BAND:VID:AUTO 0,0,0,0,1,1 ACP:OFFS2:LIST:BAND:VID:AUTO?</pre>

ACP Measurement
Meas Setup

Notes	The values shown in this table reflect the conditions after a Mode Preset. Offset sub op code. 1 for BTS, 2 for MS. Default is BTS. You must be in the mode that includes ACP measurements to use this command. Use :INSTrument:SELEct to set the mode.
Preset	SA: 22 kHz, 22 kHz, 22 kHz, 22 kHz, 22 kHz, 22 kHz WCDMA, WIMAX OFDMA: 1 MHz, 1 MHz, 1 MHz, 1 MHz, 1 MHz, 1 MHz C2K: 150 kHz, 150 kHz, 150 kHz, 150 kHz, 150 kHz, 150 kHz 150 kHz, 150 kHz, 150 kHz, 150 kHz, 150 kHz TD-SCDMA: 300 kHz, 300 kHz, 300 kHz, 300 kHz, 300 kHz, 300 kHz 1xEVDO: 30 kHz, 300 kHz, 300 kHz, 300 kHz, 300 kHz, 300 kHz 30 kHz, 300 kHz, 300 kHz, 300 kHz, 300 kHz LTE, LTETDD: 1 MHz, 1 MHz, 1 MHz, 1 MHz, 1 MHz, 1 MHz ON, ON, ON, ON, ON, ON
State Saved	Saved in instrument state.
Min	1 Hz
Max	50 MHz
Backwards Compatibility SCPI	[:SENSE]:ACPower:OFFSet[1] 2:LIST:BWIDth:VIDeo
Initial S/W Revision	Prior to A.02.00
Modified at S/W Revision	A.02.00, A.03.00

RBW Control

Accesses the resolution bandwidth control menu.

Key Path	Meas Setup, Offset/Limits, Offset BW
Initial S/W Revision	Prior to A.02.00

Filter Type

Selects the type of bandwidth filter that is used.

Key Path	Meas Setup, Offset/Limits, Offset BW, RBW Control
Mode	WCDMA, C2K, WIMAX OFDMA, TD-SCDMA, 1xEVDO, LTE, LTETDD
Remote Command	[:SENSE]:ACPower:OFFSet [1] 2:LIST:BWIDth:SHAPE GAUSSian FLATtop, GAUSSian FLATtop, GAUSSian FLATtop, GAUSSian FLATtop, GAUSSian FLATtop, GAUSSian FLATtop [:SENSE]:ACPower:OFFSet [1] 2:LIST:BWIDth:SHAPE?
Example	ACP:OFFS2:LIST:BWIDth:SHAPE FLAT,GAUS,GAUS,GAUS,GAUS,GAUS ACP:OFFS2:LIST:BWIDth:SHAPE?

Notes	Offset sub op code. 1 for BTS, 2 for MS. Default is BTS. You must be in the mode that includes ACP measurements to use this command. Use :INSTRument:SElect to set the mode.
Couplings	See the description above
Preset	GAUSSian, GAUSSian, GAUSSian, GAUSSian, GAUSSian, GAUSSian
State Saved	Saved in instrument state.
Range	GAUSSian FLATtop
Backwards Compatibility SCPI	[:SENSe]:ACPower:OFFSet[1] 2:LIST:BWIDth:SHApe
Initial S/W Revision	Prior to A.02.00
Modified at S/W Revision	A.02.00, A.03.00

Filter BW

Selects a Gaussian filter based on its –3 dB (Normal) bandwidth or its –6 dB bandwidth.

Key Path	Meas Setup, Offset/Limits, Offset BW, RBW Control
Mode	WCDMA, C2K, WIMAX OFDMA, TD-SCDMA, 1xEVDO, LTE, LTETDD
Remote Command	[:SENSe]:ACPower:OFFSet[1] 2:LIST:BANDwidth:TYPE DB3 DB6, DB3 DB6, DB3 DB6, DB3 DB6, DB3 DB6, DB3 DB6 [:SENSe]:ACPower:OFFSet[1] 2:LIST:BANDwidth:TYPE?
Example	ACP:OFFS2:LIST:BAND:TYPE DB3,DB3,DB3,DB3,DB3 ACP:OFFS2:LIST:BAND:TYPE?
Notes	Offset sub op code. 1 for BTS, 2 for MS. Default is BTS. You must be in the mode that includes ACP measurements to use this command. Use :INSTRument:SElect to set the mode.
Dependencies	Grayed out unless the Gaussian filter type is selected
Preset	DB3, DB3, DB3, DB3, DB3, DB3
State Saved	Saved in instrument state.
Range	–3 dB (Normal) –6 dB
Backwards Compatibility SCPI	[:SENSe]:ACPower:OFFSet[1] 2:LIST:BWIDth:TYPE
Initial S/W Revision	Prior to A.02.00
Modified at S/W Revision	A.02.00, A.03.00

Limits

Limits key accesses a menu of functions that contains Select Offset, Abs Limit, Rel Limit and Fail Mask

ACP Measurement
Meas Setup

parameters.

Key Path	Meas Setup, Offset/Limits
Initial S/W Revision	A.03.00

Abs Limit

Enters an absolute limit value, which sets the absolute amplitude levels to test against for each of the custom offsets. The list must contain six (6) entries. If there is more than one offset, the offset closest to the carrier channel is the first one in the list. [:SENSE]:ACP:OFFSet[n]:LIST:TEST selects the type of testing to be done at each offset.

You can turn off (not use) specific offsets with the [:SENSE]:ACP:OFFSet[n]:LIST:STATe command.

The query returns the six (6) sets of real numbers that are the current absolute amplitude test limits.

Key Path	Meas Setup, Offset/Limits, Limits
Mode	WCDMA, C2K, WIMAX OFDMA, TD-SCDMA, 1xEVDO, LTE, LTETDD
Remote Command	[:SENSE]:ACP:Power:OFFSet [1] 2:LIST:ABSolute <real>, <real>, <real>, <real>, <real> [:SENSE]:ACP:Power:OFFSet [1] 2:LIST:ABSolute?
Example	ACP:OFFS2:LIST:ABS -10,-10,-10,-10,-10,-10 ACP:OFFS2:LIST:ABS?
Notes	Offset sub op code. 1 for BTS, 2 for MS. Default is BTS. You must be in the mode that includes ACP measurements to use this command. Use :INSTrument:SELEct to set the mode.
Couplings	None
Preset	WCDMA: 50 dBm, 50 dBm, 50 dBm, 50 dBm, 50 dBm, 50 dBm 50 dBm, 50 dBm, 50 dBm, 50 dBm, 50 dBm C2K: 50 dBm, 50 dBm, 50 dBm, 50 dBm, 50 dBm, 50 dBm 50 dBm, 50 dBm, 50 dBm, 50 dBm, 50 dBm 1xEVDO: -27 dBm, -27 dBm, -13 dBm, -13 dBm, -13 dBm, -13 dBm -27 dBm, -27 dBm, -13 dBm, -13 dBm, -13 dBm, -13 dBm LTE: -8.45, -8.45, -8.45, -8.45, -8.45, -8.45 -50.0, -50.0, -50.0, -50.0, -50.0, -50.0
State Saved	Saved in instrument state.
Min	-200.0 dBm
Max	50.0 dBm
Initial S/W Revision	Prior to A.02.00
Modified at S/W Revision	A.02.00, A.03.00

Rel Lim (Car)

Enters a relative limit value for the carrier level. This sets the amplitude levels to test against for the specified offsets.

The amplitude level is relative to the carrier amplitude. If multiple offsets are available, the list contains six (6) entries. The offset closest to the carrier channel is the first one in the list.

`[:SENSe]:ACP:OFFSet:LIST:TEST` selects the type of testing to be done at each offset.

`[:SENSe]:ACP:OFFSet[n]:LIST[n]:TEST` selects the type of testing to be done at each offset.

You can turn off (not use) specific offsets with the `[:SENSe]:ACP:OFFSet[n]:LIST[n]:STATe` command.

The query returns the six (6) sets of real numbers that are the current amplitude test limits, relative to the carrier, for each offset.

Offset[n] n = 1 is base station and n = 2 is mobiles. The default is base station (1).

Key Path	Meas Setup, Offset/Limits, Limits,
Mode	WCDMA, C2K, 1xEVDO, LTE
Remote Command	<code>[:SENSe]:ACP:Power:OFFSet[1] 2:LIST:RCARrier <real>, <real>, <real>, <real>, <real></code> <code>[:SENSe]:ACP:Power:OFFSet[1] 2:LIST:RCARrier?</code>
Example	<code>ACP:OFFS2:LIST:RCAR 0,0,0,0,0,0</code> <code>ACP:OFFS2:LIST:RCAR?</code>
Notes	Offset sub op code. 1 for BTS, 2 for MS. Default is BTS. You must be in the mode that includes ACP measurements to use this command. Use <code>:INSTrument:SElect</code> to set the mode.
Couplings	None
Preset	WCDMA: -44.2, -49.2, -49.2, -49.2, -49.2, -49.2 -32.2, -42.2, -42.2, -42.2, -42.2, -42.2 C2K: 0, 0, 0, 0, 0, 0 0, 0, 0, 0, 0, 0 1xEVDO: -45, -55, -55, -55, -55, -55 -45, -55, -55, -55, -55, -55 LTE: -44.2, -44.2, -44.2, -44.2, -44.2, -44.2 -29.2, -29.2, -29.2, -29.2, -29.2, -29.2
State Saved	Saved in instrument state.
Min	-150
Max	50.0
Backwards Compatibility SCPI	<code>[:SENSe]:MCPower:OFFSet[1] 2:LIST:RCARrier (PSA WCDMA)</code>
Initial S/W Revision	Prior to A.02.00
Modified at S/W Revision	A.02.00, A.03.00, A.04.00

Positive Offset Limit

Enables you to set the upper limit for the upper segment of the specified offset pair.

Mode	WCDMA, C2K, WIMAX OFDMA, TD-SCDMA, 1xEVDO, LTE, LTETDD
Remote Command	:CALCulate:ACPower:OFFSet:LIST:LIMit:POSitive[:UPPer]:DATA <real>, <real>, <real>, <real>, <real>, <real> :CALCulate:ACPower:OFFSet:LIST:LIMit:POSitive[:UPPer]:DATA?
Example	CALC:ACP:OFFS:LIST:LIM:POS:DATA 0,0,0,0,0 CALC:ACP:OFFS:LIST:LIM:POS:DATA?
Notes	SCPI only command
Preset	WCDMA: -44.2, -49.2, -49.2, -49.2, -49.2, -49.2 -32.2, -42.2, -42.2, -42.2, -42.2, -42.2 C2K: 0, 0, 0, 0, 0, 0 0, 0, 0, 0, 0 1xEVDO: -45, -55, -55, -55, -55, -55 -45, -55, -55, -55, -55, -55
State Saved	Saved in instrument state.
Min	-150.0
Max	50.0
Backwards Compatibility SCPI	:CALCulate:MCPower:OFFSet:LIST:LIMit:POSitive[:UPPer]:DATA (PSA Power Suite)
Initial S/W Revision	A.04.00

Negative Offset Limit

Enables you to set the upper limit for the lower segment of the specified offset pair.

Mode	WCDMA, C2K, 1xEVDO, LTE
Remote Command	:CALCulate:ACPower:OFFSet:LIST:LIMit:NEGative[:UPPer]:DATA <real>, <real>, <real>, <real>, <real>, <real> :CALCulate:ACPower:OFFSet:LIST:LIMit:NEGative[:UPPer]:DATA?
Example	CALC:ACP:OFFS:LIST:LIM:NEG:DATA 0,0,0,0,0 CALC:ACP:OFFS:LIST:LIM:NEG:DATA?
Notes	SCPI only command
Preset	WCDMA: -44.2, -49.2, -49.2, -49.2, -49.2, -49.2 -32.2, -42.2, -42.2, -42.2, -42.2, -42.2 C2K: 0, 0, 0, 0, 0, 0 0, 0, 0, 0, 0 1xEVDO: -45, -55, -55, -55, -55, -55 -45, -55, -55, -55, -55, -55

State Saved	Saved in instrument state.
Min	-150.0
Max	50.0
Backwards Compatibility SCPI	:CALCulate:MCPower:OFFSet:LIST:LIMit:NEGative[:UPPer]:DATA (PSA Power Suite)
Initial S/W Revision	A.04.00

Rel Lim (PSD)

Enters a relative limit value for the level of the power spectral density. This sets the amplitude levels to test against for any custom offsets. The amplitude level is relative to the power spectral density. If multiple offsets are available, the list contains six (6) entries. The offset closest to the carrier channel is the first one in the list.

[[:SENSE]:ACP:OFFSet[n]:LIST[n]:TEST selects the type of testing to be done at each offset.

You can turn off (not use) specific offsets with the [[:SENSE]:ACP:OFFSet[n]:LIST:STATe command.

The query returns the six (6) sets of real numbers that are the current amplitude test limits, relative to the power spectral density, for each offset.

Offset[n] n = 1 is base station and n = 2 is mobiles. The default is base station (1).

Key Path	Meas Setup, Offset/Limits, Limits
Mode	WCDMA, C2K, 1xEVDO, LTE
Remote Command	[[:SENSE] :ACPower:OFFSet [1] 2:LIST:RPSDensity <rel_ampl>, <rel_ampl>, <rel_ampl>, <rel_ampl>, <rel_ampl>, <rel_ampl> [:SENSE] :ACPower:OFFSet [1] 2:LIST:RPSDensity?
Example	ACP:OFFS2:LIST:RPSD 10,10,10,10,10,10 ACP:OFFS2:LIST:RPSD?
Notes	Offset sub op code. 1 for BTS, 2 for MS. Default is BTS. You must be in the mode that includes ACP measurements to use this command. Use :INSTrument:SElect to set the mode.
Preset	WCDMA: -44.2 dB, -49.2 dB, -49.2 dB, -49.2 dB, -49.2 dB, -49.2 dB -32.2 dB, -42.2 dB, -42.2 dB, -42.2 dB, -42.2 dB, -42.2 dB C2K: 0 dB, 0 dB, 0 dB, 0 dB, 0 dB, 0 dB 0 dB, 0 dB, 0 dB, 0 dB, 0 dB, 0 dB 1xEVDO: -45, -55, -55, -55, -55, -55 -45, -55, -55, -55, -55, -55 LTE: 0, 0, 0, 0, 0, 0 0, 0, 0, 0, 0, 0
State Saved	Saved in instrument state.
Min	-150.0 dB
Max	50.0 dB

ACP Measurement
Meas Setup

Initial S/W Revision	Prior to A.02.00
Modified at S/W Revision	A.02.00, A.03.00

Fail Mask

Accesses a menu that enables you to select one of the logic keys for the fail conditions between the measurement results and the test limits. The setting defines the type of testing to be done at any custom offset frequencies. The measured powers are tested against the absolute values defined with [:SENSe]:ACP:OFFSet[n]:LIST:ABSolute, or the relative values defined with [:SENSe]:ACP:OFFSet:LIST:RPSDensity and [:SENSe]:ACP:OFFSet:LIST:RCARrier.

You can turn off (not use) specific offsets with the [:SENS]:ACP:OFFSet:LIST:STATe command.

- Absolute – Fail is shown if one of the absolute ACP measurement results is larger than the limit for Abs Limit.
- Relative – Fail is shown if one of the relative ACP measurement results is larger than the limit for Rel Lim (Car) or Rel Lim (PSD).
- Abs AND Rel – Fail is shown if one of the absolute ACP measurement results is larger than the limit for Abs Limit AND one of the relative ACP measurement results is larger than the limit for Rel Lim (Car) or Rel Lim (PSD).
- Abs OR Rel – Fail is shown if one of the absolute ACP measurement results is larger than the limit for Abs Limit OR one of the relative ACP measurement results is larger than the limit for Rel Lim (Car) or Rel Lim (PSD).

Key Path	Meas Setup, Offset/Limits, Limits
Mode	WCDMA, C2K, 1xEVDO, LTE
Remote Command	[:SENSe]:ACP:Power:OFFSet [1] 2:LIST:TEST ABSolute AND OR RELative, ABSolute AND OR RELative, ABSolute AND OR RELative, ABSolute AND OR RELative, ABSolute AND OR RELative, ABSolute AND OR RELative [:SENSe]:ACP:Power:OFFSet [1] 2:LIST:TEST?
Example	ACP:OFFS2:LIST:TEST ABS,ABS,ABS,ABS,ABS,ABS ACP:OFFS2:LIST:TEST?
Notes	Offset sub op code. 1 for BTS, 2 for MS. Default is BTS. You must be in the mode that includes ACP measurements to use this command. Use :INSTrument:SElect to set the mode.
Preset	WCDMA, C2K: REL, REL, REL, REL, REL, REL REL, REL, REL, REL, REL, REL CDMA1xEVDO: REL, REL, ABS, REL, REL, REL REL, REL, ABS, REL, REL, REL LTE: AND, AND, AND, AND, AND, AND AND, AND, AND, AND, AND, AND
State Saved	Saved in instrument state.

Range	Absolute Relative Abs AND Rel (fail if both fail) Abs OR Rel (fail if either fails)
Backwards Compatibility SCPI	[:SENSe]:MCPower:OFFSet[1] 2:LIST:TEST
Initial S/W Revision	Prior to A.02.00
Modified at S/W Revision	A.02.00, A.03.00, A.04.00
Modified at S/W Revision	A.04.00

Offset Side

Enables you to turn off (not use) specific offsets.

- NEGative - negative (lower) sideband only
- BOTH - both of the negative (lower) and positive (upper) sidebands
- POSitive - positive (upper) sideband only

Key Path	Meas Setup, Offset/Limits
Mode	WCDMA, C2K, 1xEVDO, LTE
Remote Command	[:SENSe]:ACPower:OFFSet[1] 2:LIST:SIDE NEGative BOTH POSitive,NEGative BOTH POSitive,NEGative BOTH POSitive,NEGative BOTH POSitive,NEGative BOTH POSitive,NEGative BOTH POSitive [:SENSe]:ACPower:OFFSet[1] 2:LIST:SIDE?
Example	ACP:OFFS:LIST:SIDE BOTH ACP:OFFS:LIST:SIDE?
Notes	OFFSet1 is for BTS, 2 for MS. Default is BTS. You must be in the W-CDMA mode, cdma2000 mode, 1xEVDO mode or LTE mode to use this command. Use :INSTRument:SElect to set the mode. If you set POS or NEG in an offset, result of the inactive side will return -999.
Preset	BOTH, BOTH, BOTH, BOTH, BOTH, BOTH BOTH, BOTH, BOTH, BOTH, BOTH, BOTH
State Saved	Saved in instrument state.
Range	Neg Both Pos
Initial S/W Revision	A.03.00

Method for Offset

This key allows you to turn RRC filtering of each offset on or off. The value (roll off) for the filter will be set to the value of the Filter Alpha parameter.

Key Path	Meas Setup, Offset/Limits
----------	---------------------------

ACP Measurement
Meas Setup

Mode	WCDMA, LTE
Remote Command	[:SENSE] :ACPower:OFFSet [1] 2:LIST:FILTer [:RRC] [:STATE] ON OFF 1 0, ON OFF 1 0, ON OFF 1 0, ON OFF 1 0, ON OFF 1 0, ON OFF 1 0 [:SENSE] :ACPower:OFFSet [1] 2:LIST:FILTer [:RRC] [:STATE] ?
Example	ACP:OFFS:LIST:FILT 1,0,0 ACP:OFFS:LIST:FILT?
Notes	1 ON = RRC Weighted, 0 OFF = Integ BW This parameter is not available for cdma2000 and 1xEVDO. You must be in the mode that includes ACP measurements to use this command. Use :INSTrument:SELEct to set the mode.
Preset	WCDMA: 1, 1, 1, 1, 1, 1 1, 1, 1, 1, 1, 1 C2K: NO LTE: 0, 0, 0, 0, 0, 0 0, 0, 0, 0, 0, 0
State Saved	Saved in instrument state.
Range	Integ BW RRC Weighted
Initial S/W Revision	A.03.00

Filter Alpha for Offset

Sets the alpha value for the RRC Filter for each offset.

Key Path	Meas Setup, Offset/Limits, Method, RRC Weighted
Mode	WCDMA, LTE
Remote Command	[:SENSE] :ACPower:OFFSet [1] 2:LIST:FILTer:ALPHa <real>, <real>, <real>, <real>, <real> [:SENSE] :ACPower:OFFSet [1] 2:LIST:FILTer:ALPHa?
Example	ACP:OFFS:LIST:FILT:ALPH 0.5,0.5,0.5,0.5,0.5,0.5 ACP:OFFS:LIST:FILT:ALPH?
Notes	This parameter is not available for cdma2000 and 1xEVDO. You must be in the mode that includes ACP measurements to use this command. Use :INSTrument:SELEct to set the mode.
Preset	WCDMA: 0.22,0.22,0.22,0.22,0.22,0.22 0.22,0.22,0.22,0.22,0.22,0.22 C2K: NO LTE: 0.22,0.22,0.22,0.22,0.22,0.22 0.22,0.22,0.22,0.22,0.22,0.22
State Saved	Saved in instrument state.
Min	0.01

Max	1.00
Initial S/W Revision	A.03.00

Offset Frequency Define

This key allows you to select “Offset” definition. Each standard defines each “Offset” from Carrier.

3GPP2 requires the “From Carrier Center to MeasBW Closer Edge” definition. And LTE conformance test requires “From Carrier Edge to MeasBW Center” and/or “From Carrier Edge to MeasBW Closer Edge” definition.

- CTOCenter – From the center of the carrier closest to the adjacent channel to the center of the adjacent channel Offset Integ BW
- CTOEdge - From the center of the carrier closest to the adjacent channel to the edge of the closest adjacent channel Offset Integ BW
- ETOCenter – From Center Frequency - Carrier Spacing / 2 (for lower offset), Center Frequency + Carrier Spacing / 2 (for upper offset) of the carrier closest to the adjacent channel's to the center of the adjacent channel Offset Integ BW
- ETOEdge - From Center Frequency - Carrier Spacing / 2 (for lower offset), Center Frequency + Carrier Spacing / 2 (for upper offset) of the carrier closest to the adjacent channel's to the edge of the closest adjacent channel Offset Integ BW

Key Path	Meas Setup, Offset/Limits
Mode	WCDMA, C2K, 1xEVDO, LTE
Remote Command	[:SENSe] :ACPower:OFFSet [1] 2 :TYPE CTOCenter CTOEdge ETOCenter ETOEdge [:SENSe] :ACPower:OFFSet [1] 2 :TYPE?
Example	ACP:OFFS:TYPE ETOC ACP:OFFS:TYPE?
Notes	You must be in the mode that includes ACP measurements to use this command. Use :INSTrument:SElect to set the mode.
Preset	CTOCenter
State Saved	Saved in instrument state.
Range	Carrier Center To Meas BW Center Carrier Center To Meas BW Edge Carrier Edge To Meas BW Center Carrier Edge To Meas BW Edge
Initial S/W Revision	A.03.00

Carrier Result

Allows you to view and scroll through the carrier power results.

Key Path	Meas Setup
----------	------------

ACP Measurement
Meas Setup

Mode	WCDMA, C2K, 1xEVDO, LTE
Couplings	This key will be grayed out if there is only one carrier.
Preset	1
State Saved	No
Min	1
Max	Number of carriers.
Initial S/W Revision	Prior to A.02.00
Modified at S/W Revision	A.02.00, A.03.00

PhNoise Opt

Selects the LO (local oscillator) phase noise behavior for various operating conditions.

Key Path	Meas Setup
Initial S/W Revision	Prior to A.02.00

PhNoise Opt Auto

Selects the best LO (local oscillator) phase noise behavior for the ACP measurement.

Auto works as follows:

- Looks at all the offsets that are turned on.

- Finds the largest and the smallest of the Freq Offset parameters for those offsets.

- Takes the mean.

- Compares that mean with the crossover frequency for the LO in use (see below).

- If the mean is below the crossover frequency, use "best close-in," otherwise use "best wide-offset."

Key Path	Meas Setup
Mode	WCDMA, C2K, 1xEVDO, LTE
Remote Command	[:SENSe] :ACPower:FREQuency:SYNThesis:AUTO [:STATe] OFF ON 0 1 [:SENSe] :ACPower:FREQuency:SYNThesis:AUTO [:STATe] ?
Example	ACP:FREQ:SYNT:AUTO 1 ACP:FREQ:SYNT:AUTO?
Preset	ON
State Saved	Saved in instrument state.
Range	Auto Man

Readback Text	“Auto” is underlined when Auto is selected, otherwise the Man is underlined.
Initial S/W Revision	Prior to A.02.00
Modified at S/W Revision	A.02.00, A.03.00, A.04.00

PhNoise Opt State

Selects the LO (local oscillator) phase noise behavior for various operating conditions.

Key Path	Meas Setup
Mode	WCDMA, C2K, 1xEVDO, LTE
Remote Command	[:SENSe] :ACPower:FREQuency:SYNThesis [:STATE] 1 2 3 [:SENSe] :ACPower:FREQuency:SYNThesis [:STATE] ?
Example	ACP:FREQ:SYNT 1 ACP:FREQ:SYNT?
Notes	Parameter key: 1 - optimizes phase noise for close-in from the carrier. 2 - optimizes phase noise for wide-offset from the carrier. 3 - optimizes LO for tuning speed.
Preset	Because this function is in Auto after preset, the state of this function after Preset will be automatically calculated.
State Saved	Saved in instrument state.
Range	Hardware dependent:
Readback Text	Close-in Wide-offset Fast Tuning, also the Man must be underlined.
Initial S/W Revision	Prior to A.02.00
Modified at S/W Revision	A.02.00, A.03.00 A.04.00

Meas Method

Sets the desired method to measure ACP.

Integration BW — one sweep of the trace is taken, and the band power for each offset is computed. Depending on the status of the Meas Type parameter (Total Power Reference or PSD Reference), results are displayed relative to the total power or the power spectral density. The display reflects either the current trace or a bar graph view.

Filtered IBW (max dynamic range) — the ACP Path is used to compute ACP when an ACP path is available. This method increases dynamic range, but increases measurement time as it limits the resolution bandwidth. This method is useful for improving dynamic range on a W-CDMA signal because a sharp cutoff bandpass filter is used. The accuracy of the adjacent channel power ratio is not degraded by this method, but the absolute accuracy of both adjacent channel power and carrier power are degraded by up to about 0.5 dB.

ACP Measurement
Meas Setup

RBW — the algorithm uses zero-span and an appropriate RBW setting to capture all of the power in the carrier channel and the offsets. The zero-span algorithm (RBW method) is slower than the IBW method, but greatly improves repeatability.

Fast (in WCDMA mode or SA mode with 3GPP WCDMA radio standard selected) — this provides the same method as the Integration BW method, but is optimized for speed to measure a W-CDMA signal.

Fast (in CDMA2K mode or SA mode with CDMA2K radio standard selected) — this provides faster measurement using the FFT method with a limited parameter flexibility. When this is selected, CDMA2K preset offsets are given and control of the following are grayed out:

BW menu, Sweep/Control menu except Pause/Resume, Trace/Detector menu, Carrier Setup, Offset Limit, RRC Weighting, Filter Alpha, and Noise Correction keys in Meas Setup menu.

In the TD-SCDMA mode, only the Integration BW method is available. Therefore, the Meas Method key is not displayed in the TD-SCDMA mode.

Key Path	Meas Setup
Mode	WCDMA, C2K, 1xEVDO, LTE
Remote Command	[:SENSe] :ACPower:METhod IBW IBWRange FAST RBW [:SENSe] :ACPower:METhod?
Example	ACP:METh IBW ACP:METh?
Notes	CDMA1xEVDO mode only supports RBW and Integration BW method. C2K mode only supports RBW, Integration BW and FAST method. FAST mode is only supported for WCDMA and C2K signal. You must be in the WCDMA or C2K mode with 3GPP WCDMA or CDMA2K radio standard. Otherwise a setting conflict error message will be reported. Supporting FAST mode in C2K is available with the instrument version A.02.00 or later You must be in the mode that includes ACP measurements to use this command. Use :INSTrument:SElect to set the mode.
Couplings	IBW (Range) restricts the Res BW available for making this measurement to 30 kHz. When selected, the Res BW is clipped to this value if required and an error number displayed.
Preset	LTE, LTETDD: IBW WCDMA: IBW C2K: RBW WIMAX OFDMA: IBW 1xEVDO: IBW
State Saved	Saved in instrument state.
Range	Integration BW Filtered IBW (max dynamic range) RBW Fast

Readback Text	IBW Filtered IBW RBW Fast
Backwards Compatibility SCPI	[:SENSe]:ACPR:SWEp:TYPE [:SENSe]:MCPower:METhod (PSA Power Suite)
Initial S/W Revision	Prior to A.02.00
Modified at S/W Revision	A.02.00, A.03.00

Meas Type

Changes the reference used for the measurement. This allows you to make absolute and relative power measurements of either total power or the power normalized to the measurement bandwidth.

Total Pwr Ref (TPR) sets the reference to the total carrier power. PSD Ref (PSDR) sets the reference to the power spectral density of the carrier.

Key Path	Meas Setup
Mode	WCDMA, C2K, 1xEVDO, LTE
Remote Command	[:SENSe] :ACPpower:TYPE TPRef PSDRef [:SENSe] :ACPpower:TYPE?
Example	ACP:TYPE PSDR ACP:TYPE?
Initial S/W Revision	Prior to A.02.00
Notes	You must be in the mode that includes ACP measurements to use this command. Use :INSTrument:SELEct to set the mode.
Preset	TPRef
State Saved	Saved in instrument state.
Range	Total Power Ref PSD Ref
Modified at S/W Revision	A.02.00
Modified at S/W Revision	A.03.00

PSD Ref

Sets the unit bandwidth for Power Spectral Density. The available units are dBm/Hz and dBm/MHz.

Key Path	Meas Setup
Mode	WCDMA, C2K, 1xEVDO, LTE
Remote Command	:UNIT:ACPpower:POWer:PSD DBMHZ DBMMHZ :UNIT:ACPpower:POWer:PSD?

ACP Measurement
Meas Setup

Example	UNIT:ACP:POW:PSD DBMMHZ UNIT:ACP:POW:PSD?
Couplings	When the PSD unit is changed, the PSD reference result of the “MEAS READ FETCH:ACP[n]?” is also changed by the PSD unit basis (in either dBm/Hz or dBm/MHz).
Preset	DBMHZ
State Saved	Saved in instrument state.
Range	dBm/Hz dBm/MHz
Initial S/W Revision	Prior to A.02.00
Modified at S/W Revision	A.02.00, A.03.00

Limit Test

Turns limit checking for each offset On or Off. The limits may be specified within the Offset menu, for each offset, both sides of the carrier. For results that fail the limit, a red F is appended. In the Combined view, the bar turns red.

Key Path	Meas Setup
Mode	WCDMA, C2K, 1xEVDO, LTE
Remote Command	:CALCulate:ACPower:LIMit:STATe OFF ON 0 1 :CALCulate:ACPower:LIMit:STATe?
Example	CALC:ACP:LIM:STAT OFF CALC:ACP:LIM:STAT?
Notes	You must be in the mode that includes ACP measurements to use this command. Use :INSTrument:SELect to set the mode.
Preset	WCDMA: ON C2K: ON 1xEVDO: ON LTE: ON
State Saved	Saved in instrument state.
Range	On Off
Backwards Compatibility SCPI	[:SENSe]:MCPower:LIMit[:STATe] [:SENSe]:ACPower:LIMit[:STATe]
Initial S/W Revision	Prior to A.02.00
Modified at S/W Revision	A.02.00, A.03.00

Noise Correction

Sets the measurement noise floor correction function to On or Off. On enables measurement noise correction when the measured power in the reference channel or any offset is close to the noise floor of the test set. Off turns these corrections off.

In test sets with the noise floor extensions option (option NFE) enabled, there are two ways to compensate for the test set noise floor: through the NFE and through this noise corrections key. The techniques and results are similar but not identical. NFE uses a model of the test set noise floor, adapted to the current conditions such as center frequency, RBW and ambient temperature. The parameters of this model are measured in the factory or field calibration in a highly averaged measurement. So they are consistent. However, because the model is imperfect, the corrections are imperfect. Using NFE is very convenient; the user need not wait for the ACP noise corrections calibration to occur. The ACP NC calibration, though, has advantages of being measured very recently, at the current ambient, and the exact center frequency, with no requirement that the model be perfect. So it will often (but not always) have slightly better dynamic range. If both ACP NC is turned on and NFE is turned on, the test set uses only the ACP NC. When ACP NC is turned off but NFE is on, NFE is used and performance should still be excellent.

Key Path	Meas Setup
Mode	WCDMA, C2K, 1xEVDO, LTE
Remote Command	[:SENSe] :ACPower:CORREction:NOISe [:AUTO] OFF ON 0 1 [:SENSe] :ACPower:CORREction:NOISe [:AUTO] ?
Example	ACP:CORR:NOIS OFF ACP:CORR:NOIS?
Notes	You must be in the mode that includes ACP measurements to use this command. Use :INSTrument:SELect to set the mode.
Preset	0
State Saved	Saved in instrument state.
Range	On Off
Initial S/W Revision	Prior to A.02.00
Modified at S/W Revision	A.02.00, A.03.00, A.04.00

Meas Preset

Restores all the measurement parameters to their default values.

Key Path	Meas Setup
Mode	WCDMA, C2K, 1xEVDO, LTE
Remote Command	:CONFigure:ACPower
Example	CONF:ACP

ACP Measurement
Meas Setup

Notes	You must be in the mode that includes ACP measurements to use this command. Use :INSTrument:SELEct to set the mode.
Couplings	Selecting Meas Preset will restore all measurement parameters to their default values.
Initial S/W Revision	Prior to A.02.00
Modified at S/W Revision	A.02.00, A.03.00

Offset RRC Weighting (Backward Compatibility SCPI)

Key Path	SCPI Only
Mode	WCDMA, LTE, LTETDD
Remote Command	[:SENSE] :ACPower:FILTer [:RRC] [:STATe] OFF ON 0 1 [:SENSE] :ACPower:FILTer [:RRC] [:STATe] ?
Example	ACP:FILT OFF ACP:FILT?
Initial S/W Revision	Prior to A.02.00
Notes	This parameter is not available for cdma2000 and 1xEVDO The backwards Compatibility SCPI command, [:SENSe] :ACPR:FILTer [:RRC] [:STATe], is provided to support same functionality as [:SENSe] :ACPr:FILTer [:RRC] [:STATe] (PSA W-CDMA, PSA cdma2000 and PSA 1xEVDO) due to ACPr node conflicts with ACPower node. You must be in the mode that includes ACP measurements to use this command. Use :INSTrument:SELEct to set the mode.
Couplings	This command is an alias to [:SENSe] :ACPower:OFFSet [1] [2] :LIST:FILTer [:RRC] [:STATe] Sending the commands to set values of all offsets for BS and MS, however, sending the query always return a value of BS Offset A.
Preset	WCDMA: ON
State Saved	Saved in instrument state.
Backwards Compatibility SCPI	[:SENSe] :ACPR:FILTer [:RRC] [:STATe] [:SENSe] :MCPower:FILTer [:RRC] [:STATe]
Modified at S/W Revision	A.03.00

Offset Filter Alpha (Backward Compatibility SCPI)

Key Path	SCPI Only
Mode	WCDMA, LTE, LTETDD
Remote Command	[:SENSE] :ACPower:FILTer [:RRC] :ALPHA <real> [:SENSE] :ACPower:FILTer [:RRC] :ALPHA?
Example	ACP:FILT:ALPH 0.5 ACP:FILT:ALPH?

ACP Measurement
Meas Setup

Notes	<p>This parameter is not available for cdma2000 and 1xEVDO</p> <p>The backwards Compatibility SCPI command, [:SENSe]:ACPR:FILTer[:RRC]:ALPHa, is provided to support same functionality as [:SENSe]:ACPr:FILTer[:RRC]:ALPHa (PSA W-CDMA, PSA cdma2000 and PSA 1xEVDO) due to ACPr node conflicts with ACPower node.</p> <p>You must be in the mode that includes ACP measurements to use this command. Use :INSTrument:SELEct to set the mode.</p>
Couplings	<p>This command is an alias to</p> <p>[:SENSe]:ACPower:OFFSet[1]:2:LIST:FILTer:ALPhHa</p> <p>Sending the commands to set values of all offsets for BS and MS, however, sending the query always return a value of BS Offset A.</p>
Preset	<p>WCDMA, LTE, LTETDD: 0.22</p> <p>C2K: NO</p>
State Saved	Saved in instrument state.
Min	0.01
Max	1.00
Backwards Compatibility SCPI	<p>[:SENSe]:ACPR:FILTer[:RRC]:ALPHa</p> <p>[:SENSe]:MCPower:FILTer[:RRC]:ALPHa</p>
Initial S/W Revision	Prior to A.02.00
Modified at S/W Revision	A.02.00, A.03.00

Method for Carrier (Backward Compatibility SCPI)

Key Path	SCPI Only
Mode	WCDMA, LTE, LTETDD
Remote Command	<p>[:SENSe]:ACPower:CARRier [1] 2:LIST:METhod IBW RRC, ...</p> <p>[:SENSe]:ACPower:CARRier [1] 2:LIST:METhod?</p>
Example	<p>ACP:CARR2:LIST:METh RRC</p> <p>ACP:CARR2:LIST:METh?</p>
Notes	<p>You must be in the mode that includes ACP measurements to use this command. Use :INSTrument:SELEct to set the mode.</p> <p>Maximum of Array length depends on the number of carriers.</p>

Couplings	<p>This command is an alias to [:SENSe]:ACPower:CARRier[1] 2:LIST:FILTer[:RRC][:STATe]</p> <p>The enum value translates as follows: RRC Weighted = 1 ON Integ BW = 0 OFF Maximum of Array length depends on the number of carriers.</p>
Preset	<p>WCDMA: RRC WIMAX OFDMA: IBW TD-SCDMA: RRC LTE, LTETDD: IBW LTETDD: IBW</p>
State Saved	Saved in instrument state.
Initial S/W Revision	Prior to A.02.00
Modified at S/W Revision	A.03.00

Mode

See “[Mode](#)” on page 1091 for more information.

Key Path	Front-panel key
Initial S/W Revision	Prior to A.02.00

Mode Setup

See “Mode Setup” on page 1103 for more information.

Key Path	Front-panel key
Initial S/W Revision	Prior to A.02.00

Peak Search

Accesses a menu that enables you to control the peak search function.

Key Path	Front-panel key
Initial S/W Revision	Prior to A.02.00

Peak Search

Places the selected marker on the trace point with the maximum y-axis value.

Key Path	Peak Search
Mode	WCDMA, C2K, WIMAX OFDMA, TD-SCDMA, 1xEVDO, LTE, LTETDD
Remote Command	:CALCulate:ACPower:MARKer [1] 2 3 4 5 6 7 8 9 10 11 12 :M AXimum
Example	CALC:ACP:MARK2:MAX
Initial S/W Revision	Prior to A.02.00
Modified at S/W Revision	A.02.00, A.03.00

Next Peak

Moves the selected marker to the peak that has the next highest amplitude.

Key Path	Peak Search
Mode	WCDMA, C2K, WIMAX OFDMA, TD-SCDMA, 1xEVDO, LTE, LTETDD
Remote Command	:CALCulate:ACPower:MARKer [1] 2 3 4 5 6 7 8 9 10 11 12 :M AXimum:NEXT
Example	CALC:ACP:MARK2:MAX:NEXT
Initial S/W Revision	Prior to A.02.00
Modified at S/W Revision	A.02.00, A.03.00

Next Pk Right

Moves the selected marker to the nearest peak to the right of the current marker that meets all enabled peak criteria.

Key Path	Peak Search
Mode	WCDMA, C2K, WIMAX OFDMA, TD-SCDMA, 1xEVDO, LTE, LTETDD

Remote Command	:CALCulate:ACPower:MARKer [1] 2 3 4 5 6 7 8 9 10 11 12 :MAXimum:RIGHT
Example	CALC:ACP:MARK2:MAX:RIGH
Initial S/W Revision	Prior to A.02.00
Modified at S/W Revision	A.02.00, A.03.00

Next Pk Left

Moves the selected marker to the nearest peak to the left of the current marker that meets all enabled peak criteria.

Key Path	Peak Search
Mode	WCDMA, C2K, WIMAX OFDMA, TD-SCDMA, 1xEVDO, LTE, LTETDD
Remote Command	:CALCulate:ACPower:MARKer [1] 2 3 4 5 6 7 8 9 10 11 12 :MAXimum:LEFT
Example	CALC:ACP:MARK2:MAX:LEFT
Initial S/W Revision	Prior to A.02.00
Modified at S/W Revision	A.02.00, A.03.00

Marker Delta

Sets the control mode for the selected marker to Delta mode.

See Marker Delta in the "Marker Functions" section for more information.

Key Path	Peak Search
Initial S/W Revision	Prior to A.02.00

Pk-Pk Search

Finds and displays the amplitude and frequency (or time, if in zero span) differences between the highest and lowest y-axis value.

Key Path	Peak Search
Mode	WCDMA, C2K, WIMAX OFDMA, TD-SCDMA, 1xEVDO, LTE, LTETDD
Remote Command	:CALCulate:ACPower:MARKer [1] 2 3 4 5 6 7 8 9 10 11 12 :PTPeak
Example	CALC:ACP:MARK:PTP
Notes	Turns on the Marker Δ active function.
Couplings	This key is not available (key is grayed out) when Coupled Markers is on.

ACP Measurement
Peak Search

Initial S/W Revision	Prior to A.02.00
Modified at S/W Revision	A.02.00, A.03.00

Min Search

Moves the selected marker to the minimum y-axis value on the current trace.

Key Path	Peak Search
Mode	WCDMA, C2K, WIMAX OFDMA, TD-SCDMA, 1xEVDO, LTE, LTETDD
Remote Command	:CALCulate:ACPower:MARKer [1] 2 3 4 5 6 7 8 9 10 11 12 :M INimum
Example	CALC:ACP:MARK:MIN
Initial S/W Revision	Prior to A.02.00
Modified at S/W Revision	A.02.00, A.03.00

Recall

See “Recall” on page 192 for more information.

Key Path	Front-panel key
Initial S/W Revision	Prior to A.02.00

Restart

See “Restart” on page 1125 for more information.

Key Path	Front-panel key
Initial S/W Revision	Prior to A.02.00

Save

See [“Save” on page 204](#) for more information.

Key Path	Front-panel key
Initial S/W Revision	Prior to A.02.00

Single

See “[Single \(Single Measurement/Sweep\)](#)” on page 1135 for more information.

Key Path	Front-panel key
Initial S/W Revision	Prior to A.02.00

Source (Internal)

See “Source (Internal)” on page 1137 for more information.

Key Path	Front-panel key
Initial S/W Revision	A.05.00

SPAN X Scale

Accesses a menu of functions that enable you set the horizontal scale parameters.

Key Path	Front-panel key
Initial S/W Revision	Prior to A.02.00

Span

Changes the frequency range symmetrically about the center frequency.

The default (and minimum) span is calculated using the number of carriers and the carrier width where;

$$\text{Span} = (\text{Upper Carrier Freq} + (\text{max offset IBW} * (1 + \alpha)) / 2) - (\text{Lower Carrier Freq} - (\text{max offset IBW} * (1 + \alpha)) / 2)$$

The span is increased by a factor of 1 + Filter Alpha if the RRC Filter is on.

Key Path	SPAN X Scale
Mode	WCDMA, C2K, WIMAX OFDMA, TD-SCDMA, 1xEVDO, LTE, LTETDD
Remote Command	[:SENSe] :ACPower:FREQUENCY:SPAN <freq> [:SENSe] :ACPower:FREQUENCY:SPAN?
Example	ACP:FREQ:SPAN 25 MHz ACP:FREQ:SPAN?
Notes	You must be in the mode that includes ACP measurements to use this command. Use :INSTrument:SElect to set the mode.
Couplings	The span value is clipped when the carrier settings and/or the offset settings are changed. The value is changed to satisfy following formula: Span = (Upper Carrier Freq + (max offset IBW * (1 + alpha)) / 2) - (Lower Carrier Freq - (max offset IBW * (1 + alpha)) / 2)
Preset	SA: 8 MHz WCDMA: 24.6848 MHz WIMAX OFDMA: 50 MHz C2K: 4.5 MHz TD-SCDMA: 8 MHz 1xEVDO: 4.05 MHz LTE, LTETDD: 15 MHz
State Saved	Saved in instrument state.
Min	10 Hz

Max	Hardware Dependent: Option 503 = 3.7 GHz Option 504 = 3.9 GHz
Initial S/W Revision	Prior to A.02.00
Modified at S/W Revision	A.03.00

Full Span

Changes the span to show the full frequency range of the test set.

Key Path	SPAN X Scale
Mode	WCDMA, C2K, WiMAX OFDMA, TD-SCDMA, 1xEVDO, LTE, LTETDD
Remote Command	[:SENSE] :ACPower :FREQuency :SPAN :FULL
Example	ACP:FREQ:SPAN:FULL
Notes	You must be in the mode that includes ACP measurements to use this command. Use :INSTrument:SElect to set the mode.
Initial S/W Revision	Prior to A.02.00
Modified at S/W Revision	A.02.00, A.03.00

Last Span

Changes the span to the previous span setting. If no previous span value exists, then the span will remain unchanged.

Key Path	SPAN X Scale
Mode	WCDMA, C2K, WIMAX OFDMA, TD-SCDMA, 1xEVDO, LTE, LTETDD
Remote Command	[:SENSE] :ACPower :FREQuency :SPAN :PREVIOUS
Example	ACP:FREQ:SPAN:PREV
Notes	You must be in the mode that includes ACP measurements to use this command. Use :INSTrument:SElect to set the mode.
Initial S/W Revision	Prior to A.02.00
Modified at S/W Revision	A.02.00, A.03.00

Sweep/Control

Accesses a menu of functions that enable you to set up and control the sweep time, and source.

See “Sweep/Control” on page 1267 for more information

Key Path	Front-panel key
Initial S/W Revision	Prior to A.02.00

Sweep Time

Selects the length of time in which the test set sweeps the displayed frequency span. In swept spans, the sweep time varies from 1 millisecond to 2000 seconds. Additional overhead time, which impacts the sweep rate, is not calculated as part of the sweep time. In fact:

sweep rate = span/sweep time

update rate = 1/(sweep time + overhead)

sweep cycle time = sweep time + overhead

Sweep time is coupled to RBW and VBW, and is impacted by the number of sweep points, so changing those parameters may change the sweep time.

If you increase the sweep time, you increase the length of the time data captured and the number of points measured. You might need to specify a specific sweep speed to accommodate a specific condition in your transmitter. For example, you may have a burst signal and need to measure an exact portion of the burst.

Selecting a specific sweep time may result in a long measurement time since the resulting number of data points may not be the optimum. Use [:SENSe]:ACP:OFFSet:LIST:SWEep:TIME to set the number of points used for measuring the offset channels for Basic and cdmaOne.

For cdma2000 and W-CDMA, this command sets the sweep time when using the sweep mode. See [:SENSe]:ACP:SWEep:TYPE

Key Path	Sweep/Control
Mode	WCDMA, C2K, WIMAX OFDMA, TD-SCDMA, 1xEVDO, LTE, LTETDD
Remote Command	<pre>[:SENSe]:ACP:Power:SWEep:TIME <time> [:SENSe]:ACP:Power:SWEep:TIME? [:SENSe]:ACP:Power:SWEep:TIME:AUTO OFF ON 0 1 [:SENSe]:ACP:Power:SWEep:TIME:AUTO?</pre>
Example	<pre>ACP:SWE:TIME 50ms ACP:SWE:TIME? ACP:SWE:TIME:AUTO OFF ACP:SWE:TIME:AUTO?</pre>

Notes	This parameter is preset by Meas Method selection. Preset values are as follows: IBW: 29 ms IBWR: 108 ms FAST (WCDMA): 7.5 ms
Couplings	When you manually change the Sweep Time, this state automatically goes to 'Man'.
Preset	LTE, LTETDD: Automatically calculated WCDMA: 29 ms WIMAX OFDMA: Automatically calculated C2K: Automatically calculated TD-SCDMA: Automatically calculated 1xEVDO: Automatically calculated LTE, LTETDD: ON WCDMA: OFF C2K: OFF (method IBW) WIMAX OFDMA: ON TD-SCDMA: ON
State Saved	Saved in instrument state.
Min	1 ms
Max	4000 s

Sweep Setup

Accesses the sweep setup menu.

Key Path	Sweep/Control
Initial S/W Revision	Prior to A.02.00

Auto Sweep Time Rules

Switches the test set between normal and accuracy sweep states.

Key Path	Sweep/Control, Sweep Setup
Mode	WCDMA, C2K, WIMAX OFDMA, TD-SCDMA, 1xEVDO, LTE, LTETDD
Remote Command	[:SENSE] :ACPoweR :SWEep :TIME :AUTO :RULEs NORMAl ACCuracy [:SENSE] :ACPoweR :SWEep :TIME :AUTO :RULEs?

ACP Measurement
Sweep/Control

Example	ACP:SWE:TIME:AUTO:RUL NORM ACP:SWE:TIME:AUTO:RUL?
Notes	Set to Norm when Auto Couple is pressed or sent remotely.
Preset	WCDMA, C2K, TD-SCDMA, 1xEVDO, LTE, LTETDD: ACCuracy WIMAX OFDMA: NORMal
State Saved	Saved in instrument state.
Range	Norm Accy
Initial S/W Revision	Prior to A.02.00
Modified at S/W Revision	A.02.00, A.03.00

Pause

Pauses a measurement after the current data acquisition is complete. When Paused, the label on the key changes to Resume. Pressing the Resume key resumes the measurement at the point where it was paused. When Paused, pressing **Restart**, **Single**, or **Cont** does a Resume.

See “[Pause/Resume](#)” on page 1279 for more details.

Key Path	Sweep/Control
Initial S/W Revision	Prior to A.02.00

Gate

Accesses a menu that enables you to control the gating function. The Gate functionality is used to view signals best viewed by qualifying them with other events.

Gate Method that lets you choose one of the three different types of gating is not available in this measurement.

See “[Gate](#) ” on page 1280 for more details.

Key Path	Sweep/Control
Initial S/W Revision	Prior to A.02.00

Points

Sets the number of points per sweep, from 1 to 20001. The sweep time resolution setting will depend on the number of points selected.

Key Path	Sweep/Control
Mode	WCDMA, C2K, WIMAX OFDMA, 1xEVDO, LTE, LTETDD

Remote Command	[:SENSe] :ACPower:SWEep:POINts <integer> [:SENSe] :ACPower:SWEep:POINts?
Example	ACP:SWE:POIN 500 ACP:SWE:POIN?
Notes	Whenever the number of sweep points changes: <ul style="list-style-type: none"> • All trace data is erased • Any traces with Update Off will also go to Display Off (like going from View to Blank in the older test sets) • Sweep time is re-quantized • Any limit lines that are on will be updated • If averaging/hold is on, averaging/hold starts over
Couplings	Whenever the number of sweep points changes, the sweep time is re-quantized.
Preset	1001
State Saved	Saved in instrument state.
Min	1
Max	20001
Initial S/W Revision	Prior to A.02.00
Modified at S/W Revision	A.02.00, A.03.00

Trace/Detector

Accesses a menu of functions that enable you to control the detectors for the current measurement.

Key Path	Front-panel key
Initial S/W Revision	Prior to A.02.00

Select Trace (Front-panel Only)

This key selects which trace the other parameters under the Trace/Detector menu will apply to.

Key Path	Trace/Detector
Notes	Front panel only.
Couplings	When Meas Method is RBW or FAST, Select Trace is disabled.
Preset	1
State Saved	Saved in instrument state.
Range	1 2 3
Initial S/W Revision	Prior to A.02.00

Trace Type

Allows you to select the type of trace for the current measurement. The first page of this menu contains a selection of the trace type (Clear Write, Trace Average, Max Hold, Min Hold) for the selected trace.

Key Path	Trace/Detector
Mode	WCDMA, C2K, WIMAX OFDMA, TD-SCDMA, 1xEVDO, LTE, LTETDD
Remote Command	:TRACe [1] 2 3 :ACP:TYPE WRITe AVERAge MAXHold MINHold :TRACe [1] 2 3 :ACP:TYPE?
Example	TRAC:ACP:TYPE MINH TRAC:ACP:TYPE?
Notes	WRITe = Clear Write AVERAge = Average MAXHold = Maximum Hold MINHold = Minimum Hold

Couplings	<p>When Detector setting is “Auto” ([:SENSe]:ACPower:DETECTOR:AUTO?), Detector is set to what the Radio Standard defaults states (see detector section below) for all conditions of Trace Type and for all traces. When set to Manual, all Traces use the same detector type. When Average State = Off then Trace Types AVERAge, MaxHold and MinHold will not function, since Averaging is required to be ‘on’ for them to operate.</p> <p>When Meas Method is RBW or FAST, Trace Type is disabled.</p>
Preset	AVERAge
State Saved	Saved in instrument state.
Initial S/W Revision	Prior to A.02.00
Modified at S/W Revision	A.02.00, A.03.00

View / Blank

Key Path	Trace/Detector
Mode	WCDMA, C2K, WIMAX OFDMA, TD-SCDMA, 1xEVDO, LTE, LTETDD
Initial S/W Revision	Prior to A.02.00
Notes	No SCPI. Front panel only.
Couplings	<p>The four states of this 1-of-N actually set two variables, Update and Display, to their four possible combinations. Trace On: Update and Display both On View: Update Off and Display On (Not implemented) Blank: Update Off and Display Off Background: Update On, Display Off (Not implemented)</p> <p>See tables below for detail on the SCPI to control these two variables.</p> <p>Selecting a trace type (Clear Write, Trace Average, Max Hold, Min Hold) for a trace (pressing the key or sending the equivalent SCPI command) puts the trace in 'Trace On' state (Update On and Display On), even if that trace type was already selected.</p> <p>When Meas Method is RBW or FAST, this key is grayed out.</p>
Preset	Trace On
State Saved	Saved in instrument state.
Range	Trace On Blank
Modified at S/W Revision	A.03.00

Key Path	Trace/Detector
Mode	WCDMA, C2K, WIMAX OFDMA, TD-SCDMA, 1xEVDO, LTE, LTETDD
Remote Command	:TRACe [1] 2 3 :ACPower:UPDate [:STATE] ON OFF 0 1 :TRACe [1] 2 3 :ACPower:UPDate [:STATE] ?
Example	TRAC:ACP:UPD ON TRAC:ACP:UPD?
Couplings	<p>Whenever you set Update to On for any trace, the Display is set to On for that trace.</p> <p>When Meas Method is RBW or FAST, Trace Update is disabled.</p>
Preset	1 0 0 (On for Trace 1; Off for 2 &3)
State Saved	Saved in instrument state.
Range	0 1
Initial S/W Revision	Prior to A.02.00
Modified at S/W Revision	A.03.00

Key Path	Trace/Detector
Mode	WCDMA, C2K, WIMAX OFDMA, TD-SCDMA, 1xEVDO, LTE, LTETDD
Remote Command	:TRACe [1] 2 3 :ACPower:DISPlay [:STATe] ON OFF 0 1 :TRACe [1] 2 3 :ACPower:DISPlay [:STATe] ?
Example	TRAC:ACP:DISP ON TRAC:ACP:DISP?
Couplings	Whenever you set Update to On for any trace, the Display is set to On for that trace. When Meas Method is RBW or FAST, Trace Display is disabled.
Preset	1 0 0 (On for Trace 1; Off for 2 &3)
State Saved	Saved in instrument state.
Range	0 1
Initial S/W Revision	Prior to A.02.00
Modified at S/W Revision	A.03.00

Detector

Accesses a menu of functions that enables you to control the detectors for the current measurement. Allows up to three (3) traces, but each use the same detector type choice. The following choices are available:

- Auto- the detector selected is set to AVERage, unless the Radio Standard defaults state otherwise e.g. it is set to Peak for Radio Standard = PDC when Device = both MS and BTS, and when Radio Standard = NADC and Device = MS.
- Normal-the detector determines the peak of the CW-like signals, and it yields alternating maximums and minimums of noise-like signals. This is also referred to as Rosenfell detection.
- Average-the detector determines the average of the signal within the sweep points. The averaging method is Power (RMS).
- Peak-the detector determines the maximum of the signal within the sweep points.
- Sample-the detector indicates the instantaneous level of the signal at the center of the sweep points represented by each display point.
- Negative Peak-the detector determines the minimum of the signal within the sweep points.

In swept analysis, the time interval of the data collection for the display sweep points also represents a frequency interval. In FFT analysis, the sweep points represents just a frequency interval. The detector determines the relationship between the spectrum computed by the FFT and the single data point displayed for the sweep points.

Key Path	Trace/Detector
Initial S/W Revision	Prior to A.02.00

Auto

Sets the detector for the currently selected trace to auto.

Key Path	Trace/Detector
Mode	WCDMA, C2K, WIMAX OFDMA, TD-SCDMA, 1xEVDO, LTE, LTETDD
Remote Command	[:SENSe] :ACPpower:DETECTOR:AUTO ON OFF 1 0 [:SENSe] :ACPpower:DETECTOR:AUTO?
Example	ACP:DET:AUTO 1 ACP:DET?
Couplings	When Detector setting is “Auto” ([:SENSe]:ACPpower:DETECTOR:AUTO?), Detector is set to what the Radio Standard defaults states (see detector section) for all conditions of Trace Type and for all traces. When set to Manual, all Traces use the same detector type. When Average State = Off then Trace Types AVERage, MaxHold and MinHold will not function, since Averaging is required to be ‘on’ for them to operate.
Preset	ON
State Saved	Saved in instrument state.
Range	ON OFF
Initial S/W Revision	Prior to A.02.00
Modified at S/W Revision	A.02.00, A.03.00

Detector Selection

Selects a detector to be used by the test set for the current measurement. All traces will use the same detector type, similar to Monitor Spectrum measurement

Key Path	Trace/Detector
Mode	WCDMA, C2K, WIMAX OFDMA, TD-SCDMA, 1xEVDO, LTE, LTETDD
Remote Command	[:SENSe] :ACPpower:DETECTOR[:FUNCTION] AVERage NEGative NORMal POSitive SAMPle [:SENSe] :ACPpower:DETECTOR[:FUNCTION]?
Example	ACP:DET NORM ACP:DET?

Notes	<p>When you manually select a detector (instead of selecting Auto), that detector is used regardless of other test set settings.</p> <p>The detector choices are:</p> <ul style="list-style-type: none"> • The Normal detector determines the peak of CW-like signals, and it yields alternating maximums and minimums of noise-like signals. This is also referred to as Rosenfell detection. • The Average detector determines the average of the signal within the data range. The averaging method is Power (RMS). • The Peak detector determines the maximum of the signal within the data range. • The Sample detector indicates the instantaneous level of the signal at the center of the data represented by each display point. • The Negative Peak detector determines the minimum of the signal within the data range. <p>Because they may not find a spectral component's true peak, neither average nor sample detectors measure amplitudes of CW signals as accurately as peak or normal, but they do measure noise without the biases of peak detection.</p> <p>When a detector selection is made, the menu returns to the previous menu.</p>
Couplings	<p>When Detector setting is “Auto” ([:SENSe]:ACPower:DETEctor:AUTO?), Detector is set to what the Radio Standard defaults states (see detector section) for all conditions of Trace Type and for all traces. When set to Manual, all Traces use the same detector type. When Average State = Off then Trace Types AVERage, MaxHold and MinHold will not function, since Averaging is required to be ‘on’ for them to operate.</p> <p>Only one detector type for all 3 traces is allowed.</p> <p>When Meas Method is RBW or FAST, Detector is disabled.</p>
Preset	AVERage
State Saved	Saved in instrument state.
Range	Normal Average Peak Sample Negative Peak
Backwards Compatibility SCPI	[:SENSe]:ACPR:SWEEp:DETEctor[:FUNCTion]
Initial S/W Revision	Prior to A.02.00
Modified at S/W Revision	A.02.00, A.03.00

Trigger

Accesses a menu functions that enable you to select and control the trigger source for the current measurement. See [“Trigger” on page 1339](#) for more information.

Key Path	Front-panel key
Initial S/W Revision	Prior to A.02.00

View/Display

Accesses a menu of functions that enable you to control the instrument display as well as turn the bar graph On and Off.

The display consists of the following two windows:

“Spectrum Window” on page 465

“Results Window” on page 465



Spectrum Window

When the Bar Graph is On and Limit Test is On, the color of each bar graph reflects the limit test result. When the limit test fails, the bar color is red, and when limit test passes, the bar color is blue.

When RBW is selected as the measurement method, the spectrum trace is not displayed, only the bar graph is displayed. In addition, the Bar Graph key (under the View/Display front-panel key) is set to ON and is grayed out.

The RRC Filter display item is only displayed when RRC filter is on.

Results Window

The text window displays the following results:

Total Carrier Power

This is the total power of all the carriers with carrier power present set to yes. The power is calculated by integrating across the bandwidth declared by the Carrier Integ Bw parameter for each carrier and then totaling the sums. The total integration bandwidth is shown as part of the result. This will be the total of the Carrier Integ Bw of the carriers used in calculating the total carrier power. If the RRC Filter is on, then the integration bandwidth used is $(1 + \alpha)/T$ where $T = 1/(\text{Carrier Integ Bw})$ multiplied by the number of carriers with carrier power present set to yes.

Ref Carrier Power

This is the power in the reference carrier. The power is calculated by integrating across the bandwidth declared by the Carrier Integ Bw parameter for that carrier. The integration bandwidth is shown as part of the result. This is the value of the Carrier Integ Bw for that carrier unless the RRC Filter is on, then the integration bandwidth used is the displayed value, which is $(1 + \alpha)/T$ where $T = 1/(\text{Carrier Integ Bw})$.

Carrier Power

This is the power in all the currently defined carriers. If the carrier has carrier power present, the power will be absolute. If the carrier is defined as not having power present, the power will be relative to the reference carrier. The power is calculated by integrating across the bandwidth declared by the Carrier Integ Bw parameter. The integration bandwidth is shown as part of the result. This is the value of the Carrier Integ Bw for the carrier unless the RRC Filter is on, then the integration bandwidth used is the displayed value, which is $(1 + \alpha)/T$ where $T = 1/(\text{Carrier Integ Bw})$.

As there are potentially more results than can be easily viewed on the display, a scrollable list is used to display all results. The Carrier Results menu key is used to index the carrier amplitude results. This key is grayed out unless the measurement is in single mode (as in continual measurement mode). The display is continuously updating and will not need to be accessed. The currently selected Carrier Result is displayed on the last line of the carrier power result list unless:

- The selected Carrier Result is 4 or less in normal multi carrier power results view. In this case the first 4 carrier power results will be displayed.
- The selected Carrier Result is 9 or greater in normal multi carrier power results view. In this case the last 4 carrier power results will be displayed.
- The zoom mode is selected. In this case all carrier power ranges can be displayed.

Offset Relative Power

This is the power in the offsets relative to the reference carrier. The power is calculated by integrating across the bandwidth declared by the Offset Integ Bw parameter. The offset integration bandwidth is shown as part of the result. This is the value on the Offset Integ Bw menu key unless the RRC Filter is on, then the integration bandwidth used is the displayed value, which is $(1 + \alpha)/T$ where $T = 1/(\text{Offset Integ Bw})$.

Offset Absolute Power

This is the absolute power in the offsets. The power is calculated by integrating across the bandwidth declared by the Offset Integ Bw parameter. The offset integration bandwidth is shown as part of the result. This is the value on the Offset Integ Bw menu key unless the RRC Filter is on, then the integration

bandwidth used is the displayed value, which is $(1 + \alpha)/T$ where $T = 1/(\text{Offset Integ Bw})$.

Key Path	Front-panel key
Initial S/W Revision	Prior to A.02.00

Display

Accesses a menu of functions that enable you to set the display parameters.

See “[Display](#)” on page 1393 for more information.

Key Path	View/Display
Initial S/W Revision	Prior to A.02.00

Bar Graph

Turns the Bar Graph On and Off.

Key Path	View/Display
Mode	WCDMA, C2K, WIMAX OFDMA, TD-SCDMA, 1xEVDO, LTE, LTETDD
Remote Command	:DISPlay:ACPower:VIEW [1] :WINDow [1] :BGRaph OFF ON 0 1 :DISPlay:ACPower:VIEW [1] :WINDow [1] :BGRaph?
Example	DISP:ACP:VIEW:WIND:BGR OFF DISP:ACP:VIEW:WIND:BGR?
Notes	You must be in the mode that includes ACP measurements to use this command. Use :INSTrument:SElect to set the mode.
Dependencies	When the method is RBW, this key is always set to On and grayed out.
Preset	ON
State Saved	Saved in instrument state.
Range	On Off
Initial S/W Revision	Prior to A.02.00
Modified at S/W Revision	A.02.00, A.03.00

The spectrum emission mask measures spurious signal levels in up to six pairs of offset frequencies and relates them to the carrier power. For measurement results and views, see [“View/Display” on page 566](#).

This topic contains the following sections:

[“Measurement Commands for Spectrum Emission Mask” on page 469](#)

[“Remote Command Results for Spectrum Emission Mask Measurement” on page 469](#)

[“Number of Offsets” on page 486](#)

Measurement Commands for Spectrum Emission Mask

Offsets that are turned off (inactive) return -999.0 when their results are queried via SCPI.

:CONFigure:SEMask

:CONFigure:SEMask:NDEFault

:INITiate:SEMask

:FETCh:SEMask [n] ?

:MEASure:SEMask [n] ?

:READ:SEMask [n] ?

For more measurement related commands, see the SENSE subsystem, and the section [“Remote Measurement Functions” on page 1031](#).

Remote Command Results for Spectrum Emission Mask Measurement

The following table describes the results returned by the FETCh, MEASure, and READ queries listed above, according to the index value n:

Modes	n	Return Value
All except WLAN	1	<p>Meas Type: Total Power Reference</p> <p>Returns 82 comma-separated scalar results, in the following order:</p> <ol style="list-style-type: none"> 1. Reserved for the future use, returns -999.0 2. Absolute power at the center frequency (reference) area (dBm) 3. Reserved for the future use, returns -999.0 4. Reserved for the future use, returns -999.0 5. Peak frequency in the center frequency (reference) area (Hz) 6. Reserved for the future use, returns -999.0 7. Reserved for the future use, returns -999.0 8. Reserved for the future use, returns -999.0

Modes	n	Return Value
All except WLAN (Cont)	1 (Cont)	<p>Meas Type: Total Power Reference (Cont)</p> <p>9. Reserved for the future use, returns –999.0</p> <p>10. Reserved for the future use, returns –999.0</p> <p>11. Relative integrated power on the negative offset A (dBc)</p> <p>12. Absolute integrated power on the negative offset A (dBm)</p> <p>13. Relative peak power on the negative offset A (dBc)</p> <p>14. Absolute peak power on the negative offset A (dBm)</p> <p>15. Peak power offset frequency from the center or carrier edge frequency in the negative offset A, depending on Offset Frequency Define settings (Hz)</p> <p>16. Relative integrated power on the positive offset A (dBc)</p> <p>17. Absolute integrated power on the positive offset A (dBm)</p> <p>18. Relative peak power on the positive offset A (dBc)</p> <p>19. Absolute peak power on the positive offset A (dBm)</p> <p>20. Peak power offset frequency from the center or carrier edge frequency in the positive offset A, depending on Offset Frequency Define settings (Hz)</p> <p>21. Relative integrated power on the negative offset B (dBc)</p> <p>...</p> <p>69. Absolute peak power on the positive offset F (dBm)</p> <p>70. Peak power offset frequency from the center or carrier edge frequency in the positive offset F, depending on Offset Frequency Define settings (Hz)</p> <p>71. Minimum margin from limit line on the negative offset A (dB)</p> <p>72. Minimum margin from limit line on the positive offset A (dB)</p> <p>73. Minimum margin from limit line on the negative offset B (dB)</p> <p>74. Minimum margin from limit line on the positive offset B (dB)</p> <p>75. Minimum margin from limit line on the negative offset C (dB)</p> <p>76. Minimum margin from limit line on the positive offset C (dB)</p> <p>77. Minimum margin from limit line on the negative offset D (dB)</p> <p>78. Minimum margin from limit line on the positive offset D (dB)</p> <p>79. Minimum margin from limit line on the negative offset E (dB)</p> <p>80. Minimum margin from limit line on the positive offset E (dB)</p> <p>81. Minimum margin from limit line on the negative offset F (dB)</p> <p>82. Minimum margin from limit line on the positive offset F (dB)</p>

Modes	n	Return Value
All except WLAN	1	<p>Meas Type: Power Spectral Density Reference</p> <p>Returns 82 comma-separated scalar results, in the following order:</p> <ol style="list-style-type: none"> 1. Reserved for the future use, returns -999.0 2. Absolute power at the center frequency (reference) area (dBm/Hz) 3. Reserved for the future use, returns -999.0 4. Reserved for the future use, returns -999.0 5. Peak frequency in the center frequency (reference) area (Hz) 6. Reserved for the future use, returns -999.0 7. Reserved for the future use, returns -999.0 8. Reserved for the future use, returns -999.0 9. Reserved for the future use, returns -999.0 10. Reserved for the future use, returns -999.0 11. Relative integrated power on the negative offset A (dB). 12. Absolute integrated power on the negative offset A (dBm/Hz). 13. Relative peak power on the negative offset A (dB) 14. Absolute peak power on the negative offset A (dBm/Hz) 15. Peak power offset frequency from the center or carrier edge frequency in the negative offset A, depending on Offset Frequency Define settings (Hz) 16. Relative integrated power on the positive offset A (dB). 17. Absolute integrated power on the positive offset A (dBm/Hz). 18. Relative peak power on the positive offset A (dB) 19. Absolute peak power on the positive offset A (dBm/Hz) 20. Peak power offset frequency from the center or carrier edge frequency in the positive offset A, depending on Offset Frequency Define settings (Hz) 21. Relative integrated power on the negative offset B (dB). ... 69. Absolute peak power on the positive offset F (dBm/Hz) 70. Peak power offset frequency from the center or carrier edge frequency in the positive offset F, depending on Offset Frequency Define settings (Hz) 71. Minimum margin from limit line on the negative offset A (dB) 72. Minimum margin from limit line on the positive offset A (dB) 73. Minimum margin from limit line on the negative offset B (dB) 74. Minimum margin from limit line on the positive offset B (dB) 75. Minimum margin from limit line on the negative offset C (dB) 76. Minimum margin from limit line on the positive offset C (dB)

Modes	n	Return Value
All except WLAN (Cont)	1 (Cont)	<p>Meas Type: Power Spectral Density Reference (Cont)</p> <p>77. Minimum margin from limit line on the negative offset D (dB)</p> <p>78. Minimum margin from limit line on the positive offset D (dB)</p> <p>79. Minimum margin from limit line on the negative offset E (dB)</p> <p>80. Minimum margin from limit line on the positive offset E (dB)</p> <p>81. Minimum margin from limit line on the negative offset F (dB)</p> <p>82. Minimum margin from limit line on the positive offset F (dB)</p>
All except WLAN	1	<p>Meas Type: Spectrum Peak Reference</p> <p>Returns 82 comma-separated scalar results, in the following order:</p> <ol style="list-style-type: none"> 1. Reserved for the future use, returns –999.0 2. Peak power at the center frequency (reference) area (dBm) 3. Reserved for the future use, returns –999.0 4. Reserved for the future use, returns –999.0 5. Peak frequency in the center frequency (reference) area (Hz) 6. Reserved for the future use, returns –999.0 7. Reserved for the future use, returns –999.0 8. Reserved for the future use, returns –999.0 9. Reserved for the future use, returns –999.0 10. Reserved for the future use, returns –999.0 11. Reserved for the future use, returns –999.0 12. Reserved for the future use, returns –999.0 13. Relative peak power on the negative offset A (dB) 14. Absolute peak power on the negative offset A (dBm) 15. Peak power offset frequency from the center or carrier edge frequency in the negative offset A, depending on Offset Frequency Define settings (Hz) 16. Reserved for the future use, returns –999.0 17. Reserved for the future use, returns –999.0 18. Relative peak power on the positive offset A (dB) 19. Absolute peak power on the positive offset A (dBm) 20. Peak power offset frequency from the center or carrier edge frequency in the positive offset A, depending on Offset Frequency Define settings (Hz) 21. Reserved for the future use, returns –999.0 ... 69. Absolute peak power on the positive offset F (dBm)

Modes	n	Return Value
All except WLAN (Cont)	1 (Cont)	<p>Meas Type: Spectrum Peak Reference (Cont)</p> <p>70. Peak power offset frequency from the center or carrier edge frequency in the positive offset F, depending on Offset Frequency Define settings (Hz)</p> <p>71. Minimum margin from limit line on the negative offset A (dB)</p> <p>72. Minimum margin from limit line on the positive offset A (dB)</p> <p>73. Minimum margin from limit line on the negative offset B (dB)</p> <p>74. Minimum margin from limit line on the positive offset B (dB)</p> <p>75. Minimum margin from limit line on the negative offset C (dB)</p> <p>76. Minimum margin from limit line on the positive offset C (dB)</p> <p>77. Minimum margin from limit line on the negative offset D (dB)</p> <p>78. Minimum margin from limit line on the positive offset D (dB)</p> <p>79. Minimum margin from limit line on the negative offset E (dB)</p> <p>80. Minimum margin from limit line on the positive offset E (dB)</p> <p>81. Minimum margin from limit line on the negative offset F (dB)</p> <p>82. Minimum margin from limit line on the positive offset F (dB)</p>
WLAN, with radio standard 802.11 ac (80 MHz + 80 MHz)	1	<p>Meas Type: Total Power Reference (Cont)</p> <p>Returns 82 comma-separated scalar results, in the following order:</p> <ol style="list-style-type: none"> 1. Reserved for the future use, returns -999.0 2. Absolute reference power (dBm) 3. Absolute power of the carrier of which the frequency is indicated by Freq Segment 1 (dBm) 4. Absolute power of the carrier of which the frequency is indicated by Freq Segment 2 (dBm) 5. Peak frequency in the center frequency (reference) area (Hz) 6. Reserved for the future use, returns -999.0 7. Reserved for the future use, returns -999.0 8. Reserved for the future use, returns -999.0 9. Reserved for the future use, returns -999.0 10. Reserved for the future use, returns -999.0 11. Relative integrated power on the negative offset A (dBc) 12. Absolute integrated power on the negative offset A (dBm) 13. Relative peak power on the negative offset A (dBc) 14. Absolute peak power on the negative offset A (dBm) 15. Peak power offset frequency from the center or carrier edge frequency in the negative offset A, depending on Offset Frequency Define settings (Hz)

Modes	n	Return Value
WLAN, with radio standard 802.11 ac (80 MHz + 80 MHz) (Cont)	1 (Cont)	Meas Type: Total Power Reference (Cont) 16. Relative integrated power on the positive offset A (dBc) 17. Absolute integrated power on the positive offset A (dBm) 18. Relative peak power on the positive offset A (dBc) 19. Absolute peak power on the positive offset A (dBm) 20. Peak power offset frequency from the center or carrier edge frequency in the positive offset A, depending on Offset Frequency Define settings (Hz) 21. Relative integrated power on the negative offset B (dBc) ... 69. Absolute peak power on the positive offset F (dBm) 70. Peak power offset frequency from the center or carrier edge frequency in the positive offset F, depending on Offset Frequency Define settings (Hz) 71. Minimum margin from limit line on the negative offset A (dB) 72. Minimum margin from limit line on the positive offset A (dB) 73. Minimum margin from limit line on the negative offset B (dB) 74. Minimum margin from limit line on the positive offset B (dB) 75. Minimum margin from limit line on the negative offset C (dB) 76. Minimum margin from limit line on the positive offset C (dB) 77. Minimum margin from limit line on the negative offset D (dB) 78. Minimum margin from limit line on the positive offset D (dB) 79. Minimum margin from limit line on the negative offset E (dB) 80. Minimum margin from limit line on the positive offset E (dB) 81. Minimum margin from limit line on the negative offset F (dB) 82. Minimum margin from limit line on the positive offset F (dB)

Modes	n	Return Value
WLAN, with radio standard 802.11 ac (80 MHz + 80 MHz)	1	<p>Meas Type: Power Spectral Density Reference</p> <p>Returns 82 comma-separated scalar results, in the following order:</p> <ol style="list-style-type: none"> 1. Reserved for the future use, returns -999.0 2. Absolute reference power(dBm/Hz) 3. Absolute power of the carrier of which the frequency is indicated by Freq Segment 1 (dBm/Hz) 4. Absolute power of the carrier of which the frequency is indicated by Freq Segment 2 (dBm/Hz) 5. Peak frequency in the center frequency (reference) area (Hz) 6. Reserved for the future use, returns -999.0 7. Reserved for the future use, returns -999.0 8. Reserved for the future use, returns -999.0 9. Reserved for the future use, returns -999.0 10. Reserved for the future use, returns -999.0 11. Relative integrated power on the negative offset A (dB). 12. Absolute integrated power on the negative offset A (dBm/Hz). 13. Relative peak power on the negative offset A (dB) 14. Absolute peak power on the negative offset A (dBm/Hz) 15. Peak power offset frequency from the center or carrier edge frequency in the negative offset A, depending on Offset Frequency Define settings (Hz) 16. Relative integrated power on the positive offset A (dB). 17. Absolute integrated power on the positive offset A (dBm/Hz). 18. Relative peak power on the positive offset A (dB) 19. Absolute peak power on the positive offset A (dBm/Hz) 20. Peak power offset frequency from the center or carrier edge frequency in the positive offset A, depending on Offset Frequency Define settings (Hz) 21. Relative integrated power on the negative offset B (dB). ... 69. Absolute peak power on the positive offset F (dBm/Hz) 70. Peak power offset frequency from the center or carrier edge frequency in the positive offset F, depending on Offset Frequency Define settings (Hz) 71. Minimum margin from limit line on the negative offset A (dB) 72. Minimum margin from limit line on the positive offset A (dB) 73. Minimum margin from limit line on the negative offset B (dB) 74. Minimum margin from limit line on the positive offset B (dB)

Modes	n	Return Value
WLAN, with radio standard 802.11 ac (80 MHz + 80 MHz) (Cont)	1 (Cont)	Meas Type: Power Spectral Density Reference (Cont) 76. Minimum margin from limit line on the positive offset C (dB) 77. Minimum margin from limit line on the negative offset D (dB) 78. Minimum margin from limit line on the positive offset D (dB) 79. Minimum margin from limit line on the negative offset E (dB) 80. Minimum margin from limit line on the positive offset E (dB) 81. Minimum margin from limit line on the negative offset F (dB) 82. Minimum margin from limit line on the positive offset F (dB)
All	2	Returns the displayed frequency domain spectrum trace data separated by comma. The number of data is points 2001.
All	3	Returns the displayed frequency domain absolute limit trace data separated by comma. The number of data points is 2001.
All	4	Returns the displayed frequency domain relative limit trace data separated by comma. The number of data points is 2001.

Modes	n	Return Value
All (see details)	5	<p>Meas Type: Total Power Reference</p> <p>Returns comma-separated scalar values (in dBm) of the absolute integrated power of the segment frequencies. The length of the result depends on the number of available offset (See “Number of Offsets” on page 486).</p> <ol style="list-style-type: none"> 1. Total power reference (dBm) 2. Reserved for the future use, returns –999.0 3. Absolute integrated power at negative offset frequency (A) 4. Absolute integrated power at positive offset frequency (A) ... 25. Absolute integrated power at negative offset frequency (L) 26. Absolute integrated power at positive offset frequency (L) <p>In WLAN mode.</p> <p>Returns 26 comma-separated scalar values (in dBm) of the absolute integrated power of the segment frequencies:</p> <ol style="list-style-type: none"> 1. Ref carrier power (dBm) 2. Reserved for the future use, returns –999.0 3. Absolute integrated power at negative offset frequency (A) 4. Absolute integrated power at positive offset frequency (A) ... 25. Absolute integrated power at negative offset frequency (L) 26. Absolute integrated power at positive offset frequency (L) <p>If the result is not available, –999.0 is returned.</p> <p>The number of values returned is subject to change in future releases.</p>

Modes	n	Return Value
All (see details)	5	<p>Meas Type: Power Spectral Density Reference</p> <p>Returns comma-separated scalar values (in dBm/Hz) of the absolute integrated power of the segment frequencies. The length of the result depends on the number of available offset (See “Number of Offsets” on page 486).</p> <p>Returns –999.0 for the offsets if in WLAN:</p> <ol style="list-style-type: none"> 1. Power spectral density reference (dBm/Hz) 2. Reserved for the future use, returns –999.0 3. Absolute integrated power at negative offset frequency (A) 4. Absolute integrated power at positive offset frequency (A) ... 25. Absolute integrated power at negative offset frequency (L) 26. Absolute integrated power at positive offset frequency (L) <p>In WLAN mode.</p> <p>Returns 26 comma-separated scalar values (in dBm/Hz) of the absolute integrated power of the segment frequencies:</p> <ol style="list-style-type: none"> 1. Ref carrier power (dBm/Hz) 2. Reserved for the future use, returns –999.0 3. Absolute integrated power at negative offset frequency (A) 4. Absolute integrated power at positive offset frequency (A) ... 25. Absolute integrated power at negative offset frequency (L) 26. Absolute integrated power at positive offset frequency (L) <p>If the result is not available, –999.0 is returned.</p> <p>The number of values returned is subject to change in future releases.</p>
All (see details)	5	<p>Meas Type: Spectrum Peak Reference</p> <p>Returns comma-separated scalar values (in dBm) of the absolute peak power of the segment frequencies. The length of the result depends on the number of available offset (See “Number of Offsets” on page 486).</p> <ol style="list-style-type: none"> 1. Spectrum Peak Power reference (dBm) 2. Reserved for the future use, returns –999.0 3. Absolute peak power at negative offset frequency (A) 4. Absolute peak power at positive offset frequency (A) ... 25. Absolute peak power at negative offset frequency (L) 26. Absolute peak power at positive offset frequency (L)

Modes	n	Return Value
All	6	<p>Meas Type: Total Power Reference</p> <p>Returns comma-separated scalar values (in dBc) of the integrated power relative to the carrier at the segment frequencies. The length of the result depends on the number of available offset (See “Number of Offsets” on page 486).</p> <ol style="list-style-type: none"> 1. Reserved for the future use, returns –999.0 2. Reserved for the future use, returns –999.0 3. Relative integrated power at negative offset frequency (A) 4. Relative integrated power at positive offset frequency (A) ... 25. Relative integrated power at negative offset frequency (L) 26. Relative integrated power at positive offset frequency (L) <p>If the result is not available, –999.0 is returned.</p> <p>The number of values returned is subject to change in future releases.</p>
All	6	<p>Meas Type: Power Spectral Density Reference</p> <p>Returns 14 comma-separated scalar values (in dBc/Hz) of the integrated power relative to the carrier at the segment frequencies. The length of the result depends on the number of available offset (See “Number of Offsets” on page 486). Returns –999.0 for the offsets if in WLAN:</p> <ol style="list-style-type: none"> 1. Reserved for the future use, returns –999.0 2. Reserved for the future use, returns –999.0 3. Relative integrated power at negative offset frequency (A) 4. Relative integrated power at positive offset frequency (A) ... 25. Relative integrated power at negative offset frequency (L) 26. Relative integrated power at positive offset frequency (L) <p>If the result is not available, –999.0 is returned.</p> <p>The number of values returned is subject to change in future releases.</p>

Modes	n	Return Value
All	6	<p>Meas Type: Spectrum Peak Reference</p> <p>Returns comma-separated scalar values (in dB) of the integrated power relative to the carrier at the segment frequencies. The length of the result depends on the number of available offset (See “Number of Offsets” on page 486).</p> <ol style="list-style-type: none"> 1. Reserved for the future use, returns –999.0 2. Reserved for the future use, returns –999.0 3. Relative peak power at negative offset frequency (A) 4. Relative peak power at positive offset frequency (A) ... 25. Relative peak power at negative offset frequency (L) 26. Relative peak power at positive offset frequency (L) <p>If the result is not available, –999.0 is returned.</p> <p>The number of values returned is subject to change in future releases.</p>
All	7	<p>Returns comma-separated pass/fail test results (0=passed, or 1=failed) determined by testing the minimum margin point from the limit line that is determined each offset's Limits setting. The length of the result depends on the number of available offset (See “Number of Offsets” on page 486).</p> <ol style="list-style-type: none"> 1. Reserved for the future use, returns –999.0 2. Reserved for the future use, returns –999.0 3. At negative offset frequency (A) 4. At positive offset frequency (A) ... 25. At negative offset frequency (L) 26. At positive offset frequency (L) <p>The number of values returned is subject to change in future releases.</p>

Modes	n	Return Value
All	8	<p>Returns comma-separated pass/fail test results (0=passed, or 1=failed) determined by testing the minimum margin point from the limit line that is determined each offset's Limits setting. The length of the result depends on the number of available offset (See “Number of Offsets” on page 486).</p> <p>Note: These results (n=8) are the same as n=7 result.</p> <ol style="list-style-type: none"> 1. Reserved for the future use, returns –999.0 2. Reserved for the future use, returns –999.0 3. At negative offset frequency (A) 4. At positive offset frequency (A) ... 25. At negative offset frequency (L) 26. At positive offset frequency (L) <p>The number of values returned is subject to change in future releases.</p>
All	10	<p>Returns comma-separated scalar values (in dBm) of the absolute peak power of the segment frequencies. The length of the result depends on the number of available offset (See “Number of Offsets” on page 486).</p> <ol style="list-style-type: none"> 1. Reserved for the future use, returns –999.0 2. Reserved for the future use, returns –999.0 3. At negative offset frequency (A) 4. At positive offset frequency (A) ... 25. At negative offset frequency (L) 26. At positive offset frequency (L) <p>If the result is not available, –999.0 is returned.</p> <p>The number of values returned is subject to change in future releases.</p>

Spectrum Emission Mask Measurement

Modes	n	Return Value
All	11	<p>Returns comma-separated scalar values in dBc (dB if MeasType = PSD) of the peak power relative to the carrier at the segment frequencies. The length of the result depends on the number of available offset (See “Number of Offsets” on page 486).</p> <ol style="list-style-type: none"> 1. Reserved for the future use, returns -999.0 2. Reserved for the future use, returns -999.0 3. At negative offset frequency (A) 4. At positive offset frequency (A) ... 25. At negative offset frequency (L) 26. At positive offset frequency (L) <p>If the result is not available, -999.0 is returned.</p> <p>The number of values returned is subject to change in future releases.</p>
All	12	<p>Returns the power result (the peak power of the signal in the ref channel) when Meas Type is Spectrum Peak reference. Otherwise, the value returned will be -999.0</p>

Modes	n	Return Value
All	14	<p>Meas Type: Total Power Reference</p> <p>Returns comma-separated scalar results, in the following order:</p> <ol style="list-style-type: none"> 1. Relative integrated power on the negative offset A (dBc) 2. Absolute integrated power on the negative offset A (dBm) 3. Relative peak power on the negative offset A (dBc) 4. Absolute peak power on the negative offset A (dBm) 5. Peak power offset frequency from the center or carrier edge frequency in the negative offset A, depending on Offset Frequency Define settings (Hz) 6. Relative integrated power on the positive offset A (dBc) 7. Absolute integrated power on the positive offset A (dBm) 8. Relative peak power on the positive offset A (dBc) 9. Absolute peak power on the positive offset A (dBm) 10. Peak power offset frequency from the center or carrier edge frequency in the positive offset A, depending on Offset Frequency Define settings (Hz) 11. Relative integrated power on the negative offset B (dBc) ... 119. Absolute peak power on the positive offset L (dBm) 120. Peak power offset frequency from the center or carrier edge frequency in the positive offset L, depending on Offset Frequency Define settings (Hz) <p>If the result is not available, NaN (9.91E+37) is returned.</p> <p>The length of the result depends on the number of available offsets (See “Number of Offsets” on page 486).</p> <p>The number of values returned is subject to change in future releases.</p>

Modes	n	Return Value
All	14	<p>Meas Type: Power Spectral Density Reference</p> <p>Returns comma-separated scalar results, in the following order:</p> <ol style="list-style-type: none"> 1. Relative integrated power on the negative offset A (dB) 2. Absolute integrated power on the negative offset A (dBm/Hz) 3. Relative peak power on the negative offset A (dB) 4. Absolute peak power on the negative offset A (dBm/Hz) 5. Peak power offset frequency from the center or carrier edge frequency in the negative offset A, depending on Offset Frequency Define settings (Hz) 6. Relative integrated power on the positive offset A (dB) 7. Absolute integrated power on the positive offset A (dBm/Hz) 8. Relative peak power on the positive offset A (dB) 9. Absolute peak power on the positive offset A (dBm/Hz) 10. Peak power offset frequency from the center or carrier edge frequency in the positive offset A, depending on Offset Frequency Define settings (Hz) 11. Relative integrated power on the negative offset B (dB) ... 119. Absolute peak power on the positive offset L (dBm/Hz) 120. Peak power offset frequency from the center or carrier edge frequency in the positive offset L, depending on Offset Frequency Define settings (Hz) <p>If the result is not available, NaN (9.91E+37) is returned.</p> <p>The length of the result depends on the number of available offsets (See “Number of Offsets” on page 486).</p> <p>The number of values returned is subject to change in future releases.</p>

Modes	n	Return Value
All	14	<p>Meas Type: Spectrum Peak Reference</p> <p>Returns comma-separated scalar results, in the following order:</p> <ol style="list-style-type: none"> 1. Reserved for the future use, returns NaN (9.91E+37) 2. Reserved for the future use, returns NaN (9.91E+37) 3. Relative peak power on the negative offset A (dB) 4. Absolute peak power on the negative offset A (dBm) 5. Peak power offset frequency from the center or carrier edge frequency in the negative offset A, depending on Offset Frequency Define settings (Hz) 6. Reserved for the future use, returns NaN (9.91E+37) 7. Reserved for the future use, returns NaN (9.91E+37) 8. Relative peak power on the positive offset A (dB) 9. Absolute peak power on the positive offset A (dBm) 10. Peak power offset frequency from the center or carrier edge frequency in the positive offset A, depending on Offset Frequency Define settings (Hz) 11. Relative integrated power on the negative offset B (dB) ... 119. Absolute peak power on the positive offset L (dBm) 120. Peak power offset frequency from the center or carrier edge frequency in the positive offset L, depending on Offset Frequency Define settings (Hz) <p>If the result is not available, NaN (9.91E+37) is returned.</p> <p>The length of the result depends on the number of available offsets (See “Number of Offsets” on page 486).</p> <p>The number of values returned is subject to change in future releases.</p>
All	15	<p>Meas Type: Total Power Reference</p> <p>Returns comma-separated scalar results, in the following order:</p> <ol style="list-style-type: none"> 1. Minimum margin from limit line on the negative offset A (dB) 2. Minimum margin from limit line on the positive offset A (dB) 3. Minimum margin from limit line on the negative offset B (dB) 4. Minimum margin from limit line on the positive offset B (dB) ... 23. Minimum margin from limit line on the negative offset L (dB) 24. Minimum margin from limit line on the positive offset L (dB) <p>If the result is not available, NaN (9.91E+37) is returned. The length of the result depends on the number of available offsets (See “Number of Offsets” on page 486).</p> <p>The number of values returned is subject to change in future releases.</p>

Spectrum Emission Mask Measurement

Modes	n	Return Value
WLAN only	16	Returns two carriers comma-separated scalar results when the radio standard is 802.11ac 80+80 MHz. And returns NaN otherwise. 1. Absolute power of carrier segment 1 (dBm) 2. Absolute power of carrier segment 2(dBm)

Number of Offsets

The number of available offsets varies depending on the mode and option as below.

Mode	The number of available offsets
WLAN	12 (Offset A to L)

Key Path:	Meas
Initial S/W Revision:	Prior to A.02.00
Modified at S/W Revision:	A.11.00

AMPTD Y Scale

Accesses a menu of functions that enable you to set the vertical scale parameters. The parameter values are measurement independent except all Attenuation values and Internal Preamplifier selections that are measurement global.

Key Path:	Front-panel key
Initial S/W Revision:	Prior to A.02.00

Ref Value

Sets the value for the absolute power reference. However, since Auto Scaling defaults to On, this value is automatically determined by the measurement result. When you set a value manually, Auto Scaling automatically changes to Off.

Key Path:	AMPTD Y Scale
Mode:	WCDMA, C2K, WIMAX OFDMA, TD-SCDMA, 1xEVDO, LTE, LTETDD, WLAN
Remote Command:	:DISPlay:SEMask:VIEW[1]:WINDow[1]:TRACe:Y[:SCALe]:RLEVEl <real> :DISPlay:SEMask:VIEW[1]:WINDow[1]:TRACe:Y[:SCALe]:RLEVEl?
Example:	DISP:SEM:VIEW:WIND:TRAC:Y:RLEV 100 DISP:SEM:VIEW:WIND:TRAC:Y:RLEV?
Notes:	You must be in the mode that includes SEM measurement to use this command. Use :INSTrument:SELEct to set the mode.
Couplings:	When the Auto Scaling is On, this value is automatically determined by the measurement result. When you set a value manually, Auto Scaling automatically changed to Off.
Preset:	10.0 dBm
State Saved:	Saved in instrument state.
Min:	-250 dBm
Max:	250 dBm
Initial S/W Revision:	Prior to A.02.00
Modified at S/W Revision:	A.02.00, A.03.00

Attenuation

Accesses a menu of functions that enable you to change attenuation settings. This key has read-back text

Spectrum Emission Mask Measurement
AMPTD Y Scale

that describes the total attenuator value.

See AMPTD Y Scale, “Attenuation” on page 850 for more information.

Key Path:	AMPTD Y Scale
Initial S/W Revision:	Prior to A.02.00

Scale/Div

Sets the units-per-division of the vertical scale in the logarithmic display. When Auto Scaling is On, the scale per division value is automatically determined by the measurement result. When you set a value manually, Auto Scaling automatically changes to Off.

Key Path:	AMPTD Y Scale
Mode:	WCDMA, C2K, WIMAX OFDMA, TD-SCDMA, 1xEVDO, LTE, LTETDD, WLAN
Remote Command:	:DISPlay:SEMask:VIEW[1]:WINDow[1]:TRACe:Y[:SCALe]:PDIvI sion <rel_ampl> :DISPlay:SEMask:VIEW[1]:WINDow[1]:TRACe:Y[:SCALe]:PDIvI sion?
Example:	DISP:SEM:VIEW:WIND:TRAC:Y:PDIV 15dB DISP:SEM:VIEW:WIND:TRAC:Y:PDIV?
Notes:	You must be in the mode that includes SEM measurement to use this command. Use :INSTrument:SELect to set the mode.
Couplings:	When the Auto Scaling is On, this value is automatically determined by the measurement result. When you set a value manually, Auto Scaling automatically changes to Off.
Preset:	10 dB
State Saved:	Saved in instrument state
Min:	0.10 dB
Max:	20.00 dB
Initial S/W Revision:	Prior to A.02.00
Modified at S/W Revision:	A.02.00, A.03.00

Y Axis Unit

Allows you to change the vertical (Y) axis amplitude unit.

See “Y Axis Unit” on page 871 under AMPTD Y Scale for more information.

Key Path:	AMPTD Y Scale
-----------	----------------------

Initial S/W Revision:	A.04.00
-----------------------	---------

Ref Position

Positions the reference level at the top, center or bottom of the Y scale display. Changing the reference position does not affect the reference level value.

Key Path:	AMPTD Y Scale
Mode:	WCDMA, C2K, WIMAX OFDMA, TD-SCDMA, 1xEVDO, LTE, LTETDD, WLAN
Remote Command:	:DISPlay:SEMask:VIEW[1]:WINDow[1]:TRACe:Y[:SCALe]:RPOSi tion TOP CENTer BOTTom :DISPlay:SEMask:VIEW[1]:WINDow[1]:TRACe:Y[:SCALe]:RPOSi tion?
Example:	DISP:SEM:VIEW:WIND:TRAC:Y:RPOS BOTT DISP:SEM:VIEW:WIND:TRAC:Y:RPOS?
Notes:	You must be in the mode that includes SEM measurement to use this command. Use :INSTrument:SElect to set the mode.
Preset:	TOP
State Saved:	Saved in instrument state
Range:	Top Ctr Bot
Initial S/W Revision:	Prior to A.02.00
Modified at S/W Revision:	A.02.00, A.03.00

Auto Scaling

Toggles the Auto Scaling function between On and Off.

When Auto Scaling is On and the Restart front-panel key is pressed, the analyzer automatically determines the scale per division and reference values based on the measurement results. When you set a value to either Scale/Div or Ref Value manually, Auto Scaling automatically changes to Off.

Key Path:	AMPTD Y Scale
Mode:	WCDMA, C2K, WIMAX OFDMA, TD-SCDMA, 1xEVDO, LTE, LTETDD, WLAN
Remote Command:	:DISPlay:SEMask:VIEW[1]:WINDow[1]:TRACe:Y[:SCALe]:COUPl e 0 1 ON OFF :DISPlay:SEMask:VIEW[1]:WINDow[1]:TRACe:Y[:SCALe]:COUPl e?

Spectrum Emission Mask Measurement
AMPTD Y Scale

Example:	DISP:SEM:VIEW:WIND:TRAC:Y:COUP OFF DISP:SEM:VIEW:WIND:TRAC:Y:COUP?
Notes:	You must be in the mode that includes SEM measurement to use this command. Use :INSTrument:SELEct to set the mode.
Couplings:	When Auto Scaling is On, upon pressing the Restart front-panel key, this function automatically determines the scale per division and reference values based on the measurement results. When you set a value to either Scale/Div or Ref Value manually, Auto Scaling automatically changes to Off.
Preset:	ON
State Saved:	Saved in instrument state
Range:	On Off
Initial S/W Revision:	Prior to A.02.00
Modified at S/W Revision:	A.02.00, A.03.00

Auto Couple

See [“Auto Couple” on page 887](#) for more information.

Key Path:	Front-panel key
Initial S/W Revision:	Prior to A.02.00

BW

Accesses a menu of functions that enable you to select the type of filter for the measurement.

Key Path:	Front-panel key
Initial S/W Revision:	Prior to A.02.00
Modified at S/W Revision:	A.03.00

Filter Type

Selects the type of bandwidth filter that is used in Carrier and Offsets.

When Gaussian or Flattop is selected, selected filter is applied to carriers and all offsets.

When Auto Sense is selected, filter type is automatically selected for each carriers and offsets, so that measurement speed and accuracy is optimized.

Key Path:	BW
Mode:	WCDMA, C2K, WIMAX OFDMA, TD-SCDMA, 1xEVDO, LTE, LTETDD, WLAN
Remote Command:	[:SENSe] :SEMAsk :BANDwidth :SHAPE ASENSe GAUSSian FLATtop [:SENSe] :SEMAsk :BANDwidth :SHAPE?
Example:	SEM:BAND:SHAP GAUS SEM:BAND:SHAP?
Couplings:	See the description above
Preset:	ASENSe
State Saved:	Saved in instrument state
Range:	Auto Sense (each offset and carrier) Gaussian (all offsets and carriers) Flattop (all offsets and carriers)
Initial S/W Revision:	A.03.00

Cont

See “[Cont \(Continuous Measurement/Sweep\)](#)” on page 901 for more information.

Key Path:	Front-panel key
Initial S/W Revision:	Prior to A.02.00

FREQ Channel

See “FREQ Channel” on page 903 for more information.

Key Path:	Front-panel key
Initial S/W Revision:	Prior to A.02.00

Input/Output

See [“Input/Output” on page 921](#) for more information.

Key Path:	Front-panel key
Initial S/W Revision:	Prior to A.02.00

Marker

Accesses a menu that enables you to select, set up and control the markers for the current measurement. If there are no active markers, **Marker** selects marker 1, sets it to Normal and places it at the center of the display. You can turn on and control up to 12 markers.

Key Path:	Front-panel key
Initial S/W Revision:	Prior to A.02.00

Select Marker

Displays 12 markers available for selection.

Key Path:	Marker
Initial S/W Revision:	Prior to A.02.00

Marker Type

Sets the marker control mode to Normal and Off. If the selected marker is Off, pressing Marker sets it to Normal and places it at the center of the screen on the trace determined by the **Marker Trace** rules. At the same time, **Marker X Axis Value** appears on the Active Function area. The marker X axis value entered in the active function area will display the marker value to its full entered precision. If the current control mode for the measurement is Off, there is no active function and the active function is turned off.

Key Path:	Marker
Mode:	WCDMA, C2K, WIMAX OFDMA, TD-SCDMA, 1xEVDO, LTE, LTETDD, WLAN
Remote Command:	:CALCulate:SEMAsk:MARKer [1] 2 3 4 5 6 7 8 9 10 11 12 :MODE POSITION OFF :CALCulate:SEMAsk:MARKer [1] 2 3 4 5 6 7 8 9 10 11 12 :MODE?
Example:	CALC:SEM:MARK:MODE POS CALC:SEM:MARK:MODE?
Notes:	If the selected marker is Off, pressing Marker sets it to Normal and places it at the center of the screen on the trace determined by the Marker Trace rules. At the same time, Marker X Axis Value appears on the Active Function area. Default Active Function: the active function for the selected marker's current control mode. Note that if the current control mode is Off, there is no active function and the active function is turned off. Active Function Display: the marker X axis value entered in the active function area will display the marker value to its full entered precision.

Preset:	OFF OFF OFF OFF OFF OFF OFF OFF OFF OFF OFF OFF
State Saved:	Saved in instrument state
Range:	Normal Off
Initial S/W Revision:	Prior to A.02.00
Modified at S/W Revision:	A.02.00, A.03.00

Marker X Axis Value (Remote Command Only)

Sets the marker X Axis value in the current marker X Axis Scale unit. It has no effect if the control mode is Off, but is the SCPI equivalent of entering an X value if the control mode is **Normal**.

Mode:	WCDMA, C2K, WIMAX OFDMA, TD-SCDMA, 1xEVDO, LTE, LTETDD, WLAN
Remote Command:	:CALCulate:SEMask:MARKer [1] 2 3 4 5 6 7 8 9 10 11 12 : X <freq> :CALCulate:SEMask:MARKer [1] 2 3 4 5 6 7 8 9 10 11 12 : X?
Example:	CALC:SEM:MARK3:X 1.0 GHz CALC:SEM:MARK3:X?
Notes:	If no suffix is sent it will use the fundamental units for the current marker X Axis Scale. If a suffix is sent that does not match the current marker X Axis Scale unit, an error “Invalid suffix” will be generated. The query returns the marker’s absolute X Axis value if the control mode is Normal . The query is returned in the fundamental units for the current marker X Axis scale. If the marker is Off the response is not a number. When a Marker is turned on, it is placed center of the screen on the trace. Therefore the default value depends on instrument condition, although the Preset/Default is defined as 1.5 GHz.
Preset:	After a preset, all Markers are turned OFF, so a Marker X Axis Value query will return a not a number (NAN).
State Saved:	No
Min:	-9.9E+37
Max:	9.9E+37
Initial S/W Revision:	Prior to A.02.00
Modified at S/W Revision:	A.02.00, A.03.00

Marker X Axis Position (Remote Command Only)

Sets the marker X position in trace points. It has no effect if the control mode is **Off**, but is the SCPI equivalent of entering a value if the control mode is **Normal**, except in trace points rather than X Axis Scale units. The entered value is immediately translated into the current X Axis Scale units for setting

Spectrum Emission Mask Measurement
Marker

the value of the marker.

Mode:	WCDMA, C2K, WIMAX OFDMA, TD-SCDMA, 1xEVDO, LTE, LTETDD, WLAN
Remote Command:	:CALCulate:SEMask:MARKer [1] 2 3 4 5 6 7 8 9 10 11 12 : X : POSition <real> :CALCulate:SEMask:MARKer [1] 2 3 4 5 6 7 8 9 10 11 12 : X : POSition?
Example:	CALC:SEM:MARK10:X:POS 1001 CALC:SEM:MARK10:X:POS?
Notes:	The query returns the marker's absolute X Axis value in trace points if the control mode is Normal . The value is returned as a real number, not an integer, corresponding to the translation from X Axis Scale units to trace points . If the marker is Off the response is not a number. When a Marker is turned on, it is placed center of the screen on the trace. Therefore the default value depends on the instrument condition although the Preset/Default is defined as 6507 (this value might be the expected value when all the offsets are on).
Preset:	After a preset, all Markers are turned OFF, so a Marker X Axis Value query will return a not a number (NAN).
State Saved:	No
Min:	-9.9E+37
Max:	9.9E+37
Initial S/W Revision:	Prior to A.02.00
Modified at S/W Revision:	A.02.00, A.03.00

Marker Y Axis Value (Remote Command Only)

Returns the marker Y Axis value in the current marker Y Axis unit.

Mode:	WCDMA, C2K, WIMAX OFDMA, TD-SCDMA, 1xEVDO, LTE, LTETDD, WLAN
Remote Command:	:CALCulate:SEMask:MARKer [1] 2 3 4 5 6 7 8 9 10 11 12 : Y ?
Example:	CALC:SEM:MARK11:Y 10 dBm CALC:SEM:MARK11:Y?
Notes:	Since the result value is always calculated from acquisition data, the default value is arbitrary, although the Preset/Default values is defined.
Preset:	Result dependent on markers setup and signal source
State Saved:	No

Backwards Compatibility SCPI:	:CALCulate:SEMask:MARKer[1] 2 3 4 5 6 7 8 9 10 11 12:FUNCTION:RESult?
Initial S/W Revision:	Prior to A.02.00
Modified at S/W Revision:	A.02.00, A.03.00

Couple Markers

When this function is true, moving any marker causes an equal X Axis movement of every other marker that is not **Off**. By “equal X Axis movement” we mean that we preserve the difference between each marker’s X Axis value (in the fundamental x-axis units of the trace that marker is on) and the X Axis value of the marker being moved (in the same fundamental x-axis units).

Key Path:	Marker
Mode:	WCDMA, C2K, WIMAX OFDMA, TD-SCDMA, 1xEVDO, LTE, LTETDD, WLAN
Remote Command:	:CALCulate:SEMask:MARKer:COUple[:STATe] ON OFF 1 0 :CALCulate:SEMask:MARKer:COUple[:STATe]?
Example:	CALC:SEM:MARK:COUP ON CALC:SEM:MARK:COUP?
Preset:	OFF
State Saved:	Saved in instrument state
Range:	On Off
Initial S/W Revision:	Prior to A.02.00
Modified at S/W Revision:	A.02.00, A.03.00

All Markers Off

Turns all active markers off in all views.

Key Path:	Marker
Mode:	WCDMA, C2K, WIMAX OFDMA, TD-SCDMA, 1xEVDO, LTE, LTETDD, WLAN
Remote Command:	:CALCulate:SEMask:MARKer:AOFF
Example:	CALC:SEM:MARK:AOFF
Initial S/W Revision:	Prior to A.02.00
Modified at S/W Revision:	A.02.00, A.03.00

Marker Function

There are no 'Marker Functions' supported in Spectrum Emission Mask so this front-panel key displays a blank menu when pressed.

Key Path:	Front-panel key
Initial S/W Revision:	Prior to A.02.00

Marker To

There is no 'Marker To' functionality supported in Spectrum Emission Mask so this front-panel key displays a blank menu when pressed.

Key Path:	Front-panel key
Initial S/W Revision:	Prior to A.02.00

Meas

See “[Meas](#)” on page 1031 for more information.

Key Path:	Front-panel key
Initial S/W Revision:	Prior to A.02.00

Meas Setup

Displays the setup menu for the currently selected measurement.

Key Path:	Front-panel key
Initial S/W Revision:	Prior to A.02.00

Avg/Hold Num

Toggles averaging On or Off in addition to enabling you to set the number of measurement averages used to calculate the measurement result. The average is displayed at the end of each sweep. After the specified number of average counts, the average mode (termination control) setting determines the average action.

In the remote mode, use the Average State command to turn averaging on or off.

Key Path:	Meas Setup
Mode:	WCDMA, C2K, WIMAX OFDMA, TD-SCDMA, 1xEVDO, LTE, LTETDD, WLAN
Remote Command:	[:SENSe]:SEMask:AVERage:COUNT <integer> [:SENSe]:SEMask:AVERage:COUNT? [:SENSe]:SEMask:AVERage[:STATe] ON OFF 1 0 [:SENSe]:SEMask:AVERage[:STATe]?
Example:	SEM:AVER:COUN 100 SEM:AVER:COUN? SEM:AVER ON SEM:AVER?
Notes:	You must be in the mode that includes SEM measurement to use this command. Use :INSTrument:SELEct to set the mode.
Preset:	10 OFF
State Saved:	Saved in instrument state.
Min:	1
Max:	10000
Initial S/W Revision:	Prior to A.02.00
Modified at S/W Revision:	A.02.00, A.03.00

Meas Type

Accesses a menu that enables you to select one of the following measurement reference types:

- Total Pwr Ref – Sets the reference to the total carrier power and the measured data is shown in dBc and dBm.
- PSD Ref – Sets the reference to the mean power spectral density of the carrier and the measured data is shown in dB and dBm/Hz.
- Spectrum Peak Ref – Sets the reference to the spectrum peak power of the carrier and the measured data is shown in dB and dBm.

Key Path:	Meas Setup
Mode:	WCDMA, C2K, WIMAX OFDMA, TD-SCDMA, 1xEVDO, LTE, LTETDD, WLAN
Remote Command:	[:SENSE] :SEMAsk:TYPE PSDRef TPreF SPReF [:SENSE] :SEMAsk:TYPE ?
Example:	SEM:TYPE PSDR SEM:TYPE?
Notes:	You must be in the mode that includes SEM measurement to use this command. Use :INSTrument:SElect to set the mode.
Preset:	WCDMA, C2K, TD-SCDMA, 1xEVDO, LTE, LTETDD: TPreF WIMAX OFDMA, WLAN: SPReF
State Saved:	Saved in instrument state.
Range:	Total Pwr Ref PSD Ref Spectrum Peak Ref
Initial S/W Revision:	Prior to A.02.00
Modified at S/W Revision:	A.02.00, A.03.00

Ref Channel

Accesses a menu that enables you to set up the measurement parameters used to calculate the power in the reference channel.

Key Path:	Meas Setup
Initial S/W Revision:	Prior to A.02.00

Integ BW

Specifies the integration bandwidth used to calculate the power in the reference channel.

Key Path:	Meas Setup, Ref Channel
-----------	--------------------------------

Mode:	WCDMA, C2K, WIMAX OFDMA, TD-SCDMA, 1xEVDO, LTE, LTETDD, WLAN
Remote Command:	[:SENSe] :SEMAsk:BAWdwidth[1] 2: INTEgration <bandwidth> [:SENSe] :SEMAsk:BAWdwidth[1] 2: INTEgration?
Example:	SEM:BAWd:INT 10 MHz SEM:BAWd:INT?
Notes:	10% . 100% of Channel Span Parameter Value Bandwidth sub op code, 1 is for BTS, 2 for MS. Default is BTS. You must be in the mode that includes SEM measurement to use this command. Use :INSTrument:SELEct to set the mode.
Couplings:	Cannot be higher than the channel Span. If lower than 1/10 of channel Span, then the channel Span is reduced to be 10 times the Integ BW.
Preset:	WCDMA: 3.84 MHz 3.84 MHz C2K: 1.23 MHz 1.23 MHz WIMAX OFDMA: 10 MHz 10 MHz TD-SCDMA: 1.28 MHz 1.28 MHz 1xEVDO: 1.23MHz LTE: 4.515MHz 4.5MHz LTETDD: 4.515MHz 4.5MHz WLAN: if Radio Std is 802.11a/g(OFDM/DSSS-OFDM)/802.11n(20 MHz)/ 802.11ac (20 MHz): 18 MHz if Radio Std is 802.11b/g(DSSS/CCK/PBCC): 22 MHz if Radio Std is 802.11n(40MHz)/ 802.11ac (40 MHz): 38 MHz if Radio Std is 802.11ac (80 MHz): 78 MHz if Radio Std is 802.11ac (160 MHz): 158 MHz if Radio Std is 802.11ac (80 MHz + 80 MHz): 78 MHz
State Saved:	Saved in instrument state.
Min:	1 kHz
Max:	645 MHz
Initial S/W Revision:	Prior to A.02.00
Modified at S/W Revision:	A.02.00, A.03.00

Spectrum Emission Mask Measurement
Meas Setup

Span

Specifies the span used to calculate the power in the reference channel.

Key Path:	Meas Setup, Ref Channel
Mode:	WCDMA, C2K, WIMAX OFDMA, TD-SCDMA, 1xEVDO, LTE, LTETDD, WLAN
Remote Command:	[:SENSe] :SEMAsk:FREQuency [1] 2:SPAN <freq> [:SENSe] :SEMAsk:FREQuency [1] 2:SPAN?
Example:	SEM:FREQ:SPAN 3MHz SEM:FREQ:SPAN?
Notes:	Frequency sub op code, 1 is for BTS, 2 for MS. Default is BTS. You must be in the mode that includes SEM measurement to use this command. Use :INSTrument:SELEct to set the mode.
Couplings:	Range 1 kHz to 50 MHz (although restricted by Integ BW). If you set the channel Span lower than channel Integ BW, they will both track each other. As you increase the channel Span, the Integ BW will also increase if it is less than 1/10 of the channel Span. For WLAN 802.11ac (80 + 80 MHz), the channel span is coupled with the difference between the center frequencies of the two carriers. When the difference is either less than 80 MHz or greater than 565 MHz, a “setting conflict” error message is displayed. Chan Span = Carrier Spacing + Chan IntegBW;
Preset:	WCDMA: 5.0 MHz 5.0 MHz C2K: 1.25 MHz 1.25 MHz WIMAX OFDMA: 10 MHz 10 MHz TD-SCDMA: 1.6 MHz 1.6 MHz 1xEVDO: 1.25 MHz LTE: 5 MHz LTETDD: 5 MHz WLAN: if Radio Std is 802.11a/g(OFDm/DSSS-OFDM)/802.11n(20 MHz)/ 802.11ac (20 MHz): 18 MHz if Radio Std is 802.11b/g(DSSS/CCK/PBCC): 22 MHz if Radio Std is 802.11n(40MHz)/ 802.11ac (40 MHz): 38 MHz if Radio Std is 802.11ac (80 MHz): 78 MHz if Radio Std is 802.11ac (160 MHz): 158 MHz if Radio Std is 802.11ac (80 MHz + 80 MHz): 240 MHz
State Saved:	Saved in instrument state.

Min:	1 kHz
Max:	645 MHz
Initial S/W Revision:	Prior to A.02.00
Modified at S/W Revision:	A.02.00, A.03.00

Sweep Time

Sets the sweep time used to calculate the power in the reference channel. Sweep Time can be set manually or put in auto mode.

Key Path:	Meas Setup, Ref Channel
Mode:	WCDMA, C2K, WIMAX OFDMA, TD-SCDMA, 1xEVDO, LTE, LTETDD, WLAN
Remote Command:	[:SENSE]:SEMask:SWEep[1] 2:TIME <time> [:SENSE]:SEMask:SWEep[1] 2:TIME? [:SENSE]:SEMask:SWEep[1] 2:TIME:AUTO OFF 0 ON 1 [:SENSE]:SEMask:SWEep[1] 2:TIME:AUTO?
Example:	SEM:SWE:TIME 9ms SEM:SWE:TIME? SEM:SWE:TIME:AUTO OFF SEM:SWE:TIME:AUTO?
Notes:	Sweep Time sub op code, 1 is for BTS, 2 for MS. Default is BTS. You must be in the mode that includes SEM measurement to use this command. Use :INSTrument:SELEct to set the mode.
Couplings:	When the Sweep Time is set manually, Auto is set to OFF. Value is coupled with Channel Detector selection, Channel Resolution BW, Channel Video BW if the state is Auto. When set to Auto, the Sweep Time is automatically calculated
Preset:	Automatically calculated ON
State Saved:	Saved in instrument state.
Min:	1 ms
Max:	4000 s
Initial S/W Revision:	Prior to A.02.00
Modified at S/W Revision:	A.02.00, A.03.00

Spectrum Emission Mask Measurement
Meas Setup

Res BW

Sets the resolution bandwidth used to calculate the power in the reference channel. The Channel Resolution BW can be set manually or put in to auto mode.

Radio Format		RBW (kHz)
LTE	1.4 MHz	13
	3 MHz	27
	5 MHz	47
	10 MHz	91
	15 MHz	150
	20 MHz	180
W-CDMA		75
GSM		30

Key Path:	Meas Setup, Ref Channel
Mode:	WCDMA, C2K, WIMAX OFDMA, TD-SCDMA, 1xEVDO, LTE, LTETDD, WLAN
Remote Command:	<pre>[:SENSe]:SEMAsk:BANDwidth[1] 2[:RESolution] <bandwidth> [:SENSe]:SEMAsk:BANDwidth[1] 2[:RESolution]? [:SENSe]:SEMAsk:BANDwidth[1] 2[:RESolution]:AUTO OFF ON 1 0 [:SENSe]:SEMAsk:BANDwidth[1] 2[:RESolution]:AUTO?</pre>
Example:	<pre>SEM:BAND 100 kHz SEM:BAND? SEM:BAND:AUTO ON SEM:BAND:AUTO?</pre>
Notes:	<p>Bandwidth sub op code, 1 is for BTS, 2 for MS. Default is BTS.</p> <p>You must be in the mode that includes SEM measurement to use this command. Use :INSTrument:SELEct to set the mode.</p>
Couplings:	<p>When Res BW is set manually, Channel Resolution BW Mode is set to MANual.</p> <p>Value is coupled with Channel Detector selection, Channel Sweep Time, Channel Video BW.</p> <p>When set to Auto, the resolution bandwidth is automatically calculated.</p>

Preset:	WCDMA: 75 kHz C2K: 24 kHz WIMAX OFDMA: 100 kHz TD-SCDMA: 30 kHz 1xEVDO: 30.0 KHz LTE, LTETDD: Auto (47 kHz) WLAN: 100 kHz ON
State Saved:	Saved in instrument state.
Min:	1 Hz
Max:	8 MHz
Backwards Compatibility SCPI:	[:SENSe]:SEMAsk:BWIDth[1] 2[:RESolution]
Initial S/W Revision:	Prior to A.02.00
Modified at S/W Revision:	A.02.00, A.03.00

Video BW

Sets the video bandwidth used to calculate the power in the reference channel. The Channel Video BW can be set manually or put in to auto mode.

Key Path:	Meas Setup, Ref Channel
Mode:	WCDMA, C2K, WIMAX OFDMA, TD-SCDMA, 1xEVDO, LTE, LTETDD, WLAN
Remote Command:	[:SENSe]:SEMAsk:BA NDwidth[1] 2:VIDeo <bandwidth> [:SENSe]:SEMAsk:BA NDwidth[1] 2:VIDeo? [:SENSe]:SEMAsk:BA NDwidth[1] 2:VIDeo:AUTO OFF ON 1 0 [:SENSe]:SEMAsk:BA NDwidth[1] 2:VIDeo:AUTO?
Example:	SEM:BA ND:VID 100 kHz SEM:BA ND:VID? SEM:BA ND:VID:AUTO ON SEM:BA ND:VID:AUTO?
Notes:	Bandwidth sub op code, 1 is for BTS, 2 for MS. Default is BTS. You must be in the mode that includes SEM measurement to use this command. Use :INSTrument:SELect to set the mode.

Spectrum Emission Mask Measurement
Meas Setup

Couplings:	When Video BW is set manually, Channel Video BW Mode is set to MANual Value is coupled with Channel Detector selection, Channel Sweep Time, Channel Resolution BW. When set to Auto, the video bandwidth is automatically calculated.
Preset:	WCDMA: 75 kHz C2K: 24 kHz WIMAX OFDMA: 30 kHz TD-SCDMA: 300 kHz 1xEVDO: 300.0 kHz LTE: Auto LTETDD: Auto WLAN: Auto ON
State Saved:	Saved in instrument state.
Min:	1 Hz
Max:	50 MHz
Backwards Compatibility SCPI:	[[:SENSe]:SEMAsk:BWIDth[1] 2:VIDeo
Initial S/W Revision:	Prior to A.02.00
Modified at S/W Revision:	A.02.00, A.03.00

VBW/RBW

Sets the Video BW/Resolution BW Ratio to calculate the Channel Resolution BW and Channel Video BW. The VBW/RBW Ratio can be set manually or put in to auto mode.

Key Path:	Meas Setup, Ref Channel
Mode:	WCDMA, C2K, WIMAX OFDMA, TD-SCDMA, 1xEVDO, LTE, LTETDD, WLAN
Remote Command:	[[:SENSe]:SEMAsk:BA ^N dwidth[1] 2:VIDeo:RA ^T io <real> [:SENSe]:SEMAsk:BA ^N dwidth[1] 2:VIDeo:RA ^T io [:SENSe]:SEMAsk:BA ^N dwidth[1] 2:VIDeo:RA ^T io:AUTO OFF ON 1 0 [:SENSe]:SEMAsk:BA ^N dwidth[1] 2:VIDeo:RA ^T io:AUTO?
Example:	SEM:BA ^N d:VID:RA ^T 0.1 SEM:BA ^N d:VID:RA ^T ? SEM:BA ^N d:VID:RA ^T :A ^U T ^O ON SEM:BA ^N d:VID:RA ^T :A ^U T ^O ?

Notes:	Bandwidth sub op code, 1 is for BTS, 2 for MS. Default is BTS. You must be in the mode that includes SEM measurement to use this command. Use :INSTrument:SElect to set the mode.
Couplings:	When Res BW is set manually, Mode coupling is set to MANual When set to Auto, the VBW/RBW Ratio is automatically calculated.
Preset:	WCDMA, C2K: 1.0 WIMAX OFDMA: 0.3 TD-SCDMA: 10 1xEVDO: 10.0 LTE: Auto LTETDD: Auto WLAN: Auto ON
State Saved:	Saved in instrument state.
Min:	0.00001
Max:	3000000
Backwards Compatibility SCPI:	[:SENSe]:SEMAsk:BWIDth[1]2:VIDeo:RATio
Initial S/W Revision:	Prior to A.02.00
Modified at S/W Revision:	A.02.00, A.03.00

Power Ref

Sets the power reference in the carrier that will be used to compute the relative values for the offsets.

Key Path:	Meas Setup, Ref Channel
Initial S/W Revision:	Prior to A.02.00

Total Power

Sets the power in the carrier (ref channel) that is used to compute the relative power values for the offsets. When the state is set to auto, this value is set to the measured carrier reference power. When set to manual, the result takes on the last measured value, or can be manually entered.

For WLAN 802.11ac (80 MHz + 80 MHz), the higher of the power readouts of the two carriers is used for computing the relative power values for the offset.

Key Path:	Meas Setup, Ref Channel, Power Ref
Mode:	WCDMA, C2K, WIMAX OFDMA, TD-SCDMA, 1xEVDO, LTE, LTETDD, WLAN

Spectrum Emission Mask Measurement
Meas Setup

Remote Command:	[:SENSe]:SEMAsk:CARRier[:POWer] <real> [:SENSe]:SEMAsk:CARRier[:POWer]? [:SENSe]:SEMAsk:CARRier:AUTO[:STATe] OFF ON 1 0 [:SENSe]:SEMAsk:CARRier:AUTO[:STATe]?
Example:	SEM:CARR 100dBm SEM:CARR? SEM:CARR:AUTO OFF SEM:CARR:AUTO?
Notes:	The min and max values given are for Meas Type = Total Pwr Ref. You must be in the mode that includes SEM measurement to use this command. Use :INSTrument:SELEct to set the mode.. This BAF SCPI command is available in all the Meas Type case.
Dependencies:	This "Total Power Ref" parameter is coupled with the "Meas Type" parameter. The softkey would be active if the Meas Type is set to Total Power Ref. Otherwise, it is grayed out.
Preset:	Measured carrier reference power
State Saved:	Saved in instrument state.
Min:	-200 dBm
Max:	200 dBm
Initial S/W Revision:	Prior to A.02.00
Modified at S/W Revision:	A.02.00, A.03.00

PSD

Sets the power spectral density in the carrier that is used to compute the relative power spectral density values for the offsets when Meas Type is set to PSD Ref. When the state is set to auto, this will be set to the measured carrier power spectral density.

For WLAN 802.11ac (80 MHz + 80 MHz), the higher of the power density readouts of the two carriers is used for computing the relative PSD values for the offset.

Key Path:	Meas Setup, Ref Chan, Power Ref
Mode:	WCDMA, C2K, WIMAX OFDMA, TD-SCDMA, 1xEVDO, LTE, LTETDD, WLAN
Remote Command:	[:SENSe]:SEMAsk:CARRier:CPSD <real> [:SENSe]:SEMAsk:CARRier:CPSD?
Example:	SEM:CARR:CPSD -80 SEM:CARR:CPSD?

Notes:	Although the default value is defined, the value is recalculated by the measurement result just after completing the measurement. Carrier sub op code. 1 for BTS, 2 for MS. Default is BTS. You must be in the mode that includes SEM measurement to use this command. Use :INSTrument:SElect to set the mode.
Dependencies:	See Couplings
Couplings:	This "PSD" parameter is coupled with the "Meas Type" parameter. The key will be active if the Meas Type is set to PSD. Otherwise, it is grayed out.
Preset:	Measured carrier PSD reference power
State Saved:	Saved in instrument state.
Min:	-200
Max:	200
Initial S/W Revision:	Prior to A.02.00
Modified at S/W Revision:	A.02.00, A.03.00

Spectrum Peak

Sets the spectrum peak power in the carrier that is used to compute the relative power spectral density values for the offsets when Meas Type is set to Spectrum Peak. When the state is set to auto, this is set to the measured carrier spectrum peak power. When set to manual, the result takes on the last measured value, or can be manually entered

Key Path:	Meas Setup, Ref Channel, Power Ref
Mode:	WCDMA, C2K , WIMAX OFDMA, TD-SCDMA, 1xEVDO, LTE, LTETDD, WLAN
Remote Command:	[:SENSE] :SEMAsk:CARRier:PEAK[:POWER] <real> [:SENSE] :SEMAsk:CARRier:PEAK[:POWER] ?
Example:	SEM:CARR:PEAK -80 SEM:CARR:PEAK:POWER?
Notes:	Although the default value is defined, the value is recalculated by the measurement result just after completing the measurement. Carrier sub op code. 1 for BTS, 2 for MS. Default is BTS. You must be in the mode that includes SEM measurement to use this command. Use :INSTrument:SElect to set the mode.
Dependencies:	See Couplings
Couplings:	This "Spectrum Peak Ref" parameter is coupled with the "Meas Type" parameter. This softkey would be active if the "Meas Type" is set to "Spectrum Peak Ref". Otherwise, grayout.
Preset:	Measured carrier Spectrum Peak reference power

Spectrum Emission Mask Measurement
Meas Setup

State Saved:	Saved in instrument state.
Min:	-200
Max:	200
Initial S/W Revision:	Prior to A.02.00
Modified at S/W Revision:	A.02.00, A.03.00

Offset/Limits

Accesses a menu that enables you to set up the measurement parameters for offset pairs. For example, you can assign the start and stop frequencies, select the resolution bandwidth, and set the sweep time.

Key Path:	Meas Setup
Initial S/W Revision:	Prior to A.02.00

Select Offset

Selects the offset (upper and lower) and displays the memory selection menu that enables you to store a set of parameter values for the offset, such as Start Freq, Stop Freq, Sweep Time, Res BW, Meas BW, Abs Start, and Abs Stop. Only one selection at a time is shown on this menu key label.

Key Path:	Meas Setup, Offset/Limits
Mode:	WCDMA, C2K, WIMAX OFDMA, TD-SCDMA, 1xEVDO, LTE, LTETDD, WLAN
Preset:	A
Range:	WLAN: A B C D E F G H I J K L
Initial S/W Revision:	Prior to A.02.00
Modified at S/W Revision:	A.02.00, A.03.00, A.10.00, A.11.00

Start Freq

Specifies the start frequency for the currently selected offset and enables you to toggle this function On or Off for each offset.

Key Path:	Meas Setup, Offset/Limits
Mode:	WCDMA, C2K, WIMAX OFDMA, TD-SCDMA, 1xEVDO, LTE, LTETDD, WLAN
Remote Command:	<pre>[:SENSe] :SEMask:OFFSet [1] 2 :LIST:FREQuency:START <freq>, ... [:SENSe] :SEMask:OFFSet [1] 2 :LIST:FREQuency:START? [:SENSe] :SEMask:OFFSet [1] 2 :LIST:STATe ON OFF 1 0, ... [:SENSe] :SEMask:OFFSet [1] 2 :LIST:STATe?</pre>

Example:	<p>SEM:OFFS2:LIST:FREQ:STAR 2.515 MHz, 2.715 MHz, 3.515 MHz, 4.00 MHz, 8.00 MHz, 12.50 MHz</p> <p>SEM:OFFS2:LIST:FREQ:STAR?</p> <p>SEM:OFFS:LIST:STAT ON, ON, ON, OFF, OFF, OFF</p> <p>SEM:OFFS:LIST:STAT?</p>
Notes:	<p>Comma separated list of values.</p> <p>OFFSet1 is for BTS, 2 for MS. Default is BTS.</p> <p>You must be in the mode that includes SEM measurement to use this command. Use :INSTrument:SElect to set the mode.</p>
Couplings:	<p>Coupled to Stop Freq. Start cannot go above the stop freq less 100Hz. Similarly Stop freq cannot go below Start Freq plus 100Hz.</p>

Spectrum Emission Mask Measurement
 Meas Setup

<p>Preset:</p>	<p>For modes (except WLAN), the preset value is as follows.</p> <p>WCDMA: 2.515 MHz, 2.715 MHz, 3.515 MHz, 4.000 MHz, 8.000 MHz, 12.50 MHz 2.515MHz, 4.000 MHz, 7.500 MHz, 8.500 MHz, 12.5 MHz, 15 MHz</p> <p>C2K: 750.0 kHz, 780.0 kHz, 1.980 MHz, 3.25 MHz, 7.0 MHz, 7.0 MHz 885 kHz, 1.980 MHz, 2.250 MHz, 8.0 MHz, 12.0 MHz, 12.0 MHz</p> <p>WIMAX OFDMA: 4.75 MHz,5.45 MHz,9.75 MHz,14.75 MHz,19.75 MHz,24.75 MHz 4.75 MHz,5.45 MHz,9.75 MHz,14.75 MHz,19.75 MHz,24.75 MHz</p> <p>TD-SCDMA:</p> <p>81 5kHz,1015 kHz,1815 kHz,2.3 MHz, ,2.3 MHz,,2.3 MHz 815 kHz,1.8 MHz,2.9 MHz, 2.9 MHz,2.9 MHz, 2.9 MHz</p> <p>1xEVDO: 750.0 kHz, 780.0 kHz, 1.98 MHz, 3.25 MHz, 7 MHz, 7 MHz 885.0 kHz, 1.98 MHz, 1.98 MHz , 1.98 MHz, 1.98 MHz, 1.98 MHz</p> <p>LTE, LTETDD: 50 kHz, 5.05 MHz, 10.5 MHz, 15.00 MHz, 30 MHz, 40 MHz 15.00 kHz,1.5 MHz,5.5 MHz,6.5 MHz,10 MHz,20MHz</p> <p>-----</p> <p>WLAN:</p> <p>if Radio Std is 802.11a/g(OFDM/DSSS-OFDM)/802.11n(20MHz): 9 MHz, 11 MHz, 20 MHz, 30 MHz, 50 MHz, 216 MHz, 216 MHz, 216 MHz, 216 MHz, 216 MHz, 216 MHz, 216 MHz</p> <p>if Radio Std is 802.11b/g(DSSS/CCK/PBCC): 11 MHz, 22 MHz, 50 MHz, 70 MHz, 90 MHz, 100 MHz , 100 MHz, 100 MHz, 100 MHz, 100 MHz, 100 MHz, 100 MHz</p> <p>if Radio Std is 802.11n(20MHz): 9 MHz, 11 MHz, 20 MHz, 30 MHz, 50 MHz, 100 MHz, 100 MHz, 100 MHz, 100 MHz, 100 MHz, 100 MHz, 100 MHz</p> <p>if Radio Std is 802.11n(40MHz): 19 MHz, 21 MHz, 40 MHz, 60 MHz, 100 MHz, 200 MHz, 200 MHz, 200 MHz, 200 MHz, 200 MHz, 200 MHz, 200 MHz</p> <p>if Radio Std is 802.11ac(20MHz): 9 MHz, 11 MHz, 20 MHz, 30 MHz, 30 MHz, 30 MHz, 30 MHz, 30 MHz, 30 MHz, 30 MHz, 30 MHz, 30 MHz</p> <p>if Radio Std is 802.11ac(40MHz): 19 MHz, 21 MHz, 40 MHz, 60 MHz, 60 MHz, 60 MHz, 60 MHz, 60 MHz, 60 MHz, 60 MHz, 60 MHz, 60 MHz</p> <p>if Radio Std is 802.11ac(80MHz): 39 MHz, 41 MHz, 80 MHz, 120 MHz, 120 MHz, 120 MHz, 120 MHz, 120 MHz, 120 MHz, 120 MHz, 120 MHz, 120 MHz</p> <p>if Radio Std is 802.11ac(160MHz): 79 MHz, 81 MHz, 160 MHz, 240 MHz, 240 MHz, 240 MHz, 240 MHz, 240 MHz, 240 MHz, 240 MHz, 240 MHz, 240 MHz</p> <p>if Radio Std is 802.11ac(80 MHz + 80MHz): 0 MHz, 40 MHz, 79 MHz, 159 MHz, 161 MHz, 200 MHz, 240 MHz, 240 MHz, 240 MHz, 240 MHz, 240 MHz, 240 MHz, 240 MHz</p>
----------------	---

Preset: (Cont)	<p>For modes (except WLAN), the preset value is as follows.</p> <p>WCDMA: ON, ON, ON, ON, ON, OFF ON, ON, ON, ON, OFF, OFF</p> <p>C2K: ON, ON, ON, OFF, OFF, OFF ON, ON, OFF, OFF, OFF, OFF</p> <p>WIMAX OFDMA: ON, ON, ON, OFF, OFF, OFF ON, ON, ON, OFF, OFF, OFF</p> <p>TD-SCDMA: ON, ON, ON, ON, OFF, OFF ON, ON, ON, OFF, OFF, OFF</p> <p>1xEVDO: ON, ON, ON, OFF, OFF, OFF ON, ON, OFF, OFF, OFF, OFF</p> <p>LTE, LTETDD: ON, ON, ON, OFF, OFF, OFF ON,ON,ON,ON,OFF,OFF</p> <p>-----</p> <p>WLAN:</p> <p>if Radio Std is 802.11a/g(OFDM/DSSS-OFDM)/802.11n(20MHz/40MHz): ON, ON, ON, ON, OFF, OFF, OFF, OFF, OFF, OFF, OFF, OFF</p> <p>if Radio Std is 802.11ac (20 MHz/ 40 MHz/ 80 MHz/ 160 MHz): ON, ON, ON, ON, OFF, OFF, OFF, OFF, OFF, OFF, OFF, OFF</p> <p>if Radio Std is 802.11ac (80 MHz + 80 MHz): ON, ON, ON, ON, ON, ON, ON, OFF, OFF, OFF, OFF, OFF</p>
State Saved:	Saved in instrument state.
Min:	0 Hz
Max:	Stop Freq minus (-) 100 Hz (for that offset)
Initial S/W Revision:	Prior to A.02.00
Modified at S/W Revision:	A.02.00, A.03.00, A.10.00, A.11.00

Stop Freq

Specifies the stop frequency for the currently selected offset.

Key Path:	Meas Setup, Offset/Limits
Mode:	WCDMA, C2K, WIMAX OFDMA, TD-SCDMA, 1xEVDO, LTE, LTETDD, WLAN
Remote Command:	<pre>[:SENSE] :SEMAsk:OFFSet [1] 2 :LIST:FREQuency:STOP <freq>, ... [:SENSE] :SEMAsk:OFFSet [1] 2 :LIST:FREQuency:STOP?</pre>
Example:	<pre>SEM:OFFS:LIST:FREQ:STOP 2.715 MHz, 3.515 MHz, 4.00 MHz, 8.00 MHz, 12.50 MHz, 15.0 MHz SEM:OFFS:LIST:FREQ:STOP?</pre>

Spectrum Emission Mask Measurement
Meas Setup

Notes:	Comma separated list of values. OFFSet1 is for BTS, 2 for MS. Default is BTS. You must be in the mode that includes SEM measurement to use this command. Use :INSTRument:SElect to set the mode.
Couplings:	Coupled to Start Freq. Start cannot go above the stop freq less 100Hz. Similarly Stop freq cannot go below Start Freq plus 100Hz.

Preset:	<p>For modes (except WLAN), the preset value is as follows.</p> <p>WCDMA: 2.715 MHz, 3.515 MHz, 4.000 MHz, 8.000 MHz, 12.50 MHz, 15.0 MHz, 3.485 MHz, 7.500 MHz, 8.500 MHz, 12.00 MHz, 15.00 MHz, 18.0 MHz</p> <p>C2K: 780.0 kHz, 1.980 MHz, 4.0 MHz, 4.0 MHz, 12.0 MHz, 12.0 MHz, 1.980 MHz, 4.0 MHz, 4.0 MHz, 11.5 MHz, 14.5 MHz, 14.5 MHz</p> <p>WIMAX OFDMA: 5.45 MHz, 9.75 MHz, 14.75 MHz, 19.75 MHz, 24.75 MHz, 29.75 MHz, 5.45 MHz, 9.75 MHz, 14.75 MHz, 19.75 MHz, 24.75 MHz, 29.75 MHz</p> <p>TD-SCDMA:</p> <p>1015 kHz, 1815 kHz, 2.3 MHz, 4 MHz, 4 MHz, 4 MHz, 1.8 MHz, 2385 kHz, 3.5 MHz, 3.5 MHz, 3.5 MHz, 3.5 MHz</p> <p>1xEVDO: 780.0 kHz, 1.98 MHz, 4.0 MHz, 4.0 MHz, 12 MHz, 12 MHz, 1.98 MHz, 4.0 MHz, 4.0 MHz, 4.0 MHz, 4.0 MHz, 4.0 MHz</p> <p>LTE, LTE-TDD: 5.05 MHz, 10.05 MHz, 15 MHz, 30 MHz, 40 MHz, 50 MHz, 985.0 kHz, 4.50 MHz, 5.5001 MHz, 9.50 MHz, 20 MHz, 40 MHz</p> <p>-----</p> <p>WLAN:</p> <p>if Radio Std is 802.11a/g(OFDM/DSSS-OFDM)/802.11n(20MHz): 11 MHz, 20 MHz, 30 MHz, 50 MHz, 100 MHz, 250 MHz, 250 MHz, 250 MHz, 250 MHz, 250 MHz, 250 MHz, 250 MHz</p> <p>if Radio Std is 802.11b/g(DSSS/CCK/PBCC): 22 MHz, 50 MHz, 70 MHz, 90 MHz, 100 MHz, 120 MHz, 120 MHz, 120 MHz, 120 MHz, 120 MHz, 120 MHz, 120 MHz</p> <p>if Radio Std is 802.11n(20MHz): 11 MHz, 20 MHz, 30 MHz, 50 MHz, 100 MHz, 200 MHz, 200 MHz, 200 MHz, 200 MHz, 200 MHz, 200 MHz, 200 MHz</p> <p>if Radio Std is 802.11n(40MHz): 21 MHz, 40 MHz, 60 MHz, 100 MHz, 200 MHz, 300 MHz, 300 MHz, 300 MHz, 300 MHz, 300 MHz, 300 MHz, 300 MHz</p> <p>if Radio Std is 802.11ac(20MHz): 11 MHz, 20 MHz, 30 MHz, 50 MHz, 50 MHz, 50 MHz, 50 MHz, 50 MHz, 50 MHz, 50 MHz, 50 MHz, 50 MHz</p> <p>if Radio Std is 802.11ac(40MHz): 21 MHz, 40 MHz, 60 MHz, 100 MHz, 100 MHz, 100 MHz, 100 MHz, 100 MHz, 100 MHz, 100 MHz, 100 MHz, 100 MHz</p> <p>if Radio Std is 802.11ac(80MHz): 41 MHz, 80 MHz, 120 MHz, 200 MHz, 200 MHz, 200 MHz, 200 MHz, 200 MHz, 200 MHz, 200 MHz, 200 MHz, 200 MHz</p> <p>if Radio Std is 802.11ac(160MHz): 81 MHz, 160 MHz, 240 MHz, 400 MHz, 400 MHz, 400 MHz, 400 MHz, 400 MHz, 400 MHz, 400 MHz, 400 MHz, 400 MHz</p> <p>if Radio Std is 802.11ac(80 MHz + 80MHz): 40 MHz, 79 MHz, 81 MHz, 161 MHz, 200 MHz, 240 MHz, 260 MHz, 260 MHz, 260 MHz, 260 MHz, 260 MHz, 260 MHz</p>
---------	--

Spectrum Emission Mask Measurement
Meas Setup

State Saved:	Saved in instrument state.
Min:	Start Freq plus (+) 100 Hz (for that offset)
Max:	500 MHz
Initial S/W Revision:	Prior to A.02.00
Modified at S/W Revision:	A.02.00, A.03.00, A.10.00, A.11.00

Sweep Time

Specifies the sweep time for the currently selected offset and enables you to toggle this function On or Off for each offset.

Key Path:	Meas Setup, Offset/Limits
Mode:	WCDMA, C2K, WIMAX OFDMA, TD-SCDMA, 1xEVDO, LTE, LTETDD, WLAN
Remote Command:	[:SENSE] :SEMAsk:OFFSet [1] 2 :LIST:SWEep:TIME <time>, ... [:SENSE] :SEMAsk:OFFSet [1] 2 :LIST:SWEep:TIME? [:SENSE] :SEMAsk:OFFSet [1] 2 :LIST:SWEep:TIME:AUTO ON OFF 1 0, ... [:SENSE] :SEMAsk:OFFSet [1] 2 :LIST:SWEep:TIME:AUTO?
Example:	SEM:OFFS2:LIST:SWE:TIME 1.0 ms, 3.4 ms, 2.08 ms, 1.0 ms, 1.0 ms, 1.0 ms SEM:OFFS2:LIST:SWE:TIME? SEM:OFFS2:LIST:SWE:TIME:AUTO ON, ON, ON, ON, OFF, OFF SEM:OFFS2:LIST:SWE:TIME:AUTO?
Notes:	Comma separated list of values. OFFSet1 is for BTS, 2 for MS. Default is BTS. You must be in the mode that includes SEM measurement to use this command. Use :INSTrument:SELEct to set the mode.
Couplings:	When the sweep time is set manually, Mode coupling is set to MANual
Preset:	Automatically calculated Modes (except WLAN): ON,ON,ON,ON,ON,ON WLAN: ON,ON,ON,ON,ON,ON,ON,ON, ON,ON,ON,ON
State Saved:	Saved in instrument state.
Min:	1 ms
Max:	10 s
Backwards Compatibility SCPI:	[:SENSE] :SEMAsk:OFFSet[1] 2:LIST:SWEep[:TIME]
Initial S/W Revision:	Prior to A.02.00

Modified at S/W Revision:	A.02.00, A.03.00, A.10.00, A.11.00
---------------------------	------------------------------------

Offset Side

Specifies which offset side to measure.

You can turn off (not use) specific offsets with [:SENSE]:SEMask:OFFSet[n]:LIST:STATe.

- **BOTH** - both of the negative (lower) and positive (upper) sidebands
- **NEGative** - negative (lower) sideband only
- **POSitive** - positive (upper) sideband only

Key Path:	Meas Setup, Offset/Limits
Mode:	WCDMA, C2K, WIMAX OFDMA, TD-SCDMA, 1xEVDO, LTE, LTETDD, WLAN
Remote Command:	[:SENSE] :SEMask:OFFSet [1] 2 :LIST:SIDE BOTH NEGative POSitive, ... [:SENSE] :SEMask:OFFSet [1] 2 :LIST:SIDE?
Example:	SEM:OFFS:LIST:SIDE BOTH, NEG, NEG, POS, POS, POS SEM:OFFS:LIST:SIDE?
Notes:	Comma separated list of values. OFFSet1 is for BTS, 2 for MS. Default is BTS. You must be in the mode that includes SEM measurement to use this command. Use :INSTrument:SElect to set the mode.
Preset:	Modes (except WLAN): BOTH, BOTH, BOTH, BOTH, BOTH, BOTH WLAN: BOTH, BOTH, BOTH, BOTH, BOTH, BOTH, BOTH, BOTH, BOTH, BOTH, BOTH, BOTH
State Saved:	Saved in instrument state.
Range:	Neg Both Pos
Initial S/W Revision:	Prior to A.02.00
Modified at S/W Revision:	A.02.00, A.03.00, A.10.00, A.11.00

Res BW

Specifies which Resolution BW filter to use when measuring the currently selected offset.

Offset Res BW Mode allows the instrument to determine the optimum Resolution BW filter to use when measuring the currently selected offset.. When changing the Meas BW parameter, if the Res BW needs to be changed to adhere to the rule

$$(N \times \text{Res BW}) \leq (\text{Stop freq of the offset} - \text{Start freq of the offset}),$$

Spectrum Emission Mask Measurement
Meas Setup

where N is the multiplier, this setting will automatically be changed to manual.

Key Path:	Meas Setup, Offset/Limits
Mode:	WCDMA, C2K, WIMAX OFDMA, TD-SCDMA, 1xEVDO, LTE, LTETDD, WLAN
Remote Command:	<pre>[:SENSe] :SEMAsk:OFFSet [1] 2 :LIST:BAWdwidth [:RESolution] <bandwidth>, ... [:SENSe] :SEMAsk:OFFSet [1] 2 :LIST:BAWdwidth [:RESolution] ? [:SENSe] :SEMAsk:OFFSet [1] 2 :LIST:BAWdwidth [:RESolution] :AUTO OFF ON 1 0, ... [:SENSe] :SEMAsk:OFFSet [1] 2 :LIST:BAWdwidth [:RESolution] :AUTO?</pre>
Example:	<pre>SEM:OFFS2:LIST:BAWd 30.0 kHz, 30.0 kHz, 30.0 kHz, 1.00 MHz,1.00 MHz, 1.00 MHz SEM:OFFS2:LIST:BAWd? SEM:OFFS:LIST:BAWd:AUTO 1,1,1,1,1,1 SEM:OFFS:LIST:BAWd:AUTO?</pre>
Notes:	<p>Comma separated list of values.</p> <p>OFFSet1 is for BTS, 2 for MS. Default is BTS.</p> <p>You must be in the mode that includes SEM measurement to use this command. Use :INSTrument:SELEct to set the mode.</p>
Couplings:	<p>Coupled to Start and Stop offset and Meas BW multiplier. This parameter must adhere to the rule $(N \times \text{Res BW}) \leq (\text{Stop freq of the offset} - \text{Start freq of the offset})$, where N is the multiplier. If the multiplier is changed, the Res BW will be changed to ensure this. When set manually, Res BW Coupling is set to manual.</p>

Preset:	<p>For modes (except WLAN), the preset value is as follows.</p> <p>WCDMA: 30.00 kHz, 30.00 kHz, 30.00 kHz, 100.00 kHz, 1.000 MHz, 1.00 MHz 30.00 kHz, 1.000 MHz, 1.000 MHz, 1.000 MHz, 1.000 MHz, 1.00 MHz</p> <p>C2K: 3.00 kHz, 30.00 kHz, 30.00 kHz, 6.2 kHz, 1.000 MHz, 1.00 MHz 30.00 kHz, 30.00 kHz, 6.2 kHz, 1.000 MHz, 1.000 MHz, 1.00 MHz</p> <p>WIMAX OFDMA: 100 KHz, 100 KHz, 100 KHz, 100 KHz, 100 KHz, 100 KHz 100 KHz, 100 KHz, 100 KHz, 100 KHz, 100 KHz, 100 KHz</p> <p>TD-SCDMA: 30 kHz, 30 kHz, 30 kHz, 50 kHz, 1 MHz, 1 MHz 30 kHz, 30 kHz, 50 kHz, 1 MHz, 1 MHz, 1 MHz</p> <p>1xEVDO: 30.00 kHz, 30.00 kHz, 30.00 kHz, 6.2 kHz, 1.000 MHz, 1.000 MHz 30.00 kHz, 30.00 kHz, 30.00 kHz, 30.00 kHz, 30.00 kHz, 30.00 kHz</p> <p>LTE, LTETDD: 51 kHz, 100 kHz, 1.0 MHz, 1.0 MHz, 1.0 MHz, 1.0 MHz 15.0 kHz, 510 kHz, 1.0 MHz, 1.0 MHz, 1.0 MHz, 1.0 MHz</p> <p>-----</p> <p>WLAN: 100 KHz, 100 KHz, 100 KHz, 100 KHz, 100 KHz, 100 KHz, 100 KHz, 100 KHz, 100 KHz, 100 KHz</p> <p>Modes (except WLAN): OFF, OFF, OFF, OFF, OFF, OFF OFF, OFF, OFF, OFF, OFF, OFF</p> <p>WLAN: OFF, OFF, OFF, OFF, OFF, OFF, OFF, OFF, OFF, OFF, OFF, OFF OFF, OFF, OFF, OFF, OFF, OFF, OFF, OFF, OFF, OFF, OFF, OFF</p>
State Saved:	Saved in instrument state.
Min:	1 Hz
Max:	8 MHz
Backwards Compatibility SCPI:	[[:SENSe]:SEMAsk:OFFSet[1]]2:LIST:BWIDth[:RESolution]
Initial S/W Revision:	Prior to A.02.00
Modified at S/W Revision:	A.02.00, A.03.00, A.10.00, A.11.00

Meas BW

Allows you to specify a multiplier of Res BW for the measurement integration bandwidth.

Meas BW is multiplier integer number. It shows a ratio between Integration BW and Resolution BW of the measurement result.

$$\text{Integ BW} = \text{Meas BW} * \text{Resolution BW}$$

Integration BW is desired resolution bandwidth and Resolution BW is actual bandwidth for sweep. Measurement sweeps with Resolution BW and Meas BW compensates sweep resolution bandwidth to Integration BW.

If you set this parameter greater than 1, you can set Resolution BW narrower to avoid carrier power

Spectrum Emission Mask Measurement
Meas Setup

leakage effect to the offset power integration.

Key Path:	Meas Setup, Offset/Limits
Mode:	WCDMA, C2K, WIMAX OFDMA, TD-SCDMA, 1xEVDO, LTE, LTETDD, WLAN
Remote Command:	[:SENSE] :SEMAsk:OFFSet [1] 2 :LIST:BA NDwidth:IMULti <integer>, ... [:SENSE] :SEMAsk:OFFSet [1] 2 :LIST:BA NDwidth:IMULti?
Example:	SEM:OFFS2:LIST:BA ND:IMUL 1,1,1,1,1,1 SEM:OFFS2:LIST:BA ND:IMUL?
Notes:	Comma separated list of values. OFFSet1 is for BTS, 2 for MS. Default is BTS. You must be in the mode that includes SEM measurement to use this command. Use :INSTrument:SELect to set the mode.
Couplings:	This parameter must adhere to the rule (N x Res BW) <= (Stop freq of the offset - Start freq of the offset), where N is the multiplier. If the Res Bw is changed, the multiplier will be changed to ensure this.
Preset:	For modes (except WLAN), the preset value is as follows. WCDMA: 1, 1, 1, 10, 1, 1 1, 1, 1, 1, 1, 1 C2K: 10, 1, 1, 1, 1, 1 1, 1, 1, 1, 1, 1 WIMAX OFDMA, 1xEVDO: 1, 1, 1, 1, 1, 1 1, 1, 1, 1, 1, 1 TD-SCDMA:1, 1, 1, 20, 1, 1 1, 1, 20, 1, 1, 1 LTE, LTETDD: 2, 1, 1, 1, 1, 1 2, 2, 1, 1, 1, 1 ----- WLAN: 1, 1, 1, 1, 1, 1, 1, 1, 1, 1, 1, 1
State Saved:	Saved in instrument state.
Min:	1
Max:	1000
Backwards Compatibility SCPI:	[:SENSE] :SEMAsk:OFFSet[1] 2:LIST:BWIDth:IMULti
Initial S/W Revision:	Prior to A.02.00
Modified at S/W Revision:	A.02.00, A.03.00, A.10.00, A.11.00

Video BW

Changes the analyzer post-detection filter.

Key Path:	Meas Setup, Offset/Limits
-----------	----------------------------------

Mode:	WCDMA, C2K, WIMAX OFDMA, TD-SCDMA, 1xEVDO, LTE, LTETDD, WLAN
Remote Command:	[:SENSe]:SEMAsk:OFFSet [1] 2:LIST:BANDwidth:VIDeo <freq>, ... [:SENSe]:SEMAsk:OFFSet [1] 2:LIST:BANDwidth:VIDeo? [:SENSe]:SEMAsk:OFFSet [1] 2:LIST:BANDwidth:VIDeo:AUTO OFF ON 0 1, ... [:SENSe]:SEMAsk:OFFSet [1] 2:LIST:BANDwidth:VIDeo:AUTO?
Example:	SEM:OFFS2:LIST:BAND:VID 3.00 kHz, 3.00 kHz, 3.00 kHz, 100.0 kHz, 100.0 kHz, 100.0 kHz SEM:OFFS2:LIST:BAND:VID? SEM:OFFS2:LIST:BAND:VID:AUTO ON, ON, ON, ON, ON, ON, ON SEM:OFFS2:LIST:BAND:VID:AUTO?
Notes:	Comma separated list of values. OFFSet1 is for BTS, 2 for MS. Default is BTS. You must be in the mode that includes SEM measurement to use this command. Use :INSTrument:SElect to set the mode.
Preset:	Modes (except WLAN): ON, ON, ON, ON, ON, ON ON, ON, ON, ON, ON, ON ----- WLAN: ON, ON, ON, ON, ON, ON, ON, ON, ON, ON, ON, ON ON, ON, ON, ON, ON, ON, ON, ON, ON, ON, ON, ON
State Saved:	Saved in instrument state.
Min:	1 Hz
Max:	50 MHz
Backwards Compatibility SCPI:	[:SENSe]:SEMAsk:OFFSet[1] 2:LIST:BWIDth:VIDeo
Initial S/W Revision:	Prior to A.02.00
Modified at S/W Revision:	A.02.00, A.03.00, A.10.00, A.11.00

VBW/RBW

Selects the ratio between the video and resolution bandwidths.

Key Path:	Meas Setup, Offset/Limits
Mode:	WCDMA, C2K, WIMAX OFDMA, TD-SCDMA, 1xEVDO, LTE, LTETDD, WLAN

Spectrum Emission Mask Measurement
Meas Setup

Remote Command:	<pre>[:SENSe] :SEMAsk:OFFSet [1] 2:LIST:BANDwidth:VIDeo:RATio <real>, ... [:SENSe] :SEMAsk:OFFSet [1] 2:LIST:BANDwidth:VIDeo:RATio? [:SENSe] :SEMAsk:OFFSet [1] 2:LIST:BANDwidth:VIDeo:RATio: AUTO OFF ON 0 1, ... [:SENSe] :SEMAsk:OFFSet [1] 2:LIST:BANDwidth:VIDeo:RATio: AUTO?</pre>
Example:	<pre>SEM:OFFS2:LIST:BAND:VID:RAT 0.1, 0.1, 0.1, 0.1, 0.1, 0.1 SEM:OFFS2:LIST:BAND:VID:RAT? SEM:OFFS2:LIST:BAND:VID:RAT:AUTO ON, ON, ON, ON, ON, ON SEM:OFFS2:LIST:BAND:VID:RAT:AUTO?</pre>
Notes:	<p>Comma separated list of values.</p> <p>OFFSet1 is for BTS, 2 for MS. Default is BTS.</p> <p>You must be in the mode that includes SEM measurement to use this command. Use :INSTrument:SElect to set the mode.</p>
Preset:	<p>For modes (except WLAN), the preset value is as follows.</p> <p>WCDMA, C2K, LTE, LTETDD: 0.01, 0.01, 0.01, 0.01, 0.01, 0.01 0.01, 0.01, 0.01, 0.01, 0.01, 0.01</p> <p>WIMAX OFDMA: 0.3, 0.3, 0.3, 0.3, 0.3, 0.3</p> <p>TD-SCDMA: 10, 10, 10, 10, 1, 1 10, 10, 10, 1, 1, 1</p> <p>1xEVDO: 10, 10, 10, 10, 10, 10 10, 10, 10, 10, 10, 10</p> <p>-----</p> <p>WLAN: 0.3, 0.3, 0.3, 0.3, 0.3, 0.3, 0.3, 0.3, 0.3, 0.3, 0.3, 0.3, 0.3</p> <p>Modes (except WLAN): OFF, OFF, OFF, OFF, OFF, OFF OFF, OFF, OFF, OFF, OFF, OFF</p> <p>WLAN: OFF, OFF, OFF, OFF, OFF, OFF, OFF, OFF OFF, OFF, OFF, OFF, OFF, OFF, OFF, OFF</p>
State Saved:	Saved in instrument state.
Min:	0.00001
Max:	3000000
Initial S/W Revision:	Prior to A.02.00
Modified at S/W Revision:	A.02.00, A.03.00, A.10.00, A.11.00

Limits

Accesses a menu that enables you to set the power limits for start and stop frequencies of the selected offsets.

Key Path:	Meas Setup
Initial S/W Revision:	Prior to A.02.00

Abs Start

Sets the absolute power level limit at the start frequency for the selected offset. The absolute power level limit ranges from -200 to +50 dBm.

The fail condition for each offset channel is set remotely by [:SENSE]:SEMAsk:OFFSet[n]:LIST:TEST.

You can turn off (not use) specific offset channels remotely with [:SENSE]:SEMAsk:OFFSet[n]:LIST:STATe.

The SCPI query returns the five (5) sets of real values currently set to the absolute power test limits.

Key Path:	Meas Setup, Offset/Limit, Limits
Mode:	WCDMA, C2K, WIMAX OFDMA, TD-SCDMA, 1xEVDO, LTE, LTETDD, WLAN
Remote Command:	[:SENSE]:SEMAsk:OFFSet [1] 2:LIST:STARt:ABSolute <real>, ... [:SENSE]:SEMAsk:OFFSet [1] 2:LIST:STARt:ABSolute?
Example:	SEM:OFFS2:LIST:STAR:ABS -12.50 dBm, -12.50 dBm, -24.50 dBm, -11.50 dBm, -11.50 dBm, -11.50 dBm SEM:OFFS2:LIST:STAR:ABS?
Notes:	Comma separated list of values. OFFSet1 is for BTS, 2 for MS. Default is BTS. You must be in the mode that includes SEM measurement to use this command. Use :INSTrument:SELEct to set the mode.
Couplings:	Coupled to Abs Stop if coupling set to "Couple", that is, the Start value is equal to the Stop value.

Spectrum Emission Mask Measurement
Meas Setup

Preset:	<p>For modes (except WLAN), the preset value is as follows.</p> <p>WIMAX OFDMA: -14.00 dBm , -14.00 dBm , -26.00 dBm , -13.00 dBm , -13.00 dBm, -13.00 dBm</p> <p>WCDMA: -12.50 dBm, -12.50 dBm, -24.50 dBm, -11.50 dBm, -11.50 dBm, -11.50 dBm -69.6 dBm, -54.3 dBm, -54.3 dBm, -54.3 dBm, -54.3 dBm, -54.3 dBm</p> <p>C2K: -27.00 dBm, -27.00 dBm, -27.00 dBm, -46.00 dBm, -13.00 dBm, -13.00 dBm -70.13 dBm, -70.13 dBm, -35.00 dBm, -13.00 dBm, -13.00 dBm, -13.00 dBm</p> <p>TD-SCDMA: -28 dBm, -28 dBm, -36 dBm, -21 dBm, -21 dBm, -21 dBm -71.3 dBm, -71.3 dBm, -56.07 dBm, -56.07 dBm, -56.07 dBm, -56.07 dBm</p> <p>1xEVDO: -27.0dBm, -27.00 dBm, -27.00 dBm, -46.00 dBm, -13.00 dBm, -13.00 dBm -70.13 dBm, -70.13 dBm, -70.13 dBm, -70.13 dBm, -70.13 dBm, -70.13 dBm</p> <p>LTE, LTETDD: -5.5 dBm, -12.5 dBm, -15.0 dBm, -15.0 dBm, -15.0 dBm, -15.0 dBm -13.5 dBm, -8.5 dBm, -11.5 dBm, -23.5 dBm, -23.5 dBm, -23.5 dBm</p> <p>-----</p> <p>WLAN:</p> <p>if Radio Std is 802.11a/g(OFDM/DSSS-OFDM): 16.00 dBm, -4.00 dBm, -12.00 dBm, -24.00 dBm, -24.00 dBm, -24.00 dBm, -24.00 dBm, -24.00 dBm, -24.00 dBm, -24.00 dBm, -24.00 dBm</p> <p>if Radio Std is 802.11b/g(DSSS/CCK/PBCC): -10 dBm, -30 dBm, -30 dBm, -30 dBm, -30 dBm, -30 dBm, -30 dBm, -30 dBm, -30 dBm, -30 dBm, -30 dBm</p> <p>if Radio Std is 802.11n(20MHz) or 802.11ac(20MHz): 16.00 dBm, -4.00 dBm, -12.00 dBm, -63.00 dBm, -63.00 dBm, -63.00 dBm, -63.00 dBm, -63.00 dBm, -63.00 dBm, -63.00 dBm, -63.00 dBm</p> <p>if Radio Std is 802.11n(40MHz) or 802.11ac(40MHz): 16.00 dBm, -4.00 dBm, -12.00 dBm, -66.00 dBm, -66.00 dBm, -66.00 dBm, -66.00 dBm, -66.00 dBm, -66.00 dBm, -66.00 dBm, -66.00 dBm</p> <p>if Radio Std is 802.11ac(80MHz/160MHz): 16.00 dBm, -4.00 dBm, -12.00 dBm, -69.00 dBm, -69.00 dBm, -69.00 dBm, -69.00 dBm, -69.00 dBm, -69.00 dBm, -69.00 dBm, -69.00 dBm</p> <p>if Radio Std is 802.11ac (80 MHz + 80 MHz): -69.00 dBm, -69.00 dBm, -69.00 dBm, -69.00 dBm, -69.00 dBm, -69.00 dBm, -69.00 dBm, -69.00 dBm, -69.00 dBm, -69.00 dBm, -69.00 dBm</p>
State Saved:	Saved in instrument state.
Min:	-200 dBm
Max:	50 dBm
Initial S/W Revision:	Prior to A.02.00

Modified at S/W Revision:	A.02.00, A.03.00, A.10.00, A.11.00
---------------------------	------------------------------------

Abs Stop

Sets the absolute power level limit at the stop frequency for the selected offset. The absolute power level limit ranges from –200 to +50 dBm. You can also toggle this function between couple and manual. If set to Couple, the **Abs Stop** power level limit is coupled to **Abs Start** to result in a flat limit line. If set to Man, Abs Start and Abs Stop take different values to result in a sloped limit line.

The SCPI query returns the five (5) sets of real values currently set to the offset stop absolute power limits.

Key Path:	Meas Setup, Offset/Limits, Limits
Mode:	WCDMA, C2K, WIMAX OFDMA, TD-SCDMA, 1xEVDO, LTE, LTETDD, WLAN
Remote Command:	[:SENSE]:SEMAsk:OFFSet [1] 2:LIST:STOP:ABSolute <real>, ... [:SENSE]:SEMAsk:OFFSet [1] 2:LIST:STOP:ABSolute? [:SENSE]:SEMAsk:OFFSet [1] 2:LIST:STOP:ABSolute:COUPle ON OFF 1 0, ... [:SENSE]:SEMAsk:OFFSet [1] 2:LIST:STOP:ABSolute:COUPle?
Example:	SEM:OFFS:LIST:STOP:ABS -12.50 dBm, -24.50 dBm, -24.50 dBm, -11.50 dBm, -11.50 dBm, -11.50 dBm SEM:OFFS1:LIST:STOP:ABS? SEM:OFFS:LIST:STOP:ABS:COUP ON, OFF, ON, ON, ON, ON SEM:OFFS:LIST:STOP:ABS:COUP?
Notes:	Comma separated list of values. OFFSet1 is for BTS, 2 for MS. Default is BTS. You must be in the mode that includes SEM measurement to use this command. Use :INSTrument:SElect to set the mode.
Couplings:	Coupled to Abs Start if "Auto" is selected, that is, the Stop value is equal to the Start value.

Spectrum Emission Mask Measurement
Meas Setup

<p>Preset:</p>	<p>For modes (except WLAN), the preset value is as follows.</p> <p>WIMAX OFDMA: -14.00 dBm, -26.00 dBm, -26.00 dBm, -13.00 dBm, -13.00 dBm, -13.00 dBm</p> <p>WCDMA: -12.50 dBm, -24.50 dBm, -24.50 dBm, -11.50 dBm, -11.50 dBm, -11.50 dBm -69.6 dBm, -54.3 dBm, -54.3 dBm, -54.3 dBm, -54.3 dBm, -54.3 dBm</p> <p>C2K: -27.00 dBm, -27.00 dBm, -27.00 dBm, -46.00 dBm, -13.00 dBm, -13.00 dBm -70.13 dBm, -70.13 dBm, -35.00 dBm, -13.00 dBm, -13.00 dBm, -13.00 dBm</p> <p>TD-SCDMA: -28 dBm, -36 dBm, -36 dBm, -21 dBm, -21 dBm, -21 dBm -71.3 dBm, -71.3 dBm, -56.07 dBm, -56.07 dBm, -56.07 dBm, -56.07 dBm</p> <p>1xEVDO: -27dBm, -27.00 dBm, -27.00 dBm, -46.00 dBm, -13.00 dBm, -13.00 dBm -70.13 dBm, -70.13 dBm, -70.13 dBm, -70.13 dBm, -70.13 dBm, -70.13 dBm</p> <p>LTE, LTETDD: -12.5 dBm, -12.5 dBm, -15.0 dBm, -15.0 dBm, -15.0 dBm, -15.0 dBm -13.5 dBm, -8.5 dBm, -11.5 dBm, -23.5 dBm, -23.5 dBm, -23.5 dBm</p> <p>-----</p> <p>WLAN:</p> <p>if Radio Std is 802.11a/g(OFDM/DSSS-OFDM): -4.00 dBm, -12.00 dBm, -24.00 dBm, -24.00 dBm, -24.00 dBm, -24.00 dBm, -24.00 dBm, -24.00 dBm, -24.00 dBm, -24.00 dBm</p> <p>if Radio Std is 802.11b/g(DSSS/CCK/PBCC): -10 dBm, -30 dBm, -30 dBm, -30 dBm, -30 dBm, -30 dBm, -30 dBm, -30 dBm, -30 dBm, -30 dBm</p> <p>if Radio Std is 802.11n(20MHz) or 802.11ac(20MHz): -4.00 dBm, -12.00 dBm, -24.00 dBm, -63.00 dBm, -63.00 dBm, -63.00 dBm, -63.00 dBm, -63.00 dBm, -63.00 dBm, -63.00 dBm</p> <p>if Radio Std is 802.11n(40MHz) or 802.11ac(40MHz): -4.00 dBm, -12.00 dBm, -24.00 dBm, -66.00 dBm, -66.00 dBm, -66.00 dBm, -66.00 dBm, -66.00 dBm, -66.00 dBm, -66.00 dBm</p> <p>if Radio Std is 802.11ac(80MHz/160MHz): -4.00 dBm, -12.00 dBm, -24.00 dBm, -69.00 dBm, -69.00 dBm, -69.00 dBm, -69.00 dBm, -69.00 dBm, -69.00 dBm, -69.00 dBm</p> <p>if Radio Std is 802.11ac (80 + 80 MHz): -69.00 dBm, -69.00 dBm, -69.00 dBm, -69.00 dBm, -69.00 dBm, -69.00 dBm, -69.00 dBm, -69.00 dBm, -69.00 dBm, -69.00 dBm</p>
----------------	--

Preset: (Cont)	<p>For modes (except WLAN), the preset value is as follows.</p> <p>WIMAX OFDMA: ON, OFF, ON, ON, ON, ON</p> <p>WCDMA: ON, OFF, ON, ON, ON, ON ON, ON, ON, ON, ON, ON</p> <p>C2K: ON, ON, ON, ON, ON, OFF ON, ON, ON, ON, ON, OFF</p> <p>TD-SCDMA: ON, OFF, ON, ON, ON, ON ON, ON, ON, ON, ON, ON</p> <p>1xEVDO: ON, ON, ON, ON, ON, OFF ON, ON, ON, ON, ON, OFF</p> <p>LTE, LTETDD: OFF, ON, ON, ON, ON, ON ON, ON, ON, ON, ON, ON</p> <p>-----</p> <p>WLAN:</p> <p>if Radio Std is 802.11a/g(OFDM/DSSS-OFDM)/802.11n(20MHz/40MHz)/802.11 ac(20MHz/40MHz/80MHz/160MHz): OFF, OFF, OFF, ON, ON, ON, ON, ON, ON, ON, ON, ON</p> <p>if Radio Std is 802.11 ac(80+80 MHz): ON, ON, ON, ON, ON, ON, ON, ON, ON, ON, ON, ON</p> <p>if Radio Std is 802.11b/g(DSSS/CCK/PBCC): ON, ON, ON, ON, ON, ON, ON, ON, ON, ON, ON, ON</p>
State Saved:	Saved in instrument state.
Min:	-200 dBm
Max:	50 dBm
Initial S/W Revision:	Prior to A.02.00
Modified at S/W Revision:	A.02.00, A.03.00, A.10.00, A.11.00

Rel Start

Sets a relative power level limit at the start frequency for the selected offset. The relative power level limit ranges from -200 to +50 dBc.

The fail condition is set remotely by [:SENSE]:SEMask:OFFSet[n]:LIST:TEST for each offset channel test.

You can turn off (not use) specific offset channels remotely with [:SENSE]:SEMask:OFFSet[n]:LIST:STATE.

The SCPI query returns the five (5) sets of real values currently set to the relative power test limits.

Key Path:	Meas Setup, Offset/Limits, Limits
Mode:	WCDMA, C2K, WIMAX OFDMA, TD-SCDMA, 1xEVDO, LTE, LTETDD, WLAN
Remote Command:	<pre>[:SENSE]:SEMask:OFFSet [1] 2:LIST:START:RCARrier <rel_ampl>, ... [:SENSE]:SEMask:OFFSet [1] 2:LIST:START:RCARrier?</pre>

Spectrum Emission Mask Measurement
Meas Setup

Example:	SEM:OFFS:LIST:STAR:RCAR -30, -30, -30, -30, -30, -30 SEM:OFFS:LIST:STAR:RCAR?
Notes:	Comma separated list of values. OFFSet1 is for BTS, 2 for MS. Default is BTS. You must be in the mode that includes SEM measurement to use this command. Use :INSTRument:SElect to set the mode.
Couplings:	Coupled to Rel Stop is coupling set to "Couple", that is, Start is made the same as Stop.
Preset:	For modes (except WLAN), the preset value is as follows. WCDMA: -30.00 dB, -30.00 dB, -30.00 dB, -30.00 dB, -30.00 dB, -30.00 dB -33.73 dB, -34.00 dB, -37.50 dB, -47.50 dB, -47.50 dB, -47.50 dB C2K: -45.00 dB, -45.00 dB, -55.00 dB, -55.00 dB, -55.00 dB, -55.00 dB -42.00 dB, -54.00 dB, -54.00 dB, -54.00 dB, -54.00 dB, -54.00 dB WIMAX OFDMA: 0 dB, -25 dB, -32 dB, -50 dB, -50 dB, -50 dB TD-SCDMA: -54.00 dB, -54.00 dB, -62.00 dB, -47.00 dB, -47.00 dB, -47.00 dB -35.21 dB, -49.00 dB, -44.00 dB, -44.00 dB, -44.00 dB, -44.00 dB 1xEVDO: -45dBc, -45.00 dB, -55.00 dB, -55.00 dB, -55.00 dB, -55.00 dB -42dBc, -54.00 dB, -54.00 dB, -54.00 dB, -54.00 dB, -54.00 dB LTE, LTETDD: 0 dB, 0 dB, 0 dB, 0 dB, 0 dB, 0 dB 0 dB, 0 dB, 0 dB, 0 dB, 0 dB, 0 dB ----- WLAN: if Radio Std is 802.11a/g(OFDM/DSSS-OFDM): 0 dB, -20.00 dB, -28.00 dB, -40.00 dB, -40.00 dB, -47.00 dB, -47.00 dB, -47.00 dB, -47.00 dB, -47.00 dB, -47.00 dB if Radio Std is 802.11b/g(DSSS/CCK/PBCC): -30 dB, -50 dB, -50 dB, -50 dB, -50 dB, -50 dB, -50 dB, -50 dB, -50 dB, -50 dB if Radio Std is 802.11n(20MHz/40MHz): 0 dB, -20.00 dB, -28.00 dB, -45.00 dB, -45.00 dB, -45.00 dB, -45.00 dB, -45.00 dB, -45.00 dB, -45.00 dB, -45.00 dB if Radio Std is 802.11ac (20 MHz/ 40 MHz/ 80 MHz/ 160 MHz): 0 dB, -20.00 dB, -28.00 dB, -40.00 dB, -40.00 dB, -40.00 dB, -40.00 dB, -40.00 dB, -40.00 dB, -40.00 dB, -40.00 dB if Radio Std is 802.11ac(80 MHz + 80MHz): -40.00 dB, -28.00 dB, -20 dB, 0 dB, -20 dB, -28 dB, -40 dB, -40 dB, -40.00 dB, -40.00 dB, -40.00 dB, -40.00 dB
State Saved:	Saved in instrument state.
Min:	-200 dB
Max:	50 dB

Initial S/W Revision:	Prior to A.02.00
Modified at S/W Revision:	A.02.00, A.03.00, A.10.00, A.11.00

Rel Stop

Sets a relative power level limit at the stop frequency for the selected offset. The relative power level limit ranges from –200 to +50 dBc.

The fail condition is set remotely by [:SENSE]:SEMAsk:OFFSet[n]:LIST:TEST for each offset channel.

You can turn off (not use) specific offset channels remotely with [:SENSE]:SEMAsk:OFFSet[n]:LIST:STAtE.

The SCPI query returns the five (5) sets of real values currently set to the offset stop relative power limits.

Key Path:	Meas Setup, Offset/Limits, Limits
Mode:	WCDMA, C2K, WIMAX OFDMA, TD-SCDMA, 1xEVDO, LTE, LTETDD, WLAN
Remote Command:	[:SENSE]:SEMAsk:OFFSet [1] 2:LIST:STOP:RCARrier <rel_ampl>, ... [:SENSE]:SEMAsk:OFFSet [1] 2:LIST:STOP:RCARrier? [:SENSE]:SEMAsk:OFFSet [1] 2:LIST:STOP:RCARrier:COUPle ON OFF 1 0, ... [:SENSE]:SEMAsk:OFFSet [1] 2:LIST:STOP:RCARrier:COUPle?
Example:	SEM:OFFS:LIST:STOP:RCAR -30, -30, -30, -30, -30, -30 SEM:OFFS:LIST:STOP:RCAR? SEM:OFFS:LIST:STOP:RCAR:COUP ON, ON, ON, ON, ON, ON SEM:OFFS:LIST:STOP:RCAR:COUP?
Notes:	Comma separated list of values. OFFSet1 is for BTS, 2 for MS. Default is BTS. You must be in the mode that includes SEM measurement to use this command. Use :INSTrument:SElect to set the mode.
Couplings:	Coupled to Abs Start if "Auto" is selected, that is, the Stop value is equal to the Start value.

Spectrum Emission Mask Measurement
Meas Setup

<p>Preset:</p>	<p>For modes (except WLAN), the preset value is as follows.</p> <p>WCDMA: -30.00 dB, -30.00 dB, -30.00 dB, -30.00 dB, -30.00 dB, -30.00 dB -48.28 dB, -37.50 dB, -47.50 dB, -47.50 dB, -47.50 dB, -47.50 dB</p> <p>C2K: -45.00 dB, -45.00 dB, -55.00 dB, -55.00 dB, -55.00 dB, -55.00 dB -42.00 dB, -54.00 dB, -54.00 dB, -54.00 dB, -54.00 dB, -54.00 dB</p> <p>WIMAX OFDMA: -25 dB, -32 dB, -50 dB, -50 dB, -50 dB, -50 dB</p> <p>TD-SCDMA: -54.00 dB, -62.00 dB, -62.00 dB, -47.00 dB, -47.00 dB, -47.00 dB -49.00 dB, -58.945 dB, -44.00 dB, -44.00 dB, -44.00 dB, -44.00 dB</p> <p>1xEVDO: -45dB, -45.00 dB, -55.00 dB, -55.00 dB, -55.00 dB, -55.00 dB -42dB, -54.00 dB, -54.00 dB, -54.00 dB, -54.00 dB, -54.00 dB</p> <p>LTE, LTETDD: 0 dB, 0 dB, 0 dB, 0 dB, 0 dB, 0 dB</p> <p>-----</p> <p>WLAN:</p> <p>if Radio Std is 802.11a/g(OFDM/DSSS-OFDM): -20.00 dB, -28.00 dB, -40.00 dB, -40.00 dB, -47.00 dB, -47.00 dB, -47.00 dB, -47.00 dB, -47.00 dB, -47.00 dB</p> <p>if Radio Std is 802.11b/g(DSSS/CCK/PBCC): -30 dB, -50 dB, -50 dB, -50 dB, -50 dB, -50 dB, -50 dB, -50 dB, -50 dB, -50 dB</p> <p>if Radio Std is 802.11n(20MHz/40MHz): -20.00 dB, -28.00 dB, -45.00 dB, -45.00 dB, -45.00 dB, -45.00 dB, -45.00 dB, -45.00 dB, -45.00 dB, -45.00 dB</p> <p>if Radio Std is 802.11ac (20 MHz/ 40 MHz/ 80 MHz/ 160 MHz): -20.00 dB, -28.00 dB, -40.00 dB, -40.00 dB, -40.00 dB, -40.00 dB, -40.00 dB, -40.00 dB, -40.00 dB, -40.00 dB</p> <p>if Radio Std is 802.11ac(80 MHz + 80MHz): -28.00 dB, -20.00 dB, 0 dB, -20.00 dB, -28.00 dB, -40.00 dB, -40.00 dB, -40.00 dB, -40.00 dB, -40.00 dB</p>
----------------	--

Preset: (Cont)	<p>For modes (except WLAN), the preset value is as follows.</p> <p>WCDMA: ON, ON, ON, ON, ON, ON, ON OFF, OFF, OFF, ON, ON, ON</p> <p>C2K: ON, ON, ON, ON, ON, OFF ON, ON, ON, ON, ON, OFF</p> <p>WIMAX OFDMA: OFF, OFF, OFF, ON, ON, ON OFF, OFF, OFF, ON, ON, ON</p> <p>TD-SCDMA: ON, OFF, ON, ON, ON,ON OFF,OFF,ON,ON,ON,ON</p> <p>1xEVDO: ON, ON, ON, ON, ON, OFF ON, ON, ON, ON, ON, OFF</p> <p>LTE, LTETDD: ON, ON, ON, ON, ON, ON</p> <p>-----</p> <p>WLAN:</p> <p>if Radio Std is 802.11a/g(OFDM/DSSS-OFDM)/802.11n(20MHz/40MHz): OFF, OFF, OFF, ON, ON, ON, ON, ON, ON, ON, ON, ON</p> <p>if Radio Std is 802.11b/g(DSSS/CCK/PBCC): ON, ON, ON, ON, ON, ON, ON, ON, ON, ON, ON, ON</p> <p>if Radio Std is 802.11ac (20 MHz/ 40 MHz/ 80 MHz/ 160 MHz): OFF, OFF, OFF, ON, ON, ON, ON, ON, ON, ON, ON, ON</p> <p>if Radio Std is 802.11ac(80 MHz + 80MHz): OFF, OFF, OFF, OFF, OFF, OFF, OFF, OFF, OFF, OFF, OFF, OFF</p>
State Saved:	Saved in instrument state.
Min:	-200 dB
Max:	50 dB
Initial S/W Revision:	Prior to A.02.00
Modified at S/W Revision:	A.02.00, A.03.00, A.10.00, A.11.00

Fail Mask

Selects one of the logic keys for fail conditions between the measurement results and the test limits:

- **Absolute** and **Relative** both check the results against the respective limit.
- **OR** checks against both limits, failing if either of the limits is broken.
- **AND** will only display a fail if both of the limits are broken.

The absolute or relative power limit value for each offset channel can be set remotely with
[:SENSe]:SEMask:OFFSet[n]:LIST:ABSolute or [:SENSe]:SEMask:OFFSet[n]:LIST:RCARrier.

You can turn off (not use) specific offset channels remotely with
[:SENSe]:SEMask:OFFSet[n]:LIST:STATe.

Key Path:	Meas Setup, Offset/Limits, Limits
Mode:	WCDMA, C2K, WIMAX OFDMA, TD-SCDMA, 1xEVDO, LTE, LTETDD, WLAN

Spectrum Emission Mask Measurement
Meas Setup

Remote Command:	[:SENSE] :SEMAsk:OFFSet [1] 2 :LIST:TEST ABSolute AND OR RELative, ... [:SENSE] :SEMAsk:OFFSet [1] 2 :LIST:TEST?
Example:	SEM:OFFS:LIST:TEST ABS, ABS, ABS, ABS, ABS, ABS SEM:OFFS:LIST:TEST?
Notes:	Comma separated list of values. You must be in the mode that includes SEM measurement to use this command. Use :INSTrument:SElect to set the mode.
Preset:	For modes (except WLAN), the preset value is as follows. WCDMA: ABS, ABS, ABS, ABS, ABS, ABS AND, AND, AND, AND, AND, AND C2K: REL, REL, REL, ABS, REL, REL AND, AND, ABS, REL, REL, REL WIMAX OFDMA: REL, REL, REL, REL, REL, REL REL, REL, REL, REL, REL, REL TD-SCDMA: ABS, ABS, ABS, ABS, ABS, ABS AND, AND, AND, AND, AND, AND 1xEVDO: REL, REL, REL, ABS, REL, REL AND, AND, AND, OR, AND, AND LTE, LTDTDD: ABS, ABS, ABS, ABS, ABS, ABS ----- WLAN: if Radio Std is 802.11a/g(OFDM/DSSS-OFDM) or 802.11b/g(DSSS/CCK/PBCC): REL, REL, REL, REL, REL, REL, REL, REL, REL, REL, REL, REL if Radio Std is 802.11n(20MHz/40MHz): REL, REL, REL, AND, AND, AND, AND, AND, AND, AND, AND, AND if Radio Std is 802.11ac (20 MHz/ 40 MHz/ 80 MHz/ 160 MHz): REL, REL, REL, AND, AND, AND, AND, AND, AND, AND, AND, AND, AND if Radio Std is 802.11ac (80 MHz + 80MHz): REL, REL, REL, REL, REL, REL, AND, AND, AND, AND, AND, AND, AND
State Saved:	Saved in instrument state.
Range:	Absolute Relative Abs AND Rel Abs OR Rel
Initial S/W Revision:	Prior to A.02.00
Modified at S/W Revision:	A.02.00, A.03.00, A.10.00, A.11.00

Offset Freq Define

This key enables you to select “Offset” definition. Each standard defines each “Offset” from Carrier.

Meas BW Edge means the edge of resolution band width that is represented by Meas BW and Res BW settings. Actual center frequency of Meas BW and the limit line have ½ Meas BW offset when the Meas

BW Edge is selected.

3GPP2 requires the “Carrier Center to Meas BW Edge” definition. LTE conformance test requires “Carrier Edge to Meas BW Center” and/or “Carrier Edge to Meas BW Edge” definition

- **CTOCenter** – From carrier center to the center of offset measuring filter*
- **CTOEdge** - From carrier center to the nominal –3 dB point of the offset measuring filter* closer to the carrier
- **ETOCenter** – From Center Frequency - Span of Ref Channel / 2 (for lower offset), Center Frequency + Span of Ref Channel / 2 (for upper offset) of the carrier closest to each offset to the center of offset measuring filter*
- **ETOEdge** - From Center Frequency - Span of Ref Channel / 2 (for lower offset), Center Frequency + Span of Ref Channel / 2 (for upper offset) of the carrier closest to each offset to the nominal –3 dB point of the offset measuring filter* closer to the carrier
- *Measuring filter = Meas BW (N x Res BW)

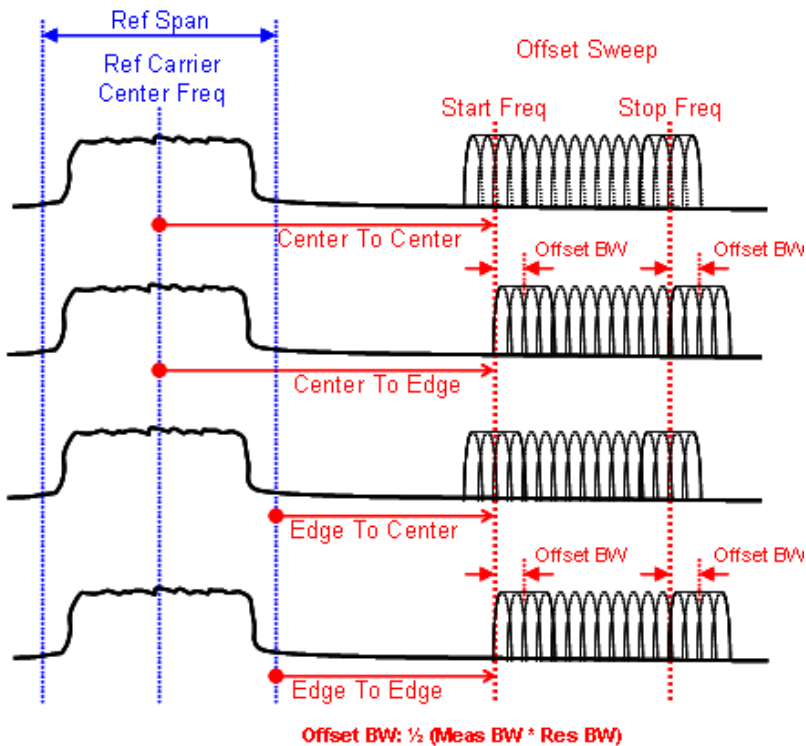

Spectrum Emission Mask Measurement
Meas Setup

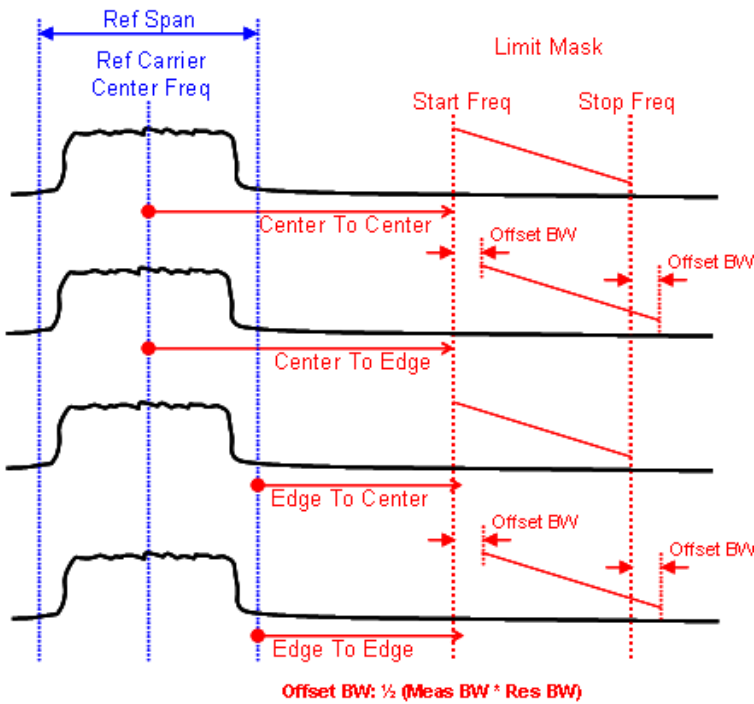

Key Path:	Meas Setup, Offset/Limits
Mode:	WCDMA, C2K, WIMAX OFDMA, TD-SCDMA, 1xEVDO, LTE, LTETDD, WLAN
Remote Command:	[:SENSe] :SEMAsk:OFFSet [1] 2 :TYPE CTOCenter CTOEdge ETOCenter ETOEdge [:SENSe] :SEMAsk:OFFSet [1] 2 :TYPE?
Example:	SEM:OFFS:TYPE ETOC SEM:OFFS:TYPE?
Notes:	You must be in the mode that includes SEM measurements to use this command. Use :INSTrument:SElect to set the mode.
Preset:	WCDMA, WIMAX OFDMA, TD-SCDMA: CTOC C2K: CTOE 1xEVDO: CTOE LTE: ETOC LTETDD: ETOC
State Saved:	Saved in instrument state.
Range:	Carrier Center To Meas BW Center Carrier Center To Meas BW Edge Carrier Edge To Meas BW Center Carrier Edge To Meas BW Edge

Initial S/W Revision:	A.03.00
-----------------------	---------

Method

Sets the measurement method:

- **Integ BW**-enables you to set the channel integration bandwidth.
- **RRC Weight**-selects Root Raised Cosine (RRC) filtering of the carriers. The α value (rolloff) for the filter is set to the value of the Filter Alpha parameter.

Key Path:	Meas Setup
Mode:	WCDMA, WIMAX OFDMA, TD-SCDMA, LTE, LTETDD, WLAN
Remote Command:	[:SENSe] :SEMAsk :FILTer [:RRC] [:STATe] OFF ON 0 1 [:SENSe] :SEMAsk :FILTer [:RRC] [:STATe] ?
Example:	SEM:FILT ON SEM:FILT?
Notes:	For the CDMA2K and CDMA1xEVDO mode, this key is not available. 1 ON = RRC Weight, 0 OFF = IntegBW You must be in the mode that includes SEM measurement to use this command. Use :INSTrument:SElect to set the mode.
Dependencies:	WLAN: RRC Weight is not supported when the radio standard is WLAN 802.11ac (80+80MHz).
Preset:	WIMAX OFDMA, LTE, LTETDD, WLAN: OFF WCDMA, TD-SCDMA: ON
State Saved:	Saved in instrument state.
Range:	RRCWeight IntegBW
Initial S/W Revision:	Prior to A.02.00
Modified at S/W Revision:	A.02.00, A.03.00

Filter Alpha

Sets the alpha value for the RRC Filter.

Key Path:	Meas Setup
Mode:	WCDMA, WIMAX OFDMA, TD-SCDMA, LTE, LTETDD,
Remote Command:	[:SENSe] :SEMAsk :FILTer [:RRC] :ALPHa <real> [:SENSe] :SEMAsk :FILTer [:RRC] :ALPHa?

Spectrum Emission Mask Measurement
Meas Setup

Example:	SEM:FILT:ALPH 0.3 SEM:FILT:ALPH?
Notes:	For the CDMA2K and CDMA1xEVDO mode, this key is not available. You must be in the mode that includes SEM measurement to use this command. Use :INSTrument:SElect to set the mode.
Preset:	0.22
State Saved:	Saved in instrument state.
Min:	0.01
Max:	1.0
Initial S/W Revision:	Prior to A.02.00
Modified at S/W Revision:	A.02.00, A.03.00

Meas Preset

Restores all the measurement parameters to their default values.

Key Path:	Meas Setup
Mode:	WCDMA, C2K, WIMAX OFDMA, TD-SCDMA, 1xEVDO, LTE, LTETDD, WLAN
Remote Command:	:CONFIgure:SEMAsk
Example:	CONF:SEM
Notes:	You must be in the mode that includes SEM measurement to use this command. Use :INSTrument:SElect to set the mode.
Couplings:	Selecting Meas Preset will restore all measurement parameters to their default values.
Initial S/W Revision:	Prior to A.02.00
Modified at S/W Revision:	A.02.00, A.03.00

Limit State(Only for TD-SCDMA)

The key “Limits State” is only displayed in the TD-SCDMA mode. The mask lines could be drawn in two different ways, according to the 3GPP standard for the base station when the key’s value is “Std”; or by the user-defined specifications listed in the Offset/Limits menu.

Key Path:	Meas Setup
Mode:	TD-SCDMA
Remote Command:	[:SENSE] :SEMAsk:LIMIts STD MAN [:SENSE] :SEMAsk:LIMIts?

Example:	SEM:LIM STD SEM:LIM?
Notes:	You must be in the TD-SCDMA mode to use this command. Use :INSTrument:SElect to set the mode.
Dependencies:	See Couplings
Couplings:	When the value of the “Limits” key is Std, the parameters displayed on the Offset/Limits panel will be modified depending on the carrier power, which corresponds to the measurement standard of the base station. All the keys except “Offset”, “Relative Atten”, “Offset Side” and “Limits” displayed on the “Offset/Limits” panel will be grayed out. All the keys displayed on the “Limits” panel will be grayed out as well. When the value of the “Limits” key is Man, all of the previous manual specifications will be restored, and the keys that were previously grayed out will be enabled again.
Preset:	MAN
State Saved:	Saved in instrument state.
Range:	STD MAN
Initial S/W Revision:	Prior to A.02.00

80+80 MHz Mask (Only for WLAN)

The key “80+80 MHz Mask” is visible only when the license for 802.11 ac format is available, and is only enabled when the radio standard is 802.11ac (80 MHz + 80 MHz). The mask lines could be drawn in two different ways, according to the IEEE 802.11ac standard (entry 22.3.18.1) when the key’s value is “Auto”; or by the user-defined specifications listed in the Offset/Limits menu.

Key Path:	Meas Setup
Mode:	WLAN
Remote Command:	[:SENSE] :SEMAsk:T80Mask:AUTO ON OFF 1 0 [:SENSE] :SEMAsk:T80Mask:AUTO?
Example:	SEM:T80M:AUTO 1 SEM:T80M:AUTO?
Notes:	You must be in the WLAN mode to use this command. Use :INSTrument:SElect to set the mode.
Dependencies:	See Couplings

Spectrum Emission Mask Measurement
Meas Setup

Couplings:	<p>When the value of the “80+80 MHz Mask” key is Auto, the offset frequencies and the offset relative limits are calculated based on the spacing between the center frequencies of the two carriers according to the IEEE 802.11ac standard. All the keys except “Offset”, “Relative Atten”, “Offset Side” and “Limits” displayed on the “Offset/Limits” panel gray out. All the keys displayed on the “Limits” panel gray out as well. On top of that, the displayed values of the keys on the “Offset/Limits” panel are not used in the measurement! On top of that, the channel span will be set to the value satisfying the equations below if its previous value is less than the value calculated through the equations.</p> <p>Chan Span = spacing between the two carriers + Chan IntegBW;</p> <p>When the value of the 80+80 MHz Mask key is Man, the keys that were previously grayed out will be enabled again.</p>
State Saved:	Saved in instrument state.
Range:	Auto Man

Mode

See “[Mode](#)” on page 1091 for more information.

Key Path:	Front-panel key
Initial S/W Revision:	Prior to A.02.00

Mode Setup

See “[Mode Setup](#)” on page 1103 for more information.

Key Path:	Front-panel key
Initial S/W Revision:	Prior to A.02.00

Peak Search

There is no ‘Peak Search’ supported in Spectrum Emission Mask so this front-panel key displays a blank menu when pressed.

Key Path:	Front-panel key
Initial S/W Revision:	Prior to A.02.00

Recall

See “[Recall](#)” on page 192 for more information.

Key Path:	Front-panel key
-----------	------------------------

Initial S/W Revision:	Prior to A.02.00
-----------------------	------------------

Restart

See [“Restart” on page 1125](#) for more information.

Key Path:	Front-panel key
Initial S/W Revision:	Prior to A.02.00

Save

See [“Save” on page 204](#) for more information.

Key Path:	Front-panel key
Initial S/W Revision:	Prior to A.02.00

Data

See [“Data \(Export\)” on page 213](#) for more information.

Key Path:	Front-panel key
-----------	------------------------

Measurement Results

Pressing this key selects Meas Results as the data type to be exported.

The Meas Results file contains information that describes the current state of the analyzer. It is detailed in [“Meas Results File Contents” on page 544](#) below.

Key Path:	Save, Data
Remote Command:	:MMEMory:STORe:RESults <string>
Example:	:MMEM:STOR:RES “MeasR_0000.csv”
Notes:	<p>If the save is initiated via SCPI and the file already exists, the file will be overwritten.</p> <p>The SCPI command exports Spectrum Emission Mask measurement results to the file specified as the parameter in the current path. The default path is My Documents\<current mode="">\data\SEM\results.</current></p> <p>Using the C: drive is strongly discouraged, since it runs the risk of being overwritten during an instrument software upgrade.</p> <p>The SCPI parameter is a quoted string that specifies the filename. Both single and double quotes are supported for any filename parameter over SCPI.</p>
Dependencies:	The current active measurement must be the Spectrum Emission Mask measurement to use this command.
Status Bits/OPC dependencies:	Sequential – waits for the previous measurement to complete

Initial S/W Revision:	Prior to A.02.00
-----------------------	------------------

Meas Results File Contents

A Meas Results File contains measurement results with the following information.

- File ID string, which is “MeasResult”
- Measurement ID following Mode ID, which is “SA:SEM” for example.
- Firmware rev and model number
- Option string
- Automatic Trigger Time
- Automatic Trigger Time State
- Center Frequency
- ChanIntegBW
- ChannelDetector
- ChannelDetectorState
- ChanPwrRefAuto
- ChanResBW
- ChanResBWAuto
- ChanSpan
- ChanSweepTime
- ChanSweepTimeAuto
- ChanVbwRbwRatio
- ChanVbwRbwRatioAuto
- ChanVideoBW
- ChanVideoBWAuto
- Electrical Atten
- Electrical Atten Bypass
- Electrical Atten State
- External1 Trigger Delay
- External1 Trigger Delay State
- External1 Trigger Level
- External1 Trigger Slope
- External2 Trigger Delay

- External2 Trigger Delay State
- External2 Trigger Level
- External2 Trigger Slope
- FilterAlpha
- Internal Preamp
- Internal Preamp Band
- Line Trigger Delay
- Line Trigger Delay State
- Line Trigger Slope
- Mechanical Atten
- Mechanical Atten Auto
- OffsetDetector
- OffsetDetectorState
- OffsetLimitAbsStartBTS
- OffsetLimitAbsStartMS
- OffsetLimitAbsStopBTS
- OffsetLimitAbsStopMS
- OffsetLimitFailMaskBTS
- OffsetLimitFailMaskMS
- OffsetLimitRelStartBTS
- OffsetLimitRelStartMS
- OffsetLimitRelStopBTS
- OffsetLimitRelStopMS
- OffsetMeasBWbts
- OffsetMeasBWms
- OffsetResolutionBWAutoBTS
- OffsetResolutionBWAutoMS
- OffsetResolutionBWbts
- OffsetResolutionBWms
- OffsetSideBTS
- OffsetSideMS
- OffsetStartFrequencyBTS

Spectrum Emission Mask Measurement Meas Setup

- OffsetStartFrequencyMS
- OffsetStateBTS
- OffsetStateMS
- OffsetStopFrequencyBTS
- OffsetStopFrequencyMS
- OffsetSweepTimeAutoBTS
- OffsetSweepTimeAutoMS
- OffsetSweepTimeBTS
- OffsetSweepTimeMS
- OffsetVbwRbwRatioAutoBTS
- OffsetVbwRbwRatioAutoMS
- OffsetVbwRbwRatioBTS
- OffsetVbwRbwRatioMS
- OffsetVideoBWAUTOBTS
- OffsetVideoBWAUTO MS
- OffsetVideoBW BTS
- OffsetVideoBW MS
- PeakReference
- Periodic Timer Period
- Periodic Timer Sync Source
- Periodic Timer Trigger Delay
- Periodic Timer Trigger Delay State
- PowerReference
- PSDReference
- Radio Device
- RFBurst Trigger Delay
- RFBurst Trigger Delay State
- RFBurst Trigger Level Abs
- RFBurst Trigger Level Rel
- RFBurst Trigger Level Type
- RFBurst Trigger Slope
- RrcFilter

- SemAverageNumber
- SemAverageState
- TotalAtten
- Trigger Holdoff
- Trigger Holdoff State
- TriggerSource
- Video Trigger Delay
- Video Trigger Delay State
- Video Trigger Level
- Video Trigger Slope
- ViewSelection

The file contains these data followed by MeasResult1 to MeasResult12 that flag the start of the measurement results. Each line of Measurement Results consists of twelve comma separated values from MeasResult1 value to MeasResult12 value. MeasResult1 contains the same results as MEAS/READ/FETCh:SEMAsk1; MeasResult2, MEAS/READ/FETCh:SEMAsk2; MeasResult3, MEAS/READ/FETCh:SEMAsk3;... (continues in the same manner)

The exported file is in CSV format, with a.csv extension. The Meas Results file, when imported into Excel, shows the following data:

MeasResult											
SA:SEM											
A.10.53	N9030 A										
B25 B40	1										
Automatic Trigger Time	0.1										
Automatic Trigger Time State	FALS E										
Center Frequency	1.33E +10										
ChanIntegB W	38400 00	38400 00									
ChannelDete ctor	Avera ge										
ChannelDete ctorState	TRUE										

Spectrum Emission Mask Measurement
Meas Setup

ChanPwrRef Auto	TRUE										
ChanResBW	100000	100000									
ChanResBW Auto	FALSE	FALSE									
ChanSpan	500000	500000									
ChanSweep Time	0.002507	0.002507									
ChanSweep TimeAuto	TRUE	TRUE									
ChanVbwRbwRatio	1	1									
ChanVbwRbwRatioAuto	FALSE	FALSE									
ChanVideoBW	100000	100000									
ChanVideoBWAuto	TRUE	TRUE									
Electrical Atten	0										
Electrical Atten Bypass	TRUE										
Electrical Atten State	FALSE										
External1 Trigger Delay	1.00E-06										
External1 Trigger Delay State	FALSE										
External1 Trigger Level	1.2										
External1 Trigger Slope	Positive										

External2 Trigger Delay	1.00E-06										
External2 Trigger Delay State	FALSE										
External2 Trigger Level	1.2										
External2 Trigger Slope	Positive										
FilterAlpha	0.22										
Internal Preamp	FALSE										
Internal Preamp Band	Low										
Line Trigger Delay	1.00E-06										
Line Trigger Delay State	FALSE										
Line Trigger Slope	Positive										
Mechanical Atten	10										
Mechanical Atten Auto	TRUE										
OffsetDetector	Peak										
OffsetDetectorState	TRUE										
OffsetLimit AbsStartBTS	-14	-14	-26	-13	-13	-13					
OffsetLimit AbsStartMS	-14	-14	-26	-13	-13	-13					
OffsetLimit AbsStopBTS	-14	-26	-26	-13	-13	-13					
OffsetLimit AbsStopMS	-14	-26	-26	-13	-13	-13					

Spectrum Emission Mask Measurement
Meas Setup

OffsetLimitFailMaskBTS	ABSolute	ABSolute	ABSolute	ABSolute	ABSolute	ABSolute					
OffsetLimitFailMaskMS	ABSolute	ABSolute	ABSolute	ABSolute	ABSolute	ABSolute					
OffsetLimitRelStartBTS	-30	-30	-30	-30	-30	-30					
OffsetLimitRelStartMS	-30	-30	-30	-30	-30	-30					
OffsetLimitRelStopBTS	-30	-30	-30	-30	-30	-30					
OffsetLimitRelStopMS	-30	-30	-30	-30	-30	-30					
OffsetMeasBWBS	1	1	1	1	1	1					
OffsetMeasBWMS	1	1	1	1	1	1					
OffsetResolutionBWAutoBTS	FALSE	FALSE	FALSE	FALSE	FALSE	FALSE					
OffsetResolutionBWAutoMS	FALSE	FALSE	FALSE	FALSE	FALSE	FALSE					
OffsetResolutionBWBS	30000	30000	30000	100000	100000	100000					
OffsetResolutionBWMS	30000	30000	30000	100000	100000	100000					
OffsetSideBTS	Both	Both	Both	Both	Both	Both					
OffsetSideMS	Both	Both	Both	Both	Both	Both					
OffsetStartFrequencyBTS	2515000	2715000	3515000	4000000	8000000	12500000					
OffsetStartFrequencyMS	2515000	2715000	3515000	4000000	8000000	12500000					
OffsetStateBTS	TRUE	TRUE	TRUE	TRUE	TRUE	FALSE					
OffsetStateMS	TRUE	TRUE	TRUE	TRUE	TRUE	FALSE					
OffsetStopFrequencyBTS	2715000	3515000	4000000	8000000	12500000	15000000					

OffsetStopFr equencyMS	27150 00	35150 00	40000 00	80000 00	1250 0000	1500 0000					
OffsetSweep TimeAutoB TS	TRUE	TRUE	TRUE	TRUE	TRU E	TRU E					
OffsetSweep TimeAutoM S	TRUE	TRUE	TRUE	TRUE	TRU E	TRU E					
OffsetSweep TimeBTS	0.0173 33	0.0693 2	0.0420 27	0.0020 53	0.00 2253	0.00 1253					
OffsetSweep TimeMS	0.0173 33	0.0693 2	0.0420 27	0.0020 53	0.00 2253	0.00 1253					
OffsetVbwR bwRatioAut oBTS	FALS E	FALS E	FALS E	FALS E	FAL SE	FAL SE					
OffsetVbwR bwRatioAut oMS	FALS E	FALS E	FALS E	FALS E	FAL SE	FAL SE					
OffsetVbwR bwRatioBTS	0.01	0.01	0.01	0.01	0.01	0.01					
OffsetVbwR bwRatioMS	0.01	0.01	0.01	0.01	0.01	0.01					
OffsetVideo BWAutoBT S	TRUE	TRUE	TRUE	TRUE	TRU E	TRU E					
OffsetVideo BWAutoMS	TRUE	TRUE	TRUE	TRUE	TRU E	TRU E					
OffsetVideo BWBTS	300	300	300	10000	1000 0	1000 0					
OffsetVideo BWMS	300	300	300	10000	1000 0	1000 0					
PeakReferen ce	-82.99 57										
Periodic Timer Period	0.02										
Periodic Timer Sync Source	None										
Periodic Timer Trigger Delay	1.00E -06										

Spectrum Emission Mask Measurement
Meas Setup

Periodic Timer Trigger Delay State	FALS E											
PowerRefere nce	-73.69 66											
PSDReferen ce	-139.5 4											
Radio Device	Bts											
RFBurst Trigger Delay	1.00E -06											
RFBurst Trigger Delay State	FALS E											
RFBurst Trigger Level Abs	-20											
RFBurst Trigger Level Rel	-6											
RFBurst Trigger Level Type	Absol ute											
RFBurst Trigger Slope	Positiv e											
RrcFilter	FALS E											
SemAverage Number	10											
SemAverage State	FALS E											
TotalAtten	10											
Trigger Holdoff	0.1											
Trigger Holdoff State	FALS E											
TriggerSourc e	Free											

Video Trigger Delay	1.00E-06										
Video Trigger Delay State	FALSE										
Video Trigger Level	-25										
Video Trigger Slope	Positive										
Video Selection	AbsPwrFreq										
MeasResult1	MeasResult2	MeasResult3	MeasResult4	MeasResult5	MeasResult6	MeasResult7	MeasResult8	MeasResult9	MeasResult10	MeasResult11	MeasResult12
-999	-78.89359	-13	999	-73.6966334099879	-999	-999	-999	-999	-999	-999	-999
-73.6966334099879	-78.95235	-13	999	-999	-999	-999	-999	-999	-999	-999	

Single

See “Single (Single Measurement/Sweep)” on page 1135 for more information.

Key Path:	Front-panel key
Initial S/W Revision:	Prior to A.02.00

Source (Internal)

Operation of this key is identical across all measurements. For details about this key, see [“Source \(Internal\)” on page 1137](#).

Key Path:	Front-panel key
-----------	------------------------

Span X Scale

Accesses a menu of functions that enable you to set the horizontal scale parameters.

Key Path:	Front-panel key
Initial S/W Revision:	A.11.00

Ref Value

Sets the X reference value.

Key Path:	SPAN X Scale
Mode:	WCDMA, CDMA2K, EDGE GSM, WIMAX OFDMA, TDSCDMA, CDMA1XEV, LTE, LTETDD, WLAN
Remote Command:	:DISPlay:SEMask:VIEW[1]:WINDow[1]:TRACe:X[:SCALE]:RLEVe l <freq> :DISPlay:SEMask:VIEW[1]:WINDow[1]:TRACe:X[:SCALE]:RLEVe l?
Example:	DISP:SEM:VIEW:WIND:TRAC:X:RLEV 10 DISP:SEM:VIEW:WIND:TRAC:X:RLEV?
Notes:	You must be in the mode that includes SEM measurement to use this command. Use :INSTRument:SElect to set the mode.
Couplings:	If Auto Scaling is set to On, this value is automatically determined by the measurement result. When you set this value manually, Auto Scaling automatically changes to Off.
Preset:	1.0 GHz
State Saved:	Saved in instrument state.
Min:	-1000 GHz
Max:	1000 GHz
Default Unit:	Hz
Initial S/W Revision:	A.11.00

Scale/Div

Sets the horizontal scale.

Key Path:	SPAN X Scale
Mode:	WCDMA, CDMA2K, EDGE GSM, WIMAX OFDMA, TDSCDMA, CDMA1XEV, LTE, LTETDD, WLAN

Remote Command:	:DISPlay:SEMask:VIEW[1]:WINDow[1]:TRACe:X[:SCALe]:PDIVi sion <freq> :DISPlay:SEMask:VIEW[1]:WINDow[1]:TRACe:X[:SCALe]:PDIVi sion ?
Example:	DISP:SEM:VIEW:WIND:TRAC:X:PDIV 500 DISP:SEM:VIEW:WIND:TRAC:X:PDIV?
Notes:	You must be in a mode that includes the SEM measurement to use this command. Use INSTRument:SElect to set the mode.
Couplings:	If Auto Scaling is set to On, this value is automatically determined by the measurement result. When you set this value manually, Auto Scaling automatically changes to Off.
Preset:	Automatically Calculated
State Saved:	Yes Saved in instrument state.
Min:	1 Hz
Max:	10.0 GHz
Initial S/W Revision:	A.11.00

Ref Position

Sets the reference position for the X axis to Left, Center or Right.

Key Path:	SPAN X Scale
Mode:	WCDMA, CDMA2K, EDGE GSM, WIMAX OFDMA, TDSCDMA, CDMA1XEV, LTE, LTETDD, WLAN
Remote Command:	:DISPlay:SEMask:VIEW[1]:WINDow[1]:TRACe:X[:SCALe]:RPOSi tion LEFT CENTer RIGHT :DISPlay:SEMask:VIEW[1]:WINDow[1]:TRACe:X[:SCALe]:RPOSi tion?
Example:	DISP:SEM:VIEW:WIND:TRAC:X:RPOS LEFT DISP:SEM:VIEW:WIND:TRAC:X:RPOS?
Notes:	You must be in a mode that includes the SEM measurement to use this command. Use INSTRument:SElect to set the mode.
Preset:	CENTer
State Saved:	Yes Saved in instrument state.
Range:	Left Ctr Right
Initial S/W Revision:	A.11.00

Auto Scaling

Toggles the scale coupling function between On and Off.

Key Path:	SPAN X Scale
Mode:	WCDMA, CDMA2K, EDGE/GSM, WIMAX/OFDMA, TDSCDMA, CDMA1XEV, LTE, LTE/TDD, WLAN
Remote Command:	:DISP:SEM:VIEW[1]:WIND:TRAC:X[:SCALE]:COUPL e 0 1 OFF ON :DISP:SEM:VIEW[1]:WIND:TRAC:X[:SCALE]:COUPL e?
Example:	DISP:SEM:VIEW:WIND:TRAC:X:COUP ON DISP:SEM:VIEW:WIND:TRAC:X:COUP?
Notes:	You must be in a mode that includes the SEM measurement to use this command. Use INSTRUMENT:SELEct to set the mode.
Couplings:	When Auto Scaling is On and the Restart front-panel key is pressed, this function automatically determines the scale per division and reference values based on the measurement results. When you set a value to either Scale/Div or Ref Value manually, Auto Scaling automatically changes to Off.
Preset:	1
State Saved:	Yes Saved in instrument state.
Range:	On Off
Initial S/W Revision:	A.11.00

Sweep/Control

Displays a menu that enables you to set up and control the sweep time, gate method, and source of the current measurement. See [“Sweep/Control” on page 1267](#) for more information.

Key Path:	Front-panel key
Initial S/W Revision:	Prior to A.02.00

Pause

Pauses a measurement after the current data acquisition is complete. When Paused, the label on the key changes to Resume. Pressing the Resume key resumes the measurement at the point it was at when paused. See [“Pause/Resume” on page 1279](#) for more details.

Key Path:	Sweep/Control
Initial S/W Revision:	Prior to A.02.00

Gate

Accesses a menu that enables you to control the gating function.

The Gate functionality is used to view signals best viewed by qualifying them with other events. See [“Gate ” on page 1280](#) for more details.

Key Path:	Sweep/Control
Initial S/W Revision:	Prior to A.02.00

Trace/Detector

Accesses a menu of functions that enable you to control trace and detector for the current measurement.

Key Path:	Front-panel key
Initial S/W Revision:	Prior to A.02.00

Trace Type

Allows you to select the type of trace for the current measurement. The menu contains a 1-of-N selection of the trace type (Clear Write, Average, Max Hold, Min Hold).

Key Path:	Trace/Detector
Mode:	WCDMA, C2K, WIMAX OFDMA, TD-SCDMA, 1xEVDO, LTE, LTETDD, WLAN
Remote Command:	:TRACe:SEMask:TYPE WRITE AVERAge MAXHold MINHold :TRACe:SEMask:TYPE?
Example:	TRAC:SEM:TYPE MINH TRAC:SEM:TYPE?
Notes:	WRITE = Clear Write AVERAge = Average MAXHold = Maximum Hold MINHold = Minimum Hold
Couplings:	When Detector setting is “Auto” ([[:SENSe]:SEMask:DETECTOR:AUTO?]), Detector ([[:SENSe]:SEMask:DETECTOR[:FUNCTION]?]) switches aligning with the switch of this parameter: “NORMal” with WRITE (Clear Write), “AVERAge” with AVERAge, “POSitive (peak)” with MAXHold, and “NEGative (peak)” with MINHold.
Preset:	AVERAge
State Saved:	Saved in instrument state.
Range:	WRITE AVERAge MAXHold MINHold
Initial S/W Revision:	Prior to A.02.00
Modified at S/W Revision:	A.02.00, A.03.00

Chan Detector

Accesses a menu of functions that enable you to control the detectors for reference channel. The following choices are available:

- Auto- the detector selected depends on marker functions, trace functions, average type, and the trace averaging function.
- Normal-the detector determines the peak of the CW-like signals, and it yields alternating maximums and minimums of noise-like signals. This is also referred to as Rosenfell detection.
- Average-the detector determines the average of the signal within the sweep points. The averaging method depends upon the Average Type selection (voltage, power or log scales).
- Peak-the detector determines the maximum of the signal within the sweep points.
- Sample-the detector indicates the instantaneous level of the signal at the center of the sweep points represented by each display point.
- Negative Peak-the detector determines the minimum of the signal within the sweep points.

Key Path:	Trace/Detector
Initial S/W Revision:	Prior to A.02.00

Chan Detector Selection

Selects the detector mode for the reference channel.

Key Path:	Trace/Detector
Mode:	WCDMA, C2K, WIMAX OFDMA, TD-SCDMA, 1xEVDO, LTE, LTETDD, WLAN
Remote Command:	[:SENSE] :SEMAsk:DETEctor:CARRier[:FUNction] AVERAge NEGAtive NORMAl POSitive SAMPle [:SENSE]:SEMAsk:DETEctor:CARRier[:FUNction]?
Example:	SEM:DET:CARR NEG SEM:DET:CARR?
Notes:	When you manually select a detector (instead of selecting Auto), that detector is used regardless of other analyzer settings. Note: This detector setting affects the reference channel. There is not a per trace detector. You must be in the mode that includes SEM measurement to use this command. Use :INSTrument:SELEct to set the mode.
Couplings:	See Couplings in the Trace Type section.
Preset:	AVERAge
State Saved:	Saved in instrument state.
Range:	Normal Average Peak Sample Negative Peak
Initial S/W Revision:	Prior to A.02.00
Modified at S/W Revision:	A.02.00, A.03.00

Chan Detector Auto

Sets the detector to the default detection mode for the reference channel. This mode is dependent upon the current reference channel conditions.

Key Path:	Trace/Detector
Mode:	WCDMA, C2K, WIMAX OFDMA, TD-SCDMA, 1xEVDO, LTE, LTETDD, WLAN
Remote Command:	[:SENSe] :SEMAsk:DETEctor:CARRier:AUTO ON OFF 1 0 [:SENSe] :SEMAsk:DETEctor:CARRier:AUTO?
Example:	SEM:DET:CARR:AUTO OFF SEM:DET:CARR:AUTO?
Notes:	See Couplings in the Trace Type section. You must be in the mode that includes SEM measurement to use this command. Use :INSTrument:SELEct to set the mode.
Preset:	ON
State Saved:	Saved in instrument state
Range:	On Off
Initial S/W Revision:	Prior to A.02.00
Modified at S/W Revision:	A.02.00, A.03.00

Offset Detector

Accesses a menu of functions that enable you to control the detector for offsets. The following choices are available.

- Auto- the detector selected depends on marker functions, trace functions, average type, and the trace averaging function.
- Normal-the detector determines the peak of the CW-like signals, and it yields alternating maximums and minimums of noise-like signals. This is also referred to as Rosenfell detection.
- Average-the detector determines the average of the signal within the sweep points. The averaging method depends upon the Average Type selection (voltage, power or log scales).
- Peak-the detector determines the maximum of the signal within the sweep points.
- Sample-the detector indicates the instantaneous level of the signal at the center of the sweep points represented by each display point.
- Negative Peak-the detector determines the minimum of the signal within the sweep points.

Key Path:	Trace/Detector
Initial S/W Revision:	Prior to A.02.00

Offset Detector Selection

Selects the detector mode for the offsets.

Key Path:	Trace/Detector
Mode:	WCDMA, C2K, WIMAX OFDMA, TD-SCDMA, 1xEVDO, LTE, LTETDD, WLAN
Remote Command:	[:SENSE] :SEMAsk:DETEctor:OFFSet [:FUNction] AVERAge NEGAtive NORMAl POSitive SAMPlE [:SENSE] :SEMAsk:DETEctor:OFFSet [:FUNction] ?
Example:	SEM:DET:OFFS AVER SEM:DET:OFFS?
Notes:	When you manually select a detector (instead of selecting Auto), that detector is used regardless of other analyzer settings. Note: This detector setting has effects all offsets. There is not a per trace detector. You must be in the mode that includes SEM measurement to use this command. Use :INSTrument:SELEct to set the mode.
Couplings:	See Couplings in the Trace Type section.
Preset:	POSitive
State Saved:	Saved in instrument state.
Range:	Normal Average Peak Sample Negative Peak
Initial S/W Revision:	Prior to A.02.00
Modified at S/W Revision:	A.02.00, A.03.00

Offset Detector Auto

Sets the detector to the default detection mode for the offsets. This mode is dependent upon the current signal conditions of the offsets.

Key Path:	Trace/Detector
Mode:	WCDMA, C2K, WIMAX OFDMA, TD-SCDMA, 1xEVDO, LTE, LTETDD, WLAN
Remote Command:	[:SENSE] :SEMAsk:DETEctor:OFFSet:AUTO ON OFF 1 0 [:SENSE] :SEMAsk:DETEctor:OFFSet:AUTO?
Example:	SEM:DET:OFFS:AUTO OFF SEM:DET:OFFS:AUTO?

Spectrum Emission Mask Measurement
Trace/Detector

Notes:	See Couplings in the Trace Type section. You must be in the mode that includes SEM measurement to use this command. Use :INSTrument:SELEct to set the mode.
Preset:	ON
State Saved:	Saved in instrument state.
Range:	On Off
Initial S/W Revision:	Prior to A.02.00
Modified at S/W Revision:	A.02.00, A.03.00

Trigger

Accesses a menu that enables you to select and control the trigger source for the current measurement.

See [“Trigger” on page 1339](#) for more information.

Key Path:	Front-panel key
Initial S/W Revision:	Prior to A.02.00

View/Display

Accesses a menu of functions that enable you to control the instrument display.

The following keys select how the results are displayed:

- **Abs Pwr Freq**-displays the absolute power levels in dBm and the corresponding frequencies in the text window.
- **Rel Pwr Freq**-displays the relative power levels in dBc and the corresponding frequencies in the text window.
- **Integrated Power**-displays the absolute and relative power levels integrated throughout the bandwidths between the start and stop frequencies in the text window.

[“View Selection by Name \(Remote Command Only\)” on page 566](#)

[“Views Selection by Number \(Remote Command only\)” on page 566](#)

View Selection by Name (Remote Command Only)

Key Path:	View/Display
Mode:	WCDMA, C2K, WIMAX OFDMA, TD-SCDMA, 1xEVDO, LTE, LTETDD, WLAN
Remote Command:	:DISPlay:SEMask:VIEW[:SElect] APFReq RPFReq IPOWER CINformation :DISPlay:SEMask:VIEW[:SElect]?
Example:	DISP:SEM:VIEW IPOW DISP:SEM:VIEW?
Notes:	You must be in the mode that includes SEM measurement to use this command. Use :INSTrument:SElect to set the mode.
Preset:	WCDMA, C2K, TD-SCDMA, 1xEVDO, LTE, LTETDD: APFReq WIMAX OFDMA, WLAN: RPFReq
State Saved:	Saved in instrument state.
Range:	Abs Pwr & Freq Rel Pwr & Freq Integrated Power Carrier Info
Initial S/W Revision:	Prior to A.02.00
Modified at S/W Revision:	A.02.00, A.03.00, A.10.00

Views Selection by Number (Remote Command only)

The following numerical selections determine how the results are displayed:

1. displays the absolute power levels in dBm and the corresponding frequencies in the text window.
2. displays the relative power levels in dBc and the corresponding frequencies in the text window.

3. displays the absolute and relative power levels integrated throughout the bandwidths between the start and stop frequencies in the text window.

Mode:	WCDMA, C2K, WIMAX OFDMA, TD-SCDMA, 1xEVDO, LTE, LTETDD, WLAN
Remote Command:	:DISPlay:SEMask:VIEW:NSElect <integer> :DISPlay:SEMask:VIEW:NSElect?
Example:	DISP:SEM:VIEW:NSEL 2 DISP:SEM:VIEW:NSEL?
Notes:	You must be in the mode that includes SEM measurement to use this command. Use :INSTrument:SElect to set the mode.
Preset:	WCDMA, C2K, TD-SCDMA, 1xEVDO, LTE, LTETDD: 1 WIMAX OFDMA, WLAN: 2
State Saved:	Saved in instrument state.
Min:	1
Max:	3
Initial S/W Revision:	Prior to A.02.00
Modified at S/W Revision:	A.02.00, A.03.00, A.10.00

Key Path:	Front-panel key
Initial S/W Revision:	Prior to A.02.00

Display

Accesses a menu of functions that enable you to set the display parameters.

See “[Display](#)” on page 1393 for more information.

Key Path:	View/Display
Initial S/W Revision:	Prior to A.02.00

Change Title

Accesses an Alpha Editor menu that enables you to write a title across the top of the display. This menu contains characters and symbols that may also be used with the numeric keypad. Press **Enter** or **Return** to complete the entry. Press **Cancel (Esc)** to cancel the entry and preserve your existing title.

The display title remains until you press **Change Title** again, or you recall a trace or state, or a Factory Preset is performed. A title can also be cleared by pressing **Title, Clear Title**.

Spectrum Emission Mask Measurement
View/Display

See “Change Title ” on page 1397 for more information.

Key Path:	View/Display, Display, Title
Initial S/W Revision:	Prior to A.02.00
Modified at S/W Revision:	A.02.00, A.03.00

Abs Pwr Freq

Sets the display to the Absolute Peak Power and Frequency view. The views differ depending on the setting of the measurement type (Meas Type) under the Measurement Setup menu.

“Abs Peak Pwr & Freq (Total Pwr Ref)” on page 569

“Abs Peak Pwr & Freq (PSD Ref)” on page 572

“Abs Peak Pwr & Freq (Spectrum Pk Ref)” on page 574

Abs Peak Pwr & Freq (Total Pwr Ref)

This view consists of the following two windows:

“Trace Window” on page 571

“Results Window ” on page 571

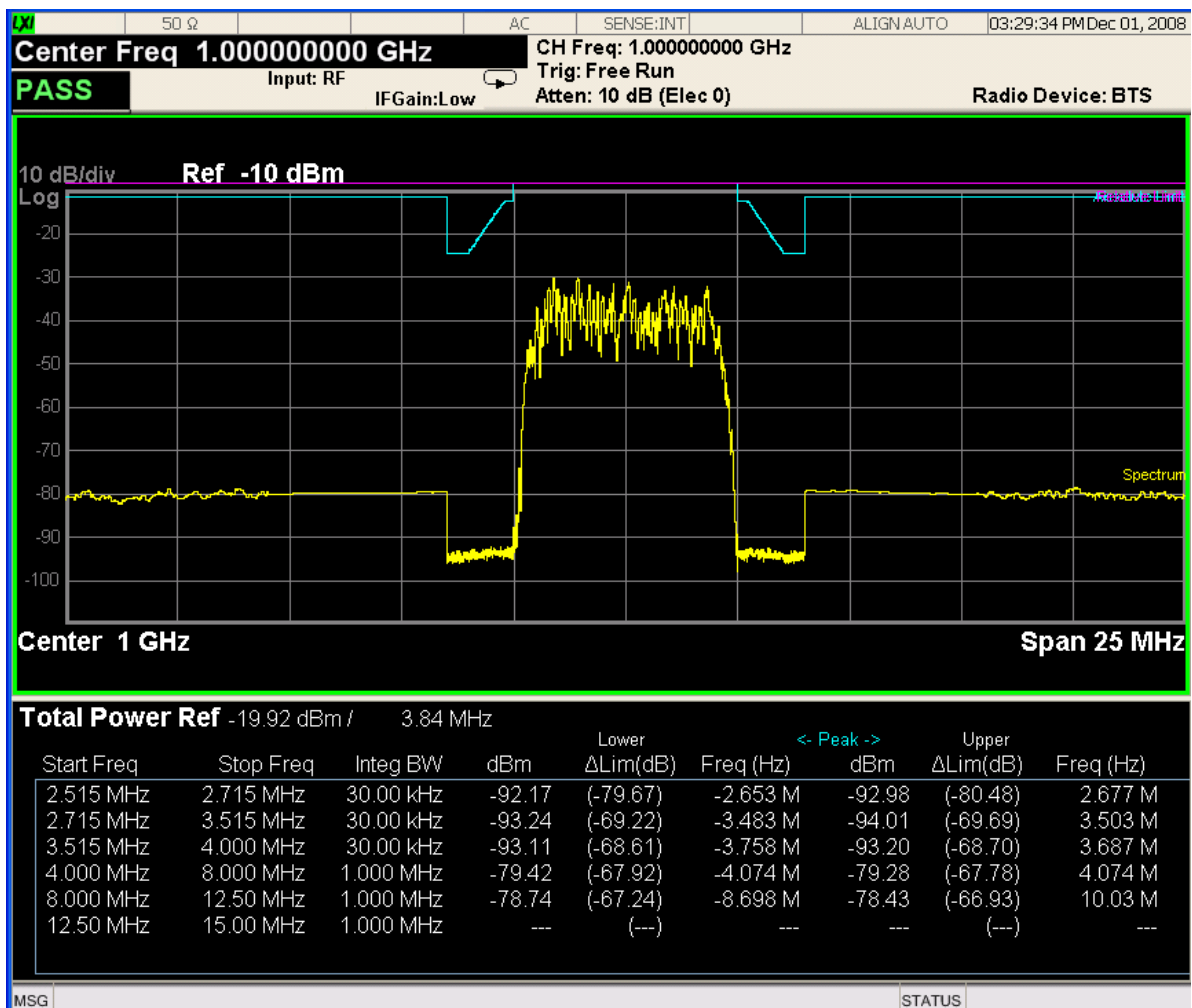

Spectrum Emission Mask Measurement
View/Display

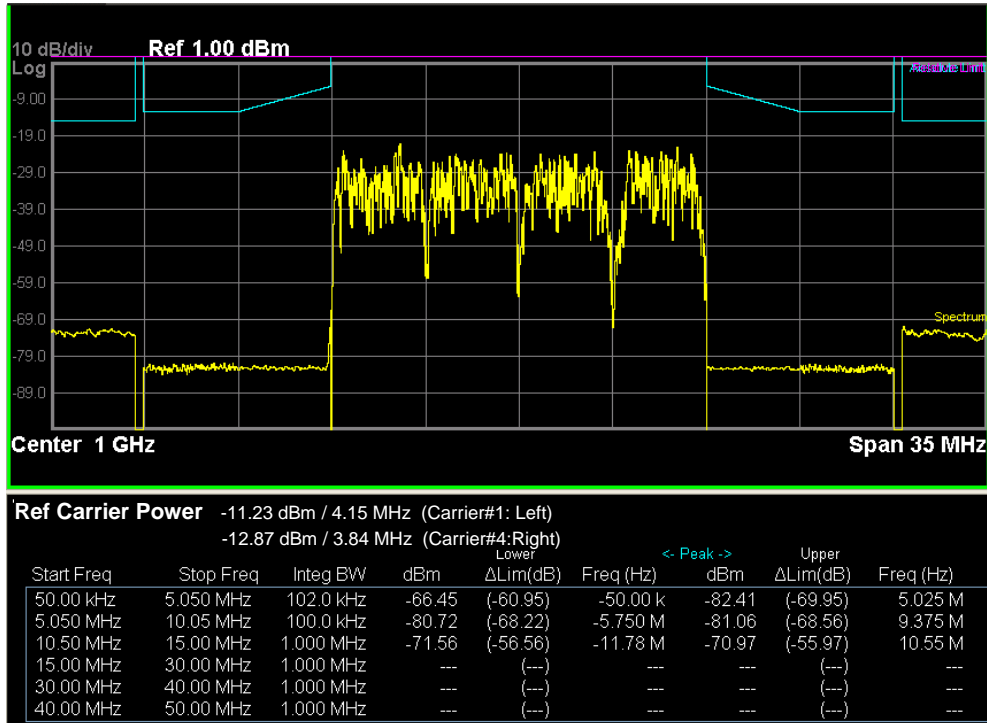

Trace Window

Corresponding Trace	yellow - Combined trace from carrier and each offset
---------------------	--

Results Window

Name	Corresponding Results
Total Pwr Ref	n=1 2nd element Absolute power at the reference area.
	Channel Integration Bandwidth
Start (Hz)	Start frequency for offset
Stop (Hz)	Stop frequency for offset
Meas BW (Hz)	Measurement bandwidth for offset
Lower Peak (dBm)	Absolute peak power on minimum margin point of the negative offset
Lower lim (dB)	Minimum margin from limit line which is decided by Fail Mask setting on the negative offset
Lower Freq (Hz)	Frequency on minimum margin point of the negative offset
Upper Peak (dBm)	Absolute peak power on minimum margin point of the positive offset
Upper lim (dB)	Minimum margin from limit line which is decided by Fail Mask setting on the positive offset
Upper Freq (Hz)	Frequency on minimum margin point of the positive offset

Spectrum Emission Mask Measurement
View/Display

Abs Peak Pwr & Freq (PSD Ref)

This view consists of the following two windows:

“Trace Window” on page 574

“Results Window ” on page 574

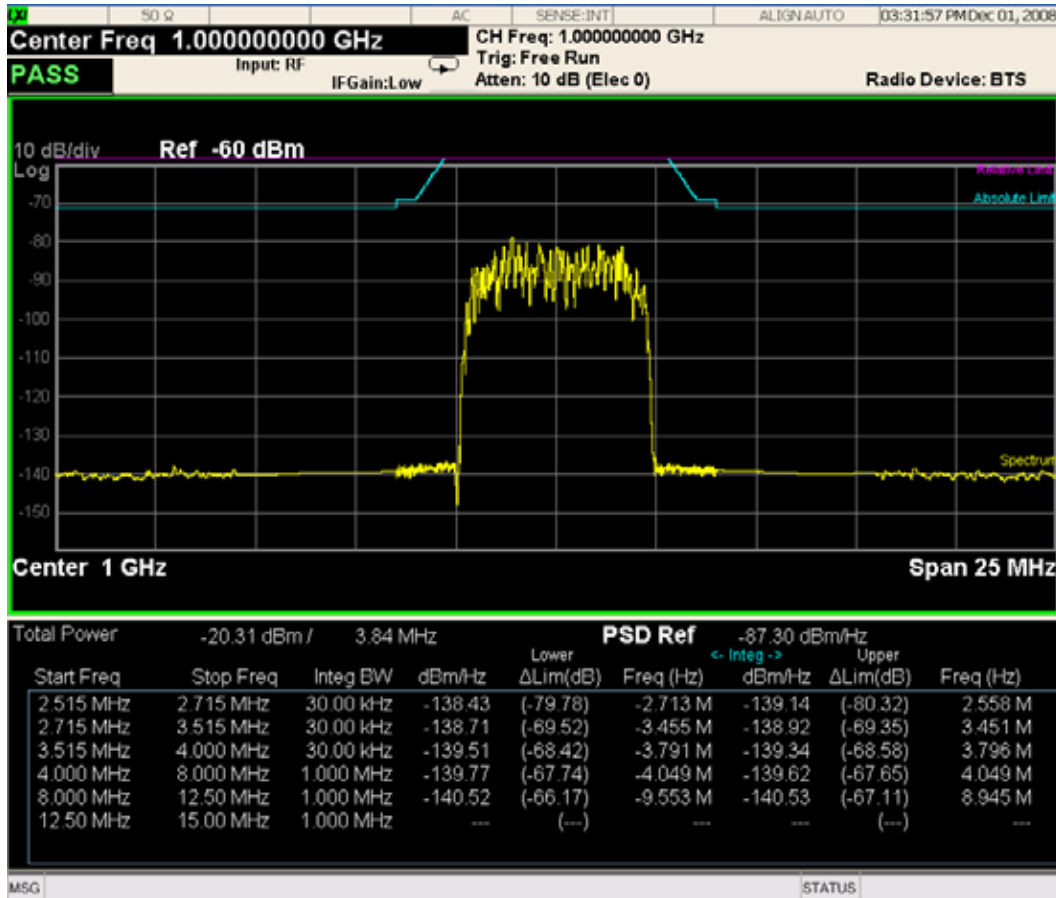

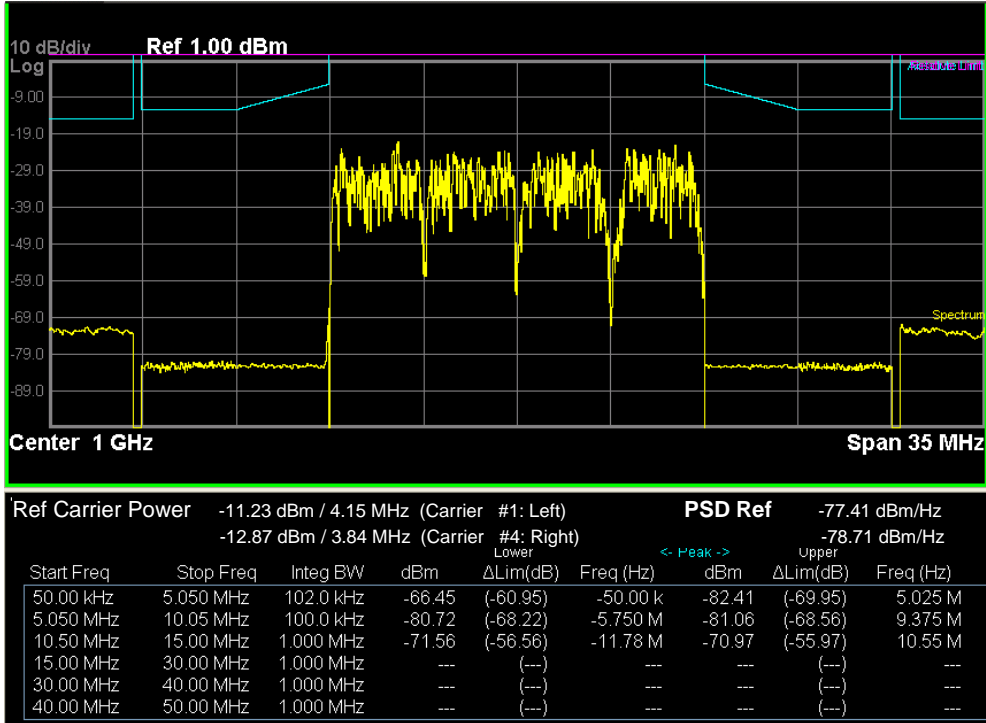

Trace Window

Corresponding Trace	yellow - Combined trace from carrier and each offset
---------------------	--

Results Window

Name	Corresponding Results
Total Pwr	n=1 2nd element Absolute power at the reference area.
	Channel Integration Bandwidth
PSD Ref	n=5 1st element Power spectral density reference at the reference area
Start (Hz)	Start frequency for offset
Stop (Hz)	Stop frequency for offset
Meas BW (Hz)	Measurement bandwidth for offset
Lower (dBm/Hz)	Absolute power spectrum density of the negative offset
Lower lim (dB)	Minimum margin from limit line which is decided by Fail Mask setting on the negative offset
Lower Freq (Hz)	Frequency on minimum margin point of the negative offset
Upper (dBm/Hz)	Absolute power spectrum density of the positive offset
Upper lim (dB)	Minimum margin from limit line which is decided by Fail Mask setting on the positive offset
Upper Freq (Hz)	Frequency on minimum margin point of the positive offset

Abs Peak Pwr & Freq (Spectrum Pk Ref)

This view consists of the following two windows:

“Trace Window” on page 574

“Results Window ” on page 574

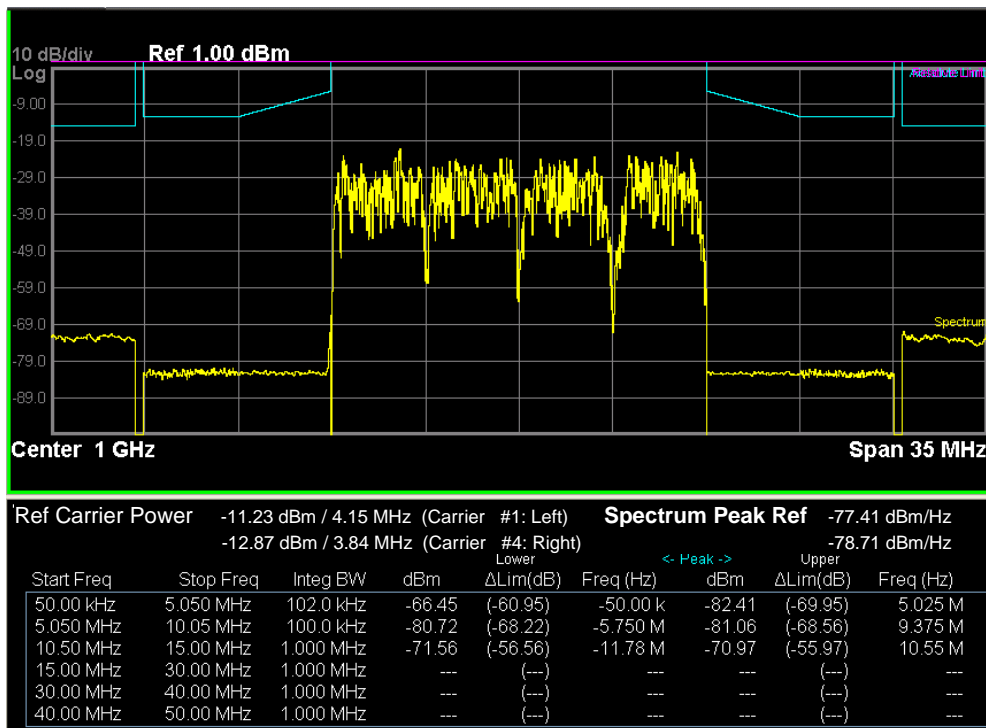
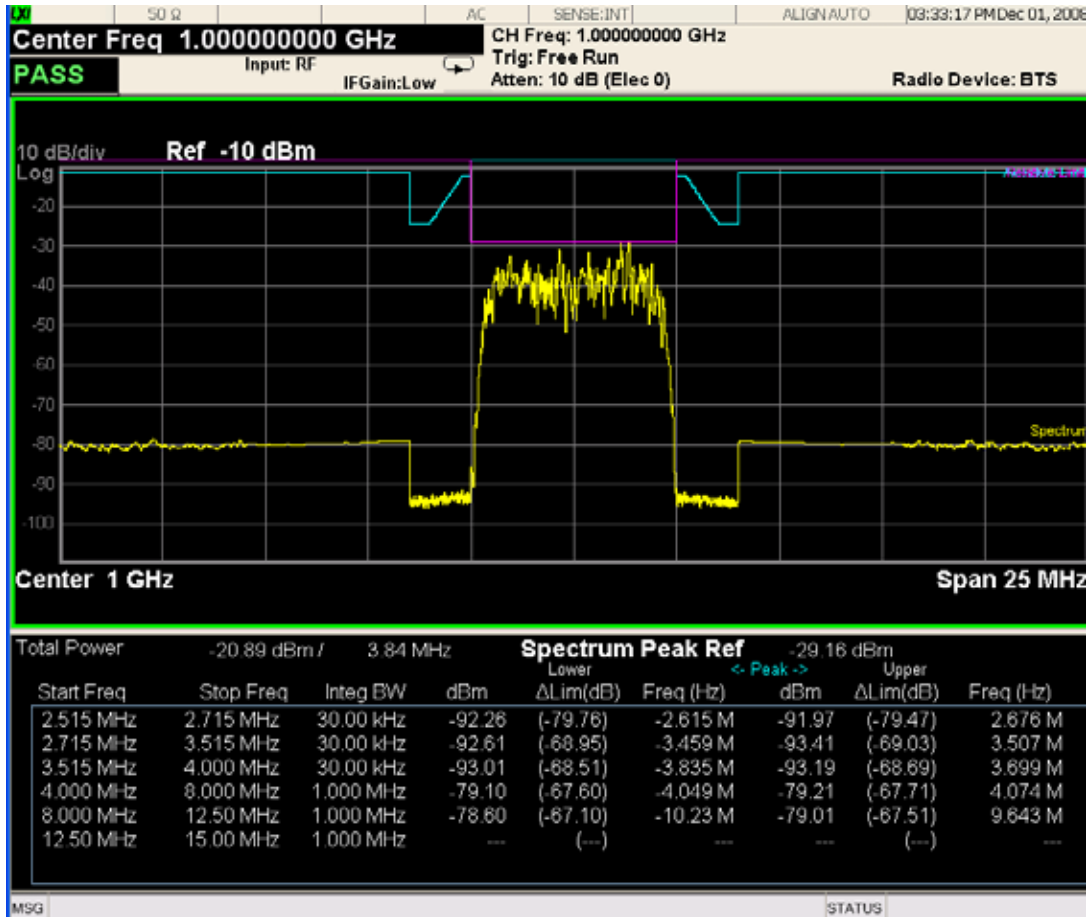

Trace Window

Corresponding Trace	yellow - Combined trace from carrier and each offset
---------------------	--

Results Window

Name	Corresponding Results
Total Pwr	Absolute power at the reference area.
	Channel Integration Bandwidth
Spectrum Peak Ref	n=5 1st element Spectrum peak power reference at the reference area
Start (Hz)	Start frequency for offset
Stop (Hz)	Stop frequency for offset
Meas BW (Hz)	Measurement bandwidth for offset
Lower(dBm)	Absolute peak power on minimum margin point of the negative offset
Lower lim (dB)	Minimum margin from limit line which is decided by Fail Mask setting on the negative offset
Lower Freq (Hz)	Frequency on minimum margin point of the negative offset
Upper (dBm)	Absolute peak power on minimum margin point of the positive offset
Upper lim (dB)	Minimum margin from limit line which is decided by Fail Mask setting on the positive offset
Upper Freq (Hz)	Frequency on minimum margin point of the positive offset

Key Path:	View/Display
Initial S/W Revision:	Prior to A.02.00

Rel Pwr Freq

Sets the display to the Relative Peak Power and Frequency view. The views differ depending on the setting of the measurement type (Meas Type) under the Measurement Setup menu.

[“Rel Peak Pwr & Freq \(Total Pwr Ref\)” on page 576](#)

[“Rel Peak Pwr & Freq \(PSD Ref\)” on page 579](#)

[“Rel Peak Pwr & Freq \(Spectrum Pk Ref\)” on page 581](#)

Rel Peak Pwr & Freq (Total Pwr Ref)

This view consists of the following two windows:

“Trace Window” on page 578

“Results Window” on page 578

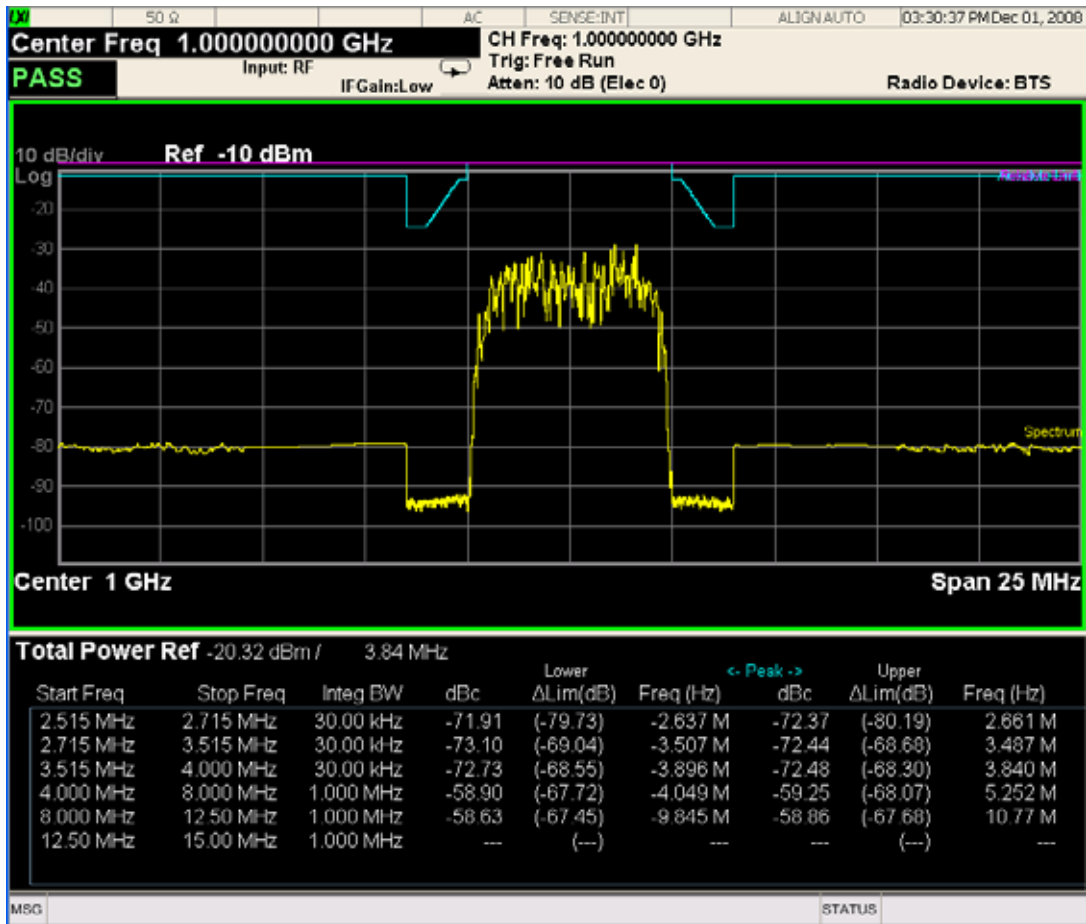

Trace Window

Corresponding Trace	yellow - Combined trace from carrier and each offset
---------------------	--

Results Window

Name	Corresponding Results
Total Pwr Ref	n=1 2nd element Absolute power at the reference area.
	Channel Integration Bandwidth
Start (Hz)	Start frequency for offset
Stop (Hz)	Stop frequency for offset
Meas BW (Hz)	Measurement bandwidth for offset
Lower Peak (dBc)	Relative peak power on minimum margin point of the negative offset
Lower Lim (dB)	Minimum margin from limit line which is decided by Fail Mask setting on the negative offset
Lower Freq (Hz)	Frequency on minimum margin point of the negative offset
Upper Peak (dBc)	Relative peak power on minimum margin point of the positive offset
Upper Lim (dB)	Minimum margin from limit line which is decided by Fail Mask setting on the positive offset
Upper Freq (Hz)	Frequency on minimum margin point of the positive offset

Rel Peak Pwr & Freq (PSD Ref)

This view consists of the following two windows:

“Trace Window” on page 580

“Results Window” on page 580

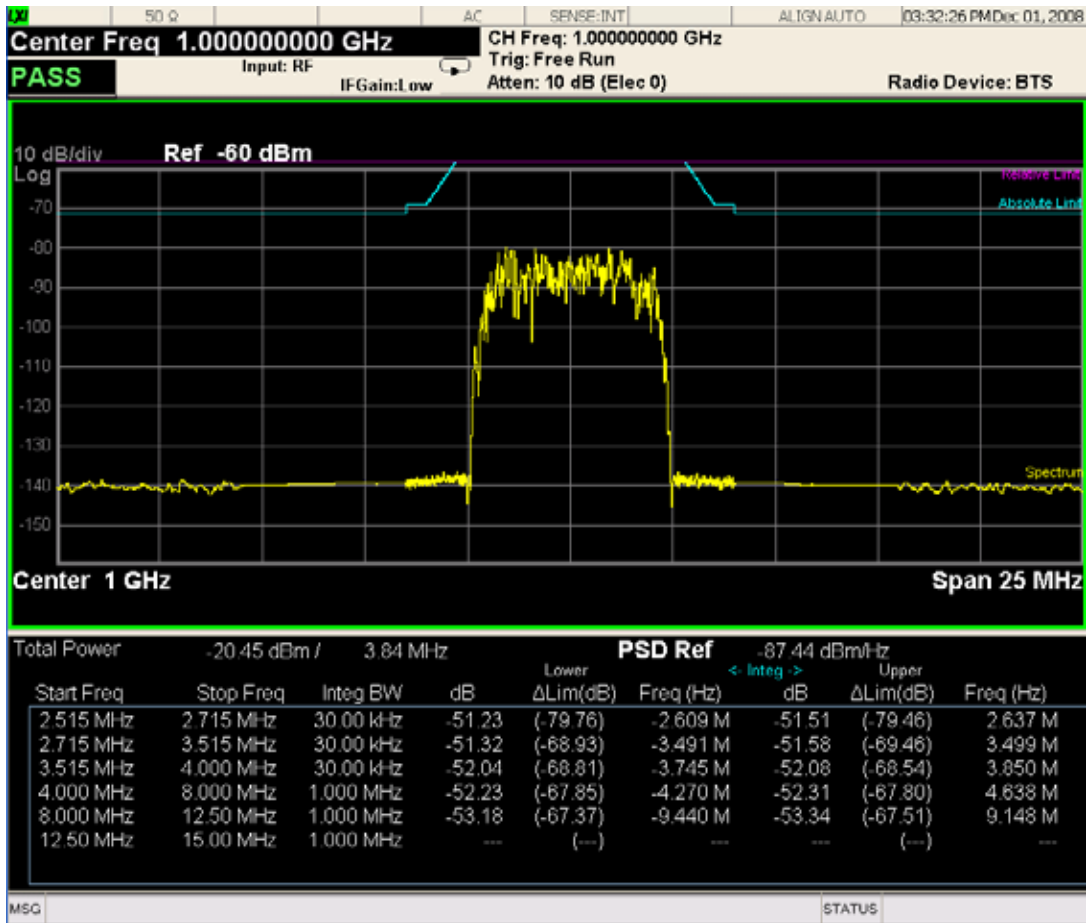

Trace Window

Corresponding Trace	yellow - Combined trace from carrier and each offset
---------------------	--

Results Window

Name	Corresponding Results
Total Pwr	n=1 2nd element Absolute power at the reference area.
	Channel Integration Bandwidth
PSD Ref	n=5 1st element Power spectral density reference at the reference area
Start (Hz)	Start frequency for offset
Stop (Hz)	Stop frequency for offset
Meas BW (Hz)	Measurement bandwidth for offset
Lower (dB)	Relative power spectrum density of the negative offset
Lower Lim (dB)	Minimum margin from limit line which is decided by Fail Mask setting on the negative offset
Lower Freq (Hz)	Frequency on minimum margin point of the negative offset
Upper (dB)	Relative power spectrum density of the positive offset
Upper Lim (dB)	Minimum margin from limit line which is decided by Fail Mask setting on the positive offset
Upper Freq (Hz)	Frequency on minimum margin point of the positive offset

Rel Peak Pwr & Freq (Spectrum Pk Ref)

This view consists of the following two windows:

“Trace Window” on page 578

“Results Window” on page 578

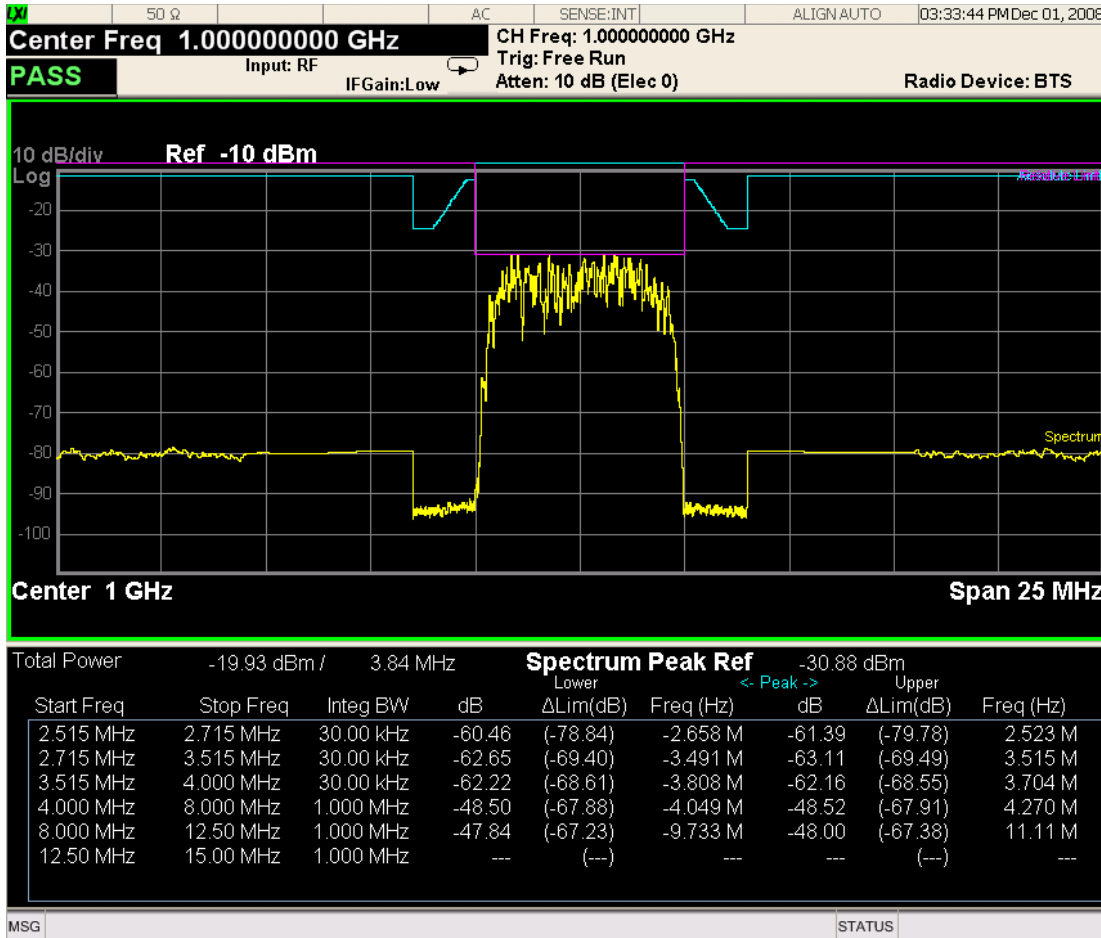

Trace Window

Corresponding Trace	yellow - Combined trace from carrier and each offset
---------------------	--

Results Window

Name	Corresponding Results
Total Pwr	Absolute power at the reference area.
	Channel Integration Bandwidth
Spectrum Peak Ref	n=5 1st element Spectrum peak power reference at the reference area
Start (Hz)	Start frequency for offset
Stop (Hz)	Stop frequency for offset
Meas BW (Hz)	Measurement bandwidth for offset
Lower Peak (dB)	Relative peak power on minimum margin point of the negative offset
Lower Lim (dB)	Minimum margin from limit line which is decided by Fail Mask setting on the negative offset
Lower Freq (Hz)	Frequency on minimum margin point of the negative offset
Upper Peak (dB)	Relative peak power on minimum margin point of the positive offset
Upper Lim (dB)	Minimum margin from limit line which is decided by Fail Mask setting on the positive offset
Upper Freq (Hz)	Frequency on minimum margin point of the positive offset

Key Path:	View/Display
Initial S/W Revision:	Prior to A.02.00

Integrated Power

Sets the display to the Integrated Power view. The views differ depending on the setting of the measurement type (Meas Type) under the Measurement Setup menu.

“Integrated Power (Total Pwr Ref)” on page 583

“Integrated Power (PSD Ref)” on page 586

“Integrated Power (Spectrum Pk Ref)” on page 589

Integrated Power (Total Pwr Ref)

“Trace Window” on page 585

“Results Window” on page 585

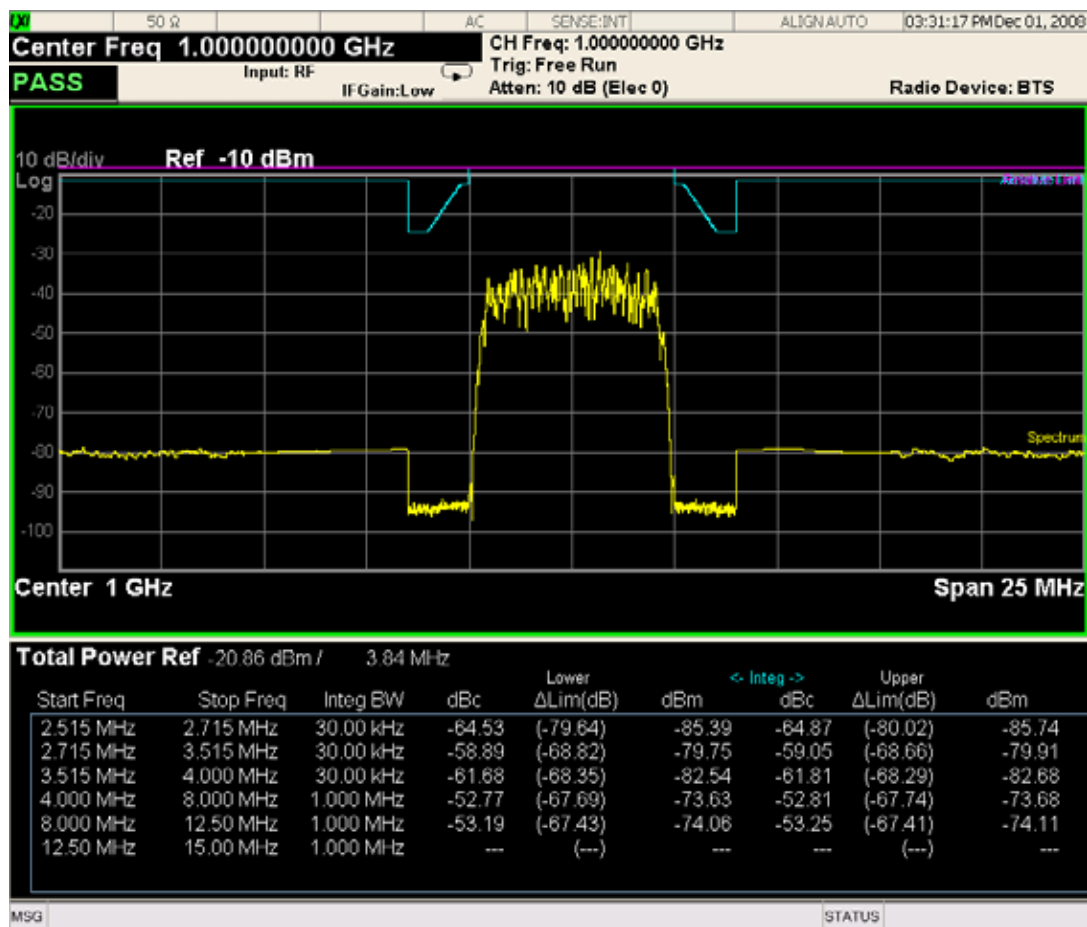

Spectrum Emission Mask Measurement
View/Display

For WLAN 802.11ac (80 + 80 MHz), power readouts of both of the carriers are displayed in the lower result window.



Trace Window

Corresponding Trace	yellow - Combined trace from carrier and each offset
---------------------	--

Results Window

Name	Corresponding Results
Total Pwr Ref	n=1 2nd element Absolute power at the reference area.
	Channel Integration Bandwidth
Start (Hz)	Start frequency for offset
Stop (Hz)	Stop frequency for offset
Meas BW (Hz)	Measurement bandwidth for offset
Lower Integ (dBc)	Relative integrated power on the negative offset
Lower Lim (dB)	Minimum margin from limit line which is decided by Fail Mask setting on the negative offset
Lower Integ (dBm)	Absolute integrated power on the negative offset
Upper Integ (dBc)	Relative integrated power on the positive offset
Upper Lim (dB)	Minimum margin from limit line which is decided by Fail Mask setting on the positive offset
Upper Integ (dBm)	Absolute integrated power on the positive offset

Spectrum Emission Mask Measurement
View/Display

Integrated Power (PSD Ref)

“Trace Window” on page 588

“Results Window” on page 588

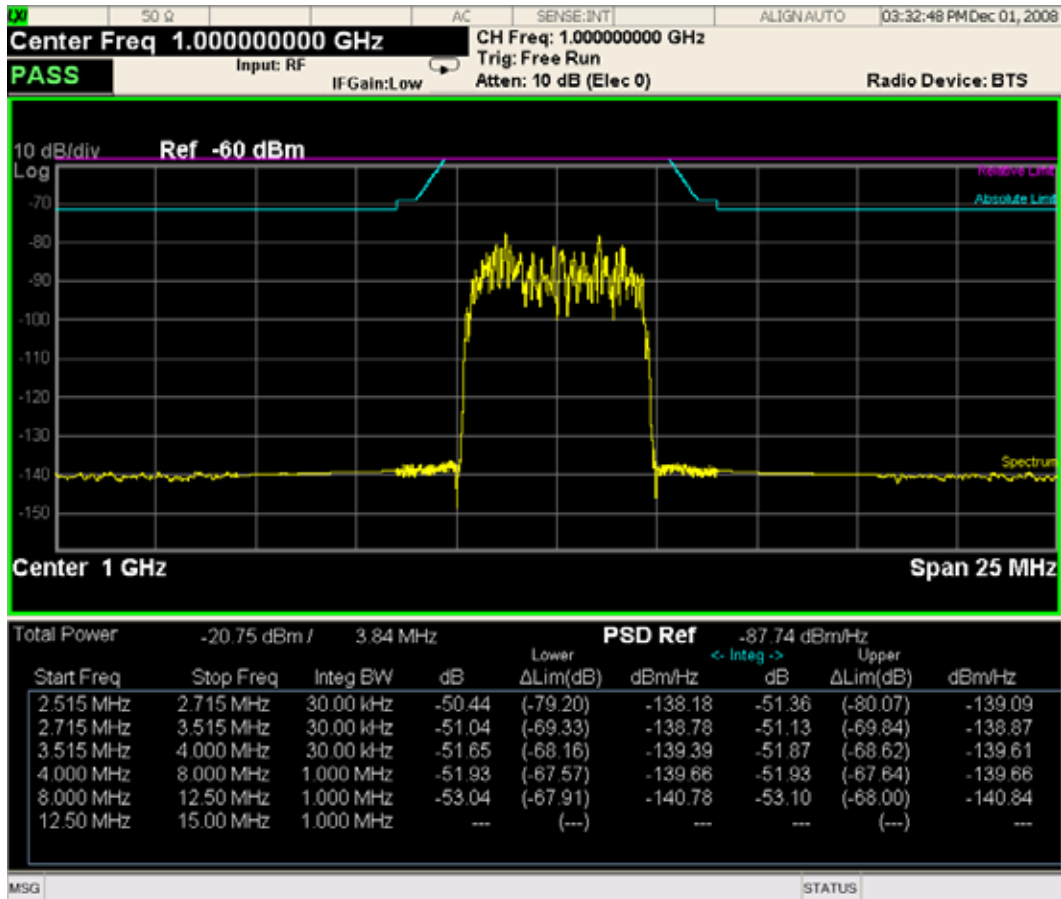

For WLAN 802.11ac (80 + 80 MHz), power readouts of both of the carriers are displayed in the lower result window.



Trace Window

Corresponding Trace	yellow - Combined trace from carrier and each offset
---------------------	--

Results Window

Name	Corresponding Results
Total Pwr	n=1 2nd element Absolute power at the reference area.
	Channel Integration Bandwidth
PSD Ref	n=5 1st element Power spectral density reference at the reference area
Start (Hz)	Start frequency for offset
Stop (Hz)	Stop frequency for offset
Meas BW (Hz)	Measurement bandwidth for offset
Lower (dB)	Relative power spectrum density of the negative offset
Lower Lim (dB)	Minimum margin from limit line which is decided by Fail Mask setting on the negative offset
Lower (dBm/Hz)	Absolute power spectrum density of the negative offset
Upper (dB)	Relative power spectrum density of the positive offset
Upper Lim (dB)	Minimum margin from limit line which is decided by Fail Mask setting on the positive offset
Upper (dBm/Hz)	Absolute power spectrum density of the negative offset

Integrated Power (Spectrum Pk Ref)

Trace Window

“Results Window” on page 585

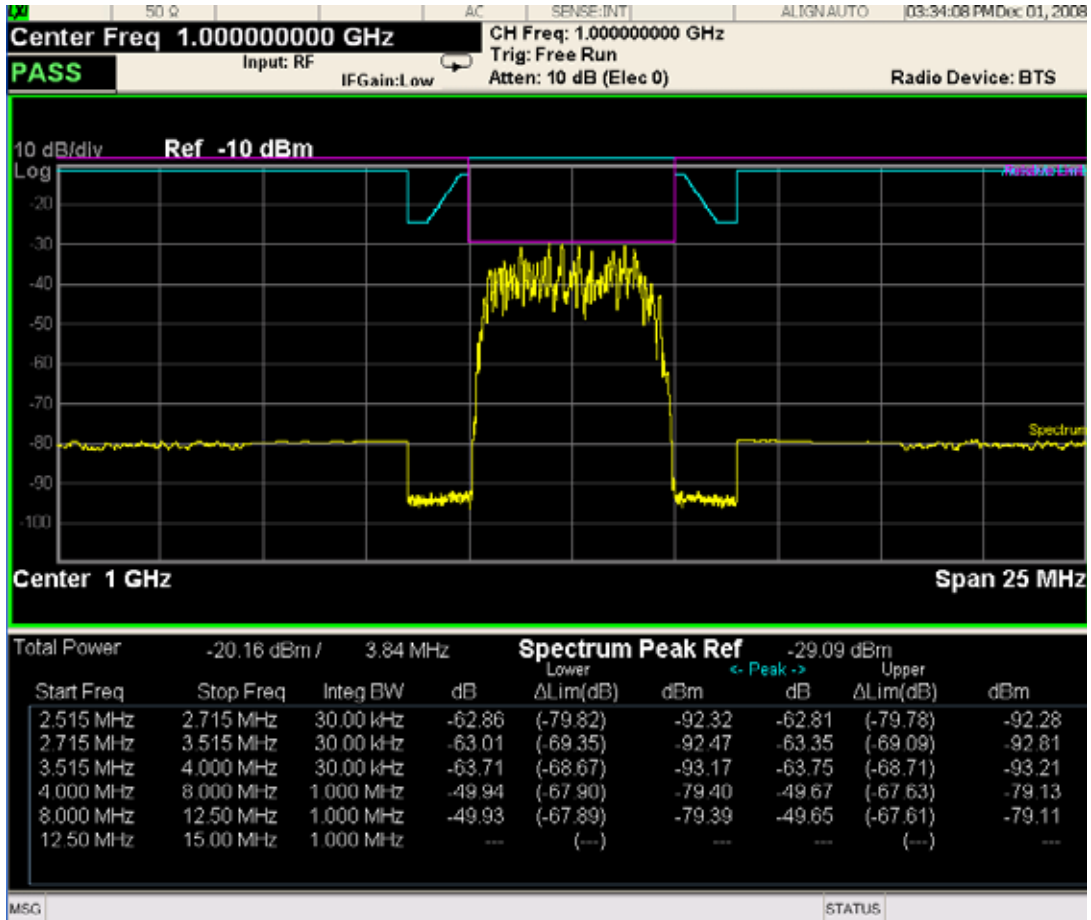

Spectrum Emission Mask Measurement
View/Display

For WLAN 802.11ac (80 + 80 MHz), power readouts of both of the carriers are displayed in the lower result window.



Trace Window

Corresponding Trace	yellow - Combined trace from carrier and each offset
---------------------	--

Results Window

Name	Corresponding Results
Total Pwr	Absolute power at the reference area.
	Channel Integration Bandwidth
Spectrum Peak Ref	n=5 1st element Peak power at the reference area
Start (Hz)	Start frequency for offset
Stop (Hz)	Stop frequency for offset
Meas BW (Hz)	Measurement bandwidth for offset
Lower Peak (dB)	Relative peak power on minimum margin point of the negative offset
Lower lim (dB)	Minimum margin from limit line which is decided by Fail Mask setting on the negative offset
Lower Peak (dBm)	Absolute peak power on minimum margin point of the negative offset
Upper Peak (dB)	Relative peak power on minimum margin point of the positive offset
Upper lim (dB)	Minimum margin from limit line which is decided by Fail Mask setting on the positive offset
Upper Peak (dBm)	Absolute peak power on minimum margin point of the positive offset

Key Path:	View/Display
Initial S/W Revision:	Prior to A.02.00

Limit Lines

Toggles the limit lines display function for the spectrum emission mask measurements On and Off.

Key Path:	View/Display
Mode:	WCDMA, C2K, WIMAX OFDMA, TD-SCDMA, 1xEVDO, LTE, LTETDD, WLAN
Remote Command:	:CALCulate:SEMask:LLINe:STATe ON OFF 1 0 :CALCulate:SEMask:LLINe:STATe?

Spectrum Emission Mask Measurement
View/Display

Example:	CALC:SEM:LLIN:STAT OFF CALC:SEM:LLIN:STAT?
Notes:	You must be in the mode that includes SEM measurement to use this command. Use :INSTrument:SELEct to set the mode.
Preset:	ON
State Saved:	Saved in instrument state.
Range:	On Off
Initial S/W Revision:	Prior to A.02.00
Modified at S/W Revision:	A.02.00, A.03.00

The Occupied Bandwidth measurement computes and displays the bandwidth occupied by a given percentage of the total mean power of a signal. For measurement results and views, see [“View/Display” on page 645](#).

This topic contains the following sections:

[“Remote Commands for Occupied Bandwidth” on page 593](#)

[“Remote Command Results for Occupied Bandwidth Measurement” on page 593](#)

Remote Commands for Occupied Bandwidth

The following commands and queries can be used to retrieve the measurement results:

```
:CONFigure:OBWidth
:CONFigure:OBWidth:NDEFault
:INITiate:OBWidth
:FETCh:OBWidth [n] ?
:MEASure:OBWidth [n] ?
:READ:OBWidth [n] ?
:FETCh:OBWidth:OBWidth?
:MEASure:OBWidth:OBWidth?
:READ:OBWidth:OBWidth?
:FETCh:OBWidth:FERRor?
:MEASure:OBWidth:FERRor?
:READ:OBWidth:FERRor?
:FETCh:OBWidth:XDB?
:MEASure:OBWidth:XDB?
:READ:OBWidth:XDB?
```

See also the section, [“Remote Measurement Functions” on page 1031](#).

Remote Command Results for Occupied Bandwidth Measurement

The following table describes the results returned by the FETCh:OBWidth[n]?, MEASure:OBWidth[n]?,

Occupied Bandwidth Measurement

and READ:OBWidth[n]? queries listed above, according to the index value n.

n	Results Returned
n=1 (or not specified)	Returns 7 scalar results, in the following order: 1. Occupied bandwidth – Hz 2. Total Power – dBm (Total Power will be obsolete in TD-SCDMA mode, this place will be replaced by NaN) 3. Span - Hz 4. Spectrum Trace Points - points 5. Res BW – Hz 6. Transmit Frequency Error Hz 7. x DB Bandwidth - Hz
2	Returns the frequency-domain spectrum trace (data array) for the entire frequency range being measured.

Key Path:	Meas
Initial S/W Revision:	Prior to A.02.00

AMPTD Y Scale (Amplitude/Y Scale)

Activates the Reference Value function and displays the Amplitude menu keys. These functions control how data on the vertical (Y) axis is displayed and control instrument settings that affect the vertical axis

See “AMPTD Y Scale” on page 849 for more information.

Key Path:	Front-panel key
Initial S/W Revision:	Prior to A.02.00

Ref Value

Sets the absolute power reference value. However, since the Auto Scaling is defaulted to On, this value is automatically determined by the measurement result. When you set a value manually, Auto Scaling automatically changes to Off.

Key Path:	AMPTD Y Scale
Mode:	WCDMA, C2K, WIMAX OFDMA, TD-SCDMA, 1xEVDO, LTE, LTETDD, BLUETOOTH, WLAN
Remote Command:	:DISPlay:OBWidth:VIEW [1] :WINDow [1] :TRACe:Y [:SCALe] :RLEV e1 <real> :DISPlay:OBWidth:VIEW [1] :WINDow [1] :TRACe:Y [:SCALe] :RLEV e1?
Example:	DISP:OBW:VIEW:WIND:TRAC:Y:RLEV 125 DISP:OBW:VIEW:WIND:TRAC:Y:RLEV?
Notes:	You must be in the W-CDMA mode, cdma2000 mode, TD-SCDMA mode, BLUETOOTH mode, LTE mode, LTE TDD mode, WLAN mode, 1xEVDO mode, or WIMAX OFDMA mode to use this command. Use:INSTRument:SElect to set the mode.
Couplings:	When the Auto Scaling is On, this value is automatically determined by the measurement result. When you set a value manually, Auto Scaling automatically changes to Off.
Preset:	10.00 dBm
State Saved:	Saved in instrument state.
Min:	-250.00 dBm
Max:	250.00 dBm
Initial S/W Revision:	Prior to A.02.00
Modified at S/W Revision:	A.03.00

Attenuation

Accesses a menu of functions that enable you to change the attenuation settings. This key has read-back text that describes the total attenuator value.

See “Attenuation” on page 850 for more information.

Key Path:	AMPTD Y Scale
Initial S/W Revision:	Prior to A.02.00

Scale/Div

Sets the logarithmic units per vertical graticule division on the display. When the Auto Scaling is On, the Scale/Div is automatically determined by the measurement result. When you set a value manually, Auto Scaling is automatically toggled to Off.

Key Path:	AMPTD Y Scale
Mode:	WCDMA, C2K, WIMAX OFDMA, TD-SCDMA, 1xEVDO, LTE, LTETDD, BLUETOOTH, WLAN
Remote Command:	:DISPlay:OBWidth:VIEW[1]:WINDow[1]:TRACe:Y[:SCALE]:PDIV ision <rel_ampl> :DISPlay:OBWidth:VIEW[1]:WINDow[1]:TRACe:Y[:SCALE]:PDIV ision?
Example:	DISP:OBW:VIEW:WIND:TRAC:Y:PDIV 5 DISP:OBW:VIEW:WIND:TRAC:Y:PDIV?
Notes:	You must be in the W-CDMA mode, cdma2000 mode, TD-SCDMA mode, BLUETOOTH mode, LTE mode, LTE TDD mode, WLAN mode, 1xEVDO mode, or WIMAX OFDMA mode to use this command. Use:INSTrument:SELEct to set the mode.
Couplings:	When the Auto Scaling is On, this value is automatically determined by the measurement result. When you set a value manually, Auto Scaling automatically changes to Off.
Preset:	10.00 dB
State Saved:	Saved in instrument state.
Min:	0.10 dB
Max:	20.00 dB
Initial S/W Revision:	Prior to A.02.00
Modified at S/W Revision:	A.03.00

Y Axis Unit

Allows you to change the vertical (Y) axis amplitude unit.

See “Y Axis Unit” on page 871 under AMPTD Y Scale for more information.

Key Path:	AMPTD/Y Scale
Initial S/W Revision:	A.04.00

Internal Preamp

Accesses a menu of functions that enable you to control the internal preamplifiers.

See “Internal Preamp” on page 883 for more information.

Key Path:	AMPTD Y Scale
Initial S/W Revision:	Prior to A.02.00

Ref Position

Positions the reference level at the top, center or bottom of the Y Scale display. Changing the reference position does not change the reference level value.

Key Path:	AMPTD Y Scale
Mode:	WCDMA, C2K, WIMAX OFDMA, TD-SCDMA, 1xEVDO, LTE, LTETDD, BLUETOOTH, WLAN
Remote Command:	:DISPlay:OBWidth:VIEW[1]:WINDow[1]:TRACe:Y[:SCALe]:RPOSition TOP CENTer BOTTom :DISPlay:OBWidth:VIEW[1]:WINDow[1]:TRACe:Y[:SCALe]:RPOSition?
Example:	DISP:OBW:VIEW:WIND:TRAC:Y:RPOS BOTT DISP:OBW:VIEW:WIND:TRAC:Y:RPOS?
Notes:	You must be in the W-CDMA mode, cdma2000 mode, TD-SCDMA mode, BLUETOOTH mode, LTE mode, LTE TDD mode, WLAN mode, 1xEVDO mode, or WIMAX OFDMA mode to use this command. Use:INSTrument:SElect to set the mode.
Preset:	TOP
State Saved:	Saved in instrument state.
Range:	Top Ctr Bot
Initial S/W Revision:	Prior to A.02.00
Modified at S/W Revision:	A.03.00

Auto Scaling

Allows you to toggle the Auto Scaling function between On and Off.

Key Path:	AMPTD Y Scale
Mode:	WCDMA, C2K, WIMAX OFDMA, TD-SCDMA, 1xEVDO, LTE, LTETDD, BLUETOOTH, WLAN
Remote Command:	:DISPlay:OBWidth:VIEW[1]:WINDow[1]:TRACe:Y[:SCALE]:COUPle 0 1 OFF ON :DISPlay:OBWidth:VIEW[1]:WINDow[1]:TRACe:Y[:SCALE]:COUPle?
Example:	DISP:OBW:VIEW:WIND:TRAC:Y:COUP ON DISP:OBW:VIEW:WIND:TRAC:Y:COUP?
Couplings:	When Auto Scaling is On, upon pressing the Restart front-panel key, this function automatically sets the scale per division to 10 dB and determines reference values based on the measurement results. When you set a value to either Scale/Div or Ref Value manually, Auto Scaling automatically changes to Off.
Preset:	1
State Saved:	Saved in instrument state.
Range:	On Off
Initial S/W Revision:	Prior to A.02.00
Modified at S/W Revision:	A.03.00

Auto Couple

The Auto Couple function is not supported in this measurement.

Key Path:	Front-panel key
Initial S/W Revision:	Prior to A.02.00

BW

Accesses a menu of functions that enable you to specify and control the video and resolution bandwidths. You can also select the type of filter for the measurement.

Key Path:	Front-panel key
Initial S/W Revision:	Prior to A.02.00

Res BW

Sets the resolution bandwidth for the current measurement. If an unavailable bandwidth is entered with the numeric keypad, the closest available bandwidth is selected.

Key Path:	BW
Mode:	WCDMA, C2K, WIMAX OFDMA, TD-SCDMA, 1xEVDO, LTE, LTETDD, BLUETOOTH, WLAN
Remote Command:	[:SENSe]:OBWidth:BANDwidth[:RESolution] <bandwidth> [:SENSe]:OBWidth:BANDwidth[:RESolution]? [:SENSe]:OBWidth:BANDwidth[:RESolution]:AUTO ON OFF 1 0 [:SENSe]:OBWidth:BANDwidth[:RESolution]:AUTO?
Example:	OBW:BAND 250000 OBW:BAND? OBW:BAND:AUTO OFF OBW:BAND:AUTO?
Notes:	You must be in the W-CDMA mode, cdma2000 mode, TD-SCDMA mode, BLUETOOTH mode, LTE mode, LTE TDD mode, WLAN mode, 1xEVDO mode, or WIMAX OFDMA mode to use this command. Use:INSTrument:SELEct to set the mode.
Couplings:	Sweep time is coupled to RBW. As the RBW changes, the sweep time (if set to Auto) is changed to maintain amplitude calibration. Video bandwidth (VBW) is coupled to RBW. As the resolution bandwidth changes, the video bandwidth (if set to Auto) changes to maintain the ratio of VBW/RBW (10:1). When Res BW is set to Auto, the resolution bandwidth is auto-coupled to span. The ratio of Span/RBW is approximately 106:1 when auto coupled. When Res BW is set to Man, bandwidths are entered manually, and these bandwidths are used regardless of other analyzer settings.

Preset:	WCDMA: 30 kHz CDMA2K: 12 kHz WIMAX OFDMA: 100 kHz TD-SCDMA: 30 kHz 1xEVDO: 30 kHz LTE: 30 kHz LTETDD: 30 kHz BLUETOOTH:10 kHz WLAN: 100kHz WCDMA, C2K,TD-SCDMA,WIMAX OFDMA, 1xEVDO, LTE, LTETDD, WLAN: OFF
State Saved:	Saved in instrument state.
Min:	1 Hz
Max:	8 MHz
Backwards Compatibility SCPI:	[:SENSe]:OBWidth:BWIDth[:RESolution]
Initial S/W Revision:	Prior to A.02.00
Modified at S/W Revision:	A.03.00

Video BW

Changes the analyzer post-detection filter.

Key Path:	BW
Mode:	WCDMA, C2K, WIMAX OFDMA, TD-SCDMA, 1xEVDO, LTE, LTETDD, BLUETOOTH, WLAN
Remote Command:	[:SENSe]:OBWidth:BANDwidth:VIDeo <bandwidth> [:SENSe]:OBWidth:BANDwidth:VIDeo? [:SENSe]:OBWidth:BANDwidth:VIDeo:AUTO ON OFF 1 0 [:SENSe]:OBWidth:BANDwidth:VIDeo:AUTO?
Example:	OBW:BAND:VID 5 MHz OBW:BAND:VID? OBW:BAND:VID:AUTO ON OBW:BAND:VID:AUTO?
Notes:	You must be in the W-CDMA mode, cdma2000 mode, TD-SCDMA mode, BLUETOOTH mode, LTE mode, LTE TDD mode, WLAN mode, 1xEVDO mode, or WIMAX OFDMA mode to use this command. Use:INSTrument:SElect to set the mode.

Occupied Bandwidth Measurement
BW

Dependencies:	When using the average detector with either Sweep Time set to Man, or in zero span, the VBW setting has no effect and is disabled (grayed out).
Couplings:	<p>Video bandwidth (VBW) is coupled to RBW. As the resolution bandwidth changes, the video bandwidth (if set to Auto) changes to maintain the ratio set by VBW/RBW.</p> <p>Sweep Time is coupled to Video Bandwidth (VBW). As the VBW is changed, the sweep time (when set to Auto) is changed to maintain amplitude calibration. This occurs because of common hardware between the two circuits, even though the Video BW filter is not actually “in-circuit” when the detector is set to Average. Because the purpose of the average detector and the VBW filter are the same, either can be used to reduce the variance of the result.</p> <p>Although the VBW filter is not “in-circuit” when using the average detector, the Video BW key can have an effect on (Auto) sweep time, and is not disabled. In this case, reducing the VBW setting increases the sweep time, which increases the averaging time, producing a lower-variance trace.</p> <p>When the video bandwidth is AUTO coupled, the video bandwidth value is set to: Resolution Bandwidth * Video Bandwidth to Resolution Bandwidth Ratio</p>
Preset:	<p>LTE, LTETDD, WLAN: Auto</p> <p>WCDMA: 300 kHz</p> <p>CDMA2K:120 kHz</p> <p>WIMAX OFDMA: 1 MHz</p> <p>TD-SCDMA: 300 kHz</p> <p>1xEVDO: 300 kHz</p> <p>BLUETOOTH: 30 kHz</p> <p>ON</p>
State Saved:	Saved in instrument state.
Min:	1 Hz
Max:	50 MHz
Backwards Compatibility SCPI:	[:SENSe]:OBWidth:BWIDth:VIDeo
Initial S/W Revision:	Prior to A.02.00
Modified at S/W Revision:	A.03.00

Filter Type

Allows you to select the type of filter to be used for the current measurement. Besides the Gaussian filter shape, there are certain special filter types, such as Flat Top, that are desirable under certain conditions.

Key Path:	BW
-----------	-----------

Mode:	WCDMA, C2K, WIMAX OFDMA, TD-SCDMA, 1xEVDO, LTE, LTETDD, BLUETOOTH, WLAN
Remote Command:	[:SENSe] :OBWidth: BANDwidth: SHAPe GAUSSian FLATtop [:SENSe] :OBWidth: BANDwidth: SHAPe?
Example:	OBW: BAND: SHAP GAUS OBW: BAND: SHAP?
Preset:	GAUSSian
State Saved:	Saved in instrument state.
Range:	Gaussian Flattop
Backwards Compatibility SCPI:	[:SENSe] :OBWidth: BWIDth: SHAPe
Initial S/W Revision:	Prior to A.02.00
Modified at S/W Revision:	A.03.00

Cont (Continuous)

See “[Cont \(Continuous Measurement/Sweep\)](#)” on page 901 for more information.

Key Path:	Front-panel key
Initial S/W Revision:	Prior to A.02.00

FREQ/Channel (Frequency or Channel)

See “[FREQ Channel](#)” on page 903 for more information.

Key Path:	Front-panel key
Initial S/W Revision:	Prior to A.02.00

Input/Output

See “[Input/Output](#)” on page 921 for more information.

Key Path:	Front-panel key
Initial S/W Revision:	Prior to A.02.00

Marker

Accesses a menu that enables you to select, set up and control the markers for the current measurement.

Key Path:	Front-panel key
Initial S/W Revision:	Prior to A.02.00

Select Marker

Displays the menu keys that enable you to select, set up and control the markers for the current measurement

Key Path:	Marker
Initial S/W Revision:	Prior to A.02.00

Marker X Axis Value (Remote Command Only)

Sets the marker X Axis value in the current marker X Axis Scale unit. It has no effect if the control mode is **Off**.

Key Path:	SCPI only
Mode:	WCDMA, C2K, WIMAX OFDMA, TD-SCDMA, 1xEVDO, LTE, LTETDD, BLUETOOTH, WLAN
Remote Command:	:CALCulate:OBWidth:MARKer [1] 2 3 4 5 6 7 8 9 10 11 12 :X <freq> : :CALCulate:OBWidth:MARKer [1] 2 3 4 5 6 7 8 9 10 11 12 :X ?
Example:	CALC:OBW:MARK3:X 0 CALC:OBW:MARK3:X?
Notes:	The query returns the marker's absolute X Axis value if the control mode is Normal , or the offset from the marker's reference marker if the control mode is Delta . The query is returned in the fundamental units for the current marker X Axis scale: Hz for Frequency .
Preset:	After a preset, all markers are turned OFF, so Marker X Axis Value query returns a not a number (NAN).
State Saved:	No
Min:	-9.9E+37
Max:	9.9E+37
Initial S/W Revision:	Prior to A.02.00

Modified at S/W Revision:	A.03.00
---------------------------	---------

Marker X Axis Position (Remote Command Only)

Sets the marker X position in trace points. It has no effect if the control mode is **Off**.

Key Path:	SCPI only
Mode:	WCDMA, C2K, WIMAX OFDMA, TD-SCDMA, 1xEVDO, LTE, LTETDD, BLUETOOTH, WLAN
Remote Command:	:CALCulate:OBWidth:MARKer [1] 2 3 4 5 6 7 8 9 10 11 12 :X :POSition <real> :CALCulate:OBWidth:MARKer [1] 2 3 4 5 6 7 8 9 10 11 12 :X :POSition?
Example:	CALC:OBW:MARK10:X:POS 0 CALC:OBW:MARK10:X:POS?
Notes:	The query returns the marker's absolute X Axis value in trace points if the control mode is Normal , or the offset from the marker's reference marker in trace points if the control mode is Delta .
Preset:	After a preset, all markers are turned OFF, so Marker X Axis Value query returns a not a number (NAN).
State Saved:	No
Min:	-9.9E+37
Max:	9.9E+37
Initial S/W Revision:	Prior to A.02.00
Modified at S/W Revision:	A.03.00

Marker Y Axis Value (Remote Command Only)

Returns the marker Y Axis value in the current marker Y Axis unit.

Key Path:	SCPI only
Mode:	WCDMA, C2K, WIMAX OFDMA, TD-SCDMA, 1xEVDO, LTE, LTETDD, BLUETOOTH, WLAN
Remote Command:	:CALCulate:OBWidth:MARKer [1] 2 3 4 5 6 7 8 9 10 11 12 :Y ?
Example:	CALC:OBW:MARK11:Y?
Preset:	Result dependent on Markers setup and signal source.
State Saved:	No
Min:	-9.9E+37

Max:	9.9E+37
Initial S/W Revision:	Prior to A.02.00
Modified at S/W Revision:	A.03.00

Marker Type

Sets the marker control mode to **Normal**, **Delta** or **Off**. If the selected marker is Off, pressing Marker sets it to Normal and places a single marker at the center of the display. At the same time, **Marker X Axis Value** appears on the Active Function area.

Key Path:	Marker
Mode:	WCDMA, C2K, WIMAX OFDMA, TD-SCDMA, 1xEVDO, LTE, LTETDD, BLUETOOTH, WLAN
Remote Command:	:CALCulate:OBWidth:MARKer [1] 2 3 4 5 6 7 8 9 10 11 12 :M ODE POSition DELTA OFF :CALCulate:OBWidth:MARKer [1] 2 3 4 5 6 7 8 9 10 11 12 :M ODE?
Example:	CALC:OBW:MARK:MODE POS CALC:OBW:MARK:MODE?
Notes:	If the selected marker is Off, pressing Marker sets it to Normal and places it at the center of the screen on the trace determined by the Marker Trace rules. At the same time, Marker X Axis Value appears on the Active Function area. Default Active Function: the active function for the selected marker's current control mode. If the current control mode is Off, there is no active function and the active function is turned off. Active Function Display: the marker X axis value entered in the active function area displays the marker value to its full entered precision.
Preset:	OFF
State Saved:	Saved in instrument state.
Range:	Normal Delta Off
Initial S/W Revision:	Prior to A.02.00
Modified at S/W Revision:	A.03.00

Properties

Accesses the marker properties menu.

Key Path:	Marker
Initial S/W Revision:	Prior to A.02.00

Select Marker

Displays 12 markers available for selection.

Key Path:	Marker, Properties
Initial S/W Revision:	Prior to A.02.00

Relative To

Selects the desired marker. The selected marker will be relative to its reference marker.

Key Path:	Marker, Properties
Mode:	WCDMA, C2K, WIMAX OFDMA, TD-SCDMA, 1xEVDO, LTE, LTETDD, BLUETOOTH, WLAN
Remote Command:	:CALCulate:OBWidth:MARKer [1] 2 3 4 5 6 7 8 9 10 11 12 :R EFerence <integer> :CALCulate:OBWidth:MARKer [1] 2 3 4 5 6 7 8 9 10 11 12 :R EFerence?
Example:	CALC:OBW:MARK:REF 2 CALC:OBW:MARK:REF?
Notes:	A marker cannot be relative to itself so that choice is grayed out, and if sent from SCPI generates error -221: "Settings conflict; marker cannot be relative to itself." When queried a single value is returned (the specified marker numbers relative marker). You must be in the W-CDMA mode, cdma2000 mode, TD-SCDMA mode, BLUETOOTH mode, LTE mode, LTE TDD mode, WLAN mode, 1xEVDO mode, or WIMAX OFDMA mode to use this command. Use:INSTrument:SELEct to set the mode.
Preset:	2 3 4 5 6 7 8 9 10 11 12 1
State Saved:	Saved in instrument state.
Min:	1
Max:	12
Readback:	Current selected relative to marker number.
Initial S/W Revision:	Prior to A.02.00
Modified at S/W Revision:	A.03.00

All Markers Off

Turns off all markers.

Key Path:	Marker
Mode:	WCDMA, C2K, WIMAX OFDMA, TD-SCDMA, 1xEVDO, LTE, LTETDD, BLUETOOTH, WLAN
Remote Command:	:CALCulate:OBWidth:MARKer:AOff
Example:	CALC:OBW:MARK:AOff
Initial S/W Revision:	Prior to A.02.00
Modified at S/W Revision:	A.03.00

Backward Compatibility SCPI Commands

Sets or queries the state of a marker. Setting a marker which is OFF to state ON or 1 puts it in **Normal** mode and places it at the center of the screen.

Key Path:	SCPI only
Mode:	WCDMA, C2K, WIMAX OFDMA, TD-SCDMA, 1xEVDO, LTE, LTETDD, BLUETOOTH, WLAN
Remote Command:	:CALCulate:OBWidth:MARKer [1] 2 3 4 5 6 7 8 9 10 11 12 : S TATe OFF ON 0 1 :CALCulate:OBWidth:MARKer [1] 2 3 4 5 6 7 8 9 10 11 12 : S TATe?
Example:	CALC:OBW:MARK3:STAT ON CALC:OBW:MARK3:STAT?
Preset:	OFF
State Saved:	Saved in instrument state.
Initial S/W Revision:	Prior to A.02.00
Modified at S/W Revision:	A.03.00

Marker Function

There are no 'Marker Functions' supported in this measurement. When pressed, this key displays a blank menu.

Key Path:	Front panel key
Initial S/W Revision:	Prior to A.02.00

Marker To

There is no 'Marker To' functionality supported in this measurement. When pressed, this key displays a blank menu.

Key Path:	Front panel key
Initial S/W Revision:	Prior to A.02.00

Meas

See “[Meas](#)” on page 1031 for more information.

Key Path:	Front-panel key
Initial S/W Revision:	Prior to A.02.00

Meas Setup

Displays the setup menu for the current measurement. The measurement setup parameters include the number of measurement averages used to calculate the measurement result and the averaging mode. The setup menu also includes the option to reset the measurement settings to their factory defaults.

Key Path:	Front-panel key
Initial S/W Revision:	Prior to A.02.00

Avg/Hold Num

Specifies the number of measurement averages used when calculating the measurement result. The average is displayed at the end of each sweep.

Initiates an averaging routine that averages the sweep points in a number of successive sweeps, resulting in trace smoothing.

After the specified number of average counts, the average mode (termination control) setting determines the average action.

Key Path:	Meas Setup
Mode:	WCDMA, C2K, WIMAX OFDMA, TD-SCDMA, 1xEVDO, LTE, LTETDD, BLUETOOTH, WLAN
Remote Command:	[:SENSE]:OBwidth:AVERage:COUNT <integer> [:SENSE]:OBwidth:AVERage:COUNT? [:SENSE]:OBwidth:AVERage[:STATE] ON OFF 1 0 [:SENSE]:OBwidth:AVERage[:STATE]?
Example:	OBW:AVER:COUN 1500 OBW:AVER:COUN? OBW:AVER ON OBW:AVER?
Notes:	You must be in the W-CDMA mode, cdma2000 mode, TD-SCDMA mode, BLUETOOTH mode, LTE mode, LTE TDD mode, WLAN mode, 1xEVDO mode, or WIMAX OFDMA mode to use this command. Use:INSTRument:SElect to set the mode.
Couplings:	None Averaging state is coupled to Max Hold. If Max Hold is changed from Off to On, Averaging state is automatically set to On.
Preset:	10 ON

Occupied Bandwidth Measurement
Meas Setup

State Saved:	Saved in instrument state.
Min:	1
Max:	10000
Backwards Compatibility SCPI:	[:SENSE]:EBWidth:AVERage:COUNT
Initial S/W Revision:	Prior to A.02.00
Modified at S/W Revision:	A.03.00

Avg Mode

Enables you to set the averaging mode.

- When set to Exponential (Exp) the measurement averaging continues using the specified number of averages to compute each averaged value. The average is displayed at the end of each sweep.
- When set to Repeat, the measurement resets the average counter each time the specified number of averages is reached.

Key Path:	Meas Setup
Mode:	WCDMA, C2K, WIMAX OFDMA, TD-SCDMA, 1xEVDO, LTE, LTETDD, BLUETOOTH, WLAN
Remote Command:	[:SENSE]:OBWidth:AVERage:TCONtrol EXPonential REPeat [:SENSE]:OBWidth:AVERage:TCONtrol?
Example:	OBW:AVER:TCON REP OBW:AVER:TCON?
Notes:	You must be in the W-CDMA mode, cdma2000 mode, TD-SCDMA mode, BLUETOOTH mode, LTE mode, LTE TDD mode, WLAN mode, 1xEVDO mode, or WIMAX OFDMA mode to use this command. Use:INSTrument:SELEct to set the mode.
Preset:	EXP
State Saved:	Saved in instrument state.
Range:	Exp Repeat
Initial S/W Revision:	Prior to A.02.00
Modified at S/W Revision:	A.03.00

Max Hold (Remote Command Only)

When On, Max Hold displays and holds the maximum responses of the current measurement. Turn Max Hold to Off to disable the maximum hold feature.

Key Path:	SCPI Only
-----------	------------------

Mode:	WCDMA, C2K, WIMAX OFDMA, TD-SCDMA, 1xEVDO, LTE, LTETDD, BLUETOOTH, WLAN
Remote Command:	[:SENSe] :OBwidth:MAXHold ON OFF 1 0 [:SENSe] :OBwidth:MAXHold?
Example:	OBW:MAXH ON OBW:MAXH?
Notes:	You must be in the W-CDMA mode, cdma2000 mode, TD-SCDMA mode, BLUETOOTH mode, LTE mode, LTE TDD mode, WLAN mode, 1xEVDO mode, or WIMAX OFDMA mode to use this command. Use:INSTrument:SElect to set the mode.
Couplings:	Max Hold is coupled to Average/Hold state. The Max Hold function is activated only if Average state is On. If Max Hold is changed to On when Average state is Off, Average state is automatically set to On.
Preset:	OFF
State Saved:	Saved in instrument state.
Range:	On Off
Backwards Compatibility SCPI:	[:SENSe] :EBwidth:MAXHold
Initial S/W Revision:	Prior to A.02.00
Modified at S/W Revision:	A.03.00

Occ BW % Pwr

Assigns the percentage of the total power that is measured within the Occupied Bandwidth for the current measurement. The resulting Occupied Bandwidth limits are displayed by markers placed on the frequencies of the specified percentage.

Key Path:	Meas Setup
Mode:	WCDMA, C2K, WIMAX OFDMA, TD-SCDMA, 1xEVDO, LTE, LTETDD, BLUETOOTH, WLAN
Remote Command:	[:SENSe] :OBwidth:PERCent <real> [:SENSe] :OBwidth:PERCent?
Example:	OBW:PERC 75 OBW:PERC?
Notes:	You must be in the W-CDMA mode, cdma2000 mode, TD-SCDMA mode, BLUETOOTH mode, LTE mode, LTE TDD mode, WLAN mode, 1xEVDO mode, or WIMAX OFDMA mode to use this command. Use:INSTrument:SElect to set the mode. If Mode is BLUETOOTH, the key will be grayed out.
Preset:	99.00

Occupied Bandwidth Measurement
Meas Setup

State Saved:	Saved in instrument state.
Min:	10
Max:	99.99
Initial S/W Revision:	Prior to A.02.00
Modified at S/W Revision:	A.03.00

x dB

Sets the x dB value used for the "x dB bandwidth" result that measures the bandwidth between two points on the signal which is x dB down from the highest signal point within the OBW Span.

Key Path:	Meas Setup
Mode:	WCDMA, C2K, WIMAX OFDMA, TD-SCDMA, 1xEVDO, LTE, LTETDD, BLUETOOTH, WLAN
Remote Command:	[[:SENSE]:OBWidth:XDB <rel_ampl> [:SENSe]:OBWidth:XDB?
Example:	OBW:XDB -20 OBW:XDB?
Notes:	You must be in the W-CDMA mode, cdma2000 mode, TD-SCDMA mode, BLUETOOTH mode, LTE mode, LTE TDD mode, WLAN mode, 1xEVDO mode, or WIMAX OFDMA mode to use this command. Use:INSTrument:SELEct to set the mode.
Preset:	-26.0 dB BLUETOOTH: -20.0 dB.
State Saved:	Saved in instrument state.
Min:	-100.0 dB
Max:	-0.1 dB
Backwards Compatibility SCPI:	[[:SENSE]:EBWidth:XDB
Initial S/W Revision:	Prior to A.02.00
Modified at S/W Revision:	A.03.00

IF Gain

The **IF Gain** key can be used to set the IF Gain function to Auto, Low Gain or High Gain. These settings affect sensitivity and IF overloads.

This only applies to the RF input. It does not apply to baseband I/Q input.

Key Path:	Meas Setup, IF Gain
-----------	----------------------------

Initial S/W Revision:	Prior to A.02.00
-----------------------	------------------

IF Gain Auto

Activates the Auto Rules for IF Gain. When Auto is active, the IF Gain is set to High Gain under and of the following conditions:

- the input attenuator is set to 0 dB
- the preamp is turned On and the frequency range is under 3.6 GHz

For other settings, Auto sets the IF Gain to Low Gain.

Key Path:	Meas Setup, IF Gain
Mode:	WCDMA, C2K, WIMAX OFDMA, TD-SCDMA, 1xEVDO, LTE, LTETDD, BLUETOOTH, WLAN
Remote Command:	[:SENSE] :OBwidth:IF:GAIN:AUTO [:STATE] ON OFF 1 0 [:SENSE] :OBwidth:IF:GAIN:AUTO [:STATE] ?
Example:	OBW : IF : GAIN : AUTO OFF OBW : IF : GAIN : AUTO ?
Couplings:	When the auto attenuation exists (for example, with electrical attenuator), the IF Gain setting is changed as following rule. Auto sets IF Gain to High Gain under any of the following conditions: the input attenuator is set to 0 dB, or the preamp is turned on and the frequency range is less than 3.6 GHz. For other settings, Auto sets IF Gain to Low Gain.
Preset:	OFF
State Saved:	Saved in instrument state.
Range:	Off On
Initial S/W Revision:	Prior to A.02.00
Modified at S/W Revision:	A.03.00

IF Gain State

Selects the range of the IF Gain.

Key Path:	Meas Setup, IF Gain
Mode:	WCDMA, C2K, WIMAX OFDMA, TD-SCDMA, 1xEVDO, LTE, LTETDD, BLUETOOTH, WLAN
Remote Command:	[:SENSE] :OBwidth:IF:GAIN [:STATE] ON OFF 1 0 [:SENSE] :OBwidth:IF:GAIN [:STATE] ?
Example:	OBW : IF : GAIN ON OBW : IF : GAIN ?

Occupied Bandwidth Measurement
Meas Setup

Notes:	Where ON = high gain OFF = low gain
Couplings:	When the auto attenuation exists (for example, with electrical attenuator), the IF Gain setting is changed as following rule. Auto sets IF Gain to High Gain under any of the following conditions: the input attenuator is set to 0 dB, or the preamp is turned on and the frequency range is less than 3.6 GHz. For other settings, Auto sets IF Gain to Low Gain.
Preset:	OFF
State Saved:	Saved in instrument state.
Range:	Low Gain High Gain
Initial S/W Revision:	Prior to A.02.00
Modified at S/W Revision:	A.03.00

Limit

Enables you to turn on or off limit checking at the specified frequency. For results that fail the limit test, a red FAIL appears in the measure bar.

Key Path:	Meas Setup
Mode:	WCDMA, C2K, WIMAX OFDMA, TD-SCDMA, 1xEVDO, LTE, LTETDD, BLUETOOTH, WLAN
Remote Command:	:CALCulate:OBwidth:LIMit:FBLimit <freq> :CALCulate:OBwidth:LIMit:FBLimit? :CALCulate:OBwidth:LIMit[:TEST] ON OFF 1 0 :CALCulate:OBwidth:LIMit[:TEST]?
Example:	CALC:OBW:LIM:FBL 50 kHz CALC:OBW:LIM:FBL? CALC:OBW:LIM OFF CALC:OBW:LIM?
Notes:	You must be in the W-CDMA mode, cdma2000 mode, TD-SCDMA mode, LTE mode, LTE TDD mode, BLUETOOTH mode, WLAN mode, 1xEVDO mode or WIMAX OFDMA mode to use this command. Use:INSTrument:SElect to set the mode.

Preset:	<p>C2K: 1.48 MHz</p> <p>WIMAX OFDMA: 10 MHz</p> <p>TD-SCDMA: 1.6 MHz</p> <p>1xEVDO: 1.48 MHz</p> <p>LTE, LTETDD: 5 MHz</p> <p>BLUETOOTH: 1 MHz</p> <p>WLAN:</p> <p>If Radio Std is 802.11a/g(OFDM/DSSS-OFDM): 20MHz</p> <p>If Radio Std is 802.11b: 25 MHz</p> <p>If Radio Std is 802.11n(20MHz): 20 MHz</p> <p>If Radio Std is 802.11n(40MHz): 40 MHz</p> <p>If Radio Std is 802.11ac(20MHz): 20 MHz</p> <p>If Radio Std is 802.11ac(40MHz): 40 MHz</p> <p>If Radio Std is 802.11ac(80MHz): 80 MHz</p> <p>If Radio Std is 802.11ac(160MHz): 160 MHz</p> <p>WCDMA, WIMAX OFDMA, TD-SCDMA, 1xEVDO, LTE, LTETDD: ON</p>
State Saved:	Saved in instrument state.
Min:	1 kHz
Max:	Depends on instrument maximum frequency.
Initial S/W Revision:	Prior to A.02.00
Modified at S/W Revision:	A.03.00

Meas Preset

Restores all measurement parameters to their default values.

Key Path:	Meas Setup
Mode:	WCDMA, C2K, WIMAX OFDMA, TD-SCDMA, 1xEVDO, LTE, LTETDD, BLUETOOTH, WLAN
Remote Command:	:CONFigure:OBWidth
Example:	CONF:OBW
Initial S/W Revision:	Prior to A.02.00
Modified at S/W Revision:	A.03.00

Mode

See “[Mode](#)” on page 1091 for more information.

Key Path:	Front-panel key
Initial S/W Revision:	Prior to A.02.00

Mode Setup

See “[Mode Setup](#)” on page 1103 for more information.

Key Path:	Front-panel key
Initial S/W Revision:	Prior to A.02.00

Peak Search

Places the selected marker on the trace point with the maximum y-axis value for that marker's trace. Pressing **Peak Search** with the selected marker off causes the selected marker to be set to Normal, then a peak search is immediately performed.

Key Path:	Front panel key
Mode:	WCDMA, C2K, WIMAX OFDMA, TD-SCDMA, 1xEVDO, LTE, LTETDD, BLUETOOTH, WLAN
Remote Command:	:CALCulate:OBWidth:MARKer [1] 2 3 4 5 6 7 8 9 10 11 12 :M AXimum
Example:	CALC:OBW:MARK2:MAX
Initial S/W Revision:	Prior to A.02.00
Modified at S/W Revision:	A.03.00

Recall

See [“Recall” on page 192](#) for more information.

Key Path:	Front-panel key
Initial S/W Revision:	Prior to A.02.00

Restart

See “Restart” on page 1125 for more information.

Key Path:	Front-panel key
Initial S/W Revision:	Prior to A.02.00

Save

See [“Save” on page 204](#) for more information.

Key Path:	Front-panel key
Initial S/W Revision:	Prior to A.02.00

Data

See [“Data \(Export\)” on page 213](#) for more information.

Key Path:	Front-panel key
-----------	------------------------

Measurement Results

Pressing this key selects Meas Results as the data type to be exported.

The Meas Results file contains measurement result sets, plus information describing the current state of the analyzer, as detailed in [“Meas Results File Definition” on page 627](#) and [“Meas Results File Example” on page 629](#) below.

Key Path:	Save, Data
Remote Command:	:MMEMory:STORe:RESults <string>
Example:	:MMEM:STOR:RES “MeasR_0000.csv”
Notes:	<p>If the save is initiated via SCPI and the file already exists, the file will be overwritten.</p> <p>The SCPI command exports Occupied Bandwidth measurement results to the file specified as the parameter in the current path. The default path is My Documents\<current mode>\data\OBW\results.</p> <p>Using the C: drive is strongly discouraged, since it runs the risk of being overwritten during an instrument software upgrade.</p> <p>The SCPI parameter is a quoted string that specifies the filename. Both single and double quotes are supported for any filename parameter over SCPI.</p>
Dependencies:	The current active measurement must be the Occupied Bandwidth measurement to use this command.
Status Bits/OPC dependencies:	Sequential – waits for the previous measurement to complete
Initial S/W Revision:	Prior to A.02.00

Meas Results File Definition

The content of a Meas Results File is defined in this section.

The first lines in the file consist of identification and instrument configuration details, as follows.

Occupied Bandwidth Measurement

Save

File ID string, which is “MeasResult”

Measurement ID following Mode ID, which is “SA:OBW” for example.

Firmware rev and model number

Option string

Auto Sweep Time Rules

Average Mode

Average Number

Average State

Center Frequency

Detector

IFGain

IFGainAuto

Internal Preamp

Internal Preamp Band

Limit

Limit State

Max Hold

OBW Percent Pwr

Resolution Band Width

Resolution Bandwidth Shape

Span

Sweep Points

Sweep Time

Sweep Time Auto

TriggerSource

Video Bandwidth

x DB

The data above is followed in the file by a line containing “MeasResult1” and “MeasResult2”. This line forms a header for each set of measurement results, which appear in subsequent lines. Each line of Measurement Results consists of two comma-separated values, for MeasResult1 and MeasResult2 respectively.

The MeasResult1 set in the file corresponds to the data returned by MEAS|READ|FETCh:OBWidth1, and the MeasResult2 set corresponds to the data returned by MEAS|READ|FETCh:OBWidth2.

The exported file is in CSV format, with a .csv extension.

Meas Results File Example

When imported into Microsoft Excel, a typical Meas Results CSV file appears as shown in the example below.

MeasResult	
SA:OBW	
A.10.53	N9030A
B25 B40	1
Auto Sweep Time Rules	Normal
Average Mode	Exponential
Average Number	10
Average State	TRUE
Center Frequency	1.33E+10
Detector	Average
IFGain	FALSE
IFGainAuto	FALSE
Internal Preamp	FALSE
Internal Preamp Band	Low
Limit	5000000
Limit State	FALSE
Max Hold	FALSE
OBW Percent Pwr	99
Resolution Band Width	27000
Resolution Bandwidth Shape	Gaussian
Span	3000000
Sweep Points	1001
Sweep Time	0.004933
Sweep Time Auto	TRUE
TriggerSource	Free
Video Bandwidth	270000
x DB	-26

Occupied Bandwidth Measurement
Save

MeasResult1	MeasResult2
2971020.10835045	-94.3702543927405
-74.9741251886604	-94.1447790390963

Single

See “[Single \(Single Measurement/Sweep\)](#)” on page 1135 for more information.

Key Path:	Front-panel key
Initial S/W Revision:	Prior to A.02.00

Source (Internal)

Operation of this key is identical across all measurements. For details about this key, see “[Source \(Internal\)](#)” on page 1137.

Key Path:	Front-panel key
Initial S/W Revision:	Prior to A.02.00

Span X Scale

Activates the Span function and displays the menu of span functions. The parameter values are measurement independent.

Key Path:	Front-panel key
Initial S/W Revision:	Prior to A.02.00

Span

Set the frequency of the occupied bandwidth span for the current measurement.

Key Path:	Span X Scale
Mode:	WCDMA, C2K, WIMAX OFDMA, TD-SCDMA, 1xEVDO, LTE, LTETDD, BLUETOOTH, WLAN
Remote Command:	[:SENSE] :OBWidth:FREQUENCY:SPAN <freq> [:SENSE] :OBWidth:FREQUENCY:SPAN?
Example:	OBW:FREQ:SPAN 2.4 MHz OBW:FREQ:SPAN?
Preset:	WCDMA: 10 MHz WIMAX OFDMA: 20 MHz CDMA2K: 2 MHz TD-SCDMA: 4.8 MHz 1xEVDO: 3.75 MHz LTE, LTETDD: 10 MHz BLUETOOTH:2 MHz WLAN: If Radio Std is 802.11a/g 802.11n(20MHz) 802.11ac(20MHz): 25 MHz If Radio Std is 802.11b: 30MHz If Radio Std is 802.11n(40MHz), 802.11ac (40MHz): 50 MHz If Radio Std is 802.11ac(80MHz): 100MHz If Radio Std is 802.11ac(160MHz): 200MHz ON
State Saved:	Saved in instrument state.
Min:	100 Hz

Occupied Bandwidth Measurement
Span X Scale

Max:	Hardware Dependent: Option 503 = 3.7 GHz Option 504 = 3.9 GHz
Backwards Compatibility SCPI:	[:SENSe]:EBWidth:FREQuency:SPAN
Initial S/W Revision:	Prior to A.02.00
Modified at S/W Revision:	A.03.00, A.10.00

Full Span

Changes the Occupied Bandwidth Span to show the full frequency range of the analyzer. When using external mixing, it changes the displayed frequency span to the frequency range specified for the selected external mixing band.

Key Path:	Span X Scale
Mode:	WCDMA, C2K, WIMAX OFDMA, TD-SCDMA, 1xEVDO, LTE, LTETDD, BLUETOOTH, WLAN
Remote Command:	[:SENSe] :OBWidth :FREQuency :SPAN :FULL
Example:	OBW:FREQ:SPAN:FULL
Notes:	You must be in the W-CDMA mode, cdma2000 mode, TD-SCDMA mode, BLUETOOTH mode, LTE mode, LTE TDD mode, WLAN mode, 1xEVDO mode, or WIMAX OFDMA mode to use this command. Use:INSTrument:SElect to set the mode.
Couplings:	Selecting full span changes the measurement span value.
Initial S/W Revision:	Prior to A.02.00
Modified at S/W Revision:	A.03.00

Last Span

Changes the measurement frequency span to previous measurement span setting. If there is no existing previous span value then the span remains unchanged.

Key Path:	Span X Scale
Mode:	WCDMA, C2K, WIMAX OFDMA, TD-SCDMA, 1xEVDO, LTE, LTETDD, BLUETOOTH, WLAN
Remote Command:	[:SENSe] :OBWidth :FREQuency :SPAN :PREVIOUS
Example:	OBW:FREQ:SPAN:PREV
Notes:	You must be in the W-CDMA mode, cdma2000 mode, TD-SCDMA mode, BLUETOOTH mode, LTE mode, LTE TDD mode, WLAN mode, 1xEVDO mode, or WIMAX OFDMA mode to use this command. Use:INSTrument:SElect to set the mode.

Couplings:	Selecting last span changes the measurement span value.
Initial S/W Revision:	Prior to A.02.00
Modified at S/W Revision:	A.03.00

Sweep/Control

Displays a menu of functions that enable you to set up and control the sweep time and source for the current measurement.

For details about this key, see “Sweep/Control” on page 1267.

Key Path:	Front-panel key
Initial S/W Revision:	Prior to A.02.00

Sweep Time

Selects the length of time in which the spectrum analyzer sweeps the displayed frequency span. Additional overhead time, which impacts the sweep rate, is not calculated as part of the sweep time. In fact:

- sweep rate = span/sweep time
- update rate = 1/(sweep time + overhead)
- sweep cycle time = sweep time + overhead

Sweep time is coupled to RBW and VBW, and is impacted by the number of sweep points, so changing those parameters may change the sweep time.

This function is not available when the selected input is I/Q.

Key Path:	Sweep/Control
Mode:	WCDMA, C2K, WIMAX OFDMA, TD-SCDMA, 1xEVDO, LTE, LTETDD, BLUETOOTH, WLAN
Remote Command:	[:SENSE] :OBwidth:SWEep:TIME <time> [:SENSE] :OBwidth:SWEep:TIME? [:SENSE] :OBwidth:SWEep:TIME:AUTO OFF ON 0 1 [:SENSE] :OBwidth:SWEep:TIME:AUTO?
Example:	OBW:SWE:TIME 50 ms OBW:SWE:TIME? OBW:SWE:TIME:AUTO ON OBW:SWE:TIME:AUTO?
Couplings:	When you manually change the Sweep Time, this state automatically goes to ‘Man’.

Preset:	WIMAX OFDMA, C2K, TD-SCDMA, 1xEVDO, LTE, LTETDD, BLUETOOTH, WLAN: Automatically Calculated WCDMA: 32.6 ms WIMAX OFDMA, C2K, TD-SCDMA, 1xEVDO, LTE, LTETDD, WLAN: ON WCDMA: OFF
State Saved:	Saved in instrument state.
Min:	1 ms
Max:	4000 s
Initial S/W Revision:	Prior to A.02.00
Modified at S/W Revision:	A.03.00

Sweep Setup

Accesses the sweep setup settings for the current measurement.

Key Path:	Sweep/Control
Initial S/W Revision:	Prior to A.02.00

Auto Sweep Time Rules

Switches the analyzer between normal and accuracy sweep states.

Setting Auto Sweep Time to Accy results in slower sweep times, usually about three times as long, but better amplitude accuracy for CW signals. The instrument amplitude accuracy specifications only apply when Auto Sweep Time is set to Accy.

Additional amplitude errors which occur when Auto Sweep Time is set to Norm are usually well under 0.1 dB, though this is not guaranteed. Because of the faster sweep times and still low errors, Norm is the preferred setting of Auto Sweep Time. Auto Sweep Time is set to Norm on a Preset or Auto Couple. This means that in the Preset or Auto Coupled state, instrument amplitude accuracy specifications do not apply.

Key Path:	Sweep/Control, Sweep Setup
Mode:	WCDMA, C2K, WIMAX OFDMA, TD-SCDMA, 1xEVDO, LTE, LTETDD, BLUETOOTH, WLAN
Remote Command:	[:SENSE] :OBWidth :SWEep :TIME :AUTO :RULes NORMal ACCuracy [:SENSE] :OBWidth :SWEep :TIME :AUTO :RULes?
Example:	OBW:SWE:TIME:AUTO:RUL NORM OBW:SWE:TIME:AUTO:RUL?
Notes:	Set to Norm when Auto Couple is pressed or sent remotely.

Occupied Bandwidth Measurement
Sweep/Control

Preset:	NORMal
State Saved:	Saved in instrument state.
Range:	Norm Accy
Initial S/W Revision:	Prior to A.02.00
Modified at S/W Revision:	A.03.00

Pause

Pauses the measurement after the current data acquisition is complete.

When Paused, the label on the key changes to **Resume**. Pressing **Resume** resumes the measurement at the point where it had been paused.

See “[Pause/Resume](#)” on page 1279 for more information.

Key Path:	Sweep/Control
Initial S/W Revision:	Prior to A.02.00

Gate

Accesses a menu that enables you to control the gating function.

The Gate functionality is used to view signals best viewed by qualifying them with other events.

This function is not available when the selected input is I/Q.

See “[Gate](#) ” on page 1280 for more information.

Key Path:	Sweep/Control
Initial S/W Revision:	Prior to A.02.00

Points

Sets the number of points per sweep. The resolution of setting the sweep time depends on the number of points selected. The current value of points is displayed parenthetically, next to the sweep time in the lower-right corner of the display.

Key Path:	Sweep/Control
Mode:	WCDMA, C2K, WIMAX OFDMA, TD-SCDMA, 1xEVDO, LTE, LTETDD, BLUETOOTH, WLAN
Remote Command:	[:SENSe] :OBWidth:SWEEp:POINTs <integer> [:SENSe] :OBWidth:SWEEp:POINTs?

Example:	OBW:SWE:POIN 1500 OBW:SWE:POIN?
Notes:	<p>This function is not available when signal identification is set to On (external mixing).</p> <p>Affected by:</p> <p>log sweep</p> <p>Grayed out in measurements that don't support swept</p> <p>Blanked in modes that do not support swept.</p> <p>Whenever the number of sweep points change:</p> <ul style="list-style-type: none"> - All trace data is erased - Any traces with Update Off also go to Display Off (like going from View to Blank in the older analyzers) - Sweep time is re-quantized - Any limit lines that are on are updated - If averaging/hold is on, averaging/hold starts over
Couplings:	Whenever the number of sweep points change, the sweep time is re-quantized.
Preset:	LTE, LTETDD: 2001 Other: 1001
State Saved:	Saved in instrument state.
Min:	101
Max:	20001
Initial S/W Revision:	Prior to A.02.00
Modified at S/W Revision:	A.03.00

Trace/Detector

Accesses a menu of functions that enable you to control the detectors for the current measurement.

Key Path:	Front-panel key
Initial S/W Revision:	Prior to A.02.00

Trace Type

Allows you to select the type of trace you want to you use for the current measurement.

The first page of this menu contains a 1-of-N selection of the trace type (Clear Write, Average, Max Hold, Min Hold) for the selected trace.

Key Path:	Trace/Detector
Mode:	WCDMA, C2K, WIMAX OFDMA, TD-SCDMA, 1xEVDO, LTE, LTETDD, BLUETOOTH, WLAN
Remote Command:	:TRACe:OBWidth:TYPE WRITe AVERAge MAXHold MINHold :TRACe:OBWidth:TYPE?
Example:	TRAC:OBW:TYPE MINH TRAC:OBW:TYPE?
Notes:	WRITe = Clear Write AVERAge = Average MAXHold = Maximum Hold MINHold = Minimum Hold
Couplings:	When Detector setting is “Auto” ([:SENSe]:OBWidth:DETEctor:AUTO?), Detector ([:SENSe]:OBWidth:DETEctor[:FUNction]?) switches aligning with the switch of this parameter: “NORMal” with WRITe (Clear Write), “AVERAge” with AVERAge, “POSitive (peak)” with MAXHold, and “NEGative (peak)” with MINHold.
Preset:	AVERAge BLUETOOTH: MAX HOLD.
State Saved:	Saved in instrument state.
Range:	WRITe AVERAge MAXHold MINHold
Initial S/W Revision:	Prior to A.02.00
Modified at S/W Revision:	A.03.00

Detector

Accesses a menu of functions that enables you to control the detectors for the current measurement. The following choices are available:

- **Auto**- the detector selected depends on marker functions, trace functions, average type, and the trace averaging function.
- **Normal**-the detector determines the peak of the CW-like signals, and it yields alternating maximums and minimums of noise-like signals. This is also referred to as Rosenfell detection.
- **Average**-the detector determines the average of the signal within the sweep points. The averaging method depends upon the Average Type selection (voltage, power or log scales).
- **Peak (Positive)**-the detector determines the maximum of the signal within the sweep points.
- **Sample**-the detector indicates the instantaneous level of the signal at the center of the sweep points represented by each display point.
- **Negative Peak**-the detector determines the minimum of the signal within the sweep points.

Key Path:	Detector
Initial S/W Revision:	Prior to A.02.00

Detector Selection

Allows you to select a specific detector for the current measurement. When the detector choice is Auto, the analyzer selects the detector. The selected detector depends on marker functions, trace functions, and trace averaging functions for the current measurement.

Key Path:	Trace/Detector
Mode:	WCDMA, C2K, WIMAX OFDMA, TD-SCDMA, 1xEVDO, LTE, LTETDD, BLUETOOTH, WLAN
Remote Command:	[:SENSE] :OBWidth:DETECTOR [:FUNCTION] NORMAL AVERAGE POSITIVE SAMPLE NEGATIVE [:SENSE] :OBWidth:DETECTOR [:FUNCTION] ?
Example:	OBW:DET NORM OBW:DET?

Notes:	<p>When you manually select a detector (instead of selecting Auto), that detector is used regardless of other analyzer settings.</p> <p>The detector choices are:</p> <p>The Normal detector determines the peak of CW-like signals, and it yields alternating maximums and minimums of noise-like signals. This is also referred to as Rosenfell detection.</p> <p>The Average detector determines the average of the signal within the sweep points. The averaging method is Power Average (RMS).</p> <p>The Peak detector determines the maximum of the signal within the sweep points.</p> <p>The Sample detector indicates the instantaneous level of the signal at the center of the sweep points represented by each display point.</p> <p>The Negative Peak detector determines the minimum of the signal within the sweep points.</p>
Couplings:	When Detector setting is “Auto” (:SENSe]:OBWidth:DETEctor:AUTO?), Detector (:SENSe]:OBWidth:DETEctor[:FUNctio]?) switches aligning with the switch of this parameter: “NORMal” with Clear Write, “AVERage” with AVERage, “POSitive (peak)” with MAXHold, and “NEGative (peak)” with MINHold.
Preset:	AVERage BLUETOOTH: Peak
State Saved:	Saved in instrument state.
Range:	Normal Average Peak Sample Negative Peak
Initial S/W Revision:	Prior to A.02.00
Modified at S/W Revision:	A.03.00

Auto

When the detector choice is Auto, the analyzer selects the detector. The selected detector depends on marker functions, trace functions, and trace averaging functions for the current measurement.

Key Path:	Trace/Detector
Remote Command:	[:SENSe]:OBWidth:DETEctor:AUTO ON OFF 1 0 [:SENSe]:OBWidth:DETEctor:AUTO?
Example:	OBW:DET:AUTO ON OBW:DET:AUTO?
Couplings:	When Detector setting is “Auto” (:SENSe]:OBWidth:DETEctor:AUTO?), Detector (:SENSe]:OBWidth:DETEctor[:FUNctio]?) switches aligning with the switch of this parameter: “NORMal” with Clear Write, “AVERage” with AVERage, “POSitive (peak)” with MAXHold, and “NEGative (peak)” with MINHold.

Preset:	ON
State Saved:	Saved in instrument state.
Initial S/W Revision:	Prior to A.02.00
Modified at S/W Revision:	A.03.00

Trigger

See “[Trigger](#)” on page 1339 for information about all keys in this menu.

Key Path:	Front-panel key
Initial S/W Revision:	Prior to A.02.00

View/Display

Accesses a menu of functions that enable you to set the view and display parameters for the current measurement.

There is a single results view available for this measurement. For more details, and samples of screen content for each supported mode, see “[Spectrum View](#)” on page 645 below.

The following result descriptions are available:

Occupied Bandwidth

The occupied bandwidth result is $f_2 - f_1$, where f_1 and f_2 are calculated.

Total Power

The total power is the power integrated in the specified span setting.

Transmit Freq Error

The transmit freq error (transmit frequency error) result is calculated as the difference between $(f_2+f_1)/2$ and the tuned center frequency of the signal, where f_1 and f_2 are calculated.

x dB Bandwidth

The x dB result is a bandwidth measured between two points on the signal which are a certain number of dBs down from the highest signal point within the OBW Span. For example, If the ‘x dB’ parameter is set to -26 dB, and the ‘Occupied BW Span’ is set to 10 MHz, then the maximum signal power level is first determined from the 10 MHz wide trace sweep. Next, the two furthest frequencies below (xdb_f_1) and above (xdb_f_2) the frequency of the maximum level occurrence are found where the signal level is 26 dB below the peak level. This calculation also uses linear interpolation to find the lower and upper carrier boundary point within the width of a sweep point (the span divided by the number of sweep points).

The x dB bandwidth is calculated to be $xdb_f_2 - xdb_f_1$.

Spectrum View

NOTE	An asterisk next to the x dB bandwidth value indicates the results may not have been determined with optimal analyzer settings. If this result (emission bandwidth) is your primary interest, select Meas Setup, Max Hold, On. Then, change the detector mode to Peak. Acquiring peak data ensures accuracy of the result.
-------------	--

For WCDMA, C2K, 1xEVDO, WIMAX OFDMA, WLAN modes:

Occupied Bandwidth Measurement
View/Display

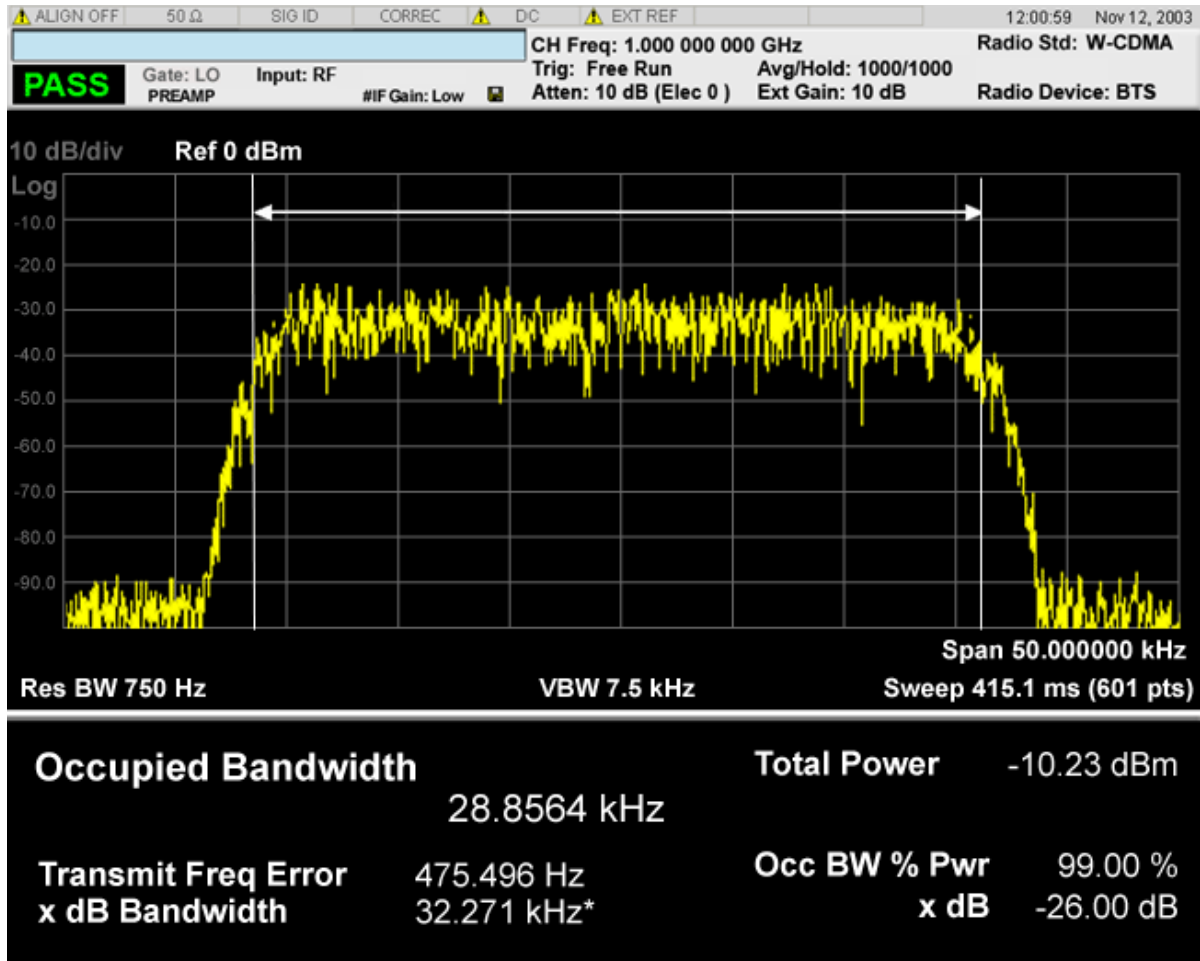

For TD-SCDMA mode only:

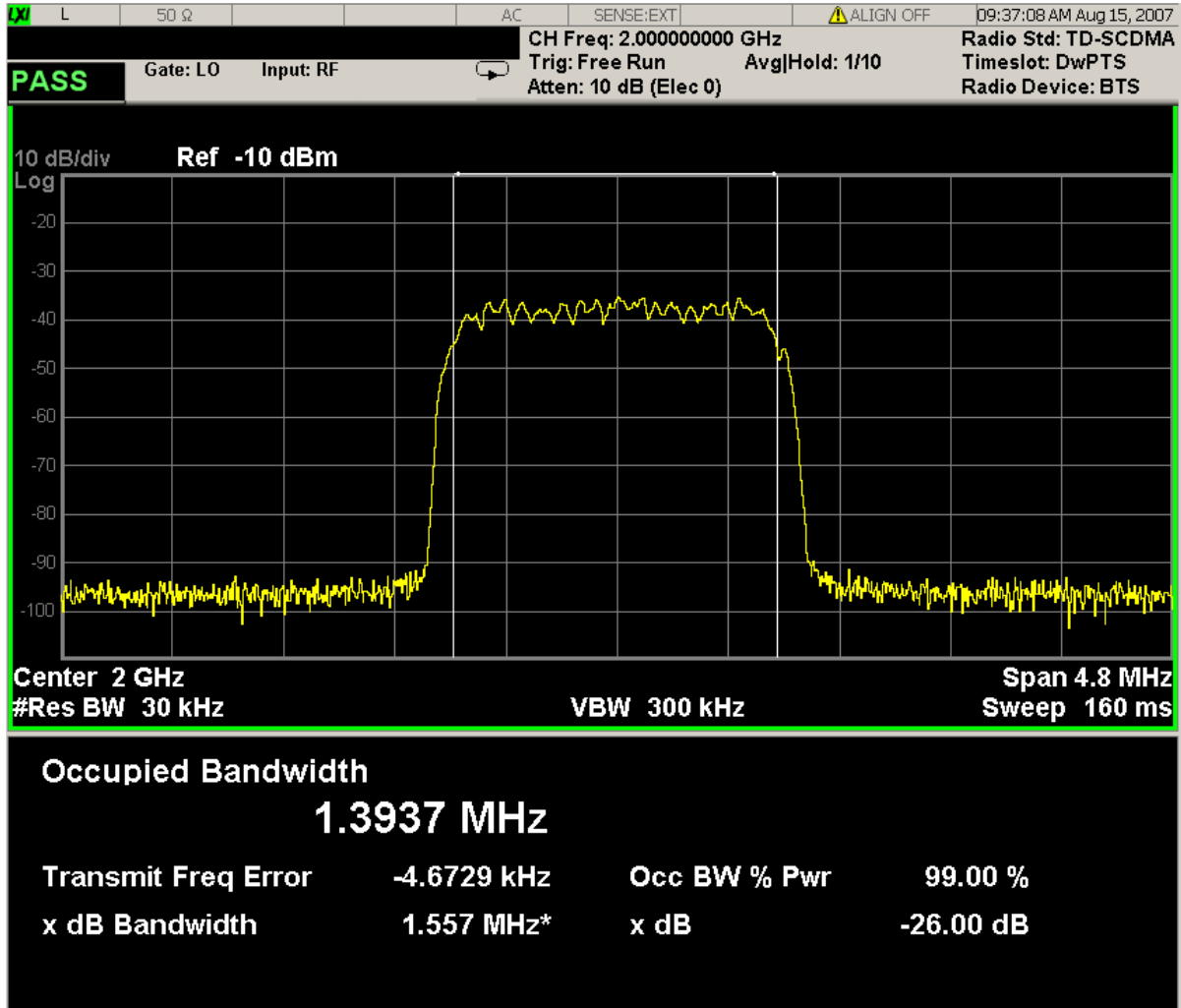

For Bluetooth mode only:

Occupied Bandwidth Measurement
View/Display

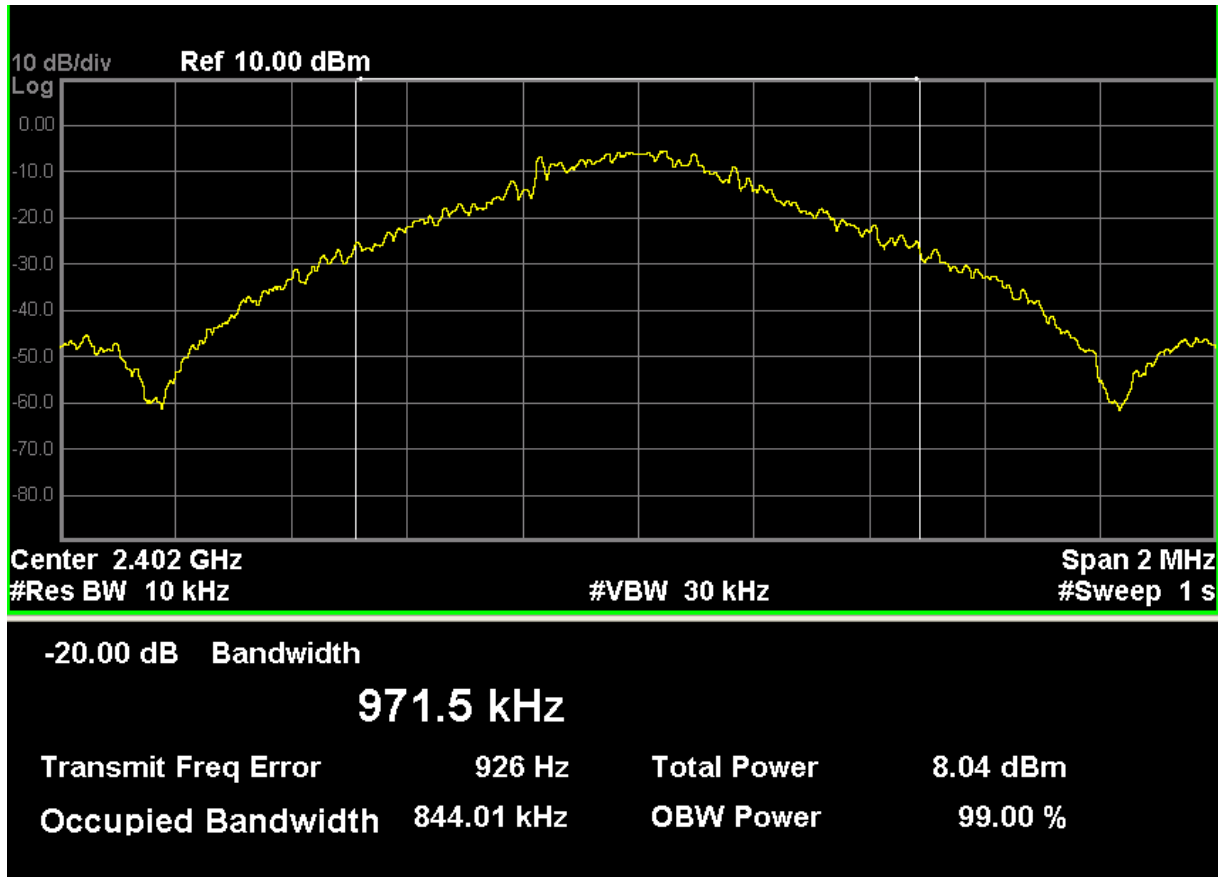

The number of active carriers is displayed. Since span is determined from detected carriers in auto mode, it is necessary to show how many carriers are identified as active., as highlighted above.

When there is one active carrier, Transmit Freq Error is displayed. Otherwise, “---“ is displayed, as shown above.

Key Path:	Front-panel key
Initial S/W Revision:	Prior to A.02.00

Display

Accesses a menu of functions that enable you to set the display parameters.

See “Display” on page 1393 for more information.

Key Path:	View/Display
Initial S/W Revision:	Prior to A.02.00

The code domain measurement displays the power for each of the de-spread channels, relative to the total power within the 1.230 MHz channel bandwidth centered at the center frequency. Each de-spread channel level is displayed as an individual vertical bar with a different width determined by a spread rate. This allows a comparison of signal levels between the Pilot and Traffic channels.

If Device is set as MS, the demodulated I and Q signals are individually shown in the code domain power graph window. Depending on the test equipment for MS, it is recommended that you use the trigger output signal from the instrument for synchronization.

Key Path	Front-panel key
----------	-----------------

Measurement Results

This measures the power levels of the spread channels in RF channel(s). You must be in the cdma2000 to use these commands. Use INSTRUMENT:SELEct to set the mode.

The general functionality of CONFigure, FETCh, MEASure, and READ are described at the beginning of this section. See the SENSE:CDPower commands for more measurement related commands.

:CONFigure:CDPower

:INITiate:CDPower

:FETCh:CDPower [n] ?

:READ:CDPower [n] ?

:MEASure:CDPower [n] ?

Index: n	Results Returned
0	Returns unprocessed I/Q trace data, as a series of comma-separated trace points, in volts. The I values are listed first in each pair, using the 0 through even-indexed values. The Q values are the odd-indexed values.

<p>not specified or n = 1</p>	<p>Returns the following 19 comma-separated scalar results:</p> <p style="text-align: center;">Result Name: (type of number) [unit] <explanation></p> <ol style="list-style-type: none"> 1. RMS symbol EVM: (floating) [percent] The dispreading RMS symbol EVM of the selected code (Walsh code length and code number) over the selected measurement period by Meas Offset and Meas Interval. 2. Peak symbol EVM: (floating) [percent] The dispreading peak symbol EVM of the selected code (Walsh code length and code number) over the selected measurement period by Meas Offset and Meas Interval. 3. Symbol magnitude error: (floating) [percent] The RMS-averaged magnitude error of symbol I/Q Polar Vector of the selected code over the selected measurement period by Meas Offset and Meas Interval. 4. Symbol phase error: (floating) [degree] The RMS-averaged Phase error of symbol I/Q Polar Vector of the selected code over the selected measurement period by Meas Offset and Meas Interval. 5. Total Power: (floating) [dBm] The total RF power over the selected measurement period by Meas Offset and Meas Interval. 6. Channel Power: (floating) [dBc or dBm] The absolute or relative (relative to Total Power) power of the selected code over the measurement period selected by Meas Offset and Meas Interval. 7. Total active power: (floating) [dBc or dBm] The sum of the active code channel powers over one PCG specified by Meas Offset. 8. Pilot power: (floating) [dBc or dBm] The average power of the pilot code (absolute or relative to Total Power) over one PCG specified by Meas Offset. 9. Sync power: (floating) [dBc or dBm] The average power of the pilot code (absolute or relative to Total Power) one PCG specified by Meas Offset. In MS mode, the value returned is -999.0. 10. Maximum active traffic power: (floating) [dBc or dBm] The maximum power of active code (absolute or relative to Total Power) over one PCG specified by Meas Offset. If no active codes are detected, the value returned is -999.0. In MS mode, the value returned is -999.0. 11. Average active traffic power: (floating) [dBc or dBm]
-----------------------------------	---

not specified or n = 1	<p>The average power of active code (absolute or relative to Total Power) over one PCG specified by Meas Offset.</p> <p>If no active codes are detected, the value returned is –999.0.</p> <p>In MS mode, the value returned is –999.0.</p> <p>12. Maximum inactive traffic power: (floating) [dBc or dBm]</p> <p>The maximum power of inactive code (absolute or relative to Total Power) over one PCG specified by Meas Offset.</p> <p>In MS mode, the value returned is –999.0.</p> <p>13. Average inactive traffic power: (floating) [dBc or dBm]</p> <p>The average power of inactive code (absolute or relative to Total Power) over one PCG specified by Meas Offset.</p> <p>In MS mode, the value returned is –999.0.</p> <p>14. Number of active channels: (integer) [no unit]</p> <p>The total number of active codes.</p> <p>In MS mode, the value returned is –999.</p> <p>15. I channel average active power: (floating) [dBc or dBm]</p> <p>The average power of the active I channels (absolute or relative to Total Power).</p> <p>If no active codes are detected, the value returned is –999.0.</p> <p>In BTS mode, the value returned is –999.0.</p> <p>16. I channel maximum inactive power: (floating) [dBc or dBm]</p> <p>The maximum power of the inactive I channels (absolute or relative to Total Power).</p> <p>In BTS mode, the value returned is –999.0</p> <p>17. Q channel average active power: (floating) [dBc or dBm]</p> <p>The average power of the active Q channels (absolute or relative to Total Power).</p> <p>If no active codes are detected, the value returned is –999.0.</p> <p>In BTS mode, the value returned is –999.0.</p> <p>18. Q channel maximum inactive: (floating) [dBc or dBm]</p> <p>The maximum power of the inactive Q channels (absolute or relative to Total Power).</p> <p>In BTS mode, the value returned is –999.0</p> <p>19. Time between trigger to PN offset: (floating) [Éps]</p> <p>The time from the trigger point to the PN offset.</p> <p>In the MS mode, the valued returned is –999.0.</p>
---------------------------	---

<p>2</p> <p><CDPower></p>	<p>Code Domain Power:</p> <p>Returns series of floating point numbers (in dB or dBm depend on the Meas Type) that represent all code domain powers.</p> <p>In BTS mode, there are 64 or 128 numbers depending on CALCulate:CDPower:WCODE:BASE</p> <p>1st number = 1st code power over one PCG specified by Meas Offset. 2nd number = 2nd code power over one PCG specified by Meas Offset. Nth number = Nth code power over one PCG specified by Meas Offset</p> <p>In MS Mode, there are total 32 IQ pairs. I and Q results are returned alternatively.If the active channel occupies more than max spreading factor, the power is duplicated.</p> <p>1st number = 1st In Phase code power over one PCG specified by Meas Offset. 2nd number = 1st Quad Phase code power over one PCG specified by Meas Offset. (2xN-1)th number = Nth In Phase code power over one PCG specified by Meas Offset. (2xN)th number = Nth Quad Phase code power over one PCG specified by Meas Offset. N = the number of codes detected. The total number of codes varies because of the different symbol rates of each code.</p>
<p>3</p>	<p>Symbol Rate:</p> <p>Returns series of floating point numbers (in symbol rate) that represent all code domain symbol rate. When In BTS Mode, total is 64 or 128 depending on CALCulate:CDPower:WCODE:BASE.</p> <p>1st number = 1st code symbol rate over one PCG specified by Meas Offset. 2nd number = 2nd code symbol rate over one PCG specified by Meas Offset. Nth number = Nth code symbol rate over one PCG specified by Meas Offset.</p> <p>In MS Mode, I and Q results are returned alternatively. Total IQ pairs are 32. If the active channel occupies more than max spreading factor, the Symbol rate is duplicated</p> <p>1st number = 1st In Phase code symbol rate over one PCG specified by Meas Offset. 2nd number = 1st Quad Phase code symbol rate one PCG specified by Meas Offset. (2xN-1)th number = Nth In Phase code symbol rate over one PCG specified by Meas Offset. (2xN)th number = Nth Quad Phase code symbol rate over one PCG specified by Meas Offset.</p>

4	<p>Active Status:</p> <p>Returns series of floating point numbers that show either active or inactive of each code returned in n=2 and 3. When the code is inactive, the result is 0.0, otherwise more than 0.0</p> <p>In BTS mode, IQ combined results are returned.</p> <p>1st number = Active or inactive flag of the 1st code.</p> <p>....</p> <p>Nth number = Active or inactive flag of the Nth code.</p> <p>In MS mode, I and Q results are returned alternatively.</p> <p>1st number = 1st In Phase code active flag.</p> <p>2nd number = 1st Quad Phase code active flag.</p> <p>....</p> <p>(2xN-1)th number = Nth In Phase code active flag</p> <p>(2xN)th number = Nth Quad Phase code active flag</p>
5 <EVM>	<p>Symbol EVM:</p> <p>Returns series of floating point numbers (in percent) that represent each sample in the EVM trace. The first number is the symbol 0 decision point. There are X points per symbol (X=points/chip). Therefore, the decision points are at 0, 1*X, 2*X, ...</p>
6 <MERRor>	<p>Symbol Magnitude error:</p> <p>Returns series of floating point numbers (in percent) that represent each sample in the magnitude error trace. The first number is the symbol 0 decision point. There are X points per symbol (X=points/chip). Therefore, the decision points are at 0, 1*X, 2*X, ...</p>
7 <PERRor>	<p>Symbol Phase error:</p> <p>Returns series of floating point numbers (in percent) that represent each sample in the phase error trace. The first number is the symbol 0 decision point. There are X points per symbol (X=points/chip). Therefore, the decision points are at 0, 1*X, 2*X, ...</p>

8	<p>Corrected Measured Trace:</p> <p>Returns series of floating point numbers that alternately represent I and Q pairs of the corrected measured trace of the selected code channel. The magnitude of each I and Q pair is normalized to 1.0. The first number is the in-phase(I) sample of symbol 1 decision point and the second is the quadrature-phase(Q) sample of symbol 1 decision point. As in the EVM, there are X points per symbol, so that:</p> <p>1st number = I of the 1st symbol decision point 2nd number = Q of the 1st symbol decision point ... (2×X)+1 number = I of the 2nd symbol decision point (2×X)+2 number = Q of the 2nd symbol decision point ... (2×X) ×(N-1)+1 number = I of the Nth symbol decision point (2×X) ×(N-1)+2 number = Q of the Nth symbol decision point</p> <p>Where X = the number of points per symbol, and N = the number of symbols.</p>
9 <SPOWer>	<p>Symbol Power vs. Time:</p> <p>Returns series of floating point number (in dBm) that represent the trace data of the symbol power vs. time of the selected code channel.</p>
10 <CPOWer>	<p>Chip Power vs. Time:</p> <p>Returns series of floating point numbers (in dBm) that represent the entire trace data of Chip Chip vs. Time.</p>
11	<p>Demod Bits:</p> <p>Returns series of floating point numbers of symbol values for the selected code channel for the entire capture length.</p> <p>If a channel's spreading has been done on only I or Q branch, queried data represents the sequence of corresponding I or Q data.</p> <p>If a channel's spreading has been done on both I and Q branch and its modulation scheme is QPSK, queried data represents alternating I and Q sequences as follows:</p> <p>1st number = in-phase bit of the 1st I/Q pair 2nd number = quad-phase bit of the 1st I/Q pair 3rd number = in-phase bit of the 2nd I/Q pair 4th number = quad-phase bit of the 2nd I/Q pair (2×N-1) th number = in-phase bit of the Nth I/Q pair (2×N) th number = quad-phase bit of the Nth I/Q pair</p> <p>where N is the number of the symbols in the entire capture length.</p>

12	<p>Code Domain Error:</p> <p>Returns a series of floating point numbers (in dB or dBm) that represents all the code domain errors.</p> <p>In BTS mode, there are 64 or 128 numbers depending on Base Code Length.</p> <p>1st number = 1st code domain error over one PCG specified by Meas Offset</p> <p>2nd number = 2nd code domain error over one PCG specified by Meas Offset...</p> <p>N th number = N th code domain error over one PCG specified by Meas Offset</p> <p>In MS mode, there are 32 I/Q pairs.</p> <p>1st number = 1st in-phase code domain error over one PCG specified by Meas Offset</p> <p>2nd number = 1st quad-phase code domain error over one PCG specified by Meas Offset.</p> <p>...</p> <p>(2×N ñ1) number = N th in-phase code domain error over one PCG specified by Meas Offset.</p> <p>(2×N) number = N th quad-phase code domain error over one PCG specified by Meas Offset.</p>
----	--

AMPTD Y Scale

Accesses a menu of functions that enable you to set the desired vertical scale parameters for the current measurement.

Numbers and default numbers are independent for each window.

Metrics window and I/Q Symbol Polar Vector and Demod Bits window does not have this menu (Blank menu).

Key Path	Front-panel key
----------	-----------------

Y Ref Value

Set the value for the absolute power reference. However, since the Auto Scaling is defaulted to On, this value is automatically determined by the measurement result. When you set a value manually, Auto Scaling automatically changes to Off.

Key Path	AMPTD Y Scale
----------	---------------

Power Graph & Metrics View CDP Window Y Ref Value

Sets the absolute power reference value in the CDP window.

Mode	cdma2000
Remote Command	:DISPlay:CDPower:VIEW[1]:WINDow[1]:TRACe:Y[:SCALe] :RLEVel <real> :DISPlay:CDPower:VIEW[1]:WINDow[1]:TRACe:Y[:SCALe] :RLEVel?
Example	DISP:CDP:VIEW:WIND:TRAC:Y:RLEV -10.0 DISP:CDP:VIEW:WIND:TRAC:Y:RLEV?
Restriction and Notes	Unit is sensitive for Meas Type (Abs/Rel) as follows: Abs: dBm Rel: dB Target window to control depends on the SubOpCode.
Dependencies/Couplings	See Restriction and Notes
Remote Command Notes	Target window to control depends on the SubOpCode.
Preset	0.00
State Saved	Saved in instrument state.
Min	-250.0
Max	250.0

Key Path	AMPTD Y Scale
----------	----------------------

CDP Graph & CDE Graph View CDP Window Y Ref Value

Sets the absolute power reference value for Code Domain Power and Code Domain Error graph views in the CDP window.

Mode	cdma2000
Remote Command	:DISPlay:CDPower:VIEW2:WINDow[1]:TRACe:Y[:SCALe]:RLEVel <real> :DISPlay:CDPower:VIEW2:WINDow[1]:TRACe:Y[:SCALe]:RLEVel?
Example	DISP:CDP:VIEW2:WIND:TRAC:Y:RLEV -10.0 DISP:CDP:VIEW2:WIND:TRAC:Y:RLEV?
Restriction and Notes	Unit is sensitive for Meas Type (Abs/Rel) as follows: Abs: dBm Rel: dB Target window to control depends on the SubOpCode.
Dependencies/Couplings	See Restriction and Notes
Remote Command Notes	Target window to control depends on the SubOpCode.
Preset	0.00
State Saved	Saved in instrument state.
Min	-250.0
Max	250.0
Key Path	AMPTD Y Scale

CDP Graph & CDE Graph View CDE Window Y Ref Value

Sets the absolute power reference value for the Code Domain Power and Code Domain Error graph views in the CDE window.

Mode	cdma2000
Remote Command	:DISPlay:CDPower:VIEW2:WINDow2:TRACe:Y[:SCALe]:RLEVel <real> :DISPlay:CDPower:VIEW2:WINDow2:TRACe:Y[:SCALe]:RLEVel?
Example	DISP:CDP:VIEW2:WIND2:TRAC:Y:RLEV -10.0 DISP:CDP:VIEW2:WIND2:TRAC:Y:RLEV?

Code Domain
AMPTD Y Scale

Restriction and Notes	Unit is sensitive for Meas Type (Abs/Rel) as follows: Abs: dBm Rel: dB Target window to control depends on the SubOpCode.
Dependencies/Couplings	See Restriction and Notes
Remote Command Notes	Target window to control depends on the SubOpCode.
Preset	0.00
State Saved	Saved in instrument state.
Min	-250.0
Max	250.0
Key Path	AMPTD Y Scale

I/Q Error View Mag Error Window Y Ref Value

Sets the absolute power reference value for the magnitude error window in the I/Q Error view.

Mode	cdma2000
Remote Command	:DISPlay:CDPower:VIEW3:WINDow [1] :TRACe:Y[:SCALE]:R LEVel <real> :DISPlay:CDPower:VIEW3:WINDow [1] :TRACe:Y[:SCALE]:R LEVel?
Example	DISP:CDP:VIEW3:WIND:TRAC:Y:RLEV 0.0 DISP:CDP:VIEW3:WIND:TRAC:Y:RLEV?
Restriction and Notes	If the Auto Scaling is set to On, this value is automatically determined by the measurement result. When you set this value manually, Auto Scaling automatically changes to Off.
Dependencies/Couplings	See Restriction and Notes
Remote Command Notes	Target window to control depends on the SubOpCode.
Preset	0.00
State Saved	Saved in instrument state.
Min	-500
Max	500
Key Path	AMPTD Y Scale

I/Q Error View Phase Error Window Y Ref Value

Sets the absolute power reference value for the phase error window in the I/Q Error view.

Mode	cdma2000
Remote Command	:DISPlay:CDPower:VIEW3:WINDow2:TRACe:Y[:SCALe]:RLEVel <real> :DISPlay:CDPower:VIEW3:WINDow2:TRACe:Y[:SCALe]:RLEVel?
Example	DISP:CDP:VIEW3:WIND2:TRAC:Y:RLEV 1.0 DISP:CDP:VIEW3:WIND2:TRAC:Y:RLEV?
Restriction and Notes	If the Auto Scaling is set to On, this value is automatically determined by the measurement result. When you set this value manually, Auto Scaling automatically changes to Off.
Dependencies/Couplings	See Restriction and Notes
Remote Command Notes	Target window to control depends on the SubOpCode.
Preset	0.00
State Saved	Saved in instrument state.
Min	-360
Max	360
Key Path	AMPTD Y Scale

I/Q Error View EVM Window Y Ref Value

Sets the absolute power reference value for the EVM window in the I/Q Error view.

Mode	cdma2000
Remote Command	:DISPlay:CDPower:VIEW3:WINDow3:TRACe:Y[:SCALe]:RLEVel <real> :DISPlay:CDPower:VIEW3:WINDow3:TRACe:Y[:SCALe]:RLEVel?
Example	DISP:CDP:VIEW3:WIND3:TRAC:Y:RLEV 1.0 DISP:CDP:VIEW3:WIND3:TRAC:Y:RLEV?
Restriction and Notes	If the Auto Scaling is set to On, this value is automatically determined by the measurement result. When you set this value manually, Auto Scaling automatically changes to Off.
Dependencies/Couplings	See Restriction and Notes
Remote Command Notes	Target window to control depends on the SubOpCode.
Preset	0.00

Code Domain
AMPTD Y Scale

State Saved	Saved in instrument state.
Min	-500
Max	500
Key Path	AMPTD Y Scale

Code Domain View CDP Window Y Ref Value

Sets the absolute power reference value for the code domain power view in the CDP window.

Mode	cdma2000
Remote Command	:DISPlay:CDPower:VIEW4:WINDow[1]:TRACe:Y[:SCALe]:RLEVel <real> :DISPlay:CDPower:VIEW4:WINDow[1]:TRACe:Y[:SCALe]:RLEVel?
Example	DISP:CDP:VIEW4:WIND:TRAC:Y:RLEV 1.0 DISP:CDP:VIEW4:WIND:TRAC:Y:RLEV?
Restriction and Notes	Unit is sensitive for Meas Type (Abs/Rel) as follows: Abs: dBm Rel: dB Target window to control depends on the SubOpCode.
Dependencies/Couplings	See Restriction and Notes
Remote Command Notes	Target window to control depends on the SubOpCode.
Preset	0.00
State Saved	Saved in instrument state.
Min	-250.0
Max	250.0
Key Path	AMPTD Y Scale

Code Domain View Symb Power Window Y Ref Value

Sets the absolute power reference value for the symbol power window in the CDP view.

Mode	cdma2000
Remote Command	:DISPlay:CDPower:VIEW4:WINDow2:TRACe:Y[:SCALe]:RLEVel <real> :DISPlay:CDPower:VIEW4:WINDow2:TRACe:Y[:SCALe]:RLEVel?

Example	DISP:CDP:VIEW4:WIND2:TRAC:Y:RLEV 1.0 DISP:CDP:VIEW4:WIND2:TRAC:Y:RLEV?
Restriction and Notes	If the Auto Scaling is set to On, this value is automatically determined by the measurement result. When you set this value manually, Auto Scaling automatically changes to Off.
Dependencies/Couplings	See Restriction and Notes
Remote Command Notes	Target window to control depends on the SubOpCode.
Preset	0.00
State Saved	Saved in instrument state.
Min	-250.0
Max	250.0
Key Path	AMPTD Y Scale

Demod Bits View CDP Window Y Ref Value

Sets the absolute power reference value for the Demod Bits view in the CDP window.

Mode	cdma2000
Remote Command	:DISPlay:CDPower:VIEW5:WINDow[1]:TRACe:Y[:SCALe]:R LEVEl <real> :DISPlay:CDPower:VIEW5:WINDow[1]:TRACe:Y[:SCALe]:R LEVEl?
Example	DISP:CDP:VIEW5:WIND:TRAC:Y:RLEV 1.0 DISP:CDP:VIEW5:WIND:TRAC:Y:RLEV?
Restriction and Notes	Unit is sensitive for Meas Type (Abs/Rel) as follows: Abs: dBm Rel: dB Target window to control depends on the SubOpCode.
Dependencies/Couplings	See Restriction and Notes
Remote Command Notes	Target window to control depends on the SubOpCode.
Preset	0.00
State Saved	Saved in instrument state.
Min	-250.0
Max	250.0
Key Path	AMPTD Y Scale

Demod Bits View Symb Power Window Y Ref Value

Sets the absolute power reference value for the symbol power window of the Demod Bits view.

Mode	cdma2000
Remote Command	:DISPlay:CDPower:VIEW5:WINDow2:TRACe:Y[:SCALe]:RLEVel <real> :DISPlay:CDPower:VIEW5:WINDow2:TRACe:Y[:SCALe]:RLEVel?
Example	DISP:CDP:VIEW5:WIND2:TRAC:Y:RLEV 1.0 DISP:CDP:VIEW5:WIND2:TRAC:Y:RLEV?
Restriction and Notes	If the Auto Scaling is set to On, this value is automatically determined by the measurement result. When you set this value manually, Auto Scaling automatically changes to Off. Target window to control depends on the SubOpCode.
Dependencies/Couplings	See Restriction and Notes
Remote Command Notes	Target window to control depends on the SubOpCode.
Preset	0.00
State Saved	Saved in instrument state.
Min	-250.0
Max	250.0
Key Path	AMPTD Y Scale

Attenuation

Accesses a menu of functions that enable you to change the attenuation settings. This key has read-back text that describes the total attenuator value.

See [“Attenuation” on page 850](#) for more information.

Key Path	AMPTD Y Scale
----------	----------------------

Y Scale/Div

Sets the units per division of vertical scale in the logarithmic display. However, since the Auto Scaling is defaulted to On, this value is automatically determined by the measurement result. When you set a value manually, Auto Scaling automatically changes to Off.

Key Path	AMPTD Y Scale
----------	----------------------

Power Graph & Metrics View CDP Window Y Scale/Div

Sets the vertical display sensitivity measurement result in the Power Graph & Metrics window of the

CDP view.

Mode	cdma2000
Remote Command	:DISPlay:CDPower:VIEW [1] :WINDow [1] :TRACe:Y[:SCALe] :PDIVision <real> :DISPlay:CDPower:VIEW [1] :WINDow [1] :TRACe:Y[:SCALe] :PDIVision?
Example	DISP:CDP:VIEW:WIND:TRAC:Y:PDIV 5.0 DISP:CDP:VIEW:WIND:TRAC:Y:PDIV?
Restriction and Notes	Target window to control depends on the SubOpCode.
Remote Command Notes	Target window to control depends on the SubOpCode.
Preset	10.00
State Saved	Saved in instrument state.
Min	0.10
Max	20.00
Key Path	AMPTD Y Scale

CDP Graph & CDE Graph View CDP Window Y Scale/Div

Sets the vertical display sensitivity measurement result for Code Domain Power and Code Domain Error graph views in the CDP window.

Mode	cdma2000
Remote Command	:DISPlay:CDPower:VIEW2:WINDow [1] :TRACe:Y[:SCALe] :P DIVision <real> :DISPlay:CDPower:VIEW2:WINDow [1] :TRACe:Y[:SCALe] :P DIVision?
Example	DISP:CDP:VIEW2:WIND:TRAC:Y:PDIV 5.0 DISP:CDP:VIEW2:WIND:TRAC:Y:PDIV?
Restriction and Notes	Target window to control depends on the SubOpCode.
Remote Command Notes	Target window to control depends on the SubOpCode.
Preset	10.00
State Saved	Saved in instrument state.
Min	0.10
Max	20.00
Key Path	AMPTD Y Scale

CDP Graph & CDE Graph View CDE Window Y Scale/Div

Sets the vertical display sensitivity measurement result for Code Domain Power and Code Domain Error graph views in the CDE window.

Mode	cdma2000
Remote Command	:DISPlay:CDPower:VIEW2:WINDow2:TRACe:Y[:SCALe]:PDI Vision <real> :DISPlay:CDPower:VIEW2:WINDow2:TRACe:Y[:SCALe]:PDI Vision?
Example	DISP:CDP:VIEW2:WIND2:TRAC:Y:PDIV 5.0 DISP:CDP:VIEW2:WIND2:TRAC:Y:PDIV?
Restriction and Notes	Target window to control depends on the SubOpCode.
Remote Command Notes	Target window to control depends on the SubOpCode.
Preset	10.00
State Saved	Saved in instrument state.
Min	0.10
Max	20.00
Key Path	AMPTD Y Scale

I/Q Error View Mag Error Window Y Scale/Div

Sets the sensitivity measurement result for the magnitude error window in the I/Q Error view.

Mode	cdma2000
Remote Command	:DISPlay:CDPower:VIEW3:WINDow[1]:TRACe:Y[:SCALe]:P DIVision <real> :DISPlay:CDPower:VIEW3:WINDow[1]:TRACe:Y[:SCALe]:P DIVision?
Example	DISP:CDP:VIEW3:WIND:TRAC:Y:PDIV 5.0 DISP:CDP:VIEW3:WIND:TRAC:Y:PDIV?
Restriction and Notes	If the Auto Scaling is set to On, this value is automatically determined by the measurement result. When you set this value manually, Auto Scaling automatically changes to Off. Target window to control depends on the SubOpCode.
Dependencies/Couplings	See Restriction and Notes
Remote Command Notes	Target window to control depends on the SubOpCode.
Preset	0.2
State Saved	Saved in instrument state.

Min	0.100
Max	50.0
Key Path	AMPTD Y Scale

I/Q Error View Phase Error Window Y Scale/Div

Sets the sensitivity measurement result for the phase error window in the I/Q Error view.

Mode	cdma2000
Remote Command	:DISPlay:CDPower:VIEW3:WINDow2:TRACe:Y[:SCALe]:PDI Vision <real> :DISPlay:CDPower:VIEW3:WINDow2:TRACe:Y[:SCALe]:PDI Vision?
Example	DISP:CDP:VIEW3:WIND2:TRAC:Y:PDIV 5.0 DISP:CDP:VIEW3:WIND2:TRAC:Y:PDIV?
Restriction and Notes	If the Auto Scaling is set to On, this value is automatically determined by the measurement result. When you set this value manually, Auto Scaling automatically changes to Off. Target window to control depends on the SubOpCode.
Dependencies/Couplings	See Restriction and Notes
Remote Command Notes	Target window to control depends on the SubOpCode.
Preset	0.1
State Saved	Saved in instrument state.
Min	0.01
Max	360
Key Path	AMPTD Y Scale

I/Q Error View Evm Window Y Scale/Div

Sets the sensitivity measurement result for the EVM window in the I/Q Error view.

Mode	cdma2000
Remote Command	:DISPlay:CDPower:VIEW3:WINDow3:TRACe:Y[:SCALe]:PDI Vision <real> :DISPlay:CDPower:VIEW3:WINDow3:TRACe:Y[:SCALe]:PDI Vision?
Example	DISP:CDP:VIEW3:WIND3:TRAC:Y:PDIV 5.0 DISP:CDP:VIEW3:WIND3:TRAC:Y:PDIV?

Code Domain
AMPTD Y Scale

Restriction and Notes	If the Auto Scaling is set to On, this value is automatically determined by the measurement result. When you set this value manually, Auto Scaling automatically changes to Off. Target window to control depends on the SubOpCode.
Dependencies/Couplings	See Restriction and Notes
Remote Command Notes	Target window to control depends on the SubOpCode.
Preset	0.1
State Saved	Saved in instrument state.
Min	0.100
Max	50.0
Key Path	AMPTD Y Scale

Code Domain View CDP Window Y Scale/Div

Sets the sensitivity measurement result for the CDP window in the Code domain view.

Mode	cdma2000
Remote Command	:DISPlay:CDPower:VIEW4:WINDow [1] :TRACe:Y[:SCALe]:P DIVision <real> :DISPlay:CDPower:VIEW4:WINDow [1] :TRACe:Y[:SCALe]:P DIVision?
Example	DISP:CDP:VIEW4:WIND:TRAC:Y:PDIV 5.0 DISP:CDP:VIEW4:WIND:TRAC:Y:PDIV?
Restriction and Notes	Target window to control depends on the SubOpCode.
Remote Command Notes	Target window to control depends on the SubOpCode.
Preset	10.00
State Saved	Saved in instrument state.
Min	0.10
Max	20.00
Key Path	AMPTD Y Scale

Code Domain View Symbol Power Window Y Scale/Div

Sets the sensitivity measurement result for the symbol power window in the code domain view.

Mode	cdma2000
------	----------

Remote Command	:DISPlay:CDPower:VIEW4:WINDow2:TRACe:Y[:SCALe]:PDI Vision <real> :DISPlay:CDPower:VIEW4:WINDow2:TRACe:Y[:SCALe]:PDI Vision?
Example	DISP:CDP:VIEW4:WIND2:TRAC:Y:PDIV 5.0 DISP:CDP:VIEW4:WIND2:TRAC:Y:PDIV?
Restriction and Notes	If the Auto Scaling is set to On, this value is automatically determined by the measurement result. When you set this value manually, Auto Scaling automatically changes to Off. Target window to control depends on the SubOpCode.
Dependencies/Couplings	See Restriction and Notes
Remote Command Notes	Target window to control depends on the SubOpCode.
Preset	5
State Saved	Saved in instrument state.
Min	0.10
Max	20.00
Key Path	AMPTD Y Scale

Demod Bits View CDP Window Y Scale/Div

Sets the sensitivity measurement result for the CDP window of the Demod Bits view.

Mode	cdma2000
Remote Command	:DISPlay:CDPower:VIEW5:WINDow[1]:TRACe:Y[:SCALe]:P DIVision <real> :DISPlay:CDPower:VIEW5:WINDow[1]:TRACe:Y[:SCALe]:P DIVision?
Example	DISP:CDP:VIEW5:WIND:TRAC:Y:PDIV 5.0 DISP:CDP:VIEW5:WIND:TRAC:Y:PDIV?
Restriction and Notes	Target window to control depends on the SubOpCode.
Remote Command Notes	Target window to control depends on the SubOpCode.
Preset	10.00
State Saved	Saved in instrument state.
Min	0.10
Max	20.00
Key Path	AMPTD Y Scale

Demod Bits View Symbol Power Window Y Scale/Div

Sets the sensitivity measurement result for the symbol power window of demod bits view.

Mode	cdma2000
Remote Command	:DISPlay:CDPower:VIEW5:WINDow2:TRACe:Y[:SCALe]:PDI Vision <real> :DISPlay:CDPower:VIEW5:WINDow2:TRACe:Y[:SCALe]:PDI Vision?
Example	DISP:CDP:VIEW5:WIND2:TRAC:Y:PDIV 5.0 DISP:CDP:VIEW5:WIND2:TRAC:Y:PDIV?
Restriction and Notes	If the Auto Scaling is set to On, this value is automatically determined by the measurement result. When you set this value manually, Auto Scaling automatically changes to Off. Target window to control depends on the SubOpCode.
Dependencies/Couplings	See Restriction and Notes
Remote Command Notes	Target window to control depends on the SubOpCode.
Preset	5
State Saved	Saved in instrument state.
Min	0.10
Max	20.00
Key Path	AMPTD Y Scale

Internal Preamp

Accesses a menu of functions that enable you to control the internal preamplifiers.

See “[Internal Preamp](#)” on page 883 for more information.

Key Path	AMPTD Y Scale
----------	----------------------

Y Ref Position

Positions the Y-axis scale reference level at the top, center or bottom of the display. Changing the reference position does not change the reference level value.

Key Path	AMPTD Y Scale
----------	----------------------

I/Q Error View Mag Error Window Y Ref Position

Positions the Y-axis scale reference level at the top, center or bottom of the display in the magnitude

error window of the I/Q Error view.

Mode	cdma2000
Remote Command	:DISPlay:CDPower:VIEW3:WINDow[1]:TRACe:Y[:SCALe]:RPOSi tion TOP CENTer BOTTom :DISPlay:CDPower:VIEW3:WINDow[1]:TRACe:Y[:SCALe]:RPOSi tion?
Example	DISP:CDP:VIEW3:WIND:TRAC:Y:RPOS CENT DISP:CDP:VIEW3:WIND:TRAC:Y:RPOS?
Restriction and Notes	Target window to control depends on the SubOpCode.
Remote Command Notes	Target window to control depends on the SubOpCode.
Preset	CENTer
State Saved	Saved in instrument state.
Range	Top Ctr Bot
Key Path	AMPTD Y Scale

I/Q Error View Phase Error Window Y Ref Position

Positions the Y-axis scale reference level at the top, center or bottom of the display in the phase error window of the I/Q Error view.

Mode	cdma2000
Remote Command	:DISPlay:CDPower:VIEW3:WINDow2:TRACe:Y[:SCALe]:RPOSiti on TOP CENTer BOTTom :DISPlay:CDPower:VIEW3:WINDow2:TRACe:Y[:SCALe]:RPOSiti on?
Example	DISP:CDP:VIEW3:WIND2:TRAC:Y:RPOS CENT DISP:CDP:VIEW3:WIND2:TRAC:Y:RPOS?
Restriction and Notes	Target window to control depends on the SubOpCode.
Remote Command Notes	Target window to control depends on the SubOpCode.
Preset	CENTer
State Saved	Saved in instrument state.
Range	Top Ctr Bot
Key Path	AMPTD Y Scale

I/Q Error View Evm Window Y Ref Position

Positions the Y-axis scale reference level at the top, center or bottom of the display in the EVM window

Code Domain
AMPTD Y Scale

of the I/Q Error view.

Mode	cdma2000
Remote Command	:DISPlay:CDPower:VIEW3:WINDow3:TRACe:Y[:SCALE]:RPOSiti on TOP CENTer BOTTom :DISPlay:CDPower:VIEW3:WINDow3:TRACe:Y[:SCALE]:RPOSiti on?
Example	DISP:CDP:VIEW3:WIND3:TRAC:Y:RPOS CENT DISP:CDP:VIEW3:WIND3:TRAC:Y:RPOS?
Restriction and Notes	Target window to control depends on the SubOpCode.
Remote Command Notes	Target window to control depends on the SubOpCode.
Preset	BOTTom
State Saved	Saved in instrument state.
Range	Top Ctr Bot
Key Path	AMPTD Y Scale

Code Domain View Symbol Power Window Y Ref Position

Positions the Y-axis scale reference level at the top, center or bottom of the display in the symbol power window of the code domain view.

Mode	cdma2000
Remote Command	:DISPlay:CDPower:VIEW4:WINDow2:TRACe:Y[:SCALE]:RPOSiti on TOP CENTer BOTTom :DISPlay:CDPower:VIEW4:WINDow2:TRACe:Y[:SCALE]:RPOSiti on?
Example	DISP:CDP:VIEW4:WIND2:TRAC:Y:RPOS CENT DISP:CDP:VIEW4:WIND2:TRAC:Y:RPOS?
Restriction and Notes	Target window to control depends on the SubOpCode.
Remote Command Notes	Target window to control depends on the SubOpCode.
Preset	CENTer
State Saved	Saved in instrument state.
Range	Top Ctr Bot
Key Path	AMPTD Y Scale

Demod Bits View Symbol Power Window Y Ref Position

Positions the Y-axis scale reference level at the top, center or bottom of the display in the symbol power

window of the Demod Bits view.

Mode	cdma2000
Remote Command	:DISPlay:CDPower:VIEW5:WINDow2:TRACe:Y[:SCALe]:RPOSit ion TOP CENTer BOTTom :DISPlay:CDPower:VIEW5:WINDow2:TRACe:Y[:SCALe]:RPOSit ion?
Example	DISP:CDP:VIEW5:WIND2:TRAC:Y:RPOS CENT DISP:CDP:VIEW5:WIND2:TRAC:Y:RPOS?
Restriction and Notes	Target window to control depends on the SubOpCode.
Remote Command Notes	Target window to control depends on the SubOpCode.
Preset	CENTer
State Saved	Saved in instrument state.
Range	Top Ctr Bot
Key Path	AMPTD Y Scale

Auto Scaling

Toggles the Auto Scaling function between On and Off. When the **Restart** front panel key or **Restart** menu key under the **Meas Control** menu is pressed, this function automatically determines the scale per division and reference values based on the measurement results.

Key Path	AMPTD Y Scale
----------	----------------------

I/Q Error View Mag Error Window Y Auto Scaling

Toggles the Auto Scaling function between On and Off for the magnitude error window of the I/Q Error view.

Mode	cdma2000
Remote Command	:DISPlay:CDPower:VIEW3:WINDow[1]:TRACe:Y[:SCALe]:C OUPle 0 1 OFF ON :DISPlay:CDPower:VIEW3:WINDow[1]:TRACe:Y[:SCALe]:C OUPle?
Example	DISP:CDP:VIEW3:WIND:TRAC:Y:COUP ON DISP:CDP:VIEW3:WIND:TRAC:Y:COUP?

Code Domain
AMPTD Y Scale

Restriction and Notes	Upon pressing the Restart front-panel key or Restart menu key under the Meas Control menu, the Auto Scaling function automatically determines the scale per division and reference values based on the measurement results if this parameter is set to On. When you set a value to either Scale/Div or Ref Value manually, Auto Scaling automatically changes to Off. Target window to control depends on the SubOpCode.
Dependencies/Couplings	See Restriction and Notes
Remote Command Notes	Target window to control depends on the SubOpCode.
Preset	ON
State Saved	Saved in instrument state.
Range	Off On
Key Path	AMPTD Y Scale

I/Q Error View Phase Error Window Y Auto Scaling

Toggles the Auto Scaling function between On and Off in the phase error window of the I/Q Error view.

Mode	cdma2000
Remote Command	:DISPlay:CDPower:VIEW3:WINDow2:TRACe:Y[:SCALE]:COU Ple 0 1 OFF ON :DISPlay:CDPower:VIEW3:WINDow2:TRACe:Y[:SCALE]:COU Ple?
Example	DISP:CDP:VIEW3:WIND2:TRAC:Y:COUP ON DISP:CDP:VIEW3:WIND2:TRAC:Y:COUP?
Restriction and Notes	Upon pressing the Restart front-panel key or Restart menu key under the Meas Control menu, the Auto Scaling function automatically determines the scale per division and reference values based on the measurement results if this parameter is set to On. When you set a value to either Scale/Div or Ref Value manually, Auto Scaling automatically changes to Off. Target window to control depends on the SubOpCode.
Dependencies/Couplings	See Restriction and Notes
Remote Command Notes	Target window to control depends on the SubOpCode.
Preset	ON
State Saved	Saved in instrument state.
Range	Off On
Key Path	AMPTD Y Scale

I/Q Error View Evm Window Y Auto Scaling

Toggles the Auto Scaling function between On and Off in the EVM window of the I/Q Error view

Mode	cdma2000
Remote Command	:DISPlay:CDPower:VIEW3:WINDow3:TRACe:Y[:SCALe]:COU Ple 0 1 OFF ON :DISPlay:CDPower:VIEW3:WINDow3:TRACe:Y[:SCALe]:COU Ple?
Example	DISP:CDP:VIEW3:WIND3:TRAC:Y:COUP ON DISP:CDP:VIEW3:WIND3:TRAC:Y:COUP?
Restriction and Notes	Upon pressing the Restart front-panel key or Restart menu key under the Meas Control menu, the Auto Scaling function automatically determines the scale per division and reference values based on the measurement results if this parameter is set to On. When you set a value to either Scale/Div or Ref Value manually, Auto Scaling automatically changes to Off. Target window to control depends on the SubOpCode.
Dependencies/Couplings	See Restriction and Notes
Remote Command Notes	Target window to control depends on the SubOpCode.
Preset	ON
State Saved	Saved in instrument state.
Range	Off On
Key Path	AMPTD Y Scale

Code Domain View Symbol Power Window Y Auto Scaling

Toggles the Auto Scaling function between On and Off in the symbol power window of the code domain view.

Mode	cdma2000
Remote Command	:DISPlay:CDPower:VIEW4:WINDow2:TRACe:Y[:SCALe]:COU Ple 0 1 OFF ON :DISPlay:CDPower:VIEW4:WINDow2:TRACe:Y[:SCALe]:COU Ple?
Example	DISP:CDP:VIEW4:WIND2:TRAC:Y:COUP ON DISP:CDP:VIEW4:WIND2:TRAC:Y:COUP?

Code Domain
AMPTD Y Scale

Restriction and Notes	Upon pressing the Restart front-panel key or Restart menu key under the Meas Control menu, the Auto Scaling function automatically determines the scale per division and reference values based on the measurement results if this parameter is set to On. When you set a value to either Scale/Div or Ref Value manually, Auto Scaling automatically changes to Off. Target window to control depends on the SubOpCode.
Dependencies/Couplings	See Restriction and Notes
Remote Command Notes	Target window to control depends on the SubOpCode.
Preset	ON
State Saved	Saved in instrument state.
Range	Off On
Key Path	AMPTD Y Scale

Demod Bits View Symbol Power Window Y Auto Scaling

Toggles the Auto Scaling function between On and Off in the symbol power window of the Demod Bits function view.

Mode	cdma2000
Remote Command	:DISPlay:CDPower:VIEW5:WINDow2:TRACe:Y[:SCALE]:COUPle 0 1 OFF ON :DISPlay:CDPower:VIEW5:WINDow2:TRACe:Y[:SCALE]:COUPle?
Example	DISP:CDP:VIEW5:WIND2:TRAC:Y:COUP ON DISP:CDP:VIEW5:WIND2:TRAC:Y:COUP?
Restriction and Notes	Upon pressing the Restart front-panel key or Restart menu key under the Meas Control menu, the Auto Scaling function automatically determines the scale per division and reference values based on the measurement results if this parameter is set to On. When you set a value to either Scale/Div or Ref Value manually, Auto Scaling automatically changes to Off. Target window to control depends on the SubOpCode.
Dependencies/Couplings	See Restriction and Notes
Remote Command Notes	Target window to control depends on the SubOpCode.
Preset	ON
State Saved	Saved in instrument state.
Range	Off On
Key Path	AMPTD Y Scale

BW

There is no BW functionality supported in the Code Domain measurement. The front-panel key displays a blank menu key when pressed.

Key Path	Front-panel key
----------	-----------------

Marker

Accesses a menu that enables you to select, set up and control the markers for the current measurement.

See the "Marker Functions" section for more information

Key Path	Front Panel Key
----------	-----------------

Marker Symbol Value (Remote Command only)

Sets the marker symbol value in the current marker for the trace of I/Q symbol polar vector. It has no effect if the control mode is **Off**, but is the SCPI equivalent of entering an X value if the control mode is **Normal**.

NOTE This command is only valid when Marker Trace is 'POLar' (I/Q symbol polar vector). And, for other Marker Trace, it's not valid and ignored.

Mode	cdma2000
Remote Command	:CALCulate:CDPower:MARKer [1] 2 3 4 5 6 7 8 9 10 11 12 :SYMBOL <real> :CALCulate:CDPower:MARKer [1] 2 3 4 5 6 7 8 9 10 11 12 :SYMBOL?
Example	CALC:CDP:MARK:SYMB 1.0 CALC:CDP:MARK:SYMB?
Restriction and Notes	If no suffix is sent it uses 'symbols'. If a suffix is not 'symbols', an error "Invalid suffix" is generated. The query returns the marker's 'symbol' value in the trace if the control mode is Normal . The query is returned in ' symbols '. If the marker is Off the response is not a number. The description provided in the MIN/MAX/DEF Support field is only for the SCPI tester. The remote command supports all the MIN/MAX/DEF parameters.
Remote Command Notes	This parameter has different meaning between the cases where the marker trace is set to Symbol I/Q Polar Vector and others. In the Symbol I/Q Polar Vector Graph, X Axis Value is also the measured value, so this parameter is meaningful only when the control mode is set to Normal
Preset	Start point of the trace on the display window
State Saved	No
Min	-9.9E+37
Max	9.9E+37

Marker X Axis Value (Remote Command only)

Sets the marker X Axis value in the current marker X Axis Scale unit. It has no effect if the control mode is **Off**, but is the SCPI equivalent of entering an X value if the control mode is **Normal** or **Delta**.

NOTE This command is not valid when Marker Trace is 'POLar' (I/Q symbol polar vector) and ignored. For Marker Trace 'POLar' (I/Q symbol polar vector), Marker Symbol Value is supported instead.

Mode	cdma2000
Remote Command	:CALCulate:CDPower:MARKer [1] 2 3 4 5 6 7 8 9 10 11 12 :X <real> :CALCulate:CDPower:MARKer [1] 2 3 4 5 6 7 8 9 10 11 12 :X?
Example	CALC:CDP:MARK3:X 0.0 CALC:CDP:MARK3:X?
Restriction and Notes	If no suffix is sent it uses the fundamental units for the current marker X Axis Scale. If a suffix is sent that does not match the current marker X Axis Scale unit, an error "Invalid suffix" is generated. The query returns the marker's absolute X Axis value if the control mode is Normal , or the offset from the marker's reference marker if the control mode is Delta . The query is returned in the fundamental units for the current marker X Axis scale: Hz for Frequency and Inverse Time , seconds for Period and Time . If the marker is Off the response is not a number.
Preset	After a preset, all Markers are turned OFF, so Marker X Axis Value query does not return a number (NAN).
State Saved	No
Min	ñ9.9E+37
Max	9.9E+37

Marker X Axis Position (Remote Command only)

Sets the marker X position in trace points. It has no effect if the control mode is **Off**, but is the SCPI equivalent of entering a value if the control mode is **Normal** or **Delta** - except in trace points rather than X Axis Scale units. The entered value is immediately translated into the current X Axis Scale units for setting the value of the marker.

Mode	cdma2000
------	----------

Code Domain
Marker

Remote Command	:CALCulate:CDPower:MARKer [1] 2 3 4 5 6 7 8 9 10 11 12 :X:POSition <real> :CALCulate:CDPower:MARKer [1] 2 3 4 5 6 7 8 9 10 11 12 :X:POSition?
Example	CALC:CDP:MARK10:X:POS 0.0 CALC:CDP:MARK10:X:POS?
Restriction and Notes	The query returns the marker's absolute X Axis value in trace points if the control mode is Normal , or the offset from the marker's reference marker in trace points if the control mode is Delta . The value is returned as a real number, not an integer, corresponding to the translation from X Axis Scale units to trace points (see "Fractional Trace Points", above). If the marker is Off the response is not a number. The description provided in the MIN/MAX/DEF Support field is only for the SCPI tester. The remote command supports all the MIN/MAX/DEF parameters.
Preset	After a preset, all Markers are turned OFF, so Marker X Axis Value query does not return a number (NAN).
State Saved	No
Min	∞9.9E+37
Max	9.9E+37

Marker Y Axis Value (Remote Command only)

Queries the marker Y Axis value in the current marker Y Axis unit.

Mode	cdma2000
Remote Command	:CALCulate:CDPower:MARKer [1] 2 3 4 5 6 7 8 9 10 11 12 :Y?
Example	CALC:CDP:MARK11:Y?
Preset	Result dependant on markers setup and signal source
State Saved	No

Marker Select

Displays 12 markers available for selection.

Key Path	Marker
----------	---------------

Marker Type

Sets the marker control mode. If the selected marker is Off, pressing Marker sets it to Normal and places it at the center of the screen on the trace determined by the **Marker Trace** rules. At the same time,

reference value of the selected marker appears on the Active Function area.

Active Function Display:

Marker symbol value at I/Q Symbol Polar Vector graph

Marker X-axis value at other graphs

Default Active Function: the active function for the selected marker's current control mode. If the current control mode is Off, there is no active function and the active function is turned off.

The marker X axis value entered in the active function area displays the marker value to its full entered precision.

NOTE When Marker Trace is 'POLar' (I/Q Polar), 'Delta' is not supported.

Remote Command	:CALCulate:CDPower:MARKer [1] 2 3 4 5 6 7 8 9 10 11 12 :MODE Position DELta OFF :CALCulate:CDPower:MARKer [1] 2 3 4 5 6 7 8 9 10 11 12 :MODE?
Example	CALC:CDP:MARK:MODE POS CALC:CDP:MARK:MODE?
Restriction and Notes	If the selected marker is Off, pressing Marker sets it to Normal and places it at the center of the screen on the trace determined by the Marker Trace rules. At the same time, Marker X Axis Value appears on the Active Function area. Default Active Function: the active function for the selected marker's current control mode. If the current control mode is Off, there is no active function and the active function is turned off. Active Function Display: Marker symbol value at I/Q Symbol Polar Vector graph Marker X-axis value at other graphs the marker X axis value entered in the active function area displays the marker value to its full entered precision.
Remote Command Notes	NORMal is changed to POSition in the new SA.
Preset	OFF
State Saved	Saved in instrument state.
Range	Normal Delta Off
Key Path	Marker

Properties

Access a menu that enables you to select a relative maker and marker trace

Key Path	Marker
----------	---------------

Marker Select

Displays 12 markers available for selection.

Key Path	Marker
----------	---------------

Relative To

Selects the marker the selected marker is relative to (its reference marker).

Mode	cdma2000
Remote Command	:CALCulate:CDPower:MARKer [1] 2 3 4 5 6 7 8 9 10 11 12 :REFErence <integer> :CALCulate:CDPower:MARKer [1] 2 3 4 5 6 7 8 9 10 11 12 :REFErence?
Example	CALC:CDP:MARK:REF 4 CALC:CDP:MARK:REF?
Restriction and Notes	A marker cannot be relative to itself so that choice is grayed out, and if sent from SCPI generates error -221: "Settings conflict; marker cannot be relative to itself."
Remote Command Notes	When queried a single value is returned (the specified marker numbers relative marker). A marker cannot be relative to itself so that choice is grayed out, and if sent from SCPI generates error -221: "Settings conflict; marker cannot be relative to itself." You must be in the Spectrum Analysis mode, GSM mode to use this command. Use INSTRument:SELEct to set the mode.
Preset	2 3 4 5 6 7 8 9 10 11 12 1
State Saved	Saved in instrument state.
Min	1
Max	12
Key Path	Marker, Properties

Marker Trace

Assigns the specified marker to the designated trace.

Mode	cdma2000
Remote Command	:CALCulate:CDPower:MARKer [1] 2 3 4 5 6 7 8 9 10 11 12 :TRACe CDPower EVM MERRor PERRor SPOWer CPOWer CDError POLar :CALCulate:CDPower:MARKer [1] 2 3 4 5 6 7 8 9 10 11 12 :TRACe?
Example	CALC:CDP:MARK:TRACE POL CALC:CDP:MARK:TRACE?
Preset	CDPower
State Saved	Saved in instrument state.
Range	Code Domain Power Code Domain Error Symbol Power Chip Power EVM Phase Error Mag Error Polar
Key Path	Marker, Properties

Couple Marker

Toggles the state of the markers to be coupled On or Off. When this function is true (On), moving any marker causes an equal X-axis movement of every other marker except those located to the polar trace, and Chip value of the marker located to the polar trace, which is not **Off**, including **Fixed** markers. "Equal X Axis movement" refers to the difference between each marker's X Axis value (in the fundamental x-axis units of the trace that marker is on) and the X Axis value of the marker being moved (in the same fundamental x-axis units). This may result in markers going off screen

See Couple Marker in the "Marker" section for more information.

Mode	cdma2000
Remote Command	:CALCulate:CDPower:MARKer:COUple [:STATe] ON OFF 1 0 :CALCulate:CDPower:MARKer:COUple [:STATe] ?
Example	CALC:CDP:MARK:COUP ON CALC:CDP:MARK:COUP?
Preset	OFF
State Saved	Saved in instrument state.
Range	On Off
Key Path	Marker

All Markers Off

Turns off all markers.

Mode	cdma2000
Remote Command	:CALCulate:CDPower:MARKer:AOFF
Example	CALC:CDP:MARK:AOFF
Key Path	Marker

Backward Compatibility SCPI Commands

Sets or queries the state of a marker. Setting a marker which is OFF to state ON or 1 puts it in Normal mode and places it at the center of the screen.

Mode	cdma2000
Remote Command	:CALCulate:CDPower:MARKer [1] 2 3 4 5 6 7 8 9 10 11 12 :STATe OFF ON 0 1 :CALCulate:CDPower:MARKer [1] 2 3 4 5 6 7 8 9 10 11 12 :STATe?
Example	CALC:CDP:MARK3:STATe ON CALC:CDP:MARK3:STAT?
Preset	OFF
State Saved	Saved in instrument state.
Range	On Off

Marker Function

There are no Marker Function operations supported in the Code Domain measurement. The front-panel key displays a blank menu when pressed.

Key Path	Front panel key
----------	-----------------

Marker To

Accesses menu keys that can copy the current marker value into other instrument parameter, for example Despread. If the currently selected marker is not on when the front panel key is pressed, it is turned on at the center of the screen as a normal type marker.

Key Path	Front panel key
----------	-----------------

Mkr -> Despread

Executes post process for selected marker.

Mode	cdma2000
Remote Command	:CALCulate:CDPower:MARKer [1] 2 3 4 5 6 7 8 9 10 11 12 [:SET] :DESPread
Example	CALC:CDP:MARK4:SET:DESP
Restriction and Notes	This function is available only when the marker trace is 'CDPower'
Key Path	Marker ->, Mkr->Despread

Meas Setup

Displays the setup menu for the currently selected measurement either BTS or MS.

Key Path	Front-panel key
----------	------------------------

Meas Type

Sets the code domain power computation type to either the absolute power or the relative value to the mean power.

Mode	cdma2000
Remote Command	:CALCulate:CDPower:TYPE RELative ABSolute :CALCulate:CDPower:TYPE?
Example	CALC:CDP:TYPE REL CALC:CDP:TYPE?
Preset	RELative
State Saved	Saved in instrument state.
Range	Abs Rel
Key Path	Meas Setup

Walsh Code Length

Sets spread code length.

Mode	cdma2000
Remote Command	:CALCulate:CDPower:WCODe:LENGth <integer> :CALCulate:CDPower:WCODe:LENGth?
Example	CALCulate:CDPower:WCODe:LENGth 64 CALCulate:CDPower:WCODe:LENGth?
Restriction and Notes	Walsh Code Length allows you to change Code Layer and Code Number of the code you select. It is equivalent with Spread Factor (SF). The Default value, Min value, and Max value depend on radio device. For BTS, default = 64, max = 128, min = 4 For Ms, default = 32, max = 32, min = 2
Dependencies/Couplings	Walsh Code Length must be power of 2. If the input is not equal to the power of 2, it is clipped to the nearest value available.

Code Domain
Meas Setup

Remote Command Notes	You must be in the cdma2000 mode to use this command. Use INSTRUMENT:SELEct to set the mode.
Preset	64 32
State Saved	Saved in instrument state.
Min	4 2
Max	128 32
Key Path	Meas Setup

Walsh Code Number

Specifies the Walsh code number.

Mode	cdma2000
Remote Command	:CALCulate:CDPower:WCODE[:NUMBER] <integer> :CALCulate:CDPower:WCODE[:NUMBER]?
Example	CALCulate:CDPower:WCODE 1 CALCulate:CDPower:WCODE?
Restriction and Notes	Set the Walsh code number depending on the channel type.
Dependencies/Couplings	Walsh Code Number must be smaller than Walsh Code Length
Remote Command Notes	You must be in the cdma2000 mode to use this command.
Preset	0
State Saved	Saved in instrument state.
Min	0
Max	Walsh Code Length – 1
Key Path	Meas Setup

I/Q Branch (MS only)

Select the I phase or Q phase for the demodulation axis.

Mode	cdma2000
Remote Command	:CALCulate:CDPower:AXIS[:MS] IPH QPH IQCombined :CALCulate:CDPower:AXIS[:MS]?
Example	CALC:CDP:AXIS IPH CALC:CDP:AXIS?

Restriction and Notes	IPH – I Phase QPH – Q Phase IQC – Combined I and Q Phase This command is effective when [:SENSe]:RADio:DEVIce is set to MS. (This menu label is blank when [:SENSe]:RADio:DEVIce is set to BTS.)
Preset	QPH
State Saved	Saved in instrument state.
Range	I Q IQC
Key Path	Meas Setup

Meas Interval

Sets the length of the measurement interval in PCG (power control group), 1 PCG = 1536chips.

Unit	PCG
Mode	cdma2000
Remote Command	:CALCulate:CDPower:SWEep:TIME <integer> :CALCulate:CDPower:SWEep:TIME?
Example	CALC:CDP:SWE:TIME 2 CALC:CDP:SWE:TIME?
Restriction and Notes	Set the length of the measurement interval that is used. If summation of Meas Interval and Meas Offset exceeds 32 after changing Meas Interval (or Meas Offset), then Meas Offset (or Meas Interval) decreases automatically to make the summation 32.
Dependencies/Couplings	Max value is dependent on Capture Interval and Meas Offset
Preset	1
State Saved	Saved in instrument state.
Min	1
Max	Capture Interval
Key Path	Meas Setup

Meas Offset

Sets the timing offset of measurement interval in PCG (power control group), 1 PCG = 1536 chips

Unit	PCG
Mode	cdma2000

Code Domain
Meas Setup

Remote Command	:CALCulate:CDPower:SWEep:OFFSet <integer> :CALCulate:CDPower:SWEep:OFFSet?
Example	CALC:CDP:SWE:OFFS 2 CALC:CDP:SWE:OFFS?
Restriction and Notes	If summation of Meas Interval and Meas Offset exceeds 32 after changing Meas Interval (or Meas Offset), then Meas Offset (or Meas Interval) decreases automatically to make the summation 32.
Dependencies/Couplings	Max value is dependent [:SENSe]:CDPwer:CAPTure:TIME and CALCulate:CDPower:SWEep:TIME
Preset	0
State Saved	Saved in instrument state.
Min	0
Max	Capture Interval – 1
Key Path	Meas Setup

PN Offset

Unit	x 64 chips
Remote Command	:CALCulate:CDPower:PNOffset <integer> :CALCulate:CDPower:PNOffset?
Example	CALC:CDP:PNOF 5 CALC:CDP:PNOF?
Restriction and Notes	Sets value for the pseudo-random noise offset. Different pseudo-random noise offsets are used for different base stations. By setting the pseudo-random noise offset to the value that your specific base station is set to, you get the correct time offset value displayed and returned back to you when you query READ:CDPower?. The instrument, by default, assumes an offset of 0. So, if you do not use this command, you have to manually calculate the time offset when the value is other than 0.
Remote Command Notes	You must be in cdma2000 mode to use this command.
Preset	0
State Saved	Saved in instrument state.
Min	0
Max	511
Key Path	Meas Setup, More

Sync Type (BTS only)

Opens a menu that enables you to set the channel type to be used for synchronization.

Mode	cdma2000
Remote Command	[:SENSe] :CDPower:SYNC [:BTS] PICH DPICH [:SENSe] :CDPower:SYNC [:BTS] ?
Example	CDP:SYNC DPIC CDP:SYNC?
Restriction and Notes	This command is effective when [:SENSe]:RADio:DEvice is set to BTS.
Preset	PICH
State Saved	Saved in instrument state.
Range	F-PICH TxDiv F-PICH
Key Path	Meas Setup

Long Code Mask (MS only)

Mode	cdma2000
Remote Command	[:SENSe] :CDPower:SYNC:LCMask <integer> [:SENSe] :CDPower:SYNC:LCMask?
Example	CDP:SYNC:LCM 0 CDP:SYNC:LCM?
Restriction and Notes	Set the long code mask for MS measurement.
Dependencies/Couplings	Only available when [:SENSe]:RADio:DEvIce is MS.
Remote Command Notes	You must be in cdma2000 to use this command
Preset	0
State Saved	Saved in instrument state.
Min	0
Max	4,398,046,511,103 (3FFFFFFFFF)
Key Path	Meas Setup

Capture Interval

Sets the data capture length in PCG (1PCG = 1.25 ms) that is used in the acquisition.

Mode	cdma2000
Remote Command	[:SENSe] :CDPower:CAPture:TIME <integer> [:SENSe] :CDPower:CAPture:TIME?
Example	CDP:CAPT:TIME 32 CDP:CAPT:TIME?
Remote Command Notes	You must be in cdma2000 to use this command
Preset	5
State Saved	Saved in instrument state.
Min	2
Max	32
Key Path	Meas Setup

Spectrum Inversion

Toggles the spectrum function between Normal and Invert.

Invert: This function conjugates the spectrum, which is equivalent to taking the negative of the

quadrature component in demodulation. The correct setting (Normal or Invert) depends on whether the signal at the input of the instrument has a high or low side mix.

Mode	cdma2000
Remote Command	[:SENSE] :CDPower :SPECTrum INVert NORMal [:SENSE] :CDPower :SPECTrum?
Example	CDP:SPEC INV CDP:SPEC?
Preset	NORMal
State Saved	Saved in instrument state.
Range	Normal Invert
Key Path	Meas Setup

Meas Preset

Restores all the measurement parameters to their default values.

Mode	cdma2000
Remote Command	:CONFigure:CDPower
Example	CONF:CDP
Dependencies/Couplings	Selecting Restore Measurement Defaults restores all measurement parameters to their default values.
Key Path	Meas Setup

Advanced

Accesses a menu of functions that enable you to set up more specific parameters for the measurement.

Key Path	Meas Setup
----------	-------------------

Active Set Threshold

Toggles the active channel identification function between Auto and Man. If set to Auto, the active channels are determined automatically by the internal algorithm. If set to Man, the active channel identification is determined by a user definable threshold ranging from 0.00 to -100.00 dB.

Mode	cdma2000
------	----------

Code Domain
Meas Setup

Remote Command	:CALCulate:CDPower:ASET:THReshold <real> :CALCulate:CDPower:ASET:THReshold? :CALCulate:CDPower:ASET:THReshold:AUTO OFF ON 0 1 :CALCulate:CDPower:ASET:THReshold:AUTO?
Example	CALC:CDP:ASET:THR -50.0 CALC:CDP:ASET:THR? CALC:CDP:ASET:THR:AUTO ON CALC:CDP:ASET:THR:AUTO?
Remote Command Notes	Turn the automatic mode On or Off, for the active channel identification function. OFF – The active channel identification for each code channel is determined by a value set by CALCulate:CDPower:ASET:THReshold. ON – The internal algorithm determines the active channels automatically.
Preset	0.0 ON
State Saved	Saved in instrument state.
Min	-100.0
Max	0.0
Key Path	Meas Setup

Filter Alpha

Specifies the alpha value of the RX filter.

Mode	cdma2000
Remote Command	[[:SENSE]]:CDPower:ALPHA <real> [[:SENSE]]:CDPower:ALPHA?
Example	CDP:ALPH 0.2 CDP:ALPH?
Preset	0.15
State Saved	Saved in instrument state.
Min	0.05
Max	0.20
Key Path	Meas Setup, Advanced

Chip Rate

Allows you to Changes the chip rate.

Mode	cdma2000
Remote Command	[:SENSe] :CDPower:CRATe <freq> [:SENSe] :CDPower:CRATe?
Example	CDP:CRAT 1228800 CDP:CRAT?
Preset	1.2288 MHz
State Saved	Saved in instrument state.
Min	1.105920 MHz
Max	1.351680 MHz
Key Path	Meas Setup, Advanced

Walsh Code QOF (BTS only)

Opens a menu to set the QOF number.

Remote Command	[:SENSe] :CDPower:QOF 0 1 2 3 [:SENSe] :CDPower:QOF?
Example	CDP:QOF 2 CDP:QOF?
Restriction and Notes	Choose among QOF = 0, 1, 2, or 3 for the specific Walsh Code that is selected. This key is available only on the BTS Mode.
Dependencies/Couplings	Only available when [:SENS2]:RADio:DEvice is BTS. when [:SENS2]:RADio:DEvice is MS, This Menu is grayed out.
Preset	0
State Saved	Saved in instrument state.
Min	0
Max	3
Key Path	Meas Setup, Advanced

IF Gain

Enables you to control an internally switched IF amplifier with approximately 10 dB of gain. When it can be turned on without an overload, the dynamic range is always better with the amplifier on than off. The **IF Gain** key can be used to set the IF Gain function to Auto, or to On (the extra 10 dB) or Off. These

Code Domain
Meas Setup

settings affect sensitivity and IF overloads.

Key Path	Meas Setup, Advanced
----------	-----------------------------

IF Gain Auto

Activates the auto rules for IF Gain.

Mode	cdma2000
Remote Command	[:SENSe] :CDPower:IF:GAIN:AUTO [:STATE] OFF ON 0 1 [:SENSe] :CDPower:IF:GAIN:AUTO [:STATE] ?
Example	CDP:IF:GAIN:AUTO ON CDP:IF:GAIN:AUTO?
Dependencies/Couplings	When either the auto attenuation works (for example, with electrical attenuator), or the optimize mechanical attenuator range is requested, the IF Gain setting is changed as following rule. 'auto' sets IF Gain 'High Gain' under any of the following conditions: the input attenuator is set to 0 dB, the preamp is turned on, or the Max Mixer Level is 20 dBm or lower. For other settings, auto sets IF Gain to 'Low Gain'.
Preset	OFF
State Saved	Saved in instrument state.
Range	Off On
Key Path	Meas Setup, Advanced, IF Gain

IF Gain State

Selects the range of IF gain between Low Gain and High Gain.

Mode	cdma2000
Remote Command	[:SENSe] :CDPower:IF:GAIN [:STATE] ON OFF 1 0 [:SENSe] :CDPower:IF:GAIN [:STATE] ?
Example	CDP:IF:GAIN ON CDP:IF:GAIN?
Dependencies/Couplings	When either the auto attenuation works (for example, with electrical attenuator), or the optimize mechanical attenuator range is requested, the IF Gain setting is changed as following rule. 'auto' sets IF Gain 'High Gain' under any of the following conditions: the input attenuator is set to 0 dB, the preamp is turned on, or the Max Mixer Level is 20 dBm or lower. For other settings, auto sets IF Gain to 'Low Gain'.
Remote Command Notes	Where ON = high gain OFF = low gain

Preset	OFF
State Saved	Saved in instrument state.
Range	Low Gain (Best for Large Signals) High Gain (Best Noise Level)
Key Path	Meas Setup, Advanced, IF Gain

Peak Search

Peak Search

Places the selected marker on the trace point with the maximum y-axis value for that marker's trace.

Mode	cdma2000
Remote Command	:CALCulate:CDPower:MARKer [1] 2 3 4 5 6 7 8 9 10 11 12 :MAXimum
Example	CALC:CDP:MARK2:MAX
Key Path	Front panel key

Next Peak

Moves the selected marker to the peak that has the next highest amplitude less than the marker's current value.

Mode	cdma2000
Remote Command	:CALCulate:CDPower:MARKer [1] 2 3 4 5 6 7 8 9 10 11 12 :MAXimum:NEXT
Example	CALC:CDP:MARK2:MAX:NEXT
Key Path	Peak Search

Next Pk Right

Moves the selected marker to the nearest peak right of the current marker which meets all enabled peak criteria.

Mode	cdma2000
Remote Command	:CALCulate:CDPower:MARKer [1] 2 3 4 5 6 7 8 9 10 11 12 :MAXimum:RIGHT
Example	CALC:CDP:MARK2:MAX:RIGH
Key Path	Peak Search

Next Pk Left

Moves the selected marker to the nearest peak left of the current marker which meets all enabled peak criteria.

Mode	cdma2000
------	----------

Remote Command	:CALCulate:CDPower:MARKer [1] 2 3 4 5 6 7 8 9 10 11 12 :MAXimum:LEFT
Example	CALC:CDP:MARK2:MAX:LEFT
Key Path	Peak Search

Marker Delta

Sets the control mode for the selected marker to **Delta** mode.

Key Path	Peak Search
----------	--------------------

Continuous Peak Search

Turns Continuous Peak Search on or off. When Continuous Peak Search is on, a peak search is automatically performed for the selected marker after each sweep. The rules for finding the peak are exactly the same as for **Peak Search**, including the peak criteria rules. If no valid peak is found, the “No Peak Found” warning is generated after each sweep. If a valid peak is found, the message “Peak Found” is displayed after each sweep.

Mode	cdma2000
Remote Command	:CALCulate:CDPower:MARKer [1] 2 3 4 5 6 7 8 9 10 11 12 :CPEak [:STATE] ON OFF 1 0 :CALCulate:CDPower:MARKer [1] 2 3 4 5 6 7 8 9 10 11 12 :CPEak [:STATE] ?
Example	CALC:CDP:MARK:CPE ON CALC:CDP:MARK:CPE?
Preset	OFF
State Saved	Saved in instrument state.
Range	Off On
Key Path	Peak Search

Pk-Pk Search

Finds and displays the amplitude and frequency (or time, if in zero span) differences between the highest and lowest y-axis value.

Mode	cdma2000
Remote Command	:CALCulate:CDPower:MARKer [1] 2 3 4 5 6 7 8 9 10 11 12 :PTPeak
Example	CALC:CDP:MARK:PTP
Restriction and Notes	Turns on the Marker Δ active function.

Code Domain
Peak Search

Dependencies/Couplings	This key is not available (key is grayed out) when Coupled Markers is on.
Key Path	Peak Search

Min Search

Moves the selected marker to the minimum y-axis value on the current trace.

Mode	cdma2000
Remote Command	:CALCulate:CDPower:MARKer [1] 2 3 4 5 6 7 8 9 10 11 12 :MINimum
Example	CALC:CDP:MARK:MIN
Key Path	Peak Search

SPAN X Scale

Accesses a menu of functions that enable you to set the desired horizontal scale parameters.

Numbers and default numbers are independent for each window.

Metrics window and I/Q Symbol Polar Vector and Demod Bits window do not have this menu (Blank menu).

Key Path	Front-panel key
----------	------------------------

Start Code Number

Sets the start value of the code range for the code domain power graph (CDP) and CDE graph

Mode	cdma2000
Remote Command	:DISPlay:CDPower:CDOMain:SPAN:STARt <integer> :DISPlay:CDPower:CDOMain:SPAN:STARt?
Example	DISP:CDP:CDOM:SPAN:STAR 5 DISP:CDP:CDOM:SPAN:STAR?
Restriction and Notes	In MS mode, there are 32 codes in all. This key is grayed out.
Dependencies/Couplings	Start Code Number and Stop Code Number are coupled to each other, according to: (A) Stop Code Number > Start Code Number and (B) Stop Code Number – Start Code Number >= 63 When changing the start code number, if it does not satisfy the above conditions, the stop code number is changed to satisfy (A) and (C). (C) Stop Code Number – Start Code Number = 63;
Preset	0
State Saved	Saved in instrument state.
Min	0
Max	64
Key Path	Span X Scale

Stop Code Number

Sets the stop value of the code range for the code domain power graph (CDP) and CDE graph.

Remote Command	:DISPlay:CDPower:CDOMain:SPAN:STOP <integer> :DISPlay:CDPower:CDOMain:SPAN:STOP?
Example	DISP:CDP:CDOM:SPAN:STOP 127 DISP:CDP:CDOM:SPAN:STOP?
Restriction and Notes	Default value is sensitive to the Base Code Length. If Base Code Length is set 64, the default value is 63. If Base Code Length is set 128, the default value is 127. For MS mode, there are 32 codes in all. This key is grayed out.
Dependencies/Couplings	1.6.2.1.1 Start Code Number and 1.6.2.1.2 Stop Code Number are coupled to each other, according to: (A) Stop Code Number > Start Code Number and (B) Stop Code Number – Start Code Number >= 63 When changing the stop code number, if it does not satisfy the above, the start code number is changed to satisfy (A) and (C). (C) Stop Code Number – Start Code Number = 63;
Preset	63
State Saved	Saved in instrument state.
Min	63
Max	127
Key Path	Span X Scale

X Ref Value

Controls the reference value of the X scale of the current measurement.

Key Path	Span X Scale
----------	---------------------

I/Q Error View Mag Error Window X Ref Value

Sets the symbol reference value on the horizontal axis in the magnitude error window of the I/Q Error view.

Mode	cdma2000
------	----------

Remote Command	:DISPlay:CDPower:VIEW3:WINDow[1]:TRACe:X[:SCALe]:RLEVel <real> :DISPlay:CDPower:VIEW3:WINDow[1]:TRACe:X[:SCALe]:RLEVel?
Example	DISP:CDP:VIEW3:WIND:TRAC:X:RLEV 10.0 DISP:CDP:VIEW3:WIND:TRAC:X:RLEV?
Restriction and Notes	If the Auto Scaling is set to On, this value is automatically determined by the measurement result. When you set this value manually, Auto Scaling automatically changes to Off. Target window to control depends on the SubOpCode.
Dependencies/Couplings	See Restriction and Notes
Remote Command Notes	You must be in the cdma2000 mode to use this command. Use INSTRument:SElect to set the mode.
Preset	0.000
State Saved	Saved in instrument state.
Min	0
Max	5000000.0
Key Path	Span X Scale

I/Q Error View Phase Error Window X Ref Value

Sets the symbol reference value on the horizontal axis in the phase error window of the I/Q Error view.

Mode	cdma2000
Remote Command	:DISPlay:CDPower:VIEW3:WINDow2:TRACe:X[:SCALe]:RLEVel <real> :DISPlay:CDPower:VIEW3:WINDow2:TRACe:X[:SCALe]:RLEVel?
Example	DISP:CDP:VIEW3:WIND2:TRAC:X:RLEV 10.0 DISP:CDP:VIEW3:WIND2:TRAC:X:RLEV?
Restriction and Notes	If the Auto Scaling is set to On, this value is automatically determined by the measurement result. When you set this value manually, Auto Scaling automatically changes to Off. Target window to control depends on the SubOpCode.
Dependencies/Couplings	See Restriction and Notes
Remote Command Notes	You must be in the cdma2000 mode to use this command. Use INSTRument:SElect to set the mode.
Preset	0.000

Code Domain
SPAN X Scale

State Saved	Saved in instrument state.
Min	0
Max	5000000.0
Key Path	Span X Scale

I/Q Error View Evm Window X Ref Value

Sets the symbol reference value on the horizontal axis in the EVM window of the I/Q Error view.

Mode	cdma2000
Remote Command	:DISPlay:CDPower:VIEW3:WINDow3:TRACe:X[:SCALe]:RLEVel <real> :DISPlay:CDPower:VIEW3:WINDow3:TRACe:X[:SCALe]:RLEVel?
Example	DISP:CDP:VIEW3:WIND3:TRAC:X:RLEV 10.0 DISP:CDP:VIEW3:WIND3:TRAC:X:RLEV?
Restriction and Notes	If the Auto Scaling is set to On, this value is automatically determined by the measurement result. When you set this value manually, Auto Scaling automatically changes to Off. Target window to control depends on the SubOpCode.
Dependencies/Couplings	See Restriction and Notes
Remote Command Notes	You must be in the cdma2000 mode to use this command. Use INSTRument:SElect to set the mode.
Preset	0.000
State Saved	Saved in instrument state.
Min	0
Max	5000000.0
Key Path	Span X Scale

Code Domain View Symb Power Window X Ref Value

Sets the symbol reference value on the horizontal axis of the symbol power window in the code domain (Quad view).

Mode	cdma2000
Remote Command	:DISPlay:CDPower:VIEW4:WINDow2:TRACe:X[:SCALe]:RLEVel <real> :DISPlay:CDPower:VIEW4:WINDow2:TRACe:X[:SCALe]:RLEVel?

Example	DISP:CDP:VIEW4:WIND2:TRAC:X:RLEV 10.0 DISP:CDP:VIEW4:WIND2:TRAC:X:RLEV?
Restriction and Notes	If the Auto Scaling is set to On, this value is automatically determined by the measurement result. When you set this value manually, Auto Scaling automatically changes to Off. Target window to control depends on the SubOpCode.
Dependencies/Couplings	See Restriction and Notes
Preset	0.000
State Saved	Saved in instrument state.
Min	0
Max	5000000.0
Key Path	Span X Scale

Demod Bits View Symb Power Window X Ref Value

Sets the symbol reference value on the horizontal axis in the symbol power window of the demod bits view.

Mode	cdma2000
Remote Command	:DISPlay:CDPower:VIEW5:WINDow2:TRACe:X[:SCALe]:RLEVel <real> :DISPlay:CDPower:VIEW5:WINDow2:TRACe:X[:SCALe]:RLEVel?
Example	DISP:CDP:VIEW5:WIND2:TRAC:X:RLEV 10.0 DISP:CDP:VIEW5:WIND2:TRAC:X:RLEV?
Restriction and Notes	If the Auto Scaling is set to On, this value is automatically determined by the measurement result. When you set this value manually, Auto Scaling automatically changes to Off. Target window to control depends on the SubOpCode.
Dependencies/Couplings	See Restriction and Notes
Preset	0.000
State Saved	Saved in instrument state.
Min	0
Max	5000000.0
Key Path	Span X Scale

X Scale/Div

Sets the horizontal scale by changing a value per division.

Key Path	Span X Scale
----------	---------------------

I/Q Error View Mag Error Window X Scale/Div

Sets the horizontal scale by changing a symbol value per division in the magnitude error window of the I/Q Error view.

Mode	cdma2000
Remote Command	:DISPlay:CDPower:VIEW3:WINDow [1] :TRACe:X [:SCALE] :P DIVision <real> :DISPlay:CDPower:VIEW3:WINDow [1] :TRACe:X [:SCALE] :P DIVision?
Example	DISP:CDP:VIEW3:WIND:TRAC:X:PDIV 1.0 DISP:CDP:VIEW3:WIND:TRAC:X:PDIV?
Restriction and Notes	If the Auto Scaling is set to On, this value is automatically determined by the measurement result. When you set this value manually, Auto Scaling automatically changes to Off. Target window to control depends on the SubOpCode. Default value is Device sensitive as follows: BTS: 2.3 MS: 4.7
Dependencies/Couplings	See Restriction and Notes
Remote Command Notes	Target window to control depends on the SubOpCode.
Preset	2.3 4.7
State Saved	Saved in instrument state.
Min	0.1
Max	500000.0
Key Path	Span X Scale

I/Q Error View Phase Error Window X Scale/Div

Sets the horizontal scale by changing a symbol value per division in the phase error window of the I/Q Error view.

Mode	cdma2000
------	----------

Remote Command	:DISPlay:CDPower:VIEW3:WINDow2:TRACe:X[:SCALe]:PDI Vision <real> :DISPlay:CDPower:VIEW3:WINDow2:TRACe:X[:SCALe]:PDI Vision?
Example	DISP:CDP:VIEW3:WIND2:TRAC:X:PDIV 1.0 DISP:CDP:VIEW3:WIND2:TRAC:X:PDIV?
Restriction and Notes	If the Auto Scaling is set to On, this value is automatically determined by the measurement result. When you set this value manually, Auto Scaling automatically changes to Off. Target window to control depends on the SubOpCode. Default value is Device sensitive as follows: BTS: 2.3 MS: 4.7
Dependencies/Couplings	See Restriction and Notes
Remote Command Notes	Target window to control depends on the SubOpCode.
Preset	2.3 4.7
State Saved	Saved in instrument state.
Min	0.1
Max	500000.0
Key Path	Span X Scale

I/Q Error View EVM Window X Scale/Div

Sets the horizontal scale by changing a symbol value per division in the EVM window of the I/Q Error view.

Mode	cdma2000
Remote Command	:DISPlay:CDPower:VIEW3:WINDow3:TRACe:X[:SCALe]:PDI Vision <real> :DISPlay:CDPower:VIEW3:WINDow3:TRACe:X[:SCALe]:PDI Vision?
Example	DISP:CDP:VIEW3:WIND3:TRAC:X:PDIV 1.0 DISP:CDP:VIEW3:WIND3:TRAC:X:PDIV?

Code Domain
SPAN X Scale

Restriction and Notes	If the Auto Scaling is set to On, this value is automatically determined by the measurement result. When you set this value manually, Auto Scaling automatically changes to Off. Target window to control depends on the SubOpCode. Default value is Device sensitive as follows: BTS: 2.3 MS: 4.7
Dependencies/Couplings	See Restriction and Notes
Remote Command Notes	Target window to control depends on the SubOpCode.
Preset	2.3 4.7
State Saved	Saved in instrument state.
Min	0.1
Max	500000.0
Key Path	Span X Scale

Code Domain View Symb Power Window X Scale/Div

Sets the horizontal scale by changing a symbol value per division in the symbol power window of the code domain (Quad view).

Mode	cdma2000
Remote Command	:DISPlay:CDPower:VIEW4:WINDow2:TRACe:X[:SCALe]:PDI Vision <real> :DISPlay:CDPower:VIEW4:WINDow2:TRACe:X[:SCALe]:PDI Vision?
Example	DISP:CDP:VIEW4:WIND2:TRAC:X:PDIV 1.0 DISP:CDP:VIEW4:WIND2:TRAC:X:PDIV?
Restriction and Notes	If the Auto Scaling is set to On, this value is automatically determined by the measurement result. When you set this value manually, Auto Scaling automatically changes to Off. Default value is Device sensitive as follows: BTS: 11.9 MS: 23.9 Target window to control depends on the SubOpCode.
Dependencies/Couplings	See Restriction and Notes
Remote Command Notes	Target window to control depends on the SubOpCode.
Preset	11.9 23.9
State Saved	Saved in instrument state.

Min	0.1
Max	500000.0
Key Path	Span X Scale

Demod Bits View Symb Power Window X Scale/Div

Sets the horizontal scale by changing a symbol value per division in the symbol power window of demod bits view.

Mode	cdma2000
Remote Command	:DISPlay:CDPower:VIEW5:WINDow2:TRACe:X[:SCALe]:PDI Vision <real> :DISPlay:CDPower:VIEW5:WINDow2:TRACe:X[:SCALe]:PDI Vision?
Example	DISP:CDP:VIEW5:WIND2:TRAC:X:PDIV 1.0 DISP:CDP:VIEW5:WIND2:TRAC:X:PDIV?
Restriction and Notes	If the Auto Scaling is set to On, this value is automatically determined by the measurement result. When you set this value manually, Auto Scaling automatically changes to Off. Default value is Device sensitive as follows: BTS: 11.9 MS: 23.9 Target window to control depends on the SubOpCode.
Dependencies/Couplings	See Restriction and Notes
Remote Command Notes	Target window to control depends on the SubOpCode.
Preset	11.9 23.9
State Saved	Saved in instrument state.
Min	0.1
Max	500000.0
Key Path	Span X Scale

Ref Position

Sets the reference position of the X axis on the display. The reference position can be set to Left, Ctr (center) or Right.

Key Path	Span X Scale
----------	---------------------

I/Q Error View Mag Error Window Ref Position

Sets the reference position of the X axis in the magnitude error window of the I/Q Error view.

Mode	cdma2000
Remote Command	:DISPlay:CDPower:VIEW3:WINDow[1]:TRACe:X[:SCALe]:RPOSiti tion LEFT CENTer RIGHT :DISPlay:CDPower:VIEW3:WINDow[1]:TRACe:X[:SCALe]:RPOSiti tion?
Example	DISP:CDP:VIEW3:WIND:TRAC:X:RPOS LEFT DISP:CDP:VIEW3:WIND:TRAC:X:RPOS?
Preset	LEFT
State Saved	Saved in instrument state.
Range	Left Ctr Right
Key Path	Span X Scale

I/Q Error View Phase Error Window Ref Position

Sets the reference position of the X axis in the phase error window of the I/Q Error view.

Mode	cdma2000
Remote Command	:DISPlay:CDPower:VIEW3:WINDow2:TRACe:X[:SCALe]:RPOSiti on LEFT CENTer RIGHT :DISPlay:CDPower:VIEW3:WINDow2:TRACe:X[:SCALe]:RPOSiti on?
Example	DISP:CDP:VIEW3:WIND2:TRAC:X:RPOS LEFT DISP:CDP:VIEW3:WIND2:TRAC:X:RPOS?
Preset	LEFT
State Saved	Saved in instrument state.
Range	Left Ctr Right
Key Path	Span X Scale

I/Q Error View Evm Window Ref Position

Sets the X axis reference position in the EVM window of the I/Q Error view.

Mode	cdma2000
Remote Command	:DISPlay:CDPower:VIEW3:WINDow3:TRACe:X[:SCALe]:RPOSiti on LEFT CENTer RIGHT :DISPlay:CDPower:VIEW3:WINDow3:TRACe:X[:SCALe]:RPOSiti on?

Example	DISP:CDP:VIEW3:WIND3:TRAC:X:RPOS LEFT DISP:CDP:VIEW3:WIND3:TRAC:X:RPOS?
Preset	LEFT
State Saved	Saved in instrument state.
Range	Left Ctr Right
Key Path	Span X Scale

Code Domain View Symb Power Window Ref Position

Sets the X axis reference position in the symbol power window of the code domain (Quad View).

Mode	cdma2000
Remote Command	:DISPlay:CDPower:VIEW4:WINDow2:TRACe:X[:SCALe]:RPOSiti on LEFT CENTer RIGHT :DISPlay:CDPower:VIEW4:WINDow2:TRACe:X[:SCALe]:RPOSiti on?
Example	DISP:CDP:VIEW4:WIND2:TRAC:X:RPOS LEFT DISP:CDP:VIEW4:WIND2:TRAC:X:RPOS?
Preset	LEFT
State Saved	Saved in instrument state.
Range	Left Ctr Right
Key Path	Span X Scale

Demod Bits View Symb Power Window Ref Position

Sets the X axis reference position for the symbol power window of Demod Bits view.

Mode	cdma2000
Remote Command	:DISPlay:CDPower:VIEW5:WINDow2:TRACe:X[:SCALe]:RPOSiti on LEFT CENTer RIGHT :DISPlay:CDPower:VIEW5:WINDow2:TRACe:X[:SCALe]:RPOSiti on?
Example	DISP:CDP:VIEW5:WIND2:TRAC:X:RPOS LEFT DISP:CDP:VIEW5:WIND2:TRAC:X:RPOS?
Preset	LEFT
State Saved	Saved in instrument state.
Range	Left Ctr Right
Key Path	Span X Scale

Auto Scaling

Determines the scale per division and reference value for the X axis based on the current measurement results.

Key Path	Span X Scale
----------	---------------------

I/Q Error View Mag Error Window Auto Scaling

When Auto Scaling is On, and the Restart front-panel key is pressed, this function automatically displays the scale per division and reference value results in the magnitude error window of the I/Q Error view.

Mode	cdma2000
Remote Command	:DISPlay:CDPower:VIEW3:WINDow [1] :TRACe:X[:SCALE]:COUPlE 0 1 OFF ON :DISPlay:CDPower:VIEW3:WINDow [1] :TRACe:X[:SCALE]:COUPlE?
Example	DISP:CDP:VIEW3:WIND1:TRAC:X:COUP ON DISP:CDP:VIEW3:WIND1:TRAC:X:COUP?
Restriction and Notes	Upon pressing the Restart front-panel key or Restart menu key under the Meas Control menu, the Auto Scaling function automatically determines the scale per division and reference values based on the measurement results if this parameter is set to On. When you set a value to either Scale/Div or Ref Value manually, Auto Scaling automatically changes to Off.
Dependencies/Couplings	See Restriction and Notes
Preset	ON
State Saved	Saved in instrument state.
Range	Off On
Key Path	Span X Scale

I/Q Error View Phase Error Window Auto Scaling

When Auto Scaling is On, and the Restart front-panel key is pressed, this function automatically displays the scale per division and reference value results in the phase error window of the I/Q Error view.

Mode	cdma2000
Remote Command	:DISPlay:CDPower:VIEW3:WINDow2:TRACe:X[:SCALE]:COUPlE 0 1 OFF ON :DISPlay:CDPower:VIEW3:WINDow2:TRACe:X[:SCALE]:COUPlE?
Example	DISP:CDP:VIEW3:WIND2:TRAC:X:COUP ON DISP:CDP:VIEW3:WIND2:TRAC:X:COUP?

Restriction and Notes	Upon pressing the Restart front-panel key or Restart menu key under the Meas Control menu, the Auto Scaling function automatically determines the scale per division and reference values based on the measurement results if this parameter is set to On. When you set a value to either Scale/Div or Ref Value manually, Auto Scaling automatically changes to Off.
Dependencies/Couplings	See Restriction and Notes
Preset	ON
State Saved	Saved in instrument state.
Range	Off On
Key Path	Span X Scale

I/Q Error View Evm Window Auto Scaling

When Auto Scaling is On, and the Restart front-panel key is pressed, this function automatically displays the scale per division and reference value results in the EVM window of the I/Q Error window.

Mode	cdma2000
Remote Command	:DISP:CDPower:VIEW3:WINDow3:TRACe:X[:SCALE]:COU Ple 0 1 OFF ON :DISP:CDPower:VIEW3:WINDow3:TRACe:X[:SCALE]:COU Ple?
Example	DISP:CDP:VIEW3:WIND3:TRAC:X:COUP ON DISP:CDP:VIEW3:WIND3:TRAC:X:COUP?
Restriction and Notes	Upon pressing the Restart front-panel key or Restart menu key under the Meas Control menu, the Auto Scaling function automatically determines the scale per division and reference values based on the measurement results if this parameter is set to On. When you set a value to either Scale/Div or Ref Value manually, Auto Scaling automatically changes to Off.
Dependencies/Couplings	See Restriction and Notes
Preset	ON
State Saved	Saved in instrument state.
Range	Off On
Key Path	Span X Scale

Code Domain View Symb Power Window Auto Scaling

When Auto Scaling is On, and the Restart front-panel key is pressed, this function automatically displays the scale per division and reference value results in the symbol power window of the code domain (quad

view).

Mode	cdma2000
Remote Command	:DISPlay:CDPower:VIEW4:WINDow2:TRACe:X[:SCALe]:COUPle 0 1 OFF ON :DISPlay:CDPower:VIEW4:WINDow2:TRACe:X[:SCALe]:COUPle?
Example	DISP:CDP:VIEW4:WIND2:TRAC:X:COUP ON DISP:CDP:VIEW4:WIND2:TRAC:X:COUP?
Restriction and Notes	Upon pressing the Restart front-panel key or Restart menu key under the Meas Control menu, the Auto Scaling function automatically determines the scale per division and reference values based on the measurement results if this parameter is set to On. When you set a value to either Scale/Div or Ref Value manually, Auto Scaling automatically changes to Off.
Dependencies/Couplings	See Restriction and Notes
Preset	ON
State Saved	Saved in instrument state.
Range	Off On
Key Path	Span X Scale

Demod Bits View Symb Power Window Auto Scaling

When Auto Scaling is On, and the Restart front-panel key is pressed, this function automatically displays the scale per division and reference value results for the symbol power window of demod bits view.

Mode	cdma2000
Remote Command	:DISPlay:CDPower:VIEW5:WINDow2:TRACe:X[:SCALe]:COUPle 0 1 OFF ON :DISPlay:CDPower:VIEW5:WINDow2:TRACe:X[:SCALe]:COUPle?
Example	DISP:CDP:VIEW5:WIND2:TRAC:X:COUP ON DISP:CDP:VIEW5:WIND2:TRAC:X:COUP?
Restriction and Notes	Upon pressing the Restart front-panel key or Restart menu key under the Meas Control menu, the Auto Scaling function automatically determines the scale per division and reference values based on the measurement results if this parameter is set to On. When you set a value to either Scale/Div or Ref Value manually, Auto Scaling automatically changes to Off.
Dependencies/Couplings	See Restriction and Notes
Preset	ON

State Saved	Saved in instrument state.
Range	Off On
Key Path	Span X Scale

Sweep/Control

Accesses a menu that enables you to pause and restart the measurement.

Key Path	Front Panel Key
----------	-----------------

Pause/Resume

Pauses a measurement after the current data acquisition is complete. When Paused, the label on the key changes to Resume. Pressing the Resume key resumes the measurement at the point it was at when paused. See the Measurement Functions section for details.

Key Path	Sweep/Control
----------	---------------

Trace/Detector

There is no Trace/Detector functionality supported in the Code Domain measurement. The front-panel key displays a blank menu key when pressed.

Key Path	Front-panel key
----------	-----------------

Trigger

Selects a trigger source. Trigger settings are mode global. Refer to Measurement Functions section for trigger settings.

Mode	cdma2000
Remote Command	:TRIGger:CDPower[:SEQuence]:SOURce EXTernal[1] EXTernal2 IMMediate LINE FRAMe RFBurst VID eo IF :TRIGger:CDPower[:SEQuence]:SOURce?
Example	TRIG:CDP:SOUR RFB TRIG:CDP:SOUR?
Remote Command Notes	You must be in the cdma2000 mode to use this command. Use INSTrument:SELEct to set the mode.
Preset	IMMediate
State Saved	Saved in instrument state.
Range	Free Run Video Line External 1 External 2 RF Burst (Wideband) Periodic Timer(Frame Trigger)
Key Path	Front panel key

View/Display

Accesses a menu of functions that enable you to control the instrument display.

Key Path	Front panel key
----------	-----------------

Display

Accesses a menu of functions that enable you to set the display parameters.

See [“Display” on page 1393](#) for more information.

Key Path	View/Display
----------	--------------

Annotation

Turns the screen annotation on or off for all windows, however, menu key annotation remains on the display. Since this functionality is mode global, see [“Annotation” on page 1393](#) for details.

Key Path	View/Display
----------	--------------

Graticule

Turns display graticule on and off. Since this functionality is mode global, see [“Graticule ” on page 1398](#) for details.

Key Path	View/Display
----------	--------------

Title

Accesses the Title menu that contains Change Title and Clear Title.

Key Path	View/Display
----------	--------------

Change Title

Accesses an Alpha Editor menu that enables you to write a title across the top of the display. This menu contains characters and symbols that may also be used with the numeric keypad. Press Enter or Return to complete the entry. Press ESC to cancel the entry and preserve your existing title.

The display title remains until you press Change Title again, or you recall a trace or state, or a Factory Preset is performed. A title can also be cleared by pressing Title, Clear Title.

This table is for SCPI definition purpose only and SCPI command and Preset/Default value are defined

on measurement basis.

Mode	cdma2000
Remote Command	:DISPlay:CDPower:ANNotation:TITLe:DATA "TITLE" :DISPlay:CDPower:ANNotation:TITLe:DATA?
Example	DISP:CDP:ANN:TITL:DATA "Code Domain" DISP:CDP:ANN:TITL:DATA?
Preset	Code Domain
State Saved	Saved in instrument state.
Range	Uppercase, Lowercase, Numeric, Symbol
Key Path	View/Display, Display, Title

Clear Title

Clears a title from the front-panel display. Once cleared, the title cannot be retrieved.

Mode	cdma2000
Key Path	View/Display, Display, Title

View (Remote Command only)

Selects the desired measurement view from the following selections:

- PGRaph (1) – Power Graph & Metrics provides a combination view of the code domain power graph and the summary data.
- CDE (2) – Power Graph & CDE Graph provides a combination view of the code domain power graph and the code domain error. Not available if the [:SENSe]:CDPower:CAPTure:TIME(Capture Interval) is 4.0 or 8.0 or 16.0(Long Mode).
- SEVM (3) – I/Q Error (Quad View) - Symbol EVM provides a combination view of magnitude error, phase error, Symbol EVM, and the summary data.
- QUAD (4) – Code Domain (Quad View) provides a combination view for the code domain power symbol power, I/Q symbol polar vector and the summary data.
- DBITs (5) – Demod Bits provides a combination view of the graphs for the code domain power and symbol power, and the I/Q demodulated bit stream data for the symbol power slots selected by the measurement interval and measurement offset

Mode	cdma2000
Remote Command	:DISPlay:CDPower:VIEW[:SElect] PGRaph CDE SEVM QUAD DBITs :DISPlay:CDPower:VIEW[:SElect]?

Example	DISP:CDP:VIEW PGR DISP:CDP:VIEW?
Remote Command Notes	You must be in the cdma2000 mode to use this command. Use INSTRUMENT:SElect to set the mode.
Preset	PGRaph
State Saved	Saved in instrument state.
Range	Power Graph & Metrics CDP Graph & CDE Graph I/Q Error (Quad View) Code Domain (Quad View) Demod Bits Long Demod

View Selection by number (SCPI Remote Command only)

Displays the numeric values of the measurement results. This function is available by SCPI command only

Remote Command	:DISPlay:CDPower:VIEW:NSElect <integer> :DISPlay:CDPower:VIEW:NSElect?
Example	DISP:CDP:VIEW:NSEL 2 DISP:CDP:VIEW:NSEL?
Remote Command Notes	You must be in the cdma2000 mode to use this command. Use INSTRUMENT:SElect to set the mode.
Preset	1
State Saved	Saved in instrument state.
Min	1
Max	5

View Settings

Power Graph & Metrics

Provides a combination view of the code domain power graph and the summary data

Key Path	View/Display
----------	--------------

Code Order

Access the selection menu for the Walsh code order function. Set the Walsh code order function to Hadamard or Bit Reverse.

The Code Order key for Power Bar Graph and CDE Graph functions are coupled to each other.

Mode	cdma2000
------	----------

Remote Command	:CALCulate:CDPower:WCODE:ORDER HADMrd BREVerse :CALCulate:CDPower:WCODE:ORDER?
Example	CALCulate:CDPower:WCODE:ORDER HADMrd CALCulate:CDPower:WCODE:ORDER?
Dependencies/Couplings	This command is effective only when the CDP window is selected.
Preset	HADMrd
State Saved	Saved in instrument state.
Range	Hadamard Bit Reverse
Key Path	View/Display, Power Graph & Metrics

Base Code Length

Toggle the Walsh base code length between 64 and 128.

The Base Code Length for Power Bar Graph and CDE Graph functions are coupled to each other.

Mode	cdma2000
Remote Command	:CALCulate:CDPower:WCODE:BASE <integer> :CALCulate:CDPower:WCODE:BASE?
Example	CALCulate:CDPower:WCODE:BASE 64 CALCulate:CDPower:WCODE:BASE?
Restriction and Notes	Set the base code length (64 or 128) This key is grayed out when MS is selected as Radio device
Dependencies/Couplings	This command is effective only when the CDP window is selected.
Preset	64
State Saved	Saved in instrument state.
Range	64, 128
Key Path	View/Display, Power Graph & Metrics

Consolidated Marker

Toggle the consolidated marker function between On and Off.

The Consolidated Marker for Power Bar Graph and CDE Graph functions are coupled to each other.

Remote Command	:DISPlay:CDPower:MARKer:CONSolidated ON OFF 1 0 :DISPlay:CDPower:MARKer:CONSolidated?
Example	DISPlay:CDPower:MARKer:CONSolidated ON DISPlay:CDPower:MARKer:CONSolidated?

Restriction and Notes	This key is displayed only when the CDP window is selected. This key shall be grayed out when the Code Order Bit Reverse key is selected. If set to On, the corresponding Walsh code channel power is marked in the different color upon placing the marker at the consolidated Walsh code channel power
Remote Command Notes	You must be in the cdma2000 mode to use this command. Use INSTRument:SElect to set the mode.
Preset	ON
State Saved	Saved in instrument state.
Range	Off On
Key Path	View/Display, Power Graph & Metrics

CDP Graph and CDE Graph

Provides a combination view of the code domain power graph and the code domain error. These two windows have the same view settings as the Power Graph & Metrics view.

Key Path	View/Display
----------	---------------------

I/Q Error (Quad View)

Provides a combination view of magnitude error, phase error, Symbol EVM, and the summary data. There is no view settings for this view.

Key Path	View/Display
----------	---------------------

Code Domain (Quad View)

Provides a combination view for the code domain power symbol power, I/Q symbol polar vector and the summary data. The Code Domain Power window has the same view settings as the Power Graph & Metrics. The Symbol Power window has the view setting of Composite Chip Power.

Key Path	View/Display
----------	---------------------

Composite Chip Power

Toggles the composite chip power display function between On and Off.

Mode	cdma2000
Remote Command	:DISPlay:CDPower:CPOWer [:STATE] 0 1 OFF ON :DISPlay:CDPower:CPOWer [:STATE] ?
Example	DISP:CDP:CPOW ON DISP:CDP:CPOW?

Restriction and Notes	Only valid for Symbol/Chip Power vs. Time window.
Preset	ON
State Saved	Saved in instrument state.
Range	On Off
Key Path	View/Display, Code Domain (Quad View)

Demod Bits

There are three windows. The Code Domain Power window has the same view settings as the Power Graph & Metrics. The Symbol Power window has the view setting of Composite Chip Power. The Demod Bits window is to allow the following controls to read the bit stream measurement results:

- Prev Page - Returns one page back to the previous page of the measurement results.
- Next Page - Moves one page forward to the next page of the measurement results.
- Scroll Up - Moves one line upward from the current page of the measurement results by each pressing.
- Scroll Down - Moves one line downward from the current page of the measurement results by each pressing.
- First Page - Moves from the current page to the first page of the measurement results.
- Last Page - Moves from the current page to the last page of the measurement results.

Key Path	View/Display
----------	---------------------

Prev Page

Returns the current page back to the previous page of the measurement results.

Mode	cdma2000
Restriction and Notes	The Demod Bits window must be the focused window.
Remote Command Notes	NO SCPI
Key Path	View/Display, Demod Bits

Next Page

Moves the current page forward to the next page of the measurement results.

Mode	cdma2000
Restriction and Notes	The Demod Bits window must be the focused window.
Remote Command Notes	NO SCPI
Key Path	View/Display, Demod Bits

Scroll Up

Moves one line upward from the current page of the measurement results by each pressing.

Mode	cdma2000
Restriction and Notes	The Demod Bits window must be the focused window.
Remote Command Notes	NO SCPI
Key Path	View/Display, Demod Bits

Scroll Down

Moves one line downward from the current page of the measurement results by each press.

Mode	cdma2000
Restriction and Notes	The Demod Bits window must be the focused window.
Remote Command Notes	NO SCPI
Key Path	View/Display, Demod Bits

First Page

Moves from the current page to the first page of the measurement results.

Mode	cdma2000
Restriction and Notes	The Demod Bits window must be the focused window.
Remote Command Notes	NO SCPI
Key Path	View/Display, Demod Bits

Last Page

Moves from the current page to the last page of the measurement results.

Mode	cdma2000
Restriction and Notes	The Demod Bits window must be the focused window.
Remote Command Notes	NO SCPI
Key Path	View/Display, Demod Bits

Rho is one of the key modulation quality metrics, along with EVM. Rho is the ratio of the correlated power in a multi coded channel to the total signal power. This measurement takes into account all possible error mechanisms in the entire transmission chain including: baseband filtering, I/Q modulation anomalies, filter amplitude and phase non-linearity, and power amplifier distortions.

This provides an overall indication of the performance level of the transmitter of the unit under test (UUT).

Key Path	Meas
----------	------

Modulation Accuracy Remote Command SCPI Results

You must be in the cdma2000 to use these commands. Use INSTRument:SElect to set the mode.

:CONFigure:RHO

:FETCh:RHO [n] ?

:READ:RHO [n] ?

:MEASure:RHO [n] ?

Modulation Accuracy (Composite Rho)

n	Results Returned
0	Returns unprocessed I/Q trace data, as a series of comma-separated trace points, in volts. The I values are listed first in each pair, using the 0 through even-indexed values. The Q values are the odd-indexed values.
not specified or n = 1	Returns the following 11 scalar results: 1. RMS EVM (Average) is a floating point number (in percent) of EVM over the entire measurement area 2. Peak EVM (Peak Hold) is a floating point number (in percent) of the peak EVM in the measurement area 3. Magnitude error (Average) is a floating point number (in percent) of the average magnitude error over the entire measurement area 4. Phase error (Average) is a floating point number (in degree) of the average phase error over the entire measurement area 5. I/Q origin offset (Average) is a floating point number (in dB) of the I and Q error (magnitude squared) offset from the origin 6. Frequency error (Average) is a floating point number (in Hz) of the frequency error in the measured signal 7. Rho (Average) is a floating point number of Rho 8. Peak Code Domain Error (Peak Hold) is a floating point number (in dB) of the Peak Code Domain Error relative to the mean reference power 9. Peak Code Domain Error Channel Number (Peak Hold) is the channel number in which the peak code domain error is detected. 10. Number of active channels. 11. Time offset (Average) is a floating point number (in chips) of the pilot phase timing from the acquisition trigger point.
2	EVM trace – returns series of floating point numbers (in percent) that represent each sample in the EVM trace. The first number is the symbol 0 decision point. There are X points per symbol (X=points/chip). Therefore, the decision points are at 0, 1*X, 2*X, ...
3	Magnitude error trace – returns series of floating point numbers (in percent) that represent each sample in the magnitude error trace. The first number is the symbol 0 decision point. There are X points per symbol (X=points/chip). Therefore, the decision points are at 0, 1*X, 2*X, ...
4	Phase error trace – returns series of floating point numbers (in percent) that represent each sample in the phase error trace. The first number is the symbol 0 decision point. There are X points per symbol (X=points/chip). Therefore, the decision points are at 0, 1*X, 2*X, ...

n	Results Returned
5	<p>Corrected measured trace – returns series of floating point numbers that alternately represent I and Q pairs of the corrected measured trace. The magnitude of each I and Q pair are normalized to 1.0. The first number is the I sample of symbol 0 decision point and the second number is the Q sample of symbol 0 decision point. There are X points per symbol (X=points/chip). Therefore, the series of numbers is:</p> <p>1st number = I of the symbol 0 decision point 2nd number = Q of the symbol 0 decision point ... (2*X)+1 number = I of the symbol 1 decision point (2*X)+2 number = Q of the symbol 1 decision point ... (2*X)*N+1 th number = I of the symbol N decision point (2*X)*N+2 th number = Q of the symbol N decision point</p>
6	<p>Returns 6 scalar values of the pass/fail (0=passed, or 1=failed) results determined by testing the EVM, the peak EVM, Rho, the peak code domain error, the time offset, and the phase error.</p>
7	<p>Returns series of floating point numbers of code level, code index, power (in dB), time offset (in ns), phase offset (in rad), and code domain error (in dB). The total number of results are six times of “number of active channels”. The number of active channels can be obtained by the 10th result of READ:RHO1 command.</p>

AMPTD Y Scale

Accesses the AMPTD Y Scale menu that allows you to set the desired vertical scale and associated settings. This menu is available when in “I/Q Error” view. It is not available when in the following views: “I/Q Measured Polar Graph” or “Power, Timing and Phase”.

Key Path	Front-panel key
----------	------------------------

Ref Value

Sets the absolute power reference value ranging from –500.00 to 500.00 dBm with 0.01 dB resolution. However, since Auto Scaling defaults to On, this value is automatically determined by the measurement result. When you set a value manually, Auto Scaling automatically changes to Off.

Key Path	AMPTD Y Scale
----------	----------------------

I/Q Error View - EVM Window

Sets the absolute power reference value in the EVM window.

Mode	cdma2000
Remote Command	:DISPlay:RHO:VIEW2:WINDow [1] :TRACe:Y[:SCALe]:RLEVE l <real> :DISPlay:RHO:VIEW2:WINDow [1] :TRACe:Y[:SCALe]:RLEVE l?
Example	DISP:RHO:VIEW2:WIND:TRAC:Y:RLEV 0.0 DISP:RHO:VIEW2:WIND:TRAC:Y:RLEV?
Restriction and Notes	If Auto Scaling is set to On, this value is automatically determined by the measurement result. When you set this value manually, Auto Scaling is automatically set to Off.
Dependencies/Couplings	See Restriction and Notes
Remote Command Notes	WINDow[1]: Evm window on I/Q Error view
Preset	0.00
State Saved	Saved in instrument state.
Min	–500.0
Max	500.0
Key Path	AMPTD Y Scale

I/Q Error View – Mag Error Window

Sets the absolute power reference value in the magnitude error window.

Mode	cdma2000
Remote Command	:DISP:RHO:VIEW2:WINDow2:TRACe:Y[:SCALe]:RLEVel <real> :DISP:RHO:VIEW2:WINDow2:TRACe:Y[:SCALe]:RLEVel?
Example	DISP:RHO:VIEW2:WIND2:TRAC:Y:RLEV 0.0 DISP:RHO:VIEW2:WIND2:TRAC:Y:RLEV?
Restriction and Notes	If Auto Scaling is set to On, this value is automatically determined by the measurement result. When you set this value manually, Auto Scaling is automatically set to Off.
Dependencies/Couplings	See Restriction and Notes
Remote Command Notes	WINDow2: Mag Error window on I/Q Error view
Preset	0.00
State Saved	Saved in instrument state.
Min	-500.0
Max	500.0
Key Path	AMPTD Y Scale

I/Q Error View – Phase Error Window

Sets the absolute power reference value in the phase error window.

Mode	cdma2000
Remote Command	:DISP:RHO:VIEW2:WINDow3:TRACe:Y[:SCALe]:RLEVel <real> :DISP:RHO:VIEW2:WINDow3:TRACe:Y[:SCALe]:RLEVel?
Example	DISP:RHO:VIEW2:WIND3:TRAC:Y:RLEV 0.0 DISP:RHO:VIEW2:WIND3:TRAC:Y:RLEV?
Restriction and Notes	If Auto Scaling is set to On, this value is automatically determined by the measurement result. When you set this value manually, Auto Scaling is automatically set to Off.
Dependencies/Couplings	See Restriction and Notes
Remote Command Notes	WINDow3: Phase Error window on I/Q Error view
Preset	0.00
State Saved	Saved in instrument state.

Modulation Accuracy (Composite Rho)
AMPTD Y Scale

Min	-36000.0
Max	36000.0
Key Path	AMPTD Y Scale

Attenuation

Accesses a menu of functions that enable you to change the attenuation settings. This key has read-back text that describes the total attenuator value.

See “Attenuation” on page 850 for more information.

Key Path	AMPTD Y Scale
----------	----------------------

Scale/Div

Sets the sensitivity for the vertical axis. The range is 0.10 to 50.00 dB with 0.01 dB resolution. However, since Auto Scaling defaults to On, this value is automatically determined by the measurement result. When you set a value manually, Auto Scaling automatically changes to Off.

Key Path	AMPTD Y Scale
----------	----------------------

I/Q Error View - EVM Window

Sets the sensitivity measurement result in the EVM window.

Mode	cdma2000
Remote Command	:DISPlay:RHO:VIEW2:WINDow [1] :TRACe:Y[:SCALe]:PDIVi sion <real> :DISPlay:RHO:VIEW2:WINDow [1] :TRACe:Y[:SCALe]:PDIVi sion?
Example	DISP:RHO:VIEW2:WIND:TRAC:Y:PDIV 10.0 DISP:RHO:VIEW2:WIND:TRAC:Y:PDIV?
Restriction and Notes	If Auto Scaling is set to On, this value is automatically determined by the measurement result. When you set this value manually, Auto Scaling is automatically set to Off.
Dependencies/Couplings	See Restriction and Notes
Preset	0.5
State Saved	Saved in instrument state.
Min	0.100
Max	50.0
Key Path	AMPTD Y Scale

I/Q Error View – Mag Error Window

Sets the sensitivity measurement result in the magnitude error window.

Mode	cdma2000
Remote Command	:DISPlay:RHO:VIEW2:WINDow2:TRACe:Y[:SCALe]:PDIVisi on <real> :DISPlay:RHO:VIEW2:WINDow2:TRACe:Y[:SCALe]:PDIVisi on?
Example	DISP:RHO:VIEW2:WIND2:TRAC:Y:PDIV 10.0 DISP:RHO:VIEW2:WIND2:TRAC:Y:PDIV?
Restriction and Notes	If Auto Scaling is set to On, this value is automatically determined by the measurement result. When you set this value manually, Auto Scaling is automatically set to Off.
Dependencies/Couplings	See Restriction and Notes
Preset	1.0
State Saved	Saved in instrument state.
Min	0.100
Max	50.0
Key Path	AMPTD Y Scale

I/Q Error View – Phase Error Window

Sets the sensitivity measurement result in the phase error window.

Mode	cdma2000
Remote Command	:DISPlay:RHO:VIEW2:WINDow3:TRACe:Y[:SCALe]:PDIVisi on <real> :DISPlay:RHO:VIEW2:WINDow3:TRACe:Y[:SCALe]:PDIVisi on?
Example	DISP:RHO:VIEW2:WIND3:TRAC:Y:PDIV 10.0 DISP:RHO:VIEW2:WIND3:TRAC:Y:PDIV?
Restriction and Notes	If Auto Scaling is set to On, this value is automatically determined by the measurement result. When you set this value manually, Auto Scaling is automatically set to Off.
Dependencies/Couplings	See Restriction and Notes
Preset	0.5
State Saved	Saved in instrument state.
Min	0.0100

Modulation Accuracy (Composite Rho)
AMPTD Y Scale

Max	360.0
Key Path	AMPTD Y Scale

Internal Preamp

Accesses a menu of functions that enable you to control the internal preamplifiers.

See “[Internal Preamp](#)” on page 883 for more information.

Key Path	AMPTD Y Scale
----------	----------------------

Ref Position

Positions the Y-axis scale reference level at the top, center or bottom of the display. Changing the reference position does not change the reference level value.

Key Path	AMPTD Y Scale
----------	----------------------

I/Q Error View - EVM Window

Sets the reference position of the vertical axis in the EVM window.

Mode	cdma2000
Remote Command	:DISPlay:RHO:VIEW2:WINDow[1]:TRACe:Y[:SCALe]:RPOSi tion TOP CENTer BOTTom :DISPlay:RHO:VIEW2:WINDow[1]:TRACe:Y[:SCALe]:RPOSi tion?
Example	DISP:RHO:VIEW2:WIND:TRAC:Y:RPOS TOP DISP:RHO:VIEW2:WIND:TRAC:Y:RPOS?
Preset	BOTTom
State Saved	Saved in instrument state.
Range	Top Ctr Bot
Key Path	AMPTD Y Scale

I/Q Error View – Mag Error Window

Sets the reference position of the vertical axis in the magnitude error window.

Mode	cdma2000
Remote Command	:DISPlay:RHO:VIEW2:WINDow2:TRACe:Y[:SCALe]:RPOSiti on TOP CENTer BOTTom :DISPlay:RHO:VIEW2:WINDow2:TRACe:Y[:SCALe]:RPOSiti on?

Example	DISP:RHO:VIEW2:WIND2:TRAC:Y:RPOS TOP DISP:RHO:VIEW2:WIND2:TRAC:Y:RPOS?
Preset	CENTer
State Saved	Saved in instrument state.
Range	Top Ctr Bot
Key Path	AMPTD Y Scale

I/Q Error View – Phase Error Window

Sets the reference position of the vertical axis in the phase error window.

Mode	cdma2000
Remote Command	:DISPlay:RHO:VIEW2:WINDow3:TRACe:Y[:SCALe]:RPOSiti on TOP CENTer BOTTom :DISPlay:RHO:VIEW2:WINDow3:TRACe:Y[:SCALe]:RPOSiti on?
Example	DISP:RHO:VIEW2:WIND3:TRAC:Y:RPOS TOP DISP:RHO:VIEW2:WIND3:TRAC:Y:RPOS?
Preset	CENTer
State Saved	Saved in instrument state.
Range	Top Ctr Bot
Key Path	AMPTD Y Scale

Auto Scaling

Toggles the Auto Scaling function between On and Off. When Auto Scaling is On, pressing the Restart front-panel key results in automatically determining scale per division and reference values based on the measurement results.

When you set a value to either Scale/Div or Ref Value manually, Auto Scaling automatically changes to Off.

Key Path	AMPTD Y Scale
----------	----------------------

I/Q Error View - EVM Window

When Auto Scaling is On, pressing the Restart front-panel key results in automatically displaying the scale per division and reference value results for the vertical axis in the EVM window.

Mode	cdma2000
------	----------

Modulation Accuracy (Composite Rho)
AMPTD Y Scale

Remote Command	:DISPlay:RHO:VIEW2:WINDow[1]:TRACe:Y[:SCALe]:COUPl e 0 1 OFF ON :DISPlay:RHO:VIEW2:WINDow[1]:TRACe:Y[:SCALe]:COUPl e?
Example	DISP:RHO:VIEW2:WIND:TRAC:Y:COUP ON DISP:RHO:VIEW2:WIND:TRAC:Y:COUP?
Restriction and Notes	When this parameter is set to On, pressing the front-panel Restart key, or the Restart key in the Meas Control menu, activates the scale coupling function, that automatically determines scale per division and reference values based on the measurement results. When you set a value to either Scale/Div or Ref Value manually, Auto Scaling is automatically set to Off.
Dependencies/Couplings	See Restriction and Notes
Remote Command Notes	WINDow[1]: EVM window on I/Q Error view
Preset	ON
State Saved	Saved in instrument state.
Range	On Off
Key Path	AMPTD Y Scale

I/Q Error View – Mag Error Window

When Auto Scaling is On, pressing the Restart front-panel key results in automatically displaying the scale per division and reference value results for the vertical axis in the magnitude error window.

Mode	cdma2000
Remote Command	:DISPlay:RHO:VIEW2:WINDow2:TRACe:Y[:SCALe]:COUPl e 0 1 OFF ON :DISPlay:RHO:VIEW2:WINDow2:TRACe:Y[:SCALe]:COUPl e?
Example	DISP:RHO:VIEW2:WIND2:TRAC:Y:COUP ON DISP:RHO:VIEW2:WIND2:TRAC:Y:COUP?
Restriction and Notes	When this parameter is set to On, pressing the front-panel Restart key, or the Restart key in the Meas Control menu, based on the measurement results if this parameter is set to On. When you set a value to either Scale/Div or Ref Value manually, Auto Scaling is automatically set to Off.
Dependencies/Couplings	See Restriction and Notes
Remote Command Notes	WINDow2: Mag Error window on I/Q Error view
Preset	ON
State Saved	Saved in instrument state.

Range	On Off
Key Path	AMPTD Y Scale

I/Q Error View – Phase Error Window

When Auto Scaling is On, pressing the Restart front-panel key will result in automatically displaying the scale per division and reference value results for the vertical axis in the phase error window.

Mode	cdma2000
Remote Command	:DISP:RHO:VIEW2:WINDow3:TRACe:Y[:SCALe]:COUPlE 0 1 OFF ON :DISP:RHO:VIEW2:WINDow3:TRACe:Y[:SCALe]:COUPlE?
Example	DISP:RHO:VIEW2:WIND3:TRAC:Y:COUP ON DISP:RHO:VIEW2:WIND3:TRAC:Y:COUP?
Restriction and Notes	When this parameter is set to On, pressing the front-panel Restart key, or the Restart key in the Meas Control menu, activates the scale coupling function, that automatically determines scale per division and reference values based on the measurement results. When you set a value to either Scale/Div or Ref Value manually, Auto Scaling is automatically set to Off.
Dependencies/Couplings	See Restriction and Notes
Remote Command Notes	WINDow3: Phase Error window on I/Q Error view
Preset	ON
State Saved	Saved in instrument state.
Range	On Off
Key Path	AMPTD Y Scale

BW

There is no BW functionality supported in the Mod Accuracy measurement. The front-panel key will display a blank menu when pressed.

Key Path	BW
----------	-----------

Marker

Accesses a menu that enables you to select, set up and control the markers for the current measurement. See the "Marker Functions" section for more information.

Key Path	Front Panel Key
----------	-----------------

Marker Select

Displays 12 markers available for selection.

Key Path	Marker
----------	--------

Marker Type

Sets the marker control mode. If the selected marker is Off, pressing Marker sets it to Normal and places it at the center of the screen on the trace determined by the **Marker Trace** rules. At the same time, reference value of the selected marker appears on the Active Function area.

Active Function Display:

Marker symbol value at I/Q Symbol Polar Vector graph

Marker X-axis value at other graphs

Default Active Function: the active function for the selected marker's current control mode. If the current control mode is Off, there is no active function and the active function is turned off.

The marker X axis value entered in the active function area will display the marker value to its full entered precision.

Mode	cdma2000
Remote Command	:CALCulate:RHO:MARKer [1] 2 3 4 5 6 7 8 9 10 11 12 :MO DE POSition DELTA OFF :CALCulate:RHO:MARKer [1] 2 3 4 5 6 7 8 9 10 11 12 :MO DE?
Example	CALC:RHO:MARK:MODE POS CALC:RHO:MARK:MODE?

Marker

Restriction and Notes	<p>If the selected marker is Off, pressing Marker sets it to Normal and places it at the center of the screen on the trace determined by the Marker Trace rules. At the same time, Marker X Axis Value appears on the Active Function area.</p> <p>Default Active Function:</p> <p>The active function for the selected marker’s current control mode. If the current control mode is Off, there is no active function and the active function is turned off.</p> <p>Active Function Display:</p> <p>- the marker X axis value for any other graph</p> <p>The value entered in the active function area will display the marker value to its full entered precision.</p>
Preset	OFF
State Saved	Saved in instrument state.
Range	Normal Delta Off
Key Path	Marker

Marker Chip Value (Remote Command only)

Sets the marker Chip value in the current marker for the I/Q Polar trace. It has no effect if the control mode is **Off**, but if the control mode is Normal, this is the SCPI equivalent of entering a Chip value.

This command is valid only when Marker Trace ‘POLar’ (I/Q Polar) is active. For any other Marker Trace, the command is ignored.

Mode	cdma2000
Remote Command	<pre>:CALCulate:RHO:MARKer [1] 2 3 4 5 6 7 8 9 10 11 12 :CHIP <real></pre> <pre>:CALCulate:RHO:MARKer [1] 2 3 4 5 6 7 8 9 10 11 12 :CHIP?</pre>
Example	<pre>CALC:RHO:MARK:CHIP 0</pre> <pre>CALC:RHO:MARK:CHIP?</pre>
Restriction and Notes	<p>If no suffix is sent, ‘chips’ will be used. If a suffix is sent that does not match ‘chips’, an error “Invalid suffix” will be generated.</p> <p>The query returns the marker’s ‘chips’ value in the trace if the control mode is Normal. The query is returned in ‘chips’. If the marker is Off the response is not a number (NAN).</p>
Remote Command Notes	<p>This parameter has different meanings when the marker trace is set to I/Q Polar and others cases. In the case of the I/Q Polar Graph, the X Axis Value is also the measured value, so this parameter is meaningful only when the control mode is set to Normal.</p>
Preset	Start point of the trace in the display window

State Saved	No
Min	-9.9E+37
Max	9.9E+37

Marker X Axis Value (Remote Command only)

Sets the marker X Axis value in the current marker X Axis Scale unit. It has no effect if the control mode is **Off**, but is the SCPI equivalent of entering an X value if the control mode is **Normal** or **Delta**.

Mode	cdma2000
Remote Command	:CALCulate:RHO:MARKer [1] 2 3 4 5 6 7 8 9 10 11 12 :X <real> :CALCulate:RHO:MARKer [1] 2 3 4 5 6 7 8 9 10 11 12 :X?
Example	CALC:RHO:MARK3:X 0.0 CALC:RHO:MARK3:X?
Restriction and Notes	If no suffix is sent, the fundamental units for the current marker X Axis Scale will be used. If a suffix is sent that does not match the current marker X Axis Scale unit, an error “Invalid suffix” will be generated. The query returns the marker’s absolute X Axis value if the control mode is Normal , or the offset from the marker’s reference marker, if the control mode is Delta . The query is returned in the fundamental units for the current marker X Axis scale: Hz for Frequency and Inverse Time , seconds for Period and Time . If the marker is Off the response is not a number (NAN).
Preset	After a preset, all Markers are turned OFF, so a Marker X Axis Value query will return a not a number (NAN).
State Saved	No
Min	-9.9E+37
Max	9.9E+37.

Marker X Axis Position (Remote Command only)

Sets the marker X position in trace points. It has no effect if the control mode is **Off**, but is the SCPI equivalent of entering a value if the control mode is **Normal** or **Delta** - except in trace points rather than X Axis Scale units. The entered value is immediately translated into the current X Axis Scale units for setting the value of the marker.

Mode	cdma2000
------	----------

Modulation Accuracy (Composite Rho)

Marker

Remote Command	:CALCulate:RHO:MARKer [1] 2 3 4 5 6 7 8 9 10 11 12 :X: POSition <real> :CALCulate:RHO:MARKer [1] 2 3 4 5 6 7 8 9 10 11 12 :X: POSition?
Example	CALC:RHO:MARK10:X:POS 0.0 CALC:RHO:MARK10:X:POS?
Restriction and Notes	The query returns the marker's absolute X Axis value in trace points if the control mode is Normal , or the offset from the marker's reference marker in trace points, if the control mode is Delta . The value is returned as a real number, not an integer, corresponding to the translation from X Axis Scale units to trace points (see "Fractional Trace Points", above). If the marker is Off the response is not a number (NAN).
Remote Command Notes	This command is not available when Marker Trace of the selected marker (:CALCulate:RHO:MARKer[1] 2 3 4 5 6 7 8 9 10 11 12:TRACe?) is set to POLar. In this case, this command is ignored.
Preset	After a preset, all Markers are turned OFF, so Marker X Axis Value query will return a not a number (NAN).
State Saved	No
Min	-9.9E+37
Max	9.9E+37

Marker Y Axis Value (Remote Command only)

Queries the marker Y Axis value in the current unit for the marker Y Axis.

Mode	cdma2000
Remote Command	:CALCulate:RHO:MARKer [1] 2 3 4 5 6 7 8 9 10 11 12 :Y?
Example	CALC:RHO:MARK11:Y?
Restriction and Notes	If no suffix is sent, the current Y Axis unit will be used. If a suffix is sent that is not expressed in units of absolute amplitude, an "Invalid suffix" error will be generated. The query returns the marker Y-axis result if the control mode is Normal or Delta . If the marker is Off the response is not a number (NAN).
Preset	Result dependent on Markers setup and signal source
State Saved	No

Properties

Accesses a menu that enables you to select a reference marker and marker trace.

Key Path	Marker
----------	---------------

Marker Select

Displays 12 markers available for selection.

Key Path	Marker
----------	---------------

Relative To

Selects the marker that the selected marker will be relative to (its reference marker).

Mode	cdma2000
Remote Command	:CALCulate:RHO:MARKer [1] 2 3 4 5 6 7 8 9 10 11 12 :RE Fere nce <integer> :CALCulate:RHO:MARKer [1] 2 3 4 5 6 7 8 9 10 11 12 :RE Fere nce?
Example	CALC:RHO:MARK:REF 3 CALC:RHO:MARK:REF?
Restriction and Notes	A marker cannot be relative to itself so that choice is grayed out, and if sent from SCPI generates error –221: “Settings conflict; marker cannot be relative to itself.”
Remote Command Notes	When queried a single value will be returned (the specified marker number’s relative marker). A marker cannot be relative to itself so that choice is grayed out, and if sent from SCPI generates error –221: “Settings conflict; marker cannot be relative to itself.”
Preset	2 3 4 5 6 7 8 9 10 11 12 1
State Saved	Saved in instrument state.
Min	1
Max	12
Key Path	Marker, Properties

Marker Trace

Assigns the specified marker to the designated trace.

Mode	cdma2000
Remote Command	:CALCulate:RHO:MARKer [1] 2 3 4 5 6 7 8 9 10 11 12 :TR ACe POLar EVM MERRor PERRor :CALCulate:RHO:MARKer [1] 2 3 4 5 6 7 8 9 10 11 12 :TR ACe?
Example	CALC:RHO:MARK2:TRAC EVM CALC:RHO:MARK2:TRACE?

Marker

Preset	EVM
State Saved	Saved in instrument state.
Range	POLar EVM MERRor PERRor
Key Path	Marker

Couple Markers

Toggles the state of the markers to be coupled On or Off. When this function is true (On), moving any marker causes an “equal X Axis movement” of every other marker which is active. By “equal X Axis movement” we mean that we preserve the difference between each marker’s X Axis value (in the fundamental x-axis units of the trace that marker is on) and the X Axis value of the marker being moved (in the same fundamental x-axis units).

See Couple Markers in the "Marker" section for more information.

This may result in markers going off screen.

Mode	cdma2000
Remote Command	:CALCulate:RHO:MARKer:COUPle[:STATe] ON OFF 1 0 :CALCulate:RHO:MARKer:COUPle[:STATe]?
Example	CALC:RHO:MARK:COUP ON CALC:RHO:MARK:COUP?
Restriction and Notes	When the marker is assigned to the IQ Measured Polar graph, a Chip value is coupled instead of an X Axis value.
Preset	OFF
State Saved	Saved in instrument state.
Range	On Off
Key Path	Marker

All Markers Off

Turns off all markers.

Mode	cdma2000
Remote Command	:CALCulate:RHO:MARKer:AOFF
Example	CALC:RHO:MARK:AOFF
Key Path	Marker

Marker Function

There are no 'Marker Functions' supported in Mod Accuracy. The front-panel key will display a blank menu when pressed.

Marker To

There is no 'Marker To' functionality supported in Mod Accuracy. The front-panel key will display a blank menu when pressed.

Meas Setup

Displays the measurement setup menu for the currently selected measurement.

Key Path	Front panel key
----------	------------------------

Avg Number

Sets the number of data acquisitions that will be averaged. After the specified number of average counts is reached, the averaging mode (termination control) setting determines the averaging action.

Mode	cdma2000
Remote Command	[:SENSe] :RHO:AVErAge:COUNt <integer> [:SENSe] :RHO:AVErAge:COUNt? [:SENSe] :RHO:AVErAge [:STATe] OFF ON 0 1 [:SENSe] :RHO:AVErAge [:STATe] ?
Example	RHO:AVER:COUN 100 RHO:AVER:COUN? RHO:AVER OFF RHO:AVER?
Remote Command Notes	You must be in the cdma2000 mode to use this command. Use INSTRument:SELEct to set the mode.
Preset	10 ON
State Saved	Saved in instrument state.
Min	1
Max	10000
Key Path	Meas Setup

Avg Mode

Selects the type of termination control used for the averaging function. This determines the averaging action after the specified number of data acquisitions (average count) is reached. You can select between the Exp (exponential) and Repeat averaging modes. This selection only affects the averaging result after the number of N averages is reached. You can use the Avg Number key to set N.

Meas Setup

KEYExponential averaging SCPIEXPonential	When Measure is set at Cont, data acquisitions will continue indefinitely. After N averages, exponential averaging is used with a weighting factor of N (the displayed average count stops at N). Exponential averaging weights new data more than old data, which allows tracking of slow-changing signals.
KEYRepeat averaging SCPIREPeat	When Measure is set at Cont, data acquisitions will continue indefinitely. After N averages is reached, all previous result data is cleared and the average count is set back to 1. This is equivalent to being in Measure Single and pressing the Restart key when the Single measurement finishes.

Mode	cdma2000
Remote Command	[:SENSe] :RHO:AVERage:TCONtrol EXPonential REPeat [:SENSe] :RHO:AVERage:TCONtrol?
Example	RHO:AVER:TCON EXP RHO:AVER:TCON?
Preset	REPeat
State Saved	Saved in instrument state.
Range	Exp Repeat
Key Path	Meas Setup

Limits

Accesses a menu that allows you to set the following limits:

RMS EVM (Composite)

Peak EVM (Composite)

Rho (Composite)

Peak Code Domain Error

Timing Error

Phase Error

Key Path	Meas Setup
----------	-------------------

RMS EVM (Composite)

Sets the limit for the composite RMS EVM measurement pass/fail test.

Mode	cdma2000
------	----------

Remote Command	:CALCulate:RHO:LIMit:RMS <real> :CALCulate:RHO:LIMit:RMS?
Example	CALC:RHO:LIM:RMS 10.0 CALC:RHO:LIM:RMS?
Preset	100.0
State Saved	Saved in instrument state.
Min	0.00
Max	100.00
Key Path	Meas Setup, Limits

Peak EVM (Composite)

Sets the limit for the composite peak EVM measurement pass/fail test.

Mode	cdma2000
Remote Command	:CALCulate:RHO:LIMit:PEAK <real> :CALCulate:RHO:LIMit:PEAK?
Example	CALC:RHO:LIM:PEAK 50.0 CALC:RHO:LIM:PEAK?
Preset	200.0
State Saved	Saved in instrument state.
Min	0.0
Max	200.0
Key Path	Meas Setup, Limits

Rho (Composite)

Sets the limit for the composite Rho measurement pass/fail test.

Mode	cdma2000
Remote Command	:CALCulate:RHO:LIMit:RHO <real> :CALCulate:RHO:LIMit:RHO?
Example	CALC:RHO:LIM:RHO 0.9 CALC:RHO:LIM:RHO?
Restriction and Notes	The default value of BTS is 0.912 and MS is 0,944.
Preset	BS: 0.912 MS: 0.944

Meas Setup

State Saved	Saved in instrument state.
Min	0
Max	1
Key Path	Meas Setup, Limits

Peak Code Domain Error

Sets the limit for the composite Peak Code Domain Error measurement pass/fail test.

Mode	cdma2000
Remote Command	:CALCulate:RHO:LIMit:CDERror <real> :CALCulate:RHO:LIMit:CDERror?
Example	CALC:RHO:LIM:CDER -50.0 CALC:RHO:LIM:CDER?
Preset	0.0
State Saved	Saved in instrument state.
Min	-100
Max	0
Key Path	Meas Setup, Limits

Timing Error

Sets limit of Timing Offset from Pilot.

Unit	s ms us ns
Mode	cdma2000
Remote Command	:CALCulate:RHO:LIMit:TIMing <float> :CALCulate:RHO:LIMit:TIMing?
Example	CALC:RHO:LIM:TIM 0.000000005 CALC:RHO:LIM:TIM?
Restriction and Notes	Set limits of Timing Offset from Pilot which is used to judge the result of Pilot Time Offset passes or fails. If a measured Timing Offset from Pilot is not larger than limit value, the result is PASS. Otherwise, the result is FAIL. The default value of BTS is 50 ns, and MS is 10 ns.
Preset	BS: 50 ns MS: 10 ns
State Saved	Saved in instrument state.

Min	0.0 s
Max	500 ns
Key Path	Meas Setup, Limits

Phase Error

Sets the limit of Phase Offset from Pilot.

Mode	cdma2000
Remote Command	:CALCulate:RHO:LIMit:PHASe <float> :CALCulate:RHO:LIMit:PHASe?
Example	CALC:RHO:LIM:PHAS 0.05 CALC:RHO:LIM:PHAS?
Restriction and Notes	Set limits of Phase Offset from Pilot which is used to judge the result of Pilot Phase Offset passes or fails. If a measured Timing Offset from Pilot is not larger than limit value, the result is PASS. Otherwise, the result is FAIL.
Preset	0.05
State Saved	Saved in instrument state.
Min	0.0
Max	3.0
Key Path	Meas Setup, Limits

PN Offset

Unit	x 64 chips
Remote Command	:CALCulate:RHO:PNOFfset <integer> :CALCulate:RHO:PNOFfset?
Example	CALC:RHO:PNOF 5 CALC:RHO:PNOF?
Restriction and Notes	Sets value for the pseudo-random noise offset. Different pseudo-random noise offsets are used for different base stations. By setting the pseudo-random noise offset to the value that your specific base station is set to, you get the correct time offset value displayed and returned back to you when you query READ:RHO? The instrument, by default, assumes an offset of 0. So, if you do not use this command, you will have to manually calculate the time offset when the value is other than 0.
Remote Command Notes	You must be in cdma2000 mode to use this command.

Modulation Accuracy (Composite Rho)

Meas Setup

Preset	0
State Saved	Saved in instrument state.
Min	0
Max	511
Key Path	Meas Setup, More

Sync Type

Accesses a menu that enables you to select the channel to synchronize with.

Key Path	Meas Setup
----------	-------------------

Sync Type BTS

Accesses the menu that enables you to select the channel to synchronize with, and to set features, such as Symbol Rate, that may affect synchronization. You can select from the following types of channels and features listed in the menu:

F-PICH: Forward Pilot Channel.

Tx-Div F-PICH: Tx diversity forward Pilot Channel.

Mode	cdma2000
Remote Command	[:SENSe] :RHO:SYNC [:BTS] PICH DPICH [:SENSe] :RHO:SYNC [:BTS] ?
Example	RHO:SYNC PICH RHO:SYNC?
Remote Command Notes	This command is effective when [:SENSe]:RADio:DEvice is set to BTS.
Preset	PICH
State Saved	Saved in instrument state.
Range	F-PICH TxDiv F-PICH
Key Path	Meas Setup, More 1 of 2

Long Code Mask MS

Accesses a menu that enables you to select long code mask for MS. You can select from the following types listed in the menu.

Mode	cdma2000
------	----------

Remote Command	[:SENSe] :RHO:SYNC:LCMask <integer> [:SENSe] :RHO:SYNC:LCMask?
Example	RHO:SYNC:LCM 0 RHO:SYNC:LCM?
Remote Command Notes	This command is effective when [:SENSe]:RADio:DEVIce is set to MS.
Preset	0
State Saved	Saved in instrument state.
Range	0 to 4,398,046,511,103 (0h to 3F,FFF,FFF,FFFh)
Key Path	Meas Setup, More 1 of 2

Radio Config

This key is only available when the radio device is MS.

Radio Configuration means a set of Forward Traffic Channel and Reverse Traffic Channel transmission formats that are characterized by physical layer parameters such as data rates, modulation characteristics, and spreading rate, its abbreviation is RC. And the n of RCn means the index of Radio Configuration. Different RCn is coupled to different data rate, spreading rate and modulation format. Currently, there are 9 Radio Configurations defined in the IS-2000 system. cdma2000 only support RC1-RC5 under SR1 mode operation (1.28 MHz chip rate). Both RC1 and RC2 are used for backwards compatible with IS95. RC3, RC4 and RC5 are new Radio Configurations that use the IS-2000 coding scheme in the SR1 mode of operation (1.2288 MHz chip rate). When the Radio Config is set as cdma2000, it means the current Radio Configuration is RC3, RC4, RC5, or their combination. When the Radio Config is set as IS95, it means the current Radio Configuration is RC1, RC2 or their combination.

For the forward link, the cdma2000 can be coexisting with IS95 and the tester supports them automatically. But for reverse link, there is great difference between cdma2000 and IS95 and also they are separate in the test, so the tester has the radio configuration selection.

For IS95, the reverse link cannot support a pilot channel for synchronous demodulation. Due to this limitation, the reverse link has less capacity than the forward link. To aid reverse link performance, the 9600 bps voice data uses a one-third rate convolution coded for more powerful error correction. Then six data bits at a time are taken to point at one of the 64 available Walsh codes, that is 64-ary orthogonal Modulator. And then XOR'ed with the long code to reach the full 1.2288 Mbps data rate. This unique long code is the channelization code for the reverse link. The modulation is QPSK in the base station, and Offset QPSK in the mobile station.

And For cdma2000, in the reverse link, each mobile now has its own Pilot channel, the reverse link uses I and Q long codes scrambled with I and Q short codes to produce a new modulation format called HPSK (Hybrid Phase Shift Keying). HPSK reduces the dynamic range of the modulation to allow a less expensive output amplifier for mobiles.

Mode	cdma2000
Remote Command	[:SENSe] :RHO:RCONfig cdma2000 IS95 [:SENSe] :RHO:RCONfig?

Meas Setup

Example	:RHO:RCON cdma2000 :RHO:RCON?
Restriction and Notes	This key is available only if the Radio Device is MS. And if Radio Config is set to IS95, it only supports the case that there is only 1 traffic channel or access channel.
Dependencies/Couplings	If Radio Config is toggled to IS95, it will be dashed out for Pk CDE, Pk CDE Position, Time Offset and Active Channels Number will be dashed out, and the view of Power, Timing and Phase will be grayed out, and the limits of Peak Code Domain Error, Timing Error, and Phase Error will be grayed out also. If Radio Config is toggled to IS95, the trace of view1 and view2 is 4 samples/ chip, which is required by HPSK.
Remote Command Notes	This command is effective when [:SENSE]:RADio:DEVice is set to MS.
Preset	cdma2000
State Saved	Saved in instrument state.
Range	cdma2000 IS95
Key Path	Meas Setup, More 1 of 2

Spectrum

Sets a spectrum to either normal or inverted for demodulation related measurements. If set to INVert, the upper and lower spectrums are swapped.

The Invert function conjugates the spectrum, which is equivalent to taking the negative of the quadrature component in demodulation. The correct setting (Normal or Invert) depends on whether the signal at the input of the instrument has a high or low side mix.

Mode	cdma2000
Remote Command	[:SENSE]:RHO:SPECTrum INVert NORMAl [:SENSE]:RHO:SPECTrum?
Example	RHO:SPEC INV RHO:SPEC?
Preset	NORMAl
State Saved	Saved in instrument state.
Range	Normal Invert
Key Path	Meas Setup, More 1 of 2

Advanced

Accesses the menu that allows you to set the I/Q origin offset function, active channel identification

function, alpha value of the Root Raised Cosine (RRC) filter, and chip rate.

Key Path	Meas Setup
----------	-------------------

EVM Result I/Q Offset

Toggles the I/Q origin offset function between Include (standard) and Exclude.

Include: The measurement results for EVM, Rho, and Modulation Accuracy (Rho) error take into account the I/Q origin offset.

Exclude: The measurement results for EVM, Rho, and Modulation Accuracy (Rho) error do not take into account the I/Q origin offset, and the message “EVM excludes I/Q Offset” is displayed in the lower right-hand graph display area.

Turns the automatic mode On or Off, for the I/Q origin offset function.

Exclude: OFF – The measurement results for EVM and Rho do not take into account the I/Q origin offset.

Include: ON – The measurement results for EVM and Rho take into account the I/Q origin offset.

Mode	cdma2000
Remote Command	:CALCulate:RHO:IQOffset:INCLude OFF ON 0 1 :CALCulate:RHO:IQOffset:INCLude?
Example	CALC:RHO:IQOF:INCL ON CALC:RHO:IQOF:INCL?
Preset	ON
State Saved	Saved in instrument state.
Range	Include Exclude
Key Path	Meas Setup, Advanced

Active Set Threshold

Toggles the active channel identification function between Auto and Man. If set to Auto, the active channels are determined automatically by the internal algorithm. If set to Man, the active channel identification is determined by a user definable threshold ranging from 0.00 to –100.00 dB.

Mode	cdma2000
Remote Command	:CALCulate:RHO:ASET:THReshold <rel_ampl> :CALCulate:RHO:ASET:THReshold? :CALCulate:RHO:ASET:THReshold:AUTO OFF ON 0 1 :CALCulate:RHO:ASET:THReshold:AUTO?

Modulation Accuracy (Composite Rho)

Meas Setup

Example	CALC:RHO:ASET:THR -20.0 CALC:RHO:ASET:THR? CALC:RHO:ASET:THR:AUTO ON CALC:RHO:ASET:THR:AUTO?
Restriction and Notes	This command is effective when [:SENSe]:RHO:SBOundary[:BTS] is set to AUTO. (For MS, this command is always effective.)
Remote Command Notes	Turn the automatic mode On or Off, for the active channel identification function. OFF – The active channel identification for each code channel is determined by a value set by CALCulate:RHO:ASET:THReshold. ON – The active channels are determined automatically by the internal algorithm.
Preset	0.0 ON
State Saved	Saved in instrument state.
Min	-100.0
Max	0.0
Key Path	Meas Setup, Advanced

Filter Alpha

Specifies the alpha value of the complimentary filter.

Mode	cdma2000
Remote Command	[:SENSe]:RHO:ALPHa <real> [:SENSe]:RHO:ALPHa?
Example	RHO:ALPH 0.15 RHO:ALPH?
Preset	0.15
State Saved	Saved in instrument state.
Min	0.05
Max	0.20
Key Path	Meas Setup, Advanced

Chip Rate

Sets the chip rate.

Mode	cdma2000
Remote Command	[:SENSe] :RHO:CRATe <freq> [:SENSe] :RHO:CRATe?
Example	RHO:CRAT 1228800 RHO:CRAT?
Preset	1.2288 MHz
State Saved	Saved in instrument state.
Min	1.105925 MHz
Max	1.351680 MHz
Key Path	Meas Setup, Advanced

Multi Channel Estimator

Sets the Multi Channel Estimator On or Off.

Mode	cdma2000
Remote Command	[:SENSe] :RHO:MCEStimator OFF ON 0 1 [:SENSe] :RHO:MCEStimator?
Example	RHO: MCES: ON RHO: MCES?
Dependencies/Couplings	Only if Multi Channel Estimator is On, the view of Power, Timing and Phase can work. If Multi Channel Estimator is Off, there will be a message “Press Meas Setup, Advanced and turn Multi Channel Estimation On to see the data” appears on the view of Power, Timing and Phase.
Preset	Off
State Saved	Saved in instrument state.
Range	On Off
Key Path	Meas Setup, Advanced

IF Gain

Enables you to control an internally switched IF amplifier with approximately 10 dB of gain. This amplifier takes full advantage of the RF dynamic range of the test set. When it can be turned on without an overload, the dynamic range is always better when the amplifier is set to On, than when it is set to Off. The **IF Gain** key can be used to set the IF Gain function to Auto, or to On (the extra 10 dB) or Off. These

Meas Setup

settings affect sensitivity and IF overloads.

Key Path	Meas Setup, Advanced
----------	-----------------------------

IF Gain Auto

Activates the Auto Rules for IF Gain When Auto is active, the IF Gain is set to High Gain under any of the following conditions:

- the input attenuator is set to 0 dB
- the preamp is turned On
- the Max Mixer Level is 20 dBm or lower

For other settings, Auto sets IF Gain to Off. And there are only two choice: Low Gain and High Gain. Low Gain is best for large signals and High Gain is best for small signals.

Remote Command	[:SENSe] :RHO:IF:GAIN:AUTO [:STATe] OFF ON 0 1 [:SENSe] :RHO:IF:GAIN:AUTO [:STATe] ?
Example	RHO:IF:GAIN:AUTO OFF RHO:IF:GAIN:AUTO?
Dependencies/Couplings	When either the auto attenuation works (for example, with the electrical attenuator) or optimize mechanical attenuator range is requested, the IF Gain setting is changed according to the following rule. 'Auto' sets IF Gain to 'High Gain' under any of the following conditions: the input attenuator is set to 0 dB, the preamp is turned on, or the Max Mixer Level is 20 dBm or lower. For other settings, 'Auto' sets IF Gain to 'Low Gain'.
Preset	OFF
State Saved	Saved in instrument state.
Range	Off On
Key Path	Meas Setup, Advanced, IF Gain

IF Gain State

Selects the range of IF gain. On sets the high gain option, which allows for better noise level measurements and Off sets low gain when measuring large signals.

Remote Command	[:SENSe] :RHO:IF:GAIN [:STATe] ON OFF 1 0 [:SENSe] :RHO:IF:GAIN [:STATe] ?
Example	RHO:IF:GAIN OFF RHO:IF:GAIN?

Dependencies/Couplings	When either the auto attenuation works (for example, with the electrical attenuator) or optimize mechanical attenuator range is requested, the IF Gain setting is changed according to the following rule. ‘Auto’ sets IF Gain to ‘High Gain’ under any of the following conditions: the input attenuator is set to 0 dB, the preamp is turned on, or the Max Mixer Level is 20 dBm or lower. For other settings, ‘Auto’ sets IF Gain to ‘Low Gain’.
Remote Command Notes	Where ON = high gain OFF = low gain
Preset	OFF
State Saved	Saved in instrument state.
Range	Low Gain (Best for Large Signals) High Gain (Best Noise Level)
Key Path	Meas Setup, Advanced, IF Gain

Meas Preset

Restores all measurement parameters to their default values.

Mode	cdma2000
Remote Command	:CONFigure:RHO
Example	CONF:RHO
Key Path	Meas Setup, More 1 of 2

Peak Search

Accesses a menu that enables you to control the peak search function and places a marker on the trace point with highest peak.

Mode	cdma2000
Remote Command	:CALCulate:RHO:MARKer [1] 2 3 4 5 6 7 8 9 10 11 12 :MAXimum
Example	CALC:RHO:MARK2:MAX
Key Path	Front panel key

Next Peak

Moves the selected marker to the peak that has the next highest amplitude that is less than the marker's current value.

Mode	cdma2000
Remote Command	:CALCulate:RHO:MARKer [1] 2 3 4 5 6 7 8 9 10 11 12 :MAXimum:NEXT
Example	CALC:RHO:MARK2:MAX:NEXT
Key Path	Peak Search

Next Pk Right

Moves the selected marker to the nearest peak to the right of the current marker that meets all enabled peak criteria.

Mode	cdma2000
Remote Command	:CALCulate:RHO:MARKer [1] 2 3 4 5 6 7 8 9 10 11 12 :MAXimum:RIGHT
Example	:CALC:RHO:MARK2:MAX:RIGH
Key Path	Peak Search

Next Pk Left

Moves the selected marker to the nearest peak to the left of the current marker that meets all enabled peak criteria.

Mode	cdma2000
------	----------

Remote Command	:CALCulate:RHO:MARKer [1] 2 3 4 5 6 7 8 9 10 11 12 :MAXimum:LEFT
Example	CALC:RHO:MARK2:MAX:LEFT
Key Path	Peak Search

Marker Delta

Sets the control mode for the selected marker to **Delta** mode.

Key Path	Peak Search
----------	--------------------

Pk-Pk Search

Finds and displays the amplitude and frequency (or time, if in zero span) differences between the highest and lowest y-axis value.

Mode	cdma2000
Remote Command	:CALCulate:RHO:MARKer [1] 2 3 4 5 6 7 8 9 10 11 12 :PTPeak
Example	CALC:RHO:MARK:PTP
Restriction and Notes	Turns on the Marker Δ active function.
Dependencies/Couplings	This key is not available (key is grayed out) when Coupled Markers is on.
Key Path	Peak Search

Min Search

Moves the selected marker to the minimum y-axis value on the current trace.

Mode	cdma2000
Remote Command	:CALCulate:RHO:MARKer [1] 2 3 4 5 6 7 8 9 10 11 12 :MINimum
Example	CALC:RHO:MARK:MIN
Key Path	Peak Search

SPAN X Scale

Accesses a menu of functions that enable you set the horizontal scale parameters.

This menu is available when in the “I/Q Error” view. It is not available when in the following views: “I/Q Measured Polar Graph” or “Power, Timing and Phase”

Key Path	Front panel key
----------	------------------------

Ref Value

Sets the chip reference value on the horizontal axis. The default setting is 0.000 chips. When Auto Scaling is set to On, the displayed graphs use a Scale/Div value determined by the test set, based on the measurement result.

Key Path	Span X Scale
----------	---------------------

I/Q Error View - EVM Window

Sets the chip reference value on the horizontal axis in the EVM window.

Mode	cdma2000
Remote Command	:DISPlay:RHO:VIEW2:WINDow[1]:TRACe:X[:SCALe]:RLEVe l <real> :DISPlay:RHO:VIEW2:WINDow[1]:TRACe:X[:SCALe]:RLEVe l?
Example	DISP:RHO:VIEW2:WIND:TRAC:X:RLEV 0.0 DISP:RHO:VIEW2:WIND:TRAC:X:RLEV?
Restriction and Notes	If Auto Scaling is set to On, this value is automatically determined by the measurement result. When you set this value manually, Auto Scaling is automatically set to Off.
Dependencies/Couplings	See Restriction and Notes
Remote Command Notes	WINDow1: Evm Error window on I/Q Error view
Preset	0.0
State Saved	Saved in instrument state.
Min	0.0
Max	5000000.0
Key Path	Span X Scale

I/Q Error View - Mag Error Window

Sets the chip reference value on the horizontal axis in the magnitude error window.

Mode	cdma2000
Remote Command	:DISP:RHO:VIEW2:WINDow2:TRACe:X[:SCALe]:RLEVel <real> :DISP:RHO:VIEW2:WINDow2:TRACe:X[:SCALe]:RLEVel?
Example	DISP:RHO:VIEW2:WIND2:TRAC:X:RLEV 0.0 DISP:RHO:VIEW2:WIND2:TRAC:X:RLEV?
Restriction and Notes	If Auto Scaling is set to On, this value is automatically determined by the measurement result. When you set this value manually, Auto Scaling is automatically set to Off.
Dependencies/Couplings	See Restriction and Notes
Remote Command Notes	WINDow2: Mag Error window on I/Q Error view
Preset	0.0
State Saved	Saved in instrument state.
Min	0.0
Max	5000000.0
Key Path	Span X Scale

I/Q Error View - Phase Error Window

Sets the chip reference value on the horizontal axis in the phase error window.

Mode	cdma2000
Remote Command	:DISP:RHO:VIEW2:WINDow3:TRACe:X[:SCALe]:RLEVel <real> :DISP:RHO:VIEW2:WINDow3:TRACe:X[:SCALe]:RLEVel?
Example	DISP:RHO:VIEW2:WIND3:TRAC:X:RLEV 0.0 DISP:RHO:VIEW2:WIND3:TRAC:X:RLEV?
Restriction and Notes	If Auto Scaling is set to On, this value is automatically determined by the measurement result. When you set this value manually, Auto Scaling is automatically set to Off.
Dependencies/Couplings	See Restriction and Notes
Remote Command Notes	WINDow3: Phase window on I/Q Error view
Preset	0.0
State Saved	Saved in instrument state.

Modulation Accuracy (Composite Rho)

SPAN X Scale

Min	0.0
Max	5000000.0
Key Path	Span X Scale

Scale/Div

Sets the horizontal scale by changing a chip value per division. When the Scale Coupling default setting On is active, the displayed plots use a Scale/Div value determined by the test set, which is based on the measurement result.

Key Path	Span X Scale
----------	---------------------

I/Q Error View - EVM Window

Sets the horizontal scale by changing a chip value per division in the EVM window.

Mode	cdma2000
Remote Command	:DISPlay:RHO:VIEW2:WINDow[1]:TRACe:X[:SCALe]:PDIVi sion <real> :DISPlay:RHO:VIEW2:WINDow[1]:TRACe:X[:SCALe]:PDIVi sion?
Example	DISP:RHO:VIEW2:WIND:TRAC:X:PDIV 100.0 DISP:RHO:VIEW2:WIND:TRAC:X:PDIV?
Restriction and Notes	If Auto Scaling is set to On, this value is automatically determined by the measurement result. When you set this value manually, Auto Scaling is automatically set to Off.
Dependencies/Couplings	See Restriction and Notes
Remote Command Notes	WINDow1: EVM window on I/Q Error view
Preset	153.6
State Saved	Saved in instrument state.
Min	1.0
Max	500000.0
Key Path	Span X Scale

I/Q Error View - Mag Error Window

Sets the horizontal scale by changing a chip value per division in the magnitude error window.

Mode	cdma2000
------	----------

Remote Command	:DISPlay:RHO:VIEW2:WINDow2:TRACe:X[:SCALE]:PDIVisi on <real> :DISPlay:RHO:VIEW2:WINDow2:TRACe:X[:SCALE]:PDIVisi on?
Example	DISP:RHO:VIEW2:WIND2:TRAC:X:PDIV 100.0 DISP:RHO:VIEW2:WIND2:TRAC:X:PDIV?
Restriction and Notes	If Auto Scaling is set to On, this value is automatically determined by the measurement result. When you set this value manually, Auto Scaling is automatically set to Off.
Dependencies/Couplings	See Restriction and Notes
Remote Command Notes	WINDow2: Mag Error window on I/Q Error view
Preset	153.6
State Saved	Saved in instrument state.
Min	1.0
Max	500000.0
Key Path	Span X Scale

I/Q Error View - Phase Error Window

Sets the horizontal scale by changing a chip value per division in the phase error window.

Mode	cdma2000
Remote Command	:DISPlay:RHO:VIEW2:WINDow3:TRACe:X[:SCALE]:PDIVisi on <real> :DISPlay:RHO:VIEW2:WINDow3:TRACe:X[:SCALE]:PDIVisi on?
Example	DISP:RHO:VIEW2:WIND3:TRAC:X:PDIV 100.0 DISP:RHO:VIEW2:WIND3:TRAC:X:PDIV?
Restriction and Notes	If Auto Scaling is set to On, this value is automatically determined by the measurement result. When you set this value manually, Auto Scaling is automatically set to Off.
Dependencies/Couplings	See Restriction and Notes
Remote Command Notes	WINDow3: Phase Error window on I/Q Error view
Preset	153.6
State Saved	Saved in instrument state.
Min	1.0
Max	500000.0

Modulation Accuracy (Composite Rho)
SPAN X Scale

Key Path	Span X Scale
----------	---------------------

Ref Position

Sets the reference position for the X axis to the left, center, or right of the display.

Key Path	Span X Scale
----------	---------------------

I/Q Error View - EVM Window

Sets the X axis reference position in the EVM window.

Mode	cdma2000
Remote Command	:DISPlay:RHO:VIEW2:WINDow[1]:TRACe:X[:SCALe]:RPOSi tion LEFT CENTer RIGHT :DISPlay:RHO:VIEW2:WINDow[1]:TRACe:X[:SCALe]:RPOSi tion?
Example	DISP:RHO:VIEW2:WIND:TRAC:X:RPOS LEFT DISP:RHO:VIEW2:WIND:TRAC:X:RPOS?
Remote Command Notes	Any value smaller than 0 will be clipped to 0. Any value larger than 10 will be clipped to 10.
Preset	LEFT
State Saved	Saved in instrument state.
Range	Left Ctr Right
Key Path	Span X Scale

I/Q Error View - Mag Error Window

Sets the X axis reference position in the magnitude error window.

Mode	cdma2000
Remote Command	:DISPlay:RHO:VIEW2:WINDow2:TRACe:X[:SCALe]:RPOSiti on LEFT CENTer RIGHT :DISPlay:RHO:VIEW2:WINDow2:TRACe:X[:SCALe]:RPOSiti on?
Example	DISP:RHO:VIEW2:WIND2:TRAC:X:RPOS LEFT DISP:RHO:VIEW2:WIND2:TRAC:X:RPOS?
Preset	LEFT
State Saved	Saved in instrument state.
Range	Left Ctr Right

Key Path	Span X Scale
----------	---------------------

I/Q Error View - Phase Error Window

Sets the X axis reference position in the phase error window.

Mode	cdma2000
Remote Command	:DISP:RHO:VIEW2:WINDow3:TRACe:X[:SCALE]:RPOSiTi on LEFT CENTer RIGHT :DISP:RHO:VIEW2:WINDow3:TRACe:X[:SCALE]:RPOSiTi on?
Example	DISP:RHO:VIEW2:WIND3:TRAC:X:RPOS LEFT DISP:RHO:VIEW2:WIND3:TRAC:X:RPOS?
Preset	LEFT
State Saved	Saved in instrument state.
Range	Left Ctr Right
Key Path	Span X Scale

Auto Scaling

Toggles the Auto Scaling function between On and Off. When Auto Scaling is On, and the Restart front-panel key is pressed, this function automatically determines the scale per division and reference values based on the measurement results.

When you set a value to either Scale/Div or Ref Value manually, Auto Scaling automatically changes to Off.

Key Path	Span X Scale
----------	---------------------

I/Q Error View - EVM Window

When Auto Scaling is On and the Restart front-panel key is pressed, will result in automatically displaying the scale per division and reference value results in the EVM window.

Mode	cdma2000
Remote Command	:DISP:RHO:VIEW2:WINDow[1]:TRACe:X[:SCALE]:COUPl e 0 1 OFF ON :DISP:RHO:VIEW2:WINDow[1]:TRACe:X[:SCALE]:COUPl e?
Example	DISP:RHO:VIEW2:WIND:TRAC:X:COUP ON DISP:RHO:VIEW2:WIND:TRAC:X:COUP?

SPAN X Scale

Restriction and Notes	When this parameter is set to On, pressing the front-panel Restart key, or the Restart key in the Meas Control menu, activates the scale coupling function, that automatically determines scale per division and reference values based on the measurement results. When you set a value to either Scale/Div or Ref Value manually, Auto Scaling is automatically set to Off.
Dependencies/Couplings	See Restriction and Notes
Remote Command Notes	WINDow[1]: Evm Error window on I/Q Error view
Preset	ON
State Saved	Saved in instrument state.
Range	On Off
Key Path	Span X Scale

I/Q Error View – Mag Error Window

When Auto Scaling is On and the Restart front-panel key is pressed, will result in automatically displaying the scale per division and reference value results in the magnitude error window.

Mode	cdma2000
Remote Command	:DISPlay:RHO:VIEW2:WINDow2:TRACe:X[:SCALe]:COUPle 0 1 OFF ON :DISPlay:RHO:VIEW2:WINDow2:TRACe:X[:SCALe]:COUPle?
Example	DISP:RHO:VIEW2:WIND2:TRAC:X:COUP ON DISP:RHO:VIEW2:WIND2:TRAC:X:COUP?
Restriction and Notes	When this parameter is set to On, pressing the front-panel Restart key, or the Restart key in the Meas Control menu, activates the scale coupling function, that automatically determines scale per division and reference values based on the measurement results. When you set a value to either Scale/Div or Ref Value manually, Auto Scaling is automatically set to Off.
Dependencies/Couplings	See Restriction and Notes
Remote Command Notes	WINDow2: Mag Error window on I/Q Error view
Preset	ON
State Saved	Saved in instrument state.
Range	On Off
Key Path	Span X Scale

I/Q Error View – Phase Error Window

When Auto Scaling is On and the Restart front-panel key is pressed, results in automatically displaying

the scale per division and reference value results in the phase error window.

Mode	cdma2000
Remote Command	:DISP:RHO:VIEW2:WINDow3:TRACe:X[:SCALe]:COUPle 0 1 OFF ON :DISP:RHO:VIEW2:WINDow3:TRACe:X[:SCALe]:COUPle?
Example	DISP:RHO:VIEW2:WIND3:TRAC:X:COUP ON DISP:RHO:VIEW2:WIND3:TRAC:X:COUP?
Restriction and Notes	When this parameter is set to On, pressing the front-panel Restart key, or the Restart key in the Meas Control menu, activates the scale coupling function, that automatically determines scale per division and reference values based on the measurement results. When you set a value to either Scale/Div or Ref Value manually, Auto Scaling is automatically set to Off.
Dependencies/Couplings	See Restriction and Notes
Remote Command Notes	WINDow3: Phase window on I/Q Error view
Preset	ON
State Saved	Saved in instrument state.
Range	On Off
Key Path	Span X Scale

Sweep/Control

Accesses a menu that enables you to pause and restart the measurement.

Key Path	Front Panel Key
----------	------------------------

Pause/Resume

Pauses a measurement after the current data acquisition is complete. When Paused, the label on the key changes to Resume. Pressing Resume un-pauses the measurement. See the Mode functionality section for details.

Key Path	Sweep/Control
----------	----------------------

Trace/Detector

There is no Trace/Detector functionality supported in the Mod Accuracy measurement. The front-panel key will display a blank menu when pressed.

Key Path	Trace/Detector
----------	-----------------------

Trigger

Accesses a menu of functions that enable you to select and control the trigger source for the current measurement

.See Trigger in the "Measurement Functions" section for more information.

Mode	cdma2000
Remote Command	:TRIGger:RHO[:SEQuence]:SOURce EXTernal [1] EXTernal2 IMMEDIATE LINE FRAME RFBurst VIDEO IF :TRIGger:RHO[:SEQuence]:SOURce?
Example	TRIG:RHO:SEQ:SOUR IMM TRIG:RHO:SEQ:SOUR?
Preset	IMMEDIATE
State Saved	Saved in instrument state.
Range	Free Run Video Line External 1 External 2 RF Burst (Wideband) Periodic Timer (Frame Trigger)
Key Path	Front panel key

View/Display

If the view “Power, Timing and Phase” is active, the View/Display key accesses the menu that enables the following controls to read the active channel list:

Prev Page - Returns one page back to the previous page of measurement results.

Next Page - Moves one page forward to the next page of measurement results.

Scroll Up - Moves one line upward from the current page of measurement results each time the key is pressed.

Scroll Down - Moves one line downward from the current page of measurement results each time the key is pressed.

First Page - Moves from the current page to the first page of measurement results.

Last Page - Moves from the current page to the last page of measurement results.

Key Path	Front panel key
----------	-----------------

Display

Accesses a menu of functions that enable you to set the display parameters. See “Display” on page 1393 for more information.

Key Path	View/Display
----------	--------------

Annotation

Turns the screen annotation On or Off for all windows, however, the menu key annotation will remain on the display.

Key Path	View/Display
----------	--------------

Graticule

Turns the display graticule On and Off.

Key Path	View/Display
----------	--------------

Title

Accesses the Title menu that contains the Change Title and Clear Title functions.

Key Path	View/Display
----------	--------------

Change Title

Writes a title at the top of the display. Press Change Title to access the Alpha Editor Menus that enable

Modulation Accuracy (Composite Rho)

View/Display

entry of available characters and symbols. You may also use the numeric keypad to enter numbers. Press Enter or Return to complete the entry. Press ESC to cancel the entry and preserve the existing title.

The display title will remain until you press Change Title again, or you recall a trace or state, or a Factory Preset is performed. A title can also be cleared by pressing Title, Clear Title.

Pressing this key cancels any active function.

Mode	cdma2000
Remote Command	:DISPlay:RHO:ANNotation:TITLe:DATA <string> :DISPlay:RHO:ANNotation:TITLe:DATA?
Example	DISP:RHO:ANN:TITL:DATA "Agilent" DISP:RHO:ANN:TITL:DATA?
Preset	Mod Accuracy
State Saved	Saved in instrument state.
Range	Uppercase, Lowercase, Numeric, Symbol
Key Path	View/Display, Display, Title

Clear Title

Clears a title from the front-panel display. Once cleared, the title cannot be retrieved.

Mode	cdma2000
Key Path	View/Display, Display, Title

View Selection (Remote Command only)

Allows you to select the desired measurement view from the following selections:

POLar (1): I/Q Measured Polar Graph - Provides a combination view of an I/Q measured polar vector graph and the summary data as shown below.

ERRor (2): I/Q Error (Tri View) - Provides a combination view of the EVM, magnitude error, and phase error graphs.

TPHase (3): Power, Timing and Phase-Provides the power of the code channels, and time/phase of the code channels to pilot channel, and also CDE of each code channel.

XXX...X(n) in the above,

XXX...X: Enum ID for :DISP:RHO:VIEW:SEL

n: Numeric ID for :DISP:RHO:VIEW:NSEL

Mode	cdma2000
------	----------

Remote Command	:DISPlay:RHO:VIEW[:SElect] POLar ERRor TPHase :DISPlay:RHO:VIEW[:SElect]?
Example	DISP:RHO:VIEW:SEL POL DISP:RHO:VIEW:SEL?
Dependencies/Couplings	TPHase (3) is available only if Multi Channel Estimator is On.
Preset	POLar
State Saved	Saved in instrument state.
Range	Polar Graph I/Q Error Power, Timing and Phase

View Selection by number (Remote Command only)

Displays the numeric values of the measurement results.

Mode	cdma2000
Remote Command	:DISPlay:RHO:VIEW:NSElect <integer> :DISPlay:RHO:VIEW:NSElect?
Example	DISP:RHO:VIEW:NSEL 1 DISP:RHO:VIEW:NSEL?
Remote Command Notes	You must be in cdma2000 mode to use this command. Use INSTRument:SElect to set the mode.
Preset	1
State Saved	Saved in instrument state.
Min	1
Max	3

View Settings

Accesses the menu that enables control of view settings for the current active display.

I/Q Polar View

Turns the display graticule On and Off.

Key Path	View/Display
----------	---------------------

I/Q Polar Vec/ConstIn

Specifies the format of the Polar Vector graph display. You can select one of the following formats:

Vec ConstIn (Vector and Constellation)

Vector (Vector only)

Modulation Accuracy (Composite Rho)
View/Display

Constellation (Constellation only)

Mode	cdma2000
Remote Command	:DISPlay:RHO:VIEW [1] :WINDow [1] :TRACe:POLar VC VECTor CONSTln :DISPlay:RHO:VIEW [1] :WINDow [1] :TRACe:POLar?
Example	DISP:RHO:VIEW:WIND1:TRAC:POL CONS DISP:RHO:VIEW:WIND1:TRAC:POL?
Preset	VC
State Saved	Saved in instrument state.
Range	Vec & Constln Vector Constellation
Key Path	View/Display, Display

Chip Offset

Specifies the number of chips offset from the first chip in a captured PCG.

Mode	cdma2000
Remote Command	:DISPlay:RHO:VIEW [1] :WINDow [1] :TRACe:COFFset <integer> :DISPlay:RHO:VIEW [1] :WINDow [1] :TRACe:COFFset?
Example	DISP:RHO:VIEW:WIND1:TRAC:COFF 100 DISP:RHO:VIEW:WIND1:TRAC:COFF?
Preset	0
State Saved	Saved in instrument state.
Min	0
Max	1535 – I/Q chips
Key Path	View/Display, Display

I/Q Chips

Specifies the number of I/Q chips displayed for the I/Q waveforms.

Mode	cdma2000
Remote Command	:DISPlay:RHO:VIEW [1] :WINDow [1] :TRACe:IQCHips <integer> :DISPlay:RHO:VIEW [1] :WINDow [1] :TRACe:IQCHips?

Example	DISP:RHO:VIEW:WIND1:TRAC:IQCH 10 DISP:RHO:VIEW:WIND1:TRAC:IQCH?
Preset	1536
State Saved	Saved in instrument state.
Min	1
Max	1536
Key Path	View/Display, Display

+45° Rotation

Toggles the display rotation function between On and Off. If set to On, the I/Q polar vector or I/Q polar constellation graph is rotated by +45° to provide a rectangular display.

Mode	cdma2000
Remote Command	:DISPlay:RHO:VIEW[1]:WINDow[1]:TRACe:ROTQpi[:STATe]] 0 1 OFF ON :DISPlay:RHO:VIEW[1]:WINDow[1]:TRACe:ROTQpi[:STATe]]?
Example	DISP:RHO:VIEW:WIND1:TRAC:ROTQ ON DISP:RHO:VIEW:WIND1:TRAC:ROTQ?
Preset	OFF
State Saved	Saved in instrument state.
Range	On Off
Key Path	View/Display, Display

Full Vector

Toggles the full vector display function between On and Off. If set to On, the full vector traces, that are shown in gray, are displayed in the background of the polar vector solid traces, which are shown in yellow.

Mode	cdma2000
Remote Command	:DISPlay:RHO:VIEW[1]:WINDow[1]:TRACe:FVECTor[:STATe]] 0 1 OFF ON :DISPlay:RHO:VIEW[1]:WINDow[1]:TRACe:FVECTor[:STATe]]?
Example	DISP:RHO:VIEW:WIND1:TRAC:FVEC ON DISP:RHO:VIEW:WIND1:TRAC:FVEC?

View/Display

Restriction and Notes	This key is grayed out if the selected view is I/Q Measured Polar Graph and the selected I/Q Polar Vec/Constln is Constellation.
Preset	OFF
State Saved	Saved in instrument state.
Range	On Off
Key Path	View/Display, Display

I/Q Error

Provides a combination view of magnitude error, phase error, and EVM. There is no view settings for this view.

Key Path	View/Display
----------	---------------------

Power Timing and Phase View

There is only one window in this view. If you need to see the metric result of power, timing and phase in channel level, you need first turn the Multi-Channel Estimator option to "ON".

- Prev Page - Returns one page back to the previous page of the measurement results.
- Next Page - Moves one page forward to the next page of the measurement results.
- Scroll Up - Moves one line upward from the current page of the measurement results by each pressing.
- Scroll Down - Moves one line downward from the current page of the measurement results by each pressing.
- First Page - Moves from the current page to the first page of the measurement results.
- Last Page - Moves from the current page to the last page of the measurement results.

Key Path	View/Display
----------	---------------------

Prev Page

Returns the current page back to the previous page of the measurement results.

Mode	cdma2000
Remote Command Notes	NO SCPI
Key Path	View/Display, Power Timing & Phase

Next Page

Moves the current page forward to the next page of the measurement results.

Mode	cdma2000
Remote Command Notes	NO SCPI
Key Path	View/Display, Power Timing & Phase

Scroll Up

Moves one line upward from the current page of the measurement results by each pressing.

Mode	cdma2000
Remote Command Notes	NO SCPI
Key Path	View/Display, Power Timing & Phase

Scroll Down

Moves one line downward from the current page of the measurement results by each press.

Mode	cdma2000
Remote Command Notes	NO SCPI
Key Path	View/Display, Power Timing & Phase

First Page

Moves from the current page to the first page of the measurement results.

Mode	cdma2000
Remote Command Notes	NO SCPI
Key Path	View/Display, Power Timing & Phase

Last Page

Moves from the current page to the last page of the measurement results.

Mode	cdma2000
Remote Command Notes	NO SCPI
Key Path	View/Display, Power Timing & Phase

Modulation Accuracy (Composite Rho)
View/Display

The quadrature phase shift keying (QPSK) error vector magnitude (EVM) measurement is a measure of phase and amplitude modulation quality that relates the performance of the actual signal compared to an ideal signal as a percentage, as calculated over the course of the ideal constellation. These phase and frequency errors are measures of modulation quality for the W-CDMA (3GPP) system, and can be quantified through QPSK EVM measurements. For measurement results and views, see [“View/Display” on page 836](#).

This topic contains the following sections:

[“Measurement Commands for QPSK EVM” on page 779](#)

[“Remote Command Results for QPSK EVM Measurement” on page 779](#)

Measurement Commands for QPSK EVM

The general functionality of CONFigure, FETCh, MEASure, and READ are described at the beginning of this section. See the SENSE:EVMQpsk commands for more measurement related commands.

:CONFigure:EVMQpsk

:CONFigure:EVMQpsk:NDEFault

:FETCh:EVMQpsk [n] ?

:READ:EVMQpsk [n] ?

:MEASure:EVMQpsk [n] ?

For more measurement related commands, see the SENSE subsystem, and the section [“Remote Measurement Functions” on page 1031](#).

Remote Command Results for QPSK EVM Measurement

n	Results Returned
0	Returns unprocessed I/Q trace data, as a series of comma-separated trace points, in volts.

n	Results Returned
not specified or n = 1	<p>Returns the following 11 scalar results:</p> <ol style="list-style-type: none"> 1. RMS EVM is a floating point number (in percent) of EVM over the entire measurement area. 2. RMS EVM maximum is the maximum RMS EVM over the average counts. 3. Peak EVM is a floating point number (in percent) of peak EVM in the measurement area. 4. Peak EVM maximum is the maximum peak EVM over the average counts. 5. Magnitude Error is a floating point number (in percent) of averaged magnitude error over the entire measurement area. 6. Magnitude Error maximum is a floating point number over the average counts. 7. Phase Error is a floating point number (in degrees) of the averaged phase error over the entire measurement area. 8. Phase Error maximum is the maximum phase error over the average counts. 9. Frequency Error is a floating point number (in Hz) of the frequency error in the measured signal. 10. Frequency Error maximum is the maximum frequency error over the average counts. 11. I/Q Origin Offset is a floating point number (in dB) of the I and Q error (magnitude squared) offset from the origin.
2	EVM trace – returns a series of floating point numbers (in percent) that represent each sample in the EVM trace. The first number is the symbol 0 decision point. There are X points per symbol (X=points/chip). Therefore, the decision points are at 0, 1*X, 2*X, and so on.
3	Magnitude error trace – returns a series of floating point numbers (in percent) that represent each sample in the magnitude error trace. The first number is the symbol 0 decision point. There are X points per symbol (X=points/chip). Therefore, the decision points are at 0, 1*X, 2*X, ...
4	Phase error trace – returns a series of floating point numbers (in percent) that represent each sample in the phase error trace. The first number is the symbol 0 decision point. There are X points per symbol (X=points/chip). Therefore, the decision points are at 0, 1*X, 2*X, ...
5	<p>Corrected measured trace – returns a series of floating point numbers that alternately represent I and Q pairs of the corrected measured trace. The magnitude of each I and Q pair are normalized to 1.0. The first number is the I sample of symbol 0 decision point and the second number is the Q sample of symbol 0 decision point. There are X points per symbol (X=points/chip). Therefore, the series of numbers is:</p> <p>1st number = I of the symbol 0 decision point 2nd number = Q of the symbol 0 decision point ... (2*X)+1 number = I of the symbol 1 decision point (2*X)+2 number = Q of the symbol 1 decision point ... (2*X)*N+1 th number = I of the symbol N decision point (2*X)*N+2 th number = Q of the symbol N decision point</p>

Key Path	Meas
Instrument S/W Revision	Prior to A.02.00

AMPTD Y Scale

Accesses the AMPTD Y Scale menu that allows you to set the desired vertical scale and associated settings for the current measurement.

Key Path	Front-panel key
Instrument S/W Revision	Prior to A.02.00

Ref Value

Enables you to set the absolute power reference value. However, since the Auto Scaling is defaulted to On, this value is automatically determined by the measurement result. When you set a value manually, Auto Scaling automatically changes to Off.

Key Path	AMPTD Y Scale
Instrument S/W Revision	Prior to A.02.00

Ref Value (Magnitude Error Window)

Sets the absolute power reference value in the magnitude error window.

Remote Command	:DISPlay:EVMQpsk:VIEW2:WINDow[1]:TRACe:Y[:SCALe]:RLEVel <real> :DISPlay:EVMQpsk:VIEW2:WINDow[1]:TRACe:Y[:SCALe]:RLEVel ?
Example	DISP:EVMQ:VIEW2:WIND:TRAC:Y:RLEV 90 DISP:EVMQ:VIEW2:WIND:TRAC:Y:RLEV?
Key Path	AMPTD Y Scale
Mode	WCDMA, C2K, 1xEVDO
Couplings	When the Auto Scaling is On, this value is automatically determined by the measurement result. When the value is set manually, Auto Scaling automatically changes to Off.
Preset	0.0
State Saved	Saved in instrument state.
Min	-500
Max	500
Instrument S/W Revision	Prior to A.02.00

Ref Value (Phase Error Window)

Sets the absolute power reference value in the phase error window.

Remote Command	:DISPlay:EVMQpsk:VIEW2:WINDow2:TRACe:Y[:SCALe]:RLEVel <real> :DISPlay:EVMQpsk:VIEW2:WINDow2:TRACe:Y[:SCALe]:RLEVel?
Example	DISP:EVMQ:VIEW2:WIND2:TRAC:Y:RLEV 90 DISP:EVMQ:VIEW2:WIND2:TRAC:Y:RLEV?
Key Path	AMPTD Y Scale
Mode	WCDMA, C2K, 1xEVDO
Couplings	When the Auto Scaling is On, this value is automatically determined by the measurement result. When the value is set manually, Auto Scaling automatically changes to Off.
Preset	0.0
State Saved	Saved in instrument state.
Min	-36000
Max	36000
Instrument S/W Revision	Prior to A.02.00

Ref Value (EVM Window)

Sets the absolute power reference value in the EVM window.

Remote Command	:DISPlay:EVMQpsk:VIEW2:WINDow3:TRACe:Y[:SCALe]:RLEVel <real> :DISPlay:EVMQpsk:VIEW2:WINDow3:TRACe:Y[:SCALe]:RLEVel?
Example	DISP:EVMQ:VIEW2:WIND3:TRAC:Y:RLEV 120 DISP:EVMQ:VIEW2:WIND3:TRAC:Y:RLEV?
Key Path	AMPTD Y Scale
Mode	WCDMA, C2K, 1xEVDO
Couplings	When the Auto Scaling is On, this value is automatically determined by the measurement result. When the value is set manually, Auto Scaling automatically changes to Off.
Preset	0.0
State Saved	Saved in instrument state.
Min	-500
Max	500

Instrument S/W Revision	Prior to A.02.00
-------------------------	------------------

Attenuation

Accesses a menu of functions that enable you to change the attenuation settings. This key has read-back text that describes the total attenuator value.

See “Attenuation” on page 850 for more information.

This is only available when the selected input is RF.

Key Path	AMPTD Y Scale
Instrument S/W Revision	Prior to A.02.00

Scale/Div

Sets the units per division of vertical scale in the logarithmic display. However, since the Auto Scaling is defaulted to On, this value is automatically determined by the measurement result. When you set a value manually, Auto Scaling automatically changes to Off.

Key Path	AMPTD Y Scale
Instrument S/W Revision	Prior to A.02.00

Scale/Div (Magnitude Error Window)

Sets the sensitivity measurement result in the magnitude error window.

Remote Command	:DISPlay:EVMQpsk:VIEW2:WINDow [1] :TRACe:Y[:SCALE] :PDIVis ion <real> :DISPlay:EVMQpsk:VIEW2:WINDow [1] :TRACe:Y[:SCALE] :PDIVis ion?
Example	DISP:EVMQ:VIEW2:WIND:TRAC:Y:PDIV 25 DISP:EVMQ:VIEW2:WIND:TRAC:Y:PDIV?
Key Path	AMPTD Y Scale
Mode	WCDMA, C2K, 1xEVDO
Couplings	When the Auto Scaling is On, this value is automatically determined by the measurement result. When the user sets a value manually, Auto Scaling automatically changes to Off.
Preset	1
State Saved	Saved in instrument state.
Min	0.1

Max	50
Instrument S/W Revision	Prior to A.02.00

Scale/Div (Phase Error Window)

Sets the sensitivity measurement result in the phase error window.

Remote Command	:DISPlay:EVMQpsk:VIEW2:WINDow2:TRACe:Y[:SCALe]:PDIVisio n <real> :DISPlay:EVMQpsk:VIEW2:WINDow2:TRACe:Y[:SCALe]:PDIVisio n?
Example	DISP:EVMQ:VIEW2:WIND2:TRAC:Y:PDIV 25.5 DISP:EVMQ:VIEW2:WIND2:TRAC:Y:PDIV?
Key Path	AMPTD Y Scale
Mode	WCDMA, C2K, 1xEVDO
Couplings	When the Auto Scaling is On, this value is automatically determined by the measurement result. When the user sets a value manually, Auto Scaling automatically changes to Off.
Preset	0.5
State Saved	Saved in instrument state.
Min	0.1
Max	360
Instrument S/W Revision	Prior to A.02.00

Scale/Div (Evm Window)

Sets the sensitivity measurement result in the EVM window.

Remote Command	:DISPlay:EVMQpsk:VIEW2:WINDow3:TRACe:Y[:SCALe]:PDIVisio n <real> :DISPlay:EVMQpsk:VIEW2:WINDow3:TRACe:Y[:SCALe]:PDIVisio n?
Example	DISP:EVMQ:VIEW2:WIND3:TRAC:Y:PDIV 20 DISP:EVMQ:VIEW2:WIND3:TRAC:Y:PDIV?
Key Path	AMPTD Y Scale
Mode	WCDMA, C2K, 1xEVDO

Couplings	When the Auto Scaling is On, this value is automatically determined by the measurement result. When the user sets a value manually, Auto Scaling automatically changes to Off.
Preset	0.5
State Saved	Saved in instrument state.
Min	0.1
Max	50
Instrument S/W Revision	Prior to A.02.00

Internal Preamp

Accesses a menu of functions that enable you to control the internal preamplifiers.

See “[Internal Preamp](#)” on page 883 for more information.

This is only available when the selected input is RF.

Key Path	AMPTD Y Scale
Initial S/W Revision	Prior to A.02.00

Ref Position

Positions the Y-axis scale reference level at the top, center or bottom of the display. Changing the reference position does not change the reference level value. This function can be used for all three QPSK EVM measurement results graphs.

Remote Command	:DISPlay:EVMQpsk:VIEW2:WINDow[1] 2 3:TRACe:Y[:SCALE]:RPOsition TOP CENTer BOTTom :DISPlay:EVMQpsk:VIEW2:WINDow[1] 2 3:TRACe:Y[:SCALE]:RPOsition?
Example	DISP:EVMQ:VIEW2:WIND3:TRAC:Y:RPOS TOP DISP:EVMQ:VIEW2:WIND3:TRAC:Y:RPOS?
Key Path	AMPTD Y Scale
Mode	WCDMA, C2K, 1xEVDO
Notes	Subop codes denote: 1: Mag error graph 2: Phase error graph 3: EVM error graph
Couplings	When Auto Scaling is On and this parameter is changed, Ref Value will change to adjust the trace to one that is most suitable for the window.

Preset	CENTer CENTer BOTTom
State Saved	Saved in instrument state.
Range	Top Ctr Bot
Instrument S/W Revision	Prior to A.02.00

Auto Scaling

Toggles the Auto Scaling function between On and Off. Upon pressing the **Restart** front-panel key, this function automatically determines the scale per division and reference values based on the measurement results.

Remote Command	:DISPlay:EVMQpsk:VIEW2:WINDow[1] 2 3 :TRACe:Y[:SCALe] :COUPlE ON OFF 1 0 :DISPlay:EVMQpsk:VIEW2:WINDow[1] 2 3 :TRACe:Y[:SCALe] :COUPlE?
Example	DISP:EVMQ:VIEW2:WIND:TRAC:Y:COUP ON DISP:EVMQ:VIEW2:WIND:TRAC:Y:COUP?
Key Path	AMPTD Y Scale
Mode	WCDMA, C2K, 1xEVDO
Couplings	When Auto Scaling is On and the Restart front-panel key is pressed, this function automatically determines the scale per division and reference values based on the measurement results. When you set a value to either Scale/Div or Ref Value manually, Auto Scaling automatically changes to Off.
Preset	ON
State Saved	Saved in instrument state.
Range	On Off
Instrument S/W Revision	Prior to A.02.00

Auto Couple

See “[Auto Couple](#)” on page 887 for more information.

Key Path	Front-panel key
Initial S/W Revision	Prior to A.02.00

BW

Accesses a menu of functions that enable you to specify and control the Info BW.

Key Path	Front-panel key
Instrument S/W Revision	Prior to A.02.00

Info BW

Activates the **Info BW** function, which enables you to manually set the information bandwidth of the test set. This is used to set the hardware filter of the ADC.

Remote Command	[:SENSE] :EVMQpsk: BANDwidth[:RESolution] <freq> [:SENSE] :EVMQpsk: BANDwidth[:RESolution] ?
Example	EVMQ: BAND 1 kHz EVMQ: BAND?
Key Path	BW
Mode	WCDMA, C2K, 1xEVDO
Notes	The values shown in this table reflect the conditions after a Mode Preset.
Preset	WCDMA: 6 MHz CDMA 1xEVDO, C2K: 1.5MHz
State Saved	Saved in instrument state.
Min	1 kHz
Max	Hardware Dependent: RF Input: No Option = 10 MHz Option B25 = 25 MHz
Instrument S/W Revision	Prior to A.02.00

Info BW Control

Accesses a menu that enables you to select either A Gaussian or Flat Top filter.

Key Path	BW
Instrument S/W Revision	Prior to A.02.00

Filter Type

Selects the type of bandwidth filter that is used. The choices are Gaussian or Flat top.

Remote Command	[:SENSE] :EVMQpsk :BANDwidth :SHAPE GAUSSian FLATtop [:SENSE] :EVMQpsk :BANDwidth :SHAPE?
Example	EVMQ:BAND:SHAP GAUS EVMQ:BAND:SHAP?
Key Path	BW, RBW Control
Mode	WCDMA, C2K, 1xEVDO
Preset	FLATtop
State Saved	Saved in instrument state.
Range	Gaussian FlatTop
Instrument S/W Revision	Prior to A.02.00

Cont

See “[Cont \(Continuous Measurement/Sweep\)](#)” on page 901 for more information.

Key Path	Front-panel key
Initial S/W Revision	Prior to A.02.00

FREQ Channel

Operation of this key is identical across all measurements in this application. For details, see [“FREQ Channel”](#) on page 903.

Key Path	Front-panel key
----------	------------------------

Input/Output

Operation of this key is identical across several measurements. For details about this key, see [“Input/Output” on page 921](#).

Key Path	Front-panel key
----------	------------------------

Marker

Accesses a menu that enables you to select, set up and control the markers for the current measurement.

Key Path	Front-panel key
Instrument S/W Revision	Prior to A.02.00

Select Marker

Displays 12 markers available for selection.

Key Path	Marker
Instrument S/W Revision	Prior to A.02.00

Marker Type

Sets the marker control mode. If the selected marker is Off, pressing Marker sets it to Normal and places it at the center of the screen on the trace determined by the **Marker Trace** rules. At the same time, reference value of the selected marker appears on the Active Function area. It is:

Marker Chip Value, at I/Q Polar

Marker X Axis Value, at EVM, Phase Error and Mag Error

Default Active Function: the active function for the selected marker's current control mode. If the current control mode is Off, there is no active function and the active function is turned off.

Remote Command	:CALCulate:EVMQpsk:MARKer [1] 2 3 4 5 6 7 8 9 10 11 12 :M ODE POSition DELTA OFF :CALCulate:EVMQpsk:MARKer [1] 2 3 4 5 6 7 8 9 10 11 12 :M ODE?
Example	CALC:EVMQ:MARK:MODE POS CALC:EVMQ:MARK:MODE?
Key Path	Marker
Mode	WCDMA, C2K, 1xEVDO

Notes	<p>If the selected marker is Off, pressing Marker sets it to Normal and places it at the center of the screen on the trace determined by the Marker Trace rules. At the same time, reference value of the selected marker appears on the Active Function area. It is:</p> <p>Marker Chip Value, at I/Q Polar</p> <p>Marker X Axis Value, at EVM, Phase Error and Mag Error</p> <p>Default Active Function: the active function for the selected marker's current control mode. If the current control mode is Off, there is no active function and the active function is turned off.</p> <p>If the selected marker's trace is I/Q Polar, Delta is not supported. If DELTA is selected on the marker of the I/Q Polar, the command is ignored.</p>
Preset	OFF
State Saved	Saved in instrument state.
Range	Normal Delta Off
Instrument S/W Revision	Prior to A.02.00

Marker X Axis Value (Remote Command Only)

Sets the marker X Axis value in the current marker X Axis Scale unit. It has no effect if the control mode is **Off**, but is the SCPI equivalent of entering an X value if the control mode is **Normal** or **Delta**.

This parameter has different meaning between the cases where the marker trace is set to I/Q Polar and others. In the I/Q Polar Graph, X Axis Value is also the measured value and this command is query only.

Remote Command	<pre>:CALCulate:EVMQpsk:MARKer [1] 2 3 4 5 6 7 8 9 10 11 12 :X <real> :CALCulate:EVMQpsk:MARKer [1] 2 3 4 5 6 7 8 9 10 11 12 :X ?</pre>
Example	<pre>CALC:EVMQ:MARK3:X 1280 CALC:EVMQ:MARK3:X?</pre>
Mode	WCDMA, C2K, 1xEVDO

Notes	<p>If no suffix is sent it will use the fundamental units for the current marker X Axis Scale. If a suffix is sent that does not match the current marker X Axis Scale unit, an error “Invalid suffix” will be generated. If the specified marker is Fixed and a Marker Function is on, error –221 “Settings conflict; cannot adjust Fixed marker while Marker Function is on” is generated.</p> <p>The query returns the marker’s absolute X Axis value if the control mode is Normal, or the offset from the marker’s reference marker if the control mode is Delta. The query is returned in the fundamental units for the current marker X Axis scale: Hz for Frequency and Inverse Time, seconds for Period and Time. If the marker is Off the response is not a number.</p> <p>This parameter has different meaning between the cases where the marker trace is set to I/Q Polar and others. In the I/Q Polar Graph, X Axis Value is also the measured value and the command is query only.</p>
Preset	After a preset, all Markers are turned OFF, so Marker X Axis Value query will return a not a number (NaN).
State Saved	No
Min	–9.9E+37
Max	9.9E+37
Instrument S/W Revision	Prior to A.02.00

Marker Chip Value (Remote Command Only)

Sets the marker Chip value in the current marker for the trace of I/Q Polar. It has no effect if the control mode is **Off**, but is the SCPI equivalent of entering an Chip value if the control mode is **Normal** or **Delta**.

In other traces than I/Q Polar, this command is meaningless and ignored.

Remote Command	<pre>:CALCulate:EVMQpsk:MARKer [1] 2 3 4 5 6 7 8 9 10 11 12 :C HIP <real></pre> <pre>:CALCulate:EVMQpsk:MARKer [1] 2 3 4 5 6 7 8 9 10 11 12 :C HIP?</pre>
Example	<pre>CALC:EVMQ:MARK3:X 0</pre> <pre>CALC:EVMQ:MARK3:X?</pre>
Mode	WCDMA, C2K, 1xEVDO

Notes	<p>If no suffix is sent it will use the fundamental units for the current marker X Axis Scale. If a suffix is sent that does not match the current marker X Axis Scale unit, an error “Invalid suffix” will be generated. If the specified marker is Fixed and a Marker Function is on, error –221 “Settings conflict; cannot adjust Fixed marker while Marker Function is on” is generated.</p> <p>The query returns the marker’s absolute X Axis value if the control mode is Normal, or the offset from the marker’s reference marker if the control mode is Delta. The query is returned in the fundamental units for the current marker X Axis scale: Hz for Frequency and Inverse Time, seconds for Period and Time. If the marker is Off the response is not a number.</p> <p>This parameter is only available in the case where the marker trace is set to I/Q Polar.</p>
Preset	0
State Saved	No
Min	–9.9E+37
Max	9.9E+37
Instrument S/W Revision	Prior to A.02.00

Marker X Axis Position (Remote Command Only)

Sets the marker X position in trace points. It has no effect if the control mode is **Off**, but is the SCPI equivalent of entering a value if the control mode is **Normal** or **Delta** except in trace points rather than X Axis Scale units. The entered value is immediately translated into the current X Axis Scale units for setting the value of the marker.

If the Marker Trace is set to I/Q Polar (POLar), this command provides no effects.

Remote Command	<pre>:CALCulate:EVMQpsk:MARKer [1] 2 3 4 5 6 7 8 9 10 11 12 :X :POSition <real> :CALCulate:EVMQpsk:MARKer [1] 2 3 4 5 6 7 8 9 10 11 12 :X :POSition?</pre>
Example	<pre>CALC:EVMQ:MARK:X:POS 0.0 CALC:EVMQpsk:MARK10:X:POS?</pre>
Mode	WCDMA, C2K, 1xEVDO

Notes	<p>If the specified marker is Fixed and a Marker Function is on, error –221 “Settings conflict; cannot adjust Fixed marker while Marker Function is on” is generated.</p> <p>The query returns the marker’s absolute X Axis value in trace points if the control mode is Normal, or the offset from the marker’s reference marker in trace points if the control mode is Delta. The value is returned as a real number, not an integer, corresponding to the translation from X Axis Scale units to trace points (see “Fractional Trace Points”, above). If the marker is Off the response is not a number.</p> <p>This command is not available when Marker Trace of the selected marker (:CALCulate:EVMQpsk:MARKer[1] 2 3 4 5 6 7 8 9 10 11 12:TRACe?) is set to POLar. In this case, this command is ignored.</p>
Preset	After a preset, all Markers are turned OFF, so Marker X Axis Value query will return a not a number (NAN).
State Saved	No
Min	–9.9E+37
Max	9.9E+37
Instrument S/W Revision	Prior to A.02.00

Marker Y Axis Value (Query Only)

Returns the Marker Y Axis value, in the current marker Y Axis unit.

Remote Command	:CALCulate:EVMQpsk:MARKer [1] 2 3 4 5 6 7 8 9 10 11 12 : Y ?
Example	CALC:EVMQ:MARK11:Y?
Mode	WCDMA, C2K, 1xEVDO
Notes	The query returns the marker Y-axis result, if the control mode is Normal or Delta . If the marker is Off , the response is not a number.
Preset	Result dependant on markers setup and signal source
State Saved	No
Instrument S/W Revision	Prior to A.02.00

Marker Properties

Accesses a menu of functions that enable you to specify and control markers for the current measurement.

Key Path	Marker
Instrument S/W Revision	Prior to A.02.00

Select Marker

Displays 12 markers available for selection.

Key Path	Marker, Properties
Instrument S/W Revision	Prior to A.02.00

Relative To

Selects the marker the selected marker will be relative to (its reference marker).

Remote Command	:CALCulate:EVMQpsk:MARKer [1] 2 3 4 5 6 7 8 9 10 11 12 :R EFerence <integer> :CALCulate:EVMQpsk:MARKer [1] 2 3 4 5 6 7 8 9 10 11 12 :R EFerence?
Example	CALC:EVMQ:MARK:REF 4 CALC:EVMQ:MARK:REF?
Key Path	Marker, Properties
Mode	WCDMA, C2K, 1xEVDO
Notes	A marker cannot be relative to itself so that choice is grayed out, and if sent from SCPI generates error -221: "Settings conflict; marker cannot be relative to itself." When queried a single value will be returned (the specified marker numbers relative marker).
Preset	2 3 4 5 6 7 8 9 10 11 12 1
State Saved	Saved in instrument state.
Min	1
Max	12
Instrument S/W Revision	Prior to A.02.00

Marker Trace

Assigns the specified marker to the designated trace.

Remote Command	:CALCulate:EVMQpsk:MARKer [1] 2 3 4 5 6 7 8 9 10 11 12 :T RACe POLar EVM PERRor MERRor :CALCulate:EVMQpsk:MARKer [1] 2 3 4 5 6 7 8 9 10 11 12 :T RACe?
Example	CALC:EVMQ:MARK:TRAC MERR CALC:EVMQ:MARK:TRAC?
Key Path	Marker

Mode	WCDMA, C2K, 1xEVDO
Notes	Assigns the specified marker to the designated trace.
Preset	POLar
State Saved	Saved in instrument state.
Range	I/Q Polar EVM Phase Error Mag Error
Instrument S/W Revision	Prior to A.02.00

Couple Marker

Toggles the state of the markers to be coupled On or Off. When this function is true (On), moving any marker causes an equal X-axis movement of every other marker except those located to the polar trace, and Chip value of the marker located to the polar trace, which is not **Off**, including **Fixed** markers. "Equal X Axis movement" refers to the difference between each marker's X Axis value (in the fundamental x-axis units of the trace that marker is on) and the X Axis value of the marker being moved (in the same fundamental x-axis units). This may result in markers going off screen

See Couple Marker in the "Marker" section for more information.

Remote Command	:CALCulate:EVMQpsk:MARKer:COUple[:STATE] ON OFF 1 0 :CALCulate:EVMQpsk:MARKer:COUple[:STATE]?
Example	CALC:EVMQ:MARK:COUP ON CALC:EVMQ:MARK:COUP?
Key Path	Marker
Mode	WCDMA, C2K, 1xEVDO
Notes	In QPSK EVM, this marker behaves specially. Coupled values are "Chips" of the markers located to the polar trace, and "X" of the markers located to the other traces than the polar trace.
Preset	OFF
State Saved	Saved in instrument state.
Range	On Off
Instrument S/W Revision	Prior to A.02.00

All Markers Off

Turns off all markers.

Remote Command	:CALCulate:EVMQpsk:MARKer:AOff
Example	CALC:EVMQ:MARK:AOff
Key Path	Marker

Mode	WCDMA, C2K, 1xEVDO
Instrument S/W Revision	Prior to A.02.00

Marker Function

There is no Marker Function functionality supported in QPSK EVM. This front panel key displays a blank menu when pressed.

Key Path	Front-panel key
Instrument S/W Revision	Prior to A.02.00

Marker To

There is no Marker To functionality supported in QPSK EVM. This front panel key displays a blank menu when pressed.

Key Path	Front-panel key
Instrument S/W Revision	Prior to A.02.00

Meas

Operation of this key is identical across several measurements. For details about this key, see [“Meas” on page 1031](#).

Key Path	Front-panel key
----------	------------------------

Meas Setup

Displays the setup menu for the currently selected measurement.

Key Path	Front-panel key
Instrument S/W Revision	Prior to A.02.00

Avg/Hold Number

Specifies the number of N averages that will be used for the measurement. After the specified number (average counts) have been averaged, the averaging mode (termination control) setting determines the averaging action.

Remote Command	[:SENSe]:EVMQpsk:AVERage:COUNT <integer> [:SENSe]:EVMQpsk:AVERage:COUNT? [:SENSe]:EVMQpsk:AVERage[:STATe] OFF ON 0 1 [:SENSe]:EVMQpsk:AVERage[:STATe]?
Example	EVMQ:AVER:COUN 1001 EVMQ:AVER:COUN? EVMQ:AVER OFF EVMQ:AVER?
Key Path	Meas Setup
Mode	WCDMA, C2K, 1xEVDO
Preset	10 ON
State Saved	Saved in instrument state.
Min	1
Max	10000
Instrument S/W Revision	Prior to A.02.00

Avg Mode

Toggles the averaging mode between Exp (exponential) and Repeat. This selection only affects the averaging result after the number of N averages is reached. The N is set using the Avg/Hold Number key.

Exponential	Each successive data acquisition after the average count is reached, is exponentially weighted and then combined with the existing average.
Repeat	After reaching the average count, the averaging is reset and a new average is started.

QPSK EVM Measurement
Meas Setup

Remote Command	[:SENSe] :EVMQpsk:AVERage:TCONtrol EXPonential REPeat [:SENSe] :EVMQpsk:AVERage:TCONtrol?
Example	EVMQ:AVER:TCON REP EVMQ:AVER:TCON?
Key Path	Meas Setup
Mode	WCDMA, C2K, 1xEVDO
Notes	Selects the type of termination control used for averaging. This determines the averaging action after the specified number of frames (average count) is reached. Exponential - Each successive data acquisition after the average count is reached, is exponentially weighted and combined with the existing average. Repeat - After reaching the average count, the averaging is reset and a new average is started.
Preset	REPeat
State Saved	Saved in instrument state.
Range	Exp Repeat
Instrument S/W Revision	Prior to A.02.00

Meas Interval

Sets the length of the measurement interval (number of data points) that are used.

Remote Command	[:SENSe] :EVMQpsk:SWEep:POINts <integer> [:SENSe] :EVMQpsk:SWEep:POINts?
Example	EVMQ:SWE:POIN 1001 EVMQ:SWE:POIN?
Key Path	Meas Setup
Mode	WCDMA, C2K
Preset	WCDMA: 2560 C2K: 512
State Saved	Saved in instrument state.
Min	128
Max	WCDMA: 5120 C2K: 1536
Instrument S/W Revision	Prior to A.02.00

Limits

Accesses a menu that enables you to change the RMS EVM and Frequency Error limits settings.

Key Path	Meas Setup
Instrument S/W Revision	Prior to A.02.00

RMS EVM

Sets the limit for the RMS EVM measurement. This value is used to judge whether the measurement passes or fails the RMS EVM limit.

Remote Command	:CALCulate:EVMQpsk:LIMit:RMS <real> :CALCulate:EVMQpsk:LIMit:RMS?
Example	CALC:EVMQ:LIM:RMS 50 CALC:EVMQ:LIM:RMS?
Key Path	Meas Setup, Limits
Mode	WCDMA, C2K, 1xEVDO
Notes	Sets the limits of RMS EVM which is used to judge the result of RMS EVM passes or fails. If a measured RMS EVM value is not larger than the limit value, the result is PASS. Otherwise, the result is FAIL. You must be in the W-CDMA mode to use this command. Use INSTRument:SElect to set the mode.
Preset	WCDMA: 17.5 C2K: 100.0 1xEVDO: 100.0
Min	0.0
Max	100.0
Instrument S/W Revision	Prior to A.02.00

Freq Error

Sets the limit, in Hz, for the frequency error measurement. This value is used to judge whether the measurement passes or fails the Frequency Error limit.

Remote Command	:CALCulate:EVMQpsk:LIMit:FERRor <freq> :CALCulate:EVMQpsk:LIMit:FERRor?
-----------------------	--

Example	CALC:EVMQ:LIM:FERR 100 CALC:EVMQ:LIM:FERR?
Key Path	Meas Setup, Limits
Mode	WCDMA, C2K, 1xEVDO
Notes	Sets the limits of the Frequency Error, which is used to judge the result of the Frequency Error, whether it passes or fails. If the measured Frequency Error value is not larger than the limit value, the result is PASS. Otherwise, the result is FAIL.
Preset	100.0
State Saved	Saved in instrument state.
Min	0.0
Max	300000
Instrument S/W Revision	Prior to A.02.00

Meas Offset & Interval

This key is active only in 1xEVDO mode.

Allows you to measure the signal occupying different time domain respectively, such as the pilot in first half slot.

Key Path	Meas Setup
Instrument S/W Revision	Prior to A.02.00

Meas Offset

Specifies how long after the data capture the signal is observed.

Remote Command	[:SENSe] :EVMQpsk:MEAS:OFFSet <integer> [:SENSe] :EVMQpsk:MEAS:OFFSet?
Example	EVMQ:MEAS:OFFS 464 EVMQ:MEAS:OFFS?
Key Path	Meas Setup, Meas Offset & Interval
Mode	1xEVDO
Couplings	Coupled with Pre-Defined OfS/Intvl. It will change according to the selected type. And Meas Offset + Meas Interval <=2048
Preset	400 chips
State Saved	Saved in instrument state.
Min	0 chips

Max	2047 chips
Instrument S/W Revision	Prior to A.02.00

Meas Interval

Specifies how long the signal is observed.

Remote Command	[:SENSE] :EVMQpsk:MEAS:LENGth < integer > [:SENSE] :EVMQpsk:MEAS:LENGth?
Example	EVMQ:MEAS:LENG 96 EVMQ:MEAS:LENG?
Key Path	Meas Setup, Meas Offset & Interval
Mode	1xEVDO
Couplings	Coupled with Pre-Defined Ofs/Intvl. It will change according to the selected type. And Meas Offset + Meas Interval <=2048
Preset	224 chips
State Saved	Saved in instrument state.
Min	1 chips
Max	2048 chips
Instrument S/W Revision	Prior to A.02.00

Spectrum

Toggles the spectrum function between Normal and Invert. If set to Invert, this function conjugates the spectrum. It is equivalent to taking the negative of the quadrature component in demodulation.

Remote Command	[:SENSE] :EVMQpsk:SPECTrum NORMal INVert [:SENSE] :EVMQpsk:SPECTrum?
Example	EVMQ:SPEC NORM EVMQ:SPEC?
Key Path	Meas Setup
Mode	WCDMA, C2K, 1xEVDO
Preset	NORMal
State Saved	Saved in instrument state.
Range	Normal Invert
Instrument S/W Revision	Prior to A.02.00

Advanced

Accesses a menu of functions that enable you to set up more specific parameters for the measurement. These parameters include:

- EVM Result I/Q Offset
- IF Gain
- RRC Filter Control
- Filter Alpha
- Chip Rate

Key Path	Meas Setup
Instrument S/W Revision	Prior to A.02.00

EVM Result I/Q Offset

Toggles the I/Q Offset to be included or excluded in the measurement result. When it is set as "Standard" (ON), EVM is calculated without any compensation of I/Q offset. When it is set as "Exclude" (OFF), I/Q offset is compensated.

Remote Command	:CALCulate:EVMQpsk:IQOFFset:INCLude OFF ON 0 1 :CALCulate:EVMQpsk:IQOFFset:INCLude?
Example	CALC:EVMQ:IQOF:INCL OFF CALC:EVMQ:IQOF:INCL?
Key Path	Meas Setup, Advanced
Mode	WCDMA, C2K, 1xEVDO
Preset	ON
State Saved	Saved in instrument state.
Range	Std Exclude
Instrument S/W Revision	Prior to A.02.00

RRC Filter Control

Allows you to change the status (ON/OFF) of the Root Raised Cosine (RRC) filter. This ON/OFF state change involve measurement restart.

Remote Command	[:SENSE] :EVMQpsk:FILTer [:RRC] [:STATE] OFF ON 0 1 [:SENSE] :EVMQpsk:FILTer [:RRC] [:STATE] ?
Example	EVMQ:FILT ON EVMQ:FILT?

Key Path	Meas Setup, Advanced
Mode	WCDMA
Preset	ON
State Saved	Saved in instrument state.
Range	On Off
Instrument S/W Revision	Prior to A.02.00

Filter Alpha

Sets the alpha value for the root raised cosine (RRC) filter. This key is available only in WCDMA mode and while employing an RRC filter.

Remote Command	[:SENSE] :EVMQpsk:FILTer:ALPHA <real> [:SENSe] :EVMQpsk:FILTer:ALPHA?
Example	EVMQ:FILT:ALPH 0.5 EVMQ:FILT:ALPH?
Key Path	Meas Setup, Advanced
Mode	WCDMA, C2K, 1xEVDO
Notes	This parameter is available only in the WCDMA mode. In other modes, this key is invisible.
Preset	0.22
State Saved	Saved in instrument state.
Min	0.01
Max	0.5
Instrument S/W Revision	Prior to A.02.00

Chip Rate

Changes the chip rate for the measurement.

Remote Command	[:SENSE] :EVMQpsk:CRATe <freq> [:SENSe] :EVMQpsk:CRATe?
Example	EVMQ:CRAT 2.5 MHz EVMQ:CRAT?
Key Path	Meas Setup, Advanced
Mode	WCDMA, C2K, 1xEVDO
Notes	Enter a frequency value to set the chip rate.

QPSK EVM Measurement
Meas Setup

Preset	WCDMA: 3.84 MHz C2K: 1.2288 MHz 1xEVDO: 1.2288 MHz
State Saved	Saved in instrument state.
Min	100 kHz
Max	20 MHz
Instrument S/W Revision	Prior to A.02.00

IF Gain

In order to take full advantage of the RF dynamic range of the test set, we will offer a switched IF amplifier with approximately 10 dB of gain. When it can be turned on without an overload, the dynamic range is always better with it on than off. The IF Gain key can be used to set the IF Gain function to Auto, or to On (the extra 10 dB) or Off. These settings affect sensitivity and IF overloads.

Sets the IF Gain function to Auto, Low Gain or High Gain. These settings affect sensitivity and IF overloads.

This only applies to the RF input. It does not apply to baseband I/Q input.

Key Path	Meas Setup, Advanced
Instrument S/W Revision	Prior to A.02.00

IF Gain Auto

Activates the auto rules for IF Gain

Remote Command	[:SENSe] :EVMQpsk : IF : GAIN : AUTO [: STATE] ON OFF 1 0 [:SENSe] :EVMQpsk : IF : GAIN : AUTO [: STATE] ?
Example	EVMQ:IF:GAIN:AUTO OFF EVMQ:IF:GAIN:AUTO?
Key Path	Meas Setup, Advanced, IF Gain
Mode	WCDMA, C2K, 1xEVDO
Notes	This only applies to the RF input. It does not apply to baseband I/Q input.
Couplings	'When either the auto attenuation works (for example, with electrical attenuator), or the optimize mechanical attenuator range is requested, the IF Gain setting is changed as following rule. Auto sets IF Gain to On under any of the following conditions: the input attenuator is set to 0 dB, the preamp is turned on, or the Max Mixer Level is -20 dBm or lower. For other settings, Auto sets IF Gain to Off.
Preset	ON

State Saved	Saved in instrument state.
Range	Auto Man
Instrument S/W Revision	Prior to A.02.00

IF Gain State

Selects the range of IF gain.

Remote Command	[:SENSE] :EVMQpsk : IF :GAIN [:STATe] ON OFF 1 0 [:SENSE] :EVMQpsk : IF :GAIN [:STATe] ?
Example	EVMQ:IF:GAIN ON EVMQ:IF:GAIN?
Key Path	Meas Setup, Advanced, IF Gain
Mode	WCDMA, C2K, 1xEVDO
Notes	This only applies to the RF input. It does not apply to baseband I/Q input. where ON = high gain OFF = low gain
Preset	OFF
State Saved	Saved in instrument state.
Range	Low Gain (Best for Large Signals) High Gain (Best Noise Level)
Readback Text	Low Gain High Gain
Instrument S/W Revision	Prior to A.02.00

Meas Preset

Restores all the measurement parameters to their default values.

Remote Command	:CONFigure:EVMQpsk
Example	CONF:EVMQ
Key Path	Meas Setup
Mode	WCDMA, C2K, 1xEVDO
Notes	Restore all defaults of parameters.
Instrument S/W Revision	Prior to A.02.00

Mode

Operation of this key is identical across all measurements in this application. For details about this key, see [“Mode” on page 1091](#).

Key Path	Front-panel key
----------	------------------------

Mode Setup

Operation of this key is identical across all measurements in this application. For details, see [“Mode Setup”](#) on page 1103.

Key Path	Front-panel key
----------	-----------------

Peak Search

Accesses a menu that enables you to control the peak search function and places a marker on the trace point with highest peak.

Remote Command	:CALCulate:EVMQpsk:MARKer [1] 2 3 4 5 6 7 8 9 10 11 12 :M AXimum
Example	CALC:EVMQ:MARK2:MAX
Key Path	Front panel key
Mode	WCDMA, C2K, 1xEVDO
Notes	This command does not work when the selected marker is located on the polar trace. In this case, the command is ignored.
Instrument S/W Revision	Prior to A.02.00

Next Peak

Moves the selected marker to the peak that has the next highest amplitude that is less than the marker's current value.

Remote Command	:CALCulate:EVMQpsk:MARKer [1] 2 3 4 5 6 7 8 9 10 11 12 :M AXimum:NEXT
Example	CALC:EVMQ:MARK2:MAX:NEXT
Key Path	Peak Search
Mode	WCDMA, C2K, 1xEVDO
Notes	This command does not work when the selected marker is located on the polar trace. In this case, the command is ignored.
Instrument S/W Revision	Prior to A.02.00

Next Pk Right

Moves the selected marker to the nearest peak to the right of the current marker that meets all enabled peak criteria.

Remote Command	:CALCulate:EVMQpsk:MARKer [1] 2 3 4 5 6 7 8 9 10 11 12 :M AXimum:RIGHT
Example	CALC:EVMQ:MARK2:MAX:RIGH
Key Path	Peak Search
Mode	WCDMA, C2K, 1xEVDO

Notes	This command does not work when the selected marker is located on the polar trace. In this case, the command is ignored.
Instrument S/W Revision	Prior to A.02.00

Next Pk Left

Moves the selected marker to the nearest peak to the left of the current marker that meets all enabled peak criteria.

Remote Command	:CALCulate:EVMQpsk:MARKer [1] 2 3 4 5 6 7 8 9 10 11 12 :M AXimum:LEFT
Example	CALC:EVMQ:MARK2:MAX:LEFT
Key Path	Peak Search
Mode	WCDMA, C2K, 1xEVDO
Notes	This command does not work when the selected marker is located on the polar trace. In this case, the command is ignored.
Instrument S/W Revision	Prior to A.02.00

Marker Delta

Sets the control mode for the selected marker to **Delta** mode. This menu key performs the same function as the Delta 1-of-N selection key in the Marker menu. It is duplicated in the Peak Search Menu to allow you the convenience to simultaneously perform a peak search and change the marker control mode to Delta without having to access two separate menus.

Key Path	Peak Search
Instrument S/W Revision	Prior to A.02.00

Pk-Pk Search

Finds and displays the amplitude and frequency (or time, if in zero span) differences between the highest and lowest value on the y-axis.

Remote Command	:CALCulate:EVMQpsk:MARKer [1] 2 3 4 5 6 7 8 9 10 11 12 :P TPeak
Example	CALC:EVMQ:MARK:PTP
Key Path	Peak Search
Mode	WCDMA, C2K, 1xEVDO
Notes	This command does not work when the selected marker is located on the polar trace. In this case, the command is ignored.
Couplings	This key is not available (key is grayed out) when Coupled Markers is on.

Instrument S/W Revision	Prior to A.02.00
-------------------------	------------------

Min Search

Moves the selected marker to the minimum value on the y-axis of the current trace.

Remote Command	:CALCulate:EVMQpsk:MARKer [1] 2 3 4 5 6 7 8 9 10 11 12 :M INimum
Example	CALC:EVMQ:MARK:MIN
Key Path	Peak Search
Mode	WCDMA, C2K, 1xEVDO
Notes	This command does not work when the selected marker is located on the polar trace. In this case, the command is ignored.
Instrument S/W Revision	Prior to A.02.00

Recall

See “Recall” on page 192 for more information.

Key Path	Front-panel key
Initial S/W Revision	Prior to A.02.00

Restart

See “[Restart](#)” on page 1125 for more information.

Key Path	Front-panel key
Initial S/W Revision	Prior to A.02.00

Save

Operation of this key is identical across all measurements. For details about this key, see [“Save” on page 204](#).

Key Path	Front-panel key
----------	------------------------

Single

See “[Single \(Single Measurement/Sweep\)](#)” on page 1135 for more information.

Key Path	Front-panel key
Initial S/W Revision	Prior to A.02.00

Source (Internal)

Operation of this key is identical across all measurements. For details about this key, see [“Source \(Internal\)” on page 1137](#).

Key Path	Front-panel key
----------	-----------------

SPAN X Scale

Accesses a menu of functions that enable you set the horizontal scale parameters.

This menu is blank if the selected **window** is:

- I/Q Measured Polar Graph or,
- RMS EVM (Numeric Results).

For details of available **views** in this measurement, see “[View/Display](#)” on page 836. Within a view, you can change the selected window by pressing the **Next Window** key.

Key Path	Front-panel key
Instrument S/W Revision	Prior to A.02.00

X Ref Value

Controls the reference value of the X scale of the current measurement

Key Path	SPAN X Scale
Instrument S/W Revision	Prior to A.02.00

Ref Value (X Scale, Magnitude Error Window)

Sets the chip reference value on the horizontal axis in the magnitude error window.

Remote Command	:DISPlay:EVMQpsk:VIEW2:WINDow[1]:TRACe:X[:SCALE]:RLEVE1 <real> :DISPlay:EVMQpsk:VIEW2:WINDow[1]:TRACe:X[:SCALE]:RLEVE1 ?
Example	DISP:EVMQ:VIEW2:WIND:TRAC:X:RLEV 1001 DISP:EVMQ:VIEW2:WIND:TRAC:X:RLEV?
Key Path	SPAN X Scale
Mode	WCDMA, C2K, 1xEVDO
Notes	This key is for control of the reference value of the X scale of the focused window of the selected view.
Couplings	When this parameter has been set, XScaleAutoMag turns off.
Preset	0
State Saved	Saved in instrument state.
Min	-5000000
Max	5000000

Instrument S/W Revision	Prior to A.02.00
-------------------------	------------------

Ref Value (X Scale, Phase Error Window)

Sets the chip reference value on the horizontal axis in the phase error window.

Remote Command	:DISP:ay:EVMQpsk:VIEW2:WINDow2:TRACe:X[:SCALe]:RLEVel <real> :DISP:ay:EVMQpsk:VIEW2:WINDow2:TRACe:X[:SCALe]:RLEVel?
Example	DISP:EVMQ:VIEW2:WIND2:TRAC:X:RLEV 1001 DISP:EVMQ:VIEW2:WIND2:TRAC:X:RLEV?
Key Path	SPAN X Scale
Mode	WCDMA, C2K, 1xEVDO
Notes	This key is for control of the reference value of the X scale of the focused window of the selected view.
Couplings	When this parameter has been set, XScaleAutoMag turns off.
Preset	0
State Saved	Saved in instrument state.
Min	-5000000
Max	5000000
Instrument S/W Revision	Prior to A.02.00

Ref Value (X Scale, EVM Window)

Sets the chip reference value on the horizontal axis in the EVM window.

Remote Command	:DISP:ay:EVMQpsk:VIEW2:WINDow3:TRACe:X[:SCALe]:RLEVel <real> :DISP:ay:EVMQpsk:VIEW2:WINDow3:TRACe:X[:SCALe]:RLEVel?
Example	DISP:EVMQ:VIEW2:WIND3:TRAC:X:RLEV 1001 DISP:EVMQ:VIEW2:WIND3:TRAC:X:RLEV?
Key Path	SPAN X Scale
Mode	WCDMA, C2K, 1xEVDO
Notes	This key is for control of the reference value of the X scale of the focused window of the selected view. The mode must be in W-CDMA, 1xEVDO or cdma2000 to use this function. Use INSTRument:SElect to set this mode.
Couplings	When this parameter has been set, XScaleAutoEvm turns off.

QPSK EVM Measurement
SPAN X Scale

Preset	0
State Saved	Saved in instrument state.
Min	-5000000
Max	5000000
Instrument S/W Revision	Prior to A.02.00

X Scale/Div

Sets the horizontal scale by changing a value per division.

Key Path	SPAN X Scale
Instrument S/W Revision	Prior to A.02.00

Scale/Div (X Scale, Magnitude Error Window)

Sets the horizontal scale by changing a chip value per division in the magnitude error window.

Remote Command	:DISPlay:EVMQpsk:VIEW2:WINDow [1] :TRACe:X[:SCALE] :PDIVis ion <real> :DISPlay:EVMQpsk:VIEW2:WINDow [1] :TRACe:X[:SCALE] :PDIVis ion?
Example	DISP:EVMQ:VIEW2:WIND:TRAC:X:PDIV 1001 DISP:EVMQ:VIEW2:WIND:TRAC:X:PDIV?
Key Path	SPAN X Scale
Mode	WCDMA, C2K, 1xEVDO
Notes	This key is for Scale/Div control.
Couplings	When this parameter has been set, XScaleAutoMag turns off.
Preset	WCDMA: 256 C2K: 51.2 1xEVDO: 25.6
State Saved	Saved in instrument state.
Min	1
Max	500000
Instrument S/W Revision	Prior to A.02.00

Scale/Div (X Scale, Phase Error Window)

Sets the horizontal scale by changing a chip value per division in the phase error window.

Remote Command	:DISPlay:EVMQpsk:VIEW2:WINDow2:TRACe:X[:SCALe]:PDIVisio n <real> :DISPlay:EVMQpsk:VIEW2:WINDow2:TRACe:X[:SCALe]:PDIVisio n?
Example	DISP:EVMQ:VIEW2:WIND2:TRAC:X:PDIV 1001 DISP:EVMQ:VIEW2:WIND2:TRAC:X:PDIV?
Key Path	SPAN X Scale
Mode	WCDMA, C2K, 1xEVDO
Notes	This key is for Scale/Div control.
Couplings	When this parameter has been set, XScaleAutoPhase turns off.
Preset	WCDMA: 256 C2K: 51.2 1xEVDO: 25.6
State Saved	Saved in instrument state.
Min	1
Max	500000
Instrument S/W Revision	Prior to A.02.00

Scale/Div (X Scale, EVM Window)

Sets the horizontal scale by changing a chip value per division in the EVM window.

Remote Command	:DISPlay:EVMQpsk:VIEW2:WINDow3:TRACe:X[:SCALe]:PDIVisio n <real> :DISPlay:EVMQpsk:VIEW2:WINDow3:TRACe:X[:SCALe]:PDIVisio n?
Example	DISP:EVMQ:VIEW2:WIND3:TRAC:X:PDIV 1001 DISP:EVMQ:VIEW2:WIND3:TRAC:X:PDIV?
Key Path	SPAN X Scale
Mode	WCDMA, C2K, 1xEVDO
Notes	This key is for Scale/Div control.
Couplings	When this parameter has been set, XScaleAutoEvm turns off.

QPSK EVM Measurement
SPAN X Scale

Preset	WCDMA: 256 C2K: 51.2 1xEVDO: 25.6
State Saved	Saved in instrument state.
Min	1
Max	500000
Instrument S/W Revision	Prior to A.02.00

X Ref Position

Sets the reference position of the X axis on the display. The reference position can be set to Left, Ctr (center) or Right.

Key Path	SPAN X Scale
Instrument S/W Revision	Prior to A.02.00

Ref Position (X Scale, Magnitude Error Window)

Sets the reference position of the X axis for the magnitude error result on the display.

Remote Command	:DISPlay:EVMQpsk:VIEW2:WINDow[1]:TRACe:X[:SCALE]:RPOSit ion LEFT CENTer RIGHT :DISPlay:EVMQpsk:VIEW2:WINDow[1]:TRACe:X[:SCALE]:RPOSit ion?
Example	DISP:EVMQ:VIEW2:WIND:TRAC:X:RPOS CENT DISP:EVMQ:VIEW2:WIND:TRAC:X:RPOS?
Key Path	SPAN X Scale
Mode	WCDMA, C2K, 1xEVDO
Couplings	If X Scale Auto Mag is On and the parameter is changed, X Scale Ref Mag will change to automatically adjust the trace to one that is most suitable for the window.
Preset	LEFT
State Saved	Saved in instrument state.
Range	Left Center Right
Instrument S/W Revision	Prior to A.02.00

Ref Position (X Scale, Phase Error Window)

Sets the reference position of the X axis for the phase error result on the display.

Remote Command	:DISPlay:EVMQpsk:VIEW2:WINDow2:TRACe:X[:SCALe]:RPOSITio n LEFT CENTer RIGHT :DISPlay:EVMQpsk:VIEW2:WINDow2:TRACe:X[:SCALe]:RPOSITio n?
Example	DISP:EVMQ:VIEW2:WIND2:TRAC:X:RPOS RIGH DISP:EVMQ:VIEW2:WIND2:TRAC:X:RPOS?
Key Path	SPAN X Scale
Mode	WCDMA, C2K, 1xEVDO
Couplings	If X Scale Auto Phase is On and the parameter is changed, X Scale Ref Phase will change to automatically adjust the trace to one that is most suitable for the window.
Preset	LEFT
State Saved	Saved in instrument state.
Range	Left Center Right
Instrument S/W Revision	Prior to A.02.00

Ref Position (X Scale, EVM Window)

Sets the X axis reference position in the EVM window.

Remote Command	:DISPlay:EVMQpsk:VIEW2:WINDow3:TRACe:X[:SCALe]:RPOSITio n LEFT CENTer RIGHT :DISPlay:EVMQpsk:VIEW2:WINDow3:TRACe:X[:SCALe]:RPOSITio n?
Example	DISP:EVMQ:VIEW2:WIND3:TRAC:X:RPOS RIGH DISP:EVMQ:VIEW2:WIND3:TRAC:X:RPOS?
Key Path	SPAN X Scale
Mode	WCDMA, C2K, 1xEVDO
Couplings	If X Scale Auto EVM is On and the parameter is changed, X Scale Ref EVM will change to automatically adjust the trace to one that is most suitable for the window.
Preset	LEFT
State Saved	Saved in instrument state.
Range	Left Center Right
Instrument S/W Revision	Prior to A.02.00

X Auto Scaling

Determines the scale per division and reference value for the X axis based on the current measurement results.

Key Path	SPAN X Scale
Instrument S/W Revision	Prior to A.02.00

Auto Scaling (X Scale, Magnitude Error Window)

When Auto Scaling is On and the Restart front-panel key is pressed, this function automatically displays the scale per division and reference value results in the magnitude error window.

Remote Command	:DISPlay:EVMQpsk:VIEW2:WINDow [1] :TRACe:X[:SCALE] :COUPlE ON OFF 0 1 :DISPlay:EVMQpsk:VIEW2:WINDow [1] :TRACe:X[:SCALE] :COUPlE ?
Example	DISP:EVMQ:VIEW2:WIND:TRAC:X:COUP ON DISP:EVMQ:VIEW2:WIND:TRAC:X:COUP?
Key Path	SPAN X Scale
Mode	WCDMA, C2K, 1xEVDO
Notes	When On, the Scale/Div, Ref Value, and Ref Position are reset to the default values. The mode must be W-CDMA, 1xEVDO or cdma2000 to use this function. Use :INSTrument:SELEctto set this mode.
Couplings	Upon pressing the Restart front-panel key, the scale coupling function automatically determines the scale per division and reference values based on the measurement results if this parameter is set to On. When you set a value to either Scale/Div or Ref Value manually, Scale Coupling automatically changes to Off.
Preset	ON
State Saved	Saved in instrument state.
Range	On Off
Instrument S/W Revision	Prior to A.02.00

Auto Scaling (X Scale, Phase Error Window)

When Auto Scaling is On, upon pressing the Restart front-panel key, this function automatically displays the scale per division and reference value results in the phase error window.

Remote Command	:DISPlay:EVMQpsk:VIEW2:WINDow2:TRACe:X[:SCALE] :COUPlE ON OFF 0 1 :DISPlay:EVMQpsk:VIEW2:WINDow2:TRACe:X[:SCALE] :COUPlE?
-----------------------	--

Example	DISP:EVMQ:VIEW2:WIND2:TRAC:X:COUP OFF DISP:EVMQ:VIEW2:WIND2:TRAC:X:COUP?
Key Path	SPAN X Scale
Mode	WCDMA, C2K, 1xEVDO
Notes	When ON, the Scale/Div, Ref Value, and Ref Position are turned back to the default values. The mode must be in W-CDMA, 1xEVDO or cdma2000 to use this function. Use :INSTrument:SELEctto set this mode.
Couplings	Upon pressing the Restart front-panel key, the scale coupling function automatically determines the scale per division and reference values based on the measurement results if this parameter is set to On. When you set a value to either Scale/Div or Ref Value manually, Scale Coupling automatically changes to Off.
Preset	ON
State Saved	Saved in instrument state.
Range	On Off
Instrument S/W Revision	Prior to A.02.00

Auto Scaling (X Scale, Evm Window)

When Auto Scaling is On and the Restart front-panel key is pressed, this function automatically displays the scale per division and reference value results in the EVM window.

Remote Command	:DISPlay:EVMQpsk:VIEW2:WINDow3:TRACe:X[:SCALe]:COUPlE ON OFF 0 1 :DISPlay:EVMQpsk:VIEW2:WINDow3:TRACe:X[:SCALe]:COUPlE?
Example	DISP:EVMQ:VIEW2:WIND3:TRAC:X:COUP ON DISP:EVMQ:VIEW2:WIND3:TRAC:X:COUP?
Key Path	SPAN X Scale
Mode	WCDMA, C2K, 1xEVDO
Notes	When ON, the Scale/Div, Ref Value, and Ref Position are reset to the default values. The mode must be in W-CDMA, 1xEVDO or cdma2000 to use this function. Use :INSTrument:SELEctto set this mode.
Couplings	Upon pressing the Restart front-panel key, the scale coupling function automatically determines the scale per division and reference values based on the measurement results if this parameter is set to On. When you set a value to either Scale/Div or Ref Value manually, Scale Coupling automatically changes to Off.
Preset	ON

QPSK EVM Measurement
SPAN X Scale

State Saved	Saved in instrument state.
Range	On Off
Instrument S/W Revision	Prior to A.02.00

Sweep/Control

Accesses a menu that enables you to pause and restart the measurement.

Key Path	Front panel key
Instrument S/W Revision	Prior to A.02.00

Pause

Pauses a measurement after the current data acquisition is complete. When Paused, the label on the key changes to **Resume**. Pressing the **Resume** key resumes the measurement from the point it was at when paused. See [“Pause/Resume” on page 1279](#) for more details.

Key Path	Sweep/Control
Instrument S/W Revision	Prior to A.02.00

Trace/Detector

There is no Trace/Detector functionality supported in QPSK EVM. This front panel key displays a blank menu when pressed.

Key Path	Front Panel Key
Instrument S/W Revision	Prior to A.02.00

Trigger

Accesses a menu of functions that enable you to select and control the trigger source for the current measurement.

See [“Trigger” on page 1339](#) for more information.

Key Path	Front-panel key
----------	-----------------

View/Display

Accesses a menu of functions that enable you to set up and control the display parameters for the current measurement.

Two views are available in this measurement, as described in the sections:

[“I/Q Measured Polar Graph” on page 837](#)

[“I/Q Error View” on page 844](#)

This topic contains the following sections:

[“View Selection by name \(Remote Command Only\)” on page 836](#)

[“View Selection by number \(Remote Command Only\)” on page 836](#)

View Selection by name (Remote Command Only)

Selects the format for the measurement results view.

Remote Command	:DISPlay:EVMQpsk:VIEW[:SElect] POLar ERRor :DISPlay:EVMQpsk:VIEW[:SElect]?
Example	DISP:EVMQ:VIEW ERR DISP:EVMQ:VIEW?
Mode	WCDMA, C2K, 1xEVDO
Couplings	Changing parameter of "ViewNum" (:DISPlay:EVMQpsk:VIEW:NSElect) also changes this parameter.
Preset	POLar
State Saved	Saved in instrument state.
Range	I/Q Measured Polar Vector I/Q Error
Instrument S/W Revision	Prior to A.02.00

View Selection by number (Remote Command Only)

Displays the numeric values of the measurement results.

Remote Command	:DISPlay:EVMQpsk:VIEW:NSElect <integer> :DISPlay:EVMQpsk:VIEW:NSElect?
Example	DISP:EVMQ:VIEW:NSEL 2 DISP:EVMQ:VIEW:NSEL?
Mode	WCDMA, C2K, 1xEVDO

Couplings	Changing parameter of "View" (:DISPlay:EVMQpsk:VIEW[:SElect]) also changes this parameter.
Preset	1
State Saved	Saved in instrument state.
Min	1
Max	2
Instrument S/W Revision	Prior to A.02.00

Key Path	Front-panel key
Instrument S/W Revision	Prior to A.02.00

Display

Accesses a menu of functions that enable you to set the display parameters.

See [“Display” on page 1393](#) for more information.

Key Path	View/Display
Instrument S/W Revision	Prior to A.02.00

I/Q Measured Polar Graph

Provides a combination view of the I/Q demodulated signals using vector lines to connect the chip dots. IQ Measured Polar Graph accesses a menu that enables you to select more advanced settings.

The view consists of the following windows:

- [“Polar Graph Window” on page 840](#)
- [“Numeric Results Window” on page 840](#)

QPSK EVM Measurement
View/Display

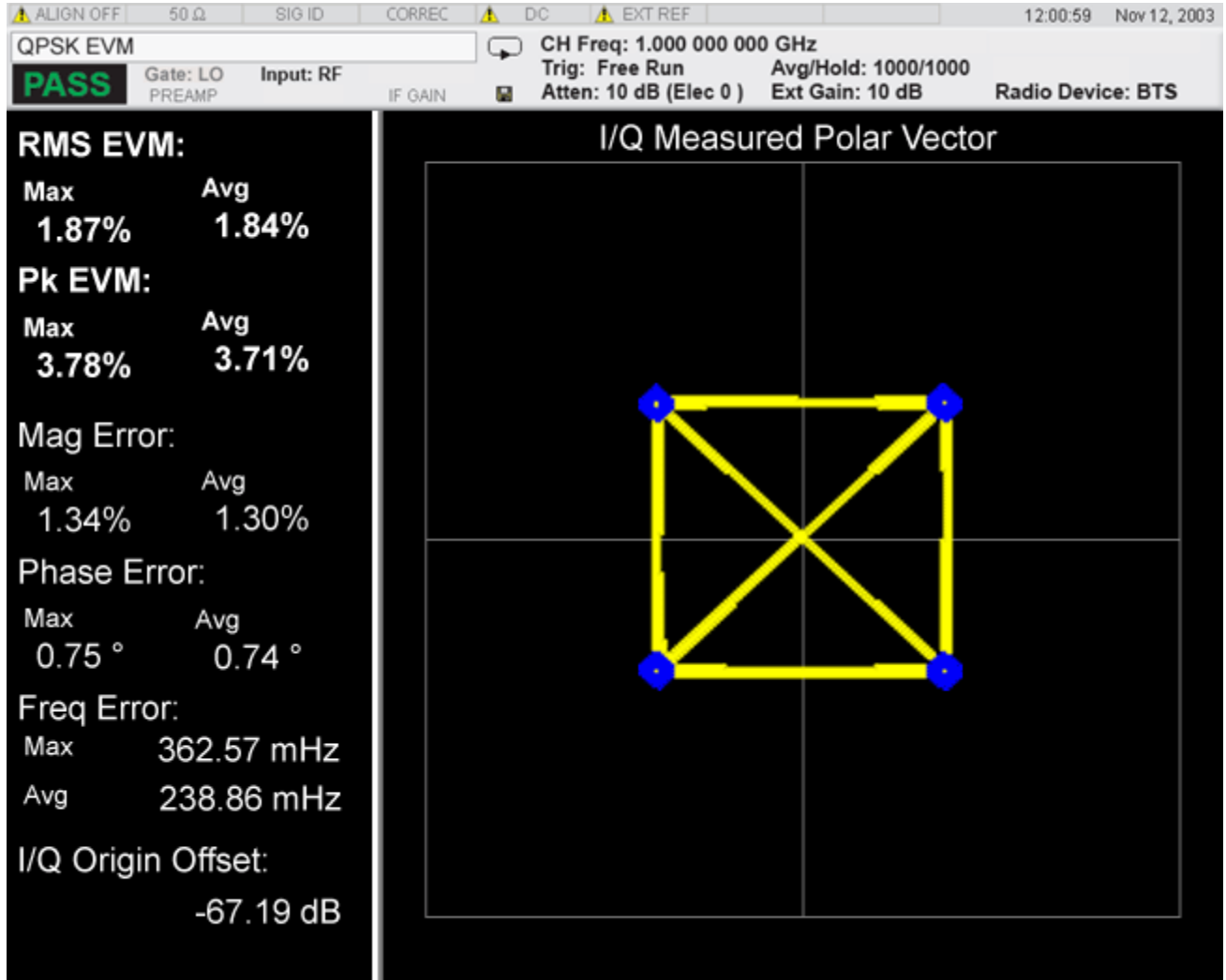

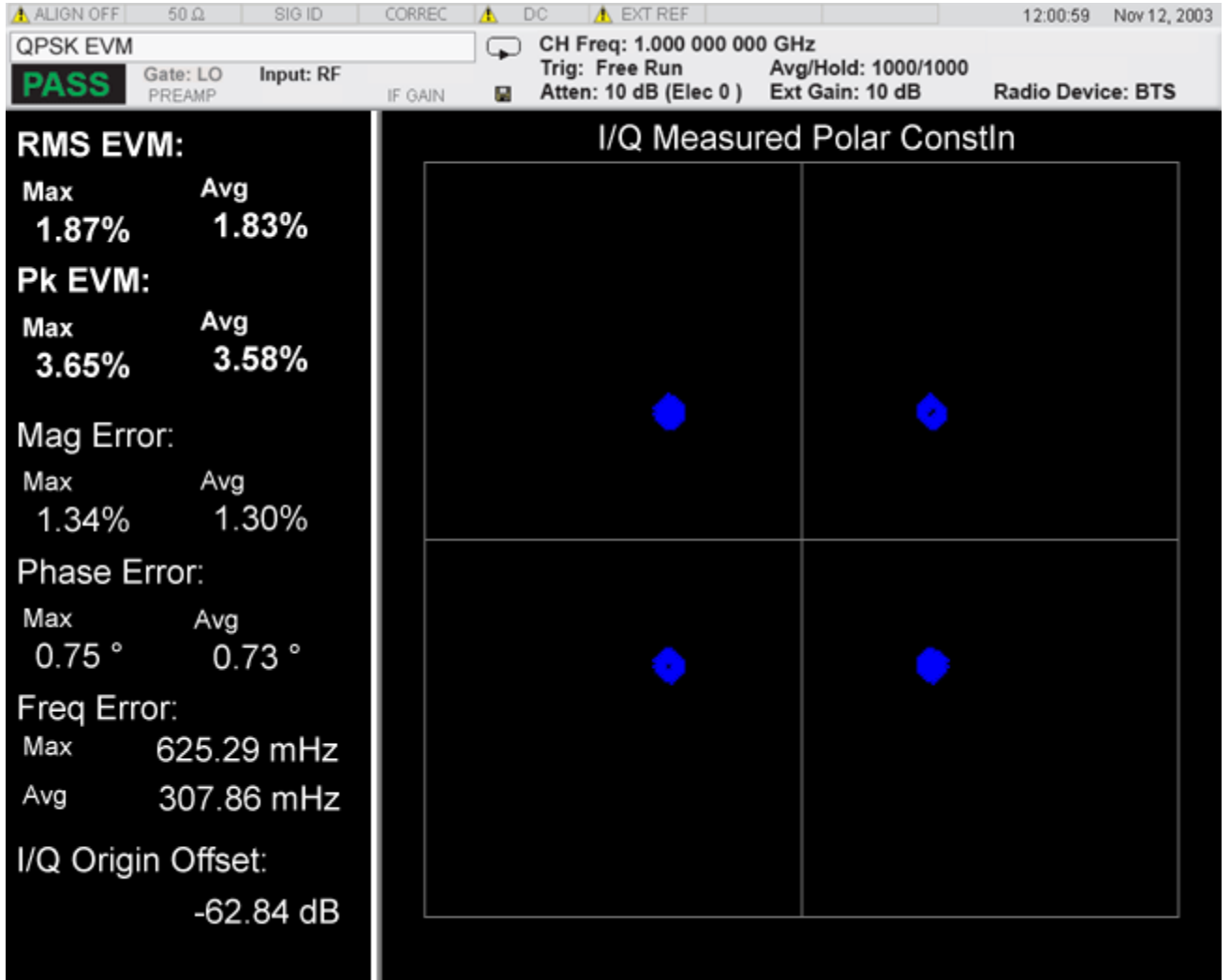

QPSK EVM Measurement
View/Display

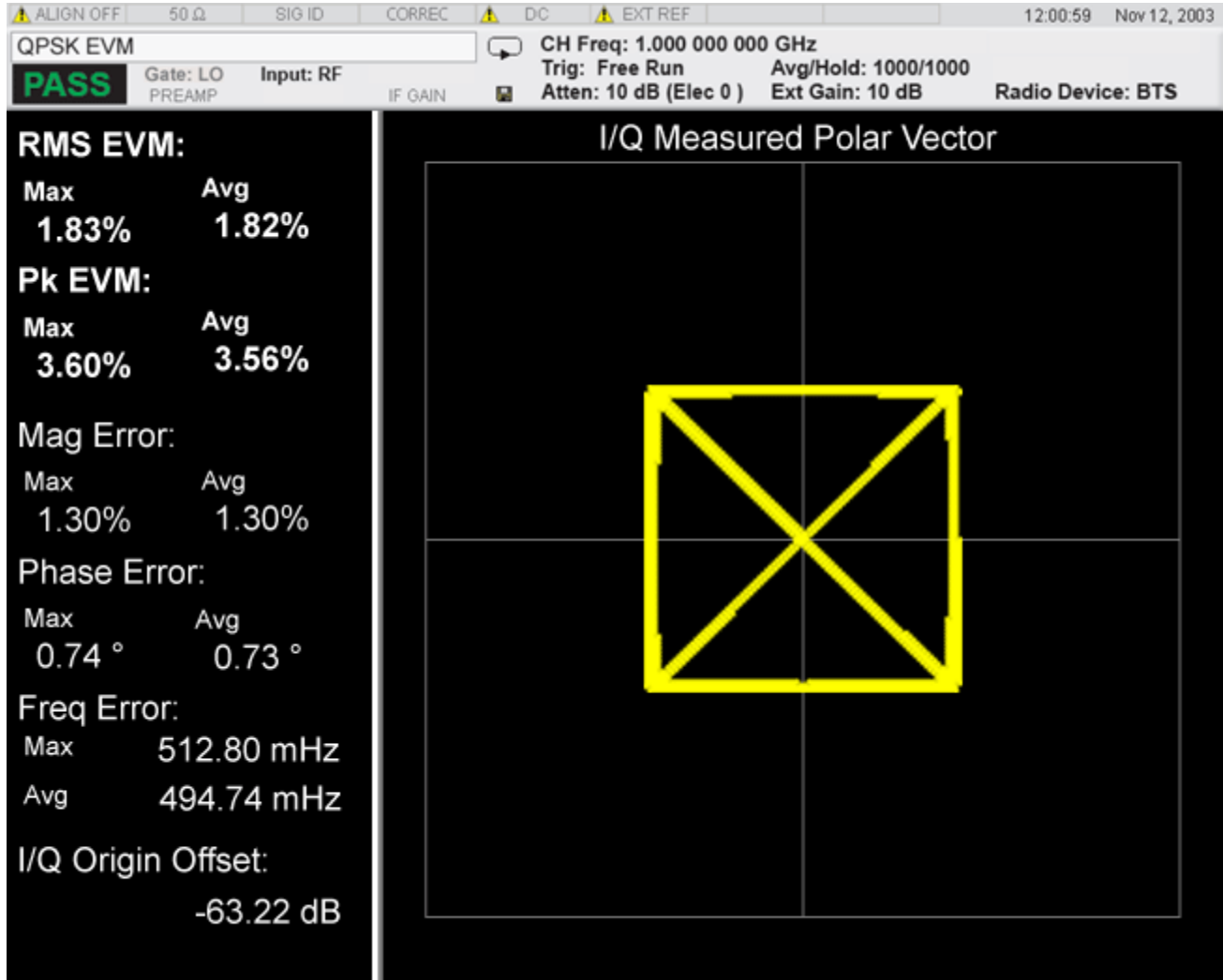

Polar Graph Window

Polar Graph consists of Constellation points and Vector line.

Marker Trace	Yes
Corresponding Trace	Display I/Q trace (n=5)

Numeric Results Window

Shows numeric results of the I/Q polar graph.

Name	Type	Description	Unit	Format
RMS EVM	float64	EVM over the entire measurement area	percent	XX.XX%
Peak EVM	float64	peak EVM in the measurement area.	percent	XX.XX%

Mag Error	Avg	float64	averaged magnitude error over the entire measurement area	percent	XX.XX%
	Max	float64	maximum magnitude error over the entire measurement area	percent	XX.XX%
Phase Error	Avg	float64	averaged phase error over the entire measurement area	°	XX.XX °
	Max	float64	maximum phase error over the entire measurement area	°	XX.XX °
Freq Error	Avg	float64	averaged frequency error in the measured signal.	Hz	XX.XX Hz
	Max	float64	maximum frequency error in the measured signal	Hz	XX.XX Hz
I/Q Origin Offset		float64	the I and Q error (magnitude squared) offset from the origin.	dB	XX.XX dB

Key Path	View/Display
Instrument S/W Revision	Prior to A.02.00

I/Q Polar Vec/Constln

Specifies the format of the polar vector graph display. The following display options are available:

Vector and Constellation

Vector Only

Constellation Only

Remote Command	:DISPlay:EVMQpsk:VIEW[1]:WINDow2:TRACe:POLar VC VECTor CONStln :DISPlay:EVMQpsk:VIEW[1]:WINDow2:TRACe:POLar?
Example	DISP:EVMQ:VIEW:WIND2:TRAC:POL VECT DISP:EVMQ:VIEW:WIND2:TRAC:POL?
Key Path	View/Display
Mode	WCDMA, C2K, 1xEVDO
Notes	Allows to specify the format of the polar vector graph display by: Vector and Constellation Vector Only Constellation Only
Preset	VC

QPSK EVM Measurement
View/Display

State Saved	Saved in instrument state.
Range	Vec & ConstIn Vector Constellation
Readback Text	Vec & ConstIn Vector ConstIn
Instrument S/W Revision	Prior to A.02.00

Chip Offset

Sets the chip offset number from the first chip in a measured signal.

Remote Command	:DISPlay:EVMQpsk:VIEW[1]:WINDow2:TRACe:COFFset <integer> :DISPlay:EVMQpsk:VIEW[1]:WINDow2:TRACe:COFFset?
Example	DISP:EVMQ:VIEW:WIND2:TRAC:COFF 1001 DISP:EVMQ:VIEW:WIND2:TRAC:COFF?
Key Path	View/Display, Display
Mode	WCDMA, C2K, 1xEVDO
Notes	The number of chip offset from the first chip in a measured signal.
Preset	0
State Saved	Saved in instrument state.
Min	0
Max	Meas Interval – I/Q Chips
Instrument S/W Revision	Prior to A.02.00

I/Q Chips

Specifies the number of I/Q chips used to display the I/Q waveforms.

Remote Command	:DISPlay:EVMQpsk:VIEW[1]:WINDow2:TRACe:IQCHips <integer> :DISPlay:EVMQpsk:VIEW[1]:WINDow2:TRACe:IQCHips?
Example	DISP:EVMQ:VIEW:WIND2:TRAC:IQCH 1001 DISP:EVMQ:VIEW:WIND2:TRAC:IQCH?
Key Path	View/Display, Display
Mode	WCDMA, C2K, 1xEVDO
Couplings	This parameter is dependent on Meas Interval and cannot be set to a value greater than Meas Interval.

Preset	C2K: 512 WCDMA: 2560 1xEVDO: 2560
State Saved	Saved in instrument state.
Min	1
Max	WCDMA: 5120 C2K:1536
Instrument S/W Revision	Prior to A.02.00

Interpolation

Toggles the interpolation function from On to Off. If set to On, the vector lines between chip dots are converted into smooth curves by the interpolation function.

Remote Command	:DISPlay:EVMQpsk:VIEW[1]:WINDow2:TRACe:INTPolation[:STATe] OFF ON 0 1 :DISPlay:EVMQpsk:VIEW[1]:WINDow2:TRACe:INTPolation[:STATe] ?
Example	DISP:EVMQ:VIEW:WIND2:TRAC:INTP ON DISP:EVMQ:VIEW:WIND2:TRAC:INTP?
Key Path	View/Display, Display
Mode	WCDMA, C2K, 1xEVDO
Notes	If set to ON, the vector lines between chip dots are converted into smoothed curves by the interpolation function.
Preset	OFF
State Saved	Saved in instrument state.
Range	On Off
Instrument S/W Revision	Prior to A.02.00

+45° Rotation

Toggles the state of the rotation of the I/Q polar trace. If set to On, the I/Q polar trace is rotated by 45 degrees to provide a rectangular display.

Remote Command	:DISPlay:EVMQpsk:VIEW[1]:WINDow2:TRACe:ROTQpi[:STATe] OFF ON 0 1 :DISPlay:EVMQpsk:VIEW[1]:WINDow2:TRACe:ROTQpi[:STATe] ?
Example	DISP:EVMQ:VIEW:WIND2:TRAC:ROTQ ON DISP:EVMQ:VIEW:WIND2:TRAC:ROTQ?

Key Path	View/Display, Display
Mode	WCDMA, C2K, 1xEVDO
Notes	Enables you to toggle whether the I/Q polar trace is rotated by 45 degrees to provide a rectangular display.
Preset	OFF
State Saved	Saved in instrument state.
Range	On Off
Instrument S/W Revision	Prior to A.02.00

Full Vector

Toggles the gray background from On to Off when displaying the full measured trace or the selected vector on the display.

Remote Command	:DISPlay:EVMQpsk:VIEW[1]:WINDow2:TRACe:FVECTor[:STATE] OFF ON 0 1 :DISPlay:EVMQpsk:VIEW[1]:WINDow2:TRACe:FVECTor[:STATE]?
Example	DISP:EVMQ:VIEW:WIND2:TRAC:FVEC ON DISP:EVMQ:VIEW:WIND2:TRAC:FVEC?
Key Path	View/Display, Display
Mode	WCDMA, C2K, 1xEVDO
Notes	This is useful when you want to observe the full vector and the selected vector set by I/Q Chips and Chip Offset simultaneously.
Preset	OFF
State Saved	Saved in instrument state.
Range	On Off
Instrument S/W Revision	Prior to A.02.00

I/Q Error View

Provides a combination view. This view consists of four windows:

[“Mag Error vs. Symbol Window” on page 845](#)

[“Phase Error vs. Symbol Window” on page 845](#)

[“EVM vs. Symbol Window” on page 846](#)

[“Numeric Results Window” on page 846](#)

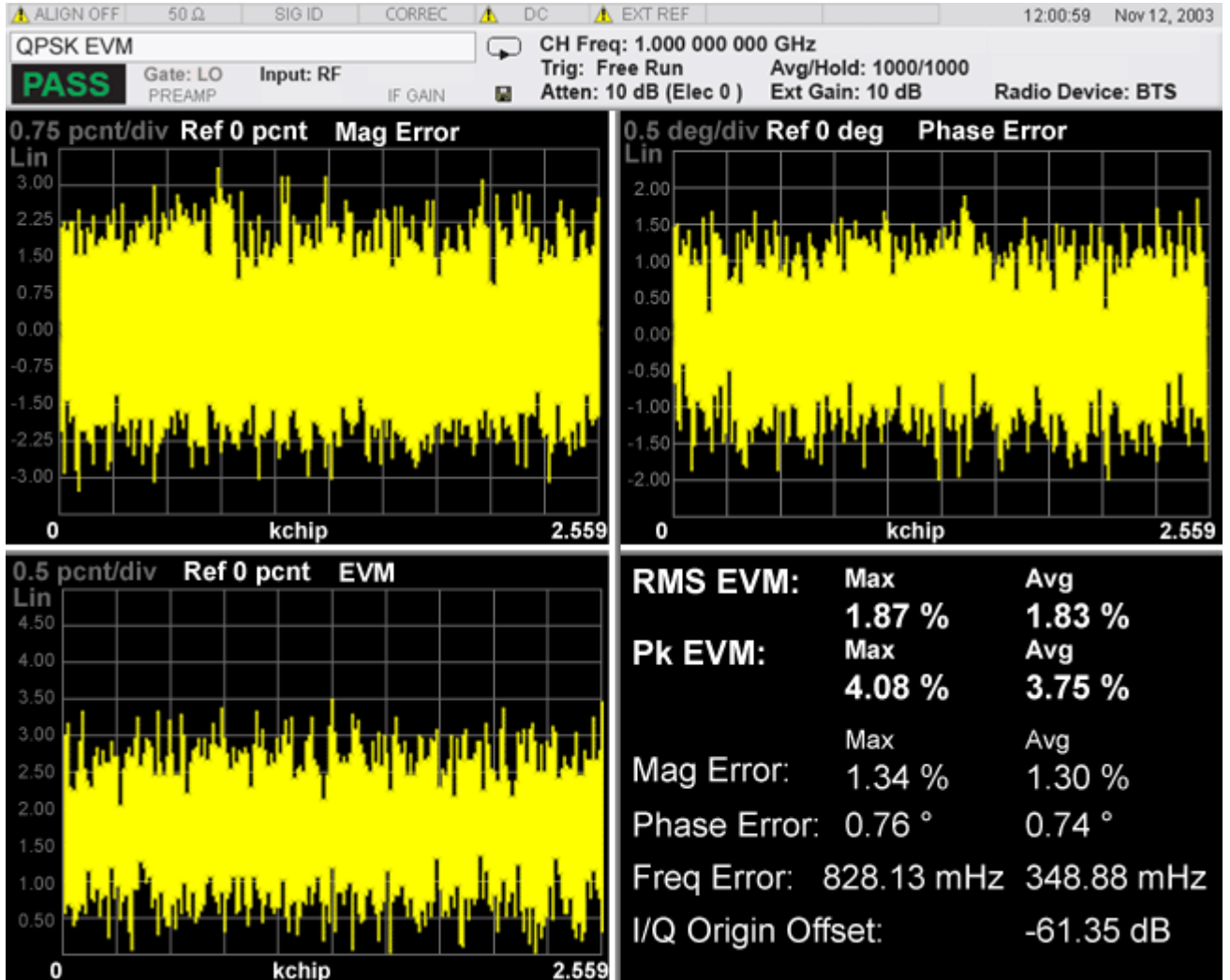

Mag Error vs. Symbol Window

Provides Magnitude Error vs. Symbol results.

Marker Trace	Yes
Corresponding Trace	Magnitude Error trace (n=3)

Phase Error vs. Symbol Window

Provides Magnitude Error vs. Symbol results.

Marker Trace	Yes
Corresponding Trace	Phase Error trace (n=4)

EVM vs. Symbol Window

Provides EVM vs. Symbol results.

Marker Trace	Yes
Corresponding Trace	EVM trace (n=2)

Numeric Results Window

Shows numeric results as the same as the numeric results of the I/Q polar graph.

Key Path	View/Display
Instrument S/W Revision	Prior to A.02.00

The key and command descriptions in this section describe functions that operate the same in multiple measurements and/or modes. This section is a library of functions that is referenced by many measurements and modes

To find the exact description and parameters for functions in a specific measurement, always look in the measurement section of this documentation. Pressing the front-panel key or key and then pressing the green Help key also provides the correct information.

NOTE

If you want to print the documentation, select this section and the measurement of interest to ensure that you have all the information you need. See [“Printing Acrobat Files” on page 120](#) for further instructions about printing.

AMPTD Y Scale

The Amplitude front-panel key activates the Amplitude menu and selects Reference Level or Reference Value (depending on the measurement) as the active function.

Some features in the Amplitude menu apply to multiple measurements; others apply only to specific measurements. Keys that only apply to some measurements are blanked or grayed out in measurements that are not supported.

Key Path:	Front-panel key
Initial S/W Revision:	Prior to A.02.00

Reference Level

The Reference Level specifies the amplitude represented by the topmost graticule line.

Changing the reference level does not restart a measurement, because it is a display function only; instead it vertically ‘pans’ all displayed traces and markers to the new value. If a change to the reference level changes the attenuation value (e.g. through an auto coupling), then the measurement will be restarted.

See [“Amplitude Representations” on page 850](#)

Key Path:	AMPTD Y Scale
Remote Command:	:DISPlay:WINDow[1]:TRACe:Y[:SCALe]:RLEVel <real> :DISPlay:WINDow[1]:TRACe:Y[:SCALe]:RLEVel?
Example:	DISP:WIND:TRAC:Y:RLEV 20 dBm Sets the reference level to 20 dBm, which displays in the current Y axis unit. For example, if the Y axis unit is dBμV, then 126.99 dBμV will be displayed.
Couplings:	If you reduce the attenuation, the analyzer may have to lower the reference level to keep it below its allowed maximum. This allowed maximum level is specified in the “Max” row, below, along with other variables which affect it. When you increase attenuation, the reference level does not change.
Preset:	0 dBm
State Saved:	Saved in instrument state
Min:	RefLevelMin = -170 dBm + RefLevelOffset - ExtGain.

AMPTD Y Scale

Max:	<p>The maximum Ref Level is typically:</p> <p>+30 dBm + RL Offset – External Gain (for MXA and PXA)</p> <p>+23 dBm + RL Offset – External Gain (for EXA and CXA)</p> <p>This maximum value is determined by the maximum power that can be safely applied to the input circuitry. The actual maximum value at any given time may be even less than this, depending on other values including Mech Atten, Int Preamp Gain, Swept IF Gain, FFT IF Gain, Max Mixer Level, and the total attenuation currently available.</p> <p>Note that the maximum reference level is unaffected by the input choice of external mixing.</p>
Default Unit:	Depends on the current selected Y axis unit
Backwards Compatibility Notes:	<ol style="list-style-type: none"> 1. In PSA, there was a restriction on Ref Level Max which was that it could not exceed 0 dBm when the preamp was on. This restriction does not apply to X-Series. 2. Ref Level – Ref Level is a display function, not a measurement control function, so a change in the setting does not start a new sweep (unless attenuation changes). This behavior differs from that of legacy analyzers
Initial S/W Revision:	Prior to A.02.00

Amplitude Representations

The following is an illustration of the reference level and Y Axis scales under various conditions:

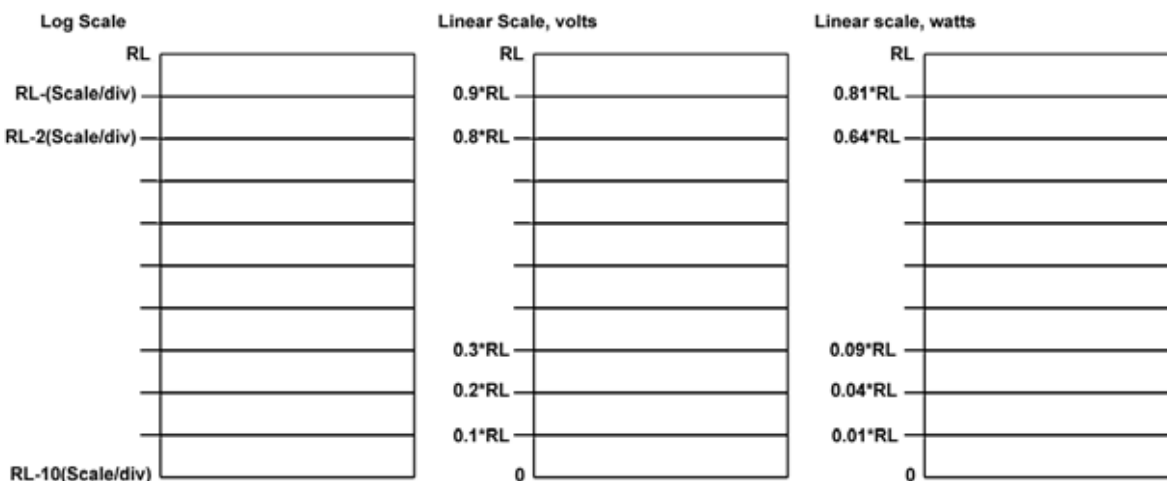

Attenuation

This menu controls the attenuator functions and interactions between the attenuation system components.

There are two attenuator configurations in the X-Series. One is a dual attenuator configuration consisting of a mechanical attenuator and an optional electronic attenuator. The other configuration uses

a single attenuator with combined mechanical and electronic sections that controls all the attenuation functions. Different models in the X-Series come with different configurations.

See “Dual Attenuator Configurations” on page 851.

See “Single Attenuator Configuration:” on page 852

Most Attenuation settings are the same for all measurements – they do not change as you change measurements. Settings like these are called “Meas Global” and are unaffected by Meas Preset.

Key Path:	AMPTD Y Scale
Scope:	Meas Global
Dependencies:	In measurements that support the I/Q inputs, this key is unavailable when I/Q is the selected input, and is replaced by the Range key in that case. Attenuator controls and settings are not available on the E6607C. If any attenuator commands are sent to the E6607C the following error will be generated: -241;Hardware missing; not available for this model number
Readback Line:	Contains a summary in [] brackets of the current total attenuation. See the descriptions of the “(Mech) Atten ” on page 852, “Enable Elec Atten” on page 854, and “Elec Atten” on page 857 keys for more detail on the contributors to the total attenuation. Note that when "Pre-Adjust for Min Clip" is on, this value can change at the start of every measurement.
Initial S/W Revision:	Prior to A.02.00
Modified at S/W Revision:	A.03.00

Dual Attenuator Configurations

Configuration 1: Mechanical attenuator + optional electronic attenuator

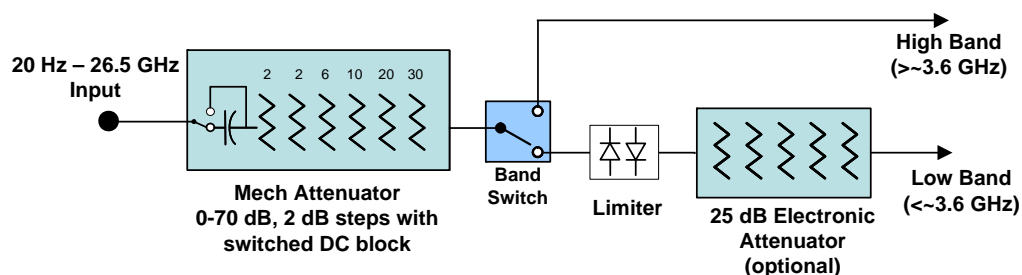

Configuration 2: Mechanical attenuator, no optional electronic attenuator

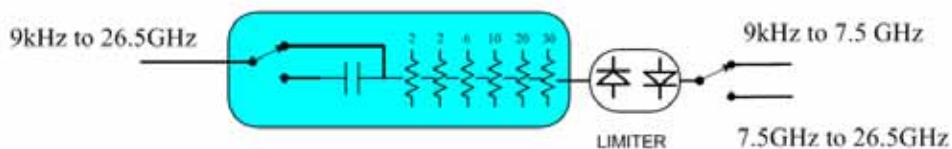

AMPTD Y Scale

(note that Configuration 2 is not strictly speaking a dual-section attenuator, since there is no electronic section available. However, it behaves exactly like Configuration 1 without the Electronic Attenuator option EA3, therefore for the sake of this document it is grouped into the “Dual Attenuator” configuration)

Single Attenuator Configuration:

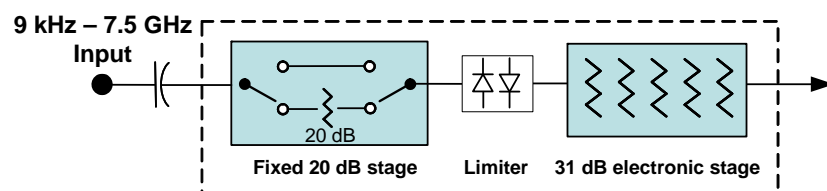

You can tell which attenuator configuration you have by pressing the Attenuation key, which (in most Modes) opens the Attenuation menu. If the first key in the Attenuation menu says **Mech Atten** you have the dual attenuator configuration. If the first key says **Atten** you have the single attenuator configuration.

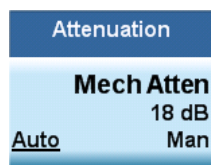

Dual Attenuator

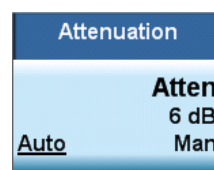

Single Attenuator

In the single attenuator configuration, you control the attenuation with a single control, as the fixed stage has only two states. In the dual attenuator configuration, both stages have significant range so you are given separate control of the mechanical and electronic attenuator stages.

When you have the dual attenuator configuration, you may still have only a single attenuator, because unless option EA3 (the Electronic Attenuator option) is available, and you purchase it, you will have only the mechanical attenuator.

(Mech) Atten

This key is labeled **Mech Atten** in dual attenuator models and **Atten** in single attenuator models. In the dual attenuator configuration, this key only affects the mechanical attenuator.

This key lets you modify the attenuation applied to the RF input signal path. This value is normally auto coupled to the Ref Level, the Internal Preamp Gain, any External Gain that is entered, and the Max Mixer Level, as described in the table below.

See “Attenuator Configurations and Auto/Man” on page 854

Key Path:	AMPTD Y Scale, Attenuation
Remote Command:	<pre>[:SENSE] :POWER [:RF] :ATTenuation <rel_amp1> [:SENSE] :POWER [:RF] :ATTenuation? [:SENSE] :POWER [:RF] :ATTenuation:AUTO OFF ON 0 1 [:SENSE] :POWER [:RF] :ATTenuation:AUTO?</pre>

<p>Example:</p>	<p>POW:ATT 20</p> <p>Dual attenuator configuration: sets the mechanical attenuator to 20 dB</p> <p>Single attenuator mode: sets the main attenuation to 20 dB (see below for definition of “main” attenuation).</p> <p>If the attenuator was in Auto, it sets it to Manual.</p>
<p>Dependencies:</p>	<p>Some measurements do not support the Auto setting of (Mech) Atten. In these measurements, the Auto/Man selection is not available, and the Auto/Man line on the key disappears.</p> <p>In dual attenuator configurations, when the electronic attenuator is enabled, the mechanical attenuator has no auto setting and the Auto/Man line on the key disappears. The state of Auto/Man is remembered and restored when the electronic attenuator is once again disabled. This is described in more detail in the “Enable Elec Atten” on page 854 key description.</p> <p>See “Attenuator Configurations and Auto/Man” on page 854 for more information on the Auto/Man functionality of Attenuation.</p>
<p>Couplings:</p>	<p>When (Mech) Atten is in Auto, it uses the following algorithm to determine a value:</p> $\text{Atten} = \text{ReferenceLevel} + \text{PreAmpGain} + \text{ExternalGain} - \text{RefLevelOffset} - \text{MaxMixerLevel} + \text{IF Gain}.$ <p>Limit this value to be between 6 dB and the Max value. No value below 6 dB can ever be chosen by Auto.</p> <p>The resulting value is rounded up to the largest value possible given the attenuation step setting. That is, 50.01 dB would change to 60 dB (for a 10 dB attenuation step).</p> <p>The “IF Gain” term in the equation above is either 0 dB or +10 dB, depending on the settings of FFT IF Gain, Swept IF Gain, max Ref Level and the Auto/Man setting of Mech Atten.</p> <p>In External Mixing and BBIQ, where the Attenuator is not in the signal path, the Attenuator setting changes as described above when (Mech) Atten is in Auto, but no changes are made to the actual attenuator hardware setting until the input is changed back to the RF Input.</p>
<p>Preset:</p>	<p>The preset for Mech Attenuation is “Auto.”</p> <p>The Auto value of attenuation is:</p> <p>CXA, EXA, MXA and PXA: 10 dB</p> <p>EXT: 6dB</p>
<p>State Saved:</p>	<p>Saved in instrument state</p>

AMPTD Y Scale

Min:	0 dB The attenuation set by this key cannot be decreased below 6 dB with the knob or step keys. To get to a value below 6 dB it has to be directly entered from the keypad or via SCPI. This protects from adjusting the attenuation to a dangerously small value which can put the instrument at risk of damage to input circuitry. However, if the current mechanical attenuation is below 6 dB it can be increased with the knob and step keys, but not decreased.
Max:	CXA N9000A–503/507: 50 dB CXA N9000A–513/526: 70dB EXA: 60 dB MXA and PXA: 70 dB EXT: 70 dB In the single attenuator configuration, the total of ATT and EATT cannot exceed 50 dB, so if the EATT is set to 24 dB first, the main attenuation cannot be greater than 26 dB and will be reduced accordingly; if the main attenuator is set to 40 dB first, EATT cannot be greater than 10 dB.
Initial S/W Revision:	Prior to A.02.00
Modified at S/W Revision:	A.03.00

Attenuator Configurations and Auto/Man

As described in the Attenuation key description, there are two distinct attenuator configurations available in the X-Series, the single attenuator and dual attenuator configurations. In dual attenuator configurations, we have the mechanical attenuation and the electronic attenuation, and the current total attenuation is the sum of the electronic + mechanical attenuation. In single attenuator configurations, we refer to the attenuation set using the **(Mech) Atten** key (or POW:ATT SCPI) as the “main” attenuation; and the attenuation that is set by the SCPI command POW:EATT as the “soft” attenuation (the POW:EATT command is honored even in the single attenuator configuration, for compatibility purposes). Then the current total attenuation is the sum of the main + soft attenuation. See the **Elec Atten** key description for more on “soft” attenuation.

In the dual attenuator configuration, when the electronic attenuator is enabled, there is no Auto/Man functionality for the mechanical attenuator, and the third line of the key label (the Auto/Man line) disappears:

Mech Atten	
	0 dB
<u>Auto</u>	Man

Mech Atten	
	0 dB

Mech Atten when elec atten disabled
--

Mech Atten when elec atten enabled

vsd05

Enable Elec Atten

Enables the Electronic Attenuator.

The electronic attenuator offers finer steps than the mechanical attenuator, has no acoustical noise, is

faster, and is less subject to wear. These advantages primarily aid in remote operation and are negligible for front panel use. See [“Using the Electronic Attenuator: Pros and Cons” on page 856](#) for a detailed discussion of the pros and cons of using the electronic attenuator.

For the single attenuator configuration, for SCPI backwards compatibility, the “soft” attenuation feature replaces the dual attenuator configuration’s electronic attenuator. All the same couplings and limitations apply. See [“Attenuator Configurations and Auto/Man” on page 854](#)

See [“More Information” on page 856](#)

Key Path:	AMPTD Y Scale, Attenuation
Remote Command:	[:SENSe] :POWer [:RF] :EATTenuation:STATe OFF ON 0 1 [:SENSe] :POWer [:RF] :EATTenuation:STATe?
Example:	POW:EATT:STAT ON
Dependencies:	<p>This key only appears in Dual Attenuator models with an Electronic Attenuator installed. It does not appear in models with the Single Attenuator configuration, as in the single attenuator configuration there is no “electronic attenuator” there is only a single integrated attenuator (which has both a mechanical and electronic stage). However, in the single attenuator configuration, EATT SCPI commands are accepted for compatibility with other X-series instruments and set a “soft” attenuation as described in “Attenuator Configurations and Auto/Man” on page 854</p> <p>The electronic attenuator (and the “soft” attenuation function provided in single attenuator configurations) is unavailable above 3.6 GHz. Therefore, if the Stop Frequency of the analyzer is > 3.6 GHz then the Enable Elec Atten key will be OFF and grayed out.</p> <p>If the Internal Preamp is on, meaning it is set to Low Band or Full, the electronic attenuator (and the “soft” attenuation function provided in single attenuator configurations) is unavailable. In this case the Enable Elec Atten key will be OFF and grayed out.</p> <p>If either of the above is true, if the SCPI command is sent, an error indicating that the electronic attenuator is unavailable will be sent.</p> <p>If the electronic/soft Attenuator is enabled, then the Stop Freq of the analyzer is limited to 3.6 GHz and the Internal Preamp is unavailable.</p> <p>The SCPI-only “soft” electronic attenuation for the single-attenuator configuration is not available in all measurements; in particular, it is not available in the Swept SA measurement.</p>
Couplings:	Enabling and disabling the Electronic Attenuator affects the setting of the Mechanical Attenuator (in dual attenuator configurations). This is described in more detail below this table.
Preset:	OFF for Swept SA measurement; ON for all other measurements that support the electronic attenuator
State Saved:	Saved in instrument state
Initial S/W Revision:	Prior to A.02.00

Modified at S/W Revision:	A.03.00
---------------------------	---------

More Information

Mechanical Attenuator Transition Rules

When the Electronic Attenuator is enabled, the Mechanical Attenuator transitions to a state that has no Auto function. Below are the rules for transitioning the Mechanical Attenuator. NOTE that the information below ONLY applies to the dual attenuator configurations, and ONLY when the Electronic Attenuator is installed:

When the Electronic Attenuation is enabled from a disabled state:

- The Mechanical Attenuator is initialized to 10 dB (this is its optimal performance setting). You can then set it as desired with SCPI, numeric keypad, step keys, or knob, and it behaves as it normally would in manual mode
- The Auto/Man state of (Mech) Atten is saved
- The Auto/Man line on the (Mech) Atten key disappears and the auto rules are disabled
- The Electronic Attenuator is set to 10 dB less than the previous value of the Mechanical Attenuator, within the limitation that it must stay within the range of 0 to 24 dB of attenuation.

Examples in the dual attenuator configuration:

- Mech Atten at 20 dB. Elec Atten enabled, Mech Atten set to 10 dB, and Elec Atten set to 10 dB. New total attenuation equals the value before Elec Atten enabled.
- Mech Atten at 0 dB. Elec Atten enabled, Mech Atten set to 10 dB, and Elec Atten set to 0 dB. New total attenuation does not equal the value before Elec Atten enabled.
- Mech Atten at 40 dB. Elec Atten enabled, Mech Atten set to 10 dB, and Elec Atten set to 24 dB. New total attenuation does not equal the value before Elec Atten enabled.

When the Electronic Attenuation is disabled from an enabled state:

- The Elec Atten key is grayed out
- The Auto/Man state of (Mech) Atten is restored
- If now in Auto, (Mech) Atten recouples
- If now in Man, (Mech) Atten is set to the value of total attenuation that existed before the Elec Atten was disabled. The resulting value is rounded up to the smallest value possible given the (Mech) Atten Step setting - (That is, 57 dB changes to 58 dB when (Mech) Atten Step is 2 dB.)

Using the Electronic Attenuator: Pros and Cons

The electronic attenuator offers finer steps than the mechanical attenuator, has no acoustical noise, is faster, and is less subject to wear.

The “finer steps” advantage of the electronic attenuator is beneficial in optimizing the alignment of the analyzer dynamic range to the signal power in the front panel as well as remote use. Thus, you can achieve improved relative signal measurement accuracy. Compared to a mechanical attenuator with 2 dB

steps, the 1 dB resolution of the electronic attenuator only gives better resolution when the odd-decibel steps are used. Those odd-decibel steps are less accurately calibrated than the even-decibel steps, so one tradeoff for this superior relative accuracy is reduced absolute amplitude accuracy.

Another disadvantage of the electronic attenuator is that the spectrum analyzer loses its “Auto” setting, making operation less convenient.

Also, the relationship between the dynamic range specifications (TOI, SHI, compression and noise) and instrument performance are less well-known with the electrical attenuator. With the mechanical attenuator, TOI, SHI and compression threshold levels increase dB-for-dB with increasing attenuation, and the noise floor does as well. With the electronic attenuator, there is an excess attenuation of about 1 to 3 dB between 0 and 3.6 GHz, making the effective TOI, SHI, and so forth, less well known. Excess attenuation is the actual attenuation relative to stated attenuation. Excess attenuation is accounted for in the analyzer calibration

Elec Atten

Controls the Electronic Attenuator in dual attenuator configurations. This key does not appear in single attenuator configurations, as the control of both the mechanical and electronic stages of the single attenuator is integrated into the single **Atten** key.

Key Path:	AMPTD Y Scale, Attenuation
Remote Command:	[:SENSE] :POWER [:RF] :EATTenuation <rel_ampl> [:SENSE] :POWER [:RF] :EATTenuation?
Notes:	Electronic Attenuation’s specification is defined only when Mechanical Attenuation is 6 dB.
Dependencies:	This key only appears in Dual Attenuator models with an Electronic Attenuator installed. It does not appear in models with the Single Attenuator configuration, as in the single attenuator configuration there is no “electronic attenuator” there is only a single integrated attenuator (which has both a mechanical and electronic stage). However, in the single attenuator configuration, EATT SCPI commands are accepted for compatibility with other X-series instruments and set a “soft” attenuation as described in “Attenuator Configurations and Auto/Man” on page 854 . The “soft” attenuation is treated as an addition to the “main” attenuation value set by the Atten softkey or the POW:ATT SCPI command and affects the total attenuation displayed on the Attenuation key and the Meas Bar. When Enable Elec Atten is off or grayed out, the Elec Atten key is grayed out.
Preset:	0 dB
State Saved:	Saved in instrument state
Min:	0 dB

AMPTD Y Scale

Max:	Dual attenuator configuration: 24 dB Single attenuator configuration: the total of ATT and EATT cannot exceed 50 dB, so if the EATT is set to 24 dB first, the main attenuation cannot be greater than 26 dB and will be reduced accordingly; if the main attenuator is set to 40 dB first, EATT cannot be greater than 10 dB
Initial S/W Revision:	Prior to A.02.00
Modified at S/W Revision:	A.03.00

Adjust Atten for Min Clip

Sets the combination of mechanical and electronic attenuation based on the current measured signal level so that clipping will be at a minimum.

This is an "immediate action" function, that is, it executes once, when the key is pressed.

This key is grayed out in measurements that do not support this functionality. The spectrum analyzer measurement, Swept SA, does not support this functionality.

Key Path:	AMPTD Y Scale, Attenuation
Remote Command:	[:SENSE] :POWER [:RF] :RANGE :OPTimize IMMEDIATE
Initial S/W Revision:	Prior to A.02.00
Modified at S/W Revision:	A.03.00

Pre-Adjust for Min Clip

If this function is on, it does the adjustment described under [“Adjust Atten for Min Clip” on page 858](#) each time a measurement restarts. Therefore, in Continuous measurement mode, it only executes before the first measurement.

In dual attenuator models, you can set **Elec+Mech Atten**, in which case both attenuators participate in the autoranging, or **Elec Atten Only**, in which case the mechanical attenuator does not participate in the autoranging. This latter case results in less wear on the mechanical attenuator and is usually faster.

This key is grayed out in measurements that do not support this functionality. The spectrum analyzer measurement, Swept SA, does not support this functionality.

Key Path:	AMPTD Y Scale, Attenuation
Remote Command:	[:SENSE] :POWER [:RF] :RANGE :OPTimize :ATTenuation OFF ELECTrical COMBined [:SENSE] :POWER [:RF] :RANGE :OPTimize :ATTenuation?
Notes:	The SCPI parameter ELECTrical sets this function to On in single attenuator models. The SCPI parameter COMBined is mapped to ELECTrical in single attenuator models; if you send COMBined, it sets the function to On and returns ELEC to a query.

Dependencies:	This key only appears in Dual Attenuator models with an Electronic Attenuator installed. It does not appear in models with the Single Attenuator configuration, as in the single attenuator configuration there is no “electronic attenuator” there is only a single integrated attenuator (which has both a mechanical and electronic stage). When Enable Elec Atten is off or grayed out, the Pre-Adjust for Min Clip key is grayed out.
Preset:	OFF for Swept SA measurement; ON for all other measurements that support Pre-Adjust for Min Clip
State Saved:	Saved in instrument state
Range:	Dual attenuator models: Off Elec Atten Only Mech + Elec Atten Single attenuator models: Off On
Initial S/W Revision:	Prior to A.02.00
Modified at S/W Revision:	A.03.00

Remote Command:	[:SENSE] :POWER[:RF] :RANGE:AUTO ON OFF 1 0 [:SENSE] :POWER[:RF] :RANGE:AUTO?
Notes:	ON aliases to "Elec Atten Only" (:POW:RANG:OPT:ATT ELEC) OFF aliases to "Off" (:POW:RANG:OPT:ATT OFF) The query :POW:RANG:AUTO? returns true if :POW:RANG:OPT:ATT is not "Off"
Initial S/W Revision:	Prior to A.02.00

Off

Turns **Pre-Adjust for Min Clip** off. This is the default setting.

This key is grayed out in measurements that do not support this functionality. The spectrum analyzer measurement, Swept SA, does not support this functionality.

Key Path:	AMPTD Y Scale, Attenuation, Pre-Adjust for Min Clip
Example:	:POW:RANGE:OPT:ATT OFF
Initial S/W Revision:	Prior to A.02.00

Elec Atten Only

Selects only the electric attenuator to participate in auto ranging. This offers less wear on the mechanical attenuator and is usually faster.

This key is grayed out in measurements that do not support this functionality. The spectrum analyzer

AMPTD Y Scale

measurement, Swept SA, does not support this functionality.

Key Path:	AMPTD Y Scale, Attenuation, Pre-Adjust for Min Clip
Example:	:POW:RANGe:OPT:ATT ELEC
Initial S/W Revision:	Prior to A.02.00

Mech + Elec Atten

In dual attenuator models, this selects both attenuators participate in the autoranging.

This key is grayed out in measurements that do not support this functionality. The spectrum analyzer measurement, Swept SA, does not support this functionality.

Key Path:	AMPTD Y Scale, Attenuation, Pre-Adjust for Min Clip
Example:	:POW:RANGe:OPT:ATT COMB
Initial S/W Revision:	Prior to A.02.00

(Mech) Atten Step

This controls the step size used when making adjustments to the input attenuation.

This key is labeled **Mech Atten Step** in dual attenuator models and **Atten Step** in single attenuator models. In the dual attenuator configuration, this key only affects the step size of the mechanical attenuator.

Key Path:	AMPTD Y Scale, Attenuation
Remote Command:	[:SENSe] :POWer [:RF] :ATTenuation:STEP [:INCRement] 10 dB 2 dB [:SENSe] :POWer [:RF] :ATTenuation:STEP [:INCRement] ?
Example:	POW:ATT:STEP 2
Notes:	Note this feature works like a 1-N choice from the front panel, but it takes a specific value (in dB) when used remotely. The only valid values are 2 and 10.
Dependencies:	Blanked in CXA and EXA if option FSA (2 dB steps) is not present. If blanked, attempts to set it via SCPI will yield an error.
Couplings:	When the attenuation step size changes, the current mechanical attenuation value is adjusted (if necessary) to be quantized to the new step size. That is, if step is set to 10 dB, mech atten is increased if necessary so it is a multiple of 10 dB
Preset:	PXA and MXA: 2 dB EXA and CXA: 10 dB (2 dB with option FSA) EXT: 2 dB
State Saved:	Saved in instrument state

Initial S/W Revision:	Prior to A.02.00
Modified at S/W Revision:	A.03.00

Max Mixer Level

Controls the limitation on the Ref Level for a given attenuation setting, and therefore also interacts with the Auto rules for selecting the attenuation as a coupling from the reference level.

Key Path:	AMPTD Y Scale, Attenuation
Remote Command:	[:SENSE] :POWER [:RF] :MIXer:RANGe [:UPPer] <real> [:SENSE] :POWER [:RF] :MIXer:RANGe [:UPPer] ?
Example:	POW:MIX:RANG -15 dBm
Preset:	-10 dBm
State Saved:	Saved in instrument state
Min:	-50 dBm
Max:	-10 dBm
Default Unit:	Depends on the current selected Y axis unit, see Swept SA discussion of Y Axis Unit
Initial S/W Revision:	Prior to A.02.00

Range

This key is only available when I/Q is the selected input. It replaces the Attenuation key in that case.

Each input channel (I and Q) has four internal gain ranges. The maximum allowed voltage in each gain range is slightly more than the nominal value, so the break point between ranges is a couple of millivolts higher than the nominal (setting a peak voltage of 0.502 mV will still map to the 0.5 V Peak range).

Gain Setting	Volts RMS	Volts Peak	Volts Peak - Peak	dBm (50W)	Break Point
0 dB	0.7071	1.0	2.0	10	n/a
6 dB	0.3536	0.5	1.0	4	0.502 V Peak
12 dB	0.1768	0.25	0.5	-2	0.252 V Peak
18 dB	0.0884	0.125	0.25	-8	0.127 V Peak

Key Path:	AMPTD Y Scale
Notes:	Visible only when the selected input is I/Q.
State Saved:	No

AMPTD Y Scale

Readback Text:	<p>When Range is Auto, "[Auto]"</p> <p>When Range is Man and I & Q are the same, "<range value>"</p> <p>When Range is Man and I & Q are different:</p> <p>"[I: <I range value> Q: <Q range value>]"</p> <p>See I Range and Q Range for the <range value> enumeration definition.</p>
Initial S/W Revision:	Prior to A.02.00

Range Auto/Man

The Auto setting for Range causes the range to be set based on the Y Scale settings. When Range is "Auto", the I & Q Range are set based on the top of the Y Scale when the Y scale is in dB units (for example, power), or to the max(abs(top), abs(bottom)) when the Y scale reference is not at the top of the screen.

Not all measurements support Range Auto/Man. If Auto is not supported in the current measurement, this key is grayed out and shows "Man" and MAN is returned to a SCPI query, but this does NOT change the Auto/Man setting for Range. When you go to a measurement that supports Auto, it goes back to Auto if it was previously in Auto mode.

Key Path:	AMPTD Y Scale, Range
Scope:	Meas Global
Remote Command:	<pre>[:SENSe] :VOLTage:IQ:RANGe:AUTO OFF ON 0 1</pre> <pre>[:SENSe] :VOLTage:IQ:RANGe:AUTO?</pre>
Example:	<p>Put the I Range and Q Range in manual.</p> <pre>VOLT:IQ:RANG:AUTO OFF</pre>
Dependencies:	If Auto is not supported, sending the SCPI command will generate an error.
Couplings:	<p>When in Auto, both I Range and Q Range are set to the same value, computed as follows:</p> <p>Maximum absolute value is computed for the Y Scale. The top and bottom of the graph are computed based on Ref Value, Scale/Div, and Ref Position. Formula: $Y_{Max} = \max(\text{abs}(\text{top}), \text{abs}(\text{bottom}))$.</p> <p>The I Range and Q Range are then set to YMax.</p>
Preset:	ON
State Saved:	Saved in instrument state
Range:	Auto Man
Initial S/W Revision:	Prior to A.02.00

Remote Command:	[:SENSE] :POWER: IQ:RANGe:AUTO OFF ON 0 1 [:SENSE] :POWER: IQ:RANGe:AUTO?
Example:	Put the I Range and Q Range in manual. POW:IQ:RANG:AUTO OFF
Notes:	The POW:IQ:RANG:AUTO is an alternate form of the VOLT:IQ:RANG:AUTO command. This is to maintain consistency with I Range and Q Range, which support both the POWER and VOLTage forms of the command.
Preset:	ON
Range:	Auto Man
Initial S/W Revision:	Prior to A.02.00

I Range

This is the internal gain range for the I channel when Input Path is I Only or I and I/Q, and it is used for both the I and Q channels when the Input Path is I+jQ. See [“I/Q Gain Ranges” on page 866](#).

Key Path:	AMPTD Y Scale, Range
Remote Command:	[:SENSE] :VOLTage: IQ [: I] :RANGe [:UPPer] <voltage> [:SENSE] :VOLTage: IQ [: I] :RANGe [:UPPer] ?
Example:	Set the I Range to 0.5 V Peak VOLT:IQ:RANG 0.5 V
Notes:	The numeric entries are mapped to the smallest gain range whose break point is greater than or equal to the value, or 1 V Peak if the value is greater than 1 V.
Couplings:	When Q Same as I is On, the I Range value will be copied to the Q Range. Changing the value will also set Range = Man.
Preset:	1 V Peak
State Saved:	Saved in instrument state
Range:	1 V Peak 0.5 V Peak 0.25 V Peak 0.125 V Peak
Initial S/W Revision:	Prior to A.02.00

Remote Command:	[:SENSE] :POWER: IQ [: I] :RANGe [:UPPer] <ampl> [:SENSE] :POWER: IQ [: I] :RANGe [:UPPer] ?
Example:	Set the I Range to 0.5 V Peak when Reference Z is 50Ω, and to 1.0 V Peak when Reference Z is 75Ω POW:IQ:RANG 4 dBm

AMPTD Y Scale

Notes:	<p>The POWER form of the command is provided for convenience. It maps to the same underlying gain range parameter as the VOLTage form of the command.</p> <p>The Reference Z (not the I channel Input Z) is used to convert the power to peak voltage, which is then used to set the I Range as with the VOLTage form of the command. The power values of the 4 range states (1V Peak, 0.5V Peak, 0.25V Peak, and 0.125V Peak) will vary with Reference Z. Here are some examples:</p> <p>50Ω: 10, 4, -2, -8</p> <p>75Ω: 8.2, 2.2, -3.8, -9.8</p> <p>600Ω: -0.8, -6.8, -12.8, -18.9</p>
Preset:	10.0 dBm
Range:	-20 dBm to 10 dBm
Min:	-20 dBm
Max:	10 dBm
Initial S/W Revision:	Prior to A.02.00

Q Range

Accesses the Q Range menu.

Key Path:	AMPTD Y Scale, Range
Readback Text:	<p>Q Same as I 1 V Peak 0.5 V Peak 0.25 V Peak 0.125 V Peak</p> <p>When Q Same as I is On, the readback is "Q Same as I", otherwise it is the Q Range value.</p>
Initial S/W Revision:	Prior to A.02.00

Q Same as I

Many, but not all, usages require the I and Q channels to have an identical setup. To simplify channel setup, the Q Same as I will cause the Q channel range to be mirrored from the I channel. That way you only need to set up one channel (the I channel). The I channel values are copied to the Q channel, so at the time Q Same as I is Off, the I and Q channel setups will be identical.

Key Path:	AMPTD Y Scale, Range, Q Range
Remote Command:	<pre>[:SENSE] :VOLTage POWER: IQ: MIRRored OFF ON 0 1 [:SENSE] :VOLTage POWER: IQ: MIRRored?</pre>
Example:	<p>Turn off the mirroring of I Range to Q Range.</p> <p>VOLT:IQ:MIRR OFF</p> <p>POW:IQ:MIRR OFF</p>
Couplings:	When On, the I Range value is mirrored (copied) to the Q Range.

Preset:	On
State Saved:	Saved in instrument state.
Range:	On Off
Readback Text:	"Q Same as I" when On, otherwise none.
Initial S/W Revision:	Prior to A.02.00

Q Range Value

This is the internal gain range for the Q channel. See [“I/Q Gain Ranges” on page 866](#). The Q Range only applies to Input Path Q Only and Ind I/Q. For input I+jQ the I Range determines both I and Q channel range settings.

Key Path:	AMPTD Y Scale, Range
Remote Command:	[:SENSE] :VOLTage:IQ:Q:RANGE [:UPPer] <voltage> [:SENSE] :VOLTage:IQ:Q:RANGE [:UPPer] ?
Example:	Set the Q Range to 0.5 V Peak VOLT:IQ:Q:RANG 0.5 V
Notes:	The numeric entries are mapped to the smallest gain range whose break point is greater than or equal to the value, or 1 V Peak if the value is greater than 1 V. The Q Range is only used for Input Path Q Only and Ind I/Q. For input I+jQ the I Range determines both I and Q channel range settings.
Couplings:	When Q Same as I is On, the I Range value will be copied to the Q Range and the range value keys are disabled. Changing the value will also set Range = Man.
Preset:	1 V Peak
State Saved:	Saved in instrument state
Range:	1 V Peak 0.5 V Peak 0.25 V Peak 0.125 V Peak
Initial S/W Revision:	Prior to A.02.00

Remote Command:	[:SENSE] :POWER:IQ:Q:RANGE [:UPPer] <ampl> [:SENSE] :POWER:IQ:Q:RANGE [:UPPer] ?
Example:	Will set the Q Range to 0.5 V Peak when Reference Z is 50Ω, and to 1.0 V Peak when Reference Z is 75Ω POW:IQ:Q:RANG 4 dBm

AMPTD Y Scale

Notes:	<p>The POWER form of the command is provided for convenience. It maps to the same underlying gain range parameter as the VOLTage form of the command.</p> <p>The Reference Z (not the Q channel Input Z) is used to convert the power to peak voltage, which is then used to set the Q Range as with the VOLTage form of the command. The power values of the 4 range states (1V Peak, 0.5V Peak, 0.25V Peak, and 0.125V Peak) will vary with Reference Z. Here are some examples:</p> <p>50Ω: 10, 4, -2, -8</p> <p>75Ω: 8.2, 2.2, -3.8, -9.8</p> <p>600Ω: -0.8, -6.8, -12.8, -18.9</p>
Preset:	10.0 dBm
Range:	-20 dBm to 10 dBm
Min:	-20 dBm
Max:	10 dBm
Initial S/W Revision:	Prior to A.02.00

I/Q Gain Ranges

See the following sections:

1 V Peak

[“0.5 V Peak” on page 866](#)

[“0.25 V Peak” on page 867](#)

[“0.125 V Peak” on page 867](#)

1 V Peak

Set the channel gain state to 1 Volt Peak.

Key Path:	AMPTD Y Scale, I Range Q Range
Initial S/W Revision:	Prior to A.02.00

0.5 V Peak

Set the channel gain state to 0.5 Volt Peak.

Key Path:	AMPTD Y Scale, I Range Q Range
Initial S/W Revision:	Prior to A.02.00

0.25 V Peak

Set the channel gain state to 0.25 Volt Peak.

Key Path:	AMPTD Y Scale, I Range Q Range
Initial S/W Revision:	Prior to A.02.00

0.125 V Peak

Set the channel gain state to 0.125 Volt Peak.

Key Path:	AMPTD Y Scale, I Range Q Range
Initial S/W Revision:	Prior to A.02.00

Scale / Div

Sets the units per vertical graticule division on the display. This function is only available when Scale Type (Log) is selected and the vertical scale is power. When Scale Type (Lin) is selected, Scale/Div is grayed out.

Key Path:	AMPTD Y Scale
Remote Command:	:DISPlay:WINDow[1]:TRACe:Y[:SCALe]:PDIVision <rel_ampl> :DISPlay:WINDow[1]:TRACe:Y[:SCALe]:PDIVision?
Example:	DISP:WIND:TRAC:Y:PDIV 5 DB
Dependencies:	Scale/Div is grayed out in linear Y scale. Sending the equivalent SCPI command does change the Scale/Div, though it has no affect while in Lin.
Preset:	10.00 dB / Div
State Saved:	Saved in instrument state
Min:	0.10 dB
Max:	20 dB
Initial S/W Revision:	Prior to A.02.00

Scale Type

Chooses a linear or logarithmic vertical scale for the display and for remote data readout.

When Scale Type (Log) is selected, the vertical graticule divisions are scaled in logarithmic units. The top line of the graticule is the Reference Level and uses the scaling per division Scale/Div to assign values to the other locations on the graticule.

When Scale Type (Lin) is selected, the vertical graticule divisions are linearly scaled with the reference level value at the top of the display and zero volts at the bottom. Each vertical division of the graticule represents one-tenth of the Reference Level.

AMPTD Y Scale

NOTE The Y Axis Unit used for each type of display is set by pressing Y Axis Unit. The analyzer remembers separate Y Axis Unit settings for both Log and Lin.

Key Path:	AMPTD Y Scale
Remote Command:	:DISPlay:WINDow[1]:TRACe:Y[:SCALe]:SPACing LINear LOGarithmic :DISPlay:WINDow[1]:TRACe:Y[:SCALe]:SPACing?
Example:	DISP:WIND:TRAC:Y:SPAC LOG DISP:WIND:TRAC:Y:SPAC?
Dependencies:	If Normalize is on, Scale Type forced to Log and is grayed out.
Couplings:	Changing the Scale Type always sets the Y Axis unit to the last unit specified for the current amplitude scale. In other words, we restore the Y Axis unit setting appropriate per log/lin.
Preset:	LOG
State Saved:	Saved in instrument state
Initial S/W Revision:	Prior to A.02.00

Presel Center

When this key is pressed, the centering of the preselector filter is adjusted to optimize the amplitude accuracy at the frequency of the selected marker. If the selected marker is not on when Presel Center is pressed, the analyzer will turn on the selected marker, perform a peak search, and then perform centering on the marker's center frequency. If the selected marker is already on and between the start and stop frequencies of the analyzer, the analyzer performs the preselector calibration on that marker's frequency. If the selected marker is already on, but outside the frequency range between Start Freq and Stop Freq, the analyzer will first perform a peak search, and then perform centering on the marker's center frequency.

The value displayed on the **Presel Adjust** key will change to reflect the new preselector tuning (see **Presel Adjust**).

A number of considerations should be observed to ensure proper operation. See [“Proper Preselector Operation”](#) on page 869.

Key Path:	AMPTD Y Scale
Remote Command:	[:SENSE]:POWER[:RF]:PCENTER
Example:	POW:PCEN
Notes:	Note that the rules outlined above under the key description apply for the remote command as well as the key. The result of the command is dependent on marker position, and so forth. Any message shown by the key press is also shown in response to the remote command.

Dependencies:	<ul style="list-style-type: none"> • Grayed out if the microwave preselector is off.) • If the selected marker's frequency is below Band 1, advisory message 0.5001 is generated and no action is taken. • Grayed out if entirely in Band 0. • Blank in models that do not include a preselector, such as option 503. If the SCPI is sent in these instruments, it is accepted without error, and the query always returns 0. • Grayed out in the Spectrogram View.
Couplings:	<p>The active marker position determines where the centering will be attempted.</p> <p>If the analyzer is in a measurement such as averaging when centering is initiated, the act of centering the preselector will restart averaging but the first average trace will not be taken until the centering is completed.</p>
Status Bits/OPC dependencies:	<p>When centering the preselector, *OPC will not return true until the process is complete and a subsequent measurement has completed, nor will results be returned to a READ or MEASure command.</p> <p>The Measuring bit should remain set while this command is operating and should not go false until the subsequent sweep/measurement has completed.</p>
Initial S/W Revision:	Prior to A.02.00
Modified at S/W Revision:	A.03.00

Proper Preselector Operation

A number of considerations should be observed to ensure proper operation:

1. If the selected marker is off, the analyzer will turn on a marker, perform a peak search, and adjust the preselector using the selected marker's frequency. It uses the "highest peak" peak search method unqualified by threshold or excursion, so that there is no chance of a 'no peak found' error. It continues with that peak, even if it is the peak of just noise. Therefore, for this operation to work properly, there should be a signal on screen in a preselected range for the peak search to find.
2. If the selected marker is already on, the analyzer will attempt the centering at that marker's frequency. There is no preselector for signals below about 3.6 GHz, therefore if the marker is on a signal below 3.6 GHz, no centering will be attempted and an advisory message generated
3. In some models, the preselector can be bypassed. If it is bypassed, no centering will be attempted in that range and a message will be generated.

Preselector Adjust

Allows you to manually adjust the preselector filter frequency to optimize its response to the signal of

AMPTD Y Scale

interest. This function is only available when “Presel Center” on page 868 is available.

For general purpose signal analysis, using Presel Center is recommended. Centering the filter minimizes the impact of long-term preselector drift. Presel Adjust can be used instead to manually optimize the preselector. One application of manual optimization would be to peak the preselector response, which both optimizes the signal-to-noise ratio and minimizes amplitude variations due to small (short-term) preselector drifting.

Key Path:	AMPTD Y Scale
Scope:	Meas Global
Remote Command:	[:SENSE] :POWER [:RF] :PADJust <freq> [:SENSE] :POWER [:RF] :PADJust?
Example:	POW:PADJ 100KHz POW:PADJ?
Notes:	The value on the key reads out to 0.1 MHz resolution.
Dependencies:	<ul style="list-style-type: none"> • Grayed out if microwave preselector is off.) • Grayed out if entirely in Band 0. • Blank in models that do not include a preselector, such as option 503. If the SCPI is sent in these instruments, it is accepted without error, and the query always returns 0. • Grayed out in the Spectrogram View.
Preset:	0 MHz
State Saved:	The Presel Adjust value set by Presel Center , or by manually adjusting Presel Adjust , is not saved in instrument state, and does not survive a Preset or power cycle.
Min:	-500 MHz
Max:	500 MHz
Default Unit:	Hz
Backwards Compatibility SCPI:	[:SENSE] :POWER [:RF] :MW :PADJust [:SENSE] :POWER [:RF] :MMW :PADJust PSA had multiple preselectors, but the X-Series has only one. These commands simply alias to [:SENSE] :POWER [:RF] :PADJust
Initial S/W Revision:	Prior to A.02.00
Modified at S/W Revision:	A.03.00

Remote Command:	[:SENSE] :POWER [:RF] :PADJust :PRESelector MWAVE MMWave EXTERNAL [:SENSE] :POWER [:RF] :PADJust :PRESelector?
Notes:	PSA had multiple preselectors, and you could select which preselector to adjust. Since the X-Series has only one mm/uW preselector, the preselector selection softkey is no longer available. However, to provide backward compatibility, we accept the legacy remote commands. The command form has no effect, the query always returns MWAVE
Initial S/W Revision:	Prior to A.02.00

Y Axis Unit

Displays the menu keys that enable you to change the vertical (Y) axis amplitude unit. The analyzer retains the entered Y Axis Unit separately for both Log and Lin amplitude scale types. For example, if Scale Type has been set to Log, and you set Y Axis Unit to dBm, pressing Scale Type (Log) sets the Y Axis Unit to dBm. If Scale Type has been set to Lin and you set Y Axis Unit to V, pressing Scale Type (Lin) sets the Y Axis Unit to V. Pressing Scale Type (Log) again sets the Y axis unit back to dBm.

NOTE The units of current (A, dBmA, dBuA) are calculated based on 50 ohms input impedance.

All four of the EMI units (dBμA/m, dBμV/m, dBG, dBpT) are treated by the instrument exactly as though they were dBuV. The user must load an appropriate correction factor using Amplitude Corrections for accurate and meaningful results.

If a SCPI command is sent to the analyzer that uses one of the EMI units as a terminator, the analyzer treats it as though DBUV had been sent as the terminator.

Key Path:	AMPTD Y Scale
Mode:	SA
Scope:	Meas Global
Remote Command:	:UNIT:POWER DBM DBMV DBMA V W A DBUV DBUA DBPW DBUVM DBUAM DBPT DBG :UNIT:POWER?
Example:	UNIT:POW dBmV UNIT:POW?

AMPTD Y Scale

Notes:	The Y axis unit has either logarithmic or linear characteristics. The set of units that is logarithmic consists of dBm, dBmV, dBmA, dB μ V, dB μ A, dB μ V/m, dB μ A/m, dBpT, and dBG. The set of units that are linear consists of V, W, and A. The chosen unit will determine how the reference level and all the amplitude-related outputs like trace data, marker data, etc. read out.
Notes:	<p>The settings of Y Axis Unit and Scale Type, affect how the data is read over the remote interface. When using the remote interface no unit is returned, so you must know what the Y axis unit is to interpret the results:</p> <p>Example 1, set the following:</p> <p>Scale Type (Log)</p> <p>Y Axis Unit, dBm</p> <p>Scale/Div, 1 dB</p> <p>Ref Level, 10 dBm</p> <p>This sets the top line to 10 dBm with each vertical division representing 1 dB. Thus, if a point on trace 1 is on the fifth graticule line from the top, it represents 5 dBm and will read out remotely as 5.</p> <p>Example 2, set the following:</p> <p>Scale Type (Lin)</p> <p>Y Axis Unit, Volts</p> <p>Ref Level, 100 mV (10 mV/div)</p> <p>This sets the top line to 100 mV and the bottom line to 0 V, so each vertical division represents 10 mV. Thus, if a point on trace 1 is on the fifth graticule line from the top, it represents 50 mV and will read out remotely as 50.</p>
Dependencies:	<p>If an amplitude correction with an Antenna Unit other than None is applied and enabled, then that antenna unit is forced and the key with that unit is the only Y Axis Unit available. All other Y Axis Unit keys are grayed out.</p> <p>If an amplitude correction with an Antenna Unit other than None is applied and enabled, and you then turn off that correction or set Apply Corrections to No, the Y Axis Unit that existed before the Antenna Unit was applied is restored.</p>
Couplings:	The analyzer retains the entered Y Axis Unit separately for both Log and Lin amplitude scale types
Preset:	dBm for log scale, V for linear. The true 'preset' value is dBm, since at preset the Y Scale type is set to logarithmic.
State Saved:	Saved in instrument state
Readback line:	1-of-N selection
Initial S/W Revision:	Prior to A.02.00
Modified at S/W Revision:	A.02.00, A.04.00, A.11.00

dBm

Sets the amplitude unit for the selected amplitude scale (log/lin) to dBm.

Key Path:	AMPTD Y Scale, Y Axis Unit
Example:	UNIT:POW DBM
Dependencies:	Grayed out if an Amplitude Correction with an Antenna Unit is ON.
Readback:	dBm
Initial S/W Revision:	Prior to A.02.00
Modified at S/W Revision:	A.02.00

dBmV

Sets the amplitude unit for the selected amplitude scale (log/lin) to dBmV.

Key Path:	AMPTD Y Scale, Y Axis Unit
Example:	UNIT:POW DBMV
Dependencies:	Grayed out if an Amplitude Correction with an Antenna Unit is ON.
Readback:	dBmV
Initial S/W Revision:	Prior to A.02.00
Modified at S/W Revision:	A.02.00

dBmA

Sets the amplitude unit for the selected amplitude scale (log/lin) to dBmA.

Key Path:	AMPTD Y Scale, Y Axis Unit
Example:	UNIT:POW DBMA
Dependencies:	Grayed out if an Amplitude Correction with an Antenna Unit is ON.
Readback:	dBmA
Initial S/W Revision:	Prior to A.02.00
Modified at S/W Revision:	A.02.00

W

Sets the amplitude unit for the selected amplitude scale (log/lin) to watt.

Key Path:	AMPTD Y Scale, Y Axis Unit
Example:	UNIT:POW W
Dependencies:	Grayed out if an Amplitude Correction with an Antenna Unit is ON.

AMPTD Y Scale

Readback:	W
Initial S/W Revision:	Prior to A.02.00
Modified at S/W Revision:	A.02.00

V

Sets the amplitude unit for the selected amplitude scale (log/lin) to volt.

Key Path:	AMPTD Y Scale, Y Axis Unit
Example:	UNIT:POW V
Dependencies:	Grayed out if an Amplitude Correction with an Antenna Unit is ON.
Readback:	V
Initial S/W Revision:	Prior to A.02.00
Modified at S/W Revision:	A.02.00

A

Sets the amplitude unit for the selected amplitude scale (log/lin) to Ampere.

Key Path:	AMPTD Y Scale, Y Axis Unit
Example:	UNIT:POW A
Dependencies:	Grayed out if an Amplitude Correction with an Antenna Unit is ON.
Readback:	A
Initial S/W Revision:	Prior to A.02.00
Modified at S/W Revision:	A.02.00

dBmV

Sets the amplitude unit for the selected amplitude scale (log/lin) to dB μ V.

Key Path:	AMPTD Y Scale, Y Axis Unit
Example:	UNIT:POW DBUV
Dependencies:	Grayed out if an Amplitude Correction with an Antenna Unit is ON.
Readback:	dB μ V
Initial S/W Revision:	Prior to A.02.00
Modified at S/W Revision:	A.02.00

dBmA

Sets the amplitude unit for the selected amplitude scale (log/lin) to dB μ A.

NOTE

The unit dBuA can also appear as an Antenna Unit. This will be used by customers using current probes, because current probes are often supplied with conversion tables that provide the transducer factors. When dBuA is used as an Antenna Unit the normal conversion from power to amps for dBuA (based on the analyzer input impedance) is not done, but instead the conversion is based solely on the Correction that contains the transducer factors. This is what distinguishes dBuA as a normal unit from dBuA as an antenna unit. When querying the Y-Axis unit, you can query the Antenna Unit to distinguish between regular dBuA and the dBuA antenna unit. If :CORR:CSET:ANT? returns NOC (for No Conversion), you are using a normal Y Axis dBuA. If it returns UA you are using an Antenna Unit dBuA.

Key Path:	AMPTD Y Scale, Y Axis Unit
Example:	UNIT:POW DBUA
Dependencies:	Grayed out if an Amplitude Correction with an Antenna Unit is ON.
Readback:	dB μ A
Initial S/W Revision:	Prior to A.02.00
Modified at S/W Revision:	A.02.00

dBpW

Sets the amplitude unit for the selected amplitude scale (log/lin) to dBpW.

Key Path:	AMPTD Y Scale, Y Axis Unit
Example:	UNIT:POW DBPW
Dependencies:	Grayed out if an Amplitude Correction with an Antenna Unit is ON.
Readback:	dB μ A
Initial S/W Revision:	A.11.00

Antenna Unit

When a Correction is turned on that uses an Antenna Unit, the Y Axis Unit changes to that Antenna Unit. All of the keys in the Y-Axis Unit menu are then greyed out, except the Antenna Unit key. The unit being used is shown on this key and is shown as selected in the submenu.

Key Path:	AMPTD Y Scale, Y Axis Unit
Dependencies:	Grayed out if no Amplitude Correction with an Antenna Unit is on.
Readback line:	Currently selected unit
Initial S/W Revision:	A.11.00

AMPTD Y Scale

dBmV/m

Sets the amplitude unit for the selected amplitude scale (log/lin) to dB μ V/m. This is an antenna unit, and this key is grayed out unless a Correction with this Antenna Unit selected is ON. If this is the case, all of the other Antenna Units are grayed out.

Key Path:	AMPTD Y Scale, Y Axis Unit, Antenna Unit
Example:	UNIT:POW DBUVM
Dependencies:	Grayed out if no Amplitude Correction with an Antenna Unit is on.
Readback:	dB μ V/m
Initial S/W Revision:	A.02.00

dBmA/m

Sets the amplitude unit for the selected amplitude scale (log/lin) to dB μ A/m. This is an antenna unit, and this key is grayed out unless a Correction with this Antenna Unit selected is ON. If this is the case, all of the other Antenna Units are grayed out.

Key Path:	AMPTD Y Scale, Y Axis Unit, Antenna Unit
Example:	UNIT:POW DBUAM
Dependencies:	Grayed out if no Amplitude Correction with an Antenna Unit is on.
Readback:	dB μ A/m
Initial S/W Revision:	A.02.00

dBmA

Sets the amplitude unit for the selected amplitude scale (log/lin) to dB μ A. This is an antenna unit, and this key is grayed out unless a Correction with this Antenna Unit selected is ON. If this is the case, all of the other Antenna Units are grayed out.

Key Path:	AMPTD Y Scale, Y Axis Unit, Antenna Unit
Example:	UNIT:POW DBUAM
Dependencies:	Grayed out if no Amplitude Correction with an Antenna Unit is on.
Readback:	dB μ A
Initial S/W Revision:	A.11.00

dBpT

Sets the amplitude unit for the selected amplitude scale (log/lin) to dBpT. This is an antenna unit, and this key is grayed out unless a Correction with this Antenna Unit selected is ON. If this is the case, all of the other Antenna Units are grayed out.

Key Path:	AMPTD Y Scale, Y Axis Unit, Antenna Unit
-----------	---

Example:	UNIT:POW DBPT
Dependencies:	Grayed out if no Amplitude Correction with an Antenna Unit is on.
Readback:	dBpT
Initial S/W Revision:	A.02.00

dBG

Sets the amplitude unit for the selected amplitude scale (log/lin) to dBG. This is an antenna unit, and this key is grayed out unless a Correction with this Antenna Unit selected is ON. If this is the case, all of the other Antenna Units are grayed out.

Key Path:	AMPTD Y Scale, Y Axis Unit, Antenna Unit
Example:	UNIT:POW DBG
Dependencies:	Grayed out if no Amplitude Correction with an Antenna Unit is on.
Readback:	dBG
Initial S/W Revision:	A.02.00

None

This is selected if no Antenna Unit is currently on, however you cannot actually set this value, since it is always grayed out. The key is included simply to provide an indication on the Readback line of the Antenna Unit key when there is no Antenna Unit selected.

Key Path:	AMPTD Y Scale, Y Axis Unit, Antenna Unit
Readback:	“None”
Initial S/W Revision:	A.11.00

Reference Level Offset

Adds an offset value to the displayed reference level. The reference level is the absolute amplitude represented by the top graticule line on the display.

See [“More Information” on page 878](#)

Key Path:	AMPTD Y Scale
Mode:	SA
Scope:	Meas Global
Remote Command:	:DISPlay:WINDow [1] :TRACe:Y[:SCALe] :RLEVel:OFFSet <rel_ampl> :DISPlay:WINDow [1] :TRACe:Y[:SCALe] :RLEVel:OFFSet?

AMPTD Y Scale

Example:	DISP:WIND:TRAC:Y:RLEV:OFFS 12.7 Sets the Ref Level Offset to 12.7 dB. The only valid suffix is dB. If no suffix is sent, dB will be assumed.
Preset:	0 dBm
State Saved:	Saved in instrument state
Min:	The range for Ref Lvl Offset is variable. It is limited to values that keep the reference level within the range of -327.6 dB to 327.6 dB.
Max:	327.6 dB
Backwards Compatibility Notes:	<ol style="list-style-type: none">1. In pre-X-Series instruments, Ref Level Offset could not be adjusted by the knob or step keys. That is no longer the case.2. In ESA and PSA, Ref Level Offset was applied to the data as it was acquired; thus if the Offset changed the new offset was not applied until new trace data was taken. In X-Series, the offset is applied as the data is displayed/queried, so if you change the offset, it will change the data immediately.
Initial S/W Revision:	Prior to A.02.00
Modified at S/W Revision:	A.04.00

More Information

Offsets are used when gain or loss occurs between a device under test and the analyzer input. Thus, the signal level measured by the analyzer may be thought of as the level at the input of an external amplitude conversion device. Entering an offset does not affect the trace position or attenuation value, just the value of the top line of the display and the values represented by the trace data. Thus, the values of exported trace data, queried trace data, marker amplitudes, trace data used in calculations such as N dB points, trace math, peak threshold, and so forth, are all affected by Ref Level Offset.

NOTE Changing the offset causes the analyzer to immediately stop the current sweep and prepare to begin a new sweep, but the data will not change until the trace data updates, because the offset is applied to the data as it is taken. If a trace is exported with a nonzero Ref Level Offset, the exported data will contain the trace data with the offset applied.

The maximum reference level available is dependent on the reference level offset. That is, Ref Level - Ref Level Offset must be in the range -170 to +30 dBm. For example, the reference level value range can be initially set to values from -170 dBm to 30 dBm with no reference level offset. If the reference level is first set to -20 dBm, then the reference level offset can be set to values of -150 to +50 dB.

If the reference level offset is first set to -30 dB, then the reference level can be set to values of -200 dBm to 0 dBm. In this case, the reference level is “clamped” at 0 dBm because the maximum limit of +30 dBm is reached with a reference level setting of 0 dBm with an offset of -30 dB. If instead, the reference level offset is first set to 30 dB, then the reference level can be set to values of -140 to +60 dBm.

μW Path Control

The **μW Path Control** functions include the **μW Preselector Bypass** (Option MPB) and **Low Noise Path** (Option LNP) controls in the High Band path circuits.

When the μW Preselector is bypassed, the user has better flatness, but will be subject to spurs from out of band interfering signals. When the Low Noise Path is enabled, the analyzer automatically switches around certain circuitry in the high frequency bands which can contribute to noise, when it is appropriate based on other analyzer settings.

For most applications, the preset state is Standard Path, which gives the best remote-control throughput, minimizes acoustic noise from switching and minimizes the risk of wear out in the hardware switches. For applications that utilize the wideband IF paths, the preset state is the μW Preselector Bypass path, if option MPB is present. This is because, when using a wideband IF such as the 140 MHz IF, the μW Preselector's bandwidth can be narrower than the available IF bandwidth, causing degraded amplitude flatness and phase linearity, so it is desirable to bypass the preselector in the default case.

Users may choose Low Noise Path Enable. It gives a lower noise floor, especially in the 21–26.5 GHz region, though without improving many measures of dynamic range, and without giving the best possible noise floor. The preamp, if purchased and used, gives better noise floor than does the Low Noise Path, however its compression threshold and third-order intercept are much poorer than that of the non-preamp Low Noise Path. There are some applications, typically for signals around 30 dBm, for which the third-order dynamic range of the standard path is good enough, but the noise floor is not low enough even with 0 dB input attenuation. When the third-order dynamic range of the preamp path is too little and the noise floor of the standard path is too high, the Low Noise Path can provide the best dynamic range.

Key Path:	AMPTD Y Scale
Mode:	SA, BASIC, PNOISE, VSA , LTE, LTETDD
Scope:	Meas Global
Remote Command:	[:SENSe] :POWer [:RF] :MW:PATH STD LNPath MPBypass FULL [:SENSe] :POWer [:RF] :MW:PATH?
Example:	:POW:MW:PATH LNP Enables the Low Noise path
Notes:	<p>If a Presel Center is performed, the analyzer will momentarily switch to the Standard Path, regardless of the setting of μW Path Control</p> <p>The DC Block will always be switched in when the low noise path is switched in, to protect succeeding circuitry from DC. Note that this does not mean “when the low noise path is enabled” but when, based on the Low Noise Path rules, the path is actually switched in. This can happen when the selection is Low Noise Path Enable . In the case where the DC Block is switched in the analyzer is now AC coupled. However, if the user has selected DC coupling, the UI will still behave as though it were DC coupled, including all annunciation, warnings, status bits, and responses to SCPI queries. This is because, based on other settings, the analyzer could switch out the low noise path at any time and hence go back to being DC coupled.</p> <p>Alignment switching ignores the settings in this menu, and restores them when finished.</p>

AMPTD Y Scale

Dependencies:	Unavailable in BBIQ and External Mixing
Preset:	All modes other than IQ Analyzer mode and VXA: STD IQ Analyzer, VXA and WLAN mode: MPB option present and licensed: MPB MPB option not present and licensed: STD
State Saved:	Save in instrument state
Readback:	Value selected in the submenu
Initial S/W Revision:	A.04.00
Modified at S/W Revision:	A.10.00

Standard Path

This path gives the best remote-control throughput, minimizes acoustic noise from switching and minimizes the risk of wear in the hardware switches, particularly in remote test scenarios where both low band and high band setups will follow in rapid succession.

In this path, the bypass of the low band/high band switch and microwave preamp is never activated, which can cause some noise degradation but preserves the life of the bypass switch.

Key Path:	AMPTD Y Scale, μW Path Control
Example:	:POW:MW:PATH STD
Readback Text:	Standard Path
Initial S/W Revision:	A.04.00

Low Noise Path Enable

You may choose Low Noise Path Enable, which gives a lower noise floor under some circumstances, particularly when operating in the 21–26.5 GHz region. With the Low Noise Path enabled, the low band/high band switch and microwave preamp are bypassed whenever all of the following are true:

- The analyzer is not in the Low Band, meaning:
 - the start frequency is above 3.5 GHz and
 - the stop frequency is above 3.6 GHz.
- the internal preamp is not installed or (if installed) is set to **Off** or **Low Band**

Note that this means that, when any part of a sweep is done in Low Band, the Low Noise Path is not used, whether or not the **Low Noise Path Enable** is selected in the user interface. Also, if the preamp is turned on, the Low Noise Path is not used, whether or not the **Low Noise Path Enable** is selected in the user interface. The only time the Low Noise Path is used is when **Low Noise Path Enable** is selected, the sweep is completely in High Band (> 3.6 GHz) and no preamp is in use.

See “More Information” on page 881

Key Path:	AMPTD Y Scale, μW Path Control
Measurement:	Swept SA
Example:	:POW:MW:PATH LNP
Notes:	<p>For measurements that use IQ acquisition, the low noise path is used when the Center Frequency is in High Band (> 3.6 GHz) and no preamp is in use.</p> <p>In other words, the rules above are modified to use only the center frequency to qualify which path to switch in.</p> <p>This is not the case for FFT's in the Swept SA measurement; they use the same rules as swept measurements.</p>
Dependencies:	<p>Key is blanked if current mode does not support it.</p> <p>Key is grayed out if mode supports it but current measurement does not support it.</p> <p>Unless Option LNP is present and licensed, key is blank and if SCPI command sent, error -241, "Hardware missing; Option not installed" is generated.</p>
Readback Text:	Low Noise Path Enable
Initial S/W Revision:	A.04.00

More Information

The user should understand that the Low Noise Path, while giving improved DANL, has the disadvantage of decreased TOI performance and decreased gain compression performance relative to the standard path.

The user should also understand that the bypass switch is a mechanical switch and has finite life, so if the **Low Noise Path** is enabled, it is possible to cause frequent cycling of this switch by frequently changing analyzer settings such that the above conditions hold true only some of the time. A user making tests of this nature should consider opting for the **Standard Path**, which will never throw the bypass switch, at the expense of some degraded noise performance.

The low noise path is useful for situations where the signal level is so low that the analyzer performance is dominated by noise even with 0 dB attenuation, but still high enough that the preamp option would have excessive third-order intermodulation or compression. The preamp, if purchased and used, gives better noise floor than does the “Low Noise Path.” However, its compression threshold and third-order intercept are much poorer than that of the non-preamp path. There are some applications, typically for signals around 30 dBm, for which the third-order dynamic range of the standard path is good enough, but the noise floor is not low enough even with 0 dB input attenuation. When the third-order dynamic range of the preamp path is too little and the noise floor of the standard path is too high, the Low Noise Path can provide the best dynamic range

The graph below illustrates the concept. It shows, in red, the performance of an analyzer at different attenuation settings, both with the preamp on and off, in a measurement that is affected by both analyzer noise and analyzer TOI. The green shows the best available dynamic range, offset by 0.5 dB for clarity. The blue shows how the best available dynamic range improves for moderate signal levels with the low

AMPTD Y Scale

noise path switched in. In this illustration, the preamp improves the noise floor by 15 dB while degrading the third-order intercept by 30 dB, and the low noise path reduces loss by 8 dB. The attenuator step size is 2 dB.

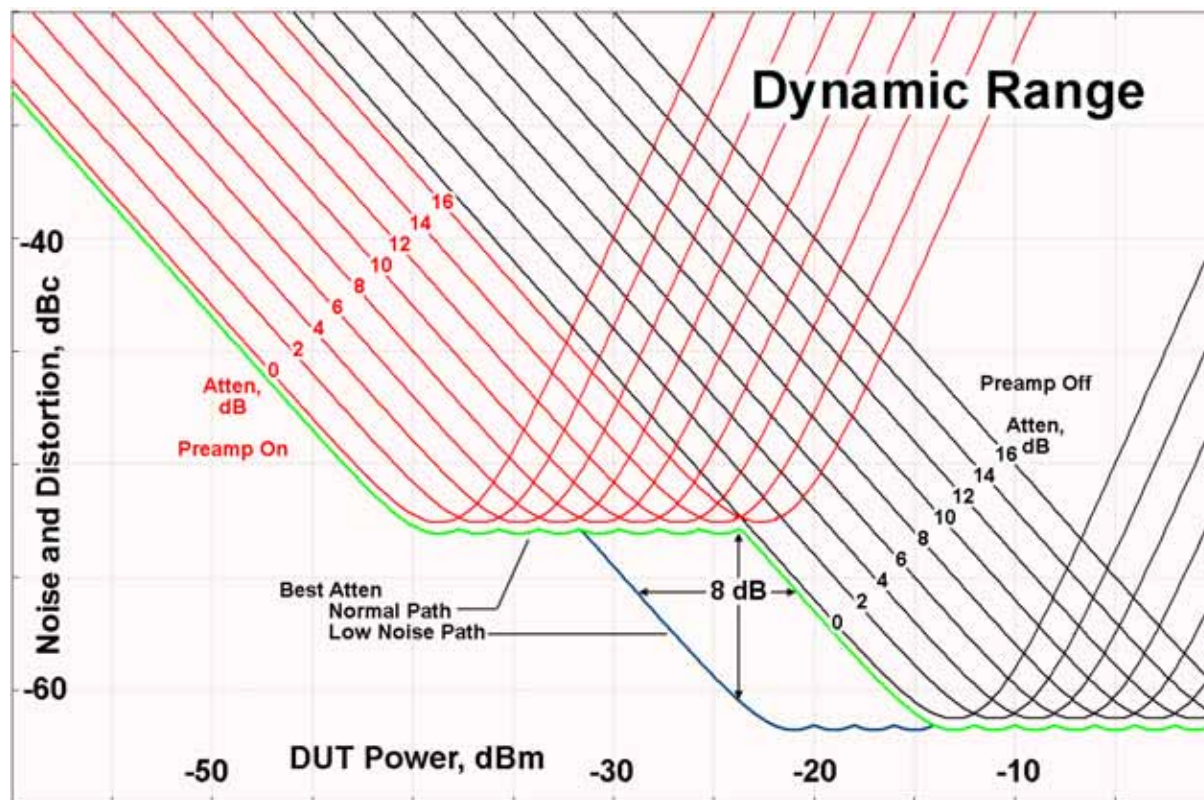

There are other times where selecting the low noise path improves performance, too.

Compression-limited measurements such as finding the nulls in a pulsed-RF spectrum can profit from the low noise path in a way similar to the TOI-limited measurement illustrated. Accuracy can be improved when the low noise path allows the optimum attenuation to increase from a small amount like 0, 2 or 4 dB to a larger amount, giving better return loss at the analyzer input. Harmonic measurements, such as second and third harmonic levels, are much improved using the low noise path because of the superiority of that path for harmonic (though not intermodulation) distortion performance.

μ W Preselector Bypass

This key toggles the preselector bypass switch for band 1 and higher. When the microwave preselector is on, the signal path is preselected. When the microwave preselector is off, the signal path is not preselected. The preselected path is the normal path for the analyzer.

The preselector is a tunable bandpass filter which prevents signals away from the frequency of interest from combining in the mixer to generate in-band spurious signals (images). The consequences of using a preselector filter are its limited bandwidth, the amplitude and phase ripple in its passband, and any amplitude and phase instability due to center frequency drift.

Option MPB or pre-selector bypass provides an unpreselected input mixer path for certain X-Series signal analyzers with frequency ranges above 3.6 GHz. This signal path allows a wider bandwidth and less amplitude variability, which is an advantage when doing modulation analysis and broadband signal analysis. The disadvantage is that, without the preselector, image signals will be displayed. Another

disadvantage of bypassing the preselector is increased LO emission levels at the front panel input port.

Key Path:	AMPTD Y Scale, μW Path Control
Example:	:POW:MW:PATH MPB
Dependencies:	Key is blanked if current mode does not support it. Key is grayed out if mode supports it but current measurement does not support it. Key is blank unless Option MPB is present and licensed. If SCPI command sent when MPB not present, error -241, "Hardware missing; Option not installed" is generated.
Readback Text:	μ W Preselector Bypass
Initial S/W Revision:	A.04.00

Remote Command:	[:SENSe] :POWer [:RF] :MW:PRESelector [:STATe] ON OFF 0 1 [:SENSe] :POWer [:RF] :MW:PRESelector [:STATe] ?
Example:	:POW:MW:PRES OFF Bypasses the microwave preselector
Notes:	The ON parameter sets the STD path (:POW:MW:PATH STD) The OFF parameter sets path MPB (:POW:MW:PATH MPB)
Preset:	ON

Internal Preamp

Accesses a menu of keys that control the internal preamps. Turning on the preamp gives a better noise figure, but a poorer TOI to noise floor dynamic range. You can optimize this setting for your particular measurement.

The instrument takes the preamp gain into account as it sweeps. If you sweep outside of the range of the preamp the instrument will also account for that. The displayed result will always reflect the correct gain.

Key Path:	AMPTD Y Scale
Scope:	Meas Global
Remote Command:	[:SENSe] :POWer [:RF] :GAIN [:STATe] OFF ON 0 1 [:SENSe] :POWer [:RF] :GAIN [:STATe] ?
Dependencies:	Preamp is not available on all hardware platforms. If the preamp is not present or is unlicensed, the key is not shown. The preamp is not available when the electronic/soft attenuator is enabled. Preamp controls and settings are not available on the E6607C. If any preamp commands are sent to the E6607C the following error will be generated: -241;Hardware missing; not available for this model number

AMPTD Y Scale

Preset:	OFF
State Saved:	Saved in instrument state
Initial S/W Revision:	Prior to A.02.00

Key Path:	AMPTD Y Scale, Internal Preamp
Scope:	Meas Global
Remote Command:	[:SENSE] :POWER [:RF] :GAIN:BAND LOW FULL [:SENSE] :POWER [:RF] :GAIN:BAND?
Dependencies:	Preamp is not available on all hardware platforms. If the preamp is not present or is unlicensed, the key is not shown. If a POW:GAIN:BAND FULL command is sent when a low band preamp is available, the preamp band parameter is to LOW instead of FULL, and an "Option not installed" message is generated.
Preset:	LOW
State Saved:	Saved in instrument state
Initial S/W Revision:	Prior to A.02.00

Off

Turns the internal preamp off

Key Path:	AMPTD Y Scale, Internal Preamp
Example:	:POW:GAIN OFF
Readback:	Off
Initial S/W Revision:	Prior to A.02.00

Low Band

Sets the internal preamp to use only the low band.

The frequency range of the installed (optional) low-band preamp is displayed in square brackets on the **Low Band** key label.

Key Path:	AMPTD Y Scale, Internal Preamp
Example:	:POW:GAIN ON :POW:GAIN:BAND LOW
Readback:	Low Band
Initial S/W Revision:	Prior to A.02.00

Full Range

Sets the internal preamp to use its full range. The low band (0–3.6 GHz or 0–3GHz, depending on the model) is supplied by the low band preamp and the frequencies above low band are supplied by the high band preamp.

The frequency range of the installed (optional) preamp is displayed in square brackets on the **Full Range** key label. If the high band option is not installed the Full Range key does not appear.

Key Path:	AMPTD Y Scale, Internal Preamp
Example:	:POW:GAIN ON :POW:GAIN:BAND FULL
Readback:	Full Range
Initial S/W Revision:	Prior to A.02.00

AMPTD Y Scale

Auto Couple

The Auto Couple feature provides a quick and convenient way to automatically couple multiple instrument settings. This helps ensure accurate measurements and optimum dynamic range. When the Auto Couple feature is activated, either from the front panel or remotely, all parameters of the current measurement that have an Auto/Manual mode are set to Auto mode and all measurement settings dependent on (or coupled to) the Auto/Man parameters are automatically adjusted for optimal performance.

However, the Auto Couple key actions are confined to the current measurement only. It does not affect other measurements in the mode, and it does not affect markers, marker functions, or trace or display attributes.

See [“More Information” on page 887](#)

Key Path:	Front-panel key
Remote Command:	:COUPle ALL NONE
Example:	:COUP ALL
Notes:	:COUPle ALL puts all Auto/Man parameters in Auto mode (equivalent to pressing the Auto Couple key). :COUPLE NONE puts all Auto/Man parameters in manual mode. It decouples all the coupled instrument parameters and is not recommended for making measurements.
Initial S/W Revision:	Prior to A.02.00

More Information

There are two types of functions that have Auto/Manual modes.

Auto/Man Active Function keys

An Auto/Man toggle key controls the binary state associated with an instrument parameter by toggling between **Auto** (where the parameter is automatically coupled to the other parameters it is dependent upon) and **Man** (where the parameter is controlled independent of the other parameters), as well as making the parameter the active function. The current mode is indicated on the softkey with either **Auto** or **Man** underlined as illustrated below.

Sweep Time	
66.24 ms	
<u>Auto</u>	Man

vsd07

Auto/Man 1-of-N keys

An Auto/Man 1-of-N key allows you to manually pick from a list of parameter values, or place the function in Auto, in which case the value is automatically selected (and indicated) as shown below. If in Auto, Auto is underlined on the calling key. If in manual operation, manual is indicated on the calling key. But the calling key does not actually toggle the function, it simply opens the menu.

Auto Couple

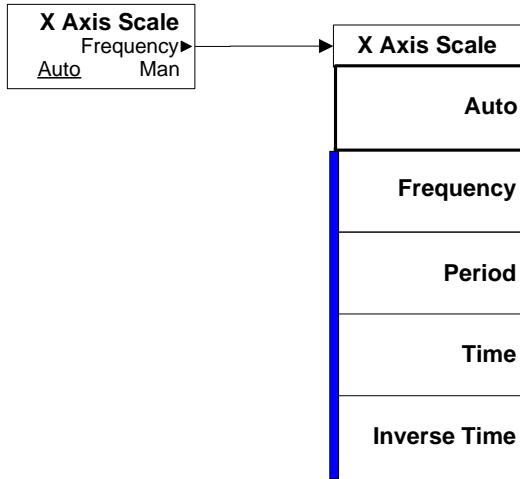

vsd08

BW

The BW key opens the bandwidth menu, which contains keys to control the Resolution Bandwidth and Video Bandwidth functions of the test set.

The Res BW functions control filter bandwidth and filter type. There are two filter types, Gaussian and Flattop. The Gaussian filters have a response curve that is parabolic on a log scale. The Flattop filter shape is a close approximation of a rectangular filter.

NOTE The AVERAGE functions are found in the Trace menu and the Meas Setup menu. In the Trace menu, you may turn Trace Averaging on or off for the desired traces (rather than globally as in the past); and in the Meas Setup menu you may configure Averaging, by setting the Average Number and the Average Type.

Key Path	Front-panel key
Initial S/W Revision	Prior to A.02.00

Res BW

Activates the resolution bandwidth active function, which allows you to manually set the resolution bandwidth (RBW) of the test set. Normally, **Res BW** (Auto) selects automatic coupling of the Res BW to **Span** using the ratio set by the Span:3dB RBW key. To decouple the resolution bandwidth, press Res BW until Man is underlined, or simply enter a different value for **Res BW**.

See [“More Information” on page 890](#)

Key Path	BW
Remote Command	[:SENSe]:BANDwidth BWIDth[:RESolution] <freq> [:SENSe]:BANDwidth BWIDth[:RESolution]? [:SENSe]:BANDwidth BWIDth[:RESolution]:AUTO OFF ON 0 1 [:SENSe]:BANDwidth BWIDth[:RESolution]:AUTO?
Example	BAND 1 KHZ BAND? BWID:AUTO ON BWID:AUTO?
Notes	For numeric entries, all RBW Types choose the nearest (arithmetically, on a linear scale, rounding up) available RBW to the value entered.
Notes	The setting and querying of values depends on the current bandwidth type.

Dependencies	When in Zero Span with no EMI Standard selected, there is no Auto setting for Res BW. The Auto/Man line on the Res BW key disappears in this case, and if the SCPI command [:SENSe]:BWID[:RESolution]:AUTO ON is sent, it generates an error.
Couplings	Res BW is normally coupled to Span; if Res BW is set to Auto, as the Span decreases, so will the Res BW. Normally, in Zero Span, this coupling is turned off and Res BW has no Auto setting. When a CISPR or MIL EMI Standard is in use, the Res BW is coupled to Center Frequency and not to Span, and this is true even in Zero Span. Sweep time is coupled to RBW when in a non-zero span. If Sweep Time is set to Auto, then the sweep time is changed as the RBW changes, to maintain amplitude calibration. Video bandwidth (VBW) is normally coupled to RBW. If VBW is set to Auto, then the VBW is changed as the RBW changes, to maintain the ratio set by VBW:3dB RBW. See the ““ VBW:3dB RBW ” on page 892” key description.
Preset	3 MHz ON
State Saved	Saved in Instrument State
Min	1 Hz
Max	8 MHz is the max equivalent –3 dB RBW, which means that the named RBW (the one shown on the key) can actually exceed 8 MHz if using a filter other than –3 dB Gaussian
Default Unit	Hz
Initial S/W Revision	Prior to A.02.00

More Information

When the **Res BW** is manually selected, it may be returned to the coupled state by pressing the **Res BW** key until **Auto** is underlined. This may also be done by pressing Auto Couple or by performing a **Preset**.

When **Res BW** is set to **Auto**, the bandwidth selected depends on the Filter Type (see “Filter Type” below).

Only certain discrete resolution bandwidths are available. The available bandwidths are dependent on the **Filter Type** or the **EMC Standard**. If an unavailable bandwidth is entered with the numeric keypad, the closest available bandwidth is selected.

The zero-span case deserves some mention, because RBW is coupled to Span when in a swept (non-zero) span and in zero span there is normally no meaningful RBW coupling in Zero Span. However, when a MIL or CISPR EMC Standard is selected, there IS a meaningful coupling for RBW in Zero Span – in fact, it is coupled to Center Frequency, in order to make measurements according to the EMI specifications.

The annotation under RBW in the bottom left of the screen shows the type of filter or bandwidth that is being used. The following examples illustrate this:

–3 dB (Normal) filter BW:Res BW 300 Hz

-6 dB filter BW: Res BW (-6 dB) 422 Hz
 Noise filter BW: Res BW (Noise) 317 Hz
 Impulse filter BW: Res BW (Impulse) 444 Hz
 CISPR filter BW:Res BW (CISPR) 200 Hz
 MIL filter BW:Res BW (MIL) 1 kHz
 Flattop filter type:Res BW (Flattop) 300 Hz

Video BW

Lets you change the test set post-detection filter (VBW) from 1 Hz to 8 MHz in approximately 10% steps. In addition, a wide-open video filter bandwidth may be chosen by selecting 50 MHz.

Normally, Video BW (Auto) selects automatic coupling of the Video BW filter to the resolution bandwidth filter using the ratio set by the VBW:3dB RBW key. To decouple the video bandwidth, press Video BW until Man is underlined, or simply enter a new value.

When the **Video BW** is manually selected, it may be returned to the coupled state by pressing the **Video BW** key until **Auto** is underlined. This may also be done by pressing Auto Couple or by performing a **Preset**.

Key Path	BW
Remote Command	[:SENSE]:BANDwidth BWIDth:VIDeo <freq> [:SENSE]:BANDwidth BWIDth:VIDeo? [:SENSE]:BANDwidth BWIDth:VIDeo:AUTO OFF ON 0 1 [:SENSE]:BANDwidth BWIDth:VIDeo:AUTO?
Example	BAND:VID 1 KHZ BAND:VID? BWID:VID:AUTO ON BWID:VID:AUTO?
Notes	For numeric entries, the test set chooses the nearest (arithmetically, on a linear scale, rounding up) available VBW to the value entered. The 50 MHz VBW is defined to mean “wide open”.
Notes	The values shown in this table reflect the conditions after a Mode Preset.

BW

Dependencies	<p>Sometimes the displayed Video BW is not actually used to process the trace data:</p> <ul style="list-style-type: none"> • When the Average Detector is selected and Sweep Type is set to Swept, the video bandwidth filter cannot be used, because it uses the same hardware as the Average Detector. • When the Quasi-Peak, EMI Average or RMS Average detector is selected the VBW is implemented by the digital IF as part of the detector <p>When this is the case, the VBW still acts to change the Sweep Time, if Sweep Time is in Auto, and still affects the data on other traces for which this is not the case.</p>
Preset	3 MHz ON
State Saved	Saved in Instrument State
Min	1 Hz
Max	50 MHz
Default Unit	Hz
Initial S/W Revision	Prior to A.02.00
Modified at S/W Revision	A.02.00

VBW:3dB RBW

Selects the ratio between the video bandwidth and the equivalent 3 dB resolution bandwidth to be used for setting VBW when VBW is in Auto.

VBW:3dB RBW (Auto) selects automatic coupling of the VBW:3 dB RBW ratio to **Detector**. See [“Coupling Auto Rules:” on page 893](#) for more information. To decouple the ratio, press VBW:3 dB RBW until Man is underlined, or simply enter a new value.

When the VBW:3dB RBW is manually selected, it may be returned to the coupled state by pressing the VBW:3 dB RBW key until **Auto** is underlined. This may also be done by pressing Auto Couple or by performing a **Preset**.

Key Path	BW
Remote Command	<pre>[:SENSe] :BANDwidth BWIDth:VIDeo:RATio <real> [:SENSe] :BANDwidth BWIDth:VIDeo:RATio? [:SENSe] :BANDwidth BWIDth:VIDeo:RATio:AUTO OFF ON 0 1 [:SENSe] :BANDwidth BWIDth:VIDeo:RATio:AUTO?</pre>

Example	BAND:VID:RAT 2 BAND:VID:RAT? BAND:VID:RAT:AUTO 0 BAND:VID:RAT:AUTO?
Notes	The values shown in this table reflect the conditions after a Mode Preset.
Couplings	See “Coupling Auto Rules:” on page 893
Preset	1 ON
State Saved	Saved in Instrument State
Min	0.00001
Max	3000000
Initial S/W Revision	Prior to A.02.00
Modified at S/W Revision	A.02.00

Coupling Auto Rules:

The Auto Rules for the **VBW:3dB RBW** function are as follows:

First, we go through the following list and find the lowest numbered detector being used on any active traces (traces for which Update is On):

- Peak
- Normal
- Average
- Sample
- Negative Peak
- EMI Average
- Quasi Peak
- RMS Average

Use that detector to pick the ratio based on the following criteria:

1. If the detector is Peak and the EMC Standard is set to either CISPR or MIL, use 10.0 (we use wide VBWs to capture peak levels accurately).
2. Otherwise, if the detector is **Negative Peak**, use 1.0 (in the Negative Peak case, there are no known significant use models so we use a medium ratio).
3. Otherwise, if the detector is **Normal**, use 1.0.
4. Otherwise, if the detector is **Average**, and the span is nonzero, use 0.1. The use of a small ratio in Average detection is desirable because of its effect on the sweep time equations. The VBW filter is

BW

not actually in-circuit when the average detector is on. If the detector is Average, and the span is zero, use 10.0, which gives optimal behavior for Interval Markers in zero span.

5. Otherwise, if the detector is EMI Average, Quasi Peak or CISPR RMS, use 1.0. In fact this is a “don’t care” since no VBW is used for these detectors, as noted under “Dependencies” for the VBW key.
6. Otherwise, the detector is simply **Peak** or **Sample**. These two detectors can use the same rules. In these cases, if any active trace is in max hold or min hold, use 10.0, because Max and Min Hold operations are usually intended to capture peaks and pits without smoothing from the VBW filter; otherwise, use 1.0 as a compromise, because you have not set the test set in a way that implies that you are measuring noise, pulsed-RF or CW signals.

Note that because the above couplings depend on which traces are active, they are re-examined whenever any trace goes active or inactive, except when this leaves no traces active. Transitioning to the state where no traces are active should not affect the couplings; in that way, the annotation will always reflect the state of the last trace which was active.

Span:3dB RBW

Selects the ratio between span and resolution bandwidth.

Normally, Span:3dB RBW (Auto) selects a Span:3dB RBW ratio of 106:1. If you manually enter the ratio, Man becomes underlined, which enables you to manually select ratios more suitable for certain measurements.

When the Span:3dB RBW is manually selected, it may be returned to the coupled state by pressing the Span:3dB RBW key until **Auto** is underlined. This may also be done by pressing Auto Couple or by performing a **Preset**.

Key Path	BW
Remote Command	<pre>[:SENSe] :FREQuency:SPAN:BANDwidth[:RESolution] :RATio <integer> [:SENSe] :FREQuency:SPAN:BANDwidth[:RESolution] :RATio? [:SENSe] :FREQuency:SPAN:BANDwidth[:RESolution] :RATio:AUTO OFF ON 0 1 [:SENSe] :FREQuency:SPAN:BANDwidth[:RESolution] :RATio:AUTO?</pre>
Example	<pre>FREQ:SPAN:BAND:RAT 200 sets a ratio of 200:1, and turns off the auto coupling. FREQ:SPAN:BAND:RAT:AUTO ON FREQ:SPAN:BAND:RAT?</pre>
Notes	The values shown in this table reflect the conditions after a Mode Preset.
Dependencies	<p>Grayed out when the EMC Standard is set to CISPR or MIL, since RBW is coupled to Center Frequency rather than Span in this case.</p> <p>If the grayed out key is pressed, an advisory message is generated. If the equivalent SCPI command is sent, the command is acted upon, but it doesn’t affect the current measurement.</p>

Preset	106 ON
State Saved	Saved in Instrument State
Min	2
Max	10000
Initial S/W Revision	Prior to A.02.00

RBW Control

Selects the type/shape for the resolution bandwidth filters. Historically, the Res BW filters in Agilent Test Sets were Gaussian filters, specified using the –3 dB bandwidth of the filter. That is, a 10 MHz Res BW filter was a Gaussian shape with its –3 dB points 10 MHz apart. In the X-Series you can, using the **Filter BW** key, specify bandwidths other than the –3 dB bandwidth (–6 dB, Noise, Impulse) for the width of the Gaussian filters. Furthermore, the **Filter BW** menu lets you choose between a Gaussian and Flat Top filter shape, for varying measurement conditions.

Key Path	BW
Dependencies]The RBW Control key is grayed out if the EMC Standard is set to CISPR or MIL . In this case the Filter Type is always Gaussian; the Filter BW is chosen as appropriate for the filter and the standard.
Readback line	[<filter type>] or, if Filter Type is Gaussian, [Gaussian,<filter BW>]
Initial S/W Revision	Prior to A.02.00
Modified at S/W Revision	A.02.00

Filter Type

Besides the familiar Gaussian filter shape, there are certain special filter types, such as Flat Top, that are desirable under certain conditions. The **Filter Type** menu gives you control over these types.

See [“More Information” on page 896](#)

Key Path	BW, RBW Control
Remote Command	[:SENSE] :BANDwidth BWIDth :SHAPE GAUSSian FLATtop [:SENSE] :BANDwidth BWIDth :SHAPE ?
Example	BAND:SHAP GAUS
Notes	GAUSSian = Gaussian FLATtop = Flattop
Dependencies	When EMC Standard is set to CISPR or MIL , the Filter Type is always Gaussian
Preset	Auto Couple chooses the preset value

BW

State Saved	Saved in State
Readback line	1-of-N selection
Initial S/W Revision	Prior to A.02.00
Modified at S/W Revision	A.02.00

More Information

Gaussian filters

When the Gaussian filter type is chosen, a set of 160 RBW filters are available whose shape is approximately Gaussian. The actual bandwidths used to realize the X-Series's Gaussian filters are chosen to come as close as possible to a 24 step per decade series, within the limitations of the digital IF.

For Gaussian filters, the annotation at the bottom of the screen shows the filter bandwidth type (unless it is Normal). This is shown parenthetically between the words "Res BW" and the value, for example

Res BW 10.0 Hz (Normal bandwidth)

Res BW (Impulse) 14.8 Hz (Impulse bandwidth)

Flattop filters

When the Flattop filter type is chosen, a new set of 134 RBW hardware settings are available. These settings realize filters that are approximately rectangular in shape. When this shape is chosen the filter bandwidth options are irrelevant and therefore unavailable.

The annotation at the bottom of the screen will show that the Flattop shape is being used, for example:

Res BW (Flattop) 10 Hz

Gaussian

Selects the Gaussian filter type. There are 160 of these RBWs. They are arranged in a 24-per-decade sequence from 1 Hz through 3 MHz, plus the 4, 5, 6 and 8 MHz settings.

Key Path	BW, RBW Control, Filter Type
Example	BAND:SHAP GAUS
Notes	Parameter is GAUSSian. See remote command in section " Filter Type " on page 895 .
Readback	Gaussian
Initial S/W Revision	Prior to A.02.00

Flattop

Selects the flat top filter type

Key Path	BW, RBW Control, Filter Type
Example	BAND:SHAP FLAT

Readback	Flattop
Initial S/W Revision	Prior to A.02.00

Filter BW

When using the Gaussian filters for certain types of applications it can be useful to be able to specify the filter width using points other than the -3 dB points. The Filter BW function allows you to pick the filter based on its -3 dB (Normal) bandwidth, its -6 dB bandwidth, its Noise bandwidth, or its Impulse bandwidth. Note that in all four cases the -3 dB bandwidth is the same. The filter does not change, but the way you specify it changes.

See [“More Information” on page 897](#)

Key Path	BW, RBW Control
Remote Command	[:SENSE] :BANDwidth BWIDth:TYPE DB3 DB6 IMPulse NOISe [:SENSE] :BANDwidth BWIDth:TYPE?
Example	BAND:TYPE NOIS
Notes	DB3 = -3 dB (Normal) DB6 = -6 dB IMPulse = Impulse NOISe = Noise
Dependencies	Grayed out if the Flattop filter type is selected. When EMC Standard is set to CISPR or MIL , the Filter BW is chosen as appropriate for the filter and the standard.
Preset	Auto Couple chooses the preset value
State Saved	Saved in State
Readback line	1-of-N selection
Initial S/W Revision	Prior to A.02.00
Modified at S/W Revision	A.02.00

More Information

The test set provides four ways of specifying the bandwidth of a Gaussian filter:

The -3 dB bandwidth of the filter

The -6 dB bandwidth of the filter

The equivalent Noise bandwidth of the filter, which is defined as the bandwidth of a rectangular filter with the same peak gain which would pass the same power for noise signals.

The equivalent Impulse bandwidth of the filter, which is defined as the bandwidth of a rectangular filter with the same peak gain which would pass the same power for impulsive (narrow pulsed) signals.

BW

The figure below shows the relationships of the various filter bandwidths for filters with the X-Series' shape factor (shape factor is defined as the ratio of the -60 dB bandwidth to the -3 dB bandwidth):

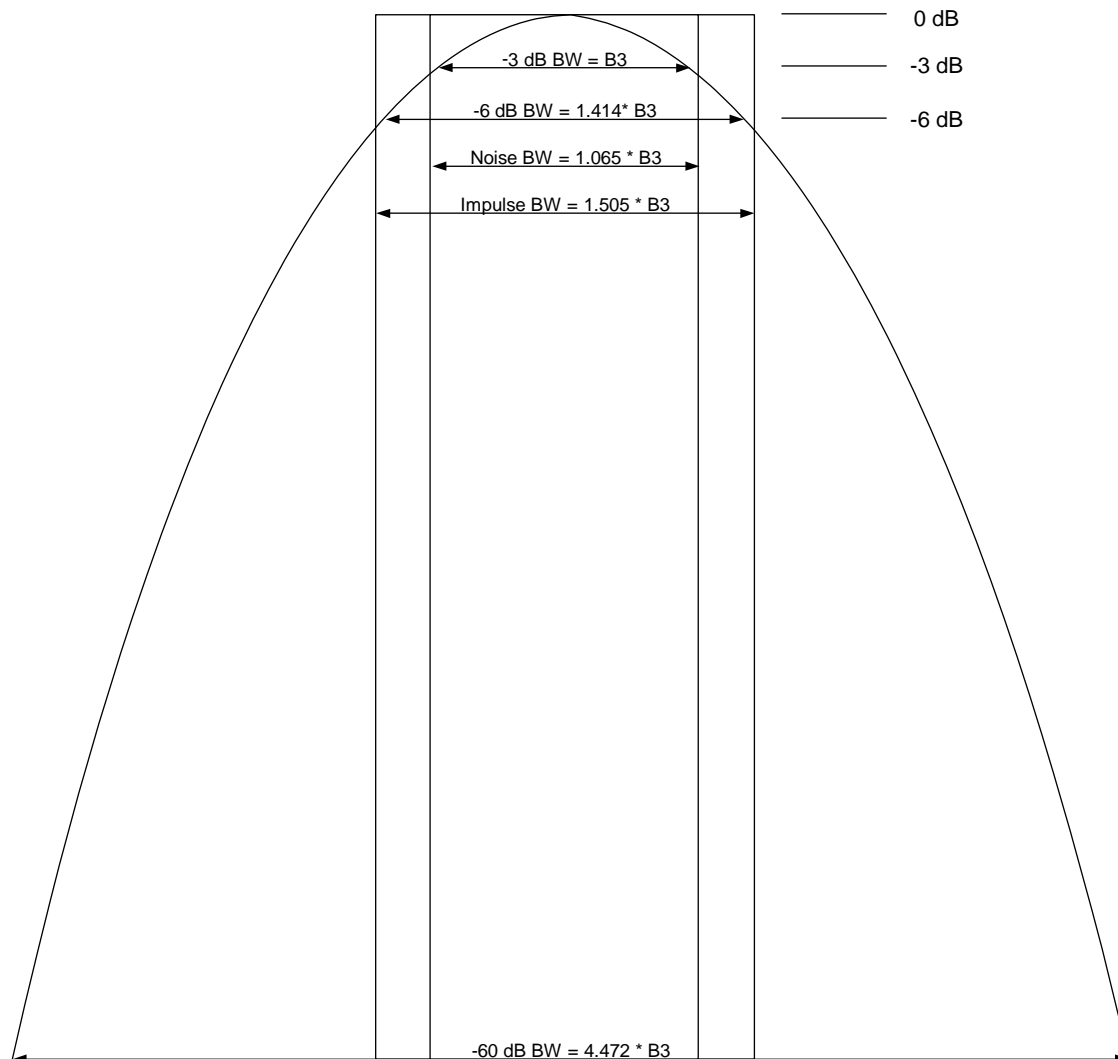

The Filter Type menu lets you choose the filter bandwidth (-3 dB, -6 dB, Noise or Impulse) that is used when specifying the width of the filter. Note that for a given Gaussian filter, changing the filter bandwidth specification does not affect the filter width at all but only the means of specifying it. For example, the filter whose -3 dB bandwidth is 1.0 kHz is the same as the filter whose -6 dB bandwidth is 1.41 kHz, whose Noise bandwidth is 1.06 kHz, and whose Impulse bandwidth is 1.48 kHz. As you cycle through these various filter bandwidths the filter does not change, but the way the filter is annotated and the value which appears in the active function area and on the key does.

-3 dB (Normal)

Selects the normal gaussian-shaped bandwidths that are defined by their -3 dB bandwidths.

Key Path	BW, RBW Control, Filter BW
Example	BAND:TYPE DB3

Readback	-3 dB
Initial S/W Revision	Prior to A.02.00

-6 dB

Selects the filter bandwidths where the bandwidth is defined at the -6 dB points. This uses the normal RBW filters, but the value displayed on the key, active function line and screen annotation changes to reflect the -6 dB bandwidth instead of the -3 dB bandwidth.

Key Path	BW, RBW Control, Filter BW
Example	BAND:TYPE DB6
Readback	-6 dB
Initial S/W Revision	Prior to A.02.00

Noise

Selects the noise filter bandwidths. This uses the normal RBW filters, but the value displayed on the key, active function line and screen annotation changes to reflect the equivalent noise bandwidth, instead of the -3 dB bandwidth.

Key Path	BW, RBW Control, Filter BW
Example	BAND:TYPE NOIS
Readback	Noise
Initial S/W Revision	Prior to A.02.00

Impulse

Selects the impulse bandwidths. This uses the normal RBW filters, but the value displayed on the key, active function line and screen annotation changes to reflect the equivalent impulse bandwidth instead of the -3 dB bandwidth.

Key Path	BW, RBW Control, Filter BW
Example	BAND:TYPE IMP
Readback	Impulse
Initial S/W Revision	Prior to A.02.00

BW

Cont (Continuous Measurement/Sweep)

Sets the test set for Continuous measurement operation. The single/continuous state is Meas Global so the setting will affect all measurements. If you are Paused, pressing **Cont** does a Resume.

Key Path:	Front-panel key
Remote Command:	:INITiate:CONTinuous OFF ON 0 1 :INITiate:CONTinuous?
Example:	:INIT:CONT 0 puts the test set in Single measurement operation. :INIT:CONT 1 puts the test set in Continuous measurement operation
Preset:	ON (Note that SYST:PRESet sets INIT:CONT to ON but *RST sets INIT:CONT to OFF)
State Saved:	Saved in instrument state
Backwards Compatibility Notes:	For Spectrum Analysis mode in ESA and PSA, there is no Cont hardkey, instead there is a Sweep Single/Cont key. In these analyzers, switching the Sweep Single/Cont key from Single to Cont restarts averages (displayed average count reset to 1), but does not restart Max Hold and Min Hold . The X-Series has Single and Cont hardkeys in place of the Sweep Single Cont softkey. In the X-Series, if in single measurement, the Cont hardkey (and INIT:CONT ON) switches to continuous measurement, but never restarts a measurement and never resets a sweep.
Initial S/W Revision:	Prior to A.02.00

With **Avg/Hold Num** (in the **Meas Setup** menu) set to **Off** or set to **On** with a value of 1, a sweep is taken after the trigger condition is met; and the test set continues to take new sweeps after the current sweep has completed and the trigger condition is again met. However, with **Avg/Hold Num** set to On with a value >1, multiple sweeps (data acquisitions) are taken for the measurement. The trigger condition must be met prior to each sweep. The sweep is not stopped when the average count k equals the number N set for Avg/Hold Num is reached, but the number k stops incrementing. A measurement average usually applies to all traces, marker results, and numeric results. But sometimes it only applies to the numeric results.

If the test set is in Single measurement, pressing the **Cont** key does not change k and does not cause the sweep to be reset; the only action is to put the test set into Continuous measurement operation.

If it is already in continuous sweep:

the INIT:CONT 1 command has no effect

the INIT:CONT 0 command will place the test set in Single Sweep but will have no effect on the current sequence until k = N, at which point the current sequence will stop and the instrument will go to the idle state.

Cont (Continuous Measurement/Sweep)

FREQ Channel

Accesses a menu of keys that allow you to control the Frequency and Channel parameters of the instrument.

Some features in the Frequency menu are the same for all measurements – they do not change as you change measurements. Settings like these are called “Meas Global” and are unaffected by Meas Preset. For example, the Center Freq setting is the same for all measurements - it does not change as you change measurements.

Key Path:	Front-panel key
Initial S/W Revision:	Prior to A.02.00

Auto Tune/Zoom Center/Zone Center

The first key in the Frequency menu can be occupied by three different keys, depending on what View you are in.

See [“Auto Tune” on page 903](#)

See [“Zoom Center ” on page 904](#)

See [“Zone Center ” on page 905](#)

Key Path:	FREQ Channel
Initial S/W Revision:	Prior to A.02.00

Auto Tune

Auto Tune appears as the top key in the Frequency menu in the Normal and Spectrogram views of the Spectrum Analyzer Mode.

Auto Tune is an immediate action key. When it is pressed, it causes the analyzer to change Center Frequency to the strongest signal in the tunable span of the analyzer, excluding the LO. It is designed to quickly get you to the most likely signal(s) of interest, with no signal analysis knowledge required. As such, there are no configurable parameters for this feature. There are only pre-selected values that work in most real world situations.

Auto Tune performs a Preset as part of its function, so it always returns you to the Normal View and a preset state, although it does leave the AC/DC coupling and Single/Cont state unaffected.

NOTE You may see a slight pause before the signal of interest is presented at midscreen.

Key Path:	FREQ Channel
Remote Command:	[:SENSe] :FREQuency:TUNE:IMMediate

Common Measurement Functions
FREQ Channel

Dependencies:	Auto Tune is not available (grayed out) when Source Mode=Tracking.
Initial S/W Revision:	Prior to A.02.00

Zoom Center

Zoom Center appears as the top key in the Frequency menu in the Trace Zoom View of the Spectrum Analyzer Mode.

Zoom Center allows you to change the frequency of the zoom region, and hence of the lower window, without changing the Zoom Span.

The **Zoom Center** value is displayed in the lower left corner of the zoom window (below the graticule) when the frequency entry mode is Center/Span (pressing Center Freq or Span sets the frequency entry mode to Center/Span). When the frequency entry mode is Start/Stop, **Zoom Start** is displayed in this lower left annotation position (pressing Start Freq or Stop Freq sets the frequency entry mode to Start/Stop).

Key Path:	FREQ Channel
Remote Command:	[:SENSe] :FREQuency:TZOom:CENTer <frequency> [:SENSe] :FREQuency:TZOom CENTer?
Example:	FREQ:TZO:CENT 20 MHz
Dependencies:	Only appears in the Trace Zoom View of the Swept SA measurement. If the SCPI command is sent in other Views, an error is reported.
Couplings:	<ul style="list-style-type: none"> The center frequency for the lower window is limited by the start and stop frequencies in the upper window. You cannot move the zoom region out of the upper window, nor does changing the Zoom Center frequency ever change the Zoom Span. When Zoom Center increases or decreases to a value that causes the zoom region to touch an edge of the top window, the Zoom Center is clipped at that value. If the analyzer Start and/or Stop frequencies change such that the Zoom Region is no longer between them, the Zoom Region is moved to the far left or right of the top window as appropriate. Affected by Freq Offset exactly the same as is Center Frequency.
Preset:	On entry to Trace Zoom, the Zoom Center frequency is the same as the analyzer Center Frequency. So if you do a Mode Preset and then immediately go into Trace Zoom, Zoom Center matches the Preset values listed in the table under the Center Freq key description.
State Saved:	Saved in instrument state
Min:	Start Frequency of top window
Max:	The maximum Zoom Center frequency is the same as the maximum analyzer Center Frequency, which is basically the instrument maximum frequency – 5 Hz. See the table under the Center Freq key description.
Default Unit:	Hz

Initial S/W Revision:	A.07.01
-----------------------	---------

Zone Center

Zone Center appears as the top key in the Frequency menu in the Trace Zoom View of the Spectrum Analyzer Mode.

Zone center allows you to change the frequency of the zone without changing the zone span. As the zone center is changed, the center frequency of the lower window is changed. Note that the lower window will not be updated to reflect the change unless it is selected as the active window.

The center frequency for the lower window is not limited by the selected start and stop frequencies in the upper window. However, if the frequency span of the lower window is at all outside of the span for the upper window, an orange arrow pointing left or right will be displayed at the left or right edge of the top window.

Key Path:	FREQ Channel
Remote Command:	[:SENSe] :FREQuency:ZSPan:CENTer <frequency> [:SENSe] :FREQuency:ZSPan:CENTer?
Example:	:FREQ:ZSP:CENT 20 MHz
Notes:	Min and Max values depend on the Hardware Options (5xx)
Dependencies:	Only appears in the Zone Span View of the Swept SA measurement. If the SCPI command is sent in other Views, an error is generated.
Couplings:	<ul style="list-style-type: none"> Center Frequency of lower window changes so that it is always the same as Zone Center, and vice-versa Affected by Freq Offset exactly the same as is Center Frequency.
Preset:	On entry to Zone Span, the Zone Center frequency is the same as the analyzer Center Frequency. So if you do a Mode Preset and then immediately go into Zone Span, Zone Center matches the Preset values listed in the table under the Center Freq key description.
State Saved:	Saved in instrument state
Min:	Hardware dependent; Zone Span dependent. Zone Center cannot go so low as to force Zone Left to be <0.
Max:	The maximum Zone Center frequency is the same as the maximum analyzer Center Frequency, which is basically the instrument maximum frequency – 5 Hz. See the table under the Center Freq key description.
Default Unit:	Hz
Status Bits/OPC dependencies:	Non-overlapped
Initial S/W Revision:	Prior to A.02.00

Center Freq

Sets the frequency that corresponds to the horizontal center of the graticule (when frequency Scale Type is set to linear). While adjusting the Center Frequency the Span is held constant, which means that both Start Frequency and Stop Frequency will change.

Pressing Center Freq also sets the frequency entry mode to Center/Span. In Center/Span mode, the center frequency and span values are displayed below the graticule, and the default active function in the Frequency menu is **Center Freq**.

The center frequency setting is the same for all measurements within a mode, that is, it is Meas Global. Some modes are also able to share a Mode Global center frequency value. If this is the case, the Mode will have a **Global Settings** key in its **Mode Setup** menu.

The **Center Freq** function sets (and queries) the Center Frequency for the currently selected input. If your analyzer has multiple inputs, and you select another input, the Center Freq changes to the value for that input. SCPI commands are available to directly set the Center Freq for a specific input.

Center Freq is remembered as you go from input to input. Thus you can set a Center Freq of 10 GHz with the RF Input selected, change to BBIQ and set a Center Freq of 20 MHz, then switch to External Mixing and set a Center Freq of 60 GHz, and when you go back to the RF Input the Center Freq will go back to 10 GHz; back to BBIQ and it is 20 MHz; back to External Mixing and it is 60 GHz.

See “RF Center Freq” on page 909

See “Ext Mix Center Freq” on page 910 Ext Mix Center Freq

See “I/Q Center Freq” on page 911

See “Center Frequency Presets” on page 907

Key Path:	FREQ Channel
Scope:	Meas Global
Remote Command:	[:SENSE] :FREQuency:CENTer <freq> [:SENSE] :FREQuency:CENTer?
Example:	FREQ:CENT 50 MHz FREQ:CENT UP changes the center frequency to 150 MHz if you use FREQ:CENT:STEP 100 MHz to set the center frequency step size to 100 MHz FREQ:CENT?
Notes:	This command sets either the RF or I/Q Center Frequency depending on the selected input. For RF input it is equivalent to FREQ:RF:CENT For I/Q input it is equivalent to FREQ:IQ:CENT Preset and Max values are dependent on Hardware Options (5xx) If no terminator (e.g. MHz) is sent the terminator Hz is used. If a terminator with unit other than Frequency is used, an invalid suffix error message is generated.

Dependencies:	The Center Frequency can be limited by Start or Stop Freq limits, if the Span is so large that Start or Stop reach their limit.
Couplings:	When operating in “swept span”, any value of the Center Frequency or Span that is within the frequency range of the analyzer is allowed when the value is being set through the front panel numeric key pad or the SCPI command. The other parameter is forced to a different value if needed, to keep the Start and the Stop Frequencies within the analyzer’s frequency range
Preset:	Depends on instrument maximum frequency, mode, measurement, and selected input. See REF T_CF_CFPresets \h *CHARFORMAT - and REF T_RFCF_MoreInformation \h *CHARFORMAT - and HYPERLINK \l "T_ExtMixCF_MoreInformation" - and REF T_IQCF_MoreInformation \h *CHARFORMAT - .
State Saved:	Saved in instrument state
Min:	Depends on instrument maximum frequency, mode, measurement, and selected input.. See “Center Frequency Presets” on page 907 and “RF Center Freq” on page 909 and “I/Q Center Freq” on page 911 .
Max:	Depends on instrument maximum frequency, mode, measurement, and selected input.. See “Center Frequency Presets” on page 907 and “RF Center Freq” on page 909 and “I/Q Center Freq” on page 911 .
Default Unit:	Hz
Status Bits/OPC Dependencies:	Non-overlapped
Initial S/W Revision:	Prior to A.02.00

Center Frequency Presets

The following table provides the Center Frequency Presets for the Spectrum Analyzer mode, and the Max Freq, for the various frequency options:

Freq Option	CFAfter Mode Preset	Stop Freq after Mode Preset	Max Freq(can't tune above)
503 (all but N9000A)	1.805 GHz	3.6 GHz	3.7 GHz
503 (N9000A)	1.505 GHz	3.0 GHz	3.08 GHz
507 (all but N9000A)	3.505 GHz	7.0 GHz	7.1 GHz
507 (N9000A)	3.755 GHz	7.5 GHz	7.58 GHz

Common Measurement Functions
FREQ Channel

508 (all but N9038A)	1.805 GHz	3.6 GHz	8.5 GHz
508 (N9038A)	4.205 GHz	8.4 GHz	8.5 GHz
513	6.805 GHz	13.6 GHz	13.8 GHz
526 (all but N9000A and N9038A)	13.255 GHz	26.5 GHz	27.0 GHz
526 (N9000A)	13.255 GHz	26.5 GHz	26.55 GHz
526 (N9038A)	1.805 GHz	3.6 GHz	27.0 GHz
532	16.005 GHz	32.0 GHz	32.5 GHz
543	21.505 GHz	43.0 GHz	TBD
544	22.005 GHz	44.0 GHz	44.5 GHz
550	25.005 GHz	50.0 GHz	51 GHz

Input 2:

Model	CFafter Mode Preset	Stop Freq after Mode Preset
N9000A opt C75	0.7505GHz	1.5 GHz
N9038A	505 MHz	1 GHz

Tracking Generator Frequency Limits (N9000A only):

Tracking Generator Option	Min Freq (clips to this freq when turn TG on and can't tune below while TG on)	If above this Freq, Stop Freq clipped to this Freq when TG turned on	Max Freq (can't tune above) while TG on
T03	9 kHz	3.0 GHz	3.08 GHz
T06	9 kHz	6.0 GHz	6.05 GHz

The following table shows the Center Frequency Presets for modes other than Spectrum Analyzer:

Mode	CF Preset for RF
WCDMA	1 GHz
WIMAXOFDMA,	1 GHz
BASIC	1 GHz
ADEMOD	1 GHz
VSA	1 GHz
TDSCDMA	1 GHz
PNOISE	1 GHz
LTE	1 GHz
LTETDD	1 GHz
MSR	1 GHz
GSM	935.2 MHz
NFIGURE	1.505 GHz

RF Center Freq

SCPI command for specifying the RF Center Frequency. This command will set the Center Frequency to be used when the RF input is selected, even if the RF input is not the input that is selected at the time the command is sent. Note that the **Center Freq** function in the **Frequency** menu on the front panel always applies to the currently selected input.

Scope:	Meas Global
Remote Command:	[:SENSe] :FREQuency:RF:CENTer <freq> [:SENSe] :FREQuency:RF:CENTer?
Example:	FREQ:RF:CENT 30 MHz
Notes:	This command is the same in all modes, but the parameter is Measurement Global. So the value is independent in each mode and common across all the measurements in the mode.
Dependencies:	If the electronic/soft attenuator is enabled, any attempt to set Center Frequency such that the Stop Frequency would be >3.6 GHz fails and results in an advisory message. If the equivalent SCPI command is sent, this same message is generated as part of a “-221, Settings conflict” warning. If Source Mode is set to Tracking, and the Max or Min Center Freq is therefore limited by the limits of the source, a warning message is generated, “Data out of range;clipped to source max/min” if these limits are exceeded. Note that for an external source, these limits can be affected by the settings of Source Numerator, Source Denominator and Power Sweep.

Common Measurement Functions
FREQ Channel

Preset:	See table above
State Saved:	Saved in instrument state.
Min:	-79.999995 MHz, unless Source Mode is set to Tracking, in which case it is limited by the minimum frequency of the Source
Max:	See table above. Basically instrument maximum frequency – 5 Hz. Note that, if the Source Mode is set to Tracking, the effective instrument maximum frequency may be limited by the source maximum frequency. If the knob or step keys are being used, also depends on the value of the other three interdependent parameters Span, Start Frequency and Stop Frequency
Initial S/W Revision:	Prior to A.02.00
Modified at S/W Revision:	A.03.00

Ext Mix Center Freq

SCPI command for specifying the External Mixer Center Frequency. This command will set the Center Frequency to be used when the External Mixer is selected, even if the External Mixer input is not the input which is selected at the time the command is sent. Note that the **Center Freq** function in the **Frequency** menu on the front panel always applies to the currently selected input.

Scope:	Meas Global
Remote Command:	[:SENSe] :FREQuency:EMIXer:CENTer <freq> [:SENSe] :FREQuency:EMIXer:CENTer?
Example:	:FREQ:EMIX:CENT 60 GHz :FREQ:EMIX:CENT?
Notes:	This command is the same in all modes, but the parameter is Measurement Global. So the value is independent in each mode and common across all the measurements in the mode.
Couplings:	When returning to External Mixing after having been switched to one of the other inputs (e.g., RF), you will come back into the settings that you had when you left External Mixing. So you will come back to the band you were in with the Center Frequency that you had. However, Span is not an input-dependent parameter, therefore you will bring the span over from the other input. Therefore, the analyzer comes back with the span from the previous input, limited as necessary by the current mixer setup.

Preset:	<p>When a Mode Preset is performed while in External Mixing, the Start frequency of the current Mode is set to the nominal Min Freq of the lowest harmonic range in the Harmonic Table for the current mixer setup. Similarly, the Stop frequency of the current Mode is set to the nominal Max Freq of the highest harmonic range in the Harmonic Table. The Center Freq thus presets to the point arithmetically equidistant from these two frequencies.</p> <p>If the current measurement has a limited Span available to it, and cannot achieve the Span shown in the table (Span=Stop Freq – Start Freq), the analyzer uses the maximum Span the measurement allows, and still sets the Center Freq to the midpoint of the Start and Stop Freq values in the Harmonic Table.</p> <p>When Restore Input/Output Defaults is performed, the mixer presets to the 11970A, whose Start and Stop frequencies are 26.5 and 40 GHz respectively. The center of these two frequencies is 33.25 GHz.</p> <p>Therefore, after a Restore Input/Output Defaults, if you go into External Mixing and do a Mode Preset while in the Spectrum Analyzer Mode, the resulting Center Freq is 33.25 GHz.</p>
State Saved:	Saved in instrument state.
Min:	The minimum frequency in the currently selected mixer band + 5 Hz
Max:	<p>The maximum frequency in the currently selected mixer band – 5 Hz</p> <p>If the knob or step keys are being used, also depends on the value of the other three interdependent parameters Span, Start Frequency and Stop Frequency</p>
Initial S/W Revision:	A.08.01

I/Q Center Freq

SCPI command for specifying the I/Q Center Frequency. This command will set the Center Frequency to be used when the I/Q input is selected, even if the I/Q input is not the input which is selected at the time the command is sent. Note that the **Center Freq** function in the **Frequency** menu on the front panel always applies to the currently selected input.

Scope:	Meas Global
Remote Command:	<pre>[:SENSE] :FREQUENCY:IQ:CENTER <freq> [:SENSE] :FREQUENCY:IQ:CENTER?</pre>
Example:	FREQ:IQ:CENT: 30 MHz
Notes:	This command is the same in all modes, but the parameter is Measurement Global. So the value is independent in each mode and common across all the measurements in the mode.
Preset:	0 Hz
State Saved:	Saved in instrument state.
Min:	-40.049995 MHz

Common Measurement Functions
FREQ Channel

Max:	40.049995 MHz
Initial S/W Revision:	Prior to A.02.00

Start Freq

Sets the frequency at the left side of the graticule. While adjusting the start frequency, the stop frequency is held constant, which means that both the center frequency and span will change.

Start Freq also sets the frequency entry mode to Start or Stop. In Start or Stop mode, the start frequency and stop frequency values are displayed below the graticule, and the default active function in the Frequency menu is **Start Freq**.

Key Path:	FREQ Channel
Remote Command:	[:SENSE] :FREQUENCY:STARt <freq> [:SENSE] :FREQUENCY:STARt?
Example:	FREQ:STAR 200 MHz FREQ:STAR?
Notes:	Max values depends on Hardware Options (5xx)
Dependencies:	<p>By direct entry: You cannot set Start frequency > Stop frequency. You cannot set Start frequency = Stop frequency. You cannot select zero span by setting Start = Stop. You cannot set Start Frequency to a value that would create a span of less than 10 Hz. If you try to do any of these, Stop Frequency will change to maintain a minimum value of 10 Hz for the difference between Start and Stop.</p> <p>With the knob or step keys: Cannot increment Start Freq to a value greater than Stop Freq – 10 Hz. If already in zero span, cannot increment at all, and the first decrement will be forced to at least 10 Hz.</p> <p>The Start Frequency can be limited by Span limits, if the Stop Frequency is below its preset value.</p> <p>If the electronic/soft attenuator is enabled, any attempt to set the Start Frequency such that the Stop Frequency would be >3.6 GHz fails and results in an advisory message. If the equivalent SCPI command is sent, this same message is generated as part of a “–221, Settings conflict” warning.</p> <p>If Source Mode is set to Tracking, and the Max or Min Start Freq is therefore limited by the limits of the source, a warning message is generated, “Data out of range;clipped to source max/min” if these limits are exceeded. Note that for an external source, these limits can be affected by the settings of Source Numerator, Source Denominator and Power Sweep.</p>

Couplings:	<p>In the Spectrum Analyzer, the four parameters Center Freq, Start Freq, Stop Freq and Span are interdependent, as changing one necessarily affects one or more of the others. The couplings between Center Freq and Span are detailed under the key descriptions for those keys. These couplings also affect Start Freq and Stop Freq.</p> <p>You cannot set Start frequency = Stop frequency. You cannot select zero span by setting Start = Stop. The instrument will alter the value of the last setting to maintain a minimum value of 10 Hz for the difference between Start and Stop.</p>
Preset:	<p>Start Freq does not preset. On Mode Preset, Span & CF preset, and Start Freq is derived. On a Meas Preset only Span presets, CF does not, so Start Freq will vary depending on CF.</p> <p>When a Mode Preset is performed while in External Mixing, the Start frequency of the current Mode is set to the nominal Min Freq of the lowest harmonic range in the Harmonic Table for the current mixer setup.</p> <p>If the current measurement has a limited Span available to it, and cannot achieve the Span shown in the table (Span=Stop Freq – Start Freq), the analyzer uses the maximum Span the measurement allows, and sets the Center Freq to the midpoint of the Start and Stop Freq values in the Harmonic Table. Thus, in this case, the Start Freq will preset to a frequency below the preset Center Freq by ½ of the maximum Span.</p> <p>When Restore Input/Output Defaults is performed, the mixer presets to the 11970A, whose Start frequency is 26.5 GHz.</p> <p>Therefore, after a Restore Input/Output Defaults, if you go into External Mixing and do a Mode Preset while in the Spectrum Analyzer Mode, the resulting Start Freq is 26.5 GHz.</p>
State Saved:	Saved in instrument state
Min:	<p>–80 MHz, unless Source Mode is set to Tracking, in which case it is limited by the minimum frequency of the Source</p> <p>If the knob or step keys are being used, depends on the value of the other three interdependent parameters</p> <p>While in External Mixing, the minimum Start Freq you can set is determined by the external mixing parameters. It will be close to the minimum LO frequency (3.8 GHz if undoubled, 8.6 GHz if doubled) times the harmonic number, for the lowest harmonic range in the Harmonic Table for the current mixer setup. It can be queried with the SCPI command :FREQ:START? MIN.</p>

Common Measurement Functions
FREQ Channel

Max:	<p>Depends on the instrument maximum frequency – 10 Hz. Note that, if the Source Mode is set to Tracking, the effective instrument maximum frequency may be limited by the source maximum frequency.</p> <p>If the knob or step keys are being used, it depends on the value of the other three interdependent parameters.</p> <p>While in External Mixing, the maximum Start Freq you can set is determined by the external mixing parameters. It will be close to the maximum LO frequency (7 GHz if undoubled, 14 GHz if doubled) times the harmonic number, for the highest harmonic range in the Harmonic Table for the current mixer setup. It can be queried with the SCPI command :FREQ:START? MAX.</p>
Default Unit:	Hz
Status Bits/OPC dependencies:	Non-overlapped
Initial S/W Revision:	Prior to A.02.00
Modified at S/W Revision:	A.03.00

Stop Freq

Sets the frequency at the right side of the graticule. While adjusting the stop Frequency, the start frequency is held constant, which means that both the center frequency and span will change.

Stop Freq also sets the frequency entry mode to Start or Stop. In Start or Stop mode, the start frequency and stop frequency values are displayed below the graticule, and the default active function in the Frequency menu is **Start Freq**.

Key Path:	FREQ Channel
Remote Command:	<pre>[:SENSE] :FREQuency:STOP <freq></pre> <pre>[:SENSe] :FREQuency:STOP?</pre>
Example:	<pre>FREQ:STOP 220 MHz</pre> <pre>FREQ:STOP?</pre>
Notes:	Preset and Max values are dependent on Hardware Options (5xx)

Dependencies:	<p>By direct entry: You cannot set the Stop frequency < Start frequency. You cannot set Start frequency = Stop frequency. You cannot select zero span by setting Start = Stop. You cannot set Stop Frequency to a value that would create a span of less than 10 Hz. If you try to do any of these, Start Frequency will change to maintain a minimum value of 10 Hz for the difference between Start and Stop.</p> <p>With the knob or step keys: Cannot decrement Stop Freq to a value less than Start Freq + 10 Hz. If already in zero span, cannot decrement at all, and the first increment will be forced to at least 10 Hz.</p> <p>The Stop Frequency can be limited by Span limits, if the Start Frequency is above its preset value.</p> <p>If the electronic/soft attenuator is enabled, any attempt to set the Stop Frequency >3.6 GHz fails and results in an advisory message. If the equivalent SCPI command is sent, this same message is generated as part of a “-221, Settings conflict” warning.</p> <p>If Source Mode is set to Tracking, and the Max or Min Stop Freq is therefore limited by the limits of the source, a warning message is generated, “Data out of range;clipped to source max/min” if these limits are exceeded. Note that for an external source, these limits can be affected by the settings of Source Numerator, Source Denominator and Power Sweep.</p>
Couplings:	<p>In the Spectrum Analyzer, the four parameters Center Freq, Start Freq, Stop Freq and Span are interdependent, as changing one necessarily affects one or more of the others. The couplings between Center Freq and Span are detailed under the key descriptions for those keys. These couplings also affect Start Freq and Stop Freq.</p> <p>You cannot set Start frequency = Stop frequency. You cannot select zero span by setting Start = Stop. The instrument will alter the value of the last setting to maintain a minimum value of 10 Hz for the difference between Start and Stop.</p>

Common Measurement Functions
FREQ Channel

<p>Preset:</p>	<p>On Mode Preset, Span & CF preset, and Stop Freq is derived. See “Center Frequency Presets” on page 907 for a table which shows the Stop Freq after Preset for various model and option numbers).</p> <p>On a Meas Preset only Span presets, CF does not, so Stop Freq will vary depending on CF.</p> <p>When a Mode Preset is performed while in External Mixing, the Stop frequency of the current Mode is set to the nominal Max Freq of the highest harmonic range in the Harmonic Table for the current mixer setup.</p> <hr/> <p>NOTE If the current measurement has a limited Span available to it, and cannot achieve the Span shown in the table (Span=Stop Freq – Start Freq), the analyzer uses the maximum Span the measurement allows, and sets the Center Freq to the midpoint of the Start and Stop Freq values in the Harmonic Table. Thus, in this case, the Stop Freq will preset to a frequency above the preset Center Freq by ½ of the maximum Span.</p> <hr/> <p>When Restore Input/Output Defaults is performed, the mixer presets to the 11970A, whose Stop frequency is 40 GHz.</p> <p>Therefore, after a Restore Input/Output Defaults, if you go into External Mixing and do a Mode Preset while in the Spectrum Analyzer Mode, the resulting Stop Freq is 40 GHz.</p>
<p>State Saved:</p>	<p>Saved in instrument state</p>
<p>Min:</p>	<p>–79.999999999 MHz, unless Source Mode is set to Tracking, in which case it is limited by the minimum frequency of the Source</p> <p>If the knob or step keys are being used, depends on the value of the other three interdependent parameters</p> <p>While in External Mixing, the minimum Stop Freq you can set is determined by the external mixing parameters. It will be close to the minimum LO frequency (3.8 GHz if undoubled, 8.6 GHz if doubled) times the harmonic number, for the lowest harmonic range in the Harmonic Table for the current mixer setup. It can be queried with the SCPI command :FREQ:STOP? MIN.</p>
<p>Max:</p>	<p>Depends on instrument maximum frequency. Note that, if the Source Mode is set to Tracking, the effective instrument maximum frequency may be limited by the source maximum frequency.</p> <p>If the knob or step keys are being used, depends on the value of the other three interdependent parameters.</p> <p>While in External Mixing, the maximum Stop Freq you can set is determined by the external mixing parameters. It will be close to the maximum LO frequency (7 GHz if undoubled, 14 GHz if doubled) times the harmonic number, for the highest harmonic range in the Harmonic Table for the current mixer setup. It can be queried with the SCPI command :FREQ:STOP? MAX.</p>
<p>Default Unit:</p>	<p>Hz</p>

Status Bits/OPC dependencies:	Non-overlapped
Initial S/W Revision:	Prior to A.02.00
Modified at S/W Revision:	A.03.00

CF Step

Changes the step size for the center frequency and start and stop frequency functions. Once a step size has been selected and the center frequency function is active, the step keys (and the UP|DOWN parameters for Center Frequency from remote commands) change the center frequency by the step-size value. The step size function is useful for finding harmonics and sidebands beyond the current frequency span of the analyzer.

Note that the start and stop frequencies also step by the CF Step value.

Key Path:	FREQ Channel
Remote Command:	<pre>[:SENSe] :FREQuency:CENTer:STEP [:INCRement] <freq> [:SENSe] :FREQuency:CENTer:STEP [:INCRement] ? [:SENSe] :FREQuency:CENTer:STEP:AUTO OFF ON 0 1 [:SENSe] :FREQuency:CENTer:STEP:AUTO?</pre>
Example:	<pre>FREQ:CENT:STEP:AUTO ON FREQ:CENT:STEP 500 MHz FREQ:CENT UP increases the current center frequency value by 500 MHz FREQ:CENT:STEP? FREQ:CENT:STEP:AUTO?</pre>
Notes:	Preset and Max values are depending on Hardware Options (503, 507, 508, 513, 526)
Notes:	Preset and Max values are dependent on Hardware Options (5xx)
Dependencies:	Freq Offset is not available in External Mixing. In this case the Freq Offset key is grayed out and shows a value of zero. It will once again be available, and show the previously set value, when you return to the RF Input.
Dependencies:	Span, RBW, Center frequency If the electronic/soft attenuator is enabled, any attempt to change the value of the center frequency >3.6 GHz by pressing the Up-arrow key, fails and results in an advisory message. If the equivalent SCPI command is sent, this same message is generated as part of a “-221, Settings conflict” warning.
Couplings:	When auto-coupled in a non-zero span, the center frequency step size is set to 10% of the span. When auto-coupled in zero span, the center frequency step size is set to the equivalent -3 dB RBW value.

Common Measurement Functions
FREQ Channel

Preset:	Auto ADEMOD: 1 MHz ON
State Saved:	Saved in instrument state
Min:	– (the maximum frequency of the instrument). That is, 27 GHz max freq instrument has a CF step range of +/- 27 GHz. Note that this is the maximum frequency given the current settings of the instrument, so in External Mixing, for example, it is the maximum frequency of the current mixer band.
Max:	The maximum frequency of the instrument. That is, 27 GHz max freq instrument has a CF step range of +/- 27 GHz. Note that this is the maximum frequency given the current settings of the instrument, so in External Mixing, for example, it is the maximum frequency of the current mixer band.
Default Unit:	Hz
Status Bits/OPC dependencies:	non-overlapped
Initial S/W Revision:	Prior to A.02.00
Modified at S/W Revision:	A.03.00

Freq Offset

Enables you to set a frequency offset value to account for frequency conversions outside of the analyzer. This value is added to the display readout of the marker frequency, center frequency, start frequency, stop frequency, and all other absolute frequency settings in the analyzer including frequency count. When a frequency offset is entered, the value appears below the center of the graticule. To eliminate an offset, perform a Mode Preset or set the frequency offset to 0 Hz.

See [“More Information” on page 919](#).

Key Path:	FREQ Channel
Scope:	Meas Global
Remote Command:	[:SENSe] :FREQuency:OFFSet <freq> [:SENSe] :FREQuency:OFFSet?
Example:	FREQ:OFFS 10 MHz
Notes:	Preset and Max values are dependent on Hardware Options (503, 507, 508, 513, 526)
Dependencies:	Freq Offset is not available in External Mixing. In this case the Freq Offset key is grayed out and shows a value of zero. However, the value of CF Offset that was set for the RF Input is retained and restored when the user switches back to the RF Input.
Preset:	See the table in See “Center Frequency Presets” on page 907
State Saved:	Saved in instrument state

Min:	-500 GHz
Max:	500 GHz
Default Unit:	Hz
Status Bits/OPC dependencies:	Non-overlapped
Backwards Compatibility SCPI:	DISPlay:WINDow[1]:TRACe:X[:SCALe]:OFFSet The DISPlay version of the command is in the instrument for compatibility across platforms and is not recommended for new development.
Backwards Compatibility Notes:	<ol style="list-style-type: none"> 1. In pre-X-Series instruments, Frequency Offset could not be adjusted by the knob or step keys. That is no longer the case. 2. Some previous spectrum analyzers did not adjust frequency counter results for the Frequency Offset. The X-Series does adjust the frequency counter for the offset.
Initial S/W Revision:	Prior to A.02.00
Modified at S/W Revision:	A.04.00, A.08.50

More Information

This command does not affect any bandwidths or the settings of relative frequency parameters such as delta markers or span. It does not affect the current hardware settings of the analyzer, but only the displayed frequency values. Entering an offset does not affect the trace position or display, just the value of the start and stop frequency and the values represented by the trace data. The frequency values of exported trace data, queried trace data, markers, trace data used in calculations such as N dB points, trace math, etc., are all affected by Freq Offset. Changing the offset, even on a trace that is not updating will immediately change all of the above, without taking new data.

NOTE If a trace is exported with a nonzero Freq Offset, the exported data will contain the trace data with the offset applied. Therefore, if that trace were to be imported back into the analyzer, you would want Freq Offset to be 0, or the offset would be applied again to data which is already offset. No such care need be taken when saving a State+Trace file because the data and state are saved together.

Input/Output

The Input/Output features are common across multiple Modes and Measurements. These common features are described in this section. See the Measurement description for information on features that are unique.

The Input/Output key accesses the softkeys that control the Input/Output parameters of the instrument. In general, these are functions associated with external connections to the test set, either to the inputs or the outputs. Since these connections tend to be fairly stable within a given setup, in general, the input/output settings do not change when you Preset the test set.

Other functions related to the input/output connections, but which tend to change on a measurement by measurement basis, can be found under the **Trigger** and **AMPTD Y Scale** keys. In addition, some of the digital I/O bus configurations can be found under the **System** key.

NOTE The functions in the Input/Output menu are "global" (common) to all Modes (applications). But individual Input/Output functions only appear in a Mode if they apply to that Mode. Functions that apply to a Mode but not to all measurements in the Mode may be grayed-out in some measurements.

[“Input/Output variables - Preset behavior” on page 923](#)

The Input Port selection is the first menu under the **Input/Output** key:

Key Path:	Front-panel key
Remote Command:	[:SENSe] :FEED RF AIQ EMIXer [:SENSe] :FEED?
Example:	:FEED RF :FEED?
Couplings:	The [:SENSe]:FEED RF command turns the calibrator OFF
Preset:	This setting is unaffected by a Preset or power cycle. It survives a Mode Preset and mode changes. It is set to RF on a "Restore Input/Output Defaults" or "Restore System Defaults->All"
State Saved:	Saved in instrument state

Input/Output

<p>Backwards Compatibility SCPI:</p>	<p><code>[:SENSe]:FEED AREFERENCE</code></p> <p>In the PSA the calibrator was one of the inputs and selected using the AREF parameter to the same :FEED command that switched the inputs. In the X-Series it is controlled in a separate menu and overrides the input selection. For code compatibility the <code>[:SENSe]:FEED AREFERENCE</code> command is provided, and is aliased to <code>[SENSe]:FEED:AREF REF50</code>, which causes the input to be switched to the 50 MHz calibrator. The <code>[:SENSe]:FEED RF</code> command switches the input back to the RF port and turns the calibrator OFF, thus providing full compatibility with the PSA calibrator function.</p> <p>Note that after sending this, the query <code>[:SENSe]:FEED?</code> will NOT return "AREF" but instead the currently selected input.</p>
<p>Backwards Compatibility SCPI:</p>	<p><code>[:SENSe]:FEED IQ IONLy QONLy</code></p> <p><code>[:SENSe]:FEED?</code></p> <p>The parameters <code>IQ IONLy QONLy</code> are supported for backwards compatibility with the E44406A.</p> <p><code>[:SENSe]:FEED IQ</code> aliases to <code>[:SENSe]:FEED:IQ:TYPE IQ</code></p> <p><code>[:SENSe]:FEED IONLy</code> aliases to <code>[:SENSe]:FEED:IQ:TYPE IONLy</code></p> <p><code>[:SENSe]:FEED QONLy</code> aliases to <code>[:SENSe]:FEED:IQ:TYPE QONLy</code></p> <p>The query <code>[:SENSe]:FEED?</code> will always returns AIQ whatever the type of legacy parameters <code>IQ IONLy QONLy</code> has been used.</p>
<p>Backwards Compatibility Notes:</p>	<p>Most of the settings in the X-Series Input/Output system, including External Gain, Amplitude Corrections settings and data, etc., are shared by all modes and are not changed by a mode switch. Furthermore, most variables in the Input/Output system key are not affected by Mode Preset. Both of these behaviors represent a departure from legacy behavior.</p> <p>In the X-Series. Input/Output settings are reset by using the "Restore Input/Output Defaults" function. They can also be reset to their default values through the System->Restore System Defaults-> In/Out Config key or through the System ->Restore System Defaults -> All key (and corresponding SCPI).</p> <p>While this matches most use cases better, it does create some code compatibility issues. For example, Amplitude Corrections are no longer turned off by a Mode Preset, but instead by using the "Restore Input/Output Defaults" key/SCPI.</p> <p>Although Input/Output settings are not part of each Mode's State, they are saved in the Save State files, so that all of the instrument settings can be recalled with Recall State, as in legacy instruments.</p>
<p>Initial S/W Revision:</p>	<p>Prior to A.02.00</p>
<p>Remote Command:</p>	<p><code>:INPut :MIXer EXTernal INTernal</code></p> <p><code>:INPut :MIXer?</code></p>

Example:	INP:MIX INT INP:MIX?
Notes:	<p>1. In legacy analyzers you choose between the Internal mixer or an External Mixer. In the X-Series, the External Mixer is one of the choices for the Input and hence is selected using the FEED command (:SENSe:FEED EXTMixer).</p> <p>For compatibility, the INPut:MIXer EXTernal INTernal legacy command is mapped as follows:</p> <ol style="list-style-type: none"> 1. When INPut:MIXer EXTernal is received, SENSe:FEED EMIXer is executed. 2. When INPut:MIXer INTernal is received, SENSe:FEED RF is executed. 3. When INPut:MIXer? is received, the response will be INT if any input other than the external mixer is selected and EXT if the external mixer is selected
Preset:	INT
Backwards Compatibility Notes:	<p>1. PSA supports the following SCPI Command :</p> <pre>:INPut:MIXer:TYPE PRESelected UNPReselect</pre> <pre>:INPut:MIXer:TYPE?</pre> <p>PXA does not support the :INPut:MIXer:TYPE command.</p>
Initial S/W Revision:	A.08.01

Input/Output variables - Preset behavior

Virtually all the input/output settings are NOT a part of mode preset. They can be set to their default value by one of the three ways - by using the Restore Input/Output Defaults key on the first page of the input/output menu, by using the System->Restore System Defaults->Input/Output Settings or by using the System -> Restore System Defaults->All. Also, they survive a Preset and a Power cycle.

A very few of the Input/Output settings do respond to a Mode Preset; for example, if the Calibrator is on it turns off on a Preset, and if DC coupling is in effect it switches to AC on a Preset. These exceptions are made in the interest of reliability and usability, which overrides the need for absolute consistency. Exceptions are noted in the SCPI table for the excepted functions.

RF Input

Selects the front-panel RF input port to be the test set signal input. If RF is already selected, pressing this key accesses the RF input setup functions.

Key Path:	Input/Output
Example:	[:SENSe]:FEED RF

Input/Output

Readback:	The RF input port, RF coupling, and current input impedance settings appear on this key as: "XX, YY, ZZ" where XX is RF, RF2, RFIO1, RFIO2, depending on what input is selected (only appears on test sets with multiple RF inputs) YY is AC or DC ZZ is 50 or 75
Initial S/W Revision:	Prior to A.02.00

Input Z Correction

Sets the input impedance for unit conversions. This affects the results when the y-axis unit is voltage or current units (dBmV, dB μ V, dB μ A, V, A), but not when it is power units (dBm, W). The impedance you select is for computational purposes only, since the actual impedance is set by internal hardware to 50 ohms. Setting the computational input impedance to 75 ohms is useful when using a 75 ohm to 50 ohm adapter to measure a 75 ohm device on an test set with a 50 ohm input impedance.

There are a variety ways to make 50 to 75 ohm transitions, such as impedance transformers or minimum loss pads. The choice of the solution that is best for your measurement situation requires balancing the amount of loss that you can tolerate with the amount of measurement frequency range that you need. If you are using one of these pads/adaptors with the **Input Z Corr** function, you might also want to use the **Ext Gain** key. This function is used to set a correction value to compensate for the gain (loss) through your pad. This correction factor is applied to the displayed measurement values.

Key Path:	Input/Output, RF Input
Remote Command:	[:SENSe] :CORRection:IMPedance [:INPut] [:MAGNitude] 50 75 [:SENSe] :CORRection:IMPedance [:INPut] [:MAGNitude] ?
Example:	CORR:IMP 75 sets the input impedance correction to 75 ohms. CORR:IMP?
Couplings:	When the main RF Input is selected, the Input Z Correction will automatically change to 50 ohms. You may then change it to whatever is desired.
Preset:	This is unaffected by a Preset but is set to 50 ohms on a "Restore Input/Output Defaults" or "Restore System Defaults->All" Some instruments/options may have 75 ohms available.
State Saved:	Saved in instrument state
Readback:	50 Ω or 75 Ω Current setting reads back to the RF key.
Initial S/W Revision:	Prior to A.02.00

RF Input Port

Specifies the RF input port used. The RF Input Port key only appears on units with multiple inputs, and lets you switch between the two inputs.

Switching from the RF input port to one of the RFIO ports, on units which have them, changes the receiver performance of the instrument.

Key Path:	Input/Output, RF Input
Remote Command:	[:SENSe] :FEED:RF:PORT [:INPut] RFIN RFIN2 RFIO1 RFIO2 [:SENSe] :FEED:RF:PORT [:INPut] ?
Example:	:FEED:RF:PORT RFIN
Dependencies:	This key only appears in models that support multiple inputs. If the SCPI command is sent with unsupported parameters in any other model, an error is generated, -221.1900, "Settings conflict;option not installed" When any input is selected in a measurement that does not support it, the "No result; Meas invalid with this input" error condition occurs, and the measurement returns invalid data when queried.
Preset:	This is unaffected by Mode Preset but is set to RF on a "Restore Input/Output Defaults" or "Restore System Defaults -> All"
State Saved:	Saved in State
Readback:	The current RF Input Port selected is read back to this key
Backwards Compatibility SCPI:	INPut<1 2>:TYPE INPUT1 INPUT2 INPut<1 2>:TYPE? included for R&S ESU compatibility. In the MXE, the INPUT1 parameter is aliased to RFIN and the INPUT2 parameter is aliased to RFIN2
Initial S/W Revision:	A.05.01

RF Input

Specifies using the main RF port for the current measurement

Key Path:	Input/Output, RF Input, RF Input Port
Example:	:FEED:RF:PORT RFIN
ReadBack:	RF Input
Initial S/W Revision:	A.05.01

RFIO1

Specifies using the RFIO 1 port, if supported, for the current measurement

Key Path:	Input/Output, RF Input, RF Input Port
-----------	--

Input/Output

Example:	:FEED:RF:PORT RFIO1
Dependencies:	Only available in EXT. If Multiport Adapter is ON, Select RF Input to RFIO1, an error message is generated: “-221, Settings conflict; RFIO1 or RFIO2 Port unavailable when Multiport Adapter is ON”.
ReadBack:	RFIO 1
Initial S/W Revision:	A.05.01

RFIO2

Specifies using the RFIO 2 port, if supported, for the current measurement

Key Path:	Input/Output, RF Input, RF Input Port
Example:	:FEED:RF:PORT RFIO2
Dependencies:	Only available in EXT. If Multiport Adapter is ON, Select RF Input to RFIO1, an error message is generated: “-221, Settings conflict; RFIO1 or RFIO2 Port unavailable when Multiport Adapter is ON”.
ReadBack:	RFIO 2
Initial S/W Revision:	A.05.01

RF Calibrator

Lets you choose a calibrator signal to look at or turns the calibrator "off".

Key Path:	Input/Output
Remote Command:	[:SENSe] :FEED:AREFERENCE REF50 REF4800 OFF [:SENSe] :FEED:AREFERENCE?
Example:	FEED:AREF REF50 selects the 50 MHz amplitude reference as the signal input. FEED:AREF REF4800 selects the 4.8 GHz amplitude reference as the signal input FEED:AREF OFF turns the calibrator "off" (switches back to the selected input – RF or I/Q)
Dependencies:	Selecting an input (RF or I/Q) turns the Calibrator OFF. This is true whether the input is selected by the keys or with the [:SENSe]:FEED command. The 4.8 GHz internal reference is only available in some models and frequency range options. If the 4.8 GHz reference is not present, the 4.8 GHz softkey will be blanked, and if the REF4800 parameter is sent, the test set will generate an error.

Couplings:	When one of the calibrator signals is selected, the test set routes that signal (an internal amplitude reference) to the test set, and changes the main input selection to RF so the calibrator signal can be seen. When you turn the calibrator off it does not switch back to the previously selected input.
Preset:	OFF
State Saved:	Saved in instrument state
Readback:	Off, 50 MHz, 4.8 GHz
Initial S/W Revision:	Prior to A.02.00

Remote Command:	:CALibration:SOURce:STATe OFF ON 0 1 :CALibration:SOURce:STATe?
Notes:	For ESA backwards compatibility. In the ESA the calibrator was a separate output which you connected to the input and switched on with this command. In the X-Series, the ON parameter is aliased to the [SENSe]:FEED:AREF REF50 command and the OFF parameter is aliased to [SENSe]:FEED:AREF OFF. When CALibration:SOURce:STATe? is received, 1 will be returned if any of the references is selected and 0 if the Calibrator is "Off"
Preset:	OFF
Initial S/W Revision:	Prior to A.02.00

50 MHz

Selects the 50 MHz internal reference as the input signal.

Key Path:	Input/Output, RF Calibrator
Example:	:FEED:AREF REF50
Readback:	50 MHz
Initial S/W Revision:	Prior to A.02.00

Off

Switches the input back to the selected input (RF or I/Q)

Key Path:	Input/Output, RF Calibrator
Example:	:FEED:AREF OFF
Readback:	Off
Initial S/W Revision:	Prior to A.02.00

External Gain

Compensates for gain or loss in the measurement system outside the test set. The External Gain is subtracted from the amplitude readout (or the loss is added to the amplitude readout). So, the displayed signal level represents the signal level at the output of the device-under-test, which can be the input of an external device that provides gain or loss.

Entering an External Gain value does not affect the Reference Level, therefore the trace position on screen changes, as do all of values represented by the trace data. Thus, the values of exported trace data, queried trace data, marker amplitudes, trace data used in calculations such as N dB points, trace math, peak threshold, etc., are all affected by External Gain. Changing the External Gain, even on a trace which is not updating, will immediately change all of the above, without new data needing to be taken.

NOTE Changing the External Gain causes the test set to immediately stop the current sweep and prepare to begin a new sweep. The data will not change until the trace data updates because the offset is applied to the data as it is taken. If a trace is exported with a nonzero External Gain, the exported data will contain the trace data with the offset applied.

Key Path:	Input/Output
Couplings:	The Ext Preamp, MS, and BS keys may be grayed out depending on which measurement is currently selected. If any of the grayed out keys are pressed, or the equivalent SCPI command is sent, an advisory message is generated.
Readback:	1-of-N selection [variable]
Initial S/W Revision:	Prior to A.02.00

Ext Preamp

This function is similar to the reference level offset function. Both affect the displayed signal level. Ref Lvl Offset is a mathematical offset only, no test set configuration is affected. Ext Preamp gain is used when determining the auto-coupled value of the Attenuator. The External Gain value and the Maximum Mixer Level settings are both part of the automatic setting equation for the RF attenuation setting. (10 dB of Attenuation is added for every 10 dB of External Gain.)

Note that the Ref Lvl Offset and Maximum Mixer Level are described in the Amplitude section. They are reset by the instrument Preset. The External Preamp Gain is reset by the "Restore Input/Output Defaults" or "Restore System Defaults->All functions. . The External Gain is subtracted from the amplitude readout so that the displayed signal level represents the signal level at the output of the device-under-test, which is the input of the external device that is providing gain or loss.

Key Path:	Input/Output, External Gain
Remote Command:	[:SENSE] :CORRection:SA [:RF] :GAIN <rel_ampl> [:SENSE] :CORRection:SA [:RF] :GAIN?

Example:	CORR:SA:GAIN 10 sets the Ext Gain value to 10 dB CORR:SA:GAIN -10 sets the Ext Gain value to -10 dB (that is, an attenuation of 10 dB)
Notes:	Does not auto return.
Dependencies:	The reference level limits are determined in part by the External Gain/Atten, Max Mixer Level, and RF Atten. This key is grayed out in Modes that do not support External Gain
Preset:	This is unaffected by Preset but is set to 0 dB on a "Restore Input/Output Defaults" or "Restore System Defaults->All"
State Saved:	Saved in instrument state
Min:	-120 dB
Max:	120 dB
Readback:	Preamp Gain, <Ext Gain value> dB
Backwards Compatibility SCPI:	[:SENSe]:CORRection:OFFSet[:MAGNitude] The legacy "Ext Preamp Gain" key is now called "Ext Gain" and the sub-menu has choices of Ext Preamp MS BTS for backwards compatibility.
Initial S/W Revision:	Prior to A.02.00

MS

Sets an external gain/attenuation value for MS (Mobile Station) tests.

Key Path:	Input/Output, External Gain
Remote Command:	[:SENSe]:CORRection:MS[:RF]:GAIN <rel_amp1> [:SENSe]:CORRection:MS[:RF]:GAIN?
Example:	CORR:MS:GAIN 10 sets the Ext Gain value to 10 dB CORR:MS:GAIN -10 sets the Ext Gain value to -10 dB (that is, a loss of 10 dB.)
Notes:	Does not auto return.
Dependencies:	The reference level limits are determined in part by the External Gain, Max Mixer Level, RF Atten This key is grayed out in modes that do not support MS.
Preset:	This is unaffected by a Preset but is set to 0 dB on a "Restore Input/Output Defaults" or "Restore System Defaults->All"
State Saved:	Saved in instrument state.

Input/Output

Min:	-100 dB
Max:	100 dB
Readback:	MS, <Ext Gain value> dB
Initial S/W Revision:	Prior to A.02.00

Remote Command:	<code>[:SENSE] :CORRection:MS [:RF] :LOSS <rel_ampl></code> <code>[:SENSE] :CORRection:MS [:RF] :LOSS?</code>
Example:	<code>CORR:MS:LOSS 10</code> sets the Ext Gain value to -10 dB, and subsequently querying <code>:LOSS</code> will give 10 dB <code>CORR:MS:LOSS -10</code> sets the Ext Gain value to 10 dB, and subsequently querying <code>:LOSS</code> will give -10 dB
Notes:	A positive value of <rel_ampl> in the above command means a loss and a negative value indicates a gain. Anytime <code>:LOSS</code> is set it sets <code>:GAIN</code> to the negative value of the parameter sent. Anytime <code>:LOSS</code> is queried it gives the negative of <code>:GAIN</code>
Preset:	This is unaffected by a Preset but is set to 0 dB on a "Restore Input/Output Defaults" or "Restore System Defaults->All"
Min:	100 dB
Max:	-100 dB
Initial S/W Revision:	Prior to A.02.00

BTS

Sets an external attenuation value for BTS (Base Transceiver Station) tests.

Key Path:	Input/Output, External Gain
Remote Command:	<code>[:SENSE] :CORRection:BTS [:RF] :GAIN <rel_ampl></code> <code>[:SENSE] :CORRection:BTS [:RF] :GAIN?</code>
Example:	<code>CORR:BTS:GAIN 10</code> sets the Ext Gain value to 10 dB <code>CORR:BTS:GAIN -10</code> sets the Ext Gain value to -10 dB (that is, a loss of 10 dB.)
Notes:	Does not auto return.
Dependencies:	The reference level limits are determined in part by the External Gain, Max Mixer Level, RF Atten This key is grayed out in modes that do not support BTS.

Preset:	This is unaffected by a Preset but is set to 0 dB on a "Restore Input/Output Defaults" or "Restore System Defaults->All"
State Saved:	Saved in instrument state.
Min:	-100 dB
Max:	100 dB
Readback:	BTS, <Ext Gain value> dB
Initial S/W Revision:	Prior to A.02.00

Remote Command:	[:SENSE] :CORRection:BTS [:RF] :LOSS <rel_ampl> [:SENSE] :CORRection:BTS [:RF] :LOSS?
Example:	CORR:BTS:LOSS 10 sets the Ext Gain value to -10 dB, and subsequently querying :LOSS will give 10 dB CORR:BTS:LOSS -10 sets the Ext Gain value to 10 dB, and subsequently querying :LOSS will give -10 dB
Notes:	A positive value of <rel_ampl> in the above command means a loss and a negative value indicates a gain. Anytime :LOSS is set it sets :GAIN to the negative value of the parameter sent. Anytime :LOSS is queried it gives the negative of :GAIN
Preset:	This is unaffected by a Preset but is set to 0 dB on a "Restore Input/Output Defaults" or "Restore System Defaults->All"
Min:	100 dB
Max:	-100 dB
Initial S/W Revision:	Prior to A.02.00

Restore Input/Output Defaults

This selection causes the group of settings and data associated with the **Input/Output** key to be a reset to their default values. In addition, when a Source is installed, licensed and selected, Restore Input/Output defaults will initiate a Source Preset.

This level of Restore System Defaults does not affect any other system settings or mode settings and does not cause a mode switch. All the features described in this section are reset using this key, including Input Corrections and Data (described in the Corrections section).

Key Path:	Input/Output
Example:	:SYST:DEF INP presets all the Input/Output variables to their factory default values.

Input/Output

Notes:	Refer to the Utility Functions for information about Restore System Defaults and the complete description of the :SYSTem:DEFault INPut: command.
Initial S/W Revision:	Prior to A.02.00

Data Source

Gives you the choice of either using a hardware input signal as the input or raw data stored in a data storage buffer from an earlier acquisition. You can also share raw data across certain measurements that support this feature. The measurements must be capable of storing raw data. There are three choices under this menu. You can select "Inputs" which is the same as selecting one of the inputs from the input port, for example RF, AREF, I/Q, or IFALign. Selecting "Capture Buffer" allows you to use data that has been stored earlier in the same measurement or from a previous measurement using the "Current Meas -> Capture Buffer" feature. Selecting "Recorded Data" allows you to playback long data capture records stored in the record buffer.

Key Path:	Input/Output
Remote Command:	[:SENSe] :FEED:DATA INPut STORed [:SENSe] :FEED:DATA?
Example:	FEED:DATA STOR FEED:DATA?
Notes:	INPutS = Inputs STORed = Capture Buffer
Dependencies:	Not all inputs are available in all modes. Unavailable keys are grayed out.
Preset:	This is unaffected by Preset but is set to INPut on a "Restore Input/Output Defaults" or "Restore System Defaults->All"
State Saved:	Saved in instrument state
Readback:	Variable
Backwards Compatibility SCPI:	[:SENSe]:FEED:SOURce INPut STORed [:SENSe]:FEED:SOURce?
Initial S/W Revision:	Prior to A.02.00

Inputs

Sets the measurement to use the input selections (RF, AREF, I/Q)

Key Path:	Input/Output, Data Source
Example:	FEED:DATA INP causes the measurement to look at the input selection
Notes:	Does not auto return.

Readback:	Inputs
Initial S/W Revision:	Prior to A.02.00

Capture Buffer

Some WCDMA and demod measurements support this feature. This allows sharing of the raw data across certain measurements. If you want to make another measurement on the same signal, you would store that raw data using the "Current Meas -> Capture Buffer" key. Then the data is available for the next measurement to use. You must have raw data stored in the instrument memory before the Capture Buffer choice is available for use.

Key Path:	Input/Output, Data Source
Example:	FEED:DATA STOR causes stored measurement data to be used with a different measurement that supports this.
Notes:	Does not auto return. This key is grayed out when you switch to a measurement that does not support this feature.
Dependencies:	If you switch to a measurement that does not support this feature, then the instrument switches to use "Inputs" and grays out this key. If the grayed out key is pressed, it generates a message.
Readback:	Stored Data
Initial S/W Revision:	Prior to A.02.00

Current Meas -> Capture Buffer

Pressing this key stores the raw data of one measurement in the internal memory of the instrument where it can then be used by a different measurement by pressing "Stored Data". When raw data is stored, then the data source selection switch automatically changes to "Stored Data". Stored raw data cannot be directly accessed by a user. There is no save/recall function to save the raw data in an external media. However if you want to get the stored raw data, you must first perform a measurement using the stored raw data. Now you can access the used raw data, which is the same as stored raw data, using the FETCh or READ commands.

Key Path:	Input/Output, Data Source
Remote Command:	[:SENSe] :FEED:DATA:STORe
Example:	FEED:DATA:STOR stores recorded data
Notes:	This is command only, there is no query
Backwards Compatibility SCPI:	[:SENSe]:FEED:SOURce:STORe
Initial S/W Revision:	Prior to A.02.00

Corrections

This key accesses the Amplitude Corrections menu.

Input/Output

Amplitude Corrections arrays can be entered, sent over SCPI, or loaded from a file. They allow you to correct the response of the test set for various use cases. The X-series supports four separate Corrections arrays, each of which can contain up to 2000 points. They can be turned on and off individually and any or all can be on at the same time.

Trace data is in absolute units and corrections data is in relative units, but we want to be able to display trace data at the same time as corrections data. Therefore we establish a reference line to be used while building or editing a Corrections table. The reference line is halfway up the display and represents 0 dB of correction. It is labeled "0 dB CORREC". It is drawn in blue.

Corrections data is always in dB. Whatever dB value appears in the correction table represents the correction to be applied to that trace at that frequency. So if a table entry shows 30 dB that means we ADD 30 dB to each trace to correct it before displaying it.

In zero span, where the frequency is always the center frequency of the test set, we apply the (interpolated) correction for the center frequency to all points in the trace. In the event where there are two correction amplitudes at the center frequency, we apply the first one in the table.

Note that the corrections are applied as the data is taken; therefore, a trace in **View** (Update Off) will not be affected by changes made to the corrections table after the trace is put in **View**.

Instruments that have multiple Input/Output RF ports can have different corrections applied to the different ports. There are 4 sets of corrections that can be applied to the RF ports; ports cannot share the same set of corrections but a single port can have multiple corrections applied to it. The correction data is applied to incoming signals as well as transmitted signals and is in the form of a list of spot frequencies and amplitude correction levels.

Key Path:	Input/Output, Corrections
Mode:	SEQAN, TDSCDMA
Dependencies:	<p>This key will only appear if you have the proper option installed in your instrument.</p> <p>Amplitude correction may not be available in all modes; if a mode does not support amplitude correction, the Corrections key should be blanked while in that mode. If an application supports corrections but the current measurement does not, then the key should be grayed out in that measurement.</p> <p>This menu selection does not have any effect when Input/Output, RF Output & Test Set Config, Multiport Adapter, Multiport Adapter is set to the On state and Input/Output, RF Output & Test Set Config, RF Output is RF Output.</p>
Preset:	Corrections arrays are reset (deleted) by Restore Input/Output Defaults. They survive shutdown and restarting of the test set application, which means they will survive a power cycle.
Initial S/W Revision:	A.02.00

Correction On/Off

Turning the Selected Correction on allows the values in it to be applied to the data. This also automatically turns on "Apply Corrections" (sets it to ON), otherwise the correction would not take effect.

A new sweep is initiated if an amplitude correction is switched on or off. Note that changing, sending or loading corrections data does NOT directly initiate a sweep, however in general these operations will turn corrections on, which DOES initiate a sweep.

Key Path:	Input/Output, Corrections
Remote Command:	[:SENSe] :CORRection:CSET [1] 2 3 4 5 6 [:STATe] ON OFF 1 0 [:SENSe] :CORRection:CSET [1] 2 3 4 5 6 [:STATe] ?
Example:	SENS:CORR:CSET1 ON
Dependencies:	Turning this on automatically turns on "Apply Corrections" Only the first correction array (Correction 1) supports antenna units. When this array is turned on, and it contains an Antenna Unit other than "None", the Y Axis Unit of the test set is forced to that Antenna Unit. All other Y Axis Unit choices are grayed out. Note that this means that a correction file with an Antenna Unit can only be loaded into the Corrections 1 register. Consequently only for Correction 1 does the dropdown in the Recall dialog include .ant, and if an attempt is made to load a correction file into any other Correction register which DOES contain an antenna unit, a Mass Storage error is generated. This command will generate an "Option not available" error unless you have the proper option installed in your instrument.
Preset:	Not affected by a Preset. Set to OFF by Restore Input/Output Defaults
State Saved:	Saved in instrument state.
Backwards Compatibility Notes:	Unlike legacy analyzers, Preset does not turn Corrections off (Restore Input/Output Defaults does).
Initial S/W Revision:	A.02.00

Properties

Accesses a menu that lets you set the properties of the selected correction.

Key Path:	Input/Output, Corrections
Initial S/W Revision:	A.02.00

Select Correction

Specifies the selected correction. The term "selected correction" is used throughout this document to specify which correction will be affected by the functions.

Key Path:	Input/Output, Corrections, Properties
Notes:	The selected correction is remembered even when not in the correction menu.
Preset:	Set to Correction 1 by Restore Input/Output Defaults.

Input/Output

Readback:	Correction 1 Correction 2 Correction 3 Correction 4 Correction 5 Correction 6
Initial S/W Revision:	A.02.00

Frequency Interpolation

This setting controls how the correction values per-bucket are calculated. We interpolate between frequencies in either the logarithmic or linear scale.

This setting is handled and stored individually per correction set.

See “[Interpolation](#)” on page 936

Key Path:	Input/Output, Corrections, Properties
Remote Command:	<code>[[:SENSE]:CORREction:CSET[1] 2 3 4 5 6:X:SPACing LINear LOGarithmic [:SENSe]:CORREction:CSET[1] 2 3 4 5 6:X:SPACing?</code>
Example:	<code>CORR:CSET:X:SPAC LIN</code>
Preset:	Unaffected by a Preset. Set to Linear by Restore Input/Output Defaults.
State Saved:	Saved in instrument state.
Initial S/W Revision:	A.02.00

Interpolation

For each bucket processed by the application, all of the correction factors at the frequency of interest (center frequency of each bucket) are summed and added to the amplitude. All trace operations and post processing treat this post-summation value as the true signal to use.

To effect this correction, the goal, for any particular start and stop frequency, is to build a correction trace, whose number of points matches the current Sweep Points setting of the instrument, which will be used to apply corrections on a bucket by bucket basis to the data traces.

For amplitudes that lie between two user specified frequency points, we interpolate to determine the amplitude value. You may select either linear or logarithmic interpolation between the frequencies.

If we interpolate on a log scale, we assume that the line between the two points is a straight line on the log scale. For example, let’s say the two points are (2,4) and (20,1). A straight line between them on a log scale looks like:

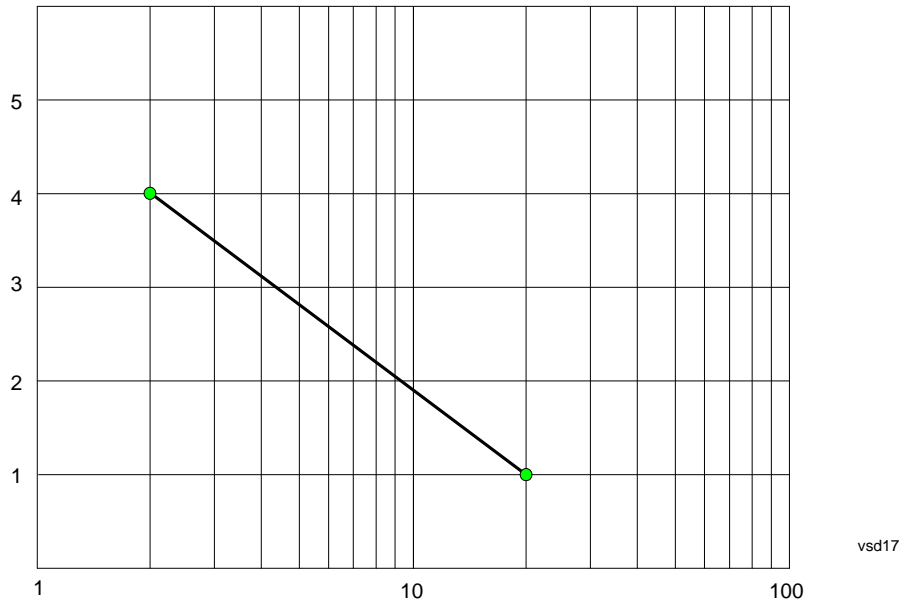

On a linear scale (like that of the test set), this translates to:

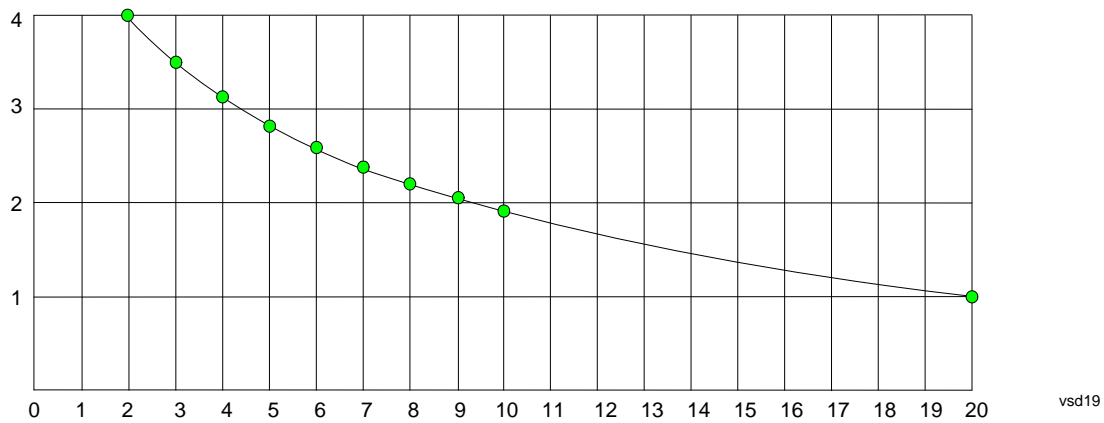

If we interpolate on a linear scale, we assume that the two points are connected by a straight line on the linear scale, as below:

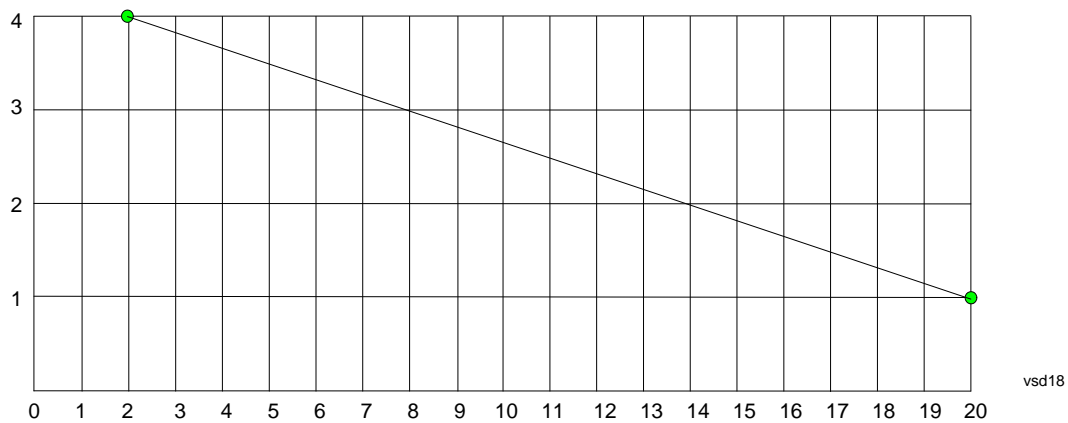

Input/Output

The correction to be used for each bucket is taken from the interpolated correction curve at the center of the bucket.

Description

Sets an ASCII description field which will be stored in an exported file. Can be displayed in the active function area by selecting as the active function, if desired to be in a screen dump.

Key Path:	Input/Output, Corrections, Properties
Remote Command:	[:SENSe] :CORRection:CSET [1] 2 3 4 5 6 :DESCRiption "text" [:SENSe] :CORRection:CSET [1] 2 3 4 5 6 :DESCRiption?
Example:	:CORR:CSET1:DESC "11941A Antenna correction"
Notes:	45 chars max; may not fit on display if max chars used
Preset:	Unaffected by a Preset. Set to empty by Restore Input/Output Defaults
State Saved:	Saved in instrument state.
Initial S/W Revision:	A.02.00

Comment

Sets an ASCII comment field which will be stored in an exported file. Can be displayed in the active function area by selecting as the active function, if desired to be in a screen dump.

Key Path:	Input/Output, Corrections, Properties
Remote Command:	[:SENSe] :CORRection:CSET [1] 2 3 4 5 6 :COMMent "text" [:SENSe] :CORRection:CSET [1] 2 3 4 5 6 :COMMent?
Example:	:CORR:CSET1:COMM "this is a comment"
Notes:	60 chars max; may not fit on display if max chars used
Preset:	Unaffected by Preset. Set to empty by Restore Input/Output Defaults
State Saved:	Saved in instrument state
Initial S/W Revision:	A.02.00

RF Port

This menu and all of its submenus are only available in the EXT.

Maps one of the sets of corrections to one of the IO ports.

Key Path:	Input/Output, Corrections, Properties
Mode:	SEQAN

Remote Command:	[:SENSE] :CORRection:CSET [1 2 3 4 5 6 :RF:PORT RFIN RFIO1 RFIO2 RFOut [:SENSE] :CORRection:CSET [1 2 3 4 5 6 :RF:PORT?
Example:	:CORR:CSET:RF:PORT RFIN
Remote Command Notes:	
Dependencies:	Only available in EXT
Couplings:	
Preset:	Unaffected by Preset. Set to RF by Restore Input/Output Defaults
State Saved:	Saved in State
Initial S/W Revision:	A.05.01

RF Input

The port that the current corrections will be applied to.

Key Path:	Input/Output, Corrections, Properties, RF Port
Example:	:CORR:CSET:RF:PORT RFIN
Dependencies:	Only available in EXT
ReadBack:	RF IN
Initial S/W Revision:	A.05.01

RFOut

The port that the current corrections will be applied to.

Key Path:	Input/Output, Corrections, Properties, RF Port
Example:	:CORR:CSET:RF:PORT RFO
Dependencies:	Only available in EXT
ReadBack:	RFOut
Initial S/W Revision:	A.05.01

RFIO1

The port that the current corrections will be applied to. Pressing this key again allows the user access to the menu for specifying which internal device the corrections for RFIO 1 will be applied to.

Key Path:	Input/Output, Corrections, Properties, RF Port
Remote Command:	[:SENSE] :CORRection:CSET [1 2 3 4 5 6 :RF:PORT:RFIO1 SOURce ANALyzer BOTH [:SENSE] :CORRection:CSET [1 2 3 4 5 6 :RF:PORT:RFIO1?

Input/Output

Example:	:CORR:CSET:RF:PORT:RFIO1 BOTH
Preset:	Both
State Saved:	Saved in State

Correct Source

Sets the corrections for the RFIO1 port to be applied to the source.

Key Path:	Input/Output, Corrections, Properties, RF Port
Example:	:CORR:CSET:RF:PORT:RFIO1 SOUR
Readback:	"Correct Source"

Correct Analyzer

Sets the corrections for the RFIO1 port to be applied to the test set.

Key Path:	Input/Output, Corrections, Properties, RF Port
Example:	:CORR:CSET:RF:PORT:RFIO1 ANAL
Readback:	"Correct Analyzer"

Correct Source and Analyzer

Sets the corrections for the RFIO1 port to be applied to both the source and the test set.

Key Path:	Input/Output, Corrections, Properties, RF Port
Example:	:CORR:CSET:RF:PORT:RFIO1 BOTH
Readback:	"Correct Source and Analyzer"

RFIO2

The port that the current corrections will be applied to. Pressing this key again allows the user access to the menu for specifying which internal device the corrections for RFIO 2 will be applied to.

Key Path:	Input/Output, Corrections, Properties, RF Port
Remote Command:	[:SENSe] :CORRection:CSET [1] 2 3 4 5 6 :RF:PORT:RFIO2 SOURce ANALyzer BOTH [:SENSe] :CORRection:CSET [1] 2 3 4 5 6 :RF:PORT:RFIO2?
Example:	:CORR:CSET:RF:PORT:RFIO2 BOTH
Preset:	Both
State Saved:	Saved in State

Correct Source

Sets the corrections for the RFIO2 port to be applied to the source.

Key Path:	Input/Output, Corrections, Properties, RF Port
Example:	:CORR:CSET:RF:PORT:RFIO2 SOUR
Readback:	"Correct Source"

Correct Analyzer

Sets the corrections for the RFIO2 port to be applied to the test set.

Key Path:	Input/Output, Corrections, Properties, RF Port
Example:	:CORR:CSET:RF:PORT:RFIO2 ANAL
Readback:	"Correct Analyzer"

Correct Source and Analyzer

Sets the corrections for the RFIO2 port to be applied to both the source and the test set.

Key Path:	Input/Output, Corrections, Properties, RF Port
Example:	:CORR:CSET:RF:PORT:RFIO2 BOTH
Readback:	"Correct Source and Analyzer"

Edit

Invokes the integrated editing facility for this correction set.

When entering the menu, the editor window turns on, the selected correction is turned **On**, **Apply Corrections** is set to **On**, the amplitude scale is set to **Log**, and the Amplitude Correction (“Ampcor”) trace is displayed. The actual, interpolated correction trace is shown in green for the selected correction. Note that since the actual interpolated correction is shown, the correction trace may have some curvature to it. This trace represents only the correction currently being edited, rather than the total, accumulated amplitude correction for all amplitude corrections which are currently on, although the total, accumulated correction for all corrections which are turned on is still applied to the data traces.

Because corrections data is always in dB, but the Y-axis of the test set is in absolute units, it is necessary to establish a reference line for display of the Corrections data. The reference line is halfway up the display and represents 0 dB of correction. It is labeled “0 dB CORREC”. It is drawn in blue.

Corrections data is always in dB. Whatever dB value appears in the correction table represents the correction to be applied to that trace at that frequency. So if a table entry shows 30 dB that means we ADD 30 dB to each trace to correct it before displaying it. By definition all points are connected. If a gap is desired for corrections data, enter 0 dB.

Note that a well-designed Corrections array should start at 0 dB and end at 0 dB. This is because whatever the high end point is will be extended to the top frequency of the instrument, and whatever the

Input/Output

low end point is will be extended down to 0 Hz. So for a Corrections array to have no effect outside its range, you should start and end the array at 0 dB.

NOTE The table editor will only operate properly if the test set is sweeping, because its updates are tied to the sweep system. Thus, you should not try to use the editor in single sweep, and it will be sluggish during compute-intensive operations like narrow-span FFT sweeps.

When exiting the edit menu (by using the **Return** key or by pressing an instrument front-panel key), the editor window turns off and the Ampcor trace is no longer displayed; however, **Apply Corrections** remains **On**, any correction that was on while in the editor remains on, and the amplitude scale returns to its previous setting.

Corrections arrays are not affected by a Preset, because they are in the Input/Output system. They also survive shutdown and restarting of the test set application, which means they will survive a power cycle.

Key Path:	Input/Output, Corrections
Initial S/W Revision:	A.02.00

Navigate

Lets you move through the table to edit the desired point.

Key Path:	Input/Output, Corrections, Edit
Notes:	There is no value readback on the key
Min:	1
Max:	2000
Initial S/W Revision:	A.02.00

Frequency

Lets you edit the frequency of the current row.

Key Path:	Input/Output, Corrections, Edit
Notes:	There is no value readback on the key.
Min:	0
Max:	1 THz
Initial S/W Revision:	A.02.00

Amplitude

Lets you edit the Amplitude of the current row.

Key Path:	Input/Output, Corrections, Edit
-----------	--

Notes:	There is no value readback on the key.
Min:	-1000 dB
Max:	1000 dB
Initial S/W Revision:	A.02.00

Insert Point Below

Inserts a point below the current point. The new point is a copy of the current point and becomes the current point. The new point is not yet entered into the underlying table, and the data in the row is displayed in light gray.

Key Path:	Input/Output, Corrections, Edit
Initial S/W Revision:	A.02.00

Delete Point

Deletes the currently-selected point, whether or not that point is being edited, and selects the Navigate functionality. The point following the currently-selected point (or the point preceding if there is none) will be selected.

Key Path:	Input/Output, Corrections, Edit
Initial S/W Revision:	A.02.00

Delete Correction

Deletes the correction values for this set. When this key is pressed a prompt is placed on the screen that says "Please press Enter or OK key to delete correction. Press ESC or Cancel to close this dialog." The deletion is only performed if you press OK or Enter.

Key Path:	Input/Output, Corrections
Remote Command:	[:SENSE] :CORRection:CSET [1] 2 3 4 5 6 :DELete
Example:	CORR:CSET:DEL CORR:CSET1:DEL CORR:CSET4:DEL
Notes:	Pressing this key when no corrections are present is accepted without error.
Initial S/W Revision:	A.02.00

Apply Corrections

Applies amplitude corrections which are marked as ON to the measured data. If this is set to OFF, then no amplitude correction sets will be used, regardless of their individual on/off settings. If set to ON, the

Input/Output

corrections that are marked as ON (see “Correction On/Off” on page 934) are used.

Key Path:	Input/Output, Corrections
Remote Command:	[:SENSe] :CORRection:CSET:ALL [:STATe] ON OFF 1 0 [:SENSe] :CORRection:CSET:ALL [:STATe] ?
Example:	SENS:CORR:CSET:ALL OFF This command makes sure that no amplitude corrections are applied, regardless of their individual on/off settings.
Preset:	Not affected by Preset. Set to OFF by Restore Input/Output Defaults
State Saved:	Saved in instrument state.
Initial S/W Revision:	A.02.00

Delete All Corrections

Erases all correction values for all 4 Amplitude Correction sets.

When this key is pressed a prompt is placed on the screen that says “Please press Enter or OK key to delete all corrections. Press ESC or Cancel to close this dialog.” The deletion is only performed if you press OK or Enter.

Key Path:	Input/Output, Corrections
Remote Command:	[:SENSe] :CORRection:CSET:ALL:DELeTe
Example:	CORR:CSET:ALL:DEL
Initial S/W Revision:	A.02.00

Remote Correction Data Set Commands

Set (Replace) Data (Remote Command Only)

The command takes an ASCII series of alternating frequency and amplitude points, each value separated by commas.

The values sent in the command will totally replace all existing correction points in the specified set.

An Ampcor array can contain 2000 points maximum.

Remote Command:	[:SENSe] :CORRection:CSET [1] 2 3 4 5 6 :DATA <freq> , <ampl> , . . . [:SENSe] :CORRection:CSET [1] 2 3 4 5 6 :DATA?
Example:	CORR:CSET1:DATA 10000000,-1.0,20000000,1.0 This defines two correction points at (10 MHz, -1.0 dB) and (20 MHz, 1.0 dB) for correction set 1.
Preset:	Empty after Restore Input/Output Defaults. Survives a shutdown or restart of test set application (including a power cycle).

State Saved:	Saved in instrument state.
Min:	Freq: 0 Hz Amptd: -1000 dBm
Max:	Freq: 1 THz Amptd: +1000 dBm
Initial S/W Revision:	A.02.00

Merge Correction Data (Remote Command Only)

The command takes an ASCII series of alternating frequency and amplitude points, each value separated by commas. The difference between this command and Set Data is that this merges new correction points into an existing set.

Any new point with the same frequency as an existing correction point will replace the existing point's amplitude with that of the new point.

An Ampcor array can contain 2000 total points, maximum.

Remote Command:	<code>[:SENSE] :CORRection:CSET [1 2 3 4 5 6 :DATA:MERGe <freq>, <ampl>, ...</code>
Example:	<code>CORR:CSET1:DATA:MERGE 15000000,-5.0,25000000,5.0</code> This adds two correction points at (15 MHz, -5.0 dB) and (25 MHz, 5.0 dB) to whatever values already exist in correction set 1.
Preset:	Empty after Restore Input/Output Defaults. Survives shutdown/restart of test set application (including power cycle)
Min:	Freq: 0 Hz Amptd: -1000 dBm
Max:	Freq: 1 THz Amptd: +1000 dBm
Initial S/W Revision:	A.02.00

Freq Ref In

Specifies the frequency reference as being the internal reference, external reference or sensing the presence of an external reference.

When the frequency reference is set to internal, the internal 10 MHz reference is used even if an external reference is connected.

When the frequency reference is set to external, the instrument will use the external reference. However, if there is no external signal present, or it is not within the proper amplitude range, a condition error message is generated. When the external signal becomes valid, the error is cleared.

If Sense is selected, the instrument checks whether a signal is present at the external reference connector and will automatically switch to the external reference when a signal is detected. When no signal is

Input/Output

present, it automatically switches to the internal reference. No message is generated as the reference switches between external and internal. The monitoring of the external reference occurs approximately on 1 millisecond intervals, and never occurs in the middle of a measurement acquisition, only at the end of the measurement (end of the request).

If for any reason the instrument's frequency reference is not able to obtain lock, Status bit 2 in the Questionable Frequency register will be true and a condition error message is generated. When lock is regained, Status bit 2 in the Questionable Frequency register will be cleared and the condition error will be cleared.

If an external frequency reference is being used, you must enter the frequency of the external reference if it is not exactly 10 MHz. The External Ref Freq key is provided for this purpose.

Key Path:	Input/Output
Remote Command:	[:SENSe] :ROSCillator :SOURce :TYPE INTernal EXTernal SENSe [:SENSe] :ROSCillator :SOURce :TYPE?
Preset:	This is unaffected by a Preset but is set to SENSe on a "Restore Input/Output Defaults" or "Restore System Defaults->All".
State Saved:	Saved in instrument state.
Status Bits/OPC dependencies:	STATus:QUEStionable:FREQUency bit 2 set if unlocked.
Backwards Compatibility Notes:	1. Freq Ref In was not saved in state in the legacy instruments. It is a part of state in the X-Series.
Initial S/W Revision:	Prior to A.02.00

Remote Command:	[:SENSe] :ROSCillator :SOURce ?
Notes:	The query [SENSe]:ROSCillator:SOURce? returns the current switch setting. This means: <ol style="list-style-type: none"> 1. If it was set to SENSe but there is no external reference so the instrument is actually using the internal reference, then this query returns INTernal and not SENSe. 2. If it was set to SENSe and there is an external reference present, the query returns EXTernal and not SENSe. 3. If it was set to EXTernal, then the query returns "EXTernal" 4. If it was set to INTernal, then the query returns "INTernal"
Preset:	SENSe

Backwards Compatibility Notes:	The query [:SENSe]:ROSCillator:SOURce? was a query-only command in ESA which always returned whichever reference the instrument was using. The instrument automatically switched to the ext ref if it was present. In PSA (which had no sensing) the command [:SENSe]:ROSCillator:SOURce set the reference (INT or EXT), so again its query returned the actual routing. Thus the query form of this command is 100% backwards compatible with both instruments.
Initial S/W Revision:	Prior to A.02.00

Remote Command:	[:SENSe]:ROSCillator:SOURce INTernal EXTernal
Notes:	For PSA compatibility the command form is provided and is directly mapped to [:SENSe]:ROSCillator:SOURce:TYPE
Initial S/W Revision:	Prior to A.02.00

Sense

The external reference is used if a valid signal is sensed at the Ext Ref input. Otherwise the internal reference is used.

Key Path:	Input/Output, Freq Ref In
Example:	:ROSC:SOUR:TYPE SENS
Readback:	Sense
Initial S/W Revision:	Prior to A.02.00

Internal

The internal reference is used.

Key Path:	Input/Output, Freq Ref In
Example:	:ROSC:SOUR:TYPE INT
Readback:	Internal
Initial S/W Revision:	Prior to A.02.00

External

The external reference is used.

Key Path:	Input/Output, Freq Ref In
Example:	:ROSC:SOUR:TYPE EXT
Readback:	External
Initial S/W Revision:	Prior to A.02.00

Input/Output

Ext Ref Freq

This key tells the test set the frequency of the external reference. When the external reference is in use (either because the reference has been switched to External or because the Reference has been switched to Sense and there is a valid external reference present) this information is used by the test set to determine the internal settings needed to lock to that particular external reference signal.

For the instrument to stay locked, the value entered must be within 5 ppm of the actual external reference frequency. So it is important to get it close, or you risk an unlock condition.

Note that this value only affects the instrument's ability to lock. It does not affect any calculations or measurement results. See "Freq Offset" in the Frequency section for information on how to offset frequency values.

Key Path:	Input/Output, Freq Ref In
Remote Command:	<code>[:SENSe] :ROSCillator :EXTernal :FREQUENCY <freq></code> <code>[:SENSe] :ROSCillator :EXTernal :FREQUENCY?</code>
Example:	ROSC:EXT:FREQ 20 MHz sets the external reference frequency to 20 MHz, but does not select the external reference. ROSC:SOUR:TYPE EXT selects the external reference.
Notes:	Still available with Internal selected, to allow setup for when External is in use.
Preset:	This is unaffected by a Preset but is set to 10 MHz on a "Restore Input/Output Defaults" or "Restore System Defaults->All"
Min:	CXA: 10 MHz EXA: 10 MHz or 13 MHz, depending on whether N9010A-R13 is licensed MXA: 1 MHz PXA: 1 MHz 1 MHz
Max:	CXA: 10 MHz EXA: 10 MHz MXA: 50 MHz PXA: 50 MHz 50 MHz
Default Unit:	Hz
Initial S/W Revision:	Prior to A.02.00

RF Output & Test Set Config

This menu and all of its submenus are only available in the EXT (E6607A/B/C).

Access the menu to select the front-panel RF output port to be the test set signal output. If RF is

already selected, pressing this key accesses the RF output setup functions.

EXT (E6607A/B)

The RF Output & Test Set Config key allows you to set the RF Output Port and multiport adapter unit which is connected to the EXT by USB for download of calibration data and additional control.

EXT (E6607C)

The RF Output & Test Set Config key allows you to set the RF Output Port and MPA settings.

Key Path:	Input/Output
Dependencies:	Only available in EXT
Preset:	All settings under this key are returned to their default state when Restore Input/Output Defaults is pressed.
State Saved:	Saved in State
Initial S/W Revision:	A.10.00

RF Output

Specifies the RF Output Port used.

Switching from the RF Output port to one of the RFIO ports changes the transmitter performance of the instrument.

Key Path:	Input/Output, RF Output & Test Set Config
Remote Command:	[:SENSE] :FEED:RF:PORT:OUTPut RFOut RFIO1 RFIO2 [:SENSE] :FEED:RF:PORT:OUTPut?
Example:	:FEED:RF:PORT:OUTP RFIO1
Dependencies:	Only available in EXT
Preset:	This is unaffected by Mode Preset but is set to RFOut on a "Restore Input/Output Defaults" or "Restore System Defaults -> All"
State Saved:	Saved in State
Readback Text:	The current RF Output Port selected is read back to this key
Initial S/W Revision:	A.05.01

RF Out

The RF port that will be used for the current output

Key Path:	Input/Output, RF Output & Test Set Config, RF Output
Example:	:FEED:RF:PORT:OUTP RFO
Dependencies:	Only available in EXT

Input/Output

ReadBack:	RF Output
Initial S/W Revision:	A.05.01

RFIO1

The RF port that will be used for the current output

Key Path:	Input/Output, RF Output & Test Set Config, RF Output
Example:	:FEED:RF:PORT:OUTP RFIO1
Dependencies:	Only available in EXT.
ReadBack:	RFIO1
Initial S/W Revision:	A.05.01

RFIO2

The RF port that will be used for the current output

Key Path:	Input/Output, RF Output & Test Set Config, RF Output
Example:	:FEED:RF:PORT:OUTP RFIO2
Dependencies:	Only available in EXT.
ReadBack:	RFIO2
Initial S/W Revision:	A.05.01

Multiport Adapter

The Multiport Adapter key allows you to set the multiport adapter unit which is connected to the EXT by USB for download of calibration data and additional control.

Multiport Adapter is only available in the EXT (E6607A/B/C), and is blanked for other models.

EXT (E6607A/B)

The Multiport Adapter key will not be displayed if the multiport adapter unit is not connected to the EXT by USB.

EXT (E6607C)

The MPA is integrated into the instrument; therefore, the Multiport Adapter key is always displayed.

See [“More Information” on page 951](#)

Key Path:	Input/Output, RF Output & Test Set Config
-----------	--

Dependencies:	Multiport adapter is only available for EXT (E6607A/B) model, and is blanked for other models. Multiport adapter unit is connected to EXT by USB for download of calibration data and additional control.
Preset:	All settings under this key are returned to their default state when Restore Input/Output Defaults is pressed.
State Saved:	All settings under this key, are remembered when you unplugged the multiport adapter unit USB connection, so that when multiport adapter unit USB is connected again, all the multiport adapter functions will retain their previous settings, with the exception of Multiport Adapter which is set to OFF.
Initial S/W Revision:	A.10.00

More Information

Multiport adapter in the EXT (E6607A/B) supports the Agilent E6617A, which provides a USB connection for download of calibration data and additional control.

The connection diagram for Agilent E6617A switch unit is:

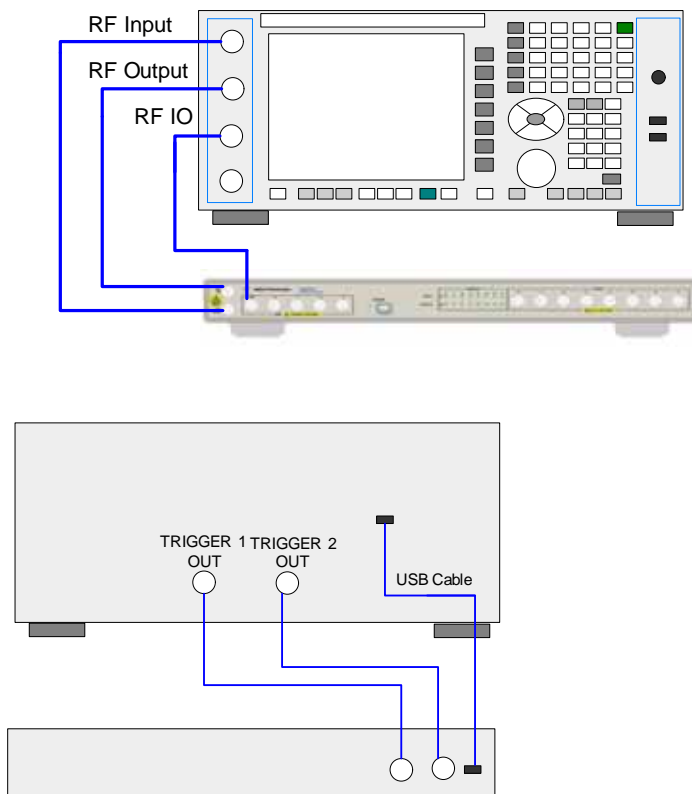

Multiport Adapter On/Off

Turning the Multiport Adapter On means that the multiport adapter unit is connected and it will be used for the measurements or source.

Turning the Multiport Adapter Off means that the multiport adapter unit will not be used for the analyzer

Input/Output

or source.

Key Path:	Input/Output, RF Output & Test Set Config, Multiport Adapter
Remote Command:	[:SENSe] :MPADapter [:STATe] ON OFF 1 0 [:SENSe] :MPADapter [:STATe] ?
Example:	:MPAD ON
Dependencies:	Only when the multiport adapter unit is connected to the EXT by USB, it is appeared. Otherwise, it will not be displayed and set to OFF. If the current RF Input port is not RF Input, turn Multiport Adapter to On , an error message is generated: “-221, Settings conflict; RFIO1 or RFIO2 Port unavailable when Multiport Adapter is ON”.
Preset:	This is unaffected by Mode Preset but is set to OFF on a "Restore Input/Output Defaults" or "Restore System Defaults -> All"
Initial S/W Revision:	A.10.00

Input Port

Specifies the multiport adapter unit input port used.

Key Path:	Input/Output, RF Output & Test Set Config, Multiport Adapter
Remote Command:	[:SENSe] :MPADapter:PORT:INPut OFF RFIO0 RFIO1 RFIO2 RFIO3 RFIO4 RFIO5 RFIO6 RFIO7 [:SENSe] :MPADapter:PORT:INPut ?
Example:	:MPAD:PORT:INP RFIO1
Dependencies:	This menu selection does not have any effect unless Input/Output, More, RF Output & Test Set Config, Multiport Adapter is set to the On state.
Preset:	This is unaffected by Mode Preset but is set to RFIO0 on a "Restore Input/Output Defaults" or "Restore System Defaults -> All"
State Saved:	Saved in State
Readback Text:	The current Multiport Adapter Input Port selected is read back to this key
Backwards Compatibility SCPI Notes:	The commands above are included for ESU compatibility
Initial S/W Revision:	A.10.00

OFF

Specifies using the multiport adapter input port OFF.

Key Path:	Input/Output, RF Output & Test Set Config, Multiport Adapter, Input Port
Example:	[:SENSe] :MPADapter:PORT:INPut OFF

ReadBack:	OFF
Initial S/W Revision:	A.10.00

RFIO0

Specifies using the multiport adapter input port RFIO 0.

Key Path:	Input/Output, RF Output & Test Set Config, Multiport Adapter, Input Port
Example:	[:SENSe] :MPADapter :PORT :INPut RFIO0
ReadBack:	RFIO 0
Initial S/W Revision:	A.10.00

RFIO1

Specifies using the multiport adapter input port RFIO 1.

Key Path:	Input/Output, RF Output & Test Set Config, Multiport Adapter, Input Port
Example:	[:SENSe] :MPADapter :PORT :INPut RFIO1
ReadBack:	RFIO 1
Initial S/W Revision:	A.10.00

RFIO2

Specifies using the multiport adapter Input port RFIO 2.

Key Path:	Input/Output, RF Output & Test Set Config, Multiport Adapter, Input Port
Example:	[:SENSe] :MPADapter :PORT :INPut RFIO2
ReadBack:	RFIO 2
Initial S/W Revision:	A.10.00

RFIO3

Specifies using the multiport adapter input port RFIO 3.

Key Path:	Input/Output, RF Output & Test Set Config, Multiport Adapter, Input Port
Example:	[:SENSe] :MPADapter :PORT :INPut RFIO3
ReadBack:	RFIO 3
Initial S/W Revision:	A.10.00

Input/Output

RFIO4

Specifies using the multiport adapter input port RFIO 4.

Key Path:	Input/Output, RF Output & Test Set Config, Multiport Adapter, Input Port
Example:	[:SENSe]:MPADapter:PORT:INPut RFIO4
ReadBack:	RFIO 4
Initial S/W Revision:	A.10.00

RFIO5

Specifies using the multiport adapter input port RFIO 5.

Key Path:	Input/Output, RF Output & Test Set Config, Multiport Adapter, Input Port, Page 2
Example:	[:SENSe]:MPADapter:PORT:INPut RFIO5
ReadBack:	RFIO 5
Initial S/W Revision:	A.10.00

RFIO6

Specifies using the multiport adapter input port RFIO 6.

Key Path:	Input/Output, RF Output & Test Set Config, Multiport Adapter, Input Port, Page 2
Example:	[:SENSe]:MPADapter:PORT:INPut RFIO6
ReadBack:	RFIO 6
Initial S/W Revision:	A.10.00

RFIO7

Specifies using the multiport adapter input port RFIO 7.

Key Path:	Input/Output, RF Output & Test Set Config, Multiport Adapter, Input Port, Page 2
Example:	[:SENSe]:MPADapter:PORT:INPut RFIO7
ReadBack:	RFIO 7
Initial S/W Revision:	A.10.00

Output Port

Specifies the multiport adapter unit output ports used. The Output Port key lets you set eight outputs

ON/OFF. See the table below for bitmapping.

Multiport Adapter Output Port	Bit
RFIO0	0
RFIO1	1
RFIO2	2
RFIO3	3
RFIO4	4
RFIO5	5
RFIO6	6
RFIO7	7

Key Path:	Input/Output, RF Output & Test Set Config, Multiport Adapter
Remote Command:	[:SENSE] :MPADapter:PORT:OUTPut:BITMap <integer> [:SENSE] :MPADapter:PORT:OUTPut:BITMap?
Example:	:MPAD:PORT:OUTPut:BITMap 1
Notes:	Each bit is associated with a multiport adapter output port; as shown in the bitmap table above. The value of a bit is '0' if the corresponding multiport adapter output port is not selected, and '1' if it is. (For example, to select multiport adapter RFIO7 output port , set Bit 7 to '1'.) The field requires a decimal entry. For example, if multiport adapter selects the RFIO 7 output port and RFIO 0 output port, the Bit Mask for this combination is 10000001, and the value of this parameter is the decimal number '129'.
Dependencies:	This menu selection does not have any effect unless Input/Output, RF Output & Test Set Config, Multiport Adapter, Multiport Adapter is set to the On state and Input/Output, RF Output & Test Set Config, RF Output is RF Output port. When Input/Output, RF Output & Test Set Config, Multiport Adapter, Multiport Adapter is set to the On state and Input/Output, RF Output & Test Set Config, RF Output is set to RFIO1 or RFIO2 port, the Multiport Adapter GPS Output Port will be used.
Preset:	This is unaffected by Mode Preset but is set to "1" on a "Restore Input/Output Defaults" or "Restore System Defaults -> All"
State Saved:	Saved in State
Backwards Compatibility SCPI Notes:	The commands above are included for ESU compatibility
Initial S/W Revision:	A.10.00

Input/Output

RFIO0

Turn on or off the multiport adapter RFIO0 output port.

Key Path:	Input/Output, RF Output & Test Set Config, Multiport Adapter, Output Port
Preset:	Not affected by a Preset. Set to ON pressing System > Restore Defaults > Input/Output Settings or System > Restore Defaults > All.
State Saved:	Saved in instrument state.
Initial S/W Revision:	A.10.0

RFIO1

Turn on or off the multiport adapter RFIO1 output port.

Key Path:	Input/Output, RF Output & Test Set Config, Multiport Adapter, Output Port
Preset:	Not affected by a Preset. Set to OFF by pressing System > Restore Defaults > Input/Output Settings or System > Restore Defaults > All.
State Saved:	Saved in instrument state.
Initial S/W Revision:	A.10.0

RFIO2

Turn on or off the multiport adapter RFIO2 output port.

Key Path:	Input/Output, RF Output & Test Set Config, Multiport Adapter, Output Port
Preset:	Not affected by a Preset. Set to OFF by pressing System > Restore Defaults > Input/Output Settings or System > Restore Defaults > All.
State Saved:	Saved in instrument state.
Initial S/W Revision:	A.10.0

RFIO3

Turn on or off the multiport adapter RFIO3 output port.

Key Path:	Input/Output, RF Output & Test Set Config, Multiport Adapter, Output Port
Preset:	Not affected by a Preset. Set to OFF by pressing System > Restore Defaults > Input/Output Settings or System > Restore Defaults > All.
State Saved:	Saved in instrument state.
Initial S/W Revision:	A.10.0

RFIO4

Turn on or off the multiport adapter RFIO4 output port.

Key Path:	Input/Output, RF Output & Test Set Config, Multiport Adapter, Output Port
Preset:	Not affected by a Preset. Set to OFF by pressing System > Restore Defaults > Input/Output Settings or System > Restore Defaults > All.
State Saved:	Saved in instrument state.
Initial S/W Revision:	A.10.0

RFIO5

Turn on or off the multiport adapter RFIO5 output port.

Key Path:	Input/Output, RF Output & Test Set Config, Multiport Adapter, Output Port
Preset:	Not affected by a Preset. Set to OFF by pressing System > Restore Defaults > Input/Output Settings or System > Restore Defaults > All.
State Saved:	Saved in instrument state.
Initial S/W Revision:	A.10.0

RFIO6

Turn on or off the multiport adapter RFIO6 output port.

Key Path:	Input/Output, RF Output & Test Set Config, Multiport Adapter, Output Port, Page 2
Preset:	Not affected by a Preset. Set to OFF by pressing System > Restore Defaults > Input/Output Settings or System > Restore Defaults > All.
State Saved:	Saved in instrument state.
Initial S/W Revision:	A.10.0

RFIO7

Turn on or off the multiport adapter RFIO7 output port.

Key Path:	Input/Output, RF Output & Test Set Config, Multiport Adapter, Output Port, Page 2
Preset:	Not affected by a Preset. Set to OFF by pressing System > Restore Defaults > Input/Output Settings or System > Restore Defaults > All.
State Saved:	Saved in instrument state.
Initial S/W Revision:	A.10.0

Preamp On/Off

Turn on or off the preamplifier of the multiport adapter input path. It will provide one fix gain for the

Input/Output

multiport adapter input path.

Key Path:	Input/Output, RF Output & Test Set Config, Multiport Adapter
Remote Command:	[:SENSe] :MPADapter:GAIN [:STATe] ON OFF 1 0 [:SENSe] :MPADapter:GAIN [:STATe] ?
Example:	:MPAD:GAIN ON
Dependencies:	This menu selection does not have any effect unless Input/Output, More, RF Output & Test Set Config, Multiport Adapter, Multiport Adapter is set to the On state.
Preset:	This is unaffected by Mode Preset but is set to OFF on a "Restore Input/Output Defaults" or "Restore System Defaults -> All"
State Saved:	Saved in instrument state.
Initial S/W Revision:	A.10.0

Amplitude Corrections

Corrections

Multiport Adapter Amplitude Corrections arrays can be entered by the user, sent over SCPI, or loaded from a file. The Multiport Adapter correction supports 16 separate Corrections arrays, each of which can contain up to 2000 points. They can be turned on and off individually and any or all can be on at the same time. Multiport Adapter has multiple Input/Output RF ports can have different corrections applied to the different ports. The correction data is applied to incoming signals as well as transmitted signals and is in the form of a list of spot frequencies and amplitude correction levels.

See section [“Amplitude Corrections” on page 958](#) for more information on Corrections.

Key Path:	Input/Output, RF Output & Test Set Config, Multiport Adapter
Mode:	Sequence Analyzer, I/Q Analyzer
Dependencies:	This key will only appear if you have the proper option installed in your instrument. Multiport Adapter Amplitude correction may not be available in all modes; if a mode does not support amplitude correction, the Correction On/Off and Apply Corrections On/Off keys should be grayed and un-accessible. This menu selection does not have any effect unless Input/Output, More, RF Output & Test Set Config, Multiport Adapter, Multiport Adapter is set to the On state.
Preset:	Multiport Adapter Corrections arrays are reset (deleted) by Restore Input/Output Defaults. They survive shutdown and restarting of the analyzer application, which means they will survive a power cycle.
Initial S/W Revision:	A.10.00

Select Correction

Specifies the selected correction. The term "selected correction" is used throughout this document to specify which correction will be affected by the functions.

Key Path:	Input/Output, RF Output & Test Set Config, Multiport adapter, Corrections
Mode:	Sequence Analyzer, I/Q Analyzer
Notes:	The selected correction is remembered even when not in the correction menu
Dependencies:	This menu selection does not have any effect unless Input/Output, More, RF Output & Test Set Config, Multiport Adapter, Multiport Adapter is set to the On state.
Preset:	Set to Correction 1 by Restore Input/Output Defaults
Readback:	Correction 1 Correction 2 Correction 3 Correction 4 Correction 5 Correction 6 Correction 7 Correction 9 Correction 9 Correction 10 Correction 11 Correction 12
Initial S/W Revision:	A.10.00

Correction On/Off

Turning the Selected Correction on allows the values in it to be applied to the data. This also automatically turns on "Apply Corrections" (sets it to ON), otherwise the correction would not take effect.

A new sweep is initiated if an amplitude correction is switched on or off. Note that changing, sending or loading corrections data does NOT directly initiate a sweep, however in general these operations will turn corrections on, which DOES initiate a sweep.

Key Path:	Input/Output, RF Output & Test Set Config, Multiport Adapter, Corrections
Remote Command:	[:SENSe] :MPADapter:CORRection:CSET [1] 2 3 4 5 6 7 8 9 10 11 12 13 14 15 16 [:STATe] ON OFF 1 0 [:SENSe] :MPADapter:CORRection:CSET [1] 2 3 4 5 6 7 8 9 10 11 12 13 14 15 16 [:STATe] ?
Example:	SENS:MPAD:CORR:CSET ON

Input/Output

Dependencies:	<p>This menu selection does not have any effect unless Input/Output, More, RF Output & Test Set Config, Multiport Adapter, Multiport Adapter is set to the On state. This menu selection is hidden if the currently active measurement or mode does not support amplitude correction.</p> <p>Turning this on automatically turns on "Apply Corrections"</p> <p>Only the first correction array (Correction 1) supports antenna units. When this array is turned on, and it contains an Antenna Unit other than "None", the Y Axis Unit of the analyzer is forced to that Antenna Unit. All other Y Axis Unit choices are grayed out.</p> <p>Note that this means that a correction file with an Antenna Unit can only be loaded into the Corrections 1 register. Consequently only for Correction 1 does the dropdown in the Recall dialog include.ant, and if an attempt is made to load a correction file into any other Correction register which DOES contain an antenna unit, a Mass Storage error is generated.</p> <p>This command will generate an "Option not available" error unless you have the proper option installed in your instrument.</p>
Preset:	Not affected by a Preset. Set to OFF by Restore Input/Output Defaults
State Saved:	Saved in instrument state.
Initial S/W Revision:	A.10.00

Properties

Accesses a menu that lets you set the properties of the selected correction.

Key Path:	Input/Output, RF Output & Test Set Config, Multiport Adapter, Corrections
Dependencies:	<p>This menu selection does not have any effect unless Input/Output, RF Output & Test Set Config, Multiport Adapter, Multiport Adapter is set to the On state. This menu selection is hidden if the currently active measurement or mode does not support amplitude correction.</p>
Initial S/W Revision:	A.10.00

Select Correction

Specifies the selected correction. The term "selected correction" is used throughout this document to specify which correction will be affected by the functions.

Key Path:	Input/Output, RF Output & Test Set Config, Multiport Adapter, Corrections, Properties
Notes:	The selected correction is remembered even when not in the correction menu
Dependencies:	This menu selection does not have any effect unless Input/Output, RF Output & Test Set Config, Multiport Adapter, Multiport Adapter is set to the On state
Preset:	Set to Correction 1 by Restore Input/Output Defaults.

Readback:	Correction 1 Correction 2 Correction 3 Correction 4 Correction 5 Correction 6 Correction 7 Correction 9 Correction 9 Correction 10 Correction 11 Correction 12 Correction 13 Correction 14 Correction 15 Correction 16
Initial S/W Revision:	A.10.00

Antenna Unit

For devices (like antennae) which make measurements of field strength or flux density, the correction array should contain within its values the appropriate conversion factors such that, when the data on the analyzer is presented in dB μ V, the display is calibrated in the appropriate units. The "Antenna Unit" used for the conversion is contained within the corrections array database. It may be specified by the user or loaded in from an external file or SCPI.

When an array with an Antenna Unit other than "None" is turned on, the Y Axis Unit of the analyzer is forced to that unit. When this array is turned on, and it contains an Antenna Unit other than "None", the Y Axis Unit of the analyzer is forced to that Antenna Unit., and all other Y Axis Unit choices are grayed out.

Antenna Unit does not appear in all Modes that support Corrections. Only the modes listed in the Mode row of the table below support Antenna Units.

Key Path:	Input/Output, RF Output & Test Set Config, Multiport Adapter, Corrections, Properties
Mode:	SA
Remote Command:	[:SENSE] :MPADapter:CORRection:CSET [1] 2 3 4 5 6 7 8 9 10 11 12 13 14 15 16 :ANTenna [:UNIT] GAUSS PTES1a UVM UAM NOConversion [:SENSE] :MPADapter:CORRection:CSET [1] 2 3 4 5 6 7 8 9 10 11 12 13 14 15 16 :ANTenna [:UNIT] ?
Example:	:MPAD:CORR:CSET:ANT GAUS
Dependencies:	Only the first correction array (Correction 1) supports antenna units. Note that this means that a correction file with an Antenna Unit can only be loaded into the Corrections 1 register. Consequently only for Correction 1 does the dropdown in the Recall dialog include.ant, and if an attempt is made to load a correction file into any other Correction register which DOES contain an antenna unit, a Mass Storage error is generated. Forceful message -250.3004
Preset:	Unaffected by Preset. Set to NOC by Restore Input/Output Defaults
State Saved:	Saved in State
Initial S/W Revision:	A.10.00

dB μ V/m

Sets the antenna unit to dB μ V/m. If this correction is turned on, and Apply Corrections is on, the Y Axis Unit will then be forced to dB μ V/m and all other Y Axis Unit selections will be grayed out.

Key Path:	Input/Output, RF Output & Test Set Config, Multiport Adapter, Corrections, Properties, Antenna Unit
-----------	--

Input/Output

Example:	:MPAD:CORR:CSET2:ANT UVM
Readback:	"dB μ V/m"
Initial S/W Revision:	A.10.00

dB μ A/m

Sets the antenna unit to dB μ A/m. If this correction is turned on, and Apply Corrections is on, the Y Axis Unit will then be forced to dB μ A/m and all other Y Axis Unit selections will be grayed out.

Key Path:	Input/Output, RF Output & Test Set Config, Multiport Adapter, Corrections, Properties, Antenna Unit
Example:	:MPAD:CORR:CSET2:ANT UVA
Readback:	" dB μ A/m"
Initial S/W Revision:	A.10.00

dBpT

Sets the antenna unit to dBpT. If this correction is turned on, and Apply Corrections is on, the Y Axis Unit will then be forced to dBpT and all other Y Axis Unit selections will be grayed out.

Key Path:	Input/Output, RF Output & Test Set Config, Multiport Adapter, Corrections, Properties, Antenna Unit
Example:	:MPAD:CORR:CSET3:ANT PTES
Readback:	"dBpT"
Initial S/W Revision:	A.10.00

dBG

Sets the antenna unit to dBG. If this correction is turned on, and Apply Corrections is on, the Y Axis Unit will then be forced to dBG and all other Y Axis Unit selections will be grayed out.

Key Path:	Input/Output, RF Output & Test Set Config, Multiport Adapter, Corrections, Properties, Antenna Unit
Example:	:MPAD:CORR:CSET:ANT GAUS
Readback:	" dBG"
Initial S/W Revision:	A.10.00

None

Selects no antenna unit for this Correction set. Thus no Y Axis unit will be forced.

Key Path:	Input/Output, RF Output & Test Set Config, Multiport Adapter, Corrections, Properties, Antenna Unit
Example:	:MPAD:CORR:CSET4:ANT NOC

Readback:	"None"
Initial S/W Revision:	A.10.00

Frequency Interpolation

This setting controls how the correction values per-bucket are calculated. We interpolate between frequencies in either the logarithmic or linear scale.

This setting is handled and stored individually per correction set.

See [“Interpolation” on page 963](#)

Key Path:	Input/Output, RF Output & Test Set Config, Multiport Adapter, Corrections, Properties
Remote Command:	[:SENSE] :MPADapter:CORRection:CSET [1] 2 3 4 5 6 7 8 9 10 11 12 13 14 15 16 :X:SPACing LINear LOGarithmic [:SENSE] :MPADapter:CORRection:CSET [1] 2 3 4 5 6 7 8 9 10 11 12 13 14 15 16 :X:SPACing?
Example:	:MPAD:CORR:CSET:X:SPAC LIN
Dependencies:	This menu selection does not have any effect unless Input/Output, More, RF Output & Test Set Config, Multiport Adapter, Multiport Adapter is set to the On state.
Preset:	Unaffected by a Preset. Set to Linear by Restore Input/Output Defaults.
State Saved:	Saved in instrument state.
Initial S/W Revision:	A.10.00

Interpolation

For each bucket processed by the application, all of the correction factors at the frequency of interest (center frequency of each bucket) are summed and added to the amplitude. All trace operations and post processing treat this post-summation value as the true signal to use.

To effect this correction, the goal, for any particular start and stop frequency, is to build a correction trace, whose number of points matches the current Sweep Points setting of the instrument, which will be used to apply corrections on a bucket by bucket basis to the data traces.

For amplitudes that lie between two user specified frequency points, we interpolate to determine the amplitude value. You may select either linear or logarithmic interpolation between the frequencies.

If we interpolate on a log scale, we assume that the line between the two points is a straight line on the log scale. For example, let's say the two points are (2,4) and (20,1). A straight line between them on a log scale looks like:

Input/Output

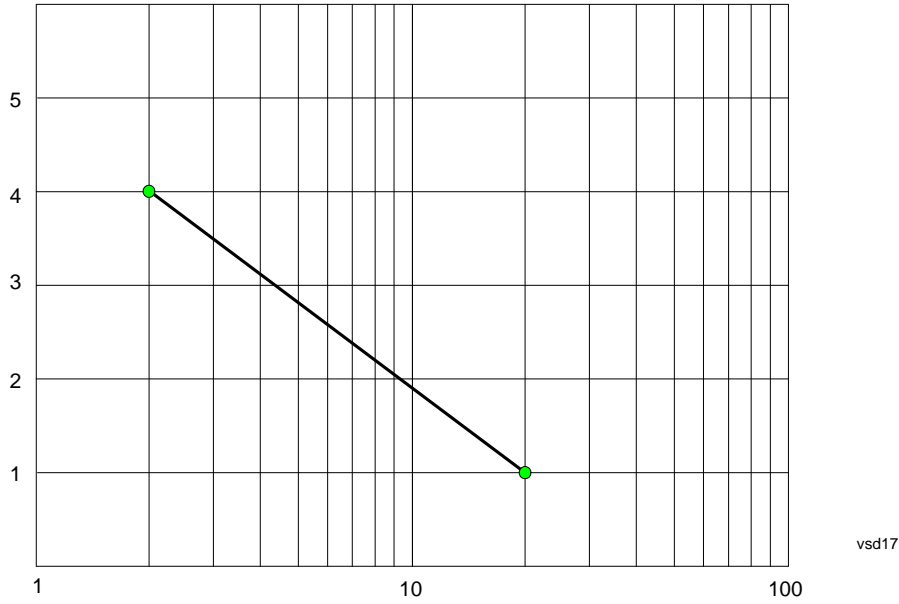

On a linear scale (like that of the spectrum analyzer), this translates to:

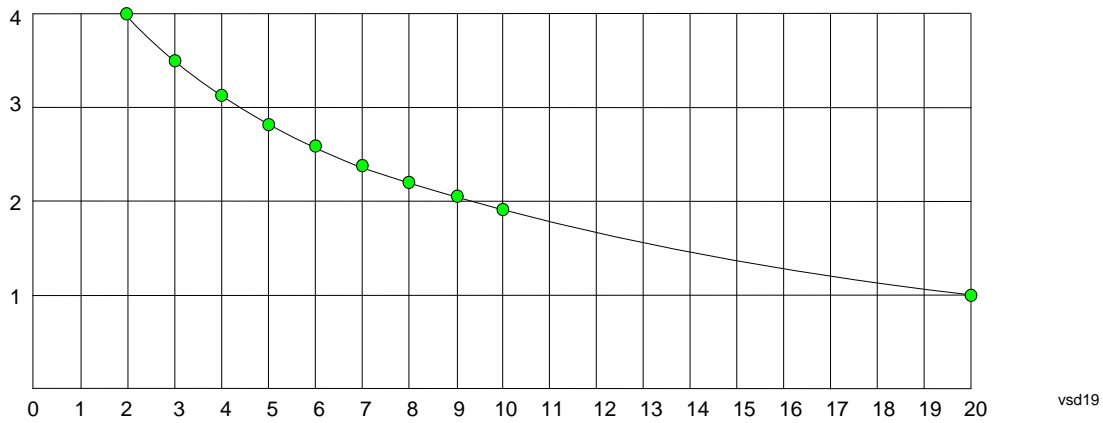

On the other hand, if we interpolate on a linear scale, we assume that the two points are connected by a straight line on the linear scale, as below:

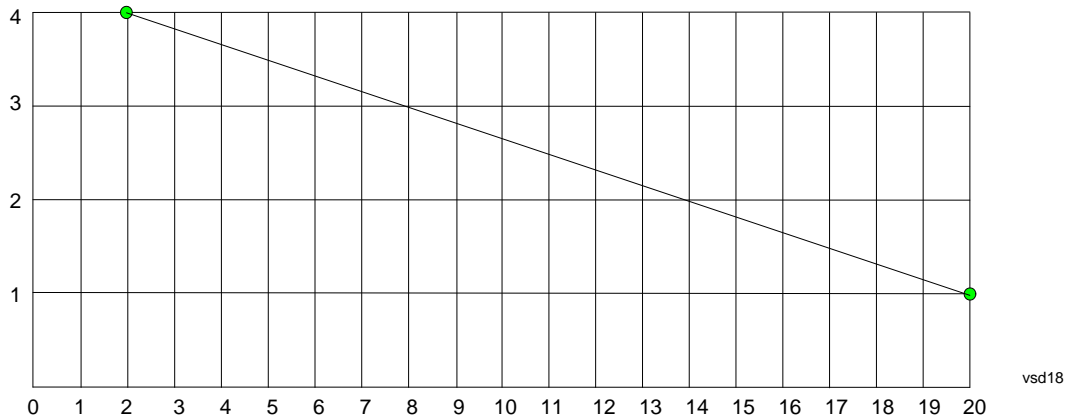

The correction to be used for each bucket is taken from the interpolated correction curve at the center of the bucket.

Description

Sets an ASCII description field which will be stored in an exported file. Can be displayed in the active function area by selecting as the active function, if desired to be in a screen dump.

Key Path:	Input/Output, RF Output & Test Set Config, Multiport Adapter, Corrections, Properties
Remote Command:	[:SENSe] :MPADapter:CORRection:CSET [1] 2 3 4 5 6 7 8 9 10 11 12 13 14 15 16:DESCription "text" [:SENSe] :MPADapter:CORRection:CSET [1] 2 3 4 5 6 7 8 9 10 11 12 13 14 15 16:DESCription?
Example:	:MPAD:CORR:CSET:DESC "11941A Antenna correction"
Notes:	45 chars max; may not fit on display if max chars used
Dependencies:	This menu selection does not have any effect unless Input/Output, More, RF Output & Test Set Config, Multiport Adapter, Multiport Adapter is set to the On state.
Preset:	Unaffected by a Preset. Set to empty by Restore Input/Output Defaults
State Saved:	Saved in instrument state.
Initial S/W Revision:	A.10.00

Comment

Sets an ASCII comment field which will be stored in an exported file. Can be displayed in the active function area by selecting as the active function, if desired to be in a screen dump.

Key Path:	Input/Output, RF Output & Test Set Config, Multiport Adapter, Corrections, Properties
Remote Command:	[:SENSe] :MPADapter:CORRection:CSET [1] 2 3 4 5 6 7 8 9 10 11 12 13 14 15 16:COMMeNt "text" [:SENSe] :MPADapter:CORRection:CSET [1] 2 3 4 5 6 7 8 9 10 11 12 13 14 15 16:COMMeNt?
Example:	:MPAD:CORR:CSET:COMM "this is a comment"
Notes:	45 chars max; may not fit on display if max chars used
Preset:	Unaffected by Preset. Set to empty by Restore Input/Output Defaults
State Saved:	Saved in instrument state
Initial S/W Revision:	A.10.00

Input/Output

RF Port

Maps one of the sets of corrections to one of the IO ports.

Key Path:	Input/Output, RF Output & Test Set Config, Multiport Adapter, Corrections, Properties
Mode:	SEQAN
Remote Command:	[:SENSe] :MPADapter:CORRection:CSET [1] 2 3 4 5 6 7 8 9 10 11 12 13 14 15 16 :RF:PORT RFIO RFIO1 RFIO2 RFIO3 RFIO4 RFIO5 RFIO6 RFIO7 [:SENSe] :MPADapter:CORRection:CSET [1] 2 3 4 5 6 7 8 9 10 11 12 13 14 15 16 :RF:PORT?
Example:	:MPAD:CORR:CSET:RF:PORT RFIO0
Notes:	
Dependencies:	Only available in EXT
Couplings:	
Preset:	Unaffected by Preset. Set to RF by Restore Input/Output Defaults
State Saved:	Saved in State
Backwards Compatibility SCPI:	
Initial S/W Revision:	A.10.00

RFIO0

The port to which the current corrections are applied. Pressing this key again allows the user access to the menu for specifying to which internal device and multiport adapter RF path the corrections for multiport adapter RFIO 0 are applied.

Key Path:	Input/Output, RF Output & Test Set Config, Multiport Adapter, Corrections, Properties, RF Port
Remote Command:	[:SENSe] :MPADapter:CORRection:CSET [1] 2 3 4 5 6 7 8 9 10 11 12 13 14 15 16 :RF:PORT:RFIO0 SOURce ANALyzer BOTH [:SENSe] :MPADapter:CORRection:CSET [1] 2 3 4 5 6 7 8 9 10 11 12 13 14 15 16 :RF:PORT:RFIO0?
Example:	:MPAD:CORR:CSET:RF:PORT:RFIO0 BOTH
Preset:	Both
State Saved:	Saved in State
Initial S/W Revision:	A.10.0

Correct Source

Sets the corrections for the multiport adapter RFIO 0 port to be applied to the source.

Key Path:	Input/Output, RF Output & Test Set Config, Multiport Adapter, Corrections, Properties, RF Port, RFIO 0
Example:	:MPAD:CORR:CSET[1] 2 3 4 5 6 7 8 9 10 11 12 13 14 15 16:RF:PORT:RFIO0 SOUR
Readback:	"Correct Source"
Initial S/W Revision:	A.10.0

Correct Analyzer

Sets the corrections for the multiport adapter RFIO 0 port to be applied to the analyzer.

Key Path:	Input/Output, RF Output & Test Set Config, Multiport Adapter, Corrections, Properties, RF Port, RFIO 0
Example:	:MPAD:CORR:CSET[1] 2 3 4 5 6 7 8 9 10 11 12 13 14 15 16:RF:PORT:RFIO0 ANAL
Readback:	"Correct Analyzer"
Initial S/W Revision:	A.10.0

Correct Source and Analyzer

Sets the corrections for the multiport adapter RFIO 0 port to be applied to both the source and the analyzer.

Key Path:	Input/Output, RF Output & Test Set Config, Multiport Adapter, Corrections, Properties, RF Port, RFIO 0
Example:	:MPAD:CORR:CSET[1] 2 3 4 5 6 7 8 9 10 11 12 13 14 15 16:RF:PORT:RFIO0 BOTH
Readback:	"Correct Source and Analyzer"
Initial S/W Revision:	A.10.0

RFIO1

The port to which the current corrections will be applied. Pressing this key again allows the user access to the menu for specifying to which internal device and multiport adapter RF path the corrections for multiport adapter RFIO 1 are applied.

Key Path:	Input/Output, RF Output & Test Set Config, Multiport Adapter, Corrections, Properties, RF Port
Remote Command:	[:SENSE] :MPADapter: CORRection: CSET [1] 2 3 4 5 6 7 8 9 10 11 12 13 14 15 16 : RF : PORT : RFIO1 SOURce ANALyzer BOTH [:SENSE] :MPADapter: CORRection: CSET [1] 2 3 4 5 6 7 8 9 10 11 12 13 14 15 16 : RF : PORT : RFIO1?
Example:	:MPAD:CORR:CSET:RF:PORT:RFIO1 BOTH

Input/Output

Preset:	Both
State Saved:	Saved in State
Initial S/W Revision:	A.10.0

Correct Source

Sets the corrections for the multiport adapter RFIO 1 port to be applied to the source.

Key Path:	Input/Output, RF Output & Test Set Config, Multiport Adapter, Corrections, Properties, RF Port, RFIO 1
Example:	:MPAD:CORR:CSET[1] 2 3 4 5 6 7 8 9 10 11 12 13 14 15 16:RF:PORT:RFIO1 SOUR
Readback:	"Correct Source"
Initial S/W Revision:	A.10.0

Correct Analyzer

Sets the corrections for the multiport adapter RFIO 1 port to be applied to the analyzer.

Key Path:	Input/Output, RF Output & Test Set Config, Multiport Adapter, Corrections, Properties, RF Port, RFIO 1
Example:	:MPAD:CORR:CSET[1] 2 3 4 5 6 7 8 9 10 11 12 13 14 15 16:RF:PORT:RFIO1 ANAL
Readback:	"Correct Analyzer"
Initial S/W Revision:	A.10.0

Correct Source and Analyzer

Sets the corrections for the multiport adapter RFIO 1 port to be applied to both the source and the analyzer.

Key Path:	Input/Output, RF Output & Test Set Config, Multiport Adapter, Corrections, Properties, RF Port, RFIO 1
Example:	:MPAD:CORR:CSET[1] 2 3 4 5 6 7 8 9 10 11 12 13 14 15 16:RF:PORT:RFIO1 BOTH
Readback:	"Correct Source and Analyzer"
Initial S/W Revision:	A.10.0

RFIO2

The port to which the current corrections are applied. Pressing this key again allows the user access to the menu for specifying to which internal device and multiport adapter RF path the corrections for multiport adapter RFIO 2 are applied.

Key Path:	Input/Output, RF Output & Test Set Config, Multiport Adapter, Corrections, Properties, RF Port
-----------	---

Remote Command:	[:SENSE] :MPADapter:CORRection:CSET [1] 2 3 4 5 6 7 8 9 10 11 12 13 14 15 16 :RF:PORT:RFIO2 SOURce ANALyzer BOTH [:SENSe] :MPADapter:CORRection:CSET [1] 2 3 4 5 6 7 8 9 10 11 12 13 14 15 16 :RF:PORT:RFIO2?
Example:	:MPAD:CORR:CSET:RF:PORT:RFIO2 BOTH
Preset:	Both
State Saved:	Saved in State
Initial S/W Revision:	A.10.0

Correct Source

Sets the corrections for the multiport adapter RFIO 2 port to be applied to the source.

Key Path:	Input/Output, RF Output & Test Set Config, Multiport Adapter, Corrections, Properties, RF Port, RFIO 2
Example:	:MPAD:CORR:CSET[1] 2 3 4 5 6 7 8 9 10 11 12 13 14 15 16:RF:PORT:RFIO2 SOUR
Readback:	"Correct Source"
Initial S/W Revision:	A.10.0

Correct Analyzer

Sets the corrections for the multiport adapter RFIO 2 port to be applied to the analyzer.

Key Path:	Input/Output, RF Output & Test Set Config, Multiport Adapter, Corrections, Properties, RF Port, RFIO 2
Example:	:MPAD:CORR:CSET[1] 2 3 4 5 6 7 8 9 10 11 12 13 14 15 16:RF:PORT:RFIO2 ANAL
Readback:	"Correct Analyzer"
Initial S/W Revision:	A.10.0

Correct Source and Analyzer

Sets the corrections for the multiport adapter RFIO 2 port to be applied to both the source and the analyzer.

Key Path:	Input/Output, RF Output & Test Set Config, Multiport Adapter, Corrections, Properties, RF Port, RFIO 2
Example:	:MPAD:CORR:CSET[1] 2 3 4 5 6 7 8 9 10 11 12 13 14 15 16:RF:PORT:RFIO2 BOTH
Readback:	"Correct Source and Analyzer"
Initial S/W Revision:	A.10.0

Input/Output

RFIO3

The port to which the current corrections will be applied. Pressing this key again allows the user access to the menu for specifying to which internal device and multiport adapter RF path the corrections for multiport adapter RFIO 3 are applied.

Key Path:	Input/Output, RF Output & Test Set Config, Multiport Adapter, Corrections, Properties, RF Port
Remote Command:	[[:SENSe]:MPADapter:CORRection:CSET[1] 2 3 4 5 6 7 8 9 10 11 12 13 14 15 16:RF:PORT:RFIO3 SOURce ANALyzer BOTH [:SENSe]:MPADapter:CORRection:CSET[1] 2 3 4 5 6 7 8 9 10 11 12 13 14 15 16:RF:PORT:RFIO3?
Example:	:MPAD:CORR:CSET:RF:PORT:RFIO3 BOTH
Preset:	Both
State Saved:	Saved in State
Initial S/W Revision:	A.10.0

Correct Source

Sets the corrections for the multiport adapter RFIO 3 port to be applied to the source.

Key Path:	Input/Output, RF Output & Test Set Config, Multiport Adapter, Corrections, Properties, RF Port, RFIO 3
Example:	:MPAD:CORR:CSET[1] 2 3 4 5 6 7 8 9 10 11 12 13 14 15 16:RF:PORT:RFIO3 SOUR
Readback:	"Correct Source"
Initial S/W Revision:	A.10.0

Correct Analyzer

Sets the corrections for the multiport adapter RFIO 3 port to be applied to the analyzer.

Key Path:	Input/Output, RF Output & Test Set Config, Multiport Adapter, Corrections, Properties, RF Port, RFIO 3
Example:	:MPAD:CORR:CSET[1] 2 3 4 5 6 7 8 9 10 11 12 13 14 15 16:RF:PORT:RFIO3 ANAL
Readback:	"Correct Analyzer"
Initial S/W Revision:	A.10.0

Correct Source and Analyzer

Sets the corrections for the multiport adapter RFIO 3 port to be applied to both the source and the analyzer.

Key Path:	Input/Output, RF Output & Test Set Config, Multiport Adapter, Corrections, Properties, RF Port, RFIO 3
-----------	---

Example:	:MPAD:CORR:CSET[1] 2 3 4 5 6 7 8 9 10 11 12 13 14 15 16:RF:PORT:RFIO3 BOTH
Readback:	"Correct Source and Analyzer"
Initial S/W Revision:	A.10.0

RFIO4

The port to which the current corrections are applied. Pressing this key again allows the user access to the menu for specifying to which internal device and multipoint adapter RF path the corrections for multipoint adapter RFIO 4 are applied.

Key Path:	Input/Output, RF Output & Test Set Config, Multipoint Adapter, Corrections, Properties, RF Port
Remote Command:	[:SENSE] :MPADapter:CORREction:CSET [1] 2 3 4 5 6 7 8 9 10 11 12 13 14 15 16 :RF:PORT:RFIO4 SOURCE ANALyzer BOTH [:SENSE] :MPADapter:CORREction:CSET [1] 2 3 4 5 6 7 8 9 10 11 12 13 14 15 16 :RF:PORT:RFIO4?
Example:	:MPAD:CORR:CSET:RF:PORT:RFIO4 BOTH
Preset:	Both
State Saved:	Saved in State
Initial S/W Revision:	A.10.0

Correct Source

Sets the corrections for the multipoint adapter RFIO 4 port to be applied to the source.

Key Path:	Input/Output, RF Output & Test Set Config, Multipoint Adapter, Corrections, Properties, RF Port, RFIO 4
Example:	:MPAD:CORR:CSET[1] 2 3 4 5 6 7 8 9 10 11 12 13 14 15 16:RF:PORT:RFIO4 SOUR
Readback:	"Correct Source"
Initial S/W Revision:	A.10.0

Correct Analyzer

Sets the corrections for the multipoint adapter RFIO 4 port to be applied to the analyzer.

Key Path:	Input/Output, RF Output & Test Set Config, Multipoint Adapter, Corrections, Properties, RF Port, RFIO 4
Example:	:MPAD:CORR:CSET[1] 2 3 4 5 6 7 8 9 10 11 12 13 14 15 16:RF:PORT:RFIO4 ANAL
Readback:	"Correct Analyzer"
Initial S/W Revision:	A.10.0

Input/Output

Correct Source and Analyzer

Sets the corrections for the multiport adapter RFIO 4 port to be applied to both the source and the analyzer.

Key Path:	Input/Output, RF Output & Test Set Config, Multiport Adapter, Corrections, Properties, RF Port, RFIO 4
Example:	:MPAD:CORR:CSET[1] 2 3 4 5 6 7 8 9 10 11 12 13 14 15 16:RF:PORT:RFIO4 BOTH
Readback:	"Correct Source and Analyzer"
Initial S/W Revision:	A.10.0

RFIO5

The port to which the current corrections are applied. Pressing this key again allows the user access to the menu for specifying to which internal device and multiport adapter RF path the corrections for multiport adapter RFIO 5 are applied.

Key Path:	Input/Output, RF Output & Test Set Config, Multiport Adapter, Corrections, Properties, RF Port
Remote Command:	[:SENSe] :MPADapter:CORRection:CSET [1 2 3 4 5 6 7 8 9 10 11 12 13 14 15 16 :RF:PORT:RFIO5 SOURce ANALyzer BOTH [:SENSe] :MPADapter:CORRection:CSET [1 2 3 4 5 6 7 8 9 10 11 12 13 14 15 16 :RF:PORT:RFIO5?
Example:	:MPAD:CORR:CSET:RF:PORT:RFIO5 BOTH
Preset:	Both
State Saved:	Saved in State
Initial S/W Revision:	A.10.0

Correct Source

Sets the corrections for the multiport adapter RFIO 5 port to be applied to the source.

Key Path:	Input/Output, RF Output & Test Set Config, Multiport Adapter, Corrections, Properties, RF Port, RFIO 5
Example:	:MPAD:CORR:CSET[1] 2 3 4 5 6 7 8 9 10 11 12 13 14 15 16:RF:PORT:RFIO5 SOUR
Readback:	"Correct Source"
Initial S/W Revision:	A.10.0

Correct Analyzer

Sets the corrections for the multiport adapter RFIO 5 port to be applied to the analyzer.

Key Path:	Input/Output, RF Output & Test Set Config, Multiport Adapter, Corrections, Properties, RF Port, RFIO 5
-----------	---

Example:	:MPAD:CORR:CSET[1] 2 3 4 5 6 7 8 9 10 11 12 13 14 15 16:RF:PORT:RFIO5 ANAL
Readback:	"Correct Analyzer"
Initial S/W Revision:	A.10.0

Correct Source and Analyzer

Sets the corrections for the multiport adapter RFIO 5 port to be applied to both the source and the analyzer.

Key Path:	Input/Output, RF Output & Test Set Config, Multiport Adapter, Corrections, Properties, RF Port, RFIO 5
Example:	:MPAD:CORR:CSET[1] 2 3 4 5 6 7 8 9 10 11 12 13 14 15 16:RF:PORT:RFIO5 BOTH
Readback:	"Correct Source and Analyzer"
Initial S/W Revision:	A.10.0

RFIO6

The port to which the current corrections are applied. Pressing this key again allows the user access to the menu for specifying to which internal device and multiport adapter RF path the corrections for multiport adapter RFIO 6 are applied.

Key Path:	Input/Output, RF Output & Test Set Config, Multiport Adapter, Corrections, Properties, RF Port, Page 2
Remote Command:	[:SENSE] :MPADapter:CORRection:CSET [1] 2 3 4 5 6 7 8 9 1 0 11 12 13 14 15 16 :RF:PORT:RFIO6 SOURce ANALyzer BOTH [:SENSE] :MPADapter:CORRection:CSET [1] 2 3 4 5 6 7 8 9 1 0 11 12 13 14 15 16 :RF:PORT:RFIO6?
Example:	:MPAD:CORR:CSET:RF:PORT:RFIO6 BOTH
Preset:	Both
State Saved:	Saved in State
Initial S/W Revision:	A.10.0

Correct Source

Sets the corrections for the multiport adapter RFIO 6 port to be applied to the source.

Key Path:	Input/Output, RF Output & Test Set Config, Multiport Adapter, Corrections, Properties, RF Port, RFIO 6
Example:	:MPAD:CORR:CSET[1] 2 3 4 5 6 7 8 9 10 11 12 13 14 15 16:RF:PORT:RFIO6 SOUR
Readback:	"Correct Source"
Initial S/W Revision:	A.10.0

Input/Output

Correct Analyzer

Sets the corrections for the multiport adapter RFIO 6 port to be applied to the analyzer.

Key Path:	Input/Output, RF Output & Test Set Config, Multiport Adapter, Corrections, Properties, RF Port, RFIO 6
Example:	:MPAD:CORR:CSET[1] 2 3 4 5 6 7 8 9 10 11 12 13 14 15 16:RF:PORT:RFIO6 ANAL
Readback:	"Correct Analyzer"
Initial S/W Revision:	A.10.0

Correct Source and Analyzer

Sets the corrections for the multiport adapter RFIO 6 port to be applied to both the source and the analyzer.

Key Path:	Input/Output, RF Output & Test Set Config, Multiport Adapter, Corrections, Properties, RF Port, RFIO 6
Example:	:MPAD:CORR:CSET[1] 2 3 4 5 6 7 8 9 10 11 12 13 14 15 16:RF:PORT:RFIO6 BOTH
Readback:	"Correct Source and Analyzer"
Initial S/W Revision:	A.10.0

RFIO7

The port to which the current corrections are applied. Pressing this key again allows the user access to the menu for specifying to which internal device and multiport adapter RF path the corrections for multiport adapter RFIO 7 are applied.

Key Path:	Input/Output, RF Output & Test Set Config, Multiport Adapter, Corrections, Properties, RF Port, Page 2
Remote Command:	[:SENSe] :MPADapter:CORRection:CSET[1] 2 3 4 5 6 7 8 9 10 11 12 13 14 15 16 :RF:PORT:RFIO7 SOURce ANALyzer BOTH [:SENSe] :MPADapter:CORRection:CSET[1] 2 3 4 5 6 7 8 9 10 11 12 13 14 15 16 :RF:PORT:RFIO7?
Example:	:MPAD:CORR:CSET:RF:PORT:RFIO7 BOTH
Preset:	Both
State Saved:	Saved in State
Initial S/W Revision:	A.10.0

Correct Source

Sets the corrections for the multiport adapter RFIO 7 port to be applied to the source.

Key Path:	Input/Output, RF Output & Test Set Config, Multiport Adapter, Corrections, Properties, RF Port, RFIO 7
-----------	---

Example:	:MPAD:CORR:CSET[1] 2 3 4 5 6 7 8 9 10 11 12 13 14 15 16:RF:PORT:RFIO7 SOUR
Readback:	"Correct Source"
Initial S/W Revision:	A.10.0

Correct Analyzer

Sets the corrections for the multiport adapter RFIO 7 port to be applied to the analyzer.

Key Path:	Input/Output, RF Output & Test Set Config, Multiport Adapter, Corrections, Properties, RF Port, RFIO 7
Example:	:MPAD:CORR:CSET[1] 2 3 4 5 6 7 8 9 10 11 12 13 14 15 16:RF:PORT:RFIO7 ANAL
Readback:	"Correct Analyzer"
Initial S/W Revision:	A.10.0

Correct Source and Analyzer

Sets the corrections for the multiport adapter RFIO 7 port to be applied to both the source and the analyzer.

Key Path:	Input/Output, RF Output & Test Set Config, Multiport Adapter, Corrections, Properties, RF Port, RFIO 7
Example:	:MPAD:CORR:CSET[1] 2 3 4 5 6 7 8 9 10 11 12 13 14 15 16:RF:PORT:RFIO7 BOTH
Readback:	"Correct Source and Analyzer"
Initial S/W Revision:	A.10.0

Table Editor

Edit

Invokes the integrated editing facility for this correction set. See description in section [“Table Editor” on page 975](#).

When entering the menu, the editor window turns on, the selected correction is turned **On**, **Apply Corrections** is set to **On**, the amplitude scale is set to **Log**, and the Amplitude Correction (“Ampcor”) trace is displayed. The actual, interpolated correction trace is shown in green for the selected correction. Note that since the actual interpolated correction is shown, the correction trace may have some curvature to it. This trace represents only the correction currently being edited, rather than the total, accumulated amplitude correction for all amplitude corrections which are currently on, although the total, accumulated correction for all corrections which are turned on is still applied to the data traces.

Because corrections data is always in dB, but the Y-axis of the analyzer is in absolute units, it is necessary to establish a reference line for display of the Corrections data. The reference line is halfway up the display and represents 0 dB of correction. It is labeled “0 dB CORREC”. It is drawn in blue. (0,0,255) and is three pixels high. The green correction trace is drawn after all other traces and this reference blue line, so it sits “on top” of them.

Corrections data is always in dB. Whatever dB value appears in the correction table represents the correction to be applied to that trace at that frequency. So if a table entry shows 30 dB that means we ADD 30 dB to each trace to

Input/Output

correct it before displaying it. By definition all points are connected. If a gap is desired for corrections data, enter 0 dB.

Note that a well-designed Corrections array should start at 0 dB and end at 0 dB. This is because whatever the high end point is will be extended to the top frequency of the instrument, and whatever the low end point is will be extended down to 0 Hz. So for a Corrections array to have no effect outside its range, you should start and end the array at 0 dB.

NOTE The table editor will only operate properly if the analyzer is sweeping, because its updates are tied to the sweep system. Thus, you should not try to use the editor in single sweep, and it will be sluggish during compute-intensive operations like narrow-span FFT sweeps.

When exiting the edit menu (by using the **Return** key or by pressing an instrument front-panel key), the editor window turns off and the Ampcor trace is no longer displayed; however, **Apply Corrections** remains **On**, any correction that was on while in the editor remains on, and the amplitude scale returns to its previous setting.

Corrections arrays are not affected by a Preset, because they are in the Input/Output system. They also survive shutdown and restarting of the analyzer application, which means they will survive a power cycle.

When editing a correction, the editor remembers which correction and which element in the correction array you were editing, and returns you to that correction and that element when you return to the editor after leaving it.

Key Path:	Input/Output, RF Output & Test Set Config, Multiport Adapter, Corrections
Initial S/W Revision:	A.10.00

Navigate

Lets you move through the table to edit the desired point.

Key Path:	Input/Output, RF Output & Test Set Config, Multiport Adapter, Corrections, Edit
Notes:	There is no value readback on the key
Min:	1
Max:	2000
Initial S/W Revision:	A.10.00

Frequency

Lets you edit the frequency of the current row.

Key Path:	Input/Output, RF Output & Test Set Config, Multiport Adapter, Corrections, Edit
Notes:	There is no value readback on the key.
Min:	0
Max:	1 THz

Initial S/W Revision:	A.10.00
-----------------------	---------

Amplitude

Lets you edit the Amplitude of the current row.

Key Path:	Input/Output, RF Output & Test Set Config, Multiport Adapter, Corrections, Edit
Notes:	There is no value readback on the key.
Min:	-1000 dB
Max:	1000 dB
Initial S/W Revision:	A.10.00

Insert Point Below

Inserts a point below the current point. The new point is a copy of the current point and becomes the current point. The new point is not yet entered into the underlying table, and the data in the row is displayed in light gray.

Key Path:	Input/Output, RF Output & Test Set Config, Multiport Adapter, Corrections, Edit
Initial S/W Revision:	A.10.00

Delete Point

Deletes the currently-selected point, whether or not that point is being edited, and selects the Navigate functionality. The point following the currently-selected point (or the point preceding if there is none) will be selected.

Key Path:	Input/Output, RF Output & Test Set Config, Multiport Adapter, Corrections, Edit
Initial S/W Revision:	A.10.00

Scale X Axis

Matches the X Axis to the selected Correction, as well as possible. Sets the Start and Stop Frequency to contain the minimum and maximum Frequency of the selected Correction. The range between Start Frequency and Stop Frequency is 12.5% above the range between the minimum and maximum Frequency, so that span exceeds this range by one graticule division on either side. If in zero-span, or there is no data in the Ampcor table, or the frequency range represented by the table is zero, no action is taken. Standard clipping rules apply if the value in the table is outside the allowable range for the X axis.

Key Path:	Input/Output, RF Output & Test Set Config, Multiport Adapter, Corrections, Edit
Dependencies:	If either the first or last point in the array is outside the frequency range of the current input, an error message is generated: “-221. Settings conflict; Start or Stop Freq out of range for current input settings”

Input/Output

Initial S/W Revision:	A.10.00
-----------------------	---------

Delete Correction

Deletes the correction values for this set. When this key is pressed a prompt is placed on the screen that says “Please press Enter or OK key to delete correction. Press ESC or Cancel to close this dialog.” The deletion is only performed if you press OK or Enter.

Key Path:	Input/Output, RF Output & Test Set Config, Multiport Adapter, Corrections
Remote Command:	[:SENSe] :MPADapter:CORRection:CSET [1 2 3 4 5 6 7 8 9 10 11 12 13 14 15 16 :DELete
Example:	MPAD:CORR:CSET:DEL MPAD:CORR:CSET1:DEL MPAD:CORR:CSET4:DEL
Notes:	Pressing this key when no corrections are present is accepted without error.
Initial S/W Revision:	A.10.00

Correction On/Off

Apply Corrections

Applies amplitude corrections which are marked as ON to the measured data. If this is set to OFF, then no amplitude correction sets will be used, regardless of their individual on/off settings. If set to ON, the corrections that are marked as ON (see “[Correction On/Off](#)” on page 959) are used.

Key Path:	Input/Output, RF Output & Test Set Config, Multiport Adapter, Corrections
Remote Command:	[:SENSe] :MPADapter:CORRection:CSET:ALL [:STATe] ON OFF 1 0 [:SENSe] :MPADapter:CORRection:CSET:ALL [:STATe] ?
Example:	SENS:MPAD:CORR:CSET:ALL OFF This command makes sure that no amplitude corrections are applied, regardless of their individual on/off settings.
Preset:	Not affected by Preset. Set to OFF by Restore Input/Output Defaults
State Saved:	Saved in instrument state.
Initial S/W Revision:	A.10.00

Delete All Corrections

Erases all correction values for all 16 Amplitude Correction sets.

When this key is pressed a prompt is placed on the screen that says “Please press Enter or OK key to delete all

corrections. Press ESC or Cancel to close this dialog.” The deletion is only performed if you press OK or Enter.

Key Path:	Input/Output, RF Output & Test Set Config, Multiport Adapter, Corrections
Remote Command:	[:SENSE] :MPADapter:CORRection:CSET:ALL:DELeTe
Example:	MPAD:CORR:CSET:ALL:DEL
Initial S/W Revision:	A.10.00

Set (Replace) Data (Remote Command Only)

The command takes an ASCII series of alternating frequency and amplitude points, each value separated by commas.

The values sent in the command will totally replace all existing correction points in the specified set.

An Ampcor array can contain 2000 points maximum.

Remote Command:	[:SENSE] :MPADapter:CORRection:CSET [1] 2 3 4 5 6 7 8 9 10 11 12 13 14 15 16 :DATA <freq>, <ampl>, . . . [:SENSE] :MPADapter:CORRection:CSET [1] 2 3 4 5 6 7 8 9 10 11 12 13 14 15 16 :DATA?
Example:	MPAD:CORR:CSET[1] 2 3 4 5 6 7 8 9 10 11 12 13 14 15 16:DATA 10000000,-1.0,20000000,1.0 This defines two correction points at (10 MHz, -1.0 dB) and (20 MHz, 1.0 dB) for correction set 1.
Preset:	Empty after Restore Input/Output Defaults. Survives a shutdown or restart of analyzer application (including a power cycle).
State Saved:	Saved in instrument state.
Min:	Freq: 0 Hz Amptd: -1000 dBm
Max:	Freq: 1 THz Amptd: +1000 dBm
Initial S/W Revision:	A.10.00

Merge Correction Data (Remote Command Only)

The command takes an ASCII series of alternating frequency and amplitude points, each value separated by commas. The difference between this command and Set Data is that this merges new correction points into an existing set.

Any new point with the same frequency as an existing correction point will replace the existing point's amplitude with that of the new point.

Input/Output

An Ampcor array can contain 2000 total points, maximum.

Remote Command:	[:SENSe] :MPADapter:CORRection:CSET [1 2 3 4 5 6 7 8 9 10 11 12 13 14 15 16 :DATA:MERGe <freq>, <ampl>, ...
Example:	MPAD:CORR:CSET[1]2 3 4 5 6 7 8 9 10 11 12 13 14 15 16:DATA:MERGE 15000000,-5.0,25000000,5.0 This adds two correction points at (15 MHz, -5.0 dB) and (25 MHz, 5.0 dB) to whatever values already exist in correction set 1.
Preset:	Empty after Restore Input/Output Defaults. Survives shutdown/restart of analyzer application (including power cycle)
Min:	Freq: 0 Hz Amptd: -1000 dBm
Max:	Freq: 1 THz Amptd: +1000 dBm
Initial S/W Revision:	A.10.00

Output Config

Accesses keys that configure various output settings, like the frequency reference output, trigger output and analog output.

Key Path:	Input/Output
Backwards Compatibility Notes:	1. In ESA there was not a user interface to enable the Video Output (Analog Output), Trigger Output, or Gate Output. In the X-Series each of these physical connectors requires configuration, thus the user interface has been added for X-Series, along with the potential for an output you think is always on to be switched off.
Initial S/W Revision:	Prior to A.02.00

Trig Out (1 and 2)

Select the type of output signal that will be output from the rear panel Trig 1 Out or Trig 2 Out connectors.

Key Path:	Input/Output, Output Config
Remote Command:	:TRIGger TRIGger1 TRIGger2 [:SEQuence] :OUTPut HSWP MEASuring MAIN GATE GTRigger OEVEN SPOint SSweep SETtled S1Marker S2Marker S3Marker S4Marker OFF :TRIGger TRIGger1 TRIGger2 [:SEQuence] :OUTPut?
Example:	TRIG:OUTP HSWP TRIG2:OUTP GATE

Dependencies:	The second Trigger output (Trig 2 Out) does not appear in all models; in models that do not support it, the Trig 2 Out key is blanked, and sending the SCPI command for this output generates an error, "Hardware missing; Not available for this model number" In models that do not support the Trigger 2 output, this error is returned if trying to set Trig 2 Out and a query of Trig 2 Out returns OFF.
Dependencies:	SSWeep SSETtled S1Marker S2Marker S3Marker S4Marker are only available for the source in the EXT.
Preset:	Trigger 1: Sweeping (HSWP) Trigger 2: Gate This is unaffected by a Preset but is preset to the above values on a "Restore Input/Output Defaults" or "Restore System Defaults->All"
State Saved:	Saved in instrument state
Initial S/W Revision:	Prior to A.02.00

Off

Selects no signal to be output to the Trig 1 Out or Trig 2 Out connector.

Key Path:	Input/Output, Output Config, Trig 1/2 Output
Example:	TRIG1:OUTP OFF
Readback:	Off
Initial S/W Revision:	Prior to A.02.00

Polarity

Sets the output to the Trig 1 Out or Trig 2 Out connector to trigger on either the positive or negative polarity.

Key Path:	Input/Output, Output Config, Trig 1/2 Output
Remote Command:	:TRIGger TRIGger1 TRIGger2[:SEquence]:OUTPut:POLarity POSitive NEGative :TRIGger TRIGger1 TRIGger2[:SEquence]:OUTPut:POLarity?
Example:	TRIG1:OUTP:POL POS
Preset:	This is unaffected by a Preset but is set to POSitive on a "Restore Input/Output Defaults" or "Restore System Defaults->All"
State Saved:	Saved in instrument state
Initial S/W Revision:	Prior to A.02.00

Input/Output

Sweeping (HSWP)

Selects the Sweeping Trigger signal to be output to the Trig 1 Out or Trig 2 Out connector when a measurement is made. This signal has historically been known as "HSWP" (High = Sweeping), and is 5 V TTL level with 50 ohm output impedance."

Key Path:	Input/Output, Output Config, Trig 1/2 Output
Example:	TRIG1:OUTP HSWP
Readback:	Sweeping
Initial S/W Revision:	Prior to A.02.00

Measuring

Selects the Measuring trigger signal to be output to the Trig 1 Out or Trig 2 Out connector. This signal is true while the Measuring status bit is true.

Key Path:	Input/Output, Output Config, Trig 1/2 Output
Example:	TRIG1:OUTP MEAS
Readback:	Measuring
Initial S/W Revision:	Prior to A.02.00

Main Trigger

Selects the current instrument trigger signal to be output to the Trig 1 Out or Trig 2 Out connector.

Key Path:	Input/Output, Output Config, Trig 1/2 Output
Example:	TRIG1:OUTP MAIN
Readback:	Main Trigger
Initial S/W Revision:	Prior to A.02.00

Gate Trigger

Selects the gate trigger signal to be output to the Trig 1 Out or Trig 2 Out connector. This is the source of the gate timing, not the actual gate signal.

Key Path:	Input/Output, Output Config, Trig 1/2 Output
Example:	TRIG1:OUTP GTR
Readback:	Gate Trigger
Initial S/W Revision:	Prior to A.02.00

Gate

Selects the gate signal to be output to the Trig 1 Out or Trig 2 Out connector. The gate signal has been delayed and its length determined by delay and length settings. When the polarity is positive, a high on

the Trig 1 Out or Trig 2 Out represents the time the gate is configured to pass the signal.

Key Path:	Input/Output, Output Config, Trig 1/2 Output
Example:	TRIG1:OUTP GATE
Readback:	Gate
Initial S/W Revision:	Prior to A.02.00

Odd/Even Trace Point

Selects either the odd or even trace points as the signal to be output to the Trig 1 Out or Trig 2 Out connector when performing swept spectrum analysis. When the polarity is positive, this output goes high during the time the test set is sweeping past the first point (Point 0) and every other following trace point. The opposite is true if the polarity is negative.

Key Path:	Input/Output, Output Config, Trig 1/2 Output
Example:	TRIG1:OUTP OEV
Readback:	Odd/Even
Initial S/W Revision:	Prior to A.02.00

Source Point Trigger

Selects the gate signal to be output to the Trig 1 Out or Trig 2 Out connector for use as the Point Trigger when operating an external source in Tracking mode. When Ext Trigger 1 is selected as the Point Trigger under Source, the Source Point Trigger under Trig1 Out automatically gets selected. Similarly, when Ext Trigger 2 is selected as the Point Trigger under Source, the Source Point Trigger key under Trig2 Out automatically gets selected

Key Path:	Input/Output, Output Config, Trig 1/2 Output
Example:	TRIG1:OUTP SPO
Readback:	Source Point
Initial S/W Revision:	Prior to A.02.00

Source Marker 1

This key is only available in the EXT.

Trigger output at marker 1 in current playing Waveform file.

Key Path:	Input/Output, Output Config, Trig 1/2 Output
Example:	:TRIG1:OUTP S1M
ReadBack:	Marker 1
Initial S/W Revision:	A.05.01

Input/Output

Source Marker 2

This key is only available in the EXT.

Trigger output at marker 2 in current playing Waveform file.

Key Path:	Input/Output, Output Config, Trig 1/2 Output
Example:	:TRIG1:OUTP S2M
ReadBack:	Marker 2
Initial S/W Revision:	A.05.01

Source Marker 3

This key is only available in the EXT.

Trigger output at marker 3 in current playing Waveform file.

Key Path:	Input/Output, Output Config, Trig 1/2 Output
Example:	:TRIG1:OUTP S3M
ReadBack:	Marker 3
Initial S/W Revision:	A.05.01

Source Marker 4

This key is only available in the EXT.

Trigger output at marker 4 in current playing Waveform file.

Key Path:	Input/Output, Output Config, Trig 1/2 Output
Example:	:TRIG1:OUTP S4M
ReadBack:	Marker 4
Initial S/W Revision:	A.05.01

Analog Out

This menu lets you control which signal is fed to the “Analog Out” connector on the test set rear panel.

See [“More Information” on page 985](#)

Key Path:	Input/Output, Output Config
Remote Command:	:OUTPut:ANALog OFF SVIDeo LOGVidEo LINVidEo DAUDio :OUTPut:ANALog?
Example:	OUTP:ANAL SVIDeo ! causes the analog output type to be Screen Video
Preset:	OFF

Preset:	This is unaffected by Preset but is set to DAUDio on a "Restore Input/Output Defaults" or "Restore System Defaults->All
State Saved:	Saved in Input/Output State
Readback line:	1-of-N selection [variable]
Backwards Compatibility Notes:	<p>Prior to A.04.00, OFF was the default functionality except when in the Analog Demod application or with Tune and Listen, in which case it was DAUDio, and there was no selection menu. So for backwards compatibility with earlier X-Series firmware versions, Auto (:OUTP:ANAL:AUTO ON) will duplicate the prior behavior.</p> <p>The DNWB and SANalyzer parameters, which were legal in PSA but perform no function in the X-Series, are accepted without error.</p>
Initial S/W Revision:	A.04.00

More Information

The table below gives the range for each output.

Analog Out	Nominal Range exc. (10% overrange)	Scale Factor	Notes
Off	0 V		
Screen Video	0 – 1 V open circuit	10%/division	8566 compatible
Log Video	0 – 1 V terminated	1/(192.66 dB/V)	dB referenced to mixer level, 1V out for –10 dBm at the mixer.
Linear Video	0 – 1 V terminated	100%/V	Linear referenced to Ref Level, 1 V out for RF envelope at the Ref Level.
Demod Audio	(varies with test set setting)		

Auto

Selects the Auto state for the Analog Output menu. In this state, the Analog Output will automatically be set to the most sensible setting for the current mode or measurement.

If you make a selection manually from the Analog Out menu, this selection will remain in force until you change it (or re-select Auto), even if you go to a mode or measurement for which the selected output does not apply.

Key Path:	Input/Output, Output Config, Analog Out
Remote Command:	:OUTPut :ANALog:AUTO OFF ON 0 1 :OUTPut :ANALog:AUTO?
Example:	OUTP:ANAL:AUTO ON
Preset:	ON
State Saved:	Saved in Input/Output State

Input/Output

Initial S/W Revision:	A.04.00
-----------------------	---------

Off

Turns off the analog output.

Key Path:	Input/Output, Output Config, Analog Out
Example:	OUTP:ANAL OFF ! causes the analog output to be off
Readback Text:	Off
Initial S/W Revision:	A.04.00

Log Video (RF Envelope, Ref=Mixer Level)

Selects the analog output to be the log of the video signal. In this mode, the pre-detector data is output to the Analog Out connector with a Log scaling. The output is referenced to the current level at the mixer, does not depend on display settings like Reference Level or dB per division, and it is not influenced by the selected detector or any digital flatness corrections or trace post-processing (like Trace Averaging), but does change with input attenuation.

The output is designed so that full scale (1 V) corresponds to -10 dBm at the mixer. The full range (0–1 V) covers 192.66 dB ; thus, 0 V corresponds to -202.66 dBm at the mixer.

Key Path:	Input/Output, Output Config, Analog Out
Example:	OUTP:ANAL LOGV
Dependencies:	<p>Because the Log Video output uses one of the two IF processing channels, only one detector is available while Screen Video is selected. All active traces will change to use the same detector as the selected trace when Log Video is activated.</p> <p>Log Video output is not available while any EMI Detector is selected (Quasi Peak, RMS Average or EMI Average), because these detectors use both IF processing channels. Consequently, if the user chooses an EMI Detector, there will be no Log Video output.</p> <p>The output holds at its last value during an alignment, during a marker count, and during retrace (after a sweep and before the next sweep starts).</p> <p>This function depends on optional capability. The key will be blanked and the command will generate an “Option not available” error unless you have Option YAV licensed in your instrument.</p>
Couplings:	Log Video output changes while in FFT Sweeps, so for measurements that use exclusively FFT Sweeps, or if the user manually chooses FFT Sweeps, the Log Video output will look different than it does in swept mode.
Readback Text:	Log Video
Initial S/W Revision:	A.04.00

Linear Video (RF Envelope, Ref=Ref Level)

Selects the analog output to be the envelope signal on a linear (voltage) scale. In this mode, the pre-detector data is output to the Analog Out connector with a Linear scaling. The output is based on the current Reference Level, and is not influenced by the selected detector or any digital flatness corrections or trace post-processing (like Trace Averaging).

The scaling is set so that 1 V output occurs with an instantaneous video level equal to the reference level, and 0 V occurs at the bottom of the graticule. This scaling gives you the ability to control the gain without having another setup control for the key. But it requires you to control the look of the display (the reference level) in order to control the analog output.

This mode is ideal for looking at Amplitude Modulated signals, as the linear envelope effectively demodulates the signal.

Key Path:	Input/Output, Output Config, Analog Out
Example:	OUTP:ANAL LINV
Dependencies:	<p>Because the Linear Video output uses one of the two IF processing channels, only one detector is available while Linear Video is selected. All active traces will change to use the same detector as the selected trace when Log Video is activated.</p> <p>Linear Video output is not available while any EMI Detector is selected (Quasi Peak, RMS Average or EMI Average), because these detectors use both IF processing channels. Consequently, if the user chooses an EMI Detector, there will be no Linear Video output.</p> <p>The output holds at its last value during an alignment and during a marker count and during retrace (after a sweep and before the next sweep starts).</p> <p>This function depends on optional capability; the key will be blanked and the command will generate an “Option not available” error unless you have Option YAV licensed in your instrument.</p>
Couplings:	Linear Video output changes while in FFT Sweeps, so for measurements that use exclusively FFT Sweeps, or if the user manually chooses FFT Sweeps, the Linear Video output will look different than it does in swept mode.
Readback Text:	Linear Video
Initial S/W Revision:	A.04.00

Demod Audio

Selects the analog output to be the demodulation of the video signal.

When Demod Audio is selected, the demodulated audio signal appears at this output whenever the Analog Demod application is demodulating a signal.

When Analog Out is in the Auto state, this output is auto-selected when in the Analog Demod mode.

If any other Analog Output is manually selected when in the Analog Demod mode, a condition warning

Input/Output

message appears.

Key Path:	Input/Output, Output Config, Analog Out
Example:	OUTP:ANAL DAUD
Dependencies:	<p>This key only appears if the Analog Demod application (N9063A), the N6141A or W6141A application, or Option EMC is installed and licensed, otherwise the key will be blanked and the command will generate an “Option not available” error.</p> <p>The output holds at its last value during an alignment and during a marker count. It is not held between sweeps, in order for Tune and Listen to work properly.</p> <p>When Demod Audio is the selected Analog Output:</p> <ul style="list-style-type: none">• all active traces are forced to use the same detector.• CISPR detectors (QPD, EMI Avg, RMS Avg) are unavailable
Readback Text:	Demod Audio
Initial S/W Revision:	Prior to A.02.00 (this was the default functionality, and there was no selection)
Modified at S/W Revision:	A.04.00

Digital Bus

This menu allows you to configure the LVDS connector located on the rear panel of the instrument. It is a unidirectional link of real time data at a 90 MSa/s rate. The ADC is sampling a 22.5 MHz IF.

The data that appears on this port is raw, uncorrected ADC samples, unless you have option RTL. With option RTL, you get fully corrected I/Q data.

This connector will only be active when the Narrowband IF Path is currently in use.

Key Path:	Input/Output, Output Config, Digital Out
Initial S/W Revision:	A.04.00

Marker

See “Marker Control Mode” on page 989.

See “Setting the Marker X-axis Value” on page 989.

See “Setting the Marker X Position in Trace Points” on page 990.

See “Setting the Marker Y-axis Value” on page 991.

The Marker key accesses the Marker menu. A marker can be placed on a trace to allow the value of the trace at the marker point to be determined precisely. The functions in this menu include a 1-of-N selection of the control mode Normal, Delta, Fixed, or Off for the selected marker. If the selected marker is Off, pressing Marker sets it to Normal and places it at the center of the screen on the trace determined by the Marker Trace rules.

Markers may also be used in pairs to read the difference (or delta) between two data points. They can be used in Marker Functions to do advanced data processing, or to specify operating points in functions like Signal Track and N dB Points.

The SCPI command in the table below selects the marker and sets the marker control mode as described under **Normal**, **Delta**, **Fixed** and **Off**, below. All interactions and dependencies detailed under the key description are enforced when the remote command is sent.

Remote Command:	:CALCulate:MARKer [1] 2 3 4 5 6 7 8 9 10 11 12 :MODE POSITION DELTA FIXED OFF :CALCulate:MARKer [1] 2 3 4 5 6 7 8 9 10 11 12 :MODE?
Preset:	OFF (all markers)
State Saved:	The marker control mode is saved in instrument state
Backwards Compatibility SCPI:	:CALCulate:MARKer[1] 2 3 4 5 6 7 8 9 10 11 12:MODE SPAN BAND These parameters are aliased to POSITION if sent. A query does not reflect them.
Initial S/W Revision:	Prior to A.02.00

Marker Control Mode

Setting the Marker X-axis Value

The command below sets the marker X-axis value in the current marker X-axis scale unit. In each case the marker that is addressed becomes the selected marker. It has no effect (other than to cause the marker to become selected) if the control mode is **Off**, **but** it is the SCPI equivalent of entering an X value if the control mode is **Normal**, **Delta**, or **Fixed**.

Remote Command:	:CALCulate:MARKer [1] 2 3 4 5 6 7 8 9 10 11 12 :X <freq> :CALCulate:MARKer [1] 2 3 4 5 6 7 8 9 10 11 12 :X?
------------------------	--

Marker

Notes:	<p>If no suffix is sent it will use the fundamental units for the current marker X-axis scale. If a suffix is sent that does not match the current marker X-axis scale unit, an invalid suffix error is generated.</p> <p>If the specified marker is Fixed and a Marker Function is on, a message is generated. If the key is pressed, an advisory message is generated. If the equivalent SCPI command is sent, this same message is generated as part of a “–221, Settings conflict” warning.</p> <p>The query returns the marker’s absolute X-axis value if the control mode is Normal or Fixed. It returns the offset from the marker’s reference marker if the control mode is Delta. The query is returned in the fundamental units for the current marker X-axis scale: Hz for Frequency and Inverse Time, seconds for Period and Time. If the marker is Off the response is not a number.</p>
Preset:	After a preset, if X is queried with no value sent first, the center of screen value is returned.
Min:	$-\infty$ (minus infinity)
Max:	$+\infty$ (plus infinity). X-Series marker values are not limited and do not clip
Default Unit:	Determined by X-axis scale
Backwards Compatibility SCPI:	:CALCulate:MARKer[1] 2 3 4:X:CENTer
Initial S/W Revision:	Prior to A.02.00

Setting the Marker X Position in Trace Points

The command below sets the marker X position in trace points. It has no effect if the marker control mode is **Off**. But it is the SCPI equivalent of entering a value if the control mode is **Normal** or **Delta** or **Fixed** – except the setting is in trace points rather than X-axis scale units.

NOTE	<p>The entered value in Trace Points is immediately translated into the current X-axis scale units for setting the value of the marker. The marker’s value in X-axis scale Units, NOT trace points, are preserved if a change is made to the X-axis scale settings. Thus, if you use this command to place a marker on bucket 500, which happens at that time to correspond to 13 GHz, and then you change the Start Frequency so that bucket 500 is no longer 13 GHz, the marker will stay at 13 GHz, NOT at bucket 500.</p>
-------------	---

Remote Command:	<pre>:CALCulate:MARKer[1] 2 3 4 5 6 7 8 9 10 11 12:X:POSitio n <real> :CALCulate:MARKer[1] 2 3 4 5 6 7 8 9 10 11 12:X:POSitio n?</pre>
------------------------	---

Notes:	<p>If the specified marker is Fixed and a Marker Function is on, a message is generated. If the key is pressed, an advisory message is generated. If the equivalent SCPI command is sent, this same message is generated as part of a “-221, Settings conflict” warning.</p> <p>The query returns the marker’s absolute X-axis value in trace points if the control mode is Normal or Fixed. It returns the offset from the marker’s reference marker in trace points if the control mode is Delta. The value is returned as a real number, not an integer, corresponding to the translation from X-axis scale units to trace points</p>
Preset:	After a preset, if X is queried with no value sent first, the center of screen value is returned. So if per default, the number of Trace points is 1001, the center value is 500.
Min:	0
Max:	Number of trace points – 1
Default Unit:	unitless
Backwards Compatibility SCPI:	:CALCulate:MARKer[1] 2 3 4:X:POSition:CENTer
Backwards Compatibility SCPI:	<p>The legacy command,</p> <p>:CALCulate:MARKer[n]:X:POSition:CENTer <param></p> <p>was used to control the center point between the Delta and Reference marker in trace points (buckets) in Span Pair mode. In the new system, this is equivalent to simply setting the marker position in trace points. So this command is aliased to the command</p> <p>:CALCulate:MARKer[n]:X:POSition <param></p> <hr/> <p>NOTE The UP/DOWN parameters will increment/decrement by one bucket. This will require a conversion to buckets and back.</p> <hr/>
Initial S/W Revision:	Prior to A.02.00

Setting the Marker Y-axis Value

The command below selects the marker and sets the marker Y-axis value; the default unit is the current Y-axis unit. It has no effect (other than selecting the marker) unless the marker control mode is **Fixed**.

Remote Command:	<pre>:CALCulate:MARKer [1] 2 3 4 5 6 7 8 9 10 11 12 : Y <real></pre> <pre>:CALCulate:MARKer [1] 2 3 4 5 6 7 8 9 10 11 12 : Y?</pre>
Example:	<p>CALC:MARK2:MODE POS turns on marker 2 as a normal marker.</p> <p>CALC:MARK2:X 20 GHZ moves marker 2 to 20 GHz if X-axis scale is Frequency. If X-axis scale is Time, the -131 invalid suffix error is generated.</p>
Preset:	Trace value at center of screen. There is no way to predict what this will be after a preset.

Marker

Min:	$-\infty$ (minus infinity)
Max:	$+\infty$ (plus infinity)
Initial S/W Revision:	Prior to A.02.00

Select Marker

Specifies the selected marker. The term “selected marker” is used throughout this document to specify which marker is affected by the functions.

Key Path	Marker
Notes	The selected marker is remembered even when not in the Marker menu and is used if a Search is done or a Band Function is turned on or for Signal Track or Continuous Peak.
Preset	Marker 1
State Saved	The number of the selected marker is saved in instrument state.
Initial S/W Revision	Prior to A.02.00

Normal

Sets the control mode for the selected marker to **Normal** and turns on the active function for setting its value. If the selected marker was **Off**, it is placed at the center of the screen on the trace specified by the marker’s Trace attribute.

A Normal mode (POSition type) marker can be moved to any point on the X-axis by specifying its X-axis value. Its absolute Y-axis value is then the value of the trace point at that X-axis value.

Key Path	Marker
Example	:CALC:MARK:MODE POS sets Marker 1 to Normal.
Notes	See the description under the “Marker” key, above.
Couplings	<ul style="list-style-type: none">The marker addressed by this command becomes the selected marker on the front panel.
State Saved	The marker control mode (Normal, Delta, Fixed, Off) and X-axis value are saved in instrument state.
Initial S/W Revision	Prior to A.02.00

Delta

Sets the control mode for the selected marker to Delta and turns on the active function for setting its delta value. If the selected marker was **Off**, it is placed at the center of the screen on the trace specified by the marker’s Trace attribute.

In Delta mode the marker result shows the relative result between the selected (Delta) marker and its reference marker. A delta marker can be moved to any point on the X-axis by specifying its X-axis offset

from a reference marker. Its absolute Y-axis value is then the value of the trace point at that X-axis value.

Key Path	Marker
Example	:CALC:MARK:MODE DELT sets marker 1 to Delta.
Notes	See the description under the “Marker” key, above.
State Saved	The marker control mode (Normal, Delta, Fixed, Off) and X-axis value are saved in instrument state
Initial S/W Revision	Prior to A.02.00

Fixed

See [“Fixed Marker X-axis Value”](#) on page 994.

See [“Fixed Marker Y-axis Value”](#) on page 994.

Sets the control mode for the selected marker to Fixed. A fixed marker is fixed in the sense that it stays where you place it. It can be directly moved in both X and Y. It can be moved with a Peak Search. It can also be indirectly moved by re-zeroing the delta if it is a relative marker. If it is moved, it again becomes fixed at the X-axis point it moved to and it has a Y-axis result that it took on when it moved there. If a Normal or Delta marker is changed to Fixed it becomes fixed at the X-axis point it was at, and with the Y-axis result it had when it was set to Fixed.

In Fixed mode the marker result shows:

- If no Marker Function is on, the absolute X-axis and Y axis value of the marker
- If a Marker Function is on, the X-axis value and the Y-axis function result the marker had when it became fixed.

Marker

Fixed Marker X-axis Value

Key Path	Marker, Fixed
Example	:CALC:MARK:MODE FIX sets Marker 1 to Fixed.
Notes	See the description under the “Marker” key, above.
Dependencies	<p>You cannot directly set the X or Y value of a Fixed marker which has a marker function turned on. If an attempt is made to actually adjust it while a Marker Function is on, a message is generated. If the key is pressed, an advisory message is generated. If the equivalent SCPI command is sent, this same message is generated as part of a “-221, Settings conflict” warning.</p> <p>you cannot directly set the Y value of a Fixed marker while Normalize is turned on. If an attempt is made to do so while Normalize is on, a message is generated. If the key is pressed, an advisory message is generated. If the equivalent SCPI command is sent, this same message is generated as part of a “-221, Settings conflict” warning.</p>
State Saved	The marker control mode (Normal, Delta, Fixed, Off) and X and Y-axis values are saved in instrument state
Initial S/W Revision	Prior to A.02.00

Fixed Marker Y-axis Value

Key Path	Marker, Fixed
Example	:CALC:MARK:MODE FIX sets Marker 1 to Fixed.
Notes	See the description under the Marker key, above.
Dependencies	you cannot directly set the X or Y value of a Fixed marker which has a marker function turned on. If an attempt is made to actually adjust it while a Marker Function is on, a message is generated. If the key is pressed, an advisory message is generated. If the equivalent SCPI command is sent, this same message is generated as part of a “-221, Settings conflict” warning.
State Saved	The marker control mode (Normal, Delta, Fixed, Off) and X and Y-axis values are saved in instrument state
Default Unit	depends on the current selected Y axis unit
Initial S/W Revision	Prior to A.02.00

Off

Turns off the selected marker and its marker function setting, if any. However, Off does not affect which marker is selected.

Key Path	Marker
Example	:CALC:MARK:MODE OFF sets Marker 1 to Off.

Notes	See the description under the “Marker” key, above.
State Saved	The marker control mode (Normal, Delta, Fixed, Off) is saved in instrument state
Initial S/W Revision	Prior to A.02.00

Properties

Opens a menu used to set certain properties of the selected marker.

Key Path	Marker
Initial S/W Revision	Prior to A.02.00

Select Marker

Duplicate of the **Select Marker** key under **Marker**. Selecting a marker here causes the same marker to be selected under **Marker**. (That is, there is only one “selected marker”.)

Relative To

Selects the marker that the selected marker is relative to (its reference marker).

Every marker has another marker to which it is relative. This marker is referred to as the “reference marker” for that marker. This attribute is set by the **Marker, Properties, Relative To** key. The marker must be a **Delta** marker to make this attribute relevant. If it is a **Delta** marker, the reference marker determines how the marker is controlled and how its value is displayed. A marker cannot be relative to itself.

Key Path	Marker, Properties
Remote Command	:CALCulate:MARKer [1] 2 3 4 5 6 7 8 9 10 11 12 :REFerence <integer> :CALCulate:MARKer [1] 2 3 4 5 6 7 8 9 10 11 12 :REFerence ?
Example	CALC:MARK1:REF 2 sets the marker 1 reference marker to 2 and turns marker 1 on as a delta marker.
Notes	A marker cannot be relative to itself so that choice is grayed out. If the grayed out key is pressed, an advisory message is generated. If the equivalent SCPI command is sent, this same message is generated as part of a “–221, Settings conflict” warning. See error –221.2200 in Master Error Messages: X-Series document for exact error text.
Notes	This command causes the marker specified with the subopcode to become selected. Range (for SCPI command): 1 to 12. If the range is exceeded the value is clipped.

Marker

Couplings	The act of specifying the selected marker's reference marker makes the selected marker a Delta marker. If the reference marker is off it is turned on in Fixed mode at the delta marker location.
Preset	The preset default "Relative To" marker (reference marker) is the next higher numbered marker (current marker +1). For example, if marker 2 is selected, then it's default reference marker is marker 3. The exception is marker 12, which has a default reference of marker 1. Set to the defaults by using Restore Mode Defaults . This is not reset by Marker Off , All Markers Off , or Preset .
State Saved	Saved in instrument state. Not affected by Marker Off and hence not affected by Preset or power cycle.
Min	1
Max	12
Status Bits/OPC dependencies	none Default (selected when Restore Mode Defaults is pressed): next higher numbered marker or 1 if marker 12.
Initial S/W Revision	Prior to A.02.00

X-axis scale (formerly Readout)

Accesses a menu that enables you to affect how the X-axis information for the selected marker is displayed in the marker area (top-right of display) and the active function area of the display, and how the marker is controlled. The available settings for the X-axis scale are Frequency, Period, Time, and Inverse Time.

See "[More Information](#)" on page 997.

Key Path	Marker, Properties
Remote Command	:CALCulate:MARKer [1] 2 3 4 5 6 7 8 9 10 11 12 :X:READout FREQuency TIME ITIME PERiod :CALCulate:MARKer [1] 2 3 4 5 6 7 8 9 10 11 12 :X:READout ? :CALCulate:MARKer [1] 2 3 4 5 6 7 8 9 10 11 12 :X:READout :AUTO ON OFF 1 0 :CALCulate:MARKer [1] 2 3 4 5 6 7 8 9 10 11 12 :X:READout :AUTO?
Example	CALC:MARK3:X:READ TIME sets the marker 3 X-axis scale to Time.
Notes	This command causes the specified marker to become selected.
Notes	This command causes the specified marker to become selected.

Preset	AUTO Marker Preset (selected when a marker is turned Off): Auto (see below). In most measurements the Auto settings results in Frequency being the preset readout.
State Saved	Saved in instrument state
Initial S/W Revision	Prior to A.02.00

More Information

The **X-axis scale** of a marker is the scale of its X-axis value. This affects the units displayed in the Marker Result block and used to specify the marker's X-axis location. The X-axis scale is specified using the **Marker, Properties, X-axis scale** key.

All markers in swept spans have both a time and frequency value. Which of these is used for the result display, and for positioning the marker, depends on the **X-axis scale** setting. The **X-axis scale** setting can be **Frequency** or **Time**, as well as the reciprocal of either (**Period** or **Inverse Time**). There is also an **Auto** setting - when in **Auto**, a marker's **X-axis scale** changes whenever the domain of the trace, upon which it set, changes. All choices for **X-axis scale** are allowed.

Auto

When in Auto, the X-Axis Scale is **Frequency** if the Marker Trace is a frequency domain trace, **Time** if the Marker Trace is a time domain trace. When in Auto, if the marker changes traces, or the domain of the trace the marker is on changes, the auto result is re-evaluated. If the X-axis scale is chosen manually, that Scale is used regardless of the domain of the trace.

Key Path	Marker, Properties, X-axis scale
Example	CALC:MARK2:X:READ:AUTO ON sets the marker 2 X-axis scaling to automatically select the most appropriate units.
Initial S/W Revision	Prior to A.02.00

Frequency

Sets the marker X-axis scale to Frequency, displaying the absolute frequency of a normal marker or the frequency of the delta marker relative to the reference marker. Frequency is the auto setting for frequency domain traces.

If Frequency is selected for a time domain trace, all of the points in the trace will show the same value. Attempting to use the knob or step keys to adjust the X-axis value of the marker or entering an X-axis value from the numeric keypad or remotely will have no effect but will generate no error.

Key Path	Marker, Properties, X-axis Scale
Example	CALC:MARK2:X:READ FREQ sets the marker 2 X-axis scale to Frequency.
Notes	1-of-N readback is Frequency
State Saved	The X-axis scale setting is saved in instrument state.
Initial S/W Revision	Prior to A.02.00

Marker

Period

Sets the marker X-axis scale to Period, displaying the reciprocal of the frequency of the marker, or the reciprocal of the frequency separation of the two markers in a delta-marker mode. The units are those of time (sec, msec, et cetera). If the markers are at the same frequency in a delta marker mode, the result is the reciprocal of 0, which is infinitely large. The display will show “---” and a SCPI query will return infinity.

If Period is selected for a time domain trace, all of the points in the trace will show the same value. Attempting to use the knob or step keys to adjust the X-axis value of the marker or entering an X-axis value from the numeric keypad or remotely will have no effect but will generate no error.

Key Path	Marker, Properties, X-axis Scale
Example	CALC:MARK2:X:READ PER sets the marker 2 X-axis scale to Period.
Notes	1-of-N readback is Period
State Saved	The X-axis scale setting is saved in instrument state.
Initial S/W Revision	Prior to A.02.00

Time

Sets the marker X-axis scale to Time, displaying the time interval between a normal marker and the start of a sweep or the time of the delta marker relative to the reference marker. Time is the auto setting for time domain traces. In a delta-marker mode it is the (sweep) time interval between the two markers.

Key Path	Marker, Properties, X Axis Scale
Example	CALC:MARK2:X:READ TIME sets the marker 2 X-axis scale to Time.
Notes	1-of-N readback is Time
Couplings	Frequency domain traces taken in FFT mode have no valid time data. Therefore when Time is selected for markers on such traces, the X-axis value is taken as the appropriate percentage of the displayed sweep time, which is a calculated estimate.
State Saved	The X-axis scale setting is saved in instrument state
Initial S/W Revision	Prior to A.02.00

Inverse Time

Sets the marker X-axis scale to Inverse Time, displaying the reciprocal time. It is useful in a delta mode to show the reciprocal of (sweep) time between two markers. This function is only meaningful when on a time domain trace and in the **Delta** control mode. If the markers are at the same X-axis value, the time between them is 0, so the reciprocal of sweep time is infinitely large. The display will show “---” and a SCPI query will return infinity.

Key Path	Marker, Properties, X Axis Scale
Example	:CALC:MARK2:X:READ ITIM sets the marker 2 X-axis scale to Inverse Time.

Notes	1-of-N readback is Inverse Time
Couplings	Frequency domain traces taken in FFT mode have no valid time data. Therefore when Inverse Time is selected for markers on such traces, the X-axis value is undefined, shows as “---” and returns not a number to a query.
State Saved	The X-axis scale setting is saved in instrument state
Initial S/W Revision	Prior to A.02.00

Marker Trace

Selects the trace that you want your marker to be placed on. A marker is associated with one and only one trace. This trace is used to determine the placement, result, and X-axis scale of the marker. All markers have an associated trace, even **Fixed** markers; it is from that trace that they determine their attributes and behaviors, and it is to that trace that they go when they become Normal or Delta markers.

See [“Auto Init On” on page 1000](#).

See [“Auto Init Rules Flowchart” on page 1000](#).

See [“Auto Init OFF” on page 1000](#).

Key Path	Marker, Properties
Remote Command	:CALCulate:MARKer [1] 2 3 4 5 6 7 8 9 10 11 12 :TRACe 1 2 3 4 5 6 :CALCulate:MARKer [1] 2 3 4 5 6 7 8 9 10 11 12 :TRACe?
Example	CALC:MARK1:TRAC 2 places marker 1 on trace 2.
Notes	A marker may be placed on a blanked and/or inactive trace, even though the trace is not visible and/or updating. An application may register a trace name to be displayed on the key instead of a trace number.
Couplings	The state of Marker Trace is not affected by the Auto Couple key. If a Marker Trace is chosen manually, Auto Init goes to Off for that marker. Sending the remote command causes the addressed marker to become selected.
Preset	Presets on Preset or All Markers Off
State Saved	The Marker Trace and state of Auto Init for each marker is saved in instrument state.
Min	1
Max	6
Readback line	[TraceN, Auto Init] or [TraceN, Manual] where N is the trace number to which the marker is currently assigned.
Initial S/W Revision	Prior to A.02.00

Marker

Auto Init On

When **Auto Init** is true, the marker's trace attribute is re-determined automatically by the test set whenever the marker turns on (Normal, Delta or Fixed) from an Off state. (The trace attribute is also determined for all markers that are on, whenever **Auto Init** is turned on).

When the marker moves between traces the marker's X position in trace points is retained as it moves. For moving between active traces this generally means the x-axis value of the marker will not change. But for moving to or from an inactive trace, the x-axis value will take on that of the new trace at the bucket the marker was on the old trace (and is still on, on the new trace, since the bucket doesn't change).

Note this is true even if the marker is off screen. Thus, a marker that is at the center of the screen on the old trace stays at the center of the screen on the new trace. A marker that is off screen one whole screen to the left on the old trace remains off screen one whole screen to the left on the new trace – even if this means it is at negative time.

Marker Trace is set to 1, and Auto Init is set to On, on a Preset or All Markers Off.

Auto Init Rules Flowchart

Auto Init OFF

This command associates the marker with the specified trace and turns Marker Trace, Auto Init OFF for that marker. If the marker is not **Off** it moves the marker from the trace it was on to the new trace. If the marker is **Off** it stays off but is now associated with the specified trace.

The query returns the number of the trace on which the marker is currently placed, even if that marker is in Auto mode.

Remote Command:	:CALCulate:MARKer [1] 2 3 4 5 6 7 8 9 10 11 12 :TRACe:AUTO OFF ON 0 1 :CALCulate:MARKer [1] 2 3 4 5 6 7 8 9 10 11 12 :TRACe:AUTO?
Notes:	Turning Marker Trace Auto Init off has no effect on the trace on which the marker is currently placed. The response to the query is 0 if OFF, 1 if ON.
Couplings:	The state of Auto Init is not affected by the Auto Couple key. Auto Init is set to True on a Preset or All Markers Off. If Auto Init is set to On for a marker and that marker is on, that marker's Marker Trace is immediately set according to the above flowchart. Sending the remote command causes the addressed marker to become selected.
Preset:	ON
Initial S/W Revision:	Prior to A.02.00

Lines

When on, displays a vertical line of graticule height and a horizontal line of graticule width, intersecting

at the indicator point of the marker (that is, the center of the X or the bottom tip of the diamond. The lines are blue in color.

If the marker is off screen the lines should be extended from the marker so that they go thru the screen area if possible. This is really useful for off screen Fixed markers as it lets you see their amplitude even though they are off the X-axis.

Key Path	Marker, Properties
Remote Command	:CALCulate:MARKer [1] 2 3 4 5 6 7 8 9 10 11 12 :LINes [:STATe] OFF ON 0 1 :CALCulate:MARKer [1] 2 3 4 5 6 7 8 9 10 11 12 :LINes [:STATe] ?
Example	:CALC:MARK2:LIN:ON turns Lines on for marker 2.
Couplings	Sending the remote command causes the addressed marker to become selected.
Preset	OFF
State Saved	Saved in State
Initial S/W Revision	Prior to A.02.00

Marker Table

When set to On the display is split into a measurement window and a marker data display window. For each marker which is on, information is displayed in the data display window, which includes the marker number, control mode, trace number, X axis scale, X axis value, and the Y-axis result. Additional information is shown for markers which have marker functions turned on.

Turning the Marker Table on turns the Peak Table off and vice versa.

Key Path	Marker
Remote Command	:CALCulate:MARKer:TABLE [:STATe] OFF ON 0 1 :CALCulate:MARKer:TABLE [:STATe] ?
Example	CALC:MARK:TABL ON turns on the marker table.
Preset	OFF
State Saved	Whether the marker table is on is saved in instrument state
Initial S/W Revision	Prior to A.02.00

Marker Count

Accesses the marker count menu.

Key Path	Marker
----------	--------

Marker

Readback line	[On] if count on for the selected marker, [Off] if it is off.
Initial S/W Revision	Prior to A.02.00

Counter On/Off

Turns the marker frequency counter on and off. The selected marker is counted, and if the selected marker is a delta marker and its reference marker is not fixed, the reference marker is counted as well.

See [“Understanding the Marker Counter”](#) on page 1003.

See [“Query Count Value”](#) on page 1003.

Key Path	Marker Function, Marker Count
Remote Command	:CALCulate:MARKer [1] 2 3 4 5 6 7 8 9 10 11 12 :FCOunt [:S TATe] OFF ON 0 1 :CALCulate:MARKer [1] 2 3 4 5 6 7 8 9 10 11 12 :FCOunt [:S TATe] ?
Example	CALC:MARK2:FCO ON selects marker 2, turns it on, and turns on the counter CALC:MARK2:FCO:X? returns the counted frequency.
Notes	Fixed markers are not counted, but a Fixed marker will have a count stored in it if it is selected or is the reference marker for the selected marker. The count already in the marker is stored when the marker becomes fixed and if there is none or the marker moves (for example, Pk Search) it is counted and stored after the next sweep. If a Fixed marker has a count stored in it, that count is displayed when the marker is selected, and used as the reference count when that marker is a reference marker. If a Fixed marker has a count stored in it, that count is deleted if the marker X is adjusted. If a Fixed marker has a count stored in it, and a Search function is performed using the Fixed marker, while the counter is on, the count stored in the marker is updated. If a Fixed marker has a count stored in it, and is a reference marker, and the reference is moved to a valid trace point by re-zeroing the delta (by pressing Delta again or sending the DELTa SCPI command), while the counter is on, the count stored in the marker is updated.
Notes	This command causes the specified marker to become selected.
Dependencies	Marker Count is unavailable (grayed out and Off) if the Gate function is on.

Couplings	<p>If the selected marker is Off when the counter is turned on, the selected marker is set to Normal and placed at center of screen on the trace determined by the Marker Trace rules.</p> <p>If a marker which is OFF is selected while the counter is on, the counter remains on, but since the marker is off, the count is undefined. In this case, the test set returns "not a number" to a SCPI count query.</p> <p>The counter is turned OFF when the selected marker is turned OFF.</p>
Preset	OFF
State Saved	The state of the counter (on/off) is saved in instrument state. In the case of Fixed markers, the count stored in the marker is saved in instrument state.
Initial S/W Revision	Prior to A.02.00

Query Count Value

Queries the frequency count. The query returns the absolute count unless the specified marker is in Delta mode, then it returns the relative count. If the marker is off, or the marker is on but the counter is off, the test set will return "not a number" to a SCPI count query. A marker with no stored count, or a non-**Fixed** marker on a stored trace, will also return not a number to a SCPI count query. Note this result may simply mean that the first sweep after the counter turned on has not yet completed.

Remote Command:	:CALCulate:MARKer [1] 2 3 4 5 6 7 8 9 10 11 12 :FCount :X?
Notes:	This query does NOT cause the specified marker to become selected.
Initial S/W Revision:	Prior to A.02.00

Understanding the Marker Counter

See [“Counting Off-screen Markers” on page 1004.](#)

See [“Delta Marker” on page 1004.](#)

See [“Fixed Markers” on page 1004.](#)

See [“More Information on "Counter"” on page 1004.](#)

Using the internal counter we can count the frequency of a marker, but we cannot count while we are actually sweeping. So, once we are done with a sweep, we move to the selected marker frequency and count that frequency. Then, if the marker is a Delta marker, the count is also taken for its reference marker. The count is actually performed by moving the LO to the frequency (or frequencies in the case of a delta marker) we wish to count. The count is executed on a marker by marker basis and no further count is taken until after the next sweep (even if the marker moves before another sweep has completed).

The Marker Count is taken by tuning the test set to the frequency of the marker and counting the IF, with the test set not sweeping. The count is adjusted for display by adding or subtracting it (as appropriate) from the LO frequency, so that you see a count that represents the signal frequency. This is true even if External Mixing is on. Since all this happens between sweeps, you never see the test set retuning to do the counts.

If you wish to see the entered frequency of a counted marker it will appear in the active function area when that marker is selected (for Fixed markers, you have to press the Marker, Fixed key to select Fixed

Marker

markers and then press it a second time to view or adjust the x or y marker values).

Counting Off-screen Markers

If the selected marker is off the X-axis the test set can still be tuned to the marker (unless it is outside the range of the test set), so the count can still be displayed. This means you can see a count for an off-screen marker even though there may be no valid Y-value for the marker. If the marker frequency is outside the range of the test set, the display will show three dashes in the count block (---), and not a number is returned to a SCPI count query.

Delta Marker

When a Delta Marker is selected while Marker Count is on:

If the reference marker is not a fixed marker, the display shows the difference between the count of the selected marker and the count of the reference marker

If the reference marker is a fixed marker and there is a count stored in the marker (because Marker Count was on when the marker became a fixed marker), the display shows the difference between the count at the marker and the count stored in the reference marker.

Marker Count works in zero span as well as in Swept analysis. The test set tunes to the frequency of the selected marker, which, for active zero span traces, is simply the center frequency of the test set.

Fixed Markers

Fixed markers have a count stored in them that is generally kept fixed and not updated. If a fixed marker is selected, or used as a reference, the signal at the marker frequency is not counted; rather the stored count is seen or used as the reference. The count is stored, if Count is on, when the marker becomes fixed or when, while fixed, the marker is moved by re-zeroing the reference (if it is the reference marker) or via a peak search (since both of these, by definition, use valid trace data). The count stored in a Fixed marker is lost if the counter is turned off, if the marker is moved to an inactive trace, or if the marker is moved by adjusting its x-value.

More Information on "Counter"

When the counter is on, the count (or the delta count) for the selected marker is displayed.

The invalid data indicator (*) will turn on until the completion of the first count.

Marker Count frequency readings are corrected using the **Freq Offset** function. Note however that Marker Delta readings are not corrected, as any offset would be applied to both.

In zero span on active traces the counter continues to function, counting any signal near the center frequency of the test set.

NOTE	No signal farther from the marker frequency than the Res BW is seen by the counter.
-------------	---

The above command turns on or off the frequency counter. If the specified marker number in the command is not the selected marker, it becomes the selected marker. If the specified marker number is not on, FCOunt ON sets it to Normal and places it at center of screen on the trace determined by the Marker Trace rules. Once the marker count is on, it is on for any selected marker, not just for the one

used in the command. A 1 is returned to the state query only if marker count is on and the specified number is the selected marker. The invalid data indicator (*) will turn on until the completion of the first count but this does not keep a value from being returned.

Gate Time Auto/Man

Controls the length of time during which the frequency counter measures the signal frequency. Longer gate times allow for greater averaging of signals whose frequency is “noisy”, though the measurement takes longer. If the gate time is an integer multiple of the length of a power-line cycle (20 ms for 50 Hz power, 16.67 ms for 60 Hz power), the counter rejects incidental modulation at the power line rate. The shortest gate time that rejects both 50 and 60 Hz modulation is 100 ms, which is the value chosen in Auto, or on Preset or when Auto Couple is pressed.

The start time of the Gate Time of the counter must be controlled by the same trigger parameters as controls the sweep. Thus, if the Trigger is not in Free Run, the counter gate must not start until after the trigger is received and delayed.

Key Path	Marker Function, Marker Count
Remote Command	:CALCulate:MARKer [1] 2 3 4 5 6 7 8 9 10 11 12 :FCOUNT :GATime <time> :CALCulate:MARKer [1] 2 3 4 5 6 7 8 9 10 11 12 :FCOUNT :GATime? :CALCulate:MARKer [1] 2 3 4 5 6 7 8 9 10 11 12 :FCOUNT :GATime:AUTO OFF ON 0 1 :CALCulate:MARKer [1] 2 3 4 5 6 7 8 9 10 11 12 :FCOUNT :GATime:AUTO?
Example	:CALC:MARK2:FCO:GAT 1e-2 sets the gate time for Marker 2 to $10^{(-2)}$ s = 10 ms.
Notes	When Auto Couple is pressed, Gate Time is set to 100 ms.
Notes	This command causes the specified marker to become selected.
Preset	100 ms ON
State Saved	Saved in instrument state.
Min	1 us
Max	500 ms
Initial S/W Revision	Prior to A.02.00

Couple Markers

When this function is true, moving any marker causes an equal X-axis movement of every other marker which is not Fixed or Off. By “equal X-axis movement” we mean that we preserve the difference between each marker’s X-axis value (in the fundamental x-axis units of the trace that marker is on) and the X-axis value of the marker being moved (in the same fundamental x-axis units).

Marker

Note that Fixed markers do not couple. They stay where they were while all the other markers move. Of course, if a Fixed marker is being moved, all the non-fixed markers do move with it.

This may result in markers going off screen.

Key Path	Marker
Remote Command	:CALCulate:MARKer:COUPle[:STATe] OFF ON 0 1 :CALCulate:MARKer:COUPle[:STATe]?
Example	:CALC:MARK:COUP ON sets Couple Markers on.
Preset	Off, presets on Mode Preset and All Markers Off
State Saved	Saved in State
Initial S/W Revision	Prior to A.02.00

All Markers Off

Turns off all markers. See Marker, “Off” on page 994.

Key Path	Marker
Remote Command	:CALCulate:MARKer:AOFF
Example	CALC:MARK:AOFF turns off all markers.
Couplings	sets the selected marker to 1.
Preset	n/a.
Initial S/W Revision	Prior to A.02.00

Marker Function

The Marker Function key opens up a menu of softkeys that allow you to control the Marker Functions of the instrument. Marker Functions perform post-processing operations on marker data. Band Functions are Marker Functions that allow you to define a band of frequencies around the marker. The band defines the region of data used for the numerical calculations. These marker functions also allow you to perform mathematical calculations on trace and marker data and report the results of these calculations in place of the normal marker result.

NOTE Unlike regular markers, marker function markers are not placed directly on the trace. They are placed at a location which is relative to the result of the function calculation.

See [“More Information”](#) on page 1007.

See [“Fixed marker functions”](#) on page 1008.

See [“Interval Markers”](#) on page 1008.

Remote Command	:CALCulate:MARKer [1] 2 3 4 5 6 7 8 9 10 11 12 :FUNctIon NOISe BPOWer BDENsity OFF :CALCulate:MARKer [1] 2 3 4 5 6 7 8 9 10 11 12 :FUNctIon?
Notes	Sending this command selects the subcoded marker The marker function result is queried in the same fashion as the Marker Result, as outlined in the Marker section, with the CALC:MARK:Y? command.
Dependencies	Fixed markers: It is not possible to change the Band Function for a Fixed marker; so all of the Band Function keys are grayed out for a Fixed marker. If a marker function was already on when the marker became Fixed then the selected Band Function is shown but cannot be changed. Therefore, you cannot directly set the X or Y value of a Fixed marker which has a marker function turned on. To turn off the function, turn off the marker.
Preset	OFF
State Saved	The band function for each marker is saved in Instrument State
Initial S/W Revision	Prior to A.02.00

More Information

The units to be used for displaying Marker Function results in Delta mode vary depending on what is the reference marker and what it is referenced to.

Marker Functions are different from Measurements, which automatically perform complex sequences of setup, data acquisition, and display operations in order to measure specified signal characteristics. Marker Functions are specified for each individual marker and may be turned on individually for each

Marker Function

marker.

The **Marker Fctn** menu controls which marker functions are turned on and allows you to adjust setup parameters for each function. The Marker Functions are **Marker Noise**, **Band/Interval Power**, and **Band/Interval Density**, only one of which can be on for a given marker.

If the selected marker is off, pressing Marker Fctn sets it to Normal and places it at the center of the display on the trace determined by the Marker Trace rules. However, if the selected marker was **Off**, **Marker Function Off** had to be the selected function, and it remains so even after the marker is thus turned on, although you may then change it.

Fixed marker functions

In the case of a fixed marker, it is not possible to turn on or change a band function. This is because a Fixed marker holds the value it had when it became fixed; the trace it was on may keep on changing, so the function value, which depends on trace data, could not be calculated on an ongoing basis.

It is possible to have a Marker Function on for a Fixed marker, in the case where a function was already on when the marker became Fixed. In this case the function value will be retained in the marker. It is also possible to have a Marker Function on for a Fixed marker in the case when the marker was off and was turned on as **Fixed** because **Delta** was pressed to create a reference marker - in which case the marker function, marker function width, Y Axis value and marker function result that the **Delta** marker had when **Delta** was pressed are copied into the Fixed marker. If **Delta** is pressed again, causing the fixed reference marker to move to the delta marker's position, the marker function, marker function width, Y Axis value and marker function result that the **Delta** marker had when **Delta** was pressed are again copied into the fixed reference marker.

If a Marker Function is on for a Fixed marker, the marker's reported value is derived by the function. Therefore you cannot directly set the X or Y value of a Fixed marker which has a marker function turned on. Indirect setting as detailed above or when a Peak Search is performed is allowed, as the Fixed marker is always placed on a trace and can derive its function value from the trace at the moment when it is placed.

Interval Markers

What is an interval marker? The band power marker computes the total power within a span in a nonzero span. The results computation must include the RBW. The interval power marker measures the average power across some time interval in zero span.

Interval Density is defined to be Interval Power divided by Bn. Bn is the noise bandwidth of the RBW filter, as noted and used within the Band Power computation.

Select Marker

See [“Select Marker” on page 992](#).

Marker Noise

Turns on the Marker Noise function for the selected marker, making it a noise marker. If the selected marker is off, it is turned on in **Normal** mode and located at the center of the screen.

When **Marker Noise** is selected while in the **Marker Function Off** state, the **Band Span** or **Interval Span** is initialized to 5% of the screen width.

When **Marker Noise** is on, the marker's Y Axis Result is the average noise level, normalized to a 1 Hz noise power bandwidth, in the band specified under the **Band Adjust** key.

See [“More Information” on page 1009](#).

See [“Off-trace Markers” on page 1009](#).

Key Path	Marker Function
Example	<p>CALC:MARK:FUNC NOIS turns on marker 1 as a noise marker.</p> <p>CALC:MARK:FUNC? returns the current marker function for the marker specified. In this case it returns the string: NOIS.</p> <p>CALC:MARK:Y? returns the y-axis value of the Marker Noise function for marker 1 (if Marker Noise is ON for marker 1). Note that the delta value when the Y axis unit is Watt is the square of the delta value when the Y axis unit is Volt. For example, when the percent ratio with Y axis unit in Volt is 0.2, the percent ratio with Y axis unit in Watt will be $0.2^2 = 0.04$. When you read the value out remotely you have to know whether your Y Axis Unit is log (dB), linear (V or A), or power (W).</p>
Notes	See the description under the ““Marker Function” on page 1007” key.
Dependencies	Fixed markers: It is not possible to change the Band Function for a Fixed marker; so all of the Band Function keys are grayed out for a Fixed marker.
Couplings	<p>Average detector and Power Averaging auto selected when Marker Noise on</p> <p>If the selected (specified) marker is off, selecting Marker Noise via front panel or SCPI will turn the marker on.</p>
Initial S/W Revision	Prior to A.02.00

More Information

To guarantee accurate data for noise-like signals, a correction for equivalent noise bandwidth is made by the test set. The **Marker Noise** function accuracy is best when the detector is set to Average or Sample, because neither of these detectors will peak-bias the noise. The trade off between sweep time and variance of the result is best when Average Type is set to Power Averaging. Therefore, Auto coupling chooses the Average detector and Power Averaging when Marker Noise is on. Though the Marker Noise function works with all settings of detector and Average Type, using the positive or negative peak detector gives less accurate measurement results.

Off-trace Markers

If a **Normal** or **Delta** noise marker is so near to the left or right edge of the trace that some of the band is off the trace, then it uses only that subset of the Band Width that is on-trace. If the marker itself is off-trace, its value becomes undefined.

Neither band/interval power nor band/interval density markers are defined if any part of the band is off-trace (unless they are Fixed with a stored function value in them), except that when the edges of the bandwidth are trivially off-screen, due to mathematical limitations in the test set or in the controlling computer, the result will still be considered valid.

Marker Function

Band/Interval Power

Turns on the Band/Interval Power function for the selected marker. If the selected marker is off it is turned on in **Normal** marker and located at the center of the screen.

When **Band/Interval Power** is selected while in the **Marker Function Off** state, the **Band Span** or **Interval Span** is initialized to 5% of the screen width.

If the detector mode for the detector on the marker's trace is set to Auto, the average detector is selected. If the Average type is set to Auto, Power Averaging is selected. Other choices for the detector or Average type will usually cause measurement inaccuracy.

Key Path	Marker Function
Example	<p>CALC:MARK:FUNC BPOW turns on marker 1 as a band power marker.</p> <p>CALC:MARK2:FUNC? returns the current setting of marker function for marker 2. In this case it returns the string: BPOW.</p> <p>CALC:MARK:Y? returns the y-axis value of the Band Power function for marker 1. Note that the delta value when the Y axis unit is Watt is the square of the delta value when the Y axis unit is Volt. For example, when the percent ratio with Y axis unit in Volt is 0.2, the percent ratio with Y axis unit in Watt will be $0.2^2 = 0.04$. When you read the value out remotely you have to know whether your Y Axis Unit is log (dB), linear (V or A), or power (W).</p>
Notes	See the description under the ““Marker Function” on page 1007” key, above.
Dependencies	Fixed markers: It is not possible to change the Band Function for a Fixed marker; so all of the Band Function keys are grayed out for a Fixed marker.
Couplings	<p>If the detector mode for the detector on the marker's trace is set to Auto, the average detector is selected. If the Average type is set to Auto, Power Averaging is selected.</p> <p>If the selected (specified) marker is off, selecting Band Power via front panel or SCPI will turn the marker on.</p>
Initial S/W Revision	Prior to A.02.00

Band/Interval Density

Turns on the Band/Interval Density function for the selected marker. If the selected marker is off it is turned on in **Normal** marker mode and located at the center of the screen.

When **Band/Interval Density** is selected while in the **Marker Function Off** state, the **Band Span** or **Interval Span** is initialized to 5% of the screen width.

See [“More Information” on page 1011](#).

See [“What is band/interval density?” on page 1011](#)

Key Path	Marker Function
----------	-----------------

<p>Example</p>	<p>CALC:MARK:FUNC BDEN turns on marker 1 as a band density marker.</p> <p>CALC:MARK:FUNC? returns the current setting of band function for the marker specified. In this case it returns the string: BDEN.</p> <p>CALC:MARK:Y? returns the y-axis value of the Band Density function for marker 1. Note that the delta value when the Y axis unit is Watt is the square of the delta value when the Y axis unit is Volt. For example, when the percent ratio with Y axis unit in Volt is 0.2, the percent ratio with Y axis unit in Watt will be $0.2^2 = 0.04$. When you read the value out remotely you have to know whether your Y Axis Unit is log (dB), linear (V or A), or power (W).</p>
<p>Notes</p>	<p>The zero-width case is treated as one bucket wide although it shows a width of 0.</p> <p>When the trace the marker is on crosses domains, the width crosses domains as well, to remain the same percentage of the trace</p>
<p>Notes</p>	<p>See the description under the ““Marker Function” on page 1007” key, above.</p>
<p>Dependencies</p>	<p>Fixed markers: It is not possible to change the Band Function for a Fixed marker; so all of the Band Function keys are grayed out for a Fixed marker.</p>
<p>Couplings</p>	<p>If the detector mode for the detector on the marker’s trace is set to Auto, the average detector is selected. If the Average type is set to Auto, Power Averaging is selected.</p> <p>If the selected (specified) marker is off, selecting Band Density via front panel or SCPI will turn the marker on.</p>
<p>State Saved</p>	<p>n/a.</p>
<p>Initial S/W Revision</p>	<p>Prior to A.02.00</p>

More Information

It may seem like the band density marker function is exactly like a function of a noise marker with variable width. But they are somewhat different. The Noise markers assume that the signal to be measured is noise-like. Based on this assumption, we can actually make reasonable measurements under very nonideal conditions: any detector may be used, any averaging type, any VBW. In contrast, the Band Power and Band Density markers make no assumption about the statistics of the signal.

If the detector mode for the detector on the marker’s trace is set to Auto, the average detector is selected. If the Average type is set to Auto, Power Averaging is selected. Other choices for the detector or Average type will usually cause measurement inaccuracy.

What is band/interval density?

On frequency domain traces, the average density across a band is the total band power divided by the bandwidth over which it is measured.

On time domain traces, interval density is the average power in the interval divided by the noise bandwidth of the RBW of the trace.

Marker Function

Marker Function Off

Turns off band functions for the selected marker.

Key Path	Marker Function
Example	:CALC:MARK:FUNC OFF turns off marker functions for marker 1
Notes	See the description under the “Marker” on page 989 key, above.
Dependencies	Fixed markers: It is not possible to change the Band Function for a Fixed marker; so all of the Band Function keys are grayed out for a Fixed marker, including Off
Couplings	Turning off the marker function has no effect on the band span nor does it turn the marker off.
Initial S/W Revision	Prior to A.02.00

Band Adjust

Opens a menu that lets you set the width or left or right edges of the band.

It is legal to change the width of the band even if there is no marker function on. Generally this can only happen by sending the SCPI command since access to the menu is restricted if no marker function is on.

Key Path	Marker Function
Dependencies	If the marker is Fixed, Band Adjust is grayed out. If the marker function is Off, Band Adjust is grayed out.
Couplings	If any of the Band Adjust functions are the active function, the wings and arms of the selected marker display in green; otherwise they display in white.
Initial S/W Revision	Prior to A.02.00

Band/Interval Span

Sets the width of the span for the selected marker.

It is legal to change the width of the band even if there is no marker function on. Generally this can only happen by sending the SCPI command since access to the menu is restricted if no marker function is on.

In the table below, $\text{sweep_width} = \max(1, \text{sweep_points} - 1)$ and sweep_points is the number of sweep points, set in the **Sweep** menu.

Key Path	Marker Function, Band Adjust
Remote Command	:CALCulate:MARKer [1] 2 3 4 5 6 7 8 9 10 11 12 :FUNCTION: BAND:SPAN <freq> :CALCulate:MARKer [1] 2 3 4 5 6 7 8 9 10 11 12 :FUNCTION: BAND:SPAN?

Example	:CALC:MARK12:FUNC:BAND:SPAN 20 MHz sets the band span of marker 12 to 20 MHz :CALC:MARK:FUNC:BAND:SPAN? queries the band span of Marker 1
Notes	Units are those of the trace's domain, Hz for frequency domain, s for time domain.
Notes	<p>Sending this command selects the subopcoded marker</p> <p>The unit of the parameter must match the current domain of the trace the selected marker is on, or an invalid suffix error will be generated. If no unit is sent the fundamental unit for the trace domain will be used (Hz for freq domain traces, s for time domain traces).</p> <p>Note that all the values provided in this table are only valid for frequency domain traces. If the current domain of the trace is time domain, values and unit will be different. In frequency domain, the Preset value is dependant on the frequency range of the instrument. The default value 1.3245 GHz is appropriate only if the instrument is a 26.5 GHz instrument (Option 526). In a 26.5 GHz Instrument, the default span is 26.49 GHz, so 5% of the span corresponds to 1.3245 GHz.</p>
Couplings	<p>Changing the Band/Interval Span necessarily changes the Band/Interval Left and Band/Interval Right values</p> <p>Band/Interval Span is set to 0 when the marker is turned off</p> <p>Band/Interval Span is set to 5% of span when any marker function is turned on if and only if it is zero at that time</p>
Preset	If 0, set to 5% of span, when a marker function is turned on
State Saved	Saved in Instrument State
Min	0 Hz
Max	Infinity. Unlike legacy analyzers, where the markers were forced to be on screen, X-Series marker values are not limited and do not clip
Backwards Compatibility SCPI	:CALCulate:MARKer[1] 2 3 4:X:SPAN
Initial S/W Revision	Prior to A.02.00

Band/Interval Left

Sets the left edge frequency or time for the band of the selected marker. The right edge is unaffected.

It is legal to change the width of the band even if there is no marker function on. Generally this can only happen by sending the SCPI command since access to the menu is restricted if no marker function is on.

In the table below, $\text{sweep_width} = \max(1, \text{sweep_points} - 1)$ and sweep_points is the number of sweep points, set in the **Sweep** menu.

Key Path	Marker Function, Band Adjust
----------	-------------------------------------

Marker Function

Remote Command	<pre>:CALCulate:MARKer[1] 2 3 4 5 6 7 8 9 10 11 12:FUNCTION: BAND:LEFT <freq></pre> <pre>:CALCulate:MARKer[1] 2 3 4 5 6 7 8 9 10 11 12:FUNCTION: BAND:LEFT?</pre>
Example	<pre>:CALC:MARK12:FUNC:BAND:LEFT 20 GHz</pre> sets the left edge of the band span of marker 12 to 20 GHz <pre>:CALC:MARK:FUNC:BAND:LEFT?</pre> queries the band span of Marker 1
Notes	Units are those of the trace's domain, Hz for frequency domain, s for time domain. When the left edge is moved, the right edge stays anchored; thus, the marker's frequency will change.
Notes	<p>Sending this command selects the subopcoded marker</p> <p>The unit of the parameter must match the current domain of the trace the selected marker is on, or an invalid suffix error will be generated. If no unit is sent the fundamental unit for the trace domain will be used (Hz for freq domain traces, s for time domain traces).</p> <p>Note that all the values provided in this table are only valid for frequency domain traces. If the current domain of the trace is time domain, values and unit will be different. In frequency domain, the Preset value is dependant on the frequency range of the instrument. The default value 1.3245 GHz is appropriate only if the instrument is a 26.5 GHz instrument (Option 526). In a 26.5 GHz Instrument, the default span is 26.49 GHz, so 5% of the span corresponds to 1.3245 GHz.</p>
Couplings	<p>Changing the Band/Interval Left necessarily changes the Band/Interval Span and Band/Interval Center values</p> <p>Band/Interval Span is set to 0 when the marker is turned off so that means Band/Interval Left is set to the center value at this time</p> <p>Band/Interval Span is set to 5% of span when any marker function is turned on if and only if it is zero at that time</p>
Preset	If 0, Band/Interval Span is set to 5% of span, when a marker function is turned on, which affects Band/Interval Left
State Saved	Saved in Instrument State
Min	0 Hz
Max	Infinity. Unlike legacy analyzers, where the markers were forced to be on screen, X-Series marker values are not limited and do not clip
Backwards Compatibility SCPI	<pre>:CALCulate:MARKer[1] 2 3 4:X:STARt</pre> <p>(This legacy command was used to control the Reference marker in Delta Pair/Band Pair mode, and is aliased to the new command.)</p>
Initial S/W Revision	Prior to A.02.00

Band/Interval Right

Sets the right edge frequency or time for the band of the selected marker. The left edge is unaffected

In the table below, $\text{sweep_width} = \max(1, \text{sweep_points} - 1)$ and sweep_points is the number of sweep points, set in the **Sweep** menu.

It is legal to change the width of the band even if there is no marker function on. Generally this can only happen by sending the SCPI command since access to the menu is restricted if no marker function is on.

Key Path	Marker Function, Band Adjust
Remote Command	:CALCulate:MARKer [1] 2 3 4 5 6 7 8 9 10 11 12 :FUNCtion: BAND:RIGHT <freq> :CALCulate:MARKer [1] 2 3 4 5 6 7 8 9 10 11 12 :FUNCtion: BAND:RIGHT?
Example	:CALC:MARK12:FUNC:BAND:RIGHT 20 GHz sets the right edge of the band span of marker 12 to 20 GHz :CALC:MARK:FUNC:BAND:RIGHT? queries the band span of Marker 1
Notes	Units are those of the trace's domain, Hz for frequency domain, s for time domain. When the right edge is moved, the left edge stays anchored; thus, the marker's frequency will change.
Notes	Sending this command selects the subopcoded marker The unit of the parameter must match the current domain of the trace the selected marker is on, or an invalid suffix error will be generated. If no unit is sent the fundamental unit for the trace domain will be used (Hz for freq domain traces, s for time domain traces). Note that all the values provided in this table are only valid for frequency domain traces. If the current domain of the trace is time domain, values and unit will be different. In frequency domain, the Preset value is dependant on the frequency range of the instrument. The default value 1.3245 GHz is appropriate only if the instrument is a 26.5 GHz instrument (Option 526). In a 26.5 GHz Instrument, the default span is 26.49 GHz, so 5% of the span corresponds to 1.3245 GHz.
Couplings	Changing the Band/Interval Right necessarily changes the Band/Interval Span and Band/Interval Center values Band/Interval Span is set to 5% of span when any marker function is turned on if and only if it is zero at that time
Preset	If 0, Band/Interval Span is set to 5% of span, when a marker function is turned on, which affects Band/Interval Right
State Saved	Saved in Instrument State
Min	0 Hz
Max	Infinity. Unlike legacy analyzers, where the markers were forced to be on screen, X-Series marker values are not limited and do not clip

Marker Function

Backwards Compatibility SCPI	:CALCulate:MARKer[1] 2 3 4:X:STOP (This legacy command was used to control the Delta marker in Delta Pair/Band Pair mode, and is aliased to the new command. For compatibility. Note that if you were using the old command for Band Power measurements it will work just fine.)
Initial S/W Revision	Prior to A.02.00

Measure at Marker

This key and all the keys in this menu only appear with the N6141A or W6141A application or Option EMC installed and licensed.

Key Path	Marker Function
Dependencies	The Measure at Marker menu is not available in Spectrogram.
Initial S/W Revision	A.02.00

Measure at Marker

When this key is pressed, the test set executes one Measure at Marker function and then returns. Measure at Marker goes to the frequency of the selected marker and takes a reading with each of the three detectors selected in the Detectors menu, using the dwell times specified there, then displays the readings in a window on the display, using the current Y-Axis Unit.

When the Measure at Marker is complete, the test set restores all settings to their pre-Measure-at-Marker values and normal sweeps resume.

Key Path	Marker Function, Measure at Marker
Remote Command	:CALCulate:MARKer [1] 2 3 4 5 6 7 8 9 10 11 12 :FUNction: MAMarker?
Example	:CALC:MARK2:FUNC:MAM? Performs a Measure at Marker function at Marker 2's current frequency and, when completed, returns the results of the measure at marker window in a query

Notes	<p>This query command returns comma separated values for the 3 specified detectors and the frequency value of the marker. If a Detector is off or if no measurement has yet completed, -999.0 will be returned. This can happen, for example, if you are operating with too large a value of (span/sweep points) and the Measure at Marker function does not execute but instead puts up the advisory message, “Span per point too large, narrow span or increase RBW or number of points” (see below).</p> <p>The size of the return data array is fixed at 4. The elements are:</p> <ol style="list-style-type: none"> 1. Detector 1 value (if off, -999.0 for backwards compatibility) 2. Detector 2 value (if off, -999.0 for backwards compatibility) 3. Detector 3 value (if off, -999.0 for backwards compatibility) 4. Frequency of Marker <p>If a sweep is in process when this function executes it aborts, and restarts after the function is complete.</p> <p>This command is not backwards compatible with the E7400 and PSA option 239 so the Backwards Compatibility command is included.</p>
Dependencies	<p>If BW & Avg Type is in Autocoupled state, the (up to three) measurements taken by Measure at Marker are taken with Auto Coupled settings for the functions in the BW menu, even if those functions are in manual.</p>
Couplings	<p>If the specified Marker is not on, the test set turns it on at center of screen and does a peak search before performing the function.</p>
Status Bits/OPC dependencies	<p>OPC goes true when the measurement is complete</p>
Backwards Compatibility SCPI	<p>:MEASure:EMI:MARKer[1] 2 3 4 5 6 7 8 9 10 11 12?</p> <p>(Performs a Measure at Marker function at specified marker’s current frequency and returns the results)</p>
Initial S/W Revision	<p>A.02.00</p>

Measure at Marker presents its information in a separate window which normally appears in the upper right of the display but can be repositioned to the upper left.

Marker Function

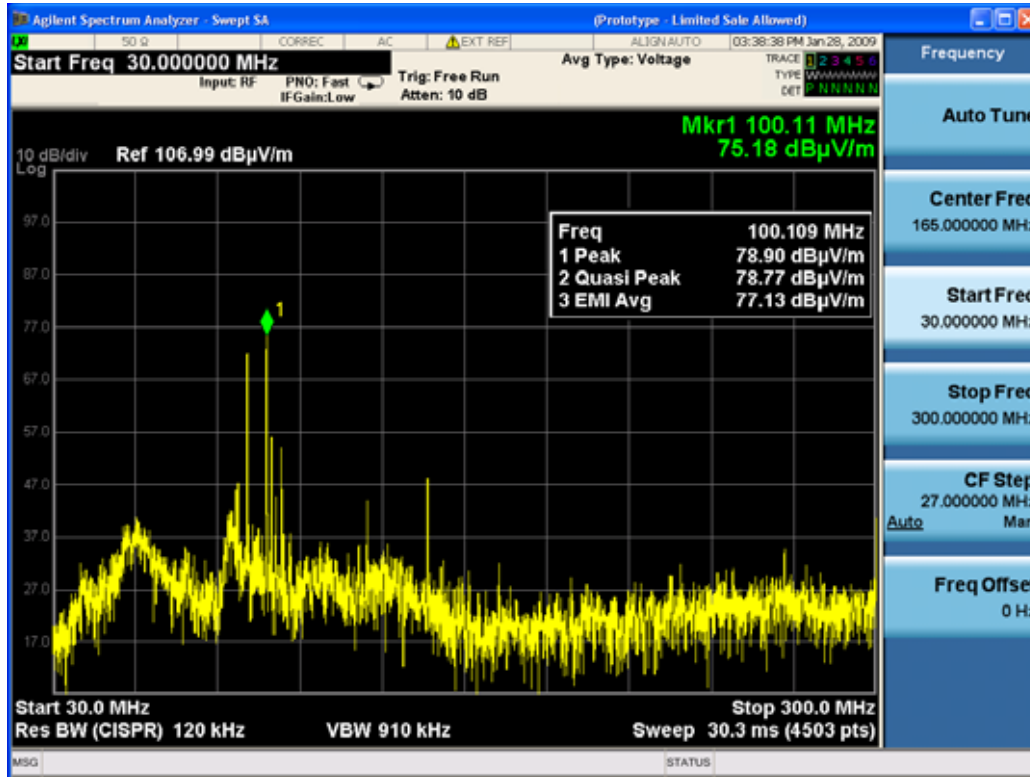

The Measure at Marker box shows the detector name for the selected detectors and “Off” for those not selected. The names used are:

Name	Detector
Normal	Normal
Peak	Peak
Sample	Sample
Neg Peak	Negative Peak
RMS	Average detector with Power Average (RMS)
Log Avg	Average detector with Log-Pwr Average
VoltageAvg	Average detector with Voltage Average
Quasi Peak	Quasi Peak
EMI Avg	EMI Average
RMS Avg	RMS Average

The marker frequency is shown in the “Freq” field. The measured value is shown for all detectors except those that are “Off.” For these, --- is displayed. The current Y-Axis unit is used, and the precision that is used for the detector value displays is exactly the same as for the Marker. The precision used for the Frequency display is six significant digits.

The sequence of steps in the measurement is as follows:

- Any sweep in progress is aborted.
- If in Zero Span, the Center Frequency is used as the frequency at which to take the reading, since in Zero Span, all markers are by definition at the Center Frequency
- If not in Zero Span:
 - If the selected marker is Off, it is first turned on in the center of the screen and a peak search performed.
 - If the selected marker is on, but offscreen, it is first moved to the center of the screen and a peak search performed.
 - A frequency “zoom” function is performed to determine the frequency of the selected marker to the required precision. If you are operating with too large a value of (span/sweep points) then the Measure at Marker window will not display, but instead an advisory message, “Span per point too large, narrow span or increase RBW or number of points”. This means you have chosen a combination of RBW, span and sweep points that makes each trace point much wider than the RBW, so that the trace point in which the signal appears is an inadequately precise measure of its frequency—for example, with a 30 MHz to 1000 MHz span, 601 trace points and 120 kHz RBW, each trace point is 13 times as wide as the RBW. In this case, a SCPI query of the results will yield -999 dBm for each detector.
 - If the zoom is successful, the test set goes to zero span at this frequency
- Each detector is then read in successive single-point zero span sweeps, using a sweep time equal to the specified dwell time. The value displayed by Measure at Marker represents the maximum value output by the detector during the dwell time Autocoupled bandwidth and average type settings are used for each detector unless the **BW & Avg Type** key is set to **As Set**, in which case the current bandwidth and average type settings are used.
- Each result is then displayed in the measure at marker window as it becomes available.
- The test set returns to its pre-Measure at Marker span and settings after executing a Measure at Marker function, including Bandwidth, Avg Type, and EMC Std - regardless of the setting of **BW & Avg Type**
- Finally, if the sweep had to be aborted, the aborted sweep is restarted.

While the function is executing, all the fields except Freq show --- for their values until the measurement is complete for that detector. As each detector is read, an informational message is displayed in the status line, for example,

Measuring with detector 1 (Peak) with RBW=120 kHz

After the last detector, the status line is cleared.

Meas at Marker Window

This key opens a menu which controls the Measure at Marker window.

Key Path	Marker Function, Measure at Marker
----------	---

Marker Function

Readback	In square brackets, the state of the window then the window position, separated by commas, as [On, Left]
Initial S/W Revision	A.02.00

Window

This key turns the Measure at Marker window on and off. It turns on automatically when Measure at Marker is initiated and turns off on a Preset. If the Window is turned on without a Measure at Marker result, --- is displayed for each result for which the detector is not “Off”.

Key Path	Marker Function, Measure at Marker, Meas at Marker Window
Remote Command	:DISPlay:WINDow:MAMarker[:STATe] ON OFF 1 0 :DISPlay:WINDow:MAMarker[:STATe]?
Example	:DISP:WIND:MAM ON
Couplings	The window turns on automatically when Measure at Marker is initiated and turns off on a Preset.
Preset	Off
State Saved	Saved in instrument state
Readback Text	On Off
Initial S/W Revision	A.02.00

Position

This key controls the placement of the Measure at Marker window on the display.

Key Path	Marker Function, Measure at Marker, Meas at Marker Window
Remote Command	:DISPlay:WINDow:MAMarker:POSition LEFT RIGHT :DISPlay:WINDow:MAMarker:POSition?
Example	:DISP:WIND:MAM:POS RIGH
Preset	Right
State Saved	Saved in instrument state
Readback Text	Left Right
Initial S/W Revision	A.02.00

Detectors

This key opens up a menu that allows you to configure the detectors to be used for the Measure at Marker reading. Any of the test set detectors can be used for each of the three detectors, or any of the three can be turned off. The dwell time for each detector is also settable.

When performing a Meas at Marker, the dwell time settings that you select will depend on the characteristics of the emission you are measuring. The default dwell time (200 ms) should work well for

typical EUT emissions, but sometimes you will encounter emissions for which the defaults are not optimal. This is especially the case for emissions that vary slowly over time or have a slow repetition rate. By lengthening the dwell times you can increase the likelihood of accurately measuring these low repetition rate signals.

When Measure at marker is activated, the receiver makes a zero span measurement for each of the (up to) three detectors selected, using the Dwell Time set for each detector. If the signal's repetition period is greater than 200 ms (the default setting), the dwell time should be increased to capture at least two and preferably more repetitions of the signal. Additionally, if you do not need or do not wish to use a detector to make a measurement, that specific detector may be turned off.

If the Measure at Marker window is being displayed, and one of the detectors is changed, any value being displayed for that detector changes to “---“ until the next successful reading from that detector.

Key Path	Marker Function, Measure at Marker,
Remote Command	:CALCulate:MAMarker:DETECTOR [1] 2 3 OFF NORMAL AVERAGE POSITIVE SAMPLE NEGATIVE QPEAK EVERAGE RAVERAGE :CALCulate:MAMarker:DETECTOR [1] 2 3?
Example	:CALC:MAM:DET2 QPE Sets the detector for measure at marker detector 2 to Quasi peak :CALC:MAM:DET OFF Sets the detector for measure at marker detector 1 to Off
State Saved	Saved in instrument state
Initial S/W Revision	A.02.00

Key Path	Marker Function, Measure at Marker,
Remote Command	:CALCulate:MAMarker:DETECTOR [1] 2 3:DWELL <dwell time> :CALCulate:MAMarker:DETECTOR [1] 2 3:DWELL?
Example	:CALC:MAM:DET2:DWELL 500 ms Sets the detector for measure at marker detector 2 to dwell for 500 ms
State Saved	Saved in instrument state
Backwards Compatibility SCPI	[:SENSE]:EMI:MEASURE:DETECTOR:DWELL <dwell time> Sets all of the detectors dwell time to the specified amount
Initial S/W Revision	A.02.00

Detector 1

This menu lets you select the detector to be used for Detector 1, or turn Detector 1 off. This is a 1-of-N menu that shows the normal list of detectors, but with the “Auto” key replaced by “Off”.

Key Path	Marker Function, Measure at Marker, Detectors
----------	---

Marker Function

Remote Command	See “Detectors” on page 1020 .
Example	:CALC:MAM:DET QPE Sets the detector for measure at marker detector 1 to Quasi peak :CALC:MAM:DET OFF Sets the detector for measure at marker detector 1 to Off
Preset	Peak
State Saved	Saved in instrument state
Readback Text	Detector name
Initial S/W Revision	A.02.00

Detector 2

This menu lets you select the detector to be used for Detector 2, or turn Detector 2 off. This is a 1-of-N menu that shows the normal list of detectors, but with the “Auto” key replaced by “Off”.

Key Path	Marker Function, Measure at Marker, Detectors
Remote Command	See “Detectors” on page 1020 .
Example	:CALC:MAM:DET2 QPE Sets the detector for measure at marker detector 2 to Quasi peak :CALC:MAM:DET2 OFF Sets the detector for measure at marker detector 2 to Off
Preset	Quasi Peak
State Saved	Saved in instrument state
Readback Text	Detector name
Backwards Compatibility SCPI	[:SENSe]:EMI:MEASure:DETEctor:QPEak[:STATe] OFF ON 0 1 If sent with On as a parameter, sets detector 2 to Quasi Peak If sent with Off as a parameter, sets detector 2 to Off
Initial S/W Revision	A.02.00

Detector 3

This menu lets you select the detector to be used for Detector 3, or turn Detector 3 off. This is a 1-of-N menu that shows the normal list of detectors, but with the “Auto” key replaced by “Off”.

Key Path	Marker Function, Measure at Marker, Detectors
Remote Command	See “Detectors” on page 1020 .

Example	:CALC:MAM:DET3 QPE Sets the detector for measure at marker detector 1 to Quasi peak :CALC:MAM:DET3 OFF Sets the detector for measure at marker detector 1 to Off
Preset	EMI Average
State Saved	Saved in instrument state
Readback Text	Detector name
Backwards Compatibility SCPI	[:SENSe]:EMI:MEASure:DETECTOR:AVERage[:STATe] OFF ON 0 1 If sent with On as a parameter, sets detector 3 to EMI Average If sent with Off as a parameter, sets detector 3 to Off
Initial S/W Revision	A.02.00

Detector 1 Dwell Time

This is the time specified by the user to dwell while taking the measurement for detector 1. The minimum allowed dwell time is based on the current detector. If “Off” is selected for detector 1, this key is grayed out and shows 200 ms.

Key Path	Marker Function, Measure at Marker, Detectors
Remote Command	See “ Detectors ” on page 1020.
Example	:CALC:MAM:DET:DWEL 400 ms Sets the dwell time for detector 1 to 400 ms
Preset	200 ms
State Saved	Saved in instrument state
Min	1 ms
Max	60 s
Initial S/W Revision	A.02.00
Default Unit	s

Detector 2 Dwell Time

This is the time specified by the user to dwell while taking the measurement for detector 2. The minimum allowed dwell time is based on the current detector. If “Off” is selected for detector 2, this key is grayed out and shows 200 ms.

Key Path	Marker Function, Measure at Marker, Detectors
Remote Command	See “ Detectors ” on page 1020.

Marker Function

Example	:CALC:MAM:DET2:DWEL 400 ms Sets the dwell time for detector 2 to 400 ms
Preset	200 ms
State Saved	Saved in instrument state
Min	1 ms
Max	60 s
Initial S/W Revision	A.02.00
Default Unit	s

Detector 3 Dwell Time

This is the time specified by the user to dwell while taking the measurement for detector 3. The minimum allowed dwell time is based on the current detector. If “Off” is selected for detector 3, this key is grayed out and shows 200 ms.

Key Path	Marker Function, Measure at Marker, Detectors
Remote Command	See “Detectors” on page 1020 .
Example	:CALC:MAM:DET3:DWEL 400 ms Sets the dwell time for detector 1 to 400 ms
Preset	200 ms
State Saved	Saved in instrument state
Min	1 ms
Max	60 s
Initial S/W Revision	A.02.00
Default Unit	s

BW & Avg Type

This key controls the type of bandwidth and average type coupling used in Measure at Marker.

If set to “Autocoupled”, then the RBW and Average Type are selected by the instrument during the Measure at Marker function, according to the normal Autocouple rules, regardless of whether RBW and Average Type are currently in Auto. If set to “As Set”, then the current value for RBW and Average Type are used (which of course, could also be “Auto”).

Here are the details of the two modes:

If **BW & Avg Type** is set to **Autocoupled**, **Measure at Marker** behaves as follows:

1. The **EMC Std** changes to CISPR if any of the CISPR detectors (EMI Avg, RMS Avg, QPD) becomes selected; for all other detectors, the value of **EMC Std** that existed before Measure at Marker is used.
2. **RBW** autocouples throughout Measure at Marker, even if **RBW** is set to **Manual**. The autocouple

rules are based on whatever the instantaneous setting of EMC Std, Span, and Center Freq are.

If **BW & Avg Type** is set to **As Set**, **Measure at Marker** behaves as follows:

1. The **EMC Std** never changes; so if it is set to **None** it stays at **None** throughout, even if one of the CISPR detectors is selected.
2. If **RBW** is set to **Auto**, then **RBW** autocouples throughout Measure at Marker. The autocouple rules are based on whatever the setting of EMC Std, Span, and Center Freq are.
3. If **RBW** is set to **Manual**, the RBW never changes at all throughout Measure at Marker, it stays at the value to which it was set before Measure at Marker began.

The test set returns to its pre-Measure at Marker span and settings after executing a Measure at Marker function, including Bandwidth, Avg Type, and EMC Std.

It is important to note that, when RBW is coupled to Frequency, as it is when **EMC Std** is anything but “None”, for all EMI measurements, the frequency it is coupled to for Measure at Marker is the MARKER frequency, not the Center Frequency.

Key Path	Marker Function, Measure at Marker
Remote Command	:CALCulate:MAMarker:COUpling ON OFF 1 0 :CALCulate:MAMarker:COUpling?
Example	:CALC:MAM:COUP ON
Preset	Autocoupled
State Saved	Saved in instrument state
Readback Text	Autocoupled As Set
Initial S/W Revision	A.02.00

Center Presel On/Off

This key controls the automatic centering of the preselector for the Measure at Marker function.

When Center Presel is On, the first step in performing the Measure at Marker function is to perform a Presel Center. This is not performed if the microwave preselector is off, or the selected marker’s frequency is below Band 1. If the function is not performed, no message is generated.

Key Path	Marker Function, Measure at Marker
Remote Command	:CALCulate:MAMarker:PCENter ON OFF 1 0 :CALCulate:MAMarker:PCENter?
Example	:CALC:MAM:PCEN ON
Dependencies	Blank in models that do not include a preselector, such as option 503. If the SCPI is sent in these instruments, it is accepted without error, and the query always returns 0.
Preset	On

Marker Function

Backwards Compatibility SCPI	[[:SENSE]:EMI:MEASure:PCENter[:STATe] OFF ON 0 1 [:SENSE]:EMI:MEASure:PCENter[:STATe]?
Initial S/W Revision	A.02.00

Marker To

The Marker -> key accesses menu keys that can copy the current marker value into other test set parameters (for example, Center Freq). The currently selected marker is made the active function on entry to this menu (if the currently selected marker is not on when you press this front-panel key, it is turned on at the center of the screen as a normal type marker and then made the active function).

The **Marker ->** (or Marker To) feature is used to quickly assign a marker's x- or y-axis value to another parameter. For example, if a marker's x-axis value is 500 MHz and y-axis value is -20 dBm, pressing **Mkr -> CF** would assign 500 MHz to **Center Freq** and pressing **Mkr ->Ref Lvl** would assign -20 dBm to **Ref Level**.

Notes	All Marker To functions executed from the front panel use the selected marker's values, while all Marker To remote commands specify in the command which marker's value to use. Consistent with other remote marker commands, sending a Marker To remote command will never change which marker is selected.
Initial S/W Revision	Prior to A.02.00

Mkr->CF

Sets the center frequency of the test set to the frequency of the selected marker. The marker stays at this frequency, so it moves to the center of the display. In delta marker mode, this function sets the center frequency to the x-axis value of the delta marker. When the frequency scale is in log mode, the center frequency is not at the center of the display.

If the currently selected marker is not on when this key is pressed, it is turned on at the center of the screen as a normal type marker.

Key Path	Marker ->
Remote Command	:CALCulate:MARKer [1] 2 3 4 5 6 7 8 9 10 11 12 [:SET] :CENTer
Example	CALC:MARK2:CENT sets the CF of the test set to the value of marker 2.
Notes	Sending this command selects the subcoded marker If specified marker is off, this command will turn it on at the center of the screen as a normal type marker.
Dependencies	This function is not available (key is grayed out) when x-axis is the time domain
Couplings	All the usual couplings associated with setting Center Frequency apply (see the Frequency Section).
Initial S/W Revision	Prior to A.02.00

Marker To

Mkr->CF Step

Sets the center frequency (CF) step size of the test set to the marker frequency, or in a delta-marker mode, to the frequency difference between the delta and reference markers.

If the currently selected marker is not on when this key is pressed, it is turned on at the center of the screen as a normal type marker.

Key Path	Marker ->
Remote Command	:CALCulate:MARKer [1] 2 3 4 5 6 7 8 9 10 11 12 [:SET] :STEP
Example	CALC:MARK1:STEP sets the CF step to the value (or delta value) of marker 1.
Notes	Sending this command selects the subopcoded marker If specified marker is off, this command will turn it on at the center of the screen as a normal type marker.
Dependencies	This function is not available (key is grayed out) when x-axis is the time domain
Couplings	All the usual couplings associated with setting CF Step apply (see the Frequency Section).
Initial S/W Revision	Prior to A.02.00

Mkr->Start

Changes the start frequency to the frequency of the selected marker. The marker stays at this frequency, so it moves to the left edge of the display. In delta marker mode, this function sets the start frequency to the x-axis value of the delta marker.

If the currently selected marker is not on when this key is pressed, it is turned on at the center of the screen as a normal type marker.

Key Path	Marker ->
Remote Command	:CALCulate:MARKer [1] 2 3 4 5 6 7 8 9 10 11 12 [:SET] :STARt
Example	CALC:MARK1:STAR sets the start frequency to the value (or delta value) of marker 1.
Notes	Sending this command selects the subopcoded marker If specified marker is off, this command will turn it on at the center of the screen as a normal type marker.
Dependencies	This function is not available (key is grayed out) when x-axis is the time domain
Couplings	All the usual couplings associated with setting Start Frequency apply (see the Frequency Section).

Initial S/W Revision	Prior to A.02.00
----------------------	------------------

Mkr->Stop

Changes the stop frequency to the frequency of the selected marker. The marker stays at this frequency, so it moves to the right edge of the display. In delta marker mode, this function sets the stop frequency to the x-axis value of the delta marker.

If the currently selected marker is not on when this key is pressed, it is turned on at the center of the screen as a normal type marker.

Key Path	Marker ->
Remote Command	:CALCulate:MARKer [1] 2 3 4 5 6 7 8 9 10 11 12 [:SET] :STOP
Example	CALC:MARK3:STOP sets the stop frequency to the value (or delta value) of marker 3.
Notes	Sending this command selects the subopcoded marker If specified marker is off, this command will turn it on at the center of the screen as a normal type marker.
Dependencies	This function is not available (key is grayed out) when x-axis is the time domain
Couplings	All the usual couplings associated with setting Stop Frequency apply (see the Frequency Section).
Initial S/W Revision	Prior to A.02.00

MkrΔ->Span

Sets the start and stop frequencies to the values of the delta markers. That is, it moves the lower of the two marker frequencies to the start frequency and the higher of the two marker frequencies to the stop frequency. The marker mode is unchanged and the two markers (delta and reference) end up on opposite edges of the display.

Key Path	Marker ->
Remote Command	:CALCulate:MARKer [1] 2 3 4 5 6 7 8 9 10 11 12 [:SET] :DEL Ta:SPAN
Example	CALC:MARK2:DELT:SPAN sets the start and stop frequencies to the values of marker 2 and its reference marker.
Notes	Sending this command selects the subopcoded marker
Dependencies	This function is only available when the selected marker is a delta marker. Otherwise the key is grayed out. In addition, this function is not available when x-axis is the time domain

Marker To

Couplings	All the usual couplings associated with setting Span apply (see the Section “Span” on page 1263”).
Backwards Compatibility SCPI	:CALCulate:MARKer[1] 2 3 4 5 6 7 8 9 10 11 12[:SET]:SPAN
Initial S/W Revision	Prior to A.02.00

MkrΔ->CF

Sets the center frequency to the frequency difference between the selected marker and its reference marker. The marker is then changed to a Normal marker and placed at the center of span.

Key Path	Marker ->
Remote Command	:CALCulate:MARKer [1] 2 3 4 5 6 7 8 9 10 11 12 [:SET] :DEL Ta:CENTer
Example	CALC:MARK2:CENT sets the CF of the test set to the value of marker 2.
Notes	Sending this command selects the subopcoded marker
Dependencies	This function is only available when the selected marker is a delta marker. Otherwise the key is grayed out. In addition, this function is not available when x-axis is the time domain
Initial S/W Revision	Prior to A.02.00

Mkr->Ref Lvl

Sets the reference level to the amplitude value of the selected marker, moving the marked point to the reference level (top line of the graticule). The marker’s mode (Normal, Delta, Fixed) doesn’t matter in this case. For example, given a delta marker, if the delta marker is the selected marker, its amplitude is applied to the reference level. If the reference marker is selected, its amplitude is applied to the reference level.

If the currently selected marker is not on when this key is pressed, it is turned on at the center of the screen as a normal type marker, and its amplitude applied to the reference level.

Key Path	Marker ->
Remote Command	:CALCulate:MARKer [1] 2 3 4 5 6 7 8 9 10 11 12 [:SET] :RLE Vel
Example	CALC:MARK2:RLEV sets the reference level of the test set to the amplitude of marker 2.
Notes	Sending this command selects the subopcoded marker If specified marker is off, this command will turn it on at the center of the screen as a normal type marker.
Couplings	All the usual couplings associated with setting Reference Level apply.
Initial S/W Revision	Prior to A.02.00

Meas

The information in this section is common to all measurements. For key and remote command information for a specific measurement, refer to the section that describes the measurement of interest.

Measurements available under the Meas key are specific to the current Mode.

When viewing Help for measurements, note the following:

NOTE Operation for some keys differs between measurements. The information displayed in Help pertains to the current measurement. To see how a key operates in a different measurement, exit Help (press the Cancel Esc key), select the measurement, then reenter Help (press the Help key) and press that key.

Key Path:	Front-panel key
Initial S/W Revision:	Prior to A.02.00

Remote Measurement Functions

This section contains the following topics:

[“Measurement Group of Commands” on page 1032](#)

[“Current Measurement Query \(Remote Command Only\)” on page 1035](#)

[“Limit Test Current Results \(Remote Command Only\)” on page 1036](#)

[“Data Query \(Remote Command Only\)” on page 1036](#)

[“Calculate/Compress Trace Data Query \(Remote Command Only\)” on page 1036](#)

[“Calculate Peaks of Trace Data \(Remote Command Only\)” on page 1041](#)

[“Format Data: Numeric Data \(Remote Command Only\)” on page 1043](#)

[“Format Data: Byte Order \(Remote Command Only\)” on page 1045](#)

Initial S/W Revision:	Prior to A.02.00
-----------------------	------------------

Meas

Measurement Group of Commands

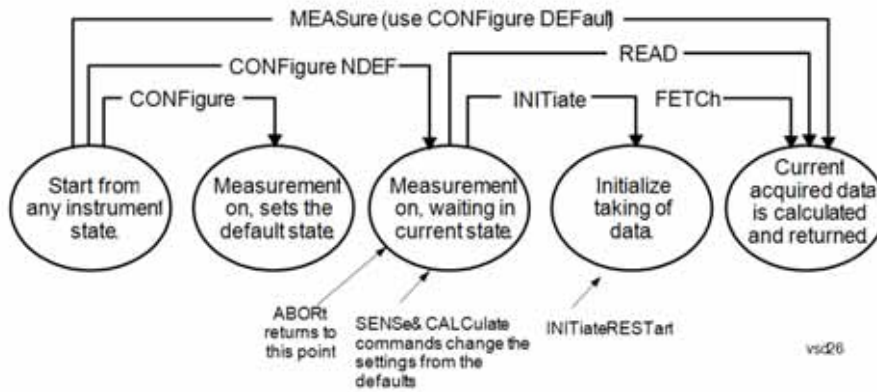

Measure Commands:**:MEASure:<measurement>[n]?**

This is a fast single-command way to make a measurement using the factory default instrument settings. These are the settings and units that conform to the Mode Setup settings (e.g. radio standard) that you have currently selected.

- Stops the current measurement (if any) and sets up the instrument for the specified measurement using the factory defaults
- Initiates the data acquisition for the measurement
- Blocks other SCPI communication, waiting until the measurement is complete before returning results.
- If the function does averaging, it is turned on and the number of averages is set to 10.
- After the data is valid it returns the scalar results, or the trace data, for the specified measurement. The type of data returned may be defined by an [n] value that is sent with the command.

The scalar measurement results will be returned if the optional [n] value is not included, or is set to 1. If the [n] value is set to a value other than 1, the selected trace data results will be returned. See each command for details of what types of scalar results or trace data results are available.

ASCII is the default format for the data output. (Older versions of Spectrum Analysis and Phase Noise mode measurements only use ASCII.) The binary data formats should be used for handling large blocks of data since they are smaller and faster than the ASCII format. Refer to the FORMat:DATA command for more information.

If you need to change some of the measurement parameters from the factory default settings you can set up the measurement with the CONFIgure command. Use the commands in the SENSE:<measurement> and CALCulate:<measurement> subsystems to change the settings. Then you can use the READ? command to initiate the measurement and query the results.

If you need to repeatedly make a given measurement with settings other than the factory defaults, you can use the commands in the SENSE:<measurement> and CALCulate:<measurement> subsystems to set up the measurement. Then use the READ? command to initiate the measurement and query results.

Measurement settings persist if you initiate a different measurement and then return to a previous one. Use READ:<measurement>? if you want to use those persistent settings. If you want to go back to the default settings, use MEASure:<measurement>?.

Configure Commands:**:CONFigure:<measurement>**

This command stops the current measurement (if any) and sets up the instrument for the specified measurement using the factory default instrument settings. It does not initiate the taking of measurement data unless INIT:CONTinuous is ON. If you change any measurement settings after using the CONFigure command, the READ command can be used to initiate a measurement without changing the settings back to their defaults.

:CONFigure:NDEFault<measurement> stops the current measurement and changes to the specified measurement. It does not change the settings to the defaults. It does not initiate the taking of measurement data unless INIT:CONTinuous is ON.

The **CONFigure?** query returns the current measurement name.

The **CONFigure:CATalog?** query returns a quoted string of all licensed measurement names in the current mode. For example, "SAN, CHP, OBW, ACP, PST, TXP, SPUR, SEM, LIST".

Fetch Commands:**:FETCh:<measurement>[n]?**

This command puts selected data from the most recent measurement into the output buffer. Use FETCh if you have already made a good measurement and you want to return several types of data (different [n] values, for example, both scalars and trace data) from a single measurement. FETCh saves you the time of re-making the measurement. You can only FETCh results from the measurement that is currently active, it will not change to a different measurement. An error message is reported if a measurement other than the current one is specified.

If you need to get new measurement data, use the READ command, which is equivalent to an INITiate followed by a FETCh.

The scalar measurement results will be returned if the optional [n] value is not included, or is set to 1. If the [n] value is set to a value other than 1, the selected trace data results will be returned. See each command for details of what types of scalar results or trace data results are available. The binary data formats should be used for handling large blocks of data since they are smaller and transfer faster than the ASCII format. (FORMat:DATA)

FETCh may be used to return results other than those specified with the original READ or MEASure command that you sent.

INITiate Commands:**:INITiate:<measurement>**

This command is not available for measurements in all the instrument modes:

- Initiates a trigger cycle for the specified measurement, but does not output any data. You must then use the FETCh<meas> command to return data. If a measurement other than the current one is specified, the instrument will switch to that measurement and then initiate it.
- For example, suppose you have previously initiated the ACP measurement, but now you are running the channel power measurement. If you send INIT:ACP? it will change from channel power to ACP and will initiate an ACP measurement.
- Does not change any of the measurement settings. For example, if you have previously started the ACP measurement and you send INIT:ACP? it will initiate a new ACP measurement using the same instrument settings as the last time ACP was run.
- If your selected measurement is currently active (in the idle state) it triggers the measurement, assuming the trigger conditions are met. Then it completes one trigger cycle. Depending upon the measurement and the number of averages, there may be multiple data acquisitions, with multiple trigger events, for one full trigger cycle. It also holds off additional commands on GPIB until the acquisition is complete.

READ Commands:**:READ:<measurement>[n]?**

- Does not preset the measurement to the factory default settings. For example, if you have previously initiated the ACP measurement and you send READ:ACP? it will initiate a new measurement using the same instrument settings.
- Initiates the measurement and puts valid data into the output buffer. If a measurement other than the current one is specified, the instrument will switch to that measurement before it initiates the measurement and returns results.

For example, suppose you have previously initiated the ACP measurement, but now you are running the channel power measurement. Then you send READ:ACP? It will change from channel power back to ACP and, using the previous ACP settings, will initiate the measurement and return results.

- Blocks other SCPI communication, waiting until the measurement is complete before returning the results

If the optional [n] value is not included, or is set to 1, the scalar measurement results will be returned. If the [n] value is set to a value other than 1, the selected trace data results will be returned. See each command for details of what types of scalar results or trace data results are available. The binary data formats should be used when handling large blocks of data since they are smaller and faster than the ASCII format.
(FORMat:DATA)

Initial S/W Revision:

Prior to A.02.00

Current Measurement Query (Remote Command Only)

This command returns the name of the measurement that is currently running.

Remote Command:

:CONFigure?

Meas

Example:	CONF?
Initial S/W Revision:	Prior to A.02.00

Limit Test Current Results (Remote Command Only)

Queries the status of the current measurement limit testing. It returns a 0 if the measured results pass when compared with the current limits. It returns a 1 if the measured results fail any limit tests.

Remote Command:	:CALCulate:CLIMits:FAIL?
Example:	CALC:CLIM:FAIL? queries the current measurement to see if it fails the defined limits. Returns a 0 or 1: 0 it passes, 1 it fails.
Initial S/W Revision:	Prior to A.02.00

Data Query (Remote Command Only)

Returns the designated measurement data for the currently selected measurement and subopcode.

n = any valid subopcode for the current measurement. See the measurement command results table for your current measurement, for information about what data is returned for the subopcodes.

This command uses the data setting specified by the FORMat:BORDER and FORMat:DATA commands and can return real or ASCII data. (See the format command descriptions under Input/Output in the Analyzer Setup section.)

Remote Command:	:CALCulate:DATA [n] ?
Notes:	The return trace depends on the measurement. In CALCulate:<meas>:DATA[n], n is any valid subopcode for the current measurement. It returns the same data as the FETCh:<measurement>? query where <measurement> is the current measurement.
Initial S/W Revision:	Prior to A.02.00

Calculate/Compress Trace Data Query (Remote Command Only)

Returns compressed data for the currently selected measurement and sub-opcode [n].

n = any valid sub-opcode for that measurement. See the MEASure:<measurement>? command description of your specific measurement for information on the data that can be returned.

The data is returned in the current Y Axis Unit of the test set. The command is used with a sub-opcode <n> (default=1) to specify the trace. With trace queries, it is best if the test set is not sweeping during the query. Therefore, it is generally advisable to be in Single Sweep, or Update=Off.

This command is used to compress or decimate a long trace to extract and return only the desired data. A typical example would be to acquire N frames of GSM data and return the mean power of the first burst

in each frame. The command can also be used to identify the best curve fit for the data.

Remote Command:	:CALCulate:DATA<n>:COMPRESS? BLOCK CFIT MAXimum MINimum MEAN DMEan RMS RMSCubed SAMPLE SDEVIation PPHase [,<soffset>[,<length>[,<roffset>[,<rlimit>]]]]
Example:	To query the mean power of a set of GSM bursts: Supply a signal that is a set of GSM bursts. Select the IQ Waveform measurement (in IQ Analyzer Mode). Set the sweep time to acquire at least one burst. Set the triggers such that acquisition happens at a known position relative to a burst. Then query the mean burst levels using, CALC:DATA2:COMP? MEAN,24e-6,526e-6 (These parameter values correspond to GSM signals, where 526e-6 is the length of the burst in the slot and you just want 1 burst.)
Notes:	The command supports 5 parameters. Note that the last 4 (<soffset>,<length>,<roffset>,<rlimit>) are optional. But these optional parameters must be entered in the specified order. For example, if you want to specify <length>, then you must also specify <soffset>. See details below for a definition of each of these parameters. This command uses the data in the format specified by FORMat:DATA, returning either binary or ASCII data.
Initial S/W Revision:	Prior to A.02.00

- **BLOCK** or block data - returns all the data points from the region of the trace data that you specify. For example, it could be used to return the data points of an input signal over several timeslots, excluding the portions of the trace data that you do not want. (This is x,y pairs for trace data and I,Q pairs for complex data.)
- **CFIT** or curve fit - applies curve fitting routines to the data. <soffset> and <length> are required to define the data that you want. <roffset> is an optional parameter for the desired order of the curve equation. The query will return the following values: the x-offset (in seconds) and the curve coefficients ((order + 1) values).

MIN, MAX, MEAN, DME, RMS, RMSC, SAMP, SDEV and PPH return one data value for each specified region (or <length>) of trace data, for as many regions as possible until you run out of trace data (using <roffset> to specify regions). Or they return the number of regions you specify (using <rlimit>) ignoring any data beyond that.

- **MINimum** - returns the minimum data point (y value) for the specified region(s) of trace data. For I/Q trace data, the minimum magnitude of the I/Q pairs is returned.
- **MAXimum** - returns the maximum data point (y value) for the specified region(s) of trace data. For I/Q trace data, the maximum magnitude of the I/Q pairs is returned.
- **MEAN** - returns a single value that is the arithmetic mean of the data point values (in dB/ dBm) for the specified region(s) of trace data. For I/Q trace data, the mean of the magnitudes of the I/Q pairs is returned. See the following equations.

NOTE If the original trace data is in dB, this function returns the arithmetic mean of those log values, not log of the mean power which is a more useful value. The mean of the log is the better measurement technique when measuring CW signals in the presence of noise. The mean of the power, expressed in dB, is useful in power measurements such as Channel Power. To achieve the mean of the power, use the RMS option.

Equation 1
Mean Value of Data Points for Specified Region(s)

$$\text{MEAN} = \frac{1}{n} \sum_{X_i \in \text{region}(s)} X_i \quad \text{vsd27-1}$$

where X_i is a data point value, and n is the number of data points in the specified region(s).

Equation 2
Mean Value of I/Q Data Pairs for Specified Region(s)

$$\text{MEAN} = \frac{1}{n} \sum_{X_i \in \text{region}(s)} |X_i| \quad \text{vsd27-2}$$

where $|X_i|$ is the magnitude of an I/Q pair, and n is the number of I/Q pairs in the specified region(s).

- DMEan - returns a single value that is the mean power (in dB/ dBm) of the data point values for the specified region(s) of trace data. See the following equation:

Equation 3
DMEan Value of Data Points for Specified Region(s)

$$\text{DME} = 10 \times \log_{10} \left(\frac{1}{n} \sum_{X_i \in \text{region}(s)} 10^{\frac{X_i}{10}} \right) \quad \text{vsd27-3}$$

- RMS - returns a single value that is the average power on a root-mean-squared voltage scale (arithmetic rms) of the data point values for the specified region(s) of trace data. See the following equation.

NOTE For I/Q trace data, the rms of the magnitudes of the I/Q pairs is returned. See the following equation.

This function is very useful for I/Q trace data. However, if the original trace data is in dB, this function returns the rms of the log values which is not usually needed.

Equation 4
RMS Value of Data Points for Specified Region(s)

$$\text{RMS} = \sqrt{\frac{1}{n} \sum_{X_i \in \text{region}(s)} X_i^2}$$

vsd27-4

where X_i is a data point value, and n is the number of data points in the specified region(s).

Equation 5

RMS Value of I/Q Data Pairs for Specified Region(s)

$$\text{RMS} = \sqrt{\frac{1}{n} \sum_{X_i \in \text{region}(s)} X_i X_i^*}$$

vsd27-5

where X_i is the complex value representation of an I/Q pair, X_i^* its conjugate complex number, and n is the number of I/Q pairs in the specified region(s).

Once you have the rms value for a region of trace data (linear or I/Q), you may want to calculate the mean power. You must convert this rms value (peak volts) to power in dBm:

$$10 \times \log[10 \times (\text{rms value})^2]$$

- **SAMPLE** - returns the first data value (x,y pair) for the specified region(s) of trace data. For I/Q trace data, the first I/Q pair is returned.
- **SDEViation** - returns a single value that is the arithmetic standard deviation for the data point values for the specified region(s) of trace data. See the following equation.

For I/Q trace data, the standard deviation of the magnitudes of the I/Q pairs is returned. See the following equation.

Equation 6

Standard Deviation of Data Point Values for Specified Region(s)

$$\text{SDEV} = \sqrt{\frac{1}{n} \sum_{X_i \in \text{region}(s)} (X_i - \bar{X})^2}$$

vsd27-7

where X_i is a data point value, \bar{X} is the arithmetic mean of the data point values for the specified region(s), and n is the number of data points in the specified region(s).

$$\text{SDEV} = \sqrt{\frac{1}{n} \sum_{X_i \in \text{region}(s)} (|X_i| - \bar{X})^2}$$

vsd27-8

where $|X_i|$ is the magnitude of an I/Q pair, \bar{X} is the mean of the magnitudes for the specified region(s), and n is the number of data points in the specified region(s).

- **PPHase** - returns the x,y pairs of both rms power (dBm) and arithmetic mean phase (radian) for every specified region and frequency offset (Hz). The number of pairs is defined by the specified number of

Meas

regions. This parameter can be used for I/Q vector (n=0) in Waveform (time domain) measurement and all parameters are specified by data point in PPHase.

The rms power of the specified region may be expressed as:

$$\text{Power} = 10 \times \log [10 \times (\text{RMS I/Q value})] + 10.$$

The RMS I/Q value (peak volts) is:

$$\sqrt{\frac{1}{n} \sum_{X_i \in \text{region}} X_i X_i^*}$$

vsd27-9

where X_i is the complex value representation of an I/Q pair, X_i^* its conjugate complex number, and n is the number of I/Q pairs in the specified region.

The arithmetic mean phase of the specified region may be expressed as:

$$\frac{1}{n} \sum_{Y_i \in \text{region}} Y_i$$

vsd27-10

where Y_i is the unwrapped phase of I/Q pair with applying frequency correction and n is the number of I/Q pairs in the specified region.

The frequency correction is made by the frequency offset calculated by the arithmetic mean of every specified region's frequency offset. Each frequency offset is calculated by the least square method against the unwrapped phase of I/Q pair.

Sample Trace Data - Constant Envelope

(See below for explanation of variables.)

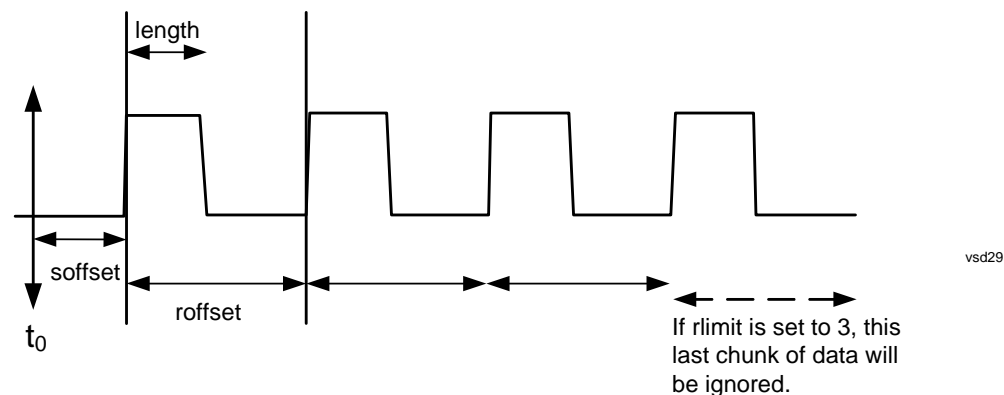

Sample Trace Data - Not Constant Envelope

(See below for explanation of variables.)

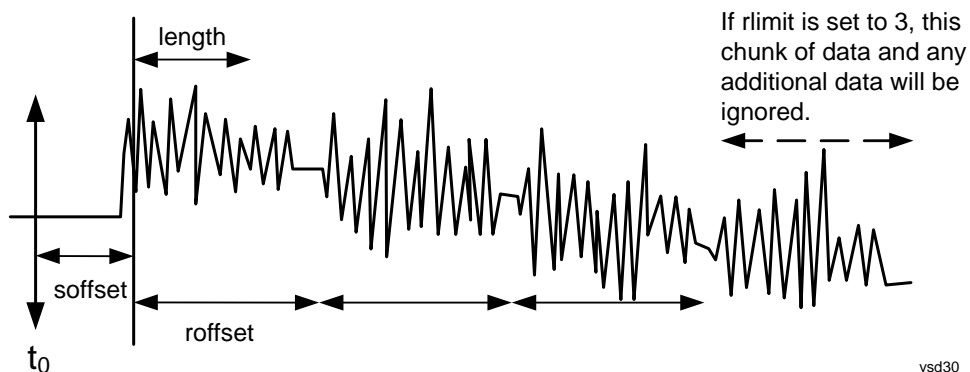

vsd30

<soffset> - start offset is an optional real number. (It is in seconds for time-domain traces, and is a dimensionless index 0 to Npoints - 1, for frequency-domain traces). It specifies the amount of data at the beginning of the trace that will be ignored before the decimation process starts. It is the time or frequency change from the start of the trace to the point where you want to start using the data. The default value is zero.

<length> - is an optional real number. (It is in seconds for time-domain traces, and is a dimensionless index 0 to Npoints - 1, for frequency-domain traces). It defines how much data will be compressed into one value. This parameter has a default value equal to the current trace length.

<roffset> - repeat offset is an optional real number. (It is in seconds for time-domain traces, and is a dimensionless index 0 to Npoints - 1, for frequency-domain traces). It defines the beginning of the next field of trace elements to be compressed. This is relative to the beginning of the previous field. This parameter has a default value equal to the <length> variable. Note that this parameter is used for a completely different purpose when curve fitting (see CFIT above).

<rlimit> - repeat limit is an optional integer. It specifies the number of data items that you want returned. It will ignore any additional items beyond that number. You can use the Start offset and the Repeat limit to pick out exactly what part of the data you want to use. The default value is all the data.

Calculate Peaks of Trace Data (Remote Command Only)

Returns a list of all the peaks for the currently selected measurement and sub-opcode [n]. The peaks must meet the requirements of the peak threshold and excursion values.

n = any valid sub-opcode for the current measurement. See the MEASure:<measurement> command description of your specific measurement for information on the data that can be returned.

The command can only be used with specific sub-ops with measurement results that are trace data. Both real and complex traces can be searched, but complex traces are converted to magnitude in dBm. In many measurements the sub-opcode n=0, is the raw trace data which cannot be searched for peaks. And Sub-opcode n=1, is often calculated results values which also cannot be searched for peaks.

This command uses the data setting specified by the FORMat:BORDER and FORMat:DATA commands and can return real or ASCII data. If the format is set to INT,32, it returns REAL,32 data.

The command has four types of parameters:

- Threshold (in dBm)
- Excursion (in dB)

Meas

- Sorting order (amplitude, frequency, time)
- Optional in some measurements: Display line use (all, > display line, < display line)

Remote Command:	<code>:CALCulate:DATA [1] 2 3 4 5 6 :PEAKs?</code> <code><threshold>, <excursion> [, AMPLitude FREQuency TIME]</code>
Example:	<p>CALC:DATA4:PEAK? -40,10,FREQ,GTDL This will identify the peaks of trace 4 that are above -40 dBm, with excursions of at least 10 dB. The peaks are returned in order of increasing frequency, starting with the lowest frequency. Only the peaks that are above the display line are returned.</p> <p>Query Results 1:</p> <p>With FORMat:DATA REAL,32 selected, it returns a list of floating-point numbers. The first value in the list is the number of peak points that are in the following list. A peak point consists of two values: a peak amplitude followed by its corresponding frequency (or time).</p> <p>If no peaks are found the peak list will consist of only the number of peaks, (0).</p>

Notes:	<p><n> - is the trace that will be used</p> <p><threshold> - is the level below which trace data peaks are ignored. Note that the threshold value is required and is always used as a peak criterion. To effectively disable the threshold criterion for this command, provide a substantially low threshold value such as -200 dBm. Also note that the threshold value used in this command is independent of and has no effect on the threshold value stored under the Peak Criteria menu.</p> <p><excursion> - is the minimum amplitude variation (rise and fall) required for a signal to be identified as peak. Note that the excursion value is required and is always used as a peak criterion. To effectively disable the excursion criterion for this command, provide the minimum value of 0.0 dB. Also note that the excursion value used in this command is independent of and has no effect on the excursion value stored under the Peak Criteria menu.</p> <p>Values must be provided for threshold and excursion. The sorting and display line parameters are optional (defaults are AMPLitude and ALL).</p> <p>Note that there is always a Y-axis value for the display line, regardless of whether the display line state is on or off. It is the current Y-axis value of the display line which is used by this command to determine whether a peak should be reported</p> <p>Sorting order:</p> <p>AMPLitude - lists the peaks in order of descending amplitude, with the highest peak first (default if optional parameter not sent)</p> <p>FREQuency - lists the peaks in order of occurrence, left to right across the x-axis.</p> <p>TIME - lists the peaks in order of occurrence, left to right across the x-axis.</p> <p>Peaks vs. Display Line:</p> <p>ALL - lists all of the peaks found (default if optional parameter not sent).</p> <p>GTDLine (greater than display line) - lists all of the peaks found above the display line.</p> <p>LTDLine (less than display line) - lists all of the peaks found below the display line.</p>
Initial S/W Revision:	Prior to A.02.00

Format Data: Numeric Data (Remote Command Only)

This command specifies the format of the trace data input and output. It specifies the formats used for trace data during data transfer across any remote port. It affects only the data format for setting and querying trace data for the :TRACe[:DATA], TRACe[:DATA]?, :CALCulate:DATA[n]? and FETCh:SANalyzer[n]? commands and queries.

Remote Command:	<pre>:FORMat [:TRACe] [:DATA] ASCii INTeger, 32 REAL, 32 REAL, 64 :FORMat [:TRACe] [:DATA] ?</pre>
------------------------	--

Meas

Notes:	<p>The query response is:</p> <p>ASCii: ASC,8</p> <p>REAL,32: REAL,32</p> <p>REAL,64: REAL,64</p> <p>INTeger,32: INT,32</p> <p>When the numeric data format is REAL or ASCii, data is output in the current Y Axis unit. When the data format is INTeger, data is output in units of m dBm (.001 dBm).</p> <p>The INT,32 format returns binary 32-bit integer values in internal units (m dBm), in a definite length block.</p>
Dependencies:	<p>Sending a data format spec with an invalid number (for example, INT,48) generates no error. The test set simply uses the default (8 for ASCii, 32 for INTeger, 32 for REAL).</p> <p>Sending data to the test set which does not conform to the current FORMat specified, results in an error. Sending ASCII data when a definite block is expected generates message -161 "Invalid Block Data" and sending a definite block when ASCII data is expected generates message -121 "Invalid Character in Number".</p>
Preset:	ASCii
Backwards Compatibility Notes:	Note that the INT,32 format is only applicable to the command, TRACe:DATA. For all other commands/queries which honor FORMat:DATA, if INT,32 is sent the analyzer will behave as though it were set to REAL,32.
Initial S/W Revision:	Prior to A.02.00

The specs for each output type follow:

ASCii - Amplitude values are in ASCII, in the current Y Axis Unit, one ASCII character per digit, values separated by commas, each value in the form:

SX.YYYYYEsZZ

Where:

S = sign (+ or -)

X = one digit to left of decimal point

Y = 5 digits to right of decimal point

E = E, exponent header

s = sign of exponent (+ or -)

ZZ = two digit exponent

REAL,32 - Binary 32-bit real values in the current Y Axis Unit, in a definite length block.

REAL,64 - Binary 64-bit real values in the current Y Axis Unit, in a definite length block.

Format Data: Byte Order (Remote Command Only)

This command selects the binary data byte order for data transfer and other queries. It controls whether binary data is transferred in normal or swapped mode. This command affects only the byte order for setting and querying trace data for the :TRACe[:DATA], TRACe[:DATA]? , :CALCulate:DATA[n]? and FETCh:SANalyzer[n]? commands and queries.

By definition any command that says it uses FORMat:DATA uses any format supported by FORMat:DATA.

The NORMal order is a byte sequence that begins with the most significant byte (MSB) first, and ends with the least significant byte (LSB) last in the sequence: 1|2|3|4. SWAPped order is when the byte sequence begins with the LSB first, and ends with the MSB last in the sequence: 4|3|2|1.

Remote Command:	:FORMat:BORDER NORMAL SWAPped :FORMat:BORDER?
Preset:	NORMal
Initial S/W Revision:	Prior to A.02.00

Meas

Meas Setup

The Meas Setup key opens up a menu of keys that allow you to control the most important parameters for the current measurement.

NOTE In the Meas Setup menu you may configure Averaging, by setting the Average Number and the Average Type.

Key Path	Front-panel key
Initial S/W Revision	Prior to A.02.00

Average/Hold Number

Sets the terminal count number N for **Average**, **Max Hold** and **Min Hold** trace types. This number is an integral part of how the average trace is calculated. Basically, increasing N results in a smoother average trace.

See [“More Information” on page 1047](#).

See [“AVER:CLE command” on page 1047](#).

Key Path	Meas Setup
Remote Command	[:SENSe] :AVERage:COUNT <integer> [:SENSe] :AVERage:COUNT?
Couplings	Restarting any of these functions (Average , Max Hold or Min Hold) restarts all of them, as there is only one count.
Preset	100
State Saved	Saved in Instrument State
Min	1
Max	10000
Status Bits/OPC dependencies	See the Section “Sweep/Control” on page 1267 for a discussion of the Sweeping, Measuring, Settling and OPC bits, and the Hi Sweep line. All are affected when a sequence is reset.
Initial S/W Revision	Prior to A.02.00

More Information

AVER:CLE command

The AVER:CLE command (below) resets the average/hold count and does an INIT:IMM, which begins

Meas Setup

another set of sweeps when trigger conditions are satisfied. It only does this if an active trace is in Average or Hold type.

Remote Command:	[:SENSe] :AVERage :CLEAr
Example:	AVER:COUN 100 AVER:CLE sets the current count (k and K) to 1 and restarts the averaging process.
Notes:	When the test set receives this command it performs an INIT:IMM, if and only if there is an active trace in Max Hold, Min Hold, or Average type.
Default Unit:	Enter
Initial S/W Revision:	Prior to A.02.00

Average Type

Lets you control the way averaging is done by choosing one of the following averaging scales: log-power (video), power (RMS), or voltage averaging. Also lets you choose Auto Average Type (default).

When performing Trace Averaging, the equation that is used to calculate the averaged trace depends on the average type. See the descriptions for the keys which select each Average Type (“[Log-Pwr Avg \(Video\)](#)” on page 1050 (Video), “[Pwr Avg \(RMS\)](#)” on page 1050 (RMS), or “[Voltage Avg](#)” on page 1051) for details on these equations.

See “[More Information](#)” on page 1049.

Key Path	Meas Setup
Remote Command	[:SENSe] :AVERage :TYPE :AUTO OFF ON 0 1 [:SENSe] :AVERage :TYPE :AUTO?
Preset	ON
State Saved	Saved in Instrument State
Readback line	1-of-N selection as Log-Pwr (Video) for Log-Pwr (Video) Avg Pwr (RMS) for Power Avg Voltagefor Voltage
Initial S/W Revision	Prior to A.02.00

Remote Command:	[:SENSe] :AVERage :TYPE RMS LOG SCALAr [:SENSe] :AVERage :TYPE?
------------------------	--

Notes:	Parameters map to avg types as: RMS = Pwr (RMS) Avg LOG = Log-Pwr (Video) Avg SCALAr = Voltage Avg
Preset:	LOG
Backwards Compatibility SCPI:	[[:SENSe]:AVERAge:TYPE LINear sets Scalar averaging [:SENSe]:AVERAge:TYPE VOLTage sets Scalar averaging [:SENSe]:AVERAge:TYPE VIDEO sets Log-Power averaging [:SENSe]:AVERAge:TYPE LPOWer sets Log-Power averaging [:SENSe]:AVERAge:TYPE POWEr sets RMS averaging
Initial S/W Revision:	Prior to A.02.00

More Information

When you select log-power averaging, the measurement results are the average of the signal level in logarithmic units (decibels). When you select power average (RMS), all measured results are converted into power units before averaging and filtering operations, and converted back to decibels for displaying. Remember: there can be significant differences between the average of the log of power and the log of the average power.

These are the averaging processes within the test set and all of them are affected by this setting:

Trace averaging (see Section [“Trace Average” on page 1304](#)) averages signal amplitudes on a trace-to-trace basis. The average type applies to all traces in Trace Average (it is not set on a trace-by-trace basis).

Average detector (see Section [“Detector” on page 1310](#)) averages signal amplitudes during the time or frequency interval represented by a particular measurement point.

VBW filtering (see Section [“BW” on page 889](#)) adds video filtering which is a form of averaging of the video signal.

When **Auto** is selected, the test set chooses the type of averaging (see below). When one of the average types is selected manually, the test set uses that type regardless of other test set settings, and shows Man on the **Average Type** key.

Auto

Chooses the optimum type of averaging for the current test set measurement settings.

Key Path	Meas setup, Average Type
Example	AVER:TYPE:AUTO ON
Notes	See Average Type , above

Meas Setup

Couplings	<p>Here are the auto-select rules for Average Type:</p> <p>Auto selects Voltage Averaging if the Detector for any active trace is EMI Average or QPD or RMS Average; otherwise it selects Power (RMS) Averaging if a Marker Function (Marker Noise, Band/Intvl Power) is on, or Detector is set to Man and Average; otherwise if Amplitude, Scale Type is set to Lin it selects Voltage Averaging; otherwise, if the EMC Standard is set to CISPR, it selects Voltage; otherwise Auto selects Log-Power Average.</p> <p>Note that these rules are only applied to active traces. Traces which are not updating do not impact the auto-selection of Average Type.</p>
State Saved	Saved in Instrument State
Readback	The type auto-selected is displayed in the readback line on the Average Type key
Initial S/W Revision	Prior to A.02.00

Log-Pwr Avg (Video)

Selects the logarithmic (decibel) scale for all filtering and averaging processes. This scale is sometimes called “Video” because it is the most common display and analysis scale for the video signal within the test set. This scale is excellent for finding CW signals near noise, but its response to noise-like signals is 2.506 dB lower than the average power of those noise signals. This is compensated for in the Marker Noise function.

The equation for trace averaging on the log-pwr scale is shown below, where K is the number of averages accumulated. (In continuous sweep mode, once K has reached the Average/Hold Number, K stays at that value, providing a continuous running average.)

$$\text{New avg} = ((K-1)\text{Old avg} + \text{New data})/K$$

Assumes all values in decibel scale.

Key Path	Meas setup, Average Type
Example	AVER:TYPE LOG
Notes	See ““Average Type” on page 1048”
Couplings	See ““Auto” on page 1049”
Readback	Log-Pwr (Video)
Initial S/W Revision	Prior to A.02.00

Pwr Avg (RMS)

In this average type, all filtering and averaging processes work on the power (the square of the magnitude) of the signal, instead of its log or envelope voltage. This scale is best for measuring the true time average power of complex signals. This scale is sometimes called RMS because the resulting voltage is proportional to the square root of the mean of the square of the voltage.

In the equation for averaging on this scale (below), K is the number of averages accumulated. (In continuous sweep mode, once K has reached the Average/Hold Number, K stays at that value, providing

a running average.)

$$\text{New avg} = 10 \log \left(\frac{1}{K} \left((K-1) \left(10^{\text{Old avg}/10} \right) + 10^{\text{New data}/10} \right) \right)$$

Equation assumes all values are in the decibel scale.

Key Path	Meas setup, Average Type
Example	AVER:TYPE RMS
Notes	See “Average Type” on page 1048
Couplings	See “Auto” on page 1049
Readback	Pwr (RMS)
Initial S/W Revision	Prior to A.02.00

Voltage Avg

In this Average type, all filtering and averaging processes work on the voltage of the envelope of the signal. This scale is good for observing rise and fall behavior of AM or pulse-modulated signals such as radar and TDMA transmitters, but its response to noise-like signals is 1.049 dB lower than the average power of those noise signals. This is compensated for in the **Marker Noise** function.

In the equation for averaging on this scale (below), K is the number of averages accumulated. (In continuous sweep mode, once K has reached the Average/Hold Number, K stays at that value.)

$$\text{New avg} = 20 \log \left(\frac{1}{K} \left((K-1) \left(10^{\text{Old avg}/20} \right) + 10^{\text{New data}/20} \right) \right)$$

Equation assumes all values are in the decibel scale.

Key Path	Meas setup, Average Type
Example	AVER:TYPE SCAL
Notes	See “Average Type” on page 1048
Couplings	See “Auto” on page 1049
Readback	Pwr (RMS)
Initial S/W Revision	Prior to A.02.00

Limits

The limits key opens up a menu of keys to control the limits for the current measurement. Limits arrays can be entered by the user, sent over SCPI, or loaded from a file.

Initial S/W Revision	A.02.00
Key Path	Meas Setup
Dependencies	This key will only appear if you have the proper option installed in your test set.

Meas Setup

Preset	Limits are turned off by a Preset, but the Limits arrays (data) are only reset (deleted) by Restore Mode Defaults. They survive shutdown and restarting of the test set application, which means they will survive a power cycle.
--------	---

Select Limit

Specifies the selected limit. The term “selected limit” is used throughout this document to specify which limit is affected by the functions.

Key Path	Meas Setup, Limits
Notes	The selected limit is remembered even when not in the Limit Menu.
Preset	Limit 1, not affected by Mode Preset, preset by Restore Mode Defaults.
State Saved	Saved in State.
Initial S/W Revision	A.02.00

Limit On/Off

Selects whether the limit and margin are displayed. If Test Limits is on, this also determines whether the test trace (see “[Test Trace](#)” on page 1053) is tested against the limit. If **Limit On/Off** is **On**, the following occurs:

- The limit line is displayed, in the same color as the limited trace, but paler. Portions of traces which fail the limits are displayed in red.
- The margin line is displayed if Margin is on and the Margin Value is non-zero (see “[Margin](#)” on page 1059). The margin line is displayed in the same color as the limit line, but paler still and dashed. Portions of traces which pass the limits but fail the margin is displayed in amber.
- The trace is tested for the purpose of the “Trace Pass/Fail” indication in the graticule if, in addition to **Limit On/Off** being **On**, the trace is displayed and **Test Limits (All Limits)** is on (see “[Test Limits](#)” on page 1064). If the trace is not tested, no report of the trace passing or failing is seen on the graticule. Note that the SCPI queries of Limit Pass/Fail are independent of these conditions; the test is always performed when queried over SCPI.

The PASS/FAIL box in the corner of the Meas Bar is only displayed if there is at least one “Trace Pass/Fail” indication displayed in the graticule.

Note that the red and amber coloring of traces which fail the limits and/or margins only applies to traces whose X-axis corresponds to the current test set X-axis. Traces which are not updating (in View, for example) will not change color if the test set X-axis settings (for example, start and stop frequency) do not match those of the trace, for example if they have been changed since the trace stopped updating. In this case, the Invalid Data indicator (*) will appear in the upper right hand corner.

When the limits are frequency limits but the trace is a zero-span trace, the limit trace is drawn at the limit amplitude of the center frequency. When the limits are time limits but the trace is a frequency domain trace, the limit trace is drawn according to the current time axis, with the left of the screen being 0 and the right being equal to sweep time.

Key Path	Meas Setup, Limits
----------	---------------------------

Remote Command	:CALCulate:LLINE [1] 2 3 4 5 6 :DISPlay OFF ON 0 1 :CALCulate:LLINE [1] 2 3 4 5 6 :DISPlay?
Example	:CALC:LLIN2:DISP ON turns on the display for limit line 2.
Dependencies	This command will generate an “Option not available” error unless you have the proper option installed in your test set.
Couplings	Limit display ON selects the limit. Testing is done on all displayed limits if Test Limits (All Limits) is ON. Entering the limit menu from the GUI turns on the selected limit.
Preset	OFF
State Saved	Saved in State.
Backwards Compatibility SCPI	:CALCulate:LLINE[1] 2:STATe OFF ON 0 1 (In the past you had to send the DISP command as well as the STATe command in order to get a limit on and testing. Now, the DISP command is sufficient, but we accept the state command and do nothing with it)
Initial S/W Revision	A.02.00

Properties

Accesses a menu which lets you set the properties of the selected limit.

Key Path	Meas Setup, Limits
Initial S/W Revision	A.02.00

Select Limit

Specifies the selected limit. The term “selected limit” is used throughout this document to specify which limit is affected by the functions.

Key Path	Meas Setup, Limits, Properties
Notes	The selected limit is remembered even when not in the Limit Menu.
Preset	Limit 1, not affected by Mode Preset, preset by Restore Mode Defaults.
State Saved	Saved in State.
Initial S/W Revision	A.02.00

Test Trace

Selects the trace you want the limit to test. A limit is applied to one and only one trace; each trace can have both an upper and a lower limit. When executing Limit Test, the limit is applied only to the specified trace.

A trace can have multiple limit lines simultaneously; in that case, only one upper and one lower limit line will affect the color of the trace. Other limit lines are displayed, and affect the pass/fail status, but the

Meas Setup

trace does not turn red if it crosses a secondary limit line.

Key Path	Meas Setup, Limits, Properties
Remote Command	:CALCulate:LLINe [1] 2 3 4 5 6 :TRACe 1 2 3 4 5 6 :CALCulate:LLINe [1] 2 3 4 5 6 :TRACe?
Example	:CALC:LLIN3:TRAC 2 applies limit 3 to trace 2.
Notes	When the trace display is off, the trace is not tested. The trace is tested only when the trace display is on and Test Limits (see “ Test Limits ” on page 1064) is on.
Couplings	This matters when testing a trace or limit line for failure, via :CALC:LLIN3:FAIL? or :CALC:TRAC2:FAIL?
Preset	Limits 1 and 2 preset to 1, Limits 3 and 4 preset to 2, Limits 5 and 6 preset to 3 Not affected by Mode Preset, preset by Restore Mode Defaults.
State Saved	Saved in State.
Min	1
Max	6
Readback	Trace 1 2 3 4 5 6
Initial S/W Revision	A.02.00

Type

Selects whether the limit you are editing is an upper or lower limit. An upper limit fails if the trace exceeds the limit. A lower limit fails if the trace falls below the limit.

Key Path	Meas Setup, Limits, Properties
Remote Command	:CALCulate:LLINe [1] 2 3 4 5 6 :TYPE UPPer LOWer :CALCulate:LLINe [1] 2 3 4 5 6 :TYPE?
Example	:CALC:LLIN2:TYPE LOW sets limit line 2 to act as a lower limit.
Couplings	If a margin has already been set for this limit line, and this key is used to change the limit type, then the margin value will reverse sign.
Preset	Upper for Line 1, 3, and 5; Lower for Line 2, 4, 6. Not affected by Mode Preset, preset by Restore Mode Defaults.
State Saved	Saved in State.
Initial S/W Revision	A.02.00

Interpolation

Accesses a menu which lets you set the frequency and amplitude interpolation of the selected limit.

Key Path	Meas Setup, Limits, Properties
Readback	[Lin Log Frequency, Lin Log Amplitude]
Initial S/W Revision	A.02.00

Frequency Interpolation

This key is grayed out if Time is the selected X-axis units. Sets the interpolation between frequency points, allowing you to determine how limit trace values are computed between points in a limit table. The available interpolation modes are linear and logarithmic. If frequency interpolation is logarithmic (Log), frequency values between limit points are computed by first taking the logarithm of both the table values and the intermediate value. A linear interpolation is then performed in this logarithmic frequency space. An exactly analogous manipulation is done for logarithmic amplitude interpolation.

Note that the native representation of amplitude is in dB.

For linear amplitude interpolation and linear frequency interpolation, the interpolation is computed as:

$$y = 20 \log\left(\frac{10^{\frac{y_{i+1}}{20}} - 10^{\frac{y_i}{20}}}{f_{i+1} - f_i}(f - f_i) + 10^{\frac{y_i}{20}}\right)$$

For linear amplitude interpolation and log frequency interpolation, the interpolation is computed as:

$$y = 20 \log\left(\frac{10^{\frac{y_{i+1}}{20}} - 10^{\frac{y_i}{20}}}{\log f_{i+1} - \log f_i}(\log f - \log f_i) + 10^{\frac{y_i}{20}}\right)$$

For log amplitude interpolation and linear frequency interpolation, the interpolation is computed as:

$$y = \frac{y_{i+1} - y_i}{f_{i+1} - f_i}(f - f_i) + y_i$$

For log amplitude interpolation and log frequency interpolation, the interpolation is computed as:

$$y = \frac{y_{i+1} - y_i}{\log f_{i+1} - \log f_i}(\log f - \log f_i) + y_i$$

NOTE

Interpolation modes determine how limit values are computed between points in the limit table. The appearance of a limit trace is also affected by the amplitude scale, which may be linear or logarithmic.

Key Path	Meas Setup, Limits, Properties, Interpolation
----------	--

Meas Setup

Remote Command	:CALCulate:LLINe [1] 2 3 4 5 6 :CONTrol:INTerpolate:TYPE LOGarithmic LINear :CALCulate:LLINe [1] 2 3 4 5 6 :CONTrol:INTerpolate:TYPE?
Example	:CALC:LLIN:CONT:INT:TYPE LIN sets limit line 1 frequency interpolation to linear.
Preset	Linear, not affected by Mode Preset, preset by Restore Mode Defaults.
State Saved	Saved in instrument state.
Initial S/W Revision	A.02.00

Amplitude Interpolation

Sets the interpolation to linear or logarithmic for the specified limiting points set, allowing you to determine how limit trace values are computed between points in a limit table. See Frequency Interpolation for the equations used to calculate limit values between points.

Key Path	Meas Setup, Limits, Properties, Interpolation
Remote Command	:CALCulate:LLINe [1] 2 3 4 5 6 :AMPLitude:INTerpolate:TYPE LOGarithmic LINear :CALCulate:LLINe [1] 2 3 4 5 6 :AMPLitude:INTerpolate:TYPE?
Example	:CALC:LLIN:AMPL:INT:TYPE LIN sets limit line 1 amplitude interpolation to linear.
Preset	Logarithmic, not affected by Mode Preset, preset by Restore Mode Defaults.
State Saved	Saved in instrument state.
Initial S/W Revision	A.02.00

Fixed / Relative

Opens a menu which will allow you to specify that the selected limit is relative to either Center Frequency or Reference level.

Key Path	Meas Setup, Limits, Properties
Readback	Fixed Rel to CF Rel to RL Rel to CF + RL (square brackets)
Initial S/W Revision	A.02.00

Relative to CF

Chooses whether the limit line frequency points are coupled to the test set center frequency, and whether the frequency points are expressed as an offset from the test set center frequency. If the limit lines are specified with time, this has no effect. The limit table must in this case support negative frequencies.

For example, assume you have a frequency limit line, and the test set center frequency is at 1 GHz. If Relative to CF is “Off”, entering a limit line segment with a frequency coordinate of 300 MHz displays the limit line segment at 300 MHz, and the limit line segment will not change frequency if the center frequency changes. If Relative to CF

is “On”, entering a limit line segment with a frequency coordinate of 300 MHz displays the limit line segment at CF + 300 MHz, or 1.3 GHz. Furthermore, if the center frequency changes to 2 GHz, the limit line segment is displayed at CF + 300 MHz, or 2.3 GHz.

It is possible to change this setting after a limit line has been entered. When changing from On to Off or vice-versa, the frequency values in the limit line table change so that the limit line remains in the same position for the current frequency settings of the test set.

Pressing this button makes Center Frequency the active function.

Key Path	Meas Setup, Limits, Properties, Fixed/Relative
Remote Command	:CALCulate:LLINe [1] 2 3 4 5 6:FREQuency:CMODE:RELative ON OFF 1 0 :CALCulate:LLINe [1] 2 3 4 5 6:FREQuency:CMODE:RELative?
Example	:CALC:LLIN:FREQ:CMOD:REL ON makes limit line 1 relative to the center frequency.
Notes	If the Trace Domain is changed to Time (:CALCulate:LLINe:CONTRol:DOMain TIME), the SCPI command :CALCulate:LLINe[1] 2 3 4 5 6:FREQuency:CMODE:RELative ON OFF 1 0 will have no effect.
Couplings	Pressing this button makes Center Frequency the active function.
Preset	Off, not affected by Mode Preset, preset by Restore Mode Defaults.
State Saved	Saved in instrument state.
Initial S/W Revision	A.02.00

Relative to RL

Chooses whether the limit line amplitude points are coupled to the test set reference level, and whether the amplitude points are expressed as an offset from the test set reference level.

For example, assume you have a limit line, and the reference level at –10 dBm. If Relative to RL is “Off”, entering a limit line segment with an amplitude coordinate of –20 dB displays the limit line segment at –20 dBm, and the limit line segment will not change amplitude if the reference level amplitude changes. If Relative to RL is “On”, entering a limit line segment with an amplitude coordinate of –20 dB displays the limit line segment at RL – 20 dB, or –30 dBm. Furthermore, if the reference level amplitude changes to –30 dBm, the limit line segment is displayed at RL – 20 dB, or –50 dBm.

It is possible to change this setting after a limit line has been entered. When changing from On to Off or vice-versa, the amplitude values in the limit line table change so that the limit line remains in the same position for the current reference level settings of the test set.

Key Path	Meas Setup, Limits, Properties, Fixed/Relative
Remote Command	:CALCulate:LLINe [1] 2 3 4 5 6:AMPLitude:CMODE:RELative ON OFF 1 0 :CALCulate:LLINe [1] 2 3 4 5 6:AMPLitude:CMODE:RELative?
Example	:CALC:LLIN:AMPL:CMOD:REL ON makes limit line 1 relative to the reference level amplitude.

Meas Setup

Couplings	Pressing this button makes Reference level the active function.
Preset	Off, not affected by Mode Preset, preset by Restore Mode Defaults.
State Saved	Saved in instrument state.
Initial S/W Revision	A.02.00

Description

Provides a description of up to 60 characters by which the operator can easily identify the limit. It is stored in the exported file. Can be displayed in the active function area by selecting as the active function, if desired to be in a screen dump.

Key Path	Meas Setup, Limits, Properties
Remote Command	:CALCulate:LLINe [1] 2 3 4 5 6 :DESCription "Description" :CALCulate:LLINe [1] 2 3 4 5 6 :DESCription?
Example	:CALC:LLIN:DESC "European Emissions"
Preset	"" (null String), not affected by Mode Preset, preset by Restore Mode Defaults.
State Saved	Saved in instrument state
Readback	As much of the description will fit on one line of the key, followed by "... " if some of the description will not fit on one line of the key.
Initial S/W Revision	A.02.00

Comment

Sets an ASCII comment field which is stored in an exported file. Can be displayed in the active function area by selecting as the active function, if desired to be in a screen dump. The Limits .csv file supports this field.

Key Path	Meas Setup, Limits, Properties
Remote Command	:CALCulate:LLINe [1] 2 3 4 5 6 :COMMeNt "text " :CALCulate:LLINe [1] 2 3 4 5 6 :COMMeNt?
Example	:CALC:LLIN:COMM "this is a comment"
Preset	"" (null String), not affected by Mode Preset, preset by Restore Mode Defaults.
State Saved	Saved in instrument state.
Readback	As much of the description will fit on one line of the key, followed by "... " if some of the description will not fit on one line of the key.
Initial S/W Revision	A.02.00

Margin

Selects a margin for this limit, which will cause a trace to Fail Margin when the trace is between the limit line and the margin line. Portions of the traces which pass the limit but fail the margin are displayed in an amber color.

A margin is always specified in dB relative to a limit – an upper limit always has a negative margin, and a lower limit always has a positive margin. If a value is entered with the incorrect sign, the system automatically takes the negative of the entered value.

If the limit type is switched from lower to upper while margin is present, the margin reverses sign.

When the Margin is selected, it may be turned off by pressing the Margin key until Off is underlined. This may also be done by performing a preset. Margin is the default active function whenever the margin is on, and it is not the active function whenever the margin is off.

The margin lines are displayed in the same color as limit lines, but paler. If the limited trace is blanked then the limit line and the margin line is blanked as well.

Key Path	Meas Setup, Limits
Remote Command	:CALCulate:LLINE [1] 2 3 4 5 6 :MARGin <rel_amp1> :CALCulate:LLINE [1] 2 3 4 5 6 :MARGin? :CALCulate:LLINE [1] 2 3 4 5 6 :MARGin:STATe OFF ON 0 1 :CALCulate:LLINE [1] 2 3 4 5 6 :MARGin:STATe?
Example	:CALC:LLIN1:MARG -2dB sets limit line 1's margin to -2 dB (Limit Line 1 is by default an upper limit). :CALC:LLIN2:MARG 1dB sets limit line 2's margin to 1 dB (Limit Line 2 is by default a lower limit). :CALC:LLIN2:MARG:STAT OFF turns off the margin for limit line 2 and removes any tests associated with that margin line.
Notes	The queries "Limit Line Fail?" (:CALCulate:LLINE[1] 2 3 4 5 6:FAIL?) and "Trace Fail?" (:CALCulate:TRACe[1] 2 3 4 5 6:FAIL?) will return 1 if the margin fails.
Couplings	This will affect :CALC:LLIN3:FAIL or :CALC:TRAC2:FAIL?
Preset	not affected by Mode Preset, set to 0 dB for all Limits by Restore Mode Defaults.
State Saved	Saved in instrument state.
Min	-40 dB (Upper); 0 dB (Lower)
Max	0 dB (Upper); 40 dB (Lower);
Default Unit	dB
Initial S/W Revision	A.02.00

Meas Setup

Edit

Opens the Table Editor for the selected limit line.

When entering the menu, the editor window (with the limit table) turns on, the selected Limit is turned **On** and the amplitude scale is set to **Log**. The display of the trace to which the selected limit applies is turned on (thus, traces in Blank are set to View and traces in Background are set to On). Turning on the Limit means it's display is on, and it's testing mode is on as well; you should turn off any other limits that are on if they interfere with the editing of the selected limit.

NOTE The table editor will only operate properly if the test set is sweeping, because its updates are tied to the sweep system. Thus, you should not try to use the editor in single sweep, and it will be slow during computer-intensive operations like narrow-span FFT sweeps.

When exiting the edit menu (by using the Return key or by pressing a test set front panel key), the editor window turns off, however the Limit is still on and displayed, and the amplitude scale remains **Log**.

Limits are turned off by a Preset, but the Limits arrays (data) are only reset (deleted) by Restore Mode Defaults. They survive shutdown and restarting of the test set application, which means they will survive a power cycle.

Key Path	Meas Setup, Limits
Couplings	Turns the Limit Peaks table off. A remote user can enter or access limit line data via :CALCulate:LLIne[1] 2 3 4 5 6:DATA
Initial S/W Revision	A.02.00

Navigate

Lets you move through the table to edit the desired point

Key Path	Meas Setup, Limits, Edit
Notes	There is no value readback on the key
Initial S/W Revision	A.02.00

Frequency

Lets you edit the frequency of the current row.

Key Path	Meas Setup, Limits, Edit
Notes	There is no value readback on the key
Initial S/W Revision	A.02.00

Amplitude

Lets you edit the Amplitude of the current row.

Key Path	Meas Setup, Limits, Edit
Notes	There is no value readback on the key
Min	-1000 dBm
Max	1000 dBm
Initial S/W Revision	A.02.00

Insert Point Below

Pressing this key inserts a point below the current point. The new point is a copy of the current point and becomes the current point. The new point is not yet entered into the underlying table, and the data in the row is displayed in light gray.

Key Path	Meas Setup, Limits, Edit
Initial S/W Revision	A.02.00

Delete Point

This is an immediate action key. It will immediately delete the currently-selected point, whether or not that point is being edited, and select Navigate. The point following the currently-selected point (or the point preceding if there is none) is selected.

Key Path	Meas Setup, Limits, Edit
Initial S/W Revision	A.02.00

Copy from Limit

Copies an existing limit into the current limit, including all secondary parameters (Description, Associated Trace, Type, Margin, Interpolation, Relative to CF/RL).

Remote Command:	:CALCulate:LLINE [1] 2 3 4 5 6 :COPY LLINE1 LLINE2 LLINE3 LLINE4 LLINE5 LLINE6
Example:	:CALC:LLINE2:COPY LLINE1 copies the data from line 1 into line 2.
Notes:	Auto return to the Edit menu.
Initial S/W Revision:	A.02.00

Build from Trace

Builds a limit using an existing trace. This command will overwrite all data in the limit. Since a straight copy would typically have hundreds or thousands of segments, the data is approximated to better represent a limit line; small excursions whose width is less than 10 trace buckets will sometimes not be captured. Secondary parameters which are not associated with traces (Description, Associated Trace,

Meas Setup

Type, Margin, Interpolation, Relative to CF/RL) are unchanged.

When taking a trace in order to build a limit, it will often work well to take the trace with a resolution bandwidth wider than the expected measurement, a video bandwidth lower than the expected measurement, and with the detector set to Max Hold or Min Hold.

Note that an upper limit is built above the trace, while a lower limit is built below the trace. If the trace is constant, the limit should pass after being built.

Remote Command:	:CALCulate:LLINe [1] 2 3 4 5 6 :BUILd TRACE1 TRACE2 TRACE3 TRACE4 TRACE5 TRACE6
Example:	:CALC:LLIN2:BUIL TRACE1 builds limit line 2 based on the data in trace 1. This will overwrite the data in the table editor.
Notes:	Auto return to Edit menu.
Initial S/W Revision:	A.02.00

Offset

Enters a menu which allows you to offset the limit trace by a specified frequency, time, or amplitude. The offsets are immediately applied to the limit trace for display and failure calculation; the offset can also be applied to the points in the limit line.

Key Path	Meas Setup, Limits, Edit
Initial S/W Revision	A.02.00

X Offset

Offsets the limit trace by some specified frequency (for Frequency-based limit lines) or a time (for time-based limit lines).

Key Path	Meas Setup, Limits, Edit, Offset
Remote Command	:CALCulate:LLINe [1] 2 3 4 5 6 :OFFSet:X <value> :CALCulate:LLINe [1] 2 3 4 5 6 :OFFSet:X? <value> = <freq> if Limit X-Axis Unit is Frequency, <value> = <time> if Limit X-Axis Unit is Time
Example	:CALC:LLIN:OFFS:X -50MHZ sets the X axis offset to -50 MHz. :CALC:LLIN:OFFS:UPD will apply the X axis offset to all points in the limit line, then reset the X axis offset to zero.
Preset	0 Hz if Limit X-Axis Unit is Frequency 0 S if Limit X-Axis Unit is Time
State Saved	Saved in State, survives Preset
Min	-500 GHz
Max	500 GHz

Default Unit	Determined by X axis scale.
Initial S/W Revision	A.02.00

Y Offset

Offsets all segments in the limit line by some specified amplitude.

Key Path	Meas Setup, Limits, Edit, Offset
Remote Command	:CALCulate:LLINE [1] 2 3 4 5 6 :OFFSet:Y <rel ampl> :CALCulate:LLINE [1] 2 3 4 5 6 :OFFSet:Y?
Example	:CALC:LLIN:OFFS:Y -3 dB sets the Y axis offset to -3 dB. :CALC:LLIN:OFFSet:UPD will apply the Y axis offset to all points in the limit line, then reset the Y axis offset to zero.
Preset	0 dB
State Saved	Saved in instrument state.
Min	-Infinity
Max	+Infinity
Default Unit	dB
Initial S/W Revision	A.02.00

Apply Offsets to Limit Table

Adds the X and Y offsets to each point in the limit table, then resets the X and Y offset values to zero. This has no effect on the position of the limit trace.

For example, if the X offset is -10 MHz and the Y offset is 1 dB, the values in the limit table are updated as follows: 10 MHz is subtracted from each X value, 1 dB is added to each Y value. The offset values are then reset to zero. The limit trace is not moved and the limit table is updated to accurately reflect the currently-displayed limit trace.

Key Path	Meas Setup, Limits, Edit, Offset
Remote Command	:CALCulate:LLINE [1] 2 3 4 5 6 :OFFSet:UPDate
Example	:CALC:LLIN:OFFS:UPD sets updates the limit table to reflect the X and Y offsets, then resets the offsets to zero.
State Saved	No state
Initial S/W Revision	A.02.00

Scale X Axis

Matches the X-axis to the selected Limit, as well as possible.

For frequency limits and a frequency-domain X-axis, sets the Start and Stop Frequency to contain the minimum and maximum Frequency of the selected Limit. The range between Start Frequency and Stop

Meas Setup

Frequency is 12.5% above the range between the minimum and maximum Frequency so that span exceeds this range by one graticule division on either side.

For time limits and a time-domain X-axis, sets the sweep time to match the maximum Time of the selected Limit.

If the domain of the selected limit does not match the domain of the X-axis, no action is taken. Standard clipping rules apply, if the value in the table is outside the allowable range for the X axis.

Key Path	Meas Setup, Limits, Edit
Initial S/W Revision	A.02.00

Delete Limit

Deletes the currently selected limit line. Pressing Delete Limit purges the data from the limit line tables.

Limit data – including secondary parameters such as description, margin value, et cetera - are cleared and returned to factory preset settings.

When this key is pressed a prompt is placed on the screen that says “Please press Enter or OK key to delete limit. Press ESC or Cancel to close this dialog.” The deletion is only performed if you press OK or Enter; if so, after the deletion, the informational message “Limit deleted” appears in the MSG line.

Key Path	Meas Setup, Limits
Remote Command	:CALCulate:LLINe [1] 2 3 4 5 6 :DElete
Example	:CALC:LLIN2:DEL deletes all data for limit line 2.
Initial S/W Revision	A.02.00

Test Limits

Selects whether displayed traces are tested against displayed limits (i.e. those for which Limit On/Off is set to On).

For each displayed trace for which a Limit is turned on, a message is displayed in the upper-left corner of the graticule to notify whether the trace passes or fails the limits.

If the trace is at or within the bounds of all applicable limits and margins, the text “Trace x Pass” is displayed in green, where x is the trace number. A separate line is used for each reported trace.

If the trace is at or within the bounds of all applicable limits, but outside the bounds of some applicable margin, the text “Trace x Fail Margin” is displayed in amber, where x is the trace number. A separate line is used for each reported trace.

If the trace is outside the bounds of some applicable limits, the text “Trace x Fail” is displayed in red, where x is the trace number. A separate line is used for each reported trace.

If the trace has no enabled limits, or the trace itself is not displayed, no message is displayed for that trace.

The PASS/FAIL box in the corner of the Meas Bar is only displayed if there is at least one “Trace Pass/Fail” indication displayed in the graticule.

If two amplitude values are entered for the same frequency, a single vertical line is the result. In this case, if an upper line is chosen, the lesser amplitude is tested. If a lower line is chosen, the greater amplitude is tested.

This command only affects the display, and has no impact on remote behavior. Limit queries over SCPI test the trace against the limit regardless of whether the trace or the limit is turned on (exception: the query `:CALCulate:TRACe[1]|2|3|4|5|6:FAIL?` tests only the limits that are turned on for that trace).

Key Path	Meas Setup, Limits
Remote Command	<code>:CALCulate:LLINE:TEST OFF ON 0 1</code> <code>:CALCulate:LLINE:TEST?</code>
Example	<code>:CALC:LLIN:TEST ON</code> turns on testing, and displays the results in the upper left corner.
Preset	On, not affected by Mode Preset, preset by Restore Mode Defaults.
State Saved	Saved in instrument state.
Initial S/W Revision	A.02.00

X-Axis Unit

Selects how the limit-line segments are defined. Pressing X-axis unit selects whether the limit lines are entered using frequency (Freq) or sweep time (Time) to define the segments. They can be specified as a table of limit-line segments of amplitude versus frequency, or of amplitude versus time. When the X-Axis Unit is set to Time, a time value of zero corresponds to the start of the sweep, which is at the left edge of the graticule, and the column and key in the Limit Table Editor will read Time instead of Frequency

Switching the limit-line definition between Freq and Time will erase all of the current limit lines. When you do this from the front panel, a warning dialog will pop up letting you know that you are about to erase all the limit lines, and prompting you to hit “OK” if you are sure.

Changing the X-axis unit will erase all your limit lines. Are you sure you want to do this? Press **Enter** or **OK** to proceed, or **Cancel (Esc)** to cancel.

Key Path	Meas Setup, Limits
Remote Command	<code>:CALCulate:LLINE:CONTROL:DOMAIN FREQUENCY TIME</code> <code>:CALCulate:LLINE:CONTROL:DOMAIN?</code>
Example	<code>:CALC:LLIN:CONT:DOM FREQ</code> deletes all currently existing limit lines, then sets all limit lines to be specified in terms of frequency.
Couplings	This affects all limit lines simultaneously, and resets all limit line data except the .wav file and email address stored in the Actions.
Preset	Freq, not affected by Mode Preset, preset by Restore Mode Defaults.
State Saved	Saved in instrument state.
Initial S/W Revision	A.02.00

Meas Setup

Delete All Limits

Deletes all limit lines. Pressing Delete All Limits purges the data from all limit line tables.

All limit data are cleared and returned to factory preset settings.

When this key is pressed a prompt is placed on the screen that says “Please press Enter or OK key to delete all limits. Press ESC or Cancel to close this dialog.” The deletion is only performed if you press OK or Enter; if so, after the deletion, the informational message “All Limits deleted” appears in the MSG line.

Key Path	Meas Setup, Limits
Remote Command	:CALCulate:LLINe:ALL:DELeTe
Example	:CALC:LLIN:ALL:DEL deletes all data for all limit lines.
Initial S/W Revision	A.02.00

Limit Line Data (Remote Command Only, Backwards Compatibility)

Defines the limit line values, and destroys all existing data. Up to 200 points may be defined for each limit using the following parameters.

<x>Frequency or time values as specified by :Calculate:LLINe:CONTrol:DOMain. Units default to Hz (for frequency) and seconds (for time).

Range: –30 Gs to +30 Gs for time limits, –3 kHz to +350 GHz for frequency limits.

<ampl>Amplitude values units default to dBm. Up to two amplitude values can be provided for each x-axis value, by repeating <x-axis> in the data list.

Range: –1000 dBm to +1000 dBm

<connect> connect values are either "0" or "1." A "1" means this point is connected to the previously defined point to define the limit line. A "0" means that it is a point of discontinuity and is not connected to the preceding point. The connect value is ignored for the first point.

Remote Command:	:CALCulate:LLINe [1] 2 3 4 5 6 :DATA <x>, <ampl>, <connect> :CALCulate:LLINe [1] 2 3 4 5 6 :DATA?
Example:	:CALC:LLIN3:DATA 1E9,-20,0,2E9,-20,1,2E9,-10,1,3E9,-10,1 describes a stair-stepped limit line.
Preset:	Limit line data is cleared by Restore Mode Defaults. However, it survives shutdown/restart of the test set application (including power cycle)
State Saved:	Saved in instrument state.
Initial S/W Revision:	A.02.00

Limit Line Fail? (Remote Command Only)

Tests a limit line against its associated trace. Returns a 0 if the trace is within the limit and margin, a 1 if the trace exceeds either the limit or the margin.

Note that this command only tests one limit line – other limit lines are not tested when executing this command. To see whether a trace passed all limits, use :CALCulate:TRACe:FAIL?.

Note this command performs the test regardless of whether the trace or the limit is turned on on the display.

Remote Command:	:CALCulate:LLINe [1] 2 3 4 5 6 :FAIL?
Example:	:CALC:LLIN:FAIL? returns a zero if limit line 1's associated trace has no failure, 1 if there is a margin or limit failure.
Initial S/W Revision:	A.02.00

Limit State (Remote Command Only, SCPI standard compatibility)

Sets or queries whether the limit line is tested. This command is identical to :CALC:LLIN[1]|2|3|4|5|6:DISP.

Remote Command:	:CALCulate:LIMit [1] 2 3 4 5 6 :STATe ON OFF 0 1 :CALCulate:LIMit [1] 2 3 4 5 6 :STATe?
Example:	:CALC:LIM:STAT ON turns on limit line 1
Couplings:	This command is identical to :CALC:LLIN:DISP Testing is done on all displayed limits if "Test All Limits" is ON.
Preset:	Off (all limits)
State Saved:	Saved in State.
Initial S/W Revision:	A.02.00

Limit Line Control (Remote Command Only, SCPI standard compatibility)

Defines a list of limit line control (frequency or time) values for a given limit line. Up to 2000 points may be defined for each limit using the following parameters.

<x>Frequency or time values as specified by :Calculate:LLINe:CONTRol:DOMain. Units default to Hz (for frequency) and seconds (for time).

Range: –30 Gs to +30 Gs for time limits, –3 kHz to +1200 GHz for frequency limits.

Note that X values may be repeated if a vertical step in the limit line is desired.

The points query returns the number of points in the control. It should match the number of points in the amplitude, that is, the number of values for the CONTRol axis and for the corresponding UPPER and/or LOWER limit lines must be identical. If one array is larger than the other, the limit trace is built using only as much data as is contained in the smaller array.

Meas Setup

An empty array returns not a number (9.91e+37 to a data query), 0 to a POINTs query.

Remote Command:	:CALCulate:LIMit [1] 2 3 4 5 6 :CONTRol [:DATA] <x>, <x>, ... :CALCulate:LIMit [1] 2 3 4 5 6 :CONTRol [:DATA] ?
Example:	:CALC:LIM:CONT 1GHz,2GHz,2GHz,3GHz describes the X values of a stair-stepped limit line.
Preset:	Limit line data is cleared by Restore Mode Defaults.
State Saved:	Saved in instrument state.
Initial S/W Revision:	A.02.00

Remote Command:	:CALCulate:LIMit [1] 2 3 4 5 6 :CONTRol :POINTs?
Example:	:CALC:LIM:CONT:POIN? returns the number of points in the limit line.
Preset:	Limit line data is cleared by Restore Mode Defaults.
State Saved:	Saved in instrument state.
Initial S/W Revision:	A.02.00

Limit Line Upper / Lower (Remote Command Only, SCPI standard compatibility)

Defines a list of amplitude values for a given limit line. Changing the number of elements in the list spectrum will automatically turn the limit line off. Using the “UPP” syntax defines an upper limit line, using the “LOW” syntax defines a lower limit line. Note that a line may not be simultaneously both upper and lower; the type of the limit line will automatically be changed as appropriate. Up to 200 points may be defined for each limit using the following parameters.

<ampl>Amplitude values units default to dBm.

Range: -200 dBm to +100 dBm

The points query returns the number of points in the amplitude list. It will not be possible to turn on the limit line unless the number of points in the control matches the number of points in the amplitude.

The points query returns the number of points in the amplitude list. It should match the number of points in the control, that is, the number of values for the CONTRol axis and for the corresponding UPPer and/or LOWer limit lines must be identical. If one array is larger than the other, the limit trace is built using only as much data as is contained in the smaller array.

An empty array returns the system error “list is empty” to a data query, 0 to a POINTs query.

Remote Command:	:CALCulate:LIMit [1] 2 3 4 5 6 :UPPer [:DATA] <ampl>, <ampl>, ... :CALCulate:LIMit [1] 2 3 4 5 6 :UPPer [:DATA] ?
Example:	:CALC:LIM:UPP -10, -10, -20, -20 describes the amplitude values of an upper limit line
Preset:	Limit line data is cleared by Restore Mode Defaults.

State Saved:	Saved in instrument state.
Initial S/W Revision:	A.02.00

Remote Command:	:CALCulate:LIMit [1] 2 3 4 5 6 :UPPer:POINts?
Example:	:CALC:LIM:UPP:POIN? returns the number of points in the upper limit line.
Preset:	Upper Limit line data/points is cleared by Restore Mode Defaults.
State Saved:	Saved in instrument state.
Initial S/W Revision:	A.02.00

Remote Command:	:CALCulate:LIMit [1] 2 3 4 5 6 :LOWer[:DATA] <ampl>, ... :CALCulate:LIMit [1] 2 3 4 5 6 :LOWer[:DATA] ?
Example:	:CALC:LIM:LOW -10, -10, -20, -20 describes the amplitude values of an lower limit line
Preset:	Limit line data is cleared by Restore Mode Defaults.
State Saved:	Saved in instrument state.
Initial S/W Revision:	A.02.00

Remote Command:	:CALCulate:LIMit [1] 2 3 4 5 6 :LOWer:POINts?
Example:	:CALC:LIM:UPP:POIN? returns the number of points in the lower limit line.
Preset:	Limit line data/points is cleared by Restore Mode Defaults.
State Saved:	Saved in instrument state.
Initial S/W Revision:	A.02.00

Limit Fail? (Remote Command Only, SCPI standard Compatibility)

Tests a limit line against its associated trace. Returns a 0 if the trace is within the limit and margin, a 1 if the trace exceeds either the limit or the margin. This command is identical to “:CALC:LLIN:FAIL?”

Note that this command only tests one limit line – other limit lines are not tested when executing this command. To see whether a trace passed all limits, use :CALCulate:TRACe:FAIL?.

Note this command performs the test regardless of whether the trace or the limit is turned on on the display.

Remote Command:	:CALCulate:LIMit [1] 2 3 4 5 6 :FAIL?
Example:	:CALC:LIM:FAIL? returns a zero if limit line 1’s associated trace has no failure, 1 if there is a margin or limit failure.
Couplings:	This command is identical to :CALC:LLIN:FAIL?
Initial S/W Revision:	A.02.00

Meas Setup

Limit Clear (Remote Command Only, SCPI standard Compatibility)

Clears a limit line, and all associated data. This command is identical to “:CALC:LLIN:DEL”

Remote Command:	:CALCulate:LIMit [1] 2 3 4 5 6 :CLEar
Example:	:CALC:LIM2:CLE deletes all data for limit line 2.
Couplings:	This command is identical to :CALC:LLIN:DEL
Initial S/W Revision:	A.02.00

Trace Fail? (Remote Command Only)

Tests a trace against all associated limit lines. Returns a 0 if the trace is within all limits and margins, a 1 if the trace exceed either the limit or the margin. If no limits apply to the selected trace, this will automatically return a 0.

Only applies to limits that are turned on, if a Limit is off it will not be tested. If a Trace is not displaying it will still be tested, and if **Test Limits (All Limits)** is off the Trace will still be tested.

This command ignores limit lines that are assigned to other traces.

Remote Command:	:CALCulate:TRACe [1] 2 3 4 5 6 :FAIL?
Example:	:CALC:TRAC3:FAIL? returns a zero if there is no failure, 1 if the trace exceeds either the limit or the margin.
Initial S/W Revision:	A.02.00

Fixed / Relative Limit (Remote Command Only, Backwards Compatibility)

This command sets both Relative to CF and Relative to RL simultaneously for all limits. If queried, it returns whether Limit Line 1 is set Relative to CF, and ignores all other fixed/relative data.

Remote Command:	:CALCulate:LLINe:CMODE FIXed RELative :CALCulate:LLINe:CMODE?
Example:	:CALC:LLIN:CMOD REL makes all limit lines relative to the center frequency and reference level.

Notes:	<p>This SCPI command is only supported for Backwards Compatibility.</p> <p>On the X-Series, this functionality is provided by a key which is specific to each limit line, and which provides a sub-menu with 2 keys (Relative to CF / Relative to RL).</p> <p>In order to be consistent with the implementation of the following new commands:</p> <pre>:CALCulate:LLINe[1] 2 3 4 5 6:FREQuency:CMODE:RELative ON OFF 1 0</pre> <pre>:CALCulate:LLINe[1] 2 3 4 5 6:FREQuency:CMODE:RELative?</pre> <p>and</p> <pre>:CALCulate:LLINe[1] 2 3 4 5 6:AMPLitude:CMODE:RELative ON OFF 1 0</pre> <pre>:CALCulate:LLINe[1] 2 3 4 5 6:AMPLitude:CMODE:RELative?</pre> <p>The :CALCulate:LLINe:CMODE? Query will returns 1 if Limit Line 1 is set Relative to CF, and returns 0 otherwise.</p>
Preset:	Fixed
Initial S/W Revision:	A.02.00

Merge Limit Line Data

Adds the points with the specified values to the current limit line, allowing you to merge limit line data. Up to two amplitude values are allowed for each X value. If more than 200 points are entered to be merged, the first 200 points are merged, then an error ‘too many DATA entries’ is reported.

Remote Command:	:CALCulate:LLINe [1] 2 3 4 5 6 :DATA:MERGe <x-axis>, <ampl>, <connected>
Example:	:CALC:LLIN1:DATA:MERG 1000000000,-20,0,2000000000,-30,1 merges the 10 GHz segment and the 20 GHz segment into limit line 1. Note that the 20 GHz segment is connected to the next lower point, which may or may not be the 10 GHz point.
Notes:	This SCPI command is only supported for Backwards Compatibility.
Preset:	Fixed
Initial S/W Revision:	A.02.00

N dB Points

Turns N dB points on and off and allows you to set the N dB value. N dB uses the selected marker. If the selected marker is not on when N dB is turned on, the selected marker turns on, as a Normal marker, at center screen, and is used by N dB.

See “[N dB Points Results Query](#)” on page 1072.

See “[More Information](#)” on page 1072.

Key Path	Meas Setup
----------	------------

Meas Setup

Remote Command	:CALCulate:BWIDth BANDwidth:NDB <rel_ampl> :CALCulate:BWIDth BANDwidth:NDB? :CALCulate:BWIDth BANDwidth[:STATE] OFF ON 0 1 :CALCulate:BWIDth BANDwidth[:STATE] ?
Notes	If the selected marker is turned Off it turns off N dB Points. N DB Points is unaffected by Auto Couple
Preset	Off, 3.01 dB OFF
Preset	Off, 3.01 dB OFF
State Saved	The on/off status and the offset value are both saved in instrument state.
Min	-140 dB
Max	-0.01 dB
Initial S/W Revision	Prior to A.02.00

N dB Points Results Query

Remote Command:	:CALCulate:BWIDth BANDwidth:RESult?
Example:	:CALC:MARK:AOFF set selected marker to 1 :CALC:MARK:MAX put marker 1 on peak :CALC:BWID ON turn on N dB for the selected marker (1) :CALC:BWID:NDB-3.01 set the offset to -3.01 dB :CALC:BWID:RES? Query the result
Notes:	-100 returned if invalid reading
Initial S/W Revision:	Prior to A.02.00

More Information

A marker should be placed on the peak of interest before turning on N dB points. The N dB points function looks for the two points on the marker's trace closest to the marker's X-axis value that are N dB below the marker's amplitude, one above and the other below the marker's X-axis value. (That is, one point is to the right and one is to the left of the selected marker.) The selected N dB value is called the offset. The function reports the frequency difference (for frequency domain traces) or time difference (for time domain traces) between those two points.

Each point is identified by a horizontal arrow pointing towards the marker, next to the trace. The arrows used by the N dB Points function is as shown in the figure below (where each square represents one pixel). They point in, horizontally, at the trace below a peak, on either side of its skirts. There is one pixel between the arrow and the trace

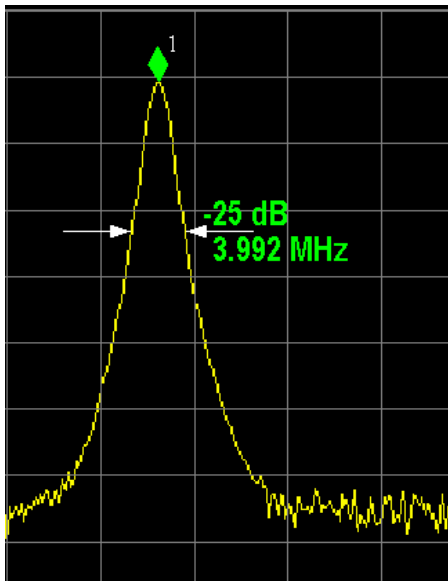

N dB Points can be used to measure the bandwidth of a signal; it is commonly used in conjunction with a tracking generator to measure filter bandwidths.

In one of the common use cases, the marker is placed on a peak, and the arrows are displayed N dB down the skirt from the marker on either side of the peak. The N dB value and the frequency difference between the two arrows is displayed around the arrow as shown in the figure above. Normally this displays on the right hand arrow, but if this would place any part of the text off screen to the right then it displays on the left arrow.

If the test set is unable to find data that is N dB below the marker on either side of the marker, the arrows are displayed at the indicator point of the marker, no value (---) is displayed as the result and -100 Hz returned remotely (see figure below):



Some sample N dB scenarios are shown below, to illustrate how the function works in various cases. In each case, the two-headed blue arrow represents N dB of amplitude.

Meas Setup

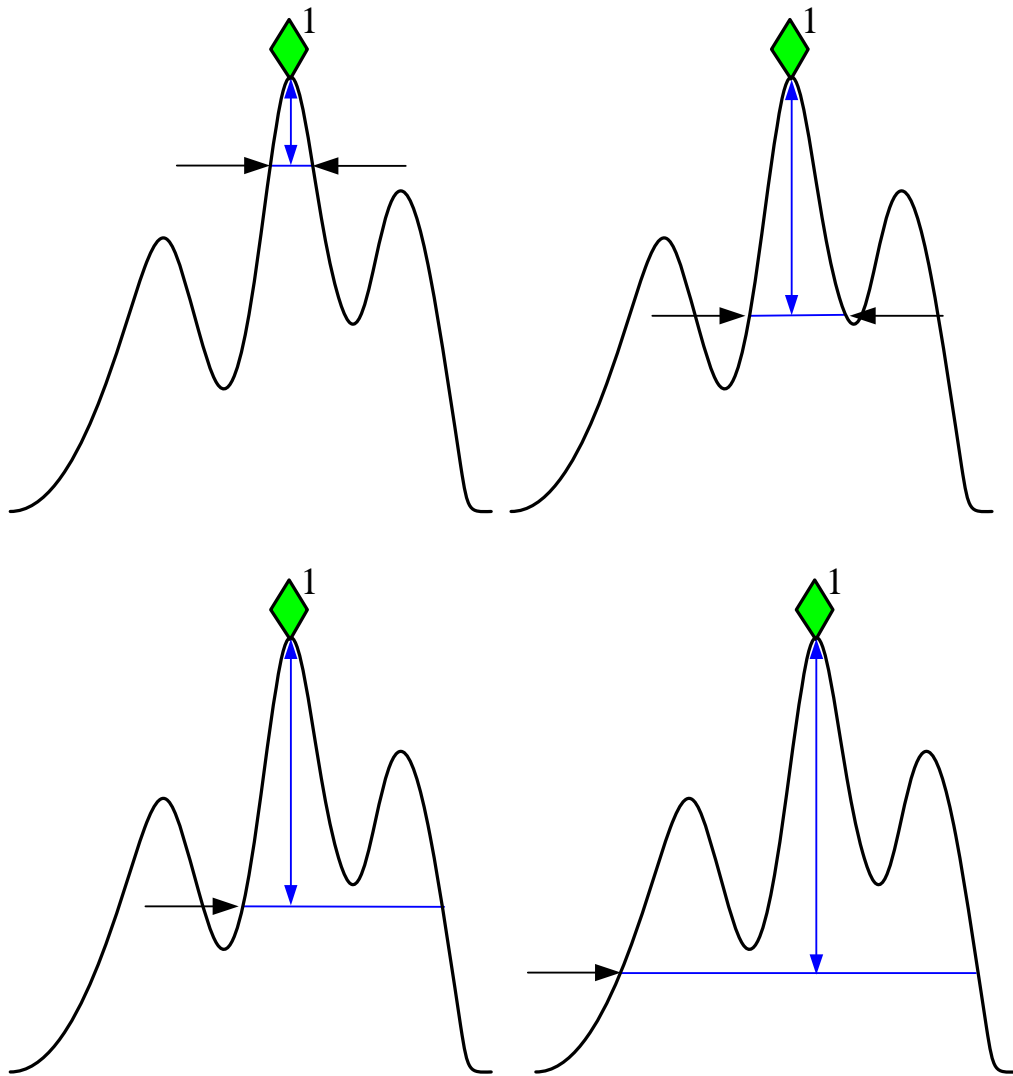

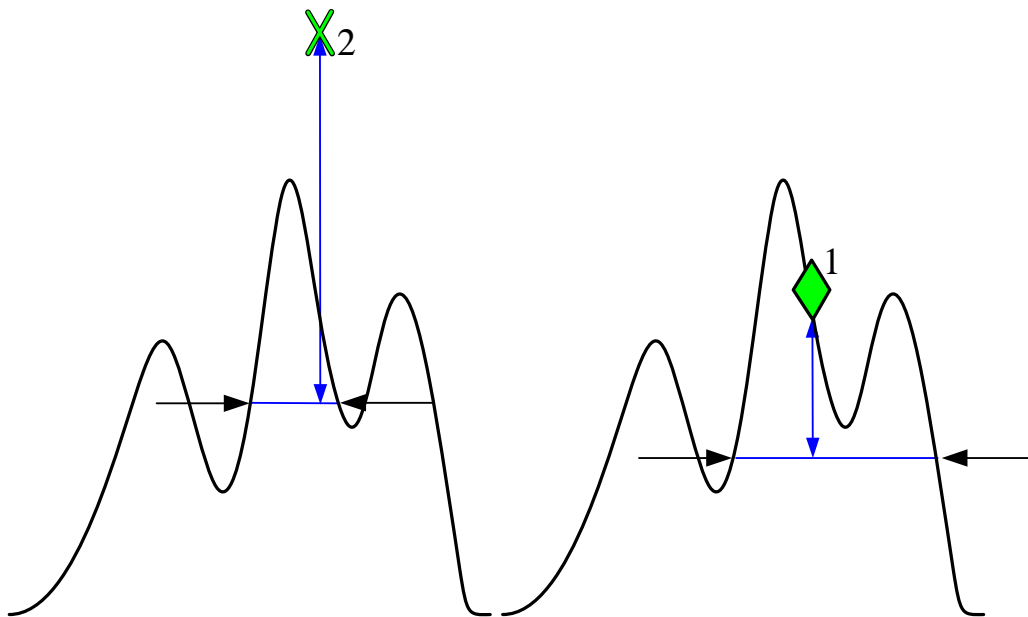

PhNoise Opt

Selects the LO (local oscillator) phase noise behavior for various desired operating conditions.

Remote Command:	[:SENSE] :FREQuency:SYNTHeSis [:STATe] 1 2 3 [:SENSE] :FREQuency:SYNTHeSis [:STATe] ?
Example:	FREQ:SYNT 2 selects optimization for best wide offset phase noise
Notes:	Parameter: 1 - optimizes phase noise for small frequency offsets from the carrier. 2 - optimizes phase noise for wide frequency offsets from the carrier. 3 - optimizes LO for tuning speed
Preset:	Because this function is in Auto after preset, and because Span after preset > 314.16 kHz (see Auto rules, next section) the state of this function after Preset is 2.
Dependencies:	Does not appear in all models. The key is blank in those models, but the SCPI command is accepted for compatibility (although no action is taken).
Initial S/W Revision:	Prior to A.02.00
Modified at S/W Revision:	A.02.00

Auto

Selects the LO (local oscillator) phase noise behavior to optimize dynamic range and speed for various test set operating conditions.

The X-Series has two grades of LO; a high performance LO that gives the best phase noise performance; and a medium-performance LO that gives excellent performance.

Meas Setup

In models with the high performance LO, Auto will choose:

Fast Tuning whenever Span > 44.44 MHz or RBW > 1.9 MHz

otherwise, if center frequency is < 195 kHz OR ALL of the following are true:

CF 1 MHz AND Span 1.3 MHz AND RBW 75 kHz

then Best Close in Phase Noise;

otherwise, Best Wide-offset Phase Noise

In models with the medium-performance LO, Auto will choose:

Fast Tuning whenever Span > 12.34 MHz or RBW > 250 kHz

otherwise, if center frequency is < 25 kHz OR ALL of the following are true:

CF >= 1 MHz AND Span <= 141.4 kHz AND RBW <= 5 kHz

then **Best Close in Phase Noise**;

otherwise, **Best Wide-offset Phase Noise**

In units whose hardware does not provide for an extra-fast tuning option, the settings for Fast Tuning are the same as Best Close-in, so in those models you will see no difference between these settings.

These rules apply whether in swept spans, zero span, or FFT spans.

Key Path	Meas Setup, PhNoise Opt
Remote Command	[:SENSE] :FREQuency:SYNTHeSis:AUTO [:STATE] OFF ON 0 1 [:SENSE] :FREQuency:SYNTHeSis:AUTO [:STATE] ?
Example	FREQ:SYNT:AUTO ON
Preset	ON
State Saved	Saved in instrument state.
Initial S/W Revision	Prior to A.02.00

Best Close-in P Noise

The LO phase noise is optimized for smaller offsets from the carrier, at the expense of phase noise farther out.

Key Path	Meas Setup, PhNoise Opt
Example	FREQ:SYNT 1
Couplings	offset <20 kHz
Readback	Close-in. If manually selected the “Man” is underlined. The actual frequency offset within which noise is optimized is shown with in square brackets, as this can vary depending on the hardware set in use. For example, in some test sets this annotation appears as [offset <20 kHz]

Initial S/W Revision	Prior to A.02.00
----------------------	------------------

Best Wide-offset Noise

The LO phase noise is optimized for wider offsets from the carrier. Optimization is especially improved for offsets from 70 kHz to 300 kHz. Closer offsets are compromised and the throughput of measurements (especially remote measurements where the center frequency is changing rapidly), is reduced.

Key Path	Meas Setup, PhNoise Opt
Example	FREQ:SYNT 2
Couplings	offset >30 kHz
Readback	Wide-offset. If manually selected the “Man” is underlined. The actual frequency offset beyond which noise is optimized is shown with in square brackets, as this can vary depending on the hardware set in use. For example, in some test sets this annotation appears as [offset >30 kHz]
Initial S/W Revision	Prior to A.02.00

Fast Tuning

In this mode, the LO behavior compromises phase noise at many offsets from the carrier in order to allow rapid measurement throughput when changing the center frequency or span. The term “fast tuning” refers to the time it takes to move the local oscillator to the start frequency and begin a sweep; this setting does not impact the actual sweep time in any way.

Key Path	Meas Setup, PhNoise Opt
Example	FREQ:SYNT 3
State Saved	Saved in instrument state.
Readback	Fast Tuning. Also, the “Man” must be underlined.
Initial S/W Revision	Prior to A.02.00

ADC Dither

Accesses the menu to control the ADC Dither function. The dither function enhances linearity for low level signals at the expense of reduced clipping-to-noise ratio. The reduced clipping-to-noise ratio results in higher noise, because we work to ensure that the clipping level of the ADC relative to the front terminals remains unchanged with the introduction of dither, and this results in reduced ADC dynamic range. So making measurements with ADC dither gives you better amplitude linearity, but turning ADC dither off gives you a lower noise floor (better sensitivity).

With dither on, the third-order distortions are usually invisible for mixer levels below –35 dBm. With dither off, these distortions can be visible, with typical power levels of –110 dBm referred to the mixer. Detection nonlinearity can reach 1 dB for dither off at mixer levels around –70 dBm and lower, while the specified nonlinearity is many times smaller with dither on.

Meas Setup

When ADC Dither is on, the linearity of low-level signals is improved. The enhanced linearity is mostly improved scale fidelity. The linearity improvements of dither are most significant for RBWs of 3.9 kHz and less in swept mode, and FFT widths of 4 kHz and less in FFT mode.

The increased noise due to turning dither on is most significant in low band (0 to 3.6 GHz) with IF Gain set to Low, where it can be about 0.2 dB.

Key Path	Meas Setup
Example	ADC:DITH:HIGH Sets the ADC dither setting to High ADC:DITH ON Sets the ADC dither setting to Medium
Remote Command	[:SENSe] :ADC:DITHer [:STATe] OFF ON HIGH [:SENSe] :ADC:DITHer [:STATe] ?
Dependencies	
Preset	AUTO
Backwards Compatibility SCPI	The old command [:SENSe]:ADC:DITHer AUTO is aliased to [:SENSe]:ADC:DITHer:AUTO[:STATe] ON; because of this, the [:SENSe]:ADC:DITHer function cannot be a true Boolean, so the query, [:SENSe]:ADC:DITHer? returns OFF or ON (not 1 or 0 like a true Boolean)
Initial S/W Revision	Prior to A.02.00
Modified at S/W Revision	A.02.00

Auto

Sets the ADC dither to automatic. The test set then chooses the dither level according to which is most likely to be the best selection, based on other settings within the digital IF.

When in Auto, the test set sets the dither to Medium whenever the effective IF Gain is Low by this definition of IF Gain = Low:

- When Sweep Type = Swept, IF Gain = Low whenever Swept IF Gain is set to Low Gain, whether by auto coupling or manual selection.
- When Sweep Type = FFT, IF Gain = Low whenever FFT IF Gain is set to "Low Gain," which cannot happen by auto coupling.

Whenever the IF Gain is not low by this definition, Auto sets the dither to Off.

Key Path	Meas Setup, ADC Dither
Remote Command	[:SENSe] :ADC:DITHer :AUTO [:STATe] OFF ON 0 1 [:SENSe] :ADC:DITHer :AUTO [:STATe] ?
Example	ADC:DITH:AUTO ON
Preset	ON
State Saved	Saved in instrument state

Readback	The “Auto” is underlined, and the readback value is whatever setting is auto-selected
Initial S/W Revision	Prior to A.02.00

High (Best Log Accy)

When ADC dither is set to High, the scale fidelity is especially good, most notably the relative scale fidelity. The trade off is that there is a modest loss of noise floor performance, up to about a decibel.

Key Path	Meas setup, ADC Dither
Example	ADC:DITH:H <u>IGH</u>
Readback	If manually selected, the readback is High, with the “Man” underlined
Initial S/W Revision	A.02.00

Medium (Log Accy)

The Medium setting of ADC Dither (known as “On” in earlier versions of the test set software) improves the linearity of low-level signals at the expense of some noise degradation.

Key Path	Meas setup, ADC Dither
Example	ADC:DITH:O <u>N</u>
Readback	If manually selected, the readback is Medium, with the “Man” underlined
Initial S/W Revision	Prior to A.02.00
Modified at S/W Revision	A.02.00

Off (Best Noise)

When ADC Dither is Off, the test set noise floor is improved, because without the need to make room for the dither, you get a lower noise floor and better sensitivity.

Key Path	Meas setup, ADC Dither
Example	ADC:DITH:O <u>FF</u>
Readback	If manually selected, the readback is Off, with the “Man” underlined.
Initial S/W Revision	Prior to A.02.00

Swept IF Gain

To take full advantage of the RF dynamic range of the test set, there is an added switched IF amplifier with approximately 10 dB of gain. When you can turn it on without overloading the test set, the dynamic range is always better with it on than off. The **Swept IF Gain** key can be used to set the IF Gain function to Auto, or to High Gain (the extra 10 dB), or to Low Gain. These settings affect sensitivity and IF overloads.

Meas Setup

This function is only active when in Swept sweeps. In FFT sweeps, the FFT IF Gain function is used instead.

Key Path	Meas Setup
Remote Command	[:SENSE] : IF : GAIN : SWEPT [: STATE] OFF ON 0 1 [:SENSE] : IF : GAIN : SWEPT [: STATE] ?
Example	IF:GAIN:SWEP ON
Notes	where ON = high gain OFF = low gain
Couplings	The 'auto' rules for Swept IF Gain depend on attenuation, preamp state, start and stop frequency and the setting of FFT IF Gain. Set the Swept IF Gain to High (On) when the total input attenuation is 0 dB, the preamp is off, the start frequency is 10 MHz or more, and the FFT IF Gain is auto coupled, or manually set to Autorange, or manually set to High. Also set the Swept IF Gain to High (On) when the total input attenuation is 2 dB or less, the preamp is on, the start frequency is 10 MHz or more, and the stop frequency is 3.6 GHz or less and the FFT IF Gain is auto coupled, or manually set to Uttering, or manually set to High. Under all other circumstances, set the Swept IF Gain to Low (Off). If the sweep type is Swept, the start frequency of the test set is less than 10 MHz, and you put Swept IF Gain in Manual On, a warning condition is generated and remains in effect as long as this condition exists. The warning message is about a possible IF overload. As with most parameters with an AUTO state, AUTO COUPLE sets it to Auto, and setting any specific value (for example on or off) will set the AUTO state to false.
Preset	Auto after a Preset which yields Off unless the Preamp is on. Auto and Off after Meas Preset.
State Saved	Saved in instrument state.
Readback Line	High Gain or Low Gain
Initial S/W Revision	Prior to A.02.00

Auto

Activates the auto rules for Swept IF Gain

Key Path	Meas setup
Remote Command	[:SENSE] : IF : GAIN : SWEPT : AUTO [: STATE] OFF ON 0 1 [:SENSE] : IF : GAIN : SWEPT : AUTO [: STATE] ?
Example	IF:GAIN:SWEP:AUTO ON
Preset	ON

Initial S/W Revision	Prior to A.02.00
----------------------	------------------

Low Gain (Best for Large Signals)

Forces Swept IF Gain to be off.

Key Path	Meas setup, ADC Ranging
Example	IF:GAIN:SWEP OFF
State Saved	Saved in instrument state.
Readback	Low Gain
Initial S/W Revision	Prior to A.02.00

High Gain (Best Noise Level)

Forces Swept IF Gain to be on.

Key Path	Meas setup, ADC Ranging
Example	IF:GAIN:SWEP ON
Dependencies	The High setting for Swept IF Gain is grayed out when FFT IF Gain is manually set to Low (not when Low is chosen by the auto-rules).
State Saved	Saved in instrument state.
Readback	High Gain
Initial S/W Revision	Prior to A.02.00

FFT IF Gain

Accesses the keys to set the ranging in the digital IF when doing FFT sweeps. When in Autorange mode, the IF checks its range once for every FFT chunk, to provide the best signal to noise ratio. You can specify the range for the best FFT speed, and optimize for noise or for large signals.

When the sweep type is FFT and this function is in Autorange, the IF Gain is set ON initially for each chunk of data. The data is then acquired. If the IF overloads, then the IF Gain is set OFF and the data is re-acquired. Because of this operation, the Auto setting uses more measurement time as the test set checks/resets its range. You can get faster measurement speed by forcing the range to either the high or low gain setting. But you must know that your measurement conditions will not overload the IF (in the high gain range) and that your signals are well above the noise floor (for the low gain range), and that the signals are not changing.

Key Path	Meas Setup
Remote Command	[:SENSe] : IF : GAIN : FFT [: STATe] AUTOrange LOW HIGH [:SENSe] : IF : GAIN : FFT [: STATe] ?

Meas Setup

Couplings	As with most parameters with an AUTO state, AUTO COUPLE sets it to Auto, which then picks Autorange, and setting any specific value (AUTOrange, LOW or HIGH) will set the AUTO state to false.
Preset	AUTOrange
State Saved	Saved in instrument state.
Readback Line	Autorange, High Gain or Low Gain
Initial S/W Revision	Prior to A.02.00

Auto

Allows the test set to pick the FFT IF Gain method as appropriate. This “Auto” state is set by the Auto Couple key, and it puts it in Autorange.

Key Path	Meas setup
Remote Command	[:SENSE] : IF : GAIN : FFT : AUTO [: STATE] OFF ON 0 1 [:SENSE] : IF : GAIN : FFT : AUTO [: STATE] ?
Example	IF:GAIN:FFT:AUTO ON
Preset	ON
State Saved	Saved in instrument state.
Backwards Compatibility SCPI	DISPlay:WINDow[1]:TRACe:Y[:SCALe]:LOG:RANGe:AUTO
Initial S/W Revision	Prior to A.02.00

Autorange (Slower – Follows Signals)

Turns the ADC ranging to automatic which provides the best signal to noise ratio. Autorange is usually preferred over the manual range choices.

Key Path	Meas setup, FFT IF Gain
Example	IF:GAIN:FFT AUTOrange
State Saved	Saved in instrument state.
Readback	Autorange
Initial S/W Revision	Prior to A.02.00

Low Gain (Best for Large Signals)

Forces FFT IF Gain to be off.

Key Path	Meas setup, FFT IF Gain
Example	IF:GAIN:FFT LOW
State Saved	Saved in instrument state.

Readback	Low Gain
Initial S/W Revision	Prior to A.02.00

High Gain (Best Noise Level)

Forces FFT IF Gain to be on.

Key Path	Meas setup, FFT IF Gain
Example	IF:GAIN:FFT HIGH
Dependencies	The High setting for FFT IF Gain is grayed out when Swept IF Gain is manually set to Low (not when Low is chosen by the auto-rules).
State Saved	Saved in instrument state.
Readback	High Gain
Initial S/W Revision	Prior to A.02.00

Analog Demod Tune & Listen

The Analog Demod Tune & Listen key opens the Analog Demod menu which contains keys to turn the demod function on and off and select modulation type. This key only appears if the U9063A Analog Demod personality is installed and licensed.

When the function is on (set to AM, FM, or PM), the demodulated signal is fed to the test set's speaker. Muting and volume control functions are done through the standard Windows speaker volume control interface.

Key Path	Meas Setup
Remote Command	[:SENSe] :DEMod AM FM PM OFF [:SENSe] :DEMod?
Example	DEM AM turns amplitude demodulation function ON
Dependencies	When Tune & Listen is turned on, all active traces are forced to use the same detector. CISPR detectors (QPD, EMI Avg, RMS Avg) and Tune & Listen are mutually exclusive. No sound output is heard if one of these detectors is selected.
Preset	OFF
State Saved	Saved in instrument state.
Initial S/W Revision	Prior to A.02.00
Modified at S/W Revision	A.02.00

AM

Pressing this key, when it is not selected, selects and activates the AM demodulation function. Pressing it

Meas Setup

a second time branches to the AM Demod menu where AM demodulation settings can be adjusted.

Key Path	Meas Setup, Analog Demod Tune&Listen
State Saved	Saved in instrument state.
Initial S/W Revision	Prior to A.02.00

Channel BW (AM Demod)

Sets the RBW setting used by the hardware during the demodulation period in nonzero spans. Note that this is a separate parameter only for the demodulation function and does not affect the RBW setting in the BW menu which is used during the normal sweep. The flat top filter type must be used during the demodulation period. A 5 kHz Video Bandwidth filter is used.

In Zero Span, the test set's RBW & VBW filters are used for the demodulation; thus, the Channel BW (and RBW filter type) will match those of the test set. This allows gap-free listening. The Channel BW key is grayed out and the value displayed on the key matches the current RBW of the test set. Upon leaving zero span, the non-zero-span setting of Channel BW is restored as well as the flattop filter type.

Key Path	Meas Setup, Analog Demod Tune&Listen, AM
Remote Command	<code>[:SENSe] :DEMod:AM:BANDwidth:CHANnel <freq></code> <code>[:SENSe] :DEMod:AM:BANDwidth:CHANnel?</code>
Example	DEM:AM:BAND:CHAN 200 kHz
Notes	This key/command is grayed out in zero span.
Dependencies	Unavailable in zero span.
Couplings	In zero span only, the value is set equal to the test set's current RBW value and it displays that value on the key, but the key is grayed out.
Preset	30 kHz
State Saved	Saved in instrument state.
Min	390 Hz
Max	8 MHz
Default Unit	Hz
Initial S/W Revision	Prior to A.02.00

FM

Pressing this key, when it is not selected, selects and activates the FM demodulation function. Pressing it a second time branches to the FM Demod menu where FM demodulation settings can be adjusted.

Key Path	Meas Setup, Analog Demod Tune&Listen
Example	DEM FM turns frequency demodulation function ON

State Saved	Saved in instrument state.
Initial S/W Revision	Prior to A.02.00

Channel BW (FM Demod)

Sets the RBW setting used by the hardware during the demodulation period in nonzero spans. Note that this is a separate parameter only for the demodulation function and does not affect the RBW setting in the BW menu which is used during the normal sweep. The flat top filter type must be used during the demodulation period. A 5 kHz Video Bandwidth filter is used.

In Zero Span, the test set's RBW & VBW filters are used for the demodulation; thus, the Channel BW (and RBW filter type) will match those of the test set. This allows gap-free listening. The Channel BW key is grayed out and the value displayed on the key matches the current RBW of the test set. Upon leaving zero span, the previous setting of Channel BW and the flattop filter type are restored.

Key Path	Meas Setup, Analog Demod Tune&Listen, FM
Remote Command	[:SENSe] :DEMod:FM:BANDwidth:CHANnel <freq> [:SENSe] :DEMod:FM:BANDwidth:CHANnel?
Example	DEM:FM:BAND:CHAN 200 MHz
Notes	This key / command is grayed out in zero span
Dependencies	Unavailable in zero span.
Couplings	In zero span only, the value is set equal to the test set's current RBW value and it displays that value on the key, but the key is grayed out.
Preset	150 kHz
State Saved	Saved in instrument state.
Min	390 Hz
Max	8 MHz
Default Unit	Hz
Initial S/W Revision	Prior to A.02.00

De-emphasis (FM Demod only)

The De-emphasis setting controls a single-pole filter (6 dB/octave roll off), usually to counter intentional pre-emphasis in the transmitter. When De-emphasis state is OFF the hardware digital filter is bypassed, otherwise the setting is applied

The De-emphasis key is only available when FM is the demod selected. It is grayed out for AM and PM.

Key Path	Meas Setup, Analog Demod Tune & Listen, FM
Remote Command	[:SENSe] :DEMod:FM:DEEMphasis OFF US25 US50 US75 US750 [:SENSe] :DEMod:FM:DEEMphasis?

Meas Setup

Example	DEM:FM:DEEM US75 DEM:FM:DEEM?
Dependencies	Only available in FM. Grayed out for AM and PM.
Preset	US75 (recommended for US commercial FM 75 μ s pre-emphasis)
State Saved	Saved in instrument state.
Readback line	1-of-N selection
Initial S/W Revision	Prior to A.02.00

Off

This setting bypasses the De-emphasis filter.

Key Path	Meas Setup, Analog Demod Tune&Listen, FM, De-emphasis
Example	DEM:FM:DEEM OFF
Readback	Off
Initial S/W Revision	Prior to A.02.00

25 μ s

Sets the De-emphasis time constant to 25 μ s.

Key Path	Meas Setup, Analog Demod Tune&Listen, FM, De-emphasis
Example	DEM:FM:DEEM US25
Readback	25 μ s
Initial S/W Revision	Prior to A.02.00

50 μ s

Sets the De-emphasis time constant to 50 μ s.

Key Path	Meas Setup, Analog Demod Tune&Listen, FM, De-emphasis
Example	DEM:FM:DEEM US50
Readback	50 μ s
Initial S/W Revision	Prior to A.02.00

75 μ s

Sets the De-emphasis time constant to 75 μ s.

Key Path	Meas Setup, Analog Demod Tune&Listen, FM, De-emphasis
Example	DEM:FM:DEEM US75

Readback	75 μ s
Initial S/W Revision	Prior to A.02.00

750 μ s

Sets the De-emphasis time constant to 750 μ sec.

Key Path	Meas Setup, Analog Demod Tune&Listen, FM, De-emphasis
Example	DEM:FM:DEEM US750
Readback	750 μ s
Initial S/W Revision	Prior to A.02.00

PM

Pressing this key, when it is not selected, selects and activates the PM demodulation function. Pressing it a second time branches to the PM Demod menu where PM demodulation settings can be adjusted.

Key Path	Meas Setup, Analog Demod Tune&Listen
Example	DEM PM turns Phase demodulation function ON
State Saved	Saved in instrument state.
Initial S/W Revision	Prior to A.02.00

Channel BW (PM Demod)

Sets the RBW setting used by the hardware during the demodulation period in nonzero spans. Note that this is a separate parameter only for the demodulation function and does not affect the RBW setting in the BW menu which is used during the normal sweep. The flat top filter type must be used during the demodulation period. A 5 kHz Video Bandwidth filter is used.

In Zero Span, the test set's RBW & VBW filters are used for the demodulation; thus, the Channel BW (and RBW filter type) will match those of the test set. This allows gap-free listening. The Channel BW key is grayed out and the value displayed on the key matches the current RBW of the test set. Upon leaving zero span, the previous setting of Channel BW and the flattop filter type are restored.

Key Path	Meas Setup, Analog Demod Tune&Listen, M
Remote Command	[:SENSe] :DEMod:PM:BAWdwidth:CHANnel <freq> [:SENSe] :DEMod:PM:BAWdwidth:CHANnel?
Example	DEM:PM:BAW:CHAN 200 MHz
Notes	This key / command is grayed out in zero span
Dependencies	Unavailable in zero span.

Meas Setup

Couplings	In zero span only, the value is set equal to the test set's current RBW value and it displays that value on the key, but the key is grayed out.
Preset	100 kHz
State Saved	Saved in instrument state.
Min	390 Hz
Max	8 MHz
Default Unit	Hz
Initial S/W Revision	Prior to A.02.00

Off

Pressing this key, turns the demodulation function off.

Key Path	Meas Setup, Analog Demod Tune&Listen
Example	DEM OFF turns the demodulation function OFF
State Saved	Saved in instrument state.
Initial S/W Revision	Prior to A.02.00

Demod Time

Sets the amount of time the test set demodulates the signal after each sweep. The demodulated signal can be heard through the speaker during demodulation. In zero span, demodulation can be performed continuously, making this parameter not applicable, hence it is grayed out in zero span.

Key Path	Meas Setup, Analog Demod Tune&Listen
Remote Command	[:SENSe] :DEMod:TIME <time> [:SENSe] :DEMod:TIME?
Example	DEM:TIME 500 ms DEM:TIME?
Notes	This key / command is grayed out in zero span
Dependencies	Unavailable in zero span.
Preset	500 ms
State Saved	Saved in instrument state.
Min	2 ms
Max	100 s
Initial S/W Revision	Prior to A.02.00

Demod State (Remote Command Only)

Sets or queries the state of the Analog Demod Tune and Listen function. Setting the state to ON with this command will select AM demodulation by default and activate it (turn it on).

The response to the query is determined by the current setting of [:SENSE]:DEMod AM|FM|PM|OFF. The response is 1 if AM, FM, PM are selected, or 0 if OFF is selected.

Remote Command:	[:SENSe] :DEMod:STATe OFF ON 0 1 [:SENSe] :DEMod:STATe?
Preset:	OFF
Initial S/W Revision:	Prior to A.02.00

Meas Setup

Mode

The Mode key allows you to select the available measurement applications or “Modes”. Modes are a collection of measurement capabilities packaged together to provide an instrument personality that is specific to your measurement needs. Each application software product is ordered separately by Model Number and must be licensed to be available. Once an instrument mode is selected, only the commands that are valid for that mode can be executed.

NOTE Key operation can be different between modes. The information displayed in Help is about the current mode.

To access Help for a different Mode you must first exit Help (by pressing the Cancel (Esc) key). Then select the desired mode and re-access Help.

For more information on Modes, preloading Modes, and memory requirements for Modes, see [“More Information” on page 1092](#)

Key Path:	Front-panel key
Remote Command:	:INSTrument [:SElect] SEQAN BASIC WCDMA EDGEgSM WIMAXOFDMA ADEMOD BT00th TDSC DMA CDMA2K CDMA1XEV LTE LTETDD :INSTrument [:SElect] ?
Example:	INST SEQAN
Notes:	The available parameters are dependent upon installed and licensed applications resident in the instrument. Parameters given here are an example, specific parameters are in the individual Application. A list of the valid mode choices is returned with the INST:CAT? Query.
Preset:	Not affected by Preset. In the EXT, the mode set by Restore System Defaults is the Sequence Analyzer mode.
State Saved:	Saved in instrument state
Backwards Compatibility SCPI:	:INSTrument[:SElect] GSM provided for backwards compatibility. Mapped to EDGEgSM.
Backwards Compatibility SCPI:	:INSTrument[:SElect] SANalyzer provided for ESU compatibility. When this command is received, the analyzer aliases it to the following: INST:SEL SCPI LC This results in the analyzer being placed in SCPI Language Compatibility Mode, in order to emulate the ESU Spectrum Analyzer Mode.

Mode

Backwards Compatibility SCPI:	:INSTrument[:SElect] RECEiver provided for ESU compatibility. When this command is received, the analyzer aliases it to the following: :INST:SEL EMI :CONF FSC This results in the analyzer being placed in the EMI Receiver Mode, running the Frequency Scan measurement, in order to emulate the ESU Receiver Mode.
Initial S/W Revision:	Prior to A.02.00
Modified at S/W Revision:	A.10.01

Example:	INST 'SEQAN'?
Notes:	The query is not a quoted string. It is an enumeration as indicated in the Instrument Select table above. The command must be sequential: i.e. continued parsing of commands cannot proceed until the instrument select is complete and the resultant SCPI trees are available.
Backwards Compatibility SCPI:	:INSTrument[:SElect] 'GSM' 'BASIC'
Initial S/W Revision:	Prior to A.02.00

More Information

It is possible to specify the order in which the Modes appear in the Mode menu, using the Configure Applications utility (**System, Power On, Configure Applications**). It is also possible, using the same utility, to specify a subset of the available applications to load into memory at startup time, which can significantly decrease the startup time of the test set. During runtime, if an application that is not loaded into memory is selected (by either pressing that applications Mode key or sending that applications :INST:SEL command over SCPI), there will be a pause while the Application is loaded. During this pause a message box that says “Loading application, please wait...” is displayed.

Each application (Mode) that runs in the X-Series test set consumes virtual memory. The various applications consume varying amounts of virtual memory, and as more applications run, the memory consumption increases. Once an application is run, some of its memory remains allocated even when it is not running, and is not released until the test set program (xSA.exe) is shut down.

Agilent characterizes each Mode and assigns a memory usage quantity based on a conservative estimate. There is a limited amount of virtual memory available to applications (note that this is virtual memory and is independent of how much physical RAM is in the instrument). The instrument keeps track of how much memory is being used by all loaded applications – which includes those that preloaded at startup, and all of those that have been run since startup.

When you request a Mode that is not currently loaded, the instrument looks up the memory estimate for that Mode, and adds it to the residual total for all currently loaded Modes. If there is not enough virtual memory to load the Mode, a dialog box and menu will appear that gives you four options:

Close and restart the test set program without changing your configured preloads. This may free up enough memory to load the requested Mode, depending on your configured preloads

Clear out all preloads and close and restart the test set program with only the requested application preloaded, and with that application running. This choice is guaranteed to allow you to run the requested application; but you will lose your previously configured preloads. In addition, there may be little or no room for other applications, depending on the size of the requested application.

Bring up the Configure Applications utility in order to reconfigure the preloaded apps to make room for the applications you want to run (this will then require restarting the test set program with your new configuration). This is the recommended choice because it gives you full flexibility to select exactly what you want.

Exit the dialog box without doing anything, which means you will be unable to load the application you requested.

In each case except 4, this will cause the test set software to close, and you will lose all unsaved traces and results.

If you attempt to load a mode via SCPI that will exceed memory capacity, the Mode does not load and an error message is returned:

```
-225, "Out of memory; Insufficient resources to load Mode (mode name) "
```

where “mode name” is the SCPI parameter for the Mode in question, for example, BASIC for IQ Analyzer Mode.

Application Mode Number Selection (Remote Command Only)

Select the measurement mode by its mode number. The actual available choices depend upon which applications are installed in your instrument. The modes appear in this table in the same order they appear in the Mode menu (if the order is not changed by the Configure Applications utility found in the **System, Power On** menu). See [“Detailed List of Modes” on page 1098](#) for Mode details.

The Mode Number is the parameter for use with the :INSTRument:NSElect command. The Mode Parameter is the parameter for use with the :INSTRument[:SElect] command.

Mode	Mode Number	Mode Parameter
Sequence Analyzer	400	SEQAN
I/Q Analyzer (Basic)	8	BASIC
WCDMA with HSPA+	9	WCDMA
GSM/EDGE/EDGE Evo	13	EDGE GSM
802.16 OFDMA (WiMAX/WiBro)	75	WIMAX OFDMA
Analog Demod	234	ADEMOD
Bluetooth	228	BTtooth
TD-SCDMA with HSPA/8PSK	211	TDSCDMA
cdma2000	10	CDMA2K
1xEV-DO	15	CDMA1XEV

Mode

Mode	Mode Number	Mode Parameter
LTE	102	LTE
LTE TDD	105	LTETDD

Remote Command:	:INSTRument:NSElect <integer> :INSTRument:NSElect?
Example:	:INST:NSEL 1
Notes:	The command must be sequential: i.e. continued parsing of commands cannot proceed until the instrument select is complete and the resultant SCPI trees are available.
Preset:	Not affected by Preset. Set to default mode following Restore System Defaults.
State Saved:	Saved in instrument state
Initial S/W Revision:	Prior to A.02.00

Application Mode Catalog Query (Remote Command Only)

Returns a string containing a comma separated list of names of all the installed and licensed measurement modes (applications). These names can only be used with the :INSTRument[:SElect] command.

Remote Command:	:INSTRument:CATalog?
Example:	:INST:CAT?
Notes:	Query returns a quoted string of the installed and licensed modes separated with a comma. Example: "BASIC,EDGE GSM,CDMA"
Backwards Compatibility Notes:	VSA (E4406A) :INSTRument:CATalog? returned a list of installed INSTRument:SElect items as a comma separated list of string values: "BASIC","GSM","EDGE GSM","CDMA","NADC","PDC","WCDMA","CDMA2K","CDMA1XEV","IDEN","WIDEN","WLAN","SERVICE" X-Series uses the ESA/PSA compatible query of a string contain comma separated values: "BASIC,CDMA,CDMA2K,WCDMA,CDMA1XEV,EDGE GSM,GSM,TSCDMA,DMODULATION,WLAN"
Initial S/W Revision:	Prior to A.02.00

Application Identification (Remote Commands Only)

Each entry in the Mode Menu will have a Model Number and associated information: Version, and Options.

This information is displayed in the Show System screen. The corresponding SCPI remote commands are defined here.

[“Current Application Model ” on page 1095](#)

[“Current Application Revision” on page 1095](#)

[“Current Application Options” on page 1096](#)

Current Application Model

Returns a string that is the Model Number of the currently selected application (mode).

Remote Command:	:SYSTem:APPLication[:CURRent] [:NAME] ?
Example:	:SYST:APPL?
Notes:	Query returns a quoted string that is the Model Number of the currently selected application (Mode). Example: "N9060A" String length is 6 characters.
Preset:	Not affected by Preset
State Saved:	Not saved in state, the value will be the selected application when a Save is done.
Initial S/W Revision:	Prior to A.02.00

Current Application Revision

Returns a string that is the Revision of the currently selected application (mode).

Remote Command:	:SYSTem:APPLication[:CURRent] :REVision?
Example:	:SYST:APPL:REV?
Notes:	Query returns a quoted string that is the Revision of the currently selected application (Mode). Example: "1.0.0.0" String length is a maximum of 23 characters. (each numeral can be an integer + 3 decimal points)
Preset:	Not affected by a Preset
State Saved:	Not saved in state, the value will be the selected application when a Save is done.
Initial S/W Revision:	Prior to A.02.00

Mode

Current Application Options

Returns a string that is the Options list of the currently selected application (Mode).

Remote Command:	:SYSTem:APPLication[:CURRent]:OPTion?
Example:	:SYST:APPL:OPT?
Notes:	Query returns a quoted string that is the Option list of the currently selected application (Mode). The format is the name as the *OPT? or SYSTem:OPTion command: a comma separated list of option identifiers. Example: "1FP,2FP" String length is a maximum of 255 characters.
Preset:	Not affected by a Preset
State Saved:	Not saved in state per se, the value will be the selected application when a Save is invoked.
Initial S/W Revision:	Prior to A.02.00

Application Identification Catalog (Remote Commands Only)

A catalog of the installed and licensed applications (Modes) can be queried for their identification.

[“Application Catalog Number of Entries” on page 1096](#)

[“Application Catalog Revision” on page 1097](#)

[“Application Catalog Options” on page 1097](#)

Application Catalog Number of Entries

Returns the number of installed and licensed applications (Modes).

Remote Command:	:SYSTem:APPLication:CATalog[:NAME]:COUNt?
Example:	:SYST:APPL:CAT:COUN?
Preset:	Not affected by Preset
State Saved:	Not saved in instrument state.
Initial S/W Revision:	Prior to A.02.00

Application Catalog Model Numbers

Returns a list of Model Numbers for the installed and licensed applications (Modes).

Remote Command:	:SYSTem:APPLication:CATalog[:NAME]?
Example:	:SYST:APPL:CAT?

Notes:	Returned value is a quoted string of a comma separated list of Model Numbers. Example, if SAMS and Phase Noise are installed and licensed: "N9060A,N9068A" String length is COUNT * 7 - 1. (7 = Model Number length + 1 for comma. -1 = no comma for the 1st entry.)
Preset:	Not affected by a Preset
State Saved:	Not saved in instrument state.
Initial S/W Revision:	Prior to A.02.00

Application Catalog Revision

Returns the Revision of the provided Model Number.

Remote Command:	:SYSTem:APPLication:CATalog:REVision? <model>
Example:	:SYST:APPL:CAT:REV? 'N9060A'
Notes:	Returned value is a quoted string of revision for the provided Model Number. The revision will be a null-string ("") if the provided Model Number is not installed and licensed. Example, if SAMS is installed and licensed: "1.0.0.0"
Preset:	Not affected by a Preset.
State Saved:	Not saved in instrument state.
Initial S/W Revision:	Prior to A.02.00

Application Catalog Options

Returns a list of Options for the provided Model Number

Remote Command:	:SYSTem:APPLication:CATalog:OPTion? <model>
Example:	:SYST:APPL:CAT:OPT? 'N9060A'
Notes:	Returned value is a quoted string of a comma separated list of Options, in the same format as *OPT? or :SYSTem:OPTion?. If the provided Model Number is not installed and licensed a null-string ("") will be returned. Example, if SAMS is installed and licensed: "2FP" String length is a maximum of 255 characters.
Preset:	Not affected by a Preset
State Saved:	Not saved in instrument state.
Initial S/W Revision:	Prior to A.02.00

Mode

Detailed List of Modes

This section contains an alphabetical list of Modes available in the X-Series, along with a brief description of each Mode.

Note that with the exception of the 89601 VSA, only licensed applications appear in the Mode menu. The 89601 will always appear, because it's licensing is handled differently.

1xEV-DO

Selects the 1xEV-DO mode for general purpose measurements of signals following this standard. There are several measurements available in this mode.

If you are using the Help feature, this mode must be currently active to access its detailed information. If it is not active, exit the Help feature (Esc key), select the mode, and re-access Help.

Key Path:	Mode
Example:	INST:SEL CDMA1XEV INST:NSEL 15
Initial S/W Revision:	Prior to A.02.00

802.16 OFDMA (WiMAX/WiBro)

Selects the OFDMA mode for general purpose measurements of WiMAX signals. There are several measurements available in this mode.

If you are using the Help feature, this mode must be currently active to access its detailed information. If it is not active, exit the Help feature (Esc key), select the mode, and re-access Help.

Key Path:	Mode
Example:	INST:SEL WIMAXOFDMA INST:NSEL 75
Initial S/W Revision:	Prior to A.02.00

Analog Demod

Selects the Analog Demod mode for making measurements of AM, FM and phase modulated signals.

If you are using the Help feature, this mode must be currently active to access its detailed information. If it is not active, exit the Help feature (Esc key), select the mode, and re-access Help.

Key Path:	Mode
Example:	INST:SEL ADEMODO INST:NSEL 234
Initial S/W Revision:	Prior to A.02.00

Bluetooth

Selects the Bluetooth mode for Bluetooth specific measurements. There are several measurements available in this mode.

If you are using the Help feature, this mode must be currently active to access its detailed information. If it is not active, exit the Help feature (Esc key), select the mode, and re-access Help.

Key Path:	Mode
Example:	INST:SEL BT INST:NSEL 228
Initial S/W Revision:	A.06.01

cdma2000

Selects the cdma2000 mode for general purpose measurements of signals following this standard. There are several measurements available in this mode.

If you are using the Help feature, this mode must be currently active to access its detailed information. If it is not active, exit the Help feature (Esc key), select the mode, and re-access Help.

Key Path:	Mode
Example:	INST:SEL CDMA2K INST:NSEL 10
Initial S/W Revision:	Prior to A.02.00

GSM/EDGE/EDGE Evo

Selects the GSM with EDGE mode for general purpose measurements of signals following this standard. There are several measurements available in this mode.

If you are using the Help feature, this mode must be currently active to access its detailed information. If it is not active, exit the Help feature (Esc key), select the mode, and re-access Help.

Key Path:	Mode
Example:	INST:SEL EDGE GSM INST:NSEL 13
Initial S/W Revision:	Prior to A.02.00
Modified at S/W Revision:	A.02.00

IQ Analyzer (Basic)

The IQ Analyzer Mode makes general purpose frequency domain and time domain measurements. These measurements often use alternate hardware signal paths. These frequency domain and time domain measurements can be used to output I/Q data results when measuring complex modulated digital signals.

If you are using the Help feature, this mode must be currently active to access its detailed information. If

Mode

it is not active, exit the Help feature (Esc key), select the mode, and re-access Help.

Key Path:	Mode
Example:	INST:SEL BASIC INST:NSEL 8
Initial S/W Revision:	Prior to A.02.00

LTE

Selects the LTE mode for general purpose measurements of signals following the LTE FDD standard. There are several measurements available in this mode.

If you are using the Help feature, this mode must be currently active to access its detailed information. If it is not active, exit the Help feature (Esc key), select the mode, and re-access Help.

Key Path:	Mode
Example:	INST:SEL LTE INST:NSEL 102
Initial S/W Revision:	Prior to A.02.00

LTE TDD

Selects the LTE TDD mode for general purpose measurements of signals following the LTE TDD standard. There are several measurements available in this mode.

If you are using the Help feature, this mode must be currently active to access its detailed information. If it is not active, exit the Help feature (Esc key), select the mode, and re-access Help.

Key Path:	Mode
Example:	INST:SEL LTETDD INST:NSEL 105
Initial S/W Revision:	A.03.00

Sequence Analyzer

Selects the Sequence Analyzer mode for sequenced measurements. Depending on licensed applications there may be a number of different measurements available in this mode. These measurements are all done on IQ captured data and can be set up to calculated on any part of the capture.

If you are using the Help feature, this mode must be currently active to access its detailed information. If it is not active, exit the Help feature (Esc key), select the mode, and re-access Help.

Key Path:	Mode
Example:	INST:SEL SEQAN INST:NSEL 400

Initial S/W Revision:	A.05.01
-----------------------	---------

TD-SCDMA with HSPA/8PSK

Selects the TD-SCDMA mode for general purpose measurements of signals following this standard. There are several measurements available in this mode.

If you are using the Help feature, this mode must be currently active to access its detailed information. If it is not active, exit the Help feature (Esc key), select the mode, and re-access Help.

Key Path:	Mode
Example:	INST:SEL TDSCDMA INST:NSEL 211
Initial S/W Revision:	Prior to A.02.00

W-CDMA with HSPA+

Selects the W-CDMA with HSPA+ mode for general purpose measurements of signals following this standard. There are several measurements available in this mode.

If you are using the Help feature, this mode must be currently active to access its detailed information. If it is not active, exit the Help feature (Esc key), select the mode, and re-access Help.

Key Path:	Mode
Example:	INST:SEL WCDMA INST:NSEL 9
Initial S/W Revision:	Prior to A.02.00

Global Settings

Opens up a menu that allows you to switch certain Meas Global parameters to a Mode Global state. These switches apply to all Modes that support global settings. No matter what Mode you are in when you set the “Global Center Frequency” switch to on, it applies to all Modes that support Global Settings.

Key Path:	Front Panel Key
Initial S/W Revision:	Prior to A.02.00

Global Center Freq

The software maintains a Mode Global value called “Global Center Freq”.

When the **Global Center Freq** key is switched to **On** in any mode, the current mode’s center frequency is copied into the Global Center Frequency, and from then on all modes which support global settings use the Global Center Frequency. So you can switch between any of these modes and the Center Freq will remain unchanged.

Adjusting the Center Freq of any mode which supports Global Settings, while **Global Center Freq** is

Mode

On, will modify the Global Center Frequency.

When **Global Center Freq** is turned **Off**, the Center Freq of the current mode is unchanged, but now the Center Freq of each mode is once again independent.

When **Mode Preset** is pressed while **Global Center Freq** is **On**, the Global Center Freq is preset to the preset Center Freq of the current mode.

This function is reset to Off when the Restore Defaults key is pressed in the Global Settings menu, or when **System, Restore Defaults, All Modes** is pressed.

Key Path:	Mode Setup, Global Settings
Scope:	Mode Global
Remote Command:	:INSTRument:COUPle:FREQuency:CENTer ALL NONE :INSTRument:COUPle:FREQuency:CENTer?
Example:	INST:COUP:FREQ:CENT ALL INST:COUP:FREQ:CENT?
Preset:	Set to Off on Global Settings, Restore Defaults and System, Restore Defaults, All Modes
Range:	On Off
Initial S/W Revision:	Prior to A.02.00

Remote Command:	:GLOBal:FREQuency:CENTer[:STATE] 1 0 ON OFF :GLOBal:FREQuency:CENTer[:STATE]?
Preset:	Off
Initial S/W Revision:	Prior to A.02.00

Restore Defaults

This key resets all of the functions in the Global Settings menu to Off. This also occurs when **System, Restore Defaults, All Modes** is pressed.

Key Path:	Mode Setup, Global Settings
Remote Command:	:INSTRument:COUPle:DEFault
Example:	INST:COUP:DEF
Backwards Compatibility SCPI:	:GLOBal:DEFault
Initial S/W Revision:	Prior to A.02.00

Mode Setup

This key accesses a menu to allow you to select mode parameters. These settings will be in effect for all measurements in the current mode.

Key Path	Front Panel
----------	--------------------

Radio

Accesses a key that enables you to select either a base transceiver station (BTS) or a mobile station (MS) as the device under test.

Key Path	Mode Setup
----------	-------------------

Device

Allows you to specify the device to be used.

Mode	cdma2000
Remote Command	[:SENSe] :RADio:STANdard:DEVice BTS MS [:SENSe] :RADio:STANdard:DEVice?
Example	RADio:DEVice BTS RADio:DEVice?
Preset	BTS
State Saved	Saved in instrument state.
Range	BTS MS
Key Path	Mode Setup, Radio

Restore Mode Defaults

Resets the state for the currently active mode by resetting the mode persistent settings to their factory default values, clearing mode data and by performing a Mode Preset

See [“Restore Mode Defaults” on page 186](#), for more information.

Mode Setup

Peak Search

Pressing the Peak Search key displays the Peak Search menu and places the selected marker on the trace point with the maximum y-axis value for that marker's trace. The Peak Search features allow you to define specific search criteria to determine which signals can be considered peaks, excluding unwanted signals from the search.

See [“More Information” on page 1105](#).

Remote Command:	:CALCulate:MARKer [1] 2 3 4 5 6 7 8 9 10 11 12:MAXimum
Example:	CALC:MARK2:MAX performs a peak search using marker 2. CALC:MARK2:Y? queries the marker amplitude (Y-axis) value for marker 2. CALC:MARK2:X? queries the marker frequency or time (X-axis) value for marker 2. SYST:ERR? can be used to query the errors to determine if a peak is found. The error -200 is returned after an unsuccessful search.
Notes:	Sending this command selects the subopcoded marker.
Initial S/W Revision:	Prior to A.02.00

More Information

If **Same as “Next Peak” Criteria** is selected, and either **Pk Excursion** or **Pk Threshold** are on, a signal must meet those criteria. If no valid peak is found, a message is generated. And then the marker is not moved. When **Highest Peak** is on, or both **Pk Excursion** and **Pk Threshold** are off, the marker is always placed at the point on the trace with the maximum y-axis value, even if that point is on the very edge of the trace (exception: negative frequencies and signals close to the LO are not searched at all).

Pressing Peak Search with the selected marker off causes the selected marker to be set to **Normal** at the center of the screen, then a peak search is immediately performed.

Pressing the front panel Peak Search key always does a peak search. Occasionally, you may need to get to the Peak Search menu key functions without doing a peak search. You can do this by first accessing the Peak Search menu. Then go to the other menus that you need to access. Finally, you can get back to the Peak Search key menu by using the front panel Return key and pressing it as many times as required to navigate back through the previously accessed menus until you get back to the Peak Search menu.

Next Peak

Pressing Next Peak moves the selected marker to the peak that has the next highest amplitude less than the marker's current value. Only peaks which meet all enabled peak criteria are considered. If there is no valid peak lower than the current marker position, an error is generated and the marker is not moved.

If the selected marker was off, then it is turned on as a normal marker and a peak search is performed.

Key Path	Peak Search
----------	--------------------

Peak Search

Remote Command	:CALCulate:MARKer [1] 2 3 4 5 6 7 8 9 10 11 12 :MAXimum:NEXT
Example	CALC:MARK2:MAX:NEXT Selects marker 2 and moves it to the peak that is closest in amplitude to the current peak, but the next lower value.
Notes	Sending this command selects the subopcoded marker.
State Saved	Not part of saved state.
Initial S/W Revision	Prior to A.02.00

Next Pk Right

Pressing Next Pk Right moves the selected marker to the nearest peak right of the current marker which meets all enabled peak criteria. If there is no valid peak to the right of the current marker position, an error is generated and the marker is not moved.

If the selected marker was off, then it is turned on as a normal marker and a peak search is performed.

Key Path	Peak Search
Remote Command	:CALCulate:MARKer [1] 2 3 4 5 6 7 8 9 10 11 12 :MAXimum:RIGHT
Example	CALC:MARK2:MAX:RIGH Selects marker 2 and moves it to the next peak to the right of the current marker position.
Notes	Sending this command selects the subopcoded marker.
State Saved	Not part of saved state.
Initial S/W Revision	Prior to A.02.00

Next Pk Left

Pressing Next Pk Left moves the selected marker to the nearest peak left of the current marker which meets all enabled peak criteria. If there is no valid peak to the left of the current marker position, an error is generated and the marker is not moved.

If the selected marker was off, then it is turned on as a normal marker and a peak search is performed.

Key Path	Peak Search
Remote Command	:CALCulate:MARKer [1] 2 3 4 5 6 7 8 9 10 11 12 :MAXimum:LEFT
Example	CALC:MARK2:MAX:LEFT selects marker 2 and moves it to the next peak to the left of the current marker position.
State Saved	Not part of saved state.
Initial S/W Revision	Prior to A.02.00

Marker Delta

Performs the same function as the Delta 1-of-N selection key in the Marker menu. Basically this sets the control mode for the selected marker to Delta mode. See the “[Marker](#)” on page 989 for the complete description of this function. The key is duplicated here in the Peak Search Menu to allow you to conveniently perform a peak search and change the marker’s control mode to Delta without having to access two separate menus.

Initial S/W Revision	Prior to A.02.00
Key Path	Peak Search or Marker
Notes	Whenever the selected marker is in Delta mode and you are in the Peak Search menu, the Marker Delta key should be highlighted and the active function for setting its delta value turned on.

Mkr->CF

Assigns the selected marker’s frequency to the Center Frequency setting. See “[Marker To](#)” on page 1027 for the description of this function. The key is duplicated here in the Peak Search Menu to allow you to conveniently perform a peak search and marker to CF without having to access two separate menus.

Key Path	Peak Search or Marker->
Dependencies	Same as specified under Marker To
Initial S/W Revision	Prior to A.02.00

Mkr->Ref Lvl

Assigns the selected marker’s level to the Reference Level setting. See “[Marker To](#)” on page 1027 for the description of this function. The key is duplicated here in the Peak Search Menu to allow you to conveniently perform a peak search and marker to RL without having to access two separate menus.

Key Path	Peak Search or Marker ->
Dependencies	Same as specified under Marker To
Initial S/W Revision	Prior to A.02.00

Peak Criteria

Pressing this key opens the Peak Criteria menu and allows you to adjust the Pk Threshold and Pk Excursion parameters used for peak search functions.

For a signal to be identified as a peak it must meet certain criteria. Signals in the negative frequency range and signals very close to 0 Hz are ignored. If either the peak excursion or peak threshold functions are on, then the signal must satisfy those criteria before being identified as a peak.

When peak excursion and peak threshold are both off:

Peak Search, Continuous Peak Search, and maximum part of **Pk-Pk Search** will search the trace for

Peak Search

the point with the highest y-axis value which does not violate the LO feed through rules. A rising and falling slope are not required for these three peak search functions.

The remaining search functions **Next Peak**, **Next Pk Right**, et cetera will only consider trace points which have a rising and falling slope on the left and right respectively.

Key Path	Peak Search
Initial S/W Revision	Prior to A.02.00

“Peak Search” Criteria

This menu lets you decide what kind of search you want to do when the Peak Search key is pressed (or the equivalent SCPI command sent).

Note that there are two “types” of peak search functions. One type is the “Peak Search” type, the other type is the “Next Peak” type. “Next Peak” searches (for example, Next Peak, Next Pk Left, Next Pk Right) are always checked using the Excursion and Threshold criteria as long as these criteria are On. The “Peak Search” type of search, simply finds the highest point on the trace. However you can change the “Peak Search” type of search so that it also uses the Excursion and Threshold criteria. This allows you to find the Maximum point on the trace that also obeys the Excursion and/or Threshold criteria.

When **Highest Peak** is selected, pressing **Peak Search** simply finds the highest peak on the marker’s trace. If **Same as “Next Peak” Criteria** is selected, then the search is also forced to consider the Excursion and Threshold found under the **“Next Peak” Criteria** menu.

Key Path	Peak Search, Peak Criteria
Remote Command	:CALCulate:MARKer:PEAK:SEARch:MODE MAXimum PARAmeter :CALCulate:MARKer:PEAK:SEARch:MODE?
Notes	MAXimum corresponds to the Highest Peak setting PARAmeter corresponds to the Same as “Next Peak” Criteria setting
Preset	MAXimum
State Saved	Saved in instrument state.
Readback line	Current state
Initial S/W Revision	Prior to A.02.00

Highest Peak

When this key is selected, pressing the Peak Search key or issuing the equivalent SCPI command finds the maximum point on the trace, subject to the peak-search qualifications. This also affects the Peak Search half of Pk-Pk search and the Continuous Peak Search.

Key Path	Peak Search, Peak Criteria, “Peak Search” Criteria
Example	CALC:MARK:PEAK:SEAR:MODE MAX

Readback	Highest Peak
Initial S/W Revision	Prior to A.02.00

Same as “Next Peak” Criteria

When this key is selected, pressing the Peak Search key or issuing the equivalent SCPI command finds the maximum point on the trace, but subject to the Excursion and Threshold set under the Next Peak Criteria menu. The search is, of course, also subject to the peak-search qualifications. This also affects the Peak Search half of Pk-Pk search and the Continuous Peak Search.

Key Path	Peak Search, Peak Criteria, “Peak Search” Criteria
Example	CALC:MARK:PEAK:SEAR:MODE PAR
Readback	Use Excurs & Thr
Initial S/W Revision	Prior to A.02.00

“Next Peak” Criteria

This key opens up a menu which allows you to independently set the Peak Excursion and Peak Threshold and turn them on and off.

Key Path	Peak Search, Peak Criteria
Initial S/W Revision	Prior to A.02.00

Pk Excursion On/Off

Turns the peak excursion requirement on/off and sets the excursion value. The value defines the minimum amplitude variation (rise and fall) required for a signal to be identified as peak. For example, if a value of 6 dB is selected, peak search functions like the marker Next Pk Right function move only to peaks that rise and fall 6 dB or more.

When both Pk Excursion and Pk Threshold are on, a signal must rise above the Pk Threshold value by at least the **Peak Excursion** value and then fall back from its local maximum by at least the **Peak Excursion** value to be considered a peak.

NOTE In the event that a sequence of trace points with precisely the same values represents the maximum, the leftmost point is found.

See [“More Information” on page 1110](#).

Key Path	Peak Search, Peak Criteria, “Next Peak” Criteria
----------	---

Peak Search

Remote Command	:CALCulate:MARKer:PEAK:EXCursion <rel_ampl> :CALCulate:MARKer:PEAK:EXCursion? :CALCulate:MARKer:PEAK:EXCursion:STATE OFF ON 0 1 :CALCulate:MARKer:PEAK:EXCursion:STATE?
Example	:CALC:MARK:PEAK:EXC:STAT ON :CALC:MARK:PEAK:EXC 30 DB sets the minimum peak excursion requirement to 30 dB
Dependencies	Available only when Y axis unit is amplitude units, otherwise grayed out.
Couplings	Whenever you adjust the value of Pk Excursion (with the knob, step keys, or by completing a numeric entry), and Peak Threshold is turned ON, the Peak Threshold Line and the Peak Excursion Region are displayed.
Preset	6.0 dB ON
Preset	6.0 dB ON
State Saved	Saved in State
Min	0.0 dB
Max	100.0 dB
Initial S/W Revision	Prior to A.02.00

More Information

If two signals are very close together and the peak excursion and threshold criteria are met at the outside edges of the combined signals, this function finds the highest of these two signals as a peak (or next peak). However, if a signal appears near the edge of the screen such that the full extent of either the rising or falling edge cannot be determined, and the portion that is on screen does not meet the excursion criteria, then the signal cannot be identified as a peak.

When measuring signals near the noise floor, you can reduce the excursion value even further to make these signals recognizable. To prevent the marker from identifying noise as signals, reduce the noise floor variations to a value less than the peak-excursion value by reducing the video bandwidth or by using trace averaging.

Pk Threshold On/Off

Turns the peak threshold requirement on/off and sets the threshold value. The peak threshold value defines the minimum signal level (or min threshold) that the peak identification algorithm uses to recognize a peak.

When both Pk Excursion and Pk Threshold are on, a signal must rise above the Pk Threshold value by at least the **Peak Excursion** value and then fall back from its local maximum by at least the **Peak Excursion** value to be considered a peak.

For example, if a threshold value of -90 dBm is selected, the peak search algorithm will only consider

signals with amplitude greater than the –90 dBm threshold. If a threshold value of –90 dBm is selected, and **Peak Excursion** is **On** and set to 6 dB, the peak search algorithm will only consider signals with amplitude greater than the –90 dBm threshold which rise 6 dB above the threshold and then fall back to the threshold.

Key Path	Peak Search, Peak Criteria, “Next Peak Criteria”
Remote Command	:CALCulate:MARKer:PEAK:THReshold <ampl> :CALCulate:MARKer:PEAK:THReshold? :CALCulate:MARKer:PEAK:THReshold:STATe OFF ON 0 1 :CALCulate:MARKer:PEAK:THReshold:STATe?
Example	CALC:MARK:PEAK:THR:STAT ON turns on the threshold criterion. CALC:MARK:PEAK:THR –60 dBm sets the threshold to –60 dBm.
Dependencies	When Ref Level Offset changes, Peak Threshold must change by the same amount.
Preset	–90.0 dBm ON
State Saved	Saved in instrument state.
Min	The current displayed Ref Level – 200 dB. The current displayed Ref Level is the current Ref Level, offset by the Ref Level Offset.
Max	The current displayed Ref Level. This means the current Ref Level, offset by the Ref Level Offset.
Default Unit	depends on the current selected Y axis unit
Initial S/W Revision	Prior to A.02.00

Pk Threshold Line On/Off

Turns the peak threshold line on or off. Preset state is off. No equivalent SCPI command.

See “[More Information](#)” on page 1111.

Dependencies	If Peak Threshold is Off and the Peak Threshold line is turned on, it should turn on Peak Threshold.
Initial S/W Revision	Prior to A.02.00

More Information

The Peak Threshold line is green and has the value of the peak threshold (for example, “–20.3 dBm”) written above its right side, above the line itself. If Peak Excursion is ON it shows on the left side as a region above the Peak Threshold line. As with all such lines (Display Line, Trigger Level line, et cetera) it is drawn on top of all traces.

Peak Search

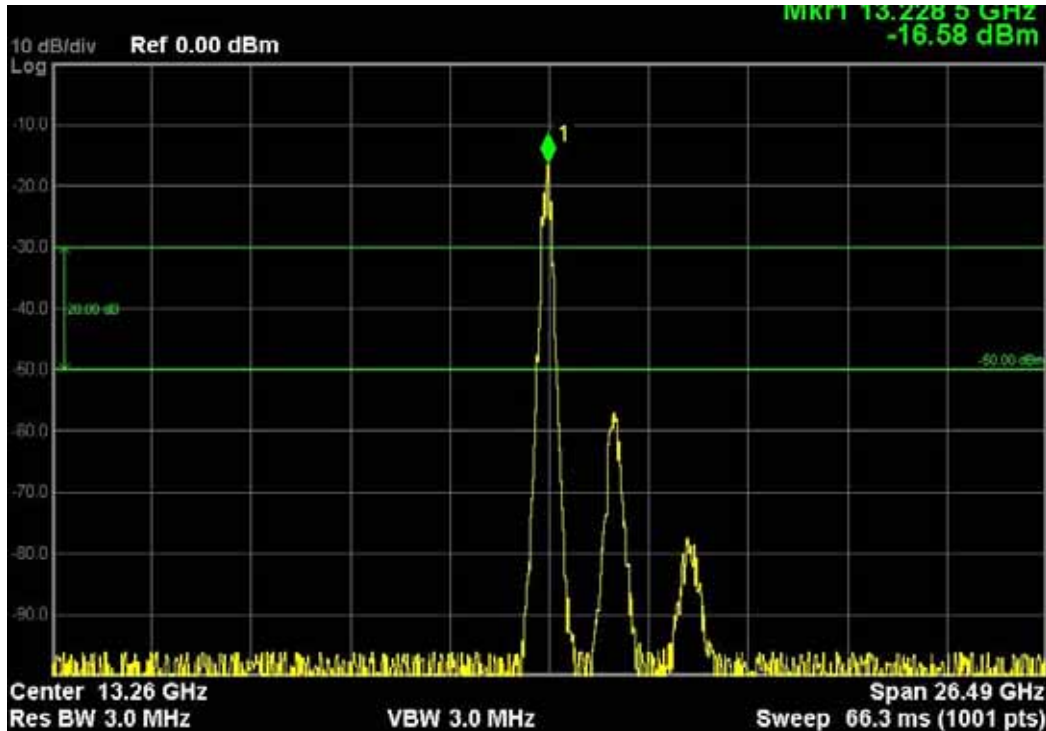

This function is automatically set to ON (thus turning on the Peak Threshold line) whenever the value of Peak Threshold or Peak Excursion becomes the active function, unless Peak Threshold is OFF. It is automatically set to OFF whenever Peak Threshold is set to OFF. Manually turning it ON automatically turns on Pk Threshold.

The Peak Excursion part is on whenever the Pk Threshold part is on, unless Peak Excursion is OFF.

Peak Table

Opens the Peak Table menu.

The Peak Table provides a displayed list of up to 20 signal peaks from the selected trace. If more than one trace window is displayed, the selected trace in the selected window is used. If there are more than 20 signals which meet the peak search criteria, only the 20 highest peaks are listed.

The Peak Table is updated after each sweep. The list of peaks in the Peak Table can be ordered either by ascending frequency or by descending amplitude. In either case, the entire trace is first evaluated and the 20 highest peaks are selected for inclusion in the list. After the peaks are selected, they are then sorted and displayed according to the Peak Sort setting.

Key Path	Peak Search
Initial S/W Revision	Prior to A.02.00

Peak Table On/Off

Turns Peak Table on/off. When turned on, the display is split into a measurement window and a peak table display window.

Turning the Peak Table on turns the Marker Table off and vice versa.

Key Path	Peak Search, Peak Table
Remote Command	:CALCulate:MARKer:PEAK:TABLE:STATe OFF ON 0 1 :CALCulate:MARKer:PEAK:TABLE:STATe?
Example	CALC:MARK:PEAK:TABL:STAT ON Turns on and displays the peak table.
Dependencies	When the Peak Table turns on, if Peak Threshold is On then it becomes the active function.
Preset	OFF
State Saved	Saved in instrument state.
Initial S/W Revision	Prior to A.02.00

Peak Sort

Sets the peak table sorting routine to list the peaks in order of descending amplitude or ascending frequency. The remote command can also be used to sort the peaks found using the :CALCulate:DATA:PEAKs command.

Key Path	Peak Search, Peak Table
Remote Command	:CALCulate:MARKer:PEAK:SORT FREQuency AMPLitude :CALCulate:MARKer:PEAK:SORT?
Example	CALC:MARK:PEAK:SORT AMPL Sets sorting routine to list peaks in order of descending amplitude. CALC:MARK:PEAK:SORT?
Preset	AMPLitude
Preset	AMPLitude
State Saved	Saved in instrument state.
Backwards Compatibility SCPI	:TRACe:MATH:PEAK:SORT
Backwards Compatibility SCPI	The old TRAC:MATH:PEAK:SORT command/query used in ESA is still supported for backward compatibility.
Initial S/W Revision	Prior to A.02.00

Peak Readout

Shows up to twenty signal peaks as defined by the setting:

All (ALL) - lists all the peaks defined by the peak criteria, in the current sort setting.

Above Display Line (GTDLLine) - lists the peaks that are greater than the defined display line, and that meet the peak criteria. They are listed in the current sort order.

Below Display Line (LTDLLine) - lists the peaks that are less than the defined display line, and that meet

Peak Search

the peak criteria. They are listed in the current sort order.

If the peak threshold is defined and turned on, then the peaks must meet this peak criteria in addition to the display line requirements.

See “[More Information](#)” on page 1114.

Key Path	Peak Search, Peak Table
Remote Command	:CALCulate:MARKer:PEAK:TABLE:READout ALL GTDLine LTDLine :CALCulate:MARKer:PEAK:TABLE:READout?
Example	CALC:MARK:PEAK:TABL:READ GTDL
Dependencies	Turning Display Line off forces Readout to ALL
Preset	All
Preset	All
State Saved	Saved in instrument state.
Readback line	1-of-N selection
Initial S/W Revision	Prior to A.02.00

More Information

If the Display Line (see the Section “View/Display”) is turned on, the Peak Table can be selected to include all peaks, only those above the Display Line, or only those below the Display Line. See Figures 1–2 and 1–3 to understand what happens if both Display Line and Pk Threshold are turned on.

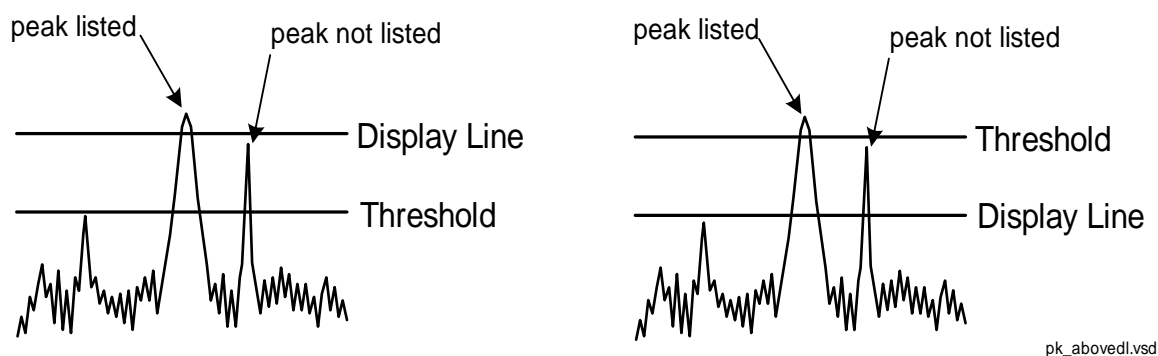

Figure 1- 2Above Display Line Peak Identification

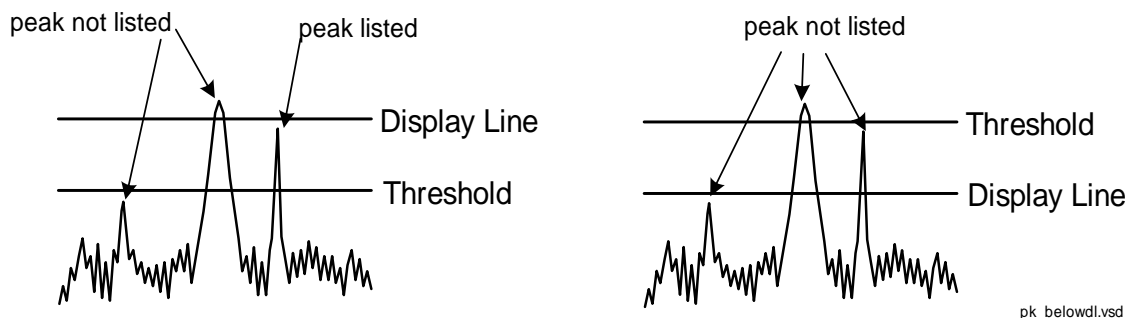

Figure 1- 3Below Display Line Peak Identification

All

Sets the peak table to display the 20 highest peaks in the order specified by the current Peak Sort setting. If the Peak Criteria are turned on, then only peaks that meet the defined Pk Excursion and Pk Threshold values are found.

Key Path	Peak Search, Peak Table, Peak Readout
Example	CALC:MARK:PEAK:TABL:READ ALL
Notes	Auto return after pressed
Readback	All
Initial S/W Revision	Prior to A.02.00

Above Display Line

Sets the peak table to display only the 20 highest peaks above the display line in the order specified by the current Sort setting. If the Peak Criteria are turned on, then only peaks that meet the defined criteria are found. If the display line is not already on, it is turned on (it has to be on or it cannot be used to exclude peaks).

Key Path	Peak Search, Peak Table, Peak Readout
Example	CALC:MARK:PEAK:TABL:READ GTDL
Notes	Auto return after pressed
Dependencies	When Above Display Line is selected, Display Line is turned on and becomes the active function.
Readback	Above DL
Initial S/W Revision	Prior to A.02.00

Below Display Line

Sets the peak table to display only the 20 highest peaks below the display line as defined by the peak in

Peak Search

the order specified by the current Sort setting. If the Peak Criteria are turned on, then only peaks that meet the defined criteria are found. If the display line is not already on, it is turned on (it has to be on or it cannot be used to exclude peaks).

Key Path	Peak Search, Peak Table, Peak Readout
Example	CALC:MARK:PEAK:TABL:READ LTDL
Notes	Auto return after pressed
Dependencies	When Below Display Line is selected, Display Line is turned on and becomes the active function.
Readback	Below DL
Initial S/W Revision	Prior to A.02.00

Continuous Peak Search On/Off

Turns Continuous Peak Search on or off. When Continuous Peak Search is on, a peak search is automatically performed for the selected marker after each sweep. The rules for finding the peak are exactly the same as for **Peak Search**, including the use of the peak criteria rules. If no valid peak is found, a warning is generated after each sweep.

See [“More Information” on page 1117](#).

Key Path	Peak Search
Remote Command	:CALCulate:MARKer [1] 2 3 4 5 6 7 8 9 10 11 12 :CPSearch [:STATe] ON OFF 1 0 :CALCulate:MARKer [1] 2 3 4 5 6 7 8 9 10 11 12 :CPSearch [:STATe] ?
Example	CALC:MARK:CPS ON Turns on Continuous Peak Search.
Notes	Sending this command selects the subopcoded marker
Couplings	The Continuous Peak Search key is grayed out when the selected marker is a Fixed marker. Also, if Continuous Peak Search is on and the selected marker becomes a fixed marker, then Continuous Peak Search is turned off and the key grayed out. Signal Track and Continuous Peak Search are mutually exclusive so if Signal Track is on, Continuous Peak Search is grayed out and vice versa.
Preset	Mode Preset
State Saved	Saved in instrument state.
Status Bits/OPC dependencies	The Measuring bit should remain set while this command is operating and should not go false until the marker position has been updated.
Initial S/W Revision	Prior to A.02.00

More Information

When Continuous Peak Search is turned on a peak search is immediately performed and then is repeated after each sweep. If Continuous Peak Search is turned on with the selected marker off, the selected marker is set to **Normal** at the center of the screen, and then a peak search is immediately performed and subsequently repeated after each sweep.

When in Continuous Peak Search, *OPC will not return true, nor will READ or MEASure return any data, until the sweep is complete and the marker has been re-peaked. Note further that if the test set is in a measurement such as averaging, and Continuous Peak Search is on, the entire measurement is allowed to complete (i.e., all the averages taken up to the average number) before the repeak takes place, and only THEN will *OPC go true and READ or MEASure return data.

When Continuous Peak Search is turned on for a marker, a little “hat” is placed above the marker.

Pk-Pk Search

Finds and displays the amplitude and frequency (or time, if in zero span) differences between the highest and lowest y-axis value. It places the selected marker on the minimum value on its selected trace. And it places that marker’s reference marker on the peak of its selected trace. This function turns on the reference marker and sets its mode to **Fixed** if it is not already on. (These markers may be on two different traces.)

The rules for finding the maximum peak are exactly the same as for **Peak Search**, including the use of the peak criteria rules. However, the minimum trace value is not required to meet any criteria other than being the minimum y-axis value in the trace.

When Pk-Pk Search is successful, a message is displayed on the message line.

If the selected marker is off, a delta type marker is turned on and the peak-to-peak search is done. If the selected marker is on, but it is not a delta marker, then it is changed to delta which turns on the reference marker if needed, and then it performs the peak-to-peak function.

Key Path	Peak Search
Remote Command	:CALCulate:MARKer [1] 2 3 4 5 6 7 8 9 10 11 12 :PTPeak
Example	CALC:MARK:PTP CALC:MARK:Y? queries the delta amplitude value for marker 1.
Notes	Turns on the Marker Δ active function.
Notes	Sending this command selects the subopcoded marker.
Dependencies	Pk-Pk Search is grayed out when Coupled Markers is on.
Couplings	The selected marker becomes a delta marker if not already in delta mode.
State Saved	Not part of saved state.
Initial S/W Revision	Prior to A.02.00

Peak Search

Min Search

Moves the selected marker to the minimum y-axis value on the current trace. Minimum (negative) peak searches do not have to meet the peak search criteria. It just looks for the lowest y-axis value. If the selected marker is Off, it is turned on before the minimum search is performed.

Key Path	Peak Search
Remote Command	:CALCulate:MARKer [1] 2 3 4 5 6 7 8 9 10 11 12 :MINimum
Example	CALC:MARK:MIN selects marker 1 and moves it to the minimum amplitude value.
Notes	Sending this command selects the subopcoded marker.
State Saved	Not part of saved state.
Initial S/W Revision	Prior to A.02.00

Recall

Most of the functions under this key work the same way in many measurements, so they are documented in [“Recall” on page 192.](#)

The Amplitude Correction Import Data function under Recall is documented here.

Amplitude Correction

This key selects the Amplitude Corrections as the data type to be imported. When pressed a second time, it brings up the Select Menu, which lets you select the Correction into which the data will be imported.

Amplitude Corrections are fully discussed in the documentation of the Input/Output key, under the Corrections softkey.

A set of preloaded Corrections files can be found in the directory

/My Documents/ EMC Limits and Ampcor.

Under this directory, the directory called Ampcor (Legacy Naming) contains a set of legacy corrections files, generally the same files that were supplied with older Agilent EMI analyzers, that use the legacy suffixes .ant, .oth, .usr, and .cbl, and the old 8-character file names. In the directory called Ampcor, the same files can be found, with the same suffixes, but with longer, more descriptive filenames.

When the Amplitude Correction is an Antenna correction and the Antenna Unit in the file is not **None**, the Y Axis Unit setting will change to match the Antenna Unit in the file.

Key Path:	Recall
Mode:	EDGE GSM
Remote Command:	:MMEMory:LOAD:CORRection 1 2 3 4 5 6, <filename>
Example:	:MMEM:LOAD:CORR 2 "myAmpcor.csv" recalls the Amplitude Correction data from the file myAmpcor.csv in the current directory to the 2nd Amplitude Correction table, and turns on Correction 2. The default path is My Documents\amplitudeCorrections.

Recall

Dependencies:	<p>Only the first correction array (Correction 1) supports antenna units. This means that a correction file with an Antenna Unit can only be loaded into the Corrections 1 register. Consequently only for Correction 1 does the dropdown in the Recall dialog include .ant, and if an attempt is made to load a correction file into any other Correction register which DOES contain an antenna unit, a Mass Storage error is generated.</p> <p>Corrections are not supported by all Measurements. If in a Mode in which some Measurements support it, this key will be grayed out in measurements that do not. The key will not show at all if no measurements in the Mode support it.</p> <p>Errors are reported if the file is empty or missing, or if the file type does not match, or if there is a mismatch between the file type and the destination data type. If any of these occur during manual operation, the test set returns to the Import Data menu and the File Open dialog goes away.</p> <p>This key does not appear unless you have the proper option installed in your instrument.</p> <p>This command will generate an “Option not available” error unless you have the proper option installed in your instrument.</p>
Couplings:	When a correction file is loaded from mass storage, it is automatically turned on (Correction ON) and Apply Corrections is set to On. This allows the user to see its effect, thus confirming the load.
Readback:	selected Correction
Backwards Compatibility SCPI:	<p>:MMEMory:LOAD:CORRection ANTenna CABLe OTHer USER, <filename></p> <p>For backwards compatibility, ANTenna maps to 1, CABLe maps to 2, OTHer maps to 3 and USER maps to 4</p>
Initial S/W Revision:	A.02.00

Amplitude Correction

These keys let you select which Correction to import the data into. Once selected, the key returns back to the Import Data menu and the selected Correction number is annotated on the key. The next step is to select the Open key in the Import Data menu.

Antenna corrections are a particular kind of Amplitude Corrections – they are distinguished in the corrections file by having the Antenna Unit set to a value other than None. Only Correction 1 supports Antenna Units.

Key Path:	Recall, Data, Amplitude Correction
Notes:	auto return
Dependencies:	Only Correction 1 may be used to load a Correction that contains an Antenna Unit other than None
Preset:	Not part of Preset, but is reset to Correction 1 by Restore Input/Output Defaults; survives shutdown.
State Saved:	The current Correction number is saved in instrument state

Initial S/W Revision:	A.02.00
-----------------------	---------

Multiport Adapter Amplitude Correction

This key selects the Multiport Adapter Amplitude Corrections as the data type to be imported. When pressed a second time, it brings up the Select Menu, which lets you select the Correction into which the data will be imported.

Amplitude Corrections are fully discussed in the documentation of the Input/Output key, under the Corrections softkey.

A set of preloaded Corrections files can be found in the directory

/My Documents/ EMC Limits and Ampcor.

Under this directory, the directory called Ampcor (Legacy Naming) contains a set of legacy corrections files, generally the same files that were supplied with older Agilent EMI analyzers, that use the legacy suffixes .ant, .oth, .usr, and .cbl, and the old 8-character file names. In the directory called Ampcor, the same files can be found, with the same suffixes, but with longer, more descriptive filenames.

When the Amplitude Correction is an Antenna correction and the Antenna Unit in the file is not **None**, the Y Axis Unit setting will change to match the Antenna Unit in the file.

Key Path:	Recall, Data, Amplitude Correction
Mode:	SA EDGE GSM PN
Remote Command:	:MMEMory:LOAD:MPADapter:CORRection 1 2 3 4 5 6 7 8 9 10 11 12 13 14 15 16, <filename>.
Example:	:MMEM:LOAD:MPAD:CORR 2 "myAmpcor.csv" recalls the Multiport Adapter Amplitude Correction data from the file myAmpcor.csv in the current directory to the 2nd Multiport Adapter Amplitude Correction table, and turns on MPA Correction 2. The default path is My Documents\amplitudeCorrections.

Recall

Dependencies:	<p>Only the first correction array (Correction 1) supports antenna units. This means that a correction file with an Antenna Unit can only be loaded into the Corrections 1 register. Consequently only for Correction 1 does the dropdown in the Recall dialog include .ant, and if an attempt is made to load a correction file into any other Correction register which DOES contain an antenna unit, a Mass Storage error is generated.</p> <p>Corrections are not supported by all Measurements. If in a Mode in which some Measurements support it, this key will be grayed out in measurements that do not. The key will not show at all if no measurements in the Mode support it.</p> <p>Errors are reported if the file is empty or missing, or if the file type does not match, or if there is a mismatch between the file type and the destination data type. If any of these occur during manual operation, the analyzer returns to the Import Data menu and the File Open dialog goes away.</p> <p>This key does not appear unless you have the proper option installed in your instrument.</p> <p>This command will generate an “Option not available” error unless you have the proper option installed in your instrument.</p> <p>If the file is empty, message –250.3005 is reported. If the file does not exist message –256 is reported. If there is a mismatch between the file and the destination data type, an message is reported. –250.3003. See error list in the X-series Messaging document for the exact error text.</p>
Couplings:	When a correction file is loaded from mass storage, it is automatically turned on (Correction ON) and Apply Corrections is set to On. This allows the user to see its effect, thus confirming the load.
Readback:	selected Correction
Backwards Compatibility SCPI:	<p>For backwards compatibility, the following parameters syntax is supported:</p> <pre>:MMEMory:LOAD:MPADapter:CORRection ANTenna CABLE OTHer USER, <filename></pre> <p>ANTenna maps to 1, CABLE maps to 2, OTHer maps to 3 and USER maps to 4</p>
Initial S/W Revision:	A.10.00

Multiport Adapter Amplitude Correction 1,2,3,4,5,6,7,8,9,10,11,~,15,16

These keys let you select which Correction to import the data into. Once selected, the key returns back to the Import Data menu and the selected Correction number is annotated on the key. The next step is to select the Open key in the Import Data menu.

Antenna corrections are a particular kind of Multiport Adapter Amplitude Corrections – they are distinguished in the corrections file by having the Antenna Unit set to a value other than None. Only Correction 1 supports Antenna Units.

Key Path:	Recall, Data, Amplitude Correction, Multiport Adptr Correction
Notes:	auto return

Dependencies:	Only Multiport Adapter Correction 1 may be used to load a Correction that contains an Antenna Unit other than None
Preset:	not part of Preset, but is reset to Correction 1 by Restore Input/Output Defaults; survives shutdown
State Saved:	The current Correction number is saved in instrument state
Initial S/W Revision:	A.10.00

Recall

Restart

The Restart function restarts the current sweep, or measurement, or set of averaged/held sweeps or measurements. If you are Paused, pressing Restart does a Resume.

The Restart function is accessed in several ways:

- Pressing the Restart key
- Sending the remote command INIT:IMMEDIATE
- Sending the remote command INIT:RESTART

Key Path:	Front-panel key
Remote Command:	:INITiate[:IMMEDIATE] :INITiate:RESTART
Example:	:INIT:IMM :INIT:REST
Notes:	:INITiate:RESTART and :INITiate:IMMEDIATE perform exactly the same function.
Couplings:	Resets average/hold count k. For the first sweep overwrites all active (update=on) traces with new current data. For application modes, it resets other parameters as required by the measurement.
Status Bits/OPC dependencies:	This is an Overlapped command. The STATUS:OPERATION register bits 0 through 8 are cleared. The STATUS:QUESTIONABLE register bit 9 (INTEGRITY sum) is cleared. The SWEEPING bit is set. The MEASURING bit is set.
Backwards Compatibility Notes:	For Spectrum Analysis mode in ESA and PSA, the Restart hardkey and the INITiate:RESTART command restart trace averages (displayed average count reset to 1) for a trace in Clear Write , but did not restart Max Hold and Min Hold . In the X-Series, the Restart hardkey and the INITiate:RESTART command restart not only Trace Average , but Max Hold and Min Hold traces as well. For wireless comms modes in ESA and PSA, the Restart hardkey and the INITiate:RESTART command restart every measurement, which includes all traces and numeric results. There is no change to this operation.
Initial S/W Revision:	Prior to A.02.00

The **Restart** function first aborts the current sweep/measurement as quickly as possible. It then resets the sweep and trigger systems, sets up the measurement and initiates a new data measurement sequence with a new data acquisition (sweep) taken once the trigger condition is met.

Restart

If the test set is in the process of aligning when **Restart** is executed, the alignment finishes before the restart function is performed.

Even when set for Single operation, multiple sweeps may be taken when Restart is pressed (for example, when averaging/holding is on). Thus when we say that **Restart** "restarts a measurement," we may mean:

- It restarts the current sweep
- It restarts the current measurement
- It restarts the current set of sweeps if any trace is in Trace Average, Max Hold or Min Hold
- It restarts the current set of measurements if Averaging, or Max Hold, or Min Hold is on for the measurement
- depending on the current settings.

With **Average/Hold Number** (in **Meas Setup** menu) set to 1, or Averaging off, or no trace in Trace Average or Hold, a single sweep is equivalent to a single measurement. A single sweep is taken after the trigger condition is met; and the test set stops sweeping once that sweep has completed. However, with **Average/Hold Number** >1 and at least one trace set to **Trace Average, Max Hold, or Averaging on (most other measurements)**, multiple sweeps/data acquisitions are taken for a single measurement. The trigger condition must be met prior to each sweep. The sweep is stopped when the average count k equals the number N set for **Average/Hold Number**. A measurement average usually applies to all traces, marker results, and numeric results; but sometimes it only applies to the numeric results.

Once the full set of sweeps has been taken, the test set will go to idle state. To take one more sweep without resetting the average count, increment the average count by 1, by pressing the step up key while **Average/Hold Number** is the active function, or sending the remote command `CALC: AVER: TCON UP`.

Save

Most of the functions under this key work the same way in many measurements, so they are documented in [“Save” on page 204](#).

The Amplitude Correction function under Save is documented here.

Amplitude Correction

Pressing this key selects **Amplitude Corrections** as the data type to be exported. Pressing this key again brings up the Select Menu, which allows the user to select which **Amplitude Correction** to save.

Amplitude Corrections are fully discussed in the documentation of the Input/Output key, under the Corrections softkey.

Key Path:	Save
Remote Command:	:MMEMory:STORe:CORRection 1 2 3 4 5 6, <filename>
Example:	:MMEM:STOR:CORR 2 "myAmpcor.csv" saves Correction 2 to the file myAmpcor.csv on the current path. The default path is My Documents\amplitudeCorrections.
Notes:	If the save is initiated via SCPI, and the file already exists, the file will be overwritten. Using the C: drive is strongly discouraged, since it runs the risk of being overwritten during an instrument software upgrade. Both single and double quotes are supported for any filename parameter over SCPI.
Dependencies:	Corrections are not supported by all Measurements. If in a Mode in which some Measurements support it, this key will be grayed out in measurements that do not. The key will not show at all if no measurements in the Mode support it. This key will not appear unless you have the proper option installed in your instrument.
Readback:	Selected Correction
Backwards Compatibility SCPI:	:MMEMory:STORe:CORRection ANTenna CABLe OTHer USER, <filename> For backwards compatibility, ANTenna maps to 1, CABLe maps to 2, OTHer maps to 3 and USER maps to 4
Initial S/W Revision:	A.02.00

Correction Data File

A Corrections Data File contains a copy of one of the test set correction tables. Corrections provide a way to adjust the trace display for predetermined gain curves (such as for cable loss).

Save

Corrections files are text files in .csv (comma separated values) form, to make them importable into Excel or other spreadsheet programs. The format for Corrections files is as follows.

Line #	Type of field	Example	Notes
1	File type, must be "Amplitude Correction"	Amplitude Correction	May not be omitted
2	File Description (in quotes)	"Correction Factors for 11966E"	60 characters max; may be empty but may not be omitted. If exceeds 60 characters, error -233 Too much data reported
3	Comment (in quotes)	"Class B Radiated"	60 characters max; may be empty but may not be omitted. . If exceeds 60 characters, error -233 Too much data reported
4	Instrument Version, Model #	A.02.06,N9020A	May be empty but may not be omitted
5	Option List, File Format Version	K03 LFE EXM ,01	May be empty but may not be omitted
6	Freq Unit to be used for all frequency values in the file	Frequency Unit,MHz	assumed to be Hz if omitted
7	Antenna Unit	Antenna Unit,None	If omitted leaves the Antenna unit unchanged. The amplitude unit in the Antenna Unit field is a conversion factor that is used to adjust the Y Axis Units of the current mode, if the mode supports Antenna Units. For more details on antenna correction data, refer to the Input/Output,Corrections key description. Allowable values: dBuv/m, dBuA/m, dBG, dBpT, None
8	Freq Interpolation	Frequency Interpolation,Linear	if omitted leaves the Freq Interpolation unchanged. Allowable values: Linear, Logarithmic
9	Bias value in mA	Bias,0.00	If omitted leaves the Bias value unchanged (added as of A.08.50)
10	Bias State	Bias State,On	If omitted leaves the Bias State unchanged. Allowable values: On, Off (added as of A.08.50)
11	Overlap, two values, Freq1 and Freq2, separated by commas.	Overlap,33500,40000	Uses Freq Unit from line 6. Thus, in this example Freq1=33.5 GHz, Freq2=40.0 GHz (see note below). If omitted leaves the overlap unchanged (added as of A.08.50)
12	DATA marker	DATA	Corrections data begins in the next line

Lines 2 through 5 can be empty but must appear in the file. Lines 6 through 11 are optional, the lines can be left out of the file altogether.

The Overlap row and the two Bias rows apply only to external mixing. Both are read-only, they are never written by the test set. The only way to insert or modify these rows is to edit the file with a text editor or a spreadsheet editor. These rows are intended for use by mixer manufacturers, as they allow the manufacturer to insert data about how the mixer corrections were generated and how they should be applied. The Bias rows allow you to specify whether to turn Bias on or off when the Correction is turned on and to specify a Bias value (turning off the Correction does not change the Bias, but turning it back on again sets it to the value specified in the file). The Overlap row allows you to specify an overlap region in which two different corrections may be applied. It is expected that in the corrections data itself, there will be TWO corrections values exactly at Max Freq, otherwise Overlap is ignored. The way the overlap is processed is as follows: if at any given time the current test set Start Freq is greater than Freq 1 and lower than Freq 2, and the current Stop Freq is greater than Freq 2, extend the first correction point at or above Freq 2 down to Freq 1, rather than using the correction data between Freq1 and Freq2.

The Antenna Unit row can only be used in Correction register 1, because there can only be one setting for Antenna Unit at any given time. If a Correction whose Antenna Unit is set to anything but None is loaded into any Correction register but 1, an error is generated (Mass storage error; Can only load an Antenna Unit into Correction 1). When a correction file is saved from any Correction register but 1, Antenna Unit is always written as None.

Similarly, the Bias rows can only be used in Correction register 1, because there can only be one setting for Bias at any given time. If a Correction file with a Bias or Bias State row is loaded into any Correction register but 1, an error is generated: Mass storage error; Can only load Bias Settings into Correction 1

The data follows the DATA row, as comma separated X, Y pairs; one pair per line.

For example, suppose you have an Antenna to correct for on an N9020A version A.02.06 and the correction data is:

- 0 dB at 200 MHz
- 17 dB at 210 MHz
- 14.8 dB at 225 MHz

Then the file will look like:

- Amplitude Correction
- "Correction Factors for 11966E"
- "Class B Radiated"
- A.02.06,N9020A
- P13 EA3 UK6,01
- Frequency Unit,MHz
- Antenna Unit,dBuV/m
- Frequency Interpolation,Linear
- DATA
- 200.000000,0.00

Save

- 210.000000,17.00
- 225.000000,14.80

The choices for the 1 of N fields in the metadata are as follows:

- Frequency Unit: Hz, kHz, MHz, GHz
- Antenna Unit: dBuv/m, dBuA/m, dBG, dBpT, None
- Frequency Interpolation: Logarithmic, Linear

Multiport Adapter Amplitude Correction

Pressing this key selects **Multiport Adapter Amplitude Corrections** as the data type to be exported. Pressing this key again brings up the Select Menu, which allows the user to select which **Multiport Adapter Amplitude Correction** to save.

Amplitude Corrections are fully discussed in the documentation of the Input/Output key, under the Corrections softkey.

Key Path:	Save, Data, Amplitude Correction
Remote Command:	:MMEMory:STORe:MPADapter:CORRection 1 2 3 4 5 6 7 8 9 10 11 12 13 14 15 16, <filename>
Example:	:MMEM:STOR:MPAD:CORR 2 "myAmpcor.csv" saves Multiport Adapter Correction 2 to the file myAmpcor.csv on the current path. The default path is My Documents\amplitudeCorrections.
Notes:	If the save is initiated via SCPI, and the file already exists, the file will be overwritten. Using the C: drive is strongly discouraged, since it runs the risk of being overwritten during an instrument software upgrade. Both single and double quotes are supported for any filename parameter over SCPI.
Dependencies:	Corrections are not supported by all Measurements. If in a Mode in which some Measurements support it, this key will be grayed out in measurements that do not. The key will not show at all if no measurements in the Mode support it. This key will not appear unless you have the proper option installed in your instrument.
Readback:	Selected Correction
Backwards Compatibility SCPI:	For backwards compatibility only, the following parameters syntax is supported: :MMEMory:STORe:MPADapter:CORRection ANTenna CABLe OTHer USER, <filename> ANTenna maps to 1, CABLe maps to 2, OTHer maps to 3 and USER maps to 4
Initial S/W Revision:	A.10.00

Correction Data File

A Corrections Data File contains a copy of one of the analyzer correction tables. Corrections provide a way to adjust the trace display for predetermined gain curves (such as for cable loss).

Corrections files are text files in .csv (comma separated values) form, to make them importable into Excel or other spreadsheet programs. The format for Corrections files is as follows.

Line #	Type of field	Example	Notes
1	File type, must be "Amplitude Correction"	Amplitude Correction	May not be omitted
2	File Description (in quotes)	"Correction Factors for 11966E"	45 characters max; may be empty but may not be omitted. If exceeds 45 characters, error -233 Too much data reported
3	Comment (in quotes)	"Class B Radiated"	45 characters max; may be empty but may not be omitted. . If exceeds 45 characters, error -233 Too much data reported
4	Instrument Version, Model #	A.02.06,N9020A	May be empty but may not be omitted
5	Option List, File Format Version	K03 LFE EXM ,01	May be empty but may not be omitted
6	Freq Unit to be used for all frequency values in the file	Frequency Unit,MHz	assumed to be Hz if omitted
7	Antenna Unit,	Antenna Unit,None	If omitted leaves the Antenna unit unchanged. The amplitude unit in the Antenna Unit field is a conversion factor that is used to adjust the Y Axis Units of the current mode, if the mode supports Antenna Units. For more details on antenna correction data, refer to the Input/Output,Corrections key description. Allowable values: dBuv/m, dBuA/m, dBG, dBpT, None
8	Freq Interpolation	Frequency Interpolation,Linear	if omitted leaves the Freq Interpolation unchanged. Allowable values: Linear, Logarithmic
9	Bias value in mA	Bias,0.00	If omitted leaves the Bias value unchanged (added as of A.08.50)
10	Bias State	Bias State,On	If omitted leaves the Bias State unchanged. Allowable values: On, Off (added as of A.08.50)

Save

11	Overlap, two values, Freq1 and Freq2, separated by commas.	Overlap,33500,40000	Uses Freq Unit from line 6. Thus, in this example Freq1=33.5 GHz, Freq2=40.0 GHz (see note below). If omitted leaves the overlap unchanged (added as of A.08.50)
12	DATA marker	DATA	Corrections data begins in the next line

Lines 2 through 5 can be empty but must appear in the file. Lines 6 through 11 are optional, the lines can be left out of the file altogether.

The Overlap row and the two Bias rows apply only to external mixing. Both are read-only, they are never written by the analyzer. The only way to insert or modify these rows is to edit the file with a text editor or a spreadsheet editor. These rows are intended for use by mixer manufacturers, as they allow the manufacturer to insert data about how the mixer corrections were generated and how they should be applied. The Bias rows allow you to specify whether to turn Bias on or off when the Correction is turned on and to specify a Bias value (turning off the Correction does not change the Bias, but turning it back on again sets it to the value specified in the file). The Overlap row allows you to specify an overlap region in which two different corrections may be applied. It is expected that in the corrections data itself, there will be TWO corrections values exactly at Max Freq, otherwise Overlap is ignored. The way the overlap is processed is as follows: if at any given time the current analyzer Start Freq is greater than Freq 1 and lower than Freq 2, and the current Stop Freq is greater than Freq 2, extend the first correction point at or above Freq 2 down to Freq 1, rather than using the correction data between Freq1 and Freq2.

The Antenna Unit row can only be used in Correction register 1, because there can only be one setting for Antenna Unit at any given time. If a Correction whose Antenna Unit is set to anything but None is loaded into any Correction register but 1, an error is generated (Mass storage error; Can only load an Antenna Unit into Correction 1). When a correction file is saved from any Correction register but 1, Antenna Unit is always written as None.

Similarly, the Bias rows can only be used in Correction register 1, because there can only be one setting for Bias at any given time. If a Correction file with a Bias or Bias State row is loaded into any Correction register but 1, an error is generated: Mass storage error; Can only load Bias Settings into Correction 1

The data follows the DATA row, as comma separated X, Y pairs; one pair per line.

For example, suppose you have an Antenna to correct for on an N9020A version A.02.06 and the correction data is:

- 0 dB at 200 MHz
- 17 dB at 210 MHz
- 14.8 dB at 225 MHz

Then the file will look like:

- Amplitude Correction
- "Correction Factors for 11966E"
- "Class B Radiated"
- A.02.06,N9020A
- P13 EA3 UK6,01

- Frequency Unit,MHz
- Antenna Unit,dBuV/m
- Frequency Interpolation,Linear
- DATA
- 200.000000,0.00
- 210.000000,17.00
- 225.000000,14.80

The choices for the 1 of N fields in the metadata are as follows:

- Frequency Unit: Hz, kHz, MHz, GHz
- Antenna Unit: dBuv/m, dBuA/m, dBG, dBpT, None
- Frequency Interpolation: Logarithmic, Linear

Multiport Adapter Amplitude Correction 1,2,3,4,5,6,7,8,9,10,11,~,15,16

These keys let you pick which Correction to save. Once selected, the key returns back to the Export Data menu and the selected Correction number is annotated on the key.

The next step in the Save process is to select the Save As key in the Export Data menu.

Key Path:	Save, Data, Amplitude Correction, Multiport Adptr Correction
Preset:	Not part of a Preset, but is reset to Correction 1 by Restore Input/Output Defaults. Survives a shutdown.
Readback:	1
Initial S/W Revision:	A.10.00

Save

Single (Single Measurement/Sweep)

Sets the test set for Single measurement operation. The single/continuous state is Meas Global, so the setting will affect all the measurements. If you are Paused, pressing **Single** does a Resume.

Key Path:	Front-panel key
Example:	:INIT:CONT OFF
Notes:	See Cont key description.
Backwards Compatibility Notes:	<p>For Spectrum Analysis mode in ESA and PSA, the Single hardkey and the INITiate:IMM switched from continuous measurement to single measurement and restarted sweeps and averages (displayed average count reset to 1), but did not restart Max Hold and Min Hold. In the X-Series, the Single hardkey and the INITiate:IMM command initiate a sweep/ measurement/ average sequence/hold sequence including Max Hold and Min Hold.</p> <p>For Spectrum Analysis mode in ESA and PSA, the Single hardkey restarted the sweep regardless of whether or not you were in an active sweep or sweep sequence. In the X-Series, Restart does this but Single only restarts the sweep or sweep sequence if you are in the idle state.</p>
Initial S/W Revision:	Prior to A.02.00

Single (Single Measurement/Sweep)

Source (Internal)

Opens a menu of keys that access various source configuration menus and settings. In the test set, pressing this key also causes the central view area to change and display the Source Control Main view.

Key Path:	Front-panel key
-----------	-----------------

RF Output

This parameter sets the source RF power output state.

Key Path:	Source
Remote Command:	:OUTPut [:EXTErnal] [:STATe] ON OFF 1 0 :OUTPut [:EXTErnal] [:STATe] ?
Example:	OUTP OFF OUTP?
Notes:	<p>The EXTErnal node is shown in RD text so the SCPI remains the same between internal and external source control. However, for EXT we do not wish to document this node to the customer since we are controlling the internal source rather than the external source.</p> <p>This setting is for the independent mode and has no effect on the “List Sequencer” on page 1219. If the “Sequencer” on page 1219 is set to ON, the list sequencer controls the source output and this key will be grayed-out. And this setting will be none-forceful grey out on front panel to indicate out-of-scope. Non-forceful means user still can change this setting by SCPI but cannot change on front panel. When set to OFF will make source leave list sequencer and this setting will be black out and take effect immediately.</p> <p>When the RF Output is ON, an “RF” annunciator is displayed in the system settings panel. When the RF Output is turned Off, the RF annunciator is cleared. If the “Sequencer” on page 1219 is set to ON, the “RF” annunciator will be replaced by “SEQ” in the system settings panel, indicating that the output is controlled by the list sequencer.</p>
Preset:	Off
Range:	On Off
Initial S/W Revision:	A.05.00

Amplitude

Allows you to access the Amplitude sub-menu.

Key Path:	Source
-----------	---------------

Source (Internal)

Notes:	The sub-menu under this button is for independent mode and has no effect on “List Sequencer” on page 1219. If the “Sequencer” on page 1219 is set to ON, the list sequencer controls the source output and this key will be grayed-out on front panel to indicate out-of-scope. When you set “Sequencer” on page 1219 to Off will make source leave list sequencer and this button will be black out.
Initial S/W Revision:	A.05.00

RF Power

Allows you to adjust the power level of the source using the numeric keypad, step keys, or RPG. Pressing any digit, 0 through 9, on the numeric keypad brings up the unit terminator.

Please refer to the “RF Power Range ” on page 1139 table below for the valid ranges.

Key Path:	Source, Amplitude
Remote Command:	:SOURce:POWer[:LEVel] [:IMMediate] [:AMPLitude] <ampl> :SOURce:POWer[:LEVel] [:IMMediate] [:AMPLitude] ?
Example:	SOUR:POW -100 dBm
Notes:	<p>Amplitude corrections can be specified for use with the source. In the event of amplitude corrections being applied, the valid ranges for the RF power do not change dependant on the current amplitude correction setting. If the combination of RF power + amplitude correction is higher or lower than the source output range, the Source Unleveled bit is set and the “Source Unleveled” indicator will appear on status panel to indicate that the source cannot maintain the output power that has been requested.</p> <p>When signal generator is unable to maintain the requested output level, the “Source Unleveled” indicator will appear on status panel. When the source output setting is restored to the normal range, the “Source Unleveled” is removed from status panel.</p> <p>Internal source has list sequence mode, which comprises of several steps which contain separate output power, frequency and waveform etc. When the source list sequence playing is complete, the last step keeps playing, and user can use this command to change the list sequence last step’s output power.</p> <p>{ A.12.50 } The multiport adapter RFIO TX ports and GPS ports cannot ensure power accuracy when power setting is lower than -130dBm, this power setting value is defined by the sum of RF Power setting and related amplitude correction value. But user settable value could be lower than this limit. When application detected there exists power setting lower than -130dBm on MPA RFIO TX ports, then popup warning message. When application detected there exists power setting lower than -130dBm on MPA GPS ports, then popup warning message. This is only warning message, and check is performed when RF is ON.</p>
Notes:	The Min and Max value here defined UI settable amplitude range. This range is larger than actual amplitude range with level accuracy defined in spec.

Dependencies:	The RF power is dependent on the RF output port and frequency, such that the current frequency and selected output port determine the valid range of power values.
Preset:	-100 dBm
Min:	The range of values depends on the current frequency and selected RF output port. Please refer to the “RF Power Range ” on page 1139 table below for the valid ranges.
Max:	The range of values depends on the current frequency and selected RF output port. Please refer to the “RF Power Range ” on page 1139 table below for the valid ranges.
Initial S/W Revision:	A.05.00

RF Power Range

RF Output Port	Frequency Range	Min Output Power	Max Output Power
High Power RF Out	10 MHz ≤ f ≤ 6 GHz	-130 dBm	20 dBm
RFIO 1 & RFIO 2	10 MHz ≤ f ≤ 6 GHz	-130 dBm	0 dBm

Set Reference Power

This key allows you to set the power reference. Pressing this key turns the power reference state to ON, sets the reference power value to the current RF output power, maintains this power at the RF output, and sets the displayed power to 0.00 dB. All subsequent RF power values entered under Source>Amplitude>RF Power are interpreted as being relative to this reference power.

When you use a power reference, the signal generator outputs an RF power that is set relative to the reference power by the value entered under Source>Amplitude>RF Power as follows:

Output power = reference power entered power

Where:

reference power equals the original RF Power entered under Source>Amplitude>RF Power and set as the reference power

entered power equals a new value entered under Source>Amplitude>Amptd Offset

In addition, the displayed power value is the same as a new value entered under Source>Amplitude>RF Power.

NOTE

If Power Ref is set to ON with a reference value set, entering a value under Source>Amplitude>RF Power and pressing Set Reference Power will add that value to the existing Power Ref value.

If you wish to change the reference power value to a new value entered under Source>Amplitude>RF Power, first you must set Power Ref to OFF and then press Set Reference Power.

Source (Internal)

Key Path:	Source, Amplitude
Dependencies:	This key is unavailable, and is grayed out when the “List Sequencer” on page 1219 is turned ON.
Initial S/W Revision:	A.05.00

Power Ref

This key allows you to toggle the state of the power reference.

When you use a power reference, the signal generator outputs an RF power that is set relative to the reference power by the value entered under Source>Amplitude>RF Power as follows:

Output power = reference power + entered power

Where:

reference power equals the original RF Power entered under Source>Amplitude>RF Power and set as the reference power

entered power equals a new value entered under Source>Amplitude>Amptd Offset

For more information on Reference Frequency refer to “Set Reference Power ” on [page 1139](#)

Key Path:	Source, Amplitude
Remote Command:	:SOURce:POWer:REFerence <ampl> :SOURce:POWer:REFerence? :SOURce:POWer:REFerence:STATe OFF ON 0 1 :SOURce:POWer:REFerence:STATe?
Example:	SOUR:POW:REF 0.00 dBm SOUR:POW:REF:STATe ON
Dependencies:	This setting is unavailable and is grayed out when the “List Sequencer” on page 1219 is turned ON.
Couplings:	This value is coupled to the “Set Reference Power ” on page 1139 key such that pressing the Set Reference Power key updates the reference power with the current output power.
Preset:	0.00 dBm OFF
Min:	-125.00 dBm
Max:	10.00 dBm
Initial S/W Revision:	A.05.00

Amptd Offset

Allows you to specify the RF output power offset value.

When the amplitude offset is set to zero (0) and you set a new offset value (positive or negative), the displayed amplitude value will change as follows and the RF output power will not change:

Displayed value = output power + offset value

Where:

output power equals the original RF Power entered under Source>Amplitude>RF Power

offset value equals the value entered under Source>Amplitude>Amptd Offset

When the amplitude offset is set to a value other than zero (0) and you enter a new RF power value under Source>Amplitude>RF Power, the displayed power will be the same as the value entered and the RF output power will be equal to the value entered minus the offset value as follows:

Output power = entered power – offset power

Displayed Power = output power + offset power

Displayed power = entered power

Where:

entered power equals the amplitude entered under Source>Amplitude>RF Power

offset power equals the value previously entered and set under Source>Amplitude>Amptd Offset

Key Path:	Source, Amplitude
Remote Command:	:SOURce:POWer[:LEVel][:IMMediate]:OFFSet <rel_amp1> :SOURce:POWer[:LEVel][:IMMediate]:OFFSet?
Example:	SOUR:POW:OFFS 0.00 dB
Dependencies:	This setting is unavailable, and is grayed out when the List Sequencer is turned ON.
Preset:	0.00 dB
Min:	-200.00 dB
Max:	200.00 dB
Initial S/W Revision:	A.05.00

ALC

Allows you to enable or disable the automatic leveling control (ALC) circuit.

The purpose of the ALC circuit is to hold output power at a desired level by adjusting the source's power circuits to compensate for power drift. Power drift occurs over time and changes in temperature.

Turning the ALC off disables the ALC circuitry, enabling you to measure the output at a specific point in a test setup and adjust as required for the desired power level at that point. Turning the ALC off is useful when the modulation consists of very narrow pulses that are below the pulse width specification of the

Source (Internal)

ALC, or when the modulation consists of slow amplitude variations that the automatic leveling would remove.

Key Path:	Source, Amplitude
Remote Command:	:SOURce:POWer:ALC[:STATe] ON OFF 1 0 :SOURce:POWer:ALC[:STATe] ?
Example:	SOUR:POW:ALC OFF SOUR:POW:ALC?
Preset:	On
Range:	On Off
Initial S/W Revision:	A.05.00

Modulation

Allows you to toggle the state of the modulation.

Key Path:	Source
Remote Command:	:OUTPut:MODulation[:STATe] ON OFF 1 0 :OUTPut:MODulation[:STATe] ?
Example:	:OUTP:MOD OFF
Notes:	This setting is for independent mode and has no effect on “List Sequencer” on page 1219 . If the “Sequencer” on page 1219 is set to ON, the list sequencer controls the source output and this key will be grayed-out. And this setting will be none-forceful grey out on front panel to indicate out-of-scope. Non-forceful means user still can change this setting by SCPI but cannot change manually on front panel. When set to Off will make source leave list sequencer and this setting will be black out and take effect immediately. When the Modulation is ON, the “MOD” annunciator is displayed in the system settings panel. When the Modulation is turned Off, the “MOD” annunciator is cleared. If the “Sequencer” on page 1219 is set to ON, the “MOD” annunciator will be replaced by “SEQ” in the system settings panel indicating that the output is controlled by list sequencer.
Preset:	Off
Range:	On Off
Initial S/W Revision:	A.05.00

Frequency

Allows you to access the Frequency sub-menu.

Key Path:	Source
-----------	---------------

Notes:	The sub-menu under this button is for independent mode and has no effect on “List Sequencer” on page 1219. If the “Sequencer” on page 1219 is set to ON, the list sequencer controls the source output and this key will be grayed-out. And this button will be grey out on front panel to indicate out-of-scope. When set to Off will make source leave list sequencer and this button will be black out.
Initial S/W Revision:	A.05.00

Frequency

Allows you to set the RF Output Frequency. You can adjust the frequency of the source using the numeric keypad, step keys, or RPG. Pressing any digit, 0 through 9, on the numeric keypad brings up the unit terminator.

Key Path:	Source, Frequency
Remote Command:	:SOURce:FREQuency[:CW] <freq> :SOURce:FREQuency[:CW] ?
Example:	SOUR:FREQ 1.00 GHz
Notes:	Internal source has list sequence mode, which comprises of several steps which contain separate output power, frequency and waveform etc. When the source list sequence playing is complete, the last step keeps playing, and user can use this command to change the list sequence last step's output frequency.
Couplings:	The frequency value is coupled to the current channel band and number, such that updates to the band and number will update the frequency value to the corresponding absolute frequency.
Preset:	1.00 GHz
Min:	10.00 MHz
Max:	Hardware Dependant: Option 503 = 3.6 GHz Option 504 = 3.8 GHz
Initial S/W Revision:	A.05.00

Channel

The frequency of the source can be specified by a channel number of a given frequency band. This key allows you to specify the current channel number. For the appropriate range of channel numbers for a given frequency band, refer to the following tables: “GSM/EDGE Channel Number Ranges” on page 1145, “W-CDMA Channel Number Ranges” on page 1145, “CDMA 2000 / 1xEVDO Channel Number Ranges” on page 1148, “LTE FDD Channel Number Ranges” on page 1150, “LTE TDD Channel Number Ranges” on page 1151, and “TDSCDMA Channel Number Ranges” on page 1152.

Key Path:	Source, Frequency
-----------	--------------------------

Source (Internal)

Remote Command:	:SOURce:FREQuency:CHANnels:NUMBer <int> :SOURce:FREQuency:CHANnels:NUMBer?
Example:	SOUR:FREQ:CHAN:NUMB 1
Notes:	This key is grayed out when the “Radio Standard” on page 1153 is set to NONE.
Dependencies:	This key is grayed out when the “Radio Standard” on page 1153 is set to NONE.
Couplings:	The channel number is coupled to the frequency value when the “Radio Standard” on page 1153 is not set to NONE. When the frequency value is changed, the channel number will increase or decrease to match the new frequency. If the frequency is not at an exact match for a channel number, the nearest channel number is displayed along with a greater than or less than sign to indicate the frequency is above or below the channel number.
Preset:	1
Min:	Please refer to the tables below for the valid ranges.
Max:	Please refer to the tables below for the valid ranges.
Initial S/W Revision:	A.05.00

GSM/EDGE Channel Number Ranges

Band	Link (Device)	Range	Frequency (MHz)
P-GSM	Uplink (MS)	$1 \leq n \leq 124$	$890.0 + 0.2*n$
	Downlink (BS)	$1 \leq n \leq 124$	$935.0 + 0.2*n$
E-GSM	Uplink (MS)	$0 \leq n \leq 124$	$890.0 + 0.2*n$
		$975 \leq n \leq 1023$	$890.0 + 0.2*(n-1024)$
	Downlink (BS)	$0 \leq n \leq 124$	$935.0 + 0.2*n$
		$975 \leq n \leq 1023$	$935.0 + 0.2*(n-1024)$
DCS 1800	Uplink (MS)	$512 \leq n \leq 885$	$1710.200 + 0.20*(n-512)$
	Downlink (BS)	$512 \leq n \leq 885$	$1805.200 + 0.20*(n-512)$
PCS 1900	Uplink (MS)	$512 \leq n \leq 810$	$1850.200 + 0.2*(n-512)$
	Downlink (BS)	$512 \leq n \leq 810$	$1930.200 + 0.2*(n-512)$
R-GSM	Uplink (MS)	$0 \leq n \leq 124$	$890.0 + 0.2*n$
		$955 \leq n \leq 1023$	$890.0 + 0.2*(n-1024)$
	Downlink (BS)	$0 \leq n \leq 124$	$935.0 + 0.2*n$
		$955 \leq n \leq 1023$	$935.0 + 0.2*(n-1024)$
GSM 450	Uplink (MS)	$256 \leq n \leq 293$	$450.6 + 0.2*(n-259)$
	Downlink (BS)	$256 \leq n \leq 293$	$460.6 + 0.2*(n-259)$
GSM 480	Uplink (MS)	$306 \leq n \leq 340$	$479.000 + 0.20*(n-306)$
	Downlink (BS)	$306 \leq n \leq 340$	$489.000 + 0.20*(n-306)$
GSM 850	Uplink (MS)	$128 \leq n \leq 251$	$824.200 + 0.20*(n-128)$
	Downlink (BS)	$128 \leq n \leq 251$	$869.200 + 0.20*(n-128)$
GSM 700	Uplink (MS)	$438 \leq n \leq 516$	$777.200 + 0.20*(n-438)$
	Downlink (BS)	$438 \leq n \leq 516$	$747.200 + 0.20*(n-438)$
T-GSM810	Uplink (MS)	$350 \leq n \leq 425$	$806.0 + 0.20*(n-350)$
	Downlink (BS)	$350 \leq n \leq 425$	$851.0 + 0.20*(n-350)$

W-CDMA Channel Number Ranges

Band	Link (Device)	Range	Frequency (MHz)
Band I	Downlink	$10562 \leq n \leq 10838$	$n \div 5$
	Uplink	$9612 \leq n \leq 9888$	$n \div 5$

Source (Internal)

Band	Link (Device)	Range	Frequency (MHz)
Band II	Downlink	$412 \leq n \leq 687$ $9662 \leq n \leq 9938$	$n+5 + 1850.1$ $n+5$
	Uplink	$12 \leq n \leq 287$ $350 \leq n \leq 425$	$n+5 + 1850.1$ $n+5$
Band III	Downlink	$1162 \leq n \leq 1513$	$n+5 + 1575$
	Uplink	$937 \leq n \leq 1288$	$n+5 + 1525$
Band IV	Downlink	$537 \leq n \leq 1738$ $1887 \leq n \leq 2087$	$n+5 + 1805$ $n+5 + 1735.1$
	Uplink	$1312 \leq n \leq 1513$ $1662 \leq n \leq 1862$	$n+5 + 1450$ $n+5 + 1380.1$
Band V	Downlink	$1007 \leq n \leq 1087$ $4357 \leq n \leq 4458$	$n+5 + 670.1$ $n+5$
	Uplink	$782 \leq n \leq 862$ $4132 \leq n \leq 4233$	$n+5 + 670.1$ $n+5$
Band VI	Downlink	$1037 \leq n \leq 1062$ $4387 \leq n \leq 4413$	$n+5 + 670.1$ $n+5$
	Uplink	$812 \leq n \leq 837$ $4162 \leq n \leq 4188$	$n+5 + 670.1$ $n+5$
Band VII	Downlink	$2237 \leq n \leq 2563$ $2587 \leq n \leq 2912$	$n+5 + 2175$ $n+5 + 2105.1$
	Uplink	$2012 \leq n \leq 2338$ $2362 \leq n \leq 2687$	$n+5 + 2100$ $n+5 + 2030.1$
Band VIII	Downlink	$2937 \leq n \leq 3088$	$n+5 + 340$
	Uplink	$2712 \leq n \leq 2863$	$n+5 + 340$
Band IX	Downlink	$9237 \leq n \leq 9387$	$n+5$
	Uplink	$8762 \leq n \leq 8912$	$n+5$
Band X	Downlink	$3112 \leq n \leq 3388$ $3412 \leq n \leq 3687$	$n+5 + 1490$ $n+5 + 1430.1$
	Uplink	$2887 \leq n \leq 3163$ $3187 \leq n \leq 3462$	$n+5 + 1135$ $n+5 + 1075.1$

Band	Link (Device)	Range	Frequency (MHz)
Band XI	Downlink	$3712 \leq n \leq 3812$	$n+5 + 736$
	Uplink	$3487 \leq n \leq 3587$	$n+5 + 733$
Band XII	Downlink	$3837 \leq n \leq 3903$	$n+5 - 37$
		$3927 \leq n \leq 3992$	$n+5 - 54.9$
	Uplink	$3612 \leq n \leq 3678$	$n+5 - 22$
		$3702 \leq n \leq 3767$	$n+5 - 39.9$
Band XIII	Downlink	$4017 \leq n \leq 4043$	$n+5 - 55$
		$4067 \leq n \leq 4092$	$n+5 - 64.9$
	Uplink	$3792 \leq n \leq 3818$	$n+5 + 21$
		$3702 \leq n \leq 3767$	$n+5 - 39.9$
Band XIV	Downlink	$4117 \leq n \leq 4143$	$n+5 - 63$
		$4167 \leq n \leq 4192$	$n+5 - 72.9$
	Uplink	$3892 \leq n \leq 3918$	$n+5 + 12$
		$3942 \leq n \leq 3967$	$n+5 + 2.1$

CDMA 2000 / 1xEVDO Channel Number Ranges

Band	Link (Device)	Range	Frequency (MHz)
US Cellular	Uplink (MS, reverse link)	$1 \leq N \leq 799$	$0.030 \times N + 825.000$
		$991 \leq N \leq 1023$	$0.030 \times (N - 1023) + 825.000$
		$1024 \leq N \leq 1323$	$0.030 \times (N - 1024) + 815.040$
	Downlink (BS, forward link)	$1 \leq N \leq 799$	$0.030 \times N + 870.000$
US PCS	Downlink (BS, forward link)	$991 \leq N \leq 1023$	$0.030 \times (N - 1023) + 870.000$
		$1024 \leq N \leq 1323$	$0.030 \times (N - 1024) + 860.040$
US PCS	Uplink (MS, reverse link)	$0 \leq N \leq 1199$	$1850.000 + 0.050 \times N$
	Downlink (BS, forward link)	$0 \leq N \leq 1199$	$1930.000 + 0.050 \times N$
Japan Cellular Band	Uplink (MS, reverse link)	$1 \leq N \leq 799$	$0.0125 \times (N + 915.000)$
		$801 \leq N \leq 1039$	$0.0125 \times (N - 800) + 898.000$
		$1041 \leq N \leq 1199$	$0.0125 \times (N - 1040) + 887.000$
		$1201 \leq N \leq 1600$	$0.0125 \times (N - 1200) + 893.000$
	Downlink (BS, forward link)	$1 \leq N \leq 799$	$0.0125 \times (N + 860.000)$
		$801 \leq N \leq 1039$	$0.0125 \times (N - 800) + 843.000$
		$1041 \leq N \leq 1199$	$0.0125 \times (N - 1040) + 832.000$
		$1201 \leq N \leq 1600$	$0.0125 \times (N - 1200) + 838.000$
Korean PCS Band	Uplink (MS, reverse link)	$0 \leq N \leq 599$	$0.050 \times N + 1750.000$
	Downlink (BS, forward link)	$0 \leq N \leq 599$	$0.050 \times N + 1840.000$
NMT-450 Band	Uplink (MS, reverse link)	$1 \leq N \leq 400$	$0.025 \times (N - 1) + 450.000$
		$472 \leq N \leq 871$	$0.025 \times (N - 472) + 410.000$
		$1039 \leq N \leq 1473$	$0.020 \times (N - 1024) + 451.010$
		$1536 \leq N \leq 1715$	$0.025 \times (N - 1536) + 479.000$
		$1792 \leq N \leq 2016$	$0.020 \times (N - 1792) + 479.000$
	Downlink (BS, forward link)	$1 \leq N \leq 400$	$0.025 \times (N - 1) + 460.000$
		$472 \leq N \leq 871$	$0.025 \times (N - 472) + 420.000$
		$1039 \leq N \leq 1473$	$0.020 \times (N - 1024) + 461.010$
		$1536 \leq N \leq 1715$	$0.025 \times (N - 1536) + 489.000$
		$1792 \leq N \leq 2016$	$0.020 \times (N - 1792) + 489.000$

Band	Link (Device)	Range	Frequency (MHz)
IMT-2000 Band	Uplink (MS, reverse link)	$0 \leq N \leq 1199$	$1920.000 + 0.050 \times N$
	Downlink (BS, forward link)	$0 \leq N \leq 1199$	$2100.000 + 0.050 \times N$
Upper 700 MHz Band	Uplink (MS, reverse link)	$0 \leq N \leq 240$	$776.000 + 0.050 \times N$
	Downlink (BS, forward link)	$0 \leq N \leq 240$	$746.000 + 0.050 \times N$
Secondary 800 MHz Band	Uplink (MS, reverse link)	$0 \leq N \leq 719$ $720 \leq N \leq 919$	$0.025 \times N + 806.000$ $0.025 \times (N - 720) + 896.000$
	Downlink (BS, forward link)	$0 \leq N \leq 719$ $720 \leq N \leq 919$	$0.025 \times N + 851.000$ $0.025 \times (N - 720) + 935.000$
2.5 GHz IMT Extension	Uplink (MS, reverse link)	$0 \leq N \leq 1399$	$2500.000 + 0.050 \times N$
	Downlink (BS, forward link)	$0 \leq N \leq 1399$	$2620.000 + 0.050 \times N$
US PCS 1.9 GHz	Uplink (MS, reverse link)	$0 \leq N \leq 1299$	$1850.000 + 0.050 \times N$
	Downlink (BS, forward link)	$0 \leq N \leq 1299$	$1930.000 + 0.050 \times N$
AWS	Uplink (MS, reverse link)	$0 \leq N \leq 899$	$1710.000 + 0.050 \times N$
	Downlink (BS, forward link)	$0 \leq N \leq 899$	$2100.000 + 0.050 \times N$
US 2.5 GHz	Uplink (MS, reverse link)	$140 \leq N \leq 1459$	$2495.000 + 0.050 \times N$
	Downlink (BS, forward link)	$140 \leq N \leq 1459$	$2617.000 + 0.050 \times N$
700 Public Safety	Uplink (MS, reverse link)	$0 \leq N \leq 240$	$787.000 + 0.050 \times N$
	Downlink (BS, forward link)	$0 \leq N \leq 240$	$757.000 + 0.050 \times N$
C2K Lower 700	Uplink (MS, reverse link)	$0 \leq N \leq 360$	$698.000 + 0.050 \times N$
	Downlink (BS, forward link)	$0 \leq N \leq 360$	$728.000 + 0.050 \times N$

Source (Internal)

Band	Link (Device)	Range	Frequency (MHz)
400 Euro PAMR	Uplink (MS, reverse link)	$1 \leq N \leq 400$	$0.025 \times (N-1) + 450.000$
		$472 \leq N \leq 871$	$0.025 \times (N-472) + 410.000$
		$1536 \leq N \leq 1715$	$0.025 \times (N-1536) + 479.000$
	Downlink (BS, forward link)	$1 \leq N \leq 400$	$0.025 \times (N-1) + 460.000$
		$472 \leq N \leq 871$	$0.025 \times (N-472) + 420.000$
		$1536 \leq N \leq 1715$	$0.025 \times (N-1536) + 489.000$
800 PAMR	Uplink (MS, reverse link)	$0 \leq N \leq 239$	$870.0125 + 0.025 \times N$
	Downlink (BS, forward link)	$0 \leq N \leq 239$	$915.0125 + 0.025 \times N$

LTE FDD Channel Number Ranges

The carrier frequency in the uplink and downlink is designated by the E-UTRA Absolute Radio Frequency Channel Number (EARFCN) in the range 0 – 65535. The relation between EARFCN and the carrier frequency in MHz for the downlink is given by the following equation, where F_{DL_low} and $N_{Offs-DL}$ are given in table 5.4.4–1 and N_{DL} is the downlink EARFCN.

$$F_{DL} = F_{DL_low} + 0.1(N_{DL} - N_{Offs-DL})$$

The relation between EARFCN and the carrier frequency in MHz for the uplink is given by the following equation where F_{UL_low} and $N_{Offs-UL}$ are given in table 5.4.4–1 and N_{UL} is the uplink EARFCN.

$$F_{UL} = F_{UL_low} + 0.1(N_{UL} - N_{Offs-UL})$$

Band	Downlink			Uplink		
	F_{DL_low} (MHz)	$N_{Offs-DL}$	Range of N_{DL}	F_{UL_low} (MHz)	$N_{Offs-UL}$	Range of N_{UL}
1	2110	0	0 – 599	1920	18000	18000 – 18599
2	1930	600	600 - 1199	1850	18600	18600 – 19199
3	1805	1200	1200 – 1949	1710	19200	19200 – 19949
4	2110	1950	1950 – 2399	1710	19950	19950 – 20399
5	869	2400	2400 – 2649	824	20400	20400 – 20649
6	875	2650	2650 – 2749	830	20650	20650 – 20749

7	2620	2750	2750 – 3449	2500	20750	20750 – 20449
8	925	3450	3450 – 3799	880	21450	21450 – 21799
9	1844.9	3800	3800 – 4149	1749.9	21800	21800 – 22149
10	2110	4150	4150 – 4749	1710	22150	22150 – 22749
11	1475.9	4750	4750 – 4949	1427.9	22750	22750 – 22949
12	729	5010	5010 – 5179	699	23010	23010 – 23179
13	746	5180	5180 – 5279	777	23180	23180 – 23279
14	758	5280	5280 – 5379	788	23280	23280 – 23379
...						
17	734	5730	5730 – 5849	704	23730	23730 – 23849
18	860	5850	5850 – 5999	815	23850	23850 – 23999
19	875	6000	6000 – 6149	830	24000	24000 – 24149
20	791	6150	6150 – 6449	832	24150	24150 – 24449
21	1495.9	6450	6450 – 6599	1447.9	24450	24450 – 24599
...						
24	1525	7700	7700 – 8039	1626.5	25700	25700 – 26039
25	1930	8040	8040 – 8689	1850	26040	26040 – 26689
...						

Note: The channel numbers that designate carrier frequencies so close to the operating band edges that the carrier extends beyond the operating band edge shall not be used. This implies that the first 7, 15, 25, 50, 75 and 100 channel numbers at the lower operating band edge and the last 6, 14, 24, 49, 74 and 99 channel numbers at the upper operating band edge shall not be used for channel bandwidths of 1.4, 3, 5, 10, 15 and 20 MHz respectively.

LTE TDD Channel Number Ranges

The carrier frequency in the uplink and downlink is designated by the E-UTRA Absolute Radio Frequency Channel Number (EARFCN) in the range 0 – 65535. The relation between EARFCN and the carrier frequency in MHz for the downlink is given by the following equation, where F_{DL_low} and $N_{Offs-DL}$ are given in table 5.4.4–1 and N_{DL} is the downlink EARFCN.

$$F_{DL} = F_{DL_low} + 0.1(N_{DL} - N_{Offs-DL})$$

The relation between EARFCN and the carrier frequency in MHz for the uplink is given by the following equation where F_{UL_low} and $N_{Offs-UL}$ are given in table 5.4.4–1 and N_{UL} is the uplink EARFCN.

Source (Internal)

$$F_{UL} = F_{UL_low} + 0.1(N_{UL} - N_{Offs-UL})$$

Band	Downlink			Uplink		
	F _{DL_low} (MHz)	N _{Offs-DL}	Range of N _{DL}	F _{UL_low} (MHz)	N _{Offs-UL}	Range of N _{UL}
33	1900	36000	36000 – 36199	1900	36000	36000 – 36199
34	2010	36200	36200 – 36349	2010	36200	36200 – 36349
35	1850	36350	36350 – 36949	1850	36350	36350 – 36949
36	1930	36950	36950 – 37549	1930	36950	36950 – 37549
37	1910	37550	37550 – 37749	1910	37550	37550 – 37749
38	2570	37750	37750 – 38249	2570	37750	37750 – 38249
39	1880	38250	38250 – 38649	1880	38250	38250 – 38649
40	2300	38650	38650 – 39649	2300	38650	38650 – 39649
41	2496	39650	39650 – 41589	2496	39650	39650 – 41589
42	3400	41590	41590 – 43589	3400	41590	41590 – 43589
43	3600	43590	43590 – 45589	3600	43590	43590 – 45589

Note: The channel numbers that designate carrier frequencies so close to the operating band edges that the carrier extends beyond the operating band edge shall not be used. This implies that the first 7, 15, 25, 50, 75 and 100 channel numbers at the lower operating band edge and the last 6, 14, 24, 49, 74 and 99 channel numbers at the upper operating band edge shall not be used for channel bandwidths of 1.4, 3, 5, 10, 15 and 20 MHz respectively.

TDSCDMA Channel Number Ranges

1.28 Mcps TDD Option

No TX-RX frequency separation is required as Time Division Duplex (TDD) is employed. Each subframe consists of 7 main timeslots where all main timeslots (at least the first one) before the single switching point are allocated DL and all main timeslots (at least the last one) after the single switching point are allocated UL.

The nominal channel spacing is 1.6 MHz, but this can be adjusted to optimise performance in a particular deployment scenario.

The carrier frequency is designated by the UTRA absolute radio frequency channel number (UARFCN). The value of the UARFCN in the IMT2000 band is defined in the general case as follows:

$$N_t = 5 * F \quad 0.0 \text{ MHz} \leq F \leq 3276.6 \text{ MHz}$$

where F is the carrier frequency in MHz

Additional channels applicable to operation in the frequency band defined in sub-clause 5.2(d) are defined via the following UARFCN definition:

$$N_t = 5 * (F - 2150.1 \text{ MHz}) \quad 2572.5 \text{ MHz} \leq F \leq 2617.5 \text{ MHz}$$

UARFCN

1.28 Mcps TDD Option

The following UARFCN range shall be supported for each band:

Table: UTRA Absolute Radio Frequency Channel Number 1.28 Mcps TDD Option

Frequency Band	Frequency Range	UARFCN Uplink and Downlink transmission
For operation in frequency band as defined in subclause 5.2 (a)	1900–1920 MHz	9504 to 9596
	2010–2025 MHz	10054 to 10121
For operation in frequency band as defined in subclause 5.2 (b)	1850–1910 MHz	9254 to 9546
	1930–1990 MHz	9654 to 9946
For operation in frequency band as defined in subclause 5.2 (c)	1910–1930 MHz	9554 to 9646
For operation in frequency band as defined in subclause 5.2 (d)	2570–2620 MHz	12854 to 13096
For operation in frequency band as defined in subclause 5.2 (e)	2300–2400 MHz	11504 to 11996
For operation in frequency band as defined in subclause 5.2 (f)	1880–1920 MHz	9404 to 9596

Radio Setup

Allows access to the sub-menus for selecting the radio standard and associated radio band. You can also set a frequency reference and offset.

Key Path:	Source, Frequency
Initial S/W Revision:	A.05.00

Radio Standard

Allows access to the channel band sub-menus to select the desired radio standard. When you have selected the radio standard, you can then set an active channel band. The radio standard and the active channel band allow you to use channel numbers to set frequency automatically.

Key Path:	Source, Frequency, Radio Setup
-----------	---------------------------------------

Source (Internal)

Remote Command:	:SOURce:FREQuency:CHANnels:BAND NONE PGSM EGSM RGSM DCS1800 PCS1900 TGSM810 GSM450 GSM480 GSM700 GSM850 BANDI BANDII BANDIII BANDIV BANDV BANDVI BANDVII BANDVIII BANDIX BANDX BANDXI BANDXII BANDXIII BANDXIV USCELL USPCS JAPAN KOREAN NMT IMT2K UPPER SECOND PAMR400 PAMR800 IMTEXT PCS1DOT9G AWS US2DOT5G PUBLIC LOWER BAND1 BAND2 BAND3 BAND4 BAND5 BAND6 BAND7 BAND8 BAND10 BAND11 BAND12 BAND13 BAND14 BAND17 BAND18 BAND19 BAND20 BAND21 BAND24 BAND25 BAND33 BAND34 BAND35 BAND36 BAND37 BAND38 BAND39 BAND40 BAND41 BAND42 BAND43 BAND4 BANDB BANDC BANDD BANDE BANDF :SOURce:FREQuency:CHANnels:BAND?
Example:	SOUR:FREQ:CHAN:BAND PGSM
Notes:	Set this setting to “NONE” will grey out “Channel” on page 1143 Channel
Initial S/W Revision:	A.05.00

None

Selects no radio standard for use. When you have selected the radio standard to NONE, you cannot use channel numbers to set frequency automatically. You will need to set the frequency manually.

Key Path:	Source, Frequency, Radio Setup, Radio Standard
Initial S/W Revision:	A.05.00

GSM/EDGE

Sets GSM/EDGE as the radio standard for use and accesses the GSM/EDGE specific channel band sub-menus.

Key Path:	Source, Frequency, Radio Setup, Radio Standard
Initial S/W Revision:	A.05.00

P-GSM

Selects P-GSM as the active channel band.

Key Path:	Source, Frequency, Radio Setup, Radio Standard, GSM/EDGE
Example:	SOUR:FREQ:CHAN:BAND PGSM
Initial S/W Revision:	A.05.00

E-GSM

Selects E-GSM as the active channel band.

Key Path:	Source, Frequency, Radio Setup, Radio Standard, GSM/EDGE
Example:	SOUR:FREQ:CHAN:BAND EGSM

Initial S/W Revision:	A.05.00
-----------------------	---------

R-GSM

Selects R-GSM as the active channel band.

Key Path:	Source, Frequency, Radio Setup, Radio Standard, GSM/EDGE
Example:	SOUR:FREQ:CHAN:BAND RGSM
Initial S/W Revision:	A.05.00

DCS 1800

Selects DCS 1800 as the active channel band.

Key Path:	Source, Frequency, Radio Setup, Radio Standard, GSM/EDGE
Example:	SOUR:FREQ:CHAN:BAND DCS1800
Initial S/W Revision:	A.05.00

PCS 1900

Selects PCS 1900 as the active channel band.

Key Path:	Source, Frequency, Radio Setup, Radio Standard, GSM/EDGE
Example:	SOUR:FREQ:CHAN:BAND PCS1900
Initial S/W Revision:	A.05.00

GSM 450

Selects GSM 450 as the active channel band.

Key Path:	Source, Frequency, Radio Setup, Radio Standard, GSM/EDGE
Example:	SOUR:FREQ:CHAN:BAND GSM450
Initial S/W Revision:	A.05.00

GSM 480

Selects GSM 480 as the active channel band.

Key Path:	Source, Frequency, Radio Setup, Radio Standard, GSM/EDGE
Example:	SOUR:FREQ:CHAN:BAND GSM480
Initial S/W Revision:	A.05.00

Source (Internal)

GSM 850

Selects GSM 850 as the active channel band.

Key Path:	Source, Frequency, Radio Setup, Radio Standard, GSM/EDGE
Example:	SOUR:FREQ:CHAN:BAND GSM850
Initial S/W Revision:	A.05.00

GSM 700

Selects GSM 700 as the active channel band.

Key Path:	Source, Frequency, Radio Setup, Radio Standard, GSM/EDGE
Example:	SOUR:FREQ:CHAN:BAND GSM700
Initial S/W Revision:	A.05.00

T-GSM 810

Selects T-GSM 810 as the active channel band.

Key Path:	Source, Frequency, Radio Setup, Radio Standard, GSM/EDGE
Example:	SOUR:FREQ:CHAN:BAND T-GSM810
Initial S/W Revision:	A.05.00

WCDMA

Sets WCDMA as the radio standard for use and accesses the W-CDMA specific channel band sub-menus.

Key Path:	Source, Frequency, Radio Setup, Radio Standard
Initial S/W Revision:	A.05.00

Band I

Selects Band I as the active channel band.

Key Path:	Source, Frequency, Radio Setup, Radio Standard, WCDMA
Example:	SOUR:FREQ:CHAN:BAND BANDI
Initial S/W Revision:	A.05.00

Band II

Selects Band II as the active channel band.

Key Path:	Source, Frequency, Radio Setup, Radio Standard, WCDMA
Example:	SOUR:FREQ:CHAN:BAND BANDII

Initial S/W Revision:	A.05.00
-----------------------	---------

Band III

Selects Band III as the active channel band.

Key Path:	Source, Frequency, Radio Setup, Radio Standard, WCDMA
Example:	SOUR:FREQ:CHAN:BAND BANDIII
Initial S/W Revision:	A.05.00

Band IV

Selects Band IV as the active channel band.

Key Path:	Source, Frequency, Radio Setup, Radio Standard, WCDMA
Example:	SOUR:FREQ:CHAN:BAND BANDIV
Initial S/W Revision:	A.05.00

Band V

Selects Band V as the active channel band.

Key Path:	Source, Frequency, Radio Setup, Radio Standard, WCDMA
Example:	SOUR:FREQ:CHAN:BAND BANDV
Initial S/W Revision:	A.05.00

Band VI

Selects Band VI as the active channel band.

Key Path:	Source, Frequency, Radio Setup, Radio Standard, WCDMA
Example:	SOUR:FREQ:CHAN:BAND BANDVI
Initial S/W Revision:	A.05.00

Band VII

Selects Band VII as the active channel band.

Key Path:	Source, Frequency, Radio Setup, Radio Standard, WCDMA
Example:	SOUR:FREQ:CHAN:BAND BANDVII
Initial S/W Revision:	A.05.00

Source (Internal)

Band VIII

Selects Band VIII as the active channel band.

Key Path:	Source, Frequency, Radio Setup, Radio Standard, WCDMA
Example:	SOUR:FREQ:CHAN:BAND BANDVIII
Initial S/W Revision:	A.05.00

Band IX

Selects Band IX as the active channel band.

Key Path:	Source, Frequency, Radio Setup, Radio Standard, WCDMA
Example:	SOUR:FREQ:CHAN:BAND BANDIX
Initial S/W Revision:	A.05.00

Band X

Selects Band X as the active channel band.

Key Path:	Source, Frequency, Radio Setup, Radio Standard, WCDMA
Example:	SOUR:FREQ:CHAN:BAND BANDX
Initial S/W Revision:	A.05.00

Band XI

Selects Band XI as the active channel band.

Key Path:	Source, Frequency, Radio Setup, Radio Standard, WCDMA
Example:	SOUR:FREQ:CHAN:BAND BANDXI
Initial S/W Revision:	A.05.00

Band XII

Selects Band XII as the active channel band.

Key Path:	Source, Frequency, Radio Setup, Radio Standard, WCDMA
Example:	SOUR:FREQ:CHAN:BAND BANDXII
Initial S/W Revision:	A.05.00

Band XIII

Selects band XIII as the active channel band.

Key Path:	Source, Frequency, Radio Setup, Radio Standard, WCDMA
-----------	--

Example:	SOUR:FREQ:CHAN:BAND BANDXIII
Initial S/W Revision:	A.05.00

Band XIV

Selects Band XIV as the active channel band.

Key Path:	Source, Frequency, Radio Setup, Radio Standard, WCDMA
Example:	SOUR:FREQ:CHAN:BAND BANDXIV
Initial S/W Revision:	A.05.00

CDMA 2000 / 1xEVDO

Sets CDMA 2000 / 1XEVDO as the radio standard for use and accesses the CDMA 2000/1xEVDO specific channel band sub-menus.

Key Path:	Source, Frequency, Radio Setup, Radio Standard
Initial S/W Revision:	A.05.00

US CELL

Selects US Cell as the active channel band.

Key Path:	Source, Frequency, Radio Setup, Radio Standard, CDMA 2000 / 1xEVDO
Example:	SOUR:FREQ:CHAN:BAND USCELL
Initial S/W Revision:	A.05.00

US PCS

Selects US PCS as the active channel band.

Key Path:	Source, Frequency, Radio Setup, Radio Standard, CDMA 2000 / 1xEVDO
Example:	SOUR:FREQ:CHAN:BAND PCS
Initial S/W Revision:	A.05.00

Japan Cell

Selects Japan Cell as the active channel band.

Key Path:	Source, Frequency, Radio Setup, Radio Standard, CDMA 2000 / 1xEVDO
Example:	SOUR:FREQ:CHAN:BAND JAPAN
Initial S/W Revision:	A.05.00

Source (Internal)

Korean PCS

Selects Korean PCS as the active channel band.

Key Path:	Source, Frequency, Radio Setup, Radio Standard, CDMA 2000 / 1xEVDO
Example:	SOUR:FREQ:CHAN:BAND KOREAN
Initial S/W Revision:	A.05.00

NMT 450

Selects NMT 450 as the active channel band.

Key Path:	Source, Frequency, Radio Setup, Radio Standard, CDMA 2000 / 1xEVDO
Example:	SOUR:FREQ:CHAN:BAND NMT
Initial S/W Revision:	A.05.00

IMT 2000

Selects IMT 2000 as the active channel band.

Key Path:	Source, Frequency, Radio Setup, Radio Standard, CDMA 2000 / 1xEVDO
Example:	SOUR:FREQ:CHAN:BAND IMT2K
Initial S/W Revision:	A.05.00

Upper 700

Selects Upper 700 as the active channel band.

Key Path:	Source, Frequency, Radio Setup, Radio Standard, CDMA 2000 / 1xEVDO
Example:	SOUR:FREQ:CHAN:BAND UPPER
Initial S/W Revision:	A.05.00

Secondary 800

Selects Secondary 800 as the active channel band.

Key Path:	Source, Frequency, Radio Setup, Radio Standard, CDMA 2000 / 1xEVDO
Example:	SOUR:FREQ:CHAN:BAND SECOND
Initial S/W Revision:	A.05.00

400 Euro PAMR

Selects 400 Euro PAMR as the active channel band.

Key Path:	Source, Frequency, Radio Setup, Radio Standard, CDMA 2000 / 1xEVDO
-----------	---

Example:	SOUR:FREQ:CHAN:BAND PAMR400
Initial S/W Revision:	A.05.00

800 PAMR

Selects 800 PAMR as the active channel band.

Key Path:	Source, Frequency, Radio Setup, Radio Standard, CDMA 2000 / 1xEVDO
Example:	SOUR:FREQ:CHAN:BAND PAMR800
Initial S/W Revision:	A.05.00

2.5GHz IMT EXT

Selects 2.5 GHz IMT EXT as the active channel band.

Key Path:	Source, Frequency, Radio Setup, Radio Standard, CDMA 2000 / 1xEVDO
Example:	SOUR:FREQ:CHAN:BAND IMTEXT
Initial S/W Revision:	A.05.00

US PCS 1.9GHz

Selects US PCS 1.9 GHz as the active channel band.

Key Path:	Source, Frequency, Radio Setup, Radio Standard, CDMA 2000 / 1xEVDO
Example:	SOUR:FREQ:CHAN:BAND PCS1DOT9G
Initial S/W Revision:	A.05.00

AWS

Selects AWS as the active channel band.

Key Path:	Source, Frequency, Radio Setup, Radio Standard, CDMA 2000 / 1xEVDO
Example:	SOUR:FREQ:CHAN:BAND AWS
Initial S/W Revision:	A.05.00

US 2.5GHz

Selects US 2.5 GHz as the active channel band.

Key Path:	Source, Frequency, Radio Setup, Radio Standard, CDMA 2000 / 1xEVDO
Example:	SOUR:FREQ:CHAN:BAND US2DOT5G
Initial S/W Revision:	A.05.00

Source (Internal)

700 Public Safety

Selects 700 Public Safety as the active channel band.

Key Path:	Source, Frequency, Radio Setup, Radio Standard, CDMA 2000 / 1xEVDO
Example:	SOUR:FREQ:CHAN:BAND PUBLIC
Initial S/W Revision:	A.05.00

C2K Lower 700

Selects C2K Lower 700 as the active channel band.

Key Path:	Source, Frequency, Radio Setup, Radio Standard, CDMA 2000 / 1xEVDO
Example:	SOUR:FREQ:CHAN:BAND LOWER
Initial S/W Revision:	A.05.00

LTE

Sets LTE FDD as the radio standard for use and accesses the LTE FDD specific channel band sub-menus..

Key Path:	Source, Frequency, Radio Setup, Radio Standard
Initial S/W Revision:	A.09.50

BAND 1

Selects BAND 1 as the band for the current step.

Key Path:	Source, Frequency, Radio Setup, Radio Standard, LTE
Example:	SOUR:FREQ:CHAN:BAND BAND1
Initial S/W Revision:	A.09.50

BAND 2

Selects BAND 2 as the band for the current step.

Key Path:	Source, Frequency, Radio Setup, Radio Standard, LTE
Example:	SOUR:FREQ:CHAN:BAND BAND2
Initial S/W Revision:	A.09.50

BAND 3

Selects BAND 3 as the band for the current step.

Key Path:	Source, Frequency, Radio Setup, Radio Standard, LTE
Example:	SOUR:FREQ:CHAN:BAND BAND3

Initial S/W Revision:	A.09.50
-----------------------	---------

BAND 4

Selects BAND 4 as the band for the current step.

Key Path:	Source, Frequency, Radio Setup, Radio Standard, LTE
Example:	SOUR:FREQ:CHAN:BAND BAND4
Initial S/W Revision:	A.09.50

BAND 5

Selects BAND 5 as the band for the current step.

Key Path:	Source, Frequency, Radio Setup, Radio Standard, LTE
Example:	SOUR:FREQ:CHAN:BAND BAND5
Initial S/W Revision:	A.09.50

BAND 6

Selects BAND 6 as the band for the current step.

Key Path:	Source, Frequency, Radio Setup, Radio Standard, LTE
Example:	SOUR:FREQ:CHAN:BAND BAND6
Initial S/W Revision:	A.09.50

BAND 7

Selects BAND 7 as the band for the current step.

Key Path:	Source, Frequency, Radio Setup, Radio Standard, LTE
Example:	SOUR:FREQ:CHAN:BAND BAND7
Initial S/W Revision:	A.09.50

BAND 8

Selects BAND 8 as the band for the current step.

Key Path:	Source, Frequency, Radio Setup, Radio Standard, LTE
Example:	SOUR:FREQ:CHAN:BAND BAND8
Initial S/W Revision:	A.09.50

Source (Internal)

BAND 9

Selects BAND 9 as the band for the current step.

Key Path:	Source, Frequency, Radio Setup, Radio Standard, LTE
Example:	SOUR:FREQ:CHAN:BAND BAND9
Initial S/W Revision:	A.09.50

BAND 10

Selects BAND 10 as the band for the current step.

Key Path:	Source, Frequency, Radio Setup, Radio Standard, LTE
Example:	SOUR:FREQ:CHAN:BAND BAND10
Initial S/W Revision:	A.09.50

BAND 11

Selects BAND 11 as the band for the current step.

Key Path:	Source, Frequency, Radio Setup, Radio Standard, LTE
Example:	SOUR:FREQ:CHAN:BAND BAND11
Initial S/W Revision:	A.09.50

BAND 12

Selects BAND 12 as the band for the current step.

Key Path:	Source, Frequency, Radio Setup, Radio Standard, LTE
Example:	SOUR:FREQ:CHAN:BAND BAND12
Initial S/W Revision:	A.09.50

BAND 13

Selects BAND 13 as the band for the current step.

Key Path:	Source, Frequency, Radio Setup, Radio Standard, LTE
Example:	SOUR:FREQ:CHAN:BAND BAND13
Initial S/W Revision:	A.09.50

BAND 14

Selects BAND 14 as the band for the current step.

Key Path:	Source, Frequency, Radio Setup, Radio Standard, LTE
-----------	--

Example:	SOUR:FREQ:CHAN:BAND BAND14
Initial S/W Revision:	A.09.50

BAND 17

Selects BAND 17 as the band for the current step.

Key Path:	Source, Frequency, Radio Setup, Radio Standard, LTE
Example:	SOUR:FREQ:CHAN:BAND BAND17
Initial S/W Revision:	A.09.50

BAND 18

Selects BAND 18 as the band for the current step.

Key Path:	Source, Frequency, Radio Setup, Radio Standard, LTE
Example:	SOUR:FREQ:CHAN:BAND BAND18
Initial S/W Revision:	A.09.50

BAND 19

Selects BAND 19 as the band for the current step.

Key Path:	Source, Frequency, Radio Setup, Radio Standard, LTE
Example:	SOUR:FREQ:CHAN:BAND BAND19
Initial S/W Revision:	A.09.50

BAND 20

Selects BAND 20 as the band for the current step.

Key Path:	Source, Frequency, Radio Setup, Radio Standard, LTE
Example:	SOUR:FREQ:CHAN:BAND BAND20
Initial S/W Revision:	A.09.50

BAND 21

Selects BAND 21 as the band for the current step.

Key Path:	Source, Frequency, Radio Setup, Radio Standard, LTE
Example:	SOUR:FREQ:CHAN:BAND BAND21
Initial S/W Revision:	A.09.50

Source (Internal)

BAND 24

Selects BAND 24 as the band for the current step.

Key Path:	Source, Frequency, Radio Setup, Radio Standard, LTE
Example:	SOUR:FREQ:CHAN:BAND BAND24
Initial S/W Revision:	A.09.50

BAND 25

Selects BAND 25 as the band for the current step.

Key Path:	Source, Frequency, Radio Setup, Radio Standard, LTE
Example:	SOUR:FREQ:CHAN:BAND BAND25
Initial S/W Revision:	A.09.50

LTE TDD

Sets LTE TDD as the radio standard for use and accesses the LTE TDD specific channel band sub-menus..

Key Path:	Source, Frequency, Radio Setup, Radio Standard
Initial S/W Revision:	A.11.50

BAND 33

Selects BAND 33 as the band for the current step.

Key Path:	Source, Frequency, Radio Setup, Radio Standard, LTE TDD
Example:	SOUR:FREQ:CHAN:BAND BAND33
Initial S/W Revision:	A.11.50

BAND 34

Selects BAND 34 as the band for the current step.

Key Path:	Source, Frequency, Radio Setup, Radio Standard, LTE TDD
Example:	SOUR:FREQ:CHAN:BAND BAND34
Initial S/W Revision:	A.11.50

BAND 35

Selects BAND 35 as the band for the current step.

Key Path:	Source, Frequency, Radio Setup, Radio Standard, LTE TDD
Example:	SOUR:FREQ:CHAN:BAND BAND35

Initial S/W Revision:	A.11.50
-----------------------	---------

BAND 36

Selects BAND 36 as the band for the current step.

Key Path:	Source, Frequency, Radio Setup, Radio Standard, LTE TDD
Example:	SOUR:FREQ:CHAN:BAND BAND36
Initial S/W Revision:	A.11.50

BAND 37

Selects BAND 37 as the band for the current step.

Key Path:	Source, Frequency, Radio Setup, Radio Standard, LTE TDD
Example:	SOUR:FREQ:CHAN:BAND BAND37
Initial S/W Revision:	A.11.50

BAND 38

Selects BAND 38 as the band for the current step.

Key Path:	Source, Frequency, Radio Setup, Radio Standard, LTE TDD
Example:	SOUR:FREQ:CHAN:BAND BAND38
Initial S/W Revision:	A.11.50

BAND 39

Selects BAND 39 as the band for the current step.

Key Path:	Source, Frequency, Radio Setup, Radio Standard, LTE TDD
Example:	SOUR:FREQ:CHAN:BAND BAND39
Initial S/W Revision:	A.11.50

BAND 40

Selects BAND 40 as the band for the current step.

Key Path:	Source, Frequency, Radio Setup, Radio Standard, LTE TDD
Example:	SOUR:FREQ:CHAN:BAND BAND40
Initial S/W Revision:	A.11.50

Source (Internal)

BAND 41

Selects BAND 41 as the band for the current step.

Key Path:	Source, Frequency, Radio Setup, Radio Standard, LTE TDD
Example:	SOUR:FREQ:CHAN:BAND BAND41
Initial S/W Revision:	A.11.50

BAND 42

Selects BAND 42 as the band for the current step.

Key Path:	Source, Frequency, Radio Setup, Radio Standard, LTE TDD
Example:	SOUR:FREQ:CHAN:BAND BAND42
Initial S/W Revision:	A.11.50

BAND 43

Selects BAND 43 as the band for the current step.

Key Path:	Source, Frequency, Radio Setup, Radio Standard, LTE TDD
Example:	SOUR:FREQ:CHAN:BAND BAND43
Initial S/W Revision:	A.11.50

TDSCDMA

Sets TDSCDMA as the radio standard for use and accesses the TDSCDMA specific channel band sub-menus..

Key Path:	Source, Frequency, Radio Setup, Radio Standard
Initial S/W Revision:	A.11.50

BAND A

Selects BAND A as the band for the current step.

Key Path:	Source, Frequency, Radio Setup, Radio Standard, TDSCDMA
Example:	SOUR:FREQ:CHAN:BAND BANDA
Initial S/W Revision:	A.11.50

BAND B

Selects BAND B as the band for the current step.

Key Path:	Source, Frequency, Radio Setup, Radio Standard, TDSCDMA
Example:	SOUR:FREQ:CHAN:BAND BANDB

Initial S/W Revision:	A.11.50
-----------------------	---------

BAND C

Selects BAND C as the band for the current step.

Key Path:	Source, Frequency, Radio Setup, Radio Standard, TDSCDMA
Example:	SOUR:FREQ:CHAN:BAND BANDC
Initial S/W Revision:	A.11.50

BAND D

Selects BAND D as the band for the current step.

Key Path:	Source, Frequency, Radio Setup, Radio Standard, TDSCDMA
Example:	SOUR:FREQ:CHAN:BAND BANDD
Initial S/W Revision:	A.11.50

BAND E

Selects BAND E as the band for the current step.

Key Path:	Source, Frequency, Radio Setup, Radio Standard, TDSCDMA
Example:	SOUR:FREQ:CHAN:BAND BANDE
Initial S/W Revision:	A.11.50

BAND F

Selects BAND F as the band for the current step.

Key Path:	Source, Frequency, Radio Setup, Radio Standard, TDSCDMA
Example:	SOUR:FREQ:CHAN:BAND BANDF
Initial S/W Revision:	A.11.50

Radio Band Link

Allows you to specify the channel band type as either uplink or downlink link direction. This value is used in conjunction with the channel band and channel number to determine the absolute frequency output by the source. When set to “Uplink”, the source will calculate the uplink frequency using an uplink formula together with the selected channel band and channel number . When set to “Downlink”, the source will calculate the downlink frequency using a downlink formula together with the selected channel band and channel number.

Key Path:	Source, Frequency, Radio Setup
-----------	---------------------------------------

Source (Internal)

Remote Command:	:SOURce:RADio:BAND:LINK DOWN UP :SOURce:RADio:BAND:LINK?
Example:	SOUR:RAD:BAND:LINK UP
Preset:	DOWN
Range:	DOWN UP
Backwards Compatibility SCPI:	:SOURce:RADio:DEVice BTS MS :SOURce:RADio:DEVice?
Backwards Compatibility Notes:	BTS maps to the Downlink frequency MS maps to the Uplink frequency
Initial S/W Revision:	A.05.00

Set Reference Frequency

This key allows you to set the frequency reference. Pressing this key turns the frequency reference state to ON, sets the reference frequency value to the current frequency, maintains this frequency at the RF output, and sets the displayed frequency to 0.00 Hz. All subsequent frequencies entered under Source>Frequency>Frequency are interpreted as being relative to this reference frequency.

When you use a frequency reference, the signal generator outputs a frequency that is set relative to the reference frequency by the value entered under Source>Frequency>Frequency as follows:

Output frequency = reference frequency - entered frequency

Where:

reference frequency equals the original RF frequency entered under Source>Frequency>Frequency and set as the reference frequency

entered frequency equals a new value entered under Source>Frequency>Frequency

In addition, the displayed frequency value will be the same as the value entered under Source>Frequency>Frequency.

NOTE If Freq Reference is set to ON with a reference value set, entering a value under Source>Frequency>Frequency and pressing Set Frequency Reference will add that value to the existing Freq Reference value.
If you wish to change the reference frequency value to the new value entered under Source>Frequency>Frequency, first you must set Freq Reference to OFF and then press Set Frequency Reference.

Key Path:	Source, Frequency
Remote Command:	:SOURce:FREQuency:REference:SET
Example:	SOUR:FREQ:REF:SET

Dependencies:	This setting is unavailable, and is grayed out when the List Sequencer is turned ON.
Initial S/W Revision:	A.05.00

Freq Reference

This key allows you to toggle the state of the frequency reference. When the frequency reference state is ON, an annunciator is displayed on the main source view to indicate this state to the user.

When you use a frequency reference, the signal generator outputs a frequency that is set relative to the reference frequency by the value entered under Source>Frequency>Frequency as follows:

Output frequency = reference frequency + entered frequency

Where:

reference frequency equals the original RF frequency entered under Source>Frequency>Frequency and set as the reference frequency

entered frequency equals a new value entered under Source>Frequency>Frequency

For more information on Reference Frequency refer to [“Set Reference Frequency” on page 1170](#)

Key Path:	Source, Frequency
Remote Command:	:SOURce:FREQuency:REFerence <freq> :SOURce:FREQuency:REFerence? :SOURce:FREQuency:REFerence:STATe OFF ON 0 1 :SOURce:FREQuency:REFerence:STATe?
Example:	SOUR:FREQ:REF 0.00 Hz SOUR:FREQ:REF:STATe ON
Dependencies:	This setting is unavailable, and is grayed out when the List Sequencer is turned ON.
Couplings:	The frequency reference state is coupled to the frequency reference set immediate action. When the reference set immediate action key is pressed, or the SCPI command issued, it turns the frequency reference state ON.
Preset:	0.00 Hz OFF
Min:	0.00 Hz
Max:	Hardware Dependant: Option 503 = 3.6 GHz Option 504 = 3.8 GHz
Initial S/W Revision:	A.05.00

Source (Internal)

Freq Offset

Allows you to specify the frequency offset value. When the frequency offset state is ON, an annunciator is displayed on the main source view to indicate this state to the user.

When the frequency offset is set to zero (0) and you set a new offset value, the displayed frequency value will change as follows and the RF output frequency will not change:

Displayed value = output frequency + offset value

Where:

output frequency equals the original frequency entered under Source>Frequency>Frequency

offset value equals the value entered under Source>Frequency>Freq Offset

When the frequency offset is set to a value other than zero (0) and you enter a new frequency value under Source>Frequency>Frequency, the displayed frequency will be the same as the value entered and the RF output frequency will be equal to the value entered minus the offset value as follows:

Output frequency = entered frequency – offset frequency

Displayed frequency = output frequency + offset frequency

Displayed frequency = entered frequency

Where:

entered frequency equals the frequency entered under Source>Frequency>Frequency

offset frequency equals the value previously entered and set under Source>Frequency>Freq Offset

Key Path:	Source, Frequency
Remote Command:	:SOURce:FREQuency:OFFSet <freq> :SOURce:FREQuency:OFFSet?
Example:	SOUR:FREQ:OFFS 0 Hz
Dependencies:	This setting is unavailable, and is grayed out when the List Sequencer is turned ON.
Preset:	0 Hz
Min:	-100.00 GHz
Max:	100.00 GHz
Initial S/W Revision:	A.05.00

Modulation Setup

Allows access to the menus for setting up the available modulation types: “ARB” on page 1173, “AM” on page 1215, “FM” on page 1216, and “PM” on page 1217.

Key Path:	Source
-----------	---------------

Initial S/W Revision:	A.05.00
-----------------------	---------

ARB

Allows you access to the ARB sub-menus.

Key Path:	Source, Modulation Setup
Initial S/W Revision:	A.05.00

ARB

Allows you to toggle the state of the ARB function. When the ARB is On, a “MOD” annunciator is displayed in the system settings panel. When the ARB is turned Off, the MOD annunciator is cleared

Key Path:	Source, Modulation Setup, ARB
Remote Command:	:SOURce:RADio:ARB[:STATe] ON OFF 1 0 :SOURce:RADio:ARB[:STATe] ?
Example:	SOUR:RAD:ARB OFF SOUR:RAD:ARB?
Notes:	If the ARB is ON, a user then loads or deletes another file to ARB memory, the playing waveform segment may not keep phase continuity during the ARB memory operation. The waveform will be replayed after the ARB operation is finished.
Dependencies:	This setting is for independent mode and has no effect on 3.3.8 list sequencer mode. Setting 7.1Sequencer to On will put source enter list sequencer mode, and even if ARB state is On, the ARB file will not be played. Setting 7.1Sequencer to Off will make source leave list sequencer mode, and this setting will take effect immediately. The ARB can only be turned on when there is a waveform file selected for playback. On the GUI If no waveform is selected, this key is grayed out. If you send the SCPI command to turn the ARB on with no waveform selected for playback, the ARB state remains OFF and an error is generated. “- When you try to recall a certain set of states in which the selected waveform is not in ARB memory and the ARB state is On, errors are reported
Preset:	Off
Range:	On Off
Initial S/W Revision:	A.05.00

Select Waveform

Allows you to access to the waveform selection sub-menus.

Source (Internal)

Pressing this key changes the central view area to show the Waveform File Selection view.

Key Path:	Source, Modulation Setup, ARB
Initial S/W Revision:	A.05.00

Select Waveform

Allows you to select a waveform sequence or segment for the dual ARB to play.

Key Path:	Source, Modulation Setup, ARB, Select Waveform
Remote Command:	:SOURce:RADio:ARB:WAVEform <string> :SOURce:RADio:ARB:WAVEform?
Example:	SOUR:RAD:ARB:WAV "test_waveform.bin"
Notes:	<p><string> - specifies the name of the waveform segment or waveform sequence to be played by the ARB.</p> <p>When in Sequence Analyzer mode, and Include Source is Yes, if the you attempt to play a waveform sequence but not all the required waveform segments are in the ARB playback memory, the application will reject the loading operation with an error is generated .</p> <p>When Include Source is No, if you attempt to play a waveform sequence but not all the required waveform segments are contained in the ARB playback memory, the application will attempt to load the required segments from either the default directory of the current directory. If the ARB memory does not have enough space for all the waveform segments to be loaded, an error is generated and none of the waveform segments is loaded.</p> <p>If the ARB is ON, and you attempt to play a waveform sequence but not all the waveform segments within the sequence could be found to be loaded into ARB memory, an error is generated. The selected waveform keeps the previous value and ARB state remains On.</p> <p>If you specify a waveform segment over SCPI but the waveform segment is not present within ARB playback memory and cannot be found for auto loading within the current directory or the default directory, an error is generated and the file selection remains unchanged.</p> <p>If you select a waveform for playback and the waveform requires a license that is not installed on the instrument, an error is generated.error is generated.</p> <p>If the ARB is ON and you load a file to ARB memory or delete a file from ARB memory, the playing waveform segment may not keep phase continuity during the ARB memory operation. The waveform will be replayed after the ARB operation is finished.</p>
Initial S/W Revision:	A.05.00

Segments on Hard Disk

Allows you access to the sub-menus for loading waveform segments from the hard disk into ARB memory. The default directory is: D:\nvarb.

Pressing this key changes the current view to the Waveform Management View.

Key Path:	Source, Modulation Setup, ARB, Select Waveform
Initial S/W Revision:	A.05.00

Load Segment To ARB Memory

Allows you to load the selected file into ARB memory. On the front panel you select the file for loading to the ARB memory by highlighting the desired file in the list. Using the SCPI command, you specify the file name on the HDD.

“NVWFM” (none-volatile storage) MSUS (Mass Storage Unit Specifier) is supported in the memory subsystem because the ARB memory cannot be accessed directly. Therefore, files must be downloaded to the instrument hard disk and then loaded into the ARB memory. “NVWFM” MSUS will be mapped to the default directory D:\NVARB. The SCPI command supports using either “NVWFM” MSUS or specifying a full path. For more information, see [“Memory Subsystem \(Remote Command Only\)” on page 1260](#).

If a file of the same name already exists within ARB memory, it is overwritten. If you wish to load two segments of the same name, you must rename one of the segments before loading it into ARB memory. To rename a segment, you can either use Windows File Explorer, or the :MMEMory:COPI command.

Key Path:	Source, Modulation Setup, ARB, Select Waveform, Segments on Hard Disk
Remote Command:	:SOURce:RADio:ARB:LOAD <string>
Example:	SOUR:RAD:ARB:LOAD “D:\NVARB\testwaveform.bin” or SOUR:RAD:ARB:LOAD “NVWFM:testwaveform.bin”

Source (Internal)

Notes:	<p><string> - specifies the path name of the file to load from the HDD into ARB memory. It could be a <full path + filename>, or <“NVWFM” MSUS + colon + filename>.</p> <p>When in Sequence Analyzer mode, and Include Source is Yes, an attempt to load a file to ARB memory will be rejected with an error.</p> <p>When Include Source is No and if there is insufficient free ARB memory to load the selected waveform, an error is generated. .</p> <p>If you specify a file over SCPI, but the file is not at the specified location, an error is generated.</p> <p>If you try to load a waveform file but the file contains less than 500 IQ samples, an error is generated.</p> <p>If you try to load a Signal Studio waveform “*.wfm” which contains invalid waveform header, an error is generated.</p> <p>If the ARB is ON when you load a file to ARB memory or delete a file from ARB memory, the playing waveform segment may not keep phase continuity during the ARB memory operation. The waveform will be replayed after the ARB operation is finished.</p> <p>ARB can be loaded into ARB memory even required licenses do not present on the instrument. In this case, a GUI only warning message -800, “Operation complete; Loaded <filename> successfully, but no license <required licenses> installed”. User can install required licenses according to <required licenses> string to license it, or multi-pack license it.</p>
Initial S/W Revision:	A.05.00

Load All To ARB Memory

Allows you to load all the segment files within the currently selected directory into ARB memory. If a file of the same name already exists within ARB memory, it is overwritten. If you wish to load two segments of the same name, you must rename one of the segments before loading it into ARB memory. To rename a segment, you can either use Windows File Explorer, or the :MEMORY:COPY command.

Key Path:	Source, Modulation Setup, ARB, Select Waveform, Segments on Hard Disk
Remote Command:	:SOURCE:RADio:ARB:LOAD:ALL <string>
Example:	SOUR:RAD:ARB:LOAD:ALL “D:\nvarb”

Notes:	<p><string> - specifies the directory on the HDD to load the files into ARB memory from.</p> <p>When in Sequence Analyzer mode, and Include Source is Yes, an attempt to load all files from a directory to ARB memory is rejected with an error.</p> <p>When Include Source is No and there is insufficient free ARB memory to load all the waveforms, when the ARB memory is full, the copy ceases, and an error is generated.</p> <p>If you specify a directory over SCPI, but the directory does not exist, an error is generated.</p> <p>If the ARB is ON, a user then loads or deletes file to ARB memory, the playing waveform segment may not keep phase continuity during the ARB memory operation. The waveform will be replayed after the ARB operation is finished.</p>
Initial S/W Revision:	A.05.00

Change Directory...

Allows you to change the currently selected directory on the hard disk. Pressing this key opens a standard windows change directory dialog allowing you to select the new directory of interest.

The current directory is used for manually loading waveform segments into ARB memory for playback, and as a search location for waveform segments that are required to be loaded into ARB memory for playback of a waveform sequence or a list sequence.

Key Path:	Source, Modulation Setup, ARB, Select Waveform, Segments on Hard Disk
Notes:	No remote command, SCPI front panel only.
Initial S/W Revision:	A.05.00

Default Directory...

Allows you to change the default directory. It is used as a search location for waveform segments that are required to be loaded into ARB memory for playback of a waveform sequence, and as a search location for selecting waveforms using SCPI.

Key Path:	Source, Modulation Setup, ARB, Select Waveform, Segments on Hard Disk
Remote Command:	:SOURce:RADio:ARB:DEFault:DIRectory <string> :SOURce:RADio:ARB: DEFault:DIRectory?
Example:	SOUR:RAD:ARB:DEF:DIR "D:\ArbFiles" SOUR:RAD:ARB:DEF:DIR?
State Saved:	Persistent, survives a power cycle and a preset but not saved in the instrument state
Initial S/W Revision:	A.05.00

Source (Internal)

Segments in ARB Memory

Allows you access to the sub-menus for managing the files within ARB memory.

Key Path:	Source, Modulation Setup, ARB, Select Waveform
Initial S/W Revision:	A.05.00

Delete Segment From ARB Mem

Allows you to remove a segment from ARB playback memory.

Key Path:	Source, Modulation Setup, ARB, Select Waveform, Segments in ARB Memory
Remote Command:	:SOURce:RADio:ARB:DELeTe <string>
Example:	SOUR:RAD:ARB:DEL "testwaveform.bin"
Notes:	<p><string> - specifies the waveform to be deleted from the ARB playback memory.</p> <p>When in Sequence Analyzer mode and Include Source is Yes, an attempt to delete a file from ARB memory is rejected with an error.</p> <p>When Include Source is No and you specify a file that does not exist within ARB memory, an error is generated.</p> <p>It is possible to delete files from within the ARB memory when the ARB is ON. However, if you attempt to delete the file that is currently playing an error is generated.</p> <p>It is possible to delete a file from within the ARB memory when the sequencer state is ON and the file is not being used by the List Sequencer. If you attempt to delete a file which is being used by the list sequencer, an error is generated.</p> <p>When sequencer state is On, even if ARB state is On, the selected waveform will not be played. In this case, if the selected waveform is not used in List Sequence, it can be deleted and the ARB state is turned Off.</p> <p>If the ARB is ON and you load a file to ARB memory or delete a file from ARB memory, the playing waveform segment may not keep phase continuity during the ARB memory operation. The waveform will be replayed after the ARB operation is finished.</p>
Initial S/W Revision:	A.05.00

Delete All From ARB Memory

Allows you to remove all segments from ARB playback memory.

Key Path:	Source, Modulation Setup, ARB, Select Waveform, Segments in ARB Memory
Remote Command:	:SOURce:RADio:ARB:DELeTe:ALL
Example:	SOUR:RAD:ARB:DELeTe:ALL

Notes:	<p>When in Sequence Analyzer mode and Include Source is Yes, an attempt to delete all files from ARB memory is rejected with an error.</p> <p>When Include Source is No and you attempt to delete all files from ARB memory when the ARB is currently playing a file, all files except the one playing are deleted and an error is generated.</p> <p>If you attempt to delete all files from ARB memory when there are waveform files used in “List Sequencer” on page 1219 and “Sequencer” on page 1219 state is ON, all files except the files currently being used in list sequencer are deleted, and an error is generated.</p> <p>If the ARB is ON and you load a file to ARB memory or delete a file from ARB memory, the playing waveform segment may not keep phase continuity during the ARB memory operation. The waveform will be replayed after the ARB operation is finished.</p>
Initial S/W Revision:	A.05.00

Query ARB Memory File List (Remote Command Only)

Queries the test set for the list of waveform segments in the ARB memory.

NOTE This command returns a string for waveform segment names in ARB memory. If you want a string list of waveform segments in the ARB memory, use “[Query ARB Memory Full File List \(Remote Command Only\)](#)” on page 1179.

Remote Command:	:SOURce:RADio:ARB:CATalog?
Example:	SOUR:RAD:ARB:CATalog?
Notes:	<p>The return data is in the following format:</p> <p><integer> - memory used</p> <p><integer> - memory free</p> <p><string> ... - comma separated list of waveform segments within ARB memory</p>
Initial S/W Revision:	A.05.00

Query ARB Memory Full File List (Remote Command Only)

Queries the test set for the string list of waveform segments in the ARB memory. It returns a string list for waveform segment names in the ARB memory.

Remote Command:	:SOURce:RADio:ARB:FCATalog?
Example:	SOUR:RAD:ARB:FCATalog?

Source (Internal)

Notes:	The return data is in the following format: <integer> - memory used <integer> - memory free <integer> - file count in ARB memory <string>,<string>, ... <string> - comma separated string list of waveform segments within ARB memory Example: SOUR:RAD:ARB:FCAT? EXT returns: 27499,2069653,3,"c2k.wfm","gsm.wfm","wcdma.wfm"
Initial S/W Revision:	A.09.00

ARB Setup

Allows access to the ARB setup sub-menus.

Key Path:	Source, Modulation Setup, ARB
Initial S/W Revision:	A.05.00

Sample Rate

Allows you to set the ARB waveform playback sample rate.

Key Path:	Source, Modulation Setup, ARB, ARB Setup
Remote Command:	:SOURce:RADio:ARB:SCLock:RATE <freq> :SOURce:RADio:ARB:SCLock:RATE?
Example:	SOUR:RAD:ARB:SCL:RATE 48.00 MHz
Dependencies:	When a new waveform is selected for playback the settings contained within the associated waveform header file are applied to the ARB. The sample rate is one of the values stored within the header file. If the newly selected waveform file has an associated header file, the sample rate is updated with the value from the header file. The sample rate will remain unchanged if the newly selected waveform does not have an associated header file.
Preset:	125.00 MHz
Min:	1.00 kHz
Max:	125.00 MHz
Initial S/W Revision:	A.05.00

Run-Time Scaling

Allows you to adjust the run-time scaling value. The run-time scaling value is applied in real-time while the waveform is playing.

Key Path:	Source, Modulation Setup, ARB, ARB Setup
-----------	---

Remote Command:	:SOURce:RADio:ARB:RSCaling <real> :SOURce:RADio:ARB:RSCaling?
Example:	SOUR:RAD:ARB:RSC 100.00
Dependencies:	When a new waveform is selected for playback the settings contained within the associated waveform header file are applied to the ARB. The run-time scaling is one of the values stored within the header file. If the newly selected waveform file has an associated header file, the run-time scaling is updated with the value from the header file. The run-time scaling will remain unchanged if the newly selected waveform does not have an associated header file.
Preset:	70.00 %
Min:	1.00 %
Max:	100.00 %
Initial S/W Revision:	A.05.00

Baseband Freq Offset

Allows you to adjust the value by which the baseband frequency is offset relative to the carrier.

Key Path:	Source, Modulation Setup, ARB, ARB Setup
Remote Command:	:SOURce:RADio:ARB:BASEband:FREQuency:OFFSet <freq> :SOURce:RADio:ARB:BASEband:FREQuency:OFFSet?
Example:	SOUR:RAD:ARB:BAS:FREQ:OFFS 0.00 Hz
Dependencies:	When a new waveform is selected for playback the settings contained within the associated waveform header file are applied to the ARB. The baseband frequency offset is one of the values stored within the header file. If the newly selected waveform file has an associated header file, the baseband frequency offset is updated with the value from the header file. The baseband frequency offset will remain unchanged if the newly selected waveform does not have an associated header file.
Preset:	0.00 Hz
Min:	-50.00 MHz
Max:	50.00 MHz
Initial S/W Revision:	A.05.00

Trigger Type

Allows access to the trigger type sub-menus. The setting for trigger type determines the behavior of the waveform when it plays.

Key Path:	Source, Modulation Setup, ARB
-----------	--------------------------------------

Source (Internal)

Remote Command:	:SOURce:RADio:ARB:TRIGger:TYPE CONTInuous SINGle SADVance GATE :SOURce:RADio:ARB:TRIGger:TYPE?
Example:	SOUR:RAD:ARB:TRIG:TYPE CONT SOUR:RAD:ARB:TRIG:TYPE?
Notes:	Gated trigger type will be implemented at a later release
Preset:	CONTInuous
Range:	Continuous Single Seg Adv Gated
Initial S/W Revision:	A.05.00

Continuous

Sets the active trigger type to Continuous. If Continuous is already selected as the active trigger type, pressing this key allows access to the continuous trigger type setup menu. In Continuous trigger mode, the waveform repeats continuously.

Key Path:	Source, Modulation Setup, ARB, Trigger Type
Remote Command:	:SOURce:RADio:ARB:TRIGger:TYPE:CONTInuous [:TYPE] FREE TRIGger RESet :SOURce:RADio:ARB:TRIGger:TYPE:CONTInuous [:TYPE] ?
Example:	SOUR:RAD:ARB:TRIG:TYPE:CONT FREE
Preset:	FREE
Range:	Free Run Trigger + Run Reset + Run
Initial S/W Revision:	A.05.00

Free Run

Selects Free Run as the trigger response for the continuous trigger type. Free Run sets the waveform generator to play a waveform sequence or segment continuously, without waiting for a trigger. In this mode, the waveform generator does not respond to triggers.

Key Path:	Source, Modulation Setup, ARB, Trigger Type, Continuous
Example:	SOUR:RAD:ARB:TRIG:TYPE:CONT FREE
Initial S/W Revision:	A.05.00

Trigger + Run

Sets Trigger and Run as the trigger response for the continuous trigger type. Trigger and Run sets the waveform generator to play a waveform sequence or segment continuously when the first trigger is received, and to ignore any subsequent triggers.

Key Path:	Source, Modulation Setup, ARB, Trigger Type, Continuous
-----------	--

Example:	SOUR:RAD:ARB:TRIG:TYPE:CONT TRIG
Initial S/W Revision:	A.05.00

Reset + Run

Sets Reset and Run as the trigger response for the continuous trigger type. Reset and Run sets the waveform generator to play a waveform sequence or segment continuously when the first trigger is received. Subsequent triggers reset the waveform sequence or segment to the start, and then play it continuously.

Key Path:	Source, Modulation Setup, ARB, Trigger Type, Continuous
Example:	SOUR:RAD:ARB:TRIG:TYPE:CONT RES
Initial S/W Revision:	A.05.00

Single

Sets the active trigger type to Single. If Single is already selected as the active trigger type, pressing this key allows access to the single trigger type setup menu. In Single trigger mode, the waveform plays once.

Key Path:	Source, Modulation Setup, ARB, Trigger Type
Remote Command:	:SOURce:RADio:ARB:RETRigger ON OFF IMMEDIATE :SOURce:RADio:ARB:RETRigger?
Example:	SOUR:RAD:ARB:RETR OFF
Notes:	ON: Buffered Trigger OFF: No Retrigger Immediate: Restart on Trigger This is defined as an enumerated SCPI command, with ON/OFF being considered as enumerated types rather than Boolean. This means the query will return OFF instead of 0, and ON instead of 1.
Preset:	ON
Range:	No Retrigger Buffered Trigger Restart on Trigger
Initial S/W Revision:	A.05.00

No Retrigger

Selects No Retrigger as the trigger response for single trigger type. No Retrigger sets the waveform generator to play a waveform sequence or segment once when a trigger is received. Any triggers then received during playback are ignored.

Key Path:	Source, Modulation Setup, ARB, Trigger Type, Single
Example:	SOUR:RAD:ARB:RETR OFF
Initial S/W Revision:	A.05.00

Source (Internal)

Buffered Trigger

Selects Buffered Trigger as the trigger response for single trigger type. Buffered Trigger sets the waveform generator to play a waveform sequence or segment once when a trigger is received. If a trigger is received during playback, the waveform generator plays the sequence or segment to the end, then plays the sequence or segment once more.

Key Path:	Source, Modulation Setup, ARB, Trigger Type, Single
Example:	SOUR:RAD:ARB:RETR ON
Initial S/W Revision:	A.05.00

Restart on Trigger

Selects Restart on Trigger as the trigger response for single trigger type. Restart on Trigger sets the waveform generator to play a waveform sequence or segment once when a trigger is received. If a trigger is received during playback, the waveform generator resets and plays the sequence or segment from the start.

Key Path:	Source, Modulation Setup, ARB, Trigger Type, Single
Example:	SOUR:RAD:ARB:RETR IMM
Initial S/W Revision:	A.05.00

Segment Advance

Sets the active trigger type to Segment Advance. If Segment Advance is already selected as the active trigger type, pressing this key allows access to the segment advance trigger type setup menu.

Segment Advance triggering allows you to control the playback of waveform segments within a waveform sequence. When a trigger is received the ARB advances to the next waveform segment within the waveform sequence. This type of triggering ignores the repetition count for the waveform segment within the waveform sequence. For example, if a waveform segment has a repetition count of 10 and you select single segment advance triggering mode, the waveform segment will only play once.

Segment Advance triggering can also be used for waveform segments only. In this situation the same waveform segment is played again when a trigger is received.

Key Path:	Source, Modulation Setup, ARB, Trigger Type
Remote Command:	:SOURce:RADio:ARB:TRIGger:TYPE:SADVance [:TYPE] SINGLE CONTinuous :SOURce:RADio:ARB:TRIGger:TYPE:SADVance [:TYPE] ?
Example:	SOUR:RAD:ARB:TRIG:TYPE:SADV SING
Preset:	CONTinuous
Range:	Single Continuous
Initial S/W Revision:	A.05.00

Single

Selects Single as the trigger response for Segment Advance trigger type. With single selected, once a trigger is received a segment is played once. If a trigger is received during playback of a segment, the segment plays to

completion and the next segment is played once.

Key Path:	Source, Modulation Setup, ARB, Trigger Type, Segment Advance
Example:	SOUR:RAD:ARB:TRIG:TYPE:SADV SING
Initial S/W Revision:	A.05.00

Continuous

Selects Continuous as the trigger response for Segment Advance trigger type. With continuous selected, once a trigger is received a segment is played continuously. When subsequent triggers are received, the currently playing segment plays to completion and then the next segment is played continuously.

Key Path:	Source, Modulation Setup, ARB, Trigger Type, Segment Advance
Example:	SOUR:RAD:ARB:TRIG:TYPE:SADV CONT
Initial S/W Revision:	A.05.00

Trigger Source

Allows access to the trigger source sub-menus. The trigger source setting determines how the source receives the trigger that starts the waveform playing. Therefore, this key is grayed out if the trigger type is free run, since free run triggers immediately with no trigger source required.

Key Path:	Source, Modulation Setup, ARB
Remote Command:	:SOURce:RADio:ARB:TRIGger[:SOURce] KEY BUS EXTernal2 :SOURce:RADio:ARB:TRIGger[:SOURce]?
Example:	SOUR:RAD:ARB:TRIGger KEY
Dependencies:	This key is grayed out if the current trigger type is Continuous, Free Run.
Preset:	EXTernal2
Range:	Trigger Key Bus External 2
Initial S/W Revision:	A.05.00

Trigger Key

Sets the current trigger source to the front panel Trigger key. When Trigger Key is selected, the waveform is triggered when you press the front panel Trigger key.

Key Path:	Source, Modulation Setup, ARB, Trigger Source
Example:	SOUR:RAD:ARB:TRIGger KEY
Initial S/W Revision:	A.05.00

Bus

Sets the current trigger source to Bus. Selecting Bus trigger source enables triggering over GPIB, LAN, or USB

Source (Internal)

using the :SOURce:RADio:ARB:TRIGger:INITiate command.

Key Path:	Source, Modulation Setup, ARB, Trigger Source
Example:	SOUR:RAD:ARB:TRIGger BUS
Initial S/W Revision:	A.05.00

External 2

Sets the current trigger source to External 2. Selecting External 2 enables triggering a waveform by an externally applied signal.

Key Path:	Source, Modulation Setup, ARB, Trigger Source
Example:	SOUR:RAD:ARB:TRIGger EXT2
Initial S/W Revision:	A.05.00

Trigger Initiate

Used to initiate an immediate trigger event if the trigger source is set to Trigger Key.

Key Path:	Source, Modulation Setup, ARB
Notes:	No remote command, SCPI front panel only.
Initial S/W Revision:	A.05.00

Waveform Sequences

Allows access to the waveform sequence sub-menus. Pressing this key changes the central view area to display the Waveform Sequence List view.

Key Path:	Source, Modulation Setup, ARB
Notes:	No remote command, SCPI front panel only.
Initial S/W Revision:	A.05.00

Build New Sequence

Allows access to the sub-menus for creating a new waveform sequence. Pressing this key changes the central view area to display the Waveform Sequence Creation and Editing view.

Key Path:	Source, Modulation Setup, ARB, Waveform Sequences
Notes:	No remote command, SCPI front panel only.
Initial S/W Revision:	A.05.00

Current Segment

Specifies the selected sequence segment that will be affected by the menu functions.

Key Path:	Source, Modulation Setup , ARB, Waveform Sequences, Build New Sequence
Notes:	No remote command, SCPI front panel only. This key is grayed out and unavailable if the sequence is currently empty.
Initial S/W Revision:	A.05.00

Insert New Waveform

Allows you access to the sub-menu for inserting a new waveform segment or sequence. Pressing this key also changes the central display to show the Waveform File Selection View.

Key Path:	Source, Modulation Setup, ARB, Waveform Sequences, Build New Sequence
Notes:	No remote command, SCPI front panel only. Waveform segment name string length upper limit is 128 chars. Please do NOT insert waveform which name string exceeds 128 chars.
Initial S/W Revision:	A.05.00

Insert Waveform

Inserts the currently highlighted waveform to the end of the waveform sequence. Pressing this key also returns you to the menus for creating or editing a sequence, and returns the central view to the sequence creation view.

Key Path:	Source, Modulation Setup, ARB, Waveform Sequences, Build New Sequence, Insert New Waveform
Notes:	No remote command, SCPI front panel only. Waveform segment NAME string length upper limit is 128 chars. Please do NOT insert waveform which name string exceeds 128 chars.
Initial S/W Revision:	A.05.00

Segments on Hard Disk

This key functions the same as [“Segments on Hard Disk”](#) on page 1174.

Key Path:	Source, Modulation Setup, ARB, Waveform Sequences, Build New Sequence, Insert New Waveform
Initial S/W Revision:	Prior to A.09.00

Source (Internal)

Load Segment To ARB Memory

This key functions the same as [“Load Segment To ARB Memory”](#) on page 1175.

Key Path:	Source, Modulation Setup, ARB, Waveform Sequences, Build New Sequence, Insert New Waveform, Segment on Hard Drive
Initial S/W Revision:	Prior to A.09.00

Load All To ARB Memory

This key functions the same as [“Load All To ARB Memory”](#) on page 1176.

Key Path:	Source, Modulation Setup, ARB, Waveform Sequences, Build New Sequence, Insert New Waveform, Segment on Hard Drive
Initial S/W Revision:	Prior to A.09.00

Change Directory ...

This key functions the same as [“Change Directory...”](#) on page 1177.

Key Path:	Source, Modulation Setup, ARB, Waveform Sequences, Build New Sequence, Insert New Waveform, Segment on Hard Drive
Initial S/W Revision:	Prior to A.09.00

Default Directory ...

This key functions the same as [“Default Directory...”](#) on page 1177

Key Path:	Source, Modulation Setup, ARB, Waveform Sequences, Build New Sequence, Insert New Waveform, Segment on Hard Drive
Initial S/W Revision:	Prior to A.09.00

Segments in ARB Memory

This key functions the same as [“Segments in ARB Memory”](#) on page 1178.

Key Path:	Source, Modulation Setup, ARB, Waveform Sequences, Build New Sequence, Insert New Waveform
Initial S/W Revision:	Prior to A.09.00

Delete Segment From ARB Memory

This key functions the same as [“Delete Segment From ARB Mem”](#) on page 1178.

Key Path:	Source, Modulation Setup, ARB, Waveform Sequences, Build New Sequence, Insert New Waveform, Segment in ARB Memory
Initial S/W Revision:	Prior to A.09.00

Delete All From ARB Memory

This key functions the same as [“Delete All From ARB Memory”](#) on page 1178.

Key Path:	Source, Modulation Setup, ARB, Waveform Sequences, Build New Sequence, Insert New Waveform, Segment in ARB Memory
Initial S/W Revision:	Prior to A.09.00

Query ARB Memory File List (Remote Command Only)

This command functions the same as [“Query ARB Memory File List \(Remote Command Only\)”](#) on page 1179.

Initial S/W Revision:	Prior to A.09.00
-----------------------	------------------

Edit Selected Waveform

Allows access to the sub-menus for editing the details of the currently selected waveform segment.

Key Path:	Source, Modulation Setup, ARB, Waveform Sequences, Build New Sequence
Notes:	No remote command, front panel only.
Initial S/W Revision:	A.05.00

Repetitions

Allows you to specify the number of times the currently selected waveform is played within the sequence.

Key Path:	Source, Modulation Setup, ARB, Waveform Sequences, Build New Sequence, Edit Selected Waveform
Notes:	No remote command, SCPI front panel only.
Preset:	1
Min:	1
Max:	65535
Initial S/W Revision:	A.05.00

Marker 1

Allows you to enable or disable marker 1 for the currently selected waveform. For a waveform sequence, you can enable and disable markers on a per-segment basis, allowing you to output markers from some waveform segments within the sequence, but not for others.

Key Path:	Source, Modulation Setup, ARB, Waveform Sequences, Build New Sequence, Edit Selected Waveform
Notes:	No remote command, front panel only.
Preset:	Enabled
Range:	Enabled Disabled

Source (Internal)

Initial S/W Revision:	A.05.00
-----------------------	---------

Marker 2

Allows you to enable or disable marker 2 for the currently selected waveform. For a waveform sequence, you can enable and disable markers on a per-segment basis, allowing you to output markers from some waveform segments within the sequence, but not for others.

Key Path:	Source, Modulation Setup, ARB, Waveform Sequences, Build New Sequence, Edit Selected Waveform
Notes:	No remote command, front panel only.
Preset:	Enabled
Range:	Enabled Disabled
Initial S/W Revision:	A.05.00

Marker 3

Allows you to enable or disable marker 3 for the currently selected waveform. For a waveform sequence, you can enable and disable markers on a per-segment basis, allowing you to output markers from some waveform segments within the sequence, but not for others.

Key Path:	Source, Modulation Setup, ARB, Waveform Sequences, Build New Sequence, Edit Selected Waveform
Notes:	No remote command, front panel only.
Preset:	Enabled
Range:	Enabled Disabled
Initial S/W Revision:	A.05.00

Marker 4

Allows you to enable or disable marker 4 for the currently selected waveform. For a waveform sequence, you can enable and disable markers on a per-segment basis, allowing you to output markers from some waveform segments within the sequence, but not for others.

Key Path:	Source, Modulation Setup, ARB, Waveform Sequences, Build New Sequence, Edit Selected Waveform
Notes:	No remote command, front panel only.
Preset:	Enabled
Range:	Enabled Disabled
Initial S/W Revision:	A.05.00

Delete Segment

Allows you to delete the selected segment from the waveform sequence.

Key Path:	Source, Modulation Setup, ARB, Waveform Sequences, Build New Sequence
Notes:	No remote command, front panel only.
Initial S/W Revision:	A.05.00

Save Sequence...

Pressing this key displays the “Save As” dialog. The sequence name is passed to the save as dialog to use as the filename for saving, and the directory the save as dialog will open into is the default waveform directory.

Key Path:	Source, Modulation Setup, ARB, Waveform Sequences, Build New Sequence
Initial S/W Revision:	A.05.00

Build New Sequence (Remote Command Only)

This command is the SCPI equivalent of the waveform sequence creation features described in [“Build New Sequence” on page 1186](#).

This command writes a waveform sequence file to the hard disk. You must specify the waveform sequence file path and filename which will be saved on the hard disk, and the waveform segment file path and name which will be nested into the waveform sequence file. You can utilize mass storage unit specifier (MSUS) “NVWFM” or use a real full path representation. See the example below. MSUS “NVWFM” is mapped to D:\NVARB directory on test set hard disk.

Any number of segments, up to a segment count limit of 64, can be used to create a sequence. Repeated segments are included in the count limit.

Each waveform segment name string length upper limit is 128 chars. Please do NOT insert waveform which name string exceeds 128 chars.

The internal source does not support nesting one waveform sequence file into another waveform sequence file.

Remote Command:	<pre>:SOURce:RADio:ARB:SEQuence[:MWAVeform] <filename>, <waveform1>, <reps>, NONE M1 M2 M3 M4 M1M2 M1M3 M1M4 M2M3 M2M4 M3M4 M1M2M3 M 1M2M4 M1M3M4 M2M3M4 M1M2M3M4 ALL, {<waveform2>, <reps>, NONE M1 M2 M3 M4 M1M2 M1M3 M1M4 M2M3 M2M4 M3M4 M1M2M3 M 1M2M4 M1M3M4 M2M3M4 M1M2M3M4 ALL, } ...</pre> <p>(For additional description of each item, see Notes below “For Setup SCPI” on page 1193 “For Setup SCPI”.)</p> <pre>:SOURce:RADio:ARB:SEQuence[:MWAVeform]? <filename></pre> <p>(For additional description of each item, see Notes “For Query SCPI” on page 1194 below.)</p>
------------------------	---

Source (Internal)

Example:	<p>For setup:</p> <pre>SOUR:RAD:ARB:SEQ "NVWFM:testSeq1.seq", "NVWFM:wfmSegment1.wfm",10, M2M3M4, "NVWFM:wfmSegment2.wfm", 20, M1M3</pre> <p>Or</p> <pre>SOUR:RAD:ARB:SEQ "D:\NVARB\testSeq1.seq", " D:\NVARB\wfmSegment1.wfm",10, M2M3M4, " D:\NVARB\wfmSegment2.wfm", 20, M1M3</pre> <p>For query, must specify which waveform sequence file to query.</p> <pre>SOUR:RAD:ARB:SEQ? "NVWFM:testSeq1.seq"</pre> <p>Or</p> <pre>SOUR:RAD:ARB:SEQ? "D:\NVARB\testSeq1.seq",</pre>
----------	--

Notes:	<p>For Setup SCPI</p> <p>For the Setup SCPI command, the parameters are:</p> <p><filename> - String Type</p> <p>This variable specifies the path and name for the waveform sequence file. The path supports MSUS (NVWFM) or a real full path representation. See example.</p> <p><waveform1> - String Type</p> <p>This variable specifies the path and name of the first existing waveform segment. The path supports MSUS (NVWFM) or a real full path representation. See example.</p> <p>The segment file must reside within ARB playback memory before it can be played by the ARB player.</p> <p><reps> - Integer Type</p> <p>This variable specifies the number of times a segment or sequence plays before moving on to the next segment or sequence.</p> <p><marker> - Enum Type</p> <p>NONE – This choice disables all four markers for the waveform. Disabling markers means that the waveform sequence ignores the segments or sequence marker settings.</p> <p>M1, M2, M3, M4 – these choices, either individually or a combination of them, enable the markers for the waveform segment or sequence. Markers not specified are ignored for that segment or sequence.</p> <p>ALL – This choice enables all four markers in the waveform segment or sequence.</p> <p><waveform2> - String type.</p> <p>This variable specifies the name of a second existing waveform segment. The path supports MSUS (NVWFM) and real full path representation both. See example.</p> <p>The segment file must reside within ARB playback memory before it can be played by the ARB player.</p> <p><reps> same as above, for the 2nd waveform segment.</p> <p><marker> same as above, for the 2nd waveform segment.</p> <p>You can insert several waveform segments into a waveform sequence file. Just repeat inserting waveform segments as described above.</p> <p>Error Checks for Setup SCPI command:</p> <p>If you do not specify a filename, or you use an unsupported MSUS (that is, not NVWFM), or have an error in the waveform sequence file path, an error is generated.</p>
--------	--

Source (Internal)

Notes:	<p>Error Checks for Query SCPI command: (Continued)</p> <p>If the specified waveform sequence file name suffix is not “.seq”, error is generated.</p> <p>If you use an unsupported MSUS (that is, not NVWFM), or have an error in the waveform segment file path, an error is generated.</p> <p>If the first specified waveform file cannot be found, an error is generated.</p> <p>If you nest one waveform sequence file into another waveform sequence file, an error is generated.</p> <p>If the specified repetition value is larger than 65535 or smaller than 1, an error is generated.</p> <p>If the specified marker type is unrecognized, an error is generated.</p> <p>For Query SCPI</p> <p>For the Query the parameters are:</p> <p><filename> - String type.</p> <p>This variable specifies the path and name of the waveform sequence file being queried. The path supports MSUS (NVWFM) or a real full path representation. See example.</p> <p>The return value is a <string>, which includes each waveform segment file name, repetitions, and marker type. For example:</p> <p>SOUR:RAD:ARB:SEQ? “NVWFM:testSeq1.seq”, <“wfmSegment1. wfm, 10, ALL, wfmSegment2.wfm, 20, M1M3”></p> <p>Error Checks for Query SCPI command:</p> <p>If you do not specify a filename, an error is generated.</p> <p>If the waveform sequence file name is empty, an error is generated.</p> <p>If the specified waveform sequence file cannot be found, an error is generated.</p>
Initial S/W Revision:	A.05.00

Edit Selected Sequence

Allows access to the sub-menus for editing the sequence currently selected within the Waveform Sequence List view. Pressing this key changes the central view area to display the Waveform Sequence Creation and Editing view.

Key Path:	Source, Modulation Setup, ARB, Waveform Sequences
Notes:	No remote command, front panel only.
Initial S/W Revision:	A.05.00

Current Segment

Specifies the selected sequence segment that will be affected by the menu functions.

Key Path:	Source, Modulation Setup, ARB, Waveform Sequences, Edit Selected Sequence
Notes:	No remote command, front panel only. This key is grayed out and unavailable if the sequence is currently empty.
Initial S/W Revision:	A.05.00

Insert New Waveform

Allows you access to the sub-menu for inserting a new waveform segment or sequence. Pressing this key also changes the central display to show the Waveform File Selection View.

Key Path:	Source, Modulation Setup, ARB, Waveform Sequences, Edit Selected Sequence
Notes:	No remote command, front panel only.
Initial S/W Revision:	A.05.00

Insert Waveform

Inserts the currently highlighted waveform to the end of the waveform sequence. Pressing this key also returns you to the menus for creating or editing a sequence, and returns the central view to the sequence creation view.

Key Path:	Source, Modulation Setup, ARB, Waveform Sequences, Edit Selected Sequence, Insert New Waveform
Notes:	No remote command, front panel only.
Initial S/W Revision:	A.05.00

Segments on Hard Disk

This key functions the same as section [“Segments on Hard Disk” on page 1174](#).

Key Path:	Source, Modulation Setup, ARB, Waveform Sequences, Edit Selected Sequence, Insert New Waveform
Initial S/W Revision:	Prior to A.09.00

Load Segment To ARB Memory

This key functions the same as section [“Load Segment To ARB Memory” on page 1175](#).

Key Path:	Source, Modulation Setup, ARB, Waveform Sequences, Edit Selected Sequence, Insert New Waveform, Segments on Hard Disk
Initial S/W Revision:	Prior to A.09.00

Source (Internal)

Load All To ARB Memory

This key functions the same as section [“Load All To ARB Memory”](#) on page 1176.

Key Path:	Source, Modulation Setup, ARB, Waveform Sequences, Edit Selected Sequence, Insert New Waveform, Segments on Hard Disk
Initial S/W Revision:	Prior to A.09.00

Change Directory ...

This key functions the same as section [“Change Directory...”](#) on page 1177

Key Path:	Source, Modulation Setup, ARB, Waveform Sequences, Edit Selected Sequence, Insert New Waveform, Segments on Hard Disk
Initial S/W Revision:	Prior to A.09.00

Default Directory ...

This key functions the same as section [“Default Directory...”](#) on page 1177

Key Path:	Source, Modulation Setup, ARB, Waveform Sequences, Edit Selected Sequence, Insert New Waveform, Segments on Hard Disk
Initial S/W Revision:	Prior to A.09.00

Segments in ARB Memory

This key functions the same as section [“Segments in ARB Memory”](#) on page 1178.

Key Path:	Source, Modulation Setup, ARB, Waveform Sequences, Edit Selected Sequence, Insert New Waveform
Initial S/W Revision:	Prior to A.09.00

Delete Segment From ARB Memory

This key functions the same as section [“Delete Segment From ARB Mem”](#) on page 1178.

Key Path:	Source, Modulation Setup, ARB, Waveform Sequences, Edit Selected Sequence, Insert New Waveform, Segments in ARB Memory
Initial S/W Revision:	Prior to A.09.00

Delete All From ARB Memory

This key functions the same as section [“Delete All From ARB Memory”](#) on page 1178.

Key Path:	Source, Modulation Setup, ARB, Waveform Sequences, Edit Selected Sequence, Insert New Waveform, Segments in ARB Memory
Initial S/W Revision:	Prior to A.09.00

Query ARB Memory File List (Remote Command Only)

This key functions the same as section [Query “Query ARB Memory File List \(Remote Command Only\)”](#) on page 1179

Key Path:	Source, Modulation Setup, ARB, Waveform Sequences, Edit Selected Sequence, Insert New Waveform, Segments in ARB Memory
Initial S/W Revision:	Prior to A.09.00

Edit Selected Waveform

Allows access to the sub-menus for editing the details of the currently selected waveform segment.

Key Path:	Source, Modulation Setup, ARB, Waveform Sequences, Edit Selected Sequence
Notes:	No remote command, front panel only.
Initial S/W Revision:	A.05.00

Repetitions

Allows you to specify the number of times the currently selected waveform is played within the sequence.

Key Path:	Source, Modulation Setup, ARB, Waveform Sequences, Edit Selected Sequence, Edit Selected Waveform
Notes:	No remote command, front panel only.
Preset:	1
Min:	1
Max:	TBD
Initial S/W Revision:	A.05.00

Marker 1

Allows you to enable or disable marker 1 for the currently selected waveform. For a waveform sequence, you can enable and disable markers on a per-segment basis, allowing you to output markers from some waveform segments within the sequence but not for others.

Key Path:	Source, Modulation Setup, ARB, Waveform Sequences, Edit Selected Sequence, Edit Selected Waveform
Notes:	No remote command, front panel only.
Preset:	Enabled
Range:	Enabled Disabled
Initial S/W Revision:	A.05.00

Marker 2

Allows you to enable or disable marker 2 for the currently selected waveform. For a waveform sequence, you can

Source (Internal)

enable and disable markers on a per-segment basis, allowing you to output markers from some waveform segments within the sequence but not for others.

Key Path:	Source, Modulation Setup, ARB, Waveform Sequences, Edit Selected Sequence, Edit Selected Waveform
Notes:	No remote command, front panel only.
Preset:	Enabled
Range:	Enabled Disabled
Initial S/W Revision:	A.05.00

Marker 3

Allows you to enable or disable marker 3 for the currently selected waveform. For a waveform sequence, you can enable and disable markers on a per-segment basis, allowing you to output markers from some waveform segments within the sequence but not for others.

Key Path:	Source, Modulation Setup, ARB, Waveform Sequences, Edit Selected Sequence, Edit Selected Waveform
Notes:	No remote command, front panel only.
Preset:	Enabled
Range:	Enabled Disabled
Initial S/W Revision:	A.05.00

Marker 4

Allows you to enable or disable marker 4 for the currently selected waveform. For a waveform sequence, you can enable and disable markers on a per-segment basis, allowing you to output markers from some waveform segments within the sequence but not for others.

Key Path:	Source, Modulation Setup, ARB, Waveform Sequences, Edit Selected Sequence, Edit Selected Waveform
Notes:	No remote command, front panel only.
Preset:	Enabled
Range:	Enabled Disabled
Initial S/W Revision:	A.05.00

Delete Segment

Allows you to delete the current segment from the waveform sequence.

Key Path:	Source, Modulation Setup, ARB, Waveform Sequences, Edit Selected Sequence
Notes:	No remote command, front panel only.

Initial S/W Revision:	A.05.00
-----------------------	---------

Save Sequence...

Pressing this key displays the “Save As” dialog box. The sequence name is passed to the save as dialog to use as the filename for saving, and the directory the save as dialog opens into is the default waveform directory.

Key Path:	Source, Modulation Setup, ARB, Waveform Sequences, Edit Selected Sequence
Notes:	No remote command, front panel only.
Initial S/W Revision:	A.05.00

Current Directory...

Allows you to change the currently selected directory on the hard disk. Pressing this key opens a standard windows change directory dialog and allows you to select the new directory of interest.

Key Path:	Source, Modulation Setup, ARB, Waveform Sequences
Notes:	No remote command, front panel only.
Initial S/W Revision:	A.05.00

Waveform Utilities

Allows you access to the waveform utilities sub-menus.

Key Path:	Source, Modulation Setup, ARB
Initial S/W Revision:	A.05.00

Multi-Pack Licenses

Allows you access to the Multi - Pack License sub-menus. Pressing this key also changes the central view area to display the Multi -Pack License Management view.

Key Path:	Source, Modulation Setup, ARB, Waveform Utilities
Dependencies:	This key is only available if there is at least one Multi-pack license installed on the instrument.
Initial S/W Revision:	A.05.00

Add Waveform

Pressing this key accesses the Add Waveform sub-menu. It also changes the central display area to display the Multi-Pack License Waveform Add view.

Key Path:	Source, Modulation Setup, ARB, Waveform Utilities, Multi-Pack Licenses
Dependencies:	This key is only available if there is at least one slot available within at least one multi-pack license.

Source (Internal)

Initial S/W Revision:	A.05.00
-----------------------	---------

Add Waveform

Allows you to add the currently selected waveform segment to a multi-pack license. The new waveform is added to the next available slot regardless of which slot was selected on the Multi-Pack License Management view.

Key Path:	Source, Modulation Setup, ARB, Waveform Utilities, Multi-Pack Licenses, Add Waveform
Remote Command:	:SYSTem:LKEY:WAVEform:ADD <string> or :SYSTem:LIcense[:FPACK]:WAVEform:ADD <string>
Example:	SYST:LKEY:WAV:ADD "mywaveform.wfm" or SYST:LIC:WAV:ADD "mywaveform.wfm"
Notes:	The second SCPI :SYSTem:LIcense[:FPACK]:WAVEform:ADD is provided to be consistent with the style of Agilent signal sources. You can use either one of them. Since adding a waveform segment to a Multi-Pack license causes the license slot to enter the trial period of only 48 hours, pressing this key causes a confirmation dialog to be displayed to ensure you do want to add the waveform segment to the Multi-Pack. If you attempt to license a waveform that is already licensed using another slot an error is generated.
Dependencies:	This key is only available if the currently selected file is a secure waveform requiring a license, and there is at least one slot available within at least one multi-pack license. If the waveform highlighted is a secure waveform, but is already licensed, this key will be unavailable.
Initial S/W Revision:	A.05.00

Segments on Hard Disk

This key functions the same as [“Segments on Hard Disk” on page 1174](#).

Key Path:	Source, Modulation Setup, ARB, Waveform Utilities, Multi-Pack Licenses, Add Waveform
Initial S/W Revision:	Prior to A.09.00

Load Segment To ARB Memory

This key functions the same as [“Load Segment To ARB Memory” on page 1175](#).

Key Path:	Source, Modulation Setup, ARB, Waveform Utilities, Multi-Pack Licenses, Add Waveform, Segment on Hard Drive
Initial S/W Revision:	Prior to A.09.00

Load All To ARB Memory

This key functions the same as [“Load All To ARB Memory”](#) on page 1176.

Key Path:	Source, Modulation Setup, ARB, Waveform Utilities, Multi-Pack Licenses, Add Waveform, Segment on Hard Drive
Initial S/W Revision:	Prior to A.09.00

Change Directory ...

This key functions the same as [“Change Directory...”](#) on page 1177.

Key Path:	Source, Modulation Setup, ARB, Waveform Utilities, Multi-Pack Licenses, Add Waveform, Segment on Hard Drive
Initial S/W Revision:	Prior to A.09.00

Default Directory ...

This key functions the same as [“Default Directory...”](#) on page 1177

Key Path:	Source, Modulation Setup, ARB, Waveform Utilities, Multi-Pack Licenses, Add Waveform, Segment on Hard Drive
Initial S/W Revision:	Prior to A.09.00

Replace Waveform

Pressing this key accesses the Replace Waveform submenu. It also changes the central display area to display the Multi-Pack License Waveform Add view.

Key Path:	Source, Modulation Setup, ARB, Waveform Utilities, Multi-Pack Licenses
Dependencies:	This key is only available if the currently selected slot is in the trial state.
Initial S/W Revision:	A.05.00

Replace Waveform

Allows you to replace the waveform in the currently selected slot with the waveform currently selected in the Multi-Pack License Waveform Add view.

Key Path:	Source, Modulation Setup, ARB, Waveform Utilities, Multi-Pack Licenses, Replace Waveform
Remote Command:	:SYSTem:LKEY:WAVEform:REPLace <int>, <string> or :SYSTem:LICense[:FPACK]:WAVEform:REPLace <int>, <string>
Example:	SYST:LKEY:WAV:REPL 1, “myotherwaveform.wfm” or :SYST:LIC:WAV:REPL 1, “myotherwaveform.wfm”

Source (Internal)

Notes:	<p>The second SCPI :SYSTem:LiCense[:FPACK]:WAVEform:REPLace is provided to be consistent with the style of Agilent signal sources. You can use either one of them.</p> <p>If you attempt to license a waveform that is already licensed using another slot an error is generated.</p> <p>Waveform slot number <int> is positive. If you attempt to input a slot number less than or equals 0, an error is generated. "-220 Parameter error; License slot <n> is illegal, slot number must be positive"</p>
Initial S/W Revision:	A.05.00

Segments on Hard Disk

This key functions the same as [“Segments on Hard Disk” on page 1174.](#)

Key Path:	Source, Modulation Setup, ARB, Waveform Utilities, Multi-Pack Licenses, Replace Waveform
Initial S/W Revision:	Prior to A.09.00

Load Segment To ARB Memory

This key functions the same as [“Load Segment To ARB Memory” on page 1175.](#)

Key Path:	Source, Modulation Setup, ARB, Waveform Utilities, Multi-Pack Licenses, Replace Waveform, Segment on Hard Drive
Initial S/W Revision:	Prior to A.09.00

Load All To ARB Memory

This key functions the same as [“Load All To ARB Memory” on page 1176.](#)

Key Path:	Source, Modulation Setup, ARB, Waveform Utilities, Multi-Pack Licenses, Replace Waveform, Segment on Hard Drive
Initial S/W Revision:	Prior to A.09.00

Change Directory ...

This key functions the same as [“Change Directory...” on page 1177.](#)

Key Path:	Source, Modulation Setup, ARB, Waveform Utilities, Multi-Pack Licenses, Replace Waveform, Segment on Hard Drive
Initial S/W Revision:	Prior to A.09.00

Default Directory ...

This key functions the same as [“Default Directory...” on page 1177](#)

Key Path:	Source, Modulation Setup, ARB, Waveform Utilities, Multi-Pack Licenses, Replace Waveform, Segment on Hard Drive
-----------	--

Initial S/W Revision:	Prior to A.09.00
-----------------------	------------------

Clear Waveform from Slot

Allows you to clear the waveform from the selected slot.

Key Path:	Source, Modulation Setup, ARB, Waveform Utilities, Multi-Pack Licenses
Remote Command:	:SYSTem:LKEY:WAVeform:CLEar <int> or :SYSTem:LICense[:FPACK]:WAVeform:CLEar <int>
Example:	SYST:LKEY:WAV:CLE 1 or :SYST:LIC:WAV:CLE 1
Notes:	The second SCPI :SYSTem:LICense[:FPACK]:WAVeform:CLEar is provided to be consistent with the style of Agilent signal sources. You can use either one of them. Waveform slot number <int> is positive. If you attempt to input a slot number less than or equals 0, an error is generated. "-220 Parameter error; License slot <n> is illegal, slot number must be positive"
Dependencies:	This key is only available if the currently selected slot is in the trial state.
Initial S/W Revision:	A.05.00

Lock Waveform in Slot

If the selected slot is in the trial state or the lock required state, the waveform that occupies the slot is locked and permanently licensed.

Key Path:	Source, Modulation Setup, ARB, Waveform Utilities, Multi-Pack Licenses
Remote Command:	:SYSTem:LKEY:WAVeform:LOCK <int> or :SYSTem:LICense[:FPACK]:WAVeform:LOCK <int>
Example:	SYST:LKEY:WAV:LOCK 1 or SYST:LIC:WAV:LOCK 1
Notes:	The second SCPI :SYSTem:LICense[:FPACK]:WAVeform:LOCK is provided to be consistent with the style of Agilent signal sources. You can use either one of them. Waveform slot number <int> is positive. If you attempt to input a slot number less than or equals 0, an error is generated. "-220 Parameter error; License slot <n> is illegal, slot number must be positive"

Source (Internal)

Dependencies:	This key is only available if the currently selected slot is in the trial state or the lock required state.
Initial S/W Revision:	A.05.00

Slot Status Query (Remote Command Only)

Returns the status of the specified slot.

Remote Command:	:SYSTem:LKEY:WAVeform:STATus? <int> or :SYSTem:LIcense[:FPACK]:WAVeform:STATus? <int>
Example:	:SYST:LKEY:WAV:STAT? 1 <"Locked" or :SYST:LIc:WAV:STAT? 1 <"Locked"
Notes:	The second SCPI :SYSTem:LIcense[:FPACK]:WAVeform:STATus is provided to be consistent with the style of Agilent signal sources. You can use either one of them. Waveform slot number <int> is positive. If you attempt to input a slot number less than or equals 0, an error is generated. "-220 Parameter error; License slot <n> is illegal, slot number must be positive" Result type is string. If input slot number exceeds total available slot number, "Nonexistent" is returned.
Range:	"Locked" "Available" "Trail" "LockRequired" "Nonexistent"
Initial S/W Revision:	A.05.00

Slots Free Query (Remote Command Only)

Returns the number of license slots free.

Remote Command:	:SYSTem:LKEY:WAVeform:FREE? or :SYSTem:LIcense[:FPACK]:WAVeform:FREE?
Example:	:SYST:LKEY:WAV:FREE? or :SYST:LIc:WAV:FREE?
Notes:	The second SCPI :SYSTem:LIcense[:FPACK]:WAVeform:FREE is provided to be consistent with the style of Agilent signal sources. You can use either one of them.
Initial S/W Revision:	A.05.00

Slot Used Query (Remote Command Only)

Returns the number of license slots used.

Remote Command:	:SYSTem:LKEY:WAVeform:USED? or :SYSTem:LIcense[:FPACK]:WAVeform:USED?
Example:	:SYST:LKEY:WAV:USED? or :SYST:LIC:WAV:USED?
Notes:	The second SCPI :SYSTem:LIcense[:FPACK]:WAVeform:USED is provided to be consistent with the style of Agilent signal sources. You can use either one of them.
Initial S/W Revision:	A.05.00

Slot Waveform Name Query (Remote Command Only)

Returns the waveform name of the specified slot

Remote Command:	:SYSTem:LKEY:WAVeform:NAME? <int> or :SYSTem:LIcense[:FPACK]:WAVeform:NAME? <int>
Example:	:SYST:LKEY:WAV:NAME? 1 <"CDMA2K_22.wfm" or :SYST:LIC:WAV:NAME? 1 <"CDMA2K_22.wfm"
Notes:	Waveform slot number <int> is positive. If you attempt to input a slot number less than or equals 0, an error is generated. "-220 Parameter error; License slot <n> is illegal, slot number must be positive". Result type is string. If input slot number exceeds total available slot number, "Nonexistent" is returned. If no waveform stored in the specified slot, then empty string is returned.
Initial S/W Revision:	A.12.00

Slot Waveform Unique ID Query (Remote Command Only)

Returns the waveform unique ID of the specified slot.

Remote Command:	:SYSTem:LKEY:WAVeform:UID? <int> or :SYSTem:LIcense[:FPACK]:WAVeform:UID? <int>
------------------------	---

Source (Internal)

Example:	:SYST:LKEY:WAV:UID? 2 <"1346752140" or :SYST:LIC:WAV:UID? 2 <"1346752140"
Notes:	Waveform slot number <int> is positive. If you attempt to input a slot number less than or equals 0, an error is generated. "-220 Parameter error; License slot <n> is illegal, slot number must be positive". Result type is string. If input slot number exceeds total available slot number, "Nonexistent" is returned. Only Signal Studio waveform has unique ID, which is a positive number. (User generated waveform has no unique ID). If no waveform stored in the specified slot, then "0" is returned
Initial S/W Revision:	A.12.00

Locked Waveform Name List Query (Remote Command Only)

Returns the waveform name list of locked.

Remote Command:	:SOURce:RADio:ARB:MPLicensed:NAME:LOCKed?
Example:	SOUR:RAD:ARB:MPL:NAME:LOCKed? <"CDMA2K_27.wfm","GSM_MCS1.WFM","c2kWfm.wfm"
Initial S/W Revision:	A.11.00

Locked Waveform Unique ID List Query (Remote Command Only)

Returns the waveform unique id list of locked.

Remote Command:	:SOURce:RADio:ARB:MPLicensed:UID:LOCKed?
Example:	SOUR:RAD:ARB:MPL:UID:LOCKed? <"2996927136","3812603511","3710986266"
Notes:	Each Signal Studio waveform has a unique id recorded in header. So if the unique ids are same, that means they are same one waveform. So besides SCPI to query locked waveform name list, also provide a SCPI to query locked waveform unique id list
Initial S/W Revision:	A.11.00

Marker Utilities

Allows access to the marker utilities sub-menus.

Key Path:	Source, Modulation Setup, ARB
Initial S/W Revision:	A.05.00

Marker Polarity

Allows access to the marker polarity sub-menu, which allows you to specify the polarity for the four markers. For a positive polarity, the marker signal is high during the marker points. For a negative marker polarity, the marker signal is high during the period of no marker points.

Key Path:	Source, Modulation Setup, ARB, Marker Utilities
Initial S/W Revision:	A.05.00

Mkr 1 Polarity

Allows you to set the polarity of marker 1.

Key Path:	Source, Modulation Setup, ARB, Marker Utilities, Marker Polarity
Remote Command:	:SOURce:RADio:ARB:MPOLarity:MARKer1 POSitive NEGative :SOURce:RADio:ARB:MPOLarity:MARKer1?
Example:	SOUR:RAD:ARB:MPOL:MARK1 NEG
Dependencies:	When a new waveform is selected for playback the settings contained within the associated waveform header file are applied to the ARB. The marker polarity is one of the values stored within the header file. If the newly selected waveform file has an associated header file, the marker polarity is updated with the value from the header file. The marker polarity will remain unchanged if the newly selected waveform does not have an associated header file.
Preset:	Pos
Range:	Neg Pos
Initial S/W Revision:	A.05.00

Mkr 2 Polarity

Allows you to set the polarity of marker 2.

Key Path:	Source, Modulation Setup, ARB, Marker Utilities, Marker Polarity
Remote Command:	:SOURce:RADio:ARB:MPOLarity:MARKer2 POSitive NEGative :SOURce:RADio:ARB:MPOLarity:MARKer2?
Example:	SOUR:RAD:ARB:MPOL:MARK2 NEG
Dependencies:	When a new waveform is selected for playback the settings contained within the associated waveform header file are applied to the ARB. The marker polarity is one of the values stored within the header file. If the newly selected waveform file has an associated header file, the marker polarity is updated with the value from the header file. The marker polarity will remain unchanged if the newly selected waveform does not have an associated header file.
Preset:	Pos

Source (Internal)

Range:	Neg Pos
Initial S/W Revision:	A.05.00

Mkr 3 Polarity

Allows you to set the polarity of marker 3.

Key Path:	Source, Modulation Setup, ARB, Marker Utilities, Marker Polarity
Remote Command:	:SOURce:RADio:ARB:MPOLarity:MARKer3 POSitive NEGative :SOURce:RADio:ARB:MPOLarity:MARKer3?
Example:	SOUR:RAD:ARB:MPOL:MARK3 NEG
Dependencies:	When a new waveform is selected for playback the settings contained within the associated waveform header file are applied to the ARB. The marker polarity is one of the values stored within the header file. If the newly selected waveform file has an associated header file, the marker polarity is updated with the value from the header file. The marker polarity will remain unchanged if the newly selected waveform does not have an associated header file.
Preset:	Pos
Range:	Neg Pos
Initial S/W Revision:	A.05.00

Mkr 4 Polarity

Allows you to set the polarity of marker 4.

Key Path:	Source, Modulation Setup, ARB, Marker Utilities, Marker Polarity
Remote Command:	:SOURce:RADio:ARB:MPOLarity:MARKer4 POSitive NEGative :SOURce:RADio:ARB:MPOLarity:MARKer4?
Example:	SOUR:RAD:ARB:MPOL:MARK4 NEG
Dependencies:	When a new waveform is selected for playback the settings contained within the associated waveform header file are applied to the ARB. The marker polarity is one of the values stored within the header file. If the newly selected waveform file has an associated header file, the marker polarity is updated with the value from the header file. The marker polarity will remain unchanged if the newly selected waveform does not have an associated header file.
Preset:	Pos
Range:	Neg Pos
Initial S/W Revision:	A.05.00

Marker Routing

Allows access to the marker routing sub-menus, which allow you to specify where the marker events are routed. It should be noted that the markers can also be routed to Trigger 1 Out and Trigger 2 Out, however this must be set up using the menus accessed by pressing the “Trigger” hard key.

Key Path:	Source, Modulation Setup, ARB, Marker Utilities
Initial S/W Revision:	A.05.00

Pulse/RF Blank

Allows you to select which marker is used for the pulse/RF blanking function. The pulse/RF blanking function blanks the RF when the marker signal goes low. The marker polarity determines when the marker signal is high. For a positive polarity, this is during the marker points. For a negative polarity, this is when there are no marker points.

Marker points should be set before using this function. Enabling this function without setting maker points may create a continuous low or high signal, dependant on the marker polarity. This causes either no RF output, or a continuous RF output.

Key Path:	Source, Modulation Setup, ARB, Marker Utilities, Marker Routing
Remote Command:	:SOURce:RADio:ARB:MDEStination:PULSe NONE M1 M2 M3 M4 :SOURce:RADio:ARB:MDEStination:PULSe?
Example:	SOUR:RAD:ARB:MDES:PULS NONE
Dependencies:	When a new waveform is selected for playback the settings contained within the associated waveform header file are applied to the ARB. The pulse/RF blanking setting is one of the values stored within the header file. If the newly selected waveform file has an associated header file, the pulse/RF blanking setting is updated with the value from the header file. The pulse/RF blanking setting will remain unchanged if the newly selected waveform does not have an associated header file.
Range:	None M1 M2 M3 M4
Initial S/W Revision:	A.05.00

None

Sets no marker to be used for the pulse/RF blanking function, essentially turning the RF blanking function off.

Key Path:	Source, Modulation Setup, ARB, Marker Utilities, Marker Routing, Pulse/RF Blank
Example:	SOUR:RAD:ARB:MDES:PULS NONE
Initial S/W Revision:	A.05.00

Source (Internal)

Marker 1

Sets marker 1 to be used for the pulse/RF blanking function.

Key Path:	Source, Modulation Setup, ARB, Marker Utilities, Marker Routing, Pulse/RF Blank
Example:	SOUR:RAD:ARB:MDES:PULS M1
Initial S/W Revision:	A.05.00

Marker 2

Sets marker 2 to be used for the pulse/RF blanking function.

Key Path:	Source, Modulation Setup, ARB, Marker Utilities, Marker Routing, Pulse/RF Blank
Example:	SOUR:RAD:ARB:MDES:PULS M2
Initial S/W Revision:	A.05.00

Marker 3

Sets marker 3 to be used for the pulse/RF blanking function.

Key Path:	Source, Modulation Setup, ARB, Marker Utilities, Marker Routing, Pulse/RF Blank
Example:	SOUR:RAD:ARB:MDES:PULS M3
Initial S/W Revision:	A.05.00

Marker 4

Sets marker 4 to be used for the pulse/RF blanking function.

Key Path:	Source, Modulation Setup, ARB, Marker Utilities, Marker Routing, Pulse/RF Blank
Example:	SOUR:RAD:ARB:MDES:PULS M4
Initial S/W Revision:	A.05.00

ALC Hold

Allows you to specify which marker is routed for use within the ALC hold function. The ALC hold marker function holds the ALC circuitry at the average value of the sample points set by the marker.

The ALC hold function operates during the low periods of the marker signal. The marker polarity determines when the marker signal is high. For positive polarity, this is during the marker points. For a negative polarity, this is when there are no marker points.

Key Path:	Source, Modulation Setup, ARB, Marker Utilities, Marker Routing
-----------	--

Remote Command:	:SOURCE:RADio:ARB:MDEStination:ALCHold NONE M1 M2 M3 M4 :SOURCE:RADio:ARB:MDEStination:ALCHold?
Example:	SOUR:RAD:ARB:MDES:ALCH NONE
Dependencies:	When a new waveform is selected for playback the settings contained within the associated waveform header file are applied to the ARB. The ALC hold setting is one of the values stored within the header file. If the newly selected waveform file has an associated header file, the ALC hold setting is updated with the value from the header file. The ALC hold setting will remain unchanged if the newly selected waveform does not have an associated header file.
Range:	None M1 M2 M3 M4
Initial S/W Revision:	A.05.00

None

Sets no marker to be used for the ALC hold function, essentially turning the ALC hold function off.

Key Path:	Source, Modulation Setup, ARB, Marker Utilities, Marker Routing, ALC Hold
Example:	SOUR:RAD:ARB:MDES:PULS NONE
Initial S/W Revision:	A.05.00

Marker 1

Sets marker 1 to be used for the ALC hold function.

Key Path:	Source, Modulation Setup, ARB, Marker Utilities, Marker Routing, ALC Hold
Example:	SOUR:RAD:ARB:MDES:PULS M1
Initial S/W Revision:	A.05.00

Marker 2

Sets marker 2 to be used for the ALC hold function.

Key Path:	Source, Modulation Setup, ARB, Marker Utilities, Marker Routing, ALC Hold
Example:	SOUR:RAD:ARB:MDES:PULS M2
Initial S/W Revision:	A.05.00

Marker 3

Sets marker 3 to be used for the ALC hold function.

Key Path:	Source, Modulation Setup, ARB, Marker Utilities, Marker Routing, ALC Hold
-----------	--

Source (Internal)

Example:	SOUR:RAD:ARB:MDES:PULS M3
Initial S/W Revision:	A.05.00

Marker 4

Sets marker 4 to be used for the ALC hold function.

Key Path:	Source, Modulation Setup, ARB, Marker Utilities, Marker Routing, ALC Hold
Example:	SOUR:RAD:ARB:MDES:PULS M4
Initial S/W Revision:	A.05.00

Header Utilities

Allows access to the header utilities sub-menu. Pressing this key also causes the central display area to change to display the File Header Information view.

Key Path:	Source, Modulation Setup, ARB
Dependencies:	This key is only available if there is currently a waveform selected for playback. If no waveform is selected, the key is grayed out.
Initial S/W Revision:	A.05.00

Clear Header

Allows you to clear the header information from the file header associated with the currently selected waveform.

Key Path:	Source, Modulation Setup, ARB, Header Utilities
Remote Command:	:SOURce:RADio:ARB:HEADer:CLEar
Example:	SOUR:RAD:ARB:HEAD:CLE
Notes:	Attempting to clear the header details via SCPI when no waveform was selected for playback will generate an error.
Initial S/W Revision:	A.05.00

Save Setup To Header

Allows you to save new file header information details to the file.

Key Path:	Source, Modulation Setup, ARB, Header Utilities
Remote Command:	:SOURce:RADio:ARB:HEADer:SAVE
Example:	SOUR:RAD:ARB:HEAD:SAVE
Notes:	Attempting to save the header details via SCPI when no waveform was selected for playback will generate an error.
Initial S/W Revision:	A.05.00

Query Waveform Unique ID (Remote Command Only)

Each Signal Studio waveform contains a unique waveform ID, which is recorded in the header. This command allows you to query the unique waveform ID from the header. This is a SCPI only command.

Remote Command:	:MMEMory:HEADer:ID? "<file name>"
Example:	:MMEM:HEAD:ID? "test.wfm" (query the waveform already loaded into the ARB memory) :MMEM:HEAD:ID? "D:\NVARB\test.wfm" (query the waveform on the hard disk by absolute path) :MMEM:HEAD:ID? "NVWFM:test.wfm" (query the waveform on the hard disk by MSUS)
Notes:	SCPI query only. The queried waveform file can be in ARB memory, or on hard disk. If want to query ARB in ARB memory, then give out the file name directly. If want to query ARB on the hard disk, then absolute file path or MSUS should be given along with the file name. The valid MSUS is "NVWFM" which is mapped to D:\NVARB on hard disk. If the file cannot be found in ARB memory or on hard disk, an error is generated and value -1 is returned
Initial S/W Revision:	A.09.00

Source (Internal)

Query Selected Waveform Header info (Remote Command Only)

This query provides a listing of the current selected ARB header info. If no ARB selected, then empty string is returned..

Remote Command:	:SOURce:RADio:ARB:HEADer:INFormation?
Example:	SOUR:RAD:ARB:HEAD:INF?
Notes:	<p>Query only</p> <p>After each colon of field title string, related header info string will be appended.</p> <p>The field title string in "Range" part cannot change, for Sequence Studio needs to accurately match those string character to know which header info field it is.</p> <p>Below are related abbreviation description:</p> <p>"DESC" - Description</p> <p>"SR" - Sample Rate</p> <p>"RTS" - Run Time Scaling</p> <p>"RMS" - Root Mean Square</p> <p>"M1P" - Marker 1 Polarity</p> <p>"M2P" - Marker 2 Polarity</p> <p>"M3P" - Marker 3 Polarity</p> <p>"M4P" - Marker 4 Polarity</p> <p>"ALCHR" - ALC Hold Routing</p> <p>"RFBR" - RF Blank Routing</p> <p>"FOFF" - Frequency Offset</p> <p>"AWGNST" - AWGN State</p> <p>"AWGNCN" - AWGN C/N Ratio</p> <p>"AWGNCBW" - AWGN Carrier Bandwidth</p> <p>"AWGNNBW" - AWGN Noise Bandwidth</p> <p>"AWGNCRMS" - AWGN Carrier RMS</p> <p>"ORP" - DAC Over Range Protection</p> <p>"UID" - Unique ID</p> <p>"LICSTS" - License Status</p>
Range:	"DESC:", "SR:", "RTS:", "RMS:", "M1P:", "M2P:", "M3P:", "M4P:", "ALCHR:", "RFBR:", "FOFF:", "AWGNST:", "AWGNCN:", "AWGNCBW:", "AWGNNBW:", "AWGNCRMS:", "ORP:", "UID:", "LICSTS"
Initial S/W Revision:	A.12.00

Bus Trigger Command (Remote Command Only)

Used to initiate an immediate trigger event if the trigger source is set to Bus.

Remote Command:	:SOURce:RADio:ARB:TRIGger:INITiate
Example:	SOUR:RAD:ARB:TRIG:INIT
Initial S/W Revision:	A.05.00

AM

Allows access to the menu for configuring the Amplitude Modulation.

Key Path:	Source, Modulation Setup
Initial S/W Revision:	A.05.00

AM

Enables or disables the amplitude modulation.

Turning AM on when another modulation format is already on results in the previous modulation format being turned off and the generation of an error.

Key Path:	Source, Modulation Setup, AM
Remote Command:	:SOURce:AM:STATe :SOURce:AM:STATe?
Example:	SOUR:AM:STAT OFF
Preset:	Off
Range:	On Off
Initial S/W Revision:	A.05.00

AM Depth

Allows you to set the amplitude modulation depth in percent.

Key Path:	Source, Modulation Setup, AM
Remote Command:	:SOURce:AM[:DEPTh] [:LiNear] :SOURce:AM[:DEPTh] [:LiNear] ?
Example:	SOUR:AM 0.1
Preset:	0.1 %
Min:	0.1 %
Max:	95.0 %
Initial S/W Revision:	A.05.00

Source (Internal)

AM Rate

Allows you to set the internal amplitude modulation rate.

Key Path:	Source, Modulation Setup, AM
Remote Command:	:SOURce:AM:INTernal:FREQuency :SOURce:AM:INTernal:FREQuency?
Example:	SOUR:AM:INT:FREQ 40.0 Hz
Preset:	400.0 Hz
Min:	10 Hz
Max:	40 kHz
Initial S/W Revision:	A.05.00

FM

Allows access to the menu for configuring the frequency modulation.

Key Path:	Source, Modulation Setup
Initial S/W Revision:	A.05.00

FM

Enables or disables the frequency modulation.

Turning FM on when another modulation format is already on results in the previous modulation format being turned off and the generation of an error.

Key Path:	Source, Modulation Setup, FM
Remote Command:	:SOURce:FM:STATe :SOURce:FM:STATe?
Example:	SOUR:FM:STAT OFF
Preset:	Off
Range:	On Off
Initial S/W Revision:	A.05.00

FM Deviation

Allows you to set the frequency modulation deviation.

Key Path:	Source, Modulation Setup, FM
Remote Command:	:SOURce:FM[:DEVIation] :SOURce:FM[:DEVIation]?

Example:	SOUR:FM 1.00 kHz
Preset:	1.00 Hz
Min:	1.00 Hz
Max:	100.00 kHz
Initial S/W Revision:	A.05.00

FM Rate

Allows you to set the internal frequency modulation rate.

Key Path:	Source, Modulation Setup, FM
Remote Command:	:SOURce:FM:INTernal:FREQuency :SOURce:FM:INTernal:FREQuency?
Example:	SOUR:FM:INT:FREQ 40.0 Hz
Preset:	400.0 Hz
Min:	10 Hz
Max:	40 kHz
Initial S/W Revision:	A.05.00

PM

Allows access to the menu for configuring the phase modulation.

Key Path:	Source, Modulation Setup
Initial S/W Revision:	A.05.00

PM

Enables or disables the phase modulation.

Turning PM on when another modulation format is already on results in the previous modulation format being turned off and the generation of an error.

Key Path:	Source, Modulation Setup, PM
Remote Command:	:SOURce:PM:STATe :SOURce:PM:STATe?
Example:	SOUR:PM:STAT OFF
Preset:	Off
Range:	On Off
Initial S/W Revision:	A.05.00

Source (Internal)

PM Deviation

Allows you to set the phase modulation deviation.

Key Path:	Source, Modulation Setup, PM
Remote Command:	:SOURce:PM[:DEVIation] :SOURce:PM[:DEVIation]?
Example:	SOUR:PM 1.00 rad
Preset:	0.1 rad
Min:	0.1 rad
Max:	20.0 rad
Initial S/W Revision:	A.05.00

PM Rate

Allows you to set the internal phase modulation rate.

Key Path:	Source, Modulation Setup, PM
Remote Command:	:SOURce:PM:INTernal:FREQuency :SOURce:PM:INTernal:FREQuency?
Example:	SOUR:PM:INT:FREQ 40.0 Hz
Preset:	400.0 Hz
Min:	10 Hz
Max:	40 kHz
Initial S/W Revision:	A.05.00

Multiport Adapter Output Port Amplitude Correction Configuration Validation (Remote Command Only)

This command is used to validate MPA TX port amplitude correction for Source MXG Mode.

Key Path:	Remote Command Only
Remote Command:	:SOURce:RADio:MPADapter:CORRection:ERRor?
Example:	SOUR:RAD:MPAD:CORR:ERR?

Note	<p>Query Only SCPI</p> <p>Remote command only</p> <p>If detected invalid configuration, popup error message</p> <p>"-221 Settings conflict; MPA TX port<n> amplitude correction value <n>dB is out of range. The valid range is <n> ~ <n>dB"</p> <p>Or</p> <p>"-221 Settings conflict; MPA TX port<n> amplitude correction delta exceeds <n>dB between port<n> and port<n>"</p> <p>to report the first detected conflict.</p>
Range:	"No error" Error info of the first found conflic
Initial S/W Revision:	A.12.00

List Sequencer

Allows you access to the sub-menus for configuring the list sequencer.

List sequences allows you to enter frequencies and amplitudes at unequal intervals in nonlinear ascending, descending or random order. Each step within the list can also include its own waveform file for playback, step duration, trigger event and trigger output.

The complexities involved in configuring the list sequencer do not lend itself to manual configuration; hence the manual configuration for this feature is limited. For easier configuration of the list sequencer, it is recommended that you use either SCPI or load a tab delimited file containing the setup parameters in a tabular form. The details of the SCPI for configuring the list sequencer can be found in [“Step Configuration \(Remote Command Only\)” on page 1248](#).

Once the List Sequencer has been configured using the front panel, SCPI, or loading in a tab delimited file, the sequence must be initiated using the front panel Initiate Sequence key or the corresponding SCPI command.

Key Path:	Source
Initial S/W Revision:	A.05.00

Sequencer

Allows you to set the state of the list sequencer. When the list sequencer is on, the source is outputting the sequence defined by the sequencer. When the list sequencer is off, the source outputs a single waveform segment or sequence (independent mode) at a single frequency and amplitude.

Key Path:	Source, List Sequencer
Remote Command:	:SOURce:LIST[:STATe] ON OFF 1 0 :SOURce:LIST[:STATe] ?
Example:	SOUR:LIST OFF

Source (Internal)

Notes:	When the sequencer is set to ON, the list sequencer controls the output of the source.
Couplings:	When in Sequence Analyzer mode and the list sequencer state is Off, Include Source is forced to No, and the Include Source key is grayed out. When in Sequence Analyzer mode and the list sequencer state is On, Include Source is available to set. And, an ARB memory related operation, like load or delete will be rejected.
Preset:	Off
Range:	On Off
Initial S/W Revision:	A.05.00

Initiate Sequence

Pressing this key arms the sequence for single execution. Once the sequence is armed the source begins the sequence as soon as the trigger is received. If the trigger is set to Free Run, the sequence starts immediately.

Key Path:	Source, List Sequencer
Remote Command:	:SOURCE:LIST:TRIGGER[:IMMEDIATE]
Example:	SOUR:LIST:TRIG
Notes:	When in Sequence Analyzer mode and Include Source is Yes, the Initiate list sequencer operation is rejected, and the key is grayed out, since source list sequence request is sent to physics via Parallel batch by sequence analyzer. If the file needed by the sequencer is not already in ARB memory, the sequence cannot be initiated and an error will be generated. There is a blocking SCPI query which can be used to query if source list sequence being initiated successfully or not. (see “Query List Sequence Initiation Armed Status (Remote Command Only)” on page 1258 Query Source List Sequence Armed Status)
Dependencies:	Under the Sequence Analyzer Mode, if Meas Setup->Include Source is set to YES, Source->List Sequencer->Initiate Sequence is disabled.
Initial S/W Revision:	A.05.00

Remote Software Trigger (Remote command Only)

During execution of a list sequence, the sequence will halt and wait at any step that has Step Trigger set to “Bus”. Sending this command will trigger the step and continue the sequence.

Remote Command:	:SOURCE:LIST:TRIGGER:INITIATE[:IMMEDIATE]
Example:	SOUR:LIST:TRIG:INIT
Initial S/W Revision:	A.05.00

List Sequencer Setup

Allows you access to the list sequencer setup menus.

Key Path:	Source, List Sequencer
-----------	-------------------------------

Number of Steps

Allows you to specify the number of steps within the list sequence.

Key Path:	Source, List Sequencer, List Sequencer Setup
Remote Command:	:SOURCE:LIST:NUMBER:STEPS <integer> :SOURCE:LIST:NUMBER:STEPS?
Example:	SOUR:LIST:NUMB:STEP 1
Notes:	Increasing the number of steps creates additional steps at the end of the list, with all the settings within the steps set to their default values. Decreasing the number of steps removes steps from the end of the list. The settings within the removed steps are not reset. This means that increasing the number of steps again would allow you to retrieve these steps.
Dependencies:	The Step Count parameter is increased or decreased when you insert or delete a point from within the GUI interface to the sequencer.
Preset:	1
Min:	1
Max:	1000
Initial S/W Revision:	A.05.00

Current Step

Allows you to select the step number you wish to view or edit.

Key Path:	Source, List Sequencer, List Sequencer Setup
Notes:	No remote command, front panel only.
Preset:	1
Min:	1
Max:	Step Count
Initial S/W Revision:	A.05.00

Insert Step Before

Allows you to insert a new step, containing default values, before the currently selected step. Inserting a step will automatically increase the Step Count parameter by 1. If sequence already reaches upper limit of 1000 steps, then insert more step will be rejected and popup error -221, "Setting Conflict; Cannot

Source (Internal)

insert more steps, maximum number of steps reached”

Key Path:	Source, List Sequencer, List Sequencer Setup
Notes:	No remote command, front panel only. If the list already contains the maximum limit of 1000 steps, no operation will be made after pressing this key.
Initial S/W Revision:	A.05.00

Delete Step

Allows you to delete the current step. Deleting a step will automatically decrease the Step Count parameter by 1. If sequence only has one step left, delete step will be rejected and popup error –221, “Setting conflict; Cannot delete current step, minimum number of steps reached”

Key Path:	Source, List Sequencer, List Sequencer Setup
Notes:	No remote command, Front Panel key only. If the list already contains the minimum limit of 1 step, no operation will be made after pressing this key
Initial S/W Revision:	A.05.00

Clear List

Allows you to clear the list. Clearing the list sets the number of steps to the default value of 1 and sets the parameters for the only step to their default values.

Key Path:	Source, List Sequencer, List Sequencer Setup
Initial S/W Revision:	A.05.00

Step Trigger

Allows access to the sub-menu for selecting the trigger input for the current step.

Key Path:	Source, List Sequencer, List Sequencer Setup
Remote Command:	:SOURce:LIST:STEP [1] 2 3...1000:SETup:INPut:TRIGger IMMediate INTernal EXTernal2 KEY BUS :SOURce:LIST:STEP [1] 2 3...1000:SETup:INPut:TRIGger?
Example:	SOUR:LIST:STEP2:SET:INP:TRIG BUS SOUR:LIST:STEP2:SET:INP:TRIG?
Notes:	SCPI is supported after A.09.40
Preset:	Free Run
Range:	Free Run Internal Manual (Trigger Key) Bus External 2
Initial S/W Revision:	A.05.00

Free Run

Sets the trigger input for the current step to Free Run.

Key Path:	Source, List Sequencer, List Sequencer Setup, Step Trigger
Example:	SOUR:LIST:STEP2:SET:INP:TRIG IMM
Notes:	SCPI is supported after A.09.40
Initial S/W Revision:	A.05.00

Internal

Sets the trigger input for the current step to Internal.

Key Path:	Source, List Sequencer, List Sequencer Setup, Step Trigger
Example:	SOUR:LIST:STEP2:SET:INP:TRIG INT
Notes:	SCPI is supported after A.09.40
Initial S/W Revision:	A.05.00

Manual (Trigger Key)

Sets the trigger input for the current step to Manual (Trigger Key). Any step in the sequence set to Manual will cause the sequence execution to stop until the manual trigger key is pressed. Sending the Bus Trigger SCPI command will have no effect. At any point in the sequence where the list sequencer is paused waiting for a software trigger, a pop up dialog is displayed until the trigger event occurs.

Key Path:	Source, List Sequencer, List Sequencer Setup, Step Trigger
Example:	SOUR:LIST:STEP2:SET:INP:TRIG KEY
Notes:	SCPI is supported after A.09.40
Initial S/W Revision:	A.05.00

Bus

Sets the trigger input for the current step to Bus. Any step in the sequence set to Bus will cause the sequence execution to stop until the Bus Trigger SCPI command is sent. Pressing the manual trigger key has no effect. At any point in the sequence where the list sequencer is paused waiting for a software trigger, a pop up dialog is displayed until the trigger event occurs.

Key Path:	Source, List Sequencer, List Sequencer Setup, Step Trigger
Example:	SOUR:LIST:STEP2:SET:INP:TRIG BUS
Notes:	SCPI is supported after A.09.40
Initial S/W Revision:	A.05.00

Source (Internal)

External 2

Sets the trigger input for the current step to External 2.

Key Path:	Source, List Sequencer, List Sequencer Setup, Step Trigger
Example:	SOUR:LIST:STEP2:SET:INP:TRIG EXT2
Notes:	SCPI is supported after A.09.40
Initial S/W Revision:	A.05.00

Transition Time

Allows you to specify the transition time for the current step.

The transition time is the amount of time allowed for the source to settle at the current frequency or amplitude value.

Transition Time should not be taken as additional time before or inside the Step Duration. You can set a value for the settling time to allow the source output frequency or amplitude to become stable. Make sure that during this period of time, you do not use the source output signal.

The following table lists recommended values for appropriate settling times to allow for changes within the source.

Value Changed	Recommended Transition Time
Frequency	Switching within same frequency band: 300 μ s Switching across frequency bands: 1 ms The band ranges are: Frequency Band 1: -0.08 GHz to 0.6075 GHz Frequency Band 2: 0.5075 GHz to 2.1775 GHz Frequency Band 3: 2.0775 GHz to 3.6 GHz
Amplitude	500 μ s

If the Transition Time value is shorter than the time necessary for the hardware to settle and a List Sequence is initiated, a **warning** is generated.

If the Transition Time value is longer than the Step Duration, an error is generated when initiating a source list sequence. For source list sequence, transition time is included in the step duration length. If the Transition Time value is longer than the Step Duration Time, the real step duration length is extended to equal the transition time and cause a timing shift.

Key Path:	Source, List Sequencer, List Sequencer Setup
Remote Command:	:SOURce:LIST:STEP [1] 2 3...1000:SETup:TRANSition:TIME <time> :SOURce:LIST:STEP [1] 2 3...1000:SETup:TRANSition:TIME?

Example:	SOUR:LIST:STEP2:SET:TRAN:TIME 1ms SOUR:LIST:STEP2:SET:TRAN:TIME?
Notes:	SCPI is supported after A.09.40
Preset:	1.0 ms
Min:	0.0 ms
Max:	4.0 ks
Initial S/W Revision:	A.05.00

Radio Setup

Allows you access to the sub-menus for setting up the radio standard, band, and radio band link direction for the current step.

Key Path:	Source, List Sequencer, List Sequencer Setup
Notes:	No remote command, front panel only.
Initial S/W Revision:	A.05.00

Radio Standard

Allows access to the sub-menus for selecting the radio standard and the associated radio band for use in the current step.

Key Path:	Source, List Sequencer, List Sequencer Setup, Radio Setup
Remote Command:	:SOURce:LIST:STEP [1] 2 3...1000:SETup:RADio:BAND NONE PGSM EGSM RGSM DCS1800 PCS1900 TGSM810 GSM450 GSM480 GSM700 GSM850 BAND I BAND II BAND III BAND IV BAND V BAND VI BAND VII BAND VIII BAND IX BAND X BAND XI BAND XII BAND XIII BAND XIV USCELL USPCS JAPAN KOREAN NMT IMT2K UPPER SECOND PAMR400 PAMR800 IMTEXT PCS1DOT9G AWS US2DOT5G PUBLIC LOWER NONE BAND1 BAND2 BAND3 BAND4 BAND5 BAND6 BAND7 BAND8 BAND10 BAND11 BAND12 BAND13 BAND14 BAND17 BAND18 BAND19 BAND20 BAND21 BAND24 BAND25 BAND33 BAND34 BAND35 BAND36 BAND37 BAND38 BAND39 BAND40 BAND41 BAND42 BAND43 BANDA BANDB BANDC BANDD BANDE BANDF :SOURce:LIST:STEP [1] 2 3...1000:SETup: RADio:BAND?
Example:	SOUR:LIST:STEP2:SET:RAD:BAND PGSM SOUR:LIST:STEP2:SET:RAD:BAND?
Notes:	SCPI is supported after A.09.40
Initial S/W Revision:	A.05.00

Source (Internal)

None

Selects no radio standard for use on the current step.

Key Path:	Source, List Sequencer, List Sequencer Setup, Radio Setup, Radio Standard
Example:	SOUR:LIST:STEP2:SET:RAD:BAND NONE
Notes:	SCPI is supported after A.09.40
Initial S/W Revision:	A.05.00

GSM/EDGE

Pressing this key once selects GSM/EDGE as the radio standard and the current GSM/EDGE band as the active channel band. Pressing this key again allows access to the sub-menus for selecting a different GSM/EDGE band.

Key Path:	Source, List Sequencer, List Sequencer Setup, Radio Setup, Radio Standard
Initial S/W Revision:	A.05.00

P-GSM

Selects P-GSM as the band for the current step.

Key Path:	Source, List Sequencer, List Sequencer Setup, Radio Setup, Radio Standard, GSM/EDGE
Initial S/W Revision:	A.05.00

E-GSM

Selects E-GSM as the band for the current step.

Key Path:	Source, List Sequencer, List Sequencer Setup, Radio Setup, Radio Standard, GSM/EDGE
Initial S/W Revision:	A.05.00

R-GSM

Selects R-GSM as the band for the current step.

Key Path:	Source, List Sequencer, List Sequencer Setup, Radio Setup, Radio Standard, GSM/EDGE
Initial S/W Revision:	A.05.00

DCS 1800

Selects DCS 1800 as the band for the current step.

Key Path:	Source, List Sequencer, List Sequencer Setup, Radio Setup, Radio Standard, GSM/EDGE
-----------	--

Initial S/W Revision:	A.05.00
-----------------------	---------

PCS 1900

Selects PCS 1900 as the band for the current step.

Key Path:	Source, List Sequencer, List Sequencer Setup, Radio Setup, Radio Standard, GSM/EDGE
Initial S/W Revision:	A.05.00

GSM 450

Selects GSM 450 as the band for the current step.

Key Path:	Source, List Sequencer, List Sequencer Setup, Radio Setup, Radio Standard, GSM/EDGE
Initial S/W Revision:	A.05.00

GSM 480

Selects GSM 480 as the band for the current step.

Key Path:	Source, List Sequencer, List Sequencer Setup, Radio Setup, Radio Standard, GSM/EDGE
Initial S/W Revision:	A.05.00

GSM 850

Selects GSM 850 as the band for the current step.

Key Path:	Source, List Sequencer, List Sequencer Setup, Radio Setup, Radio Standard, GSM/EDGE
Initial S/W Revision:	A.05.00

GSM 700

Selects GSM 700 as the band for the current step.

Key Path:	Source, List Sequencer, List Sequencer Setup, Radio Setup, Radio Standard, GSM/EDGE
Initial S/W Revision:	A.05.00

T-GSM 810

Selects T-GSM 810 as the band for the current step.

Key Path:	Source, List Sequencer, List Sequencer Setup, Radio Setup, Radio Standard, GSM/EDGE
Initial S/W Revision:	A.05.00

Source (Internal)

WCDMA

Pressing this key once selects WCDMA as the radio standard and the current WCDMA band as the active channel band. Pressing this key again allows access to the sub-menus for selecting a different WCDMA band.

Key Path:	Source, List Sequencer, List Sequencer Setup, Radio Setup, Radio Standard
Initial S/W Revision:	A.05.00

Band I

Selects Band I as the band for the current step.

Key Path:	Source, List Sequencer, List Sequencer Setup, Radio Setup, Radio Standard, WCDMA
Initial S/W Revision:	A.05.00

Band II

Selects Band II as the band for the current step.

Key Path:	Source, List Sequencer, List Sequencer Setup, Radio Setup, Radio Standard, WCDMA
Initial S/W Revision:	A.05.00

Band III

Selects Band III as the band for the current step.

Key Path:	Source, List Sequencer, List Sequencer Setup, Radio Setup, Radio Standard, WCDMA
Initial S/W Revision:	A.05.00

Band IV

Selects Band IV as the band for the current step.

Key Path:	Source, List Sequencer, List Sequencer Setup, Radio Setup, Radio Standard, WCDMA
Initial S/W Revision:	A.05.00

Band V

Selects Band V as the band for the current step.

Key Path:	Source, List Sequencer, List Sequencer Setup, Radio Setup, Radio Standard, WCDMA
Initial S/W Revision:	A.05.00

Band VI

Selects Band VI as the band for the current step.

Key Path:	Source, List Sequencer, List Sequencer Setup, Radio Setup, Radio Standard, WCDMA
Initial S/W Revision:	A.05.00

Band VII

Selects Band VII as the band for the current step.

Key Path:	Source, List Sequencer, List Sequencer Setup, Radio Setup, Radio Standard, WCDMA
Initial S/W Revision:	A.05.00

Band VIII

Selects Band VIII as the band for the current step.

Key Path:	Source, List Sequencer, List Sequencer Setup, Radio Setup, Radio Standard, WCDMA
Initial S/W Revision:	A.05.00

Band IX

Selects Band IX as the band for the current step.

Key Path:	Source, List Sequencer, List Sequencer Setup, Radio Setup, Radio Standard, WCDMA
Initial S/W Revision:	A.05.00

Band X

Selects Band X as the band for the current step.

Key Path:	Source, List Sequencer, List Sequencer Setup, Radio Setup, Radio Standard, WCDMA
Initial S/W Revision:	A.05.00

Band XI

Selects Band XI as the band for the current step.

Key Path:	Source, List Sequencer, List Sequencer Setup, Radio Setup, Radio Standard, WCDMA
Initial S/W Revision:	A.05.00

Source (Internal)

Band XII

Selects Band XII as the band for the current step.

Key Path:	Source, List Sequencer, List Sequencer Setup, Radio Setup, Radio Standard, WCDMA
Initial S/W Revision:	A.05.00

Band XIII

Selects Band XIII as the band for the current step.

Key Path:	Source, List Sequencer, List Sequencer Setup, Radio Setup, Radio Standard, WCDMA
Initial S/W Revision:	A.05.00

Band XIV

Selects Band XIV as the band for the current step.

Key Path:	Source, List Sequencer, List Sequencer Setup, Radio Setup, Radio Standard, WCDMA
Initial S/W Revision:	A.05.00

CDMA 2000 / 1xEVDO

Pressing this key once selects CDMA 2000/1xEVDO as the radio standard and the current CDMA 2000/1xEVDO band as the active channel band. Pressing this key again allows access to the sub-menus for selecting a different CDMA 2000/1xEVDO band.

Key Path:	Source, List Sequencer, List Sequencer Setup, Radio Setup, Radio Standard
Initial S/W Revision:	A.05.00

US CELL

Selects US Cell as the band for the current step.

Key Path:	Source, List Sequencer, List Sequencer Setup, Radio Setup, Radio Standard, CDMA 2000 / 1xEVDO
Initial S/W Revision:	A.05.00

US PCS

Selects US PCS as the band for the current step.

Key Path:	Source, List Sequencer, List Sequencer Setup, Radio Setup, Radio Standard, CDMA 2000 / 1xEVDO
Initial S/W Revision:	A.05.00

Japan Cell

Selects Japan Cell as the band for the current step.

Key Path:	Source, List Sequencer, List Sequencer Setup, Radio Setup, Radio Standard, CDMA 2000 / 1xEVDO
Initial S/W Revision:	A.05.00

Korean PCS

Selects Korean PCS as the band for the current step.

Key Path:	Source, List Sequencer, List Sequencer Setup, Radio Setup, Radio Standard, CDMA 2000 / 1xEVDO
Initial S/W Revision:	A.05.00

NMT 450

Selects NMT 450 as the band for the current step.

Key Path:	Source, List Sequencer, List Sequencer Setup, Radio Setup, Radio Standard, CDMA 2000 / 1xEVDO
Initial S/W Revision:	A.05.00

IMT 2000

Selects IMT 2000 as the band for the current step.

Key Path:	Source, List Sequencer, List Sequencer Setup, Radio Setup, Radio Standard, CDMA 2000 / 1xEVDO
Initial S/W Revision:	A.05.00

Upper 700

Selects Upper 700 as the band for the current step.

Key Path:	Source, List Sequencer, List Sequencer Setup, Radio Setup, Radio Standard, CDMA 2000 / 1xEVDO
Initial S/W Revision:	A.05.00

Secondary 800

Selects Secondary 800 as the band for the current step.

Key Path:	Source, List Sequencer, List Sequencer Setup, Radio Setup, Radio Standard, CDMA 2000 / 1xEVDO
Initial S/W Revision:	A.05.00

Source (Internal)

400 Euro PAMR

Selects 400 Euro PAMR as the band for the current step.

Key Path:	Source, List Sequencer, List Sequencer Setup, Radio Setup, Radio Standard, CDMA 2000 / 1xEVDO
Initial S/W Revision:	A.05.00

800 PAMR

Selects 800 PAMR as the band for the current step.

Key Path:	Source, List Sequencer, List Sequencer Setup, Radio Setup, Radio Standard, CDMA 2000 / 1xEVDO
Initial S/W Revision:	A.05.00

2.5GHz IMT EXT

Selects 2.5 GHz IMT EXT as the band for the current step.

Key Path:	Source, List Sequencer, List Sequencer Setup, Radio Setup, Radio Standard, CDMA 2000 / 1xEVDO
Initial S/W Revision:	A.05.00

US PCS 1.9GHz

Selects US PCS 1.9 GHz as the band for the current step.

Key Path:	Source, List Sequencer, List Sequencer Setup, Radio Setup, Radio Standard, CDMA 2000 / 1xEVDO
Initial S/W Revision:	A.05.00

AWS

Selects AWS as the band for the current step.

Key Path:	Source, List Sequencer, List Sequencer Setup, Radio Setup, Radio Standard, CDMA 2000 / 1xEVDO
Initial S/W Revision:	A.05.00

US 2.5GHz

Selects US 2.5 GHz as the band for the current step.

Key Path:	Source, List Sequencer, List Sequencer Setup, Radio Setup, Radio Standard, CDMA 2000 / 1xEVDO
Initial S/W Revision:	A.05.00

700 Public Safety

Selects 700 Public Safety as the band for the current step.

Key Path:	Source, List Sequencer, List Sequencer Setup, Radio Setup, Radio Standard, CDMA 2000 / 1xEVDO
Initial S/W Revision:	A.05.00

C2K Lower 700

Selects C2K Lower 700 as the band for the current step.

Key Path:	Source, List Sequencer, List Sequencer Setup, Radio Setup, Radio Standard, CDMA 2000 / 1xEVDO
Initial S/W Revision:	A.05.00

LTE

Pressing this key once selects LTE FDD as the radio standard and the current LTE FDD band as the active channel band. Pressing this key again allows access to the sub-menus for selecting a different LTE FDD band.

Key Path:	Source, List Sequencer, List Sequencer Setup, Radio Setup, Radio Standard
Initial S/W Revision:	A.09.50

BAND 1

Selects BAND 1 as the band for the current step.

Key Path:	Source, List Sequencer, List Sequencer Setup, Radio Setup, Radio Standard, LTE
Initial S/W Revision:	A.09.50

BAND 2

Selects BAND 2 as the band for the current step.

Key Path:	Source, List Sequencer, List Sequencer Setup, Radio Setup, Radio Standard, LTE
Initial S/W Revision:	A.09.50

BAND 3

Selects BAND 3 as the band for the current step.

Key Path:	Source, List Sequencer, List Sequencer Setup, Radio Setup, Radio Standard, LTE
Initial S/W Revision:	A.09.50

Source (Internal)

BAND 4

Selects BAND 4 as the band for the current step.

Key Path:	Source, List Sequencer, List Sequencer Setup, Radio Setup, Radio Standard, LTE
Initial S/W Revision:	A.09.50

BAND 5

Selects BAND 5 as the band for the current step.

Key Path:	Source, List Sequencer, List Sequencer Setup, Radio Setup, Radio Standard, LTE
Initial S/W Revision:	A.09.50

BAND 6

Selects BAND 6 as the band for the current step.

Key Path:	Source, List Sequencer, List Sequencer Setup, Radio Setup, Radio Standard, LTE
Initial S/W Revision:	A.09.50

BAND 7

Selects BAND 7 as the band for the current step.

Key Path:	Source, List Sequencer, List Sequencer Setup, Radio Setup, Radio Standard, LTE
Initial S/W Revision:	A.09.50

BAND 8

Selects BAND 8 as the band for the current step.

Key Path:	Source, List Sequencer, List Sequencer Setup, Radio Setup, Radio Standard, LTE
Initial S/W Revision:	A.09.50

BAND 9

Selects BAND 9 as the band for the current step.

Key Path:	Source, List Sequencer, List Sequencer Setup, Radio Setup, Radio Standard, LTE
Initial S/W Revision:	A.09.50

BAND 10

Selects BAND 10 as the band for the current step.

Key Path:	Source, List Sequencer, List Sequencer Setup, Radio Setup, Radio Standard, LTE
Initial S/W Revision:	A.09.50

BAND 11

Selects BAND 11 as the band for the current step.

Key Path:	Source, List Sequencer, List Sequencer Setup, Radio Setup, Radio Standard, LTE
Initial S/W Revision:	A.09.50

BAND 12

Selects BAND 12 as the band for the current step.

Key Path:	Source, List Sequencer, List Sequencer Setup, Radio Setup, Radio Standard, LTE
Initial S/W Revision:	A.09.50

BAND 13

Selects BAND 13 as the band for the current step.

Key Path:	Source, List Sequencer, List Sequencer Setup, Radio Setup, Radio Standard, LTE
Initial S/W Revision:	A.09.50

BAND 14

Selects BAND 14 as the band for the current step.

Key Path:	Source, List Sequencer, List Sequencer Setup, Radio Setup, Radio Standard, LTE
Initial S/W Revision:	A.09.50

BAND 17

Selects BAND 17 as the band for the current step.

Key Path:	Source, List Sequencer, List Sequencer Setup, Radio Setup, Radio Standard, LTE
Initial S/W Revision:	A.09.50

Source (Internal)

BAND 18

Selects BAND 18 as the band for the current step.

Key Path:	Source, List Sequencer, List Sequencer Setup, Radio Setup, Radio Standard, LTE
Initial S/W Revision:	A.09.50

BAND 19

Selects BAND 19 as the band for the current step.

Key Path:	Source, List Sequencer, List Sequencer Setup, Radio Setup, Radio Standard, LTE
Initial S/W Revision:	A.09.50

BAND 20

Selects BAND 20 as the band for the current step.

Key Path:	Source, List Sequencer, List Sequencer Setup, Radio Setup, Radio Standard, LTE
Initial S/W Revision:	A.09.50

BAND 21

Selects BAND 21 as the band for the current step.

Key Path:	Source, List Sequencer, List Sequencer Setup, Radio Setup, Radio Standard, LTE
Initial S/W Revision:	A.09.50

BAND 24

Selects BAND 24 as the band for the current step.

Key Path:	Source, List Sequencer, List Sequencer Setup, Radio Setup, Radio Standard, LTE
Initial S/W Revision:	A.09.50

BAND 25

Selects BAND 25 as the band for the current step.

Key Path:	Source, List Sequencer, List Sequencer Setup, Radio Setup, Radio Standard, LTE
Initial S/W Revision:	A.09.50

LTE TDD

Pressing this key once selects LTE TDD as the radio standard and the current LTE TDD band as the active channel band. Pressing this key again allows access to the sub-menus for selecting a different LTE TDD band

Key Path:	Source, List Sequencer, List Sequencer Setup, Radio Setup, Radio Standard
Initial S/W Revision:	A.11.50

BAND 33

Selects BAND 33 as the band for the current step.

Key Path:	Source, List Sequencer, List Sequencer Setup, Radio Setup, Radio Standard, LTE TDD
Initial S/W Revision:	A.11.50

BAND 34

Selects BAND 34 as the band for the current step.

Key Path:	Source, List Sequencer, List Sequencer Setup, Radio Setup, Radio Standard, LTE TDD
Initial S/W Revision:	A.11.50

BAND 35

Selects BAND 35 as the band for the current step.

Key Path:	Source, List Sequencer, List Sequencer Setup, Radio Setup, Radio Standard, LTE TDD
Initial S/W Revision:	A.11.50

BAND 36

Selects BAND 36 as the band for the current step.

Key Path:	Source, List Sequencer, List Sequencer Setup, Radio Setup, Radio Standard, LTE TDD
Initial S/W Revision:	A.11.50

BAND 37

Selects BAND 37 as the band for the current step.

Key Path:	Source, List Sequencer, List Sequencer Setup, Radio Setup, Radio Standard, LTE TDD
Initial S/W Revision:	A.11.50

Source (Internal)

BAND 38

Selects BAND 38 as the band for the current step.

Key Path:	Source, List Sequencer, List Sequencer Setup, Radio Setup, Radio Standard, LTE TDD
Initial S/W Revision:	A.11.50

BAND 39

Selects BAND 39 as the band for the current step.

Key Path:	Source, List Sequencer, List Sequencer Setup, Radio Setup, Radio Standard, LTE TDD
Initial S/W Revision:	A.11.50

BAND 40

Selects BAND 40 as the band for the current step.

Key Path:	Source, List Sequencer, List Sequencer Setup, Radio Setup, Radio Standard, LTE TDD
Initial S/W Revision:	A.11.50

BAND 41

Selects BAND 41 as the band for the current step.

Key Path:	Source, List Sequencer, List Sequencer Setup, Radio Setup, Radio Standard, LTE TDD
Initial S/W Revision:	A.11.50

BAND 42

Selects BAND 42 as the band for the current step.

Key Path:	Source, List Sequencer, List Sequencer Setup, Radio Setup, Radio Standard, LTE TDD
Initial S/W Revision:	A.11.50

BAND 43

Selects BAND 43 as the band for the current step.

Key Path:	Source, List Sequencer, List Sequencer Setup, Radio Setup, Radio Standard, LTE TDD
Initial S/W Revision:	A.11.50

TDSCDMA

Pressing this key once selects TDSCDMA as the radio standard and the current TDSCDMA band as the active channel band. Pressing this key again allows access to the sub-menus for selecting a different TDSCDMA band

Key Path:	Source, List Sequencer, List Sequencer Setup, Radio Setup, Radio Standard
Initial S/W Revision:	A.11.50

BAND A

Selects BAND A as the band for the current step.

Key Path:	Source, List Sequencer, List Sequencer Setup, Radio Setup, Radio Standard, TDSCDMA
Initial S/W Revision:	A.11.50

BAND B

Selects BAND B as the band for the current step.

Key Path:	Source, List Sequencer, List Sequencer Setup, Radio Setup, Radio Standard, TDSCDMA
Initial S/W Revision:	A.11.50

BAND C

Selects BAND C as the band for the current step.

Key Path:	Source, List Sequencer, List Sequencer Setup, Radio Setup, Radio Standard, TDSCDMA
Initial S/W Revision:	A.11.50

BAND D

Selects BAND D as the band for the current step.

Key Path:	Source, List Sequencer, List Sequencer Setup, Radio Setup, Radio Standard, TDSCDMA
Initial S/W Revision:	A.11.50

BAND E

Selects BAND E as the band for the current step.

Key Path:	Source, List Sequencer, List Sequencer Setup, Radio Setup, Radio Standard, TDSCDMA
Initial S/W Revision:	A.11.50

Source (Internal)

BAND F

Selects BAND F as the band for the current step.

Key Path:	Source, List Sequencer, List Sequencer Setup, Radio Setup, Radio Standard, TDSCDMA
Initial S/W Revision:	A.11.50

Radio Band Link

Allows you to specify the radio band link direction for the steps within the list sequence. The link is used in conjunction with the channel band and channel number to determine the output frequency.

When set to “Uplink”, the source will calculate the uplink frequency according to an uplink formula together with selected channel band and channel number. When set to “Downlink”, the source will calculate the downlink frequency according to a downlink formula together with selected channel band and channel number.

Key Path:	Source, List Sequencer, List Sequencer Setup, Radio Setup
Remote Command:	:SOURce:LIST:STEP [1] 2 3...1000:SETup:RADio:BAND:LINK DOWN UP :SOURce:LIST:STEP [1] 2 3...1000:SETup:RADio:BAND:LINK?
Example:	SOUR:LIST:STEP2:SET:RAD:BAND:LINK UP SOUR:LIST:STEP2:SET:RAD:BAND:LINK?
Notes:	SCPI is supported after A.09.40
Preset:	DOWN
Range:	DOWN UP
Initial S/W Revision:	A.05.00

Channel

Allows you to specify the frequency of the current step via a channel number.

Key Path:	Source, List Sequencer, List Sequencer Setup
Remote Command:	:SOURce:LIST:STEP [1] 2 3...1000:SETup:CNFRequency <double> :SOURce:LIST:STEP [1] 2 3...1000:SETup:CNFRequency?
Example:	SOUR:LIST:STEP2:SET:CNFR 124 SOUR:LIST:STEP2:SET:CNFR?
Notes:	SCPI is supported after A.09.40. This SCPI is used to setup channel number or frequency setting, according to current Radio Band setting. If Radio Band is “NONE”, then it’s frequency. If Radio Band is not “NONE”, then it’s channel number.

Couplings:	The channel number is coupled to the step frequency value. When the step frequency value is changed, the channel number will increase or decrease to match the new step frequency. If the step frequency is not at an exact match for a channel number, the nearest channel number is displayed, along with a greater than, or less than sign to indicate the frequency is above or below the channel number.
Preset:	1
Min:	0 (Please refer to for valid ranges.)
Max:	10838 (Please refer to for valid ranges.)
Initial S/W Revision:	A.05.00

Frequency

Allows you to specify a frequency value for the current step.

Key Path:	Source, List Sequencer, List Sequencer Setup
Remote Command:	:SOURce:LIST:STEP [1] 2 3...1000:SETup:CNFRfrequency <double> :SOURce:LIST:STEP [1] 2 3...1000:SETup:CNFRfrequency?
Example:	SOUR:LIST:STEP2:SET:CNFR 1GHz SOUR:LIST:STEP2:SET:CNFR?
Notes:	SCPI is supported after A.09.40. This SCPI is used to setup channel number or frequency setting, according to current Radio Band setting. If Radio Band is "NONE", then it's frequency. If Radio Band is not "NONE", then it's channel number.
Couplings:	The frequency value is coupled to the channel band and number for the step, such that updates to the radio band and channel number will update the frequency value to the corresponding absolute frequency. The reverse is also true, changing the frequency value causes the value of the channel number to be updated.
Preset:	1.00 GHz
Min:	10.00 MHz
Max:	Hardware Dependant: Option 503 = 3.6 GHz Option 504 = 3.8 GHz
Initial S/W Revision:	A.05.00

Source (Internal)

Power

Allows you to specify a power value for the current step.

Key Path:	Source, List Sequencer, List Sequencer Setup
Remote Command:	:SOURce:LIST:STEP [1] 2 3...1000:SETup:AMPLitude <double> :SOURce:LIST:STEP [1] 2 3...1000:SETup:AMPLitude?
Example:	SOUR:LIST:STEP2:SET:AMPL -50dBm SOUR:LIST:STEP2:SET:AMPL?
Notes:	SCPI is supported after A.09.40
Notes:	Amplitude corrections can be specified for use with the source. In the event of amplitude corrections being applied, the valid ranges for the RF power do not change dependant on the current amplitude correction setting. Instead, if the combination of RF power + amplitude correction is higher or lower than the source output range, the Source Unleveled bit is set and the “Source Unleveled” indicator will appear on status panel to indicate that the source cannot maintain the output power that has been requested.
Notes:	The Min and Max value here defined UI settable amplitude range. This range is larger than actual amplitude range with level accuracy defined in spec.
Dependencies:	The RF power is dependent on the RF output port and frequency, such that the current frequency and selected output port determine the valid range of power values.
Preset:	-100 dBm
Min:	The range of values depends on the current frequency and selected RF output port. Please refer to “RF Power” on page 1138 and the table RF Power Range for the valid ranges.
Max:	The range of values depends on the current frequency and selected RF output port. Please refer to “RF Power” on page 1138 and the table RF Power Range for the valid ranges.
Initial S/W Revision:	A.05.00

Waveform

Allows you access to the sub-menus for selecting the waveform to be played back during the current step. Pressing this key also changes the central display area to show the Waveform File Selection view.

Key Path:	Source, List Sequencer, List Sequencer Setup
Remote Command:	:SOURce:LIST:STEP [1] 2 3...1000:SETup:WAVEform <string> :SOURce:LIST:STEP [1] 2 3...1000:SETup:WAVEform?
Example:	SOUR:LIST:STEP2:SET:WAV “CW” SOUR:LIST:STEP2:SET:WAV?
Notes:	SCPI is supported after A.09.40

Remote Command Notes:	String type, takes “Off” “CW” “Cont” “waveform name”
Preset:	CW
Range:	Waveform Continue Previous CW Off
Initial S/W Revision:	A.05.00

CW

Sets the current step to output a CW tone.

Key Path:	Source, List Sequencer, List Sequencer Setup, Waveform
Example:	SOUR:LIST:STEP2:SET:WAV “CW”
Notes:	SCPI is supported after A.09.40
Initial S/W Revision:	A.05.00

Selected Waveform

Inserts the currently selected waveform in the waveform selection view as the waveform for playback during the current step.

Key Path:	Source, List Sequencer, List Sequencer Setup, Waveform
Example:	SOUR:LIST:STEP2:SET:WAV “waveform name”
Notes:	SCPI is supported after A.09.40 If the selected waveform contains header (which contains ARB play parameters), source list sequence will automatically apply header settings of the selected waveform in that step.
Initial S/W Revision:	A.05.00

Continue Previous

Sets the current step to continue with playback of the waveform from the previous step. When continuing the previous waveform, the ARB playback will not pause while the source retunes to the new frequency or amplitude that may be defined for the new step.

Key Path:	Source, List Sequencer, List Sequencer Setup, Waveform
Example:	SOUR:LIST:STEP2:SET:WAV “Cont”
Notes:	SCPI is supported after A.09.40
Initial S/W Revision:	A.05.00

Off

Disable RF output of the current step.

Key Path:	Source, List Sequencer, List Sequencer Setup, Waveform
-----------	---

Source (Internal)

Example:	SOUR:LIST:STEP2:SET:WAV "Off"
Notes:	SCPI is supported after A.09.40
Initial S/W Revision:	A.05.00

Segments on Hard Disk

This key functions the same as ["Segments on Hard Disk"](#) on page 1174.

Key Path:	Source, List Sequencer, List Sequencer Setup, Waveform
Initial S/W Revision:	Prior to A.09.00

Load Segment To ARB Memory

This key functions the same as ["Load Segment To ARB Memory"](#) on page 1175.

Key Path:	Source, List Sequencer, List Sequencer Setup, Waveform, Segment on Hard Drive
Initial S/W Revision:	Prior to A.09.00

Load All To ARB Memory

This key functions the same as ["Load All To ARB Memory"](#) on page 1176.

Key Path:	Source, List Sequencer, List Sequencer Setup, Waveform, Segment on Hard Drive
Initial S/W Revision:	Prior to A.09.00

Change Directory ...

This key functions the same as ["Change Directory..."](#) on page 1177.

Key Path:	Source, List Sequencer, List Sequencer Setup, Waveform, Segment on Hard Drive
Initial S/W Revision:	Prior to A.09.00

Default Directory ...

This key functions the same as ["Default Directory..."](#) on page 1177

Key Path:	Source, List Sequencer, List Sequencer Setup, Waveform, Segment on Hard Drive
Initial S/W Revision:	Prior to A.09.00

Segments in ARB Memory

This key functions the same as [“Segments in ARB Memory” on page 1178](#).

Key Path:	Source, List Sequencer, List Sequencer Setup, Waveform, Segments in ARB Memory
Initial S/W Revision:	Prior to A.09.00

Delete Segment From ARB Memory

This key functions the same as [“Delete Segment From ARB Mem” on page 1178](#).

Key Path:	Source, List Sequencer, List Sequencer Setup, Waveform, Segments in ARB Memory, Segment in ARB Memory
Initial S/W Revision:	Prior to A.09.00

Delete All From ARB Memory

This key functions the same as [“Delete All From ARB Memory” on page 1178](#).

Key Path:	Source, List Sequencer, List Sequencer Setup, Waveform, Segments in ARB Memory, Segment in ARB Memory
Initial S/W Revision:	Prior to A.09.00

Step Duration

Allows access to the sub-menus for setting up the duration of play for the current step.

The duration can be set to be either the number of times for the ARB file associated with the sequence to play, or a specific time value, or continuous. If the step is set to play a CW tone, the step duration cannot be set to a play count.

Key Path:	Source, List Sequencer, List Sequencer Setup
Remote Command:	:SOURce:LIST:STEP [1] 2 3...1000:SETup:DURation:TYPE TIME COUNT CONTInuous :SOURce:LIST:STEP [1] 2 3...1000:SETup:DURation:TYPE?
Example:	SOUR:LIST:STEP2:SET:DUR:TYPE TIME SOUR:LIST:STEP2:SET:DUR:TYPE?
Notes:	SCPI is supported after A.09.40
Notes:	If “Step Duration” is set to “Time” or “Play Count” for the last step, the last step of ARB keeps playing as if set to “Continuous”, until the set “Time” has expired or until the “Play Count” setting is reached.
Range:	Time Play Count Continuous
Initial S/W Revision:	A.05.00

Source (Internal)

Time

Sets the duration of the current step to be a time value for the length of time the step will play. Pressing this key again opens another menu which allows you to set the time value for the step duration.

Key Path:	Source, List Sequencer, List Sequencer Setup, Step Duration
Example:	SOUR:LIST:STEP2:SET:DUR:TYPE TIME
Notes:	SCPI is supported after A.09.40
Initial S/W Revision:	A.05.00

Duration Time

Allows you to specify the length of time the current step will play.

If the Transition Time value is longer than the Step Duration Time, an error is generated when initiating a source list sequence. For source list sequence, transition time is included in the step duration length. If the Transition Time value is longer than the Step Duration Time, the real step duration length is extended to equal the transition time and cause a timing shift.

Key Path:	Source, List Sequencer, List Sequencer Setup, Step Duration, Time
Remote Command:	:SOURce:LIST:STEP [1] 2 3...1000:SETup:DURation:TCOUNT <double> :SOURce:LIST:STEP [1] 2 3...1000:SETup:DURation:TCOUNT?
Example:	SOUR:LIST:STEP2:SET:DUR:TCO 1s SOUR:LIST:STEP2:SET:DUR:TCO?
Notes:	SCPI is supported after A.09.40 This SCPI is reused by “Play Count” and “Duration Time” according to current Duration Type setting if “Play Count” or “Duration Time”. If current “Duration Type” is “Continuous”, then popup error -221, "Settings conflict; Cannot accept time or count input when step duration type is Continuous on step #"
Notes:	If “Duration Time” is set for the last step, the last step of ARB keeps playing as if set to “Continuous” after set time expires. However, you can query Source Sweeping Condition Message (:STAT:OPER:COND?) to find out if the current list sequence is complete or not.
Preset:	1.00 ms
Min:	100 μ s
Max:	1800 s
Initial S/W Revision:	A.05.00

Play Count

Sets the duration of the current step to be an integer value for the number of times (play count) the ARB file is

selected for playback during this step. For example, a 5 second ARB will be set to play 5 times during the step.

Key Path:	Source, List Sequencer, List Sequencer Setup, Step Duration
Example:	SOUR:LIST:STEP2:SET:DUR:TYPE COUN
Notes:	SCPI is supported after A.09.40 This key is unavailable and is grayed out if the current step is configured to CW tone rather than an ARB waveform.
Initial S/W Revision:	A.05.00

Play Count

Allows you to specify the number of times the current ARB waveform file will play during a step.

Key Path:	Source, List Sequencer, List Sequencer Setup, Step Duration, Time, Play Count
Remote Command:	:SOURce:LIST:STEP [1] 2 3...1000:SETup:DURation:TCoun <double> :SOURce:LIST:STEP [1] 2 3...1000:SETup:DURation:TCoun?
Example:	SOUR:LIST:STEP2:SET:DUR:TCO 10 SOUR:LIST:STEP2:SET:DUR:TCO?
Notes:	SCPI is supported after A.09.40 This SCPI is reused by “Play Count” and “Duration Time” according to current Duration Type setting if “Play Count” or “Duration Time”. If current “Duration Type” is “Continuous”, then popup error –221, "Settings conflict;Cannot accept time or count input when step duration type is Continuous on step #"
Notes:	If “Play Count” is set for the last step, the last step of ARB keeps playing as if set to “Continuous” after play count setting is reached.
Preset:	1
Min:	1
Max:	65536
Initial S/W Revision:	A.05.00

Continuous

Sets the current step to be played continuously until the next step starts.

Key Path:	Source, List Sequencer, List Sequencer Setup, Step Duration
Example:	SOUR:LIST:STEP2:SET:DUR:TYPE CONT
Notes:	SCPI is supported after A.09.40
Initial S/W Revision:	A.05.00

Source (Internal)

Output Trigger

Allows you to specify the trigger output for the current step. The trigger output signal is sent at the start of the step.

When select “On”, trigger event will occur on both Internal and External2 paths. Select “Off” will turn off trigger output.

Key Path:	Source, List Sequencer, List Sequencer Setup
Remote Command:	:SOURce:LIST:STEP [1] 2 3...1000:SETup:OUTPut:TRIGger ON OFF 1 0 :SOURce:LIST:STEP [1] 2 3...1000:SETup:OUTPut:TRIGger
Example:	SOUR:LIST:STEP2:SET:OUTP:TRIG ON SOUR:LIST:STEP2:SET:OUTP:TRIG?
Notes:	SCPI is supported after A.09.40
Preset:	Off
Range:	On Off
Initial S/W Revision:	A.05.00

Step Configuration (Remote Command Only)

This SCPI command is used to configure the List Sequencer and is detailed in the table below. The command is defined such that you send one command per step, with the step number being specified as a subopcode of the SCPI command. Each command includes all the parameter settings for the step. As a step is setup, the values entered are run through several levels of validation.

Remote Command:	:SOURce:LIST:STEP [1] 2 3 4..1000:SETup IMMediate INTernal KEY BUS EXTernal2, <time>, NONE PGSM EGSM RGSM DCS1800 PCS1900 TGSM810 GSM450 GSM4 80 GSM700 GSM850 BANDI BANDII BANDIII BANDIV BANDV BAND VI BANDVII BANDVIII BANDIX BANDX BANDXI BANDXII BANDXII I BANDXIV USCELL USPCS JAPAN KOREAN NMT IMT2K UPPER SEC OND PAMR400 PAMR800 IMTEXT PCS1DOT9G AWS US2DOT5G PUBLI C LOWER NONE BAND1 BAND2 BAND3 BAND4 BAND5 BAND6 BAND7 BAND8 BAND10 BAND11 BAND12 BAND13 BAND14 BAND17 BAND18 BAND19 BAND20 BAND21 BAND24 BAND25 BAND33 BAND34 BAND35 BAND36 BAND37 BAND38 BAND39 BAND40 BAND41 BAND42 BAND4 3 BANDA BANDB BANDC BANDD BANDE BANDF, DOWN UP, <freq>, <ampl>, <string>, TIME COUNT CONTInuous, <time>, ON OFF 1 0, [<int>], :SOURce:LIST:STEP [1] 2 3 4..1000:SETup?
Example:	SOUR:LIST:STEP1:SET INT, 1ms, PGSM, DOWN, 10, -25 dBm, “GSM_Test1.bin”, TIME, 10ms, OFF, 255

Notes:	<p>The parameters are: (There is a total of 11 items in each step, the following is a list of the items in the order they must appear in the remote command.)</p> <ol style="list-style-type: none"> 1. Step Trigger <enum> - specifies the input trigger for the step. For details of the valid types of step trigger see “Step Trigger” on page 1222. 2. Transition Time <time> - specifies the transition time for the step in seconds. For details of the valid ranges for the transition time see “Transition Time” on page 1224. 3. Radio Band <enum> - specifies the radio band for the step. For details of the valid radio bands see “Radio Setup” on page 1225. 4. Radio Band Link <enum> - specifies the radio band link direction for the step. For details of the valid link types, see “Radio Band Link” on page 1240. 5. Frequency/Channel Number <freq>/<chan num> - specifies the frequency in Hz or the channel number for the step. The channel number and frequency are combined as one parameter that represents the frequency or channel number depending on the radio band setting. If the radio band is set to NONE, this value is interpreted as a frequency value in Hz. If the radio band is set to a valid band, this value is interpreted as a channel number. For details of the valid ranges for frequency and channel numbers, see “Channel” on page 1240 and “Frequency” on page 1241. 6. Power <ampl> - specifies the output power for the step in dBm. For details of the valid ranges see “Power” on page 1242. 7. Waveform <string> - specifies the waveform for playback during the step. The step can output either a new ARB waveform, continue playback of the previous waveform, or output a CW tone. The options for specifying these are: <ul style="list-style-type: none"> <filename> - plays the specified waveform from the start. The filename value is the name of the file within ARB playback memory, it does not include the windows path to the file on the HDD. If you enter a filename for a waveform that does not reside within ARB playback memory, an error is generated. CONT – continues playback of the ARB file from the previous step CW – outputs a CW tone OFF – disable RF output 8. Step Duration <enum> - specifies the duration of the step. The duration can be specified to be either time, or play count of the ARB file associated with the step, or continuous. If Waveform is set to “CW”, this value cannot be set to Play Count and an error will be generated. If continuous is selected, the following Time or Count value is ignored. For further details of this setting, see “Step Duration” on page 1245. 9. Time or Count <time/int> - specifies time duration in seconds or play count of the ARB file associated with the step. For further details of this setting, including the valid ranges for the time or play count setting, “Time” on page 1246 and “Play Count” on page 1246. 10. Output Trigger <Boolean> - specifies the output trigger for the step. For details of the ranges for this setting see “Output Trigger” on page 1248.
--------	---

Source (Internal)

Dependencies:	The range of subopcode values is 1 to 1000 and the value you enter is determined by the number of steps you have configured. For details see “Number of Steps” on page 1221 . If you attempt to remotely set or query a subopcode that is out of range, an error is generated.
Initial S/W Revision:	A.05.00

Step Configuration of Step Trigger parameter list (Remote Command Only)

This SCPI command is to configure “Step Trigger” parameter array of the whole List Sequencer at one time. The number of array is same as step number defined in [“Number of Steps” on page 1221](#) Number of Steps. As a step is setup, the value entered run through several levels of validation.

Remote Command:	:SOURce:LIST:SETup:INPut:TRIGger <enum>, <enum>, <enum>, ... :SOURce:LIST:SETup:INPut:TRIGger?
Example:	SOUR:LIST:SET:INP:TRIG IMM,INT,EXT2 SOUR:LIST:SET:INP:TRIG?
Notes:	The command is to setup below parameter array of whole list sequence. Step Trigger <enum> - specifies the input trigger for the step. For details of the valid types of step trigger see “Step Trigger” on page 1222 . If input parameter number exceeds the step number defined by Number of Steps then generate error ", and only those parametes whose index number falls in number of steps will be updated.
Remote Command Notes:	IMMediate INTErnal KEY BUS EXTernal2
Dependencies:	The range is 1 to 1000 which is determined by the number of steps you have configured. For details see “Number of Steps” on page 1221 .
Initial S/W Revision:	A.09.40

Step Configuration of Transition Time parameter list (Remote Command Only)

This SCPI command is to configure “Transition Time” parameter array of the whole List Sequencer at one time. The number of array is same as step number defined in [“Number of Steps” on page 1221](#) Number of Steps. As a step is setup, the value entered run through several levels of validation.

Remote Command:	:SOURce:LIST:SETup:TRANSition:TIME <time>, <time>, <time>, ... :SOURce:LIST:SETup:TRANSition:TIME?
Example:	SOUR:LIST:SET:TRAN:TIME 1ms,1ms,1ms SOUR:LIST:SET:TRAN:TIME?

Notes:	The command is to setup below parameter array of whole list sequence. Transition Time <time> - specifies the transition time for the step in seconds. For details of the valid ranges for the transition time see “Transition Time” on page 1224 If input parameter number exceeds the step number defined by Number of Steps then generate error ", and only those parameters whose index number falls in number of steps will be updated.
Dependencies:	The range is 1 to 1000 which is determined by the number of steps you have configured. For details see “Number of Steps” on page 1221 .
Initial S/W Revision:	A.09.40

Step Configuration of Radio Band parameter list (Remote Command Only)

This SCPI command is to configure “Radio Band” parameter array of the whole List Sequencer at one time. The number of array is same as step number defined in [“Number of Steps” on page 1221](#) Number of Steps. As a step is setup, the value entered run through several levels of validation.

Remote Command:	:SOURCE:LIST:SETup:RADio:BAND <enum>, <enum>, <enum>, ... :SOURCE:LIST:SETup:RADio:BAND?
Example:	SOUR:LIST:SET:RAD:BAND PGSM, EGSM, RGSM SOUR:LIST:SET:RAD:BAND?
Notes:	The command is to setup below parameter array of whole list sequence. Radio Band <enum> - specifies the radio band for the step. For details of the valid radio bands see “Radio Setup” on page 1225 . If input parameter number exceeds the step number defined by Number of Steps then generate error ", and only those parameters whose index number falls in number of steps will be updated.
Remote Command Notes:	NONE PGSM EGSM RGSM DCS1800 PCS1900 TGSM810 GSM450 GSM480 GSM700 GSM850 BANDI BANDII BANDIII BANDIV BANDV BANDVI BANDVII BANDVIII BANDIX BANDX BANDXI BANDXII BANDXIII BANDXIV USCELL USPCS JAPAN KOREAN NMT IMT2K UPPER SECOND PAMR400 PAMR800 IMTEXT PCS1DOT9G AWS US2DOT5G PUBLIC LOWER NONE BAND1 BAND2 BAND3 BAND4 BAND5 BAND6 BAND7 BAND8 BAND10 BAND11 BAND12 BAND13 BAND14 BAND17 BAND18 BAND19 BAND20 BAND21 BAND24 BAND25
Dependencies:	The range is 1 to 1000 which is determined by the number of steps you have configured. For details see “Number of Steps” on page 1221 .
Initial S/W Revision:	A.09.40

Step Configuration of Radio Band Link parameter list (Remote Command Only)

This SCPI command is to configure “Radio Band Link” parameter array of the whole List Sequencer at one time. The number of array is same as step number defined in [“Number of Steps” on page 1221](#) Number of Steps. As a

Source (Internal)

step is setup, the value entered run through several levels of validation.

Remote Command:	:SOURce:LIST:SETup:RADio:BAND:LINK <enum>, <enum>, <enum>, ... :SOURce:LIST:SETup:RADio:BAND:LINK?
Example:	SOUR:LIST:SET:RAD:BAND:LINK DOWN,UP,UP SOUR:LIST:SET:RAD:BAND:LINK?
Notes:	The command is to setup below parameter array of whole list sequence. Radio Band Link <enum> - specifies the radio band link direction for the step. For details of the valid link types, see “Radio Band Link” on page 1240 . If input parameter number exceeds the step number defined by Number of Steps then generate error ", and only those parametes whose index number falls in number of steps will be updated.
Remote Command Notes:	DOWN UP
Dependencies:	The range is 1 to 1000 which is determined by the number of steps you have configured. For details see “Number of Steps” on page 1221 .
Initial S/W Revision:	A.09.40

Step Configuration of Frequency/Channel Number parameter list (Remote Command Only)

This SCPI command is to configure “Frequency” or “Channel Number” parameter array of the whole List Sequencer at one time. The number of array is same as step number defined in [“Number of Steps” on page 1221](#) Number of Steps. As a step is setup, the value entered run through several levels of validation.

Remote Command:	:SOURce:LIST:SETup:CNFRrequency <double>, <double>, <double>, ... :SOURce:LIST:SETup:CNFRrequency?
Example:	SOUR:LIST:SET:CNFR 1GHz,100MHz,100MHz SOUR:LIST:SET:CNFR? SOUR:LIST:SET:CNFR 124,124,124 SOUR:LIST:SET:CNFR?

Notes:	<p>The command is to setup below parameter array of whole list sequence.</p> <p>Frequency/Channel Number <freq>/<chan num> - specifies the frequency in Hz or the channel number for the step. The channel number and frequency are combined as one parameter that represents the frequency or channel number depending on the radio band setting. If the radio band is set to NONE, this value is interpreted as a frequency value in Hz. If the radio band is set to a valid band, this value is interpreted as a channel number. For details of the valid ranges for frequency and channel numbers, see “Channel” on page 1240 and “Frequency” on page 1241</p> <p>This SCPI is used to setup/query channel number or frequency setting, according to current Radio Band setting of that step. If Radio Band is “NONE”, then it’s frequency. If Radio Band is not “NONE”, then it’s channel number</p> <p>If input parameter number exceeds the step number defined by Number of Steps then generate error ", and only those parametes whose index number falls in legal step number will be updated.</p>
Dependencies:	The range is 1 to 1000 which is determined by the number of steps you have configured. For details see “Number of Steps” on page 1221 .
Initial S/W Revision:	A.09.40

Step Configuration of Power parameter list (Remote Command Only)

This SCPI command is to configure “Power” parameter array of the whole List Sequencer at one time. The number of array is same as step number defined in [“Number of Steps” on page 1221](#) Number of Steps. As a step is setup, the value entered run through several levels of validation.

Remote Command:	:SOURCE:LIST:SETup:AMPLitude <ampl>, <ampl>, <ampl>, ... :SOURCE:LIST:SETup:AMPLitude?
Example:	SOUR:LIST:SET:AMPL -50dBm,-40dBm,-30dBm SOUR:LIST:SET:AMPL?
Notes:	<p>The command is to setup below parameter array of whole list sequence.</p> <p>Power <ampl> - specifies the output power for the step in dBm. For details of the valid ranges see “Power” on page 1242.</p> <p>If input parameter number exceeds the step number defined by Number of Steps then generate error ", and only those parametes whose index number falls in legal step number will be updated.</p>
Dependencies:	The range is 1 to 1000 which is determined by the number of steps you have configured. For details see “Number of Steps” on page 1221 .
Initial S/W Revision:	A.09.40

Step Configuration of Waveform parameter list (Remote Command Only)

This SCPI command is to configure “Waveform” parameter array of the whole List Sequencer at one time. The number of array is same as step number defined in [“Number of Steps” on page 1221](#) Number of Steps. As a step is

Source (Internal)

setup, the value entered run through several levels of validation.

Remote Command:	:SOURCE:LIST:SETup:WAVEform <string>, <string>, <string>, ... :SOURCE:LIST:SETup:WAVEform?
Example:	SOUR:LIST:SET:WAV "CW","Off","CONT" SOUR:LIST:SET:WAV?
Notes:	The command is to setup below parameter array of whole list sequence. Waveform <string> - specifies the waveform for playback during the step. The step can output either a new ARB waveform, continue playback of the previous waveform, or output a CW tone. The options for specifying these are: <filename> - plays the specified waveform from the start. The filename value is the name of the file within ARB playback memory, it is does not include the windows path to the file on the HDD. If you enter a filename for a waveform that does not reside within ARB playback memory, an error is generated. CONT – continues playback of the ARB file from the previous step CW – outputs a CW tone OFF – disable RF output If input parameter number exceeds the step number defined by Number of Steps then generate error ", and only those parametes whose index number falls in number of steps will be updated.
Dependencies:	The range is 1 to 1000 which is determined by the number of steps you have configured. For details see "Number of Steps" on page 1221 .
Range:	"filename" "CW" "Off" "CONT"
Initial S/W Revision:	A.09.40

Step Configuration of Step Duration parameter list (Remote Command Only)

This SCPI command is to configure "Step Duration" parameter array of the whole List Sequencer at one time. The number of array is same as step number defined in ["Number of Steps" on page 1221](#) Number of Steps. As a step is setup, the value entered run through several levels of validation.

Remote Command:	:SOURCE:LIST:SETup:DURation:TYPE <enum>, <enum>, <enum>, ... :SOURCE:LIST:SETup:DURation:TYPE?
Example:	SOUR:LIST:SET:DUR:TYPE COUN,TIME,CONT SOUR:LIST:SET:DUR:TYPE?

Notes:	<p>The command is to setup below parameter array of whole list sequence.</p> <p>Step Duration <enum> - specifies the duration of the step. The duration can be specified to be either time, or play count of the ARB file associated with the step, or continuous. If Waveform is set to "CW", this value cannot be set to Play Count and an error will be generated. If continuous is selected, the following Time or Count value is ignored. For further details of this setting, see "Step Duration" on page 1245.</p> <p>If input parameter number exceeds the step number defined by Number of Steps then generate error ", and only those parametes whose index number falls in number of steps will be updated.</p>
Remote Command Notes:	TIME COUNT CONTInuous
Dependencies:	The range is 1 to 1000 which is determined by the number of steps you have configured. For details see "Number of Steps" on page 1221 .
Initial S/W Revision:	A.09.40

Step Configuration of Duration Time or Play Count parameter list (Remote Command Only)

This SCPI command is to configure "Duration Time" or "Play Count" parameter array of the whole List Sequencer at one time. The number of array is same as step number defined in ["Number of Steps" on page 1221](#) Number of Steps. As a step is setup, the value entered run through several levels of validation.

Remote Command:	<pre>:SOURCE:LIST:SETup:TOCount <time/int>, <time/int>, <time/int>, ... :SOURCE:LIST:SETup:TOCount?</pre>
Example:	<pre>SOUR:LIST:SET:TOC 1s,2s,3s SOUR:LIST:SET:TOC? SOUR:LIST:SET:TOC 5,6,7 SOUR:LIST:SET:TOC?</pre>
Notes:	<p>The command is to setup below parameter array of whole list sequence.</p> <p>Time or Count <time/int> - specifies time duration in seconds or play count of the ARB file associated with the step. For further details of this setting, including the valid ranges for the time or play count setting, "Time" on page 1246 and "Play Count" on page 1246.</p> <p>If input parameter number exceeds the step number defined by Number of Steps then generate error ", and only those parametes whose index number falls in number of steps will be updated.</p> <p>If current "Step Duration" on page 1245 is "Continuous", then generate error -221, "Settings conflict;Cannot accept time or count input when step duration type is Continuous on step #"</p>
Dependencies:	The range is 1 to 1000 which is determined by the number of steps you have configured. For details see "Number of Steps" on page 1221 .
Initial S/W Revision:	A.09.40

Source (Internal)

Step Configuration of Output Trigger parameter list (Remote Command Only)

This SCPI command is to configure “Output Trigger” parameter array of the whole List Sequencer at one time. The number of array is same as step number defined in “Number of Steps” on page 1221 Number of Steps. As a step is setup, the value entered run through several levels of validation.

Remote Command:	:SOURce:LIST:SETup:OUTPut:TRIGger <bool>, <bool>, <bool>, ... :SOURce:LIST:SETup:OUTPut:TRIGger ?
Example:	SOUR:LIST:SET:OUTP:TRIG ON,OFF,ON SOUR:LIST:SET:OUTP:TRIG?
Notes:	The command is to setup below parameter array of whole list sequence. Output Trigger <Boolean> - specifies the output trigger for the step. For details of the ranges for this setting see “Output Trigger” on page 1248. If input parameter number exceeds the step number defined by Number of Steps then generate error ", and only those parametes whose index number falls in legal step number will be updated.
Remote Command Notes:	ON OFF 1 0
Dependencies:	The range is 1 to 1000 which is determined by the number of steps you have configured. For details see “Number of Steps” on page 1221.
Initial S/W Revision:	A.09.40

Clear List (Remote Command Only)

This command is the SCPI equivalent of the Clear List UI feature described in.

Remote Command:	:SOURce:LIST:SETup:CLEar
Example:	SOUR:LIST:SETup:CLE
Initial S/W Revision:	A.05.00

Multiport Adapter Output Port Bitmap Mode

When this setting is set to LIST, it will allow you to select the multiport adapter output path of each step. When this setting is set to FIXEd, source list sequence multiport adapter output path on each step is controlled by global multiport adapter output port bitmap setting (same as source independent mode). Under this situation, source list sequence will ignore local multiport adapter output port bitmap setting defined in each step, they are still there and can be queried out, but take no effect.

Key Path:	Source, List Sequencer
Remote Command:	:SOURce:LIST:MPADapter:PORT:OUTPut:BITMap:MODE LIST FIXEd :SOURce:LIST:MPADapter:PORT:OUTPut:BITMap:MODE?

Example:	SOUR:LIST:MPAD:PORT:OUTP:BITM:MODE LIST SOUR:LIST:MPAD:PORT:OUTP:BITM:MODE?
Preset:	FIXed
Range:	LIST FIXed
State Saved:	Yes
Initial S/W Revision:	A.09.40

Multiport Adapter Output Port Amplitude Correction Configuration Validation for List Sequencer (Remote Command Only)

This command is used to validate MPA TX port amplitude correction for Source List Sequencer.

Key Path:	Source, List Sequencer
Remote Command:	:SOURce:LIST:MPADapter:CORRection:ERRor?
Example:	SOUR:LIST:MPAD:CORR:ERR?
Notes:	Query Only SCPI Remote command only If detected invalid configuration, popup error message: "-221 Settings conflict; Source List Step<n> MPA TX port<n> amplitude correction value <n>dB is out of range. The valid range is <n> ~ <n>dB" Or "-221 Settings conflict; Source List Step<n> MPA TX port<n> amplitude correction delta exceeds <n>dB between port<n> and port<n>" to report the first detected conflict.
Range:	"No error" Error info of the first found conflict
State Saved:	Yes
Initial S/W Revision:	A.12.00

Manual Trigger Now

Pressing this key provides a software trigger event to the list sequencer. During execution of sequence, if the sequencer is halted on any step that has been configured with a "Manual" step trigger, then this key press will cause the sequencer to continue and execute the step.

Key Path:	Source, List Sequencer
Remote Command:	No remote command, front panel only.
Initial S/W Revision:	A.05.00

Source (Internal)

Query List Sequence Initiation Armed Status (Remote Command Only)

This is a blocking SCPI query to determine if source list sequence being initiated successfully or not.

Remote Command:	:SOURce:LIST:INITiation:ARMed?
Example:	SOUR:LIST:INIT:ARMed?
Notes:	The return data is in the following format: Integer
Notes:	Query only SCPI. Returning “1” if list sequence has been initiated successfully, returning “0” if not. Once get “0”, you can use :SYST:ERR? to query what error happened. Just like “*OPC?”, this command can be blocked until event/status “IsSourceSweeping” happens, and then returns. Doing so can help user’s script query armed status only once during the time interval of the initiation. As an ancillary SCPI of existing SCPI “:SOUR:LIST:TRIGger[:IMMediate]” (see “Initiate Sequence” on page 1220 Initiate Sequence), the right usage of this command is to use it after “:SOUR:LIST:TRIG”. If not, this command will return “1” immediately.
Notes:	There is an alias SCPI “:SOURce:LIST:TRIGger:INITiation:ARMed?”.
Initial S/W Revision:	A.09.40

Source Preset

Allows you to preset the source settings to their default values.

Key Path:	Source
Remote Command:	:SOURce:PRESet
Example:	SOUR:PRES

Source Self Test

Internal Source

This key in the System, Diagnostics menu gives you access to diagnostic capabilities of Internal Source of the instrument.

Key Path:	System, Diagnostics
Initial S/W Revision:	Prior to A.09.20

Source Self Test

This key invokes internal source self test. When operation is complete, the generated test summary file is: E:\Agilent\Instrument\CRFSSelfTestLog.txt. This test summary file can be retrieved from the instrument using the MMEM set of SCPI command, once you have the fully qualified path and file name.

If self test fails, error message “–330, Self-test failed, see log file E:\Agilent\Instrument\CRFSSelfTestLog.txt” is generated. If self test passes, an advisory message “Source self-test completed successfully” is generated.

Key Path:	System, Diagnostics, Internal Source, Self Test
Remote Command:	:SOURce:SELF:TEST[:ALL]
Example:	SOUR:SELF:TEST
Notes:	MMEM:DATA? "E:\ Agilent\Instrument\CRFSSelfTestLog.txt"
Initial S/W Revision:	A.09.20

Recall

Most of the functions under this key work the same way in many measurements, so they are documented in the System Functions section. For details about this key, see [“Recall” on page 192](#)

Save

Most of the functions under this key work the same way in many measurements, so they are documented in the Utility Functions section. For details about this key, see [“Save” on page 204](#)

Signal Studio Commands

Overview

EXT supports connectivity with Signal Studio. To achieve this, the SCPI commands described in this chapter enable you to connect Signal Studio to the EXT test set and to download waveform into the hard disk. They are SCPI only, no menu

Initial S/W Revision:	A.05.00
-----------------------	---------

Query License List (Remote Command Only)

This query provides a listing of the current licenses for external software installed for the test set internal source.

Remote Command:	:SYSTem:LIcense:EXTErnal:LIST?
Example:	SYST:LIC:EXT:LIST?
Notes:	Query only.
Initial S/W Revision:	A.05.00

Query License List Detail (Remote Command Only)

This is an obsolete command for Signal Studio. However, it has not been removed from Signal Studio to prevent a Signal Studio connectivity time out. Using this command returns a null string and does not

Source (Internal)

affect Signal Studio.

Remote Command:	:SYSTem:LIcense:LIST:DETail?
Example:	SYST:LIC:LIST:DET?
Notes:	Query only. Always returns a null string "".
Initial S/W Revision:	A.05.00

Memory Subsystem (Remote Command Only)

To be compatible with other Signal Generator products, the EXT test set internal source provides a memory subsystem for Signal Studio to download waveform file into the instrument.

“NVWFM” (non-volatile storage) MSUS (Mass Storage Unit Specifier) is supported in the memory subsystem because the ARB memory cannot be accessed directly. Therefore, files must be downloaded to the instrument hard disk and then loaded into the ARB memory. “NVWFM” MSUS will be mapped to the default directory D:\NVARB.

In addition, you can load a waveform file from the hard disk to the ARB memory, using the [“Load Segment To ARB Memory”](#) on page 1175 remote command :SOURce:RADio:ARB:LOAD, which also supports using either “NVWFM” MSUS or specifying a full path.

Remote Command:	:MEMory[:SOURce]
Example:	MEM
Initial S/W Revision:	A.05.00

:DATA (Remote Command Only)

This command loads data into the EXT test set hard disk using the <data> parameter and saves the data to a file designated by the <file_name> variable. For downloads to non-volatile waveform memory, use the path “NVWFM:<file_name>”.

Remote Command:	:MEMory[:SOURce]:DATA <file_name>, <data>
Example:	MEM:DATA “NVWFM:test.wfm”, #1212 or MEM:DATA “D:\NVARB\test.wfm”, #1212
Notes:	Data is in 488.2 block format. If a file already exists with same name, the file will be overwritten without warning.
Initial S/W Revision:	A.05.00

:DATA:APPend (Remote Command Only)

This command appends data to an existing file stored in hard disk using the <data> parameter and saves

the data to a file designated by the <file_name> variable. For downloads to non-volatile waveform memory, use the path “NVWFM:<file_name>”.

Remote Command:	:MEMory[:SOURce]:DATA:APPend <file_name>, <data>
Example:	MEM:DATA:APP “NVWFM:test.wfm”, #14Y9oL or MEM:DATA:APP “D:\NVARB\test.wfm”, #14Y9oL
Notes:	Data is in 488.2 block format. If no file exists with the name designated in the command, a file will be created the first time this command is used with that designated name.
Initial S/W Revision:	A.05.00

Sequence Studio Commands

Overview

EXT supports connectivity with Sequence Studio. The SCPI commands described in this chapter are used to support connectivity from Sequence Studio to the EXT test set. These are only intended for Sequence Studio, so provided as service commands, and SCPI only, no menu

Initial S/W Revision	A.12.00
----------------------	---------

Query Supportable System Information Query SCPI List (Remote Command Only)

This query provides a listing of the current EXT supportable list of query SCPI which is used to query EXT HW/SW information. It returns string result and parsed by Sequence Studio.

Sequecne Studio needs to query some EXT system information like capability etc. when connecting. With more and more new SCPIs added in EXT FW, each time when Sequence Studio try to connect to an old version FW without those new SCPI commands, VISA timeout in Sequence Studio will occur and just make Sequence Studio looks dead. To avoid that, this SCPI is provided to give a list of current supportable information-query SCPI list.

Remote Command	:SERVice[:PRODUCTION]:SIQuery:SCPI:LIST?
Example	SERV:SIQ:SCPI:LIST?

Source (Internal)

Notes	<p>Query only</p> <p>The string in “Range” part cannot change, for Sequence Studio needs to accurately match those string character.</p> <p>If “SEQ Ver Info” string presents, then means “:SERVice[:PRODUCTION]:LSEQuencer:ANALyzer:FILE:VERSion?” and “:SERVice[:PRODUCTION]:LSEQuencer:SOURce:FILE:VERSion?” query SCPIs are supported in current version.</p> <p>If “ARB Header Info” string presents, that means “Query Selected Waveform Header info (Remote Command Only)” on page 1214 query SCPI is supported in current version.</p>
Range	“HW Capability Info”, “SEQ Ver Info”, “ARB Header Info”
Initial S/W Revision	A.12.00

Span

Activates the Span function and displays a menu of span functions.

Initial S/W Revision:	Prior to A.02.00
-----------------------	------------------

Span

Changes the displayed frequency range symmetrically about the center frequency. While adjusting the Span the Center Frequency is held constant, which means that both Start Frequency and Stop Frequency will change.

Span also sets the frequency entry mode to Center/Span. In Center/Span mode, the center frequency and span values are displayed below the graticule, and the default active function in the Frequency menu is **Center Freq**.

While discussing the Span function we make the distinction between “swept spans” and “zero span”. We use the term “swept spans” to mean spans other than zero; recognizing that, because of this terminology, the user can be in what we call a “swept span” even while performing an FFT “sweep”.

While in swept spans, setting the span to 0 Hz through SCPI or the front panel numeric key pad puts the test set into zero span. However, using the Step keys and the RPG in swept spans, the Span can only go as far down as 10 Hz and cannot be set to zero.

While in zero span, setting the Span to a non-zero value through SCPI or the front panel puts the test set in swept spans.

If the Span is set to a value greater than the maximum allowable span of the test set, an error is generated indicating the data is out of range and was clipped to upper limit.

Key Path	SPAN X Scale
Remote Command	[:SENSE] :FREQuency:SPAN <freq> [:SENSE] :FREQuency:SPAN?
Example	FREQ:SPAN 2GHz sets the span to 2 GHz FREQ:SPAN 0 Hz sets the span to 0 Hz and puts the test set in Zero Span
Notes	Preset and Max values depend on the Hardware Options
Dependencies	If the electrical attenuator is enabled, any attempt to set Span such that the Stop Frequency would be >3.6 GHz results in an error. If the key is pressed, an advisory message is generated. If the equivalent SCPI command is sent, this same message is generated as part of a “-221, Settings conflict” warning.

Span

Couplings	Span affects RBW, sweep time, FFT & Sweep choice (including FFT Width, Phase Noise Optimization and ADC Dither auto couplings.) When operating in “swept span”: <ul style="list-style-type: none"> Any value of the Center Frequency or Span that is within the frequency range of the test set is allowed when the value is being set through the front panel numeric key pad or the SCPI command. The other parameter is forced to a different value if needed, to keep the Start and the Stop Frequencies within the test set’s frequency range When using the knob or the step up/down keys or the UP DOWN keywords in SCPI, the value that is being changed i.e. the Center Frequency or Span, is limited so that the other parameter is not forced to a new value The Span cannot be set to Zero by setting Start Frequency = Stop Frequency. The value of the last setting is changed to maintain a minimum value of 10 Hz for the difference between start and stop frequencies.
Preset	Depends on test set maximum frequency: Option 503 (3.6 GHz models): 3.59 GHz Option 504 (3.8 GHz models): 3.8 GHz
State Saved	Saved in State
Min	10 Hz unless entered directly, then 0 Hz is allowed, but nothing between 0 and 10 is ever allowed.
Max	Option 503 (3.6 GHz models): 3.7 GHz Option 504 (3.8 GHz models): 3.9 GHz If the knob or step keys are being used, depends on the value of the other three interdependent parameters Center Frequency, Start Frequency, Stop Frequency
Default Unit	Hz
Status Bits/OPC dependencies	Overlapped if Signal Track is on (OPC shouldn’t return or clear until the zooming has completed for the new span)
Initial S/W Revision	Prior to A.02.00

Full Span

Changes the frequency span of the test set to the Preset frequency span of the test set and sets the Frequency entry mode to Center/Span.

The span is dependent on the currently selected Input (see the Section “Input/Output”).

Pressing this key while in zero span puts the test set back in swept span.

Key Path	SPAN X Scale
Remote Command	[:SENSe] :FREQuency :SPAN :FULL

Example	FREQ:SPAN:FULL sets the span to full frequency range of the test set
Notes	n / a
Couplings	Turns off signal tracking (span zoom). It does NOT turn off the markers, nor the current active function.
Initial S/W Revision	Prior to A.02.00

Zero Span

Changes the displayed frequency span to 0 Hz. The horizontal axis changes to time rather than frequency. The amplitude displayed is the input signal level at the current center frequency. This is a time-domain mode that changes several measurement functions and couplings. The test set behavior is similar to an oscilloscope with a frequency selective detector installed in front of the oscilloscope. See Application Note 150 for more information on how to use zero span.

You can enter Zero Span in several ways:

Press the Zero Span key in Span

Set Span = 0 Hz

Press last Span if the last span was 0

You cannot go to Zero Span by setting start freq = stop freq, or rolling span down with the RPG, that will limit you to 10 Hz

You can go back to Swept Span by setting Span to a nonzero value or pressing Last Span, assuming the last span was not also zero span.

Pressing Zero Span places the test set in Center/Span frequency entry mode.

The following table summarizes the differences between Zero Span and Swept Spans:

Zero Span	Swept Spans
X axis is time	X axis is frequency
There is no auto-RBW selection unless the EMC Standard is CISPR or MIL	RBW coupled to Span when RBW in auto
There is no auto sweep time	Sweep time coupled to RBW when sweep time in auto
Interval Power calculated in Mkr Function	Band Power calculated in Mkr Function
Can only define time limits when in zero span	Can only define frequency limits when in swept spectrum analysis
Marker Count counts at the center frequency	Marker Count counts at the marker frequency
CF Step Size set to RBW value	CF Step auto couples to 10% of Span
Some "Marker ->" commands not available.	Other "Marker ->" commands not available
Freq entry mode always Center/Span	Freq entry mode can be Center/Span or Start/Stop

Span

N dB points reports a time difference.	N dB points reports a frequency difference.
--	---

Key Path	SPAN X Scale
Example	FREQ:SPAN 0 Hz sets the span to zero, switches to Zero Span Sending FREQ:SPAN 1 MHz while in Zero Span, switches to Swept span
Notes	Setting the Span to 0 Hz will change to Zero Span and setting the span to a non-zero value will select a swept span
Notes	n /a
Dependencies	Zero Span key is unavailable (grayed out) if the following is true: Frequency scale type is LOG (for example, Log Sweep is On)
Couplings	Pressing Zero Span key (switching to Zero Span): Turns off signal track function (span zoom). Turns off the auto-coupling of RBW and sweep time.
Initial S/W Revision	Prior to A.02.00

Last Span

Changes the displayed frequency span to the previous span setting. If it is pressed immediately after Signal Track is turned off, then the span setting returns to the span that was in effect before Signal Track was turned on.

If this key is pressed while in a nonzero span, and the previous value of span was 0, it will put the test set back in Zero Span. And if it is pressed while in zero span, it will set the test set back to its last nonzero span.

Pressing Last Span places the test set in Center/Span frequency entry mode.

Key Path	SPAN X Scale
Remote Command	[:SENSE] :FREQuency:SPAN:PREVious
Example	FREQ:SPAN:PREV sets the span to the previous value
Notes	n /a
Initial S/W Revision	Prior to A.02.00

Sweep/Control

Accesses a menu that enables you to configure the Sweep and Control functions of the analyzer, such as Sweep Time and Gating.

Key Path:	Front-panel key
Initial S/W Revision:	Prior to A.02.00

Sweep Time

Controls the time the analyzer takes to sweep the current frequency span when the Sweep Type is Swept, and displays the equivalent Sweep Time when the Sweep Type is FFT.

When Sweep Time is in Auto, the analyzer computes a sweep time which will give accurate measurements based on other settings of the analyzer, such as RBW and VBW.

NOTE

Significantly faster sweep times are available for the Swept SA measurement with Option FS1.

The Meas Uncal (measurement uncalibrated) warning is given in the Status Bar in the lower right corner of the screen when the manual sweep time entered is faster than the sweep time computed by the analyzer's sweep time equations, that is, the Auto Sweep Time. The analyzer's computed sweep time will give accurate measurements; if you sweep faster than this your measurements may be inaccurate. A Meas Uncal condition may be corrected by returning the Sweep Time to Auto; by entering a longer Sweep Time; or by choosing a wider RBW and/or VBW

On occasion other factors such as the Tracking Generator's maximum sweep rate, the YTF sweep rate (in high band) or the LO's capability (in low band) can cause a Meas Uncal condition. The most reliable way to correct it is to return the Sweep Time to Auto.

If the analyzer calculates that the Auto Sweep Time would be greater than 4000s (which is beyond its range), the warning message "Settings Alert;Sweep Rate Unavailable" is displayed. In this case increase the RBW or reduce the span.

If the analyzer's estimated sweep time in an FFT sweep is greater than 4000s, the warning message "Settings Alert;Span:RBW Ratio too big" is displayed. In this case reduce the span or increase the RBW and/or FFT Width.

When Sweep Type is FFT, you cannot control the sweep time, it is simply reported by the analyzer to give you an idea of how long the measurement is taking.

Note that although some overhead time is required by the analyzer to complete a sweep cycle, the sweep time reported when Sweep Type is Swept does not include the overhead time, just the time to sweep the LO over the current Span. When Sweep Type is FFT, however, the reported Sweep Time takes into account both the data acquisition time and the processing time, in order to report an equivalent Sweep

Sweep/Control

Time for a meaningful comparison to the Swept case.

Because there is no “Auto Sweep Time” when in zero span, the Auto/Man line on this key disappears when in Zero Span. The Auto/Man line also disappears when in an FFT sweep. In this case the key is grayed out as shown below.



NOTE When using a Tracking Source (**Source, Source Mode** set to “**Tracking**”), the sweep time shown includes an estimate of the source’s settling time. This estimate may contain inaccuracies, particularly when software triggering is used for the source. This can result in the reported sweep time being shorter than the actual sweep time.

Key Path:	Sweep/Control
Remote Command:	<pre>[:SENSe] :SWEep:TIME <time> [:SENSe] :SWEep:TIME? [:SENSe] :SWEep:TIME:AUTO OFF ON 0 1 [:SENSe] :SWEep:TIME:AUTO?</pre>
Example:	<pre>SWE:TIME 500 ms SWE:TIME:AUTO OFF</pre>
Notes:	The values shown in this table reflect the “swept spans” conditions which are the default settings after a preset. See “Couplings” for values in the zero span domain.
Dependencies:	<p>The third line of the softkey (Auto/Man) disappears in Zero Span. The SCPI command SWEep:TIME:AUTO ON if sent in Zero Span generates an error message.</p> <p>Softkey grayed out and third line of the softkey (Auto/Man) disappears in FFT sweeps. Pressing the key or sending the SCPI for sweep time while the instrument is in FFT sweep generates a –221, “Settings Conflict;” error. F</p> <p>The SCPI command :SWEep:TIME:AUTO ON if sent in FFT sweeps generates an error.</p> <p>Grayed out while in Gate View, to avoid confusing those who want to set GATE VIEW Sweep Time.</p> <p>Key is grayed out in Measurements that do not support swept mode.</p> <p>Key is blanked in Modes that do not support swept mode.</p> <p>Set to Auto when Auto Couple is pressed or sent remotely</p>

Couplings:	<p>Sweep Time is coupled primarily to Span and RBW. Center Frequency, VBW, and the number of sweep points also can have an effect. So changing these parameters may change the sweep time.</p> <p>The Sweep Time used upon entry to Zero Span is the same as the Sweep Time that was in effect before entering Zero Span. The Sweep Time can be changed while in Zero Span. Upon leaving Zero Span, the Auto/Man state of Sweep Time that existed before entering Zero Span is restored.</p> <p>If Sweep Time was in Auto before entering Zero Span, or if it is set to Auto while in zero span (which can happen via remote command or if Auto Couple is pressed) it returns to Auto and recouples when returning to non-zero spans.</p> <p>If Sweep Time was in Man before entering Zero Span, it returns to Man when returning to non-zero spans, and any changes to Sweep Time that were made while in Zero Span are retained in the non-zero span (except where constrained by minimum limits, which are different in and out of zero span).</p>
Preset:	The preset Sweep Time value is hardware dependent since Sweep Time presets to “Auto”.
State Saved:	Saved in instrument state
Min:	<p>in zero span: 1 μs</p> <p>in swept spans: 1 ms</p> <p>in Stepped Tracking (as with option ESC): same as auto sweep time</p> <p>(in Swept Tracking, with Tracking Generator option T03 or T06, the minimum sweep time is 1 ms, but the Meas Uncal indicator is turned on for sweep times faster than 50 ms)</p>
Max:	<p>in zero span: 6000 s</p> <p>in swept spans: 4000 s</p>
Status Bits/OPC dependencies:	Meas Uncal is Bit 0 in the STATUS:QUESTionable:INTEgrity:UNCalibrated register
Initial S/W Revision:	Prior to A.02.00

Sweep Setup

Lets you set the sweep functions that control features such as sweep type and time.

Key Path:	Sweep/Control
Dependencies:	<p>The whole Sweep Setup menu is grayed out in Zero Span, however, the settings in the menus under Sweep Setup can be changed remotely with no error indication.</p> <p>Grayed out in measurements that do not support swept mode.</p> <p>Blanked in modes that do not support swept mode</p>
Initial S/W Revision:	Prior to A.02.00

Sweep/Control

Sweep Time Rules

Allows the choice of three distinct sets of sweep time rules. These are the rules that are used to set the sweep time when **Sweep Time** is in Auto mode. Note that these rules only apply when in the Swept **Sweep Type** (either manually or automatically chosen) and not when in FFT sweeps.

See “[More Information](#)” on page 1271.

Key Path:	Sweep/Control, Sweep Setup
Remote Command:	[:SENSe] :SWEep:TIME:AUTO:RULes NORMal ACCuracy SRESponse [:SENSe] :SWEep:TIME:AUTO:RULes?
Example:	SWE:TIME:AUTO:RUL ACC
Dependencies:	In Zero Span, this key is irrelevant and cannot be accessed (because the whole Sweep Setup menu is grayed out in Zero Span), however its settings can be changed remotely with no error indication. Grayed out in FFT sweeps. Pressing the key while the instrument is in FFT sweep generates an advisory message. The SCPI is acted upon if sent, but has no effect other than to change the readout on the key, as long as the analyzer is in an FFT sweep.
Couplings:	Set to Auto on Auto Couple
Preset:	AUTO
State Saved:	Saved in instrument state
Backwards Compatibility SCPI:	:SWEep:TIME:AUTO:MODE SRESponse This legacy command is aliased to :SWEep:TIME:AUTO:RULes SRESponse
Backwards Compatibility SCPI:	:SWEep:TIME:AUTO:MODE SANalyzer This legacy command is aliased to :SWEep:TIME:AUTO:RULes NORMal
Backwards Compatibility SCPI:	:SWEep:TIME:AUTO:MODE? This legacy query is aliased to :SWEep:TIME:RULes?, so it will match for SRESponse but not for SANalyzer
Backwards Compatibility Notes:	The old Auto Sweep Time command was the same [:SENSe]:SWEep:TIME:AUTO:RULes NORMal ACCuracy so it still works although it now has a third parameter (SRESponse). The old Sweep Coupling command was [:SENSe]:SWEep:TIME:AUTO:MODE SRESponse SANalyzer and it is aliased as below:
Initial S/W Revision:	Prior to A.02.00

More Information

The first set of rules is called **SA – Normal**. **Sweep Time Rules** is set to **SA-Normal** on a **Preset** or **Auto Couple**. These rules give optimal sweep times at a loss of accuracy. Note that this means that in the Preset or Auto Coupled state, instrument amplitude accuracy specifications do not apply.

Setting **Sweep Time Rules** to **SA-Accuracy** will result in slower sweep times than **SA-Normal**, usually about three times as long, but with better amplitude accuracy for CW signals. The instrument absolute amplitude accuracy specifications only apply when **Sweep Time** is set to **Auto**, and **Sweep Time Rules** are set to **SA-Accuracy**. Additional amplitude errors which occur when **Sweep Time Rules** are set to **SA-Normal** are usually well under 0.1 dB, though this is not guaranteed. Because of the faster sweep times and still low errors, **SA-Normal** is the preferred setting of **Sweep Time Rules**.

The third set of sweep time rules is called **Stimulus/Response** and is automatically selected when an integrated source is turned on, such as a Tracking Generator or a synchronized external source. The sweep times for this set of rules are usually much faster for swept-response measurements. Stimulus-response auto-coupled sweep times are typically valid in stimulus-response measurements when the system's frequency span is less than 20 times the bandwidth of the device under test. You can select these rules manually (even if not making Stimulus-Response measurements) which will allow you to sweep faster before the “Meas Uncal” warning comes on, but you are then not protected from the over-sweep condition and may end up with uncalibrated results. However, it is commonplace in measuring non-CW signals such as noise to be able to get excellent measurement accuracy at sweep rates higher than those required for CW signal accuracy, so this is a valid measurement technique.

Auto

Sets the analyzer to automatically choose the Sweep Time Rules for the measurement.

Key Path:	Sweep/Control, Sweep Setup, Sweep Time Rules
Remote Command:	[:SENSE] :SWEep:TIME:AUTO:RULEs:AUTO [:STATe] ON OFF 1 0 [:SENSE] :SWEep:TIME:AUTO:RULEs:AUTO [:STATe] ?
Example:	:SWE:TIME:AUTO:RUL:AUTO ON
Couplings:	Set on Preset or Auto Couple
Preset:	ON
Initial S/W Revision:	Prior to A.02.00

SA - Normal

Chooses Sweep Time Auto Rules for optimal speed and generally sufficient accuracy.

Key Path:	Sweep/Control, Sweep Setup, Sweep Time Rules
Example:	:SWE:TIME:AUTO:RUL NORM
Dependencies:	Not available (grayed out) when Source Mode=Tracking.
Couplings:	Automatically selected unless Source is on If directly selected, sets AUTO to Off

Sweep/Control

Readback:	SA - Normal
Initial S/W Revision:	Prior to A.02.00

SA - Accuracy

Chooses Sweep Time Auto Rules for specified absolute amplitude accuracy.

NOTE For specified accuracy, do not allow sweep time to fall below 20 ms when in SA - Accuracy

Key Path:	Sweep/Control, Sweep Setup, Sweep Time Rules
Example:	:SWE:TIME:AUTO:RUL ACC
Dependencies:	Not available (grayed out) when Source Mode=Tracking.
Couplings:	If directly selected, sets AUTO to Off
Readback:	SA - Accuracy
Initial S/W Revision:	Prior to A.02.00

Stimulus/Response

The Stimulus-Response setting for sweep time rules provides different sweep time settings, for the case where the analyzer is sweeping in concert with a source. These modified rules take two forms:

1. Sweeping along with a swept source, which allows faster sweeps than the normal case because the RBW and VBW filters do not directly interact with the Span. We call this “Swept Tracking”
2. Sweeping along with a stepped source, which usually slows the sweep down because it is necessary to wait for the stepped source and the analyzer to settle at each point. We call this “Stepped Tracking”

The analyzer chooses one of these methods based on what kind of a source is connected or installed; it picks Swept Tracking if there is no source in use.

As always, when the X-series analyzer is in Auto Sweep Time, the sweep time is estimated and displayed in the Sweep/Control menu as well as in the annotation at the bottom of the displayed measurement; of course, since this can be dependent on variables outside the analyzer’s control, the actual sweep time may vary slightly from this estimate.

You can always choose a shorter sweep time to improve the measurement throughput, (with some potential unspecified accuracy reduction), but the Meas Uncal indicator will come on if the sweep time you set is less than the calculated Auto Sweep time. You can also select a longer sweep time, which can be useful (for example) for obtaining accurate insertion loss measurements on very narrowband filters. The number of measurement points can also be reduced to speed the measurement (at the expense of frequency resolution).

Key Path:	Sweep/Control, Sweep Setup, Sweep Time Rules
Example:	:SWE:TIME:AUTO:RUL SRES

Couplings:	Automatically selected when the Source is on (Source Mode not set to OFF). If directly selected sets AUTO to Off
Readback:	SR
Initial S/W Revision:	Prior to A.02.00

Sweep Type

Chooses between the FFT and Sweep types of sweep.

Sweep Type refers to whether or not the instrument is in Swept or FFT analysis. When in Auto, the selection of sweep type is governed by two different sets of rules, depending on whether you want to optimize for dynamic range or for speed.

FFT “sweeps” should not be used when making EMI measurements; therefore, when a CISPR detector (Quasi Peak, EMI Average, RMS Average) is selected for any active trace (one for which Update is on), the FFT key in the Sweep Type menu is grayed out, and the Auto Rules only choose Swept. If Sweep Type is manually selected to be FFT, the CISPR detectors are all grayed out.

FFT sweeps will never be auto-selected when Screen Video, Log Video or Linear Video are the selected Analog Output.

Key Path:	Sweep/Control, Sweep Setup
Remote Command:	[:SENSe] :SWEep :TYPE FFT SWEep [:SENSe] :SWEep :TYPE?
Dependencies:	In Zero Span, this key is irrelevant and cannot be accessed (because the whole Sweep Setup menu is grayed out in Zero Span), however its settings can be changed remotely with no error indication. When Gate is on, Gate Method selection affects Sweep Type: Method FFT&Sweep menu FFT - Swept grayed out and rules choose FFT Video - FFT grayed out and rules choose Swept LO - FFT grayed out and rules choose Swept
Preset:	AUTO
Backwards Compatibility SCPI:	[:SENSe] :SWEep :TYPE AUTO sets sweep type Auto to On but the query will return either FFT or SWE depending on the auto setting. [:SENSe] :SWEep :TYPE SWP selects sweep type Swept but will return SWE on a query
Initial S/W Revision:	Prior to A.02.00

Auto

When in Auto, the selection of sweep type is governed by two different sets of rules, depending on

Sweep/Control

whether you want to optimize for dynamic range or for speed. These rules are chosen under the **Sweep Type Rules** key.

Key Path:	Sweep/Control, Sweep Setup, Sweep Type
Remote Command:	[:SENSE] :SWEep:TYPE:AUTO OFF ON 0 1 [:SENSE] :SWEep:TYPE:AUTO?
Example:	:SWE:TYPE:AUTO ON
Couplings:	Pressing Auto Couple always sets Sweep Type to Auto. Swept is always chosen whenever any form of Signal ID is on, or the Source Mode is set to Tracking, or any EMI detector is selected, or the RF Preselector is ON.
Preset:	ON
State Saved:	Saved in instrument state
Initial S/W Revision:	Prior to A.02.00

Swept

Manually selects swept analysis, so it cannot change automatically to FFT.

Key Path:	Sweep/Control, Sweep Setup, Sweep Type
Example:	SWE:TYPE SWE
Dependencies:	Grayed out while in Gated FFT (meaning Gate is ON and Gate Method is FFT). If this key is selected, the gate method Gated FFT is grayed out.
Couplings:	This selection is chosen automatically if any of the CISPR detectors is chosen for any active trace, in which case the FFT Sweep Type selection is also grayed out.
State Saved:	Saved in instrument state
Readback:	Swept
Initial S/W Revision:	Prior to A.02.00
Modified at S/W Revision:	A.02.00

FFT

Manually selects FFT analysis, so it cannot change automatically to Swept.

Key Path:	Sweep/Control, Sweep Setup, Sweep Type
Example:	SWE:TYPE FFT

Dependencies:	<p>When a CISPR detector (Quasi Peak, EMI Average, RMS Average) is selected for any active trace, the FFT key is grayed out.</p> <p>When the RF Preselector is on, the FFT key is grayed out.</p> <p>When Source Mode is set to Tracking, Manual FFT is grayed out.</p> <p>When Signal ID is on, Manual FFT is grayed out.</p> <p>Grayed out while in Gated LO (meaning Gate is ON and Gate Method is LO).</p> <p>Grayed out while in Gated Video (meaning Gate is ON and Gate Method is Video).</p>
State Saved:	Saved in instrument state
Readback:	FFT
Initial S/W Revision:	Prior to A.02.00

Sweep Type Rules

Selects which set of rules will be used for automatically choosing the Sweep Type when Sweep Type is in Auto.

Key Path:	Sweep/Control, Sweep Setup
Remote Command:	<pre>[:SENSE] :SWEep:TYPE:AUTO:RULEs SPEed DRANge</pre> <pre>[:SENSE] :SWEep:TYPE:AUTO:RULEs?</pre>
Dependencies:	In Zero Span, this key is irrelevant and cannot be accessed (because the whole Sweep Setup menu is grayed out in Zero Span), however its settings can be changed remotely with no error indication.
Preset:	DRANge
State Saved:	Saved in instrument state
Backwards Compatibility Notes:	The legacy parameter DYNami crange is unsupported
Initial S/W Revision:	Prior to A.02.00

Auto

This selection is automatically chosen when Auto Couple is pressed. When in Auto, the Sweep Type Rules are set to Best Dynamic Range. It seems like a very simple Auto function but the use of this construct allows a consistent statement about what the Auto Couple key does.

Key Path:	Sweep/Control, Sweep Setup, Sweep Type Rules
Remote Command:	<pre>[:SENSE] :SWEep:TYPE:AUTO:RULEs:AUTO [:STATe] OFF ON 0 1</pre> <pre>[:SENSE] :SWEep:TYPE:AUTO:RULEs:AUTO [:STATe] ?</pre>
Example:	:SWE:TYPE:AUTO:RUL:AUTO ON
Couplings:	Pressing Auto Couple always sets Sweep Type Rules to Auto.

Sweep/Control

Preset:	ON
State Saved:	Saved in instrument state
Initial S/W Revision:	Prior to A.02.00

Best Dynamic Range

This selection tells the analyzer to choose between swept and FFT analysis with the primary goal of optimizing dynamic range. If the dynamic range is very close between swept and FFT, then it chooses the faster one. This auto selection also depends on RBW Type.

In determining the Swept or FFT setting, the auto rules use the following approach:

- If the RBW Filter Type is Gaussian use the RBW for the Normal Filter BW and if that RBW > 210 Hz, use swept; for RBW ≤ 210 Hz, use FFT
- If the RBW Filter Type is Flat Top, use the same algorithm but use 420 Hz instead of 210 Hz for the transition point between Swept and FFT
- If any of the CISPR detectors is chosen for any active trace, always use Swept.

Key Path:	Sweep/Control, Sweep Setup, Sweep Type Rules
Example:	SWE:TYPE:AUTO:RUL DRAN sets the auto rules to dynamic range.
Couplings:	Directly selecting this setting sets AUTO to OFF.
Readback:	Dynamic Range
Initial S/W Revision:	Prior to A.02.00

Best Speed

This selection tells the analyzer to choose between FFT or swept analysis based on the fastest analyzer speed.

Key Path:	Sweep/Control, Sweep Setup, Sweep Type Rules
Example:	SWE:TYPE:AUTO:RUL SPE sets the rules for the auto mode to speed
Couplings:	Directly selecting this setting sets AUTO to OFF.
Readback:	Speed.
Initial S/W Revision:	Prior to A.02.00

FFT Width

This menu displays and controls the width of the FFT's performed while in FFT mode. The "FFT width" is the range of frequencies being looked at by the FFT, sometimes referred to as the "chunk width" -- it is not the resolution bandwidth used when performing the FFT.

It is important to understand that this function does not directly set the FFT width, it sets the limit on the FFT Width. The actual FFT width used is determined by several other factors including the Span you have set. Usually the instrument picks the optimal FFT Width based on the current setup; but on

occasion you may wish to limit the FFT Width to be narrower than that which the instrument would have set.

NOTE This function does not allow you to widen the FFT Width beyond that which the instrument might have set; it only allows you to narrow it. You might do this to improve the dynamic range of the measurement or eliminate nearby spurs from your measurement.

Note that the **FFT Width** setting will have no effect unless in an FFT sweep.

See [“More Information” on page 1278](#)

Key Path:	Sweep/Control, Sweep Setup
Remote Command:	[:SENSe] :SWEep:FFT:WIDTh <real> [:SENSe] :SWEep:FFT:WIDTh?
Example:	SWE:FFT:WIDTh 167 kHz sets this function to “<167.4 kHz”
Notes:	The parameter is in units of frequency. For values sent from SCPI, the analyzer chooses the smallest value that is at least as great as the requested value. Examples: Parameter 3.99 kHz is sent over SCPI. Analyzer chooses 4.01 kHz Parameter 4.02 kHz is sent over SCPI. Analyzer chooses 28.81 kHz Parameter 8 MHz is sent over SCPI. Analyzer chooses 10 MHz
Dependencies:	In some models, the analog prefilters are not provided. In these models the FFT Width function is always in Auto . The FFT Width key is blanked in these models, and the SCPI commands are accepted without error but have no effect. In Zero Span, this key is irrelevant and cannot be accessed (because the whole Sweep Setup menu is grayed out in Zero Span). However, its settings can be changed remotely with no error indication.
Couplings:	The FFT Width affects the ADC Dither function (see Meas Setup key) and the point at which the instrument switches from Swept to FFT acquisition.
Preset:	The Preset is Auto, but Preset will also pick Best Dynamic Range and hence this function will be set to ~Maximum
State Saved:	Saved in instrument state
Min:	4.01 kHz

Sweep/Control

Max:	The maximum available FFT width is dependent on the IF Bandwidth option. The maximum available width is: Option B10, 10 MHz; Option B25, 25 MHz, Option B40, 40 MHz.
Backwards Compatibility SCPI:	[:SENSe]:SWEep:FFT:SPAN:RATio <integer> [:SENSe]:SWEep:FFT:SPAN:RATio? This is the legacy “FFTs per Span” command, because in the PSA, this is what you set rather than the FFT Width. The behavior of the analyzer when it receives this command is to compute the “intended segment width” by dividing the Span by the FFTs/Span parameter, then converting this intended width to an actual width by using the largest available FFT Width that is still less than the intended segment width. The “Span” used in this computation is whatever the Span is currently set to, whether a sweep has been taken at that Span or not.
Initial S/W Revision:	Prior to A.02.00
Modified at S/W Revision:	A.04.00

Key Path:	Sweep/Control, Sweep Setup
Remote Command:	[:SENSe] :SWEep:FFT:WIDTh:AUTO OFF ON 0 1 [:SENSe] :SWEep:FFT:WIDTh:AUTO?
Example:	:SWE:FFT:WIDTh:AUTO ON
Couplings:	Pressing Auto Couple always sets FFT Width to Auto.
Preset:	ON
State Saved:	Saved in instrument state
Initial S/W Revision:	Prior to A.02.00

More Information

An FFT measurement can only be performed over a limited span known as the “FFT segment”. Several segments may need to be combined to measure the entire span. For advanced FFT control in the X-Series, you have direct control over the segment width using the **FFT Width** control. Generally, in automatic operation, the X-Series sets the segment width to be as wide as possible, as this results in the fastest measurements.

However, in order to increase dynamic range, most X-series models provide a set of analog prefilters that precede the ADC. Unlike swept measurements, which pass the signal through a bandpass before the ADC, FFT measurements present the full signal bandwidth to the ADC, making them more susceptible to overload, and requiring a lower signal level. The prefilters act to alleviate this phenomenon - they allow the signal level at the ADC to be higher while still avoiding an ADC overload, by eliminating signal power outside the bandwidth of interest, which in turn improves dynamic range.

Although narrowing the segment width can allow higher dynamic ranges some cases, this comes at the

expense of losing some of the speed advantages of the FFT, because narrower segments require more acquisitions and proportionately more processing overhead.

However, the advantages of narrow segments can be significant. For example, in pulsed-RF measurements such as radar, it is often possible to make high dynamic range measurements with signal levels approaching the compression threshold of the analyzer in swept spans (well over 0 dBm), while resolving the spectral components to levels below the maximum IF drive level (about -8 dBm at the input mixer). But FFT processing experiences overloads at the maximum IF drive level even if the RBW is small enough that no single spectral component exceeds the maximum IF drive level. If you reduce the width of an FFT, an analog filter is placed before the ADC that is about 1.3 times as wide as the FFT segment width. This spreads out the pulsed RF in time and reduces the maximum signal level seen by the ADC. Therefore, the input attenuation can be reduced and the dynamic range increased without overloading the ADC.

Further improvement in dynamic range is possible by changing the **FFT IF Gain** (in the **Meas Setup** menu of many measurements). If the segments are reduced in width, **FFT IF Gain** can be set to High, improving dynamic range.

Depending on what IF Bandwidth option you have ordered, there can be up to three different IF paths available in FFT sweeps, as seen in the diagram below:

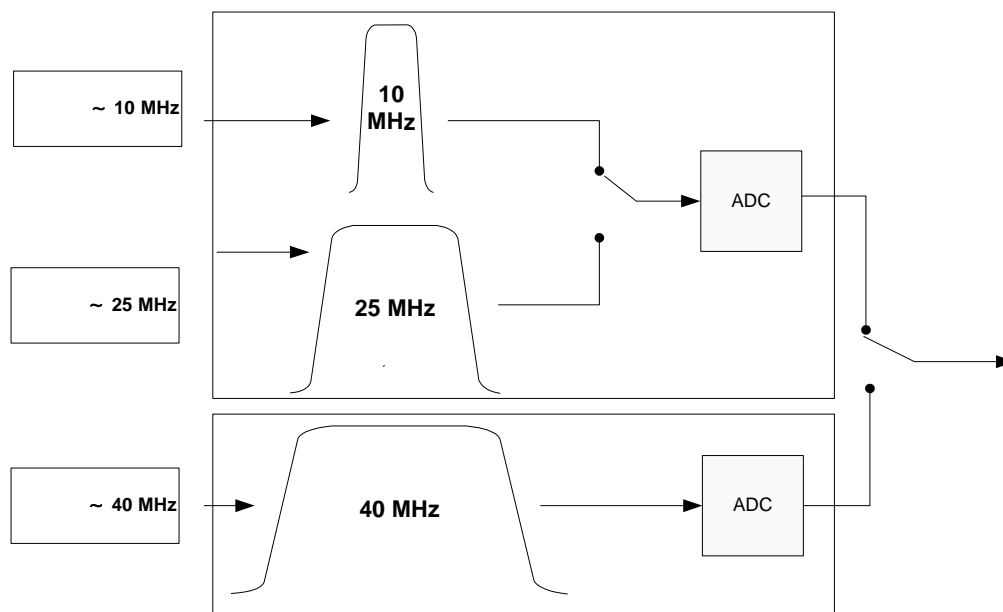

The 10 MHz path is always used for Swept sweeps. It is always used for FFT sweeps as well, unless the user specifies ~ 25 MHz in which case the 25 MHz path will be used for FFT sweeps, or ~ 40 MHz, in which case the 40 MHz path will be used for FFT sweeps. Note that, although each of these keys picks the specified path, the analyzer may choose an FFT width less than the full IF width, in order to optimize speed, trading off acquisition time versus processing time.

Pause/Resume

Pauses a measurement after the current data acquisition is complete.

When Paused, the label on the key changes to Resume. Pressing Resume un-pauses the measurement.

Sweep/Control

When you are Paused, pressing **Restart**, **Single** or **Cont** does a Resume.

Key Path:	Sweep/Control
Remote Command:	: INITiate: PAUSE
Dependencies:	Grayed out in Measurements that do not support Pausing. Blanked in Modes that do not support Pausing.
Initial S/W Revision:	Prior to A.02.00

Key Path:	Sweep/Control
Remote Command:	: INITiate: RESume
Dependencies:	Grayed out in Measurements that do not support Pausing. Blanked in Modes that do not support Pausing.
Initial S/W Revision:	Prior to A.02.00

Gate

Accesses a menu that enables you to control the gating function. The Gate functionality is used to view signals best viewed by qualifying them with other events.

Gate setup parameters are the same for all measurements – they do not change as you change measurements. Settings like these are called “Meas Global” and are unaffected by Meas Preset.

Note that Sweep Time autocoupling rules and annotation are changed by Gate being on.

Key Path:	Sweep/Control
Scope:	Meas Global
Readback:	The state and method of Gate, as [Off, LO] or [On, Video]. Note that for measurements that only support gated LO, the method is nonetheless read back, but always as LO.
Initial S/W Revision:	Prior to A.02.00

Gate On/Off

Turns the gate function on and off.

When the Gate Function is on, the selected Gate Method is used along with the gate settings and the signal at the gate source to control the sweep and video system with the gate signal. Not all measurements allow every type of Gate Methods.

When Gate is on, the annunciation in the measurement bar reflects that it is on and what method is used, as seen in the following "Gate: LO" annunciator graphic.

Key Path:	Sweep/Control, Gate
Remote Command:	[:SENSe] :SWEep:EGATe [:STATe] OFF ON 0 1 [:SENSe] :SWEep:EGATe [:STATe] ?
Example:	SWE:EGAT ON SWE:EGAT?
Dependencies:	<p>The function is unavailable (grayed out) and Off when:</p> <ul style="list-style-type: none"> • Gate Method is LO or Video and FFT Sweep Type is manually selected. • Gate Method is FFT and Swept Sweep Type is manually selected. • Marker Count is ON. <p>The following are unavailable whenever Gate is on:</p> <ul style="list-style-type: none"> • FFT under Sweep Type when Method=LO or Video or Swept under Sweep Type when Method=FFT • Marker Count <p>While Gate is on, the Auto Rules for Sweep Type are modified so that the choice agrees with the Gate Method: i.e., FFT for Method = FFT and Swept for Method = LO or Video.</p> <p>The Gate softkey and all SCPI under the [:SENSe]:SWEep:EGATe SCPI node are grayed out when Source Mode is Tracking with an external source. This is because the Gate circuitry is used to sync the external source. If the Tracking Source is turned on, the Gate is turned off.</p> <p>When in the ACP measurement:</p> <ul style="list-style-type: none"> • When Meas Method is RBW or FAST, this function is unavailable and the key is grayed out. • Whenever Gate is on, Meas Method, RBW or FAST is unavailable and keys for those are grayed out. • When Gate is on, Offset Res BW and Offset Video BW are ignored (if you set these values) and the measurement works as if all Offset Res BW and all Offset Video BW are coupled with the Res BW and the Video BW under the BW menu. When Gate is on, the Offset BW key in the Offset/Limit menu is grayed out.
Preset:	Off
State Saved:	Saved in instrument state
Range:	On Off
Backwards Compatibility SCPI:	[:SENSe]:SWEep:TIME:GATE[:STATe] ESA compatibility

Sweep/Control

Backwards Compatibility Notes:	In ESA, Trig Delay (On) and Gate (On) could not be active at the same time.. This dependency does not exist in PSA or in the X-Series.
Initial S/W Revision:	Prior to A.02.00

Gate View On/Off

Turning on Gate View in the Swept SA measurement provides a single-window gate view display..

Turning on Gate View in other measurements shows the split-screen Gate View. In these measurements, when the Gate View is on, the regular view of the current measurement traces and results are reduced vertically to about 70% of the regular height. The Zero Span window, showing the positions of the Gate, is shown between the Measurement Bar and the reduced measurement window. By reducing the height of the measurement window, some of the annotation on the Data Display may not fit and is not shown.

Key Path:	Sweep/Control, Gate
Remote Command:	[:SENSe] :SWEp:EGATe:VIEW ON OFF 1 0 [:SENSe] :SWEp:EGATe:VIEW?
Example:	SWE:EGAT:VIEW ON turns on the gate view.
Dependencies:	In the Swept SA measurement: In Gate View, the regular Sweep Time key is grayed out . When pressed, the grayed out key puts up the informational message "Use Gate View Sweep Time in the Gate menu." In the other measurements: When you turn Gate View on, the lower window takes on the current state of the instrument. Upon leaving Gate View, the instrument takes on the state of the lower window. When you turn Gate View on, the upper window Sweep Time is set to the gate view sweep time.
Couplings:	These couplings apply to the Swept SA measurement: <ul style="list-style-type: none"> • When Gate View is turned on, the instrument is set to Zero Span. • Gate View automatically turns off whenever a Span other than Zero is selected. • Gate View automatically turns off if you press the Last Span key while in Gate View, and the instrument returns to the Span it was in before entering Gate View (even if that is Zero Span). • When Gate View is turned on, the sweep time used is the gate view sweep time. This is set according to the rules in section “Gate View Setup ” on page 1285 • When Gate View is turned off, Sweep Time is set to the normal Swept SA measurement sweep time. • If Gate View is on and Gate is off, then turning on Gate turns off Gate View.

Preset:	OFF
State Saved:	Saved in instrument state
Range:	On Off
Initial S/W Revision:	Prior to A.02.00

A sample of the Gate View screen in the Swept SA measurement is shown in the following graphic :



A sample of the Gate View screen in other measurements is shown in the following graphic . This example is for the ACP measurement:



Turning Gate View off returns the analyzer to the Normal measurement view.

In the Swept SA, the normal measurement view is the single-window Swept SA view. When returning to this view, the Swept SA measurement returns to the Span it was in before entering **Gate View** (even if that is Zero Span).

The **Gate View** window is triggered from the Gate Source, with zero trigger delay. Also, when updating the **Gate View** window, the Gate itself must not operate. So it is internally shut off while the gate view window is being updated. For the Swept SA measurement, this means that the Gate is internally shut off whenever the gate view window is displayed. The measurement bar and softkeys continue to show the Trigger source for the main sweep window and give no indication that the Gate is shut off or that the Gate View window is triggered from the Gate Source.

When in **Gate View**, vertical lines are displayed in the Gate View window as follows:

- Green lines are displayed at the gate edges as follows: in Edge Gate, a line is shown for Delay and one for the end of the Gate period (defined by Length, even in FFT. In Level Gate a line is shown only for Delay. You can adjust the position of the green lines by adjusting the gate length and the gate delay. These lines update in the Gate View window as the active function changes, even if the window is not being updated. In Gated LO and Gated Video, these lines are positioned relative to the delay reference line (not relative to 0 time). In Gated FFT, their location is relative to the left edge of the screen.
- A blue line is displayed showing the delay reference, that is, the reference point for the Gate Delay within the Zero Span window. The blue line represents where (in time) the effective location of the gate start would be if the gate were programmed to zero delay.
- The second blue line is labeled "MIN FAST" as shown in the figure above because it represents the

minimum Gate Delay for fast Gated LO operation. This line is only displayed in Gated LO. You cannot scroll (knob) or decrement (down key) the Gate Delay to less than that represented by the position of this line, it can only be set below this position manually, although once there it can be moved freely with the knob while below the line.

- A yellow line in the Gated Video case only, is displayed at B_{length} , where B_{length} is the display point (bucket) length for the swept trace, which is given by the sweep time for that trace divided by number of Points – 1. So it is referenced to 0 time, not to the delay reference. This line is labeled NEXT PT (it is not shown in the figure above because the figure above is for Gated LO). The yellow line represents the edge of a display point (bucket). Normally in Gated Video, the bucket length must be selected so that it exceeds the off time of the burst. There is another way to use the analyzer in Gated Video measurements, and that is to set the bucket width much shorter than the off time of the burst. Then use the Max Hold trace function to fill in "missing" buckets more slowly. This allows you to see some of the patterns of the Gated Video results earlier, though seeing a completely filled-in spectrum later.

Gate View Setup

Accesses a menu that enables you to setup parameters relevant to the Gate View

Key Path:	Sweep/Control, Gate
Scope:	Meas Global
Initial S/W Revision:	A.10.00

Gate View Sweep Time

Controls the sweep time in the Gate View window. To provide an optimal view of the gate signal, the analyzer initializes Gate View Sweep Time based on the current settings of Gate Delay and Gate Length.

Key Path:	Sweep/Control, Gate, Gate View Setup
Remote Command:	[:SENSe] :SWEep:EGATe:TIME <time> [:SENSe] :SWEep:EGATe:TIME?
Example:	SWE:EGAT:TIME 500 ms
Dependencies:	Gate View Sweep Time is initialized: <ul style="list-style-type: none"> • On Preset (after initializing delay and length). • Every time the Gate Method is set/changed. <p>Additionally, in the Swept SA measurement, whenever you do a Preset, or leave Gate View, the analyzer remembers the Gate Delay and Gate Length settings. Then, when returning to Gate View, if the current Gate Delay and/or Gate Length do not match the remembered values Gate View Sweep Time is re-initialized.</p> <ol style="list-style-type: none"> 1. Compute the location of the "gate stop" line, which you know is at time $t = t_{\text{min}} + \text{GateDelay} + \text{GateLength}$.

Sweep/Control

Preset:	519.3 μ s WiMAX OFDMA: 5 ms GSM/EDGE: 1 ms
State Saved:	Saved in instrument state
Min:	1 μ s
Max:	6000 s
Initial S/W Revision:	Prior to A.02.00

Gate View Start Time

Controls the time at the left edge of the Gate View.

Key Path:	Sweep/Control, Gate, Gate View Setup
Remote Command:	[:SENSe] :SWEep:EGATe:VIEW:START <time> [:SENSe] :SWEep:EGATe:VIEW:START?
Example:	SWE:EGAT:VIEW:STAR 10ms
Notes:	Units of time are required or no units; otherwise an invalid suffix error message will be generated. See error -131.
Preset:	0 ms
State Saved:	Saved in instrument state
Min:	0
Max:	500 ms
Initial S/W Revision:	A.10.00

Gate Delay

Controls the length of time from the time the gate condition goes True until the gate is turned on.

Key Path:	Sweep/Control, Gate
Remote Command:	[:SENSe] :SWEep:EGATe:DELaY <time> [:SENSe] :SWEep:EGATe:DELaY?
Example:	SWE:EGAT:DELaY 500ms SWE:EGAT:DELaY?
Notes:	Units of time are required or no units; otherwise an invalid suffix error message will be generated.

Preset:	57.7 us WiMAX OFDMA: 71 us GSM/EDGE: 600 us
State Saved:	Saved in instrument state
Min:	0.0 us
Max:	100 s
Backwards Compatibility SCPI:	[:SENSe]:SWEep:TIME:GATE:DELay ESA compatibility
Initial S/W Revision:	Prior to A.02.00

Gate Length

Controls the length of time that the gate is on after it opens.

Key Path:	Sweep/Control, Gate
Remote Command:	[:SENSe]:SWEep:EGATe:LENGth <time> [:SENSe]:SWEep:EGATe:LENGth?
Example:	SWE:EGAT:LENG 1 SWE:EGAT:LENG?
Notes:	Units of time are required or no units; otherwise an invalid suffix error message will be generated.
Dependencies:	Grayed out when Gate Method is set to FFT in which case the label changes to that shown below.  The key is also grayed out if Gate Control = Level.
Preset:	461.6 us WiMAX OFDMA: 50 us GSM/EDGE: 200 us
State Saved:	Saved in instrument state
Min:	100 ns
Max:	5 s
Backwards Compatibility SCPI:	[:SENSe]:SWEep:TIME:GATE:LENGth ESA compatibility
Initial S/W Revision:	Prior to A.02.00

Method

This lets you choose one of the three different types of gating.

Sweep/Control

Not all types of gating are available for all measurements.

Key Path:	Sweep/Control, Gate
Remote Command:	[:SENSe] :SWEep:EGATe:METhod LO VIDEo FFT [:SENSe] :SWEep:EGATe:METhod?
Example:	SWE:EGAT:METH FFT
Preset:	LO
State Saved:	Saved in instrument state
Initial S/W Revision:	Prior to A.02.00

LO

When Gate is set to On, the LO sweeps whenever the gate conditions as specified in the Gate menu are satisfied by the signal at the Gate Source.

This form of gating is more sophisticated, and results in faster measurements. With Gated LO, the analyzer only sweeps while the gate conditions are satisfied. This means that a sweep could take place over several gate events. It would start when the gate signal goes true and stop when it goes false, and then continue when it goes true again. But since the LO is sweeping as long as the gate conditions are satisfied, the sweep typically finishes much more quickly than with Gated Video.

When in zero span, there is no actual sweep performed. But data is only taken while the gate conditions are satisfied. So even though there is no sweep, the gate settings will impact when data is acquired.

Key Path:	Sweep/Control, Gate, Method
Dependencies:	Key is unavailable when Gate is On and FFT Sweep Type manually selected. When selected, Sweep Type is forced to Swept and the FFT key in Sweep Type is grayed out.
Readback:	LO
Initial S/W Revision:	Prior to A.02.00

Video

When Gate is set to On, the video signal is allowed to pass through whenever the gate conditions as specified in the Gate menu are satisfied by the signal at the Gate Source.

This form of gating may be thought of as a simple switch, which connects the signal to the input of the spectrum analyzer. When the gate conditions are satisfied, the switch is closed, and when the gate conditions are not satisfied, the switch is open. So we only look at the signal while the gate conditions are satisfied.

With this type of gating, you usually set the analyzer to sweep very slowly. In fact, a general rule is to sweep slowly enough that the gate is guaranteed to be closed at least once per data measurement interval (bucket). Then if the peak detector is used, each bucket will represent the peak signal as it looks with the

gate closed.

Key Path:	Sweep/Control, Gate, Method
Dependencies:	Key is unavailable when Gate is On and FFT Sweep Type manually selected. When selected, Sweep Type is forced to Swept and the FFT key in Sweep Type is grayed out
Readback:	Video
Initial S/W Revision:	Prior to A.02.00

FFT

When Gate is set to On, an FFT is performed whenever the gate conditions as specified in the Gate menu are satisfied by the signal at the Gate Source. This is an FFT measurement which begins when the gate conditions are satisfied. Since the time period of an FFT is approximately $1.83/\text{RBW}$, you get a measurement that starts under predefined conditions and takes place over a predefined period. So, in essence, this is a gated measurement. You have limited control over the gate length but it works in FFT sweeps, which the other two methods do not.

Gated FFT cannot be done in zero span since the instrument is not sweeping. So in zero span the Gated LO method is used. Data is still only taken while the gate conditions are satisfied, so the gate settings do impact when data is acquired.

The Gate Length will be $1.83/\text{RBW}$.

This is a convenient way to make a triggered FFT measurement under control of an external gating signal.

Key Path:	Sweep/Control, Gate
Dependencies:	Key is unavailable when Gate is On and Swept Sweep Type is manually selected. Key is unavailable when gate Control is set to Level. When selected, Sweep Type is forced to FFT and the Swept key in Sweep Type is grayed out Forces Gate Length to $1.83/\text{RBW}$
Readback:	FFT
Initial S/W Revision:	Prior to A.02.00

Gate Source

The menus under the **Gate Source** key are the same as those under the **Trigger key**, with the exception that neither **Free Run** nor **Video** are available as Gate Source selections. However, a different SCPI command is used to select the Gate Source (see table below) because you may independently set the Gate Source and the Trigger Source.

Any changes to the settings in the setup menus under each **Gate Source** selection key (for example: **Trigger Level, Trigger Delay, etc**) also affect the corresponding settings under the **Trigger** menu keys.

Sweep/Control

The SCPI commands used for these are the same for Trigger and Gate, since there is only one setting which affects both Gate and Trigger. Example: to set the Trigger Level for External 1 you use the command :TRIG:EXT1:LEV regardless of whether you are using External 1 as a Trigger Source or a Gate Source.

Key Path:	Sweep/Control, Gate
Remote Command:	[:SENSE] :SWEep:EGATe:SOURce EXTernal1 EXTernal2 LINE FRAME RFBurst [:SENSe] :SWEep:EGATe:SOURce?
Dependencies:	In some models, there is no second External input. In these models, the External 2 key is blanked and the EXTernal2 parameter will generate a “Hardware missing; Not available for this model number” error.
Preset:	EXTernal 1 GSM/EDGE: FRAME
Backwards Compatibility Notes:	In ESA, there is a single Gate input port. In PSA, the Gate Source may be taken from one of two specified input ports. In the X-Series, any Trigger Source can be a Gate Source.
Initial S/W Revision:	Prior to A.02.00
Modified at S/W Revision:	A.03.00

Control Edge/Level

Sets the method of controlling the gating function from the gating signal.

Edge

In Edge triggering, the gate opens (after the Delay) on the selected edge (for example, positive) of the gate signal and closes on the alternate edge (for example, negative).

Level

In Level triggering, the gate opens (after the Delay) when the gate signal has achieved a certain level and stays open as long as that level is maintained.

Key Path:	Sweep/Control, Gate
Remote Command:	[:SENSe] :SWEep:EGATe:CONTrol EDGE LEVEl [:SENSe] :SWEep:EGATe:CONTrol?
Example:	SWE:EGAT:CONT EDGE
Dependencies:	If the Gate Method is FFT the Control key is grayed out and Edge is selected. If the Gate Source is TV, Frame or Line, the Control key is grayed out and Edge is selected.
Preset:	EDGE
State Saved:	Saved in instrument state

Backwards Compatibility SCPI:	[[:SENSE]:SWEep:TIME:GATE:TYPE ESA Compatibility
Initial S/W Revision:	Prior to A.02.00

Gate Holdoff

Lets you increase or decrease the wait time after a gate event ends before the analyzer will respond to the next gate signal.

After any Gate event finishes, the analyzer must wait for the sweep system to settle before it can respond to another Gate signal. The analyzer calculates a "wait time," taking into account a number of factors, including RBW and Phase Noise Optimization settings. The goal is to achieve the same accuracy when gated as in ungated operation. The figure below illustrates this concept:

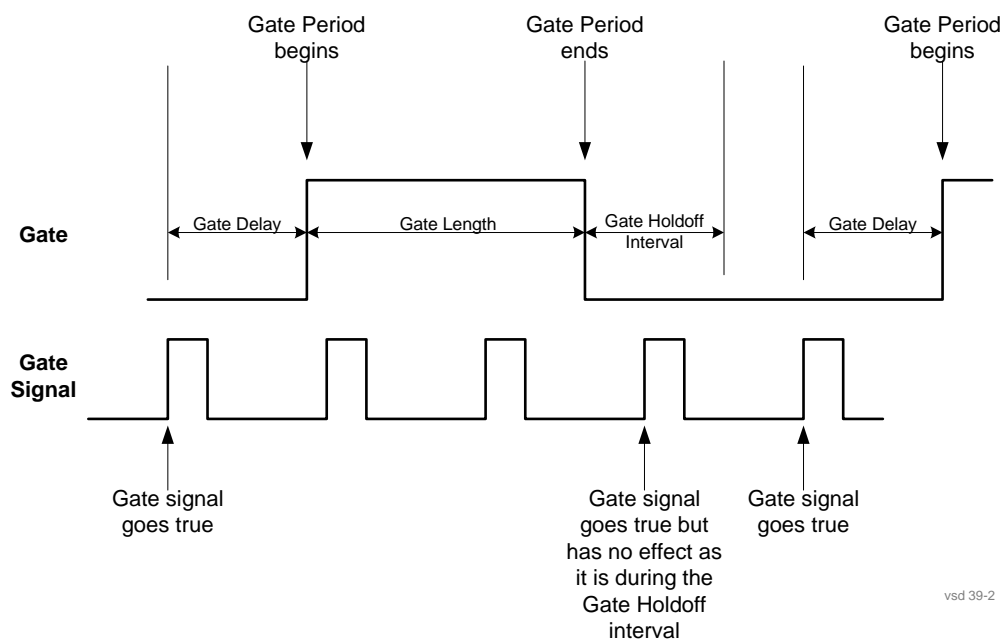

When Gate Holdoff is in Auto, the wait time calculated by the analyzer is used. When Gate Time is in Manual, the user may adjust the wait time, usually decreasing it in order to achieve greater speed, but at the risk of decreasing accuracy.

When the **Method** key is set to **Video** or **FFT**, the **Gate Holdoff** function has no effect.

In measurements that do not support Auto, the value shown when Auto is selected is "---" and the manually set holdoff is returned to a query.

Key Path:	Sweep/Control, Gate
Remote Command:	<pre>[:SENSE] :SWEep:EGATe:HOLDoff <time> [:SENSE] :SWEep:EGATe:HOLDoff? [:SENSE] :SWEep:EGATe:HOLDoff:AUTO OFF ON 0 1 [:SENSE] :SWEep:EGATe:HOLDoff:AUTO?</pre>

Sweep/Control

Example:	SWE:EGAT:HOLD 0.0002 SWE:EGAT:HOLD? SWE:EGAT:HOLD:AUTO ON SWE:EGAT:HOLD:AUTO?
Couplings:	<p>When Gate Holdoff is Auto, the Gate Holdoff key shows the value calculated by the analyzer for the wait time.</p> <p>Pressing the Gate Holdoff key while it is in Auto and not selected, causes the key to become selected and allows the user to adjust the value. If the value is adjusted, the setting changes to Man.</p> <p>Pressing the Gate Holdoff key, while it is in Auto and selected, does not change the value of Gate Holdoff, but causes the setting to change to Man. Now the user can adjust the value.</p> <p>Pressing the key while it is in Man and selected, cause the value to change back to Auto.</p> <p>Pressing the key while it is in Man and not selected, causes the key to become selected and allows the user to adjust the value.</p> <p>When Method is set to Video or FFT, the Gate Holdoff function has no effect.</p>
Preset:	Auto Auto/On
State Saved:	Saved in instrument state
Min:	1 μ sec
Max:	1 sec
Initial S/W Revision:	Prior to A.02.00

Gate Delay Compensation

This function allows you to select an RBW-dependent value by which to adjust the gate delay, to compensate for changes in the delay caused by RBW effects.

You can select between uncompensated operation and two types of compensation, **Delay Until RBW Settled** and **Compensate for RBW Group Delay**.

See [“More Information” on page 1293](#)

Key Path:	Sweep/Control, Gate
Scope:	Meas Global
Remote Command:	[:SENSe] :SWEep:EGATe:DELAy:COMPensation:TYPE OFF SETTled GDELAy [:SENSe] :SWEep:EGATe:DELAy:COMPensation:TYPE?
Example:	SWE:EGAT:DEL:COMP:TYPE SETT SWE:EGAT:DEL:COMP:TYPE?

Notes:	<p>Although this function is Meas Global, there are some measurements that do not support this function. In those measurements the operation will be Uncompensated. Going into one of those measurements will not change the Meas Global selection; it will simply display the grayed-out menu key with “Uncompensated” showing as the selection. This is a non-forceful grayout, so the SCPI command is still accepted.</p> <p>If Gate Delay Compensation is not supported at all within a particular mode, the key is not displayed, and if the SCPI command is sent while in a measurement within that mode, an “Undefined Header” message is generated.</p> <p>Measurements that do not support this function include: Swept SA</p>
Preset:	<p>TD-SCDMA mode: Compensate for RBW Group Delay</p> <p>All other modes: Delay Until RBW Settled</p>
State Saved:	Saved in instrument state
Range:	Uncompensated Delay Until RBW Settled Compensate for RBW Group Delay
Readback text:	Uncompensated Settled Group Delay
Initial S/W Revision:	Prior to A.02.00
Modified at S/W Revision:	A.11.0

More Information

Selecting **Uncompensated** means that the actual gate delay is as you sets it.

Selecting **Delay Until RBW Settled** causes the gate delay to be increased above the user setting by an amount equal to $3.06/\text{RBW}$. This compensated delay causes the GATE START and GATE STOP lines on the display to move by the compensation amount, and the actual hardware gate delay to be increased by the same amount. All the other gate lines (for example, MIN FAST) are unaffected. If the RBW subsequently changes, the compensation is readjusted for the new RBW. The value shown on the **Gate Delay** key does NOT change.

Delay Until RBW Settled allows excellent measurements of gated signals, by allowing the IF to settle following any transient that affects the burst. Excellent measurements also require that the analysis region not extend into the region affected by the falling edge of the burst. Thus, excellent measurements can only be made over a width that declines with narrowing RBWs, which is achieved by decreasing the gate length below the user setting by an amount equal to $2.53/\text{RBW}$. Therefore, for general purpose compensation, you will still want to change the gate length with changes in RBW even if the gate delay is compensated. The compensated Gate Length is limited by the analyzer so that it will never go below 10% of the value shown on the Gate Length key, as otherwise the sweep times could get very long. Anytime the **Gate Length and RBW** values combine in such a way that this limiting takes place, a warning is displayed. For measurements which contain multiple sweeps with different RBW like SEM and SPUR, the smallest RBW is used for this limiting.

Selecting **Compensate for RBW Group Delay** causes the gate delay to be increased above the user setting by an amount equal to $1.81/\text{RBW}$. This compensated delay causes the GATE START, GATE

Sweep/Control

STOP lines on the display to move by the compensation amount, and the actual hardware gate delay to be increased by the same amount. All the other gate lines (for example, MIN FAST) are unaffected. If the RBW subsequently changes, the compensation is readjusted for the new RBW. The value shown on the **Gate Delay** key does NOT change. **Compensate for RBW Group Delay** also includes gate length compensation; the gate length itself is adjusted as necessary to attempt to compensate for delay effects imposed by the RBW.

Compensate for RBW Group Delay is similar to **Delay Until RBW Settled**, but compensates for the group delay of the RBW filter, rather than the filter settling time. As the RBW gets narrow, this can allow the settling tail of the RBW to affect the beginning part of the gated measurement, and allow the beginning of the RBW settling transient to affect the end of the gated measurement. These two effects are symmetric because the RBW response is symmetric. Because the gate length is not automatically compensated, some users might find this compensation to be more intuitive than compensation for RBW settling.

Min Fast Position Query (Remote Command Only)

This command queries the position of the MIN FAST line, relative to the delay reference (REF) line. See section “[Gate View On/Off](#)” on page 1282. If this query is sent while not in gate view, the MinFast calculation is performed based on the current values of the appropriate parameters and the result is returned. Knowing this value lets you set an optimal gate delay value for the current measurement setup.

Remote Command:	[:SENSe] :SWEep:EGATe:MINFast?
Example:	SWE:EGAT:MIN?
Initial S/W Revision:	Prior to A.02.00

Gate Preset (Remote Command Only)

Presets the time-gated spectrum analysis capability.

This command sets gate parameter values to the ESA preset values, as follows:

Gate trigger type = edge

Gate polarity = positive

Gate delay = 1 us

Gate length = 1 us

Remote Command:	[:SENSe]:SWEep:TIME:GATE:PRESet ESA Compatibility
Initial S/W Revision:	Prior to A.02.00

Gate Level (Remote Command Only)

Sets the gate input transition point level for the external TRIGGER inputs on the front and rear panel. This is a legacy command for PSA compatibility. It is simply an alias to the equivalent trigger level

command.

Remote Command:	[:SENSE] :SWEep:EGATe:EXTeRnal [1] 2:LEVel <voltage> [:SENSE] :SWEep:EGATe:EXTeRnal [1] 2:LEVel?
Notes:	This command is simply an alias to :TRIGger[:SEQuence]:EXTeRnal[1] 2:LEVel For details refer
Initial S/W Revision:	Prior to A.02.00

Gate Polarity (Remote Command Only)

Sets the polarity for the gate signal. This setup is now done using the gate trigger's slope setting.

When Positive (Pos) is selected, a positive-going edge (Edge) or a high voltage (Level) will satisfy the gate condition, after the delay set with the Gate Delay key. When Negative (Neg) is selected, a negative-going edge (Edge) or a low voltage (Level) will satisfy the gate condition after the delay.

Remote Command:	[:SENSE] :SWEep:EGATe:POLarity NEGative POSitive [:SENSE] :SWEep:EGATe:POLarity?
Example:	SWE:EGAT:POL NEG SWE:EGAT:POL?
Preset:	POSitive
State Saved:	Saved in instrument state
Backwards Compatibility SCPI:	[:SENSe] :SWEep:TIME:GATE:POLarity ESA compatibility
Initial S/W Revision:	Prior to A.02.00

Remote Command:	[:SENSE] :SWEep:TIME:GATE:LEVel HIGH LOW [:SENSE] :SWEep:TIME:GATE:LEVel? ESA compatibility
Preset:	HIGH
Initial S/W Revision:	Prior to A.02.00

Points

Sets the number of points taken per sweep, and displayed in the traces. The current value of points is displayed parenthetically, next to the sweep time in the lower-right corner of the display. Using more points provides greater resolution. Using fewer points compacts the data and decreases the time required to access a trace over the remote interface.

Increasing the number of points does not increase the sweep time; however, it can slightly impact the trace processing time and therefore the overall measurement speed. Decreasing the number of points

Sweep/Control

does not decrease the sweep time, but it may speed up the measurement, depending on the other sweep settings (for example, in FFT sweeps). Fewer points will always speed up the I/O.

Due to minimum sweep rate limitations of the hardware, the minimum sweep time available to the user will increase above its normal value of 1 ms as the number of sweep points increases above 15001.

Changing the number of sweep points has several effects on the analyzer. The sweep time resolution will change. Trace data for all the traces will be cleared and, if Sweep is in Cont, a new trace taken. If any trace is in average or hold, the averaging starts over.

When in a split screen display each window may have its own value for points.

When sweep points is changed, an informational message is displayed, "Sweep points changed, all traces cleared."

Key Path:	Sweep/Control
Remote Command:	<code>[:SENSE] :SWEep:POINTs <integer></code> <code>[:SENSE] :SWEep:POINTs?</code>
Example:	SWE:POIN 5001 SWE:POIN?
Dependencies:	<ul style="list-style-type: none">• This function is not available when signal identification is set to On in External Mixing• Neither the knob nor the step keys can be used to change this value. If it is tried, a warning is given.• Clipped to 1001 whenever you are in the Spectrogram View in all models but MXE, clipped to 20001 whenever you are in the Spectrogram View in MXE• Grayed out in measurements that do not support swept. Forceful message -221.3200• Blanked in modes that do not support Swept• Grayed out if Normalize is on; you can't change the number of sweep points with Normalize on, as it will erase the reference trace.

Couplings:	<ul style="list-style-type: none"> When Source Mode is set to Tracking, and Stepped Tracking is used (as with option ESC), 201 source steps are used to achieve optimal speed. The number of sweep points in the analyzer is then set to match the number of steps in the source. When Source Mode is set to Off, the previous number of points (the value that existed when Source Mode was Off previously) is restored, even if the user has changed the Points value while the Source Mode was set to Tracking. Whenever the number of sweep points change: <ul style="list-style-type: none"> All trace data is erased Any traces with Update Off will also go to Display Off (like going from View to Blank in the older analyzers) Sweep time is re-quantized Any limit lines that are on will be updated If averaging/hold is on, averaging/hold starts over
Preset:	1001
State Saved:	Saved in instrument state
Min:	Normally the minimum is 1, but in Tracking Source Mode, the minimum value of Points is 101. If you go into Tracking Source Mode with fewer points than 101, it sets Points to 101.
Max:	40001 when not in Tracking Source mode In Tracking Source mode: <ul style="list-style-type: none"> in Stepped Tracking (e.g., External Source), 1601 or the maximum number of points supported by the source, whichever is less in Swept Tracking (e.g., Tracking Generator), 10000
Backwards Compatibility Notes:	<ol style="list-style-type: none"> In ESA and PSA, Sweep Points was adjustable with the knob and step keys. This caused the sweep time to increase whenever Points was adjusted (either up or down), due to excessive application of the quantization rules. In the X-Series the value of Sweep Points must be entered manually, which avoids this anomaly In ESA the preset value of Sweep Points is 401, in PSA it is 601. In X-Series it is 1001.
Initial S/W Revision:	Prior to A.02.00
Modified at S/W Revision:	A.11.00

Zoom Points

In the Trace Zoom View of the Swept SA measurement, the Points key changes to Zoom Points whenever the focus (thick green border) is on the bottom window. Zoom Points controls how many points are displayed in the Zoom Window and hence indirectly controls the Zoom Span.

Key Path:	Sweep/Control
-----------	----------------------

Sweep/Control

Remote Command:	[:SENSe] :SWEep:TZOom:POINts <integer> [:SENSe] :SWEep:TZOom:POINts?
Example:	SWE:TZO:POIN 5001
Dependencies:	Only appears in the Trace Zoom View of the Swept SA measurement. If the SCPI command is sent in other Views, gives an error.
Couplings:	Zoom Points is coupled to Zoom Span and Sweep Points; if Zoom Span changes, Zoom Points will change but Sweep Points will not; if Sweep Points changes, Zoom Points will change but Zoom Span will not. Zoom Span is directly coupled to Zoom Points; if Zoom Points changes, Zoom Span will change but Sweep Points will not.
Preset:	On entry to Trace Zoom, 10% of the number of points in the upper window.
State Saved:	Saved in instrument state
Min:	1
Max:	Number of points in top window
Initial S/W Revision:	A.07.01

Abort (Remote Command Only)

This command is used to stop the current measurement. It aborts the current measurement as quickly as possible, resets the sweep and trigger systems, and puts the measurement into an "idle" state. If the analyzer is in the process of aligning when ABORT is sent, the alignment finishes before the abort function is performed. So ABORT does not abort an alignment.

If the analyzer is set for Continuous measurement, it sets up the measurement and initiates a new data measurement sequence with a new data acquisition (sweep) taken once the trigger condition is met.

If the analyzer is set for Single measurement, it remains in the "idle" state until an :INIT:IMM command is received.

Remote Command:	:ABORT
Example:	:ABOR
Notes:	If :INITiate:CONTinuous is ON, then a new continuous measurement will start immediately; with sweep (data acquisition) occurring once the trigger condition has been met. If :INITiate:CONTinuous is OFF, then :INITiate:IMMEDIATE is used to start a single measurement; with sweep (data acquisition) occurring once the trigger condition has been met.
Dependencies:	For continuous measurement, ABORT is equivalent to the Restart key. Not all measurements support the abort command.

Status Bits/OPC dependencies:	<p>The STATUS:OPERation register bits 0 through 8 are cleared.</p> <p>The STATUS:QUEStionable register bit 9 (INTEgrity sum) is cleared.</p> <p>Since all the bits that feed into OPC are cleared by the ABORT, the ABORT will cause the *OPC query to return true.</p>
Initial S/W Revision:	Prior to A.02.00

Sweep/Control

Trace/Detector

The **Trace/Detector** menu lets you control the acquisition, display, storage, detection and manipulation of trace data for the six available traces. The first page of this menu contains a selection of the trace type (**Clear Write, Trace Average, Max Hold, Min Hold**) for the selected trace. Those choices are described here.

A trace is a series of data points, each having an x and a y value. The x value is usually frequency (or time) and the y value is amplitude. Each data point is referred to as a trace point. In any given trace, trace point 0 is the first point, and trace point (sweep_points – 1) is the last. For example, in a 1001 point trace, the first point is 0 and the last is 1000. Another term sometimes used to describe traces is bucket. A bucket is the frequency span before and after the trace point equal to the point spacing. The y value is measured across (during) this bucket.

For more information see:

[“Trace Update Indicator” on page 1302](#)

[“Trace Annotation” on page 1303](#)

Key Path	Trace/Detector
Remote Command	:TRACe [1] 2 3 4 5 6 :TYPE WRITE AVERAge MAXHold MINHold :TRACe [1] 2 3 4 5 6 :TYPE?
Notes	WRITE = Clear Write AVERAge = Trace Average MAXHold = Maximum Hold MINHold = Minimum Hold
Couplings	Sending a trace command does not cause the specified trace to become selected. Selecting a trace type (pressing any of the four keys or sending a TRAC:TYPE command) puts Update in On and Display in On , even if that trace type was already selected.
Preset	Write. During normal operation of the instrument (that is, other than at power up), after a mode preset is performed, all active traces are cleared. This is so their domains and initial x values will match the current X-axis of the test set. Inactive traces are not cleared after a preset, so a trace which is in Update = On before a preset, and in Update = Off after the preset, will still have the data that it had before the preset.
State Saved	The type of each trace is saved in Instrument State
Initial S/W Revision	Prior to A.02.00

Trace/Detector

Trace Update Indicator

Trace updates can take one of two forms:

The trace is updated in a single operation that affects all of the points in the trace at once. This happens, for example, in the case of very fast (< 200 ms) sweeps, single-chunk FFT's, and the initial math operation after a math function is set for a trace.

The trace is updated in a series of discrete steps, with measurement data being gathered between each step. This is the case for slow sweeps, multi-chunk FFT's, et cetera.

In the first case, no update indicator is required. In the second case, however, a visual indicator exists on the trace where the new data is being written, a green "caret" or ^ symbol, which moves across the bottom of the graticule showing the current trace point.

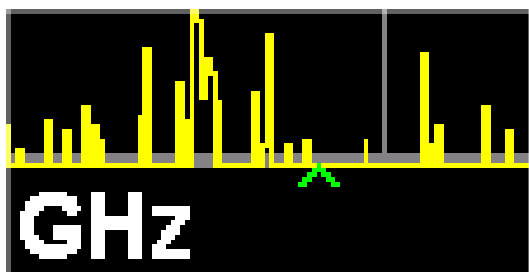

Trace Annunciator Panel

The trace annunciator panel appears on the right hand side of the Meas Bar. Here is an explanation of the fields in this panel:



On the line labeled "TRACE", each trace number is shown, in the trace color. A green box is drawn around the currently selected trace

Below each trace number, on the line labeled "TYPE", is a letter signifying the trace type for that trace number, where

- W = Clear Write
- A = Trace Average
- M = Max Hold
- m = Min Hold

If the letter is white it means the trace is being updated (**Update = On**); if the letter is dimmed, it means the trace is not being updated (**Update = Off**). A strike through (for example, ~~W~~) indicates that the trace is blanked (**Display = Off**). Note that it is possible for a trace to be updating and blanked, which is useful if the trace is a trace math component.

The third line, labeled "DET", shows the detector type for each trace, or, if trace math is on for that trace,

it shows an “f” (for “math function”). It is not always possible to have a unique detector for each trace, but the test set hardware provides the maximum flexibility of detector selection in order to maintain the highest accuracy. The letters used for this readout are:

N = Normal
 A = Average
 P = peak
 p = negative peak
 S = Sample
 Q = Quasi Peak
 E = EMI Average
 R = RMS Average
 f = math function

If the DET letter is green it means the detector is in Auto; if it is white it means the detector has been manually selected.

Trace Annotation

When Trace Annotation (see View/Display menu) is On, each non-blanked trace is labeled on the trace with the detector used to take it, unless a trace math function is on for that trace, in which case it is labeled with the math function.

The detector labels are:

NORM = Normal
 PEAK = Peak
 SAMP = Sample
 NPEAK = Negative Peak
 RMS = Average detector with Power Average (RMS)
 LG AVG = Average detector with Log-Pwr Average
 VAVG = Average detector with Voltage Average
 QPEAK = Quasi Peak
 EMI AVG = EMI Average
 RMS AVG = RMS Average

The trace math labels are:

PDIF = Power Difference
 PSUM = Power Sum
 LOFF = Log Offset
 LDIF = Log Difference

Select Trace

Determines which trace the type control keys will affect. Press **Trace** until the number of the desired

Trace/Detector

trace is underlined.

Key Path	Trace
Preset	Trace 1
State Saved	The number of the selected trace is saved in Instrument State
Initial S/W Revision	Prior to A.02.00

Clear Write

In **Clear Write** type each trace update replaces the old data in the trace with new data. Pressing the **Clear Write** key for the selected trace, or sending the TRAC:TYPE WRIT command for the specified trace, sets the trace type to **Clear Write** and causes the trace to be cleared. Then a new sweep is initiated.

Because pressing **Clear Write** stops the current sweep and initiates a new one, **Trace Average**, **Max Hold** and **Min Hold** data may be interrupted in mid-sweep, and may not accurately reflect the displayed count. Therefore, when **Clear Write** is pressed for one trace, **Trace Average**, **Max Hold** and **Min Hold** must restart for all traces.

When in **Clear Write**, if a measurement-related instrument setting is changed, a new sweep is initiated but the trace is not cleared.

Key Path	Trace/Detector
Example	TRAC:TYPE WRIT
Notes	See “Trace/Detector” on page 1301 ”.
Couplings	Whenever you press Clear Write or send the equivalent SCPI command, Update is set to On and Display is set to On . Automatic detector selection and the VBW:RBW ratio auto rules both depend on the trace type selections
Preset	After a Preset, any trace that is in Clear Write is cleared (all trace points set to mintracevalue).
State Saved	The type for each trace is saved in Instrument State
Initial S/W Revision	Prior to A.02.00

Trace Average

In **Trace Average** type the test set maintains and displays an average trace, which represents the cumulative average on a point-by-point basis of the new trace data and previous averaged trace data. Details of the averaging calculations may be found under [“Average/Hold Number” on page 1047](#) and [“Average Type” on page 1048](#) in the Meas Setup Section.

See [“Trace Averaging: More Information” on page 1305](#).

Key Path	Trace/Detector
----------	-----------------------

Example	TRAC2:TYPE AVER
Notes	See “Trace/Detector” on page 1301 .
Couplings	Affected by Average Type and Average/Hold Number Whenever you press Trace Average or send the equivalent SCPI command, Update is set to On and Display is set to On . Automatic detector selection and the VBW:RBW ratio auto rules both depend on the trace type selections.
Preset	after a Preset, any trace that is in Trace Average is cleared (all trace points set to mintracevalue).
State Saved	the type for each trace is saved in Instrument State
Initial S/W Revision	Prior to A.02.00

Trace Averaging: More Information

Pressing the **Trace Average** key (for the selected trace), or sending the TRAC:TYPE AVER command (for the specified trace), sets the trace type to **Trace Average** and causes the average to be restarted.

When in **Trace Average**, if a measurement-related instrument setting is changed, the average restarts and a new sweep is initiated but the trace is not cleared.

Restarting the average means:

The average/hold count k is set to 1, so that the next time the average trace is displayed it simply represents one trace of new data

A new sweep is initiated.

Once the new sweep starts, the trace is overwritten with current trace data as the first trace of the new average

Remember that restarting averaging also restarts **Max Hold** and **Min Hold**, as there is only one count for Trace Average and Hold.

Max Hold

In **Max Hold** type the test set maintains and displays a max hold trace, which represents the maximum data value on a point-by-point basis of the new trace data and previous trace data.

Pressing the **Max Hold** key for the selected trace, or sending the :TRAC:TYPE MAXH command for the specified trace, sets the trace type to **Max Hold**, causes the trace to be cleared, and causes the **Max Hold** sequence to be restarted.

When in **Max Hold**, if a measurement-related instrument setting is changed, the **Max Hold** sequence restarts and a new sweep is initiated but the trace is not cleared.

Restarting the **Max Hold** sequence means:

- The average/hold count k is set to 1, so that the next time the max hold trace is displayed it simply represents one trace of new data
- A new sweep is initiated.

Trace/Detector

Remember that restarting **Max Hold** also restarts averaging and **Min Hold**, as there is only one count for Trace Average and Hold.

Key Path	Trace/Detector
Example	TRAC4:TYPE MAXH
Notes	See “Trace/Detector” on page 1301 ”.
Couplings	Affected by Average Type and Average/Hold Number Whenever you press Max Hold or send the equivalent SCPI command, Update is set to On and Display is set to On . Automatic detector selection and the VBW:RBW ratio auto rules both depend on the trace type selections.
Preset	After a Preset, any trace that is in Max Hold is cleared (all trace points set to mintracevalue).
State Saved	The type for each trace is saved in Instrument State
Initial S/W Revision	Prior to A.02.00

Min Hold

In **Min Hold** type the test set maintains and displays a min hold trace, which represents the minimum data value on a point-point basis of the new trace data and previous trace data. Details of the count limiting behavior may be found under [“Average/Hold Number” on page 1047](#) in the Meas Setup Section.

Pressing the **Min Hold** key for the selected trace, or sending the TRAC:TYPE MINH command for the specified trace, sets the trace type to **Min Hold**, causes the trace to be cleared, and causes the **Min Hold** sequence to be restarted.

When in **Min Hold**, if a measurement-related instrument setting is changed, the **Min Hold** sequence restarts and a new sweep is initiated but the trace is not cleared.

Restarting the **Min Hold** sequence means:

- The average/hold count k is set to 1, so that the next time the min hold trace is displayed it simply represents one trace of new data
- A new sweep is initiated.

Remember that restarting **Min Hold** also restarts **Max Hold** and averaging, as there is only one count for Trace Average and Hold.

Key Path	Trace/Detector
Example	TRAC3:TYPE MINH
Notes	See “Trace/Detector” on page 1301 ”.

Couplings	Affected by Average Type and Average/Hold Number . Whenever you press Min Hold or send the equivalent SCPI command, Update is set to On and Display is set to On . Automatic detector selection and the VBW:RBW ratio auto rules both depend on the trace type selections.
Preset	After a Preset, any trace that is in Min Hold is cleared (all trace points set to maxtracevalue).
State Saved	The type for each trace is saved in Instrument State
Initial S/W Revision	Prior to A.02.00

View/Blank

This key lets you set the state of the two trace variables, Update and Display. The four choices available in this 1-of-N menu are:

Trace On: Update and Display both On

View: Update Off and Display On

Blank: Update Off and Display Off

Background: Update On, Display Off (this allows a trace to be blanked and continue to update “in the background”, which was not possible in the past)

A trace with Display Off is indicated by a strikethrough thru the type letter in the trace annotation panel in the Measurement bar. A trace with Update Off is indicated by dimming the type letter in the trace annotation panel in the Measurement bar. So in the example below, Traces 3, 4, 5 and 6 have Update Off and Traces 4 and 6 have Display Off.

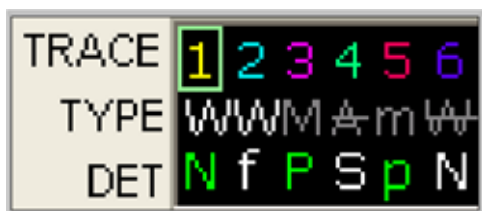

See [“Trace Update State On/Off”](#) on page 1309.

See [“Trace Display State On/Off”](#) on page 1309.

See [“More Information”](#) on page 1309.

Key Path	Trace/Detector
----------	----------------

Trace/Detector

Notes	<p>The four states of this 1-of-N actually set two variables, Update and Display, to their four possible combinations:</p> <p>Trace On: Update and Display both On</p> <p>View: Update Off and Display On</p> <p>Blank: Update Off and Display Off</p> <p>Background: Update On, Display Off</p> <p>See tables below for detail on the SCPI to control these two variables.</p>
Couplings	<p>Selecting a trace type (Clear Write, Trace Average, Max Hold, Min Hold) for a trace (pressing the key or sending the equivalent SCPI command) puts the trace in Trace On (Update On and Display On), even if that trace type was already selected.</p> <p>Selecting a detector for a trace (pressing the key or sending a [:SENS]:DET:TRAC command) puts the trace in Trace On (Update On and Display On), even if that detector was already selected.</p> <p>Selecting a math mode other than Off for a trace (pressing the key or sending the equivalent SCPI command) puts the trace in Trace On (Update On and Display On), even if that math mode was already selected.</p> <p>Loading a trace from a file puts that trace in View regardless of the state it was in when it was saved; as does being the target of a Copy or a participant in an Exchange.</p>
Initial S/W Revision	Prior to A.02.00

Trace Update State On/Off

Key Path	Trace/Detector
Remote Command	:TRACe [1] 2 3 4 5 6 :UPDate [:STATe] ON OFF 0 1 :TRACe [1] 2 3 4 5 6 :UPDate [:STATe] ?
Example	TRAC2:UPD 0 Makes trace 2 inactive (stops updating)
Couplings	Whenever you set Update to On for any trace, the Display is set to On for that trace.
Preset	1 0 0 0 0 0 (On for Trace 1; Off for 2–6)
State Saved	Saved in Instrument State
Initial S/W Revision	Prior to A.02.00

Trace Display State On/Off

Key Path	Trace/Detector
Remote Command	:TRACe [1] 2 3 4 5 6 :DISPlay [:STATe] ON OFF 0 1 :TRACe [1] 2 3 4 5 6 :DISPlay [:STATe] ?
Example	TRAC2:DISP,1 Makes trace 2 visible TRAC3:DISP,0 Blanks trace 3
Couplings	Whenever you set Update to On for any trace, the Display is set to On for that trace.
Preset	1 0 0 0 0 0 (On for Trace 1; Off for 2–6)
State Saved	Saved in Instrument State
Initial S/W Revision	Prior to A.02.00

More Information

When a trace becomes inactive, the following things happen:

Any update from the SENSE system (detectors) immediately stops (does not wait for end of sweep)
the trace is displayed at half intensity (as long as it stays inactive)

Inactive traces display across the entire X-axis of the instrument. Their horizontal placement does not change even if X-axis settings subsequently are changed, although Y-axis settings will affect the vertical placement of data.

In most cases, inactive traces are static and unchanging; however, there are cases when an inactive trace will update, specifically:

if data is written to that trace from remote

if trace data is loaded from mass storage

Trace/Detector

if the trace is the target of a Copy or participant in an Exchange

if the trace is cleared using the Clear Trace function (below)

When a trace becomes active (Update = On), the trace is cleared, the average count is reset, and a new sweep is initiated.

Traces which are blanked (Display = off) do not display nor appear on printouts but are otherwise unaffected. They may be queried and markers may be placed on them.

Note that the action of putting a trace in Display = Off and/or Update = Off does not restart the sweep and does not restart Averaging or Hold functions for any traces.

Note also that whenever you set **Update** to **On** for any trace, **Display** is set to **On** for that trace.

Detector

Selects a detector. The detector selected is then applied to the selected trace.

For the SCPI UI, two commands are provided. One is a legacy command, which affects all traces. There is also a command which is new for the X-Series, which uses a subopcode to specify to which trace the specified detector is to be applied.

The three detectors on the second page of the Detector menu, Quasi Peak, EMI Average, and RMS Average, are referred to collectively as the “CISPR detectors” because their behaviors are specified by the CISPR 16–1–1 specification.

See “[More Information](#)” on page 1312

Key Path	Trace/Detector, Detector
Remote Command	[:SENSE] :DETector:TRACe [1] 2 3 4 5 6 AVERage NEGative NORMal POSitive SAMPlE QPEak EAverage RAverage [:SENSE] :DETector:TRACe [1] 2 3 4 5 6?
Example	DET:TRAC AVER -- Sets trace 1’s detector to average DET:TRAC1 AVER -- Sets trace 1’s detector to average DET:TRAC2 SAMP -- Sets trace 2’s detector to sample
Notes	When a detector selection is made, the menu returns to the previous menu. Selecting any CISPR detector on any active trace sets the EMI Standard to CISPR.

Notes	<p>The query returns a name that corresponds to the detector type as shown below, and indicates the setting for Trace 1.</p> <p>String ReturnedDefinition</p> <p>NORM = Normal</p> <p>AVER = Average / RMS</p> <p>POS = Positive peak</p> <p>SAMP = Sample</p> <p>NEG = Negative peak</p> <p>QPE = Quasi Peak</p> <p>EAV = EMI Average</p> <p>RAV = RMS Average</p>
Dependencies	<p>When Tune & Listen is turned on, or Demod Audio is the selected Analog Output:</p> <ul style="list-style-type: none"> all active traces are forced to use the same detector. CISPR detectors (QPD, EMI Avg, RMS Avg) are unavailable <p>CISPR detectors are grayed out when you have manually selected FFT sweep. Conversely, if any CISPR detector is selected on an active trace, the auto rules for sweep type will never select FFT, and manual FFT selection is grayed out.</p> <p>If the grayed out key is pressed, an advisory message is generated. If the equivalent SCPI command is sent, this same message is generated as part of a “-221, Settings conflict” warning.</p>
Couplings	<p>The auto detector rules depend upon marker type, averaging state and type, trace state writing mode, and trace active state.</p> <p>If the Avg Type is in Auto, and any of the CISPR detectors is selected on any active trace, the Voltage Averaging type is auto-selected.</p>
Preset	Preset returns all traces to “auto”, which will result in Normal (Rosenfell) detection for all traces.
State Saved	Saved in State
Initial S/W Revision	Prior to A.02.00
Modified at S/W Revision	A.02.00
Remote Command:	<pre>[:SENSE] :DETector [:FUNction] NORMAL AVERage POSitive SAMPlE NEGAtive QPEak EAverage EPOSitive MPOSitive RMS [:SENSE] :DETector [:FUNction] ?</pre>
Example:	<p>DET AVER Sets detector to average for all traces</p> <p>DET:FUNC? Returns trace 1's detector setting</p>

Trace/Detector

Notes:	<p>This is a SCPI only legacy command to preserve the classic functionality wherein all traces are affected when a detector is selected.</p> <p>The query returns a name that corresponds to the detector type as shown below, and indicates the setting for Trace 1.</p> <p>The RMS selection sets the detector type to AVERage and the Average Type to RMS. Therefore if RMS has been selected, the query will return the "AVER" string.</p> <p>The EPOS selection sets the detector type to Peak and the EMI Standard to CISPR. A query will then return POS</p> <p>The MPOS selection sets the detector type to Peak and the EMI Standard to MIL Impulse. A query will then return POS</p> <p>The RAV parameter is not included in the command because this is not a legacy detector; nonetheless, if it happens to be the detector on Trace 1 then RAV is returned.</p> <p>String ReturnedDefinition</p> <p>NORM Normal</p> <p>AVER Average / RMS</p> <p>POS Positive peak</p> <p>SAMP Sample</p> <p>NEG Negative peak</p> <p>QPE Quasi Peak</p> <p>EAV EMI Average</p> <p>RAV RMS Average</p>
Preset:	NORMal
State Saved:	Saved in State
Initial S/W Revision:	Prior to A.02.00
Modified at S/W Revision:	A.02.00

More Information

The available detectors are:

The Sample detector indicates the instantaneous level of the signal at the center of the bucket represented by each display point.

The Normal detector determines the peak of CW-like signals, and it yields alternating maximums and minimums of noise-like signals. This is also referred to as Rosenfell detection.

The Average detector determines the average of the signal within the bucket. The averaging method depends upon Average Type selection (voltage, power or log scales).

The Peak detector determines the maximum of the signal within the bucket.

The Negative Peak detector determines the minimum of the signal within the bucket.

The Quasi-Peak detector is a fast-rise, slow-fall detector used in making CISPR compliant EMI measurements.

The EMI-Average detector provides a standard means to “smooth” the signal while still providing compliance to CISPR pulse response standards. It displays the average value of the amplitude envelope, rather than the average value of sample-detected amplitude, and uses an advanced algorithm to realize a lowpass filter that conforms to the latest CISPR standard.

The RMS Average detector is a frequency dependent RMS or Averaging filter, used in making CISPR compliant EMI measurements, which performs one averaging process (in the VBW hardware) on the "power" (a.k.a. RMS) scale, and another process on the voltage scale using a "meter movement simulator". This filter conforms to the 2007 revision of the CISPR 16-1-1 standard.

Because they may not find a spectral component's true peak, neither average nor sample detectors measure amplitudes of CW signals as accurately as peak or normal, but they do measure noise without the biases of peak detection.

When the Detector choice is Auto, the detector selected depends on marker functions, trace functions, average type, and the trace averaging function.

When you manually select a detector (instead of selecting Auto), that detector is used regardless of other test set settings.

Multiple Detectors

The test set always provides the requested detector on the specified trace. Depending on the detectors requested the test set can provide up to three different detectors simultaneously, within the constraints of its digital processing algorithms. Some detectors utilize more resources; the Quasi-Peak detector, for example, utilizes most of the digital IF's resources, and the hardware in some test sets is incapable of providing another detector when Quasi-Peak is on. If the limit of system resources is exceeded, detectors on some existing traces may be forced to change. When this happens, they change to match the detector just requested, and a message is generated: “Detector <X> changed due to physical constraints”, where X might contain multiple values.

Example: User has traces 1, 2, and 3 with Peak, Average, and Negative Peak. User specifies QPD for trace 1. Traces 2 and 3 also change to QPD and we generate the message “Detector 2,3 changed due to physical constraints”. Now all three traces have the QPD.

Auto

This sets the detector for the currently selected trace to Auto. (For SCPI, the trace number is specified as a subopcode.) This will immediately apply the auto rules to determine a new detector value.

Key Path	Trace/Det, Detector
Remote Command	[:SENSE] :DETECTOR:TRACe [1] 2 3 4 5 6 :AUTO ON OFF 1 0 [:SENSE] :DETECTOR:TRACe [1] 2 3 4 5 6 :AUTO?
Example	DET:TRACE2:AUTO ON sets trace 2 detection to automatic.
Dependencies	The auto detector rules depend upon marker type, averaging state and type, trace state writing mode, and trace active state.

Trace/Detector

Couplings	Selecting AUTO, whether by pressing the key or sending the equivalent SCPI command, will turn trace math to Off for the selected/specified trace.
Preset	Auto (On) for all detectors.
State Saved	Saved in state
Initial S/W Revision	Prior to A.02.00

Remote Command:	[:SENSe] :DETECTOR:AUTO ON OFF 1 0 [:SENSe] :DETECTOR:AUTO?
Example:	DET:AUTO ON
Notes:	SCPI only. Turns AUTO on or off for ALL detectors. This is a legacy command to preserve the classic functionality wherein all traces are affected when a detector is addressed
Notes:	The query returns the Auto state of Trace 1.
Initial S/W Revision:	Prior to A.02.00

Normal

This sets the detector for the current selected trace to Normal (Rosenfell).

When the signal is CW-like, it displays the peak-detected level in the interval (bucket) being displayed. If the signal is noise-like (within a bucket the signal both rose and fell), it alternates displaying the max/min values. That is, an even bucket shows the peak (maximum) within a two-bucket wide interval centered on the even bucket. And an odd bucket will show the negative peak (minimum) within a two-bucket wide interval. For example, for an even bucket the two-bucket wide interval is a combination of one-half bucket to the left of the even bucket, the even bucket itself, and one-half bucket to the right of the even bucket, so the peak found is displayed in the correct relative location on screen. The odd buckets are similar.

Key Path	Trace/Det, Detector
Example	DET:TRAC3 NORM sets the detector to normal for trace 3.
Dependencies	Selecting any detector (even the currently selected detector) for a given trace turns Update and Display on for that trace. Normal detector is grayed out when the X scale is Log.
Couplings	Selecting a specific detector type turns “Auto” to false for this trace (manual). Selecting a detector for a trace (pressing the key or sending a [:SENS] :DET:TRAC command) puts Update On and Display On for that trace, even if that detector was already selected. Note that the legacy command [:SENS] :DET[:FUNC] does NOT exhibit this behavior. Selecting a detector, whether by pressing the key or sending the equivalent SCPI command, will turn trace math to Off for the selected/specified trace.
Initial S/W Revision	Prior to A.02.00

Average (Log/RMS/V)

For each bucket (interval) in the trace, Average detection displays the average of the amplitude within the bucket using one of the following averaging methods:

Log power (also known as video)

Power (also known as RMS)

Voltage envelope

To explicitly set the averaging method, use the **Meas Setup, Average Type** key. When you are using average detection with the Power method is equivalent to what is sometimes referred to as “RMS detection”. The detailed information about the different types of averaging is found in **Average Type** in the **Meas Setup** key menu.

Key Path	Trace/Det, Detector
Example	DET:TRAC3 AVER sets the detector to average for trace 3.
Notes	For the specific case of a customer wanting RMS detection, they need to set the averaging type to RMS, and also select average detection for the trace: AVER:TYPE RMS DET:TRAC AVER
Dependencies	Selecting any detector (even the currently selected detector) for a given trace turns Update and Display on for that trace.
Couplings	Selecting a specific detector type turns “Auto” to false for this trace (manual). Selecting a detector for a trace (pressing the key or sending a [:SENS]:DET:TRAC command) puts Update On and Display On for that trace, even if that detector was already selected. Note that the legacy command [:SENS]:DET[:FUNC] does NOT exhibit this behavior. Selecting a detector, whether by pressing the key or sending the equivalent SCPI command, will turn trace math to Off for the selected/specified trace. The VBW filter is not used for this detector, so varying the VBW will have no effect for any traces for which this detector is selected (other than to slow down the sweep, because of the coupling to Sweep Time of VBW). If the only traces which are active are traces for which VBW does not apply (traces with Average, EMI Average, RMS Average or Quasi Peak detectors), then the VBW annotation shows “---” on the front panel, although still returns the current value of VBW to a SCPI query. Use of the Average detector affects the VBW setting because of its effect on the VBW/RBW coupling. See the BW section under the key ““Video BW” on page 891”.
Initial S/W Revision	Prior to A.02.00

Peak

For each bucket (interval) in the trace, Peak detection displays the highest amplitude within the bucket.

Peak detection is used for CW measurements and some pulsed-RF measurements. For FFT analysis, the

Trace/Detector

highest amplitude across the frequency width of a bucket is displayed, even if that peak amplitude falls between samples of the spectrum computed in the FFT process.

Key Path	Trace/Det, Detector
Example	DET:TRAC2 POS sets the detector to peak for trace 2.
Couplings	Selecting a specific detector type turns “Auto” to false for this trace (manual). Selecting a detector for a trace (pressing the key or sending a [:SENS]:DET:TRAC command) puts Update On and Display On for that trace, even if that detector was already selected. Note that the legacy command [:SENS]:DET[:FUNC] does NOT exhibit this behavior. Selecting a detector, whether by pressing the key or sending the equivalent SCPI command, will turn trace math to Off for the selected/specified trace.
Initial S/W Revision	Prior to A.02.00

Sample

The sample detector displays the instantaneous level of the signal at the center of the bucket (interval) represented by each trace point.

Sample detection is good for displaying noise or noise-like signals.

Sample detection is not the best for making amplitude measurements of CW-like signals for two reasons. First, the peak response to a signal can occur between samples. So unless the Span to RBW ratio is lower than usual, then the highest sample can be well below the peak signal amplitude. Second, for the high sweep rates normally used, the peak response of the RBW filters is up to -0.5 dB. This sweeping error is compensated when using the peak and normal detectors by changing the overall gain. But the gain is not changed when in the sample detector, because doing so would cause errors in the response to noise. Instead, the auto-couple rules for sweep time are modified to give slower sweeps.

Key Path	Trace/Det, Detector
Example	DET:TRAC SAMP selects the Sample detector for trace 1.
Couplings	Selecting a specific detector type turns “Auto” to false for this trace (manual). Selecting a detector for a trace (pressing the key or sending a [:SENS]:DET:TRAC command) puts Update On and Display On for that trace, even if that detector was already selected. Note that the legacy command [:SENS]:DET[:FUNC] does NOT exhibit this behavior. Selecting a detector, whether by pressing the key or sending the equivalent SCPI command, will turn trace math to Off for the selected/specified trace.
Initial S/W Revision	Prior to A.02.00

Negative Peak

For each bucket (interval) in the trace, Negative Peak detection displays the lowest sample within the

bucket. Negative peak detection is similar to peak detection, but selects the minimum video signal.

Key Path	Trace/Det, Detector
Example	DET:TRAC2 NEG selects the negative peak detector for trace 2.
Couplings	<p>Selecting a specific detector type turns “Auto” to false for this trace (manual).</p> <p>Selecting a detector for a trace (pressing the key or sending a [:SENS]:DET:TRAC command) puts Update On and Display On for that trace, even if that detector was already selected. Note that the legacy command [:SENS]:DET[:FUNC] does NOT exhibit this behavior.</p> <p>Selecting a detector, whether by pressing the key or sending the equivalent SCPI command, will turn trace math to Off for the selected/specified trace.</p>
Initial S/W Revision	Prior to A.02.00

Preset Detectors

The keys in this menu provide a quick way of setting a number of traces to convenient common detector settings. It is important to point out that these are not toggles or ‘modes’, and do not keep any detectors in a particular configuration. The effect is identical to just setting the traces’ detectors individually. These are simply one-time settings that are quicker than making many individual changes.

Dependencies	When you have manually selected FFT sweep, the Detector Preset choices that contain any CISPR detectors, are grayed out. If the grayed out key is pressed, an advisory message is generated. If the equivalent SCPI command is sent, this same message is generated as part of a “-221, Settings conflict” warning.
Preset	No interaction with preset
State Saved	Not saved in state
Initial S/W Revision	Prior to A.02.00

All Traces Auto

This is designed to quickly return the selected set of detectors to the “preset” state, which is auto-selected.

Couplings	Sets all traces’ Detector Auto to true.
Initial S/W Revision	Prior to A.02.00

Trace/Detector

Peak / Average / NPeak

This is a setting for making a measurement of the average power and the signal envelope.

Couplings	Trace 1: Set to peak detection, and Clear-Write. Trace 2: Set to average detection, and Clear-Write. Trace 3: Set to negative peak detection, and Clear-Write.
Initial S/W Revision	Prior to A.02.00

Peak / Sample / NPeak

This is a setting for making a measurement that displays a power sample and the signal envelope.

Couplings	Trace 1: Set to peak detection, and Clear-Write. Trace 2: Set to sample detection, and Clear-Write. Trace 3: Set to negative peak detection, and Clear-Write.
Initial S/W Revision	Prior to A.02.00

Clear Trace

Clears the selected trace (from the front panel) or the specified trace (from SCPI). Does not affect the state of any function or variable in the instrument. Loads mintracevalue into all of the points in the selected trace, unless the trace is in Min Hold in which case it loads maxtracevalue. It does this even if Update = Off.

This key only appears in the Normal View. It does not appear when in the Spectrogram View.

Key Path	Trace/Detector
Remote Command	:TRACe:CLEAr TRACE1 TRACE2 TRACE3 TRACE4 TRACE5 TRACE6
Example	TRAC:CLE TRACE1 clears trace 1
Initial S/W Revision	Prior to A.02.00

Clear All Traces

Clears all traces. Does not affect the state of any function or variable in the instrument. Loads mintracevalue into all of the points all traces, except traces in Min Hold in which case it loads maxtracevalue. Does so even if Update = Off.

This key only appears in the Normal View. It does not appear when in the Spectrogram View.

Key Path	Trace/Detector
Remote Command	:TRACe:CLEAr:ALL
Example	TRAC:CLE:ALL clears all traces

Initial S/W Revision	Prior to A.02.00
----------------------	------------------

Math

This menu lets you turn on trace math functions. Trace math functions perform mathematical operations between traces and, in some cases, user-specified offsets. When in a trace math function, the indicated function is performed during the sweep with the math function used in place of a detector. The trace operands for the math function are set using the **Trace Operands** key.

See [“Math: More Information”](#) on page 1321.

This key only appears in the Normal View. It does not appear when in the Spectrogram View.

Key Path	Trace/Detector
Remote Command	:CALCulate:MATH TRACE1 TRACE2 TRACE3 TRACE4 TRACE5 TRACE6 , PDIFference PSUM LOFFset LDIFference OFF, TRACE1 TRACE2 TRACE3 TRACE4 TRACE5 TRACE6 , TRACE1 TRACE2 TRACE3 TRACE4 TRACE5 TRACE6 , <real> , <real> :CALCulate:MATH? TRACE1 TRACE2 TRACE3 TRACE4 TRACE5 TRACE6
Notes	The lower level menu, which contains an embedded 1-of-N, does not auto-return when a selection is made.

Notes	<p>The Trace Math Function command has 6 main set of parameters:</p> <ul style="list-style-type: none"> - Set 1 defines the “result trace”: TRACE1 TRACE2 TRACE3 TRACE4 TRACE5 TRACE6 -Set 2 defines the “function”: PDifference PSUM LOFFset LDifference OFF - Set 3 is a “trace operand” (1): TRACE1 TRACE2 TRACE3 TRACE4 TRACE5 TRACE6 - Set 4 is a “trace operand” (2): TRACE1 TRACE2 TRACE3 TRACE4 TRACE5 TRACE6 - Set 5 defines the “Log Offset” (in dB). - Set 6 defines the “Log Difference Reference” (in dBm). <p>Note that the trace math mode is an enumeration; that is, when a math function is set for a trace it turns off any math function that is on for that trace and sets the new math function.</p> <p>The parameters sent in the command are reflected in the values in the key menu. There is no default for any parameter; all 6 parameters must be sent to satisfy the parser. Failure to specify a parameter will result in a missing parameter error.</p> <p>Note that for some of the math modes some of the parameters are not relevant. For those modes, the parameters are ignored, and sending “,” is sufficient for those parameters.</p> <p>The query returns the math mode, the operand traces, the offset and the reference for the specified trace, all separated by commas. The return value of irrelevant parameters is undefined; empty fields (“,”) would be desirable.</p> <p>Remote command examples are included in each section below.</p>
Dependencies	<p>Trace Math is not available if Normalize is on.</p> <p>None of the trace operands can be the destination trace. If any of the three trace math commands is sent with a destination trace number matching one of the operands a warning is generated and the function does not turn on.</p>
Couplings	<p>Whenever a math function is turned on for a trace, that trace is set to Display = On and Update = On.</p>
Preset	<p>OFF,TRACE5,TRACE6,0,0 OFF,TRACE6,TRACE1,0,0 OFF,TRACE1,TRACE2,0,0 OFF,TRACE2,TRACE3,0,0 OFF,TRACE3,TRACE4,0,0 OFF,TRACE4,TRACE5,0,0</p>
State Saved	<p>The trace math function for each trace is saved in Instrument State.</p>
Status Bits/OPC dependencies	<p>*OPC can be used to detect the completion of a sweep, which will also correspond to the completion of the math operation, since all math takes place during the sweep</p>
Initial S/W Revision	<p>Prior to A.02.00</p>

Math: More Information

IMPORTANT: to generate a trace math result, you must take a sweep. The trace math engine, described below, operates in concert with the sweep engine in the test set. Until a sweep has been taken, even if the constituent traces are not in Update mode, no result is generated. Note that certain events can affect the trace in ways that affects all points at once. This can happen in any number of ways, including:

A trace clear taking place

A trace being loaded from the file system

Trace data being sent in from the remote interface

A copy or exchange of trace data

You should try to avoid these occurrences during a sweep, as they will tend to invalidate the math result being accumulated.

How trace math is processed:

Whenever a trace math function is turned on, or the parameters and/or operands of an existing trace math function are changed, the destination trace is cleared. After the trace is cleared, all x-axis values in the trace, and the domain of the trace, are set to match the X-axis settings of the first trace operand. When this is complete, a new sweep is initiated.

The process of acquiring data, processing it using the math and average/hold functions, and presenting it to the user as trace data, consists of several functional blocks, as shown below:

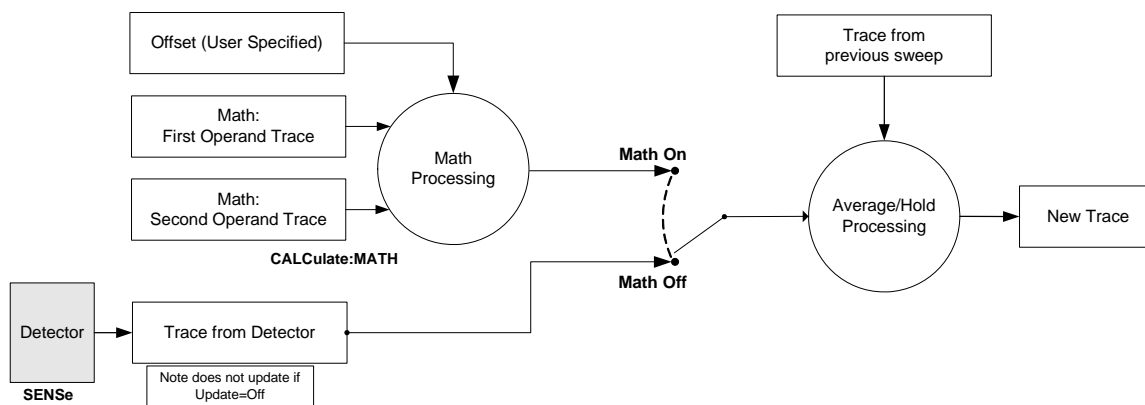

For each active trace, the current trace point is processed for Trace 1, then Trace 2, then Trace 3, et cetera. Trace data is taken from either the detector for that trace, or from the mathematical result of up to two other traces and an offset, depending on whether trace math is on or not. The resultant data is then fed to the Average/Hold processing block, where (if the trace type is Average, Max Hold, or Min Hold) it is processed with previous trace data. The new trace data resulting from this process is then available for display, storage or remote output.

When the processing is complete for Trace 1, Trace 2 is processed, and so on until all six traces have been processed. This allows a downstream trace to use as one of its math components a fully processed upstream trace. In other words, if math is on for Trace 4, and its operand traces are Trace 2 and Trace 3, all detector, math, average and hold processing for traces 2 and 3 is complete before the math is performed for trace 4. When the current trace point is completed for all traces, the test set moves on to the next trace point.

Trace/Detector

Power Diff (Op1-Op2)

Calculates a power difference between the **First Trace** operand and the **Second Trace** operand and puts the result in the destination trace.

During the sweep, the following formula is executed for each point in the trace operands, and the corresponding point is generated for the destination trace:

$$\text{DestinationTrace} = 10 \log(10(1/10)(\text{FirstTrace}) - 10(1/10)(\text{SecondTrace}))$$

The values of the trace points are assumed to be in a decibel scale, as they are internally stored.

If a point in FirstTrace is equal to maxtracevalue, the resultant point is also maxtracevalue.

Otherwise, if the result of the subtraction is less than or equal to 0, the resultant point is mintracevalue.

Key Path	Trace/Detector, Math
Example	:CALC:MATH TRACE1,PDIF,TRACE4,TRACE5,, sets Trace 1 to Power Diff trace math function, and sets the First Trace operand (for Trace 1) to Trace 4 and the Second Trace operand (for Trace 1) to Trace 5.
Couplings	Selecting a math mode other than Off for a trace (pressing the key or sending the equivalent SCPI command) puts the trace in View (Update On and Display On), even if that math mode was already selected.
Initial S/W Revision	Prior to A.02.00

Power Sum (Op1+Op2)

Calculates a power sum between the **First Trace** operand and the **Second Trace** operand and puts the result in the destination trace.

During the sweep, the following formula is executed for each point in the trace operands, and the corresponding point is generated for the destination trace.:

$$\text{DestinationTrace} = 10 \log(10(1/10)(\text{FirstTrace}) + 10(1/10)(\text{SecondTrace}))$$

The values of the trace points are assumed to be in a decibel scale, as they are internally stored.

If a point in either trace operand is equal to maxtracevalue, the resultant point is also maxtracevalue.

Key Path	Trace/Detector, Math
Example	:CALC:MATH TRACE1,PSUM,TRACE4,TRACE5,, sets Trace 1 to Power Sum trace math function and sets the First Trace operand (for Trace 1) to Trace 4 and the Second Trace operand (for Trace 1) to Trace 5.
Couplings	Selecting a math mode other than Off for a trace (pressing the key or sending the equivalent SCPI command) puts the trace in View (Update On and Display On), even if that math mode was already selected.
Initial S/W Revision	Prior to A.02.00

Log Offset (Op1 + Offset)

Calculates a log offset from the **First Trace** operand and puts the result in the destination trace. This is like the B-DL function in some older test sets. The offset is entered as the active function. Each destination trace has its own offset.

During the sweep, the following formula is executed for each point in the trace operand, and the corresponding point is generated for the destination trace.:

$$\text{DestinationTrace} = \text{FirstTrace} + \text{Offset}$$

The values of the trace points are assumed to be in dBm (as they are internally stored) and the offset is in dB.

If a point in the trace operand is equal to maxtracevalue, the resultant point is also maxtracevalue.

If a point in the trace operand is equal to mintracevalue, the resultant point is also mintracevalue.

Example: If offset is 25 dB, then our destination trace is higher than the operand trace by 25 dB.

Note that the **Second Trace** operand is not used for this function.

Key Path	Trace/Detector, Math
Example	:CALC:MATH TRACE1,LOFF,TRACE4,,-6.00, sets Trace 1 to Log Offset trace math function, sets the First Trace operand (for Trace 1) to Trace 4, leaves the Second Trace operand (for Trace 1) unchanged (it is irrelevant for this function) and sets the Log Offset (for Trace 1) to -6 dB.
Couplings	Selecting a math mode other than Off for a trace (pressing the key or sending the equivalent SCPI command) puts the trace in View (Update On and Display On), even if that math mode was already selected.
State Saved	The Log Offset value for each trace is saved in Instrument State
Min	-100 dB
Max	100 dB
Initial S/W Revision	Prior to A.02.00

Log Diff (Op1-Op2+Ref)

Offsets the difference between the **First Trace** operand and the **Second Trace** operand by a reference and puts the result in the destination trace. This is like the A-B+DL function in some older test sets. The reference is entered as the active function. Each destination trace has its own reference.

During the sweep, the following formula is executed for each point in the trace operands, and the corresponding point is generated for the destination trace:

$$\text{DestinationTrace} = (\text{FirstTrace} - \text{SecondTrace}) + \text{Reference}$$

The values of the operand trace points are assumed to be in decibel units (as they are internally stored) and the reference is in dBm so the result is in dBm.

Example: If the first operand trace 1 is at 5 dBm, the second operand trace 2 is at -5 dBm, and the

Trace/Detector

reference is -25 dBm, then the destination trace is -15 dBm.

Example: If the first operand trace1 is at 60 dBuV, the second operand trace 2 is at 50 dBuV, and the reference is 35 dBuV, then the destination trace is 45 dBuV.

See “[More Information](#)” on page 1324.

Key Path	Trace/Detector, Math
Example	:CALC:MATH TRACE1,LDIF,TRACE4,TRACE5,,-6.00 sets Trace 1 to Log Diff trace math function, sets the First Trace operand (for Trace 1) to Trace 4, sets the Second Trace operand (for Trace 1) to Trace 5, and sets the Log Difference reference for Trace 1 to -6 dBm.
Couplings	Selecting a math mode other than Off for a trace (pressing the key or sending the equivalent SCPI command) puts the trace in View (Update On and Display On), even if that math mode was already selected.
State Saved	The Log Difference reference value for each trace is saved in Instrument State
Min	Same as reference level
Max	Same as reference level
Default Unit	depends on the current selected Y axis unit
Initial S/W Revision	Prior to A.02.00

More Information

If a point in FirstTrace is equal to maxtracevalue, the resultant point is also maxtracevalue.

If a point in FirstTrace is equal to mintracevalue, the resultant point is also mintracevalue.

If neither of the above is true for a given point, then:

If that point in SecondTrace is equal to maxtracevalue, the resultant point is mintracevalue.

If that point in SecondTrace is equal to mintracevalue, the resultant point is maxtracevalue.

Off

Turns off Trace Math.

Key Path	Trace/Detector, Math
Example	CALC:MATH TRACE1 OFF turns off trace math for trace 1.
Notes	See Trace “Math”.
State Saved	The current trace math function is saved in Instrument State
Readback	Off
Initial S/W Revision	Prior to A.02.00

Operands

Selects the trace operand(s) to be used for the trace math functions for the destination trace.

Key Path	Trace, Math
Notes	The operands of the trace math commands specify the trace operands. Since the operands are common to all math functions for a given trace, the most recently sent math function command sets the operands for each trace and are reflected on the trace operand keys.
Dependencies	The destination trace cannot be an operand.
Readback line	In square brackets, the First Trace operand, new line, and the second trace operand, as: [Op1 = Trace 1, Op2 = Trace2] where Trace 1 is operand 1 and Trace 2 is operand 2.
Initial S/W Revision	Prior to A.02.00

Operand 1

Selects the first trace operand to be used for the trace math functions for the destination trace.

Key Path	Trace, Math, Trace Operands
Dependencies	The First Trace cannot be the same as the destination trace. The destination trace number is gray on the key, and the underline skips that number when selecting the trace.
Preset	Trace number – 2 (wraps at 1). For example, for Trace 1, the First Trace presets to Trace 5; for Trace 6, it presets to Trace 4.
State Saved	The First Trace operand for each trace is stored in instrument state.
Readback	Trace <trace number>
Initial S/W Revision	Prior to A.02.00

Operand 2

Selects the second trace operand to be used for the trace math functions for the destination trace.

Key Path	Trace, Math, Trace Operands
Dependencies	The Second Trace cannot be the same as the destination trace. The destination trace number is gray on the key, and the underline skips that number when selecting the trace.
Preset	Trace number – 1 (wraps at 1). For example, for Trace 1, the Second Trace presets to Trace 6; for Trace 6, it presets to Trace 5.
State Saved	The Second Trace operand for each trace is stored in instrument state

Trace/Detector

Readback	Trace <trace number>
Initial S/W Revision	Prior to A.02.00

Normalize

Displays menu keys that let you normalize trace data.

This key only appears in the Normal View. It does not appear when in the Spectrogram View.

Key Path	Trace/Detector
Readback	[On] or [Off]
Initial S/W Revision	Prior to A.02.00

Normalize On/Off

Normalize (On) activates the normalize function. On each sweep, the normalized trace (Trace 3) is subtracted from Trace 1 and the result is added to the normalized reference level. This arithmetic assumes all values are in decibel units, so we are actually taking a ratio.

This key only appears in the Normal View. It does not appear when in the Spectrogram View.

See [“More Information” on page 1326](#).

See [“Normalize Block Diagram” on page 1327](#).

Key Path	Trace/Detector, Normalize
Remote Command	:CALCulate:NTData[:STATe] OFF ON 0 1 :CALCulate:NTData[:STATe] ?
Example	CALC:NTD ON CALC:NTD?
Dependencies	<ul style="list-style-type: none">• If Normalize (On) is pressed before Store Ref (1 3), an error message is generated. Normalize remains off in this case.• Normalize is not available (grayed out) if any Trace Math function is on.
Couplings	When Normalize is turned on, Trace 1 is placed in Clear/Write with Update = On and Display = On.
Preset	OFF
State Saved	Saved in Instrument State.
Initial S/W Revision	Prior to A.02.00

More Information

First the following calculation is performed:

Trace 1 = (Trace 1D – Normalized Trace)

Where:

Trace 1D is the measured value of trace 1, as it comes from the SENSE subsystem.

Normalized Trace is Trace 3, in which you have previously stored a reference trace

All values are in decibel units.

This Trace 1 contains the values that are returned from a trace query, or if the marker is placed on the trace.

For example, let's say bucket 1 on Trace 1 is at 0 dBm, and bucket 1 on Trace 3 is at 10 dBm. The resultant bucket is at $0 \text{ dBm} - 10 \text{ dBm} = -10 \text{ dB}$ (just like with a delta marker).

You are also given the ability to define what (dB) value to use for Ref Level, and to define where on the screen the Ref Lvl line will appear using Normalized Reference Position. This flexibility in displaying the result allows a wide range of devices, including amplifiers, to be tested using Normalize.

In the example above, bucket 1 has the value of -10 dB . Let us assume you have set Norm Ref Lvl to 5 dB. Thus bucket 1 will display 1.5 divisions below the Reference Level line (assuming 10 dB per division).

The Reference Level line is normally the top line of the graticule. If Norm Ref Posn is set to 10, this is the case. If it is set to 9, it is the next line down. If it is set to 5, it is the middle line of the graticule. If set to 0 it is the bottom line.

So in the example above, if Norm Ref Posn is set to 9, then bucket 1 will display 2.5 divisions below the top line of the graticule.

None of the manipulations of Norm Ref Posn and Norm Ref Lvl affect the data in the trace.

As Normalize displays a ratio between two traces (a difference, in dB) the Y-Axis Unit while in Normalize is dB in Log Amplitude and dimensionless in Linear. The Y-axis unit chosen in the Y-axis unit menu is unaffected by Normalize. When you leave Normalize the Y-axis unit returns to the value set in the Y-axis unit menu. While in Normalize, all amplitude functions, such as Marker Y and the values in other traces, should be always in db unit, and so should the returned trace query results. In other words, both trace query result and marker Y become independent of the Y-axis unit chosen in the Y-axis unit menu when normalize is on.

(In Linear, the equivalent calculation is performed but it yields a dimensionless ratio, so the normalized reference level is unitless, presetting to 1, just as in Log it presets to 0 dB).

Y-axis annotation is blanked while in Normalize. Any other traces on the display are plotted in dB, where the dB value used is equivalent to the dBm value of the trace. For example, if bucket 1 in trace 2 is at -40 dBm , that bucket is plotted at -40 dB . All traces use Norm Ref Lvl and Norm Ref Posn for positioning on the display. When Normalize exits, the normal Ref Lvl is restored. This normal Ref Level is unaffected by Normalize.

Normalize Block Diagram

A block diagram showing how Normalize works is presented below:

Trace/Detector

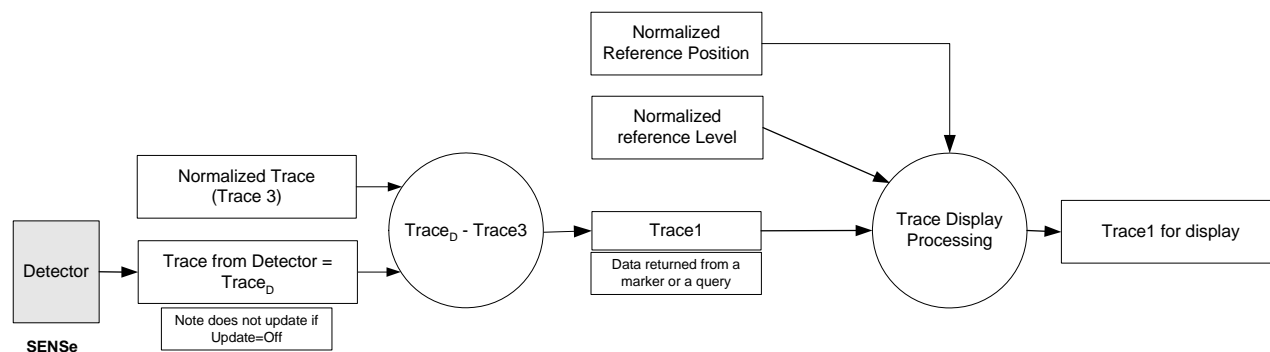

The normalize function is most useful for applying correction data to a trace while making a stimulus-response measurement with a tracking generator (or synchronized source). For example, connect the cables and a through line, in place of the device to be measured, between the tracking generator and the test set input. Notice that the frequency response is not perfectly flat, showing the response of the cables, as well as the flatness of both the tracking generator and the test set. Now press Store Ref (1 3), Normalize On. Notice that the displayed trace is now flat, or normalized. The position of the normalized trace can now be moved to a different position on the display by changing the normalized reference position. This may be useful if the device to be tested has positive gain, such as an amplifier. Now replace the through line with the device under test, and an accurate measurement of the gain or loss can be made.

Store Ref (1 -> 3)

Copies trace 1 into trace 3. Store Ref (1 3) must be pressed before pressing Normalize (On). Note that this puts Trace 3 in Update = Off (not updating) and Display = On (visible).

Key Path	Trace/Detector, Normalize
Notes	There is no remote command for this function, however the trace copy command can be used for this purpose.
Dependencies	<ul style="list-style-type: none"> If Normalize (On) is pressed before Store Ref (1 3), an error message is generated. Normalize remains off in this case.
Initial S/W Revision	Prior to A.02.00

Show Ref Trace (Trace 3)

Views or blanks the reference trace on the display. The reference trace is trace 3, so this is the same as setting Trace 3's "Display" attribute.

Key Path	Trace/Detector, Normalize
Example	TRAC3:DISP 1 shows the reference trace.
Notes	Use the TRAC3:DISP command to show or blank the reference trace Trace 3 is always the reference trace by definition.
State Saved	Saved in instrument state.
Initial S/W Revision	Prior to A.02.00

Norm Ref Lvl

Sets the level (in dB) of the normalized reference.

Key Path	Trace/Detector, Normalize
Remote Command	:DISPlay:WINDow[1]:TRACe:Y[:SCALe]:NRLevel <rel_ampl> :DISPlay:WINDow[1]:TRACe:Y[:SCALe]:NRLevel?
Example	DISP:WIND:TRAC:Y:NRL .10 dB DISP:WIND:TRAC:Y:NRL?
Preset	0 dB
State Saved	Saved in instrument state.
Min	-327.6 dB
Max	327.6 dB
Initial S/W Revision	Prior to A.02.00

Norm Ref Posn

Offsets the displayed trace without affecting the instrument gain or attenuation settings. This allows the displayed trace to be moved without decreasing measurement accuracy. The normalized reference position is indicated with a right arrow on the left side of the display and a left arrow on the right side of the display, just inside the graticule. See picture below:

Trace/Detector

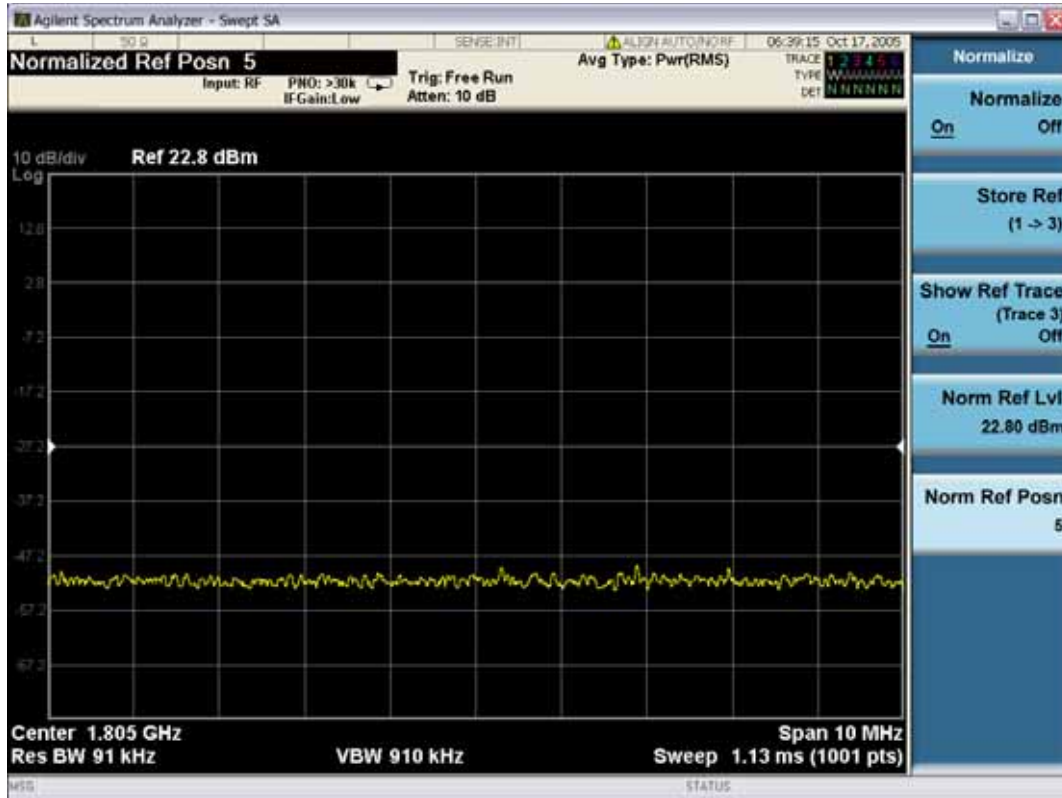

Key Path	Trace/Detector, Normalize
Remote Command	:DISPlay:WINDow[1]:TRACe:Y[:SCALE]:NRPosition <integer> :DISPlay:WINDow[1]:TRACe:Y[:SCALE]:NRPosition?
Example	DISP:WIND:TRAC:Y:NRP 5 DISP:WIND:TRAC:Y:NRP?
Notes	The top and bottom graticule lines correspond to 10 and 0, respectively.
Preset	10
State Saved	Saved in Instrument State.
Min	0
Max	10
Initial S/W Revision	Prior to A.2.00

Copy/Exchange

This menu lets you copy any trace to any other trace, or exchange any trace with any other trace. The action is performed once, it is not an “every sweep” type of thing.

The X-axis settings and domain of a trace go with it when it is copied or exchanged.

Key Path	Trace/Detector
Remote Command	:TRACe:COPIY TRACE1 TRACE2 TRACE3 TRACE4 TRACE5 TRACE6 , TRACE1 TRACE2 TRACE3 TRACE4 TRACE5 TRACE6 :TRACe:COPIY?
Example	TRAC:COPIY TRACE1,TRACE3 copies Trace 1 to Trace 3 and puts Trace 3 in Update = Off, Display = On
Notes	The TRACe:COPIY command is of the form: :TRACe:COPIY <source_trace>,<dest_trace>
Notes	In the case of a Copy , the destination trace is put in Update = Off, Display = On after the copy. In the case of an Exchange , both traces are put into Update = Off, Display = On after the exchange.
Preset	TRACE1, TRACE2
Initial S/W Revision	Prior to A.02.00

Remote Command:	:TRACe:EXCHange TRACE1 TRACE2 TRACE3 TRACE4 TRACE5 TRACE6 , TRACE1 TRACE2 TRACE3 TRACE4 TRACE5 TRACE6 :TRACe:EXCHange?
Example:	TRAC:EXCH TRACE1,TRACE2 exchanges Trace 1 and Trace 2 and puts both traces in Update = Off, Display = On .
Notes:	The TRACe:EXCHange command is of the form: :TRACe:EXCHange <trace_1>,<trace_2>
Preset:	TRACE1, TRACE2
Initial S/W Revision:	Prior to A.02.00

From Trace

Selects the trace to be copied to or exchanged with the **To Trace**

Key Path	Trace/Detector, Copy/Exchange
Notes	See "Copy/Exchange".
Preset	1
Initial S/W Revision	Prior to A.02.00

Trace/Detector

To Trace

Selects the trace to be copied from or exchanged with the **From Trace**

Key Path	Trace/Detector, Copy/Exchange
Notes	See “Copy/Exchange”.
Preset	2
Initial S/W Revision	Prior to A.02.00

Copy Now

Executes the Copy operation and puts the destination trace in **Update = Off, Display = On**.

Key Path	Trace/Detector, Copy/Exchange
Notes	See “Copy/Exchange”.
Initial S/W Revision	Prior to A.02.00

Exchange Now

Executes the Exchange operation and puts both traces in **Update = Off, Display = On**.

Key Path	Trace/Detector, Copy/Exchange
Notes	See “Copy/Exchange”.
Initial S/W Revision	Prior to A.02.00

Send/Query Trace Data (Remote Command Only)

This command allows trace data to be sent to the test set or queried from the test set. The response to the query is a list of the amplitude points which comprise the requested trace in the current Y-axis unit of the test set. The X-axis unit is that of the destination trace (for send) or the source trace (for query).

See “[Query Trace Data](#)” on page 1333.

See “[More Information](#)” on page 1333.

Remote Command:	:TRACe[:DATA] TRACE1 TRACE2 TRACE3 TRACE4 TRACE5 TRACE6, <data>
------------------------	--

Notes:	<p>The TRACe[:DATA] command is of the form:</p> <pre>:TRACe:DATA <trace>,<data></pre> <p>where <trace> can be one of the following parameters:</p> <p>TRACE1, TRACE2, TRACE3, TRACE4, TRACE5, TRACE6</p> <p>and where <data> can be</p> <ul style="list-style-type: none"> - ASCII data, which consists of a string of values separated by comma or - REAL or INTeger sent as a definite length block, with a header describing the data to follow.
Couplings:	<p>Sweep points will affect the amount of data</p> <p>The FORMat:DATA command describes the different types of data formats that can be used with trace data.</p> <p>Use the FORMat:BORDER command to set the byte order.</p>
Initial S/W Revision:	Prior to A.02.00

Query Trace Data

Remote Command:	:TRACe[:DATA]? TRACE1 TRACE2 TRACE3 TRACE4 TRACE5 TRACE6
Example:	<p>TRAC TRACE1,-1,-2,-3,-4,-5 sends five points to Trace 1. Assuming that FORMat:DATA is set to ASCII, Y-axis unit is set to dBm, and sweep points is set to 5, this will result in Trace 1 consisting of the five points -1 dBm, -2 dBm, -3 dBm, -4 dBm, and -5 dBm.</p> <p>TRAC? TRACE2 queries the test set for the contents of trace 2.</p>
Initial S/W Revision:	Prior to A.02.00

More Information

The format and byte-ordering of the sent or received data is dependent on the FORMat :DATA and FORMat :BORDER commands. ASCII data consists of a string of comma separated values. REAL or INTeger data is sent as a definite length block, with a header describing the data to follow.

For example, a four point trace might look like this if in ASCII (FORMat :DATA ASCII):

```
-5.87350E+01, -5.89110E+01, -5.87205E+01, -5.12345E+01<NL><END>
```

and like this if in INTeger with 4 bytes per point (FORMat :DATA INT, 32):

```
#216<16 bytes of data><NL><END>
```

where the 2 in the #216 means “2 digits of numeric data to follow”, and the 16 is the 2 digits and means “16 binary bytes to follow” (this is the definite length block format).

Note that the data is terminated with <NL><END>. (For GPIB this is newline, or linefeed, followed by EOI set true. For LAN, this is newline only.)

Trace/Detector

The data format set by `FORMat:DATA` and `FORMat:BORDER` is used both for sending data to the instrument and receiving data from the instrument.

When sending data to the instrument, the data block must contain exactly the number of points currently specified in **Sweep, Points** or error is generated and there is no change to the target trace.

No units terminator (for example, dB or V) is used when sending data; the data is taken as being in the current Y-axis unit of the test set.

When a trace is sent to the instrument, it immediately overwrites all of the data in the target trace, even if that trace is inactive, or even if it is active and in the middle of a sweep. If in the middle of a set of **Trace Average** or **Max/Min Hold** operations, it can totally mess up the result, so you must be careful. Similarly, when querying trace data, it is best if the test set is not sweeping during the query. Therefore, it is generally advisable to be in **Single Sweep, or Update = Off** when sending trace data to the test set or querying trace data from the test set.

Format Data: Numeric Data (Remote Command Only)

This command specifies the format of the trace data input and output. It specifies the formats used for trace data during data transfer across any remote port. It affects only the data format for setting and querying trace data for the `:TRACe[:DATA]`, `TRACe[:DATA]?`, `:CALCulate:DATA[n]?` and `FETCh:SANalyzer[n]?` commands and queries.

Remote Command:	<code>:FORMat [:TRACe] [:DATA] ASCii INTeger, 32 REAL, 32 REAL, 64</code> <code>:FORMat [:TRACe] [:DATA] ?</code>
Notes:	The query response is: ASCii: ASC,8 REAL,32: REAL,32 REAL,64: REAL,64 INTeger,32: INT,32 When the numeric data format is REAL or ASCii, data is output in the current Y Axis unit. When the data format is INTeger, data is output in units of m dBm (.001 dBm). The INT,32 format returns binary 32-bit integer values in internal units (m dBm), in a definite length block.
Dependencies:	Sending a data format spec with an invalid number (for example, INT,48) generates no error. The analyzer simply uses the default (8 for ASCii, 32 for INTeger, 32 for REAL). Sending data to the analyzer which does not conform to the current FORMat specified, results in an error. Sending ASCII data when a definite block is expected generates message -161 "Invalid Block Data" and sending a definite block when ASCII data is expected generates message -121 "Invalid Character in Number".
Preset:	ASCii

Backwards Compatibility Notes:	Note that the INT,32 format is only applicable to the command, TRACe:DATA. This preserves backwards compatibility for the Swept SA measurement. For all other commands/queries which honor FORMat:DATA, if INT,32 is sent the analyzer will behave as though it were set to REAL,32.
Initial S/W Revision:	Prior to A.02.00

The specs for each output type follow:

ASCIi - Amplitude values are in ASCII, in the current Y Axis Unit, one ASCII character per digit, values separated by commas, each value in the form:

SX.YYYYYEsZZ

Where:

S = sign (+ or -)

X = one digit to left of decimal point

Y = 5 digits to right of decimal point

E = E, exponent header

s = sign of exponent (+ or -)

ZZ = two digit exponent

REAL,32 - Binary 32-bit real values in the current Y Axis Unit, in a definite length block.

REAL,64 - Binary 64-bit real values in the current Y Axis Unit, in a definite length block.

Format Data: Byte Order (Remote Command Only)

This command selects the binary data byte order for data transfer and other queries. It controls whether binary data is transferred in normal or swapped mode. This command affects only the byte order for setting and querying trace data for the :TRACe[:DATA], TRACe[:DATA]? , :CALCulate:DATA[n]? and FETCh:SANalyzer[n]? commands and queries.

By definition any command that says it uses FORMat:DATA uses any format supported by FORMat:DATA.

The NORMal order is a byte sequence that begins with the most significant byte (MSB) first, and ends with the least significant byte (LSB) last in the sequence: 1|2|3|4. SWAPped order is when the byte sequence begins with the LSB first, and ends with the MSB last in the sequence: 4|3|2|1.

Remote Command:	:FORMat:BORDER NORMal SWAPped :FORMat:BORDER?
Preset:	NORMal
Initial S/W Revision:	Prior to A.02.00

Smooth Trace Data (Remote Command Only)

Not recommended for new designs. Use the CALCulate:DATA:COMPRESS command instead.

Smooths the trace according to the number of points specified in :TRACe:MATH:SMOoth:POINTs. There is no equivalent front panel function.

The purpose of this function is to perform a spatial video averaging, as compared to the temporal version supplied by the video-average command [:SENSe]:AVERAge:TYPE VIDEo. The functions of TRACe:MATH:SMOoth <trace> and [:SENSe]:AVERAge:TYPE VIDEo|POWEr are not interchangeable.

Remote Command:	:TRACe:MATH:SMOoth TRACE1 TRACE2 TRACE3 TRACE4 TRACE5 TRACE6
Initial S/W Revision:	Prior to A.02.00

Number of Points for Smoothing (Remote Command Only)

Not recommended for new designs. (Will not be supported in future designs.) Use the CALCulate:DATA:COMPRESS command instead.

Specifies the number of points that are smoothed. Increasing the number of points increases smoothing at the cost of decreasing resolution. If the number of points is an even number, then the number of points is increased by one. If the number of points is larger than the number of sweep points, then the number of sweep points is used, unless the number of sweep points is even, in which case the number of points is the sweep points minus one. The number of points smoothed is always an odd number.

Remote Command:	:TRACe:MATH:SMOoth:POINTs <integer> :TRACe:MATH:SMOoth:POINTs?
Example:	TRAC:MATH:SMO:POIN 501
Notes:	Only odd values allowed; if <integer> even, add 1 unless <integer> = number of sweep points, in which case subtract 1 Used with the TRACe:MATH:SMOoth command.
Preset:	11
Min:	3
Max:	Number of sweep points
Initial S/W Revision:	Prior to A.02.00

Mean Trace Data (Remote Command Only)

Not recommended for new designs. Use the CALCulate:DATA:COMPRESS command instead.

Returns the mean of the amplitudes of the trace amplitude elements in measurement units.

Remote Command:	: TRACe :MATH:MEAN? TRACE1 TRACE2 TRACE3 TRACE4 TRACE5 TRACE6
Example:	TRAC:MATH:MEAN? TRACE2
Initial S/W Revision:	Prior to A.02.00

Trigger

Accesses a menu of keys to control the selection of the trigger source and the setup of each of the trigger sources. The analyzer is designed to allow triggering from a number of different sources, for example, Free Run, Video, External, RF Burst, and so forth.

The TRIG:SOURCe command (below) will specify the trigger source for the currently selected input (RF or I/Q). If you change inputs, the new input remembers the trigger source it was last programmed to for the current measurement, and uses that trigger source. You can directly set the trigger source for each input using the TRIGger:RF:SOURce and TRIGger:IQ:SOURce commands (later in this section). When in External Mixing, the analyzer uses the RF trigger source.

Note the inclusion of the <measurement> parameter in the command below. Because each measurement remembers its own Trigger Source, the command must be qualified with the measurement name. Note that for the Swept SA measurement this is not the case; for backwards compatibility, no <measurement> parameter is used when setting the Trigger Source for the Swept SA measurement.

See [“Trigger Source Presets” on page 1341](#)

See [“RF Trigger Source” on page 1344](#)

See [“I/Q Trigger Source” on page 1345](#)

See [“More Information” on page 1346](#)

Key Path:	Front-panel key
Remote Command:	<pre>:TRIGger:<measurement>[:SEquence]:SOURce EXTErnal1 EXTErnal2 IMMediate LINE FRAMe RFBurst VIDeo IF ALARm LAN IQMag IDEMod QDEMod IINPut QINPut AIQMag T V :TRIGger:<measurement>[:SEquence]:SOURce? where <measurement> is the measurement for which you wish to set the Source (blank for the Swept SA measurement)</pre>
Example:	<pre>TRIG:ACP:SOUR EXT1 Selects the external 1 trigger input for the ACP measurement and the selected input TRIG:SOUR VID Selects video triggering for the Swept SA (SANalyzer) measurement in the Spectrum Analyzer mode. For SAN, do not use the <measurement> keyword. Only send this form in the Spectrum Analyzer mode or you will get an Undefined Header error</pre>

Trigger

Notes:	<p>Not all measurements have all the trigger sources available to them. Check the trigger source documentation for your specific measurement to see what sources are available.</p> <p>Not all trigger sources are available for each input. See the “RF Trigger Source” on page 1344 and “I/Q Trigger Source” on page 1345 commands for detailed information on which trigger sources are available for each input.</p> <p>Other trigger-related commands are found in the INITiate and ABORt SCPI command subsystems.</p> <p>*OPC should be used after requesting data. This will hold off any subsequent changes to the selected trigger source, until after the sweep is completed and the data is returned.</p> <p>Available ranges and presets can vary from mode to mode.</p>
Dependencies:	In some models, there is no second External input. In these models, the External 2 key is blanked and the EXTernal2 parameter will generate a “Hardware missing; Not available for this model number” message.
Preset:	See table below
Status Bits/OPC dependencies:	The Status Operation Register bit 5 "Waiting for Trigger" is set at the same time as the Sweeping or Measuring bit is set. It is cleared when the trigger actually occurs (that is, after the trigger event occurs and all the applicable trigger criteria have been met). A corresponding pop-up message ("Waiting for trigger") is generated if no trigger signal appears after approximately 2 sec. This message goes away when a trigger signal appears.
Backwards Compatibility SCPI:	:TRIGger[:SEQuence]:SOURCe EXTernal For backward compatibility, the parameter EXTernal is mapped to EXTernal1
Backwards Compatibility SCPI:	[:SENSe] :<measurement> :TRIGger :SOURce This backwards compatibility alias command is provided for ESA/PSA compatibility This backwards compatibility command does not apply to the Swept SA measurement, for that just use :TRIGger:SOURCe This backwards compatibility command does not apply to the monitor spectrum, log plot and spot frequency measurements
Backwards Compatibility SCPI:	[:SENSe] :<measurement> :TRIGger :SOURce IF In earlier instruments, the parameter IF was used by apps for the video trigger, so using the IF parameter selects VIDEo triggering. Sending IF in the command causes VID to be returned to a query.
Backwards Compatibility SCPI:	[:SENSe] :ACPR :TRIGger :SOURce This backwards Compatibility SCPI command is provided to support the same functionality as [:SENSe] :ACPr :TRIGger :SOURce (PSA W-CDMA, PSA cdma2000 and PSA 1xEVDO) due to the fact that the ACPr node conflicts with the ACPower node.
Initial S/W Revision:	Prior to A.02.00

Modified at S/W Revision:	A.03.00
---------------------------	---------

Trigger Source Presets

Here are the Trigger Source Presets for the various measurements:

Meas	Mode	Preset for RF	Preset for IQ	Notes
Swept SA	SA	IMM	IQ not supported	
CHP	SA, WCDMA, C2K, WIMAX OFDMA, 1xEVDO, DVB-T/H, DTMB, LTE, LTETDD, CMMB, ISDB-T, Digital Cable TV, MSR	IMM	IQ not supported	
OBW	SA, WCDMA, C2K, WIMAX OFDMA, TD-SCDMA, 1xEVDO, LTE, LTETDD, CMMB, ISDB-T, MSR	1xEVDO: EXT1 others: IMM	IQ not supported	For 1xEVDO mode, the trigger source is coupled with the gate state, as well as the gate source. When the trigger source changes to RFBurst, External1 or External2, the gate state is set to on, and the gate source is set identically with the trigger source. When the trigger source changes to IMMEDIATE, VIDEO, LINE, FRAME or IF, the gate state is set to off.
CCDF	SA, WCDMA, C2K, WIMAX OFDMA, TD-SCDMA, 1xEV-DO, DVB-T/H, DTMB, LTE, LTETDD, CMMB, ISDB-T, Digital Cable TV, MSR	WIMAX OFDMA : RFBurst LTETDD: BTS: External 1 MS: Periodic Timer TD-SCDMA and 1xEV-DO: BTS: External 1 MS: RFBurst SA, WCDMA, C2K, LTE, CMMB, ISDB-T, DVB-T/H, DTMB, Digital Cable TV, MSR: IMMEDIATE	TD-SCDMA and 1xEV-DO: BTS: External 1 MS: IQMag LTETDD: BTS: External 1 MS: Periodic Timer Others: IMM	For TD-SCDMA: Trigger source is coupled with radio device. When radio device changes to BTS, trigger source will be changed to EXTERNAL1. When radio device changes to MS, trigger source will be set as RFBurst for RF or IQ Mag for BBIQ. When TriggerSource is RFBurst or IQ Mag, Measure Interval is grayed out.

Trigger

Meas	Mode	Preset for RF	Preset for IQ	Notes
ACP	SA, WCDMA, C2K, WIMAX OFDMA, TD-SCDMA, 1xEVDO, DVB-T/H, DTMB, LTE, LTETDD, CMMB, ISDB-T, Digital Cable TV, MSR	IMM	IQ not supported	
Tx Power	SA, GSM, TD-SCDMA	SA, GSM: RFBurst TD-SCDMA: EXternal	IMM	TD-SCDMA doesn't support the Line and Periodic Timer parameters. When the mode is TD-SCDMA, if the Radio Device is switched to BTS, the value will be changed to External 1 and if the Radio device is switched to MS, the value will be changed to RFBurst
SPUR	SA, WCDMA, C2K, WIMAX OFDMA, TD-SCDMA, 1xEVDO, DVB-T/H, LTE, LTETDD, MSR	IMM	IQ not supported	
SEM	SA, WCDMA, C2K, WIMAX OFDMA, TD-SCDMA, 1xEVDO, DVB-T/H, DTMB, LTE, LTETDD, CMMB, ISDB-T, Digital Cable TV, MSR	1xEVDO(BTS): EXternal1 All others: IMMEDIATE	IQ not supported	
CDP	WCDMA	IMM	IMM	
RHO	WCDMA	IMM	IMM	
PCON	WCDMA	IMM	IMM	
QPSK	WCDMA, C2K, 1xEVDO	All except CDMA1xEVDO: IMMEDIATE CDMA1xEVDO: EXT1	IMM	

Meas	Mode	Preset for RF	Preset for IQ	Notes
MON	All except SA and BASIC	IMM	IQ not supported	
WAV		LTETDD: BTS: External 1 MS: Periodic Timer GSM/EDGE: RFBurst All others: IMMediate	LTETDD: BTS: External 1 MS: Periodic Timer GSM/EDGE: IQMag All others: IMMMediate	
PVT	WIMAXOFDMA	RFB	IMM	
EVM	WIMAXOFDMA , DVB-T/H, DTMB, LTE, LTETDD, CMMB, ISDB-T, Digital Cable TV	All but CMMB: IMM CMMB: Periodic Timer	All but CMMB: IMM CMMB: External 1	LTE, LTETDD supports Free Run, Video and External 1 only.
SPEC	BASIC	IMM	IMM	
LOG Plot	PN	IMM	IQ not supported	
Spot Freq	PN	IMM	IQ not supported	
GMSK PVT	EDGE/GSM	RFB	IMM	
GMSK PFER	EDGE/GSM	RFB	IQMag	
GMSK ORFS	EDGE/GSM	RF Burst	IQ not supported	
EDGE PVT	EDGE/GSM	RFB	IMM	
EDGE EVM	EDGE/GSM	RFB	IQMag	
EDGE ORFS	EDGE/GSM	Periodic Timer	IQ not supported	
Combined WCDMA	WCDMA	IMM	IQ not supported	
Combined GSM	EDGE/GSM	RFB	IQ not supported	

Trigger

Meas	Mode	Preset for RF	Preset for IQ	Notes
List Power Step	WCDMA, EDGE/GSM	IMM	IQ not supported	
Transmit On/Off Power	LTETDD	LTETDD: BTS: External 1 MS: Periodic Timer	LTETDD: BTS: External 1 MS: Periodic Timer	
Transmit Analysis	BLUETOOTH	RFB	IQ not supported	
Adjacent Channel Power	BLUETOOTH	IMM	IQ not supported	
LE In-band Emissions	BLUETOOTH	IMM	IQ not supported	
EDR In-band Spurious Emissions	BLUETOOTH	Periodic Timer	IQ not supported	
Conformance EVM	LTE, LTETDD, MSR	IMM	IMM	

RF Trigger Source

The **RF Trigger Source** command selects the trigger to be used for the specified measurement when RF is the selected input. The RF trigger source can be queried and changed even while another input is selected, but it is inactive until RF becomes the selected input.

Note the inclusion of the <measurement> parameter in the command below. Because each measurement remembers its own Trigger Source, the command must be qualified with the measurement name. Note that for the Swept SA measurement this is not the case; for backwards compatibility, no <measurement> parameter is used when setting the Trigger Source for the Swept SA measurement.

Remote Command:	:TRIGger:<measurement>[:SEQuence]:RF:SOURce EXTernal1 EXTernal2 IMMediate LINE FRAME RFBurst VIDeo IF ALARm LAN TV :TRIGger:<measurement>[:SEQuence]:RF:SOURce?
Example:	TRIG:ACP:RF:SOUR EXT1 Selects the external 1 trigger input for the ACP measurement and the RF input TRIG:RF:SOUR VID Selects video triggering for the SANalyzer measurement and the RF input. For SAN, do not use the <measurement> keyword.

Notes:	<p>Not all measurements have all the trigger sources available to them. Check the trigger source documentation for your specific measurement to see what sources are available.</p> <p>Not all trigger sources are available for each input. For the RF Trigger Source, the following trigger sources are available:</p> <ul style="list-style-type: none"> — IMMEDIATE - free run triggering — VIDEO - triggers on the video signal level — LINE - triggers on the power line signal — EXTERNAL1 (or EXTERNAL) - triggers on an externally connected trigger source marked "Trigger 1 In" on the rear panel — EXTERNAL2 - triggers on an externally connected trigger source marked "Trigger 2 In" on the front panel. In some models, there is no second External input. In these models, the External 2 key is blanked and the EXTERNAL2 parameter will generate a "Hardware missing; Not available for this model number" message — RFBURST - triggers on the bursted frame — FRAME - triggers on the periodic timer — IF (video) - same as video, for backwards compatibility only <p>*OPC should be used after requesting data. This will hold off any subsequent changes to the selected trigger source, until after the sweep is completed and the data is returned.</p> <p>Available ranges, and presets can vary from mode to mode.</p>
Status Bits/OPC dependencies:	<p>The Status Operation Register bit 5 "Waiting for Trigger" is set at the same time as the Sweeping or Measuring bit is set. It is cleared when the trigger actually occurs (that is, after the trigger event occurs and all the applicable trigger criteria have been met). A corresponding pop-up message ("Waiting for trigger") is generated if no trigger signal appears after approximately 2 sec. This message goes away when a trigger signal appears.</p>
Initial S/W Revision:	Prior to A.02.00

I/Q Trigger Source

This command selects the trigger to be used for the specified measurement when I/Q (which requires option BBA) is the selected input. The I/Q trigger source can be queried and changed even while another input is selected, but it is inactive until I/Q becomes the selected input.

Remote Command:	<pre>:TRIGger:<measurement>[:SEQUENCE]:IQ:SOURce EXternal1 EXternal2 IMMEDIATE IQMag IDEMod QDEMod IINPu t QINPut AIQMag :TRIGger:<measurement>[:SEQUENCE]:IQ:SOURce?</pre>
Example:	<p>TRIG:WAVEform:SOUR IQM</p> <p>Selects I/Q magnitude triggering for the IQ Waveform measurement and the I/Q input</p>

Trigger

Notes:	<p>Not all measurements have all the trigger sources available to them. Check the trigger source documentation for your specific measurement to see what sources are available.</p> <p>Not all trigger sources are available for each input. For the I/Q Trigger Source, the following trigger sources are available:</p> <ul style="list-style-type: none">— IMMEDIATE - free run triggering— EXTERNAL1 (or EXTERNAL) - triggers on an externally connected trigger source on the rear panel— EXTERNAL2 - triggers on an externally connected trigger source on the front panel— IQMAG - triggers on the magnitude of the I/Q signal— IDEMOD - triggers on the I/Q signal's demodulated I voltage— QDEMOD - triggers on the I/Q signal's demodulated Q voltage— IINPUT - triggers on the I channel's ADC voltage— QINPUT - triggers on the Q channel's ADC voltage— AIQMAG - triggers on the magnitude of the auxiliary receiver channel I/Q signal <p>*OPC should be used after requesting data. This will hold off any subsequent changes to the selected trigger source, until after the sweep is completed and the data is returned.</p> <p>Available ranges, and from mode to mode presets can vary</p>
Status Bits/OPC dependencies:	<p>The Status Operation Register bit 5 "Waiting for Trigger" is set at the same time as the Sweeping or Measuring bit is set. It is cleared when the trigger actually occurs (that is, after the trigger event occurs and all the applicable trigger criteria have been met). A corresponding pop-up message ("Waiting for trigger") is generated if no trigger signal appears after approximately 2 sec. This message goes away when a trigger signal appears.</p>
Initial S/W Revision:	Prior to A.02.00

More Information

The trigger menus let you select the trigger source and trigger settings for a sweep or measurement. In triggered operation (basically, any trigger source other than Free Run), the analyzer will begin a sweep or measurement only with the selected trigger conditions are met, generally when your trigger source signal meets the specified trigger level and polarity requirements. (In FFT measurements, the trigger controls when the data acquisition begins for FFT conversion.)

For each of the trigger sources, you may define a set of operational parameters or settings which will be applied when that source is selected as the current trigger source. Examples of these settings are Trigger Level, Trigger Delay, and Trigger Slope. You may apply different settings for each source; so, for example, you could have a Trigger Level of 1v for External 1 trigger and -10 dBm for Video trigger.

Once you have established the settings for a given trigger source, they generally will remain unchanged for that trigger source as you go from measurement to measurement within a Mode (although the settings do change as you go from Mode to Mode). Furthermore, the trigger settings within a Mode are the same

for the **Trigger** menu, the **Gate Source** menu, and the **Sync Source** menu that is part of the **Periodic Timer Trigger Setup** menu. That is, if **Ext1** trigger level is set to 1v in the **Trigger** menu, it will appear as 1v in both the **Gate Source** and the **Sync Source** menus. For these reasons the trigger settings commands are not qualified with the measurement name, the way the trigger source commands are.

The settings setup menu can be accessed by pressing the key for the current trigger source a second time. For example, one press of Video selects the Video trigger as the source. The Video key becomes highlighted and the hollow arrow on the key turns black. Now a second press of the key takes you into the Video Trigger Setup menu.

Trigger Setup Parameters:

The following examples show trigger setup parameters using an external trigger source.

Example 1 illustrates the trigger conditions with negative slope and no trigger occurs during trigger Holdoff time.

Example 2 illustrates the trigger conditions with positive slope, trigger delay, and auto trigger time.

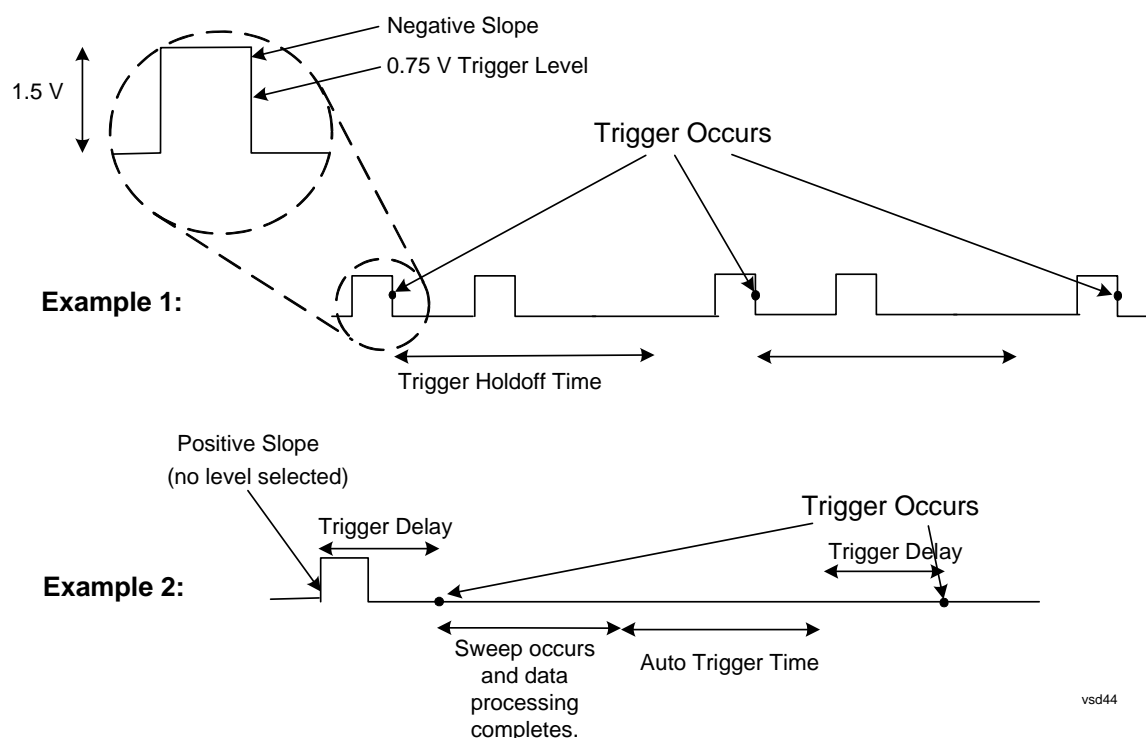

vsd44

Free Run

Pressing this key, when it is not selected, selects free-run triggering. Free run triggering occurs immediately after the sweep/measurement is initiated.

Key Path:	Trigger
Example:	TRIG:SOUR IMM Swept SA measurement TRIG:<meas>:SOUR IMM Measurements other than Swept SA

Trigger

State Saved:	Saved in instrument state
Status Bits/OPC dependencies:	The Status Operation Register bit 5 "Waiting for Trigger" is set at the same time as the Sweeping or Measuring bit is set. It is cleared when the trigger actually occurs (that is, after the trigger event occurs and all the applicable trigger criteria have been met). A corresponding pop-up message ("Waiting for trigger") is generated if no trigger signal appears after approximately 2 sec. This message goes away when a trigger signal appears.
Initial S/W Revision:	Prior to A.02.00

Video (IF Envelope)

Pressing this key, when it is not selected, selects the video signal as the trigger. The Video trigger condition is met when the video signal (the filtered and detected version of the input signal, including both RBW and VBW filtering) crosses the video trigger level.

NOTE When the detector selected for all active traces is the average detector, the video signal for triggering does not include any VBW filtering.

The video trigger level is shown as a labeled line on the display. The line is displayed as long as video is the selected trigger source.

Pressing this key, when it is already selected, accesses the video trigger setup functions.

Key Path:	Trigger
Example:	TRIG:SOUR VID Swept SA measurement TRIG:<meas>:SOUR VID Measurements other than Swept SA
Notes:	Log Plot and Spot Frequency measurements do not support Video Trigger
Dependencies:	Video trigger is allowed in average detector mode.
State Saved:	Saved in instrument state
Status Bits/OPC dependencies:	The Status Operation Register bit 5 "Waiting for Trigger" is set at the same time as the Sweeping or Measuring bit is set. It is cleared when the trigger actually occurs (that is, after the trigger event occurs and all the applicable trigger criteria have been met). A corresponding pop-up message ("Waiting for trigger") is generated if no trigger signal appears after approximately 2 sec. This message goes away when a trigger signal appears.
Backwards Compatibility Notes:	1. In the past, the Average detector was not available when Video triggering was on, and consequently, functions that set the detector to average (such as Marker Noise or Band/Intvl Power) were not available when the video trigger was on. Similarly, Video triggering was not available when the detector was Average. In the X-Series, these restrictions are removed.
Initial S/W Revision:	Prior to A.02.00

Trigger Level

Sets a level for the video signal trigger. When the video signal crosses this level, with the chosen slope, the trigger occurs. This level is displayed with a horizontal line only if **Video** is the selected trigger source.

Key Path:	Trigger, Video
Remote Command:	:TRIGger[:SEQuence]:VIDeo:LEVel <ampl> :TRIGger[:SEQuence]:VIDeo:LEVel?
Example:	TRIG:VID:LEV -40 dBm
Notes:	<p>When sweep type = FFT, the video trigger uses the amplitude envelope in a bandwidth wider than the FFT width as a trigger source. This might often be useful, but does not have the same relationship between the displayed trace and the trigger level as in swept triggering.</p> <p>Amplitude Corrections are not taken into account by the Video Trig Level. For example, if you have given yourself effective gain with an amplitude correction factor, the Video Trigger will not fire until you have dropped the trigger line that far below the displayed signal level, rather than simply dropping it down to the displayed signal level.</p> <p>Note that other corrections, specifically External Gain and Ref Level Offset, modify the actual trace data as it is taken and therefore ARE taken into account by Trig Level.</p>
Couplings:	This same level is used for the Video trigger source in the Trigger menu and for the Video selection in the Gate Source menu.
Preset:	Set the Video Trigger Level -25 dBm on Preset. When the Video Trigger Level becomes the active function, if the value is off screen, set it to either the top or bottom of screen, depending on which direction off screen it was.
State Saved:	Saved in instrument state
Min:	-170 dBm
Max:	+30 dBm
Default Unit:	Depends on the current selected Y axis unit
Backwards Compatibility SCPI:	:TRIGger[:SEQuence]:IF:LEVel :TRIGger[:SEQuence]:IF:LEVel?
Backwards Compatibility Notes:	This alias is provided for backward compatibility with VSA/PSA comms apps.
Initial S/W Revision:	Prior to A.02.00

Trig Slope

Controls the trigger polarity. It is set positive to trigger on a rising edge and negative to trigger on a

Trigger

falling edge.

Key Path:	Trigger, Video
Remote Command:	:TRIGger[:SEquence]:VIDeo:SLOPe POSitive NEGative :TRIGger[:SEquence]:VIDeo:SLOPe?
Example:	TRIG:VID:SLOP NEG
Preset:	POSitive
State Saved:	Saved in instrument state
Backwards Compatibility SCPI:	:TRIGger[:SEquence]:IF:SLOPe NEGative POSitive :TRIGger[:SEquence]:IF:SLOPe? For backward compatibility with VSA/PSA comms apps
Backwards Compatibility Notes:	The legacy :TRIGger[:SEquence]:SLOPe command affects the slopes for the VID, LINE, EXT1, EXT2, and RFB triggers.
Initial S/W Revision:	Prior to A.02.00

Remote Command:	:TRIGger[:SEquence]:SLOPe POSitive NEGative :TRIGger[:SEquence]:SLOPe?
Example:	TRIG:SLOP NEG
Preset:	POSitive
State Saved:	Saved in instrument state
Backwards Compatibility Notes:	In ESA/PSA, the Trigger Slope was global to all triggers. In the X-Series, the slope can be set individually for each Trigger Source. For backward compatibility, the global SLOPe command updates all instances of trigger slope (VID, LINE, EXT1, EXT2, TV, RFB). The query returns the trigger slope setting of the currently selected trigger source.
Initial S/W Revision:	Prior to A.02.00

Trig Delay

Controls a time delay during that the analyzer will wait to begin a sweep after meeting the trigger criteria. You can use negative delay to pre-trigger the instrument in the time domain or FFT, but not in swept spans.

Key Path:	Trigger, Video
Remote Command:	:TRIGger[:SEquence]:VIDeo:DELAy <time> :TRIGger[:SEquence]:VIDeo:DELAy? :TRIGger[:SEquence]:VIDeo:DELAy:STATE OFF ON 0 1 :TRIGger[:SEquence]:VIDeo:DELAy:STATE?

Example:	TRIG:VID:DEL:STAT ON TRIG:VID:DEL 100 ms
Notes:	Video trigger delay may be set to negative values, in time domain, FFT and even swept. It makes intuitive sense in time domain and works well in FFT mode where the bandwidth of the filter before the video trigger is about 1.25 span. In swept spans, negative settings of Trig Delay are treated as a zero setting within the internal hardware and the advisory message "Neg. Trig Delay unavailable in Swept Mode, zero delay used." is generated when such a delay is set.
Preset:	Off, 1 us
State Saved:	Saved in instrument state
Min:	-150 ms
Max:	+500 ms
Default Unit:	s
Backwards Compatibility Notes:	! For backward compatibility with VSA/PSA comms apps :TRIGger[:SEQuence]:IF:DELay :TRIGger[:SEQuence]:DELay The legacy :TRIGger[:SEQuence]:DELay command affects the delay for the VID, LINE, EXT1, EXT2, and RFB triggers.
Initial S/W Revision:	Prior to A.02.00

Remote Command:	:TRIGger[:SEQuence]:DELay <time> :TRIGger[:SEQuence]:DELay? :TRIGger[:SEQuence]:DELay:STATe OFF ON 0 1 :TRIGger[:SEQuence]:DELay:STATe?
Example:	TRIG:DEL 1 ms
Preset:	1 us
State Saved:	Saved in instrument state
Backwards Compatibility Notes:	In ESA/PSA, the Trigger Delay was global to all triggers. In the X-Series, the delay can be set individually for each Trigger Source. For backward compatibility, the global DELay command updates all instances of trigger slope (VID, LINE, EXT1, EXT2) except TV and RFBurst. The query returns the trigger delay setting of the currently selected trigger source.
Initial S/W Revision:	Prior to A.02.00

Trigger

Remote Command:	:TRIGger[:SEQuence]:OFFSet <time> :TRIGger[:SEQuence]:OFFSet? :TRIGger[:SEQuence]:OFFSet:STATe OFF ON 0 1 :TRIGger[:SEQuence]:OFFSet:STATe?
Example:	TRIG:OFFS ON TRIG:OFFS -100 ms
Notes:	These are ESA commands for trigger offset that allowed you to use a positive or negative delay when in zero span and in a Res BW >= 1 kHz. For ESA compatibility, X-series analyzers keep track of this offset and adds it to the Trigger Delay for VIDEo, LINE, EXTernal1 or EXTernal2 whenever the value is sent to the hardware, if in Zero Span and RBW >= 1 kHz.
Preset:	Off, 0 s
State Saved:	Saved in instrument state
Min:	-11 s
Max:	+11 s
Initial S/W Revision:	Prior to A.02.00

Line

Pressing this key, when it is not selected, selects the line signal as the trigger. A new sweep/measurement will start synchronized with the next cycle of the line voltage. Pressing this key, when it is already selected, access the line trigger setup menu.

Key Path:	Trigger
Example:	TRIG:SOUR LINE Swept SA measurement TRIG:<meas>:SOUR LINE Measurements other than Swept SA
Dependencies:	Line trigger is not available when operating from a "dc power source", for example, when the instrument is powered from batteries.
State Saved:	Saved in instrument state
Status Bits/OPC dependencies:	The Status Operation Register bit 5 "Waiting for Trigger" is set at the same time as the Sweeping or Measuring bit is set. It is cleared when the trigger actually occurs (that is, after the trigger event occurs and all the applicable trigger criteria have been met). A corresponding pop-up message ("Waiting for trigger") is generated if no trigger signal appears after approximately 2 sec. This message goes away when a trigger signal appears.
Initial S/W Revision:	Prior to A.02.00

Trig Slope

Controls the trigger polarity. It is set positive to trigger on a rising edge and negative to trigger on a falling edge.

Key Path:	Trigger, Line
Remote Command:	:TRIGger[:SEQuence]:LINE:SLOPe POSitive NEGative :TRIGger[:SEQuence]:LINE:SLOPe?
Example:	TRIG:LINE:SLOP NEG
Preset:	POSitive
State Saved:	Saved in instrument state
Backwards Compatibility Notes:	The legacy :TRIGger[:SEQuence]:SLOPe command affects the slopes for the VID, LINE, EXT1, EXT2, and RFB triggers.
Initial S/W Revision:	Prior to A.02.00

Trig Delay

Controls a time delay during which the analyzer will wait to begin a sweep after meeting the trigger criteria. You can use negative delay to pre-trigger the instrument in time domain or FFT, but not in swept spans.

Key Path:	Trigger, Line
Remote Command:	:TRIGger[:SEQuence]:LINE:DELay <time> :TRIGger[:SEQuence]:LINE:DELay? :TRIGger[:SEQuence]:LINE:DELay:STATe OFF ON 0 1 :TRIGger[:SEQuence]:LINE:DELay:STATe?
Example:	TRIG:LINE:DEL:STAT ON TRIG:LINE:DEL 100 ms
Notes:	Video trigger delay may be set to negative values, in time domain, FFT and even swept. It makes intuitive sense in time domain and works well in FFT mode where the bandwidth of the filter before the video trigger is about 1.25 span. In swept spans, negative settings of Trig Delay are treated as a zero setting within the internal hardware and the advisory message "Neg. Trig Delay unavailable in Swept Mode, zero delay used." is generated when such a delay is set.
Preset:	Off, 1.000 us
State Saved:	Saved in instrument state
Min:	-150 ms
Max:	500 ms
Default Unit:	S

Trigger

Backwards Compatibility Notes:	The legacy :TRIGger[:SEQuence]:DELay command affects the delay for the VID, LINE, EXT1, EXT2, and RFB triggers. The legacy :TRIGger[:SEQuence]:OFFSet command is supported for the VIDEo, LINE, EXT1, and EXT2 triggers.
Initial S/W Revision:	Prior to A.02.00

External 1

Pressing this key, when it is not selected, selects an external input signal as the trigger. A new sweep/measurement will start when the external trigger condition is met using the external 1 input connector on the rear panel.

Pressing this key, when it is already selected, accesses the external 1 trigger setup menu.

Key Path:	Trigger
Example:	TRIG:SOUR EXT1 Swept SA measurement TRIG:<meas>:SOUR EXT1 Measurements other than Swept SA
Dependencies:	Grayed out if in use by Point Trigger in the Source Setup menu. Forced to Free Run if already selected and Point Trigger is set to External 1.
State Saved:	Saved in instrument state
Status Bits/OPC dependencies:	The Status Operation Register bit 5 "Waiting for Trigger" is set at the same time as the Sweeping or Measuring bit is set. It is cleared when the trigger actually occurs (that is, after the trigger event occurs and all the applicable trigger criteria have been met). A corresponding pop-up message ("Waiting for trigger") is generated if no trigger signal appears after approximately 2 sec. This message goes away when a trigger signal appears.
Initial S/W Revision:	Prior to A.02.00

Trigger Level

Sets the value where the external 1 trigger input will trigger a new sweep/measurement.

Key Path:	Trigger, External 1
Remote Command:	:TRIGger[:SEQuence]:EXTernal1:LEVel <level> :TRIGger[:SEQuence]:EXTernal1:LEVel?
Example:	TRIG:EXT1:LEV 0.4 V
Couplings:	This same level is used for the Ext1 trigger source in the Trigger menu, for the Ext1 selection in the Periodic Timer sync source (in the Trigger menu and in the Gate Source menu), and also for the Ext1 selection in the Gate Source menu.
Preset:	1.2 V
State Saved:	Saved in instrument state

Min:	-5 V
Max:	5 V
Default Unit:	V
Backwards Compatibility SCPI:	:TRIGger[:SEQuence]:EXTernal:LEVel For backward compatibility, the parameter EXTernal is mapped to EXTernal1
Backwards Compatibility SCPI:	:TRIGger[:SEQuence]:FRAMe:EXTernal1:LEVel
Initial S/W Revision:	Prior to A.02.00

Trig Slope

Controls the trigger polarity. It is set positive to trigger on a rising edge and negative to trigger on a falling edge.

Key Path:	Trigger, External 1
Remote Command:	:TRIGger[:SEQuence]:EXTernal1:SLOPe POSitive NEGative :TRIGger[:SEQuence]:EXTernal1:SLOPe?
Example:	TRIG:EXT1:SLOP NEG
Couplings:	This same slope is used in the Ext1 selection for the trigger source in the Trigger menu and for the period timer sync source (in the Trigger menu and in the Gate Source menu).
Preset:	POSitive
State Saved:	Saved in instrument state
Backwards Compatibility SCPI:	:TRIGger[:SEQuence]:EXTernal:SLOPe For backward compatibility, the parameter EXTernal is mapped to EXTernal1
Backwards Compatibility SCPI:	:TRIGger[:SEQuence]:FRAMe:EXTernal1:SLOPe
Backwards Compatibility Notes:	The legacy :TRIGger[:SEQuence]:SLOPe command affects the slopes for the VID, LINE, EXT1, EXT2, and RFB triggers.
Initial S/W Revision:	Prior to A.02.00

Trig Delay

Controls a time delay during which the analyzer will wait to begin a sweep after meeting the trigger criteria. You can use negative delay to pre-trigger the instrument in time domain or FFT, but not in swept spans.

Key Path:	Trigger, External 1
-----------	----------------------------

Trigger

Remote Command:	:TRIGger[:SEquence]:EXTernal1:DElay <time> :TRIGger[:SEquence]:EXTernal1:DElay? :TRIGger[:SEquence]:EXTernal1:DElay:STATe OFF ON 0 1 :TRIGger[:SEquence]:EXTernal1:DElay:STATe?
Example:	TRIG:EXT1:DEL:STAT ON TRIG:EXT1:DEL 100 ms
Notes:	Video trigger delay may be set to negative values, in time domain, FFT and even swept. It makes intuitive sense in time domain and works well in FFT mode where the bandwidth of the filter before the video trigger is about 1.25 span. In swept spans, negative settings of Trig Delay are treated as a zero setting within the internal hardware and the advisory message "Neg. Trig Delay unavailable in Swept Mode, zero delay used." is generated when such a delay is set.
Preset:	Off, 1.000 us
State Saved:	Saved in instrument state
Min:	-150 ms
Max:	+500 ms
Default Unit:	s
Backwards Compatibility SCPI:	:TRIGger[:SEquence]:EXTernal:DElay For backward compatibility, the parameter EXTernal is mapped to EXTernal1
Backwards Compatibility Notes:	The legacy :TRIGger[:SEquence]:DElay command affects the delay for the VID, LINE, EXT1, EXT2, and RFB triggers. The legacy :TRIGger[:SEquence]:OFFSet command is supported for the VIDEO, LINE, EXT1, and EXT2 triggers.
Initial S/W Revision:	Prior to A.02.00

Zero Span Delay Comp On/Off

In zero span, there is a natural delay in the signal path, which comes from the RBW filter. This is usually desirable, as it allows you to trigger on events and also see those events, because the signal is delayed from the trigger event. However, in some cases it is desirable to eliminate this delay, so that trigger events line up exactly with the zero time point in zero span. You can use the **Zero Span Delay Comp On/Off** feature to enable or disable zero span delay compensation.

Key Path:	Trigger, External 1
Remote Command:	:TRIGger[:SEquence]:EXTernal1:DElay:COMPensation OFF ON 0 1 :TRIGger[:SEquence]:EXTernal1:DElay:COMPensation?
Example:	TRIG:EXT1:DEL:COMP ON

Dependencies:	No effect except in zero-span, but not locked out in nonzero spans. Blanked in modes that do not support zero-span measurements. If the SCPI command is sent when the key is blanked, an error is returned: -221, "Settings conflict; Feature not supported for this measurement" In analyzers shipping N9060A, this feature requires N9060A-7FP.
Preset:	OFF
State Saved:	Saved in instrument state
Initial S/W Revision:	A.11.00

External 2

Pressing this key, when it is not selected, selects an external input signal as the trigger. A new sweep/measurement will start when the external trigger condition is met using the external 2 input connector. The external trigger 2 input connector is on the rear panel.

Pressing this key, when it is already selected, accesses the external 2 trigger setup menu.

Key Path:	Trigger
Example:	TRIG:SOUR EXT2 Swept SA measurement TRIG:<meas>:SOUR EXT2 Measurements other than Swept SA
Dependencies:	In some models, there is no second External input. In these models, the External 2 key is blanked and the EXTERNAL2 parameter will generate a "Hardware missing; Not available for this model number" message. Grayed out if in use by Point Trigger in the Source Setup menu. Forced to Free Run if already selected and Point Trigger is set to External 2.
State Saved:	Saved in instrument state
Status Bits/OPC dependencies:	The Status Operation Register bit 5 "Waiting for Trigger" is set at the same time as the Sweeping or Measuring bit is set. It is cleared when the trigger actually occurs (that is, after the trigger event occurs and all the applicable trigger criteria have been met). A corresponding pop-up message ("Waiting for trigger") is generated if no trigger signal appears after approximately 2 sec. This message goes away when a trigger signal appears.
Initial S/W Revision:	Prior to A.02.00
Modified at S/W Revision:	A.03.00

Trigger Level

Sets the value where the external 2 trigger input will trigger a new sweep/measurement.

Key Path:	Trigger, External 2
-----------	----------------------------

Trigger

Remote Command:	:TRIGger[:SEquence]:EXTernal2:LEVel :TRIGger[:SEquence]:EXTernal2:LEVel?
Example:	TRIG:EXT2:LEV 1.1 V
Couplings:	This same level is used for the Ext2 trigger source in the Trigger menu, for the Ext2 selection in the Periodic Timer sync source (in the Trigger menu and in the Gate Source menu), and also for the Ext2 selection in the Gate Source menu.
Preset:	1.2 V
State Saved:	Saved in instrument state
Min:	-5 V
Max:	5 V
Default Unit:	V
Backwards Compatibility SCPI:	:TRIGger[:SEquence]:FRAME:EXTernal2:LEVel
Initial S/W Revision:	Prior to A.02.00

Trig Slope

Controls the trigger polarity. It is set positive to trigger on a rising edge and negative to trigger on a falling edge.

Key Path:	Trigger, External 2
Remote Command:	:TRIGger[:SEquence]:EXTernal2:SLOPe POSitive NEGative :TRIGger[:SEquence]:EXTernal2:SLOPe?
Example:	TRIG:EXT2:SLOP NEG
Couplings:	This same slope is used in the Ext2 selection for the trigger source in the Trigger menu and for the period timer sync source (in the Trigger menu and in the Gate Source menu).
Preset:	POSitive
State Saved:	Saved in instrument state
Backwards Compatibility SCPI:	:TRIGger[:SEquence]:FRAME:EXTernal2:SLOPe
Backwards Compatibility Notes:	The legacy :TRIGger[:SEquence]:SLOPe command affects the slopes for the VID, LINE, EXT1, EXT2, and RFB triggers.
Initial S/W Revision:	Prior to A.02.00

Trig Delay

Controls a time delay during which the analyzer will wait to begin a sweep after meeting the trigger criteria. You can use negative delay to pre-trigger the instrument in time domain or FFT, but not in swept

spans.

Key Path:	Trigger, External 2
Remote Command:	:TRIGger[:SEquence]:EXTernal2:DElay <time> :TRIGger[:SEquence]:EXTernal2:DElay? :TRIGger[:SEquence]:EXTernal2:DElay:STATe OFF ON 0 1 :TRIGger[:SEquence]:EXTernal2:DElay:STATe?
Example:	TRIG:EXT2:DEL:STAT ON TRIG:EXT2:DEL 100 ms
Notes:	Video trigger delay may be set to negative values, in time domain, FFT and even swept. It makes intuitive sense in time domain and works well in FFT mode where the bandwidth of the filter before the video trigger is about 1.25 span. In swept spans, negative settings of Trig Delay are treated as a zero setting within the internal hardware and the advisory message "Neg. Trig Delay unavailable in Swept Mode, zero delay used." is generated when such a delay is set.
Preset:	Off, 1.000 us
State Saved:	Saved in instrument state
Min:	-150 ms
Max:	500 ms
Default Unit:	s
Backwards Compatibility Notes:	The legacy :TRIGger[:SEquence]:DElay command affects the delay for the VID, LINE, EXT1, EXT2, and RFB triggers. The legacy :TRIGger[:SEquence]:OFFSet command is supported for the VIDEo, LINE, EXT1, and EXT2 triggers.
Initial S/W Revision:	Prior to A.02.00

Zero Span Delay Comp On/Off

In zero span, there is a natural delay in the signal path, which comes from the RBW filter. This is usually desirable, as it allows you to trigger on events and also see those events, because the signal is delayed from the trigger event. However, in some cases it is desirable to eliminate this delay, so that trigger events line up exactly with the zero time point in zero span. You can use the **Zero Span Delay Comp On/Off** feature to enable or disable zero span delay compensation.

Key Path:	Trigger, External 2
Remote Command:	:TRIGger[:SEquence]:EXTernal2:DElay:COMPensation OFF ON 0 1 :TRIGger[:SEquence]:EXTernal2:DElay:COMPensation?
Example:	TRIG:EXT2:DEL:COMP ON

Trigger

Dependencies:	No effect except in zero-span, but not locked out in nonzero spans. Blanked in modes that do not support zero-span measurements. If the SCPI command is sent when the key is blanked, an error is returned: –221, “Settings conflict; Feature not supported for this measurement” In analyzers shipping N9060A, this feature requires N9060A–7FP.
Preset:	OFF
State Saved:	Saved in instrument state
Initial S/W Revision:	A.11.00

RF Burst

Pressing this key, when it is not selected, selects the RF Burst as the trigger. A new sweep/measurement will start when an RF burst envelope signal is identified from the signal at the RF Input connector. Pressing this key, when it is already selected, accesses the RF Burst trigger setup menu.

In some models, a variety of burst trigger circuitry is available, resulting in various available burst trigger bandwidths. The analyzer automatically chooses the appropriate trigger path based on the hardware configuration and other settings of the analyzer.

Key Path:	Trigger
Example:	TRIG:SOUR RFB Swept SA measurement TRIG:<meas>:SOUR RFB Measurements other than Swept SA
State Saved:	Saved in instrument state
Status Bits/OPC dependencies:	The Status Operation Register bit 5 "Waiting for Trigger" is set at the same time as the Sweeping or Measuring bit is set. It is cleared when the trigger actually occurs (that is, after the trigger event occurs and all the applicable trigger criteria have been met). A corresponding pop-up message ("Waiting for trigger") is generated if no trigger signal appears after approximately 2 sec. This message goes away when a trigger signal appears.
Backwards Compatibility Notes:	The legacy command: :TRIGger[:SEQuence]:RFBurst:FSElectivity[:STATe] OFF ON 0 1 is not supported in the X-Series, as the hardware to do Frequency Selective burst triggers does not exist in X-Series.
Initial S/W Revision:	Prior to A.02.00
Modified at S/W Revision:	A.04.00

Absolute Trigger Level

Sets the absolute trigger level for the RF burst envelope.

NOTE When using the External Mixing path, the Absolute Trigger Level is uncalibrated because the factory default was set to accommodate the expected IF levels for the

RF path.

Key Path:	Trigger, RF Burst
Scope:	Meas Global
Remote Command:	:TRIGger[:SEquence]:RFBurst:LEVel:ABSolute <ampl> :TRIGger[:SEquence]:RFBurst:LEVel:ABSolute?
Example:	TRIG:RFB:LEV:ABS 10 dBm sets the trigger level of the RF burst envelope signal to the absolute level of 10 dBm
Notes:	Sending this command does not switch the setting from relative to absolute; to switch it you need to send the :TRIGger[:SEquence]:RFBurst:LEVel:TYPE command, below. Amplitude Corrections are not taken into account by the Absolute Trigger Level. For example, if you have given yourself effective gain with an amplitude correction factor, the Absolute Trigger will not fire until you have set the trigger level that far below the displayed signal level, rather than simply to the displayed signal level. This is only true for Amplitude Corrections, not External Gain or Ref Level Offset functions. If mode is Bluetooth, the default value is -50 dBm.
Couplings:	This same level is used for the RF Burst trigger source in the Trigger menu, for the RF Burst selection in the Periodic Timer sync source (in the Trigger menu and in the Gate Source menu), and also for the RF Burst selection in the Gate Source menu
Preset:	-20 dBm
State Saved:	Saved in instrument state
Min:	-200 dBm
Max:	100 dBm
Default Unit:	depends on the current selected Y-Axis unit
Backwards Compatibility SCPI:	:TRIGger[:SEquence]:FRAME:RFBurst:LEVel:ABSolute
Initial S/W Revision:	Prior to A.02.00
Modified at S/W Revision:	A.04.00

Key Path:	Trigger, RF Burst
Remote Command:	:TRIGger[:SEquence]:RFBurst:LEVel:TYPE ABSolute RELative :TRIGger[:SEquence]:RFBurst:LEVel:TYPE?

Trigger

Example:	TRIG:RFB:LEV:TYPE REL sets the trigger level type of the RF burst trigger to Relative.
Preset:	ABSolute
State Saved:	Saved in instrument state
Initial S/W Revision:	Prior to A.02.00
Modified at S/W Revision:	A.04.00

Relative Trigger Level

Sets the relative trigger level for the RF burst envelope.

In some models, the relative burst trigger function is implemented in hardware. In other models, without the advanced triggering hardware required, the relative burst trigger function is implemented in software in some measurements, and is unavailable in other measurements.

When implemented in software, the relative RF Burst trigger function is implemented as follows:

1. The measurement starts with the absolute RF Burst trigger setting. If it cannot get a trigger with that level, auto trigger fires and the acquisition starts anyway. After the acquisition, the measurement searches for the peak in the acquired waveform and saves it.
2. Now, in the next cycle of the measurement, the measurement determines a new absolute RF Burst level based on the peak value from the first measurement and the Relative RF Burst Trigger Level (always 0 or negative dB) set by the user. The following formula is used:

$$\text{absolute RF Burst level} = \text{peak level of the previous acquisition} + \text{relative RF Burst level}$$

3. If the new absolute RF Burst level differs from the previous by more than 0.5 dB, the new level is sent to the hardware; otherwise it is not updated (to avoid slowing down the acquisition)

Steps 2 and 3 repeat for subsequent measurements.

Key Path:	Trigger, RF Burst
Scope:	Meas Global
Remote Command:	:TRIGger[:SEQuence]:RFBurst:LEVel:RELative <rel_ampl> :TRIGger[:SEQuence]:RFBurst:LEVel:RELative?
Example:	TRIG:RFB:LEV:REL -10 dB sets the trigger level of the RF burst envelope signal to the relative level of -10 dB
Notes:	Sending this command does not switch the setting from absolute to relative; to switch it you need to send the :TRIGger[:SEQuence]:RFBurst:LEVel:TYPE command, above. The relative trigger level is not available in some measurements. In those measurements the RELative parameter, and the :TRIGger[:SEQuence]:RFBurst:LEVel:TYPE command (above), will generate an error if sent.

Dependencies:	This key is grayed out and Absolute Trigger Level selected if the required hardware is not present in your analyzer and the current measurement does not support Relative triggering.
Preset:	-6 dB GSM: -25 dB
State Saved:	Saved in instrument state
Min:	-45 dB
Max:	0 dB
Default Unit:	dB or dBc
Backwards Compatibility SCPI:	:TRIGger[:SEQuence]:RFBurst:LEVel This legacy command is aliased to :TRIGger[:SEQuence]:RFBurst:LEVel:RELative because the PSA had ONLY relative burst triggering
Initial S/W Revision:	Prior to A.02.00
Modified at S/W Revision:	A.04.00

Trigger Slope

It is set positive to trigger on a rising edge and negative to trigger on a falling edge.

Key Path:	Trigger, RF Burst
Remote Command:	:TRIGger[:SEQuence]:RFBurst:SLOPe POSitive NEGative :TRIGger[:SEQuence]:RFBurst:SLOPe?
Example:	TRIG:RFB:SLOP NEG
Couplings:	This same slope is used in the RF Burst selection for the trigger source in the Trigger menu and for the period timer sync source (in the Trigger menu and in the Gate Source menu).
Preset:	POSitive
State Saved:	Saved in instrument state
Backwards Compatibility SCPI:	:TRIGger[:SEQuence]:FRAME:RFBurst:SLOPe
Backwards Compatibility Notes:	The legacy :TRIGger[:SEQuence]:SLOPe command affects the slopes for the VID, LINE, EXT1, EXT2, and RFB triggers.
Initial S/W Revision:	Prior to A.02.00

Trig Delay

Controls a time delay during which the analyzer will wait to begin a sweep after meeting the trigger criteria. You can use negative delay to pre-trigger the instrument in time domain or FFT, but not in swept

Trigger

spans.

Key Path:	Trigger, RF Burst
Remote Command:	:TRIGger[:SEquence]:RFBurst:DElay <time> :TRIGger[:SEquence]:RFBurst:DElay? :TRIGger[:SEquence]:RFBurst:DElay:STATe OFF ON 0 1 :TRIGger[:SEquence]:RFBurst:DElay:STATe?
Example:	TRIG:RFB:DEL:STAT ON TRIG:RFB:DEL 100 ms
Notes:	Video trigger delay may be set to negative values, in time domain, FFT and even swept. It makes intuitive sense in time domain and works well in FFT mode where the bandwidth of the filter before the video trigger is about 1.25 span. In swept spans, negative settings of Trig Delay are treated as a zero setting within the internal hardware and the advisory message "Neg. Trig Delay unavailable in Swept Mode, zero delay used." is generated when such a delay is set.
Preset:	Off, 1.000 us
State Saved:	Saved in instrument state
Min:	-150 ms
Max:	500 ms
Default Unit:	s
Backwards Compatibility Notes:	The legacy :TRIGger[:SEquence]:DElay command affects the delay for the VID, LINE, EXT1, EXT2, and RFB triggers.
Initial S/W Revision:	Prior to A.02.00

Zero Span Delay Comp On/Off

In zero span, there is a natural delay in the signal path, which comes from the RBW filter. This is usually desirable, as it allows you to trigger on events and also see those events, because the signal is delayed from the trigger event. However, in some cases it is desirable to eliminate this delay, so that trigger events line up exactly with the zero time point in zero span. You can use the **Zero Span Delay Comp On/Off** feature to enable or disable zero span delay compensation.

Key Path:	Trigger, RF Burst
Remote Command:	:TRIGger[:SEquence]:RFBurst:DElay:COMPensation OFF ON 0 1 :TRIGger[:SEquence]:RFBurst:DElay:COMPensation?
Example:	TRIG:RFB:DEL:COMP ON

Dependencies:	No effect except in zero-span, but not locked out in nonzero spans. Blanked in modes that do not support zero-span measurements. If the SCPI command is sent when the key is blanked, an error is returned: -221, "Settings conflict; Feature not supported for this measurement" In analyzers shipping N9060A, this feature requires N9060A-7FP.
Preset:	OFF
State Saved:	Saved in instrument state
Initial S/W Revision:	A.11.00

Periodic Timer (Frame Trigger)

Pressing this key, when it is not selected, selects the internal periodic timer signal as the trigger. Triggering occurrences are set by the **Period** parameter, which is modified by the **Sync Source** and **Offset**. Pressing this key, when it is already selected, accesses the periodic timer trigger setup functions.

If you do not have a sync source selected (it is Off), then the internal timer will not be synchronized with any external timing events.

Key Path:	Trigger
Example:	TRIG:SOUR FRAM Swept SA measurement TRIG:<meas>:SOUR FRAM Measurements other than Swept SA
State Saved:	Saved in instrument state
Readback:	[Sync: <value of Sync Source>], for example, [Sync: External 1]
Status Bits/OPC dependencies:	The Status Operation Register bit 5 "Waiting for Trigger" is set at the same time as the Sweeping or Measuring bit is set. It is cleared when the trigger actually occurs (that is, after the trigger event occurs and all the applicable trigger criteria have been met). A corresponding pop-up message ("Waiting for trigger") is generated if no trigger signal appears after approximately 2 sec. This message goes away when a trigger signal appears.
Initial S/W Revision:	Prior to A.02.00

Periodic Timer Triggering:

This feature selects the internal periodic timer signal as the trigger. Trigger occurrences are set by the **Periodic Timer** parameter, which is modified by the **Sync Source** and **Offset**.

The figure below shows the action of the periodic timer trigger. Before reviewing the figure, we'll explain some uses for the periodic trigger.

A common application is measuring periodic burst RF signals for which a trigger signal is not easily available. For example, we might be measuring a TDMA radio which bursts every 20 ms. Let's assume that the 20 ms period is very consistent. Let's also assume that we do not have an external trigger source available that is synchronized with the period, and that the signal-to-noise ratio of the signal is not high enough to provide a clean RF burst trigger at all of the analysis frequencies. For example, we might want to measure spurious transmissions at an offset from the carrier that is larger than the bandwidth of the RF

Trigger

burst trigger. In this application, we can set the Periodic Timer to a 20.00 ms period and adjust the offset from that timer to position our trigger just where we want it. If we find that the 20.00 ms is not exactly right, we can adjust the period slightly to minimize the drift between the period timer and the signal to be measured.

A second way to use this feature would be to use **Sync Source** temporarily, instead of **Offset**. In this case, we might tune to the signal in a narrow span and use the RF Burst trigger to synchronize the periodic timer. Then we would turn the sync source off so that it would not mis-trigger. Mis-triggering can occur when we are tuned so far away from the RF burst trigger that it is no longer reliable.

A third example would be to synchronize to a signal that has a reference time element of much longer period than the period of interest. In some CDMA applications, it is useful to look at signals with a short periodicity, by synchronizing that periodicity to the "even-second clock" edge that happens every two seconds. Thus, we could connect the even-second clock trigger to Ext1 and use then Ext1 as the sync source for the periodic timer.

The figure below illustrates this third example. The top trace represents the even-second clock. It causes the periodic timer to synchronize with the leading edge shown. The analyzer trigger occurs at a time delayed by the accumulated offset from the period trigger event. The periodic timer continues to run, and triggers continue to occur, with a periodicity determined by the analyzer time base. The timer output (labeled "late event") will drift away from its ideal time due to imperfect matching between the time base of the signal being measured and the time base of the analyzer, and also because of imperfect setting of the period parameter. But the synchronization is restored on the next even-second clock event. ("Accumulated offset" is described in the in the **Offset** function section.)

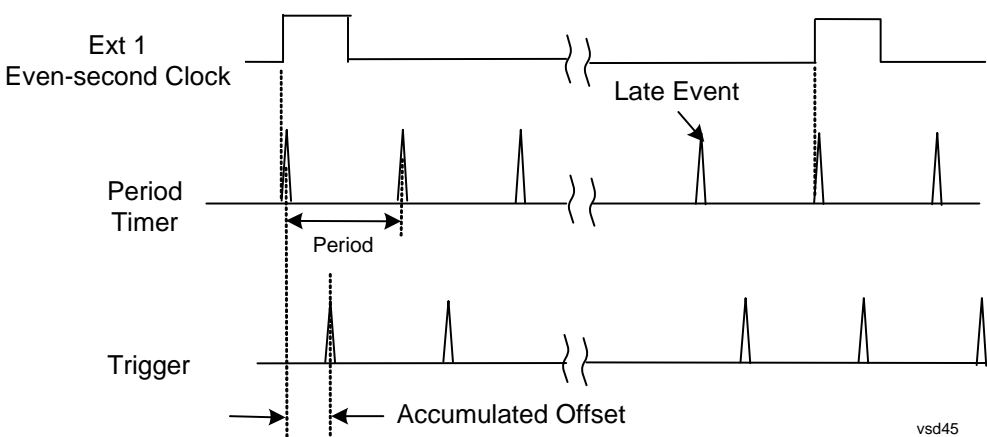

Period

Sets the period of the internal periodic timer clock. For digital communications signals, this is usually set to the frame period of your current input signal. In the case that sync source is not set to OFF, and the external sync source rate is changed for some reason, the periodic timer is synchronized at the every external synchronization pulse by resetting the internal state of the timer circuit.

Key Path:	Trigger, Periodic Timer
Remote Command:	:TRIGger[:SEquence]:FRAME:PERiod <time> :TRIGger[:SEquence]:FRAME:PERiod?

Example:	TRIG:FRAM:PER 100 ms
Dependencies:	The invalid data indicator turns on when the period is changed, until the next sweep/measurement completes.
Couplings:	The same period is used in the Gate Source selection of the period timer.
Preset:	20 ms GSM: 4.615383
State Saved:	Saved in instrument state
Min:	100.000 ns
Max:	559.0000 ms
Default Unit:	S
Initial S/W Revision:	Prior to A.02.00

Offset

Adjusts the accumulated offset between the periodic timer events and the trigger event. Adjusting the accumulated offset is different than setting an offset, and requires explanation.

The periodic timer is usually not synchronized with any external events, so the timing of its output events has no absolute meaning. Since the timing relative to external events (RF signals) is important, you need to be able to adjust (offset) it. However, you have no direct way to see when the periodic timer events occur. All that you can see is the trigger timing. When you want to adjust the trigger timing, you will be changing the internal offset between the periodic timer events and the trigger event. Because the absolute value of that internal offset is unknown, we will just call that the accumulated offset. Whenever the Offset parameter is changed, you are changing that accumulated offset. You can reset the displayed offset using Reset Offset Display. Changing the display does not change the value of the accumulated offset, and you can still make additional changes to accumulated offset.

To avoid ambiguity, we define that an increase in the "offset" parameter, either from the knob or the SCPI adjust command, serves to delay the timing of the trigger event.

Key Path:	Trigger, Periodic Timer
Remote Command:	:TRIGger [:SEquence]:FRAM:OFFSet <time> :TRIGger [:SEquence]:FRAM:OFFSet?
Example:	TRIG:FRAM:OFFS 1.2 ms

Trigger

Notes:	<p>The front panel interface (for example, the knob), and this command, adjust the accumulated offset, which is shown on the active function display. However, the actual amount sent to the hardware each time the offset is updated is the delta value, that is, the current accumulated offset value minus the previous accumulated offset value. Note that the accumulated offset value is essentially arbitrary; it represents the accumulated offset from the last time the offset was zeroed (with the Reset Offset Display key).</p> <p>Note that this command does not change the period of the trigger waveform. Note also that Offset is used only when the sync source is set to OFF, otherwise delay is used, see section “Trig Delay” on page 1372.</p> <p>An increase in the "offset" parameter, either from the knob or the SCPI adjust command, serves to delay the timing of the trigger event.</p>
Notes:	<p>When the SCPI command is sent the value shown on the key (and the Active Function, if this happens to be the active function) is updated with the new value. However, the actual amount sent to the hardware is the delta value, that is, the current accumulated offset value minus the previous accumulated offset value.</p> <p>The SCPI query simply returns the value currently showing on the key.</p>
Dependencies:	The invalid data indicator turns on when the offset is changed, until the next sweep/measurement completes.
Couplings:	The same offset is used in the Gate Source selection of the period timer.
Preset:	0 s
State Saved:	Saved in instrument state
Min:	-10.000 s
Max:	10.000 s
Default Unit:	S
Initial S/W Revision:	Prior to A.02.00

Offset Adjust (Remote Command Only)

This remote command does not work at all like the related front panel keys. This command lets you advance the phase of the frame trigger by the amount you specify.

It does not change the period of the trigger waveform. If the command is sent multiple times, it advances the phase of the frame trigger an additional amount each time it is sent. Negative numbers are permitted.

Remote Command:	:TRIGger [:SEquence] :FRAMe:ADJust <time>
Example:	TRIG:FRAM:ADJ 1.2 ms
Notes:	<p>Note also that Offset is used only when the sync source is set to OFF, otherwise delay is used, see section “Trig Delay” on page 1372</p> <p>An increase in the "offset" parameter, either from the knob or the SCPI adjust command, serves to delay the timing of the trigger event.</p>

Notes:	<p>The front panel interface (for example, the knob) and the :TRIG:FRAM:OFFS command adjust the accumulated offset, which is shown on the active function display. However, the actual amount sent to the hardware is the delta value, that is, the current offset value minus the previous offset value.</p> <p>When the SCPI command is sent the value shown on the key (and the Active Function, if this happens to be the active function) is updated by increasing it (or decreasing it if the value sent is negative) by the amount specified in the SCPI command.</p> <p>This is a "command only" SCPI command, with no query.</p>
Dependencies:	The invalid data indicator turns on when the offset is changed, until the next sweep/measurement completes.
Couplings:	The same offset is used in the Gate Source selection of the period timer.
Preset:	0 s
State Saved:	Saved in instrument state
Min:	-10.000 s
Max:	10.000 s
Default Unit:	S
Initial S/W Revision:	Prior to A.02.00

Reset Offset Display

Resets the value of the periodic trigger offset display setting to 0.0 seconds. The current displayed trigger location may include an offset value defined with the **Offset** key. Pressing this key redefines the currently displayed trigger location as the new trigger point that is 0.0 s offset. The **Offset** key can then be used to add offset relative to this new timing.

Key Path:	Trigger, Periodic Timer
Remote Command:	:TRIGger[:SEquence]:FRAMe:OFFSet:DISPlay:RESet
Example:	TRIG:FRAM:OFFS:DISP:RES
Initial S/W Revision:	Prior to A.02.00

Sync Source

Selects a signal source for you to synchronize your periodic timer trigger to, otherwise you are triggering at some arbitrary location in the frame. Synchronization reduces the precision requirements on the setting of the period.

For convenience you may adjust the level and slope of the selected sync source in a conditional branch setup menu accessed from the Sync Source menu. Note that these settings match those in the **Trigger** and **Gate Source** menus; that is, each trigger source has only one value of level and slope, regardless of which menu it is accessed from.

Key Path:	Trigger, Periodic Timer
-----------	--------------------------------

Trigger

Remote Command:	:TRIGger [:SEQuence] :FRAMe:SYNC EXTernal1 EXTernal2 RFBurst OFF :TRIGger [:SEQuence] :FRAMe:SYNC?
Example:	TRIG:FRAM:SYNC EXT2
Dependencies:	In some models, there is no second External input. In these models, the External 2 key is blanked and the EXTernal2 parameter will generate a “Hardware missing; Not available for this model number” message.
Preset:	Off GSM/EDGE: RFBurst
State Saved:	Saved in instrument state
Readback:	The current setting is read back to this key and it is also Readback to the previous Periodic Timer trigger key.
Backwards Compatibility SCPI:	:TRIGger[:SEQuence]:FRAMe:SYNC EXTernal For backward compatibility, the parameter EXTernal is mapped to EXTernal1
Initial S/W Revision:	Prior to A.02.00
Modified at S/W Revision:	A.03.00

Off

Turns off the sync source for your periodic trigger. With the sync source off, the timing will drift unless the signal source frequency is locked to the analyzer frequency reference.

Key Path:	Trigger, Periodic Timer, Sync Source
Example:	TRIG:FRAM:SYNC OFF
Readback:	Off
Initial S/W Revision:	Prior to A.02.00

External 1

Pressing this key, when it is not selected, selects the external input port that you will use for the periodic trigger synchronization. Pressing this key, when it is already selected, accesses the external 1 sync source setup menu.

Key Path:	Trigger, Periodic Timer, Sync Source
Example:	TRIG:FRAM:SYNC EXT
Couplings:	Same as External 1 trigger source.
Readback:	External 1
Initial S/W Revision:	Prior to A.02.00

Trigger Level

Sets the value where the signal at the external 1 trigger input will synchronize with the periodic timer trigger. This same level is used in the Ext1 trigger source in the Trigger menu. See section [“Trigger Level ” on page 1354](#) for information on this key and the SCPI command.

Trig Slope

Controls the trigger polarity. It is set positive to trigger on a rising edge and negative to trigger on a falling edge. This same value is used in the Ext1 trigger source in the Trigger menu. See section [“Trig Slope ” on page 1355](#) for information on this key and the SCPI command

External 2

Pressing this key, when it is not selected, selects the external input port that you will use for the periodic frame trigger synchronization.

Pressing this key, when it is already selected, accesses the external 2 sync source setup menu.

Key Path:	Trigger, Periodic Timer, Sync Source
Example:	TRIG:FRAM:SYNC EXT2
Dependencies:	In some models, there is no second External input. In these models, the External 2 key is blanked and the EXternal2 parameter will generate a “Hardware missing; Not available for this model number” message.
Couplings:	Same as External 2 trigger source.
Readback:	External 2
Initial S/W Revision:	Prior to A.02.00
Modified at S/W Revision:	A.03.00

Trigger Level

Sets the value where the signal at the external 2 trigger input will synchronize with the periodic timer trigger. This same level is used in the Ext2 trigger source in the Trigger menu. See section [“Trigger Level ” on page 1357](#) for information on this key and the SCPI command.

Trig Slope

Controls the trigger polarity. It is set positive to trigger on a rising edge and negative to trigger on a falling edge. This same value is used in the Ext2 trigger source in the Trigger menu. See section [“Trig Slope ” on page 1358](#) for information on this key and the SCPI command

RF Burst

Pressing the key once selects the RF burst envelope signal to be used for the periodic timer trigger synchronization.

Press the key a second time to access the RF burst sync source setup menu.

Key Path:	Trigger, Periodic Timer, Sync Source
Example:	TRIG:FRAM:SYNC RFB

Trigger

Couplings:	Same as RF Burst trigger source.
Readback:	RF Burst
Initial S/W Revision:	Prior to A.02.00

Trigger Level

Sets the trigger level to be used for the RF Burst trigger. This same level is used in the RF Burst trigger source in the Trigger menu. See section [“Absolute Trigger Level” on page 1360](#) for information on this key and the SCPI command.

Trig Slope

Controls the RF Burst trigger polarity. It is set positive to trigger on a rising edge and negative to trigger on a falling edge. This same value is used in the RF Burst trigger source in the Trigger menu. See section [“Trigger Slope” on page 1363](#) for information on this key and the SCPI command

Trig Delay

This setting delays the measurement timing relative to the Periodic Timer.

Key Path:	Trigger, Periodic Timer
Remote Command:	:TRIGger [:SEquence] :FRAMe:DELay <time> :TRIGger [:SEquence] :FRAMe:DELay? :TRIGger [:SEquence] :FRAMe:DELay:STATe OFF ON 0 1 :TRIGger [:SEquence] :FRAMe:DELay:STATe?
Notes:	Note that delay is used when the sync source is not set to OFF. If the sync source is set to OFF, offset is used.
Preset:	Off, 1.000 us
State Saved:	Saved in instrument state
Min:	-150 ms
Max:	+500 ms
Default Unit:	s
Initial S/W Revision:	Prior to A.02.00

Sync Holdoff

Sync Holdoff specifies the duration that the sync source signal must be kept false before the transition to true to be recognized as the sync timing. The periodic timer phase is aligned when the sync source signal becomes true, after the Holdoff time is satisfied.

A holdoff of 2 ms will work with most WiMAX signals, but there may be cases where the burst off duration is less than 1 ms and this value will need to be changed.

Key Path:	Trigger, Periodic Timer
-----------	--------------------------------

Remote Command:	:TRIGger[:SEQuence]:FRAMe:SYNC:HOLDoff <time> :TRIGger[:SEQuence]:FRAMe:SYNC:HOLDoff? :TRIGger[:SEQuence]:FRAMe:SYNC:HOLDoff:STATe OFF ON 0 1 :TRIGger[:SEQuence]:FRAMe:SYNC:HOLDoff:STATe?
Preset:	On, 1.000 ms
State Saved:	Saved in instrument state
Min:	0 ms
Max:	+500 ms
Default Unit:	s
Initial S/W Revision:	Prior to A.02.00

Baseband I/Q

Pressing this key when it is not selected selects Baseband I/Q as the trigger. Pressing the key when it is already selected accesses the Baseband I/Q trigger type selection menu. The key is annotated to display which of the Baseband I/Q trigger types is currently selected.

Key Path:	Trigger
State Saved:	Saved in instrument state
Readback:	The Baseband I/Q trigger source that becomes active when this key is selected is displayed. The possible values are "I/Q Mag", "I", "Q", "Input I", "Input Q", and "Aux I/Q Mag".
Initial S/W Revision:	Prior to A.02.00

I/Q Mag

Pressing this key, when it is not selected, selects the I/Q magnitude signal as the trigger. The I/Q Magnitude trigger condition is met when the I/Q magnitude crosses the I/Q magnitude trigger level. The magnitude is measured at the output of the main I/Q digital receiver.

Key Path:	Trigger, Baseband I/Q
Example:	TRIG:<meas>:SOUR IQM
Readback Text:	I/Q Mag
Initial S/W Revision:	Prior to A.02.00

Trigger Level

Sets a level for the I/Q magnitude trigger. When the signal crosses this level, with the chosen slope, the trigger occurs. If the specific Measurement displays the signal from the chosen sampling point a green

Trigger

line will be displayed to indicate the trigger level.

Key Path:	Trigger, Baseband I/Q, I/Q Mag
Remote Command:	:TRIGger[:SEquence]:IQMag:LEVel <ampl > :TRIGger[:SEquence]:IQMag:LEVel?
Example:	TRIG:IQM:LEV -30 dBm
Notes:	The I/Q reference impedance is used for converting between power and voltage.
Preset:	-25 dBm
State Saved:	Saved in instrument state
Range:	-200 dBm to 100 dBm
Readback Text:	<level> dBm
Initial S/W Revision:	Prior to A.02.00

Trig Slope

Controls the trigger polarity. It is set positive to trigger on a rising edge and negative to trigger on a falling edge.

Key Path:	Trigger, Baseband I/Q, I/Q Mag
Remote Command:	:TRIGger[:SEquence]:IQMag:SLOPe POSitive NEGative :TRIGger[:SEquence]:IQMag:SLOPe?
Example:	TRIG:IQM:SLOP POS
Preset:	POSitive
State Saved:	Saved in instrument state
Initial S/W Revision:	Prior to A.02.00

Trig Delay

Controls a time delay during which the analyzer will wait to begin a sweep after meeting the trigger criteria. You can use negative delay to pre-trigger the instrument in time domain or FFT.

Key Path:	Trigger, Baseband I/Q, I/Q Mag
Remote Command:	:TRIGger[:SEquence]:IQMag:DELAy <time> :TRIGger[:SEquence]:IQMag:DELAy? :TRIGger[:SEquence]:IQMag:DELAy:STATE OFF ON 0 1 :TRIGger[:SEquence]:IQMag:DELAy:STATE?

Example:	TRIG:IQM:DEL 10 ms TRIG:IQM:DEL:STAT ON
Preset:	1 us OFF
State Saved:	Saved in instrument state
Range:	-2.5 s to +10 s
Initial S/W Revision:	Prior to A.02.00

I (Demodulated)

Pressing this key, when it is not selected, selects the main receiver's output I voltage as the trigger. The I (Demodulated) trigger condition is met when the I voltage crosses the I voltage trigger level.

Key Path:	Trigger, Baseband I/Q
Example:	TRIG:<meas>:SOUR IDEM
Readback Text:	I
Initial S/W Revision:	Prior to A.02.00

Trigger Level

Sets a level for the I (Demodulated) trigger. When the signal crosses this level, with the chosen slope, the trigger occurs. If the specific Measurement displays the signal from the chosen sampling point a green line will be displayed to indicate the trigger level.

Key Path:	Trigger, Baseband I/Q, I (Demodulated)
Remote Command:	:TRIGger [:SEquence] :IDEMod:LEVel <voltage> :TRIGger [:SEquence] :IDEMod:LEVel?
Example:	TRIG:IDEM:LEV 0.5 V
Preset:	0.25 V
State Saved:	Saved in instrument state
Range:	-1 to 1 V
Readback Text:	0.1 of displayed unit (V, mV, etc.)
Initial S/W Revision:	Prior to A.02.00

Trig Slope

Controls the trigger polarity. It is set positive to trigger on a rising edge and negative to trigger on a falling edge.

Key Path:	Trigger, Baseband I/Q, I (Demodulated)
-----------	---

Trigger

Remote Command:	:TRIGger[:SEquence]:IDEMod:SLOPe POSitive NEGative :TRIGger[:SEquence]:IDEMod:SLOPe?
Example:	TRIG:IDEM:SLOP POS
Preset:	POSitive
State Saved:	Saved in instrument state
Initial S/W Revision:	Prior to A.02.00

Trig Delay

Controls a time delay during which the analyzer will wait to begin a sweep after meeting the trigger criteria. You can use negative delay to pre-trigger the instrument in time domain or FFT.

Key Path:	Trigger, Baseband I/Q, I (Demodulated)
Remote Command:	:TRIGger[:SEquence]:IDEMod:DELay <time> :TRIGger[:SEquence]:IDEMod:DELay? :TRIGger[:SEquence]:IDEMod:DELay:STATe OFF ON 0 1 :TRIGger[:SEquence]:IDEMod:DELay:STATe?
Example:	TRIG:IDEM:DEL 10 ms TRIG:IDEM:DEL:STAT ON
Preset:	1 us OFF
State Saved:	Saved in instrument state
Range:	-2.5 s to +10 s
Initial S/W Revision:	Prior to A.02.00

Q (Demodulated)

Pressing this key, when it is not selected, selects the main receiver's output Q voltage as the trigger. The Q (Demodulated) trigger condition is met when the Q voltage crosses the Q voltage trigger level.

Key Path:	Trigger, Baseband I/Q
Example:	TRIG:<meas>:SOUR QDEM
Readback Text:	Q
Initial S/W Revision:	Prior to A.02.00

Trigger Level

Sets a level for the Q (Demodulated) trigger. When the signal crosses this level, with the chosen slope, the trigger occurs. If the specific Measurement displays the signal from the chosen sampling point a

green line will be displayed to indicate the trigger level.

Key Path:	Trigger, Baseband I/Q, Q (Demodulated)
Remote Command:	:TRIGger[:SEquence]:QDEMod:LEVel <voltage> :TRIGger[:SEquence]:QDEMod:LEVel?
Example:	TRIG:QDEM:LEV 0.5 V
Preset:	0.25 V
State Saved:	Saved in instrument state
Range:	-1 to 1 V
Readback Text:	0.1 of displayed unit (V, mV, etc.)
Initial S/W Revision:	Prior to A.02.00

Trig Slope

Controls the trigger polarity. It is set positive to trigger on a rising edge and negative to trigger on a falling edge.

Key Path:	Trigger, Baseband I/Q, Q (Demodulated)
Remote Command:	:TRIGger[:SEquence]:QDEMod:SLOPe POSitive NEGative :TRIGger[:SEquence]:QDEMod:SLOPe?
Example:	TRIG:QDEM:SLOP POS
Preset:	POSitive
State Saved:	Saved in instrument state
Initial S/W Revision:	Prior to A.02.00

Trig Delay

Controls a time delay during which the analyzer will wait to begin a sweep after meeting the trigger criteria. You can use negative delay to pre-trigger the instrument in time domain or FFT.

Key Path:	Trigger, Baseband I/Q, Q (Demodulated)
Remote Command:	:TRIGger[:SEquence]:QDEMod:DELay <time> :TRIGger[:SEquence]:QDEMod:DELay? :TRIGger[:SEquence]:QDEMod:DELay:STATe OFF ON 0 1 :TRIGger[:SEquence]:QDEMod:DELay:STATe?
Example:	TRIG:QDEM:DEL 10 ms TRIG:QDEM:DEL:STAT ON

Trigger

Preset:	1 us OFF
State Saved:	Saved in instrument state
Range:	-2.5 s to +10 s
Initial S/W Revision:	Prior to A.02.00

Input I

Pressing this key, when it is not selected, selects the I channel's ADC voltage as the trigger. The Input I trigger condition is met when the voltage crosses the trigger level.

Key Path:	Trigger, Baseband I/Q
Example:	TRIG:<meas>:SOUR IINP
Readback Text:	Input I
Initial S/W Revision:	Prior to A.02.00

Trigger Level

Sets a level for the Input I trigger. When the signal crosses this level, with the chosen slope, the trigger occurs.

Key Path:	Trigger, Baseband I/Q, Input I
Remote Command:	:TRIGger[:SEquence]:IINPut:LEVel <voltage> :TRIGger[:SEquence]:IINPut:LEVel?
Example:	TRIG:IINP:LEV 0.5 V
Preset:	0.25 V
State Saved:	Saved in instrument state
Range:	-1 to 1 V
Readback Text:	0.1 of displayed unit (V, mV, etc.)
Initial S/W Revision:	Prior to A.02.00

Trig Slope

Controls the trigger polarity. It is set positive to trigger on a rising edge and negative to trigger on a falling edge.

Key Path:	Trigger, Baseband I/Q, Input I
Remote Command:	:TRIGger[:SEquence]:IINPut:SLOPe POSitive NEGative :TRIGger[:SEquence]:IINPut:SLOPe?
Example:	TRIG:IINP:SLOP POS

Preset:	POSitive
State Saved:	Saved in instrument state
Initial S/W Revision:	Prior to A.02.00

Trig Delay

Controls a time delay during which the analyzer will wait to begin a sweep after meeting the trigger criteria. You can use negative delay to pre-trigger the instrument in time domain or FFT.

Key Path:	Trigger, Baseband I/Q, Input I
Remote Command:	:TRIGger[:SEquence]:IINPut:DELay <time> :TRIGger[:SEquence]:IINPut:DELay? :TRIGger[:SEquence]:IINPut:DELay:STATe OFF ON 0 1 :TRIGger[:SEquence]:IINPut:DELay:STATe?
Example:	TRIG:IINP:DEL 10 ms TRIG:IINP:DEL:STAT ON
Preset:	1 us OFF
State Saved:	Saved in instrument state
Range:	-2.5 s to +10 s
Initial S/W Revision:	Prior to A.02.00

Input Q

Pressing this key, when it is not selected, selects the Q channel's ADC voltage as the trigger. The Input Q trigger condition is met when the voltage crosses the trigger level.

Key Path:	Trigger, Baseband I/Q
Example:	TRIG:<meas>:SOUR QINP
Readback Text:	Input Q
Initial S/W Revision:	Prior to A.02.00

Trigger Level

Sets a level for the Input Q trigger. When the signal crosses this level, with the chosen slope, the trigger occurs.

Key Path:	Trigger, Baseband I/Q, Input Q
Remote Command:	:TRIGger[:SEquence]:QINPut:LEVel <voltage> :TRIGger[:SEquence]:QINPut:LEVel?

Trigger

Example:	TRIG:QINP:LEV 0.5 V
Preset:	0.25 V
State Saved:	Saved in instrument state
Range:	-1 to 1 V
Readback Text:	0.1 of displayed unit (V, mV, etc.)
Initial S/W Revision:	Prior to A.02.00

Trig Slope

Controls the trigger polarity. It is set positive to trigger on a rising edge and negative to trigger on a falling edge.

Key Path:	Trigger, Baseband I/Q, Input Q
Remote Command:	:TRIGger[:SEquence]:QINPut:SLOPe POSitive NEGative :TRIGger[:SEquence]:QINPut:SLOPe?
Example:	TRIG:QINP:SLOP POS
Preset:	POSitive
State Saved:	Saved in instrument state
Initial S/W Revision:	Prior to A.02.00

Trig Delay

Controls a time delay during which the analyzer will wait to begin a sweep after meeting the trigger criteria. You can use negative delay to pre-trigger the instrument in time domain or FFT.

Key Path:	Trigger, Baseband I/Q, Input Q
Remote Command:	:TRIGger[:SEquence]:QINPut:DELay <time> :TRIGger[:SEquence]:QINPut:DELay? :TRIGger[:SEquence]:QINPut:DELay:STATe OFF ON 0 1 :TRIGger[:SEquence]:QINPut:DELay:STATe?
Example:	TRIG:QINP:DEL 10 ms TRIG:QINP:DEL:STAT ON
Preset:	1 us OFF
State Saved:	Saved in instrument state
Range:	-2.5 s to +10 s
Initial S/W Revision:	Prior to A.02.00

Auxiliary Channel I/Q Mag

Pressing this key, when it is not selected, selects the Auxiliary Channel I/Q magnitude signal as the trigger. The Auxiliary Channel I/Q Magnitude trigger condition is met when the auxiliary receiver's I/Q magnitude output crosses the Auxiliary I/Q magnitude trigger level.

Key Path:	Trigger, Baseband I/Q
Example:	TRIG:<meas>:SOUR AIQM
Readback Text:	Aux I/Q Mag
Initial S/W Revision:	Prior to A.02.00

Trigger Level

Sets a level for the I/Q magnitude trigger. When the signal crosses this level, with the chosen slope, the trigger occurs.

Key Path:	Trigger, Baseband I/Q, Aux Channel I/Q Mag
Remote Command:	:TRIGger [:SEquence] :AIQMag:LEVEl <ampl > :TRIGger [:SEquence] :AIQMag:LEVEl?
Example:	TRIG:AIQM:LEV -30 dBm
Notes:	The I/Q reference impedance is used for converting between power and voltage.
Preset:	-25 dBm
State Saved:	Saved in instrument state
Range:	-200 dBm to 100 dBm
Readback Text:	<level> dBm
Initial S/W Revision:	Prior to A.02.00

Trig Slope

Controls the trigger polarity. It is set positive to trigger on a rising edge and negative to trigger on a falling edge.

Key Path:	Trigger, Baseband I/Q, Aux Channel I/Q Mag
Remote Command:	:TRIGger[:SEquence]:AIQMag:SLOPe POSitive NEGative :TRIGger[:SEquence]:AIQMag:SLOPe?
Example:	TRIG:AIQM:SLOP POS
Preset:	POSitive
State Saved:	Saved in instrument state
Initial S/W Revision:	Prior to A.02.00

Trigger

Trig Delay

Controls a time delay during which the analyzer will wait to begin a sweep after meeting the trigger criteria. You can use negative delay to pre-trigger the instrument in time domain or FFT.

Key Path:	Trigger, Baseband I/Q, Aux Channel I/Q Mag
Remote Command:	:TRIGger [:SEQuence] :AIQMag:DELay <time> :TRIGger [:SEQuence] :AIQMag:DELay? :TRIGger [:SEQuence] :AIQMag:DELay:STATe OFF ON 0 1 :TRIGger [:SEQuence] :AIQMag:DELay:STATe?
Example:	TRIG:AIQM:DEL 10 ms TRIG:AIQM:DEL:STAT ON
Preset:	1 us OFF
State Saved:	Saved in instrument state
Range:	-2.5 s to +10 s
Initial S/W Revision:	Prior to A.02.00

Trigger Center Frequency

This key sets the center frequency to be used by the auxiliary receiver.

Key Path:	Trigger, Baseband I/Q, Aux Channel I/Q Mag
Remote Command:	:TRIGger [:SEQuence] :AIQMag:CENTer <freq> :TRIGger [:SEQuence] :AIQMag:CENTer?
Example:	:TRIG:AIQM:CENT 10 MHz
Notes:	Trigger CF + 1/2 Trigger BW < Max Trigger CF - 1/2 Trigger BW > Min
Preset:	0 Hz
State Saved:	Saved in instrument state
Range:	-40 MHz to 40 MHz
Initial S/W Revision:	Prior to A.02.00

Trigger Bandwidth

This key sets the information bandwidth used by the auxiliary receiver for the Auxiliary Channel I/Q Magnitude trigger.

Key Path:	Trigger, Baseband I/Q, Aux Channel I/Q Mag
-----------	---

Remote Command:	:TRIGger[:SEquence]:AIQMag:BANDwidth <freq> :TRIGger[:SEquence]:AIQMag:BANDwidth?
Example:	:TRIG:AIQM:BAND 8 MHz
Notes:	The combined sample rate for the main and auxiliary receivers cannot exceed 100 MSa/sec. The bandwidth available to the Trigger BW is limited to what is available after the main receiver's bandwidth (Info BW, sometimes pre-FFT BW) is set. Because of this limitation, the Max is not always achievable. The combination of Trigger Center Freq and Trigger BW is also limited: Trigger CF + 1/2 Trigger BW < Max Trigger CF – 1/2 Trigger BW > Min
Preset:	Bandwidth option dependent: No Opt: 10 MHz Opt B25: 25 MHz Opt S40: 40 MHz
State Saved:	Saved in instrument state
Range:	10 Hz to Maximum
Initial S/W Revision:	Prior to A.02.00

TV

Pressing this key, when it is not selected, selects the TV input signal as the trigger. A new sweep/measurement will start synchronized with the next occurrence of the synchronizing pulse of the selected TV line number.

Pressing this key, when it is already selected, opens a menu of TV Trigger setup functions. The default active function in this menu is the TV line number on which you want to trigger.

The Frame and Field options enable you to determine how the fields of the TV picture signal will be affected by the trigger system. One complete TV image consists of one frame of 525 or 625 horizontal lines depending on the TV standard being used. Each frame is composed of two fields of interlacing lines, each consisting of 262 1/2 lines (or 312 1/2 lines). The fields are called Field One and Field Two. Field One is viewed as having 263 lines (or 313 lines) and Field Two is viewed as having 262 lines (or 312 lines).

For the 525 line NTSC video standard, we refer to TV lines as follows (these are the Field Modes):

Entire Frame, lines 1 to 525

Field One, lines 1 to 263

Field Two, lines 1 to 262 (note that this really refers to "actual" lines 264 to 525)

For the 625 line PAL and SECAM video standards, we refer to TV lines as follows:

Entire Frame, lines 1 to 625

Field One, lines 1 to 313

Trigger

Field Two, lines 314 to 625

As the Field is changed, the appropriate value for Line is chosen to keep triggering on the same line as before, or if this is not possible, the corresponding line in the new Field. For example, suppose line 264 is selected while in the NTSC-M standard and the Entire Frame mode. This is the first line in Field Two. If Field Two is then selected, the Line number changes to Line 1, the same actual line in the TV signal. If Field One is then selected, the line number stays at 1, but now we are triggering in the first line in Field One. The only exception to this is if we are on the last line of Field One and change to Field Two. In this case, we go to the last line in Field Two.

Key Path:	Trigger
Example:	TRIG:SOUR TV Swept SA measurement TRIG:<meas>:SOUR TV Measurements other than Swept SA
Dependencies:	This key only appears in Modes which support TV Trigger, otherwise the key is blanked. If the SCPI command is sent while the key is blanked, an error is returned.
Readback:	This key displays the value read back from TV Line
Status Bits/OPC dependencies:	The Status Operation Register bit 5 "Waiting for Trigger" is set at the same time as the Sweeping or Measuring bit is set. It is cleared when the trigger actually occurs (that is, after the trigger event occurs and all the applicable trigger criteria have been met). A corresponding pop-up message ("Waiting for trigger") is generated if no trigger signal appears after approximately 2 sec. This message goes away when a trigger signal appears.
Initial S/W Revision:	Prior to A.02.00

TV Line

Selects the TV line number to trigger on. Line number range is dependent on the settings of the **Standard** and **Field** menus within the TV trigger setup functions. When the line number is incremented beyond the upper limit, the value will change to the lower limit and continue incrementing from there. When the line number is decremented below the lower limit, the value will change to the upper limit and continue decrementing from there.

Key Path:	Trigger, TV
Remote Command:	:TRIGger[:SEquence]:TV:LINE <integer> :TRIGger[:SEquence]:TV:LINE?
Example:	TRIG:TV:LINE 20 TRIG:TV:LINE?
Notes:	The range of the TV line number is dependent on the settings of the Standard and Field menus within the TV trigger setup functions.
Preset:	17
State Saved:	Saved in instrument state

Min:	The minimum value is the minimum line, and rolls over to the maximum value. The minimum line number depends on which Field and standard are selected.
Max:	The maximum value is the maximum line, and rolls over to the minimum value. The maximum line number depends on which Field and standard are selected.
Initial S/W Revision:	Prior to A.02.00

Field

Accesses the menu to select the field.

Key Path:	Trigger, TV
Remote Command:	:TRIGger [:SEquence] :TV:FMODE ENTire ODD EVEN :TRIGger [:SEquence] :TV:FMODE?
Example:	TRIG:TV:FMODE EVEN
Notes:	ODD is Field 1 EVEN is Field 2
Dependencies:	This command is available only when Option B7B (TV trigger) is installed.
Preset:	ENTire
Readback:	Displays the Readback value
Initial S/W Revision:	Prior to A.02.00

Entire Frame

When you select Entire Frame it causes the selected line number to be viewed as an offset into the entire frame starting with line 1, the first line in Field One.

Key Path:	Trigger, TV, Field
Example:	TRIG:TV:FMODE ENT
Min:	1, for all formats.
Max:	525, for formats NTSC-M, NTSC-Japan, NTSC-4.43, PAL-M and PAL-60 625, for formats PAL-B, D, G, H, I, PAL-N, PAL-N Combin, and SECAM-L.
Readback:	Entire Frame
Initial S/W Revision:	Prior to A.02.00

Field One

When you select Field One it causes the selected line number to be viewed as an offset into the first field starting

Trigger

with Line 1, the first line in Field One.

Key Path:	Trigger, TV, Field
Example:	TRIG:TV:FMOD ODD
Min:	Field 1 (ODD) The minimum line is 1
Max:	Field 1 (ODD) Maximum line is 263 for formats NTSC-M, NTSC-Japan, NTSC-4.43, PAL-M and PAL-60 Maximum line is 313 for formats PAL-B, D, G, H, I, PAL-N, PAL-N Combin, and SECAM-L.
Readback:	Field 1
Initial S/W Revision:	Prior to A.02.00

Field Two

When you select Field Two it causes the selected line number to be viewed as an offset into the second field. If Line 1 is selected, it is the 264th line of the frame (NTSC-M, NTSC-Japan, NTSC-4.43, PAL-M, PAL-60) or the 314th line of the frame (PAL-B,D,G,H,I, PAL-N, PAL-N-Combin, SECAM-L).

Key Path:	Trigger, TV, Field
Example:	TRIG:TV:FMOD EVEN
Min:	Field 2 (EVEN) The minimum line is 1
Max:	Field 2 (EVEN) The maximum line 262 for formats NTSC-M, NTSC-Japan, NTSC-4.43, PAL-M and PAL-60 The maximum line is 312 for formats PAL-B, D, G, H, I, PAL-N, PAL-N Combin, and SECAM-L
Readback:	Field 2
Initial S/W Revision:	Prior to A.02.00

Standard

Accesses the Standard menu keys which select from the following TV standards: **NTSC-M, NTSC-Japan, NTSC-4.43, PAL-M, PAL-B,D,G,H,I, PAL-N, PAL-N-Combin, PAL-60, SECAM-L.**

As the TV standard is changed, the current line value is clipped as necessary to keep it valid for the chosen standard and field mode. For example, line 600 is selected in Entire Frame mode in PAL-N; if NTSC-M is selected, the line number is clipped to 525. Or, if line 313 is selected in Field 1 mode in PAL-N and NTSC-M is selected, the line number is clipped to 263. Changing back to the PAL-N

standard will leave the line number at 263.

Key Path:	Trigger, TV
Remote Command:	:TRIGger [:SEquence] :TV:STANdard MNTSc JNTSc NTSC443 MPAL BPAL NPAL CPAL PAL60 LSEC :TRIGger [:SEquence] :TV:STANdard?
Example:	TRIG:TV:STAN MPAL TRIG:TV:STAN?
Preset:	MNTS
State Saved:	Saved in instrument state
Readback:	Displays Readback value
Initial S/W Revision:	Prior to A.02.00

NTSC-M

Sets the TV standard to **NTSC-M**.

Key Path:	Trigger, TV, Standard
Example:	TRIG:TV:STAN MNTS
Readback:	NTSC-M
Initial S/W Revision:	Prior to A.02.00

NTSC-Japan

Sets the TV standard to **NTSC-Japan**.

Key Path:	Trigger, TV, Standard
Example:	TRIG:TV:STAN JNTS
Readback:	NTSC-Japan
Initial S/W Revision:	Prior to A.02.00

NTSC-4.43

Sets the TV standard to **NTSC-4.43**.

Key Path:	Trigger, TV, Standard
Example:	TRIG:TV:STAN NTSC443
Readback:	NTSC-Japan
Initial S/W Revision:	Prior to A.02.00

Trigger

PAL-M

Sets the TV standard to **PAL-M**.

Key Path:	Trigger, TV, Standard
Example:	TRIG:TV:STAN MPAL
Readback:	PAL-M
Initial S/W Revision:	Prior to A.02.00

PAL-N

Sets the TV standard to **PAL-N**.

Key Path:	Trigger, TV, Standard
Example:	TRIG:TV:STAN NPAL
Readback:	PAL-N
Initial S/W Revision:	Prior to A.02.00

PAL-N-Combin

Sets the TV standard to **PAL-N-Combin**.

Key Path:	Trigger, TV, Standard
Example:	TRIG:TV:STAN CPAL
Readback:	PAL-N-C
Initial S/W Revision:	Prior to A.02.00

PAL-B,D,G,H,I

Sets the TV standard to **PAL-B,D,G,H,I**

Key Path:	Trigger, TV, Standard
Example:	TRIG:TV:STAN BPAL
Readback:	PAL-B
Initial S/W Revision:	Prior to A.02.00

PAL-60

Sets the TV standard to **PAL-60**.

Key Path:	Trigger, TV, Standard
Example:	TRIG:TV:STAN PAL60

Readback:	PAL-N
Initial S/W Revision:	Prior to A.02.00

SECAM-L

Sets the TV standard to **SECAM-L**.

Key Path:	Trigger, TV, Standard
Example:	TRIG:TV:STAN LSEC
Readback:	SECAM-L
Initial S/W Revision:	Prior to A.02.00

Auto/Holdoff

Opens up a menu that lets you adjust Auto Trigger and Trigger Holdoff parameters

Key Path:	Trigger
Readback line:	<p>Displays a summary of the Auto Trig and Holdoff settings, in square brackets</p> <p>First line: Auto Off or Auto On</p> <p>Second Line: "Hldf" followed by:</p> <ul style="list-style-type: none"> • If Holdoff is Off, readback Off • If Holdoff On and Type = Normal, readback value • If Holdoff On and Type = Above, readback value followed by AL • If Holdoff On and Type = Below, readback value followed by BL • If Holdoff Type selection is not supported by the current measurement, Holdoff Type is always Normal
Initial S/W Revision:	A.02.00

Auto Trig

Sets the time that the analyzer will wait for the trigger conditions to be met. If they are not met after that much time, then the analyzer is triggered anyway.

Key Path:	Trigger, Auto/Holdoff
Remote Command:	<pre>:TRIGger[:SEquence]:ATRigger <time> :TRIGger[:SEquence]:ATRigger? :TRIGger[:SEquence]:ATRigger:STATe OFF ON 0 1 :TRIGger[:SEquence]:ATRigger:STATe?</pre>
Example:	<pre>TRIG:ATR:STAT ON TRIG:ATR 100 ms</pre>

Trigger

Notes:	The "time that the analyzer will wait" starts when the analyzer is ready for a trigger, which may be hundreds of ms after the data acquisition for a sweep is done. The "time" ends when the trigger condition is satisfied, not when the delay ends.
Preset:	Off, 100 ms
State Saved:	Saved in instrument state
Min:	1 ms
Max:	100 s
Default Unit:	s
Initial S/W Revision:	Prior to A.02.00

Trig Holdoff

Sets the holdoff time between triggers. When the trigger condition is satisfied, the trigger occurs, the delay begins, and the holdoff time begins. New trigger conditions will be ignored until the holdoff time expires. For a free-running trigger, the holdoff value is the minimum time between triggers.

Key Path:	Trigger, Auto/Holdoff
Remote Command:	:TRIGger[:SEquence]:HOLDoff <time> :TRIGger[:SEquence]:HOLDoff? :TRIGger[:SEquence]:HOLDoff:STATe OFF ON 0 1 :TRIGger[:SEquence]:HOLDoff:STATe?
Example:	TRIG:HOLD:STAT ON TRIG:HOLD 100 ms
Dependencies:	Unavailable if the selected Input is BBIQ. If this is the case, the key is grayed out if it is pressed the informational message "Feature not supported for this Input" is displayed. If the SCPI command is sent, the error "Settings conflict; Feature not supported for this Input" is generated.
Preset:	Off, 100 ms
State Saved:	Saved in instrument state
Min:	0 s
Max:	0.5 s
Default Unit:	s
Initial S/W Revision:	Prior to A.02.00

Holdoff Type

Lets you set the Trigger Holdoff Type.

NOTE Holdoff Type is not supported by all measurements. If the current measurement does not support it, this key will be blank and the Holdoff Type will be Normal. If the Holdoff Type SCPI is sent while in such a measurement, the SCPI will be accepted and the setting remembered, but it will have no effect until a measurement is in force that supports Holdoff Type.

Trigger Holdoff Type functionality:

- **NORMal**
This is the “oscilloscope” type of trigger holdoff, and is the setting when the Holdoff Type key does not appear. In this type of holdoff, no new trigger will be accepted until the holdoff interval has expired after the previous trigger.
- **ABOVe**
If the trigger slope is positive, a trigger event is generated only if the signal characteristic of interest crosses the trigger threshold (with positive slope) and then remains above the threshold for at least the holdoff time. For negative slope, the trigger event is generated if the signal characteristic crosses the threshold (with negative slope) after having been above the threshold for at least the holdoff time. In either case, the trigger event is associated with the time the level was crossed.
- **BELow**
If the trigger slope is positive, a trigger event is generated only if the signal characteristic of interest crosses the trigger threshold (with positive slope) after having been below the threshold for at least the holdoff time. For negative slope, the trigger event is generated if the signal characteristic crosses the threshold (with negative slope) and then remains below the threshold for at least the holdoff time. In either case, the trigger event is associated with the time the level was crossed.

Key Path:	Trigger, Auto/Holdoff
Remote Command:	:TRIGger[:SEquence]:HOLDoff:TYPE NORMal ABOVe BELow :TRIGger[:SEquence]:HOLDoff:TYPE?
Example:	TRIG:HOLD:TYPE NORM
Preset:	All modes but GSM/EDGE: Normal GSM/EDGE: Below
State Saved:	Saved in instrument state
Initial S/W Revision:	A.02.00

Trigger

View/Display

This section describes the Display key, which is the key in the View/Display menu that is common to multiple Modes and Measurements. See the Measurement descriptions for information on the View functions of each measurement.

Display

The **Display** menu is common to most measurements, and is used for configuring items on the display. Some **Display** menu settings apply to all the measurements in a mode, and some only to the current measurement. Those under the **System Display Settings** key apply to all measurements in all modes.

Key Path:	Display
Key Path:	View/Display
Initial S/W Revision:	Prior to A.02.00

Annotation

Turns on and off various parts of the display annotation. The annotation is divided up into four categories:

1. **Meas Bar:** This is the measurement bar at the top of the screen. It does not include the settings panel or the Active Function. Turning off the Meas Bar turns off the settings panel and the Active Function. When the Meas Bar is off, the graticule area expands to fill the area formerly occupied by the Meas Bar.
2. **Screen Annotation:** this is the annotation and annunciation around the graticule, including any annotation on lines (such as the display line, the threshold line, etc.) This does NOT include the marker number or the N dB result. When off, the graticule expands to fill the entire graticule area.
3. **Trace annotation:** these are the labels on the traces, showing their detector (or their math mode).
4. **Active Function annotation:** this is the active function display in the meas bar, and all of the active function values displayed on softkeys.

See the figure below. Each type of annotation can be turned on and off individually.

View/Display

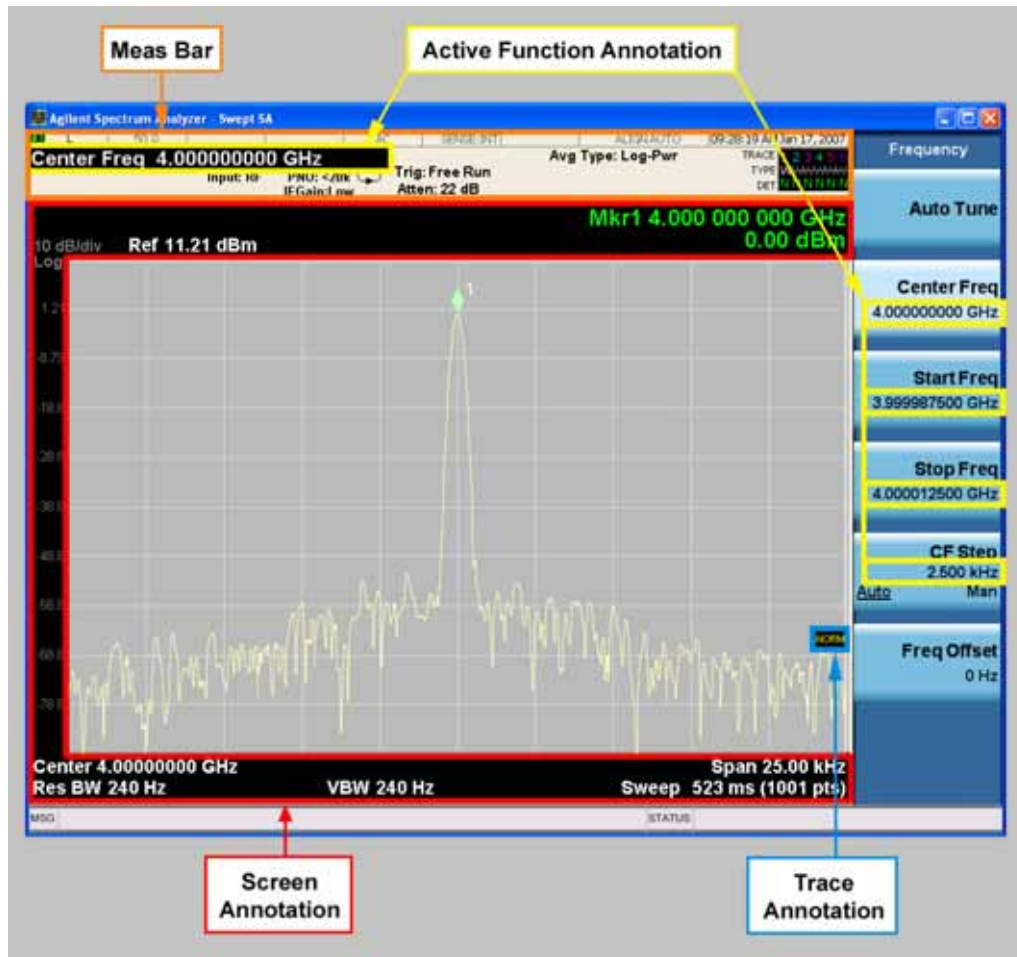

Key Path:	View/Display, Display
Initial S/W Revision:	Prior to A.02.00

Meas Bar On/Off

This function turns the Measurement Bar on and off, including the settings panel. When off, the graticule area expands to fill the area formerly occupied by the Measurement Bar.

Key Path:	View/Display, Display, Annotation
Remote Command:	:DISPlay:ANNotation:MBAR[:STATe] OFF ON 0 1 :DISPlay:ANNotation:MBAR[:STATe]?
Example:	DISP:ANN:MBAR OFF
Dependencies:	Grayed out and forced to OFF when System Display Settings, Annotation is set to Off.

Preset:	On This should remain Off through a Preset when System Display Settings, Annotation is set to Off.
State Saved:	Saved in instrument state.
Initial S/W Revision:	Prior to A.02.00

Screen

This controls the display of the annunciation and annotation around the graticule, including any annotation on lines (such as the display line, the threshold line, etc.) and the y-axis annotation. This does NOT include marker annotation (or the N dB result). When off, the graticule expands to fill the entire graticule area, leaving only the 1.5% gap above the graticule as described in the Trace/Detector chapter.

Key Path:	View/Display, Display, Annotation
Remote Command:	:DISPlay:ANNOtation:SCREen[:STATe] OFF ON 0 1 :DISPlay:ANNOtation:SCREen[:STATe] ?
Example:	DISP:ANN:SCR OFF
Dependencies:	Grayed-out and forced to OFF when System Display Settings, Annotation is set to Off.
Preset:	On This should remain Off through a Preset when System Display Settings, Annotation is set to Off
State Saved:	Saved in instrument state.
Initial S/W Revision:	Prior to A.02.00

Trace

Turns on and off the labels on the traces, showing their detector (or their math mode) as described in the Trace/Detector section.

If trace math is being performed with a trace, then the trace math annotation will replace the detector annotation.

Key Path:	View/Display, Display, Annotation
Remote Command:	:DISPlay:ANNOtation:TRACe[:STATe] ON OFF 1 0 :DISPlay:ANNOtation:TRACe[:STATe] ?
Example:	DISP:ANN:TRAC OFF
Preset:	Off
State Saved:	Saved in instrument state.
Initial S/W Revision:	Prior to A.02.00

View/Display

Active Function Values On/Off

Turns on and off the active function display in the Meas Bar, and all of the active function values displayed on the softkeys.

Note that all of the softkeys that have active functions have these numeric values blanked when this function is on. This is a security feature..

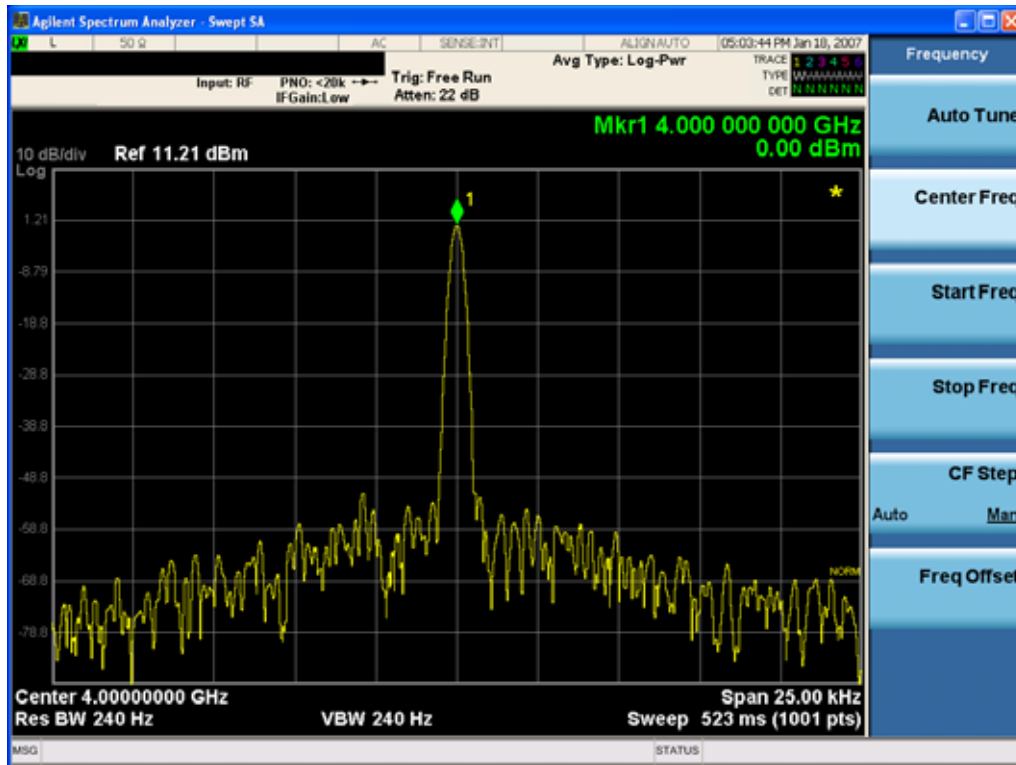

Key Path:	View/Display, Display, Annotation
Remote Command:	:DISPlay:ACTivefunc[:STATE] ON OFF 1 0 :DISPlay:ACTivefunc[:STATE]?
Example:	DISP:ACT OFF
Dependencies:	Grayed out and forced to OFF when System Display Settings, Annotation is set to Off.
Preset:	On This should remain Off through a Preset when System Display Settings, Annotation is set to Off
State Saved:	Saved in instrument state.
Initial S/W Revision:	Prior to A.02.00

Title

Displays menu keys that enable you to change or clear a title on your display.

Key Path:	View/Display, Display
Initial S/W Revision:	Prior to A.02.00

Change Title

Writes a title into the "measurement name" field in the banner, for example, "Channel Power".

Press **Change Title** to enter a new title through the alpha editor. Press **Enter** or **Return** to complete the entry. Press **Cancel (Esc)** to cancel the entry and preserve your existing title.

The display title will replace the measurement name. It remains for this measurement until you press **Change Title** again, or you recall a state, or a Preset is performed. A title can also be cleared by pressing **Title, Clear Title**.

NOTE Notice the inclusion of the <measurement> parameter in the command below. Because each measurement remembers the Display Title, the command must be qualified with the measurement name.

Key Path:	View/Display, Display, Title
Mode:	All
Remote Command:	:DISPlay:<measurement>:ANNotation:TITLe:DATA <string> :DISPlay:<measurement>:ANNotation:TITLe:DATA?
Example:	DISP:ACP:ANN:TITL:DATA "This Is My Title" This example sets the title to: This Is My Title
Notes:	Pressing this key cancels any active function. When a title is edited the previous title remains intact (it is not cleared) and the cursor goes at the end so that characters can be added or BKSP can be used to go back over previous characters.
Preset:	No title (measurement name instead)
State Saved:	Saved in instrument state.
Initial S/W Revision:	Prior to A.02.00
Modified at S/W Revision:	A.02.00, A.03.00

Clear Title

Clears a title from the front-panel display. Once cleared, the title cannot be retrieved. After the title is cleared, the current Measurement Name replaces it in the title bar.

Key Path:	View/Display, Display, Title
-----------	-------------------------------------

View/Display

Example:	The following commands clear the title and restore the measurement's original title: DISP:ACP:ANN:TITL:DATA "" This example is for ACP; the measurement name is required.
Notes:	Uses the :DISPlay:<measurement>:ANNotation:TITLe:DATA <string> command with an empty string.
Preset:	Performed on Preset.
Initial S/W Revision:	Prior to A.02.00

Graticule

Pressing Graticule turns the display graticule On or Off. It also turns the graticule y-axis annotation on and off.

Key Path:	View/Display, Display
Remote Command:	:DISPlay:WINDow [1] :TRACe:GRATicule:GRID [:STATe] OFF ON 0 1 :DISPlay:WINDow [1] :TRACe:GRATicule:GRID [:STATe] ?
Example:	DISP:WIND:TRAC:GRAT:GRID OFF
Notes:	The graticule is the set of horizontal and vertical lines that make up the grid/divisions for the x-axis and y-axis.
Preset:	On
State Saved:	saved in instrument state
Initial S/W Revision:	Prior to A.02.00

Display Line

Activates an adjustable horizontal line that is used as a visual reference line. The line's vertical position corresponds to its amplitude value. The value of the display line (for example, "-20.3 dBm") appears above the line itself on the right side of the display in the appropriate font.

The display line can be adjusted using the step keys, knob, or numeric keypad. The unit of the Display Line is determined by the **Y axis unit** setting under **Amplitude**. If more than one window has a display line, the display line of the selected window is controlled.

If the display line is off the screen, it shows as a line at the top/bottom of the screen with an arrow pointing up or down. As with all such lines (Pk Thresh, Trigger Level, etc.) it is drawn on top of all traces.

The display line is unaffected by Auto Couple.

Key Path:	View/Display, Display
-----------	------------------------------

Remote Command:	:DISPlay:WINDow[1]:TRACe:Y:DLINe <amp1> :DISPlay:WINDow[1]:TRACe:Y:DLINe? :DISPlay:WINDow[1]:TRACe:Y:DLINe:STATe OFF ON 0 1 :DISPlay:WINDow[1]:TRACe:Y:DLINe:STATe?
Example:	DISP:WIND:TRAC:Y:DLIN:STAT ON DISP:WIND:TRAC:Y:DLIN:STAT -32 dBm
Preset:	Set the Display Line to Off and -25 dBm on Preset. When the Display Line goes from Off to On, if it is off screen, set it to either the top or bottom of screen, depending on which direction off screen it was. The Display Line's value does not change when it is turned off.
State Saved:	Saved in instrument state.
Min:	-∞ (minus infinity) in current units
Max:	+∞ (plus infinity) in current units
Default Unit:	Depends on the current selected Y axis unit
Initial S/W Revision:	Prior to A.02.00

System Display Settings

These settings are "Mode Global" – they affect all modes and measurements and are reset only by **Restore Misc Defaults** or **Restore System Defaults** under System.

Key Path:	View/Display, Display
Initial S/W Revision:	Prior to A.02.00

Annotation Local Settings

This is a Mode Global override of the meas local annotation settings. When it is **All Off**, it forces **Screen Annotation, Meas Bar, Trace, and Active Function Values** settings to be **OFF** for all measurements in all modes. This provides the security based "annotation off" function of previous test sets; hence it uses the legacy SCPI command.

When it is **All Off**, the **Screen, Meas Bar, Trace, and Active Function Values** keys under the **Display, Annotation** menu are grayed out and forced to **Off**. When **Local Settings** is selected, you are able to set the local annotation settings on a measurement by measurement basis.

Key Path:	View/Display, Display, System Display Settings
Remote Command:	:DISPlay:WINDow[1]:ANNotation[:ALL] OFF ON 0 1 :DISPlay:WINDow[1]:ANNotation[:ALL]?
Example:	:DISP:WIND:ANN OFF
Preset:	On (Set by Restore Misc Defaults)

View/Display

State Saved:	Not saved in instrument state.
Backwards Compatibility Notes:	The WINDow parameter and optional subopcode is included for backwards compatibility but ignored – all windows are equally affected.
Initial S/W Revision:	Prior to A.02.00

Theme

This key allows you to change the Display theme. This is similar to the Themes selection under Page Setup and Save Screen Image. The four themes are detailed below.

Key Path:	View/Display, Display, System Display Settings
Remote Command:	:DISPlay:THEMe TDColor TDMonochrome FCOLor FMONochrome :DISPlay:THEMe?
Example:	DISP:THEM TDM sets the display theme to 3D Monochrome.
Notes:	TDColor – 3D is the standard color theme with filling and shading TDMonochrome – is similar to 3D color, but only black is used FCOLor – flat color is intended for inkjet printers to conserve ink. It uses a white background instead of black. FMONochrome – is like flat color, but only black is used
Preset:	TDColor (Set by Restore Misc Defaults)
State Saved:	Not saved in instrument state.
Initial S/W Revision:	Prior to A.02.00

Backlight

Accesses the display backlight on/off keys. This setting may interact with settings under the Windows "Power" menu.

When the backlight is off, pressing ESC, TAB, SPACE, ENTER, UP, DOWN, LEFT, RIGHT, DEL, BKSP, CTRL, or ALT turns the backlight on without affecting the application. Pressing any other key will turn backlight on and could potentially perform the action as well.

Key Path:	View/Display, Display, System Display Settings
Remote Command:	:DISPlay:BACKlight ON OFF :DISPlay:BACKlight?
Preset:	ON (Set by Restore Misc Defaults)
Initial S/W Revision:	Prior to A.02.00

On

Turns the display backlight on.

Key Path:	View/Display, Display, System Display Settings, Backlight
Example:	DISP:BACK ON
Readback:	On
Initial S/W Revision:	Prior to A.02.00

Off

Turns the display backlight off.

Key Path:	View/Display, Display, System Display Settings, Backlight
Example:	DISP:BACK OFF
Readback:	Off
Initial S/W Revision:	Prior to A.02.00

Backlight Intensity

An active function used to set the backlight intensity. It goes from 0 to 100 where 100 is full on and 0 is off. This value is independent of the values set under the Backlight on/off key.

Key Path:	View/Display, Display, System Display Settings
Remote Command:	:DISPlay:BACKlight:INTensity <integer> :DISPlay:BACKlight:INTensity?
Example:	DISP:BACK:INT 50
Preset:	100 (Set by Restore Misc Defaults)
Min:	0
Max:	100
Initial S/W Revision:	Prior to A.02.00

Full Screen

When **Full Screen** is pressed the measurement window expands horizontally over the entire instrument display. The screen graticule area expands to fill the available display area.

It turns off the display of the softkey labels, however the menus and active functions still work. (Though it would obviously be very hard to navigate without the key labels displayed.) Pressing **Full Screen** again while Full Screen is in effect cancels Full Screen.

Note that the banner and status lines are unaffected. You can get even more screen area for your data display by turning off the Meas Bar (in the Display menu) which also turns off the settings panel.

View/Display

Full Screen is a Meas Global function. Therefore it is cancelled by the **Preset** key.

Key Path:	Display
Remote Command:	:DISPlay:FSCReen[:STATe] OFF ON 0 1 :DISPlay:FSCReen[:STATe] ?
Preset:	Off
State Saved:	Not saved in instrument state.
Backwards Compatibility SCPI:	:DISPlay:MENU[:STATe] OFF ON 0 1 This emulates ESA full screen functionality, which is the same as the FSCReen command in PSA except that the sense of on/off is reversed (that is, OFF means the menus are OFF, so Fullscreen is ON) and the default is ON (meaning Fullscreen is OFF).
Backwards Compatibility Notes:	1. In ESA/PSA, Full Screen was turned on with a softkey, so pressing any other key turned Full Screen off. In the X-Series, because a hardkey is provided to turn this function on and off, pressing any other key no longer turns off Full Screen
Initial S/W Revision:	Prior to A.02.00

Display Enable (Remote Command Only)

Turns the display on/off, including the display drive circuitry. The backlight stays lit so you can tell that the instrument is on. The display enable setting is mode global. The reasons for turning the display off are three:

- To increase speed as much as possible by freeing the instrument from having to update the display
- To reduce emissions from the display, drive circuitry
- For security purposes

If you have turned off the display:

- and you are in local operation, the display can be turned back on by pressing any key or by sending the SYSTem:DEFaults MISC command or the DISPlay:ENABle ON (neither *RST nor SYSTem:PRESet enable the display.)
- and you are in remote operation, the display can be turned back on by pressing the **Local** or **Esc** keys or by sending the SYSTem:DEFaults MISC command or the DISPlay:ENABle ON (neither *RST nor SYSTem:PRESet enable the display.)

and you are using either the SYSTem:KLOCK command or GPIB local lockout, then no front-panel key press will turn the display back on. You must turn it back on remotely.

Remote Command:	:DISPlay:ENABle OFF ON 0 1 :DISPlay:ENABle?
Example:	DISP:ENAB OFF

Couplings:	DISP:ENAB OFF turns Backlight OFF and DISP:ENAB ON turns Backlight ON. However, settings of Backlight do not change the state of DISP:ENAB
Preset:	On Set by SYST:DEF MISC, but Not affected by *RST or SYSTem:PRESet.
State Saved:	Not saved in instrument state.
Backwards Compatibility Notes:	1. SYST:PRES no longer turns on DISPlay:ENABLE as it did in legacy analyzers
Initial S/W Revision:	Prior to A.02.00