

# Keysight E6650A EXF Wireless Test Set for Femtocell

Notice: This document contains references to Agilent. Please note that Agilent's Test and Measurement business has become Keysight Technologies. For more information, go to [www.keysight.com](http://www.keysight.com).

Source User's  
Guide

## Notices

© Keysight Technologies, Inc. 2014

No part of this manual may be reproduced in any form or by any means (including electronic storage and retrieval or translation into a foreign language) without prior agreement and written consent from Keysight Technologies as governed by United States and international copyright laws.

### Trademark Acknowledgments

N/A

## Manual Part Number

E6650-90008

Supersedes: N/A

### Print Date

October 2014

Supersedes: N/A

Published in USA

Keysight Technologies Inc.  
1400 Fountaingrove Parkway  
Santa Rosa, CA 95403

### Warranty

The material contained in this document is provided “as is,” and is subject to being changed, without notice, in future editions. Further, to the maximum extent permitted by applicable law, Keysight disclaims all warranties, either express or implied, with regard to this manual and any information contained herein, including but not limited to the implied warranties of merchantability and fitness for a particular purpose. Keysight shall not be liable for errors or for incidental or consequential damages in connection with the furnishing, use, or performance of this document or of any information contained herein. Should Keysight and the user have a separate written agreement with warranty terms covering the material in this document that conflict with these terms, the warranty terms in the separate agreement shall control.

### Technology Licenses

The hardware and/or software described in this document are furnished under a license and may be used or copied only in accordance with the terms of such license.

## Restricted Rights Legend

If software is for use in the performance of a U.S. Government prime contract or subcontract, Software is delivered and licensed as “Commercial computer software” as defined in DFAR 252.227-7014 (June 1995), or as a “commercial item” as defined in FAR 2.101(a) or as “Restricted computer software” as defined in FAR 52.227-19 (June 1987) or any equivalent agency regulation or contract clause. Use, duplication or disclosure of Software is subject to Keysight Technologies’ standard commercial license terms, and non-DOD Departments and Agencies of the U.S. Government will receive no greater than Restricted Rights as defined in FAR 52.227-19(c)(1-2) (June 1987). U.S. Government users will receive no greater than Limited Rights as defined in FAR 52.227-14 (June 1987) or DFAR 252.227-7015 (b)(2) (November 1995), as applicable in any technical data.

## Safety Notices

### CAUTION

A **CAUTION** notice denotes a hazard. It calls attention to an operating procedure, practice, or the like that, if not correctly performed or adhered to, could result in damage to the product or loss of important data. Do not proceed beyond a CAUTION notice until the indicated conditions are fully understood and met.

### WARNING

A **WARNING** notice denotes a hazard. It calls attention to an operating procedure, practice, or the like that, if not correctly performed or adhered to, could result in personal injury or death. Do not proceed beyond a WARNING notice until the indicated conditions are fully understood and met.

## Warranty

This Keysight technologies instrument product is warranted against defects in material and workmanship for a period of one year from the date of shipment. During the warranty period, Keysight Technologies will, at its option, either repair or replace products that prove to be defective.

For warranty service or repair, this product must be returned to a service facility designated by Keysight Technologies. Buyer shall prepay shipping charges to Keysight Technologies, and Keysight Technologies shall pay shipping charges to return the product to Buyer. For products returned to Keysight Technologies from another country, Buyer shall pay all shipping charges, duties, and taxes.

## Where to Find the Latest Information

Documentation is updated periodically. For the latest information about these products, including instrument software upgrades, application information, and product information, see the following URLs:

<http://www.keysight.com/find/e6650a>

Information on preventing instrument damage can be found at:

<http://www.keysight.com/find/PreventingInstrumentRepair>

## Is your product software up-to-date?

Periodically, Keysight releases software updates to fix known defects and incorporate product enhancements. To check for software updates for your product, go to the Keysight website at:

[http://www.keysight.com/find/e6650a\\_software](http://www.keysight.com/find/e6650a_software)



# Contents

## 1 Source Overview

|                          |    |
|--------------------------|----|
| Test Set Source Features | 10 |
| Modes of Operation       | 11 |
| Continuous Wave          | 11 |
| Analog Modulation        | 11 |
| Digital Modulation       | 11 |
| List Sequencer           | 11 |

## 2 Basic Operation

|  |    |
|--|----|
| Viewing Key Descriptions                                       | 14 |
| Setting test set source parameters                             | 14 |
| Presetting the Source  | 15 |
| Saving and Recalling States                                    | 16 |
| Selecting Source Output  | 16 |
| Setting Frequency and Power (Amplitude)                        | 17 |
| Example: Configuring a 700 MHz, -20 dBm Continuous Wave Output | 17 |
| Basic Sequencing   | 19 |
| Setting Up the Sequence  | 19 |
| Modulating the Carrier Signal                                  | 22 |
| Example  | 22 |
| Working with Files   | 23 |
| Viewing a List of Stored Files                                 | 23 |
| Storing a Sequence   | 24 |

|   |    |
|---|----|
| Loading (Recalling) a Stored File                     | 24 |
| Reading Error Messages                                | 25 |
| <b>3 Using Analog Modulation</b>                      |    |
| The Basic Procedure                                   | 28 |
| <b>4 Optimizing Performance</b>                       |    |
| Using Unleveled Operating Modes                       | 30 |
| ALC Off Mode  | 30 |
| Using an Output Offset, Reference, or Multiplier      | 31 |
| Setting an Output Offset                              | 31 |
| Setting an Output Reference                           | 31 |
| Using Amplitude Corrections                           | 33 |
| Selecting a port                                      | 33 |
| Setting up a corrections table                        | 33 |
| <b>5 Basic Digital Operation</b>                      |    |
| Waveform File Basics                                  | 36 |
| Instrument Memory                                     | 36 |
| Dual ARB Player                                       | 36 |
| Storing, Loading, and Playing a Waveform Segment      | 37 |
| Loading a Waveform Segment into ARB memory            | 37 |
| Renaming/Deleting a Waveform Segment on Internal Disk | 37 |
| Deleting a Waveform Segment from ARB memory           | 38 |
| Playing a Waveform Segment                            | 38 |
| Waveform Sequences                                    | 39 |
| Waveform Components                                   | 39 |
| Creating a Sequence                                   | 40 |
| Viewing the Contents of a Sequence                    | 41 |
| Editing a Sequence                                    | 42 |
| Playing a Sequence                                    | 43 |
| Saving a Waveform Settings & Parameters               | 45 |
| Viewing and Modifying Header Information              | 46 |
| Using Waveform Markers                                | 49 |
| Waveform Marker Concepts                              | 50 |
| Accessing Marker Utilities                            | 53 |
| Selecting which Marker to output                      | 53 |
| Viewing a Marker Pulse                                | 54 |

|   |    |
|---|----|
| Using the Pulse/RF Blanking Marker Function               | 54 |
| Setting Marker Polarity                                   | 55 |
| Controlling Markers in a Waveform Sequence                | 56 |
| Using the TRIGGER 2 OUT Signal as a Test Set Trigger      | 57 |
| Triggering a Waveform                                     | 59 |
| Trigger Type  | 59 |
| Trigger Source  | 60 |
| Example: Segment Advance Triggering                       | 60 |
| Setting the Baseband Frequency Offset                     | 62 |
| Alignment   | 64 |
| Alignment   | 65 |
| Licensing   | 67 |
| Signal Studio   | 67 |
| Waveform multi-pack licensing                             | 67 |
| Installing an Option N5182A–22x Waveform 5–Pack Licensing | 69 |
| Licensing a Source Waveform File                          | 69 |
| Waveform Licensing keys Overview                          | 69 |

## 6 List Sequencer

|  |    |
|--|----|
| List Sequencer                             | 74 |
| Terminology                                | 75 |
| Sequence                                   | 75 |
| Step                                       | 75 |
| Front panel setup                          | 79 |
| Saving the sequence                        | 81 |
| Tab separated value file                   | 81 |
| Spreadsheet setup                          | 81 |
| TSV file generation                        | 83 |
| Loading a tsv file into the List Sequencer | 84 |
| Tab separated value file editing           | 85 |
| Importing a tsv file into a spreadsheet    | 85 |

## 7 Troubleshooting

|                                |    |
|--------------------------------|----|
| Front panel lock-up            | 88 |
| RF Output                      | 89 |
| No RF Output                   | 89 |
| Power Supply Shuts Down        | 89 |
| No Modulation at the RF Output | 89 |
| RF Output Power too Low        | 89 |

|  |    |
|--|----|
| Distortion   | 90 |
| Signal Loss While Working with a Spectrum Analyzer | 90 |
| Signal Loss While Working with a Mixer             | 90 |
| Preset   | 93 |
| The Source Does Not Respond                        | 93 |
| Error Messages                                     | 94 |
| Licenses   | 95 |
| A time-based license stops working                 | 95 |
| Cannot load a time-based license                   | 95 |
| Contacting Keysight Technologies                   | 96 |



# 1

## Source Overview

The source in this instrument can be operated independently of the test set analyzer to provide arbitrary waveform generation to test wireless mobile devices. The source can also be used together with the test set analyzer to simultaneously test both the transmitter and receiver of a wireless device.

**"Test Set Source Features"** on page 10

**"Modes of Operation"** on page 11

## Test Set Source Features

- 76 MHz to 6.0 GHz (range may be smaller, depending on options ordered)
- list sequence of frequency, power, or frequency and power
- ability to include waveforms in list sequence
- analog modulation: AM, FM, and FM
- arbitrary I/Q waveform playback up to 80 MSa/s
- power calibration
- GPIB, USB 2.0, and 100Base-T LAN interfaces
- manual power search (ALC off)
- SCPI and IVI-COM driver
- user flatness correction
- four output connectors
- with Signal Studio Software, the test set can generate 802.11 WLAN, W-CDMA, cdma2000, 1xEV-DO, GSM, EDGE, and more.

For more details on hardware, firmware, software, and documentation features and options, refer to the data sheet shipped with the test set and available from the Keysight Technologies website at: <http://www.Keysight.com/find/e6650a>

## Modes of Operation

The instrument source provides four basic modes of operation: continuous wave (CW), analog modulation, digital modulation, and List Sequencer mode.

### Continuous Wave

In this mode, the test set produces a CW signal. The test set is set to a single frequency and power level, which is set up using the **Source** front-panel key menu. To learn more, refer to [Chapter 2](#), Basic Operation.

### Analog Modulation

In this mode, the test set modulates a CW signal with an analog signal. The analog modulation types are AM, FM and PM. The analog modulation types are accessed using the **Source** front-panel key, followed by the **Modulation Setup** key menu. To learn more, refer to [Chapter 3](#), Using Analog Modulation.

### Digital Modulation

In this mode, an internal baseband generator in the test set modulates a CW signal with an arbitrary I/Q waveform (ARB). The ARB waveforms are downloaded through a remote interface into the ARB memory. The ARB waveform setup is accessed using the **Source** front-panel key, followed by the **Modulation Setup** key menu. To learn more, refer to [Chapter 5](#), Basic Digital Operation.

### List Sequencer

In this mode, the source can be set up to output a series of waveform sequences either on its own or in synchronism with the test set analyzer. The source List Sequencer is designed to allow the testing and calibration of a mobile device receiver. In synchronism with the analyzer List Sequencer, the source List Sequencer allows simultaneous testing/calibration of both transmitter and receiver of the mobile device. The source List Sequencer is accessed using the **Source** front-panel key, followed by the **List Sequencer** key. To learn more, refer to [Chapter 6](#), List Sequencer.



## 2 Basic Operation

This chapter introduces fundamental front panel operation. For information about remote operation, refer to the *Online Help* or the *User's and Programmer's Guide*

- **"Viewing Key Descriptions"** on page 14
- **"Setting test set source parameters"** on page 14
- **"Presetting the Source"** on page 15
- **"Basic Sequencing"** on page 19
- **"Modulating the Carrier Signal"** on page 22
- **"Working with Files"** on page 23
- **"Reading Error Messages"** on page 25

**NOTE** The E6650A test set has no instrument front-panel. Therefore, the PC mouse and monitor are required for instrument control through a virtual front panel (VFP). For ease in using the VFP, the PC keyboard is recommended. The instructions in this chapter for front-panel keys and softkeys apply to the VFP keys.

**NOTE** The instructions in this chapter for front-panel keys and softkeys apply to the VFP keys.

## Viewing Key Descriptions

|   |  |
|---|--|
|  | <p>Press the <b>Help</b> key for comprehensive test set information. The online help is context-sensitive (that is, the help opens to a page that is relevant to the last key you pressed). Also, while the help screen is open, press any key, and a page relevant to that key is displayed; the normal key function does not execute. To exit the online help, press the Cancel (ESC) key, located above the numerical entry keypad.</p> |
|---|--|

## Setting test set source parameters

The source functionality on the test set is accessed by pressing the **Source** front-panel key on the virtual front panel. This is in the SETUP set of keys.

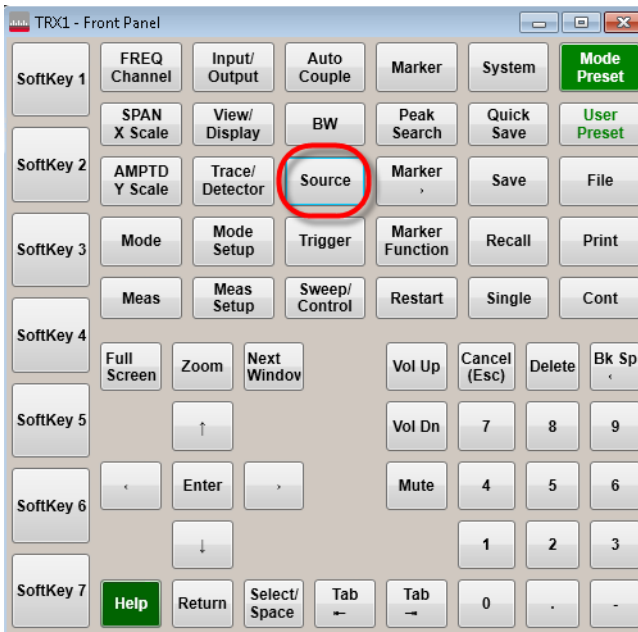

Pressing the **Source** key opens up a menu of Source keys on the right hand side of the display. These keys allow complete configuration of the Source parameters.

### NOTE

In a key menu at the right of the screen, more keys may be included than are visible at first, as indicated by the presence of a **More** key at the bottom. Press **More** as many times as necessary to cycle through all the keys included in the menu. In the procedures given here, the **More** key is usually not mentioned. For example, in the instruction to select **Source, List Sequencer**, the **List Sequencer** key on the **Source** menu only becomes visible when you press **More**.

## Presetting the Source

Presetting the source is a method of restoring all source settings to their default values, after some or all of them have been changed. If you want to be able to return the source settings to the values they had before the preset, save the current state before you preset the source (see [“Saving and Recalling States”](#) below).

1. Press the **Source** front-panel key.
2. In the **Source** key menu (viewed on right of display) select **More**, until **Source Preset** appears.
3. Select **Source Preset**.
4. Because presetting the source will cause the current source settings to be lost, a confirmation window appears. Select **OK** or **Cancel**.

**NOTE**

Pressing the **Mode Preset** button also has the effect of presetting the source, but in that case analyzer settings are affected as well.

---

## Saving and Recalling States

The current state of the test set (including both source and analyzer settings) can be saved and later recalled.

1. Press the **Save** front-panel key, followed by the **State** key.
2. In the **State** key menu, choose a register in which to save the state by pressing one of the six **Register** keys. (A register with no state saved in it is labeled “empty”; when you save a state in it, the register is labeled with the date and time.)
3. Alternatively, you can save the state to a file rather than to a register. Press the **To File...** key, and use the file-save window to choose a name and location for the file.
4. Recall a saved state by pressing the **Recall** front-panel key, followed by the **State** key.
5. In the **State** key menu, choose a register from which to retrieve a state by pressing one of the six **Register** keys.
6. Alternatively, you can retrieve the state from a file rather than from a register. Press the **From File...** key, and use the file-open window to choose a name and location for the file.

## Selecting Source Output

To select the output port for the source, use the **Input/Output** VFP key.

1. Press **Input/Output, More, RF Output & Test Set Config, RF Output**.
2. Select from **RF Output, RFIO 1, or RFIO 2**. If you select **RF Output**, this only means that whichever of the two half-duplex ports (RF3 I/O or RF4 I/O) is designated as an output will be used.
3. If you selected **RF Output** in the previous step, return to the **RF Output & Test Set Config** menu and select **Half Duplex Config, RF Output Port** to toggle between the **RF3 I/O** and **RF4 I/O** settings. Note that this also toggles the **RF Input Port** setting, because neither of these two ports can serve both as an output and an input.



## Setting Frequency and Power (Amplitude)

### NOTE

The E6650A test set does not have an Automatic Level Control feature; amplitude accuracy is regulated by means of calibration for frequency and temperature variations.

To set the frequency and power of the source output proceed as follows:

1. Select **Source, Amplitude, RF Power**.
2. Use the numeric keypad, step keys, or RPG to set a value for power. If you use the numeric keypad, press the appropriate units key to complete the entry.
3. Select **Source, Frequency, Frequency**.
4. Use the numeric keypad, step keys, or RPG to set a value for frequency. If you use the numeric keypad, press the appropriate units key to complete the entry.
5. Press the **Source** front-panel key and set the **RF Output** key to **On**.

Example: Configuring a 700 MHz, –20 dBm Continuous Wave Output

1. Preset the source by pressing **Source, More, Source Preset**.
2. Press the **Source** front-panel key, followed by the keys **Frequency, Frequency**. Press **700** on the keypad and select the **MHz** key.

The source displays 700 MHz in the Active Function area of the display, see below.

3. Set the amplitude to –20 dBm: Press the **Source** front-panel key, followed by the keys **Amplitude, RF Power**. Press **20** on keypad and select the **-dBm** key.

The display changes to –20 dBm in the Active Function area of the display, and the amplitude value becomes the active entry. Amplitude remains the active function until you press another function key.

4. Turn on the RF Output: Press the **Source** front-panel key, then set the **RF Output** to **On**.
5. Press **Input/Output, More, RF Output & Test Set Config, RF Output Port, RF Output**.

The 700 MHz, –20 dBm CW signal is available at the selected RF OUTPUT connector (to select the output connector see **"Selecting Source Output"** on page 16).

## 2 Basic Operation

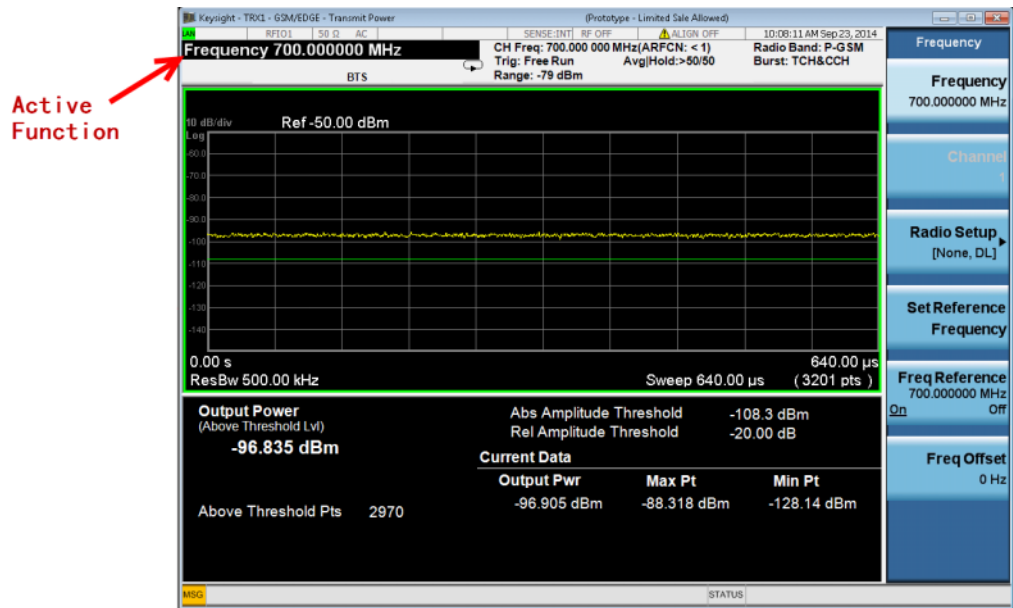

## Basic Sequencing

The Source List Sequencer can be used to generate a series of signals, each with its characteristics defined in advance. The procedures below can be used to generate a simple sequence, with frequency and power defined for each step (for more advanced List Sequencer features see [Chapter 6](#)).

### Setting Up the Sequence

1. Preset the source (see [“Presetting the Source”](#) on page 15).
2. Press the **Source** front-panel key.
3. Select **More, List Sequencer, List Sequencer Setup**.
4. Set the number of steps by pressing **Number of Steps**, enter the number of steps desired and press **Enter**.
5. Set **Current Step** to 1.
6. Set the desired frequency by pressing **More, Frequency**, enter the desired frequency value and press the appropriate units key.
7. Set the desired power by pressing **Power**, enter the desired power value and press the appropriate units key.
8. Set Current Step to 2.
9. Set **Frequency** to 2nd frequency in your list and then set corresponding **Power**.
10. Continue to increment the **Current Step** number and populate the frequencies and power until you reach the stop frequency.
11. Press **Return** and set the **Sequencer** key to **On**.
12. Press **Initiate Sequence**.

When the Initiate Sequence key is pressed:

If the trigger is set to Free Run, the sequence starts immediately and the full sequence repeats continuously until the List Sequencer parameters are changed.

If the trigger is not set to Free Run, the List Sequencer sweep starts once the trigger arrives and the sequence repeats only when it receives a new trigger.

### Saving a List Sweep

To save a sweep that you have set up use the **Save** front-panel key.

1. Press the **Save** front-panel key.
2. Select the **Sequences** key.
3. Select **Source Sequence**.

4. Select **Save As...**
5. In the Save As dialog box type in a unique filename for the sequence you have created. The file is saved on the D: drive to My Documents\Sequences.

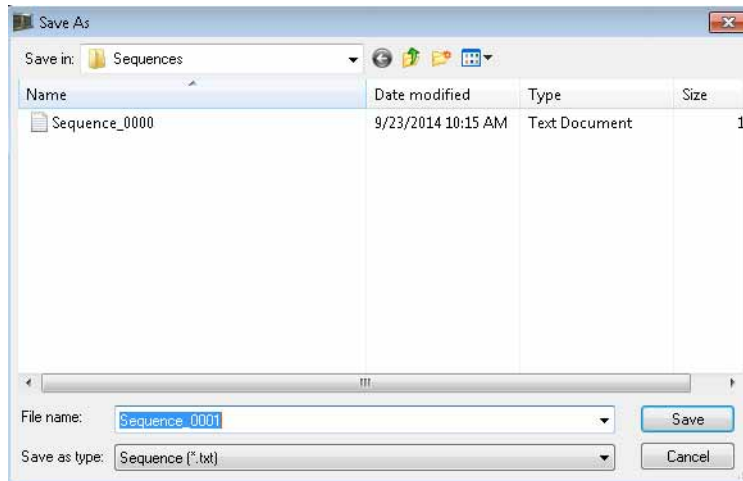

### Editing a List Sequencer sweep

To edit a sweep that you have set up:

1. Press the **Source** front-panel key.
2. Select the **More, List Sequencer, List Sequencer Setup** keys.

3. Select from List Seq Setup menu keys to edit the current sequence.

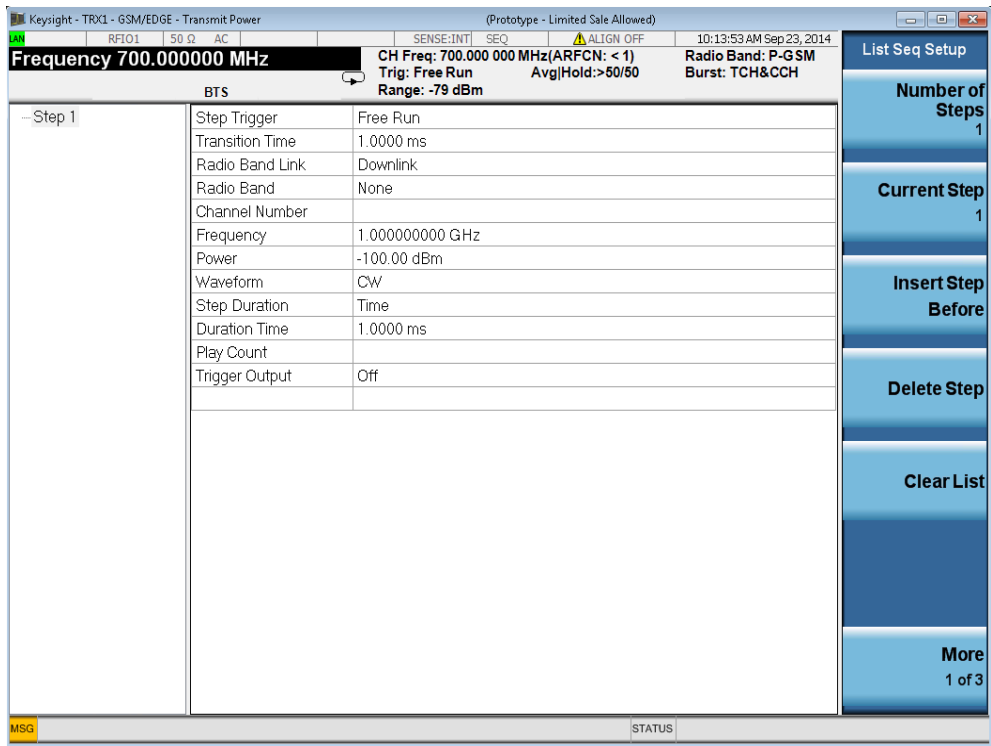

## Modulating the Carrier Signal

To modulate the carrier signal, you must have both an active modulation format and modulation of the RF output enabled. This signal can be viewed by setting the analyzer set to the Analog Demod mode with the measurement set to FM.

### Example

1. Preset the test set source by pressing **Source, More, Source Preset, Enter**.
2. Press **Modulation Setup, FM**.
3. From the FM Modulation menu, press **FM Deviation, 10, and kHz**.
4. Press **FM Rate, 1, and kHz**.
5. Press **FM** until **On** is underlined.

**NOTE**

To turn modulation off, select **Source** front-panel key and select the **Modulation** key to turn it off.

When **Modulation** is off, the carrier signal is not modulated, even with an active modulation format.

---

**NOTE**

If you enable modulation without an active modulation format, the carrier signal does not modulate until you subsequently turn on a modulation format.

---

6. To make the modulated carrier available at the RF output connector, press the **Source** front-panel key, then press **RF Output** until **On** is selected (underlined).

For more information on using Analog Modulation, refer to **"The Basic Procedure"** on page 28.

## Working with Files

- “**Viewing a List of Stored Files**” on page 23
- “**Storing a Sequence**” on page 24
- “**Loading (Recalling) a Stored File**” on page 24

The test set recognizes several types of files, such as state files, license files, and list sequence files. Files are stored in the test set internal storage. This section provides an overview of how to navigate the test set file menus, and how to view, store, load, and move files.

See also: “**Storing, Loading, and Playing a Waveform Segment**” on page 37.

### Viewing a List of Stored Files

The arbitrary waveform generator (ARB) files that have been created on the test set can be viewed using the Waveform Selection screen.

#### Viewing a List of Files Stored on the test set

1. Press the **Source** front-panel key.
2. Press **More, Modulation Setup, ARB**.
3. Press **Select Waveform**.

The files listed are identified as either waveform Sequences or waveform Segments. A Sequence is made up of two or more Segments.

The list is navigated using either the RPG or the up/down arrow keys. It is also possible to highlight a waveform for selection using the mouse. Once the desired file is highlighted, use the **Select Waveform** key to select the waveform to be output.

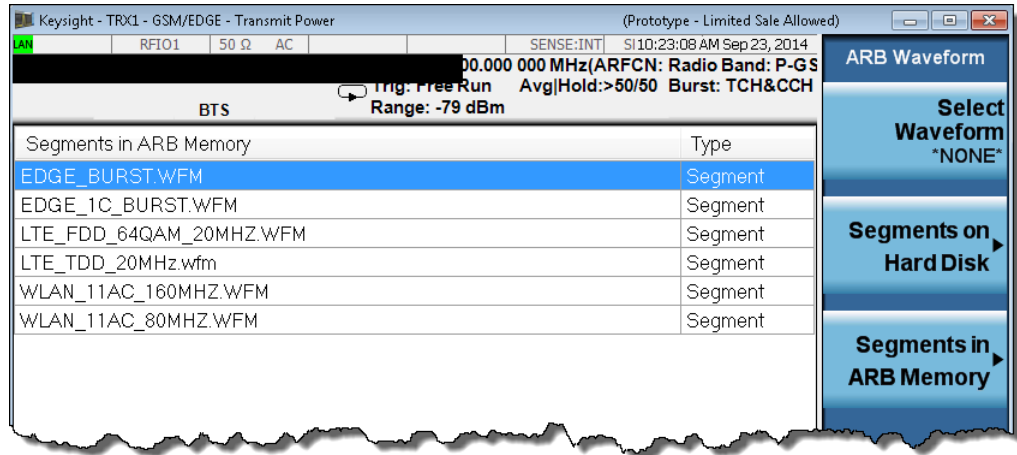

### Storing a Sequence

To store a sequence that you have set up use the **Save** front-panel key as described in **"Saving a List Sweep"** on page 19.

To store a test set state that you have set up and may want to re-use, use the **Save** front-panel key and select the State sub-menu to select a register in which to store the state.

For more information about the Save function see the online help.

### Loading (Recalling) a Stored File

To recall a test set state or Sequence file that you have previously saved, use the **Recall** front-panel key on the front panel. For test set state recalls, select **State** from the sub-menu and select the required register. For Sequence recall select the **Sequences** key followed by the **Open...** key.

For more information about the Recall function see the online help.



## Reading Error Messages

If an error condition occurs, the test set reports it to both the front panel display error queue and the SCPI (remote interface) error queue. These two queues are viewed and managed separately; for information about the SCPI error queue, refer to the *Online Help or the User's and Programmer's Guide*. From the online help you can access the *Instrument Messages* guide (pdf) which describes all the errors associated with the test set. This is also available on the Keysight Technologies website. [www.keysight.com/find/ext](http://www.keysight.com/find/ext)

## 2 Basic Operation

# 3

## Using Analog Modulation

Before using this information, you should be familiar with the basic operation of the source. If you are not comfortable with functions such as setting the power level and frequency, refer to **Chapter 2, Basic Operation** and familiarize yourself with the information in that chapter.

**"The Basic Procedure"** on page 28

**NOTE** The E6650A test set has no instrument front-panel. Therefore, the PC mouse and monitor are required for instrument control through a virtual front panel (VFP). For ease in using the VFP, the PC keyboard is recommended. The instructions in this chapter for front-panel keys and softkeys apply to the VFP keys.

**NOTE** The instructions in this chapter for front-panel keys and softkeys apply to the VFP keys.

**NOTE** The instructions in this chapter for front-panel keys and softkeys apply to the VFP keys.

## The Basic Procedure

1. Preset the source (see [page 15](#)).
2. Set the carrier (RF) frequency.
3. Set the RF amplitude.
4. Configure the modulation by selecting the **Source** front-panel key, followed by **Modulation Setup** key.

| AM   | FM  | PM  |
|--|---|---|
| a. Select <b>AM</b><br>b. Set the AM Depth: <b>AM Depth</b> > <i>value</i><br>Default 0.01%<br>Range 0.01 to 100%<br>c. Set the rate:<br><b>AM Rate</b> > <i>value</i> > <i>frequency unit</i> | a. Select <b>FM</b><br>b. Set the deviation:<br><b>FM Deviation</b> > <i>value</i> > <i>frequency unit</i><br>c. Set the rate:<br><b>FM Rate</b> > <i>value</i> > <i>frequency unit</i> | a. Select <b>PM</b><br>b. Set the deviation:<br><b>PM Deviation</b> > <i>value</i> > <i>pi rad</i><br>c. Set the rate:<br><b>PM Rate</b> > <i>value</i> > <i>frequency unit</i> |

5. Turn on the modulation:

| AM                                | FM                                | PM                                |
|-----------------------------------|-----------------------------------|-----------------------------------|
| <b>AM On Off</b> key to <b>On</b> | <b>FM On Off</b> key to <b>On</b> | <b>PM On Off</b> key to <b>On</b> |

The appropriate modulation annunciator displays, indicating that you have enabled modulation.

6. Turn on the RF output (Press the **Source** front-panel key and set the **RF Output** key to **On**).

## 4 Optimizing Performance

Before using this information, you should be familiar with the basic operation of the test set source. If you are not comfortable with functions such as setting the power level and frequency, refer to **Chapter 2, Basic Operation** and familiarize yourself with the information in that chapter.

- **"Using Unleveled Operating Modes"** on page 30
- **"Using an Output Offset, Reference, or Multiplier"** on page 31
- **"Using Amplitude Corrections"** on page 33

**NOTE** The E6650A test set has no instrument front-panel. Therefore, the PC mouse and monitor are required for instrument control through a virtual front panel (VFP). For ease in using the VFP, the PC keyboard is recommended. The instructions in this chapter for front-panel keys and softkeys apply to the VFP keys.

**NOTE** The instructions in this chapter for front-panel keys and softkeys apply to the VFP keys.

**NOTE** The instructions in this chapter for front-panel keys and softkeys apply to the VFP keys.

## Using Unleveled Operating Modes

### ALC Off Mode

Turning ALC off deactivates the source automatic leveling circuitry, enabling you to measure the output at a specific point in a test setup and adjust as required for the desired power level at that point. Turning ALC off is useful when the modulation consists of very narrow pulses that are below the pulse width specification of the ALC or when the modulation consists of slow amplitude variations that the automatic leveling would remove.

1. Preset the source (see [page 15](#)).
2. Set the desired frequency.
3. Set the desired amplitude.
4. Connect the power meter to the point at which you want a specific power level.
5. Turn the RF output on.
6. Deactivate the source automatic leveling control: Press the **Source** front-panel key followed by the **Amplitude** key. Set the **ALC** key to **Off**.
7. Adjust the output amplitude until the power meter measures the desired level.

## Using an Output Offset, Reference, or Multiplier

### Setting an Output Offset

Using an output offset, the source can output a frequency or amplitude that is offset (positive or negative) *from* the entered value.

$$\text{RF Output} = \text{entered value} - \text{offset value}$$

$$\text{Displayed Value} = \text{output frequency (or power)} + \text{offset value}$$

To set an offset:

- **Frequency:** Press the **Source** front-panel key followed by the **Frequency, Freq Offset** keys > *offset value* > *frequency unit* keys.
- **Amplitude:** Press the **Source** front-panel key followed by the **Amplitude, Amptd Offset** > *offset value* > **dB** keys.

### Examples

| Parameter                      | Example #1 | Example #2 | Example #3 | Comments  |
|--------------------------------|------------|------------|------------|---|
| Entered (and displayed) Value: | 300 MHz    | 300 MHz    | 2 GHz      | The entered value must be positive.   |
| Offset:                        | 50 MHz     | -50 MHz    | -1 GHz     | An offset value can be positive or negative.                                |
| Output Frequency:              | 250 MHz    | 350 MHz    | 3 GHz      | The source alerts you if the output frequency or amplitude is out of range. |

When using the source as a local oscillator (LO), you can use the offset to display the frequency of interest, as illustrated below:

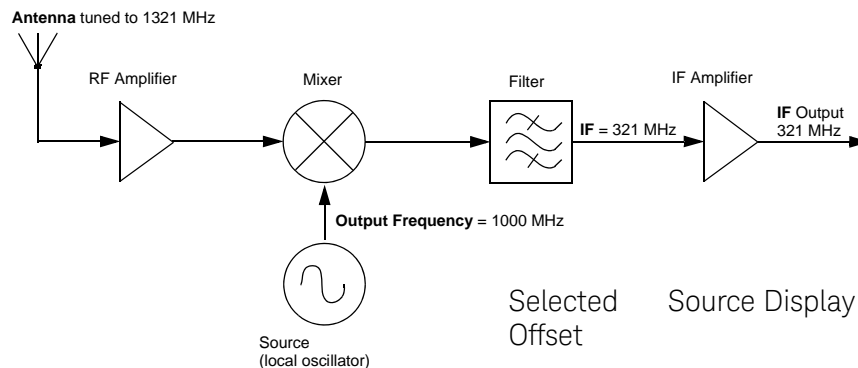

### Setting an Output Reference

Using an output reference, the source can output a frequency or amplitude that is offset (positive or negative) *by* the entered value *from* a chosen reference value.

RF Output = reference value + entered value

To set a reference:

1. Set the frequency or amplitude to the value you want as the output reference level.
2. *Frequency:* Press **Source, Frequency, Set Reference Frequency**. The frequency displays 0.00 Hz, indicating that this is the RF output frequency “zero level.” All frequencies entered are interpreted as being relative to this reference frequency.

*Amplitude:* Press **Source, Amplitude, Set Reference Power**.

The amplitude displays 0.00 dB, indicating that this is the RF output amplitude “zero level.”

All amplitudes entered are interpreted as being relative to this reference amplitude.

Examples

| Parameter                      | Example #1 | Example #2 | Example #3 | Comments  |
|--------------------------------|------------|------------|------------|---|
| Reference:                     | 50 MHz     | 50 MHz     | 2 GHz      | A reference value must be positive.   |
| Entered (and displayed) Value: | 2 MHz      | -2 MHz     | -1 GHz     | The entered value can be positive or negative.                              |
| Output Frequency:              | 52 MHz     | 48 MHz     | 1 GHz      | The source alerts you if the output frequency or amplitude is out of range. |

To set a new frequency or amplitude reference, turn the frequency reference off, and then follow the steps above.



## Using Amplitude Corrections

Amplitude corrections can be applied to both source and analyzer ports on the test set when the selected mode is Sequence Analyzer. The Amplitude Corrections arrays can be entered by the user, sent over SCPI or loaded from a file. They allow a user to correct the response of the test set for variations in signal paths external to the test set. For example if you have a test system with a frequency dependant path due to cable, amplifier or attenuator non-linearities, similar to path illustrated below, then provided you can quantify the frequency variations, you can apply a frequency dependent correction to the test set source output. In this way the signal appearing at the receiving device can appear to have the spectral characteristics associated with a flat path.

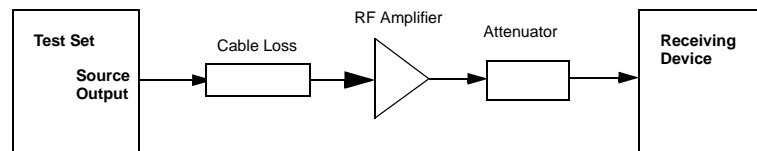

The corrections are applied as a table of x and y parameters with the x specifying the frequency and y specifying the correction to be applied at the frequency, x. There are four sets of corrections and each may be individually enabled or disabled. All of the enabled corrections are added together to give the resultant correction. In the instrument, each port can have four different corrections applied to it, but two different ports cannot have the same set of corrections applied to both.

To access the Amplitude Corrections menu press the **Input/Output** front-panel key on the front panel. Select the **More, Corrections** keys.

### Selecting a port

You can select whether you want to apply the corrections to all or some of the ports. In the case of the dual purpose ports, RFIO1 and RFIO2 the corrections can be applied to the input, output or both directions.

To select the port, from the **Corrections** menu, select **Properties, RF Port**. You can select one of the four ports to which the selected corrections apply. For the two RFIO ports, click on required port to select it, and then click on it again to select whether to apply the corrections to the source output, the analyzer input or both.

### Setting up a corrections table

To set up the corrections table using the front panel, from the Corrections menu, select Edit. The **Frequency** and **Amplitude** keys allow you to enter a frequency and the correction in dB that you require at that frequency. As you enter values the actual entries are displayed in tabular format on the left of the display and also,

## 4 Optimizing Performance

the entered values appear on the graticule as a graph. Because of the large number of possible entries in the corrections table, the **Navigate** key allows you to select an entry by row number to quickly access and edit a particular row.

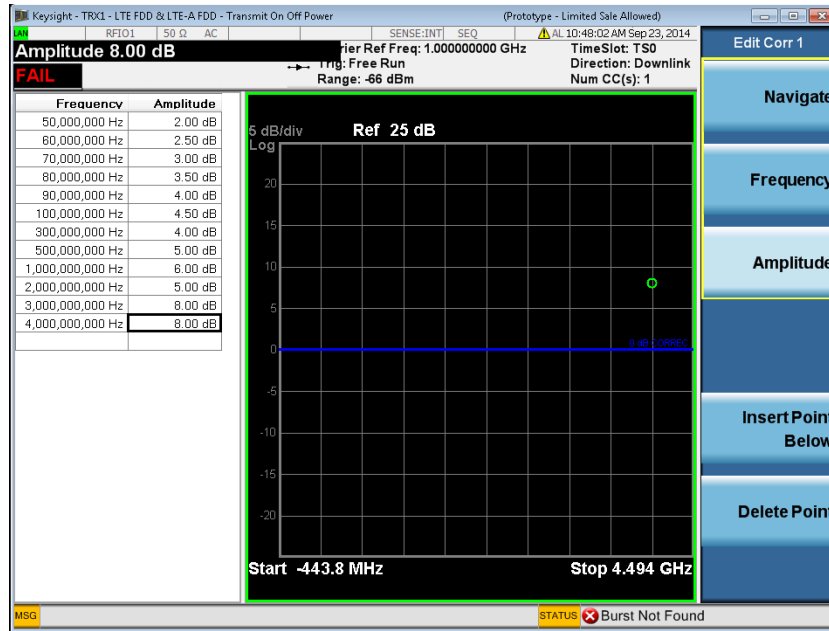

For more detailed information about the correction data keys and the remote control commands see the Sequence Analyzer online help, accessible by pressing the Help button on the front panel (or in pdf format, the *User's and Programmer's Reference*).

# 5

## Basic Digital Operation

Before using this information, you should be familiar with the basic operation of the test set source. If you are not comfortable with functions such as setting power level and frequency, refer to **Chapter 2** and familiarize yourself with the information in that chapter.

- **"Waveform File Basics"** on page 36
- **"Storing, Loading, and Playing a Waveform Segment"** on page 37
- **"Waveform Sequences"** on page 39
- **"Saving a Waveform Settings & Parameters"** on page 45
- **"Using Waveform Markers"** on page 49
- **"Triggering a Waveform"** on page 59
- **"Setting the Baseband Frequency Offset"** on page 62
- **"Licensing"** on page 67

**NOTE** The E6650A test set has no instrument front-panel. Therefore, the PC mouse and monitor are required for instrument control through a virtual front panel (VFP). For ease in using the VFP, the PC keyboard is recommended. The instructions in this chapter for front-panel keys and softkeys apply to the VFP keys.

**NOTE** The instructions in this chapter for front-panel keys and softkeys apply to the VFP keys.

**NOTE** The instructions in this chapter for front-panel keys and softkeys apply to the VFP keys.

## Waveform File Basics

There are two types of waveform files:

- A *segment* is a waveform file that you download to the test set.
- A *sequence* is a file you create in the test set source that contains pointers to one or more waveform files (segments, other sequences, or both).

For information about creating sequences, see [page 39](#).

### Instrument Memory

The instrument has two types of memory:

- *Volatile* memory, baseband generator (ARB) media, where waveform files are played from or edited.
- *Non-volatile* memory, the test set internal hard disk, where waveform files are stored.

### Dual ARB Player

The dual ARB waveform player enables you to play, rename, delete, store, and load (external or internal) waveform files in addition to building waveform sequences. The dual ARB waveform player also provides markers ([page 49](#)) and triggering ([page 59](#)) capabilities.

## Storing, Loading, and Playing a Waveform Segment

Before using this information, you should be familiar with the source file menus. If you are not, refer to **“Working with Files”** on page 23 and familiarize yourself with that information.

See also: **“Waveform Sequences”** on page 39.

The test set source has two types of waveform storage. The waveforms are stored on the test set hard disk which is non-volatile storage. In order to play the files out they must be moved into ARB memory which is volatile storage. ARB memory is also called “working” media, because before you can play, edit, or include a waveform file in a sequence, the waveform file must be loaded into ARB memory.

To access the waveform segments and menus for moving files between storage media use the **Source** front-panel key followed by the **Modulation Setup, ARB** keys.

### Loading a Waveform Segment into ARB memory

Waveforms must reside in ARB memory before they can be played, edited, or included in a sequence. Cycling power or rebooting the test set deletes the files in ARB memory.

1. Press the **Source** front-panel key.
2. Press **Modulation Setup, ARB, Select Waveform**.
3. Press **Segments on Hard Disk** to display files on the hard disk in **D:INVARB** and, then, using the mouse, arrow keys or RPG, highlight the desired waveform segment.
4. If there is already a copy of this segment in the currently selected media and you do not want to overwrite it, rename the waveform segment before you load it (refer to **“Renaming/Deleting a Waveform Segment on Internal Disk”** on page 37).
5. Press **Load Segment to ARB Memory**.

To load *all* files from the internal disk into ARB memory, press **Load All To ARB Memory**.

### Renaming/Deleting a Waveform Segment on Internal Disk

Use the following steps to re-name a copy of a file on the hard disk.

1. Press the **Source** front-panel key.
2. Press **Modulation Setup, ARB, Select Waveform**.
3. Press **Segments on Hard Disk**.

4. Press **Current Directory...** to open a window on the current directory in which you can re-name or delete any file.

#### Deleting a Waveform Segment from ARB memory

Use the following steps to delete a segment from ARB memory.

1. Press the **Source** front-panel key.
2. Press **Modulation Setup, ARB, Select Waveform**.
3. Press **Segments in ARB memory** to display files in ARB memory and, then, using the mouse, arrow keys or RPG, highlight the desired waveform segment.
4. Press **Delete Segment From ARB Mem**.

Alternatively, if you want to clear all ARB memory select **Delete All From ARB Memory**.

#### Playing a Waveform Segment

1. Press the **Source** front-panel key.
2. Press **Modulation Setup, ARB, Select Waveform**.
3. Select a waveform from the list in the display.
4. Press **Select Waveform**.
5. In the **ARB** menu, press **ARB** until **On** is underlined.

This plays the selected waveform segment. Both the **I/Q** and **ARB** annunciators turn on, and the waveform modulates the RF carrier.

6. Configure the RF Output:

Set the RF carrier frequency and amplitude, and turn on the RF output.

The waveform segment is now available at the test set RF Output connector.

## Waveform Sequences

A waveform sequence is a file that contains pointers to one or more waveform segments or other waveform sequences, or both. This allows the test set source to play multiple waveform segments, or other sequences, or both, thereby eliminating the need to stop waveform playback just to select another waveform.

The segments that a waveform sequence points to must be in playback (ARB) memory before a sequence can be played. If all the waveform segments required by the waveform sequence are not in ARB memory when the user selects the waveform sequence, the source attempts to load the required waveform segments from either the current directory or the default directory on the test set D: drive (D:\NVARB). If the required waveform segments cannot be found, an error is generated and the user must manually load the waveform segments (see **“Loading a Waveform Segment into ARB memory”** on page 37) before the waveform sequence can be selected for playback. If this happens and the segments are not stored on the test set hard disk, you must recreate the segments using the same file names that the sequence points to before you can play the sequence.

Additionally, the segments that a waveform sequence points to are *not* automatically stored when you store the sequence; you must also store the individual segments or they are lost when you turn off or reboot the test set.

### Waveform Components

The test set allows you to download waveform files. These files are created external to the test set. To play back waveform segments, the waveform files should consist of three binary files:

- I/Q file
- Marker file
- Header file

The test set automatically creates the marker file and the header file if they are not part of the download. In this situation, the test set sets the file header information to unspecified and the test set uses the current ARB settings and the markers are set to zero (off).

The marker and header files must be stored in the same directory as the I/Q data file. They must also have the same filename as the I/Q data file, but with an additional “\_mkr” or “\_hdr” tagged on, to uniquely identify them on the hard disk. For example, if the I/Q data file was called testwaveform.bin, the marker file is called testwaveform\_mkr.bin and the header file is called testwaveform\_hdr.bin.

Signal Studio waveform files are encrypted and the three waveform files are combined into one single file. Therefore Signal Studio files do not have a separate header or marker file. The extension on Signal Studio files is .wfm.

### Header File

For a given waveform it is possible to save the ARB settings and parameters in the waveform header file. When the waveform file is then selected for playback by the ARB, the header file settings automatically apply, so that the ARB player is set up the same way each time the waveform plays. If a setting is unspecified within the file header, the ARB uses its current value for that setting when the user selects and plays the waveform.

When the waveform sequence is created, the source automatically creates a waveform sequence header based on the header file for the first waveform segment within the waveform sequence. This new waveform sequence header takes priority over the individual waveform segment headers. During a waveform sequence playback, the segment headers are ignored, except to verify that all required options are installed.

### I/Q File

The I/Q file contains the interleaved I and Q data points. Each I/Q point equals one waveform point. The I/Q data points must be formatted as binary data in big endian order. For each I/Q data point, the source uses four bytes, two bytes for the I point and two bytes for the Q point.

### Marker File

The marker file uses one byte per I/Q waveform point to set the state of the four markers either on (1) or off (0) for each I/Q point. Because the markers are set at each waveform point, the marker file contains the same number of bytes as there are waveform points.

### Creating a Sequence

A waveform sequence can contain up to 64 segments. The source lets you set the number of times the segments repeat during play back. Each segment can repeat up to 65,535 times, but no matter how many times a segment repeats, it counts as a single segment.

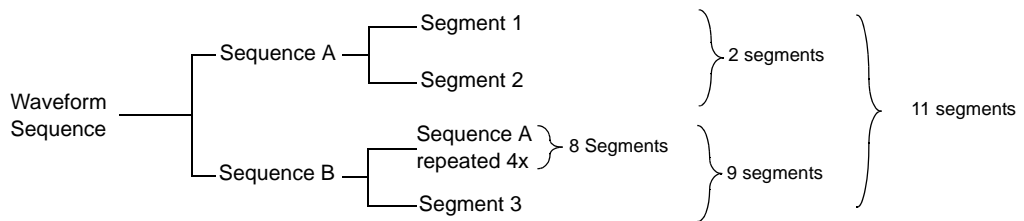

### Example

Use the following procedure to create and store a waveform sequence using one repetition each of two different segments.



*Assumption:* Two waveform segments have been created and stored in ARB memory.

1. Menu access
  - a. Press **Source** front-panel key.
  - b. Press **More, Modulation Setup, ARB** keys.
  - c. Press **More, Waveform Sequences, Build New Sequence** keys.
2. Select the first segment
  - a. In the Sequence menu press the **Insert new Waveform** key.
  - b. Select a waveform segment.
  - c. Press **Insert Waveform** key.
3. Select the second segment:
  - a. In the Sequence menu press the **Insert new Waveform** key.
  - b. Select a waveform segment.
  - c. Press **Insert Waveform** key. (Note that **Current Segment** key has incremented to 2)
4. Save the sequence:
  - a. In the Sequence menu press the **Save Sequence...** key.
  - b. In the *Save As...* dialog box, the default sequence name appears and the directory that opens is the default waveform directory. Press Save to select these choices.

See also, "[Viewing the Contents of a Sequence](#)" on page 41.

### Viewing the Contents of a Sequence

1. Press the **Source** front-panel key.
2. Select **More, Modulation Setup, ARB** keys.
3. Press **More, Waveform Sequences, Edit Selected Sequence** keys.

On the display, the contents of the sequence is displayed. You can select the segments and the display shows how often they are repeated and what the marker settings are:



2. Change the first segment so that it repeats 100 times:
  - a. Highlight the first segment entry and press **Edit Selected Waveform**.
  - b. Press **Repetitions**. Enter the number 100.
3. Change the repetition for the selected entry to 200:
  - a. Select the next segment in the sequence.
  - b. Press **Repetitions**. Enter the number 200.
4. Save the changes made in the previous steps:  
In the Sequence menu, select **Save As...** and save the file using the existing name or to a different file.

To save the changes as a *new* sequence:

- a. Press **Save As...**
- b. Enter a file name (for example, SINE100+RMP200).
- c. Press **Save**.

The edited sequence saves as a new waveform sequence.

## Playing a Sequence

If you have not created a waveform sequence, refer to **“Creating a Sequence”** on page 40.

### NOTE

To play a waveform segment individually or as part of a waveform sequence, the segment must reside in ARB memory. See also, **“Loading a Waveform Segment into ARB memory”** on page 37.

1. Select a waveform sequence:
  - a. Press **Source** front-panel key.
  - b. Select **More, Modulation Setup, ARB** keys.
  - c. Press **Select Waveform**.
  - d. Highlight a waveform sequence on the display.
  - e. Press **Select Waveform**.

The display shows the currently selected waveform (for example, Selected Waveform: 16E\_10M\_ULDL\_PUSC\_MULT).

| Waveform               | Type     |
|------------------------|----------|
| 16E_10M_ULDL_PUSC_MULT | Segment  |
| 16E_10M_DL_PUSC_MULT   | Segment  |
| WiMax_Sequence         | Sequence |
| GSM_GPRS_GSM           | Sequence |
|                        |          |
|                        |          |
|                        |          |
|                        |          |
|                        |          |
|                        |          |

2. Generate the waveform:  
In the **ARB** menu, press **ARB** until **On** is underlined.

This plays the selected waveform sequence. During the waveform sequence generation, both the **I/Q** and **ARB** annunciators turn on, and the waveform modulates the RF carrier.

3. Configure the RF output:
  - a. Press **Source** front-panel key.
  - b. Set the RF Frequency.
  - c. Set the RF amplitude.
  - d. Turn on the RF output.

The waveform sequence is now available at the test set RF OUTPUT connector.

## Saving a Waveform Settings & Parameters

This section describes how to edit and save a file header. When you download only a waveform file (I/Q data, which the source treats as a waveform segment), the source automatically generates a file header and a marker file with the same name as the waveform file. Initially the file header has no source settings saved to it, and the marker file consists of all zeros. For a given waveform, you can save source settings and parameters in its file header and marker settings in its marker file (page 49); when you load a stored waveform file into ARB memory, the file header and marker file settings automatically apply to the source so that the dual ARB player sets up the same way each time the waveform file plays.

When you create a waveform sequence (as described on page 40), the source automatically creates a waveform sequence header that takes priority over the individual waveform segment headers. During a waveform sequence playback, the segment headers are ignored, except to verify that all required options are installed. Storing a waveform sequence also stores its file header.

Some of the current source settings shown in the file header appear as part of the key labels, and others appear in the dual ARB summary display, shown in the following example. To view the file header:

1. Press **Source** front-panel key.
2. Press **More, Modulation Setup, ARB** keys. Ensure that a waveform has been selected under the **Select Waveform** key.
3. Press **More, Header Utilities** keys.

| File Header Information: My_Waveform.wfm |               |                  |
|--|---------------|------------------|
| Fields                                   | File Settings | Current Settings |
| Description                              |               |                  |
| Sample Rate                              | Unspecified   | 48.00 MHz        |
| Runtime Scaling                          | 78.78 %       | 70.00 %          |
| RMS                                      | Unspecified   | N/A              |
| Marker 1 Polarity                        | Unspecified   | Pos              |
| Marker 2 Polarity                        | Unspecified   | Pos              |
| Marker 3 Polarity                        | Unspecified   | Pos              |
| Marker 4 Polarity                        | Unspecified   | Pos              |
| ALC Hold Routing                         | Unspecified   | None             |
| RF Blanking Routing                      | Unspecified   | None             |
| BB Frequency Offset                      | Unspecified   | 0.00 Hz          |
| AWGN State                               | Unspecified   | N/A              |
| AWGN C/N Ratio                           | Unspecified   | N/A              |
| AWGN Carrier BW                          | Unspecified   | N/A              |
| AWGN Noise BW                            | Unspecified   | N/A              |
| AWGN Carrier RMS                         | Unspecified   | N/A              |
| Over-Range Protection                    | Unspecified   | On               |
| Unique Waveform ID                       | 00000000      | N/A              |
| License Required                         | None          | N/A              |
| Can be Read Out                          | Yes           | N/A              |

|                                 |  |
|---------------------------------|--|
| <b>32-Character Description</b> | A description entered for the header, such as a the waveform function.   |
| <b>Sample Rate</b>              | The waveform playback rate. This is the ARB sample clock rate, set in the Arb Setup menu.  |
| <b>Runtime Scaling</b>          | The Runtime scaling value is applied in real-time while the waveform is playing. This setting can be changed only for files playing in the dual ARB player.  |
| <b>RMS</b>                      | When the modulator attenuation setting is set to Auto, this value is used to calculate the I/Q modulator attenuation setting to optimize ACPR. Value: 0 to 1.414213562   |
| <b>Marker 1...4 Polarity</b>    | Marker polarity can be positive or negative (described on <a href="#">page 55</a> ).   |
| <b>ALC Hold Routing</b>         | Which marker, if any, implements the ALC hold function (described on <a href="#">page 51</a> ), which holds the ALC at its current level when the marker signal is low. All waveforms generated in the source have a marker on the first sample point. To see the results from the three routing selections, you may need to select a range of sample (marker) points. |
| <b>RF Blank Routing</b>         | Which marker, if any, implements the Pulse/RF Blanking function (described on <a href="#">page 54</a> ) when the marker signal is low. Pulse/RF Blanking also uses ALC hold. There is no need to select the ALC Hold Routing for the same marker when you are using the RF Blank Routing function. When the marker signal goes high, Pulse/RF Blanking discontinues.   |
| <b>BB Freq Offset</b>           | The baseband frequency offset, in Hz (see <a href="#">page 62</a> ).   |
| <b>Modulation Filter</b>        |  |
| <b>Over-Range Protect</b>       | Indicated whether DAC Over-Range Protection is on (1) or off (0).  |
| <b>Unique Waveform Id</b>       | 0 = no Id; once an Id is assigned, it cannot be changed.   |
| <b>License Required</b>         | Indicates whether a license is required to play the waveform.  |
| <b>Can be Read Out</b>          | Indicates whether the waveform can be queried through SCPI or FTP.   |

### Viewing and Modifying Header Information

The following example uses the factory-supplied waveform file [WLAN20MHZ54M64QAM.WFM](#).

1. From ARB memory, select the waveform `WLAN20MHZ54M64QAM.WFM`:
  - a. Press **Source** front-panel key.
  - b. Press **More, Modulation Setup, ARB, Select Waveform**.
  - c. In the display, select the waveform `WLAN20MHZ54M64QAM.WFM`.
  - d. Press **Select Waveform**.
2. Open the Header Utilities menu:
 

In the ARB menu select **More, Header Utilities**

The Figure below shows the default file header for the factory-supplied waveform `WLAN20MHZ54M64QAM.WFM`.

The **File Settings** column shows that most of the settings are **Unspecified**. Unspecified means that there is no setting saved for that particular parameter.

The **Current Settings** column shows the current source settings. In this example, these are the settings that are saved to the file header.

**NOTE**

If a setting is unspecified in the file header, the source uses its current value for that setting when you select and play the waveform.

### Example File Header

| File Header Information: WLAN20MHZ54M64QAM.WFM |                                  |                   |
|--|----------------------------------|-------------------|
| Fields   | File Settings                    | Current Settings  |
| Description                                    | WLAN OFDM 64QAM 54Mbps 20 MHz BW | ----              |
| Sample Rate                                    | 80 MHz                           | 80.000000000 MHz  |
| Runtime Scaling                                | 99 %                             | 99.00 %           |
| RMS  | 0.373543807469492                | 0.373543807469492 |
| Marker 1 Polarity                              | Positive                         | Positive          |
| Marker 2 Polarity                              | Positive                         | Positive          |
| Marker 3 Polarity                              | Positive                         | Positive          |
| Marker 4 Polarity                              | Positive                         | Positive          |
| ALC Hold Routing                               | None                             | None              |
| RF Blanking Routing                            | Marker 2                         | Marker 2          |
| ARB Frequency Offset                           | 0                                | 0.000 Hz          |
| AWGN State                                     | 0                                | ----              |
| AWGN C/N Ratio                                 | 20                               | ----              |
| AWGN Carrier BW                                | 16250000                         | ----              |
| AWGN Noise BW                                  | 1                                | ----              |
| AWGN Carrier RMS                               | Unspecified                      | ----              |
| Over-Range Protection                          | Unspecified                      | ----              |
| Unique Waveform ID                             | 4129927897                       | ----              |
| License Required                               | No license required              | ----              |

**Clear Header**

**Save Setup To Header**

3. Save the information in the **Current Settings** column to the file header:

Press **Save Setup To Header** key.

Both the **File Settings** column and the **Current Settings** column now display the same values; the **File Settings** column lists the settings saved in the file header.

4. Edit and update settings

- a. Return to the ARB menu:

Select **Return** front-panel key. From the ARB menu, press **ARB Setup** key.

From this menu you can access some of the source settings that are saved to the file header. The parameters that are circled in **Figure** are the parameters that can be changed.

- b. Set the ARB sample rate to 5 MHz:  
Press **Sample Rate, 5, MHz**.
- c. Set waveform runtime scaling to 60%:  
Press **Run-time Scaling, 60, Enter**.
- d. Return to the Header Utilities menu:  
Press **Return, More, Header Utilities**.

As shown in the following figure, the *Current Settings* column now reflects the changes to the current source setup, but the *saved header* values have not changed.

| File Header Information: WLAN20MHZ54M64QAM.WFM |                                  |                   |
|--|----------------------------------|-------------------|
| Fields   | File Settings                    | Current Settings  |
| Description                                    | WLAN OFDM 64QAM 54Mbps 20 MHz BW | ----              |
| Sample Rate                                    | 80 MHz                           | 5.000000000 MHz   |
| Runtime Scaling                                | 99 %                             | 60.00 %           |
| RMS  | 0.373543807469492                | 0.373543807469492 |
| Marker 1 Polarity                              | Positive                         | Positive          |
| Marker 2 Polarity                              | Positive                         | Positive          |
| Marker 3 Polarity                              | Positive                         | Positive          |
| Marker 4 Polarity                              | Positive                         | Positive          |
| ALC Hold Routing                               | None                             | None              |
| RF Blanking Routing                            | Marker 2                         | Marker 2          |
| RF Frequency Offset                            | 0                                | 0.000 Hz          |
| AWGN State                                     | 0                                | ----              |
| AWGN C/N Ratio                                 | 20                               | ----              |
| AWGN Carrier BW                                | 16250000                         | ----              |
| AWGN Noise BW                                  | 1                                | ----              |
| AWGN Carrier RMS                               | Unspecified                      | ----              |
| Over-Range Protection                          | Unspecified                      | ----              |
| Unique Waveform ID                             | 4129927897                       | ----              |
| License Required                               | No license required              | ----              |

**Clear Header**

**Save Setup To Header**

- e. Save the current settings to the file header:  
Press the **Save Setup To Header** key.

The settings from the *Current Settings* column now appear in the *File Settings* column. This saves the new current test set settings to the file header.

If you change any of the settings listed in the file header after you select the waveform file, the changed setting(s) appear in the file header *Current Settings* column and are used instead of the saved header settings. To reapply the saved header settings, reselect the waveform for playback.



## Using Waveform Markers

The source provides four waveform markers to mark specific points on a *waveform segment*. When the source encounters an enabled marker, an auxiliary signal is routed to a rear panel trigger output. The marker that is routed to the TRIGGER 2 OUT output connector is selected using the Input/Output front-panel key menu.

You can use the output signal to synchronize another test set with the waveform, or as a trigger signal to start a measurement at a given point on a waveform.

You can also configure markers to initiate ALC hold or Pulse/RF Blanking (which includes ALC hold).

When you download a waveform file that does not have a marker file associated with it, the source creates a marker file without any marker points.

Factory-supplied segments (for example [WLAN20MHZ54M64QAM.WFM](#) and [SINE\\_TEST.WFM](#)) have a marker point on the first sample for all four markers.

The following procedures demonstrate how to use markers while working with the ARB player. These procedures also discuss two types of points: a *marker point* and a *sample point*. A *marker point* is a point at which a given marker is set on a waveform; you can set one or more marker points for each marker. A *sample point* is one of the many points that compose a waveform.

To manipulate waveform markers:

**“Controlling Markers in a Waveform Sequence”** on page 56

This section also provides the following information:

- **“Waveform Marker Concepts”**
- **“Accessing Marker Utilities”** on page 53
- **“Viewing a Marker Pulse”** on page 54
- **“Using the Pulse/RF Blanking Marker Function”** on page 54
- **“Setting Marker Polarity”** on page 55

## Waveform Marker Concepts

The source dual ARB provides four waveform markers for use on a waveform segment. You can set each marker polarity and marker points (on a single sample point or over a range of sample points). Each marker can also perform ALC hold, or Pulse/RF Blanking and ALC hold.

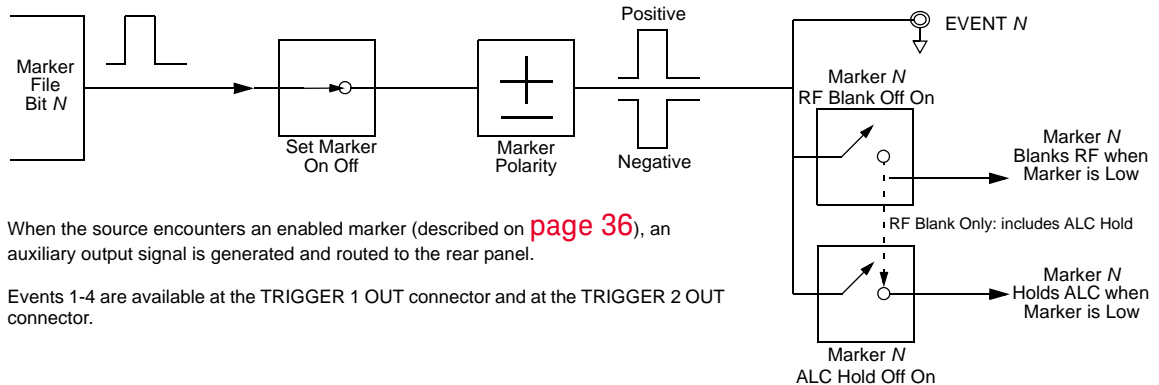

## Marker Signal Response

The source aligns the marker signals with the I and Q signals at the baseband generator. However some settings such as amplitude, filters, and so forth within the RF output path can create delays between the marker TRIGGER 2 OUT output signal and the modulated RF output. When using the marker TRIGGER 2 OUT output signal, observe the signals (marker relative to modulated RF) for any latency, and if needed, reset the marker point positions, include delay or both.

## Marker File Generation

Downloading a waveform file that does not have a marker file associated with it causes the source to automatically create a marker file, but does *not* place any marker points.

## Marker Point Edit Requirements

Before you can modify a waveform segment marker points, the segment must reside in ARB memory (see [“Loading a Waveform Segment into ARB memory”](#) on page 37).

## Saving Marker Polarity and Routing Settings

Marker polarity and routing settings remain until you reconfigure them, preset the source, or cycle power. To ensure that a waveform uses the correct settings when it is played, set the marker polarities or routing (Pulse/RF Blanking and ALC Hold) and save the information to the file header ([page 45](#)).

**NOTE**

When you use a waveform that does not have marker routings and polarity settings stored in the file header, and the previously played waveform used Pulse/RF Blanking, ensure that you set Pulse/RF Blanking to **None**. Failure to do so can result in no RF output or a distorted waveform.

**ALC Hold Marker Function**

While you can set a marker function (described as **Marker Routing** on the key label) either before or after you set marker points, setting a marker function before setting marker points may cause power spikes or loss of power at the RF output.

Use the ALC hold function by itself when you have a waveform signal that incorporates idle periods, burst ramps, or when the increased dynamic range encountered with Pulse/RF Blanking (page 54) is not desired.

The ALC hold marker function holds the ALC circuitry at the *average* value of the sampled points set by the marker(s). For both positive and negative marker polarity, the ALC samples the RF output signal (the carrier plus any modulating signal) when the marker signal goes high:

|           |   |
|-----------|---|
| Positive: | The signal is sampled during the on marker points.  |
| Negative  | The signal is sampled during the off marker points. |

**NOTE**

Because it can affect the waveform output amplitude, do not use the ALC hold for longer than 100 ms.

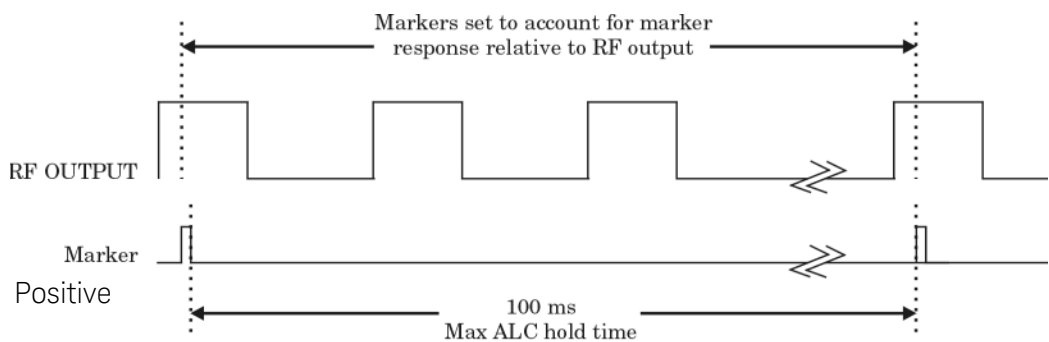

**CAUTION**

Incorrect ALC sampling can create a sudden unlevelled condition that may create a spike in the RF output, potentially damaging a DUT or connected test set. To prevent this condition, ensure that you set markers to let the ALC sample over an amplitude that accounts for the higher power levels encountered within the signal

Example of Correct Use

Waveform: 1022 points  
 Marker range: 95–97  
 Marker polarity: Positive

This example shows a marker set to sample the waveform area of highest amplitude. Note that the marker is set well before the waveform area of lowest amplitude. This takes into account any

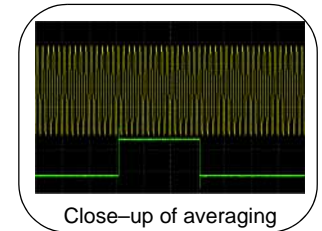
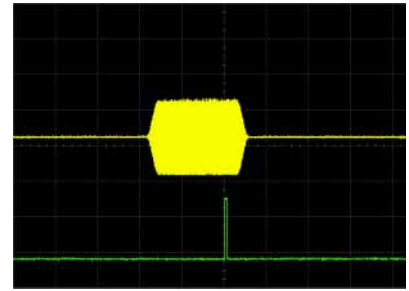

The ALC samples the waveform when the marker signal goes high, and uses the average of the sampled waveform to set the ALC circuitry.

Here the ALC samples during the *on* marker

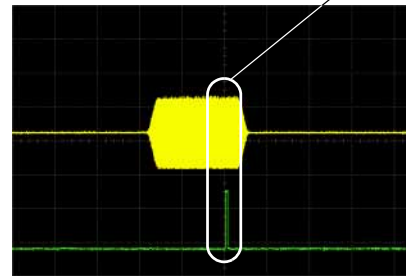

Example of Incorrect Use

Waveform: 1022 points  
 Marker range: 110–1022  
 Marker polarity: Positive

This example shows a marker set to sample the low part of the same waveform, which sets the ALC modulator circuitry for that level; this usually results in an unlevelled condition for the source when it encounters the high amplitude of

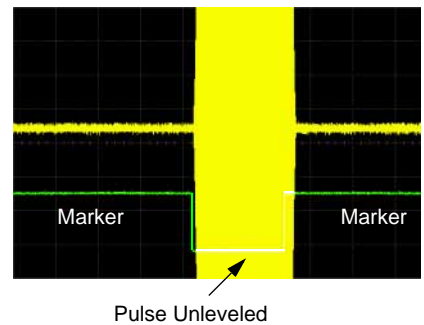

### Example of Incorrect Use

Waveform: 1022 points  
 Marker range: 110–1022  
 Marker polarity: Negative

This figure shows that a negative polarity marker goes low during the marker *on* points; the marker signal goes high during the *off* points. The ALC samples the waveform during the *off* marker points.

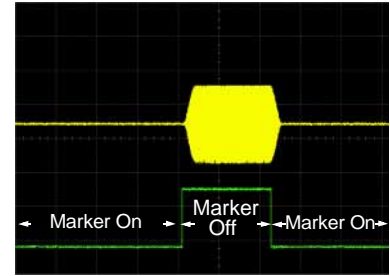

Sample range begins on first point of sig

Sampling both on and off time sets the modulator circuitry incorrectly for higher signal levels. Note the increased amplitude at the beginning of the pulse.



Negative range set between signal and o  
time

## Accessing Marker Utilities

To access marker utilities:

1. Press **Source** front-panel key
2. Press **More, Modulation Setup, ARB** keys.
3. Press **More, Marker Utilities** keys.

## Selecting which Marker to output

To select which one of the four markers is output at the TRIGGER 2 OUT connector:

1. Press **Input/Output** front-panel key
2. Press **More, Output Config, Trig 2 Out** keys.
3. Press **More, More, Source Marker 1, Source Marker 2, Source Marker 3,** or **Source Marker 4** key as required to choose which marker to output at the rear panel.

### Viewing a Marker Pulse

When a waveform plays (page 43), you can detect an enabled marker pulse at the rear panel TRIGGER 2 OUT connector. This example demonstrates how to view a marker pulse generated by a waveform segment that has at least one marker point set. The process is the same for a waveform sequence.

This example uses the factory-supplied segment, SINE TEST.WFM in the dual ARB Player. Factory-supplied segments have a marker point on the first sample point for all four markers.

1. Press **Source**, **More**, **Modulation Setup**, **ARB**, and **Select Waveform**.
2. Highlight the SINE TEST.WFM segment and press **Select Waveform**.
3. Press **Return** and in the **ARB** menu, press **ARB** until **On** is underlined.
4. Connect the instrument source output to the oscilloscope channel 1 input.
5. Connect the instrument front panel TRIG OUT 2 output to the oscilloscope channel 2 input.

When marker 1 is present, the instrument outputs a signal through TRIG OUT 2 as shown in the following example.

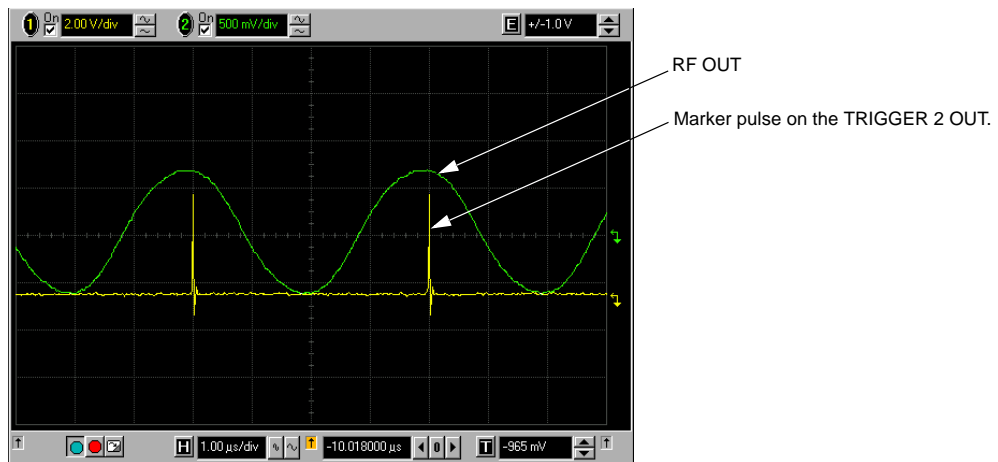

### Using the Pulse/RF Blanking Marker Function

While you can set a marker function (described as **Marker Routing** on the key label in the Marker Utilities menu) either before or after setting the marker points, setting a marker function before you set marker points may change the RF output. Pulse/RF Blanking includes ALC hold (described on page 51, note the **Caution** regarding unlevelled power). The source blanks the RF output when the marker signal goes low. This example is a continuation of the previous example, "**Viewing a Marker Pulse**" on page 54.

1. Using the factory-supplied segment SINE TEST.WFM, assume Marker 1 is set across points 1–180.
2. From the **Marker Routing** key menu, assign Pulse/RF Blanking to Marker 1: In the ARB menu, press **Marker Utilities, Marker Routing, Pulse/RF Blank, Marker 1**.

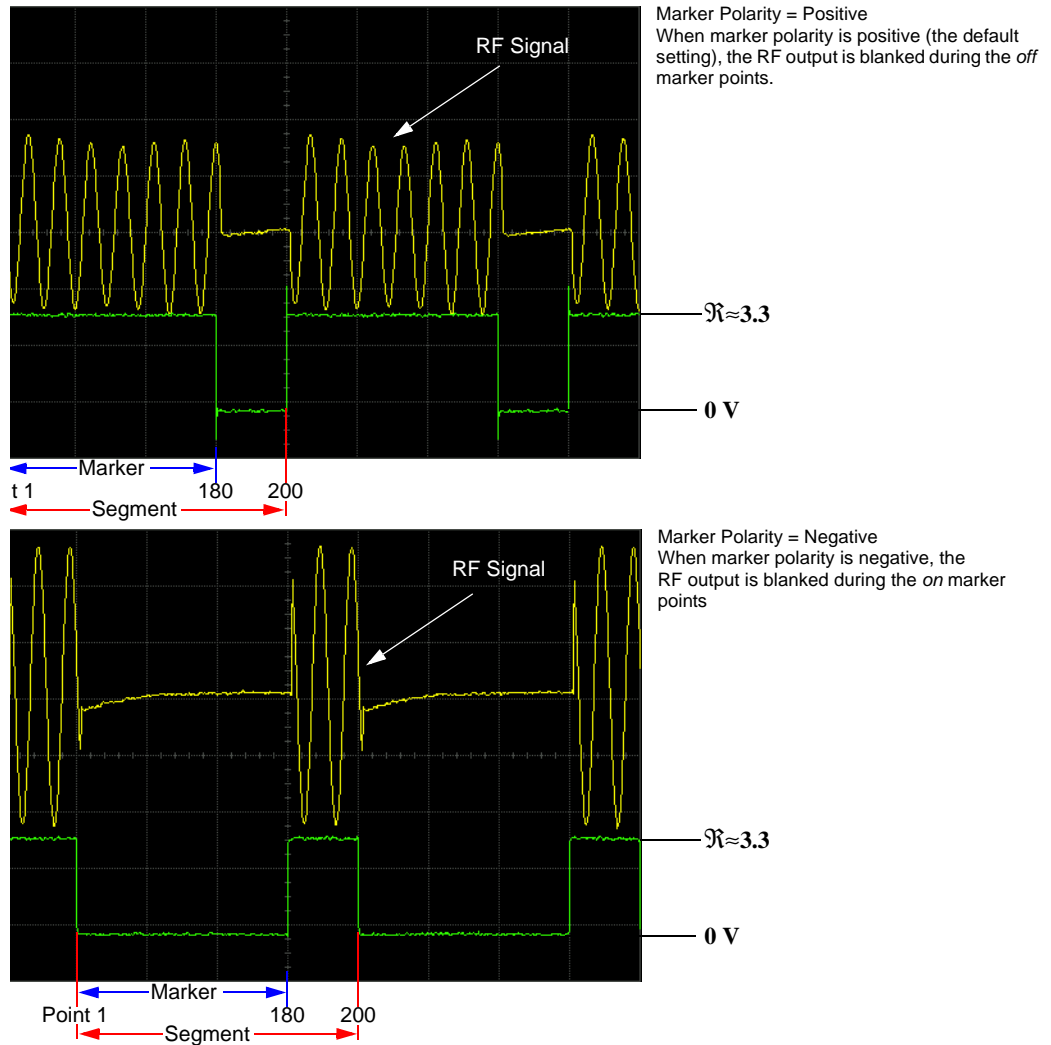

### Setting Marker Polarity

Setting a negative marker polarity inverts the marker signal.

1. In ARB menu, press **Marker Utilities, Marker Polarity**.
2. For each marker, set the marker polarity as desired.
  - The default marker polarity is positive.
  - Each marker polarity is set independently.

See also, **“Saving Marker Polarity and Routing Settings”** on page 50.

As shown on [page 54](#):

Positive Polarity: *On* marker points are high ( $\approx 3.3$  V).

Negative Polarity: *On* marker points are low (0 V).

Pulse/RF Blanking always occurs on the low part of the signal regardless of the polarity setting.

## Controlling Markers in a Waveform Sequence

In a waveform segment, an enabled marker point generates an auxiliary output signal that is routed to the rear panel TRIGGER 2 output. For a waveform sequence, you enable or disable markers on a segment-by-segment basis; this enables you to output markers for some segments in a sequence, but not for others. Unless you change the sequence marker settings or cycle the power, the marker setting for the last segment edited in the sequence applies to all segments in the next sequence that you build. For information about building a waveform sequence, see [“Creating a Sequence”](#) on page 40.

### Enabling and Disabling Markers in a Waveform Sequence

Select the waveform segments within a waveform sequence to enable or disable each segment markers independently. You can enable or disable the markers either at the time of creating the sequence or after the sequence has been created and stored. If the sequence has already been stored, you must store the sequence again after making any changes. Enabling a marker that has no marker points has no effect on the marker output. This example assumes that a waveform sequence exists.

1. Ensure that all waveform segments for the sequence reside in ARB memory (see [“Loading a Waveform Segment into ARB memory”](#) on page 37).
2. From the ARB menu, press **Waveform Sequences**.
3. Highlight the desired waveform sequence.
4. Press **Edit Selected Sequence, Edit Selected Waveform**.
5. Toggle the markers:
  - a. Highlight the first waveform segment.
  - b. Press **Marker 1**, **Marker 2**, **Marker 3**, or **Marker 4** to enable or disable them as required.

An entry in the right hand column (see figure below) indicates whether the marker is enabled or disabled for that segment.
  - c. In turn, highlight each of the remaining segments and repeat **Step b**.
6. Press **Return, Save As...**



7. Either rename the sequence (see [“Renaming/Deleting a Waveform Segment on Internal Disk”](#) on page 37) or just press **Enter** to save the sequence with the existing name.

The markers are enabled or disabled per the selections, and the changes saved to the sequence file.

The following figure shows a sequence built using three waveform segments; each segment has a marker point on the first sample. In this example for segment 2, marker 1 and marker 2 are enabled and markers 3 and 4 are disabled.

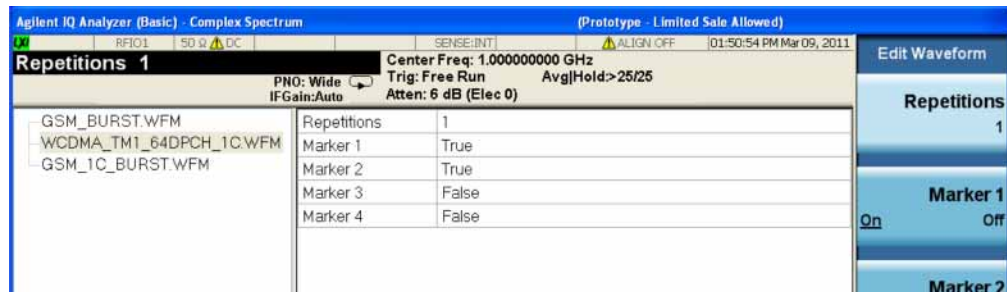

For each segment, only the markers enabled for that segment can produce a rear panel output signal. In this example, whether Marker 1 or Marker 2 appears on the rear panel output is determined by the settings on the Input/Output menu (see [“Selecting which Marker to output”](#) on page 53).

### Using the TRIGGER 2 OUT Signal as a Test Set Trigger

One of the uses for the TRIGGER 2 OUT signal (marker signal) is to trigger a measurement instrument. You can set up the markers to start the measurement at the beginning of the waveform, at any single point in the waveform, or on multiple points in the waveform. To optimize the use of the TRIGGER 2 OUT signal for measurements, you may also need to adjust the sample rate. To change the sample rate setting use the **Source** front-panel key, followed by the **Modulation Setup, ARB, ARB Setup, Sample Rate** keys.

The TRIGGER 2 OUT output signal can exhibit jitter of up to  $\pm 4$  ns on the rising and falling edge. This jitter can be minimized in either of two ways.

*Method 1:* Use a sample clock of  $200 \text{ MHz}/N$  where  $N$  is a positive integer and where  $200 \text{ MHz}/N$  can be represented exactly on the display.

For example: 200 MHz, 100 MHz, 50 MHz, 25 MHz, and so on.

If the result cannot be represented exactly on the display, jitter will be present. For example:  $N = 6$  will result in jitter, because  $200 \text{ MHz}/6 = 33.333 \text{ MHz}$ , which is truncated when displayed.

*Method 2:* Select a sample clock and waveform length that spaces the markers by a multiple of 8 ns. For example: A 200 point waveform with a marker on the first point and a sample clock of 50 MHz provides a marker every  $4 \mu\text{s}$ . Because  $4 \mu\text{s}$  is a multiple of 8 ns, the jitter is minimized.

When the TRIGGER 2 OUT signal exhibits jitter and it is used as a measurement trigger, it can cause the waveform to falsely appear as having jitter. If this condition occurs, you can adjust the sample rate to a value (see above) that does not cause the jitter appearance. To maintain the integrity of the original waveform with a sample rate change, you will have to also recalculate the sample values. The following figures illustrate the marker signal jitter and its effect on the waveform.

TRIGGER 2 OUT signal exhibits jitter due to a non-optimal sample rate

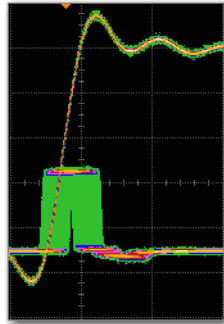

Oscilloscope triggering on waveform

Waveform appears to exhibit jitter when triggered using EVENT signal with jitter.

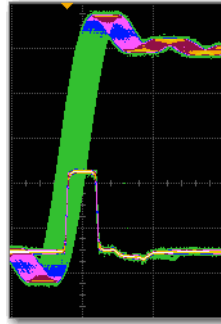

Oscilloscope triggering on EVENT signal

The jitter is gone with an optimal sample rate

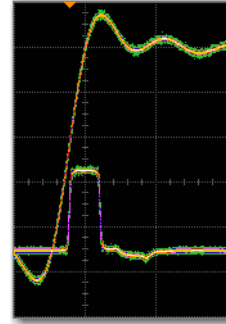

Oscilloscope triggering on EVENT signal

## Triggering a Waveform

Triggers control data transmission by controlling when the test set transmits the modulating signal. You can configure trigger settings so that data transmission occurs once (Single mode), continuously (Continuous mode), or starts and stops repeatedly (Segment Advance modes).

A trigger signal contains both positive and negative states; you can use either for triggering.

When you initially select a trigger mode or when you change from one triggering mode to another, you may lose the carrier signal at the RF output until the modulating signal is triggered. This is because the source sets the I and Q signals to zero volts prior to the first trigger event. To maintain the carrier signal at the RF output, create a data pattern with the initial I and Q voltages set to values other than zero.

When you initially turn the Arb ON or select a trigger mode or when you change from one triggering mode to another, you may temporarily lose the carrier signal for a few tens of milliseconds at the RF output. The Arb will present the idle IQrms value of the next Arb waveform to the IQ modulator. This ensures that the RF carrier output is at the correct amplitude level while the Arb waits for a trigger. When that trigger is received, the Arb begins playing the waveform and the modulated RF carrier exhibits no undesirable transients.

There are two parts to configuring a waveform trigger:

- *Type* determines the behavior of the waveform when it plays (see “**Trigger Type**” on page 59).
- *Source* determines how the source receives the trigger that starts the modulating waveform playing (see “**Trigger Source**” on page 60).

### Trigger Type

Type defines the trigger mode: how the waveform plays when triggered. Trigger Type is selected by pressing the **Source** front-panel key, followed by the **Modulation Setup, ARB, Trig Type** keys.

- **Continuous** mode repeats the waveform until you turn the signal off or select a different waveform, trigger mode, or response
  - **Free Run** immediately triggers and plays the waveform; triggers received while the waveform is playing are ignored.
  - **Trigger and Run** plays the waveform when a trigger is received; subsequent triggers are ignored.
  - **Reset and Run** plays the waveform when a trigger is received; subsequent triggers restart the waveform.
- **Single** mode plays the waveform once.

- **No Retrigger** ignores triggers received while a waveform is playing. If a trigger is received early it will be ignored. The gap in your playback is dependant on the trigger period, after which time the RF will start up again where it is expected.
- **Buffered Trig** - a trigger received while a waveform is playing waits until the current waveform completes, then plays the waveform once more. The RF will not be aligned with this early trigger.
- **Restart on Trigger** - a trigger received while the waveform is playing immediately restarts the waveform. The ARB will reset itself and trigger again but there will some gap in the playback while this is occurring.
- **Segment Advance** mode plays a segment in a sequence only if triggered. The *trigger source* controls segment-to-segment playing (see “**Example: Segment Advance Triggering**” on page 60). A trigger received during the last segment loops play to the *first* segment in the sequence.

### Trigger Source

Trigger Source is selected by pressing the **Source** front-panel key, followed by the **Modulation Setup, ARB, Trig Source** keys.

- **Trigger** key - the waveform is triggered when the front panel **Single** key is pressed
- **Bus** - the waveform is triggered over GP-IB, LAN or USB using the `:SOURCE:RADio:ARB:TRIGger:INITiate` SCPI command.
- **External 2** - the waveform is triggered by a trigger signal on the TRIGGER 1 IN port or the TRIGGER 2 IN port on the test set rear panel.
- **Periodic Timer** - the waveform is triggered by an internally generated periodic timer. Pressing the key selects Periodic Timer; pressing the key again allows you to select the period of the timer.

### Example: Segment Advance Triggering

Segment advance triggering enables you to control the segment playback within a waveform sequence. This type of triggering ignores the repetition value (page 42). For example if a segment has repetition value of 50 and you select **Single** as the segment advance triggering mode, the segment still plays only once. The following example uses a waveform sequence that has two segments.

If you have not created and stored a waveform sequence, refer to “**Creating a Sequence**” on page 40.

1. Preset the source.
2. Configure the RF output:
  - Set the desired frequency.
  - Set the desired amplitude.

- Turn on the RF output.
3. Select a waveform sequence for playback:
    - a. Press **Source** front-panel key, followed by **Modulation Setup, ARB, Select Waveform**.
    - b. In the display, highlight a waveform sequence file.
    - c. Press **Select Waveform**.
  4. Set the triggering as follows:
    - Trigger Type: continuous Segment Advance  
Press **Return, Trigger Type, Segment Advance, Continuous**.
    - Trigger source: Trigger front-panel key  
Press **Trigger Source, Trigger Key**.
  5. Generate the waveform sequence:  
In the **ARB** menu, press **ARB** until **On** is underlined.
  6. (Optional) Monitor the waveform:  
  
Connect the RF OUTPUT of the source to the input of an oscilloscope, and configure the oscilloscope so that you can see the signal.
  7. Trigger the first waveform segment to begin playing continuously:  
Press the **Single** front-panel key.
  8. Trigger the second segment:  
Press the **Single** front-panel key.  
  
Pressing the **Single** front-panel key causes the currently playing segment to finish and the next segment to start.  
  
If the last segment in the sequence is playing, pressing the **Single** front-panel key causes the *first* segment in the waveform sequence to start when the last segment finishes.

## Setting the Baseband Frequency Offset

The baseband frequency offset specifies a value to shift the baseband frequency up to  $\pm 50$  MHz within the ARB 100 MHz signal bandwidth. To access the **Baseband Frequency Offset** key press the **Source** front-panel key, followed by the **Modulation Setup, ARB, ARB Setup** keys.

When the Baseband Frequency Offset is non-zero, the hardware rotator accumulates phase-shift of the baseband signal. This residual phase remains even after the offset value is returned to zero. To remove this phase accumulation, either restart the personality or select the **Baseband Frequency Offset Phase Reset** key. This key will grey out whenever the phase, due to the frequency offset, is zero. In addition, while there is a non-zero residual phase present in the signal, the DAC Over-Range Protection feature will automatically ensure that the reduced internal scaling is applied. This reduced scaling will be removed when both the frequency offset is returned to zero and the phase is reset.

Common uses for the offset feature include:

- offsetting the carrier from any LO feedthrough (carrier signal spur at the carrier frequency)
- sum the baseband signal with external I and Q inputs to create a multicarrier signal
- use the source I/Q signal as an IF

### NOTE

Changing the baseband frequency offset may cause a DAC over range condition that generates error 628, Baseband Generator DAC over range.

The baseband frequency offset value is one of the file header parameters ("**Saving a Waveform Settings & Parameters**" on page 45), which means you can store this value with the waveform. When you select a waveform with a stored frequency offset value, the source changes the current value to match the stored file header value. If there is no stored baseband offset frequency value for the current waveform, the source uses the last set frequency offset value.

You can also use the Save function to store this value as part of the source setup. When you Recall a setup stored with the Save function, the baseband frequency offset value becomes the current test set setting value, disregarding the stored file header value.

Use the following steps to offset the carrier from LO/carrier feedthrough. This example uses the factory supplied waveform, **SINE TEST.WFM** available in the Dual ARB Player. To view the output for this example, connect the RF OUTPUT to the RF INPUT.

1. Ensure RF INPUT selected.
  - a. Press **Input/Output** front-panel key.

- b. Press **RF Input, RF Input Port, RF** keys to select the RF Input port.
  2. Select and play the waveform.
    - a. Press the **Source** front-panel key, followed by **Modulation Setup, ARB, Select Waveform**.
    - b. In the Segments in ARB Memory display, select SINE TEST.WFM.
    - c. Press **Select Waveform**.
  3. Generate the waveform: In the **ARB** menu, press **ARB** until **On** is underlined.
  4. Configure the carrier signal:
    - a. Set the carrier signal to 1 GHz.
    - b. Set the amplitude to 0 dBm.
    - c. Turn on the RF OUTPUT.
  5. Press **Source** front-panel key, followed by **Modulation Setup, ARB, ARB Setup, Baseband Freq Offset, 20 MHz**.

The modulated RF signal is now offset from the carrier frequency by 20 MHz as shown in the following figures.

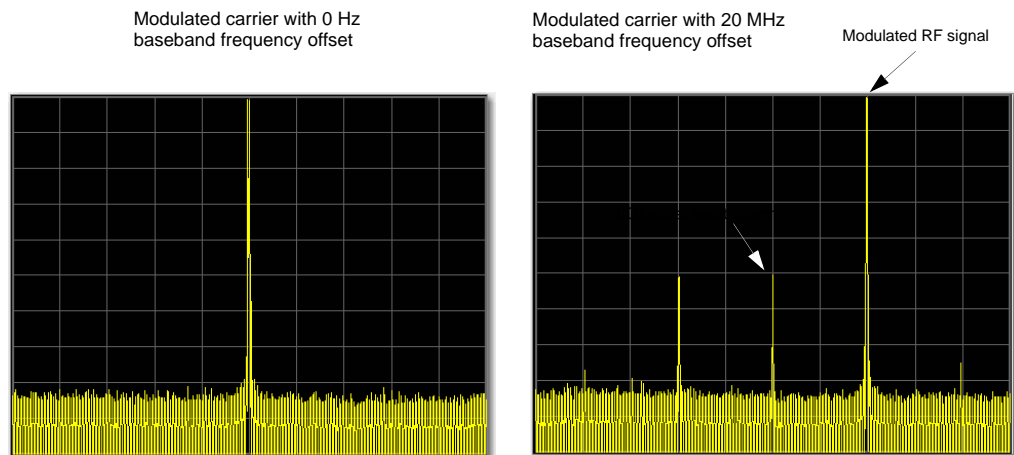

Spectrum analyzer set to a span of 100 MHz

## Alignment

Use the Alignments menu to provide a manual signal alignment of the source. When you execute an alignment of the source. The test set stops any sequence of the source, presets the source, and performs the alignment.

Run the source alignment as follows:

1. press the **System** front-panel key, followed by **Alignments, Align Now, Source**. A message box appears advising you of the alignment time.
  - a. To start the alignment, click on **Ok** or press the **Enter** key.
  - b. To abort the alignment, click on **Cancel** or press the **Cancel (Esc)** key.



## Alignment

Use the Alignments menu to provide either automatic or manual signal alignment of the source. The source can be coupled to the system alignment or can be aligned independently of the system alignment.

To de-couple the source from the system alignment, press the **System** front-panel key, followed by the **Alignments, Align Now** keys and select **Couple Source to Align Now** as **Off**.

To set up the source alignments, press the **System** front-panel key, followed by the **Alignments** key. You can set the source to auto-align or to be manually aligned as described in the following:

1. **Auto Align:** Press the **Auto Align, Source Align Type** keys. From this menu select from:
  - **DC** - select DC to carry out an alignment on the source using the current source settings; this typically takes a few seconds. The **Align Now, Source** menu setting determines which part of the source alignment is carried out (All, All but RF or RF).
  - **User** - select User to carry out an alignment on the source on the current User Frequency Type frequencies in the User sub-menu. The **Align Now, Source** setting determines which part of the source alignment is carried out. User provides a quicker alignment when a full alignment is not required. You can limit the alignment by specifying the alignment start and stop frequencies.
    - **User - Frequency Range** - select this option to set the frequency range over which you want the alignments to be done. Use the **Start** and **Stop Frequency** keys to set the range.
    - **User - Frequency Sequence** - uses the list of frequencies that have been set up in the source List Sequencer for the alignment.
  - **Full** - select Full to carry out an alignment on the source over the entire frequency range of the test set. If the system alignment type is set to Normal and the Auto Align, Source Align Type is set to Full then the alignment takes several minutes.
  - **Off** - select Off to turn the alignments off, regardless of the system Auto Align setting.
2. **Manual Align:** Press the **Align Now, Source Align Type** keys. From this menu select from:
  - **DC** - select DC to carry out an alignment on the source using the current source settings; this typically takes a few seconds. The **Align Now, Source** menu setting determines which part of the source alignment is carried out (All, All but RF or RF).

- **User** - select User to carry out an alignment on the source on the current User Frequency Type frequencies in the User sub-menu. The **Align Now, Source** setting determines which part of the source alignment is carried out. User provides a quicker alignment when a full alignment is not required. You can limit the alignment by specifying the alignment start and stop frequencies.
  - **User - Frequency Range** - select this option to set the frequency range over which you want the alignments to be done. Use the **Start** and **Stop Frequency** keys to set the range.
  - **User - Frequency Sequence** - uses the list of frequencies that have been set up in the source List Sequencer for the alignment.
- **Full** - select Full to carry out an alignment on the source over the entire frequency range of the test set. If the system alignment type is set to Normal and the Auto Align, Source Align Type is set to Full then the alignment takes several minutes.

Now from the **Align Now** menu select Source key. The following options are available:

- **All** - immediately executes an alignment of the complete source. The test set stops any sequence of the source, performs the alignment and then re-starts the sequence from the beginning.
- **All but RF** - immediately executes an alignment of the source except the RF section. The test set stops any output signal, performs the alignment and then re-starts the signal from the beginning. The alignment is carried out on the IQ section of the source over the frequency range stipulated by **Source Align Now Type**.
- **RF** - immediately executes an alignment of the source RF section. The test set stops any output signal, performs the alignment and then re-starts the signal from the beginning.

## Licensing

You can create your own signal waveforms to output from the test set ARB using a number of methods. One of them is to use Keysight Signal Studio which is a suite of PC-based signal creation software that allows you to create customized signals for multiple radio standards. You can also create your own signals using other signal creation software (such as MATLAB or ADS) and download them to the test set hard disk. You can use Signal Studio Toolkit to process your customized files for use on the test set, if necessary. The instrument also provides a multi-pack licensing solution, a cost-effective solution that allows you to license individual Signal Studio waveforms rather than purchase the Signal Studio software.

### NOTE

Note that the Signal Studio files are encrypted waveforms; they are stored on the hard disk on the test set and are moved to the volatile ARB memory for playout. Other waveforms that you create may not be encrypted.

## Signal Studio

Signal Studio is software that allows you to create technology-specific waveforms. It can be downloaded from the Keysight website ([www.agilent.com/find/signalstudio](http://www.agilent.com/find/signalstudio)). To use Signal Studio waveforms on the test set you can either purchase a Signal Studio license or use waveform multi-pack licensing (see next section). The Signal Studio website allows you to purchase the Signal Studio license and also provides trial licenses. The Signal Studio license is test set specific and therefore cannot be used on a test set other than the one specified in the purchase agreement. Once you have licensed the required Signal Studio software package, any waveforms that you create using this package can be used on the test set.

## Waveform multi-pack licensing

each license gives you five slots - to buy 45 buy every 5-pack licence - to licence 500 buy all 10 50 pack license - to licence 545 buy all 9 5-packs and all 10 50 packs

Waveform multi-pack licensing (Option 2xx) enables you to create, generate and permanently license multiple Signal Studio waveforms without the need to purchase the full Signal Studio license.

A multi-pack license includes a number of license slots which are used to license waveform segments. The number of license slots varies depending on the multi-pack license option that has been purchased. When a waveform segment is licensed, it is assigned to one of the license slots. Waveform segments licensed with a multi-pack license are perpetual and cannot be exchanged. Once a waveform is licensed, that license is permanent and cannot be revoked or replaced.

Each multi-pack license includes one N7699-D01 30-day Signal Studio license. The N7699A-D01 license allows access to all N76xxB Signal Studio software products to create and generate signals for 30 days so the user can build, test and license individual waveform segments. Waveform segments can be multi-pack licensed either during or after the N7699-D01 trial period but during the 30 day period, you do not have to assign a waveform to a license slot in the multi-pack in order to play it out. However, after the expiration of the N7699-D01 license, unlicensed waveform segments cannot be played until the waveform segment is licensed using the multi-pack option. The waveform segment must be stored on the instrument hard disk before it can be multi-pack licensed. The 30-day countdown for N7699A-D01, begins at the time of the redemption. For maximum usage when purchasing multiple Option 2xx, only redeem one N7699A-D01 at a time (e.g. after the first 30-day N7699A-D01 license expires, redeem the 2nd, etc.). This maximizes the time allowed for waveform creation using the N7699A-D01 30-day Signal Studio demo license (refer to the *Entitlement Certificate*). N7699A-D01 30-day Signal Studio demo license *cannot* be purchased separately from Option 2xx.

Option 2xx waveform licenses are test set specific (i.e. test set serial number specific). If the licensed waveform segment is transferred from one instrument to another, or to a separate Keysight signal generator, the segment file must be re-licensed on the new instrument by a multi-pack license on that instrument before it can be played back.

To license additional waveforms that exceed the number permitted by a multi-pack option, you must purchase an additional multi-pack option that you do not already own. For example, if you have Option 221 and need additional waveforms, you should purchase Option 222. Re-purchasing Option 221 for the same test set provides no additional multi-pack licenses.

Waveforms licensed with Options 2xx cannot be *exchanged for different waveforms*. Once a waveform is licensed, that license is permanent and cannot be revoked or replaced.

After licensing a waveform, you can make copies of the waveform using different file names for use on the same source and even rename the original file without affecting the waveform license.

You can also use the Option 22x to license waveforms from N76xxB Signal Studio software downloaded during its 14-day free trial license. All of the N76xxB Signal Studio software products provide a 14-day trial period (trial license). This 14-day trial license lets you download and play back waveforms during the trial period. These waveforms are denoted by the TRL in the status message area of the waveform segment catalog. After the trial period expires, the TRL message is removed but the waveform remains. You can license these waveforms after the TRL message is gone.

To redeem Option 2xx, refer to the *Entitlement Certificate* that comes with the instrument order.

## Installing an Option N5182A–22x Waveform 5–Pack Licensing

1. Load a Waveform 5–Pack license, Option N5182A–22x, into the source using License Manager or a USB media. For more information on loading the Waveform 5–Pack License, refer to the *N5182A–22x Entitlement Certificate*.
2. Redeem the N7699A–D01 that came with your copy of Option 22x. For more information on redeeming the N7699A–D01, refer to the *N5182A–22x Entitlement Certificate*.

## Licensing a Source Waveform File

1. Create the waveform:
  - a. Download any of the N76xxB Signal Studio software that interests you. For downloading N76xxB Signal Studio software, refer to the N5182A–22x Entitlement Certificate.
  - b. Create and download a waveform to the test set using any of the N76xxB Signal Studio software. Refer to your *Signal Studio* software Help. You can add the waveform to a license slot for a 48-hour trial period. During the trial period, the waveform can be played and replaced any number of times. When the trial time expires, the slot can no longer be used for playback until the slot is locked for permanent playback capability

## Waveform Licensing keys Overview

To access the Waveform menu on the test set, press the **Source** front-panel key, followed by **Modulation Setup, ARB, More, Waveform Utilities** keys. The display looks similar to the following:

### Waveform Multi-pack license display

| Licenses Used: 2/45  |                                 |                 |
|----------------------|---------------------------------|-----------------|
| Waveform             | Status                          | Redemption Date |
| 16E_10M_DLUL_PUSC    | Multi-Pack Licensed             | 05/03/07        |
| 16E_10M_DL_PUSC_MULT | Multi-Pack License Not Required |                 |
| 16E_875M_DL_PUSC     |                                 |                 |
|                      |                                 |                 |
|                      |                                 |                 |
|                      |                                 |                 |
|                      |                                 |                 |
|                      |                                 |                 |
|                      |                                 |                 |

The list can be navigated using the mouse, the arrow keys or the RPG. If you highlight a waveform and the waveform segment requires a license, and provided there is a slot available, the **Add Waveform** key is enabled and can be used to add the waveform segment to the multi-pack license.

### Waveform Multi-Pack Licensing Status Messages

The following messages appear in the Waveform Multi-Pack license display in the Status column. **Table** shows the meaning of the entries in the Status column.

#### Waveform Multi-Pack Licensing Status Messages

| Status Message                  | Meaning   | Notes  |
|---------------------------------|---|--|
| <i>Empty field</i>              | If no status message, then the waveform is licensable.  | Once a Trial (TRL)* license expires, the waveform becomes licensable (i.e. the status message for the TRL waveform becomes an <i>empty field</i> ).<br><br>If a licensed Option 2xx waveform file is downloaded to <i>another</i> test set, the waveform becomes licensable on that <i>other</i> test set(i.e. the status message field is <i>empty</i> ). |
| Multi-Pack Licensed             | This waveform is licensed by Option 2xx.  |  |
| Multi-Pack License Not Required | This status message applies to:<br><br>Any free waveforms provided with the instrument<br>(e.g. WLAN20MHZ54M64QAM.WFM)<br><br>Any customer created waveform<br><br>Any waveforms that have a valid license (e.g. Trial (TRL) licenses, Advanced Design System (ADS), etc.). | Once a Trial (TRL) license expires, the waveform becomes licensable (i.e. the status message for the TRL waveform becomes an <i>empty field</i> ).<br><br>If a licensed Option 2xx waveform file is downloaded to <i>another</i> test set, the waveform becomes licensable on that <i>other</i> test set (i.e. the status message field is <i>empty</i> ). |

\*. Trial license (TRL) is *not* applicable to N7699A–D01. A license downloaded with N7699A–D01 *always* has an empty field before it is licensed with Option 2xx. A trial license is *not* licensable with Option 2xx until *after* the 14–day trial expires.

#### Example: Licensing a Signal Studio Waveform

The following steps add a waveform file to a license slot and lock the slot for permanent playback.

1. Press **Source, Modulation Setup, ARB, Waveform Utilities**

The source displays a catalog of files.

2. Use the arrow keys to highlight and select the file to be licensed.
3. Press Add Waveform to add the selected waveform to the first available slot. A confirmation dialog appears which prompts you to ensure that you want to permanently license this waveform.
4. Press Return and the licensing status of the slot is changed to Multi-Pack Licensed and the date is shown in the Redemption Date column.





## 6 List Sequencer

This chapter introduces the front panel operation for the List Sequencer for the Source. It also provides information on how to set up the List Sequencer using a spreadsheet, which allows faster data entry. For information about remote operation, refer to the *Online Help or the User's and Programmer's Guide*. The List Sequencer in the source and the analyzer may be triggered from each other but otherwise operate independently.

- **"Terminology"** on page 75
- **"Front panel setup"** on page 79
- **"Saving the sequence"** on page 81
- **"Tab separated value file"** on page 81
- **"Spreadsheet setup"** on page 81
- **"TSV file generation"** on page 83
- **"Loading a tsv file into the List Sequencer"** on page 84
- **"Tab separated value file editing"** on page 85
- **"Importing a tsv file into a spreadsheet"** on page 85

**NOTE** The E6650A test set has no instrument front-panel. Therefore, the PC mouse and monitor are required for instrument control through a virtual front panel (VFP). For ease in using the VFP, the PC keyboard is recommended. The instructions in this chapter for front-panel keys and softkeys apply to the VFP keys.

**NOTE** The instructions in this chapter for front-panel keys and softkeys apply to the VFP keys.

**NOTE** The instructions in this chapter for front-panel keys and softkeys apply to the VFP keys.

## List Sequencer

The List Sequencer functionality in the test set source is designed to allow the source to output a waveform which can change in defined way over varying time periods, between frequencies, power levels, trigger events and even radio standards. It can be run independently or in conjunction with the test set analyzer List Sequencer, to calibrate and test a mobile device.

The complexities involved in configuring the List Sequencer make it unlikely that the test set front panel will be used for setting it up on a regular basis. A more simple way to set up the List Sequencer is to use a spreadsheet to enter the step values and the spreadsheet can then be saved to a format that can be used directly by the test set to set up the List Sequencer. The spreadsheet is used to set up both the source and analyzer List Sequencer values.

This chapter describes how to set up the source List Sequencer both from the front panel and using the spreadsheet. Detailed information about setting up the analyzer List Sequencer can be found in the Sequence Analyzer measurement guide, which is available on the test set and accessed through the online help, Additional Documentation topic. This is also available on the Keysight Technologies website: [www.keysight.com/find/ext](http://www.keysight.com/find/ext).

## Terminology

### Sequence

A source sequence consists of a numbered series of steps, during each of which an RF waveform is generated by the test set's source.

### Step

A step is a user-defined period of time during which a signal with a defined set of parameters is generated. Source steps are numbered sequentially (1 through n), and executed sequentially. One source step must end before the next step begins.

The parameters which define the step are listed below and explained in the following sections. These parameters can be set up on the front panel, in the spreadsheet, or in the SCPI command which sets up all the parameters at once for a given step.

1. Step Number
2. Step Trigger
3. Transition Time
4. Radio Band
5. Radio Band Link
6. Frequency/Channel
7. Power
8. Waveform
9. Step Duration
10. Time/Count
11. Output Trigger

#### **1: Step Number**

Source steps are numbered sequentially (1 through n), and executed sequentially. One source step must end before the next begins.

#### **2: Step Trigger**

This parameter specifies how the source step is to be triggered. The choices are:

- IMMEDIATE (equivalent to Free Run); the source begins generating a waveform without waiting for a trigger.

- KEY (equivalent to Manual); the sequence is halted until the user presses the manual trigger key on the front panel. A popup window is displayed to indicate that the test set is waiting for the trigger input. (Sending the Bus Trigger SCPI command while the test set is waiting for a manual trigger had no effect.)
- BUS; the sequence is halted until the Bus Trigger SCPI command is sent (see the note below). A popup window is displayed to indicate that the test set is waiting for the trigger input. (Pressing the manual trigger key while the test set is waiting for the Bus Trigger SCPI command will have no effect.)
- INTernal; the source step is triggered from the test set's analyzer.
- EXTernal2; the source step is triggered from the TRIGGER 2 IN port on the rear panel of the test set.

**NOTE**

The Bus Trigger SCPI command is in the form:  
`:SOURce:LIST:TRIGger:INITiate[:IMMediate]`

The key path for setting Step Trigger from the front panel menus is:

**[Source], List Sequencer, List Sequencer Setup, Step Trigger**

### 3: Transition Time (also known as Setup Time)

This parameter specifies the time required within a given step to allow the source to settle at the specified frequency and amplitude settings. Recommended settings are as follows:

- Frequency change: 0.5 ms
- Amplitude change to within 1.0 dB: 0.1 ms
- Amplitude change to within 0.1 dB: 0.02 ms

The key path for setting Transition Time from the front panel menus is:

**[Source], List Sequencer, List Sequencer Setup, Transition Time**

### 4: Step Radio Band

This parameter specifies a radio band to be used. The choices are outlined below (listed beside the radio standards to which they apply).

**Table 0-1**

| Radio Standard | Radio Band  |
|----------------|---|
| NONE           | NONE  |
| GSM or EDGE    | PGSM, EGSM, RGSM, DCS1800, PCS1900, TGSM810, GSM450, GSM480, GSM700, GSM850 |

**Table 0-1**

| <b>Radio Standard</b>           | <b>Radio Band</b>   |
|---------------------------------|---|
| WCDMA                           | BANDI, BANDII, BANDIII, BANDIV, BANDV, BANDVI, BANDVII, BANDVIII, BANDIX, BANDX, BANDXI, BANDXII, BANDXIII, BANDXIV                           |
| C2K (cdma2000) or C1X (1xEV-DO) | USCELL, USPCS, JAPAN, KOREAN, NMT, IMT2K, UPPER, SECOND, PAMR400, PAMR800, IMTEXT, PCS1DOT9G, AWS, US2DOT5G, PUBLIC, LOWER                    |
| LTE                             | BAND1, BAND2, BAND3, BAND4, BAND5, BAND6, BAND7, BAND8, BAND9, BAND10, BAND11, BAND12, BAND13, BAND14, BAND17, BAND18, BAND19, BAND20, BAND21 |

The key path for setting Radio Band from the front panel menus is:

**[Source], List Sequencer Setup, Radio Setup, Radio Standard <select band>**

### 5: Radio Band Link

This parameter specifies the link direction for the present step within the source sequence. The link direction is used in conjunction with the Radio Band and Channel parameters to determine the output frequency. When set to “UP”, the source will calculate the uplink frequency according to an uplink formula together with selected radio band and channel number. When set to “DOWN”, the source will calculate the downlink frequency according to a downlink formula together with selected channel band and channel number.

The key path for setting Radio Band Link from the front panel menus is:

**[Source], List Sequencer, List Sequencer Setup, Radio Setup, Radio Band Link**

### 6: Frequency/Channel

This parameter specifies the frequency to be generated, either directly (in MHz) or by channel number. If the radio band specified by the previous parameter is NONE, the present parameter represents the frequency in MHz; otherwise, the present parameter represents the channel number.

The key path for setting Frequency or Channel from the front panel menus is:

**[Source], List Sequencer, List Sequencer Setup, Frequency / Channel**

### 7: Power

This parameter defines the output power level to be generated, in dBm.

The key path for selecting Power from the front panel menus is:

**[Source], List Sequencer, List Sequencer Setup, Power**

## 8: Waveform

This parameter specifies the waveform to be generated. The choices are:

- <Waveform>: the name of a waveform file currently in ARB memory. The supported file types are .wfm, .bin, and .WAVEFORM.
- CONT: Continue Previous (that is, continue playback of the waveform from the previous step in the seequence).
- CW: Continuous wave (that is, generate an unmodulated tone).
- OFF: Disables RF output of the test set.

### NOTE

If this parameter is set to CONT, the ARB playback will not pause while the source is retuning to a new frequency or power level which the step may require.

The key path for selecting Waveform from the front panel menus is:

**[Source], List Sequencer, List Sequencer Setup, Waveform**

## 9: Step Duration

This parameter, in combination with the following parameter (Time/Count), determines the duration of the step. The choices are:

- TIME: the duration of the step is specified in absolute terms; if this choice is selected, the value of the Time/Count parameter is interpreted as a duration in ms.
- COUNT: the duration of the step is specified as the number of times the waveform file in ARB memory is played; if this choice is selected, the value of the Time/Count parameter is interpreted as a a waveform playback count. This choice is applicable only if a waveform file is being played; it cannot be selected if the step has been set up (by the Waveform parameter) to play a CW tone.
- CONTInuous: if this choice is selected, the step will play continuously until the next step starts.

The key path for setting Step Duration from the front panel menus is:

**[Source], List Sequencer, List Sequencer Setup, Step Duration**

## 10: Time / Count

This parameter specifies the duration of the step in ms (if the Step Duration parameter has been set to “TIME”), or as the number of times a waveform file is played (if the Step Duration parameter has been set to “COUNT”). If the Step Duration parameter has been set to “CONTInuous”, this parameter is ignored.

The key path for selecting the Time/Count from the front panel menus is:

**[Source], List Sequencer, List Sequencer Setup, Step Duration, Time / Count**

## 11: Output Trigger

This parameter specifies the type of trigger output signal which will be sent at the start of the step. The choices are:

- ON: the trigger output is sent to the test set's analyzer (for triggering of the analyzer list sequencer), and also to the TRIGGER 2 OUT port at the rear panel of the test set.
- OFF; no trigger output is generated by the source.

The key path for selecting the Output Trigger from the front panel menus is:

**[Source], List Sequencer, List Sequencer Setup, Output Trigger**

## 12: Multiport Adapter Output Port Bit Map

This parameter is the decimal value of an 8-bit binary number representing the On/Off status of the eight RF I/O ports ("1" for On). Select any combination of the eight RFIO ports on the E6617A (designated RFIO 0 through RFIO 7) as the ports to which the output of the test set's RF source will be supplied. There is no restriction on how many of the eight ports can be selected at once. The bit assignment is as follows:

Bit 0 = RFIO 0  
 Bit 1 = RFIO 1  
 Bit 2 = RFIO 2  
 Bit 3 = RFIO 3  
 Bit 4 = RFIO 4  
 Bit 5 = RFIO 5  
 Bit 6 = RFIO 6  
 Bit 7 = RFIO 7

For example, to set RFIO 0 and RFIO 7 to "On" (Bits 0 + 7, or 10000001), set the integer value to 129 (1 + 128).

The key path for selecting the Output Ports from the front panel menus is:

**[Source], List Sequencer, List Sequencer Setup, Multiport Adptr Output Port**

### Front panel setup

To access the List Sequencer from the front panel press the **Source** front-panel key, followed by the **List Sequencer** key, followed by the **List Sequencer Setup** key. Use the keys to set up the step parameters as listed above. There are three keys that are only available on the front panel:

- Insert Step Before - allows you to insert a step before the Current Step
- Delete Step - deletes Current Step in the Sequence
- Clear List - clears all the steps and sets Number of Steps to the default of 1 and sets the parameters for the one step to their default value.

### Example setup for a two-step sequence

- Press **Source, More, List Sequencer, List Sequencer Setup**.
- Select **Number of Steps**. Type 2 and press **Enter** key.
- Set **Current Step** to 1
  1. Press **More, Step Trigger** and set to **Free Run**.
  2. Select **Transition Time**. Type 500 and press **ms** key.
  3. Press **Radio Setup** to open the Radio Setup menu. This menu effectively allows you to set the frequency of the output signal.
  4. Set the **Device** selection to **Downlink**.
  5. Select **Radio Standard, GSM/EDGE, PGSM**.
  6. Press the **Return** front-panel key twice to return to the List Seq Setup menu.
  7. Press **Channel**. Type 1 and press **Enter** key.
  8. Press **Power**. Type **10** and select the **-dBm** key (or type **-10** and select the **dBm** key).
  9. Press **More, Waveform** to open the Waveform File Selection view:

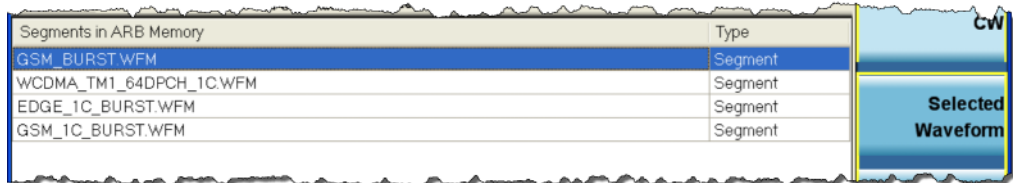

10. Select a waveform from the list of ARB files, using the mouse or up/down arrows and select the **Selected Waveform** key (If there are no waveforms in the list, just select **CW** from the Waveform menu).
  11. Press **More, More, Step Duration, Time, Duration Time**. The test set sets the duration of the current step to the time taken for the selected waveform to play. (If you chose CW in the last step select the **Time** key and set to 1 ms.) Press **Return** twice to return to the List Seq Setup menu.
  12. Leave the **Output Trigger** as is. Press **More**.
- Set **Current Step** to 2
  - Repeat Steps 1 to 12 above, changing the Channel number in step 7 to 2.

Now that the steps have been configured, you can turn on and start the sequence

- Press the **Source** front-panel key and set the **RF Output** key to **On**.
- Press the **Source** front-panel key, followed by **More, List Sequencer** keys.
- From the List Sequencer menu, set **Sequencer** to **On**.
- Press **Initiate Sequence** to allow the sequence to start when the next trigger arrives.



## Saving the sequence

To save the sequence you have set up using the front panel, use the **Save** front-panel key. Select the **Sequences** key and then select the type of sequence you are saving. For example, if you have only set up a source sequence, save the sequence as type: **Source Sequence**. Then select the **Save As...** key. In the **Save As** dialog box, enter the name of your file. The file is saved by default to the **My Documents\Sequences** directory on the **D:** drive of the test set. The file can be recalled in the future by using the **Recall** front-panel key menus which can be navigated in a similar way to the **Save** menus.

## Tab separated value file

A tab separated value (tsv) file can be used to store the settings associated with both analyzer and source sequences. There are two ways to generate the tsv file. You can set up the source and analyzer sequences using the front panel (see **"Front panel setup"** on page 79) and then save the sequence settings using the Save front panel front-panel key (see **"Saving the sequence"** on page 81). The values you have entered are saved into a tsv file. Alternatively, you can use a spreadsheet to generate a tsv file. The tsv file generated from the spreadsheet is then saved to the D-drive on the test set in My Documents\Sequences and can be used to set up the List Sequencers.

The tsv file generation can also be done remotely using SCPI commands.

This following section shows you how to enter data using a spreadsheet to quickly and easily generate a tsv file for use in the List Sequencer. A specially designed spreadsheet template is available on the Keysight web or simply use the guidelines below to make your own. You can take a copy of the spreadsheet template and enter values for the source parameters as required.

## Spreadsheet setup

Using a spreadsheet to enter data into the List Sequencer provides a quick and easy way to generate a tab separated file which is used directly on the test set to set up the source and/or analyzer List Sequencer.

An example of a spreadsheet is shown in the following table. The spreadsheet shows both the source and analyzer List Sequencer entries; this section describes the setup of the source parameters only.

### Sample spreadsheet

| #Step Number   | Step Trigger | Transition Time(ms) | Radio Band | Radio Band Link | Freq(MHz)Chan | Power(dBm) | Waveform   | Step Duration | Time(ms)Count | Output Trigger |
|----------------|--------------|---------------------|------------|-----------------|---------------|------------|------------|---------------|---------------|----------------|
| ### Source ### |              |                     |            |                 |               |            |            |               |               |                |
| 1              | INTernal     | 1                   | USCELL     | DOWN            | 722           | -55        | tw01.wfm   | TIME          | 4.62          | OFF            |
| 2              | INTernal     | 1.3                 | JAPAN      | DOWN            | 1058          | -35        | tw02.wfm   | COUNT         | 13            | OFF            |
| 3              | INTernal     | 1.3                 | PGSM       | DOWN            | 8             | -55        | twgsm1.bin | COUNT         | 20            | OFF            |

In order to generate a tab separated values file that can be used in the source List Sequencer, the spreadsheet layout should adhere to the following rules which can also be seen in the example in the table above

- All row entries should start in column 1 (left most column).
- All rows that start with a single # are treated as comment rows and are ignored by the List Sequencer.
- The first row is optional and contains the names of the source parameters. Precede this row with a # so that it is ignored by the List Sequencer.
- The start of the source List Sequencer information is a row with the 1st column entry having the string ### Source ###. See the table above.
- The next row contains the information for the first source Step; the first column should contain the number 1. The entries allowed in each column are listed in the following table.
- The following rows contain the information for successive Source Steps, with the number in column 1 incrementing in every row.

Allowed entries for source sequence spreadsheet

| Spreadsheet Column (Parameter) | Allowed Values  |
|--------------------------------|---|
| Step Number                    | (Sequential integers)   |
| Step Trigger                   | IMMEDIATE, INTERNAL, KEY, BUS, EXTERNAL2  |
| Transition Time                | (Time in ms)  |
| Radio Band                     | NONE PGSM EGSM RGSM DCS1800 PCS1900<br>GSM450 GSM480 GSM850 GSM700 TGSM810<br>BANDI BANDII BANDIII BANDIV BANDV BANDVI<br>BANDVII BANDVIII BANDIX BANDX BANDXI<br>BANDXII BANDXIII BANDXIV USCELL USPCS<br>JAPAN KOREAN NMT IMT2K UPPER SECOND<br>PAMR400 PAMR800 IMTEXT PCS1DOT9G AWS<br>US2DOT5G PUBLIC LOWER BAND1 BAND2<br>BAND3 BAND4 BAND5 BAND6 BAND7 BAND8<br>BAND9 BAND10 BAND11 BAND12 BAND13<br>BAND14 BAND17 BAND18 BAND19 BAND20<br>BAND21 BAND24 BAND25 BAND26 BAND27<br>BAND28 BAND31 BAND33 BAND34 BAND35<br>BAND36 BAND37 BAND38 BAND39 BAND40<br>BAND41 BAND42 BAND43 BAND44 BANDA<br>BANDB BANDC BANDD BANDE BANDF |
| Radio Band Link                | DOWN, UP  |
| Freq / Chan                    | Channel Number<br>(or frequency in MHz, if Radio Band = NONE)   |

## Allowed entries for source sequence spreadsheet

| Spreadsheet Column (Parameter) | Allowed Values                        |
|--------------------------------|---------------------------------------|
| Power                          | Power in dBm                          |
| Waveform                       | CW, <filename>, CONT, OFF             |
| Step Duration                  | TIME, COUNT, CONTInuous               |
| Time / Count                   | Time in ms, or count number (integer) |
| Output Trigger                 | ON, OFF                               |

**NOTE**

A fast way to populate a spreadsheet which has uniformly distributed values across multiple cells is to enter values in the first two cells in the spreadsheet, select the spreadsheet cells, click and hold the small square at the bottom right of the selection and pull the square across the rows or columns that you require. The parameters are incremented by the same amount as in the first two cells.

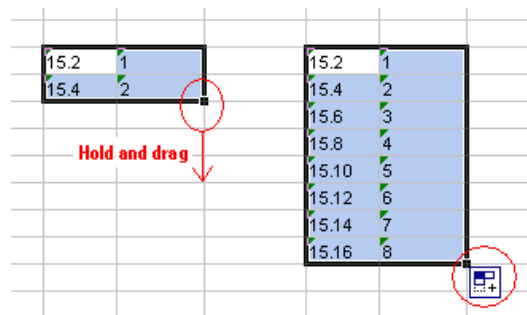

## TSV file generation

To save the spreadsheet as a tab separated value file select the file type in the **Save As** dialog box as Text (Tab delimited)(\*.txt). To use the tsv file on the test set, it should be placed in My Documents\Sequences directory on the D-drive of the test set.

Saving spreadsheet as tsv file

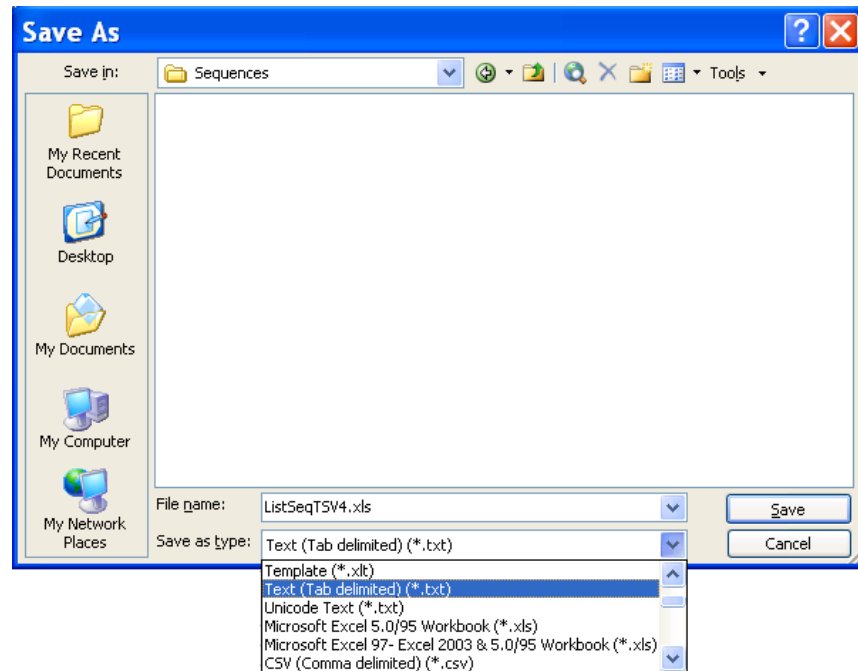

Loading a tsv file into the List Sequencer

When the tsv file is in the My Documents\Sequences directory on the test set it is imported into the List Sequencer using the **Recall** front-panel key menu.

- Press **Recall, Sequences**
- Select from **Source Sequence, Analyzer Sequence** or **Source and Analyzer Sequence**.
- Select **Open....**
- In the Open dialog box, select a Sequence file and select Open (see Figure Load tsv file below). The selected file is now ready for use in the List Sequencer.

Load tsv file

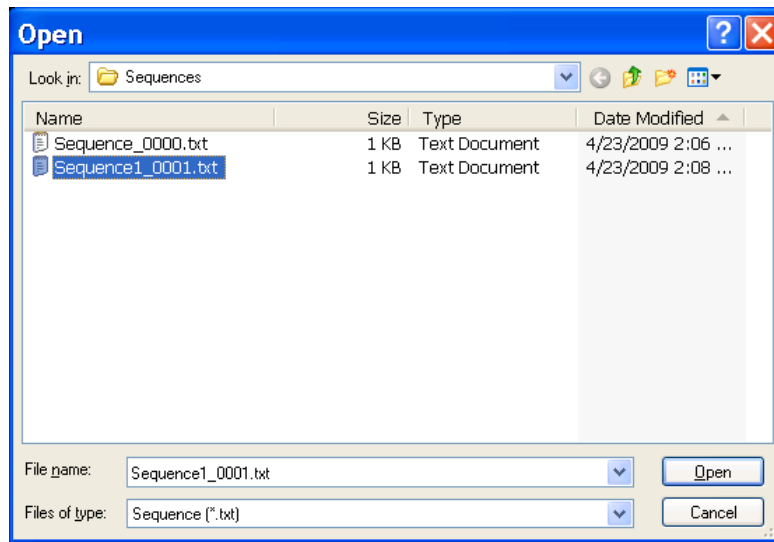

### Tab separated value file editing

The tab separated value (tsv) file which is used by the test set to set up the Sequence can be edited using a standard text editor. The tsv file is located in the test set on the D-drive at My Documents\Sequences. The default name of the file is Sequence\_XXXX.txt, where XXXX is a number that is automatically appended when the file is saved. It is easier to edit the tsv file if it is imported into a spreadsheet.

### Importing a tsv file into a spreadsheet

The tab separated value (tsv) file can be imported into a spreadsheet for ease of viewing and subsequent editing. To do this, open the spreadsheet and select **File, Open**. In the **Open** dialog box, change the **Files of type:** entry to **Text Files (\*.prn; \*.txt; \*.csv)**

## Spreadsheet Open dialog box

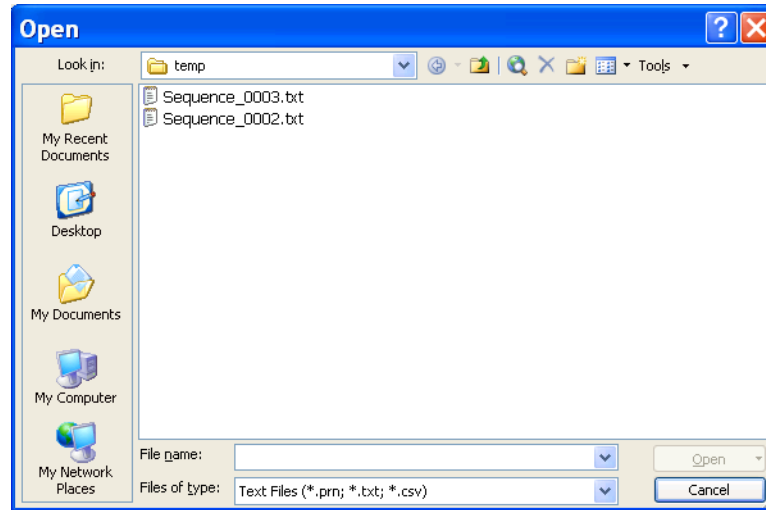

Select a .txt file to open and select **Open**. The **Text Import Wizard - Step 1 of 3** dialog box opens. The Text Wizard detects that the file is a tab separated values file and automatically selects the **Delimited** radio button. Select **Next >**. The **Delimiters** box should have **Tab** ticked. Select **Next >**. Select the **Column data format** as **General**. Select **Finish**.

You can edit the spreadsheet values as required and save the spreadsheet as a new tsv file for use in the Sequence Analyzer.

# 7

## Troubleshooting

This chapter identifies some checks you can make if the source in the test set is not operating as expected. For information about non-source related problems see the Getting Started Guide.

- **“Front panel lock-up”** on page 88
- **“RF Output”** on page 89
  - **“No RF Output**
  - **“Power Supply Shuts Down**
  - **“No Modulation at the RF Output**
  - **“RF Output Power too Low**
  - **“Distortion**
  - **“Signal Loss While Working with a Spectrum Analyzer**
  - **“Signal Loss While Working with a Mixer**
- **“Preset”** on page 93
  - **“The Source Does Not Respond**
- **“Error Messages”** on page 94
- **“Licenses”** on page 95
- **“Contacting Keysight Technologies”** on page 96

**NOTE** The E6650A test set has no instrument front-panel. Therefore, the PC mouse and monitor are required for instrument control through a virtual front panel (VFP). For ease in using the VFP, the PC keyboard is recommended. The instructions in this chapter for front-panel keys and softkeys apply to the VFP keys.

**NOTE** The instructions in this chapter for front-panel keys and softkeys apply to the VFP keys.

**NOTE** The instructions in this chapter for front-panel keys and softkeys apply to the VFP keys.

## Front panel lock-up

- Ensure that the test set is not in remote mode (the  $\mathbb{R}$  annunciator shows on the display). To exit remote mode and unlock the front panel, press **Local Cancel/(Esc)**.
- Ensure that the test set is not in local lockout, which prevents front panel operation. For information about local lockout, refer to the *Programming Guide*.
- If a progress bar appears on the test set display, an operation is in progress.
- Preset the source.
- Cycle power on the test set.



## RF Output

### No RF Output

- Check the **RF Output On/Off** key (Use **Source** front-panel key). If it is off, press the **RF Output On/Off** to turn the output on (selection is underlined).
- Ensure that the amplitude is set within the source range.
- If the test set is playing a waveform, ensure that marker polarity and routing settings are correct (see **“Saving Marker Polarity and Routing Settings”** on page 50).

### Power Supply Shuts Down

If the power supply does not work, it requires repair or replacement. If you are unable to service the test set, send the source to an Keysight service center for repair (see **“Contacting Keysight Technologies”** on page 96).

### No Modulation at the RF Output

Check the **Modulation On/Off** key, and ensure that it is on (**On** underlined). See also **“Modulating the Carrier Signal”** on page 22.

### RF Output Power too Low

- Check to see if the amplitude offset is set and if necessary, reset to 0 dB:  
Press the **Source** front-panel key followed by the **Amplitude** key. Set **Amptd Offset** to **0 dB**. See also **“Setting an Output Offset”** on page 31.

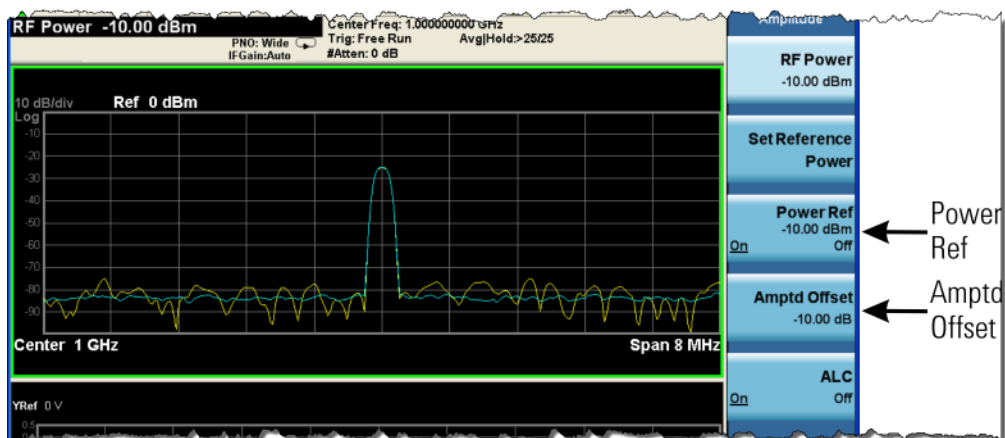

- Check to see if power reference is set and turned on and if necessary, turn off the reference mode:

1. Press the **Source** front-panel key followed by the **Amplitude** key. Press **Power Ref** to set to **Off**.
2. Reset the output power to the desired level.

See also **“Setting an Output Reference”** on page 31.

- If you are using the source with an external mixer, see **page 90**.
- If you are using the source with a spectrum analyzer, see **page 90**.
- If pulse modulation is on, turn off the ALC, and check that pulse width is within specifications.

## Distortion

If you edit and resave a segment in a waveform sequence, the sequence does not automatically update the RMS value stored in the waveform header. This can cause distortion on the output signal. Display the sequence header information and recalculate the RMS value (see **page 45**).

## Signal Loss While Working with a Spectrum Analyzer

The effects of reverse power can cause problems with the RF output when you use the source with a spectrum analyzer that does not have preselection. Use an unleveled operating mode (described on **page 30**).

A spectrum analyzer can have as much as +5 dBm LO feedthrough at its RF input port at some frequencies. If the frequency difference between the LO feedthrough and the RF carrier is less than the ALC bandwidth, the LO reverse power can amplitude modulate the test set RF output. The rate of the undesired AM equals the difference in frequency between the spectrum analyzer LO feedthrough and the source RF carrier.

Reverse power problems can be solved by using one of the unleveled operating modes.

See:

- **“ALC Off Mode”** on page 30

## Signal Loss While Working with a Mixer

To fix signal loss at the test set RF output during low-amplitude coupled operation with a mixer, add attenuation and increase the RF output amplitude.

The figure on the right shows a configuration in which the source provides a low amplitude signal to a mixer.

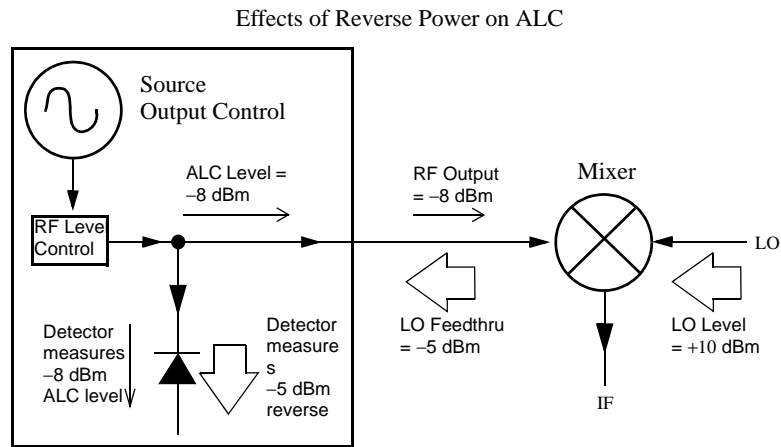

The internally leveled source RF output (and ALC level) is -8 dBm.

The mixer is driven with an LO of +10 dBm and has an LO-to-RF isolation of 15 dB. The resulting -5 dBm LO feedthrough enters the test set RF output connector and arrives at the internal detector.

Depending on frequency, it is possible for most of this LO feedthrough energy to enter the detector. Because the detector responds to its total input power regardless of frequency, this excess energy causes the ALC to reduce the RF output. In this example, the reverse power across the detector is actually greater than the ALC level, which can result in loss of signal at the RF output.

The solution at right shows a similar configuration with the addition of a 10 dB attenuator connected between the RF output of the source and the input of the mixer. The source ALC level increases to +2 dBm and transmits through a 10 dB attenuator to achieve the required -8 dBm amplitude at the mixer input.

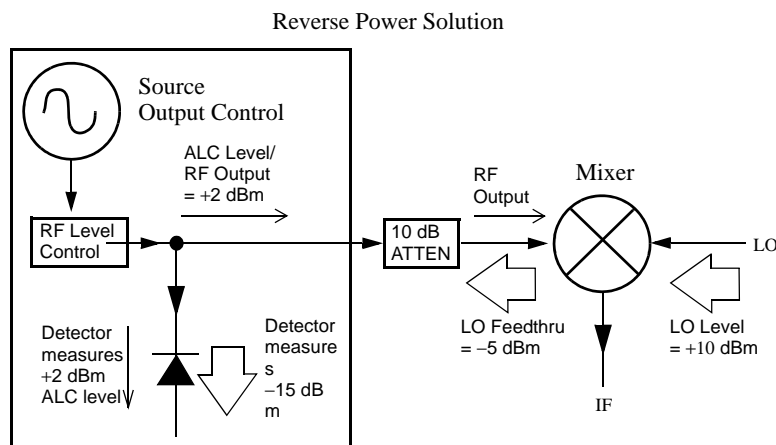

Compared to the original configuration, the ALC level is 10 dB higher while the attenuator reduces the LO feedthrough (and the source RF output) by 10 dB. Using the attenuated configuration, the detector is exposed to a +2 dBm desired signal versus the -15 dBm undesired LO feedthrough. This 17 dB difference between desired and undesired energy results in a maximum 0.1 dB shift in the source RF output level.

## Preset

### The Source Does Not Respond

If the test set does not respond to a preset, the test set may be in remote mode, which locks the keypad.

To exit remote mode and unlock the preset keys, press **Local Cancel/(Esc)**.

## Error Messages

A complete list of error messages is provided in PDF format on the test set (accessible from the Additional Documentation page of the online help) and also on the Keysight website ([www.keysight.com/find/e6650a](http://www.keysight.com/find/e6650a)).

## Licenses

### A time-based license stops working

- The test set time or date may have been reset forward causing the time-based license to expire.
- The test set time or date may have been reset backward more than approximately 25 hours, causing the test set to ignore time-based licenses.

### Cannot load a time-based license

The test set time or date may have been reset backward more than approximately 25 hours, causing the test set to ignore time-based licenses.

## Contacting Keysight Technologies

- assistance with test and measurements needs, and information on finding a local Keysight office:  
<http://www.Keysight.com/find/assist>
- accessories, documentation, or new firmware releases:  
[www.keysight.com/find/e6650a](http://www.keysight.com/find/e6650a)

If you do not have access to the Internet, please contact your field engineer.

**NOTE**

In any correspondence or telephone conversation, refer to the test set by its model number and full serial number. With this information, the Keysight representative can determine whether your unit is still within its warranty period.

---



# Glossary

## A

### Active Entry

The currently selected, and therefore editable, entry or parameter.

### ARB

Arbitrary waveform generator

### ARB memory

Baseband generator media. Volatile memory, where waveform files are played or edited.

## B

### BNC Connector

Bayonet Neill-Concelman connector. A type of RF connector used to terminate coaxial cable.

## C

### CCW

Counterclockwise

### C/N

Carrier-to-noise ratio

### CW

Continuous wave.

## D

### DHCP

Dynamic host communication protocol

### Dwell Time

In a sweep, the time that the signal is settled and you can make a measurement before the sweep moves to the next point.

## E

### EVM

Error vector magnitude; the magnitude of the vector difference at a given instant between the ideal reference signal and the measured signal.

## F

### Filter factor Alpha

The filter alpha coefficient. It is only valid for root nyquist and nyquist filters.

### Filter Factor BbT

The filter bandwidth-bit-time (BbT). It is only valid for a Gaussian filter (similar to alpha). BbT is defined by the GSM standard as 0.3 and by the DECT standard as 0.5.

Front-panel key (Hardkey)

A labeled button on the test set.

## G

### Gaussian filter

The Gaussian filter does not have a zero Inter-Symbol Interference (ISI). Wireless system architects must decide just how much of the ISI can be tolerated in a system and combine that with noise and interference. The Gaussian filter is gaussian shaped in both the time and frequency domains, and it does not ring like the root nyquist filters do. The effects of this filter in the time domain are relatively short and each symbol interacts significantly (or causes ISI) with only the preceding and succeeding symbols. This reduces the tendency for particular sequences of symbols to interact, which makes amplifiers easier to build and more efficient.

### GPIB

General purpose interface bus. An 8-bit parallel bus common on test equipment.

## H

Hardkey (Front-panel key)

A labeled button on the test set.

|  |   |   |
|--|---|---|
| I  | That which survives a power cycle (such as files stored in USB media).  | Also referred to as a Root cosine filter. These filters have the property that their impulse response rings at the symbol rate. Adjacent symbols do not interfere with each other at the symbol times because the response equals zero at all symbol times except the center (desired) one. Root nyquist filters heavily filter the signal without blurring the symbols together at the symbol times. This is important for transmitting information without errors caused by ISI. Note that ISI does exist at all times except the symbol (decision) times. A cascade of two of these filters has the transfer function of a Nyquist filter. One is in the transmitter, the other in the receiver, so that the system taken as a whole has the zero-ISI properties of an ISI filter. |
| IF   |   |   |
| Intermediate frequency   | Nyquist filter  |   |
| Int Media  | Also referred to as a cosine filter. These filters have the property that their impulse response rings at the symbol rate. Adjacent symbols do not interfere with each other at the symbol times because the response equals zero at all symbol times except the center (desired) one.  |   |
| Internal media. Non-volatile Source memory, where waveform files are stored.                         |   |   |
| IP   |   |   |
| Internet protocol. The network layer for the TCP/IP protocol suite widely used on Ethernet networks. |   |   |
| L  | P   |   |
| LAN  | Persistent  |   |
| Local area network   | That which is unaffected by preset, user preset, or power cycle.  |   |
| M  | R   |   |
| Modulation Format  | Rectangular filter  | RMS   |
| Custom modulation, Two Tone, or Multitone.   | Also referred to as a ideal low pass filter. These filters have very steep cut-off characteristics. The pass band is set to equal the symbol rate of the signal. Due to a finite number of coefficients, the filter has a predefined length and is not truly "ideal". The resulting ripple in the cut-off band is effectively minimized with a Hamming window. This filter is recommended for achieving optimal ACP. A symbol length of 32 or greater is recommended for this filter. | Root mean square. A time-varying signal effective value (the equivalent DC voltage required to generate the equivalent heat across a given resistor). For a sinewave, $RMS = 0.707 \times \text{peak value}$ .  |
| Modulation Mode  |   |   |
| Dual ARB, Custom modulation, Two Tone, or Multitone.   |   |   |
| Modulation Standard  |   |   |
| Refers to a Cellular standard format (i.e. NADC, PDC, PHS, etc.).                                    |   |   |
| Modulation Type  |   | S   |
| Refers to the various I/Q constellation types (i.e. PSK, MSK, FSK, C4FM, etc.)                       |   | key   |
| N  | Root Nyquist filter   | A button located along the test set display that performs whatever function is shown next to it on that display.  |
| Non-volatile   |   | T   |
|  |   | TCP   |



Transmission control protocol.  
The most common transport layer protocol used on Ethernet and the Internet.

Terminator

A unit indicator (such as Hz or dBm) that completes an entry. For example, for the entry 100 Hz, *Hz* is the terminator.

Type-N Connector

Threaded RF connector used to join coaxial cables.

U

USB

Universal serial bus. See also <http://www.usb.org>

V

Volatile

That which does not survive a power cycle (such as files stored in ARB memory).