

**Revision 1.00**

**Apr-21, 2014**

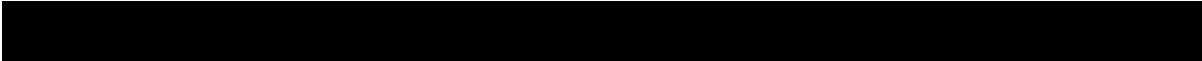

**10GBASE-KR/40GBASE-KR4  
Agilent Method of Implementation (MOI) for  
10GBASE-KR/40GBASE-KR4 Backplane Ethernet  
Transmitter/Receiver Using Agilent E5071C ENA Option  
TDR**

## **Table of Contents**

1.	Revision History .....	3
2.	Purpose .....	3
3.	References .....	3
4.	Required Equipment .....	3
5.	Test Procedure .....	4
5.1.	Outline of Test Procedure .....	4
5.2.	Instrument Setup .....	6
5.2.1.	Recalling a State File .....	6
5.2.2.	Saving a State File .....	7
5.3.	Calibration .....	8
5.3.1.	Frequency Domain Calibration .....	8
5.4.	Measurement .....	10
5.4.1.	Differential Output Return Loss (Tx) .....	10
5.4.2.	Common-mode Output Return Loss (Tx) .....	11
5.4.3.	Differential Input Return Loss (Rx) .....	12
6.	[Appendix] Manual Setup .....	14
6.1.	Channel & Trace Setup .....	14
6.2.	Differential Output/Input Return Loss (Tx/Rx) .....	15
6.3.	Common-mode Output Return Loss (Tx) .....	15
6.4.	Defining Limit Line Tables .....	16

## **1. Revision History**

<b>Revision</b>	<b>Comments</b>	<b>Issue Date</b>
1.00	Initial Revision.	Apr-21, 2014

## **2. Purpose**

This test procedure was written to explain how to use the Agilent ENA Option TDR to make the 10GBASE-KR/40GBASE-KR4 Backplane Ethernet transmitter/receiver (Tx/Rx) measurements.

## **3. References**

- IEEE 802.3-2012 Section 5 (Jun. 2013)
- UNH-IOL Clause 72 10GBASE-KR PMD Test Suite Version 1.1

## **4. Required Equipment**

1. E5071C ENA Series Network Analyzer
  - Option 280/285/480/485/2D5/4D5/2K5/4K5 (one of port/freq. options)
  - Option TDR (Enhanced time domain analysis)
2. Test Fixture
  - n/a
3. 2/4-port ECal Module
  - N4431B (for E5071C-280/285/480/485)
  - N4433A (for E5071C-2D5/4D5/2K5/4K5)
4. Coaxial RF cables
5. 50 Ohm terminators (if required)

## 5. Test Procedure

### 5.1. Outline of Test Procedure

#### 1. Instrument Setup

- Automatic setup by recalling a state file or manual setup.

#### 2. Calibration

- ECal Calibration

#### 3. Measurements

##### 4-1. Time-domain Measurements

- n/a

##### 4-2. Frequency-domain Measurements

- Differential Output Return Loss (Tx)
- Common-mode Output Return Loss (Tx)
- Differential Input Return Loss (Rx)

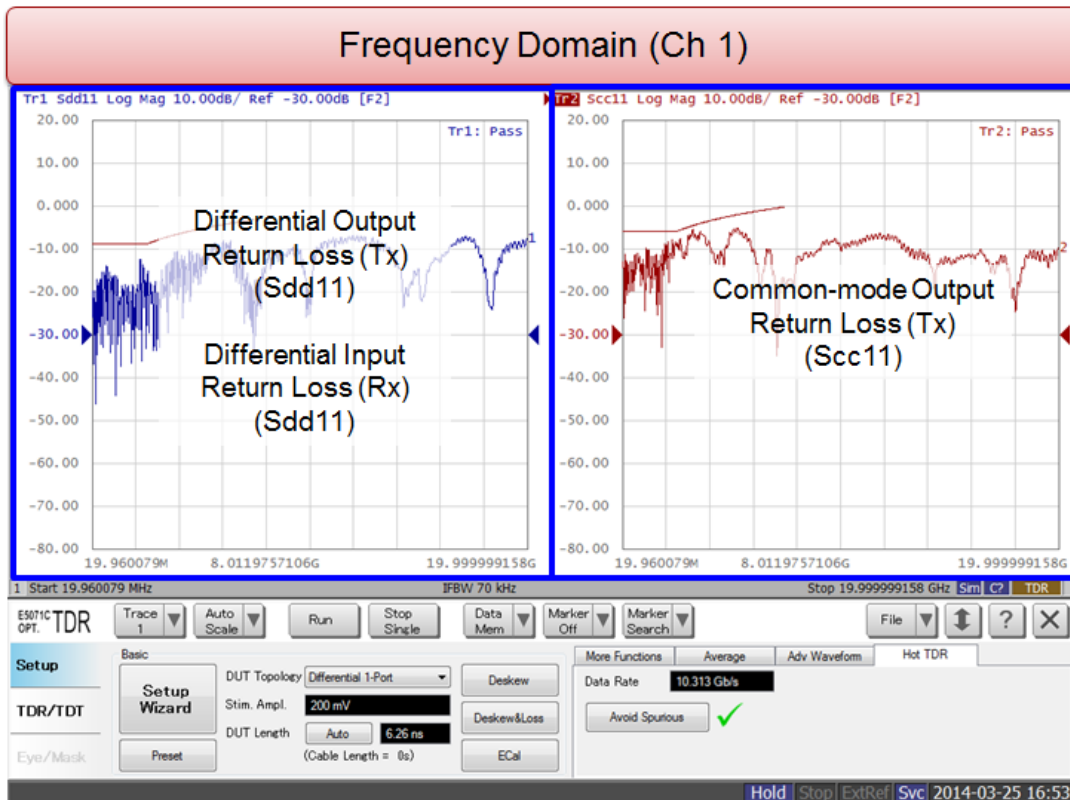

## *Agilent MOI for 10GBASE-KR/40GBASE-KR4 Tx/Rx Tests*

Note: Hard Keys (Keys on the E5071C's front panel) are displayed in **Blue color** and **Bold**. (Example: **Avg, Analysis**)

Note: Soft keys (Keys on the E5071C's screen) are displayed in **Bold**. (Example: **S11, Real, Transform**)

Note: Buttons of the TDR software are displayed in **Green color** and **Bold**. (Example: **Trace, Rise Time**)

Note: Tabs of the TDR software are displayed in **Brown color** and **Bold**. (Example: **Setup, Trace Control**)

## Agilent MOI for 10GBASE-KR/40GBASE-KR4 Tx/Rx Tests

### 5.2. Instrument Setup

#### 5.2.1. Recalling a State File

This section describes how to recall a state file of the E5071C that includes all the measurement settings for 10GBASE-KR/40GBASE-KR4 backplane Ethernet Tx/Rx tests.

The state file can be downloaded at: [www.agilent.com/find/ena-tdr\\_ethernet-txrx](http://www.agilent.com/find/ena-tdr_ethernet-txrx)

Copy the state file into the E5071C's directory via USB mass storage device and recall the state file using the TDR software. Necessary parameters for testing are automatically set up in the E5071C. Refer to Appendix for the details about manual setup.

If TDR setup wizard is shown, click **Close** button in the TDR setup wizard main window.

1. Open **Setup** tab.
2. Click **Advanced Mode** to show the dialog box.

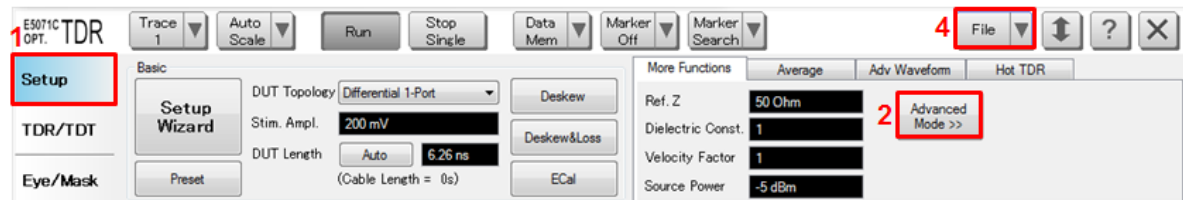

3. A dialog box appears requesting for confirmation. Then click **Yes**. (Uncheck “Use Advanced Calibration Methods”)

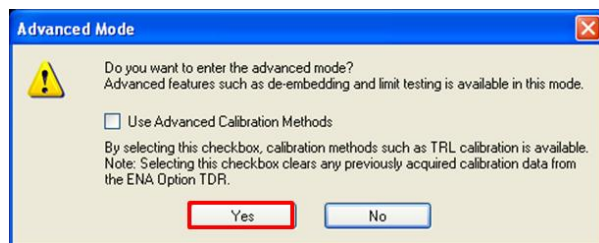

4. Click **File** and select **Recall State** to open the Recall State dialog box.
5. Specify a folder and a file name, and click **Open**.

The E5071C's channel 1 is used for frequency domain measurements by using the TDR software at the bottom of the E5071C's screen.

## Agilent MOI for 10GBASE-KR/40GBASE-KR4 Tx/Rx Tests

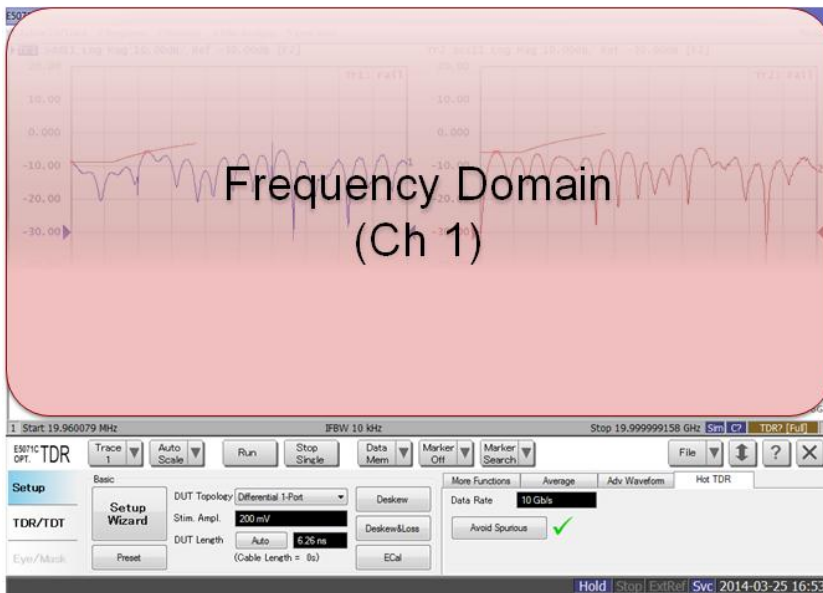

### 5.2.2. Saving a State File

All the measurement settings including calibration information can be saved in a state file (\*.tdr). After performing calibration, all necessary calibration coefficients are saved in a state file and can be recalled for the next measurements.

1. Press **Save/Recall** > **Save Type** and select **State & Cal** as a state file type.
2. Click **File** of the TDR software.

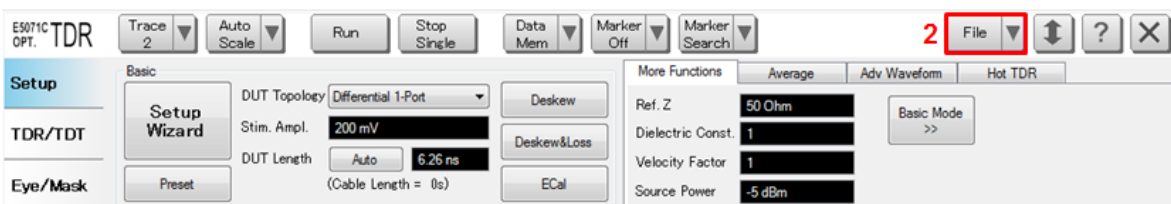

3. Select “Save State”.
4. Enter file name and save the state file with calibration information

### 5.3. Calibration

#### 5.3.1. Frequency Domain Calibration

The purpose of this step is to calibrate the delay and loss of the RF cables and test fixtures by following the wizard of the E5071C TDR software. Full calibration is performed by using the ECal Module at the end of RF cables connected to the E5071C's test ports. After connecting the test fixture to the cables, the effect of the fixture can be removed by the fixture compensation function of the TDR software if required.

##### 5.3.1.1. ECal Calibration & Fixture Compensation

Calibration for frequency domain measurements is performed by the TDR software. The ECal Module (i.e. N4431B/N4433A) connected to the USB port of the E5071C is necessary for the calibration procedure.

1. Open **Setup** tab of the TDR software.
2. Click **ECal** to launch calibration wizard.

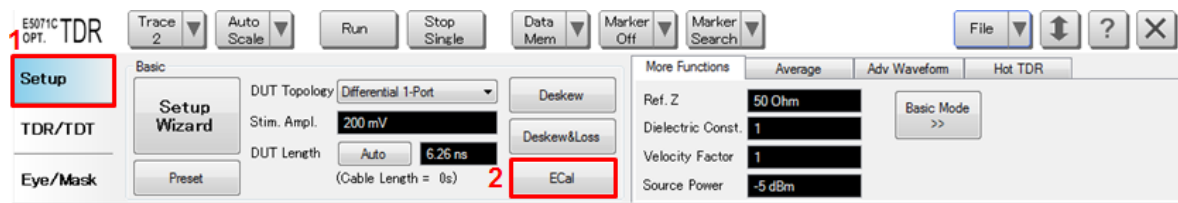

3. Connect all test cables to the ECal Module and click **Calibrate**. Once green check mark appears, click **Next>**.



## Agilent MOI for 10GBASE-KR/40GBASE-KR4 Tx/Rx Tests

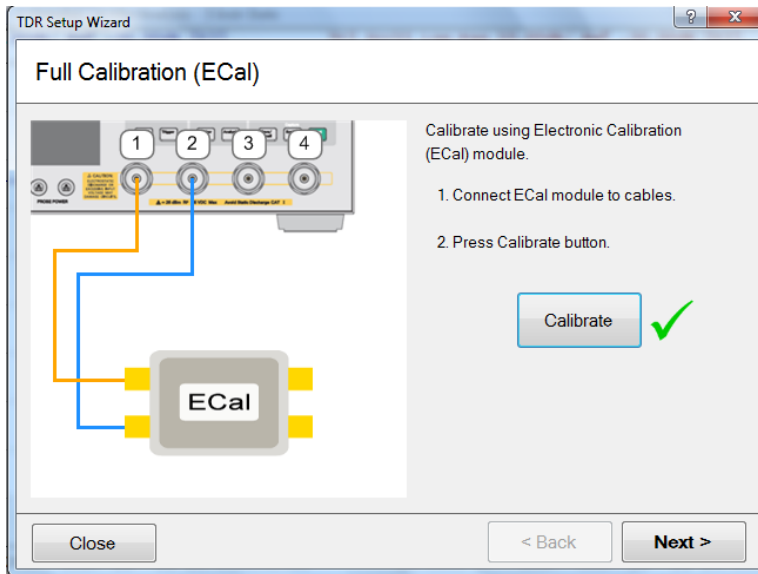

4. If it is not required to perform the fixture compensation, click **Finish**. If required to compensate the fixture effects, disconnect the ECal Module and connect the test fixtures to the RF cables. Click **Fixture Comp** to perform fixture compensation. Once green check mark appears, click **Finish** to complete the compensation.

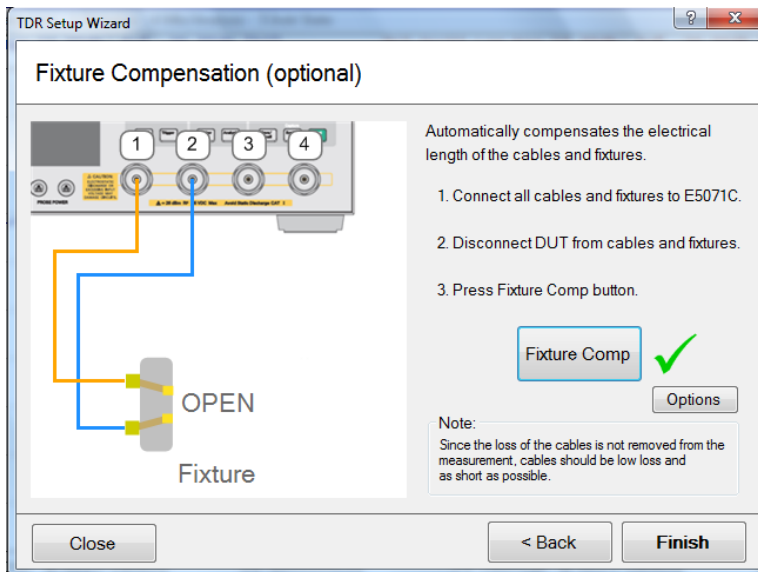

## 5.4. Measurement

The procedures for frequency-domain measurements are introduced in this section.

### 5.4.1. Differential Output Return Loss (Tx)

1. Configure the DUT so that it is sourcing normal IDLE signaling such as PRBS 31, 1010 data patterns. 1010 periodical data pattern is recommended to be used as the worst case measurement condition.
2. Connect the DUT's transmitter to the E5071C with the RF cables (Figure 5-1).

E5071C	Port 1	Port 2
Test Point	TP1 +	TP1 -

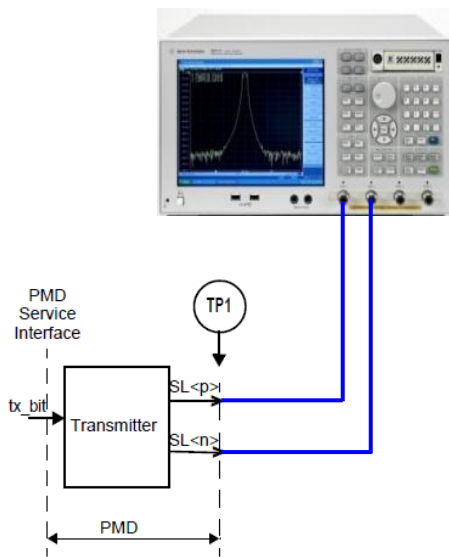

**Figure 5-1 Differential/Common-mode Output Return Loss (Tx) Test Setup**

Note: Unused fixture ports should be terminated with 50 ohm terminators if required.

3. Select **Trace 1** (Sdd11).
4. Open **Setup** tab.
5. Open **Hot TDR** tab.
6. Click **Data Rate** and set “10.3125 Gb/s” in a dialog box.
7. Click **Avoid Spurious**. Click **OK** in a dialog box.

## Agilent MOI for 10GBASE-KR/40GBASE-KR4 Tx/Rx Tests

8. Click **Stop Single**.



9. Left-click and hold the mouse button then drag the area you would like to zoom and release the mouse button.

10. Click **Display Zoom**.

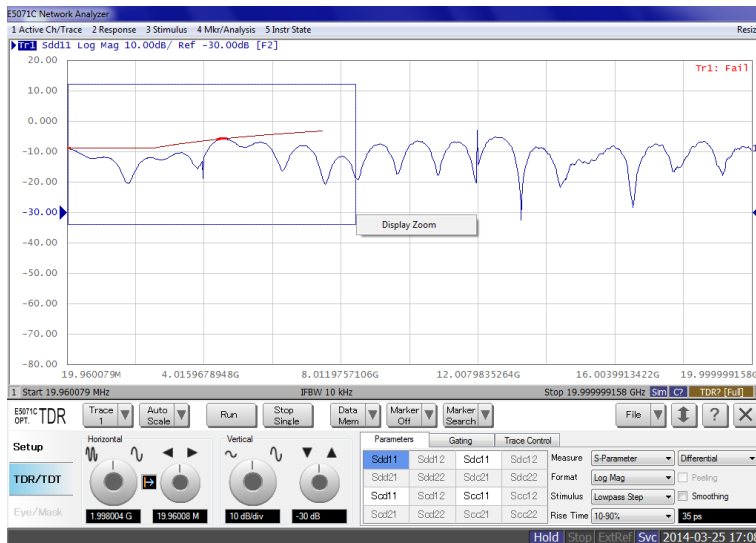

11. Confirm the measured differential output return loss meets the limit shown below.

$$ReturnLoss(f) \geq 9$$

$$\text{for } 50 \text{ MHz} \leq f < 2500 \text{ MHz}$$

$$ReturnLoss(f) \geq 9 - 12 \log_{10} \left( \frac{f}{2500 \text{ MHz}} \right)$$

$$\text{for } 2500 \text{ MHz} \leq f \leq 7500 \text{ MHz}$$

### 5.4.2. Common-mode Output Return Loss (Tx)

1. Select **Trace 2** (Scc21).
2. Click **Stop Single**.

## Agilent MOI for 10GBASE-KR/40GBASE-KR4 Tx/Rx Tests

3. Left-click and hold the mouse button then drag the area you would like to zoom and release the mouse button.
4. Click **Display Zoom**.
5. Confirm the measured common-mode output return loss meets the limit shown below.

$$ReturnLoss(f) \geq 6$$

$$\text{for } 50 \text{ MHz} \leq f < 2500 \text{ MHz}$$

$$ReturnLoss(f) \geq 6 - 12 \log_{10} \left( \frac{f}{2500 \text{ MHz}} \right)$$

$$\text{for } 2500 \text{ MHz} \leq f \leq 7500 \text{ MHz}$$

### 5.4.3. Differential Input Return Loss (Rx)

1. Connect the DUT's receiver to the E5071C with the RF cables (Figure 5-2).

E5071C	Port 1	Port 2
Test Point	TP4 +	TP4 -

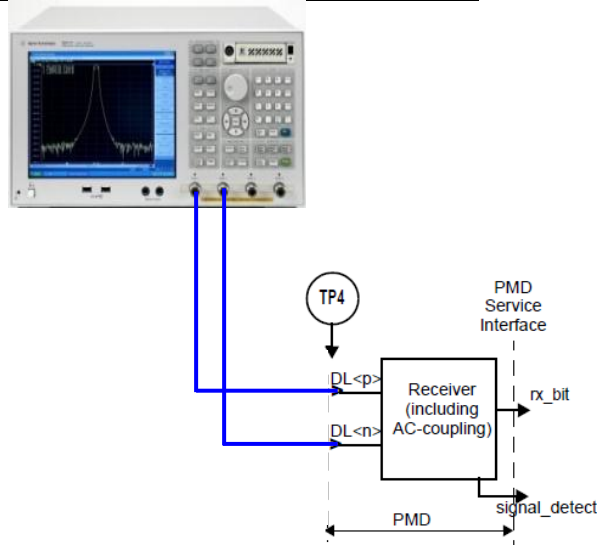

**Figure 5-2 Differential Input Return Loss (Rx) Test Setup**

Note: Unused fixture ports should be terminated with 50 ohm terminators if required.

## Agilent MOI for 10GBASE-KR/40GBASE-KR4 Tx/Rx Tests

2. Select **Trace 1** (Sdd11).
3. Click **Stop Single**.
4. Left-click and hold the mouse button then drag the area you would like to zoom and release the mouse button.
5. Click **Display Zoom**.
6. Confirm the measured differential input return loss meets the limit shown below.

$$\text{ReturnLoss}(f) \geq 9$$

$$\text{for } 50 \text{ MHz} \leq f < 2500 \text{ MHz}$$

$$\text{ReturnLoss}(f) \geq 9 - 12 \log_{10} \left( \frac{f}{2500 \text{ MHz}} \right)$$

$$\text{for } 2500 \text{ MHz} \leq f \leq 7500 \text{ MHz}$$

## 6. [Appendix] Manual Setup

The procedures of manual setup for frequency-domain measurements are introduced in the section. All the following parameters are saved in the E5071C's state file, which is available at: [www.agilent.com/find/ena-tdr\\_ethernet-txrx](http://www.agilent.com/find/ena-tdr_ethernet-txrx)

### 6.1. Channel & Trace Setup

If TDR setup wizard is shown when launching the TDR software, click **Close** button in the TDR setup wizard main window.

1. Open **Setup** tab in the TDR software.
2. Click **Preset** to preset the instrument. Click **OK** in a dialog box to continue.
3. Set **DUT Topology** to “Differential 1-Port”. Click **OK** in a dialog box.
4. Click **Advanced Mode >>**.

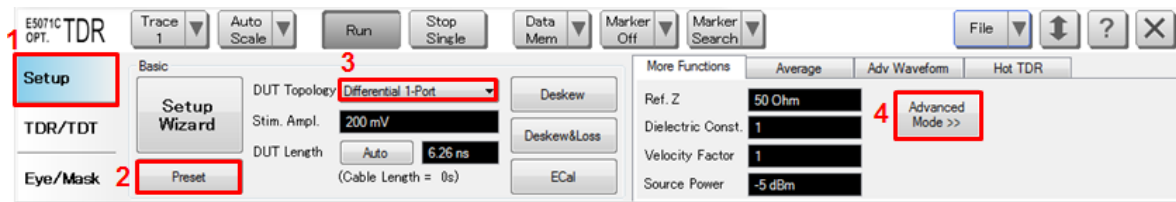

5. A dialog box appears requesting for confirmation. Then click **Yes** (Clear the check box for “Use Advanced Calibration Methods”).

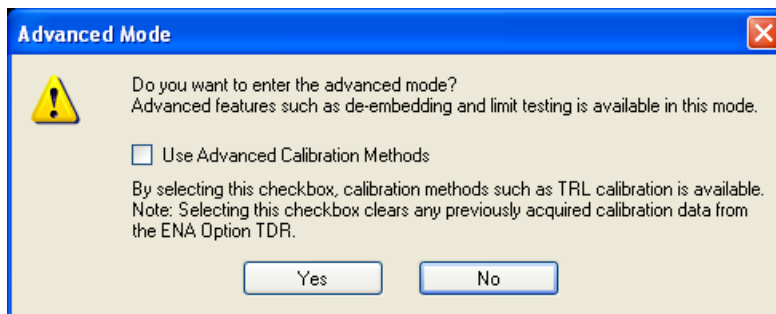

6. Click **Stop Single**.
7. Press **Display** > **Num of Traces** > 2.
8. Press **Display** > **Allocate Traces** > x2 (1 column by 2 rows).

## Agilent MOI for 10GBASE-KR/40GBASE-KR4 Tx/Rx Tests

### 6.2. Differential Output/Input Return Loss (Tx/Rx)

1. Select **Trace 1**.
2. Open **TDR/TDT** tab.
3. Open **Parameters** tab.
4. Select “S-Parameter” and “Differential” for Measure.
5. Select Format to “Log Mag”
6. Click **Sdd11**.
7. Click the box below the left knob under Vertical. Set the vertical scale to “10 dB/div” in a dialog box.
8. Click the box below the right knob under Vertical. Set the vertical position to “-30 dB” in a dialog box.

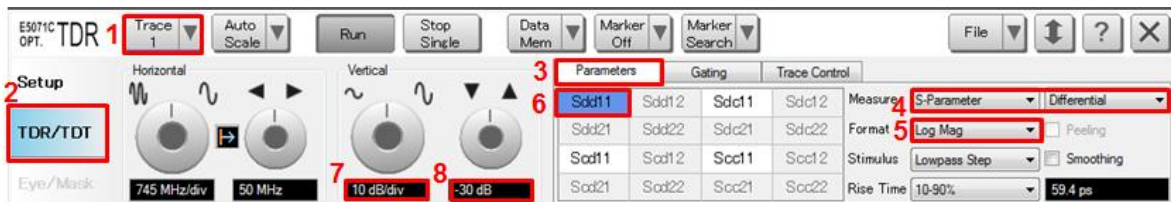

### 6.3. Common-mode Output Return Loss (Tx)

9. Select **Trace 2**.
10. Open **TDR/TDT** tab.
11. Open **Parameters** tab.
12. Select “S-Parameter” and “Differential” for Measure.
13. Select Format to “Log Mag”
14. Click **Scc11**.
15. Click the box below the left knob under Vertical. Set the vertical scale to “10 dB/div” in a dialog box.
16. Click the box below the right knob under Vertical. Set the vertical position to “-30 dB” in a dialog box.

#### 6.4. Defining Limit Line Tables

1. Press **Trace Next** to select trace to set the limit line table.
2. Press **Analysis > Limit Test > Limit Line** and turn it **ON** to display limit lines.
3. Press **Analysis > Limit Test > Edit Limit Line** to edit the limit line table.

	Type	Begin Stimulus	End Stimulus	Begin Response	End Response
1	MAX	0 s	600 ps	105 u	105 u
2	MIN	0 s	600 ps	75 u	75 u
3					

4. Press **Analysis > Limit Test > Limit Test** and turn it **ON**.
5. Press **Analysis > Limit Test > Limit Test > Fail Sign** to switch the fail sign ON/OFF.  
When turned on, the Fail sign is displayed on the E5071C's screen, if one or more failed traces are within the channel.
6. Press **System > Misc Setup > Beeper > Beep Warning** to turn ON/OFF the warning beeper.