

Keysight Technologies  
Impedance and Network Analysis

Catalog

# Introduction

You face increasing technical and operational complexity. Keysight Technologies, Inc. measurement and application expertise helps you anticipate these growing complexities.

Keysight impedance analyzers, LCR meters and ENA series network analyzers support various applications for impedance and network analysis. This catalog provides the information of unique and new solutions that we cannot tell all in product brochures. Please find the solution that fits your case or helps your similar test challenge in this catalog, and contact Keysight to accelerate your business.

## Table of Contents

Circuit measurement	
DC-DC converter and Power Distribution Network (PDN) measurements.....	4
PSRR in Linear Regulator/Low Dropout (LDO) Regulator.....	5
OP amp circuit measurements.....	6
RFID tag measurements.....	7
Wireless power transmission measurement and simulation.....	8
In-circuit impedance measurements (grounded measurements).....	9
Component measurement	
Passive intermodulation (PIM) measurement.....	10
Cable and connector assembly test for USB, HDMI, SATA and DisplayPort.....	11
Tx (source) and Rx (receiver) test for SATA and MIPI.....	12
Device characterization for PCB quality control.....	13
Automotive ethernet test and debug.....	14
Automotive antenna test.....	15
RF amplifier measurements.....	16
High-gain amplifier measurements with low power signal.....	17
Pulsed S-parameter measurements.....	18
RF coaxial cable measurements.....	19
LAN/telecom cable measurements.....	20
High-rejection filter measurements.....	21
Capacitance characteristics of liquid crystal cell.....	22
MEMS/NEMS device modeling, failure analysis and process control.....	23
EMC component measurement under actual operating conditions.....	24
Production test for inductor, EMI filter, capacitor and register.....	25
On-chip device measurements with probing system.....	26
Mixer and converter measurement.....	27
Multiport device measurement (up to 40-port).....	28

## Table of Contents (continued)

On-wafer measurement	
On-wafer C-V characterization of MOS device.....	29
On-wafer device characterization from low frequency to microwave.....	30
Material measurement	
Solid and liquid material measurements with test fixtures.....	31
RF material measurements using dielectric probe.....	32
Phantom material evaluation for Specific Absorption Rate (SAR) test.....	33
Permittivity measurements of PCB and substrate materials.....	34
Quality evaluation of foods by dielectric measurement.....	35
General purpose	
Component impedance and S-parameters measurement.....	36
Component impedance measurements (most accurate over broad impedance range).....	37
Temperature characteristic evaluations of RF components and materials.....	38
Appendix	
1. Product based application list.....	39
2. Product replacement guide.....	41

## DC-DC Converter and Power Distribution Network (PDN) Measurements

### Abstract

The E5061B-3L5 LF-RF network analyzer (5 Hz to 3 GHz) with the option 005 impedance analysis function is a comprehensive solution for evaluating frequency-domain characteristics of DC-DC converters (switching voltage regulators) and subsequent PCB power planes (PDNs: Power Distribution Networks) which distribute the converter's DC output power to load devices such as LSIs and other electronic devices.

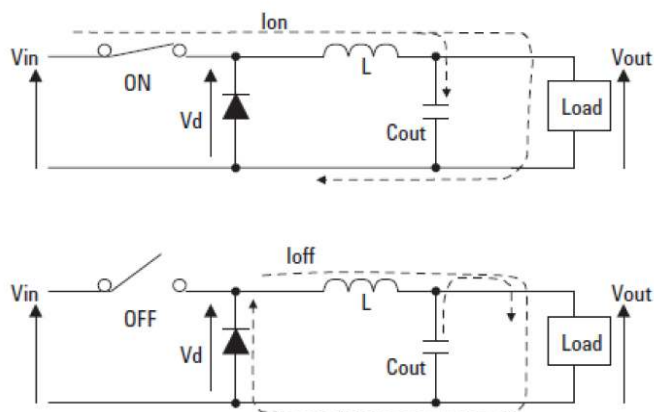

### Test challenges

- Loop gain measurements by appropriately injecting the analyzer's source signal.
- Milliohm impedance measurements of DC-DC converters, bypass capacitors, and PCB power planes.
- Low frequency coverage down to 10 or 100 Hz is necessary for DC-DC converter measurements. In addition, to
- evaluate the PDNs for high-speed LSIs, high frequency coverage up to the GHz range is needed.

### How to solve

- The E5061B-3L5's gain-phase test port with built-in 1 Mohm inputs (5 Hz to 30 MHz) enables you to perform in-circuit probing for the loop gain measurements easily. Also, injection transformers supplied by picotest ensures reliable source signal injection to the loop (recommendation: Picotest J2110A).
- The shunt-thru measurement method supported by the E5061B-3L5/005 provides accurate milliohm impedance measurements.
- The E5061B-3L5's broad frequency range of 5 Hz to 3 GHz (at S-parameter test port) fully covers required test frequencies for DC-DC converters, bypass capacitors, and PDNs.

### Customer type

R&D, education

### Product & web resources

E5061B-3L5 LF-RF network analyzer with Option 005 [www.keysight.com/find/e5061b](http://www.keysight.com/find/e5061b)

### Reference

Application note: *Evaluating DC-DC converters and PDN with the E5061B LF-RF network analyzer (5990-5902EN)*

Tech paper: *Accuracy improvements of PDN Z measurements in the low to middle freq range*

Test accessories info (including picotest's transformers): *E5061B network analyzer configuration guide (5990-4391EN)*

Picotest's injectors homepage: [https://www.picotest.com/products\\_injectors.html](https://www.picotest.com/products_injectors.html)

## PSRR in Linear Regulator/Low Dropout (LDO) Regulator

### Abstract

The combination of the E5061B-3L5 LF-RF network analyzer (5 Hz to 3 GHz) and the picotest J2120A line injector offers DC current biased gain-phase measurements from the low frequency range. This enables PSRR measurements of linear regulators/LDOs (low dropout regulators), and PMICs (power management ICs) for mobile phones.



### Test challenges

- Combining the analyzer's AC source signal with the DC current of more than 1 Adc, which is necessary for linear regulators/LDOs but cannot be covered by the E5061B-3L5's built-in DC bias source (up to 100 mAdc).
- Measuring high rejections (high attenuations) of more than 80 dB in the low frequency range, which was difficult with the traditional LF VNAs due to the ground loop error caused by the grounded receivers.

### How to solve

- The picotest J2120A line injector (10 Hz to 10 MHz, up to 50 Vdc/5 Adc) enables you to combine the analyzer's AC source signal with an external DC current easily up to 5 Adc.
- The semi-floating receivers of the E5061B-3L5's gain-phase test port (5 Hz to 30 MHz) enables high-attenuation measurements in the low frequency range accurately, eliminating the measurement error associated with the ground loop.

### Customer type

R&D, education

### Product & web resources

E5061B-3L5 LF-RF network analyzer—[www.keysight.com/find/e5061b](http://www.keysight.com/find/e5061b)

### Reference

Test accessories info (including picotest's injectors): *E5061B network analyzer configuration guide (5990-4391EN)*  
Application Note: *Measuring frequency response with the Keysight E5061B LF-RF network analyzer (5990-5578EN)*  
(about the E5061B-3L5's semi-floating receivers)

Picotest's injectors web site: [https://www.picotest.com/products\\_injectors.html](https://www.picotest.com/products_injectors.html)

Picotest's application note: *Measuring the PSRR of voltage references (need registration)*

## OP Amp Circuit Measurements

### Abstract

OP amp circuits are widely used for low-frequency analog signal conditioning of sensor systems, such as ultrasound sensors. Evaluating their frequency responses such as the gain/phase response and CMRR is essential for ensuring the system's reliable operations. The E5061B-3L5 LF-RF network analyzer (5 Hz to 3 GHz) provides easy and accurate measurement solutions for evaluating OP amp circuits.



### Test challenges

- Choosing an appropriate high-impedance probing method, depending on the requirements of the dynamic range, frequency range, and the maximum allowable input capacitance ( $C_{in}$ ).
- DC-biased measurement from the low frequency range is needed in some cases.
- Measuring high rejections (high attenuations) of more than 90 dB for evaluating CMRR and PSRR, which was difficult with the traditional LF VNAs due to the ground loop error caused by the grounded receivers.

### How to solve

- The E5061B-3L5 offers the gain-phase test port with built-in 1 Mohm inputs (5 Hz to 30 MHz,  $C_{in}$ : depend on the test cable/probe), and the S-parameter test port with the 41800A active probe (5 Hz to 500 MHz,  $C_{in}=3$  pF), and you can choose a suitable probing method for your applications.
- The E5061B-3L5 has the built-in DC bias source (up to 40 Vdc, max 100 mAdc) and you can easily perform DC-biased gain-phase measurements, without making an external DC bias circuit,
- The semi-floating receivers of the E5061B-3L5's gain-phase test port provides accurate high-attenuation measurements in the low frequency range, eliminating the measurement error associated with the ground loop.

If you also want to evaluate impedance characteristics of sensor elements, such as ultrasound resonators and antenna coils, the E5061B-005 impedance analysis function is the solution. See "Component impedance measurements in general R&D" in the next page.

### Customer type

R&D, education

### Product & web resources

E5061B-3L5 LF-RF network analyzer      [www.keysight.com/find/e5061b](http://www.keysight.com/find/e5061b)

### Reference

Application note: *Measuring frequency response with the Keysight E5061B LF-RF network analyzer (5990-5578EN)*

## RFID Tag Measurements

### Abstract

For component level measurements, the 4294A impedance analyzer or E5061B-3L5 LF-RF network analyzer with option 005 impedance analysis function is an optimum choice for measuring the electrical characteristics of basic components of L, C, and R make up an RFID tags. For evaluating packaged RFID tags, ENA series network analyzer allows you to measure the resonant frequency of an RFID tag with a loop antenna.

### Test challenges

- Need to measure component parts on RFID tags to improve the yield and the communication performance of completed RFID tags.
- Need to evaluate packaged RFID tag.
- Need to evaluate the resonance characteristics that often change depending on the RF power transmitted from the loop antenna. In some cases, it is desired that the network analyzer can provide high source power level up to nearly +20 dBm.

### How to solve

- The 4294A impedance analyzer or E5061B-3L5 LF-RF network analyzer with Option 005 impedance analysis function is an optimum choice for measuring the characteristics of L and C component parts (loop antenna, card material and external chip capacitor).
- Not only for L and C measurement, the 4294A or E5061B-3L5 with Option 005 is the optimum solution to measure the resonance characteristics of the completed tag in its entirety, and measure the resistance values on a part by part basis.
- The ENA series network analyzer provides the non-contact measuring method with loop antennas and helps you to measure the resonant frequencies of packaged RFID tags.
- The E5072A network analyzer is an optimum choice when high source power up to nearly +20 dBm is desired for the non-contact measurements.

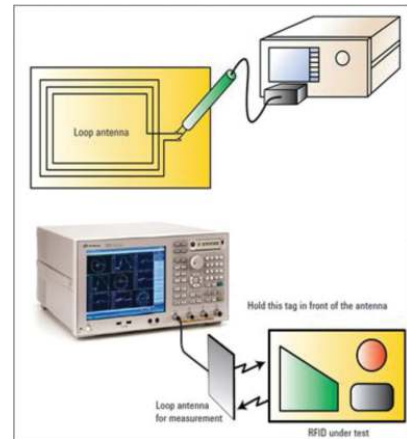

### Customer type

R&D, production, quality assurance, procurement

### Product & web resources

RFID test [www.keysight.com/find/rfid](http://www.keysight.com/find/rfid)

### Reference

Application note: *Using a network and impedance analyzer to evaluate 13.56 MHz RFID tags and readers/writers (5990-3442EN)*

## Wireless Power Transmission Measurement and Simulation

### Abstract

“Wireless connection” has eliminated most of the wired connections. Power transmission cannot be an exception too. Wireless power transmission is being challenged in many industries, such as mobile phones, PCs, consumer electronics and even automotive industries. The Keysight E5061B has the capability of accurately measuring impedances and S-parameters of the antennas, the core elements of the wireless power transmission. The accurate model of the antennas will improve the productivity of the circuit/system designers by realizing a reliable design simulation using the Keysight ADS simulator.

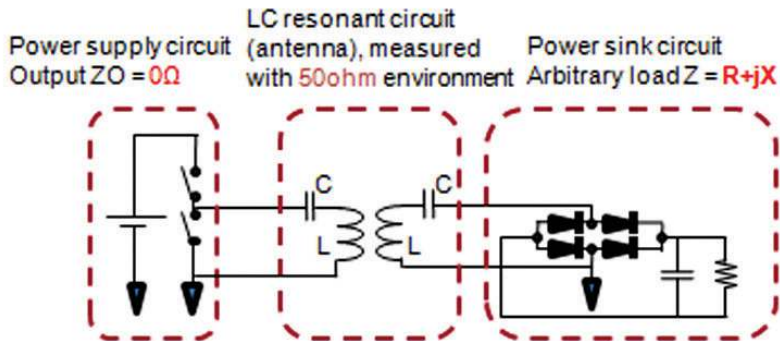

### Test challenges

- There was not a way to obtain an accurate and reliable model of an antenna, which is the most important component of wireless power transmission design.
- There is a misunderstanding that S-parameters are NOT useful for a voltage driving circuit design because they are measured with a 50ohm environment.

### How to solve

- The E5061B has the capability of measuring both impedances and S-parameters. It helps the designer to obtain two ways of accurately modeling the antennas, circuit models (“white box”) and S-parameters models (“black box”).
- A circuit model provides component level information of the antennas, such as inductances, series resistances (Q factors) and coupling coefficients. Circuit models when used with the ADS simulator are extremely useful when the designer wants to know the effect of the change of the individual component parameters, e.g. “what if the series resistance of my antenna is smaller (Q is higher)?”.
- S-parameters model are proven to be very useful models even for voltage driving circuits. S-parameters models when used with the ADS simulator are extremely useful when the designer wants to know the effect of the real-world use-case where there cannot be simple circuit models, e.g. “what if a conductive material is half way inserted between the two antennas?”.

### Customer type

R&D

### Product & web resources

E5061B-3L5 LF-RF network analyzer [www.keysight.com/find/e5061b](http://www.keysight.com/find/e5061b)  
 Advanced design system (ADS) [www.keysight.com/find/ads](http://www.keysight.com/find/ads)



## In-circuit Impedance Measurements (Grounded Measurements)

### Abstract

Although it is inherently difficult for an auto-balancing bridge technique to measure grounded components due to the signal current bypass, the 4294A Impedance Analyzer (ZA) with the dedicated 42941A Z probe kit provides the accurate “grounded” measurements over a broad impedance range using auto-balancing bridge technique with a built-in floating power supply. While characterization of components under actual operating conditions is essential for circuit design, it is also critical to characterize the circuit itself operating over a wide frequency and level etc at R&D/QA. Circuit blocks such as amplifier and filter circuits can be characterized by measuring output/input impedance. Printed Circuit Boards (PCB) evaluation is required when mounting components, typically pattern inductance and stray capacitance between patterns.



**4294A precision impedance analyzer  
+ 42941A impedance probe kit**

### Test challenges

- Grounded measurements of components/circuit blocks mounted on a printed circuit board
- Broad impedance range due to very small pattern inductance and stray capacitance (e.g 1  $\Omega$  to 1 M $\Omega$ )
- Difficult to contact DUT and to make repeatable measurements for various DUT pitches
- Test efficiency mainly for DUT contact and calibration/compensation to remove errors

### How to solve

- 4294A built-in floating power supply enables grounded device measurements with 42941A probe kit or 42942A terminal adapter
- Broad impedance range using 4294A + 42941A probe kit (100 m $\Omega$  to 100 M $\Omega$ )
- 42941A probe pitch variable from 0.5 mm to 13.5 mm and center pin with spring-loaded (pogo) pin
- BNC adapter and clip lead besides pin probe available in 42941A for various DUT (e.g large devices)
- Component (e.g SMD) and material test fixtures (e.g PCB material) available as additive solutions

### Customer type

R&D, production, education

### Product & web resources

4294A precision impedance analyzer, 40 Hz to 110 MHz     [www.keysight/find/4294a](http://www.keysight/find/4294a)

### Reference

Technical overview: *Reliable electronic component evaluation and circuit design with the 4294A impedance analyzer (5968-4505E)*

Application note: *Impedance measurement handbook (5950-3000)*

## Passive Intermodulation (PIM) Measurement

### Abstract

Passive intermodulation (PIM) is the unwanted signal or intermodulation signals generated in the passive device with two or more frequency signals. With the continuing evolution of communication systems, having low-PIM components in the BTS system is becoming increasingly important, resulting growing need for evaluation or testing for PIM for every passive device such as antenna, cable, connector, duplexer, etc.

The ENA based PIM + S-parameter solution is a total system which provides cost efficiency for testing in production, QA, and R&D at BTS passive component manufacturing market.

### Test challenges

- Need more flexibility in the test system to measure various types of DUTs with minimum investment
- Need higher total throughput in PIM and S-parameter test
- Need more reliable measurement test results

### How to solve

- Flexible configurations (PIM + S-parameter in a single solution, multiple band configuration)
- Fast measurement (PIM + S-parameter measurement with a single connection, faster PIM measurement speed)
- Accurate measurement (user calibration)

The innovative solution with the E5072A ENA series network analyzer offers higher performance than the conventional solutions with the lower cost of investment for the PIM and S-parameter measurements. The solution has new key features of Flexible configurations, Fast measurements and Accurate measurements, which can replace the existing test systems for passive component tests.

There are several solution partners that deliver a total test solution to customers in your region. Contact Keysight or individual solution partners if you are looking for a complete solution of PIM measurements.

### Customer type

R&D, production, quality assurance

### Product & web resources

E5072A ENA series network analyzer [www.keysight.com/find/e5072a](http://www.keysight.com/find/e5072a)  
 PIM solution page [www.keysight.com/find/PIM](http://www.keysight.com/find/PIM)

### Reference

Application note: *Innovative passive intermodulation (PIM) and S-parameter measurement solution with the ENA (5991-0332EN)*

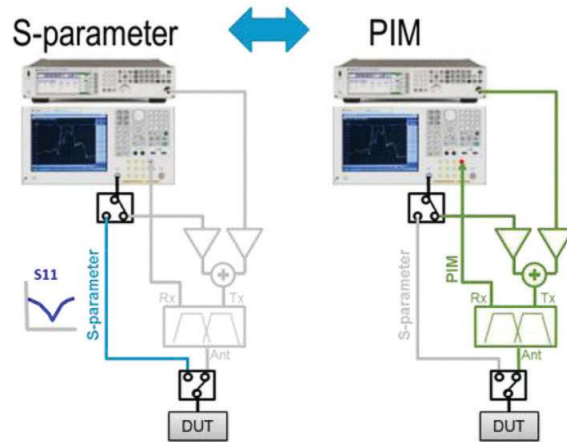

## Cable and Connector Assembly Test for USB, HDMI, SATA and DisplayPort

### Abstract

Keysight's E5071C ENA Option TDR provides the method of implementation (MOI) which is a guide of measurement procedure to support compliance test for each standard, such as USB, HDMI, SATA and DisplayPort. Each high speed communication standard establishes a specification to ensure the quality of products cable/connector. To verify compliance, components are tested in accordance with the specification. Using MOIs and state files, you can efficiently perform compliance tests.

### Test challenges

- Not only measurement procedure, but also preparation is troublesome/complex.
- Multiple measurements parameters with many instruments are required.
- Keeping test quality and performance is time consuming/expensive to run

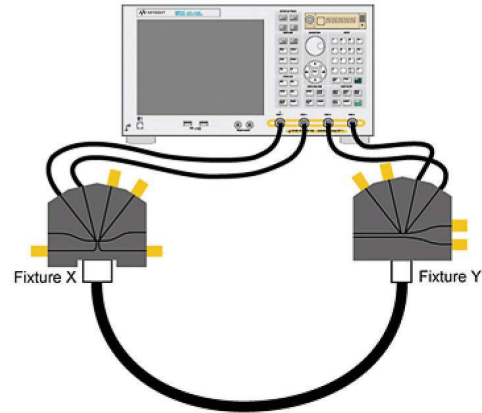

### How to solve

- MOI guides you to perform compliance test for each standard properly, simply follow this.
- The E5071C ENA Option TDR supports multiple parameters across domains, not only S-parameters (frequency domain), but also impedance and eye diagrams (time domain).
- The E5071C ENA Option TDR provides fast and accurate measurement with ESD robustness, and improve measurement throughput/cost efficiency.

### Customer type

R&D, production, quality assurance, procurement

### Product & web resources

E5071C ENA Option TDR

[www.keysight.com/find/ena-tdr](http://www.keysight.com/find/ena-tdr)

E5071C-TDR MOI for high speed digital applications

[www.keysight.com/find/ena-tdr\\_compliance](http://www.keysight.com/find/ena-tdr_compliance)

### Reference

Technical overview: *E5071C ENA Option TDR enhanced time domain analysis technical overview (5990-5237EN)*

Application note: *Comparison of measurement performance between VNA and TDR oscilloscope (5990-5446EN)*

## Tx (Source) and Rx (Receiver) Test for SATA and MIPI

### Abstract

Keysight's E5071C ENA Option TDR provides method of implementation (MOI) which is a guide of measurement procedure to support the compliance test for each standard such as SATA and MIPI. Each high speed communication standard establishes a specification to ensure the quality of Tx (source) and Rx (receiver). To verify compliance, components are tested in accordance with the specification. Using MOIs and state files, you can efficiently perform compliance tests.

### Test challenges

- Not only measurement procedure, but also preparation is trouble some/complex.
- Multiple measurements parameters with many instruments are required.
- Impedance analysis of active devices under actual operating conditions is required.

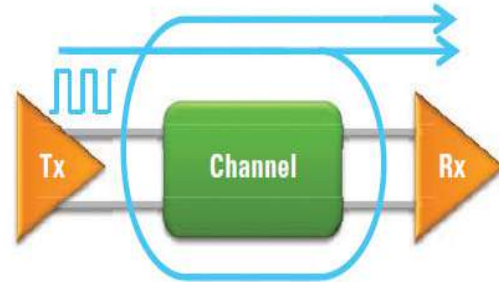

### How to solve

- MOI guides you properly to perform compliance test for each standard, simply follow this.
- E5071C ENA Option TDR supports multiple parameters across domains, not only S-parameters (frequency domain), but also impedance and eye diagrams (time domain).
- Hot TDR measurement capability enables you to do TDR and return loss measurement of active devices in the power-on state.

### Customer type

R&D, quality assurance, production

### Product & web resources

E5071C ENA Option TDR

[www.keysight.com/find/ena-tdr](http://www.keysight.com/find/ena-tdr)

E5071C-TDR MOI for high speed digital applications

[www.keysight.com/find/ena-tdr\\_compliance](http://www.keysight.com/find/ena-tdr_compliance)

### Reference

Technical overview: E5071C ENA Option TDR enhanced time domain analysis technical overview (5990-5237EN)

Application note: Effective reflection characterization for active devices using ENA Option TDR (5990-9676EN)

Application note: Comparison of measurement performance between VNA and TDR oscilloscope (5990-5446EN)

## Device Characterization for PCB Quality Control

### Abstract

Keysight E5071C ENA Option TDR can help you to characterize and verify signal integrity of Printed Circuit Boards (PCB) for better quality control with three breakthrough features: multiple measurement capabilities, high Repeatability & Reproducibility (R&R), and excellent ESD robustness.

### Test challenges

- Multiple measurements parameters with many instruments are required to characterize PCB.
- Pass/fail margin becomes tighter, and higher R&R is required for instruments
- Traditional TDR oscilloscopes are sensitive to ESD and high repair fee is the result when the instruments breakdown.

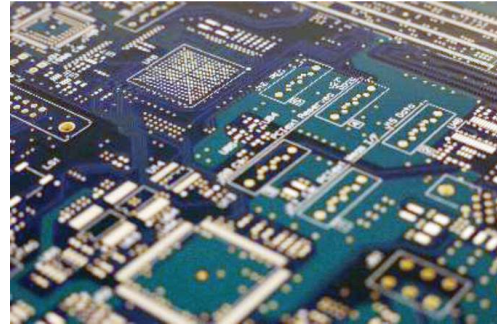

### How to solve

- ENA Option TDR has all the necessary measurement capabilities for PCB characterization in one-box.
- With high dynamic range and various calibration methods, ENA Option TDR achieves high repeatability (typ. 0.05 ohm) and reproducibility (typ. 0.8 ohm).
- ENA Option TDR has proprietary protection circuit in each test port to protect the instrument from ESD damage (typ. 3,000 V) without sacrificing RF performance.

ENA Option TDR is an ideal solution for PCB quality control because it's capable of measuring all the necessary parameters of TDR, insertion loss, and eye diagram in one-box to simplify test instrumentation.

### Customer type

R&D, quality assurance, production

### Product & web resources

E5071C ENA Option TDR     [www.keysight.com/find/ena-tdr](http://www.keysight.com/find/ena-tdr)

### Reference

Technical overview: *E5071C ENA Option TDR enhanced time domain analysis technical overview (5990-5237EN)*

Application note: *Comparison of measurement performance between VNA and TDR oscilloscope (5990-5446EN)*

## Automotive Ethernet Test and Debug

### Abstract

Automotive Ethernet, which can cover both control and information systems is gaining attention. Investigation into the automotive Ethernet specification is based on the IEEE802.3 100BASE Ethernet standard. Keysight E5071C ENA Option TDR provides a solution for 100Base physical layer evaluation (cable measurement, return loss measurement).

### Test challenges

- It's necessary to use both TDR oscilloscope for cable impedance (time domain analysis) and network analyzer for return loss, insertion loss and near-end crosstalk (frequency domain analysis).
- It's necessary to evaluate impedance mismatched systems under actual operating conditions because the transmission waveform quality is deteriorated due to multiple reflections caused by the impedance miss-matching.



### How to solve

- The E5071C ENA Option TDR supports multiple parameters across domains, not only frequency domain, but also impedance and eye diagrams (time domain).
- Hot TDR measurement capability enables you to analyze impedance matching of active devices in the power-on state. Typically, the impedance is significantly different between the OFF state and operating state (Hot TDR).

The U7237A Ethernet test fixture is used to connect to the device under test. For more accurate measurements, calibration is possible with the calibration kit (RJ-45 type Open, Short, Load standards).

### Customer type

R&D, production

### Product & web resources

E5071C ENA Option TDR

[www.keysight.com/find/ena-tdr](http://www.keysight.com/find/ena-tdr)

E5071C-TDR MOI for high speed digital applications

[www.keysight.com/find/ena-tdr\\_compliance](http://www.keysight.com/find/ena-tdr_compliance)

### Reference

Technical overview: *E5071C ENA Option TDR enhanced time domain analysis technical overview (5990-5237EN)*

Application note: *Effective reflection characterization for active devices using ENA Option TDR (5990-9676EN)*

Application note: *Comparison of measurement performance between VNA and TDR oscilloscope (5990-5446EN)*

## Automotive Antenna Test

### Abstract

Keysight ENA series network analyzers offer great value to design or test automotive antennas and peripheral components such as filters and amplifiers. These components request to measure down to 50 kHz or 150 kHz based on the countries to be used in. ENA series' unmatched analog performance, fast measurement speed, good PC connectivity with its low start frequency and affordable price contributes to make your antennas and peripheral components with low cost and high quality.

### Test challenges

- Down to 50 kHz (out-band rejection check not to violate other communication) or 150 kHz range (AM radio used in Europe, ISM frequency band for key less entry, etc.)
- Fast and accurate pass/fail test



### How to solve

- Keysight ENA series network analyzers offer wide frequency range from 5 Hz to 20 GHz
- With its superior analog performance, the ENA series ensure fast throughput with great accuracy.
- Plenty of limit test functions, built-in VBA programming environment, handler interface offers in-box pass/fail analysis without external PC, which contributes lower cost of test and faster through-put

The E5061B is an ideal solution as low cost network analyzer from 100 kHz to 1.5 GHz or 3 GHz (RF option), or the lowest 5 Hz to 3 GHz (LF-RF option). The E5072A's covers wider RF frequency range from 30 kHz to 4.5/8.5 GHz and suitable for active device measurement. The E5071C covers the widest range as 9 kHz to 4.5/6.5/8.5 GHz or from 300 kHz to 14/20 GHz. Unmatched small trace noise and fast measurement speed decrease the error in evaluation or minimize the test margin with good through put. Every ENA model has limit test functions and built-in VBA programming environment and LAN/USB/GPIB interface. Pass/fail results can be output to automation test machine using a handler interface.

### Customer type

R&D, production

### Product & web resources

ENA series network analyzers      [www.keysight.com/find/ena](http://www.keysight.com/find/ena)

## RF Amplifier Measurements

### Abstract

The Keysight E5072A ENA series network analyzer is a cost-effective and best suited solution for general-purpose RF amplifier measurements used in a wide variety of industries. The E5072A enables you to adjust power level at the DUT's interface for accurate measurements of your amplifiers in nonlinear operation.

### Test challenges

- Amplifiers especially in compression are very sensitive to input power; external leveling is desired for accurate device characterization.
- The complexity of rack & stack test systems should be reduced for lower overall cost of ownership.
- To accelerate time-to-market, total measurement time must be reduced.

### How to solve

- The E5072A has receiver leveling that adjust power level at the DUT's interface within tolerance or specifications for measurements.
- The E5072A can be the replacement of test systems for harmonic distortion or IMD measurements, which are conventionally performed by the combination of signal generator(s), power sensor or spectrum analyzer.
- The E5072A has wizard programs for amplifier measurements, which minimizes the time spent on time-consuming measurement setup and calibration.

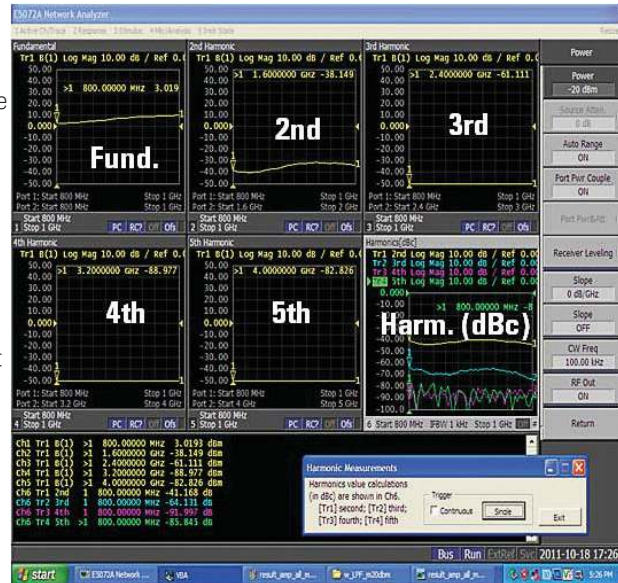

Among many useful features for amplifier measurements, the E5072A has power calibration techniques including receiver leveling function that help you to achieve accurate absolute power level for characterization of power-dependent active devices in nonlinear operation.

### Customer type

R&D, production, quality assurance, procurement, education

### Product & web resources

E5072A ENA series network analyzer, 30 kHz to 4.5/8.5 GHz [www.keysight.com/find/e5072a](http://www.keysight.com/find/e5072a)

### Reference

Application note: *Basics of RF amplifier measurements with the E5072A ENA series network analyzer (5990-9974EN)*



## High-gain Amplifier Measurements with Low Power Signal

### Abstract

The Keysight E5072A ENA Series Network Analyzer has hardware capabilities for making S-parameter measurements with very low power signals. High-gain amplifiers or RF components in the receiver path at front-end of wireless communication systems can be measured to simulate real operation condition.

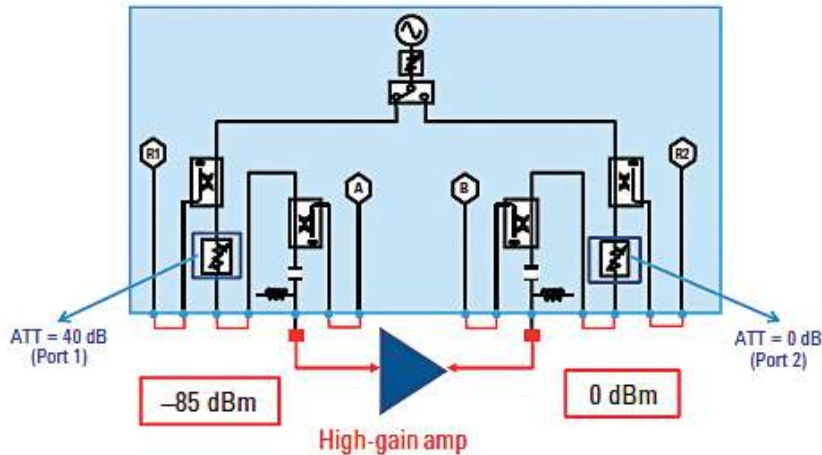

### Test challenges

- It is necessary to optimize the signal-to-noise ratio when handling very low power signals for measurements.

### How to solve

- The E5072A has the source power specified down to -85 dBm.
- The E5072A features uncoupling port power which is useful for measuring high-gain amplifiers with a very low input power to the DUT.

Because of the E5072A's built-in source attenuators are located between the internal bridges, the signal-to-noise ratio of reflection measurements (i.e. S11 or S22) can be maximized for measurements with low-power signals. The E5072A's very low output power (i.e. specified at -85 dBm, available at -109 dBm) eliminates the need for an external attenuator to reduce power level at the DUT's input.

### Customer type

R&D, production, quality assurance, procurement

### Product & web resources

E5072A ENA series network analyzer, 30 kHz to 4.5 /8.5 GHz [www.keysight.com/find/e5072a](http://www.keysight.com/find/e5072a)

### Reference

Application note: Basics of RF amplifier measurements with the E5072A ENA series network analyzer (5990-9974EN)

## Pulsed S-parameter Measurements

### Abstract

The Keysight E5072A ENA series network analyzer is the common tool for characterizing RF components such as power amplifiers or transmitters in both CW and pulsed operation.

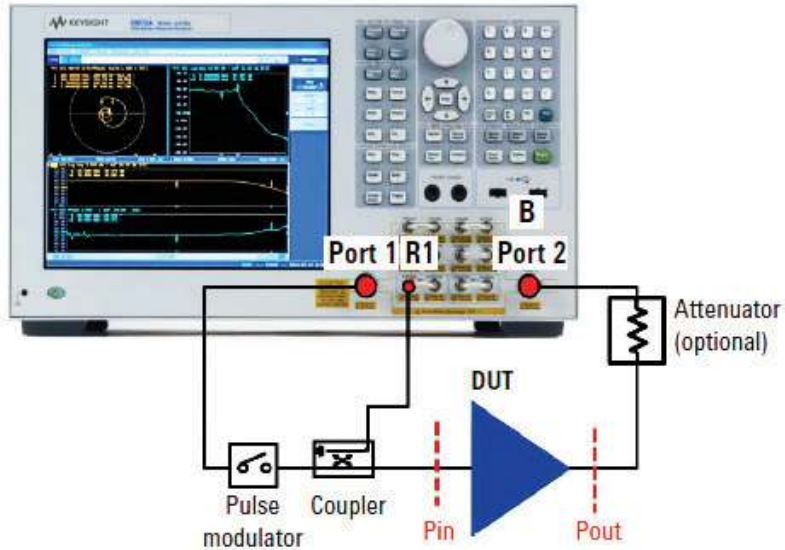

### Test challenges

- Some power devices such as GSM power amplifiers are designed for burst operation and do not operate correctly with a CW signals.
- Pulsed RF techniques must be employed for accurate S-parameter measurements.

### How to solve

- The E5072A have the triggering capability to synchronize measurements with pulsed RF signals.
- The E5072A has receiver leveling that eliminates short-term drift of a pulse modulator used in the signal path.

The E5072A's receiver leveling is recommended when the pulse modulator in the signal path has temperature drift. The variation of the DUT's input power due to the drift is eliminated automatically by the receiver leveling function, and measurement accuracy can be increased for the characterization of power-sensitive devices in pulsed operation.

### Customer type

R&D, production, quality assurance, procurement, education

### Product & web resources

E5072A ENA series network analyzer, 30 kHz to 4.5 /8.5 GHz [www.keysight.com/find/e5072a](http://www.keysight.com/find/e5072a)

### Reference

Application note: *Basics of RF amplifier measurements with the E5072A ENA series network analyzer (5990-9974EN)*

## RF Coaxial Cable Measurements

### Abstract

The ENA series network analyzers support your RF coax cable tests with an excellent dynamic range/noise floor performance, powerful analysis capabilities, and a variety of product and frequency lineup which allows you to select the best suited solution to your test needs.

### Test challenges

- Requires a wide dynamic range/low noise floor.
- Distance to fault analysis in the time domain.
- CATV cables must be tested in the 75 ohm system impedance.

### How to solve

- The ENA series offer an excellent dynamic range performance (130 dB: supplemental performance data), which significantly exceeds the performance of legacy RF VNAs such as the 871x/8753/8720.
- For very high attenuation measurements that require an extremely low noise floor, such as long cable measurements and shield transfer impedance measurements, the E5072A is the best solution due to its high power output capability and extremely low noise floor using the direct receiver access
- The time domain analysis options of the ENA series allow you to perform the fault location analysis by converting the frequency-domain measurement data to the time-domain responses.
- The E5061B RF options (100 k to 1.5/3 GHz) support the 75 ohm test sets.



### Customer type

R&D, production, quality assurance, procurement

### Product & web resources

ENA series network analyzers      [www.keysight.com/find/ena](http://www.keysight.com/find/ena)

### Reference

The solution for testing the shield transfer impedance of the cable is provided by DCM Industries.  
DCM Industries web page: <http://dcmindustries.com>  
DCM's transfer impedance measurement system:  
(<http://www.dcmindustries.com/uploads/images/PDF/NEW-TI3000datasheet032910.pdf>)

## LAN/Telecom Cable Measurements

### Abstract

Keysight's ENA Series network analyzers comprehensively support LAN/telecom cable measurements for R&D environments, and also for manufacturing environments in conjunction with solutions provided by test system vendors.

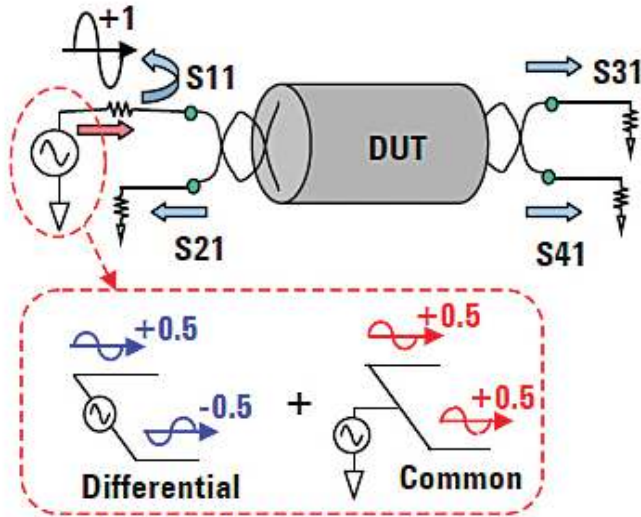

### Test challenges

- Differential S-parameter measurements
- Need to test from low frequencies (100 kHz, or less).
- Effectively test multi-pair cables in production tests.

### How to solve

- The E5071C 4-port option offers a mathematical single-ended to differential S-parameter conversion which enables more accurate measurements and wider frequency coverage than the traditional test methods, using physical balun transformers.
- For LAN cable tests, the E5061B RF option and E5071C covers 100 kHz. For telecom cable tests requiring much lower frequencies, the E5061B-3L5 covers down to 5 Hz.
- For production tests of these multi-pair balanced cables, the following companies are providing cable test systems equipped with the 2-port ENA, switch matrix, and baluns (or a balunless test system using the 4-port ENA).  
DCM Industries: <http://www.dcmindustries.com>  
AESA Cortailod: <http://www.aesa-cortailod.com>

### Customer type

R&D, production, quality assurance, procurement

### Product & web resources

ENA series network analyzers [www.keysight.com/find/ena](http://www.keysight.com/find/ena)

### Reference

FAQ: For fundamentals on evaluating multi-pair differential cables using the 4-port ENA  
[http://www.home.keysight.com/upload/cmc\\_upload/All/BalancedCable\\_FAQ.pdf](http://www.home.keysight.com/upload/cmc_upload/All/BalancedCable_FAQ.pdf)

## High-rejection Filter Measurements

### Abstract

The Keysight E5072A ENA Series Network Analyzer with configurable test set function has extended dynamic range of as wide as 151 dB for forward measurements. This great performance will enable to make accurate measurements for high-rejection filters and faster measurements can be performed for devices with high-attenuation characteristics such as the stop band of BTS filters.

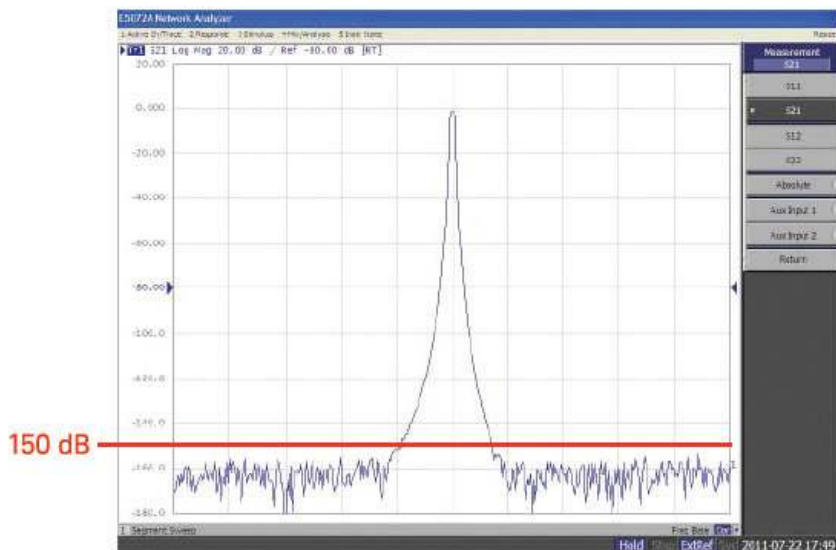

### Test challenges

- Necessary to test the stop band of BTS filters (i.e. -110 dB) by faster measurement sweep with wider IF bandwidth of the VNA.
- Dynamic range of conventional VNAs is NOT sufficient for high throughput needs of production tests.

### How to solve

- The E5072A has the configurable test set that can directly access to the internal receivers. The loss associated with internal bridges is eliminated, so the dynamic range of forward measurements (i.e. S21) can be increased up to 151 dB with the E5072A.
- The wider IF bandwidth is selected with extended dynamic range configuration, and measurement speed is improved for the test. If the dynamic range is increased with the configuration by 20 dB, 100-times faster measurements can be performed to get the same result with trace noise.

### Customer type

R&D, production, quality assurance, procurement

### Product & web resources

E5072A ENA series network analyzer, 30 kHz to 4.5 /8.5 GHz [www.keysight.com/find/e5072a](http://www.keysight.com/find/e5072a)

### Reference

Technical overview: *E5072A Technical Overview (5990-8004EN)*

## Capacitance Characteristics of Liquid Crystal Cell

### Abstract

Capacitance measurement is a common method used for characterizing dielectric properties of liquid crystal materials. Dynamic behavior of liquid crystal molecules can be determined from the frequency dependence of the capacitance. The Keysight 4294A provides precise capacitance measurement up to 110MHz. High AC voltage up to 20 Vrms is available using the Keysight E4980A with option 001.

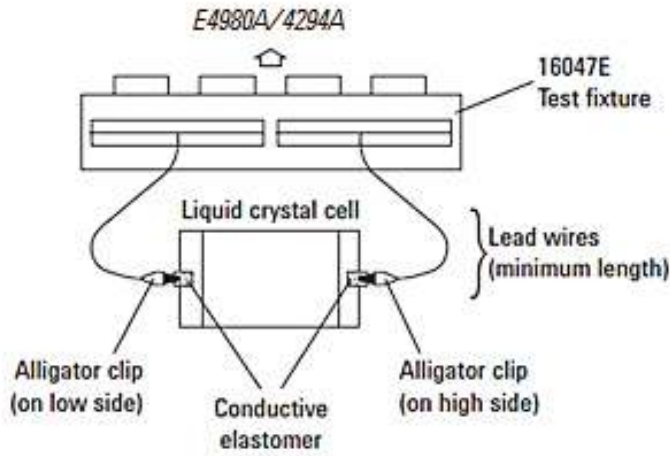

### Test challenges

- Accurate capacitance/loss tangent measurement over wide frequency range is required to characterize LC materials such as dynamic behavior, dielectric relaxation and so on.
- The test signal voltage needs to be high enough for  $C_{//}$  (capacitance in the same direction as director) measurement.
- Actual voltage applied to the material should be known to evaluate the voltage-capacitance characteristics

### How to solve

- The E4980A Precision LCR Meter has frequency range of 20 Hz to 2 MHz with basic accuracy of 0.05%. With option 001 which extends test signal level up to 20 Vrms, capacitance-voltage profile can be measured at higher voltage without any external power amplifiers.
- The 4294A Precision Impedance Analyzer covers wider frequency range from 40 Hz to 110 MHz providing best-in-class accuracy (0.08% basic accuracy) over wide impedance range.
- Both 4294A and E4980A has powerful capability such as DC bias, level monitor, fixture compensation to eliminate errors introduced by measurement cells.

### Customer type

R&D, education

### Product & web resources

E4980A precision LCR meter, 20 Hz to 2 MHz [www.keysight.com/find/e4980a](http://www.keysight.com/find/e4980a)  
 4294A precision impedance analyzer, 40 Hz to 110 MHz [www.keysight.com/find/4294a](http://www.keysight.com/find/4294a)

### Reference

Application note: *Measurement of capacitance characteristics of liquid crystal cell (5950-2994)*

## MEMS/NEMS Device Modeling, Failure Analysis and Process Control

### Abstract

For MEMS/NEMS sensor, actuator and microphone, Keysight E4980A precision LCR meter and 4294A precision impedance analyzer can help you to establish more accurate modeling, more efficient failure analysis, and better process controls using state-of-the-art impedance techniques. For MEMS resonators and their application devices such as gyro sensors, The E5061B-3L5 LF-RF network analyzer helps you to measure the high-attenuation (S21 frequency responses) of the resonators, or the total responses of the resonators plus subsequent I-V converter amps.

### Test challenges

- Test as early in the process as possible in lowering the production cost.
- Improve yields and throughput while the stability of mechanical stimuli such as pressure, acceleration, is and/or sound waves are difficult to control.
- Need to measure the high-attenuation when evaluating S21 and evaluate DC bias dependency of the resonator.

### How to solve

- Electrical tests such as impedance measurements do not require mechanical stimulus so throughput can be improved.
- Electrical stimulus and measurements with the E4980A and/or 4294A are easier to maintain, improves repeatability.
- The E5061B-3L5's good dynamic range (120 to 130 dB in actual performance) in kHz to GHz ranges and sweepable built-in DC bias source provides the total solutions for MEMS resonator evaluation.

E4980A precision LCR meter has best-in-class accuracy (0.05%), superb repeatability ( $\sigma < 1\text{fF}$ ), and fast measurement time. E4980A is the ideal solution for

- C-V test for the capacitive sensor/actuator/microphone
- Inductance and DC resistance test for the electromagnetic actuator 4294A

precision impedance analyzer has the capability for a resonance/anti-resonance evaluation, a Q-factor evaluation and an equivalent circuit analysis. 4294A is the ideal solution for

- Test of the piezoelectric element in the piezoelectric type sensor actuator
- Frequency response test of the sensor, actuator and silicon microphone

The E5061B-3L5 LF-RF network analyzer (5 Hz to 3 GHz) is the ideal solution for resonator evaluations

### Customer type

R&D, production, quality assurance, procurement, education

### Product & web resources

E4980A precision LCR meter, 20 Hz to 2 MHz

[www.keysight.com/find/e4980a](http://www.keysight.com/find/e4980a)

4294A precision impedance analyzer, 40 Hz to 110 MHz

[www.keysight.com/find/4294a](http://www.keysight.com/find/4294a)

MEMS/NEMS device measurement solution

[www.keysight.com/find/mems](http://www.keysight.com/find/mems)

### Reference

Application note: *Accelerate your MEMS device development and manufacturing efficiency (5989-7517EN)*

## Electro-magnetic Compatibility (EMC) Component Measurement

### Abstract

Electro-magnetic compatibility (EMC) is the key specification in broadband wireless communication and automotive electronics, where EMC components play an important role in meeting strict standard requirements. Keysight E5071C ENA series network analyzer and E4991A RF impedance/material Analyzer's powerful analysis functions help you determine the true performance of your product under the actual working conditions.

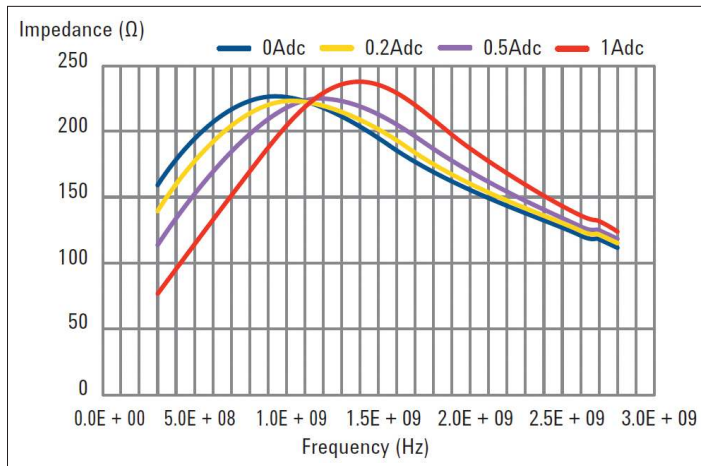

### Test challenges

- Identify component characteristics under the actual working conditions.
- EMC/noise regulations have been expanding to cover ever higher frequencies including the GHz band.

### How to solve

- The E5071C supports built-in Bias-T and also external Bias-T to evaluate frequency response of EMC components under the actual working conditions.
- The E4991A provides accurate component measurements and also provides total material measurement of core materials.
- The temperature characteristic test kit for the E4991A (E4991A-007) provides highly accurate temperature characteristic analysis capability within the wide temperature range from  $-55\text{ }^{\circ}\text{C}$  to  $+150\text{ }^{\circ}\text{C}$  with a powerful temperature drift compensation function.

### Customer type

R&D, education

### Product & web resources

E5071C ENA series network analyzer      [www.keysight.com/find/e5071c](http://www.keysight.com/find/e5071c)  
 E4991A RF impedance/material analyzer      [www.keysight.com/find/e4991a](http://www.keysight.com/find/e4991a)

### Reference

Application note: *Evaluating EMC components with DC bias superimposed (5989-9887EN)*  
 Application note: *Introduction to the fixture simulator function of the ENA series RF Network analyzers: Network de-embedding/embedding and balanced measurement (5988-4923EN)*  
 Application note: *8 Hints for successful impedance measurements (5968-1947E)*  
 Application note: *Solutions for measuring permittivity and permeability with LCR meters and impedance analyzers (5980-2862EN)*



## Production Test for Inductor, EMI Filter, Capacitor and Register

### Abstract

Keysight's LCR meters, capacitance meters and resistance meters deliver the best performance for manufacturing passive components such as inductor, EMI filter, capacitor and register.

### Test challenges

- Need more accurate and repeatable measurement for better yields
- Need faster measurement speed for better throughput
- Need to provide the traceable data for the end user

### How to solve

- Keysight solutions offer the best accuracy and repeatable measurement with smallest measurement variation.
- Keysight solutions provide fastest measurement speed to maximize the throughput.
- Keysight solutions offer the warranted accuracy for the measurement results with various test fixtures and test standards, and allow you the traceable test on both the component production and the end user side.

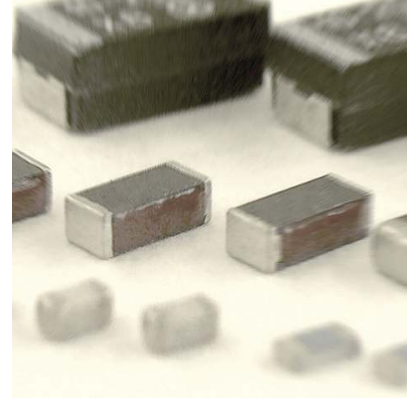

The E4980A LCR meter (20 Hz to 2 MHz) and the 4285A LCR meter (75 kHz to 30 MHz) provide a precise, reliable, high-speed solution and support various type of component test.

The E4982A LCR meter supports wide frequency range from 1 MHz to 3 GHz, and offers a high-speed with reliable measurements for SMD inductor and EMI filter testing in the production lines. The E4982A's powerful list measurements make it suitable also for R&D and quality assurance.

The E4981A capacitance meter offers a high-speed with reliable measurements for ceramic capacitor testing in the production lines.

The 4339B high-resistance meter is the advanced tool for making precision high-resistance ( $10^3 \Omega$  to  $1.6 \times 10^{16} \Omega$ ).

### Customer type

Production

### Product & web resources

Bench top LCR & resistance meters [www.home.keysight.com/find/benchtop\\_lcr](http://www.home.keysight.com/find/benchtop_lcr)

### Reference

Selection guide: *LCR meters, impedance analyzers and test fixtures selection guide (5952-1430E)*

## On-chip Device Measurements With Probing System

### Abstract

The E4991A RF impedance/material analyzer with Opt.010 probe station connection kit integrating with probing system (cascade microtech) provides highly accurate spiral inductor and capacitor measurements for RF-IC and LTCC circuit up to 3 GHz.

### Test challenges

- Resources/time wasting to configure probing system
- How to perform calibration at probing system
- Accurate measurements for high Q devices (low ESR measurement is critical to accurately measure high Q)

### How to solve

- Easy connection to probe station using Opt.010 probe station connection kit
- Impedance standard substrate (ISS) available for on-wafer calibration (cascade Microtech)
- RF-IV technique to accurately measure equivalent series resistance (ESR) for high Q devices up to 3 GHz



### Customer type

R&D, quality assurance, education

### Product & web resources

E4991A RF impedance/material analyzer, 1 MHz to 3 GHz      [www.keysight.com/find/e4991a](http://www.keysight.com/find/e4991a)

### Reference

Application note: *Accurate impedance measurement with cascade microtech probe system (5988-3279EN)*

Configuration guide: *E4991A RF impedance/material analyzer (5989-8521EN)*

Application note: *impedance measurement handbook (5950-3000)*

Cascade microtech web site: [www.cascademicrotech.com](http://www.cascademicrotech.com)

## Mixer and Converter Measurement

### Abstract

Frequency-translating devices (FTDs) such as mixers and converters present unique measurement challenges since input and output frequencies differ. The E5071C ENA series network analyzer reduces setup, measurement and operating time with powerful and easy-to-use functions. And the E5071C provides more accurate measurement with advanced calibration methods including Keysight patented vector mixer calibration (VMC).

### Test challenges

- It's necessary to setup and operate complicated test configuration for different frequencies at the input and output ports.
- It's necessary to select an appropriate calibration method for accurate measurement.

### How to solve

- You can reduce the setup and measurement time with the powerful built-in software functions in the E5071C, such as frequency offset mode (FOM) option, balanced mixer measurement and absolute group delay measurement.
- You can reduce the operating time with easy-to-use analysis software for the E5071C, such as a mixer measurement wizard program and vector mixer characterization program.
- The E5071C provides state-of-the-art calibrations and the user can characterize frequency converting devices accurately.

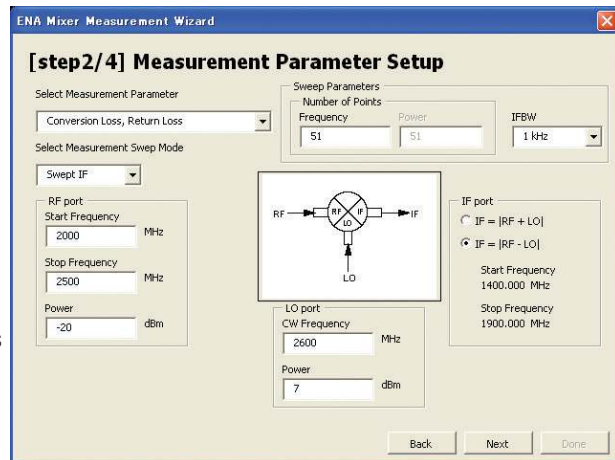

The E5071C provides three calibration methods which are the power and receiver calibration, scalar mixer calibration (SMC) for math corrected amplitude measurement and vector mixer calibration (VMC), in addition to phase and absolute group delay measurements. Mixer measurement wizard program provides useful functions, such as conversion loss and group delay measurement (ENA Opt 008 FOM is required), gain compression measurement (CW/Swept), return loss measurement and calibration assist (power meter calibration, SMC, VMC).

### Customer type

R&D, production, education

### Product & web resources

E5071C ENA series network analyzer [www.keysight.com/find/e5071c](http://www.keysight.com/find/e5071c)

### Reference

Application note: *Accurate mixer measurements using the frequency-offset mode (5989-1420EN)*

ENA mixer measurement wizard: [www.keysight.com/find/enavba](http://www.keysight.com/find/enavba)

## Multiport Device Measurement (up to 40-port)

### Abstract

The 4-port E5071C ENA series network analyzer with the E5092A configurable multiport test set offers a complete multiport solution up to 20 GHz for testing multiport devices such as front-end modules (FEM) for cellular handsets, WLAN application or other general-purpose multiport devices. The E5092A can be used with the measurement wizard assistant (MWA) software for the E5071C (Option 790) which can simplify the complex multiport test setup and increase the efficiency of test station and measurement productivity.

### Test challenges

- Many components have multiple RF input or output ports, which require multiport measurement total device characterization.
- For multiport network analysis, measurement setup time is usually much longer than the actual testing time.

### How to solve

- You can increase your E5071C's test ports up to 22-port with an E5092A, and up to 40-port with cascading E5092As.
- MWA software for the E7071C (Option 790) simplifies complicated multiport measurements.



The 4-port E5071C and E5092A can support either up to 10-port full crossbar measurement or up to 22-port measurement. You can increase the number of test ports by cascading two E5092As with up to 16-port full crossbar measurement or up to 40-port measurement capability. Multiport measurement can be dramatically simplified by using the E5092A and the E5071C's MWA software that reduces the setup time of complicated multiport measurements

### Customer type

R&D, production, education

### Product & web resources

E5071C ENA series network analyzer [www.keysight.com/find/e5092a](http://www.keysight.com/find/e5092a)

E5092A Configurable Multiport Test Set

### Reference

Application note: *Comprehensive multiport solution for the ENA network analyzer (5989-8737EN)*

Application note: *Measurement wizard assistant (MWA) software for the ENA (5989-4855EN)*

Configuration guide: *E5071C network analyzer & E5092A configurable multiport test set configuration guide (5989-5480EN)*

## On-wafer C-V Characterization of MOS Device

### Abstract

C-V characteristic measurement is the standard method to evaluate the manufacturing process of a MOS FET and to analyze MOS device parameters such as oxide thickness, impurity concentration, and interface trap density in wafer processes. The Keysight E4980A precision LCR meter and the 4294A precision impedance analyzer provide broad impedance coverage over wide frequency range, with high accuracy of measurement and precise control of DC bias voltage to perform reliable C-V measurement.

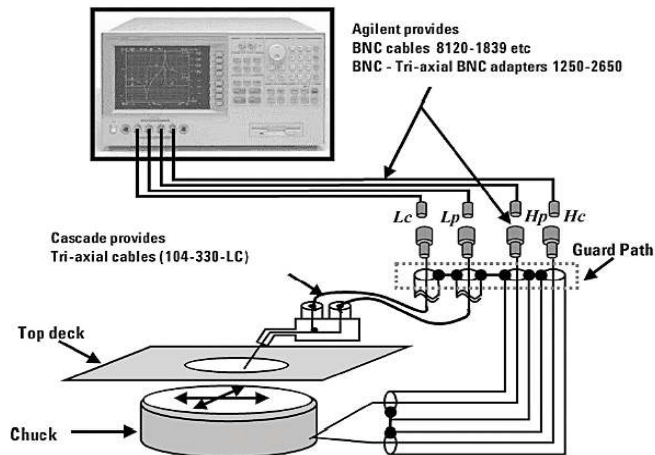

### Test challenges

- Very low capacitance needs to be measured with high accuracy and high resolution (1 fF resolution).
- From low to high frequency measurement is required to accurately characterize semiconductor devices.
- Additional errors caused by cable extensions and probes degrade the measurement reliabilities.
- The accuracy of the DC bias voltage is not sufficient to perform repeatable C-V measurements.

### How to solve

- The E4980A covers frequency range of 20 Hz-2 MHz with outstanding performance of 0.05% basic impedance accuracy and 1fF capacitance resolution.
- Its faster measurement speed along with low-noise internal design provides more throughput reducing cost of test in the evaluation of semiconductor processes.
- The 4294A extends the capability up to 110 MHz using state-of-the-art technology, which also enables grounded device measurement as well as standard four-terminal-pair (4TP) configuration
- Built-in DC bias sources of the E4980A and the 4294A provide highly accurate C-V measurements with higher efficiency.
- Keysight impedance analyzers/LCR meters have advanced calibration and fixture compensation capabilities and offer enhanced accuracy by removing residual errors caused by the test fixtures used.

### Customer type

R&D, production, quality assurance, education

### Product & web resources

E4980A Precision LCR Meter, 20 Hz to 2 MHz

[www.keysight.com/find/e4980a](http://www.keysight.com/find/e4980a)

4294A Precision Impedance Analyzer, 40 Hz to 110 MHz

[www.keysight.com/find/4294a](http://www.keysight.com/find/4294a)

### Reference

Application note: *Evaluation of MOS capacitor oxide C-V characteristics using the Keysight 4294A (5988-5102EN)*

Application note: *Multi-frequency C-V measurement of semiconductors (5950-2953)*

## On-wafer Device Characterization from Low Frequency to Microwave

### Abstract

C-V characteristic measurement is the standard method to evaluate the manufacturing process of a MOS FET and to analyze MOS device parameters such as oxide thickness, impurity concentration, and interface trap density in wafer processes. The Keysight E4980A precision LCR meter and the 4294A precision impedance analyzer provide broad impedance coverage over wide frequency range, with high accuracy of measurement and precise control of DC bias voltage to perform reliable C-V measurement.

### Test challenges

- Full 2-port S-parameter measurement capability down to the low frequency range.
- Wide dynamic range in the low frequency range below 10 or 100 MHz, where microwave network analyzers' dynamic range is degraded.
- Need to perform the same TRL-type calibration not only in the high frequency range but in the low frequency range, so that there is no measurement discontinuity between the low and high frequency ranges.

### How to solve

- The E5061B-3L5's S-parameter test port fully covers 5 Hz to 3 GHz.
- The E5061B-3L5 offers the widest dynamic range in the frequency range below 10 MHz among Keysight's network analyzers.
- The E5061B-3L5 with the firmware revision 2.06 or later is supported by Cascade Microtech's WinCalXETM calibration software and this enables you to perform the TRL-type calibrations with the E5061B-3L5<sup>1</sup>.

### Customer type

R&D, education

### Product & web resources

E5061B-3L5 LF-RF network analyzer	<a href="http://www.keysight.com/find/e5061b">www.keysight.com/find/e5061b</a>
ENA Series network analyzers	<a href="http://www.keysight.com/find/ena">www.keysight.com/find/ena</a>
PNA network analyzers	<a href="http://www.keysight.com/find/pna">www.keysight.com/find/pna</a>

### Reference

Cascade microtech web site: <http://www.cmico.com>

Cascade WinCalXETM data sheet: <http://www.cmico.com/file/wincal-xe-specification-sheet>

1. Unlike the PNA and the E5071C/72A, the E5061B does not support the TRL calibration as a firmware function. Cascade's WinCalXETM software is necessary for performing the TRL calibration.

## Solid and Liquid Material Measurements with Test Fixtures

### Abstract

Evaluation of the electrical characteristics of materials is very important to develop new devices or to improve the performance. It is also used to investigate physical or chemical property in research area. Keysight impedance analyzers/LCR meters combined with the test fixtures prepared for the material measurements provide various solutions for these applications.

### Test challenges

- Characterize dielectric/magnetic property from low to high frequency range where they are actually used.
- Wider impedance coverage with enough accuracy is required to evaluate various materials. Phase accuracy is critical to measure low-loss materials.
- Dedicated test fixtures that hold the material under test should be used with software to convert the measured impedance to the material parameters.

### How to solve

- Keysight offers a wide variety of impedance measurement solution covering from 20Hz to 3GHz frequency range with best-in-class accuracy.
- The Keysight 16451B dielectric test fixture and 16452A liquid test fixture support permittivity measurement of solid or liquid materials up to 30MHz.
- The 16453A dielectric test fixture and the 16454A magnetic test fixture are designed for accurate permittivity and permeability measurement up to 1GHz.
- The E4991A with option 002 offers direct readout of material parameters (complex permittivity/permeability). With option 007 temperature characteristic test kit, the capability is extended over the wide temperature range from  $-55\text{ C}^{\circ}$  to  $+150\text{ C}^{\circ}$

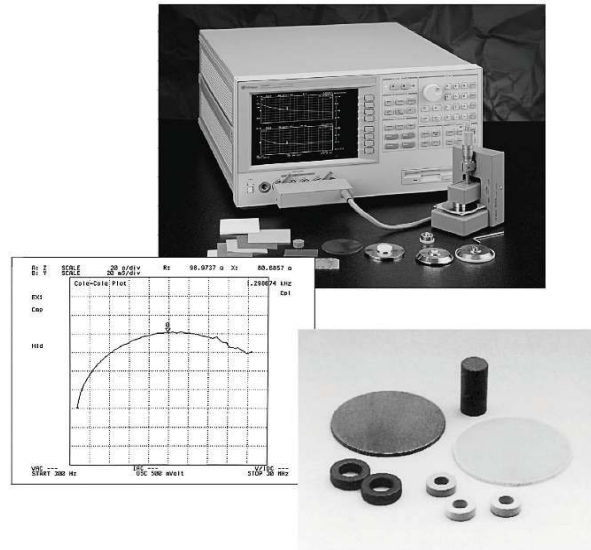

### Customer type

R&D, education

### Product & web resources

E4980A Precision LCR Meter, 20 Hz to 2 MHz

[www.keysight.com/find/e4980a](http://www.keysight.com/find/e4980a)

4294A Precision Impedance Analyzer, 40 Hz to 110 MHz

[www.keysight.com/find/4294a](http://www.keysight.com/find/4294a)

E4991A RF Impedance/Material Analyzer

[www.keysight.com/find/e4991a](http://www.keysight.com/find/e4991a)

Materials Test Equipment

[www.keysight.com/find/materials](http://www.keysight.com/find/materials)

### Reference

Selection guide: *Accessories selection guide for impedance measurements (5965-4792E)*

Application note: *Solutions for measuring permittivity and permeability (5980-2862EN)*

Application note: *Temperature characteristic evaluations of RF components and materials using the E4991A impedance/material analyzer (5988-9772EN)*

## RF Material Measurements Using Dielectric Probe

### Abstract

Keysight ENA series network analyzer offers RF material measurement solution by using with 85071E materials measurement software at affordable price. This solution covers wide range of applications from dielectric parameter (permittivity) evaluation for new material developments to process monitor using dielectric parameter measurements.

### Test challenges

- Evaluate RF material's permittivity and permeability accurately, Fast with low cost frequency range, so that there is no measurement discontinuity between the low and high frequency ranges.

### How to solve

- Keysight ENA series network analyzer offers wide frequency range vector network analysis capability. By using with the 85071E Materials measurement software and 85070E dielectric probe kit, it provides reflection method up to 20 GHz for liquids, semi-solids materials.
- By using with the 85071E Option 300, it provides resonant cavity method up to 20 GHz for thin films, substrate materials and other low loss materials.

The E5061B is ideal solution for low cost network analyzer base material measurements up to 1.5 GHz or 3 GHz. The E5072A's covers wide RF frequency range from 30 kHz to 4.5 GHz or 8.5 GHz. The E5071C covers from 300 kHz to 14 GHz or 20 GHz.

### Customer type

R&D, education

### Product & web resources

ENA series network analyzers	<a href="http://www.keysight.com/find/ena">www.keysight.com/find/ena</a>
85071E Material measurement software and 85070E Dielectric probe kit	<a href="http://www.keysight.com/find/materials">www.keysight.com/find/materials</a>

### Reference

Technical overview: *85071E materials measurement software (5988-9472EN)*

Technical overview: *85070E dielectric probe kit (5989-0222EN)*





## Phantom Material Evaluation for Specific Absorption Rate (SAR) Test

### Abstract

Keysight ENA series network analyzer with the 85070E dielectric probe kit is an ideal solution for the dielectric properties check of specific absorption rate (SAR) phantom materials. SAR test requirement is recently increased due to the attention to the mobile phone's safety usage against radiated RF energy into human body. Phantom materials are key component for SAR test, but deteriorate over time, so its dielectric properties need to be checked before the test if it meets specifications. Keysight's solution helps to construct accurate and cost effective measurement system of SAR test with its superior performance and affordable price.

### Test challenges

- Evaluate phantom material dielectric parameter accurately and easily

### How to solve

- Keysight ENA series network analyzer offers wide frequency range vector network analysis capability and regarded as industry standard RF network analyzer. By using with the 85070E Dielectric Probe kit, it provides reliable dielectric parameter result that ensures accurate SAR test results.

ENA series provide wide variety of frequency range selection. The E5061B is ideal solution for low cost network analyzer base material measurements from 100 kHz to 1.5 GHz or 3 GHz. The E5071C covers from 9 kHz to 4.5/6.5/8.5 GHz or 300 kHz to 14 GHz/20 GHz. The E5072A's covers from 30 kHz to 4.5 GHz or 8.5 GHz with high output power with flexible configurable test set.

### Customer type

Certificate test company or system provider for SAR test, R&D

### Product & web resources

ENA series network analyzers

[www.keysight.com/find/ena](http://www.keysight.com/find/ena)

85071E Material measurement software and 85070E Dielectric probe kit

[www.keysight.com/find/materials](http://www.keysight.com/find/materials)

### Reference

Technical overview: *85070E dielectric probe kit (5989-0222EN)*

## Permittivity Measurements of PCB and Substrate Materials

### Abstract

Due to the increasing of the circuit complexity, density and bit rate, relative complex permittivity (permittivity and loss tangent) of printed circuit board (PCB) and substrate material is a critical parameter that affects circuit performance. The Keysight E4991A RF impedance/material analyzer with the 16453A dielectric material test fixture offers a simple and highly accurate solution to sheet-material permittivity measurements up to 1 GHz.

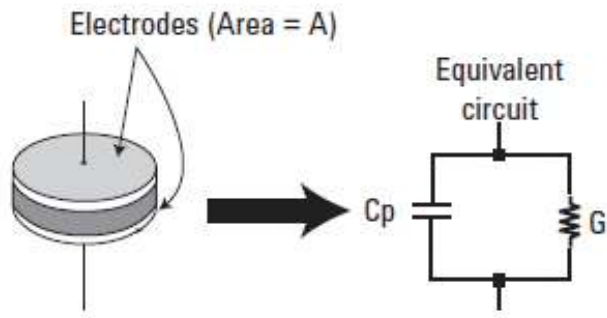

### Test challenges

- Permittivity measurements of thin sheet-material in the RF range have been difficult due to the lack of adequate fixtures, insufficient accuracy and narrow frequency coverage.
- To calculate the material parameter from the measured result (impedance or S-parameters), precise knowledge of the physical size of the sample is required because it affects to the calculation directly.

### How to solve

- The E4991A with 16453A is an ideal solution for PC board and substrate measurement from 1 MHz to 1 GHz, providing accurate relative complex permittivity measurements and easy operation. Sample-under-test is simply sandwiched between the fixture electrodes and doesn't require extensive preparation of the material.
- The E4991A with Option 002 offers direct readouts of complex permittivity. It also corrects the edge capacitance effect and reduces measurement errors.

### Customer type

R&D

### Product & web resources

E4991A RF impedance/material analyzer  
16453A dielectric material test fixture

[www.keysight.com/find/e4991a](http://www.keysight.com/find/e4991a)  
[www.keysight.com/find/impedance-accessory](http://www.keysight.com/find/impedance-accessory)

### Reference

Application note: *Solutions for measuring permittivity and permeability (5980-2862EN)*

Application note: Temperature characteristic evaluations of RF components and materials using the E4991A impedance/material analyzer (5988-9772EN)

## Quality Evaluation of Foods by Dielectric Measurement

### Abstract

The use of dielectric property to determine the quality of foods (meat, fruits, vegetables, etc.) is one of the major research area, where complex impedance is measured as function of frequency. It is not established yet, but expected to be a fast and non-destructive measuring technique for future application. Keysight impedance analyzers/LCR meters help to accelerate these researches providing wide frequency range, higher accuracy and efficiency.

### Test challenges

- There is no established method or equipment for evaluating quality of food. Researchers investigate measurement method along with electrical measurement instruments.
- Measuring equipment need to have enough stability and repeatability as measurement result often varies with a range of conditions such as temperature and sample variation.
- Efficient measurement is required to evaluate many samples at various conditions.



### How to solve

- The 4294A Precision Impedance Analyzer is the most suitable solution for the application because of its accuracy and repeatability, flexibility of measurement from 40 Hz to 110 MHz frequency range.
- The E4980A is another solution for lower frequency (< 2 MHz) with superior performance and lower cost.
- Although Keysight does not prepare direct solution that meet with all the applications, wide range of fixtures and accessories along with technical experience in the electronic measurement area will give opportunities to help the customers in these research areas.

### Customer type

R&D, education

### Product & web resources

E4980A Precision LCR Meter, 20 Hz to 2 MHz

[www.keysight.com/find/e4991a](http://www.keysight.com/find/e4991a)

4294A Precision Impedance Analyzer, 40 Hz to 110 MHz

[www.keysight.com/find/4294a](http://www.keysight.com/find/4294a)

### Reference

Application note: *Impedance Measurement Handbook (5950-3000)*

Paper: S.N. Jha, et.al. , "Measurement techniques and application of electrical properties for nondestructive quality evaluation of foods—a review," journal of Food Science and Technology, vol. 48, pp. 387–411, 2011.

Paper: G. M. Castro, et.al. "Low- frequency dielectric spectrum to determine pork meat quality," innovative food science and emerging technologies, vol.11, pp. 376–386, 2010.

## Component Impedance and S-parameters Measurement

### Abstract

In general R&D environments where we need to evaluate various kinds of components, including not only 1-port (2-terminal) passive components but 2-port components like filters and amplifiers, a network analyzer (NA) based impedance measurement solution is often preferred to a dedicated impedance analyzer (ZA). The E5061B-3L5 LF-RF network analyzer (5 Hz to 3 GHz) with the Option 005 impedance analysis function offers NA and ZA functions in a single box and is the right solution for this requirement.

### Test challenges

- Although very high accuracy is not needed, it is necessary to measure impedance of various components of low to high impedance ranges.
- In the case of migrating legacy NA/ZA combination analyzers (4192A, 4194A, 4195A, 4395A, and 4396A/B), their major functionalities being used must be also covered with a new analyzer.

### How to solve

- The E5061B-3L5/005 supports three impedance measurement techniques (reflection, series-thru, and shunt-thru) to cover a wide impedance range from milliohm to nearly 100 kohm.
- The E5061B-3L5/005 fully covers major NA/ZA functionalities of above legacy analyzers. (For the spectrum analysis of the 4195A and 439x, migrate to dedicated spectrum analyzers such as the EXA and MXA.)

### Customer type

R&D, education

### Product & web resources

E5061B-3L5 LF-RF network analyzer with Option 005      [www.keysight.com/find/e4991a](http://www.keysight.com/find/e4991a)

### Reference

Presentation: *Migrating 419x/439x to E5061B LF-RF VNA with new impedance analysis function (5990-7501EN)*

Presentation: *Impedance measurement with E5061B LF-RF network analyzer*

## Component Impedance Measurements (Most Accurate Over Broad Impedance Range)

### Abstract

Impedance is an important parameter to characterize electronic circuits, components, and materials. Since none of the real-world components (capacitor/inductor/resonator/diode etc) are purely resistive or reactive due to its parasitic, they act like complex circuits under actual operating conditions. Thus, it is essential to make accurate component characterization under various measurement conditions at R&D/QA. The component dependency factors vs. frequency, AC signal level, DC bias level etc can be characterized by the LCR meters and the impedance analyzers, which provide the best accuracy (traceable) over a broad impedance range using sophisticated auto-balancing bridge or RF-IV technique.

### Test challenges

- Although very high accuracy is not needed, it is necessary to measure impedance of various components of low to high impedance ranges.
- In the case of migrating legacy NA/ZA combination analyzers (4192A, 4194A, 4195A, 4395A, and 4396A/B), their major functionalities being used must be also covered with a new analyzer.

### How to solve

- Auto-balancing bridge type exceptionally accurate over a broad impedance range (mΩ to order of 100 MΩ)
- RF-IV type very accurate over a broad impedance range (mΩ to MΩ) up to 3 GHz
- Equivalent circuit analysis function using three/four-element circuit models in 4294A and E4991A
- Over 40 accessories such as for leaded devices, 0402 (mm) SMD, high temperature characterization
- Material test fixtures and impedance probe kit for in-circuit test available as additive solutions

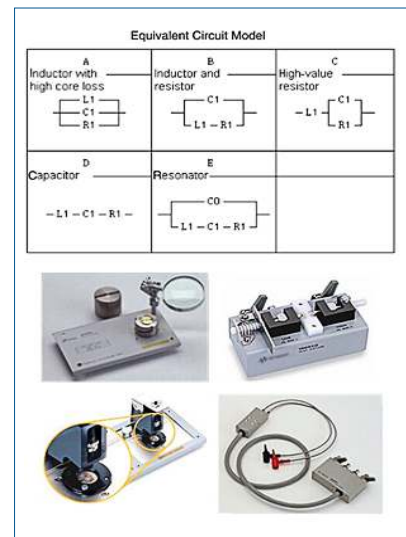

### Customer type

R&D, production, quality assurance, education

### Product & web resources

LCR Meters & Impedance Measurement Products

[www.keysight.com/find/e4991a](http://www.keysight.com/find/e4991a)

LCR Meter & Impedance Measurement Product Accessories

[www.keysight.com/find/impedance-accessory](http://www.keysight.com/find/impedance-accessory)

### Reference

Presentation: *Migrating 419x/439x to E5061B LF-RF VNA with new impedance analysis function (5990-7501EN)*

Presentation: *Impedance measurement with E5061B LF-RF network analyzer*

## Temperature Characteristic Evaluations of RF Components and Materials

### Abstract

The E4991A RF impedance/material analyzer with Option 007 temperature characteristic test kit is a solution for temperature characteristic measurements of components and materials. By integrating with an external temperature chamber such as ESPEC SU-261, VBA sample program performs temperature characteristic evaluation from  $-55\text{ }^{\circ}\text{C}$  to  $+150\text{ }^{\circ}\text{C}$  efficiently.

### Test challenges

- Resources/time wasting to configure system, develop control program, and perform measurements
- Measurement results fluctuate due to temperature drift
- Resources/time wasting to develop sub-routine program for temperature chamber control

### How to solve

- Opt.007 contains a set of extension cable, heat-resistant cable, test head stand, test fixture station, and VBA sample program for temperature characteristic measurements from  $-55\text{ }^{\circ}\text{C}$  to  $+150\text{ }^{\circ}\text{C}$
- 16194A high temperature component test fixture, 16453A dielectric material test fixture, and 16454A magnetic material test fixture available for temperature characteristic measurements
- Temperature drift compensation function employed to reduce drift error drastically
- VBA sample program available for easy system integration of chamber over USB/GPIB interface



### Customer type

R&D, quality assurance, education

### Product & web resources

E4991A RF Impedance/Material Analyzer, 1 MHz to 3 GHz      [www.keysight.com/find/e4991a](http://www.keysight.com/find/e4991a)

### Reference

Application note: *Temperature characteristic evaluations of RF components and materials using the E4991A impedance/material analyzer (5988-9772EN)*

Configuration guide: *E4991A RF impedance/material analyzer configuration guide (5989-8521EN)*

Application note: *Impedance measurement handbook (5950-3000)*

## Appendix-1: Product Based Application List

### E5061B ENA series network analyzers

- RF coaxial cable measurements
- LAN/telecom cable measurements

### E5061B-3L5 LF-RF network analyzer

- DC-DC converter and power distribution network (PDN) measurements
- PSRR in linear regulator/low dropout (LDO) regulator
- OP amp circuit measurements
- MEMS/NEMS device modeling, failure analysis and process control
- On-wafer device characterization from low frequency to microwave
- Component impedance and S-parameters measurement

### E5071C ENA series network analyzers

- RF coaxial cable measurements
- LAN/telecom cable measurements
- EMC component measurement under actual operating conditions
- Mixer and converter measurement
- Multiport device measurement (up to 40-port)

### E5071C ENA Option TDR

- Cable and connector assembly test for USB, HDMI, SATA and DisplayPort
- Tx (source) and Rx (receiver) test for SATA and MIPI
- Device characterization for PCB quality control
- Automotive Ethernet test and debug

### E5092A configurable multiport test set

- Multiport device measurement (up to 40-port)

### E5072A ENA series network analyzers

- Passive Intermodulation (PIM) measurement
- RF amplifier measurements
- High gain amplifier measurements with low power signal
- Pulsed S-parameter measurements
- High-rejection filter measurements

### ENA series network analyzers

- RFID tag measurements
- Automotive antenna test
- RF material measurements using dielectric probe
- Phantom material evaluation for specific absorption rate (SAR) test

## Appendix-1: Product Based Application List (continued)

### E4980A precision LCR meter

- Capacitance characteristics of liquid crystal cell
- MEMS/NEMS Device modeling, failure analysis and process control
- On-wafer C-V characterization of MOS device
- Solid and liquid material measurements with test fixtures
- Quality evaluation of foods by dielectric measurement

### 4294A precision impedance analyzer

- RFID tag measurements
- In-circuit impedance measurements (grounded measurements)
- Capacitance characteristics of liquid crystal cell
- MEMS/NEMS Device modeling, failure analysis and process control
- On-wafer C-V characterization of MOS device
- Quality evaluation of foods by dielectric measurement

### E4991A RF impedance/material analyzer

- EMC component measurement under actual operating conditions
- On-chip device measurements with probing system
- Solid and liquid material measurements with test fixtures
- Permittivity measurements of PCB and substrate materials
- Temperature characteristic evaluations of RF components and materials

### Impedance analyzers/LCR meters

- Production test for inductor, EMI filter, capacitor and register
- Component impedance measurements (most accurate over wide impedance range)



## Appendix-2: Product replacement guide

	Legacy products	Replacement
Network Analyzer	8712/14ET	E5061B
	8712/14ES	E5061B
	8719/20C/22C	E5071C, E5072A
	8719/20/22D	E5071C, E5072A
	8719/20/22ET	E5071C, E5072A
	8719/20/22ES	E5071C, E5072A
	8752A/B/C	E5071C, E5072A, E5061B RF NA
	8753A/B/C	E5071C, E5072A, E5061B RF NA
	8753D/E/ET/ES	E5071C, E5072A, E5061B RF NA
	E5061A/62A	E5061B RF NA
	E5070A/71A	E5071C, E5072A
	E5070B/71B	E5071C, E5072A
	3577A/B	E5061B LF-RF NA
	R&S ZVA, ZVB, ZVL, ZVT, ZVR, ZVC, ZVM	E5071C, E5072A, E5061B RF NA, E5061B LF-RF NA
	Multiport Test Set	E5091A
Impedance/Gain Phase/Material Analyzer	4192A/94A/95A	E5061B LF-RF NA, 4294A
LCR Meter	4396A	E5061B LF-RF NA, E4991A
	4395A / 4396B	E5061B LF-RF NA, 4294A
	4191A	E4991A
	4291B	E4991A
	4191A	E4991A
	4261/62A/63A	4263B
	4332A	4263B
	4274/76/84A	E4980A
	4275/77A	E4980A, 4285A
	4329/39A	4339B
	4268/88A	E4981A
	4286/87A	E4982A
TDR (Sampling) Oscilloscope	Tektronix DSA8200, CSA8200, CSA8000, CSA8000B, TDS8000, TDS8000B, TDS8200B, 11801, 11801A/B/C	E5071C ENA Option TDR

Refresh your technology at a lower cost with maximum flexibility

Premium Trade-In Solutions: [www.keysight.com/find/trade](http://www.keysight.com/find/trade)

**myKeysight**

**myKeysight**

[www.keysight.com/find/mykeysight](http://www.keysight.com/find/mykeysight)

A personalized view into the information most relevant to you.

**Three-Year Warranty**

[www.keysight.com/find/ThreeYearWarranty](http://www.keysight.com/find/ThreeYearWarranty)

Keysight's commitment to superior product quality and lower total cost of ownership. The only test and measurement company with three-year warranty standard on all instruments, worldwide.



**Keysight Assurance Plans**

[www.keysight.com/find/AssurancePlans](http://www.keysight.com/find/AssurancePlans)

Up to five years of protection and no budgetary surprises to ensure your instruments are operating to specification so you can rely on accurate measurements.



[www.keysight.com/go/quality](http://www.keysight.com/go/quality)

Keysight Technologies, Inc.  
DEKRA Certified ISO 9001:2008  
Quality Management System



**Keysight Channel Partners**

[www.keysight.com/find/channelpartners](http://www.keysight.com/find/channelpartners)

Get the best of both worlds: Keysight's measurement expertise and product breadth, combined with channel partner convenience.

For more information on Keysight Technologies' products, applications or services, please contact your local Keysight office. The complete list is available at: [www.keysight.com/find/contactus](http://www.keysight.com/find/contactus)

**Americas**

Canada	(877) 894 4414
Brazil	55 11 3351 7010
Mexico	001 800 254 2440
United States	(800) 829 4444

**Asia Pacific**

Australia	1 800 629 485
China	800 810 0189
Hong Kong	800 938 693
India	1 800 112 929
Japan	0120 (421) 345
Korea	080 769 0800
Malaysia	1 800 888 848
Singapore	1 800 375 8100
Taiwan	0800 047 866
Other AP Countries	(65) 6375 8100

**Europe & Middle East**

Austria	0800 001122
Belgium	0800 58580
Finland	0800 523252
France	0805 980333
Germany	0800 6270999
Ireland	1800 832700
Israel	1 809 343051
Italy	800 599100
Luxembourg	+32 800 58580
Netherlands	0800 0233200
Russia	8800 5009286
Spain	0800 000154
Sweden	0200 882255
Switzerland	0800 805353
	Opt. 1 (DE)
	Opt. 2 (FR)
	Opt. 3 (IT)
United Kingdom	0800 0260637

For other unlisted countries:  
[www.keysight.com/find/contactus](http://www.keysight.com/find/contactus)  
(BP-07-10-14)