

Agilent U3606B Multimeter | DC Power Supply

Quick Start Guide



Agilent Technologies

Notices

© Agilent Technologies, Inc. 2012

No part of this manual may be reproduced in any form or by any means (including electronic storage and retrieval or translation into a foreign language) without prior agreement and written consent from Agilent Technologies, Inc. as governed by United States and international copyright laws.

Manual Part Number

U3606-90061

Edition

First Edition, December 12, 2012

Agilent Technologies, Inc.
5301 Stevens Creek Blvd.
Santa Clara, CA 95051 USA

Warranty

The material contained in this document is provided “as is,” and is subject to being changed, without notice, in future editions. Further, to the maximum extent permitted by applicable law, Agilent disclaims all warranties, either express or implied, with regard to this manual and any information contained herein, including but not limited to the implied warranties of merchantability and fitness for a particular purpose. Agilent shall not be liable for errors or for incidental or consequential damages in connection with the furnishing, use, or performance of this document or of any information contained herein. Should Agilent and the user have a separate written agreement with warranty terms covering the material in this document that conflict with these terms, the warranty terms in the separate agreement shall control.

Technology Licenses

The hardware and or software described in this document are furnished under a license and may be used or copied only in accordance with the terms of such license.

Restricted Rights Legend

U.S. Government Restricted Rights. Software and technical data rights granted to the federal government include only those rights customarily provided to end user customers. Agilent provides this customary commercial license in Software and technical data pursuant to FAR 12.211 (Technical Data) and 12.212 (Computer Software) and, for the Department of Defense, DFARS 252.227-7015 (Technical Data - Commercial Items) and DFARS 227.7202-3 (Rights in Commercial Computer Software or Computer Software Documentation).

Safety Notices

CAUTION





A **CAUTION** notice denotes a hazard. It calls attention to an operating procedure, practice, or the like that, if not correctly performed or adhered to, could result in damage to the product or loss of important data. Do not proceed beyond a **CAUTION** notice until the indicated conditions are fully understood and met.

WARNING

A **WARNING** notice denotes a hazard. It calls attention to an operating procedure, practice, or the like that, if not correctly performed or adhered to, could result in personal injury or death. Do not proceed beyond a **WARNING** notice until the indicated conditions are fully understood and met.

Safety Symbols

The following symbols on the instrument and in the documentation indicate precautions which must be taken to maintain safe operation of the instrument.

	Direct current (DC)		Alternating current (AC)
	Both direct and alternating current		Caution, risk of danger (refer to this manual for specific Warning or Caution information)

Environmental Conditions

This instrument is designed for indoor use and in an area with low condensation. The table below shows the general environmental requirements for this instrument.





Environmental condition	Requirement
Temperature	<ul style="list-style-type: none">• Operating condition<ul style="list-style-type: none">• 0 °C to 55 °C• Storage condition<ul style="list-style-type: none">• -40 °C to 70 °C
Humidity	<ul style="list-style-type: none">• Operating condition<ul style="list-style-type: none">• Up to 80% RH at 40°C (non-condensing)• Storage condition<ul style="list-style-type: none">• Up to 95% RH at 40°C (non-condensing)
Altitude	Up to 2000 m
Pollution degree	2

NOTE

The U3606B Multimeter|DC Power Supply complies with the following safety and EMC requirements:

- IEC 61010-1:2001/EN 61010-1:2001 (2nd Edition)
- Canada: CAN/CSA-C22.2 No. 61010-1-04
- USA: ANSI/UL 61010-1:2004
- IEC 61326-1:2005/EN61326-1:2006
- CISPR11:2003/EN55011:2007, Group 1 Class A
- Canada: ICES/NMB-001:Issue 4, June 2006
- Australia/New Zealand: AS/NZS CISPR 11:2004

Regulatory Markings

 <p>ISM 1-A</p>	<p>The CE mark is a registered trademark of the European Community. This CE mark shows that the product complies with all the relevant European Legal Directives.</p>	 <p>N10149</p>	<p>The C-tick mark is a registered trademark of the Spectrum Management Agency of Australia. This signifies compliance with the Australia EMC Framework regulations under the terms of the Radio Communication Act of 1992.</p>
<p>ICES/NMB-001</p>	<p>ICES/NMB-001 indicates that this ISM device complies with the Canadian ICES-001. Cet appareil ISM est conforme a la norme NMB-001 du Canada.</p>		<p>This instrument complies with the WEEE Directive (2002/96/EC) marking requirement. This affixed product label indicates that you must not discard this electrical or electronic product in domestic household waste.</p>
 <p>C US</p>	<p>The CSA mark is a registered trademark of the Canadian Standards Association.</p>		

Additional Safety Information

For further information on safety, refer to the *U3606B User's Guide*.

1 Standard Shipped Items

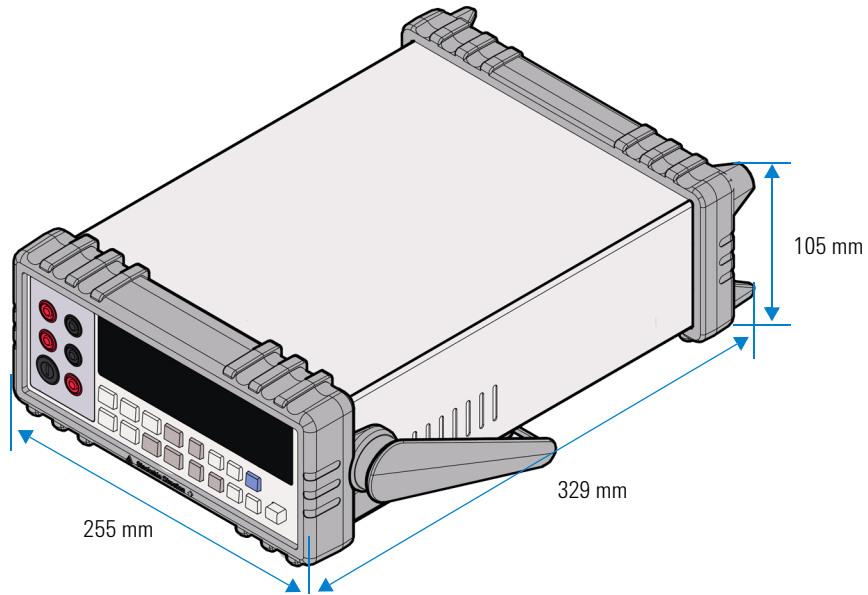

Agilent U3606B Multimeter | DC Power Supply

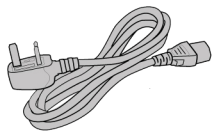

Power cord

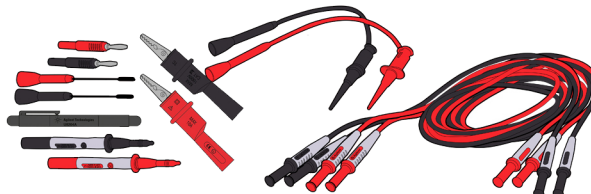

U8201A combo test lead kit



USB Standard-A to Type-B interface cable



Certificate of Calibration



Agilent U3606B Quick Start Guide (this manual)

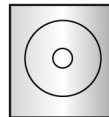

Agilent Automation-Ready CD-ROM

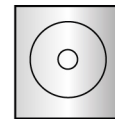

Agilent U3606B Product Reference CD-ROM

2 The Front Panel at a Glance

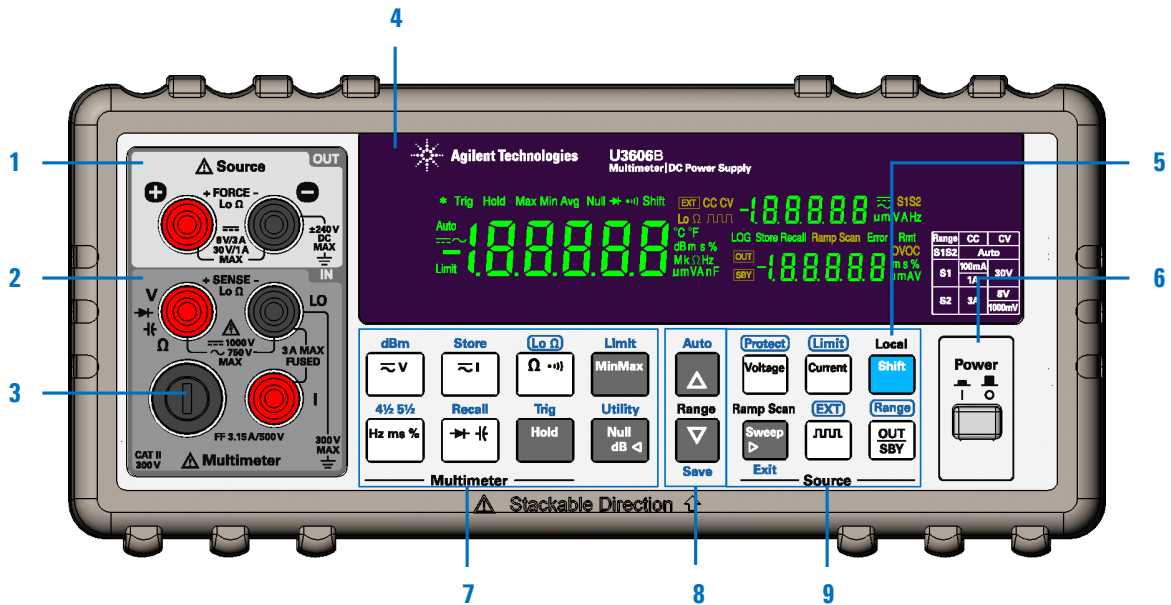

- | | |
|--|---|
| <ul style="list-style-type: none"> 1 Output terminals 2 Input terminals 3 Current fuse 4 Vacuum fluorescent display (VFD) 5 Shift/Local | <ul style="list-style-type: none"> 6 Power ON/OFF switch 7 Keys for multimeter operation 8 Autorange and manual range 9 Keys for source operation |
|--|---|

NOTE

For a complete list of all the keypad functions and descriptions, see *Chapter 1, "Getting Started"* in the *U3606B User's Guide*.

3 The Display at a Glance

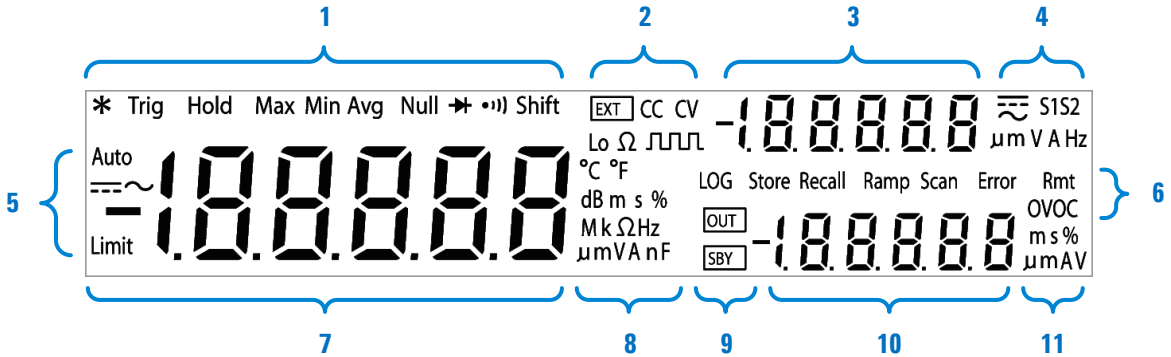

- 1 Trigger, hold, statistics, null, diode, audible continuity, and shift annunciator
- 2 Source functions, Lo Ω annunciator
- 3 Primary display for source functions (upper secondary display)
- 4 Calibration and source functions and units, S1 and S2 range annunciators
- 5 Autoranging, AC, DC, and limit annunciator
- 6 Log, store, recall, ramp, scan, error, remote, and over-voltage/over-current annunciator
- 7 Primary display for digital multimeter measurements
- 8 Measurement functions and units
- 9 OUT and SBY annunciators
- 10 Secondary display for source functions (lower secondary display)
- 11 Source functions and units

NOTE

For a complete list of all the annunciator descriptions, see *Chapter 1, "Getting Started"* in the *U3606B User's Guide*.

4 Power-On the U3606B

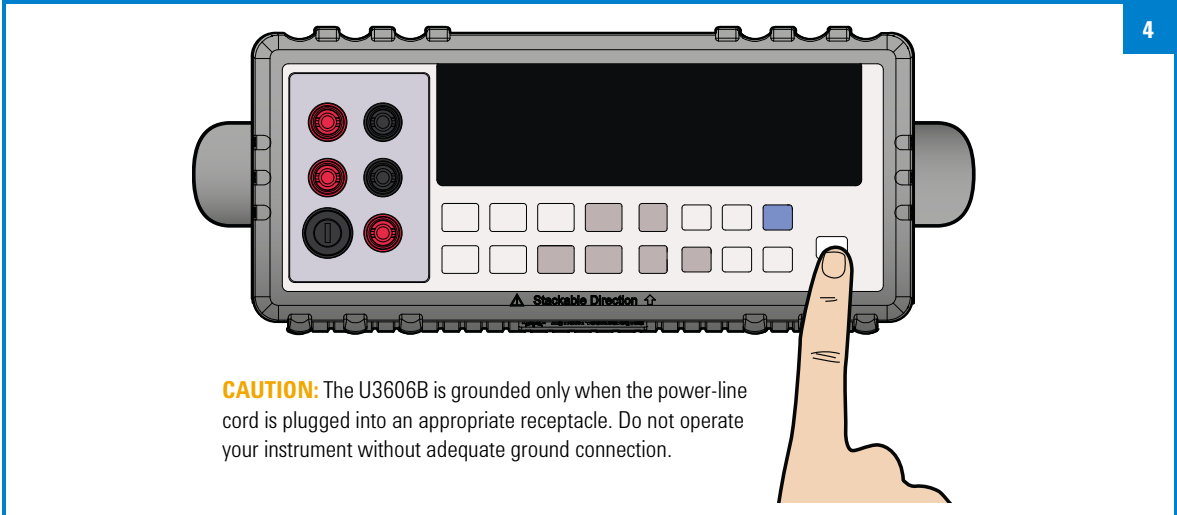
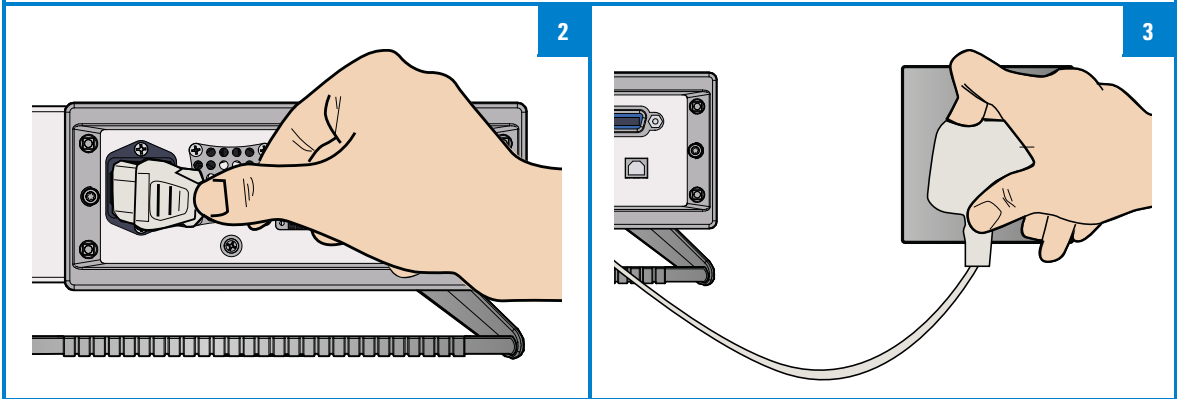
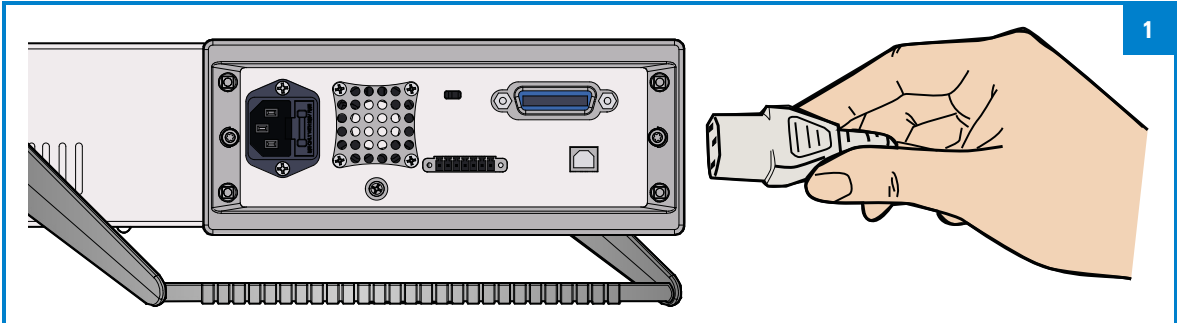

5 Adjust the Carrying Handle

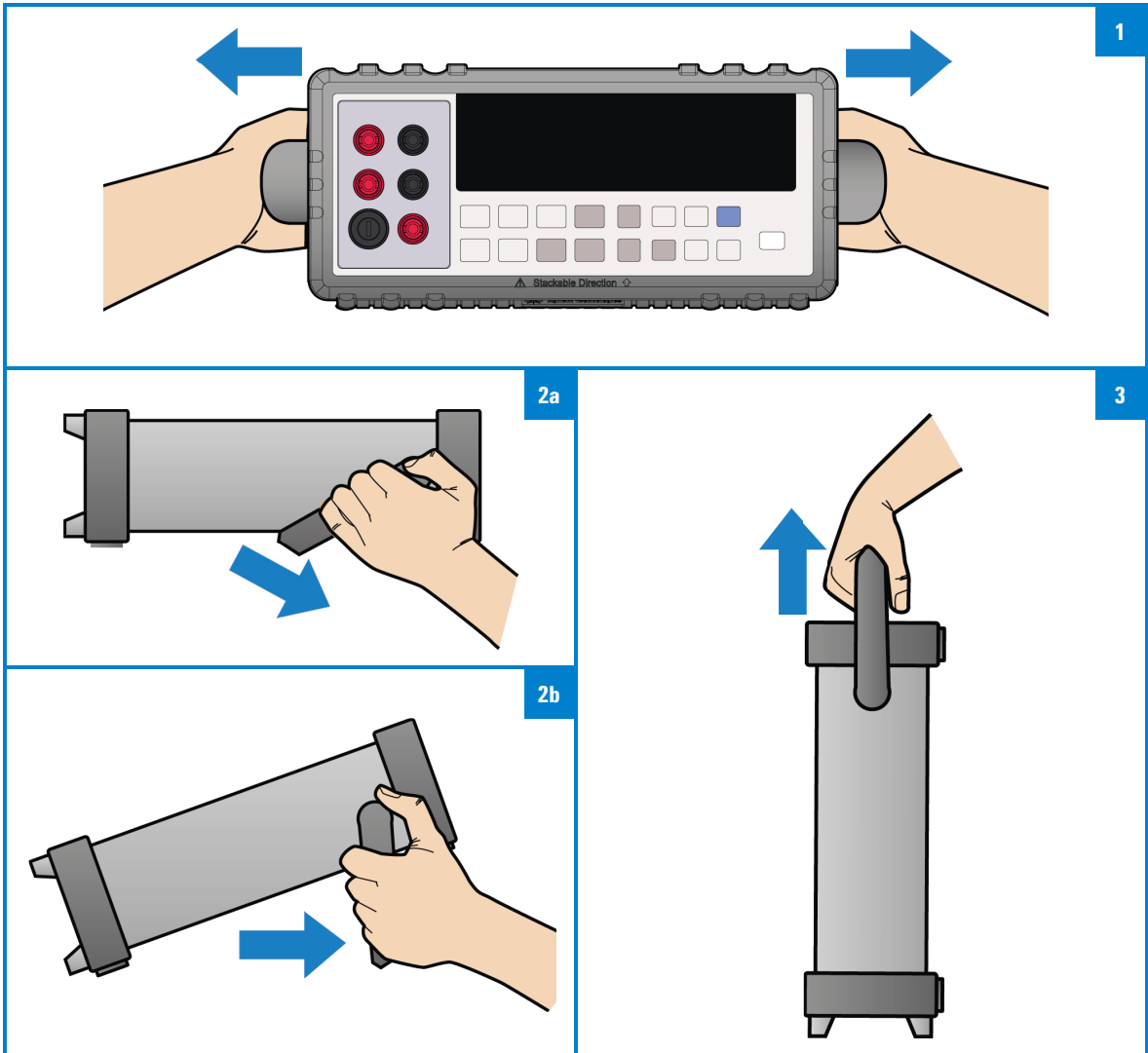

6 Connect the Test Leads to the Terminals

Multimeter operations

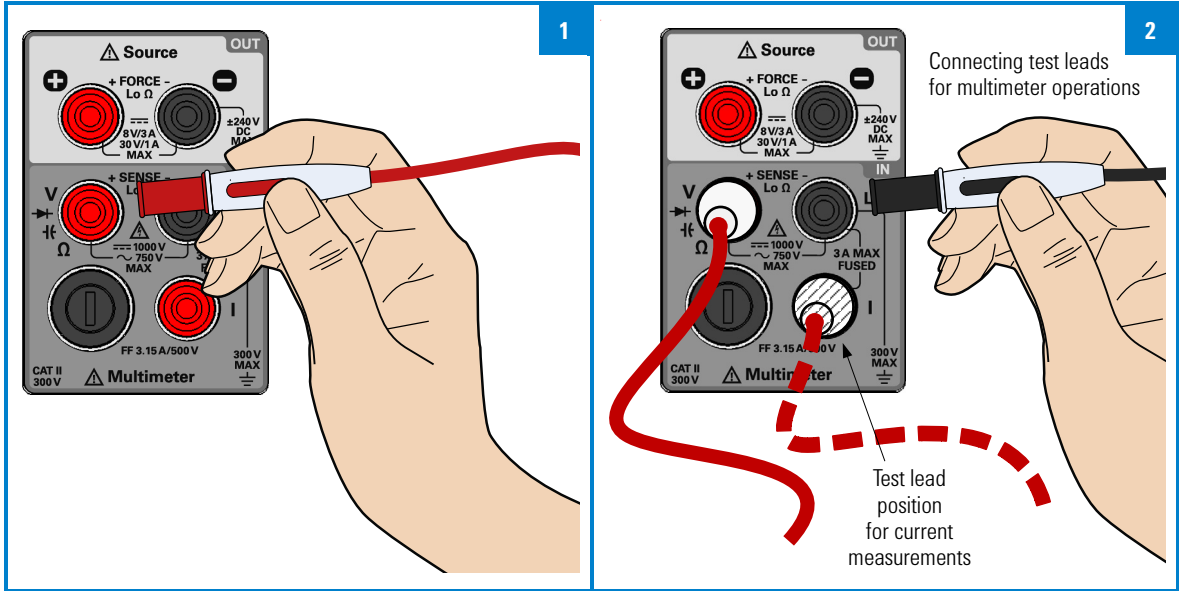

Source operations

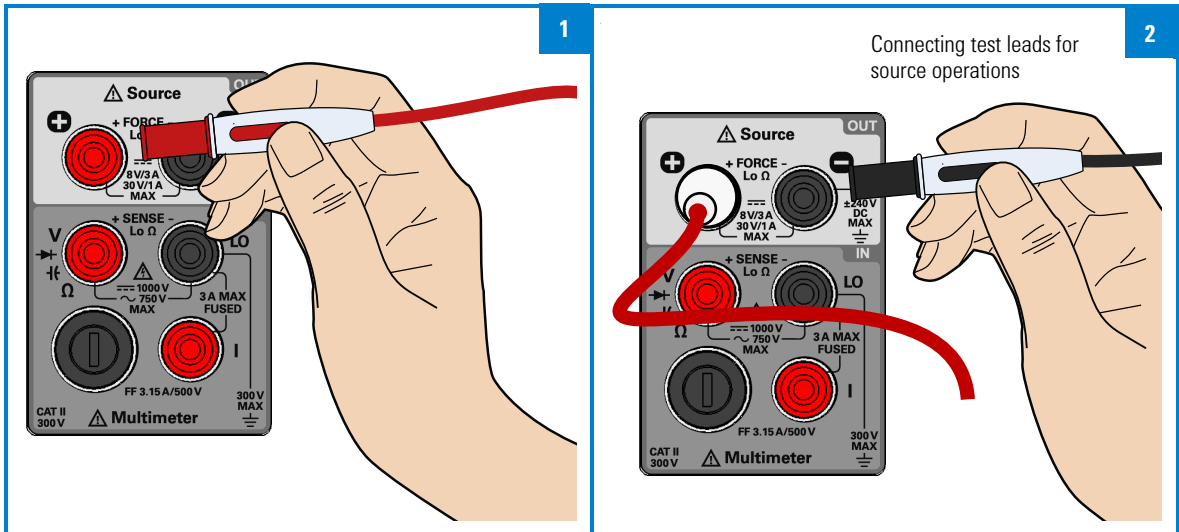

Input connections for multimeter functions

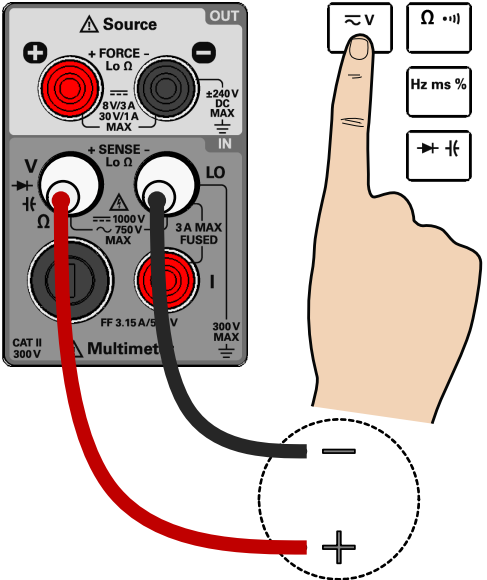

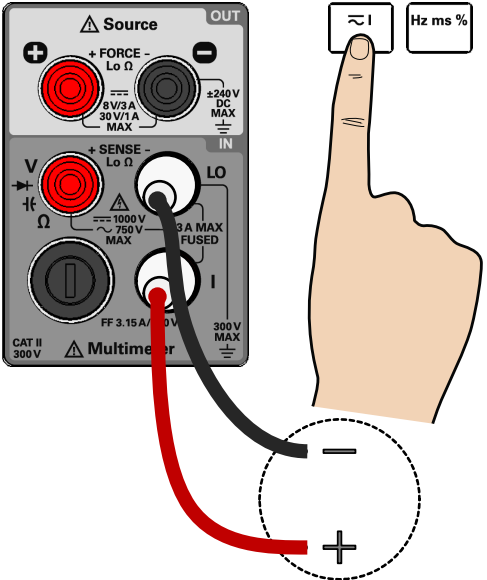

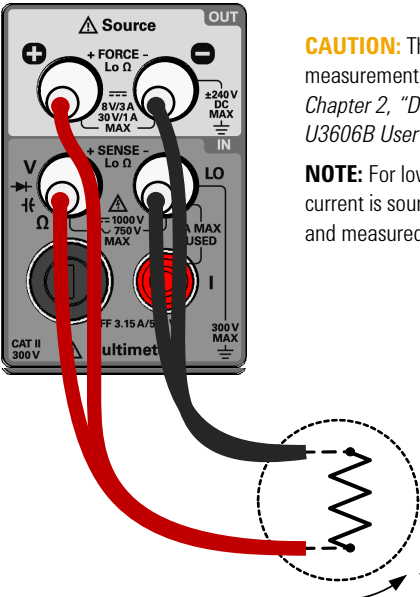

CAUTION: The low-resistance (Lo Ω) 4-wire measurement uses a higher current. Refer to Chapter 2, “Digital Multimeter Operation” in the U3606B User’s Guide for more information.

NOTE: For low-resistance (Lo Ω) measurements, current is sourced from the + FORCE – terminals and measured from the + SENSE – terminals.

Low-resistance (Lo Ω) 4-wire measurements

Test current

Output connections for source functions

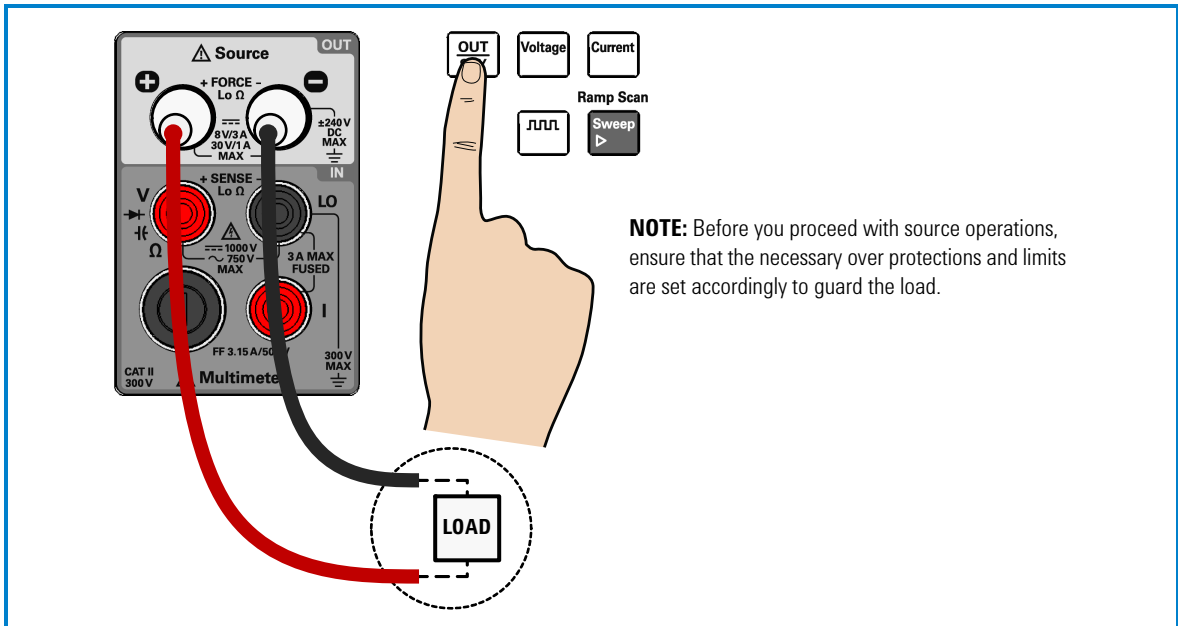

CAUTION

To avoid damaging this device, do not exceed the rated input limit.

NOTE

For a detailed breakdown of all input/output terminal connections, see *Chapter 1, "Getting Started"* in the *U3606B User's Guide*.

7 Select a Function

Selecting a measurement and math function

1

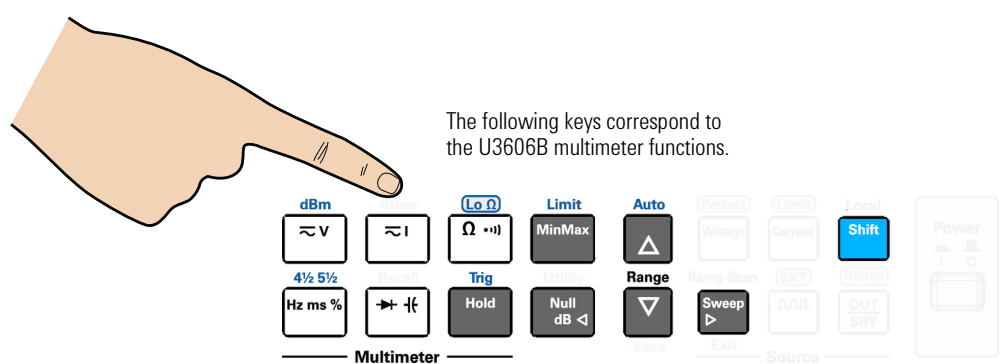

The following keys correspond to the U3606B multimeter functions.

2

Press these keys to select a measurement function.

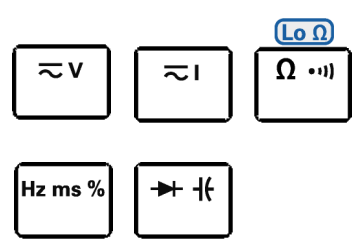

3

Press these keys to select a math function.

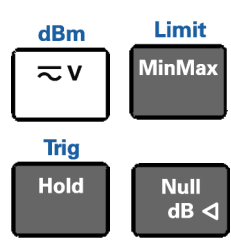

4

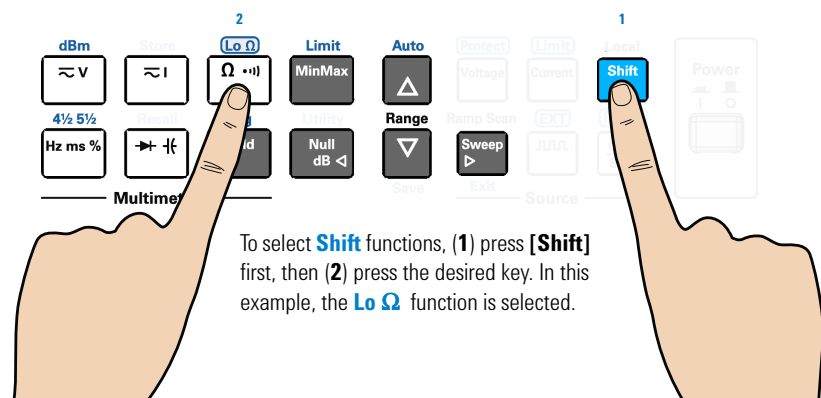

To select **Shift** functions, (1) press [**Shift**] first, then (2) press the desired key. In this example, the **Lo Ω** function is selected.

Selecting a source function

1

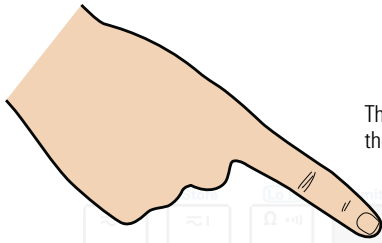

The following keys correspond to the U3606B source functions.

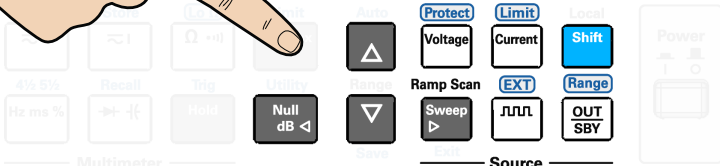

2

Press these keys to select a source function.

Voltage

Current



Ramp Scan



Sweep 



3

Press **[Shift]** > **[Protect]** to set the OV or OC protection value.
Press **[Shift]** > **[Limit]** to set the OV or OC limit value.

 + 

 + 

NOTE: You must first enable the output protection state from the Utility menu to activate the OC and OV protection features.

* OV = Over Voltage
OC = Over Current

4

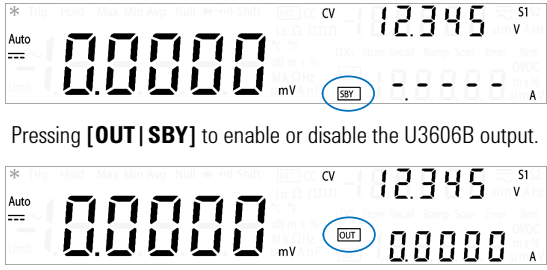

Pressing **[OUT|SBY]** to enable or disable the U3606B output.

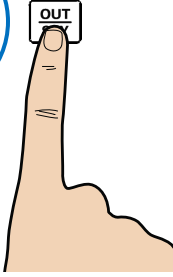

Entering the Utility menu

Press **[Shift]** > **[Utility]** to enter the Utility menu. The first menu item allows you to read error messages. 1



Use the arrow keys to navigate the Utility menu. 2

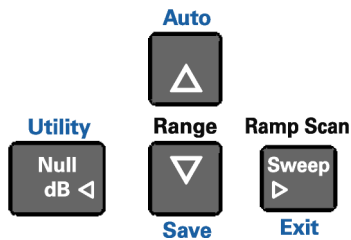

- Press [**<**] or [**>**] to step through the available menu items.
- Press [**△**] or [**▽**] to switch between two values, to select a value from the list, or to decrease or increase a value.

Press **[Shift]** > **[Save]** to save a changed setting. 3

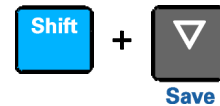

Press **[Shift]** > **[Exit]** to exit the Utility menu. 4

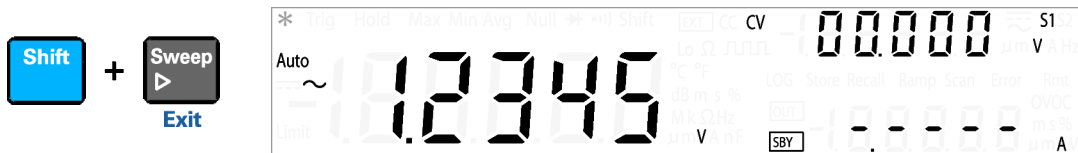

The U3606B resumes normal operation. The saved settings are store in the U3606B's non-volatile memory.

Setting the range and resolution

For multimeter functions:

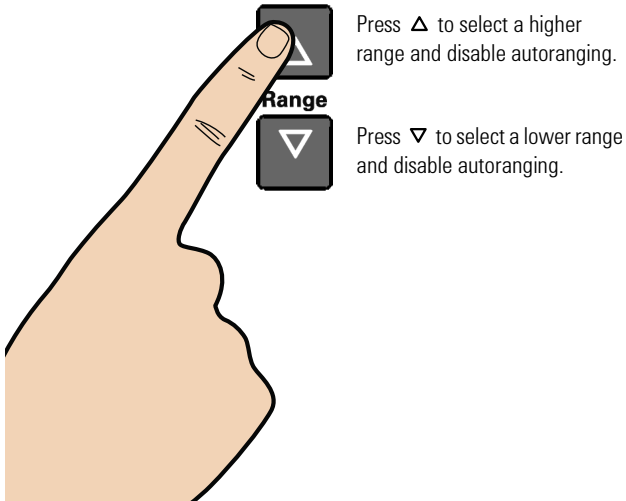

For source functions:

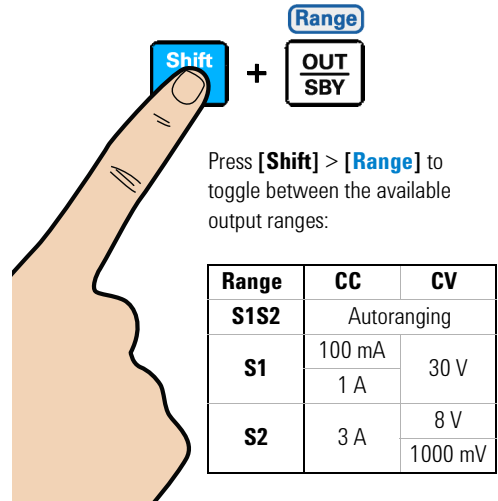

Enable autoranging (for multimeter functions):

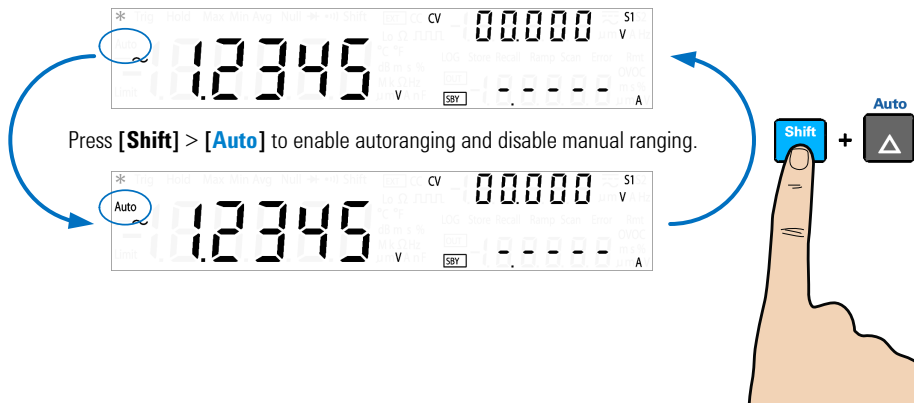

Setting the resolution:

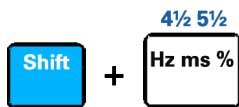

Press [**Shift**] > [**4 1/2 5 1/2**] to toggle between 4 1/2 digit and 5 1/2 digit mode.

5 1/2 digit resolution has the best accuracy with noise rejection.

4 1/2 digit resolution provides faster reading rates.

8 Where to Go Next?

User references

User's Guide The Agilent *U3606B Multimeter|DC Power Supply User's Guide* contains more detailed information on the front panel, measurement functions, math operations, source operations, output functions, and the utility menu (the utility menu allows you to customize the instrument settings). It also contains information requisite to do performance tests, adjustments, troubleshooting, and repairs.

Programmer's Reference For information on remote programming and SCPI commands, see the Agilent *U3606B Multimeter|DC Power Supply Programmer's Reference*.

Agilent support and contact information

Check www.agilent.com/find/U3606B for the latest version of the User's Guide, additional information, downloads, and services related to your Agilent product.

The website provides information on the use of Agilent products and services. If you need to contact customer service, check the list of local Agilent contact centers on www.agilent.com/find/contactus.

For maintenance services, check your nearest Agilent Service Center on www.agilent.com/find/assist.

THIS PAGE HAS BEEN INTENTIONALLY LEFT BLANK.

www.agilent.com

Contact us

To obtain service, warranty, or technical assistance, contact us at the following phone or fax numbers:

United States:

(tel) 800 829 4444 (fax) 800 829 4433

Canada:

(tel) 877 894 4414 (fax) 800 746 4866

China:

(tel) 800 810 0189 (fax) 800 820 2816

Europe:

(tel) 31 20 547 2111

Japan:

(tel) (81) 426 56 7832 (fax) (81) 426 56 7840

Korea:

(tel) (080) 769 0800 (fax) (080) 769 0900

Latin America:

(tel) (305) 269 7500

Taiwan:

(tel) 0800 047 866 (fax) 0800 286 331

Other Asia Pacific Countries:

(tel) (65) 6375 8100 (fax) (65) 6755 0042

Or visit Agilent World Wide Web at:

www.agilent.com/find/assist

Product specifications and descriptions in this document are subject to change without notice. Always refer to the Agilent website for the latest revision.

© Agilent Technologies, Inc. 2012

First Edition, December 12, 2012
U3606-90061



Agilent Technologies