

Agilent 34405A
5 ½ Digit Multimeter

User's and Service Guide



Agilent Technologies

Notices

© Agilent Technologies, Inc. 2006–2014

No part of this manual may be reproduced in any form or by any means (including electronic storage and retrieval or translation into a foreign language) without prior agreement and written consent from Agilent Technologies, Inc. as governed by United States and international copyright laws.

Manual Part Number

34405-91000

Edition

Thirteenth Edition, July 3, 2014

Printed in Malaysia

Agilent Technologies, Inc.
3501 Stevens Creek Blvd.
Santa Clara, CA 95052 USA

Software Revision

This guide is valid for the firmware that was installed in the instrument at the time of manufacture. However, upgrading the firmware may add or change product features. For the latest firmware and documentation, go to the product page at:

www.agilent.com/find/34405A

Warranty

The material contained in this document is provided “as is,” and is subject to being changed, without notice, in future editions. Further, to the maximum extent permitted by applicable law, Agilent disclaims all warranties, either express or implied, with regard to this manual and any information contained herein, including but not limited to the implied warranties of merchantability and fitness for a particular purpose. Agilent shall not be liable for errors or for incidental or consequential damages in connection with the furnishing, use, or performance of this document or of any information contained herein. Should Agilent and the user have a separate written agreement with warranty terms covering the material in this document that conflict with these terms, the warranty terms in the separate agreement shall control.

Technology Licenses

The hardware and/or software described in this document are furnished under a license and may be used or copied only in accordance with the terms of such license.

Restricted Rights Legend

U.S. Government Restricted Rights. Software and technical data rights granted to the federal government include only those rights customarily provided to end user customers. Agilent provides this customary commercial license in Software and technical data pursuant to FAR 12.211 (Technical Data) and 12.212 (Computer Software) and, for the Department of Defense, DFARS 252.227-7015 (Technical Data - Commercial Items) and DFARS 227.7202-3 (Rights in Commercial Computer Software or Computer Software Documentation).

Safety Notices

CAUTION

A **CAUTION** notice denotes a hazard. It calls attention to an operating procedure, practice, or the like that, if not correctly performed or adhered to, could result in damage to the product or loss of important data. Do not proceed beyond a **CAUTION** notice until the indicated conditions are fully understood and met.

WARNING

A **WARNING** notice denotes a hazard. It calls attention to an operating procedure, practice, or the like that, if not correctly performed or adhered to, could result in personal injury or death. Do not proceed beyond a **WARNING** notice until the indicated conditions are fully understood and met.

Safety Information

Do not defeat power cord safety ground feature. Plug in to a grounded (earthed) outlet.

Do not use product in any manner not specified by the manufacturer.

Do not install substitute parts or perform any unauthorized modification to the product. Return the product to an Agilent Technologies Sales and Service Office for service and repair to ensure that safety features are maintained.

Safety Symbols



Earth Ground



Chassis Ground



Risk of electric shock



Refer to manual for additional safety information

CAT II (300V) IEC Measurement Category II. Inputs may be connected to mains (up to 300 VAC) under Category II overvoltage conditions.

WARNING

Main Power and Test Input Disconnect: Unplug instrument from wall outlet, remove power cord, and remove all probes from all terminals before servicing. Only qualified, service-trained personnel should remove the cover from the instrument.

WARNING

Line and Current Protection Fuses: For continued protection against fire, replace the line fuse and the current-protection fuse only with fuses of the specified type and rating.

WARNING

IEC Measurement Category II. The HI and LO input terminals may be connected to mains in IEC Category II installations for line voltages up to 300 VAC. To avoid the danger of electric shock, do not connect the inputs to mains for line voltages above 300 VAC. See "IEC Measurement Category II Overvoltage Protection" on the following page for further information.

WARNING

Protection Limits: To avoid instrument damage and the risk of electric shock, do not exceed any of the Protection Limits defined in the following section.

WARNING

Do not exceed any of the measurement limits defined in the specifications to avoid instrument damage and the risk of electric shock.

Protection Limits

The Agilent 34405A Digital Multimeter provides protection circuitry to prevent damage to the instrument and to protect against the danger of electric shock, provided that the Protection Limits are not exceeded. To ensure safe operation of the instrument, do not exceed the Protection Limits shown on the front panel, as defined below:

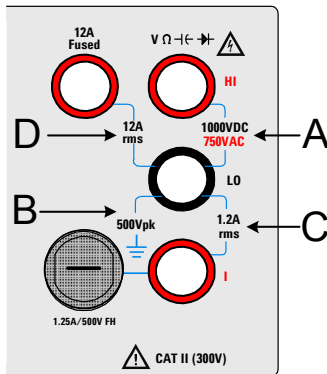

Note: The front-panel terminals and current protection fuse are shown above.

Input Terminal Protection Limits

Protection Limits are defined for the input terminals:

Main Input (HI and LO) Terminals. The HI and LO input terminals are used for voltage, resistance, capacitance, and diode test measurements. Two Protection Limits are defined for these terminals:

HI to LO Protection Limit. The Protection Limit from HI to LO ("A" in the figure at left) is 1000 VDC or 750 VAC, which is also the maximum voltage measurement. This limit can also be expressed as 1000 Vpk maximum.

LO to Ground Protection Limit. The LO input terminal can safely "float" a maximum of 500 Vpk relative to ground. This is Protection Limit "B" in the figure.

Although not shown on the figure, the Protection Limit for the HI terminal is a maximum of 1000 Vpk relative to the ground. Therefore, the sum of the "float" voltage and the measured voltage must not exceed 1000 Vpk

Current Input Terminal. The current input ("I") terminal has a Protection Limit of 1.2A (rms) maximum current flowing from the LO input terminal. This is Protection Limit "C" in the figure. Note that the current input terminal will be at approximately the same voltage as the LO terminal.

Note: The current-protection circuitry includes a fuse on the front panel. To maintain protection, replace this fuse only with a fuse of the specified type and rating.

12A Current Input Terminal. The 12A current input terminal has a Protection Limit of 12A (rms) maximum current flowing from the LO input terminal. This is Protection Limit "D" in the figure. Note that the current input terminal will be at approximately the same voltage as the LO terminal.

Note: The current-protection circuitry includes an internal fuse. To maintain protection, service-trained personnel should replace this fuse only with a fuse of the specified type and rating.

IEC Measurement Category II Overvoltage Protection

To protect against the danger of electric shock, the Agilent 34405A Digital Multimeter provides overvoltage protection for line-voltage mains connections meeting *both* of the following conditions:

The HI and LO input terminals are connected to the mains under Measurement Category II conditions, defined below, *and* The mains are limited to a maximum line voltage of 300 VAC.

IEC Measurement Category II includes electrical devices connected to mains at an outlet on a branch circuit. Such devices include most small appliances, test equipment, and other devices that plug into a branch outlet or socket. The 34405A may be used to make measurements with the HI and LO inputs connected to mains in such devices, or to the branch outlet itself (up to 300 VAC). However, the 34405A may not be used with its HI and LO inputs connected to mains in permanently installed electrical devices such as the main circuit-breaker panel, sub-panel disconnect boxes, or permanently wired motors. Such devices and circuits are subject to overvoltages that may exceed the protection limits of the 34405A.

Note: Voltages above 300 VAC may be measured only in circuits that are isolated from mains. However, transient overvoltages are also present on circuits that are isolated from mains. The Agilent 34405A is designed to safely withstand occasional transient overvoltages up to 2500 Vpk. Do not use this equipment to measure circuits where transient overvoltages could exceed this level.

Additional Notices

This product complies with the WEEE Directive (2002/96/EC) marking requirement. The affixed product label (see below) indicates that you must not discard this electrical/electronic product in domestic household waste.

Product Category: With reference to the equipment types in the WEEE directive Annex 1, this product is classified as a "Monitoring and Control instrumentation" product.

Do not dispose in domestic household waste.

To return unwanted products, contact your local Agilent office, or see www.agilent.com/environment/product for more information.



The Agilent 34405A is provided with an Agilent 34138A Test Lead Set, described below.

Test Lead Ratings

Test Leads - 1000V, 15A

Fine Tip Probe Attachments - 300V, 3A

Mini Grabber Attachment - 300V, 3A

SMT Grabber Attachments - 300V, 3A

Operation

The Fine Tip, Mini Grabber, and SMT Grabber attachments plug onto the probe end of the Test Leads.

Maintenance

If any portion of the Test Lead Set is worn or damaged, do not use. Replace with a new Agilent 34138A Test Lead Set.

WARNING

If the Test Lead Set is used in a manner not specified by Agilent Technologies, the protection provided by the Test Lead Set may be impaired. Also, do not use a damaged or worn Test Lead Set. Instrument damage or personal injury may result.

Declaration of Conformity (DoC)

The Declaration of Conformity (DoC) for this instrument is available on the Web site. You can search the DoC by its product model or description.

<http://regulations.corporate.agilent.com/DoC/search.htm>

NOTE

If you are unable to search for the respective DoC, please contact your local Agilent representative.

Contents

1	Getting Started Tutorial	11
	Introducing the Agilent 34405A Multimeter	12
	Checking the Shipping Contents	13
	Connecting Power to the Multimeter	13
	Adjusting the Handle	14
	The Front Panel at a Glance	15
	The Display at a Glance	16
	The Rear Panel at a Glance	17
	Remote Operation	18
	Configuring and Connecting the USB Interface	18
	SCPI Commands	18
	Making Measurements	20
	Measuring AC or DC Voltage	20
	Measuring Resistance	21
	Measuring AC (RMS) or DC Current up to 1.2A	21
	Measuring AC (RMS) or DC Current up to 12A	22
	Measuring Frequency	22
	Testing Continuity	23
	Checking Diodes	23
	Measuring Capacitance	24
	Measuring Temperature	24
	Selecting a Range	25
	Setting the Resolution	26
2	Features and Functions	27
	Math Operations	28
	Null	29
	dBm	29
	dB	30
	Min/Max	30
	Limit	31
	Hold	31

Math Annunciators	32
Using the Secondary Display	33
Measurement Functions and the Secondary Display	33
Math Operations and the Secondary Display	35
Using the Utility Menu	36
Changing Configurable Settings	37
Reading Error Messages	38
The Beeper	39
Editing Values in the Secondary Display	40
Selecting the Value to Edit	40
Editing Values	40
Storing and Recalling Instrument States	41
Storing a State	41
Recalling a Stored State	42
Reset/Power-On State	43
Triggering the Multimeter	45
3 Measurement Tutorial	47
DC Measurement Considerations	48
Noise Rejection	49
Resistance Measurement Considerations	51
AC Measurements	52
True RMS AC Measurements	53
Other Primary Measurement Functions	56
Frequency Measurement Errors	56
DC Current Measurements	56
Capacitance Measurements	57
Temperature Measurements	58
Other Sources of Measurement Error	59
4 Performance Tests and Calibration	63
Calibration Overview	64
Closed - Case Electronic Calibration	64
Agilent Technologies Calibration Services	64
Calibration Interval	64
Time Required for Calibration	65
Recommended Test Equipment	66

Test Considerations	67
Input Connections	67
Performance Verification Tests Overview	68
Self -Test	68
Quick Performance Check	69
Performance Verification Tests	70
Zero Offset Verification	71
Gain Verification	73
Optional AC Voltage Performance Verification Test	79
Optional AC Current Performance Verification Test	80
Optional Capacitance Performance Verification Test	81
Calibration Security	82
Unsecuring the Instrument for Calibration	83
Calibration Process	85
Using the Front Panel for Adjustments	86
Adjustments	88
Zero Adjustment	88
Gain Adjustments	89
DC Voltage Gain Adjustment Procedure	91
DC Current Gain Adjustment Procedure	92
AC Voltage Gain Adjustment Procedure	94
AC Current Gain Adjustment Procedure	95
Ohms Gain Adjustment Procedure	97
Frequency Gain Adjustment Procedure	98
Capacitance Gain Adjustment Procedure	99
Finishing the Adjustments	101
Calibration Message	102
To Read the Calibration Count	102
Calibration Errors	103
5 Disassembly and Repair	105
Operating Checklist	106
Types of Service Available	107
Repackaging for Shipment	108
Cleaning	108
To Replace the Power Line Fuse	109
To Replace a Current Input Fuse	110
Electrostatic Discharge (ESD) Precautions	112

Contents

	Mechanical Disassembly	113
	Replaceable Parts	120
	Rack Mounting	121
6	Specifications	123
	DC Specifications ^[1]	125
	AC Specifications ^[1]	126
	Temperature and Capacitance Specifications ^[1]	128
	Operating Specifications	129
	Supplemental Measurement Specifications	130
	General Characteristics	134
	To Calculate Total Measurement Error	136
	Accuracy Specifications	137
	Configuring for Highest Accuracy Measurements	138
	Index	139



1 Getting Started Tutorial

Introducing the Agilent 34405A Multimeter	12
Checking the Shipping Contents	13
Connecting Power to the Multimeter	13
Adjusting the Handle	14
The Front Panel at a Glance	15
The Rear Panel at a Glance	17
Measuring AC or DC Voltage	20
Measuring Resistance	21
Measuring AC (RMS) or DC Current up to 1.2A	21
Measuring AC (RMS) or DC Current up to 12A	22
Measuring Frequency	22
Testing Continuity	23
Checking Diodes	23
Measuring Capacitance	24
Measuring Temperature	24
Selecting a Range	25
Setting the Resolution	26

This chapter contains a quick tutorial showing how to use the front panel to make measurements.



Introducing the Agilent 34405A Multimeter

The multimeter's key features are:

- 5 ½-digit dual display measurements
- Ten measurement functions:
 - AC voltage
 - DC voltage
 - Two-wire resistance
 - AC current
 - DC current
 - Frequency
 - Continuity
 - Diode Test
 - Temperature
 - Capacitance
- Six math functions:
 - Null
 - dBm
 - dB
 - Min/Max
 - Limit
 - Hold
- 4 ½- or 5 ½-digit measurements
- Dual display
- USB 2.0, USBTMC-USB488 device class

Checking the Shipping Contents

Verify that you have received the following items with your multimeter:

- One test lead kit
- One power cord
- One USB interface cable
- A Quick Start Guide
- A Certificate of Calibration (test report included)
- A CD-ROM containing the remote programming online help, online manuals, application software, and instrument drivers
- An Agilent IO Library CD-ROM

If anything is missing, contact your nearest Agilent Sales Office.

Connecting Power to the Multimeter

Connect the power cord and press the Power switch to turn on the multimeter.

The front-panel display illuminates while the multimeter performs its power-on self-test. (If the multimeter does not power-on, refer [“Operating Checklist”](#) on page 106).

The multimeter powers up in the DC voltage function with autoranging enabled. If self-test is successful, the multimeter goes to normal operation. If the self-test is not successful, **Error** is displayed on the left side of the display and an error number is displayed in the upper right side of the display. In the unlikely event that self-test repeatedly fails, contact your nearest Agilent Sales Office.

NOTE

A more extensive self-test is available from the Utility menu see [“Using the Utility Menu”](#) on page 36 for details.

Adjusting the Handle

To adjust the handle, grasp the handle by the sides and pull outward. Then, rotate the handle to the desired position.

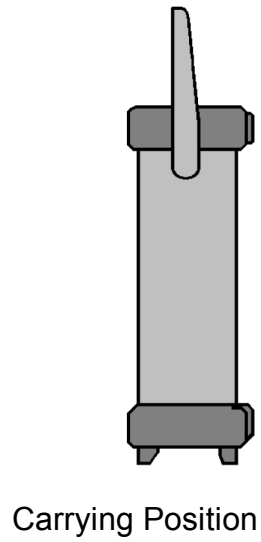
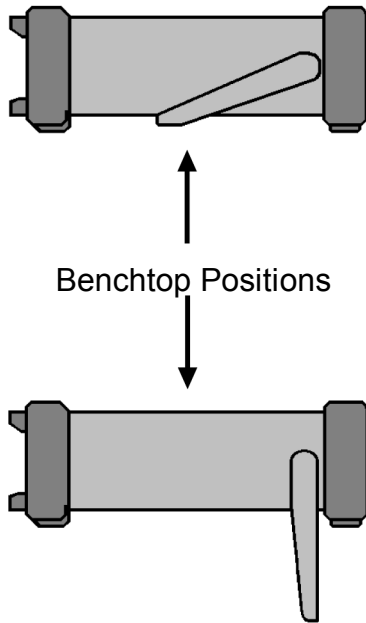

The Front Panel at a Glance

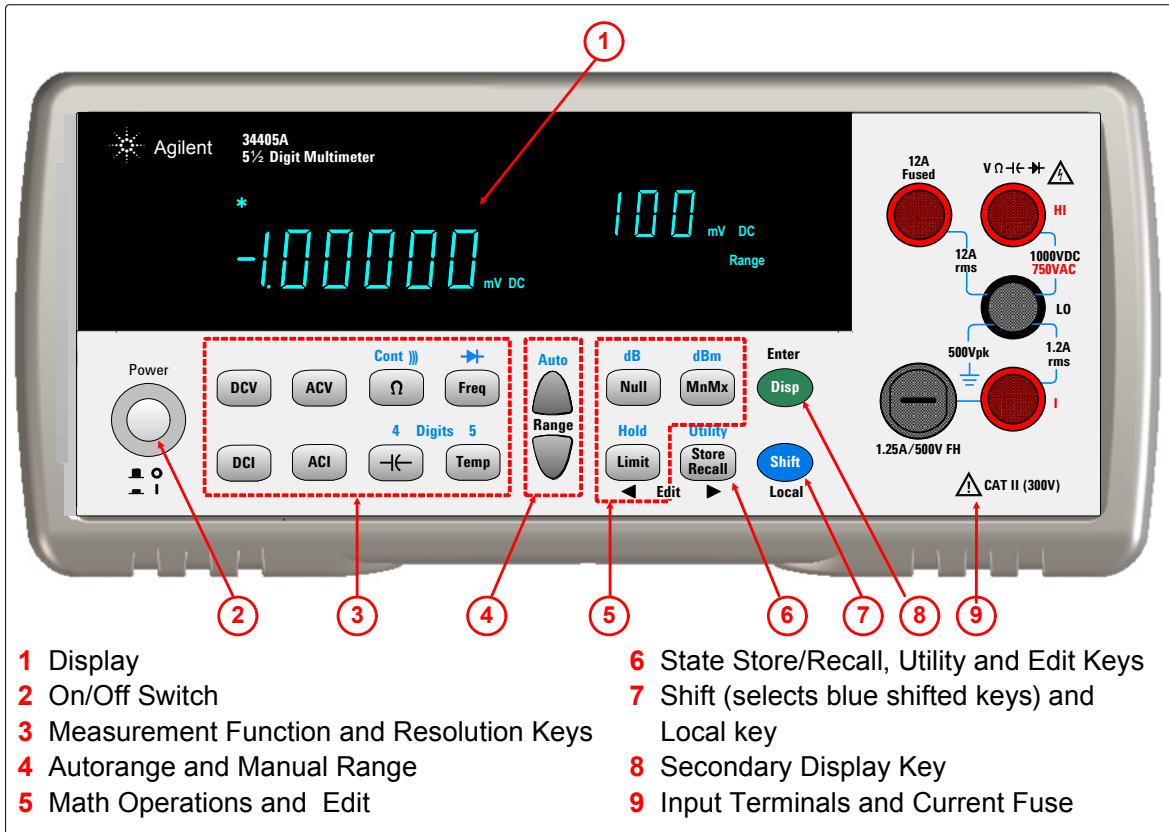

The Display at a Glance

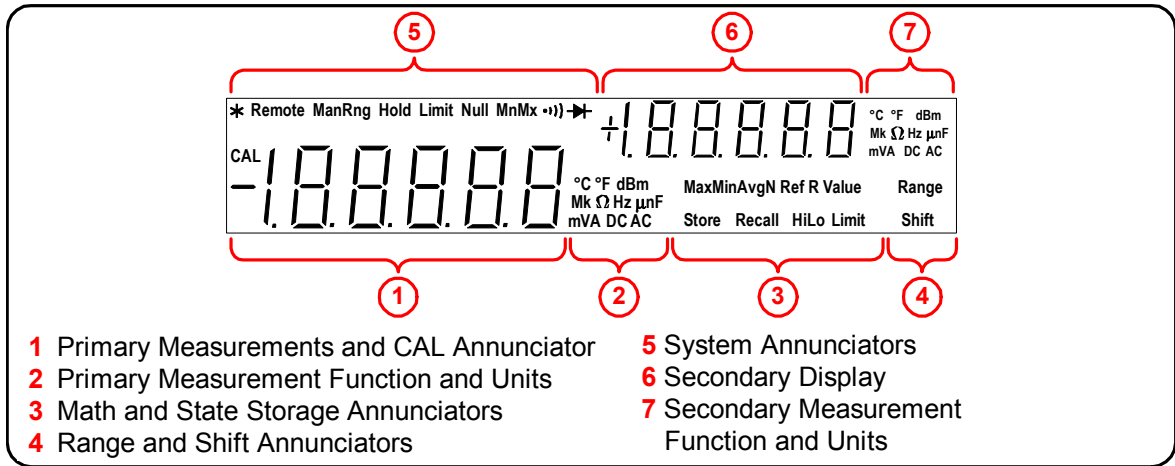

The System Annunciators (above the primary display) are described below (see [page 32](#) for Math Annunciators and [Chapter 4](#) for the calibration annunciator).

System Annunciator	Description
*	Sample annunciator--indicates readings being taken.
Remote	The multimeter is operating in the remote interface mode.
ManRng	Fixed range selected (autoranging disabled).
Hold	Reading hold function enabled.
Limit	Limit math feature enabled
Null	Null math feature enabled.
MnMx	Min/Max feature enabled.
))	Continuity test function selected.
⚡	Diode test function selected.
Shift	Shift key has been pressed.

The Rear Panel at a Glance

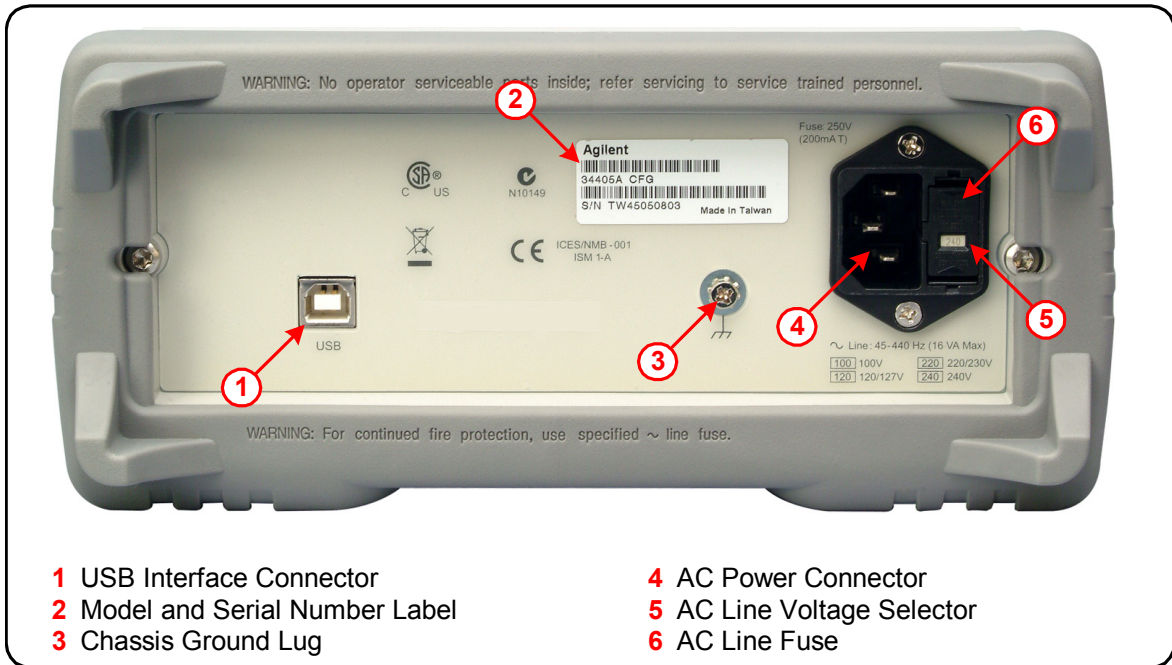

Remote Operation

The instrument automatically enters the Remote state whenever SCPI commands are received over the USB bus interface. When in the Remote state, pressing  returns the multimeter to front panel operation.

Configuring and Connecting the USB Interface

There is nothing to configure on your instrument for a USB connection. Just connect the instrument to your PC using the USB 2.0 cable included with the instrument.

NOTE

To easily configure and verify an interface connection between the 34405A and your PC, use the Automation-Ready CD, which is shipped with your 34405A. This CD includes the *Agilent IO Libraries Suite* and the *Agilent Connection Expert* application. For more information about Agilent's I/O connectivity software, visit www.agilent.com/find/iolib.

SCPI Commands

The Agilent 34405A complies with the syntax rules and conventions of SCPI (*Standard Commands for Programmable Instruments*).

NOTE

For a *complete* discussion of 34405A SCPI syntax, refer to the *Agilent 34405A Programmer's Reference Help*. This help is provided on the *Agilent 34405A Product Reference CD-ROM* that came with your instrument.

SCPI Language Version

You can determine the multimeter's SCPI language version by sending the `SYSTem:VERSion?` command from the remote interface.

- You can query the SCPI version from the remote interface only.
- The SCPI version is returned in the form “YYYY.V”, where “YYYY” represents the year of the version, and “V” represents a version number for that year (for example, 1994.0).

Making Measurements

The following pages show how to make measurement connections and how to select measurement functions from the front panel for each of the measurement functions.

For remote operation, refer to the MEASure Subsystem in the *Agilent 34405A Online Programmer's Reference* online help.

Measuring AC or DC Voltage

AC Voltage:

- Five Ranges: 100.000 mV, 1.00000 V, 10.0000 V, 100.000 V, 750.00 V
- Measurement Method: AC coupled true rms - measures the AC component with up to 400 VDC bias on any range.
- Crest Factor: Maximum 5:1 at full scale
- Input Impedance: $1\text{ M}\Omega \pm 2\%$ in parallel with $<100\text{pF}$ on all ranges
- Input Protection: 750V rms on all ranges (HI terminal)

DC Voltage:

- Five Ranges: 100.000 mV, 1.00000 V, 10.0000 V, 100.000 V, 1000.00 V
- Measurement Method: Sigma Delta A-to-D converter
- Input Impedance: $\sim 10\text{ M}\Omega$ all ranges (typical)
- Input Protection: 1000V on all ranges (HI terminal)

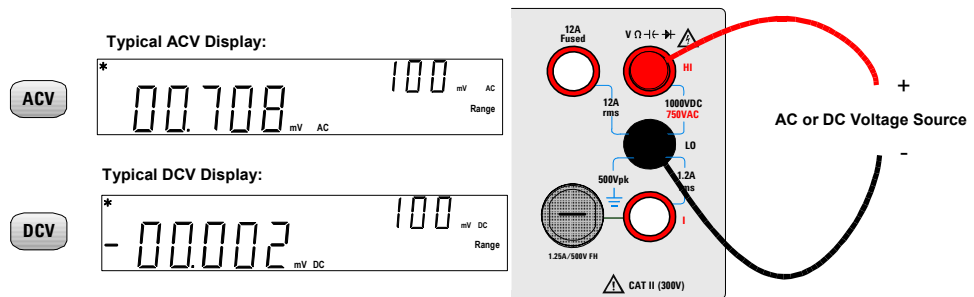

Measuring Resistance

- Seven Ranges: 100.000 Ω , 1.00000 k Ω , 10.0000 k Ω , 100.000 k Ω , 1.00000 M Ω , 10.0000 M Ω , 100.000 M Ω
- Measurement Method: two-wire ohms
- Open-circuit voltage limited to < 5 V
- Input protection 1000 V on all ranges (HI terminal)

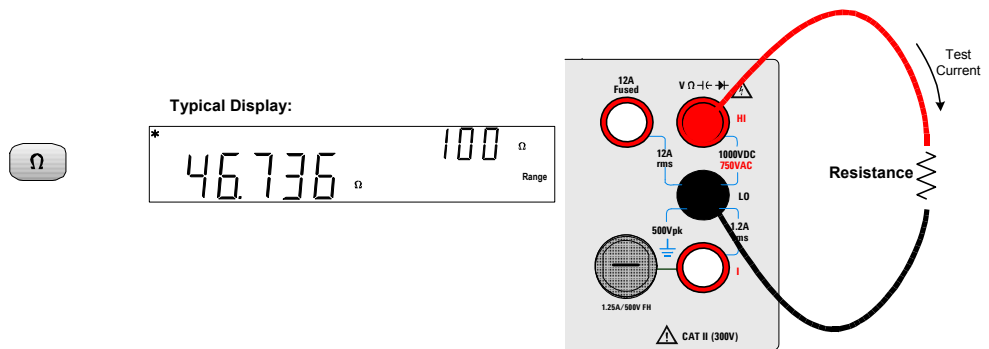

Measuring AC (RMS) or DC Current up to 1.2A

- Three AC Current or DC Current Ranges: 10.0000 mA, 100.000 mA, 1.00000 A
- Shunt Resistance: 0.1 Ω to 10 Ω for 10mA to 1A ranges
- Input Protection: Front Panel 1.25A, 500V FH fuse for I terminal

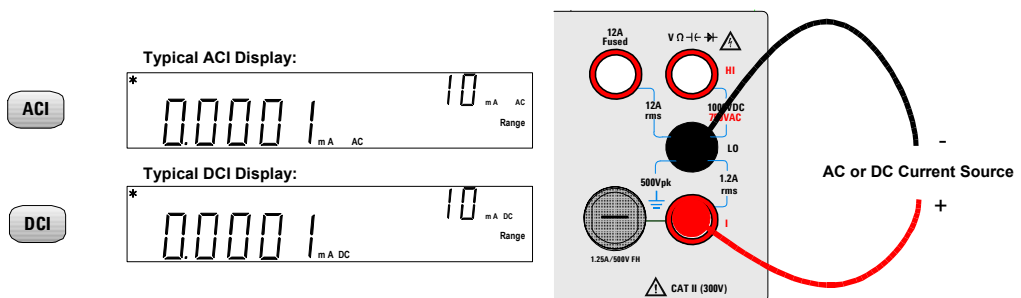

Measuring AC (RMS) or DC Current up to 12A

- 10 Amp AC Current or DC Current Range
- Shunt Resistance: 0.01 Ω for 10A range
- Internal 15A, 600V fuse for 12A terminal

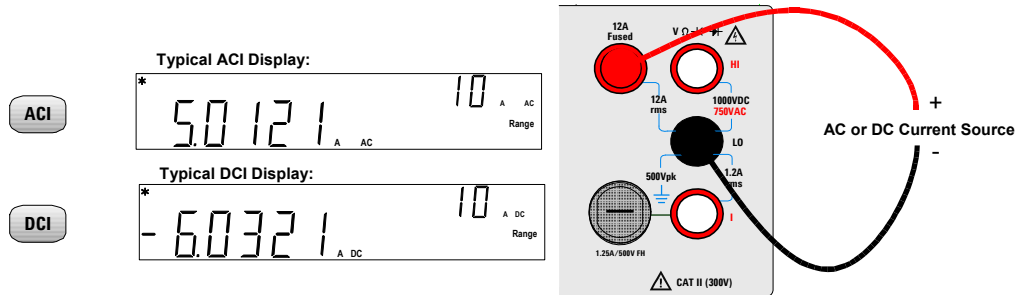

Measuring Frequency

- Five Ranges: 100.000 mV, 1.00000 V, 10.0000 V, 100.000 V, 750.00 V. Range is based on the voltage level of the signal, not frequency.
- Measurement Method: Reciprocal counting technique.
- Signal level: 10% of range to full scale input on all ranges
- Gate Time: 0.1 second or 1 period of the input signal, whichever is longer.
- Input Protection: 750V rms on all ranges (HI terminal)

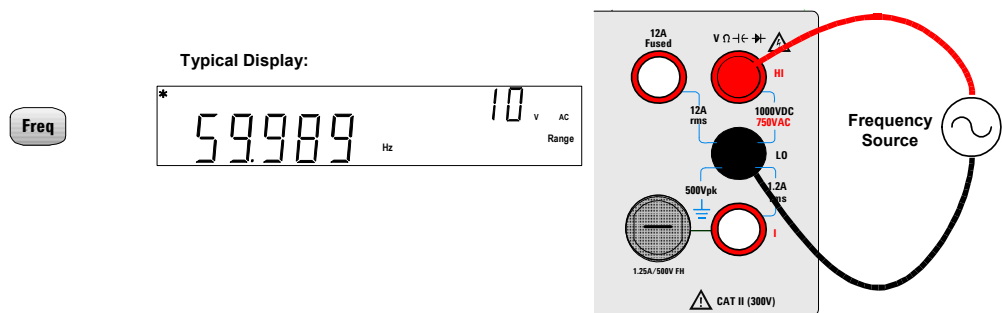

Testing Continuity

- Measurement Method: $0.83 \text{ mA} \pm 0.2\%$ constant current source, $< 5 \text{ V}$ open circuit voltage.
- Response Time: 70 samples/ second with audible tone
- Continuity Threshold: 10Ω fixed
- Input Protection: 1000 V (HI terminal)

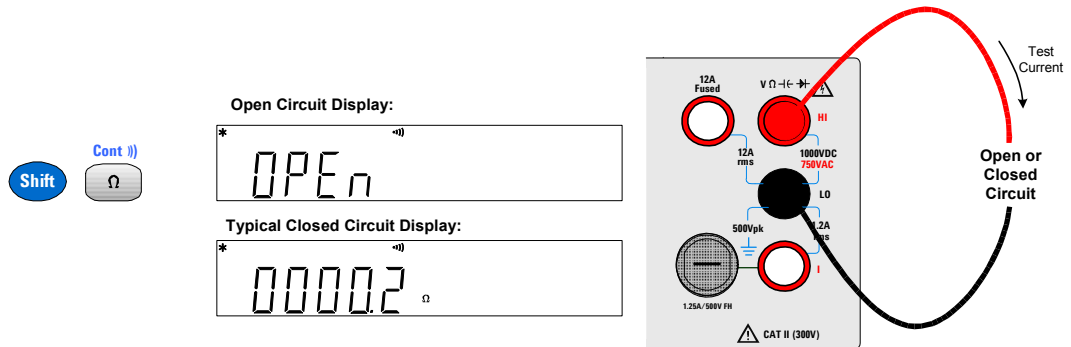

Checking Diodes

- Measurement Method: Uses $0.83 \text{ mA} \pm 0.2\%$ constant current source, $< 5 \text{ V}$ open circuit voltage.
- Response Time: 70 samples/ second with audible tone
- Input Protection: 1000 V (HI terminal)

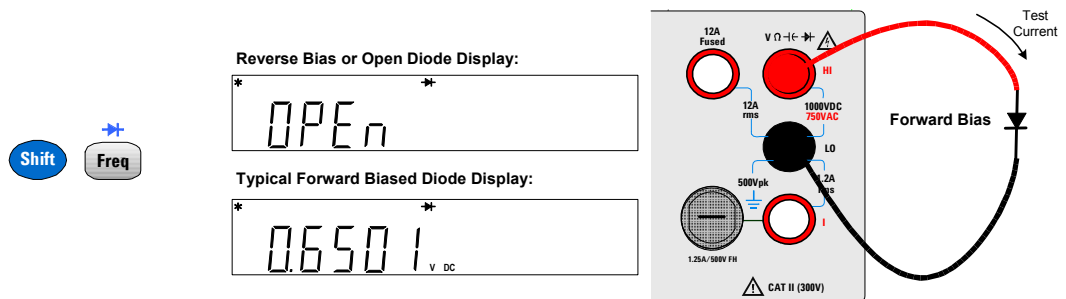

Measuring Capacitance

- Eight ranges: 1nF, 10nF, 100nF, 1 μ F, 10 μ F, 100 μ F, 1000 μ F, 10,000 μ F and autorange
- Measurement Method: Computed from constant current source charge time. Typical 0.2V - 1.4V AC signal level
- Input Protection: 1000 V (HI terminal)

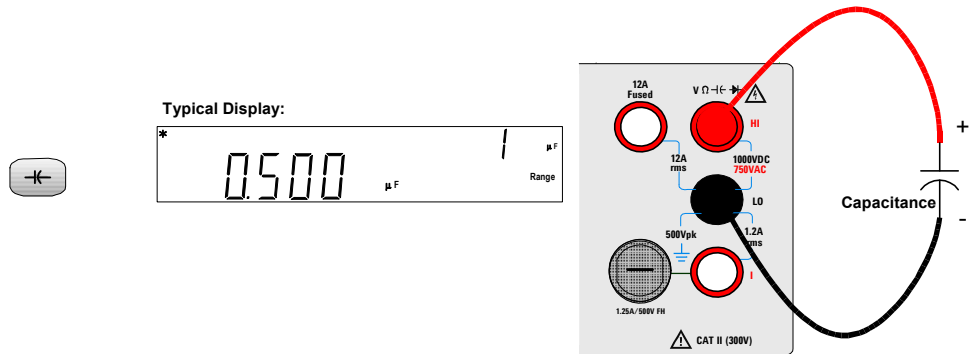

Measuring Temperature

- -80.0°C to 150.0 °C, -110.0°F to 300.0 °F
- Auto-ranging measurement, no manual range selection
- Measurement Method: 2-wire Ohms measurement of 5 k Ω thermistor sensor (E2308A) with computed conversion
- Input Protection: 1000 V (HI terminal)

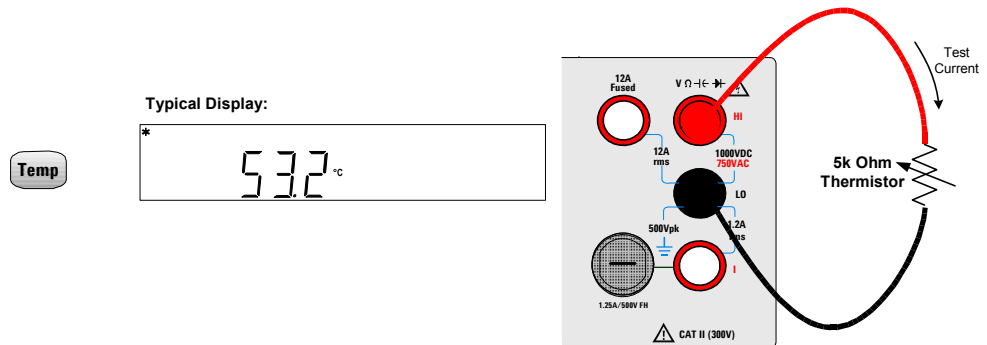

Selecting a Range

You can let the multimeter automatically select the range using *autoranging*, or you can select a fixed range using *manual ranging*. Autoranging is convenient because the multimeter automatically selects the appropriate range for sensing and displaying each measurement. However, manual ranging results in better performance, since the multimeter does not have to determine which range to use for each measurement.



Selects a lower range and disables autoranging.



Selects a higher range and disables autoranging.



Selects autoranging and disables manual ranging.

- **The ManRng** annunciator is on when manual range is enabled.
- Autoranging is selected at power-on and after a remote reset.
- Manual ranging – If the input signal is greater than can be measured on the selected range, the multimeter provides these overload indications: **OL** from the front panel or “±9.9E+37” from the remote interface.
- For frequency measurements, ranging applies to the signal’s input voltage, not its frequency.
- The range is fixed for continuity (1 kΩ range) and diode (1 VDC range).
- The multimeter remembers the selected ranging method (auto or manual) and the selected manual range for each measurement function.
- Autorange thresholds – The multimeter shifts ranges as follows:
 - Down range at <10% of current range
 - Up range at >120% of current range
- For remote operation, refer to the MEASure Subsystem in the *Agilent 34405A Online Programmer’s Reference* online help.

Setting the Resolution

You can select either 4½ or 5½-digit resolution for the DCV, DCI, resistance, ACV, ACI and frequency measurement functions.

- 5½-digit readings have the best accuracy and noise rejection.
- 4½-digit readings provide for faster readings.
- The continuity and diode test functions have a fixed, 4½-digit display.
- Capacitance and temperature have a fixed 3½-digit display.

  Selects 4½-digit mode.

  Selects 5½-digit mode.

- For remote operation, refer to the MEASure Subsystem in the *Agilent 34405A Online Programmer's Reference* online help.



2 Features and Functions

Math Operations	28
Using the Secondary Display	33
Using the Utility Menu	36
Editing Values in the Secondary Display	40
Storing and Recalling Instrument States	41
Reset/Power-On State	43
Triggering the Multimeter	45

This chapter contains detailed information on the multimeter and how to use the front panel. It builds on information you learned in the Quick Start Guide and the previous Getting Started Tutorial Chapter.



Math Operations

The table below describes the math operations that can be used with each measurement function.

Measurement Function	Allowed Math Operations					
	Null	dBm	dB	Min/Max	Limit	Hold
DCV	✓	✓	✓	✓	✓	✓
DCI	✓			✓	✓	✓
Ohms	✓			✓	✓	✓
ACV	✓	✓	✓	✓	✓	✓
ACI	✓			✓	✓	✓
Frequency	✓			✓	✓	✓
Capacitance	✓			✓	✓	✓
Temperature	✓			✓	✓	✓
Continuity						
Diode						

- All math operations can be toggled on and off by re-selecting the same math operation.
- Only one math operation can be turned-on at a time. Selecting another math operation when one is already on turns off the first operation and then turns on the second math operation.
- All math operations are automatically turned-off when changing measuring functions.
- Range changing is allowed for all math operations.
- For remote operation, refer to the CALCulate Subsystem in the *Agilent 34405A Online Programmer's Reference* online help.

Null



When making null measurements, also called relative, each reading is the difference between a stored null value and the input signal. For example, this feature can be used to make more accurate resistance measurements by nulling the test lead resistance.

After you enable the Null operation, the multimeter stores the next reading into the Offset register and immediately displays on the primary display:

Primary Display = Reading - Offset

You can view and edit the Offset value in the secondary display as described in “[Editing Values in the Secondary Display](#)” on page 40.

The multimeter allows Null settings for the following measurement functions: DC Volts, AC Volts, DC Current, AC Current, Resistance, Frequency, Capacitance and Temperature.

dBm



The logarithmic dBm (decibels relative to one milliwatt) scale is often used in RF signal measurements. The multimeter’s dBm operation takes a measurement and calculates the power delivered to a reference resistance (typically 50, 75 or 600Ω). The formula used for conversion from the voltage reading is:

$$dBm = 10 \times \text{Log}_{10} [(\text{Reading}^2 / R_{REF}) / 0.001W]$$

You can choose from several reference resistance values:

$R_{REF} = 2\Omega, 4\Omega, 8\Omega, 16\Omega, 50\Omega, 75\Omega, 93\Omega, 110\Omega, 124\Omega, 125\Omega, 135\Omega, 150\Omega, 250\Omega, 300\Omega, 500\Omega, 600\Omega, 800\Omega, 900\Omega, 1000\Omega, 1200\Omega, \text{ or } 8000\Omega.$

Numeric results are in the range of ± 120.000 dBm with 0.01 dBm resolution shown, independent of the number of digits setting.

You can view and select the R_{REF} value in the secondary display as described in “[Editing Values in the Secondary Display](#)” on page 40.

dB



When enabled, the dB operation computes the dBm value for the next reading, stores the dBm result into the dB Ref register and immediately produces the following calculation. The first displayed reading is always precisely 000.00 dB.

$$dB = 10 \times \text{Log}_{10} [(\text{Reading}^2 / R_{REF}) / 0.001W] - \text{dB Ref}$$

- You can set dB Ref to any value between 0 dBm and ± 120.0000 dBm. The default R_{REF} is 0 dBm.
- Numeric results are displayed in the range of ± 120.000 dB with 0.01 dB resolution shown, independent of the number of digits setting.

You can view and edit the dB Ref Value in the secondary display as described in “Editing Values in the Secondary Display” on page 40. The dB Ref value is displayed on the secondary display in the range of ± 120.000 dBm with 0.001 dBm resolution shown.

Min/Max



The Min/Max (Minimum/Maximum) operation stores the minimum and maximum values, the average, and the number of readings during a series of measurements.

When enabled, the Min/Max operation turns on the **MnMx** annunciator and begins accumulating various statistics about the readings being displayed.

Each time a new minimum or maximum value is stored, the instrument beeps once (if the beeper is enabled) and briefly turns on the appropriate **Max** or **Min** annunciator. The multimeter calculates the average of all readings and records the number of readings taken since Min/Max was enabled.

- Accumulated statistics are:
- Max--maximum reading since Min/Max was enabled
- Min--minimum reading since Min/Max was enabled
- Avg--average of all readings since Min/Max was enabled
- N--number of readings taken since Min/Max was enabled

When Min/Max is enabled, pressing  steps through the various Max, Min, Avg, and N values in the secondary display. Count values display in integer format until the maximum display value (120000) is reached after which counts are displayed in scientific notation.

Limit



The Limit operation allows you to perform pass/fail testing against specified upper and lower limits. You can set the upper and lower limits to any value between 0 and $\pm 120\%$ of the highest range for the present function.

- You should specify the upper limit to always be a more positive number than the lower limit. The initial factory setting for each limit is **0**.
- The secondary display shows **PASS** when readings are within the specified limits. The secondary display shows **HI** when the reading is outside the high limit and **LO** when the reading is outside the low limit.
- When the beeper is ON (see “Using the Utility Menu” on page 36) the beeper beeps on the transition from **PASS** to **HI** or **PASS** to **LO** or when transitioning directly from **HI** to **LO** or **LO** to **HI** (no **PASS** in between).

You can view and edit HI Limit and LO Limit values in the secondary display as described in “Editing Values in the Secondary Display” on page 40.

Hold



The reading hold feature allows you to capture and hold a stable reading on the front panel display. When a stable reading is detected, the multimeter emits a beep (if the beeper is enabled) and holds the reading on the primary display. The secondary display shows the present reading.

When enabled, the Hold operation turns on the **Hold** annunciator and begins evaluating readings using the rules described below:

Primary Display = Reading_N IF Max() - Min() \leq 0.1% x Reading_N

The decision to update a new reading value in the primary display is based upon the box-car moving statistics of the present reading and the three previous readings as described below:

Max (Reading_N Reading_{N-1} Reading_{N-2} Reading_{N-3})

Min (Reading_N Reading_{N-1} Reading_{N-2} Reading_{N-3})

NOTE

- Minimum delta value to trigger an update on held value : 0.1% of full scale
- Minimum level to enable update on held value : 5% of full scale

Math Annunciators

The math **Hold**, **Limit**, **Null** and **MnMx** annunciators are located above the primary display and the **dB/dBm** annunciator is located right of the primary display (see “[The Display at a Glance](#)” on page 16). The Math Value Annunciators are located under the secondary display and assist in viewing and editing math values in the secondary display.

Table 1 Math Value Annunciators

Math Operation	When Viewing/Editing	Editable	Math Annunciator
Null	Offset	✓	Ref Value
dBm	R _{REF}	✓	Ref R Value
dB	dB Ref	✓	Ref Value
MnMx	Maximum		Max
	Minimum		Min
	Average		Avg
	Reading Count		N
Limit	HI Limit	✓	Hi Limit
	LO Limit	✓	Lo Limit

Using the Secondary Display

Most measurement functions have predefined range or measurement capabilities that can be displayed in the secondary display. All math operations have predefined operations that are displayed on the secondary display.

Measurement Functions and the Secondary Display

When making measurements, the secondary display allows you to show the measurement range (for most measurement functions) or to select a predefined secondary measurement function. For example, a typical primary display showing DCV and a secondary display showing the DCV range is:

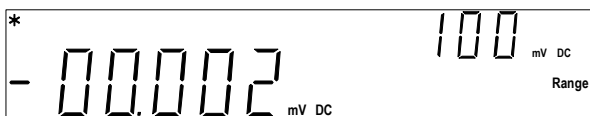

As another example, a typical primary display showing ACV and a secondary display showing the measured frequency of the input signal is:

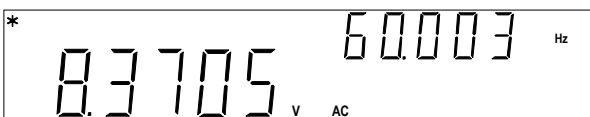

The secondary display is based on the selected primary measurement function and how many times you press:



2 Features and Functions

The table below shows the secondary display capabilities for all measurement functions.

Repeatedly pressing  cycles through the secondary display choices for the present measurement function as shown in the table below. The temperature, continuity and diode functions do not have secondary displays.

Primary Display	Secondary Display		
	Default Secondary Display	Press Disp Key Once	Press Disp Key Twice
DCV	DCV range	ACV	Off
DCI	DCI range	ACI	Off
Resistance	Resistance range	Off	Resistance Range
ACV	ACV range	Frequency	Off
ACI	ACI range	Frequency	Off
Frequency	AC Voltage Range	ACV	Off
Capacitance	Capacitance range	Off	Capacitance Range
Temperature	Off	Off	Off
Continuity	Off	Off	Off
Diode Test	Off	Off	Off

- When a second measurement function is selected, its resolution will match the primary measurement setting and, whenever possible, it will use autorange.
- Enabling any math operation turns off the secondary display for measurements. All math operations offer predefined displays that can be presented on the secondary display as described on the next page.
- For remote operation, refer to the DISPLAY:WINDow2 commands in the *Agilent 34405A Online Programmer's Reference* online help.

Math Operations and the Secondary Display

When a math operation is selected, the secondary display shows the result of the math operation or the value(s) being used by the math operation. For example, a typical primary display showing the Limit math operation for DCV measurements and a secondary display showing a HI limit exceeded is:

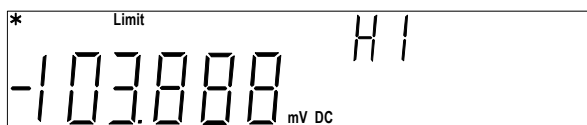

Repeatedly pressing  cycles through the secondary display choices for the present math operation as shown in the table below. (*Reading* is used in the table below to indicate the original measured reading value.)

Secondary Display						
Math Operation	Primary Display	Default Secondary Display	Press Disp Key Once	Press Disp Key Twice	Press Disp Key Three Times	Press Disp Key Four Times
Null	Nulled Reading	Reference Value	Off			
dBm	dBm	Present Reading	R _{REF}	Off		
dB	dB	Present Reading	dB Ref (in dBm)	Off		
Min/Max	Reading	Max value	Min value	Avg value	N (count) value	Off
Limit	Reading	PASS HI LO	HI Limit	LO Limit	Off	
Hold	Held Reading	Present Reading	Off			







Using the Utility Menu

The Utility Menu allows you to customize a number of non-volatile instrument configurations. It also displays error messages and hardware revision codes. The contents of the Utility Menu are shown in the table below.

Primary Display	Secondary Display Settings		Description	Remote Command
tSt	no	YES	IF YES, immediately execute self-test upon next Store/Recall button push. After self-test completes, returns to normal instrument operation.	*TST? (self-test is executed immediately)
°unit	°C	°F	Changes displayed units for temperature measurements	UNIT:TEMPerature <units>
bEEP	On	OFF	Enable, disable Diode, Min/Max, Limit Test, and Hold beep operations	SYSTem:BEEPer:STATe <mode>
P-On	rESet	LAST	Enable or disable power-on recall of State 0 (last power-off instrument state). Note: The multimeter always saves the power-down state. This just determines whether or not to recall the state at power-on.	MEMory:STATe:RECall:AUTO <mode>
2.diSP	On	OFF	Turn the secondary display on or off.	DISPlay:WINDow2[:STATe] <mode>
StorE	On	OFF	Enable, disable all front panel state store operation	MEMory:STATe:STORe <mode>
Edit	On	OFF	Enable, disable all math register editing	None
Error	nonE	nn.Err	See Reading Error Messages below.	SYSTem:ERRor?
CodE	1-dd.d	2-dd.d	Displays processor code revision numbers. 1= Measurement processor revision. 2= IO processor revision.	*IDN? (from remote also returns manufacturer's name, model number, and the serial number)
UtitY	donE		Display donE on primary display for 1 second then return to normal operation	None

Changing Configurable Settings

The first seven items in the Utility Menu are configurable (**Error** and **Code** are not configurable).

- 1 To access the Utility Menu, press   .
- 2 The first Utility Menu selection (**tESt**) is shown in the primary display. When stepping through the configurable items, the present setting for each item is displayed in the secondary display.
- 3 To change the setting, use the  and  keys to select the setting you want.
- 4 When the correct setting is displayed in the secondary display, press   to save the setting and advance to the next item.





NOTE

If you set **tESt** to **On**, pressing Store/Recall immediately exits the Utility Menu and executes self-test. If you set **tESt** to **OFF**, go on to the next step (step 5).



- 5 Repeat steps 4 and 5 for all items in the Utility Menu.
- 6 When you reach the end of the Utility Menu, the primary display shows **utitY** and the secondary display briefly shows **donE**, after which the multimeter returns to normal operation.



Reading Error Messages

The following procedure shows you to read error messages from the front panel. For remote operation, refer to the `SYSTEM:ERRor?` command in the *Agilent 34405A Online Programmer's Reference* online help.

- 1 To access the Utility Menu, press  .
- 2 Press    seven times until **Error** is shown in the primary display.
- 3 If there are no errors in the error queue, the secondary display shows **nonE**.

If there are one or more errors, **Error** is shown in the primary display and **nn.Err** is shown flashing in the secondary display (where **nn** is the total number of errors in the error queue). For example, if there are three errors in the queue, **03.Err** will flash in the secondary display. Errors are numbered and stored in the queue in the order they occurred.

- 4 If there are errors in the error queue, press  to read the first error. The error number in the queue is shown in the primary display and the actual error number is shown in the secondary display.
- 5 Repeat step 4 for all errors in the error queue
(you can also use  to view the previous error).
- 6 After reading all errors,

press    twice to exit the Utility Menu.

- 7 The error queue is automatically cleared after  has been pressed and the utility menu is exited.

The Beeper

Normally, the multimeter beeps whenever certain conditions are met (for example, the multimeter beeps when a stable reading is captured in reading hold mode). The beeper is factory set to ON, but may be disabled or enabled manually.

- Turning off the beeper does *not* disable the key click generated when you press a front-panel key.
- A beep tone is always emitted (even with the beep state turned OFF) in the following cases.
 - A continuity measurement is less than or equal to the continuity threshold.
 - A SYSTem:BEEPer command is sent.
 - An error is generated.
- In addition to the beep operations just described, when the beeper is ON, a single beep occurs for the following cases (turning the beeper OFF disables the beep for the following cases):
 - When a new Min or Max value is stored
 - When a new stable reading is updated on display for Math Hold operation
 - When a measurement exceeds the HI or LO Limit value
 - When a forward-biased is measured in the Diode function

Editing Values in the Secondary Display

Many Math function values are editable in the secondary display. The table below describes key operations during number editing. These rules also apply for editing within the Utility menu.

You can edit the values used for the Null, Limit, dB or dBm math function. For remote operation, refer to the *CALCulate Subsystem* in the *Agilent 34405A Online Programmer's Reference* online help.

Selecting the Value to Edit

With the math function enabled, press  until the **Ref Value**, **Ref R Value**, **Hi Limit** or **Lo Limit** you want to edit is displayed in the secondary display.

To select the editing mode, press:



The secondary display will briefly show **Edit** to indicate you are in editing mode.

Editing Values

Use these keys to position the cursor on a digit:



Moves cursor to the left



Moves cursor to the right

When the cursor is positioned on a digit, use these keys to edit the value:



Increments digit



Decrements digit

When done editing, save the new value by pressing:



Storing and Recalling Instrument States

You can save and recall complete instrument states including all front panel settings, all math registers, all Utility Menu settings, and all bus specific settings. There are four user storage registers numbered 1 through 4. An additional state, state 0, is managed by the instrument and stores the last power-down state. The instrument automatically saves the complete instrument configuration to State 0 whenever a power-down event occurs.







For remote operation, refer to the MEMory Subsystem, the *SAV, and *RCL commands in the *Agilent 34405A Online Programmer's Reference* online help.

NOTE

The store function in the utility menu must be enabled (On) before you can store states. Refer to [“Using the Utility Menu”](#) on page 36 for details.

Storing a State

Before storing an instrument state, select the measurement function, range, math operations, and so on, that you want saved as a state. To store the instrument state:







- 1 Press , the display **Store** and **Recall** annunciators will begin flashing.
- 2 Press  or  until only the **Store** annunciator is flashing.
- 3 Press  again.
- 4 Press  or  until the state number (1-4) you want to use is shown flashing in the secondary display.
- 5 Press  to store the state. The secondary display briefly shows **done** when the state is successfully saved.

NOTE

To escape the recall operation without recalling a state, select **ESC** in step 4 above and press  to escape. After escaping, the secondary display briefly shows - - -

Recalling a Stored State

To recall an instrument state:

- 1 Press , the display **Store** and **Recall** annunciators will begin flashing.
- 2 Press  or  until only the **Recall** annunciator is flashing.
- 3 Press  again.
- 4 Press  or  until the state number you want to recall is shown flashing in the secondary display. You can select state **1** through **4** or **LAST** for the power-down state. To exit without recalling a state, select **ESC**.
- 5 Press  to perform the recall (or **ESC**) operation. When finished, the secondary display briefly shows **donE**.

NOTE

To escape the recall operation without recalling a state, select **ESC** in step 4 above and press  to escape. After escaping, the secondary display briefly shows - - -

Reset/Power-On State

The table below summarizes the 34405A's settings as received from the factory, following power cycling, and following the *RST command received over the USB remote interface. Non-volatile, user customizable behavioral differences are shown in **BOLD** type.

Table 2 Reset/Power-On State

Parameter	Factory Setting	Power-on / Reset State
Measurement Configuration		
Function	DCV	DCV
Range	AUTO	AUTO
Resolution	5-½ digits	5-½ digits
Temperature Units	°C	User setting
Math Operations		
Math State, Function	Off, Null	Off, Null
Math Registers	Cleared	Cleared
dBm Reference Resistance	600Ω	User setting
Math Register Editing	On	User setting
Trigger Operations		
Trigger Source*	Auto Trigger (Local Mode) IMMediate (Remote Mode)	Auto Trigger (Local Mode) IMMediate (Remote Mode)
System-Related Operations		
Power-Down Recall	Disabled	User Setting
Stored States	0-4 cleared	No Change
Beeper	On	User Setting
Display	On	On
Remote/ Local State*	Local	Local
Keyboard*	Unlocked, Local key enabled	Unlocked, Local key enabled

2 Features and Functions

Table 2 Reset/Power-On State

Parameter	Factory Setting	Power-on / Reset State
Reading Output Buffer*	Cleared	Cleared
Error Queue*	Cleared	Cleared
Power-on Status Clear*	Last	User Setting
Status Registers, Masks & Transition Filters*	Cleared	Cleared if power-on status clear enabled; no change otherwise
Serial Number	Unique value per-instrument	No Change
Calibration		
Calibration state	Secured	User Setting
Calibration value	0	No Change
Calibration String	Cleared	No Change

**State managed by IO Processor firmware.*

Triggering the Multimeter

From the front panel (Local mode), the multimeter always auto-triggers. Auto triggering takes continuous readings at the fastest rate possible for the selected measurement configuration.

From the remote interface, triggering the multimeter is a three-step process:

- 1 Configure the multimeter for the measurement by selecting the function, range, resolution, and so on.
- 2 Specify the multimeter's trigger source. Choices are a software (bus) trigger from the remote interface or an immediate internal trigger (default trigger source).
- 3 Ensure that the multimeter is ready to accept a trigger from the specified source (called the *wait-for-trigger* state).

Immediate Triggering

The immediate triggering mode is available from the remote interface only.

In the *immediate* trigger mode, the trigger signal is always present. When you place the multimeter in the wait-for-trigger state, the trigger is issued immediately. This is the default trigger source for remote interface operation.

- **Remote Interface Operation:** The following command selects the immediate trigger source:

```
TRIGger:SOURce IMMEDIATE
```

The CONFigure and MEASure? commands automatically set the trigger source to IMMEDIATE.

Refer to the *Agilent 34405A Programmer's Reference* for complete description and syntax for these commands.

Software (Bus) Triggering

The bus trigger mode is available from the remote interface only.

The bus trigger mode is initiated by sending a bus trigger command, after selecting BUS as the trigger source.

- The TRIGger:SOURce BUS command selects the bus trigger source.

2 Features and Functions

- The MEASure? command overwrites the BUS trigger and triggers the DMM and returns a measurement.
- The READ? command does not overwrite the BUS trigger, and if selected, generates an error. It will only trigger the instrument and return a measurement when the IMMEDIATE trigger is selected.
- The INITiate command only initiates the measurement and needs a trigger (BUS or IMMEDIATE) to make the actual measurement.

Refer to the *Agilent 34405A Programmer's Reference* for complete description and syntax for these commands.



3 Measurement Tutorial

DC Measurement Considerations	48
Noise Rejection	49
Resistance Measurement Considerations	51
True RMS AC Measurements	53
Other Primary Measurement Functions	56
Other Sources of Measurement Error	59

The Agilent 34405A multimeter is capable of making very accurate measurements. In order to achieve the greatest accuracy, you must take the necessary steps to eliminate potential measurement errors. This chapter describes common errors found in measurements and gives suggestions to help you avoid these errors.



DC Measurement Considerations

Thermal EMF Errors

Thermoelectric voltages are the most common source of error in low-level DC voltage measurements. Thermoelectric voltages are generated when you make circuit connections using dissimilar metals at different temperatures. Each metal-to-metal junction forms a thermocouple, which generates a voltage proportional to the junction temperature. You should take the necessary precautions to minimize thermocouple voltages and temperature variations in low-level voltage measurements. The best connections are formed using copper-to-copper crimped connections, as the multimeter's input terminals are a copper alloy. The table below shows common thermoelectric voltages for connections between dissimilar metals.

Copper to –	Approx. mV / °C	Copper to –	Approx. mV / °C
Cadmium-Tin Solder	0.2	Aluminum	5
Copper	<0.3	Tin-Lead Solder	5
Gold	0.5	Kovar or Alloy 42	40
Silver	0.5	Silicon	500
Brass	3	Copper-Oxide	1000
Beryllium Copper	5		

Noise Rejection

Rejecting Power-Line Noise Voltages

A desirable characteristic of integrating analog-to-digital (A/D) converters is their ability to reject power-line related noise present with DC input signals. This is called normal mode noise rejection, or NMR. The multimeter achieves NMR by measuring the average DC input by "integrating" it over a fixed period.

Common Mode Rejection (CMR)

Ideally, a multimeter is completely isolated from earth-referenced circuits. However, there is finite resistance between the multimeter's input LO terminal and earth ground, as shown below. This can cause errors when measuring low voltages which are floating relative to earth ground.

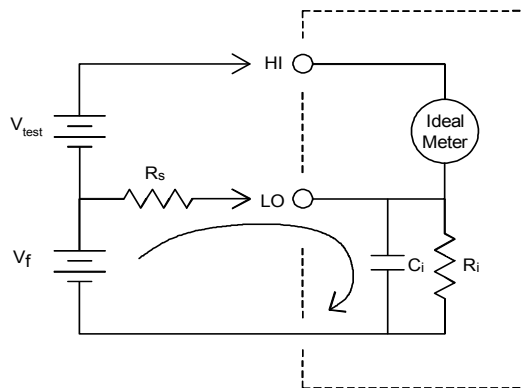

V_f = Float Voltage
 R_s = DUT Source Resistance
 Imbalance
 R_i = Multimeter Isolation Resistance
 (LO-Earth)
 C_i = Multimeter Input Capacitance:

$$\text{Error (v)} = \frac{V_f \times R_s}{R_s + R_i}$$

Refer to [“Measurement Noise Rejection”](#) on page 131 for the multimeter’s NMR and CMR characteristics.

Noise Caused by Magnetic Loops

If you are making measurements near magnetic fields, take caution to avoid inducing voltages in the measurement connections. You should be especially careful when working near conductors carrying large currents. Use twisted-pair connections to the multimeter to reduce the noise pickup loop area, or dress the test leads as close together as possible. Loose or

vibrating test leads will also induce error voltages. Tie down test leads securely when operating near magnetic fields. Whenever possible, utilize magnetic shielding materials or increased distance from magnetic sources.

Noise Caused by Ground Loops

When measuring voltages in circuits where the multimeter and the device under test are both referenced to a common earth ground, a ground loop is formed. As shown below, any voltage difference between the two ground reference points (V_{ground}) causes a current to flow through the measurement leads. This causes noise and offset voltage (usually power-line related), which are added to the measured voltage.

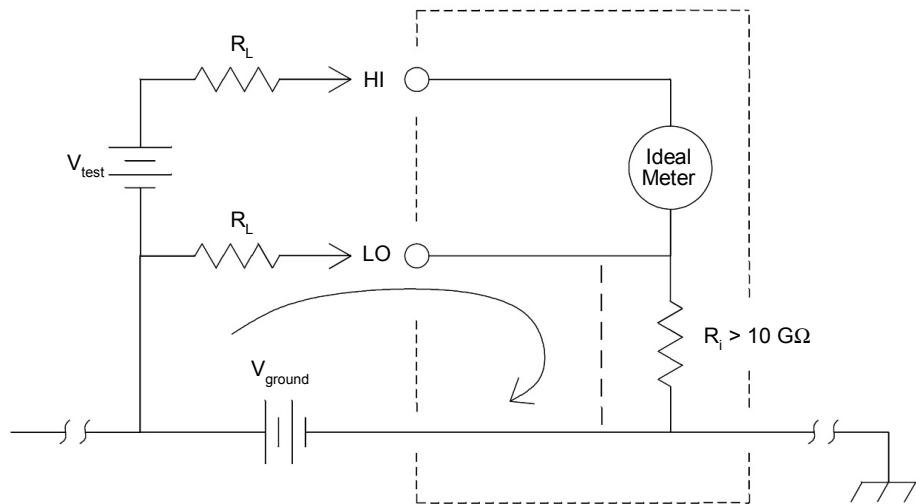

R_L = Lead Resistance
 R_i = Multimeter Isolation Resistance
 V_{ground} = Voltage Drop on Ground Bus

The best way to eliminate ground loops is to isolate the multimeter from earth by *not* grounding the input terminals. If the multimeter must be earth-referenced, connect it and the device under test to the same common ground point. Also connect the multimeter and device under test to the same electrical outlet whenever possible.

Resistance Measurement Considerations

When measuring resistance, the test current flows from the input HI terminal through the resistor being measured. The voltage drop across the resistor being measured is sensed internal to the multimeter. Therefore, test lead resistance is also measured.

The errors mentioned earlier in this chapter for DC voltage measurements also apply to resistance measurements. Additional error sources unique to resistance measurements are discussed here.

Removing Test Lead Resistance Errors

To eliminate offset errors associated with the test lead resistance in 2-wire ohms measurements, follow the steps below.

- 1 Connect the ends of the test leads together. The multimeter displays the test lead resistance.
- 2 Press . The multimeter stores the test lead resistance as the 2-wire ohms null value, and subtracts that value from subsequent measurements.

Minimizing Power Dissipation Effects

When measuring resistors designed for temperature measurements (or other resistive devices with large temperature coefficients), be aware that the multimeter will dissipate some power in the device under test.

If power dissipation is a problem, you should select the multimeter's next higher measurement range to reduce the errors to acceptable levels. The following table shows several examples.

Range	Test Current	DUT Power at Full Scale
100 Ω	1 mA	100 μ W
1 k Ω	0.83 mA	689 μ W
10 k Ω	100 μ A	100 μ W
100 k Ω	10 μ A	10 μ W
1 M Ω	900 nA	810 nW

10 M Ω	205 nA	420 nW
100 M Ω	205 nA 10 M Ω	35 nW

Errors in High Resistance Measurements

When you are measuring large resistances, significant errors can occur due to insulation resistance and surface cleanliness. You should take the necessary precautions to maintain a "clean" high-resistance system. Test leads and fixtures are susceptible to leakage due to moisture absorption in insulating materials and "dirty" surface films. Nylon and PVC are relatively poor insulators ($10^9 \Omega$) when compared to PTFE insulators ($10^{13} \Omega$). Leakage from nylon or PVC insulators can easily contribute a 0.1% error when measuring a 1 M Ω resistance in humid conditions.

AC Measurements

Each single ACV or ACI measurement is computed based upon a RMS (root-mean-square) value calculated on an array of 25 sequential A/D converter samples acquired with constant sample-to-sample timing. Samples are acquired at a rate very close to the maximum trigger-settle rate for the A/D converter as shown below.

When configured for an ACV or ACI measurement, the multimeter acquires an array of 25 sequential samples which comprise the AC reading data set. The final AC reading result is computed from the acquired data set as shown by the equation below:

$$\text{AC Reading} = \sqrt{\text{Average} [\text{Data} (1:25)]^2}$$

True RMS AC Measurements

True RMS responding multimeters, like the Agilent 34405A, measure the "heating" potential of an applied voltage. Power dissipated in a resistor is proportional to the square of an applied voltage, independent of the waveshape of the signal. This multimeter accurately measures true RMS voltage or current, as long as the wave shape contains negligible energy above the instrument's effective bandwidth.

Note that the 34405A uses the same techniques to measure true RMS voltage and true RMS current.

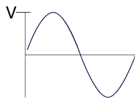
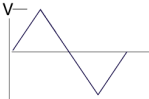
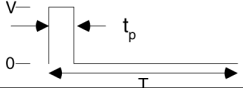
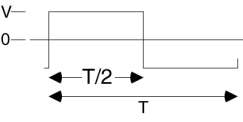
Waveform Shape	Crest Factor	AC RMS	AC + DC RMS
	$\sqrt{2}$	$\frac{V}{\sqrt{2}}$	$\frac{V}{\sqrt{2}}$
	$\sqrt{3}$	$\frac{V}{\sqrt{3}}$	$\frac{V}{\sqrt{3}}$
	$\sqrt{\frac{T}{t_p}}$	$\frac{V}{CF} \times \sqrt{1 - \frac{1}{CF^2}}$	$\frac{V}{CF}$
	1	V	V

The multimeter's AC voltage and AC current functions measure the *AC-coupled* true RMS value. In this Agilent instrument, the "heating value" of *only the AC components* of the input waveform are measured (DC is rejected). As seen in the figure above; for sinewaves, triangle waves, and square waves, the *AC-coupled* and *AC+DC* values are equal, since these waveforms do not contain a DC offset. However, for non-symmetrical waveforms, such as pulse trains, there is a DC voltage content, which is rejected by Agilent's AC-coupled true RMS measurements. This can provide a significant benefit.

An AC-coupled true RMS measurement is desirable when you are measuring small AC signals in the presence of large DC offsets. For example, this situation is common when measuring AC ripple present on DC power supplies. There are situations, however, where you might want to know the AC+DC true RMS value. You can determine this value by combining results from DC and AC measurements, as shown below:

$$ac + dc = \sqrt{ac^2 + dc^2}$$

For the best AC noise rejection, you should perform the DC measurement at 5½-digits.

True RMS Accuracy and High-Frequency Signal Content

A common misconception is that "since an AC multimeter is true RMS, its sine wave accuracy specifications apply to all waveforms." Actually, the shape of the input signal can dramatically affect measurement accuracy, for any multimeter, especially when that input signal contains high-frequency components which exceed the instrument's bandwidth. Error in RMS measurements arise when there is significant input signal energy at frequencies above the multimeter's bandwidth.

Estimating High-Frequency (Out-of-Band) Error

A common way to describe signal waveshapes is to refer to their "Crest Factor". Crest factor is the ratio of the peak value to RMS value of a waveform. For a pulse train, for example, the crest factor is approximately equal to the square root of the inverse of the duty cycle.

$$CF = \frac{1}{\sqrt{d}} = \frac{1}{\sqrt{\frac{t_p}{T}}} = \frac{1}{\sqrt{prf \times t_p}}$$

Notice that crest factor is a composite parameter, dependent upon the pulse-width and repetition frequency; crest factor alone is not enough to characterize the frequency content of a signal.

Traditionally, DMMs include a crest factor derating table that applies at all frequencies. The measurement algorithm used in the 34405A multimeter is not inherently sensitive to crest factor, so no such derating is necessary.

With this multimeter, as discussed in the previous section, the focal issue is high-frequency signal content which exceeds the multimeter's bandwidth.

For periodic signals, the combination of crest factor and repetition rate can suggest the amount of high-frequency content and associated measurement error. The first zero crossing of a simple pulse occurs at

$$f_1 = \frac{1}{t_p}$$

This gives an immediate impression of the high-frequency content by identifying where this crossing occurs as a function of crest

factor: $f_1 = CF^2 \cdot prf$

The following table shows the typical error for various pulse waveforms as a function of input pulse frequency:

Typical error for square wave, triangular wave, and pulse trains of CF=3, 5, or 10					
prf	square wave	triangle wave	CF=3	CF=5	CF=10
200	-0.02%	0.00%	-0.04%	-0.09%	-0.34%
1000	-0.07%	0.00%	-0.18%	-0.44%	-1.71%
2000	-0.14%	0.00%	-0.34%	-0.88%	-3.52%
5000	-0.34%	0.00%	-0.84%	-2.29%	-8.34%
10000	-0.68%	0.00%	-1.75%	-4.94%	-26.00%
20000	-1.28%	0.00%	-3.07%	-8.20%	-45.70%
50000	-3.41%	-0.04%	-6.75%	-32.0%	-65.30%
100000	-5.10%	-0.12%	-21.8%	-50.6%	-75.40%

This table gives an additional error for each waveform, to be added to the value from the accuracy table provided in the Specifications chapter.

Example: A pulse train with level $1 V_{\text{rms}}$, is measured on the 1 V range. It has pulse heights of 3 V (that is, a Crest Factor of 3) and duration 111 μs . The prf can be calculated to be 1000 Hz, as follows:

$$prf = \frac{1}{CF^2 \times t_p}$$

Thus, from the table above, this AC waveform can be measured with 0.18 percent additional error.

Other Primary Measurement Functions

Frequency Measurement Errors

The multimeter uses a reciprocal counting technique to measure frequency. This method generates constant measurement resolution for any input frequency. All frequency counters are susceptible to errors when measuring low-voltage, low-frequency signals. The effects of both internal noise and external noise pickup are critical when measuring "slow" signals. The error is inversely proportional to frequency. Measurement errors also occur if you attempt to measure the frequency of an input following a DC offset voltage change. You must allow the multimeter's input to fully settle before making frequency measurements.

DC Current Measurements

When you connect the multimeter in series with a test circuit to measure current, a measurement error is introduced. The error is caused by the multimeter's series burden voltage. A voltage is developed across the wiring resistance and current shunt resistance of the multimeter, as shown below.

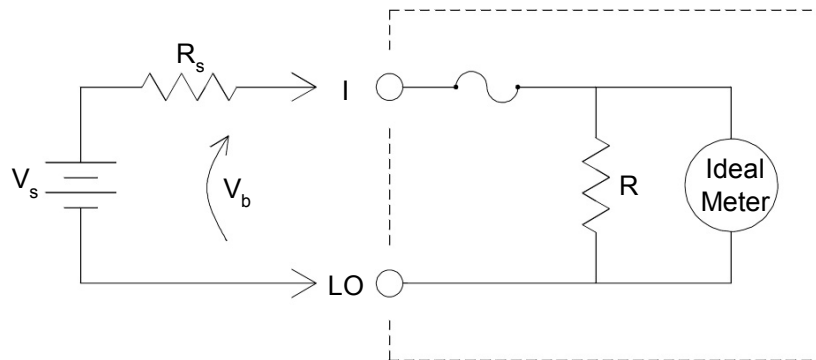

V_s = Source Voltage
 R_s = DUT Source Resistance
 V_b = Multimeter Burden Voltage
 R = Multimeter Current Shunt

$$\text{Error (\%)} = \frac{-100\% \times V_b}{V_s}$$

Capacitance Measurements

The multimeter implements capacitance measurements by applying a known current to the capacitor as shown below:

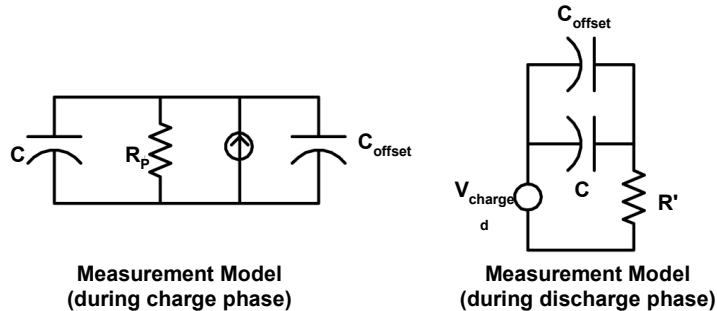

Capacitance is calculated by measuring the change in voltage (ΔV) that occurs over a “short aperture” time, (Δt). The measurement cycle consists of two parts: a charge phase and a discharge phase.

The values of capacitance and loss resistance measured with the multimeter may differ from the values measured using an LCR meter. This is to be expected, since this is essentially a DC measurement method, while LCR measurement uses applied frequencies anywhere from 100 Hz to 100 kHz. In most cases, neither method measures the capacitor at its exact frequency of application.

For the best accuracy, take a zero null measurement with open probes, to null out the test lead capacitance, before connecting the probes across the capacitor to be measured.

Temperature Measurements

The multimeter measures temperature by measuring the temperature sensitive resistance of 5 k Ω thermistors.

Thermistors consist of semiconductor materials and provide roughly 10 times the sensitivity of an RTD. Because they are semiconductors, their temperature range is more limited, commonly to $-80\text{ }^{\circ}\text{C}$ to $150\text{ }^{\circ}\text{C}$. Thermistors have highly non-linear temperature-resistance relationships; therefore their conversion algorithms are more complex. Agilent multimeters use the standard Hart-Steinhart Approximation to provide accurate conversions.

Other Sources of Measurement Error

Loading Errors (AC volts)

In the AC voltage function, the input of the multimeter appears as a 1 M Ω resistance in parallel with 100 pF of capacitance. The cabling that you use to connect signals to the multimeter also adds capacitance and loading.

For low frequencies, the loading error is:

$$\text{Error (\%)} = \frac{-100 \times R_s}{R_s + 1 \text{ M}\Omega}$$

At high frequencies, the additional loading error is:

$$\text{Error (\%)} = 100 \times \left[\frac{1}{\sqrt{1 + (2 \pi \times F \times R_s \times C_{in})^2}} - 1 \right]$$

R_s = Source Resistance

F = Input Frequency

C_{in} = Input Capacitance (100 pF) Plus Cable Capacitance

Measurements Below Full Scale

You can make the most accurate AC measurements when the multimeter is at or near the full scale of the selected range. Autoranging occurs at 10% (down-range) and 120% (up-range) of full scale. This enables you to measure some inputs at full scale on one range and 10% of full scale on the next higher range. In general, the accuracy is better on the lower range; for the highest accuracy, select the lowest manual range possible for the measurement.

High-Voltage Self-Heating Errors

If you apply more than 300 V_{rms}, self-heating occurs in the multimeter's internal signal-conditioning components. These errors are included in the multimeter's specifications.

Temperature changes inside the multimeter due to self-heating may cause additional error on other AC voltage ranges.

AC Current Measurement Errors (Burden Voltage)

Burden voltage errors, which apply to DC current, also apply to AC current measurements. However, the burden voltage for AC current is larger due to the multimeter's series inductance and your measurement connections. The burden voltage increases as the input frequency increases. Some circuits may oscillate when performing current measurements due to the multimeter's series inductance and your measurement connections.

Low-Level Measurement Errors

When measuring AC voltages less than 100 mV, be aware that these measurements are especially susceptible to errors introduced by extraneous noise sources. An exposed test lead acts as an antenna and a properly functioning multimeter will measure the signals received. The entire measurement path, including the power line, acts as a loop antenna. Circulating currents in the loop create error voltages across any impedances in series with the multimeter's input. For this reason, you should apply low-level AC voltages to the multimeter through shielded cables. You should connect the shield to the input LO terminal.

Make sure the multimeter and the AC source are connected to the same electrical outlet whenever possible. You should also minimize the area of any ground loops that cannot be avoided. A high-impedance source is more susceptible to noise pickup than a low-impedance source. You can reduce the high-frequency impedance of a source by placing a capacitor in parallel with the multimeter's input terminals. You may have to experiment to determine the correct capacitor value for your application.

Most extraneous noise is not correlated with the input signal. You can determine the error as shown below.

$$\text{Voltage Measured} = \sqrt{V_{\text{in}}^2 + \text{Noise}^2}$$

Correlated noise, while rare, is especially detrimental. Correlated noise always adds directly to the input signal. Measuring a low-level signal with the same frequency as the local power line is a common situation that is prone to this error.

Pulse Measurement Error

You can use the DC measurement function to measure a pulse signal and obtain its relevant average measurement quickly. The formula of the equivalent DC average of a pulse signal is provided below.

$$\frac{1}{T} \int f(x) dx$$

where $f(x)$ is the function representing the signal waveform over a period of T .

Error may occur when the pulse signal is measured at low voltage range due to saturation of the multimeter's analog-to-digital (ADC) rail voltage.

THIS PAGE HAS BEEN INTENTIONALLY LEFT BLANK.



4 Performance Tests and Calibration

Calibration Overview	64
Recommended Test Equipment	66
Test Considerations	67
Performance Verification Tests Overview	68
Performance Verification Tests	70
Calibration Security	82
Calibration Process	85
Adjustments	88
Calibration Errors	103

This chapter contains performance test procedures and calibration procedures. The performance tests procedures allow you to verify that the multimeter is operating within its published specifications.

The calibration procedures show how to make zero and gain adjustments to the multimeter.

WARNING

SHOCK HAZARD. Only service-trained personnel who are aware of the hazards involved should perform the procedures in this chapter. To avoid electrical shock and personal injury, make sure to read and follow all test equipment safety instructions.

Use only completely electrically insulated test lead sets with connectors that prevent contact with test voltages.



Calibration Overview

NOTE

Make sure you have read “[Test Considerations](#)” on page 67 before calibrating the instrument.

Closed - Case Electronic Calibration

The instrument features closed-case electronic calibration. No internal mechanical adjustments are required. The instrument calculates correction factors based upon the input reference value you set. The new correction factors are stored in non-volatile memory until the next calibration adjustment is performed. Non - volatile EEPROM calibration memory does not change when power has been off or after a remote interface reset

Agilent Technologies Calibration Services

When your instrument is due for calibration, contact your local Agilent Service Center for a low-cost recalibration. The 34405A is supported on automated calibration systems, which allow Agilent to provide this service at competitive prices.

Calibration Interval

A 1-year interval is adequate for most applications. Accuracy specifications are warranted only if adjustment is made at regular calibration intervals. Accuracy specifications are not warranted beyond the 1-year calibration interval. Agilent does not recommend extending calibration intervals beyond 2 years for any application.

Time Required for Calibration

The 34405A can be automatically calibrated under computer control. With computer control you can perform the complete calibration procedure and performance verification tests in less than 30 minutes once the instrument is warmed-up (see “[Test Considerations](#)” on page 67). Refer to the *34405A Programmer’s Reference* online help for more information.

Recommended Test Equipment

The test equipment recommended for the performance verification and adjustment procedures is listed below. If the exact instrument is not available, substitute calibration standards of equivalent accuracy.

A suggested alternate method would be to use the Agilent 3458A 8½-Digit Digital Multimeter to measure less accurate yet stable sources. The output value measured from the source can be entered into the instrument as the target calibration value.

Table 3 Recommended Test Equipment

Application	Recommended Equipment	Recommended Accuracy Requirements
Zero Calibration	Shorting Plug--Dual banana plug with copper wire short between the two terminals	
DC Voltage	Fluke 5520A	<1/5 instrument 1 year spec
DC Current	Fluke 5520A	<1/5 instrument 1 year spec
Resistance	Fluke 5520A	<1/5 instrument 1 year spec
AC Voltage	Fluke 5520A	<1/5 instrument 1 year spec
AC Current	Fluke 5520A	<1/5 instrument 1 year spec
Frequency	Fluke 5520A	<1/5 instrument 1 year spec
Capacitance	Fluke 5520A	<1/5 instrument 1 year spec

Test Considerations

Errors may be induced by AC signals present on the input leads during a self-test. Long test leads can also act as an antenna causing pick-up of AC signals.

For optimum performance, all procedures should comply with the following recommendations:

- Assure that the calibration ambient temperature is stable and between 18 °C and 28 °C. Ideally the calibration should be performed at 23 °C ± 1 °C.
- Assure ambient relative humidity is less than 80%.
- Allow a 1-hour warm-up period with a Shorting Plug connected to the HI and LO input terminals.
- Use shielded twisted pair PTFE-insulated cables to reduce settling and noise errors. Keep the input cables as short as possible.
- Connect the input cable shields to earth ground. Except where noted in the procedures, connect the calibrator LO source to earth ground at the calibrator. It is important that the LO to earth ground connection be made at only one place in the circuit to avoid ground loops.

Because the instrument is capable of making very accurate measurements, you must take special care to ensure that the calibration standards and test procedures used do not introduce additional errors. Ideally, the standards used to verify and adjust the instrument should be an order of magnitude more accurate than each instrument range full-scale error specification.

Input Connections

Test connections to the instrument are best accomplished using the dual banana plug with copper wire short between two terminals for low-thermal offset measurement. Shielded, twisted-pair, PTFE interconnect cables of minimum length are recommended between the calibrator and the multimeter. Cable shields should be earth ground referenced. This configuration is recommended for optimal noises and settling time performance during calibration.

Performance Verification Tests Overview

Use the Performance Verification Tests to verify the measurement performance of the instrument. The performance verification tests use the instrument's specifications listed in [Chapter 6](#), “Specifications”.

You can perform four different levels of performance verification tests:

Self-Test A series of internal verification tests that give a high confidence that the instrument is operational.

Quick Verification A combination of the internal self-tests and selected verification test.

Performance Verification Tests An extensive set of tests that are recommended as an acceptance test when you first receive the instrument or after performing adjustments.

Optional Verification Tests Tests not performed with every calibration. Perform these tests to verify additional specifications or functions of the instrument.

Self -Test

- A brief power-on self-test occurs automatically whenever you turn on the instrument. This limited test assures that the instrument is capable of operation.
- During the self-test all display segments and annunciators are lit.
- If the self-test fails, an error is reported on the front panel. You can also use the `SYSTEM: ERRor?` command query from the remote interface. If repair is required, contact an Agilent Service Center.
- If all tests pass, you have a high confidence (~90%) that the instrument is operational.
- You can initiate a more complete self-test by sending the `*TST?` command to the instrument. This command returns a "+0" if all the self-tests pass, or a "+1" if a failure occurred. This command may take up to 30 seconds to complete. You may need to set an appropriate interface time-out value.

Quick Performance Check

The quick performance check is a combination of internal self-test and an abbreviated performance test (specified by the letter **Q** in the performance verification tests). This test provides a simple method to achieve high confidence in the instrument's ability to functionally operate and meet specifications. These tests represent the absolute minimum set of performance checks recommended following any service activity. Auditing the instrument's performance for the quick check points (designated by a **Q**) verifies performance for "normal" accuracy drift mechanisms. This test does not check for abnormal component failures.

To perform the quick performance check, do the following:

- Perform a self-test as described in the preceding section.
- Perform only the performance verification tests indicated in the following tables with the letter **Q**.

If the instrument fails the quick performance check, adjustment or repair is required

Performance Verification Tests

The performance verification tests are recommended as acceptance tests when you first receive the instrument. The acceptance test results should be compared against the 1-year test limits. After acceptance, you should repeat the performance verification tests at every calibration interval.

If the instrument fails performance verification, adjustment or repair is required.

Adjustment is recommended at every calibration interval. If adjustment is not made, you must establish a 'guard band', using no more than 80% of the specifications, as the verification limits.

NOTE

Make sure you have read [“Test Considerations”](#) on page 67 before doing the performance verification tests.

Zero Offset Verification

This test is used to check the zero offset performance of the instrument. Verification checks are only performed for those functions and ranges with unique offset calibration constants. Measurements are checked for each function and range as described in the procedure on the next page.

Zero Offset Verification Test

- 1 Connect the Shorting Plug to the HI and LO input terminals. (see “[Input Connections](#)” on page 67). Leave the current inputs open.
- 2 Select each function and range in the order shown in the table below. Make a measurement and observe the result. Compare measurement results to the appropriate test limits shown in the table below (table continued on the following page).

NOTE

Note that resistance measurements use the Null math function (Null reading taken with test leads connected together) to eliminate test lead resistance.

Table 4 Zero Offset Verification Test

Input	Function ^[1]	Range	Quick Check	Error from Nominal 1 year
Open	DC Current	10mA	Q	±1.5µA
Open		100mA		±5 µA
Open		1A		±70µA
Open		10A		±0.7mA
Open	Capacitance	1nF		±8pF
Open		10nF		±0.05nF
Open		100nF		±0.5nF
Open		1µF		±5nF
Open		10µF		±0.05µF
Open		100µF		±0.5µF

4 Performance Tests and Calibration

Table 4 Zero Offset Verification Test

Input	Function ^[1]	Range	Quick Check	Error from Nominal 1 year
Open		1000 μ F		$\pm 5\mu$ F
Open		10000 μ F		± 0.05 mF
Short	DC Volts	100mV		$\pm 8\ \mu$ V
Short		1 V	Q	$\pm 60\ \mu$ V
Short		10 V		± 0.5 mV
Short		100 V		± 5 mV
Short		1000 V		± 50 mV
Short	2-Wire Ohms	100 Ω		± 8 m Ω [2]
Short		1 k Ω		± 50 m Ω [2]
Short		10 k Ω	Q	± 600 m Ω [2]
Short		100 k Ω		$\pm 7\ \Omega$
Short		1 M Ω		$\pm 70\ \Omega$
Short		10 M Ω		$\pm 500\ \Omega$
Short		100 M Ω		± 5 k Ω

[1] Select 5 $\frac{1}{2}$ - digit measurement resolution

[2] Specifications are for 2-wire ohms function using the Null math function enabled to eliminate lead resistance. Without Null, add 0.2 Ω additional error.

Q = Quick performance verification test points

Gain Verification

This test checks the full-scale reading accuracy of the instrument. Verification checks are performed only for those functions and ranges with unique gain calibration constants.

DC Voltage Gain Verification Test

- 1 Connect the calibrator to the front panel HI and LO input terminals.
- 2 Select each function and range in the order shown below. Provide the input shown in the table below.
- 3 Make a measurement and observe the result. Compare measurement results to the appropriate test limits shown in the table. (Be certain to allow for appropriate source settling when using the Fluke 5520A.)

Table 5 DC Voltage Gain Verification Test

Input	Function ^[1]	Range	Quick Check	Error from Nominal 1 year
100mV	DC Volts	100mV		±33 µV
-100mV		100mV		±33 µV
1V		1 V	Q	±0.31 mV
-1V		1 V		±0.31 mV
10V		10 V		±3.0 mV
100V		100 V	Q	±30 mV
1000V		1000 V		±0.3 V

Caution: Set the calibrator output to 0V before disconnecting it from the multimeter input terminals.

[1] Select 5½-digit measurement resolution

Q = Quick performance verification test points

DC Current Gain Verification Test

- 1 Connect the calibrator to the front panel I and LO input connectors.
- 2 Select each function and range in the order shown below. Provide the input shown in the table below.
- 3 Make a measurement and observe the result. Compare measurement results to the appropriate test limits shown in the table. (Be certain to allow for appropriate source settling when using the Fluke 5520A.)

Table 6 DC Current Gain Verification Test

Input	Function ^[1]	Range	Quick Check	Error from Nominal 1 year
10mA	DC Current	10 mA	Q	± 6.5µA
100mA		100 mA		± 55µA
1A		1 A	Q	± 2.07mA
Caution: Connect calibrator to multimeter's 12A and LO terminals before applying 10A				
10A		10 A		± 25.7mA

[1] Select 5½- digit measurement resolution

Q = Quick performance verification test points

Ohms Gain Verification Test

Configuration: 2-Wire Ohms (CONFigure:RESistance)

- 1 Select the Ohms function.
- 2 Select each range in the order shown below. Provide the resistance value indicated. Compare measurement results to the appropriate test limits shown in the table. (Be certain to allow for appropriate source settling.)

Table 7 Ohms Gain Verification Test

Input	Function ^[1]	Range	Quick Check	Error from Nominal 1 year
100 Ω	2-Wire Ohms	100 Ω		± 58 m Ω [2]
1 k Ω		1 k Ω	Q	± 550 m Ω [2]
10 k Ω		10 k Ω		± 5.6 Ω [2]
100 k Ω		100 k Ω		± 57 Ω
1 M Ω		1 M Ω		± 670 Ω
10 M Ω		10 M Ω	Q	± 25.5 k Ω
100 M Ω		100 M Ω		± 2.005 M Ω

[1] Select 5½- digit measurement resolution

[[2] Specifications are for 2-wire ohms function using the Null math function enabled to eliminate lead resistance. Without Null, add 0.2 Ω additional error.

Q = Quick performance verification test points

Frequency Gain Verification Test

Configuration: Frequency (CONFigure:FREQuency)

- 1 Select the Frequency function.
- 2 Select each range in the order shown below. Provide the input voltage and frequency indicated. Compare measurement results to the appropriate test limits shown in the table. (Be certain to allow for appropriate source settling.)

Table 8 Frequency Gain Verification Test

Voltage	Input Frequency	Function ^[1]	Range	Quick Check	Error from Nominal 1 year
200mVrms	1kHz	Frequency	1V	Q	±0.23Hz
200mVrms	10kHz		1V		±2.3Hz

[1] Select 5½- digit measurement resolution

Q = *Quick performance verification test points*

AC Voltage Verification Test

Configuration: AC Volts (CONFigure[:VOLTage]:AC)

- 1 Select the AC Voltage function.
- 2 Select each range in the order shown below. Provide the indicated input voltage and frequency. Compare measurement results to the appropriate test limits shown in the table. (Be certain to allow for appropriate source settling.)

Table 9 AC Volts Verification Test

Vrms	Input Frequency	Function ^[1]	Range	Quick Check	Error from Nominal 1 year
100mV	1kHz	AC Voltage	100mV		± 0.3 mV
100mV	30kHz		100mV		± 1.8 mV
100mV	100kHz		100mV		± 5.3 mV
1V	1kHz		1V	Q	± 3.0 mV
1V	30kHz		1V		± 11 mV
1V	100kHz		1V		± 32 mV
10V	45Hz		10V		± 110 mV
10V	1kHz		10V		± 30 mV
10V	30kHz		10V	Q	± 0.11 V
10V	100kHz		10V		± 0.32 V
100V	1kHz		100V	Q	± 0.3 V
100V	30kHz		100V		± 1.1 V
100V	100kHz		100V		± 3.2 V
750V	1kHz		750V		± 2.25 V

Caution: Set the calibrator output to 0V before disconnecting it from the multimeter input terminals.

[1] Select 5½- digit measurement resolution

Q = Quick performance verification test points

AC Current Verification Test

Configuration: AC Current (CONFigure:CURRent:AC)

- 1 Select the AC Current function.
- 2 Select each range in the order shown below. Provide the input current and frequency indicated. Compare measurement results to the appropriate test limits shown in the table. (Be certain to allow for appropriate source settling.)

Table 10 AC Current Verification Test

Current	Input Frequency	Function ^[1]	Range	Quick Check	Error from Nominal 1 year
10 mA	1 kHz	AC Current	10 mA	Q	± 60 µA
10 mA	10 kHz		10 mA		± 220 µA
100 mA	1 kHz		100 mA		± 600 µA
100 mA	10 kHz		100 mA		± 2.2 mA
1 A	1 kHz		1 A		± 6 mA
1 A	5 kHz		1 A		± 22 mA
Caution: Connect calibrator to multimeter's 12A and LO terminals before applying 10A					
10 A	1 kHz		10 A		± 60 mA
2 A	5 kHz		10 A		± 0.06 A

[1] Select 5½- digit measurement resolution

Q = Quick performance verification test points

Optional AC Voltage Performance Verification Test

Configuration: AC Volts (CONFigure[:VOLTage]:AC)

- 1 Select the AC Voltage function.
- 2 Select each range in the order shown below. Provide the indicated input voltage and frequency. Compare measurement results to the appropriate test limits shown in the table. (Be certain to allow for appropriate source settling.)

Table 11 Optional AC Voltage Performance Verification Test

Vrms	Input Frequency	Function ^[1]	Range	Error from Nominal 1 year
1V	45Hz	AC Voltage	1V	±11mV
1V	1kHz		1V	±3mV
1V	10kHz		1V	±3mV
1V	30kHz		1V	±11mV
1V	100kHz		1V	±32mV
10V	1kHz		10V	±30mV
1V	1kHz		10V	±12mV
0.1V	1kHz		10V	±10.2mV

[1] Select 5½- digit measurement resolution

Optional AC Current Performance Verification Test

Configuration: AC Current (CONFigure:CURRent:AC)

- 1 Select the AC Current function.
- 2 Select each range in the order shown below. Provide the indicated input voltage and frequency. Compare measurement results to the appropriate test limits shown in the table. (Be certain to allow for appropriate source settling.)

Table 12 Optional AC Current Performance Verification Test

Current	Input Frequency	Function ^[1]	Range	Error from Nominal 1 year
10mA	20Hz	AC Current	10mA	± 0.16mA
10mA	45Hz		10mA	± 0.16mA
10mA	1kHz		10mA	± 60µA
10mA	10kHz		10mA	± 0.22mA
1A	1kHz		1A	± 6mA
100mA	1kHz		1A	± 1.5mA
10mA	1kHz		1A	± 1.05mA

[1] Select 5½- digit measurement resolution

Optional Capacitance Performance Verification Test

Configuration: Capacitance (CONFigure:CAPacitance)

- 1 Select the Capacitance function.
- 2 Select each range in the order shown below. Provide the indicated input voltage and frequency. Compare measurement results to the appropriate test limits shown in the table. (Be certain to allow for appropriate source settling.)

Table 13 Optional Capacitance Performance Verification Test

Input Capacitance	Range	Function ^[1]	Error from Nominal 1 year
1nF	1nF	Capacitance	± 28pF
10nF	10nF		± 0.15nF
100nF	100nF		± 1.5nF
1μF	1μF		± 15nF
10μF	10μF		± 0.15μF
100μF	100μF		± 1.5μF
1000μF	1000μF		± 15μF
10000μF	10000μF		± 0.25mF

[1] For the best accuracy, take a zero null measurement with open test leads, to null out the test lead capacitance, before connecting the test leads to the calibrator.

Calibration Security

The calibration security code prevents accidental or unauthorized adjustments to the instrument. When you first receive your instrument, it is secured. Before you can adjust the instrument, you must unsecure it by entering the correct security code (see [“Unsecuring the Instrument for Calibration”](#) on page 83).

The security code is set to AT34405 when the instrument is shipped from the factory. The security code is stored in non-volatile memory, and does not change when power is turned off or after a Factory Reset (*RST command) or after an Instrument Preset (SYSTem:PRESet command).

NOTE

You can unsecure the instrument from the front panel, but you cannot enter a new security code or change the security code from the front panel. The security code can only be changed from the remote interface after the instrument has been unsecured. Refer to the CAL:SEC:CODE command in the 34405A Programmer's Reference Help File for more details.

The security code may contain up to 12 alphanumeric characters. The first character must be a letter. The remaining characters can be letters or numbers. You do not have to use all 12 characters.

Unsecuring the Instrument for Calibration

Before you can adjust the instrument, you must unsecure it by entering the correct security code. The security code is set to AT34405 when the instrument is shipped from the factory. The security code is stored in non-volatile memory, and does not change when power has been off or after a Factory Reset (*RST command).

Unsecuring from the Front Panel

Only five characters (the third through seventh characters) of the security code are used to unsecure the instrument from the front panel. If there are letters instead of digits in any of the third through seventh characters, those letters will be represented as "0" from the front panel.

Example 1

Assume the calibration security code is the factory setting of *AT34405*. When unsecuring from the front panel, the code length is five characters and the first two characters are ignored. In our example, the code now becomes:

34405

Example 2

Assume the calibration security code was set to *AT01A405* from the remote interface. When unsecuring from the front panel, the first two characters and any characters after the eighth through twelfth character are ignored. In our example, the code now becomes:

01A40

From the front panel, any letters (*A* in this example) are represented by 0. Use this code to unsecure:



01040



Example 3

Assume the calibration security code has been set to *ATB1* through remote interface. The first two characters (AT) are ignored. The B is represented by a zero. The “1” is still used and trailing zeros fill in the remaining characters. Use this code to unsecure:

01000

To Unsecure the Instrument from the Front Panel

- 1 Press  and  simultaneously to enter the Calibration Security Code entry mode.
- 2 The primary display shows **SECur** and the secondary display shows _ _
_ _ .

- 3 Use the editing keys    to step to each character in the code.

Use the range keys  to select each character.

- 4 Press  (Enter) when done.
- 5 If the correct security code was entered, the **CAL** annunciator illuminates and the primary display briefly shows **PASS**.

Calibration Process

The following general procedure is the recommended method to complete a full instrument calibration.

- 1 Read “[Test Considerations](#)” on page 67.
- 2 Perform the verification tests to characterize the instrument (incoming data).
- 3 Unsecure the instrument for calibration (see “[Calibration Security](#)” on page 82). Once unsecured, the instrument will be in Adjustment Mode as indicated by the illuminated CAL annunciator.
- 4 Perform the adjustment procedures (see “[Adjustments](#)” on page 88).
- 5 Secure the instrument against calibration.
- 6 Note the new security code and calibration count in the instrument's maintenance records.

NOTE

Make sure to quit the Adjustment Mode then turn off the instrument.

Using the Front Panel for Adjustments



This section describes the process used to perform adjustments from the front panel. Refer to the *34405A Programmer's Reference* online help for remote interface commands.

Selecting the Adjustment Mode

Unsecure the instrument see “[Unsecuring the Instrument for Calibration](#)” on page 83. Once unsecured, the display **CAL** annunciator illuminates to indicate you are in Adjustment Mode.

Entering Adjustment Values

In the DMM adjustment procedures, to enter an input calibration value from the front panel:

Use the edit keys   to select each digit in the Secondary display.

Use the up  and down  arrow keys to advance through the digits 0 through 9.

Press   when done.

Aborting a Calibration in Progress

Sometimes it may be necessary to abort a calibration after the procedure has already been initiated. You can abort a calibration at any time by pressing:



The calibration will be aborted, the primary display will show **FAIL** and *Error 705, CAL Aborted* will occur.

CAUTION

If you abort a calibration in progress when the instrument is attempting to write new calibration constants to EEPROM, you may lose all calibration constants for the function. Typically, upon re-applying power, the instrument will report error 742 through 748 (whichever is applicable). If this occurs, you should not use the instrument until a complete re-adjustment has been performed. A list of the possible calibration errors is given on [page 103](#).

Adjustments

You will need a test input cable and connectors set, and a Shorting Plug to adjust the instrument (see “[Input Connections](#)” on page 67).

NOTE

After each adjustment finishes successfully, the primary display briefly shows **PASS**. If the calibration fails, the multimeter beeps, the primary display shows **FAil** and an error number is shown in the secondary display. Calibration error messages are described on [page 103](#). In the event of a calibration failure, correct the problem and repeat the procedure.

Zero Adjustment

Each time you perform a zero adjustment, the instrument stores a new set of offset correction constants for measurement functions and ranges. The instrument will sequence through all required functions and ranges automatically and store new zero offset calibration constants.

CAUTION

Never turn off the instrument during Zero Adjustment. This may cause ALL calibration memory to be lost.





Zero Adjustment Procedure

Be sure to allow the instrument to warm up and stabilize for 2 hours before performing the adjustments.

- 1 Follow the steps outlined below. Review “[Test Considerations](#)” on page 67 before beginning this test.
- 2 After unsecuring the instrument, the instrument goes into the Adjustment Mode (as indicated by the **CAL** annunciator) with the secondary display showing **Short**. Connect the Shorting Plug (see [page 68](#)) between the HI and LO front panel input terminals. Leave the current inputs open.

NOTE

To minimize thermal effects wait at least 1 minute after connecting the Shorting Plug before executing the zero adjustment.

- 3 Press   ^{dB}, the display **CAL** annunciator starts flashing to indicate the calibration is in progress.
- 4 The display will show the measurement functions and ranges as the adjustments progress.
- Successful completion of the adjustment is indicated by a short beep and the primary display briefly showing **PASS**.
 - An adjustment failure is indicated by a long beep, the primary display showing **FAiL** and a calibration error number appearing in the secondary display. Correct the problem and repeat this procedure.
- 5 Remove the Shorting Plug from the input terminals.
- 6 Press   ^{Hold}, the display CAL annunciator will start flashing.
- 7 The display will show the functions as the open input adjustments progress.
- Successful completion of the adjustment is indicated by a short beep and the primary display briefly showing **PASS**.
 - An adjustment failure is indicated by a long beep, the primary display showing **FAiL** and a calibration error number appearing in the secondary display. Correct the problem and repeat this procedure.
- 8 Perform the “Zero Offset Verification” on page 71 to check zero calibration results.

Gain Adjustments

The instrument calculates and stores gain corrections for each input value. The gain constant is computed from the calibration value entered for the calibration command and from measurements made automatically during the adjustment procedure.

Most measuring functions and ranges have gain adjustment procedures. The 100 M Ω range does not have gain calibration procedures.

Adjustments for each function should be performed **ONLY** in the order shown.

Gain Adjustment Considerations

- The zero adjustment procedure must have been recently performed prior to beginning any gain adjustment procedures.
- Be sure to allow the instrument to warm up and stabilize for 2 hours before performing the adjustments.
- Consider the thermal effects as you are connecting test leads to the calibrator and multimeter. It is recommended to wait one minute before starting the calibration after connecting the test leads.

CAUTION

Never turn off the instrument during a Gain Adjustment. This may cause calibration memory for the present function to be lost.

Valid Gain Adjustment Input Values Gain adjustment can be accomplished using the following input values.

Table 14 Valid Gain Adjustment Input Values

Function	Range	Valid Amplitude Input Values
DC Volts	100 mV, 1 V, 10 V, 100 V, 1000 V	0.9 to 1.1 x Full Scale
DC Current	10 mA, 100 mA, 1000 mA, 10 A	0.9 to 1.1 x Full Scale
Ohms	100 Ω, 1 kΩ, 10 kΩ, 100 kΩ, 1MΩ, 10 MΩ	0.9 to 1.1 x Full Scale
Frequency	Autorange/1 kHz	Input ≥ 100 mV rms, 900 Hz to 1100 Hz
AC Current	1 mA, 10 mA, 100 mA, 1000 mA, 10 A	0.9 to 1.1 x Full Scale
AC Volts	10 mV, 100 mV, 1 V, 10 V, 100 V, 750 V	0.9 to 1.1 x Full Scale
Capacitance	0.4 nF, 1 nF, 10 nF, 100 nF, 1 μF, 10 μF, 100 μF, 1000 μF, 10000 μF	0.9 to 1.1 x Full Scale



DC Voltage Gain Adjustment Procedure

Review the “[Test Considerations](#)” on page 67 and “[Gain Adjustment Considerations](#)” on page 90 sections before beginning this procedure.

- 1 Press  to enter DC Voltage Gain Calibration.
- 2 The primary display will show the uncalibrated value and the secondary display will show the reference value of the **Cal Item**.
- 3 Configure each **Cal Item** shown in the adjustment table below.

NOTE

If the zero adjustment procedure has been recently performed prior to the DC Voltage gain calibration procedure, the **Cal Item** 'Short' can be neglected.

- 4 Use  (Auto) or  (Range) to select the **Cal Item**.
- 5 Apply the input signal shown in the "Input" column of the table.

NOTE

Always complete tests in the same order as shown in the appropriate table.

- 6 Enter the actual applied input (see “[Entering Adjustment Values](#)” on page 86).
- 7 Press  to start the adjustment. The **CAL** annunciator flashes to indicate the calibration is in progress.
 - Successful completion of each adjustment value is indicated by a short beep and the primary display briefly showing **PASS**.
 - An adjustment failure is indicated by a long beep, the primary display showing **FAiL** and a calibration error number appearing in the secondary display. Check the input value, range, function, and entered adjustment value to correct the problem and repeat the adjustment step.
- 8 Repeat steps 3 through 7 for each gain adjustment point shown in the table.

- 9 Verify the DC Voltage Gain adjustments using the “DC Voltage Gain Verification Test” on page 73.

Table 15 DC Voltage Gain Adjustment

Input	Function	Cal Item
Dual Banana Plug with copper wire short between 2 terminals	DC Voltage	Short
100 mV		100 mV
+ 1 V		+ 1 V
- 1 V		- 1 V
10 V		10 V
100 V		100 V
1000 V		1000 V

Caution: Set the calibrator output to 0V before disconnecting from the multimeter input terminals.



DC Current Gain Adjustment Procedure

Review the “Test Considerations” on page 67 and “Gain Adjustment Considerations” on page 90 sections before beginning this procedure.

- 1 Press  to enter DC Current Gain Calibration.
- 2 The primary display will show the uncalibrated value and the secondary display will show the reference value of **Cal Item**.
- 3 Configure each **Cal Item** shown in the adjustment table below.

NOTE

If the zero adjustment procedure has been recently performed prior to the DC Current gain calibration procedure, the **Cal Item** 'Open' can be neglected.

- 4 Use  (Auto) or  (Range) to select the **Cal Item**.
- 5 Apply the input signal shown in the "Input" column of the table.

NOTE

Always complete tests in the same order as shown in the appropriate table.





- 6 Enter the actual applied input (see “[Entering Adjustment Values](#)” on page 86).
- 7 Press  to start the adjustment. The **CAL** annunciator flashes to indicate the calibration is in progress.
 - Successful completion of each adjustment value is indicated by a short beep and the primary display briefly showing **PASS**.
 - An adjustment failure is indicated by a long beep, the primary display showing **FAiL** and a calibration error number appearing in the secondary display. Check the input value, range, function, and entered adjustment value to correct the problem and repeat the adjustment step.
- 8 Repeat steps 3 through 7 for each gain adjustment point shown in the table.
- 9 Verify the DC Current Gain adjustments using the “[DC Current Gain Verification Test](#)” on page 74.

Table 16 DC Current Gain Adjustment

Input	Function	Cal Item
Remove test leads from Input terminals	DC Current	Open
10 mA		10 mA
100 mA		100 mA
1000 mA		1000 mA
Caution: Connect calibrator to multimeter’s 12A and LO terminals before applying 10A		
10 A		10 A

AC Voltage Gain Adjustment Procedure

Review the “[Test Considerations](#)” on page 67 and “[Gain Adjustment Considerations](#)” on page 90 sections before beginning this procedure.

- 1 Press  to enter AC Voltage Gain Calibration.
- 2 The primary display will show the uncalibrated value and the secondary display will show the reference value of **Cal Item**.
- 3 Configure each **Cal Item** shown in the adjustment table below.
- 4 Use  (Auto) or  (Range) to select the **Cal Item**.
- 5 Apply the input signal shown in the Input and Frequency columns of the table below.

NOTE

Always complete tests in the same order as shown in the appropriate table.

- 6 Enter the actual applied input (see “[Entering Adjustment Values](#)” on page 86).
- 7 Press  to start the adjustment. The **CAL** annunciator flashes to indicate the calibration is in progress.
 - Successful completion of each adjustment value is indicated by a short beep and the primary display briefly showing **PASS**.
 - An adjustment failure is indicated by a long beep, the primary display showing **FAiL** and a calibration error number appearing in the secondary display. Check the input value, range, function, and entered adjustment value to correct the problem and repeat the adjustment step.
- 8 Repeat steps 3 through 7 for each gain adjustment point shown in the table.
- 9 Verify the AC Voltage Gain adjustments using the “[AC Voltage Verification Test](#)” on page 77.



Table 17 AC Voltage Gain Adjustment

Input Vrms	Frequency	Function	Frequency as 1kHz Cal Item
10 mV	1kHz	AC Voltage	10 mV
100 mV	1kHz		100 mV
1 V	1kHz		1 V
10V	1kHz		10 V
100 V	1kHz		100 V
750 V	1kHz		750 V

Caution: Set the calibrator output to 0V before disconnecting from the multimeter input terminals.

AC Current Gain Adjustment Procedure

Review the “[Test Considerations](#)” on page 67 and “[Gain Adjustment Considerations](#)” on page 90 sections before beginning this procedure.

- 1 Press  to enter AC Current Gain Calibration.
- 2 The primary display will show the calibration value and the secondary display will show the reference value of the **Cal Item**.
- 3 Configure each **Cal Item** shown in the adjustment table below.
- 4 Use  (Auto) or  (Range) to select the **Cal Item**.
- 5 Apply the input signal shown in the Input and Frequency columns of the table below.

NOTE

Always complete tests in the same order as shown in the appropriate table.

- 6 Enter the actual applied input (see “[Entering Adjustment Values](#)” on page 86).
- 7 Press  to start the adjustment. The **CAL** annunciator flashes to indicate the calibration is in progress.
 - Successful completion of each adjustment value is indicated by a short beep and the primary display briefly showing **PASS**.
 - An adjustment failure is indicated by a long beep, the primary display showing **FAiL** and a calibration error number appearing in the secondary display. Check the input value, range, function, and entered adjustment value to correct the problem and repeat the adjustment step.
- 8 Repeat steps 3 through 7 for each gain adjustment point shown in the table.
- 9 Verify the AC Current Gain adjustments using the “[AC Current Verification Test](#)” on page 78.

Table 18 AC Current Gain Adjustment

Input Current	Frequency	Function	Frequency as 1kHz Cal Item
1 mA	1kHz	AC Current	1 mA
10 mA	1kHz		10 mA
100 mA	1kHz		100 mA
1000 mA	1kHz		1000 mA
Caution: Connect calibrator to multimeter’s 12A and LO terminals before applying the following 1A and 10A			
1 A	1kHz		1 A
10 A	1kHz		10 A

Ohms Gain Adjustment Procedure



Review the “[Test Considerations](#)” on page 67 and “[Gain Adjustment Considerations](#)” on page 90 sections before beginning this procedure.

This procedure adjusts the gain for the two-wire ohms function. The gain for the 100 M Ω range is derived from the 10 M Ω range and does not have a separate adjustment point.

- 1 Press  to enter the Ohms Gain Adjustment Mode.
- 2 The primary display will show the calibration value and the secondary display will show the first reference value of the **Cal Item (Short)**.
- 3 Configure each **Cal Item** shown in the adjustment table below.

NOTE

If the zero adjustment procedure has been recently performed prior to the ohms gain calibration procedure, the **Cal Items Short** and *Open* can be skipped.

- 4 Use  (Auto) or  (Range) to select the **Cal Item**.
- 5 Apply the input signal shown in the **Input** column of the table.

NOTE

Always complete tests in the same order as shown in the appropriate table.

- 6 Enter the actual applied input (see “[Entering Adjustment Values](#)” on page 86).
- 7 Press  to start the adjustment. The **CAL** annunciator flashes to indicate the calibration is in progress.
 - Successful completion of each adjustment value is indicated by a short beep and the primary display briefly showing **PASS**.
 - An adjustment failure is indicated by a long beep, the primary display showing **FAiL** and a calibration error number appearing in the secondary display. Check the input value, range, function, and entered adjustment value to correct the problem and repeat the adjustment step.
- 8 Repeat steps 3 through 7 for each gain adjustment point shown in the table.



- Verify the Ohm Gain adjustments using the “Ohms Gain Verification Test” on page 75.

Table 19 Ohms Gain Adjustment

Input	Function	Cal Item
Dual Banana Plug with copper wire short between 2 terminals	2 - Wire Ohms	Short
Input terminals open (remove any test leads or shorting plugs from the input terminals)		Open
10 M Ω		10 M Ω
1 M Ω		1 M Ω
100 k Ω		100 k Ω
10 k Ω		10 k Ω
1 k Ω		1 k Ω
100 Ω		100 Ω

Frequency Gain Adjustment Procedure

Review the “Test Considerations” on page 67 and “Gain Adjustment Considerations” on page 90 sections before beginning this procedure.

- Press  to enter Frequency Gain Calibration.
- The primary display will show the calibration value and the secondary display will show the reference value of **Cal Item**.
- Configure each **Cal Item** shown in the adjustment table below.
- Use  (Auto) or  (Range) to select the **Cal Item**.
- Apply the input signal shown in the Input Voltage and Frequency column of the table.

NOTE

Always complete tests in the same order as shown in the appropriate table.



- 6 Enter the actual applied input (see “[Entering Adjustment Values](#)” on page 86).
- 7 Press  to start the adjustment. The **CAL** annunciator flashes to indicate the calibration is in progress.
 - Successful completion of each adjustment value is indicated by a short beep and the primary display briefly showing **PASS**.
 - An adjustment failure is indicated by a long beep, the primary display showing **FAiL** and a calibration error number appearing in the secondary display. Check the input value, range, function, and entered adjustment value to correct the problem and repeat the adjustment step.
- 8 Repeat steps 3 through 7 for each gain adjustment point shown in the table.
- 9 Verify the Frequency Gain adjustments using the “[Frequency Gain Verification Test](#)” on page 76.

Table 20 Frequency Gain Adjustment

Input Voltage	Frequency	Function	Voltage as 1Vrms Cal Item
1Vrms	1kHz	Frequency	1kHz

Capacitance Gain Adjustment Procedure



Review the “[Test Considerations](#)” on page 67 and “[Gain Adjustment Considerations](#)” on page 90 sections before beginning this procedure.

- 1 Press  to enter Capacitance Gain Calibration.
- 2 The primary display will show the calibration value and the secondary display will show the reference value of **Cal Item**.
- 3 Configure each **Cal Item** shown in the adjustment table below.

4 Performance Tests and Calibration

NOTE

If the zero adjustment procedure has been recently performed prior to Capacitance gain calibration procedures, the **Cal Item** 'Short' can be neglected.

- 4 Use  (Auto) or  (Range) to select the **Cal Item**.
- 5 Apply the input signal shown in the "Input" column of the table.

NOTE

Always complete tests in the same order as shown in the appropriate table.



- 6 Enter the actual applied input (see [“Entering Adjustment Values”](#) on page 86).
- 7 Press  to start the adjustment. The **CAL** annunciator flashes to indicate the calibration is in progress.
 - Successful completion of each adjustment value is indicated by a short beep and the primary display briefly showing **PASS**.
 - An adjustment failure is indicated by a long beep, the primary display showing **FAiL** and a calibration error number appearing in the secondary display. Check the input value, range, function, and entered adjustment value to correct the problem and repeat the adjustment step.
- 8 Repeat steps 3 through 7 for each gain adjustment point shown in the table.
- 9 Verify the Capacitance Gain adjustments using the [“Optional Capacitance Performance Verification Test”](#) on page 81.

Table 21 Capacitance Gain Adjustment

Input	Function	Cal Item
Input terminals open (remove any test leads or shorting plugs from the input terminals)	Capacitance	Open
0.4 nF		0.4 nF
1 nF		1 nF
10 nF		10 nF
100 nF		100 nF
1 μ F		1 μ F
10 μ F		10 μ F
100 μ F		100 μ F
1000 μ F		1000 μ F
10000 μ F		10000 μ F

Finishing the Adjustments

- 1 Remove all shorting plugs and connections from the instrument.
- 2 Reset the Calibration Message (see below).
- 3 Record the new Calibration Count (see [page 102](#)).
- 4 Press  and  simultaneously to exit the Adjustment Mode. The instrument will be secured and returns to DC Voltage, autoranging measurements.

Calibration Message

The instrument allows you to store a message in calibration memory. For example, you can store such information as the date when the last calibration was performed, the date when the next calibration is due, the instrument's serial number, or even the name and phone number of the person to contact for a new calibration. The calibration message may contain up to 40 characters.

You can record a calibration message only when the instrument is unsecured. You can read the calibration message (from remote only) whether the instrument is secured or unsecured.

To store a calibration message use the `CALibration:STRing` and `CALibration:STRing?` commands from the remote interface.

To Read the Calibration Count

You can query the instrument to determine how many calibrations have been performed. Note that your instrument was calibrated before it left the factory. When you receive your instrument, read the count to determine its initial value.

The count value increments by one for each calibration point, and a complete calibration will increase the value by many counts. The calibration count increments up to a maximum of 32767 after which it rolls over to 0. The calibration count can be read either remotely or from the front panel after the instrument has been unsecured. To read the calibration count from remote, use the `CALibration:COUNT?` command. Use the following procedure to read the calibration count from the front panel.

- 1 In Adjustment Mode (**CAL** annunciator illuminated)

press  . The secondary display shows the calibration count.

- 2 Make note of the count.

- 3 Press  again to exit the calibration count mode.

Calibration Errors

The following errors indicate failures that may occur during a calibration.

Number	Description	Number	Description
702	Cal secured	726	Cal RES open out of range
703	Invalid secure code	742	Cal checksum failed DCV corrections
704	Secure code too long	743	Cal checksum failed DCI corrections
705	Cal aborted	744	Cal checksum failed RES corrections
706	Cal value out of range	745	Cal checksum failed ACV corrections
707	Cal signal measurement out of range	746	Cal checksum failed ACI corrections
720	Cal DCV offset out of range	747	Cal checksum failed FREQ corrections
721	Cal DCI offset out of range	748	Cal checksum failed CAP corrections
722	Cal RES offset out of range		

THIS PAGE HAS BEEN INTENTIONALLY LEFT BLANK.

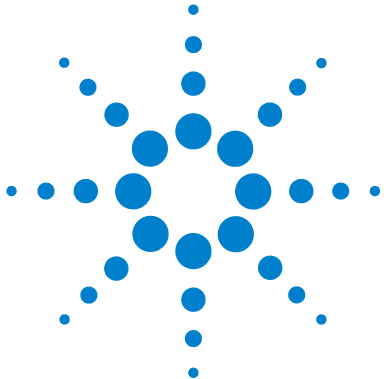

5 Disassembly and Repair

Operating Checklist	106
Types of Service Available	107
Repackaging for Shipment	108
Cleaning	108
To Replace the Power Line Fuse	109
To Replace a Current Input Fuse	110
Self-Test Errors	111
Electrostatic Discharge (ESD) Precautions	112
Mechanical Disassembly	113
Replaceable Parts	120

This chapter will help you troubleshoot a failing multimeter. It describes how to disassemble the multimeter, how to obtain repair services, and lists replaceable parts.



Operating Checklist

Before returning your multimeter to Agilent for service or repair check the following items:

Is the multimeter inoperative?

- Verify the power line voltage setting.
- Verify the power line fuse is installed.
- Verify that the power cord is connected to the multimeter and to AC line power.
- Verify the front panel power switch is depressed.

See [page 109](#)

Does the multimeter fail self-test?

- Remove all test connections to the multimeter and run the self-test again.

Errors may be induced by AC signals present on the multimeter input terminals during self-test. Long test leads can act as an antenna causing pick-up of AC signals.

Is the mutimeter's current input inoperative?

- Verify the current input fuse.

Types of Service Available

If your instrument fails during the warranty period, Agilent Technologies will repair or replace it under the terms of your warranty. After your warranty expires, Agilent offers repair services at competitive prices.

Extended Service Contracts

Many Agilent products are available with optional service contracts that extend the *covered period* after the standard warranty expires. If you have such a service contract and your instrument fails during the covered period, Agilent Technologies will repair or replace it in accordance with the contract.

Obtaining Repair Service (Worldwide)

To obtain service for your instrument (in-warranty, under service contract, or post-warranty), contact your nearest Agilent Technologies Service Center. They will arrange to have your unit repaired or replaced, and can provide warranty or repair-cost information where applicable.

To obtain warranty, service, or technical support information you can contact Agilent Technologies at one of the following telephone numbers:

In the United States: (800) 829-4444

In Europe: 31 20 547 2111

In Japan: 0120-421-345

Or use our Web link for information on contacting Agilent worldwide:

www.agilent.com/find/assist

Or contact your Agilent Technologies Representative.

Before shipping your instrument, ask the Agilent Technologies Service Center to provide shipping instructions, including what components to ship. Agilent recommends that you retain the original shipping carton for use in such shipments.

Repackaging for Shipment

If the unit is to be shipped to Agilent for service or repair, be sure to:

- Attach a tag to the unit identifying the owner and indicating the required service or repair. Include the model number and full serial number.
- Place the unit in its original container with appropriate packaging material for shipping.
- Secure the container with strong tape or metal bands.
- If the original shipping container is not available, place your unit in a container which will ensure at least 4 inches of compressible packaging material around all sides for the instrument. Use static-free packaging materials to avoid additional damage to your unit.

Agilent suggests that you always insure shipments.

Cleaning

Clean the outside of the instrument with a soft, lint-free, slightly dampened cloth. Do not use detergent. Disassembly is not required or recommended for cleaning.

To Replace the Power Line Fuse

The power line fuse is located within the multimeter's fuse-holder assembly on the rear panel. The multimeter is shipped from the factory with a power-line fuse installed. The supplied fuse is a time-lag, low-breaking, 0.2A/ 250V, 5x20mm fuse, Agilent part number 2110-1395. If you determine that the fuse is faulty, replace it with one of the same size and rating.

1 Disconnect power cord. Depress tabs 1 and 2 and pull fuse holder from rear panel.

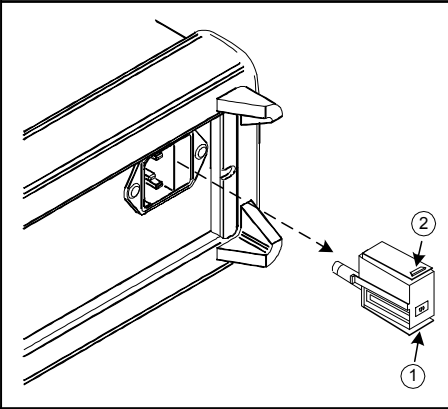

2 Remove the line voltage selector from fuse holder assembly.

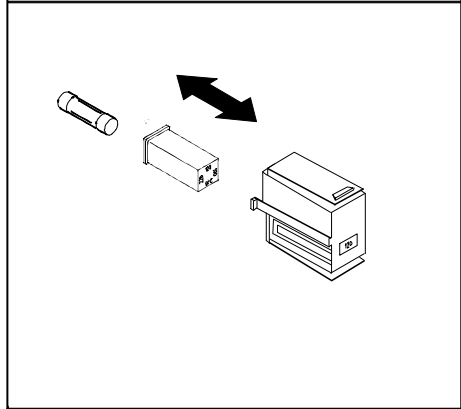

3 Rotate line voltage selector and reinstall so correct voltage appears in fuse holder window.

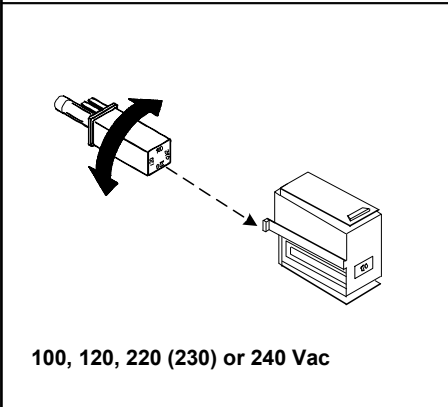

4 Replace fuse holder assembly in rear panel.

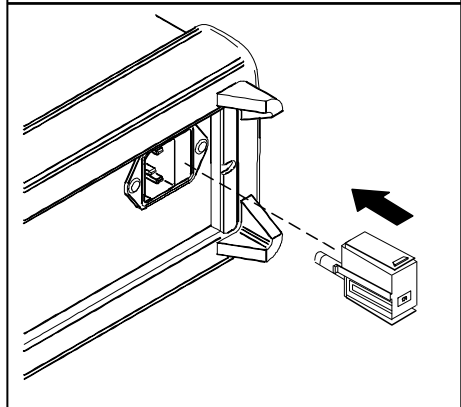

To Replace a Current Input Fuse

Both the 1.2A and the 12A current input terminals are fuse protected. The fuse for the 1.2A input terminal is located on the front panel (see [page 15](#)). The fuse is a 1.25A, 500V fuse, Agilent part number 2110-1394. If you determine that the fuse is faulty, replace it with one of the same size and rating.

The fuse for the 12A current input terminal is located inside the multimeter (see [page 117](#)) and requires partial disassembly of the multimeter. The fuse is a 15A, 600V fast-acting fuse, Agilent part number 2110-1396. If you determine that the fuse is faulty, replace it with one of the same size and rating.

Self-Test Errors

The following errors indicate failures that may occur during a self-test.

NOTE

On the remote interface, a self-test failure will generate SCPI error –330 and a supplemental message indicating one of the test numbers shown below. On the front panel, only the failing test is shown.

Table 22 Self-Test Error Numbers

Error Number	Description
626	I/O processor failed self-test
630	Unstable Oscillator
631	Program ROM checksum failed
632	Program RAM failed
633	Display board failed
634	ADC failed
635	Interface board failed
636	DC Path error
637	AC path attenuated error
638	AC path attenuated 100 error
639	AC path attenuated 1000 and amplified 10 error
640	Frequency measurement path failed
641	Constant Current 0.2V/1kohm error
642	Constant Current 0.2V/10kohm or amplification of 11 error
643	Constant Current 0.8V/100kohm or amplification of 11 error
644	Constant Current 1V/1.1Mohm or amplification of 11 error

Electrostatic Discharge (ESD) Precautions

Almost all electrical components can be damaged by electrostatic discharge (ESD) during handling. Component damage can occur at electrostatic discharge voltages as low as 50 volts.

The following guidelines will help prevent ESD damage when servicing the instrument or any electronic device.

- Disassemble instruments only in a static-free work area.
- Use a conductive work area to reduce static charges.
- Use a conductive wrist strap to reduce static charge accumulation.
- Minimize handling.
- Keep replacement parts in original static-free packaging.
- Remove all plastic, foam, vinyl, paper, and other static-generating materials from the immediate work area.
- Use only anti-static solder suckers.

Mechanical Disassembly

For procedures in this manual, the following tools are required for disassembly:

- T20 Torx driver (most disassembly)
- Flat Blade screw driver
- #2 Pozi-drive screw driver

WARNING

SHOCK HAZARD. Only service-trained personnel who are aware of the hazards involved should remove the instrument covers. To avoid electrical shock and personal injury, make sure to disconnect the power cord from the instrument before removing the covers. Some circuits are active and have power applied even when the power switch is turned off.

General Disassembly

- 1 Remove power and all cables from the instrument.
- 2 Remove the carrying handle by rotating the handle upright and pulling out from the sides of the instrument.



5 Disassembly and Repair

- 3 Remove the instrument bumpers.** Pull from a corner and stretch the bumpers off the instrument.



- 4 Remove the rear bezel.** Loosen the two captive screws in the rear bezel and remove the rear bezel.



- 5 Remove the cover.** Remove the screw in the bottom of the cover and slide the cover off the instrument.



Front Panel Removal

- 6 Remove on/off switch push rod.** Gently move the power switch push rod toward the front of the instrument to disengage it from the switch. Be careful not to twist or bend the push rod.

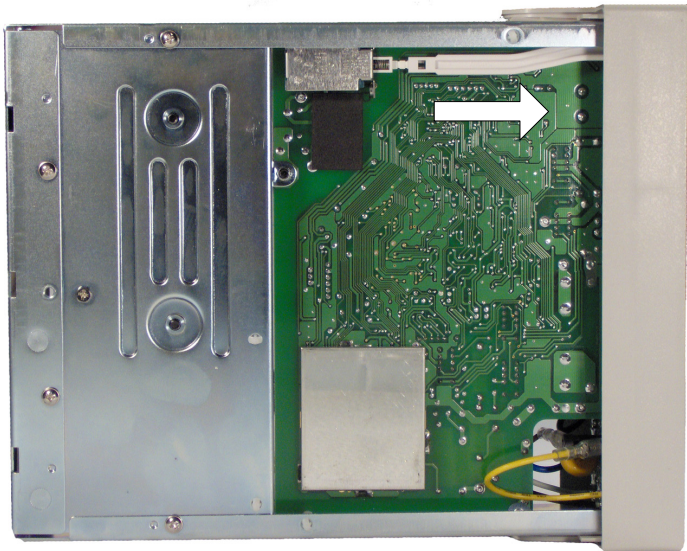

5 Disassembly and Repair

7 Remove the two screws holding the front panel.

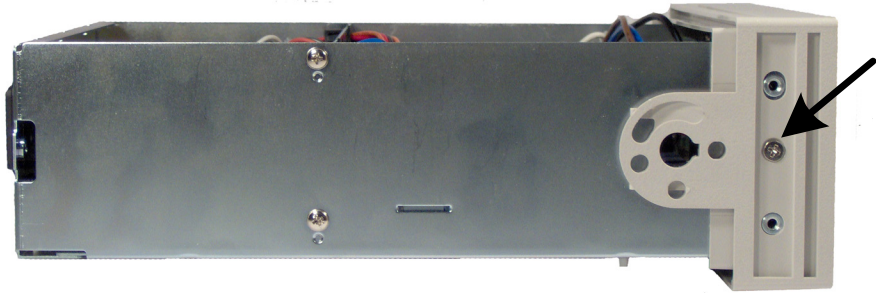

8 Disconnect the two ribbon cable connectors from the front panel.

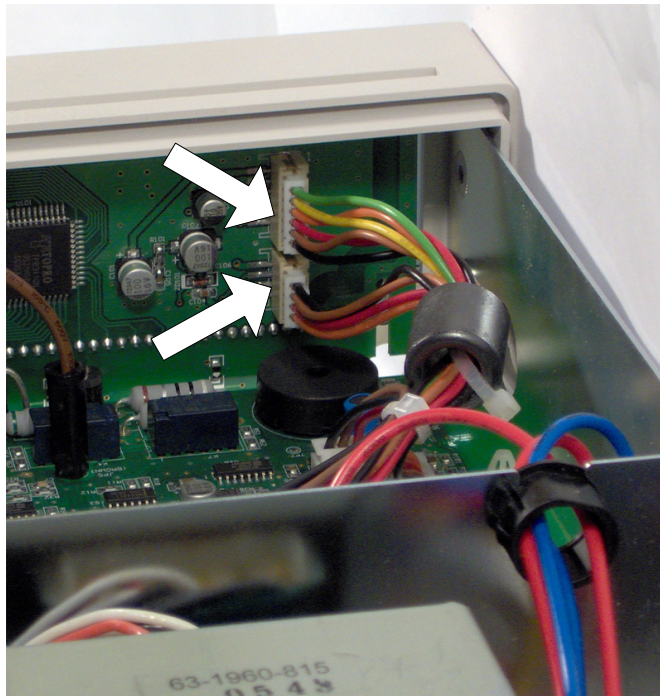

9 Disconnect the individual front panel wires shown below.

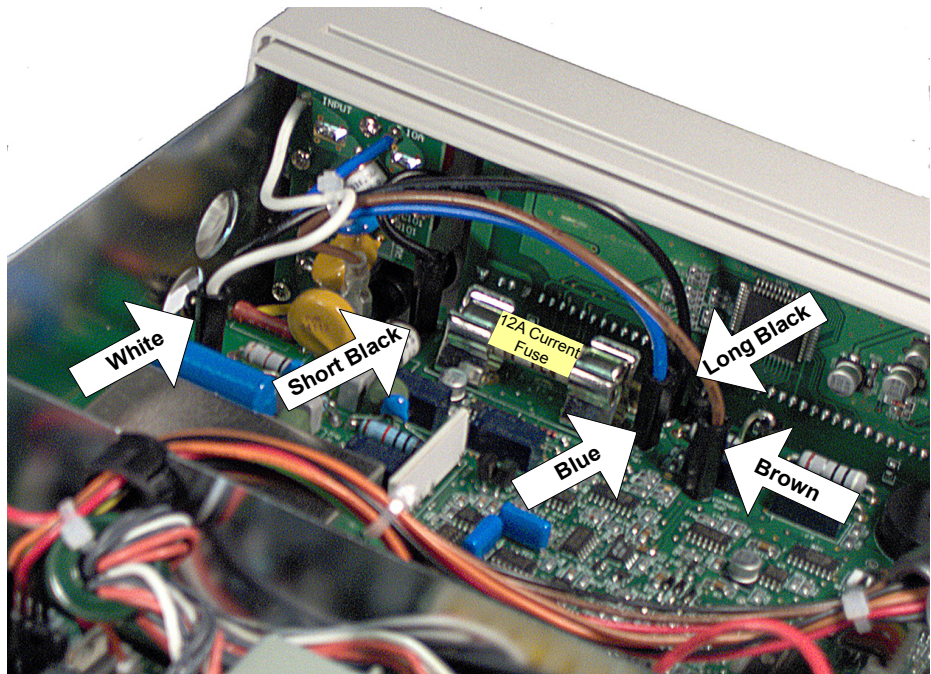

10 There is now enough play to allow the side of the front panel to be pried from the chassis and removed as an assembly.

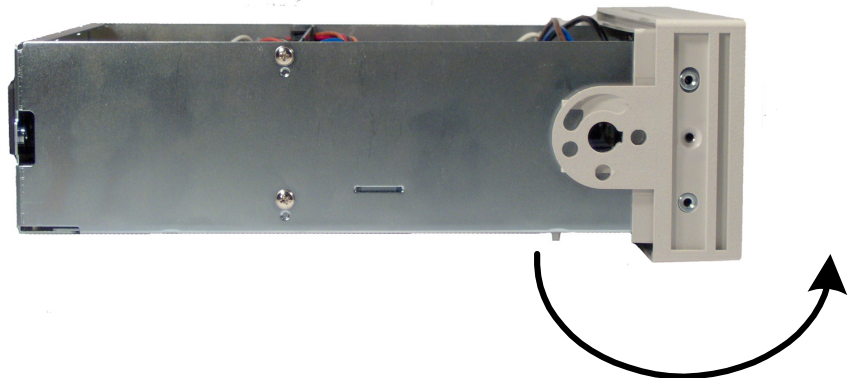

Front Panel Disassembly

- 1 **Remove the keyboard and display assembly.** Using a flat blade screwdriver, gently pry up on the circuit board tab (shown below) and slide the board to disengage from the tabs. Lift the keyboard and display assembly from the plastic housing.

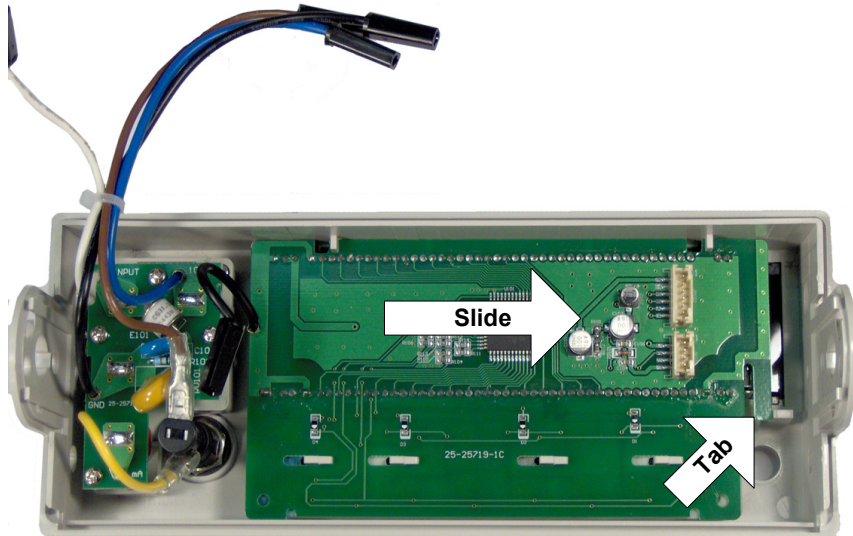

- a The rubber keypad can now be pulled from the plastic housing.

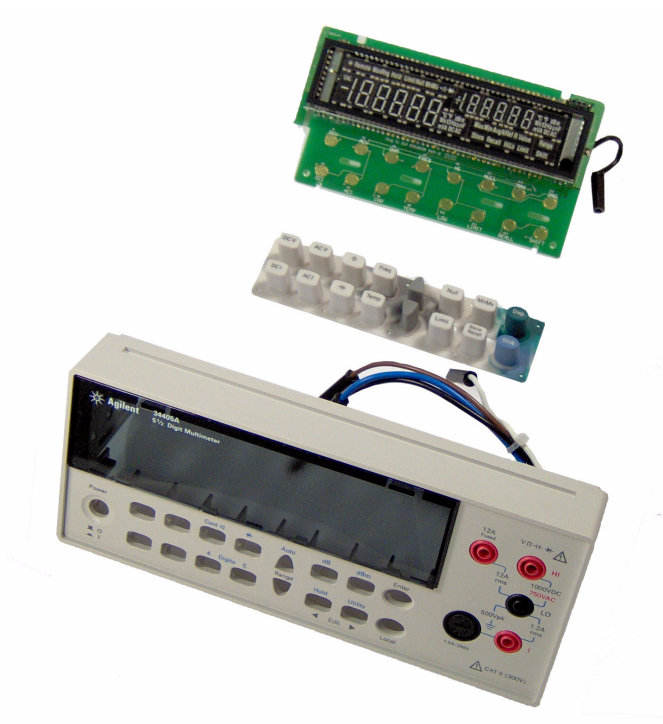

Replaceable Parts

This section contains information for ordering replacement parts for your instrument. The parts lists are divided into the following sections.

Parts are listed in alphanumeric order according to their reference designators. The parts lists include a brief description of each part with applicable Agilent part number.

To Order Replaceable Parts

You can order replaceable parts from Agilent using the Agilent part number. Note that not all parts listed in this chapter are available as field-replaceable parts. To order replaceable parts from Agilent, do the following:

- 1 Contact your nearest Agilent Sales Office or Service Center.
- 2 Identify the parts by the Agilent part number shown in the replaceable parts list.
- 3 Provide the instrument model number and serial number.

Table 23 Replaceable Parts

Part Number	Description
34405-81912	Keypad
34405-40201	Front Panel
34405-43711	Pushrod
34405-84101	Cover
34405-49321	Front Window
34401-86020	Kit-Bumpers
34401-45021	Front Handle
2110-1394	1.25A, 500V Fuse (I Input)
2110-1396	15A, 600V Fast Acting Fuse (12A Input)
2110-1395	0.2A, 250V, Time-Lag, Low-Breaking, Line Power Fuse

Rack Mounting

You can mount the multimeter in a standard 19-inch rack cabinet using one of three optional kits shown below.

NOTE

You must remove the carrying handle (see [page 113](#)) and the front and rear bumpers (see [page 114](#)) before rack mounting the multimeter.

To rack mount a single instrument, order adapter kit 5063-9240.

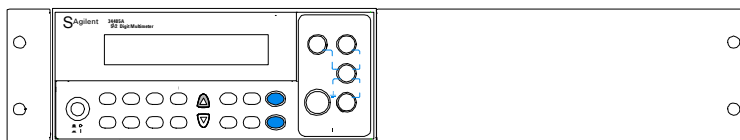

To rack mount two instruments side-by-side, order lock-link kit 5061-9694 and flange kit 5063-9212.

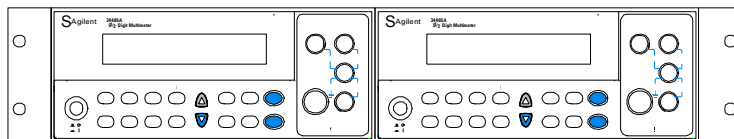

THIS PAGE HAS BEEN INTENTIONALLY LEFT BLANK.



6 Specifications

DC Specifications[1]	125
AC Specifications[1]	126
Temperature and Capacitance Specifications[1]	128
Operating Specifications	129
Supplemental Measurement Specifications	130
General Characteristics	134

This chapter describes the multimeter's specifications and operating specifications.



These specifications apply when using the 34405A multimeter in an environment that is *free* of electromagnetic interference and electrostatic charge.

When using the multimeter in an environment where electromagnetic interference or significant electrostatic charge *is* present, measurement accuracy may be reduced. *Particularly note:*

- The voltage measurement probes are not shielded and can act as antennas, causing electromagnetic interference to be added to the signal being measured.
- Electrostatic discharges of 4000 V or greater may cause the multimeter to temporarily stop responding, resulting in a lost or erroneous reading.

NOTE

Specifications are subject to change without notice. For the latest specifications, go to the product page:

www.agilent.com/find/34405A

DC Specifications^[1]

Table 24 DC Accuracy \pm (% of reading + % of range)

Function	Range ^[2]	Test Current or Burden Voltage	Input Impedance ^[13]	1 Year 23° C \pm 5° C	Temperature Coefficient 0° C - 18° C 28° C - 55° C
DC Voltage	100.000mV	-	10M Ω \pm 2%	0.025+0.008	0.0015+0.0005
	1.00000V	-	10M Ω \pm 2%	0.025+0.006	0.0010+0.0005
	10.0000V	-	10.1M Ω \pm 2%	0.025+0.005	0.0020+0.0005
	100.000V	-	10.1M Ω \pm 2%	0.025+0.005	0.0020+0.0005
	1000.00V	-	10M Ω \pm 2%	0.025+0.005	0.0015+0.0005
Resistance	100.000 Ω	1.0mA	-	0.05+0.008 ^[3]	0.0060+0.0008
	1.00000k Ω	0.83mA	-	0.05+0.005 ^[3]	0.0060+0.0005
	10.0000k Ω	100 μ A	-	0.05+0.006 ^[3]	0.0060+0.0005
	100.000k Ω	10.0 μ A	-	0.05+0.007	0.0060+0.0005
	1.00000M Ω	900nA	-	0.06+0.007	0.0060+0.0005
	10.0000M Ω	205nA	-	0.25+0.005	0.0250+0.0005
	100.000M Ω	205nA 10M Ω	-	2.00+0.005	0.3000+0.0005
DC Current	10.0000mA	<0.2V	-	0.05+0.015	0.0055+0.0005
	100.000mA	<0.2V	-	0.05+0.005	0.0055+0.0005
	1.00000A	<0.5V	-	0.20+0.007	0.0100+0.0005
	10.0000A	<0.6V	-	0.25+0.007	0.0150+0.0005
Continuity	1000 Ω	0.83mA	-	0.05+0.005	0.0050+0.0005
Diode Test ^[4]	1.0000V	0.83mA	-	0.05+0.005	0.0050+0.0005

AC Specifications^[1]

WARNING

Exceeding the crest factor limit may result in an incorrect or a lower reading. Do not exceed the crest factor limit to avoid instrument damage and the risk of electric shock.

Table 25 AC Accuracy \pm (% of reading + % of range)

Function	Range ^[5]	Frequency	Temperature Coefficient	
			1 Year 23° C \pm 5° C	0° C - 18° C 28° C - 55° C
True RMS AC Voltage ^[6]	100.000 mV	20 Hz - 45 Hz	1+0.1	0.02+0.02
		45 Hz - 10 kHz	0.2+0.1	0.02+0.02
		10 kHz - 30 kHz	1.5+0.3	0.05+0.02
		30 kHz - 100 kHz ^[7]	5.0+0.3	0.10+0.02
	1.00000 V to 750.00 V	20 Hz - 45 Hz	1+0.1 ⁽¹⁴⁾	0.02+0.02
		45 Hz - 10 kHz	0.2+0.1	0.02+0.02
		10 kHz - 30 kHz	1+0.1	0.05+0.02
		30 kHz - 100 kHz ⁽⁷⁾	3+0.2 ⁽¹⁵⁾	0.10+0.02
True RMS AC Current ^[8]	10.0000 mA to 10.0000 A	20 Hz - 45 Hz	1.5+0.1	0.02+0.02
		45 Hz - 1 kHz	0.5+0.1	0.02+0.02
		1 kHz - 10 kHz ^[9]	2+0.2	0.02+0.02

Table 26 Frequency Accuracy \pm (% of reading + 3 counts)

Function	Range ^[5]	Frequency	Temperature Coefficient	
			1 Year 23° C \pm 5° C	0° C - 18° C 28° C - 55° C
Frequency ^[10]	100.000 mV to 750.00 V	<2Hz ^[17]	0.18+0.003	0.005
		<20Hz	0.04+0.003	0.005
		20Hz - 100kHz ^[11]	0.02+0.003	0.005
	10.0000 mA to 10.0000 A	100kHz - 300kHz ^[12]	0.02+0.003	0.005
		<2Hz ^[17]	0.18+0.003	0.005
		<20Hz	0.04+0.003	0.005
		20Hz - 10kHz ^[16]	0.02+0.003	0.005

Temperature and Capacitance Specifications^[1]

Table 27 Temperature and Capacitance Accuracy ± (% of reading + % of range)

Function	Range	Probe Type or Test Current	1 Year 23° C ± 5° C	Temperature Coefficient
				0° C - 18° C 28° C - 55° C
Temperature	-80.0° C to 150° C	5 kΩ thermistor probe	Probe accuracy + 0.2 °C	0.002 °C
	-110.0° F to 300.0° F	5 kΩ thermistor probe	Probe accuracy + 0.4 °F	0.0036 °F
Capacitance	1.000 nF	0.75 μA	2+0.8	0.02+0.001
	10.00 nF	0.75 μA	1+0.5	0.02+0.001
	100.0 nF	8.3 μA	1+0.5	0.02+0.001
	1.000 μF - 100.0 μF	83 μA	1+0.5	0.02+0.001
	1000 μF	0.83 mA	1+0.5	0.02+0.001
	10,000 μF	0.83 mA	2+0.5	0.02+0.001

[1] Specifications are for 30 minutes warm-up, 5½-digit resolution and calibration temperature 18° C - 28° C.

[2] 20% over range on all ranges except 1000Vdc.

[3] Specifications are 2-wire ohms using Math Null. If without Math Null, add 0.2Ω additional error.

[4] Specifications are for the voltage measured at the input terminals only.

[5] 20% over range on all ranges except 750 VAC

[6] Specifications are for sinewave inputs > 5% of range. Maximum crest factor : 3 at full scale.

[7] Additional error to be added as frequency > 30kHz and signal input < 10% of range. 30kHz ~ 100kHz: 0.003% of full scale per kHz.

[8] For 12A terminal, 10A DC or AC rms continuous, > 10A DC or AC rms for 30 seconds ON and 30 seconds OFF.

[9] Frequencies > 5 kHz are typical for all ranges.

[10] Specifications are for half-hour warm-up, using 0.1 second aperture. The frequency can be measured up 1Mhz as 0.5V signal to 100mV/1V ranges.

[11] For 20Hz - 100kHz, the sensitivity is AC input voltage from 10% to 120% of range except where noted.

[12] For 100kHz ~ 300kHz, the sensitivity will be 12% ~ 120% of range except 750V range.

[13] Input Impedance is in parallel with capacitance < 120 pF.

[14] For input < 200V rms.

[15] For input < 300V rms.

[16] For 20Hz - 10kHz, the sensitivity is AC input current from 10% to 120% of range except where noted.

[17] Minimum measured frequency is 1 Hz.

Operating Specifications

Table 28 Operating Specifications

Function	Digits	Reading Speed ^[1]	Function Change (sec) ^[2]	Range Change (sec) ^[3]	Auto Range (sec) ^[4]	Reading Speed over USB/(sec) ^[5]
DCV	5.5	15 /s	0.3	0.3	<1.2	8
	4.5	70 /s	0.2	0.2	<1.1	19
DCI	5.5	15 /s	0.4	0.4	<1.0	8
	4.5	70 /s	0.3	0.3	<0.5	19
ACV	5.5	2.5 /s	1.3	1.7	<5.7	2
	4.5	2.5 /s	1.2	1.5	<5.1	2
ACI	5.5	2.5 /s	1.8	2.2	<4.7	2
	4.5	2.5 /s	1.5	1.9	<4.0	2
FREQ ^[6]	5.5	9 /s	2.8	2.8	<5.8	1
	4.5	9 /s	2.5	2.5	<5.0	1

[1] Reading rate of the A/D converter.

[2] Time to change from 2-wire resistance to this specified function and to take at least one reading using SCPI "FUNC" and "READ?" commands.

[3] Time to change from one range to the next higher range and to take at least one reading using SCPI "FUNC" and "READ?" commands.

[4] Time to automatically change one range and to take at least one reading using SCPI "CONF AUTO" and "READ?" commands.

[5] Number of measurements per second that can be read through USB using SCPI " READ?" command.

[6] Reading rate depends on signal frequency >10Hz.

Supplemental Measurement Specifications

Table 29 Supplemental Measurement Specifications

DC Voltage

- Measuring Method:
 - Sigma Delta A-to-D converter
- Input Resistance:
 - $10\text{M}\Omega \pm 2\%$ range (typical)
- Input Protection:
 - 1000V on all ranges (HI terminal)

Resistance

- Measurement Method:
 - 2-wire Ohms
- Open-circuit voltage:
 - Limited to $< 5\text{V}$
- Input Protection:
 - 1000V on all ranges (HI terminal)

DC Current

- Shunt Resistance:
 - 0.1Ω to 10Ω for 10mA to 1.2A ranges
 - 0.01Ω for 12A range
- Input Protection:
 - Front Panel 1.25A, 500V fuse for I terminal
 - Internal 15A, 600V fuse for 12A terminal

Table 29 Supplemental Measurement Specifications**Continuity / Diode Test**

- Measurement Method:
 - Uses $0.83\text{mA} \pm 0.2\%$ constant current source, $< 5\text{V}$ open circuit voltage
 - Response Time:
 - 70 samples/second with audible tone
 - Continuity Threshold:
 - 10Ω fixed
 - Input Protection:
 - 1000V (HI terminal)
-

Temperature

- Measurement Method:
 - 2-wire Ohms measurement of $5\text{k}\Omega$ thermistor sensor (YSI 4407) with computer conversion
 - Auto-ranging measurement, no manual range selection
 - Input Protection:
 - 1000V (HI terminal)
-

Measurement Noise Rejection

- CMR (Common Mode Rejection) For $1\text{k}\Omega$ unbalance LO lead
 - DC 120 dB
 - AC 70 dB
 - NMR (Normal Mode Rejection) For 60 Hz ($50\text{ Hz} \pm 0.1\%$)
 - $5\frac{1}{2}$ digits 65 dB (55 dB)
 - $4\frac{1}{2}$ digits 0 dB
-

AC Voltage

- Measurement Method:
 - AC coupled true-rms - measure the AC component with up to 400 VDC bias any range

Table 29 Supplemental Measurement Specifications

- Crest Factor:
 - Maximum 5:1 at full scale
 - Input Impedance:
 - $1\text{M}\Omega \pm 2\%$ in parallel with $< 100\text{pF}$ of all ranges
 - Input Protection:
 - 750V rms on all ranges (HI terminal)
-

AC Current

- Measurement Method:
 - DC coupled to the fuse and current shunt, AC coupled true rms measurement (measures the AC component only)
 - Shunt Resistance:
 - 0.1Ω to 10Ω for 10mA to 1.2A range
 - 0.01Ω for 12A range
 - Input Protection:
 - Externally accessible 1.25A, 500V FH fuse for I terminal
 - Internal 15A, 600V fuse for 12A terminal
-

Frequency

- Measurement Method:
 - Reciprocal counting technique. AC coupled input using AC voltage function.
- Signal Level:
 - 10% of range to full scale input on all ranges
 - Auto or manual range selection
- Gate Time:
 - 0.1 second or 1 period of the input signal, whichever is longer.
- Input Protection:
 - 750V rms on all ranges (HI terminal)

Table 29 Supplemental Measurement Specifications**Math Functions**

- Null, dBm, dB, Min/Max/Avg, Hold, Limit Test
-

Triggering and Memory

- Single trigger, 1 reading memory
-

Remote Interface

- USB 2.0 full speed, USBTMC-USB488 device class
-

Programming Language

- SCPI, IEEE-488.1, IEEE-488.2
-

General Characteristics

Table 30 General Characteristics

Power Supply

- 100V/120V(127V)/220V(230V)/240V \pm 10%
- AC line frequency 45Hz - 66Hz and (360Hz - 440Hz, 100/120V operation)

Power Consumption

- 16VA maximum, <11W average

Operating Environment

- Full accuracy at 0° C to 55° C
- Full accuracy to 80% RH at 30° C (non-condensing)
- Altitude up to 3000 meters

Storage Compliance

- - 40° C to 70° C

Safety Compliance

- Certified by CSA for IEC/EN/CSA/UL 61010-1 2nd Edition

Measurement Category

- CAT II, 300V: CAT I 1000Vdc, 750Vac rms, 2500Vpk transient over voltages
- Pollution degree 2

EMC Compliance

- Certified to IEC61326-1: 2005 / EN61326-1:2006
- CISPR 11:2003 / EN 55011:2007 Group 1 Class A
- Canada: ICES-001:2004
- Australia/New Zealand: AS/NZS CISPR 11:2004

Shock and Vibration

- Tested to IEC/EN 60086-2

Dimension (HxWxD)

- Rack: 88.5mm x 212.6mm x 272.3mm

Table 30 General Characteristics

- Bench: 103.8mm x 261.1mm x 303.2 mm

Weight

- 3.75 kg (8.27 lb.) approximate
-

Warm Up Time

- 30 minutes
-

Warranty

- 3 years
-

To Calculate Total Measurement Error

The multimeter's accuracy specifications are expressed in the form: (% of reading + % of range). In addition to the reading error and range error, you may need to add additional errors for certain operating conditions. Check the list below to make sure you include all measurement errors for a given function. Also, make sure you apply the conditions as described in the footnotes on the specification pages.

- If you are operating the multimeter outside the temperature range specified, apply an additional temperature coefficient error.
- For AC voltage and AC current measurements, you may need to apply an additional low frequency error or crest factor error.

Accuracy Specifications

Transfer Accuracy

Transfer accuracy refers to the error introduced by the multimeter due to noise and short-term drift. This error becomes apparent when comparing two nearly-equal signals for the purpose of "transferring" the known accuracy of one device to the other.

1-Year Accuracy

These long-term accuracy specifications are valid at the calibration temperature ($T_{\text{cal}} \pm 5 \text{ }^\circ\text{C}$) temperature range. These specifications include the initial calibration errors plus the multimeter's long-term drift errors.

Temperature Coefficients

Accuracy is usually specified at the calibration temperature ($T_{\text{cal}} \pm 5 \text{ }^\circ\text{C}$) temperature range. This is a common temperature range for many operating environments. You must add additional temperature coefficient errors to the accuracy specification if you are operating the multimeter outside the $\pm 5 \text{ }^\circ\text{C}$ temperature range (the specification is per $^\circ\text{C}$).

Configuring for Highest Accuracy Measurements

The measurement configurations shown below assume that the multimeter is in its power-on or reset state. It is also assumed that auto-ranging is enabled to ensure proper full scale range selection.

- Select 5½ digits.
- Null the test lead resistance for 2-wire ohms measurements, and to remove any interconnection offset for DC voltage measurements.

Index

A

- AC Characteristics, [126](#)
- AC Current
 - Gain Adjustment Procedure, [95](#)
 - Performance Verification Test, [80](#)
 - Verification Test, [78](#)
- AC Current Measurements
 - Errors In, [60](#)
- AC Voltage
 - Gain Adjustment Procedure, [94](#)
 - Performance Verification Test, [79](#)
 - Verification Test, [77](#)
- AC Voltage Measurements
 - Errors In, [53](#)
 - Loading Errors, [59](#)
- Accuracy, [138](#)
- Accuracy Specification Explained, [136](#)
- Adjusting the Handle, [14](#)
- Adjustments, [88](#)
- Adjustments, finishing, [101](#)
- Agilent Technologies Calibration Services, [64](#)
- Autorange thresholds, [25](#)

B

- bEEP, [36](#)
- Beeper, [39](#)
- Burden Voltage, [60](#)
- Bus Triggering, [45](#)

C

- Calculate Total Measurement Error, [136](#)

Calibration

- Count, [102](#)
 - Errors, [103](#)
 - Interval, [64](#)
 - Message, [102](#)
 - Overview, [64](#)
 - Process, [85](#)
 - Services, [64](#)
 - Time required, [65](#)
- ## Capacitance
- Characteristics, [128](#)
 - Gain Adjustment Procedure, [99](#)
 - Performance Verification Test, [81](#)
- ## Capacitance Measurements
- Errors In, [57](#)
- ## Characteristics, operating, [129, 130](#)
- ## Checking Diodes, [23](#)
- ## Checking the Shipping Contents, [13](#)
- ## Cleaning, [108](#)
- ## Closed - Case Electronic Calibration., [64](#)
- ## CodE, [36](#)
- ## Configurable Settings, [37](#)
- ## Configuring and Connecting the USB Interface, [18](#)
- ## Connecting Power to the Multimeter, [13](#)
- ## Current Input Fuse, [110](#)

D

- dB, [30](#)
- dBm, [29](#)
- DC Accuracy, [125](#)
- DC Characteristics, [125](#)
- DC Current
 - Gain Adjustment Procedure, [92](#)
 - Gain Verification Test, [74](#)
- DC Current Measurements
 - Errors In, [56](#)

DC Voltage

- Gain Adjustment Procedure, [91](#)
 - Gain Verification Test, [73](#)
- ## DC Voltage Measurements
- Errors In, [48](#)
 - Thermal EMF Error, [48](#)
- ## Dimension (HxWxD), [134](#)
- ## Disassembly, [113](#)
- ## Display at a Glance, [16](#)

E

- Edit, [36](#)
- Editing Values, [40](#)
- Editing Values in the Secondary Display, [40](#)
- Edition, [11](#)
- Electronic Calibration, [64](#)
- Electrostatic Discharge (ESD)
 - Precaution, [112](#)
- EMC Compliance, [134](#)
- Entering Adjustment Values, [86](#)
- Error, [36](#)
- Error Messages, [38](#)
- Errors, [111](#)
- Errors, calibration, [103](#)
- ESD Precautions, [112](#)

F

- Frequency Gain Adjustment Procedure, [98](#)
- Frequency Gain Verification Test, [76](#)
- Frequency Measurements
 - Errors In, [56](#)
- Front Panel
 - Adjustments, [86](#)
 - At a Glance, [15](#)
 - Unsecuring, [84](#)

Index

G

- Gain
 - Adjustment Considerations, 90
 - Adjustment Procedure, 91
 - Adjustments, 89
 - Verification, 73
- General Characteristics, 134
- General Disassembly, 113
- Ground Loops, 50

H

- High Voltage Self-Heating Error, 59
- Hold, 31

I

- IEC Measurement Category II Overvoltage Protection, IV
- IMMediate Triggering, 45
- Input Connections, 67
- Input Terminal Protection Limits, IV
- Input Values, 90
- Integration Time, 49
- Interval, calibration, 64
- Introducing the Agilent 34405A Multimeter, 12

L

- Limit, 31
- Line Fuse, 109
- Loading Errors, 59

M

- Magnetic Loop Noise, 49
- Making Measurements, 20
- ManRng annunciator, 25
- Manual Part Number, II
- Math Annunciators, 32
- Math Operations, 28
- Math Operations and the Secondary Display, 35
- Measurement Category, 134

- Measurement Error, 136
 - Below Full Scale, 59
 - Burden Voltage, 60
 - Ground Loops, 50
 - High Resistance Measurements, 52
 - Loading, 59
 - Low Level Measurements, 60
 - Magnetic Loops, 49
 - Noise, 49
 - Power Dissipation, 51
 - Self-Heating, 59
 - Test Lead Resistance, 51
 - Thermal EMF, 48

- Measurement Functions and the Secondary Display, 33

- Measurement Noise Rejection, 131

Measuring

- AC (RMS) or DC Current up to 1.2A, 21
- AC (RMS) or DC Current up to 12A, 22
- AC or DC Voltage, 20
- Capacitance, 24
- Frequency, 22
- Resistance, 21
- Temperature, 24

- Mechanical Disassembly, 113

- Min/Max, 30

- Mounting, rack, 121

Multimeter

- Triggering, 45

N

- NMR, 49
- Noise, 49, 50, 60
- Null, 29

O

- Ohms Gain Adjustment Procedure, 97
- Ohms Gain Verification Test, 75
- Operating Characteristics, 129
- Operating Checklist, 106
- Operating Environment, 134

Optional

- AC Current Performance Verification Test, 80
- AC Voltage Performance Verification Test, 79
- Capacitance Performance Verification Test, 81
- Verification Tests, 68
- Order Replaceable Parts, 120
- °unit, 36

P

- Parts, 120
- Performance Verification Tests, 68, 70
- Performance Verification Tests Overview, 68
- Period Measurements
 - Errors In, 56
- P-On, 36
- Power
 - Consumption, 134
 - Dissipation, 51
 - Supply, 134
- Power Line Fuse, 109
- Power Line Noise, Rejecting, 49
- Power-On State, 43
- Protection Limits, IV

Q

- Quick Performance Check, 69
- Quick Verification, 68

R

- Rack Mounting, 121
- Read the Calibration Count, 102
- Reading Error Messages, 38
- Rear Panel at a Glance, 17
- Recalling a Stored a State, 42
- Recommended Test Equipment, 66
- Remote Operation, 18
- Repackaging for Shipment, 108

Replace
 Current Input Fuse, 110
 Power Line Fuse, 109
 Replaceable Parts, 120
 Reset/Power-On State, 43
 Resistance Measurements
 Errors In, 51
 High Resistance Errors, 52
 Restricted Rights Legend, II

S

Safety
 Compliance, 134
 Information, III
 Notices, II
 Symbols, III
 SCPI
 Commands, 18
 Language Version, 19
 Secondary Display, 33
 Selecting a Range, 25
 Selecting the Adjustment Mode, 86
 Self -Test, 68
 Setting
 Beeper, 39
 Resolution, 26
 Shock and Vibration, 134
 Software Revision, II
 Software Triggering, 45
 Specifications, 137
 Explained, 136
 Transfer Accuracy, 137
 Storage Compliance, 134
 StorE, 36
 Storing a State, 41
 Storing and Recalling Instrument
 States, 41
 Supplemental Measurement
 Characteristics, 130

T

Technology Licenses, II

Temperature
 And Capacitance Characteristics, 128
 Temperature Coefficients (and
 Accuracy), 137
 Temperature Measurements
 Errors In, 58
 Test
 Considerations, 67
 Equipment, 66
 tEst, 36
 Test Lead Resistance, 51
 Testing Continuity, 23
 Thermal EMF Errors, 48
 Time Required for Calibration, 65
 Total Measurement Error, 136
 Transfer Accuracy, 137
 Triggering, 45
 Bus, 45
 Immediate, 45
 Software, 45
 Triggering the Multimeter, 45
 True RMS, 53

U

Unsecure the Instrument from the Front
 Panel, 84
 Unsecuring the Instrument for
 Calibration, 83
 USB Interface, 18
 Using the Front Panel for Adjustments, 86
 Utility Menu, 36
 UtitY, 36

V

Valid Gain Adjustment Input Values, 90
 Verification Tests, 70
 Verification Tests Overview, 68

W

Warm Up Period, Calibration, 67
 Warm Up Time, 135
 Warranty, II, 135

Weight, 135

Z

Zero
 Adjustment, 88
 Offset Verification, 71
 Offset Verification Test, 71

THIS PAGE HAS BEEN INTENTIONALLY LEFT BLANK.

www.agilent.com

Contact us

To obtain service, warranty, or technical assistance, contact us at the following phone or fax numbers:

United States:

(tel) 800 829 4444 (fax) 800 829 4433

Canada:

(tel) 877 894 4414 (fax) 800 746 4866

China:

(tel) 800 810 0189 (fax) 800 820 2816

Europe:

(tel) 31 20 547 2111

Japan:

(tel) (81) 426 56 7832 (fax) (81) 426 56 7840

Korea:

(tel) (080) 769 0800 (fax) (080) 769 0900

Latin America:

(tel) (305) 269 7500

Taiwan:

(tel) 0800 047 866 (fax) 0800 286 331

Other Asia Pacific Countries:

(tel) (65) 6375 8100 (fax) (65) 6755 0042

Or visit the Agilent World Wide Web at:

www.agilent.com/find/assist

Product specifications and descriptions in this document are subject to change without notice. Always refer to the English version at the Agilent Web site for the latest revision.

© Agilent Technologies, Inc., 2006–2014

Thirteenth Edition, July 3, 2014
34405-91000



Agilent Technologies