

HP 11664A DETECTOR

SERIAL NUMBERS

This manual applies directly to serial number 25000 and above.

For additional information concerning serial numbers, see INSTRUMENTS COVERED BY MANUAL, in Section I.

© Copyright HEWLETT-PACKARD COMPANY 1983
1400 FOUNTAINGROVE PARKWAY, SANTA ROSA, CA 95401 U.S.A.

MANUAL PART NUMBER 11664-90044
Microfiche Part Number 11664-90045

Printed: NOVEMBER 1983



CONTENTS

Section	Page
I GENERAL INFORMATION	1-1
1-1. Introduction	1-1
1-4. Specifications	1-1
1-6. Safety Considerations	1-1
1-8. Instruments Covered by Manual	1-1
1-11. Description	1-2
1-14. Options	1-2
1-16. Equipmet Required but not Supplied	1-2
1-18. Sweep Oscillator	1-2
1-22. Modulator	1-3
1-24. Equipment Available	1-3
1-25. Directional Couplers	1-3
1-27. Directional Bridges	1-3
1-30. Power Splitters	1-3
1-32. Accessories	1-4
1-34. Recommended Test Equipment	1-4
II INSTALLATION	2-1
2-1. Introduction	2-1
2-3. Initial Inspection	2-1
2-6. Preparation For Use	2-1
2-7. Power Requirements	2-2
2-9. Replacing RF Input Connectors	2-2
2-12. Connecting the HP 11664A Detector	2-2
2-14. Mating Connectors	2-3
2-16. Detector Lead Identification	2-3
2-18. Operating Invironment	2-3
2-22. Storage and Shipment	2-3
III OPERATION	3-1
3-1. Introduction	3-1
3-3. Features	3-1
3-5. Operator's Check	3-2
3-7. Operating Precautions	3-2
3-9. Operating Instructions	3-3
3-10. Typical Measurement Configuration	3-3

Model 11664A - Contents

Section	Page
IV PERFORMANCE TESTS	4-1
4-1. Introduction	4-1
4-3. Equipment Required	4-1
4-5. Test Record Card	4-1
4-7. Return Loss	4-2
4-8. Tracking Between Two Detectors	4-7
V ADJUSTMENTS	5-1
VI REPLACEABLE PARTS	6-1
6-1. Introduction	6-1
6-3. Replaceable Parts	6-1
6-5. Ordering Instructions	6-1
VII MANUAL CHANGES	7-1
7-1. Introduction	7-1
VIII SERVICE	8-1
8-1. Introduction	8-1
8-3. Recommended Test Equipment	8-1
8-5. Repair	8-1
8-7. Replacing Input Connector	8-2
8-9. Replacing Cable Assembly	8-2

Model 11664A - Contents

ILLUSTRATIONS

Figure	Page
1-1. Model 11664A Detector	1-0
3-1. HP 11664A Features	3-2
3-2. HP 11664A/8756A Typical Measurement Setup	3-4
3-3. HP 11664A/8756A Typical Measurement Setup Using HP 11665B External Modulator	3-4
4-1. Return Loss Test Setup	4-3
4-2. Trace Before Adjustment	4-4
4-3. Properly Adjusted Trace	4-4
4-4. M-MEM Display	4-5
4-5. Reading Marker Value	4-5
4-6. DUT Return Loss .04 to 18 GHz	4-6
4-7. Reading Curser Value	4-6
4-8. Tracking Test Setup	4-7
4-9. Detector Tracking M-MEM Trace	4-8
4-10. Detector Tracking Display	4-9
8-1. Major Assemblies	8-1
8-2. Cable Connections	8-2

Model 11664A - Contents

TABLES

Table	Page
1-1. Specifications	1-5
1-2. Supplemental Characteristics	1-5
1-3. Recommended Test Equipment	1-6
4-1. Return Loss Measurement Uncertainty	4-2
4-2. Performance Test Record	4-11
6-1. Reference Designators and Abbreviations Used In Manual	6-2
6-2. Manufacturers Code List	6-2
6-3. Replaceable Parts	6-3

HP 11664A DETECTOR

TOP

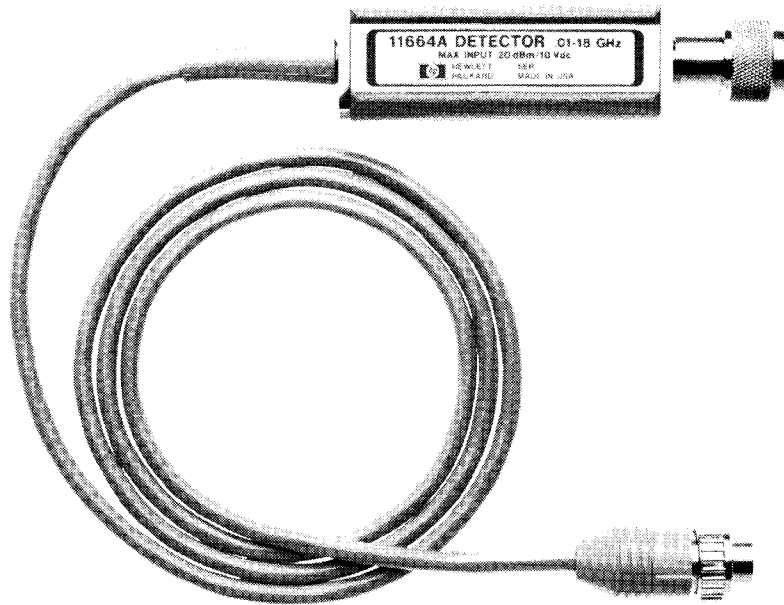

BOTTOM

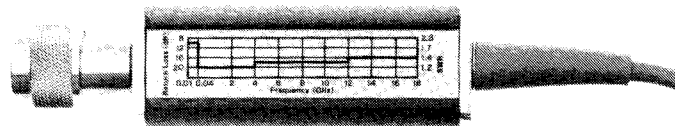

CABLE MARKER KIT

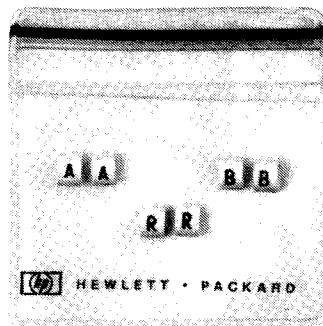

Figure 1-1. Model 11664A Detector

**SECTION I
GENERAL INFORMATION**

1-1. INTRODUCTION

1-2. This manual contains operating and service information for the Hewlett-Packard Model 11664A detector. The instrument and the supplied Cable Marker Kit are shown in Figure 1-1. Cable markers are used for identification when more than one detector is used in a test setup.

1-3. On the title page of this manual is a microfiche part number that can be used to order 10 cm x 15 cm (4 in x 6 in) microfilm transparencies of the manual. Each microfiche contains photocopies of up to 98 manual pages. The microfiche package also includes the latest Manual Changes Supplement as well as all pertinent Service Notes.

1-4. SPECIFICATIONS

1-5. Listed in Table 1-1 are the performance specifications for the HP 11664A detector. These are performance standards or limits against which the instrument may be tested. Table 1-2 lists Supplemental Characteristics. These are not specifications, but are typical characteristics included as additional information for the user.

1-6. SAFETY CONSIDERATIONS

1-7. The voltages present in the HP 11664A are not in the range to warrant more than normal caution.

1-8. INSTRUMENTS COVERED BY MANUAL

1-9. Each HP 11664A has a unique serial number. The contents of this manual apply directly to instruments with serial number 25000 and above. For instruments with serial numbers below 25000, refer to Operating and Service Manual HP Part Number 11664-90037.

1-10. An HP 11664A manufactured after the printing of this manual may require a yellow Manual Changes Supplement to document instrument "change information." The supplement will be included with the instrument manual. In addition to change information, the supplement contains information for correcting manual errors. To keep this manual as current as possible, Hewlett-Packard recommends that you periodically request the latest Manual Changes Supplement. The supplement for this manual is keyed to its print date and part number, which appear on the title page. Complimentary copies of the

supplement are available from your local Hewlett-Packard office listed at the back of this manual.

1-11. DESCRIPTION

1-12. The HP 11664A detector must be used in conjunction with either the HP 8755C swept amplitude analyzer, or the HP 8756A scalar network analyzer. The HP 11664A detects RF signal levels from -50 to +10 dBm in the frequency range of 10 MHz to 18 GHz. The use of three HP 11664A detectors, or two detectors and a bridge enables simultaneous (amplitude only) transmission and reflection measurements via the analyzer CRT.

1-13. The HP 11664A detector and the input stages of the HP 8755C/8756A comprise an ac-coupled system. This detection scheme requires a 27.8 kHz squarewave amplitude modulation of the RF input signal. Additional information is provided in Paragraph 1-16, EQUIPMENT REQUIRED BUT NOT SUPPLIED.

1-14. OPTIONS

1-15. The HP 11664A detector is available with an *APC-7[®] RF input connector by ordering Option 001.

1-16. EQUIPMENT REQUIRED BUT NOT SUPPLIED

1-17. Reflection and transmission measurements require two or three HP 11664A detectors and either an HP 8755C swept amplitude analyzer, or an HP 8756A scalar network analyzer. Swept frequency measurements will require a sweep oscillator. In addition, the RF source signal must be amplitude modulated by a 27.8 kHz squarewave signal.

1-18. Sweep Oscillator

1-19. A sweep oscillator furnishes the RF input signal. The HP 8350 series or the HP 8620 series sweep oscillators may be used.

1-20. HP 8350B Sweep Oscillator. The HP 8350B sweep oscillator, used with an HP 83500 series RF plug-in, internally modulates the RF output signal when the front panel [⌞ MOD] button is enabled.

1-21. HP 8620C Sweep Oscillator. The HP 8620C sweep oscillator, used with an HP 86200 series plug-in, requires that the MODULATOR DRIVE signal from the analyzer be used. See plug-in Operating and Service Manual for details. This MODULATOR DRIVE signal is available at the front panel of the HP 8755C, and at the rear panel of the HP 8756A.

*APC-7[®] is a U.S. registered trademark of the Bunker Ramo Corp.

NOTE

Some earlier RF plug-ins (compatible with the HP 8620C) will require the use of an external Modulator (HP 11665B). Refer to the RF plug-in Operating and Service Manual for detailed information.

1-22. Modulator

1-23. The HP 11665B Modulator is designed to be used with either the HP 8755C swept amplitude analyzer, or the HP 8756A scalar network analyzer. The HP 8755C/8756A supplies a 27.8 kHz squarewave signal to the HP 11665B to squarewave modulate the RF signal.

1-24. EQUIPMENT AVAILABLE

1-25. Directional Couplers

1-26. Reflection measurements require the use of a dual directional coupler or bridge, or two single directional couplers to separate the reference, incident, and reflected signals. Reflection and transmission measurements can be made concurrently with this setup. The HP 778D covers .1 to 2 GHz, and the HP 11692D covers from 2 to 18 GHz.

1-27. Directional Bridges

1-28. The HP 85021A/C are single-port directional bridges that allow transmission and reflection measurements from .01 to 18 GHz, with -40 dB directivity. The test port connector on the HP 85021A is an APC-7, and on the HP 85021C is a precision Type-N female.

1-29. The HP 11666A reflectometer bridge allows transmission and reflection measurements from .015 to 18 GHz. The HP 11666A houses two detectors, one in the reflection port, and one in the reference port. Because of this, only one HP 11664A detector is required for a ratio measurement.

1-30. Power Splitters

1-31. Ratio measurements to determine frequency response or other transmission characteristics can be obtained with a power splitter and two HP 11664A detectors. The HP 11667A power splitter provides this function from DC to 18 GHz.

Model 11664A

1-32. Accessories

1-33. The following accessories for the HP 11664A detector are available:

Model 11679A: 7.5 metre (25 foot) extension cable

Model 11679B: 60 metre (200 foot) extension cable

1-34. RECOMMENDED TEST EQUIPMENT

1-35. Equipment required for testing the HP 11664A is listed in Table 1-3. Other equipment may be substituted if it meets or exceeds the critical specifications indicated in the table.

Model 11664A
Table 1-1. Specifications

SPECIFICATIONS

FREQUENCY

Frequency Range: 10 MHz to 18 GHz

REFLECTION

Return Loss (15 - 35° C):

10 MHz to 40 MHz: ≥ 10 dB (≤ 1.92 SWR)
 40 MHz to 4 GHz: ≥ 20 dB (≤ 1.22 SWR)
 4 GHz to 12 GHz: ≥ 18 dB (≤ 1.29 SWR)
 12 GHz to 18 GHz: ≥ 16 dB (≤ 1.38 SWR)

**TRACKING BETWEEN
TWO HP 11664A DETECTORS**

Tracking between two HP 11664A Detectors:
Specified at same relative power level. Does not
include mismatch or coupler uncertainties.

10 MHz to 8 GHz: < 0.5 dB
 8 GHz to 12 GHz: < 1.0 dB
 12 GHz to 18 GHz: < 1.5 dB

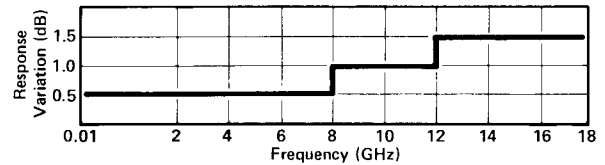
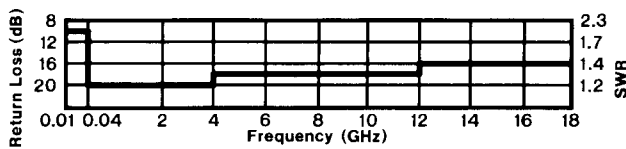

GENERAL

Input Power Range: +10 to -50 dBm

Temperature Range: Operation: 0° to 55°C (32° to 131°F);
Storage: -40° to 75°C (-40° to 167°F)

Input Impedance: 50 ohms nominal

Connectors: Standard: Type N male
Option 001: APC-7®
Special Order: Type N Female

Dimensions: Cable length is 1.2 metres (4 feet)

Weight: Net 0.17 kg (6 oz.)

Table 1-2. Supplemental Characteristics

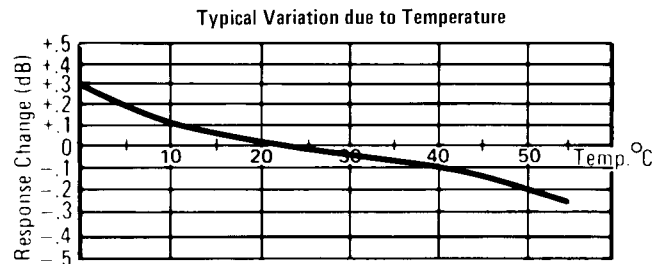
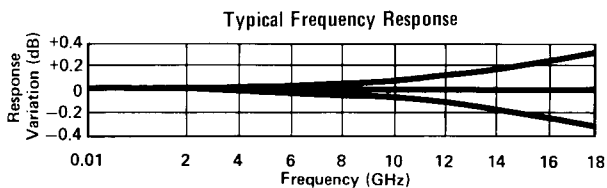
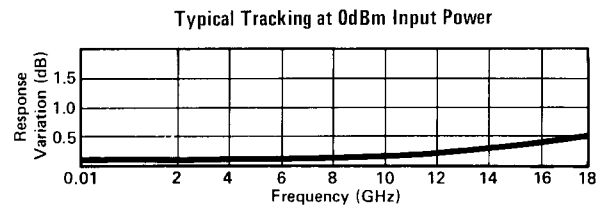
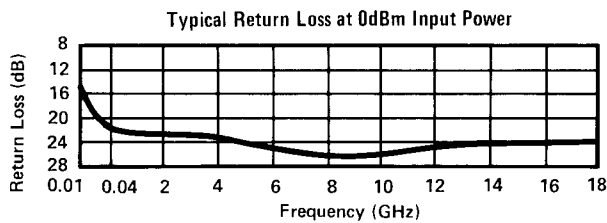

GENERAL

Input Damage Level:
+ 20 dBm (100 mW) RF power 10 Vdc

Model 11664A

Table 1-3. Recommended Test Equipment

Instrument Type	Critical Specification	Suggested Model
Sweep Oscillator	Frequency: 10 MHz to 18 GHz	HP 8350B mainframe with HP 83592A/B/C RF plug-in or HP 86222A/B RF plug-in and HP 86290A/B/C RF plug-in and HP 11869A adapter or HP 8620C mainframe with: HP 86222A/B RF plug-in and HP 86290A/B RF plug-in
Network Analyzer	Provides 27.8 kHz modulation signal. Powers 3 HP 11664A detectors. Processes/displays detected signals.	HP 8756A or HP 8755C with HP 182T/HP 180 series display mainframe.
Directional Bridge	Frequency: 10 MHz to 18 GHz	HP 85021A (APC-7®) HP 85021C (Type-N Female)
Detector	Frequency: 10 MHz to 18 GHz	HP 11664A
Power Splitter	Frequency: 10 MHz to 18 GHz	HP 11667A
Coaxial Short	Type-N Male	HP 11512A
Open	Type-N Male	HP Part Number 85032-60001
Calibrated Open/Short	APC-7®	HP Part Number 85021-60001
Adapters (2)	Type-N (m) to Type-N (m)	HP Part Number 1250-0778
Open-end Wrench	Thin 1/2 x 9/16	HP Part Number 8710-0877

**SECTION II
INSTALLATION**

2-1. INTRODUCTION

2-2. This section contains information concerning initial inspection, preparation for use, mating connectors, storage and shipment.

2-3. INITIAL INSPECTION

2-4. If the shipping container or cushioning material is damaged, it should be kept until the contents of the shipment have been checked for completeness, and the instrument has been checked both mechanically and electrically.

2-5. Section IV contains procedures for checking electrical performance. If the instrument does not pass these electrical tests, or shipping contents are incomplete, or there is mechanical damage or defect, notify your nearest Hewlett-Packard Office. If the shipping container is damaged, or the cushioning material shows signs of stress, notify the carrier as well as Hewlett-Packard. Keep the shipping materials for the carrier's inspection. Hewlett-Packard will arrange for repair or replacement without waiting for claim settlement.

2-6. PREPARATION FOR USE

CAUTION

Repeated electrostatic discharge (ESD) as low as 250 volts can destroy microwave diodes. If static discharge is noticed by the operator, it indicate a voltage of 20,000 volts or more. Materials conducive to static build-up include carpeting, nylon, dry air, paper adhesive tape, styrofoam and vinyl. The best method of preventing ESD is for the operator to wear a grounding strap connected to a conductive bench mat that provides a path to ground of between 1 and 2.5 Megohms. Alternatively, the operator can ground himself by touching any grounded instrument chassis before touching the HP 11664A connector. NEVER touch connector center contacts.

2-7. Power Requirements

2-8. Power for the Model 11664A Detector is supplied by either the Model 8755C Swept Amplitude Analyzer, or the Model 8756A Scalar Network Analyzer. Each detector requires 0.35 watts. The HP 8755C/8756A normally powers up to three detectors requiring a maximum total of 1.05 watts.

2-9. Replacing RF Input Connector

2-10. The RF input connector outer shell may be replaced with an alternate type of RF connector. HP Part Numbers for several available connectors are given in Section VI, Replaceable Parts. The procedure for connector replacement is documented in Section VIII, Service.

2-11. If the RF connector is, or has been replaced by, an APC-7 type connector, refer to Figure 2-1 for user instructions.

2-12. Connecting the HP 11664A Detector

2-13. Connect the HP 11664A to the HP 8755C/8756A as follows:

1. Insert the DC connector of the HP 11664A into the HP 8755C/8756A mating connector. The HP 11664A connector is keyed; the plug should be inserted with the key downward.
2. Secure the dc connector in the analyzer by turning the outer shell clockwise.
3. Connect the RF input as follows:

CAUTION

Do not apply more than 3 in/lb (3.5 cm/kg) of torque when tightening the connectors. Greater torque may deform the mating surfaces.

CAUTION

Do not apply more than +20 dBm RF power or more than +10 volts DC into the HP 11664A.

4. Turn the outer shell of the male connector clockwise to secure the connection to the HP 11664A RF input.
5. If the RF input connector is an APC-7 type, refer to Figure 2-1 for user instructions.

2-14. Mating Connectors

2-15. Type-N connectors mate with the corresponding Type-N connectors whose dimensions conform to U.S. specification MIL-C-39012. APC-7 connectors mate with any other APC-7 connector.

2-16. Detector Lead Identification

2-17. Coded cable clips are furnished for lead identification. Place matching clips on either end of the cable.

2-18. Operating Environment

2-19. **Temperature:** 0°C to +55°C.

NOTE

See Table 1-2 for detector response variation with temperature

2-20. **Humidity:** Up to 95%. Protection should be provided from temperature extremes, which can cause condensation within the instrument.

2-21. **Altitude:** Up to 7,620 metres (25,000 feet).

2-22. STORAGE AND SHIPMENT

2-23. Environment

2-24. The instrument may be stored or shipped in environments within the following limits:

Temperature: -25°C to +75°C

Humidity: Up to 95%

Altitude: Up to 7,620 metres (25,000 feet)

2-25. Protection should be provided from temperature extremes, which can cause condensation within the instrument.

2-26. Packaging

2-27. **Original Packaging.** Containers and materials identical to those used in factory packaging are available through Hewlett-Packard offices. If the instrument is being returned to Hewlett-Packard for servicing, attach a tag indicating the type of service required, return address, model number, and full serial number. Ensure that the container is marked **FRAGILE** to assure careful handling. In any correspondence, refer to the instrument by model number and full serial number.

Model 11664A - Installation

2-28. Other Packaging. The following general instructions should be used for repackaging with commercially available materials:

1. Wrap the instrument in heavy paper or plastic. If shipping to a Hewlett-Packard Office or Service Center, attach a tag indicating the type of service required, return address, model number, and full serial number.
2. Use a strong shipping container. A double wall carton made of 350-pound test material is adequate.
3. Use enough shock absorbing material (3 to 4 inch layer) around all sides of the instrument to provide firm cushion and prevent movement inside the container.
4. Seal the shipping container securely.
5. Mark the shipping container **FRAGILE** to assure careful handling.

**SECTION III
OPERATION**

CAUTION

**SUSCEPTIBLE TO DAMAGE
FROM STATIC DISCHARGE**

Repeated electrostatic discharge (ESD) as low as 250 volts can destroy microwave diodes. If static discharge is noticed by the operator, it indicates a voltage of 20,000 volts or more. Materials conducive to static build-up include carpeting, nylon, dry air, paper, adhesive tape, styrofoam and vinyl. The best method of preventing ESD is for the operator to wear a grounding strap connected to a conductive bench mat that provides a path to ground of between 1 and 2.5 Megohms. Alternatively, the operator can ground himself by touching any grounded instrument chassis before touching the HP 11664A connector. NEVER touch connector center contacts.

3-1. INTRODUCTION

3-2. This section contains information concerning operation of the HP 11664A detector.

3-3. FEATURES

3-4. Features of the HP 11664A are shown in Figure 3-1.

Model 11664A - Operation

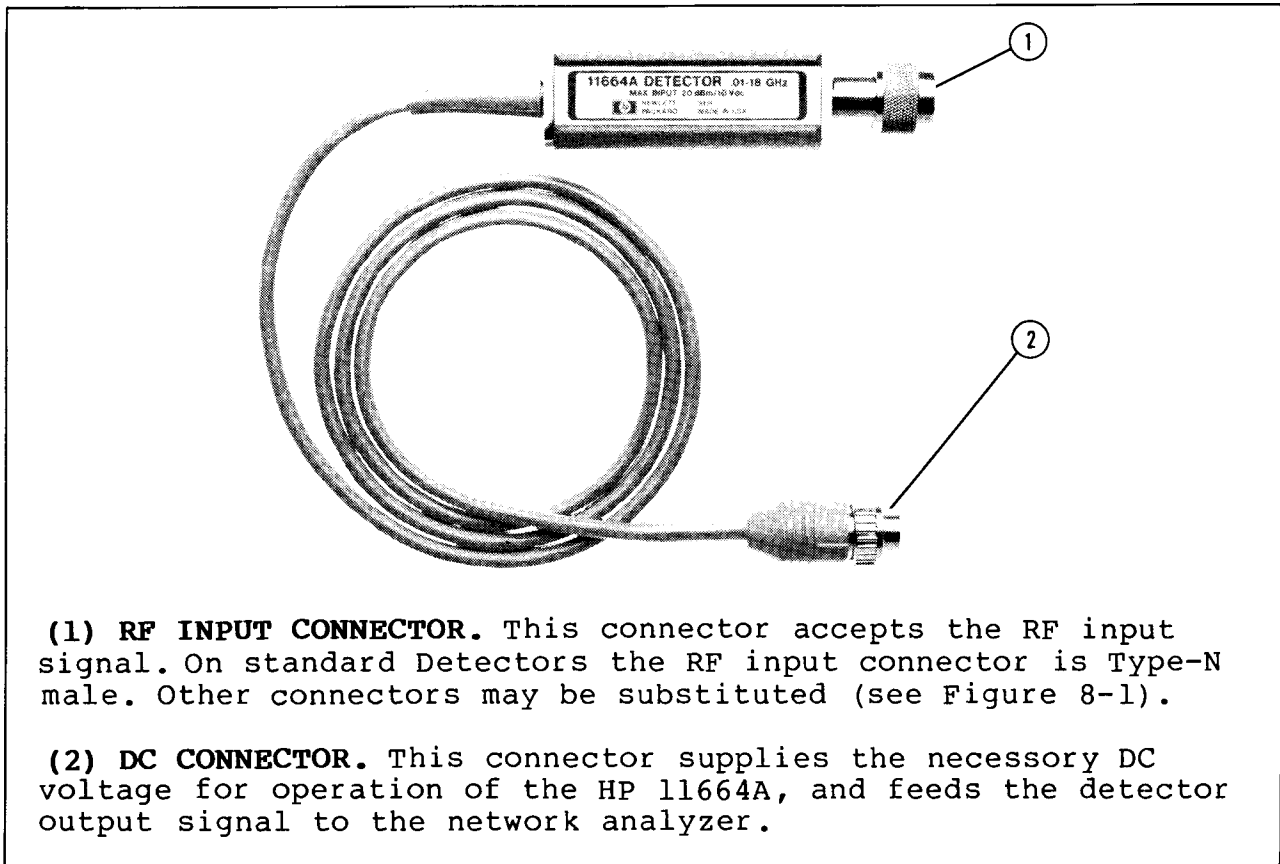

Figure 3-1. Model 11664A Features

3-5. OPERATOR'S CHECK

3-6. An Operator's Check of the HP 11664A is included in the Operator's Check provided in both the HP 8755C and the HP 8756A Operating and Service Manuals.

3-7. OPERATING PRECAUTIONS

See **CAUTION** on page 3-1.

3-8. Tighten the HP 11664A connectors with fingers only. Do NOT use a wrench.

CAUTION

Do NOT apply more than 8 in/lb (9.2 cm/kg) of torque when tightening the connectors. Greater torque may deform the mating surfaces.

Do not apply more than +20 dBm RF CW power or more than +10 volts DC to the HP 11664A, or damage may occur

Before connecting a cable to the HP 11664A RF connector, always discharge the cable's center conductor static electricity to instrument ground.

Do not drop the HP 11664A, or subject it to mechanical shock. The diode is easily damaged.

3-9. OPERATING INSTRUCTIONS

3-10. Operating instructions are given in the Operating and Service Manuals for the HP 8755C and the HP 8756A analyzers.

3-11. Typical Measurement Configuration

3-12. Amplitude measurement with the HP 11664A/8755C or 8756A analyzer system requires a modulation envelope to be developed via 27.8 kHz amplitude modulation of the RF test signal. Test set connections will vary depending on the analyzer and source oscillator selected.

3-13. Figure 3-2 illustrates a typical setup with the HP 8350B sweep oscillator/RF plug-in using internal modulation.

3-14. Figure 3-3 shows a similar test setup with an external modulator, HP 11665B, being driven by a MODULATOR DRIVE of the HP 8756A. This setup must be used for RF plug-ins that cannot respond to the 27.8 kHz drive signal. Refer to the Operation section of the particular RF plug-in Operating and Service Manual for details.

Model 11664A - Operation

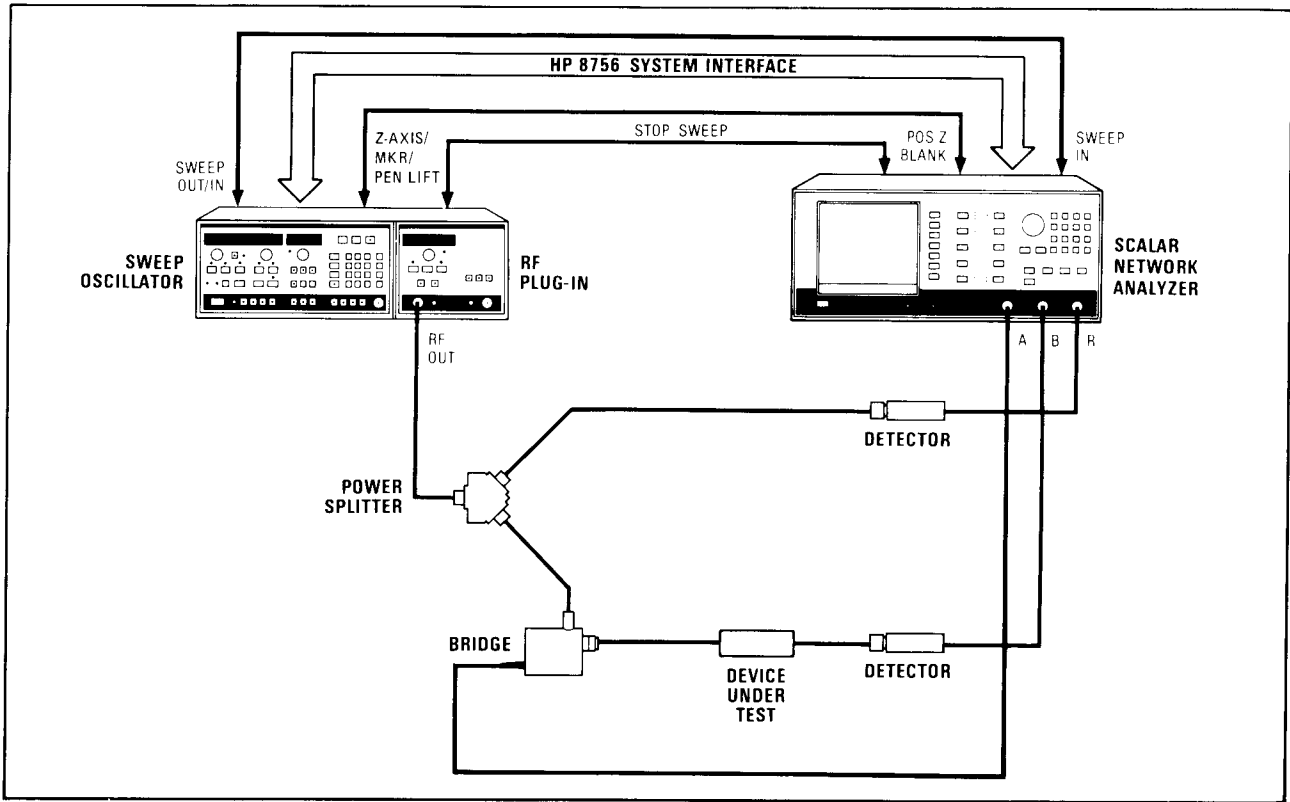

Figure 3-2. Model 11664A/8756A Typical Measurement Setup

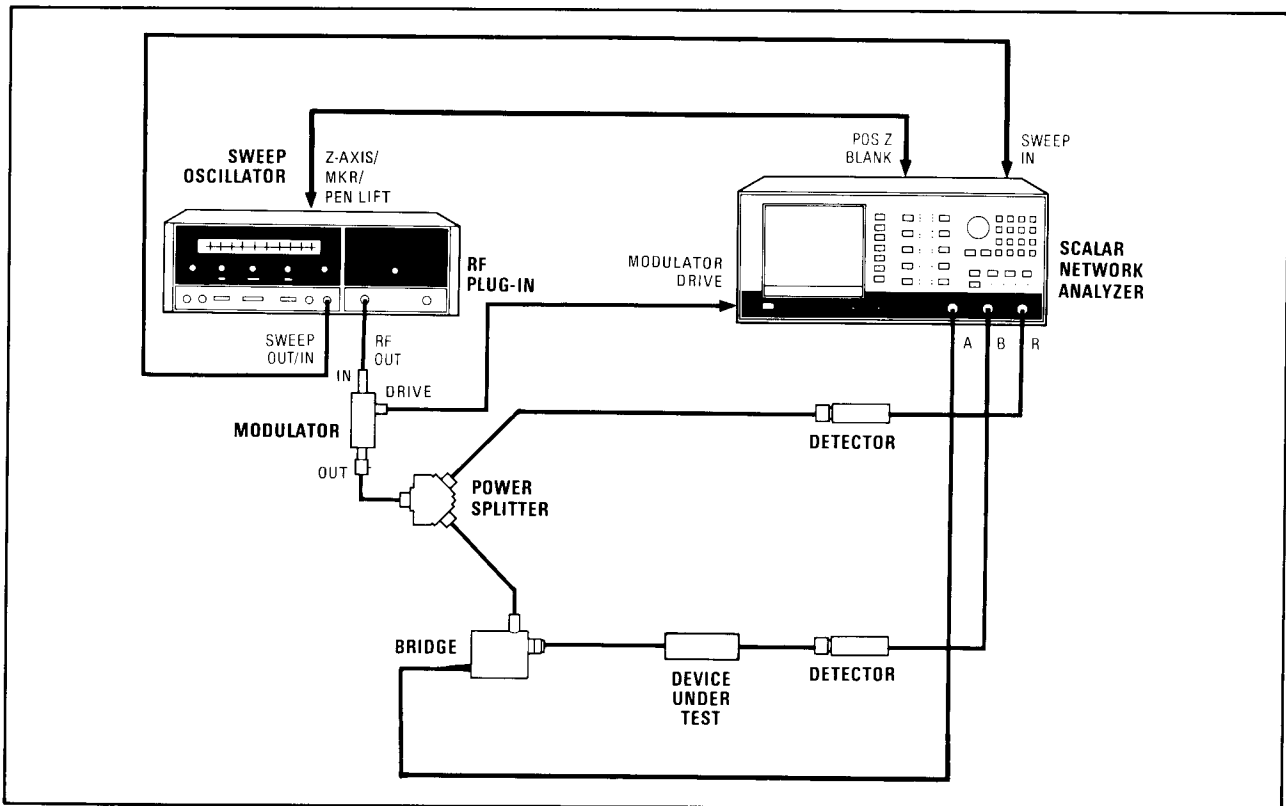

Figure 3-3. Model 11664A/8756A Typical Measurement Setup using Model 11665B External Modulator

**SECTION IV
PERFORMANCE TESTS**

4-1. INTRODUCTION

4-2. The procedures in this section test the instrument's electrical performance to the specifications in Table 1-1. None of the tests in this section requires access to the interior of the instrument.

4-3. EQUIPMENT REQUIRED

4-4. Table 1-3 lists the Recommended Test Equipment for testing the performance standards of this instrument. Any equipment that satisfies the critical specifications given in that table may be substituted for the recommended model.

4-5. TEST RECORD CARD

4-6. Results of the performance tests may be tabulated in Table 4-2, Performance Test Record. This Record lists all of the tested specifications and their acceptable limits. Space is provided for recording test results.

4-7. RETURN LOSS

SPECIFICATIONS:

.01 GHz to .04 GHz:	>10 dB (<1.92 SWR)
.04 GHz to 4 GHz:	>20 dB (<1.22 SWR)
4 GHz to 12 GHz:	>18 dB (<1.28 SWR)
12 GHz to 16 GHz:	>16 dB (<1.38 SWR)

DESCRIPTION:

An HP 11664A detector, a directional bridge, and a power splitter comprise a reflectometer test setup. The test setup is calibrated using a short and an open to minimize frequency response errors. The device under test (DUT) is connected to the **TEST PORT** of the bridge, and return loss is measured on the HP 8756A.

The return loss should be equal to or greater than the limits listed above. Table 4-1 lists measurement uncertainty due to coupler directivity.

If the return loss is within the measurement uncertainty range, a vector impedance measurement with error correction should be made. At Hewlett-Packard, this is accomplished by using either the HP 8408 or the HP 8409 automatic network analyzers (the HP 8507 may be used for frequencies below 1.3 GHz). Further information is available in the HP 11863E/F Applications Pac and Application Note 221A.

Table 4-1. Return Loss Measurement Uncertainty

FREQUENCY (GHz)	SPECIFICATION (dB)	MEASUREMENT UNCERTAINTY RANGE (dB)	
		85021A (APC-7)	85021C (TYPE-N)
.01 to .04	>10	9.5 to 10.5	9.5 to 10.5
.04 to 4.0	>20	19.1 to 21.0	18.7 to 21.5
4.0 to 12	>18	17.3 to 18.8	16.9 to 19.2
12 to 18	>16	15.5 to 16.9	14.9 to 17.2

Model 11664A - Performance Tests

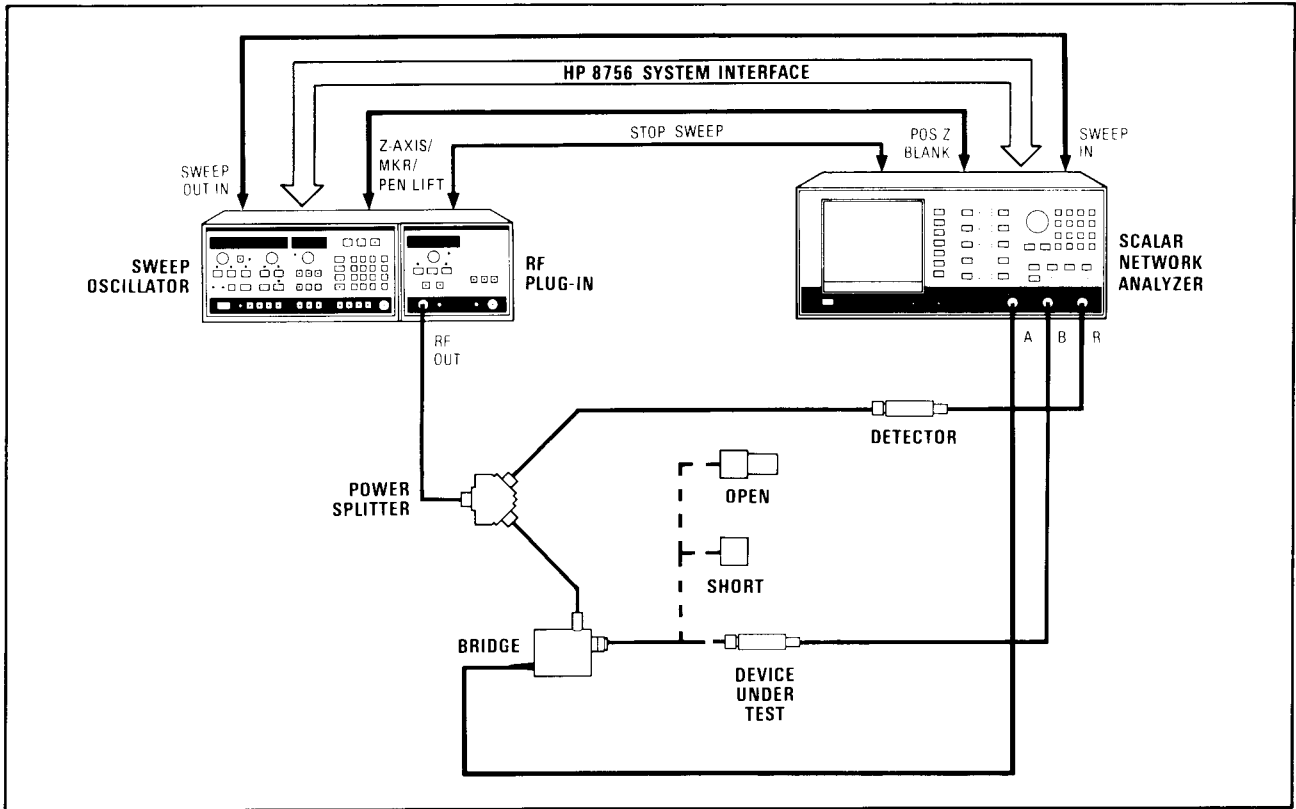

Figure 4-1. Return Loss Test Setup

EQUIPMENT:

Sweep Oscillator	HP 8350B
RF Plug-In	HP 83592A/B/C
Power Splitter	HP 11667A
Directional Bridge	
Type-N Female	HP 85021C
APC-7	HP 85021A
Detector	HP 11664A
Scalar Network Analyzer	HP 8756A
Coaxial Short	
Type-N Male	HP 11512A
Open	
Type-N Male	HP PN 85032-60001
Calibrated Open/Short	
APC-7	HP PN 85021-60001
Adapters (2 required)	
Type-N Male to Type-N Male	HP PN 1250-0778

PROCEDURE:

10 to 40 MHz

1. Set up equipment as shown in Figure 4-1, with nothing connected to the bridge **TEST PORT**. Press [**PRESET**] on the HP 8756A. This will preset both the HP 8756A and the HP 8350B (this will turn the HP 8350B [**MOD**] on and set the sweep time to 200ms). Allow 30 minutes warm-up.

NOTE

If testing a standard (Type-N) HP 11664A, use an HP 85021C bridge. If testing an option 001 (APC-7), use an HP 85021A bridge. Do not connect adaptors to the TEST PORT, as measurement accuracy may be severely degraded.

2. On the HP 8350B, set **START** to 10 MHz, and **STOP** to 18 GHz. Adjust RF plug-in for maximum leveled output power. Set **START** to -10 MHz, and **STOP** to 40 MHz (unleveled light will flicker). Set markers **M1** to 0 MHz, **M2** to 10 MHz, and **M3** to 40 MHz.

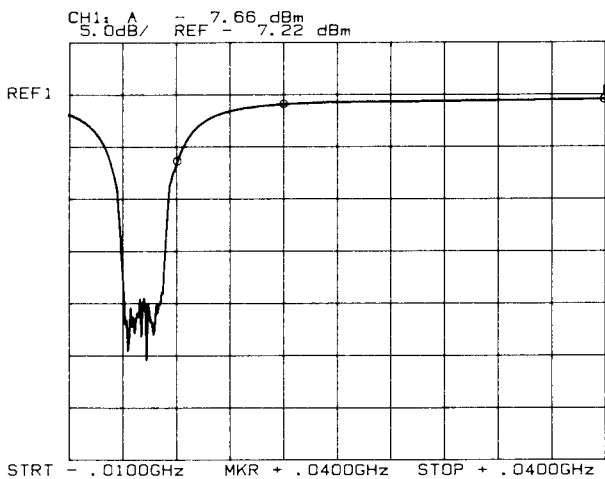

Figure 4-2. Trace Before Adjustment

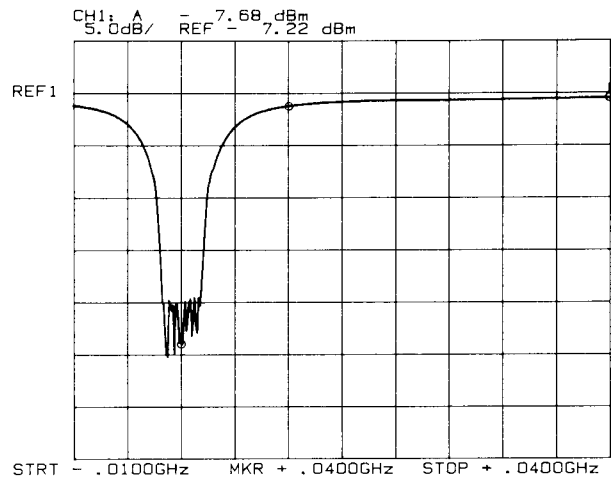

Figure 4-3. Properly Adjusted Trace

3. On the HP 8756A Channel 2, press **[SHIFT] [MEAS RATIO]** to turn Channel 2 off. On Channel 1, press **[MEAS PWR]** until the **A** LED is on. Press **[REF]** until the **POSN** LED is on, and use the step keys or knob to move the **REF POS** one line down from the top CRT graticule. Press **[SHIFT] [SCALE]**. A response dip similar to Figure 4-2 should be visible on the display. This dip is formed because the sweeper is a hetrodyned source (in Band 1), sweeping through low frequencies where it is incapable of generating output power. The middle of this response dip is the "ZERO FREQUENCY" point.
4. Using the **FREQ CAL** adjustment on the front panel of the HP 83592A/B/C, center the 0 MHz dip around the 0 MHz marker (the vertical graticule line two divisions from the left. See Figure

Model 11664A - Performance Tests

- 4-3). Change Channel 1 to **A/R** by pressing **[MEAS RATIO]** until the **A/R** LED is on.
5. With the **MAIN MENU** soft keys, select **[CAL]**, then **[SHORT/OPEN]**, then **[CHAN 1]**. Following the CRT prompts, connect the short to the **TEST PORT** of the bridge, and press **[STORE/SHORT]**. Connect the open and press **[STORE/OPEN]**. The CRT will display **OPEN/SHORT CAL SAVED IN CH1 MEM**.
6. On the HP 8756A, select **M-MEM** (press **[DISPLAY]** until the **M-MEM** LED is on). The CRT display should be similar to Figure 4-4.

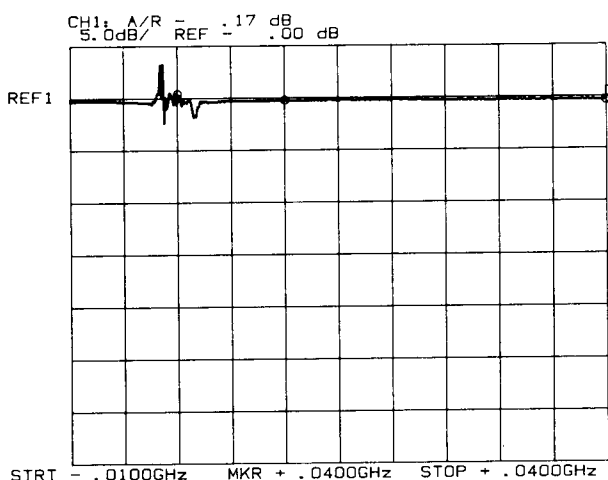

Figure 4-4. M-MEM Display

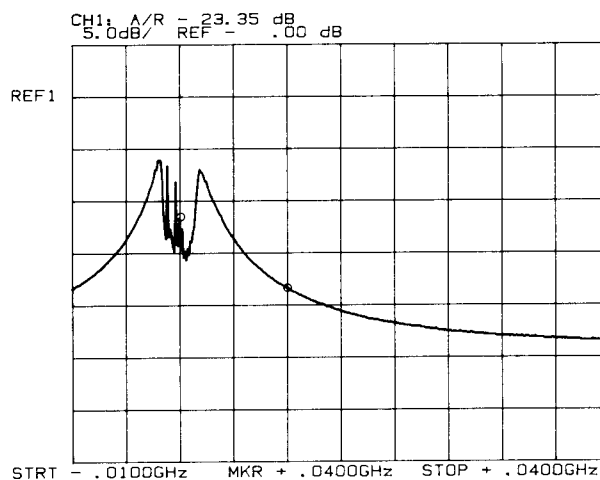

Figure 4-5. Reading Marker Value

7. Connect the DUT to the **TEST PORT**, and press **[SCALE] [5] [DB]** on the HP 8756A. The CRT display should be similar to Figure 4-5.
8. Select **M2**, then **M3**, and read the return loss from the marker value given in the upper left corner of the CRT (see Figure 4-5). Record these values on the test record card.

40 MHz to 18 GHz

9. On the HP 8350B, set **START** to 40 MHz, and **STOP** to 18 GHz. Set markers **M1** to 40 MHz, **M2** to 4 GHz, **M3** to 12 GHz, and **M4** to 18 GHz.
10. Remove the DUT, and ensure that **A/R** is selected for Channel 1 on the HP 8756A.

Model 11664A - Performance Tests

11. With the **MAIN MENU** soft keys, calibrate as in Step 5 above. Ensure that Channel 1 DISPLAY is still in **M-MEM**.

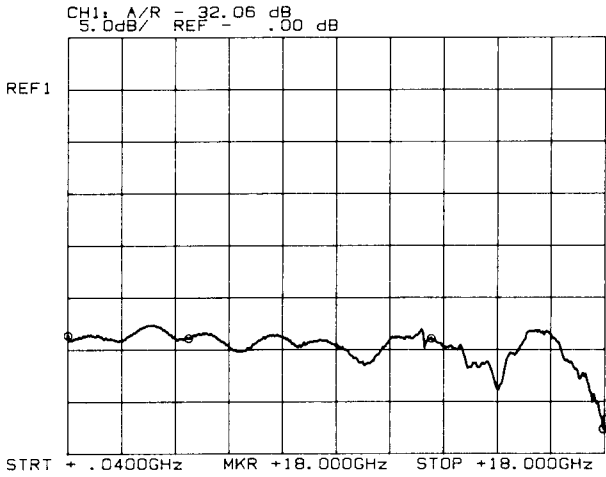

Figure 4-6. DUT Return Loss .04 to 18 GHz

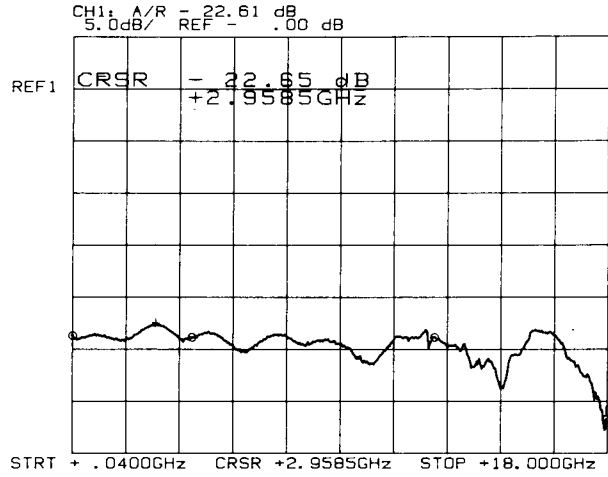

Figure 4-7. Reading Cursor Value

12. Connect the DUT to the **TEST PORT**, and press **[SCALE] [5] [DB]** on the HP 8756A. The display should be similar to Figure 4-6.
13. Using **MAIN MENU** soft keys, press **[CURSER]**. Use the knob to set the cursor to the highest trace value (lowest return loss value) between **M1** and **M2** (.04 to 4 GHz), and read the cursor value from the CRT (see Figure 4-7). Do the same thing between **M2** and **M3** (4 to 12 GHz), and between **M3** and **M4** (12 to 18 GHz). Note these values on the test record card.

4-8. TRACKING BETWEEN TWO DETECTORS

SPECIFICATIONS:

Tracking is specified between two detectors at the same relative power level. This does not include mismatch or coupler uncertainties.

Response Variation:

- .01 to 8 GHz: <0.5 dB
- 8 to 11 GHz: <1.0 dB
- 12 to 18 GHz: <1.5 GHz

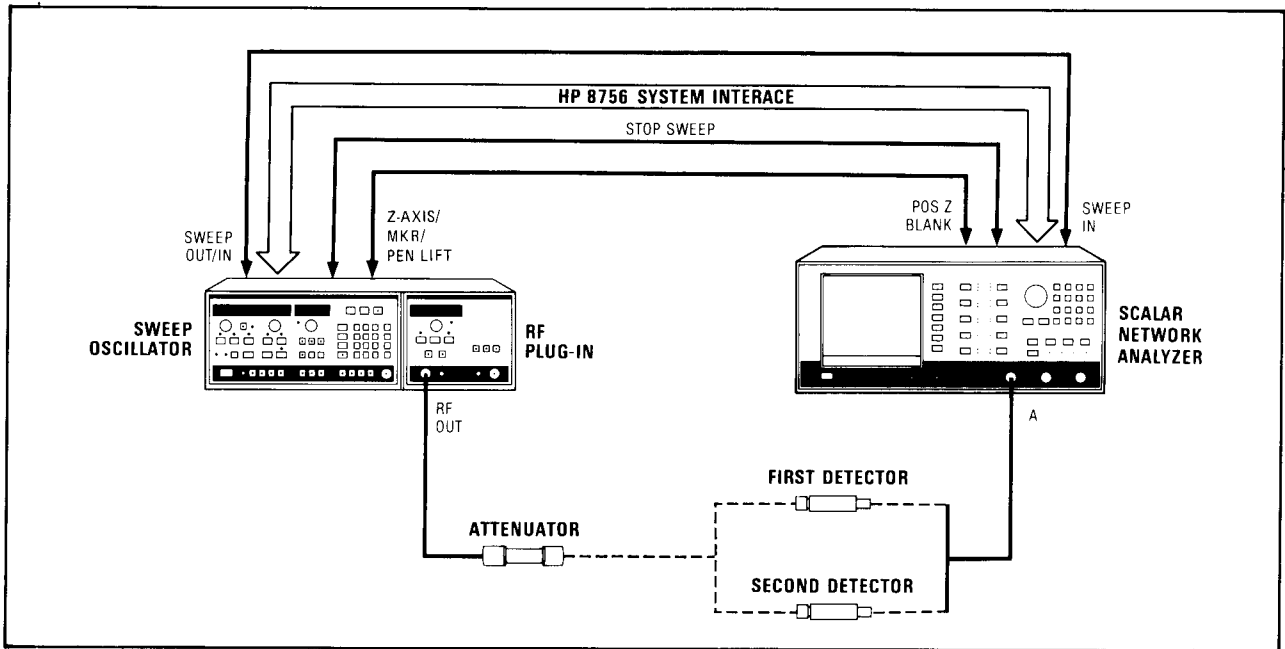

Figure 4-8. Tracking Test Setup

DESCRIPTION:

The frequency response of two detectors are compared using a sweep oscillator and a frequency response test instrument.

EQUIPMENT:

Sweep Oscillator	HP 8350B
RF Plug-In	HP 83592A/B/C
Scalar Network Analyzer	HP 8756A
10 dB Attenuator	HP 8491B Option 010
Detectors (1 plus DUT)	HP 11664A

Model 11664A - Performance Tests

PROCEDURE:

1. Connect equipment as shown in Figure 4-8. Press **[PRESET]** on the HP 8756A. This will preset both the HP 8756A and the HP 8350B (this will also turn the HP 8350B **[MOD]** on and set the sweep rate to 200ms). Set the source power level to 0dB and allow 30 minutes warm-up.
2. On the HP 8756A Channel 2, press **[SHIFT] [MEAS RATIO]** to turn Channel 2 off. On Channel 1, select **A** (press **[MEAS PWR]** until the **A** LED is on). Press **[REF]** until the **POSN** LED is on, and use the step keys or knob to set the reference level to mid-screen. Press **[SCALE] [.] [5] [DB]**.
3. Connect the first detector to the attenuator. On the HP 8350B, set **START** to 10 MHz, and **STOP** to 18 GHz. Set markers **M1** to 10 MHz, **M2** to 8 GHz, **M3** to 12 GHz and **M4** to 18 GHz.

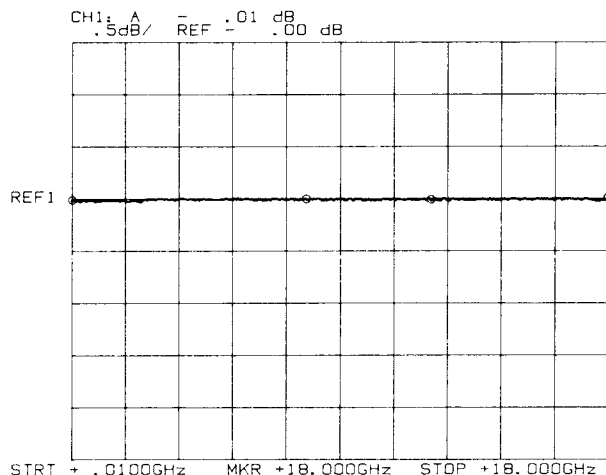

Figure 4-9. Detector Tracking M-MEM Trace

4. On the HP 8756A, press **[SHIFT] [DISPLAY]** to store the trace in memory. Press **[DISPLAY]** until the **M-MEM** LED is on. The display should be similar to Figure 4-9.
5. Remove the first detector from the HP 8756A and the attenuator, and connect the second detector. On the HP 8350B, press **M1** (the **FREQUENCY/TIME** display will read 0 MHz).

Model 11664A - Performance Tests

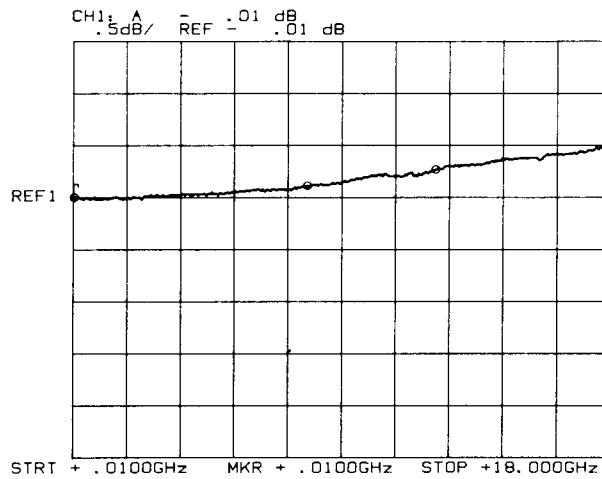

Figure 4-10. Detector Tracking Display

6. On the HP 8756A, press **[SHIFT] [REF]** to bring the active marker (**M1**) to the reference line. The trace between markers **M1** and **M2** (.01 to 8 GHz) should now be within one division (+.5 dB) of the reference line (see Figure 4-10). Read the trace between **M2** and **M3** (8 to 12 GHz). It should be within two divisions (+1 dB) of the reference line. Between **M3** and **M4** (12 to 18 GHz), the trace should be within three divisions (+1.5 dB) of the reference line.

Model 11664A - Performance Tests

Table 4-2. Performance Test Record

HP 11664A Detector		Tested by _____		
Serial No. _____		Date _____		
Paragraph Number	Test	Minimum	Actual	Maximum
4-7.	RETURN LOSS			
	0.01 to 0.04 GHz	10 dB	_____	
	0.04 to 4 GHz	20 dB	_____	
	4 to 12 GHz	18 dB	_____	
	12 to 18 GHz	16 dB	_____	
4-8.	TRACKING BETWEEN TWO DETECTORS			
	0.01 to 8 GHz		_____	<0.5 dB
	8 to 12 GHz		_____	<1.0 dB
	12 to 18 GHz		_____	<1.5 dB

Model 11664A - Adjustments

**SECTION V
ADJUSTMENTS**

5-1. The Model 11664A Detector has no field adjustable components.

**SECTION VI
REPLACEABLE PARTS**

6-1. INTRODUCTION

6-2. This section contains information for ordering parts. Table 6-1 lists abbreviations used in the parts list and throughout the manual. Table 6-2 gives all the manufacturers' code numbers that are used in the parts list. Table 6-3 lists all replaceable parts in reference designator order.

6-3. REPLACEABLE PARTS LIST

6-4. Table 6-3 is the list of replaceable parts. The information given for each part consists of the following:

- a. The Hewlett-Packard part number.
- b. The part number check digit (CD).
- c. The total quantity (Qty) in the instrument.
- d. Description of the part.
- e. A typical manufacturer of the part in a five-digit code.
- f. The manufacturer's number for the part.

6-5. ORDERING INSTRUCTIONS

6-6. To order a part listed in the replaceable parts table, quote the Hewlett-Packard part number (with check digit), indicate the quantity required, and address the order to the nearest Hewlett-Packard office. The check digit will ensure accurate and timely processing of your order.

6-7. To request information on a part that is not listed in the replaceable parts table, include the instrument model number, instrument serial number, and the description and function of the part. Address the inquiry to the nearest Hewlett-Packard office.

Model 11664A/Replaceable Parts

Table 6-1. Reference Designators and Abbreviations Used In Manual

REFERENCE DESIGNATORS		
A Assembly	J Jack	R Resistor
C Capacitor	P Plug	W Cable
CR Diode	Q Transistor	
ABBREVIATIONS		
B	I	PNP..... Positive Negative Positive (Transistor)
BE Baume, Beryllium	IN Inch, Indium	R
C	K	RF Radio Frequency
CER Ceramic	K Kelvin, Key, Kilo, Potassium	S
CM Centimeter		
CU Copper, Cubic	M	SI Silicon, Square Inch
D	MA Milliampere	T
DBM Decibels Referred to 1 Milliwatt	MHZ Megahertz	TA Ambient Temperature, Tantalum
DC Direct Current, Double Contact	MW Milliwatt	TC Thermoplastic
DIM Dimension	N	TO Package Type Designation, Troy Ounce
DO ... Package Type Designation	N Fan Out, Intrinsic Stand Off Ratio, Nano, Nanosecond, Nitrogen, None	U
F	NPN Negative Positive Negative (Transistor)	UF Microfarad
F Fahrenheit, Farad, Female, Film (Resistor), Fixed, Flange, Flint, Fluorine, Frequency	P	V
FT Current Gain Bandwidth Product (Transition Frequency); Feet, Foot	P Peak, Phosphorus, Pico, Picosecond, Pitch, Plastic, Plug, Pole, Polyester, Power, Probe, Pure	V Vanadium, Variable, Violet, Volt, Voltage
FXD Fixed	PD Pad, Palladium, Pitch Diameter, Power Dissipation	VDC Volts, Direct Current
G	PF Picofarad; Pipe, Female Connection; Power Factor	W
GHZ Gigahertz		W Watt, Wattage, White, Wide, Width, Wire

Table 6-2. Manufacturer's Code List

Mfr. No.	Manufacturer Name	Address	Zip Code
28480	HEWLETT-PACKARD CO. CORPORATE HQ.	PALO ALTO, CA.	94303

Model 11664A/Replaceable Parts

Table 6-3. Replaceable Parts

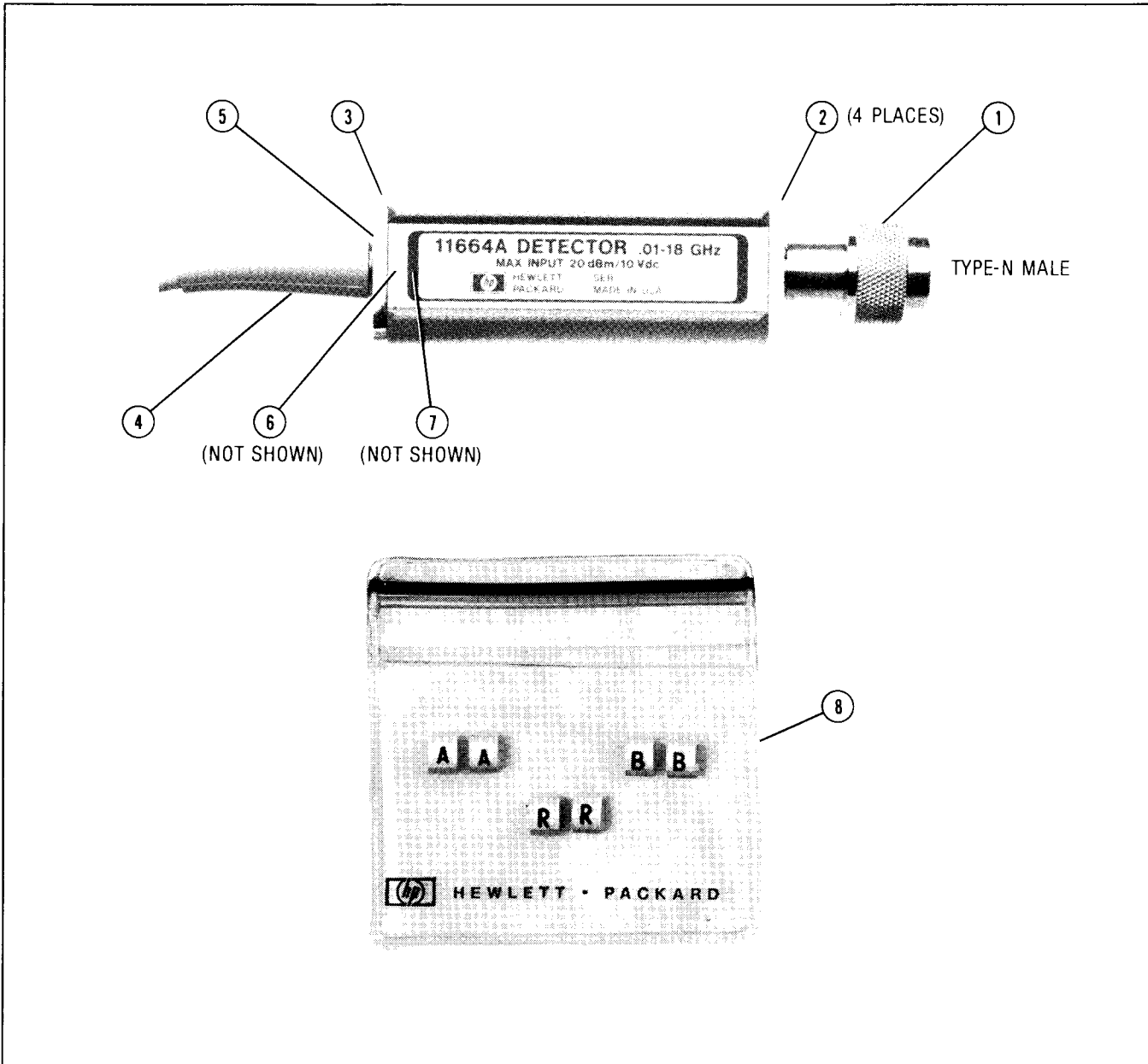

Item	HP Part Number	CD	Qty	Description	Mfr. Code	Mfr. Part Number
1	11664-60022	3	1	Input Connector (J1): Type-N (m) Standard	28480	11664-60022
	11664-60023	4	0	Input Connector (J1): APC-7 [®] Option 001	28480	11664-60023
	11664-60024	5	0	Input Connector (J1): Type-N (f) Special Order	28480	11664-60024
2	2200-0167	8	4	Screw-Machine 4-40 .188-IN-LG 82 Degree	28480	2200-0167
3	11664-20004	7	1	End Plate	28480	11664-20004
4	8120-1788	7	1	Cable Assembly (W1)	28480	8120-1783
5				Washer, P/O W1		
6	2190-0016	3	1	Washer-Lock Internal Tooth 3/8 in .377-IN-ID (Not Shown)	28480	2190-0016
7	2950-0001	8	1	Nut-Hex-Double Chamfer (Not Shown)	28480	2950-0001
8	5061-1044	9	1	Cable Marker Kit	28480	5061-1044

**SECTION VII
MANUAL CHANGES**

7-1. INTRODUCTION

7-2. This manual was written for and applies directly to instruments with serial number 25000 and above. Earlier versions of the instrument (serial numbers lower than 25000) may be slightly different in design or appearance. For earlier versions of the HP 11664A, refer to Operating and Service Manual HP Part Number 11664-90037.

7-3. Any changes made to instruments manufactured after the printing of this manual are documented in a yellow Manual Changes Supplement. Complimentary copies of this supplement can be obtained from your nearest Hewlett-Packard office. Refer to INSTRUMENTS COVERED BY MANUAL in Section I, for additional information.

**SECTION VIII
SERVICE**

8-1. INTRODUCTION

8-2. This section provides procedures for replacing the connector and the cable of the HP 11664A.

8-3. RECOMMENDED TEST EQUIPMENT

8-4. Table 1-3 lists the recommended model numbers of equipment required to test the HP 11664A detector.

8-5. REPAIR

8-6. The following repair procedures are provided:

Replacing Input Connectors

Replacing Cable Assembly

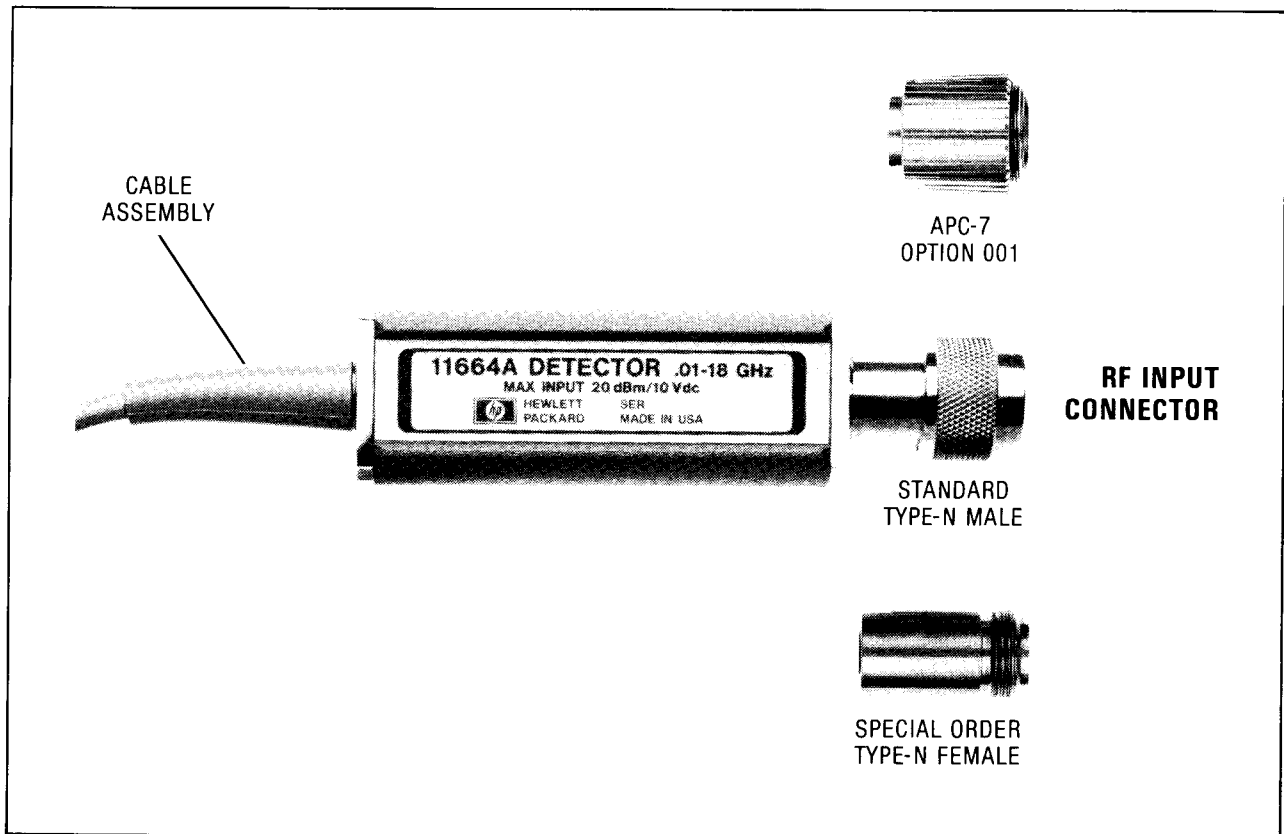

Figure 8-1. Major Assemblies

8-7. Replacing Input Connector

8-8. Order the assembled connector (J1 in Table 6-3), from your nearest Hewlett-Packard office. When it arrives, simply remove the old connector and replace it with the new one using a thin open-ended wrench (1/2" x 9/16", HP Part Number 8710-0877).

8-9. Replacing Cable Assembly

8-10. Remove the two pozi-drive screws on the cable end plate of the HP 11664A. Slide the printed circuit assembly out of the housing by pulling on the cable.

8-11. Carefully remove all cable wires from the board. Remove the lock washer and hex nut that hold the cable to the end plate, and remove the old cable.

8-12. Place new cable through end plate and secure with lock washer and hex nut. Install wires of the replacement cable in the printed circuit assembly (refer to Figure 8-2 for proper placement). Ensure that all cable wires are securely connected to the board. Slide the board into the runners on the inside of the housing. Reinstall and tighten the two pozi-drive screws.

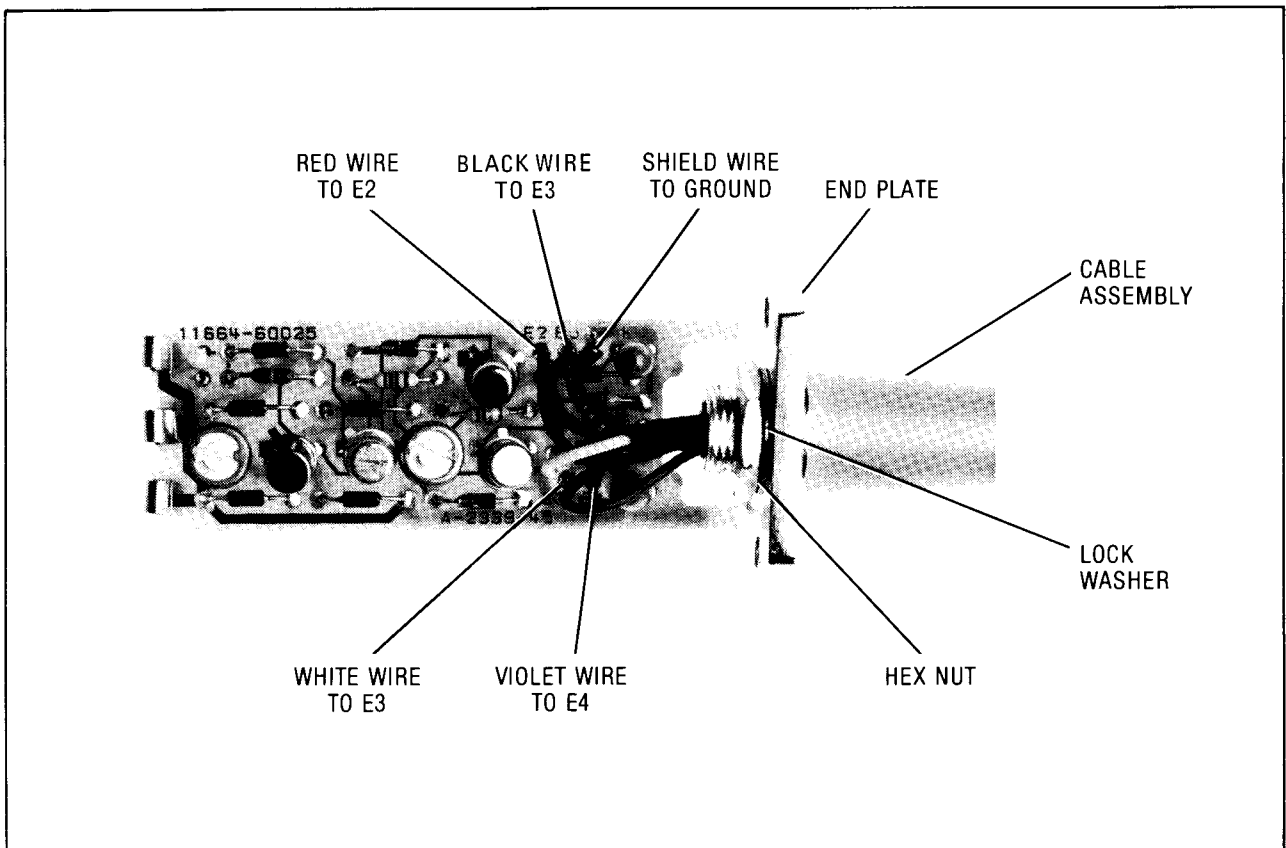

Figure 8-2. Cable Connections

