



OPERATING AND PROGRAMMING MANUAL

HP LOGIC ANALYZERS MODELS 1631A/D

© COPYRIGHT HEWLETT-PACKARD COMPANY/COLORADO SPRINGS DIVISION 1985
1900 GARDEN OF THE GODS ROAD, COLORADO SPRINGS, COLORADO, U.S.A.

ALL RIGHTS RESERVED

HP Part Number 01631-90904
Microfiche Part Number 01631-90804
Binder Part Number 9282-0100

PRINTED: AUGUST 1985

SAFETY SUMMARY

The following general safety precautions must be observed during all phases of operation, service, and repair of this instrument. Failure to comply with these precautions or with specific warnings elsewhere in this manual violates safety standards of design, manufacture, and intended use of the instrument. Hewlett-Packard Company assumes no liability for the customer's failure to comply with these requirements.

GROUND THE INSTRUMENT.

To minimize shock hazard, the instrument chassis and cabinet must be connected to an electrical ground. The instrument is equipped with a three-conductor ac power cable. The power cable must either be plugged into an approved three-contact electrical outlet or used with a three-contact to two-contact adapter with the grounding wire (green) firmly connected to an electrical ground (safety ground) at the power outlet. The power jack and mating plug of the power cable meet International Electrotechnical Commission (IEC) safety standards.

DO NOT OPERATE IN AN EXPLOSIVE ATMOSPHERE.

Do not operate the instrument in the presence of flammable gases or fumes. Operation of any electrical instrument in such an environment constitutes a definite safety hazard.

KEEP AWAY FROM LIVE CIRCUITS.

Operating personnel must not remove instrument covers. Component replacement and internal adjustments must be made by qualified maintenance personnel. Do not replace components with power cable connected. Under certain conditions, dangerous voltages may exist even with the power cable removed. To avoid injuries, always disconnect power and discharge circuits before touching them.

DO NOT SERVICE OR ADJUST ALONE.

Do not attempt internal service or adjustment unless another person, capable of rendering first aid and resuscitation, is present.

USE CAUTION WHEN EXPOSING OR HANDLING THE CRT.

Breakage of the Cathode-ray Tube (CRT) causes a high-velocity scattering of glass fragments (implosion). To prevent CRT implosion, avoid rough handling or jarring of the instrument. Handling of the CRT shall be done only by qualified maintenance personnel using approved safety mask and gloves.

DO NOT SUBSTITUTE PARTS OR MODIFY INSTRUMENT.

Because of the danger of introducing additional hazards, do not install substitute parts or perform any unauthorized modification of the instrument. Return the instrument to a Hewlett-Packard Sales and Service Office for service and repair to ensure that safety features are maintained.

DANGEROUS PROCEDURE WARNINGS.

Warnings, such as the example below, precede potentially dangerous procedures throughout this manual. Instructions contained in the warnings must be followed.

WARNING

**Dangerous voltages, capable of causing death, are present in this instrument.
Use extreme caution when handling, testing, and adjusting.**

1631A/D Operating and Programming Manual

Table of Contents

Chapter 1. General Information

Introduction	1-1
Manual Organization	1-1
Manual Contents	1-1
Analyzer Description	1-2
Analyzer Memory	1-2
Analog Performance Features	1-2
Timing Performance Features	1-3
State Performance Features	1-3
Using the 1631A/D Logic Analyzer	1-3
The System Specification	1-3
The Format Specification	1-4
The Trace Specification	1-4
Waveform Displays	1-4
List Displays	1-4
Chart Displays	1-4
Physical Configurations	1-4
Analyzer Configurations	1-4
Standard Accessories	1-5
Optional Accessories	1-5
Safety Considerations	1-5
Specifications, Operating and General Characteristics	1-5

Chapter 2. Installation

Introduction	2-1
Initial Inspection	2-1
Power Requirements	2-1
Line Voltage Selection	2-1
AC Power Cable	2-2
Operator's Maintenance	2-2
Site Selection	2-2
Rear Panel Address Switch	2-2
Rear Panel BNC Connectors	2-3
Connecting Operating Power	2-3
Applying Operating Power	2-3
Self-Test	2-3
1631A/D Self-Test	2-3
Connecting Analyzer to System Under Test	2-4
Connecting Analyzer Through Probe Interface 10269A/B	2-4
Connecting Probes Directly to System Under Test	2-5

Chapter 3. Front Panel Controls and Menu Map

Introduction	3-1
Analog Measurements	3-1
Timing Measurements	3-1
State Measurements	3-1
Interactive Analog/Timing/State Measurements	3-1

Chapter 4. Analog Measurements

Introduction	4-1
Post Processing	4-2
Statistical Measurements	4-2
The Analog Format Specification	4-2
Channel Label Assignments	4-2
Probe Type and Voltage Selection	4-2
Activity Monitor	4-3
The Analog Trace Specification	4-4
Single/Continuous Trace Modes	4-4
Single/Cumulative Display Modes	4-4
Sample Period	4-5
Tracepoint Specification	4-5
Trigger Specification	4-5
Capturing an Analog Trace	4-5
Setting up the Analog Format Specification	4-5
Controlling the Analog [Waveform/Trace] Display	4-6
Selecting Trace Positions on the Display	4-6
Triggering on a Voltage	4-7
Specifying the Tracepoint	4-7
Controlling the Analog [Waveform Diagram]	4-9
Voltage Readings	4-10
Analog Post Processing	4-11
Placing Cursors on Acquired Data	4-12
Continuous Runs and Statistical Measurements	4-13
The Analog Display	4-14
The Analog [Waveform Diagram]	4-14
The Analog [Waveform/Trace]	4-16

Chapter 5. Timing Measurements

Introduction	5-1
Glitches	5-1
Triggering	5-1
Post Processing	5-2
Statistical Measurements	5-2
How to Make Simple Timing Measurements	5-2
Activating the Timing Analyzer	5-2
Controlling the Timing Display	5-3
Selecting Trace Positions on the Display	5-4
Triggering on a Timing Event	5-5
The Timing Format Specification	5-7
Timing Format [Assignment] Specification	5-7
Label Assignments	5-7
Pod Threshold Assignments	5-7
Timing Format [User Base] Specification	5-8
The Timing Trace Specification	5-8
Single/Continuous Trace Modes	5-8
Timing Post Processing and Statistical Measurements	5-9
The Timing [Post Processing] Trace Specification	5-11
Marking Events on Acquired Data	5-11
On Acquired Data Place Cursors x and o	5-11
On Acquired Data Mark Listing for Events a, b, c, d	5-14
Continuous Runs and Statistical Measurements	5-16
Pattern (and Glitch) Definition	5-18

Chapter 5. Timing Measurements (Continued)

The Timing Display	5-18
Waveform Displays	5-18
List Displays	5-19
The Timing Listing	5-19
The [Timing + Postproc] Listing	5-20
Chart Displays	5-21

Chapter 6. State Measurements

Introduction	6-1
Capturing a State Trace	6-1
The State Format Specification	6-3
The State [Assignment] Format Specification	6-3
Clock Assignments	6-4
Multiplex Assignment	6-4
Threshold Assignments	6-4
Activity Line	6-4
Label Assignments and Polarity	6-4
The State [Relocation] Format Specification	6-8
The State [User Base] Format Specification	6-10
Inverse Assemblers for the Logic Analyzer	6-12
The State Trace Specification	6-13
Resource Terms	6-15
Trigger [Start/Center/End] Trace	6-15
Sequential Triggering	6-18
Sequence Restart	6-21
Store Qualifiers	6-21
[Compare] Trace Mode	6-23
The State Display	6-26
List Displays	6-26
[Single] List Displays	6-26
[Continuous] List Displays	6-26
[Compare] List Displays	6-27
[Overview] List Displays	6-27
Waveform Displays	6-27
XY Charts of Label Activity	6-28

Chapter 7. Performance Analysis Measurements

Introduction	7-1
State Label Overview Measurement	7-1
Time Interval Overview Measurement	7-3

Chapter 8. Interactive Measurements

Introduction	8-1
Simultaneous Acquisition Systems	8-1
Cross Domain Triggering	8-1
Master Triggers Slave	8-2
Master Arms Slave	8-2
Event Correlation Between Domains	8-2
Making Coordinated State and Timing Measurements	8-2
Setup for State and Timing Measurements	8-3
Executing Coordinated State/Timing Measurements	8-4

Chapter 8. Interactive Measurements (Continued)

Making Coordinated Analog and Timing Measurements	8-7
Setup for Analog and Timing Measurements	8-7
Cursor Correlation	8-9
Displaying Timing and Analog Channels	8-11

Chapter 9. Peripherals

System [Peripherals] Configuration	9-1
Using the Disc Memory Accessory	9-2
Connecting the 9121D/S Flexible Disc Drive	9-2
The [Storage Operations] Menu	9-2
How to Read a Disc File	9-3
How to Create a New Disc File	9-4
How to Find a Disc File	9-4
How to Delete a Disc File	9-5
How to Format a Disc	9-5
Using a Printer Accessory	9-6
Obtaining Hard Copy From a Printer	9-6
Using a Controller to Operate the Analyzer and Printer	9-7

Chapter 10. Using HP-IB or HP-IL Interface

Introduction	10-1
HP-IB and HP-IL Interface Capabilities	10-1
Keyboard Mnemonics	10-1
Non-Keyboard Mnemonics	10-2
Learn String Commands	10-5
Data Formats	10-5
Data Formatting Examples	10-6
TC-Transmit Configuration Learn String	10-12
TS-Transmit State Acquisition Learn String	10-13
TA-Transmit Analog Acquisition Learn String	10-17
TT-Transmit Timing Acquisition Learn String	10-19
TE-Transmit Everything Learn String	10-20
Data Transfer Termination	10-20

Appendix A Display Messages

Appendix B HP-IB Overview

List of Figures

Figure 3-1. Front Panel Controls	3-2
Figure 3-2. Input/Output Displays Menu Map	3-3
Figure 4-1. 1631D Default System [Configuration] Menu	4-1
Figure 4-2. Analog Format Specification Menu	4-2
Figure 4-3. Analog Trace Specification Menu	4-4
Figure 4-4. Activity on Analog INPUT 1	4-6
Figure 4-5. Analog Activity Captured From INPUT 1	4-6
Figure 4-6. Triggering the Analog Analyzer on a Voltage	4-7
Figure 4-7. Trigger Centers Trace	4-7
Figure 4-8. Trigger Ends Trace	4-8
Figure 4-9. [End] Trace 10 ns After Trigger	4-8
Figure 4-10. Magnification Around the x Cursor	4-9
Figure 4-11. Voltage Readouts for x and o Cursors	4-10

List of Figures (Continued)

Figure 4-12. Selecting Post Processing in the Analog Trace Specification	4-11
Figure 4-13. The Analog [Post Processing] Menu	4-11
Figure 4-14. Post Processing Specification for Time Interval of a Waveform	4-12
Figure 4-15. Time Interval of a Repetitive Waveform	4-12
Figure 4-16. Analog [Waveform Diagram]	4-14
Figure 4-17. Analog [Waveform Diagram] with Statistical Information	4-15
Figure 4-18. Analog [Waveform/Trace] Display	4-16
Figure 5-1. Selecting the Timing Analyzer Configuration of the 1631D	5-2
Figure 5-2. Default Timing Measurement for 1631D	5-3
Figure 5-3. Magnification Around "x"	5-3
Figure 5-4. Selecting Waveform Positions on Display	5-5
Figure 5-5. Triggering on a Pattern and Edge Transition	5-6
Figure 5-6. Triggering on a Timing Event	5-6
Figure 5-7. Timing Format [Assignment] Specification	5-7
Figure 5-8. Timing Format [User Base] Specification	5-8
Figure 5-9. Timing Trace Specification with Glitch Mode Selected	5-9
Figure 5-10. Selecting Post Processing in the Timing Trace Specification	5-10
Figure 5-11. Timing [Post Processing] Menu	5-10
Figure 5-12. Timing Waveform Diagram with x and o Cursors Defaulted	5-11
Figure 5-13. Post Processing Specification for Duration of a Pattern	5-12
Figure 5-14. Time Interval of a Pattern	5-12
Figure 5-15. Post Processing Specification of an Extended Pattern	5-13
Figure 5-16. Time Duration of an Extended Pattern	5-13
Figure 5-17. Defining Events in the Timing Post Processing Menu	5-14
Figure 5-18. Timing Waveform Diagram with Marked Events	5-15
Figure 5-19. [Timing + Postproc] Listing Showing Marked Events	5-15
Figure 5-20. Specification for Sample Marking Line Conditions	5-16
Figure 5-21. Listing of Sample Marked Line Conditions	5-16
Figure 5-22. Typical Timing Waveform Diagram	5-18
Figure 5-23. Typical Timing Listing of Timing Activity	5-19
Figure 5-24. Typical [Timing + Postproc] Listing	5-20
Figure 5-25. Typical Timing XY Chart of a Label	5-21
Figure 6-1. System [Configuration] Specification Assigning State Channels	6-2
Figure 6-2. Free-run State Trace Captured by the 1631A/D	6-2
Figure 6-3. 1631A/D Default State Format Specification Menu	6-3
Figure 6-4. State Listing Including the ADDR Label	6-5
Figure 6-5. State [Assignment] Format Specification Menu	6-6
Figure 6-6. State Listing for ADDR, DATA, and STAT Labels	6-6
Figure 6-7. State Assignment with Bits Assigned to Multiple Labels	6-7
Figure 6-8. State Listing with Bits Assigned to Multiple Labels	6-7
Figure 6-9. Default State [Relocation] Format Specification Menu	6-8
Figure 6-10. State [Relocation] Format Specification with Assigned Modules	6-9
Figure 6-11. State Listing Using Relocation Values	6-9
Figure 6-12. State Listing with Relocation and Absolute Value Lists	6-10
Figure 6-13. State [User Base] Format Specification Menu	6-11
Figure 6-14. User Base Specification with Assigned Conditions to STAT Label	6-11
Figure 6-15. State Listing with User Base Names in STAT List	6-12
Figure 6-16. State Listing with Disassembled Data List	6-12
Figure 6-17. 1631A/D Default State Trace Specification Menu	6-13
Figure 6-18. State Listing with Specific States Marked	6-14
Figure 6-19. State Listing Showing a Specific State	6-14
Figure 6-20. The State Trace Specification with Fields for Resource Terms	6-15

List of Figures (Continued)

Figure 6-21. Specification of Trigger on First Occurrence of a Specific Trace 6-16

Figure 6-22. Trigger Starts Trace Listing 6-16

Figure 6-23. Trigger Centers Trace State Listing 6-17

Figure 6-24. Trigger Ends Trace State Listing 6-17

Figure 6-25a. Branching Network with Specified Paths 6-18

Figure 6-25b. Analyzer Sequence Triggering Flowchart 6-19

Figure 6-26. State Trace Specification with Sequence Terms 6-20

Figure 6-27. State Trace Specification with Sequence Terms and ORed Trigger
Start Terms 6-20

Figure 6-28. Maximum Sequence Restart ORed Resource Terms 6-21

Figure 6-29. ORed Resource Terms as Store Qualifiers When Trigger Starts Trace 6-22

Figure 6-30. Store Qualifying Data Between Sequence Terms 6-22

Figure 6-31. Maximum Amount of Resource Terms for the State Trace Specification 6-23

Figure 6-32. [Compare] State Trace Specification 6-23

Figure 6-33. The [State + Compare] List 6-24

Figure 6-34. Trace Taken in Compare [until ≠] Mode 6-25

Figure 6-35. Original Compare List with Compare Event Differences 6-25

Figure 6-36. Typical List Display in Single Trace Mode 6-26

Figure 6-37. Typical List Display in [Compare] Trace Mode 6-27

Figure 6-38. Typical State Waveform Display 6-27

Figure 6-39. Typical State XY Chart of a Label 6-28

Figure 7-1. Example State Label Overview Trace Specification 7-2

Figure 7-2. State Label Overview Histogram of Example Measurement 7-2

Figure 7-3. State Trace Specification for Example Time Interval Overview 7-3

Figure 7-4. Time Interval Overview Chart for Example Measurement 7-4

Figure 8-1. Combined State/Timing Analyzer System Configuration for 1631D 8-3

Figure 8-2. State Assignment Format Specification 8-3

Figure 8-3. State Trace Specification in State/Timing Measurements 8-4

Figure 8-4. State Trace Specification with Trigger in Row "b" 8-4

Figure 8-5. Timing Trace Specification for Combined State/Timing Measurements 8-5

Figure 8-6. Timing Waveform Display 8-6

Figure 8-7. Timing Trace Specification with Master [Timing] 8-6

Figure 8-8. Timing Listing Display 8-7

Figure 8-9. Combined Analog/Timing System Configuration for the 1631D 8-7

Figure 8-10. [Timing] Trace Specification Triggers Analog Analyzer 8-8

Figure 8-11. Analog Analyzer Triggered from Timing Specification 8-8

Figure 8-12. [Timing] Waveform Diagram 8-9

Figure 8-13. x Cursor Placed on First Falling Edge of B0 8-9

Figure 8-14. Correlating the x Cursor to the [Timing] [Waveform Diagram] 8-10

Figure 8-15. Correlating the x Cursor to the [Analog] [Waveform Diagram] 8-10

Figure 8-16. Displaying Timing and Analog Channels 8-11

Figure 9-1. 1631A/D System [Peripherals] Specifications Menu 9-1

Figure 9-2. The [Storage Operations] Menu 9-2

List of Tables

1-1. 1631A/D Features and Specifications 1-6

1-2. Operating Characteristics 1-8

1-3. General Characteristics 1-12

4-1. Probe Type and Voltage Range Selection 4-3

6-1. Address Map for Relocation Example 6-8

6-2. User Base Names for STAT Label 6-11

10-1. HP-IB/HP-IL Keyboard Mnemonics 10-2

Chapter 1

General Information

INTRODUCTION

The 1631A/D is a general purpose Logic Analyzer capable of performing State, Timing and Analog waveform measurements. Each of these analyzer functions may be used alone or simultaneously and interactively. The high performance, ease of use, and interactive nature of the 1631 measurement set lends itself readily to the design, debug and characterization of digital systems. The 1631 provides the digital hardware designer, the microprocessor software designer and the system integrator with a diversity of windows into the system under test which allows observations never before attainable in a single stand alone instrument.

MANUAL ORGANIZATION

This manual describes how to install, operate and program the HP Models 1631A and 1631D Logic Analyzers. For the first time user, Chapter 1 and the introductions to each of the chapters on Analog, Timing, State, and Interactive measurements will provide the overview of the machine organization and the process of making measurements necessary to get started. The experienced user will find the detailed menu information in the chapters as well as the menu map in chapter 3 to be a good reference source when making complex measurement setups.

MANUAL CONTENTS

Chapter 1 contains a description of the 1631 measurement capability as well as physical and electrical information about the logic analyzer. At the end of this chapter tables list the specifications and operating characteristics of the analyzer.

Chapter 2 describes how to install the logic analyzer. Directions are provided for initiating the self test and for connecting the analyzer to the target system.

Chapter 3 is a front panel keyboard description and a menu map. The menu map is a hierarchical description of the logic analyzer menus.

Chapter 4 describes the analog measurement capability of the machine followed by a detailed description of analog user interface menus.

Chapter 5 contains a description of the analyzer's timing measurement set followed by a detailed description of the timing menus.

Chapter 6 is devoted to state measurements.

Chapter 7 describes software performance analysis. These measurements are an extension of state measurements and allow software to be viewed on a higher level than the state to state transaction detail provided by the state analyzer.

Chapter 8 addresses configuring the analyzer for interactive analog/timing/state measurements.

Chapter 9 describes the use of peripherals with the logic analyzer. The peripherals menu is described and use of the analyzer with a disc memory and printer is explained.

Chapter 10 contains the instructions for remotely programming the analyzer via HP-IB or HP-IL.

Appendix A delineates and interprets all the possible status, error, and prompt messages which may appear on the logic analyzer display during operation.

Appendix B contains information to aid in HP-IB interfacing.

ANALYZER DESCRIPTION

The 1631 is a general purpose instrument for use in the design, debug, and functional test of digital hardware and microprocessor hardware and software. It features measurement capability in all three domains of interest to the digital system designer: Analog, Timing, and State. Functionality in each of these domains is available to the user separately or in interactive combination.

The 1631 is a stand alone, benchtop instrument with integral keyboard and display, but it may be remotely programmed by an external controller over its built in HP-IB. HP-IB also provides linkage to peripherals such as a number of discs and printers. A micro floppy disc can be connected to the 1631 for the store and recall of measurement configurations and acquired data. A printer will provide hardcopy of waveforms, listings, and instrument configurations at the touch of a key.

The two channel Analog Analyzer has all the utility of a general purpose digitizing oscilloscope. It provides the hardware designer with the power to reliably trigger and display single shot of low repetition rate events with ease. Because of its digital storage architecture, simultaneous acquisition on both channels with inherent time correlation and negative time capture are possible. When triggered interactively from the Timing or State Analyzers, the Analog Analyzer can capture highly qualified parametric data which could never before be observed with a conventional oscilloscope.

The Timing Analyzer couples high speed asynchronous sampling on up to 16 channels (1631D) with the convenience of a logic waveform display. It allows the designer to view and measure timing relationships across all channels and to observe and trigger on glitches, patterns, and edges. Built-in Post Processing of acquired timing data extends the power of the Timing Analyzer. Automatic post acquisition marking of the x and o cursor system on user specified events provided instant time interval measurements. For repetitive events, post processing provides statistical characterization of user specified events and increased time interval measurement accuracy.

The State Analyzer is a synchronous acquisition system up to 43 channels wide (1631D) which derives its clock from the system under test. The analyzer captures the logic state of all its input channels on the user specified edge of this clock. The State Analyzer is frequently used to monitor microprocessor program flow by probing the processor's address, data, and status busses but it also has utility in debugging synchronous communication busses or algorithmic state machine. The State Analyzer features powerful sequencing and data storage qualification through its Trace Specification which allows the hardware or software designer to window in on events of interest. The Format Specification maps user specified labels to input channels to make the analyzer's displays reflect activity in the context of the user's system. A number of useful output display formats are available including state listings, disassembled code listings, or histograms of activity.

Analyzer Memory

The trace memory of each section of the analyzer (analog, timing, or analog) is 1024 states deep. The analog memory stores 1024 six-bit samples per channel during a trace measurement. The state memory stores each qualified state captured by the input probes. The compare memory of the state mode is sixteen states deep. It stores up to sixteen lines for comparison with the corresponding lines in the trace memory. The timing memory stores 1024 sample measurements for the timing listing so periods of time between occurrences of interest may be analyzed.

Analog Performance Features

- 200 MHz sample rate
- 50MHz analog bandwidth
- 2 channel simultaneous acquisition
- 1024 deep acquisition memory per channel

- analog triggering - slope/level on internal or external
- analog waveform displayed in full pixel graphics
- x and o cursor system for waveform time and voltage measurements
- post acquisition processing for auto answers and statistical characterization
- cumulative display mode for infinite persistence applications

Timing Performance Features

- 100 MHz sample rate on up to 16 channels
- 1024 deep acquisition memory per channel
- pattern, edge, and glitch triggering
- waveform or list displays of acquired data
- x and o cursor system for waveform time interval measurements
- post acquisition processing for auto answers and statistical characterization

State Performance Features

- external clock rates to 25 MHz
- two phase demultiplexing
- up to 43 channels (1631D)
- 1024 deep acquisition memory per channel
- pattern, sequence, and occurrence count triggering
- storage qualification
- state and time interval histogramming

USING THE 1631A/D LOGIC ANALYZER

The 1631A/D is a menu driven instrument with six basic menus divided equally between input specification menus and output display menus. The six keys along the top of the analyzer's keyboard select the currently displayed menu. The user interacts with the machine by selecting the menu of interest and moving the on-screen flashing cursor into inverse video select fields in the displayed menu. NEXT[] and PREV[] keys may then be used to roll through the options available in that select field. User specified input such as labels or numeric entry is accomplished via the keyboard. The function of each of the six major menus are outlined as follows.

The System Specification

The System Specification menu is used to configure the function modes of the analyzer: as an analog, timing, state or mixed machine. This menu is also used to identify how the analyzer will operate, as part of a system or, when capabilities offered by accessories are available.

The Format Specification

The Format Specification menus are used to set up the way the analyzer will organize and arrange the acquired data. Individual bits, or groups of bits may be labeled to identify address ranges or specific values found in the labeled bits. The analyzer displays are composed from the labels.

The Trace Specification

Parameters and conditions for making measurements are determined by the Trace Specification menus. Trace measurements are made when the conditions of the trace specification have been met. Post processing and statistical measurements for analog and timing are specified in this menu. The software performance overview measurements are set up in the state trace specification menu.

Waveform Displays

The analyzer displays up to 16 state or timing waveforms, both analog channels, or a combination of timing and analog channels. Each state and timing trace is shown as a continuous line of high and low states. The waveform shows how the states changed with time at each monitored point. When glitch mode has been selected, points on the timing trace where glitches were detected are marked. Glitch detection is accomplished by internally combining two timing channels attached to a single probe, using one channel for data values and the other channel for glitch detection. The trace specification can be displayed with the analog waveforms for stand alone scope operation.

List Displays (State and Timing Analyzers)

The analyzer composes lists of information captured from the labeled sets of bits. The lists show series of software executions or a sequence of electrical activities at nodes in a target system. Values in these lists can be expressed with user names or in binary, octal, decimal, or hexadecimal number bases. Values may also be expressed as ASCII codes for labels having from 6 to 16 bits.

Chart Displays (State and Timing Analyzers)

The analyzer formats two types of chart displays: XY charts and histograms. XY charts show a plot of the flow of values on a labeled set of bits. The horizontal and vertical scales of the chart may be controlled to examine the details around areas of interest on the XY chart.

Histogram charts are bar graphs used to measure the performance of software modules in a target system. The analyzer can show two types of histograms: state label histograms and time interval histograms. A state label histogram shows the relative number of executions within each range of states that have been defined in the state label overview specification. Up to eight ranges of states can be defined for a label histogram. Time interval histograms show eight time ranges which are user defined in the time interval overview specification. Time interval measurements are made each time the software executes from one selected point to another in the target system. The time interval histogram shows how often execution of the selected software module was completed within each time of the ranges defined in the overview specification.

PHYSICAL CONFIGURATIONS

The following are lists of physical configurations of the 1631A/D, the standard accessories shipped with each instrument and the optional accessories available.

Analyzer Configurations

HP Model 1631A Logic Analyzer. Offers 35 channels for state measurements, of which 8 channels may be used for timing measurements, and 2 analog channels with an external trigger channel.

HP Model 1631D Logic Analyzer. Offers 43 channels for state measurements, of which 16 channels may be used for timing measurements, and 2 analog channels with an external trigger channel.

Standard Accessories

HP Model 10271A General Purpose State Probe with 10 channel clip assembly. Provides nine channels for collecting state activity and one channel for an input clock. Used to supply state activity only. Three state probes are supplied with the 1631A and the 1631D.

HP Model 10272A General Purpose State/Timing Probe with 8 channel clip assembly. Provides eight channels for collecting state or timing activity. No input clock channel. One state/timing probe is supplied with the 1631A and two are supplied with the 1631D.

HP Model 10017A Probe. 10:1 1 Megohm/8.0 pF probe for 1 Megohm/9-14 pF Input. Each probe is supplied with one retractable hook tip, on IC probe tip adapter, one alligator clip, one 20 cm (8 inches) ground lead, one grounding spring, and one Operating Note. Two probes are supplied with each 1631A and 1631D.

HP Model 1250-1454. BNC to Probe Adapter. For logic analyzer rear panel BNC calibration signal for analog probe compensation.

One 2.3 meter (7.5 feet) power cord.

One Operating and Programming Manual.

Optional Accessories

HP Model 9121D/S or 9122D/S Flexible Disc Drive. Accessory to store instrument setups and captured data in disc memory.

HP Model 10269A/B Probe Interface. Accessory used to make connections to interface the analyzer to a specific microprocessor.

SAFETY CONSIDERATIONS

**WARNING**

To prevent personal injury, observe all safety precautions and warnings stated on the instrument and in the manual.

This product is a Safety Class I instrument (provided with a protective earth terminal). The instrument and all related documentation must be reviewed for familiarization with safety markings and instructions before operation. Refer to the Safety Considerations page supplied at the beginning of this manual for a summary of general safety information. Safety precautions for installation, operation, are placed in appropriate locations throughout the Operating and Programming Manual. These precautions must be observed during all phases of operation, service, and repair of this instrument. Failure to comply with these precautions or with specific warnings elsewhere in the manual violates safety standards of design, manufacture, and intended use of this instrument. Hewlett-Packard assumes no liability for failure to comply with these requirements.

SPECIFICATIONS, OPERATING AND GENERAL CHARACTERISTICS

Features and specifications are listed in tables 1-1. The specifications in table 1-1 are the performance standards or limits by which the instrument is tested and guaranteed by Hewlett-Packard. The operating characteristics are listed in table 1-2 and general characteristics are listed in table 1-3. The characteristics are not specifications but typical characteristics included as additional information for the user.

Table 1-1. 1631A/D Features and Specifications

MEASUREMENT CONFIGURATION/CHANNELS

HP 1631A State	HP 1631A Timing	HP 1631A Analog	HP 1631D State	HP 1631D Timing	HP 1631D Analog
35	—	—	43	—	—
27	8	—	35	8	—
—	8	—	27	16	—
—	—	2	—	16	—
—	8	2	—	—	2
27	8	2	—	16	2
35	—	2	27	16	2
			35	8	2
			43	—	2

NOTE: Number of timing channels halved in glitch mode.

MEASUREMENT FUNCTIONS

Analog Specifications

Channels 1 and 2 (Vertical)

Probe Factors: 1:1, 10:1, or 50:1 probe attenuation factors may be entered to scale the HP 1631A/D to input voltages at the probe tip. All vertical specifications relate to a 1:1 probe factor.

Range: 40 mV to 2.5 V full-scale, automatically calibrated internally with two-digit resolution with each change in format specification.

Bandwidth (-3 dB)
dc coupled: dc to 50 MHz

Dc gain accuracy: ±2.5% of full-scale
Channel isolation: 55 dB from dc to 50 MHz

Analog-to-Digital Conversion (ADC) resolution:
±1 LSB, which is ±1.6% of full-scale

Dc offset range/resolution:
Offset Range Offset Resolution
±1.5 V approximately 1 mV

Transition time: ≤5.25 ns, 20% to 80% of full-scale.

Input coupling: dc
Input RC: 1 MΩ ±2%, shunted by approximately 14 pF
Maximum safe input voltage: ±40 V (dc + peak ac)

Trigger (Analog)

Sources: channel 1, channel 2, or external trigger input.
Edge: rising or falling edge may be selected for any source.

Sensitivity: (square wave up to 10 MHz)
.2 of full-scale for channels 1 and 2
50 mV p-to-p for external
Up to 50 MHz
.3 of full-scale for channels 1 and 2
100 mV p-to-p for external

Table 1-1. 1631A/D Features and Specifications (Cont'd)

Level range/resolution:
 internal: within the display window/approximately 1% of full scale
 external: ± 2 V in 1 mV steps

External trigger input:
 Maximum safe input voltage: ± 40 V (dc + peak ac)
 input coupling: dc
 input RC: $1\text{ M}\Omega \pm 2\%$, shunted by approximately 14 pF

Time Base (Horizontal)

Sample period: 5 ns to 500 ms in a 1-2-5 sequence.

Range: 125 ns to 500 s full-scale (10 divisions).

Time base accuracy
 sample period: $\pm .01\%$
 time-interval measurement accuracy: (equal rise and fall times)
 single-shot: ± 1.5 ns for 5 ns sample period
 ± 1 sample period for sample periods of 10 ns or greater
 continuous: $\pm .15$ times sample period, based on 100 averages

Tracepoint and Delay

tracepoint: equals trigger plus delay; trace point can be delayed from 0 to 262, 143 sample periods after the trigger.

tracepoint placement accuracy: within ± 1 sample period $\pm .1$ times full-scale voltage divided by the slew rate of the input signal.

tracepoint position: can be set approximately 50 sample periods from the start, end, or near the center of the data record. A 1024-sample record can be positioned with about 950 samples before the tracepoint, or with the entire data record beginning up to 262, 074 samples after the trigger.

Notes: specifications apply after a 30 minute warm up period.

Single-shot reconstruction uncertainty = ± 1 ns (applies for time ranges of 50 ns thru 2 us)

State/Timing Input Specifications**Probes**

RC: $100\text{ k}\Omega \pm 2\%$ shunted by approximately 5 pF at probe body.

Minimum, Swing: 600 mV p-to-p

Minimum Input Overdrive (Above Pod Threshold): 250 mV or 30% of input amplitude, whichever is greater.

Maximum Voltage: ± 40 V, peak.

Threshold Voltage: -9.9 V to $+9.9$ V in 0.1 V increments.

accuracy: $2.5\% \pm 120$ mV.

Dynamic Range: ± 10 V about threshold.

State Mode**Clock Repetition Rate**

single phase: 25 MHz with single clock and single edge specified; 20 MHz with any ORed combination of clocks and edges.

multiplexed: master-slave clock timing; master clock must follow slave clock by at least 10 ns and precede next slave clock by 50 ns or more.

Clock Pulse Width: ≥ 20 ns at threshold.

Setup Time: ≥ 20 ns, the time data must be present prior to clock transition.

Hold Time: 0 ns, the time data must be present after clock transition.

Time Mode

Glitch: with glitch detection on, number of timing channels is halved.

Minimum detectable glitch: 5 ns width at threshold.

Table 1-2. 1631A/D Operating Characteristics

ANALOG

Digitizer: Two channels are digitized simultaneously.

Digitizing Technique Real-time digitizing: all data points are digitized, at equal selectable increments in time, on each acquisition.

Digitizing Rate: selectable, 2 samples/second to 200 megasamples/second

Voltage Resolution: 6 bits; 1 part in 64.

Acquisition Memory: 1024 samples, 6 bits each per channel, 2 channels; up to 1000 samples are used for display; magnifier allows full screen display from 1000 samples to 25 samples; the entire 1024 sample record can be accessed via HP-IB and HP-IL.

Display

Waveform

Straight line: waveforms are displayed by connecting adjacent sample points with a vertical and a horizontal line.

Filtered: a post acquisition interpolation filter provides up to 19 additional points between each sample point; waveforms are displayed by connecting adjacent interpolated points with two lines, as above.

Data Display Formats: one or two analog waveforms can be displayed simultaneously in the analog waveform display or with a combination of timing waveforms in the timing waveform display.

Number of Analog Waveforms	Number of Timing Waveforms Without Glitch	Number of Timing Waveforms With Glitch
2	8	4
1	12	6

Single: the display retains the previous acquisition until RUN is pressed.

Continuous: the display is updated with each new waveform acquisition.

Cumulative: all successive waveform acquisitions are displayed together until STOP is pressed.

Real-time: allows selected trace point conditions to be changed in continuous trace/display mode.

Graticules: full grid

Indicators

Memory: the amount of acquisition memory displayed is indicated below the graticule as a solid bar with the remaining memory shown in dots at double the graticule dot density.

Cursors: x and o cursors are shown as solid vertical lines in the display. The x cursor is indicated as a tic mark on the top of the memory bar; the o cursor is indicated as a tic mark on the bottom of the memory bar.

Tracepoint: Shown as a vertical dashed line in the display.

Run/Real-Time/Stop/Resume

RUN: allows an acquisition when tracepoint conditions are met. Clears all previous traces and statistics.

STOP: immediately halts acquisition; acquisition can be resumed. If in continuous trace mode/single display mode, acquisition is halted after trace is complete.

RESUME: Allows acquisition to continue after STOP for the purpose of continuing to obtain statistics under tracepoint and/or x-o cursor conditions. The waveform display is not cleared if in the cumulative display mode.

STOP/STOP: aborts acquisition; acquisition cannot be resumed.

Measurement Aids

Cursors: two cursors (x and o) are provided for making voltage and time measurements on displayed waveforms. Both absolute and differential values are provided for voltage measurements. Dual cursor time measurements can be made between two points on the same waveform or between two points on different waveforms.

Table 1-2. Operating Characteristics (Cont'd)

Cursor Statistics: x to o cursor statistics are provided for continuous voltage and time measurements: maximum, minimum, mean, and standard deviation. Single cursor voltage statistics can be obtained on either waveform. Dual cursor statistics can be obtained between two points on the same waveform or between two points on different waveforms (time only).

Cursor Placement: Both x and o cursors can be uniquely specified with respect to the tracepoint or acquisition start, by selection of channel 1 or 2, rising or falling edge, voltage level, hold or delay time.

STOP Continuous RUN: pressing RUN processes waveform acquisitions until the cursor-based RUN-STOP condition is met; RUN-STOP conditions include greater-than/less-than time intervals, or a specific number of acquisitions. The time from the end of an acquisition until the instrument is ready to accept a new acquisition is approximately 40 ms (with statistical measurements OFF).

Setup Aids

Presets: scales the vertical range to predetermined values for displaying ECL (0.0 V to -2.0 V) or TTL (-0.5 V to +5.5 V) waveforms.

Activity: aids the scaling of vertical range and offset using a display of signal activity placed with respect to the voltage limits specified. Activity shown while not running.

TIMING

Timing Mode/clock

Ranges: 10 ns to 500 ms in a 1-2-5 sequence.

Timebase Accuracy

sample period: $\pm 0.01\%$

time interval accuracy

single-shot: $= \pm 1$ sample period

continuous: $= \pm .15$ sample period, based on 100 averages.

Timing Mode/data Indexing

Asynchronous pattern: 20 ns to 1 ms in a 1-2-5 sequence with an accuracy of $\pm 20\%$ or 15 ns, whichever is greater. Glitch or edge on selected channels ANDed with asynchronous pattern.

Maximum time delay: Approximately 2^{18} times the sample period to a maximum of 9999 seconds.

Timing Mode/expansion

Times 1 to times 40 in a 1-2-4 sequence. Display is a compressed representation of the 1k memory in times 1 magnification. In times 2 magnification and above, each display sample represents a single sample in memory.

Timing Mode/overview

Graph: A graph of any user-defined label can be shown. The user can specify the upper and lower bounds of the graph, and all 1024 states of the memory can be simultaneously displayed.

Measurement Aids

Cursors: two cursors (x and o) are provided for making time measurements on waveform patterns.

Cursor Statistics: x-to-o cursor statistics are provided for time measurements: maximum, minimum, mean, and standard deviation.

Cursor Placement/data Marks: both x and o cursors and up to four data marks (a,b,c, and d) can be uniquely specified with respect to the trace point or acquisition start by selecting up to eight timing patterns (Pn) in conjunction with choices of entering/leaving the pattern (including any glitch) along with greater-than/less-than time intervals.

STOP Continuous RUN: Pressing RUN processes timing data acquisitions until the cursor-based RUN-STOP condition is met. RUN-STOP conditions include greater-than/less-than time intervals or a specific data mark quantity, a specific number of acquisitions, or a sequence of up to four data mark terms. The time from the end of the acquisition until the instrument is ready to accept a new acquisition is approximately 100 ms (with statistical measurements and data marking off).

Table 1-2. Operating Characteristics (Cont'd)

STATE

Memory

Data acquisition: 1024 words

Compare: 16 words

Search: Memory may be searched for any pattern defined within a label set. All pattern matches in memory may be marked or separately displayed.

State Mode/clocks: three ORed clocks operate in one-phase or two-phase demultiplexing mode. Clock edge is selectable as positive, negative, or both edges for each clock. Different edge selections may be made on the same clock if it is used in both phases of the multiplexed mode.

State Mode/data Indexing

Resources: four terms including the Boolean NOT of each term, any pattern or NO pattern; a term is the AND combination of bit patterns in each label. Terms may be used as often as desired.

Trigger: up to four resource terms may be used in sequence to establish the trace parameter. The last term in the sequence may use up to four resource terms in an ORed format.

Restart: one to four resource terms may be used in an ORed condition for a sequence restart condition.

Store qualifiers: one to four resource terms may be used in an ORed format. Store qualification may be separately defined for each term in the trigger sequence.

Occurrence: the number of occurrences of the last event in the sequence may be specified up to $n=59999$.

Edit compare: trace until compare "equal to" or "not equal to" is provided. The compare file is the width of the analyzer, with a depth of up to 16 words. Each word in the compare buffer can have "don't cares" and can be compared anywhere in the 1024-word memory.

State Mode/overview

XY chart: a chart of any user-defined label can be shown. The user can specify the upper and lower bounds of the chart, and all 1024 states of the memory can be simultaneously displayed.

Time-interval measurement: A timer can be started on completion of a sequence of up to three resource terms with restart and occurrence capabilities such as state data indexing. The timer can be stopped on an ORed combination of one to four resource terms. A histogram of the start/stop measurement is displayed. The user can specify up to eight time ranges. Minimum time, maximum time, average time, last time, total time, and total samples are also displayed.

Resolution: displayed statistics—250 ns or 1% of reading, whichever is greater, (four digit display).
histogram ranges: 1 ms.

State label measurement: a histogram of any user-defined label can be shown. The user can specify up to eight labels and ranges.

Maximum count: $2^{63} - 1$.

INTERACTIVE MEASUREMENTS

Acquisition: analog, timing and state data acquisition occur simultaneously.

Arming: either of the three analyzers can be master while the remaining two are slave.

Master state: the waveform analyzer and the timing analyzer can be simultaneously armed by the full data indexing capability of the state analyzer.

Master timing: the waveform analyzer and the state analyzer can be simultaneously armed by the full data indexing capability of the timing analyzer.

Master analog: the timing analyzer and the state analyzer can be simultaneously armed by the full analog indexing capability of the waveform analyzer.

Arming time: the time required to arm and be armed in a master/slave configuration is:

state index to arm reference high: approximately 75 ns.

timing index to arm reference: approximately 12 times (sample period) + 10 ns

analog index to arm reference high: approximately eight times (sample period) + 10 ns

arm reference high to analog armed: approximately -5 ns

arm reference high to timing armed: approximately -20 ns

arm reference high to state armed: approximately -30 ns

Table 1-2. Operating Characteristics (Cont'd)

Tracepoint Alignment: analog, timing, and state acquisition data can be correlated in time.

Mixed display: timing channels can be displayed on the same screen with analog channels; the tracepoint and time/div are common to timing and analog in this display mode, and set by the timing analyzer.

Tracepoint alignment: analog waveform data alignment to timing analyzer data is less than 1 analog sample period + timing sample period + 15 ns

Operating modes: to correlate data between analyzers, the slave analyzer must be set up to trigger on a DON'T CARE (timing) or TRIGGER IMMEDIATE (analog) condition. Any other slave trigger condition results in uncorrelated data.

Timing analyzer master: analog slave - trigger immediate.

Analog master: timing analyzer slave - trigger pattern, all DON'T CARES.

State analyzer master: timing analyzer slave - trigger pattern, all DON'T CARES; analog slave - trigger immediate.

Insert-to-correlate: provides cursor correlation, between timing and analog data. Cursors in one waveform display can be directly placed at the same time location as those cursors in the other waveform display by pressing insert-to-correlate. The cursor in the MAGNIFY ABOUT [] selection is cursor-correlated. Going to a post-processing menu causes the cursors to return to their specified location.

Table 1-3. General Characteristics

Labels

Input channel labels: up to eight state, 16 timing, user-defined, five-character labels may be assigned bit patterns in any configuration up to 43 bits per label. Bits may be used in more than one label and need not be contiguous. Primary use is for identifying bits assigned to bus structures such as address, data, and status.

User field: all labels with four bits or less allow mnemonics to be assigned to specific patterns. Primary use is to identify such functions as read, write, opcode, etc.

Relocatable field: any single label may be defined to have relocatable properties to facilitate viewing software modules in the format they were written. Up to sixteen module starting-locations may be specified, allowing trigger parameters to be based on module names, plus an offset value. An on board calculator that operates in hex, octal, binary, or decimal facilitates generating the offset table.

Time-of-day-clock: a 24-hour clock prints out the time of data collection on all stored records.

Activity Markers: provided in the format display for identification of active inputs.

HP-IB Outputs: an HP-IB connector, along with an eight-position HP-IB switch, is located on the rear panel. Five positions on the switch are used to determine the address, two positions are used to determine "talk-only," for hardcopy, or system controller modes. The HP-IB can be used in the following environments.

1. Logic analyzer being controlled from a controller, such as an HP 9826A.
2. Hardcopy on graphics printer, such as the HP 2225A.
3. Storage of setups and data. Using the HP 9121S/D or 9122S/D disc drive, up to 64 files can be stored on one disc. Also, when coupled with an appropriate microprocessor, the HP 1631A/D can assume a microprocessor-specific personality to present data in a mnemonic format.

Outputs/rear-panel BNCs: one output BNC is located on the rear panel with TTL output. High is $\geq 2V$ into 50Ω ; low is 0.4 V into 50Ω . The BNC can be programmed from the keyboard to provide the following signals.

1. Pulse on state tracepoint
2. High until state tracepoint
3. Low until state tracepoint
4. High on last sequence
5. Constant high
6. Constant low
7. High on timing pattern
8. Probe compensation source
9. Positive edge on analog trigger.

A second BNC is located on the rear panel to provide +5 V for the HP 10269B probe (processor) interface.

Operating Environment

Temperature: 0° to 55° C (32 to 131° F)

Humidity: up to 95% relative humidity at 40° C.

Altitude: to 4 600 m (15 000 ft).

Vibration: vibrated in three planes for 15 minutes each with 0.3 mm excursions, 5 to 55 Hz.

Dimensions: refer to outline drawing:

Weight: HP 1631A: 13.2 kg (29 lb) net; 17.7 kg (39 lb) shipping.

HP 163D: 13.8 kg (30 lb) net; 18.4 kg (40 lb) shipping.

Power: 115/230 Vac, -22% to +10%; 300 W max; 48-66 Hz.

Programmability; all instrument configurations and acquisition data may be remotely programmed via HP-IB (IEEE-448) or HP-IL.

Chapter 2

Installation

INTRODUCTION

The purpose of this chapter is to describe how the analyzer is set up and the probe cables are connected for measurements to a system under test. The self test of the analyzer and messages that may be displayed during the self test are also described.

INITIAL INSPECTION

WARNING

To avoid hazardous electrical shock, do not perform electrical tests when there are signs of shipping damage to any portion of the outer enclosures of the instrument (covers and panels).

Inspect the shipping container for damage. If the shipping container or cushioning material is damaged, it should be kept until the contents of the shipment have been inspected mechanically and electrically. If the contents are incomplete, if there is mechanical damage or defect, or if the instrument does not pass the self test, notify your nearest Hewlett-Packard Sales and Service Office. If the shipping container is damaged, or the cushioning materials show signs of stress, notify the carrier as well as the Hewlett-Packard office. Keep the shipping materials for inspection by the carrier.

POWER REQUIREMENTS

The 1631A/D Logic Analyzer requires a power source of either 115 or 230 Vac -22% to $+10\%$; single phase, 48 to 66 Hz; 275 Watts maximum power.

WARNING

This is a Safety Class I product (provided with a protective earth terminal). An uninterruptible safety earth ground must be provided from the main power source to the product input wiring terminals, power cord, or supplied power cord set. Whenever it is likely that the protection has been impaired, the instrument must be made inoperative and be secured against any unintended operation.

If this instrument is to be energized via an autotransformer for voltage reduction, make sure the common terminal is connected to the earthed pole of the power source.

LINE VOLTAGE SELECTION

CAUTION

BEFORE CONNECTING THIS INSTRUMENT to line (Mains) voltage, be sure the line voltage switch is set correctly and that the proper fuse is installed.

If the line fuse burns out, do not replace it until the cause for failure has been determined and repaired by a qualified service person. Replacing this fuse in a damaged instrument can cause additional damage.

AC POWER CABLE



BEFORE CONNECTING THIS INSTRUMENT, the protective earth terminal of the instrument must be connected to the protective conductor of the (Mains) power cord. The Mains plug must be inserted in a socket outlet provided with a protective earth contact. The protective action must not be negated by the use of an extension cord (power cable) without a protective conductor (grounding). Grounding one conductor of a two conductor outlet does not provide an instrument ground.

This instrument is equipped with a three-wire power cable. When connected to an appropriate power receptacle this cable grounds the instrument cabinet. The type of power cable shipped with each instrument depends on the country of destination.

OPERATOR'S MAINTENANCE

The only instrument maintenance an operator needs to perform is to occasionally clean the display screen and the front panel keyboard. When cleaning the 1631A/D, caution must be used with which cleaning agents are used. Use a mild soap and water solution. If a harsh soap or solvent is used, the water-base paint finish will be damaged.



Use care when cleaning the front panel keyboard. Water can damage the keyboard circuitry if it seeps under the keys.



Do not use chemical cleaning agents or abrasive cleaners that may damage the plastics in this instrument. Recommended cleaning agents are isopropyl alcohol, or a solution of 1% mild detergent and 99% water.

SITE SELECTION

Place the logic analyzer on a clean workspace which has adequate ventilation.

REAR-PANEL ADDRESS SWITCH

The dip (dual-inline-package) switch on the rear panel of the logic analyzer is used to configure the analyzer for operation on the HP-IB and/or HP-IL interface buses, and to execute the self-test routine. The first five switches set the address of the analyzer for HP-IB operation. Switch six executes the analyzer self-test when set to '1'. The positions of switches 7 and 8 determine the analyzer configuration on the HP-IB/HP-IL interface buses as follows:

Switches	HP-IL	HP-IB
7 8		
0 0	Inactive	1631 Controller
1 0	External Controller	1631 Controller
0 1	Inactive	External Controller
1 1	Inactive	1631 Controller

NOTE

A switch is set to "1" when its toggle lever is up, and set to "0" when its toggle lever is down.

REAR PANEL BNC CONNECTORS

The rear-panel BNC labeled ACCESSORY POWER provides 5 volts (1 ampere maximum) for operating an external HP preprocessor interface module.

The rear-panel BNC labeled PORT provides a TTL control signal whose characteristics are selectable in the SYSTEM [Peripherals] menu for control of external measurement instruments and equipment.

CONNECTING OPERATING POWER

WARNING

Before switching the instrument on, connect all protective earth terminals, extension cords, auto-transformers, and devices to a protective earth grounded socket. Any interruption of protective earth grounding is a potential shock hazard that could result in personal injury or death.

Use only the recommended fuse with the required current rating. Do not use repaired fuses or short-circuited fuseholders. To do so could cause severe shock or fire hazard.

CAUTION

Before switching the instrument power switch to the on position, the line selection switch on the rear panel must be set to the voltage power source, or damage to the instrument may result.

Excessive input voltage will damage the input attenuators. Observe the maximum input rating described in table 1-1.

APPLYING OPERATING POWER

Follow these steps before applying line power to the instrument.

On rear panel:

1. Check VOLTAGE SELECTOR switch for correct setting.
2. Plug supplied power cable to appropriate power source.

Press front panel LINE to 1 (down position).

Self-Test

The analyzer has a self-test routine contained in the analyzer ROM. The self-test of the 1631A/D checks RAM, ROM, and functioning of the measurement channels within the analyzer. The self-test also checks the HP-IB port.

The self-test provides troubleshooting information if the analyzer is not functioning in the normal manner. If an error is displayed during the self-test, or if the self-test does not occur, contact your nearest Hewlett-Packard Sales and Service Office.

NOTE

Before initiating the self-test, disconnect any connected pods from the target system and the HP-IB cable from the rear panel of the analyzer.

To initiate the self-test, set switch 6 of the HP-IB address switch, on the rear panel to "1" (switch lever up). Cycle the front panel LINE power, off and on, and the analyzer automatically executes the self-test.

1631A/D Self-Test

When the self-test of the 1631A/D has been successfully completed, the following messages are displayed on-screen:

RAM ok

ROM ok

Acquisition ok

Analog Board ok

HP-IB ok

SELF TEST PASSED

Reset rear panel switches to xxxx xOxx to continue

If the self-test has not been successful, one or more of the following messages will appear on-screen:

Error in RAM
Error in ROM #n Expected XX was YY

Acq error
nn nn nn nn nn nn nn

NOTE

Acquisition error messages are for servicing the logic analyzer and are explained in the service documentation.

CONNECTING ANALYZER TO SYSTEM UNDER TEST

The analyzer can collect information through either HP Model 10269A/B Probe Interface or through direct connections from the general purpose probes. The procedures to be followed when making the connections will differ, depending upon which of the two types of connections are made. Refer to the procedures given in the following paragraphs for a description of how to make the connections for your particular equipment.

Connecting Analyzer Through Probe Interface 10269A/B

1. Install the preprocessor interface module in the probe interface.
2. Connect the ribbon cable from the probe interface (with preprocessor interface module installed) to the microprocessor in the target system.
3. Connect the probe pods from the analyzer to the appropriate pod sockets on the probe interface. Refer to the general purpose preprocessor operating note for appropriate pod connections.
4. Connect a BNC cable from the ACCESSORY POWER BNC on the analyzer rear panel to the ACCESSORY POWER (+5V) BNC connector on the probe interface.

NOTE

Some interface modules can draw up to 1 ampere from the 5-volt supply. If using coaxial cable, HP recommends using 4 feet, maximum, of type RG-58 coaxial cable to minimize voltage drop.

Connecting Probes Directly To System Under Test

1. Snap on the clip assembly adapters for each of the general purpose probe pods.
2. Connect the line for each probe bit to monitor a node in the system under test. Leave extra lines unconnected. Do not connect signals with different threshold levels (some TTL and some ECL, for example) in the same probe pod.
3. Connect the ground probe from each pod to a ground point in the system under test.

Chapter 3

Front Panel Controls And Menu Map

INTRODUCTION

This chapter consists of two figures to help familiarize the user with the operation of the 1631A/D Logic Analyzers. Figure 3-1 is the front panel keyboard of the 1631D. The function of each key is described in the figure.

Figure 3-2 is a map of the available menus selectable through the INPUT/OUTPUT DISPLAYS keys at the top of the front panel keyboard. In general, making analog, timing, state or interactive measurements may be accomplished with the following steps:

For Analog Measurements

- Start with the SYSTEM Specification [Configuration] menu (power-up or press SYSTEM).
- Configure for analog analysis by selecting analog channels. Power-up and DEFAULT condition is for analog analysis.
- FORMAT the input data by assigning labels, probe type and voltage levels (press FORMAT).
- Specify the TRACE to be collected by the analog analyzer (press TRACE).

For Timing Measurements

- Start with the SYSTEM Specification [Configuration] menu (power-up or press SYSTEM).
- Configure for timing analysis by selecting timing channels and glitch mode (on or off).
- FORMAT the input data by assigning labels (press FORMAT).
- Specify the TRACE to be collected by the timing analyzer (press TRACE).

For State Measurements

- Start with the SYSTEM Specification [Configuration] menu (power-up or press SYSTEM).
- Configure for state analysis by selecting all channels for state measurements (use ROLL keys).
- FORMAT the input data by assigning labels to groups of probe bits (press FORMAT).
- Specify the TRACE to be collected by the state analyzer (press TRACE).

For Interactive Analog/Timing/State Measurements

- Start with the SYSTEM Specification [Configuration] menu (power-up or press SYSTEM).
- Configure for interactive measurements by selecting a combination of analog, timing, and state channels.
- FORMAT the input data by assigning labels to all input channels (toggle FORMAT).
- Specify the TRACE to be collected by the analog, timing, and state analyzers (toggle TRACE).

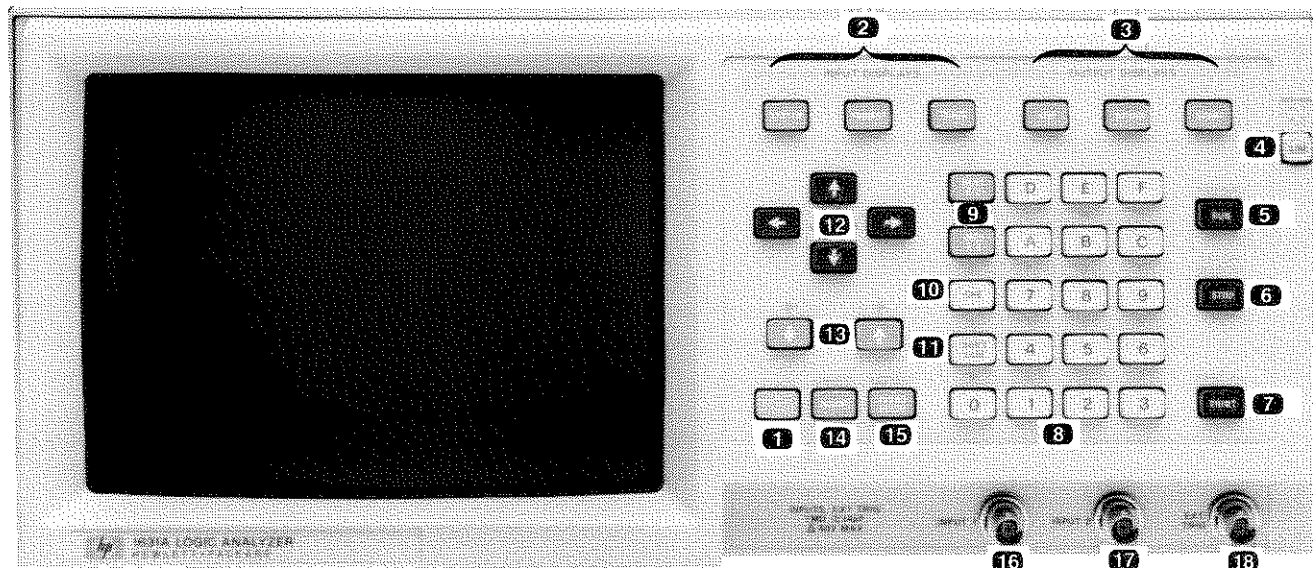
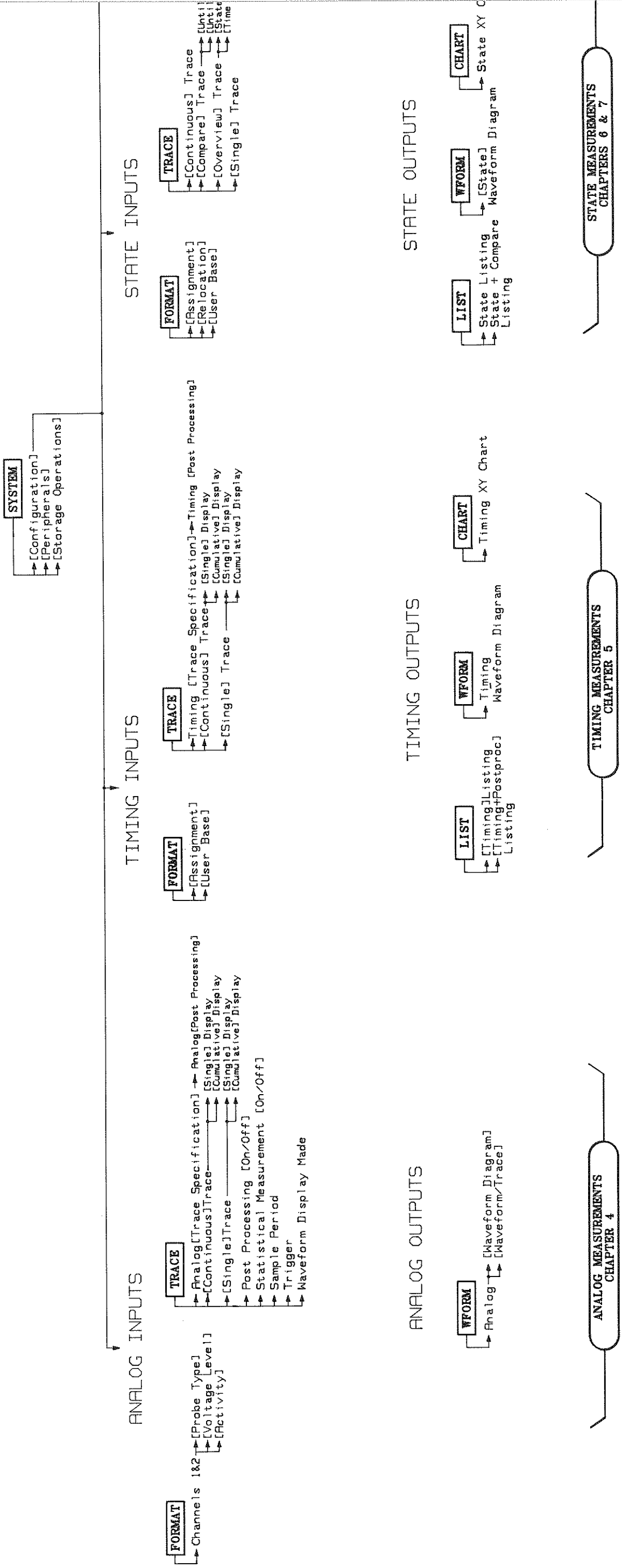

Figure 3-1. Front Panel Controls

- 1** Blue key. This key activates the blue SHIFT function assigned to each keyboard key. A momentary press activates the SHIFT function for the next keystroke. The SHIFT function will continue as long as you keep the blue key pressed.
- 2** INPUT DISPLAYS. Three keys that select sets of 1631A/D menus. SYSTEM calls up menus that define the instrument configuration, set up secondary configurations and outputs for peripherals, and storage operations (when a disc drive is connected and active). FORMAT has three menus that determine how data is collected and interpreted on the display. TRACE has a series of menus that specify the measurement mode and parameters for collecting data.
- 3** OUTPUT DISPLAYS. three keys that select a state display (LIST), timing and analog displays (WFORM), or performance overview chart(CHART).
- 4** LINE. Switches operating power to On or Off position.
- 5** RUN. initiates a new measurement; RESUME continues an incomplete measurement that was halted by pressing the STOP key.
- 6** STOP. Terminates a measurement or print out; RETURN TO LOCAL overrides an HP-IB or HP-IL controller to return control of the analyzer to the keyboard.
- 7** PRINT. commands the current display content to be printed on an HP-IB graphics printer. PRINT ALL prints the entire content of a displayed menu or, when a list is displayed, prints the entire trace list (including all off-screen information) from the on-screen information to the the end of trace memory.
- 8** Hex keyboard for data entry.
- 9** NEXT [] and PREV [] keys cycle through all the menu selections available for fields enclosed in brackets, [].
- 10** CHS. Used to change ± signs when specifying memory locations in either direction from the trigger event, and when specifying polarities. This key will also print a dash when used in a text field.
- 11** DON'T CARE. enters an "X" in lieu of a number, to indicate "any value will serve". When used in a text field in lieu of a letter, enters a space.
- 12** CURSOR. These keys move the cursor from field to field in the menus. The blue SHIFT function allows these keys to rearrange the order of labels in the menus, and to move the cursor from pod to pod in the label lines of the FORMAT [Assignment] menu. The CURSOR keys can also move the configuration bar in the SYSTEM [Configuration] menu, and the "x" and "o" markers on the waveform and chart displays.
- 13** ROLL keys move timing displays left or right, state lists up or down, and the configuration bar in the SYSTEM [Configuration] menu.
- 14** INSERT/DELETE are used to add or delete fields and labels.
- 15** CLEAR ENTRY. This is the field eraser key; DEFAULT returns all fields in the displayed menu to their power-up conditions.
- 16** INPUT 1. Channel 1 analog input.
- 17** INPUT 2. Channel 2 analog input.
- 18** EXT TRIG. Analog channel input for external trigger signal.

INPUT/OUTPUT DISPLAYS MENU MAP



ANALOG MEASUREMENTS
CHAPTER 4

M1631B1B-25JUN85

TIMING MEASUREMENTS
CHAPTER 5

STATE MEASUREMENTS
CHAPTERS 6 & 7

all
rval]

INTERACTIVE INPUTS

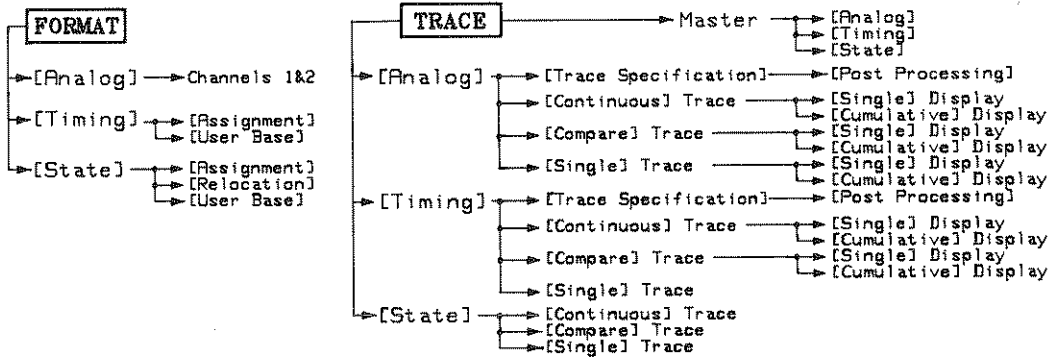

INTERACTIVE OUTPUTS

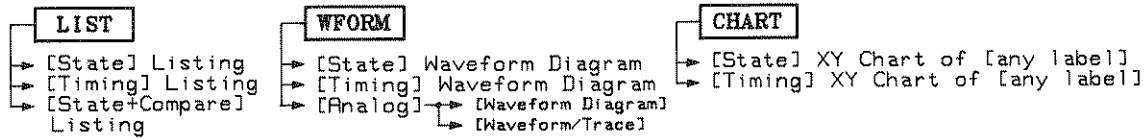

INTERACTIVE MEASUREMENTS
CHAPTER 8

Figure 3-2.
Input/Output Displays Menu Map
3-3/(3-4 blank)

Chapter 4

Analog Measurements

INTRODUCTION

The 1631A/D Logic Analyzer contains an integral two channel high speed analog acquisition system which combines the utility of a general purpose digitizing oscilloscope with the power of interactive analog, timing, and state measurements. Because of the digital storage architecture of the analyzer, simultaneous acquisition on both channels with inherent time correlation and negative time capture is possible. This allows the designer to reliably trigger on and display single shot or low repetition rate events with ease. When triggered interactively from the timing or state analyzer, the analog analyzer can capture highly qualified parametric data which could never before be observed with a conventional oscilloscope.

There are two modes of operation available when making analog measurements. The first offers the same interface to analog data acquisition as to the state and timing analyzers. The System [Configuration] Specification menu is used to select the desired mix of state, timing, and analog functions for the particular measurement situation. The Format Specification menu provides selections for probe attenuation and voltage ranges for each analog input channel. Analog trigger conditions and tracepoint placement are set up in the Analog Trace Specification menu. These logic analyzer interface menus ideally suit the analog measurements to the interactive measurement environment.

The second mode of operation is aimed at using the analog acquisition system as a stand alone general purpose oscilloscope. Provision is made to display selections from the trace specification on the same screen as the waveform diagram which allows the user to run the analyzer in a continuous trace mode and observe the captured waveform diagram while changing the trigger specification. This mode of operation is the power on default mode of operation for the logic analyzer. When RUN is pressed, the analyzer is in the stand alone, free running oscilloscope mode. Figure 4-1 is the power up default System [Configuration] menu of the logic analyzer configuring the analyzer for analog measurements.

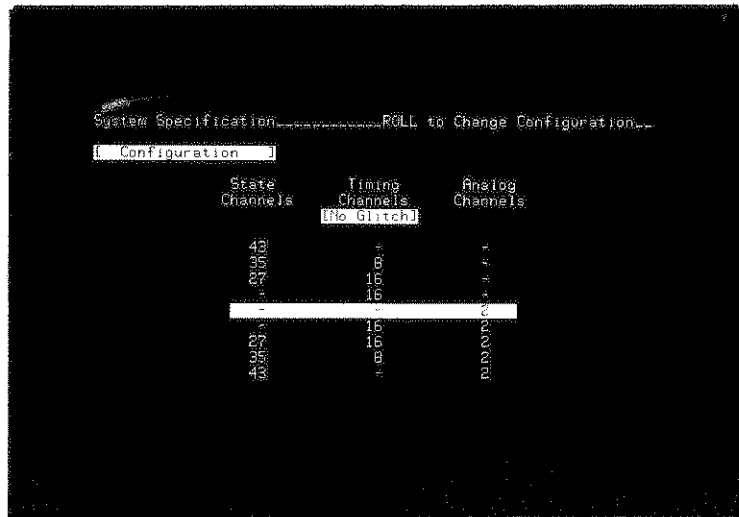

Figure 4-1. 1631D Default System [Configuration] Menu

NOTE

The figures in this manual pertain to the 1631D. The 1631D has 16 timing channels and the 1631A has 8 timing channels.

The Analog Format Specification Menu allows assignment of user defined labels to the two input analog channels. Probe type and input voltage ranges are also selected in this menu.

The trace specification is used to qualify data before it is stored in the data acquisition memory of the logic analyzer. Selective tracing techniques are specified in the Analog Trace Specification to recognize triggers and store only qualified data.

Post Processing

The Post Processing menu allows placement of the x and o cursors anywhere in the stored data trace. A readout of the time interval between the x and o cursor is available on the display of the data trace.

Statistical Measurements

Statistical measurements are part of the analog post processing mode which supply statistical information on the Analog [Waveform Diagram]. The readouts are field selectable and include the mean and the standard deviation of the time interval or the voltages of the x or o cursor on either channel, and minimum and maximum time of the time interval or voltages of the x or o cursors on either channel.

THE ANALOG FORMAT SPECIFICATION

The Analog Format Specification is used to identify and set up the incoming analog activity for the logic analyzer. Figure 4-2 is the Analog Format Specification menu in the default, power-up condition.

Channel Labels:	one to five alphanumeric characters.
Probe Type:	[1X], [10X], or [50X] sets full scale voltages of 2.50V, 25.0V or 125V respectively.
Voltage Levels:	two predefined ranges for TTL and ECL or may be specified within the full scale voltage range set with probe type.
Activity Monitor:	shows the voltage activity on each channel. Arrows indicate activity above Upper Limit or below Lower Limit.

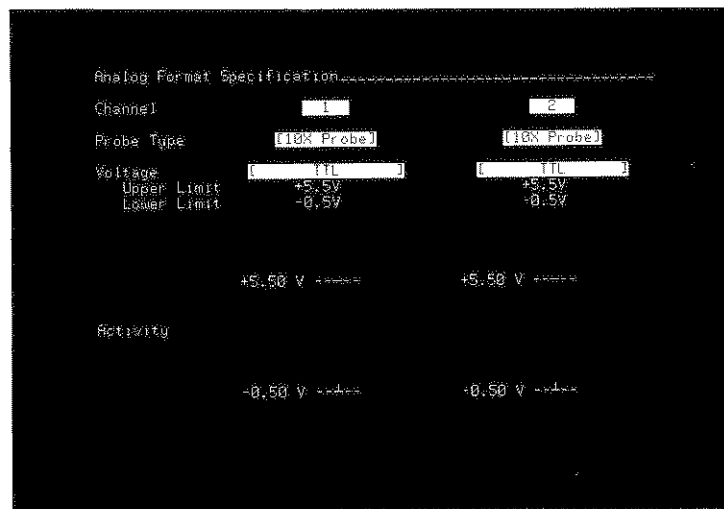

Figure 4-2. Analog Format Specification Menu

Channel Label Assignments

The two input analog channels are automatically labeled 1 and 2 on power-up of the logic analyzer. Any label of up to five alphanumeric characters can be assigned to a channel by moving the cursor to the label field and entering the characters with the logic analyzer front panel keys.

Probe Type and Voltage Selection

The logic analyzer uses the selected probe type to determine the scale of the waveform to be displayed. Either 1X, 10X, or 50X probe type may be selected.

NOTE

When a field is enclosed in brackets, [], the other possible choices for that field are selected with the NEXT[] or PREV[] keys when the cursor is in the field.

Selecting a probe type also determines the maximum input for the channel. Table 4-1 lists the voltages that may be selected with the given probe types.

Table 4-1. Probe Type and Voltage Range Selection

Probe Type	Voltage Range	Default Upper Limit	Default Lower Limit	Full Scale Voltage
[1X]	[ECL]	0.0V	-2.0V	NA
	[Specified Below]	+1.2V	0.0V	2.50V
[10X]	[ECL]	0.0V	-2.0V	NA
	[TTL]	+5.5V	-0.5V	NA
	[Specified Below]	+12.00V	00.00V	25.0V
[50X]	[TTL]	+5.5V	-0.5V	NA
	[Specified Below]	+120.0V	000.0V	125V

When [Specified Below] is selected, upper and lower voltage limits are assigned to the input channel by the logic analyzer. Different voltage levels may be assigned by moving the cursor into the Upper Limit or Lower Limit field and entering the different voltage level from the logic analyzer front panel. The Upper Limit must be greater than the Lower Limit. The difference between the upper and lower limit must be greater than 0.04V for the 1X probe, greater than 0.4V for the 10X probe, and greater than 2.0V for the 50X probe.

Activity Monitor

The area on the lower half of the Analog Format Specification Menu is the Activity Monitor. The logic analyzer senses the activity on the analog probe and indicates the voltage level within the upper and lower limits specified. An arrow above the upper limit or below the lower limit indicates voltage activity beyond the range specified which will be clipped on the Analog Waveform Display. The activity monitor can be used to help set up the logic analyzer for an unknown voltage. The unknown voltage level is set up by selecting [Specified Below] for the Voltage range and setting the Upper and Lower Limits to just above and below the voltage activity indicated by the Activity Monitor.

NOTE

The activity monitor senses probe activity only when the analyzer is not capturing a trace.

THE ANALOG TRACE SPECIFICATION

There are two trace modes available in the Analog Trace Specification menu: [Single] and [Continuous]. The default and power-up mode is the [Continuous] Trace Mode. Figure 4-3 is the Analog Trace Specification in the default condition.

Trace Mode:	[Single] or [Continuous] traces of analog data.
Display Mode:	[Single] or [Cumulative] displays of analog data.
Post Processing:	[On] - Post Processing accessible from the Analog [Trace Specification] menu.
Statistical Measurements:	[On] - Statistical information available on the Analog [Waveform Diagram] when Post Processing is [On].
Sample Period:	Selectable in 1,2,5 sequence. Ranges are from 5 ns to 500 ms (26 sample periods).
Acquisition Time:	Function of sample period, amount of time for analyzer to collect samples for one trace (approx 1K samples).
Tracepoint Location:	[Start], [Center], or [End] trace at specified trigger plus delay. Determines amount of pretrigger and posttrigger time in memory.
Trigger:	[Immediate], [1], [2], or [External]
Waveform Display Mode:	[Straight Line] displays acquired data points connected by straight lines. [Filtered] mode uses a line reconstruction algorithm to display points between the acquired data points.

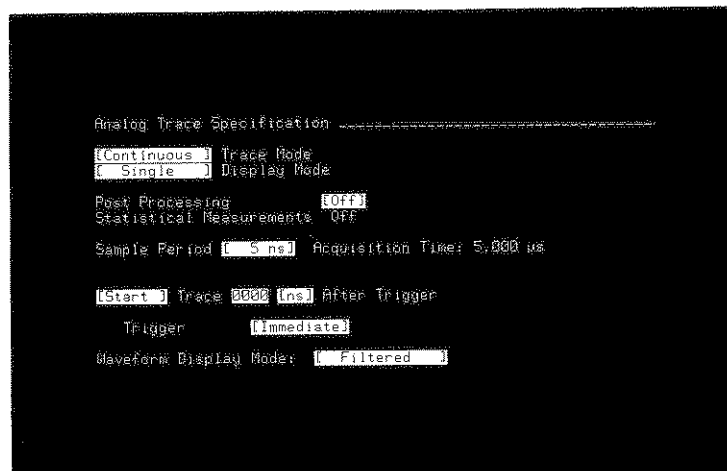

Figure 4-3. Analog Trace Specification Menu

[Single/Continuous] Trace Modes

The [Single] Trace Mode is used to capture a single trace of analog activity for each of the analog input channels. The trace is invoked by pressing RUN. The analog trace is displayed until the next trace is taken.

In [Continuous] Trace Mode, RUN is pressed to invoke consecutive single trace measurements. As soon as a measurement is completed, the display is updated and the analyzer begins another measurement. The consecutive measurements continue until STOP is pressed or a Stop Continuous Runs specification from the Post Processing menu is fulfilled.

[Single/Cumulative] Display Modes

In [Single] Display Mode, the analyzer displays one trace acquired from each channel. The screen is cleared before the next trace is displayed. In the [Cumulative] mode, the display is not cleared before the next trace is displayed.

Sample Period

Sample periods are field selectable with the NEXT[] and PREV[] keys. The sample periods range from 5 ns (200 MHz sample rate) to 500 ms (2 Hz sample rate). The sample periods are in a 1, 2, 5 sequence.

Tracepoint Specification

The tracepoint specification is defined as the trigger plus a user specified delay. It is used to see samples of a waveform after, around, or leading up to a specified trigger.

When the tracepoint is specified as the [Start] of the analog trace, the analyzer finds the trigger, stores approximately 50 samples, the trigger and the next 950 samples. The acquired waveform is then displayed, starting with the specified trigger.

To see samples before and after the trigger, the tracepoint can be specified at [Center] Trace. In this case, as soon as the data acquisition memory sees the trigger, approximately 500 samples previous to the trigger, the trigger, and the next 500 samples are stored. The resulting waveform display centers the sampled waveform at the specified tracepoint.

When the tracepoint is specified as [End] Trace, the data acquisition memory stores samples until the trigger is found. The resulting waveform displayed is approximately 950 samples leading up to the specified trigger, the trigger, and the next 50 samples.

The tracepoint can be further delayed by specifying a delay period in the tracepoint specification.

Trigger Specification

There are four trigger selections available in the Analog Trace Specification menu: [Immediate], channel [1] or [2], and [External].

Trigger [Immediate] is the default trigger condition and is the same as a Don't Care trigger specification. Trigger immediate is also used in a mixed analyzer mode to allow full triggering capability from the state or timing analyzer. When the analyzer is in analog only mode (no channels assigned to state or timing) and in [Continuous] Trace Mode, the analyzer is in a free-run mode. If in mixed mode (channels assigned to either state or timing) and in [Continuous] Trace Mode with Trigger [Immediate], the analyzer will be triggered off the assigned master.

CAPTURING AN ANALOG TRACE

Setting Up the Analog Format Specification

1. Switch logic analyzer LINE power to ON position. The analyzer will power up in the analog mode with no channels assigned for state or timing measurements as figure 4-1.
2. Press FORMAT. The Analog Format Specification will be displayed as in figure 4-2.
3. Connect the probe from analog INPUT 1 to a node of the target system. In this example, AO (address line 0) of an 8085 microprocessor is connected to INPUT 1.
4. Figure 4-4 shows the change in the activity monitor when a signal is connected to INPUT 1. The activity on INPUT 1 is within the specified TTL limits set by the logic analyzer on power-up.

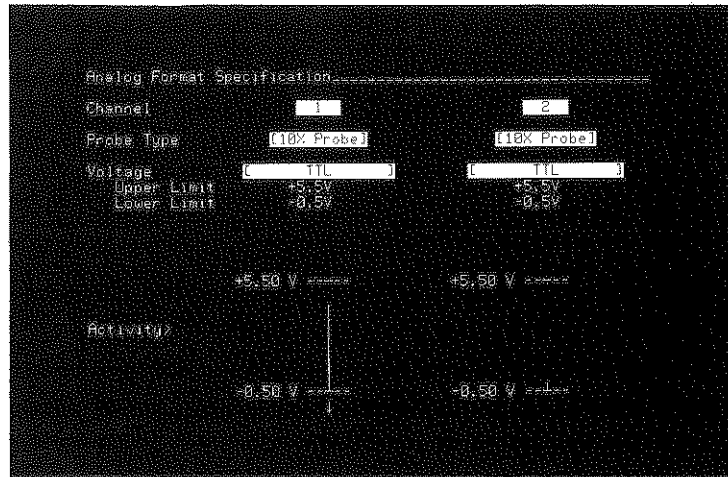

Figure 4-4. Activity on Analog INPUT 1

- Press RUN. The logic analyzer will take continuous traces of the activity on both analog channels and display the activity on the Analog [Waveform/Trace] display.
- Press STOP and the analyzer will capture a single trace from each channel and display them as in figure 4-5.

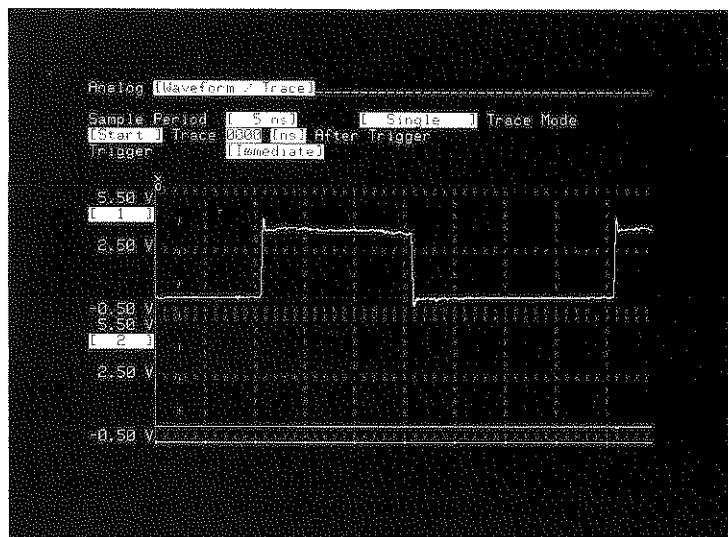

Figure 4-5. Analog Activity Captured from INPUT 1

Controlling the Analog [Waveform/Trace] Display

The Analog [Waveform/Trace] display contains trace specifications from the Analog Trace Specification menu. The specifications may be changed in either menu and affect both.

Selecting Trace Positions on the Display

- Press the cursor down key to move the cursor into the channel [2] field beside the waveform display for channel 2.
- Press the NEXT[] key several times to see the selections that can be displayed rather than channel 2.
- Press the blue shift key and DELETE to remove channel 2 from the display. (Channel 2 can be restored to the display by pressing INSERT.)

Triggering on a Voltage

1. Move the cursor to the Trigger field and select [1] by pressing NEXT[]. When a trigger other than [Immediate] is selected, slope and trigger level may then be specified.
2. Move the cursor to the Trigger Level field and specify a voltage on the rising edge of the displayed waveform for the analyzer to trigger on.
3. Press RUN and the analyzer will take a trace triggered on channel 1 at the specified voltage as in figure 4-6.

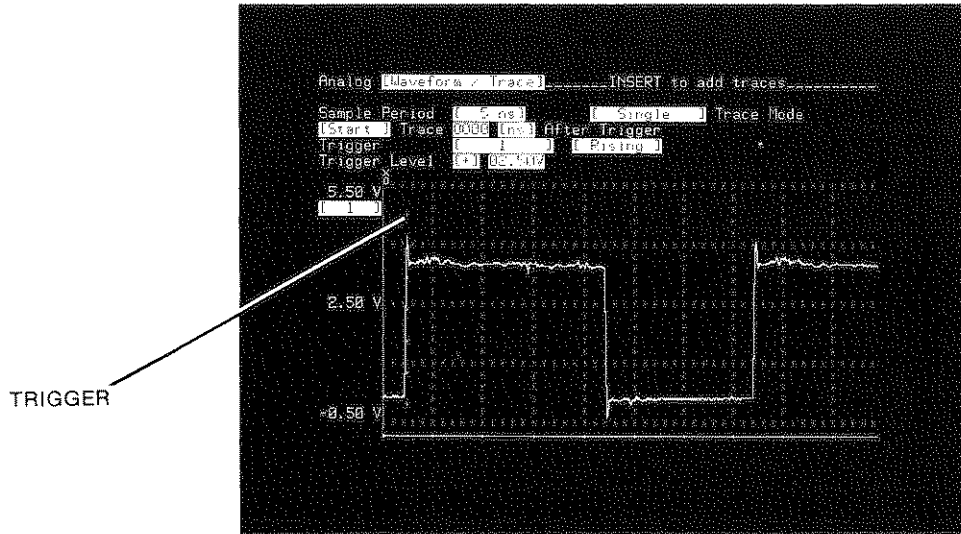

Figure 4-6. Triggering the Analog Analyzer on a Voltage

Specifying the Tracepoint

The tracepoint can be changed from the start of the of the trace to the center or end.

1. Move the cursor to [Start] Trace field in the Analog [Waveform/Trace] menu.
2. Select [Center] Trace After Trigger by pressing NEXT[] or PREV[].
3. Press RUN. One trace will be displayed which has the tracepoint centered in the trace as in figure 4-7.

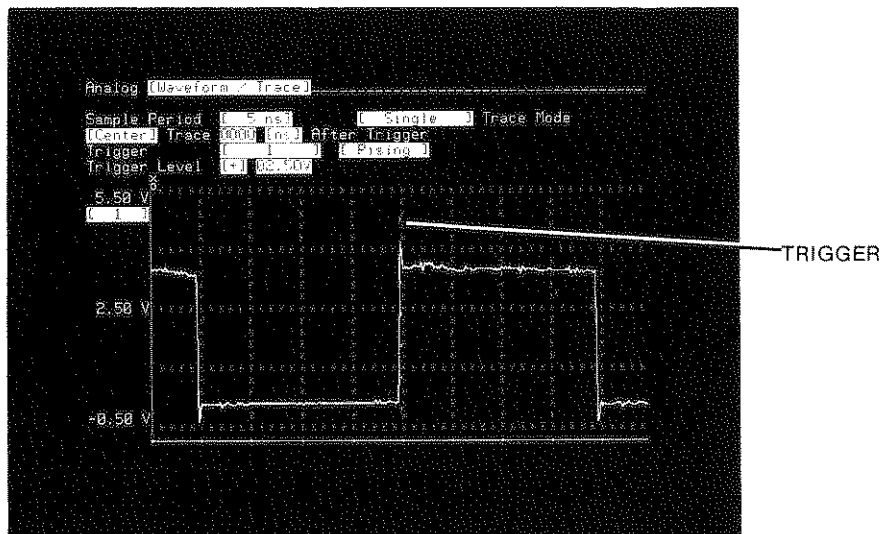

Figure 4-7. Trigger Centers Trace

- Select [End] with the NEXT[] key to specify the trace to end at the trigger. Press RUN and the trace will be displayed as in figure 4-8.

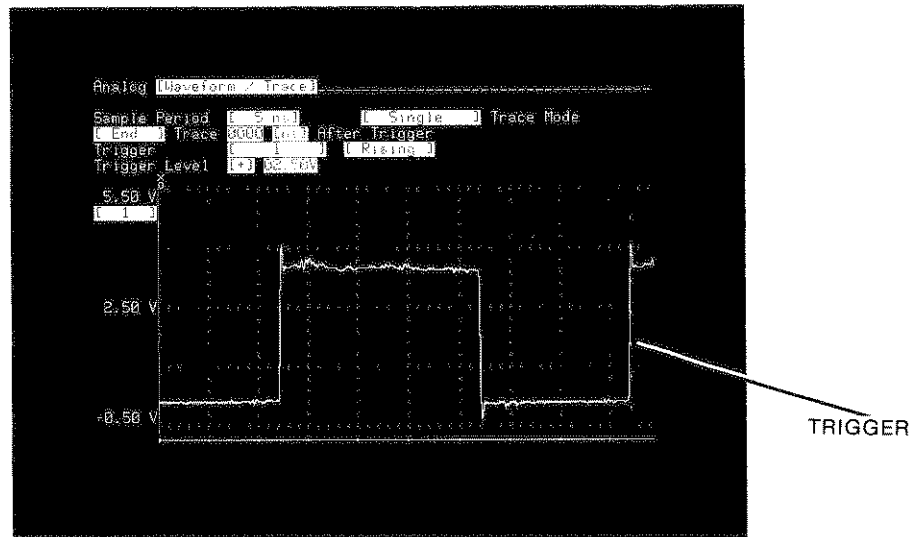

Figure 4-8. Trigger Ends Trace

- The tracepoint can be further delayed by adding a delay in the tracepoint specification. If a 50 ns delay is added to the previous specification, the resulting trace will look like figure 4-9.

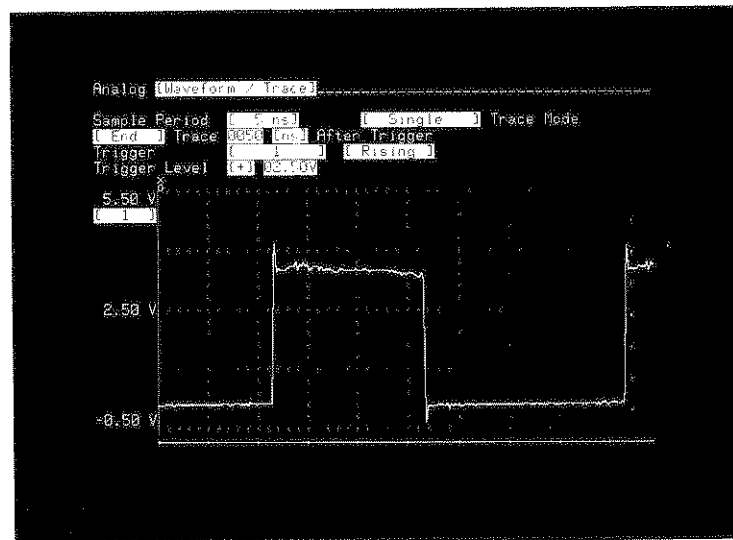

Figure 4-9. [End] Trace 50 ns After Trigger

Controlling the Analog [Waveform Diagram]

1. Select the Analog [Waveform Diagram] by pressing WFORM or by moving the cursor to Analog [Waveform/Trace] field (if in that menu) and press NEXT[] or PREV[].
2. Move the cursor to the Magnification field.
3. Press NEXT[] or PREV[] to obtain 4X magnification. This shows a window in the analog memory. One-fourth of the memory is on screen.
4. Press the ROLL down key to see the window move through the analog memory (display moves across the screen).
5. Press the NEXT[] key several times to see the magnifications available. Return the magnification back to 1X or one that leaves a waveform or two on screen.
6. Press and hold the CURSOR right key until the x cursor moves out into the display area. Place the x cursor on a transition on the waveform. Notice the bottom line just above the waveform display, it is a readout of the time measurement between the start of memory and the position of the x cursor (o to x).
7. Press the NEXT[] key several times to see that magnification of the display occurs around the area in memory where the x cursor is placed as in figure 4-10.

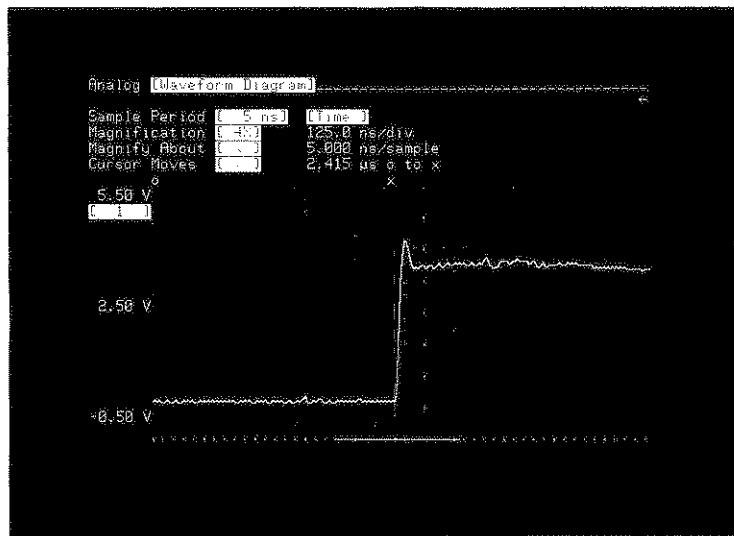

Figure 4-10. Magnification Around the x Cursor

8. Move the cursor to the Magnify About field.
9. Press the NEXT[] key to change [x] to [o].
10. Move the cursor into the Magnification field.
11. Press the NEXT[] key several times. Notice that display magnification now occurs around the position of the o cursor (at the start of the analog memory).
12. Select a magnification that leaves the x cursor on screen.
13. Move the cursor into the Cursor Moves field.
14. Press the NEXT[] key to change [x] to [o].
15. Press the CURSOR right key and hold it to move the o cursor onto the display area. Notice the time measurement indicator change as the o cursor moves closer to the x cursor.

16. Place the o cursor on another transition of the waveform. The time measurement indicator on the display will give the measure of time between the two transitions marked with the x and o cursors.
17. With the cursor in the Cursor Moves field, press the NEXT[] key to obtain [x&o]. With this selection, the x and o cursors will move together and maintain a constant interval between them. These markers can be used to compare intervals between any two points of interest on the display.
18. Move the cursor into the Magnification field and use the NEXT[] key to obtain 1X display.
19. Use the CURSOR right and left arrow keys to move the x and o cursor to a different transition on the waveform.
20. Move the cursor into the Cursor Moves field and press PREV[] to select Cursor Moves [o].
21. If the events are not the same distance apart as the first set, use the CURSOR keys to move the o cursor alone. Measure the new time reading between the x and o cursor.
22. Press the CURSOR left and CURSOR right keys. Notice the o cursor crosses the x cursor and the time measurement indicator corrects itself showing o to x reading or x to o reading.

Voltage Readings

1. Move the cursor into the [Time] field. Press NEXT[] or PREV[]. The readouts for the time readouts change to readouts of the x and o cursors for INPUT 1 as in figure 4-11.

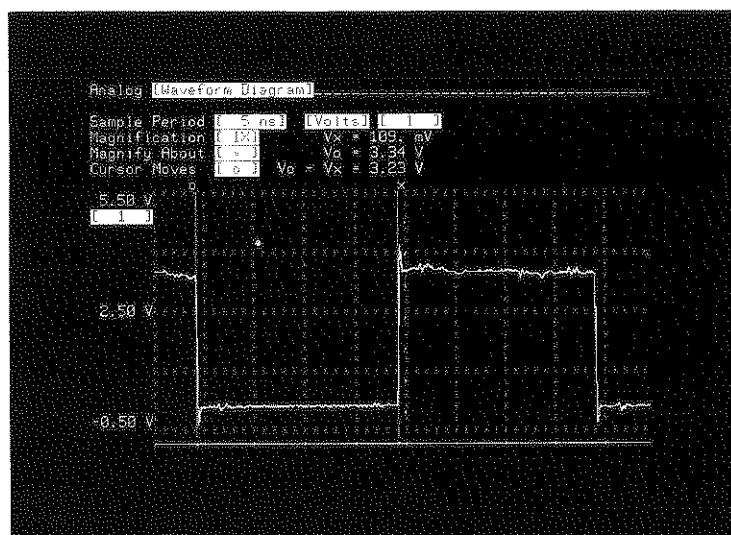

Figure 4-11. Voltage Readouts for x and o Cursors

2. Use the CURSOR left and right arrows to read the voltage at any point on the waveform trace.
3. To read voltages on INPUT 2, move the cursor into the [1] field beside [Volts] and change it to [2]. The readouts now pertain to INPUT 2.

ANALOG POST PROCESSING

The Analog Post Processing Menu is used to define events on which the x and o cursors may be placed on the acquired waveform. Also, when the Post Processing mode is on and the logic analyzer is in continuous trace mode, statistical information may be gathered by the analyzer.

To display the Analog Post Processing menu, Post Processing [On] must be selected in the Analog Trace Specification menu as in figure 4-12. Move the cursor to the Analog [Trace Specification] field and press NEXT[] or PREV[] for the Analog [Post Processing] menu. Figure 4-13 is the Analog [Post Processing] menu in the default condition.

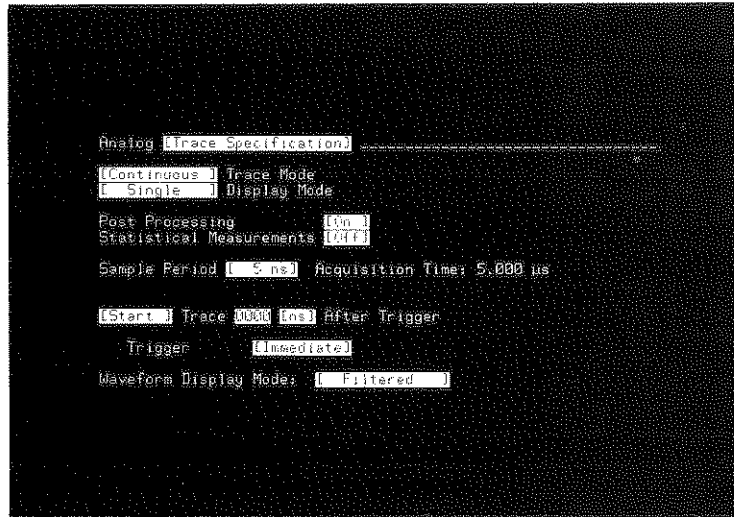

Figure 4-12. Selecting Post Processing in the Analog Trace Specification

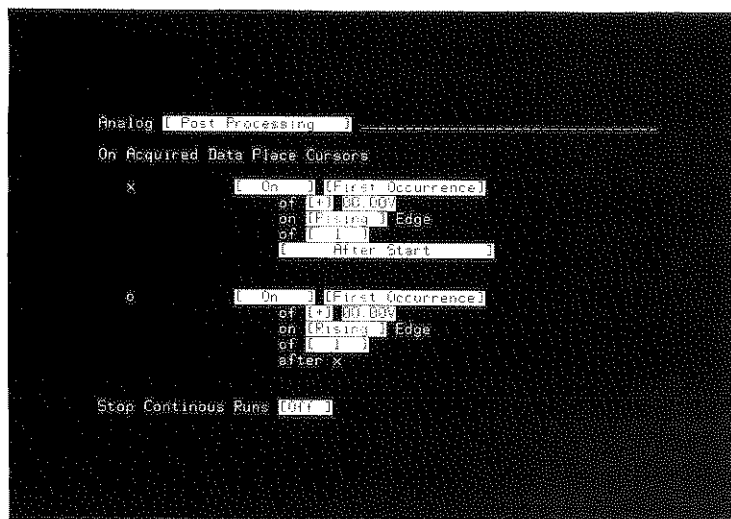

Figure 4-13. The Analog [Post Processing] Menu

Placing Cursors on Acquired Data

On Acquired Data Place Cursor x (or o) On [First through Fifth Occurrence] of [\pm] --- V on [Rising/Falling] Edge of [1/2] [After Start/Before Tracepoint/After Tracepoint] (or after x)

These combinations of selectable fields can assign the x cursor at any one of five occurrences of a voltage level on either slope [Rising/Falling] of either input [1/2] after the start of the trace or before or after the tracepoint [After Start/Before Tracepoint/After Tracepoint]. The o cursor can be placed on any one of five occurrences of a specified voltage on either slope [Rising/Falling] of either channel [1/2] after x.

By using combinations of the selectable fields a change of voltage on either input, or a combination of the inputs, may be defined and identified in the trace.

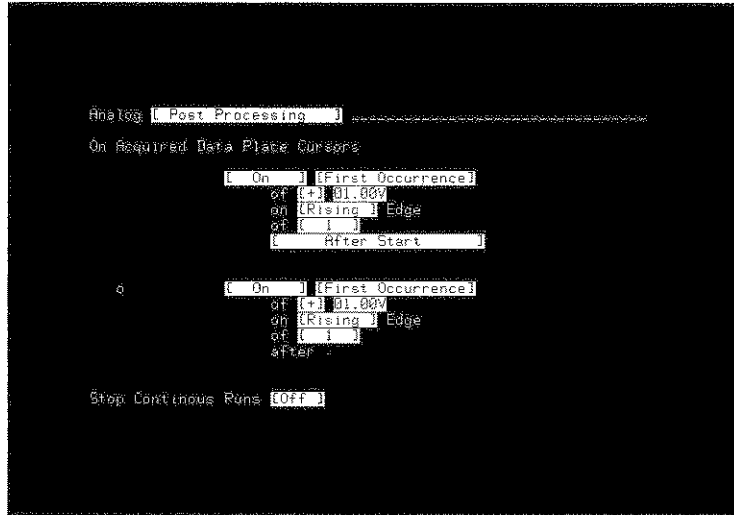

Figure 4-14. Post Processing Specification for Time Interval of a Waveform

When combinations of this specification are used, the time interval of a repetitive waveform can be measured by defining x at a particular voltage on the rising edge of the waveform and o at the next occurrence of the voltage on the same slope. Figure 4-14 is the Analog [Post Processing] specification for this type of measurement. Figure 4-15 is the resulting waveform display and time interval.

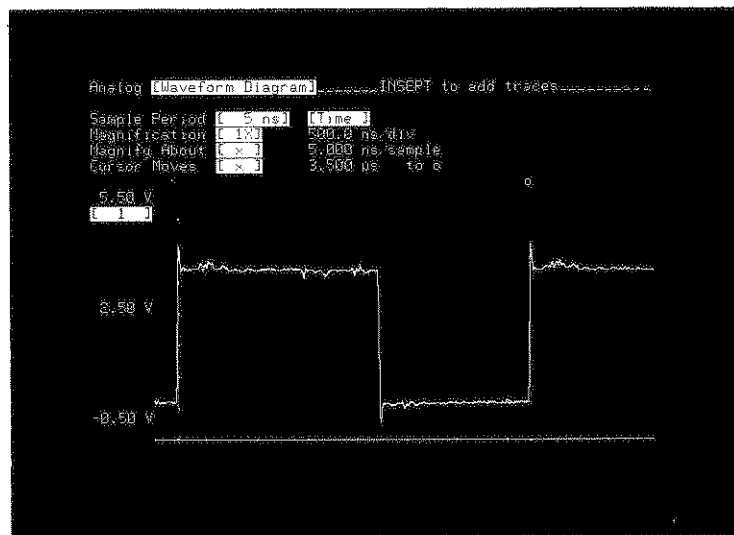

Figure 4-15. Time Interval of a Repetitive Waveform

On Acquired Data Place Cursor x [On] [Tracepoint]

The x cursor is assigned the same definition as the Tracepoint specification in the Analog Trace Specification.

On Acquired Data Place Cursor o [On] [End]

With this specification, the o cursor is assigned to the end of the trace.

On Acquired Data Place Cursor x (or o) ---- [ns/us/ms/s] [Before/After] [First through Fifth Occurrence] of [±] ---- V on [Rising/Falling] Edge of [1/2] [After Start/Before Tracepoint/After Tracepoint] (after x)

By using combinations of these selectable fields, the x cursor can be placed a specified amount of time before or after any one of five occurrences of the specified voltage. The o cursor can be placed after a specified voltage level after x has occurred.

On Acquired Data Place Cursor x ---- [ns/us/ms/s] [After/Before] [Tracepoint]

This combination of selectable fields places the x cursor at a point the specified amount of time before or after the tracepoint.

On Acquired Data Place Cursor o ---- [ns/us/ms/s] [After] [x]

This combination of selectable fields places the 0 cursor the specified amount of time after the x cursor.

Continuous Runs and Statistical Measurements

By combining the [Continuous] Trace Mode with Statistical Measurements, statistics can be gathered by the logic analyzer.

To gather statistics, [Continuous] Trace Mode and Post Processing must be selected in the Analog Trace Specification menu. Statistical Measurements may then be selected [On]. The statistical information will be automatically displayed on the Analog [Waveform Diagram] while the statistics are being gathered.

The following statistics are field selectable and displayed in the Analog [Waveform Diagram].

	[Time]	or	Voltages of [1x/1o/2x/2o]
[Mean & Dev.]	[Max. & Min.]	[Mean & Dev.]	[Max. & Min.]
Mean x to o	Max x to o	Mean	Maximum
Std. Dev.	Min x to o	Std. Dev.	Minimum

There are three specifications available in the Analog [Post Processing] menu to Stop Continuous Runs. The menu specification directs the analyzer to examine the acquired data for a certain trigger condition, use the occurrence of that condition to stop continuous runs and capture the current trace.

NOTE

Stop Continuous Run specifications can be used when Statistical Measurements are [Off].

Stop Continuous Runs [When] [Time x-o] [Greater Than/Less Than] ---- [ns/us/ms/s]

This specification directs the analyzer to take continuous traces until the time interval [Time x-o] is [Greater Than/Less Than] the amount specified ---- [ns/us/ms/s].

This specification can be used with an analog waveform of a known interval. The analyzer will take traces and keep track of the time interval. Each time the trace is taken and the time interval is the specified duration, the analyzer takes another trace. When the interval is shorter or longer, depending on whether [Greater Than] or [Less Than] is specified, the analyzer stops taking traces and the current trace may be examined.

Stop Continuous Runs [When] [#Runs] ----

This specification can be used with statistical measurements to gather an exact number of samples. The statistical information is displayed on the Analog [Waveform Diagram].

Stop Continuous Runs [Off]

This specification is the default condition. When this specification is assigned, the analyzer will take continuous traces. It may also be used to cancel either of the other Stop Continuous Runs specifications. The cancelled specification may be re-selected and the definition will remain the same as before it was cancelled.

THE ANALOG DISPLAY

The analyzer can present two types of analog waveform displays: the Analog [Waveform Diagram] and the Analog [Waveform/Trace] display.

The Analog [Waveform Diagram]

Figure 4-16 is a typical Analog [Waveform Diagram]. It displays an analog waveform from each input. The inputs are identified by the labels to the left of each waveform. Figure 4-17 is the same waveform display with statistical information from statistical measurements.

Sample Period: [Time/Volts]:	5 ns to 500 ms. Ranges are in a 1, 2, 5, sequence. Time readings for time/div, time/sample and time interval from x to o cursor. Voltage readings for x and o cursors and voltage difference between x and o cursors. Selectable for either input 1 or 2.
Magnification:	1X to 40X. 1X shows entire memory-40X shows 1/40 of memory.
Magnify About:	Moves magnified display window to area around x or o cursor.
Cursor Moves:	Selects x, o, or x&o cursors to be moved by CURSOR keys.
Runs:	Readout of number of traces taken by analyzer when in [Continuous] Trace Mode.
Hits:	Readout of number of times the post processing specification was met and marked during continuous traces. Hits are used for Statistical Measurements and in Stop Continuous Run Specifications.

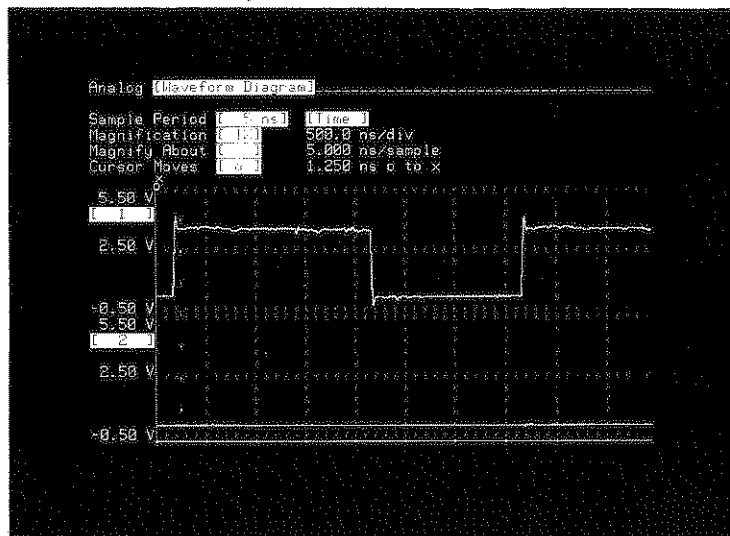

Figure 4-16. Analog [Waveform Diagram]

Sample Period: Same as figure 4-16.
 [Time/Volts]: Same as figure 4-16.
 Magnification: Same as figure 4-16.
 Magnify About: Same as figure 4-16.
 Cursor Moves: Same as figure 4-16.
 Runs: Same as figure 4-16.
 Hits: Same as figure 4-16.

Statistical Information

Time: Mean and Standard Deviation of the Mean or Maximum and Minimum values of the time interval.
 Voltage: Mean and Standard Deviation of the Mean or Maximum and Minimum values of any one of four cursors [1x/1o/2x/2o].

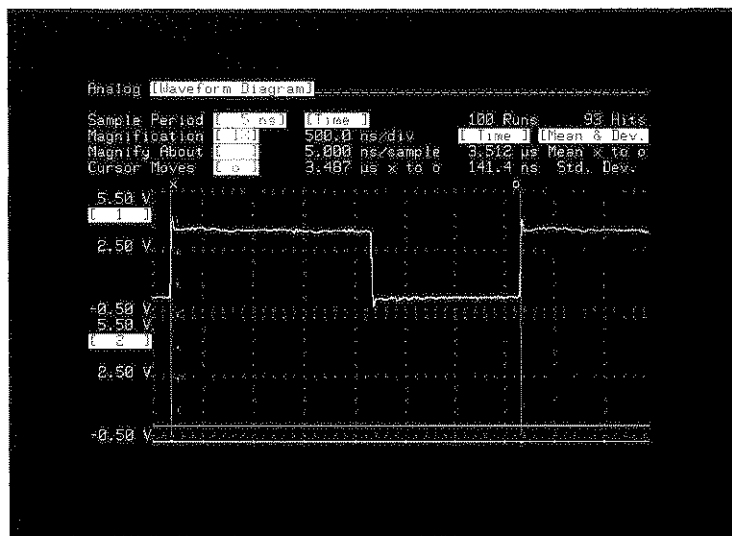

Figure 4-17. Analog [Waveform Diagram] with Statistical Information

The Analog [Waveform/Trace]

The Analog [Waveform/Trace] is a display of the analog input channels with specifications from the Analog Trace Specification. In this display menu, the sample period, trace mode, tracepoint and trigger specifications can be changed without going to the Analog Trace Specification menu. Figure 4-18 is a typical Analog [Waveform/Trace] display.

Sample Period:	5 ns to 500 ms. Ranges are in a 1, 2, 5 sequence.
Trace Mode:	Single or Continuous.
Tracepoint:	Start, Center or End trace at a specified trigger plus delay. Determines amount of pretrigger and posttrigger time in memory.
Trigger:	Immediate, 1, 2, or External Trigger and slope of trigger.
Trigger Level:	Specified up to $\pm 99.99V$ (with 50X probe specification).

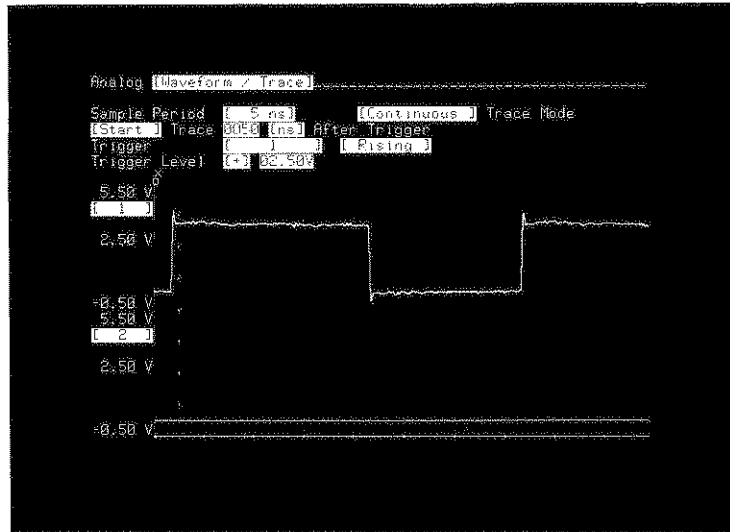

Figure 4-18. Analog [Waveform/Trace] Display

Chapter 5

Timing Measurements

INTRODUCTION

The timing analyzer in the 1631A/D Logic analyzer is a synchronous data acquisition system up to 16 channels wide (1631D) capable of storing 1024 states at up to 100 MHz sample rate. The data is captured using an internal clock with selectable sample rates from 10 ns to 500 ms. Timing analysis is useful to the hardware designer for testing and verifying timing specifications such as setup and hold, propagation delays, and handshake sequences. The timing analyzer can also be configured to glitch mode to identify transients between timing analyzer samples.

When the logic analyzer is configured for timing analysis, samples of data are taken, asynchronously, on every pulse of a clock internal to the analyzer. The analyzer determines whether the data is less or greater than a prespecified threshold voltage level and displays the result as either a logic 1 or 0. The display stays at the same level until the next sample is taken.

The timing analyzer format specification allows the user to map input data channels to user defined labels which have meaning in the context of the users measurement. The format specification also allows the user to label bit patterns containing up to 4 bits. This is useful when 1 or more bits define an operation or status such as read, write, I/O on many microprocessors.

The timing trace specification allows the user to select the sample rate and the trigger specification. The trigger can be specified with a combination of patterns, edges, and glitches. Timing post processing allows the user to set marks on events and gather statistics on the events. This is useful for characterizing digital patterns on the target system. Events may also be used for stopping data acquisition. This method of acquiring data is useful for capturing infrequent erroneous data patterns and events.

Captured data may be displayed in list, waveform, or chart formats. When post processing is used, the list format allows selective viewing and finding of marked events.

Glitches

Glitches are handled by a glitch detection circuit which is independent of the sampling rate. Dual detectors are on an alternate sample period with a slight overlap. Each detector looks for two threshold crossings, identifying a glitch. If a glitch is found, it is stored in a memory separate from the timing data. When glitch detection is on, the number of assigned timing channels is halved since two channels must monitor a common signal in order to detect differences in threshold crossings.

Triggering

Trigger detection is accomplished by a method independent of the sampling clock. To eliminate false triggering, the analyzer has a filter which is used when specifying trigger duration. Trigger pattern duration is selectable from 20ns to 1ms to qualify the trigger with respect to time.

Edge triggering is available on four channels per pod assigned to timing measurements. It is used where a pattern may not be adequate for triggering or may be used to qualify a pattern. With edge detection, triggering can take place on an edge that doesn't show up in the trace (glitch triggering).

When the analyzer finds the trigger, the tracepoint is positioned as specified in the specification menu (at start, center, or end of trace). The trace specification tells the analyzer when to stop the measurement. Enough information is captured after the trigger to place it properly in trace memory. Usually timing measurements are taken with the trigger in the center trace position. The tracepoint may be delayed up to 9999 seconds after the trigger.

Post Processing

Post processing is available for marking events occurring in data that has been acquired by the timing analyzer. The Post Processing menu provides the means to identify the x and o cursors and four other events to be marked in the timing data memory.

Statistical Measurements

Statistical measurements are part of the timing post processing mode which supply statistical information on the Timing Waveform Diagram. The readouts are field selectable and include the minimum and maximum time of an interval or the count of marked events within the interval. The mean and the standard deviation of the time interval or the marked events may also be displayed in the selectable fields.

HOW TO MAKE SIMPLE TIMING MEASUREMENTS

The following procedure demonstrates how to use the timing analyzer to make measurements of time related activity in a logic system. The procedure describes triggering traces on electrical activity, composing displays and measuring the activity.

Activating The Timing Analyzer

1. Press the SYSTEM key.
2. Press the ROLL up key one time or CURSOR up key two times. This moves the bright bar to the timing analyzer configuration. All channels which can collect timing information are activated for timing measurements.

No channels are active for state or analog measurements. See figure 5-1.

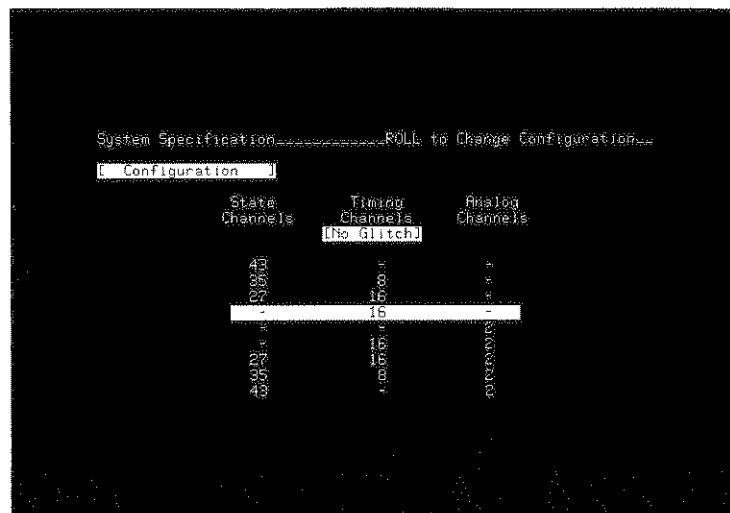

Figure 5-1. Selecting the Timing Analyzer Configuration of the 1631D (1631A has 8 less channels)

3. Press the RUN key. The analyzer will execute continuous measurements using the default specification (trigger on any pattern), and present waveform displays on screen. The displays are at X1 magnification. The entire 1K memory content is shown on screen after each trace. Unconnected timing bits are constant lows. Press the STOP key to obtain a trace display.

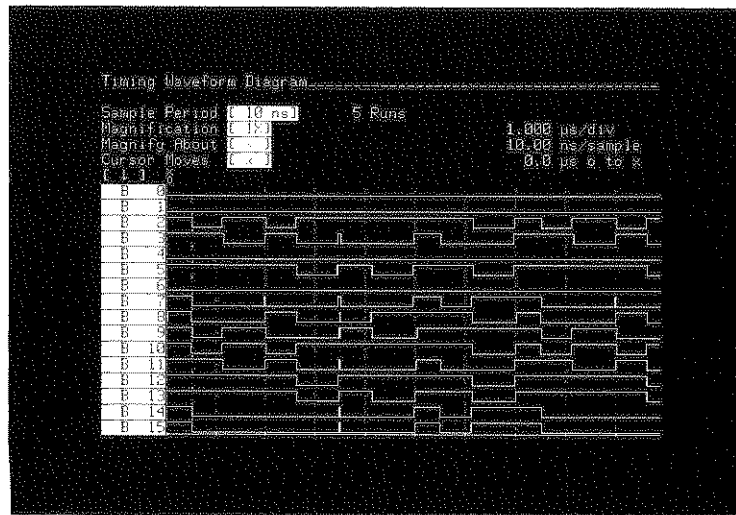

Figure 5-2. Default Timing Measurement For 1631D (1631A has 8 less channels)

Controlling The Timing Display

1. Move the cursor to the Magnification field in the Timing Waveform Diagram.
2. Press the NEXT[] key to obtain 4X magnification. This shows a window in the timing memory. One-fourth of the memory is on screen.
3. Press the ROLL down key to see the window move through the timing memory (display moves across the screen).
4. Press the NEXT[] key several times to see the magnifications available. Select a magnification factor that leaves several waveform transitions on screen.
5. Press and hold the CURSOR right key until the "x" marker moves onto the display area. Place the "x" marker on one of the waveform transitions on the display. The first line above the waveforms on the right-hand side of the screen shows the measurement of time between the start of the memory and the position where "x" is placed (o to x).
6. Press the NEXT[] key several times to see that magnification of the display occurs around the area in memory you selected by the position of "x". See figure 5-3.

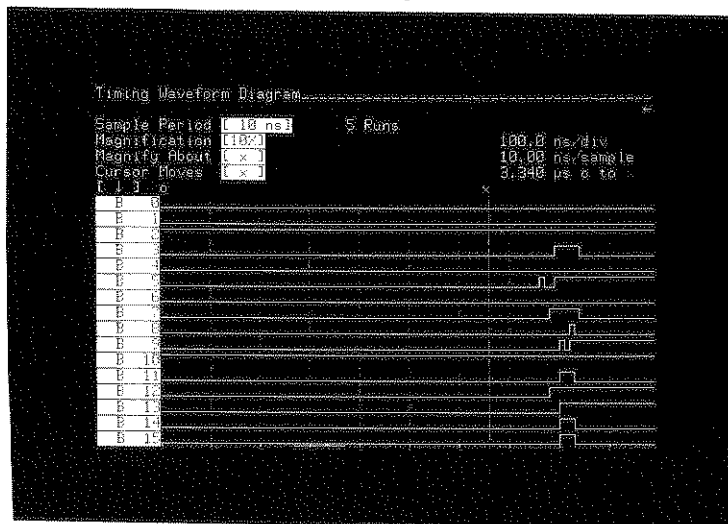

Figure 5-3. Magnification Around "x"

7. Press the CURSOR down key to move cursor to the Magnify About field.
8. Press the NEXT[] key to change "x" to "o".
9. Move the cursor into the Magnification field.
10. Press the NEXT[] or PREV[] key. Notice that display magnification now occurs around the position of "o" (at the start of the timing memory).
11. Select a magnification that leaves the "x" marker on screen.
12. Press the CURSOR down key to move the cursor to the Cursor Moves field.
13. Press the NEXT[] key to change "x" to "o".
14. Press the CURSOR right key and hold it to move the "o" on the display. Notice the time measurement indication change as the "o" moves closer to the "x".
15. Place the "o" marker on another waveform transition on the display.
16. The time measurement indication on the display will show the measure of time between the two waveform transitions selected using the "x" and "o" markers.
17. With the cursor in the Cursor Moves field, press the NEXT[] key to obtain the [x&o] indication. With this selection, the "x" and "o" markers will move together and maintain a constant interval between them. These two markers are used together to compare intervals between any two points of interest on the display.
18. Move the cursor into the Magnification field and use the NEXT[] key to obtain a X1 display.
19. Use the CURSOR right key and CURSOR left keys to move the "o" and "x" markers together to another set of waveform transitions on the display.
20. Place the "x" marker on one of the waveform transitions.
21. Move the cursor into the Cursor Moves field and press the PREV[] key to select Cursor Moves [o].
22. If the events are not the same distance apart as the first set, use the CURSOR keys to move the "o" marker alone. You can measure the time between the two new waveform transitions.
23. Press the CURSOR left key and CURSOR right keys. Notice that the "o" marker can cross the "x" marker, and the measurement indication above the traces will correct itself (show "x to o" or "o to x").

Selecting Trace Positions On The Display

1. Press the CURSOR down key to move the cursor into the field labeled B5.
2. Press the PREV[] key several times. Any of the bits from the timing memory can be placed at any location of the display. Any channel can also be turned off.
3. Press the DELETE key several times. Channels can be eliminated from the display, if desired. Note that the vertical display is magnified when eight or less channels are on screen.
4. Press the INSERT key several times. Channels can be added to the display. Up to a maximum of 16 channels in non-glitch mode and 8 in glitch mode can be added. See figure 5-4.
5. Press the blue SHIFT key and DEFAULT. This restores all channels in the display to their original positions.

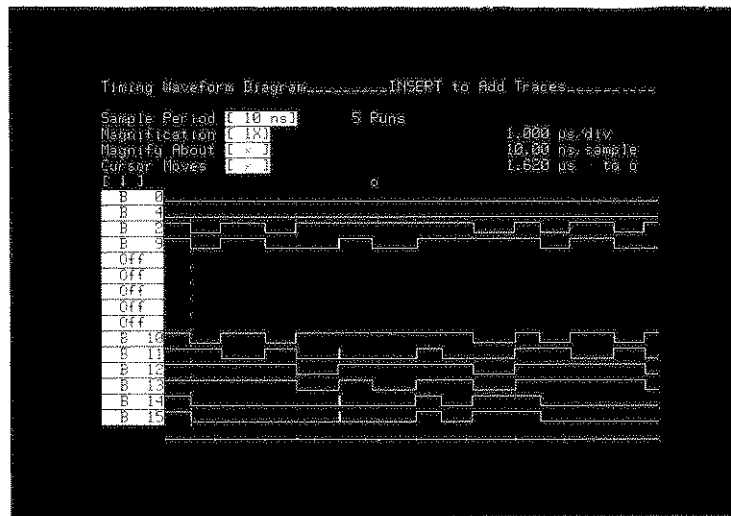

Figure 5-4. Selecting Waveform Positions On Display

Triggering On A Timing Event

1. Find a point on the waveform display where two of the channels are high at the same time, while one of the other channels has a transition from low to high (change display magnification, if necessary). Write down these three channel numbers and their conditions.
2. Press the TRACE key. Use NEXT[] or PREV[] to select [Single] trace mode.
3. Use the CURSOR keys to place the cursor in the row of X's in the Pattern field. This is an AND field. Its default state is all don't cares. All "1" or "0" specifications that are entered in this field must be met during the same clock period in order for the timing analyzer to recognize them as its trigger.
4. Use the CURSOR keys to place the cursor at the points in the Pattern field which correspond to the bits that you noted as having high states. Enter a '1' from the keyboard in each of these two bits. (B0 is the first bit on the right-hand side of the field.)
5. Use the CURSOR keys to place the cursor in the Edge field. The Edge field is an OR field. Recognition of low-to-high transitions, high-to-low transitions, or both transitions in any of the bits where such selections are available can be specified. If any of the selected transitions occur in any bit during a clock period, the condition is satisfied.
6. Use the CURSOR keys to position the cursor on the point in this field corresponding to the bit you noted as having a low-to-high transition (B0 is on the right-hand side).
7. If there is a dot in the field where the cursor is positioned, press the NEXT[] key one time to obtain the rising-edge. If there is an N/A (not available) notation in this field, then return to the WFORM display and, if necessary, select new channels, one with a low-to-high transition and two other channels that are high. Note the edge recognition is not available for all of the timing bits. See figure 5-5.

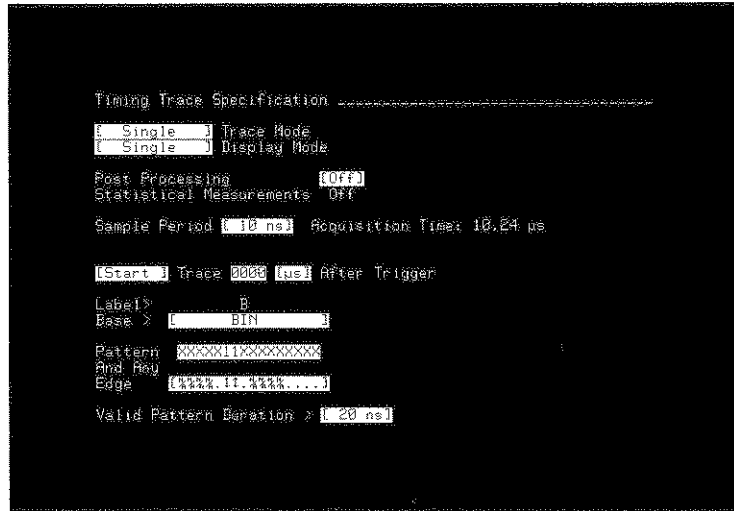

Figure 5-5. Triggering On A Pattern And Edge Transition

8. Press the RUN key. The analyzer will search the incoming activity until it finds a clock period in which both of the high channels specified are high and a low-to-high transition occurs in the selected channel. Then the analyzer will trigger a trace and fill the memory.
9. See figure 5-6. Note the vertical, dashed line on the display. This line identifies the trigger point.
10. Move the cursor up into the Sample Period field and press the NEXT[] key several times.
11. Press the RUN key to take a measurement using the new sample period.

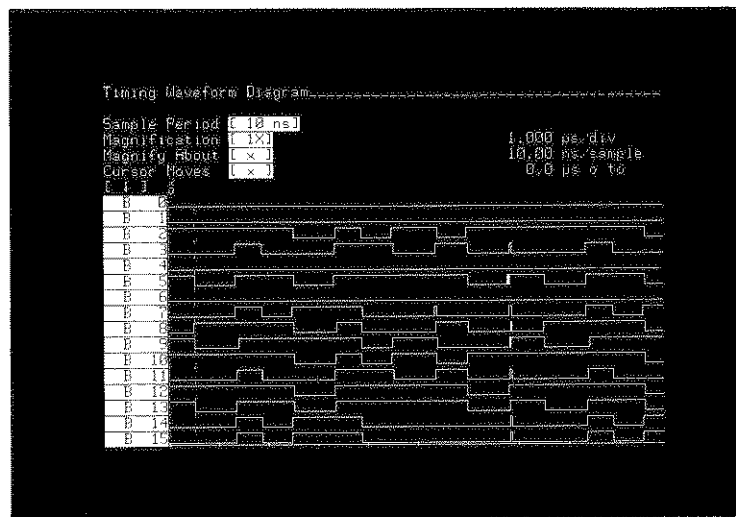

Figure 5-6. Triggering on a Timing Event

THE TIMING FORMAT SPECIFICATION

Timing Format [Assignment] Specification

The [Assignment] menu allows set up of the analyzer to present information in a format that will be useful. In the [Assignment] menu, two set up assignments are performed: label assignments and threshold assignments. See figure 5-7.

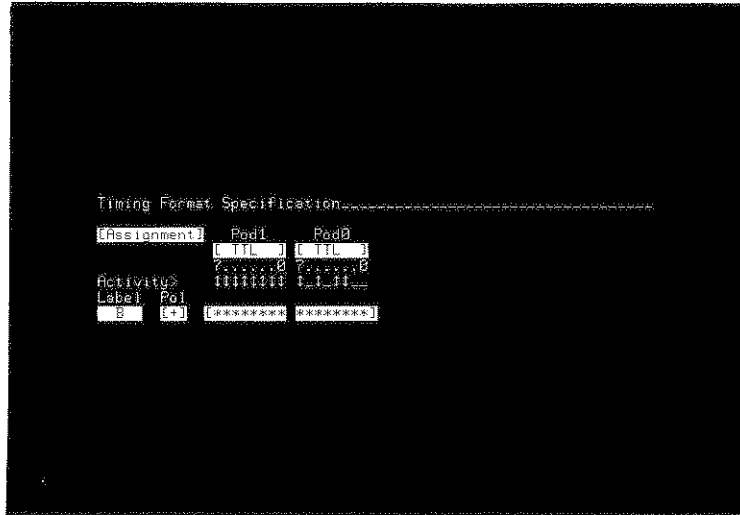

Figure 5-7. Timing Format Assignment Specification

Label Assignments

When the analyzer makes a measurement, it collects data from all input bits (whether part of a label or not). When a bit is assigned a label, that bit is then available to the display. The analyzer cannot place the activity from a bit on the display unless the bit has a label assigned to it.

A benefit of labeling sets of bits during a timing analysis is that abnormal occurrences, such as two handshake lines high during the same instant of time, are easily identified in the context of the user's system.

The label capabilities and limitations are as follows:

- Maximum no. of labels: 16
- Label size: 1 to 5 alphanumeric characters.
- Label content: 1 to all bits. Same bit can be included in all labels.
- Label polarity: [+] = positive-true; [-] = negative-true (only affects LIST displays and TRACE specification).
- Label bit arrangement: (Example of 4-bit label)

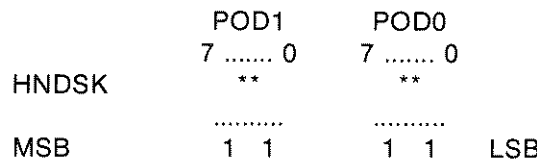

Pod Threshold Assignments

The pod threshold capabilities and limitations are as follows:

- Pod assignments: Each pod defined separately.
- Thresholds available: TTL, ECL, selectable from -9.9 V to +9.9 V, in 0.1 V increments.

Timing Format [User Base] Specification

The [User Base] menu allows assigned names to be displayed in place of numbers when identifying patterns found on labeled bits. Different names may be specified to label each of the patterns, such as "ACTIV" and "INACT" to identify the two states found on the interrupt bit. Any base label, up to five characters, may be assigned to a state.

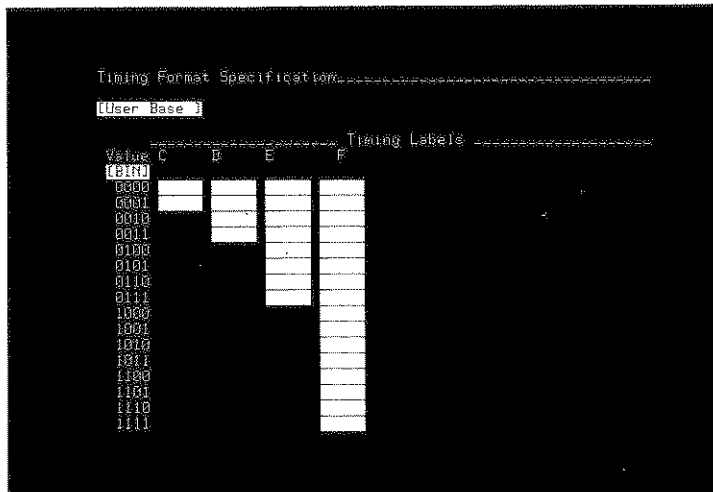

Figure 5-8. Timing Format [User Base] Specification

The [User Base] capabilities and limitations are as follows

Max labels on menu:	8.
Label size:	1 to 4 bits.
Max names/label:	One name for each possible value (16 names on a 4-bit label).
Name Composition:	1 to 5 alphanumeric characters.

THE TIMING TRACE SPECIFICATION

There are two timing trace modes offered by the analyzer: [Single] and [Continuous]. The trace modes are discussed separately in the following paragraphs. Figure 5-9 is the Timing Trace Specification menu. This menu allows selection of trace and display modes, post processing and statistical measurements, sample period, trigger location, trigger activity, and the valid trigger pattern duration.

[Single/Continuous] Tracing Modes

The [Single] trace mode is used to capture a single trace of timing activity for each bit in the timing probe pod(s). The trace is displayed on the Timing Waveform Diagram until the next trace is acquired and displayed.

In the [Continuous] trace mode, the analyzer performs a timing measurement the same as in [Single]. As soon as the measurement is complete and the display is updated, the analyzer begins another measurement. This process continues until STOP is pressed.

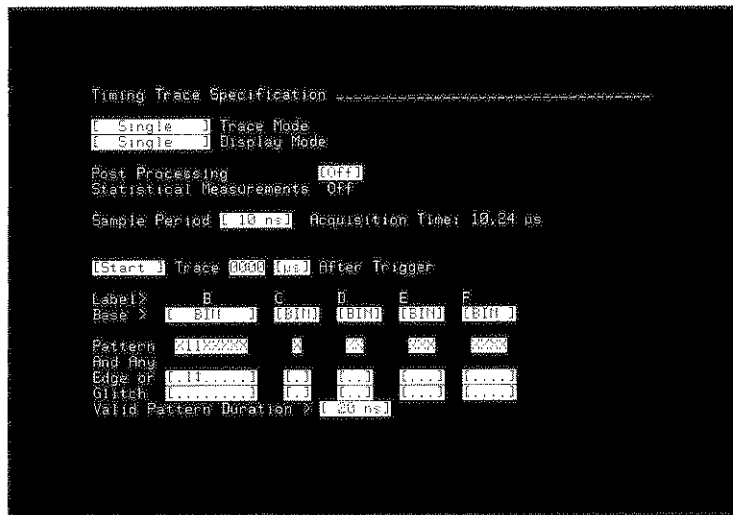

Figure 5-9. Timing Trace Specification with Glitch Mode Selected

Display Mode:	[Single] or [Cumulative] displays of timing data.
Post Processing:	[On] or [Off].
Statistical Measurements:	[On] or [Off], available only when Post Processing is [On] and Trace Mode is [Continuous].
Sample Period:	from one sample every 10 ns to one sample every 500 ms (24 sample period selections) in 1, 2, 5 sequences.
Trigger Location:	[Start], [Center], or [End] (determines amount of pretrigger and posttrigger time in memory).
Trigger:	combination of pattern and edge.
Pattern:	“And” field composed of 1, 0, or X logic levels on all bits in all labels.
Edge:	“OR” field composed of positive-going, negative-going, either-edge, or off [.] for each capable bit. Bits not capable of edge recognition are identified by N/A.
Duration:	from 20 ns to 1 ms (period that pattern must remain stable to be recognized as trigger) in 1, 2, 5 sequence.
Trace Point Delay:	from 0000 ns to 9999 sec after trigger recognition. Max delay depends on Sample Period selected. Note: the analyzer rounds off the delay entry to the nearest multiple of four times the selected sample period.

TIMING POST PROCESSING AND STATISTICAL MEASUREMENTS

The Timing [Post Processing] Trace Specification

Post processing of acquired data is controlled with the Timing [Post Processing] menu. The x and o cursors may be defined and placed on the first occurrence of any two events in the acquired data. Up to four more events, identified as a, b, c, or d, may also be defined and marked. The events a, b, c, and d are identified within the trace listing as many times as samples meet their specifications. Statistical Measurements and Stop Continuous Runs specifications only use marks between the x and o cursor.

To display the Timing Post Processing menu on the logic analyzer, first select Post Processing [On] in the Timing Trace Specification menu, as in figure 5-10. Move the cursor to the Timing [Trace Specification] field and use the NEXT[] or PREV[] key to select the Timing [Post Processing] menu. Figure 5-11 is the Timing [Post Processing] menu in its default condition.

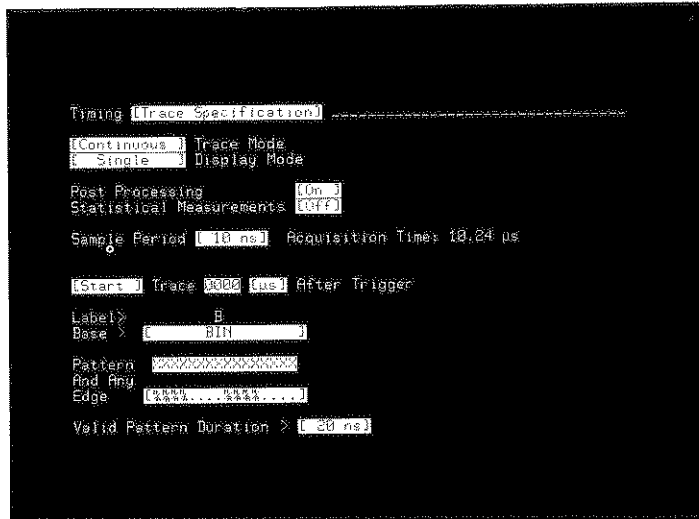

Figure 5-10. Selecting Post Processing in the Timing Trace Specification

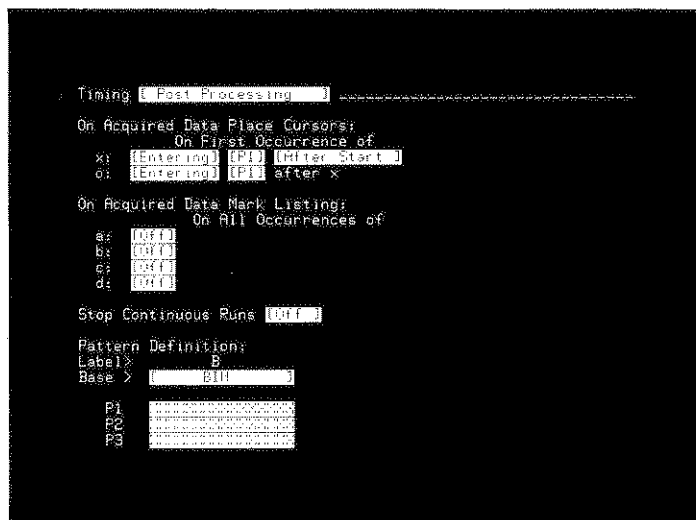

Figure 5-11. Timing [Post Processing] Menu

Marking Events on Acquired Data

The Mark specifications within the Timing [Post Processing] menu allow identification of samples in the acquired data trace list. The events are defined as x, o, a, b, c, and d. The primary importance of the x and o cursors is the automatic time interval measurement readout on the Timing Waveform Display. The events on which x and o cursors are placed may be defined within the post processing menu.

After defining the time interval of interest by specifying x and o cursor placement, each time a trace is taken the x and o cursors are automatically marked. The time interval, x to o, is displayed on the Timing Waveform Diagram. On repetitive runs, the number of hits (the number of times the time interval is found) are also displayed on the Timing Waveform Diagram. Both cursors must be placed to be considered a hit.

On Acquired Data Place Cursors x and o

The x and o cursor events may be defined by any of eight events. The eight events are patterns (P1 through P8) defined by the user in the Timing [Post Processing] menu. The following specifications are used to define the x and o cursors.

Place Cursor x (or o) On First Occurrence [Entering/Leaving] [P1 through P8] [After Start/Before Trcpt/After Trcpt] (or after x)

These combinations of selectable fields can define the x cursor as the start or end [Entering/Leaving] on any one of eight patterns [P1 through P8] between the start of the trace and the tracepoint or after the tracepoint [After Start/Before Trcpt/After Trcpt]. The o cursor may be defined as the start or end [Entering/Leaving] on any of eight patterns [P1 through P8] after x.

By using combinations of the selectable fields a change of value on a single probe bit, or a combination of probe bits, may be defined and identified in the trace. The change of value follows a reference point selected in the [After Start/Before Trcpt/After Trcpt] field of the specification.

Figure 5-12. is a Timing Waveform Diagram display of a trace taken with the default x and o cursor definition, placing x at the start of the trace and o at the end of the trace.

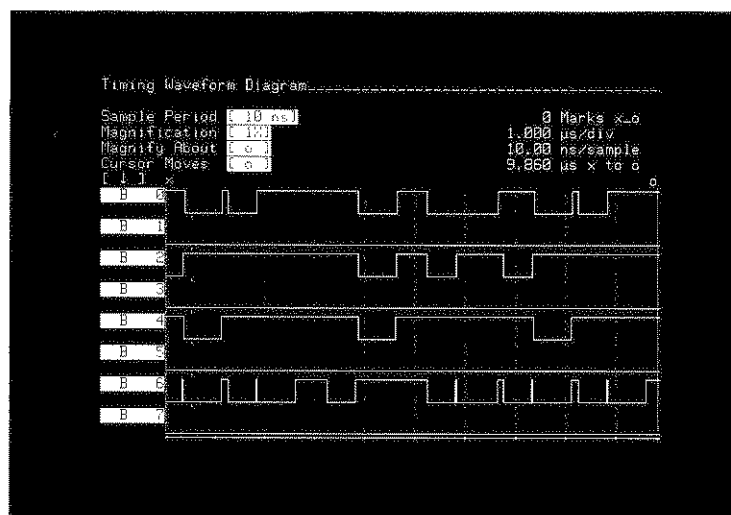

Figure 5-12. Timing Waveform Diagram with x and o Cursors Defaulted

When combinations of this specification are used, a measurement of the time that a selected line in a system remains true may be made. For this type of measurement, assign the x cursor to the start [Entering] of a defined pattern [P1] and the o cursor to the end [Leaving] of the same pattern [P1] after x. The specification for this type of measurement is shown in figure 5-13. Figure 5-14 is the resulting Timing Waveform Display of the time interval of pattern P1.

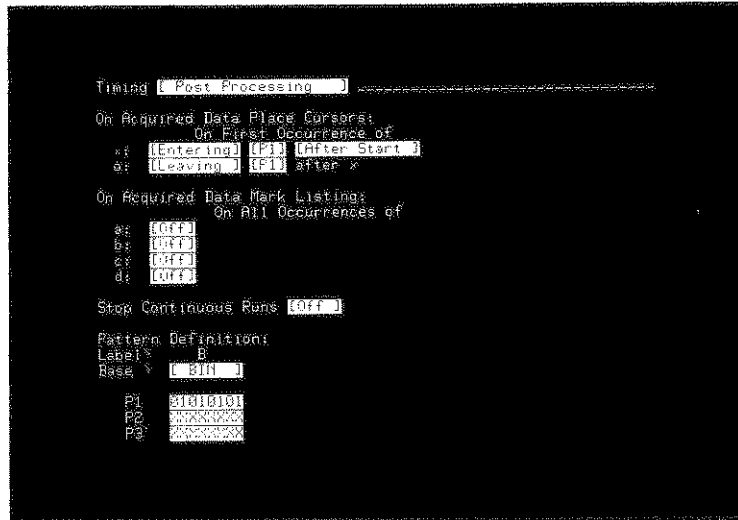

Figure 5-13. Post Processing Specification for Duration of a Pattern

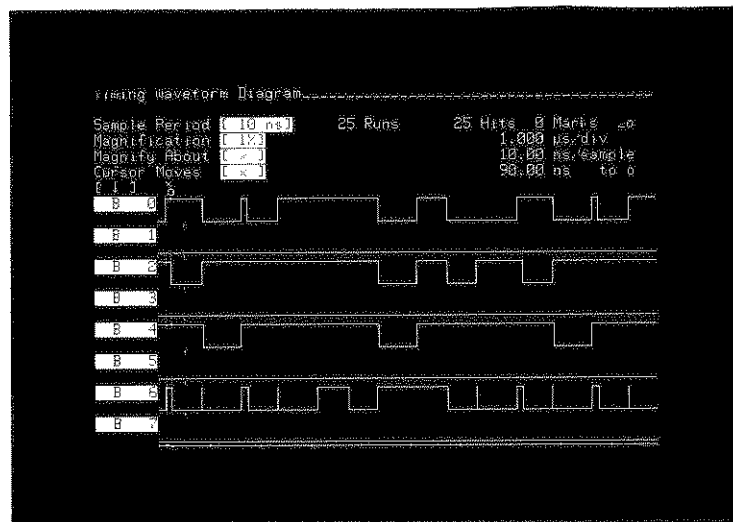

Figure 5-14. Time Interval of a Pattern

Place Cursor x or o On First Occurrence [Entering/Leaving] [Greater/Less] than ---- [ns/us/ms/s] of [P1 through P8] [After Start/Before Trcpt/After Trcpt]

These combinations of selectable fields can assign the x or o cursor at the start or end [Entering/Leaving] of any one of eight patterns [P1 through P8] which has remained the same or changed before [Greater/Less] than a specified amount of time in [ns/us/ms/s] between the start and trigger or after the trigger [After Start/Before Trcpt/After Trcpt].

Place Cursor x or o On First Occurrence [Greater/Less] than ---- [ns/us/ms/s] of [P1 through P8] [After Start/Before Trcpt/After Trcpt]

These of combinations of selectable fields can assign the x or o cursor to any one of eight defined patterns [P1 through P8] which has remained the same or changed before [Greater/Less] a certain amount of time in [ns/us/ms/s] occurring between the start of the trace and tracepoint or after the tracepoint [After Start/Before Trcpt/After Trcpt].

When this specification is used, the analyzer searches the trace memory for the first occurrence of the specified pattern and keeps track of the duration of the pattern. The cursor is assigned to the first occurrence of the pattern meeting the duration specified.

A condition of one probe bit or a combination of bits may be specified. The condition must follow a reference point which is specified in the [After Start/Before Trcpt/After Trcpt] field of the specification.

By using these combinations, a measurement may be made to find a certain condition remaining in a system for an extended period of time. Assignments are made to mark x cursor where the pattern first exceeds the specified duration and mark o cursor when the pattern changes to the next state. Set the Timing [Post Processing] menu to mark cursor x on first occurrence [Greater] than ---- [ns/us/ms/s] of [P1] [After Trcpt] and mark o cursor on first occurrence [Leaving] [P1] [After Trcpt] as in figure 5-15. Figure 5-16 is the resulting Timing Waveform Display showing the time duration, x to o, that the pattern exceeded the specified time.

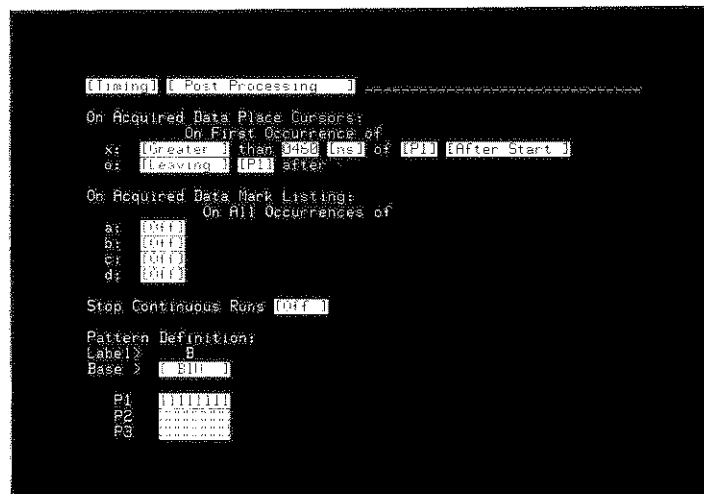

Figure 5-15. Post Processing Specification of an Extended Pattern

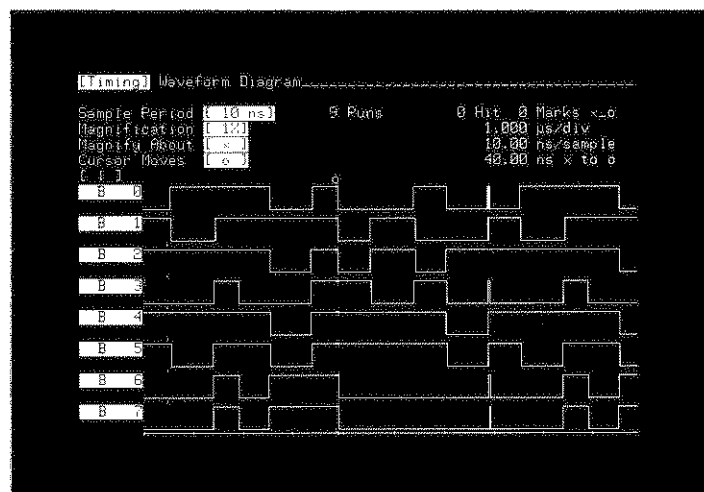

Figure 5-16. Time Duration of Extended Pattern

Place Cursor x On First Occurrence of [Start].

This specification assigns the x cursor to the start of the trace.

Place Cursor x On First Occurrence of [Trcpt].

This specification assigns the x cursor at the sample that is recognized as the tracepoint in the trace list.

Place Cursor o On First Occurrence [End].

This specification assigns the o cursor to the end of the trace list.

Place Cursor x (or o) on First Occurrence [Pattern] [P1 through P8] And Glitch [G1 through G8] [After Start/Before Trcpt/After Trcpt] (after x)

This specification is available only when [Glitch] mode is selected in the System [Configuration] Specification. The x cursor can be assigned to any one of eight patterns [P1 through P8], or glitches [G1 through G8], after the start of the trace, or before or after the trace point [After Start/ Before Trcpt/ After Trcpt]. The o cursor can be assigned to any one of eight patterns [P1 through P8] and glitches [G1 through G8] after x.

On Acquired Data Mark Listing for Events a, b, c, d

Marks a, b, c, d are used to identify or highlight events other than where x and o cursors are placed in the trace list. The marking capability is the same as with the x and o cursors but a, b, c, d events are marked on all occurrences. The events a, b, c, d have an added specification which allows bit processing of data for examination of data flow.

All marked events are shown with the x and o cursors in the Timing Listing. Once the events a, b, c, d are defined they may be individually turned off and on without disturbing the definition. The x and o cursors identify one sample each in memory. The a, b, c, d events identify as many samples as meet their specifications. Figure 5-17 is the Timing Post Processing specification with all events defined around P1. Figure 5-18 is the resulting Waveform Diagram indicating the number of marked events, and figure 5-19 [Show]s all marked events in the [Timing + Postproc] Listing.

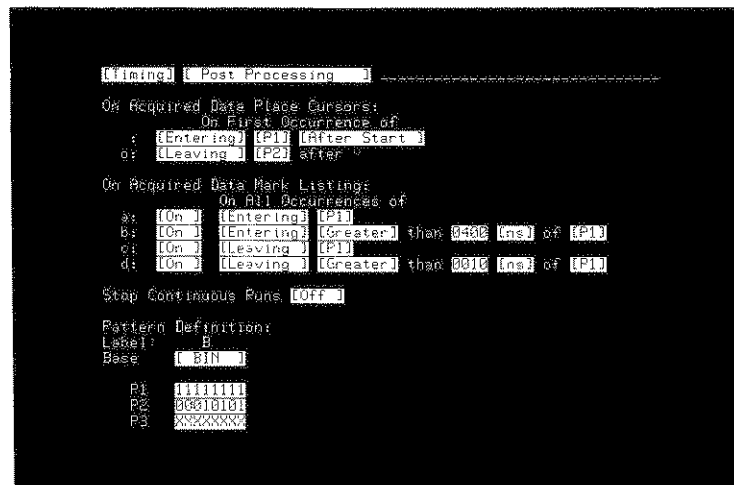

Figure 5-17. Defining Events in the Timing Post Processing Menu

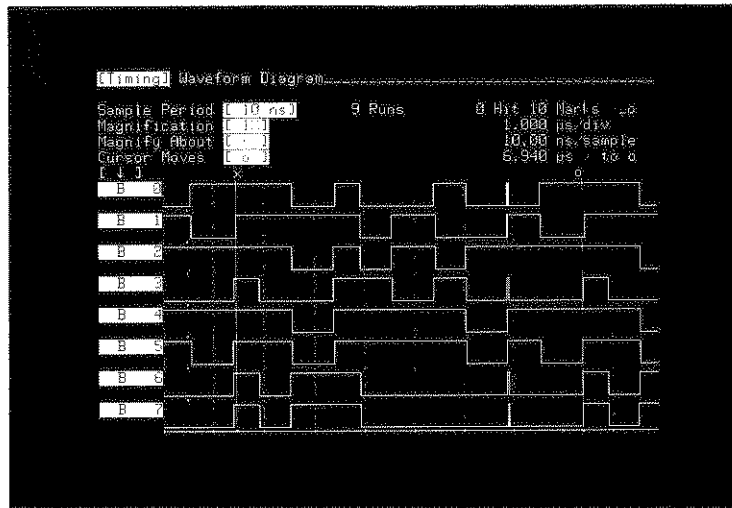

Figure 5-18. Timing Waveform Diagram with Marked Events

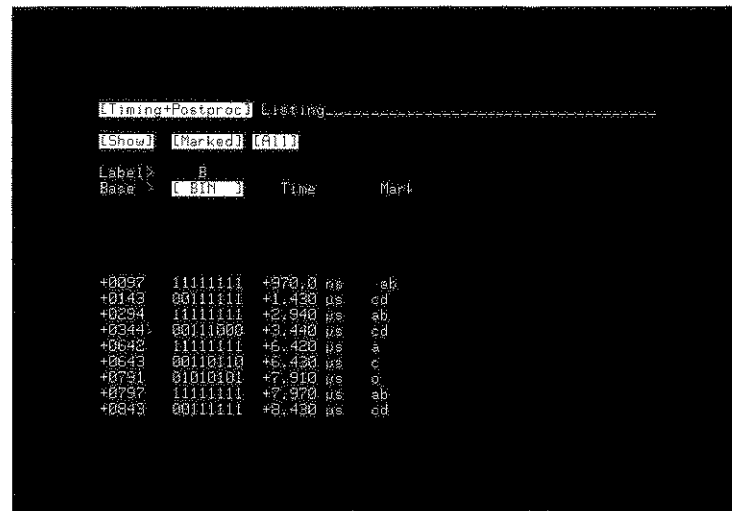

Figure 5-19. [Timing + Postproc] Listing Showing Marked Events

The number of marks between hits (marks between the x and o cursors) are displayed on the Timing Waveform Diagram. On statistical measurements, the statistical information is also displayed on the Timing Waveform Diagram. The minimum and maximum number of marks are counted and displayed in the selectable fields in the upper right of the Timing Waveform Diagram. Sequences and occurrences of marks may be specified in the post processing menu to stop continuous runs.

On Acquired Data Mark Listing On All Occurrences Of a, b, c, d [Sample] [0 through 9] [After/Before] [Pos Tran/Neg Tran/Any Tran] on [Pod 1 or Pod 0] bit [0 through 7].

These combinations of selectable fields can assign marks to any of ten clock pulses [Sample] [0 through 9] which occur after or before [After/Before] a negative transition, positive transition, or either transition [Neg Tran/Pos Tran/Any Tran] on any of eight bits [Pod 1 or Pod 0] bit [0 through 7].

By using these combinations, a measurement may be made to mark a transition state of a line and the condition of the line 30 ns later. Figure 5-20 is the post processing specification defining event a as any transition on bit 7 of Pod 1. Event b is defined as the condition of bit 7, 3 clock pulses after event a occurs. The sample period is set to 10 ns in the Timing Trace Specification menu. Figure 5-21 is the resulting [Timing + Postproc] Listing.

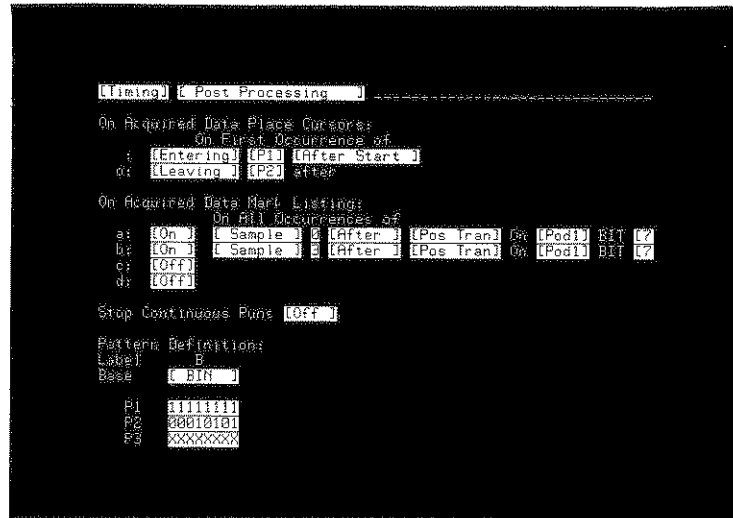

Figure 5-20. Specification for Sample Marking Line Conditions

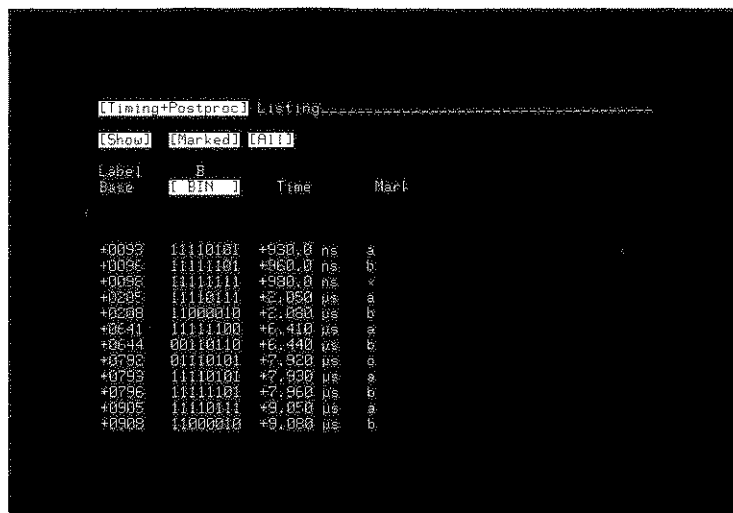

Figure 5-21. Listing of Sample Marked Line Conditions

Continuous Runs and Statistical Measurements

The triggering capability of the timing analyzer may be extended by using continuous tracing with the post processing mode. By setting specifications in the Timing [Post Processing] menu, triggering can be extended further than the timing clock function which operates on a 1, 2, 5 sequencing range.

By using the continuous tracing mode and taking repetitive traces of a time interval, more information can be provided by the timing analyzer by making statistical measurements. If the time interval is varying, statistics can be gathered to show the minimum, maximum, mean and standard deviation of the time interval.

NOTE

Stop Continuous Runs specifications can be used when Statistical Measurements are [Off].

To make statistical measurements [Continuous] trace mode must be selected in the Timing Trace Specification. Post Processing and Statistical Measurements must also be selected [On]. The statistical information is automatically displayed on the Timing Display Diagram.

The menu specifications for continuous measurements in the Timing [Post Processing] menu direct the timing analyzer to examine the acquired data for a trigger condition, use the occurrence of that condition to stop the continuous runs, and capture the current trace. There are five specifications in the Timing [Post Processing] menu to use for extended triggering with the continuous trace mode.

Stop Continuous Runs When [Mark ___ x ___ o] [Greater/Less] than ----

This specification directs the analyzer to take traces until the number of marks from the x to o cursor [Mark ___ x ___ o] has changed [Greater/Less] than the amount specified ---- from 0 to 999.

This specification can be used in a system when a known condition, such as interrogating an I/O port, occurs a known number of times. The analyzer will run continuous traces and count the number of times the system interrogates the I/O port. Each time the analyzer finds the specified number of marks, a new trace is taken. When the analyzer finds too few or too many marks, depending on whether greater than or less than has been selected, the analyzer stops tracing and the list may be examined.

Stop Continuous Runs When [Time ___ x ___ o] [Greater/Less] than ---- [ns/us/ms/s]

This specification directs the analyzer to take continuous traces until the amount of time between the x and o cursors [Time ___ x ___ o] has changed [Greater/Less] from the amount specified ---- [ns/us/ms/s].

This specification can be used when a routine, such as handshaking, usually takes a certain amount of time but occasionally fails. The analyzer will take continuous traces and keep track of the amount of time the handshaking takes. Each time the handshake is completed in the specified amount of time the analyzer takes another trace. When the task takes shorter or longer than the amount of time specified, depending on whether greater than or less than was selected, the analyzer stops taking traces and that trace may be examined.

Stop Continuous Runs When [#Runs] equals ----

This specification is used for statistical measurements when an exact number of samples are to be used for the statistical information. Marks are defined in the Timing [Post Processing] menu for important events to be used in the statistical computations.

Stop Continuous Runs When [Sequence ___ x ___ o] [Any Sequence/ a through ≠d]

This specification directs the analyzer to take continuous traces while the events between the x and o cursors [Sequence ___ x ___ o] occur in the given sequence of (up to eight) events [Any Sequence/ a through ≠d].

This specification can be used when a routine normally performs a sequence of tasks in a special order, such as activating a series of asynchronous lines. The analyzer can run continuous traces and keep track of the sequence of the assigned events. Each time the events occur in the specified sequence, the analyzer takes another trace. When the sequence is different than the specification, the analyzer stops tracing and the trace with the events out of sequence can be examined.

The events are set up as marks in the Timing [Post Processing] menu and are defined as a, b, c, d, ≠a, ≠b, ≠c, and ≠d. Up to eight events may be defined. The default sequence of events is [Any Sequence] with which, the analyzer will take continuous traces.

Stop Continuous Runs When [Off]

This specification is the default condition and the analyzer will take continuous traces. It may also be used to cancel any of the other Continuous Run specifications. The cancelled specification may be re-selected and the definition will remain the same as before it was cancelled.

Pattern (and Glitch) Definition

Patterns are defined in the last specification field in the Timing [Post Processing] menu. When [Glitch] mode is selected in the System [Configuration] Specification, fields to define glitches are also displayed on the Timing [Post Processing] menu. Use the ROLL keys to display Pattern and Glitch Definitions that are not on the display screen.

THE TIMING DISPLAY

The analyzer can present three kinds of displays: waveforms, two types of lists, and XY charts. These displays are discussed in this chapter.

Waveform Displays

Figure 5-22 is a typical timing waveform display. It shows the states of six channels during a measurement. The probe channels shown on the waveform display are identified on the left-hand side of the display by their label names and numbers which identify bit positions within the label.

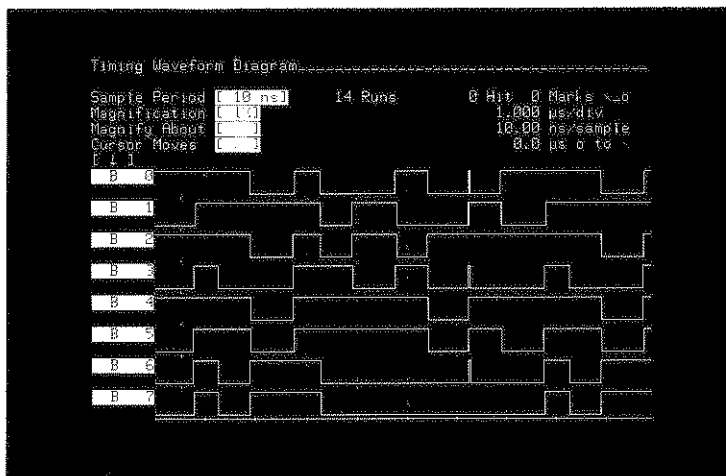

Figure 5-22. Typical Timing Waveform Display

Display Content:	1 to 16 channels (X2 vertical magnification with 8 or less channels.)
Channels on Display:	Any bit in any position, identified by label name and bit number (if in multi-bit label) on left-hand side.
Display control fields	
Sample Period:	10 ns to 500 ms. You can change sample period and run new traces when in this menu.
Magnification:	selects from 1X to 40X. Bright bar in dotted line at bottom shows position of display window in memory.
Magnify About:	Moves magnified display window to area around "x" or "o" markers.
Cursor Moves:	Selects "x", "o", or "x&o" markers to be moved by CURSOR keys. Scale at top shows time period between "o" and "x" on display.
Label Moves:	Shift and cursor changes order of labels.
Bit Labels:	Press NEXT[] key to bring any bit to any point. Press INSERT and DELETE to add or remove channels. Press CLEAR ENTRY to turn off a display channel. Press LABEL up-arrow or down-arrow to move a channel up or down on the display.
Roll indicator:	arrows in upper, right-hand corner indicate whether display window can be positioned left or right by ROLL keys.

List Displays

List displays can be obtained when you are performing timing measurements. Figure 5-23 is a typical list of timing information captured from a logic software system. The time column shows the absolute time interval between each line of information and the trigger line.

The message "Continuous Trace in Process" appears at the top of the display when in the [Continuous] trace mode. In this mode, the analyzer makes a continuous series of single traces, updating the display after it completes each trace. The content of the list will change after each new trace is completed if the display is updated with new information. To stop a continuous trace, press the STOP[] key. This causes the analyzer to complete the trace it has in progress and not start a new trace.

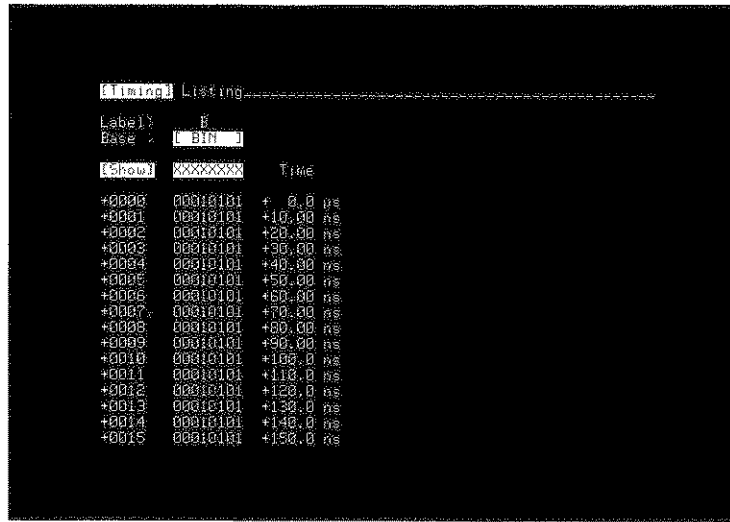

Figure 5-23. Typical Timing Listing Of Timing Activity

Display Control Fields

- Base:** hexadecimal, decimal, octal, binary, ASCII (for labels from 6 to 16 bits), and user (values assigned in [User Base] menu). User values not specified are shown in hexadecimal numbers.
- [Mark]:** places asterisk beside each line number that has values specified in [Mark] line.
- [Show]:** shows only those lines on screen that have values specified in [Show] line.
- Line no.:** inverse-video field can be changed to any line number in memory. Display window will shift to area in memory which includes selected line.
- Display Information:** Blanked while analyzer gathers activity. If timing activity is captured at a slow rate, top line will show amount of memory still to be filled. After trace complete, up to 16 lines of activity from memory will be on screen. Every label defined in Format Specification will be on screen (subject to max screen width). Labels can be reordered by placing cursor in the base field under a label and pressing the blue SHIFT key plus LABEL right or left key.
- Roll Indicator:** arrow(s) in upper, right corner indicates whether display window can be positioned up, down, left, or right by ROLL keys.
- Time column:** shows absolute time between each sample and trigger line.

The [Timing + Postproc] Listing

When the timing analyzer is in the post processing mode, a special listing is available. The [Timing + Postproc] Listing is obtained by pressing the LIST key. The timing + post processing list is the timing data listing with the post processing marked events. Figure 5-24 is a [Timing + Postproc] Listing.

```

[Timing+Postproc] Listing.....INSERT to FIND.....
[Find] Marked [All] [Thru End]
Label >
Base 0 BIN Time Mark
-0007 00010101 -70.00 ns
-0006 00010101 -50.00 ns
-0005 00010101 -30.00 ns
-0004 00010101 -10.00 ns
-0003 00010101 +10.00 ns
-0002 00010101 +30.00 ns
-0001 00010101 +50.00 ns
+0000 00010101 +70.00 ns
+0001 00010101 +90.00 ns
+0002 00010101 +110.00 ns
+0003 00010101 +130.00 ns
+0004 00010101 +150.00 ns
+0005 00010101 +170.00 ns
+0006 00010101 +190.00 ns
+0007 00010101 +210.00 ns
+0008 00010101 +230.00 ns
  
```

Figure 5-24. Typical [Timing + Postproc] Listing

Display Control Fields

[Show] [All] shows all timing and post processing marked events in timing data list.
[Show][Marked][All] shows only marked events that are defined in the timing [Post Processing] specification. Any defined event may be selected in the [All] field.

[Find] Marked [All]
[Thru Start] when INSERT is pressed, finds the next marked event towards the start of the list. The event is placed in center screen and its position is displayed in inverse video. Any defined event may be selected with NEXT[] or PREV[] when the cursor is in the [All] field.

[Find] Marked [All] when INSERT is pressed, finds the next marked event towards the end of the list. The event is placed in the center of the screen and its position is displayed in inverse video. Any defined event may be selected with NEXT[] or PREV[] when the cursor is in the [All] field.

Display Information: blanked while analyzer gathers activity. If timing activity is captured at a slow rate, top line will show amount of memory to be filled. After trace complete, up to 16 lines of activity from memory will be on screen. Every label defined in Format Specification will be on screen (subject to max screen width). Labels can be reordered by placing cursor in the base field under a label and pressing the blue SHIFT key plus LABEL right or left key.

Roll Indicator: arrow(s) in upper, right corner indicate whether display window can be positioned up, down, left, or right by ROLL keys.

Time column: shows absolute time between each sample and the tracepoint line.

Mark column: shows events as defined in the Post Processing menu.

Chart Displays

The analyzer can format XY charts of the activity collected for any labeled set of bits. You can use these charts to see patterns of activity. Figure 5-25 is a typical XY chart for label B (a label composed of four bits).

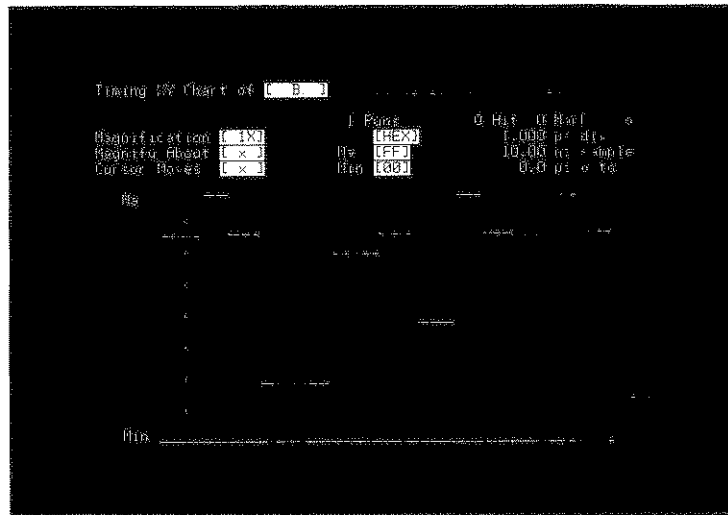

Figure 5-25. Typical Timing XY Chart of a Label

Display Control Fields

- Magnification:** selects from 1X to 40X. Bright bar on dotted line at bottom shows position of display window in memory.
- Magnify About:** Moves magnified display window to area around "x" or "o" markers.
- Cursor Moves:** selects "x", "o", or "x&o" markers to be moved by CURSOR keys. Scale at top shows period of time between "x" and "o" on the display.
- Max and Min:** selects vertical display scale.

Chapter 6

State Measurements

INTRODUCTION

The state analyzer in the 1631A/D Logic Analyzer is synchronous data acquisition system up to 43 channels wide (in the 1631D) capable of storing 1024 states at up to 25 MHz clock rate. Data is captured using a clock external to the analyzer which is derived from the ORed combination of up to three clock sources from the system under test.

State analysis is particularly useful to the microprocessor system software designer for monitoring the flow and performance of assembly language code. In conjunction with an inverse assembler, the state analyzer can be personalized to a given microprocessor and can provide output listings in the mnemonics of the target machine. The state analyzer is also useful to the digital hardware designer in the design and debug of synchronous data busses and algorithmic state machines.

The analyzer's trace specification allows selective tracing to be performed so that events of interest may be triggered on. Store qualification assures that the analyzer may be optimally utilized to capture only states of interest. A number of resource terms may be specified for simple triggering, sequence triggering, sequence restart, and store qualifying.

Data formatting capability provides the user with the means of mapping input data channels to labels which have meaning in the context of the user's measurement. This makes the analyzer's listing, chart, and histogram displays immediately understandable and allows hardcopy outputs of these displays to be useful documentation.

The target system used throughout this manual for examples, except for chapter 7, is the HP 5036A Microprocessor Lab which contains an 8085 microprocessor. All traces in the accompanying figures are from data captured from a 5036A.

CAPTURING A STATE TRACE

1. Make all the required connections to the target system. Information for connecting the probes, directly or through an interface, is in chapter 2 of this manual.
2. Apply operating power to the logic analyzer and to the target system.

NOTE

When using a preprocessor, be sure to apply power to the analyzer first or the target system may not run.

The logic analyzer will execute power-up sequences and display the system menu in the default configuration. See Power-up Display Messages in chapter 2 for more information on the power-up sequence and messages. The default system configuration assigns the two analog channels and no channels to the state or timing analyzers. The 1631A default System Specification menu has eight less channels than the 1631D. Power-up display messages will appear on the display only when the analyzer is powered up. Use the ROLL keys to select all state channels as in figure 6-1.

NOTE

The blue shift key enters the alternate function/character shown in blue above each key. When the blue key is pressed the next key pressed will enter the blue alternate function/character. The blue key may be held down for repeated entries.

Use the blue key and the ROLL keys to move the entire display area left and right.

Use the blue shift key and LABEL arrow keys to move entire labels or, when the cursor is within a label field, the blue shift key and an arrow key may be used to move the cursor to the first position in the next field of the label.

NOTE

In the upper right hand corner of the display, arrows indicate the keys that may be used to control the display. The arrows indicate the CURSOR left, right, up, or down keys and the ROLL up or down keys.

THE STATE FORMAT SPECIFICATION

The State [Assignment] Format Specification

The logic analyzer must acquire data from the target system in exactly the same manner as the target system interprets the data. Therefore, the clock assignments and voltage thresholds utilized by the system must also be used by the logic analyzer. The logic analyzer will then see the exact information that the target system sees. This type of information is specified in the analyzer with the State [Assignment] Format Specification menu. The State [Assignment] Format Specification menu is also used to group incoming channels and assign names (labels) to the groups. Assigning labels to groups (such as the address, data and status channels) makes the data displayed on the logic analyzer much easier for the user to interpret and analyze.

Figure 6-3 is the default State Format Specification menu that is displayed on the 1631A/D when the FORMAT key is pressed. When the analyzer runs a trace, only probe channels assigned to a label are displayed in the listing. All channels on the 1631A/D are defaulted to label "A". All probe channels are initially assigned to a label so when a trace is listed, all channels are included in the listing. All channels not connected are indicated by a zero in the State Listing.

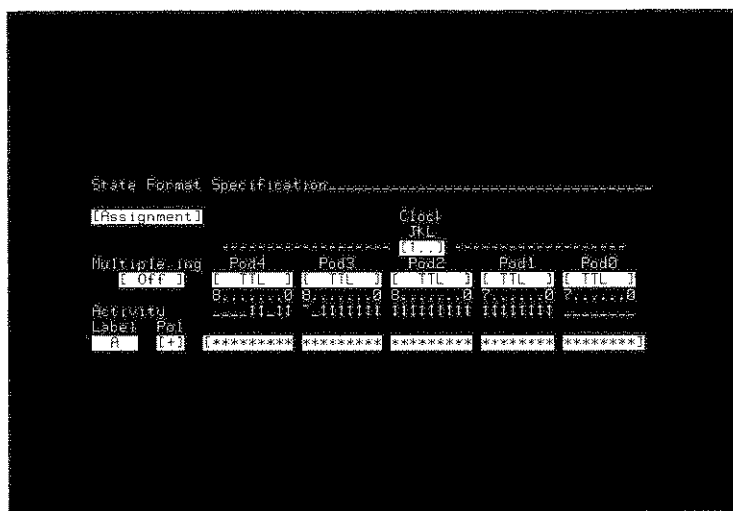

Figure 6-3. 1631A/D Default State Format Specification Menu

Clock Assignments

The logic analyzer must recognize data on the same clock edge as the target system when taking state measurements. Three ORed clocks are available in the State [Assignment] Format Specification. The default clock assignment specifies the analyzer to collect data on the positive edge of the J clock. Other clock specifications may be made by moving the cursor to the ORed clock field on the assignment menu and using the NEXT[] or PREV[] keys to select different clocks and edges.

Multiplex Assignment

Some microprocessor systems may use multiplexing in which certain signal lines are used for different information at different times. In the target system used for the examples in this manual, the data bits and eight lower address bits are multiplexed on the same pins of the microprocessor. The logic analyzer can demultiplex these lines so the data and address will be listed in separate columns in the state listing. To set the multiplexing mode on, move the cursor to the field under Multiplexing in the State [Assignment] Format Specification and press the NEXT[] or PREV[] key. The multiplex choices are displayed in ratios that indicate the number of channels to be processed by the slave/master clocks. The slave clock moves information to a holding register and the master clock puts both sets of information into the logic analyzer memory. When multiplexing is on, edges for the master and slave clock are automatically assigned. To change clock assignments, move the cursor to the clock field and use the NEXT[] or PREV[] keys to select different clocks and edges.

For the target system used in examples for this manual, the multiplex field is set to [27/16]. This is the typical setting for 8-bit microprocessors that multiplex data and address lines in the same manner as the 8085. For 16-bit microprocessors that utilize multiplexed lines, demultiplexing is usually set at 18 channels for the slave clock instead of 27.

Threshold Assignments

Input threshold levels are selectable for each pod. The threshold is selected by moving the cursor into the field under an individual pod and selecting TTL, ECL, or absolute voltages between -9.9V and +9.9V. The threshold level determines whether the incoming voltage will be recorded as a logic 1 (if above the threshold) or a logic 0 (if below the threshold level).

NOTE

All probe connections within a pod are assigned the same threshold level.

Activity Line

The activity line under each pod in the State [Assignment] Format Specification indicates the channels on which voltage changes are taking place. A double-ended arrow indicates an active channel (>400Hz) and a single bar indicates a steady state, either high or low.

Label Assignments and Polarity

1. Move the cursor to the label column in the State [Assignment] Format Specification menu. A message will appear on the display screen indicating a new label may be added. Press INSERT and a new label field will be added. Labels are entered with numeric keys and/or the blue shift key and the alphabetic characters. Up to eight labels may be assigned and each label may consist of up to five characters. (Labels are deleted by pressing the blue shift key and DELETE when the cursor is anywhere on the line of the label to be deleted.)
2. Add the label ADDR to the label column in the new field. Notice the field to the right of the label field. By using the NEXT[] or PREV[] key, + or - may be selected to indicate whether a voltage above the threshold voltage is to be displayed as a 1 or 0. A + in this field indicates voltages above the threshold are 1 and voltages below are 0. Choosing - gives the opposite display.

NOTE

Polarity choice does not affect the waveform display.

3. Press and hold the CURSOR-right-arrow to move the cursor across the label field to bit 6 of pod 3. This is the MSB (most significant bit) of the address channels connected to the analyzer.
4. Press either NEXT[] or PREV[] key sixteen times, or hold either key down, until sixteen asterisks appear in the entries beneath Pod3 and Pod2. The asterisks assign the corresponding probe bits to the label designated ADDR.
5. Press LIST. The bits that are assigned to the label ADDR are now listed in a new label column, ADDR, in the State Listing. Figure 6-4 is the state listing with the address bits assigned to the label ADDR.

NOTE

When a trace is run, data is acquired on all channels (assigned to a label or not). The format may be modified and new information may be displayed without taking a new trace. Acquired data may be manipulated by changing the format menu.

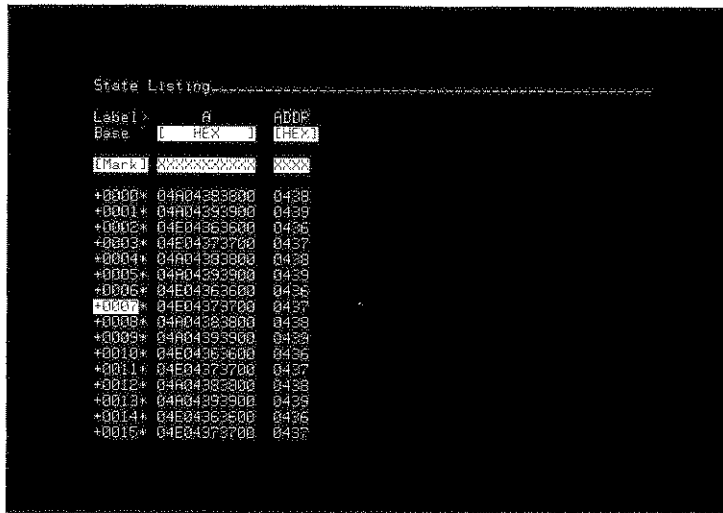

Figure 6-4. State Listing Including the ADDR Label

6. Press FORMAT and add labels for DATA lines and STAT (status) lines the same way the ADDR label was added. Assign the appropriate bits (as connected in chapter 2) to the added labels.

NOTE

The bits assigned to labels need not be physically adjacent. Bit 2 in Pod1 may be combined with bit 5 in Pod3 for assignment of a single label consisting of the two probe channels.

7. Move the cursor to label A on the 1631A/D with the CURSOR arrow keys. Press the blue shift key and DELETE to remove label A from the State Format Specification. Figure 6-5 is the State [Assignment] Format Specification with the appropriate probe bits assigned to labels ADDR, DATA, and STAT.

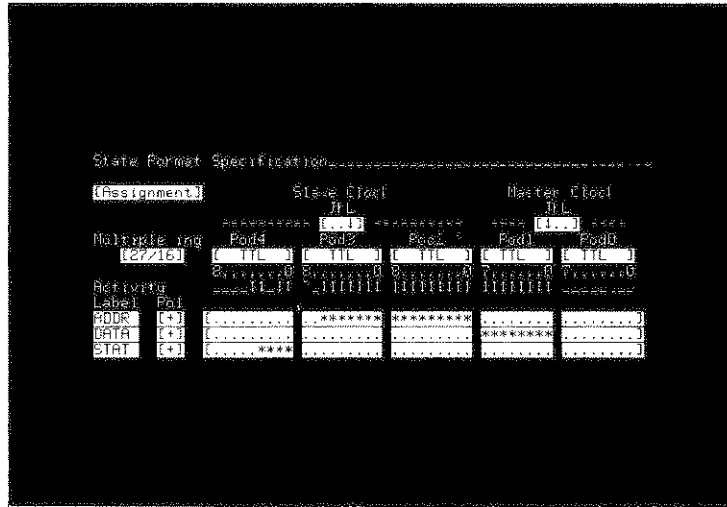

Figure 6-5. State [Assignment] Format Specification Menu

NOTE

The format specification in figure 6-5 is for the target system, with a 8085 microprocessor, being used for the examples in this manual. All assignments pertain to the 8085 including the clock and multiplex assignments.

8. Press LIST and see that all assigned labels now appear in the state listing and the default label A is no longer displayed, as in figure 6-6. The State Listing makes more sense now and the list is easier to analyze. The number base for any label may be changed by moving the cursor to the base field under the label and using the NEXT[] or PREV[] keys to select different bases.

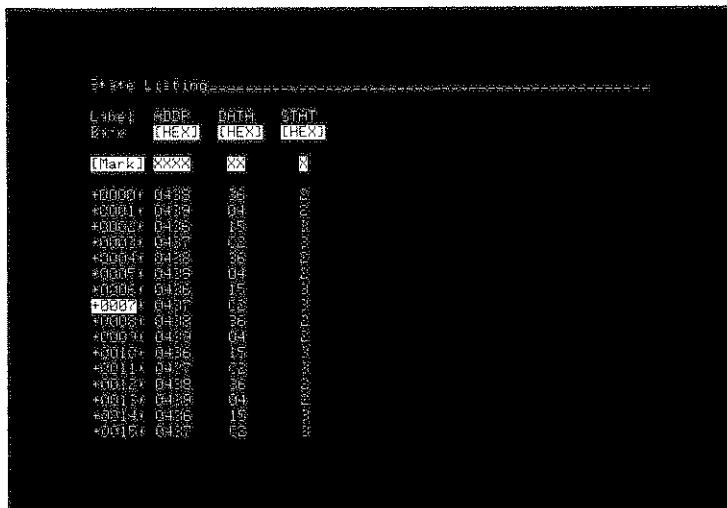

Figure 6-6. State Listing for ADDR, DATA, and STAT Labels

9. Channels are not restricted to a single label, they may be assigned to two or more label groups. Press FORMAT and add a new label, MIX, as in figure 6-7. Assign all the STAT bits, the last four ADDR bits and the first four DATA bits to the label MIX. Steps 2 through 6 describe how to add a new label and assign bits.

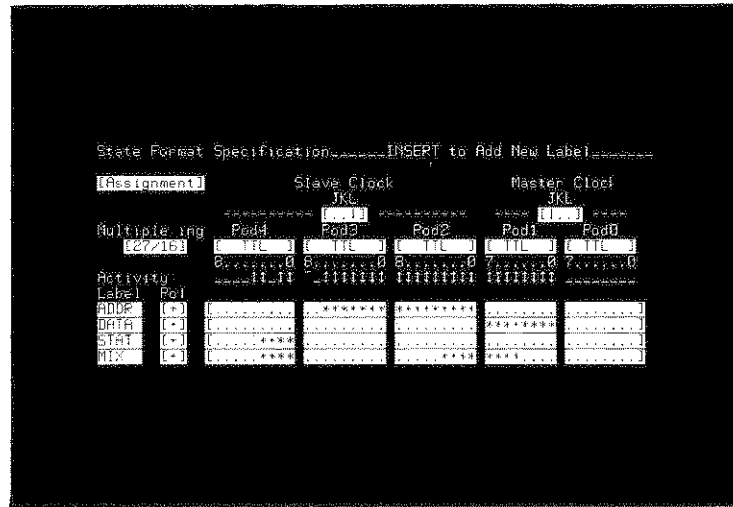

Figure 6-7. State Assignment with Bits Assigned to Multiple Labels

- Return to the State Listing by pressing the LIST output display key. The label MIX has been added to the display as shown in figure 6-8. The characters under the MIX label are STAT, the LSB (least significant bit) of ADDR, and the MSB (most significant bit) of DATA.

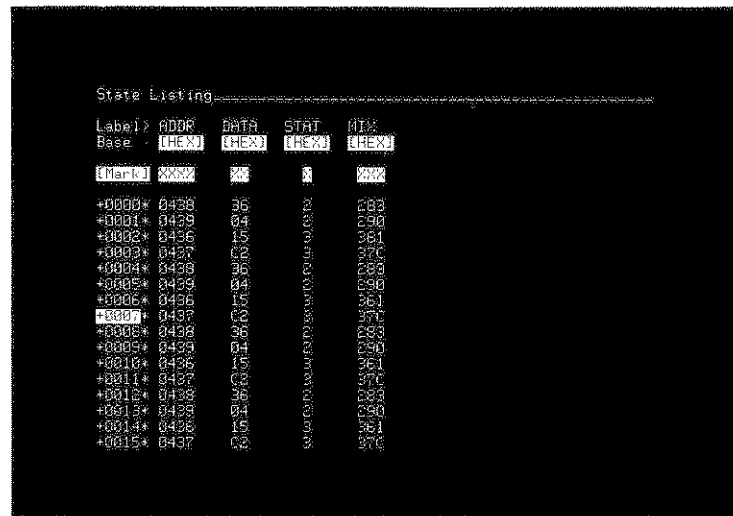

Figure 6-8. State Listing With Bits Assigned to Multiple Labels

- The MIX label has no purpose at this time, but assigning bits to more than one label can be helpful in troubleshooting. To remove the label, return to the State [Assignment] Format Specification menu by pressing FORMAT. Move the cursor anywhere on the MIX label line. Delete the entire line by pressing the blue shift key and DELETE.

The State [Relocation] Format Specification

The State [Assignment] Format Specification provides a means to group the incoming channels to the logic analyzer into meaningful labels, making it possible to interpret the display in the context of the user system. These labels may be further grouped and labeled to make the display even easier to analyze. In the following steps, the address ranges in the label designated ADDR in the State [Assignment] Format Specification are grouped and given module names.

The target system in this example has four operations that we want to label: a keyboard checking routine, a timing routine, stack operation, and OUT addresses for scan and display. Each routine has a starting address and uses a known number of addresses, however, there is unknown code in the addresses between the routines to be labeled. Table 6-1 is a listing of the routine modules with starting addresses and the known amount of addresses used for each module.

Table 6-1. Address Map for Relocation Example

Named Module	Starting Address	Addresses Used
KEYBD	01D0	0012H
TIME	0429	001EH
STACK	0BB0H	0050H
SCAN	2828H	0001H
DSPLY	3838H	0001H

1. Press FORMAT. The State [Assignment] Specification menu will be displayed. Change [Assignment] to [Relocation] by using the NEXT[] or PREV[] key. Relocation applies to any label previously defined in the State [Assignment] Specification.
2. Figure 6-9 is the default State [Relocation] Format Specification menu. Since ADDR is the first label assigned in the [Assignment] specification, it is shown in the label field. Move the cursor to the label field and cycle through the labels available for relocation by using the NEXT[] or PREV[] key.

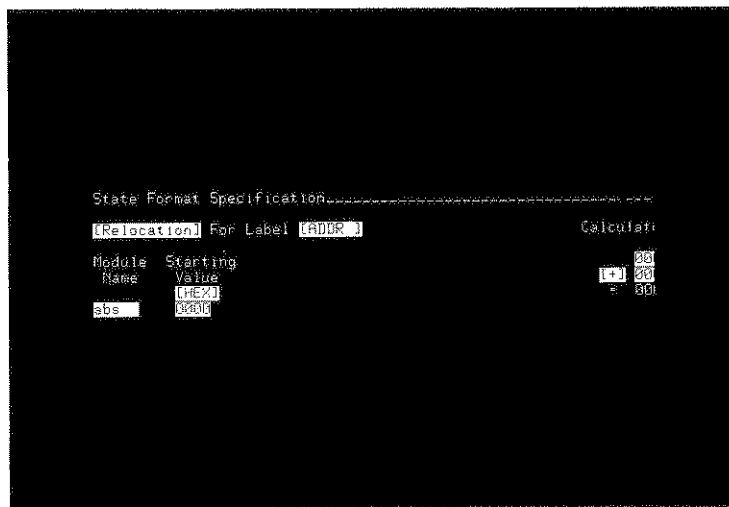

Figure 6-9. Default State [Relocation] Format Specification Menu

3. Select [ADDR] for the label field. Only one label at a time may be used in the [Relocation] mode. By naming ranges in the [ADDR] label, routines that are executing may be identified in the State Listing.
4. Move the cursor to the abs 0000 field in the Module Name column. Enter the module name KEYBD and the starting address value in the next column.
 - a. Move the cursor to the first field under Calculator and enter the starting address for the module name.
 - b. Move the cursor to the middle field of Calculator and enter the number of addresses used for the module.
 - c. The last number in the Calculator field shows the first address of unnamed code after the module. Use this address as the starting address of the next module name.
5. There is code between the modules KEYBD and TIME which can be labeled module A to differentiate it from the KEYBD and TIME modules. Move the cursor to the Module Name column and add module A. Use the address determined by the calculator for the starting address.
6. Continue to INSERT the rest of the code modules until the State [Relocation] Format Specification looks like figure 6-10.

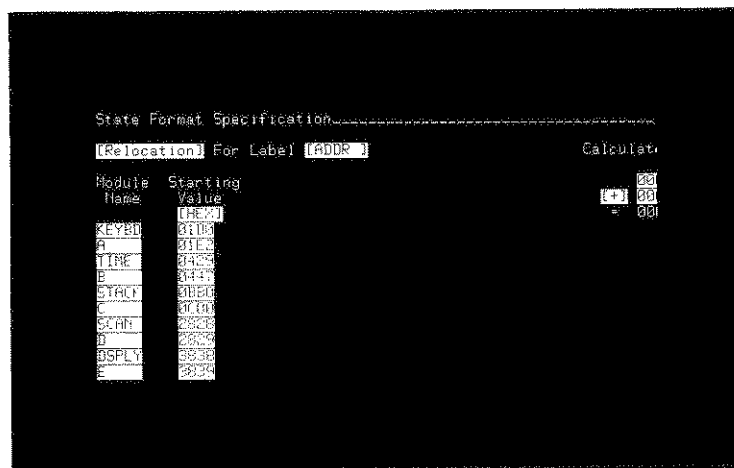

Figure 6-10. State [Relocation] Format Specification With Assigned Modules

7. Press LIST. Change the base field for ADDR with the NEXT[] key to [REL + HEX]. Now the state list for the ADDR label includes the relocatable module name and the offset address referenced from the beginning of the module (in hexicecimal base). The new state listing is shown in figure 6-11. In figure 6-11 the trigger is now TIME + 0010 which means the trigger is located 10 addresses into the TIME module.

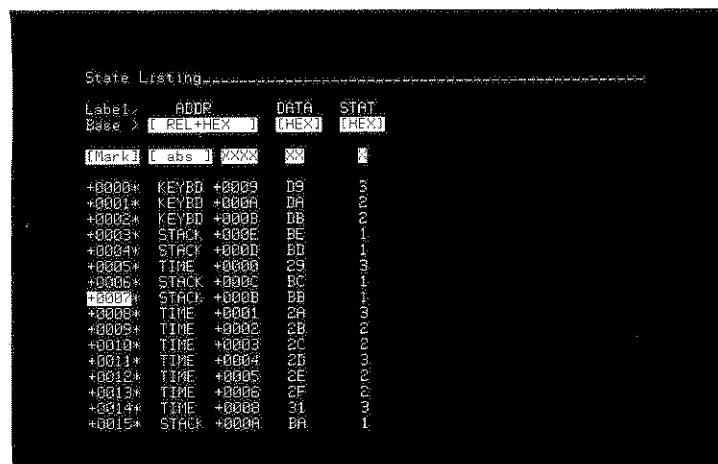

Figure 6-11. State Listing Using Relocation Values

8. A comparison of the relocatable code modules and the absolute hexadecimal values, two columns of the same states may be made.
 - a. Press FORMAT twice to return to the State [Assignment] Format Specification menu.
 - b. INSERT a new label, ADDR1, and assign all address probe bits to the label.
 - c. Press LIST and both lists for the address bits will be displayed in the state listing as in figure 6-12.

NOTE

For easy comparison of lists, the ADDR1 list may be moved to the right of ADDR. Move the cursor to the ADDR1 label field and press the blue shift key and then the LABEL CURSOR left key.

9. Similar relocation ranges and names may be assigned to the other labels from the State [Assignment] Format Specification.

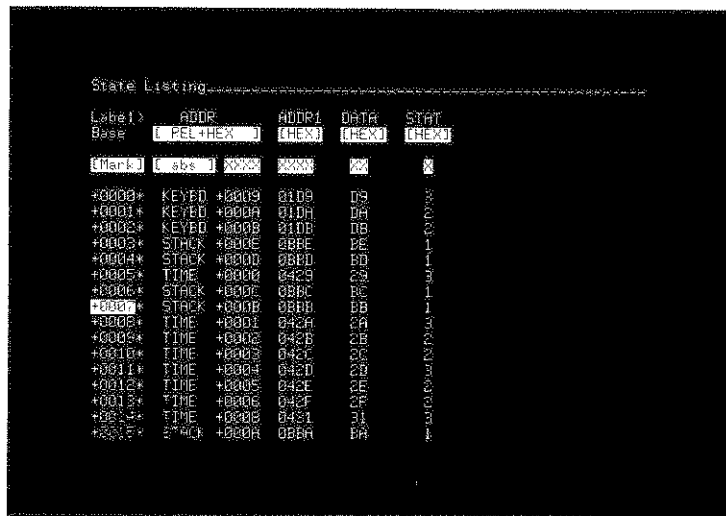

Figure 6-12. State Listing With Relocation and Absolute Value Lists

The State [User Base] Format Specification

The State [User Base] Format Specification is used to assign user defined names to conditions on control and status lines. The user base names may then be displayed on the state listing in place of the numeric values to make the data on the display easier to interpret.

Only labels with four probe bits or less may be assigned user base names. The maximum amount of user base conditions for each label is sixteen. All labels that have been assigned in the State [Assignment] Format Specification may have user base names assigned providing four or less bits are assigned to each label. The user base names may be any of 1 to 5 alphanumeric characters.

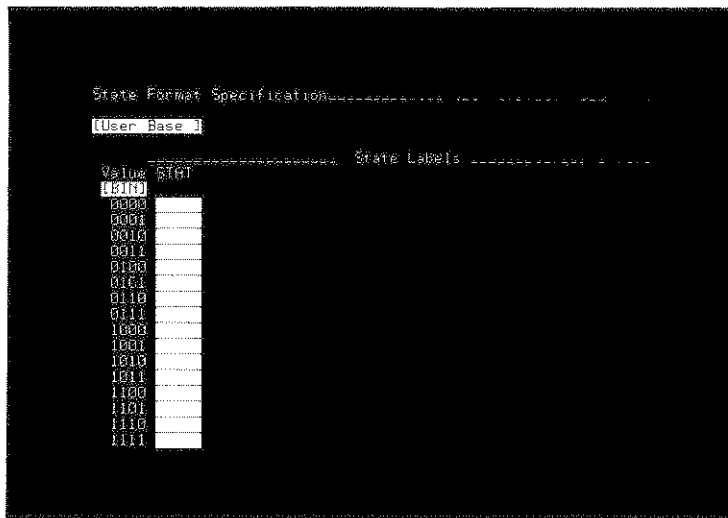

Figure 6-13. State [User Base] Format Specification Menu

1. Press FORMAT and select [User Base] with NEXT[] or PREV[] key. STAT is the label from the assignment specification with four or fewer probe bits assigned to it and is automatically displayed in the State [User Base] Format Specification menu, shown in figure 6-13. Since there are four bits assigned to the label, STAT, there are sixteen possible conditions that may exist in the STAT label. When the 8085 is executing instructions, there are six basic types of operations that are performed. The six operations, the STAT label binary conditions, and the user base names to be assigned are listed in table 6-2.

Table 6-2. User Base Names for STAT Label

8085A Operation	User Base Name	Binary Value
Read from memory	MEMRD	0001
Write to memory	MEMWR	0010
Read from input	IO-RD	1001
Write to output	IO-WR	1010
Opcode fetch	OPFCH	0011
Interrupt acknowledge (transferring control to another location)	INTAK	1011

2. Assign the STAT label codes to the appropriate conditions in the State [User Base] Format Specification as shown in figure 6-14.

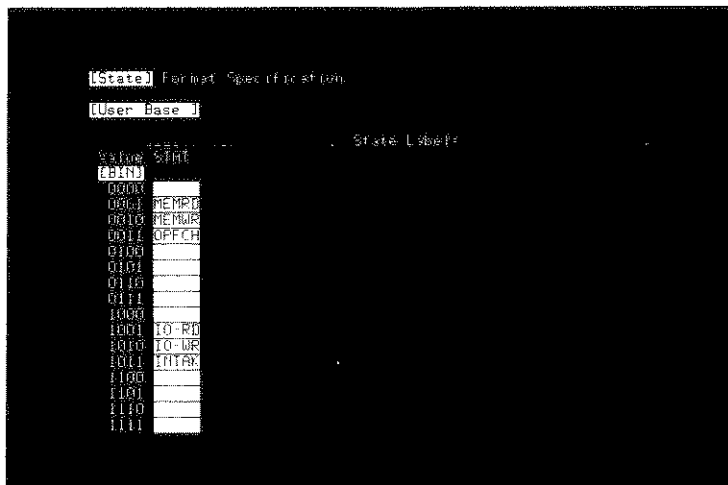

Figure 6-14. User Base Specification With Assigned Conditions to STAT Label

- Press LIST. Move the cursor to the base field under the STAT listing and press the NEXT[] key twice. The STAT listing is now in the user base names, as in figure 6-15, instead of numeric values.

```

State Listing-----
Label> ADDR      DATA      STAT
Base > [PEL+HEX] [HEX]  [USR ]
[Mark] [abs] [XXX] [X] [XXXXX]
+0000* FEYBD +000A 0A MEMRD
+0001* FEYBD +000B 0B MEMRD
+0002* STACK +000D 0D MEMRD
+0003* STACK +000E 0E MEMRD
+0004* TIME +0008 08 GRPCH
+0005* TIME +0009 09 MEMRD
+0006* STACK +000A 0A MEMRD
+0007* TIME +000B 0B GRPCH
+0008* TIME +000C 0C MEMRD
+0009* TIME +000D 0D MEMRD
+0010* TIME +000E 0E GRPCH
+0011* TIME +000F 0F MEMRD
+0012* TIME +0010 10 GRPCH
+0013* TIME +0011 11 MEMRD
+0014* STACK +0012 12 MEMRD
+0015* STACK +0013 13 MEMRD
    
```

Figure 6-15. State Listing With User Base Names in STAT List

INVERSE ASSEMBLERS FOR THE LOGIC ANALYZER

Inverse assemblers display the data from the target system on the logic analyzer screen in mnemonics similar to those of the microprocessor in the target system. Figure 6-16 is a state listing after the data from the system used for examples in this manual has been disassembled with the 8085 Inverse Assembler.

```

State Listing-----
Label> ADDR      8085 Mnemonic  STAT
Base > [PEL+HEX] [HEX]  [HEX]
[Mark] [abs] [XXX] [Instructions] [ ]
+0000 TIME +0010 04 memory read 0
+0001* TIME +000D DCR D 0
+0002* TIME +000E JNZ TIME+0000 0
+0003 TIME +000F 36 memory read 0
+0004 TIME +0010 04 memory read 0
+0005* TIME +000D DCR D 0
+0006* TIME +000E JNZ TIME+0000 0
+0007 TIME +000F 36 memory read 0
+0008 TIME +0010 04 memory read 0
+0009* TIME +000D DCR D 0
+0010* TIME +000E JNZ TIME+0000 0
+0011 TIME +000F 36 memory read 0
+0012 TIME +0010 04 memory read 0
+0013* TIME +000D DCR D 0
+0014* TIME +000E JNZ TIME+0000 0
+0015 TIME +000F 36 memory read 0
    
```

Figure 6-16. State Listing With Disassembled Data List

The inverse assembler file automatically sets up the State [Assignment] Format Specification and, in some inverse assemblers, the State [User Base] Format Specification.

Inverse assemblers are available, for many of the widely-used microprocessors, on floppy disc. Each inverse assembler is supplied with an Operating Note. See Chapter 9 of this manual for information on using an HP 9121D/S Flexible Disc Drive with the 1631A/D.

Most of the inverse assemblers available for use with the 1631A/D come in versions for HP 10269A/B Interface Module and for direct connection with individual probe connections. Refer to the operating note supplied with each inverse assembler for instructions about connections to the logic analyzer.

THE STATE TRACE SPECIFICATION

The Trace Specification determines where the logic analyzer starts a trace and what kind of information is collected in the trace. The logic analyzer can take [Single] or [Continuous] traces, [Compare] lists before storing a data, or perform [Overview] performance analysis measurements.

1. Press TRACE. The default State Trace Specification menu is shown in figure 6-17. In the default mode, the analyzer will take a single trace starting at the first occurrence of any state of the target system. All states thereafter will be stored until 1024 states are captured. The analyzer then automatically displays the stored trace.

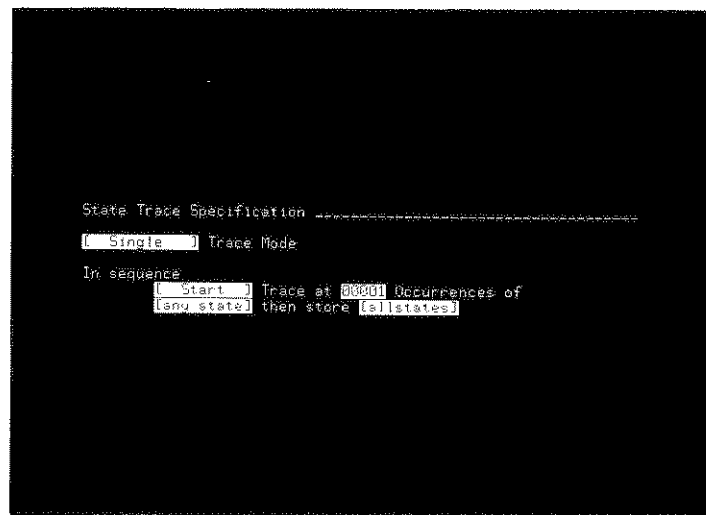

Figure 6-17. 1631D Default State Trace Specification Menu

2. Use the NEXT[] key and select the [Continuous] mode. Press RUN and the analyzer will perform series of trace measurements. At the completion of each measurement, the analyzer updates the display and starts a new trace measurement. The trace measurements continue until the STOP key is pressed.

NOTE

When STOP is pressed once, the analyzer completes and displays the measurement presently in progress. If STOP is pressed twice, the trace measurement is aborted and any states captured at that point are displayed in the listing.

3. Press TRACE again and return to the [Single] trace mode by using the PREV[] key.
4. When the analyzer captures a trace from the target system, the analyzer stores 1024 states, however sixteen states are displayed at one time. The list may be scrolled through by using the ROLL keys. Another way to quickly locate portions of the list is to move the cursor to the location in the State Listing marked by the inverse field and put a new value in the field. The list automatically changes to place the specified location in that position of the list. Typically, when a measurement is taken, only a few states or a particular event is of interest and it is not necessary to see the entire list. These states or events may be located by using the [Mark/Show] function of the analyzer.

- Move the cursor to the field under ADDR at the right of the [Mark] field in the State Listing. Select an address in the list and place the value into this field. The asterisks that were beside each listing in the state list are now only at the locations that contain the address specified in the Mark field under the ADDR label, as in figure 6-18. If using relocatable module codes for display, use the NEXT[] or PREV[] key to select module name and enter the address to be marked with the front panel numerical keys.

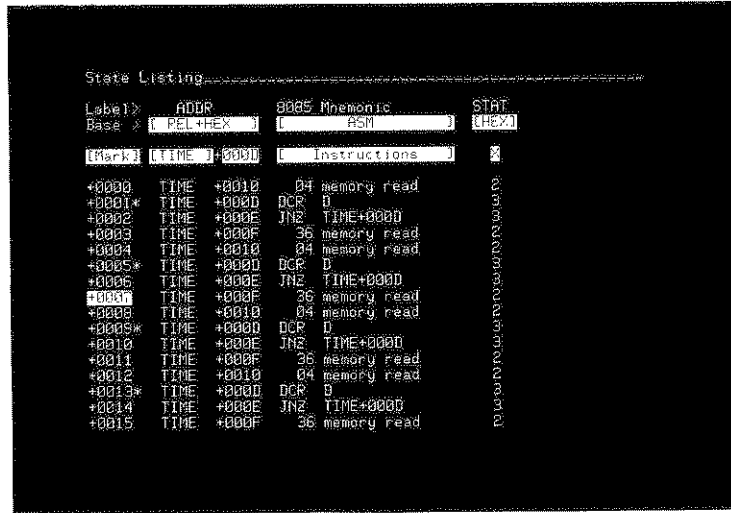

Figure 6-18. State Listing With Specific States Marked

- Move the cursor back to the [Mark] field and change the field to [Show] with the NEXT[] or PREV[] key. Now only the states that contain the address specified are displayed, as in figure 6-19. The original trace is still preserved in memory, but has been temporarily edited.

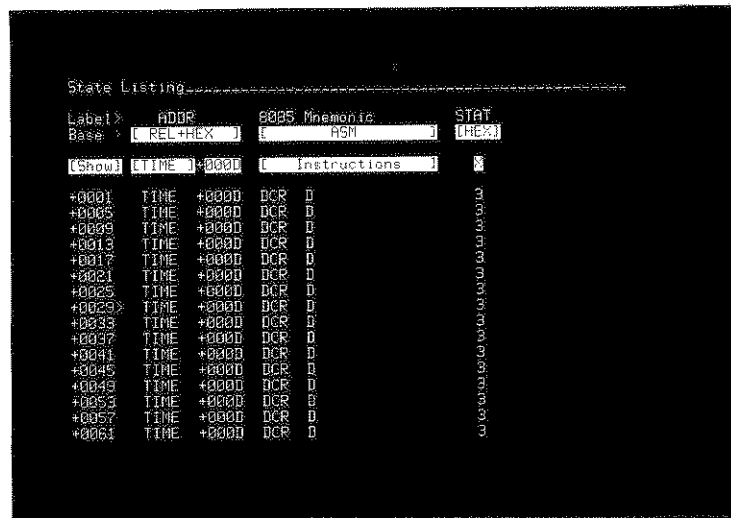

Figure 6-19. State Listing Showing Only a Specific State

- The original list may be obtained by changing [Show] to [Mark] with the NEXT[] or PREV[] key and replacing the the specified address under the ADDR label by X's with the DON'T CARE key.

NOTE

DON'T CARE triggering is useful for fault-finding in a system when part of the trigger word is unknown or unimportant. For instance, if the trigger word is defined as 030X, (hexidecimal), the trace will trigger on any word from 0300 to 030F. The amount of words possible for triggering could be decreased further by specifying the trigger in binary base and defining only certain bits or one bit as DON'T CARE.

Resource Terms

When the logic analyzer takes state traces, activity is clocked into the analyzer by a clock from the target system. After 1024 consecutive states have been stored, the trace halts and is displayed on the analyzer screen. This method of taking traces is used in many cases, but usually a sequence of data or a particular event is of interest, making need for qualification of data before it is captured. Resource terms are used to define specific states for qualifying data before it is captured by the logic analyzer.

Resource terms may be defined with the logic analyzer, with which the analyzer compares incoming bit patterns. Only activity complying with terms specified in the State Trace Specification is stored by the analyzer. Four terms are available for use as resource terms: a, b, c, and d. The resource terms are user defined and may be assigned for simple triggering, sequence triggering, sequence restart, and/or store qualifying.

Trigger [Start/Center/End] trace

When a resource term is defined as the trigger term to [Start] the state trace, the analyzer waits until the trigger is found and then starts storing states in memory. After 1024 states have been stored, the trace is halted. The captured state list is then displayed on the analyzer screen with the trigger term at line location 0000 in the State Listing. Selective storing of states may be specified in the State Trace Specification by defining terms to be stored after the trigger is found.

When the resource term is defined as the trigger term to [Center] the trace, the analyzer keeps track of the trigger term in the same manner as a when a start trace term has been defined. After the trigger term is found and identified as the center of trace, states previous to the trigger term, the trigger term and the next 511 states are stored. The entire memory length of 1024 states may not always be listed in the State Listing. For instance, if the trigger term is found at the tenth state after RUN is pressed, nine states will be listed before the trigger in the listing (and labeled with a minus sign), the trigger (at line 0000), and 511 states after the trigger (labeled with a plus sign). The total listing will be 521 states long. Additional resource terms may be defined for selective storing.

The trace is stopped at the trigger term when the State Trace Specification defines the trigger term as the end of the trace. The analyzer displays the trigger term and up to 1024 states previous to the trigger depending on where the trigger is found after the RUN key is pressed. If the trigger term is found after 100 states, the State Listing will consist of 101 states.

Up to 59,999 occurrences of a state may be specified in the occurrence field of the State Trace Specification in order to pass loops in program activity that are well removed from the defined trigger term.

1. Press RUN and select one of the addresses from the ADDR column in the State Listing.
2. Press TRACE. Move the cursor to the [any state] field and select resource term [a] by pressing the NEXT[] key twice. When one or more resource terms have been selected, the four fields to define the terms are automatically added to the State Trace Specification menu as shown in figure 6-20.

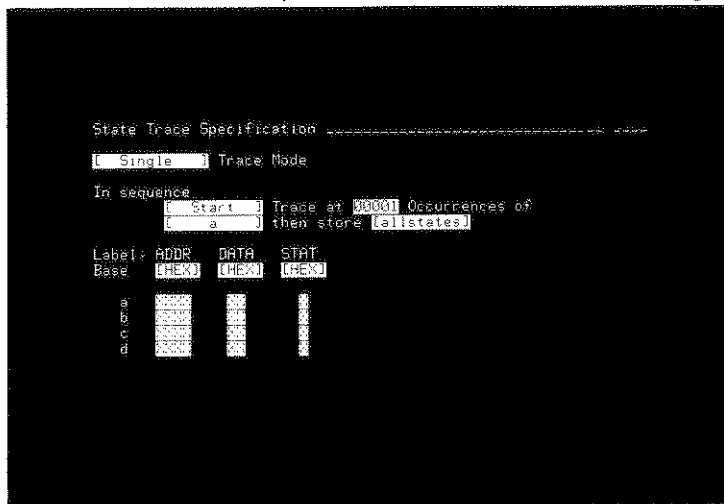

Figure 6-20. The State Trace Specification With Fields For Resource Terms

- Move the cursor to the first field under the ADDR label and enter in the address selected in step 1. This specification tells the analyzer to start storing the trace in memory when it finds the selected address on the lines that have been labeled ADDR. The X's in the other fields indicate that any value on those lines will satisfy the trigger specification. Figure 6-21 is the trace specification to trigger on the first occurrence of a specified address.

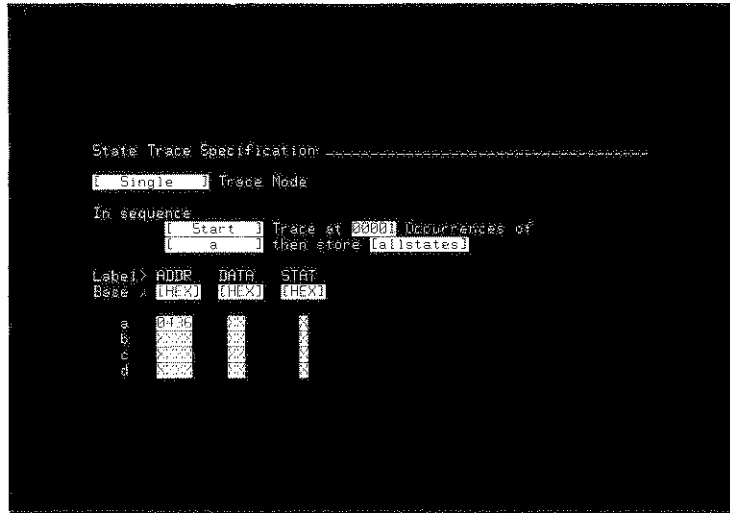

Figure 6-21. Specification of Trigger on First Occurrence of a Specific State

- Press RUN. The analyzer will monitor activity from the system under test until it finds the condition specified on the address lines. Then it captures that state in memory and all successive states until the memory is filled one time. The message "Trace Complete" will be displayed after a trace has been completed by the analyzer. The State Listing is shown in figure 6-22.

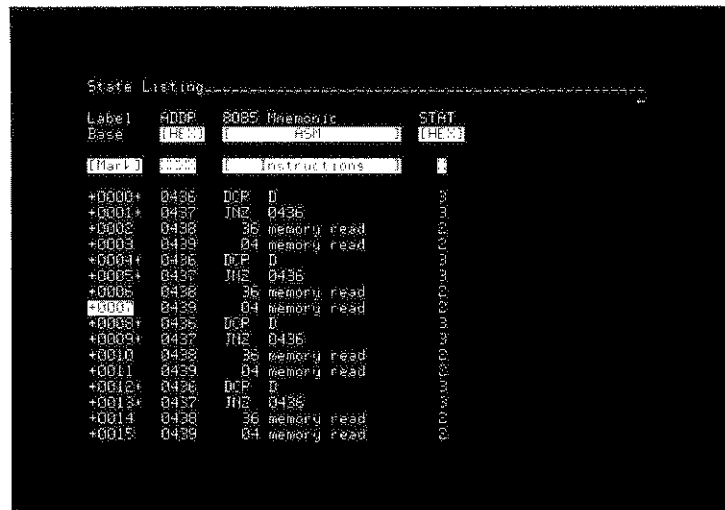

Figure 6-22. Trigger Starts Trace Listing

- The trigger state specified in the trace specification is at location 0000 on the State Listing. Trigger was specified to be the start of the trace.
- Press TRACE and move the cursor to the [Start] field. Select [Center] with the NEXT[] key to place the trigger position at the center of the trace. This specification is used when it is desired to see states before and after the trigger condition. Notice a field to the right of the [a] resource term has been added to the menu for store qualifying data. Store qualifying is explained later in this chapter.

- Press RUN. The analyzer will begin storing states into memory. When the specified state is found, the analyzer will capture that state and store an additional 512 states. The states captured before the trigger will be identified on the state list with line numbers preceded by minus signs. The trigger and the states captured after the trigger are identified by line numbers preceded with plus signs as in figure 6-23.

```

State Listing-----
Label> ADDR      0005 Mnemonic  STAT
Base > [HEX]    [ 50]
[Mark] [XOR]    [ Instructions ] [  ]

-0003* 0437 JNZ 0436
-0002 0438 36 memory read
-0001 0439 04 memory read
+0000* 0436 DCR D
+0001* 0437 JNZ 0436
+0002 0438 36 memory read
+0003 0439 04 memory read
+0004* 0436 DCR D
+0005* 0437 JNZ 0436
+0006 0438 36 memory read
+0007 0439 04 memory read
+0008* 0436 DCR D
    
```

Figure 6-23. Trigger Centers Trace State Listing

- The trigger may be placed at the end of the trace list in cases where activity after the trigger is not important but activity before the trigger is the necessary data. Press TRACE and select [End] trace on trigger. The analyzer captures activity from the target system until the trigger is found. The trigger condition and the previously captured states are then displayed in the state list, as in figure 6-24.

```

State Listing-----
Label> ADDR      0005 Mnemonic  STAT
Base > [HEX]    [ 50]
[Mark] [XOR]    [ Instructions ] [  ]

-0007 0BB9 44 memory write 1
-0006* 0432 XRA A 3
-0005* 0433 PUSH D 3
-0004 0BB8 02 memory write 1
-0003 0BB7 47 memory write 1
-0002 0434 MVI D,BC 3
-0001 0435 0C memory read 3
+0000* 0436 DCR D 3
    
```

Figure 6-24. Trigger Ends Trace State Listing

Sequential Triggering

Sequential triggering is used to trigger the analyzer only after a certain set of events has occurred in the specified sequence. It is used in defining a path of a branching network within the programming of the target system.

For example, figure 6-25 is a typical branch network. The analyzer is to execute a trace at the trigger term 6000, but only if the program has followed path 2 to reach the location 6000. Resource terms can define the trace specifications as: In sequence find [0300], then [0305], then [0500], then start trace on the first [00001] occurrence of [6000].

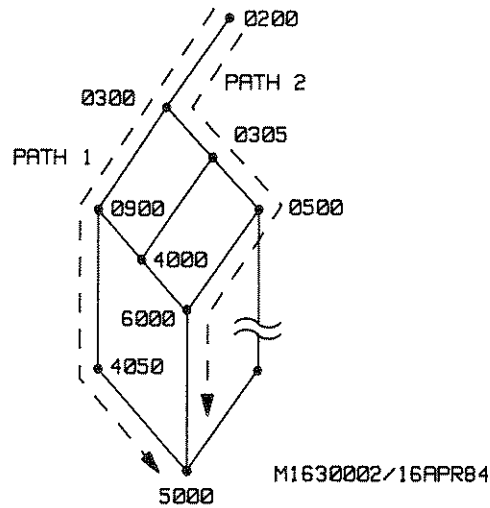

Figure 6-25a. Branching Network With Specified Paths

Each resource term arms the analyzer for the next term to be recognized. The analyzer executes the trace only after all the terms have been recognized in the given sequence. Figure 6-25b is the analyzer flowchart for triggering on sequence terms.

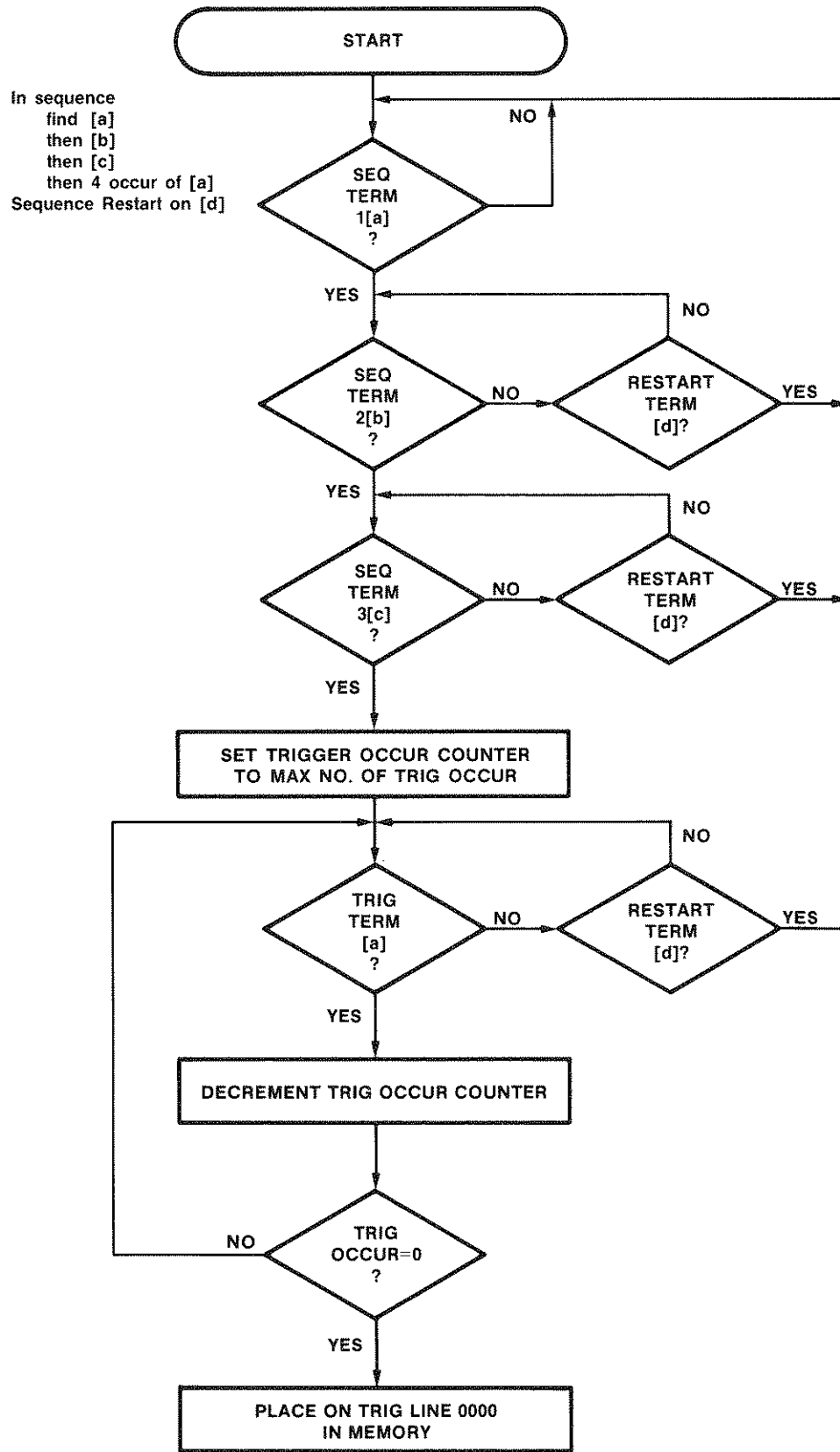

Figure 6-25b. Analyzer Sequence Triggering Flowchart

1. Press TRACE and move the cursor to the [Start] field.
2. Press INSERT three times to open three fields for sequential triggering. Initially, all fields begin at [a].
3. Use the NEXT[] key to specify the sequence terms of find [a], then [b], then [c], then start trace at [d] as in figure 6-26. Notice the find sequence term [d] may be set for multiple occurrences before the trigger starts the trace.

When using [then] find terms, the analyzer looks for the specified state at any time after the first state specified. The state may occur immediately after the first state or a significant time period later.

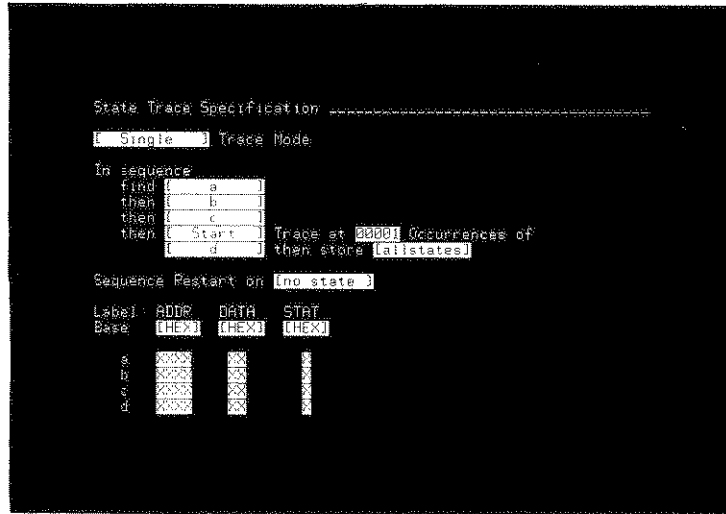

Figure 6-26. State Trace Specification With Sequence Terms

4. Move the cursor to the [d] resource term and press INSERT three times. Three resource terms are added which may be used to define an ORed relationship to the trigger term. The NEXT[] and PREV[] keys are used to select a specific resource term for each field. The fields provide an ORed relationship for the final trigger term as shown in figure 6-27.

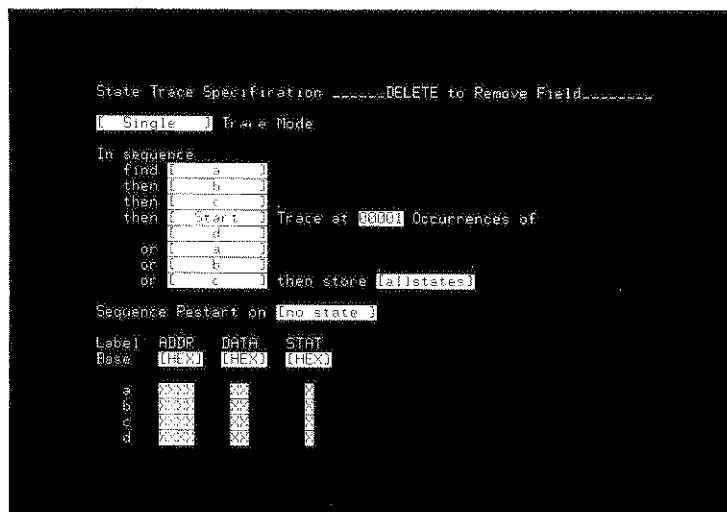

Figure 6-27. State Trace Specification With Sequence Terms and ORed Trigger Start Terms

Sequence Restart

Sequence triggering occasionally requires a restart term to ensure the sequence is found in one pass through a branch network. If a restart term is not specified, the analyzer may eventually see all the sequence terms, though not in the path specified, and a trace will be executed. If the logic analyzer finds part of the sequence terms but not all the terms, then finding a sequence restart term will instruct the analyzer to repeat the sequence until all terms are found in the specified sequence.

1. Move the cursor to the sequence restart field.
2. Press NEXT[] or PREV[] to select a restart term.
3. As many as four resource terms may be selected to be ORed with the initial restart term by pressing the INSERT key. The State Trace Specification figure 6-28 contains the maximum amount of resource terms to be ORed.

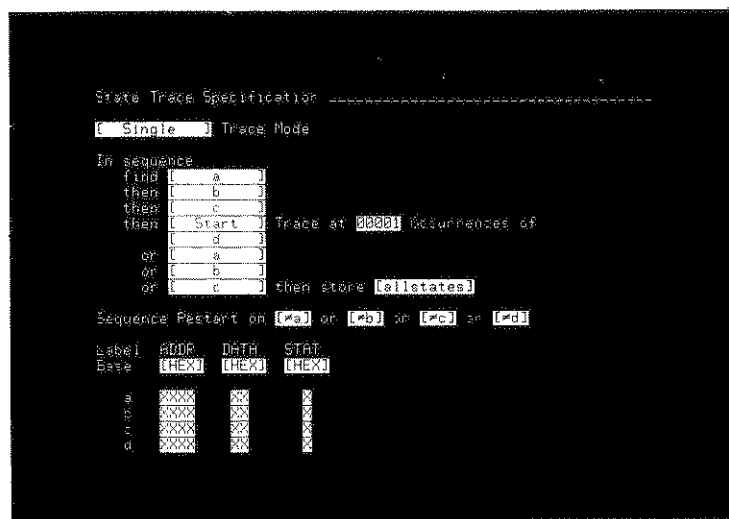

Figure 6-28. Maximum Sequence Restart ORed Resource Terms

Store Qualifiers

Resource terms may be used to qualify data before it is stored by the logic analyzer. When resources terms are used as store qualifiers, only data matching the specified terms will be captured in analyzer memory. Resource terms are used to store qualified data after a sequence of terms are found, or for storing specified terms before a sequence term is found. When used for storing data before terms, the sequence terms are used as breakpoints to change the store qualifiers.

1. Move the cursor to the store [all states] field.
2. Cycle through the resource terms that may be selected by pressing the NEXT[] or PREV[] keys.
3. By pressing INSERT, up to four terms may be specified as store qualifiers to be ORed. The maximum amount of ORed store qualifiers when the trigger starts the trace is shown in figure 6-29.

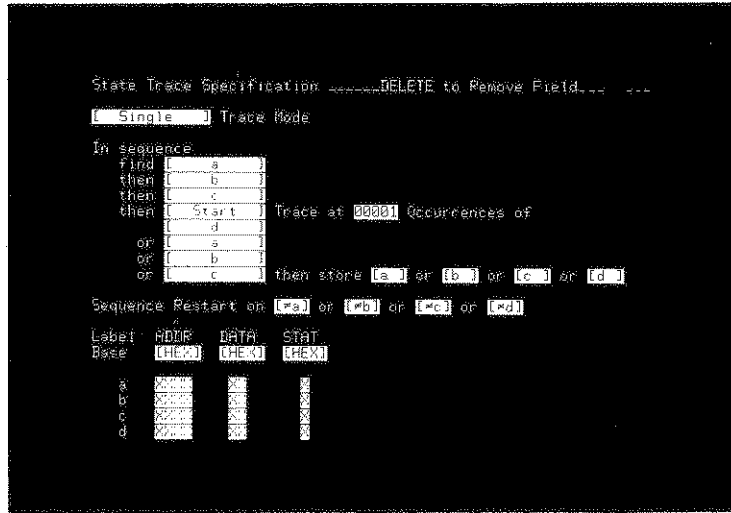

Figure 6-29. ORed Resource Terms as Store Qualifiers When Trigger Starts Trace

4. Move the cursor to the [Start] field and select [Center] with the NEXT[] key. Three more fields for resource terms are automatically added, one after each of the first three sequence terms. The added fields are shown in figure 6-30.

NOTE

Use ROLL up key to see resource term d.

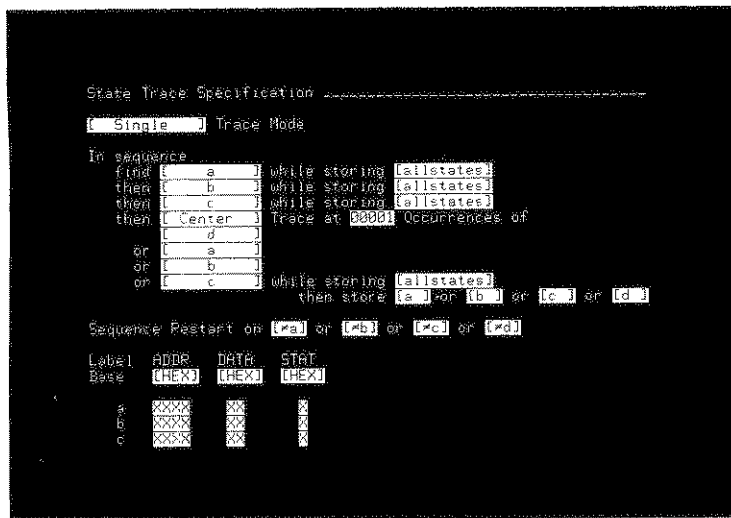

Figure 6-30. Store Qualifying Data Between Sequence Terms

5. Move the cursor to any of the while storing [all states] fields and use the NEXT[] or PREV[] key to specify one resource term.
6. To OR store qualifiers between sequence terms, press INSERT to add as many as four ORed store qualifiers. The maximum amount of store qualifiers are shown in figure 6-31. In fact, figure 6-31 contains the maximum amount of resource terms used for sequence triggering, sequence restart, and store qualifying.

NOTE

Use ROLL up key to see resource term d.

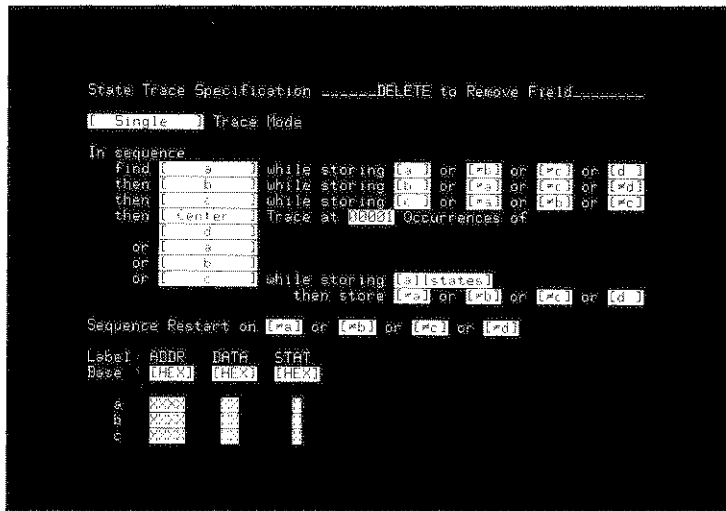

Figure 6-31. Maximum Amount of Resource Terms For the State Trace Specification

[Compare] Trace Mode

The compare mode of the 1631A/D Logic Analyzer provides the means to compare traces with previously stored data. In the compare mode, a trigger point is specified and traces are copared with a previously defiend compare list of data. The compare mode is useful for production line testing and fault analysis. The trace is checked at selected points with reference to the trigger. For example, a compare list might specify the value FFFF (hex) should be found in the fifth transaction (line + 0005 in the trace memory) after the trigger.

Up to 16 events may be specified to set a basis for comparison for continuous state flow. The comparison events need not be continuous, but rather are defined by line number in 1631 memory. The compare termination condition may be set for a trace that matches the comparison sequence (compare trace mode [until =]), or when a new state flow fails to match the compare list (compare trace mode [until ≠]).

1. Press TRACE and use the NEXT[] or PREV[] key to select the [Compare] trace mode of operation.
2. Enter the parameters shown in figure 6-32. The relocation and user base information is the same as previously set up in figures 6-10 and 6-13.

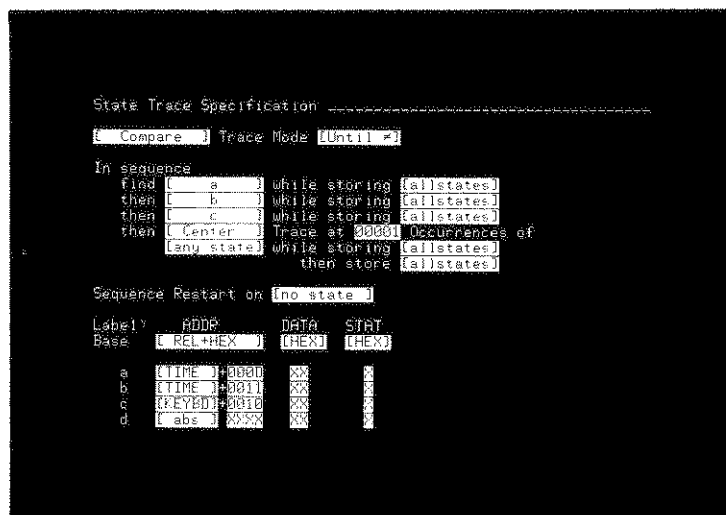

Figure 6-32. [Compare] State Trace Specification

3. Press RUN to obtain a listing which will be used to compose a compare image. When in compare mode, the analyzer takes continuous traces. Press STOP to switch into single trace mode and obtain a state listing.
4. The trace will be displayed in the [State] Listing.
5. Use the NEXT[] or PREV[] key to select [Compare + State] Listing, or press LIST.
6. Choose 5 lines for compare events. In figure 6-33 lines -1, 2, 6, 9, and 13 have been selected.
 - a. Move the cursor to the inverse video field at the center of the listing.
 - b. Use the ROLL keys to place each line to be inserted in the inverse video field.
 - c. Press INSERT. The line is entered into the compare list and is marked by inverse video.
 - d. Up to 16 lines may be entered for the compare list.

NOTE

To delete a line from the compare list, place the cursor in the inverse video field of the line to be deleted and press the blue shift key and DELETE.

7. Move the cursor to the [Mark] field and change it to [Show]. The compare list will be displayed as in figure 6-33.

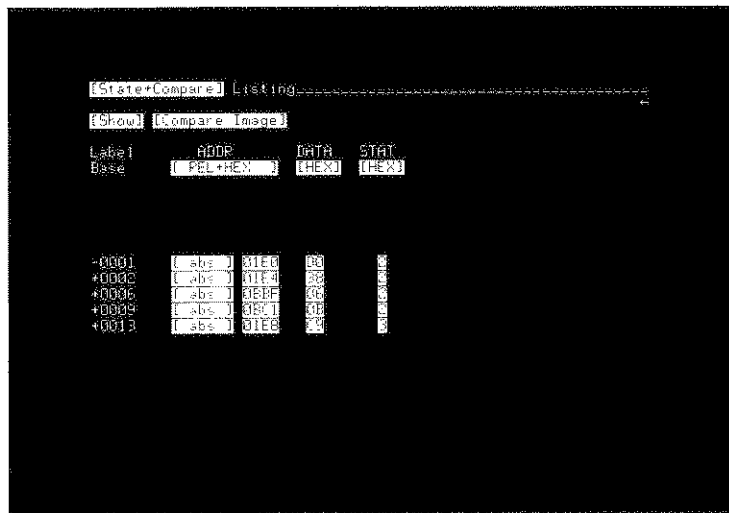

Figure 6-33. The [State + Compare] List

- Press RUN. The analyzer will run a continuous trace until the trace does not have the same events on the lines specified in the compare list. Figure 6-34 is the first trace taken which is not the same as the compare list.

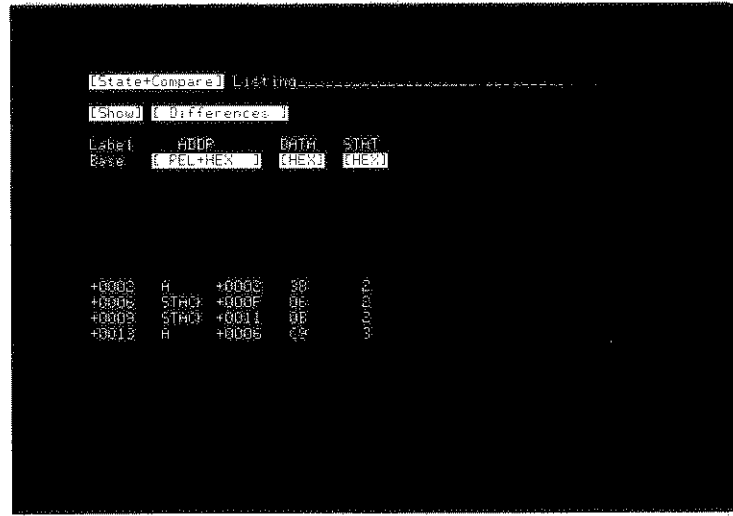

Figure 6-34. Trace Taken in Compare [until ≠] Mode

- Change [Show] to [Mark]. The original listing plus the compare states are displayed in the list, as in figure 6-35. Only the compare states that are different from the original states are marked with an asterisk.

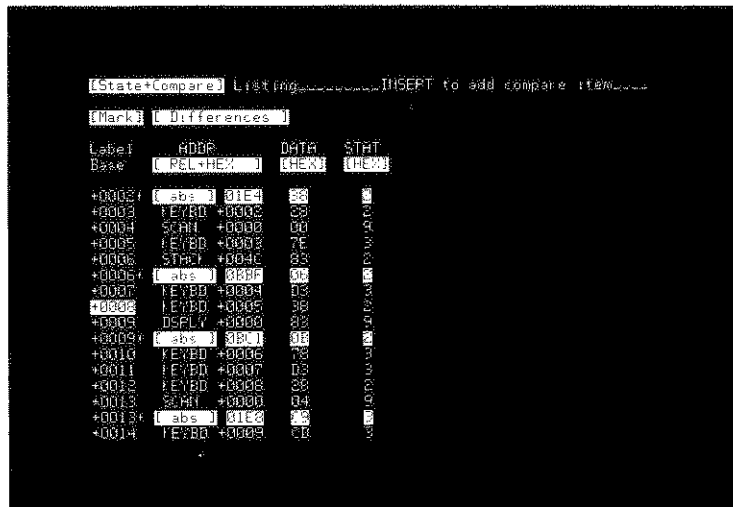

Figure 6-35. Original Compare List with Compare Event Differences

- Pressing RUN will produce different state listings.

NOTE

When using the State [Compare] mode with interactive measurements (State, Timing and Analog combinations), the [Timing] and [Analog] Trace Specifications will also indicate a [Compare] mode. This serves to indicate the analyzer will stop all measurements when the State [Compare] mode condition is met.

THE STATE DISPLAY

List Displays

List displays may be obtained when any of the state trace mode measurements are being performed, except when in the time interval overview mode. The content and use of the list display depends upon which trace mode is being used. Therefore, list displays are discussed for each trace mode.

[Single] List Displays

Figure 6-36 shows a typical list of states that were captured from a logic software system. Line 0000 (the trigger line) is on screen. Lines -0003 through -0001 show three lines of pretrigger information (a pretrigger sequence in the Trace Specification.)

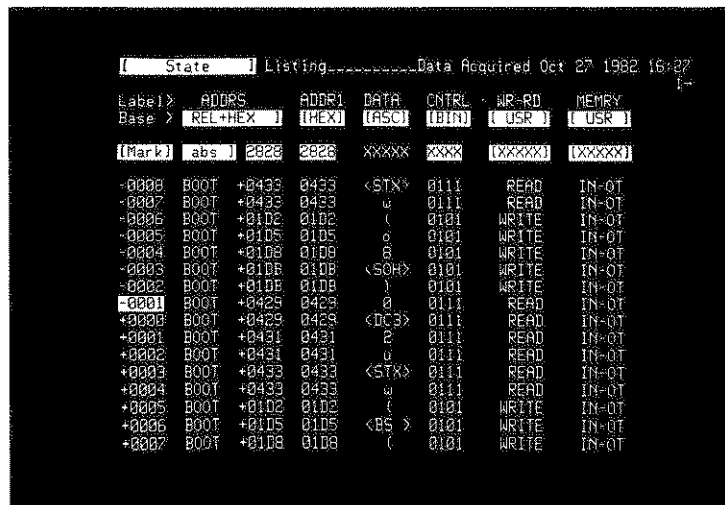

Figure 6-36. Typical List Display In Single Trace Mode

Display Control Fields

- Base: hexadecimal, decimal, octal, binary, ASCII (for labels from 6 to 16 bits), user (values assigned in [User Base] menu), and REL + HEX (values assigned in [Relocation] menu).
- [Mark]: places asterisk beside each line number that has values specified in [Mark] line.
- [Show]: shows only those lines on screen that have values specified in [Show] line.
- Line no.: inverse-video field can be changed to any line number in memory. Display window will shift to area in memory which includes selected line.
- Display Information: Blanked while analyzer gathers states. If states are captured at a slow rate, top line will show count of states still to be captured. After trace complete, up to 16 lines of state memory will be on screen. Every label defined in Format Specification will be on screen (subject to max screen width). Labels can be reordered by placing cursor in the base field under a label and pressing blue SHIFT key plus LABEL right-arrow or left-arrow key.
- Roll Indicator: arrow(s) in upper, right-hand corner. Indicate whether display window can be positioned up, down, left, or right by ROLL keys.

[Continuous] List Displays

The list in the continuous trace mode is like the list in the single trace mode, except that "Continuous Trace in Process" appears at the top. In this mode, the analyzer makes a continuous series of single traces, updating the display each time it completes a trace. The content of the list will change as each new trace is completed if the display is updated with different information. To stop a continuous trace, press the STOP key. This causes the analyzer to complete its trace in progress and not start a new trace.

[Compare] List Displays

Figure 6-37 shows a typical display that may be obtained in the [Compare] mode. On the top line, either the display of [State] or [State + Compare] may be selected. If [State] is selected, the display will show only the content of the trace memory, just as you would see in the [Single] trace mode. The [State + Compare] display is unique to the [Compare] trace mode.

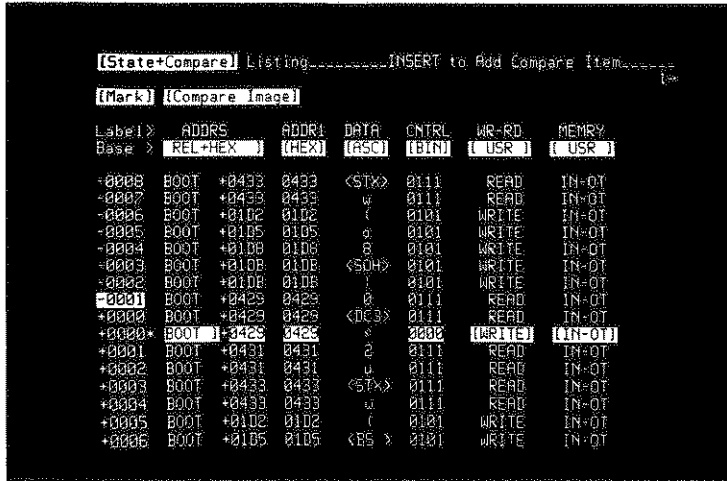

Figure 6-37. Typical List Display in [Compare] Trace Mode

Display Control Fields

- [Mark]: places integrated display of trace list and Compare list on screen.
- [Show]: places only lines of Compare List on screen in [Show] mode or marks lines of Compare List in [Mark] mode.
- [Compare Image]: all lines of Compare List can be on screen.
- [Differences]: only lines of Compare List that are different from corresponding lines in trace list can be on screen in [Show] mode or marked in [Mark] mode.

[Overview] List Displays

A State Listing is not available when the the analyzer is performing overview measurements.

Waveform Displays

Figure 6-38 shows a typical state waveform display. It represents the states on eight channels. Waveform displays may be obtained in any of the state trace modes, except overview. The information on the display is the same, regardless of the trace mode where it was obtained.

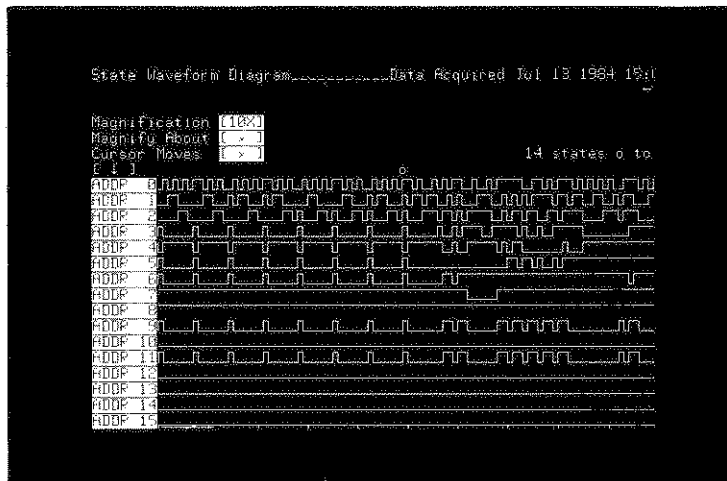

Figure 6-38. Typical State Waveform Display

Display Content:	1 to 16 channels (X2 vertical magnification with 8 or less channels).
Channels on Display:	Any bit in any position, identified by label name and bit number (if in multi-bit label) on left-hand side.
Display control fields	
Magnification:	selects from 1X to 40X. Bright bar in dotted line at bottom shows position of display window in memory.
Magnify About:	Moves magnified display window to area around "x" or "o" markers.
Cursor Moves:	Selects "x", "o", or "x&o" markers to be moved by CURSOR keys. Scale at top shows number of states between "o" and "x" on display.
Bit Labels:	Press NEXT[] key to bring any bit to any point. Press INSERT and DELETE to add or remove channels. Press CLEAR ENTRY to turn off a channel. Press LABEL up-arrow or down-arrow to move a channel up or down on the display.
Roll Indicator:	arrows in upper, right-hand corner indicate whether display window can be positioned left or right by ROLL keys.

XY Charts Of Label Activity

The analyzer can format XY charts of the activity collected from any labeled set of bits. These charts can show patterns of activity. Figure 6-39 shows a typical XY chart of a label.

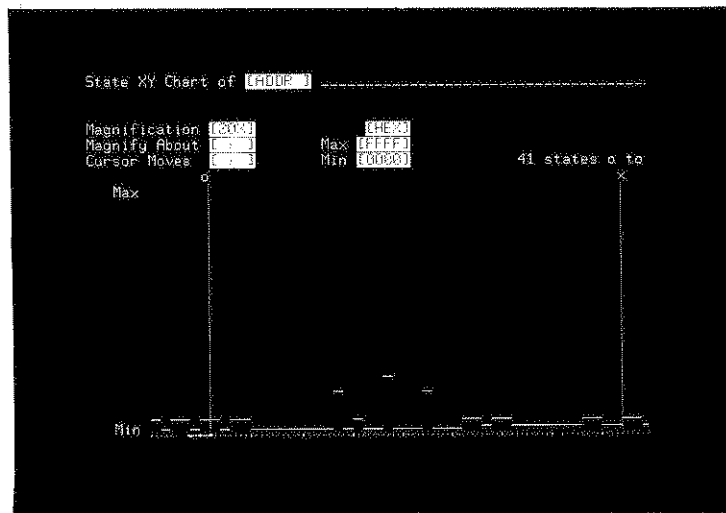

Figure 6-39. Typical State XY Chart Of A Label

Display Control Fields	
Magnification:	selects from 1X to 40X. Bright bar on dotted line at bottom shows position of display window in memory.
Magnify About:	Moves magnified display window to area around "x" or "o" markers.
Cursor Moves:	selects "x", "o", or "x&o" markers to be moved by CURSOR keys. Scale at top shows number of states between "x" and "o" on the display.
Max and Min:	selects vertical display scale.

Chapter 7

Performance Analysis Measurements

INTRODUCTION

As the software of a system begins to push the hardware limitations of a system, the need for more efficient code becomes apparent. The software must be able to respond to all of its inputs in a timely fashion, with little or no delays. Performance Analysis of the software allows the programmer to analyze code—to find bottlenecks and inefficiencies. The overview measurements of the 1631A/D Logic Analyzers provide the programmer the tools to perform this analysis. These tools allow the programmer to analyze module processor usage and module duration. Overview measurements are available on the logic analyzer only when it is configured assigning all channels to state measurements.

The output of overview measurements appear as bargraphs (histograms) relating the relative actions between the measured items. The histograms are presented on the analyzer in the XY Chart menu after the trace specification has been set up for the overview measurement. Overview measurements operate in a continuous random sample mode. A sample consists of 1024 qualified states. The time between states varies randomly to ensure random sampling. To stop a measurement immediately, press the STOP key twice. The first press will force the analyzer to take one more sample and then quit. Two consecutive STOPS will force the analyzer to abort the current sample.

The 1631A/D can perform two types of software performance analysis measurements: State Label Overview and Time Interval Overview. Both overview measurements are described in this chapter.

The examples in this chapter are not from the HP 5036A Microprocessor Lab used in the examples in the rest of the manual.

STATE LABEL OVERVIEW MEASUREMENT

The State Label Overview measurement allows the programmer to define module code ranges and the analyzer will compute the amount of time spent within these modules, relative to each other, or relative to the entire system software. The ranges are defined for one of the eight possible labels defined in the State Format [Assignment] Specification menu. (For a typical inverse assembler, the labels are ADDR, DATA, and STAT.) The ranges may be defined as any of the locations between the minimum and maximum values possible for the selected label.

State Label Overview is very beneficial in improving overall system performance. It allows the programmer to define sections of code critical to the overall system or module performance, and thereby avoid wasting time attempting to optimize code that may not be affecting overall performance.

For example, a module that performs floating point processing is found to be noticeably slow. The floating point module consists of seven routines: F__ADD, F__SUB, F__MUL, F__DIV, F__CMP, F__MOVE, and F__NORM. These routines provide floating point addition, subtraction, multiplication, division, comparison, moves, and normalization. To improve the module performance, the individual routines are defined in the State Trace Specification menu, and then analyzed, as in the following steps that were used to set up the measurement for this example.

1. With the NEXT[] or PREV[] key, select [Overview] in the State Trace Specification menu.
2. Use the NEXT[] or PREV[] key to select the [ADDR] label in the field next to the [Select Label] field. ADDR must be previously defined in the State Format [Assignment] Specification menu.
3. Move the cursor to the ALL label in the Ranges field located at the bottom of the [Overview] menu.

- 5. Use the INSERT key and add the remaining labels (FSUB, FMUL, FDIV, FCMP, FMOVE, and FNORM). Figure 7-1 is the State Trace Specification set up for this example State Label Overview measurement.

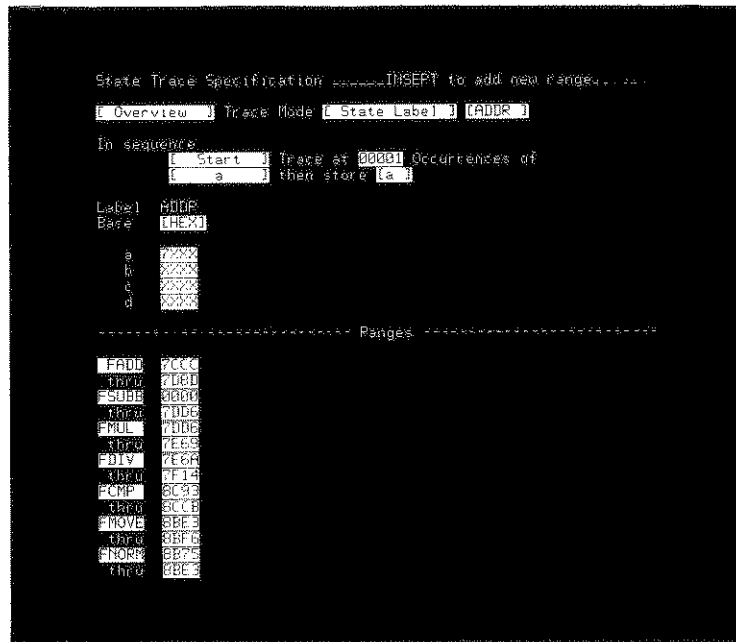

Figure 7-1. Example State Label Overview Trace Specification

- 6. To invoke the State Label Overview measurement, press the RUN key. Figure 7-2 is the resulting histogram chart of the example measurement.

The state label samples the program activity in groups of 1024 states per sample. In between each sample, a random delay is invoked to ensure random sampling. After running the given example, the routine F__NORM was found to consume the majority of the floating point processing time. F__MOVE was also found to consume much of the processing time. By making the F__NORM and F__MOVE routines more efficient, the module performance could be greatly improved. Therefore, a great increase in module performance could be achieved by modifying only two of the routines in the module.

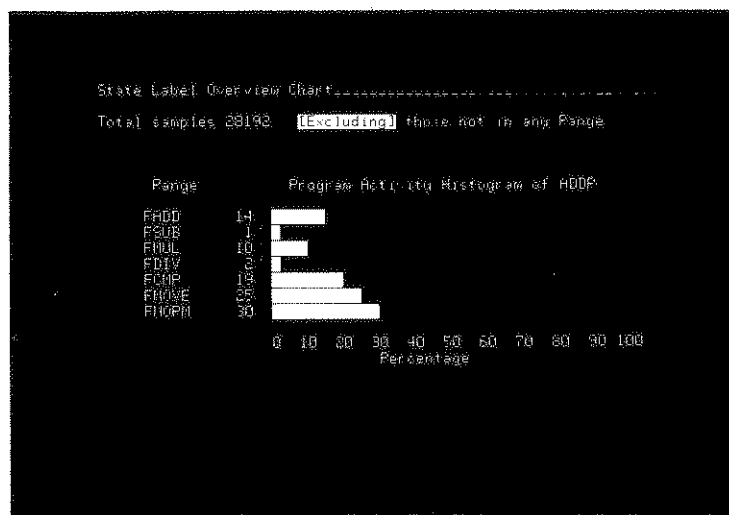

Figure 7-2. State Label Overview Histogram of Example Measurement

6. The Ranges columns are set to likely values by entering values and units for the limits of each of the ranges from 1 to 8.
7. Press RUN and the analyzer will begin the Time Interval Overview measurement.

Figure 7-4 is the resulting histogram from the example Time Interval Overview measurement. The measurements are taken in continuous mode and in the [start] trace condition. The histogram indicates that the driver operates in the 1.0 ms to 4.0 ms range the majority of the time. It also shows that the driver executes a great deal of the time in the 500 us to 1.0 ms range. Since the only handler to operate in the latter range is the unknown interrupt case, the results indicate there is a severe problem with undefined interrupts. The maximum field indicates that one of the handlers can run for over 5.0 ms. Since the handler keeps interrupts turned off during this time, the large processor usage of this handler could be dangerous.

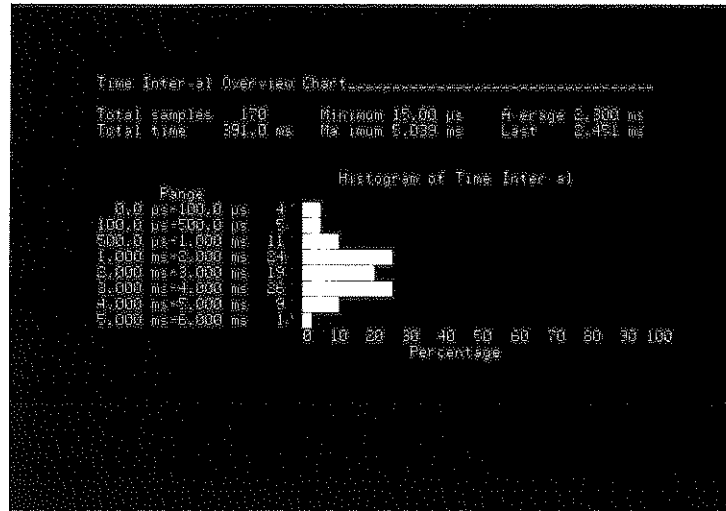

Figure 7-4. Time Interval Overview Chart for Example Measurement

The readouts give the following indications:

Total Samples:	total number of states sampled and sorted.
Total Time:	accumulated time of all the time intervals acquired on the display.
Minimum:	shortest time interval acquired.
Maximum:	longest time interval acquired.
Average:	average of all time intervals acquired.
Last:	duration of the last time interval acquired.

This measurement could also be used to monitor the time elapsed between the acknowledgement and processing of an interrupt. In the case of a clock value update, large delays between the interrupt occurring and the processing of the interrupt could indicate a slowing of the clock value.

Chapter 8

Interactive Measurements

INTRODUCTION

The analyzer can perform simultaneous state and timing measurements when in interactive mode. The capabilities of the analyzer are nearly the same as when performing dedicated state, timing, or analog measurements. The analysis mode named as master finds the specified trigger point and arms the second analysis mode. If the second analyzer is set in a free-run mode, it effectively is triggered by the master analyzer. By using the interactive analysis modes, asynchronous and synchronous signals from the target system may be correlated.

Simultaneous Acquisition Systems

The 1631 logic analyzer can perform simultaneous triggering and data acquisition in the state, timing and analog domains via separate and independent hardware subsystems. Each acquisition subsystem contains circuitry to perform data qualification in a fashion most suitable to that domain and each has its own high speed acquisition memory. This parallel architecture means to the user that he can configure the instrument as a stand alone state, timing or analog analyzer or just as easily as a combination instrument particular to his needs at a given time without losing any of the analyzer's capability.

In the case of interactive measurements, separate acquisition memory for each of the measurement domains is a significant advantage. Not only can the data of interest in one domain be displayed, but the data leading up to, surrounding or following the triggering condition from another domain can be examined, giving the user the confidence that the data qualification that he established was the one he really got.

Cross Domain Triggering

Conceptually the three resident hardware acquisition subsystems in the 1631 logic analyzer interact by means of a single entity . . . the TRACEPOINT. Through the trace specification the user establishes the tracepoint as a means of qualifying the data acquisition in order to pinpoint and capture only the activity of interest. The tracepoint is commonly referred to as the trigger but strictly speaking this is only true when no delay has been specified in the trace specification. The actual relationship between trigger and tracepoint is:

$$\text{TRACEPOINT} = \text{TRIGGER} + \text{USER SPECIFIED DELAY}$$

A unique tracepoint may be established for each of the three acquisition subsystems and that point may be placed at the start, center or end of the acquisition memory of that subsystem. When it is at the start, data is captured following the tracepoint. When at the center, data on both sides of the tracepoint is captured. When at the end, data leading up to the tracepoint is acquired. The tracepoint is indicated in waveform diagram displays as a vertical dashed line and in listing displays as line 0000.

At any given time any one of the three domains may be designated as the "Master". The master's tracepoint is then used to arm the trigger circuits of the other acquisition systems. This is accomplished in hardware by means of a single wired OR which interconnects the three triggering circuits. The master's tracepoint is programmed to drive this line while the slave machines are programmed to receive it as a trigger enable. By means of this configuration, the master may affect data acquisition in the slave machines in two ways: Master TRIGGERS Slave and Master ARMS Slave.

Master TRIGGERS Slave

When the slave subsystem has a "trigger immediate" specification established, the receipt of the master trigger enable signal triggers the slave machine's data acquisition. In the case of the state acquisition system this "trigger immediate" is represented by "Trigger on Any State"; for the timing analyzer it is specified as a "Don't Care" on the trigger pattern; the analog acquisition system likewise has a "Trigger Immediate" mode.

When the "Master Triggers Slave" mode of operation is used, there is only one tracepoint specification established (the master's) the tracepoint indicator in each of the three domains represents the same point in time and event timing correlation between domains is possible. The position of the tracepoint in each domain may be arbitrarily selected to be start, center or end.

Master ARMS Slave

In this case both the master and the slave machines have a specified trigger specification other than "trigger immediate". The master first finds its specified tracepoint and then arms the slave(s) to look for its own trigger. Now two separate tracepoints exist, the one in the master and the one in the slave which do not represent the same point in time. The tracepoint indicators in each domain are local to that domain.

Event Correlation Between Domains

The last step in making this kind of interactive architecture into a powerful analysis tool is to allow events captured in one domain to be time correlated to simultaneously captured events in the other domains. The way in which events may be correlated in a cross domain analysis scenario depends on the measurement setup.

Three factors play an important role: relative sample rates between acquisition systems, placement of tracepoint in each domain (start, center, end or delay), and interaction mode (Master triggers Slave or Master arms Slave).

The combination of relative sample rates and tracepoint placement determines the degree of overlap of the acquired data from one domain onto another. With identical sample rates and tracepoint placement in the master and slave machines, the overlap is one to one. When the tracepoint in the Master is placed at the end of the trace and the tracepoint in the slave is placed at the start of the trace, there is no overlap at all. When the Master is sampling at a rate one half that of the slave, the Master machine takes twice as long to fill its acquisition memory and the full slave memory overlaps only half of the slave memory. By varying sample rates and tracepoint placement virtually any orientation of data from one domain to another can be realized.

In the case of the master triggers slave mode of operation, the tracepoint indicator in each domain represents the same point in time and event time correlation is possible. When using the timing and analog analyzers interactively in this mode there are two convenient ways to correlate events. First of all both the acquisition memories can be viewed simultaneously by inserting analog channels into the timing waveform display. The analog data is scaled to timing analyzer time base and positioned with the timing waveforms in time correlated fashion. To add analog channels to the Timing [Waveform] Diagram, delete 4 timing channels per analog channel. Press INSERT and then PREV[] and an analog channel will be displayed. The second way to correlate events is by means of the cursor system on the waveform diagrams. Positioning a cursor on an event on one waveform diagram, toggling to the other waveform display and hitting the INSERT key will move the cursor to the same point in time on the second waveform display.

MAKING COORDINATED STATE AND TIMING MEASUREMENTS

The following procedure shows how the state and timing measurement functions can perform independent measurements using separate trigger events at the same time. This procedure also demonstrates the ability of one of the measurement function modes (state or timing) to arm the other function to perform its trigger recognition.

4. Press the TRACE key. The state trace specification will be on screen. See figure 8-3. Set up the trace specification to trigger when it finds the first occurrence of a state that matches the specification in row "a". Move the cursor into the trigger field and press NEXT[], as required, to obtain [a].
5. Move the cursor down into the ADDR5 field in row "a" and enter [TIME] + 0011. Use the NEXT[] key to obtain [TIME] and the numeric keys to obtain +0011 as in figure 8-3.

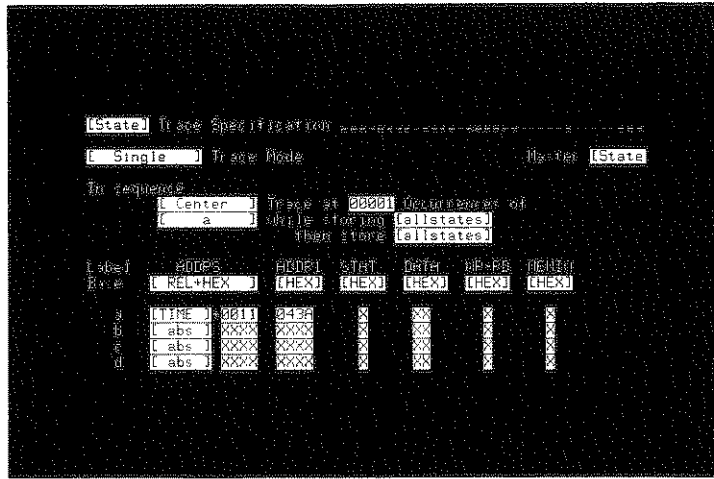

Figure 8-3. State Trace Specification In State/Timing Measurements

Executing Coordinated State/Timing Measurements

1. Press the RUN key. The analyzer will find the state you specified as its trigger, and complete a state trace. If the analyzer does not find its state trigger (TIME + 0011 on the 16 address lines of the address bus), the message "Waiting for State Trigger" will be on screen. In this case, press the STOP key. The message "Trace Aborted" will be on screen, along with a listing of the last eight transactions before you pressed the STOP key.
2. Write down one of the executions shown on the display under the ADDR5 label (such as TIME + 001A).
3. Press the TRACE key.
4. Move the cursor down into the row "b" line.
5. Enter the module name and offset value from step 2 (use keyboard NEXT[] and hexadecimal keys). See figure 8-4.

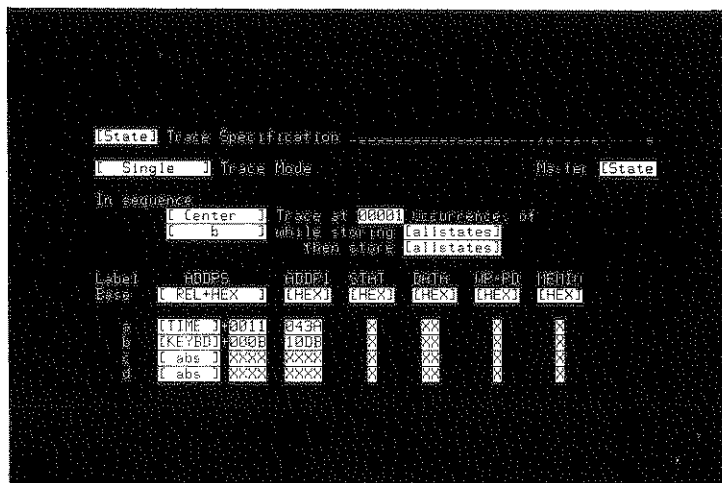

Figure 8-4. State Trace Specification With Trigger in Row "b"

6. Move the cursor up into the trigger field and press the NEXT[] key to change [a] to [b]. This sets the analyzer to trigger when it finds the state in row "b" (the state from step 2).
7. Press the RUN key. The analyzer will find the state specified as its trigger, and complete a state trace. It will show the message "Trace Complete" at the top of the display. The state selected as the trigger will be on line 0000.
8. Press the LIST key several times. Notice that pressing any of the INPUT DISPLAYS and OUTPUT DISPLAYS keys will toggle between the state analyzer and timing analyzer.
9. Press the FORMAT key. Press it a second time, if necessary, to place the [Timing] Format Specification on screen.
10. Check the display of the Activity line. If bit 2 in the timing pod shows no activity, connect bit 2 (the third line) from the timing probe to any active node in the target system.
11. Press the TRACE key. See figure 8-5.
12. Move the cursor into the Pattern field and enter a pattern of XXXX1X1X (with a binary display base).

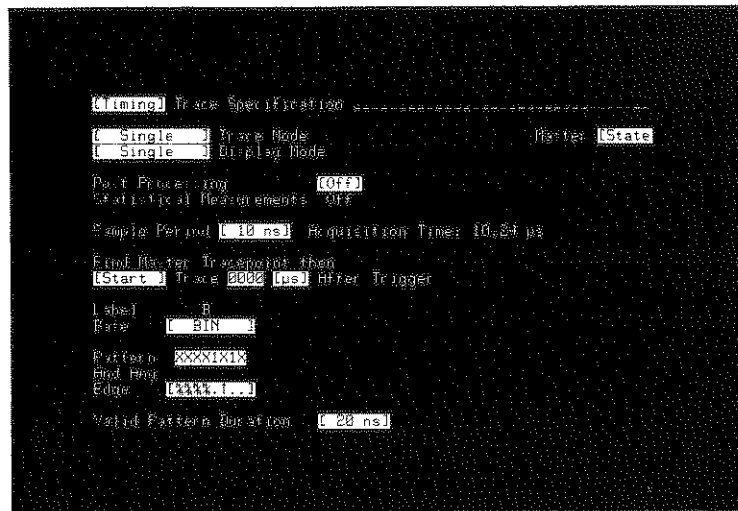

Figure 8-5. Timing Trace Specification For Combined State/Timing Measurements

13. Move the cursor down into the Edge field and use the NEXT[] key to enter a positive-going transition requirement (up arrow) for channel B2 (third from right-hand side) on the timing pod.
14. Press the RUN key. The state measurement in the analyzer will be completed as before. After the state trigger has been found, the timing function will search for the timing trigger. If it finds the timing trigger, it will complete its trace and show a waveform display. If it does not find its trigger, the analyzer will show the message "Waiting for Timing Trigger" on screen. In this case, press the STOP key. The message on screen will show "Trace Aborted". There will be waveforms displayed.
15. Press the LIST key two times. The trace list that was completed by the state measurement function will be displayed. It will show the state trigger on screen, along with other states it captured.
16. Press the TRACE key two times. This will place the specification for the timing function on screen.
17. Move the cursor down into the Pattern field and press and hold the DON'T CARE key until the field is all X's. This can also be done by pressing CLEAR ENTRY. Now the timing analyzer trigger will be satisfied when the first low-to-high edge is found on channel 2 in pod 0.

18. Press the RUN key. The analyzer will search through the incoming states until it finds the state trigger. When it finds the state trigger, it will begin capturing states into memory, and at the same time, it will arm the timing analyzer to search for its trigger. The timing analyzer will monitor the incoming activity until it finds a rising edge on bit B2. Then it will store a series of samples of activity to complete its timing measurement. It will show "Trace Complete" on top of the screen, and waveforms of timing information across the display. See figure 8-6.
19. Press the TRACE key. See figure 8-7.
20. Move the cursor into the "Master" field and press the NEXT[] key to change [State] to [Timing]. This makes the analyzer recognize its timing trigger before it can arm the state function to recognize the state trigger.
21. Press the RUN key. The analyzer will begin its measurement by looking for the condition that satisfies its timing trigger. When it finds this condition (rising edge on B2), it starts collecting timing information, and arms the state measurement function to look for its trigger. The timing analyzer displays its waveform information on screen while the state function completes its measurement.
22. Press the LIST key. The display will show a listing of the timing activity. See figure 8-8.
23. Press the LIST key again. The display will change to a listing of the information from the state analysis function.

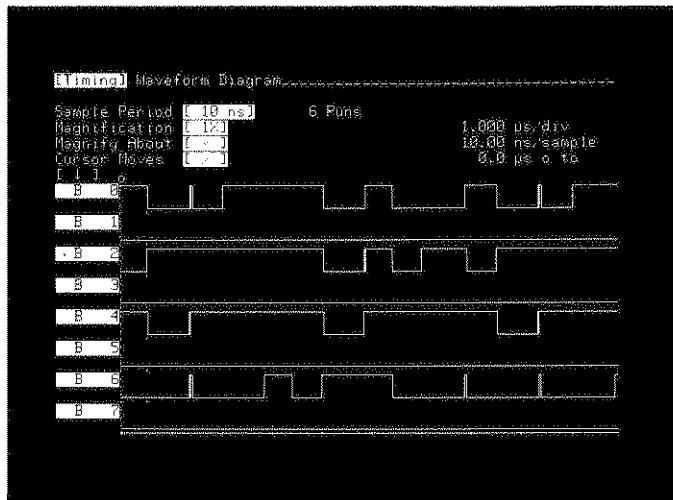

Figure 8-6. Timing Waveform Display

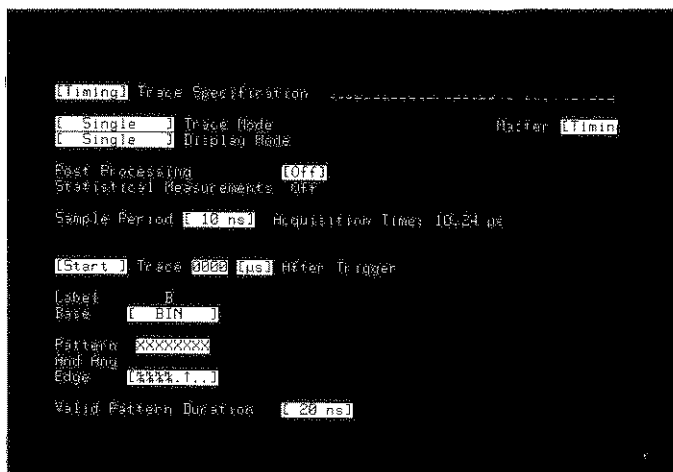

Figure 8-7. Timing Trace Specification With Master [Timing]

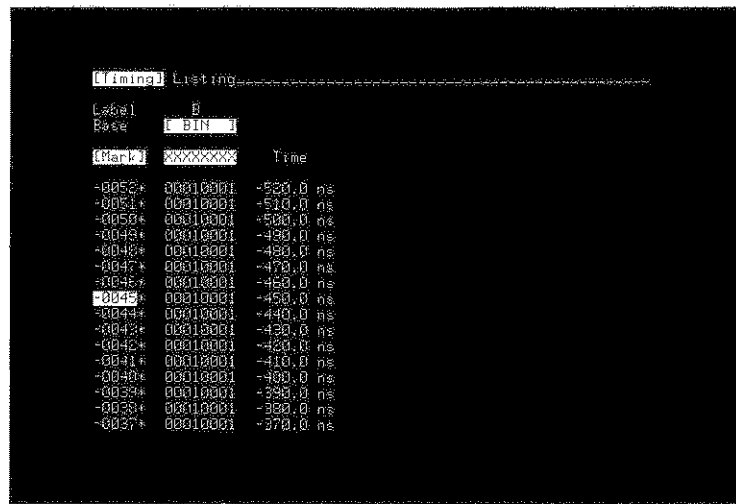

Figure 8-8. Timing Listing Display

MAKING COORDINATED ANALOG AND TIMING MEASUREMENTS

The following procedure shows how the analog and timing analyzers can perform independent measurements using the same trigger event. Cursor correlation between timing and analog waveform diagrams is also described in a step-by-step method.

Setup for Analog and Timing Measurements

1. Press the SYSTEM key and select the combined analog and timing system specification as in figure 8-9. The 1631A will have 8 timing channels assigned in the interactive mode.

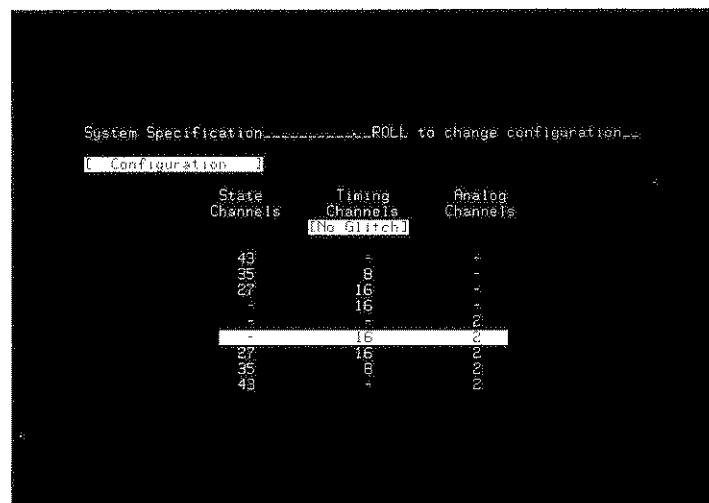

Figure 8-9. Combined Analog/Timing System Configuration for the 1631D

2. Press TRACE to display the [Timing] Trace Specification menu.
3. Move the cursor to the Master field and select [Timing] as the master trigger.

- Select a pattern for the timing analyzer to trigger on. Figure 8-10 is the [Timing] Trace Specification set up for this example.

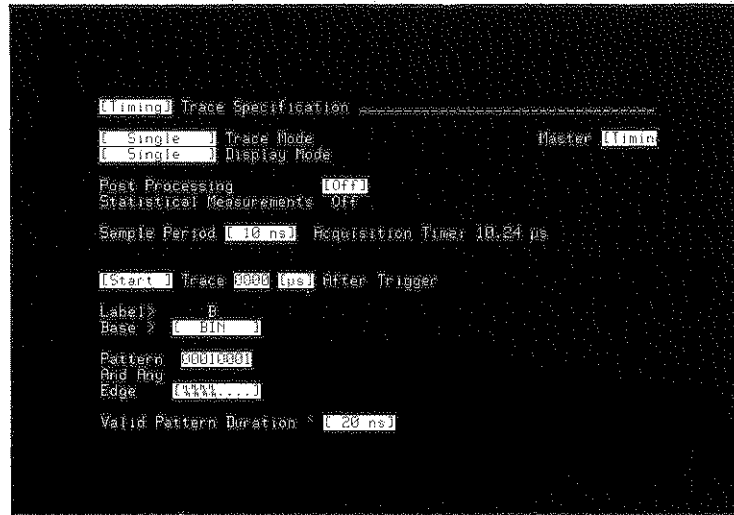

Figure 8-10. [Timing] Trace Specification Triggers Analog Analyzer

- Press TRACE to display the [Analog] Trace Specification menu. In this example, analog INPUT 1 is connected to the same node of the target system as the timing channel labeled B0. The sample period is set for [10 ns] and the Trigger is [Immediate]. The analog analyzer will trigger when the trigger condition of the [Timing] Trace Specification is met. See figure 8-11.

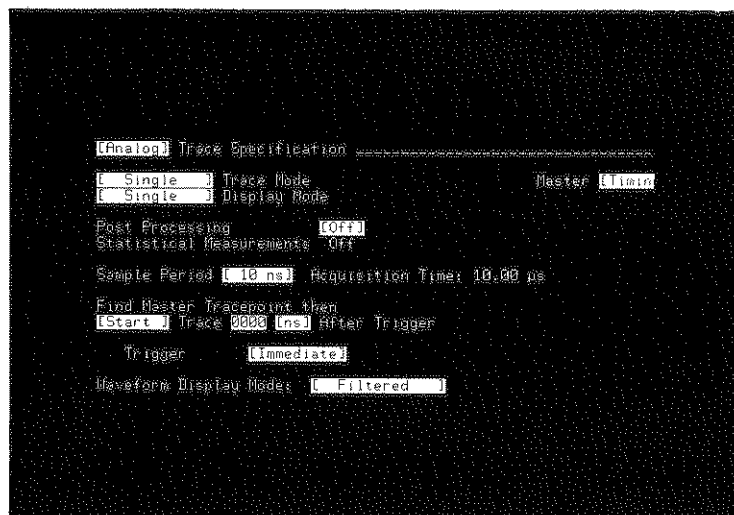

Figure 8-11. Analog Analyzer Triggered From Timing Specification

6. Press RUN. Figure 8-12 is the resulting [Timing] Waveform Diagram. The x and o cursor are placed at the beginning of the trace.

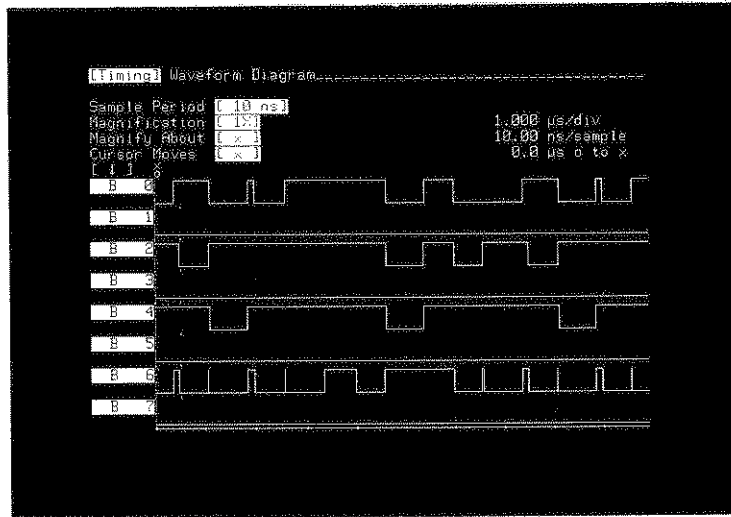

Figure 8-12. [Timing] Waveform Diagram

Cursor Correlation

1. Move the x cursor to the first falling edge on the timing channel field labeled B0 as in figure 8-13.

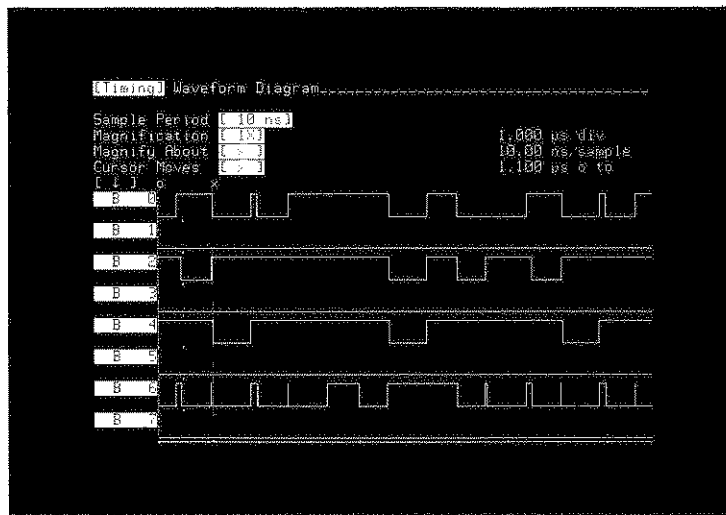

Figure 8-13. x Cursor Placed on First Falling Edge of B0

2. Press WFORM to display [Analog] [Waveform Diagram].
3. Use the CURSOR down arrow key to move the cursor into one of the selectable fields in the [Analog] [Waveform Diagram]. The message "INSERT to correlate mag. cursor" will appear at the top of the display.

- Press INSERT and the x cursor will be correlated to the x cursor placement set in the [Timing] Waveform Diagram as in figure 8-14.

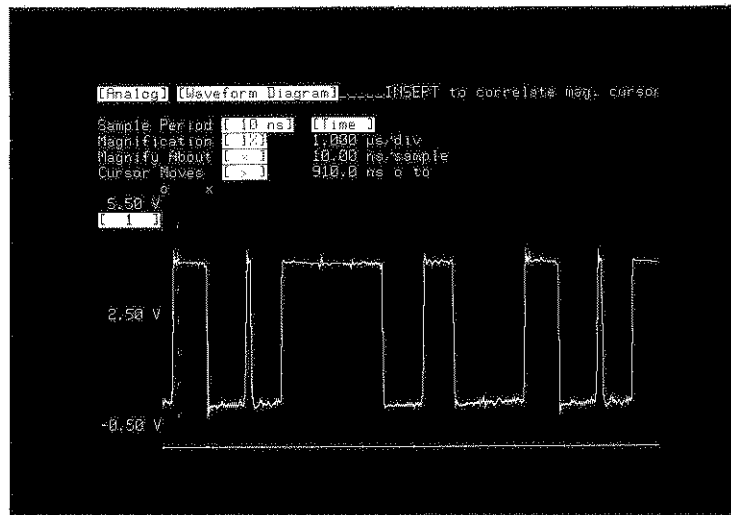

Figure 8-14. Correlating the x Cursor to the Timing Waveform Diagram

- Move the cursor to the next rising edge of the analog waveform.
- Press WFORM to display the [Timing] Waveform Diagram and move the cursor into one of the selectable fields.
- Press INSERT and the x cursor will be correlated to the position selected previously in the [Analog] [Waveform Diagram] as in figure 8-15.

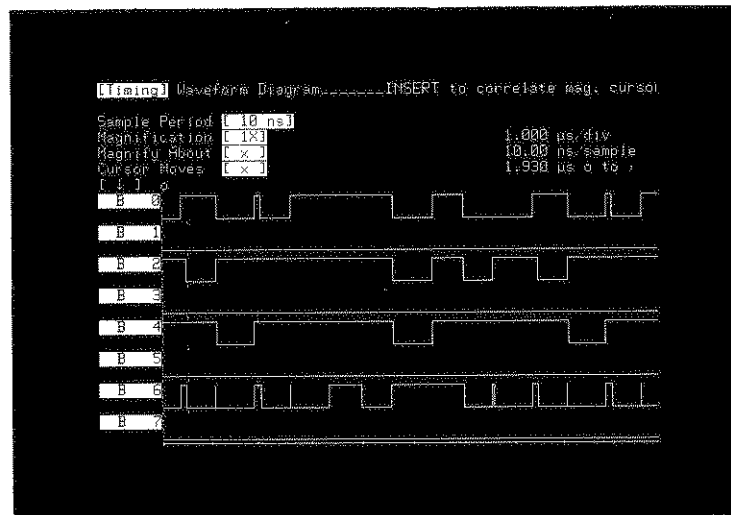

Figure 8-15. Correlating the x Cursor to the Analog Waveform Diagram

NOTE

If sample periods of State and Timing specifications are greater than 20 to 1, the State and Timing displays cannot be correlated.

Displaying Timing and Analog Channels

1. To display analog and timing waveforms on the same display, some of the timing channels must be deleted. Four timing channels must be deleted to display one analog channel.
2. Move the cursor to timing channel 4 and press the blue shift key and DELETE. Delete the timing channels labeled B4, B5, B6, and B7.
3. Press INSERT and a channel labeled OFF will be added to the display.
4. Press PREV[] until analog channel labeled "1 an" is added to the display as in figure 8-16.
5. To add both analog channels to the [Timing] Waveform Diagram, more timing channels must be deleted.

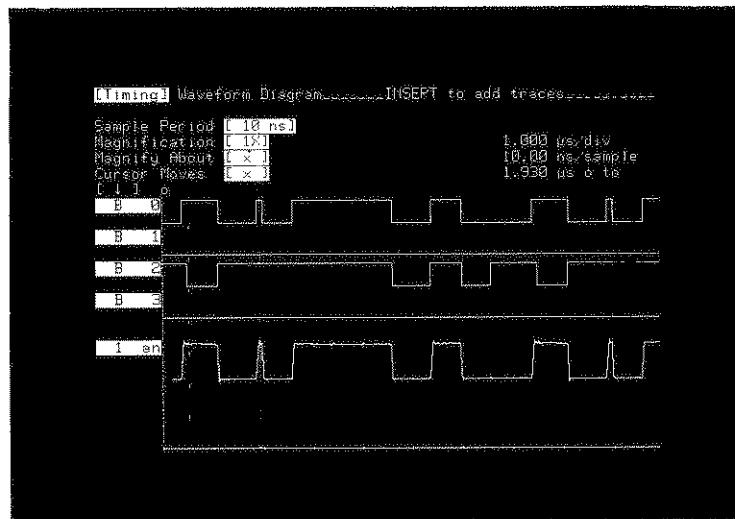

Figure 8-16. Displaying Timing and Analog Channels

NOTE

Simultaneous Timing and Analog Waveform Diagrams cannot be displayed if the sample periods of the analog and timing specifications are greater than 20:1.

Chapter 9

Peripherals

SYSTEM [PERIPHERALS] CONFIGURATION

This menu is used to configure the analyzer for interaction, through its interface connectors, with peripheral instruments. The analyzer clock and beeper are also set from this menu. The analyzer beeps at predetermined points in operation and when error conditions are detected. If desired, the beeper may be turned off. Figure 9-1 is the System [Peripherals] menu of the 1631A/D.

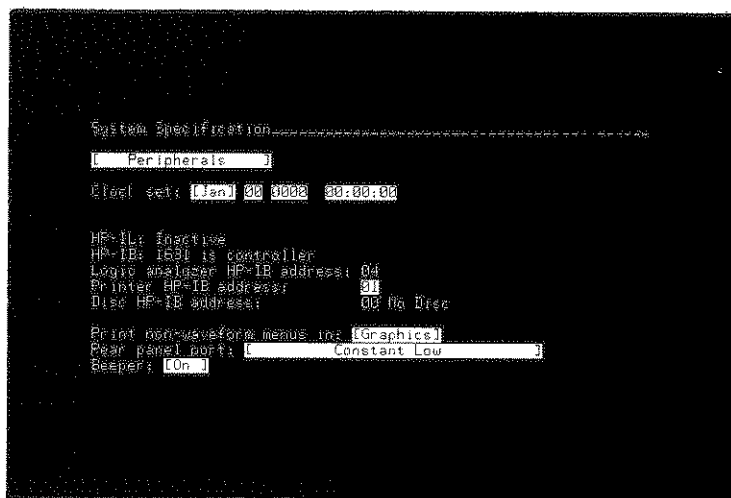

Figure 9-1. 1631A/D System [Peripherals] Specification Menu

- Clock Set:** Field used by analyzer to identify when information was captured into memory. Enter [month], day, year, hour: minute: second. Once set, this clock will continue to keep time as long as analyzer power is on.
- Print non-waveform Menus:** Selects code for information transfer to external printer. [Text] selects information transfer using ASCII codes. [Graphics] selects information transfer using HP-GRAPHICS codes.
- Rear Panel Port:** Selects control signal to be supplied through the rear panel BNC output PORT to an external device.
- [Pulse on State Tracepoint] analyzer outputs 15 ns TTL positive pulse when it finds state tracepoint.
 - [High Until State Tracepoint] after run start, analyzer outputs TTL high until it finds state tracepoint. Then it switches to TTL low.
 - [Low Until State Tracepoint] after run start, analyzer outputs TTL low until it finds state tracepoint. Then it switches to TTL high.
 - [High on Last Sequence] analyzer outputs TTL high when it is searching for the last term in a trigger sequence.
 - [High on Timing Pattern] analyzer outputs TTL high as long as the timing trigger pattern occurs for longer than the specified valid pattern duration.
 - [High on Analog Trigger] analyzer outputs TTL high on analog trigger.
 - [Constant High] analyzer outputs TTL high.
 - [Constant Low] analyzer outputs TTL low.
 - [5 ms Burst: 1 KHz TTL on Start] probe compensation source for analog probes.
- Beeper:** When [On], the analyzer will beep whenever it completes a measurement, and whenever it flashes an error or warning message on screen. When [Off], the analyzer will not beep at any time.

The [Storage Operations] menu contains the following information:

1. Bus address field - defaults to lowest available bus address at power up. 0 through 7 may be entered as the bus address.

NOTE

The printer bus address defaults to 1 on power up. Therefore, if the 1631 is set to bus address 0, the bus address field will default to address 2. If the 1631 is any other address than 0, the bus address defaults to 0.

2. Unit field - defaults to zero. A unit number 1 through 7 may be entered. This is the unit number of the disc to be used. With the 9121D or 9122D this number may be either 0 or 1.
3. Disc type - defaults to none when disc drive is not present and contains the model number of the disc drive after a disc is read. This is a response from the disc drive to a request of the 1631.
4. Bus Address - defaults to 0 and is the HP-IB address that the 1631 is using to address the disc. When INSERT is pressed, this address will be the same as the Bus Address that is contained in the Bus Address field.
5. LIF volume - defaults to None. LIF data is entered when the disc is read. Contains an identifier code from the instrument that formatted the disc.
6. Disc Unit - defaults to 0 and is the unit number of the disc drive the 1631 is using to address the disc. When INSERT is pressed, the Disc Unit will become the same as the unit contained in the Unit field.
7. File directory - contains the following information:

File Name - any name assigned by the originator of the file. The file name must begin with with an alpha character, maximum length of 9 characters and contain only alpha and numeric characters.

Type - indicates the type of file on the disc. See "How to Create a New File" for more information.

Date/Time - the date and time which was set on the 1631 [Peripherals] menu when the file was recorded.

File Description - description as entered by the originator of the file. This is not a required entry.

On prerecorded inverse assembler discs, all inverse assembler files begin with the letter "I". This is followed by the processor name of the inverse assembler. The last character of the File Name field contains an "I" or a "P", indicating whether the inverse assembler is for use with the 10269A/B interface (I) or for General Purpose Probes (P).

The File Description field contains a description of the inverse assembler followed by one or more spaces, then a four digit data code. The date code is changed if the inverse assembler software is changed. The larger number will be the most recent software revision.

How to Read a Disc File

1. Make sure the logic analyzer HP-IB switch 8 is set to the down position. Apply power to the logic analyzer. The System [Configuration] menu is displayed and the cursor is in the [Configuration] field. Press NEXT[] or PREV[] until the [Storage Operations] menu is displayed. The Bus address field will display the same address number as in the [Peripherals] menu.
2. Enter the unit number of the disc drive to be used by pressing the CURSOR right key twice and entering the unit number.

NOTE

Unit number defaults to 0 at power up, therefore, if unit 0 is to be the active disc drive, no entry need be made.

3. Obtain the directory of the disc files by pressing INSERT. When INSERT is pressed, the selected disc is read and the disc directory is displayed on the logic analyzer screen.

NOTE

Response time may be up to four seconds.

4. Load the desired file from the disc into the logic analyzer memory by placing the file name to be loaded next to the directory pointer (greater than sign: >) by pressing the ROLL keys. Move the cursor to the Operation field at the bottom of the menu and press NEXT[] or PREV[] until [Load] is displayed. Press INSERT to load the file from the disc.

NOTE

The [Load] Operation cannot take place when the logic analyzer is in [Continuous] Trace Mode and currently taking a trace.

How to Create a New Disc File

1. Place the cursor in the Operation field and press NEXT[] or PREV[] until [Store] is displayed.
2. Move the cursor into the Type field and use the NEXT[] or PREV[] key to select the type of data to be stored. The selections are as follows:
 - a. [config] - stores all menu configurations, except Storage Operations on disc. The clock data on the peripherals menu is not stored.
 - b. [state] - stores all state data.
 - c. [timing] - stores all timing data.
 - d. [analog] - stores all analog data.
 - e. [all] - stores all configuration, state, timing, and analog information.
3. Move the cursor to the Name field. Enter a file name in the field.

NOTE

The File Name must begin with an alphabetic character, be a maximum of 9 characters and contain only alpha and numeric characters. If file exists, message "INSERT to overwrite" will be displayed. File will be overwritten when INSERT is pressed.

4. Add a description of the file as required, then press INSERT to store the data. To place a space in the description, use the DON'T CARE key. CLEAR will clear the entire description field.

While the data is being stored, the disc drive indicator lamps will be lit. After the disc operation, the new file name will appear in the directory of the menu aligned with the indicator (>).

How to Find a Disc File

1. Enter the [Storage Operations] menu and load the file directory from the disc.

2. Place the cursor in the Operation field and select [Find].
3. Move the cursor to the Type field and select the type of file that is to be located. The [prog] type file is a down loadable program generated by HP for the 1631. (An example is the COPYFILE program.) The [unknown] type file is written by another controller, therefore, the 1631 cannot identify the file type.
4. Move the cursor to the Name field and enter the name of the file that is to be found.

NOTE

If the file type or file name is not correct, the file will not be found and the error message "ERROR file not found" will be displayed.

5. Press INSERT to find the file name in the directory.

NOTE

The file name is located in the directory, however, the file must be loaded to the 1631 memory in a separate operation. If the file is not found, the directory pointer will be left pointing to the file that would alphabetically be following the file that could not be found.

How to Delete a Disc File

1. Enter the [Storage Operations] menu and display the disc directory.
2. Place the cursor in the Operation field and press NEXT[] or PREV[] until [Delete] is displayed in the field.
3. Move the cursor to the Type field and use the NEXT[] or PREV[] key to display the proper type of file.
4. Place the cursor in the Name field and enter the name of the file to be deleted. Press INSERT and the advisory "Insert to confirm" will be displayed. Press INSERT again and the file will be deleted.

NOTE

If Type is set to [all], then [config], [state], [timing], and [analog] files with that file name will be deleted.

While the data is being deleted, the disc indicator lamps will be lit. After the disc operation is complete, the name of the deleted file is gone and the directory pointer will indicate the file that was just preceding the deleted file.

How to Format a Disc

When a disc is formatted, all data on the disc is erased and the disc directory is set up to contain a maximum of 64 file name entries. The number of data files that can be stored on a disc is determined by the amount of data to be stored. Normally, it would be impossible to store enough data on the disc to fill the directory. The disc is formatted as follows:

1. Enter the [Storage Operations] field, place the cursor in the Operation field, and press PREV[] or NEXT[] until [Format disc] is displayed. No other selections are required. Press INSERT. The message "Enter "Y" to confirm —" is displayed. The cursor must be moved to the entry field following the and a "Y" placed in that field.

CAUTION

Anything stored on the disc that is being formatted will be erased during the Format Disc operation.

USING A PRINTER ACCESSORY

The analyzer can be connected through an HP-IB interface cable to a graphics printer that understands the HP-IB command set. The analyzer can control the printer to obtain hard copies of any of its displays, as well as hard copies of the entire content of its list memory. The following steps describe how to connect the printer to the logic analyzer and how to obtain hard copy.

The speed of which a copy of a display can be obtained depends upon the printer being used, the complexity of the display being copied, and whether [Text] or [Graphics] mode has been selected in the [Peripherals] menu. The following list is a guide to estimate the speed of the printer being used.

Max. Data Transfer Rate: approximately 4K bytes/sec.

Example times for making copies on HP 2671G printer using [Text] language ([Text] is approximately twice as fast as [Graphics]).

Copy small menu: approximately 7 seconds.

Copy large menu: approximately 20 seconds.

Copy complete timing diagram: approximately 30 seconds.

Copy Max width list (8 labels): approximately 80 words/minute. Full 1K list can be copied in approximately 12 minutes.

Obtaining Hard Copy From a Printer

1. Connect an HP-IB interface cable between the logic analyzer rear panel and the printer.
2. Set switches 7 and 8 of the rear panel address switch to "0", which makes the 1631 controller on the HP-IB.
3. Set the printer to the "Listen Only" mode.
4. Turn printer operating power to on position.
5. Select the [Peripherals] menu on the logic analyzer. The HP-IB message in the menu will indicate the 1631 is controller.
6. Select either [Text] or [Graphics] in the "Print non-waveform menus in" field.
7. Set up a display on the logic analyzer to be copied and press the analyzer PRINT key. The analyzer will send the commands required to obtain a complete copy of the display. In [Text] mode, lines that are in inverse video on the analyzer display are underlined on the hard copy. In [Graphics] mode, the inverse video fields are printed in inverse video.
8. A copy of the trace memory beyond the portion shown on the display may be obtained. Place the desired list display on screen. Use the ROLL keys to position the first line of the desired copy on screen (if the hard copy is to start at line +0100, roll the display to the point where line +0100 is on the top line of the screen).
9. Press the blue shift key and then the PRINT ALL key. The analyzer will activate the printer to start printing at the top line of the display screen. It will continue to send print information to the printer until the entire content of the trace memory has been printed. The display heading information will be sent to the printer each time a new page is started.
10. The hard copy print can be stopped at any time by pressing the STOP key. When the STOP key is pressed, the analyzer stops sending new information to the printer buffer. The information for the lines on screen will already be in the printer buffer and the print will continue until the last line on the present display is printed. The printer will then halt.

Using a Controller to Operate the Analyzer and Printer

1. Set the logic analyzer address switches to the HP-IL or HP-IB controlled position as applicable. The switch positions are described in chapter 2 of this manual.
2. Cycle the analyzer LINE power.
3. Check the System [Peripherals] menu to see that the analyzer is controlled either by the HP-IL or HP-IB device and that it lists the desired address.

When in the controlled mode, the PRINT key can still be used to obtain hard copy from the analyzer. If the PRINT key, (or "PR" is sent from the controller), the analyzer must be addressed to talk and the printer addressed to listen before the print will occur. Chapter 10 contains the complete list of the device dependent commands for controlling the operation of the analyzer.

Chapter 10

Using HP-IB or HP-IL Interface

INTRODUCTION

This chapter will help you program the operation of the analyzer using the HP-IB or HP-IL interfaces. The HP-IB and HP-IL interface capabilities and device-dependent commands are identical. All operations that can be obtained by pressing a front-panel key can also be obtained by using the analyzer device-dependent commands when they are sent over an HP-IB or HP-IL interface from a controller. This chapter provides detailed information about each of the device-dependent commands and how these commands affect the analyzer.

HP-IB AND HP-IL INTERFACE CAPABILITIES

The following HP-IB and HP-IL interface functions are implemented in the analyzer.

SERVICE REQUEST (SRQ) — Programmable service request for various conditions specified in the Mask Byte (MB) command. Reset when status byte read by SERIAL POLL or via SB command.

SERIAL POLLING — The serial poll represents the unmasked status of the machine and is identical to the SB1 response. Status bits are unmasked using the Mask Byte (MB) command. Serial polling is the preferred method of checking machine status because serial polling will not cause the analyzer to abort any currently pending output. The "SB" command does cause such aborts.

PARALLEL POLLING — Complete parallel polling capability. Sense bit of ENABLE message is used to determine whether a service request is indicated by a 1 or 0 on the specified bit. Request is cleared by a serial poll or by sending SB1.

GROUP EXECUTE TRIGGER — Executes a measurement similar to pressing the run key.

REMOTE/LOCAL/LOCAL LOCKOUT — Complete capability.

INTERFACE CLEAR — Clears the interface to an untalk/unlisten state.

DEVICE CLEAR — Aborts any interface operation and clears input/output buffers.

The analyzer will abort any pending output if it receives a new command from the controller before it has been addressed to send its output. For example, if the controller commands a menu change in the analyzer before it addressed the analyzer to talk, the analyzer will abort its status byte message.

KEYBOARD MNEMONICS

The device-dependent commands for keyboard functions are implemented in a mnemonic-per-keystroke format. Table 10-1 lists the HP-IB and HP-IL command mnemonic for each key. Any key mnemonic can be followed by an ASCII number that indicates how many times to repeat that key. For example "CD 5" will cause the "Cursor Down" command to be executed five times. Sending the command "NX 10" is the same as pressing the NEXT key ten times.

To send data keys (i.e., numeric 0123456789ABCDEFX or alphabetic values) enclose the ASCII representations of those keys in field delimiters. For example, if a pattern is to be sent after positioning the cursor to a particular field, send the pattern in field delimiters, i.e., OUTPUT 700; "(01XX1533)". Three different field delimiters are allowed: ",", " ", and "()". Use the same delimiter at the start and end of a field. Mnemonics can be

sent using either upper case or lower case letters. Commands must be delimited by one or more of the delimiting characters: semicolon(;), carriage return(cr), or linefeed(lf). When any of the delimiting characters are encountered, following a command, the command will be transmitted. More than one delimiter may be used in a string, however, any one will cause the command to be transmitted. The following examples all cause the command (TC) to be transmitted: TC;, TCcr, TClf, TC;crlf.

Table 10-1. HP-IB/HP-IL Keyboard Mnemonics

Key	Mnemonic	Key	Mnemonic
SYSTEM menu	SM	INSERT	IN
FORMAT menu	FM	DELETE	DE
TRACE menu	TM		
LIST menu	LM	CLEAR ENTRY	CE
WFORM menu	WM	DEFAULT	DM
CURSOR left	CL	NEXT[]	NX
CURSOR right	CR	PREV[]	PV
CURSOR up	CU	DON'T CARE	
CURSOR down	CD		
LABEL left	LL	RUN	RN
LABEL right	LR	RESUME	RE
LABEL up	LU	STOP	ST
LABEL down	LD	PRINT	PR
		PRINT ALL	PA
ROLL down	RD		
ROLL up	RU		
ROLL left	RL		
ROLL right	RR		

NON-KEYBOARD MNEMONICS

The following HP-IB and HP-IL mnemonics command the analyzer to take actions that are not possible from the keyboard.

BP — Beep. Sounds analyzer beeper.

SYNTAX: BP;

CH — Cursor Home. Moves cursor to known location at upper leftmost field of analyzer display.

SYNTAX: CH;

DB — Display Blank. Clears analyzer display. For proper operation, the SYSTEM [Configuration] menu should be on the display when you issue the "DB" command. The word "REMOTE" will not disappear from the display. If a trace is in process, the message area of the screen may be asynchronously updated.

SYNTAX: DB;

DR — Display Read. Command causes analyzer to read from display memory, starting from specified row and column, specified number of characters for transfer to HP-IB/HP-IL interface followed by CR/LF. Inverse video characters are sent as the ASCII character value plus 128.

SYNTAX: DR <ROW><COL><BYTE__ COUNT>;

where BYTE__ COUNT has a maximum integer value of 1472 (23 rows X 64 columns)

ROW is integer value with range of 1 to 23

COL is integer value with range of 1 to 64

- DW** — Display Write. Writes ASCII string of 80 or less characters to analyzer display, beginning at position specified by row and column.

SYNTAX: DW[I] <ROW><COL>(STRING);

where I is optional parameter specifying that string be displayed in inverse video.

Legal delimiters for STRING are ", ', and ().

- ID** — Send Identification code. Causes analyzer to send identification code indicating instrument configuration followed by CR/LF.

SYNTAX: ID;

where returned value is a string containing the instrument model number ("HP1631A" or "HP1631D").

HP1631A - (35-channel state, 8 timing, 2 analog)

HP1631D - (43-channel state, 16 timing, 2 analog)

- KE** — Send buffered key. Causes analyzer to send key mnemonic or alphanumeric character followed by CR/LF (refer to table 10-1) for any key that has been pressed while in remote mode. Buffer saves up to the last 15 key presses. If no keys have been pressed, the analyzer returns double question marks (??).

SYNTAX: KE;

- MB** — Set service request mask byte. Enables SRQ, PP response, and bits in the serial poll and SB1 registers specified in argument. Mask byte is set to 0 at power-on, disabling any service requests.

SYNTAX: MB mask __ value;

where mask __ value is an ASCII integer (i.e., 0 to 255) in decimal format. A service request (SRQ) will be generated if the mask bit for a condition is set to one and that condition occurs. The mask bit positions are:

- Bit 0 (1) = Print Complete
- Bit 1 (2) = Measurement Complete
- Bit 2 (4) = Slow Clock
- Bit 3 (8) = Key Pressed (Front Panel Request)
- Bit 4 (16) = Not Busy
- Bit 5 (32) = Error in Last Command

- PU** — Power-up. Defaults all instrument menus. Buffered keys, SRQ, PP and status bytes are unmodified.

SYNTAX: PU;

- RST** — Reset. Reset analyzer to power-up condition as if power was cycled. A one second delay is recommended after RST prior to sending any other remote commands.

- SB** — Status Byte. Returns analyzer status byte to controller on next read. One of four status bytes may be requested. Status bytes are returned as a single byte without termination. The character decimal value returned represents the status.

SYNTAX: SB <N>;

where N is an integer value from 1 to 4. If argument N is omitted, the default condition is status byte 1. Requesting status byte 1 or executing a serial poll resets the SRQ and PP response and clears the bits in the serial poll or SB1 register.

Status Byte 1 - Machine status (of bits currently enabled by Service Request Mask Byte).

- Bit 0 (1) = Print Complete
- Bit 1 (2) = Measurement Complete
- Bit 2 (4) = Slow Clock
- Bit 3 (8) = Key Pressed (Front Panel Request)
- Bit 4 (16) = Not Busy
- Bit 5 (32) = Error in Last Command
- Bit 6 (64) = Reserved for indicating Service Request

Status Byte 2 - Machine status of all bits regardless of the service request mask byte. These bits are cleared when the condition causing the bit to be set is cleared.

Same as status byte 1.

Status Byte 3 - Trace status consisting of the service request mask byte. Status is cleared on trace in progress. Q2 represents bits B4 through B7. Q1 represents bits B0 through B3.

- | | |
|--------------------------|--|
| Q2 = 0 - No Trace Taken | Q1 = 0 - Not Active (no measurement in progress) |
| 1 - Trace in Progress | 1 - Waiting for State Trigger Term |
| 2 - Measurement Complete | 2 - Waiting for Sequence Term #1 |
| 3 - Measurement Aborted | 3 - Waiting for Sequence Term #2 |
| | 4 - Waiting for Sequence Term #3 |
| | 5 - Waiting for Time Interval End Term |
| | 6 - Waiting for Time Interval Start Term |
| | 7 - Slow Clock |
| | 8 - Waiting for Timing Trigger |
| | 9 - Delaying Timing Trace |
| | 10 - Timing Trace in Progress |

Status byte 4 - Controller error codes indicating error condition or action required from controller.

Error Code =

- | | |
|---------------------------------|------------------------------------|
| 4 - value not allowed | 24 - use CHS key |
| 8 - use NEXT[] PREV[] keys | 30 - maximum INSERTs used |
| 9 - numeric entry required | 40 - disc contains non-HP1631 data |
| 10 - use hex keys | 41 - CRC does not match |
| 11 - use alphanumeric keys | 47 - illegal name file |
| 13 - requires correction first | 48 - duplicate HP-IB address |
| 15 - DON'T CARE not allowed | 49 - reload disc first |
| 16 - use 0 or 1 | 50 - storage operation aborted |
| 17 - use 0, 1, or DON'T CARE | 51 - file not found |
| 18 - use 0 thru 7 | 58 - in controller command |
| 19 - use 0 thru 7 or DON'T CARE | 60 - write protected disc |
| 20 - use 0 thru 3 | 61 - RESUME not allowed |
| 21 - use 0 thru 3 or DON'T CARE | 62 - invalid in this trace mode |
| 22 - value is too large | 82 - incorrect revision code |

LEARN STRING COMMANDS

The following learn string commands instruct the analyzer to transmit its internal configuration, state acquisition data, timing acquisition data, and/or analog acquisition data to the controller. Learn string commands provide a means of saving configurations and acquisition data for later use and analysis. Measurement configurations can be stored and reloaded to repeat complex measurements. Likewise, acquisition data can be returned to the analyzer for analysis at a more convenient time. You need only transmit the learn string back to the analyzer to restore configuration or an acquisition. The learn string is transmitted as a receive learn string, that is, nothing need be added or changed in the learn string in order to return it to the logic analyzer.

Each learn string contains the proper mnemonic header (RS, RT, RA) to receive state, timing, or analog data, a binary byte-count word, the binary data, and two Cyclic Redundancy Check (CRC) bytes. The binary byte-count word, returned most significant byte (MSB) first and least significant byte (LSB) last, gives the number of bytes contained in the binary data file, including the two CRC bytes but not the byte count word or the mnemonic.

Data Formats

Data Transmission

Data is transmitted in one of the following formats. The format type is indicated by abbreviation in the syntax contents column for each learn string.

- (A) - ASCII data
- (B) - BCD (binary coded decimal) data
- (I) - Integer data (if multi-byte MSB first, LSB last)
- (R) - Real data (in floating point decimal format)
- (S) - Switch (Boolean data) 0=False, ≠0 (not 0)=True
- (T) - Time Byte 0 Byte 1

0 - 1	0 - ns
1 - 2	1 - μ s
2 - 5	2 - ms
3 - 10	
4 - 20	
5 - 50	
6 - 100	
7 - 200	
8 - 500	

- (W) - Wide special six byte internal structure

Date/Time Information

Each of the learn strings contain month, day and time information. This data is formatted as follows:

- Month - (I) defined using one byte and is an integer value 0 through 11 where 0 = January, 1 = February, etc.
- Day - (B) defined using one byte containing two BCD digits.
- Hour - (B) defined using one byte containing two padded BCD digits.
- Minute - (B) defined using one byte containing two padded BCD digits.
- Second - (B) defined using one byte containing two padded BCD digits.
- Year - (I) defined using two bytes representing one 16 bit integer transmitted as MSB first and LSB last

All data that contains more than one byte in the string is transmitted MSB first and LSB last.

Data Formatting Examples

The following examples are intended to demonstrate decoding of various learn string bytes that are coded in different formats. The bytes are sent from the logic analyzer over the HP-IL cable or the HP-IB bus. These examples assume HP-IB use with an HP Series 200 controller with Basic 2.0 Language System.

ASCII (A) Format

ASCII format is used at various points in many of the logic analyzer learn strings. One usage of the ASCII format is in the State Label Overview Learn String. The last five bytes in each 23 byte interval range represent the state label name formatted in ASCII.

When the following commands are sent from a Series 200 controller to the logic analyzer, the State Label Overview Learn String will be received by the controller. (This example assumes the logic analyzer has a State Label Overview acquisition and the logic analyzer is in the State Label Overview trace mode.)

```
Output @Logic_analyzer using "#, K";"TS;"
Enter  @Logic_analyzer using "%,-K";S$
```

Byte positions 40-44 are the bytes when translated to ASCII and then alpha characters give the name of the first state label range (a total of eight characters are allowed). For instance, if the first range name is "DELAY", bytes 40-44 would be represented:

Parameter: State assignment label name (State Label Overview Learn String)

Byte Position:	Byte 40	Byte 41	Byte 42	Byte 43	Byte 44
ASCII:	D	E	L	A	Y
Hexadecimal:	44	45	4C	41	59
Decimal:	68	69	76	65	89

Binary Coded Decimal (B)/Integer (I) Format

The most common usage of the binary coded decimal and integer formats is the encoding of the Date/Time settings. The precise byte positions of these parameters within the particular learn string is in the learn string listing. The interpretation of this information is given in the following example. The byte positions are from a State Trace Learn String which are bytes 5 through 11 in the learn string. The Date/Time is August 28, 1985 at 10:50:07.

Parameter:	Month	Day	Hour	Min.	Second	Year	Year
Byte Position:	5	6	7	8	9	10	11
Format:	(B)	(B)	(B)	(B)	(B)	(I)	(I)
Hexadecimal:	07	28	10	50	07	07	C1

Interpreting the hexadecimal representations for month, day, hour, and second are straightforward. The month is represented from 0 to 11 as described for month in Date/Time Information previously in this chapter. However, the integer decoding for the year is not as apparent. It can be regarded as having the MSB (most significant byte) coming first as follows:

Byte Position:	Byte 10	Byte 11
Hexadecimal:	0 7	C 1
Binary:	0000 0111	1100 0001
	16 ³ 16 ²	16 ¹ 16 ⁰

$$(7 \times 16^2) + (12 \times 16^1) + (1 \times 16^0) = 1985$$

Real Data (R) Format

Data that is structured using the floating point system is indicated with the abbreviation (R) in the contents column of the learn string. The floating point format used in the learn strings consists of 32 bits arranged as shown in the following example.

Byte 0	BYTE 1	BYTE 2	BYTE 3
EEEEEEES	MMMMMMMM	MMMMMMMM	MMMMMMMM

Where:

- EEEEEEES = 7-bit 2's Complement Power of 2
- S = Sign of Mantissa (0=Positive, 1=Negative)
- M.....M = 24-bit Unsigned Mantissa (Fraction)

NOTE

When acquisition is timing trace, this number refers to number of marks or number of sample period intervals.

The floating point format is an efficient method of representing large numbers using minimum memory space. The interpretation of a particular parameter using real format is dependent on the context of the parameter. A real number for a parameter involving "time" must be multiplied by a standard time increment which is peculiar to that learn string. An example is in the Timing Trace learn string where the real numbers obtained must be multiplied by the sample period to obtain the proper time. However, in the State Time Interval Overview Learn String, the number obtained is always in seconds which is essentially the same as multiplying by one.

In a case where a parameter does not involve time, the decoded real number is directly translatable. This is evident in the Timing Trace Learn String parameter for the number of marks or runs. This is also true in the Analog Trace Learn String for the mean voltage parameter.

The following example is from a State Time Interval Learn String. A run was made which acquired a total of 76 samples in 145.5 μ sec.

Parameter:	Total Number of States			
Byte Position:	14	15	16	17
Format:	(R)	(R)	(R)	(R)
Hexadecimal:	0E	98	00	00

The first byte (byte 14) is the exponent and is decoded as:

Hexadecimal:	0	E	
Binary:	0000	1110	_____ indicates positive number
(EXPONENT):	0000	111	
	0	7	_____ indicates binary power of 2 ⁷

The least significant bit in binary representation of the byte indicates the number is positive. The remaining seven bits are then considered a separate binary number which, in this case is seven. There are two ways to interpret the remainder of the number (bytes 15 through 17).

The first way to interpret the remaining number is to use the floating point translation which can be generalized as:

$$(\text{MANTISSA}) \times 2^{(\text{EXPONENT})}$$

(The mantissa is a fraction less than one.)

In this case, the binary point is assumed left of byte 15. The mantissa could then be represented in decimal as follows:

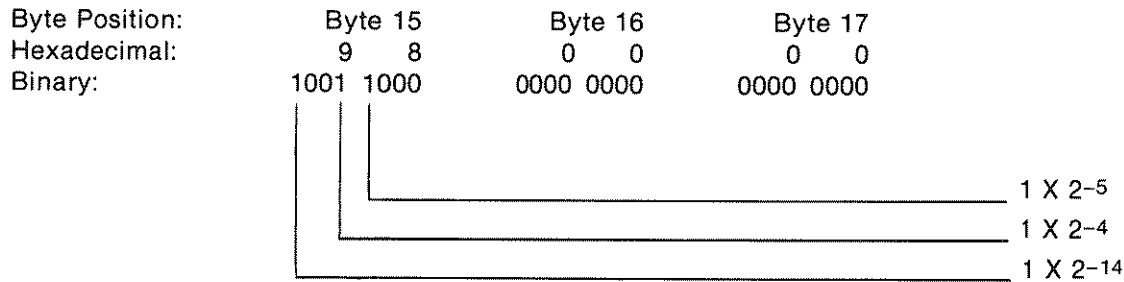

Decimal: $(1 \times 2^{-14}) + (1 \times 2^{-4}) + (1 \times 2^{-5}) = .594 = (\text{MANTISSA})$

Therefore, the equation $(\text{MANTISSA}) \times 2^{(\text{EXPONENT})}$ reveals:

$$(.594) \times 2^{(7)} = 76 \text{ runs}$$

Another method of decoding this number is to move the binary point to the right the same number of places as the exponent indicates. Then, interpret the binary number directly as a number greater than one as indicated below.

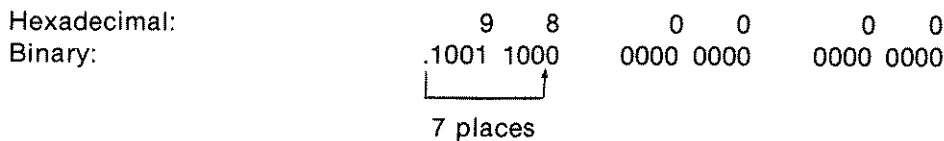

$$1001100 = 64 + 8 + 4 = 76 \text{ runs}$$

The exponent is a 7-bit 2's complement number, therefore, positive value exponents are not required to be converted to normal binary since they are the same. However, a negative exponent value must first be translated to normal binary representation before interpreting the exponent as a negative number.

The following example of the State Time Interval Overview Learn String parameter for Total Time demonstrates a negative value exponent.

Parameter:	Total Accumulated Time (State Time Interval Overview Learn String)			
Byte Position:	18	19	20	21
Format:	(R)	(R)	(R)	(R)
Hexadecimal:	E8	98	91	5E

Referring to the real format arrangement example, byte 18 is the exponent byte. Byte 18 is decoded as:

Hexidecimal:	E	8	
Binary:	1110	1000	
	└──────────────────┘		indicates number is positive
	└──────────────────┘		indicates exponent is negative
7-bit 2's complement:	1110	100	
Invert:	0001	011	
Add one:		+1	
Exponent:	0001	100 = -12	

Since the binary point is to the left of byte 19, the first place to the right is 2^{-13} . The rest of the number (bytes 19 through 21) can be translated as follows:

	Byte 19	Byte 20	Byte 21	
Hexadecimal:	9 8	9 1	5 E	
Binary:	1001 1000	1001 0001	0101 1110	
	└──────────────────┘			1 X 2^{-35}
	└──────────────────┘			1 X 2^{-34}
	└──────────────────┘			1 X 2^{-33}
	└──────────────────┘			1 X 2^{-32}
	└──────────────────┘			1 X 2^{-30}
	└──────────────────┘			1 X 2^{-28}
	└──────────────────┘			1 X 2^{-24}
	└──────────────────┘			1 X 2^{-21}
	└──────────────────┘			1 X 2^{-17}
	└──────────────────┘			1 X 2^{-16}
	└──────────────────┘			1 X 2^{-13}

The sum of the entire column to the right is 145.44 μ sec total accumulated time.

Time (T) Format

Another example involving the Timing Trace Learn String illustrates the prior discussion pertaining to multiplication by a standard time increment. In this example, the timing trace was acquired with a 10 nsec sample period with a mean time between the x and o cursors of 1.52 μ sec.

Parameter:	Sample Period (Timing Trace Learn String)	
Byte Position:	11	12
Format:	(T)	(T)
Hexadecimal:	03	00

From the listing for time in the Data Format section of this chapter, this translates to 10 nsec.

Parameter: Mean Time Between Cursors (Timing Trace Learn String)

Byte Position:	24	25	26	27
Format:	(R)	(R)	(R)	(R)
Hexadecimal:	1 0	9 8	9 4	7 B
Binary:	0001 0000	.1001 1000	1001 0010	0111 1011

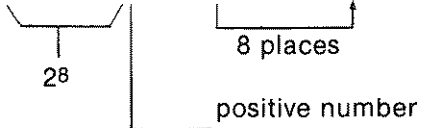

$$1001\ 1000 = 128 + 16 + 8 = 152$$

At 10 nsec: $152 \times 10\ \text{nsec} = 1.52\ \mu\text{sec}$ mean time between cursors.

TC - Transmit Configuration Learn String

The transmit configuration learn string command causes the analyzer to transmit a string containing its configuration data plus two CRC bytes.

SYNTAX: TC;

Learn String Format:

Starting Byte Position In String	Number Of Bytes	Contents
1	2	(A) RC (Receive Configuration Command)
3	2	(I) Binary byte count (refer to Note)
5	5138	CRC STARTS ACCUMULATING WITH NEXT BYTE Configuration Data CRC STOPPED ACCUMULATING WITH PREVIOUS BYTE
5143	1	Revision Code
5144	2	(I) CRC bytes

NOTE

The binary value of these bytes is the number of bytes to follow including the CRC bytes. This value is transmitted as MSB first and LSB last. The number of bytes transmitted is 5138.

TS - Transmit State Acquisition Learn String

The transmit state acquisition learn string command causes the analyzer to transmit a string containing its state measurement data plus two CRC bytes. The measurement data consists of state trace data, state label overview data, or time interval overview data.

The actual state data (trace, label overview, or time interval) is transmitted in the following manner. The first five bits of the MSB is internal. The three least significant bits of the MSB correspond to data from Pod 4 bit 8, etc., as shown below.

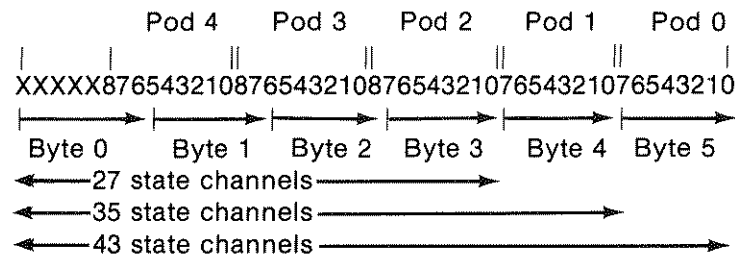

There are four bytes per state for 27 state channel data, five bytes per state for 35 state channel data, and six bytes for 43 state channel data.

SYNTAX: TS;

Learn String Format (for State Trace Data):

Starting Byte Position In String	Number Of Bytes	Contents
1	2	(A) RS (Receive State Command)
3	2	(I) Binary byte count (refer to Note) CRC STARTS ACCUMULATING WITH NEXT BYTE
5	7	(I,B) Date/Time information
12	1	Internal
13	1	(I) Type of Data (0 = State Trace Data)
14	1	(I) Number of state channels
15	2	(I) Number of valid states captured
17	2	(I) State Trace Point
19	N	(I) Data Acquired N = (Number of Valid States) * M Where: M = 0 if no state channels. M = 4 if 27 state channels. M = 5 if 35 state channels. M = 6 if 43 state channels. CRC STOPPED ACCUMULATING WITH PREVIOUS BYTE
N + 19	1	Revision Code
N + 20	2	(I) CRC

Note

The binary value of these bytes is the number of bytes to follow including the CRC bytes. This value is transmitted as MSB first and LSB last. The maximum number of bytes that can be transmitted is 4113 for 27 channels, 5137 for 35 channels, and 6161 for 43 channels.

SYNTAX: TS;

Learn String Format (for State Label Overview):

<u>Starting Byte Position In String</u>	<u>Number Of Bytes</u>	<u>Contents</u>
1	2	(A) RS (Receive State Command)
3	2	(I) Binary byte count (refer to Note) CRC STARTS ACCUMULATING WITH NEXT BYTE
5	7	(I,B) Date/Time information
12	1	Internal
13	1	(I) Type of Data (1 = State Label Overview)
14	8	Internal
22	184	(I) Data acquired from 8 state label ranges- fewer bytes if less than 8 ranges
		Each state label range contains:
	2	Internal
	4	(R) Number of samples in this range
	6	(W) End address of this range
	6	(W) Start address of this range
	5	(A) The five character name of this range
206	5	(A) State assignment label (ADDRS, STAT, etc.)
211	6	Internal
217	4	(R) Total number of samples taken (excluding "Other" bucket)
221	4	(R) Number of samples in "Other" bucket CRC STOPPED ACCUMULATING WITH PREVIOUS BYTE
225	1	Revision Code
226	2	(I) CRC

NOTE

The binary value of these bytes is the number of bytes to follow including the CRC bytes. This value is transmitted as MSB first and LSB last. The maximum byte count is 223.

SYNTAX: TS;

Learn String Format (for Time Interval Overview):

Starting Byte Position In String	Number Of Bytes	Contents
1	2	(A) RS (Receive State Command)
3	2	(I) Binary byte count (refer to Note) CRC STARTS ACCUMULATING WITH NEXT BYTE
5	7	(I,B) Date/Time information
12	1	Internal
13	1	(I) Type of Data (2 = State Time Interval)
14	4	(R) Total Number of States
18	4	(R) Total Accumulated Time
22	4	(R) Minimum interval found
26	4	(R) Maximum interval found
30	4	(R) Average time of interval
34	4	(R) Time of last interval acquired
38	8	Internal
46	112	(I) Data acquired from 8 time interval ranges- fewer bytes if less than 8 ranges
		Each time interval range contains:
	2	Internal
	4	(R) Number of samples in this range
	4	(R) End time of this range
	4	(R) Start time of this range
158	1	Revision Code
159	2	(I) CRC

NOTE

The binary value of these bytes is the number of bytes to follow including the CRC check bytes. This value is transmitted as MSB first and LSB last. The maximum byte count is 156.

TA - Transmit Analog Acquisition Learn String

The transmit analog acquisition learn string command causes the analyzer to transmit a string containing its analog measurement data plus two CRC bytes. The syntax for this learn string is shown below.

Syntax: TA;

Learn String Format (for Analog Trace Learn):

Starting Byte Position In String	Number Of Bytes	Contents
1	2	(A) RA (Receive Analog Command)
3	2	(I) Binary byte count (refer to Note 1) CRC STARTS ACCUMULATING WITH NEXT BYTE
5	1	(I) Number of analog channels (0 or 2)
6	2	(I) Number of valid analog states
8	2	(I) Index of the tracepoint
10	2	(T) Sample period
12	7	(I,B) Date/Time information
19	1	(I) Probe type of first channel (0 = 10X; 1 = 1X; 2 = 50X)
20	1	(I) Probe type of second channel (0 = 10X; 1 = 1X; 2 = 50X)
21	4	(R) Mean time between cursors
25	4	(R) Standard Deviation
29	4	(R) Maximum time between cursors
33	4	(R) Minimum time between cursors
37	4	(R) Mean voltage of channel 1, x cursor
41	4	(R) Standard Deviation
45	4	(R) Maximum voltage of channel 1, x cursor
49	4	(R) Minimum voltage of channel 1, x cursor
53	4	(R) Mean voltage of channel 1, o cursor
57	4	(R) Standard Deviation
61	4	(R) Maximum voltage of channel 1, o cursor
65	4	(R) Minimum voltage of channel 1, o cursor
69	4	(R) Mean voltage of channel 2, x cursor
73	4	(R) Standard Deviation
77	4	(R) Maximum voltage of channel 2, x cursor
81	4	(R) Minimum voltage of channel 2, x cursor
85	4	(R) Mean voltage of channel 2, o cursor
89	4	(R) Standard Deviation
93	4	(R) Maximum voltage of channel 2, o cursor
97	4	(R) Minimum voltage of channel 2, o cursor
101	44	Internal
145	2	(I) Number of hits
147	2	(I) Number of runs

Syntax: TA;

Learn String Format (for Analog Trace Learn):(Cont'd)

Starting Byte Position In String	Number Of Bytes	Contents
Values for channel 1;		
149	1	(I) 0 for ECL, 1 for User Defined, 2 for TTL
150	1	(I) 0 for positive lower limit, 1 for negative
151	4	Array of four digits giving lower voltage limit (refer to Note 2)
155	1	(I) 0 for positive upper limit, 1 for negative
156	4	Array of four digits giving upper voltage limit (refer to Note 2)
Values for channel 2;		
160	1	(I) 0 for ECL, 1 for User Defined, 2 for TTL
161	1	(I) 0 for positive lower limit, 1 for negative
162	4	Array of four digits giving lower voltage limit (refer to Note 2)
166	1	(I) 0 for positive upper limit, 1 for negative
167	4	Array of four digits giving upper voltage limit (refer to Note 2)
171	1	(I) # of samples skipped for internal display
172	N	Channels 1 and 2 data acquisition (up to 1024 samples per channel) N = number valid states acquired CRC STOPPED ACQUIRING DATA WITH PREVIOUS BYTE
N+174	1	Revision Code
N+175	2	(I) CRC bytes

NOTE 1

The binary value of these bytes is the number of bytes to follow including the CRC bytes. This value is transmitted as MSB first and LSB last. The maximum byte count is 2218 transmitted is 2218.

NOTE 2

These four digit arrays contain a numeric value that describes a user defined voltage limit. The placement of the decimal point within the array is determined by the divider ratio of the probe in use. The decimal points are placed as follows: If a X1 probe is used the data format is X.XXX; if a X10 probe is used the data format is XX.XX; if a X50 probe is used the data format is XXX.X.

TT - Transmit Timing Acquisition Learn String

The transmit timing acquisition learn string command causes the analyzer to transmit a string containing its timing measurement data plus two CRC bytes. Glitch information will also be transmitted if the analyzer is in the glitch mode of operation.

The actual timing data is transmitted as in the following manner:

1 byte per record for 8 channels
2 bytes per record for 16 channels

```

| Pod 1 || Pod 0 |
7654321076543210
|       ||       |
| Byte 0 || Byte 1 |
|       || 8 Chan |
|       || 16 Chan |

```

When the contents of the acquisition is formatted as real data (R), the number refers to number of marks or number of sample period intervals.

SYNTAX: TT;

Learn String Format (for Timing Trace Learn):

Starting Byte Position In String	Number Of Bytes	Contents
1	2	(A) RT (Receive Timing Command)
3	2	(I) Binary byte count (refer to Note) CRC STARTS ACCUMULATING WITH NEXT BYTE
5	1	(I) Number of timing channels
6	2	(I) Number of valid timing states
8	2	(I) Index of the tracepoint state
10	1	(S) Glitch mode on
11	2	(T) Sample period
13	7	(I,B) Date/Time information
20	2	(I) Number of marks between cursors
22	2	(I) Number of samples between cursors
24	4	(R) Average time between cursors
28	4	(R) Standard Deviation
32	2	(I) Maximum number of samples between cursors
34	2	(I) Minimum number of samples between cursors
36	4	(R) Average number of marks between cursors
40	4	(R) Standard Deviation

SYNTAX: TT;

Learn String Format (for Timing Trace Learn): (Cont'd)

Starting Byte Position In String	Number Of Bytes	Contents
44	2	(I) Maximum number of marks between cursors
46	2	(I) Minimum number of marks between cursors
48	2	(I) Number of hits
50	2	(I) Number of runs
52	N	(I) Data File Where N = (Number of records) * M M = 1 byte per record for 8 channels M = 2 bytes per record for 16 channels CRC STOPPED ACCUMULATING WITH PREVIOUS BYTE
N + 52	1	Revision Code
N + 53	2	(I) CRC

Note

The binary value of these bytes is the number of bytes to follow including the CRC bytes. The maximum binary number, if the memory is full, is 2092 for 16 channels and 1071 for 8 channels. With partial memories, the binary value of these bytes will include the last word in memory plus two CRC bytes.

TE - Transmit Everything Learn String

The transmit everything learn string command instructs the analyzer to transmit the following data in the listed sequence: (1) Configuration learn string, (2) State data acquisition learn string, (3) Timing data acquisition learn string, and (4) Analog acquisition learn string. Refer to the TC, TS, TT and TA command descriptions for learn string formats. The maximum number of bytes will be the sum of the bytes of the individual commands. The maximum number of bytes (13 576) will occur in the State and Timing mode.

DATA TRANSFER TERMINATION

Binary transfers of data are terminated by setting EOI true with the last byte transferred. Non-binary transfers are terminated by sending CR LF with EOI true.

Appendix A

Display Messages

This appendix lists and defines each of the status, error, and prompt messages that the analyzer presents on screen.

All names must be unique - This message is displayed when a name has been created that is identical to one of the other names already in use on that menu.

At least 1 clock edge required - This message is displayed when the CLOCK field in the state FORMAT specification is set up so that no clock line is active.

Continuous trace in process - This message is displayed when the analyzer has a continuous trace in process, such as during the execution of an overview measurement.

Correlating point not in data - Insert to correlate failed because correlating point was outside the range of the current data. The cursor was placed at the end or the beginning of the waveform depending on which end is closer to the correlating data.

Data acquired Month, Day, Year, Time - This message indicates when the current trace data was acquired. The initial setting is filled in from the clock set in the system peripherals menu. If the clock was not set when the trace was taken, this message will not be displayed at all.

Delaying - This message pertains to a trace in progress.

Delay too big for sample period - This message is displayed when a trigger delay is selected, in the timing TRACE specification, that is too long for the analyzer to measure using its present sample period selection.

DELETE to remove field - This message is displayed on menus which have all available fields assigned, such as when the state [Assignment] menu of the FORMAT specification has 8 labels assigned. This message prompts to delete fields from a full menu.

ERROR CRC does not match - This message is displayed when the Cyclic Redundancy Check (CRC) value read in during a learn string or down-loaded program did not match the CRC value calculated by the analyzer when it received the data. Could also mean an attempt was made to load an inverse assembler from internal storage that was corrupt.

ERROR directory full - the directory on the currently inserted disc has no more room for entries. Delete unwanted files before attempting to store to this disc.

ERROR disc changed - The disc has been changed since the last INSERT to check for disc was performed.

ERROR disc failure - The disc drive logic has failed. Indicates possible problems with the disc drive.

ERROR disc is not LIF disc - The disc inserted in the addressed unit is not in an appropriate format. Discs used must be in LIF (Logical Interchange Format).

ERROR disc is write protected - A write, delete, or format operation was attempted on a write protected disc.

ERROR disc operation aborted - A disc operation was stopped prematurely.

ERROR disc unformatted - The currently inserted disc is unformatted. It must be a LIF (Logical Interchange Format) disc.

ERROR DON'T CARE not allowed - This message is displayed when the DON'T CARE key is pressed and the cursor is in a field where "don't care" entries can not be accepted.

ERROR duplicate HP-IB address - The logic analyzer, printer, and disc must all be assigned unique HP-IB addresses.

ERROR file not found - The desired file was not found on the addressed disc unit.

ERROR format failed - Attempt to format a bad disc medium.

ERROR illegal file name - A disc file name must start with a letter, followed by an optional sequence of letters and/or numerals. No spaces, hyphens, or underscores are allowed.

ERROR in controller command - This message is displayed when the analyzer received a command from the controller (HP-IB or HP-IL) and did not recognize the command. A second line shows <...>??? with the first character of the unrecognized command in inverse video.

ERROR in HP-IB transfer - The HP-IB interface is not operating properly.

ERROR in post processing voltage - indicates illegal voltage in Analog Post Processing menu.

ERROR internal: bad file length - Indicates internal problems with the analyzer. Record events leading up to this message and contact Hewlett-Packard.

ERROR internal: bad file type - Indicates internal problems with the analyzer. Record events leading up to this message and contact Hewlett-Packard.

ERROR internal: bad request - Indicates internal problems with the analyzer. Record events leading up to this message and contact Hewlett-Packard.

ERROR internal: disc error - Indicates internal problems with the analyzer. Record events leading up to this message and contact Hewlett-Packard.

ERROR internal: undefined error - Indicates internal problems with the analyzer. Record events leading up to this message and contact Hewlett-Packard.

ERROR in trigger level - The analog trigger level is illegal.

ERROR invalid analog menu - LIST and CHART are not available analog menus.

ERROR in voltage offset - The voltage range does not meet the requirements of | upper voltage + lower | voltage <4.0V (1X), 40.0V (10X), or 200V (50X).

ERROR in voltage range - The differences of the assigned upper and lower voltages is 2.5V (1X), 25V (10X), or 125 V (50X).

ERROR invalid in this trace mode - This message is displayed when a display is requested that is not available in the selected trace mode, such as a trace list when the analyzer is performing an overview measurement.

ERROR item not found - This message signifies that a Find operation in the [Timing + Postproc] Listing was not successful.

ERROR LIF directory too big - A disc with too many LIF directory entries is in the addressed drive. Use a different disc.

ERROR maximum INSERT's used - This message is displayed when the INSERT key is used to insert an

additional field, such as another label in the [Assignment] menu of the FORMAT specification, and the menu already has as many entries of that type as it can accept.

ERROR no disc drive present - There is no disc drive at the present address.

ERROR no disc media present - There is no disc inserted in the addressed unit.

ERROR no room on disc - The current disc is too full to complete the selected operation.

ERROR numeric entry required - This message is displayed when a non-numeric key is pressed, such as NEXT[], and the cursor is in a field that accepts only numeric entries.

ERROR only bits 0-3 edge trigger - This message is displayed when trying to assign edge triggering to one of the timing bits that does not have edge-trigger capability.

ERROR operation time out - The current HP-IB disc operation was not completed. It was aborted because of a lack of response from the disc.

ERROR reload disc first - The cursor must be positioned on the top line of the Storage Operations menu, then the INSERT key pressed, before the desired operation can be completed.

ERROR requires correction first - This message is displayed when a partial specification has been entered, and before completing it, another analyzer menu is selected, such as when entering the name of a label in the FORMAT specification, and then trying to change to the TRACE specification before assigning a bit for that label.

ERROR RESUME not allowed - This message is displayed when the RESUME key has been pressed for an operation that the analyzer has completed and cannot resume.

ERROR unexpected EOI - The disc drive logic has failed. Indicates possible problems with the disc drive.

ERROR use alphanumeric keys - This message is displayed after pressing the NEXT[] or PREV[] keys while the cursor is in a field which accepts only alphanumeric entries, such as a module name field in the [User Base] menu of the FORMAT specification.

ERROR use CHS key - This message is displayed when the cursor is on a mathematical sign, and something other than the CHS (change sign) key is pressed.

ERROR use hex keys - This message is displayed when pressing a non-hex key when the cursor is in a field that accepts only hexadecimal entries.

ERROR use NEXT[] PREV[] keys - This message is displayed when pressing a keyboard letter or number key a field where selections must be made with the NEXT[] or PREV[] keys.

ERROR use 0 or 1 - This message is displayed when trying to enter a non-binary character in a specification that is set to accept only binary entries.

ERROR use 0, 1, or DON'T CARE - This message is displayed when trying to enter a non-binary character in a specification field that is set up to accept only binary or "don't care" entries.

ERROR use 0 thru 3 - This message is displayed when trying to enter too large a value into a field made up of only two bits, and set to accept a number base other than binary.

ERROR use 0 thru 3 or DON'T CARE - This message is displayed when trying to enter too large a value into a field made up of only two bits, and set to accept either a DON'T CARE, or a number with a non-binary base.

ERROR use 0 thru 7 - This message is displayed when pressing an "8" or "9" key for an entry in a field that accepts only numbers in the octal number base or is made up of only 3 bits.

ERROR use 0 thru 7 or DON'T CARE - This message is displayed when trying to enter a non-octal character in a specification field that is set up to accept only octal or 'don't care' entries, or is made up of only 3 bits.

ERROR value is too large - This message is displayed when pressing a numeric key in a numeric field, but the number is too large for the cursor position in the numeric field.

ERROR write protected file - This message is displayed when the highlighted bar is on a file that is write protection enabled and a write operation is attempted.

INSERT to add compare item - This message is displayed in the state and compare list display. It indicates that a duplicate of the line shown in inverse video can be added to the compare list by pressing the INSERT key.

INSERT to add new label - This message is displayed when the cursor is in the label field of the format [Assignment] menu. It describes what must be done to create a new label in this menu.

INSERT to add new module - This message is displayed when creating code modules on the [Relocation] menu of the FORMAT specification. It describes what must be done to create an additional code module in the map.

INSERT to add new range - This message is displayed when the cursor is in the range field of a menu, and the analyzer has space available in that field for creating additional ranges.

INSERT to add or'd pattern - This message is displayed when the cursor is in the proper position to allow entry of an additional term to be OR'd with the present term in the specification. It describes what must be done to create this additional term.

INSERT to add sequence term - This message is displayed when the cursor is in the proper position to allow entry of a sequence term. It describes what must be done to create a new sequence term in this menu.

INSERT to add traces - This message is displayed in the waveform display when the cursor is in the proper area to add more waveform channels to the display. The message indicates how to add the additional channels.

INSERT to autoscale - This message is displayed in the chart menus. Press INSERT to set the max and min scale values to the maximum and minimum data values currently displayed.

INSERT to correlate mag. cursor - This message is displayed in the waveform menus of an interactive analog/timing measurements only. When this message appears, press INSERT to update the cursor indicated by the Magnify About field to align to the same point in time as the timing cursor.

INSERT to check for disc - This message is displayed when the cursor is in the top row of the Storage Operations menu. Pressing INSERT will cause the analyzer to see if a disc is present at the assigned HP-IB address and unit.

INSERT to confirm - Before the current operation can continue, INSERT must be pressed to confirm that the selected operation is desired.

INSERT to find - function in the [Timing + Postproc] Listing.

INSERT to inverse assemble - This message is displayed in the state list menu when certain inverse assemblers are active. the current inverse assembler cannot accurately determine where the first state of an instruction fetch is. Position the display so that the state aligned with the inverse video line number is the first state of an instruction fetch. Press INSERT to start the inverse assembly from the indicated state.

INSERT to overwrite - A request has been made to overwrite a disc file. Before the old file is destroyed, INSERT must be pressed to overwrite it.

INSERT to start operation - This message is displayed when the cursor is in the bottom row of the Storage Operations menu. Pressing INSERT will cause the analyzer to begin the currently selected operation.

INSERT to store compare image - This message is displayed in the state full compare list menu when viewing the trace data. Press INSERT to store the current trace data as the compare image.

Internal message error - Indicates internal problems with the analyzer. Record events leading up to this message and contact Hewlett-Packard.

Invalid clock setting - This message is displayed when the analyzer clock in the SYSTEM [Peripherals] menu has not been set to a correct date. The clock date must be later than December, 1981.

Note: Compare list is empty - This message is displayed when the state Compre Trace Mode is selected and the list in the compare memory has no entries.

One "*" required for each label - This message is displayed when a name for a new label has been created before assigning the first bit to be identified by that label.

Power-up complete - This message is displayed after the analyzer has successfully completed the power-up test routine.

Reading directory - The analyzer is reading the directory on the external mass storage device.

ROLL to change configuration - This message is displayed when in the SYSTEM [Configuration] menu. It prompts use of the ROLL keys to change the distribution of input bits between the state and timing measurement channels.

Single trace in process - This message is displayed while the instrument is making a single trace or is finishing up a trace after the STOP key was pressed during a continuous trace.

Timing trace in process - This message pertains to a trace in progress.

Timing: XXXX secs to completion - This message pertains to a trace in progress.

Trace aborted - This message is displayed after pressing the STOP key during a single trace execution, before that trace has been completed.

Trace complete - This message is displayed after the analyzer completes a single trace.

WAIT checking directory - This is a disc operation.

WAIT creating directory - This is a disc operation.

WAIT disc operation in process - The analyzer is currently accessing the external mass storage.

WAIT formatting disc - This disc operation can take up to 5 minutes.

Waiting for analog trigger - This message pertains to a trace in progress.

Waiting for sequence term - This message pertains to a trace in progress.

Waiting for start term - This message pertains to a trace in progress.

Waiting for state term - This message pertains to a trace in progress.

Waiting for stop term - This message pertains to a trace in progress.

Waiting for timing trigger - This message pertains to a trace in progress.

Wait loading analog data - This disc operation takes about 15 seconds.

WAIT loading configuration - This disc operation takes about 15 seconds.

WAIT loading executable - This disc operation takes about 15 seconds.

WAIT loading internal storage - This message is displayed while data is being transferred into the logic analyzers internal storage. Configurations take about 30 seconds. Inverse assemblers can take up to 3 minutes.

WAIT loading inverse assembler - This disc operation takes about 10 seconds.

WAIT loading state data - This disc operation takes about 25 seconds.

WAIT loading timing data - This disc operation takes about 5 seconds.

WAIT PRINT in progress - This message is displayed while the analyzer is sending data to a printer after the PRINT key has been pressed.

WAIT reading directory - This is a disc operation.

WAIT storing analog data - This disc operation takes about 10 seconds.

WAIT storing configuration - This disc operation takes about 15 seconds.

WAIT storing state data - This disc operation takes about 25 seconds.

WAIT storing timing data - This disc operation takes about 5 seconds.

WARNING auto calibration off - This message identifies an internal problem with the analog board and is displayed after the auto calibration has failed to calibrate the board. After this message is displayed, auto calibration is turned off and the default values are used. Contact Hewlett-Packard.

WARNING awaiting HP-IB transfer - This message is displayed when the analyzer has been commanded to send data but the HP-IB controller is not accepting transmissions from the analyzer. The message will disappear when data transfer begins.

WARNING awaiting HP-IL transfer - This message is displayed when the analyzer has been commanded to send data but the HP-IL controller is not accepting transmissions from the analyzer. The message will disappear when data transfer begins.

WARNING command ignored - This message is displayed when attempting to execute a command that is invalid for the field that is identified by the position of the cursor, such as trying to INSERT a label in the [Assignment] FORMAT specification when the cursor is in the [Assignment] field.

WARNING incorrect revision code - This message indicates that the data stored is not from a 1630A/D or 1631A/D. The data received is not stored by the 1631A/D.

WARNING press STOP key first - This message appears after trying to change a trace parameter during a measurement. The analyzer cannot change trace parameters while a measurement is in process.

WARNING printer down - This message is displayed when the analyzer tries to send data to print a copy of the display on an external printer, and the data transfer is not taking place or has been suspended for approximately one second.

WARNING slow clock - This message is displayed when the repetition rate of the incoming state clock is slower than the minimum rate. It usually means that the analyzer is not receiving any clock activity on the line(s) selected to clock data.

WARNING value not allowed - This message is displayed when trying to enter too large a value into a decimal field.

XXXX Intervals to completion - This message pertains to a trace in progress. The Xs represent a decimal number that is continuously updated to reflect the current trace status.

XXXX States to completion - This message pertains to a trace in progress. The Xs represent a decimal number that is continuously updated to reflect the current trace status.

Appendix B

An HP-IB Overview

INTRODUCTION

The HP Interface Bus (HP-IB) provides an interconnecting channel for data transfer between devices on the HP-IB.

The following list defines the terms and concepts used to describe HP-IB (bus) system operations.

HP-IB SYSTEM TERMS

1. **Addressing** — The characters sent by a controlling device specifying which device sends information on the bus and which device(s) receives the information.
2. **Byte** — A unit of information consisting of 8 binary digits (bits).
3. **Device** — An unit that is compatible with the ANSI/IEEE 488-1978 Standard.
4. **Device Dependent** — A response to information sent on the HP-IB that is characteristic of an individual device's design, and may vary from device to device.
5. **Operator** — The person that operates either the system or any device in the system.
6. **Polling** — The process typically used by a controller to locate a device that needs to interact with the controller. There are two types of polling:
 - **Serial Poll** — This method obtains one byte of operational information about an individual device in the system. The process must be repeated for each device from which information is desired.
 - **Parallel Poll** — This method obtains information about a group of devices simultaneously.

INTERFACE BUS CONCEPTS

Devices which communicate along the interface bus can be classified into three basic categories.

1. **Talkers** — Devices which send information on the bus when they have been addressed.
2. **Listeners** — Devices which receive information sent on the bus when they have been addressed.
3. **Controllers** — Devices that can specify the talker and listeners for an information transfer. Controllers can be categorized as one of two types:
 - **Active Controller** — The current controlling device on the bus. Only one device can be the active controller at any time.
 - **System Controller** — The only controller that can take priority control of the bus if it is not the current active controller. Although each bus system can have only one system controller, the system can have any number of devices capable of being the active controller.

A typical HP-IB system is shown below.

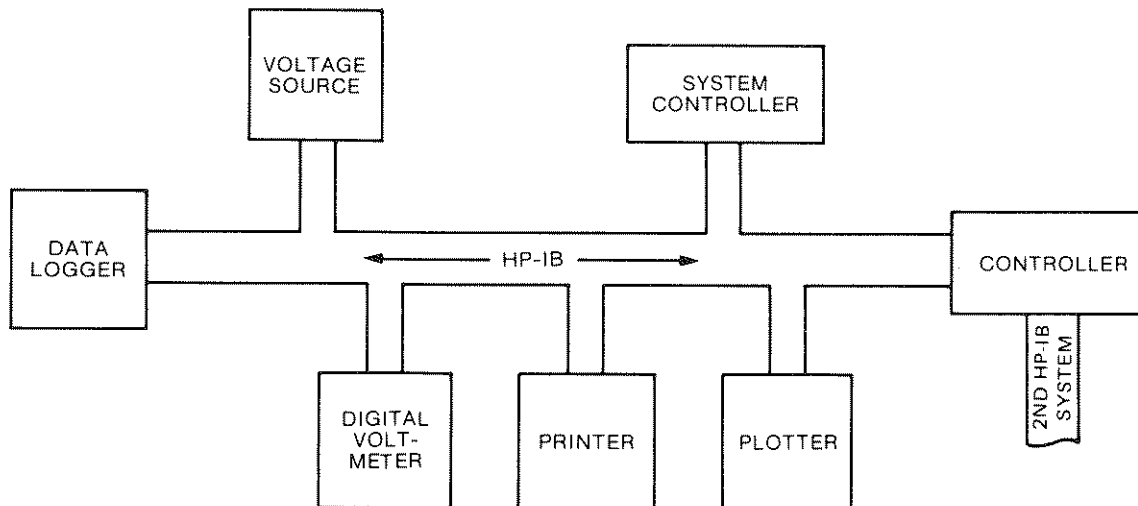

9872-A-172-1

MESSAGE CONCEPTS

Devices which communicate along the interface bus are transferring quantities of information. The transfer of information can be from one device to another device, or from one device to more than one device. These quantities of information can easily be thought of as "messages".

In turn, the messages can be classified into twelve types. The list below gives the twelve message types for the HP-IB.

1. **The Data Message** — This is the actual information which is sent from one talker to one or more listeners along the interface bus.
2. **The Trigger Message** — This message causes the listening device(s) to perform a device-dependent action when addressed.
3. **The Clear Message** — This message causes either the listening device(s) or all of the devices on the bus to return to their predefined device-dependent states.
4. **The Remote Message** — This message causes listening devices to switch from local front-panel to remote program control when addressed to listen.
5. **The Local Message** — This message clears the Remote Message from the listening device(s) and returns the device(s) to local front-panel control.
6. **The Local Lockout Message** — This message prevents a device operator from manually inhibiting remote program control.
7. **The Clear Lockout/Local Message** — This message causes all devices on the bus to be removed from Local Lockout and revert to Local. This message also clears the Remote Message for all devices on the bus.
8. **The Require Service Message** — A device can send this message at any time to signify that the device needs some type of interaction with the controller. This message is cleared by sending the device's Status Byte Message if the device no longer requires service.
9. **The Status Byte Message** — A byte that represents the status of a single device on the bus. Bit 6 indicates whether the device sent a Require Service Message, and the remaining bits indicate operational conditions defined by the device. This byte is sent from a talking device in response to a serial poll operation performed by a controller.

- 10. **The Status Bit Message** — A byte that represents the operational conditions of a group of devices on the bus. Each device responds on a particular bit of the byte thus identifying a device-dependent condition. This bit is typically sent by devices in response to a parallel poll operation.

The Status Bit Message can also be used by a controller to specify the particular bit and logic level that a device will respond with when a parallel poll operation is performed. Thus more than one device can respond on the same bit.

- 11. **The Pass Control Message** — This transfers the bus management responsibilities from the active controller to another controller.
- 12. **The Abort Message** — The system controller sends this message to unconditionally assume control of the bus from the active controller. This message terminates all bus communications (but does not implement a Clear Message).

These messages represent the full implementation of all HP-IB system capabilities. Each device in a system may be designed to use only the messages that are applicable to its purpose in the system. It is important for you to be aware of the HP-IB functions implemented on each device in your HP-IB system to ensure the operational compatibility of the system.

THE HP INTERFACE BUS

HP-IB Lines And Operations

The HP Interface Bus transfers data and commands between the components of an instrumentation system on 16 signal lines. The interface functions for each system component are performed within the component so only passive cabling is needed to connect the systems. The cables connect all instruments, controllers, and other components of the system in parallel to the signal lines.

The eight Data I/O lines (DI01 through DI08) are reserved for the transfer of data and other messages in a byte-serial, bit-parallel manner. Data and message transfer is asynchronous, coordinated by the three handshake lines: Data Valid (DAV), Not Ready For Data (NRFD), and Not Data Accepted (NDAC). The other five lines are for management of bus activity. See the figure on the right.

Devices connected to the bus may be talkers, listeners, or controllers. The controller dictates the roll of each of the other devices by setting the ATN (attention) line true and sending talk or listen addresses on the data lines. Addresses are set into each device at the time of system configuration either by switches built into the device or by jumpers on a PC board. While the ATN line is true, all devices must listen to the data lines. When the ATN line is false, only devices that have been addressed will actively send or receive data. All others ignore the data lines.

Several listeners can be active simultaneously but only one talker can be active at a time. Whenever a talk address is put on the data lines (while ATN is true), all other talkers will be automatically unaddressed.

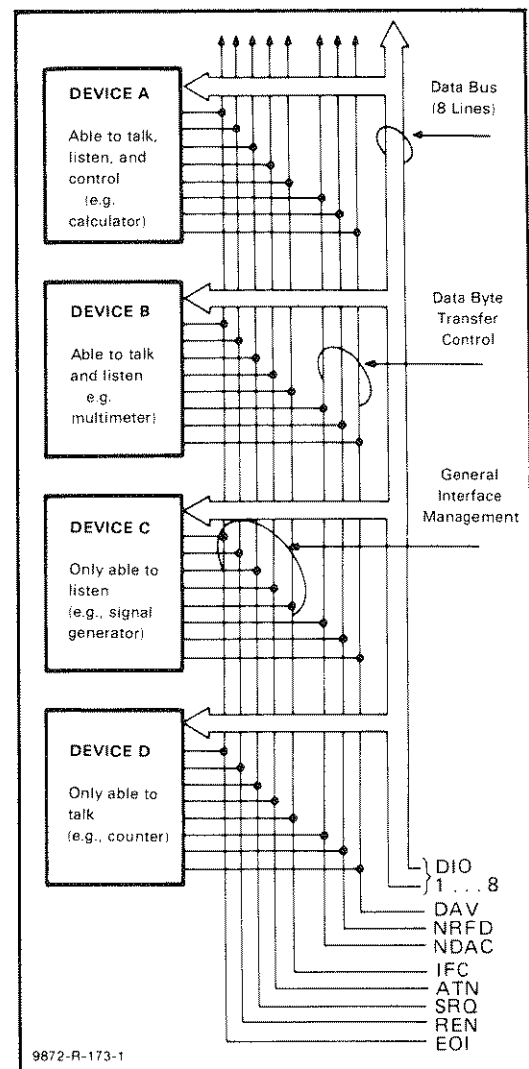

HP-IB Signal Lines

Information is transmitted on the data lines under sequential control of the three handshake lines (DAV, NRFD, and NDAC). No step in the sequence can be initiated until the previous step is completed. Information transfer can proceed as fast as devices can respond, but no faster than allowed by the slowest device presently addressed as active. This permits several devices to receive the same message byte concurrently.

The ATN line is one of the five bus management lines. When ATN is true, addresses and universal commands are transmitted on only seven of the data lines using the ASCII code. When ATN is false, any code of 8 bits or less understood by both talker and listener(s) may be used.

The IFC (interface clear) line places the interface system in a known quiescent state.

The REN (remote enable) line is used with the Remote, Local, and Clear Lockout/Set Local Messages to select either local or remote control of each device.

Any active device can set the SRQ (service request) line true via the Require Service Message. This indicates to the controller that some device on the bus wants attention, such as a counter that has just completed a time-interval measurement and wants to transmit the reading to a printer.

The EOI (end or identify) line is used by a device to indicate the end of a multiple-byte transfer sequence. When a controller sets both the ATN and EOI lines true, each device capable of a parallel poll indicates its current status on the DIO line assigned to it.

In the interest of cost-effectiveness, it is not necessary for every device to be capable of responding to all the lines. Each can be designed to respond only to those lines that are pertinent to its function on the bus.

The operation of the interface is generally controlled by one device equipped to act as controller. The interface transmits a group of commands to direct the other instruments on the bus in carrying out their functions of talking and listening.

The controller has two ways of sending interface messages. Multi-line messages, which cannot exist concurrently with other multi-line messages, are sent over the eight data lines and the three handshake lines. Uni-line messages are transferred over the five individual lines of the management bus.

The commands serve several different purposes:

- Addresses, or talk and listen commands select the instruments that will transmit and accept data. They are all multi-line messages.
- Universal commands cause every instrument equipped to do so to perform a specific interface operation. They include multi-line messages and three uni-line commands: interface clear (IFC), remote enable (REN), and attention (ATN).
- Addressed commands (also referred to as primary commands) are similar to universal commands, except that they affect only those devices that are addressed and are all multi-line commands. An instrument responds to an addressed command, however, only after an address has already told it to be talker or listener.
- Secondary commands are multi-line messages that are always used in series with an address, universal command, or addressed command to form a longer version of each. Thus they extend the code space when necessary.

To address an instrument, the controller uses seven of the eight data-bus lines. This allows instruments using the ASCII 7-bit code to act as controllers. As shown in the table, five bits are available for addresses, and a total of 31 allowable addresses are available in one byte. If all secondary commands are used to extend this into a two-byte addressing capability, 961 addresses become available (31 allowable addresses in the second byte for each of the 31 allowable in the first byte).

Command and Address Codes

Code Form							Meaning
X 0	1	A ⁵	A ⁴	A ³	A ²	A ¹	Universal Commands
X 0	1	A ⁵	A ⁴	A ³	A ²	A ¹	Listen Addresses
except							
X 0	1	1	1	1	1	1	Unlisten Command
X 1	0	A ⁵	A ⁴	A ³	A ²	A ¹	Talk Address
except							
X 1	0	1	1	1	1	1	Untalk Command
X 1	1	A ⁵	A ⁴	A ³	A ²	A ¹	Secondary Commands
except							
X 1	1	1	1	1	1	1	Ignored

Code used when attention (ATN) is true (low).

X = don't care

INTERFACE FUNCTIONS

Interface functions provide the physical capability to communicate via HP-IB. These functions are defined in the ANSI/IEEE 488-1978 Standard. This standard, which is the designer's guide to the bus, defines each interface function in terms of state diagrams that express all possible interactions.

Bus capability is grouped under 10 interface functions, for example: Talker, Listener, Controller, Remote/Local. The following table lists the functions, including two special cases of Controller.

HP-IB Interface Functions

Mnemonic	Interface Function Name
SH	Source Handshake
AH	Acceptor Handshake
T	Talker (or TE = Extended Talker)*
L	Listener (or LE = Extended Listener)*
SR	Service Request
RL	Remote Local
PP	Parallel Poll
DC	Device Clear
DT	Device Trigger
C	Any Controller
CN	A Specific Controller (for example: CA, CB . . .)
CS	The System Controller

*Extended Talkers and Listeners use a two-byte address. Otherwise, they are the same as Talker and Listener.

BUS MESSAGES

Since interface functions are the physical agency through which bus messages are implemented, each device must implement one or more functions to enable it to send or receive a given bus message.

The following table lists the functions required to implement each bus message. Each device's operating manual lists the functions implemented by that device. Some devices, such as the 98034A Interface, list the functions implemented directly on the device.

Functions Used By Each Bus Message

Bus Message	Functions Required sender function - receiver function(s) (support functions)
Data	T - L* (SH, AH)
Trigger	C - DT* (L, SH, AH)
Clear	C - DC* (L, SH, AH)
Remote	CS - RL* (SH, AH)
Local	C - RL* (L, SH, AH)
Local Lockout	C - RL* (SH, AH)
Clear Lockout/Set Local	CS - RL*
Require Service	SR* - C
Status Byte	T - L* (SH, AH)
Status Bit	PP* - C
Pass Control	CA - CB (T, SH, AH)
Abort	CS - T, L*C

*Since more than one device can receive (or send) this message simultaneously, each device must have the function indicated by an *.

HP 1631 HP-IB IMPLEMENTATION

Functions Implemented (ANSI/IEEE 488-1978)

HP-IB Implementation when 1631 is non-controller

- a. Source Handshake (SH1)
- b. Acceptor Handshake (AH1)
- c. Talker (T6) Serial Poll
- d. Talker-Extended (TE0) No
- e. Listener (L4)
- f. Listener-Extended (LE0) No
- g. Service Request (SR1)
- h. Remote/Local (RL1) Yes
- i. Parallel Poll (PP1)
- j. Device Clear (DC1)
- k. Device Trigger (DT1)
- l. Controller (C0) No
- m. Drive Electronics (E2) Tri-state

Index

A

Accessories	1-5
Accessory Power	2-4
Activity Monitor	4-3
Address Switch	2-2
Analog DISPLAYS	
[Waveform Diagram]	4-14, 4-15
[Waveform/Trace]	4-16
Analog FORMAT Specification	4-2
Analog Performance Features	1-2
Analog Post Processing	4-11
Analog Statistical Measurements	4-13
Analog TRACE Specification	4-4
Analyzer Description	1-2
Analyzer Memory	1-2
Analyzer Operating Power	2-3
[Assignment] Menu	
State	6-3
Timing	5-7

B

Blue key	3-2
----------------	-----

C

Capturing Traces	
Analog	4-5
State	6-1
Timing	5-2
Clock Assignments	6-4
Clock Set	9-1
Compare Trace Mode	6-23
[Configuration] Menu	
Analog configuration	4-1
State configuration	6-2
Timing configuration	5-2
Interactive configuration	8-3, 8-7
Configurations, Physical	1-4
Connections	
to target system	2-4
through probe interface	2-4
directly to system	2-5
operating power	2-1
Continuous Runs	
Analog	4-4, 4-13
Timing	5-16
Control	
front panel	3-2
HP-IB/HP-IL	10-1

Correlation of Events	8-2
Cross Domain Triggering	8-1
Cummulative Trace Mode	
Analog	4-4
Timing	5-9
Cursor Moves	
Analog	4-9
Timing	5-4
Cursors Placed on Acquired Data	
Analog	4-12
Timing	5-11

D

Deleting a Disc File	9-5
Disc Memory	9-2
Display Messages	Appendix A
Display Modes	
Analog	4-4
State	6-13
Timing	5-9
DON'T CARE	3-2
DON'T CARE Triggering	6-14
DISPLAYS Keys	3-2

E

Edge Triggering	5-1, 5-6
Error Messages	Appendix A
Event Correlation	8-2

F

Finding a Disc File	9-4
Free-run Mode	6-2, 8-1
FORMAT Specification, Analog	4-2
FORMAT Specification, State	
[Assignment]	6-3
[Relocation]	6-8
[User Base]	6-10
FORMAT Specification, Timing	
[Assignment]	5-7
[User Base]	5-8
Formatting a Disc	9-5
Front Panel Keys	3-2

G

Glitches	5-1
Glitch Mode	5-1

- H**
- Hard Copy, Printer 9-6
 - Histogram
 - State Label 7-2
 - Time Interval 7-4
 - HP-IB/HP-IL 9-1
 - HP Model 5036A 1-5
 - HP Model 9121D/S 1-5
 - HP Model 10269A/B 1-5
 - HP Model 10271A 1-5
 - HP Model 10272A 1-5
 - HP Part Number 1250-1454 1-5
- I**
- Initial Inspection 2-1
 - Installation 2-1
 - Interactive Measurements 8-1
 - Inverse Assemblers 6-12
- L**
- Labels
 - moving on display 6-10
 - analog channel 4-2
 - state 6-6
 - timing 5-7
 - Learn String Commands 10-5
 - TA, Transmit Analog 10-7
 - TC, Transmit Configuration 10-5
 - TE, Transmit Everything 10-10
 - TS, Transmit State 10-6
 - TT, Transmit Timing 10-9
 - Line Voltage Selection 2-1
 - LIST Displays
 - State 6-26
 - Timing 5-5
- M**
- Magnification
 - Analog 4-9
 - Timing 5-3
 - Magnify About
 - Analog 4-9
 - Timing 5-4
 - Maintenance, Operator's 2-2
 - Marking Events on Acquired Data 4-12, 5-11
 - Memory
 - analyzer description 1-2
 - disc 9-2
 - Menu Map 3-3
 - Messages Appendix A
 - ERROR A-1
 - INSERT A-4
 - WAIT A-6
 - WARNING A-6
 - Mnemonics 10-1, 10-2
 - Monitor, Activity 4-3
 - Multiple labels for bits 6-6
- O**
- On Acquired Data Place Cursors
 - Analog 4-12
 - Timing 5-11
 - On Acquired Data Mark Listing for Events .. 5-14
 - Operator's Maintenance 2-2
 - Overview Measurements
 - State Label 7-1
 - Time Interval 7-3
- P**
- Performance Analysis, Software 7-1
 - Performance features
 - Analog 1-2
 - State 1-3
 - Timing 1-3
 - Peripherals
 - disc memory 9-2
 - menu 9-1
 - printer 9-6
 - Physical Configuration 1-4
 - Pod Threshold
 - State 6-4
 - Timing 5-7
 - Post Processing
 - Analog 4-11
 - Timing 5-9
 - Power Cable, AC 2-2
 - Power Requirements 2-1
 - Printer 9-6
 - Probe Interface 2-4
 - Probe Type Selection 4-3
- R**
- Reading a Disc File 9-3
 - Rear Panel Address Switch 2-2
 - Rear Panel BNC Connector 2-4
 - [Relocation] menu 6-8
 - Resource Terms 6-15
 - Restart sequence 6-21
 - RESUME 3-2
 - RETURN TO LOCAL 3-2
 - RUN 3-2

S

Safety Considerations	1-5
Sample Period	
Analog	4-5
Timing	5-9
Self-Test	2-3
Sequence Triggering	6-18
Service	2-3
Simultaneous Acquisition	8-1
Single Trace Mode	
Analog	4-4
State	6-2
Timing	5-8
Specifications	1-6
Standard Accessories	1-5
State DISPLAYS	
CHART	6-28
LIST	6-26
WFORM	6-27
State FORMAT	6-4
[Assignment]	6-3
[Relocation]	6-8
[User Base]	6-10
State Label Overview	7-1
State TRACE Specification	6-13
State Performance Features	1-3
[Storage Operations] Menu	9-2
SYSTEM Specification	
Analog	4-1
State	6-2
Timing	5-2
Interactive	8-3, 8-7
SYSTEM Menus	
[Configuration]	4-15-2, 6-2, 8-3, 8-7
[Peripherals]	9-1
[Storage Operations]	9-2

T

Target System	6-1
connections to	2-4
used for examples	6-1

Timing Performance Features	1-3
Timing DISPLAYS	5-18
Timing FORMAT Specification	
[Assignment]	5-7
[User Base]	5-8
Timing Measurements	5-1
Timing TRACE Specification	5-8
Time Interval Overview Measurement	7-3
Tracepoint Specification	
Analog	4-5
State	6-15
Transfer Termination of Data	10-10
Trigger [Center] Trace	
Analog	4-7
State	6-17
Trigger Edge	5-1, 5-5
Trigger [End] Trace	
Analog	4-8
State	6-17
Trigger DON'T CARE	6-14
Trigger [Start] Trace	
Analog	4-7
State	6-16
Trigger Terms	6-15

U

[User Base]	6-10
-------------------	------

V

Voltage Range Selection	4-3
Voltage Readout	4-10

W

Waveform Displays	
State	6-27
Timing	5-10

X

XY Chart Displays	
State	6-28
Timing	5-21

SAFETY

This product has been designed and tested according to International Safety Requirements. To ensure safe operation and to keep the product safe, the information, cautions, and warnings in this manual must be heeded. Refer to Section I and the Safety Summary for general safety considerations applicable to this product.

CERTIFICATION

Hewlett-Packard Company certifies that this product met its published specifications at the time of shipment from the factory. Hewlett-Packard further certifies that its calibration measurements are traceable to the United States National Bureau of Standards, to the extent allowed by the Bureau's calibration facility, and to the calibration facilities of other International Standards Organization members.

WARRANTY

This Hewlett-Packard product is warranted against defects in material and workmanship for a period of one year from date of shipment. During the warranty period, Hewlett-Packard Company will, at its option, either repair or replace products which prove to be defective.

For warranty service or repair, this product must be returned to a service facility designated by HP. However, warranty service for products installed by HP and certain other products designated by HP will be performed at Buyer's facility at no charge within the HP service travel area. Outside HP service travel areas, warranty service will be performed at Buyer's facility only upon HP's prior agreement and Buyer shall pay HP's round trip travel expenses.

For products returned to HP for warranty service, Buyer shall prepay shipping charges to HP and HP shall pay shipping charges to return the product to Buyer. However, Buyer shall pay all shipping charges, duties, and taxes for products returned to HP from another country.

LIMITATION OF WARRANTY

The foregoing warranty shall not apply to defects resulting from improper or inadequate maintenance by Buyer, Buyer-supplied software or interfacing, unauthorized modification or misuse, operation outside of the environmental specifications for the product, or improper site preparation or maintenance.

NO OTHER WARRANTY IS EXPRESSED OR IMPLIED. HP SPECIFICALLY DISCLAIMS THE IMPLIED WARRANTIES OF MERCHANTABILITY AND FITNESS FOR A PARTICULAR PURPOSE.

EXCLUSIVE REMEDIES

THE REMEDIES PROVIDED HEREIN ARE BUYER'S SOLE AND EXCLUSIVE REMEDIES. HP SHALL NOT BE LIABLE FOR ANY DIRECT, INDIRECT, SPECIAL, INCIDENTAL, OR CONSEQUENTIAL DAMAGES, WHETHER BASED ON CONTRACT, TORT, OR ANY OTHER LEGAL THEORY.

ASSISTANCE

Product maintenance agreements and other customer assistance agreements are available for Hewlett-Packard products.

For any assistance, contact your nearest Hewlett-Packard Sales and Service Office. Addresses are provided at the back of this manual.



Product Line Sales/Support Key

Key Product Line

- A Analytical
- CM Components
- C Computer Systems Sales only
- CH Computer Systems Hardware Sales and Services
- CS Computer Systems Software Sales and Services
- E Electronic Instruments & Measurement Systems
- M Medical Products
- MP Medical Products Primary SRO
- MS Medical Products Secondary SRO
- P Personal Computation Products
- * Sales only for specific product line
- ** Support only for specific product line

IMPORTANT: These symbols designate general product line capability. They do not insure sales or support availability for all products within a line, at all locations. Contact your local sales office for information regarding locations where HP support is available for specific products.

HP distributors are printed in italics.

HEADQUARTERS OFFICES

If there is no sales office listed for your area, contact one of these headquarters offices.

NORTH/CENTRAL AFRICA

Hewlett-Packard S.A.
7, Rue du Bois-du-Lan
CH-1217 MEYRIN 2, Switzerland
Tel: (022) 83 12 12
Telex: 27835 hpse
Cable: HEWPACKSA Geneve

ASIA

Hewlett-Packard Asia Ltd.
6th Floor, Sun Hung Kai Centre
30 Harbour Rd.
G.P.O. Box 795

HONG KONG

Tel: 5-832 3211
After Jan. 1, 1984
47th Floor, China Resources Bldg.
26 Harbour Rd., Wanchai

HONG KONG

Telex: 66678 HEWPA HX
Cable: HEWPACK HONG KONG

CANADA

Hewlett-Packard (Canada) Ltd.
6877 Goreway Drive
MISSISSAUGA, Ontario L4V 1M8
Tel: (416) 678-9430
Telex: 610-492-4246

EASTERN EUROPE

Hewlett-Packard Ges.m.b.h.
Liebigasse 1
P.O.Box 72
A-1222 VIENNA, Austria
Tel: (222) 2365110
Telex: 1 3 4425 HEPA A

NORTHERN EUROPE

Hewlett-Packard S.A.
Uilenstede 475
P.O.Box 999
NL-1180 AZ AMSTELVEEN
The Netherlands
Tel: 20 437771

SOUTH EAST EUROPE

Hewlett-Packard S.A.
7, Rue du Bois-du-Lan
CH-1217 MEYRIN 2, Switzerland
Tel: (022) 83 12 12
Telex: 27835 hpse
Cable: HEWPACKSA Geneve

OTHER EUROPE

Hewlett-Packard S.A.
P.O. Box
150, Rte du Nant-D'Avril
CH-1217 MEYRIN 2, Switzerland
Tel: (022) 83 8111
Telex: 22486 hpsa
Cable: HEWPACKSA Geneve

MEDITERRANEAN AND MIDDLE EAST

Hewlett-Packard S.A.
Mediterranean and Middle East
Operations
Atrina Centre
32 Kifissias Ave.
Paradissos-Amarousion, ATHENS
Greece
Tel: 682 88 11
Telex: 21-6588 HPAT GR
Cable: HEWPACKSA Athens

EASTERN USA

Hewlett-Packard Co.
4 Choke Cherry Road
ROCKVILLE, MD 20850
Tel: (301) 258-2000

MIDWESTERN USA

Hewlett-Packard Co.
5201 Tollview Drive
ROLLING MEADOWS, IL 60008
Tel: (312) 255-9800

SOUTHERN USA

Hewlett-Packard Co.
2000 South Park Place
P.O. Box 105005
ATLANTA, GA 30348
Tel: (404) 955-1500

WESTERN USA

Hewlett-Packard Co.
3939 Lankershim Blvd.
P.O. Box 3919
LOS ANGELES, CA 91604
Tel: (213) 506-3700

OTHER INTERNATIONAL AREAS

Hewlett-Packard Co.
Intercontinental Headquarters
3495 Deer Creek Road
PALO ALTO, CA 94304
Tel: (415) 857-1501
Telex: 034-8300
Cable: HEWPACK

ANGOLA

Telectra
Empresa Técnica de Equipamentos
R. Barbosa Rodrigues, 41-1 DT.
Caixa Postal 6487
LUANDA
Tel: 355 15,355 16
E,P

ARGENTINA

Hewlett-Packard Argentina S.A.
Avenida Santa Fe 2035
Martinez 1640 BUENOS AIRES
Tel: 798-5735, 792-1293
Telex: 17595 BIONAR
Cable: HEWPACKARG
A,E,CH,CS,P
Biotron S.A.C.I.M. e l.
Av Paseo Colon 221, Piso 9
1399 BUENOS AIRES
Tel: 30-4846, 30-185 1
Telex: 17595 BIONAR
M

AUSTRALIA

Adelaide, South Australia Office

Hewlett-Packard Australia Ltd.
153 Greenhill Road
PARKSIDE, S.A. 5063
Tel: 272-5911
Telex: 82536
Cable: HEWPARAD Adelaide
A*,CH,CM,*,E,MS,P

Brisbane, Queensland Office

Hewlett-Packard Australia Ltd.
10 Payne Road
THE GAP, Queensland 4061
Tel: 30-4133
Telex: 42133
Cable: HEWPARD Brisbane
A,CH,CM,E,M,P

Canberra, Australia Capital Territory Office

Hewlett-Packard Australia Ltd.
121 Wollongong Street
FYSHWICK, A.C.T. 2609
Tel: 80 4244
Telex: 62650
Cable: HEWPARD Canberra
CH,CM,E,P

Melbourne, Victoria Office

Hewlett-Packard Australia Ltd.
31-41 Joseph Street
BLACKBURN, Victoria 3130
Tel: 895-2895
Telex: 31-024
Cable: HEWPARD Melbourne
A,CH,CM,CS,E,MS,P

Perth, Western Australia Office

Hewlett-Packard Australia Ltd.
261 Stirling Highway
CLAREMONT, W.A. 6010
Tel: 383-2188
Telex: 93859
Cable: HEWPARD Perth
A,CH,CM,E,MS,P

Sydney, New South Wales Office

Hewlett-Packard Australia Ltd.
17-23 Talavera Road
P.O. Box 308
NORTH RYDE, N.S.W. 2113
Tel: 887-1611
Telex: 21561
Cable: HEWPARD Sydney
A,CH,CM,CS,E,MS,P

AUSTRIA

Hewlett-Packard Ges.m.b.h.
Grottenhofstrasse 94
A-8052 GRAZ
Tel: (0316) 291 5 66
Telex: 32375
CH,E
Hewlett-Packard Ges.m.b.h.
Liebigasse 1
P.O. Box 72
A-1222 VIENNA
Tel: (0222) 23 65 11-0
Telex: 134425 HEPA A
A,CH,CM,CS,E,MS,P

BAHRAIN

Green Salon
P.O. Box 557
Manama
BAHRAIN
Tel: 255503-255950
Telex: 84419
P

Wael Pharmacy

P.O. Box 648
BAHRAIN
Tel: 256123
Telex: 8550 Wael BN
E,C,M

BELGIUM

Hewlett-Packard Belgium S.A./N.V.
Blvd de la Woluwe, 100
Woluwedal
B-1200 BRUSSELS
Tel: (02) 762-32-00
Telex: 23-494 paloben bru
A,CH,CM,CS,E,MP,P

BRAZIL

Hewlett-Packard do Brasil I.e.C. Ltda.
Alameda Rio Negro, 750
Alphaville
06400 BARUERI SP
Tel: (011) 421.1311
Telex: (011) 33872 HPBR-BR
Cable: HEWPACK Sao Paulo
A,CH,CM,CS,E,M,P
Hewlett-Packard do Brasil I.e.C. Ltda.
Avenida Epitacio Pessoa, 4664
22471 RIO DE JANEIRO-RJ
Tel: (021) 286.0237
Telex: 021-21905 HPBR-BR
Cable: HEWPACK Rio de Janeiro
A,CH,CM,E,MS,P*
ANAMED I.C.E.I. Ltda.
Rua Bage, 103
04012 SAO PAULO
Tel: (011) 570-5726
Telex: 021-21905 HPBR-BR
M



SALES & SUPPORT OFFICES

Arranged alphabetically by country

CANADA

Alberta

Hewlett-Packard (Canada) Ltd.
3030 3rd Avenue N.E.
CALGARY, Alberta T2A 6T7
Tel: (403) 235-3100
A,CH,CM,E*,MS,P*

Hewlett-Packard (Canada) Ltd.
11120A-178th Street
EDMONTON, Alberta T5S 1P2
Tel: (403) 486-6666
A,CH,CM,CS,E,MS,P

British Columbia

Hewlett-Packard (Canada) Ltd.
10691 Shellbridge Way
RICHMOND,
British Columbia V6X 2W7
Tel: (604) 270-2277
Telex: 610-922-5059
A,CH,CM,CS,E*,MS,P*

Manitoba

Hewlett-Packard (Canada) Ltd.
380-550 Century Street
WINNIPEG, Manitoba R3H 0Y1
Tel: (204) 786-6701
A,CH,CM,E,MS,P*

Nova Scotia

Hewlett-Packard (Canada) Ltd.
P.O. Box 931
900 Windmill Road
DARTMOUTH, Nova Scotia B2Y 3Z6
Tel: (902) 469-7820
CH,CM,CS,E*,MS,P*

Ontario

Hewlett-Packard (Canada) Ltd.
3325 N. Service Rd., Unit 6
BURLINGTON, Ontario P3A 2A3
Tel: (416) 335-8644
CS,M*

Hewlett-Packard (Canada) Ltd.
552 Newbold Street
LONDON, Ontario N6E 2S5
Tel: (519) 686-9181
A,CH,CM,E*,MS,P*

Hewlett-Packard (Canada) Ltd.
6877 Goreway Drive
MISSISSAUGA, Ontario L4V 1M8
Tel: (416) 678-9430
A,CH,CM,CS,E,MP,P

Hewlett-Packard (Canada) Ltd.
2670 Queensview Dr.
OTTAWA, Ontario K2B 8K1
Tel: (613) 820-6483
A,CH,CM,CS,E*,MS,P*

Hewlett-Packard (Canada) Ltd.
220 Yorkland Blvd., Unit #11
WILLOWDALE, Ontario M2J 1R5
Tel: (416) 499-9333
CH

Quebec

Hewlett-Packard (Canada) Ltd.
17500 South Service Road
Trans-Canada Highway
KIRKLAND, Quebec H9J 2M5
Tel: (514) 697-4232
A,CH,CM,CS,E,MP,P*

Hewlett-Packard (Canada) Ltd.
Les Galeries du Vallon
2323 Du Versant Nord
STE. FOY, Quebec G1N 4C2
Tel: (418) 687-4570
CH

CHILE

Jorge Calcagni y Cia. Ltda.
Av. Italia 634 Santiago
Casilla 16475
SANTIAGO 9
Tel: 222-0222
Telex: Public Booth 440001
A,CM,E,M

Olympia (Chile) Ltda.
Av. Rodrigo de Araya 1045
Casilla 256-V
SANTIAGO 21
Tel: (02) 22 55 044
Telex: 240-565 OLYMP CL
Cable: Olympiachile Santiagochile
CH,CS,P

CHINA, People's Republic of

China Hewlett-Packard Rep. Office
P.O. Box 418
1A Lane 2, Luchang St.
Beiwei Rd., Xuanwu District
BEIJING
Tel: 33-1947, 33-7426
Telex: 22601 CTSHP CN
Cable: 1920
A,CH,CM,CS,E,P

COLOMBIA

Instrumentación
H. A. Langebaek & Kier S.A.
Carrera 4A No. 52A-26
Apartado Aereo 6287
BOGOTA 1, D.E.
Tel: 212-1466
Telex: 44400 INST CO
Cable: AARIS Bogota
CME,M
Casa Humboldt Ltda.
Carrera 14, No. 98-60
Apartado Aereo 51283
BOGOTA 1, D.E.
Tel: 256-1686
Telex: 45403 CCAL CO.
A

COSTA RICA

Cientifica Costarricense S.A.
Avenida 2, Calle 5
San Pedro de Montes de Oca
Apartado 10159
SAN JOSE
Tel: 24-38-20, 24-08-19
Telex: 2367 GALGUR CR
CME,M

CYPRUS

Telerexa Ltd.
P.O. Box 4809
14C Stassinis Avenue
NICOSIA
Tel: 62698
Telex: 2894 LEVIDO CY
E,M,P

DENMARK

Hewlett-Packard A/S
Datavej 52
DK-3460 BIRKEROD
Tel: (02) 81-66-40
Telex: 37409 hpas dk
A,CH,CM,CS,E,MS,P
Hewlett-Packard A/S
Rølhedsvej 32
DK-8240 RISSKOV, Aarhus
Tel: (06) 17-60-00
Telex: 37409 hpas dk
CH,E

DOMINICAN REPUBLIC

Microprog S.A.
Juan Tomás Mejía y Cotes No. 60
Arroyo Hondo
SANTO DOMINGO
Tel: 565-6268
Telex: 4510 ARENTA DR (RCA) P

ECUADOR

CYEDE Cia. Ltda.
Avenida Eloy Alfaro 1749
Casilla 6423 CCI
QUITO
Tel: 450-975, 243-052
Telex: 2548 CYEDE ED
CME,P

Hospitalar S.A.

Robles 625
Casilla 3590
QUITO
Tel: 545-250, 545-122
Telex: 2485 HOSPTEL ED
Cable: HOSPITALAR-Quito
M

EGYPT

International Engineering Associates
24 Hussein Hegazi Street
Kasr-el-Aini
CAIRO
Tel: 23829, 21641
Telex: IEA UN 93830
CH,CS,E,M
EGYPOR
P.O.Box 2558
42 El Zahraa Street
CAIRO, Egypt
Tel: 65 00 21
Telex: 93 337
P

EL SALVADOR

IPESA de El Salvador S.A.
29 Avenida Norte 1216
SAN SALVADOR
Tel: 26-6858, 26-6868
Telex: 20539 IPESASAL
A,CH,CM,CS,E,P

FINLAND

Hewlett-Packard Oy
Revontulentie 7
PL 24
SF-02101 ESPOO 10
Tel: (90) 4550211
Telex: 121563 hewpa sf
CH,CM,CS,P
Hewlett-Packard Oy
(Olarinluoma 7)
PL 24
02101 ESPOO 10
Tel: (90) 4521022
A,E,MS

Hewlett-Packard Oy
Aatoksenkatu 10-C
SF-40720-72 JYVASKYLA
Tel: (941) 216318
CH

Hewlett-Packard Oy
Kainvuntie 1-C
SF-90140-14 OULU
Tel: (981) 338785
CH

FRANCE

Hewlett-Packard France
Z.I. Mercure B
Rue Berthelot
F-13763 Les Milles Cedex
AIX-EN-PROVENCE
Tel: 16 (42) 59-41-02
Telex: 410770F
A,CH,E,MS,P*

Hewlett-Packard France
64, rue Marchand Saillant
F-61000 ALENCON
Tel: 16 (33) 29 04 42

Hewlett-Packard France
Boite Postale 503
F-25026 BESANCON
28 rue de la Republique
F-25000 BESANCON
Tel: 16 (81) 83-16-22
CH,M

Hewlett-Packard France
13, Place Napoleon III
F-29000 BREST

Tel: 16 (98) 03-38-35

Hewlett-Packard France
Chemin des Mouilles
Boite Postale 162
F-69130 ECULLY Cedex (Lyon)
Tel: 16 (78) 833-81-25
Telex: 310617F
A,CH,CS,E,MP

Hewlett-Packard France
Tour Lorraine
Boulevard de France
F-91035 EVRY Cedex
Tel: 16 6 077-96-60
Telex: 692315F
E

Hewlett-Packard France
Parc d'Activite du Bois Briard
Ave. du Lac
F-91040 EVRY Cedex
Tel: 16 6 077-8383
Telex: 692315F
E

Hewlett-Packard France
5, avenue Raymond Chanas
F-38320 EYBENS (Grenoble)
Tel: 16 (76) 25-81-41
Telex: 980124 HP GRENOB EYBE
CH

Hewlett-Packard France
Centre d'Affaire Paris-Nord
Bâtiment Ampère 5 étage
Rue de la Commune de Paris
Boite Postale 300
F-93153 LE BLANC MESNIL
Tel: 16 (1) 865-44-52
Telex: 211032F
CH,CS,E,MS

Hewlett-Packard France
Parc d'Activités Cadera
Quartier Jean Mermoz
Avenue du Président JF Kennedy
F-33700 MERIGNAC (Bordeaux)
Tel: 16 (56) 34-00-84
Telex: 550105F
CH,E,MS

Hewlett-Packard France
Immueble "Les 3 B"
Nouveau Chemin de la Garde
ZAC de Bois Briard
F-44085 NANTES Cedex
Tel: 16 (40) 50-32-22
CH**

**FRANCE (Cont'd)**

Hewlett-Packard France
125, rue du Faubourg Bannier
F-45000 ORLEANS
Tel: 16 (38) 68 01 63

Hewlett-Packard France
Zone Industrielle de Courtaboeuf
Avenue des Tropiques
F-91947 Les Ulis Cedex ORSAY
Tel: (6) 907-78-25
Telex: 600048F
A,CH,CM,CS,E,MP,P

Hewlett-Packard France
Paris Porte-Maillot
15, Avenue de L'Amiral Bruix
F-75782 PARIS CEDEX 16
Tel: 16 (1) 502-12-20
Telex: 613663F
CH,MS,P

Hewlett-Packard France
164, Boulevard Tourasse
F-64000 PAU
Tel: 16 (59) 80 38 02

Hewlett-Packard France
2 Allée de la Bourgonnette
F-35100 RENNES
Tel: 16 (99) 51-42-44
Telex: 740912F
CH,CM,E,MS,P*

Hewlett-Packard France
98 Avenue de Bretagne
F-76100 ROUEN
Tel: 16 (35) 63-57-66
CH** ,CS

Hewlett-Packard France
4 Rue Thomas Mann
Boite Postale 56
F-67033 STRASBOURG Cedex
Tel: 16 (88) 28-56-46
Telex: 890141F
CH,E,MS,P*

Hewlett-Packard France
Le Péripole
20, Chemin du Pigeonnier de la
Cépière
F-31083 TOULOUSE Cedex
Tel: 16 (61) 40-11-12
Telex: 531639F
A,CH,CS,E,P*

Hewlett-Packard France
9, rue Baudin
F-26000 VALENCE
Tel: 16 (75) 42 76 16

Hewlett-Packard France
Carolor
ZAC de Bois Briand
F-57640 VIGY (Metz)
Tel: 16 (8) 77 1 20 22
CH

Hewlett-Packard France
Immeuble Péricentre
F-59658 VILLENEUVE D'ASCO Cedex
Tel: 16 (20) 91-41-25
Telex: 160124F
CH,E,MS,P*

**GERMAN FEDERAL
REPUBLIC**

Hewlett-Packard GmbH
Geschäftsstelle
Keithstrasse 2-4
D-1000 BERLIN 30
Tel: (030) 24-90-86
Telex: 018 3405 hpbln d
A,CH,E,M,P

Hewlett-Packard GmbH
Geschäftsstelle
Herrenberger Strasse 130
D-7030 BOBLINGEN
Tel: (7031) 14-0
Telex:
A,CH,CM,CS,E,MP,P

Hewlett-Packard GmbH
Geschäftsstelle
Emanuel-Leutze-Strasse 1
D-4000 DUSSELDORF
Tel: (0211) 597 1-1
Telex: 085/86 533 hpdd d
A,CH,CS,E,MS,P

Hewlett-Packard GmbH
Geschäftsstelle
Schleefstr. 28a
D-4600 DORTMUND-Aplerbeck
Tel: (0231) 45001

Hewlett-Packard GmbH
Vertriebszentrale Frankfurt
Berner Strasse 117
Postfach 560 140
D-6000 FRANKFURT 56
Tel: (0611) 50-04-1
Telex: 04 13249 hpfm d
A,CH,CM,CS,E,MP,P

Hewlett-Packard GmbH
Geschäftsstelle
Aussonstelle Bad Homburg
Louisenstrasse 115
D-6380 BAD HOMBURG
Tel: (06172) 109-0

Hewlett-Packard GmbH
Geschäftsstelle
Kapstadtring 5
D-2000 HAMBURG 60
Tel: (040) 63804-1
Telex: 021 63 032 hphd d
A,CH,CS,E,MS,P

Hewlett-Packard GmbH
Geschäftsstelle
Heidering 37-39
D-3000 HANNOVER 61
Tel: (0511) 5706-0
Telex: 092 3259
A,CH,CM,E,MS,P

Hewlett-Packard GmbH
Geschäftsstelle
Rosslauer Weg 2-4
D-6800 MANNHEIM
Tel: (0621) 70050
Telex: 0462105
A,C,E

Hewlett-Packard GmbH
Geschäftsstelle
Messerschmittstrasse 7
D-7910 NEU ULM
Tel: 0731-70241
Telex: 0712816 HP ULM-D
A,C,E*

Hewlett-Packard GmbH
Geschäftsstelle
Ehhericherstr. 13
D-8500 NÜRNBERG 10
Tel: (0911) 5205-0
Telex: 0623 860
CH,CM,E,MS,P

Hewlett-Packard GmbH
Geschäftsstelle
Eschenstrasse 5
D-8028 TAUFKIRCHEN
Tel: (089) 6117-1
Telex: 0524985
A,CH,CM,E,MS,P

GREAT BRITAIN**See United Kingdom****GREECE**

Kostas Karayannis S.A.
8 Omirou Street
ATHENS 133
Tel: 32 30 303, 32 37 371
Telex: 215962 RKAR GR
A,CH,CM,CS,E,M,P

PLAISIO S.A.
G. Gerardos
24 Stournara Street
ATHENS
Tel: 36-11-160
Telex: 221871
P

GUATEMALA

IPESA
Avenida Reforma 3-48, Zona 9
GUATEMALA CITY
Tel: 316627, 314786
Telex: 4192 TELTRO GU
A,CH,CM,CS,E,M,P

HONG KONG

Hewlett-Packard Hong Kong, Ltd.
G.P.O. Box 795
5th Floor, Sun Hung Kai Centre
30 Harbour Road
HONG KONG
Tel: 5-8323211
Telex: 66678 HEWPA HX
Cable: HEWPACK HONG KONG
E,CH,CS,P

CET Ltd.
1402 Tung Wah Mansion
199-203 Hennessy Rd.
Wanchia, HONG KONG
Tel: 5-729376
Telex: 85148 CET HX
CM

Schmidt & Co. (Hong Kong) Ltd.
Wing On Centre, 28th Floor
Connaught Road, C.
HONG KONG
Tel: 5-455644
Telex: 74766 SCHMX HX
A,M

ICELAND

Elding Trading Company Inc.
Hafnarholi-Tryggvagotu
P.O. Box 895
IS-REYKJAVIK
Tel: 1-58-20, 1-63-03
M

INDIA

Computer products are sold through
Blue Star Ltd. All computer repairs and
maintenance service is done through
Computer Maintenance Corp.

Blue Star Ltd.
Sabri Complex II Floor
24 Residency Rd.
BANGALORE 560 025
Tel: 55660
Telex: 0845-430
Cable: BLUESTAR
A,CH*,CM,CS*,E

Blue Star Ltd.
Band Box House
Prabhadevi
BOMBAY 400 025
Tel: 422-3101
Telex: 011-3751
Cable: BLUESTAR
A,M

Blue Star Ltd.
Sahas
414/2 Vir Savarkar Marg
Prabhadevi
BOMBAY 400 025
Tel: 422-6155
Telex: 011-4093
Cable: FROSTBLUE
A,CH*,CM,CS*,E,M

Blue Star Ltd.
Kalyan, 19 Vishwas Colony
Alkapuri, BORODA, 390 005
Tel: 65235
Cable: BLUE STAR
A

Blue Star Ltd.
7 Hare Street
CALCUTTA 700 001
Tel: 12-01-31
Telex: 021-7655
Cable: BLUESTAR
A,M

Blue Star Ltd.
133 Kodambakkam High Road
MADRAS 600 034
Tel: 82057
Telex: 041-379
Cable: BLUESTAR
A,M

Blue Star Ltd.
Bhandari House, 7th/8th Floors
91 Nehru Place
NEW DELHI 110 024
Tel: 682547
Telex: 031-2463
Cable: BLUESTAR
A,CH*,CM,CS*,E,M

Blue Star Ltd.
15/16:C Wellesley Rd.
PUNE 411 011
Tel: 22775
Cable: BLUE STAR
A

Blue Star Ltd.
2-2-47/1108 Bolarum Rd.
SECUNDERABAD 500 003
Tel: 72057
Telex: 0155-459
Cable: BLUEFROST
A,E

Blue Star Ltd.
T.C. 7/603 Poornima
Maruthankuzhi
TRIVANDRUM 695 013
Tel: 65799
Telex: 0884-259
Cable: BLUESTAR
E

Computer Maintenance Corporation
Ltd.
115, Sarojini Devi Road
SECUNDERABAD 500 003
Tel: 310-184, 345-774
Telex: 031-2960
CH**



SALES & SUPPORT OFFICES

Arranged alphabetically by country

INDONESIA

BERCA Indonesia P.T.
P.O.Box 496/Jkt.
Jl. Abdul Muis 62
JAKARTA
Tel: 21-373009
Telex: 46748 BERSAL IA
Cable: BERSAL JAKARTA
P

BERCA Indonesia P.T.
P.O.Box 2497/Jkt
Anlara Bldg., 17th Floor
Jl. Medan Merdeka Selatan 17
JAKARTA-PUSAT
Tel: 21-344-181
Telex: BERSAL IA
A,CS,E,M

BERCA Indonesia P.T.
P.O. Box 174/SBY.
Jl. Kutei No. 11
SURABAYA
Tel: 68172
Telex: 31146 BERSAL SB
Cable: BERSAL-SURABAYA
A*,E,M,P

IRAQ

Hewlett-Packard Trading S.A.
Service Operation
Al Mansoor City 9B/3/7
BAGHDAD
Tel: 551-49-73
Telex: 212-455 HEPAlRAQ IK
CH,CS

IRELAND

Hewlett-Packard Ireland Ltd.
82/83 Lower Leeson Street
DUBLIN 2
Tel: 0001 608800
Telex: 30439
A,CH,CM,CS,E,M,P
Cardiac Services Ltd.
Kilmore Road
Artane
DUBLIN 5
Tel: (01) 351820
Telex: 30439
M

ISRAEL

Eidan Electronic Instrument Ltd.
P.O.Box 1270
JERUSALEM 91000
16, Ohaliav St.
JERUSALEM 94467
Tel: 533 221, 553 242
Telex: 25231 AB/PAKRD IL
A
Electronics Engineering Division
Motorola Israel Ltd.
16 Kremenetski Street
P.O. Box 25016
TEL-AVIV 67899
Tel: 3 88 388
Telex: 33569 Motil IL
Cable: BASTEL Tel-Aviv
CH,CM,CS,E,M,P

ITALY

Hewlett-Packard Italiana S.p.A.
Traversa 99C
Via Giulio Petroni, 19
I-70124 **BARI**
Tel: (080) 41-07-44
M

Hewlett-Packard Italiana S.p.A.
Via Martin Luther King, 38/III
I-40132 **BOLOGNA**
Tel: (051) 402394
Telex: 511630
CH,E,MS

Hewlett-Packard Italiana S.p.A.
Via Principe Nicola 43G/C
I-95126 **CATANIA**
Tel: (095) 37-10-87
Telex: 970291
C,P

Hewlett-Packard Italiana S.p.A.
Via G. Di Vittorio 9
I-20063 **CERNUSCO SUL NAVIGLIO**
(Milano)
Tel: (02) 923691
Telex: 334632
A,CH,CM,CS,E,MP,P
Hewlett-Packard Italiana S.p.A.
Via C. Colombo 49
I-20090 **TREZZANO SUL NAVIGLIO**
(Milano)
Tel: (02) 4459041
Telex: 322116
C,M

Hewlett-Packard Italiana S.p.A.
Via Nuova San Rocco a
Capodimonte, 62/A
I-80131 **NAPOLI**
Tel: (081) 7413544
Telex: 710698
A,CH,E

Hewlett-Packard Italiana S.p.A.
Viale G. Modugno 33
I-16156 **GENOVA PEGLI**
Tel: (010) 68-37-07
Telex: 215238
E,C

Hewlett-Packard Italiana S.p.A.
Via Pelizzo 15
I-35128 **PADOVA**
Tel: (049) 664888
Telex: 430315
A,CH,E,MS

Hewlett-Packard Italiana S.p.A.
Viale C. Pavese 340
I-00144 **ROMA EUR**
Tel: (06) 54831
Telex: 610514
A,CH,CM,CS,E,MS,P*

Hewlett-Packard Italiana S.p.A.
Via di Casellina 57/C
I-50018 **SCANDICCI-FIRENZE**
Tel: (055) 753863
Hewlett-Packard Italiana S.p.A.
Corso Svizzera, 185
I-10144 **TORINO**
Tel: (011) 74 4044
Telex: 221079
CH,E

JAPAN

Yokogawa-Hewlett-Packard Ltd.
152-1, Onna
ATSUGI, Kanagawa, 243
Tel: (0462) 28-0451
CM,C*,E

Yokogawa-Hewlett-Packard Ltd.
Meiji-Seimei Bldg. 6F
3-1 Hon Chiba-Cho
CHIBA, 280
Tel: 472 25 7701
E,CH,CS

Yokogawa-Hewlett-Packard Ltd.
Yasuda-Seimei Hiroshima Bldg.
6-11, Hon-dori, Naka-ku
HIROSHIMA, 730
Tel: 82-241-0611

Yokogawa-Hewlett-Packard Ltd.
Towa Building
2-3, Kaigan-dori, 2 Chome Chuo-ku
KOBE, 650
Tel: (078) 392-4791
C,E

Yokogawa-Hewlett-Packard Ltd.
Kumagaya Asahi 82 Bldg
3-4 Tsukuba
KUMAGAYA, Saitama 360
Tel: (0485) 24-6563
CH,CM,E

Yokogawa-Hewlett-Packard Ltd.
Asahi Shinbun Daiichi Seimei Bldg.
4-7, Hanabata-cho
KUMAMOTO, 860
Tel: (0963) 54-7311
CH,E

Yokogawa-Hewlett-Packard Ltd.
Shin-Kyoto Center Bldg.
614, Higashi-Shiokoji-cho
Karasuma-Nishiiru
Shiokoji-dori, Shimogyo-ku
KYOTO, 600
Tel: 075-343-0921
CH,E

Yokogawa-Hewlett-Packard Ltd.
Mito Mitsui Bldg
4-73, Sanno-maru, 1 Chome
MITO, Ibaraki 310
Tel: (0292) 25-7470
CH,CM,E

Yokogawa-Hewlett-Packard Ltd.
Sumitomo Seimei 14-9 Bldg.
Meieki-Minami, 2 Chome
Nakamura-ku
NAGOYA, 450
Tel: (052) 571-5171
CH,CM,CS,E,MS

Yokogawa-Hewlett-Packard Ltd.
Chuo Bldg.,
4-20 Nishinakajima, 5 Chome
Yodogawa-ku
OSAKA, 532
Tel: (06) 304-6021
Telex: YHPOSA 523-3624
A,CH,CM,CS,E,MP,P*

Yokogawa-Hewlett-Packard Ltd.
27-15, Yabe, 1 Chome
SAGAMIHARA Kanagawa, 229
Tel: 0427 59-1311

Yokogawa-Hewlett-Packard Ltd.
Daiichi Seimei Bldg.
7-1, Nishi Shinjuku, 2 Chome
Shinjuku-ku, **TOKYO** 160
Tel: 03-348-4611
CH,E

Yokogawa-Hewlett-Packard Ltd.
29-21 Takaido-Higashi, 3 Chome
Suginami-ku **TOKYO** 168
Tel: (03) 331-6111
Telex: 232-2024 YHPTOK
A,CH,CM,CS,E,MP,P*

Yokogawa-Hewlett-Packard Ltd.
Daiichi Asano Building
2-8, Odori, 5 Chome
UTSUNOMIYA, Tochigi 320
Tel: (0286) 25-7155
CH,CS,E

Yokogawa-Hewlett-Packard Ltd.
Yasuda Seimei Nishiguchi Bldg.
30-4 Tsuruya-cho, 3 Chome
YOKOHAMA 221
Tel: (045) 312-1252
CH,CM,E

JORDAN

Mouasher Cousins Company
P.O. Box 1387
AMMAN
Tel: 24907, 39907
Telex: 21456 SABCO JO
CH,E,M,P

KENYA

ADCOM Ltd., Inc., Kenya
P.O.Box 30070
NAIROBI
Tel: 331955
Telex: 22639
E,M

KOREA

Samsung Electronics HP Division
12 Fl. Kinam Bldg.
San 75-31, Yeoksam-Dong
Kangnam-Ku
Yeongdong P.O. Box 72
SEOUL
Tel: 555-7555, 555-5447
Telex: K27364 SAMSAN
A,CH,CM,CS,E,M,P

KUWAIT

Al-Khaldiya Trading & Contracting
P.O. Box 830 Safat
KUWAIT
Tel: 42-4910, 41-1726
Telex: 22481 Areeg kt
CH,E,M
Photo & Cine Equipment
P.O. Box 270 Safat
KUWAIT
Tel: 42-2846, 42-3801
Telex: 22247 Matin kt
P

LEBANON

G.M. Daimadjan
Achratifieh
P.O. Box 165.167
BEIRUT
Tel: 290293
MP**
Computer Information Systems
P.O. Box 11-6274
BEIRUT
Tel: 89 40 73
Telex: 22259
C

LUXEMBOURG

Hewlett-Packard Belgium S.A./N.V.
Blvd de la Woluwe, 100
Woluwedal
B-1200 **BRUSSELS**
Tel: (02) 762-32-00
Telex: 23-494 paloben bru
A,CH,CM,CS,E,MP,P

MALAYSIA

Hewlett-Packard Sales (Malaysia)
Sdn. Bhd.
1st Floor, Bangunan British
American
Jalan Semantan, Damansara Heights
KUALA LUMPUR 23-03
Tel: 943022
Telex: MA31011
A,CH,E,M,P*

**MAYLAISIA (Cont'd)**

Protel Engineering
P.O.Box 1917
Lot 6624, Section 64
23/4 Pending Road
Kuching, **SARAWAK**
Tel: 36299
Telex: MA 70904 PROMAL
Cable: PROTELENG
A,E,M

MALTA

Philip Toledo Ltd.
Notabile Rd.
MRIEHEL
Tel: 447 47, 455 66
Telex: Media MW 649
E,P

MEXICO

Hewlett-Packard Mexicana, S.A.
de C.V.
Av. Periferico Sur No. 6501
Tepepan, Xochimilco
16020 **MEXICO D.F.**
Tel: 6-76-46-00
Telex: 17-74-507 HEWPACK MEX
A,CH,CS,E,MS,P
Hewlett-Packard Mexicana, S.A.
de C.V.
Ave. Colonia del Valle 409
Col. del Valle
Municipio de Garza Garcia
MONTERREY, Nuevo Leon
Tel: 78 42 41
Telex: 038 410
CH
ECISA
José Vasconcelos No. 218
Col. Condesa Deleg. Cuauhtémoc
MEXICO D.F. 06140
Tel: 553-1206
Telex: 17-72755 ECE ME
M

MOROCCO

Dolbeau
81 rue Karatchi
CASABLANCA
Tel: 3041-82, 3068-38
Telex: 23051, 22822
E
Gerep
2 rue d'Agadir
Boite Postale 156
CASABLANCA
Tel: 272093, 272095
Telex: 23 739
P

NETHERLANDS

Hewlett-Packard Nederland B.V.
Van Heuven Goedhartlaan 121
NL 1181KK **AMSTELVEEN**
P.O. Box 667
NL 1180 AR **AMSTELVEEN**
Tel: (020) 47-20-21
Telex: 13 216 HEPAC NL
A,CH,CM,CS,E,MP,P
Hewlett-Packard Nederland B.V.
Bongerd 2
NL 2906VK **CAPELLE A/D IJSSEL**
P.O. Box 41
NL 2900AA **CAPELLE A/D IJSSEL**
Tel: (10) 51-64-44
Telex: 21261 HEPAC NL
A,CH,CS,E

Hewlett-Packard Nederland B.V.
Pastoor Petersstraat 134-136
NL 5612 LV **EINDHOVEN**
P.O. Box 2342
NL 5600 CH **EINDHOVEN**
Tel: (040) 326911
Telex: 51484 hepae nl
A,CH*,E,M

NEW ZEALAND

Hewlett-Packard (N.Z.) Ltd.
5 Owens Road
P.O. Box 26-189
Epsom, **AUCKLAND**
Tel: 687-159
Cable: HEWPACK Auckland
CH,CM,E,P*

Hewlett-Packard (N.Z.) Ltd.
4-12 Cruickshank Street
Kilbirnie, **WELLINGTON 3**
P.O. Box 9443
Courtenay Place, **WELLINGTON 3**
Tel: 877-199
Cable: HEWPACK Wellington
CH,CM,E,P

Northrop Instruments & Systems Ltd.
369 Khyber Pass Road
P.O. Box 8602
AUCKLAND
Tel: 794-091
Telex: 60605
A,M

Northrop Instruments & Systems Ltd.
110 Mandeville St.
P.O. Box 8388
CHRISTCHURCH
Tel: 486-928
Telex: 4203
A,M
Northrop Instruments & Systems Ltd.
Sturdee House
85-87 Ghuznee Street
P.O. Box 2406
WELLINGTON
Tel: 850-091
Telex: NZ 3380
A,M

NORTHERN IRELAND

See **United Kingdom**

NORWAY

Hewlett-Packard Norge A/S
Folke Bernadottes vei 50
P.O. Box 3558
N-5033 **FYLLINGSDALEN** (Bergen)
Tel: 0047/5/16 55 40
Telex: 16621 hpnas n
CH,CS,E,MS

Hewlett-Packard Norge A/S
Østerdalen 16-18
P.O. Box 34
N-1345 **ØSTERÅS**
Tel: 0047/2/17 11 80
Telex: 16621 hpnas n
A,CH,CM,CS,E,MP

OMAN

Khimjil Ramdas
P.O. Box 19
MUSCAT
Tel: 722225, 745601
Telex: 3289 BROKER MB **MUSCAT**
P
Suhail & Saud Bahwan
P.O. Box 169
MUSCAT
Tel: 734 201-3
Telex: 3274 **BAHWAN MB**

PAKISTAN

Mushko & Company Ltd.
1-B, Street 43
Sector F-8/1
ISLAMABAD
Tel: 51071
Cable: FEMUS Rawalpindi
A,E,M

Mushko & Company Ltd.
Oosman Chambers
Abdullah Haroon Road
KARACHI 0302
Tel: 524131, 524132
Telex: 2894 MUSKO PK
Cable: COOPERATOR Karachi
A,E,MP*

PANAMA

Electrónico Balboa, S.A.
Calle Samuel Lewis, Ed. Alfa
Apartado 4929
PANAMA 5
Tel: 63-6613, 63-6748
Telex: 3483 ELECTRON PG
A,CM,E,MP

PERU

Cía Electro Médica S.A.
Los Flamencos 145, San Isidro
Casilla 1030
LIMA 1
Tel: 41-4325, 41-3703
Telex: Pub. Booth 25306
CM,E,MP

PHILIPPINES

The Online Advanced Systems Corporation
Rico House, Amorsolo Cor. Herrera Street
Legaspi Village, Makati
P.O. Box 1510
Metro MANILA
Tel: 85-35-81, 85-34-91, 85-32-21
Telex: 3274 ONLINE
A,CH,CS,E,M
Electronic Specialists and Proponents Inc.
690-B Epifanio de los Santos Avenue
Cubao, **QUEZON CITY**
P.O. Box 2649 Manila
Tel: 98-96-81, 98-96-82, 98-96-83
Telex: 40018, 42000 ITT GLOBE
MACKAY BOOTH
P

PORTUGAL

Mundinter
Intercambio Mundial de Comércio
S.A.R.L.
P.O. Box 2761
Av. Antonio Augusto de Aguiar 138
P-LISBON
Tel: (19) 53-21-31, 53-21-37
Telex: 16691 munter p
M
Soquimica
Av. da Liberdade, 220-2
1298 **LISBOA** Codex
Tel: 56 21 81/2/3
Telex: 13316 SABASA
P
Telectra-Empresa Técnica de Equipamentos Eléctricos S.A.R.L.
Rua Rodrigo da Fonseca 103
P.O. Box 2531
P-LISBON 1
Tel: (19) 68-60-72
Telex: 12598
CH,CS,E,P

PUERTO RICO

Hewlett-Packard Puerto Rico
Ave. Muñoz Rivera #101
Esq. Calle Ochoa
HATO REY, Puerto Rico 00918
Tel: (809) 754-7800
Hewlett-Packard Puerto Rico
Calle 272 Edificio 203
Urb. Country Club
RIO PIEDRAS, Puerto Rico
P.O. Box 4407
CAROLINA, Puerto Rico 00628
Tel: (809) 762-7255
A,CH,CS

QATAR

Computeartbia
P.O. Box 2750
DOHA
Tel: 883555
Telex: 4806 CHPARB
P
Eastern Technical Services
P.O. Box 4747
DOHA
Tel: 329 993
Telex: 4156 EASTEC DH
Nasser Trading & Contracting
P.O. Box 1563
DOHA
Tel: 22170, 23539
Telex: 4439 NASSER DH
M

SAUDI ARABIA

Modern Electronic Establishment Hewlett-Packard Division
P.O. Box 22015
Thuobah
AL-KHOBAR
Tel: 895-1760, 895-1764
Telex: 671 106 HPMEEK SJ
Cable: ELECTA AL-KHOBAR
CH,CS,E,M
Modern Electronic Establishment Hewlett-Packard Division
P.O. Box 1228
Redec Plaza, 6th Floor
JEDDAH
Tel: 644 38 48
Telex: 4027 12 FARNAS SJ
Cable: ELECTA JEDDAH
CH,CS,E,M
Modern Electronic Establishment Hewlett-Packard Division
P.O. Box 22015
RIYADH
Tel: 491-97 15, 491-63 87
Telex: 202049 MEERYD SJ
CH,CS,E,M
Abdul Ghani El Ajou
P.O. Box 78
RIYADH
Tel: 40 41 717
Telex: 200 932 EL AJOU
P

SCOTLAND

See **United Kingdom**

SINGAPORE

Hewlett-Packard Singapore (Sales)
Pte. Ltd.
#08-00 Inchcape House
450-2 Alexandra Road
P.O. Box 58 Alexandra Rd. Post Office
SINGAPORE, 9115
Tel: 631788
Telex: HPSGSO RS 34209
Cable: HEWPACK, Singapore
A,CH,CS,E,MS,P



SALES & SUPPORT OFFICES

Arranged alphabetically by country

SINGAPORE (Cont'd)

Dynamar International Ltd.
Unit 05-11 Block 6
Kolam Ayer Industrial Estate
SINGAPORE 1334
Tel: 747-6188
Telex: RS 26283
CM

SOUTH AFRICA

Hewlett-Packard So Africa (Pty.) Ltd.
P.O. Box 120
Howard Place CAPE PROVINCE 7450
Pine Park Center, Forest Drive,
Pinelands

CAPE PROVINCE 7405

Tel: 53-7954
Telex: 57-20006
A,CH,CM,E,MS,P

Hewlett-Packard So Africa (Pty.) Ltd.
P.O. Box 37099
92 Overport Drive
DURBAN 4067
Tel: 28-4178, 28-4179, 28-4110
Telex: 6-22954
CH,CM

Hewlett-Packard So Africa (Pty.) Ltd.
6 Linton Arcade
511 Cape Road
Linton Grange
PORT ELIZABETH 6000
Tel: 041-302148
CH

Hewlett-Packard So Africa (Pty.) Ltd.
P.O. Box 33345
Glenstantia 0010 TRANSVAAL
1st Floor East
Constantia Park Ridge Shopping
Centre
Constantia Park
PRETORIA
Tel: 982043
Telex: 32163
CH,E

Hewlett-Packard So Africa (Pty.) Ltd.
Private Bag Wendywood
SANDTON 2144
Tel: 802-5111, 802-5125
Telex: 4-20877
Cable: HEWPACK Johannesburg
A,CH,CM,CS,E,MS,P

SPAIN

Hewlett-Packard Española S.A.
Calle Entenza, 321
E-BARCELONA 29
Tel: 322.24.51, 321.73.54
Telex: 52603 hpbee
A,CH,CS,E,MS,P

Hewlett-Packard Española S.A.
Calle San Vicente S/No
Edificio Albia II
E-BILBAO 1
Tel: 423.83.06
A,CH,E,MS

Hewlett-Packard Española S.A.
Crta. de la Coruña, Km. 16, 400
Las Rozas
E-MADRID
Tel: (1) 637.00.11
CH,CS,M

Hewlett-Packard Española S.A.
Avda. S. Francisco Javier, S/no
Planta 10. Edificio Sevilla 2,
E-SEVILLA 5
Tel: 64.44.54
Telex: 72933
A,CS,MS,P

Hewlett-Packard Española S.A.
Calle Ramon Gorrillo, 1 (Enllo.3)
E-VALENCIA 10
Tel: 361-1354
CH,P

SWEDEN

Hewlett-Packard Sverige AB
Sunnanvagen 14K
S-22226 LUND
Tel: (046) 13-69-79
Telex: (854) 17886 (via Spånga
office)
CH

Hewlett-Packard Sverige AB
Östra Tullgatan 3
S-21128 MALMÖ
Tel: (040) 70270
Telex: (854) 17886 (via Spånga
office)

Hewlett-Packard Sverige AB
Västra Vintergatan 9
S-70344 ÖREBRO
Tel: (19) 10-48-80
Telex: (854) 17886 (via Spånga
office)
CH

Hewlett-Packard Sverige AB
Skalholtsgatan 9, Kista
Box 19
S-16393 SPÅNGA
Tel: (08) 750-2000
Telex: (854) 17886
Telefax: (08) 7527781
A,CH,CM,CS,E,MS,P

Hewlett-Packard Sverige AB
Frötällsgatan 30
S-42132 VÄSTRA-FRÖLUNDA
Tel: (031) 49-09-50
Telex: (854) 17886 (via Spånga
office)
CH,E,P

SWITZERLAND

Hewlett-Packard (Schweiz) AG
Clarastrasse 12
CH-4058 BASEL
Tel: (61) 33-59-20
A

Hewlett-Packard (Schweiz) AG
7, rue du Bois-du-Lan
Case Postale 365
CH-1217 MEYRIN 2
Tel: (0041) 22-83-11-11
Telex: 27333 HPAG CH
CH,CM,CS

Hewlett-Packard (Schweiz) AG
Ailmend 2
CH-8967 WIDEN
Tel: (0041) 57 31 21 11
Telex: 53933 hpag ch
Cable: HPAG CH
A,CH,CM,CS,E,MS,P

SYRIA

General Electronic Inc.
Nuri Basha Ahnaf Ebn Kays Street
P.O. Box 5781
DAMASCUS
Tel: 33-24-87
Telex: 411 215
Cable: ELECTROBOR DAMASCUS
E

Middle East Electronics
P.O. Box 2308
Abu Rummaneh
DAMASCUS
Tel: 33 4 5 92
Telex: 411 304
M

TAIWAN

Hewlett-Packard Far East Ltd.
Kaohsiung Office
2/F 68-2, Chung Cheng 3rd Road
KAOHSIUNG
Tel: (07) 241-2318
CH,CS,E

Hewlett-Packard Far East Ltd.
Taiwan Branch
8th Floor
337 Fu Hsing North Road
TAIPEI
Tel: (02) 712-0404
Telex: 24439 HEWPACK

Cable: HEWPACK Taipei
A,CH,CM,CS,E,M,P
Ing Lih Trading Co.
3rd Floor, 7 Jen-Ai Road, Sec. 2
TAIPEI 100
Tel: (02) 3948191
Cable: INGLIH TAIPEI
A

THAILAND

Unimesa
30 Patpong Ave., Suriwong
BANGKOK 5
Tel: 235-5727
Telex: 84439 Simonco TH
Cable: UNIMESA Bangkok
A,CH,CS,E,M
Bangkok Business Equipment Ltd.
5/5-6 Dejo Road
BANGKOK
Tel: 234-8670, 234-8671
Telex: 87669-BEQUIPT TH
Cable: BUSIQUIPT Bangkok
P

TRINIDAD & TOBAGO

Caribbean Telecoms Ltd.
50/A Jerningham Avenue
P.O. Box 732
PORT-OF-SPAIN
Tel: 62-44213, 62-44214
Telex: 235,272 HUGCO WG
CM,E,M,P

TUNISIA

Tunisie Electronique
31 Avenue de la Liberté
TUNIS
Tel: 280-144
E,P

Corema
1 ter. Av. de Carthage
TUNIS
Tel: 253-821
Telex: 12319 CABAM TN
M

TURKEY

Teknim Company Ltd.
Iran Caddesi No. 7
Kavaklidere, ANKARA
Tel: 275800
Telex: 42155 TKNM TR
E

E.M.A.
Medina Eldem Sokak No.41/8
Yuksek Caddesi
ANKARA
Tel: 175 622
Telex: 42 591
M

UNITED ARAB EMIRATES

Emilac Ltd.
P.O. Box 2711
ABU DHABI
Tel: 82 04 19-20
Cable: EMITAC ABUDHABI
Emilac Ltd.
P.O. Box 1641
SHARJAH
Tel: 591 181
Telex: 68136 Emilac Sh
CH,CS,E,M,P

UNITED KINGDOM

GREAT BRITAIN
Hewlett-Packard Ltd.
Trafaigar House
Navigation Road
ALTRINCHAM
Cheshire WA14 1NU
Tel: 061 928 6422
Telex: 668068
A,CH,CS,E,M,MS,P
Hewlett-Packard Ltd.
Eistree House, Eistree Way
BOREHAMWOOD, Herts WD6 1SG
Tel: 01 207 5000
Telex: 8952716
E,CH,CS,P

Hewlett-Packard Ltd.
Oakfield House, Oakfield Grove
Clifton BRISTOL, Avon BS8 2BN
Tel: 0272 736806
Telex: 444302
CH,CS,E,P

Hewlett-Packard Ltd.
Bridewell House
Bridewell Place
LONDON EC4V 6BS
Tel: 01 583 6565
Telex: 298163
CH,CS,P

Hewlett-Packard Ltd.
Fourier House
257-263 High Street
LONDON COLNEY

Herts. AL2 1HA, St. Albans
Tel: 0727 24400
Telex: 1-8952716
CH,CS

Hewlett-Packard Ltd.
Pontefract Road
NORMANTON, West Yorkshire WF6 1RN
Tel: 0924 895566
Telex: 557355
CH,CS,P

Hewlett-Packard Ltd.
The Quadrangle
106-118 Station Road
REDHILL, Surrey RH1 1PS
Tel: 0737 68655
Telex: 947234
CH,CS,E,P

**GREAT BRITAIN (Cont'd)**

Hewlett-Packard Ltd.
Avon House
435 Stratford Road
Shirley, **SOLIHULL**, West Midlands
B90 4BL

Tel: 021 745 8800
Telex: 339105
CH,CS,E,P

Hewlett-Packard Ltd.
West End House
41 High Street, West End

SOUTHAMPTON
Hampshire SO3 3DQ
Tel: 04218 6767
Telex: 477138
CH,CS,P

Hewlett-Packard Ltd.
Eskdale Rd.
Winnersh, **WOKINGHAM**
Berkshire RG11 5DZ
Tel: 0734 696622
Telex: 848884
E

Hewlett-Packard Ltd.
King Street Lane
Winnersh, **WOKINGHAM**
Berkshire RG11 5AR
Tel: 0734 784774
Telex: 847178
A,CH,CS,E,M,MP,P

Hewlett-Packard Ltd.
Nine Mile Ride
Easthampstead, **WOKINGHAM**
Berkshire, 3RG11 3LL
Tel: 0344 773100
Telex: 848805
CH,CS,E,P

IRELAND**NORTHERN IRELAND**

Hewlett-Packard Ltd.
Cardiac Services Building
95A Finaghy Road South
BELFAST BT10 0BY
Tel: 0232 625-566
Telex: 747626
CH,CS

SCOTLAND

Hewlett-Packard Ltd.
SOUTH QUEENSFERRY
West Lothian, EH30 9TG
Tel: 031 331 1188
Telex: 72682
CH,CM,CS,E,M,P

UNITED STATES**Alabama**

Hewlett-Packard Co.
700 Century Park South, Suite 128
BIRMINGHAM, AL 35226
Tel: (205) 822-6802
A,CH,M

Hewlett-Packard Co.
420 Wynn Drive
HUNTSVILLE, AL 35805
P.O. Box 7700
HUNTSVILLE, AL 35807
Tel: (205) 830-2000
CH,CM,CS,E,M*

Arizona

Hewlett-Packard Co.
8080 Pointe Parkway West
PHOENIX, AZ 85044
Tel: (602) 273-8000
A,CH,CM,CS,E,MS

Hewlett-Packard Co.
2424 East Aragon Road
TUCSON, AZ 85706
Tel: (602) 889-4631
CH,E,MS**

California

Hewlett-Packard Co.
99 South Hill Dr.
BRISBANE, CA 94005
Tel: (415) 330-2500
CH,CS

Hewlett-Packard Co.
P.O. Box 7830 (93747)
5060 E. Clinton Avenue, Suite 102
FRESNO, CA 93727
Tel: (209) 252-9652
CH,CS,MS

Hewlett-Packard Co.
P.O. Box 4230
1430 East Orangethorpe
FULLERTON, CA 92631
Tel: (714) 870-1000
CH,CM,CS,E,MP

Hewlett-Packard Co.
320 S. Kellogg, Suite B
GOLETA, CA 93117
Tel: (805) 967-3405
CH

Hewlett-Packard Co.
5400 W. Rosecrans Boulevard
LAWDALE, CA 90260
P.O. Box 92105
LOS ANGELES, CA 90009
Tel: (213) 970-7500
Telex: 910-325-6608
CH,CM,CS,MP

Hewlett-Packard Co.
3155 Porter Oaks Drive
PALO ALTO, CA 94304
Tel: (415) 857-8000
CH,CS,E

Hewlett-Packard Co.
4244 So. Market Court, Suite A
P.O. Box 15976
SACRAMENTO, CA 95852
Tel: (916) 929-7222
A*,CH,CS,E,MS

Hewlett-Packard Co.
9606 Aero Drive
P.O. Box 23333
SAN DIEGO, CA 92139
Tel: (619) 279-3200
CH,CM,CS,E,MP

Hewlett-Packard Co.
2305 Camino Ramon "C"
SAN RAMON, CA 94583
Tel: (415) 838-5900
CH,CS

Hewlett-Packard Co.
3005 Scott Boulevard
SANTA CLARA, CA 95050
Tel: (408) 988-7000
Telex: 910-338-0586
A,CH,CM,CS,E,MP

Hewlett-Packard Co.
5703 Corsa Avenue
WESTLAKE VILLAGE, CA 91362
Tel: (213) 706-6800
E*,CH*,CS*

Colorado

Hewlett-Packard Co.
24 Inverness Place, East
ENGLEWOOD, CO 80112
Tel: (303) 649-5000
A,CH,CM,CS,E,MS

Connecticut

Hewlett-Packard Co.
47 Barnes Industrial Road South
P.O. Box 5007
WALLINGFORD, CT 06492
Tel: (203) 265-7801
A,CH,CM,CS,E,MS

Florida

Hewlett-Packard Co.
2901 N.W. 62nd Street
P.O. Box 24210
FORT LAUDERDALE, FL 33307
Tel: (305) 973-2600
CH,CS,E,MP

Hewlett-Packard Co.
6177 Lake Ellenor Drive
P.O. Box 13910
ORLANDO, FL 32859
Tel: (305) 859-2900
A,CH,CM,CS,E,MS

Hewlett-Packard Co.
5750B N. Hoover Blvd., Suite 123
P.O. Box 15200
TAMPA, FL 33614
Tel: (813) 884-3282
A*,CH,CM,CS,E*,M*

Georgia

Hewlett-Packard Co.
2000 South Park Place
P.O. Box 105005
ATLANTA, GA 30348
Tel: (404) 955-1500
Telex: 810-766-4890
A,CH,CM,CS,E,MP

Hawaii

Hewlett-Packard Co.
Kawaiahao Plaza, Suite 190
567 South King Street
HONOLULU, HI 96813
Tel: (808) 526-1555
A,CH,E,MS

Illinois

Hewlett-Packard Co.
304 Eldorado Road
P.O. Box 1607
BLOOMINGTON, IL 61701
Tel: (309) 662-9411
CH,MS**

Hewlett-Packard Co.
1100 31st Street, Suite 100
DOWNERS GROVE, IL 60515
Tel: (312) 960-5760
CH,CS

Hewlett-Packard Co.
5201 Tollview Drive
ROLLING MEADOWS, IL 60008
Tel: (312) 255-9800
Telex: 910-687-1066
A,CH,CM,CS,E,MP

Indiana

Hewlett-Packard Co.
7301 No. Shadeland Avenue
P.O. Box 50807
INDIANAPOLIS, IN 46250
Tel: (317) 842-1000
A,CH,CM,CS,E,MS

Iowa

Hewlett-Packard Co.
1776 22nd Street, Suite 1
WEST DES MOINES, IA 50265
Tel: (515) 224-1435
CH,MS**

Kansas

Hewlett-Packard Co.
7804 East Funston Road, #203
WICHITA, KS 67207
Tel: (316) 684-8491
CH

Kentucky

Hewlett-Packard Co.
10300 Linn Station Road, #100
LOUISVILLE, KY 40223
Tel: (502) 426-0100
A,CH,CS,MS

Louisiana

Hewlett-Packard Co.
160 James Drive East
ST. ROSE, LA 70087
P.O. Box 1449
KENNER, LA 70063
Tel: (504) 467-4100
A,CH,CS,E,MS

Maryland

Hewlett-Packard Co.
3701 Koppers Street
BALTIMORE, MD 21227
Tel: (301) 644-5800
Telex: 710-862-1943
A,CH,CM,CS,E,MS

Hewlett-Packard Co.
2 Choke Cherry Road
ROCKVILLE, MD 20850
Tel: (301) 948-6370
A,CH,CM,CS,E,MP

Massachusetts

Hewlett-Packard Co.
1775 Minuteman Road
ANDOVER, MA 01810
Tel: (617) 682-1500
A,C,CH,CS,CM,E,MP,P*
Hewlett-Packard Co.
32 Hartwell Avenue
LEXINGTON, MA 02173
Tel: (617) 861-8960
CH,CS,E

Michigan

Hewlett-Packard Co.
4326 Cascade Road S.E.
GRAND RAPIDS, MI 49506
Tel: (616) 957-1970
CH,CS,MS

Hewlett-Packard Co.
1771 W. Big Beaver Road
TROY, MI 48084
Tel: (313) 643-6474
CH,CS

Minnesota

Hewlett-Packard Co.
2025 W. Larpenteur Ave.
ST. PAUL, MN 55113
Tel: (612) 644-1100
A,CH,CM,CS,E,MP

Missouri

Hewlett-Packard Co.
11131 Colorado Avenue
KANSAS CITY, MO 64137
Tel: (816) 763-8000
A,CH,CM,CS,E,MS

Hewlett-Packard Co.
13001 Hollenberg Drive
BRIDGETON, MO 63044
Tel: (314) 344-5100
A,CH,CS,E,MP



SALES & SUPPORT OFFICES

Arranged alphabetically by country

UNITED STATES (Cont'd)

Nebraska

Hewlett-Packard
10824 Old Mill Rd., Suite 3
OMAHA, NE 68154
Tel: (402) 334-1813
CM,MS

New Jersey

Hewlett-Packard Co.
120 W. Century Road
PARAMUS, NJ 07652
Tel: (201) 265-5000
A,CH,CM,CS,E,MP

Hewlett-Packard Co.
60 New England Av. West
PISCATAWAY, NJ 08854
Tel: (201) 981-1199
A,CH,CM,CS,E

New Mexico

Hewlett-Packard Co.
11300 Lomas Blvd., N.E.
P.O. Box 11634
ALBUQUERQUE, NM 87112
Tel: (505) 292-1330
CH,CS,E,MS

New York

Hewlett-Packard Co.
5 Computer Drive South
ALBANY, NY 12205
Tel: (518) 458-1550
A,CH,E,MS

Hewlett-Packard Co.
9600 Main Street
P.O. Box AC
CLARENCE, NY 14031
Tel: (716) 759-8621
CH

Hewlett-Packard Co.
200 Cross Keys Office Park
FAIRPORT, NY 14450
Tel: (716) 223-9950
CH,CM,CS,E,MS

Hewlett-Packard Co.
7641 Henry Clay Blvd.
LIVERPOOL, NY 13088
Tel: (315) 451-1820
A,CH,CM,E,MS

Hewlett-Packard Co.
No. 1 Pennsylvania Plaza
55th Floor
34th Street & 8th Avenue
MANHATTAN NY 10119
Tel: (212) 971-0800
CH,CS,E*,M*

Hewlett-Packard Co.
250 Westchester Avenue
WHITE PLAINS, NY 10604
Tel: (914) 684-6100
CM,CH,CS,E

Hewlett-Packard Co.
3 Crossways Park West
WOODBURY, NY 11797
Tel: (516) 921-0300
A,CH,CM,CS,E,MS

North Carolina

Hewlett-Packard Co.
5605 Roanne Way
P.O. Box 26500
GREENSBORO, NC 27420
Tel: (919) 852-1800
A,CH,CM,CS,E,MS

Ohio

Hewlett-Packard Co.
9920 Carver Road
CINCINNATI, OH 45242
Tel: (513) 891-9870
CH,CS,MS

Hewlett-Packard Co.
16500 Sprague Road
CLEVELAND, OH 44130
Tel: (216) 243-7300
A,CH,CM,CS,E,MS

Hewlett-Packard Co.
962 Crupper Ave.
COLUMBUS, OH 43229
Tel: (614) 436-1041
Eff: Nov. 25, 1983
675 Brooksedge Blvd.
WESTERVILLE, OH 43081
CH,CM,CS,E*

Hewlett-Packard Co.
330 Progress Rd.
DAYTON, OH 45449
Tel: (513) 859-8202
A,CH,CM,E*,MS

Oklahoma

Hewlett-Packard Co.
304 N. Meridian, Suite A
P.O. Box 75609
OKLAHOMA CITY, OK 73147
Tel: (405) 946-9499
A*,CH,E*,MS

Hewlett-Packard Co.
3840 S. 103rd E. Avenue, #100
P.O. Box 35747
TULSA, OK 74153
Tel: (918) 665-3300
A**,CH,CS,M*

Oregon

Hewlett-Packard Co.
9255 S. W. Pioneer Court
P.O. Box 328
WILSONVILLE, OR 97070
Tel: (503) 682-8000
A,CH,CS,E*,MS

Pennsylvania

Hewlett-Packard Co.
111 Zeta Drive
PITTSBURGH, PA 15238
Tel: (412) 782-0400
A,CH,CS,E,MP
Hewlett-Packard Co.
2750 Monroe Boulevard
P.O. Box 713
VALLEY FORGE, PA 19482
Tel: (215) 666-9000
A,CH,CM,E,M

South Carolina

Hewlett-Packard Co.
Brookside Park, Suite 122
1 Harbison Way
P.O. Box 21708
COLUMBIA, SC 29221
Tel: (803) 732-0400
CH,E,MS

Hewlett-Packard Co.
Koger Executive Center
Chestersfield Bldg., Suite 124
GREENVILLE, SC 29615
Tel: (803) 297-4120

Tennessee

Hewlett-Packard Co.
224 Peters Road, Suite 102
P.O. Box 22490
KNOXVILLE, TN 37922
Tel: (615) 691-2371
A*,CH,MS

Hewlett-Packard Co.
3070 Directors Row
MEMPHIS, TN 38131
Tel: (901) 346-8370
A,CH,MS

Texas

Hewlett-Packard Co.
4171 North Mesa
Suite C-110
EL PASO, TX 79902
Tel: (915) 533-3555
CH,E*,MS**

Hewlett-Packard Co.
10535 Harwin Drive
P.O. Box 42816
HOUSTON, TX 77042
Tel: (713) 776-6400
A,CH,CM,CS,E,MP

Hewlett-Packard Co.
930 E. Campbell Rd.
P.O. Box 1270
RICHARDSON, TX 75080
Tel: (214) 231-6101
A,CH,CM,CS,E,MP

Hewlett-Packard Co.
1020 Central Parkway South
P.O. Box 32993
SAN ANTONIO, TX 78216
Tel: (512) 494-9336
CH,CS,E,MS

Utah

Hewlett-Packard Co.
3530 W. 2100 South
SALT LAKE CITY, UT 84119
Tel: (801) 974-1700
A,CH,CS,E,MS

Virginia

Hewlett-Packard Co.
4305 Cox Road
GLEN ALLEN, VA 23060
P.O. Box 9669
RICHMOND, VA 23228
Tel: (804) 747-7750
A,CH,CS,E,MS

Washington

Hewlett-Packard Co.
15815 S.E. 37th Street
BELLEVUE, WA 98006
Tel: (206) 643-4000
A,CH,CM,CS,E,MP
Hewlett-Packard Co.
Suite A
708 North Argonne Road
SPOKANE, WA 99212
Tel: (509) 922-7000
CH,CS

West Virginia

Hewlett-Packard Co.
4604 MacCorkle Ave.
P.O. Box 4297
CHARLESTON, WV 25304
Tel: (304) 925-0492
A,MS

Wisconsin

Hewlett-Packard Co.
150 S. Sunny Slope Road
BROOKFIELD, WI 53005
Tel: (414) 784-8800
A,CH,CS,E*,MP

URUGUAY

Pablo Ferrando S.A.C. e.l.
Avenida Italia 2877
Casilla de Correo 370
MONTEVIDEO
Tel: 80-2586
Telex: Public Booth 901
A,C,M,E,M

VENEZUELA

Hewlett-Packard de Venezuela C.A.
3RA Transversal Los Ruices Norte
Edificio Segre 1, 2 & 3
Apartado 50933
CARACAS 1071
Tel: 239-4133
Telex: 251046 HEWPACK
A,CH,CS,E,MS,P

Hewlett-Packard de Venezuela C.A.
Calle-72-Entre 3H y 3Y, No. 3H-40
Edificio Ada-Evelyn, Local B
Apartado 2646
4001, **MARACAIBO**, Estado Zulia
Tel: (061) 80.304
C,E*

Hewlett-Packard de Venezuela C.A.
Calle Vargas Rondón
Edificio Seguros Carabobo, Piso 10
VALENCIA
Tel: (041) 51 385
CH,CS,P

Bioelectronica Medica C.A.

Calle Buen Pastor
Edif. Cota Mil-Piso 2 y Semi Sotano 1
Boleita Norte
Apartado 50710 CARACAS 1050A
Tel: 239 84 41
Telex: 26518

ZIMBABWE

Field Technical Sales
45 Kelvin Road, North
P.B. 3458
SALISBURY
Tel: 705 231
Telex: 4-122 RH
C,E,M,P

July 1983

5952-6900

Indicates main office

HP distributors are printed in italics.