

Publication number 16500-97010  
First edition, April 1994

For Safety information, Warranties, and Regulatory  
information, see the pages behind the index

© Copyright Hewlett-Packard Company 1987, 1990, 1993, 1994  
All Rights Reserved

---

# HP 16500B/16501A Logic Analysis System



Welcome to the Hewlett-Packard Logic Analysis System! The HP 16500B Logic Analysis System is designed to be the easiest system to use, ever. Its modular design allows you to configure it with just the measurement modules you need now, yet add other modules later.

This reference explains the operation of the system mainframe and Internodule menus. Also included is information on the most common system options.

### **Organization**

When you order the HP 16500B, you get two binders (one is extra for later use). The mainframe reference information is found behind the first tab "HP 16500B Mainframe."

Information on the optional keyboard, mouse, and the HP 16501A Expansion Frame is found behind the second tab, "System Options." As you accumulate other system options, place these references behind this tab.

Behind the third tab "Common Module Operations" is information common to most modules, like installing modules, using symbols, and assigning labels.

As you purchase additional measurement modules, place their references at the back of this binder or in the second binder.

<b>1</b>	<b>What is the HP 16500B Logic Analysis System</b>	
<b>2</b>	<b>System Configuration Menu</b>	
<b>3</b>	<b>The HP-IB and RS-232C Interfaces</b>	
<b>4</b>	<b>Connecting a Printer</b>	
<b>5</b>	<b>Disk Drive Menus</b>	
<b>6</b>	<b>System Utilities Menu</b>	
<b>7</b>	<b>Internodule Measurements</b>	
<b>8</b>	<b>General Characteristics</b>	
<b>9</b>	<b>Maintaining the HP 16500B</b>	
<b>10</b>	<b>Error Messages</b>	
	<b>Index</b>	

- Chapter 2 describes the mainframe's System Configuration menu.
- Chapter 3 describes the HP-IB and RS-232C interfaces. They are used for printing screens and computer controlled measurements.
- Chapter 4 explains how to print screens to various graphics printers.
- Chapter 5 describes the flexible disk and hard disk operations.
- Chapter 6 describes the System Utilities menu. Adjustments to the real-time clock, touch calibration, and screen colors are made here.
- Chapter 7 explains how to make intermodule measurements.
- Chapter 8 lists the instrument specifications and characteristics.
- Chapter 9 explains the general instrument maintenance and repacking information. Also included is a description of the self-test that is performed when the instrument is turned on.
- Chapter 10 describes all system and disk error messages.

#### **What is in the System Options?**

- Chapter 1 explains the keyboard and mouse options.
- Chapter 2 describes the HP 16501A Expansion Frame option. Even though you may not have purchased these options yet, keep this information for possible future use.

#### **What is in the Common Module Operations?**

- Chapter 1 describes assigning labels.
- Chapter 2 describes using symbols.
- Chapter 3 explains the general installation for individual modules.

#### **Where to go next**

If you haven't already read *Setting Up The HP 16500 Logic Analysis System*, please read it before continuing.

MS-DOS<sup>®</sup> is a US registered trademark of Microsoft Corporation.



**HP 16500B  
Mainframe**

**1 What Is the HP 16500B Logic Analysis System?**

- Key Features 1-3
- Optional Features 1-3
- User Interfaces 1-4
- Default Configurations 1-4
- Accessories Supplied 1-5
- Accessories Available 1-5

**2 The System Configuration Menu**

- Getting into the System Configuration Menus 2-4
- Layout of the System Configuration Menus 2-5
- Slot Designators 2-6

**3 Configuring the HP-IB and RS-232C**

- Configuring the HP-IB Interface 3-4
- Configuring the RS-232C Interface 3-5
- Configuring the Interface for a Controller or Printer 3-8

**4 Connecting a Printer**

- Connecting HP-IB Printers 4-3
- Connecting RS-232C Printers 4-6
- Connecting to Other Hewlett-Packard Printers 4-9
- Printing the Display 4-11

## **5 The Disk Drive Menus**

- Accessing the Disk Menus 5-5
- Installing a Flexible Disk 5-6
- Selecting a Disk Operation 5-7
- Loading a File 5-8
- Formatting a Disk 5-10
- Storing Files on a Disk 5-12
- Renaming a File 5-15
- Autoloading a File 5-17
- Purging a File 5-19
- Copying a File 5-20
- Packing a Disk 5-22
- Duplicating a Disk 5-23
- Making a Directory 5-24
- Changing the Directory 5-25
- Creating a System Flexible Disk 5-26

## **6 The System Utilities Menu**

- The Touch and Sound Fields 6-4
  - Touch Calibration 6-4
  - Setting the Real-time Clock 6-6
  - Turning the Sound On/Off 6-7
- Display Color Selection 6-8
  - Selecting the Color, Hue, Saturation, and Luminosity Fields 6-10
  - Selecting Colors 6-12
  - Returning to the Default Colors 6-14

## **7 Intermodule Measurements**

- Accessing the Intermodule Menu 7-5
- Configuring a Group Run 7-6
- Configuring Port In/Out 7-8
- The Group Run/Stop Field 7-10
- The Modules List 7-11
- Status Indicators and Time Correlation Bars 7-12
- Adjusting Skew 7-13
- What Are Some Typical Intermodule Measurements? 7-14
- Displaying Multiple Module Data on One Screen 7-18
- Helpful Hints 7-21

## **8 General Characteristics**

- Characteristics 8-2

## **9 Maintaining the HP 16500B**

- Cleaning Requirements 9-2
- Degaussing 9-3
- Service and Calibration 9-3
- The System Test Menu 9-4
- Repackaging for Storage or Shipment 9-5

## **10 Error Messages**

- Disk Error Messages 10-3
- Disk Warning Messages 10-5
- Powerup Self-Test Documentation 10-6
- Fail Codes 10-7
- Critical Errors 10-8
- Non-Critical Errors 10-8

## **System Options**

### **1 Using the Optional Keyboard and Mouse**

- Moving the Cursor 1-3
- Entering Data into a Menu 1-5
- Using the Keyboard Overlays 1-7
- Defining Time Units 1-9
- Defining Voltage Units 1-9
- Assigning Edge Triggers 1-10
- Closing a Menu 1-10
- Connecting the Keyboard and Mouse 1-11

### **2 The Option HP 16501A Expansion Frame**

- Component Details 2-3
- System Configuration 2-4
- System Arming and Triggering 2-4
- Connecting the HP 16501A Expansion Frame 2-7

## **Common Module Operations**

### **1 Labels Assignment**

- Label Assignment Fields 1-3
- Rolling Labels and Pods 1-5

### **2 Symbols Assignment**

- Symbols Field 2-3

### **3 Installing and Removing Cards**

- General Installation Procedure 3-3
- HP 16532A Installation Considerations 3-7
- HP 16517A/18A Installation Considerations 3-11



**What Is the  
HP 16500B Logic  
Analysis System?**

# The HP 16500B

The HP 16500B is the mainframe of the Hewlett-Packard Logic Analysis System. It offers a modular structure for plug-in cards with a wide range of state, timing, oscilloscope, and pattern generator capabilities. This allows you to configure the HP 16500B using only the modules you need in order to perform a desired measurement or set of measurements, while giving you the flexibility to change or update them later.

The Logic Analysis System provides both experienced and first-time users with powerful measurement capabilities. The pop-up menus and color graphics lead you through setups and measurements quickly and easily, without the need to memorize a lot of steps. By touching the appropriate fields or using the cursor of either the optional mouse or keyboard, you can perform functions, configure menus, and move from one menu to another.

With the intermodule capabilities of the Logic Analysis System, you can make interactive measurements between modules. This allows you to configure modules to interact with each other, using the triggering capabilities of one module and the acquisition capabilities of another.

## **System Options**

The HP 16501A is the add-on mainframe for expanding the module capacity of the HP 16500B. When the HP 16501A is connected to the HP 16500B, they function as a single ten-card system which is turned on and controlled by the HP 16500B. The HP 16501A forms a tightly coupled system with the HP 16500B, permitting each of the two mainframes to arm or trigger any module from any other module.

An optional LAN interface is available for direct connection to computers located on an Ethernet local area network (LAN). The LAN interface enables you to upload measurement data for the most comprehensive post-processing needs and easy access to data files.

---

## Key Features

The key features of the HP 16500B are:

- Modular mainframe with five card slots.
- 9-inch color monitor.
- Touchscreen with on/off control.
- Battery backed Real-time clock.
- Programmable PORT IN voltage level and edge selection.
- 3.5-inch flexible disk drive with DOS and LIF format support.
- 170 Mbyte hard disk drive with DOS format support.
- Intermodule triggering and 2 ns time correlation of acquired data.
- HP-IB and RS-232C interfaces for:
  - Hardcopy output to a printer
  - Controller interface.

---

## Optional Features

The optional features of the HP 16500B:

- HP 16501A Expansion Frame. Increase available card slots to ten when you connect the expansion frame to an HP 16500B.
- Mouse.
- Keyboard.
- Ethernet LAN interface.
- Expandable system memory up to 64 Mbytes.

### **See Also**

"System Options" for more information on available system software and hardware options.

---

## User Interfaces

The HP 16500B has four user interface devices: the knob on the front panel, the touchscreen, the optional mouse, and the optional keyboard.

The knob on the front panel is used to move the cursor on certain menus, increment or decrement numeric fields, and to roll the display.

The touchscreen fields can be selected by touch or with the optional mouse or keyboard. To activate a field by touch, press the dark blue field on the display with your finger until the field changes color. Then move your finger away from the screen to activate your selection. You have the option of disabling the touchscreen with the front-panel Touch On/Off button.

### See Also

The "System Options" part for more information on using the optional keyboard and mouse.

### Screen Contrast and Brightness

Screen contrast and brightness are adjusted by turning the two small knobs located beneath the Touch Screen button. The left knob is for brightness and the right knob is for contrast.

---

## Default Configurations

When the instrument is powered up, predetermined values are automatically assigned to the different fields of the menus to configure the instrument for basic measurements. This allows you to make a basic measurement by turning on the instrument, connecting the probes, and touching the Run field. Often, only minor changes are needed for more complex measurements.

### Storing Default Configurations

The default configurations may be stored on a disk for later use or reset by cycling the power. Storing default configurations on a disk is a convenient way to return to the default values without cycling the power. Default values for each module can be stored separately or together in one file.

### See Also

The "Using the Disk Drive Menus" chapter for more information on the Store operation.



---

## Accessories Supplied

The following list of accessories is supplied with the HP 16500B Logic Analysis System. If any accessory is missing, contact your local sales office.

<b>Accessories Supplied</b>	<b>Qty</b>
Training Kit	1
User's Reference Guide	1
Programming Reference Guide	1
Service Guide	1
Setting Up the System Guide	1
RS-232C Loopback Connector	1
Power Cord	1
Disk pouch containing composite software	1
Feeling Comfortable With Logic Analyzers guide	1
Feeling Comfortable with Digitizing Oscilloscopes guide	1
Filler Panels	*

\* Quantity depends on how many modules are ordered with the HP 16500B/16501A

---

## Accessories Available

Other accessories available for the HP 16500B/16501A Logic Analysis System are listed in the *Accessories for HP Logic Analyzers* brochure.





The System  
Configuration  
Menu

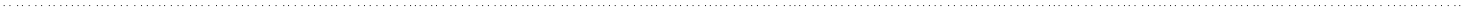

# The System Configuration Menu

The System Configuration menu is the first menu you see after the initial power-up of the instrument. This menu lists the modules and software options that your system is configured with and shows whether there are five card slots (the HP 16500B alone) or ten card slots (the HP 16500B with the optional HP 16501A attached) available. It also shows if either the optional mouse or keyboard is connected. If a mouse is connected, the system configuration menu indicates whether the mouse is connected directly to the HP 16500B or to a keyboard connected to the mainframe. Finally, the system configuration menu gives you access to the configuration of the HP-IB, RS-232C, and optional LAN interfaces.

## Menu Map

The following menu map illustrates all fields and available options in the System Configuration menu. The menu map will help you get an overview as well as provide you with a quick reference of what the System Configuration menu contains.

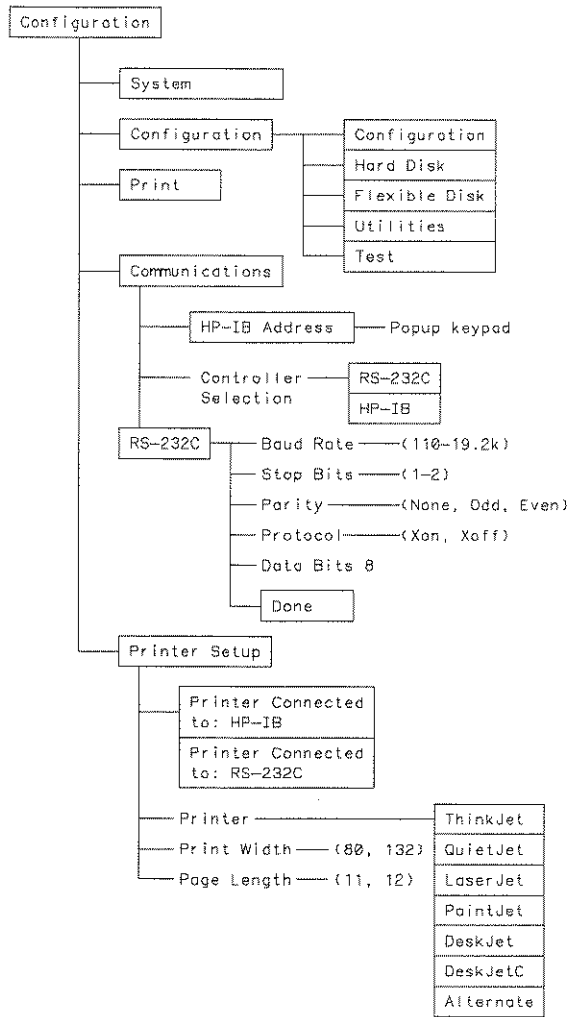

16500B52

### System Configuration Menu Map

---

## Getting into the System Configuration Menus

In the upper-left corner of the menu are two fields that indicate the current menu and module. The field to the extreme left (System) shows you which module you're in and the one to the right of the module field (Configuration) shows you what menu within the module you've accessed.

To access the System Configuration menu, follow these steps:

- 1 If the module field in the upper-left corner of the screen does not display "System," select this field and when the pop-up appears, select **System**. This will get you into one of the System menus.
- 2 If the module field in the upper-left corner of the screen displays "System," but the menu field to the right of System doesn't display "Configuration," select this field. When the pop-up appears, select **Configuration** to display the System Configuration menu.

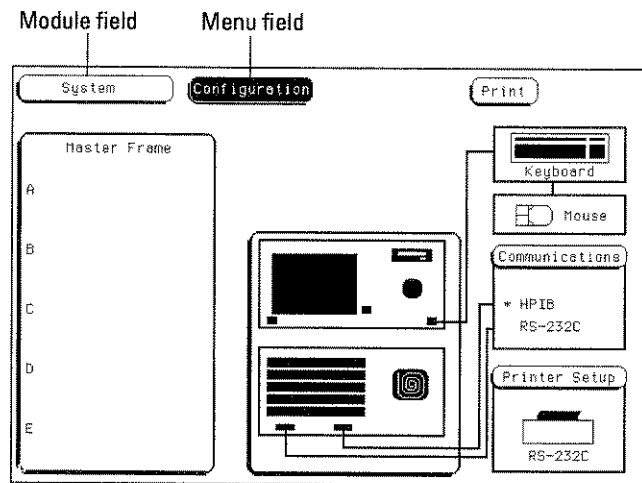

**Module and Menu Fields**

## Layout of the System Configuration Menu

The figure below shows the layout of the System Configuration menu for the HP 16500B. The figure is labelled with the major features and functions of the menu.

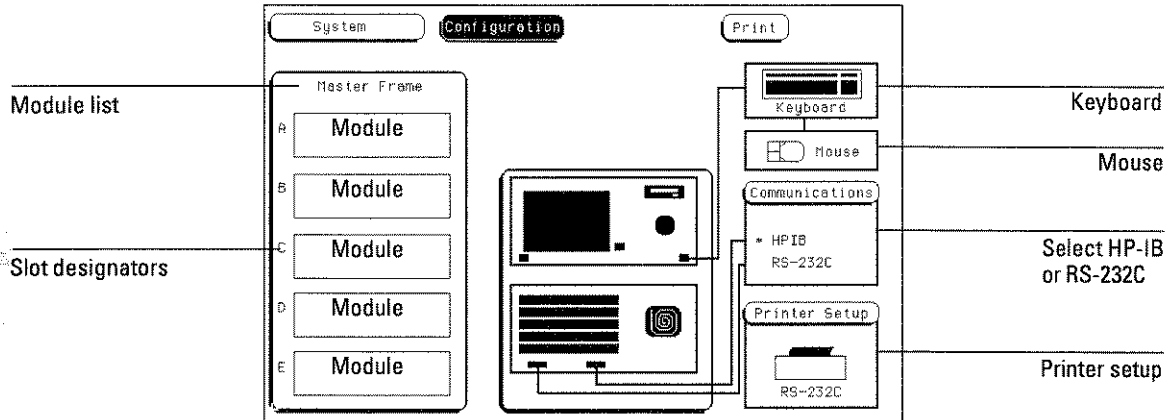

**System Configuration Menu**

---

## Slot Designators

The slot designators are listed as A through E for the HP 16500B alone, or A through J for the HP 16500B with the HP 16501A attached. The slot designators are displayed to the left of the list of cards for the system and indicate the locations or slots for each card. When you select the Module field, a pop-up appears. The letters after the name of each module indicate the location of each “master” card for that module.

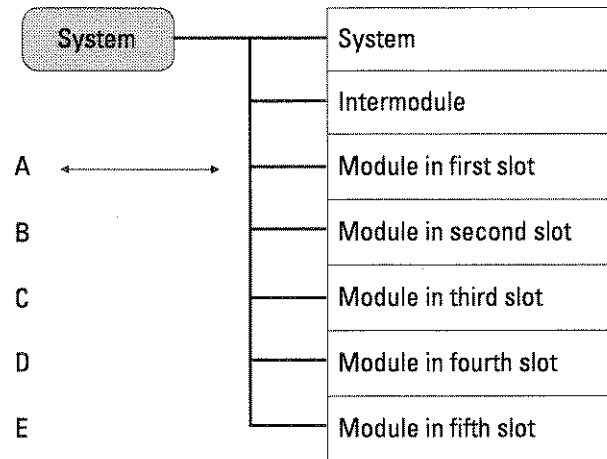

### Slot Designators in Master Frame





**Configuring the  
HP-IB and RS-232C**



# The HP-IB and RS-232C Interfaces

This chapter describes the controller and printer interfaces and their configurations. It defines the HP-IB interface and describes how to select any one of the 31 different HP-IB addresses available. It also defines the RS-232C interface and tells you how to select a baud rate, how to change the stop bits, how to set the parity and data bits, and how to change the protocol.

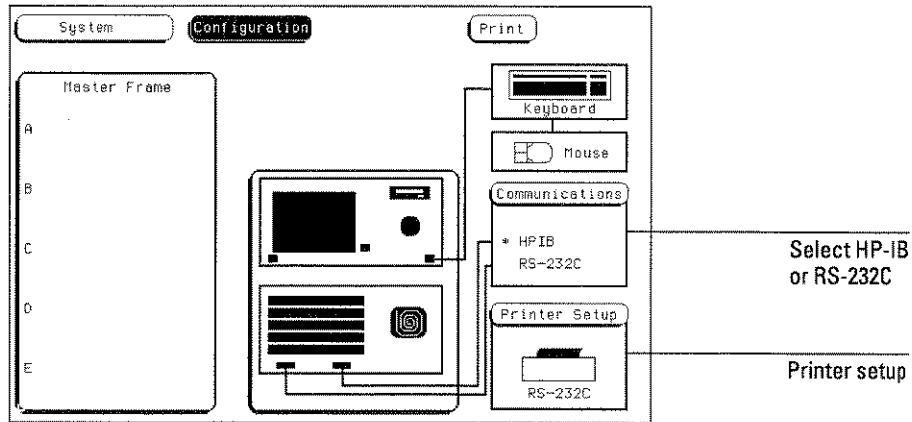

**Controller and Printer Configuration**

### **The Controller Interface**

The HP 16500B is equipped with a standard RS-232C interface and an HP-IB interface that allow you to connect to a controller. This gives you remote access for running measurements, for uploading and downloading configurations and data, for printing, and more. The controller interface is explained in more detail in the *HP 16500B/16501A Programmer's Guide*.

### **The Printer Interface**

The HP 16500B can output its screen display to various HP-IB and RS-232C graphics printers. Configured menus, waveforms, and other data can be printed for complete measurement documentation. The printer interface is explained in more detail in chapter "Connecting a Printer."

## Configuring the HP-IB Interface

The Hewlett-Packard Interface Bus (HP-IB) is Hewlett-Packard's implementation of IEEE Standard 488-1978, "Standard Digital Interface for Programmable Instrumentation." The HP-IB is a carefully defined interface that simplifies the integration of various instruments and computers into systems. It uses an addressing technique to ensure that each device on the bus (interconnected by HP-IB cables) receives only the data intended for it. To accomplish this, each device is set to a different address and this address is used to communicate with other devices on the bus.

### Selecting an HP-IB Address

The HP-IB address can be set to 31 different HP-IB addresses, from 0 to 30. Simply choose an address that is compatible with your device or software. The default is 7.

- 1 Select the **Communications** field.
- 2 Using the knob or keypad, enter an HP-IB address in the field directly under "HP-IB Address."
- 3 When you are finished configuring the HP-IB Address, select **Done**.

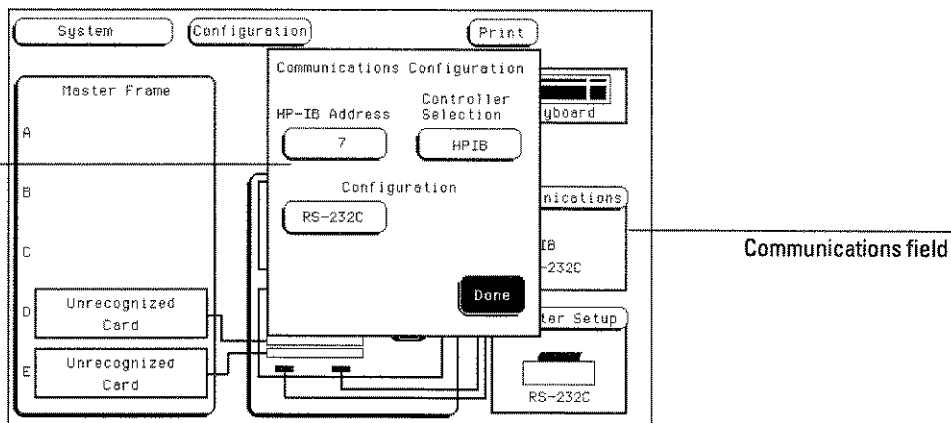

**Communications Configuration pop-up Menu**

## Configuring the RS-232C Interface

The RS-232C interface on this instrument is Hewlett-Packard's implementation of EIA Recommended Standard RS-232C, "Interface Between Data Terminal Equipment and Data Communications Equipment Employing Serial Binary Data Interchange." This interface sends data one bit at a time, and characters are not synchronized with preceding or subsequent data characters. Each character is sent as a complete entity without relationship to other events.

### Baud Rate

The baud rate is the rate at which bits are transferred between the interface and the peripheral. The baud rate must be set to transmit and receive at the same rate as the peripheral, or data cannot be successfully transferred.

- 1 Select the **Communications** field.
- 2 Select the **RS-232C** field located directly under the HP-IB Address field.
- 3 When the pop-up menu appears, select the field directly to the right of "Baud Rate."

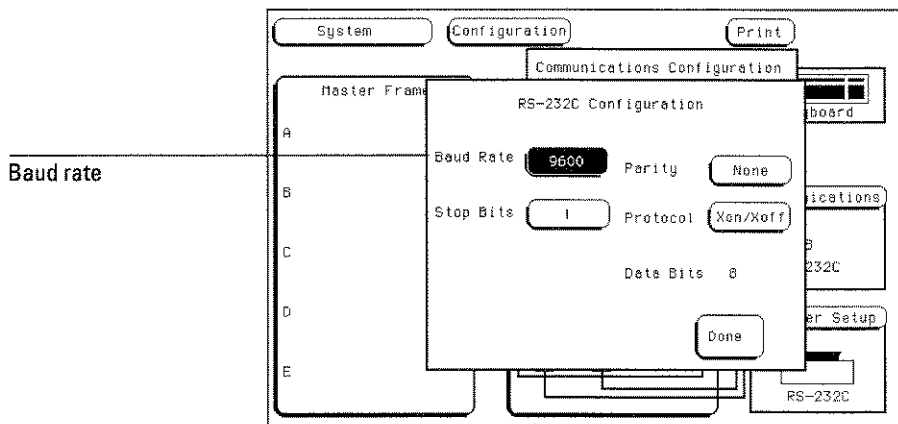

**RS-232C Configuration**

- 4 When the second pop-up appears, select the baud rate you want from the list displayed in the pop-up (110 to 19.2k) and the pop-up will disappear.

### **Stop Bits**

Stop bits are used to identify the end of a character. The number of stop bits must be the same for the controller as for the Logic Analysis System.

- 1 Select the **Communications** field.
- 2 Select the **RS-232C** field located directly under the HP-IB Address field.
- 3 Select the field directly to the right of "Stop Bits" in the RS-232C Configuration pop-up menu.
- 4 When the new pop-up appears, select **1**, **1.5**, or **2** stop bits to identify the end of the character. The pop-up disappears, placing your selection in the appropriate field.

### **Parity**

The parity bit detects errors as incoming characters are received. If the parity bit does not match the expected value, the character is assumed to be incorrectly received. The action taken when an error is detected depends on how the interface and the device program are configured.

Parity is determined by the requirements of the system. The parity bit may be included or omitted from each character by enabling or disabling the parity function.

- 1 Select the **Communications** field.
- 2 Select the **RS-232C** field located directly under the HP-IB Address field.
- 3 Select the field directly to the right of "Parity" in the RS-232C Configuration menu.
- 4 When the pop-up appears, select **None**, **Odd**, or **Even** to match the parity of the external device. After you make your selection, the pop-up disappears.

### **Protocol**

Protocol governs the flow of data between the instrument and the external device.

- 1 Select the **Communications** field.
- 2 Select the **RS-232C** field located directly under the **HP-IB Address** field.
- 3 Select the field directly to the right of "Protocol" in the **RS-232C Configuration pop-up menu**.
- 4 When the pop-up appears, select **None** or **Xon/Xoff**.

#### **None**

- With less than a 5-wire interface, selecting **None** does not allow the sending or receiving device to control how fast the data is being sent. No control over the data flow increases the possibility of missing data or transferring incomplete data.
- With a full 5-wire interface, selecting **None** allows a hardware handshake to occur. With a hardware handshake, hardware signals control data flow. The HP 13242G cable allows the HP 16500B to support hardware handshake.

#### **Xon/Xoff**

- **Xon/Xoff** stands for **Transmit On/Transmit Off**. With this mode, the receiver controls the data flow and can request that the printer stop data flow at any time.
- 5 Select **Done**.

#### **Data Bits**

Data bits are the number of bits sent and received per character that represent the binary code of that character. The HP 16500B supports the 8-bit binary code.

---

## Configuring the Interface for a Controller or Printer

Both the HP-IB and RS-232C interfaces can be configured for either a controller or a printer. You can select the interface and what it controls (printer or controller) in either of two places. When one interface is configured to either the printer or controller, the other interface is automatically switched to the other. One interface is never configured to control both.

- In the Printer Setup menu, toggle the **Printer Connected to:** field.
  - In the Communications menu, set the **Controller Selection** field.
- For example, one way to configure the RS-232C interface for a printer:
- 1 Select the **Printer Setup** field, then toggle the **Printer Connected to:** field to **RS-232C**.

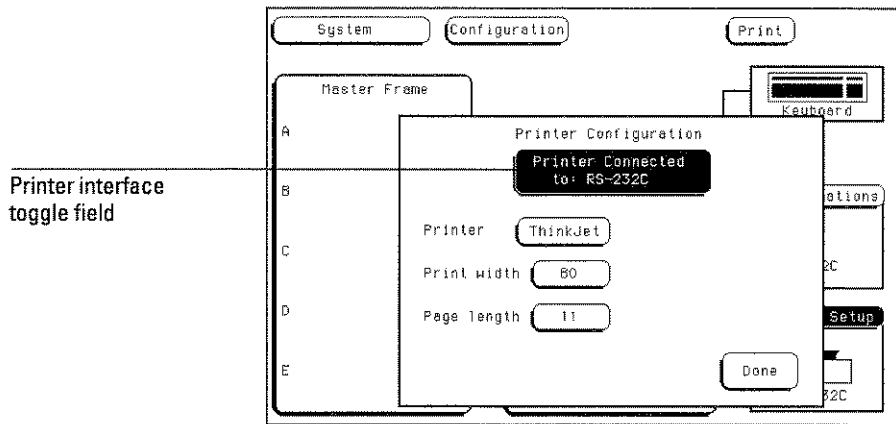

### RS-232C Printer Configuration

Any HP-IB type printer must be set to **Listen Always** for the HP-IB interface. Also, in this mode no HP-IB addressing is necessary.

### See Also

The "Connecting a Printer" chapter for more information on using a printer.





# Connecting a Printer

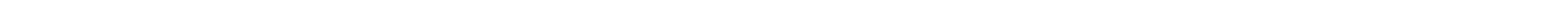

# Connecting a Printer

The HP 16500B can output its screen display to various HP-IB and RS-232C graphics printers. Configured menus, waveforms, and other data can be printed for complete measurement documentation.

---

## Connecting HP-IB Printers

The HP 16500B interfaces directly with HP PCL printers supporting the printer command language or with Epson printers supporting the Epson standard command set. These printers must also support HP-IB and Listen Always. Printers currently available from Hewlett-Packard with these features include:

- HP ThinkJet.
- HP QuietJet.
- HP LaserJet.
- HP PaintJet.
- HP DeskJet.
- HP DeskJetC

The printer must be in Listen Always when HP-IB is the printer interface. In addition, the HP 16500B HP-IB port does not respond to service requests (SRQ) when controlling a printer. The SRQ enable setting for the HP-IB printer has no effect on HP 16500B printer operation.

### HP-IB Printer Setup

- 1 Turn off the HP 16500B and connect an HP-IB cable from the printer to the HP-IB connector on the rear panel as shown below.

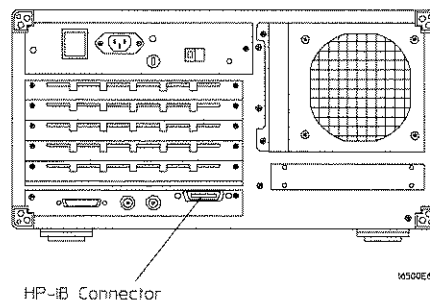

**HP-IB Connector on Rear Panel**

**2 Make sure the printer is in the Listen Always (or Listen Only) mode.**

For example, the figure below shows the configuration switches for an HP-IB ThinkJet printer. For the **Listen Always** mode, move the second switch from the left to the "1" position. Since the HP 16500B doesn't respond to SRQ EN (Service Request Enable), the position of the first switch doesn't matter.

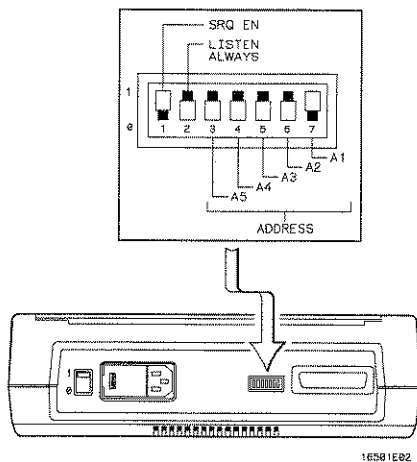

**Configuration Switches for the HP ThinkJet Printer**

**HP-IB Instrument Setup**

- 1** Turn on the HP 16500B. From the System Configuration menu, select the **Printer Setup** field.
- 2** When the Printer Configuration menu appears, toggle the **Printer Connected to:** field to **HP-IB**.
- 3** Select the field to the right of "Printer." When the printer selection pop-up appears, select the printer that you're using (such as ThinkJet, QuietJet). If you're using an Epson graphics printer or an Epson-compatible printer, select **Alternate**.

- 4 Select the field to the right of "Print Width" and depending on your application, toggle the width to either **80** or **132**.

Print width tells the printer that you are sending up to 80 or 132 characters per line (when you Print All) and is totally independent of the printer itself.

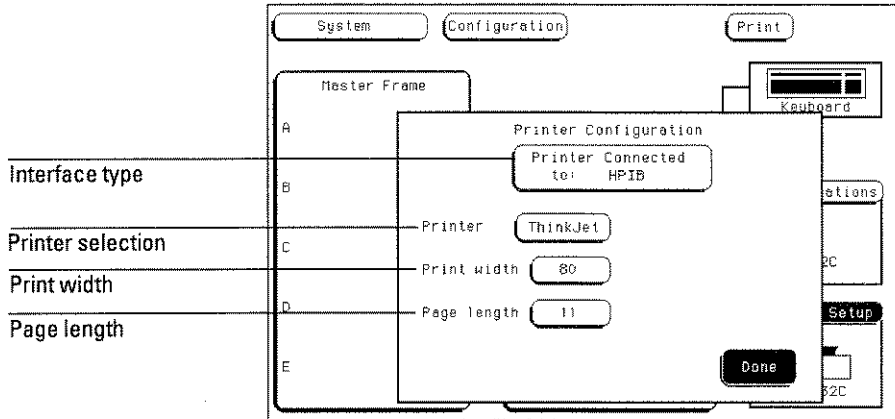

#### HP-IB Printer Configuration

- If you select 132 characters per line when using other than the QuietJet selection, the listings are printed in a compressed mode. Compressed mode uses smaller characters to allow the printer to print more characters within a given area.
  - If you select 132 characters per line for the QuietJet selection it can print a full 132 characters per line without going to compressed mode, but the printer must have wider paper.
  - If you select 80 characters per line for any printer, a maximum of 80 characters are printed per line.
- 5 Select the field to the right of Page Length. Depending on your application, toggle it to either **11** or **12**.  
Page length tells the printer the page length for the type of paper you are using.
  - 6 Select **Done** when you finished.

---

## Connecting RS-232C Printers

The HP 16500B interfaces directly with RS-232C printers, including the HP ThinkJet, HP QuietJet, HP LaserJet, HP PaintJet, HP DeskJet and HP DeskJetC printers.

### RS-232C Printer Setup

- 1 Turn off the HP 16500B and connect an RS-232C cable (HP 13242G) from the printer to the RS-232C connector on the rear panel.

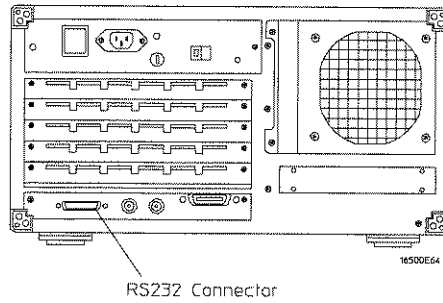

**RS-232C Connector on Rear Panel**

**2 Before turning on the printer, set the mode switches as follows:**

- The HP QuietJet series printers have two banks of mode function switches inside the front cover. Push all the switches down to the “0” position as shown in the figure below.

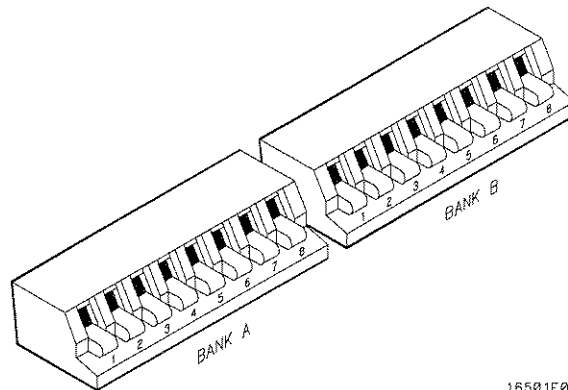

**Switch Configuration for HP QuietJet Printers**

- For the HP 2225D (RS-232 HP ThinkJet) printer, the mode switches are on the rear panel of the printer. Push all the switches down to the “0” position as in the figure below.

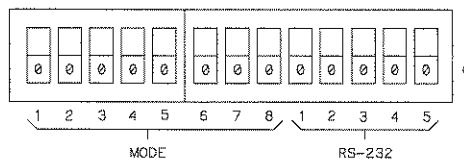

**Switch Configuration for HP ThinkJet Printers**

- For the HP LaserJet printer, the switch settings can remain in the factory default settings.

### RS-232C Instrument Setup

- 1 Turn on the HP 16500B and from the System Configuration menu, select the **Printer Setup** field.
- 2 When the Printer Configuration menu appears, toggle the **Printer Connected to:** field to **RS-232C**.

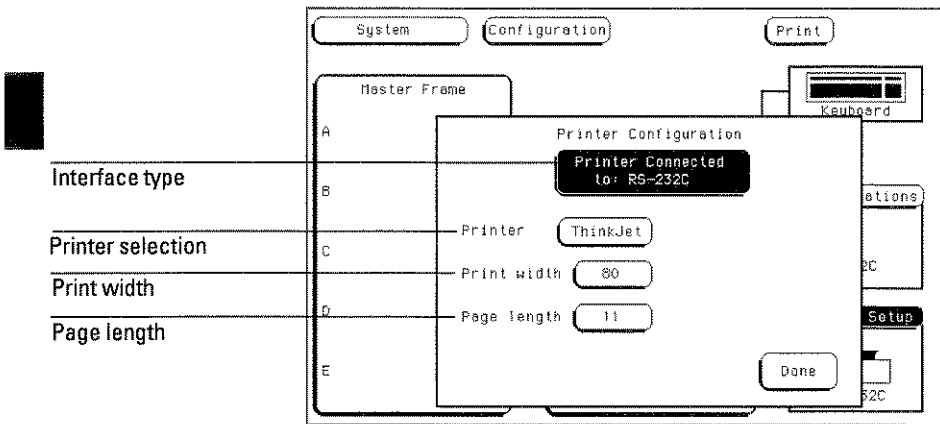

**RS-232C Printer Configuration**

- 3 Select the field to the right of "Printer." When the printer selection pop-up appears, select the printer that you're using (such as ThinkJet, QuietJet). If you're using an Epson graphics printer or an Epson-compatible printer, select **Alternate**.
- 4 Select the field to the right of "Print Width." Depending on your application, toggle the width to either **80** or **132**.  
Print width tells the printer that you are sending up to 80 or 132 characters per line (when you Print All) and is totally independent of the printer itself.
- 5 Select the field to the right of "Page Length." Depending on your application, toggle it to either **11** or **12**.  
Page length tells the printer the page length for the type of paper you are using.
- 6 Select **Done** when you finished.



### RS-232C Interface Setup

- 1 From the System Configuration menu, select the **Communications** field.
- 2 From the Communications Configuration menu that appears, select the **RS-232C** field just to the right of the HP-IB Address field.
- 3 From the RS-232C Configuration menu that appears, set the baud rate, stop bits, parity, and protocol depending on your application.

For complete information on these RS-232C interface parameters go to "What is the RS-232C Interface" section in the HP-IB and RS-232C chapter found earlier in this manual.

---

## Connecting to Other Hewlett-Packard Printers

The HP 16500B can also be used with other Hewlett-Packard graphics printers. Simply connect the printer to the HP 16500B using the appropriate cable (HP-IB or RS-232C) and configure the HP 16500B as shown in the following table.

---

### HP Printer Selection

---

For this HP Printer	Select this Printer from the pop-up
HP 2631G	QuietJet
HP 2671G	ThinkJet
HP 2673A	ThinkJet
HP 9876A	ThinkJet
HP 2932/34 (option 046)	QuietJet

HP-IB printers must support Listen Always to work with the HP 16500B. The HP 82906A graphics printer is not supported because it does not support Listen Always on HP-IB.

The HP 2932A or HP 2934A option 046 printer is configured from the front panel of the printer, instead of with switches on the rear panel. The correct configuration for the HP 16500A is shown in the figure below.

**See Also**

Refer to the *HP 16500B Programming Manual* for information on setting up an external controller to activate the printer.

```
***** SETTINGS *****
***** LIST *****
PRINTER INTERFACE PRINTER INTERFACE
***** LIST INTERFACE *****
HP-IB
SECONDARY COMMANDS LISTEN ALWAYS SERVICE REQUEST ADDRESS SET DEFAULTS
off on off 1
***** END OF SETTINGS *****
```

16501001

**Configuration for the HP 2932/34 Option 046**

---

## Printing the Display

Each menu has a Print field in the upper-right corner. Select the Print field and a pop-up appears, displaying your choices. Depending on the measurement module and menu you are printing, only some of the following choices will appear.

- **Cancel** stops the print.
- **Print Screen** prints everything shown on the screen.
- **Print All** prints all of the information listed for that display, including any listings that do not appear on screen. These listings can be 80 or 132 characters wide, depending on the print width setting.
- **Print Partial** prints a partial range.
- **Print Line** prints lines between a designated start and end line.
- **Print Record** prints records between a designated start and end record.
- **Print Disk** prints everything shown on a single screen, or all data from the listing buffer, to either the flexible or hard disk.

### Configuring a Print to Disk

When you select the **Print Disk** option, a Print to Disk configuration menu appears as shown below.

Filename field

Output format field

Output disk field

**Print to Disk Menu**

- 1 Select the **Filename** field, then enter a filename (LIF), or the path and filename (DOS).

If the file is stored to a DOS disk, the filename can contain up to 8 characters plus a 3 character extension. If the file is stored on a LIF disk, up to 10 characters can be used for the filename and no extension is required. The filename plus any path may contain up to 64 characters.

- 2 Select the **Output Format** field, then select one of the following formats:

**ASCII (All)** All data in listing buffer in ASCII form.

**B/W TIF (Screen)** The current screen in black and white with TIF format.

**Color TIF (Screen)** The current screen in color with TIF format.

**PCX (Screen)** The current screen in color with PCX format.

When storing to DOS disk, if you forget to add the extension, it will be added automatically according to the format type.

- 3 Select the **Output Disk** field, then select the destination disk.



# The Disk Drive Menus



# Using the Disk Drive Menus

The logic analysis system has both a 3.5 inch, double-sided, high-density or double-density, flexible disk drive and an 85 Mbyte hard disk drive build in. The flexible disk drive is compatible with both LIF (Logical Interchange Format) and DOS (Disk Operating System) formats. The hard disk drive is formatted for a DOS file system.

This chapter describes the disk operations available in both the hard disk and flexible disk menus, and how to use them. It is organized into separate "How to" examples demonstrating the use of the Disk menus and all the disk operations.

## The Disk Operations

- Autoload

Designates a set of configuration files to be loaded automatically the next time the analyzer is turned on.

- Copy

Any file can be copied from one disk to another or to the same disk.

- Duplicate Disk

All volume labels, directories, and file positions from one disk are copied exactly to another disk. The new disk is formatted to match the source disk if it is required. All files on the destination disk will be destroyed with this operation.

- Format Disk

The hard disk, and any double-sided, double-density, or high-density, 3.5-inch flexible disk can be formatted in either LIF or DOS format. The directory and all files on the disk will be destroyed with this operation.

- Load

Instrument system configurations, analyzer measurement setups, including measurement data, and inverse assembler files for the analyzer can be loaded from the disk drive.

- Pack Disk

This function packs files on a LIF disk. Packing removes all empty or unused sectors between files on a disk so that more space is available for files at the end of the disk.

- Purge

Any file on a disk can be purged (deleted) from the disk.

- Rename

Any filename on a disk can be changed to another name.

- Store

Instrument system configurations and analyzer measurement setups including measurement data can be stored to either disk drive.

- Change Directory

The present working directory (PWD) can be changed to any other directory on either the hard disk or flexible disk drives.

- Make Directory

New directories can be created on both the hard disk and flexible disk.

### **Disk Operation Safeguards**

If there is a problem or additional information is needed to execute an operation, an advisory will appear displaying an error message or a prompt for more information. If executing any disk operation could destroy or damage a file, a warning appears before you select Execute.

### **Disk Operations using the Optional LAN**

Performing disk operations using the optional LAN interface is restricted to DOS formatted disks. For more information refer to the *LAN Interface Module User's Guide*.

## Menu Map

The following menu map illustrates all fields and available options in the Disk Drive menu. The menu map will help you get an overview as well as provide you with a quick reference of what the Disk Drive menu contains.

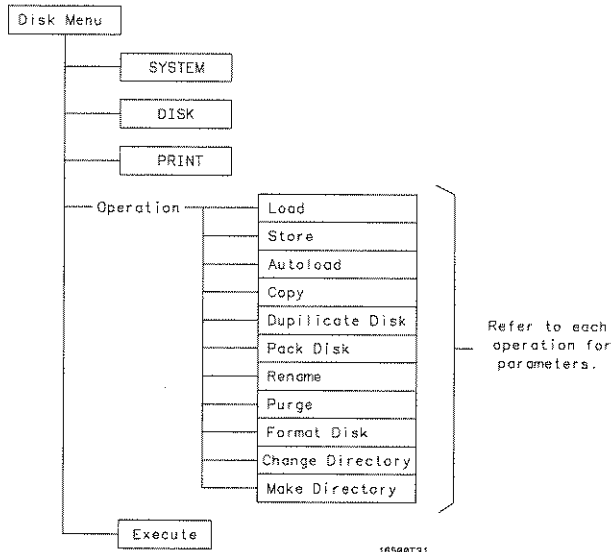

**Disk Drive Menu Map**



---

## Accessing the Disk Menus

- 1 Select the **Module** field.
- 2 From the pop-up menu that appears, select **System**.
- 3 Select the **Menu** field.
- 4 From the pop-up that appears, select either the **Flexible disk** or **Hard disk** field.

The directory of each disk is automatically read and displayed as each disk menu is accessed.

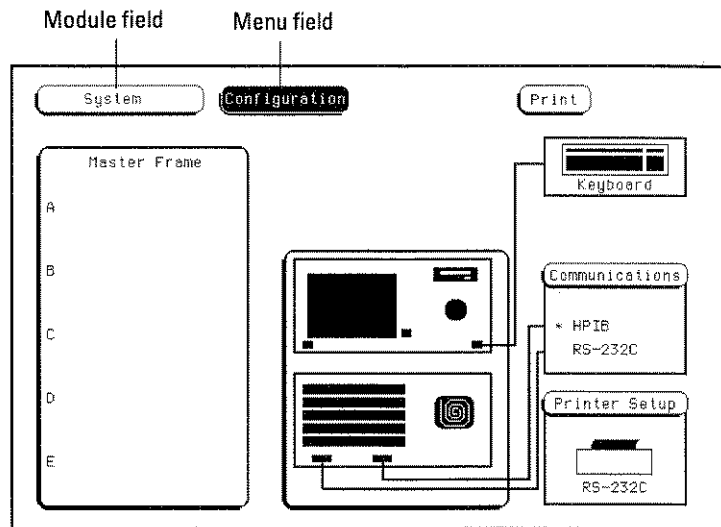

**Menu Name Field**

---

## Installing a Flexible Disk

- 1 Hold the disk so the disk label is on top and the metal auto-shutter is away from you.
- 2 Push the disk gently, but firmly, into the disk drive until it clicks into place.

You can use double-sided, double-density and double-sided, high-density disks. To display all files on any disk, insert the disk into the drive, then turn the knob.

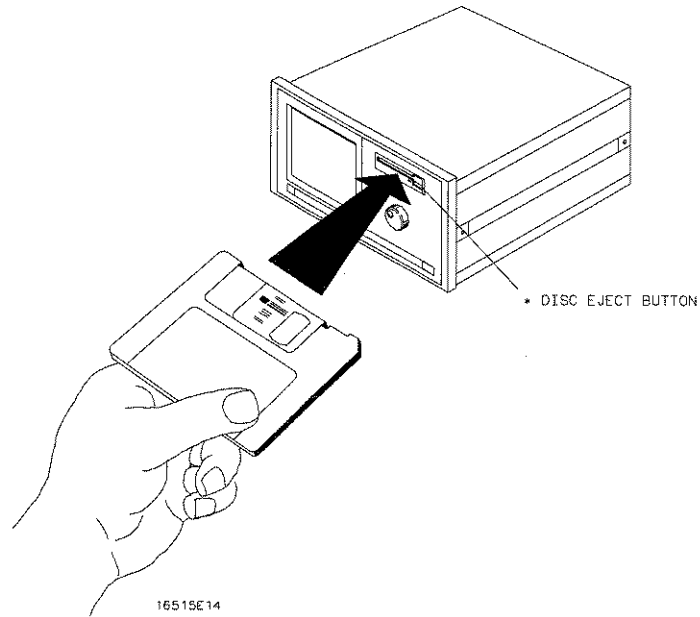

### Installing a Disk

---

## Selecting a Disk Operation

Although some default parameters are provided, a disk operation may require new information from the user. This information is entered in the appropriate parameter fields within each disk operation menu.

- 1 Select the **Disk Operation** field.
- 2 From the pop-up menu that appear, select the desired disk operation.

Disk operation field

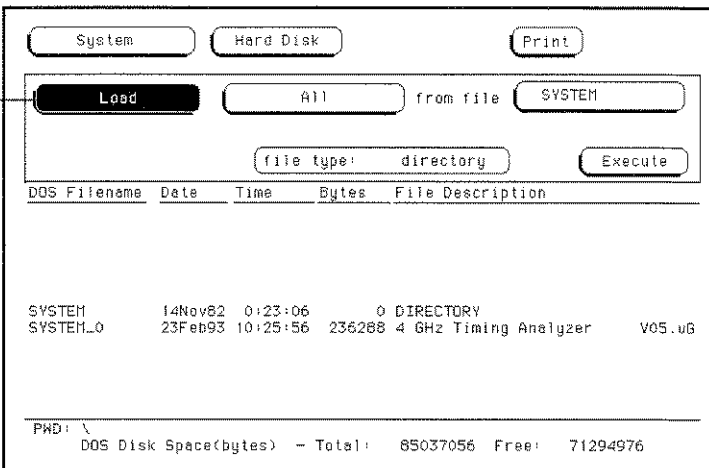

The screenshot shows a DOS disk operation menu with the following elements:

- Buttons: System, Hard Disk, Print
- Selected operation: Load
- File selection: All from file SYSTEM
- File type: directory
- Execute button
- Table header: DOS Filename Date Time Bytes File Description
- Table content:

DOS Filename	Date	Time	Bytes	File Description
SYSTEM	14Nov82	0:23:06	0	DIRECTORY
SYSTEM.LO	23Feb93	10:25:56	236268	4 GHz Timing Analyzer V05.u6
- Footer: PWD: \ DOS Disk Space(bytes) - Total: 85037056 Free: 71294976

### Disk Operation Field

When performing disk operations, the path and disk capacity information located at the bottom of the menu will be helpful.

### DOS Formats

**PWD:** is the present working directory from which the files are contained.

**Total:** is the total memory capacity (bytes) of the flexible or hard disk.

**Free:** is the total memory capacity (bytes) remaining.

### LIF Formats

**Total:** is the total memory capacity (blocks) of the flexible disk.

**Free:** is the total memory capacity (blocks) remaining.

**Largest:** is the size of the largest block remaining.

---

## Loading a File

The Load operation allows you to load prestored configuration files. Use this operation when you want to quickly restore the analyzer to a configuration used in a previous measurement or condition.

- 1 Insert the source disk into the disk drive.
- 2 Select the **Load** operation.

When the Load selection is made, the analyzer reads the disk directory and displays a list of all files on the disk.

- 3 Select the **File type** field.

File type field

DOS Filename	Date	Time	Bytes	File Description
SYSTEM	13Apr93	0:59:58	812032	HP16500B System Software V01.ee
SYS_004	13Apr93	1:02:26	413952	4 GHz Timing/1 GHz State V01.qe

PWD: \  
DOS Disk Space(bytes) - Total: 1474560 Free: 231424

### File Type Parameter Field

4 From the pop-up that appears, select the desired file type.

The **System** choice loads things like interface (RS-232C /HP-IB) and intermodule configurations, and defaults from the Utilities menu.

The **Module** choice loads measurement module configurations and data.

The **All** choice loads both System and module configurations and data files.

5 Select the desired file name from the list by rotating the knob. As the knob is rotated, the file names are rolled into the Filename field.

The two spaces(\_ \_) after the filename designates that this file is for the system. One space and a letter (for example, "\_A") after the filename designates that the file is for the measurement module in slot A.

The screenshot shows a file selection interface with the following elements:

- Buttons: System, Flexible Disk, Print, Load, All, Execute
- Filename field: from file SYS\_004
- File type: 004@16500B
- Table with columns: DGS Filename, Date, Time, Bytes, File Description
- Table content:

DGS Filename	Date	Time	Bytes	File Description
SYSTEM	13Apr93	0:59:58	812032	HP16500B System Software V01.ee
SYS_004	13Apr93	1:02:26	413952	4 GHz Timing/1 GHz State V01.qe
- Footer: PWD: \ DOS Disk Space(bytes) - Total: 1474560 Free: 231424

Labels in the image:

- Filename field (points to the SYS\_004 field)
- Scroll bar (points to the bottom of the table)

**Filename Selection**

7 Select the **Execute** field.

The disk drive indicator light illuminates as the file is being loaded.

## Formatting a Disk

The Format operation initializes new flexible disks for use in the analyzer as well as reformats the hard drive. The analyzer will format double-sided, double density or high density flexible disks in both LIF and DOS formats. The analyzer does not support single-sided formats.

The logic analyzer does not support track sparing during formatting. If a bad track is found, the disk is considered bad. If a disk has been formatted elsewhere with track sparing, it will be read successfully.

To format a flexible disk, perform the following steps:

- 1 Insert the flexible disk to format into the disk drive.
- 2 Select the **Format Disk** operation.

When the Format selection is made, the disk directory is displayed. The UNSUPPORTED FORMAT message appears if the disk is a new unformatted disk. This is normal, continue the format operation.

- 3 Select the **Format type** field, and toggle to either the **LIF** or **DOS**.

The analyzer recognizes a variety of sector sizes for LIF disks. However, when formatting LIF disks, the analyzer only creates 1024 byte sectors. When formatting DOS disks, the analyzer creates 512 byte sectors.

The screenshot shows a graphical user interface for formatting a disk. At the top, there are three buttons: "System", "Flexible Disk", and "Print". Below these is a "Format Disk" section containing a "Format Disk" button, a "DOS Format" button, a "file type: autoload\_file" field, and an "Execute" button. A line points from the text "Format type field" to the "DOS Format" button. Below the buttons is a table with columns: LIF Filename, Date, Time, Blocks, and File Description. The table contains three rows of data. At the bottom of the interface, there is a summary line: "LIF Disk Space(blocks) - Total: 3060 Free: 895 Largest: 778".

LIF Filename	Date	Time	Blocks	File Description
AUTOLOAD	24Feb93	14:59:45	1	status: ENABLED file: YYJLOAD_?
SYSTEM_001	24Apr92	10:06:29	200	1 GHz Timing Analyzer V05.0!
SYSTEM_032	24Apr92	10:06:21	1696	100MHz State/500MHz Time V05.0!
YYJLOAD_B			268	status: ENABLED file: 500T_?

LIF Disk Space(blocks) - Total: 3060 Free: 895 Largest: 778

### LIF or DOS Format Selection

---

**CAUTION**

---

**BEFORE YOU CONTINUE**, be sure you are in the **FLEXIBLE DISK** menu. Since you can format both the flexible and hard disks, you always should be sure as to which disk menu you are in.

---

**CAUTION**

---

Once the format operation is executed, all files are permanently erased from the disk being formatted. This includes the **HARD DISK**. There is no way to retrieve the original information from a formatted disk.

4 Select the **Execute** field, then select **Continue**.

## Storing Files on a Disk

The Store operation allows you to store instrument configurations and measurement data. Use this operation when you want to save the present analyzer setup for recalling at a later time. When configurations are stored to disk, you are given the option to store System only, module only, or All (System and module).

- 1 If you are storing to a flexible disk, insert the destination disk into the flexible disk drive.
- 2 Select the **Store** operation.

When the Store selection is made, the analyzer reads the disk directory and displays a list of all files on the disk.

- 3 Select the **File type** field.

File type field

The screenshot shows a terminal window titled "File type field". At the top, there are three buttons: "System", "Flexible Disk", and "Print". Below these, there is a "Store" button (highlighted), a dropdown menu set to "All", and a "to file" field containing "SYSTEM\_001". Below that, the "file description" is "1 GHz Timing Analyzer V05.01" and the "file type" is "001@16500A". An "Execute" button is on the right. A table lists files on the disk:

LIF Filename	Date	Time	Blocks	File Description
AUTLOAD	24Feb93	14:59:45	1	status: ENABLED file: VYJLGAD_?
SYSTEM_001	24Apr92	10:06:29	200	1 GHz Timing Analyzer V05.01
SYSTEM_032	24Apr92	10:06:21	1696	100MHz State/500MHz Time V05.01
VYJLOAD_B			268	status: ENABLED file: BGOT_?

At the bottom, a status bar shows: "LIF Disk Space(blocks) - Total: 3060 Free: 895 Largest: 778".

### File Type Parameter Field

- 4 From the pop-up that appears, select the desired file type.

The **System** choice loads interface (RS-232C and HP-IB) and intermodule configurations, and defaults from the Utilities menu.

The **Module** choice loads measurement module configurations and data.

The **All** choice loads both System and module configurations and data files.



- 5 If you are storing to a new name, select the "to file" field and type in the new name.

The filename must start with a letter and may contain up to eight characters. It can be any combination of letters and numbers, but there can be no blank spaces between any of the characters.

If you are storing to an existing file name, simply turn the knob to scroll existing file names through the field.

The screenshot shows a menu with buttons for "System", "Flexible Disk", and "Print". The "Store" button is highlighted. Below it, there are fields for "All", "to file" (containing "SYSTEM\_001"), "file description" (containing "1 GHz Timing Analyzer V05.01"), and "file type" (containing "001@16500A"). An "Execute" button is also present.

LIF Filename	Date	Time	Blocks	File Description
AUTOLOAD	24Feb93	14:59:45	1	status: ENABLED file: VVJLOAD_?
SYSTEM_001	24Apr92	10:06:29	200	1 GHz Timing Analyzer V05.01
SYSTEM_032	24Apr92	10:06:21	1696	100MHz State/500MHz Time V05.01
VVJLOAD.B			268	status: ENABLED file: BOOT_?

At the bottom of the menu, it displays: LIF Disk Space(blocks) - Total: 3060 Free: 895 Largest: 778

to file: field

### File Name Field

When performing disk operations, the path and disk capacity information located at the bottom of the menu will be helpful.

### DOS Formats

**PWD** is the present working directory from which the files are contained.

**Total:** is the total memory capacity (bytes) of the flexible or hard disk.

**Free:** is the total memory capacity (bytes) remaining.

### LIF Formats

**Total:** is the total memory capacity (blocks) of the flexible disk.

**Free:** is the total memory capacity (blocks) remaining.

**Largest:** is the size of the largest block remaining.

- 6 Select the "file description" field and using the pop-up keypad, type in a description of the file.

A file description can contain up to 32 characters, but also can be left blank. This field is for your convenience to make it easier for identifying the type of data in each file.

File description:  
field

The screenshot shows a file management interface with the following elements:

- Buttons: System, Flexible Disk, Print
- Buttons: Store, All, to file, SYSTEM\_001
- File description field: 1 GHz Timing Analyzer V05.01
- File type field: 001@16500A
- Execute button
- Table header: LIF Filename Data Time Blocks File Description
- Table content:

LIF Filename	Data	Time	Blocks	File Description
AUTOLOAD	24Feb93	14:59:45	1	status: ENABLED file: YYJLOAD_?
SYSTEM_001	24Apr92	10:06:29	200	1 GHz Timing Analyzer V05.01
SYSTEM_032	24Apr92	10:06:21	1696	100MHz State/500MHz Time V05.01
YYJLOAD_B			268	status: ENABLED file: BOOT_?
- Footer: LIF Disk Space(blocks) - Total: 3060 Free: 695 Largest: 776

### File Description Field

## Renaming a File

The Rename operation allows you to give a new name to a previously stored file. The only restriction is that you cannot rename a file to an already existing filename.

- 1 Select the **Rename** operation.
- 2 Turn the knob until the file name you want to rename is scrolled into the file field.

File field

Type field

System    Hard Disk    Print

**Rename**    file: SYSTEM\_0    type: 004@16500A

to:    file type: 004@16500A    Execute

DOS Filename	Date	Time	Bytes	File Description
SYSTEM	14Nov82	0:23:06	0	DIRECTORY
SYSTEM_0	23Feb93	10:25:56	236288	4 GHz Timing Analyzer    V05.u6

PWD: \

DOS Disk Space(bytes) - Total: 85037056    Free: 71094272

### File Field

- 3 Select the file **Type** field. From the pop-up that appears, select the desired type selection.

The **All** selection allows you to rename both the system and module types.

The **Module** selection allows only the module file type to be renamed.

4 Select the new file name field.

New file name field

System Hard Disk Print

Rename file SYSTEM\_0 type 004@16500A

to **NEW\_NAME** file type: 004@16500A Execute

DOS Filename	Date	Time	Bytes	File Description
SYSTEM	14Nov82	0:23:06	0	DIRECTORY
SYSTEM_0	23Feb93	10:25:56	236288	4 GHz Timing Analyzer V05.uG

PWD: \

DOS Disk Space(bytes) - Total: 85037056 Free: 71294976

**New File name Field**

5 Using the pop-up keypad, type in the new filename, then select **Done**.

## Autoloading a File

The Autoload operation allows you to designate a set of configuration files to be loaded automatically the next time the instrument is turned on. This allows you to change the default configuration of certain menus to a configuration that better fits your needs.

- 1 Select the **Autoload** operation.
- 2 Select the **Enable/Disable** field then select **Enable**.
- 3 Turn the knob until the file name you want to autoload is scrolled into the file name parameter field.

Enable/Disable field

DOS Filename	Date	Time	Bytes	File Description
SYSTEM	14Nov82	0:23:06	0	DIRECTORY
SYSTEM_0	23Feb93	10:25:56	236268	4 GHz Timing Analyzer V05.u6

PWD: \  
DOS Disk Space(bytes) - Total: 65037056 Free: 71094272

### Autoload File name Parameter Field

#### 4 Select the **Execute** field.

An autoload file is created and placed at the top of the list of files. The file description contains the file name to be autoloaded and indicates whether or not the Autoload operation is enabled.

System Flexible Disk Print

Autoload **Enable** File : AUTOLOAD

Current AUTOLOAD status : ENABLED  
Current AUTOLOAD file : YYJJLOAD\_?  
file type: autoload\_file Execute

LIF Filename Date Time Blocks File Description

AUTOLOAD	24Feb93	14:59:45	1	status: ENABLED file: YYJJLOAD_?
SYSTEM_091	24Apr92	10:06:29	200	1 GHz Timing Analyzer V05.01
SYSTEM_032	24Apr92	10:06:21	1696	100MHz State/500MHz Time V05.01
YYJJLOAD_B			268	status: ENABLED file: BOOT_?

LIF Disk Space(blocks) - Total: 3060 Free: 895 Largest: 776

File name parameter field

#### **Autoload File name Field**

The Autoload operation loads all files for a given file name. If you want to load only the file for a type, rename that file to separate it from the other files and enable it as the current Autoload file.

As long as Autoload is enabled before the instrument is shut off, Autoload will remain enabled when you powerup the instrument and load the configuration files.

## Purging a File

The Purge operation allows you to delete a file from the list of file names. The file type can be either the Module type or All type.

- 1 Select the **Purge** operation.
- 2 Turn the knob to scroll the file name to be purged into the "file" field.

System Hard Disk Print

Purge file SYSTEM\_0 type 004@16500A

file type: 004@16500A Execute

DOS Filename	Date	Time	Bytes	File Description
SYSTEM	14Nov82	0:23:06	0	DIRECTORY
SYSTEM_0	23Feb93	10:25:56	236288	4 GHz Timing Analyzer 905.u6

PHD: \  
DOS Disk Space(bytes) - Total: 85037056 Free: 71286784

### File Field

- 3 Select the file "type" field, then select the file type to purge. The **All** selection allows you to purge both the system and module types. The **Module** selection allows only the analyzer type to be purged.
- 4 Select the **Execute** field, then select **Continue**.

---

## Copying a File

The Copy operation allows you to make a duplicate copy of an existing file on the same disk or a different disk. If you copy the file to the same disk, the only restriction is that you must give the copied file a new name. You can specify to copy **All** types or just the **Module** part of a file.

- 1 Select the **Copy** operation.
- 2 Turn the knob until the file name you want to copy is scrolled into the "file" field.

File field

Type field

System    Hard Disk    Print

**Copy**    file SYSTEM\_0    type 004@16500A    to

on Flexible Disk    file type: 004@16500A    Execute

DOS Filename	Date	Time	Bytes	File Description
SYSTEM	14Nov92	0:23:06	0	DIRECTORY
SYSTEM_0	23Feb93	10:25:56	236266	4 GHz Timing Analyzer V05.u6

PWD: \

DOS Disk Space(bytes) - Total: 85037056 Free: 71094272

### Copy Filename Parameter Field

- 3 Select the "type" field, then select the desired file type.

The **All** selection allows you to copy both the system and module parts of a configuration file set.

The **Module** selection allows only the module part to be copied.



4 Select the new file name field, then from the pop-up keypad that appears, enter the new file name in one of two ways:

- If you want to keep the old name, simply select **CLEAR**, then the **DONE** field from the keypad. The old name is transferred automatically.
- If you want a new name, type in the new name, then select **DONE**.

New file name field

DDS Filename	Date	Time	Bytes	File Description
SYSTEM	14Nov82	0:23:06	0	DIRECTORY
SYSTEM_0	23Feb93	10:25:56	236288	4 GHz Timing Analyzer V05.uG

PHD: \ DOS Disk Space(bytes) - Total: 85037056 Free: 71286784

**New filename Field**

5 Select the **Execute** field.

## Packing a Disk

By purging files from the disk and adding other files, you may end up with blank areas on the disk (between files) that are too small for the new files you are creating. On LIF disks, the Pack Disk operation packs the current files together, removing unused areas from between the files so that more space is available for files at the end of the disk.

- 1 Select the **Pack Disk** operation.
- 2 Select the **Execute** field, then select **Continue**.

DOS Filename	Date	Time	Bytes	File Description
SYSTEM	14Nov82	0:23:06	0	DIRECTORY
SYSTEM_0	23Feb93	10:25:56	236266	4 GHz Timing Analyzer V05.uG

PWD: \\  
DOS Disk Space(bytes) - Total: 85037056 Free: 71286784

### Pack Disk Operation

---

## Duplicating a Disk

The Duplicate Disk operation copies the volume labels and directories from one disk to another. If the new disk is not formatted, this operation also formats the disk. This operation allows you to make a backup copy of your important disks so you won't lose important data in the event that a disk wears out, is damaged, or a file is accidentally deleted.

- 1 Select the **Duplicate Disk** operation.
- 2 Select the **Execute** field, then select **Continue**.

DOS Filename	Date	Time	Bytes	File Description
SYSTEM	14Nov82	0:23:06	0	DIRECTORY
SYSTEM_0	23Feb93	10:25:56	236268	4 GHz Timing Analyzer V05.uG

PWD: \  
DOS Disk Space(bytes) - Total: 85037056 Free: 71094272

### The Duplicate Disk Operation

- 3 When "Insert DESTINATION disk" appears, insert the destination disk into the disk drive. When "Insert SOURCE disk" appears, remove the destination disk and reinstall the source disk.

The number of times you need to change the disks depends on whether you have a double-density or high-density disk. Simply follow the instructions and select Continue to continue.

---

#### CAUTION

The original directory and files on the destination disk are destroyed by the **Duplicate Disk** operation.

---

## Making a Directory

- 1 Select the **Make Directory** operation.
- 2 Select the directory name field and using the pop-up keypad or keyboard, type in the new directory name.
- 3 Select **Execute**, then select **Continue**.

System	Hard Disk	Print		
<b>Make Directory</b>	directory name	SYSTEM		
	file type: directory	Execute		
DOS Filename	Date	Time	Bytes	File Description
SYSTEM	14Nov82	0:23:06	0	DIRECTORY
SYSTEM_0	23Feb93	10:25:56	236288	4 GHz Timing Analyzer V05.u6
PHD: \				
DOS Disk Space(bytes) - Total: 85037056 Free: 71286764				

### Make Directory

---

## Changing the Directory

- 1 Select the **Change Directory** operation.
- 2 Select the directory name field. Using the pop-up keypad or keyboard, type in the new directory name.
- 3 Select **Execute**.

System Hard Disk Print

Change Directory directory name SVSTEN

file type: directory Execute

DOS Filename	Date	Time	Bytes	File Description
SVSTEN	14Nov82	0:23:06	0	DIRECTORY
SVSTEN_0	23Feb93	10:25:56	236268	4 GHz Timing Analyzer V05.UG

PWD: \

DOS Disk Space(bytes) - Total: 85037056 Free: 71286784

### Change Directory

When performing disk operations, the path and disk capacity information located at the bottom of the menu will be helpful.

### DOS Formats

**PWD:** is the present working directory from which the files are contained.

**Total:** is the total memory capacity (bytes) of the flexible or hard disk.

**Free:** is the total memory capacity (bytes) remaining.

### LIF Formats

**Total:** is the total memory capacity (blocks) of the flexible disk.

**Free:** is the total memory capacity (blocks) remaining.

**Largest:** is the size of the largest block remaining.

---

## Creating a System Flexible Disk

### Location of the System Files

When the logic analysis system is configured at Hewlett-Packard with the appropriate modules, the system files for the mainframe and individual modules were loaded onto the hard disk drive in the subdirectory called "SYSTEM". It is recommended that if new modules are added or any system file revisions occur, they be loaded onto the hard disk drive in this subdirectory.

However, if you want system files on a flexible disk, use the appropriate disk operations, such as store or copy, to store all required system files on a flexible disk.

### What Files are Required on a System Disk?

A system disk consists of the software required to operate the mainframe and each module in the system. For the mainframe, this is the file SYSTEM\_ of the file type 16500B\_system. For the individual modules, it is the file SYS\_XXX of the file type XXXXXX\_system. The three characters (XXX) in the filename represent the identification code for each individual module. The six characters (XXXXXX) in the file type represent the product model number for each module.

### What is a system performance verification disk?

A system performance verification disk is a disk that contains all the performance verification software required to run the performance verification tests for the HP 16500B Logic Analysis System and the corresponding modules configured in the system. This composite disk is found in each software pouch. For more information on the performance verification tests, refer to the *HP 16500B Service Guide*.

All system performance verification files are stored on the hard disk in the /SYSTEM subdirectory.



The System  
Utilities Menu

# The System Utilities Menu

The System Utilities menu is one of the menus within the System module. The menu is used for turning the sound on and off, recalibrating the touchscreen, setting the clock, and changing the default instrument colors.

## Accessing the System Utilities Menu

In the upper-left corner of the screen are two fields that indicate which module, and which menu within that module you are in.

If the Module field in the upper-left corner doesn't display System, select this field and when the pop-up appears, select **System**. This will bring up one of the System menus.

Once in the System module, if the Menu field doesn't display Utilities, select this field. When the pop-up appears, select **Utilities** to bring up the System Utilities menu.

Layout of the System Utilities Menu:

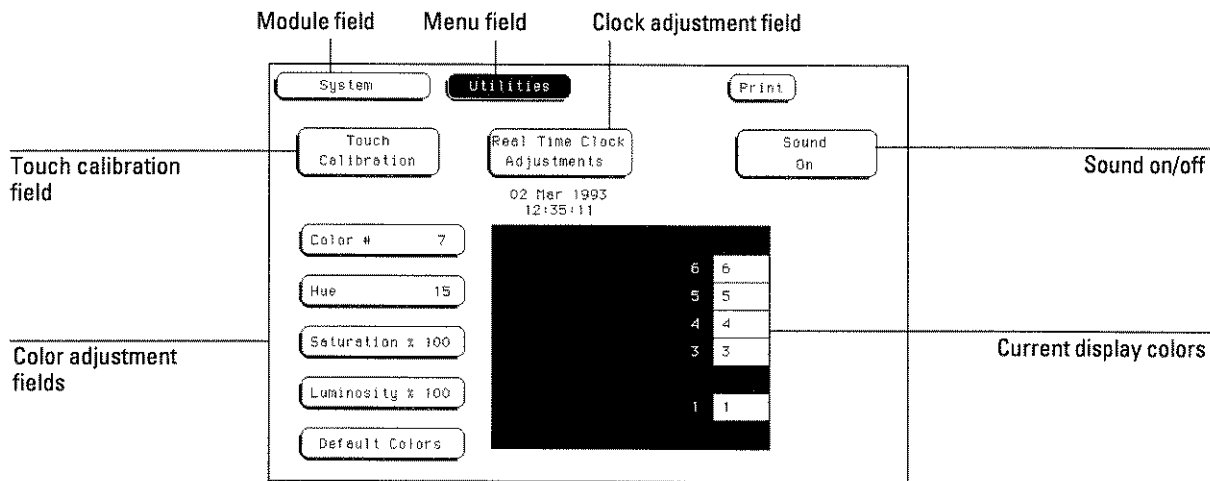

The System Utilities Menu



## Menu Map

The following menu map illustrates all fields and available options in the Utilities menu. The menu map will help you get an overview as well as provide you with a quick reference of what the Utilities menu contains.

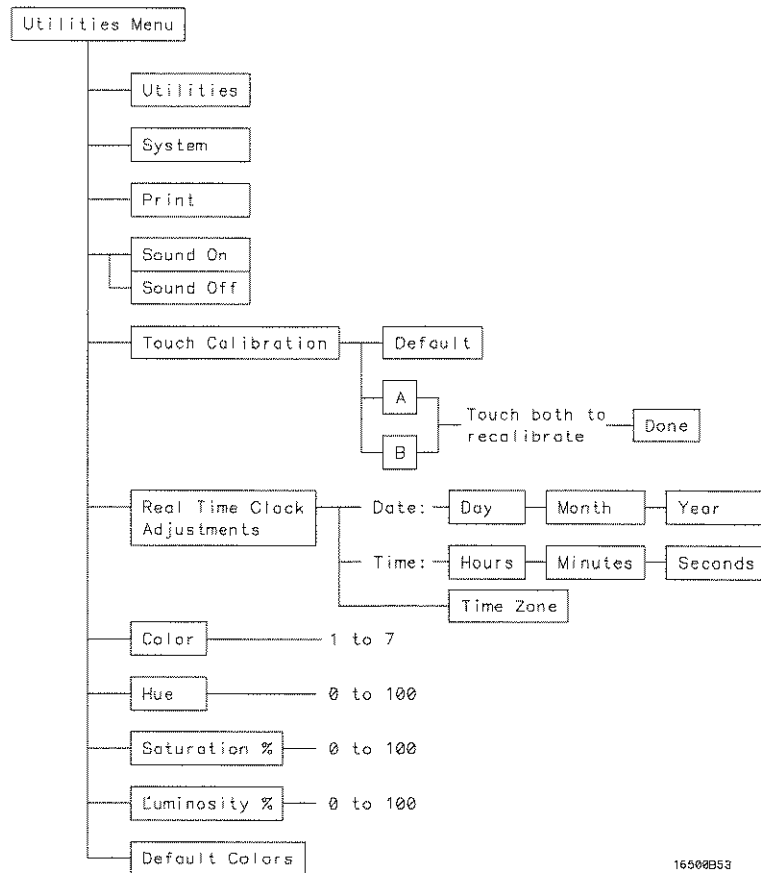

16500B53

## System Utilities Menu Map

This section covers the Touch and Sound fields of the System Utilities menu. These fields allow you to recalibrate the touchscreen for better line-of-sight use and turn on and off the sound of the instrument.

## Touch Calibration

It is unnecessary to periodically calibrate the touchscreen. Touch calibration just allows you to reset the touchscreen to your needs and compensate for parallax from different viewing angles.

The Touch Calibration field in the upper-left corner of the display brings up the pop-up for adjusting the touchscreen calibration to your own line of sight and to the angle at which you touch the screen.

Touch Calibration field

The screenshot shows a menu with three tabs: 'System', 'Utilities', and 'Print'. The 'Utilities' tab is active. Under 'Utilities', there are three options: 'Touch Calibration' (highlighted in black), 'Reel Time Clock Adjustments', and 'Sound On'. Below the 'Touch Calibration' option, the date and time '02 Mar 1993 12:38:04' are displayed. To the left of a large black square are five input fields: 'Color # 7', 'Hue 15', 'Saturation % 100', 'Luminosity % 100', and 'Default Colors'. To the right of the black square is a vertical column of five small input fields, each containing the number '6', '5', '4', '3', and '1' from top to bottom.

### Selecting Touch Calibration

The default calibration is acceptable for most uses, but to change the calibration do the following:

- 1 Select the **Touch Calibration** field.
- 2 Select the **A** field as accurately as possible.
- 3 Select the **B** field as accurately as possible.

Recalibration is done immediately after you touch A or B. The point at which you remove your finger from A or B determines where you place your finger to activate subsequent fields.

- 4 Select **Done** when you are finished.

To return to the default Touch calibration, select the **Touch Calibration** field and when the pop-up appears, select the **Default** field. This returns the instrument to its default touchscreen calibration. Select **Done** when you are finished.

At power-up, touch returns to the default calibration, unless a customized HP 16500B configuration file is loaded as part of an autoload sequence.

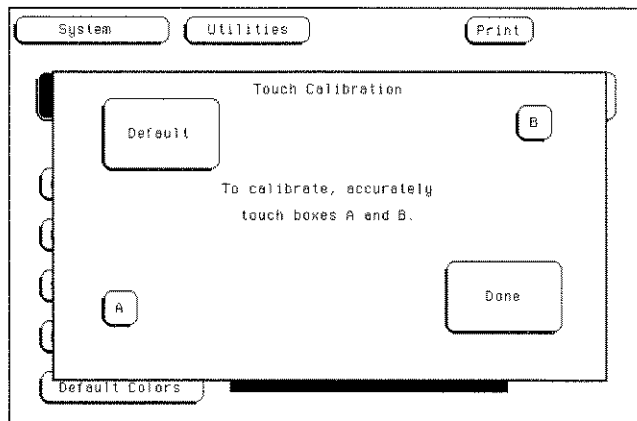

#### Touch Calibration Pop-up

#### Touch On/Off

To turn the Touch function off, press the **Touch Disable** button on the front panel.

---

## Setting the Real-time Clock

For documentation purposes, a real-time clock readout appears in the display menus. To adjust the real-time clock, simply select the **Real Time Clock Adjustments** field, then select the date or time element desired from the pop-up menu shown below. Use the knob to set numbers and the keyboard or touchscreen to select the correct month. When you are finished, select **Done**.

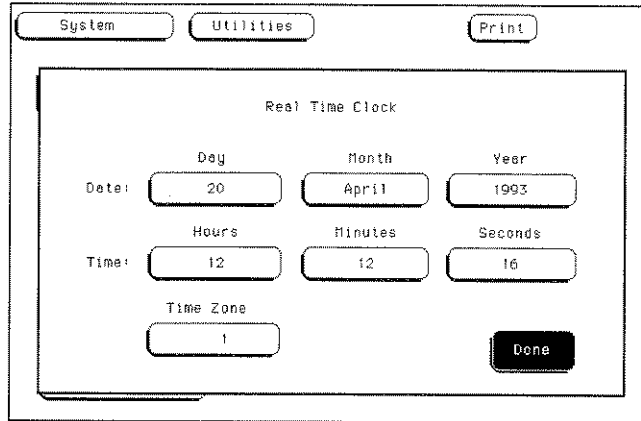

The image shows a screenshot of a 'Real Time Clock' adjustment pop-up menu. At the top, there are three buttons: 'System', 'Utilities', and 'Print'. The main content area is titled 'Real Time Clock' and contains several input fields:

- Date:** Three fields for 'Day', 'Month', and 'Year'. The values are '20', 'April', and '1993' respectively.
- Time:** Three fields for 'Hours', 'Minutes', and 'Seconds'. The values are '12', '12', and '16' respectively.
- Time Zone:** A single field with the value '1'.
- A **Done** button is located at the bottom right of the pop-up.

**Real-time Clock Pop-up**

---

## Turning the Sound On/Off

In the upper-right corner, below the Print field, is the Sound On field. This field is used to turn the instrument's sound on and off. These include the clicks you hear when you select fields on the menus and the beeps you hear on error messages.

To turn off the sound, select **Sound On** and it changes to **Sound Off**, shutting off the sound. To turn them on again, select Sound Off and it changes back to Sound On, turning the sound on again.

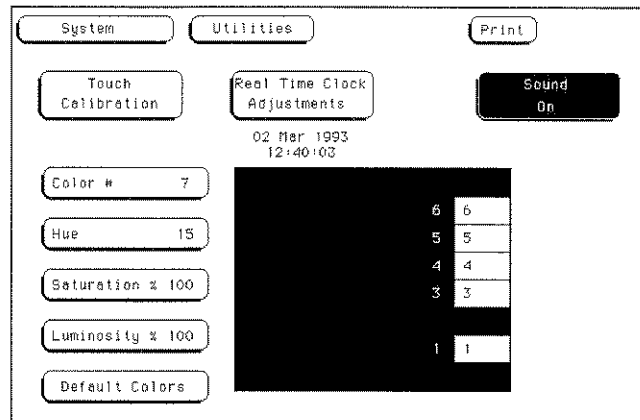

**The Sound On Field**

In the HP 16500B, color saves time and prevents errors by clarifying the display, making it easier to distinguish one major area from another.

The color selection feature of the HP 16500B allows you to customize display colors, which improves contrast and lessens eye fatigue caused by your operating environment. If you are color-blind to certain colors, are operating in a difficult light environment, or don't like the default colors, you can quickly and easily change them.

### **The Color Model**

The HP 16500B uses the HSL color model (Hue, Saturation, and Luminosity). This model is very effective for interactive color selection. Similar in concept to the method used by artists for mixing paints, pure hues are selected, and then white and black are mixed to dilute the color or darken it.

- Hue is the pure color. 0 is red, 33 green, and 67 blue. The selection ranges from 0 to 100.
- Saturation is the ratio of the pure color mixed with white (0 to 100%)
- Luminosity is the brightness per unit area (0 to 100%).

The figure on the next page shows a cylindrical representation of the HSL model (Hue, Saturation, and Luminosity). Hue is the angular coordinate, Saturation is the radial coordinate, and Luminosity is the altitude above the polar coordinate plane.

The cylinder rests on a black plane (Luminosity = 0%) and extends upward. As you increase in altitude, you increase luminosity, which represents an increase in brightness. Whenever luminosity is zero, the values of saturation and hue do not matter. Zero luminosity is black, and 100% luminosity gives you the pure color.

White is the center of the top of the cylinder (Luminosity = 100%, Saturation = 0%). The center line of the cylinder (Saturation = 0%) is a line which connects the center of the black plane (Luminosity = 0%, Saturation = 0%) with white (Luminosity = 100%, Saturation = 0%) through a series of gray steps (Luminosity from 0% to 100%, Saturation = 0%). Whenever saturation is 0%, the value of hue does not matter. Zero saturation is white, and 100% saturation gives you the pure color. The outer edge of the cylinder (Saturation = 100%) represents the fully saturated color.

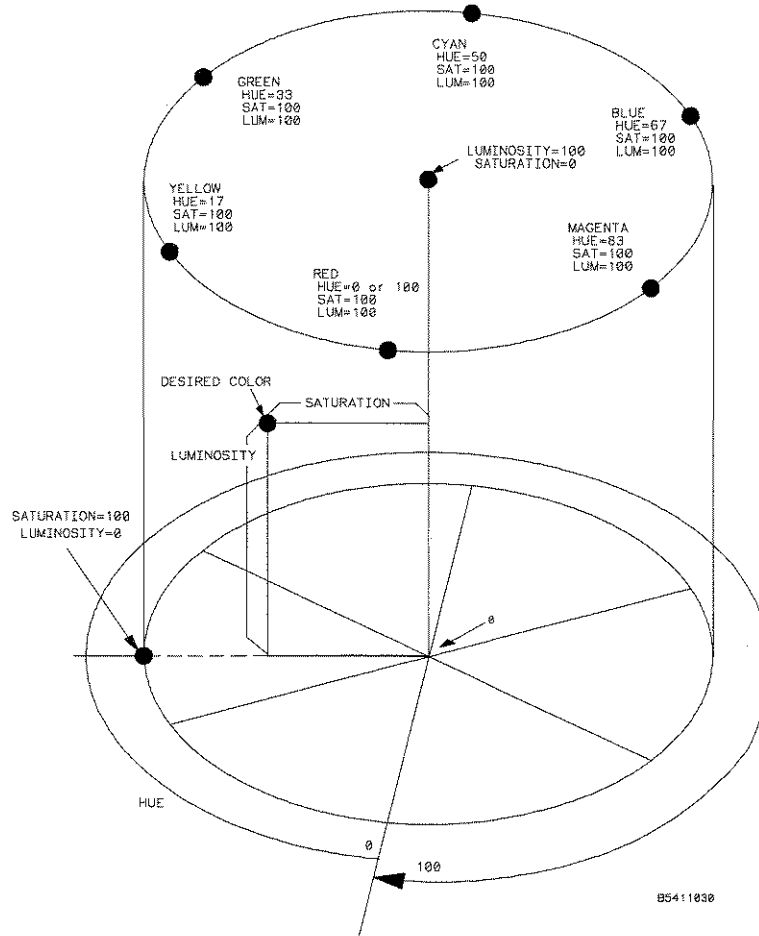

**The Color Model**

---

## Selecting the Color, Hue, Saturation, and Luminosity Fields

To select the Color, Hue, Saturation, or Luminosity fields, see if the field you want has a different background than the other fields (light blue for the default colors). If it already has a different background, rotate the knob to change the value in that field. Otherwise, select the field once and its background will change color, indicating that it has been selected. Then rotate the knob to change the value. If you look at the large field in the center of the display, you can see how the knob affects the color.

If you know the value you want in a particular field, see if that field has a different background than the other fields (light blue for the default colors). If it already has a different background, select this field and a pop-up keypad will appear. Otherwise, select the field once to select it and a second time to bring up the pop-up keypad. Then enter the value you want with the keypad and select Done. The pop-up will disappear, placing your new value in the appropriate field and changing the color.

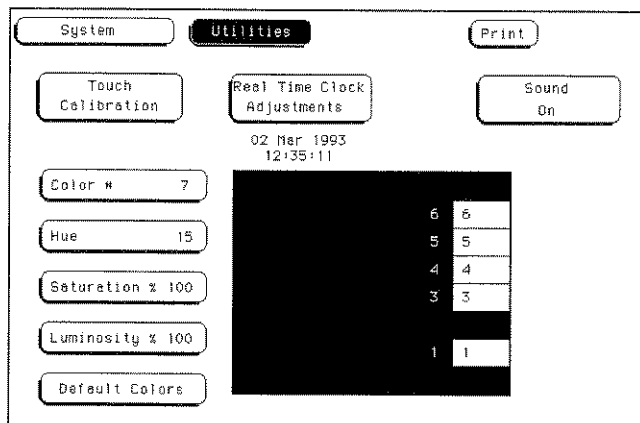

### Color Selection



**Example**

Use the knob to change the value of Hue to 45.

- 1 Select the **Hue** field once.
- 2 When the background of the **Hue** field changes color (light blue for default colors), turn the knob to change the value for **Hue** to 45. You can see how the knob affects the color in the large field at the center of the display.

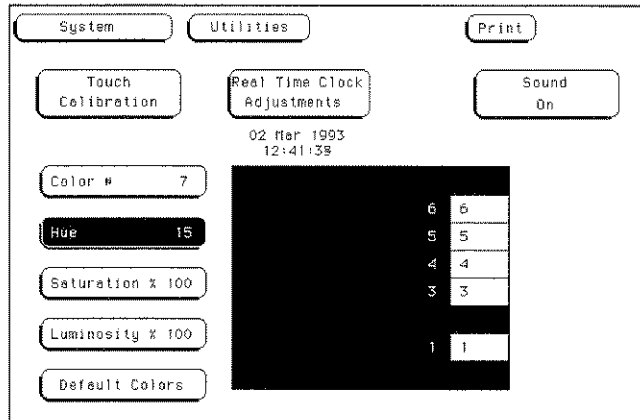

**Changing the Value for Hue**

---

**Example**

Use the pop-up keypad to change the value of Luminosity to 65.

- 1 Select the **Luminosity** field once and its background changes color (light blue for default colors).
- 2 Select the **Luminosity** field a second time and a pop-up keypad appears.
- 3 Enter 65 with the keypad and notice that your value appears in the box at the top of the keypad.
- 4 When you are finished, select **Done** and the pop-up keypad will disappear, placing your value in the appropriate field and changing the color.

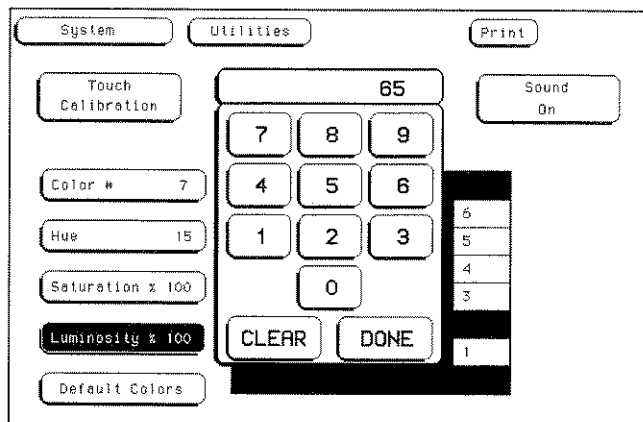

**Changing the Value for Luminosity**

---

## Selecting Colors

Once the Color field has been selected, you can select any one of seven variable display colors by rotating the knob on the front panel. The Color field displays your choice (1 through 7). The large field to the right of the Color field displays the color you are working with, and the small numbered fields within this large field display the other colors available. The table on the next page lists the display colors for the HP 16500B.

The screen may be turned off when using an external controller by setting the Luminosity of each color to zero.

## HP 16500B Display Colors

Color	Default Color	Hue	Saturation	Luminosity	Uses
1	Tan	13	43%	76%	Main background color for the display
2	White	0	0%	100%	Light text and timing waveforms on certain modules
3	Dark Blue	60	100%	60%	For touch items (touch-sensitive fields)
4	Light Blue	60	45%	90%	For selected items, items that the knob is assigned to, limited background use, and certain display channels on the oscilloscope module
5	Green	33	100%	75%	For the Run field, advisory fields, the X marker on certain modules, certain display channels for the oscilloscope module, and miscellaneous other uses
6	Red	0	100%	100	For the Stop field, error fields, the Cancel Print field, the trigger point, and certain display channels on the oscilloscope module
7	Yellow	15	100%	100%	For warning or advisory fields, the O marker on certain modules, certain display channels on the oscilloscope module, and miscellaneous other uses
0*	Black	—	—	0%	For dark text, background, and waveform areas

\* Color "0" is a non-variable color.

---

## Returning to the Default Colors

The Default Colors field, below the Luminosity field, allows you to return to the default colors simply by selecting that field. These default colors are listed in the table on the previous page.



---

# Intermodule Measurements

---

---

# Intermodule Measurements

The HP 16500B can be configured with several different modules inside the instrument at one time. The Intermodule menu allows you to make interactive measurements between these modules. As an example, you would use the acquisition capabilities of one module to look at a signal, while using the triggering capabilities of another module to properly trigger the measurement.

When modules are configured in the Intermodule menu, you also have the capability to display the resulting waveforms and state listings from several modules together in the same display menu.

The basic functions of the Intermodule menu are:

- Configure modules to run simultaneously or in an arming sequence between modules.
- Synchronize with external equipment.
- Adjust skew between modules.

## Configuring Arming Sequences

You select modules to run either independently or within an intermodule configuration. As you make module selections, a configuration tree begins to form. In addition, an arming order forms dependent on the order in which you select the modules.

Within the configuration tree, modules that are connected directly to the large **Group Run** field are armed immediately after a **Group Run** is executed. Modules that appear connected below other modules are armed when the preceding module finds its trigger.

## Synchronizing with External Equipment

Once a module is added to the configuration tree, the PORT OUT signal can be added beneath that module or any other module, which sends an arming signal out to a BNC connector on the rear panel.

The PORT IN signal can be selected to arm the intermodule configuration in conjunction with the Group Run/Stop field. You can qualify the PORT IN signal by defining level and edge criteria.

## Adjusting Skew between Modules

You can modify the skew or timing deviation between the modules within the intermodule measurement. This allows you to compensate for any known delay of the system under test or compare two signals by removing any displayed skew between the signals.

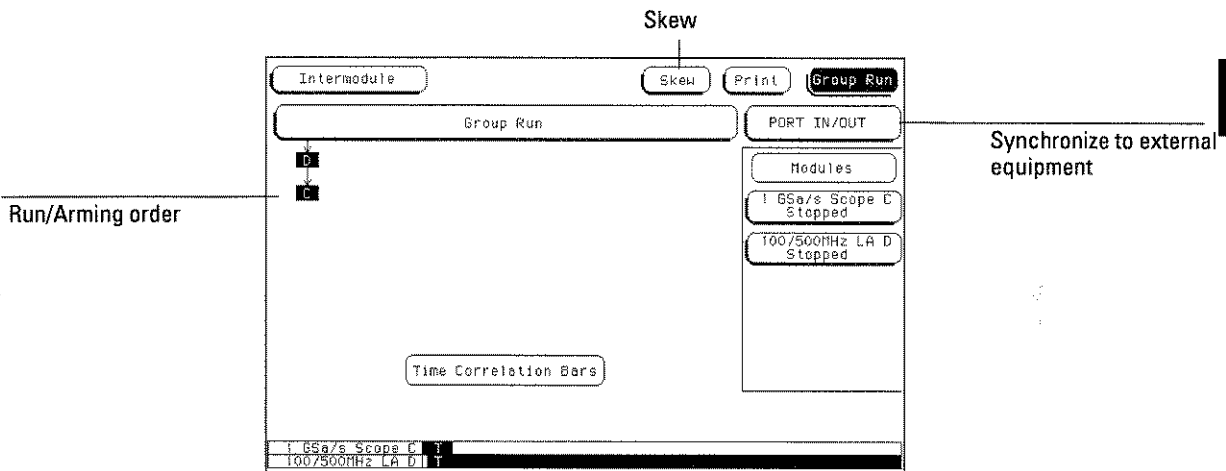

The Intermodule Menu

## Menu Map

The following menu map illustrates all fields and available options in the Intermodule menu. The menu map will help you get an overview as well as provide you with a quick reference of what the Intermodule menu contains.

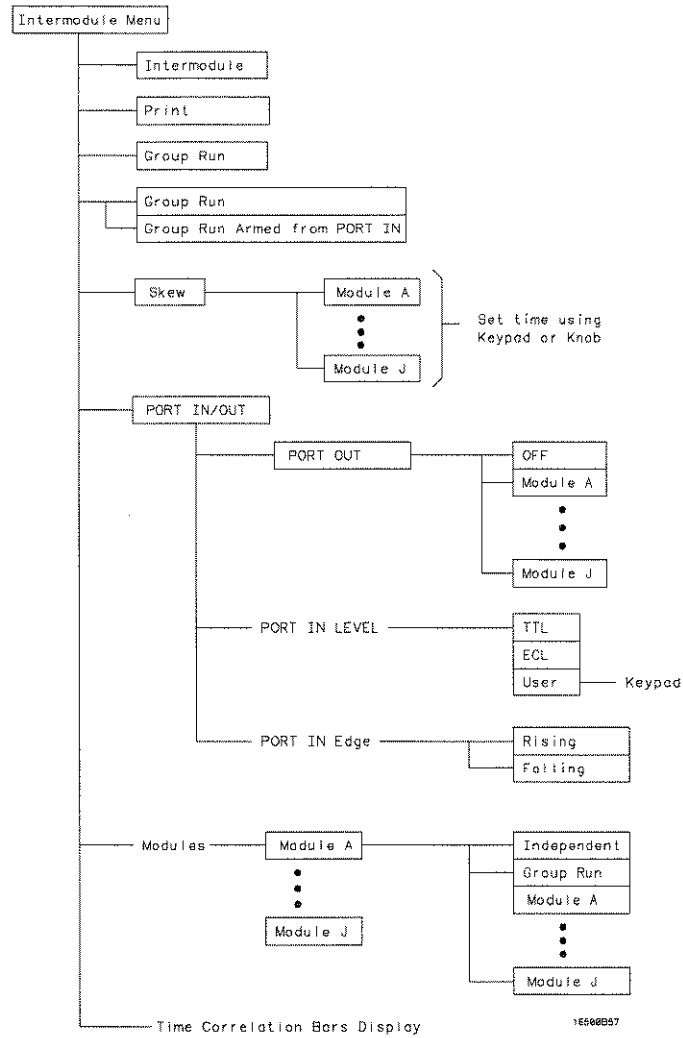

### Intermodule Menu Map



---

## Accessing the Intermodule Menu

To bring up the Intermodule menu, select the module field in the upper-left corner of any menu. When the selection pop-up appears, select the **Intermodule** field to bring up the Intermodule menu.

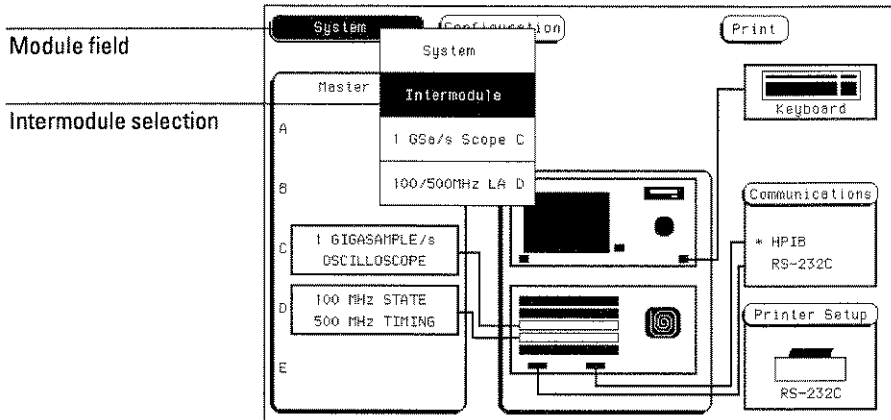

### Accessing the Intermodule Menu

With only one measurement module loaded into the system, intermodule measurements are not possible, so, the Intermodule menu is not available. If you have an HP 16501A Expansion Frame connected, modules loaded into the expansion frame are available for an intermodule measurement.

## Configuring a Group Run

When the **Group Run** field is selected, it toggles between two choices which sets how the intermodule measurement is armed.

**Group Run** This selection starts the intermodule measurement when you select the Group Run field in any of the module menus. This field is also the Run field, but when you have an intermodule measurement configured, the Run field changes to Group Run. You still have the choice to run the group in Single or Repetitive acquisition mode.

### Group Run Armed from PORT IN

This selection starts the intermodule measurement when an external trigger source, matching the trigger level and edge requirements you set, is seen at the PORT IN BNC connector on the rear panel.

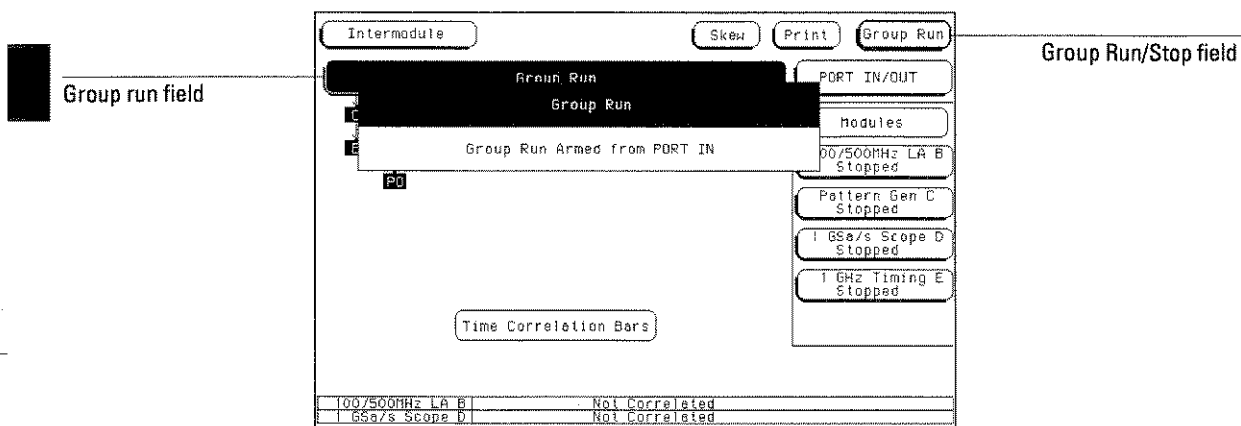

### Group Run Field

## Example

The following example illustrates what happens when you execute a Group Run. For this example we use the intermodule configuration shown in the figure below.

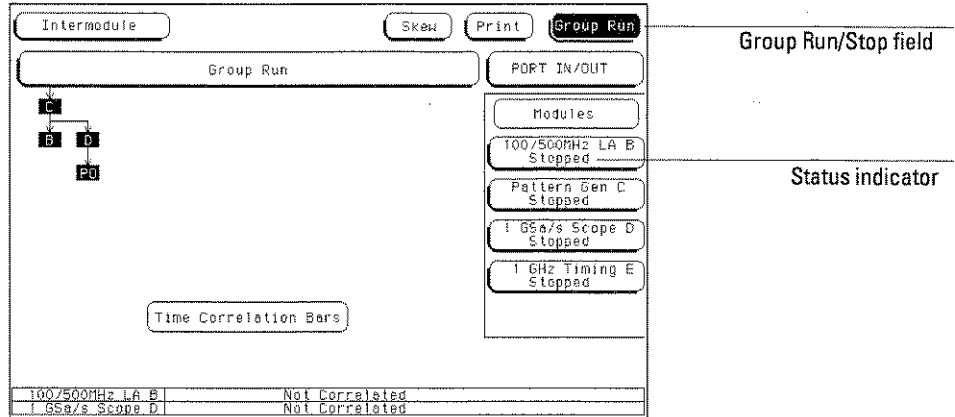

When you select the **Group Run** field, the following events occur:

- 1 The status indicator of each module involved changes from **Stopped** to **Running**.
- 2 The prestore and trigger qualification status of module B (analyzer) and module D (oscilloscope) is checked.
- 3 When prestore and trigger qualification of modules B and D are met, module C is armed and its appropriate measurement is run.
- 4 Module C triggers, and simultaneously arms modules B and D.
- 5 Module D triggers, and sends a signal to an external device through "PO" (PORT OUT).
- 6 The status of each module changes to **Stopped** when the module finishes its operations. After all the modules are finished, the data is displayed in the individual display menus of the modules.

If the modules are time correlated, the time correlation bars at the bottom of the menu display the start and stop acquisition window of each module relative to the other modules.

---

## Configuring Port In/Out

The PORT IN/OUT field accesses a configuration menu which is used to configure which module an external arming signal (PORT OUT) is sent from. Also, from this menu you define voltage level and edge criteria that must be matched by any incoming arming signal (PORT IN) before the intermodule measurement can begin. The PORT IN/OUT field is shown below.

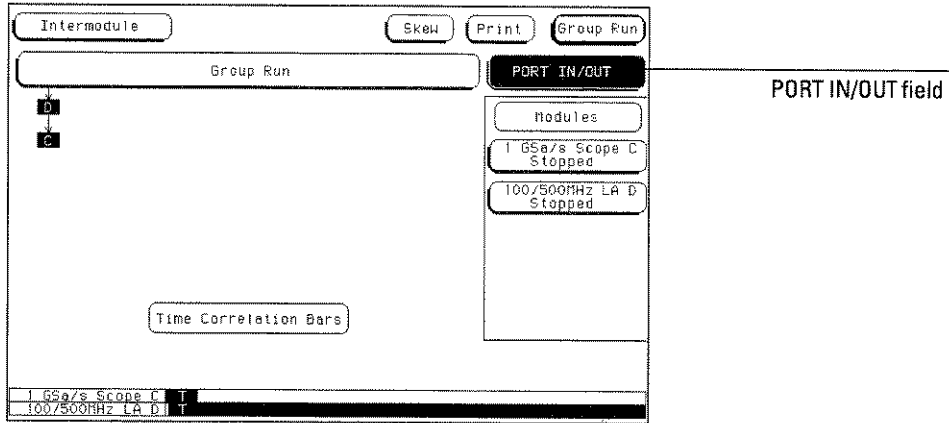

### PORT IN/OUT Field

#### PORT OUT

PORT OUT is used to enable an external device from another module in the intermodule configuration tree. To configure a PORT OUT signal, do the following:

- 1 Select the **PORT IN/OUT** field above the module field, then select the **PORT OUT** field from the PORT IN/OUT Setup menu that appears.
- 2 From the selection list choose the module you want the signal to come from.

The selection list will contain the names of all the modules configured in the group run. A "PO" indicator will appear in the configuration tree originating from the module you select.

The PORT OUT signal is a positive-going TTL pulse whose width varies depending on the module that is driving it. The port may be terminated by a 50  $\Omega$  load to reduce ringing, however, the signal will then be less than or equal to 0.4 V when low and at least 2.0 V when high.

### PORT IN

With a trigger signal connected to the PORT IN BNC on the rear panel, the intermodule measurement can be started with this signal after preset voltage and edge criteria is met. To configure a PORT IN signal, do the following:

- 1 Select the **PORT IN Level** field and set the level to TTL, ECL, or a User defined level between +5 V and -4 V.
- 2 Select the **PORT IN Edge** field and toggle the edge type to either Rising or Falling.
- 3 After the PORT IN voltage level and edge criteria is set, select the **Group Run/Stop** field. The analyzer will wait until the proper signal is seen at the PORT IN BNC before the measurement begins.

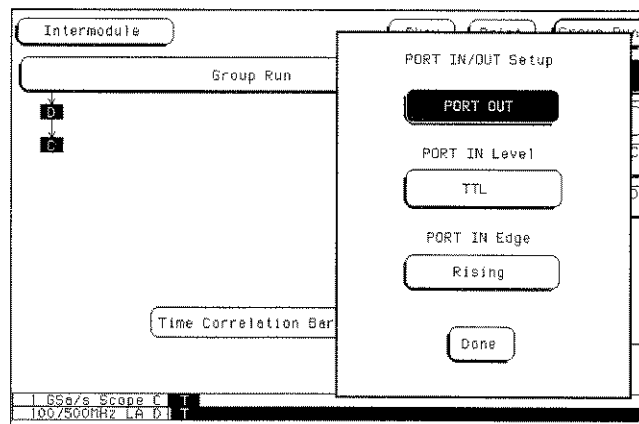

### PORT IN/OUT Setup Menu

Only the HP 16500B has the PORT IN BNC. However, the PORT IN signal is available to modules in both the HP 16500B and HP 16501A frames.

When using PORT IN, an external device must be connected to the PORT IN BNC on the rear panel. If an external device isn't connected, or is accidentally disconnected, the instrument will not trigger.

## The Group Run/Stop Field

When a module is added to the intermodule configuration tree, that module's Run/Stop field changes to the Group Run/Stop field. A Group Run/Stop field is also available in the Intermodule menu. This field starts an acquisition just like any individual module's Group Run/Stop field. When an acquisition is started in the intermodule menu, you can monitor the results with the Running/Stopped status indicators and time-correlation bars.

When you select the **Group Run/Stop** field, a pop-up appears with two choices for acquiring data.

- Single, which is the default, allows you to run the measurement once.
- Repetitive allows you to run the measurement as many times as you want to collect data for statistical measurements, etc. Press **Stop** when you want to stop a repetitive run.

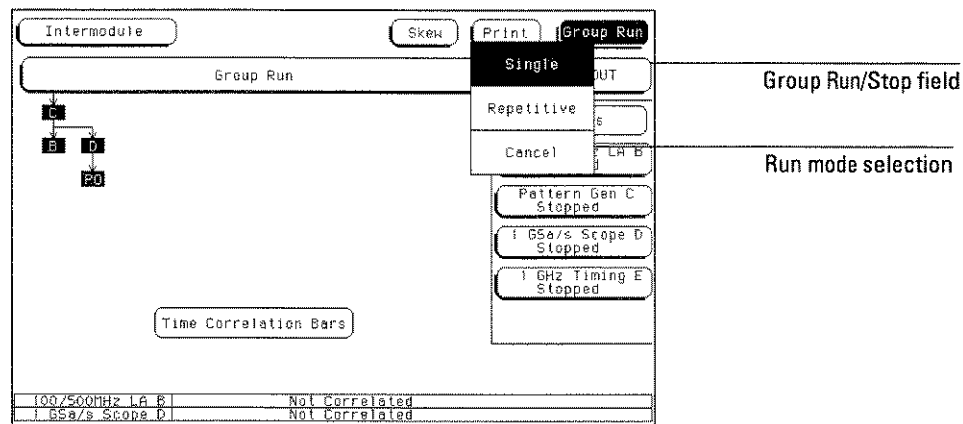

**Group Run/Stop Field**

## The Modules List

On the right side of the screen are fields listing the different modules that can be configured in the Intermodule menu. When you select one of the module fields, a pop-up appears displaying the possible locations of the module in the intermodule configuration tree.

- Independent allows the module to run independently of the other modules and removes it from the intermodule configuration tree.
- Group Run places the module directly below the large Group Run Configuration field. This module is armed immediately after the Group Run/Stop field is touched.
- The other fields in the pop-up list the name of the modules that are already part of the intermodule configuration tree, and can be used to arm this module. Selecting one of these fields places the current module below the module indicated by the field you selected. The current module is then armed when the preceding module finds its trigger.

After you make your selection, a box appears in the intermodule configuration tree with the module's slot location (A through E for the HP 16500B alone, or A through J for the HP 16500B with the HP 16501A attached) representing the location of the module in the tree.

The screenshot shows the 'Intermodule' configuration interface. On the left is a tree view with a 'Group Run' node containing sub-nodes 'C', 'B', 'D', and 'PG'. A 'Time Correlation Bars' button is below the tree. A central pop-up menu is open, showing options: 'Independent', 'Group Run', '100/500MHz LA B', 'Pattern Gen C', and '1 GSa/s Scope D'. To the right is a 'PORT IN/OUT' section with a 'Modules' list containing: '100/500MHz LA B Stopped', 'Pattern Gen C Stopped', '1 GSa/s Scope D Stopped', and '1 GHz Timing E' (which is highlighted). At the bottom, a table shows correlation status for the selected modules.

100/500MHz LA B	Not Correlated
1 GSa/s Scope D	Not Correlated

### The Module Pop-up Menu

## Status Indicators and Time Correlation Bars

The message "Running" or "Stopped" appears below the names of the individual modules that are listed on the right side of the Intermodule menu. This indicates the current status for each module and can be used to monitor the intermodule measurement. If there is a problem with the measurement, a quick check of these status indicators can show you which modules have completed their operations (Stopped) and which ones are still Running. Generally:

- If a module was running and is stopped now, you can assume it received its arming signal and triggered properly.
- If a module located below a stopped module on the intermodule configuration tree has received an arming signal and is still running, it is still looking to satisfy its trigger specification.
- If a module below a running module on the intermodule configuration tree has not received its arming signal, it will not begin running.

The time correlation bars at the bottom of the menu display the start and stop time of each module relative to the other modules.

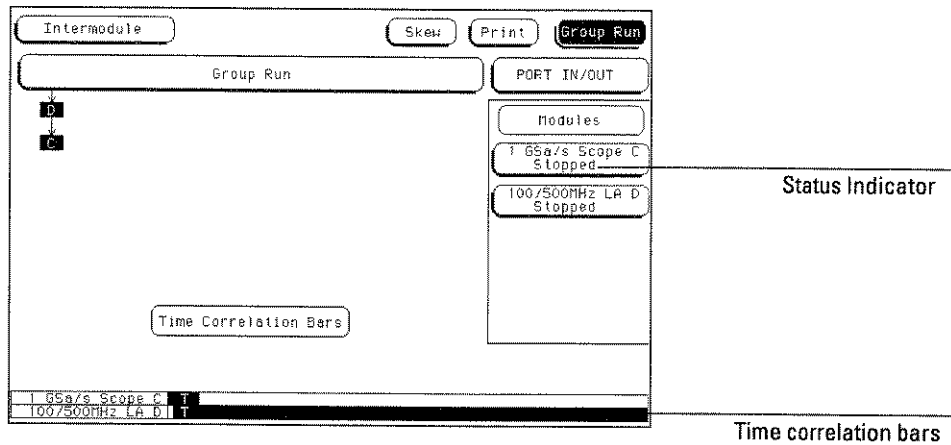

Status Indicators/Time Correlation Bars



## Adjusting Skew

Selecting the Skew field brings up the Intermodule Skew menu.

The Intermodule Skew menu is used to skew waveforms or state listings between modules on the display. This allows for display adjustment to within 2 ns between modules. The major purpose of this adjustment is to compensate for variances in internal probing delays across modules.

To adjust the skew of the module, select the individual module within the Skew menu and add or subtract a known time value. This value may be calculated with the markers by measuring the skew between some common signal sampled by both modules.

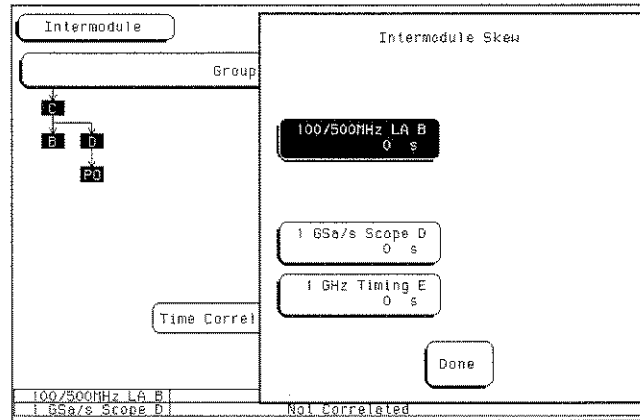

**The Skew Pop-up**

---

## What Are Some Typical Intermodule Measurements?

Intermodule measurements may be as simple as starting several modules at once, or very complex with multiple arming sequences between modules and external equipment. Some examples are:

---

### Example

#### Analyzing a Glitch

A glitch is defined as two or more transitions between the samples of a timing analyzer that cross the logic threshold. A timing analyzer can trigger on a glitch and capture it, but doesn't have the voltage or timing resolution to look at the glitch in detail. On the other hand, an oscilloscope can acquire waveforms with a great deal of resolution, but it can't trigger on glitches, combinations of glitches, or patterns.

To analyze a glitch, use a timing analyzer and an oscilloscope interactively. Set up the timing analyzer to trigger on a glitch and when the timing analyzer triggers, capture the glitch with the oscilloscope. Then use the oscilloscope to look at the waveform parameters of the glitch, including its width, shape, and amplitude.

For this intermodule measurement, you are using the triggering capabilities of the timing analyzer and the acquisition capabilities of the oscilloscope.

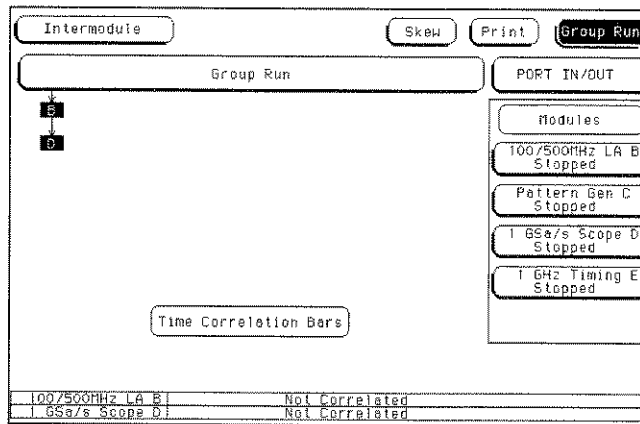

#### Glitch Example

---

**Example****Analyzing Interrupt Handling in a CPU System**

Most microprocessor programs can be interrupted by an asynchronous hardware signal. Software designers are interested in the processor's real-time response to interrupts. In particular, you need to answer these kinds of questions:

- Does the processor branch to the proper interrupt handling routine?
- Are registers and status information saved properly?
- How long does it take to service the interrupt?
- Is the interrupt acknowledged properly?
- After the interrupt is serviced, does the processor restore registers and status information and continue with the previous routine as expected?

Usually, software designers want to look at the program flow of the microprocessor system around an asynchronous event.

A state analyzer, coupled with a preprocessor and an inverse assembler, is useful for tracing the flow of a microprocessor program. A timing analyzer or an oscilloscope is designed to trigger on asynchronous events like edges.

In this example, use an oscilloscope with a sample rate faster than the microprocessor clock to trigger on the asynchronous event and to arm the state analyzer. Then use the state analyzer to check the address of the interrupt routine. You may also use the state analyzer to see if the microprocessor is properly servicing interrupts and returning to the correct address after each interrupt routine.

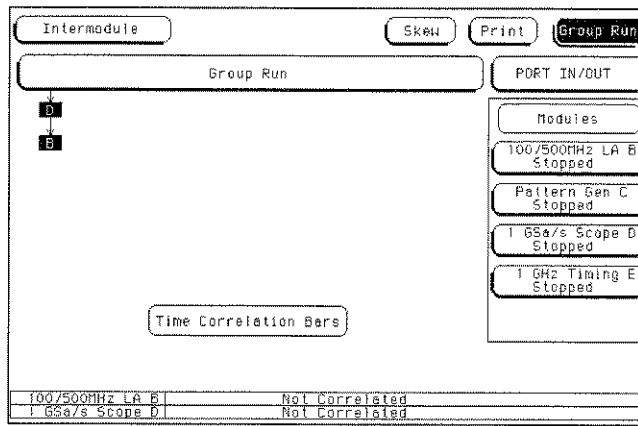

### Interrupt Handling Example

Set up the oscilloscope to trigger on the asynchronous interrupt line. This is usually an edge-sensitive line on which the oscilloscope can trigger.

The state analyzer should be armed by the oscilloscope. Set the state analyzer to trigger on all "don't cares" and it will capture the interrupt service routine when the arm signal is received. For this intermodule measurement, arming the state analyzer with the oscilloscope allows a software designer to track the flow of a microprocessor program around a hardware interrupt.

### Example

#### A Simple Stimulus/Response System

During system development, designers are often faced with verifying a part of a design when the input signals for that part are unavailable. Here are some common examples of this problem:

- Verifying hardware operation when a part of the hardware is unavailable to drive the circuit.
- Testing a PC board without a board test system.

The traditional solution is to use word generators to emulate the missing part of the design, and to use logic analyzers and oscilloscopes to capture the system response.

Unfortunately, designers are often faced with an awkward solution of stacking several boxes on top of each other, with a maze of cables tying them together, and a different interface for each instrument.

The pattern generator in the HP 16500B can act as the stack of word generators in this problem. State, timing, and analog modules can all be used to capture the response of the system.

The pattern generator is loaded with the proper patterns and when it starts sending patterns, it sends an arm signal over the intermodule bus.

The acquisition modules are armed from the pattern generator module and set to trigger on the appropriate event in the system.

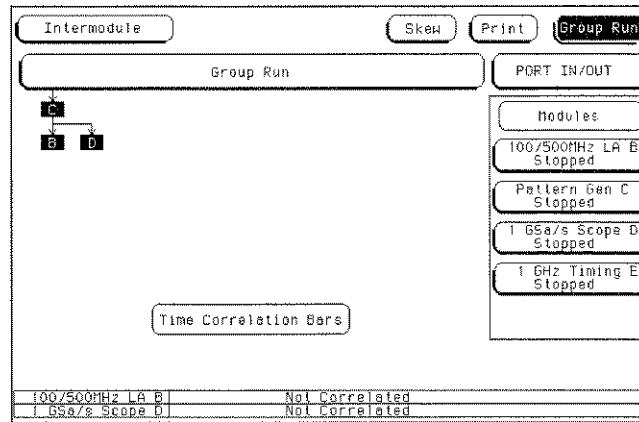

#### Stimulus/Response Example

## Displaying Multiple Module Data on One Screen

When you are making intermodule measurements, you can display the resulting waveforms or state listings for several modules together on one screen. For example, to display waveform data for an oscilloscope and a timing analyzer on an oscilloscope menu, the procedure below may be followed. You may not have the exact same configuration of modules, however, the procedure steps will be similar.

- 1 Select the module field in the upper-left corner of the screen.
- 2 When the pop-up appears, select the HP 16532A **Oscilloscope** module.
- 3 When the oscilloscope menu appears, select the menu in which you want to view the data (for this example, **Auto-Measure**).
- 4 Select the **channel label** field to the left of the waveform display once to scroll the waveforms. Select this field again to access the display parameters.

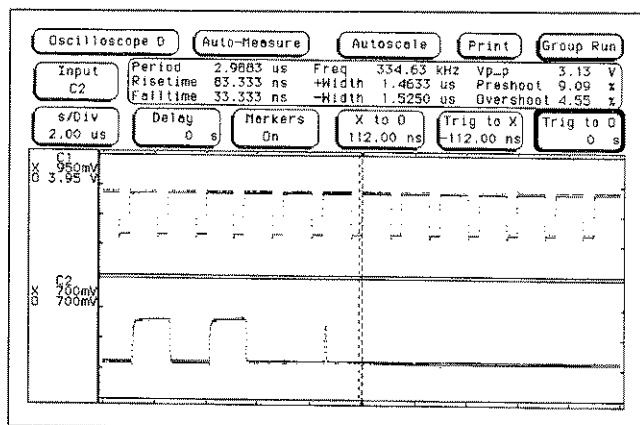

Selecting the Waveform Selection Pop-up

- 5 When the **Waveform Selection** pop-up appears, select the field displaying **Module Oscilloscope D**.
- 6 When the pop-up appears, select **State/Timing E**. After the pop-up disappears, the appropriate labels for the channels of the HP 16550A State/Timing Analyzer will be listed under the State/Timing E field.

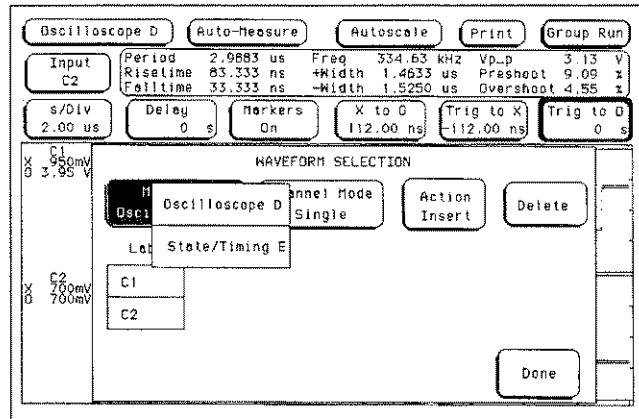

**Selecting State/Timing E**

- 7 Select the labels for the channels that you want displayed. For this example, select **OUT\_4**.

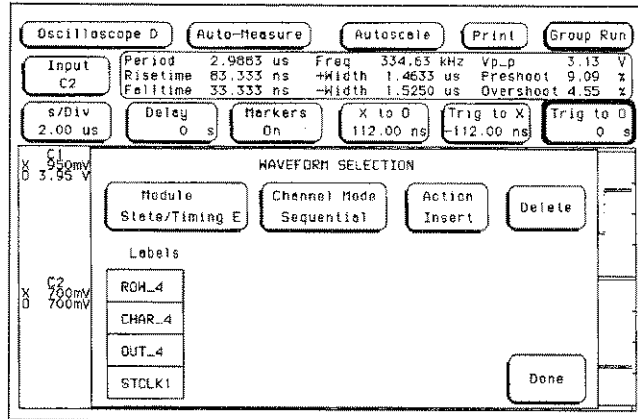

#### Selecting HP 16510B Channels

- 8 Select **Done** and the Waveform Selection pop-up will disappear, returning you to the waveform display. As shown in the figure below, the five HP 16550A timing analyzer channels (**OUT\_4**) are now displayed with the HP 16532A oscilloscope channels C1 and C2 on the Oscilloscope D Auto-Measure menu.

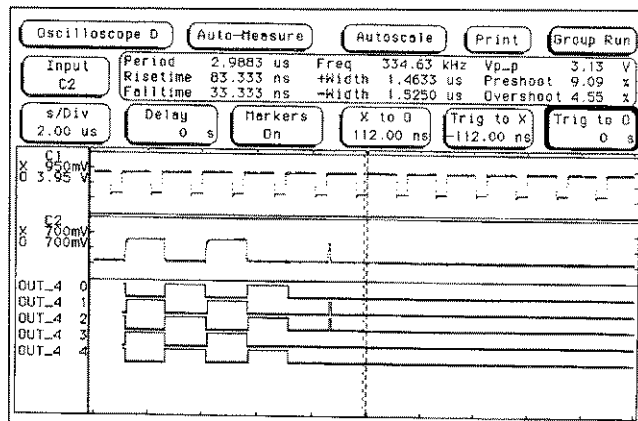

#### Displaying Multiple Module Data on One Screen



---

## Helpful Hints

- When setting up measurements, start with simple setups and work up to more complex ones. For example, set up the module that will trigger first and take a measurement with only this module. Once you've verified that this first trigger works properly, start adding additional modules to be armed by this trigger.
- Before starting the measurement, setup a simple trigger condition, then set all modules to store data while they search for the trigger condition. This way, you can see information on both sides of the trigger condition as you fine-tune the measurement.
- For complex triggering between modules, initially set the modules that are armed from the intermodule bus to trigger on all "don't cares" or to "trigger immediately." Then increase the triggering requirements in stages by starting with the first modules that are armed and working from the top to the bottom of the intermodule configuration tree.





General  
Characteristics

# General Characteristics

This chapter describes the general characteristics of the HP 16500B/16501A Logic Analysis System, including hardcopy capability, the input/output rear panel BNCs, and information about making interactive measurements. This chapter also includes the weight and dimensions of the HP 16500B/16501A, and information about the operating environment necessary to ensure optimum equipment performance.

---

## Characteristics

These characteristics are not specifications, but are included as additional information. The following characteristics are typical for the HP 16500B/16501A system.

### Hard Disk Drive

**Capacity** 85 Mbyte unformatted; Formatted as a Microsoft<sup>®</sup> DOS disk drive IDE Interface Bus

### Flexible Disk Drive

**Capacity** 1.44 Mbyte formatted, Microsoft DOS or LIF supported.

### Programmability

Instrument settings and operating modes, including automatic measurements, may be remotely programmed via RS-232C, HP-IB (IEEE-488), or optional HP 16500L (Ethernet).

### Hardcopy Output

**Printers Supported** HP ThinkJet, HP QuietJet, HP LaserJet, HP PaintJet, HP Deskjet, HP Deskjet C, Epson and Epson-compatible (for example Epson FX-80) via RS-232C or HP-IB.

**RS-232C Configurations** Protocols: XON/XOFF, Hardware; Data bits: 8; Stop bits: 1, 1 1/2, 2; Parity: none, odd, or even; Baud rates: 110, 300, 600, 1200, 2400, 4800, 9600, 19200.

**HP-IB Interface Functions** SH1, AH1, T5, TE0, L3, LE0, SR1, RL1, PP1, DC1, DT1, C0 and E2.

**Input/Output  
Rear Panel BNCs:**

**Port-in** User selectable: TTL, ECL or user defined;  $Z_{in} = 4\text{ k}\Omega$  ;  
 $V_{in} = -4.0\text{ V}$  at 1.5 mA to +5 V at 1.6 mA.

**Port-out** Output signal is active high, TTL output level, high > 2 V into  
50  $\Omega$ , low < 0.4 V into 50  $\Omega$ .

**Intermodule Bus  
(IMB)  
Characteristics**

**Run Control** Oscilloscope, timing, state, and pattern generation can be  
armed by Group Run. Modules can run concurrently or be armed in  
series. Each module can arm one or more modules.

**Mixed Display Mode** Any timing or oscilloscope waveform displays  
can be mixed. State listings can be included with waveforms in the  
State/Timing Mixed Mode display.

**Acquiring Data for Mixed Displays** To obtain a mixed display,  
multiple modules must be armed through the IMB. To include state  
listings in mixed mode displays, state time tagging must be on.

**Time Interval Accuracy Between Modules** Equals the sum of the  
channel-to-channel time interval accuracies of each module used in the  
measurement, for a deskewed measurement.

**Time Correlation Resolution** 2 ns (500 MHz)

**Operating  
Environment**

**Temperature**

**Instrument** 0 °C to 50 °C (32 °F to 122 °F).

**Disk Media** 10 °C to 40 °C (50 °F to 104 °F).

**Probes and Cables** 0 °C to 65 °C (32 °F to 149 °F).

**Humidity**

**Instrument** up to 95% relative humidity at 40 °C (104 °F).

**Disk media and hard drive** 8% to 80% relative humidity at 40 °C  
(104 °F).

**Altitude** Up to 4600 m (15 000 ft). Hard drive to 300 m (10,000 ft).

**Vibration**

**Operating** Random vibration 5-500 Hz, 10 minutes per axis, 2.41 g (rms.)

**Nonoperating** Random vibration 5-500Hz, 10 minutes per axis, ~ 2.4 g (rms); and swept sine resonant search, 5-500Hz, 0.75g (0-peak), 5 minute dwell at 4 resonances per axis.

**Power** 115 V/230 V, 48-66 Hz, 475 W max.

**Weight**

**HP 16500B**

**Net** 18.1 kg (40 lbs) + (0.7 kg (1.6 lbs) x number of optional cards installed).

**Shipping** 25.9 kg (57 lbs) + (3.6 kg (8 lbs) x number of optional cards installed).

**HP 16501A**

**Net** 12.2 kg (27 lbs) + (0.7 kg (1.6 lbs) x number of optional cards installed).

**Power Requirements**

**HP 16500B** 115 V/230 V, 48 to 66 Hz, 475 W max.

**HP 16501A** 115 V/230 V, 48 to 66 Hz, 420 W max.

**Dimensions**

Refer to the following figure for dimensional detail.

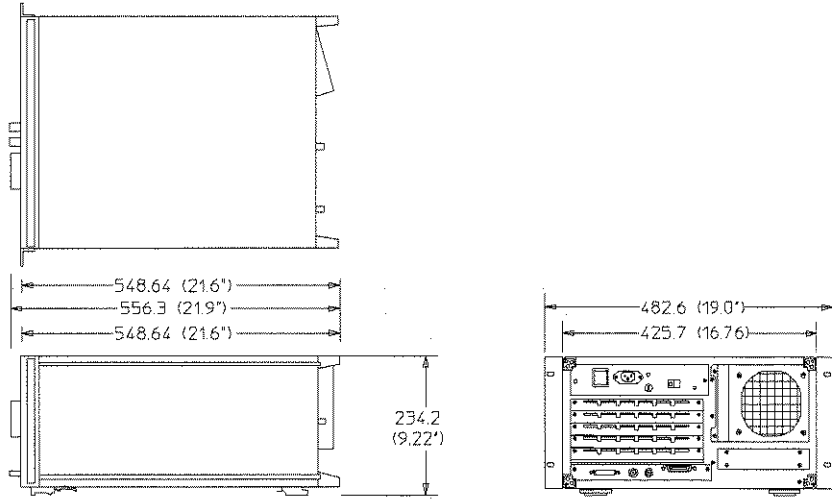

HP 16500B

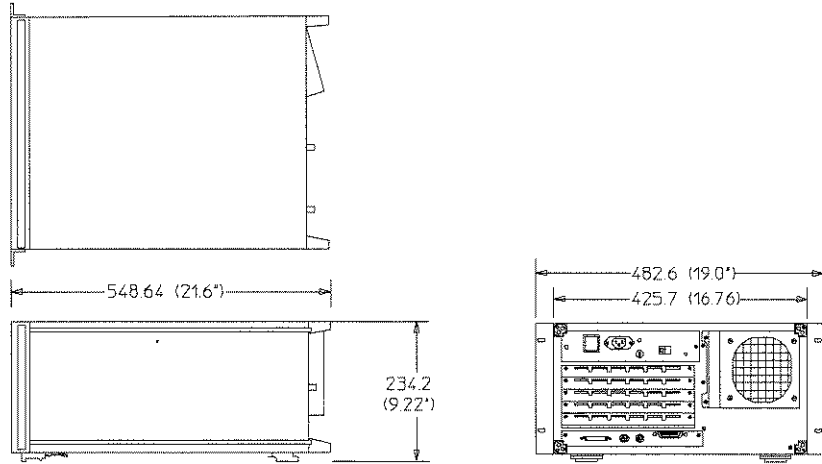

HP 16501A

16500E52

**Dimensional Detail**







Maintaining the  
HP 16500B



# Maintaining the HP 16500B

This chapter describes the maintenance requirements for the HP 16500B Logic Analysis System. It explains cleaning requirements and degaussing procedures, and tells you where to look for information when the instrument needs service or recalibration. It also explains how the System Test menu is used.

---

## Cleaning Requirements

When cleaning the HP 16500B, USE MILD SOAP AND WATER only. A harsh soap or solvent may damage the water-base paint finish.

Clean the CRT display and surrounding area regularly. DO NOT place tape or other foreign material on the screen.

Vacuum the ventilation slots on the sides of the instrument and the fan on the rear panel whenever there is a visible amount of dust on them.

---

## Degaussing

After you have used the instrument for a while, the CRT may become magnetized and start to distort the colors on the screen or other display data. To remedy this problem, simply degauss the CRT by pressing and releasing the button on the rear panel marked DEGAUSS. If the screen is in particularly bad condition, repeat this procedure several times until the screen clears up.

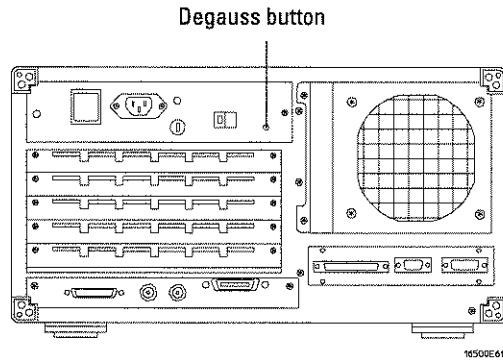

### The Degaussing Button

---

## Service and Calibration

If at any time the instrument fails to operate properly or needs to be adjusted, refer to the *HP 16500B Service Guide*.

---

## The System Test Menu

The System Test menu is used to test portions of the microprocessor board including the system peripheral interfaces and the disk drives. It also allows you to check the color module for color purity. For more information on this menu, refer to the *HP 16500B Service Guide*.

SLOT	Module Name	Code Version	Card ID Code
SYSTEM		V01.ag	
OPT 1			
OPT 2			
SLOT A			none
SLOT B			none
SLOT C			none
SLOT D			013
SLOT E			032

ROM Version: 01.ec System Memory: 8.0 MB

### Loading the Test System Software

SLOT	Module Name	Code Version	Card ID Code
SYSTEM		V01.ag	
OPT 1			
OPT 2			
SLOT A			none
SLOT B			none
SLOT C			none
SLOT D			013
SLOT E			032

ROM Version: 01.ec System Memory: 8.0 MB

### Reloading the Mainframe System

---

## Repackaging for Storage or Shipment

Proper repackaging is necessary to prevent damage to the HP 16500B. The instrument may be stored or shipped in environments within these limits:

### **Temperature**

40 to 70 degrees C (-40 to +158 ° F)

### **Humidity**

Up to 90% relative humidity at 65 ° C  
(149 ° F)

### **Altitude**

Up to 15,300 m (50,000 ft)

The instrument should also be protected from temperature extremes which could cause condensation within the instrument. Condensation within the instrument may cause it to malfunction.

### **Tagging the Instrument for Service**

If the instrument is to be shipped to a Hewlett-Packard office for service or repair, attach a tag with the owner's name and address, the model number, the complete serial number, and a description of the service required. In any correspondence, refer to the instrument by model number and serial number.

### **Repacking the Instrument**

Before repacking the instrument, insert a shipping disk into the flexible disk drive. The shipping disk helps protect the disk drive from damage during shipping.

If the original packing material is unavailable or unserviceable, material identical to factory packaging is available through Hewlett-Packard offices. Always mark the container **FRAGILE** to ensure careful handling.

If you use other packaging, follow these general instructions:

- 1** Wrap the instrument in heavy paper or plastic.
- 2** Use a strong shipping container. A double-wall carton made of 350-lb test material is adequate.
- 3** Protect the control panel with a piece of cardboard.
- 4** Put a layer of shock-absorbing material 70- to 100-mm (3- to 4-in.) thick around the instrument to firmly cushion it and prevent any movement inside the container.
- 5** Seal the shipping container securely.
- 6** Mark the container **FRAGILE** to ensure careful handling.



## Error Messages



# Error Messages

This chapter lists the disk error messages and disk warning messages you may receive while operating the disk menus in the HP 16500B/16501A Logic Analysis System. In addition, there is information on the powerup self tests errors.



---

## Disk Error Messages

The following is a list and description of error messages that may be displayed in the disk menus.

**Configuration not loadable** This module or option does not have the ability to load a configuration.

**Configuration not storable** This module or option does not have the ability to store a configuration.

**Destination disk has different capacity** The disk drive only permits the duplicate disk operation between floppy diskettes with the same capacity (double density or high density) and format (LIF or DOS).

**Directory contains files** You cannot purge a directory that contains files. Delete all files within the directory first, then purge the directory.

**Directories not supported on LIF disk** Directory operations may not be performed on LIF disks.

**Disk CRC error** Cyclical Redundancy Check (CRC) failed on this disk. Try to recover any needed files and reformat the disk. Formatting the disk may not correct the current problem. If it doesn't correct the problem, discard the disk.

**Disk data lost** Unable to read the disk. Try re-installing the disk or cycling the power.

**Disk is write-protected** The current disk is write-protected. Disengage the write-protect tab on the disk.

**Disk record not found** The disk format has been damaged. Recover any needed files and reformat the disk. Formatting the disk may not correct the current problem. If it doesn't correct the problem, discard the disk.

**Disk timeout** The disk drive may not be working properly or the media was removed while being accessed.

**Duplicate filename** A file with the same name already exists on the current disk. Select a different destination name.

**End of file encountered** Trying to read data beyond the end of the file. The file was generated improperly or its contents have been altered.

**File is being used** You cannot purge a file or directory that is being used by another operation. Operations may be initiated using the touch screen, controller, or ethernet. Finish the other operation and try your operation again.

**File not found** The specified file is not on the disk. Also, when copying a file, the directory that contains the destination file may not exist.

**Filename already exists** A file with the same name already exists on the current disk. Select a different destination name.

**Insufficient memory** There is not enough memory to perform the selected operation at this time. Reduce the number of operations being performed on the logic analyzer (using the touch screen, controller, or ethernet) and try the operation again.

**Invalid configuration file** The contents of this file are incorrect.

**Invalid file name** The file name is invalid for any of the following reasons. The name contains invalid characters for the disk format (LIF or DOS). The name is too long. The file name has spaces imbedded in the wrong places.

**Invalid file type for this operation** The current operation may not be performed with a file of the current type.

**No destination disk** No disk is currently installed in the destination disk drive.

**No disk** No disk is installed in the flexible disk drive.

**No room in directory** The directory on the disk is full. Purge any files no longer needed.

**No room on disk** The disk is full and the currently written file does not fit. Deleting unneeded files and/or packing the disk may correct the problem.

**Permission for this operation denied** The logic analyzer does not permit certain operations: duplicating the hard disk, formatting the hard disk in LIF format, or writing or purging a file that has its read-only attribute set.

**Selected file is incompatible** The file being loaded is incompatible for this module or option.

**Too many files open** The logic analyzer's maximum number of simultaneously open files has been exceeded. File operations may be initiated from the touch screen, the controller, or the ethernet. Reduce the number of file operations and try again.

**Unsupported disk format** The disk in the disk drive is unformatted or formatted on a non-compatible system. If the contents of the disk are NOT needed, format it.

**Wrong format on high density diskette** A high density (black) diskette has been formatted with a double density format. The logic analyzer cannot read this diskette.

---

## Disk Warning Messages

Disk warning messages are displayed when the contents of a file or a disk are in danger of being destroyed by an operation.

**Duplicate Disk destroys contents of destination** A warning that the duplicate disk command does not append the source files to the destination. It overwrites any files on the destination disk in a packed form.

**Filenames must begin with a capital letter** This warning indicates that the disk will not accept the filename as it has been entered. Retype the filename with a capital letter at the beginning.

**Embedded blanks not allowed in filename** This warning indicates that the disk will not accept the filename as it has been entered. Remove the blank spaces or replace them with an underscore character.

---

## Powerup Self-Test Documentation

When you turn on the HP 16500B it initiates a set of self-tests to check the basic condition of the instrument and the operating system. This is a limited set of tests that checks whether or not the CPU board is working well enough to boot the rest of the software from disk.

If a test fails, consult your *HP 16500B Service Guide*.

No self-test routines are performed for any modules at power-up. The following is a list of self tests performed.

© COPYRIGHT 1992 HEWLETT-PACKARD COMPANY HP 16500B V XX.XX

### PERFORMING POWERUP SELF TESTS

passed ROM Test  
passed RAM Test  
passed Interrupt Test  
passed Display Test  
passed HIL Controller Test  
passed Front Panel Test  
passed Touch Screen Test  
passed Correlator Test  
passed Hard Disk Test  
passed Flexible Disk Test

### LOADING SYSTEM FILES

### LOADING MODULE FILES

### LOADING SOFTWARE OPTIONS

### AUTOLOADING CONFIGURATION

---

## Fail Codes

The type of fail codes you might encounter are:

<b>Disk Test</b>	passed failed no disk - Install a disk or re-install the current disk.
<b>Touchscreen</b>	passed impaired - Not a complete touchscreen, but the instrument can still be operated; or the touch failed, but a mouse was detected on the interface loop. Try wiping the bezel on the display and cleaning the CRT. Make sure no objects are blocking the screen on power-up. failed - Not enough touchscreen to operate the instrument (major failure).
<b>All Others</b>	Passed or Failed

---

## Critical Errors

Critical errors are system load errors detected at power-up. When one of these is detected, they are displayed on the screen in yellow and the self-test routine is stopped IMMEDIATELY. These include:

**SYSTEM FILE NOT FOUND** Indicates the last drive searched for a system file had a disk, but no system file was found on the disk.

**SYSTEM DISK NOT FOUND** Indicates the last drive checked had no disk on it.

**SYSTEM FILE READ ERROR** Indicates an error was detected during all three attempts to load the system file.

**SYSTEM DISK ERROR** Indicates the drive that the system file was on failed during load.

---

## Non-Critical Errors

Non-critical errors allow sequences to continue and won't stop the power-up routine. These include "impaired" and "no disk."

**A**

Address, selecting, 3-4  
Autoload, 5-2  
  enabling, 5-17

**B**

Baud rate  
  defined, 3-5  
  setting, 3-5

**C**

Calibration, 9-3  
Cleaning instructions, 9-2  
Clock, setting, 6-6  
Color  
  for display, 6-12  
  returning to defaults, 6-14  
  selecting, 6-10  
Color model, 6-8  
Configuration tree, 7-18  
Controller interface, defined, 3-3  
Copy, 5-2, 5-20

**D**

Data bits  
  defined, 3-7  
  supported, 3-7  
Default configuration  
  defined, 1-4  
  storing, 1-4  
Degaussing, 9-3  
Description of analyzer, 1-2  
Disk drive  
  autoload a file, 5-17 to 5-18  
  copy a file, 5-20 to 5-21  
  duplicate a disk, 5-23  
  pack a disk, 5-22  
  purge a file, 5-19  
  select an operation, 5-7  
  store a file, 5-12 to 5-14  
Disk Drive Operations, 5-2  
Disk operations  
  autoload, 5-2, 5-17 to 5-18  
  change directory, 5-25  
  copy, 5-2, 5-20 to 5-21  
  default values, 5-8, 5-10, 5-12, 5-15  
  duplicate disk, 5-2, 5-23  
  format disk, 5-2, 5-10 to 5-11  
  load, 5-3, 5-8 to 5-9

  make directory, 5-24  
  pack disk, 5-3, 5-22  
  purge, 5-3, 5-19  
  rename, 5-3, 5-15 to 5-16  
  selecting, 5-7  
  store, 5-3, 5-12 to 5-14

**Disks**

  duplicating, 5-23  
  formatting, 5-10  
  packing, 5-22  
  storing files on, 5-12

**Display**

  multiple module data on one screen, 7-18  
  printing, 4-11  
  selecting color for, 6-12

**Duplicate disk, 5-2, 5-23****E**

Environment  
  storage, 9-5  
Epson printers, 4-3

**F**

File identification code, 5-26  
File types, 5-15  
Files  
  copying, 5-20  
  identification code, 5-26  
  loading, 5-8  
  purging, 5-19  
  renaming, 5-15  
  storing, 5-12

Format a disk, 5-10 to 5-11

Format disk, 5-2, 5-10

Formatting, 5-10 to 5-11

**G**

Group Run  
  for HP 16500B, 7-6  
Group Run/Stop  
  repetitive, 7-10  
  using, 7-10

**H**

HP 16500A  
  defined, 1-2  
  key features, 1-3  
  optional features, 1-3

  tagging for service, 9-5

HP 16500B

  repacking, 9-6

HP 16501A

  defined, 1-2

HP-IB interface

  configuring, 3-8

  defined, 3-4

  Listen Always, 3-8

  selecting an address, 3-4

HP-IB printers

  configuration, 4-4

  Listen Always, 4-3 to 4-4

  setup, 4-3

  supported, 4-3

Hue

  defined, 6-8

  selecting, 6-10

**I**

Intermodule measurements

  accessing, 7-18

  analyzing a glitch, 7-14

  analyzing interrupt handling, 7-15

  helpful hints, 7-21

  simple stimulus/response, 7-16

Intermodule menu

  accessing, 7-5

  configuring, 7-18

  described, 7-2

  menu map, 7-4

**K**

Key analyzer features, 1-3

Knob

  use of, 1-4

**L**

Listen Always, 3-8, 4-3 to 4-4

Load, 5-3, 5-8

Logic Analysis System

  defined, 1-2

  maintenance, 9-2

Luminosity

  defined, 6-8

  selecting, 6-10

---

**M**

Maintenance  
  calibration, 9-3  
  cleaning requirements, 9-2  
  degaussing, 9-3  
Menu maps  
  disk menu, 5-4  
Modules  
  adjusting skew, 7-13  
  displaying data on screen, 7-18  
  locations in configuration tree, 7-11  
  status of, 7-12  
Mouse  
  use of, 1-4  
**O**  
Optional features, 1-3  
**P**  
Pack disk, 5-3, 5-22  
Packing material, 9-6  
Parity  
  defined, 3-6  
  selecting, 3-6  
Performance Verification Software, 5-26  
Port out  
  BNC connection, 7-9  
  use of, 7-18  
Print all, 4-11  
Print disk, 4-11  
Print line, 4-11  
Print partial, 4-11  
Print record, 4-11  
Print screen, 4-11  
Printer interface, defined, 3-3  
Printers  
  alternate, 4-4, 4-8  
  EpsonB, 4-3  
  HP-IB, 4-3  
  other HP, 4-9  
  RS-232C, 4-6  
  supported, 4-2  
Printing the display, 4-11 to 4-12  
Protocol  
  defined, 3-7  
Purge, 5-3, 5-19

**R**

Rename, 5-3, 5-15  
RS-232C interface  
  configuring, 3-8  
  defined, 3-5  
RS-232C printers  
  configuration, 4-8  
  mode configuration switches, 4-7  
  supported, 4-6

**S**

Saturation  
  defined, 6-8  
  selecting, 6-10  
Screen brightness, 1-4  
Screen contrast, 1-4  
Service, 9-3  
Shipping container, 9-6  
Shipping disks, 9-6  
Skew  
  adjusting, 7-13  
Skew menu  
  accessinf, 7-13  
  use of, 7-13  
Slot designators  
  defined, 2-6  
Sound  
  turning off, 6-7  
  turning on, 6-7  
Status indicators, 7-12  
Stop bits  
  changing, 3-6  
  defined, 3-6  
Storage environment, 9-5  
Store, 5-3, 5-12  
System Configuration Menu  
  accessing, 2-4  
  defined, 2-2  
  layout, 2-5  
  menu map, 2-3  
  slot designators, 2-6  
System Disk Menu  
  menu map, 5-4  
System options, 1-2  
System Test Menu, 9-4  
System Utilities Menu  
  accessing, 6-2

described, 6-2  
menu map, 6-3  
sound, 6-7  
touch calibration, 6-4

**T**

Time correlation bars, 7-12  
Touch calibration, 6-4  
Touch on/off button, 1-4  
Touchscreen  
  calibrating, 6-4  
  on/off, 6-5  
  use of, 1-4

**U**

User interfaces, 1-4  
  knob, 1-4  
  mouse, 1-4  
  touchscreen, 1-4

**W**

Waveforms, selecting, 7-19



# DECLARATION OF CONFORMITY

according to ISO/IEC Guide 22 and EN 45014

**Manufacturer's Name:** Hewlett-Packard Company

**Manufacturer's Address:** 1900 Garden of the Gods Road  
Colorado Springs, CO 80901  
U.S.A.

## Declares, That the product

**Product Name:** HP 16500B Logic Analysis System

**Model Number(s):** HP 16500B

**Product Options:** All

## Conforms to the following Product Specifications:

**Safety:** IEC 348 / HD 401  
UL 1244  
CSA - C22.2 No. 231 Series M-89

**EMC:** CISPR 11:1990 /EN 55011 (1991): Group 1 Class A  
IEC 801-2:1991 /EN 50082-1 (1992): 4 kV CD, 8 kV AD  
IEC 801-3:1984 /EN 50082-1 (1992): 3 V/m  
IEC 801-4:1988 /EN 50082-1 (1992): 1 kV

## Supplementary Information:

The product herewith complies with the requirements of the Low Voltage Directive 73/23/EEC and the EMC Directive 89/336/EEC.

Colorado Springs, May 1, 1993

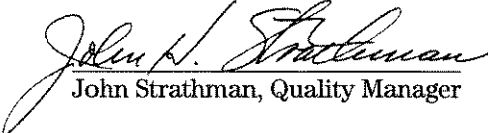
  
John Strathman, Quality Manager

European Contact: Your local Hewlett-Packard Sales and Service Office or Hewlett-Packard GmbH,  
Department ZQ / Standards Europe, Herrenberger Straße 130, D-7030 Böblingen (FAX: +49-7031-143143)

.....



.....

.....

.....

.....

Reproduction, adaptation, or translation without prior written permission is prohibited, except as allowed under the copyright laws.

#### Document Warranty

The information contained in this document is subject to change without notice.

**Hewlett-Packard makes no warranty of any kind with regard to this material, including, but not limited to, the implied warranties or merchantability and fitness for a particular purpose.**

Hewlett-Packard shall not be liable for errors contained herein or for incidental or consequential damages in connection with the furnishing, performance, or use of this material.

Complete product warranty information is given on the last page of this guide.

designed and tested in accordance with IEC Publication 348, Safety Requirements for Measuring Apparatus, and has been supplied in a safe condition. This is a Safety Class I instrument (provided with terminal for protective earthing). Before applying power, verify that the correct safety precautions are taken (see the following warnings). In addition, note the external markings on the instrument that are described under "Safety Symbols."

#### Warning

- Before turning on the instrument, you must connect the protective earth terminal of the instrument to the protective conductor of the (mains) power cord. The mains plug shall only be inserted in a socket outlet provided with a protective earth contact. You must not negate the protective action by using an extension cord (power cable) without a protective conductor (grounding). Grounding one conductor of a two-conductor outlet is not sufficient protection.
- Only fuses with the required rated current, voltage, and specified type (normal blow, time delay, etc.) should be used. Do not use repaired fuses or short-circuited fuseholders. To do so could cause a shock of fire hazard.

To avoid dangerous electric shock, do not perform any service unless qualified to do so. Do not attempt internal service or adjustment unless another person, capable of rendering first aid and resuscitation, is present.

- If you energize this instrument by an auto transformer (for voltage reduction), make sure the common terminal is connected to the earth terminal of the power source.
- Whenever it is likely that the ground protection is impaired, you must make the instrument inoperative and secure it against any unintended operation.
- Do not operate the instrument in the presence of flammable gasses or fumes. Operation of any electrical instrument in such an environment constitutes a definite safety hazard.
- Do not install substitute parts or perform any unauthorized modification to the instrument.
- Capacitors inside the instrument may retain a charge even if the instrument is disconnected from its source of supply.
- Use caution when exposing or handling the CRT. Handling or replacing the CRT shall be done only by qualified maintenance personnel.



Instruction manual symbol: the product is marked with this symbol when it is necessary for you to refer to the instruction manual in order to protect against damage to the product.



Hazardous voltage symbol.



Earth terminal symbol: Used to indicate a circuit common connected to grounded chassis.

#### WARNING

The Warning sign denotes a hazard. It calls attention to a procedure, practice, or the like, which, if not correctly performed or adhered to, could result in personal injury. Do not proceed beyond a Warning sign until the indicated conditions are fully understood and met.

#### CAUTION

The Caution sign denotes a hazard. It calls attention to an operating procedure, practice, or the like, which, if not correctly performed or adhered to, could result in damage to or destruction of part or all of the product. Do not proceed beyond a Caution symbol until the indicated conditions are fully understood or met.

product has a warranty against defects in material and workmanship for a period of one year from date of shipment. During the warranty period, Hewlett-Packard Company will, at its option, either repair or replace products that prove to be defective.

For warranty service or repair, this product must be returned to a service facility designated by Hewlett-Packard.

For products returned to Hewlett-Packard for warranty service, the Buyer shall prepay shipping charges to Hewlett-Packard and Hewlett-Packard shall pay shipping charges to return the product to the Buyer. However, the Buyer shall pay all shipping charges, duties, and taxes for products returned to Hewlett-Packard from another country.

Hewlett-Packard warrants that its software and firmware designated by Hewlett-Packard for use with an instrument will execute its programming instructions when properly installed on that instrument.

Hewlett-Packard does not warrant that the operation of the instrument software, or firmware will be uninterrupted or error free.

#### **Limitation of Warranty**

The foregoing warranty shall not apply to defects resulting from improper or inadequate maintenance by the Buyer, Buyer-supplied software or interfacing, unauthorized modification or misuse, operation outside of the environmental specifications for the product, or improper site preparation or maintenance.

No other warranty is expressed or implied. Hewlett-Packard specifically

merchandise and fitness for a particular purpose.

#### **Exclusive Remedies**

The remedies provided herein are the buyer's sole and exclusive remedies. Hewlett-Packard shall not be liable for any direct, indirect, special, incidental, or consequential damages, whether based on contract, tort, or any other legal theory.

#### **Assistance**

Product maintenance agreements and other customer assistance agreements are available for Hewlett-Packard products. For any assistance, contact your nearest Hewlett-Packard Sales Office.

#### **Certification**

Hewlett-Packard Company certifies that this product met its published specifications at the time of shipment from the factory. Hewlett-Packard further certifies that its calibration measurements are traceable to the United States National Institute of Standards and Technology, to the extent allowed by the Institute's calibration facility, and to the calibration facilities of other International Standards Organization members.

HP 16500B Logic Analysis System User's Reference Guide

Publication number  
16500-97010

Printed in USA.

Edition dates are as follows:

First edition, April 1994

New editions are complete revisions of the manual. Update packages, which are issued between editions, contain additional and replacement pages to be merged into the manual by you. The dates on the title page change only when a new edition is published.

A software or firmware code may be printed before the date. This code indicates the version level of the software or firmware of this product at the time the manual or update was issued. Many product updates do not require manual changes; and, conversely, manual corrections may be done without accompanying product changes. Therefore, do not expect a one-to-one correspondence between product updates and manual updates.

edition and of any changed pages to that edition.

All pages original edition



**HP 16550A State/Timing Logic Analyzer  
User's Reference Guide**

Insert this package in the back of either binder included with the  
HP 16500B Logic Analysis System.





Publication number 16550-97003  
First edition, April 1994

For Safety information, Warranties, and Regulatory  
information, see the pages behind the index

© Copyright Hewlett-Packard Company 1992 - 1994  
All Rights Reserved

---

**HP 16550A**  
**100-MHz State/500-MHz Timing**  
**Logic Analyzer**

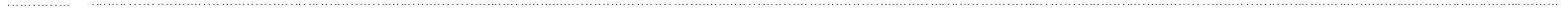



The User's Reference manual contains field and feature definitions. Use this manual for information on what the menu fields do, what they are used for, and how the features work.

The manual is divided into chapters covering general product information, probing, and separately tabbed chapters for each analyzer menu. Also, chapters on error messages and instrument specifications are provided.

In the Configuration menu you have the choice of configuring an analyzer as either a State analyzer or a Timing analyzer. Some menus in the analyzer will change depending on the analyzer type you choose. For example, since a Timing analyzer does not use external clocks, the clock assignment fields in the Format menu will not be available.

If a menu field is only available to a particular analyzer type, the field is designated (Timing only) or (State only) after the field name. If no designation is shown, the field is available for both types.

As you purchase measurement modules for the HP 16500B system, insert the reference manuals into either of the HP 16500B mainframe binders.

<b>1</b>	<b>General Information</b>	
<b>2</b>	<b>Probing</b>	
<b>3</b>	<b>The Configuration Menu</b>	
<b>4</b>	<b>The Format Menu</b>	
<b>5</b>	<b>The Trigger Menu</b>	
<b>6</b>	<b>The Listing Menu</b>	
<b>7</b>	<b>The Waveform Menu</b>	
<b>8</b>	<b>The Chart Menu</b>	
<b>9</b>	<b>The Compare Menu</b>	
<b>10</b>	<b>The Mixed Display Menu</b>	
<b>11</b>	<b>Error Messages</b>	
<b>12</b>	<b>Specifications and Characteristics</b>	
<b>13</b>	<b>Installation</b>	
	<b>Index</b>	

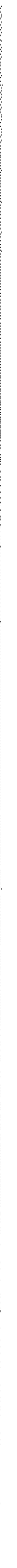

## **1 General Information**

- User Interface 1-3
- Configuration Capabilities 1-4
- Key Features 1-5
- Accessories Supplied 1-6
- Accessories Available 1-7

## **2 Probing**

- General Purpose Probing System Description 2-7
- Assembling the Probing System 2-11

## **3 The Configuration Menu**

- Name Field 3-3
- Type Field 3-4
- Unassigned Pods List 3-5
- Activity Indicators 3-7

## **4 The Format Menu**

- State Acquisition Mode Field (State only) 4-4
- Timing Acquisition Mode Field (Timing only) 4-5
- Clock Inputs Display 4-13
- Pod Field 4-14
- Pod Clock Field (State only) 4-15
- Pod Threshold Field 4-19
- Master and Slave Clock Field (State only) 4-21
- Setup/Hold Field (State only) 4-23
- Symbols Field 4-25
- Label Assignment Fields 4-25
- Rolling Labels and Pods 4-25
- Label Polarity Fields 4-26
- Bit Assignment Fields 4-27

## **5 The Trigger Menu**

Trigger Sequence Levels 5-6

Modify Trigger Field 5-8

Pre-defined Trigger Macros 5-11

Using Macros to Create a Trigger Specification 5-13

Timing Trigger Macro Library 5-14

State Trigger Macro Library 5-16

Modifying the User-level Macro 5-19

Resource Terms 5-26

Assigning Resource Term Names and Values 5-28

Label and Base Fields 5-32

Arming Control Field 5-33

Acquisition Control 5-36

Trigger Position Field 5-37

Sample Period Field 5-38

Branches Taken Stored / Not Stored Field 5-38

Count Field (State only) 5-39

## **6 The Listing Menu**

Markers Field 6-4

Pattern Markers 6-5

Find X-pattern / O-pattern Field 6-6

Pattern Occurrence Fields 6-7

From Trigger / Start / X Marker Field 6-8

Specify Patterns Field 6-9

Label / Base Roll Field 6-12

Stop Measurement Field 6-13

Clear Pattern Field 6-16

Time Markers 6-17  
Trig to X / Trig to O Fields 6-18

Statistics Markers 6-19

States Markers (State only) 6-21  
Trig to X / Trig to O Fields 6-22  
Data Roll Field 6-23  
Label and Base Fields 6-24  
Label / Base Roll Field 6-24

## **7 The Waveform Menu**

Acquisition Control Field 7-5  
Accumulate Field 7-6  
States Per Division Field (State only) 7-7  
Seconds Per Division Field (Timing only) 7-8  
Delay Field 7-9  
Sample Period Display (Timing only) 7-10  
Markers Field 7-12

Pattern Markers 7-13

X-pat / O-pat Occurrence Fields 7-14  
From Trigger / Start / X Marker Field 7-15  
X to O Display Field (Timing only) 7-16  
Center Screen Field 7-17  
Specify Patterns Field 7-18  
Label / Base Roll Field 7-21  
Stop Measurement Field 7-22  
Clear Pattern Field 7-25

Time Markers 7-26  
Trig to X / Trig to O Fields 7-27  
Marker Label / Base and Display 7-28

Statistics Markers 7-29

States Markers (State only) 7-31

Trig to X / Trig to O Fields 7-32

Marker Label / Base and Display 7-33

Waveform Display 7-34

Blue Bar Field 7-36

Channel Mode Field 7-38

Module and Label Fields 7-40

Action Insert/Replace Field 7-41

Delete and Delete All Fields 7-42

Waveform Size Field 7-43

## **8 The Chart Menu**

Selecting the Axes for the Chart 8-6

Y-axis Label Value Field 8-7

X-axis Label / State Type Field 8-8

Scaling the Axes 8-9

Min and Max Scaling Fields 8-10

Markers / Range Field 8-11

Pattern Markers 8-12

Find X-pattern / O-pattern Field 8-13

Pattern Occurrence Fields 8-14

From Trigger / Start / X Marker Fields 8-15

Specify Patterns Field 8-16

Label / Base Roll Field 8-18

Stop Measurement Field 8-19

Clear Pattern Field 8-22

Time Markers 8-23  
Trig to X / Trig to O Fields 8-24

Statistics Markers 8-25

States Markers 8-27  
Trig to X / Trig to O Fields 8-28

## **9 The Compare Menu**

Reference Listing Field 9-5  
Difference Listing Field 9-6  
Copy Listing to Reference Field 9-8  
Find Error Field 9-9  
Compare Full / Compare Partial Field 9-10  
Mask Field 9-11  
Specify Stop Measurement Field 9-12  
Data Roll Field 9-15  
Bit Editing Field 9-16  
Label and Base Fields 9-17  
Label / Base Roll Field 9-17

## **10 The Mixed Display Menu**

- The Mixed Display Menu 10-2
- Intermodule Configuration 10-3
- Inserting Waveforms 10-4
- Interleaving State Listings 10-5
- Time-Correlated Displays 10-7
- Markers 10-8

## **11 Error Messages**

- Error Messages 11-3
- Warning Messages 11-5
- Advisory Messages 11-8

## **12 Specifications and Characteristics**

- Specifications 12-3
- Characteristics 12-4

## **13 Installation**

- General Installation Procedures 13-3
- HP 16550A Installation Considerations 13-7





General  
Information

# Logic Analyzer Description

The HP 16550A State/Timing Analyzer module is part of a new generation of general-purpose logic analyzers. The HP 16550A module is used with the HP 16500B mainframe, which is designed as a stand-alone instrument for use by digital and microprocessor hardware and software designers. The HP 16500B mainframe has HP-IB and RS-232C interfaces for hard copy printouts and control by a host computer.

The HP 16550A State/Timing Analyzer module has 96 data channels, and six clock/data channels. A second HP 16550A card can be added to expand the module to 204 data and clock/data channels.

Memory depth is 4 Kbytes in all pod pair groupings, or 8 Kbytes on just one pod (half channels). All resource terms can be assigned to either configured analyzer machine.

Measurement data is displayed as data listings or waveforms, and can be plotted on a chart or compared to a reference image.

The 100-MHz state analyzer has master, slave, and demultiplexed clocking modes available. Measurement data can be stamped with either state or time tags. For triggering and data storage, the state analyzer uses 12 sequence levels with two-way branching, 10 pattern resource terms, 2 range terms, and 2 timers/counters.

The 500-MHz timing analyzer has conventional, transitional, and glitch timing modes with variable width, depth, and speed selections. Sequential triggering uses 10 sequence levels with two-way branching, 10 pattern resource terms, 2 range terms, 2 timers/counters and 2 edge/glitch terms.

Defining a trigger specification is as easy as picking a predefined macro from a trigger macro library. Trigger macros can be used by themselves or in combination with each other.

## User Interface

The HP 16500B has four easy-to-use user interface devices: the knob, the touchscreen, the optional mouse, and the optional keyboard.

The knob on the front panel is used to move the cursor on certain menus, to increment or decrement numeric fields, and to roll the display.

The touchscreen fields can be selected by touch or with the optional mouse. To activate a touchscreen field by touch, simply press the screen over any dark blue box on the display with your finger until the field changes color. Then remove your finger from the screen to activate your selection.

To activate a field with the optional mouse, position the cursor (+) of the mouse over the desired field and press the button on the upper-left corner of the mouse.

The optional keyboard can control all instrument functions by using special function keys, the arrow keys, and the ENTER key. Alpha numeric entry is simply typed in.

All user interface devices are discussed in more detail in the HP 16500B Reference manual.

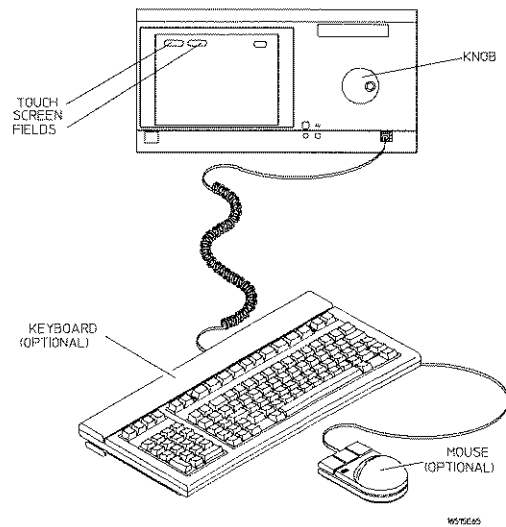

**Front Panel Interface Devices**

## Configuration Capabilities

The HP 16550A can be configured as a single or two card module. The number of data channels range from 102 channels using just one HP 16550A, up to 204 channels when a second HP 16550A is connected. A half channel acquisition mode is available which reduces the channel width by half, but doubles memory depth from 4K-deep to 8K-deep per channel.

The configuration guide below illustrates the channel width and memory depth combinations in all acquisition modes with a one or two card module.

### State Analyzer

	Full Channel Mode 100 MHz	Half Channel Mode 100 MHz
1 Card Module	4K-deep on 102 chan. 96 data + 6 clock or data	8K-deep on 51 chan. 48 data + 3 clock or data
— or —		
2 Card Module	4K-deep on 204 chan. 198 data + 6 clock or data	8K-deep on 102 chan. 99 data + 3 clock or data

16550B23

- Unused clock channels can be used as data channels
- Time or State tags reduces memory by half. However, full depth is retained if you leave one pod pair unassigned.
- Maximum of 6 clocks in a two card module.

### Timing Analyzer

	Conventional full channel 250 MHz	Conventional half channel 500 MHz	Transitional full channel 125 MHz	Transitional half channel 250 MHz	Glitch half channel 125 MHz
1 Card Module	4K-deep on 102 chan. 96 data + 6 clock or data	8K-deep on 51 chan. 48 data + 3 clock or data	4K-deep on 102 chan. 96 data + 6 clock or data	8K-deep on 51 chan. 48 data + 3 clock or data	4K-deep on 51 chan. 48 data + 3 clock or data
— or —					
2 Card Module	4K-deep on 204 chan. 198 data + 6 clock or data	8K-deep on 102 chan. 96 data + 6 clock or data	4K-deep on 204 chan. 198 data + 6 clock or data	8K-deep on 102 chan. 96 data + 6 clock or data	4K-deep on 102 chan. 96 data + 6 clock or data

16550B24

- Unused clock channels can be used as data channels

---

## Key Features

- 100-MHz state and 500-MHz timing acquisition speed.
- 96 data channels/6 clocks expandable to 198 data/6 clock channels.
- Lightweight passive probes for easy hookup and compatibility with previous HP logic analyzers and preprocessors.
- HP-IB and RS-232C interface for programming and hard copy printouts.
- Variable setup/hold time, 3.5 ns window.
- External arming to/from other modules through the intermodule bus.
- 4 Kbytes deep memory on all channels with 8 Kbytes in half channel modes.
- Marker measurements.
- 12 levels of trigger sequencing for state and 10 levels of sequential triggering for Timing.
- Both state and timing analyzers can use 10 pattern resource terms, two range terms, and two timer/counters to qualify and trigger on data. The timing analyzer also has two edge terms available.
- Predefined trigger macros for easy configuration of trigger specifications.
- 100-MHz time and number-of-states tagging.
- Full programmability.
- Mixed State/Timing and State/State (interleaved) display.
- Compare, Chart, and Waveform displays.

---

## Accessories Supplied

The table below lists the accessories supplied with your logic analyzer. If any of these accessories are missing, contact your nearest Hewlett-Packard sales office. If you need additional accessories, refer to the *Accessories for HP Logic Analyzers*.

**Table 1**

---

### Accessories Supplied

---

<b>Accessory</b>	<b>HP Part No.</b>	<b>Quantity</b>
Probe tip assemblies	01650-61608	6
Probe cables	16550-61601	3
Grabbers (20 per pack)	5090-4356	6
Extra probe leads (5 per pack)	5959-9333	1 pkg
Probe cable and pod labels	01650-94310	1
Probe cable ID clip	16500-41201	1
Operating system disks	Call	1
User's Guide	Call	1
User's Reference Guide	Call	1
Programming Reference Guide	Call	1
Service Guide	Call	1

---

## Accessories Available

There are a number of accessories available that will make your measurement tasks easier and more accurate. You will find these listed in *Accessories for HP Logic Analyzers*.

### **Preprocessor Modules**

The preprocessor module accessories enable you to quickly and easily connect the logic analyzer to your microprocessor under test.

Included with each preprocessor module is a 3.5-inch disk which contains a configuration file and an inverse assembler file. When you load the configuration file, it configures the logic analyzer for making state measurements on the microprocessor for which the preprocessor is designed.

Configuration files from other analyzer modules can also be loaded. For information on translating other configuration files into the analyzer, refer to "Preprocessor File Configuration Translation and Pod Connections" in the Probing chapter.

The inverse assembler file is a software routine that will display captured information in a specific microprocessor's mnemonics. The DATA field in the State Listing is replaced with an inverse assembly field. The inverse assembler software is designed to provide a display that closely resembles the original assembly language listing of the microprocessor's software. It also identifies the microprocessor bus cycles captured, such as Memory Read, Interrupt Acknowledge, or I/O write.

Many of the preprocessor modules require the HP 10269C General Purpose Probe Interface. The HP 10269C accepts the specific preprocessor PC board and connects it to five connectors on the general purpose interface to which the logic analyzer probe cables connect.

A list of preprocessor modules is found in *Accessories for HP Logic Analyzers*. Descriptions of the preprocessor modules are found with the preprocessor module accessories.







Probing

# Probing

This chapter contains a description of the probing system for the logic analyzer. It also contains the information you need for connecting the probe system components to each other, to the logic analyzer, and to the system under test.

## Probing Options

You can connect the logic analyzer to your system under test in one of the following ways:

- HP 10320C User-Definable Interface (optional).
- Microprocessor and bus specific interfaces (optional).
- The standard general purpose probing (provided).
- Direct connection to a 20-pin, 3M-Series type header connector using the optional termination adapter.

### The HP 10320C User-Definable Interface

The optional HP 10320C User-Definable Interface module combined with the optional HP 10269C General Purpose Probe Interface allows you to connect the logic analyzer to the microprocessor in your target system. The HP 10320C includes a breadboard which you custom wire for your system.

Another option for use with the HP 10320C is the HP 10321A Microprocessor Interface Kit. This kit includes sockets, bypass capacitors and a fuse for power distribution. Also included are wire-wrap headers to simplify wiring of your interface when you need active devices to support the connection requirements of your system.

You will find additional information about the HP 10320C and the HP 10321A in the *Accessories for HP Logic Analyzers*.

### **Microprocessor and Bus Specific Interfaces**

There are a number of microprocessor and bus specific interfaces available as optional accessories which are listed in the *Accessories for HP Logic Analyzers*. Microprocessors are supported by Universal Interfaces or Preprocessor Interfaces, or in some cases both.

Universal Interfaces are aimed at initial hardware turn-on, and will provide the following:

- Fast, reliable, and convenient connections to the microprocessor system.

Preprocessor interfaces are aimed at hardware turn-on and hardware/software integration, and will provide the following:

- All clocking and demultiplexing circuits needed to capture the system's operation.
- Additional status lines to further decode the operation of the CPU.
- Inverse assembly software to translate logic levels captured by the logic analyzer into microprocessor mnemonics.

Bus interfaces will support bus analysis for the following:

- Bus support for HP-IB, RS-232C, RS-449, SCSI, VME, and VXI.

### **General Purpose Probing**

General purpose probing involves connecting the logic analyzer probes directly to your target system without using any interface. General purpose probing does not limit you to specific hook up schemes, for an example, as the probe interface does. General purpose probing uses grabbers that connect to both through hole and surface mount components.

General purpose probing comes as the standard probing option provided with the logic analyzer. There is a full description of its components and use later in this chapter.

### **The Termination Adapter**

The optional termination adapter allows you to connect the logic analyzer probe cables directly to test ports on your target system without the probes.

The termination adapter is designed to connect to a 20 (2x10) pin, 4-wall, low-profile header connector, 3M-Series 3592 or equivalent.

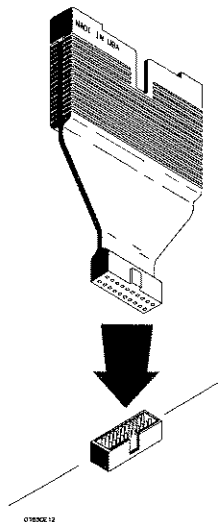

**Termination Adapter**

### Preprocessor File Configuration Translation and Pod Connections

Preprocessor configuration files from an HP 16510B, HP 16511B, and HP 16540A,D can be used by the HP 16550A logic analyzer. However, some pods must be connected differently in order for the configuration files (version 5.0 or later) to work properly. The table below and on the next page gives information on what configuration files to load and the required connecting order between the pods in the old configuration and the new HP 16550A pods.

At the end of the table there are definitions of the terms used in the table and any notes found in the table.

---

#### Software and Hardware Translation Information

---

Preprocessor Number	Target Microprocessor	Recommended Configuration File to Transfer	Old Pods to New Pods in a One Card Module	Old Pods to New Pods in a Two Card Module
10314D	80386DX	16510B	No Changes Required	N/A
E2409B	80286	Factory	N/A	N/A
10305B	8086/88	16510B	1,2,3 to 3,1,2	N/A
E2426A/B	68020/EC020	16510B or Factory	No Change Required	N/A
E2423A	SCSI-2	16510B	No Change Required	N/A
10311B	68000/10	16510B	No Change Required	N/A
10311G	68000/10	16510B	No Change Required	N/A
10316G	68030	16510B or Factory	No Change Required	N/A
E2403A	80486	Factory	N/A	N/A
E2401A	R3000	16540A,D	No Change Required	1,2,3,4,5,6,7 to M1,M2,M3,M4,M5,M6,E1
E2420A	68040	16540A,D	1,2,3,4,5,6 to 1,2,5,6,3,4	1,2,3,4,5,6,7 to M1,M2,M5,M6,M3,M4,E1

Preprocessor Number	Target Microprocessor	Recommended Configuration File to Transfer	Old Pods to New Pods in a One Card Module	Old Pods to New Pods in a Two Card Module
E2406A	68030	16510B	1,2,3,4,5 to 1,2,4,5,3	N/A
E2415A	MCS-51	16510B	No Change Required	N/A
E2418A	320C20/25	16510B	No Change Required	N/A
10341B	1553	16510B	No Change Required	N/A
E2432A	80960CA	16511B	1,2,3,4,5,6 to 1,2,5,3,4,6	1,2,3,4,5,6,7 to M1,M2,M5,M3,M4,M6,E1
E2431A	320C30/31	Factory	N/A	N/A
10342B	RS232/HPIB	Factory	N/A	N/A
10342G	HPIB	Factory	N/A	N/A
10300B	Z80	16510B	No Change Required	N/A
E2413B	68331/2	File E68332_6	1,2,3,4,5,6 to 3,5,1,2,4,6	N/A
E2412A	I860XP	16540A,D	N/A	1,2,3,4,5,6,7,8,9 to M1,M2,M3,M4,M5,M6,E2,E3,E1
E2414B	68302	16540A,D	1,2,3,4,5,6 to 3,5,1,2,4,6	N/A
E2435A	I860XR	16511B or 16540A,D	N/A	1,2,3,4,5,6,7 to M3,M1,M2,M4,M5,M6,E1
E2416A	MCS96	16510B	No Change Required	N/A

**Recommended Configuration File to Transfer:** The recommended configuration file will work the best. If Factory is recommended, you should use files specifically made for the HP 16550A.

**Old Pods to New Pods in a One Card Module:** Pods are reordered respectively.

**Old Pods to New Pods in a Two Card Module:** Pods are reordered respectively. Master = M and is located in lower slot, Expander = E and is located in upper slot.

## General Purpose Probing System Description

The standard probing system provided with the logic analyzer consists of a probe tip assembly, probe cable, and grabbers. Because of the passive design of the probes, there are no active circuits at the outer end of the cable. The rest of this chapter is dedicated to general-purpose probing.

The passive probing system is similar to the probing system used with high-frequency oscilloscopes. It consists of a series RC network (90 k $\Omega$  in parallel with 8 pF) at the probe tip, and a shielded resistive transmission line. The advantages of this system include the following:

- 250  $\Omega$  in series with 8-pF input capacitance at the probe tip for minimal loading.
- Signal ground at the probe tip for higher speed timing signals.
- Inexpensive removable probe tip assemblies.

### Probe Tip Assemblies

Probe tip assemblies allow you to connect the logic analyzer directly to the target system. This general-purpose probing is useful for discrete digital circuits. Each probe tip assembly contains 16 probe leads (data channels), one clock lead, a pod ground lead, and a ground tap for each of the 16 probe leads.

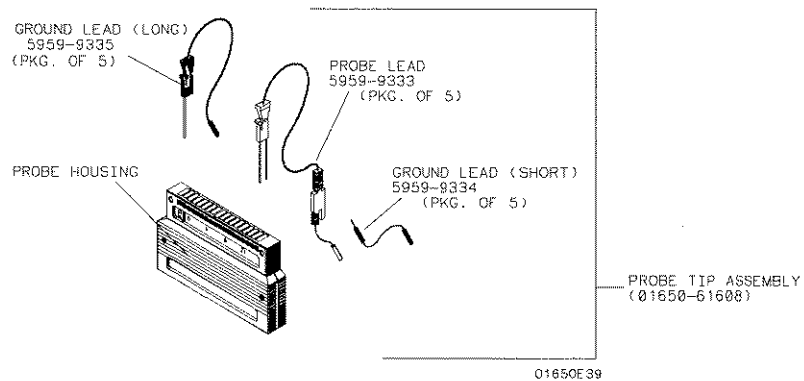

**Probe Tip Assembly**

## Probe and Pod Grounding

Each pod is grounded by a long black pod ground lead. You can connect the ground lead directly to a ground pin on your target system or use a grabber. To connect the ground lead to grounded pins on your target system, you must use 0.63 mm (0.025 in) square pins, or use round pins with a diameter of 0.66 mm (0.026 in) to 0.84 mm (0.033 in). The pod ground lead should always be used.

Each probe can be individually grounded with a short black extension lead that connects to the probe tip socket. You can then use a grabber or the grounded pins on your target system in the same way you connect the data lines.

When probing signals with rise and fall times of  $\leq 1$  ns, grounding each probe lead with the 2-inch ground lead is recommended. In addition, always use the probe ground on a clock probe.

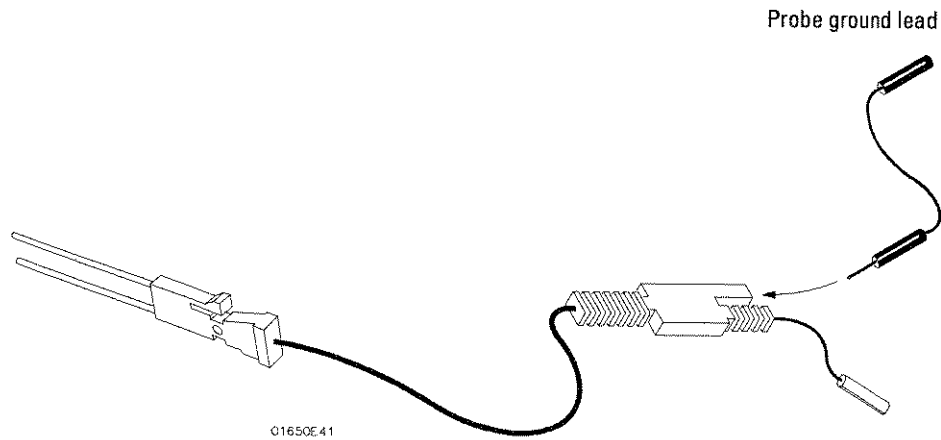

### Probe Grounds



### Probe Leads

The probe leads consists of a 12-inch twisted pair cable, a ground tap, and one grabber. The probe lead, which connects to the target system, has an integrated RC network with an input impedance of  $100\text{ k}\Omega$  in parallel with approximately  $8\text{ pF}$ , and all in series with  $250\ \Omega$ .

The probe lead has a two-pin connector on one end that snaps into the probe housing.

Probe lead connector.

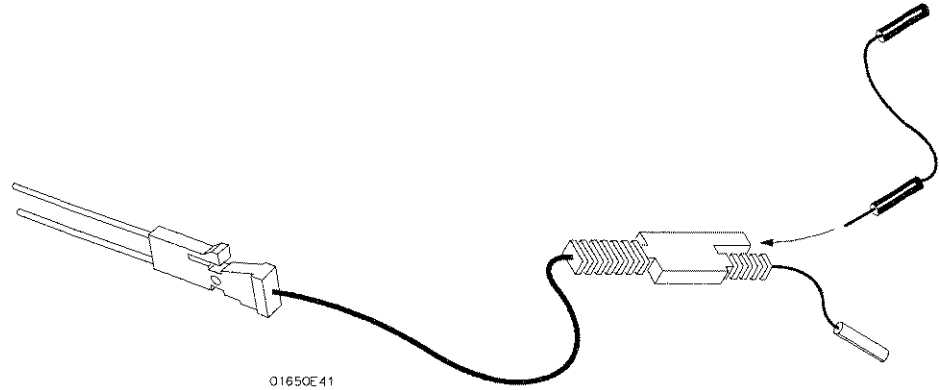

### Probe Lead

### Grabbers

The grabbers have a small hook that fits around the IC pins and component leads. The grabbers have been designed to fit on adjacent IC pins on either through hole or surface mount components with lead spacing greater than or equal to  $0.050\text{ in.}$

### **Probe Cable**

The probe cable contains 18 signal lines, 17 chassis ground lines and two power lines for preprocessor use. The cables are woven together into a flat ribbon that is 4.5 feet long. The probe cable connects the logic analyzer to the pods, termination adapter, HP 10269C General-Purpose Probe Interface, or preprocessor. Each cable is capable of carrying 0.33 amps for preprocessor power.

---

**CAUTION**

---

DO NOT exceed this 0.33 amps per cable or the cable will be damaged.

Preprocessor power is protected by a current limiting circuit. If the current limiting circuit is activated, the fault condition must be removed.

---

**WARNING**

---

After the fault condition is removed, the circuit will reset in one minute.

### **Minimum Signal Amplitude**

Any signal line you intend to probe with the logic analyzer probes must supply a minimum voltage swing of 500 mV to the probe tip. If you measure signal lines with a voltage swing of less than 500 mV, you may not obtain a reliable measurement.

### **Maximum Probe Input Voltage**

The maximum input voltage of each logic analyzer probe is  $\pm 40$  volts peak.

### **Pod Thresholds**

Logic analyzer pods have two preset thresholds and a user-definable pod threshold. The two preset thresholds are ECL ( $-1.3$  V) and TTL ( $+1.5$  V). The user-definable threshold can be set anywhere between  $-6.0$  volts and  $+6.0$  volts in 0.05 volt increments.

All pod thresholds are set independently.

## Assembling the Probing System

The general-purpose probing system components are assembled as shown below to make a connection between the measured signal line and the pods displayed in the Format menu.

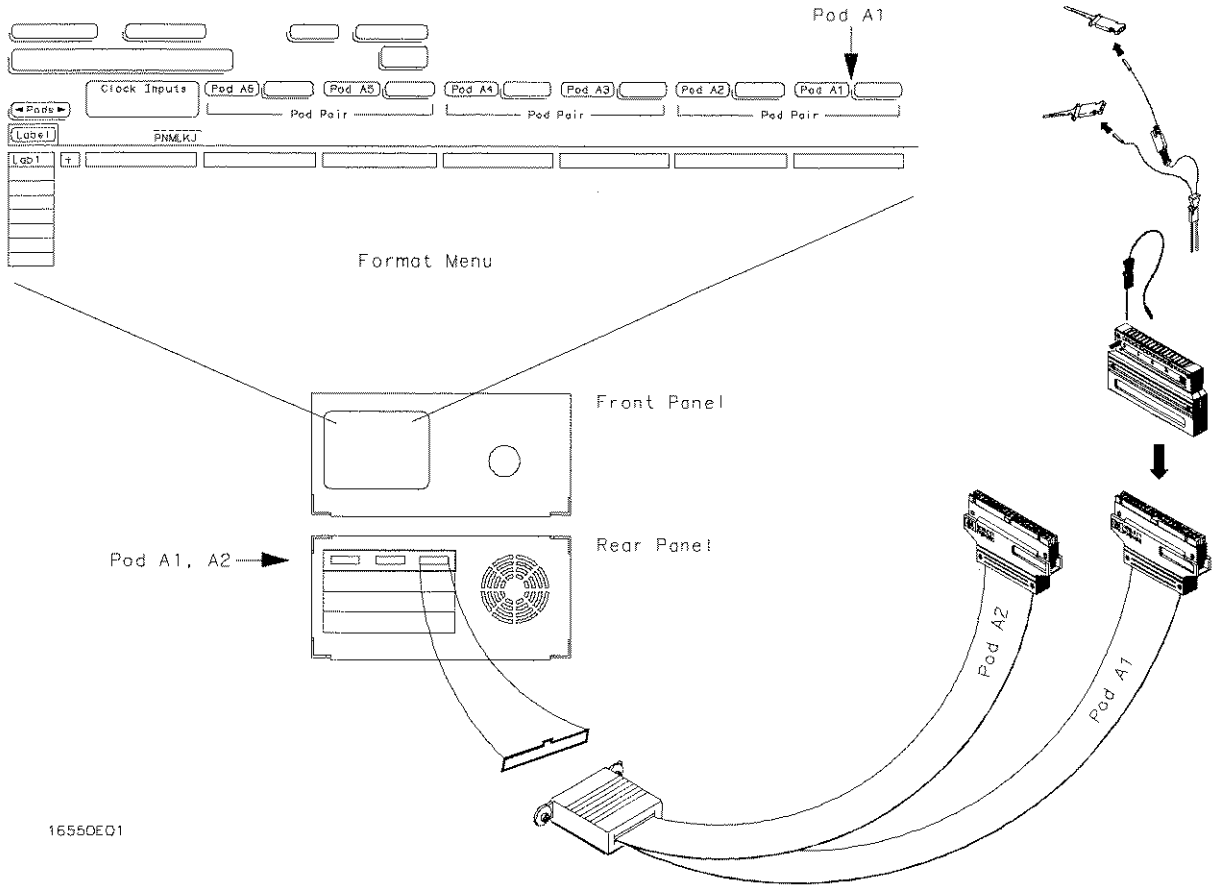

### Connecting Probe Cables to the Logic Analyzer

## Connecting Probe Cables to the Logic Analyzer

All probe cables are installed at Hewlett-Packard. If you need to replace a probe cable, refer to the Service Manual that is supplied with the logic analyzer.

### Connecting the Probe Tip Assembly to the Probe Cable

To connect a probe tip assembly to a cable, align the key on the cable connector with the slot on the probe housing and press them together.

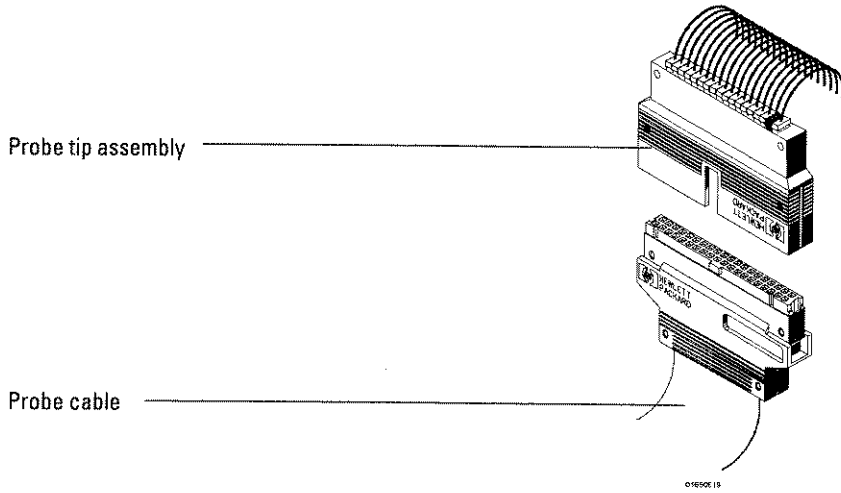

### Connecting Probe Tip Assembly

### Disconnecting Probe Leads from Probe Tip Assemblies

When you receive the logic analyzer, the probe leads are already installed in the probe tip assemblies. To keep unused probe leads out of your way during a measurement, you can disconnect them from the pod if desired.

To disconnect a probe, insert the tip of a ball-point pen into the latch opening. Push on the latch while gently pulling the probe out of the pod connector as shown in the figure below.

To connect the probes into the pods, insert the double pin end of the probe into the probe housing. Both the double pin end of the probe and the probe housing are keyed so they will fit together only one way.

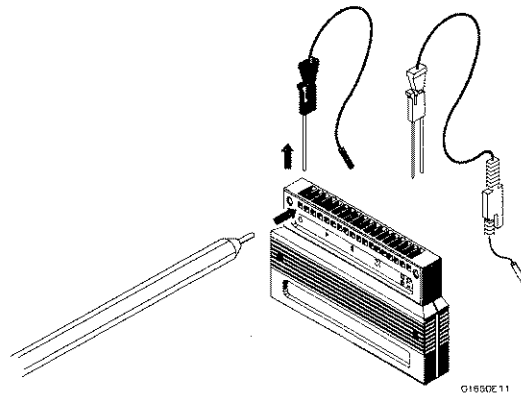

### Installing Probe Leads

## Probing Assembling the Probing System

### Connecting the Grabbers to the Probes

Connect the grabbers to the probe leads by slipping the connector at the end of the probe onto the recessed pin located in the side of the grabber. If you need to use grabbers for either the pod or the probe grounds, connect the grabbers to the ground leads in the same manner.

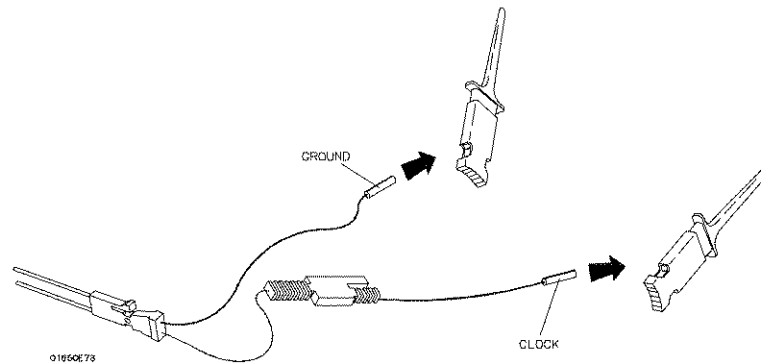

### Connecting Grabbers to Probes

#### Connecting the Grabbers to the Test Points

The grabbers have a hook that fits around the IC pins and component leads. Connect the grabber to the test point by pushing the rear of the grabber to expose the hook. Hook the lead and release your thumb as shown below.

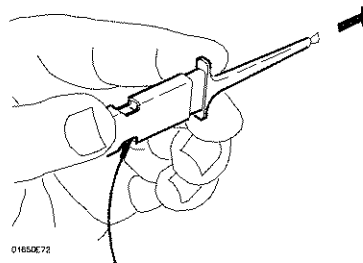

### Connecting Grabbers to Test Points



# The Configuration Menu

# The Configuration Menu

The Configuration menu is one of the analyzer menus that allows you to set module level parameters. For example, in the Configuration menu the pod pair assignments are made. In addition, the type of clocking is selected and a custom analyzer name can be assigned.

## Configuration Menu Map

The following menu map illustrates all fields and the available options in the Configuration menu. The menu map will help you get an overview as well as provide you with a quick reference of what the Configuration menu contains.

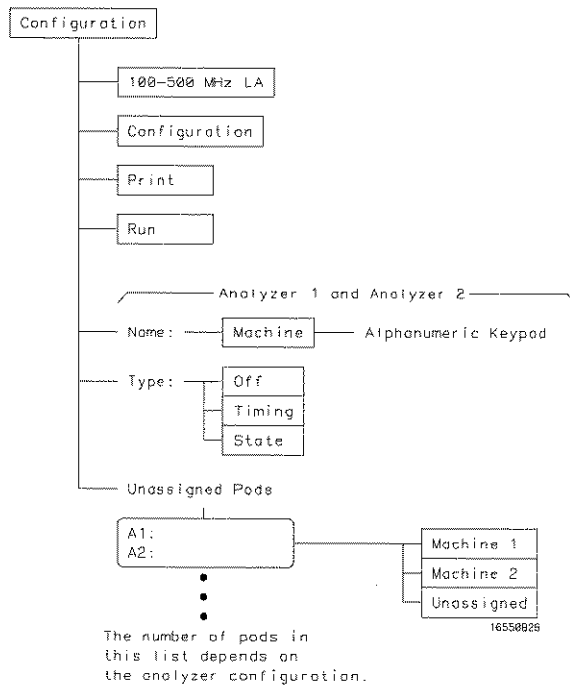

## Configuration Menu Map



### Name Field

The Name field allows you to assign a specific name to the analyzer machine. The name is entered by using the pop-up alpha-numeric keypad. When configurations are stored to disk and later reloaded, a specific name can help identify the measurement setup.

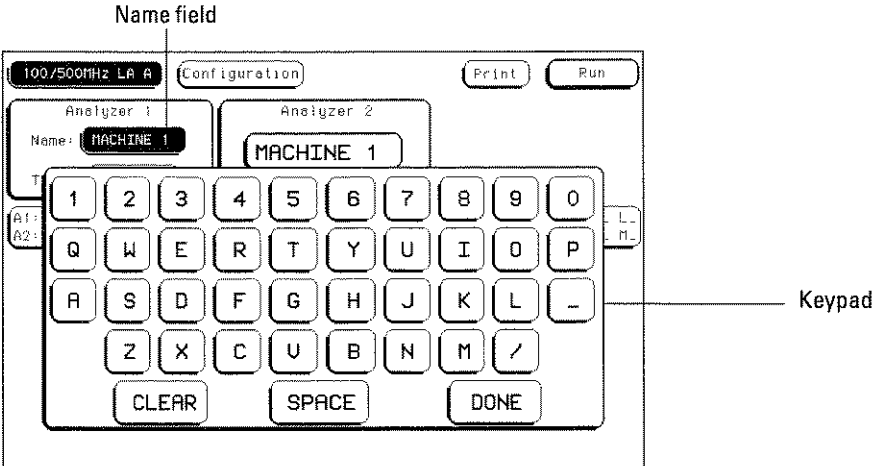

**Name Field**

## The Configuration Menu

### Type Field

## Type Field

The Type field allows you to configure the available analyzers as a state analyzer or a timing analyzer. When the Type field is selected, the following choices are available.

### Timing

When Timing is selected, the analyzer uses its own internal clock to clock measurement data into the acquisition memory. This clock is asynchronous to the signals in the target system. When this option is selected, some fields specific to external clocks will not appear in the analyzer menus.

The analyzer can only be configured with one timing analyzer. If two are selected, the first will be turned off.

### State

When State is selected, the data analyzer uses a clock from the system under test to clock measurement data into acquisition memory. This clock is synchronous to the signals in the target system.

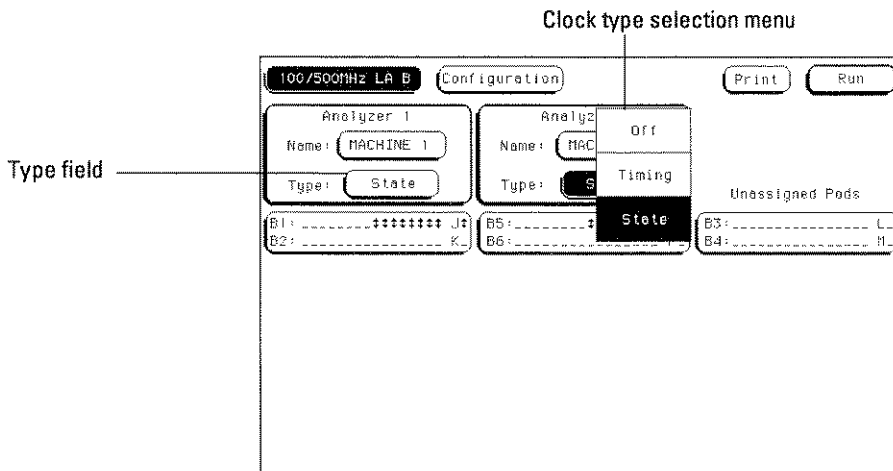

### Type Field

## Unassigned Pods List

The list of Unassigned Pods in the Configuration menu shows the available pods for the module configuration. Pod grouping and assignment is by pod pairs. When a pod pair is selected from the Unassigned Pods list, an assignment menu appears. From the assignment menu, select a destination for the pod pair.

Within each pod pair, activity indicators show the integrity of the connected signals.

**See Also**

For more information on the activity indicators, refer to "Activity Indicators" found later in this chapter.

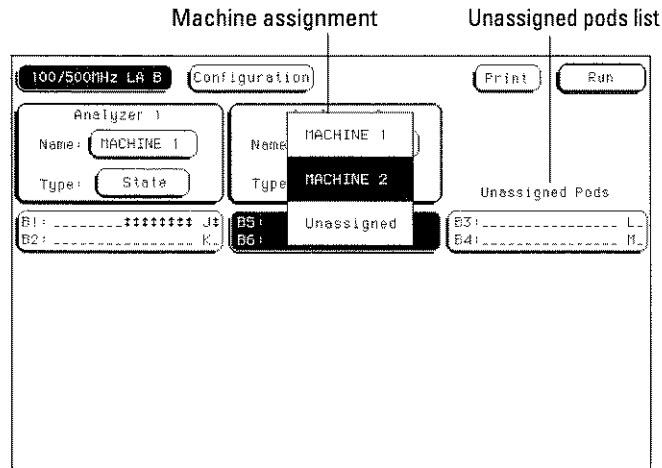

**Unassigned Pods Display**

## The Configuration Menu

### Unassigned Pods List

#### Illegal Configuration

When both analyzers are turned on, pod pair 1,2 and pod pair 5,6 cannot be assigned to the same analyzer. If this configuration is set, the analyzer will display a help menu. Use this help menu to reconfigure the pod assignment to a legal configuration.

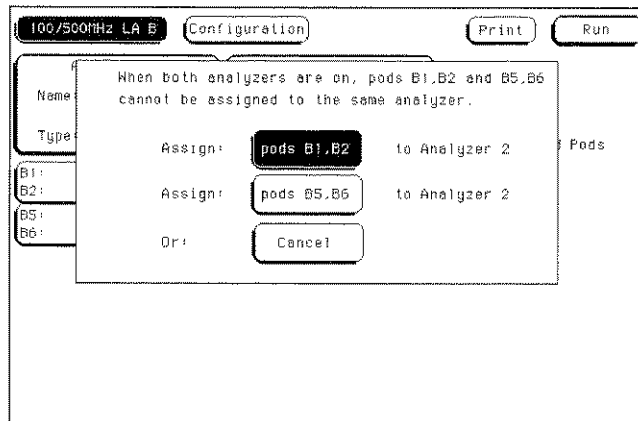

#### Pod Configuration Help Menu

## Activity Indicators

A portion of the Configuration menu that is not a selectable field is the Activity Indicators. The indicators appear in two places. One is in the pod pair displays of this Configuration menu. The other place is in the bit reference line in the Format menu just above the pod bit numbers.

When the logic analyzer is properly connected to an active target system, you see either a high level dash, a low level dash, or a transitional arrow in the Activity Indicator displays for each pod pair. These indicators are very useful in showing proper probe connection and that the logic levels are as expected according to the threshold level setting.

### See Also

The "Bit Assignment Fields" in the Format menu chapter for more information on the activity indicators.

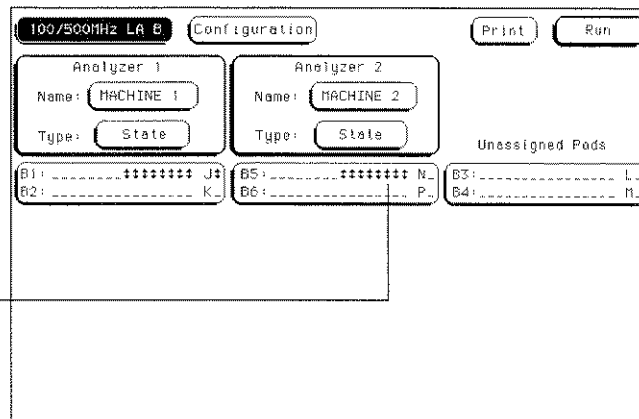

Activity Indicators





## The Format Menu

---

## The Format Menu

The Format menu is where you assign which data channels are measured and what clocking arrangement is used to capture valid data.

The configuration of the Format menu consists of grouping and labeling the data channels from the system under test to fit your particular measurement. In addition, for your convenience in recognizing bit groupings, you can specify symbols to represent them.

If the analyzer is configured as a state analyzer, there are master and slave clocks, clock qualifiers and a variable clock setup and hold to further qualify what data is captured. In addition, you can set individual pod clock threshold levels.

### **Format Menu Map**

The following menu map graphically illustrates all fields in the Format menu. Use the menu map as an overview and as a quick reference to the available options in the Format menu.



# The Format Menu

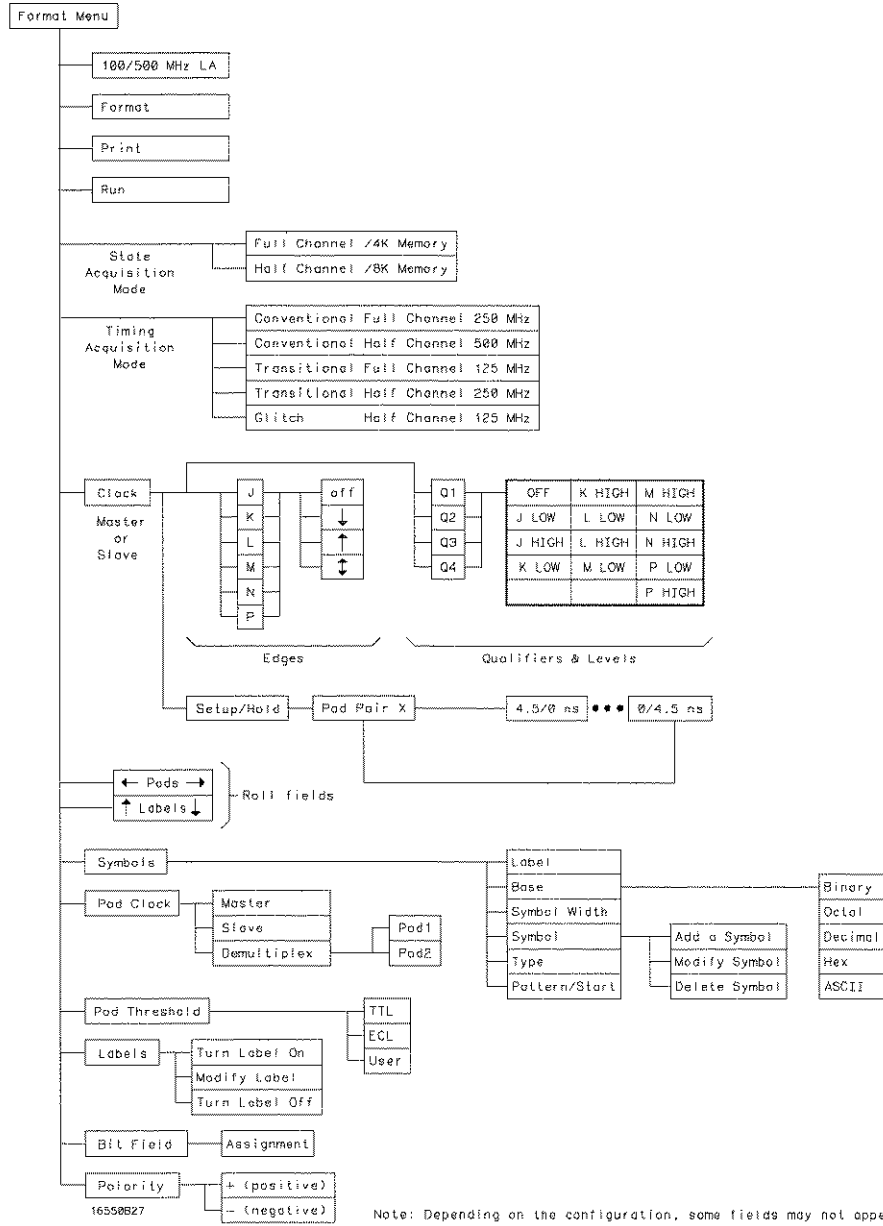

Note: Depending on the configuration, some fields may not appear.

## The State Format Menu Map

The Format Menu  
**State Acquisition Mode Field (State only)**

---

## State Acquisition Mode Field (State only)

The State Acquisition Mode field identifies the channel width and memory depth of the selected acquisition mode. When the State Acquisition Mode field is selected, two configurations of channel width and memory depth become available. Use the State Acquisition Mode to configure the analyzer for the best use of available memory and channel width.

### Full Channel 4K Memory 100MHz

The full channel selection uses both pods in a pod pair for 34 channels of width and a total memory depth of 4096 per channel. If time or state tags are turned on, the total memory could be split between data acquisition storage and time or state tag storage. To maintain the full 4096 per channel depth, leave one pod pair unassigned. State clock speed is 100 MHz.

### Half Channel 8K Memory 100MHz

The half channel selection cuts the channel width to 17 channels. When in this mode, the pod you use is selectable by selecting the Pod field, then choosing one of the two pods within the pair. In Half Channel mode, the memory depth is increased to 8192 per channel. Time or state tags are not available in this mode. State clock speed is 100 MHz.

The screenshot shows a menu titled "Pod field" with the following elements:

- Buttons: 100/500MHz LA B, Format 1, Print, Run
- State Acquisition Mode field: Full Channel/4K Memory/100MHz (highlighted)
- Acquisition mode selection menu: Full Channel/4K Memory/100MHz, Half Channel/8K Memory/100MHz
- Other options: Master Clock, B2, TTL, Pod B1, TTL, Master Clock
- Labels: + Labels, KJ 15 87 0 15 87 0
- Channel list: NRCH 1, Lab2, Lab3, Lab4, Lab5, Lab6, Lab7, Lab8

Annotations on the left side:

- "State acquisition mode field" points to the "Full Channel/4K Memory/100MHz" option.
- "Acquisition mode selection menu" points to the menu containing both "Full Channel/4K Memory/100MHz" and "Half Channel/8K Memory/100MHz".

### State Acquisition Mode Field

## Timing Acquisition Mode Field (Timing only)

The Timing Acquisition Mode field displays the acquisition type, the channel width, and sampling speed of the present acquisition mode. The Timing Acquisition Mode field is used to access an acquisition mode selection menu.

### Conventional Acquisition Mode

In Conventional Acquisition mode the analyzer stores measurement data at each sampling interval.

**Conventional Full Channel 250MHz** The total memory depth is 4096 with data being sampled and stored as often as every 4 ns.

**Conventional Half Channel 500MHz** The total memory depth of 8192 with data being sampled and stored as often as every 2 ns.

### Glitch Acquisition Mode

In Glitch Acquisition mode, a glitch is defined as a pulse with a minimum width of 3.5 ns and a maximum width of 8 ns, or the sample period, whichever is larger. As an example, if the sample period is 8 ns, then a glitch is defined as being between 3.5 ns and 8 ns. One advantage of the glitch mode is that if you expand the sample rate, a pulse that is less than the sample rate will still be displayed as a vertical dashed line.

**Glitch Half Channel 125MHz** The total memory depth is split between data storage and glitch storage. Data acquisition memory depth is 2048 per channel. Glitch storage is 2048 per channel. Data is sampled for new transitions every 8 ns.

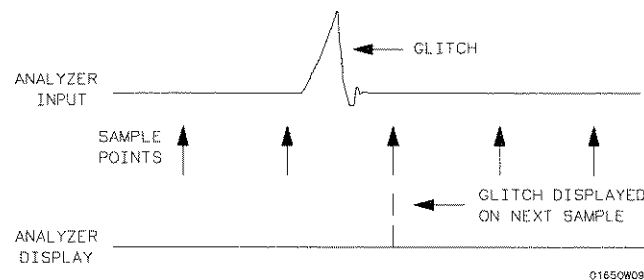

### Glitch in a Timing Waveform

The Format Menu  
**Timing Acquisition Mode Field (Timing only)**

**Transitional Acquisition Mode**

In Transitional Acquisition mode, the timing analyzer samples data at regular intervals, but only stores data when there is a level transition on currently assigned bits of a pod pair. Each time a level transition occurs on any of the bits, all bits of the pod pair are stored. A time tag is stored with each stored data sample so the measurement can be reconstructed and displayed later.

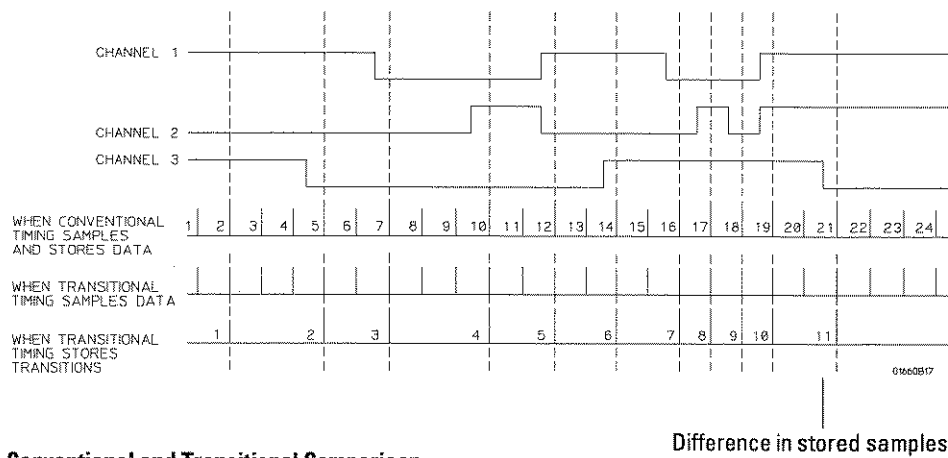

**Conventional and Transitional Comparison**

One issue when using transitional timing is how many transitions can be stored. The number depends on the mode and frequency of transition occurrence. The following overview explains the number of transitions stored for each transitional timing mode and why.

**Timing Acquisition Mode Field (Timing only)**

Timing acquisition mode field

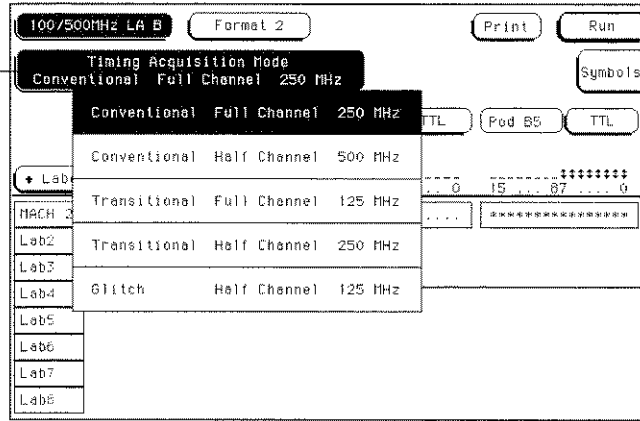

Acquisition mode selection menu

**Timing Acquisition Mode Selection**

**Transitional Full Channel 125 MHz Mode**

The total memory depth is 4 Kbytes per channel with a channel width of 34 channels per pod pair. Data is sampled for new transitions every 8 ns.

When the Timing analyzer runs in the 125 MHz mode, it operates very similar to the state analyzer with count Time turned on. The only exceptions are that the store qualification comes from transition detectors instead of the sequencer. Also, the analyzer uses an internal clock.

With 4 Kbytes of memory per channel and count Time turned on, the analyzer uses half its memory (2 Kbytes) to store time tags. It should be noted that each pod pair must store transitions at its own rate, therefore it must store its own set of time-tags. You do not have the option of using a free pod to retain full memory as you have in the normal state mode.

When a transition is detected after a sample with no detected transition, two samples are stored. One sample is a "before transition sample" and the other is an "after transition sample." Then, as long as there are transitions in the subsequent sample, only 1 sample is stored. When the next sample occurs without a transition, the two stored sample sequence (one before, one after) repeats with the next detected transition.

The Format Menu  
**Timing Acquisition Mode Field (Timing only)**

**Minimum Transitions Stored** Normally, transitions occur at a relatively slow rate. A rate slow enough to insure at least one sample with no transitions between the samples with transitions. This is illustrated below with time-tags 2, 5, 7, and 14. When transitions happen at this rate, two cycles are stored for every transition. This means that with 2 Kbytes of memory, 1 Kbytes of transitions are stored. You must subtract 1, which is necessary for a starting point, for a minimum of 1023 stored transitions.

**Maximum Transitions Stored** If transitions occur at a fast rate, such that there is a transition at each sample point, only one sample is stored for each transition as shown by time-tags 17 through 21 below. If this continues for the entire trace, the number of transitions stored is 2 Kbytes. Again, you must subtract the starting point sample which then yields a maximum of 2047 stored transitions.

In most cases a transitional timing trace is stored by a mixture of the minimum and maximum cases. Therefore, the actual number of transitions stored will be between 1023 and 2047.

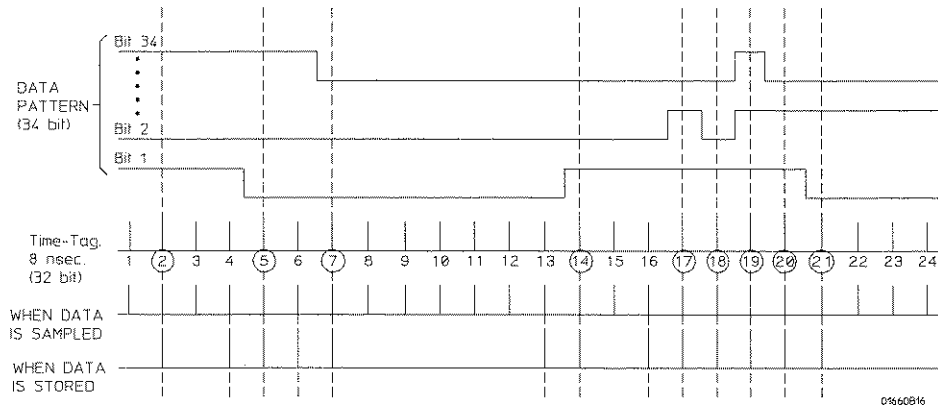

**Storing Time-tags and Transitions**

**Transitional Half Channel 250 MHz Mode**

The total memory depth is 8 Kbytes with a channel width of 17 channels on one pod. The pod used within the pod pair is selectable. Data is sampled for new transitions every 4 ns.

Transitional timing running at 250 MHz is the same as the 125 MHz mode, except that two single pod data samples (17 bits x 2 = 34 bits) are stored instead of one full pod pair data sample (34 bits). This is because in half channel mode, data is multiplexed into the sequencer pipeline in two 17 bit samples. The first 17 bit sample is latched, the next 17 bit sample is sent down the pipeline along with the latched 17 bit sample.

This operation keeps the pipeline frequency down to 125 MHz. It should be noted that the transition detector still looks at a full 34 bits. This means it is looking at two samples at a time instead of one. In this mode, between 682 and 4094 transitions are stored.

**Minimum Transitions Stored** The following example shows what data is stored from a data stream with transitions that occur at a slow rate (more than 24 ns apart).

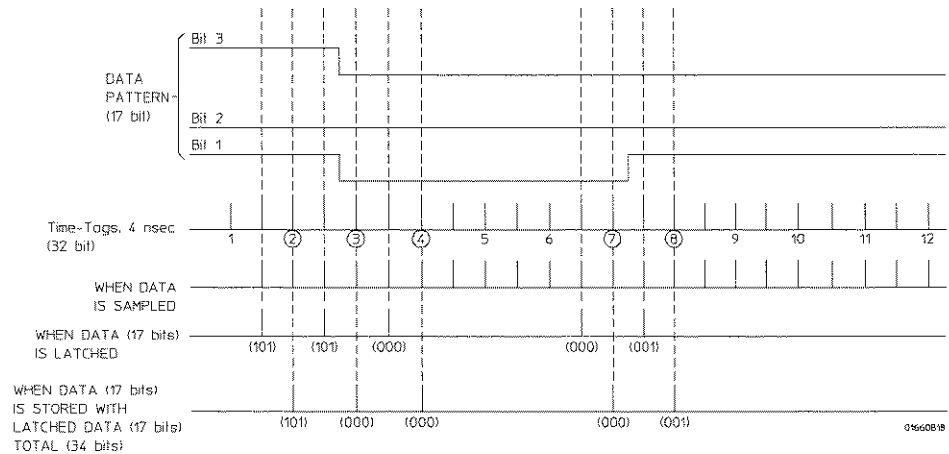

**Minimum Transitions Stored**

**The Format Menu**  
**Timing Acquisition Mode Field (Timing only)**

As you can see, transitions are stored in two different ways, depending strictly on chance. Remember that the transition detector only looks at the full 34 bits while the data is stored as two 17 bit samples. So, the transition detector will not see time-tag 3 (101/000) as a transition. However, when it compares it to time-tags 2 (101/101) or 4 (000/000), it sees a difference and detects them as transitions. For this first set of time-tags, the transition detector sees more transitions than are really there. This causes the analyzer to store 6 samples per transition (three-34 bit sample pairs), instead of just two, like in the 125-MHz mode. If all the transitions will be stored in this way throughout the trace, the minimum number of stored transitions are 682 (4096/6).

However, as you see with time-tags 7 (000/000) and 8 (001/001), transitions can fall between the pairs of samples. When this happens, only one transition is detected and only 4 samples (two sample pairs) are stored. If all transitions will be stored in this way, 1023 (4096/4) transitions are stored.

From run to run, the actual number of transitions stored for transitions that occur at a slower rate will fall between these two numbers, based on the probability of a transition falling between a sample pair or falling within a sample pair.

**Maximum Transitions Stored** The following example shows the case where the transitions are occurring at a 4 ns rate:

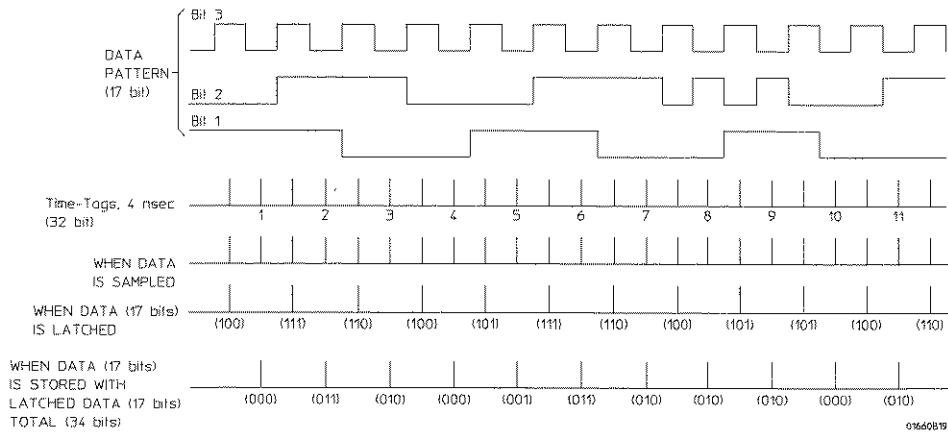

**Maximum Transitions Stored**



In this case, transitions are being detected with each sample. Therefore, they are all being stored. In addition, each sample pair contains a transition. For example, time tag 1 (100/000) contains a transition and is different from time tag 2 (111/011), which also contains a transition. The difference between the two will trigger the transition detector.

If this were to continue throughout the trace, You would store 4 Kbytes –1 transitions, or 4095. As with the 125-MHz mode, the actual number of transitions stored will fall somewhere between 682 and 4095, depending on the frequency of transitions.

### **Other Transitional Timing Considerations**

**Pod Pairs are Independent** In single run mode each pod pair runs independently. This means when one pod pair fills its trace buffer it will not shut the others down. Should you have a pod pair with enabled data lines and with no transitions on its lines, you get a message "Storing transitions after trigger for pods nn/nn." In repetitive run mode, a full pod pair waits 2 seconds, then halts all other pod pairs.

## The Format Menu

### Timing Acquisition Mode Field (Timing only)

**Increasing Duration of Storage** In the 125-MHz mode a transition on any one of the 34 bits each sample (if they are all turned on) will cause storage. Reducing the number of bits that are turned on for any one pod pair will more than likely increase data storage time.

Separating data lines which contain fast occurring transitions from lines with slow occurring transitions also helps. When doing this, be sure to cross pod pair boundaries. It does not help to move fast lines from pod 1 to pod 2, they must be moved to pod 3, which is a different pod pair.

In the 250 MHz mode a transition on any one of 17 bits (half channel) each sample (if they are all turned on) will cause storage.

**Invalid Data** The analyzer only looks for transitions on data lines that are turned on. Data lines that are turned off store data, but only when one of the lines that is turned on transitions. If the data line is turned on after a run, you would see data, but it is unlikely that every transition that occurred was captured.

## Clock Inputs Display

Beneath the Clock Inputs display, and next to the bit reference line, is a display of all clock inputs available in the present configuration. In a one card module the J and K clocks appears with pod pair 1/2, the L and M with pod pair 3/4, and clocks N and P with pod pairs 5/6. In a two card module the next six clocks appear to the left of the displayed master clocks, and are used as data channels. With the exception of the Range resource, all unused clock bits can be used as data channels. If any clock line is used as a data channel, the bit must be assigned. Activity indicators above the clock identifier show clock or data signal activity.

Clock inputs display

The screenshot shows the 'Clock inputs display' interface. At the top, there are buttons for 'Format', 'Print', and 'Run'. Below these are 'State Acquisition Mode' (Full Channel/4K Memory/100MHz) and 'Master Clock' (J). There are also 'Pod B2' and 'Pod B1' buttons, each with a 'TTL' option and a 'Master Clock' label. A 'Symbols' button is also present. A 'Labels' section is expanded to show a list of clock inputs: MACH 1, Lab2, Lab3, Lab4, Lab5, Lab6, Lab7, and Lab8. A table below the list shows the bit patterns for each clock input. An arrow points from the text 'Clocks assigned as data channels' to the Lab2 through Lab8 entries in the table.

Label	Bit Pattern
MACH 1	.....
Lab2	.....
Lab3	.....
Lab4	.....
Lab5	.....
Lab6	.....
Lab7	.....
Lab8	.....

Clocks assigned as data channels

Clock Inputs Display

The Format Menu  
**Pod Field**

## Pod Field

The Pod field identifies which pod of a pod pair the settings of the bit assignment field, pod threshold field, and pod clock fields effect. In the full channel modes, this field is simply an identifier and is not selectable. However, in the half channel mode, the Pod field turns dark which means it is selectable. In the half channel mode, one pod of a pod pair is selectable and all pod settings effect the selected pod.

Pod field

The screenshot shows a menu titled "Pod field" with the following elements:

- Buttons: 100/500MHz LA B, Format 1, Print, Run
- State Acquisition Mode: Full Channel/4K Memory/100MHz
- Master Clock: Jt
- Buttons: Symbols
- Buttons: Clock Inputs, Pod B2, TTL, Pod B1, TTL
- Buttons: Master Clock, Master Clock
- Labels: Labels (with expand/collapse icons)
- Fields: KJ, 15 ... 87 ... 0, 15 ... 87 ... 0
- Table:

MACH 1	+	**	.....	.....
Lab2				
Lab3				
Lab4				
Lab5				
Lab6				
Lab7				
Lab8				

**Pod Field**

## Pod Clock Field (State only)

The Pod Clock field identifies the type of clock arrangement assigned to each pod. When the Pod Clock field is selected, a clock arrangement type menu appears with the choices of Master, Slave, or Demultiplex. Once a pod clock is assigned a clock arrangement, its identity and function follows what is configured in the Master and Slave Clock fields. The Pod Clock field and the clocking arrangement is only available in a state analyzer.

### Master

This option specifies that data on all pods designated "Master Clock", in the same analyzer, are strobed into memory when the status of the clock lines match the clocking arrangement specified under the Master Clock..

### See Also

The "Master and Slave Clock Field" found later in this chapter for information about configuring a clocking arrangement.

The "Type Field" in the Configuration menu chapter for information on selecting analyzer types.

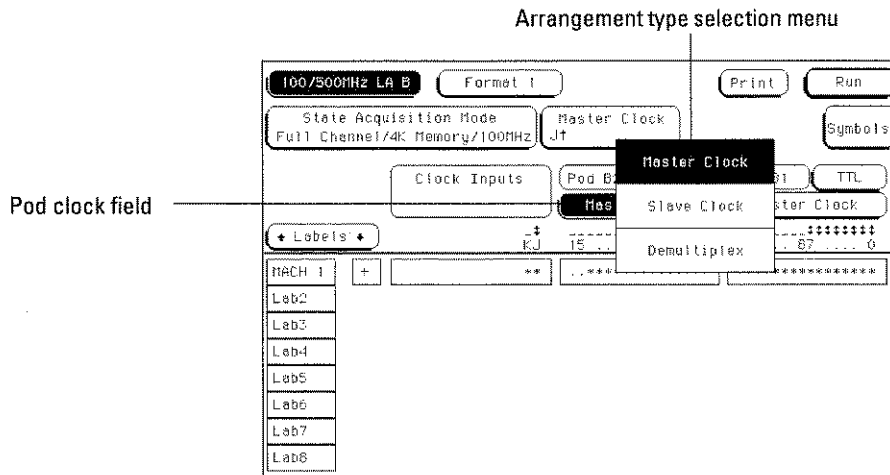

### Pod Clock Field

The Format Menu  
**Pod Clock Field (State only)**

**Slave**

This option specifies that data on a pod designated "Slave Clock", are latched when the status of the slave clock inputs meet the requirements of the slave clocking arrangement. Then, followed by a match of the master clock and the master clock arrangement, the slave data is strobed into analyzer memory along with the master data. See the figure below.

If multiple slave clocks occur between master clocks, only the data latched by the last slave clock prior to the master clock is strobed into analyzer memory.

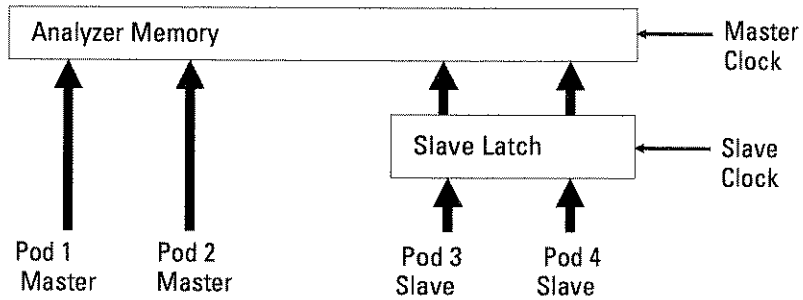

**Latching Slave Data**

Slave clock arrangement field

100/500MHz LA A		Format 1		Print	Run
State Acquisition Mode		Master Clock	Slave Clock	Symbols	
Full Channel/4K Memory/100MHz		Jf	K4		
Clock Inputs		Pod A2	TTL	Pod A1	TTL
		Master Clock		Slave Clock	
+ Labels +		KJ 15 ... 87 ... 0		15 ... 87 ... 0	
DATA	+	..	.....*****	.....	.....
ADDR	+	..	.....	.....	.....*****
Lab3					
Lab4					
Lab5					
Lab6					
Lab7					
Lab8					

**Slave Clock Field**

**Demultiplex**

The Demultiplex mode is used to store two different sets of data that occur at different times on the same channels. In Demultiplex mode, only one pod of the pod pair is used, and that pod is selectable. Both the master and slave clocks are used in the Demultiplex mode. Channels assignments are displayed as Demux Master and Demux Slave. For easy recognition of the two sets of data assign slave and master data to separate labels.

Demultiplex mode field

The screenshot shows a control interface for the Demultiplex mode. At the top, there are buttons for '100/500MHz LA A', 'Format 1', 'Print', and 'Run'. Below these are 'Master Clock J↑' and 'Slave Clock K↓' buttons, along with a 'Symbols' button. A 'Clock Inputs' section contains three buttons: 'Pod A1', 'TTL', and 'Pod A1'. Below these are 'Demux Master' and 'Demux Slave' buttons. A 'Labels' section is expanded to show a list of labels: DATA, ADDF, Lab3, Lab4, Lab5, Lab6, Lab7, and Lab8. To the right of the labels, there are two columns of data, each with a header row containing a series of asterisks and a row below containing the values '15 .. 87 .. 0'. The 'Demultiplex mode field' label points to the 'Labels' section.

**Demultiplex Clocking Mode**

The Format Menu  
**Pod Clock Field (State only)**

When the analyzer sees a match between the slave clock input and the Slave Clock arrangement, Demux Slave data is latched. Then, followed by a match of the master clock and the master clock arrangement, the slave data is strobed into analyzer memory along with the master data. If multiple slave clocks occur between master clocks, only the data latched by the last slave clock prior to the master clock is strobed into analyzer memory.

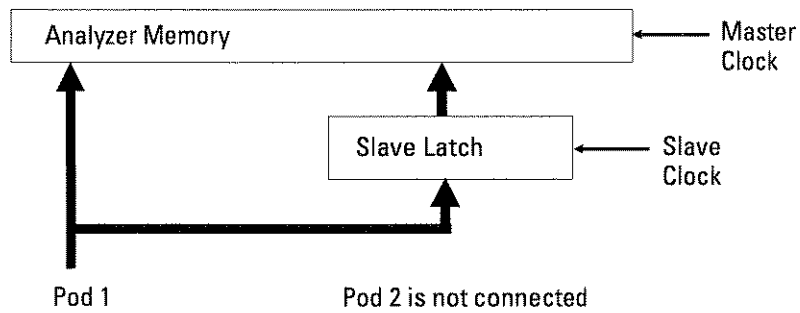

**Latching Slave Data In Demultiplex Mode**



---

## Pod Threshold Field

The pod threshold field is used to set a voltage level which the data must reach before the analyzer recognizes and displays it as a change in logic levels. You specify a threshold level for each pod in a pod pair. The level specified for each pod is also assigned to the pods clock threshold.

When the Pod Threshold field is touched, a threshold selection pop-up appears with the following choices:

### **TTL**

When TTL is selected as the threshold level, the data signals must reach +1.5 volts.

### **ECL**

When ECL is selected as the threshold level, the data signals must reach -1.3 volts.

**The Format Menu**  
**Pod Threshold Field**

**USER**

When USER is selected as the threshold level, the data signals must reach a user selectable value between -6.0 volts to +6.0 volts.

Pod threshold field

The screenshot shows a terminal window with the following elements:

- Top bar: 100/500MHz LA B, Format 1, Print, Run
- State Acquisition Mode: Full Channel/4K Memory/100MHz
- Master Clock: J↑
- Clock Inputs: Pod B2, TTL, Pod
- Pod Threshold selection menu (open): TTL, ECL, User (selected)
- Labels: + Labels +
- Labels list: Lab1, Lab2, Lab3, Lab4, Lab5, Lab6, Lab7, Lab8

Pod Threshold selection menu

**Pod Threshold Field**

## Master and Slave Clock Field (State only)

The Master and Slave Clock fields are used to construct a clocking arrangement. A clocking arrangement is the assignment of appropriate clocks, clock edges, and clock qualifier levels which allow the analyzer to synchronize itself on valid data.

### Clock Selections

When the Master or Slave Clock field is selected, a clock/qualifier selection menu appears showing the available clocks and qualifiers for a clocking arrangement. There are up to six clocks available (J through P), and four clock qualifiers available (Q1 through Q4).

Each pod cable has one clock line and at least one clock edge must be assigned for all pods in a state analyzer. If a second analyzer card is connected, the lower card in the frame becomes the master and only its six clocks can be assigned as clocks. The remaining unassigned clocks can be used as data channels.

### See Also

The "Pod Clock Field" found earlier in this chapter for information on selecting clocking arrangement types such as Master, Slave, or Demultiplex.

Master clock field

100/500MHz LA A	Format 1	Print	Run
State Acquisition Mode Full Channel/4K Memory/100MHz	Master Clock J↑	Slave Clock K↓	Symbols
Clock Inputs	Pod A2 TTL	Pod A1 TTL	
	Master Clock	Slave Clock	
+ Labels +	↑↑ KJ	↑↑↑↑↑↑ 15 87 0	↑↑↑↑↑↑ 15 87 0
DATA	+	.....	.....
ADDR	+	.....	.....
Lab3			
Lab4			
Lab5			
Lab6			
Lab7			
Lab8			

Master Clock Field

The Format Menu  
**Master and Slave Clock Field (State only)**

All combinations of the J, K, and L clock and Q1 and Q2 qualifiers, are ORed to the clock combinations of the M, N, and P clocks and Q3 and Q4 qualifiers. Clock edges are ORed to clock edges, clock qualifier are ANDED to clock edges, and clock qualifiers can be either ANDED or ORed together.

The clock threshold level is the same as the level assigned in the Pod Threshold field.

Clock edge selection menu

100/500MHz LA B    Format 1    Print    Run

State Acquisition Mode    Master Clock    Slave Clock    Symbols  
 Full Channel/4K Memory/100MHz    J    K

Master Clock

[(J+K)+ (J=0+K=0)]

EDGES: J  K  L  M  N  P

QUALS: Q1  J Low    And    Q2  K Low    Q3  Off    And    Q4  Off

Setup/Hold    Done

**Clock Edges and Levels**

## Setup/Hold Field (State only)

Setup/Hold adjusts the relative position of the clock edge with respect to the time period that data is valid. When the Setup/Hold field is selected, a configuration menu appears. Use this Setup/Hold configuration menu to select each pod in the analyzer and assign a Setup/Hold selection from the selection list.

With a single clock edge assigned, the choices range from 3.5 ns Setup/0.0 ns Hold, to 0.0 ns Setup/3.5 ns Hold. With both edges of a single clock assigned, the choices are from 4.0 ns Setup/0.0 ns Hold, to 0.0 ns Setup/4.0 ns Hold. If the analyzer has multiple clock edges assigned, the choices range from 4.5 ns Setup/0.0 ns Hold, to 0.0 ns Setup/4.5 ns Hold.

Setup and hold menu

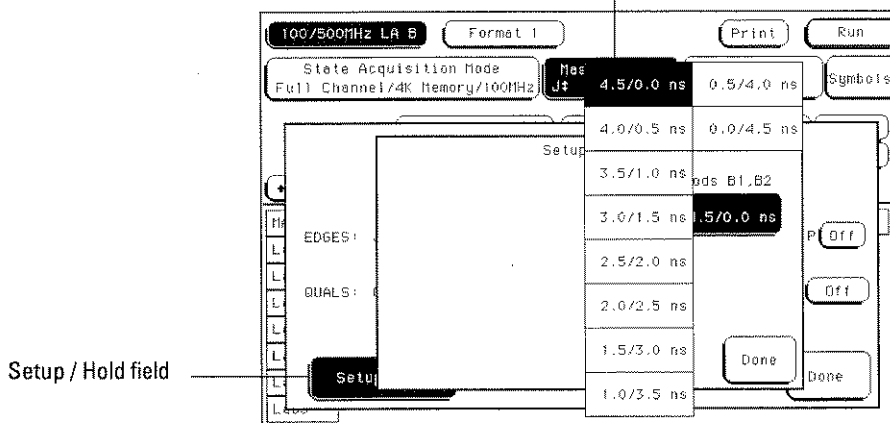

**Setup and Hold Menu**

## The Format Menu Setup/Hold Field (State only)

The relationship of the clock signal and valid data under the default setup and hold is shown in the figure below.

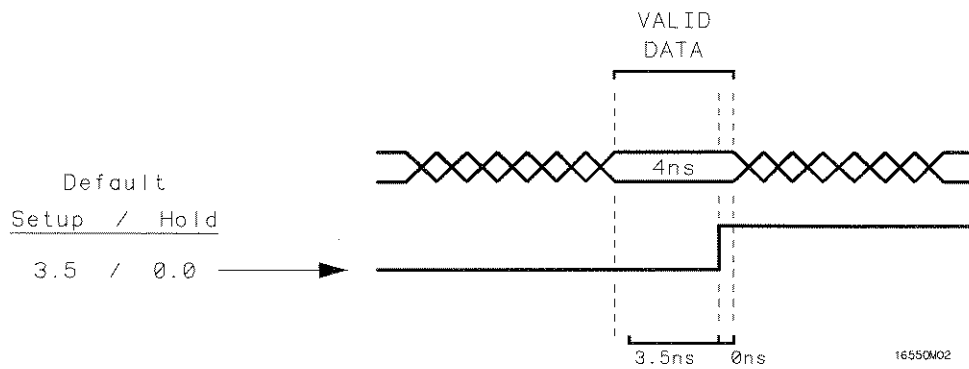

## Default Setup and Hold

If the relationship of the clock signal and valid data is such that the data is valid for 1 ns before the clock occurs and 3 ns after the clock occurs, you will want to use the 1.0 setup and 2.5 hold setting.

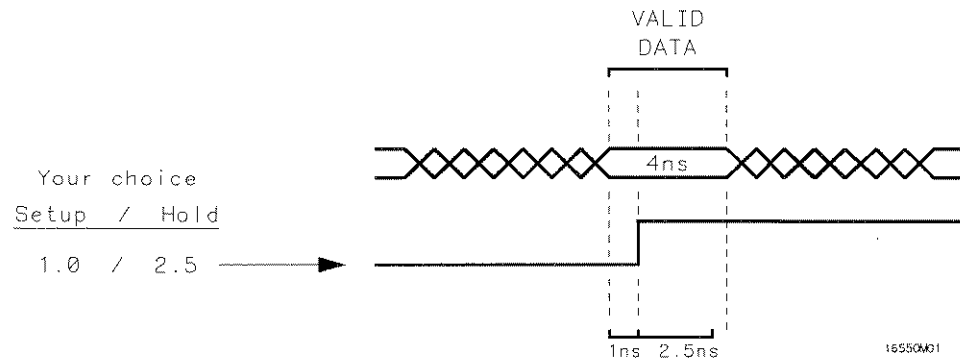

## Clock Position in Valid Data

---

## Symbols Field

**See Also**

Refer to Symbols Assignment in the "Common Module Operations" part of the *HP 16500B User's Reference Guide* for complete information on using symbols.

---

## Label Assignment Fields

**See Also**

Refer to Labels Assignment in the "Common Module Operations" part of the *HP 16500B User's Reference Guide* for complete information on using labels.

---

## Rolling Labels and Pods

**See Also**

The rolling function is the same for all items that are stored offscreen. For more information on rolling labels and pods, refer to Labels Assignment in the "Common Module Operations" part of the *HP 16500B User's Reference Guide* for complete information.

The Format Menu  
**Label Polarity Fields**

## Label Polarity Fields

The Label Polarity fields are used to assign a polarity to each label. The default polarity for all labels is positive (+). You change the label polarity by touching the polarity field, which toggles the polarity between positive (+) and negative (-).

When the polarity is inverted, all data as well as bit pattern specific configurations used for identifying, triggering, or storing data reflect the change of polarity.

In a timing analyzer with the data inverted, the waveform display does not change.

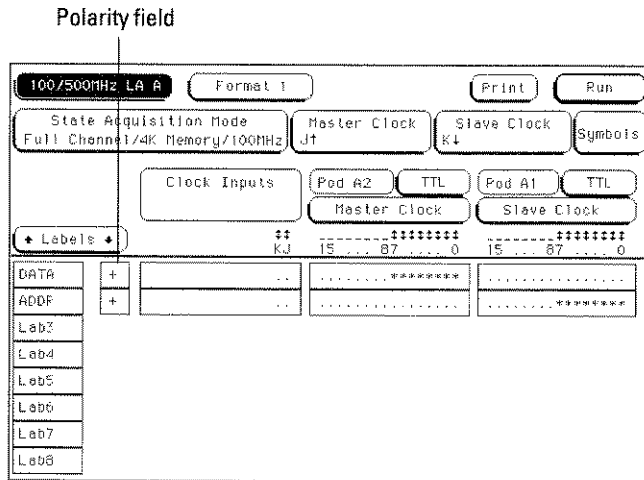

**Polarity Field**



## Bit Assignment Fields

The bit assignment fields are used to assign bits (channels) to labels. The convention for bit assignment is as follows:

\* (asterisk) indicates assigned bit.

. (period) indicates unassigned bit.

To change a bit assignment, select the bit assignment field and using the knob, move the cursor to the bit you want to change, then select an asterisk or a period. When the bits are assigned as desired, and you close the pop-up, the screen displays the new bit assignment.

Above each column of bit assignment fields is a bit reference line that tells you the bit numbers from 0 to 15, with the left bit numbered 15 and the right bit numbered 0. This bit reference line helps you know exactly which bits you have assigned by displaying activity indicators when a proper connection from the probe is recognized.

### See Also

The "Activity Indicators" in the Configuration menu chapter for more information on the bit reference line and the activity indicators on the bit reference line.

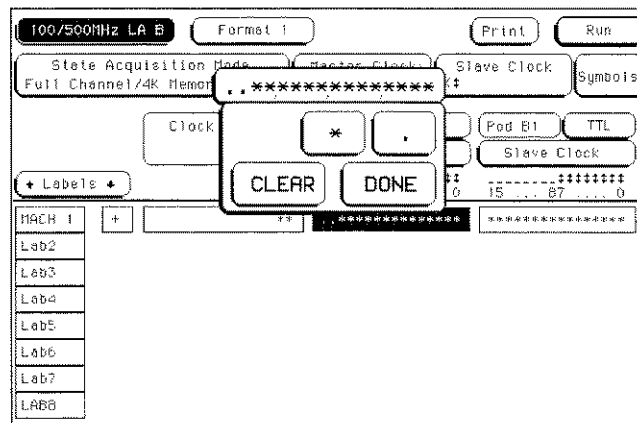

Bit Assignment Field

**The Format Menu**  
**Bit Assignment Fields**

Labels may have from 1 to 32 channels assigned to them. If you try to assign more than 32 channels to a label, the logic analyzer will beep, indicating an error, and a message will appear at the top of the screen telling you that 32 channels per label is the maximum.

Channels assigned to a label are numbered from right to left by the logic analyzer. The least significant assigned bit on the far right is numbered 0, the next assigned bit is numbered 1, and so on. Since 32 channels can be assigned to one label at most, the highest number that can be given to a channel is 31.

Although labels can contain split fields, assigned channels are always numbered consecutively within a label.

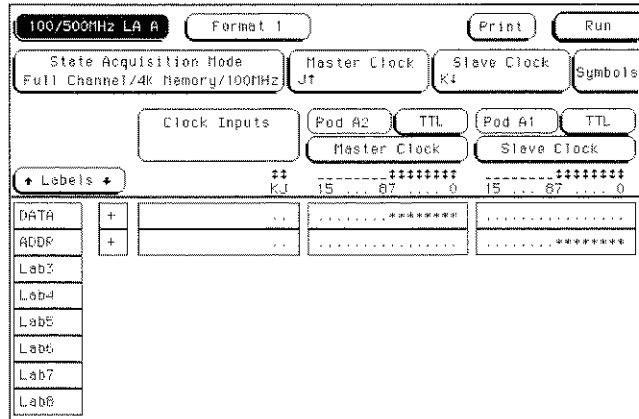

**Bit Assignment Example**



# The Trigger Menu

# The Trigger Menu

The trigger menu is used to configure when the analyzer triggers, what the analyzer triggers on, and what is stored in acquisition memory. In addition, within the Acquisition Control function, prestore and poststore requirements are set. The Trigger menu is divided into three areas, each dealing with a different area of general operation.

- Sequence Levels
- Resource Terms
- Acquisition Control

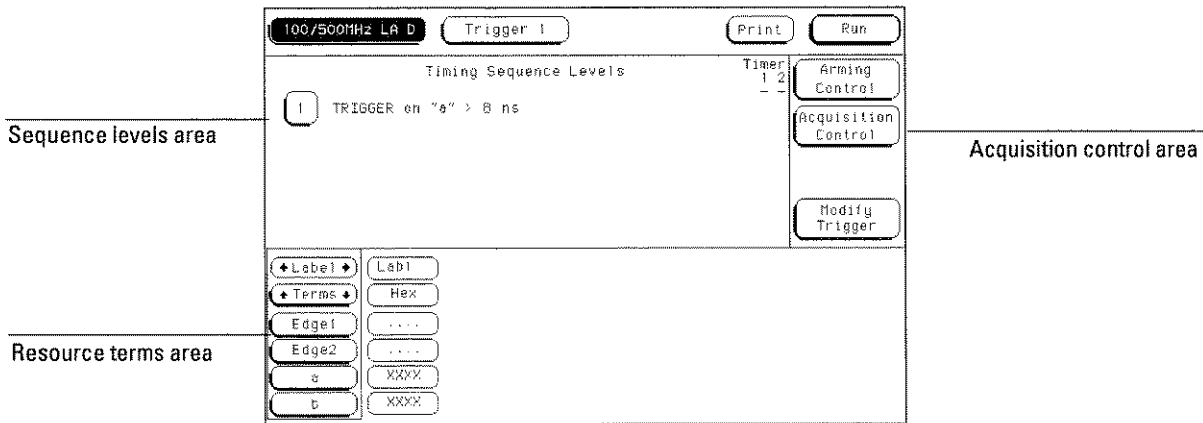

**Trigger Menu Areas**

### **Sequence Levels Area**

You use the sequence levels area to view the sequence levels currently used in the trigger specification and their timer status. From this area you can also access each individual level for editing.

### **Resource Terms Area**

You use the resource terms area to assign values to the resource terms. Resource terms take the form of bit patterns, ranges, and edges. In addition to assigning values to the resource terms, you also assign values to the two timers, and assign custom names to all the resource terms.

Once defined and inserted into the trigger specification, the resource terms will identify key points in the data stream for branching or the point for data acquisition to occur.

### **Control Area**

You use the acquisition control area to manage the efficient use of analyzer memory. You define any arming control or whether you want time or count tags placed in the stored data.

Within the Acquisition Control function, you can adjust trigger position, sample period, memory length, and whether the resource term that generated a branch is stored.

### **Trigger Menu Map**

The following menu map illustrates all fields and available options in the Trigger menu. The menu map will give you an overview as well as provide you with a quick reference of what the Trigger menu contains.

# The Trigger Menu

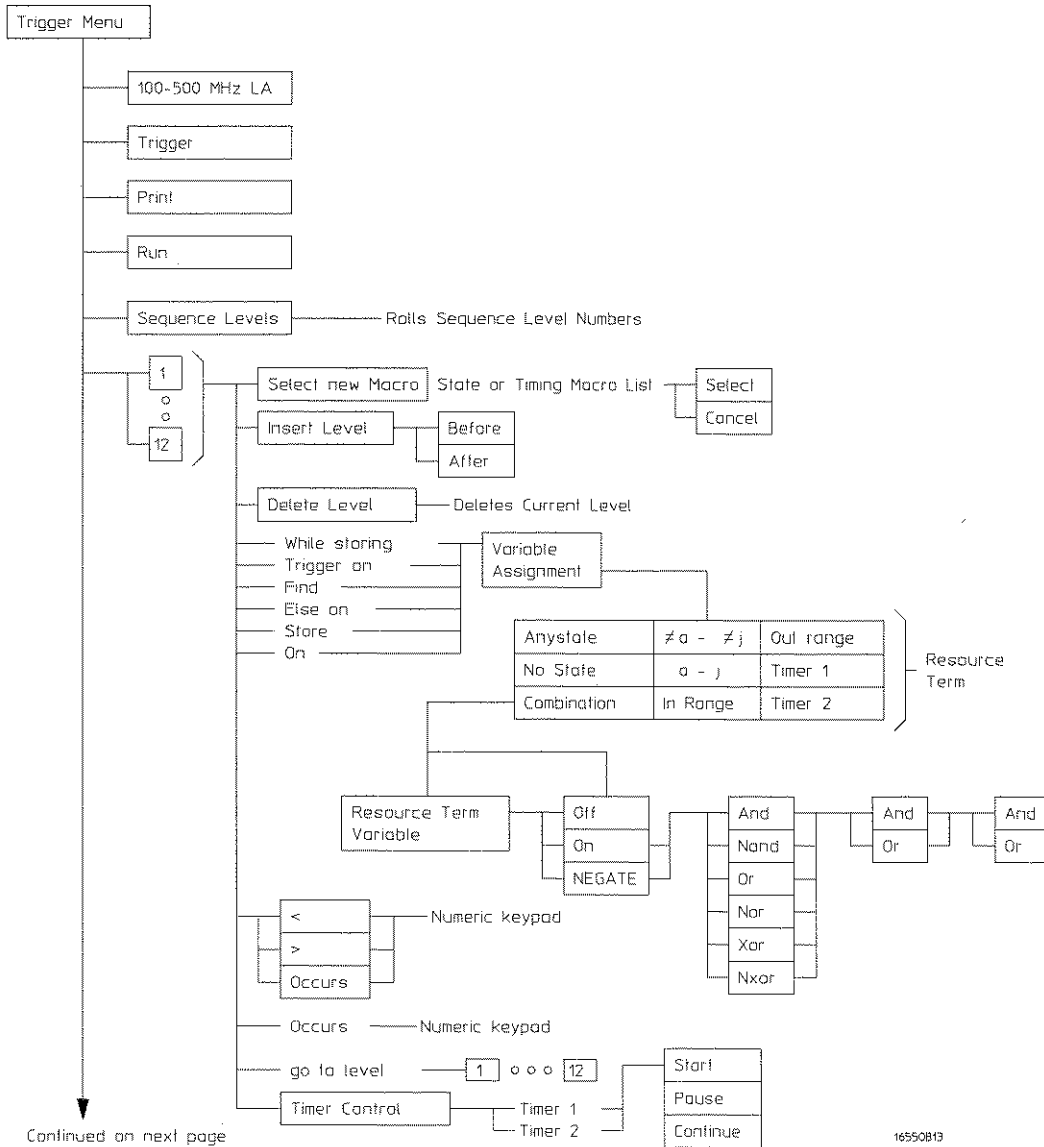

Continued on next page

16550B13

## Trigger Menu Map

Continued from previous page

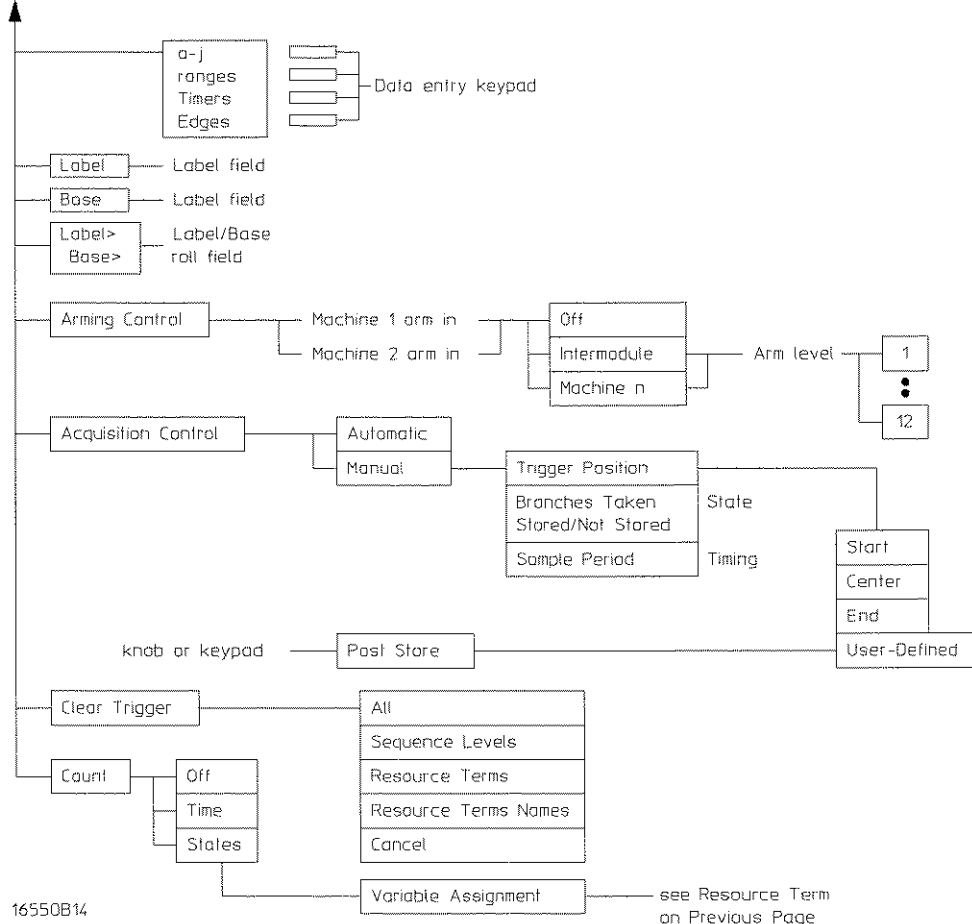

16550B14

see Resource Term  
on Previous Page

Trigger Menu Map (Continued)

---

## Trigger Sequence Levels

Sequence levels are the definable stages of the total trigger specification. When defined, sequence levels control what the analyzer triggers on, when the analyzer triggers, and where trigger will be located in the total block of acquired data. In addition, you can qualify what data is stored when trigger occurs.

By using sequence levels, you create a sequence of instructions for the analyzer to follow. As the sequence levels are executed, all subsequent branching and sequence flow is directed by the statements within the sequence levels. The path taken resembles a flow chart, and the end result is the desired trigger point.

Individual sequence levels are assigned either a pre-defined trigger macro, or a User-level trigger macro. The total trigger specification, (one or more sequence levels) can contain pre-defined macros, User-level macros, or a combination of both. You finish defining each level by inserting resource terms, timers, or occurrence counters into assignment fields within each macro.

In State Acquisition Mode, there are 12 sequence levels available. In Timing Acquisition Mode there are 10 sequence levels available.

### Sequence Level Usage

Generally, you would think using one macro in one sequence level uses up one of the available sequence levels. This may not always be the case. Some of the more complex pre-defined macros require multiple sequence levels. Keep this point in mind if you are near the limit on remaining sequence levels. The exact number of internal levels required per macro, and the remaining available levels, is shown within the macro library list.

The only instance where multiple levels are used with the User-level macro, is when the "<" duration is assigned.



### Editing Sequence Levels

The higher level editing, such as adding or deleting entire sequence levels, is done using the Modify Trigger field in the main Trigger menu. You can also modify any existing sequence level from the Modify Trigger field.

Another way of editing a specific sequence level is to select the sequence level number field. If the number field is offscreen, select the sequence levels roll field turning it light blue, then use the knob to roll the level back onscreen.

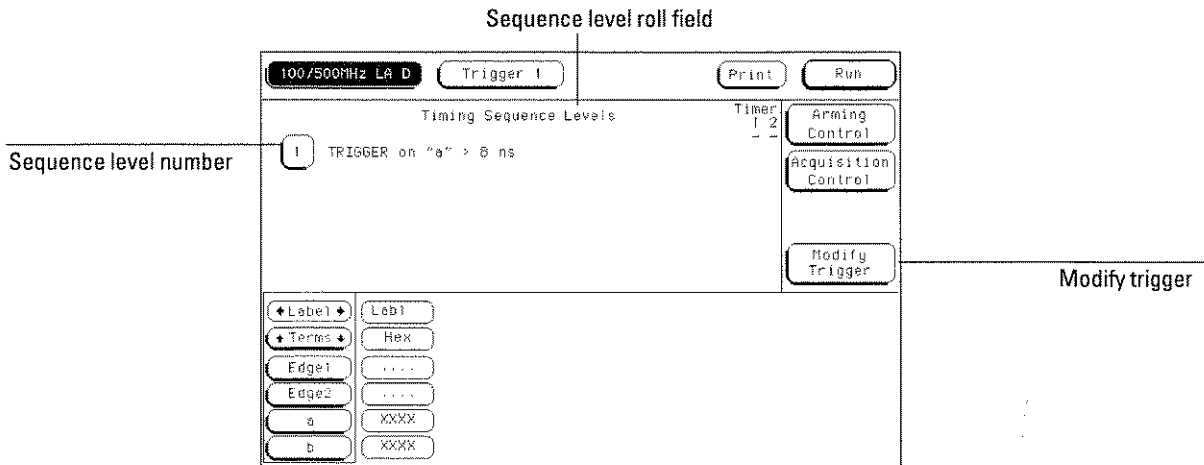

### Accessing Sequence Levels

Once you are in any sequence level, you can reconfigure the existing macro by selecting and reassigning the assignment fields and value fields. All appropriate resource terms appear in pop-up selection lists after any of the assignment fields are selected.

To edit the actual values assigned to the resource terms, exit the sequence level and make changes to the terms assignment fields in the resource terms area.

**See Also**

"Assigning Resource Term Names and Values" found later in this chapter.

---

## Modify Trigger Field

The Modify Trigger field allows you to modify the statements of any single sequence level as well as other high level actions like global clearing of existing trigger statements, and adding or deleting sequence levels.

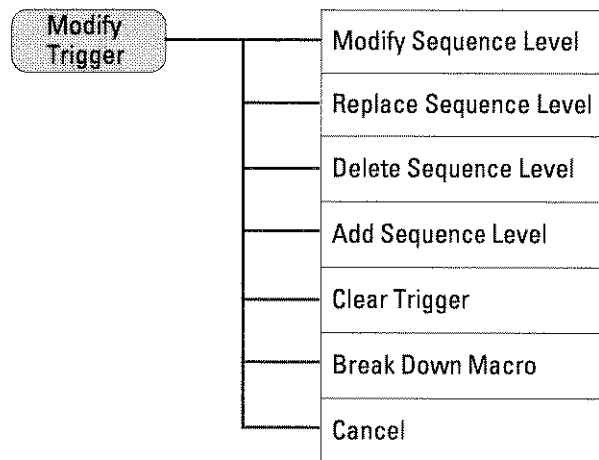

### **Modify Sequence Level**

If there is more than one sequence level assigned, you are asked which level to modify. Once in the desired sequence level, make all appropriate resource changes, then select Done.

### **Replace Sequence Level**

If there is more than one sequence level assigned, you are asked which level to replace. When you replace a level, you pick a new macro to replace the old one. You then assign the appropriate resource in the new level.

**Delete Sequence Level**

If there is more than one sequence level assigned, you are asked which level to delete.

**Add Sequence Level**

By default you have one sequence level available at powerup. When you add sequence levels, you are given the choice of inserting them before or after a sequence level.

**Clear Trigger**

The Clear Trigger field accesses a selection menu used to clear any user-defined values within the trigger specification or within the resource terms list.

**Clear All** The Clear All option clears sequence levels, resource terms, and resource term names back to their default values.

**Clear Sequence Levels** The Clear Sequence Levels option resets all assignment fields in the sequence levels to their default values. Any custom names assigned to the resource terms will remain.

**Clear Resource Terms** The Clear Resources Terms option will reset all assignment fields for the resource terms back to their default values.

**Clear Resource Term Names** The Clear Resource Term Names option resets all custom names assigned to the resource terms back their default values.

## The Trigger Menu

### Modify Trigger Field

#### **Break Down Macros / Restore Macros**

When a pre-defined macro is broken down, the contents of that macro are displayed in the same long form used in the User-level macro. If the macro uses multiple internal levels, all levels are separated out and displayed in the sequence level area of the Trigger menu. Once the macros in your trigger specification are broken down, the Break Down Macros field changes to Restore Macros. Use the Restore Macros field to restore all macros to their original structure.

While in a broken down form, you can change the structure. However, when the macros are restored, all changes are lost and any branching that is part of the original structure is restored.

Use the Break Down Macros if you want to view a particular macro part in its long form to see exactly what flow the sequencer is following. It can also be used as an aid in creating a custom trigger specification. In this application, you would start with a pre-defined macro, break it down, then customize the long form to meet your needs.

When a macro is broken down, you have all the assignment fields and branching options available as if you have configured a User-level macro. For information on the assignment fields, branching, occurrence counters, and time duration function, refer to the section, "Modifying the User-level Macro" found later in this chapter.

---

## Pre-defined Trigger Macros

Both the state and timing acquisition modes have a macro library containing pre-defined trigger macros. Depending on which acquisition mode you are using, you get the corresponding library.

Each macro will require at least one sequence level, and in some cases, may require multiple levels. Sequence levels containing pre-defined macros flow linear without branching. However, if branching is required, the User-level macro can be inserted to provide a branch.

Both lists of macros are divided into the following different groups depending on their function.

### Timing Trigger Macro Library:

- User Mode (User-level macro)
- Basic Macros
- Pattern/Edge Combination Macros
- Time Violation Macros
- Delay Macros

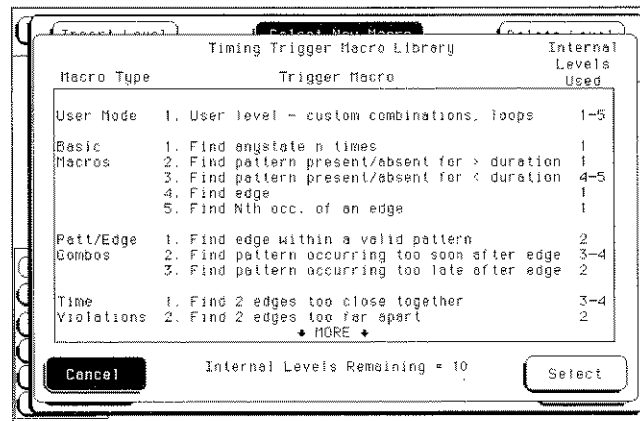

**Timing Trigger Macro Library**

## The Trigger Menu

### Modify Trigger Field

#### State Trigger Macro Library:

- User Mode (User-level macro)
- Basic Macros
- Sequence Dependent Macros
- Time Violation Macros
- Delay Macros

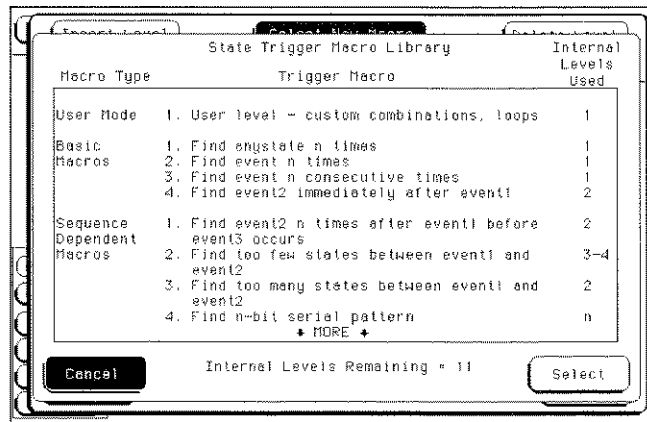

#### State Trigger Macro Library

## Using Macros to Create a Trigger Specification

To configure a trigger specification using trigger macros, follow the procedure below.

- 1 From the **Trigger** menu, enter the desired sequence level through the **Modify Trigger** field, or by selecting a sequence level number.

**See Also**

"Editing Sequence Levels" and "Modify Trigger Field" found earlier in this chapter for information on accessing levels.

- 2 From within the sequence level, select the **Select New Macro** field.

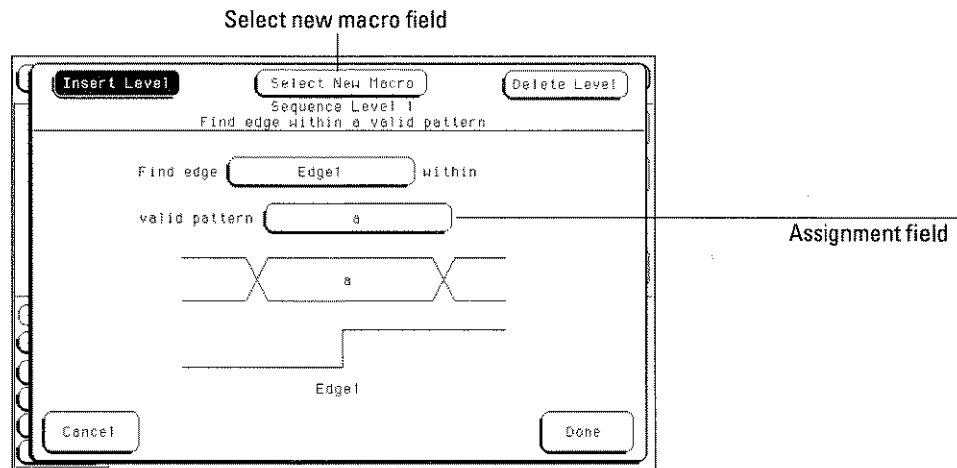

### Select New Macro Field

- 3 Scroll and highlight the macro you want, then select the **Select** field.
- 4 Select the appropriate assignment fields and insert the desired pre-defined resource terms, numeric values, and other parameter fields required by the macro. Select the **Done** field.

In State Acquisition mode, a "Store" sequence level is always the last level. This level is placed at the end of the trigger specification automatically.

**See Also**

"Resource Terms" found later in this chapter for information on using pre-defined resource terms.

---

## Timing Trigger Macro Library

The following list contains all the macros in the Timing Trigger Macro Library. They are listed in the same order as they appear onscreen.

### **User level - custom combinations, branching**

The User level is a user-definable level. This level offers low level configuration and uses one internal sequence level. If the "<" duration is used, four levels are required.

#### **1. Find anystate "n" times**

This macro becomes true when it sees any state occurring "n" number of times. It uses one internal sequence level.

#### **2. Find pattern present/absent for > duration**

This macro becomes true when it finds a designated pattern that has been present or absent for greater than or equal to the set duration. It uses one internal sequence level.

#### **3. Find pattern present/absent for < duration**

This macro becomes true when it finds a designated pattern that has been present or absent for less than the set duration. It uses four internal sequence levels.

#### **4. Find edge**

This macro becomes true when the designated edge is seen. It uses one internal sequence level.

#### **5. Find Nth occurrence of an edge**

This macro becomes true when it finds the "n" th occurrence of a designated edge. It uses one internal sequence level.



Pattern/Edge  
Combinations

**1. Find edge within a valid pattern.**

This macro becomes true when a selected edge type is seen within the time window defined by a designated pattern. It uses two internal sequence levels.

**2. Find pattern occurring too soon after edge**

This macro becomes true when a designated pattern is seen occurring within a set duration after a selected edge type is seen. It uses three internal sequence levels.

**3. Find pattern occurring too late after edge**

This macro becomes true when one selected edge type occurs, and for a designated period of time after that first edge is seen, a pattern is not seen. It uses two internal sequence levels.

Time Violations

**1. Find two edges too close together**

This macro becomes true when a second selected edge is seen occurring within a designated period of time after the occurrence of a first selected edge. It uses three internal sequence levels.

**2. Find two edges too far apart**

This macro becomes true when a second selected edge occurs beyond a designated period of time after the first selected edge. It uses two internal sequence levels.

**3. Find width violation on a pattern/pulse**

This macro becomes true when the width of a pattern violates designated minimum and maximum width settings. It uses four internal sequence levels.

Delay

**1. Wait "t" seconds**

This macro becomes true after a designated time period has expired. It uses one internal sequence level.

---

## State Trigger Macro Library

The following list contains all the macros in the State Trigger Macro Library. They are listed in the same order as they appear onscreen.

User Mode

### **User level - custom combinations, loops**

The User level is a user-definable level. This level offers low level configuration and uses one internal sequence level.

Basic Macros

#### **1. Find anystate "n" times**

This macro becomes true when the first state it sees occurs "n" number of times. It uses one internal sequence level.

#### **2. Find event "n" times**

This macro becomes true when it sees a designated pattern occurring a designated number of times consecutively or nonconsecutively. It uses one internal sequence level.

#### **3. Find event "n" consecutive times**

This macro becomes true when it sees a designated pattern occurring a designated number of consecutive times. It uses one internal sequence level.

#### **4. Find event 2 immediately after event 1**

This macro becomes true when the first designated pattern is seen immediately followed by a second designated pattern. It uses two internal sequence levels.

Sequence  
Dependent macros

**1. Find event 2 "n" times after event 1, before event 3 occurs**

This macro becomes true when it first finds a designated pattern 1, followed by a selected number of occurrences of a designated pattern 2. In addition, if a designated pattern 3 is seen anytime while the sequence is not yet true, the sequence starts over. If patt2's "nth" occurrence is coincident with patt3, patt2 takes precedence. It uses two internal sequence levels.

**2. Find too few states between event 1 and event 2.**

This macro becomes true when a designated pattern 1 is seen, followed by a designated pattern 2, and with less than a selected number of states occurring between the two patterns. It uses three internal sequence levels.

**3. Find too many states between event 1 and event 2.**

This macro becomes true when a designated pattern 1 is seen, followed by at least a selected number of states, then followed by a designated pattern 2. It uses two internal sequence levels.

**4. Find n-bit serial pattern**

This macro finds an "n" bit serial pattern on a given channel for a given label.

The Trigger Menu  
**State Trigger Macro Library**

Time Violations

**1. Find event 2 occurring too soon after event 1**

This macro becomes true when a designated pattern 1 is seen, followed by a designated pattern 2, and with less than a selected time period occurring between the two patterns. It uses two internal sequence levels..

**2. Find event 2 occurring too late after event 1**

This macro becomes true when a designated pattern 1 is seen, followed by at least a selected time period, before a designated pattern 2 occurs. It uses two internal sequence levels.

Delay

**1. Wait "n" external clock states**

This macro becomes true after a designated number of user clock states have occurred. It uses one internal sequence level.

## Modifying the User-level Macro

Before you begin building a trigger specification using the User-level macro, it should be noted that in most cases one of the pre-defined trigger macros will work.

If you need to accommodate a specific trigger condition, or you prefer to construct a trigger specification from scratch, you will use the User-level macro to build from. This macro appears in long form, which means it has the analyzer's total flexibility available in terms of resource terms, global timers, occurrence counters, duration counters, and two way branching.

The User-level macro has a "fill-in-the-blanks" type statement. You have the following elements to use:

- Bit Patterns, Ranges, and Edges
- Storage Qualification
- < and > Durations
- Occurrence Counters
- Timers
- Branching

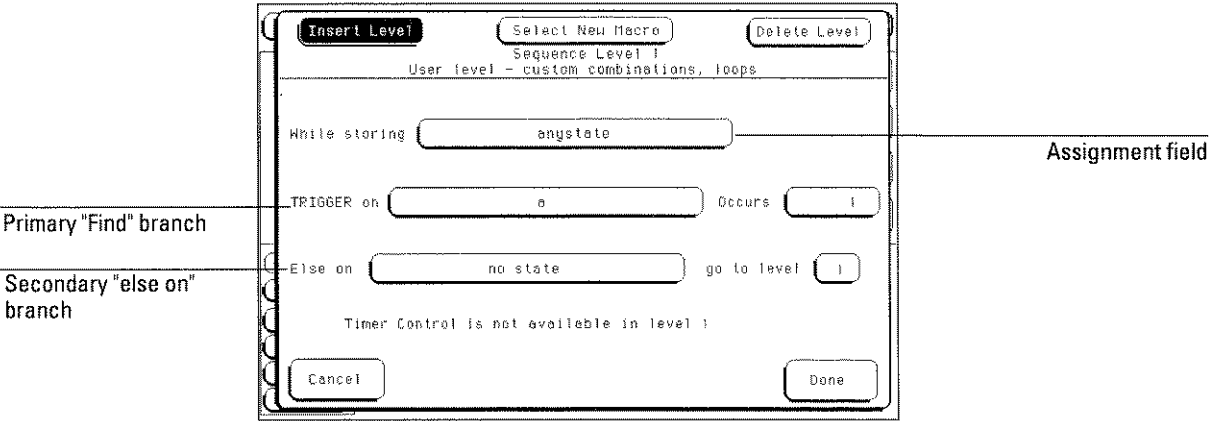

User-level Macro

## The Trigger Menu

### Modifying the User-level Macro

The number of User-level macros you will use, or what you assign to the resource terms is difficult to predict because of the variety of applications. A general approach is to think of each field assignment or each new sequence level as an opportunity to lead the analyzer through key points in the data stream. Your end result is to select the desired point in the data to trigger on, and to store only the data you want. If you know the data structure and flow well enough, you could build a flowchart.

A typical method used during a debug operation is to first trigger on a known pattern, edge or range. From that point, it becomes an iterative process of adding more levels to further filter the data. It is important for you to know how to use such elements as occurrence counters, timers, and branching, to zero in and trigger at the desired point.

As the analyzer executes the trigger specification, it searches for a match between the resource term value and the data. When a match is found, that part of the sequence statement becomes true and the sequencing continues to the next part of the statement or the next sequence level.

Eventually a path of "true" resource terms leads to your trigger command. If timers or occurrence counters are used, the analyzer waits or counts occurrences of a specified value before continuing.

The following examples illustrate the use of resource terms, occurrence counters, timers, branching, and store qualification. You will use them in your trigger specification either by themselves or in combination with each other.

#### Using Bit Patterns, Ranges, and Edges

Bit patterns are set to match specific data values, and ranges are set to match a range of bit patterns. In the Timing Acquisition mode, edges are set to match specific edges of a timing pulse.

---

#### Example

The following statement looks for the bit pattern you assigned to term "a" to occur "1" time, before it triggers.

TRIGGER on  Occurs

---

**Example**

The following statement looks for the positive, negative, or either going edge type you assigned to term "Edge1" to occur "1" time, before it Triggers .

TRIGGER on  Occurs

---

---

**Example**

The following statement looks for the combination of either a bit pattern you assigned to "a" or an edge type you assigned to "Edge1" to occur "1" time before it Triggers.

TRIGGER on  Occurs

---

---

**Example**

The following statement looks for a range of bit patterns assigned to "Range1" to occur "2" times before it branches to the next sequence level.

TRIGGER on  Occurs

---

---

**See Also**

"Assigning Resource Term Names and Values" for more information on using resource terms by themselves and in combinations.

The Trigger Menu  
**Modifying the User-level Macro**

**Using Storage Qualification**

Store qualification enables you to store all data, no data, or just selected data, before trigger occurs.

**Example**

The following statement determines that all occurrences of the bit pattern you assigned to "a" will be stored before trigger occurs.

While storing

**Setting < and > Durations (Timing only)**

When a resource term is found during a timing sequence evaluation, you can dictate how long the term must remain before the term actually becomes true. When < or > duration is assigned, the secondary branching (Else on) is not available.

**Example**

The following statement dictates the bit pattern you assigned to "a" must appear and remain present for greater than 8 ns.

TRIGGER on

**> Field** When greater-than (>) is used, the analyzer continues sequence level evaluation only after the resource term has been true for greater than or equal to the amount of duration specified.

**< Field** When less-than (<) is used, the analyzer continues sequence level evaluation only after the resource term has been true for less than or equal to the amount of duration specified. For each (<) assignment, you must delete 4 levels from the total number of sequence levels. So in actuality, using a less than sign requires four sequence levels.



**Using the Occurrence Counters**

**Occurs Field** When "Occurs" is selected, the < and > duration functions change to an occurrence counter. Use the occurrence counter to delay sequence evaluation until the resource term has occurred a designated number times. If the "else on" branch becomes true before all specified occurrences of the primary "Trigger on" branch, the secondary "else on" branch is taken.

**Example**

The following statement assigns the Occurrence Counter to the primary "Trigger on" branch. Once the Occurrence Counter is assigned, a new assignment field appears to set the number of occurrences.

```
TRIGGER on  Occurs 
```

The Trigger Menu  
**Modifying the User-level Macro**

**Using the Timer**

Timers are like other resource terms in that they are either true or false. Timers can be set to Start, Stop, Pause, or Continue as the analyzer enters a sequence level. The two timers are global, so each sequence level has the ability to control the same timer. The default timer condition in all sequence levels is Off.

**Example**

The following statement assigns the "Timer 1" to the secondary "else on" branch. If the bit pattern is not seen before the timer counts 400ns, the secondary branch is taken to level 2.

TRIGGER on  Occurs

Else on  go to level

**See Also**

The "Timer Terms" found later in this chapter for information on how timers work and how to assign a value to a timer.

### Branching

If either the < or > durations is used, only the primary "Trigger on" branch is available, otherwise each sequence level has two way branching.

If the primary branch is taken, the analyzer triggers and goes to the next level. If the primary branch is not found, the analyzer immediately evaluates the "Else on" secondary branching term.

If the "Else on" term is found, the secondary branch taken is to the designated sequence level. If the "Else on" term is not found, the analyzer continues to loop within the same sequence level until one of the two branches are found. If the "Else on" branch is taken, the occurrence counter is reset even if the "go to level" branch is back to the same level. If both branches are found true at the same time, the primary branch is taken.

Branching across trigger levels is possible. If this occurs, the sequence level evaluation could loop without ever seeing a trigger term. Care should be taken in designing your sequence instructions.

---

#### Example:

The following statement instructs the analyzer to find the bit pattern you assigned to "a." If it finds "a," then the analyzer branches to the next sequence level. If it doesn't find "a", the sequence evaluation immediately branches to sequence level 3 .

Then find  Occurs

Else on  go to level

---

---

## Resource Terms

Resource terms are user-defined variables that are assigned to sequence levels. They are placed into the sequence statement where their bit pattern or edge type is searched for within the data stream. When a match is found, a branch is initiated and the next statement or sequence level is acted upon. Resource terms take the following forms:

- Bit Patterns Terms a–j
- Range Terms 1 and 2
- Edge Terms 1 and 2 (Timing only)

### **Bit Patterns Terms a–j**

When the logic analyzer is configured as a state analyzer, up to twelve resource terms can be assigned in your trigger specification. You can use any of the 10 bit pattern terms a – j, plus any of the two range terms 1 and 2.

When the logic analyzer is configured as a timing analyzer, up to ten resource terms can be assigned in your trigger specification. You can use any of the 10 bit pattern terms a – j, and any of the two edge terms 1 and 2 as long as the total does not exceed ten.

Bit patterns terms can also take the NOTed form of  $\neq a - \neq j$ .

### **Range Terms 1 and 2**

Two range terms are available which can be set to a range of bit pattern values. The first pattern and the last pattern are part of the range which must be matched.

Range terms take the form of either In Range, or the NOTed form of Out Range.

### **Edge Terms 1 and 2 (Timing only)**

The two edge terms are only available in the timing analyzer. Edge terms are assigned either a positive going , negative going, or both edge type.

### **Two global Timers**

In addition to the resource terms available, there are two global timers available. Each timer can be started, paused, continued, or stopped, from any sequence level.

All resource terms and timer terms are listed under a scrollable Terms field. To view all offscreen terms, select the Terms field, then use the knob to roll the terms list onscreen.

## Assigning Resource Term Names and Values

The Terms field identifies the list of available resource terms within the analyzer. The resource term names (a – j, Edge1, Edge2, Range1, Range2) are default names that can be changed if desired. You assign values in the following two ways:

- Using Preset Values
- Bit by Bit Assignment

### Using Preset Values

When any of the individual term fields are selected, a configuration pop-up appears. Use this pop-up menu to quickly assign the resource term to a preset value, or, assign a customized name to the resource term.

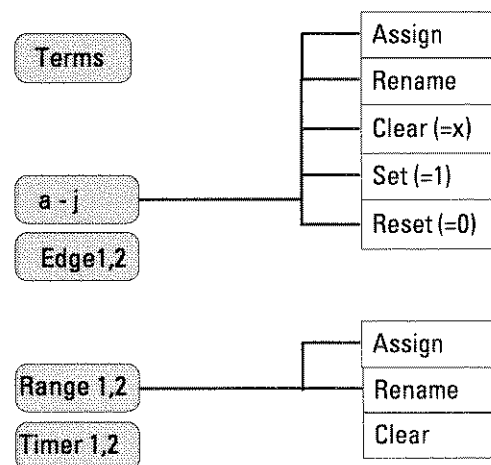

**Assign** All of the available resource terms except the Edge terms can be assigned to any analyzer. However, a term can only be assigned to one analyzer at a time. When either resource term is selected, it toggles between analyzers.

**Rename** This function accesses a keypad which you use to create a custom name or edit the existing name for the resource term. This function works for all terms.

**Clear (=X)** Sets the Term Assignment fields as follows:

In Terms a – j, the assignment field is set to all Xs (don't cares).

In Range 1, 2 terms, the two assignment fields are set to maximum (Fs) and minimum (0s) settings.

In Timers 1, 2 terms, the assignment field is reset to a minimum time of 400 ns.

In Edge 1, 2 terms, the assignment field is reset to a period (.).

**Set (=1)** Sets the Term Assignment fields as follows:

In Terms a – j, the assignment field is set to all 1s (high).

This option is not available for the two Ranges Timer, and Edge terms.

**Reset (=0)** Sets the assignment fields as follows:

In Terms a – j, the assignment field is set to all 0s (low).

This option is not available for the two Range, Timer, and Edge terms.

**Bit by Bit Assignment**

**Bit Pattern Terms** Just to the right of the bit pattern name fields are the term assignment fields. When any of the individual assignment fields are selected, a keypad appears. Use this keypad to assign real values or Don't Care (x) values.

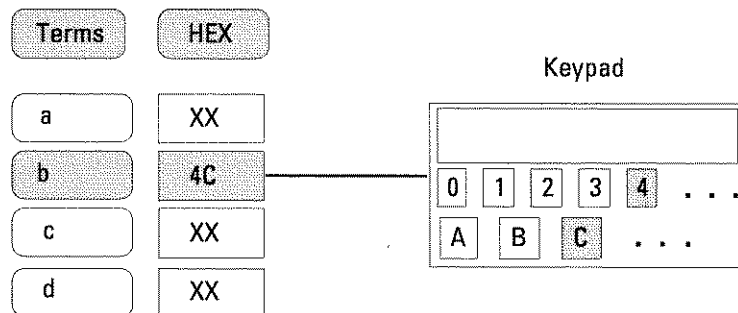

## The Trigger Menu

### Assigning Resource Term Names and Values

**Edge Terms** If you want to qualify an edge, place the appropriate edge on the data channel you are watching. When the analyzer sees the correct edge, the term becomes true.

Edge terms can be used singularly or in combination with each other across all assigned channels. When you specify an edge on more than one channel, the analyzer ORs the edges.

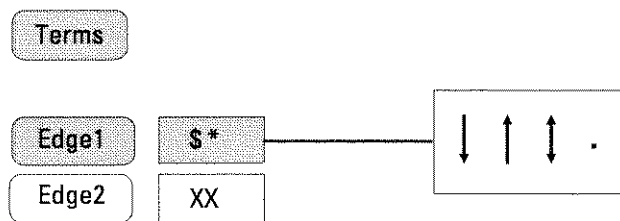

The following edge choices are available for each bit:

- Positive edge (↑)
- Negative edge (↓)
- Either positive or negative (↕)
- No edge (.)

After the assignment menu closes, you may see "\$" indicators in the assignment field display. This symbol indicates the assignment can't totally be displayed in the selected base. It was assigned in another base. When Binary is selected for the numeric base, you see the actual assignments.

**Range Terms** Range terms bracket groups of bit patterns. Each Range term is assigned to either of the two analyzers, but not both. You assign an upper and lower bit pattern boundary. The range is recognized as the data that is numerically between or on the two specified boundaries. In addition, the range must be contained in a single pod pair, with no clock bits allowed.

To assign bit patterns to the upper and lower boundaries of a Range term, you use a pop-up keypad. The keypad appears when you select the upper or lower Range term assignment fields.



### Timer Terms

Each Timer term is assigned to either of the two analyzers, but not both. With timers inserted into sequence levels, you can start a timer in one level, pause it, or stop it in another sequence level.

Timers are either true or false. Timers start as you enter the sequence level, and when its count expires, it becomes true. If a timer is paused in one level, it must be continued in another level before it can count through.

As more sequence levels are added, the timer status in the new levels default to Off. Timers must be continue or started in each new level if it is appropriate. When a timer expires or stops, its count resets to zero.

### Combination of Terms

Combination terms are configured and selected from within sequence levels. All user-defined resource terms can be combined to create complex qualifiers that occupy a single assignment field space.

When the term assignment field is selected, and "Combination" is selected from the pop-up selection list, a logical assignment menu appears. Use this menu to turn on resource terms and input them into a chain of logical operators.

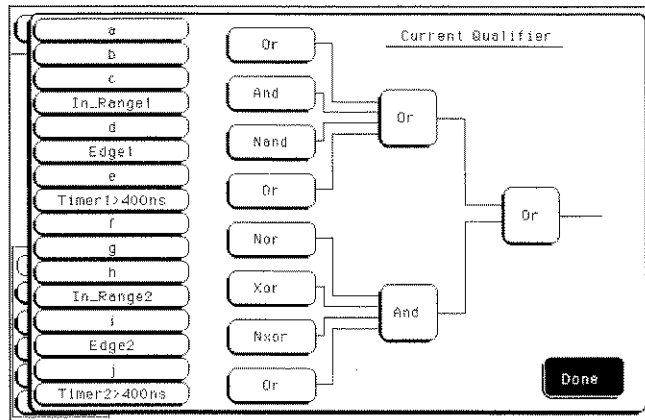

### Logic Operation Choices

When the combination is placed in the assignment field, if the term is too long to fit in the assignment field, the display is truncated.

---

## Label and Base Fields

The Label and Base fields show up together in all menus except the Format menu. When a new label is assigned, a base field is automatically assigned to that label.

**Label Field** Labels are displayed throughout the analyzer as they were assigned in the Format menu. To reorder currently displayed labels in the Trigger menu and the Specify Pattern sub-menus, select the label you want to move, then from the selection menu that appears, choose the label you want to switch positions with.

### See Also

"Labels Assignment" chapter, in the Common Modules Operations section of the *HP 16500B Logic Analysis User's Reference*.

**Base Field** All assigned labels will have a base field assigned to it. If the numeric base is changed in a menu, the base in other menus may not change accordingly. As an example, the base assigned to symbols is unique, as is the base assigned in the Compare and Listing menus. If you change one, you may not want the others to change. The base choices are Binary, Octal, Decimal, Hex, ASCII, Symbol and Twos.

### Label and Terms Roll Field

The rolling function is the same for all items that are stored offscreen. For more information on rolling labels, base, and pods, refer to the "Labels Assignment" chapter in the *HP 16500B Logic Analysis User's Reference*.

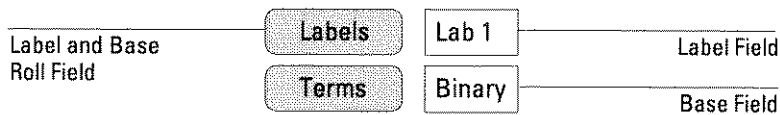

## Arming Control Field

The Arming Control field shown below accesses an Arming Control menu. The Arming Control menu is used to configure the arm signals between analyzers and the Arm In/Out signals between other measurement modules in the mainframe. By using the arming signals, you influence the order in which the analyzers and other measurement modules trigger in a cross-domain measurement.

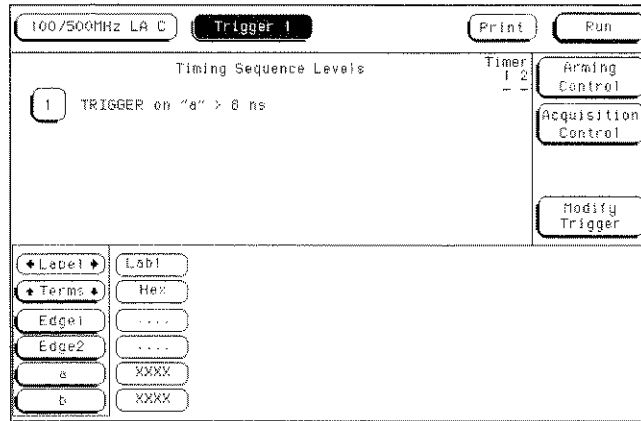

Arming Control field

Arming Control Field

## The Trigger Menu Arming Control Field

### Arming Control Between Analyzers

If both analyzers in a module are turned on, you can configure one analyzer to arm the other. An example of this is when a state analyzer triggers on a bit pattern, then arms a timing analyzer which captures and displays the waveform after it triggers.

When you select the analyzer name field in the Arming Control menu shown below, a pop-up menu appears which you use to select where the Arm In signal is coming from. In addition, a sequence level number field appears which you use to select the sequence level in which an "arm" flag is placed.

When an analyzer receives an Arm In signal, an "arm" term is placed in a user selected sequence level and the analyzer automatically begins evaluating its trigger sequence instruction. If, in the sequence evaluation the "arm" term is seen first, the analyzer will trigger. However, if the "arm" term is placed down in the sequence level order, the preceding sequencing could trigger the analyzer before the "arm" term is seen. Generally, the "arm" term is evaluated and used the same as the other resource terms within the sequence instruction.

After you configure the Arming Control menu, a graphical representation of the analyzer arming configuration is displayed as shown below.

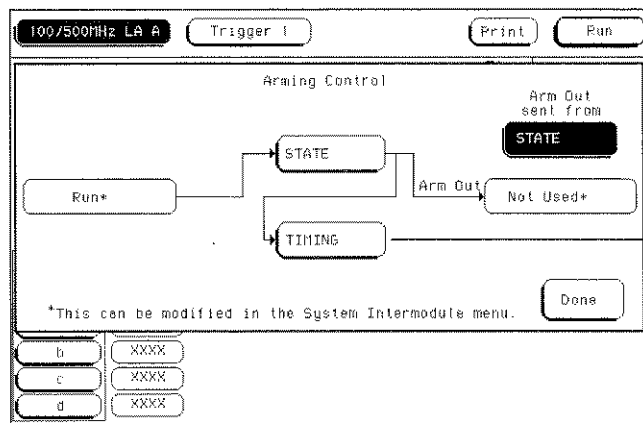

Analyzer name

### Two Analyzer Arming

### Arming Control between Modules

A more complex arming example involves intermodule arming with other modules in the mainframe. Intermodule arming requires all involved modules be configured in the system's Intermodule menu.

The first analyzer is armed by an Arm In signal from another module in the mainframe. After the first analyzer triggers, it arms the second analyzer. After the second analyzer triggers, it can send a Port Out signal to an external BNC which can be used to arm an external measurement module such as an oscilloscope.

An Arm Out signal is generated by one of the two analyzers which you select. The Arm Out signal is sent out to the Port Out BNC on the back panel of the mainframe.

After you configure the Arming Control menu, a graphical representation of the analyzer arming configuration is displayed as shown below.

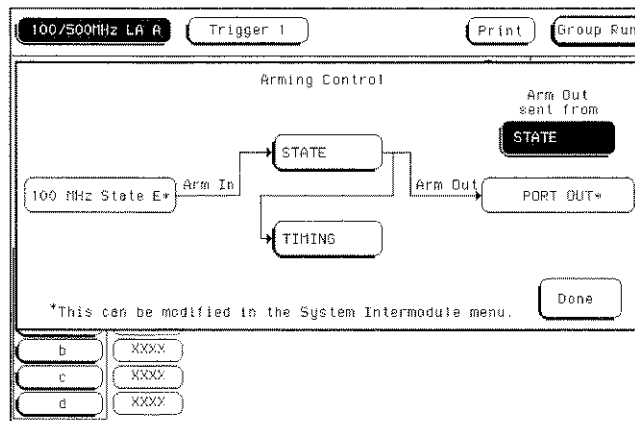

### Intermodule Arming

**See Also**

"Intermodule Measurements" chapter in the *HP 16500B Logic Analysis System User's Reference Guide* for more information.

---

## Acquisition Control

The Acquisition Control menu is used to set the acquisition mode, the trigger position within available memory, and the sample period.

### Acquisition Mode Field

The Acquisition Mode field toggles between Manual and Automatic. When set to Automatic, the position of stored data relative to trigger and the sample rate are based on the sec/Div and delay settings in the Waveform menu.

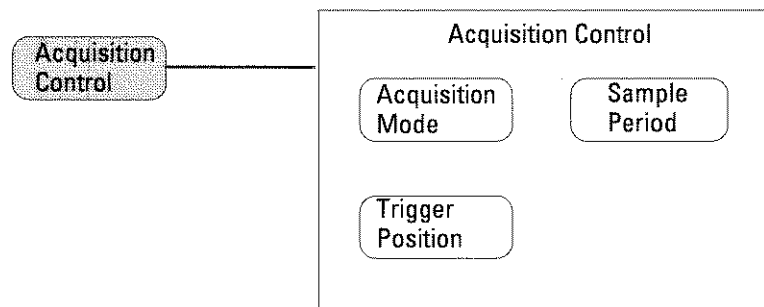

When the Acquisition Mode field is set to Manual, additional configuration fields become available. The additional configuration fields work together with the sequence instructions, in a prioritized manner, to position the memory in relation to the trigger point.

---

## Trigger Position Field

The Trigger Position field accesses a selection menu with the options of Start, Center, End, User Defined, or Delay. When an option is selected, that point of the available memory is positioned relative to the trigger. A representation of this is shown by the blue graphic bar with the "Trig" indicator line. The Trigger Position field determines how much data is stored before and after the trigger occurs for all subsequent acquisitions.

When a Run is started, the analyzer will not look for a trigger until at least the proper percent of pretrigger data has been stored. After a trigger has been detected, the proper percent of posttrigger data is stored before the analyzer halts.

Even when the trigger position is set to Start or End, there will always be a small portion of pretrigger and posttrigger data stored.

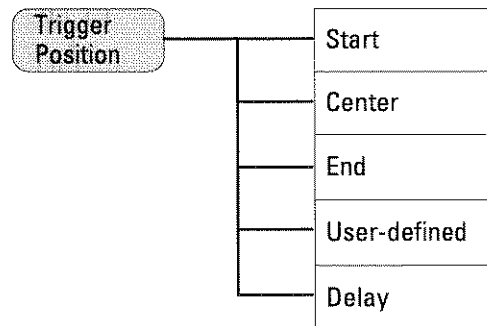

**Start** When the trigger position is set to Start, the starting point of available memory is positioned relative to the trigger point. This results in maximum posttrigger data and minimum pretrigger data.

**Center** When the trigger position is set to Center, the center point of available memory is positioned relative to the trigger point. This results in half pretrigger data and half posttrigger data.

## The Trigger Menu

### Sample Period Field

**End** When the trigger position is set to End, the end point of available memory is positioned relative to the trigger point. This results in maximum pretrigger data and minimum posttrigger data.

**User Defined** When the trigger position is set to User Defined, a Post Store field appears. Use this field to set the trigger position any where between 0% and 99%. As the Post Store is adjusted, the blue graphic bar indicates the trigger position.

**Delay** Use the Delay field to delay the start of acquisition storage after the trigger. The range of the delay time is affected by the sample period but could range between 16ns to 8ks.

---

### Sample Period Field

The Sample Period field is used to set the time period between data samples. Every time a new sample is taken, the analyzer will see updated measurement data.

---

### Branches Taken Stored / Not Stored Field

The Branches Taken field is a toggle field which sets the analyzer to store, or not to store, the resource term that sent the analyzer off on a branch.

As the analyzer steps through the sequence instructions, it may be repeatedly sent off to secondary branches because the first resource term was bypassed (false), and the second "Else" resource term is qualified (true). With Branches Taken set to Stored, both the state data values that caused the secondary branches and the secondary branch is stored into memory.



## Count Field (State only)

The Count field is used to access a selection menu which is used to stamp the acquisition data at each memory location with either a Time tag or a State count tag.

### Storing Time or State tags

If you have all pod pairs assigned, the state acquisition memory is reduced by half, when time or state tags are turned on. You can maintain full memory depth if you leave a specified pod pair unassigned.

**States** States count places numbered tags on all pretrigger and posttrigger data. Data stored before trigger has negative numbers and data stored after trigger has positive numbers. State tag numbering is set to be either relative to the previous memory location or absolute from the trigger point. Selecting the Absolute or Relative option is done by toggling the Absolute/Relative field. When State count is selected in the Trigger menu, the exact state locations tagged can be selectively chosen from the Resource Term selection list.

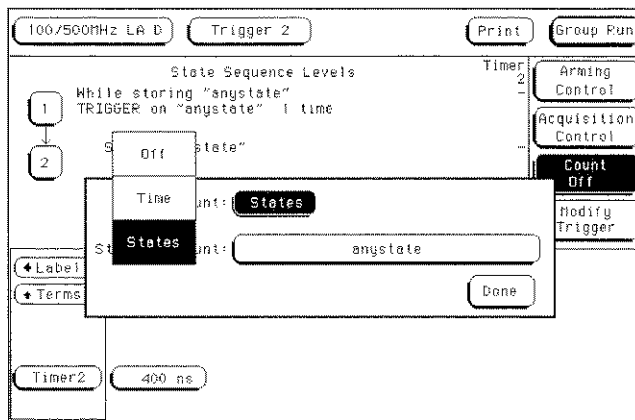

### Count Field

**The Trigger Menu**  
**Count Field (State only)**

**Time** Time count places time tags on all displayed pretrigger and posttrigger data. Data stored before trigger has negative time numbers and data stored after trigger has positive time numbers. Time tag numbering is set to be either relative to the previous memory location or absolute from the trigger point. Selecting the Absolute or Relative option is done by toggling the Absolute/Relative field. Time tag resolution is 8 ns.

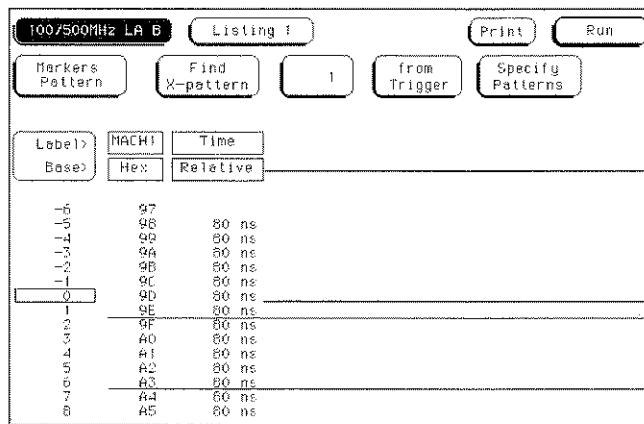

Relative/Absolute toggle field

Times tag

**Relative/Absolute Toggle Field**

**To Retain Full Memory Using Time or State Tags** To retain the full memory depth when using time or state tags requires the unassigned of one pod pair. The exact pod pair to unassigned in all possible configurations varies. The table below shows the pod pairs to unassign in most applications.

One Configured Analyzer	Two Configured Analyzers
Pod Pair 3/4	Pod Pair 3/4
Pod Pair 3/4, 5/6	Pod Pair 3/4, 5/6

---

The Listing Menu

---

## The Listing Menu

The Listing menu is a display menu for state and timing analyzer measurements. The listing is a display of data, address, and control status in memory at each clock cycle in a microprocessor based system.

The acquired data is displayed in the order the analyzer placed the data into analyzer memory. Data is grouped and displayed by label and in a selectable numeric base. Labeled data from other analyzer machines can be interleaved into the same display.

### **Listing Menu Map**

The menu map on the next page illustrates all fields and the available options in the Listing menu. The menu map will help you get an overview as well as provide you with a quick reference of what the Listing menu contains.

### **See Also**

The "Interleaving State Listings" in the Mixed Display menu chapter for more information on interleaving state data.

# The Listing Menu

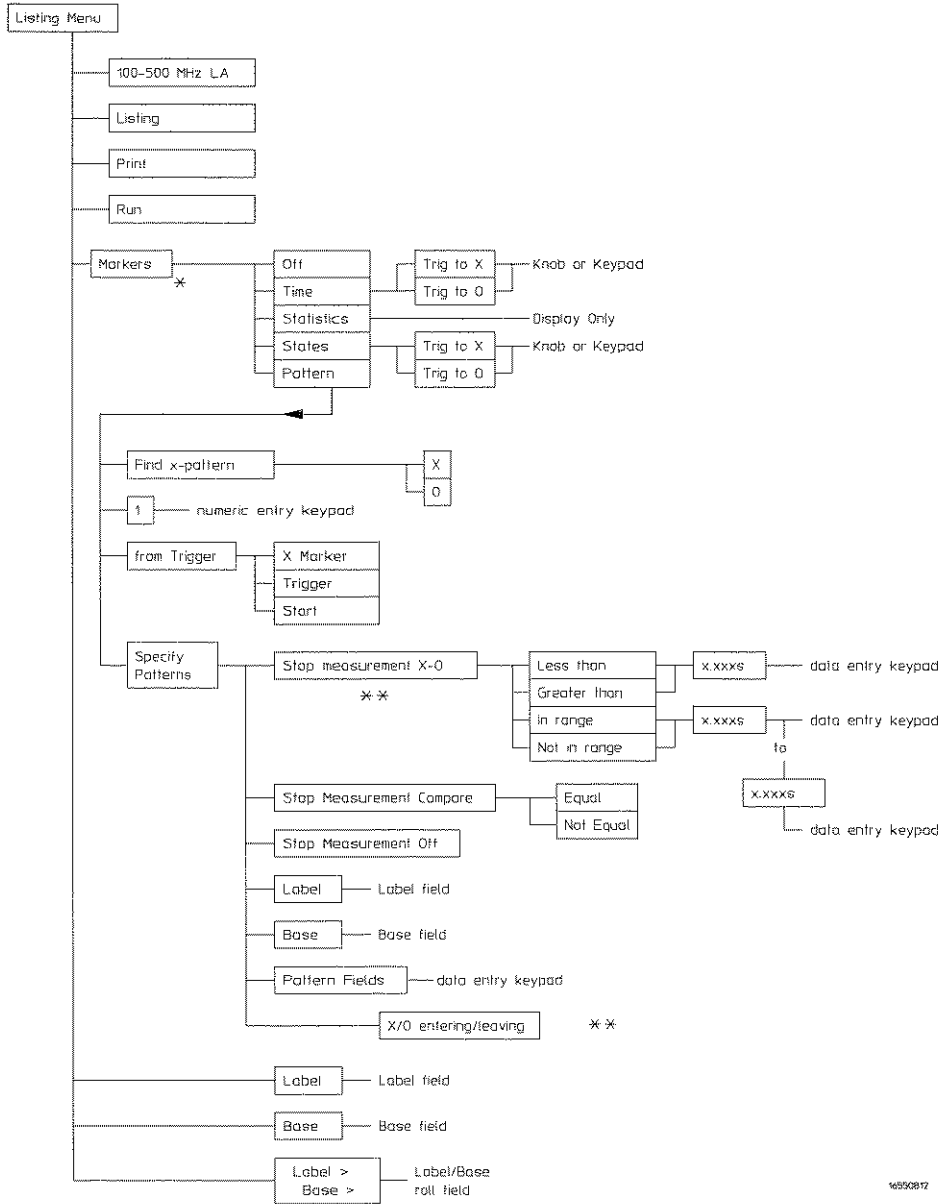

\* Different marker types appear depending on analyzer configurations.

\*\* Only available in Timing analyzer or State analyzer with Count set to Time.

## Listing Menu Map

The Listing Menu  
**Markers Field**

---

## Markers Field

The Markers field is used to access the markers selection menu. When the Markers field is selected, a marker selection menu appears with the marker choices available with the present analyzer configuration.

### State Analyzer Types

In a state analyzer with time and state count turned off in the Trigger menu, only Pattern markers are available. With count Time turned on, additional choices of Time markers and Statistics markers become available.

With count States turned on, in addition to Pattern markers there are States markers available.

### Timing Analyzer Types

If a timing analyzer you have marker choices of Off, Pattern, Time, or Statistics.

### Off

The Off selection turns marker operations off. If a Stop measurement was previously specified, and the Stop measurement criteria are met, the measurement will stop even though the markers are off.

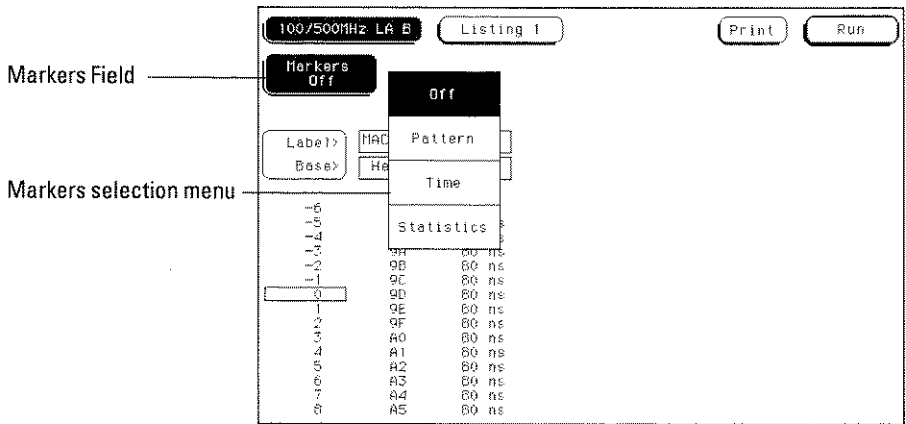

### Markers Field

---

## Pattern Markers

When Pattern markers are selected, two markers labeled X and O become available. Pattern markers identify and mark unique bit patterns in the data listing. Once the unique bit patterns are marked, they can be used as reference points or as criteria for a stop measurement.

The markers are color coded for easy recognition in the data listing. The X-marker is represented by a horizontal green line and the O-marker is represented by a horizontal yellow line.

When a marker is positioned in the Listing menu, it is also positioned in the Chart menu and Waveform menu.

**See Also**

The "Specify Patterns Field" found later in this chapter for more information on creating a pattern for the X and O markers.

The Listing Menu  
Find X-pattern / O-pattern Field

---

## Find X-pattern / O-pattern Field

The Find X-pattern / O-pattern field is a toggle field. When selected, the target of occurrence and trace start field assignments switches to the other marker. In addition, when this field is selected, the data listing will shift so the data marked will appear at center screen.

Find X-pattern field

The screenshot shows a software interface with the following elements:

- Buttons: 100/500Hz LA B, Listing 1, Print, Run
- Buttons: Markers Pattern, Find X-pattern, 1, from Trigger, Specify Patterns
- Fields: Label > MACH1, Time; Base > Hex, Relative
- Data Listing:

Label >	MACH1	Time
-5	97	
-5	98	80 ns
-4	99	80 ns
-4	9A	80 ns
-3	9B	80 ns
-3	9C	80 ns
-2	9D	80 ns
-2	9E	80 ns
-1	9F	80 ns
-1	A0	80 ns
0	A1	80 ns
0	A2	80 ns
1	A3	80 ns
1	A4	80 ns
2	A5	80 ns

X-pattern at center screen

### Find X-pattern / O-pattern Field



## Pattern Occurrence Fields

The X-pattern and O-pattern occurrence fields designate which pattern occurrence the marker is placed on. The range for the occurrence counter is - 8192 to +8192.

The occurrence field can be set in two ways. When the field is selected one time, it turns light blue and knob operation becomes the entry method. If the field is selected a second time, a pop-up keypad appears and becomes the entry method.

The reference point from which the occurrence counter starts is either the trigger point, the start of the trace, or in the case of the O-marker, the X-marker. If a negative occurrence number is set, the analyzer will search for pretrigger occurrences.

Pattern occurrence field

Label	HACH	Time
Base	Hex	Relative
-5	97	
-4	98	80 ns
-3	99	80 ns
-2	9A	80 ns
-1	9B	80 ns
0	9C	80 ns
1	9D	80 ns
2	9E	80 ns
3	9F	80 ns
4	A0	80 ns
5	A1	80 ns
6	A2	80 ns
7	A3	80 ns
8	A4	80 ns
9	A5	80 ns

First occurrence of X pattern after trigger

### X-pattern and O-pattern Occurrence Fields

The Listing Menu  
From Trigger / Start / X Marker Field

---

## From Trigger / Start / X Marker Field

The from Trigger/Start/X marker field is used to access the selection pop-up for the start point of the X and O marker occurrence counters.

The start points available for the green X-marker are either the trace start point or the trigger point.

The start points available for the yellow O-marker are either the trace start point, trigger point, or the X-marker.

If the marker pattern can not be found, a message appears at the top of the display indicating the search failed. If the O-marker is referenced from the X-marker, and the X-marker is not found, the search for both markers will fail.

Trigger/Start/X Marker field

Label	Hex	Relative
-6	97	
-5	98	80 ns
-4	99	80 ns
-3	9A	80 ns
-2	9B	80 ns
-1	9C	80 ns
0	9D	80 ns
1	9E	80 ns
2	9F	80 ns
3	A0	80 ns
4	A1	80 ns
5	A2	80 ns
6	A3	80 ns
7	A4	80 ns
8	A5	80 ns

First occurrence of X pattern after trigger

### Trigger/Start/X Marker Field

### Specify Patterns Field

The Specify Patterns field only appears when the markers are set to Pattern. When the Specify Patterns field is selected, a pop-up menu appears that is used to assign the bit patterns for the X and O markers, the X and O entering/leaving, and the Stop measurement criteria.

The screenshot shows a software interface with several buttons: 'Markers Pattern', 'Find X-pattern', 'I', 'From Trigger', and 'Specify Patterns'. The 'Specify Patterns' button is highlighted with a line pointing to the label 'Specify pattern field'. Below the buttons is a table with columns for 'Label', 'MACH', and 'Time'. The 'Label' column has a sub-column 'Base' and the 'MACH' column has a sub-column 'Hex'. The table lists markers from -6 to 8 with their corresponding hex values and 80 ns time intervals.

Label	MACH	Time
Base	Hex	Relative
-6	97	
-5	98	80 ns
-4	99	80 ns
-3	9A	80 ns
-2	9B	80 ns
-1	9C	80 ns
0	9D	80 ns
1	9E	80 ns
2	9F	80 ns
3	A0	80 ns
4	A1	80 ns
5	A2	80 ns
6	A3	80 ns
7	A4	80 ns
8	A5	80 ns

Specify Patterns Field

## The Listing Menu

### Specify Patterns Field

#### X and O entering / leaving Fields (Timing only)

If the analyzer is configured as Timing, the X and O pattern markers are placed at either the beginning of the pattern occurrence (entering) or at the end of the pattern occurrence (leaving). When the entering/leaving field of either X or O markers is selected, it toggles between the two choices.

Whichever choice you toggle the field to, the pattern you place in the pattern display field will apply to that choice.

#### X marker and O marker Fields (State only)

If the analyzer is configured as State, X marker and O marker fields replace the X and O entering/leaving fields. The pattern you place in the pattern display field will apply to the marker labeled at the left.

X and O entering and leaving fields

The screenshot shows a menu with the following options:

- Label: MACH1
- Base: Hex
- X entering: 9E
- O entering: A3
- Stop measurement: Off
- Clear Pattern
- Done

1746	9D	4 ns
1747	9E	4 ns
1748	9E	4 ns
1749	9E	4 ns
1750	9E	4 ns
1751	9E	4 ns
1752	9E	4 ns
1753	9E	4 ns
1754	9E	4 ns
1755	9E	4 ns

#### X and O entering / leaving Fields

### Pattern Display Fields

The pattern display field displays the alpha-numeric bit pattern specified for each X and O marker in all designated labels. The bit pattern is displayed in the same numeric base and same order as the data listing. When the pattern display field is selected, a pop-up keypad appears which is used to set the bit pattern.

When there are more labels assigned than can be displayed in a single screen, the pattern display fields are rolled back on screen by the Label/Base roll field.

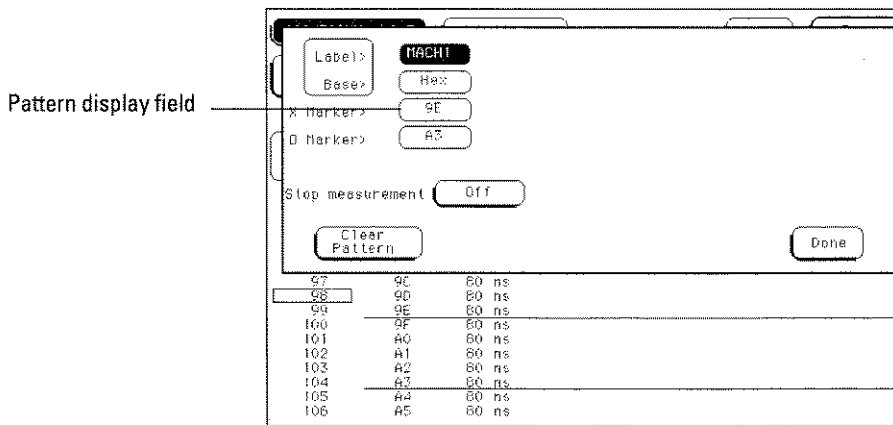

Pattern Display Field

The Listing Menu  
**Label / Base Roll Field**

**Label and Base Fields**

The Label and Base fields show up together in all menus except the Format and Configuration menus. When a new label is assigned, a base field is automatically assigned to that label.

**Label Field** Labels in the Specify Patterns menu are the same labels assigned in the Format menu. These labels will be displayed throughout the analyzer as they were assigned in the Format menu.

To reorder currently displayed labels, select the label you want to move, then from the selection menu that appears, choose the label you want to switch positions with.

**Base Field** The function of the Base field is the same in all menus. To change the numeric base, select the base field, then choose the desired base from the selection menu.

---

## Label / Base Roll Field

The rolling function is the same for all items that are stored offscreen. For more information on rolling labels, base, and pods, refer to Labels Assignment in the "Common Module Operations" part of the *HP 16500B User's Reference Guide* for complete information.

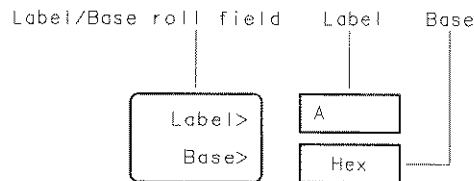

16542B03

**Label / Base Roll Field**

## Stop Measurement Field

The Stop measurement function allows you to specify a condition which stops the analyzer measurement during a repetitive run. If two analyzers are configured, both analyzers will stop when either specified stop condition is satisfied.

When the Stop measurement field is selected, a Stop measurement type menu appears. Depending on the analyzer configuration, you have the choices of Off, X-O, and Compare.

### Off

The Off selection turns all Stop measurement operations off.

If the Stop measurement operation is not turned off and the stop criteria are met, the measurement will stop even though the markers are set to other types or turned off.

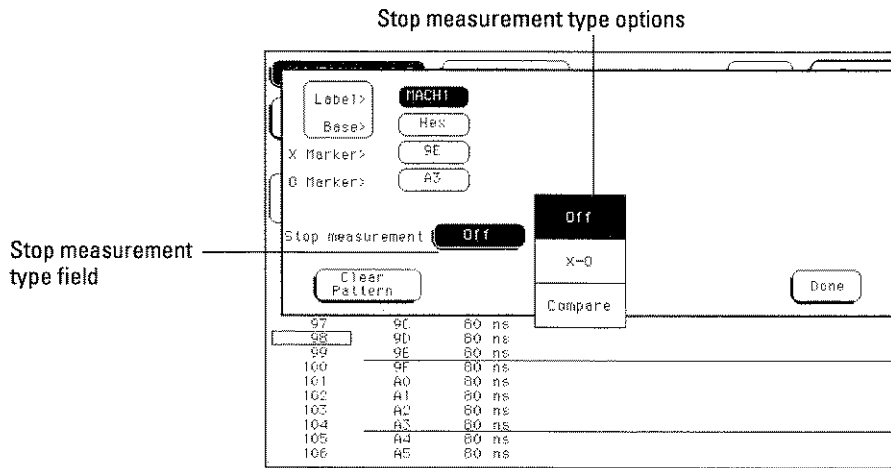

### Stop Measurement Field

The Listing Menu  
**Stop Measurement Field**

**X-O**

The X-O option is available in the timing analyzer and in the state analyzer with its count set to Time.

When X-O is selected, a repetitive run is stopped when a comparison of the time period between the X and O markers and one of the following time period options is true:

**Less Than** X-O time must be less than the time value that you specify in the Time field.

**Greater Than** X-O time must be greater than the time value that you specify in the Time field.

**In Range** X-O pattern must be within the time range value that you specify in the two Time fields.

**Not in Range** X-O pattern must not be within the time range value that you specify in the two Time fields.

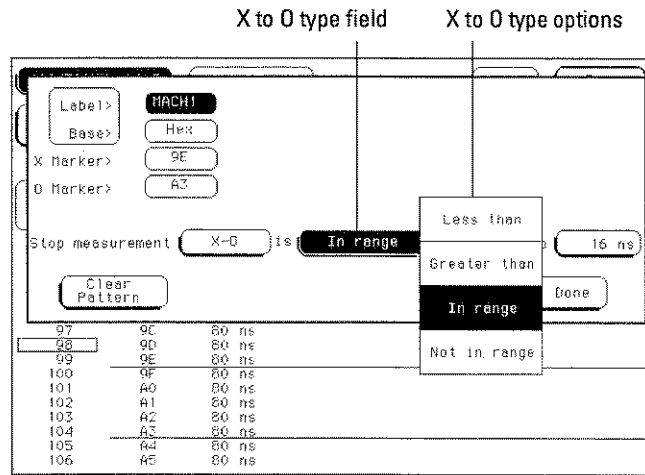

**X-O Field**



**Compare**

When Compare is selected, a repetitive run is stopped when a comparison of data in the Listing menu and data/criteria in the Reference listing of the Compare menu matches an equality selection. The equality selection is set from the Equal/Not Equal selection pop-up menu.

**Equal** The data and compare criteria in the Compare menu must be equal to the data in the Listing menu.

**Not Equal** The data and compare criteria in the Compare menu must not be equal to the data in the Listing menu.

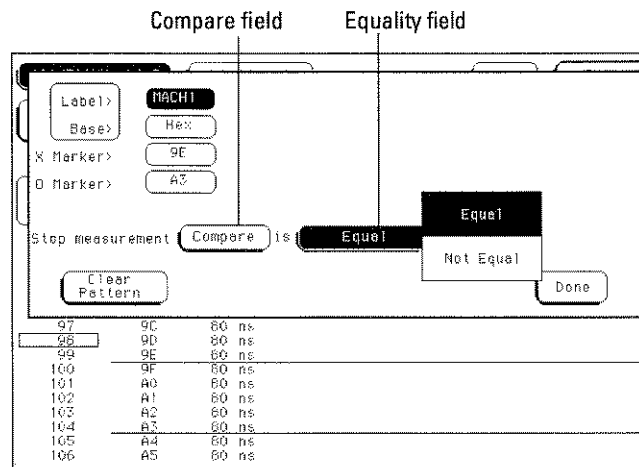

**Equal / Not Equal Selection Menu**

The Listing Menu  
**Clear Pattern Field**

---

## Clear Pattern Field

The Clear Pattern field is used to reset the X and O Marker pattern display fields back to default (don't care = X). The Clear Pattern field accesses a selection menu with the choices of All, X pattern, or O pattern.

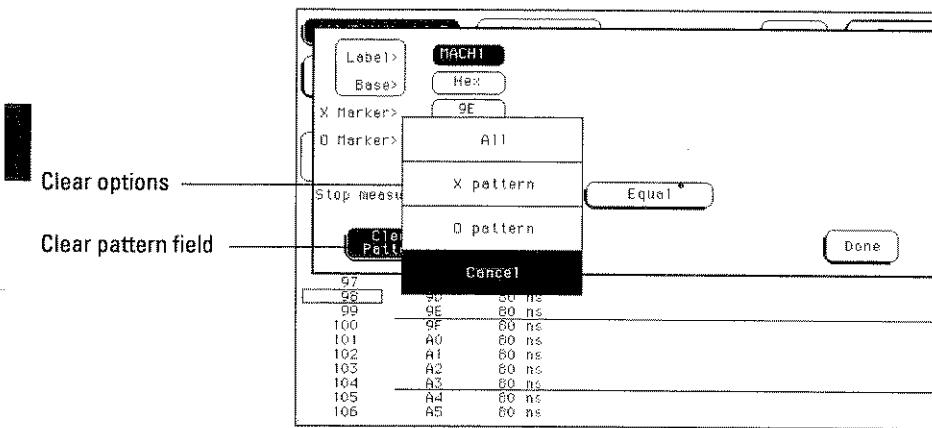

### Clear Pattern

---

## Time Markers

Time markers are indicators located in the data listing that are used as reference marks to obtain time values between each marker, or between each marker and the trigger point.

In a state analyzer, Time markers only become available when the Count field is set to Time, in the Trigger menu.

The markers are color coded for easy recognition. The X-marker is represented by a horizontal green line and the O-marker is represented by a horizontal yellow line.

If Pattern markers have been assigned, the Time markers will be initially placed at the same locations in the data listing.

The Listing Menu  
**Trig to X / Trig to O Fields**

---

## Trig to X / Trig to O Fields

The Trig to X and Trig to O fields are display fields as well as configuration fields. Marker position is set by selecting the fields, then after the fields turn light blue, rotate the Knob. Marker position can also be set by selecting the light blue field a second time, then enter a value with the pop-up keypad.

The Trig to X and Trig to O fields display the time between the trigger point and the marker.

### X to O Display Field

The X to O display field is a "read only" field that displays the time between the X and O markers. As the X and O markers are changed, the display changes accordingly.

Trig to X field

The screenshot shows a control panel with the following elements:

- Buttons: 100/500MHz LA B, Listing 1, Print, Run
- Fields: Markers Time, Trig to X (7.920 us), Trig to O (8.320 us), X to O (400 ns)
- Table with columns: Label, Base, MACH1, He, Time

Label	Base	MACH1	He	Time
91		56		7.200 us
92		57		7.360 us
93		58		7.440 us
94		59		7.520 us
95		5A		7.600 us
96		5B		7.680 us
97		5C		7.760 us
98		5D		7.840 us
99		5E		7.920 us
100		5F		8.000 us
101		60		8.080 us
102		61		8.160 us
103		62		8.240 us
104		63		8.320 us
105		64		8.400 us
106		65		8.480 us

X to O display

### Trig to X / Trig to O Fields

---

## Statistics Markers

After patterns are assigned to the X and O markers, statistical information is available when markers are set to Statistics. The logic analyzer displays the following information:

- Number of valid runs (runs where Pattern markers were able to be placed on specified patterns).
- Minimum time between the X and O Pattern markers.
- Maximum time between the X and O Pattern markers.
- Average time between the X and O Pattern markers.

In a state analyzer, Statistics markers only become available when the Count field is set to Time, in the Trigger menu.

The markers are color coded for easy recognition in the data listing. The X-marker is represented by a horizontal green line and the O-marker is represented by a horizontal yellow line.

## The Listing Menu Trig to X / Trig to O Fields

Statistics are based on the time between the X and O. Both markers must be found before valid statistical information is displayed.

In repetitive run mode, the display is updated each time a valid run occurs until you select Stop. If you select Run after Stop, the statistics continue to update without loss of information.

In single run mode, each time you select Run an additional valid run will be added to the data and the statistics will be updated. This process continues unless you change the placement of the X and O Pattern markers between runs.

Label>	MACH		Time
	Base>	Hex	
205		96	80 ns
206		97	80 ns
207		98	80 ns
208		99	80 ns
209		9A	80 ns
210		9E	80 ns
211		9C	80 ns
212		9D	80 ns
213		9E	80 ns
214		9F	80 ns
215		A0	80 ns
216		A1	80 ns
217		A2	80 ns
218		A3	80 ns
219		A4	80 ns
220		A5	80 ns

Statistics display

### Statistics Display

---

## States Markers (State only)

States markers are indicators located in the data listing that are used as reference marks to obtain the number of states between each marker, or between each marker and the trigger point.

States markers are only available in a state analyzer with the Count field set to States, in the Trigger menu.

The markers are color coded for easy recognition in the data listing. The X-marker is represented by a horizontal green line and the O-marker is represented by a horizontal yellow line.

The Listing Menu  
**Trig to X / Trig to O Fields**

---

## Trig to X / Trig to O Fields

The Trig to X and Trig to O fields are display fields as well as configuration fields. Marker position is set by selecting the fields, then after the fields turn light blue, rotate the knob. Marker position can also be set by selecting the light blue field a second time, then enter a value with the pop-up keypad.

The Trig to X and Trig to O fields display the number of states between the trigger point and the marker.

### X to O Display Field

The X to O display field is a "read only" field that displays the number of states between the X and O Pattern markers. As the X and O markers are changed, the display changes accordingly.

Trig to X field

The screenshot shows a control panel with several buttons: '100/500MHz LA B', 'Listing f', 'Print', and 'Run'. Below these are four fields: 'Markers States', 'Trig to X' (value 235), 'Trig to O' (value 239), and 'X to O' (value 4). An arrow points from the 'X to O' field to the label 'X to O display'. Below the fields is a table with columns for 'Label', 'MACH1', and 'States'. The table lists states from 227 to 242 with corresponding MACH1 values and absolute addresses.

Label	MACH1	States
Base	Hex	Absolute
227	B7	227
228	B8	228
229	B9	229
230	BA	230
231	BB	231
232	BC	232
233	BD	233
234	BE	234
235	BF	235
236	C0	236
237	C1	237
238	C2	238
239	C3	239
240	C4	240
241	C5	241
242	C6	242

### Trig to X / Trig to O Fields



## Data Roll Field

The column of numbers at the far left represents the location of the acquired data in the state analyzer's memory. The numbered positions are also known as the state locations and are relative to the trigger state location.

The column of state location along with its data can be rolled to display other data by using the data roll field. The data roll field is the small rectangular box located in the middle of the state location column.

The data roll field is used to either roll the data listing or to select an exact state for display. When the data roll field is light blue, the knob is active and can roll data in either direction. If you touch the data roll field when it is light blue, a pop-up keypad appears for the number of an exact state. When the pop-up keypad is used, the data listing shifts, leaving the selected state in the light blue data roll box.

The screenshot shows a control panel with several buttons: "100/500MHz LA B", "Listing 1", "Print", and "Run". Below these are four buttons: "Markers States", "Trig to X 235", "Trig to 0 239", and "X to 0 4".

The main display is a table with columns for "Label", "MACHI", and "States". The "Label" column has sub-columns for "Base" and "Hex". The "MACHI" column has sub-columns for "Hex" and "Absolute".

Label	MACHI	States
Base	Hex	Absolute
237	B7	237
238	B8	238
239	B9	239
240	BA	240
241	BB	241
242	BC	242
243	BD	243
244	BE	244
245	BF	245
246	C0	246
247	C1	247
248	C2	248
249	C3	249
240	C4	240
241	C5	241
242	C6	242

Annotations on the left side of the image:

- "State location column" points to the first column of the table (Label/States).
- "Data roll field" points to the highlighted cell containing "239" in the "States" column.

**Data Roll Field**

The Listing Menu  
**Label and Base Fields**

---

## Label and Base Fields

The Label and Base fields show up together in all menus except the Format and Configuration menus. When a new label is assigned, a base field is automatically assigned to that label.

### Label Field

Labels in the Listing menu are the same labels assigned in the Format menu. These labels will be displayed throughout the analyzer as they were assigned in the Format menu.

### Base Field

The function of the Base field is the same in all menus. To change the numeric base, select the base field, then choose the desired base from the selection menu.

---

## Label / Base Roll Field

The rolling function is the same for all items that are stored offscreen. For more information on rolling labels, base, and pods, refer to Labels Assignment in the "Common Module Operations" part of the *HP 16500B User's Reference Guide* for complete information.

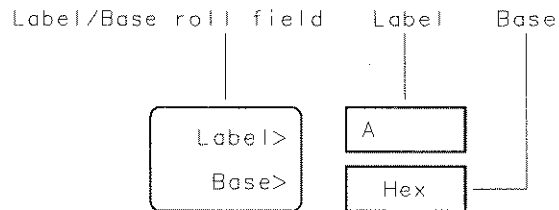

16542B03

### Label / Base Roll Field



2.



3.



# The Waveform Menu



---

## The Waveform Menu

The Waveform menu is one of the analyzer display menus. You use the Waveform menu to view either state or timing data in a format similar to an oscilloscope display. Data is displayed with the horizontal axis representing either states or time, and the vertical axis representing logic highs and lows. The type of data displayed depends on whether the Type field in the Configuration menu is set to State or Timing.

If State is selected, the analyzer displays state relevant activity in reference to the trigger point with the horizontal resolution being states per division.

If Timing is selected, the analyzer displays time relevant activity in reference to the trigger point with the horizontal resolution being time per division.

### **Waveform Menu Map**

The following menu map illustrates all fields and the available options in the Waveform menu. The menu map will help you get an overview as well as provide you with a quick reference of what the Waveform menu contains.

# The Waveform Menu

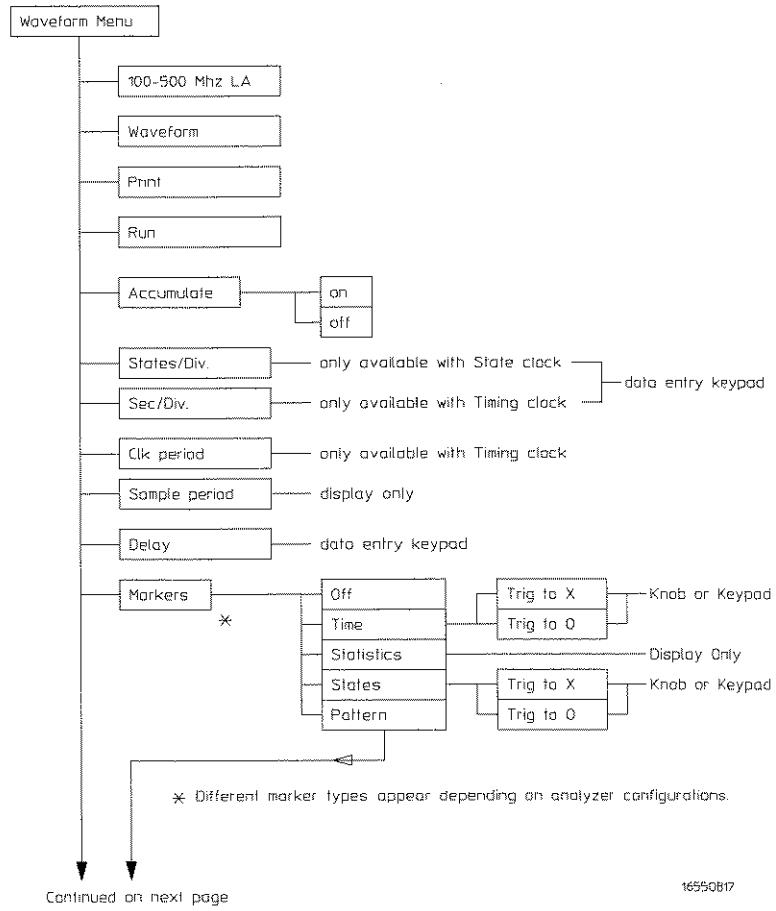

## Waveform Menu Map

# The Waveform Menu

Continued from previous page

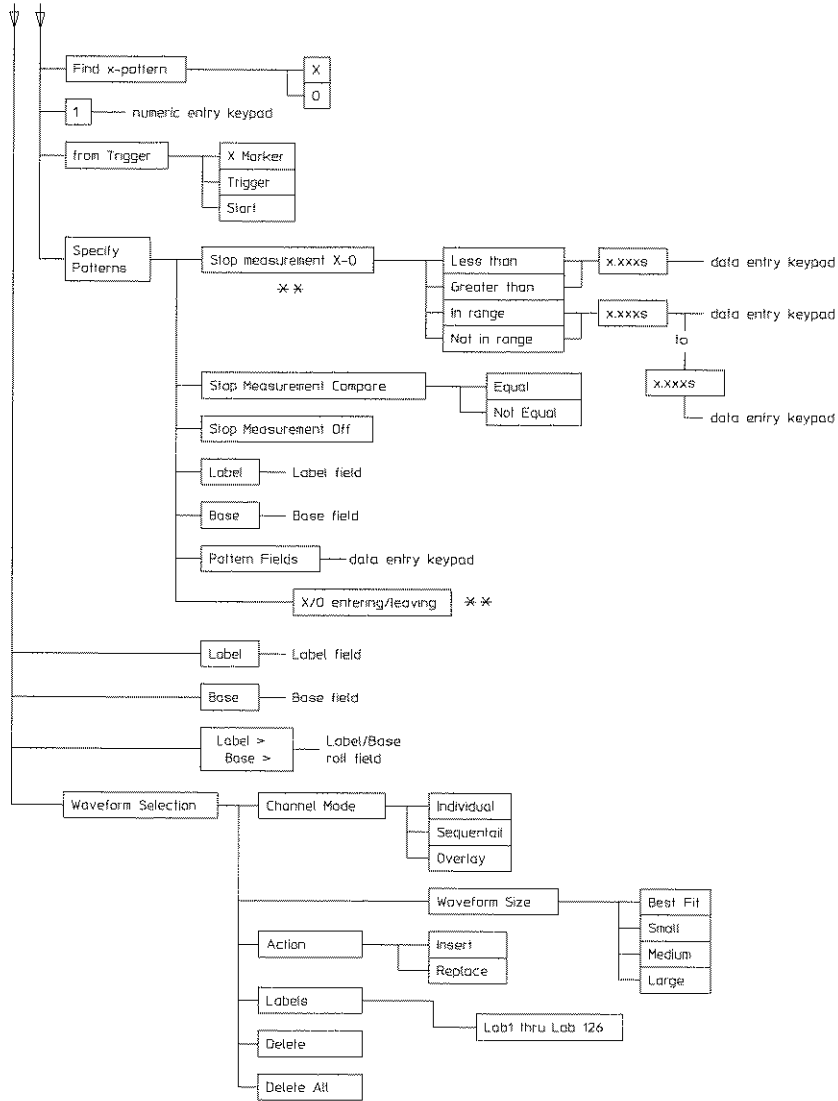

16550818

\* \* Only available in Timing analyzer or State analyzer with Count set to Time.

## Waveform Menu Map (cont.)

## Acquisition Control Field

**See Also**

The function of the Acquisition Control field in the Waveform menu is the same as in the Trigger menu. Refer to the "Acquisition Control Field" in the Trigger menu for complete details.

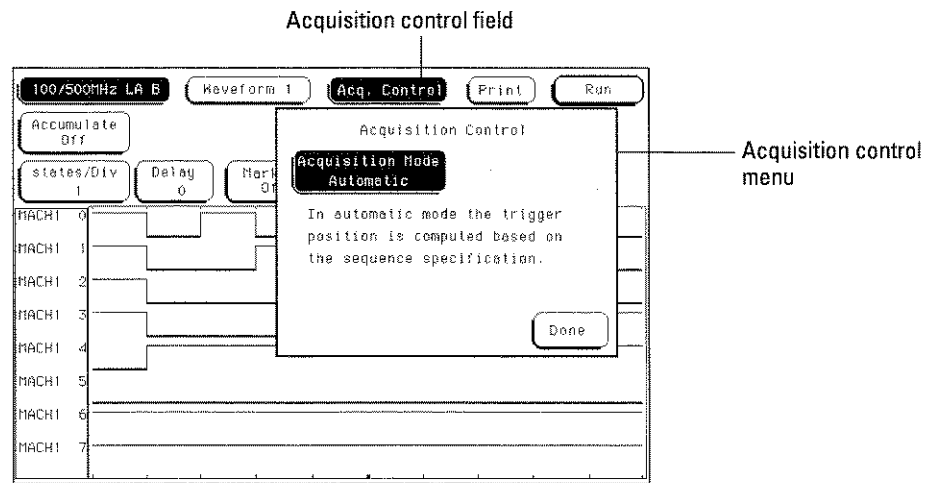

**Acquisition Control field**

The Waveform Menu  
**Accumulate Field**

---

## Accumulate Field

The Accumulate field controls whether old data is cleared or displayed with new data. The Accumulate field will toggle On/Off. When Accumulate is on, the analyzer displays the data from a current acquisition on top of the previously acquired data.

The time at which the old data is cleared, depends on whether the analyzer is run in Single or Repetitive mode. In Single, new data will be displayed on top of the old each time the Run field is selected. In Repetitive mode, data is cleared from the screen only when you start a run after stopping an acquisition with the Stop field.

If you leave the Waveform menu, or pop up a menu over the waveform display, any accumulated display data is lost and the accumulation process starts over.

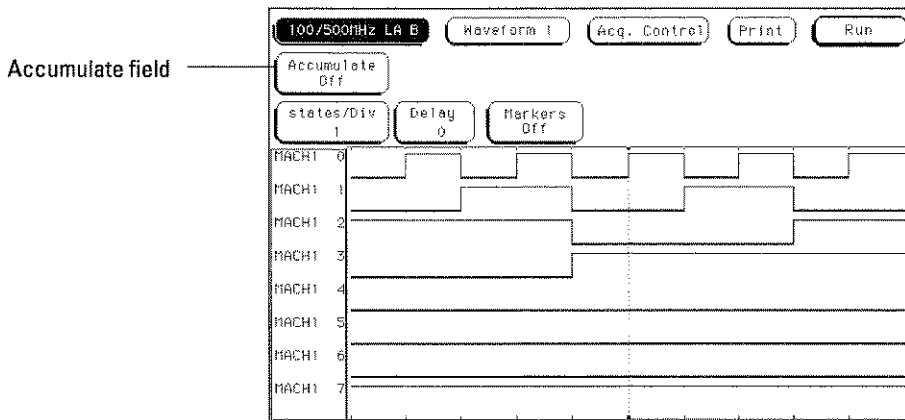

**Accumulate Field**



## States Per Division Field (State only)

When the analyzer Type field in the Configuration menu is set to State, the analyzer uses external clocks from the system under test. In this mode, the X-axis of the waveform display is measured in states per division.

You use the states/Div field to select the states per division resolution of the X axis. You can specify between 1 and 500 states per division by touching the states/Div field and rotating the knob, or by touching the states/Div field twice and then use the pop-up keypad. By adjusting the states/Div, you can zoom in to view a desired part of the display.

States per division field

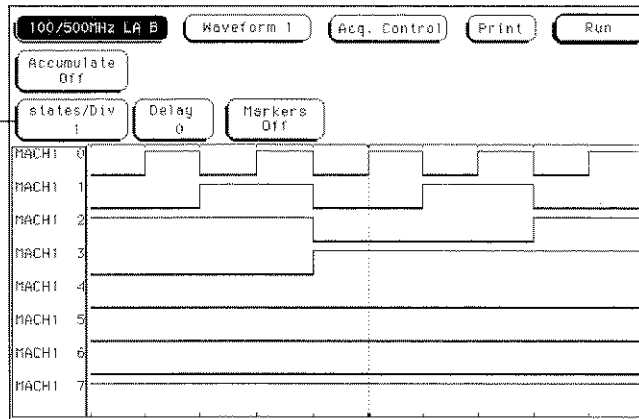

States Per Division Field

The Waveform Menu  
**Seconds Per Division Field (Timing only)**

---

## Seconds Per Division Field (Timing only)

When the analyzer Type field in the Configuration menu is set to Timing, the analyzer uses its own internal clock. In this mode, the X-axis of the waveform display is measured in seconds per division (sec/Div).

You use the sec/Div field to select the seconds per division resolution of the X axis. The range of the sec/Div field is 1 ns/Div to 1.0 ks. You set the sec/Div field by either touching the sec/Div field and rotating the knob, or by touching the sec/Div field twice and then using the pop-up keypad. When using the knob to set the sec/Div, the value will change in a 1-2-5 sequence. By adjusting the sec/Div, you can zoom in to view a desired part of the display.

Seconds per  
division field

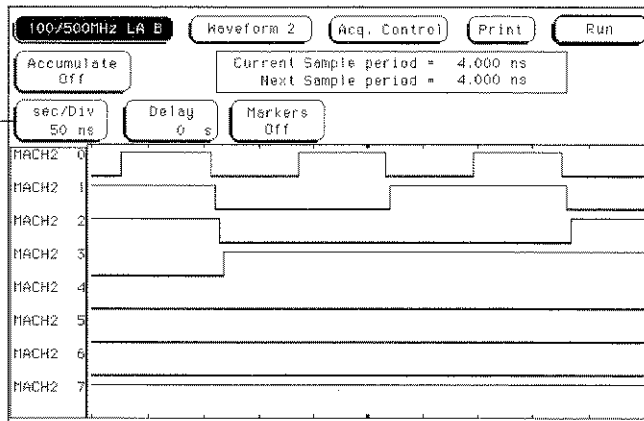

**Seconds Per Division Field**

## Delay Field

Depending on the analyzer configuration, a positive or negative delay measured in either states or time can be set. The Delay field allows you to scroll the data and place the display window at center screen. Changing the delay will not effect the data acquisition unless it is a timing analyzer and the acquisition mode is automatic.

The delay range of a timing analyzer is from -2500 seconds to + 2500 seconds. The delay range of a state analyzer is from -8192 states to +8192 states.

If you want to move the display window to view data located off screen to the right, enter a positive delay. If you want to move the display window to view data located off screen to the left, enter a negative delay.

You can enter a delay using the knob by selecting the Delay field once, which turns it light blue, then turning the knob. If you select the Delay field a second time when it is light blue, a pop-up keypad appears which enables you to enter an exact number.

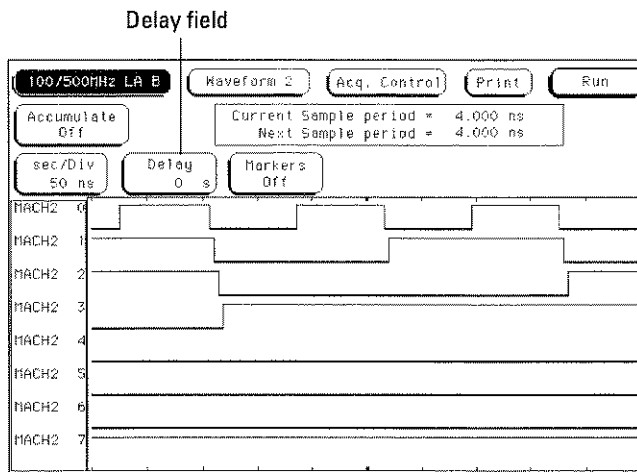

**Delay Field**

The Waveform Menu  
**Sample Period Display (Timing only)**

---

## Sample Period Display (Timing only)

The Sample period display only appears in a timing analyzer. A sample period is the interval of time between new data samples. Every time a new sample is taken, the analyzer updates the measurement.

The Current Sample period display is the sample period used for the last acquisition. The Next Sample period is the new sample period to be used at the next acquisition. If the acquisition mode is set to automatic, changing the sec/Div or delay will effect the sample period.

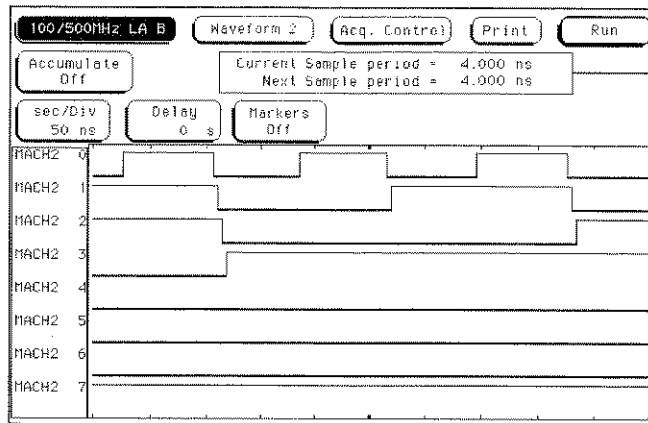

Sample period display

**Sample Period Display**

## The Waveform Menu Sample Period Display (Timing only)

Timing waveforms are reconstructed relevant to the sample period. The shorter sample period puts more sample points on the waveform for a more accurate reconstruction but also fills memory quicker.

If the sec/Div is changed resulting in a change in the next sample period, you must run the analyzer again before the current sample period display is updated.

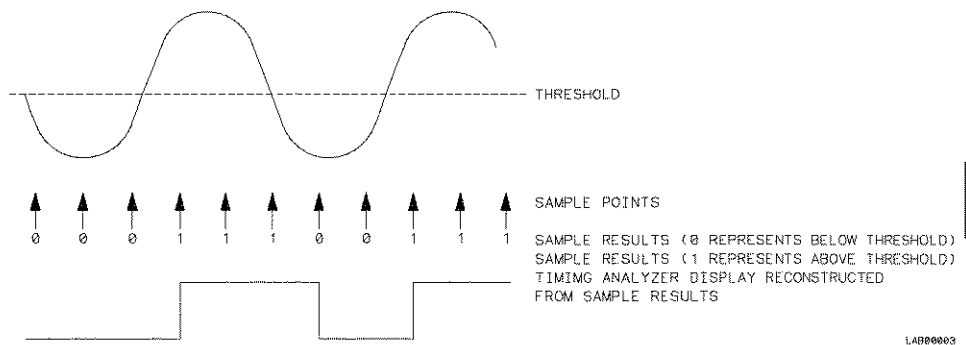

### Sample Points

The Waveform Menu  
**Markers Field**

---

## Markers Field

The Markers field is used to access the markers selection menu. When the Markers field is selected, a marker selection menu appears with the marker choices available under the present analyzer configuration.

### State Analyzer Types

In a state analyzer with time and state count turned off in the Trigger menu, only Pattern markers are available. With time count turned on, additional choices of Time markers and Statistics markers become available.

With states count turned on, in addition to Pattern markers, States markers are available.

### Timing Analyzer Types

If a timing analyzer you have marker choices of Off, Pattern, Time, or Statistics.

### Off

The Off selection turns marker operations off. If a Stop measurement was previously specified, and the Stop measurement criteria are met, the measurement will stop even though the markers are off.

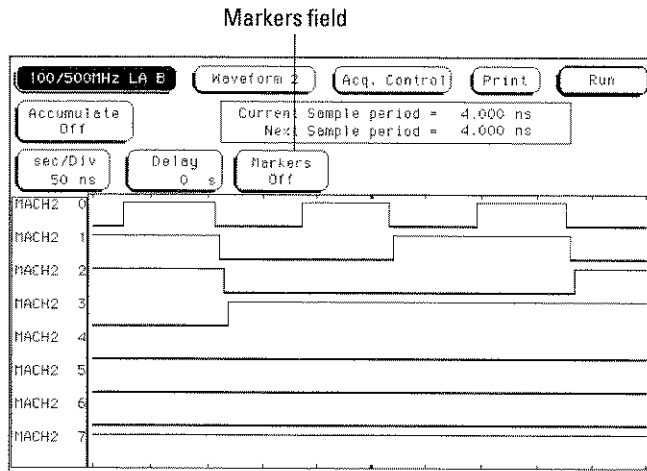

### Markers Field

---

## Pattern Markers

When Pattern markers are selected, two markers labeled X and O become available. Pattern markers identify and mark unique bit patterns in the waveform display. Once the unique bit patterns are marked, they can be used as reference points or as criteria for a stop measurement.

The markers are color coded for easy recognition in the waveform display. The X-marker is represented by a vertical green line and the O-marker is represented by a vertical yellow line. In addition each marker is labeled at the bottom of the display in the Display Location Reference Line.

When a marker is positioned in the waveform display, it is also positioned in the chart display and data listing.

**See Also**

The "Specify Patterns Field" found later in this chapter for more information on creating a pattern for the X and O markers.

The Waveform Menu  
**X-pat / O-pat Occurrence Fields**

---

## X-pat / O-pat Occurrence Fields

The X-pattern and O-pattern occurrence fields designate which pattern occurrence the marker is placed on. The range for the occurrence counter is from - 8192 to +8192.

The occurrence field can be set in two ways. When the field is selected one time, it turns light blue and knob operation becomes the entry method. If the field is selected a second time, a pop-up keypad appears and becomes the entry method.

The reference point from which the occurrence counter starts is either the trigger point, the start of the trace, or in the case of the O marker, the X marker. If a negative number is set, the analyzer will search for pretrigger occurrences.

Pattern occurrence field

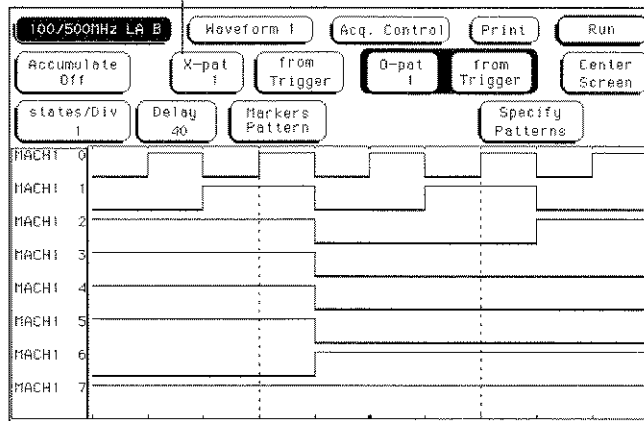

### X-pattern and O-pattern Occurrence Fields



### From Trigger / Start / X Marker Field

The from Trigger/Start/X marker field is used to access the selection pop-up for the start point of the X and O marker occurrence counters.

The start points available for the green X-marker are either the trace start point or the trigger point.

The start points available for the yellow O-marker are either the trace start point, trigger point, or the X-marker.

If the marker pattern can not be found, a message appears at the top of the display indicating the search failed. If the O-marker is referenced from the X-marker, and the X-marker is not found, the search for both markers will fail.

Trigger / Start / X marker field

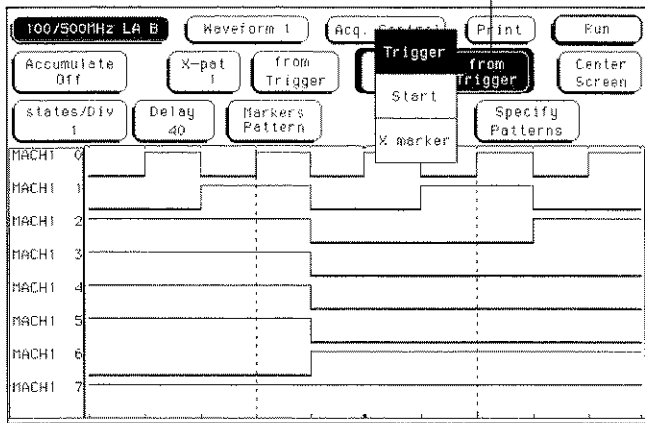

Trigger / Start / X Marker Field

The Waveform Menu  
**X to O Display Field (Timing only)**

---

**X to O Display Field (Timing only)**

The X to O display field only appears when the analyzer is configured as Timing. The X to O display field shows the time between the X and O markers.

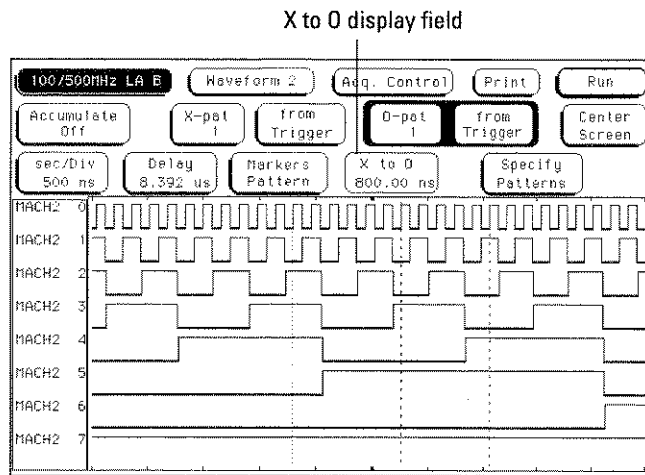

**X to O Display Field**

## Center Screen Field

The Center Screen field accessed a menu which allows you to position the marked points of the waveform display relative to the center of the waveform display.

**About Trigger** The About Trigger selection is the default position. This choice will position the point of the waveform where the trigger occurred, at center screen.

**About X Marker** This choice adjusts the delay to position the point of the waveform where the X-Marker is placed, at center screen.

**About O Marker** This choice adjusts the delay to position the point of the waveform where the O-Marker is placed, at center screen.

**About X & O** This choice adjusts the sec/Div to allow both X and O markers to be displayed simultaneously.

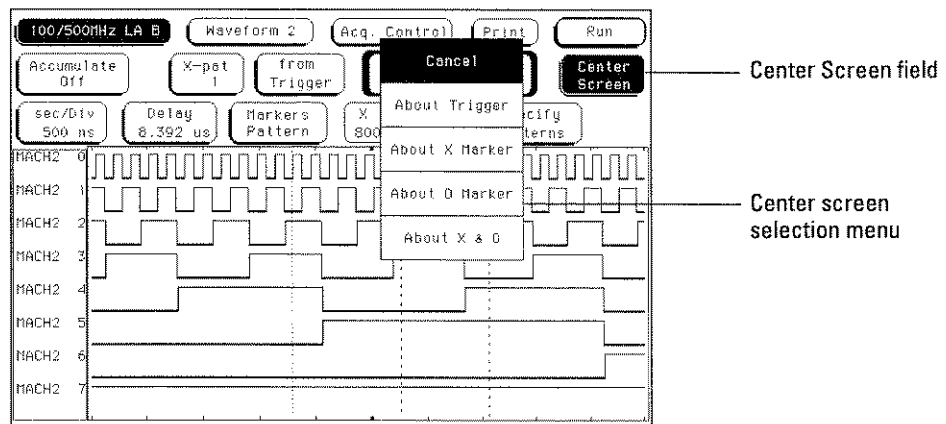

Center Screen Field

The Waveform Menu  
**Specify Patterns Field**

---

## Specify Patterns Field

The Specify Patterns field only appears when the markers are set to Pattern. When the Specify Patterns field is selected, a pop-up menu appears that is used to assign the bit patterns for the X and O markers, the X and O entering/leaving, and the Stop measurement criteria.

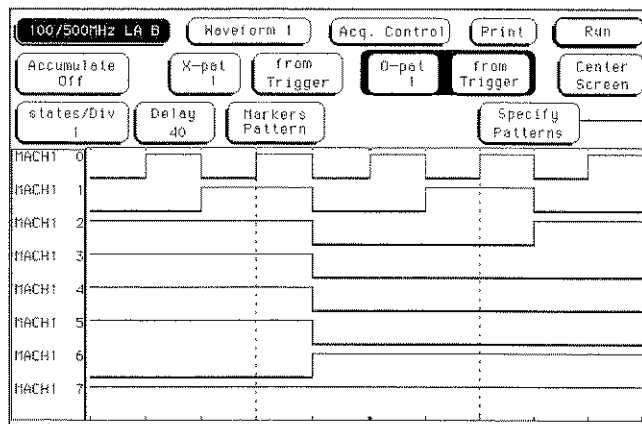

Specify patterns field

### Specify Patterns Field

**X and O entering / leaving Fields (Timing only)**

In a timing analyzer, the X and O pattern markers are placed at either the beginning of the pattern occurrence (entering) or at the end of the pattern occurrence (leaving). When the entering/leaving field of either X or O markers is selected, it will toggle between the two choices.

Which ever choice you toggle the field to, the pattern you place in the pattern display field will apply to that choice.

**X marker and O marker Fields (State only)**

In a state analyzer, X-marker and O-marker fields replace the X and O entering/leaving fields. The pattern you place in the pattern display field will apply to the marker labeled at the left.

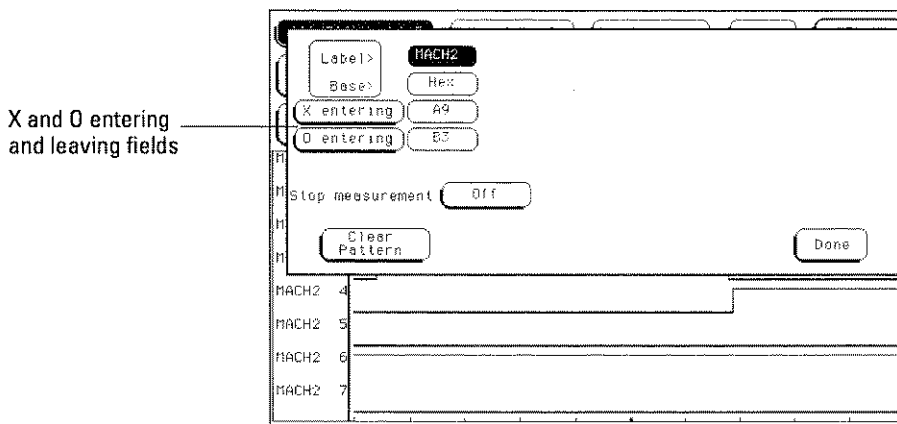

**X and O entering / leaving Fields**

## The Waveform Menu

### Specify Patterns Field

#### Pattern Display Fields

The pattern display field displays the alpha-numeric bit pattern specified for each X and O marker in all designated labels. The bit pattern is displayed in the same numeric base and same order as the data listing. When the pattern display field is selected, a pop-up keypad appears which is used to set the bit pattern.

When there are more labels assigned than can be displayed in a single screen, the pattern display fields are rolled back on screen by the Label/Base roll field.

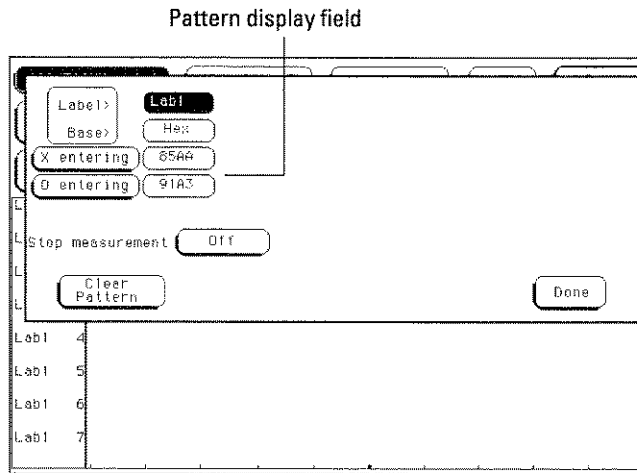

#### Pattern Display Field

**Label and Base Fields**

The Label and Base fields show up together in all menus except the Format and Configuration menus. When a new label is assigned, a base field is automatically assigned to that label.

**Label Field** Labels in the Specify Patterns menu are the same labels assigned in the Format menu. These labels will be displayed throughout the analyzer as they were assigned in the Format menu.

To reorder currently displayed Labels, select the label you want to move, then from the selection menu that appears, choose the label you want to switch positions with.

**Base Field** The function of the Base field is the same in all menus. To change the numeric base, select the base field, then choose the desired base from the selection menu.

---

**Label / Base Roll Field**

The function of the Label and Base roll field is the same in all menus. The rolling function is the same for all items that are stored offscreen. For more information on rolling labels, base, and pods, refer to Labels Assignment in the "Common Module Operations" part of the *HP 16500B User's Reference Guide*.

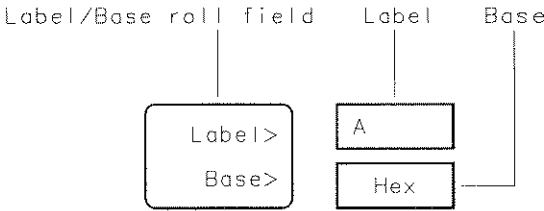

16542B03

**Label / Base Roll Field**

The Waveform Menu  
**Stop Measurement Field**

---

## Stop Measurement Field

The Stop measurement function allows you to specify a condition which stops the analyzer measurement during a repetitive run.

When the Stop measurement field is selected, a Stop measurement type menu appears. Depending on the analyzer configuration, you have choices of Off, X-O, and Compare.

### Off

The Off selection turns all Stop measurement operations off.

If the Stop measurement operation is not turned off and the Stop measurement criteria are met, the measurement will stop even though the markers are set to other types or turned off.

Stop measurement type options

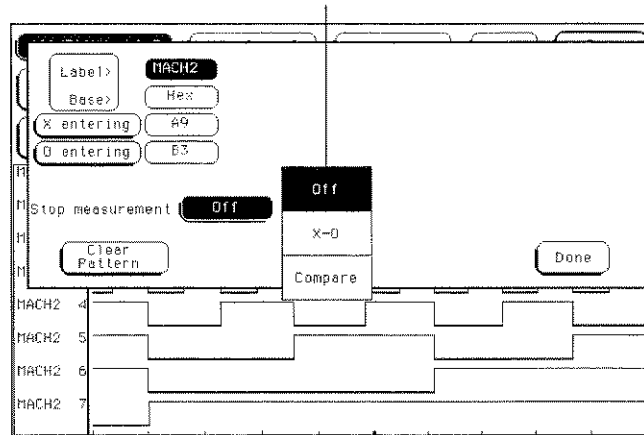

### Stop Measurement Field



**X-O**

The X-O option is available in the timing analyzer and in the state analyzer with its count set to Time.

When X-O is selected, a repetitive run is stopped when a comparison of the time period between the X and O markers and one of the following time period options is true:

**Less Than** X-O time must be less than the time value that you specify in the Time field.

**Greater Than** X-O time must be greater than the time value that you specify in the Time field.

**In Range** X-O pattern must be within the time range value that you specify in the two Time fields.

**Not in Range** X-O pattern must not be within the time range value that you specify in the two Time fields.

X to O option menu

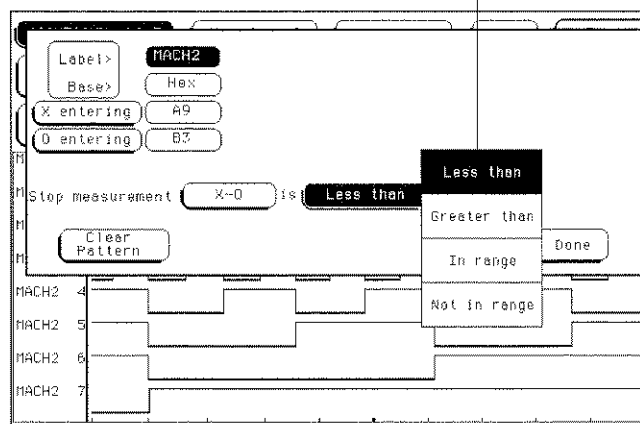

**X-O Field**

## The Waveform Menu Stop Measurement Field

### Compare

When Compare is selected, a repetitive run will be stopped when a comparison of data in the Listing menu and data and criteria in a compare image matches an equality selection. The equality selection is set from the Equal/Not Equal selection pop-up menu.

**Equal** The data and compare criteria in the Compare menu must be equal to the data in the Listing menu.

**Not Equal** The data and compare criteria in the Compare menu must not be equal to the data in the Listing menu.

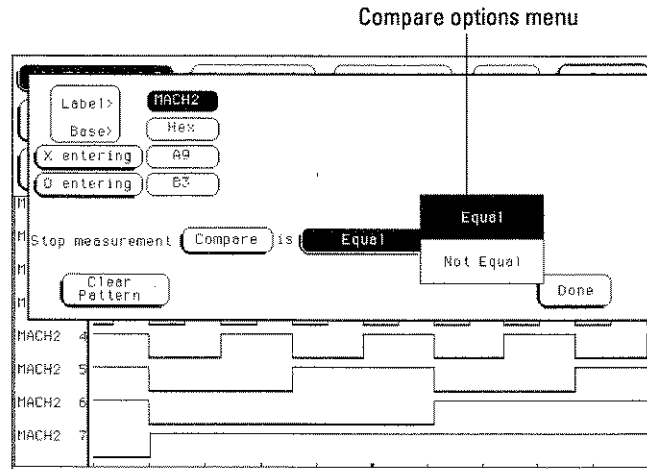

### Equal / Not Equal Selection Menu

## Clear Pattern Field

The Clear Pattern field is used to reset the X and O Marker pattern display fields back to default (don't care = X). The Clear Pattern field accesses a selection menu with the choices of All, X pattern, or O pattern.

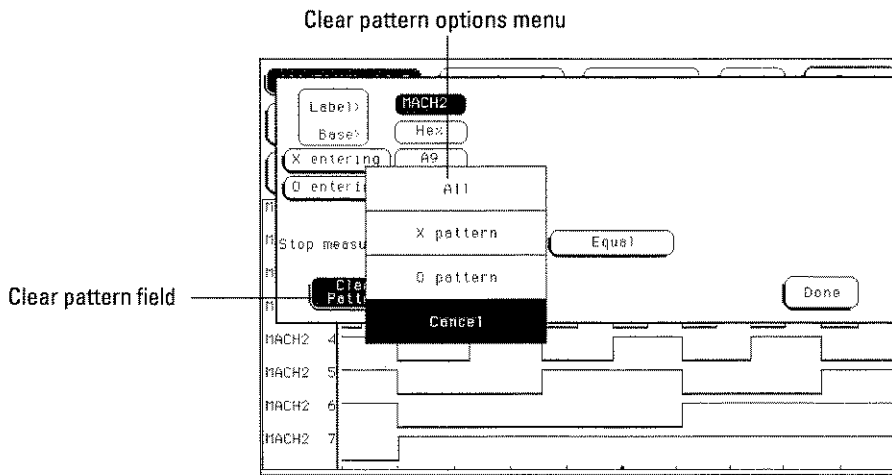

### Clear Pattern

---

## Time Markers

Time markers are indicators located in the waveform display that are used as reference marks to obtain time values between each marker, or between each marker and the trigger point.

In a state analyzer, Time markers only become available when the Count field is set to Time, in the Trigger menu.

The markers are color coded for easy recognition in the waveform display. The X-marker is represented by a vertical green line and the O-marker is represented by a vertical yellow line. In addition, both markers are labeled at the bottom of the display in the Display Location Reference Line.

If Pattern markers are assigned, the Time markers are initially placed at the same locations in the data listing.

## Trig to X / Trig to O Fields

The Trig to X and Trig to O fields display the time between the trigger point and the marker. They are also used to position the markers with reference to the vertical red trigger line.

Marker position is set by selecting the Trig to X and Trig to O fields, then after the fields turn light blue, rotate the knob. In addition, values can be entered by selecting the light blue field a second time, then use the pop-up keypad that appears.

### X to O Field

In a state analyzer configuration, the X to O field is a "read only" field that displays the difference between the X and O markers. As the X and O markers are changed, the display changes accordingly.

In a timing analyzer configuration, the X to O field can be selected and set. If this field is changed, both X and O markers will move simultaneously with the relative difference remaining unchanged.

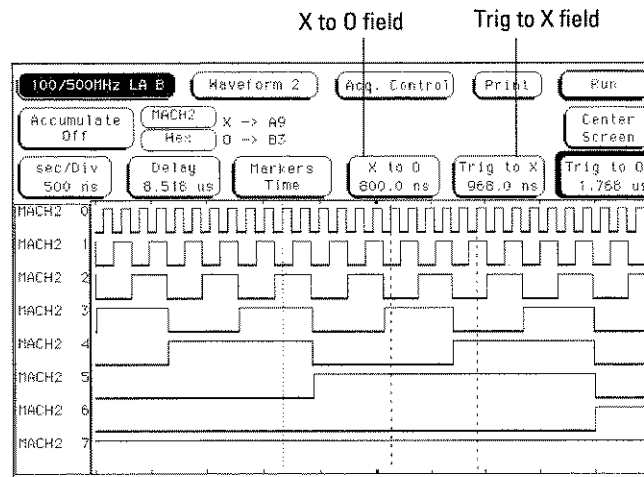

### Trig to X / Trig to O Fields

The Waveform Menu  
**Marker Label / Base and Display**

---

## Marker Label / Base and Display

The label field displays the label name for which the X and O marker values are assigned. To display other labels, select the label field and choose the new label from the selection menu that appears. Only pre-assigned labels are available in the label selection menu

The base field underneath the label field displays the numeric base the marker values are displayed in. To change the numeric base, select the base field, then choose the desired base from the selection menu.

Bit patterns where the markers are currently placed, appear next to the appropriate marker..

**See also**

Labels Assignment in the "Common Module Operations" part of the *HP 16500B User's Reference Guide* for complete information on assigning labels.

Marker data pattern display

Marker label  
and base

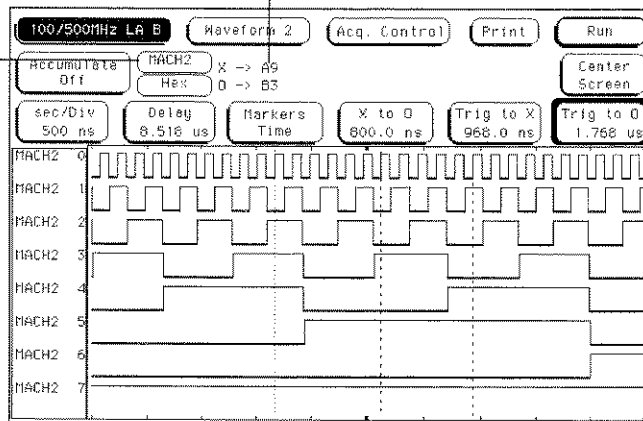

### Marker Label / Base and Display

---

## Statistics Markers

After patterns are assigned to the X and O markers, statistical information is available when markers are set to Statistics. The logic analyzer displays the following information:

- Number of valid runs (runs where Pattern markers were placed on specified patterns).
- Minimum time between the X and O Pattern markers.
- Maximum time between the X and O Pattern markers.
- Average time between the X and O Pattern markers.

In a state analyzer, Statistics markers only become available when the Count field is set to Time, in the Trigger menu.

The markers are color coded for easy recognition. The X-marker is represented by a vertical green line and the O-marker is represented by a vertical yellow line. In addition, both markers are labeled at the bottom of the display in the Display Location Reference Line.

## The Waveform Menu Marker Label / Base and Display

Statistics are based on the time between the X and O markers. Both markers must be found before valid statistical information is displayed.

In repetitive run mode, the display is updated each time a valid run occurs until you press Stop. If you press Run after Stop, the statistics continue to update without loss of information. All statistical information can be cleared at any time by selecting the Reset Statistics field.

In single run mode, each time you press Run an additional valid run will be added to the data and the statistics will be updated. This process continues unless you change the placement of the X and O Pattern markers between runs.

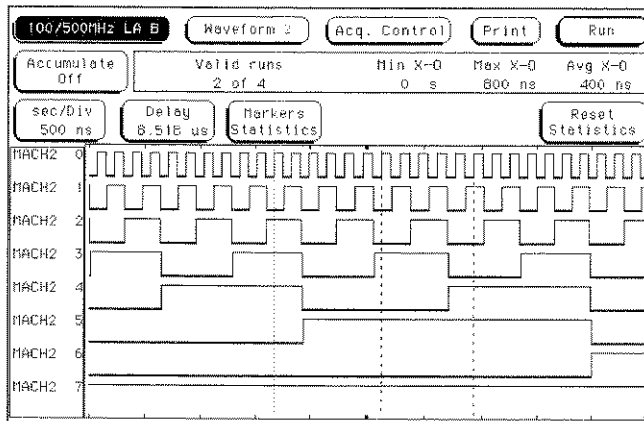

**Statistics Display**



---

## States Markers (State only)

States markers are indicators located in the waveform display that are used as reference marks to obtain the number of states between each marker, or between each marker and the trigger point.

State markers are only available in a state analyzer with the Count field set to States, in the Trigger menu.

The markers are color coded for easy recognition in the waveform display. The X-marker is represented by a vertical green line and the O-marker is represented by a vertical yellow line. In addition, both markers are labeled at the bottom of the display in the Display Location Reference Line.

## The Waveform Menu Trig to X / Trig to O Fields

### Trig to X / Trig to O Fields

The Trig to X and Trig to O fields display the time between the trigger point and the marker. They are also used to position the markers with reference to the vertical red trigger line.

Marker position is set by selecting the Trig to X and Trig to O fields, then after the fields turn light blue, rotate the knob. In addition, values can be entered by selecting the light blue field a second time, then use the pop-up keypad that appears.

### X to O Display Field

The X to O display field is a "read only" field that displays the number of states between the X and O markers. As the X and O markers are changed, the display changes accordingly.

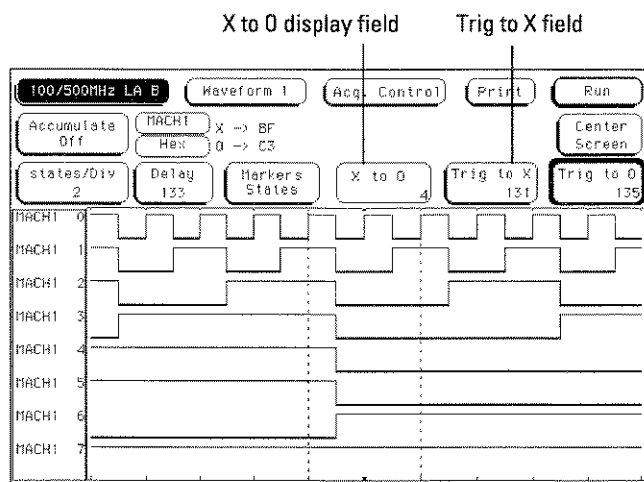

### Trig to X / Trig to O Fields

## Marker Label / Base and Display

The label field displays the label name for which the X and O marker values are assigned. To display other labels, select the label field and choose the new label from the selection menu that appears. Only pre-assigned labels are available in the label selection menu.

The base field, underneath the label field, displays the numeric base the marker values are displayed in. To change the numeric base, select the base field, then choose the desired base from the selection menu.

Data patterns where the markers are currently placed, appear next to the appropriate marker.

**See also**

Labels Assignment in the "Common Module Operations" part of the *HP 16500B User's Reference Guide* for complete information on assigning labels.

Marker Label / Base and Display

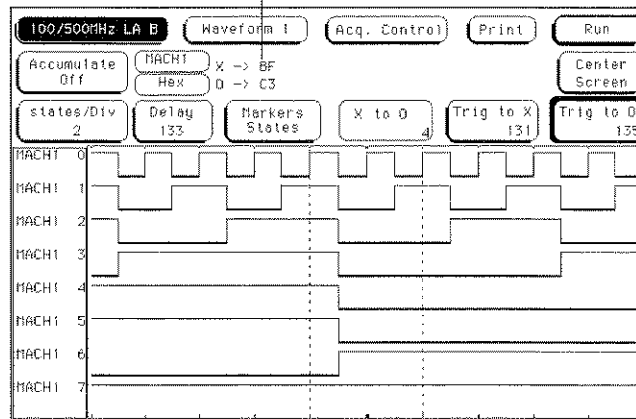

Marker Label / Base and Display

---

## Waveform Display

The waveform display area of the Waveform menu displays state and timing waveforms for labels assigned in the Format menu. If the Waveform menu is from a state analyzer, the display is state waveforms. If the Waveform menu is from a timing analyzer, the display is timing waveforms.

The waveform display area also accesses the fields used to select, delete, or modify waveforms. The function of selecting waveforms for display, and modifying or deleting waveforms is identical for both state and timing waveforms.

Only waveforms with their bits assigned in the Format menu can be displayed. Each waveform is a member of a set of waveforms grouped under a label. The label name you assign in the Format menu is the label name that appears in the Labels selection list.

### Display Location Reference Line

At the bottom of the Waveform menu is a reference line which displays the relative location of the display window, the markers, and the trigger point with reference to the total memory.

Total memory is represented by a horizontal dotted line. The display window is represented by an overlaid solid line. The markers and trigger point are represented by an X, O, and t, all of which are located below the dotted line.

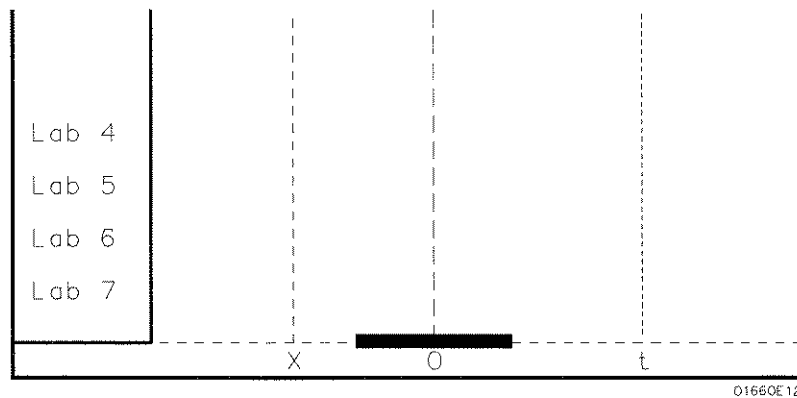

Display Location Reference Line

The Waveform Menu  
**Blue Bar Field**

---

## Blue Bar Field

The blue bar on the left side of the waveform display, is both a display and configuration field. After all desired waveforms are configured for display, they are listed in the blue bar. If there are more waveforms than can be displayed, the list is rolled by selecting the dark blue bar, then after it turns light blue, turn the knob. If the blue bar is already light blue, just turn the knob.

If the blue bar is selected when it is light blue, the Waveform Selection menu appears. Use this menu to configure the waveform display.

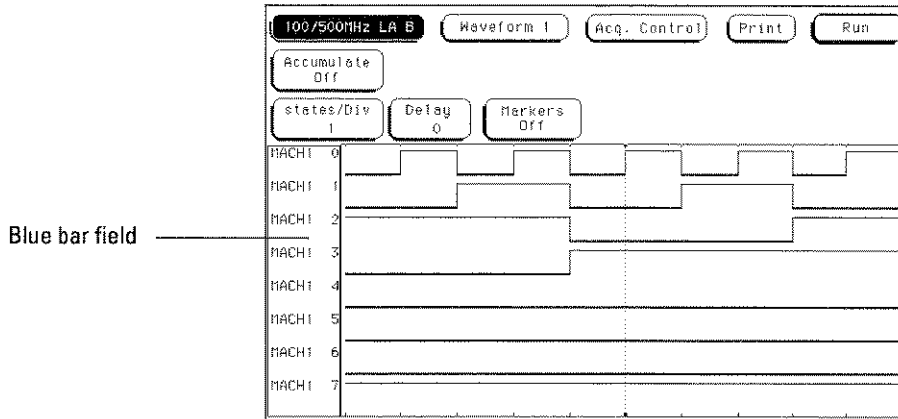

**Blue Bar Field**

The Waveform Menu  
Blue Bar Field

When the Waveform Selection pop-up menu appears, you will select which waveforms are displayed, replaced, or modified. You can display up to 24 waveforms on screen at one time.

Single waveforms or all waveforms under a label can be displayed or turned off. How the waveform bits are assigned for display depends on what Channel Mode is currently selected.

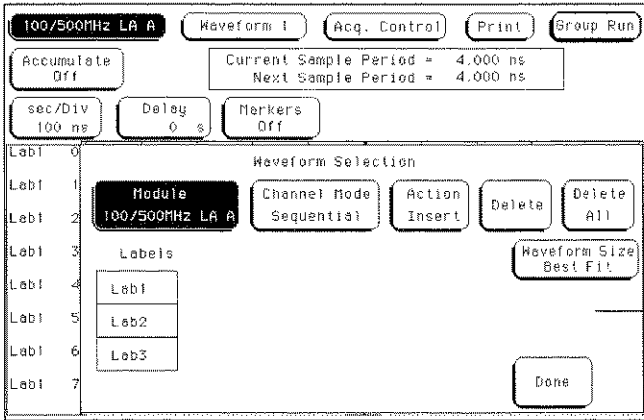

Waveform selection menu

Waveform Selection Menu

The Waveform Menu  
**Channel Mode Field**

---

## Channel Mode Field

The Channel Mode field selects which method the waveform labels are inserted into the display. All inserted labels are placed below the cursor in the blue bar field. When the Channel Mode field is selected, a selection menu appears with the choices below.

### Sequential

The Sequential mode inserts all channels from the selected label, in order starting below the white cursor.

### Individual

The Individual mode inserts selected channels from a label's channel selection list. The channel selection list appears when a label name is selected. Channels are inserted starting below the white cursor.

Channel mode selection pop-up

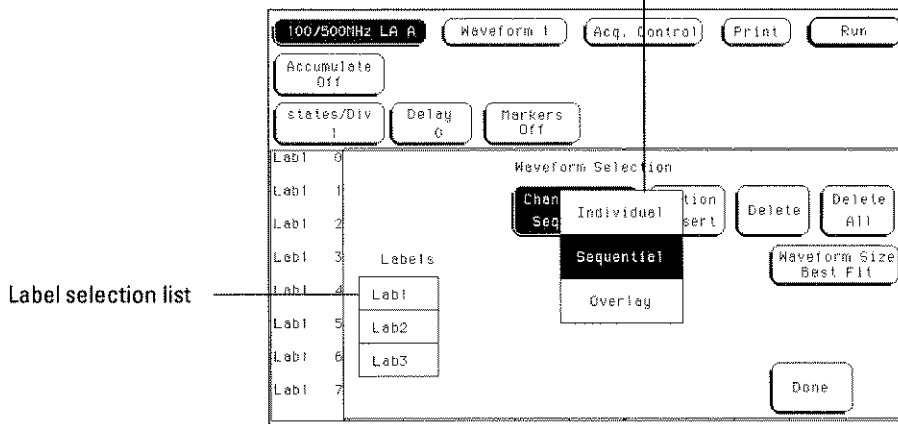

Channel mode Selection Menu



**Overlay**

The Overlay mode inserts all bits of a label in a single waveform to form a composite waveform label. The onscreen indication for the Overlay mode is "All" following the label name.

**Viewing State Data in Overlay Mode**

When all assigned waveforms in a label are Overlaid, the value of the data is displayed to the right of each new transition in the waveform display.

If the sec/Div is set to view a large increment of time, or the waveform scaling is set to Small or medium, the state data readout will not fit between transitions. To display the state data readouts within the waveform, expand the sec/Div and use the large waveform setting. If symbols are assigned to represent data values, the symbol is displayed.

Overlaid waveforms

Data value or Symbol displayed in waveform

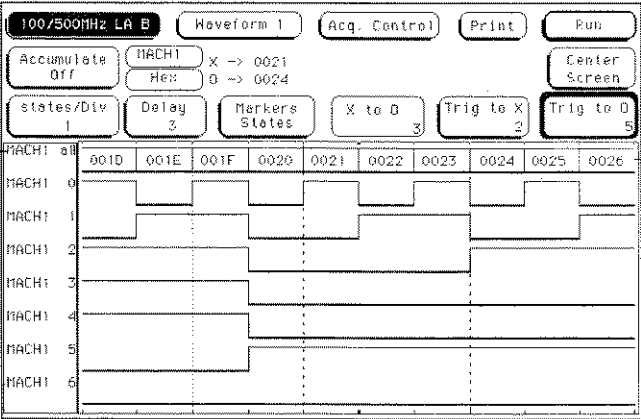

**State Data or Symbols In Overlaid Waveform**

The Waveform Menu  
**Module and Label Fields**

---

## Module and Label Fields

If there are multiple timing or oscilloscope modules installed in the mainframe, waveforms from the other modules can be displayed in the waveform menu. The Module field accesses a selection list that contains the modules installed in the mainframe, that are configured in a Group Run, and have timing or oscilloscope waveforms.

Module and label fields

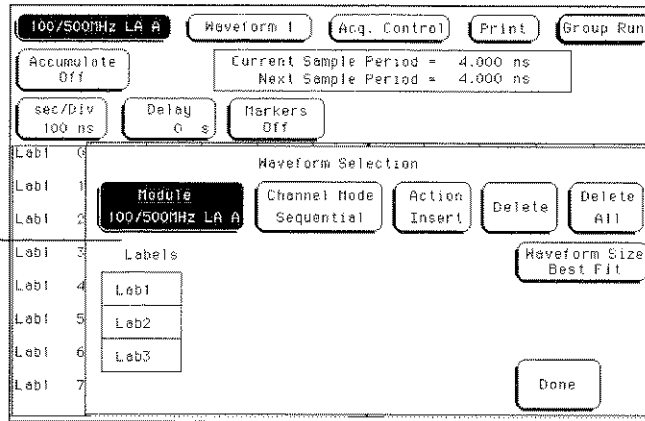

**Module and Label Fields**

## Action Insert/Replace Field

The Action field determines if a label or channel is inserted into the display or replaces another label or channel.

Insert will append the selected label or channel to the end of the list of displayed labels.

To replace one waveform with another, position the cursor with the knob, on the waveform you wish to replace. Touch the Action Insert field to toggle it to Action Replace. Then select the label that will replace the old label.

Action insert and replace field

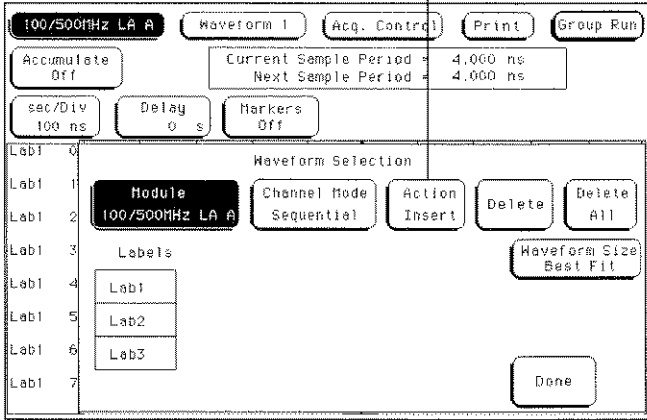

Action Insert/Replace Field

The Waveform Menu  
**Delete and Delete All Fields**

---

## Delete and Delete All Fields

The Delete field is used to delete single channels within the group of displayed waveforms. To delete any single channel, you first highlight the desired channel by placing the cursor on the channel, then select the Delete field.

You can delete all currently displayed waveforms by selecting Delete All, then selecting Continue.

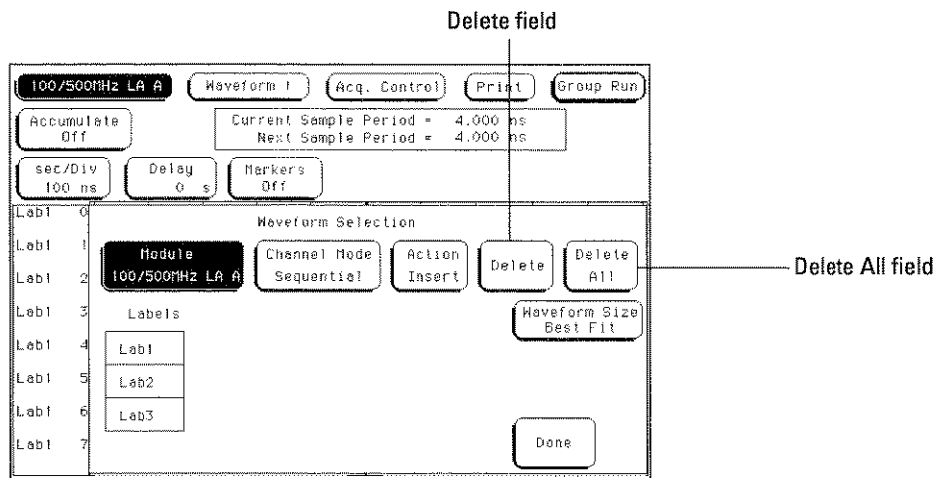

### Action Insert/Replace Field

---

## Waveform Size Field

The Waveform Size field accesses a selection menu which contains choices that scale the displayed waveforms to different sizes. A different waveform size can increase the number of waveforms in the display or make the viewing better for just a few.

### Best Fit

When Best Fit is used, the analyzer picks the largest font, either small, medium, or large, that allows all waveforms to be displayed.

### Small

The small font will allow 24 waveforms displayed.

### Medium

The medium font will allow 16 waveforms displayed.

### Large

The large font will allow 8 waveforms displayed.

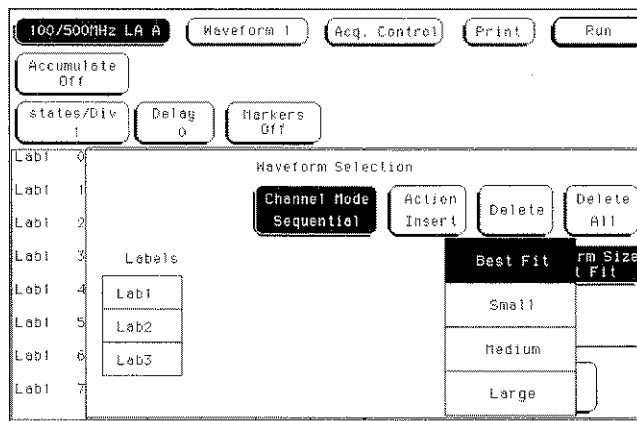

**Waveform Size Selection Menu**





# The Chart Menu

---

## The Chart Menu

State Chart is a software post-processing feature that provides the ability to build x-y charts of label activity using state data. The Chart menu builds a graphical representation of the system under test. The y-axis always represents data values for a specified label. You can select whether the x-axis represents states (ie. rows in the state listing) or the data values for another label.

### **Chart Post-Processing Features**

When the x-axis is set to State, X and O markers are available which display the current sample relative to the trace point and the corresponding y-axis data value. Marker placement is synchronized with the normal state listing.

An accumulate mode is available that allows the chart display to build up over several runs.

You can generate x-y charts of Label vs Label or Label vs State.



### **Label Value vs. Label Value Charts**

When labels are assigned to both axis, the chart shows how the data acquired under one label varies in relation to the other for a particular measurement. Label values are always plotted in ascending order from the bottom to the top of the chart and in ascending order from left to right across the chart. Plotting a label against itself will result in a diagonal line from the lower left to upper right corner. All markers are disabled when plotting this kind of chart.

### **Label Value vs. States Charts**

The Label value versus State is a plot of data values acquired under a label versus the memory location of the same data. The label value is plotted against successive memory locations numbers.

### **Chart Menu Map**

The following menu map illustrates all fields and the available options in the Chart menu. The menu map will help you get an overview as well as provide you with a quick reference of what the Chart menu contains.

# The Chart Menu

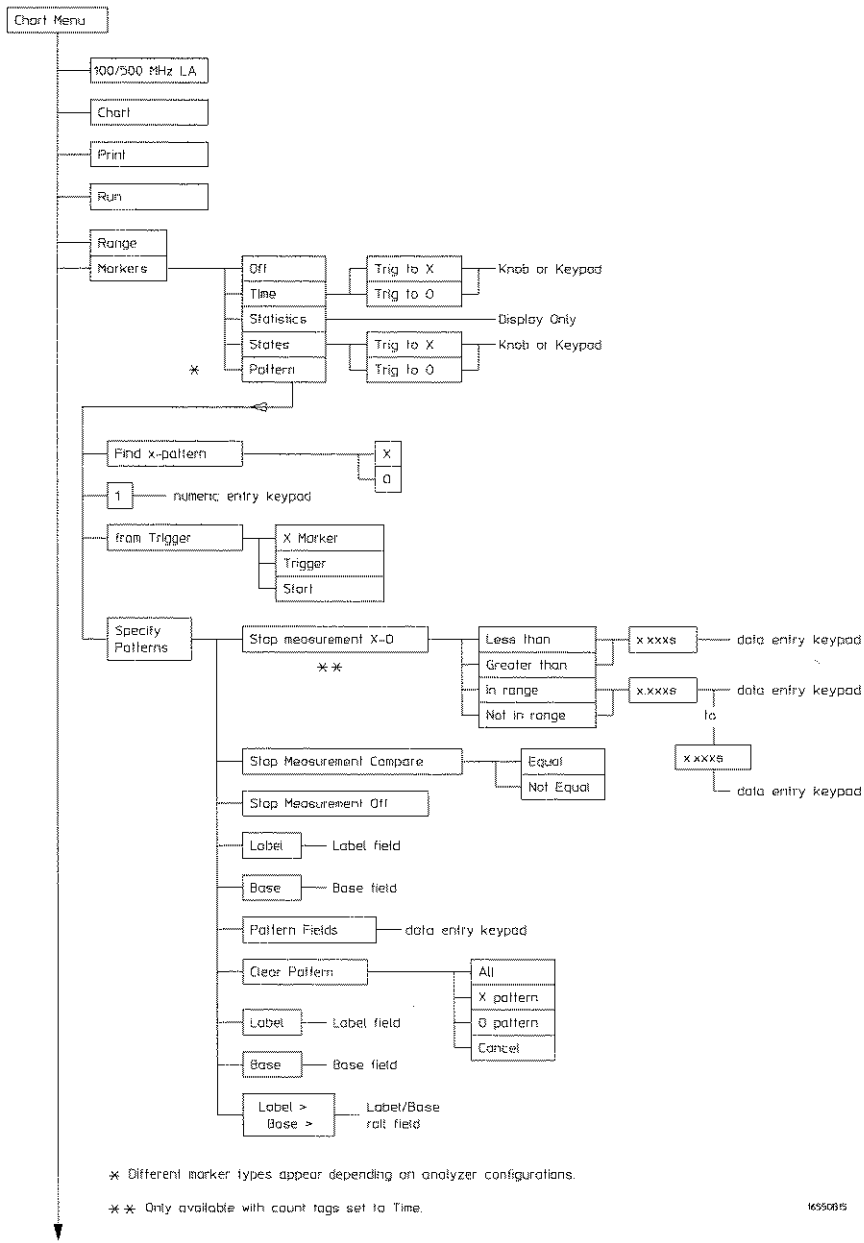

Continued on next page

## Chart Menu Map

# The Chart Menu

Cont'd from prev page

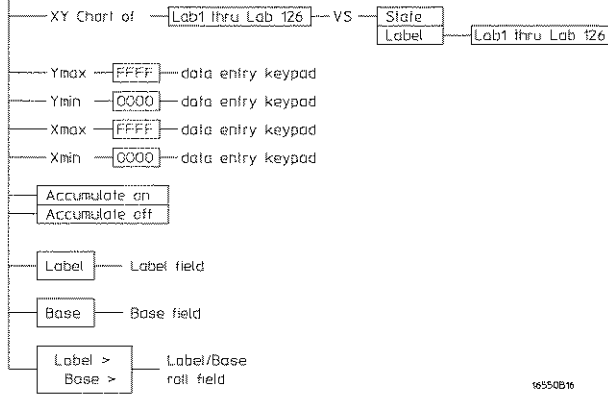

16550B16

## Chart Menu Map (cont.)

---

## Selecting the Axes for the Chart

When using the State Chart display, you first select what data you want plotted on each axis. The vertical y-axis will always be the data under a label. The available labels are those which you assigned in the Format menu. The horizontal x-axis can be either the same labels available for the y-axis or state memory location numbers.

---

## Y-axis Label Value Field

The y-axis label field displays the label assigned to the vertical y-axis. Vertical axis labels are assigned by selecting the y-axis display field, then selecting a label from a selection list. The only label choices available are the labels that were defined in the Format menu.

The value plotted is the measured data value represented by that label, and in the numeric base selected.

The placement of the label data on the graph is determined by the scaling of the Ymin and Ymax fields.

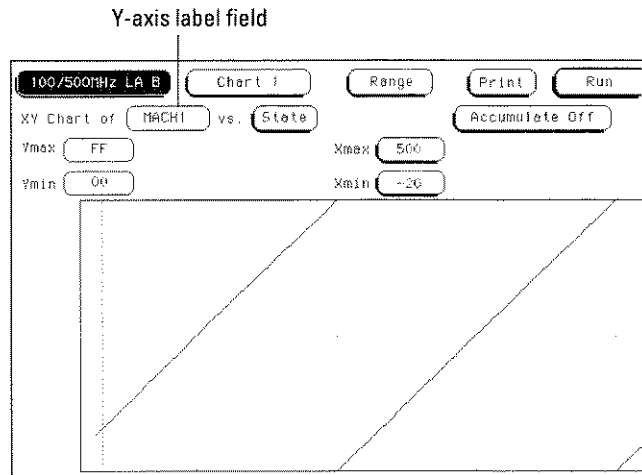

**The Y-axis Label Field**

The Chart Menu  
**X-axis Label / State Type Field**

---

## X-axis Label / State Type Field

The Label/State type field displays the axis type assigned to the horizontal axis. The x-axis represents state data values, or state memory location numbers.

The x-axis type field is just to the right of "vs." text, and toggles between State and Label. The x-axis type field must be set to either Label or State before the chart's x-axis scaling is assigned.

To assign a label, select the x-axis Label field, then select the desired label from a label selection list. The value plotted is the measured data value represented by that label, and in the numeric base previously selected. The only label choices available are the labels that were defined in the Format menu

To assign the axis type to State, toggle the field to State. The value plotted is the state memory location numbers or a range of memory locations assigned by the Xmin and Xmax fields.

**See Also**

The "Scaling the Axes" found later in this chapter for information on setting the Xmin, Xmax, Ymin, and Ymax fields.

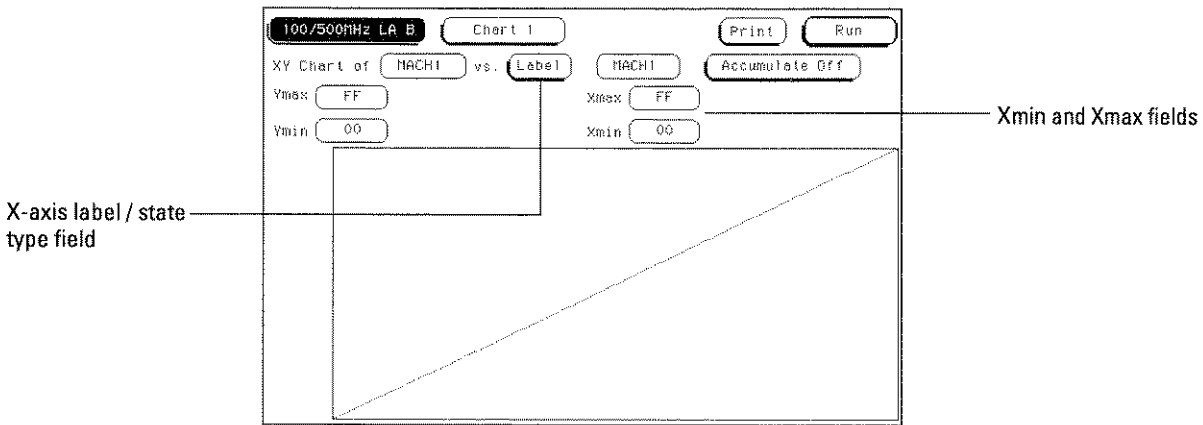

**The X-axis Label / State Type Field**

---

## Scaling the Axes

When the x-axis is set to State, the horizontal axis represents state memory location numbers. The range of the x-axis can be a single memory location, or a range of memory locations.

When the x-axis is set to Label, the horizontal axis represents a range of data values under the selected label.

Use the Xmin and Xmax fields to set the horizontal axis start point and end point, with the difference between them setting the total axis range.

When the y-axis is set to Label, the vertical axis represents a range of data values under the selected label.

Use the Ymin and Ymax fields to set the vertical axis start point and end point, with the difference between them setting the total axis range.

The Chart Menu  
**Min and Max Scaling Fields**

---

## Min and Max Scaling Fields

Either axis of the x-y chart can be scaled by using the associated vertical or horizontal min (minimum) or max (maximum) value fields. When the scaling fields are selected, a pop up keypad appears in which you specify the actual minimum and maximum values that will be displayed.

When State is selected for the x-axis, the minimum and maximum values can range from -8192 to +8192 depending on the trace point location.

When Label is selected for the x-axis, the minimum and maximum values range from 00000000 to FFFFFFFF regardless of axis, since labels are restricted to 32 bits.

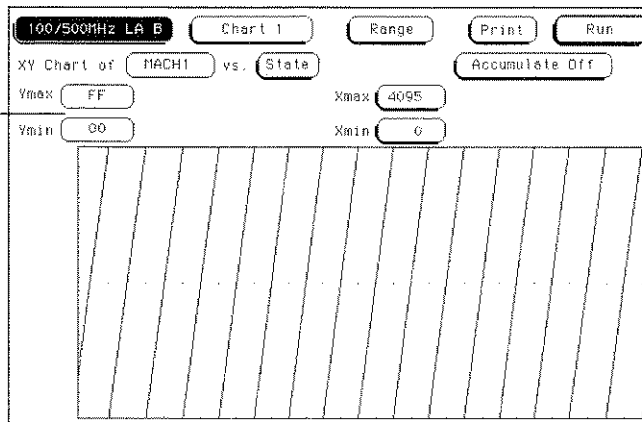

**Axes Scaling Fields**



---

## Markers / Range Field

The Marker/Range field is a toggle field that switches between Markers and Range when it is selected. If the field is set to Range, x and y range fields become available to set the chart minimum and maximum range points. The Ymin and Ymax fields display the numeric value of the selected label. The numeric base of the label value is what ever was previously set.

When the Marker/Range field is toggled to Markers, a marker selection menu appears with marker choices available with the present analyzer configuration.

In a state analyzer with Time and State count turned off in the Trigger menu, only Pattern markers are available. With Time count turned on, additional choices of Time markers and Statistics markers become available.

With States count turned on, in addition to Pattern markers, States markers are available.

### Off

The Off selection turns marker operations off. If a Stop measurement was previously specified, and the Stop measurement criteria are met, the measurement will stop even though the markers are off.

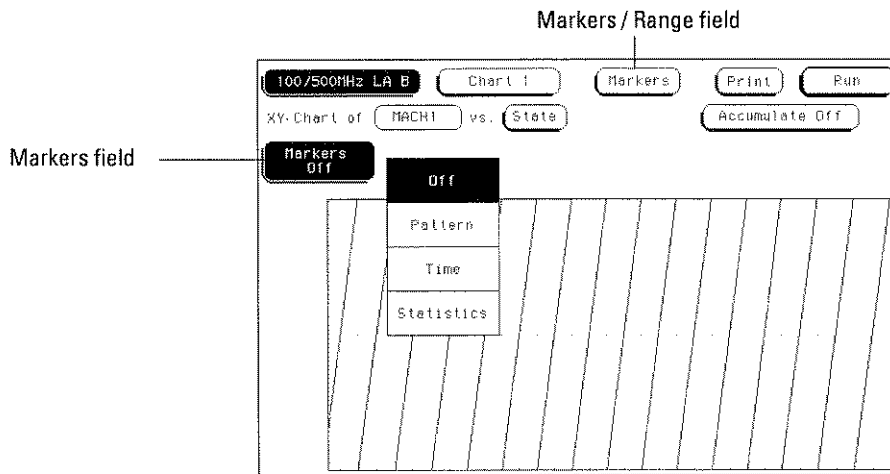

**Markers / Range Field**

---

## Pattern Markers

When Pattern is selected from the markers type selection menu, two markers labeled X and O become available. Pattern markers identify and mark unique bit patterns in the data listing. Once the unique bit patterns are marked, they can be used as reference points or as criteria for a stop measurement.

The markers are color coded for easy recognition in the x-y chart. The X-marker is represented by a vertical green line and the O-marker is represented by a vertical yellow line.

When a marker is positioned in the Listing menu, it is also positioned in the Chart menu and Waveform menu.

**See Also**

The "Specify Patterns Field" found later in this chapter for more information on creating a pattern for the X and O markers.

---

## Find X-pattern / O-pattern Field

The Find X-pattern / O-pattern Field is a toggle field. When selected, the occurrence and trace start field assignments switches to the other marker. In addition, when this field is selected, the marker identified and the data it marks, will automatically shift to center screen.

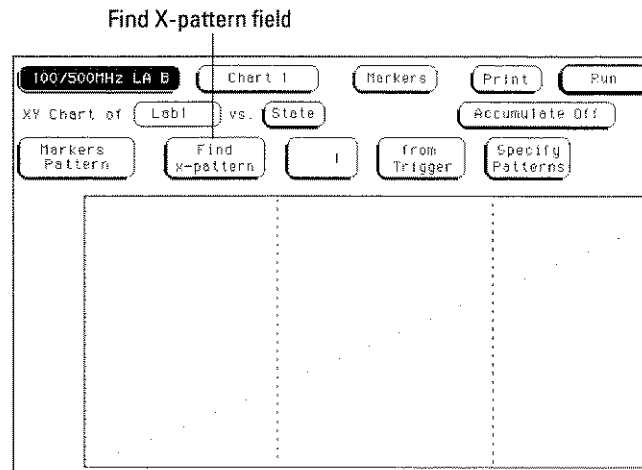

**Find X-pattern / O-pattern Field**

The Chart Menu  
**Pattern Occurrence Fields**

---

## Pattern Occurrence Fields

The X-pattern and O-pattern occurrence fields designate which pattern occurrence the marker is placed on. The numeric range of the occurrence field is -8192 to +8192.

The occurrence field can be set in two ways. When the field is selected one time, it turns light blue and knob operation becomes the entry method. If the field is selected a second time, a pop-up keypad appears and becomes the entry method.

The reference point from which the occurrence counter starts is either the trigger point, the start of the trace, or in the case of the O-marker, the X-marker.

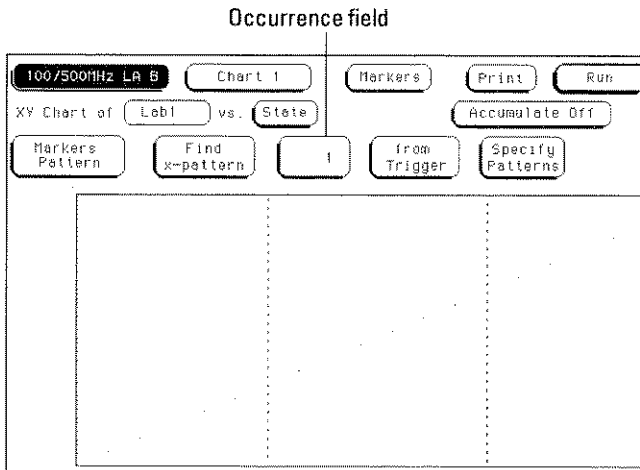

### X-pattern and O-pattern Occurrence Fields

---

## From Trigger / Start / X Marker Fields

The from Trigger/Start/X marker field is used to access the selection pop-up for the start point of the X and O marker occurrence counters.

The start points available for the green X-marker are either the trace start point or the trigger point.

The start points available for the yellow O-marker are either the trace start point, trigger point, or the X-marker.

If the marker pattern can not be found, a message appears at the top of the display indicating the search failed. If the O-marker is reference from the X-marker, and the X-marker is not found, the search for both markers will fail.

From Trigger / Start / X marker field

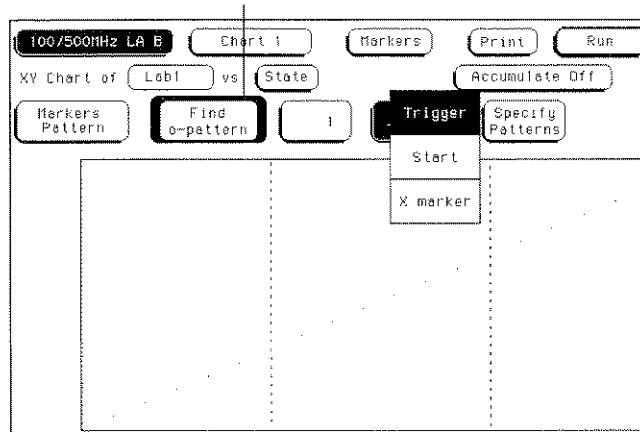

Trigger / Start / X Marker Field

The Chart Menu  
**Specify Patterns Field**

---

## Specify Patterns Field

The Specify Patterns field only appears when the markers are set to Pattern. When the Specify Patterns field is selected, a pop-up menu appears that is used to assign the bit patterns for the X and O markers, and the Stop measurement criteria.

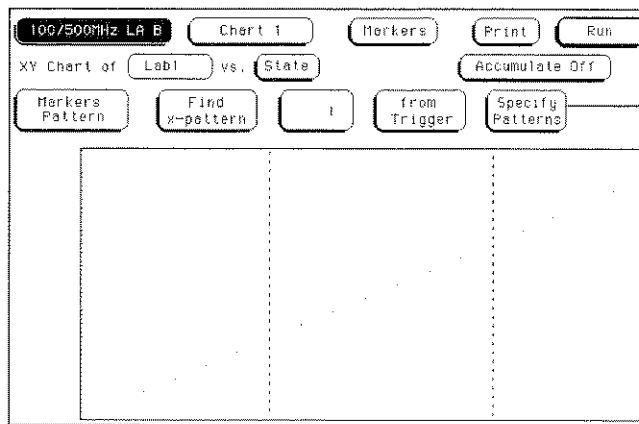

Specify patterns field

### Specify Patterns Field

### Pattern Display Fields

The pattern display fields display the alpha-numeric bit pattern specified for each X and O marker in all designated labels. The bit pattern is displayed in the same numeric base and same order as the data listing. When the pattern display field is selected, a pop-up keypad appears which is used to set the bit pattern.

When there are more labels assigned than can be displayed in a single screen, the pattern display fields are rolled back on screen by the Label/Base roll field.

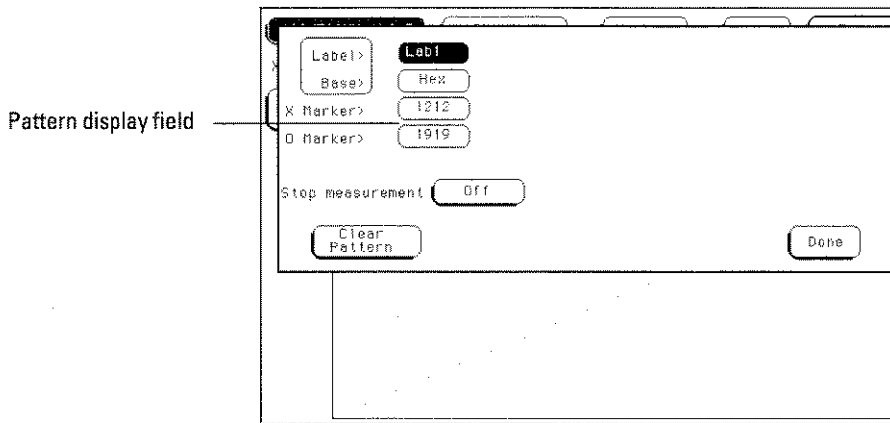

**Pattern Display Field**

The Chart Menu  
**Label / Base Roll Field**

**Label and Base Fields**

The Label and Base fields show up together in all menus except the Format and Configuration menus. When a new label is assigned, a base field is automatically assigned to that label.

**Label Field** Labels in the Specify Patterns menu are the same labels assigned in the Format menu. These labels will be displayed throughout the analyzer as they were assigned in the Format menu.

To reorder currently displayed Labels, select the label you want to move, then from the selection menu that appears, choose the label you want to switch positions with.

**Base Field** The function of the Base field is the same in all menus. To change the numeric base, select the base field, then choose the desired base from the selection menu.

---

**Label / Base Roll Field**

The function of the Label and Base roll field is the same in all menus. The rolling function is the same for all items that are stored offscreen. For more information on rolling labels, base, and pods, refer to Labels Assignment in the "Common Module Operations" part of the *HP 16500B User's Reference Guide*.

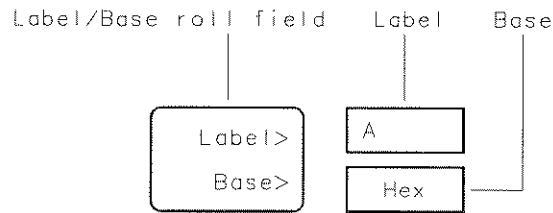

16542B03

**Label / Base Roll Field**



## Stop Measurement Field

The Stop measurement function allows you to specify a condition which stops the analyzer measurement during a repetitive run.

When the Stop measurement field is selected, a stop measurement type menu appears. Depending on the analyzer configuration, you have the choices of Off, X-O, and Compare.

### Off

The Off selection turns all Stop measurement operations off.

If the Stop measurement operation is not turned off and Stop measurement criteria are met, the measurement will stop even though the markers are off.

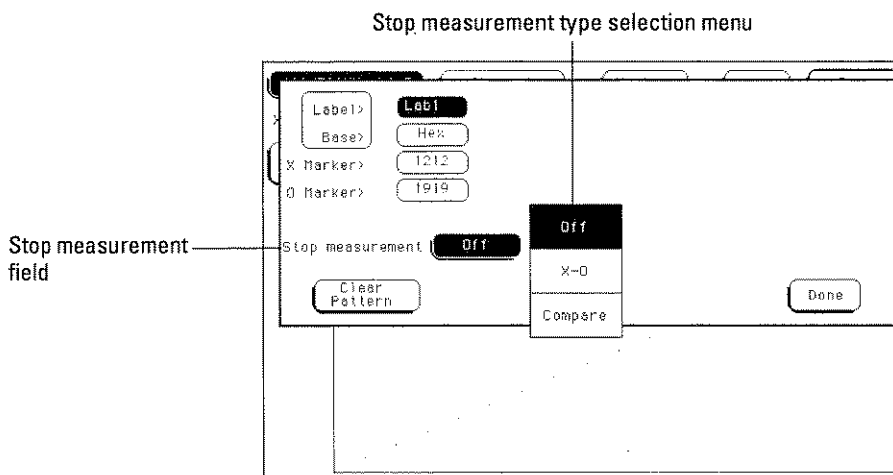

### Stop Measurement Field

## The Chart Menu

### Stop Measurement Field

#### X-O

The X-O option is available when the Count field in the Trigger menu is set to Time.

When X-O is selected, a repetitive run is stopped when a comparison of the time period between the X and O markers and one of the following time period options is true:

**Less Than** X-O time must be less than the time value that you specify in the Time field.

**Greater Than** X-O time must be greater than the time value that you specify in the Time field.

**In Range** X-O pattern must be within the time range value that you specify in the two Time fields.

**Not in Range** X-O pattern must not be within the time range value that you specify in the two Time fields.

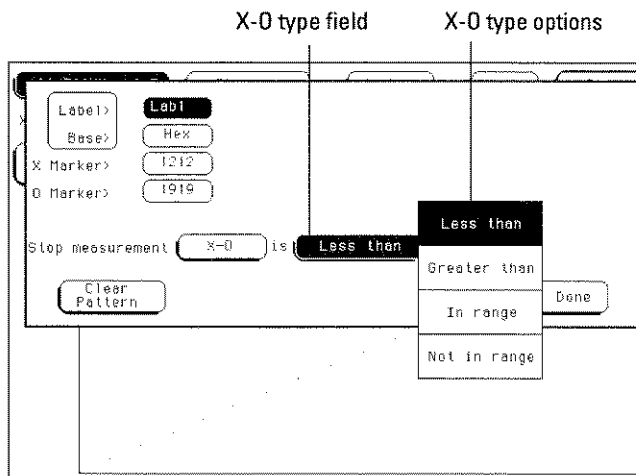

#### X-O Field

### Compare

When Compare is selected, a repetitive run is stopped when a comparison of data in the Listing menu and data and criteria in a compare image matches an equality selection. The equality selection is set from the Equal/Not Equal selection pop-up menu.

**Equal** The data and compare criteria in the Compare menu must be equal to the data in the Listing menu.

**Not Equal** The data and compare criteria in the Compare menu must not be equal to the data in the Listing menu.

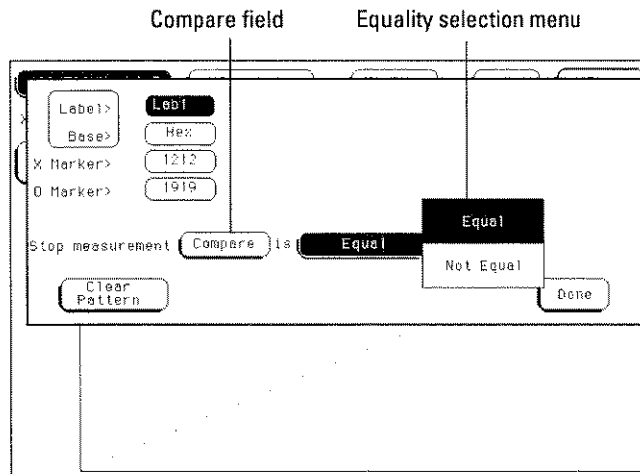

### Equal / Not Equal Selection Menu

The Chart Menu  
**Clear Pattern Field**

---

## Clear Pattern Field

The Clear Pattern field is used to reset the X and O Marker pattern display fields back to default (don't care = X). The Clear Pattern field accesses a selection menu with the choices of all, X pattern, or O pattern.

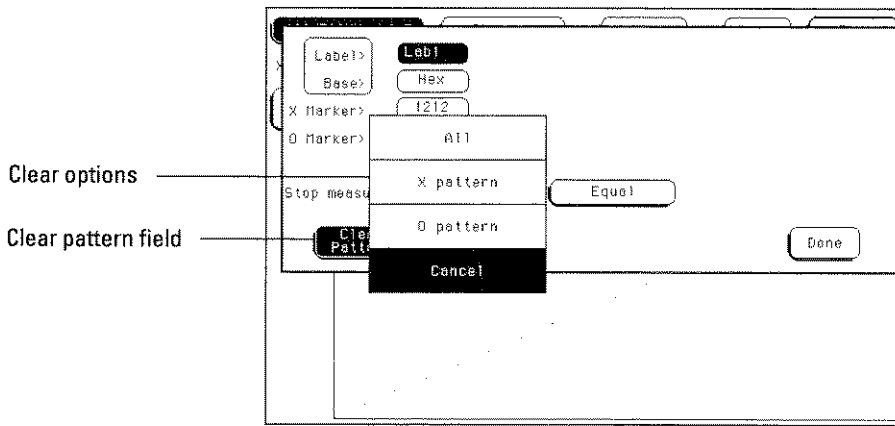

### Clear Pattern

---

## Time Markers

Time markers are indicators located in the x-y chart that are used as reference marks to obtain time values between each marker, or between each marker and the trigger point.

Time markers only become available when the Count field is set to Time, in the Trigger menu.

The markers are color coded for easy recognition. The X-marker is represented by a vertical green line and the O-marker is represented by a vertical yellow line.

If Pattern markers have been assigned, the Time markers will be initially placed at the same locations as in the data listing.

The Chart Menu  
**Trig to X / Trig to O Fields**

---

## Trig to X / Trig to O Fields

The Trig to X and Trig to O fields are display fields as well as configuration fields. Marker position is set by selecting the fields, then after the fields turn light blue, rotate the knob. Marker position can also be set by selecting the light blue field a second time, then enter a value with the pop-up keypad.

The Trig to X and Trig to O fields display the time between the trigger point and the marker.

### X to O Display Field

The X to O display field is a "read only" field that displays the time between the X and O markers. As the X and O markers are changed, the display changes accordingly.

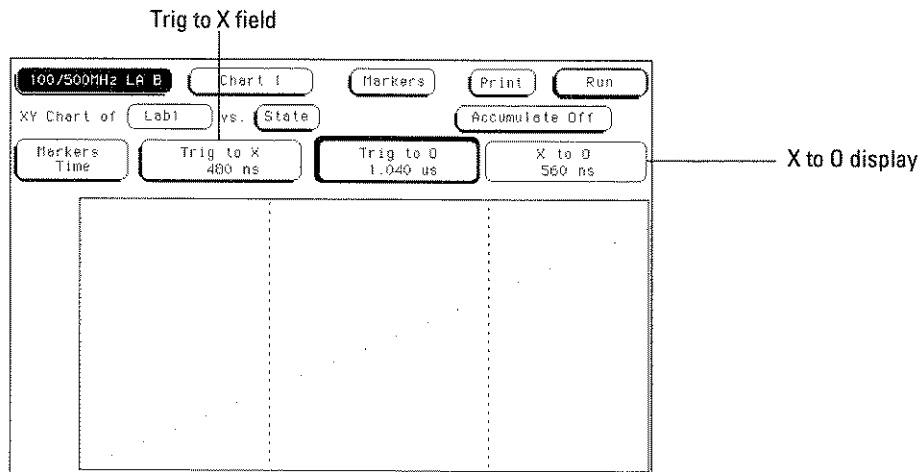

### Trig to X / Trig to O Fields

---

## Statistics Markers

After patterns are assigned to the X and O markers, statistical information is available when markers are set to Statistics. The logic analyzer displays the following information:

- Number of valid runs (runs where Pattern markers were able to be placed on specified patterns).
- Minimum time between the X and O Pattern markers.
- Maximum time between the X and O Pattern markers.
- Average time between the X and O Pattern markers.

Statistics markers only become available when the Count field is set to Time, in the Trigger menu.

The markers are color coded for easy recognition in the x-y plot. The X-marker is represented by a vertical green line and the O-marker is represented by a vertical yellow line.

Statistics are based on the time between the X and O markers. Both markers must be found before valid statistical information is displayed.

In repetitive run mode, the display is updated each time a valid run occurs until you select Stop. If you select Run after a Stop, the statistics continue to update without loss of information.

In single run mode, each time you select Run, an additional valid run will be added to the data and the statistics will be updated. This process continues unless you change the placement of the X and O markers between runs.

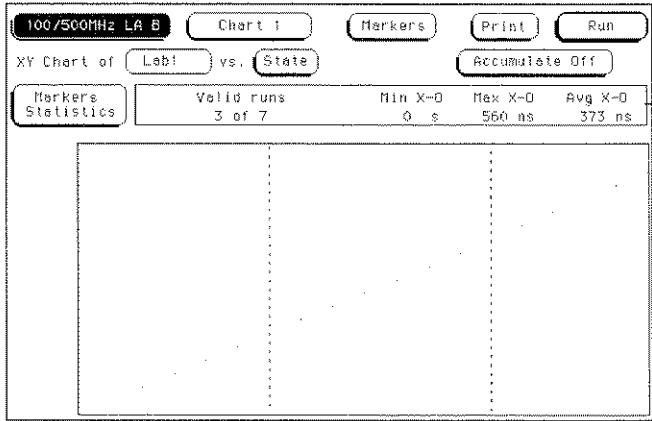

Statistics display

**Statistics Display**



---

## States Markers

States markers are indicators located in the x-y chart that are used as reference marks to obtain the number of states between each marker, or between each marker and the trigger point.

States markers are only available in a State analyzer with the Count field in the Trigger menu set to States.

The markers are color coded for easy recognition in the x-y chart. The X-marker is represented by a vertical green line and the O-marker is represented by a vertical yellow line.

The Chart Menu  
**Trig to X / Trig to O Fields**

---

## Trig to X / Trig to O Fields

The Trig to X and Trig to O fields are display fields as well as configuration fields. Marker position is set by selecting the fields, then after the fields turn light blue, rotate the knob. Marker position can also be set by selecting the light blue field a second time, then enter a value with the pop-up keypad.

The Trig to X and Trig to O fields display the number of states between the trigger point and the marker.

### X to O Display Field

The X to O display field is a "read only" field that displays the number of states between the X and O Pattern Markers. As the X and O markers are changed, the display changes accordingly.

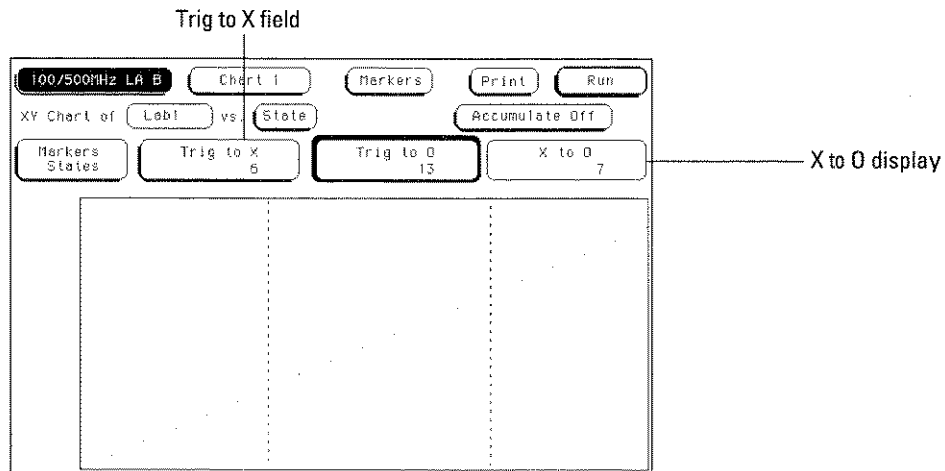

### Trig to X / Trig to O Fields



# The Compare Menu

---

## The Compare Menu

State Compare is a software post-processing feature that provides the ability to do a bit by bit comparison between the acquired state data listing and a reference listing.

The comparison between the acquired state listing data and the data in the reference listing is done relative to the trigger points. This means that the two data records are aligned at the trigger points and then compared bit by bit.

Any bits in the acquired data that do not match the bits in the compare image are treated as unequal.

### **Compare Post-Processing Features**

You can view in separate listings the acquired data, your reference listing, and a listing that highlights the bits in the acquired data that do not match the corresponding bits in the reference listing.

You can edit the reference listing for unique comparisons.

You can mask specific bits that you do not want to compare. These "Don't compare" bits can be specified individually for a given label and state row, or specified by channel across all state rows.

You can select a range of states to compare. When a range is selected, only the bits in states on or between the specified boundaries are compared. Also, you can save the reference listing along with the analyzer configuration to disk.

### **Compare Menu Map**

The following menu map graphically illustrates all fields in the Compare menu. Use the menu map as an overview and as a quick reference to the available options in the Compare menu.

# The Compare Menu

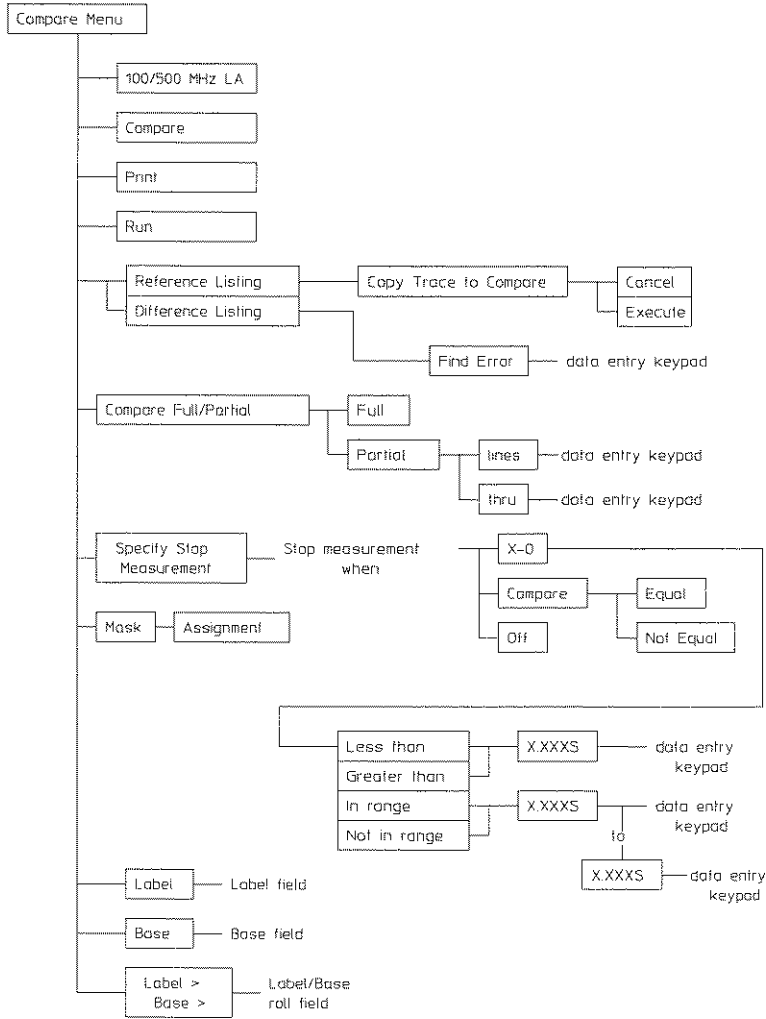

16550827

## Compare Menu Map

## Reference Listing Field

The Reference listing and Difference listing field is a toggle field that switches the listing type between the Reference image listing and the Difference listing.

The Reference listing is a display of the image (or template) that acquired data is compared to during a comparison measurement. The boundaries of the image (or size of the template) is controlled by using the channel masking and compare range functions. Any bits in the reference listing displayed as "X" have been set to don't care bits during bit editing.

When the data listing is rolled, the difference data listing and the data listing in the Listing menu are also rolled.

Reference listing field

The screenshot shows a software interface for a Reference Listing Field. At the top, there is a status bar with '100/500MHz LA A' and a 'Compare 1' button. To the right are 'Print' and 'Run' buttons. Below the status bar, there are four main control buttons: 'Reference listing' (which is highlighted), 'Copy Listing To Reference', 'Compare Full', and 'Specify Stop Measurement'. The main display area contains a list of hexadecimal values from 0 to 15. The value '8528' at index 7 is highlighted. Above the list, there are input fields for 'Mask' (set to '\*\*\*\*'), 'Label' (set to 'Lab1'), and 'Base' (set to 'Hex').

Index	Value
0	7E7E
1	7F7F
2	8000
3	8101
4	8202
5	8303
6	8404
7	8528
8	8606
9	8707
10	8808
11	8909
12	8A0A
13	8B0B
14	8C0C
15	8D0D

Reference Listing Field

The Compare Menu  
**Difference Listing Field**

---

## Difference Listing Field

The Reference listing and Difference listing field is a toggle field that switches the listing type between the Reference image listing and the Difference listing.

The Difference listing is a display of the acquired data listing with the data that differs, if any, from the Reference listing, highlighted with inverse video. If the base is inverse assembled symbols, the entire line is highlighted with inverse video.

Difference listing field

The screenshot shows a control panel for the 'Difference Listing Field'. At the top, there is a status bar '100/500MHz LA B' and buttons for 'Compare 1', 'Print', and 'Run'. Below this are four main function buttons: 'Difference listing' (which is highlighted), 'Find Error 1', 'Compare Full', and 'Specify Stop Measurement'. The main display area contains a list of hexadecimal values. On the left side of the list are labels: 'Mask>', 'Label>', and 'Base>'. The list itself consists of two columns: the first column contains numbers 0 through 15, and the second column contains hexadecimal values from E1E1 to F0F0. The value 'E8E8' at index 7 is highlighted with inverse video. A label 'Difference listing field' with a pointer is located to the left of the interface.

Mask>	Label>	Base>	Value
	Lab1	Hex	
0			E1E1
1			E2E2
2			E3E3
3			E4E4
4			E5E5
5			E6E6
6			E7E7
7			E8E8
8			E9E9
9			EAEA
10			EBEB
11			ECEC
12			EDED
13			EEEE
14			EFEF
15			F0F0

**Difference Listing Field**



## The Compare Menu Difference Listing Field

The controls that roll the listing in all three menus, the normal State listing, the Reference listing, and the Difference listing are synchronized unless the number of pretrigger states differ between the Reference listing and the acquired data.

This means that when you change the current row position in the Difference listing, the analyzer automatically updates the current row in the acquired State listing, Reference listing and vice-versa.

If the three listings are synchronized and you re-acquire data, the Reference listing may have a different number of pretrigger states depending on the state trace trigger criteria. The Reference listing can be resynchronized to the State and Difference listings by entering the desired state (acquisition memory) location from the pop-up keypad.

This allows you to view corresponding areas of all lists, to cross check the alignment, and to analyze the bits that do not match.

The Compare Menu  
**Copy Listing to Reference Field**

---

## Copy Listing to Reference Field

The initial Reference image is generated by either copying the data listing from the listing menu or by loading an analyzer configuration file which contains a Reference listing. You should be aware that if you load an analyzer configuration to get a Reference image, the other menu setups will change.

When the Copy Listing to Reference field is selected, the contents of the acquisition data structure (Listing menu display) is copied to the Reference image buffer. The previous Reference image is lost if it has not been saved to a disk.

Copy listing to reference field

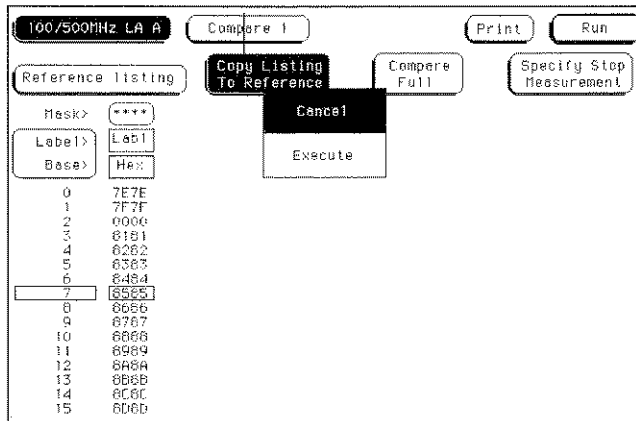

### Copy Listing to Reference Field

## Find Error Field

The Find Error field allows you to easily locate any patterns that did not match in the last comparison. Occurrences of differences, or errors, are found in numerical ascending order from the start of the listing. The first occurrence of an error has the numerical value of one.

When you select the Find Error field, the field turns light blue and the knob can be used to select a number. If the field is touched a second time, a pop-up keypad appears in which you enter a number. The number you enter indicates which error you want to find. The listing is then scanned sequentially until the specified occurrence is found and rolled into view.

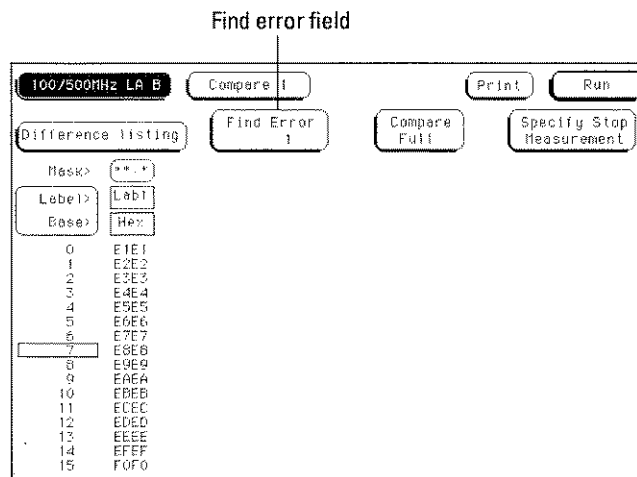

### Find Error Field

The Compare Menu  
**Compare Full / Compare Partial Field**

---

## Compare Full / Compare Partial Field

The Compare Full/Compare Partial field is a toggle field which allows you to compare either the full range of states or define a subset of the total number of states in the Reference image to be used in the comparison.

The Compare mode is accessed by touching the Compare Full/Compare Partial field in either the Compare or Difference listing menus. When selected, a pop-up appears in which you select either the Full or Partial option.

When you select the Partial option, fields appear for setting the start state and stop state values. Only bits in states (lines) on or between the boundaries are compared against the acquired data.

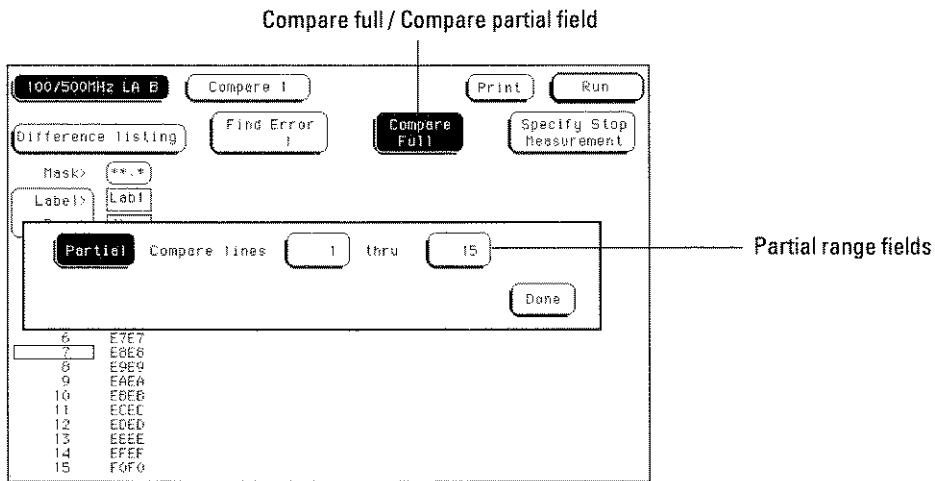

### Compare Full / Compare Partial Field

## Mask Field

The channel masking field is used to specify a bit, or bits in each label that you do not want compared. This causes the corresponding bits in all states to be ignored in the comparison. The Reference data image itself remains unchanged on the display.

When you select the Mask field an assignment pop-up appears in which you specify which channels are to be compared and which channels are to be masked. A "." (period) indicates a don't compare mask for that channel and an "\*" (asterisk) indicates that channel is to be compared.

Mask field

Label	Hex
0	E1E1
1	E2E2
2	E3E3
3	E4E4
4	E5E5
5	E6E6
6	E7E7
7	E8E8
8	E9E9
9	EAEAE
10	EBEB
11	ECEC
12	EDED
13	EEEE
14	EFEF
15	FCFC

**Mask Field**

The Compare Menu  
**Specify Stop Measurement Field**

---

## Specify Stop Measurement Field

The Stop measurement function allows you to specify a condition which stops the analyzer measurement during a repetitive run. When the Specify Stop Measurement field is selected, a Stop measurement menu appears which is used to set the stop criteria.

When the Stop measurement type field is selected, a selection menu appears. Depending on the analyzer configuration, you will have the choices of Off, Compare, and X-O.

### Off

The Off selection turns all Stop measurement operations off.

If the stop measurement operation is not turned off and the stop measurement criteria are met, the measurement will stop even though the markers are turned off.

Stop measurement selection menu

Stop measurement type field

6	E7E7
7	EBE8
8	E9E9
9	EAFE
10	EBEB
11	ECEC
12	EDED
13	EEEE
14	EFEE
15	FOFO

### Stop Measurement Fields

## The Compare Menu Specify Stop Measurement Field

### Compare

When Compare is selected, a repetitive run is stopped when a comparison of data in the Listing menu and data and criteria in a Reference image matches an equality selection. The equality selection is set from the Equal/Not Equal selection pop-up menu.

**Equal** The data and compare criteria in the Compare menu must be equal to the data in the Listing menu.

**Not Equal.** The data and compare criteria in the Compare menu must not be equal to the data in the Listing menu.

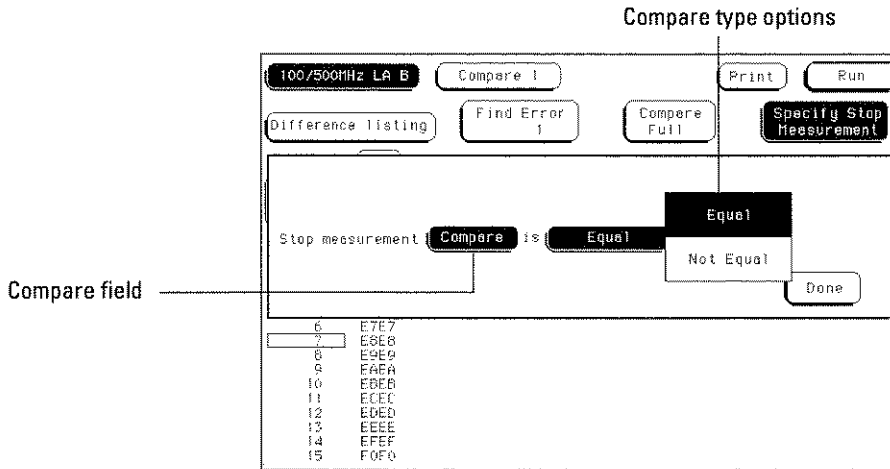

Compare field

### Compare Stop Measurement Type Fields

## The Compare Menu Specify Stop Measurement Field

### X-O

The X-O option is available in the State analyzer with its count set to Time. When X-O is selected, a repetitive run is stopped when a comparison of the time period between the X and O markers and one of the following time period options is true.

**Less Than** X-O time must be less than the time value that you specify in the Time field.

**Greater Than** X-O time must be greater than the time value that you specify in the Time field.

**In Range** X-O pattern must be within the time range value that you specify in the two Time fields.

**Not in Range** X-O pattern must not be within the time range value that you specify in the two Time fields.

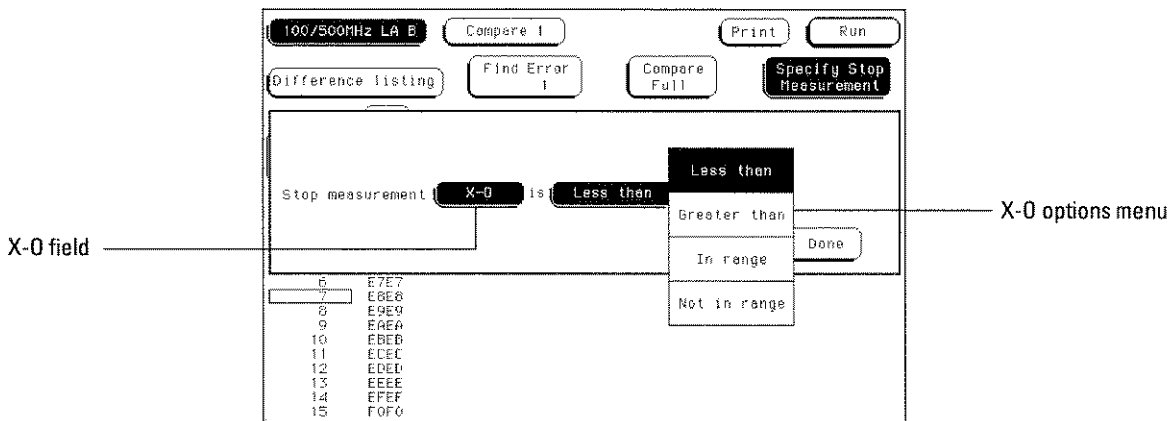

### X-O Stop Measurement Type Fields



## Data Roll Field

The column of numbers at the far left represents the location of the acquired data in the state analyzer's memory. The numbered positions are also known as the state locations and are relative to the trigger state location, which is always represented by 0.

The column of state location along with its data can be rolled to display off-screen data by using the data roll field. The data roll field is the small rectangular box located in the middle of the state location column.

The data roll field is used to either roll the data listing or to select an exact state for display. When the data roll field is light blue, the knob is active and can roll data in either direction. If you touch the data roll field when it is light blue, a pop-up keypad appears for the number of an exact state. When the pop-up keypad is used, the data listing shifts, leaving the selected state in the light blue data roll box.

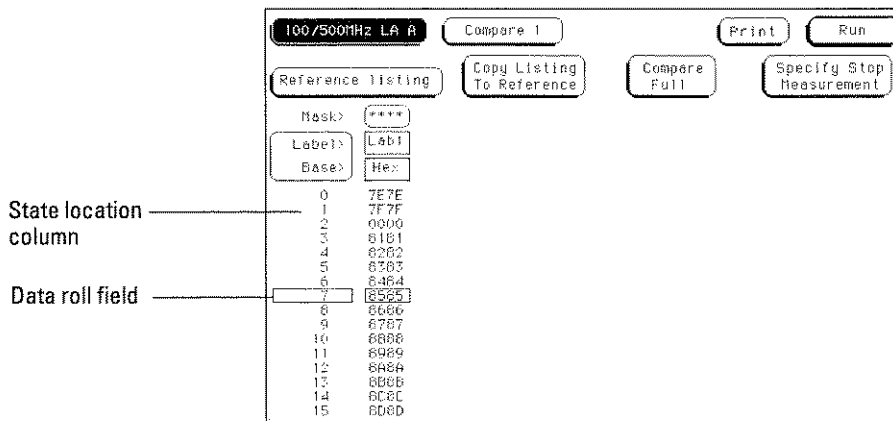

State location column

Data roll field

Data Roll Field

## The Compare Menu Bit Editing Field

### Bit Editing Field

The bit editing fields are located in the center of the Reference listing display. A bit editing field exists for every label in the display unless the label's base is ASCII or inverse assembled symbols. Bit editing field allows you to modify the values of individual bits in the Reference image or specify them as don't compare bits.

You access data in the Reference listing by rolling the data listing using the knob until the data is located in the bit editing field. To enter a desired pattern or don't compare (X) for a bit, select the field and use the pop-up keypad which appears.

100/500MHz LA A    Compare 1    Print    Run

Reference Listing    Copy Listing To Reference    Compare Full    Specify Stop Measurement

Mask>    \*\*\*\*

Label>    Lab1

Base>    Hex

0	7E7E
1	7F7F
2	0000
3	0101
4	0202
5	0303
6	0404
7	0505
8	0606
9	0707
10	0808
11	0909
12	0A0A
13	0B0B
14	0C0C
15	0D0D

Bit editing field

### Bit Editing Field

---

## Label and Base Fields

The Label and Base fields show up together in all menus except the Format and Configuration menus. When a new label is assigned, a base field is automatically assigned to that label.

### Label Field

Labels in the Compare menu are the same labels assigned in the Format menu. These labels will be displayed throughout the analyzer as they were assigned in the Format menu.

**Base Field** The function of the Base field is the same in all menus. To change the numeric base, select the base field, then choose the desired base from the selection menu.

---

## Label / Base Roll Field

The function of the Label and Base roll field is the same in all menus. The rolling function is the same for all items that are stored offscreen. For more information on rolling labels, base, and pods, refer to Labels Assignment in the "Common Module Operations" part of the *HP 16500B User's Reference Guide*.

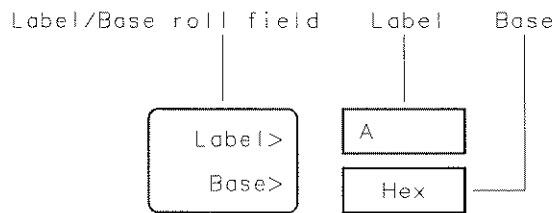

16542B03

### Label / Base Roll Field





## The Mixed Display Menu



---

## The Mixed Display Menu

The Mixed Display menu is a multi-display menu. The Mixed Display menu consists of a state listing display located at the top of the menu and a waveform display located at the bottom of the menu.

The state listing display shows state listings from the state analyzer currently accessed, and interleaved state listings from other modules. If the analyzer is configured with two state analyzers, both state listing displays can be interleaved as well as shown separately.

The waveform display shows timing analyzer waveforms, and oscilloscope waveforms from other modules within the HP 16500B mainframe.

The Mixed Display menu is only available when the analyzer is configured as a state analyzer with the Count field set to Time in the Trigger menu. In addition, before waveforms or state listings from other modules are displayed, they must be configured in a Group Run in the Intermodule menu.

For the most part, the operation of the menu fields in the listing and waveform portions of the Mixed Display menu are identical to their operation in their respective menus.

Only the unique functions and features of the Mixed Display menu are described in this chapter. For complete information of the menu fields refer to the Listing menu and Waveform menu chapters found earlier in this manual.

## Intermodule Configuration

Before waveforms or state listings from one module are displayed in the Mixed Display menus of other modules, all modules involved in the measurement must be configured in a Group Run. The Group Run configuration takes place in the mainframe's Intermodule menu. In addition, all state analyzers must have their Count fields set to Time in their Trigger menus.

**See Also**

The "Intermodule Measurements" chapter in the *HP 16500B User's Reference Guide* for complete information on intermodule operation.

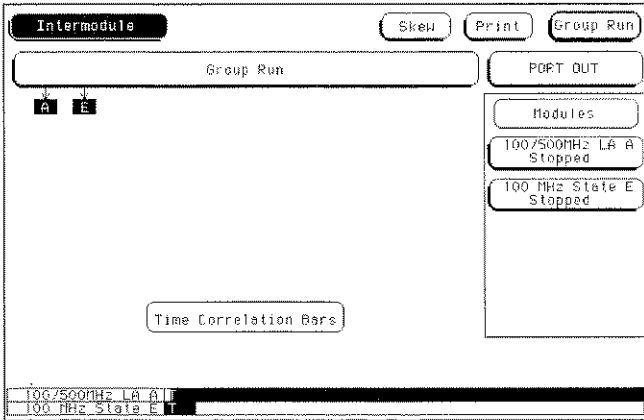

**Intermodule Menu**

## The Mixed Display Menu Inserting Waveforms

### Inserting Waveforms

To insert waveforms from other modules, use the same procedure for selecting waveforms when in the Waveform menu.

#### See Also

The "Waveform Display" in the Waveform menu chapter for information on the field definitions and the waveform selection functions.

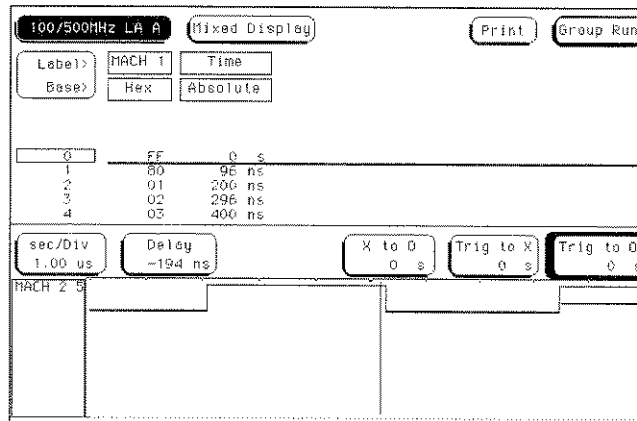

Waveform Display



## Interleaving State Listings

Interleaved state listings allows you to view two labels and their data from different analyzers in the same column. The process of interleaving state listings can be performed in either the Listing menu or the Mixed Display menu. For example, if data is interleaved in the Listing menu, it will be automatically interleaved in the Mixed Display menu.

Before a state listing from a second analyzer can be interleaved into the listing, both analyzers must be configured in a Group Run in the Intermodule menu and the Count fields set to Time in both Trigger menus.

The interleaved label is placed directly above the selected label and all interleaved data is displayed in yellow. In addition, the state numbers of the interleaved data are indented to the right. Because of the lack of room available in the listing portion of the Mixed Display menu, the label identifying the interleaved data is not displayed.

Label	RACH 1	RACH 2	RACH 2	Time
Base:	Hex	Hex	Hex	Absolute
-4		0057	0057	-312 ns
-3	0058		0058	-240 ns
-3		0058	0058	-232 ns
-2	0059		0059	-160 ns
-2		0059	0059	-152 ns
-1	005A		005A	-80 ns
-1		005A	005A	-72 ns
0	005B		005B	0 s

sec/Div: 100 ns    Delay: 0 s    X to 0: 0 s    Trig to X: 0 s    Trig to 0: 0 s

**Interleaved State Listings**

## The Mixed Display Menu Interleaving State Listings

State listings from an HP 16510B and HP 16540A/D analyzers can be interleaved into the state listing of an HP 16550A. However, the HP 16510B will not accept state listings back from the other two products.

With one exception, the process to interleave a label is the same as inserting labels. After the Interleave option is selected, an analyzer selection is made from a list containing the analyzers configured in the Group Run. Labels for each analyzer become available when the desired analyzer is selected.

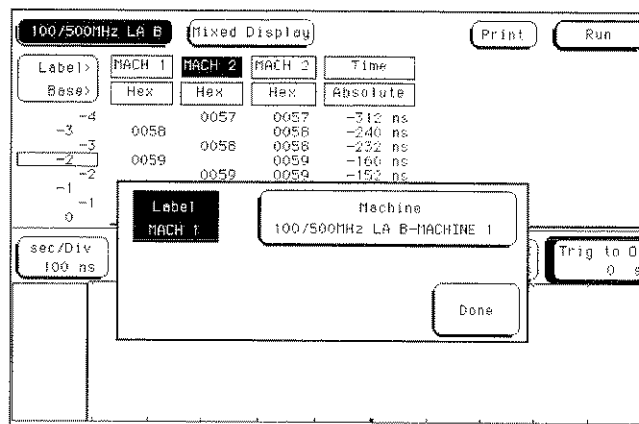

## Label Selection Menu

## Time-Correlated Displays

Once the Time markers are set in the Waveform display area of the Mixed Display menu, time-correlated X and O Pattern markers will be displayed in both the listing and the waveform display areas.

The analyzer uses a counter to track time between the triggering of one display and the triggering of the other display. It uses this count to reconstruct time-correlated data.

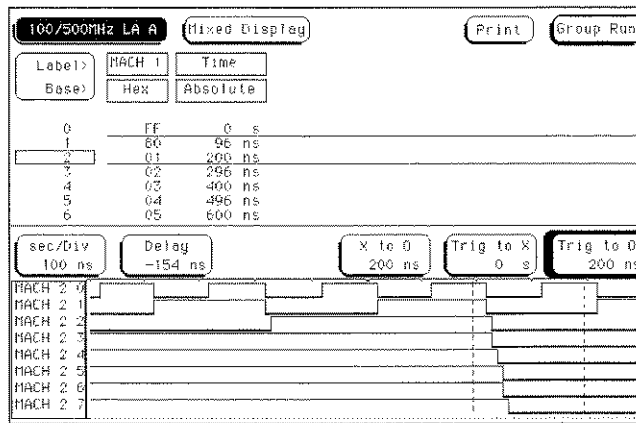

**Time Correlated Markers**

## The Mixed Display Menu

### Markers

## Markers

The markers in the Mixed Display menu are not the same as in the individual Listing and Waveform menus. You must place new Time markers on your points of interest in the Mixed Display. Even though you have placed markers in the individual listing and waveform displays, the markers will not transfer to the Mixed Display menu.

### Time Markers

Only Time markers are available in the Mixed Display menu. You set the Time markers in the waveform display area of the menu. Refer to the chapter "The Waveform Menu" found earlier in this manual for complete information on Time marker operation.

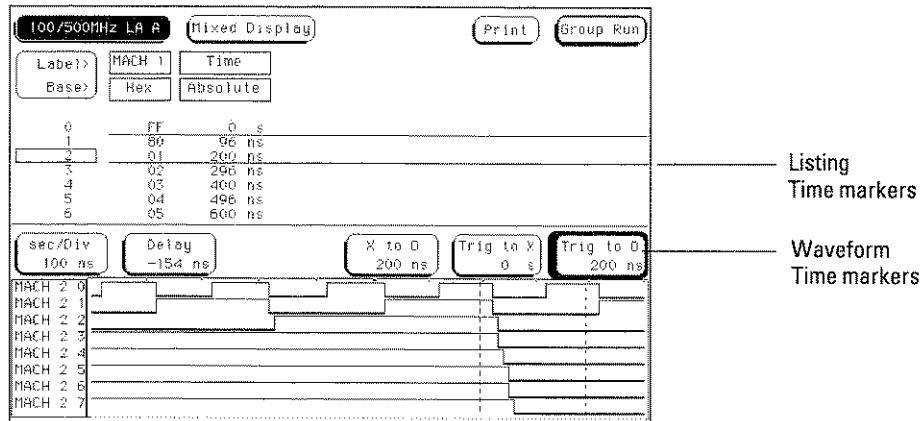

### Time Markers



## Error Messages



---

## Introduction

This chapter lists the error messages, warning messages and advisory messages that may be encountered during operation of the analyzer. Error messages have a red background, warning messages have a yellow background, and advisory messages have a green background.

If an error is encountered during analyzer configuration or general operation, there could be more than one cause for the problem. In most cases, the analyzer is configured improperly.

### **For more information**

If a message is encountered while running Self Tests, you can refer to the Service guide for information on test descriptions and troubleshooting procedures.

---

## Error Messages

**Must have at least 1 edge specified.** You must assign at least one clock edge to one of the available clocks in the Master clocking arrangement. In addition, if the Slave clock is being used, it must have at least one clock edge assigned. The analyzer will not let you close the clock assignment pop-up until an edge is specified.

**Time correlation of data is not possible.** Before time correlation of data is possible, time tags must be placed on the data. If you want time correlated data, set the Count field in the Trigger menu to Time.

**Maximum of 32 channels per label.** This message appears when you try to assign more than 32 channels to a single label. The logic analyzer will only allow 32 channels to be assigned to any single label.

**NO DISK.** There are no disks in the disk drives. You must place a disk into the disk drive before configurations can be loaded or stored.

**Timer is off in sequence level.** At least one sequence level has specified a timer as part of the sequence instruction and that timer is not turned on. The timer must be set to either Start, Pause, or Continue.

**Timer is specified in sequence, but never started.** A timer is specified somewhere in the sequence, but was not started. The timer must be set to Start. The timer can be set to Start in any sequence level.

**Problems reading file.** The user is trying to translate a configuration file that can not be opened a second time.

**Inverse assembler not loaded - bad object code.** Corrupt inverse assemble file. Try getting another copy of the inverse assembler file and loading that.

**Insufficient memory to load IAL - load aborted.** There is not a block of free memory large enough to load inverse assembler.

**ASCII entry not available.** The ASCII base is not available. You must use another base selection.

**No Room for Selected Macro.** The macro selected required more physical sequence levels than are available. Reconfigure sequence levels or use a different macro.

## Error Messages

### Error Messages

**Cannot insert after last sequence level.** Sequence levels cannot be added after the last level. Add levels before the last level.

**Last level of state sequence must be a user level.** The last level of a state sequence must be a user macro level. If the user tries to select a new macro or replace this level, this error results.

**Cannot delete last level in state sequence.** The last level in a state sequence cannot be deleted.

**Too many sequence levels needed! Choose "Cancel" to leave the menu.** This message is displayed when changes in a sequence level menu causes the translation too use more than the maximum number of levels available.

**Too many sequence levels needed!** This message is displayed when using HP-IB commands and when changes in a sequence level menu causes the translation too use more than the maximum number of levels available.

**Error: Min time is = Max time.** This error message is displayed if the user attempts to exit the pattern width violation macro level menu with the min width time = to the max width time.

**Macro requires timer resource assigned to this machine.** If the user tries to select the "event too soon after event", or the "event too late after event" macro, and there are no timer resources assigned to the current machine, the selection is ignored and the user is given this error message.

**This macro cannot be selected when no labels are turned on.** A macro has been selected that has a label entry, but has no labels turned on in the Format menu. Make sure the configuration is consistent across menus.

**Warning! Turning off this label will default trigger sequence!** This message appears if a label is used in a macro, and then it is turned OFF in the Format menu. Make sure the configuration is consistent across menus.

**This macro requires two unused patterns assigned to this machine.** If the user tries to select the n-bit serial pattern macro and there are not at least two pattern resources assigned to the machine that are "unused" (defined as BOTH all don't cares AND not used in the sequence) then this error results, and the selection is ignored.



---

## Warning Messages

**Waiting for Prestore.** This message is displayed for a timing analyzer waiting for prestore.

**Search failed - X pattern not found.** The X pattern specified could not be found, therefore the pattern marker could not be placed in the data.

**Search failed - O pattern not found.** The O pattern specified could not be found, therefore the pattern marker could not be placed in the data.

**Warning: Run HALTED due to variable change.** This message appears when certain analyzer settings are changed during a repetitive run. When this occurs, the analyzer stops.

**Compare not available - Insufficient Memory.** There is not enough memory available to store a compare image.

**Error not found.** The Find Error number specified could not be found.

**s/Div set to limit.** The s/Div field is set to its limit.

**Delay set to limit.** The Delay field is set to its limit.

**Machine name: "al name" inverse assembler not found.** This message appears when the inverse assembler file could not be found.

**Slow or missing clock.** This message indicates a slow or missing clock. This is displayed for a state analyzer only until the first clock occurs.

**Data was acquired without time tags** Time tag values will not be displayed because data was stored without time tags. If you want time tags stamped on the data, set Count in the Trigger menu to Time.

**Data was acquired without state tags** State tag values will not be displayed because data was stored without state tags. If you want state tags stamped on the data, set Count in the Trigger menu to State.

**Count Time/States not available when in 8K Memory Mode.**

When the state mode is changed to Half Channel/8K mode, the time or state tags are not available.

Error Messages  
**Warning Messages**

**Two pod pairs are needed to use both timers.** If both timers are being used in a single chip analyzer, and there are no spare chips, this message is shown when Run is selected. Timer2 references in the sequencer will not be valid.

**No active analyzer.** This message is displayed if Run is selected with no analyzers turned on.

**Cannot read unrecognized data.** The user is trying to translate a SPA configuration from a foreign module.

**Demultiplexed clocking cannot be translated.** The user is trying to translate a configuration that has demultiplexed or mixed clocks.

**User thresholds have been truncated.** The user is trying to translate a configuration having thresholds greater than 6 Volts or less than -6 Volts.

**Slave clocks may need manual adjustment.** The user is trying to translate an HP 16540/41A,D configuration which has slave clocks specified. This message appears when the translation is not direct.

**Clock Qualifiers not fully restored.** The user is trying to translate a configuration that has more than two qualifiers.

**No state machines for this module.** The user is trying to load an inverse assembler into a module with no state machines.

**Error loading DISPLAY1.** User is loading a configuration with a corrupt DISPLAY1 section.

**Pods have been truncated.** User is loading a configuration with number of chips greater than the current system's number of chips.

**Clock pod and least significant pods have been preserved.** User is loading a configuration with number of chips greater than the current system's number of chips

**Need to have two free sequence levels.** For each sequence level with a "<" assigned, you must leave two sequence levels free. To free up two levels, simply delete two levels.

**Mixed Mode not available** User is trying to show mixed mode incorrectly.

**Ymin is greater than Ymax.** The value assigned to Y minimum is greater than the value assigned to Y maximum.

**Xmin is greater than Xmax.** The value assigned to X minimum is greater than the value assigned to X maximum.

**Ymin is equal to Ymax.** The value assigned to Y minimum is equal to the value assigned to Y maximum.

**Xmin is equal to Xmax.** The value assigned to X minimum is equal to the value assigned to X maximum.

**Computing chart information. Please Wait.** This message is displayed when the analyzer is busy computing the data to be charted. When the computing is finished, the new chart will be displayed.

**Sequencer full - cannot insert another level.** All available sequence levels are used.

**Changes to sequence since "Break Down" will be lost!** User has selected the Redo Macros control. All changes will be lost if user continues.

**Warning! Resource allocated by sequence level.** Occurs when user tries to reassign a resource that is "reserved" by a macro in the trigger sequence.

**Warning! Resource locked by sequence level.** Occurs when user tries to modify the value of a resource that is "locked" by a macro in the trigger sequence.

## Advisory Messages

**No valid data. Reference memory cleared.** This advisory appears when the Copy Listing To Reference field is selected in the Compare menu and there is no listing data to copy.

**Insert failed - Maximum of 60 entries.** 60 listing columns is the maximum number allowed. This advisory appears when you try to configure more than 60 columns.

**Occurrences Remaining in Level "n".** The analyzer is waiting for the specified level to be satisfied. This advisory is used in analyzers that use the Occurs parameter.

**Waiting in Level "n".** The analyzer is waiting for the specified level to be satisfied. This advisory is used in analyzers that use the > or < parameter.

**Filling Memory after Trigger.** This message is displayed for a transitional timing analyzer that has triggered but has not yet finished storing data. This message is also displayed for a conventional timing analyzer with a very slow sample rate.

**n.nnn s remaining to delay.** This advisory is displayed for a conventional/glitch timing analyzer that is doing a long hardware delay (after trigger and during the delay).



## Specifications and Characteristics



---

## Specifications and Characteristics

This chapter lists the specifications and characteristics. The specifications are the performance standards against which the product is tested.

The characteristics are not specifications, but are included as additional information.

For complete information on the test procedures to verify product performance, refer to the Service Guide.

---

## Specifications

The specifications are the performance standards against which the product is tested.

Maximum State Speed	100 MHz
Minimum State Clock Pulse Width <sup>1</sup>	3.5 ns
Minimum Master to Master Clock Time <sup>1</sup>	10.0 ns
Minimum Glitch Width	3.5 ns
Threshold Accuracy	± (100 mV + 3% of threshold setting)
Setup/Hold Time <sup>1</sup> :	
Single Clock, Single Edge	0/3.5 ns through 3.5/0 ns, adjustable in 500 ps increments
Single Clock, Multiple Edges	0.0/4.0 ns through 4.0/0.0 ns, adjustable in 500 ps intervals
Multiple Clocks, Multiple Edges	0.0/4.5 ns through 4.5/0.0 ns, adjustable in 500 ps increments

<sup>1</sup> Specified for an input signal  $V_H = -0.9$  V,  $V_L = -1.7$  V, slew rate = 1 V/ns, and threshold = -1.3 V.

Specifications and Characteristics  
**Characteristics**

---

## Characteristics

The characteristics are not specifications, but are included as additional information.

	Full Channel	Half Channel
Maximum State Clock Rate	100 MHz	100 MHz
Maximum Conventional Timing Rate	250 MHz	500 MHz
Maximum Transitional Timing Rate	125 MHz	250 MHz
Maximum Timing with Glitch Rate	N/A	125 MHz
Channel Count <sup>2</sup>	102/204	51/102
Memory Depth	4K	8K

## Supplemental Characteristics

### Probes

Input Resistance	100 K $\Omega$ , $\pm$ 2%
Input Capacitance	~ 8 pF
Minimum Voltage Swing	500 mV, peak-to-peak
Threshold Range	$\pm$ 6.0 V, adjustable in 50 mV increments

### State Analysis

State/Clock Qualifiers	6
Time Tag Resolution <sup>3</sup>	8 ns
Maximum Time Count Between States	34 seconds
Maximum State Tag Count <sup>3</sup>	4.29 x 10 <sup>9</sup>

<sup>2</sup>Channel count is doubled when two HP 16550A cards are connected together.

<sup>3</sup>Maximum state clock rate with time or state tags on is 100 MHz. When all pods are assigned to a state or timing machine, time or state tags halve the memory depth.



Specifications and Characteristics  
**Characteristics**

**Timing Analysis**

Sample Period Accuracy	0.01 % of sample period
Channel-to-Channel Skew	2 ns, typical
Time Interval Accuracy	$\pm$ (sample period + chan-to-chan skew + 0.01% of time reading)

**Triggering**

Sequencer Speed	125 MHz, maximum
State Sequence Levels	12
Timing Sequence Levels	10
Max. Occurrence Counter Value	1,048,575
Pattern Recognizers	10
Maximum Pattern Width	102 channels in a 1 card configuration. 204 channels in a 2 card configuration.
Range Recognizers	2
Range Width	32 bits each
Timers	2
Timer Value Range	400 ns to 500 seconds
Glitch/Edge Recognizers	2 (timing only)
Maximum Glitch/Edge Width	102 channels in a 1 card configuration. 204 channels in a 2 card configuration.

Specifications and Characteristics  
**Characteristics**

**Measurement and Display Functions**

**Arming** Each module can be armed by the RUN key, external PORT IN, or by another module via the Intermodule Bus (IMB).

**Displayed Waveforms** 24 lines maximum, with scrolling across 96 waveforms.

**Measurement Functions**

**Run/Stop Functions** Run Starts acquisition of data in specified trace mode.

**Stop** In single trace mode or the first run of a repetitive acquisition, STOP halts acquisition and displays the current acquisition data. For subsequent runs in repetitive mode, STOP halts acquisition of data and does not change current display.

**Trace Mode** Single mode acquires data once per trace specification. Repetitive mode repeats single mode acquisitions until stop is pressed or until time interval between two specified patterns is less than or greater than a specified value, or within or not within a specified range.

**Indicators**

**Activity Indicators** Provided in the Configuration and Format menus for identifying high, low, or changing states on the inputs.

**Markers** Two markers (X and 0) are shown as dashed lines on the display.

**Trigger** Displayed as a vertical dashed line in the Timing Waveform display and a line 0 in the State Listing display.

### **Data Entry/Display**

**Labels** Channels may be grouped together and given a 6-character name. Up to 126 labels in each analyzer may be assigned with up to 32 channels per label.

**Display Modes** State listing, State Waveforms, Chart, Compare Listing, Compare Difference Listing, Timing Waveforms, and Timing Listings. State Listing, Timing Waveforms and Oscilloscope Waveforms can be time-correlated on the same displays.

**Timing Waveform** Pattern readout of timing waveforms at X or 0 marker.

**Bases** Binary, Octal, Decimal, Hexadecimal, ASCII (display only), Two's Complement, and User-defined symbols.

**Symbols** 500 maximum. Symbols can be downloaded over RS-232 or HP-IB.

### **Marker Functions**

**Time Interval** The X and 0 markers measure the time interval between one point on a timing waveform and trigger, two points on the same timing waveform, two points on different waveforms, or two states (time tagging on).

**Delta States (state analyzer only)** The X and 0 markers measure the number of tagged states between one state and trigger or between two states.

**Patterns** The X and 0 markers can be used to locate the *n*th occurrence of a specified pattern from trigger, or from the beginning of data. The 0 marker can also find the *n*th occurrence of a pattern from the X marker.

**Statistics** X and 0 marker statistics are calculated for repetitive acquisitions. Patterns must be specified for both markers and statistics are kept only when both patterns can be found in an acquisition. Statistics are minimum X to 0 time, maximum X to 0 time, average X to 0 time, and ratio of valid runs to total runs.

**Specifications and Characteristics**  
**Characteristics**

**Auxiliary Power**

Power Through Cables      1/3 amp at 5 V maximum per cable

**Operating Environment**

Temperature                    Instrument, 0 °C to 55 °C (+32 °F to 131 °F).  
   Probe lead sets and cables,  
   0 °C to 65 °C (+32 °F to 149 °F).

Humidity                        Instrument, probe lead sets, and cables, up to  
   95% relative humidity at +40 °C (+122 °F).

Altitude                         To 4600 m (15,000 ft).

Vibration                        Operating: Random vibration 5-500 Hz,  
   10 minutes per axis, ≈0.3 g (rms).  
   Non-operating: Random vibration 5 to 500 Hz,  
   10 minutes per axis, ≈ 2.41 g (rms);  
   and swept sine resonant search, 5 to 500 Hz,  
   0.75 g (0-peak), 5 minute resonant dwell  
   at 4 resonances per axis.



## Installing and Removing Cards

---

## Installing and Removing Cards

This chapter is organized into two types of information. First, there is a general installation section which contains the procedure to install and remove modules from the mainframe. If there is no specific cabling considerations for a single card module, this section is all that is required for installation information.

After the general installation information are sections which contain inter-card cable information for multimodule configurations. You should first refer to these sections to make sure any cables are connected properly, then you can install the module into the mainframe.

Because of the modular design of the Logic Analysis System, it allows you to move modules within and between the HP 16500B and the HP 16501A frames. Be sure you check each specific models calibration considerations for any unique calibration concerns.

### **General Installation Considerations**

- When modules have both a master card and an expansion card, both cards must be installed in the same frame. For example, an HP 16520A master card must be installed in the same frame as the HP 16521A expansion card.
- Do not install, remove, or replace cards unless the instrument is shut off and the power cord is disconnected.
- Filler panels must be installed in all unused card slots to ensure correct air circulation.
- Save all unused cables and filler panels for future configurations

# General Installation Procedure

## Where Do Cards Mount?

Turn off the instrument and unplug it. Then turn the frame around so the rear panel is facing you.

Each frame contains five slots in which to insert the cards. Each slot has a label to its right. The top slot on the HP 16500B is A, the next one down is B, then C, D, and E. The CPU board of the frame is located beneath slot E.

The top slot on the HP 16501A is labeled F, the next one down is G, then H, I, and J.

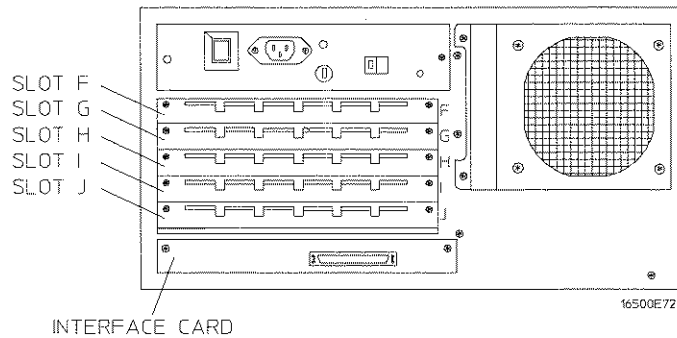
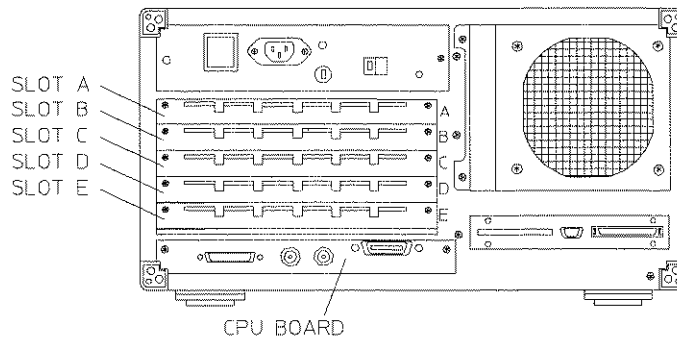

## The HP 16500/16501 Card Cages

## Installing and Removing Cards

### Installing Cards in the HP 16500B/16501A

#### CAUTION

The effects of ELECTROSTATIC DISCHARGE can damage electronic components. Grounded wriststraps and mats should be used when you perform any kind of service to the mainframe or the cards in it.

- 1 Starting from the top of the card cage, loosen the thumb screws on the filler panel(s) and pull them out of the frame.

Since the endplates of the cards overlap, you must start with the top slot of the frame you want to change and work down when removing cards. To install cards, start with the first open slot at the bottom of the card cage in the frame in which you are changing the cards and work up.

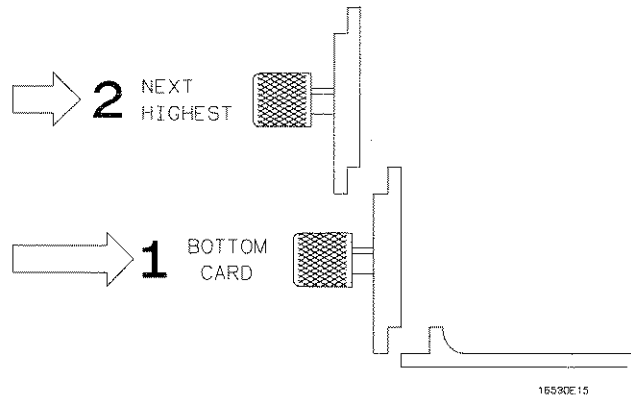

#### Endplate Overhang



- 2 Hold the card (or set of cards) so that the components are facing upward and the main connector is pointing away from you.
- 3 Align the card (or set of cards) with an appropriate set of slots on the rear panel, filling the slots closest to the bottom first. Gently slide the card in until the connector on the card touches the connector on the frame .

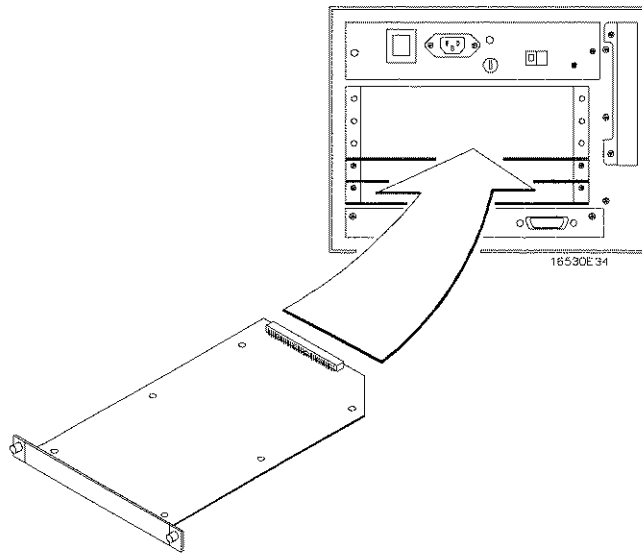

#### Installing Cards

- 4 Gently, but firmly, push the card in until the endplate on the card is flush with the rear panel.
- 5 While applying pressure to the center of the card endplate, tighten down the thumb screws on either side of the endplate.
- 6 After you are finished installing cards, install filler panels in all unused slots.

## Installing and Removing Cards

### **Removing Cards from the HP 16500B/16501A**

To remove cards from the frame, you must start with the card in the top slot (slot A in the HP 16500B or slot F in the HP 16501A) of the frame in which you are changing cards. Remove the next card down. Proceed in this manner until you get to the card you need. To remove the cards from their slots:

- 1** Loosen the thumb screws on either side of the endplate of the card until the thumb screws are free from the frame. If two cards need to be removed together, loosen the screws from both cards before trying to remove the cards.
- 2** Gently, but firmly, pull on the heads of the thumb screws and slide the cards out.

## HP 16550 Installation Considerations

Before installing a one-card module, be sure the cables are connected correctly for a one-card module.

Directions for connecting the cables are printed on the circuit board.

### To configure a one-card module

- When shipped separately, the module is configured as a one-card module. The cables should be connected as shown.

To reconfigure a two-card module into a one-card module, remove the cables connecting the two cards, then re-connect the cables as shown.

### CAUTION

To remove a cable from the cable connector on the board, gently pry the hard plastic part of the cable assembly away from the connector using a screwdriver. Do not pull on the soft ribbon part of the cable assembly as this can damage the cable assembly.

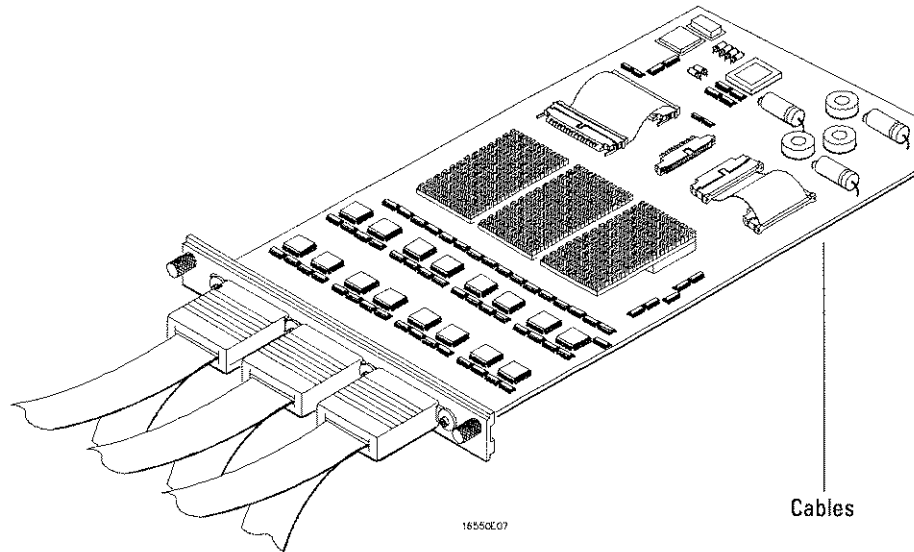

Cables

Cables

## Installing and Removing Cards

### To configure a two-card module

Directions for connecting the cables are printed on the circuit board.

To configure a two-card module, connect the cables as follows.

- 1 Disconnect the two cables from J4 and J5 and from J7 and J8 on the card to go in the upper slot.

#### CAUTION

To remove a cable from the cable connector on the board, gently pry the hard plastic part of the cable assembly away from the connector using a screwdriver. Do not pull on the soft ribbon part of the cable assembly as this can damage the cable assembly.

- 2 Disconnect the cable from J7 and J8 of the card to go in the lower slot.

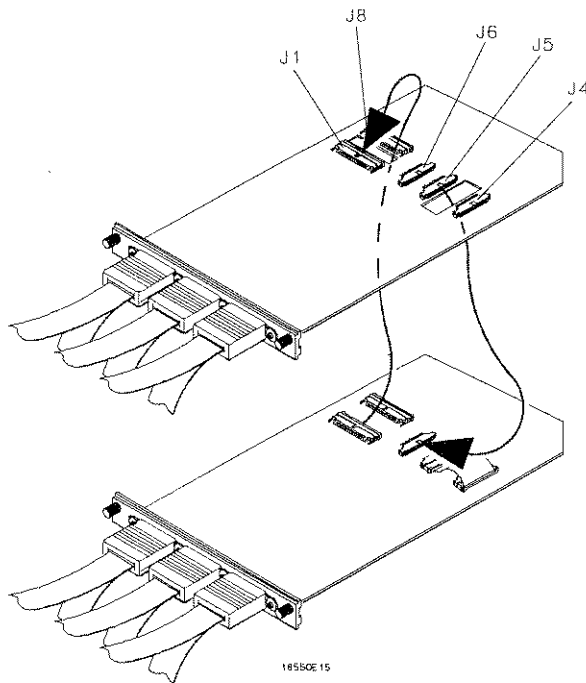

### Two Card Module

- 3** Connect the 80-pin cable from J6 of the lower card to J5 of the upper card. The cable between J4 and J5 of the lower board should remain connected.
- 4** Connect the 100-pin cable from J7 of the lower board to J7 of the upper board.



---

## Index

---

**Symbols**

- (<) field less than, 5-22
- (>) field greater than, 5-22

**A**

- Accessories
  - available, 1-7
  - preprocessor modules, 1-7
  - supplied, 1-6
- Accumulate field, 7-6
- Acquisition control
  - mode types, 5-36
  - trigger position, 5-37
- Acquisition Control field, 7-5
- Acquisition Mode, 5-36
- Activity Indicators, 3-7
- Advisory Messages, 11-8
- Analyzer
  - accessories available, 1-7
  - accessories supplied, 1-6
  - configuration capabilities, 1-4
  - description, 1-2
  - key features, 1-5
  - user interface, 1-3
- Analyzer type considerations
  - clock types, 1-3
  - state, 1-3
  - timing, 1-3
- Arming
  - between analyzers, 5-34
- Arming control field, 5-33 to 5-35

**B**

- Base field, 5-32
- Bit Assignment, 4-27 to 4-28
- Bit Editing field, 9-16
- Bit patterns, using, 5-20
- Bit reference line, 4-27
- Blue Bar field, 7-36 to 7-37
- Branches Taken Stored/Not Stored, 5-38
- Branching, 5-19, 5-38
- Branching, using, 5-25
- Break down/restore macros, 5-10

**C**

- Center Screen field, 7-17
- Channel masking, 9-11
- Chart Menu, 8-2
  - clear pattern field, 8-22
  - find x-pattern/o-pattern fields, 8-13
  - from trigger/start/x-marker field, 8-15
  - label and base fields, 8-18
  - markers field, 8-11
  - menu map, 8-3
  - min and max scaling fields, 8-10
  - occurrence field, 8-14
  - pattern display field, 8-17
  - post-processing features, 8-2
  - selecting axes for the chart, 8-6
  - specify patterns field, 8-16 to 8-17
  - stop measurement field, 8-19 to 8-21
  - trig to x/trig to o fields, 8-24, 8-28
  - X to O display field, 8-24, 8-28
  - x-axes label/state value field, 8-8
  - y-axes label value field, 8-7
- Chart types
  - label value vs label value, 8-3

- label value vs states, 8-3
- Clear Pattern Field, 6-16, 7-25, 8-22
- Clock Inputs Display, 4-13
- Clocks
  - demultiplexed clocking arrangement, 4-17
  - master clocking arrangement, 4-15
  - selection, 4-21
  - slave clocking arrangement, 4-16
  - state configuration, 3-4
  - timing configuration, 3-4
- Compare Full/Compare Partial field, 9-10
- Compare image, 9-5
- Compare Menu, 9-2
  - bit editing field, 9-16
  - compare full/compare partial field, 9-10
  - copy trace to compare field, 9-8
  - data roll field, 9-15
  - difference listing field, 9-6 to 9-7
  - find error field, 9-9
  - label and base fields, 9-17
  - mask field, 9-11
  - menu map, 9-3
  - post-processing features, 9-3
  - reference listing field, 9-5
  - specify stop measurement, 9-12 to 9-14
- Configuration capabilities, 1-4
- Configuration File Translation, 2-5
- Configuration Menu, 3-2
  - activity indicators, 3-7
  - menu map, 3-2
  - name: field, 3-3
  - type: field, 3-4
- Configuring the analyzer, 1-4
- Connecting
  - Grabbers to probes, 2-14

## Index

- probe cables to analyzer, 2-11
  - Conventional Acquisition Mode, 4-5
  - Copy Trace to Compare field, 9-8
  - Count Field, 5-39 to 5-40
  - Cursor, 1-3
- D**
- Data Roll field, 6-23, 9-15
  - Delay field
    - negative/positive, 7-9
  - Description
    - accessories supplied, 1-6
  - Difference Listing field, 9-6 to 9-7
- E**
- Error Messages, 11-3 to 11-4
- F**
- Find Error field, 9-9
  - Find X Pattern/Find O Pattern fields, 8-13
  - Find X-pattern/O-pattern, 6-6
  - Format Menu, 4-2
    - bit assignment fields, 4-27 to 4-28
    - clock inputs display, 4-13
    - label and pod rolling fields, 4-25
    - label assignment fields, 4-25
    - label polarity fields, 4-26
    - labels, 4-25
    - master and slave clock field, 4-21 to 4-22
    - menu map, 4-2
    - pod clock field, 4-15 to 4-18
    - pod threshold field, 4-19 to 4-20
    - setup/hold field, 4-23 to 4-24
    - state acquisition mode field, 4-4
    - symbol field, 4-25
    - timing acquisition mode field, 4-5 to 4-12
  - From Trigger/Start/X-marker Field, 6-8, 7-15, 8-15
- G**
- General Purpose Probing, 2-7 to 2-10
  - Glitch Acquisition Mode, 4-5
  - Grabbers, 2-9
- I**
- Illegal configuration, 3-6
  - Input Voltage for Probes, 2-10
  - Installation, 13-3
  - interfaces
    - HP-IB, 1-2
    - RS-232C, 1-2
    - user, 1-3
  - Intermodule Configuration
    - in mixed display, 10-3
- K**
- Keyboard, 1-3
  - Knob, 1-3
- L**
- Label and Pod Rolling fields, 4-25
  - Label Assignment fields, 4-25
  - Label polarity fields, 4-26
  - Labels, 4-25
  - Labels Assignment, 5-32
  - Labels field, 5-32
  - Listing Menu, 6-2
    - clear pattern field, 6-16
    - data roll field, 6-23
    - find x-pattern/o-pattern field, 6-6
    - from trigger/start/x-marker field, 6-8
    - label and base fields, 6-12, 6-24
    - label/base roll field, 6-12, 6-24
    - markers field, 6-4
    - menu map, 6-2
    - pattern display field, 6-11
    - pattern occurrence field, 6-7
    - specify patterns field, 6-9 to 6-11
    - states markers, 6-21
    - statistics markers, 6-19
    - stop measurement field, 6-13 to 6-15
    - trig to x/trig to o field, 6-22
    - trig to x/trig to o fields, 6-18, 6-20
    - x and o entering/leaving fields, 6-10
    - x to o display field, 6-18, 6-22
  - Loading on signal line, 2-10
  - Logic analyzer, 1-2
- M**
- Macros, 5-11
    - definition, 5-11
    - state, 5-16 to 5-18
    - timing, 5-14 to 5-15
    - using, 5-13
  - Marker Label/Base and Display, 7-28, 7-30, 7-33, 7-35
  - Markers
    - chart menu, 8-12
    - listing menu, 6-5
    - mixed display menu, 10-8
    - pattern, 7-13
    - states, 6-21, 7-31, 8-27
    - statistics, 7-29
    - statistics markers, 6-19, 8-25
    - time, 7-26
    - time markers, 6-17, 8-23
  - Markers field, 6-4, 7-12, 8-11
  - Mask field, 9-11
  - Master and Slave Clock field, 4-21 to 4-22
  - Master and Slave Clock selections, 4-21
  - Maximum Probe Input Voltage, 2-10
  - Menu Maps
    - chart menu, 8-3
    - compare menu, 9-3
    - configuration menu, 3-2
    - format menu, 4-2
    - listing menu, 6-2
    - trigger menu, 5-3
    - waveform menu, 7-2
  - Microprocessor measurements, 1-7
  - Min and Max Scaling Fields, 8-10
  - Mixed Display
    - markers, 10-8
  - Mixed Display Menu, 10-2
    - inserting waveforms, 10-4
    - interleaving state listings, 10-5 to 10-6
    - intermodule configuration, 10-3
    - markers, 10-8
    - time-correlated displays, 10-7
  - Modify trigger field, 5-8 to 5-10, 5-12
  - Mouse, 1-3
- N**
- Name: field, 3-3
  - Negative delay, 7-9
- O**



- Occurrence counters, using, 5-23  
 Occurrence field, 6-7, 7-14, 8-14  
 Occurs Field, 5-23
- P**  
 Pattern durations, using, 5-22  
 Pattern Markers, 6-5, 7-13, 8-12  
   chart menu, 8-12  
   listing menu, 6-5  
   waveform menu, 7-13  
 Pattern occurrence fields, 6-7, 7-14, 8-14  
 Pod Clock Field, 4-15 to 4-18  
 Pod Field, 4-4, 4-14  
 Pod Grounding, 2-8  
 Pod Threshold  
   levels, 4-19  
 Pod Threshold field, 4-19 to 4-20  
 Pod Thresholds, 2-10  
 Polarity, 4-26  
 Post-processing Features  
   chart menu, 8-2  
   compare menu, 9-3  
 Pre-defined sequence type, 5-11  
 Preprocessors, 1-7  
   using, 1-7  
 Probe Cables, 2-10  
 Probe Connecting  
   disconnecting probes from pods, 2-13  
   grabbers to probes, 2-14  
   grabbers to test points, 2-14  
   pods to probe cables, 2-12  
   Probe Cables to Analyzer, 2-11 to 2-12  
 Probe Leads, 2-9  
 Probe Tip Assemblies, 2-7  
 Probing, 2-2  
   assembly, 2-11 to 2-14  
   general purpose, 2-3  
   grabbers, 2-9  
   maximum probe input voltage, 2-10  
   microprocessor and bus, 2-3  
   minimal signal amplitude, 2-10  
   options, 2-2  
   pod thresholds, 2-10  
   probe and pod grounding, 2-8  
   probe cable, 2-10  
   probe leads, 2-9  
   probe tip assemblies, 2-7  
   termination adapter, 2-4  
   user definable interface, 2-2  
 Probing Options  
   General Purpose Probing, 2-3  
   HP 10320C User-Definable Interface, 2-2
- R**  
 Reference Listing field, 9-5  
 Resource terms, 5-26  
   assigning combinations, 5-31  
   assigning custom names, 5-28 to 5-31  
   assigning edges, 5-30  
   assigning timers, 5-31  
   bit patterns, 5-26  
   edge terms, 5-27  
   edges, 5-26  
   range terms, 5-26  
   timers, 5-27  
   using bit by bit, 5-29  
   using presets, 5-28
- S**  
 Sample period, 5-38  
 Sample Period Display, 7-10 to 7-11  
 Scaling the Axes, 8-9  
 Seconds per division field, 7-8  
 Selecting Waveforms Display  
   blue bar field, 7-36 to 7-37  
   channel mode foeld, 7-38 to 7-39  
   delete and delete all fields, 7-42  
   insert/delete, 7-41  
   module and label fields, 7-40  
   sequential/individual/overlay, 7-38  
   waveform display size, 7-43  
 Sequence levels  
   branching, 5-19, 5-25  
   definition, 5-6  
   editing, 5-7  
   types, 5-6  
   usage, 5-6  
 Setup/Hold field, 4-23 to 4-24  
 Signal Line Loading, 2-10  
 Specify Patterns field, 6-9 to 6-11, 7-18 to 7-20, 8-16 to 8-17  
 Specify Stop Measurement, 9-12 to 9-14  
   compare, 9-13  
   x - o, 9-14  
 State Acquisition Mode  
   full channel 4K memory, 4-4  
   half channel 8K memory, 4-4  
 State Acquisition Mode Field, 4-4  
 State Data in Timing Waveform Display, 7-39  
 State tags, 5-39  
 States Markers, 6-21  
   chart menu, 8-27  
   waveform menu, 7-31  
 States per Division field, 7-7  
 Statistics Markers, 8-25  
   chart menu, 8-25  
   listing menu, 6-19  
   waveform menu, 7-29  
 Stop Measurement field, 6-13 to 6-15, 7-22 to 7-24, 8-19 to 8-21  
   compare, 6-15, 7-24, 8-21  
   x - o, 6-14, 7-23, 8-20  
 Storage qualification, using, 5-22  
 Storing Branches, 5-38  
 Symbol field, 4-25
- T**  
 Tagging Data, 5-39 to 5-40  
 Template, 9-5  
 Termination Adapter, 2-4  
 Time Markers  
   chart menu, 8-23  
   listing menu, 6-17  
   waveform menu, 7-26  
 Time tags, 5-40  
 Time-Correlated Displays, 10-7  
 Timers, using, 5-24  
 Timing Acquisition Mode, 4-6  
   conventional full Channel, 4-5  
   conventional half channel, 4-5  
   glitch, 4-5  
   glitch half channel, 4-5  
 Timing Acquisition Mode Field, 4-5 to 4-12  
 Touchscreen, 1-3  
 Transitional Timing, 4-6  
   full channel 125MHz mode, 4-7  
   half channel 250MHz mode, 4-9  
   other considerations, 4-11  
 Translating Preprocessor Configuration Files, 2-5  
 Trig to X/Trig to O Field, 6-22  
 Trig to X/Trig to O Fields, 6-18, 6-20,

## Index

7-27, 7-32, 8-24, 8-28

Trigger macros, 5-11

Trigger Menu

count field, 5-39 to 5-40

menu map, 5-3

Trigger position, 5-37

Trigger sequence levels, 5-6

Type: field, 3-4

### U

Unassigned Pods Display, 3-5 to 3-6

User Interface, 1-3

User's Reference, 1-3

User-Definable Interface, 2-2

User-level macro, modify, 5-19 to 5-25,  
5-27

### W

Warning Messages, 11-5 to 11-7

Waveform Display, 7-34

Waveform Menu, 7-2

accumulate field, 7-6

acquisition control field, 7-5

blue bar field, 7-36 to 7-37

center screen field, 7-17

clear pattern field, 7-25

delay field, 7-9

from trigger/start/x-marker field, 7-15

label and base fields, 7-21

label/base roll field, 7-21, 8-18, 9-17

marker label/base and display, 7-28, 7-30,  
7-33, 7-35

markers field, 7-12

menu map, 7-2

pattern display field, 7-20

sample period display, 7-10 to 7-11

seconds per division field, 7-8

specify patterns field, 7-18 to 7-20

states per division field, 7-7

stop measurement field, 7-22 to 7-24

trig to X/trig to O fields, 7-27, 7-32

waveform display, 7-34

x and o entering/leaving fields, 7-19

X to O display, 7-32

X to O display field, 7-16

x-pattern/o-pattern field occurrence field,  
7-14

Waveform reconstruction, 7-11

Waveform Size, 7-43

### X

X to O Display Field, 6-18, 6-22, 7-32,  
8-24, 8-28

X to O field, 7-16

X-axes Label/State Value field, 8-8

### Y

Y-axes Label Value field, 8-7

© Copyright Hewlett-Packard Company 1992-1994  
All Rights Reserved.  
MS-DOS<sup>®</sup> is a US registered trademark of Microsoft Corporation.

Reproduction, adaptation, or translation without prior written permission is prohibited, except as allowed under the copyright laws.

#### Document Warranty

The information contained in this document is subject to change without notice.

**Hewlett-Packard makes no warranty of any kind with regard to this material, including, but not limited to, the implied warranties or merchantability and fitness for a particular purpose.**

Hewlett-Packard shall not be liable for errors contained herein or for incidental or consequential damages in connection with the furnishing, performance, or use of this material.

#### Safety

This apparatus has been designed and tested in accordance with IEC Publication 348, Safety Requirements for Measuring Apparatus, and has been supplied in a safe condition. This is a Safety Class I instrument (provided with terminal for protective earthing). Before applying power, verify that the correct safety precautions are taken (see the following warnings). In addition, note the external markings on the instrument that are described under "Safety Symbols."

#### Warning

- Before turning on the instrument, you must connect the protective earth terminal of the instrument to the protective conductor of the (mains) power cord. The mains plug shall only be inserted in a socket outlet provided with a protective earth contact. You must not negate the protective action by using an extension cord (power cable) without a protective conductor (grounding). Grounding one conductor of a two-conductor outlet is not sufficient protection.
- Only fuses with the required rated current, voltage, and specified type (normal blow, time delay, etc.) should be used. Do not use repaired fuses or short-circuited fuseholders. To do so could cause a shock of fire hazard.

- Service instructions are for trained service personnel. To avoid dangerous electric shock, do not perform any service unless qualified to do so. Do not attempt internal service or adjustment unless another person, capable of rendering first aid and resuscitation, is present.
- If you energize this instrument by an auto transformer (for voltage reduction), make sure the common terminal is connected to the earth terminal of the power source.
- Whenever it is likely that the ground protection is impaired, you must make the instrument inoperative and secure it against any unintended operation.

- Do not operate the instrument in the presence of flammable gasses or fumes. Operation of any electrical instrument in such an environment constitutes a definite safety hazard.
- Do not install substitute parts or perform any unauthorized modification to the instrument.
- Capacitors inside the instrument may retain a charge even if the instrument is disconnected from its source of supply.
- Use caution when exposing or handling the CRT. Handling or replacing the CRT shall be done only by qualified maintenance personnel.

#### Safety Symbols



Instruction manual symbol: the product is marked with this symbol when it is necessary for you to refer to the instruction manual in order to protect against damage to the product.



Hazardous voltage symbol.



Earth terminal symbol: Used to indicate a circuit common connected to grounded chassis.

#### WARNING

The Warning sign denotes a hazard. It calls attention to a procedure, practice, or the like, which, if not correctly performed or adhered to, could result in personal injury. Do not proceed beyond a Warning sign until the indicated conditions are fully understood and met.

#### CAUTION

The Caution sign denotes a hazard. It calls attention to an operating procedure, practice, or the like, which, if not correctly performed or adhered to, could result in damage to or destruction of part or all of the product. Do not proceed beyond a Caution symbol until the indicated conditions are fully understood or met.

Hewlett-Packard  
P.O. Box 2197  
1900 Garden of the Gods Road  
Colorado Springs, CO 80901

### **Product Warranty**

This Hewlett-Packard product has a warranty against defects in material and workmanship for a period of one year from date of shipment. During the warranty period, Hewlett-Packard Company will, at its option, either repair or replace products that prove to be defective. For warranty service or repair, this product must be returned to a service facility designated by Hewlett-Packard.

For products returned to Hewlett-Packard for warranty service, the Buyer shall prepay shipping charges to Hewlett-Packard and Hewlett-Packard shall pay shipping charges to return the product to the Buyer. However, the Buyer shall pay all shipping charges, duties, and taxes for products returned to Hewlett-Packard from another country.

Hewlett-Packard warrants that its software and firmware designated by Hewlett-Packard for use with an instrument will execute its programming instructions when properly installed on that instrument. Hewlett-Packard does not warrant that the operation of the instrument software, or firmware will be uninterrupted or error free.

### **Limitation of Warranty**

The foregoing warranty shall not apply to defects resulting from improper or inadequate maintenance by the Buyer, Buyer-supplied software or interfacing, unauthorized modification or misuse, operation outside of the environmental specifications for the product, or improper site preparation or maintenance.

**No other warranty is expressed or implied. Hewlett-Packard specifically disclaims the implied warranties or merchantability and fitness for a particular purpose.**

### **Exclusive Remedies**

The remedies provided herein are the buyer's sole and exclusive remedies. Hewlett-Packard shall not be liable for any direct, indirect, special, incidental, or consequential damages, whether based on contract, tort, or any other legal theory.

### **Assistance**

Product maintenance agreements and other customer assistance agreements are available for Hewlett-Packard products. For any assistance, contact your nearest Hewlett-Packard Sales Office.

### **Certification**

Hewlett-Packard Company certifies that this product met its published specifications at the time of shipment from the factory. Hewlett-Packard further certifies that its calibration measurements are traceable to the United States National Institute of Standards and Technology, to the extent allowed by the Institute's calibration facility, and to the calibration facilities of other International Standards Organization members.

### **About this edition**

This is the first edition of the HP 16550 100-MHz State 500-MHz Timing Logic Analyzer User's Reference Guide

Publication number  
16550-97003

Printed in USA.

Edition dates are as follows:

First edition: April 1994.

New editions are complete revisions of the manual. Update packages, which are issued between editions, contain additional and replacement pages to be merged into the manual by you. The dates on the title page change only when a new edition is published.

A software or firmware code may be printed before the date. This code indicates the version level of the software or firmware of this product at the time the manual or update was issued. Many product updates do not require manual changes; and, conversely, manual corrections may be done without accompanying product changes. Therefore, do not expect a one-to-one correspondence between product updates and manual updates.

The following list of pages gives the date of the current edition and of any changed pages to that edition.

All pages original edition