

Errata

Title & Document Type: 1650A/1651A Logic Analyzers Setting Up the Logic Analyzer

Manual Part Number: 5959-6012

Revision Date: April 1988

HP References in this Manual

This manual may contain references to HP or Hewlett-Packard. Please note that Hewlett-Packard's former test and measurement, semiconductor products and chemical analysis businesses are now part of Agilent Technologies. We have made no changes to this manual copy. The HP XXXX referred to in this document is now the Agilent XXXX. For example, model number HP8648A is now model number Agilent 8648A.

About this Manual

We've added this manual to the Agilent website in an effort to help you support your product. This manual provides the best information we could find. It may be incomplete or contain dated information, and the scan quality may not be ideal. If we find a better copy in the future, we will add it to the Agilent website.

Support for Your Product

Agilent no longer sells or supports this product. You will find any other available product information on the Agilent Test & Measurement website:

www.tm.agilent.com

Search for the model number of this product, and the resulting product page will guide you to any available information. Our service centers may be able to perform calibration if no repair parts are needed, but no other support from Agilent is available.

Setting Up the Logic Analyzer

HP 1650A/51A Logic Analyzers



© Copyright Hewlett-Packard Company 1987

Printed in U.S.A. June 1987

Introduction

About this book...

The purpose of this guide is to tell you how to prepare your logic analyzer for operation. In this guide you will learn how to install the operating system flexible disc, turn on the logic analyzer, and connect the probe cables and a printer.

You should read this guide if this is your first experience with the HP 1650A/51A logic analyzers.

Chapter 1 covers everything you need to know to get your logic analyzer ready for power-up.

Chapter 2 shows you how to load the operating system, turn on the logic analyzer and set the intensity of the display.

Chapter 3 introduces you to the new probes and shows you how to connect them.

Chapter 4 shows you how to connect your logic analyzer's RS-232C interface bus to other equipment like a printer.

Once you have the logic analyzer up and running, you will want to read the *Getting Started Guide*. It explains the basic operation of your logic analyzer.

Table of Contents

Introduction

Chapter 1: Getting Ready to Operate

- 1-1 Initial Inspection
 - 1-1 Accessories
 - 1-3 Probe Assembly Identification
 - 1-4 Removing Yellow Shipping Disc
 - 1-5 Selecting the Line Voltage
 - 1-6 Checking for the Correct Fuse
 - 1-7 Getting Power to the Instrument
 - 1-7 Operating Environment
 - 1-7 Ventilation
-

Chapter 2: Turning on the Instrument

- 2-1 Loading the Operating System
- 2-2 Installing the Operating System Disc
- 2-3 Line Switch
- 2-3 Intensity Control
- 2-4 Power-up Self-Test

Table of Contents (Continued)

Chapter 3: **Connecting the Logic Analyzer to the Target System**

- 3-1 Probes and Probe Pods
- 3-1 Connecting Pod Cables to the Logic Analyzer
- 3-2 Connecting Pods to Probe Cables
- 3-3 Disconnecting Probes from Pods
- 3-4 Connecting Grabbers to Probes
- 3-4 Connecting Grabbers to Test Points
- 3-5 Pod Grounds
- 3-5 Probe Grounds
- 3-6 Labeling Pods, Probes, and Cables
- 3-7 Signal Line Loading
- 3-7 Probe Interface

Chapter 4: **Connecting to External Equipment**

- 4-2 Connecting the Logic Analyzer to a Printer

Chapter 5: **What's Next?**

1

Getting Ready to Operate

Initial Inspection

Inspect the shipping container for damage. If the shipping container or packaging materials are damaged, you should keep them until the contents of the shipment have been checked for completeness and the instrument has been checked mechanically and electrically.

If the contents of the shipping container have been damaged or the instrument does not operate properly, refer to the service manual.

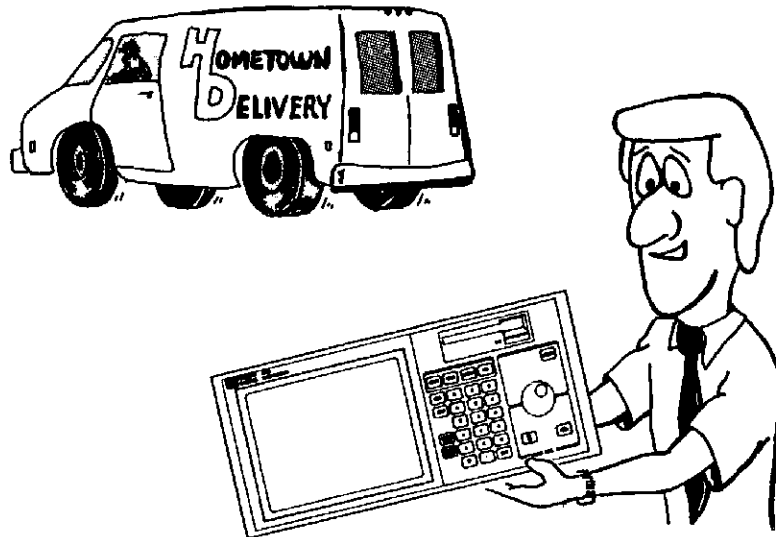

Accessories

In addition to checking the instrument for damage, you should also check to see that the accessories supplied with it are complete. Accessories can sometimes be lost in transit when the shipping container is damaged.

The table on the next page lists all the accessories for the HP 1650A/51A logic analyzers. If any of these items are missing, contact your nearest Hewlett-Packard office.

Table 1 Accessories

Accessory	HP Part No.	Quantity	
		HP 1650A	HP 1651A
Probe assemblies	01650-61608	5	2
Probe cables	01650-61607	5	2
Grabbers (Note 1)	5959-0288	100	40
Ground leads (long)	01650-82102	5	2
Ground leads (short)	01650-82103	10	4
RS-232C Loop back adapter	01650-63202	1	1
Probe and probe cable numbering label card	01650-94303	1	1
AC power cable	Note 2	1	1
Operating system disc	01650-13501	2	2
Operating and Programming manual set	01650-90903	1	1
Service manual	01650-90901	1	1

Notes:

1. Package of 20 per part number.
2. The type of power cord you receive with your logic analyzer depends on your country. If you need more information about power cords, refer to the *HP 1650A/51A Reference Manual*.

Probe Assembly Identification

The following illustration will help you identify the various parts of the probe assemblies. Chapter 3 explains how to connect and disconnect the parts of this assembly.

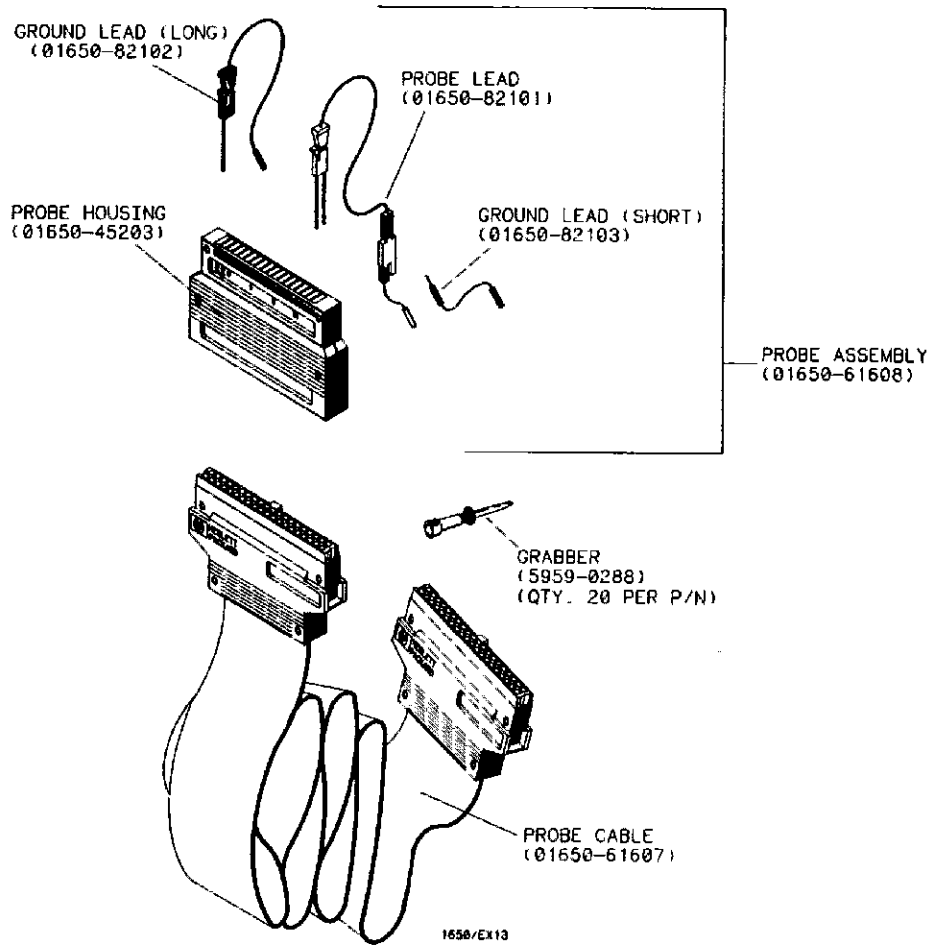

Removing Yellow Shipping Disc

Your logic analyzer is shipped with a protective yellow shipping disc in the disc drive. Before you can insert the operating system disc, you must remove the yellow shipping disc. Press the disc eject button as shown in the figure. The yellow shipping disc will pop out part way so you can pull it out of the disc drive.

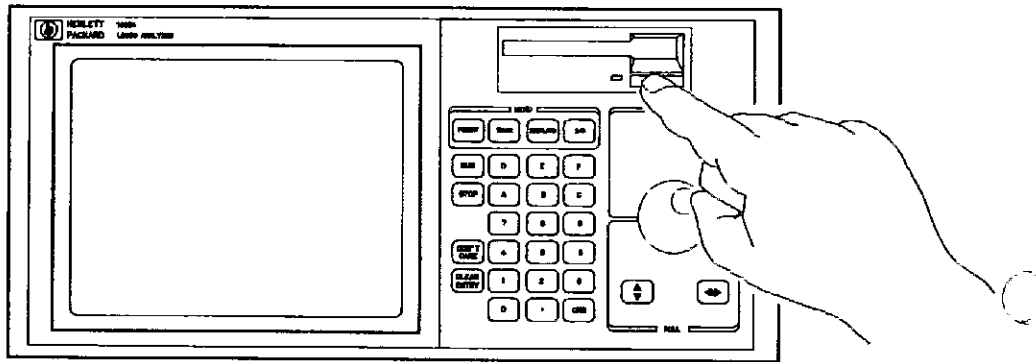

1650/EX25

Selecting the Line Voltage

The line voltage selector has been factory set to the line voltage used in your country. It is a good idea to check the setting of the line voltage selector so you can become familiar with what it looks like. If the setting needs to be changed, follow the procedure in the next paragraph.

CAUTION

You can damage the logic analyzer if the module is not set to the correct position.

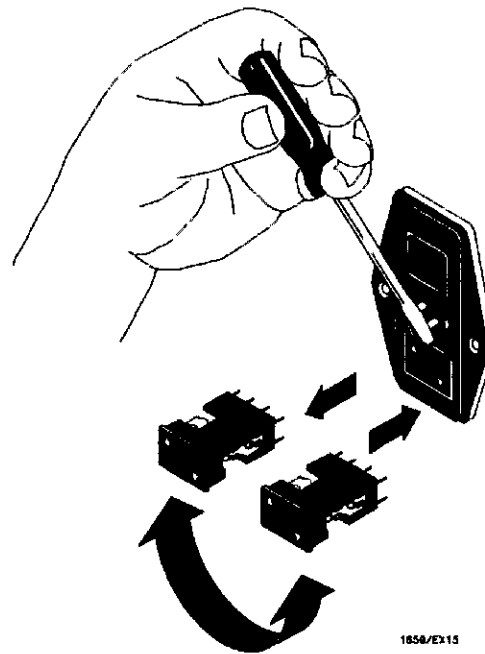

1858/EX15

You change the line voltage setting by pulling the fuse module out and reinserting it with the proper arrows aligned. To remove the fuse module, carefully pry at the top center of the module (as shown) until you can grasp it and pull it out by hand.

Getting Ready to Operate

1-5

**Checking for
the Correct Fuse**

If you need to check for the correct fuses, remove the fuse module and look at the amperage and voltage of each fuse. The following figure will help you locate the 115 V and 230 V fuses. To remove the fuse module, carefully pry at the top center of the module (as shown) until you can grasp it and pull it out by hand. (Refer to "Selecting the Line Voltage" on the previous page.)

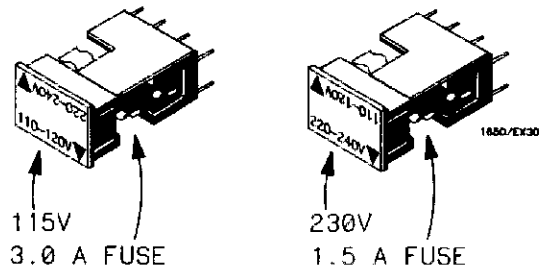

Getting Power to the Instrument

The HP 1650A/51A comes with a 3-wire power cable. When you connect the cable to an AC appropriate power receptacle, a ground is provided for the instrument cabinet. The type of power cable you receive with the instrument depends on your country.

WARNING

To avoid possible shock hazard, you must connect the instrument to a properly grounded 3-wire receptacle.

Operating Environment

You may operate your logic analyzer in a normal lab or office environment without any additional considerations. But don't block its ventilation. If you intend to use it in another type of environment, you must not exceed certain limits. You can find these limits in the *HP 1650A/51A Reference Manual*.

Ventilation

You must provide an unrestricted airflow for the fan and ventilation openings in the rear of the logic analyzer. However, you may stack the logic analyzer under, over, or in-between other instruments as long as the surfaces of the other instruments aren't needed for their ventilation.

2

Turning on the Instrument

Loading the Operating System

Before you can operate the logic analyzer, it must transfer its operating system from a disc to its memory. This is called "loading the operating system" or "booting."

The logic analyzer operating system is a set of instructions that control the operation of the instrument. The operating system resides on a 3.5-inch flexible disc. You received two identical operating system discs. You should mark one of them **Master** and store it in a safe place. Mark the other one **Work** and use only the work copy. This will provide you with a back-up in case your work copy becomes corrupt.

CAUTION

To prevent damage to your operating system disc, DO NOT remove the disc from the disc drive while it is running. Only remove it after the indicator light has gone out.

Installing the Operating System Disc

To load the logic analyzer's operating system, you must install the disc as shown below **before** you turn on the power. When the disc snaps into place, the disc eject button will pop out. Now you can turn on the logic analyzer.

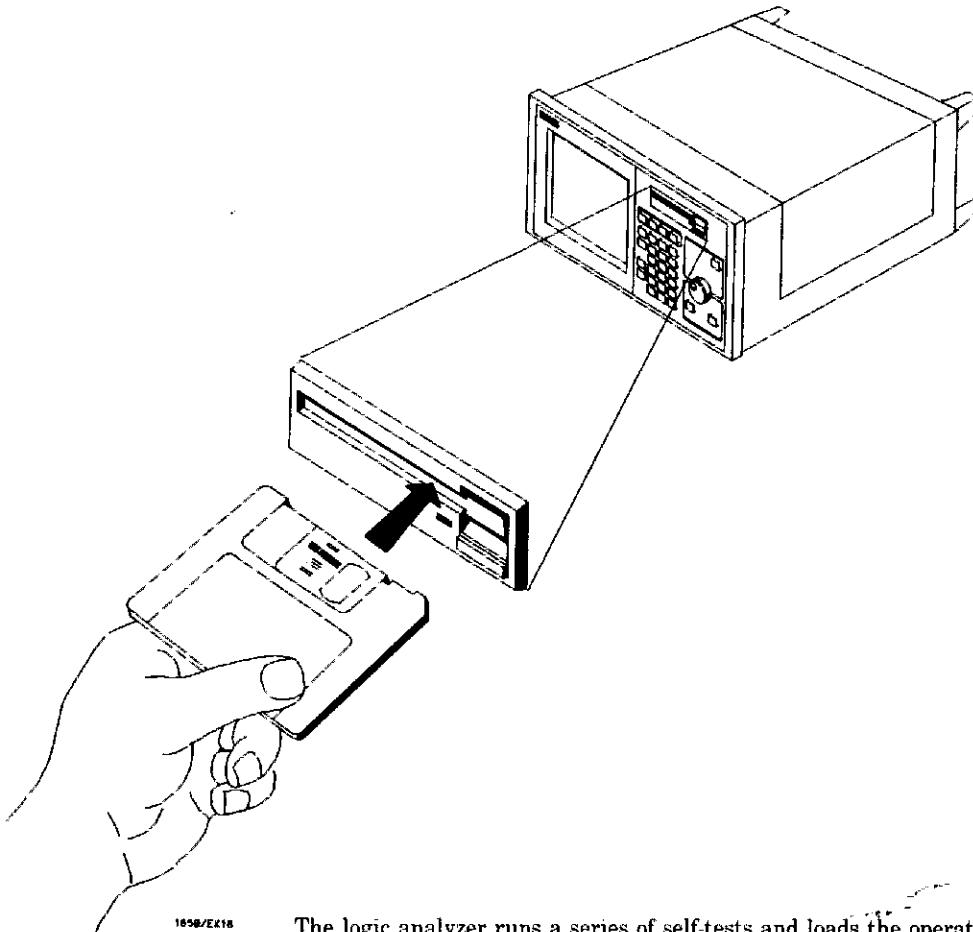

1058/EK18

The logic analyzer runs a series of self-tests and loads the operating system before it is ready to be operated.

Line Switch

The line switch is on the rear panel. You turn on the logic analyzer by pressing the 1 on the rocker switch. Make sure the operating system disc is in the disc drive before you turn it on. If you forget the disc, don't worry, you won't harm anything. You will merely have to repeat the turn-on procedure with the disc in the drive.



Control

display intensity to a different level that's more comfortable for you. You do this by turning the INTENSITY control on the rear panel.

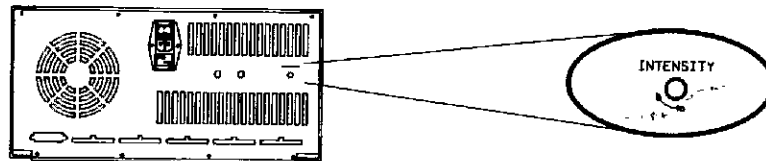

1850/EE23

Turning on the Instrument

2-3

**Power-up
Self-Test**

When you turn on the logic analyzer, it performs a series of self-tests. When it has successfully completed these tests, it loads the operating system into memory from the disc.

When the logic analyzer has completely loaded the operating system, it displays the System Configuration menu as shown below.

Note

*This is the HP 1650A System Format Specification menu. If you have an HP 1651A, the only difference is pod 1 will be assigned to analyzer 1 and pod 2 will be assigned to analyzer 2. There won't be any pods in the **UNASSIGNED** area of the display.*

3

Connecting the Logic Analyzer to the Target System

Probes and Probe Pods

Probes and probe pods allow you to connect the logic analyzer to your target system. Each probe pod carries 16 data channels, one clock channel, one pod ground and two power lines for preprocessors.

Connecting Pod Cables to the Logic Analyzer

You connect the pod cables to the pod connectors on the rear panel of the logic analyzer. The connectors are keyed for proper orientation. You can connect either end of the cable to the rear panel since both ends of the cables are alike.

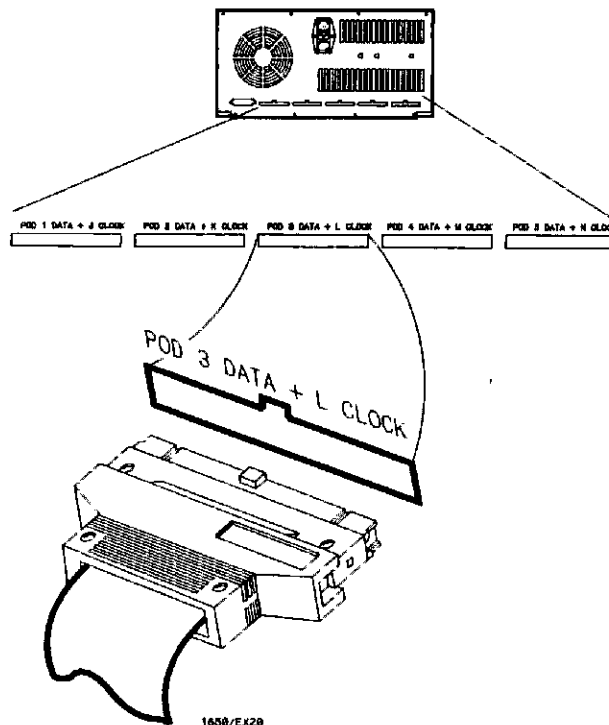

Connecting Pods to Probe Cables

The pods of the HP 1650A/51A differ from the pods in other logic analyzers in that they are passive (have no active circuits at the outer end of the cable). The pods, as they will be referred to for consistency, are the connector bodies (as shown below) that the probes are installed in when you receive your logic analyzer.

To connect a pod to a cable, you align the key on the cable connector with the slot on the pod connector and connect them the same way you connected the other end to the logic analyzer.

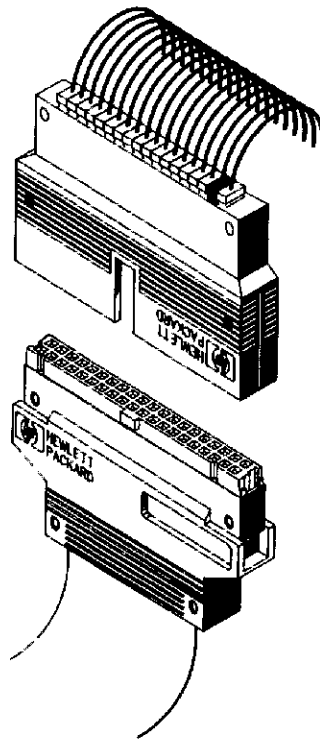

1650A/51A

Disconnecting Probes From Pods

You can disconnect un-used probes from the pods to eliminate clutter. To disconnect a probe, insert the tip of a ball-point pen in the latch opening and push while gently pulling the probe out of the pod connector as shown below

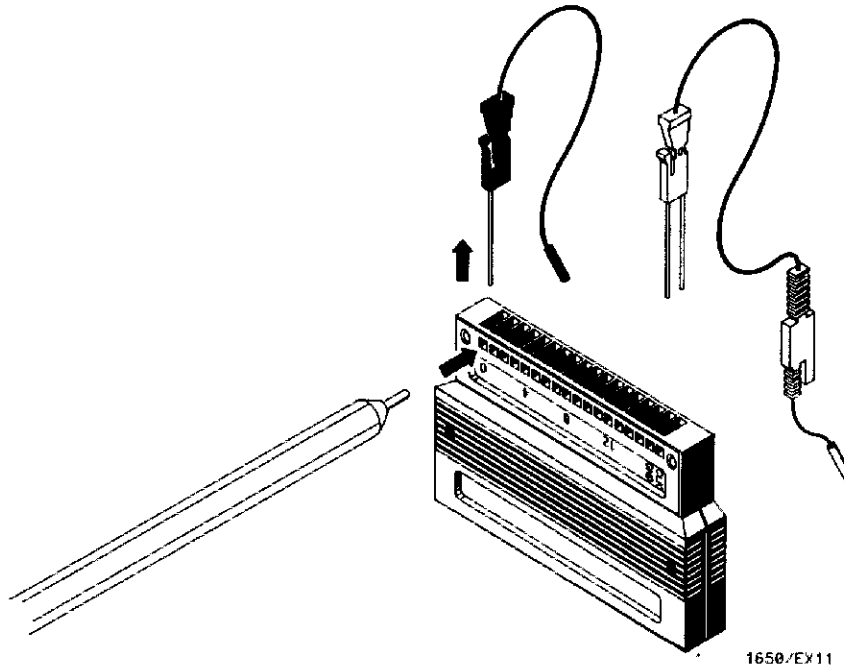

You re-connect a probe to a pod by inserting the double pin end of the probe into the pod. The probes and pod connector body are both keyed (chamfered) so that they will fit together in only one way.

Connecting Grabbers to Probes

You connect the grabbers to the probes by slipping the connector at the end of the probe onto the recessed pin in the side of the grabber.

Connecting Grabbers to Test Points

The grabbers have a hook that fits around IC pins and component leads. You connect the grabber by pushing the rear of the grabber to expose the hook, hooking the lead and releasing your thumb as shown below.

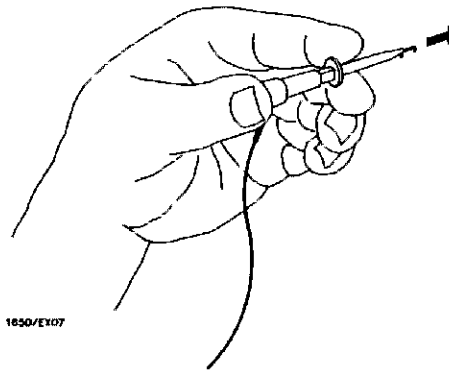

Pod Grounds

Each pod is grounded by a pod ground lead that should always be used. You can connect the lead directly to a ground pin on your target system or use a grabber. The grabber connects to the ground lead the same way it connects to the probe lead.

To connect the ground lead to grounded pins on your target system, you must use 0.63 mm (0.025 in) square pins or round pins with a diameter from 0.66 mm (0.026 in) to 0.84 (0.033 in).

Probe Grounds

You can ground the probes in one of two ways. You can ground them with the pod ground only; however, the ground path won't be the same length as the signal path through the probe. If your probe ground path must be the same as your signal path, use the short ground lead (probe ground). The probe ground lead connects to the molded probe body via a pin and socket. You can then use a grabber or grounded pins on your target system the same way as the pod ground.

If you need additional probe ground leads, order HP part number 01650-82103 from your nearest Hewlett-Packard sales office.

**Labeling
Pods, Probes
and Cables**

So you can find the pods and probes you want to connect to your target system, you need to be able to quickly identify them. Included with your logic analyzer are self-adhesive labels for each pod, cable and probe.

They come in sets. Each set has labels for each end of the cable—a label for the pod connector body, a label for the clock probe and 15 labels for each of the channels.

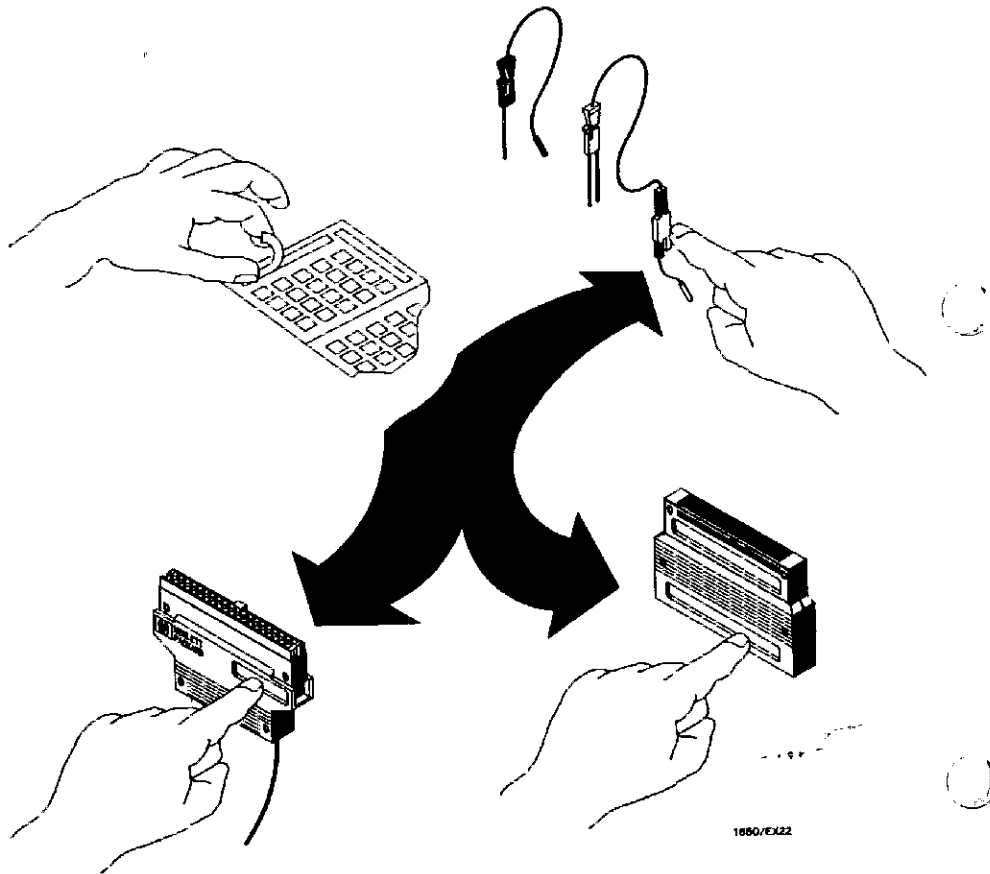

Signal Line Loading

Any signal line to be connected to a probe must be able to supply a minimum of 600 mV to the probe tip, which has an input impedance of 100 k Ω shunted by 8 pF. If the signal line can't supply this voltage, you will not only get an incorrect measurement but the system-under-test may also malfunction

Probe Interface

Instead of connecting the probe tips directly to the signal lines, you may use the HP 10269C Probe Interface (optional accessory). It allows you to connect the pod cables (without the probes) to connectors on the interface. When the appropriate preprocessor is installed in the interface, you will be able to connect the interface directly to the microprocessor-under-test. A number of microprocessor specific preprocessors are available as optional accessories. You will find them listed in the *HP 1650A/51A Reference Manual* along with additional details on how the probe interface and preprocessors work.

4

Connecting to External Equipment

Your logic analyzer is equipped with a standard RS-232C interface, which allows you to connect the logic analyzer to a printer or controller. The connector is a standard 25 pin "D" connector as shown below.

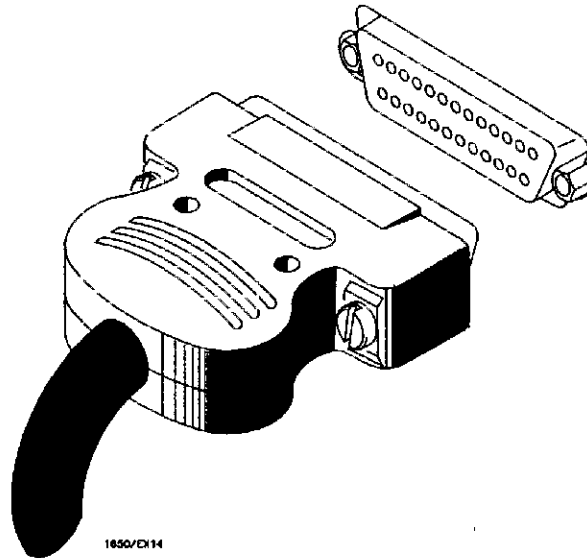

1650/EN14

Connecting the Logic Analyzer to a Printer

You can connect a printer to the logic analyzer's RS-232C interface when a controller isn't connected. The printer enables you to print various data from the logic analyzer.

To connect the printer to the logic analyzer, use a standard RS-232C cable (HP Model number 13242G) and make your connections as shown below.

You will find the complete details of how to operate the printer with the logic analyzer in the *HP 1650A/51A Reference Manual*.

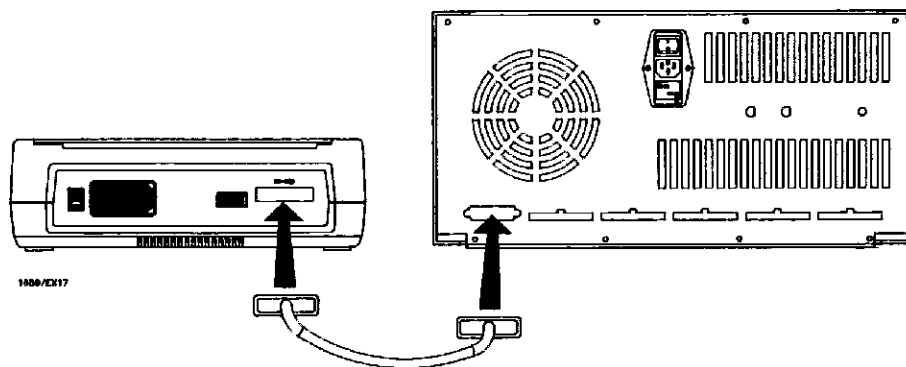

5

What's Next?

Now that you have unpacked, inspected, and begun operating the logic analyzer, the next step will depend on your needs. If you are a first-time logic analyzer user who wanted to get the instrument running before reading *Feeling Comfortable with Logic Analyzers*, you should read it now. If you are familiar with logic analysis, read either the *Getting Started Guide* or the *HP 1650A/51A Reference Manual*.

In a task format the *Getting Started Guide* teaches you the basics of how to operate the front panel and configure it for task measurements.

The *HP 1650A/51A Reference Manual* describes all the front-panel and programming functions of the logic analyzers. Once you feel comfortable with the basic operation of the front panel, use this book.

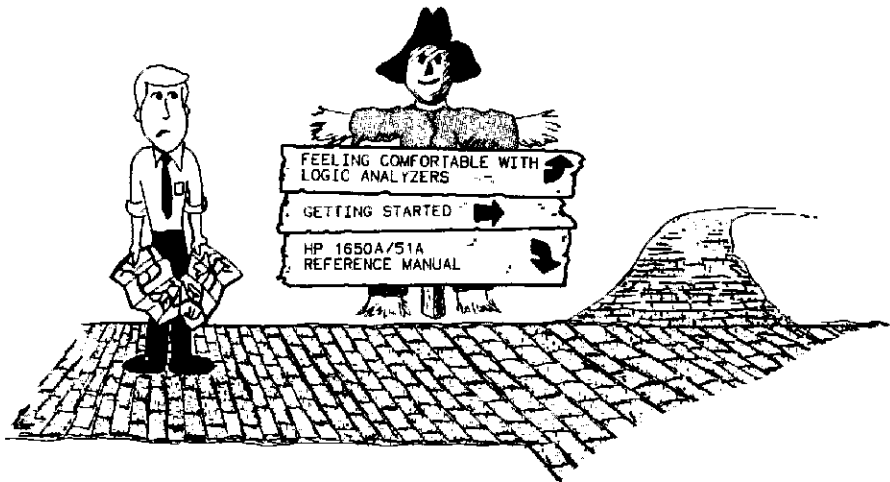



HEWLETT
PACKARD

5959-6012

PRINTED IN U.S.A.