User's Reference

Publication number 16555-97005
First edition, November 1994

For Safety information, Warranties, and Regulatory information, see the
pages behind the index

© Copyright Hewlett-Packard Company 1992-1994
All Rights Reserved

HP 16554A and HP 16555A State/Timing Logic Analyzer



In This Book

The User's Reference manual contains field and feature definitions. Use this manual to learn what the menu fields do, what they are used for, and how the features work.

The manual is divided into chapters covering general product information, probing, and separately tabbed chapters for each analyzer menu. Chapters on error messages and instrument specifications are also provided.

In the Configuration menu you have the choice of configuring an analyzer as either a State analyzer or a Timing analyzer. Some menus in the analyzer will change depending on the analyzer type you choose. For example, because a Timing analyzer does not use external clocks, the clock assignment fields in the Format menu will not be available.

If a menu field is only available to a particular analyzer type, the field is designated (Timing only) or (State only) after the field name. If no designation is shown, the field is available for both types.

As you purchase measurement modules for the HP 16500B system, insert the reference manuals into either of the HP 16500B mainframe binders.

1	General Information	
2	Probing	
3	The Configuration Menu	
4	The Format Menu	
5	The Trigger Menu	
6	The Listing Menu	
7	The Waveform Menu	
8	The Chart Menu	
9	The Compare Menu	
10	The Mixed Display Menu	
11	Error Messages	
12	Specifications and Characteristics	
13	Installation	
	Index	



Contents

1 General Information

- User Interface 1-3
- Configuration Capabilities 1-4
- Key Features of the HP 16554A 1-5
- Key Features for the HP 16555A 1-6
- Accessories Supplied 1-7
- Accessories Available 1-8

2 Probing

- General-Purpose Probing System Description 2-17
- Assembling the Probing System 2-21

3 The Configuration Menu

- Analyzer Name Field 3-4
- Analyzer Type Field 3-5
- Unassigned Pods List 3-6
- Activity Indicators 3-8

4 The Format Menu

- State Acquisition Mode Field (State only) 4-4
- Timing Acquisition Mode Field (Timing only) 4-5
- Data on Clocks Display 4-6
- Pod Field 4-7
- Pod Clock Field (State only) 4-8
- Pod Threshold Field 4-12
- Master and Slave Clock Field (State only) 4-13
- Setup/Hold Field (State only) 4-15
- Symbols Field 4-17
- Label Assignment Fields 4-17
- Rolling Labels and Pods 4-17
- Label Polarity Fields 4-18
- Bit Assignment Fields 4-19

5 The Trigger Menu

Contents

Predefined Trigger Macros	5-5
Timing Trigger Macro Library	5-7
State Trigger Macro Library	5-9
Sequence Levels	5-11
Sequence Level Number Field	5-12
Sequence Instruction Menu	5-13
Resource Terms	5-19
Resource Term Fields	5-20
Bit Pattern Terms	5-23
Range Terms	5-25
Timer Terms	5-27
Edge Terms (Timing only)	5-29
Combination of Terms	5-31
Control Fields	5-33
Arming Control Field	5-34
Count Field (State only)	5-37
Acquisition Control Field	5-39
Clear Trigger Field	5-43

6 The Listing Menu

Markers Field	6-4
Pattern Markers	6-5
Find X-pattern / O-pattern Field	6-6
Pattern Occurrence Fields	6-7
From Trigger / Start / X Marker Field	6-8
Specify Patterns Field	6-9
Label / Base Roll Field	6-12
Stop Measurement Field	6-13
Clear Pattern Field	6-15

Time Markers 6-16
Trig to X / Trig to O Fields 6-17
Statistics Markers 6-18
Data Roll Field 6-20

7 The Waveform Menu

Basic Controls 7-5
Acquisition Control Field 7-6
Accumulate Field 7-7
States Per Division Field (State only) 7-8
Seconds Per Division Field (Timing only) 7-9
Delay Field 7-10
Sample Period Display (Timing only) 7-11
Markers Field 7-13

Pattern Markers 7-14
X-pat / O-pat Occurrence Fields 7-15
From Trigger / Start / X Marker Field 7-16
X to O Display Field (Timing only) 7-17
Center Screen Field 7-18
Specify Patterns Field 7-19
Label / Base Roll Field 7-22
Stop Measurement Field 7-23
Clear Pattern Field 7-25

Time Markers 7-26
Trig to X / Trig to O Fields 7-27
Marker Label / Base and Display 7-28

Statistics Markers 7-29

Waveform Display 7-31

Contents

Display Location Reference Line	7-32
Blue Bar Field	7-33
Channel Mode Field	7-35
Module and Label Fields	7-37
Action Insert/Replace Field	7-38
Delete and Delete All Fields	7-39
Waveform Size Field	7-40

8 The Chart Menu

The Y Markers	8-7
The X Markers and the Markers Field	8-8
Sample	8-8
Pattern	8-9
Rescale	8-16
Axis Control Field	8-18
Accumulate Field	8-21
Cancel Field	8-21

9 The Compare Menu

Reference Listing Field	9-5
Difference Listing Field	9-6
Copy Listing to Reference Field	9-8
Find Error Field	9-9
Compare Full / Compare Partial Field	9-10
Mask Field	9-11
Specify Stop Measurement Field	9-12
Data Roll Field	9-15
Bit Editing Field	9-16
Label and Base Fields	9-17
Label / Base Roll Field	9-17

10 The Mixed Display Menu

- Intermodule Configuration 10-3
- Inserting Waveforms 10-4
- Interleaving State Listings 10-4
- Time-Correlated Displays 10-5
- Markers 10-5

11 Error Messages

- Error Messages 11-3
- Warning Messages 11-4
- Advisory Messages 11-7

12 Specifications and Characteristics

- Specifications 12-3
- Supplemental Characteristics 12-4

13 Installation

- To configure a one-card module 13-2
- To configure a multocard module 13-3
- To install modules 13-8

Contents





General Information

Logic Analyzer Description

The HP 6554A and 16555A State/Timing Analyzer modules are part of a new generation of general-purpose logic analyzers. They are used with the HP 16500B mainframe, which is designed as a stand-alone instrument for use by digital and microprocessor hardware and software designers. The HP 16500B mainframe has HP-IB and RS-232C interfaces for hard copy printouts and control by a host computer.

Both State/Timing Analyzer modules have 64 data channels, and four clock/data channels. As many as two additional HP 16554A or 16555A cards can be added to expand the module to 200 data and 4 clock/data channels.

Memory depth on the HP 16554A is 500K in all pod pair groupings, or 1M on just one pod (half channels). Memory depth on the HP 16555A is 1M in all pod pair groupings, or 2M on just one pod (half channels). All available resource terms can be assigned to either configured analyzer machine.

Measurement data is displayed as data listings or waveforms.

The 70 MHz and 110-MHz state analyzers have master, slave, and demultiplexed clocking modes available. Measurement data can be stamped with either state or time tags. For triggering and data storage, the state analyzer uses 12 sequence levels with two-way branching, 10 pattern resource terms, 2 range terms, and 2 timers/counters.

The 250 MHz and 500-MHz conventional timing analyzers have variable width, depth, and speed selections. Sequential triggering uses 10 sequence levels with two-way branching, 10 pattern resource terms, 2 range terms, 2 timers/counters and 2 edge/glitch terms.

User Interface

The HP 16500B has four easy-to-use user interface devices: the knob, the touchscreen, the optional mouse, and the optional keyboard.

The knob on the front panel is used to move the cursor on certain menus, to increment or decrement numeric fields, and to roll the display.

The touchscreen fields can be selected by touch or with the optional mouse. To activate a touchscreen field by touch, simply press the screen over any dark blue box on the display with your finger until the field changes color. Then remove your finger from the screen to activate your selection.

To activate a field with the optional mouse, position the cursor (+) of the mouse over the desired field and press the button on the upper-left corner of the mouse.

The optional keyboard can control all instrument functions by using special function keys, the arrow keys, and the ENTER key. Alphanumeric entry is simply typed in.

All user interface devices are discussed in more detail in the *HP 16500B User's Reference*.

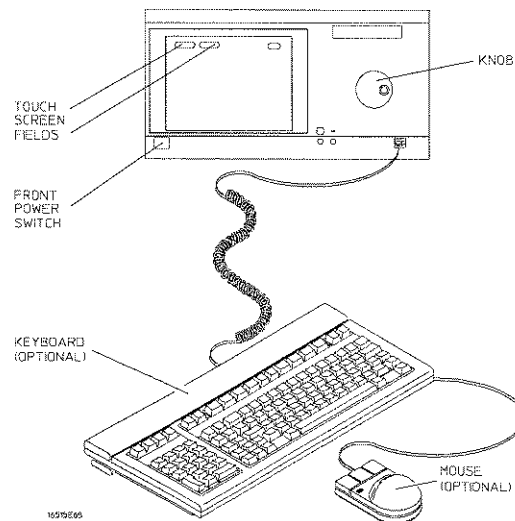

Front Panel Interface Devices

General Information
Configuration Capabilities

Configuration Capabilities

The HP 16554A and 16555A can be configured as a single card or up to a three-card system. The number of data channels range from 68 channels using just one card, and up to 204 channels when three cards are installed. A half-channel acquisition mode is available which reduces the channel width by half, but doubles memory depth from 500K-deep to 1 M-deep per channel on the HP 16554A and from 1M-deep to 2M-deep per channel on the HP 16555A.

Key Features of the HP 16554A

- 70-MHz state and 250-MHz timing acquisition speed.
- 64 data channels/4 clocks expandable to 200 data/4 clock channels.
- Lightweight passive probes for easy hookup and compatibility with previous HP logic analyzers and preprocessors.
- HP-IB and RS-232C interface for programming and hard copy printouts.
- Variable setup/hold time, 3.5-ns window.
- External arming to and from other modules through the intermodule bus.
- 500-K deep memory on all channels with 1 Mbyte in half-channel modes.
- Marker measurements.
- 12 levels of trigger sequencing for state and 10 levels of sequential triggering for Timing.
- Both state and timing analyzers can use 10 pattern resource terms, two range terms, and two timer/counters to qualify and trigger on data. The timing analyzer also has two edge terms available.
- Time (8 ns resolution) and number-of-qualified-states tagging.
- Full programmability.
- Mixed State/Timing and State/State (interleaved) display.
- Waveform display.

Key Features for the HP 16555A

- 110-MHz state and 500-MHz timing acquisition speed.
- 64 data channels/4 clocks expandable to 200 data/4 clock channels.
- Lightweight passive probes for easy hookup and compatibility with previous HP logic analyzers and preprocessors.
- HP-IB and RS-232C interface for programming and hard copy printouts.
- Variable setup/hold time, 3.5-ns window.
- External arming to and from other modules through the intermodule bus.
- 1-M deep memory on all channels with 2 Mbytes in half-channel modes.
- Marker measurements.
- 12 levels of trigger sequencing for state and 10 levels of sequential triggering for Timing.
- Both state and timing analyzers can use 10 pattern resource terms, two range terms, and two timer/counters to qualify and trigger on data. The timing analyzer also has two edge terms available.
- Time (8 ns resolution) and number-of-qualified-states tagging.
- Full programmability.
- Mixed State/Timing and State/State (interleaved) display.
- Waveform display.

Accessories Supplied

The table below lists the accessories supplied with your logic analyzer. If any of these accessories are missing, contact your nearest Hewlett-Packard sales office. If you need additional accessories, refer to the *Accessories for HP Logic Analyzers* brochure (P/N 5091-1808E).

Accessories Supplied

Accessory	HP Part No.	Quantity
Probe tip assemblies	01650-61608	4
Probe cables	16550-61601	2
Grabbers (20 per pack)	5090-4356	4 pkgs
Extra probe leads (5 per pack)	5959-9333	1 pkg
Probe cable and pod labels	01650-94310	1
Probe cable ID clip	16500-41201	4
Double probe adapter	16542-61607	1
External reference cable	16555-61608	1
Update Notification Card	16555-92000	1
Probe grounds (5 per pack)	5959-9334	4
Operating system disks	Call	1
User's Reference	Call	1
Programmer's Reference	Call	1
Service Guide	Call	1

Accessories Available

There are a number of accessories available that will make your measurement tasks easier and more accurate. You will find these listed in *Accessories for HP Logic Analyzers (P/N 5963-3376E)*.

Preprocessor Modules

The preprocessor module accessories enable you to quickly and easily connect the logic analyzer to your microprocessor under test.

Included with each preprocessor module is a 3.5-inch disk which contains a configuration file and an inverse assembler file. When you load the configuration file, it configures the logic analyzer for making state measurements on the microprocessor for which the preprocessor is designed.

Configuration files from other analyzer modules can also be loaded. For information on translating other configuration files into the analyzer, refer to "Preprocessor File Configuration Translation and Pod Connections" in chapter 2, "Probing".

The inverse assembler file is a software routine that will display captured information in a specific microprocessor's mnemonics. The DATA field in the State Listing is replaced with an inverse assembly field. The inverse assembler software is designed to provide a display that closely resembles the original assembly language listing of the microprocessor's software. It also identifies the microprocessor bus cycles captured, such as Memory Read, Interrupt Acknowledge, or I/O write.

Many of the preprocessor modules require the HP10269C General Purpose Probe Interface. The HP 10269C accepts the specific preprocessor PC board and connects it to five connectors on the general purpose interface to which the logic analyzer probe cables connect.

A list of preprocessor modules is found in the *Accessories for HP Logic Analyzers* brochure. Descriptions of the preprocessor modules are found with the preprocessor module accessories.



Probing

Probing

This chapter contains a description of the probing system for the logic analyzer. It also contains the information you need for connecting the probe system components to each other, to the logic analyzer, and to the system under test.

Probing Options

You can connect the logic analyzer to your system under test in one of the following ways:

- HP E2445A User-Definable Interface (optional).
- Microprocessor and bus specific interfaces (optional).
- The standard general purpose probing (provided).
- Direct connection to a 20-pin, 3M-Series type header connector using the optional termination adapter.

The HP E2445A User-Definable Interface

The optional HP E2445A User-Definable Interface allows you to connect the logic analyzer to the microprocessor in your target system. The HP E2445A includes a breadboard that you custom-wire for your system.

Another option for use with the HP E2445A is the HP 10321A Microprocessor Interface Kit. This kit includes sockets, bypass capacitors and a fuse for power distribution. Also included are wire-wrap headers to simplify wiring of your interface when you need active devices to support the connection requirements of your system.

You will find additional information about the HP E2445A and the HP 10321A in *Accessories for HP Logic Analyzers* (P/N 5963-3376E).

Microprocessor and Bus-Specific Interfaces

There are a number of microprocessor and bus-specific interfaces available as optional accessories which are listed in *Accessories for HP Logic Analyzers*. Microprocessors are supported by Universal Interfaces or Preprocessor Interfaces, or in some cases both.

Universal Interfaces are aimed at initial hardware turn-on, and will provide fast, reliable, and convenient connections to the microprocessor system.

Preprocessor interfaces are aimed at hardware turn-on and hardware/software integration, and will provide the following:

- All clocking and demultiplexing circuits needed to capture the system's operation.
- Additional status lines to further decode the operation of the CPU.
- Inverse assembly software to translate logic levels captured by the logic analyzer into microprocessor mnemonics.
- Bus interfaces to support bus analysis for HP-IB, RS-232C, RS-449, SCSI, VME, and VXI.

General-Purpose Probing

General-purpose probing involves connecting the logic analyzer probes directly to your target system without using any interface. General purpose probing does not limit you to specific hook up schemes, as for example, the probe interface does. General-purpose probing uses grabbers that connect to both through hole and surface mount components.

Probing

General-purpose probing is the standard probing option provided with the logic analyzer. There is a full description of its components and use later in this chapter.

The Termination Adapter

The optional termination adapter allows you to connect the logic analyzer probe cables directly to test ports on your target system without the probes.

The termination adapter is designed to connect to a 20 (2x10) pin, 4-wall, low-profile header connector, 3M-Series 3592 or equivalent.

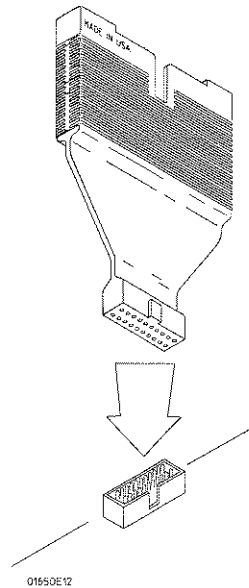

Termination Adapter

Preprocessor File Configuration Translation and Pod Connections

Preprocessor configuration files from an HP 16550A can be used by the HP16554A and 16555A logic analyzers. However, some pods must be connected differently in order for the configuration files to work properly. The tables on the next several pages provide information on what configuration files to load and the required connections between the preprocessor interface and the new HP 16554A and 16555A pods.

In the tables, expansion and master card pods are referred to as either A or B pods. Those designations are done for convenience. The letter designation of pods in your system will depend on the slots in which your cards reside. They may be any letter from A through E for the 16500B Logic Analysis System master frame, or F through J for the 16501A expander frame

In a five card system, for example, the master card pods would be labeled C. The expansion card pods then would be labeled A, B, D, and E. Look at the Format menu for the slot designators for expansion cards in your system.

Probing

Software and Hardware Translation Information

Single-card HP 16550A configuration loaded into a single-card HP 16555A

HP Model	Processor	16550A Config Filename	Master Card Pods				Clocks	Drop Pods
			B4	B3	B2	B1		
10300B	Z80	FZ80	--	P2	--	P1	J↓+L↓	No
Inverse Assembler Labels: P1=DATA/STAT.clk P2=ADDR.clk								
10304B	8085	C8085_IF	--	P3	P2	P1	J↓, K↓ mclk, sclk	No
Inverse Assembler Labels: P1=DATA/STAT.master_clk P2=ADDR.slave_clk								
10305B	8086	F8086_I	P3	P2	--	P1	J↓	No
Inverse Assembler Labels: P1=DATA.clk P2=ADDR P3=ADDR/STAT								
10305B	8088	F8088_I	P3	P2	--	P1	J↓	No
Inverse Assembler Labels: P1=DATA.clk P2=ADDR P3=ADDR/STAT								
10315G/H	68HC11	F68HC11	--	P2	--	P1	L↓, J↓ mclk, sclk	Timing P3, P4
Inverse Assembler Labels: P1=ADDR/DATA.slave_clk P2=ADDR/STAT.master_clk								
10341B	1553	F1553	--	P2	--	P1	J↑	Timing P3
Inverse Assembler Labels: P1=DATA.clk (no Inverse Assembler capability)								
10342B	RS232	FRS232	--	P3	P4	P1	K↓	No
Inverse Assembler Labels: P1=DATA/STAT P4=.clk								
10342B	HPIB	FHPIB	.	P3	P2		J↓	No

Single-card HP 16550A configuration loaded into a single-card HP 16555A

HP Model	Processor	16550A Config Filename	Master Card Pods				Clocks	Drop Pods
			B4	B3	B2	B1		
Inverse Assembler Labels: P2=DATA/STAT.clk P3=DATA								
10342G	HPIB	FHPIB	--	J2	--	J2	J↓	No
Inverse Assembler Labels: J2=DATA/STAT.clk								
E2409B	80286	F80286S	P3	P2	--	P1	J↑	Timing
Inverse Assembler Labels: P1=Data.clk P2=ADDR P3=ADDR/STAT								
E2409B	80286	F80286T	P3	P2	--	P4	Timing	Timing
Inverse Assembler Labels: n/a								
E2413B	68331/2	F68332	P4	P3	P5	P1	J↑	State
Inverse Assembler Labels: P1=DATA.clk P3=ADDR P4=ADDR P5=STAT								
E2414B	68302	F68302	--	P4	P3	P1	J↑	No
Inverse Assembler Labels: P1=DATA.clk P3=ADDR P4=ADDR/STAT								
E2415A	MCS-51	FMCS51	--	P2	P3	P1	J↓	State
Inverse Assembler Labels: P1=DATA.clk P2=ADDR P3=STAT								
E2416A	MCS-96	FMCS96	--	P3	P2	P1	J↑	No
Inverse Assembler Labels: P1=DATA.clk P2=ADDR P3=STAT								
E2418A	320C20/25	F320C25	J3	J1	--	J2	J↑	No
Inverse Assembler Labels: J1=DATA J2=ADDR.clk J3=STAT								
E2419A	68HC16	FHC16	P4	P3	P5	P1	J↑	State

Probing

Single-card HP 16550A configuration loaded into a single-card HP 16555A

HP Model	Processor	16550A Config Filename	Master Card Pods				Clocks	Drop Pods
			B4	B3	B2	B1		
Inverse Assembler Labels: P1=DATA.clk P3=ADDR P5=STAT (P4=ADDR not required)								
E2423A	SCSI-2	FSCSI2	P4	P3	P2	P1	J↓	No
Inverse Assembler Labels: P1=STAT.clk P2=ADDR/DATA								
E2424B	68340	F68340	P4	P3	P5	P1	K↑	No
Inverse Assembler Labels: P1=DATA P3=ADDR P5=STAT.clk (P4=ADDR_B not required)								
E2424B	68340	FEV340	P4	P3	P5	P1	J↑	No
Inverse Assembler Labels: P1=DATA.clk P3=ADDR P5=STAT (P4=ADDR not required)								
E2431A	320C30/31	P_320C3X	P4	P3	P2	P1	J↓	No
Inverse Assembler Labels: P1=DATA.clk P2=DATA P3=ADDR P4=ADDR/STAT								
E2431A	320C30/31	Q_320C30	P6	P5	--	P7	J↓	No
Inverse Assembler Labels: P5=DATA P6=DATA P7=ADDR/STAT.clk								
Note: A single-card HP 16555A is not recommended for this preprocessor because it does not allow simultaneous viewing of both the primary and expansion microprocessor buses.								
E2434A	80186XL/88	C186EA09	P4	P3	--	P1	J↑	No
Inverse Assembler Labels: P1=DATA.clk P3=ADDR P4=ADDR/STAT								
E2434A	80186XL/88	C186EA10	P6	P5	P4	P2	Timing	No
Inverse Assembler Labels: n/a								
E2434B	80186/88EB	C186EB_7	P4	P3	--	P1	J↑	No
Inverse Assembler Labels: P1=DATA.clk P3=ADDR P4=ADDR/STAT								

Single-card HP 16550A configuration loaded into a single-card HP 16555A

HP Model	Processor	16550A Config Filename	Master Card Pods				Clocks	Drop Pods
			B4	B3	B2	B1		
E2434B	80186/88EB	C186EB_8	P6	P5	P4	P2	Timing	Timing P7
Inverse Assembler Labels: n/a								
E2434C	80186/88EC	C186EC_7	P4	P3	P6	P1	J↓	No
Inverse Assembler Labels: P1=DATA.clk P3=ADDR P4=ADDR/STAT								
E2434C	80186/88EC	C186EC_8	P5	P6	P7	P2	Timing	Timing P8
Inverse Assembler Labels: n/a								
E2442A	TMS320C5X	D_320C5X	P5	P2	P3	P1	J↑+K↑+L↑	State P4, P6
Inverse Assembler Labels: P1=DATA.clk P2=STAT.clk P3=ADDR.clk								
E2447AA	68000	F68000	P6	P1	P4	P3	K↑	No
Inverse Assembler Labels: P1=DATA P3=ADDR P4=ADDR/STAT.clk								
E2447AA	68010	F68010	P6	P1	P4	P3	K↑	No
Inverse Assembler Labels: P1=DATA P3=ADDR P4=ADDR/STAT.clk								
E2447AB	68EC000	FEC000	P6	P1	P4	P3	K↑	No
Inverse Assembler Labels: P1=DATA P3=ADDR P4=ADDR/STAT.clk								
E2451A	Ethernet	CETH_4	P4	P3	P2	P1	J↑	No
Inverse Assembler Labels: P1=DATA.clk P2=ADDR/DATA_B P3=ADDR/DATA_B P4=STAT								
E2453A	DS1	C_DS1_6	.	--	xx		J↓	No
Inverse Assembler Labels: Carrier/Customer=ADDR/DATA/STAT.clk								
E2453A	DS1	C_DS1_7	--	Cu	--	Ca	J↓ L↑	No
Inverse Assembler Labels: Carrier=ADDR/DATA/STAT.clk Customer=ADDR/DATA/STAT.clk								
mach2 mach1 mach1 mach2								

Probing

Single-card HP 16550A configuration loaded into a multocard HP 16555A

HP Model	Processor	16550A Config Filename	Expansion Card Pods				Master Card Pods			Clocks	Drop Pods		
			A4	A3	A2	A1	B4	B3	B2			B1	
10300B	Z80	FZ80					--	P2	--	P1	J↓+L↓	No	
Inverse Assembler Labels: P1=DATA/STAT.clk P2=ADDR.clk													
10304B	8085	C8085_IF				--	P3		P2	P1	J↓, K↓	No	
Inverse Assembler Labels: P1=DATA/STAT.master_clk P2=ADDR.slave_clk													
10305B	8086	F8086_I			P3	P2		--	P1		J↓	No	
Inverse Assembler Labels: P1=DATA.clk P2=ADDR P3=ADDR/STAT													
10305B	8088	F8088_I			P3	P2		--	P1		J↓	No	
Inverse Assembler Labels: P1=DATA.clk P2=ADDR P3=ADDR/STAT													
10315G/H	68HC11	F68HC11					--	P2	--	P1	L↓, J↓	Timing	
Inverse Assembler Labels: P1=ADDR/DATA.slave_clk P2=ADDR/STAT.master_clk													
10341B	1553	F1553				--	P2	--	P3	--	P1	J↑	No
Inverse Assembler Labels: P1=DATA.clk (no Inverse Assembler capability)													
10342B	RS232	FRS232					--	P3	P4	P1	K↓	No	
Inverse Assembler Labels: P1=DATA/STAT P4=.clk													
10342B	HPIB	FHPIB						P3	P2		J↓	No	
Inverse Assembler Labels: P2=DATA/STAT.clk P3=DATA													
10342G	HPIB	FHPIB					--	J2	---	J2	J↓	No	
Inverse Assembler Labels: J2=DATA/STAT.clk													

Single-card HP 16550A configuration loaded into a multicard HP 16555A

HP Model	Processor	16550A Config Filename	Expansion Card Pods				Master Card Pods				Clocks	Drop Pods
			A4	A3	A2	A1	B4	B3	B2	B1		
E2409B	80286	F80286S	P5	P4	P3	P2	.	--	P1	J↑	No	
Inverse Assembler Labels: P1=DATA.clk P2=ADDR P3=ADDR/STAT												
E2409B	80286	F80286T	.	.	P5	P4	.	P3	P2	Timing	No	
Inverse Assembler Labels: n/a												
E2413B	68331/2	F68332	P6	P5	P4	P3	.	P2	P1	J↑	No	
Inverse Assembler Labels: P1=DATA.clk P3=ADDR P4=ADDR P5=STAT												
E2414B	68302	F68302	--	P4	--	P3	.	--	P1	J↑	No	
Inverse Assembler Labels: P1=DATA.clk P3=ADDR P4=ADDR/STAT												
E2415A	MCS-51	FMCS51	P5	P3	--	P2	.	--	P1	J↓	No	
Inverse Assembler Labels: P1=DATA.clk P2=ADDR P3=STAT												
E2416A	MCS-96	FMCS96	.	--	P3	.	P2	P1	J↑	No		
Inverse Assembler Labels: P1=DATA.clk P2=ADDR P3=STAT												
E2418A	320C20/25	F320C25	--	J3	--	J1	.	--	J2	J↑	No	
Inverse Assembler Labels: J1=DATA J2=ADDR.clk J3=STAT												
E2419A	68HC16	FHC16	P6	P5	P4	P3	.	P2	P1	J↑	No	
Inverse Assembler Labels: P1=DATA.clk P3=ADDR P5=STAT (P4=ADDR not required)												
E2419A	68HC16EVB	FHC16	P6	P5	P3	P1	.	P4	P2	J↑	No	
Inverse Assembler Labels: P2=DATA.clk P1=ADDR P5=STAT (P3=ADDR not required)												

Probing

Single-card HP 16550A configuration loaded into a multicard HP 16555A

HP Model	Processor	16550A Config Filename	Expansion Card Pods				Master Card Pods				Clocks	Drop Pods
			A4	A3	A2	A1	B4	B3	B2	B1		
E2423A	SCSI-2	FSCSI2					P4	P3	P2	P1	J↓	No
Inverse Assembler Labels: P1=STAT.clk P2=ADDR/DATA												
E2424B	68340	F68340	P4	P3	--	P1			--	P5	J↑	No
Inverse Assembler Labels: P1=DATA P3=ADDR P5=STAT.clk (P4=ADDR_B not required)												
E2424B	68340	FEV340	--	P5	P4	P3			--	P1	J↑	No
Inverse Assembler Labels: P1=DATA.clk P3=ADDR P5=STAT (P4=ADDR not required)												
E2431A	320C30/31	O_320C30	--	P7			P2	P1	P4	P3	J↑+L↓	No
Inverse Assembler Labels: P1=DATA.clk P2=DATA P3=ADDR.clk P4=ADDR/STAT P7=STAT												
Note: This is actually an HP 16510 configuration file.												
E2434A	80186XL/88	C186EA09				P4	P3		--	P1	J↑	No
Inverse Assembler Labels: P1=DATA.clk P3=ADDR P4=ADDR/STAT												
E2434A	80186XL/88	C186EA10				P6	P5	P4	P2		Timing	No
Cable Mapping: 1-B3 2-B4 3-A1 4-A2 5-B1 6-B2												
Inverse Assembler Labels: n/a												
E2434B	80186/88EB	C186EB_7				P4	P3		--	P1	J↑	No
Inverse Assembler Labels: P1=DATA.clk P3=ADDR P4=ADDR/STAT												
E2434B	80186/88EB	C186EB_8	--	P7	P6	P5	P4	P2			Timing	No
Inverse Assembler Labels: n/a												
E2434C	80186/88EC	C186EC_7				P4	P3		P6	P1	J↓	No
Inverse Assembler Labels: P1=DATA.clk P3=ADDR P4=ADDR/STAT												
E2434C	80186/88EC	C186EC_8	--	P8	P5	P6	P7	P2			Timing	No
Inverse Assembler Labels: n/a												

Single-card HP 16550A configuration loaded into a multicard HP 16555A

HP Model	Processor	16550A Config Filename	Expansion Card Pods				Master Card Pods				Clocks	Drop Pods
			A4	A3	A2	A1	B4	B3	B2	B1		
E2442A	TMS320C5X	D_320C5X	.		--	P4	P5	P2	P3	P1	J↑+K↑+L↑	No
Inverse Assembler Labels: P1=DATA.clk P2=STAT.clk P3=ADDR.clk												
E2447AA	68000	F68000	.		P6	P1	.	P4	P3		K↑	No
Inverse Assembler Labels: P1=DATA P3=ADDR P4=ADDR/STAT.clk												
E2447AA	68010	F68010	.		P6	P1	.	P4	P3		K↑	No
Inverse Assembler Labels: P1=DATA P3=ADDR P4=ADDR/STAT.clk												
E2447AB	68EC000	FEC000	.		P6	P1	.	P4	P3		K↑	No
Inverse Assembler Labels: P1=DATA P3=ADDR P4=ADDR/STAT.clk												
E2451A	Ethernet	CETH_4	.		P4	P3	.	P2	P1		J↑	No
Inverse Assembler Labels: P1=DATA.clk P2=ADDR/DATA_B P3=ADDR/DATA_B P4=STAT												
E2453A	DS1	C_DS1_6	.		--	xx	.				J↓	No
Inverse Assembler Labels: Carrier/Customer=ADDR/DATA/STAT.clk												
E2453A	DS1	C_DS1_7	.		--	Cu	--	Ca			J↓ L↓	No
mach2 mach1 mach1 mach2												
Inverse Assembler Labels: Carrier=ADDR/DATA/STAT.clk Customer=ADDR/DATA/STAT.clk												

Probing

Two-card HP 16550A configuration loaded into a two-card HP 16555A.
 (Or one-card HP 16550 which requires more than four pods for inverse assembly.)

HP Model	Processor	16550A Config Filename	Expansion Card Pods				Master Card Pods				Clocks	Drop Pods
			A4	A3	A2	A1	B4	B3	B2	B1		
E2401A	R3000	FR3KA	--	P7	P6	P5	P4	P3	P2	P1	J↑	No
Inverse Assembler Labels: P1=STAT.clk P2=DATA P3=DATA P4=ADDR/STAT P5=ADDR P6=ADDR P7=STAT												
FR3KB Same as FR3KA												
FR3KC Same as FR3KA												
E2403A	80486	UI_486_21	--	J4	J6	J7	J3	J5	J1	J2	J↑	No
E2406A	68030	C68030_4	.	P5	P4	--	P3	P2	P1		K↑+L↑	No
Inverse Assembler Labels: P1=DATA P2=DATA.clk P3=STAT.clk P4=ADDR P5=ADDR												
E2411C	80486	F486S2	--	P7	P6	P5	P4	P3	P2	P1	(J↑)*(K=1)	No
Inverse Assembler Labels: P1=STAT.clk P2=STAT.clk P3=DATA P4=DATA P5=ADDR P6=ADDR												
E2412A	I860XP	F_I860XP	P6	P5	P9	P8	P3	P2	P7	P1	J↑	No
Inverse Assembler Labels: P1=STAT.clk P2=DATA P3=DATA P5=DATA_B P6=DATA_B P7=STAT P8=ADDR P9=ADDR												
E2420A	68040	F68040	P4	P3	P2	P1	.	--	P5		J↑	No
Inverse Assembler Labels: P1=ADDR P2=ADDR P3=DATA P4=DATA P5=STAT.clk												
E2426A/B	68020	F68020E	P6	P5	P2	P1	.	P4	P3		J↑	No
Inverse Assembler Labels:												
P1=DATA P2=DATA P3=ADDR.clk P4=ADDR P5=STAT (P6=STAT_B not accessed by inverse assembler)												
E2426A/B	68EC020	FEC020E	P6	P5	P2	P1	.	P4	P3		J↑	No
Inverse Assembler Labels:												
P1=DATA P2=DATA P3=ADDR.clk P4=ADDR P5=STAT (P6=STAT_B not accessed by inverse assembler)												

Two-card HP 16550A configuration loaded into a two-card HP 16555A.
 (Or one-card HP 16550 which requires more than four pods for inverse assembly.)

HP Model	Processor	16550A Config Filename	Expansion Card Pods				Master Card Pods				Clocks	Drop Pods	
			A4	A3	A2	A1	B4	B3	B2	B1			
E2432A	80960CA	PI960CA_06	--	P7	P5	P4		P3	P2	P6	P1	J↓	No
Inverse Assembler Labels: P1=STAT.clk P2=DATA P3=DATA P4=ADDR P5=ADDR													
E2435A	I860XR	I860XR3	--	P7	P6	P5		P3	P2	P4	P1	J↓	No
Inverse Assembler Labels: P1=STAT.clk P2=ADDR P3=ADDR P4=DATA_B P5=DATA P6=DATA P7=DATA_B													
E2438A	R4000	F_R4K		P6	P5	P4	P3	P8	P7	P2	P1	J↓+K↑	State P9
Inverse Assembler Labels: P1=STAT.clk P2=STAT.clk P3=DATA P4=DATA P5=ADDR P6=ADDR P7=DATA_B P8=DATA_B													
E2441B	VME/VXI	FE2441		P6	P5	P4	P3			P2	P1	J↓	No
Inverse Assembler Labels: P1=DATA.clk P2=DATA P3=ADDR P4=ADDR P5=STAT													
E2443B	Pentium	CPENT_2		P6	P5	P4	P3	P8	P7	P2	P1	(J↑)*(K=0)	State P9, P10
Inverse Assembler Labels: P1=STAT.clk P2=STAT.clk P3=ADDR P4=ADDR P5=DATA P6=DATA P7=DATA_B P8=DATA_B													
E2444A	80386DX	PI386_04	--	P5	P4	P3				P2	P1	J↑	No
Inverse Assembler Labels: P1=DATA.clk P2=DATA P3=ADDR P4=ADDR P5=STAT													

Probing

Two-card HP 16550A configuration loaded into a two-card HP 16555A.
 (Or one-card HP 16550 which requires more than four pods for inverse assembly.)

HP Model	Processor	16550A Config Filename	Expansion Card Pods				Master Card Pods				Clocks	Drop Pods
			A4	A3	A2	A1	B4	B3	B2	B1		
E2448A	68360	C68360_0	P6	P5	P4	P3	.	P2	P1	J↑	No	
^ Asynchronous Operation Inverse Assembler Labels: P1=STAT.clk P2=STAT P3=DATA P4=DATA P5=ADDR P6=ADDR												
E2448A	68360	C68360_4	.	P4	P3	P6	P5	P2	P1	J↑+L↓,K↓	No	
^Synchronous Operation Inverse Assembler Labels: P1=STAT.master_clk P2=STAT.slave_clk P3=DATA P4=DATA P5=ADDR.master_clk P6=ADDR												
E2457A	P54C	CP54C_2	P6	P5	P4	P3	P8	P7	P2	P1	(J↑)*(K=0)	State P9, P10
Inverse Assembler Labels: P1=STAT.clk P2=STAT.clk P3=ADDR P4=ADDR P5=DATA P6=DATA P7=DATA_B P8=DATA_B												

General-Purpose Probing System Description

The standard probing system provided with the logic analyzer consists of a probe tip assembly, probe cable, and grabbers. Because of the passive design of the probes, there are no active circuits at the outer end of the cable.

The passive probing system is similar to the probing system used with high-frequency oscilloscopes. It consists of a series RC network (90 k Ω in parallel with 8 pF) at the probe tip, and a shielded resistive transmission line. The advantages of this system include the following:

- 250 Ω in series with 8-pF input capacitance at the probe tip for minimal loading.
- Signal ground at the probe tip for higher speed timing signals.
- Inexpensive removable probe tip assemblies.

Probe Tip Assemblies

Probe tip assemblies allow you to connect the logic analyzer directly to the target system. This general-purpose probing is useful for discrete digital circuits. Each probe tip assembly, or pod, contains 16 probe leads (data channels), one clock lead, a pod ground lead, and a ground tap for each of the 16 probe leads.

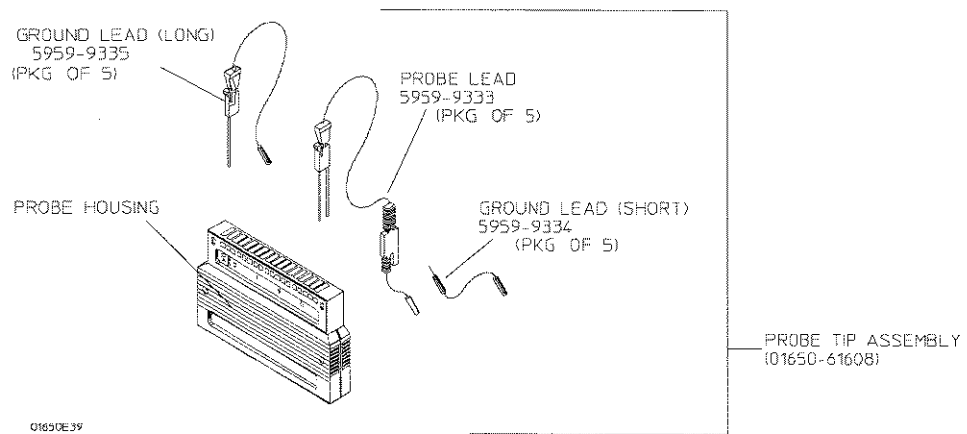

Probe Tip Assembly

Probing
General-Purpose Probing System Description

Probe and Pod Grounding

Each pod is grounded by a long black pod ground lead. You can connect the ground lead directly to a ground pin on your target system or use a grabber. To connect the ground lead directly to grounded pins on your target system, you must use 0.63 mm (0.025 in) square pins, or use round pins with a diameter of 0.66 mm (0.026 in) to 0.84 mm (0.033 in). The pod ground lead should always be used.

Each probe can be individually grounded with a short black extension lead that connects to the probe tip socket. You can then use a grabber or the grounded pins on your target system in the same way you connect the data lines.

When probing signals with rise and fall times of ≤ 1 ns, grounding each probe lead with the 2-inch ground lead is recommended. In addition, always use the probe ground on a clock probe.

Probe ground lead

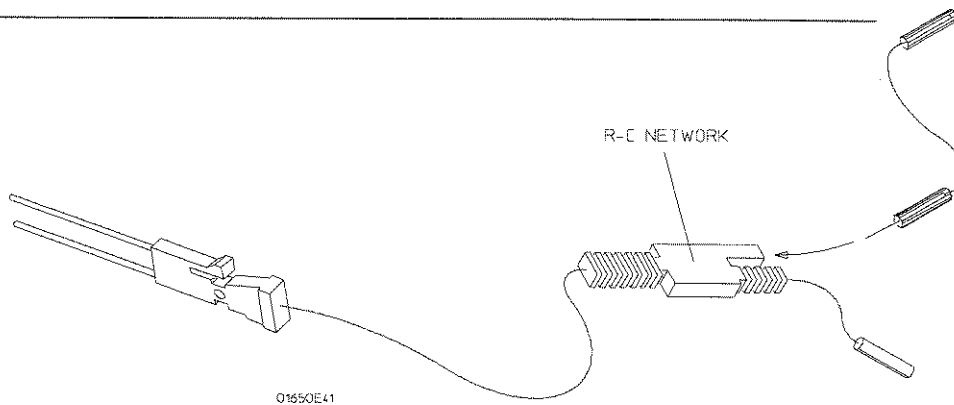

Probe Grounds

Probe Leads

The probe leads consists of a 12-inch twisted pair cable, a ground tap, and one grabber. The probe lead, which connects to the target system, has an integrated RC network with an input impedance of $100\text{ k}\Omega$ in parallel with approximately 8 pF , and all in series with $250\ \Omega$.

The probe lead has a two-pin connector on one end that snaps into the probe housing.

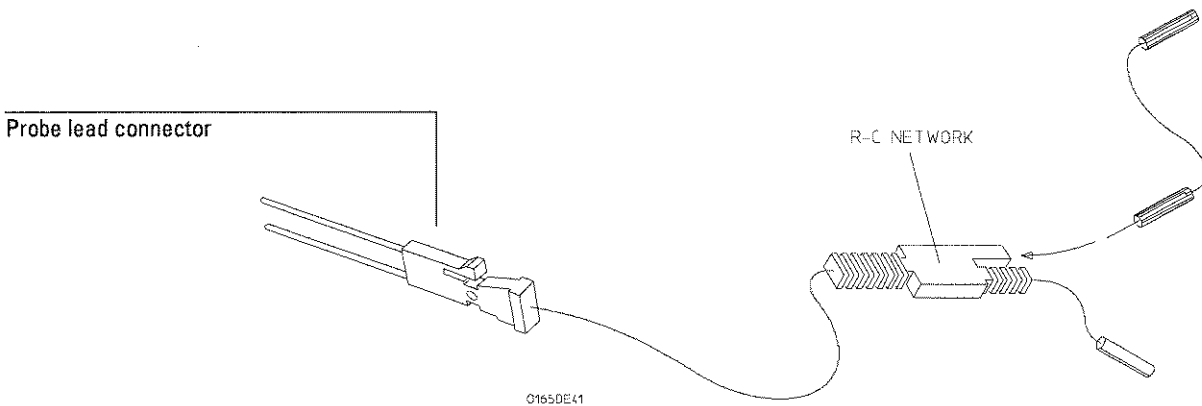

Probe Lead

Grabbers

The grabbers have a small hook that fits around the IC pins and component leads. The grabbers have been designed to fit on adjacent IC pins on either through-hole or surface-mount components with lead spacing greater than or equal to 0.050 in.

Probing
General-Purpose Probing System Description

Probe Cable

The probe cable contains 18 signal lines, 17 chassis ground lines, and two power lines for preprocessor use. The cables are woven together into a flat ribbon that is 4.5 feet long. The probe cable connects the logic analyzer to the pods, termination adapter, HP 10269C General-Purpose Probe Interface, or preprocessor. Each cable is capable of carrying 0.33 amps for preprocessor power.

CAUTION

DO NOT exceed this 0.33 amps per cable or the cable will be damaged.

WARNING

Preprocessor power is protected by a current limiting circuit. If the current limiting circuit is activated, the fault condition must be removed. After the fault condition is removed, the circuit will reset in one minute.

Minimum Signal Amplitude

Any signal line you intend to probe with the logic analyzer probes must supply a minimum voltage swing of 500 mV to the probe tip. If you measure signal lines with a voltage swing of less than 500 mV, you may not obtain a reliable measurement.

Maximum Probe Input Voltage

The maximum input voltage of each logic analyzer probe is 40 volts peak.

Pod Thresholds

Logic analyzer pods have two preset thresholds and a user-definable threshold. The two preset thresholds are ECL (- 1.3 V) and TTL (+1.5 V). The user-definable threshold can be set anywhere between - 6.0 volts and +6.0 volts in 0.05-volt increments.

All pod thresholds are set independently.

Assembling the Probing System

The general-purpose probing system components are assembled as shown below to make a connection between the measured signal line and the pods displayed in the Format menu.

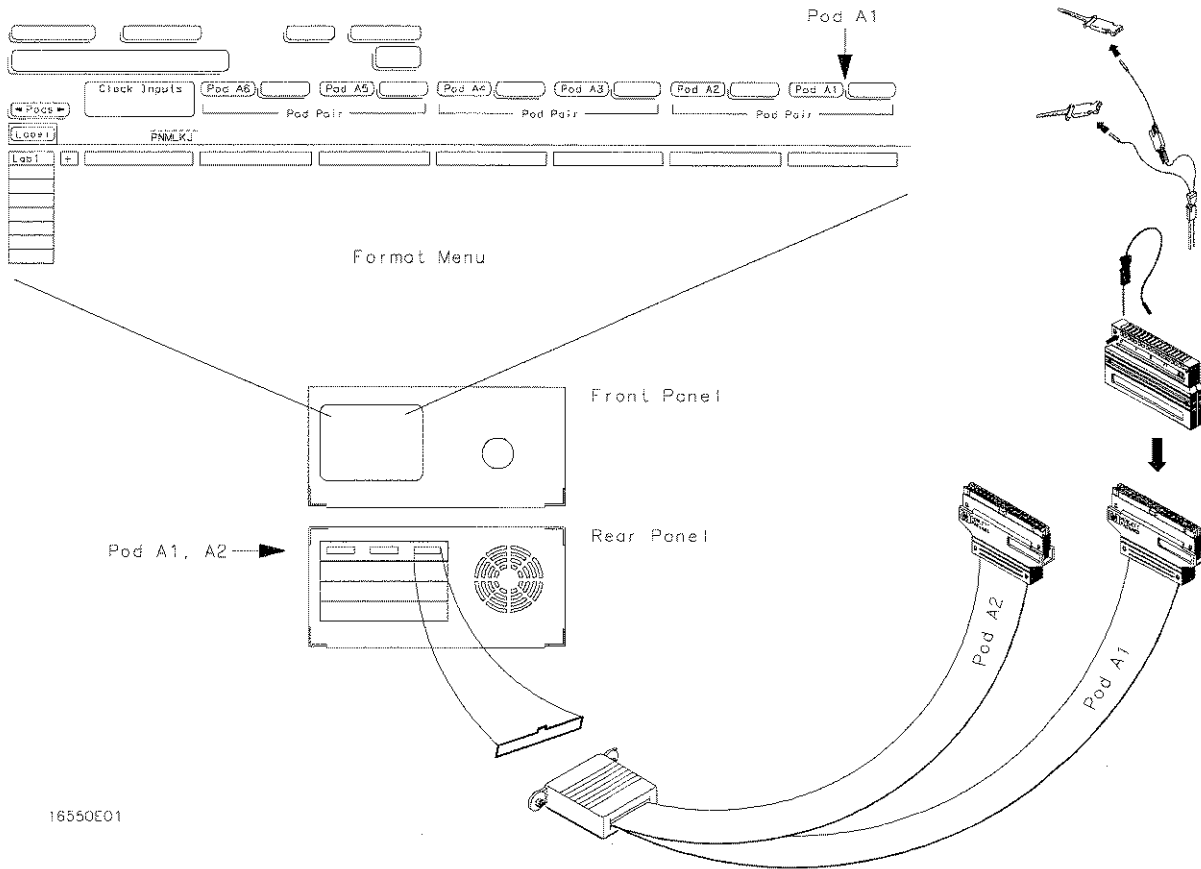

16550E01

Connecting Probe Cables to the Logic Analyzer

Probing
Assembling the Probing System

Connecting Probe Cables to the Logic Analyzer

All probe cables are installed at Hewlett-Packard. If you need to replace a probe cable, refer to the Service Guide that is supplied with the logic analyzer.

Connecting the Probe Tip Assembly to the Probe Cable

To connect a probe tip assembly to a cable, align the key on the cable connector with the slot on the probe housing and press them together.

Probe tip assembly

Probe cable

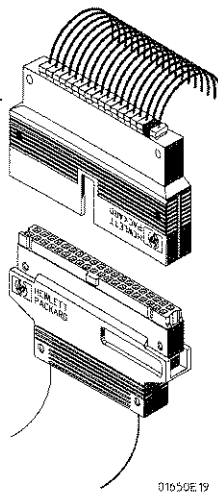

Connecting Probe Tip Assembly

Disconnecting Probe Leads from Probe Tip Assemblies

When you receive the logic analyzer, the probe leads are already installed in the probe tip assemblies. To keep unused probe leads out of your way during a measurement, you can disconnect them from the pod.

To disconnect a probe, insert the tip of a ball-point pen into the latch opening. Push on the latch while gently pulling the probe out of the pod connector as shown in the figure below.

To connect the probes into the pods, insert the double pin end of the probe into the probe housing. Both the double pin end of the probe and the probe housing are keyed so they will fit together only one way.

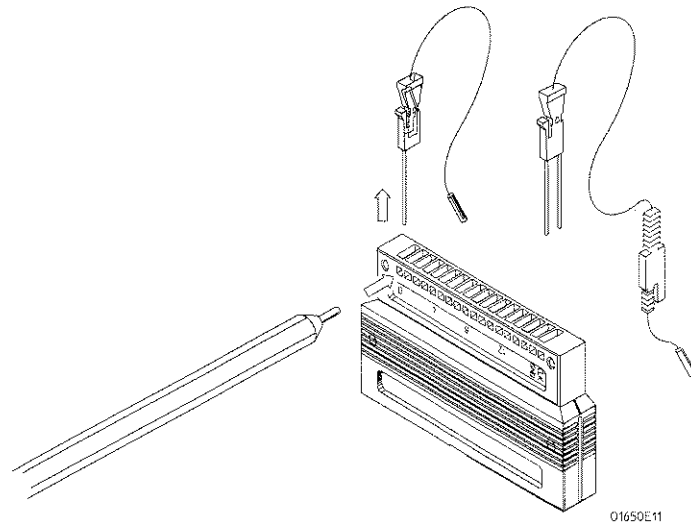

Installing Probe Leads

Probing Assembling the Probing System

Connecting the Grabbers to the Probes

Connect the grabbers to the probe leads by slipping the connector at the end of the probe onto the recessed pin located in the side of the grabber. If you need to use grabbers for either the pod or the probe grounds, connect the grabbers to the ground leads in the same manner.

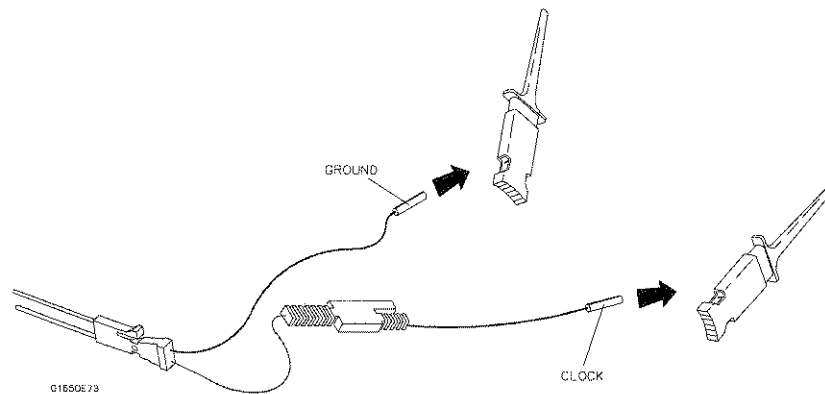

Connecting Grabbers to Probes

Connecting the Grabbers to the Test Points

The grabbers have a hook that fits around the IC pins and component leads. Connect the grabber to the test point by pushing the rear of the grabber to expose the hook. Hook the lead and release your thumb as shown.

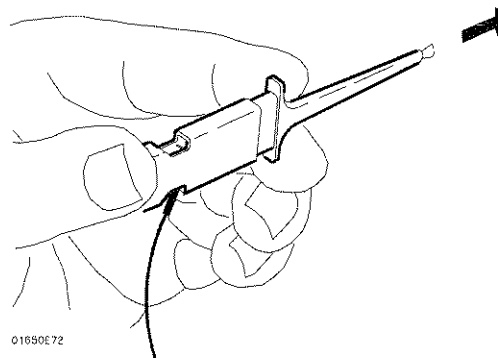

Connecting Grabbers to Test Points



The Configuration Menu

The Configuration Menu

The Configuration menu allows you to set module level parameters. You can partition the module into one or two independent analyzers. You can also assign pods to either analyzer, select the type of clocking needed (state or timing), and provide names for each analyzer.

The fields on this menu are:

- Analyzer Name Field
- Analyzer Type Field
- Unassigned Pods List
- Activity Indicators

The screenshot shows a configuration menu with the following elements:

- Buttons: "IN Sample LA C", "Configuration", "Print", and "Run".
- Analyzer 1**: Name: MACHINE 1, Type: Timing.
- Analyzer 2**: Name: MACHINE 2, Type: State.
- Unassigned Pods**: A list of pods with their respective clocking indicators:
 - C1: ... J
 - C2: ... K
 - B1: ... J
 - B2: ... K
 - B3: ... L
 - B4: ... M
 - C3: ... L
 - C4: ... M

Config menu with partition, pods, names

Configuration Menu Map

The following menu map illustrates all fields and the available options in the Configuration menu. The menu map will help you get an overview as well as provide you with a quick reference of what the Configuration menu contains.

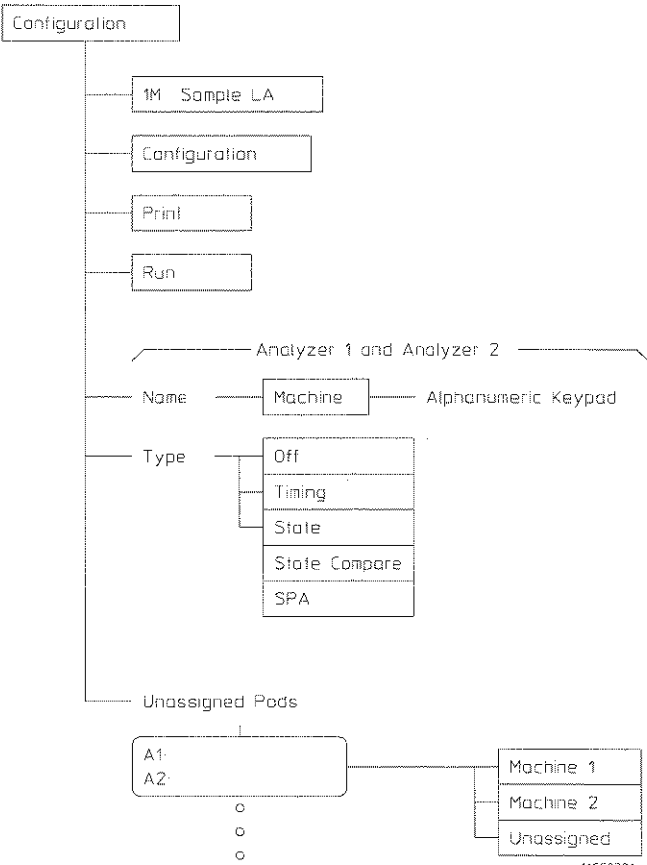

The number of pods in this list depends on the analyzer configuration.

Configuration Menu Map

The Configuration Menu Analyzer Name Field

Analyzer Name Field

The Name field lets you assign a specific name to the analyzer machine. Use the pop-up alphanumeric keypad to enter the name. When you have stored several configurations to disk and later reload them, having assigned a specific name to an analyzer can help identify the measurement setup.

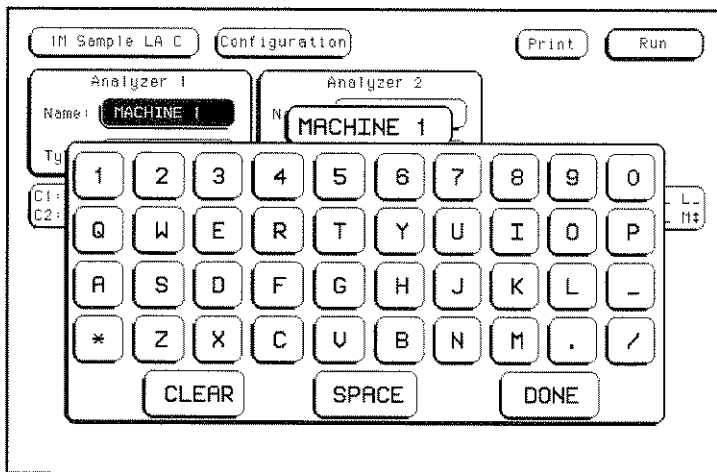

Name Field

Analyzer Type Field

The Type field allows you to configure each analyzer as either a state or timing analyzer. When the Type field is selected, the following choices are available.

- Timing
- State

Timing

When you select Timing, the analyzer uses its own internal clock to clock measurement data into the acquisition memory. This clock is asynchronous to the signals in the target system. When this option is selected, some fields specific to external clocks will not appear in the analyzer menus. You can configure the machine with only one timing analyzer. If you try to select both analyzers as timing analyzers, the first will be turned off.

State

When you select State, the data analyzer uses a clock from the system under test to clock measurement data into acquisition memory. This clock is synchronous with the signals in the target system. You can configure both analyzers as state analyzers.

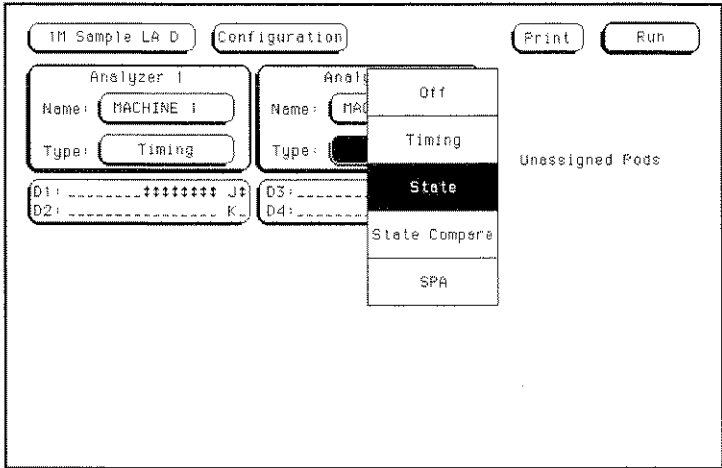

Type Field

The Configuration Menu
Unassigned Pods List

Unassigned Pods List

The list of Unassigned Pods in the Configuration menu shows the available pods for the module configuration. Pod grouping and assignment is by pod pairs. When you want to assign a pod pair to an analyzer, touch the pod field. From the assignment menu, select a destination for the pod pair. Use the same procedure to reassign pod pairs that have previously been assigned to an analyzer.

Because you may have a system with up to five analyzer cards, it is possible to assign more pod pairs to an analyzer than will fit on the display. When that happens, a pod scrolling box appears above the Unassigned Pods list. To view pod pairs assigned to an analyzer that are not visible, touch the pod scrolling box to turn it light blue and use the knob to scroll through the list

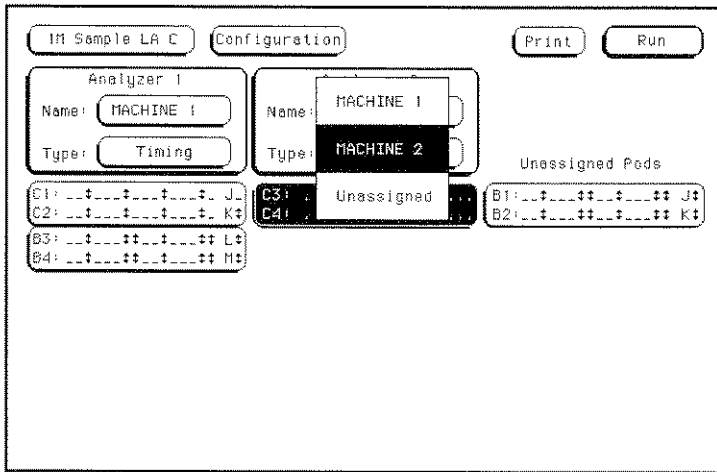

Unassigned Pods Display

The Configuration Menu
Unassigned Pods List

When both analyzers are turned on, some combinations of pod pairs cannot be assigned to the same analyzer. If you do assign them to the same analyzer, you'll get an error message when you try to exit the configuration menu. The error message gives an explanation of the problem and provides selection fields with options for reassigning one of the pod pairs.

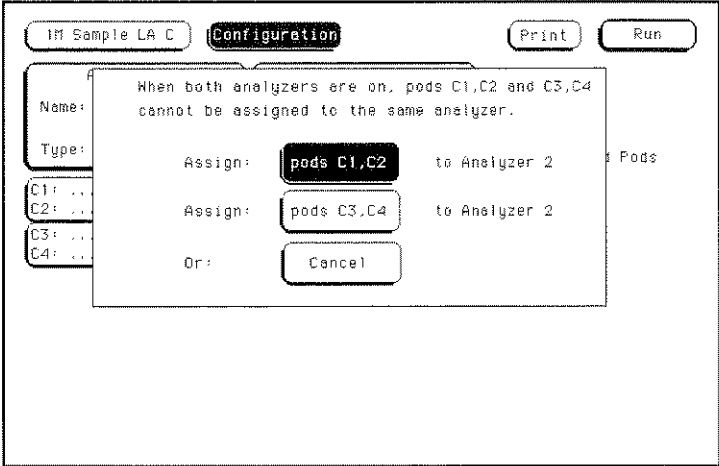

Pod Configuration Help Menu

The Configuration Menu

Activity Indicators

Activity Indicators

Within each pod pair you'll notice activity indicators for each bit of each pod. These indicators appear in two places. One is in the pod pair displays of this Configuration menu. The other place is in the bit reference line in the Format menu just above the pod bit numbers.

When the logic analyzer is properly connected to an active target system, you'll see either a high-level dash, a low-level dash, or a transitional arrow in the Activity Indicator displays for each pod pair. These indicators are very useful in showing proper probe connections and that the logic levels are as expected.

See Also

The "Bit Assignment Fields" in chapter 4, "The Format Menu," for more information on the activity indicators.

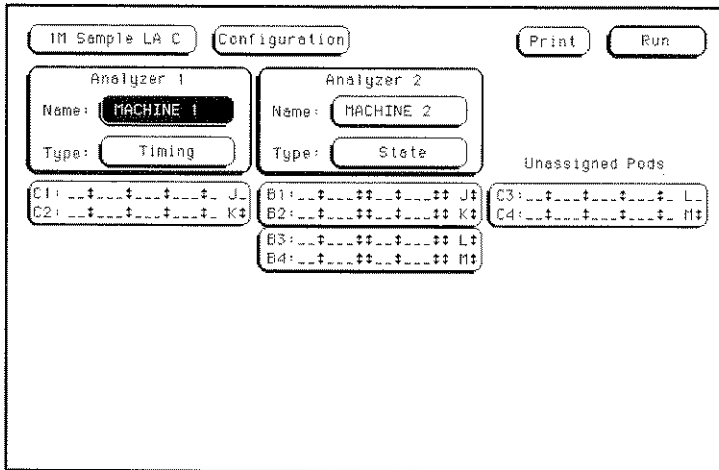

Activity Indicators



The Format Menu



The Format Menu

Use the Format menu to select which data channels are measured and to set up the clocking arrangement to capture valid data. It allows you to group and label the data channels from the system under test to fit your particular measurement. In addition, for your convenience in recognizing bit groupings, you can specify symbols to represent them. If the analyzer is configured as a state analyzer, there are master and slave clocks, clock qualifiers, and a variable clock setup and hold to further qualify what data is captured. In addition, you can set individual pod clock threshold levels. The Format menu contains the following fields:

- State Acquisition Mode Field
- Timing Acquisition Mode Field
- Clock Inputs Display Field
- Pod Field Pod Clock Field
- Master and Slave Clock Field (State only)
- Setup/Hold Field (State only)
- Symbols Field
- Label Assignment Field
- Rolling Labels and Pods Field
- Label Polarity Fields
- Bit Assignment Fields

Format Menu Map

The following menu map graphically illustrates all fields in the Format menu. Use the menu map as an overview and as a quick reference to the available options in the Format menu.

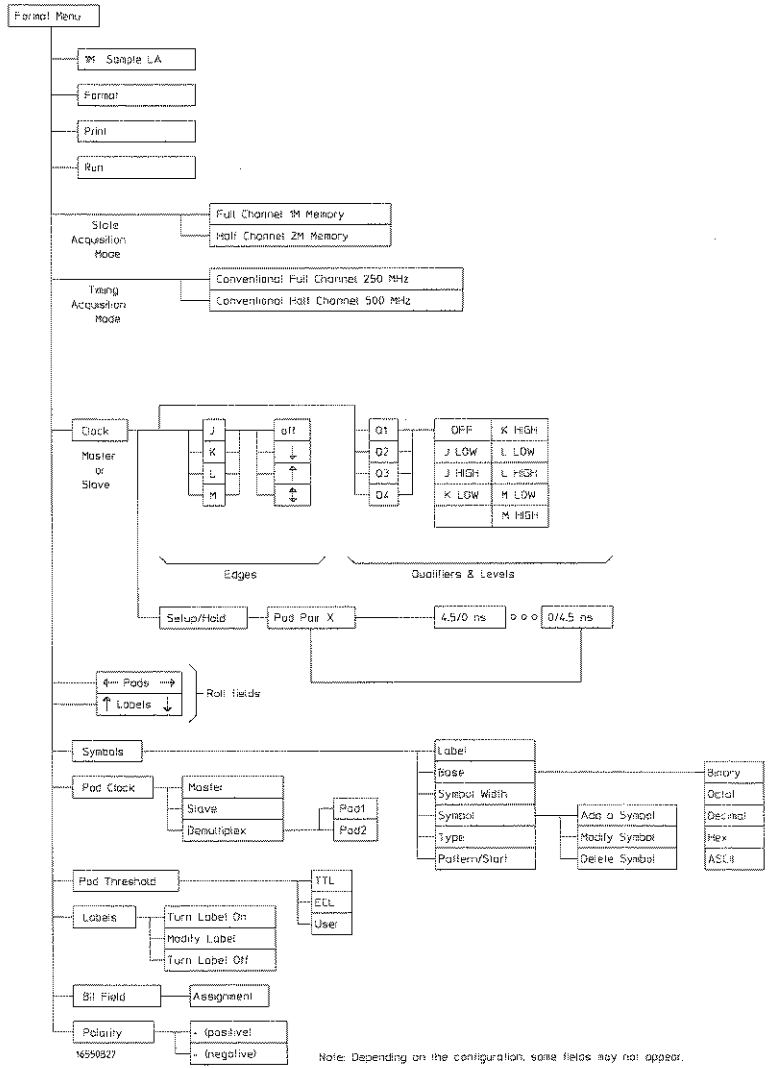

The State Format Menu Map

The Format Menu
State Acquisition Mode Field (State only)

State Acquisition Mode Field (State only)

The State Acquisition Mode field identifies the channel width and memory depth of the selected acquisition mode.

70 MHz/500 K State (HP 16554A)

The State Acquisition Mode uses both pods in a pod pair for 34 channels of width (16 data bits and one clock bit in each pod, and a total memory depth of 500 K per channel). If time or state tags are turned on, the total memory could be split between data acquisition storage and time or state tag storage. To maintain the full 500 K per channel depth, leave one pod pair unassigned. State clock speed is 70 MHz.

100 MHz/1 M State (HP 16555A)

The State Acquisition Mode uses both pods in a pod pair for 34 channels of width (16 data bits and one clock bit in each pod, and a total memory depth of 1M per channel). If time or state tags are turned on, the total memory could be split between data acquisition storage and time or state tag storage. To maintain the full 1M per channel depth, leave one pod pair unassigned. State clock speed is 100 MHz.

Pod field

State acquisition mode field

The screenshot shows a control panel for the State Acquisition Mode. At the top, there are buttons for '1M Sample LA C', 'Format 2', 'Print', and 'Run'. Below these, the 'State acquisition mode field' is set to '100 MHz/1M State'. To its right is the 'Master Clock (C)' field, set to 'L+'. A 'Symbols' button is also present. Below the mode field, there are 'Data On Ciks' buttons for 'B' and 'C', and 'Pod B4' and 'Pod B3' buttons, each with a 'TTL' option. A 'Master Clock' button is highlighted. Below these are two rows of status indicators: 'HLKJ' and '15 ... 87 ... 0'. At the bottom, there is a list of labels: 'DATA', 'ADDR', 'Lab3', 'Lab4', 'Lab5', 'Lab6', 'Lab7', and 'Lab8'. Each label has a '+' sign to its left.

State Acquisition Mode Field

Timing Acquisition Mode Field (Timing only)

The Timing Acquisition Mode field displays the acquisition type, the channel width, and sampling speed of the present acquisition mode. Use the Timing Acquisition Mode field to access an acquisition mode selection menu.

Timing Acquisition Mode

The analyzer stores measurement data at each sampling interval.

500K Sample Full Channel 125MHz (HP 16554A)

The total memory depth is 500K, with data being sampled and stored every 4 ns.

1M Sample Half Channel 500MHz (HP 16554A)

The total memory depth is 1M, with data being sampled and stored every 2 ns. @HEAD3 = 1M Sample Full Channel 250MHz (HP 16555A)

The total memory depth is 1M, with data being sampled and stored every 4 ns.

2M Sample Half Channel 500MHz (HP 16555A)

The total memory depth is 2M, with data being sampled and stored every 2 ns.

Timing acquisition mode field

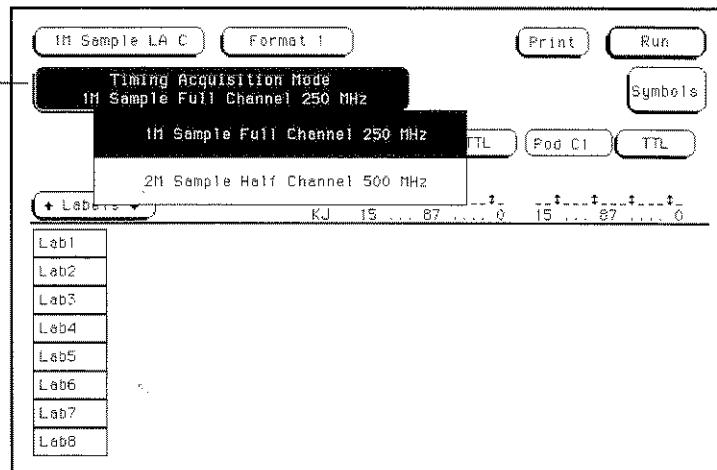

Timing Acquisition Mode Field

Data on Clocks Display

This display shows the clock input channels available for the present configuration. There are four clock input channels (J, K, L, and M) for each card of a module, one for each pod. This display shows only the clock input channels for those pods that are assigned in the present configuration.

A single-card module has four clock input channels, each of which may be used as a state clock (when the machine is configured for state mode) or as a data channel (in either state or timing modes). In a multicard module, only the four clock input channels connected to the Clock Master card of the module are available for use as state clocks, but all of the clock input channels of the module (there are four for each card in the module) may be used as data channels. A clock input channel, when used as a data channel, is treated as an ordinary data channel, except it cannot be included in a Range resource.

In the display panel, the clock input channels of the Clock Master card are grouped on the right, underneath the slot letter of the Clock Master card, with the clock input channels of the other cards displayed to the left of those of the Clock master card. If any clock input channel is used as a data channel, that bit must be assigned. Activity indicators above the clock identifier show signal activity on that clock input channel.

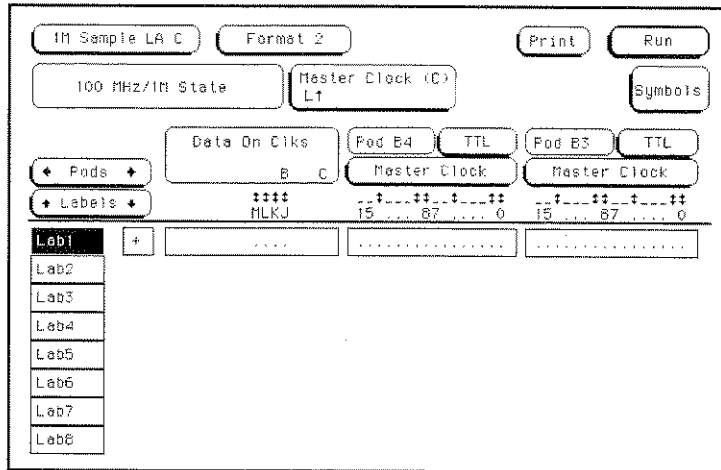

Data on Clks Display

Pod Field

The Pod field identifies which pod of a pod pair is affected by the settings of the bit assignment field, pod threshold field, and pod clock fields. In the full channel modes, this field is simply an identifier and is not selectable. However, in the half channel mode, the Pod field turns dark which means it is selectable. In the half channel mode, one pod of a pod pair is selectable and all pod settings affect the selected pod.

The screenshot shows a control interface for the Pod Field. At the top, there are buttons for 'IM Sample LA C', 'Format 2', 'Print', and 'Run'. Below these are '100 MHz/IM State' and 'Master Clock (C) Lt'. A 'Symbols' button is on the right. The middle section contains 'Data On Clks' with 'B' and 'C' options, and two 'Pod' buttons (Pod B4 and Pod B3) each with a 'TTL' button and a 'Master Clock' button. Below this is a 'Labels' section with a grid of labels and values. At the bottom is a list of pods from Lab1 to Lab8, with Lab1 highlighted.

Labels	****	..****..****	..****..****
MLKJ	15 ... 87 ... 0	15 ... 87 ... 0	
Lab1	+
Lab2			
Lab3			
Lab4			
Lab5			
Lab6			
Lab7			
Lab8			

Pod Field

The Format Menu
Pod Clock Field (State only)

Pod Clock Field (State only)

There is one Pod Clock field for each pod in the machine, and it is used to indicate whether that pod's data lines are to be strobed into memory by the Master clock, Slave clock, or both, in the Demultiplex mode of operation. When the Pod Clock field is selected, a clock menu appears with the following choices:

- Master
- Slave
- Demultiplex

The Master and Slave clock events are specified in the Master and Slave clock fields. These clock functions are available only in a state analyzer.

Master

This option specifies that data on all pods designated "Master Clock," in the same analyzer, are strobed into memory when the status of the clock lines matches the clocking arrangement specified under the Master Clock.

See Also

The "Master and Slave Clock Field" later in this chapter for information about configuring a clocking arrangement.

The Format Menu
Pod Clock Field (State only)

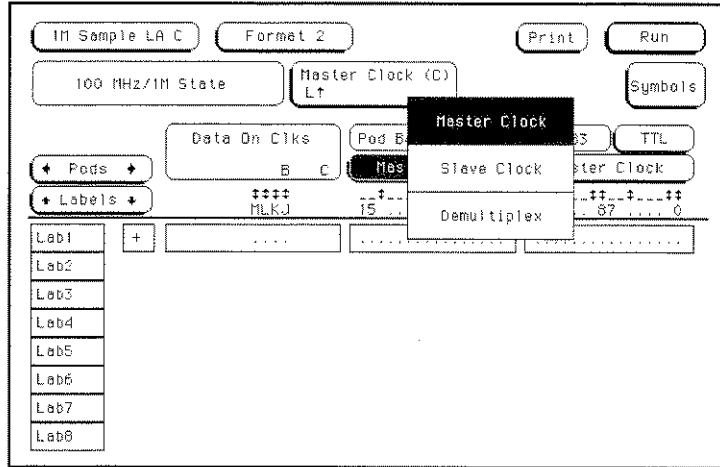

Pod Clock Field

Slave

This option specifies that data on a pod designated "Slave Clock" is latched when the status of the state clock inputs meets the requirements of the slave clocking arrangement. Then, followed by a match of the master clock and the master clock arrangement, the slave data is strobed into analyzer memory along with the master data. If multiple slave clocks occur between master clocks, only the data latched by the last slave clock prior to the master clock is strobed into analyzer memory.

The Format Menu
Pod Clock Field (State only)

Demultiplex

The Demultiplex mode is used to store two different sets of data that occur at different times on the same channels. In Demultiplex mode, only one pod of the pod pair is used, and that pod is selectable. Both the master and slave clocks are used in the Demultiplex mode. Channel assignments are displayed as Demux Master and Demux Slave. For easy recognition of the two sets of data, assign slave and master data to separate labels.

The screenshot shows a control panel for the Demultiplex mode. At the top, there are buttons for '1M Sample LA C', 'Format 2', 'Print', and 'Run'. Below these are fields for '100 MHz/1M State', 'Master Clock (C) Lt', 'Slave Clock (C) Lt', and 'Symbols'. A 'Pods' dropdown menu is set to 'B C'. The 'Data On Clks' section includes 'Pod B4', 'TTL', and another 'Pod B4' dropdown. Below this are 'Demux Master' and 'Demux Slave' labels. A 'Labels' dropdown menu is set to 'M KJ'. The main data capture area has a table with columns for 'DATA', 'ADDR', and two data streams. The 'DATA' and 'ADDR' rows have '+' signs in the second column. The data streams are labeled '15 ... B7 ... 0' and '15 ... B7 ... 0'. On the left side, there is a vertical list of labels: Lab3, Lab4, Lab5, Lab6, Lab7, and Lab8.

Demultiplex Clocking Mode

The Format Menu
Pod Clock Field (State only)

When the analyzer sees a match between the state clock inputs and the slave clock specification, Demux Slave data is latched. Then, followed by a match of the state clocks and the master clock specification, the slave data is strobed into analyzer memory along with the master data. If multiple slave clocks occur between master clocks, only the data latched by the last slave clock prior to the master clock is strobed into analyzer memory.

The Format Menu
Pod Threshold Field

Pod Threshold Field

Use the Pod Threshold field to set a voltage level the data must reach before the analyzer recognizes and displays it as a change in logic levels. You specify a threshold level for each pod. The level specified for each pod is also assigned to the pod's clock threshold. When the Pod Threshold field is touched, a threshold selection pop-up appears with the following choices:

TTL

When TTL is selected as the threshold level, the data signals must reach +1.5 volts.

ECL

When ECL is selected as the threshold level, the data signals must reach -1.3 volts.

USER

When USER is selected as the threshold level, the data signals must reach a user selectable value between -6.0 volts to +6.0 volts.

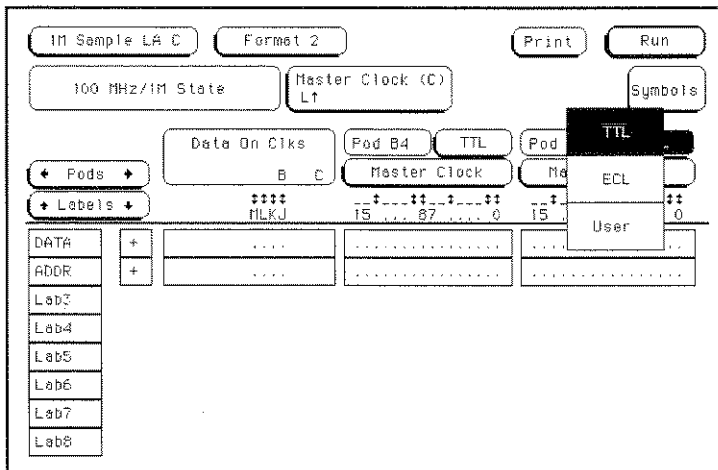

Pod Threshold Field

Master and Slave Clock Field (State only)

The Master and Slave Clock fields are used to construct a clocking arrangement. A clocking arrangement is the assignment of appropriate clocks, clock edges, and clock qualifier levels which allow the analyzer to synchronize itself on valid data.

When the Master or Slave Clock field is selected, a clock/qualifier selection menu appears showing the available clocks and qualifiers for a clocking arrangement. There are four clocks available (J, K, L, M), and four clock qualifiers available (Q1 through Q4).

A single-card module has four clock inputs (one for each pod), and any of these four clocks may be used as state clocks for specifying Master and Slave clocking arrangements. For a multiboard module, only the four clocks of the Clock Master board are available for use as state clocks. Any unassigned clocks may be used as data channels.

See Also

The "Pod Clock Field" earlier in this chapter for information on selecting clocking arrangement types such as Master, Slave, or Demultiplex.
 "Installing HP 16555A Cards in a Mainframe" in chapter 13, "Installation."

1M Sample LA C Format 2 Print Run

100 MHz/1M State Master Clock (C) Lt Slave Clock (C) Lt Symbols

Data On Clks Pod B4 TTL Pod B3 TTL

← Pods → B C Master Clock Slave Clock

Labels HLKJ 15 ... 87 ... 0 15 ... 87 ... 0

DATA	+
ADDR	+
Lob3				
Lob4				
Lob5				
Lob6				
Lob7				
Lob8				

Master Clock Field

The Format Menu
Master and Slave Clock Field (State only)

All combinations of the J and K clock and Q1 and Q2 qualifiers are ORed to the clock combinations of the L and M clocks and Q3 and Q4 qualifiers. Clock edges are ORed to clock edges, clock qualifier are ANDED to clock edges, and clock qualifiers can be either ANDED or ORed together. The clock threshold level is the same as the level assigned in the Pod Threshold field.

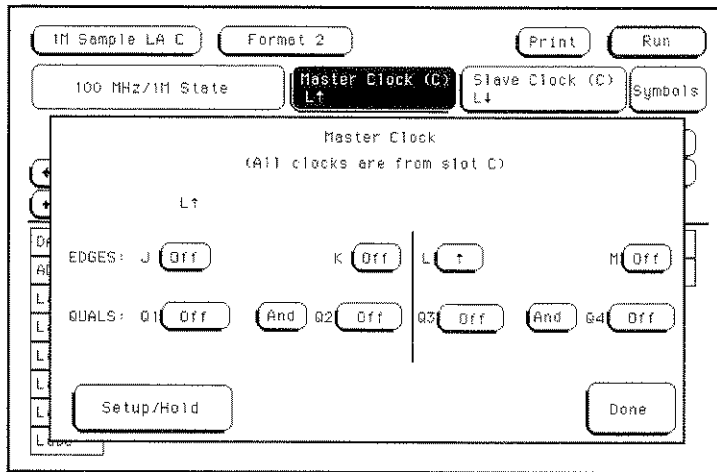

Clock Edges and Levels

Setup/Hold Field (State only)

Setup/Hold adjusts the relative position (in time) of the clock edge with respect to the time period that data is valid. When the Setup/Hold field is selected, a configuration menu appears. Use this Setup/Hold configuration menu to select each pod in the analyzer and assign a Setup/Hold selection from the selection list.

With a single clock edge assigned, the choices range from 3.5 ns Setup/0.0 ns Hold to 0.0 ns Setup/3.5 ns Hold. With both edges of a single clock assigned, the choices are from 4.0 ns Setup/0.0 ns Hold to 0.0 ns Setup/4.0 ns Hold. If the analyzer has multiple clock edges assigned, the choices range from 4.5 ns Setup/0.0 ns Hold to 0.0 ns Setup/4.5 ns Hold.

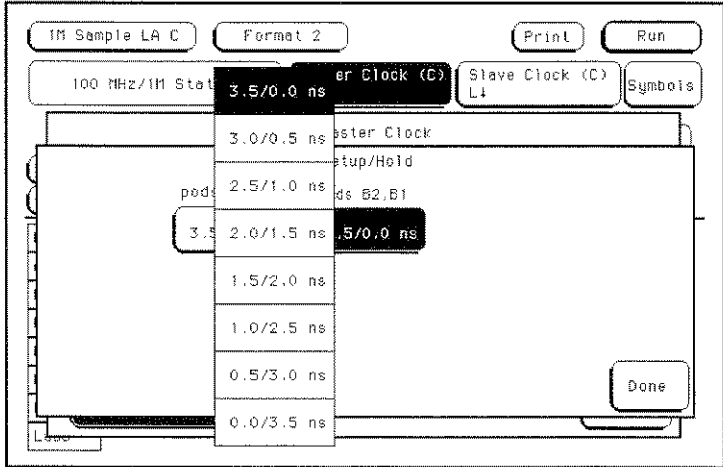

Setup and Hold Menu

The Format Menu
Setup/Hold Field (State only)

The relationship of the clock signal and valid data under the default setup and hold is shown.

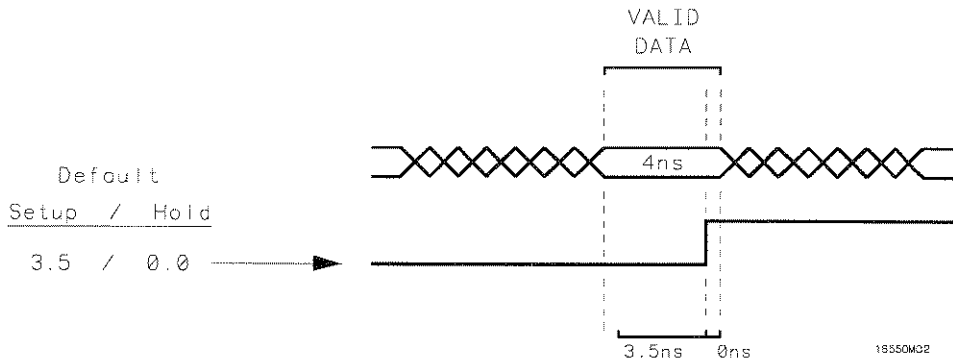

Default Setup and Hold

If the relationship of the clock signal and valid data is such that the data is valid for 1 ns before the clock occurs and 3 ns after the clock occurs, you will want to use the 1.0 setup and 2.5 hold setting.

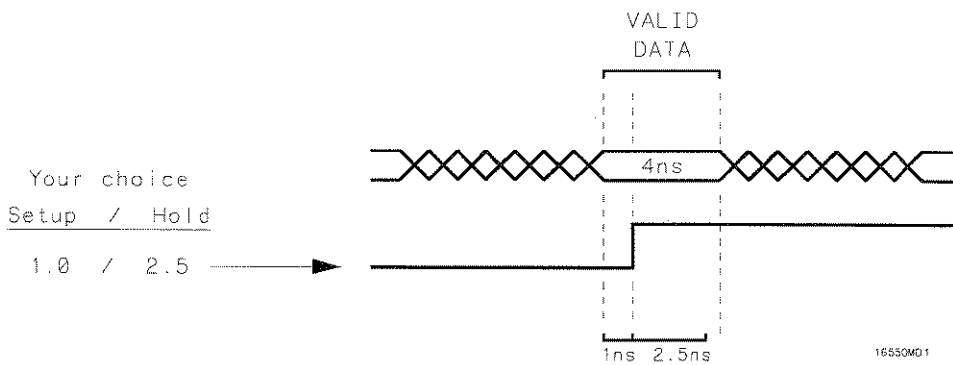

Clock Position in Valid Data

Symbols Field

See Also

Symbols Assignment in "Common Module Operations" in the *HP 16500B User's Reference* for complete information on using symbols.

Label Assignment Fields

See Also

Labels Assignment in "Common Module Operations" in the *HP 16500B User's Reference* for complete information on using labels.

Rolling Labels and Pods

The rolling function is the same for all items that are stored off screen.

See Also

Labels Assignment in "Common Module Operations" in the *HP 16500B User's Reference* for complete information about rolling labels and pods.

The Format Menu Label Polarity Fields

Label Polarity Fields

Use the Label Polarity fields to assign a polarity to each label. The default polarity for all labels is positive (+). Change the label polarity by touching the polarity field, which toggles between positive (+) and negative (-) polarity.

When the polarity is inverted, all data, as well as bit pattern specific configurations used for identifying, triggering, or storing data, reflect the change of polarity. In a timing analyzer with the data inverted, the waveform display does not change.

The screenshot shows a software interface for configuring a timing analyzer. At the top, there are buttons for '1M Sample LA C', 'Format 2', 'Print', and 'Run'. Below these are fields for '100 MHz/1M State', 'Master Clock (C) L1', 'Slave Clock (C) L1', and 'Symbols'. A section labeled 'Data On Clks' contains 'Pod B4 TTL', 'Pod B3 TTL', 'Master Clock', and 'Slave Clock'. A 'Labels' section lists 'DATA', 'ADDR', 'Lab3', 'Lab4', 'Lab5', 'Lab6', 'Lab7', and 'Lab8'. Each label has a polarity field, currently set to '+'. A line from the text 'Polarity field' points to the '+' sign for 'Lab3'.

Label	Polarity	Bit Pattern
DATA	+
ADDR	+
Lab3	+
Lab4	+
Lab5	+
Lab6	+
Lab7	+
Lab8	+

Polarity field

Polarity Field

Bit Assignment Fields

The bit assignment fields are used to assign bits (channels) to labels. The convention for bit assignment is as follows:

- * (asterisk) indicates an assigned bit.
- . (period) indicates an unassigned bit.

To change a bit assignment, select the bit assignment field and, using the knob, move the cursor to the bit you want to change, then select an asterisk or a period. When the bits are assigned as desired and you close the pop-up, the screen displays the new bit assignment.

See Also

"Activity Indicators" in chapter 3, "The Configuration Menu," for more information on the bit reference line and the activity indicators on the bit reference line.

Bit assignment field

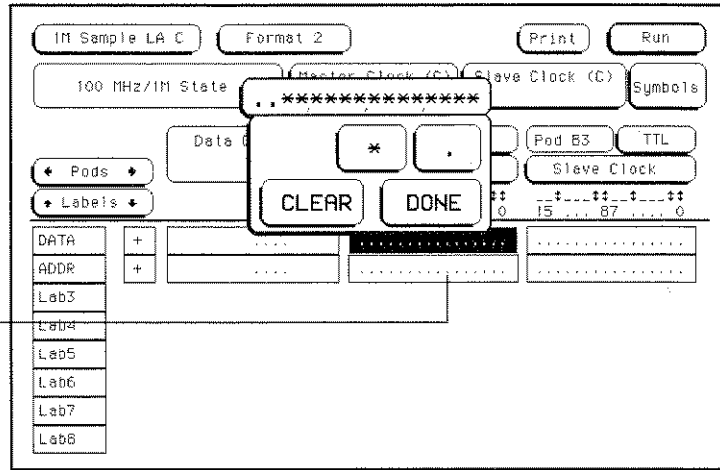

Bit Assignment Field

The Format Menu
Bit Assignment Fields

Labels may have from 1 to 32 channels assigned to them. If you try to assign more than 32 channels to a label, the logic analyzer will beep and a message will appear at the top of the screen telling you that 32 channels per label is the maximum. Channels assigned to a label are numbered from right to left, with the least significant bit on the far right, numbered 0.

Although labels can contain split fields, assigned channels are always numbered consecutively within a label.

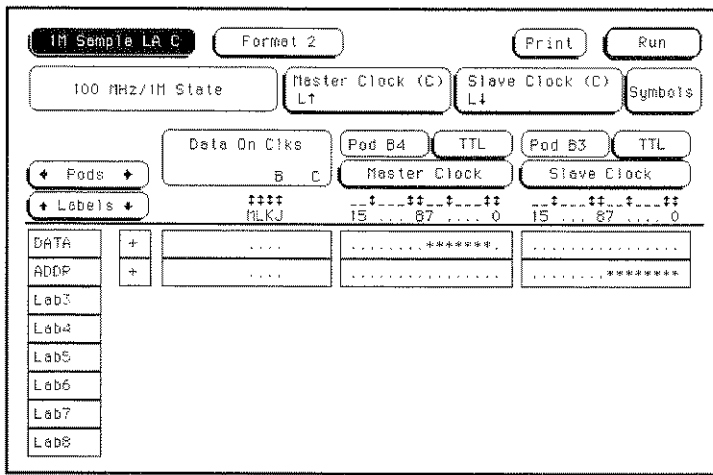

Bit Assignment Example



The Trigger Menu

The Trigger Menu

The Trigger menu is used to specify when the analyzer triggers and what the analyzer stores in acquisition memory. The Trigger menu can be viewed as having four functionally different sections:

- Automatic Sequence Levels, located in the large light blue center box
- Manual Sequence Levels, also located in the large light blue center box Control
- Resource Terms, located at the bottom of the menu
- Control Fields, located at the right side of the display

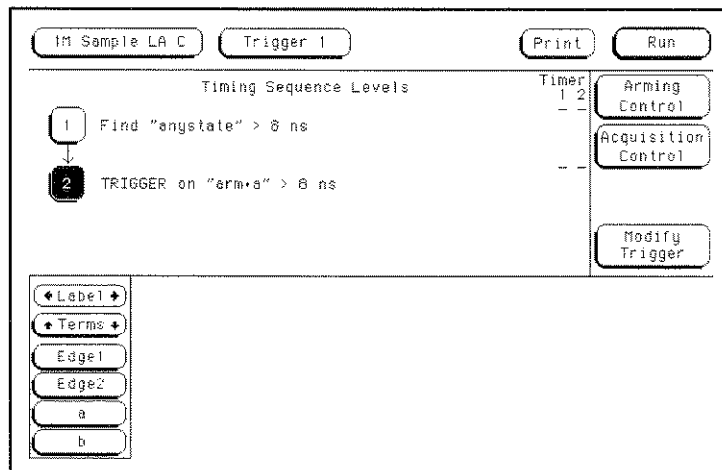

The Trigger Menu

Trigger Menu Map

The following menu map illustrates all fields and available options in the Trigger menu. The menu map will help you get an overview as well as provide you with a quick reference as to what each menu contains.

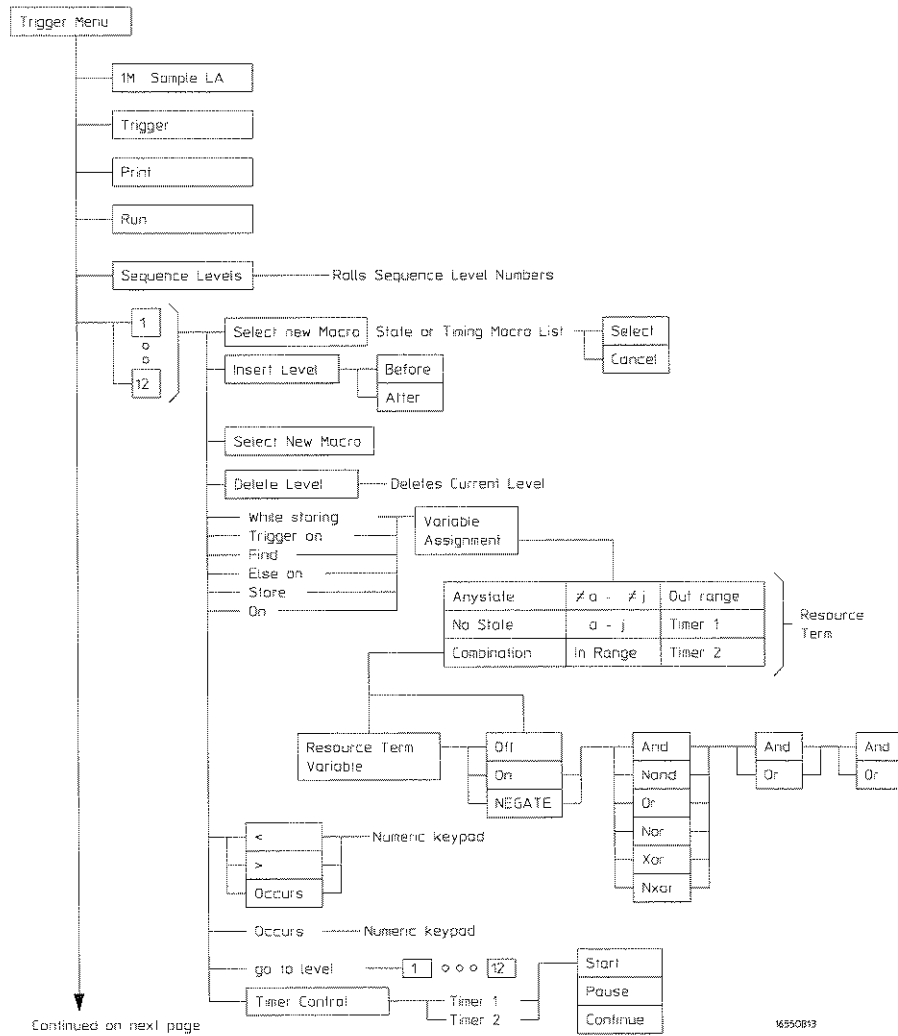

Continued on next page

16550613

Trigger Menu Map

The Trigger Menu

Continued from previous page

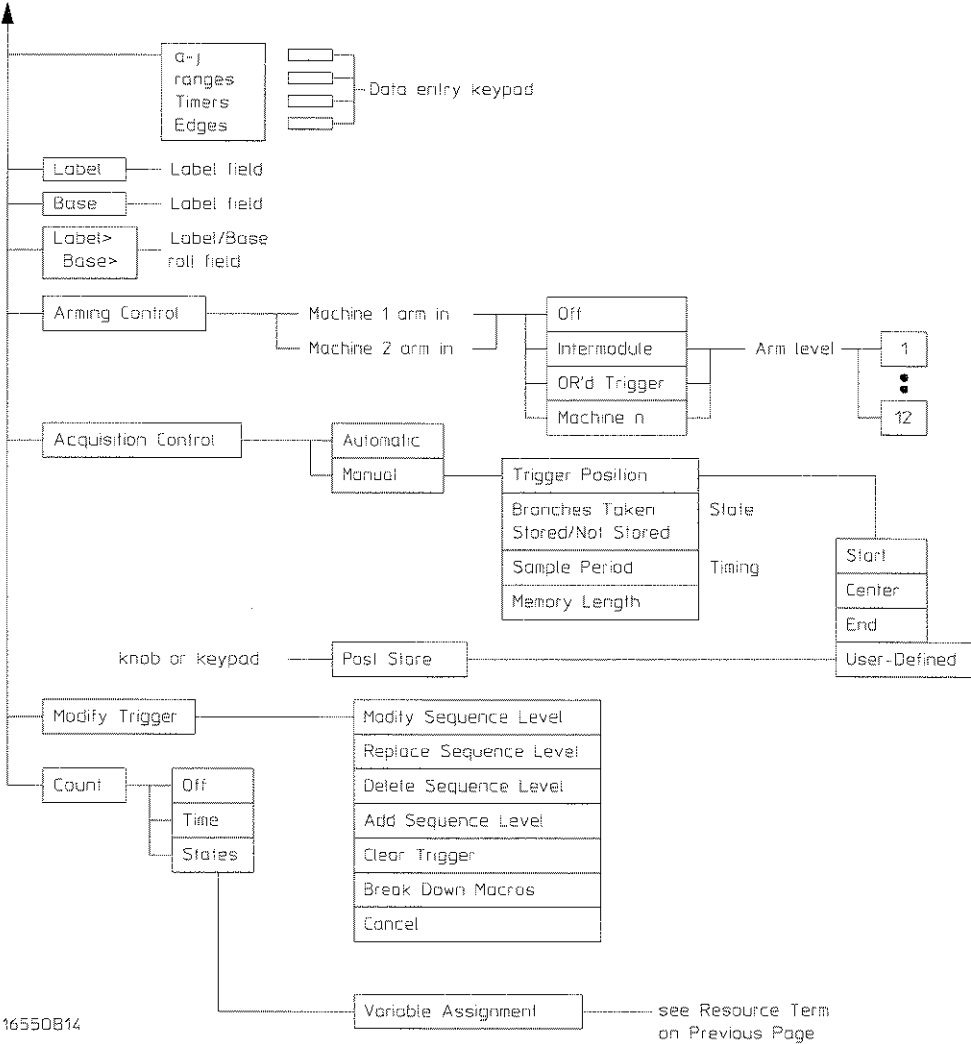

16550814

Trigger Menu Map (cont.)

Predefined Trigger Macros

The state and timing acquisition modes each have a macro library containing predefined trigger macros. Each macro will require at least one sequence level, and in some cases, several levels. Macros can be branched to by combining a user-defined level with a macro level. To use these predefined trigger macros, see "Using Macros to Create a Trigger Specification" on the next page. The macro libraries are as follows:

Timing Trigger Macro Library:

- User Mode (user-defined macro)
- Basic Macros
- Pattern/Edge Combination Macros
- Time Violation Macros
- Delay Macros

State Trigger Macro Library:

- User Mode (user-defined macro)
- Basic Macros
- Sequence Dependent Macros
- Time Violation Macros
- Delay Macros

The Trigger Menu

Using Macros to Create a Trigger Specification

1. From the Trigger menu, enter the desired sequence level by selecting the Modify Trigger field or by selecting a sequence level number.

See Also "Editing Sequence Level" and "Modify Trigger Field" for information on accessing levels.

2. From within the sequence level, select the Select New Macro field

3. Scroll to highlight the macro you want, then select the Done field.

4. Select the appropriate assignment fields and insert the desired predefined resource terms, numeric values, and other parameter fields required by the macro. Select the Done field.

See Also "Resource Terms" for information on using predefined resource terms.

Timing Trigger Macro Library

The following list contains the macros in the Timing Trigger Macro Library. They are listed in the order in which they appear on the screen.

User Mode

User level - custom combinations, branching

The User level lets you manually design a sequence level. It uses one internal sequence level.

Basic Macros

1. Find anystate n times

This macro becomes true with the nth state it sees. It uses one internal sequence level.

2. Find pattern present/absent for > duration

This macro becomes true when it finds a pattern you have designated that has been present or absent for greater than or equal to the set duration. It uses one internal sequence level.

3. Find pattern present/absent for < duration

This macro becomes true when it finds a pattern you have designated that has been present or absent for less than the set duration. It uses one internal sequence level.

4. Find edge

This macro becomes true when the edge you have designated is seen. It uses one internal sequence level.

5. Find nth occurrence of an edge

This macro becomes true when it finds the designated occurrence of an edge you have designated. It uses one internal sequence level. It should be noted that the 500 MHz trigger sequencer may not count edges captured closer than 2 ns apart.

The Trigger Menu
Timing Trigger Macro Library

Pattern/Edge
Combinations

1. Find edge within a valid pattern

This macro becomes true when a selected edge type is seen within the time window defined by a pattern you have designated. It uses one internal sequence level.

2. Find pattern occurring too soon after edge

This macro becomes true when a pattern you have designated is seen occurring within a set duration after a selected edge type is seen. It uses two internal sequence levels.

3. Find pattern occurring too late after edge

This macro becomes true when one edge type you have selected occurs and, for a designated period after that first edge is seen, a pattern is not seen. It uses two internal sequence levels.

Time Violations

1. Find 2 edges too close together

This macro becomes true when a second selected edge is seen occurring within a period you have designated after the occurrence of a first selected edge. It uses two internal sequence levels.

2. Find 2 edges too far apart

This macro becomes true when a second selected edge occurs beyond a period you have designated after the first selected edge. It uses two internal sequence levels.

3. Find width violations on a pattern/pulse

This macro becomes true when the width of a pattern violates minimum and maximum width settings you have designated. It uses one internal sequence level.

Delay

1. Wait t sec

This macro becomes true after a period you have designated has expired. It uses one internal sequence level.

State Trigger Macro Library

The following list contains the macros in the State Trigger Macro Library. They are listed in the order in which they appear on the screen.

User Mode

User Level - custom combinations, loops

The User level lets you manually design a sequence level. It uses one internal sequence level.

Basic Macros

1. Find anystate n times

This macro becomes true with the nth state it sees. It uses one internal sequence level.

2. Find event n times

This macro becomes true when it sees an event you have designated occurring a designated number of times. The events may occur consecutively, but does not have to. It uses one internal sequence level.

3. Find event n consecutive times

This macro becomes true when it sees an event you have designated occurring a designated number of consecutive times. It uses one internal sequence level.

4. Find event2 immediately following event1

This macro becomes true when the first event you have designated is seen immediately followed by a second designated event. It uses two internal sequence levels.

Sequence Dependent Macros

1. Find event2 n times after event1, before event3 occurs

This macro becomes true when it first finds a designated event1, followed by a selected number of occurrences of a designated event2. In addition, if a designated event3 is seen anytime while the sequence is not yet true, the sequence starts over. If event2's nth occurrence is coincident with event3, the sequence starts over. It uses two internal sequence levels.

The Trigger Menu
State Trigger Macro Library

2. Find too few states between event1 and event2

This macro becomes true when a designated event1 is seen, followed by a designated event2, and with less than a selected number of states occurring between the two events. It uses two internal sequence levels.

3. Find too many states between event1 and event2

This macro becomes true when a designated event1 is seen, followed by more than a selected number of states, before a designated event2. It uses two internal sequence levels.

4. Find n-bit serial pattern

This macro becomes true when a specified serial pattern of n bits is found.

Time Violations

1. Find event2 occurring too soon after event1

This macro becomes true when a designated event1 is seen, followed by a designated event2, and with less than a selected period occurring between the two events. It uses two internal sequence levels.

2. Find event2 occurring too late after event1

This macro becomes true when a designated event1 is seen, followed by at least a selected period, before a designated event2 occurs. It uses two internal sequence levels.

Delay

1. Wait n external clock states

This macro becomes true after a number of user clock states you have designated have occurred. It uses one internal sequence level.

Sequence Levels

The Sequence Levels section controls when the analyzer triggers, what the analyzer triggers on, and what data is stored in memory before and after triggering occurs. By using sequence levels, you create a sequence of instructions for the analyzer to follow. The instructions contain user-defined resource terms representing such things as timers, ranges, edges, and bit patterns.

As the resource terms are evaluated and acted upon by the analyzer, all subsequent branching and storing within the sequence flow is directed by your instructions. The path taken resembles a flow chart, and the end result is the storage of only the data you need.

When operating at 100 MHz, state analyzers have 12 sequence levels available and the timing analyzer has 10 sequence levels available. When operating at 110 MHz, state analyzers have 10 sequence levels available and the timing analyzer has 8 sequence levels available.

The Trigger Menu
Sequence Level Number Field

Sequence Level Number Field

The Sequence Level Number field identifies an instruction to be evaluated by the analyzer. In addition, use the number field to access the Sequence Instruction menu, which is used to access the automated trigger macros and to manually construct sequence instructions.

The sequence instruction for each level is displayed in text and located just to the right of the level number. The timer status in each level is also displayed to the right of the instruction text.

Sequence Level Roll Field

Rolls offscreen sequence levels back on screen by using the knob when the Sequence Levels field is light blue. If the field is dark blue, select it, turning it light blue.

Sequence level roll field

Sequence level number field

The screenshot displays a control interface for sequence levels. At the top, there are buttons for 'In Sample LA C', 'Trigger 2', 'Print', and 'Run'. Below these is a dropdown menu for 'State Sequence Levels'. The main area shows three levels of instructions, each with a level number in a box on the left and a timer status on the right. Level 1: 'While storing "no state" TRIGGER on "anystate" occurring 1 time'. Level 2: 'While storing "anystate" Then find "anystate" occurring 1 time'. Level 3: 'While storing "anystate" Then find "no state" occurring 1 time Else on "anystate" go to level 4'. To the right of the instructions are buttons for 'Arming Control', 'Acquisition Control', 'Count Off', and 'Modify Trigger'. At the bottom, there is a 'Label' dropdown and a 'Terms' dropdown, followed by a grid of buttons for 'DATA', 'ADDR', 'Hex', and 'XX'.

Sequence Level Number

Sequence Instruction Menu

When a Sequence Level Number field is selected, a Sequence Instruction menu appears. Use this menu to create instructions for the Sequence Level Number, to insert adjacent sequence levels, select a new macro, or to delete the current level. The instruction you create will read like a sentence, with the assigned resource terms directing how the analyzer qualifies and stores the desired data. This Sequence Instruction Menu contains the following fields to help you set up trigger conditions:

- Insert Level and Delete Level Fields
- Select New Macro field
- Term assignment fields
- Occurrence counter fields
- Branching fields
- Duration counter field (Timing only)
- Timer Control field

Insert Level and Delete Level Fields

The Insert Level field is used to add another sequence level. When this field is selected, depending on the analyzer configuration, you are given choices to add a field before or after the current sequence level. A message appears letting you know when all available sequence levels are inserted. The Delete Level field is used to delete a selected sequence level.

See Also

"Resource Term Fields" later in this chapter for information on assigning a value to the Resource Terms.

Select New Macro Field

The Select New Macro field brings up a list of triggers that have been built with predefined macros. There are separate libraries of predefined triggers for State and Timing acquisition.

See Also

"Predefined Trigger Macros" in this chapter for more information on predefined trigger macros.

The Trigger Menu
Sequence Instruction Menu

Term Assignment Fields

The Term Assignment fields hold user-defined Bit Patterns, Ranges, Timers, and logical Combination resource terms. You can logically combine different resource terms to form whatever kind of instruction needed to qualify the trigger and store operations.

Occurrence Counter Field

The Occurrence Counter field indicates the number of times the analyzer must see the resource term before it is allowed to advance to the next sequence level. To assign an occurrence number, simply turn the knob, or select the Occurrence Counter field and use the keypad that appears. The maximum number of occurrences is 1048575. If the "Else on" term is seen before all specified occurrences have taken place, the flow of the sequence instruction goes to the sequence level designated in the Branching field.

See Also

For information on selecting resource term choices and how to assign a value to a resource term, refer to the term types, such as Bit Pattern, Range, or Timers in this chapter.

Term assignment field

The screenshot shows a menu interface for sequence instructions. At the top, there are three buttons: "Insert Level", "Select New Macro", and "Delete Level". Below these, the text "Sequence Level 2" and "User level - custom combinations, loops" is displayed. The main area contains three rows of controls: "While storing" with a text field containing "f"; "Then find" with a text field containing "g" and an "Occurs" knob set to "5"; and "Else on" with a text field containing "≠h" and a "go to level" knob set to "4". At the bottom, there are buttons for "Timer Control", "Cancel", and "Done". A line from the text "Term assignment field" on the left points to the text input fields in the "While storing", "Then find", and "Else on" rows.

Occurrence Counter Field

Branching Field

Each sequence level has two-way branching. If the first resource term is found, the branch is to the next sequence level. If the first resource term is not found, the analyzer evaluates the "Else on" secondary branching term.

If the "Else on" term is found, the secondary branch taken is to the designated sequence level in the Branching field. If the "Else on" term is not found, the analyzer continues to loop within the sequence level until one of the two branches is found. If the "Else on" branch is taken, the occurrence counter is reset even if the "go to level" branch is to the same level.

If both terms are found at the same time, the branch is to the next sequence level after the required number of first term occurrences.

Branching across trigger levels is possible. If this occurs, the sequence level evaluation could loop without ever seeing a trigger term. Take care in designing your flowchart and constructing the sequence instructions to avoid this possibility.

To set a sequence level branch, select the Branching field, then select a destination sequence level number.

The screenshot shows a software interface for configuring a sequence instruction. At the top, there are three buttons: "Insert Level", "Select New Macro", and "Delete Level". Below these, the text "Sequence Level 2" and "User level - custom combinations, loops" is displayed. The main area contains three rows of input fields: "While storing" with a text box containing "r", "Then find" with a text box containing "g" and a numeric field "Occurs" set to "5", and "Else on" with a text box containing "wh" and a numeric field "go to level" set to "4". Below these fields is a "Timer Control" button. At the bottom of the window are "Cancel" and "Done" buttons.

Branching in a Sequence Instruction

The Trigger Menu
Sequence Instruction Menu

Duration Counter Field (Timing only)

The Duration Counter field displays a user definable period for which the resource term must be valid before the analyzer continues with the sequence evaluation.

> Field When the greater-than sign (>) precedes the Duration Counter field, the analyzer continues sequence level evaluation only after the resource term has been true for a period greater than or equal to the duration specified.

< Field When the less-than sign (<) precedes the Duration Counter field, the analyzer continues sequence level evaluation only after the resource term has been true for a period less than or equal to the duration specified. Each (<) assignment uses three sequence levels.

When < or > duration is assigned, the secondary branching (Else on) is not available. To assign a duration, simply turn the knob, or select the Duration Counter field and use the keypad that appears.

Occurs Field When "Occurs" is selected, the Duration Counter field changes to an occurrence counter, and the sequence evaluation is delayed until the resource term has occurred for the number of occurrences selected. To assign an occurrence number, simply turn the knob, or select the occurrence field and use the keypad that appears. The maximum number of occurrences is 1048575.

The Trigger Menu
Sequence Instruction Menu

When the "Occurs" selection is made, the "Else on" resource term (secondary branch) becomes available for a second branching option. If the first resource term (primary branch) is not found, and the second resource term is found, the analyzer branches to the sequence level designated in the Branching field.

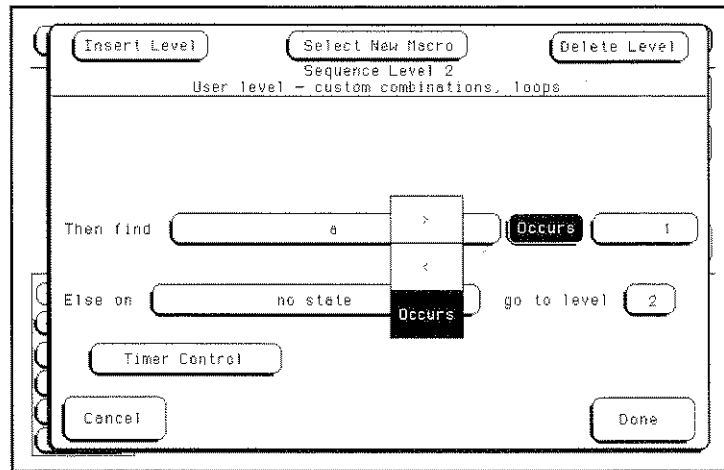

Sequence Level Instruction

The Trigger Menu
Sequence Instruction Menu

Timer Control Field

The Timer Control field is used to access the Timer Control menu. Use the Timer Control menu to Start, Stop, Pause, or Continue timer operation as the analyzer enters a sequence level. You can control the same timer from each sequence level. The default timer condition in all sequence levels is Off.

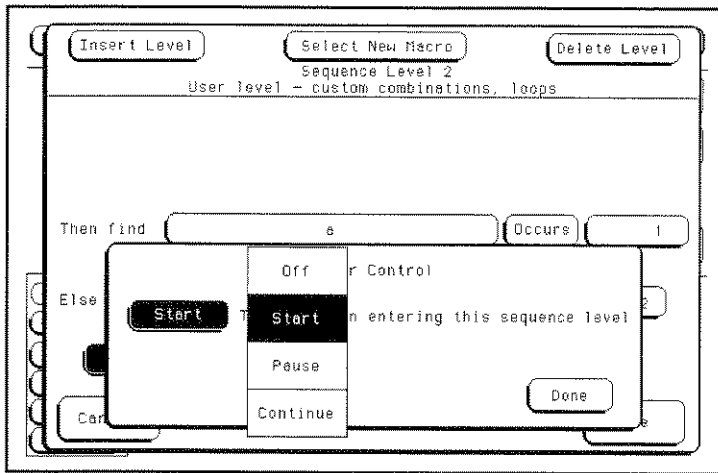

Timer Control Menu

Resource Terms

Resource terms are the user-defined variables that you can place in the Term Assignment fields of the sequence instructions. Resource terms can take the form of Bit Patterns, Ranges, Timers, or Edge terms. They are used separately or in logical combinations with other terms. The analyzer evaluates the sequence instruction and resource terms and determines if the instruction is true or false. Depending on a true or false evaluation, the appropriate branching direction occurs. The terms and fields are:

- Resource Term Fields
- Bit Pattern Terms
- Range Terms
- Timer Terms
- Edge Terms (Timing only)
- Combination of Terms

IM Sample LA C Trigger 2 Print Run

State Sequence Levels

1 While storing "f"
TRIGGER on "h" occurring 5 times
Else on "in_range2" go to level 2

2 While storing "f"
Then find "g" occurring 5 times
Else on "wh" go to level 4

3 While storing "anystate"
Then find "no state" occurring 1 time
Else on "anystate" go to level 4

Timer 2

Arming Control

Acquisition Control

Count Off

Modify Trigger

Label

DATA	ADDR
Hex	Hex
f	XX
g	XX
h	XX
j	XX

Resource terms fields

Resource Term Fields

The Trigger Menu

Resource Term Fields

Resource Term Fields

The Resource Term fields identify the terms available for use within the analyzer. The Resource Term fields are also used to access the Resource Term Configuration menu.

Just to the right of the Resource Term fields are the corresponding assignment fields which display the assigned values and are also used to access an assignment keypad.

Resource Terms Roll Field

Offscreen resource terms are rolled back on screen by using the knob when the Terms field is light blue. If the Terms field is dark blue, it must be selected, which then turns it light blue.

The screenshot displays the Trigger Menu interface. At the top, there are buttons for "IM Sample LA C", "Trigger 2", "Print", and "Run". Below these is a section titled "State Sequence Levels" with a dropdown arrow. The main area contains a sequence of three levels:

- Level 1: While storing "f" TRIGGER on "h" occurring 5 times Else on "in_range2" go to level 2
- Level 2: While storing "f" Then find "g" occurring 5 times Else on "wh" go to level 4
- Level 3: While storing "anystate" Then find "no state" occurring 1 time Else on "anystate" go to level 4

To the right of the levels is a "Timer" column with values 2, S, and -. Further right are three assignment fields: "Arming Control", "Acquisition Control", and "Count Off". Below the levels is a "Label" field with a dropdown arrow, and a "Terms" field with a dropdown arrow. Below these are two columns of assignment fields: "DATA" and "ADDR". The "DATA" column has buttons for "Hex", "XX", "XX", "XX", and "XX". The "ADDR" column has buttons for "Hex", "XX", "XX", "XX", and "XX".

Resource Term Fields

Resource Term Configuration Menu

When any of the Resource Term fields are selected, a Resource Terms Configuration menu appears. Use this configuration menu to assign a resource term to an analyzer, set the resource term to a value, or customize the name of a resource term. The following functions can also be accomplished by selecting the assignment field and using the pop-up keypad.

Clear (=X) Sets the Term Assignment fields as follows:

In Terms a - j, the assignment field is set to all Xs (don't care).

In Range 1 and 2 terms, the two assignment fields are set to maximum (Fs) and minimum (0s) settings.

In Timers 1 and 2 terms, the assignment field is reset to a minimum time of 400 ns.

In Edge 1 and 2 terms, the assignment field is reset to a period (.).

Set (=1) Sets the Term Assignment fields as follows:

In Terms a - j, the assignment field is set to all 1s (high).

This option is not available for the two Range, Timer, and Edge terms.

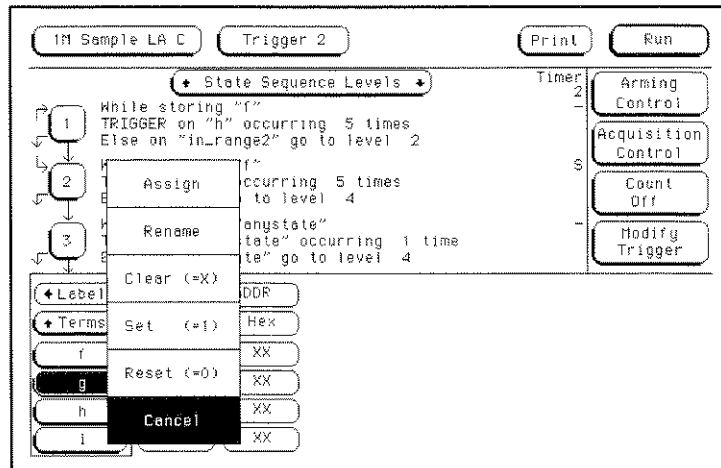

Resource Terms Configuration Menu

The Trigger Menu Resource Term Fields

Reset (=0) Sets the assignment fields as follows:

In Terms a - j, the assignment field is set to all 0s (low). This option is not available for the two Range, Timer, and Edge terms.

Rename This function accesses a keypad that you use to create a custom name for the resource term. This function works for all resource terms.

Assign All of the available resource terms except Edge terms can be assigned to any analyzer. The Edge terms are only used in a timing analyzer. A term, however, can be assigned to only one analyzer at a time. When a resource term is selected, it toggles between analyzers.

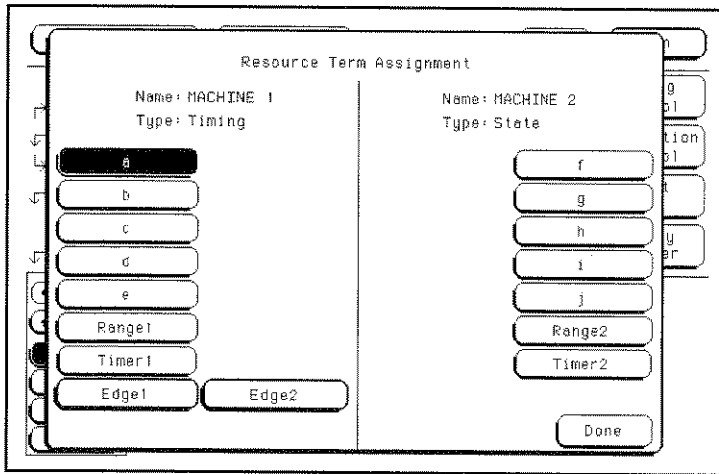

Resource Term Assignment Menu

Bit Pattern Terms

Bit Pattern terms are set to match the numeric value or bit pattern of a group of data channels. The ten available Bit Pattern terms are "a" through "j." Each term can be assigned to either of the two analyzers, but not both. The complement of the bit patterns you specify for "a" through "j" are available by selecting "#a" through "#j." Note that when operating at 110 MHz state speed and in timing mode, resource terms "h" and "j" are not available.

Bit Pattern Assignment

The assignment of a bit pattern to the resource terms "a" through "j" can be done in two ways. If you want a pattern of all 1s, all 0s, or all Xs (don't care), you can insert these values by selecting the resource term field itself, then select your choice from the Resource Term Configuration menu.

If you want some other pattern, use the pop-up keypad to assign the bit pattern. The keypad becomes available when you select the assignment field for each term.

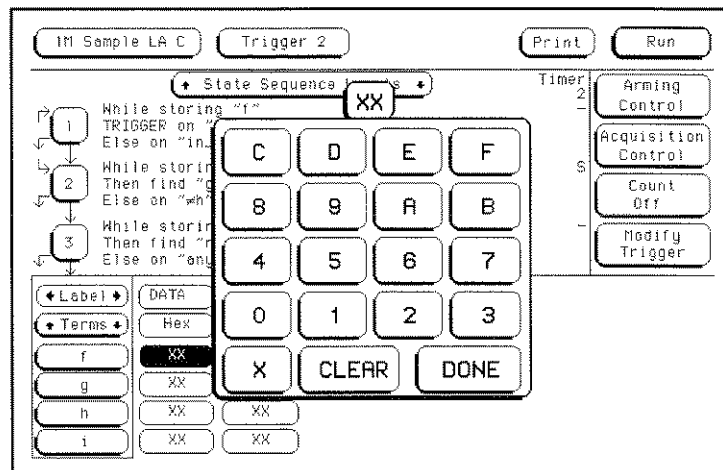

Bit Pattern Resource Term

The Trigger Menu

Bit Pattern Terms

Bit Pattern Selection

After the resource terms have values assigned, they are inserted into the sequence instruction where they direct the flow of that sequence instruction. Insert Bit Pattern terms into a sequence instruction by selecting the Term Assignment field, then selecting a term "a" through "j" from the pop-up selection list.

Term	Description
onystate	≠g
no state	≠h
f	≠i
g	≠j
h	In range2
i	Out range2
j	timer2>400ns
≠f	Combination

Level 2 combinations, loops

Occurs: 5

go to level: 4

Done

Bit Pattern Term Selection

Range Terms

Range terms bracket groups of bit patterns. There are two available Range terms. Each Range term is assigned to either of the two analyzers, but not both.

When you assign an upper and lower bit pattern boundary, the range is recognized when the data is numerically between or on the two specified boundaries. In addition, the range must be contained in a single pod pair, with no clock bits allowed.

Range Assignment

To assign bit patterns to the upper and lower boundaries of a Range term, you use a pop-up keypad. The keypad appears when you select the upper or lower Range term assignment fields.

You can clear the range boundaries by setting them to all Xs (don't cares) by selecting the Range term field and selecting the Clear (=X) field from the Resource Term Configuration menu. The Clear (=X) option places zeros and Fs in the upper and lower boundaries respectively.

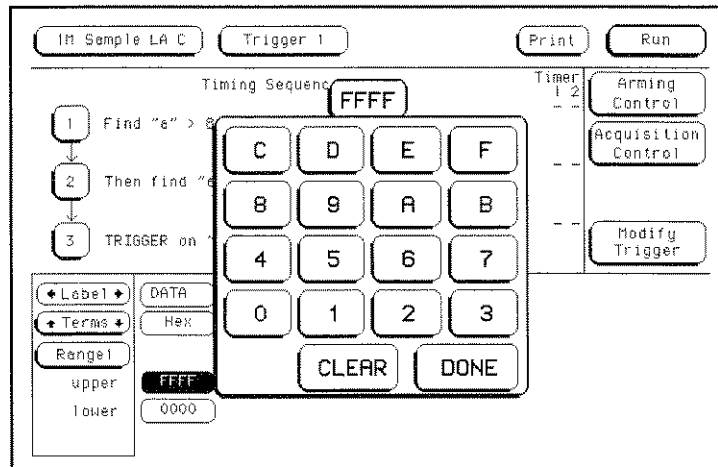

Range Term

The Trigger Menu

Range Terms

Range Term Selection

With upper and lower range boundaries assigned, insert the appropriate In range or Out range terms into the sequence instruction. The In range term is true when the analyzer recognizes a bit pattern on or between the assigned range boundaries. The Out range term is true when the In range term is false.

In and Out range terms are inserted into a sequence instruction by selecting the Term Assignment field, then selecting an "In range 1, 2" or "Out range 1, 2" term from the pop-up selection list.

Term	Assignment
anystate	#g
no state	#h
f	#i
g	#j
h	In range2
i	Out range2
j	timer2>400ns
ref	Combination

Occurs: 5

go to level: 4

Done

Range Term Selection

Timer Terms

There are two available Timer terms, each of which may be assigned to either of the two analyzers, but not both. Timers can be used as either the trigger term, the store term, or a branching term, within a sequence level. With timers inserted into sequence levels, you can start a timer in one level, pause it, or stop it in another sequence level.

As with other resource terms, timers are either true or false. Timers start as you enter the sequence level, and when its count expires, it becomes true. If a timer is paused in one level, it must be continued in another level before it can count through and become true. Timers can also be inverted, so it can start as true and become false when its count expires.

Timer Assignment

To assign a time value to the Timer 1, 2 terms, you use a pop-up keypad which appears when you select the assignment field.

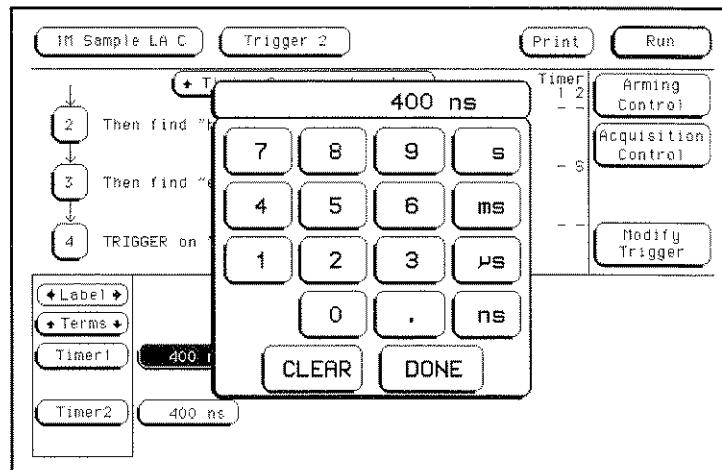

Timer Term Assignment

The Trigger Menu

Timer Terms

The minimum value a timer can have is 400 ns, and that is the default value. As more sequence levels are added, the timer status in the new levels defaults to Off. Timers must be continued or started in each new level as is appropriate. When a timer expires or stops, its count resets to zero.

Timer Term Selection

Timer terms are inserted into a sequence instruction by selecting the Term Assignment field, then selecting a "Timer 1, 2" term from the pop-up selection list.

Term	Macro	Description	Occurs	go to level	timer2
enystate	#g	Level 2 combinations, loops			
no state	#h				
f	#i				
g	#j		5		
h	In range2			4	
i	Out range2				
j	timer2>400ns				400ns
#f	Combination				

Timer Term Selection

Edge Terms (Timing only)

Edges and glitches can be used to qualify a trigger, store, or branch operation within a sequence instruction. They can be used singularly or in combination with each other across all assigned channels. When you specify an edge or glitch on more than one channel, the analyzer ORs the edges and glitches. If you want to qualify a glitch, place an asterisk (*) on the data channel you are watching. If you want to qualify an edge, place the appropriate edge on the data channel you are watching. The following edge choices are available:

- Positive edge (↑)
- Negative edge (↓)
- Either positive or negative (↕)
- No edge (.)

Edge Assignment

After you select the edge assignment field, an assignment menu appears. Use the knob to position the cursor over the bit you want to qualify, then select the glitch or edge choice.

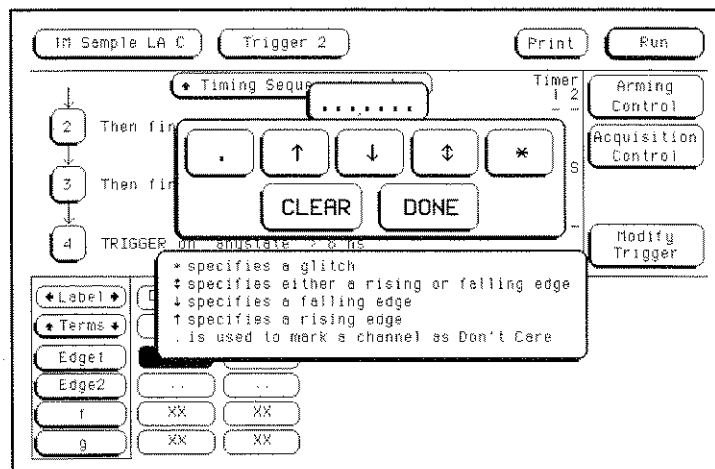

Edge Term

The Trigger Menu

Edge Terms (Timing only)

When you finish assigning edges and glitches, select Done. After the assignment menu closes, you will see "\$" or "*" or both indicators in the assignment field display. These symbols signify an assigned edge (\$) or glitch (*) qualifier. When Binary is selected for the numeric base, you see the actual edge and glitch assignments.

The screenshot shows a software interface for configuring a trigger. At the top, there are buttons for 'in Sample LA C', 'Trigger 2', 'Print', and 'Run'. Below these is a section titled 'Timing Sequence Levels' with a dropdown arrow. It contains three steps:

- 2 Then find "h" > 8 ns
- 3 Then find "edge1" occurring 1 time
- 4 TRIGGER on "anystate" > 8 ns

To the right of the steps is a 'Timer' column with values 1, 2, and 5. Further right are buttons for 'Arming Control', 'Acquisition Control', and 'Modify Trigger'. At the bottom, there is a table for 'Edge and Glitch Identifiers':

Label	DATA	ADDR
Terms	Hex	Hex
Edge1	\$\$	*\$
Edge2
f	XX	XX
g	XX	XX

Edge and Glitch Identifiers

Combination of Terms

The Combination selection in the pop-up selection list allows you to create a resource term with a value that is the result of a combination process. The combination process uses the logical AND, NAND, OR, NOR, and XOR functions to combine predefined resource terms. All resource terms that have been assigned to the analyzer are available to influence the value of the combination resource term.

A combination of terms is used as either a trigger term, a store term, or a branching term within a sequence instruction.

Combination Assignment

To assign a combination of terms, first select "Combination" from the pop-up selection list, and then configure the process that creates the value for the combination.

Term	Macro	Value
any state	#b	timer1>400ns
no state	#c	Combination
a	#d	
b	#e	
c	In range!	
d	Out range!	
e	Edge1	
#s	edge2	

Occurs: 5
 go to level: 4
 Done

Combination of Terms

The Trigger Menu

Combination of Terms

Combination Creation

Before a combination of terms is created and inserted into a sequence instruction, the combination process must be configured. When the Term Assignment field is selected, and "Combination" is selected from the pop-up selection list, a Logical Assignment menu appears. Use this menu to select predefined resource terms as inputs to a chain of logical operators.

Configure resource terms into the chain by selecting the desired term, then selecting to either include it (ON), turn it off, or include it in a complemented form (NEGATE).

Configure logical operators into the chain by selecting the Logical Operation field, and then selecting the desired operation from a selection list.

When the configuration process is complete, and the "Done" field is selected, the created Combination of terms is inserted into the Term Assignment field in the sequence instruction.

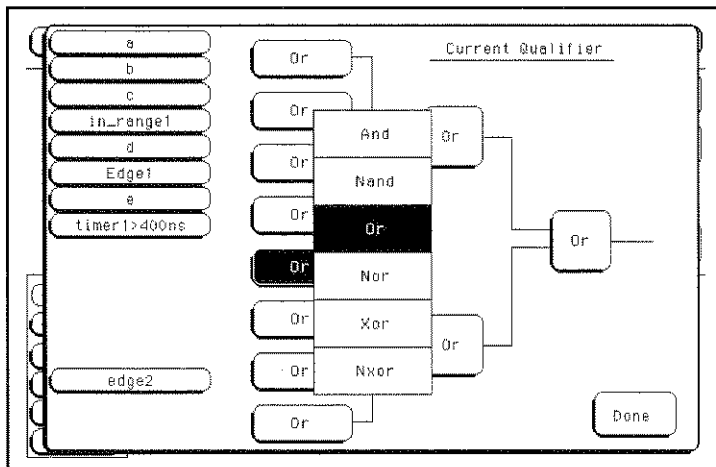

Logical Assignment Menu

Control Fields

The Control fields are located to the right of the large light blue Sequence Levels box. The four control fields are:

- Arming Control Field
- Count Field (State only)
- Acquisition Control Field
- Clear Trigger Field

The Trigger Menu

Arming Control Field

Arming Control Field

The Arming Control field accesses an Arming Control menu which is used to configure the arm signals between analyzers and the Arm In/Out signals between other measurement modules in the mainframe. The arming signals influence the order in which the analyzers and other measurement modules trigger in cross-domain measurements. The three types of arming control are:

- Arming Control Between Analyzers
- Arming Control Between Modules
- ORed Trigger

The screenshot displays the 'Arming Control Field' configuration window. At the top, it shows 'IM Sample LA C' and 'Trigger 2'. Below this is a 'State Sequence Levels' section with three levels:

- Level 2: While storing "f", Then find "g" occurring 5 times, Else on "h" go to level 4
- Level 3: While storing "anystate", Then find "no state" occurring 1 time, Else on "anystate" go to level 4
- Level 4: While storing "anystate", Then find "anystate" occurring 1 time

On the right side, there are buttons for 'Arming Control', 'Acquisition Control', 'Count Off', and 'Modifg Trigger'. Below the state sequence is a table for defining terms:

Label	DATA	ADDR
Terms	Hex	Hex
f	XX	XX
g	XX	XX
h	XX	XX
i	XX	XX

Arming Control Field

Arming Control Between Analyzers

If both analyzers in a module are turned on, you can configure one analyzer to arm the other. For example, when a state analyzer triggers on a bit pattern, it could arm a timing analyzer which then captures and displays the waveform after it triggers. As you configure the Arming Control menu, a graphical representation of the analyzer arming configuration is displayed.

When you select the analyzer name field in the Arming Control menu, a pop-up menu appears that you use to select where the Arm In signal comes from. In addition, a sequence level number field appears which you use to select the sequence level in which an "arm" flag is placed.

When an analyzer receives an Arm-In signal, an "arm" term is placed in a user-selected sequence level and the analyzer automatically begins evaluating its trigger sequence instruction. If in the sequence evaluation, the "arm" term is seen first, the analyzer will trigger. However, if the "arm" term is placed down in the sequence level order, the preceding sequencing could trigger the analyzer before the "arm" term is seen. Generally, the "arm" term is evaluated and used in the same way as the other resource terms within the sequence instruction.

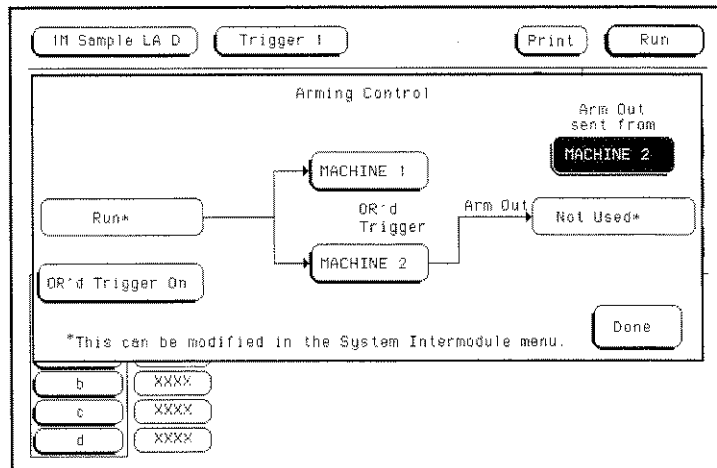

Two Analyzer Arming

The Trigger Menu

Arming Control Field

Arming Control Between Modules

A more complex arming example involves arming between modules in the mainframe. Intermodule arming requires using the Intermodule menu to configure all the modules involved. As you configure the Arming Control menu, a graphical representation of the analyzer arming configuration is displayed.

The first analyzer is armed by an Arm-In signal from another module in the mainframe. After the first analyzer triggers, it arms the second analyzer. After the second analyzer triggers, it can send a Port-Out signal to the Port-Out BNC on the back panel of the mainframe. This signal can be used to arm an external measurement module, such as an oscilloscope.

ORed Trigger

The ORed trigger allows you to configure two machines to trigger on completely different sets of data and allow either to trigger the other machine to capture data. Let's assume, for example, you have a system with two microprocessors which is having problems, and you aren't sure which one is causing the problem. You can connect one machine to microprocessor 1 and the other machine to microprocessor 2. When one of the microprocessors sees the problem, it will trigger the other, so you have captured parallel data for both machines. This data is time correlated to help you determine the cause of the problem.

Count Field (State only)

The Count field accesses a selection menu which stamps the acquisition data at each memory location with either a Time tag or a State count tag. If you have all pod pairs assigned, the state acquisition memory is reduced by half, when time or state tags are turned on. You can maintain full memory depth if you leave a pod pair unassigned. This section discusses:

- State Tags
- Time Tags
- Memory Depth Considerations

State Tags

If you select States count, then each time the system stores a data record it counts the number of occurrences of a particular combination of states that you specify, until the time a new data record is stored. The system then stores the count, or "state tag," along with the new data record, and the process repeats. When the measurement is completed, each piece of stored data is displayed with its associated "state tag" count.

State tags displayed this way are RELATIVE to the previous count, or they can be displayed as ABSOLUTE, indicating cumulative counts relative to the trigger point.

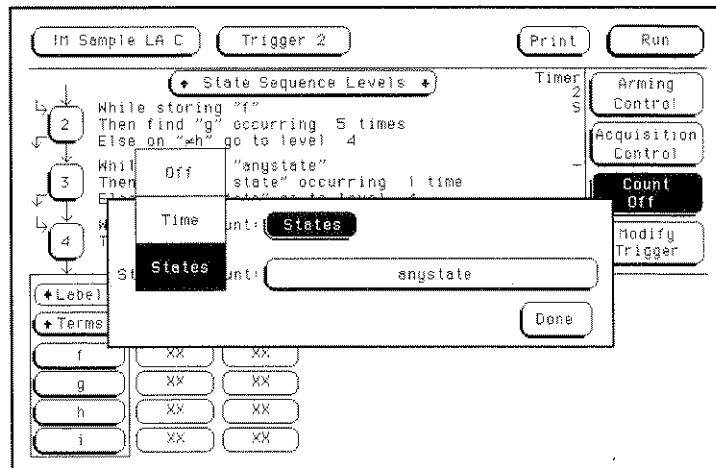

Count Field

The Trigger Menu
Count Field (State only)

Time Tags

If you select Time count, the system places a time stamp on all displayed data. Data stored before the trigger has negative values and data stored after the trigger has positive values. Time tag numbering is set to be either relative to the previous memory location or absolute from the trigger point. Select Absolute or Relative by toggling the Absolute/Relative field. Time tag resolution is 8 ns.

Memory Depth Considerations

If you have all pod pairs assigned, the state acquisition memory is reduced by half, when time or state tags are turned on. To retain the full memory depth when using time or state tags, you must have at least one unassigned pod pair.

Acquisition Control Field

The Acquisition Control field accesses an Acquisition Control menu from which you can set the acquisition mode and trigger position within available memory. In a state analyzer you can set whether or not the data that causes a branch to be taken is stored into memory. In a timing analyzer, you can set the sample period.

In a state analyzer, the acquisition control settings are imposed on the qualified data after the trigger has occurred. Depending on what data is qualified in the sequence levels and when trigger occurred, the additional data qualifying by the acquisition control will result in more efficient use of available memory. Two control fields accessed are from the acquisition control menu:

- Acquisition Mode Field
- Trigger Position Field

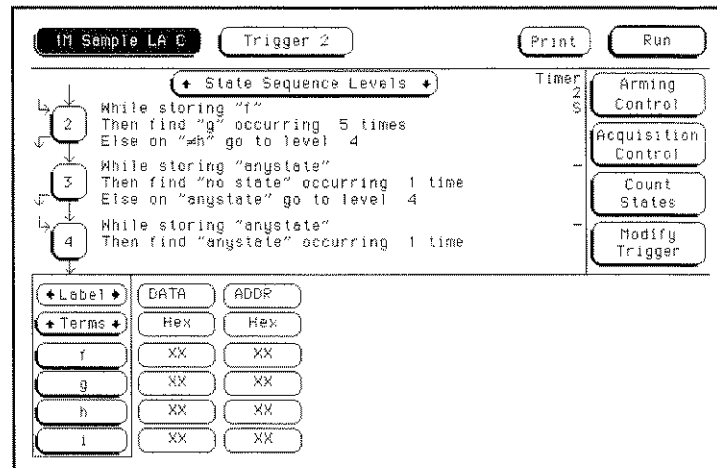

Acquisition Control field

The Trigger Menu

Acquisition Control Field

Acquisition Mode Field

The Acquisition Mode field toggles between Automatic and Manual. When set to Automatic in a state analyzer, the trigger position is computed based on the sequence specification. In a timing analyzer, the trigger position and sample period are computed based on the sec/Div and delay settings in the Waveform menu.

When the Acquisition Mode field is set to Manual, additional configuration fields become available. Use these fields to further qualify what data is stored. The additional configuration fields work together with the sequence instructions, in a prioritized manner, to position the trigger point in relation to the beginning and end of stored data.

Trigger Position Field

In a state analyzer, the trigger point position is determined after the sequence instructions are evaluated. This process could result in a varying portion of available memory being filled with posttrigger data. The remainder of memory is considered free and is filled with less significant data.

In a timing analyzer, after the specified trigger term is found, memory is filled with posttrigger data starting at the trigger position represented by a blue graphic bar with the "Trig" indicator line. If the trigger position is set to store pretrigger data, any true sequence instruction or trigger seen is ignored until the proper amount of pretrigger data has been stored.

The Trigger Position field accesses a selection of options:

- Start
- Center
- End
- User Defined
- Delay
- Sample Period Field
- Branches Taken Stored/Not Stored

Start When the trigger position is set to Start, it places the trigger near the beginning of memory and most of the data in memory is posttrigger data.

The Trigger Menu Acquisition Control Field

Center When the trigger position is set to Center, the trigger is placed at the middle of memory and half the data is pretrigger data and half posttrigger data.

End When the trigger position is set to End, the trigger is placed near the end of memory and most of the data in memory is pretrigger data.

User Defined When the trigger position is set to User Defined, a Post Store field appears which shows what the percentage of the data captured will be posttrigger data. Use this field to set the trigger position any where between 0% and 100%.

Delay In a timing analyzer a Delay option is available. Use the Delay field to delay the start of acquisition storage after the trigger. The range of the delay is affected by the sample period but could range between 16 ns to 8 ks. There may be a variable number of stored samples displayed prior to the user-defined delayed start point for acquisition storage.

Sample Period Field The Sample Period field is used to set the time period between data samples. Every time a new sample is taken, the analyzer will see updated measurement data.

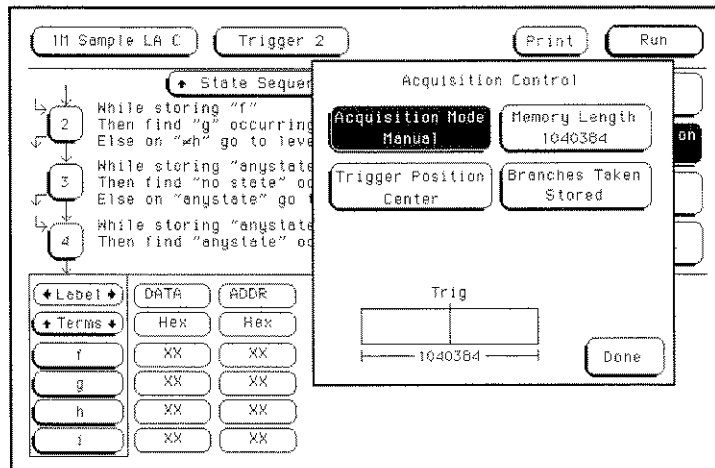

Acquisition Control Selection Menu (State analyzer)

The Trigger Menu Acquisition Control Field

Branches Taken Stored / Not Stored The Branches Taken field is a toggle field which tells the analyzer to store or not to store the resource term that caused the analyzer to branch.

As the analyzer steps through the sequence instructions, it may repeatedly branch to secondary branches because the first resource term was bypassed (false) and the second "Else" resource term is qualified (true). With Branches Taken set to Stored, both the state data values that caused the secondary branches and the secondary branch are stored in memory.

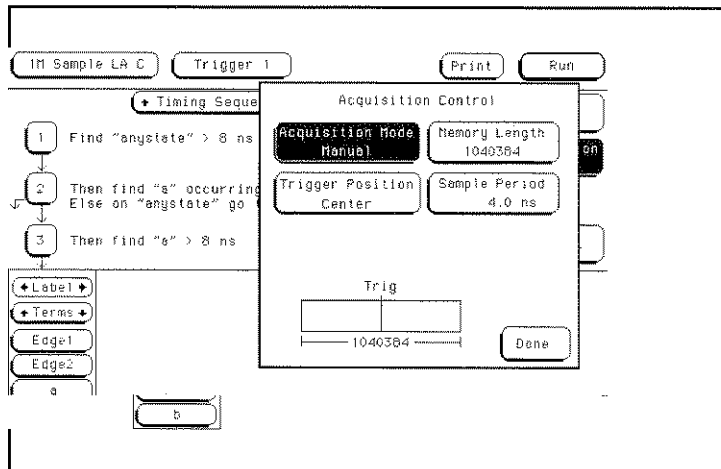

Acquisition Control Configuration Menu (Timing analyzer)

Clear Trigger Field

The Clear Trigger field accesses a selection menu used to clear any user-defined values present within the trigger condition. These user-defined values appear in the sequence levels and in the Resource Term display fields.

All The All option resets sequence levels, resource terms, and resource term names to default settings.

Sequence Levels The Sequence Levels option resets all assignment fields in the sequence levels to default. Custom names assigned to the resource terms will remain.

Resource Terms The Resources Terms option resets all assignment fields for the resource terms to default.

Resource Term Names The Resource Term Names option resets all custom names assigned to the resource terms to default.

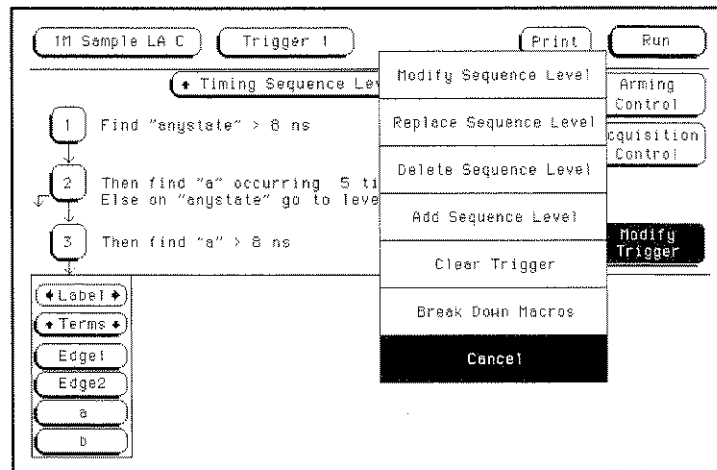

Clear Trigger





The Listing Menu

The Listing Menu

The Listing menu allows you to display data stored to memory during state or timing analyzer measurements. The acquired data is displayed in the order the analyzer placed the data into analyzer memory and is grouped by label and in a selectable numeric base. Labeled data from other analyzer machines can be interleaved into the same display. You can access three kinds of markers:

- Pattern Markers
- Time Markers
- Statistics Markers

Listing Menu Map

The menu map on the next page illustrates all fields and the available options in the Listing menu. The menu map will help you get an overview as well as provide you with a quick reference of what the Listing menu contains.

See Also

"Interleaving State Listings" in chapter 10, Mixed Display Menu, for more information on interleaving state data.

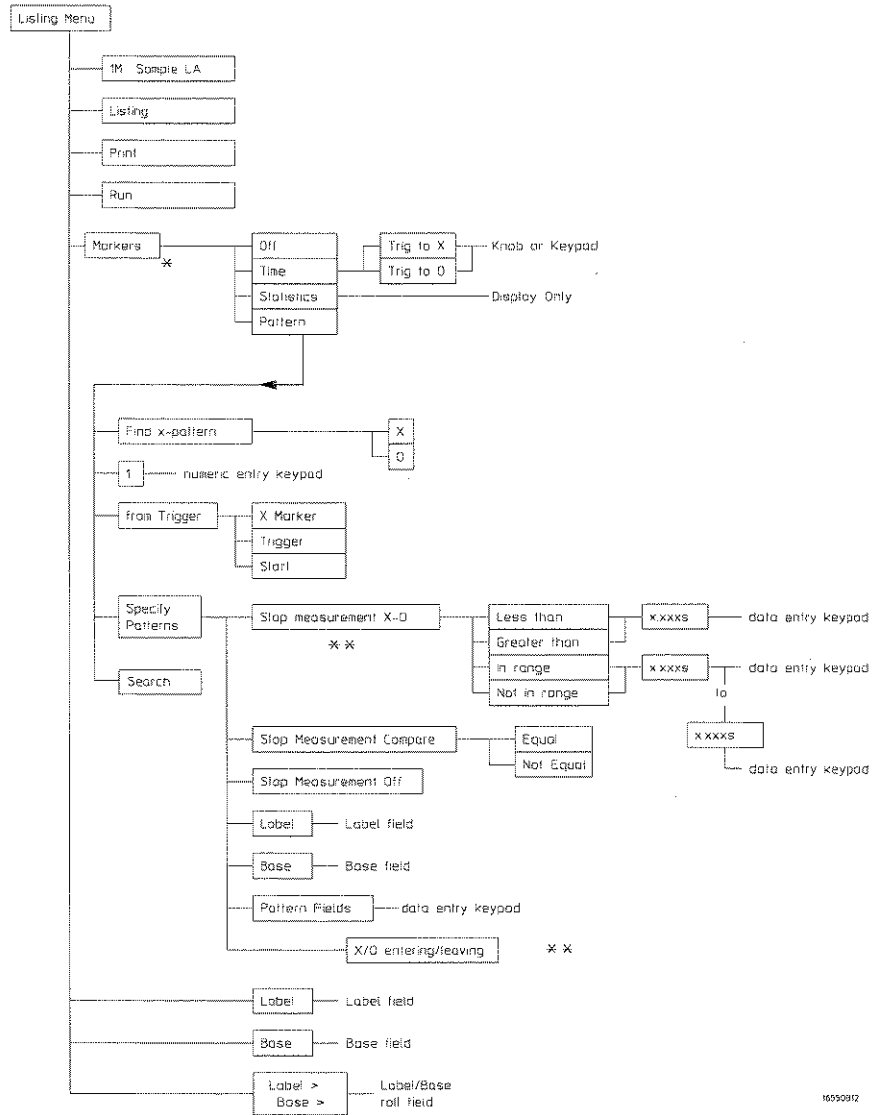

16550912

* Different marker types appear depending on analyzer configurations

* * Only available in Timing analyzer or State analyzer with Count set to Time.

Listing Menu Map

Markers Field

The Markers field is used to access the markers selection menu. When this field is selected, a marker selection menu appears with the choices available for the present analyzer configuration.

State Analyzer Types

In a state analyzer with time and state count turned off in the Trigger menu, only Pattern markers are available. With time count turned on, choices of Pattern, Time, and Statistics markers become available. With States count turned on, Pattern and States markers are available.

Timing Analyzer Types

In a timing analyzer you have marker choices of Pattern, Time, and Statistics.

Off

The Off selection turns marker operations off. If a Stop measurement was previously specified, and the Stop measurement criteria are met, the measurement will stop even though the markers are off.

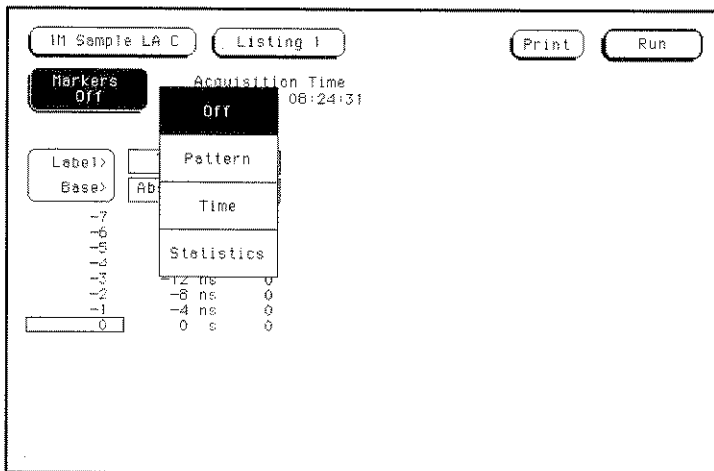

Markers Field

Pattern Markers

When Pattern markers are selected, two markers labeled X and O become available. These markers identify and mark unique bit patterns in the data listing. Once the unique bit patterns are marked, they can be used as reference points or as criteria for a stop measurement.

The markers are color coded for easy recognition in the data listing. The X-marker is represented by a horizontal green line and the O-marker is represented by a horizontal yellow line.

When a marker is positioned in the Listing menu, it is also positioned in the Waveform menu.

The fields associated with Pattern Markers are:

- Find X-pattern / O-pattern Field
- Pattern Occurrence Fields
- From Trigger / Start / X Marker Field
- Specify Patterns Field
- Label / Base Roll Field
- Stop Measurement Field
- Clear Pattern Field

The Listing Menu
Find X-pattern / O-pattern Field

Find X-pattern / O-pattern Field

The Find X-pattern / O-pattern field is a toggle field. When selected, the target of occurrence and trace start field assignments switches to the other marker. In addition, when this field is selected, the data listing will shift so the data marker will appear at center screen.

Label>	Time	ADDR
Base>	Relative	Hex
-7	4 ns	0
-6	4 ns	0
-5	4 ns	0
-4	4 ns	0
-3	4 ns	0
-2	4 ns	0
-1	4 ns	0
0	4 ns	0

Find X-pattern / O-pattern Field

Pattern Occurrence Fields

The X-pattern and O-pattern occurrence fields designate which pattern occurrence the marker is placed on. The range for the occurrence counter is -8192 to +8192.

The occurrence field can be set in two ways. When the field is selected one time, it turns light blue and knob operation becomes the entry method. If the field is selected a second time, a pop-up keypad appears and becomes the entry method.

The reference point from which the occurrence counter starts is either the trigger point, the start of the trace, or in the case of the O-marker, the X-marker. If a negative occurrence number is set, the analyzer will search for pretrigger occurrences.

Label>	Time		ADDR
	Relative	Hex	
-7	4 ns	0	
-6	4 ns	0	
-5	4 ns	0	
-4	4 ns	0	
-3	4 ns	0	
-2	4 ns	0	
-1	4 ns	0	
0	4 ns	0	

X-pattern and O-pattern Occurrence Fields

The Listing Menu
From Trigger / Start / X Marker Field

From Trigger / Start / X Marker Field

The From Trigger/Start/X Marker field is used to access the selection pop-up for the start point of the X and O marker occurrence counters.

The start points available for the green X-marker are either the trace start point or the trigger point.

The start points available for the yellow O-marker are either the trace start point, trigger point, or the X-marker.

If the marker pattern can not be found, a message appears at the top of the display indicating the search failed. If the O-marker is referenced from the X-marker, and the X-marker is not found, the search for both markers will fail.

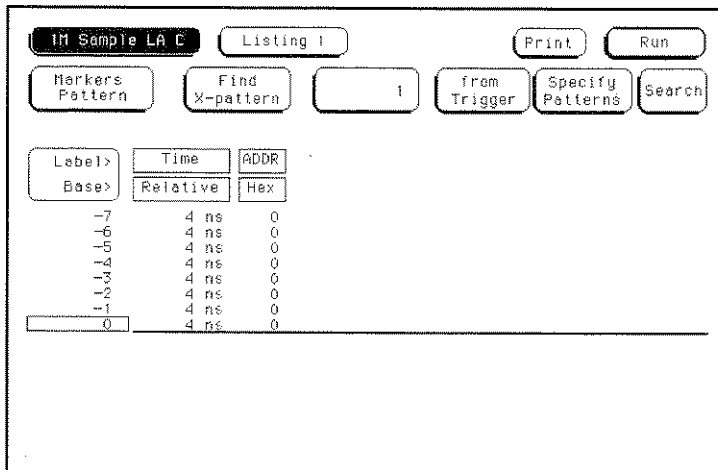

Trigger/Start/X Marker Field

Specify Patterns Field

The Specify Patterns field appears only when the markers are set to Pattern. When the Specify Patterns field is selected, a pop-up menu appears with which you can assign the bit patterns for the X and O markers, the X and O entering/leaving, and the Stop measurement criteria.

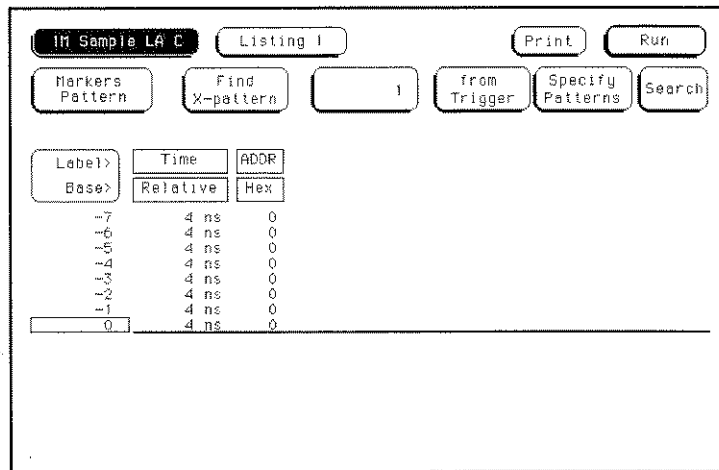

Specify Patterns Field

The Listing Menu
Specify Patterns Field

X and O entering / leaving Fields (Timing only)

If the analyzer is configured as Timing, the X and O pattern markers are placed at either the beginning of the pattern occurrence (entering) or at the end of the pattern occurrence (leaving). When the entering/leaving field of either X or O markers is selected, it toggles between the two choices. Whichever choice you toggle the field to, the pattern you place in the pattern display field will apply to that choice.

X marker and O marker Fields (State only)

If the analyzer is configured as State, X marker and O marker fields replace the X and O entering/leaving fields. The pattern you place in the pattern display field will apply to the marker labeled at the left.

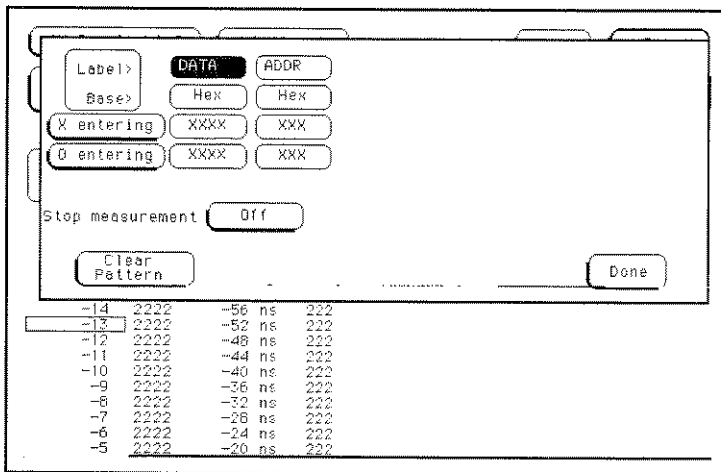

X and O entering / leaving Fields

Pattern Display Fields

The pattern display field displays the alphanumeric bit pattern specified for each X and O marker in all designated labels. The bit pattern is displayed in the same numeric base and same order as the data listing. When the pattern display field is selected, a pop-up keypad appears which is used to set the bit pattern.

When there are more labels assigned than can be displayed in a single screen, the pattern display fields are rolled back on screen by selecting the Label/Base roll field and scrolling with the knob.

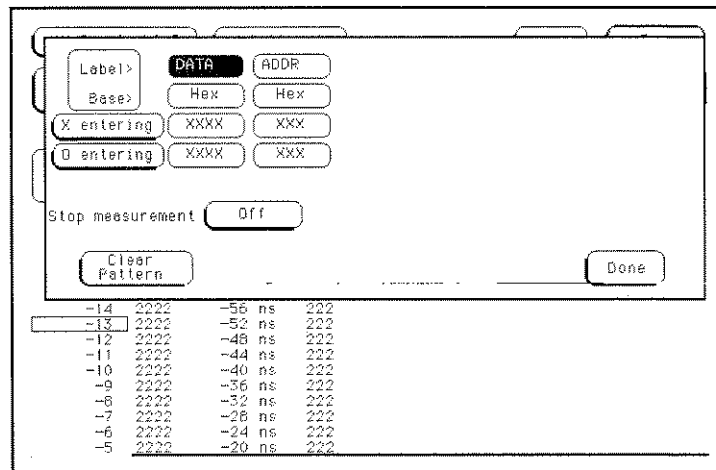

Pattern Display Field

The Listing Menu
Label / Base Roll Field

Label and Base Fields

The Label and Base fields show up together in all menus except the Format and Configuration menus. When a new label is assigned, a base field is automatically assigned to that label.

Label Field Labels in the Specify Patterns menu will be displayed throughout the analyzer as they were assigned in the Format menu.

To reorder currently displayed labels, select the label you want to move, then from the selection menu that appears, choose the label you want to switch positions with.

Base Field The function of the Base field is the same in all menus. To change the numeric base, select the base field, then choose the desired base from the selection menu.

Label / Base Roll Field

The rolling function is the same for all items that are stored offscreen. For more information on rolling labels, base, and pods, refer to "Labels Assignment" in the "Common Module Operations" chapter of the *HP 16500B User's Reference* for complete information.

Stop Measurement Field

The Stop measurement function allows you to specify a condition which stops the analyzer measurement during a repetitive run. If two analyzers are configured, both analyzers will stop when either specified stop condition is satisfied.

When the Stop measurement field is selected, a Stop measurement type menu appears. Depending on the analyzer configuration, you have the choices of Off, X-O, and Compare.

Off

The Off selection turns all Stop measurement operations off. If the Stop measurement operation is not turned off and the stop criteria are met, the measurement will stop even though the markers are set to other types or turned off.

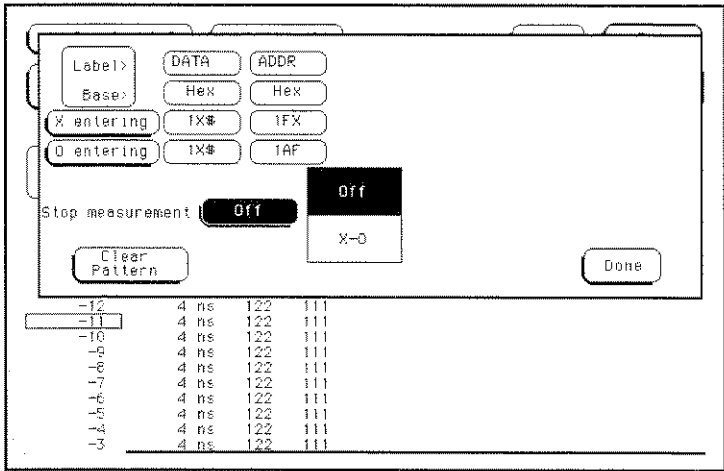

Stop Measurement Field

The Listing Menu
Stop Measurement Field

X-O

The X-O option is available in the timing analyzer and in the state analyzer with its count set to Time. When X-O is selected, a repetitive run is stopped when a comparison of the time period between the X and O markers and one of the following time period options is true:

Less Than X-O time must be less than the time value that you specify in the Time field.

Greater Than X-O time must be greater than the time value that you specify in the Time field.

In Range X-O pattern must be within the time range value that you specify in the two Time fields.

Not in Range X-O pattern must not be within the time range value that you specify in the two Time fields.

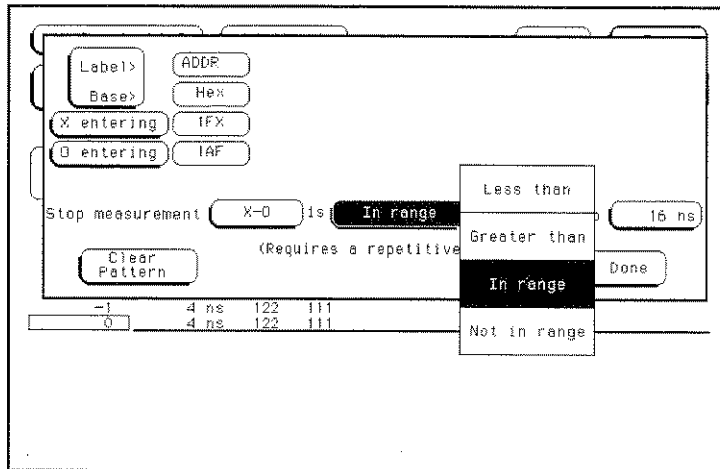

X-O Field

Clear Pattern Field

The Clear Pattern field is used to reset the X and O Marker pattern display fields to default (don't care = X). The Clear Pattern field accesses a selection menu with the choices of All, X pattern, or O pattern.

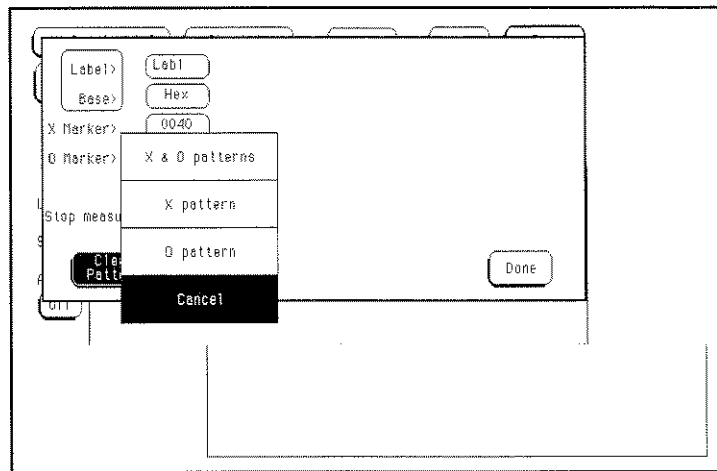

Clear Pattern

Time Markers

Time markers are indicators located in the data listing that are used as reference marks to obtain time values between markers or between each marker and the trigger point.

In a state analyzer, time markers become available only when the Count field is set to Time in the Trigger menu.

The markers are color coded for easy recognition. The X-marker is represented by a horizontal green line and the O-marker is represented by a horizontal yellow line.

If pattern markers have been assigned, the time markers will be placed initially at the same locations in the data listing. Set values for time markers with the following fields:

- Trig to X / Trig to O Fields

Trig to X / Trig to O Fields

The Trig to X and Trig to O fields are both display fields and configuration fields. Set the marker position by selecting the fields, then, after the fields turn light blue, rotating the knob. You can also set marker position by selecting the light blue field a second time and entering a value with the pop-up keypad.

The Trig to X and Trig to O fields display the time between the trigger point and the marker.

X to O Display Field

The X to O display field is a "read only" field that displays the time between the X and O markers. As the X and O markers are changed, the display changes accordingly.

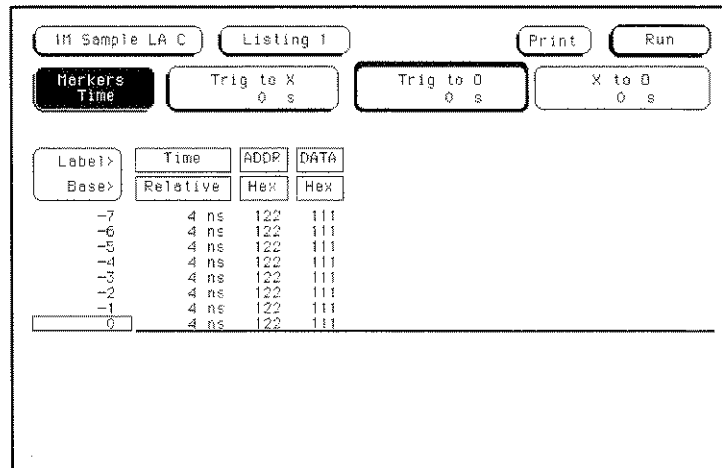

The screenshot shows a menu interface with several buttons and a data table. At the top, there are buttons for 'IH Sample LA C', 'Listing 1', 'Print', and 'Run'. Below these are four fields: 'Markers Time', 'Trig to X 0 s', 'Trig to O 0 s', and 'X to O 0 s'. The 'Markers Time' field is highlighted. Below the fields is a table with columns 'Label>', 'Time', 'ADDR', and 'DATA'. The 'Label>' column has a sub-column 'Base>'. The table contains data for labels -7 through 0, all with a time of 4 ns and address 122. The 'DATA' column shows '111' for labels -7 through -1 and '0' for label 0.

Label>	Time	ADDR	DATA
Base>	Relative	Hex	Hex
-7	4 ns	122	111
-6	4 ns	122	111
-5	4 ns	122	111
-4	4 ns	122	111
-3	4 ns	122	111
-2	4 ns	122	111
-1	4 ns	122	111
0	4 ns	122	0

Trig to X / Trig to O Fields

Statistics Markers

After you have assigned patterns to the X and O markers, statistical information is available when you set markers to Statistics. The logic analyzer displays the following information:

- Number of valid runs (runs where Pattern markers were able to be placed on specified patterns).
- Minimum time between the X and O Pattern markers.
- Maximum time between the X and O Pattern markers.
- Average time between the X and O Pattern markers.

In a state analyzer, Statistics markers become available only when the Count field in the Trigger menu is set to Time.

The markers are color coded for easy recognition in the data listing. The X-marker is represented by a horizontal green line and the O-marker is represented by a horizontal yellow line.

Statistics are based on the time between the X and O markers, therefore both markers must be found before valid statistical information is displayed.

In repetitive run mode, the display is updated each time a valid run occurs until you select Stop. If you select Run after selecting Stop, the statistics continue to update without loss of information.

In single run mode, each time you select Run an additional valid run will be added to the data and the statistics will be updated. This process continues unless you change the placement of the X and O Pattern markers between runs.

Statistics display

IN Sample LA C
Listing 1
Print
Run

Markers Statistics	Valid runs 1 of 3	Min X=0 0 s	Max X=0 0 s	Avg X=0 0 s
---------------------------	----------------------	----------------	----------------	----------------

Clr Stats

Label>	Time	ADDR	DATA
Base>	Relative	Hex	Hex
-7	4 ns	122	111
-6	4 ns	122	111
-5	4 ns	122	111
-4	4 ns	122	111
-3	4 ns	122	111
-2	4 ns	122	111
-1	4 ns	122	111
0	4 ns	122	111

Statistics Display

The Listing Menu Data Roll Field

Data Roll Field

The column of numbers at the far left represents the location of the acquired data in the state analyzer's memory. The numbered positions are also known as the state locations and are relative to the trigger state location. The column of state location along with its data can be rolled to display other data by using the data roll field.

The data roll field is the small rectangular box located in the middle of the state location column. The data roll field is used to either roll the data listing or to select an exact state for display. When the data roll field is light blue, the knob is active and can roll data in either direction.

If you touch the data roll field when it is light blue, a pop-up keypad appears for the number of an exact state. When the pop-up keypad is used, the data listing shifts, leaving the selected state in the light blue data roll box.

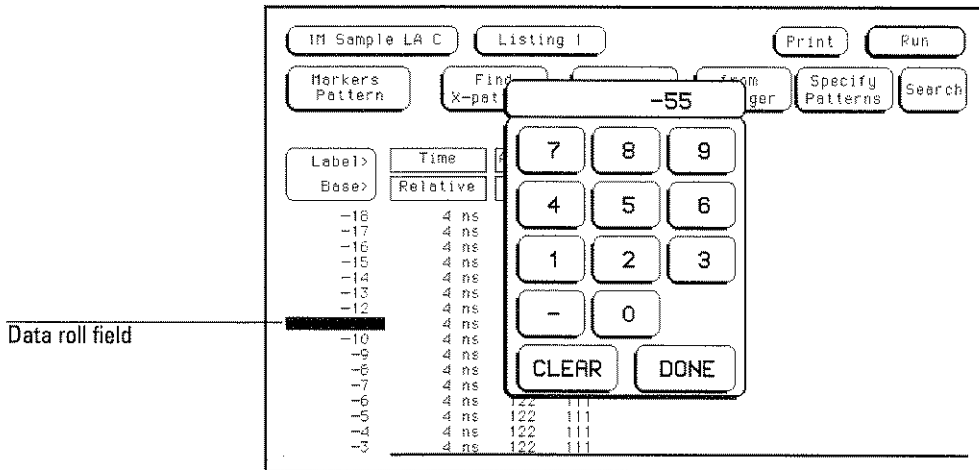

Data Roll Field



The Waveform Menu

The Waveform Menu

Use the Waveform menu to view state or timing data in a format similar to an oscilloscope display. Data is displayed with the horizontal axis representing either states (if operating in state mode) or time (if in timing mode) and the vertical axis representing logic highs and lows. In state mode, the analyzer displays state data in reference to the trigger point with the horizontal resolution being states per division. In timing mode, the analyzer displays timing data in reference to the trigger point with the horizontal resolution being time per division. The Waveform Menu includes the following controls and markers:

- Basic Controls
- Pattern Markers
- Time Markers
- Waveform Display

Waveform Menu Map

The following menu map illustrates all fields and the available options in the Waveform menu. The menu map will help you get an overview as well as provide you with a quick reference of what the Waveform menu contains.

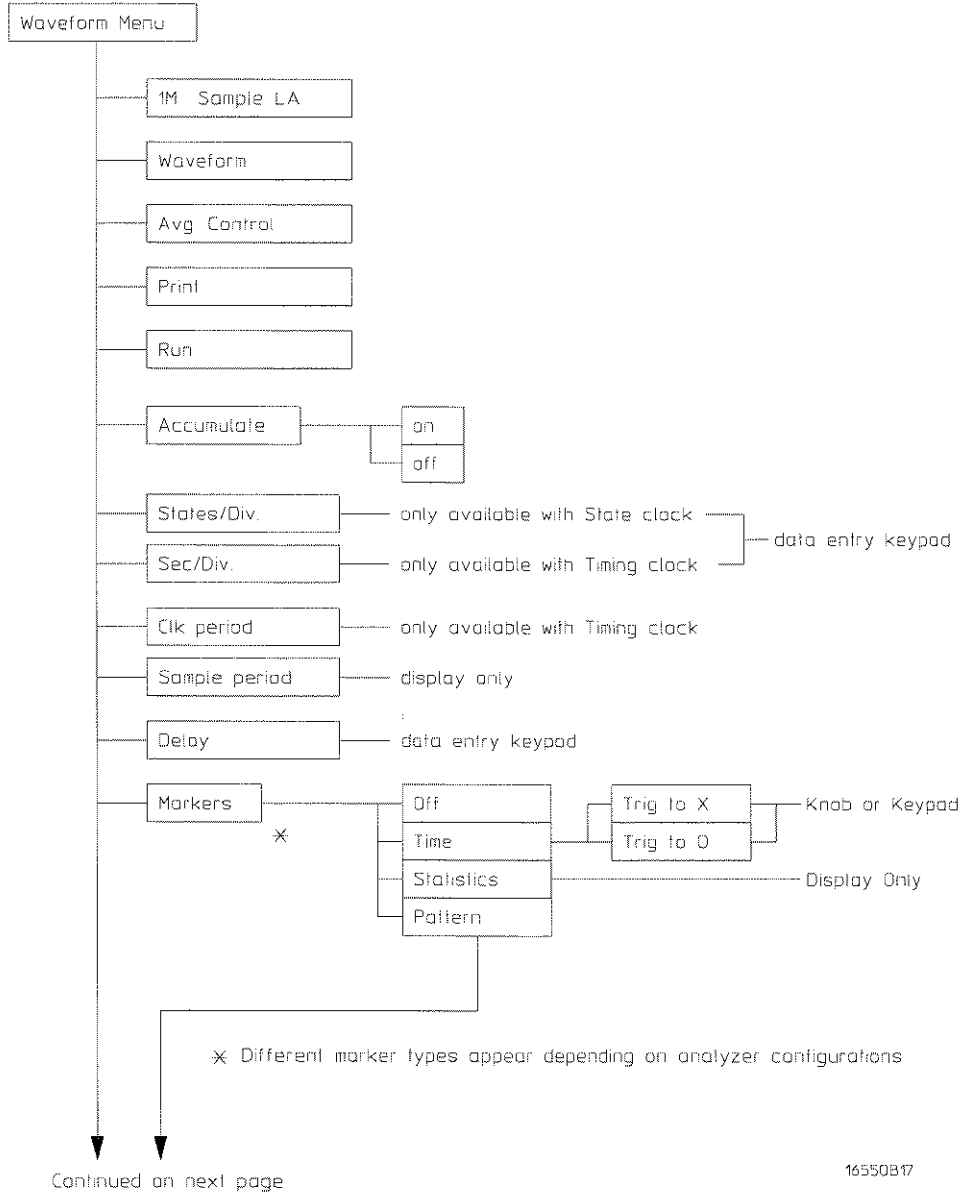

Waveform Menu Map

The Waveform Menu

Continued from previous page

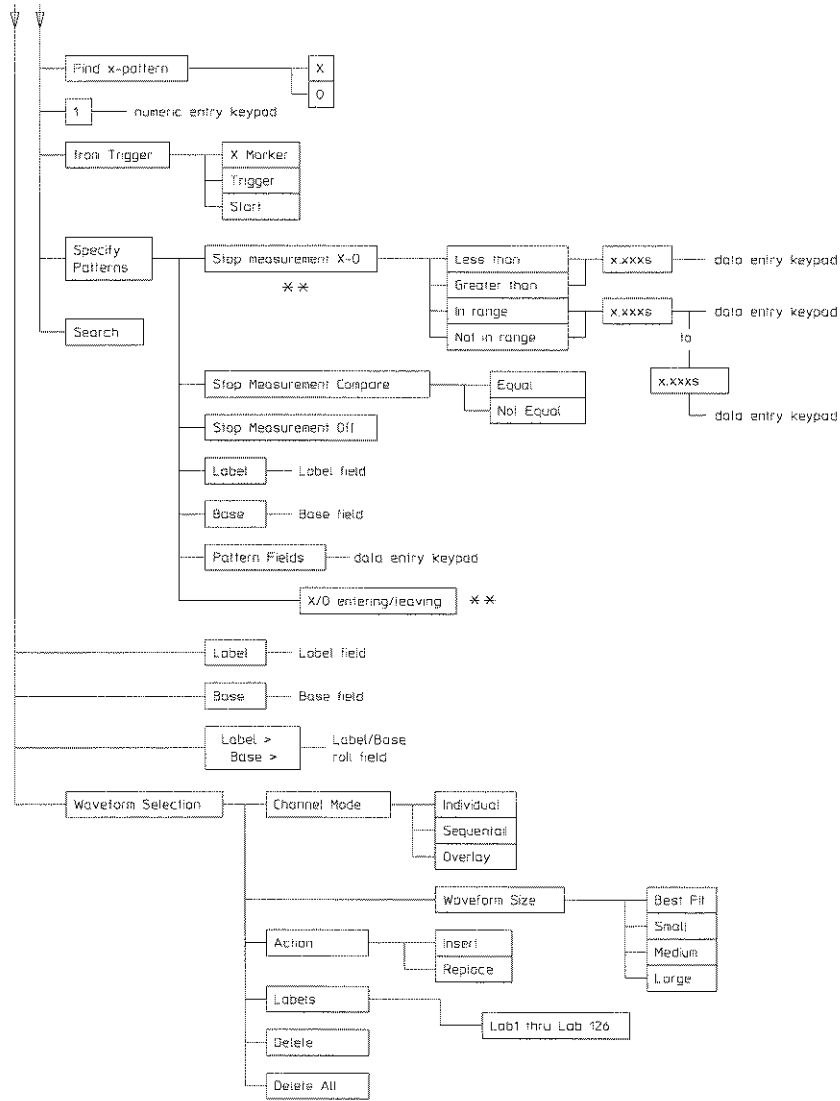

16550818

* * Only available in Timing analyzer or State analyzer with Count set to Time.

Waveform Menu Map (cont.)

Basic Controls

The basic controls on the initial Waveform screen let you configure this display using the following controls:

- Acquisition Control Field
- Accumulate Field
- States Per Division Field (State only)
- Seconds Per Division Field (Timing only)
- Delay Field
- Sample Period Display (Timing only)
- Markers Field

The Waveform Menu
Acquisition Control Field

Acquisition Control Field

The function of the Acquisition Control field in the Waveform menu is the same as in the Trigger menu. Refer to the "Acquisition Control Field" in chapter 5, "The Trigger Menu" for complete details.

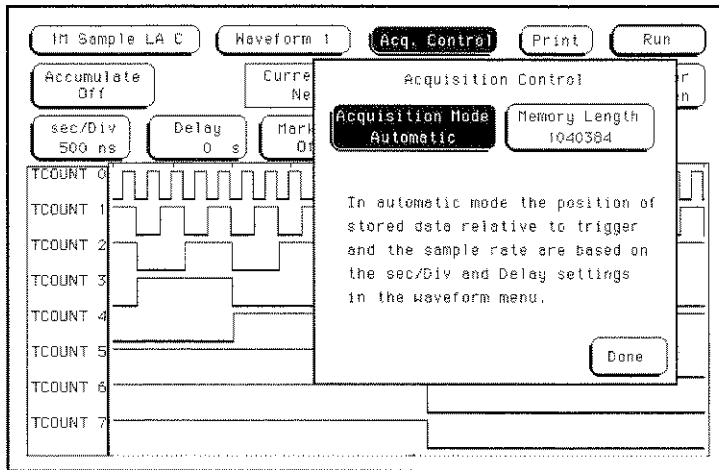

Acquisition Control field

Accumulate Field

The Accumulate field controls whether old data is cleared or displayed with new data. The Accumulate field will toggle On/Off. When Accumulate is on, the analyzer displays the data from a current acquisition on top of the previously acquired data.

The time at which the old data is cleared depends on whether the analyzer is run in Single or Repetitive mode. In Single, new data will be displayed on top of the old each time the Run field is selected. In Repetitive mode, data is cleared from the screen only when you start a run after stopping an acquisition with the Stop field.

If you leave the Waveform menu or pop up a menu over the waveform display, any accumulated display data is lost and the accumulation process starts over.

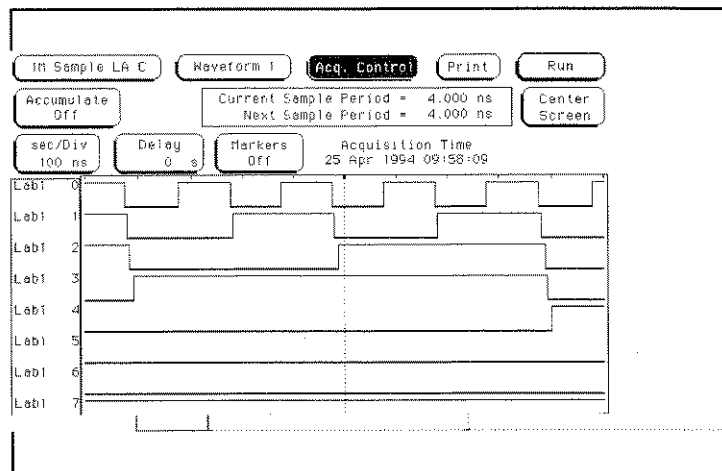

Accumulate Field

The Waveform Menu
States Per Division Field (State only)

States Per Division Field (State only)

When you set the analyzer Type field in the Configuration menu to State, the analyzer uses external clocks from the system under test. In this mode, the X-axis of the waveform display is measured in states per division.

Use the states/Div field to select the states per division resolution of the X-axis. You can specify between 1 and 500 states per division by touching the states/Div field and rotating the knob or by touching the states/Div field twice and using the pop-up keypad. By adjusting the states/Div, you can zoom in to view a desired part of the display.

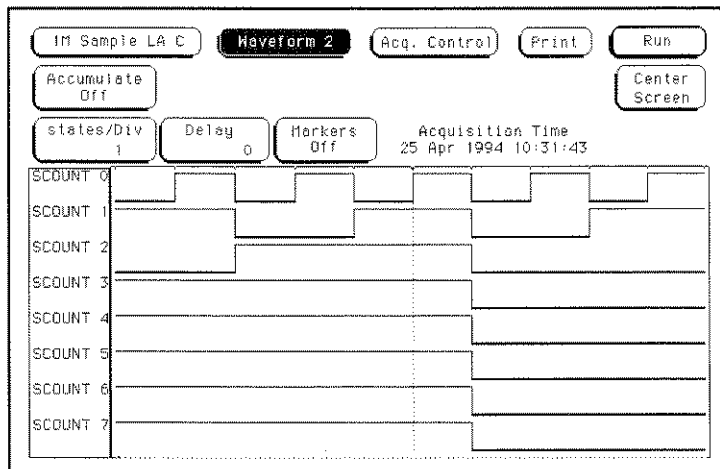

States Per Division Field

Seconds Per Division Field (Timing only)

When you set the analyzer Type field in the Configuration menu to Timing, the analyzer uses its own internal clock. In this mode, the X-axis of the waveform display is measured in seconds per division (sec/Div).

Use the sec/Div field to select the seconds per division resolution of the X-axis. The range of the sec/Div field is 1 ns/Div to 1.0 ks. You set the sec/Div field either by touching the sec/Div field and rotating the knob or by touching the sec/Div field twice and then using the pop-up keypad.

When using the knob to set the sec/Div, the value will change in a 1-2-5 sequence. By adjusting the sec/Div, you can zoom in to view a desired part of the display.

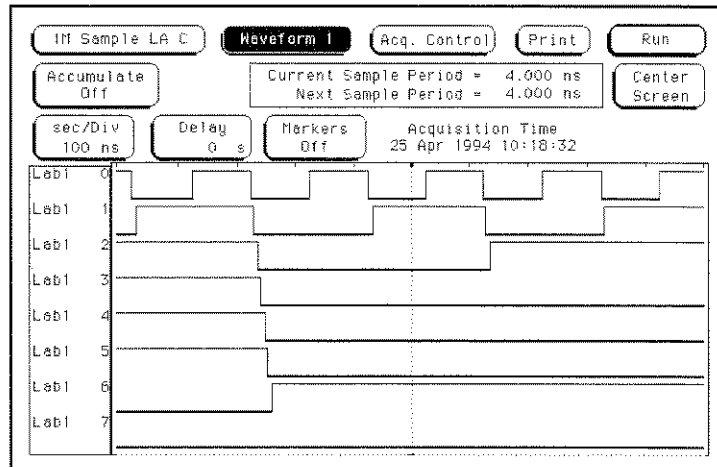

Seconds Per Division Field

The Waveform Menu
Delay Field

Delay Field

Depending on the analyzer configuration, a positive or negative delay measured in either states or time can be set. The Delay field allows you to scroll the data and place the display window desired at center screen. Changing the delay will not affect the next data acquisition unless it is a timing analyzer and the acquisition mode is automatic.

The delay range of a timing analyzer is from -2500 seconds to + 2500 seconds. The delay range of a state analyzer is from -8192 states to +8192 states.

If you want to move the display window to view data located off screen to the right, enter a positive delay. If you want to move the display window to view data located off screen to the left, enter a negative delay.

You can enter a delay using the knob by selecting the Delay field once, which turns it light blue, and then turning the knob. If you select the Delay field a second time, when it is light blue, a pop-up keypad appears which enables you to enter an exact number.

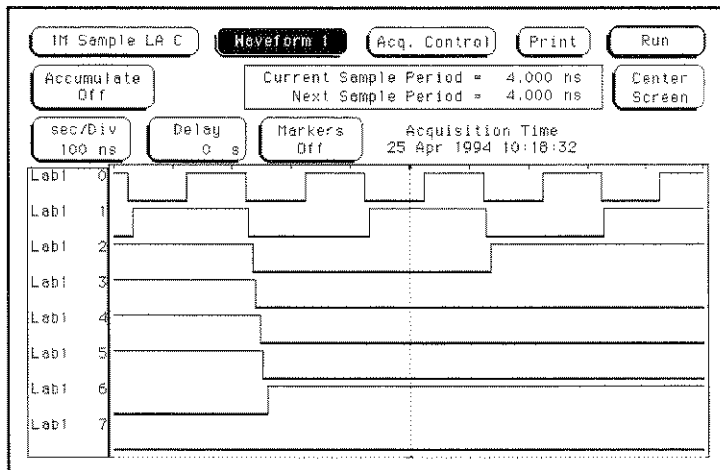

Delay Field

Sample Period Display (Timing only)

The Sample period display only appears in a timing analyzer. A sample period is the interval of time between new data samples. Every time a new sample is taken, the analyzer updates the measurement.

The Current Sample period display is the sample period used for the last acquisition. The Next Sample period is the new sample period to be used at the next acquisition. If the acquisition mode is set to automatic, changing the sec/Div or delay will affect the sample period for the next acquisition.

Sample period display

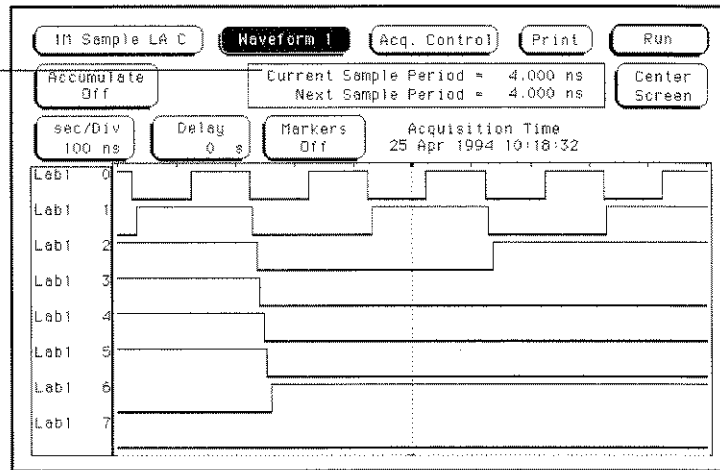

Sample Period Display

The Waveform Menu
Sample Period Display (Timing only)

Timing waveforms are reconstructed with respect to the sample period. A shorter sample period puts more sample points on the waveform for a more accurate reconstruction, but also fills memory quicker.

If the sec/Div is changed resulting in a change in the next sample period, you must run the analyzer again before the current sample period display is updated.

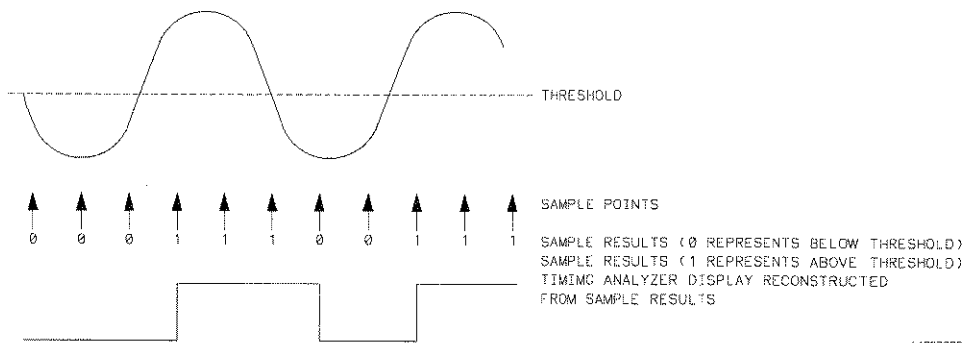

Sample Points

Markers Field

The Markers field is used to access the markers selection menu. When the Markers field is selected, a marker selection menu appears with the marker choices available under the present analyzer configuration.

State Analyzer Markers

In a state analyzer with time and state count turned off in the Trigger menu, only Pattern markers are available. With time count turned on, choices of Pattern, Time, and Statistics markers become available.

With states count turned on, Pattern and State markers are available.

Timing Analyzer Markers

In a timing analyzer you have marker choices of Pattern, Time, or Statistics.

Off

The Off selection turns marker operations off. If a Stop measurement was previously specified and the Stop measurement criteria are met, the measurement will stop even though the markers are off.

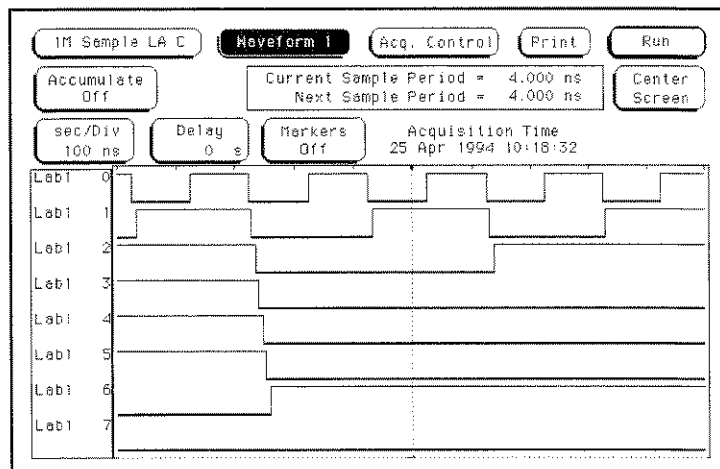

Markers Field

Pattern Markers

When Pattern markers are selected, two markers labeled X and O become available which you can use to identify and mark unique bit patterns in the waveform display. Once the unique bit patterns are marked, you can use them as reference points or as criteria for a stop measurement.

The markers are color coded for easy recognition in the waveform display. The X-marker is a vertical green line, and the O-marker is a vertical yellow line. In addition each marker is labeled at the bottom of the display. When a marker is positioned in the waveform display, it is also positioned in the data listing display. You control pattern markers with the following fields:

- X-pat / O-pat Occurrence Fields
- From Trigger / Start / X Marker Field
- X to O Display Field (Timing only)
- Center Screen Field
- Specify Patterns Field
- X and O entering / leaving Fields (Timing only)
- Pattern Display Fields
- Label and Base Fields
- Label / Base Roll Field
- Stop Measurement Field
- Clear Pattern Field

X-pat / O-pat Occurrence Fields

The X-pattern and O-pattern occurrence fields designate which pattern occurrence the marker is placed on. The range for the occurrence counter is from -8192 to +8192.

The occurrence field can be set in two ways. When the field is selected one time, it turns light blue and the knob becomes the entry method. If the field is selected a second time, a pop-up keypad appears and becomes the entry method.

The reference point from which the occurrence counter starts is either the trigger point, the start of the trace, or in the case of the O marker, the X marker. If a negative number is set, the analyzer will search for pretrigger occurrences.

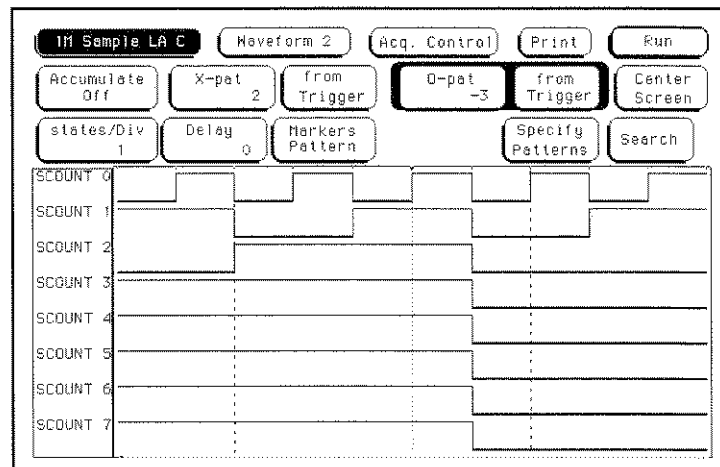

X-pattern and O-pattern Occurrence Fields

The Waveform Menu
From Trigger / Start / X Marker Field

From Trigger / Start / X Marker Field

The From Trigger/Start/X Marker field is used to access the selection pop-up for the start point of the X and O marker occurrence counters.

The start points available for the green X-marker are either the trace start point or the trigger point.

The start points available for the yellow O-marker are the trace start point, the trigger point, or the X-marker.

If the marker pattern can not be found, a message appears at the top of the display indicating the search failed. If the O-marker is referenced from the X-marker, and the X-marker is not found, the search for both markers will fail.

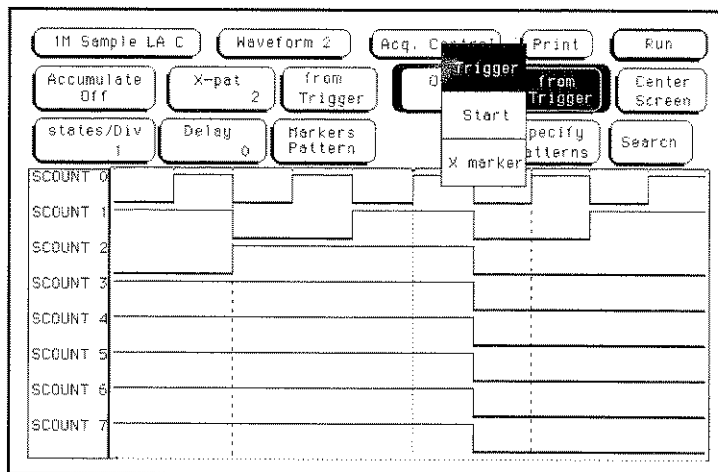

Trigger / Start / X Marker Field

X to O Display Field (Timing only)

The X to O display field only appears when the analyzer is configured as Timing. The X to O display field shows the time between the X and O markers.

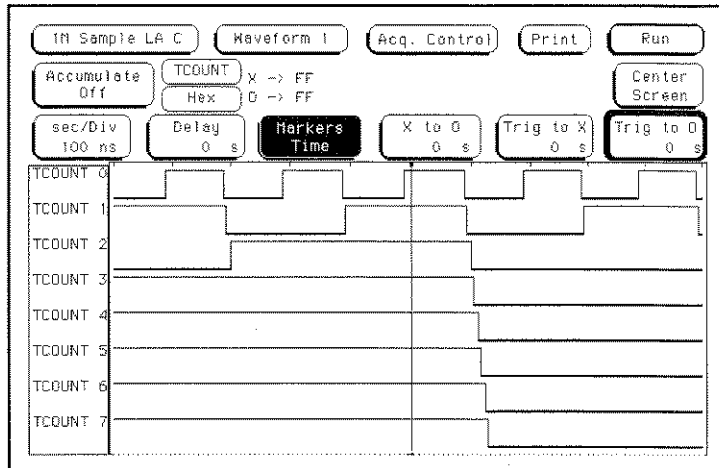

X to O Display Field

The Waveform Menu
Center Screen Field

Center Screen Field

The Center Screen field accesses a menu which allows you to position the marked points of the waveform display relative to the center of the waveform display.

About Trigger The About Trigger selection is the default position. This choice will position the trigger at center screen.

About X Marker This choice adjusts the delay to position the X-Marker at center screen.

About O Marker This choice adjusts the delay to position O-Marker at center screen.

About X & O This choice adjusts the sec/Div to allow both X and O markers to be displayed simultaneously.

About Start This choice adjusts the delay to position the start of the data record at the center of the screen.

About End This choice adjusts the delay to position the end of the data record at the center of the screen.

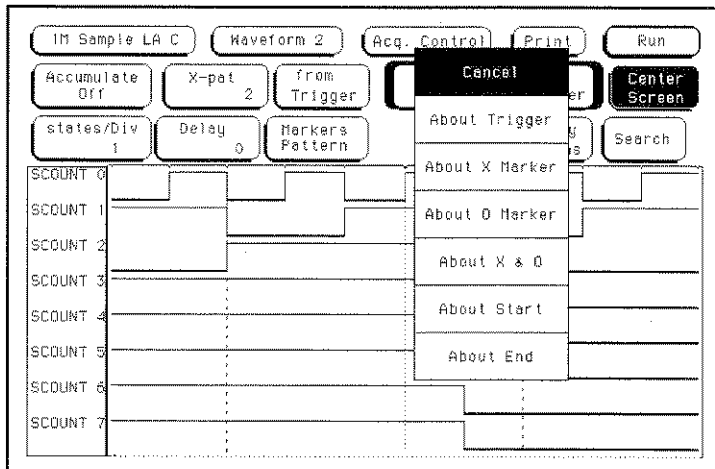

Center Screen Field

Specify Patterns Field

The Specify Patterns field only appears when the markers are set to Pattern. When the Specify Patterns field is selected, a pop-up menu appears with which you can assign the bit patterns for the X and O markers, the X and O entering/leaving, and the Stop measurement criteria.

The screenshot shows a control panel with the following elements:

- Buttons: IN Sample LA C, Waveform 2, Acq. Control, Print, Run
- Buttons: Accumulate Off, X-pat 2, from Trigger, O-pat -3, from Trigger, Center Screen
- Buttons: states/Div 1, Delay 0, Markers Pattern, Specify Patterns, Search

Below the buttons is a waveform display with 8 rows labeled SCOUNT 0 through SCOUNT 7. The SCOUNT 0 row shows a complex digital waveform. The other rows (SCOUNT 1-7) are mostly flat lines, indicating no activity or a specific state.

Specify Patterns Field

The Waveform Menu Specify Patterns Field

X and O entering / leaving Fields (Timing only)

In a timing analyzer, the X and O pattern markers are placed at either the beginning of the pattern occurrence (entering) or at the end of the pattern occurrence (leaving). When the entering/leaving field of either X or O markers is selected, it will toggle between the two choices.

Which ever choice you toggle the field to, the pattern you place in the pattern display field will apply to that choice.

X marker and O marker Fields (State only)

In a state analyzer, X-marker and O-marker fields replace the X and O entering/leaving fields. The pattern you place in the pattern display field will apply to the marker labeled at the left.

-14	2222	-56 ns	222
-13	2222	-52 ns	222
-12	2222	-48 ns	222
-11	2222	-44 ns	222
-10	2222	-40 ns	222
-9	2222	-36 ns	222
-8	2222	-32 ns	222
-7	2222	-28 ns	222
-6	2222	-24 ns	222
-5	2222	-20 ns	222

X and O entering / leaving Fields

Pattern Display Fields

The pattern display field displays the alphanumeric bit pattern specified for each X and O marker in all designated labels. The bit pattern is displayed in the same numeric base and in the same order as the data listing. When the pattern display field is selected, a pop-up keypad appears which you can use to set the bit pattern.

When there are more labels assigned than can be displayed in a single screen, the pattern display fields are rolled back on screen by the Label/Base roll field.

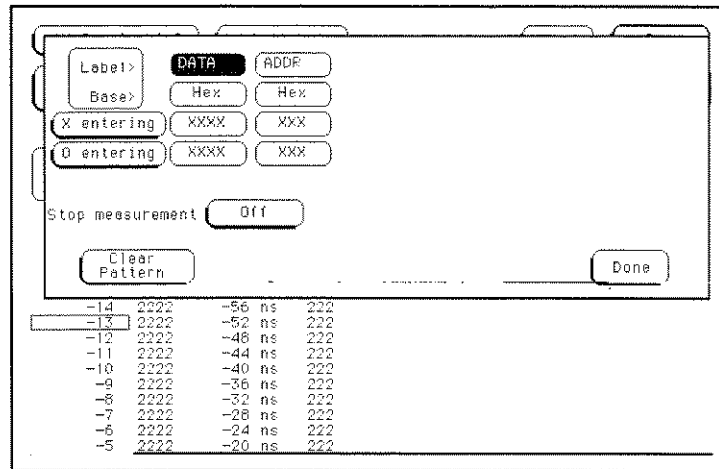

Pattern Display Field

The Waveform Menu
Label / Base Roll Field

Label and Base Fields

The Label and Base fields show up in all menus except the Format and Configuration menus. When a new label is assigned, a base field is automatically assigned to that label.

Label Field Labels in the Specify Patterns menu are the same labels assigned in the Format menu. These labels will be displayed throughout the analyzer as they were assigned in the Format menu.

To reorder currently displayed Labels, select the label you want to move, then from the selection menu that appears, choose the label you want to switch positions with.

Base Field The function of the Base field is the same in all menus. To change the numeric base, select the base field, then choose the desired base from the selection menu.

Label / Base Roll Field

The function of the Label and Base roll field is the same in all menus. The rolling function is the same for all items that are stored off screen. For more information on rolling labels, base, and pods, refer to "Labels Assignment" in the "Common Module Operations" part of the *HP 16500B User's Reference*.

Stop Measurement Field

The Stop measurement function allows you to specify a condition which stops the analyzer measurement during a repetitive run. When the Stop measurement field is selected, a Stop measurement type menu appears. Depending on the analyzer configuration, you have choices of Off and X-O.

Off

The Off selection turns all Stop measurement operations off. If the Stop measurement operation is not turned off and the Stop measurement criteria are met, the measurement will stop even though the markers are set to other types or are turned off.

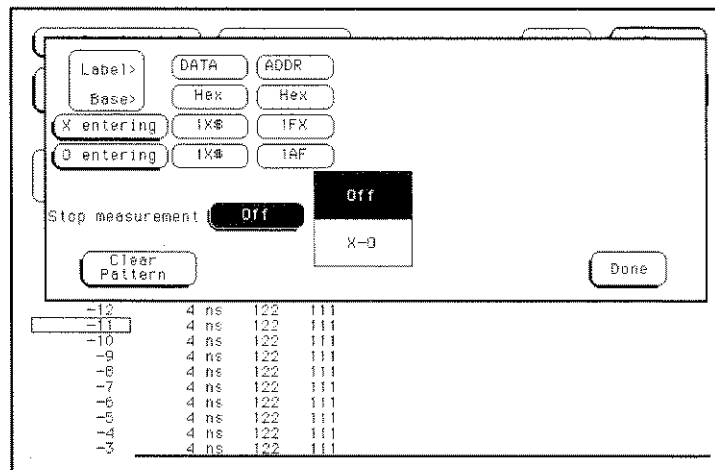

Stop Measurement Field

The Waveform Menu
Stop Measurement Field

X-O

The X-O option is available in the timing analyzer and in the state analyzer with its count set to Time. When X-O is selected, a repetitive run is stopped when a comparison of the time period between the X and O markers and one of the following time period options is true:

Less Than X-O time must be less than the time value that you specify in the Time field.

Greater Than X-O time must be greater than the time value that you specify in the Time field.

In Range X-O pattern must be within the time range value that you specify in the two Time fields.

Not in Range X-O pattern must not be within the time range value that you specify in the two Time fields.

Clear Pattern Field

The Clear Pattern field is used to reset the X and O Marker pattern display fields back to default (don't care = X). The Clear Pattern field accesses a selection menu with the choices of All, X pattern, or O pattern.

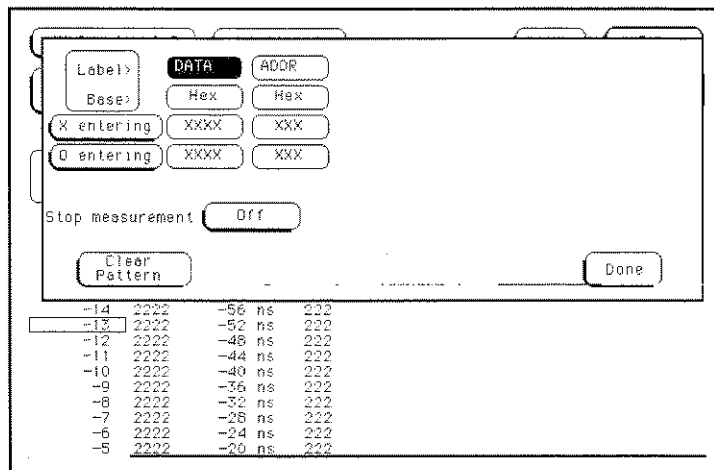

Clear Pattern

Time Markers

Time markers are indicators located in the waveform display that are used as reference marks to obtain time values between markers, or between each marker and the trigger point.

In a state analyzer, Time markers only become available when the Count field is set to Time, in the Trigger menu.

The markers are color coded for easy recognition in the waveform display. The X-marker is represented by a vertical green line and the O-marker is represented by a vertical yellow line. In addition, both markers are labeled at the bottom of the display.

If Pattern markers are assigned, the Time markers are initially placed at the same locations in the data listing.

Time markers have two fields for control and display:

- Trig to X/Trig to O Fields
- Marker Label/Base and Display

Trig to X / Trig to O Fields

The Trig to X and Trig to O fields display the time between the trigger point and the marker. They are also used to position the markers with reference to the vertical red trigger line.

Set the marker position by selecting the Trig to X and Trig to O fields, then, after the fields turn light blue, rotate the knob. In addition, values can be entered by selecting the light blue field a second time, then using the pop-up keypad that appears.

X to O Field

In a state analyzer configuration, the X to O field is a "read only" field that displays the difference between the X and O markers. As the X and O markers are changed, the display changes accordingly.

In a timing analyzer configuration, the X to O field can be selected and set. If this field is changed, both X and O markers will move simultaneously with the relative difference remaining unchanged.

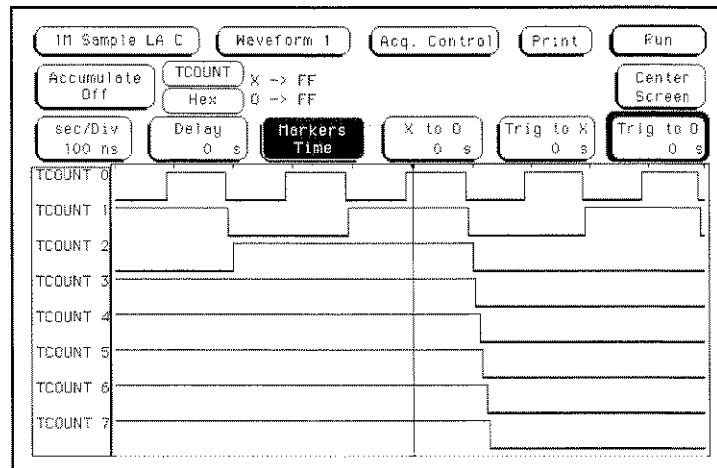

Trig to X / Trig to O Fields

The Waveform Menu
Marker Label / Base and Display

Marker Label / Base and Display

The label field displays the label name for which the X and O marker values are assigned. To display other labels, select the label field and choose the new label from the selection menu that appears. Only pre-assigned labels are available in the label selection menu.

The base field underneath the label field displays the numeric base of the marker values. To change the numeric base, select the base field, then choose the desired base from the selection menu. Bit patterns where the markers are currently placed, appear next to the appropriate marker.

See also

"Labels Assignment" in the "Common Module Operations" part of the *HP 16500B User's Reference* for complete information on assigning labels.

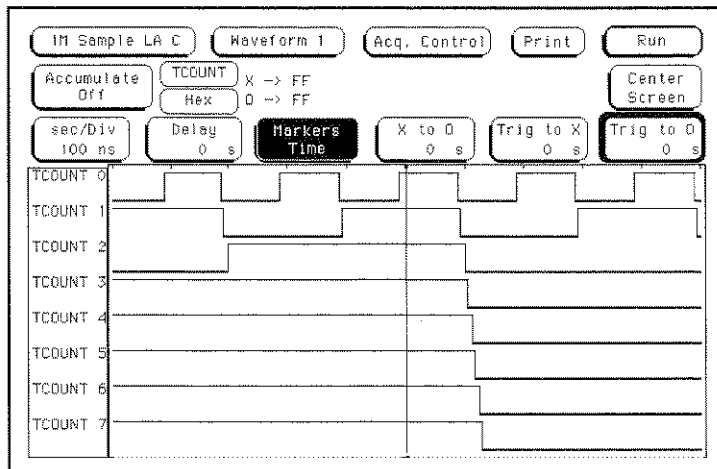

Marker Label / Base and Display

Statistics Markers

After patterns are assigned to the X and O markers, statistical information is available when you set the markers to Statistics. The logic analyzer displays the following information:

- Number of valid runs (runs where Pattern markers were placed on specified patterns).
- Minimum time between the X and O Pattern markers.
- Maximum time between the X and O Pattern markers.
- Average time between the X and O Pattern markers.

In a state analyzer, Statistics markers only become available when the Count field is set to Time, in the Trigger menu.

The markers are color coded for easy recognition. The X-marker is represented by a vertical green line and the O-marker is represented by a vertical yellow line. In addition, both markers are labeled at the bottom of the display.

The Waveform Menu Marker Label / Base and Display

The statistics generated are based on the time between the X and O markers. Both markers must be found before valid statistical information is displayed.

In repetitive run mode, the display is updated each time a valid run occurs until you press Stop. If you press Run after pressing Stop, the statistics continue to update without loss of information. All statistical information can be cleared at any time by selecting the Reset Statistics field.

In single run mode, each time you press Run an additional valid run will be added to the data and the statistics will be updated. This process continues unless you change the placement of the X and O Pattern markers between runs.

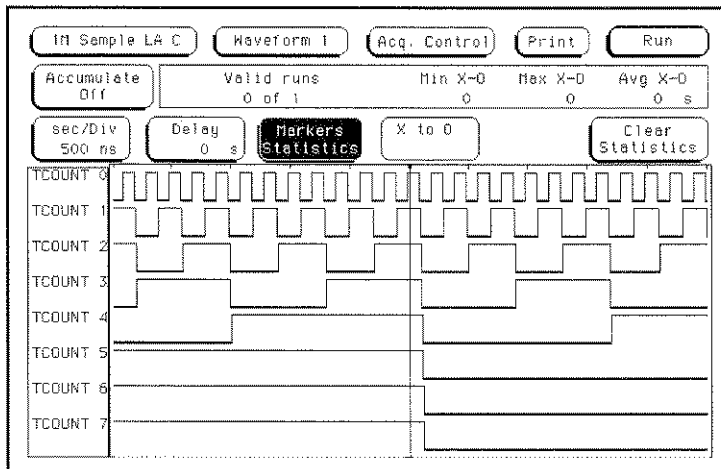

Statistics Display

Waveform Display

The waveform display area of the Waveform menu displays state and timing waveforms for labels assigned in the Format menu. If the Waveform menu is from a state analyzer, the display is state waveforms. If the Waveform menu is from a timing analyzer, the display is timing waveforms.

Selecting waveforms for display, and modifying or deleting waveforms is identical for both state and timing waveforms. This area also accesses the following fields used to select, delete, or modify waveforms:

- Display Location Reference Line
- Blue Bar Field
- Channel Mode Field
- Module and Label Fields
- Action Insert/Replace Field
- Delete and Delete All Fields
- Waveform Size Field

Only waveforms with their bits assigned in the Format menu can be displayed. Each waveform is a member of a set of waveforms grouped under a label. The label name you assign in the Format menu is the label name that appears in the Labels selection list.

The Waveform Menu
Display Location Reference Line

Display Location Reference Line

At the bottom of the Waveform menu is a reference line that displays the relative location of the display window, the markers, and the trigger point with reference to the total memory.

Total memory is represented by a horizontal dotted line. The display window is represented by an overlaid solid line. The markers and trigger point are represented by an X, O, and t, all of which are located below the dotted line.

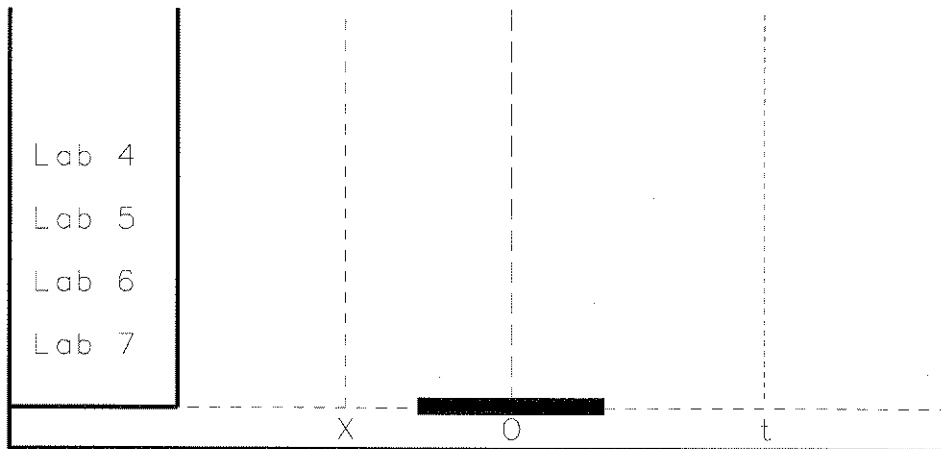

01680E 12

Display Location Reference Line

Blue Bar Field

The blue bar on the left side of the waveform display is both a display and configuration field. After all desired waveforms are configured for display, they are listed in the blue bar. If there are more waveforms than can be displayed, you can scroll through the list by selecting the dark blue bar, and, after it turns light blue, by turning the knob.

If the blue bar is already light blue, just turn the knob. If the blue bar is selected when it is light blue, the Waveform Selection menu appears. Use this menu to configure the waveform display.

Blue bar field

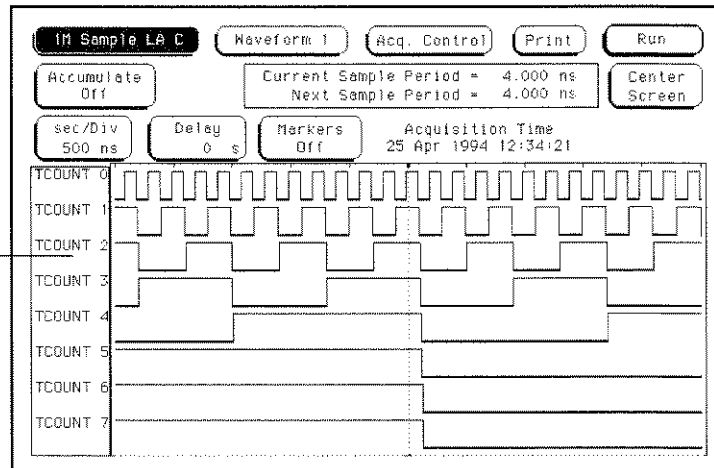

Blue Bar Field

The Waveform Menu Blue Bar Field

When the Waveform Selection pop-up menu appears, you can select which waveforms are displayed, replaced, or modified. You can display up to 24 waveforms on screen at one time.

Single waveforms or all waveforms under a label can be displayed or turned off. How the waveform bits are assigned for display depends on what Channel Mode is currently selected.

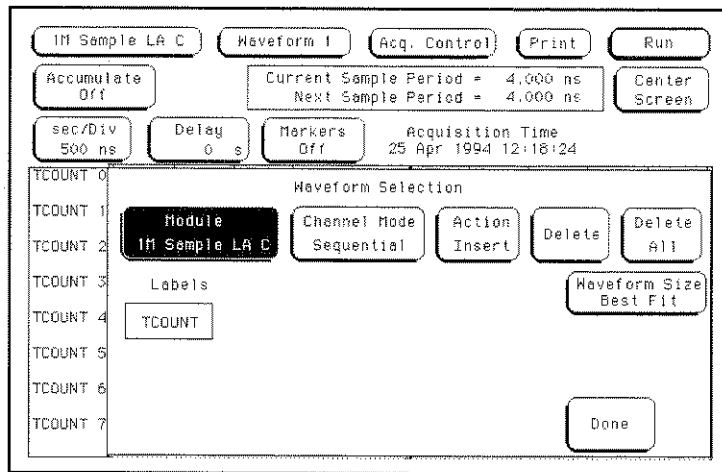

Waveform Selection Menu

Channel Mode Field

The Channel Mode field selects the method by which waveform labels are inserted into the display. All inserted labels are placed below the cursor in the blue bar field. When the Channel Mode field is selected, a selection menu appears with the choices below.

Sequential

The Sequential mode inserts all channels from the selected label in order starting below the white cursor.

Individual

The Individual mode inserts selected channels from a label's channel selection list. The channel selection list appears when a label name is selected. Channels are inserted starting below the white cursor.

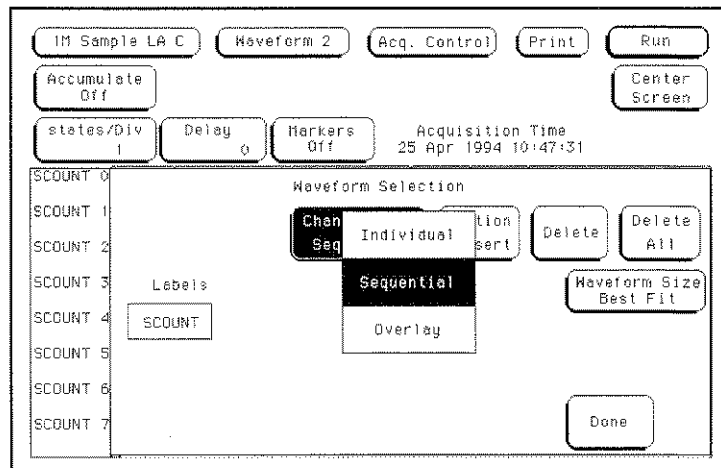

Channel mode Selection Menu

The Waveform Menu
Channel Mode Field

Overlay

The Overlay mode inserts all bits of a label in a single waveform to form a composite waveform label. The on screen indication for the Overlay mode is "All" following the label name.

Viewing State Data in Overlay Mode

When all assigned waveforms in a label are overlaid, the value of the data is displayed to the right of each new transition in the waveform display.

If the sec/Div is set to view a large increment of time, or the waveform scaling is set to small or medium, the state data readout will not fit between transitions. To display the state data readouts within the waveform, expand the sec/Div and use the large waveform setting. If symbols are assigned to represent data values, the symbol is displayed.

Module and Label Fields

If there are multiple timing or oscilloscope modules installed in the mainframe, this field will appear in the menu, and waveforms from the other modules can be displayed in the waveform menu. The Module field accesses a selection list that contains the modules installed in the mainframe that are configured in a Group Run and that have timing or oscilloscope waveforms.

The Waveform Menu
Action Insert/Replace Field

Action Insert/Replace Field

Use the Action field to insert a label or channel into the display or replace a label or channel.

Insert will append the selected label or channel to the end of the list of displayed labels.

To replace one waveform with another, use the knob to position the cursor on the waveform you wish to replace. Touch the Action Insert field to toggle it to Action Replace. Then select the label that will replace the old label.

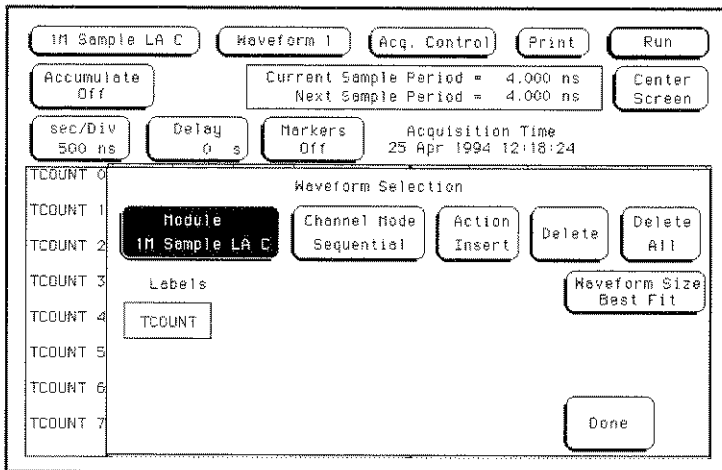

Action Insert/Replace Field

Delete and Delete All Fields

Use the Delete field to delete single channels within the group of displayed waveforms. To delete any single channel, first highlight the desired channel by placing the cursor on the channel, then select the Delete field.

You can delete all currently displayed waveforms by selecting Delete All, then by selecting Continue.

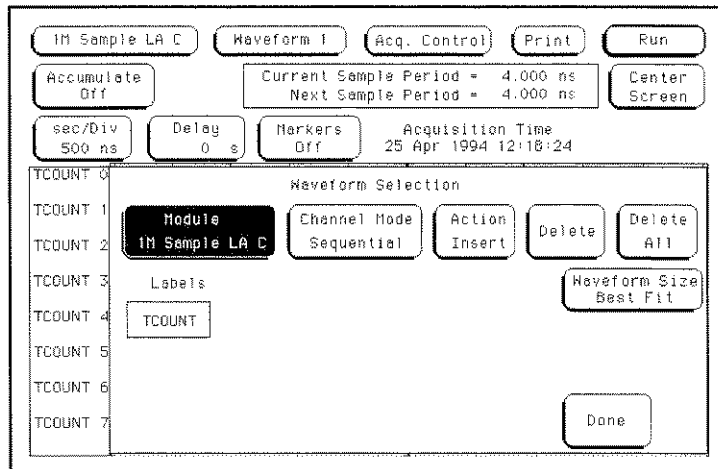

Action Insert/Replace Field

The Waveform Menu
Waveform Size Field

Waveform Size Field

The Waveform Size field accesses a selection menu which contains choices that scale the displayed waveforms to different sizes. Use this feature to increase the number of waveforms in the display or to make viewing better for just a few.

Best Fit

When Best Fit is used, the analyzer picks the largest font, either small, medium, or large, that allows all waveforms to be displayed.

Small

The small font will allow 24 waveforms displayed.

Medium

The medium font will allow 16 waveforms displayed.

Large

The large font will allow 8 waveforms displayed.

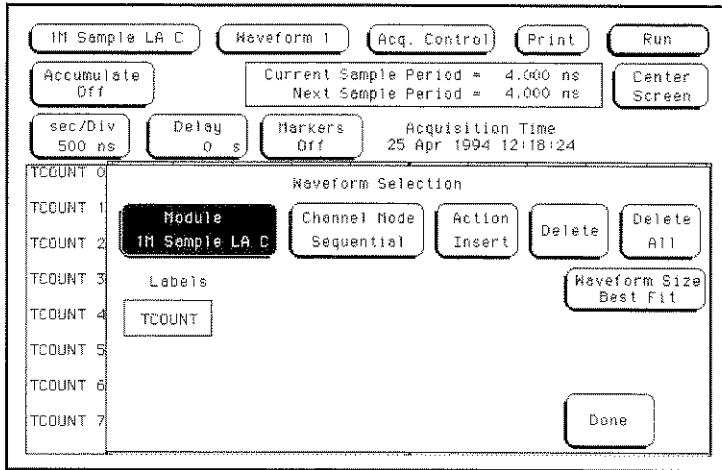

Waveform Size Selection Menu



The Chart Menu

The Chart Menu

State Chart is a software post-processing feature that provides the ability to build X-Y graphs of label activity using state or timing data. The Y-axis always represents data values for a specified label. You can select whether the X-axis represents states (ie. rows in the Listing menu) or the data values for another label.

Chart Post-Processing Features

- When the X-axis is set to State, X and O markers are available which can be used to search for specific data patterns, document time intervals of interest in timing mode, and gather statistics on the time between specific patterns in timing mode.
- Marker placement is synchronized with the Listing and Waveform menus.
- An accumulate mode is available that allows the chart display to build up over several runs.
- You can set a range of data to plot which scales both the axes to selectively view only data of interest.
- You can generate XY plots of Label versus Label or Label versus State.

Label Value Versus Label Value Charts

When labels are assigned to both axes, the chart shows how one label varies in relation to the other for a particular trace record. Label values are always plotted in ascending order from the bottom to the top of the chart and in ascending order from left to right across the chart. Plotting a label against itself will result in a diagonal line from the lower left to upper right corner. X and O pattern markers are disabled when operating in the label versus label mode.

Label Value Versus States Charts

The Label value versus State chart is a graph of label activity versus the memory location in which the label data is stored. The label value is plotted against successive analyzer memory locations.

Chart Menu Map

The following menu map illustrates all fields and the available options in the Chart menu. The menu map will help you get an overview as well as provide you with a quick reference of what the Chart menu contains.

The Chart Menu

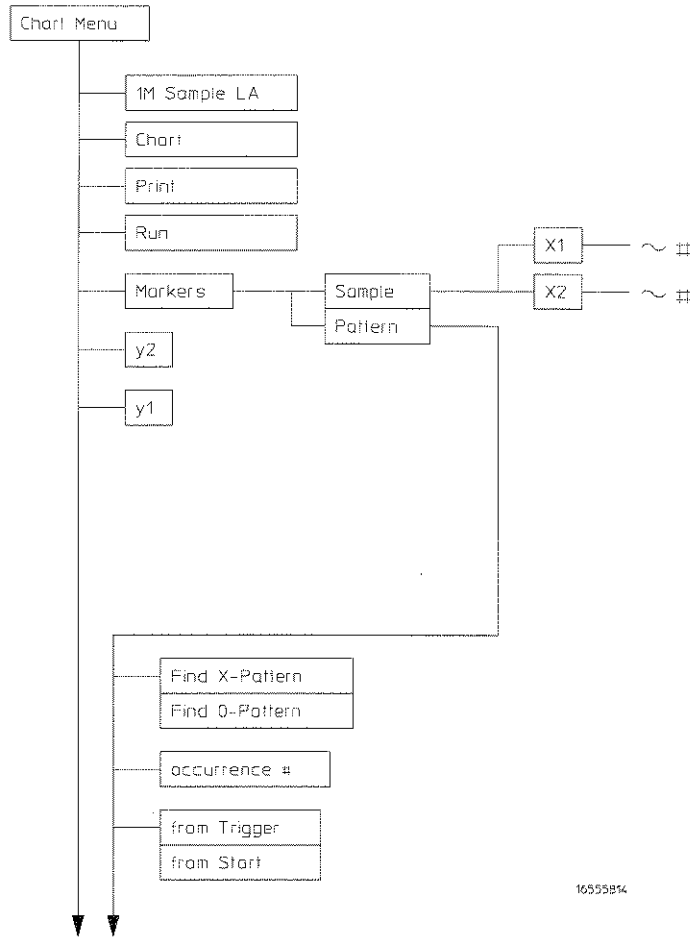

16555B54

Chart Menu Map

The Chart Menu

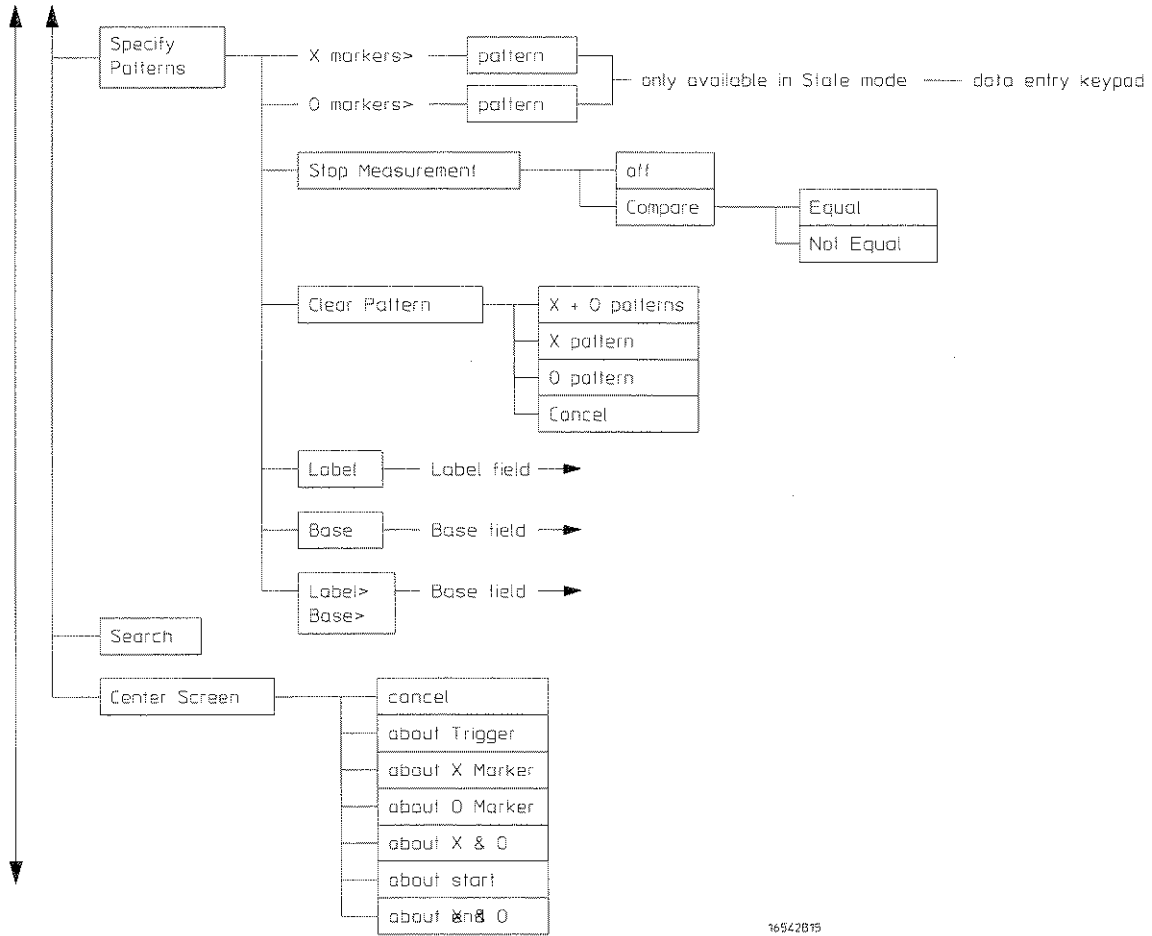
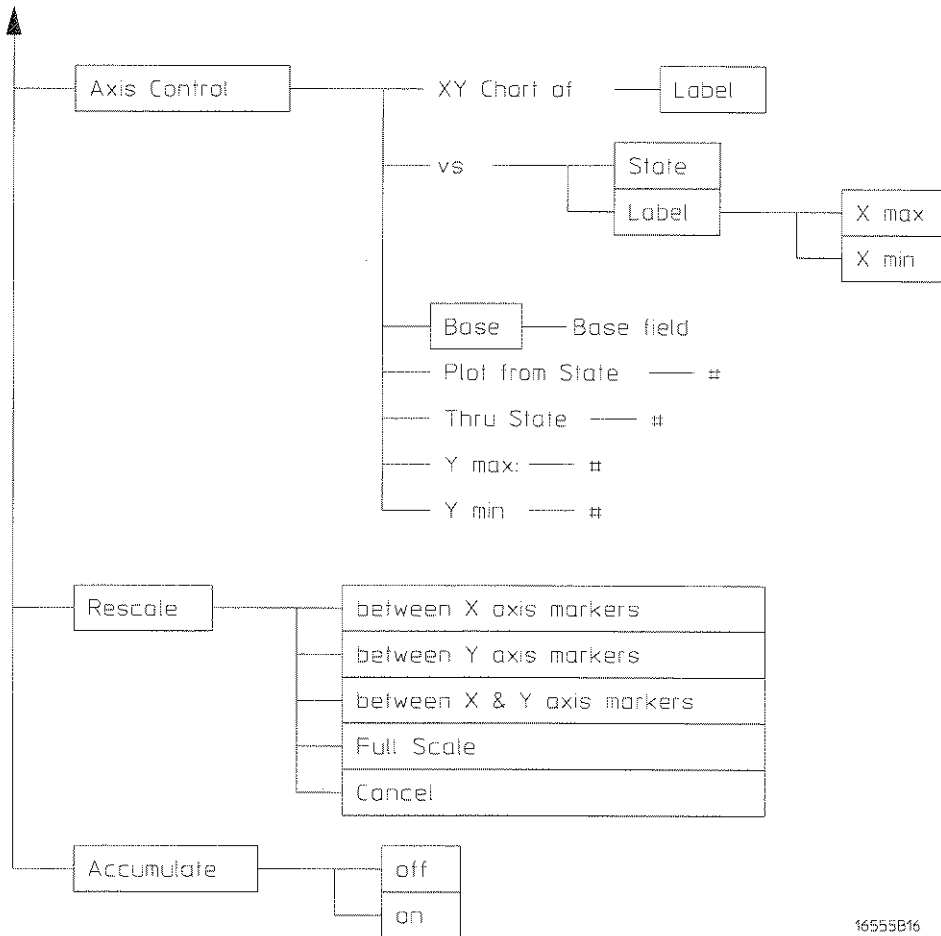

Chart Menu Map (cont.)

16542815

The Chart Menu



16555B16

Chart Menu Map (cont.)

The Y Markers

Y1 and Y2 Fields

The Y1 and Y2 markers are used for rescaling data on the vertical axis. Assigning values to these fields can be accomplished in either of two ways. When the field is selected the first time, it turns light blue and operating the knob will change the Y marker value. If the field is selected a second time, a pop-up keypad appears and becomes the entry method for the Y marker value. The Y1 and Y2 markers may be used to zoom in on data of interest in the vertical range. To do this, touch the Rescale field, then select "between Y axis markers." For more information on rescaling data, refer to the "Rescale Field" section later in this chapter.

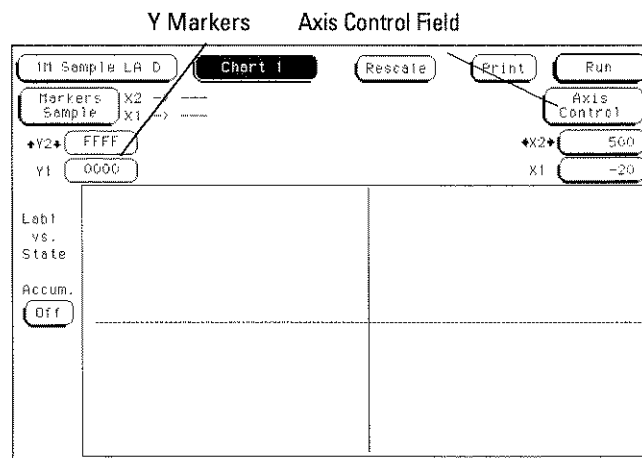

Y Markers for Rescaling the Vertical Axis

The Chart Menu
The X Markers and the Markers Field

The X Markers and the Markers Field

The Markers field is used to access the markers selection pop-up. When the Markers field is selected, a marker selection pop-up menu appears which is used to select Sample or Pattern in state mode, and Sample, Pattern, Time or Statistics in timing mode.

Sample

The Sample selection turns X and O marker operations off, and enables the X1 and X2 markers. The data values at the X1 and X2 markers are automatically displayed to the right of the Marker field when charting label versus state. Data between the X1 and X2 markers may be rescaled. For more information on rescaling, refer to the "Rescale Field" later in this chapter.

If a Compare Stop measurement is specified in the Stop measurement field, and the Stop measurement criteria are met, the measurement will stop even though the Markers are set to Sample. However, an X-O Stop measurement will not complete if Markers are set to Sample.

Markers field

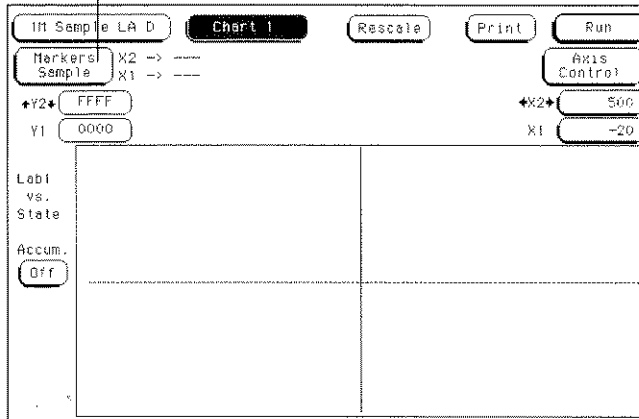

Markers Field and Pop-up Menu in Timing Mode

X1 and X2 Fields (Markers Sample mode only)

The X1 and X2 markers are used for displaying and rescaling specific data values. Assigning values to these fields can be accomplished in either of two ways. When the field is selected the first time, it turns light blue and operating the knob changes the value. If the field is selected a second time, a pop-up keypad appears and becomes the entry method. The X1 field positions the green X-axis marker and the X2 field positions the yellow X-axis marker. You can zoom in on the data between the X1 and X2 markers by selecting the Rescale Field and selecting "between X axis markers." For more information on rescaling data, refer to the "Rescale Field" section later in this chapter.

Pattern

When Pattern is selected, two markers labeled X and O become available. Pattern markers identify and mark unique bit patterns in the data. Once the unique bit patterns are marked, they can be used as reference points or, in timing mode, as criteria for a stop measurement.

Find X-pattern / Find O-pattern Field

The Find X-pattern / Find O-pattern field is a toggle field which is used to select the X or O marker for setup. The marker criteria set will be assigned to the pattern marker that is designated in this field. To assign marker criteria to the other marker, the other pattern marker must be designated in this field.

Occurrence Field

The occurrence field for both the X and O markers designates which pattern occurrence the marker is placed on. The maximum numeric value in the occurrence field is limited only by the total number of samples allowed by the memory configuration.

The occurrence field can be set in two ways. When the field is selected one time, it turns light blue and knob operation becomes the entry method. If the field is selected a second time, a pop-up keypad appears and becomes the entry method.

The reference point from which the counting of occurrences starts is either the trigger point, the start of the trace, or in the case of the O-marker, the X-marker.

The Chart Menu
Pattern

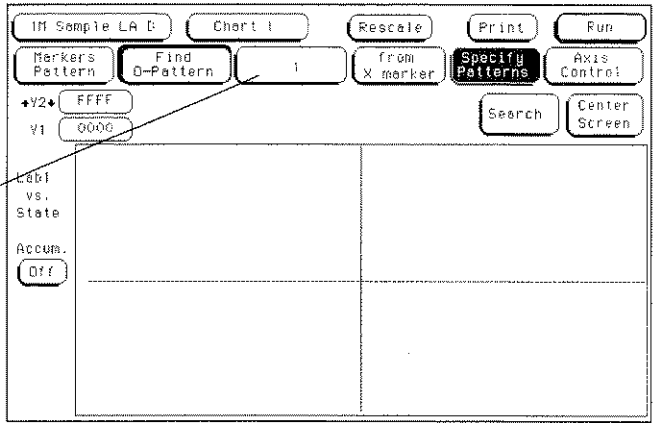

Occurrence field

From Trigger / Start / X Marker Field

The from Trigger/Start/X marker field is used to define the search start point of the X and O markers.

The start points for the green X marker are either the trace start point or the trigger point.

The start points available for the yellow O marker are either the trace start point, trigger point, or the X marker.

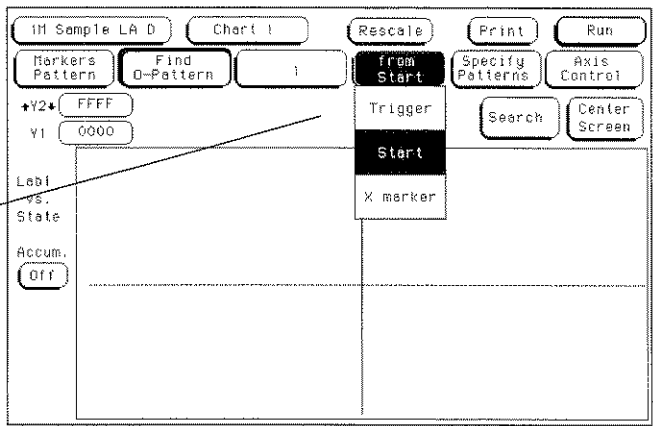

From Trigger/Start/X Marker Field

Specify Patterns Field

When the Specify Patterns field is selected, a pop-up menu appears that is used to assign the bit patterns for the X and O markers, the X and O entering/leaving (timing mode only), and the Stop measurement criteria.

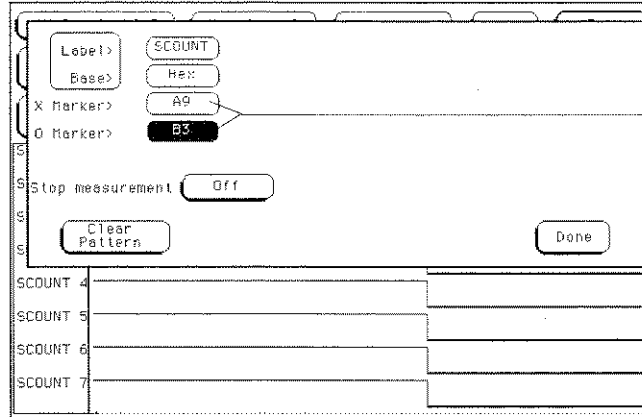

Pattern display fields

Specify Patterns Pop-up Menu (State mode)

X and O entering / leaving (Timing mode only)

The X and O entering/leaving fields appear in the Timing mode only. The X and O pattern markers are placed at either the beginning of the pattern occurrence (entering) or at the end of its occurrence (leaving). When the entering/leaving field of either the X or O marker is selected, it will toggle between the two choices.

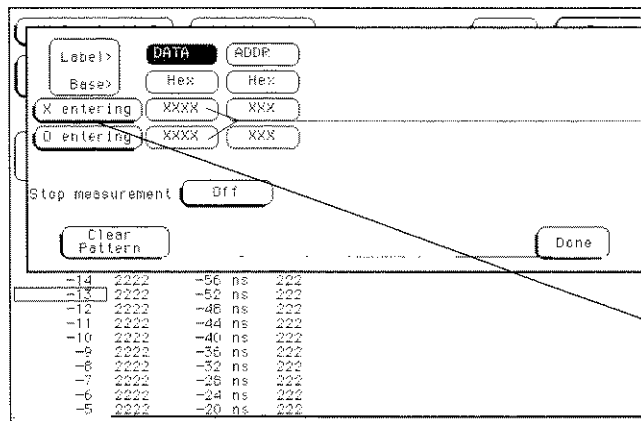

Pattern display fields

X and O entering / leaving

Specify Patterns Pop-up Menu (Timing mode)

The Chart Menu

Pattern

Pattern Display Field

The pattern display field displays the alphanumeric bit pattern specified for each X and O marker for all designated labels. The bit pattern is displayed in the same numeric base as in the Trigger menu. When the pattern display field is selected, a pop-up keypad appears which is used to set the bit pattern. When there are more labels assigned than can be displayed in a single screen, the pattern display fields not shown can be rolled back onscreen by using the Label / Base roll field.

Clear Pattern

The Clear Pattern field gives you access to quickly clearing the X pattern, the O pattern, both X and O at once, or canceling your Clear Pattern request

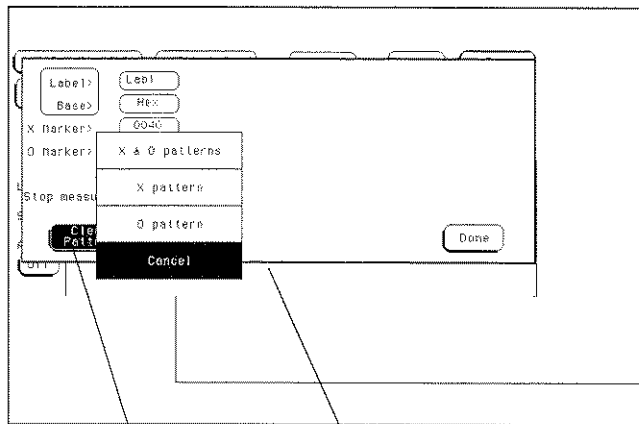

Clear Pattern field and pop-up menu

Label and Base Fields

The Label and Base fields show up together in all menus except the Format menu. When a new label is assigned, a base field is automatically assigned to that label.

Label Field Labels in the Listing menu are the same labels assigned in the Format menu. These labels will be displayed throughout the analyzer as they were assigned in the Format menu. For a complete definition of label assignment and modification, go to "Label Assignment Fields" in the Format menu chapter.

Base Field The function of the Base field is the same in most menus.

Label / Base Roll Field

The function of the Label and Base roll field is the same in all menus.

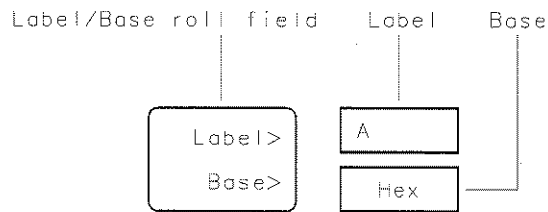

16542803

Label / Base Roll Field

The Chart Menu Pattern

Stop Measurement Field (Timing and State Compare modes only)

The Stop measurement function allows you to specify a condition which stops the analyzer measurement during a repetitive run.

When the Stop measurement field is selected, a Stop measurement type selection pop-up appears with the choices of Off, X-O, or Compare.

Off

The Off selection turns all Stop measurement operations off.

If a Compare Stop measurement is specified in this field, and Stop measurement criteria are met, the measurement will stop even though the Markers are set to Sample. An X-O Stop measurement will not complete if Markers are set to Sample.

Stop measurement selection menu

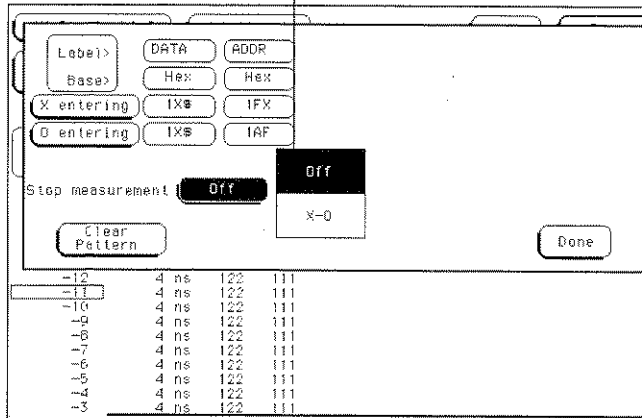

Stop Measurement Field and Pop-up Menu (Compare is disabled.)

X-O (Timing mode only)

The X-O is the time between the X and O markers. During a repetitive run, the X-O is compared to a selectable time value which uses one of the following four options. If a match is found, the repetitive run is terminated.

Less Than X-O time must be less than the time value that you specify in the Time field.

Greater Than X-O time must be Greater than the time value that you specify in the Time field.

In Range X-O pattern must be within the time range value that you specify in the two Time fields.

Not in Range X-O pattern must not be within the time range value that you specify in the two Time fields.

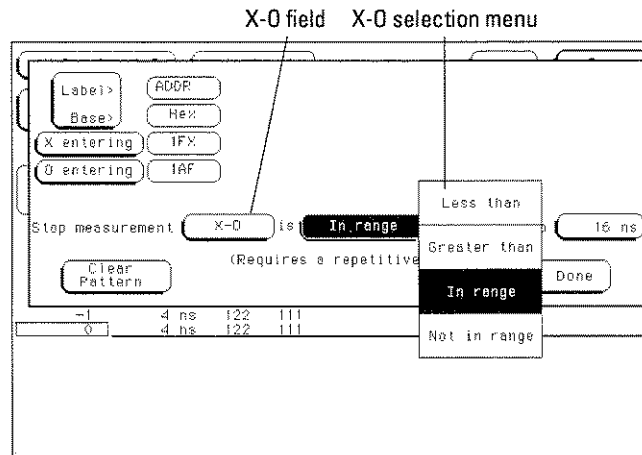

X-O Field and Pop-up Menu (Timing mode only)

The Chart Menu Pattern

Compare

For this choice to appear, Compare Memory must be enabled in the Configuration menu. When Compare is selected, a repetitive run will be terminated when a comparison of data in the Listing menu and the data and criteria in the Reference listing matches an equality selection. The equality selection is set from the Equal/Not Equal selection pop-up menu.

Equal The data and compare criteria in the Compare menu must be equal to the data in the Listing menu.

Not Equal The data and compare criteria in the Compare menu must not be equal to the data in the Listing menu.

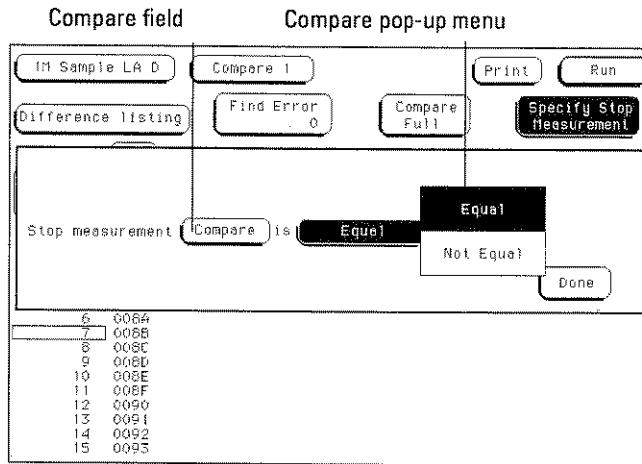

Compare Field and Pop-up Menu

Search Field

The Search field initiates a search through the acquisition data for the specified occurrence of the user-defined X and O bit patterns. During the search, the Search field turns red and becomes the Cancel Search field until the search is finished. For more information on specifying bit patterns, refer to "Specify Patterns Field" section later in this chapter.

Center Screen Field

The Center Screen field is used to reposition the center of your display around the trigger, the X marker, the O marker or the X & O markers. This allows you to quickly move through the chart display to the events of interest.

Center Screen pop-up menu

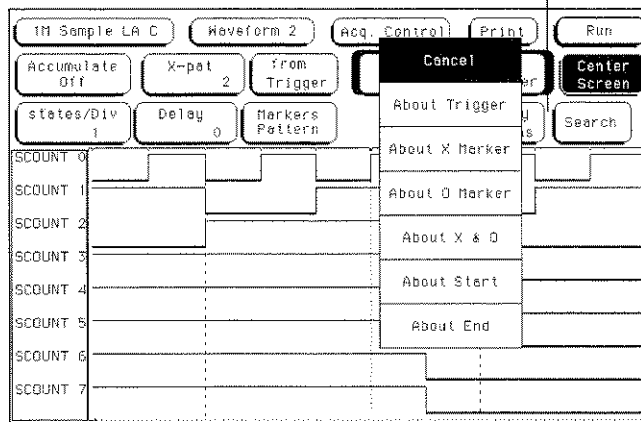

The Chart Menu
Rescale

Rescale

The Rescale field is used to scale the sampled states based on the position of the Y1, Y2, X1 and X2 axis markers. To zoom in on a section of the displayed chart data, position the markers around the area of interest. When the Rescale field is selected, the pop-up menu allows you to choose rescaling between the X axis markers, the Y axis markers, between X&Y axis markers, Full Scale, or Cancel.

Between X axis markers This selection will rescale data on the horizontal X axis based on the positions or settings of X1 and X2. At the end of the rescaling operation, the X1 marker will reside at the far left side of the display screen and the X2 marker will reside at the far right side of the display.

Between Y axis markers This selection will rescale data on the vertical Y axis based on Y1 and Y2 settings. At the end of the rescaling operation, the Y1 marker will be positioned at the far top of the display screen and the Y2 marker will be positioned at the far bottom of the display.

Between X&Y axis markers This selection will execute both X and Y markers operations as discussed above, resulting in the rescaling of both the horizontal and vertical axes.

Rescale pop-up menu

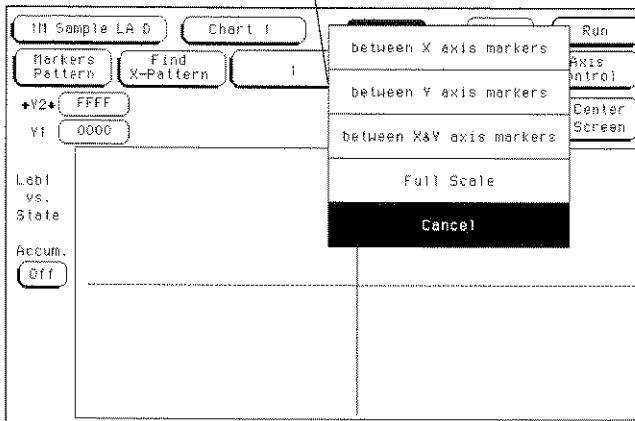

The Chart Menu Rescale

Full Scale This selection will rescale the horizontal and vertical axes so that all data samples are charted in the XY chart window. Seleting Full Scale will overwrite Y1, Y2, X1 and X2 settings, in addition to the Axis Control Ranges specified in the Axis Control pop-up menu.

Replotting Full Scale can take minutes to complete. To cancel plotting, touch the red Cancel field at the bottom right of the display screen.

Cancel The Cancel selection allows you to exit this pop-up menu without changing the current scaling.

The Chart Menu
Axis Control Field

Axis Control Field

Touching the Axis Control field causes a pop-up menu, Chart axis controls, to appear. In this menu, you specify the relation to be charted and the boundaries for the chart. The vertical Y-axis will always be a label. The available labels are those which you defined in the Format menu. The horizontal X-axis can be one of the same labels available for the Y-axis or it can be sample memory locations.

"XY Chart of" Field (Y-axis Label)

The Y-axis label field is just to the right of "XY Chart of" text. To specify a vertical axis label, touch the Y-axis Label field then select the desired label from the label list pop-up menu. The label choices are the labels that were defined in the state Format menu.

The values charted are the acquired data value represented by that label, in the number base selected in the Axis Control menu. The placement of the label data on the chart is determined by the scaling of the two axes. You select values for the axes scaling in the X-axis and Y-axis fields found in the Axis Control menu.

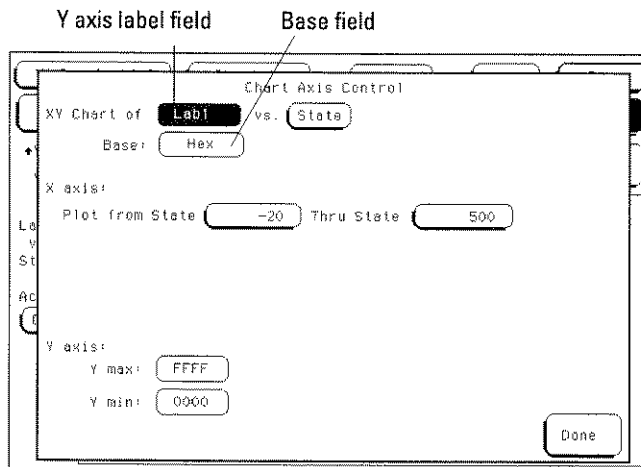

The Y-axis Label Field

"vs." State/Label Field (X-axis)

The X-axis can represent a label's value or sample location. The X-axis assignment field is just to the right of "vs." text, and toggles between State and Label. To assign sample location to the horizontal axis, set this field to State. To assign a label's value to the X-axis, set this field to Label. Another field appears to the right of the Label field. Touch this field, and a pop-up menu appears showing all the labels that are defined in the Format menu. Select one of these labels to assign its value to the X-axis.

An XY chart, with Y-axis data values for Lab1 of: state 0=15, state 1=16, state 2=17,...state 99=114, and X-axis data values for Lab2 of: state 0=6, state 1=7, state 2=8,...,state 99=105, would result in the chart coordinates: (6,15), (7,16), (8,17),..., (105,114). The placement of the label data on the X and Y axes is determined by the values of the Xmin, Xmax, Ymin, and Ymax fields.

Base Field

The function of the Base Field is the same in most menus. For a complete definition of the Base field, go to "Base Field" in the Fields Common to Menus chapter.

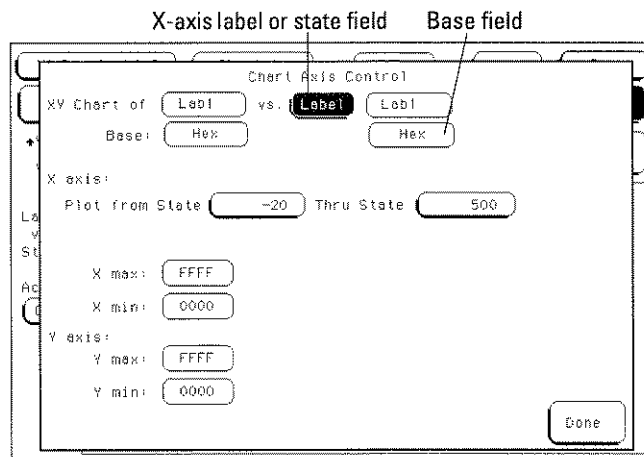

The Chart Menu Axis Control Field

X axis and Y axis Fields

Either axis of the XY chart can be scaled by using the associated vertical or horizontal min (minimum) or max (maximum) value fields. When selected, a pop up keypad appears in which you specify the minimum and maximum values that will be displayed.

When State is selected for the X axis, sample locations are plotted on the X axis. The min and max state locations are specified in the "X axis: Plot from State" field. For State, the minimum and maximum values that are selectable depend upon the memory depth you specified in the Configuration menu. For labels, the minimum and maximum values can range from 00000000H to FFFFFFFFH regardless of axis, since labels are restricted to 32 bits.

When Record mode is active, the min and max record/state locations are the selectable fields that are used to indicate which range of states to chart on the horizontal axis.

When plotting Label versus Label, both the Y axis and the X axis can be scaled. Charted memory locations are selectable in the "Plot from State" field for the X axis.

The screenshot shows the "Chart Axis Control" menu. At the top, it displays "XY Chart of Lab1 vs. Label Lab1". Below this, there are "Base:" and "Hex:" fields. The "X axis:" section includes a "Plot from State" field with values "-20" and "500" in adjacent boxes. Below the X axis section are "X max:" (FFFF) and "X min:" (0000) fields. The "Y axis:" section includes "Y max:" (FFFF) and "Y min:" (0000) fields. A "Done" button is located at the bottom right. Two horizontal lines with labels "X axis fields" and "Y axis fields" point to the X and Y axis scaling fields respectively.

Axes Scaling Fields in Records Mode

Record Mode (State mode only, with Records on)

The Record mode field in the Axis Control menu is available when records are turned on in the Trigger menu. When the Record mode field is selected, a display selection pop-up menu appears which is used to select either Sequential mode or Overlay mode.

Sequential This selection will plot states in the record range specified in the "X axis: Plot from" fields, in sequence.

Overlay This selection will plot states in the record range, specified in the "X axis: Plot from" fields, by plotting records on top of one another. Overlay allows easy detection of errors when each record is expected to be identical. Erroneous data will appear as extraneous data samples that reside outside the expected data range.

Accumulate Field

The Accumulate field may be toggled between off and on. When Accumulate On is selected, data from multiple acquisitions are charted on top of one another. When Accumulate Off is selected, only the current acquisition is displayed.

Cancel Field

The red Cancel field on the left side of the screen appears while the specified chart is being plotted. When Cancel is selected, the plotting halts, and the Cancel field disappears.

The Chart Menu
Cancel Field





The Compare Menu

The Compare Menu

State Compare is a software post-processing feature that provides the ability to do a bit by bit comparison between the acquired state data listing and a reference listing.

The comparison between the acquired state listing data and the data in the reference listing is done relative to the trigger points. This means that the two data records are aligned at the trigger points and then compared bit by bit.

Any bits in the acquired data that do not match the bits in the compare image are treated as unequal.

Compare Post-Processing Features

You can view in separate listings the acquired data, your reference listing, and a listing that highlights the bits in the acquired data that do not match the corresponding bits in the reference listing.

You can edit the reference listing for unique comparisons.

You can mask specific bits that you do not want to compare. These "Don't compare" bits can be specified individually for a given label and state row, or specified by channel across all state rows.

You can select a range of states to compare. When a range is selected, only the bits in states on or between the specified boundaries are compared. Also, you can save the reference listing along with the analyzer configuration to disk.

Compare Menu Map

The following menu map graphically illustrates all fields in the Compare menu. Use the menu map as an overview and as a quick reference to the available options in the Compare menu.

The Compare Menu

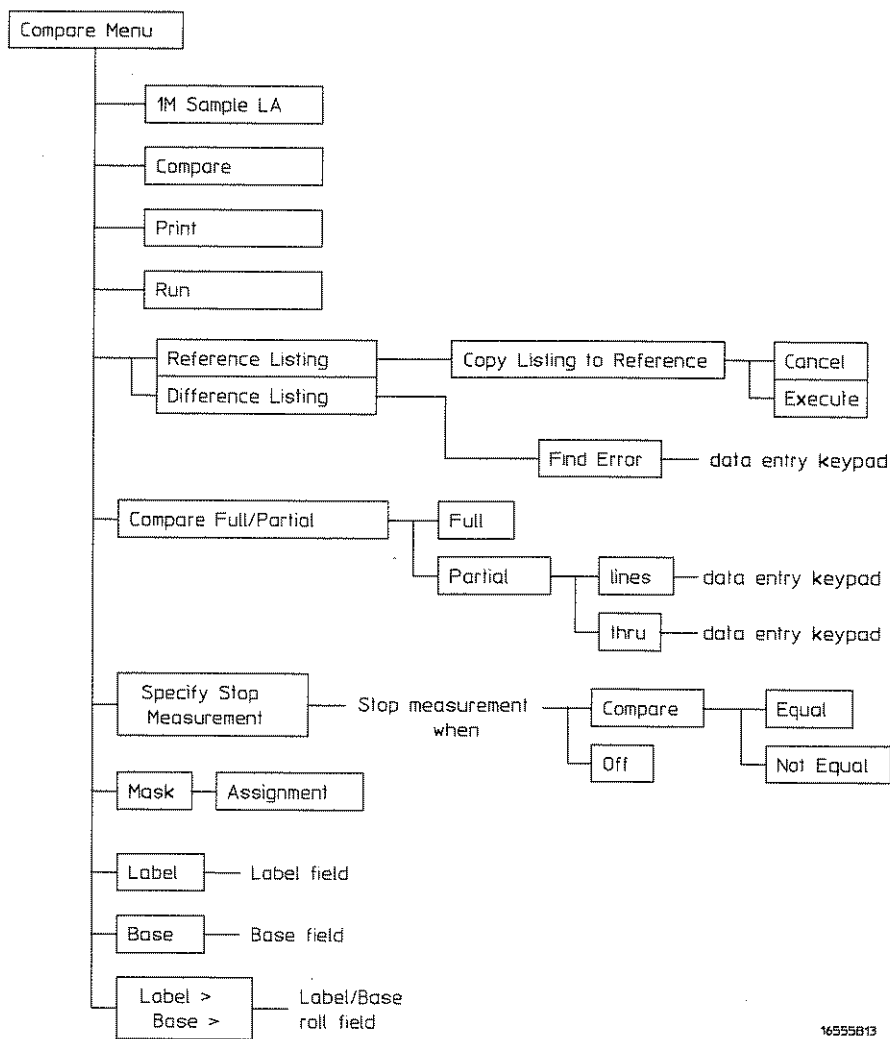

16555B13

Compare Menu Map

Reference Listing Field

The Reference listing and Difference listing field is a toggle field that switches the listing type between the Reference image listing and the Difference listing.

The Reference listing is a display of the image (or template) that acquired data is compared to during a comparison measurement. The boundaries of the image (or size of the template) is controlled by using the channel masking and compare range functions. Any bits in the reference listing displayed as "X" have been set to don't care bits during bit editing.

When the data listing is rolled, the difference data listing and the data listing in the Listing menu are also rolled.

Reference listing field

The screenshot shows a software interface for a Reference Listing Field. At the top, there are buttons for "1st Sample LA B", "Compare 1", "Print", and "Run". Below these are "Reference listing" (highlighted), "Copy Listing To Reference", "Compare Full", and "Specify Stop Measurement". The main area contains a list of bit positions (0-15) and their corresponding values. The value for bit 7 is highlighted with a box.

Bit	Value
0	0002
1	0003
2	0004
3	0005
4	0006
5	0007
6	0008
7	0009
8	000A
9	000B
10	000C
11	000D
12	000E
13	000F
14	0010
15	0011

Reference Listing Field

The Compare Menu
Difference Listing Field

Difference Listing Field

The Reference listing and Difference listing field is a toggle field that switches the listing type between the Reference image listing and the Difference listing.

The Difference listing is a display of the acquired data listing with the data that differs, if any, from the Reference listing, highlighted with inverse video. If the base is inverse assembled symbols, the entire line is highlighted with inverse video.

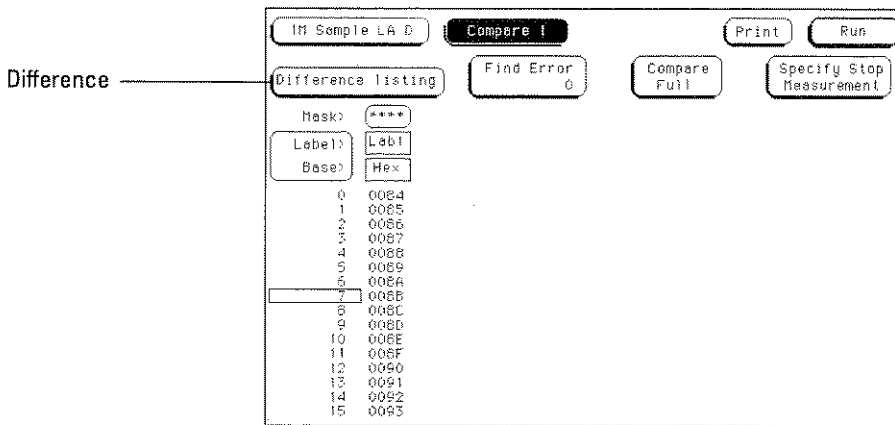

Difference Listing Field

The Compare Menu Difference Listing Field

The controls that roll the listing in all three menus, the normal State listing, the Reference listing, and the Difference listing are synchronized unless the number of pretrigger states differ between the Reference listing and the acquired data.

This means that when you change the current row position in the Difference listing, the analyzer automatically updates the current row in the acquired State listing, Reference listing and vice-versa.

If the three listings are synchronized and you re-acquire data, the Reference listing may have a different number of pretrigger states depending on the state trace trigger criteria. The Reference listing can be resynchronized to the State and Difference listings by entering the desired state (acquisition memory) location from the pop-up keypad.

This allows you to view corresponding areas of all lists, to cross-check the alignment, and to analyze the bits that do not match.

The Compare Menu
Copy Listing to Reference Field

Copy Listing to Reference Field

The initial Reference image is generated by either copying the data listing from the listing menu or by loading an analyzer configuration file which contains a Reference listing. You should be aware that if you load an analyzer configuration to get a Reference image, the other menu setups will change.

When the Copy Listing to Reference field is selected, the contents of the acquisition data structure (Listing menu display) is copied to the Reference image buffer. The previous Reference image is lost if it has not been saved to a disk.

Copy listing to reference field

Mask>	----
Label>	Label
Base>	Hex
0	0002
1	0003
2	0004
3	0005
4	0006
5	0007
6	0008
7	0009
8	000A
9	000B
10	000C
11	000D
12	000E
13	000F
14	0010
15	0011

Copy Listing to Reference Field

Find Error Field

The Find Error field allows you to easily locate any patterns that did not match in the last comparison. Occurrences of differences, or errors, are found in numerical ascending order from the start of the listing. The first occurrence of an error has the numerical value of one.

When you select the Find Error field, the field turns light blue and the knob can be used to select a number. If the field is touched a second time, a pop-up keypad appears in which you enter a number. The number you enter indicates which error you want to find. The listing is then scanned sequentially until the specified occurrence is found and rolled into view.

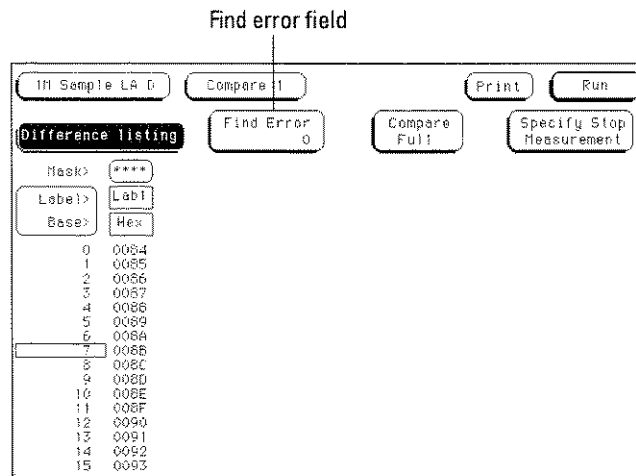

Find Error Field

The Compare Menu Compare Full / Compare Partial Field

Compare Full / Compare Partial Field

The Compare Full/Compare Partial field is a toggle field which allows you to compare either the full range of states or define a subset of the total number of states in the Reference image to be used in the comparison.

The Compare mode is accessed by touching the Compare Full/Compare Partial field in either the Compare or Difference listing menus. When selected, a pop-up appears in which you select either the Full or Partial option.

When you select the Partial option, fields appear for setting the start state and stop state values. Only bits in states (lines) on or between the boundaries are compared against the acquired data.

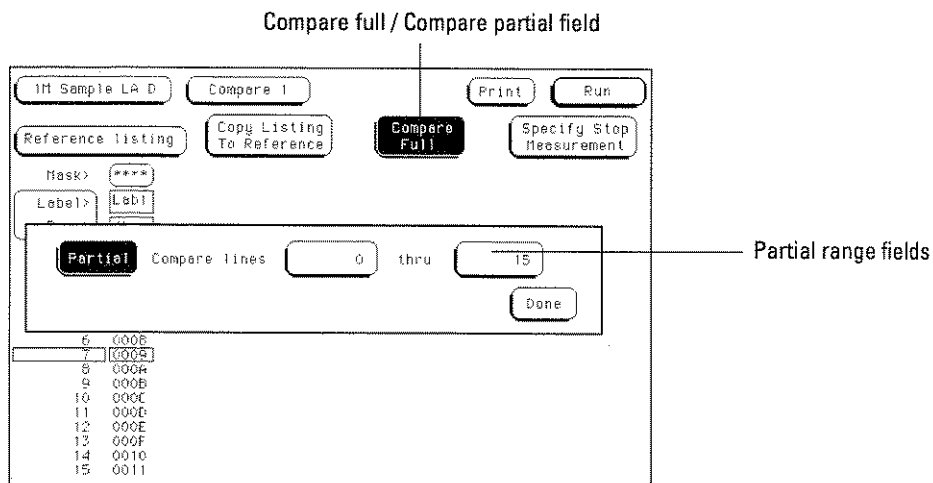

Compare Full / Compare Partial Field

Mask Field

The channel masking field is used to specify a bit, or bits in each label that you do not want compared. This causes the corresponding bits in all states to be ignored in the comparison. The Reference data image itself remains unchanged on the display.

When you select the Mask field an assignment pop-up appears in which you specify which channels are to be compared and which channels are to be masked. A "." (period) indicates a don't compare mask for that channel and an "*" (asterisk) indicates that channel is to be compared.

Mask field

The screenshot shows a software interface with a 'Mask field' dialog box. The dialog has a title bar with 'In Sample LA D', 'Compare 1', 'Print', and 'Run' buttons. Below the title bar are four buttons: 'Difference listing', 'Find Error 0', 'Compare Full', and 'Specify Stop Measurement'. The main area of the dialog contains a 'Mask' field with the value '****', a 'Label' field with 'Lab1', and a 'Base' field with 'Hex'. Below these fields is a list of 16 channels, numbered 0 to 15, with their corresponding hexadecimal values: 0 0084, 1 0085, 2 0086, 3 0087, 4 0088, 5 0089, 6 008A, 7 008B, 8 008C, 9 008D, 10 008E, 11 008F, 12 0090, 13 0091, 14 0092, 15 0093. The 'Mask' field is highlighted with a mouse cursor.

Mask Field

The Compare Menu
Specify Stop Measurement Field

Specify Stop Measurement Field

The Stop measurement function allows you to specify a condition which stops the analyzer measurement during a repetitive run. When the Specify Stop Measurement field is selected, a Stop measurement menu appears which is used to set the stop criteria.

When the Stop measurement type field is selected, a selection menu appears. Depending on the analyzer configuration, you will have the choices of Off, Compare, and X-O.

Off

The Off selection turns all Stop measurement operations off.

If the stop measurement operation is not turned off and the stop measurement criteria are met, the measurement will stop even though the markers are turned off.

Stop measurement selection menu

Stop measurement

In Sample LA D	Compare 1	Print	Run
Difference listing	Find Error 0	Compare Partial	Specify Stop Measurement
Stop measurement	Off	Off	
		X-O	
		Compare	Done
6	006A		
7	006B		
8	006C		
9	006D		
10	006E		
11	006F		
12	0090		
13	0091		
14	0092		
15	0093		

Stop Measurement Fields

The Compare Menu
Specify Stop Measurement Field

Compare

When Compare is selected, a repetitive run is stopped when a comparison of data in the Listing menu and data and criteria in a Reference image matches an equality selection. The equality selection is set from the Equal/Not Equal selection pop-up menu.

Equal The data and compare criteria in the Compare menu must be equal to the data in the Listing menu.

Not Equal. The data and compare criteria in the Compare menu must not be equal to the data in the Listing menu.

Compare type options

Print Run
Specify Stop Measurement
Difference listing Find Error 0 Compare Full
Stop measurement Compare is Equal Not Equal Done
6 006A
7 006B
8 006C
9 006D
10 006E
11 006F
12 0090
13 0091
14 0092
15 0093

Compare Stop Measurement Type Fields

The Compare Menu Specify Stop Measurement Field

X-O

The X-O option is available in the State analyzer with its count set to Time. When X-O is selected, a repetitive run is stopped when a comparison of the time period between the X and O markers and one of the following time period options is true.

Less Than X-O time must be less than the time value that you specify in the Time field.

Greater Than X-O time must be greater than the time value that you specify in the Time field.

In Range X-O pattern must be within the time range value that you specify in the two Time fields.

Not in Range X-O pattern must not be within the time range value that you specify in the two Time fields.

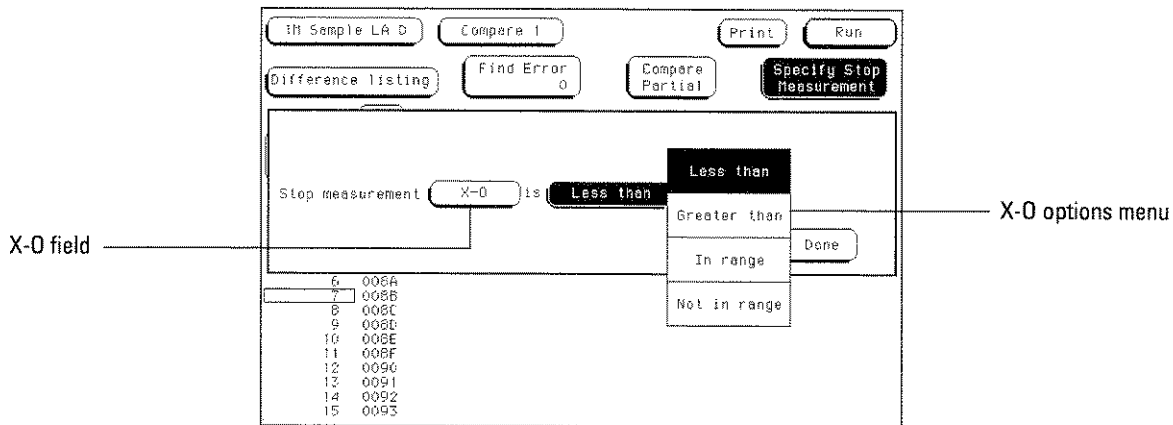

X-O Stop Measurement Type Fields

Data Roll Field

The column of numbers at the far left represents the location of the acquired data in the state analyzer's memory. The numbered positions are also known as the state locations and are relative to the trigger state location, which is always represented by 0.

The column of state location along with its data can be rolled to display off-screen data by using the data roll field. The data roll field is the small rectangular box located in the middle of the state location column.

The data roll field is used to either roll the data listing or to select an exact state for display. When the data roll field is light blue, the knob is active and can roll data in either direction. If you touch the data roll field when it is light blue, a pop-up keypad appears for the number of an exact state. When the pop-up keypad is used, the data listing shifts, leaving the selected state in the light blue data roll box.

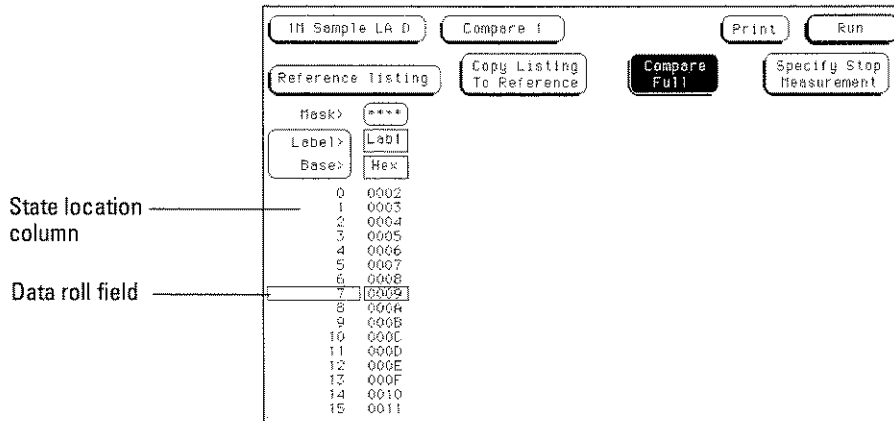

Data Roll Field

The Compare Menu Bit Editing Field

Bit Editing Field

The bit editing fields are located in the center of the Reference listing display. A bit editing field exists for every label in the display unless the label's base is ASCII or inverse assembled symbols. Bit editing field allows you to modify the values of individual bits in the Reference image or specify them as don't compare bits.

You access data in the Reference listing by rolling the data listing using the knob until the data is located in the bit editing field. To enter a desired pattern or don't compare (X) for a bit, select the field and use the pop-up keypad which appears.

Bit editing field

Mask	Label	Base
0	0002	
1	0003	
2	0004	
3	0005	
4	0006	
5	0007	
6	0008	
7	0002	
8	000A	
9	000B	
10	000C	
11	000D	
12	000E	
13	000F	
14	0010	
15	0011	

Bit Editing Field

Label and Base Fields

The Label and Base fields show up together in all menus except the Format and Configuration menus. When a new label is assigned, a base field is automatically assigned to that label.

Label Field

Labels in the Compare menu are the same labels assigned in the Format menu. These labels will be displayed throughout the analyzer as they were assigned in the Format menu.

Base Field

The function of the Base field is the same in all menus. To change the numeric base, select the base field, then choose the desired base from the selection menu.

Label / Base Roll Field

The function of the Label and Base roll field is the same in all menus. The rolling function is the same for all items that are stored offscreen. For more information on rolling labels, base, and pods, refer to Labels Assignment in the "Common Module Operations" part of the *HP 16500B User's Reference Guide*.

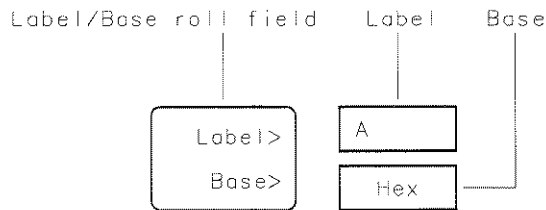

16542B03

Label / Base Roll Field



The Mixed Display Menu

The Mixed Display Menu

The Mixed Display menu allows you to view state listings at the top of the display and waveforms at the bottom.

The state listing display shows data from the state analyzer currently accessed and interleaved state listings from other modules. If the analyzer is configured with two state analyzers, both state listing displays can be interleaved as well as shown separately.

The waveform display shows timing analyzer waveforms and oscilloscope waveforms from other modules within the HP 16500B mainframe.

The Mixed Display menu is only available when the analyzer is configured as a state analyzer with the Count field set to Time in the Trigger menu. In addition, before waveforms or state listings from other modules are displayed, they must be configured in a Group Run in the Intermodule menu. For the most part, the operation of the menu fields in the listing and waveform portions of the Mixed Display menu are identical to their operation in their respective menus. The unique functions and features of the mixed display are:

- Intermodule Configuration
- Inserting Waveforms
- Interleaving State Listings
- Time-Correlated Displays
- Markers

Intermodule Configuration

Before waveforms or state listings from one module are displayed in the Mixed Display menus of other modules, all modules involved in the measurement must be configured in a Group Run. The Group Run configuration takes place in the mainframe's Intermodule menu. In addition, all state analyzers must have their Count fields set to Time in their Trigger menus.

See Also

The "Intermodule Measurements" chapter in the *HP 16500B User's Reference* for complete information on intermodule operation.

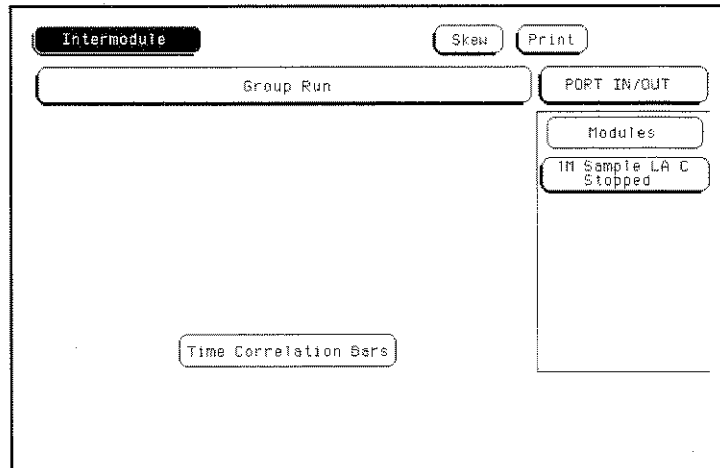

Intermodule menu

Inserting Waveforms

To insert waveforms from other modules, use the same procedure for selecting waveforms as you would in the Waveform menu.

See Also

"Waveform Display" in chapter 7, "The Waveform Menu," for information on the field definitions and the waveform selection functions.

Interleaving State Listings

Interleaved state listings allows you to view two labels and their data from different analyzers in the same column. The process of interleaving state listings can be performed in either the Listing menu or the Mixed Display menu. For example, if data is interleaved in the Listing menu, it will be automatically interleaved in the Mixed Display menu.

Before a state listing from a second analyzer can be interleaved into the listing, both analyzers must be configured in a Group Run in the Intermodule menu and the Count fields set to Time in both Trigger menus.

The interleaved label is placed directly above the selected label and all interleaved data is displayed in yellow. In addition, the state numbers of the interleaved data are indented to the right. Because of the lack of room in the listing portion of the Mixed Display menu, the label identifying the interleaved data is not displayed.

State listings from an HP 16510B, 16540A/D, and 16550A analyzers can be interleaved into the state listing of an HP 16554A or 16555A. However, the HP 16510B will not accept state listings from the other products. With one exception, the process to interleave a label is the same as inserting labels. After the Interleave option is selected, an analyzer selection is made from a list containing the analyzers configured in the Group Run. Labels for each analyzer become available when the desired analyzer is selected.

Time-Related Displays

Once the Time markers are set in the Waveform display area of the Mixed Display menu, time-related X and O Pattern markers will be displayed in both the listing and the waveform display areas.

The analyzer uses a counter to track time between the triggering of one display and the triggering of the other display. It uses this count to reconstruct time-related data.

Markers

The markers in the Mixed Display menu are not the same as in the Listing and Waveform menus. Only Time markers are available in the Mixed Display menu. Even though you have placed time markers in the listing and waveform displays, you must place new ones on your points of interest in the Mixed Display. You set the time markers in the waveform display area of the menu.



Error Messages

About Messages

This chapter lists the error, warning, and advisory messages that you may encounter during operation of the analyzer. Error messages have a red background, warning messages a yellow background, and advisory messages a green background.

For more information

If any messages are encountered while running Self-Tests, refer to the Service Guide for information on test descriptions and troubleshooting procedures. If an error is encountered during analyzer configuration or general operation, there could be more than one cause of the problem. In most cases, the analyzer is configured improperly.

Error Messages

Must have at least 1 edge specified. You must assign at least one clock edge to one of the available clocks in the Master clocking arrangement. In addition, if the Slave clock is being used, it must have at least one clock edge assigned. The analyzer will not let you close the clock assignment pop-up until an edge is specified.

Time correlation of data is not possible. Before time correlation of data is possible, time tags must be placed on the data. If you want time correlated data, set the Count field in the Trigger menu to Time.

Maximum of 32 channels per label. This message appears when you try to assign more than 32 channels to a single label

NO DISK. There are no disks in the disk drives. You must place a disk into the disk drive before configurations can be loaded or stored.

Timer is off in sequence level. At least one sequence level has specified a timer as part of the sequence instruction and that timer is not turned on. The timer must be set to either Start, Pause, or Continue.

Timer is specified in sequence, but never started. A timer is specified somewhere in the sequence, but was not started. The timer must be set to Start. The timer can be set to Start in any sequence level.

Problems reading file. The user is trying to translate a configuration file that can not be opened a second time.

Inverse assembler not loaded - bad object code. Corrupt inverse assembler file. Try getting another copy of the inverse assembler file and loading that.

Insufficient memory to load IAL - load aborted. There is not a block of free memory large enough to load inverse assembler.

ASCII entry not available. The ASCII base is not available. You must use another base selection.

Warning Messages

Waiting for Prestore. This message is displayed for a timing analyzer waiting for prestore.

Search failed - X pattern not found. The X pattern specified could not be found; therefore, the pattern marker could not be placed in the data.

Search failed - O pattern not found. The O pattern specified could not be found, therefore the pattern marker could not be placed in the data.

Warning: Run HALTED due to variable change. This message appears when certain analyzer settings are changed during a repetitive run. When this occurs, the analyzer stops.

Error not found. The Find Error number specified could not be found.

s/Div set to limit. The s/Div field is set to its limit.

Delay set to limit. The Delay field is set to its limit.

Machine name: "al name" inverse assembler not found. This message appears when the inverse assembler file could not be found.

Slow or missing clock. This message indicates a slow or missing clock. This is displayed for a state analyzer only until the first clock occurs.

Data was acquired without time tags. Time tag values will not be displayed because data was stored without time tags. If you want time tags stamped on the data, set Count in the Trigger menu to Time.

Data was acquired without state tags. State tag values will not be displayed because data was stored without state tags. If you want state tags stamped on the data, set Count in the Trigger menu to State.

Two pod pairs are needed to use both timers. If both timers are being used in a single chip analyzer, and there are no spare chips, this message is shown when Run is selected. Timer2 references in the sequencer will not be valid.

No active analyzer. This message is displayed if Run is selected with no analyzers turned on.

Cannot read unrecognized data. The user is trying to translate a SPA configuration from a foreign module.

Demultiplexed clocking cannot be translated. The user is trying to translate a configuration that has demultiplexed or mixed clocks.

User thresholds have been truncated. The user is trying to translate a configuration having thresholds greater than 6 Volts or less than -6 Volts.

Slave clocks may need manual adjustment. The user is trying to translate an HP 16540/41A,D configuration which has slave clocks specified. This message appears when the translation is not direct.

Clock Qualifiers not fully restored. The user is trying to translate a configuration that has more than two qualifiers.

No state machines for this module. The user is trying to load an inverse assembler into a module with no state machines.

Error loading DISPLAY1. User is loading a configuration with a corrupt DISPLAY1 section.

Pods have been truncated. User is loading a configuration with number of chips greater than the current system's number of chips.

Clock pod and least significant pods have been preserved. User is loading a configuration with number of chips greater than the current system's number of chips

Need to have two free sequence levels. For each sequence level with a "<" assigned, you must leave two sequence levels free. To free up two levels, simply delete two levels.

Mixed Mode not available. User is trying to show mixed mode incorrectly.

Error Messages
Warning Messages

Ymin is greater than Ymax. The value assigned to Y minimum is greater than the value assigned to Y maximum.

Xmin is greater than Xmax. The value assigned to X minimum is greater than the value assigned to X maximum.

Ymin is equal to Ymax. The value assigned to Y minimum is equal to the value assigned to Y maximum.

Xmin is equal to Xmax. The value assigned to X minimum is equal to the value assigned to X maximum.

Advisory Messages

Insert failed - Maximum of 60 entries. 60 listing columns is the maximum number allowed. This advisory appears when you try to configure more than 60 columns.

Occurrences Remaining in Level "n". The analyzer is waiting for the specified level to be satisfied. This advisory is used in analyzers that use the Occurs parameter.

Waiting in Level "n". The analyzer is waiting for the specified level to be satisfied. This advisory is used in analyzers that use the OR parameter.

n.nnn s remaining to delay. This advisory is displayed for a conventional/glitch timing analyzer that is doing a long hardware delay (after trigger and during the delay).



**Specifications and
Characteristics**

Specifications and Characteristics

This chapter lists specifications and characteristics for the HP 16554A and 16555A. Specifications are the performance standards against which the product is tested.

Characteristics are not specifications, but are included as additional information.

For complete information on the test procedures to verify product performance, refer to the *HP 16554A* and *HP 16555A Service Guides*.

Specifications

The specifications are the performance standards against which the product is tested.

HP 16554A

Maximum State Speed	70 MHz
Maximum Conventional Timing Rate (1/2 Channel)	250 MHz
Maximum Conventional Timing Rate (full channel)	125 MHz
Channel Count Per Board	68
Maximum Channel Count on One Time Base	204
Memory Depth (full channel)	500 K
Memory Depth (1/2 channel)	1 M

HP 16555A

Maximum State Speed	110 MHz
Maximum Conventional Timing Rate (1/2 Channel)	500 MHz
Maximum Conventional Timing Rate (full channel)	250 MHz
Channel Count Per Board	68
Maximum channel Count on One Time Base	204
Memory Depth (full channel)	1 M
Memory Depth (1/2 channel)	2 M

Specifications and Characteristics
Supplemental Characteristics

Supplemental Characteristics

These characteristics are not specifications, but are included as additional information.

Probes

Input Resistance	100 K Ω , 2%
Input Capacitance	~ 8 pF
Minimum Voltage Swing	500 mV, peak-to-peak
Threshold Range	± 6.0 V, adjustable in 50 mV increments

State Analysis

Setup/Hold Time ¹	0/3.5 ns through 3.5/0 ns, adjustable in 500 ps increments
Minimum State Clock Width	3.5 ns
State Clock/Qualifiers	4/4
Time Tag Resolution ²	8 ns
Maximum Time Count Between States	34 seconds
Maximum State Tag Count ²	4.29×10^9

¹Minimum setup/hold time specified for single-edge, single-clock acquisition. Single-clock, multiedge setup/hold window is 4 ns. Multiclock, multiedge setup/hold window is 4.5 ns. All setup/hold windows are adjustable in 500-ps increments.

²Maximum state clock rate with time or state tags on is 110 MHz for the HP 16555A and 70 MHz for HP 16554A. When all pods are assigned to a state or timing machine, time or state tags halve the memory depth.

Timing Analysis

Sample Period Accuracy	0.01 % of sample period
Channel-to-Channel Skew	2 ns, typical
Time Interval Accuracy	\pm (sample period + channel-to-channel skew + 0.01% of time interval reading)
Minimum Detectable Glitch	3.5 ns

Specifications and Characteristics
Supplemental Characteristics

Triggering

Sequencer Speed	110 MHz, maximum for HP 16555A, and 70 MHz for HP 16554A
State Sequence Levels	12
Timing Sequence Levels	10
Max. Occurrence Counter Value	1,048,575
Pattern Recognizers ³	10
Range Recognizers	2
Range Width	32 bits each
Timers	2
Timer Value Range	400 ns to 500 seconds
Glitch/Edge Recognizers	2 (timing only)

³Eight pattern recognizers are available in HP 16554A timing modes and HP 16555A timing and 110 MHz state analysis modes.

Specifications and Characteristics

Supplemental Characteristics

Measurement and Display Functions

Arming Each module can be armed by the RUN key, external PORT IN, or by another module via the Intermodule Bus (IMB).

Displayed Waveforms 24 lines maximum, with scrolling across 96 waveforms.

Measurement Functions

Run/Stop Functions

Run Starts acquisition of data in specified trace mode.

Stop In single trace mode or the first run of a repetitive acquisition, STOP halts acquisition and displays the current acquisition data. For subsequent runs in repetitive mode, STOP halts acquisition of data and updates the current display.

Trace Mode Single mode acquires data once per trace specification. Repetitive mode repeats single mode acquisitions until stop is pressed or until time interval between two specified patterns is less than or greater than a specified value, or within or not within a specified range.

Indicators

Activity Indicators Provided in the Configuration and Format menus for identifying high, low, or changing states on the inputs.

Markers Two markers (X and 0) are shown as dashed lines on the display.

Trigger Displayed as a vertical dashed line in the Timing Waveform display and a line0 in the State Listing display.

Data Entry/Display

Labels Channels may be grouped together and given a 6-character name. Up to 126 labels in each analyzer may be assigned with up to 32 channels per label.

Display Modes State listing, State Waveforms, Timing Waveforms, Timing Listings, Chart, and System Performance Analysis. State Listing, Timing Waveforms, and Oscilloscope Waveforms can be time-correlated on the same displays.

Timing Waveform Pattern readout of timing waveforms at X or 0 marker.

Bases Binary, Octal, Decimal, Hexadecimal, ASCII (display only), Two's Complement, and User-defined symbols.

Symbols 500 maximum. Symbols can be downloaded over RS-232 or HP-IB.

Marker Functions

Time Interval The X and 0 markers measure the time interval between one point on a timing waveform and trigger, two points on the same timing waveform, two points on different waveforms, or two states (time tagging on).

Delta States (state analyzer only) The X and 0 markers measure the number of tagged states between one state and trigger or between two states.

Patterns The X and 0 markers can be used to locate the nth occurrence of a specified pattern from trigger, or from the beginning of data. The 0 marker can also find the nth occurrence of a pattern from the X marker.

Statistics X and 0 marker statistics are calculated for repetitive acquisitions. Patterns must be specified for both markers, and statistics are kept only when both patterns can be found in an acquisition. Statistics are minimum X to 0 time, maximum X to 0 time, average X to 0 time, and ratio of valid runs to total runs.

Specifications and Characteristics
Supplemental Characteristics

Auxiliary Power

Power Through Cables 1/3 amp at 5 V maximum per cable

Operating Environment

Temperature Instrument, 0 C to 55 C (+32 F to 131 F)
Probe lead sets and cables, 0 C to 65 C
(+32 F to 149 F).

Humidity Instrument, probe lead sets, and cables,
up to 95% relative humidity at +40 C
(+122 F)

Altitude To 4600 m (15,000 ft)

Vibration Operating: Random vibration 5-500 Hz, 10
minutes per axis, 0.3 g (rms)
Non-operating: Random vibration 5 to 500
Hz, 10 minutes per axis, 2.41 g (rms); and
swept sine resonant search, 5 to 500 Hz,
0.75 g (0-peak), 5 minute resonant dwell
at 4 resonances per axis.

13



Installation



Installation

To configure a one-card module

To configure a one-card module

- When shipped separately, the module is configured as a one-card module. The cables should be connected as shown in the figure.
- To configure a multi-card module into one-card modules, remove the cables connecting the cards. then connect the free end of the 2x10 cable on the connector labeled "Master" (J6) on each card (see figure below).

CAUTION

If you pull on the flexible ribbon part of the 2x10 cable, you might damage the cable assembly. Using your thumb and finger, grasp the ends of the cable connector. Apply pressure to the ends of the cable connector to disengage the metal locking tabs of the connector from the cable socket on the board. Then pull the connector from the cable socket.

Save unused cables for future configurations.

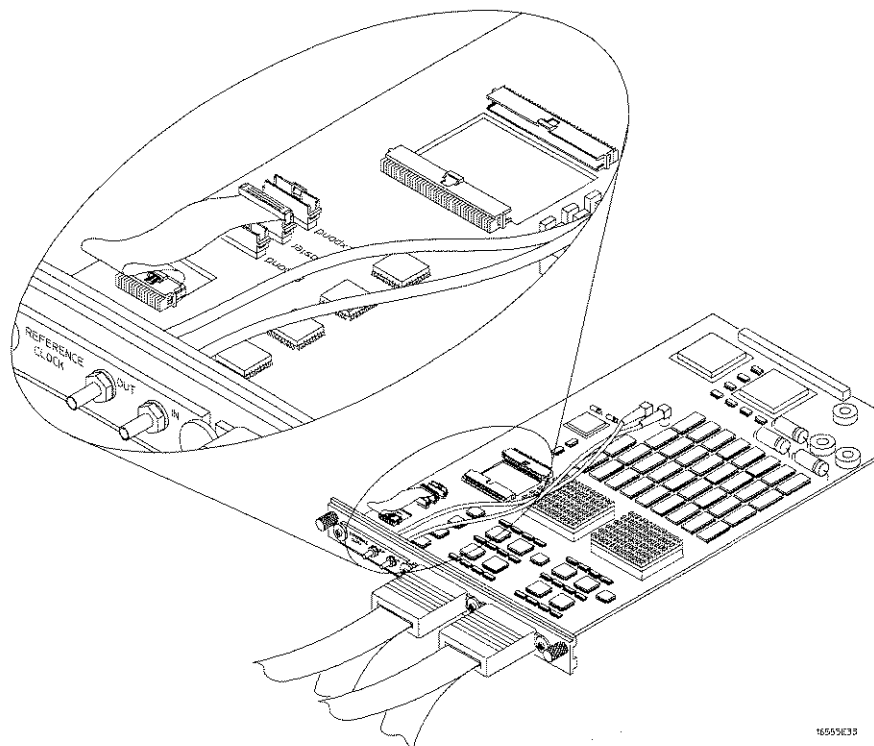

16551E35

To configure a multcard module

- 1 Plan the configuration. Multicard modules can only be connected as shown in the illustration. Select the card that will be the master card, and set the remaining boards aside.

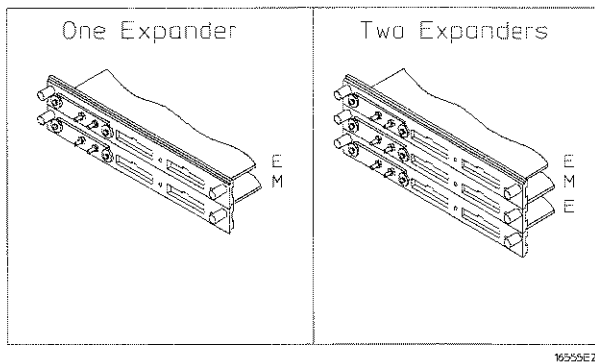

- 2 Obtain two 2x25 cables from the accessory pouch that match the number of expanders being configured. The illustration shows the cables that are available and which cable is used in each expander configuration.

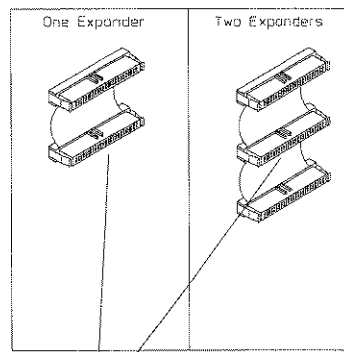

This connector is plugged into the Master Card

Installation

To configure a multicard module

- 3 Look at the illustration in the previous step. The illustration shows which of the cable connectors is plugged into the master card. Plug one 2x25 cable into the master card J9. Observe which cable connector (as shown in the illustration) is plugged into J9. Follow the same procedure to connect the second 2x25 cable into the master card J10.

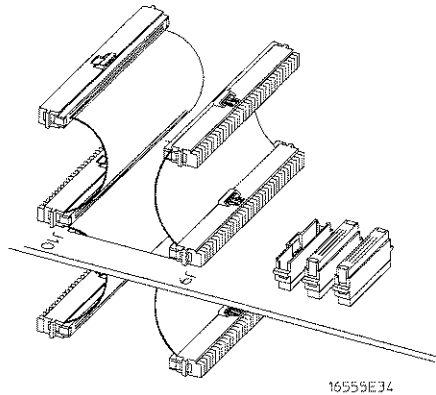

- 4 On the expander cards, disconnect the end of the 2x10 cable that is plugged into the connector labeled "Master."

CAUTION

If you pull on the flexible ribbon part of the 2x10 cable, you might damage the cable assembly. Using your thumb and finger, grasp the ends of the cable connector. Apply pressure to the ends of the cable connector to disengage the metal locking tabs of the connector from the cable socket on the board. Then pull the connector from the cable socket.

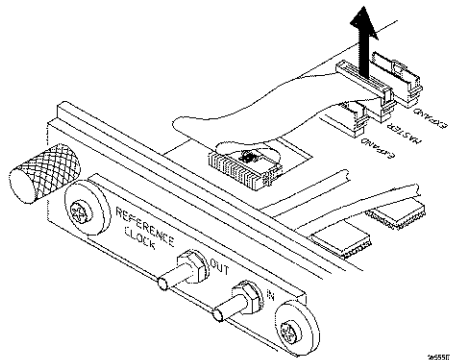

Installation
To configure a multicard module

- 5 Place the master card on top of any expander cards that are under the master card. Feed the 2x25 cables that are plugged into the master card through the cable access holes of the expander cards. Plug the 2x25 cables into J9 and J10 of the expander cards.

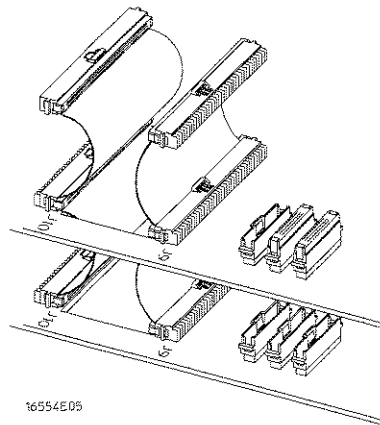

- 6 Feed the free end of the 2x10 cables of the expander cards through the access holes to the master card. Plug the 2x10 cables into J4 (bottom-most expander in a five-card configuration) and J5 (expander that is next to the master card) on the master card.

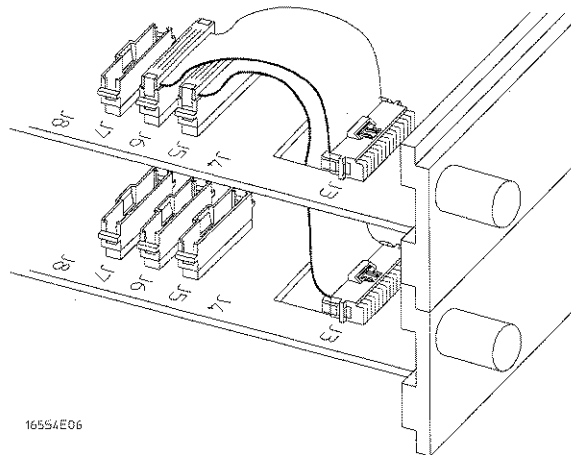

Installation

To configure a multicard module

- 7 Place the remaining expander boards on top of the master board. Feed the 2x25 cables that are plugged into the master card through the cable access holes of the expander cards. Plug the 2x25 cables into J9 and J10 of the expander cards.

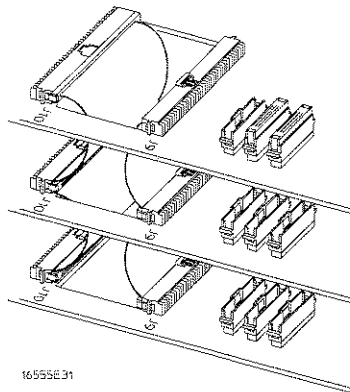

- 8 Feed the free end of the 2x10 cables of the expander cards through the access holes to the master card. Plug the 2x10 cables into J7 (expander that is next to the master card) and J8 (top-most expander in a four- or five-card configuration) on the master card.

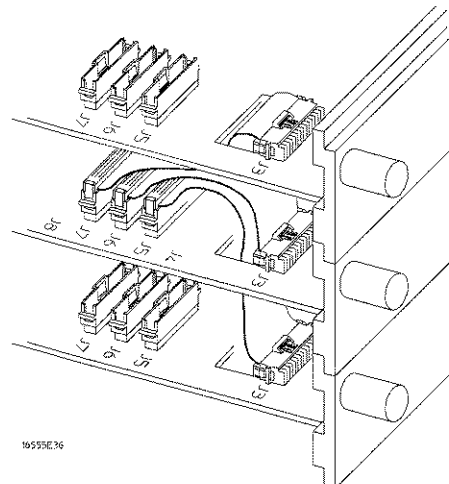

Installation
To configure a multcard module

- 9 The following illustration shows the proper connection of the 2x25 cables and the 2x10 cables for a three card module. If a two-card module was configured, not all cables will be present; however, the existing cables will be routed in the same manner. Make sure ALL cables are firmly seated.

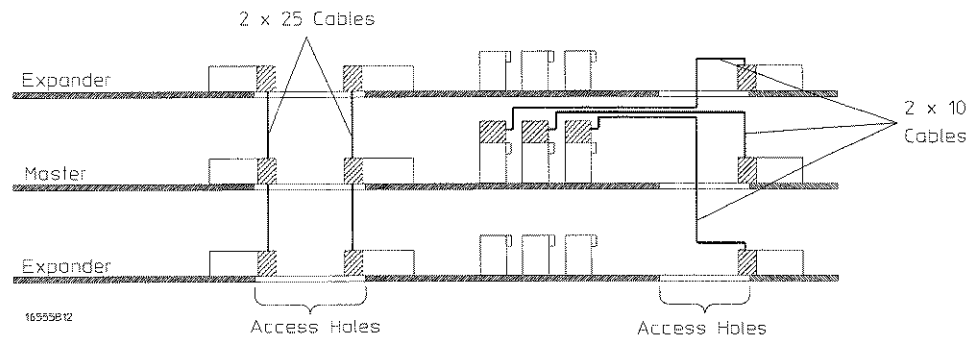

Installation
To install modules

To install modules

- 1 Slide the cards which are above the slots into which you want to put modules about halfway out of the mainframe.
- 2 With the probe cables facing away from the instrument, slide the modules approximately halfway into the mainframe.

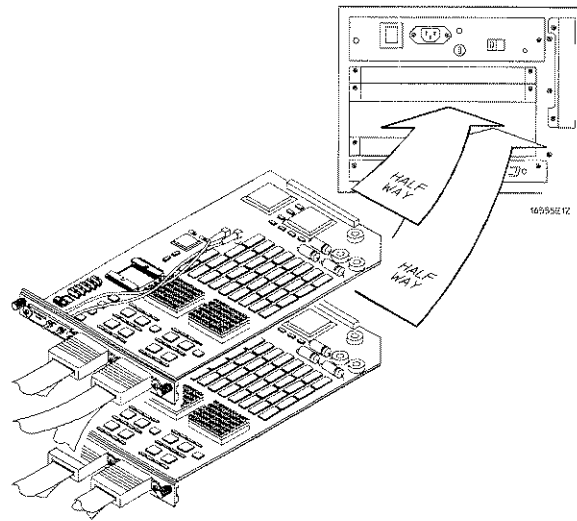

- 3 Slide the assembled modules into the mainframe, but not completely in.
Each card in the instrument will be firmly seated and tightened in step 5.
- 4 Position all cards and filler panels so that the endplates overlap.
- 5 Seat the cards and tighten the thumbscrews.

Starting with the bottom card, firmly seat the cards into the backplane connector of the mainframe. Keep applying pressure to the center of the card endplate while tightening the thumbscrews finger-tight. Repeat this for all cards and filler panels from the bottom up.

CAUTION

Correct air circulation keeps the instrument from overheating. For correct air circulation, filler panels must be installed in all unused card slots. Keep any extra filler panels for future use.

Index

A

- accessories
 - available 1-8
 - supplied 1-7
- accumulate field 7-7
- acquisition control
 - waveform menu 7-6
- acquisition control field
 - state analyzer 5-39
 - timing analyzer 5-39
- acquisition mode
 - automatic 5-40
 - manual 5-40
- action insert/replace field 7-38
- activity indicators 3-8
- advisory messages 11-2, 11-7
- analyzer name field 3-4
- analyzer type
 - state 3-5
 - timing 3-5
- Arm-In signal 5-36
- arming
 - intermodule 5-36
- arming between modules 5-36
- arming configuration 5-35
- arming control
 - between analyzers 5-35
 - graphical representation 5-35
- arming control field 5-34
- arming external instrument 5-36
- assignment field indicators 5-30
- asynchronous clock 3-5
- auxiliary power characteristics 12-8

B

- base field 6-12, 7-22, 7-28
- basic controls 7-5
- bit assignment field 4-19
- Bit Editing field 9-16
- bit pattern assignment 5-23
- bit pattern terms 5-23
- blue bar field 7-33
- branches taken field 5-42
- branching
 - across trigger levels 5-15
 - edge terms 5-29
 - secondary term 5-15
- branching field 5-15
- bus interfaces 2-3

C

- center screen field 7-18
- channel depth, maintain 4-4
- Channel masking 9-11
- channel mode
 - full 4-7
 - half 4-7
 - individual 7-35
 - overlay 7-36
 - sequential 7-35
- channel mode field 7-35
- channels
 - clock 1-2
 - data 1-2
- characteristics, listed 12-4
- characteristics 12-2
 - auxiliary power 12-8
 - data entry and display 12-7
 - measurement 12-6
 - measurement and display 12-6
 - operating environment 12-8
 - probe 12-4
 - state analysis 12-4
 - timing analysis 12-4
 - triggering 12-5
- Chart Menu 8-2
 - find o-pattern field 8-9
 - find x-pattern field 8-9
 - from trigger/start/x-marker field 8-10
 - label and base fields 8-13
 - label/base roll field 8-13
 - markers field 8-8
 - menu map 8-3
 - occurrence field 8-9
 - pattern display field 8-12
 - post-processing features 8-2
 - specify patterns field 8-11
 - stop measurement field 8-14
 - x-axes label/state value field 8-19
- Charts
 - label value vs label value 8-3
 - label value vs states 8-3
- clear pattern field 6-15, 7-25
- clear trigger field 5-43
- clock
 - asynchronous 3-5
 - input channels 4-6
 - master 4-2, 4-6, 4-8, 4-13
 - qualifier 4-2
 - slave 4-2, 4-8 - 4-9, 4-13
 - synchronous 3-5
 - threshold levels 4-2
- clock combinations 4-14
- clock inputs
 - multicard 4-13
- clock input channel
 - as data channel 4-6
- clock inputs
 - single card 4-13
- clock qualifiers 4-14
- clock threshold level 4-14
- clock/qualifier 4-13
- clocking
 - preprocessor 2-3
- clocking modes 1-2
- clocking, select 3-2
- combination assignment 5-31
- combination terms 5-31
- Compare Full/Compare Partial field 9-10
- Compare image 9-5
- Compare Menu 9-2
 - bit editing field 9-16
 - compare full/compare partial field 9-10
 - copy trace to compare field 9-8
 - data roll field 9-15
 - difference listing field 9-6 - 9-7
 - find error field 9-9
 - label and base fields 9-17
 - mask field 9-11
 - menu map 9-3
 - post-processing features 9-3
 - reference listing field 9-5
 - specify stop measurement 9-12 - 9-14
- configuration 1-4
- configuration file 1-8
- configuration menu 3-2
- configuration menu map 3-3
- configure
 - one-card module 13-2
- configure a multicard module 13-3 - 13-7
- control field
 - arming 5-34
- control fields 5-33
- controls
 - basic 7-5
- Copy Trace to Compare field 9-8

Index

count field 5-37
counters 1-2
cross-domain measurements 5-34
current sample 7-11

D

data
 acquired 6-2
 interleaved 6-2
 scrolling 7-10
 state 7-2
 timing 7-2
data entry and display characteristics 12-7
data foll field 6-20
Data Roll field 9-15
default timer 5-18
delay 5-41
delay field 7-10
delay range 7-10
delete and delete all fields 7-39
demultiplex mode 4-8, 4-10
demultiplexing
 preprocessor 2-3
Difference Listing field 9-6 - 9-7
display
 zoom 7-8 - 7-9
display hidden data 6-20
displays
 time-correlated 10-5
duration counter field 5-16

E

ECL 4-12
edge assignment 5-29
edge choices 5-29
edge term symbols 5-30
edge terms 5-29
error messages 11-2 - 11-3
expander card
 cabling 13-4
expander cards 13-3
external clocks 7-8

F

features 1-5 - 1-6
file configuration, preprocessor 2-5
file translation, preprocessor 2-5
Find Error field 9-9

Find x-pattern/find o-pattern field 8-9
find X-pattern/O-pattern 6-6
format menu 4-2
format menu map 4-3
from start X-marker field 6-8, 7-16
from trigger X-marker field 6-8, 7-16
From trigger/start/x-marker field 8-10

G

grabbers
 connecting to probes 2-24
 connecting to test points 2-24
 probe 2-19
grounding
 pod 2-18
 probe 2-18
group run 10-2 - 10-4

H

HP 10269C General Purpose Probe
Interface 1-8, 2-2
HP 10320C User-Definable Interface 2-2
HP 10321A Microprocessor Interface Kit
2-2

I

indicators 12-6
individual channel mode 7-35
inserting waveforms 10-4
install a multcard module 13-3 - 13-7
installation
 one-card module 13-2
installing modules 13-8
installing probe leads 2-23
interface
 preprocessor 2-3
 universal 2-3
interface kit
 microprocessor 2-2
 probing 2-2
interleaved state listings 10-4
intermodule configuration 10-3
intermodule menu 10-2
inverse assembler 1-8
 preprocessor 2-3

K

keyboard 1-3

L

label field 6-12, 7-22, 7-28
label polarity 4-18
label/base roll field 7-22
leads, probe 2-19
listing menu 6-2
listing menu map 6-3

M

macro library 5-5
macros
 predefined 5-5
 state trigger 5-9
 timing trigger 5-7
 user defined 5-5
macros, predefined
 how to use 5-6
map
 format menu 4-3
 trigger menu 5-3
markers
 chart menu 8-7
 color 6-5
 field 6-4
 in data listing display 7-14
 in mixed display 10-5
 in waveform display 7-14
 pattern 7-14
 state analyzer 6-4, 7-13
 timing analyzer 6-4, 7-13
markers field 7-13, 8-8
Mask field 9-11
master card 13-3
 cabling 13-4
master clock 4-2, 4-13
measurement and display characteristics
12-6
measurement characteristics 12-6
measurements
 cross-domain 5-34
memory
 reference line 7-32
memory contents
 posttrigger data 5-40
 pretrigger data 5-40

memory depth 1-2, 4-5
 memory depth considerations 5-38
 menu
 configuration 3-2
 format 4-2
 resource term configuration 5-20
 sequence instruction 5-13
 trigger 5-2
 Menu maps
 chart menu 8-3
 compare menu 9-3
 messages
 advisory 11-2, 11-7
 error 11-2
 warning 11-2, 11-4 - 11-6
 Microprocessor Interface Kit 2-2
 microprocessor mnemonics 2-3
 mixed display markers 10-5
 mixed display menu 10-2
 mnemonics
 microprocessor 2-3
 module and label fields 7-37
 module installation 13-8
 mouse 1-3
 multcard module 4-6
 multcard module, configure 13-3 - 13-7

N
 name field 3-4
 naming analyzers 3-4
 next sample 7-11

O
 O marker field 6-10
 O-pattern occurrence field 7-15
 occurrence counter
 reference point 7-15
 occurrence counter field 5-14
 Occurrence field 8-9
 occurrences
 maximum number 5-14
 occurrences, number of 5-37
 one-card module
 configuration 13-2
 operating environment characteristics 12-8
 overlay channel mode 7-36

P
 pattern display fields 6-11, 7-21
 pattern markers 6-5, 7-14
 color 7-14
 pattern occurrence
 fields 6-7
 reference point 6-7
 performance verification 12-2
 Plot from State 8-20
 pod clock field 4-8
 pod connections
 preprocessor 2-5
 pod field 4-7
 pod grounding 2-18
 pod scrolling box 3-6
 pod threshold field 4-12
 pod voltage thresholds 2-20
 pods
 unassigned 3-6
 pods, assign 3-2
 polarity
 default 4-18
 label 4-18
 Port-Out signal 5-36
 Post-processing features
 chart menu 8-2
 compare menu 9-3
 posttrigger data 5-40
 predefined resource terms
 combination 5-31
 predefined resource terms
 selection 5-31
 preprocessor file configuration 2-5
 preprocessor modules 1-8
 preprocessor pod connections 2-5
 pretrigger data 5-40
 probe
 grabbers 2-19
 leads 2-19
 probe cable 2-20
 power caution 2-20
 probe cables
 connecting 2-22
 probe characteristics 12-4
 probe grounding 2-18
 probe input voltage
 maximum 2-20
 Probe interface 2-2

probe leads
 disconnecting 2-23
 installing 2-23
 probe tip assembly
 connecting 2-17
 probes
 connecting grabbers 2-24
 probing
 general purpose 2-3, 2-17
 options 2-2
 passive 2-17
 system components 2-21
 product performance, verify 12-2

R
 range assignment 5-25
 range terms 1-2, 5-25
 Reference Listing field 9-5
 repetitive mode 7-7
 resource terms 1-2, 5-11, 5-19, 5-43
 combine 5-14
 field 5-20
 menu 5-20

S
 sample period display 7-11
 sample period field 5-41
 scrolling data 7-10
 seconds per division field 7-9
 select new macro field 5-13
 sequence instruction menu 5-13
 sequence instructions
 stored data 5-42
 sequence level
 insert, delete 5-13
 sequence level number field 5-12
 sequence levels 1-2, 5-11, 5-43
 sequence of instructions 5-11
 sequential channel mode 7-35
 setup and hold
 default 4-16
 setup and hold adjustments 4-15
 signal amplitude
 probing 2-20
 single mode 7-7
 single-card module 4-6
 slave clock 4-2, 4-13
 specifications 12-2

Index

specifications, listed 12-3
specify patterns field 6-9, 7-19, 8-11
Specify Stop Measurement 9-12 - 9-14
 compare 9-13
 x - o 9-14
state acquisition mode 4-4
state analysis characteristics 12-4
state analyzer 3-5
state analyzer markers 7-13
state listings
 interleaved 10-4
 viewing 10-2
state listings from other analyzers 10-4
state tags 4-4, 5-37
 absolute 5-37
 relative 5-37
states per division 7-2
states per division field 7-8
statistical information 7-29
statistics markers 6-18, 7-29
 color 6-18
 in a state analyzer 7-29
 in repetitive run mode 6-19
 in single run 7-30
 in single run mode 6-19
 repetitive run 7-30
 state analyzer 6-18
status lines
 preprocessor 2-3
stop measurement
 X-O option 6-14
stop measurement field 6-13, 7-23, 8-14
symbols 4-2
synchronous clock 3-5

T

tags
 state 4-4
 time 4-4
Template 9-5
term assignment field 5-14
termination adapter 2-4
terms
 resource 5-19
test points
 connecting grabbers 2-24
test procedures
 verify product performance 12-2

time markers 7-26
 color 6-16
 in a state analyzer 7-26
 state analyzer 6-16
 timing analyzer 6-16
 with pattern markers 7-26
time per division 7-2
time tags 4-4, 5-38
 absolute 5-38
 relative 5-38
 resolution 5-38
time-correlated displays 10-5
timer
 minimum value 5-28
timer assignment 5-27
timer control field 5-18
timer status 5-12
timer terms 5-27
 inverted 5-27
 within sequence level 5-27
timer, default 5-18
timers 1-2
timing acquisition mode 4-5
timing analysis characteristics 12-4
timing analyzer 3-5
timing analyzer markers 7-13
timing waveforms reconstructed 7-12
translation information
 table 2-6
trig to O field 7-27
trig to X field 7-27
trig to X/trig to O fields 6-17
trigger menu 5-2
trigger menu map 5-3
trigger point placement 5-40
trigger position
 center 5-41
 end 5-41
 start 5-40
 user defined 5-41
trigger position field 5-40
triggering characteristics 12-5
TTL 4-12

U

unassigned pods 3-6
user-defined macros 5-5

V

valid data
 clock position in 4-16
viewing state listings 10-2
voltage level
 user selected 4-12

W

warning messages 11-2, 11-4 - 11-6
waveform display 7-31
waveform menu 7-2
 acquisition control 7-6
 basic controls 7-5
 label/base roll field 9-17
waveform menu map 7-3
waveform size field 7-40
waveforms
 inserting 10-4

X

X and O entering/ leaving fields 6-10
X and O entering/leaving fields 7-20
X marker and O marker fields 7-20
X marker field 6-10
X to O display field 6-17, 7-17
X to O field 7-27
 in state analyzer 7-27
 in timing analyzer 7-27
X-axes label/state value field 8-19
X-O option 7-24
X-pattern occurrence field 7-15

Z

zoom 7-8 - 7-9

© Copyright Hewlett-Packard Company 1991-1994
All Rights Reserved.

Reproduction, adaptation, or translation without prior written permission is prohibited, except as allowed under the copyright laws.

Restricted Rights Legend

Use, duplication, or disclosure by the U.S. Government is subject to restrictions set forth in subparagraph (C) (1) (ii) of the Rights in Technical Data and Computer Software Clause in DFARS 252.227-7013.

Hewlett-Packard Company,
3000 Hanover Street, Palo Alto, CA 94304 U.S.A.
Rights for non-DOD U.S. Government Departments and Agencies are set forth in FAR 52.227-19(c)(1,2).

Document Warranty

The information contained in this document is subject to change without notice.

Hewlett-Packard makes no warranty of any kind with regard to this material, including, but not limited to, the implied warranties of merchantability or fitness for a particular purpose.

Hewlett-Packard shall not be liable for errors contained herein or for damages in connection with the furnishing, performance, or use of this material.

Safety

This apparatus has been designed and tested in accordance with IEC Publication 348, Safety Requirements for Measuring Apparatus, and has been supplied in a safe condition. This is a Safety Class I instrument (provided with terminal for protective earthing). Before applying power, verify that the correct safety precautions are taken (see the following warnings). In addition, note the external markings on the instrument that are described under "Safety Symbols."

Warning

- Before turning on the instrument, you must connect the protective earth terminal of the instrument to the protective conductor of the (mains) power cord. The mains plug shall only be inserted in a socket outlet provided with a protective earth contact. You must not negate the protective action by using an extension cord (power cable) without a protective conductor (grounding). Grounding one conductor of a two-conductor outlet is not sufficient protection.
- Only fuses with the required rated current, voltage, and specified type (normal blow, time delay, etc.) should be used. Do not use repaired fuses or short-circuited fuseholders. To do so could cause a shock or fire hazard.
- Service instructions are for trained service personnel. To avoid dangerous electric shock, do not perform any service unless qualified to do so. Do not attempt internal service or adjustment unless another person, capable of rendering first aid and resuscitation, is present.
- If you energize this instrument by an auto transformer (for voltage reduction), make sure the common terminal is connected to the earth terminal of the power source.
- Whenever it is likely that the ground protection is impaired, you must make the instrument inoperative and secure it against any unintended operation.
- Do not operate the instrument in the presence of flammable gasses or fumes. Operation of any electrical instrument in such an environment constitutes a definite safety hazard.
- Do not install substitute parts or perform any unauthorized modification to the instrument.
- Capacitors inside the instrument may retain a charge even if the instrument is disconnected from its source of supply.
- Use caution when exposing or handling the CRT. Handling or replacing the CRT shall be done only by qualified maintenance personnel.

Safety Symbols



Instruction manual symbol: the product is marked with this symbol when it is necessary for you to refer to the instruction manual in order to protect against damage to the product.



Hazardous voltage symbol.



Earth terminal symbol: Used to indicate a circuit common connected to grounded chassis.

WARNING

The Warning sign denotes a hazard. It calls attention to a procedure, practice, or the like, which, if not correctly performed or adhered to, could result in personal injury. Do not proceed beyond a Warning sign until the indicated conditions are fully understood and met.

CAUTION

The Caution sign denotes a hazard. It calls attention to an operating procedure, practice, or the like, which, if not correctly performed or adhered to, could result in damage to or destruction of part or all of the product. Do not proceed beyond a Caution symbol until the indicated conditions are fully understood or met.

Hewlett-Packard
P.O. Box 2197
1900 Garden of the Gods Road
Colorado Springs, CO 80901-2197, U.S.A.

Product Warranty

This Hewlett-Packard product has a warranty against defects in material and workmanship for a period of one year from date of shipment. During the warranty period, Hewlett-Packard Company will, at its option, either repair or replace products that prove to be defective.

For warranty service or repair, this product must be returned to a service facility designated by Hewlett-Packard.

For products returned to Hewlett-Packard for warranty service, the Buyer shall prepay shipping charges to Hewlett-Packard and Hewlett-Packard shall pay shipping charges to return the product to the Buyer. However, the Buyer shall pay all shipping charges, duties, and taxes for products returned to Hewlett-Packard from another country.

Hewlett-Packard warrants that its software and firmware designated by Hewlett-Packard for use with an instrument will execute its programming instructions when properly installed on that instrument.

Hewlett-Packard does not warrant that the operation of the instrument software, or firmware will be uninterrupted or error free.

Limitation of Warranty

The foregoing warranty shall not apply to defects resulting from improper or inadequate maintenance by the Buyer, Buyer-supplied software or interfacing, unauthorized modification or misuse, operation outside of the environmental specifications for the product, or improper site preparation or maintenance.

No other warranty is expressed or implied. Hewlett-Packard specifically disclaims the implied warranties of merchantability or fitness for a particular purpose.

Exclusive Remedies

The remedies provided herein are the buyer's sole and exclusive remedies.

Hewlett-Packard shall not be liable for any direct, indirect, special, incidental, or consequential damages, whether based on contract, tort, or any other legal theory.

Assistance

Product maintenance agreements and other customer assistance agreements are available for Hewlett-Packard products.

For any assistance, contact your nearest Hewlett-Packard Sales Office.

Certification

Hewlett-Packard Company certifies that this product met its published specifications at the time of shipment from the factory. Hewlett-Packard further certifies that its calibration measurements are traceable to the United States National Institute of Standards and Technology, to the extent allowed by the Institute's calibration facility, and to the calibration facilities of other International Standards Organization members.

About this edition

This is the first edition of the *HP 16554A and HP 16555A 100-MHz State/500-MHz Timing Logic Analyzer User's Reference*.

Publication number
16555-97005

Printed in USA.

Edition dates are as follows:

First edition, November 1994

New editions are complete revisions of the manual. Many product updates do not require manual changes and manual corrections may be done without accompanying product changes. Therefore, do not expect a one-to-one correspondence between product updates and manual updates.