



HEWLETT
PACKARD

OPERATING AND SERVICE MANUAL

214B PULSE GENERATOR

(Including Options 001 and 907 to 910)

SERIAL NUMBERS

This manual applies directly to instruments with serial number 1846 G 00596 and higher. Any changes made in instruments having serial numbers higher than the above number will be found in a "Manual Changes" supplement supplied with this manual. Be sure to examine this supplement for any changes which apply to your instrument and record these changes in the manual. Any changes made in instruments having serial numbers lower than the above number can be found in the Backdating Section 7.

2118 G 02935

© HEWLETT-PACKARD GmbH 1980
D-7030 BÖBLINGEN, HERRENBERGER STR. 110
FEDERAL REPUBLIC OF GERMANY

MANUAL PART NO. 00214-90012
Microfiche Part No. 00214-95012

Printed: February 1981

*Recall Cycle: CMOS
unit assigned to CCI GJW QE Component Lab*

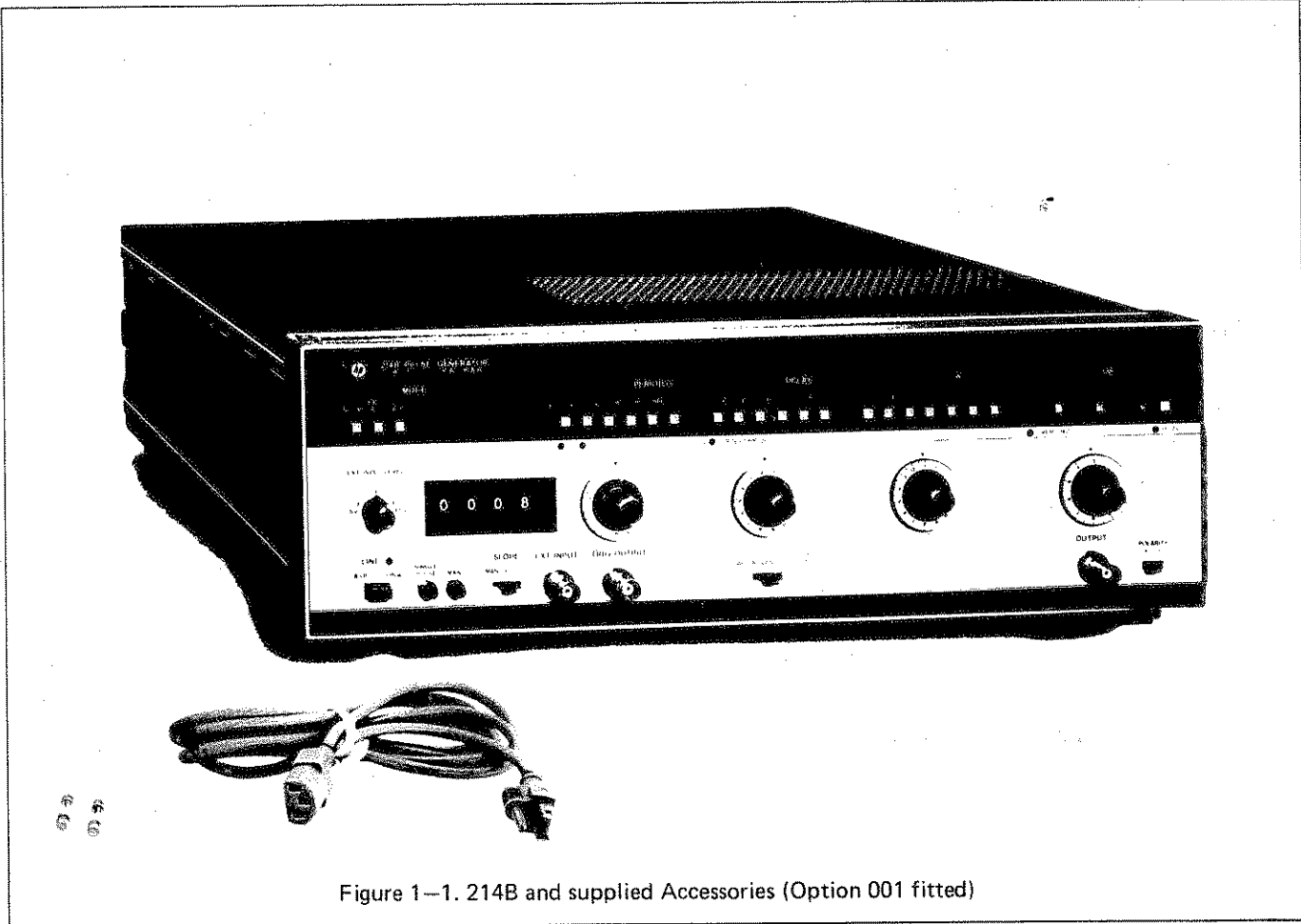
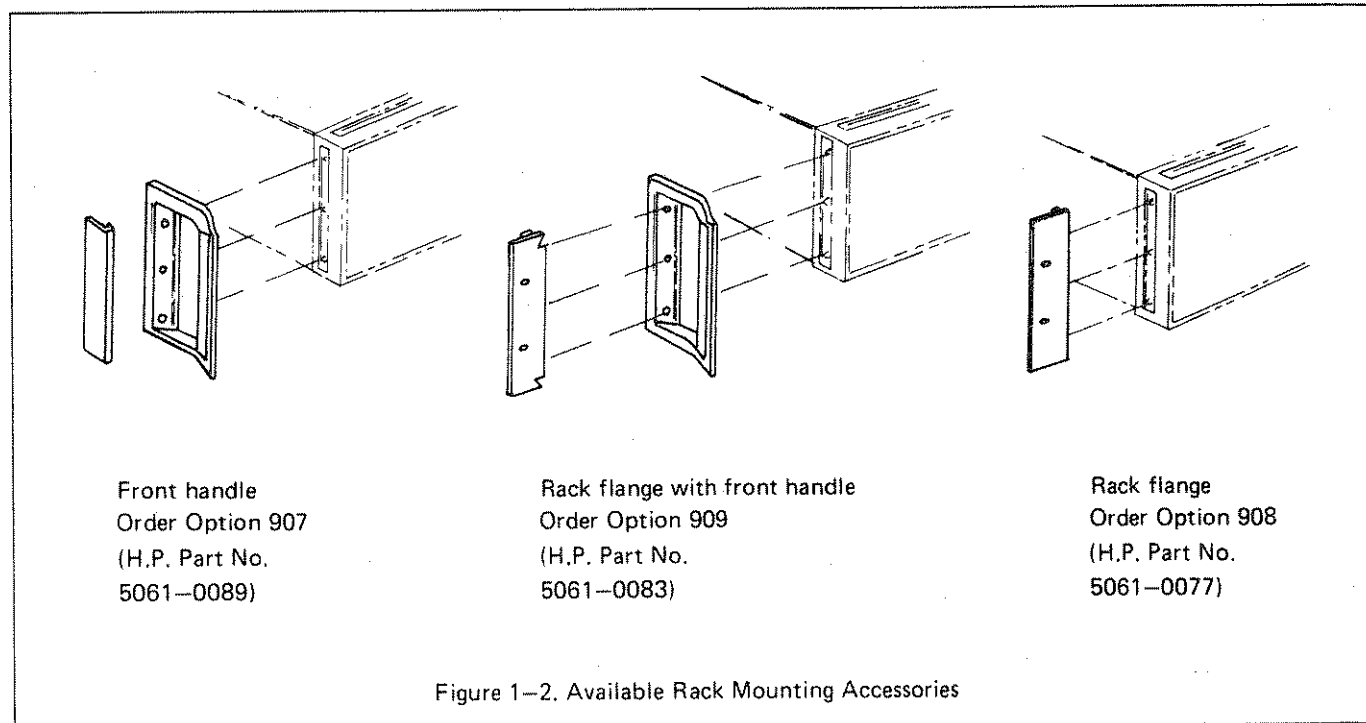

Figure 1-1. 214B and supplied Accessories (Option 001 fitted)



Front handle
Order Option 907
(H.P. Part No.
5061-0089)

Rack flange with front handle
Order Option 909
(H.P. Part No.
5061-0083)

Rack flange
Order Option 908
(H.P. Part No.
5061-0077)

Figure 1-2. Available Rack Mounting Accessories

SECTION I GENERAL INFORMATION

1-1 INTRODUCTION

1-2 This Operating and Service Manual contains information required to install, operate, test, adjust and service the Hewlett-Packard Model 214B. Figure 1-1 shows the main-frame and accessories supplied. This section covers instrument identification, description, accessories, specifications, and other basic information.

1-3 A microfiche version of this manual is available on 4 x 6 inch microfilm transparencies (order number on title page). Each microfilm contains up to 60 photo-duplicates of the manual pages. The microfiche package also includes the latest Manual Changes supplement as well as all pertinent Service Notes.

1-4 SPECIFICATIONS

1-5 Instrument specifications are listed in Table 1-2. These specifications are the performance standards or limits against which the instrument is tested.

1-6 SAFETY CONSIDERATIONS

1-7 The Model 214B is a Safety Class 1 instrument (it has an exposed metal chassis that is directly connected to earth via the power supply cable).

1-8 This operating and service manual contains information, cautions, and warnings which must be followed by the user to ensure safe operation and to maintain the instrument in a safe condition.

1-9 INSTRUMENTS COVERED BY MANUAL

1-10 Attached to the rear of this instrument is a serial number plate (Figure 1-3). The first four digits of the serial number only change when there is a significant change to the instrument. The last five digits are assigned to instruments sequentially. The contents of this manual apply directly to the instrument serial number quoted on the title page. For instruments with lower serial numbers, refer to the backdating information in Section 7 of this manual. For instruments with higher serial numbers, refer to the Manual Change sheets at the end of this manual. In addition to change information, the Manual Change sheets may contain information for correcting errors in the manual. To keep this manual as up-to-date and accurate

as possible, Hewlett-Packard recommends that you periodically request the latest Manual Change supplement. The supplement for this manual is identified with this manual's print date and part number, both of which appear on this manual's title page. Complimentary copies of the supplement are available from Hewlett-Packard.

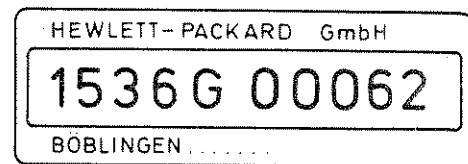

Figure 1-3. Serial Number Plate

1-11 DESCRIPTION

1-12 The Model 214B is a high power pulse generator delivering 200 watts pulse power at up to 4 MHz repetition rate and 15ns or less transition times. With reduced power, the repetition rate can be increased to 10 MHz.

1-13 Variable pulse parameters of the 214B include repetition rate, width, delay/advance, and duty cycle. In addition, the 214B constant Duty Cycle Mode ensures that duty cycle remains constant with a frequency range, thus maintaining a constant pulse energy at the output.

1-14 User orientated features of the 214B include push-button selection for parameter ranges, calibrated verniers for continuous setting within these ranges, and LED indications of timing error and output amplifier overload.

1-15 For a complete description of controls and modes of operation, refer to Section III.

1-16 OPTIONS

1-17 214B-Option 001: This allows a preselected number of pulses to be generated on receipt of a trigger signal. (Not retrofittable).

1-18 214B-Options 907, 908 and 909: Provides means of rack mounting the 214B. Further details are given in Figure 1-2.

Table 1-1. Recommended Test Equipment

QTY	INSTRUMENT TYPE	RECOMMENDED MODEL	REQUIRED CHARACTERISTICS	REQUIRED FOR		
					A	T
1	Digital Multimeter	3465A/B	10-1000VDC, AC; OHM Floating Input		A	T
1	Sampling Oscilloscope	180C Mainframe 1810A Sampling Plug In	1 GHz Bandwidth	P	A	T
1	Oscilloscope	1740A	100 MHz Bandwidth	P	A	T
1	Counter/Timer	5300B 5308A <i>NO LONGER AVAILABLE</i> AC 504	50 MHz Start-Stop Mode	P	A	T
1	Test Oscillator	651 B <i>FC-504</i>	10 MHz Sinewave	P		T
1	20 dB Attenuator	8491A	20 dB Coax Attenuator	P	A	T
1	20 dB Attenuator 50 W	Narda 765-20	20 dB Coax Attenuator 50W	P	A	T
1	Pulse Generator	8012B <i>FC-504</i>	10 ns Pulse Width	P		T
1	Variac		Isolating Transformer		A	T

NOTE: P = Performance Check
 A = Adjustment
 T = Troubleshooting

Table 1-2. Specifications

OUTPUT CHARACTERISTICS**Pulse Amplitude**

0.3V to 100V into 50 ohm. 5 ranges with calibrated vernier providing continuous adjustment within ranges.

Vernier Accuracy: $\pm 10\%$ of setting.

Source Impedance

Fixed 50 ohm nominal on ranges up to 10V. Selectable 50 ohm nominal or high impedance on 10-30V and 30-100V ranges. (Note: with 50 ohm source and load impedance, 10-30V and 30-100V ranges reduce to 5-15V and 15-50V respectively).

Polarity: Positive or negative, switch selectable.

Preshoot, Overshoot and Ringing: $\leq \pm 5\%$ of pulse amplitude.

Pulse Top Perturbations: $\leq \pm 5\%$ of pulse amplitude.

Transition Times: ≤ 15 ns for leading and trailing edges.

TIMING**Repetition Rate**

10 Hz to 10 MHz in 6 decade ranges. In 30V-100V amplitude range, maximum repetition rate is 4 MHz. Calibrated vernier provides continuous adjustment within ranges.

Vernier Accuracy: $\pm (10\%$ of setting + 1% of full scale).

Period Jitter: $\leq 0.1\% + 300$ ps.

Pulse Position**Pulse Delay**

Pulse can be delayed with respect to the Trigger Output from +10ns [+ fixed delay] to +10ms. [Fixed delay is 50 ns \pm 10ns].

Pulse Advance

Pulse can be delayed with respect to the Trigger Output from +10ns [- fixed delay] to +10ms. [Fixed delay is 50 ns \pm 10ns].

Controls

5 decade ranges with calibrated vernier providing continuous adjustment within ranges.

Vernier Accuracy: $\pm (10\%$ of setting + 1% of full scale) + fixed delay.

Maximum Pulse Position Duty Cycle: $\geq 50\%$.

Position Jitter: $\leq 0.1\% + 500$ ps.

Pulse Width

25ns to 10ms in 6 decade ranges. Calibrated vernier provides continuous adjustment within ranges.

Vernier Accuracy: $\pm (10\%$ of setting + 1% of full scale + 5ns).

Width Jitter: $\leq 0.1\% + 500$ ps.

Maximum Duty Cycle

$\geq 10\%$ for 30-100V amplitude range.

$\geq 50\%$ for all other ranges. (max. 10 ms width)

Constant Duty Cycle Mode (Disabled in External Trigger Mode)

Duty cycle of output pulse (hence output power) remains constant when the pulse period is changed. In this mode the duty cycle limits are:

Typically 8% fixed for 10M - 1 MHz frequency range (max. frequency 4 MHz without loss of amplitude)

2.5% to 10% for 1 M - .1 MHz frequency range

.25% to 10% for .1 MHz - 10 kHz frequency range

0.1% to 10% for all other frequency ranges

Calibrated vernier provides continuous adjustment within duty cycle ranges.

Vernier Accuracy: $\pm (15\%$ of setting + 1% of full scale).

Double Pulse

5 MHz maximum in all ranges except 30V-100V range. In 30V-100V range, the maximum frequency is 2 MHz. Minimum separation is 100ns.

Trigger Output

Amplitude: $\geq + 5$ V (from 50 ohm into open circuit).

Pulse Width: 10ns typical.

Source Impedance: 50 ohm nominal.

EXTERNALLY CONTROLLED OPERATION

External Trigger Mode: An output pulse is generated for each input pulse.

Gate Mode

Gating signal turns on repetition rate generator. First pulse occurs after start of gate signal, and last pulse is always completed even if gate ends during generation of last pulse.

Burst Mode (Optional)

Preselected number of pulses generated on receipt of trigger signal.

Number of Pulses: 1 to 9999.

Minimum Spacing between Bursts: 200ns.

External Input

Repetition Rate: DC to 10 MHz.

Sensitivity: 500mV peak to peak, dc coupled.

Slope: Positive or negative.

Trigger Level: Continuously adjustable from -5V to +5V

Maximum Input Level: ± 100 V.

Trigger Pulse Width: ≥ 10 ns.

Input Impedance: 10k ohm nominal.

Manual

Pushbutton can be used for:

- triggering single pulses (EXT TRIGGER Mode)
- generating gate signals (GATE Mode)
- triggering pulse bursts (BURST Mode)

GENERAL

Environmental: Instrument operates within 0°C to 55°C.

Power Requirements

100V, 120V, 220V or 240V, +5%, -10%. 48 Hz to 66 Hz, 360VA max.

Weight: Net 13.6 kg (30.1 lb), shipping 15.6 kg (34.3 lb).

Dimensions

133mm high, 426mm wide, 422mm deep (5.2 x 16.8 x 16.6 inches).

NOTES

1. Dimensions are for general information only. If dimensions are required for building special enclosures, contact your HP field engineer.

2. Dimensions are in millimetres and (inches).

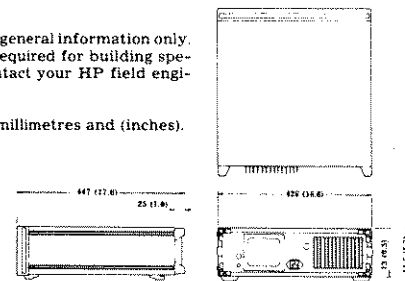
**OPTIONS****Option 001**

Burst. Preselected number of pulses generated on receipt of trigger signal. Number of Pulses: 1 to 9999.

Option 907

Front Handle Kit, part number 5061-0089.

Option 908

Rack Mounting Kit, part number 5061-0079

Option 909

Combined Front Handle and Rack Mounting Kit, part number 5061-0083.

Option 910

Additional Operating and Service Manual

Data subject to change

SECTION II INSTALLATION

2-1 INTRODUCTION

2-2 This section provides installation instructions for the instrument and its accessories. It also includes information about initial inspection and damage claims, preparation for use, and packaging, storage and shipment.

2-3 INITIAL INSPECTION

2-4 Inspect the shipping container for damage. If the container or cushioning material is damaged, it should be kept until the contents of the shipment have been checked for completeness and the instrument has been checked mechanically and electrically. The contents of the shipment should be as shown in Figure 1-1 plus any accessories that were ordered with the instrument. Procedures for checking the electrical operation are given in Section 4. If the contents are incomplete, if there is mechanical damage or defect, or if the instrument does not pass the operator's checks, notify the nearest Hewlett-Packard office. Keep the shipping materials for carrier's inspection. The HP office will arrange for repair or replacement without waiting for settlement.

2-5 PREPARATION FOR USE

2-6 Power Requirements

2-7 The instrument requires a power source of 100V, 120V, 220V or 240V (+5%, -10%) at a frequency of 48 to 66 Hz single phase. The maximum power consumption is 380V A.

2-8 Line Voltage Selection

CAUTION

BEFORE SWITCHING ON THIS INSTRUMENT make sure that the instrument is set to the local line voltage.

2-9 Figure 2-1 provides information for line voltage and fuse selection:

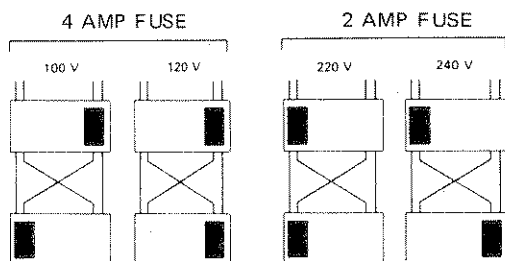

Figure 2-1. Switch Settings for the various Nominal Power-line Voltages

2-10 Power Cable

WARNING

To avoid the possibility of injury or death, the following precautions must be followed before the instrument is switched on:

- a. If this instrument is to be energized via an autotransformer for voltage reduction, make sure that the common terminal is connected to the grounded pole of the power source.*
- b. The power cable plug shall only be inserted into a socket outlet provided with a protective ground contact. The protective action must not be negated by the use of an extension cord without a protective conductor.*
- c. Before switching on the instrument, the protective ground terminal of the instrument must be connected to a protective conductor of the power cable. This is verified by checking that the resistance between the instrument chassis and the front panels of all modules in the instrument and the ground pin of the power cable plug is zero ohms.*

2-11 In accordance with international safety standards, this instrument is equipped with a three-wire power cable. When connected to an appropriate ac power receptacle, this cable grounds the instrument cabinet. The type of power cable shipped with each instrument depends on the country of destination. Refer to Figure 2-2 for the part number of the power cords available.

2-12 If the plug on the cable supplied does not fit your power outlet, then cut the cable at the plug end and connect a suitable plug. The plug should meet local safety requirements and include the following features:

- Minimum current rating of 4A
- Ground connection
- Cable clamp.

The colour coding used in the cable will depend on the cable supplied (see Figure 2-2).

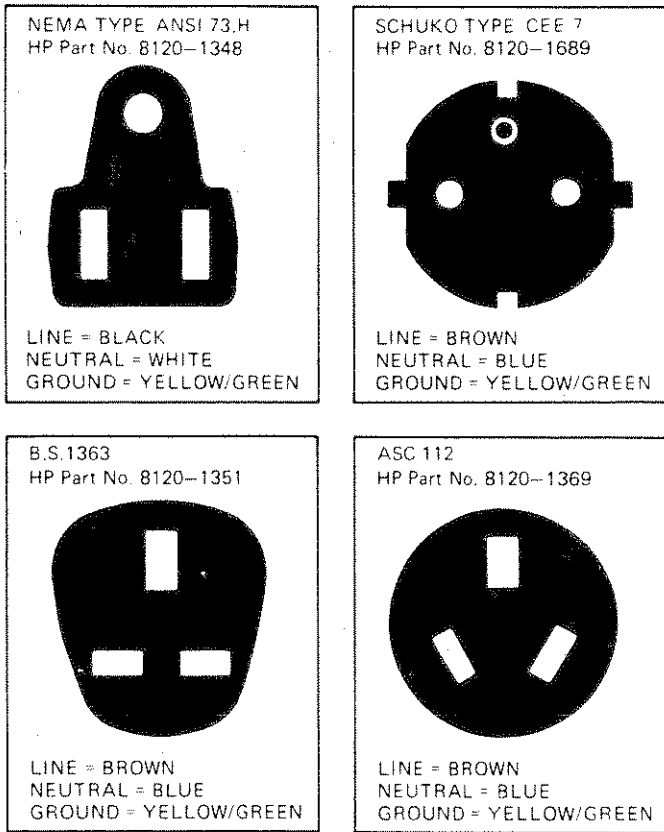

Figure 2-2. Power Cables Available: Plug Identification

2-13 Operating Environment

2-14 The instrument will operate within specifications when the ambient temperature is between 0°C and 55°C.

2-15 FRONT HANDLE/RACK MOUNTING

2-16 Figure 1-2 shows the possible handle/rack-mounting configurations. If handles are fitted and subsequently need to be removed, the plastic trim must first be taken off as shown in Figure 2-3.

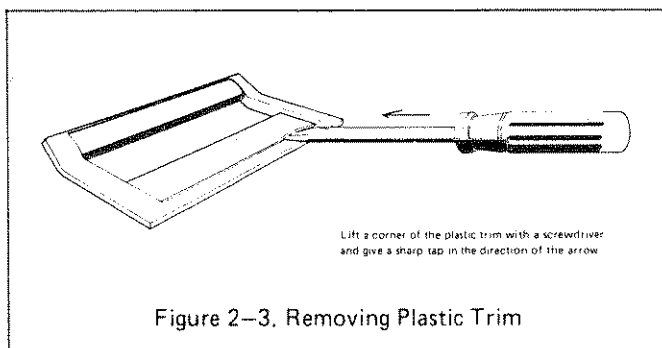

Figure 2-3. Removing Plastic Trim

2-17 CLAIMS AND REPACKAGING

2-18 Claims for Damage

2-19 If physical damage is evident or if the instrument does not meet specification when received, notify the carrier and the nearest Hewlett-Packard Sales/Service Office. The Sales/Service Office will arrange for repair or replacement of the unit without waiting for settlement of the claim against the carrier.

2-20 STORAGE AND SHIPMENT

2-21 The instrument can be stored or shipped at temperatures between -40°C and 75°C. The instrument should be protected from temperature extremes which cause condensation within the instrument.

2-22 If the instrument is to be shipped to a Hewlett-Packard Sales/Service Office, attach a tag showing owner, return address, model number and full serial number and the type of service required. The original shipping carton and packaging material may be re-usable but the Hewlett-Packard Sales/Service office will also provide information and recommendations on materials to be used if the original packing is not available or re-usable. General instructions for re-packing are as follows:

1. Wrap instrument in heavy paper or plastic.
2. Use strong shipping container. A double wall carton made of 350-pound test material is adequate.
3. Use enough shock-absorbing material (3 to 4-inch layer) around all sides of instrument to provide firm cushion and prevent movement inside container. Protect control panel with cardboard.
4. Seal shipping container securely.
5. Mark shipping container FRAGILE to encourage careful handling.
6. In any correspondence, refer to instrument by model number and serial number.

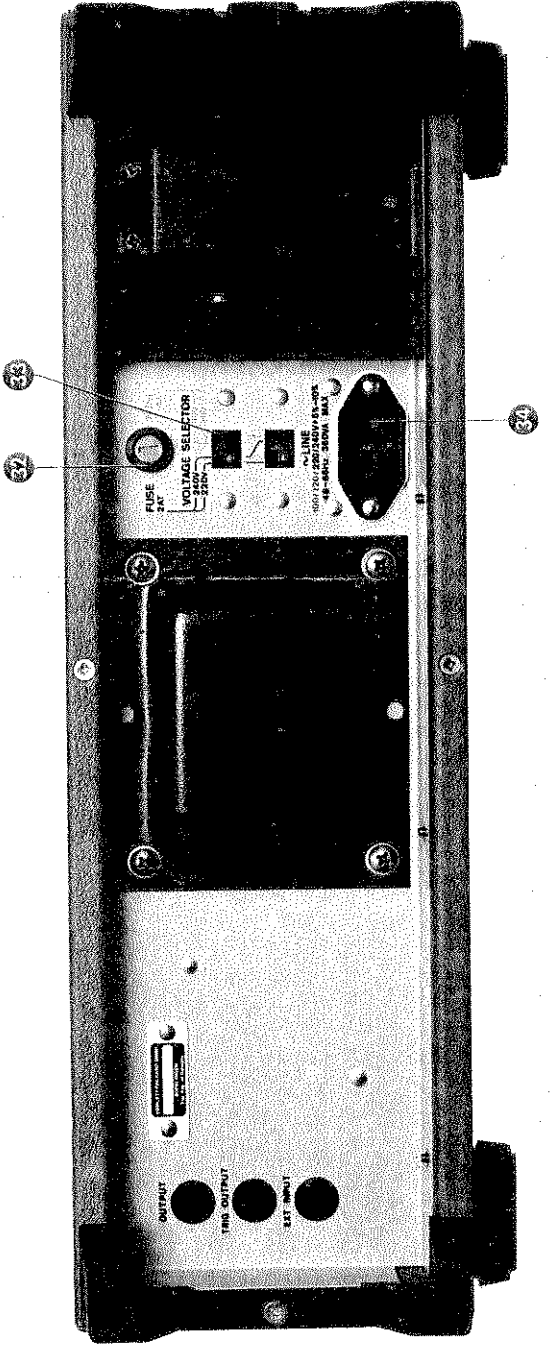
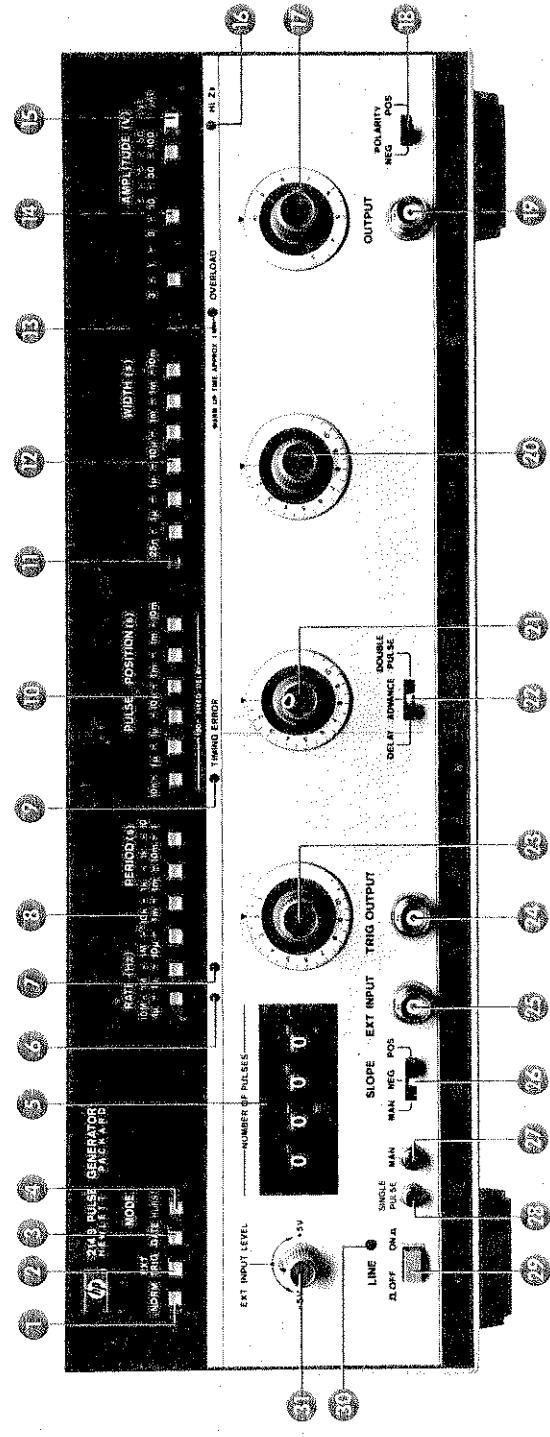

- 1 **NORM.** Pushbutton for selecting internal repetition rate.
- 2 **EXT TRIG.** Pushbutton for selecting external trigger source. In this mode an output pulse is generated for every transition (slope selectable at 23) at the EXT INPUT connector, or for each momentary operation of the MAN pushbutton 27.
- 3 **GATE.** Pushbutton for selecting gating mode of operation. In this mode, output pulses are generated for the duration of a signal applied to the EXT INPUT connector, or for as long as the MAN pushbutton 27 remains pressed.
- 4 **BURST.** (Option 001). Pushbutton for selecting burst mode of operation. In this mode a preselected number of pulses are output on receipt of a signal at the EXT INPUT connector, or by momentary operation of MAN pushbutton 27.
- 5 **NUMBER OF PULSES** (Option 001). Thumb-wheel switch for presetting the number of output pulses in burst mode.
- 6 **8 % FXD LED.** Provides visual indication that duty cycle is fixed at 8 % and will remain constant should frequency vernier 23 be adjusted. Width pushbuttons 7 and vernier 20 are disabled when this LED is illuminated.
- 7 **2.5-10 % LED.** Provides visual indication that duty cycle can be varied within the limits 2.5-10 %, and that once set, will remain constant should frequency vernier 23 be adjusted.

- 8 **RATE/PERIOD.** Row of pushbuttons for selecting internal repetition rate.
- 9 **TIMING ERROR LED.** In NORM mode, provides visual indication of timing error in the settings of the width, delay and period controls.
- 10 **PULSE POSITION (DELAY).** Row of pushbuttons for selecting the range in which the output pulse can be delayed/advanced with respect to the trigger output.
- 11 **DUTY CYCLE.** Pushbutton for selecting constant duty cycle mode. In this mode, duty cycle remains constant, when the frequency is changed.
- 12 **WIDTH.** Row of pushbuttons for selecting the width range of the output pulse. When DUTY CYCLE pushbutton 11 is pressed, then the first two pushbuttons in this row are used to select the duty cycle range.
- 13 **OVERLOAD LED.** Provides visual indication that duty cycle limit is exceeded. When this LED is illuminated, the output is disabled.
- 14 **AMPLITUDE.** Pushbutton row for selecting the amplitude range.
- 15 **INT LOAD.** Pushbutton for selecting a 50 ohm source impedance.
- 16 **HI Zs LED.** Provides visual indication that high source impedance is selected.
- 17 **AMPLITUDE VERNIER.** Calibrated vernier for continuous adjustment between the limits set by

- 18 pushbutton row 19. Two scales are provided, the outer scale corresponding to any range selected by a light grey pushbutton at 19, the inner scale corresponding to ranges selected by a dark grey pushbutton.
- 19 **POLARITY.** Slide switch for selecting the polarity of the output pulse.
- 20 **OUTPUT.** BNC connector for the 214B output pulse.
- 21 **WIDTH VERNIER.** Calibrated vernier for continuous adjustment of width within the limits set by pushbutton row 12. In constant duty cycle mode, this vernier provides continuous adjustment within the selected duty cycle range.
- 22 **PULSE POSITION VERNIER.** Calibrated vernier for continuous adjustment of pulse delay/advance within the range set by pushbutton row 10.
- 23 **DELAY/ADVANCE/DOUBLE PULSE.** Slide switch for selecting the output pulse to be delayed/advanced with respect to the trigger, or selecting double pulse operation.
- 24 **RATE VERNIER.** Calibrated vernier for continuous adjustment of the repetition rate within the limits selected at pushbutton row 8.
- 25 **TRIG. OUTPUT.** BNC connector for the trigger output pulse.
- 26 **EXT INPUT.** BNC connector for external trigger/gating signals.

- 27 **SLOPE.** Slide switch for selecting trigger slope of external signal or for selecting manual command operation.
- 28 **MAN.** Pushbutton for providing a manual trigger in EXT TRIG mode, or gate signal in GATE mode. When Option 001 is fitted, this switch also provides a trigger signal for a pulse output burst.
- 29 **SINGLE PULSE** (Option 001). Pushbutton for providing a single pulse output in BURST mode.
- 30 **LINE OFF/ON.** Switch for applying primary ac power to the instrument.
- 31 **LINE LED.** Indicates when primary ac power is applied to the instrument.
- 32 **EXT INPUT LEVEL.** Control for adjusting trigger level of external input signal.
- 33 **FUSE.** Accepts standard fuses to provide instrument protection in case of current overload. A 2A slow-blow fuse must be used when operating from 240V/220V power source. A 4A fuse is used when operating from 100V/120V power source.
- 34 **VOLTAGE SELECTOR.** These switches connect the internal power transformer to accept the primary power source voltage. BOTH SWITCHES must be set to the position marked for the power source being used.
- 35 **LINE.** A three-pronged receptacle to provide operator protection.

SECTION III OPERATION

3-1 INTRODUCTION

3-2 This operating section explains the functions of the controls and indicators of the Model 214B Pulse Generator. Front and rear panel controls and connectors are identified and briefly described in Figure 3-1. A more detailed description of the control and connector functions is given in the following paragraphs.

3-3 SPECIAL OPERATING CONSIDERATIONS

3-4 Prior to operating the Model 214B, the operator should familiarise himself with the controls and connectors by reading this section in its entirety.



When operating in the 30-100V amplitude range, the output voltage is dangerous to life. Care should therefore be taken when connecting the 214B to external instruments.

3-5 The following steps should be taken before applying power to the 214B.

- a) Read the safety summary at the front of this manual.
- b) Be sure the power selector switches are set properly for the power source being used to avoid instrument damage.



Do not change the LINE SELECTOR switch setting with the instrument on or with power connected to the rear panel.

- c) When connecting the 214B to an external device, ensure that the device cannot be overloaded by the 214B output.

3-6 OPERATING MODE

3-7 The 214B operating mode is selected by pressing one of three pushbuttons.

- NORM when rate is determined by the internal generator.
- EXT TRIG when an external trigger source is connected.
- GATE when the internal repetition rate generator needs to be switched on only for the duration of an external gating signal.

3-8 A more complete description of these three operating modes is given in the following paragraphs.

3-9 NORM MODE

3-10 With this mode selected, the frequency is set via the RATE pushbutton row and the calibrated RATE vernier. For each pushbutton selection of rate range, a corresponding period range is shown to simplify adjustment of pulse position and pulse width, i.e. correct timing is assured when the pulse position and pulse width settings are less than the selected period.

3-11 EXT TRIGGER MODE

3-12 With external trigger mode selected, a 214B output pulse is generated either by applying an external trigger signal to the EXT INPUT connector or by operation of the MAN pushbutton.

3-13 When operating from an external trigger source, the trigger signal can be from dc to 10MHz, with minimum amplitude 0.5V centred on the trigger level, and minimum pulse width 10ns. The trigger slope is then selectable via the SLOPE slide switch, and trigger level adjustable between -5V and +5V via the EXT INPUT LEVEL control.

NOTE:

To avoid incompatible timing settings, the pulse position and pulse width settings should each be less than the period of the external trigger signal.

3-14 When using the MAN pushbutton to generate an output pulse, the SLOPE slide switch must be set to MAN, and then a single pulse is generated every time the MAN pushbutton is pressed. Other front panel controls are set to obtain the desired pulse characteristics e.g. pulse position, pulse width, amplitude.

3-15 GATE MODE

3-16 With gate mode selected, the internal repetition rate generator is turned on either by applying an external signal to the EXT INPUT connector or by operation of the MAN pushbutton.

3-17 If an external signal is applied, then pulses occur at the 214B output when:

- with positive slope selected, the external signal is more positive than the selected trigger level (selected by EXT INPUT LEVEL control). See figure 3-2.
- with negative slope selected, the external signal is more negative than the selected trigger level. See figure 3-2.

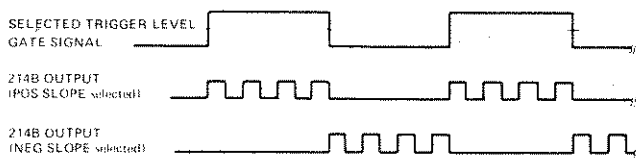

Figure 3-2 214B Outputs in Gate Mode

In either case, the effective period of the gate signal should be greater than the period selected at the RATE/PERIOD controls. Also, as in NORM trigger mode, pulse position and pulse width settings should be less than PERIOD setting to avoid timing errors.

3-18 When using the MAN pushbutton to generate output pulses, the SLOPE slide switch must be set to MAN, then 214B output pulses occur for as long as the MAN pushbutton remains pressed. Other front panel controls are set to obtain the desired pulse characteristics e.g. frequency, delay, width etc.

3-19 PULSE POSITION

3-20 The output pulse of the 214B can be delayed or advanced with respect to the trigger output, according to the setting of DELAY/ADVANCE slide switch. In either case, the range is selected via the PULSE POSITION pushbutton row, and exact setting accomplished via the PULSE POSITION calibrated vernier.

3-21 In the event of the selected delay/advance being greater than the selected period, the TIMING ERROR LED will be illuminated and remain illuminated as long as this error relationship exists. (Note: the TIMING ERROR LED functions only in NORM mode).

3-22 For DOUBLE PULSE operation, the PULSE POSITION controls are used to set the delay between the start of

the first pulse and start of the second pulse. In this mode, the following timing conditions should be observed for a true output:

- the pulse position setting less than the selected period. (Note: in this mode, range $10n-.1\mu$ is not specified)
- the minimum separation between the first and second pulse (see figure 3-3) is the minimum setting of the selected pulse position range e.g. in $1m-10m$ pulse position range, minimum separation is 1ms.

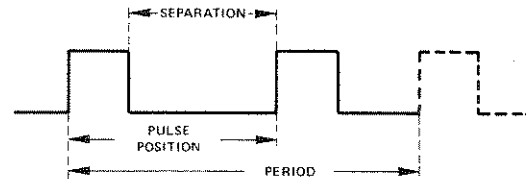

Figure 3-3. Timing parameters in Double Pulse Mode.

3-23 DUTY CYCLE

3-24 Duty cycle is defined as the percentage ratio of pulse width to pulse period. With the 214B, a DUTY CYCLE pushbutton is provided, whereby:

- if released, the WIDTH pushbutton row is operational, and the vernier provides continuous width adjustment within the selected range. In this case, the width remains constant when the period is changed, hence duty cycle varies with frequency.
- if pressed, then only the DUTY CYCLE range pushbuttons are operational, and the vernier provides continuous adjustment of duty cycle within the selected range. Once set, the duty cycle remains constant in the event of a frequency change. This feature is referred to as Constant Duty Cycle Mode of operation.

3-25 When the DUTY CYCLE pushbutton is released, the pulse width is set via the WIDTH pushbutton row and related vernier, the duty cycle then being operator — calculated by relating this time to the output pulse period. The maximum duty cycle in this case (whether internal or external trigger) is:

- at least 10 % for the 30-100 V amplitude range
- at least 50 % for all other amplitude ranges (up to a max. pulse width 10 ms)

If the maximum allowed duty cycle is exceeded, the 214B output will be automatically disabled and thus safeguarded from overload.

The disabled condition is generally indicated by the OVERLOAD LED. At rates above 4 MHz, however, the

LED may not operate. Consequently, the user should verify width/period settings and not rely on the LED when operating at higher rates.

The output is automatically re-enabled when the width/period relationship is adjusted for a duty cycle at or below the allowed maximum.

3-26 CONSTANT DUTY CYCLE MODE

3-27 The constant duty cycle mode is selected by pressing the DUTY CYCLE pushbutton, and only functions when the internal trigger is in operation i.e. NORM mode, GATE mode, and BURST mode if option 001 is fitted.

3-28 When operating in constant duty cycle mode, different duty cycle limits exist according to the rate setting.

These are:

- typically 8 % fixed in the 1MHz-10MHz rate range
- 2.5-10 % in the .1MHz-1MHz rate range.
- .25-10 % in the 10 kHz - .1 MHz rate range.
- 0.1-10 % for all other frequency ranges.

For the two highest rate ranges, the duty cycle limits are indicated by an illuminated LED. In those rate ranges where the constant duty cycle can be adjusted (1MHz and lower), the duty cycle is set via the DUTY CYCLE range push-buttons and duty cycle vernier.

Whereas the settings on this vernier correspond to width times, when the DUTY CYCLE pushbutton is released, they are now used to set percentage duty cycle.

3-29 AMPLITUDE

3-30 The Model 214B output amplitude is determined primarily by the AMPLITUDE pushbutton row and

AMPLITUDE vernier. Also affecting the output amplitude are the 214B source impedance and the load impedance. In the .3-1-3-10V amplitude ranges, the source impedance is a fixed 50 ohm, and the amplitude indicated by the pushbutton range and vernier setting is true when operating with a 50 ohm load.

With a high load impedance in these ranges, the front panel amplitude indication is one-half of the actual amplitude. On the 10-30-100V amplitude ranges, the source impedance is selectable via the INT LOAD pushbutton. When this pushbutton is in the released position, a high source impedance exists, and when depressed, a 50 ohm source impedance is switched in. The lower amplitude scale (10-30-100) applies when either the load or the source impedance is high (**NOTE: one 50 ohm termination must remain**). The upper scale (5-15-50) applies when both source and load impedances are 50 ohm. When the source impedance is high, the HIZs LED is illuminated.

3-31 POLARITY

3-32 The polarity slide switch is used to set the polarity of the selected amplitude with respect to 0V. e.g. with amplitude set to 36V and polarity set to NEG, then the output pulse transitions between 0V and -36V.

SECTION IV PERFORMANCE TESTS

4-1 INTRODUCTION

4-2 The procedures in this section test the electrical performance of the pulse generator using the specifications of Table 1-2 as performance standards. All tests can be performed without access to the interior of the instrument.

4-3 EQUIPMENT REQUIRED

4-4 Equipment required for the performance tests is listed in Table 1-1, Recommended Test Equipment. Any equipment that satisfies the critical specifications given in the table may be substituted for the recommended model(s).

4-5 TEST RECORD

4-6 Results of the performance tests may be tabulated on the Test Record at the end of the test procedures. The Test Record lists all of the tested specifications and their acceptable limits. Test results recorded at incoming inspection can be used for comparison in periodic maintenance, troubleshooting, and after repairs or adjustments.

4-7 PERFORMANCE TESTS

4-8 The performance tests given in this section are suitable for incoming inspection, troubleshooting, or preventive maintenance. During any performance test, all shields and connecting hardware must be in place. The tests are designed to verify the published instrument specifications, perform the tests in the order given and record the data on the test card and/or in the data spaces provided at the end of each procedure.

4-9 Each test is arranged so that the specification is written as it appears in Table 1-2. Next, a description of the test and any special instructions or problem areas are included. Each test that requires test equipment has a setup drawing and a list of the required equipment. The initial steps of each procedure give control settings required for that particular test.

PERFORMANCE TESTS

4-10 REPETITION RATE; VERNIER ACCURACY

SPECIFICATION:

Repetition Rate 10 Hz to 10 MHz in six decade ranges.
 In 30V – 100V amplitude range, maximum repetition rate is 4 MHz.
 Calibrated vernier provides continuous adjustment within ranges.
 Vernier Accuracy: \pm (10% of setting + 1% of full scale).

EQUIPMENT:

Counter/Timer
 50 Ω Feedthrough

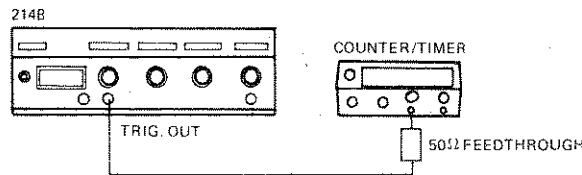

Figure 4-1.

1. Connect equipment as shown in Figure 4-1 and set 214B controls as follows:

MODE	NORM
PERIOD Range1 μ – 1 μ
PERIOD Vernier	10
POSITION Range	10n – .1 μ
POSITION Vernier	1
DUTY CYCLE %	* 4.5 ^{OUT} can set with period
DUTY CYCLE Range	*
DUTY CYCLE Vernier	*
WIDTH RANGE	* \approx 4.5
AMPLITUDE Range	3-10
AMPLITUDE Vernier	3
INT LOAD	*
SLOPE	* +
DEL/ADV/D.P.	* ADV
POLARITY	* +

* = don't care

2. Set counter to Period or Period AVG to get the best resolution.

PERFORMANCE TESTS

3. Set PERIOD VERNIER exactly to 10.
Switch from range to range and check that Counter/Timer reading is within the listed results.

use freq counter or scope for steps 3, 4 & 5
DC503A works well

PERIOD RANGE	VERNIER SETTING	RESULT
.1μ - 1μ	10	890ns - 1110ns
1μ - 10μ	10	8900ns - 11100ns
10μ - .1m	10	89μs - 111μs
.1m - 1m	10	890μs - 1110μs
1m - 10m	10	8900μs - 11100μs
10m - .1	10	89ms - 111ms

4. Set PERIOD VERNIER exactly to 1.
Switch from range to range and check that Counter/Timer reading is within the listed results.

PERIOD RANGE	VERNIER SETTING	RESULT
10m - .1	1	8000μs - 12000μs
1m - 10m	1	800μs - 1200μs
.1m - 1m	1	80μs - 120μs
10μ - .1m	1	8000ns - 12000ns
1μ - 10μ	1	800ns - 1200ns
.1μ - 1μ	1	80ns - 120ns

5. For checking dial tracking set PERIOD VERNIER exactly to the listed settings and check results.

PERIOD RANGE	VERNIER SETTING	RESULT
.1μ - 1μ	2	170ns - 230ns
.1μ - 1μ	3	260ns - 340ns
.1μ - 1μ	4	350ns - 450ns
.1μ - 1μ	5	440ns - 560ns
.1μ - 1μ	6	530ns - 670ns
.1μ - 1μ	7	620ns - 780ns
.1μ - 1μ	8	710ns - 890ns
.1μ - 1μ	9	800ns - 1000ns

PERFORMANCE TESTS

4-11 PULSE POSITION: DELAY; ADVANCE; VERNIER ACCURACY

SPECIFICATION:

DELAY: Pulse can be delayed with respect to the Trigger Output from +10ns (+ fxd delay) to +10ms in 5 decade ranges. [Fixed delay is 50 ns ± 10 ns]

ADVANCE: Pulse can be advanced with respect to the Trigger Output from +10 ns (-fxd delay) to +10 ms in 5 decade ranges. [Fixed delay is 50 ns ± 10 ns]

VERNIER: Accuracy ± (10% of setting + 1% of full scale) + fixed delay . Fixed delay is 50 ns ± 10 ns.

EQUIPMENT:

- Sampling Oscilloscope 485
- 2 x 20dB Coax Attenuator 2 x 50Ω Terminators
- 2 x 50 Ω Feedthrough
- Counter / Timer

CAUTION: Do not overload Attenuators and Oscilloscope Inputs.

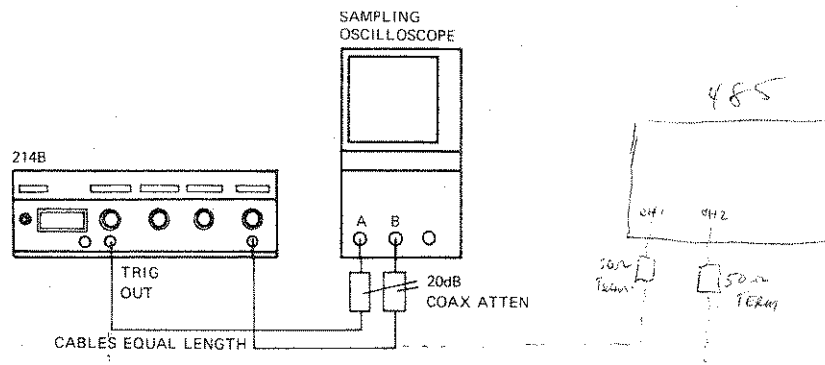

Figure 4-2.

1. Connect equipment as shown in Figure 4-2 and set 214B controls as follows:

MODE	NORM
PERIOD Range1μ - 1μ
PERIOD Vernier	10 Roll CW
POSITION Range	10n - .1μ
POSITION Vernier	10
DUTY CYCLE %	Depressed
DUTY CYCLE Range	*
DUTY CYCLE Vernier	*
AMPLITUDE Range	1-3
AMPLITUDE Vernier	as required
INT LOAD	*
SLOPE	*
DEL/ADV /D.P.	DELAY
OUTPUT POLARITY	POS

* = don't care

adjusted inputs for 5 DIVS P-P sig. Vertically centered scope. Measured time difference @ 50% point of rising waveform. Used int trig - 0.51 only. as appropriate to set delay accuracy.

Start Machine ALT. Stop Speed 10 divisions as needed for steps 1-6

PERFORMANCE TESTS

2. Trigger Sampling Oscilloscope to Channel A and set Timebase to 20ns/DIV. *sync with trigout into ch 2*
3. Ensure that POSITION VERNIER is set exactly to 10, and measure time between TRIG OUTPUT and OUTPUT signal. RESULT: 129 ns – 171 ns.
4. Set VERNIER exactly to 1 and check that delay is 48 ns – 72 ns.
5. Switch 214B to ADVANCED and with VERNIER set to 1 delay should be 28 ns – 52 ns.
6. Set Vernier exactly to 10 and measure time between OUTPUT and TRIG OUTPUT signal. RESULT: 29 ns to 71 ns. *sync with sig. output into ch 1*
8. Change test setup to that shown in Figure 4-3 to check DELAY RANGES. $.1\mu - 1\mu$ to 1m-10m.

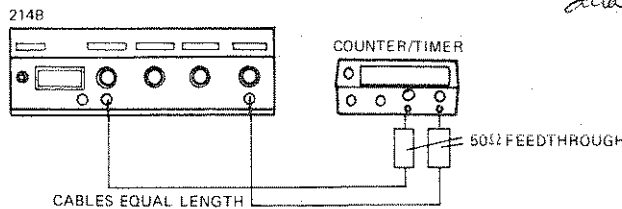

Figure 4-3.

delay range may exceed time period allowed with setting of period control - do at full CW to avoid timing error digit operation

of follow-up in period

9. Set 214B controls as follows:

MODE	NORM
PERIOD Range	10m - .1
PERIOD Vernier	10 <i>ca</i>
POSITION Range1μ - 1μ
POSITION Vernier	10
DUTY CYCLE	Depressed
DUTY CYCLE Range	*
DUTY CYCLE Vernier	*
AMPLITUDE Range	1-3
AMPLITUDE Vernier	as required
INT LOAD	*
SLOPE	*
DEL/ADV/D.P.	DEL
OUTPUT POLARITY	POS

* = don't care

10. Measure time between positive going edge of Trigger and positive going edge of Output signal for specifications. First with POSITION VERNIER set exactly to 10 and then with POSITION VERNIER exactly set to 1.

(use scope to measure + compute delay)

POSITION RANGE	VERNIER SETTING	RESULT	VERNIER SETTING	RESULT
.1μ - 1μ	10	93μs - 1.17μs	1	120ns - 180ns
1μ - 10μ	10	8.94 μs - 11.16 μs	1	.840 μs - 1.26 μs
10μ - .1m	10	89.04 μs - 111.06 μs	1	8.04 μs - 12.06 μs
.1m - 1m	10	890 μs - 1110 μs	1	80 μs - 120 μs
1m - 10m	10	8900 μs - 11100 μs	1	800 μs - 1200 μs

11. For checking dial tracking set POSITION VERNIER exactly to the listed settings and check results.

use alt swp After delay Int. Trig w/ Trig Out into ch 2 Int Trig ch 2

POSITION RANGE	VERNIER SETTING	RESULT
1 m - 10 m	2	1700 μs - 2300 μs
	3	2600 μs - 3400 μs
	4	3500 μs - 4500 μs
	5	4400 μs - 5600 μs
	6	5300 μs - 6700 μs
	7	6200 μs - 7800 μs
	8	7100 μs - 8900 μs
	9	8000 μs - 10000 μs

*2ms I,3
3 ± .4
4 ± .5
5 ± .6
6 ± .7
7 ± .8
8 ± .9
9 ± 1.0*

PERFORMANCE TESTS

4-12 PULSE WIDTH; VERNIER ACCURACY; MAX. DUTY CYCLE

SPECIFICATION:

- WIDTH 25ns to 10ms in 6 decade ranges continuously adjustable by vernier.
- VERNIER ACCURACY — (10% of setting + 1% of full scale)
+ (10% of setting + 1% of full scale + 5ns).
- DUTY CYCLE \geq 10% for 30–100V amplitude range
 \geq 50% for all other ranges

EQUIPMENT:

- Sampling Oscilloscope
- 20dB Attenuator
- 20dB Attenuator 50W
- Tee

CAUTION: Do not overload Attenuators and Oscilloscopes Inputs.

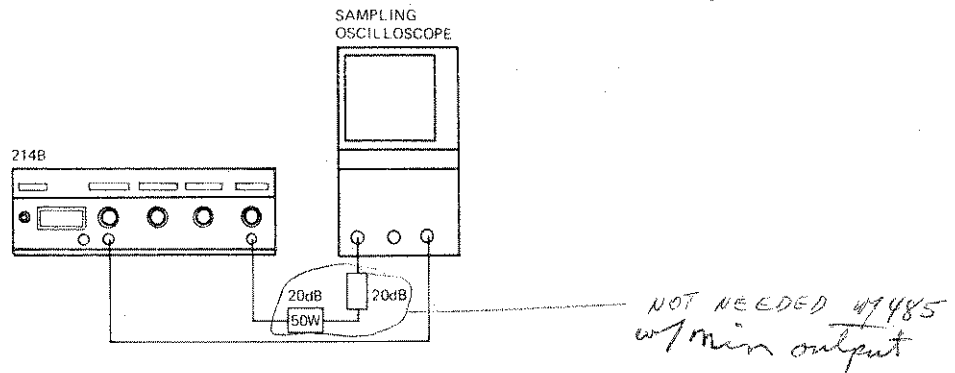

Figure 4-4.

1. Connect equipment as shown in Figure 4-4 and set 214B controls as follows:

MODE	NORM
PERIOD Range	1 μ – 10 μ
PERIOD Vernier	10
POSITION Range	10n – .1 μ
POSITION Vernier	10
DUTY CYCLE %	Released
WIDTH Range	25n – .1 μ
WIDTH Vernier	2.5
AMPLITUDE Range	10–30
AMPLITUDE Vernier	3 (30V)
INT LOAD	Depressed
SLOPE	*
DEL/ADV/D.P.	DEL
OUTPUT POLARITY	POS

* = don't care

2. Measure pulse width at 50% of amplitude with WIDTH VERNIER set exactly to ^{2.5} 2.5.
RESULT: 21.5 – 33.5ns.

2.5

PERFORMANCE TEST

3. Set WIDTH VERNIER exactly to 10. Pulse Width should be 89 – 116ns. *2106*
4. Select .1μ – 1μ WIDTH range and check pulse width with WIDTH VERNIER set to 10;
 RESULT: .890μ – 1.115μs. *21.92*
 With VERNIER set to 1; RESULT: 80 ns – 125 ns.
5. Select .1μ – 1μ PERIOD range and set PERIOD vernier to 3 and adjust the Sampling Oscilloscope so that one period is displayed.
6. Increase WIDTH (duty cycle). RESULT: Maximum Duty Cycle must be ≥ 50% before signal disappears and 214B OVERLOAD LED is illuminated.
7. Select 25 n – .1 μ WIDTH range and set OUTPUT AMPLITUDE to 100V (50V). *use 2V/div with X10 attenuator in series w/ scope input*
8. Increase WIDTH and check that Duty Cycle is ≥ 10% before 214B OUTPUT is switched off and OVERLOAD LED is on. Switch 214B to 1–3 V AMPLITUDE range. *wouldn't overload with max duty cycle internal load.*

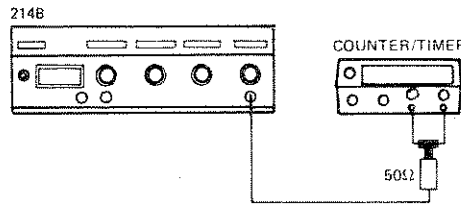

Figure 4-5.



Remove X10 Attenuator

9. Change Test setup as shown in Figure 4-5 to measure Pulse Width in the 4 highest ranges. Set 214B controls as follows:

MODE	NORM
PERIOD Range	10m – .1
PERIOD Vernier	3
POSITION Range	*
POSITION Vernier	*
DUTY CYCLE %	Released
WIDTH Range	1μ – 10μ
WIDTH Vernier	1
AMPLITUDE Range	1–3
AMPLITUDE Vernier	3 (3V)
INT LOAD	*
SLOPE	*
DEL/ADV/D.P.	DEL
OUTPUT POLARITY	POS

* = don't care

PERFORMANCE TESTS

10. Trigger Counter/Timer Channel A to  and Channel B to  and check Pulse Width for specifications.
11. Check Vernier Accuracy for specifications as listed.

WIDTH RANGE	VERNIER SETTING	RESULT	VERNIER SETTING	RESULT
1μ - 10μ	1	.8 μs - 1.205 μs	10	8.90 μs - 11.10 μs
10μ - .1m	1	8.00 μs - 12.00 μs	10	89.0 μs - 111.0 μs
.1m - 1m	1	80 μs - 120 μs	10	890 μs - 1110 μs
1m - 10m	1	800 μs - 1200 μs	10	8900 μs - 11100 μs

WIDTH RANGE	VERNIER SETTING	RESULT
1m - 10m	9	8000 μs - 10 000 μs
1m - 10m	8	7100 μs - 8900 μs
1m - 10m	7	6200 μs - 7800 μs
1m - 10m	6	5300 μs - 6700 μs
1m - 10m	5	4400 μs - 5600 μs
1m - 10m	4	3500 μs - 4500 μs
1m - 10m	3	2600 μs - 3400 μs
1m - 10m	2	1700 μs - 2300 μs

*5ms/DIV w/ HORIZ INTEN
 OUTPUT to scope ~~is~~ EXT TRIG
 TRIG OUT TO - EXT TRIG
 TRIG set for NORM, AC, EXT
 slope + level as necessary*

PERFORMANCE TESTS

4-13 CONSTANT DUTY CYCLE; VERNIER ACCURACY

SPECIFICATION :

- Duty cycle of output pulse remains constant when pulse period is changed.
- Typically 8% fixed for 10–1 MHz frequency range
- 2.5% to 10% for 1 – .1 MHz frequency range
- .25% to 10% for .1 MHz – 10 KHz
- .1% to 10% for all other frequency ranges
- Vernier Accuracy \pm (15% of setting + 1% of full scale)

EQUIPMENT:

- Sampling Oscilloscope
- Counter/Timer
- 50 Ω Feedthrough
- Tee
- 20dB Attenuator

CAUTION: Do not overload Attenuators and Inputs

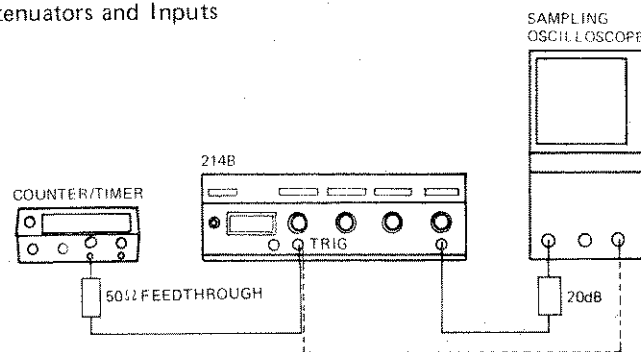

Figure 4-6

- Connect equipment as shown in Figure 4-6 and set 214B controls as follows:

MODE	NORM
PERIOD Range1 μ – 1 μ
PERIOD Vernier	10
POSITION Range	10n – .1 μ
POSITION Vernier	1
DUTY CYCLE %	Depressed
DUTY CYCLE Vernier	*
DUTY CYCLE Range	*
AMPLITUDE Range	1-3
AMPLITUDE Vernier	3 (3V)
INT LOAD	*
SLOPE	*
DEL/ADV/D.P.	DEL
OUTPUT POLARITY	POS

* = don't care

PERFORMANCE TESTS

2. Adjust 214B PERIOD VERNIER for exactly 1000ns reading on counter and measure output pulse width: RESULT: typically 80ns. (8%). Fixed duty cycle is indicated by LED. $\approx 8\%$
3. Select $1\mu s - 10\mu s$ PERIOD range and adjust PERIOD for 10 000ns. (2.5-10% duty cycle range is indicated by LED). $10^4 s = 100\mu s$
4. Set DUTY CYCLE VERNIER (WIDTH VERNIER) to 2.5 and measure pulse width. RESULT: 202.5 - 297.5ns.
5. With VERNIER set to 10 width should be 840 - 1160ns.

NOTE: Trigger Sampling Oscilloscope EXT after adjusting PERIOD with Counter/Timer.

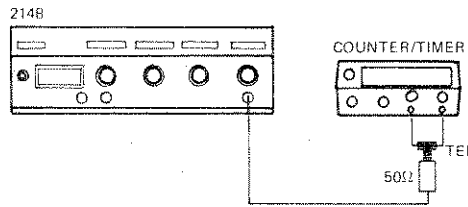

Figure 4-7

measure time with scope @ 500ns/div to TA

6. Change Test Setup as shown in Figure 4-7 and set 214B controls as follows:

MODE	NORM
PERIOD Range	10m - .1
PERIOD Vernier	10
POSITION Range	10n - .1 μ
POSITION Vernier	10
DUTY CYCLE %	Depressed
DUTY CYCLE Range1 - 1
DUTY CYCLE Vernier	1
AMPLITUDE Range	1-3
AMPLITUDE Vernier	3 (3V)
INT LOAD	*
SLOPE	*
DEL/ADV/D.P.	DEL
OUTPUT POLARITY	POS

* = don't care

7. Trigger Counter/Timer channel A to \int and channel B to \sim . Switch to PERIOD and adjust 214B PERIOD for exactly 100.0ms. *PUSH DUTY CYCLE 1-10*
8. Set 214B DUTY CYCLE VERNIER exactly to 1 (.1%) and switch Counter/Timer to Time Interv. A to B. RESULT: 75 - 125 μs .
9. Set DUTY CYCLE VERNIER exactly to 10 (1%) and measure pulse width. RESULT: 840 - 1160 μs .

can measure Time of scope + freq w/ counter 100 μs + 10HZ. measure Pw

PERFORMANCE TESTS

10. Select 1 — 10% DUTY CYCLE range on the 214B and check DUTY CYCLE vernier accuracy with PERIOD set exactly to 100.0ms.

PERIOD	VERNIER SETTING	
100.0ms	10	8.4ms — 11.6ms
100.0ms	9	7.55ms — 10.45ms
100.0ms	8	6.70ms — 9.30ms
100.0ms	7	5.85ms — 8.15ms
100.0ms	6	5.00ms — 7.00ms
100.0ms	5	4.15ms — 5.85ms
100.0ms	4	3.30ms — 4.70ms
100.0ms	3	2.45ms — 3.55ms
100.0ms	2	1.60ms — 2.40ms
100.0ms	1	.75ms — 1.25ms

11. Adjust PERIOD to exactly 10ms and check that with DUTY CYCLE vernier set to 1 width is $75\mu\text{s} - 125\mu\text{s}$.

PERFORMANCE TESTS

4-14 PULSE AMPLITUDE; VERNIER ACCURACY; SOURCE IMPEDANCE

SPECIFICATION:

0.3V to 100V into 50 Ω , 5 Ranges with calibrated vernier providing continuous adjustment within ranges.
 Vernier Accuracy: ± 10% of setting.

EQUIPMENT:

- Sampling Oscilloscope
- 20dB Attenuator
- 20dB Attenuator 50W

CAUTION: Do not overload Attenuators and Inputs.

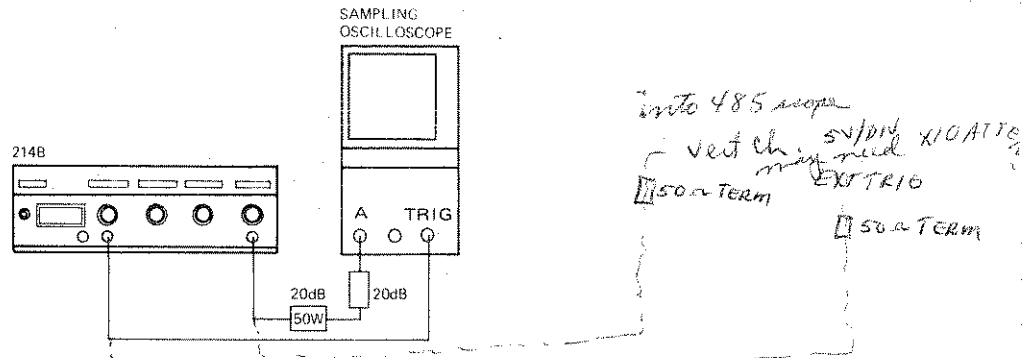

Figure 4-8

1. Connect equipment as shown in Figure 4-8 and set 214B controls as follows:

MODE	NORM	
PERIOD Range	10 μ - .1m	} 100K Hz
PERIOD Vernier	1	
POSITION Range1 μ - 1 μ	
POSITION Vernier	as required	
DUTY CYCLE %	Released	
WIDTH Range	25 - .1μ	
WIDTH Vernier	10	
AMPLITUDE Range	30-100	
AMPLITUDE Vernier	3 (30V)	
INT LOAD	Released	
SLOPE	*	
DEL/ADV/D.P.	DEL	
OUTPUT POLARITY	POS	

* = don't care

PERFORMANCE TESTS

2. Measure pulse amplitude with INT. LOAD pushbutton released and then depressed in 30–100 and 10–30V AMPLITUDE ranges for specifications listed below.

NOTE: High source impedance is indicated by LED.

use 50Ω terminator for cell readings

AMPLITUDE RANGE	VERNIER SETTING	RESULT INT. LOAD OFF	RESULT INT. LOAD ON	
30–100 <i>odd 10X ATTN</i>	3	27V – 33V	13.5V – 16.5V	
	10	90V – 110V	45V – 55V	
10–30	3	27V – 33V	13.5V – 16.5V	DARK
	1	9V – 11V	4.5V – 5.5V	SCALE

use ramp envelope that is most easy to measure signal

3. Switch 214B AMPLITUDE range to .3 – 1 and ~~remove one 20dB attenuator.~~ *remove 10X*
4. Check AMPLITUDE ranges with VERNIER settings as listed.

AMPLITUDE RANGE	VERNIER SETTING	RESULT	
.3V – 1	3	.27V – .33V	
.3V – 1	10	.9V – 1.1V	
1V – 3	3	2.7V – 3.3V	DARK
1V – 3	1	.9V – 1.1V	SCALE

5. Select 3–10V AMPLITUDE range and measure Vernier Accuracy.

AMPLITUDE RANGE	VERNIER SETTING	RESULT
3–10	3	2.7V – 3.3V
3–10	4	3.6V – 4.4V
3–10	5	4.5V – 5.5V
3–10	6	5.4V – 6.6V
3–10	7	6.3V – 7.7V
3–10	8	7.2V – 8.8V
3–10	9	8.1V – 9.9V
3–10	10	9V – 11V

PERFORMANCE TESTS

4-15 TRANSITION TIMES; PRESHOOT; OVERSHOOT; RINGING; PULSE POLARITY

SPECIFICATION:

Transition times $\leq 15\text{ns}$ for leading and trailing edges. Preshoot, overshoot and Ringing $\leq \pm 5\%$ of pulse amplitude. Polarity: Positive or negative, switch selectable.

EQUIPMENT:

Sampling Oscilloscope 485 2-50 Ω TERMINATORS
 20dB Attenuator
 20dB Attenuator 50W

CAUTION: Do not overload Attenuators and Inputs

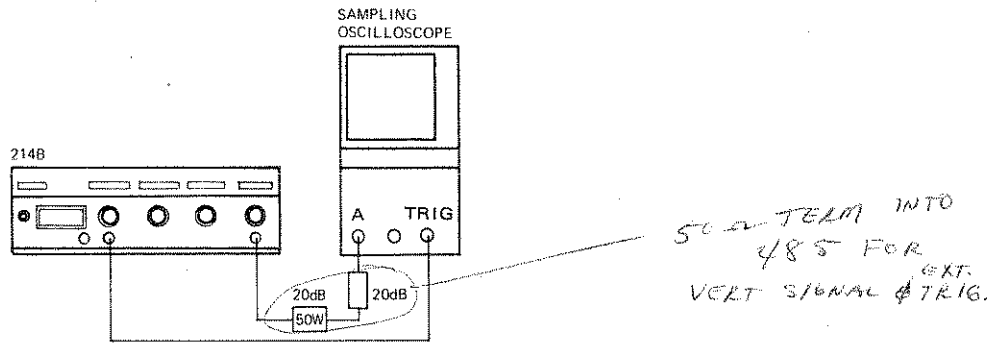

Figure 4-9

1. Connect equipment as shown in Figure 4-9 and set 214B controls as follows:

- MODE NORM
- PERIOD Range 10 μ - .1m
- PERIOD Vernier 1
- POSITION Range1 μ - 1 μ
- POSITION Vernier as required
- DUTY CYCLE % Released
- WIDTH Range 25n - .1 μ
- WIDTH Vernier 10
- AMPLITUDE Range 10 - 30
- AMPLITUDE Vernier 1 (10V)
- INT LOAD Released
- SLOPE *
- DEL/ADV/D.P. DEL
- OUTPUT POLARITY as required

5 DIVS VERTICAL SIGNAL -
 TO ALLOW USE OF % SCALE
 FACTOR ON SCREEN

* = don't care

PERFORMANCE TESTS

- Measure transition time of leading and trailing edge from 10% to 90% of pulse amplitude for positive and negative going pulse.

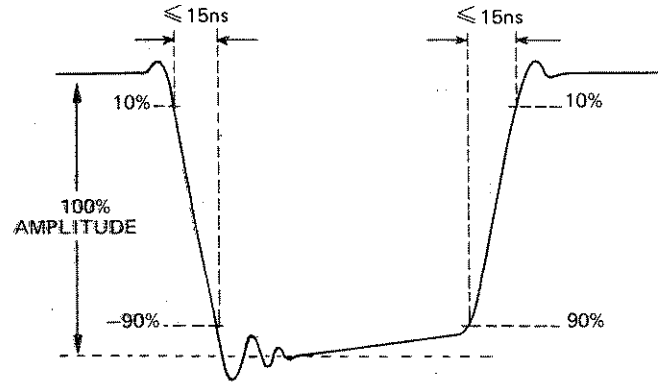
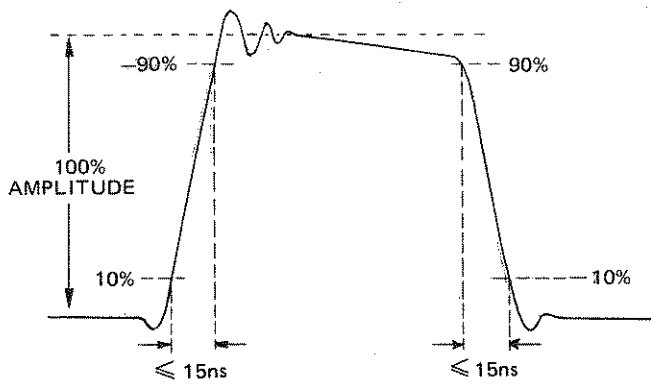

- Measure Preshoot, Overshoot and Ringing of Positive and Negative pulse.

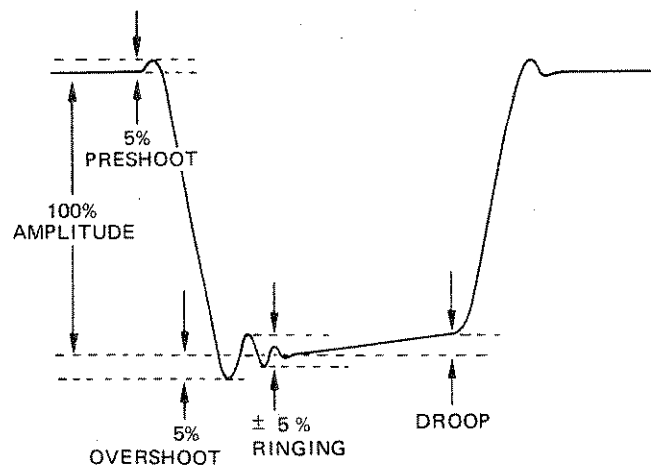
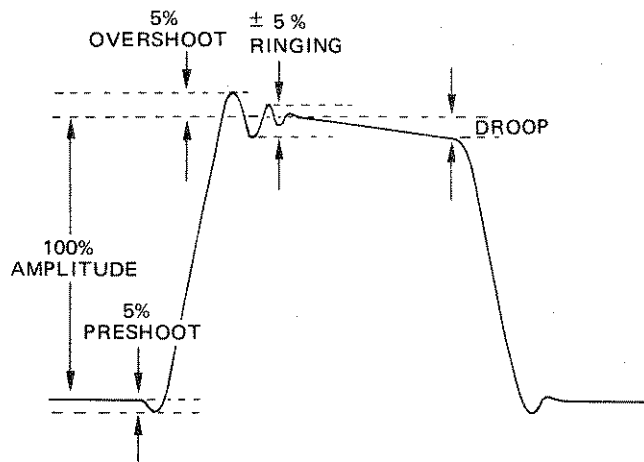

PERFORMANCE TESTS

4-16 TRIGGER OUTPUT; DOUBLE PULSE

SPECIFICATION:

Trigger Output: Minimum Amplitude +5V
(from 50 ohm into open circuit). Pulse Width: 10ns typical.

Double Pulse: 5 MHz in all ranges except 30V – 100V range.
In 30V–100V range, the maximum frequency is 2 MHz. Minimum separation between double pulse is 100ns.

EQUIPMENT:

- Sampling Oscilloscope
- 20dB Attenuator
- 20dB Attenuator 50W

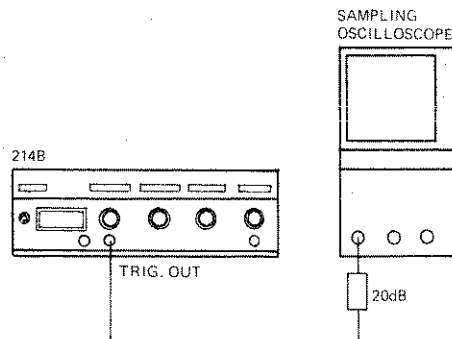

Figure 4-10.

1. Connect equipment as shown in Figure 4-10 and set 214B controls as follows:

- MODE NORM
- PERIOD Range $.1\mu - 1\mu$
- PERIOD Vernier2
- POSITION Range $10n - .1\mu$
- POSITION Vernier 1
- DUTY CYCLE % *
- DUTY CYCLE / WIDTH Range *
- AMPLITUDE Range 3-10
- AMPLITUDE Vernier 3 (3V)
- INT LOAD *
- SLOPE *
- DEL/ADV/D.P. *
- OUTPUT POLARITY *

* = don't care

2. Measure amplitude and width of trigger signal.
RESULT: Amplitude $\geq 2.5V$ (from 50Ω into 50Ω)
Width 10ns typical.

PERFORMANCE TESTS

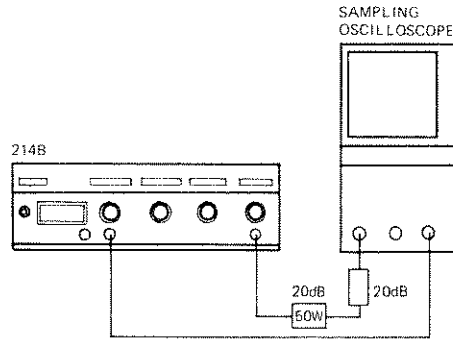

Figure 4-11

3. Change Test Setup as shown in Figure 4-11 to check Double Pulse Mode. Set 214B controls as follows:

CAUTION: Do not overload Attenuators and Inputs.

MODE	NORM
PERIOD Range1μ - 1μ
PERIOD Vernier	5 (2 MHz)
POSITION Range1μ - 1μ
POSITION Vernier	2
DUTY CYCLE %	Released
WIDTH Range	25ns - .1μ
WIDTH Vernier	2
AMPLITUDE Range	30-100
AMPLITUDE Vernier	5 (50V)
INT LOAD	Released
SLOPE	*
DEL/ADV/D.P.	DOUBLE PULSE
OUTPUT POLARITY	POS

* = don't care

4. Adjust Sampling Oscilloscope so that both pulses are displayed.
5. Turn POSITION Vernier slowly CCW and check that both pulses are still displayed when minimum separation (100ns) is reached.
6. Set 214B PERIOD Vernier to 2 (5 MHz) and switch to 10-30 V AMPLITUDE range.
7. Check that DOUBLE PULSE mode is operating at .2μs PERIOD setting.

FULL CCW BRINGS PULSES TOGETHER AND MAKES ONE, + gives timing error light

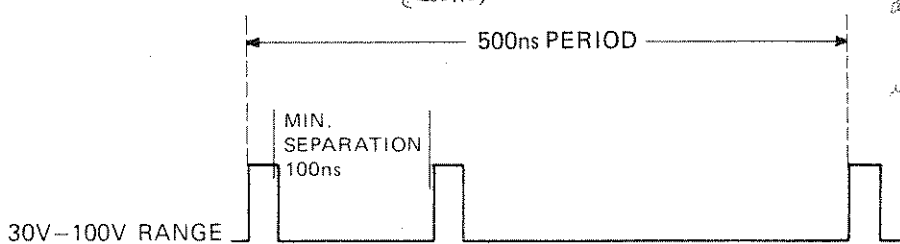

also can see trig to Ch. 2 + ext trig jacks use alt. sweep to see both trig output Scope on Norm Mode AC coupling EXT trig slopes level as desired

PERFORMANCE TESTS

4-17 EXTERNAL MODES; TRIGGER; GATE; BURST

OPT 001 ON-Y

SPECIFICATION:

Ext. Trigger Mode. An output pulse is generated for each input pulse.
Gate Mode. Gating signal turns on repetition rate generator. First pulse occurs after start of gate signal, and last pulse is always completed even if gate ends during generation of last pulse.
Burst Mode. Preselected number of pulses generated on receipt of trigger signal. Number of pulses: 1 to 9999. Minimum Spacing between Bursts: 200ns.

EQUIPMENT:

- Pulse Generator
- Oscilloscope
- 2 x 50 Ω Feedthrough
- Tee

CAUTION: Do not overload Attenuators and Inputs.

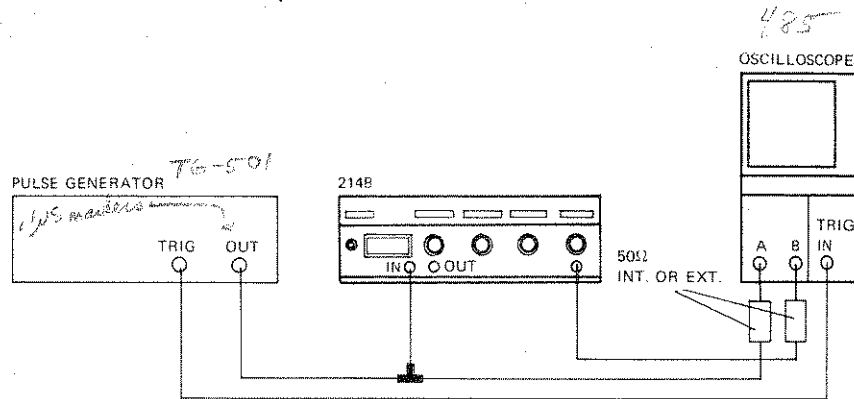

Figure 4-12

1. Connect equipment as shown in Figure 4-12 and set 214B controls as follows:

MODE	EXT TRIG
PERIOD Range1 μ - 1 μ
PERIOD Vernier	1
POSITION Range	10n - .1 μ
POSITION Vernier	1
DUTY CYCLE %	Released
WIDTH Range	25n - .1 μ
WIDTH Vernier	3
AMPLITUDE Range	1-3
AMPLITUDE Vernier	as required
INT. LOAD	*
SLOPE	as required
DEL. ADV. D.P.	DEL
OUTPUT POLARITY	POS

* = don't care

PERFORMANCE TESTS

TG-501, 1/2 S marker - 10MHz output @ 0.5V p.p.k., 20ns wide

2. Set Pulse Generator to 10ns pulse width, amplitude to 0.5V peak to peak min. and adjust *works fine* PERIOD for 100ns.
3. Trigger 214B with EXT INPUT LEVEL Control and check that for each ext. trigger pulse one 214B output pulse is generated with SLOPE set to NEG and then one pulse with SLOPE set to POS.

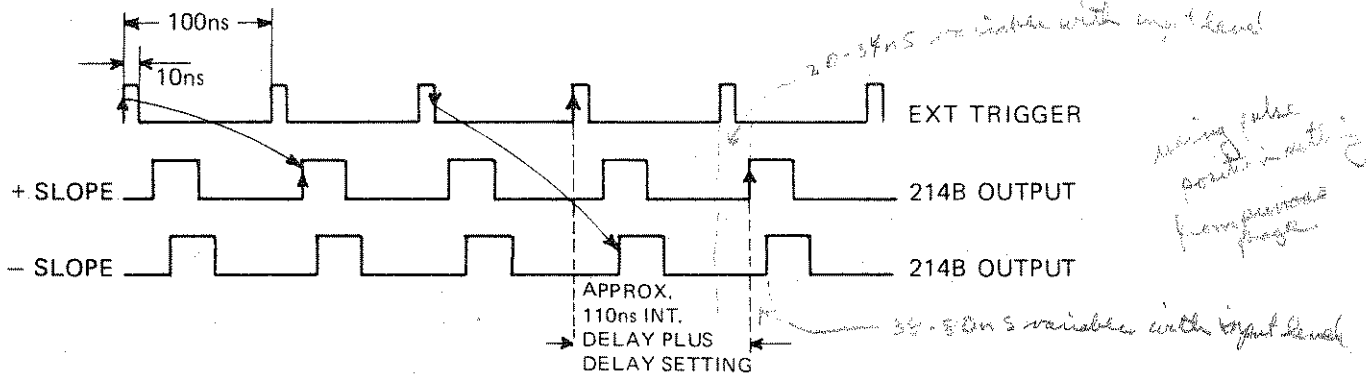

NOTE: It might be necessary to readjust INPUT LEVEL Control when changing SLOPE.

4. Select BURST MODE and set Pulse Generator to the next PERIOD range down the scale.
5. Set NUMBER OF PULSES from 0001 up to 0009 and check that the selected number of pulses corresponds to the displayed signal.
6. Switch 214B to GATE MODE and increase external pulse width (GATE SIGNAL). *use 50-500 10MHz sq. wave - decrease*
7. When increasing GATE SIGNAL number of pulses should increase step by step. *freq + check for increased number of pulses out*
8. Check GATE MODE with SLOPE set to - .

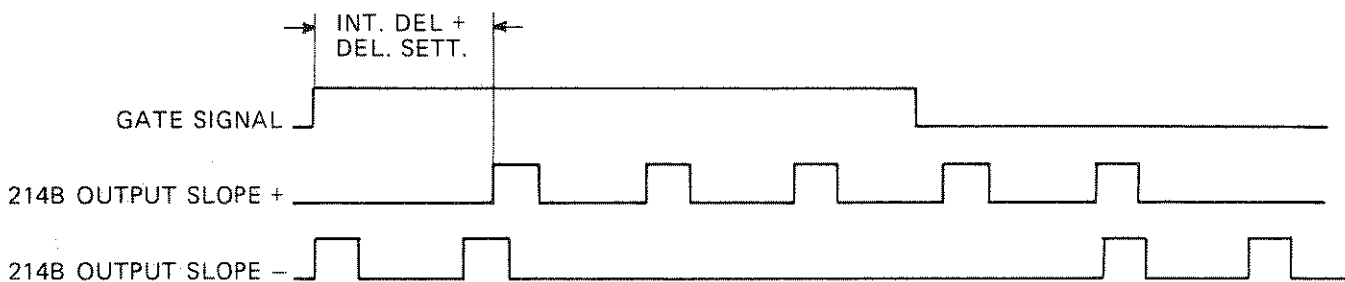

PERFORMANCE TESTS

4-18 VARIABLE TRIGGER LEVEL; SENSITIVITY

SPECIFICATION:

Trigger Level: Continuously variable from -5V to +5V.
 Sensitivity: 500mV peak to peak.

EQUIPMENT:

- Oscilloscope
- Sinewave Generator
- Tee

CAUTION: Do not overload Oscilloscope Inputs.

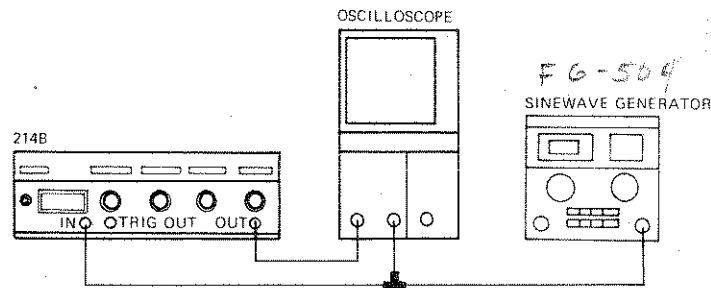

Figure 4-13

1. Connect equipment as shown in Figure 4-13 and set 214B controls as follows:

MODE	EXT TRIG
PERIOD Range	*
PERIOD Vernier	*
POSITION Range	10n - .1μ
POSITION Vernier	1
DUTY CYCLE %	Released
WIDTH Range1μ - 1μ
WIDTH Vernier	10
AMPLITUDE Range	3-10V
AMPLITUDE Vernier	as required
INT LOAD	*
SLOPE	*
DEL/ADV/D.P.	DEL
OUTPUT POLARITY	POS
EXT INPUT LEVEL	as required

2. Set Sinewave Generator to 100 KHz and 11V amplitude peak to peak.

PERFORMANCE TESTS

3. Set Oscilloscope controls to get a display as shown in Figure 4-14.
4. Vary EXT. INPUT LEVEL control from CCW to CW and check that trigger level is adjustable within +5V and -5V (Figure 4-14).
5. Repeat step 4 with SLOPE set to - and check trigger level variation as shown in Figure 4-15.

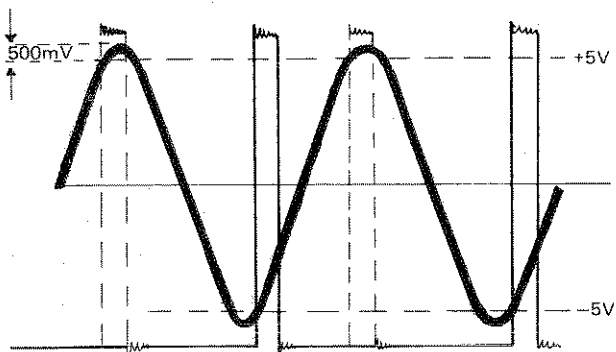

Figure 4-14

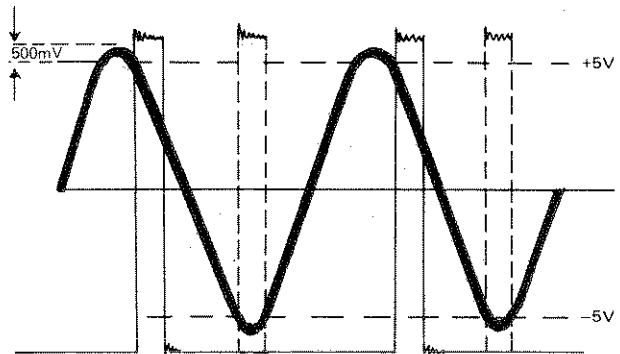

Figure 4-15

*min ext trig amp \approx 60 mV p-p
using FG 503*

PERFORMANCE TESTS

Para No.	Test Description	Result		
		Min.	Max.	Actual.
4-11	PULSE POSITION: DELAY; ADVANCE; VERNIER ACCURACY			
	Time between TRIGGER OUTPUT and OUTPUT DELAY: with VERNIER set to 10	129 ns	171 ns	_____
	DELAY: with VERNIER set to 1	48 ns	72 ns	_____
	ADVANCE: with POSITION VERNIER set to 1	28 ns	52 ns	_____
	Time between OUTPUT and TRIGGER OUTPUT ADVANCED: with POSITION VERNIER set to 10	29 ns	71 ns	_____
	DELAY RANGE VERNIER SETTING			
	.1 μ - 1 μ 10	.930 μs	1.170 μs	_____
	1 μ - 10 μ 10	8.94 μs	11.16 μs	_____
	10 μ - .1 m 10	89.04 μs	111.06 μs	_____
	.1 m - 1 m 10	890 μs	1110 μs	_____
	1 m - 10 m 10	8900 μs	11100 μs	_____
	.1 μ - 1 μ 1	120 ns	180 ns	_____
	1 μ - 10 μ 1	.840 μs	1.26 μs	_____
	10 μ - .1 m 1	8.04 μs	12.06 μs	_____
	.1 m - 1 m 1	80 μs	120 μs	_____
	1 m - 10 m 1	800 μs	1200 μs	_____
	1 m - 10 m 2	1700 μs	2300 μs	_____
	1 m - 10 m 3	2600 μs	3400 μs	_____
	1 m - 10 m 4	3500 μs	4500 μs	_____
	1 m - 10 m 5	4400 μs	5600 μs	_____
1 m - 10 m 6	5300 μs	6700 μs	_____	
1 m - 10 m 7	6200 μs	7800 μs	_____	
1 m - 10 m 8	7100 μs	8900 μs	_____	
1 m - 10 m 9	8000 μs	10000 μs	_____	

PERFORMANCE TESTS

Para No.	Test Description	Result			
		Min.	Max.	Actual	
4-12	PULSE WIDTH; VERNIER ACCURACY MAX. DUTY CYCLE				
	Pulse width WIDTH VERNIER set to 2.5	21.5 ns	33.5 ns	_____	
	Pulse width WITH VERNIER set to 10	89 ns	116 ns	_____	
	.1 - 1 Range WIDTH VERNIER set to 10	.890 μ s	1.115 μ s	_____	
	.1 - 1 Range WIDTH VERNIER set to 1	80 ns	125 ns	_____	
	Maximum Duty Cycle	\geq 50 %		_____	
	Maximum Duty Cycle (100 V amplitude)	\geq 10 %		_____	
	WIDTH RANGE	VERNIER SETTING			
	1 μ - 10 μ	1	.80 μ s	1.205 μ s	_____
	10 μ - .1 m	1	8.00 μ s	12.00 μ s	_____
	.1 m - 1 m	1	80.0 μ s	120.0 μ s	_____
	1 m - 10 m	1	800.0 μ s	1200 μ s	_____
	1 m - 10 m	10	8900 μ s	11100 μ s	_____
	.1 m - 1 m	10	890 μ s	1110 μ s	_____
	10 μ - .1 m	10	89.0 μ s	111.0 μ s	_____
	1 μ - 10 μ	10	8.90 μ s	11.10 μ s	_____
	1 m - 10 m	9	8000 μ s	10000 μ s	_____
	1 m - 10 m	8	7100 μ s	8900 μ s	_____
	1 m - 10 m	7	6200 μ s	7800 μ s	_____
	1 m - 10 m	6	5300 μ s	6700 μ s	_____
1 m - 10 m	5	4400 μ s	5600 μ s	_____	
1 m - 10 m	4	3500 μ s	4500 μ s	_____	
1 m - 10 m	3	2600 μ s	3400 μ s	_____	
1 m - 10 m	2	1700 μ s	2300 μ s	_____	

PERFORMANCE TESTS

Para. No.	Test Description	Result		
		Min.	Max.	Actual
4-13	CONSTANT DUTY CYCLE; VERNIER ACCURACY			
	Constant Duty Cycle at 1000 ns Period	80 ns typ.		_____
	Constant Duty Cycle with Vernier set to 2.5	202.5 ns	297.5 ns	_____
	Constant Duty Cycle with Vernier set to 10	840 ns	1160 ns	_____
	Constant Duty Cycle at 100 ms PERIOD with Vernier set to 1	75 μ s	125 μ s	_____
	Constant Duty Cycle at 100 ms PERIOD with Vernier set to 10	840 μ s	1160 μ s	_____
	PERIOD VERNIER SETTING			
	100.0 ms 10	8.4 ms	11.6 ms	_____
	100.0 ms 9	7.55 ms	10.45 ms	_____
	100.0 ms 8	6.70 ms	9.30 ms	_____
	100.0 ms 7	5.85 ms	8.15 ms	_____
	100.0 ms 6	5.00 ms	7.00 ms	_____
	100.0 ms 5	4.15 ms	5.85 ms	_____
	100.0 ms 4	3.30 ms	4.70 ms	_____
	100.0 ms 3	2.45 ms	3.55 ms	_____
100.0 ms 2	1.60 ms	2.40 ms	_____	
100.0 ms 1	.75 ms	1.25 ms	_____	
10 ms 1	75 μ s	125 μ s	_____	
4-14	PULSE AMPLITUDE; VERNIER ACCURACY SOURCE IMPEDANCE			
	AMPLITUDE RANGE VERNIER SETTING			
	INTERNAL LOAD OFF			
	30 - 100 3	27 V	33 V	_____
	10	90 V	110 V	_____
	10 - 30 3 DARK	27 V	33 V	_____
	1 SCALE	9 V	11 V	_____
	INTERNAL LOAD ON			
	30 - 100 3	13.5 V	16.5 V	_____
	10	45 V	55 V	_____
10 - 30 3 DARK	13.5 V	16.5 V	_____	
1 SCALE	4.5 V	5.5 V	_____	

PERFORMANCE TESTS

Para. No.	Test Description	Result		
		Min.	Max.	Actual
4-17	<p>EXTERNAL MODES; TRIGGER; GATE; BURST</p> <p>Trigger Output for each Pulse positive Slope negative Slope</p> <p>Number of Bursts</p> <p>Increasing number pulses in GATE MODE</p>			<p>_____</p> <p>_____</p> <p>_____</p> <p>_____</p>
4-18	<p>VARIABLE TRIGGER LEVEL; SENSIVITY</p> <p>Trigger Level positive slope Trigger Level negative slope</p> <p>Trigger Sensivity</p>	<p>-5 V to +5 V -5 V to +5 V</p>	<p>≤ 500 mVpp</p>	<p>_____</p> <p>_____</p> <p>_____</p>

SECTION V ADJUSTMENTS

5-1 INTRODUCTION

5-2 This section describes the adjustments which will return the instrument to peak operating condition after repairs are completed.

5-3 SAFETY CONSIDERATIONS

5-4 Although this instrument has been designed in accordance with international safety standards, this manual contains information, cautions, and warnings which must be followed to ensure safe operation and to retain the instrument in safe condition (see Sections II and III). Service and adjustments should be performed only by qualified service personnel.

WARNING

Any interruption of the protective (grounding) conductor (inside or outside the instrument or disconnection of the protective earth terminal is likely to make the instrument dangerous. Intentional interruption is prohibited.

5-5 Any adjustment, maintenance, and repair of the opened instrument with voltage applied should be avoided as much as possible and, when inevitable, should be carried out only by a skilled person who is aware of the hazard involved.

5-6 Capacitors inside the instrument may still be charged even if the instrument has been disconnected from its source of supply.

5-7 Make sure that only fuses with the required rated current and of the specified type (normal blow, time delay, etc.) are used for replacement. The use of repaired fuses and the shortcircuiting of fuseholders must be avoided.

5-8 Whenever it is likely that the protection offered by fuses has been impaired, the instrument must be made inoperative and secured against any unintended operation.



Adjustments described herein are performed with power supplied to the instrument while protective covers are removed. Energy available at many points may, if contacted, result in personal injury or death.

5-9 EQUIPMENT REQUIRED

5-10 The test equipment required for the adjustment procedures is listed in Table 1-1, Recommended Test Equipment. The critical specifications of substitute test instruments must meet or exceed the standards listed in the table if the instrument is to meet the standards set forth in Table 1-2, Specifications.

ADJUSTMENTS

5-11 POWER SUPPLY

EQUIPMENT:

Digital Multimeter 10-1000 V DC

WARNING

High Voltage dangerous to life.

PROCEDURE:

Set 214B controls as follows:

MODE	EXT
PERIOD Range	*
PERIOD Vernier	*
POSITION Range	*
POSITION Vernier	*
DUTY CYCLE %	released
DUTY CYCLE Range	*
DUTY CYCLE Vernier	*
WIDTH RANGE	*
AMPLITUDE Range	3-10 V
AMPLITUDE Vernier	*
INT LOAD	*
SLOPE	*
DEL/ADV/D.P.	DEL
POLARITY	NEG

* = don't care

NOTE: All voltages are measured with reference ground (TP7 $\frac{+}{-}$).

1. Measure voltage on TP1 (approx. 155 V) and TP5 (approx. 133 V) and adjust A4R604 so that the voltage difference between TP1 and TP5 is $22\text{ V} \pm 220\text{ mV}$.
2. Switch to 30-100 V AMPLITUDE Range and check that voltages increase to approx. 263 V (TP1) and 241 V (TP5). $\Delta\text{V} = 22\text{ V}$.
3. Check that power supply voltages are within limits as listed:

VOLTAGE	TEST POINT	RESULT
-5.2	MARKED ON PC-BOARD	4.94 V - 5.46 V
+15	MARKED ON PC-BOARD	14.25 V - 15.75 V
-15	MARKED ON PC-BOARD	14.25 V - 15.75 V
+5	MARKED ON PC-BOARD	4.75 V - 5.25 V

4. Check that the Q602 collector voltage is approximately half the Q601 collector voltage.

ADJUSTMENTS

5-12 PERIOD ADJUST

EQUIPMENT:

Counter/Timer
50 Ω Feedthrough

WARNING

High voltage dangerous to life.

Note: If potentiometer R107 has been replaced, set the new potentiometer so that its resistance is 200 Ω. Next, fit the dial so that the '1' on the light grey scale is exactly beneath the arrow. (It may be necessary to slightly readjust the dial when specifications cannot be reached).

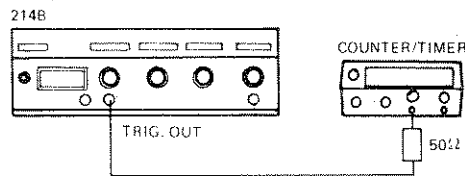

Figure 5-1

PROCEDURE:

1. Connect equipment as shown in Figure 5-1 and set 214B controls as follows:

MODE	NORM
PERIOD Range1m – 1m
PERIOD Vernier	10
POSITION Range	1μ – 10μ
POSITION Vernier	1
DUTY CYCLE %	released
WIDTH Vernier	1
WIDTH Range	1μ – 10μ
AMPLITUDE Range	3–10
AMPLITUDE Vernier	*
INT LOAD	*
SLOPE	*
DEL/ADV/D.P.	DEL
OUTPUT POLARITY	*

* = don't care

2. Ensure that Period Vernier is exactly set to 10 (1 ms) and if necessary adjust A1R69 (on Output Amplifier Board) for a counter reading of 1000 μ.

Note: Due to the influence of A1R69 on the width circuit, width and duty cycle must be readjusted by any adjustment of A1R69.

3. Set 214B Period Vernier exactly to 1 (.1 ms) and adjust A2R46 for 100 μs. (≤ 1 %).
4. Repeat step 2 and step 3 and readjust if necessary.

ADJUSTMENTS

5. Check Vernier tracking for specifications as listed below.

PERIOD RANGE	VERNIER SETTING	RESULT
.1m – 1m	1	80 μ s – 120 μ s
.1m – 1m	2	170 μ s – 230 μ s
.1m – 1m	3	260 μ s – 340 μ s
.1m – 1m	4	350 μ s – 450 μ s
.1m – 1m	5	440 μ s – 560 μ s
.1m – 1m	6	530 μ s – 670 μ s
.1m – 1m	7	620 μ s – 780 μ s
.1m – 1m	8	710 μ s – 890 μ s
.1m – 1m	9	800 μ s – 1000 μ s
.1m – 1m	10	890 μ s – 1110 μ s

6. Set Pulse Position to 10 ns and press Duty Cycle pushbutton. Select .1 μ – 1 μ Period Range and turn Period Vernier fully ccw.
7. Using the counter, adjust A2R126 for 12.5 MHz. Check that the frequency is in specification with dial set to 1 (8.9 MHz – 11.1 MHz) and dial set to 10 (0.8 MHz – 1.2 MHz).
8. Re-adjust A2R126 if specifications cannot be reached.

ADJUSTMENTS

5-13 POSITION ADJUST

EQUIPMENT: Counter/Timer
2 x 50 Ω Feedthrough

WARNING

High voltage dangerous to life.

CAUTION

Do not overload feedthroughs and inputs.

Note: If position potentiometer R158 has been replaced, set the new potentiometer so that its resistance is 300 Ω. Next, fit the dial so that the '1' on the light grey scale is exactly beneath the arrow. (It may be necessary to slightly readjust if specifications cannot be reached).

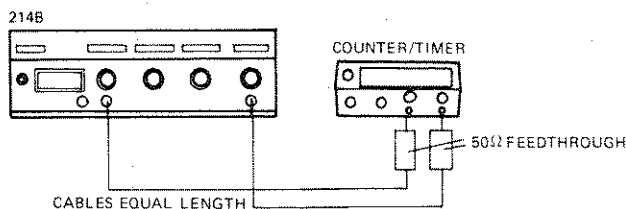

Figure 5-2

PROCEDURE:

1. Connect equipment as shown in Figure 5-2 and set 214B controls as follows:

MODE	NORM
PERIOD Range	1m - 10m
PERIOD Vernier	10
POSITION Range1m - 1m
POSITION Vernier	10
DUTY CYCLE %	released
WIDTH Vernier	10
WIDTH Range	1μ - 10μ
AMPLITUDE Range	3-10
AMPLITUDE Vernier	as required
INT LOAD	*
SLOPE	*
DEL/ADV/D.P.	DEL
OUTPUT POLARITY	POS

* = don't care

2. Set Counter/Timer to TIME INTERV. A to B, trigger both channels to slope and measure time between trigger and output signal.
3. Adjust A2R45 for 1000μs delay ± 10μs. (POSITION Vernier exactly set to 10).
4. Set Position Vernier exactly to 1 and adjust A2R119 for 100μs ± 1μs.

ADJUSTMENTS

5. Repeat step 3 and step 4 and readjust if necessary.
6. Check Vernier Accuracy for specifications as listed below.

POSITION RANGE	VERNIER SETTING	RESULT
.1m – 1m	2	170 μ s – 230 μ s
.1m – 1m	3	260 μ s – 340 μ s
.1m – 1m	4	350 μ s – 450 μ s
.1m – 1m	5	440 μ s – 560 μ s
.1m – 1m	6	530 μ s – 670 μ s
.1m – 1m	7	620 μ s – 780 μ s
.1m – 1m	8	710 μ s – 890 μ s
.1m – 1m	9	800 μ s – 1000 μ s

ADJUSTMENTS

5-14 CONSTANT DUTY CYCLE AND WIDTH

EQUIPMENT: Counter/Timer
50 Ω Feedthrough

WARNING

High voltage dangerous to life.

CAUTION

Do not overload feedthrough or counter inputs.

Note: If width potentiometer R222 has been replaced, set the new potentiometer so that its resistance is 200 Ω. Next, fit the dial so that the '1' on the light grey scale is exactly beneath the arrow. (It may be necessary to slightly readjust if specifications cannot be reached).

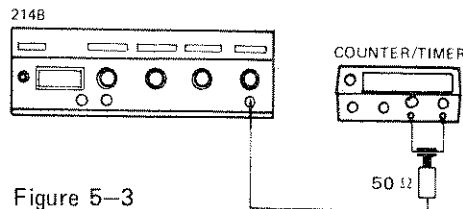

Figure 5-3

PROCEDURE:

1. Connect equipment as shown in Figure 5-3 and set 214B controls as follows:

MODE	NORM
PERIOD Range	1ms – 10ms
PERIOD Vernier	10
POSITION Range	0.1μ – 1μ
POSITION Vernier	1
DUTY CYCLE %	depressed
DUTY CYCLE Range	1% – 10%
DUTY CYCLE Vernier	10
WIDTH RANGE	—
AMPLITUDE Range	1–3 V
AMPLITUDE Vernier	as required
INT LOAD	*
SLOPE	*
DEL/ADV/D.P.	DEL
POLARITY	POS

* = don't care

NOTE: Period settings must be done by using the counter.

2. Set 214B period to ^{10ms} 10 000μs.
3. Measure time between positive and negative transition of 214B output pulse and adjust A2R51 for 1000μs. (10% duty cycle).

ADJUSTMENTS

4. Set 214B period to $1000\mu s$ (without changing the range) and measure time between positive and negative transition. Adjust A2R217 for $100\mu s$.
5. Set 214B period to $10\ 000\mu s$ and release DUTY CYCLE pushbutton.
6. Select $.1m - 1m$ WIDTH Range, set Width Vernier exactly to 10 and adjust A2R216 for $1000\mu s$ width.
7. Set Width Vernier exactly to 1 and adjust A2R128 for $100\mu s$ width.
8. Repeat steps 1 to 7 and readjust if necessary.
9. Check Vernier Accuracy for 1–10% DUTY CYCLE range and $.1m - 1m$ WIDTH Range.

DUTY CYCLE RANGE	VERNIER SETTING	RESULT
1–10% Period 10 000 μs	1	$75\mu s - 125\mu s$
	2	$160\mu s - 240\mu s$
	3	$245\mu s - 355\mu s$
	4	$330\mu s - 470\mu s$
	5	$415\mu s - 585\mu s$
	6	$500\mu s - 700\mu s$
	7	$585\mu s - 815\mu s$
	8	$670\mu s - 930\mu s$
	9	$755\mu s - 1045\mu s$
	10	$840\mu s - 1160\mu s$

WIDTH RANGE	VERNIER SETTING	RESULT
$.1m - 1m$ PERIOD 10 000 μs	1	$80\mu s - 120\mu s$
	2	$170\mu s - 230\mu s$
	3	$260\mu s - 340\mu s$
	4	$350\mu s - 450\mu s$
	5	$440\mu s - 560\mu s$
	6	$530\mu s - 670\mu s$
	7	$620\mu s - 780\mu s$
	8	$710\mu s - 890\mu s$
	9	$800\mu s - 1000\mu s$
	10	$890\mu s - 1110\mu s$

ADJUSTMENTS

5-15 PULSE AMPLITUDE

EQUIPMENT: Oscilloscope
 20dB Attenuator
 20dB Attenuator 50W

WARNING

High voltage dangerous to life.

CAUTION

Do not overload Attenuator or Oscilloscope inputs.

Note: If the amplitude potentiometer R460 has been replaced, set the new potentiometer so that the resistance between the white/red/grey wire and the white/violet wire is 70 Ω. Next, fit the dial so that the '3' on the light grey scale is exactly beneath the arrow. (It may be necessary to slightly readjust the dial when specifications cannot be reached).

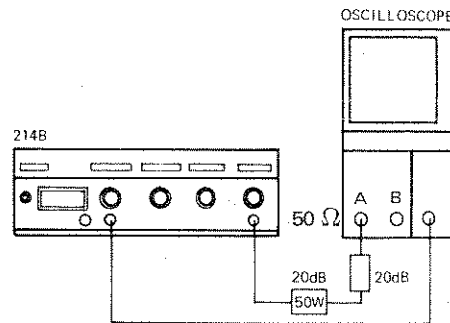

Figure 5-4

PROCEDURE:

1. Connect equipment as shown in Figure 5-4 and set 214B controls as follows:

MODE	NORM
PERIOD Range	10m - .1
PERIOD Vernier	10
POSITION Range	10n - .1μ
POSITION Vernier	1
DUTY CYCLE %	depressed
DUTY CYCLE Range	1-10%
DUTY CYCLE Vernier	5
AMPLITUDE Range	30-100V
AMPLITUDE Vernier	3
INT LOAD	OFF
SLOPE	*
DEL/ADV/D.P.	DEL
OUTPUT POLARITY	POS

* = don't care

2. Set oscilloscope so that one pulse with approx. 5 DIV. width is displayed on screen.
3. Turn A1R462 CW and adjust A1R457 for 29 V output amplitude.

ADJUSTMENTS

4. Set Amplitude Vernier exactly to 10 and adjust A1R462 for 105 V amplitude.
5. Recheck 29 V and 105 V adjustment and readjust if necessary.
6. Select the 10 V – 30 V range, set vernier to 1 and check that 10 V setting is within $\pm 10\%$. With vernier fully CCW the amplitude must be ≤ 10 V. Readjust R457 if necessary.
7. Select 3 V – 10 V range and check that the amplitude is > 10 V with vernier set to CW. Readjust R462 if necessary.
8. Check Amplitude vernier accuracy in the 30 – 100 V and 10 – 30 V ranges as listed below.

AMPLITUDE RANGE	VERNIER SETTING	RESULT
30V–100V	10	90V–110V
30V–100V	9	81V– 99V
30V–100V	8	72V– 88V
30V–100V	7	63V– 77V
30V–100V	6	54V– 66V
30V–100V	5	45V– 55V
30V–100V	4	36V– 44V
30V–100V	3	27V– 33V

AMPLITUDE RANGE	VERNIER SETTING (DARK SCALE)	RESULT
10–30V	1	9 V – 11 V
10–30V	2	18 V – 22 V
10–30V	3	27 V – 33 V

ADJUSTMENTS

5-16 MINIMUM WIDTH; OVERSHOOT; RISE TIME; INT. LOAD; FIXED DUTY CYCLE

EQUIPMENT: Sampling Oscilloscope
 20dB Attenuator
 20dB Attenuator 50W

WARNING

High voltage dangerous to life.

CAUTION

Do not overload Attenuators or Oscilloscope inputs.

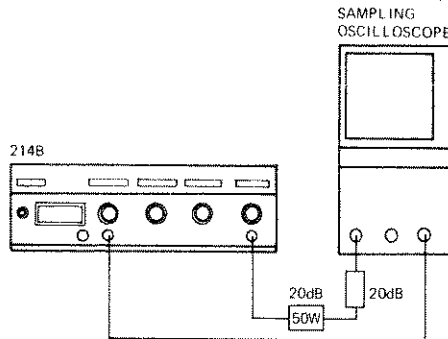

Figure 5-5

PROCEDURE:

1. Connect equipment as shown in Figure 5-5 and set 214B controls as follows:

MODE	NORM
PERIOD Range	1 μ - 10 μ
PERIOD Vernier	10
POSITION Range	10n - .1 μ
POSITION Vernier	1
DUTY CYCLE %	released
WIDTH Range	25n - .1 μ
WIDTH Vernier	2.5
AMPLITUDE Range	10-30V
AMPLITUDE Vernier	3 (DARK SCALE)
INT LOAD	OFF
SLOPE	*
DEL/ADV/D.P.	DEL
OUTPUT POLARITY	POS

* = don't care

2. Adjust A1R480 (MIN. PULSE WIDTH) for 25ns WIDTH.

ADJUSTMENTS

3. Select $.1 \mu - 1 \mu$ WIDTH range and set vernier to 2 (200 ns). Set Amplitude to 100 V with internal load switched off.
4. Adjust A1R436 and A1R408 for fastest risetime.
5. Adjust A1R419 for minimum overshoot before amplitude decreases.
6. Check that risetime is < 15 ns and overshoot and ringing is $< 5\%$. If necessary readjust A1R419, A1R436 and A1R408.
7. Select 10 – 30 V amplitude range, switch internal load on, and set amplitude to 30 V.
8. Adjust A1C501 for overshoot = ringing.
9. Adjust A1R487 and A1R421 for flat pulse top.
10. Adjust R506 for minimum ringing.
11. Adjust A1C504 for overshoot \approx ringing.
12. Check risetime, overshoot and ringing for specifications and, if necessary, optimize pulse via C501, C504, R421 and R487.
13. Switch internal load off, check pulse specifications, and optimize adjustment if necessary.
14. Recheck risetime, overshoot and ringing at 100 V amplitude with and without internal load.
15. Select $.3 - 1$ V amplitude range, set amplitude for 1 V and adjust A2C514 for minimum ringing.
16. Select the $.1 \mu - 1 \mu$ period range and press DUTY CYCLE pushbutton.
17. Set the Sampling Oscilloscope so that exactly one period is displayed.
18. Adjust A2R197 for 8 % duty cycle at 50 % of amplitude.

ADJUSTMENTS

5-17 TRIGGER LEVEL SENSITIVITY

EQUIPMENT:

- Oscilloscope
- Sinewave Generator
- Tee

CAUTION: Do not overload Oscilloscope Inputs.

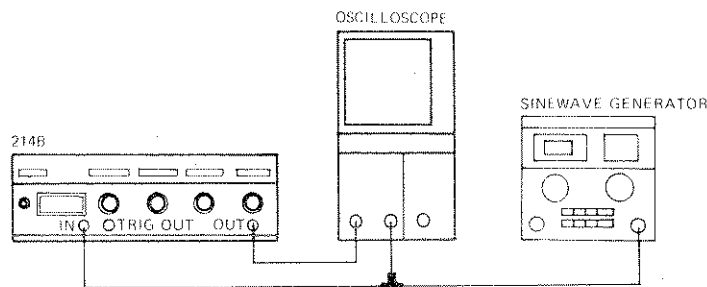

Figure 5-6

1. Connect equipment as shown in Figure 5-6 and set 214B controls as follows:

MODE	EXT TRIG
PERIOD Range	*
PERIOD Vernier	*
POSITION Range	10n - .1μ
POSITION Vernier	1
DUTY CYCLE %	Released
WIDTH Range	.1μ - 1μ
WIDTH Vernier	10
AMPLITUDE Range	3-10V
AMPLITUDE Vernier	as required
INT LOAD	*
SLOPE	*
DEL/ADV/D.P.	DEL
OUTPUT POLARITY	POS
EXT INPUT LEVEL	as required

2. Set Sinewave Generator to 100 KHz and 300 mV amplitude peak to peak.

ADJUSTMENTS

3. Set EXT. INPUT LEVEL vernier to mid-range.
4. Adjust A2R19 so that output pulses appear.
5. Switch to NEG. SLOPE and readjust A2R19 to obtain output pulses.
6. Optimize adjustment with A2R19 until output pulses appear with SLOPE switch set to NEG or to POS.

Note: It might be necessary to set the LEVEL vernier slightly off center position to get triggering on NEG and POS SLOPE. The arrow of the knob should stay within ± 1 mm of center position.

7. When R15 has been replaced, proceed as follows: Measure the voltage at the junction of A2R14 and R15 (with *firm/long* wire) and set LEVEL vernier R15 for 0 V. Then perform adjustment as described above and tighten the knob until the arrow points to mid-range.

ADJUSTMENTS

Para No.	ADJUSTMENT	adjust		RANGE
5-11	POWER SUPPLY	A4R604	$\Delta V = 22 V \pm 220 \text{ mV}$ (TP1/TP5)	3 V – 10 V
5-12	PERIOD	A1R69 A2R46 A2R126	1000 $\mu\text{s} \pm 1\%$ 99 $\mu\text{s} \pm 1\%$ $\approx 12.5 \text{ MHz}$ with VERNIER CCW	.1 m – 1 m .1 m – 1 m .1 μ – 1 μ
5-13	POSITION	A2R45 A2R119	1000 $\mu\text{s} \pm 1\%$ 100 $\mu\text{s} \pm 1\%$.1 m – 1 m .1 m – 1 m
5-14	C. DUTY CYCLE	A2R51 A2R217	1000 $\mu\text{s} \pm 1\%$ 100 $\mu\text{s} \pm 1\%$	1% – 10% 1% – 10%
5-14	WIDTH	A2R216 A2R128	1000 $\mu\text{s} \pm 1\%$ 100 $\mu\text{s} \pm 1\%$.1 m – 1 m .1 m – 1 m
5-15	AMPLITUDE	A1R457 A1R462	29 V 105 V	30 V – 100 V 30 V – 100 V
5-16	MIN. WIDTH	A1R480	25 ns	25 n – .1 μs
5-16	PULSE PARAMETERS	A1R436 A1R408 A1R419 A3C501 A1R487 A1R421 A2R506 A3C504 A2C514	max. risetime max. risetime max. amplitude; min. overshoot overshoot = ringing flat pulse top flat pulse top min. ringing opt. risetime and ringing min. ringing	30 V – 100 V 30 V – 100 V 30 V – 100 V 10 V – 30 V 10 V – 30 V 10 V – 30 V 10 V – 30 V 10 V – 30 V .3 V – 1 V
5-16	FIXED D.C.	A2R197	8% duty cycle	.1 μ – 1 μ Period
5-17	SLOPE	A2R19	output with NEG/POS SLOPE	