

Errata

Title & Document Type: 3336A/B/C Synthesizer/Level Generator Operating Manual

Manual Part Number: 03336-90011

Revision Date: 1983-07-01

HP References in this Manual

This manual may contain references to HP or Hewlett-Packard. Please note that Hewlett-Packard's former test and measurement, semiconductor products and chemical analysis businesses are now part of Agilent Technologies. We have made no changes to this manual copy. The HP XXXX referred to in this document is now the Agilent XXXX. For example, model number HP8648A is now model number Agilent 8648A.

About this Manual

We've added this manual to the Agilent website in an effort to help you support your product. This manual provides the best information we could find. It may be incomplete or contain dated information, and the scan quality may not be ideal. If we find a better copy in the future, we will add it to the Agilent website.

Support for Your Product

Agilent no longer sells or supports this product. You will find any other available product information on the Agilent Test & Measurement website:

www.tm.agilent.com

Search for the model number of this product, and the resulting product page will guide you to any available information. Our service centers may be able to perform calibration if no repair parts are needed, but no other support from Agilent is available.



**HEWLETT
PACKARD**

OPERATING MANUAL

MODEL 3336A/B/C

SYNTHESIZER/LEVEL GENERATOR

Serial Number 1930A00101 (3336A)
1931A00101 (3336B)
1932A00101 (3336C)

IMPORTANT NOTICE

This manual applies to instruments with the above serial numbers and greater. As changes are made in the instrument to improve performance and reliability, the appropriate pages will be revised to include this information.

WARNING

To prevent potential fire or shock hazard, do not expose equipment to rain or moisture.

Manual Part No. 03336-90011

Microfiche Part No. 03336-90061

©Copyright 1979, 1981, 1983 Hewlett-Packard Company

Printed: July 1983

CERTIFICATION

Hewlett-Packard Company certifies that this product met its published specifications at the time of shipment from the factory. Hewlett-Packard further certifies that its calibration measurements are traceable to the United States National Bureau of Standards, to the extent allowed by the Bureau's calibration facility, and to the calibration facilities of other International Standards Organization members.

WARRANTY

This Hewlett-Packard product is warranted against defects in material and workmanship for a period of one year from date of shipment [except that in the case of certain components listed in Section I of this manual, the warranty shall be for the specified period]. During the warranty period, Hewlett-Packard Company will, at its option, either repair or replace products which prove to be defective.

For warranty service or repair, this product must be returned to a service facility designated by -hp-. Buyer shall prepay shipping charges to -hp- and -hp- shall pay shipping charges to return the product to Buyer. However, Buyer shall pay all shipping charges, duties, and taxes for products returned to -hp- from another country.

HP software and firmware products which are designated by HP for use with a hardware product, when properly installed on that hardware product, are warranted not to fail to execute their programming instructions due to defects in materials and workmanship. If HP receives notice of such defects during the warranty period, HP shall repair or replace software media and firmware which do not execute their programming instructions due to such defects. HP does not warrant that the operation of the software, firmware or hardware shall be uninterrupted or error free.

LIMITATION OF WARRANTY

The foregoing warranty shall not apply to defects resulting from improper or inadequate maintenance by Buyer, Buyer-supplied software or interfacing, unauthorized modification or misuse, operation outside of the environmental specifications for the product, or improper site preparation or maintenance.

NO OTHER WARRANTY IS EXPRESSED OR IMPLIED. HEWLETT-PACKARD SPECIFICALLY DISCLAIMS THE IMPLIED WARRANTIES OF MERCHANTABILITY AND FITNESS FOR A PARTICULAR PURPOSE.

EXCLUSIVE REMEDIES

THE REMEDIES PROVIDED HEREIN ARE BUYER'S SOLE AND EXCLUSIVE REMEDIES. HEWLETT-PACKARD SHALL NOT BE LIABLE FOR ANY DIRECT, INDIRECT, SPECIAL, INCIDENTAL, OR CONSEQUENTIAL DAMAGES, WHETHER BASED ON CONTRACT, TORT, OR ANY OTHER LEGAL THEORY.

ASSISTANCE

Product maintenance agreements and other customer assistance agreements are available for Hewlett-Packard products.

For any assistance, contact your nearest Hewlett-Packard Sales and Service Office.



**HEWLETT
PACKARD**

SAFETY SUMMARY

The following general safety precautions must be observed during all phases of operation, service, and repair of this instrument. Failure to comply with these precautions or with specific warnings elsewhere in this manual violates safety standards of design, manufacture, and intended use of the instrument. Hewlett-Packard Company assumes no liability for the customer's failure to comply with these requirements. This is a Safety Class 1 instrument.

GROUND THE INSTRUMENT

To minimize shock hazard, the instrument chassis and cabinet must be connected to an electrical ground. The instrument is equipped with a three-conductor ac power cable. The power cable must either be plugged into an approved three-contact electrical outlet or used with a three-contact to two-contact adapter with the grounding wire (green) firmly connected to an electrical ground (safety ground) at the power outlet. The power jack and mating plug of the power cable meet International Electrotechnical Commission (IEC) safety standards.

DO NOT OPERATE IN AN EXPLOSIVE ATMOSPHERE

Do not operate the instrument in the presence of flammable gases or fumes. Operation of any electrical instrument in such an environment constitutes a definite safety hazard.

KEEP AWAY FROM LIVE CIRCUITS

Operating personnel must not remove instrument covers. Component replacement and internal adjustments must be made by qualified maintenance personnel. Do not replace components with power cable connected. Under certain conditions, dangerous voltages may exist even with the power cable removed. To avoid injuries, always disconnect power and discharge circuits before touching them.

DO NOT SERVICE OR ADJUST ALONE

Do not attempt internal service or adjustment unless another person, capable of rendering first aid and resuscitation, is present.

DO NOT SUBSTITUTE PARTS OR MODIFY INSTRUMENT

Because of the danger of introducing additional hazards, do not install substitute parts or perform any unauthorized modification to the instrument. Return the instrument to a Hewlett-Packard Sales and Service Office for service and repair to ensure that safety features are maintained.

DANGEROUS PROCEDURE WARNINGS

Warnings, such as the example below, precede potentially dangerous procedures throughout this manual. Instructions contained in the warnings must be followed.

WARNING

Dangerous voltages, capable of causing death, are present in this instrument. Use extreme caution when handling, testing, and adjusting.

SAFETY SYMBOLS

General Definitions of Safety Symbols Used On Equipment or In Manuals.



Instruction manual symbol: the product will be marked with this symbol when it is necessary for the user to refer to the instruction manual in order to protect against damage to the instrument.



Indicates dangerous voltage (terminals fed from the interior by voltage exceeding 1000 volts must be so marked).

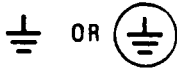

Protective conductor terminal. For protection against electrical shock in case of a fault. Used with field wiring terminals to indicate the terminal which must be connected to ground before operating equipment.



Low-noise or noiseless, clean ground (earth) terminal. Used for a signal common, as well as providing protection against electrical shock in case of a fault. A terminal marked with this symbol must be connected to ground in the manner described in the installation (operating) manual, and before operating the equipment.

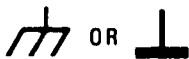

Frame or chassis terminal. A connection to the frame (chassis) of the equipment which normally includes all exposed metal structures.



Alternating current (power line).



Direct current (power line).



Alternating or direct current (power line).

WARNING

The **WARNING** sign denotes a hazard. It calls attention to a procedure, practice, condition or the like, which, if not correctly performed or adhered to, could result in injury or death to personnel.

CAUTION

The **CAUTION** sign denotes a hazard. It calls attention to an operating procedure, practice, condition or the like, which, if not correctly performed or adhered to, could result in damage to or destruction of part or all of the product.

NOTE:

The **NOTE** sign denotes important information. It calls attention to procedure, practice, condition or the like, which is essential to highlight.

TABLE OF CONTENTS

Section	Page	Section	Page
I. GENERAL INFORMATION.....	1-1	III. OPERATION (Cont'd)	
1-1. Introduction.....	1-1	3-47. Level Entry.....	3-9
1-5. Specifications.....	1-1	△ 3-49. Amplitude Leveling.....	3-9
1-7. Safety Considerations.....	1-1	3-54. Amplitude Blanking.....	3-10
1-9. Instruments Covered By This Manual.....	1-1	3-57. Phase Entry.....	3-11
1-13. Description.....	1-7	3-60. Frequency Sweep.....	3-11
1-15. Available Models.....	1-7	3-63. Single Sweep Execution.....	3-12
1-17. Accessories Supplied.....	1-7	3-65. Sweep Entry.....	3-12
1-19. Accessories Available.....	1-8	3-67. Continuous Sweep Execution.....	3-12
1-21. Options.....	1-9	3-69. Log Sweep.....	3-12
		3-71. Sweep Time Limits.....	3-13
		3-73. Sweep Bandwidth Limits.....	3-13
		3-75. Sweep Modification.....	3-13
		3-78. Sweep Marker.....	3-14
		3-81. X Axis Drive.....	3-14
		3-83. Z Axis Blank.....	3-14
		3-85. Amplitude Modulation.....	3-15
		3-86. Amplitude Modulation Selection.....	3-15
		3-90. Phase Modulation.....	3-15
		3-91. Phase Modulation Selection.....	3-15
		3-94. Operating State Storage.....	3-15
		3-97. Operator Maintenance.....	3-16
		3-99. Line Fuse Replacement.....	3-16
		3-101. Air Filter Replacement.....	3-16
		3-103. Remote Operation.....	3-16
		3-104. Introduction.....	3-16
		3-108. HP-IB Operating Principles.....	3-17
		3-113. Abridged Description of the HP-IB.....	3-18
		3-118. Producing Controller Statements.....	3-19
		3-128. System Management Messages.....	3-23
		3-150. Remote Operation of the -hp- 3336.....	3-26
Section	Page		
II. INSTALLATION.....	2-1		
2-1. Introduction.....	2-1		
2-3. Initial Inspection.....	2-1		
2-5. Preparation For Use.....	2-1		
2-6. Power Requirements.....	2-1		
2-8. Line Voltage Selection.....	2-1		
2-10. Power Cable.....	2-2		
2-12. HP-IB Connectors.....	2-2		
2-15. 3336 Listen/Talk Address.....	2-3		
2-17. HP-IB Description.....	2-5		
2-19. Connecting Oven Option 004.....	2-5		
2-21. Operating Environment.....	2-5		
2-23. Cooling System.....	2-5		
2-26. Bench Operation.....	2-5		
2-30. Storage and Shipment.....	2-6		
2-31. Environment.....	2-6		
2-33. Instrument Identification.....	2-6		
2-35. Packaging.....	2-6		
2-38. Rack Mounting.....	2-7		
Section	Page		
III. OPERATION.....	3-1		
3-1. Introduction.....	3-1		
3-4. Panel Features.....	3-1		
3-6. Power Requirements.....	3-4		
3-8. Warm-Up.....	3-4		
3-10. Initial (Turn-On) Operating Conditions.....	3-4		
△ 3-12. Front Panel Signal Outputs.....	3-4		
3-14. Frequency Limits.....	3-5		
3-16. Frequency Resolution.....	3-5		
3-18. Level Limits.....	3-6		
3-20. Sync Output.....	3-6		
3-23. Ext Ref Input.....	3-6		
3-25. 10MHz Oven Output (Option 004).....	3-7		
3-29. Ref Out (Frequency Reference Output).....	3-7		
3-31. Manual Programming.....	3-7		
3-36. Programming Errors.....	3-8		
3-39. Clear Display.....	3-9		
3-41. Output Selection.....	3-9		
3-43. Frequency Entry.....	3-9		
3-45. 21-60MHz Aux Output.....	3-9		

SECTION I

GENERAL INFORMATION

1-1. INTRODUCTION.

1-2. This Operating Manual contains information necessary to install and operate the Hewlett-Packard Model 3336A/B/C Synthesizer/Level Generator. Also included with the -hp-3336A/B/C is a Service Manual that provides procedures to install, operate, test, adjust, and service the -hp-3336A/B/C.

1-3. This manual is divided into three sections, each covering a specific topic or aspect of the instrument. The section divisions are: General Information, Installation and Interfacing, and Front Panel and Remote Operation. This section of the manual contains the performance specifications and general operating characteristics of the -hp-3336A/B/C. Also listed are available options and accessories, and instrument and manual identification information.

1-4. The -hp- part number of this Operating Manual is listed on the title page. Also listed on the title page is a Microfiche part number. This Microfiche part number can be used to order 4 × 6 inch microfilm transparencies of the Operating Manual. Each microfiche package also includes the latest Manual Changes supplement as well as pertinent Service Notes.

1-5. SPECIFICATIONS.

1-6. Instrument specifications and supplemental characteristics are listed in Table 1-1. The specifications are the performance standards or limits against which the instrument is tested. Supplemental characteristics are included in Table 1-1 as additional information for the user.

1-7. SAFETY CONSIDERATIONS.

1-8. This product is a Safety Class 1 instrument (provided with a protective earth terminal). The instrument and manual should be reviewed for safety markings, instructions, cautions and warnings to ensure safe operation.

1-9. INSTRUMENTS COVERED BY THIS MANUAL.

1-10. Attached to the instrument rear panel is a serial number plate. The serial number is in the form: 0000A00000. It is in two parts; the first four digits and letter are the serial prefix and the last five digits are the suffix. The prefix is the same for all identical instruments; it changes only when a major change is made to the instrument. The suffix, however, is assigned sequentially and is different for each instrument. The contents of this manual apply to instruments with the same serial number prefix and higher serial number suffixes listed under SERIAL NUMBERS on the title page.

1-11. If your instrument's serial number suffix is lower than that listed on the title page, refer to Section VII, Backdating of the Service Manual. There, you will find information to backdate your manual, making it apply to your instrument.

Table 1-1. Specifications and General Information.

FREQUENCY		
Range:		
Model 3336A:	75 ohm unbalanced 150 ohm balanced 600 ohm balanced	10 Hz to 20.999 999 999 MHz 10 kHz to 2.099 999 999 MHz 200 Hz to 109.999 999 kHz
Model 3336B:	75 ohm unbalanced 124 ohm balanced 135 ohm balanced 600 ohm balanced	10 Hz to 20.999 999 999 MHz 10 kHz to 10.999 999 999 MHz 10 kHz to 2.099 999 999 MHz 200 Hz to 109.999 999 kHz
Model 3336C:	50 ohm unbalanced 75 ohm unbalanced	10 Hz to 20.999 999 999 MHz 10 Hz to 20.999 999 999 MHz
Resolution:		
1 μ Hz for frequencies < 100 kHz		
1 mHz for frequencies \geq 100 kHz		
Aging Rate: (instruments without Option 004)		
$\pm 5 \times 10^{-6}$ per year (20° to 30°C)		
Warm-Up Time:		
30 minutes		
AMPLITUDE		
Range:		
Model 3336A:	75 ohm output 150 ohm output 600 ohm output	- 72.99 to + 7.00 dBm - 78.23 to + 1.76 dBm - 72.99 to + 7.00 dBm
Model 3336B:	75 ohm output 124 ohm output 135 ohm output 600 ohm output	- 72.99 to + 7.00 dBm - 78.23 to + 1.76 dBm - 78.23 to + 1.76 dBm - 72.99 to + 7.00 dBm
Model 3336C:	50 ohm output 75 ohm output	- 71.23 to + 8.76 dBm - 72.99 to + 7.00 dBm
Absolute Accuracy: specified at 10 kHz for the 50, 75 and 600 ohm outputs; specified at 50 kHz for the 124, 135 and 150 ohm outputs, after 30 minutes warmup.		
$\pm .05$ dB, for the top 9.99 dB of amplitude range (20° to 30°C)		
$\pm .08$ dB, for the top 9.99 dB of amplitude range (0° to 55°C)		
Flatness: referenced to amplitudes at 10 kHz for the 50, 75 and 600 ohm outputs; referenced to amplitudes at 50 kHz for the 124, 135 and 150 ohm outputs.		
Model 3336A	10Hz 200 10K 50K 109K 2.09M 20.9MHz	
75 ohm output	± .1 dB (± .07 dB with Option 005)	
150 ohm output	± .12 dB	
600 ohm output	± .25 dB	
Model 3336B	10Hz 200 10K 50K 109K 2.09M 10.9M 20.9MHz	
75 ohm output	± .1 dB (± .07 dB with Option 005)	
124 ohm output	± .15dB	± .1 dB
135 ohm output	± .12 dB	
600 ohm output	± .25 dB	
Model 3336C	10Hz	20.9 MHz
50 and 75 ohm outputs	± .1 dB (± .07 dB with Option 005)	

Table 1-1. Specifications and General Information (Cont'd).

Attenuator Accuracy: (instruments without Option 005)				
Attenuation	10Hz	1 M	10M	20.9MHz
10 to 19.99 dB	± .1 dB	± .15 dB	± .2 dB	
20 to 39.99 dB	± .15 dB	± .2 dB	± .25 dB	
40 to 79.99 dB	± .2 dB	± .25 dB	± .3 dB	

NOTE

Amplitude Accuracy is the sum of Absolute Accuracy and, as needed, Flatness and Attenuator Accuracy.

Warm-Up Time:
30 minutes

MAIN SIGNAL OUTPUTS

On Carrier Return Loss:

Model	Output	10Hz	10K	30K	2.09M	10.9M	20.9MHz
Model 3336A	75 ohm output	> 30 dB					
	150 ohm output	> 20 dB		> 30 dB			
Model 3336B	75 ohm output	> 30 dB					
	124 ohm output	> 20 dB		> 30 dB			
	135 ohm output	> 20 dB		> 30 dB			
Model 3336C	50 ohm output	> 30 dB				> 25 dB*	
	75 ohm output	> 30 dB					

*Return Loss of 50 ohm output is > 30 dB to 20.9 MHz with Option 005.

Balance:

Model	Output	300Hz	10K	50 K	2.09MHz
Model 3336A	150 ohm output	> 36 dB			
	600 ohm output	> 38 dB			
Model 3336B	124 ohm output	> 30 dB			
	135 ohm output	> 36 dB			
	600 ohm output	> 38 dB			

SPECTRAL PURITY

Integrated Phase Noise:

Model 3336A and 3336B
< - 72 dB, for a 3 kHz band, centered 2 kHz either side of a 20 MHz carrier.

Model 3336C
< - 64 dB, for a 30 kHz band, centered on a 20 MHz carrier, excluding 1 Hz about the carrier.

Phase Jitter:
.3° peak to peak maximum, measured per Bell System Technical Reference PUB 41009, "Transmission Parameters Affecting Voiceband Data Transmission-Measuring Techniques May 1975" and per CCITT Orange Book, Volume IV.2 "Specifications of Measuring Equipment".

Table 1-1. Specifications and General Information (Cont'd).

HARMONIC DISTORTION								
No harmonically related signal will exceed these values with respect to the carrier:								
10Hz	30	50	10K	100K	1M	5M	20.9MHz	
-35dB	-50dB	-60dB			-55dB	-50dB		Fast Leveling Off
			-50dB	-60dB	-55dB	-50dB		Fast Leveling On
Spurious: (dc to 200 MHz except where noted)								
All non-harmonically related signals from dc to 200 MHz will be more than 70 dB below the carrier or less than one of the following levels, whichever is greater.								
Model 3336A			without Option 005			with Option 005		
75 ohm output			-100 dBm			-115 dBm		
150 ohm output			-100 dBm (to 10 MHz)			-100 dBm (to 10 MHz)		
600 ohm output*			-100 dBm (to 10 MHz)			-100 dBm (to 10 MHz)		
Model 3336B			without Option 005			with Option 005		
75 ohm output			-100 dBm			-115 dBm		
124 ohm output			-100 dBm			-115 dBm		
135 ohm output			-100 dBm			-115 dBm		
600 ohm output*			-100 dBm			-115 dBm		
Model 3336C			without Option 005			with Option 005		
50 ohm output			-100 dBm			-115 dBm		
75 ohm output			-100 dBm			-115 dBm		
*Line related signals from the 600 ohm outputs will be more than 70 dB below the carrier or -83 dBm whichever is greater.								
Amplitude Blanking:								
Maximum signal output during amplitude blanking: < -85 dBm								
Impulse Level in adjacent channels caused by amplitude blanking: > 22 dBm 0								
PHASE OFFSET								
Range:								
± 719.9° with respect to arbitrary starting phase or assigned zero phase.								
Resolution: 0.1°								
Increment Accuracy: ± 0.2°								
Ambient Stability: ± 1 degree of phase per degree C.								
FREQUENCY SWEEP								
Sweep Flatness:								
± .15 dB, Normal Leveling, 50 Hz to 1 MHz, .5s Sweep Time.								
± .15 dB, Fast Leveling, 10 kHz to 20 MHz, .03s Sweep Time.								
Sweep Time								
Linear Sweep: .01 sec to 99.99 sec								
Single Log Sweep: 2 sec to 99.99 sec								
Continuous Log Sweep: .1 sec to 99.99 sec								
Minimum Sweep Width								
Log Sweep: 1 decade								
Linear Sweep: Minimum Bandwidth (Hz) = .1(Hz/sec) x Sweep Time (sec)								

Table 1-1. Specifications and General Information (Cont'd).**Phase Continuity:**

Sweep is phase continuous over the full frequency range

AMPLITUDE MODULATION

Modulation Depth: 0 to 100 %

Modulation Frequency Range: 50 Hz to 50 kHz

Envelope Distortion: < -30 dBc to 80% modulation

Input Impedance: >20 k Ω

PHASE MODULATION

Range: 0 to $\pm 850^\circ$

Linearity: < $\pm .5\%$ of peak to peak deviation from best fit straight line.

Modulation Frequency Range: dc to 5 kHz

Input Sensitivity: ± 5 V peak for $\approx 850^\circ$ phase shift ($\approx 170^\circ/\text{volt}$)

Input Impedance: >20 k Ω

HP-IB CONTROL

Frequency Switching Time: (Time to settle to within 1 Hz to final value, exclusive of programming and processing time)

< 10 ms for 100 kHz step

< 25 ms for 1 MHz step

< 70 ms for 20 MHz step

Phase Switching Time: (to within 90° of phase lock, exclusive of programming and processing time)

< 15 ms

Amplitude Switching Time: (to within .1 dB of final value, exclusive of programming and processing time)

< 500 ms

AUXILIARY OUTPUTS**AUX 0 dBm:**

Frequency range is from 21 MHz to 60.999 999 999 MHz (underrange to 20.000 000 001 MHz). Amplitude is 0 dBm (50 ohm).

SYNC OUT:

Square wave with $V_{\text{high}} \geq 1.2$ V, $V_{\text{low}} \leq 0.2$ V into 50 ohms, to synchronize other instruments to the Main Signal Outputs. Level transition occurs at Main Signal Output zero crossing.

REF OUT:

0 dBm (50 ohm), 1 MHz signal for phase-locking additional instruments to the Model 3336.

10 MHz OVEN OUT:

Instruments with Option 004, only. 0 dBm (50 ohm), 10 MHz signal from a temperature stabilized, crystal oscillator for phase-locking the Model 3336 or other instruments.

X DRIVE:

0 to > + 10 Vdc linear ramp proportional to the sweep frequency. Linearity, $\pm 1\%$ of final value, 10% to 90%, best fit straight line.

Z BLANK:

Sweep related TTL compatible voltage levels. Low level is capable of sinking current from a positive voltage source.

Maximum Current = 200 mA

Maximum Voltage = + 45 Vdc

Maximum Power Dissipation = 1 W (V x A)

MARKER:

TTL compatible high to low level transition at the programmed Marker Frequency.

Table 1-1. Specifications and General Information (Cont'd).

AUXILIARY INPUTS

EXT REF IN:

For phase-locking the 3336A/B/C to an external frequency reference. Signal from 0 dBm to + 20 dBm (50 ohm). Signal frequency must be within 1×10^{-6} of a sub-harmonic of 10 MHz from 1 MHz to 10 MHz.

AMPTD MOD:

Amplitude modulation input (see AMPLITUDE MODULATION specifications)

PHASE MOD:

Phase modulation input (see PHASE MODULATION specifications)

EXTERNAL LEVELING:

Input from an External Leveling voltage source to regulate the signal amplitude at a remote point. Input Sensitivity: 1 dB/Volt, $\pm .25$ dB

OPTION 004, HIGH STABILITY FREQUENCY REFERENCE

Aging Rate:

- $\pm 5 \times 10^{-8}$ per week after 72 hours continuous operation.
- $\pm 1 \times 10^{-7}$ per month after 15 days continuous operation.

Ambient Stability:

$\pm 5 \times 10^{-8}$ maximum, 0° to 55°C

Warm-Up Time:

Reference frequency will be within 1×10^{-7} of the turn-off frequency, 20 minutes after turn-on, for an off time less than 24 hours.

OPTION 005, HIGH ACCURACY ATTENUATOR

Attenuation	10Hz	20 MHz
10 to 19.99 dB	$\pm .035$ dB	
20 to 39.99 dB	$\pm .06$ dB	
40 to 79.99 dB	$\pm .1$ dB	

GENERAL

Operating Environment:

- Temperature: 0° to 55°C
- Relative Humidity: $\leq 85\%$, 0° to 40°C
- Altitude: < 15,000 ft. (< 4600 meters)

Storage Environment:

- Temperature: - 50° to + 65°C
- Altitude: < 50,000 ft. (< 15,000 meters)

Power Requirements:

100/120, 220/240 V, + 5%, - 10%, 48 to 66 Hz, 60 VA (100 VA with all options), 10 VA standby.

Size: 132.6 mm (5 1/4 in) high x 425.5 mm (16-3/4) wide x 497.8 (19-5/8) deep

Weight: 10 kg (22 lbs.) net, 15.5 kg (34 lbs.) shipping

1-12. This manual may have a yellow Manual Change Supplement with it. This supplement contains information for correcting errors in the manual and new information to keep your manual current. To keep this manual as current and accurate as possible, Hewlett-Packard recommends that you periodically request the latest Manual Change Supplement. The supplement for this manual is identified with the manual print date and part number. Both appear on the manual title page. Complimentary copies of the supplement are available from Hewlett-Packard.

1-13. DESCRIPTION.

1-14. The Hewlett-Packard Model 3336 Synthesizer/Level Generator is an accurate, stable and spectrally pure sine wave source, producing synthesized frequencies with 11 digits of resolution from 10 Hz to 20.999 999 999 MHz and precise output levels from -72.99 to $+7.00$ dBm (75 ohm output) in .01 dBm steps. A general purpose model and two communications models are available, each having a different combination of balanced and unbalanced outputs, output impedances and output connectors.

1-15. AVAILABLE MODELS.

1-16. The Model 3336 is manufactured as one of three models identified by the letters A, B or C following the model number. The difference between models is the configuration of the front panel outputs. The outputs on each model are:

MODEL	OUTPUTS	ACCEPTS CONNECTOR TYPE
3336A	75 ohm unbal 150 ohm bal 600 ohm bal	75 ohm BNC Siemens type 3 prong 9REL STP-6 AC Siemens type 3 prong 9REL STP-6 AC
3336A with Option 001	75 ohm unbal 150 ohm bal 600 ohm bal	Siemens type 1.6/5mm coaxial Siemens type 3 prong 9REL STP-6 AC Siemens type 3 prong 9REL STP-6 AC
3336B	75 ohm unbal 124 ohm bal 135 ohm bal 600 ohm bal	WECO type 439A or 440A WECO type 443A WECO type 241A WECO type 310
3336B with Option 001	75 ohm unbal 124 ohm bal 135 ohm bal 600 ohm bal	WECO type 358A WECO type 372A WECO type 241A WECO type 310
3336C	50 ohm unbal 75 ohm unbal	50 ohm BNC 75 ohm BNC

1-17. ACCESSORIES SUPPLIED.

1-18. A special BNC to BNC connector is supplied with the High Stability Frequency Reference (Option 004) to connect the High Stability Frequency Reference to the instrument. This connector is -hp- Part No. 1250-1499.

1-19. ACCESSORIES AVAILABLE.

1-20. The following accessories are available for use with the Model 3336A/B/C:

-hp- Part No.	Description
11048C	50 ohm Feedthrough Termination
11094B	75 ohm Feedthrough Termination
11356A	Ground Isolator
85428B	50 to 75 Ω Minimum Loss Impedance Matching Pad
03336-68702	High Stability Frequency Reference Kit (converts standard instrument to Option 004)
5061-0077	Rack Mount Flange Kit (Option 908)
5061-0083	Rack Mount Flange/Front Handle Kit (Option 909)
5061-0089	Front Handle Kit (Option 907)

1-21. OPTIONS.

1-22. The following options are available for the Model 3336 Synthesizer/Level Generator;

Option 001, Special Output connectors (Model 3336A and B only)

See Paragraph 1-15

Option 004, High Stability Frequency Reference

Option 005, High Accuracy Attenuator

Option 907, Front Handle Assembly

Option 908, Rack Mount Flange Kit

Option 909, Rack Mount Flange Kit/Front Handle Assembly

Option 910, Additional Operating and Service Manuals

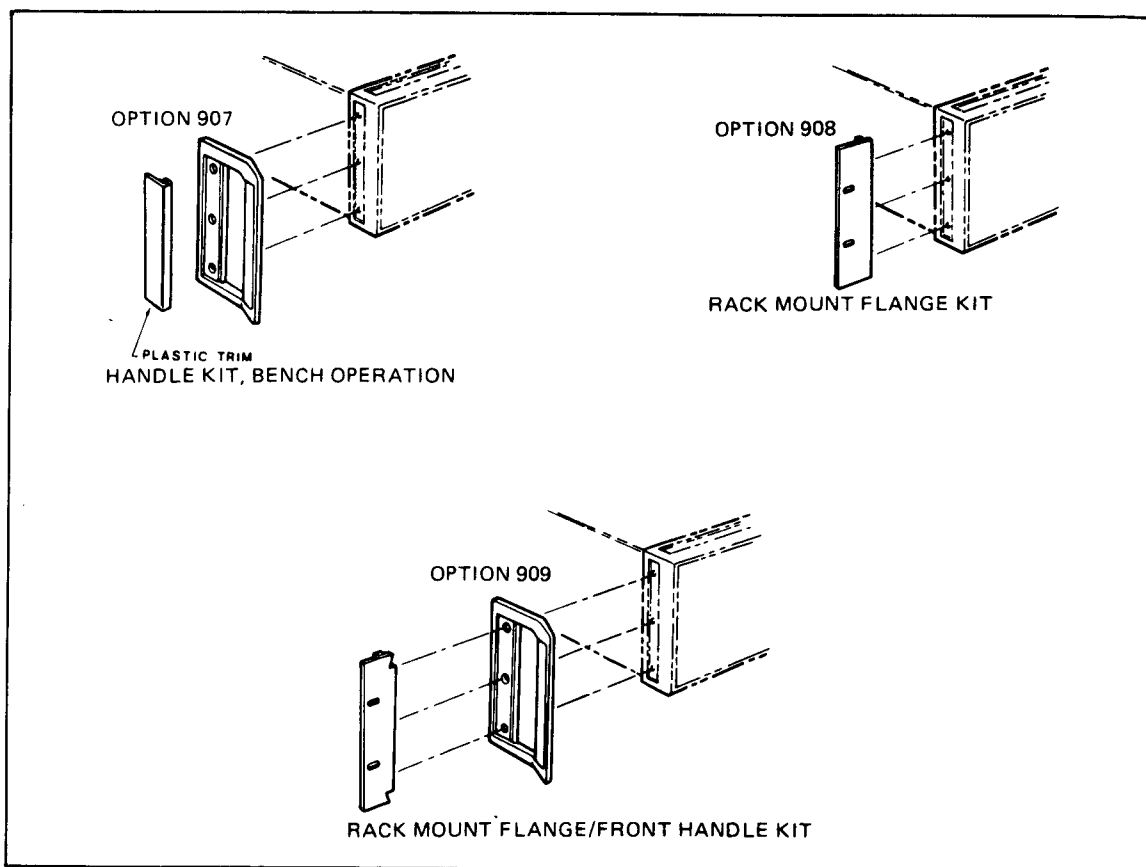

Figure 1-1, Rack Mounting and Handle Kits.

SECTION II

INSTALLATION

2-1. INTRODUCTION.

2-2. This section contains instructions for installing and interfacing the Model 3336A/B/C Synthesizer/Level Generator. Included are initial inspection procedures, power and grounding requirements, line voltage selection, environmental requirements, installation instructions, HP-IB connection procedure, and instructions for repackaging for shipment.

2-3. INITIAL INSPECTION.

2-4. Inspect the shipping container for damage. If the shipping container or cushioning material is damaged, it should be kept until the contents of the shipment have been checked for completeness and the instrument has been checked mechanically and electrically. This instrument was carefully inspected both mechanically and electrically before shipment. It should be free of marks and scratches and in perfect electrical order upon receipt. Procedures for checking electrical performance are given in Section IV. If there is mechanical damage or defect or if the instrument does not pass the electrical performance test, notify the nearest Hewlett-Packard Sales and Service Office listed at the end of this manual. If the shipping container is damaged or the cushioning material shows signs of stress, notify the carrier as well as the Hewlett-Packard office. Keep the shipping material for the carrier's inspection. The warranty statement is located in the front of this manual.

2-5. PREPARATION FOR USE.

2-6. Power Requirements.

2-7. The Model 3336 requires a power source of 100, 120, 220, or 240 V ac, +5%, -10%, 48 to 66 Hz single phase. Power consumption is 100 VA maximum.

2-8. Line Voltage Selection.



Before connecting ac power to this instrument, make sure the Model 3336 is set to the line voltage of the power source. Also ensure that the common connection of the power outlet is connected to a protective earth contact.

2-9. The line voltage selection switches are set at the factory to correspond to the most commonly used line voltage of the country of destination. The serial number plate (located on the rear panel) is marked at the factory to indicate the selected line voltage. To reduce confusion, update this plate every time the line voltage switches are changed. Information necessary to change the line voltage selection is in the Power Supply Service Group of the Operating and Service Manual.



Make sure the correct fuse is installed for the selected line voltage!

Line Voltage	Fuse	-hp- Part Number
100/120 Vac	1 Amp	2110-0001
220/240 Vac	½ Amp	2110-0012

USE FAST BLOW TYPE FUSES ONLY! Using slow blow type fuses or fuse values other than those recommended defeats an important protection circuit and will damage the Model 3336.

2-10. Power Cable.

2-11. In accordance with international safety standards, this instrument is equipped with a three-wire cable. When connected to an appropriate power line outlet, this cable grounds the instrument cabinet. The type of power cable shipped with each instrument depends on the country of destination. Refer to Figure 2-1 for the connector configuration and -hp- part number of the available power cables.

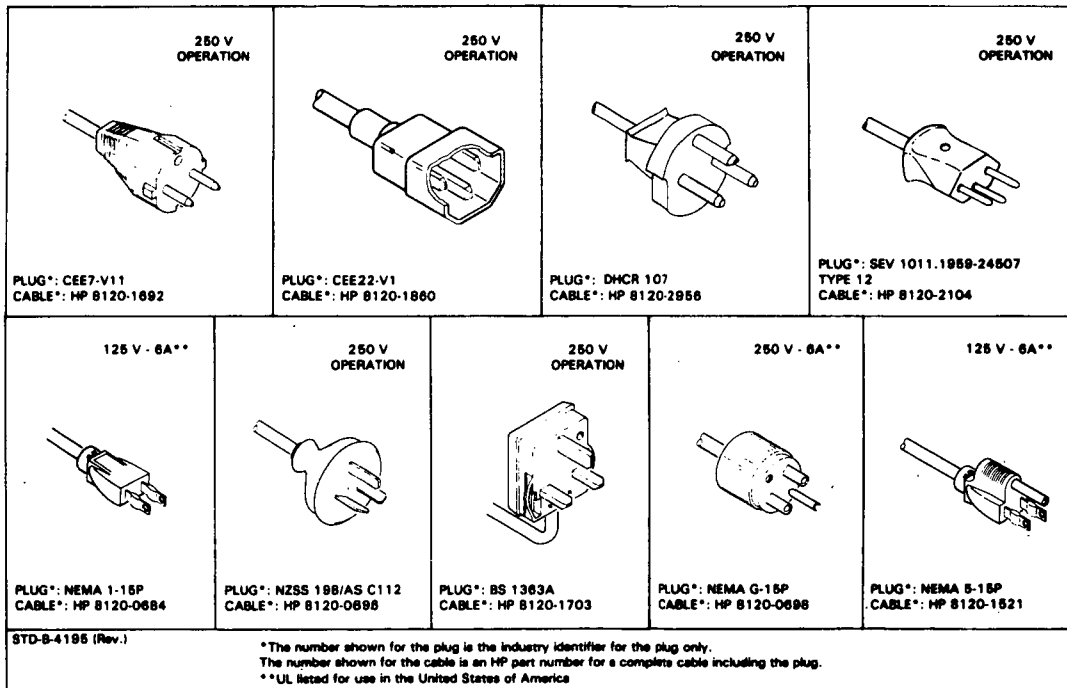

Figure 2-1. Power Cables.

2-12. HP-IB Connections.

2-13. Interconnection data concerning the rear panel HP-IB connector is provided in Figure 2-2. This connector is compatible with the -hp- 10833 (A,B,C, or D) HP-IB cables. The lengths of these cables are as follows:

10833A	1 meter
10833B	2 meters
10833C	4 meters
10833D	.5 meters

Up to 15 instruments (including the controller) may be connected in an HP-IB system. The HP-IB cables have identical stacking connectors on both ends so that several cables can be connected to a single source. As a practical matter, avoid stacking more than three or four cables on any one connector. If the stack gets too large, the force on the stack can produce enough leverage to damage the connector mounting. Be sure that the connector screws are tightened firmly in place to keep it from working loose during use, and be sure to observe the CAUTION of Figure 2-2.

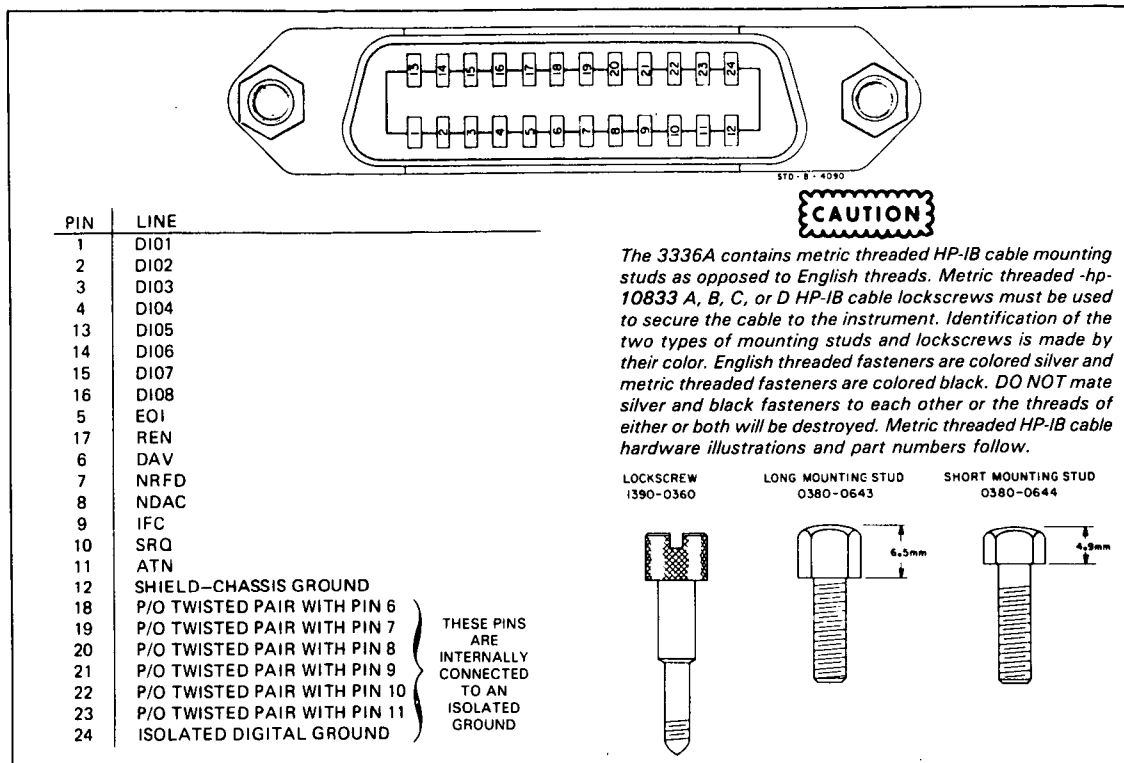

Figure 2-2. HP-IB Connector.

2-14. Cable Length Restrictions. System components can be interconnected in virtually any configuration. However, to achieve reliable system performance, proper voltage levels and timing relationships must be maintained. If the system cable is too long, the lines cannot be driven properly and the system will fail to perform. The maximum length of cable that can be used to connect a group of instruments must not exceed 2 meters (6.5 ft.) times the number of instruments to be connected, or 20 meters (65.6 ft.), whichever is less.

2-15. 3336 Listen/Talk Address.

2-16. The Model 3336 is normally shipped from the factory with the Device address of 4, (talk address D, listen address \$). The address switches are located on the rear panel. The binary weighted HP-IB address switches 1 thru 5 set the Device address and consequently the Talk and Listen address. All the possible Device, Listen and Talk addresses and the HP-IB address switch positions are shown in Table 2-1. Switch 6, marked "Listen Only", disables the instruments talk capability. This is normally left in the 0 position (talk enabled). Switch 7 is not used. The instrument will display its Device address for 1 second after pressing the Blue Shift key and then the LOCAL key.

Table 2-1. HP-IB Addresses.

ASCII Code Character		Address Switches					5-bit Decimal Code
Listen	Talk	A5	A4	A3	A2	A1	
SP	@	0	0	0	0	0	00
!	A	0	0	0	0	1	01
"	B	0	0	0	1	0	02
#	C	0	0	0	1	1	03
\$	D	0	0	1	0	0	04
%	E	0	0	1	0	1	05
&	F	0	0	1	1	0	06
'	G	0	0	1	1	1	07
(H	0	1	0	0	0	08
)	I	0	1	0	0	1	09
*	J	0	1	0	1	0	10
+	K	0	1	0	1	1	11
,	L	0	1	1	0	0	12
-	M	0	1	1	0	1	13
.	N	0	1	1	1	0	14
/	O	0	1	1	1	1	15
0	P	1	0	0	0	0	16
1	Q	1	0	0	0	1	17
2	R	1	0	0	1	0	18
3	S	1	0	0	1	1	19
4	T	1	0	1	0	0	20
5	U	1	0	1	0	1	21
6	V	1	0	1	1	0	22
7	W	1	0	1	1	1	23
8	X	1	1	0	0	0	24
9	Y	1	1	0	0	1	25
:	Z	1	1	0	1	0	26
;	[1	1	0	1	1	27
<	\	1	1	1	0	0	28
=]	1	1	1	0	1	29
>	~	1	1	1	1	0	30

Factory Selected Address →

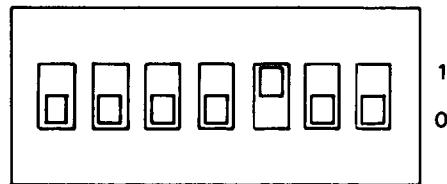
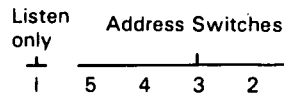

NOTE

The Equivalent Codes shown correspond only to the 5-bit binary switch code. These bits are the same for both listen and talk addresses. The sixth and seventh bits determine whether the address is listen (01) or talk (10). Some controllers distinguish between talk and listen automatically, requiring only the Device address (decimal equivalent).

2-17. HP-IB Description.

2-18. A description of the HP-IB is provided in Section III of this manual. A study of this information is necessary if you are not familiar with the HP-IB concept. Additional information concerning the design criteria and operation of the bus is available in IEEE Standard 488-1978 "IEEE Standard Digital Interface for Programmable Instrumentation".

2-19. Connecting Oven Option 004.

2-20. In order to use the Oven Option 004, an external connection must be made between the rear panel 10 MHz OVEN OUTPUT and the REF IN connectors. A special connector for this purpose, -hp- Part No. 1250-1499, is supplied with instruments having Option 004.

2-21. OPERATING ENVIRONMENT.**WARNING**

To prevent potential electrical or fire hazard, do not expose equipment to rain or moisture.

2-22. In order for the Model 3336 to meet the specifications listed in Table 1-1, the operating environment must be within the following limits:

Temperature	0 to +55°C
Relative Humidity	< 85% at 40°C
Altitude	4600 meters (15,000 feet)

2-23. Cooling System.

2-24. The cooling fan intake and the exhaust vent are located in the rear panel. When operating the instrument, provide at least 75 mm (3 inches) of clearance at the rear, and at least 7 mm (¼ inch) on all sides of the instrument. Failure to allow adequate air circulation will result in excessive internal temperature, reducing instrument reliability.

2-25. It is imperative that the fan filter be inspected frequently and cleaned or replaced as necessary to permit the free flow of air through the instrument. To clean the filter, remove the four nuts that secure the filter retainer. Remove the filter and flush with soapy water, rinse clean, and air dry.

2-26. Bench Operation.

2-27. The instrument has plastic feet attached to the bottom panel. The front feet contain foldaway tilt stands for convenience in bench operation. The tilt stand raises the front of the instrument for easier viewing of the control panel. The plastic feet are shaped to make full width modular instruments self-align when they are stacked. A front handle kit, -hp- Part No. 5061-0089 (Option 907), can be installed for ease of handling the instrument on the bench (see Figure 2-3). The kit is shipped with the instrument if Option 907 is ordered. Otherwise, the front handle kit is available separately by its -hp- part number.

2-30. STORAGE AND SHIPMENT.**2-31. Environment.**

2-32. The instrument should be stored in a clean, dry environment. The following environmental limitations apply to both storage and shipment:

Temperature	- 50°C to + 65°C
Relative Humidity	95% at 40°C
Altitude	15,300 meters (50,000 feet)

2-33. Instrument Identification.

2-34. If the instrument is being returned to Hewlett-Packard for servicing, attach a tag indicating the type of service required, return address, model number, and full serial number. In any correspondence, refer to the instrument by model number and full serial number.

2-35. Packaging.

2-36. Original Packaging. If the original packaging has been retained, pack the instrument in the same manner as it was received. Be sure to seal the shipping container securely. Also, mark the container FRAGILE to assure careful handling.

2-37. Other Packaging. The following general instructions should be used for repackaging with commercially available materials.

a. Wrap the instrument in heavy paper or plastic. (If shipping to a Hewlett-Packard office or service center, attach a tag indicating the type of service required, return address, model number, and full serial number.)

b. Use a strong shipping container. A double-wall carton made of 250-pound test material is adequate.

c. Use enough shock-absorbing material (3-to-4 inch layer) around all sides of the instrument to provide firm cushion and prevent movement inside the container. Protect the control panel with cardboard.

d. Seal the shipping container securely.

e. Mark the shipping container FRAGILE to assure careful handling.

2-38. Rack Mounting.

2-39. The Model 3336 can be mounted in a rack having an EIA standard width of 482.6 mm (19 inches). The instrument can be rack mounted with or without a handle kit by use of the following items:

- a. Rack mounting without handles; use Rack Mount Flange Kit -hp- Part No. 5061-0077 (Option 908).
- b. Rack mounting with handles; use the combination Rack Mount Flange/Front Handle Kit -hp- Part No. 5061-0083 (Option 909).

NOTE

The Rack Mount Flange Kit (item a) will not provide the space requirement for rack mounting when used with the bench handle assembly (-hp- Part No. 5060-9899, Option 907). To rack mount with handles, the combination kit of item b (Option 909) must be used (see Figure 2-3). If either Option 908 or 909 is ordered, the corresponding kit is shipped with the instrument. Otherwise, both kits are available separately by their -hp- part numbers.

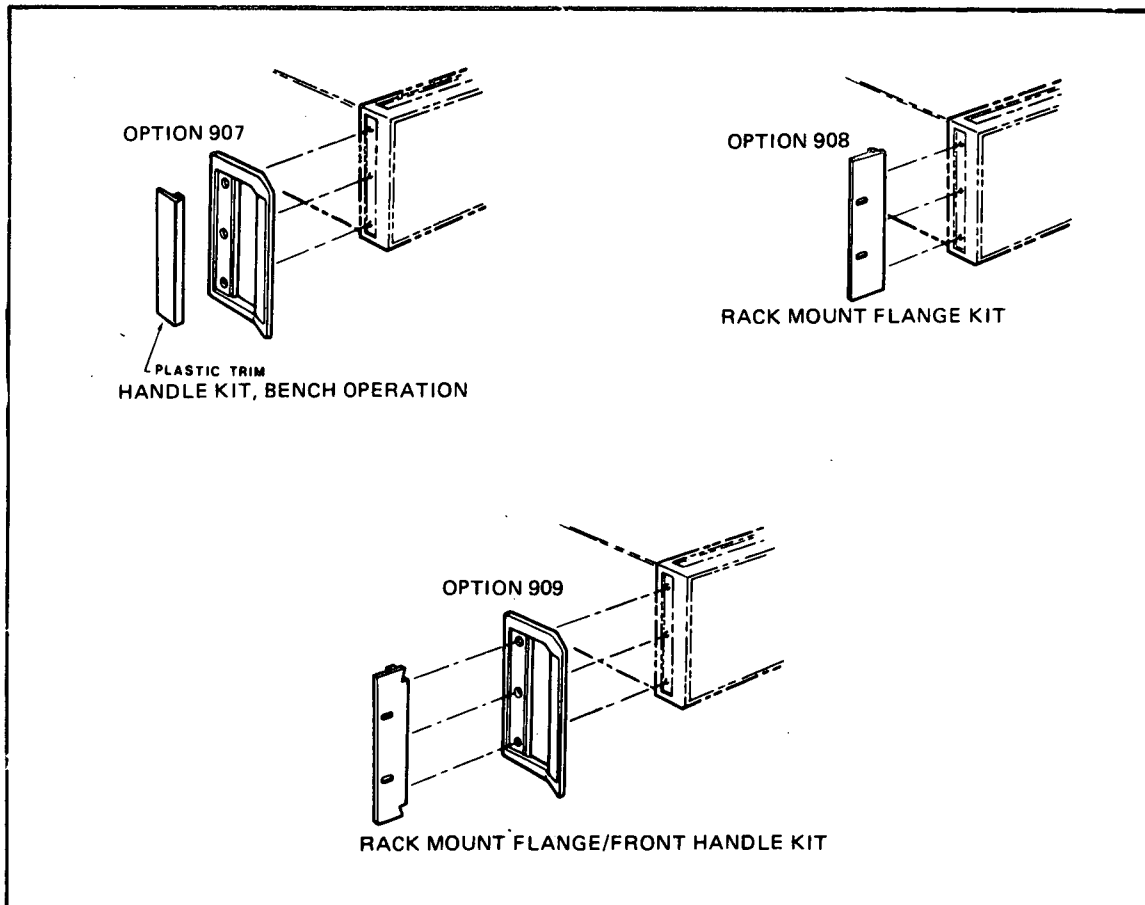

Figure 2-3. Rack Mount and Handle Kits.

SECTION III OPERATION

3-1. INTRODUCTION.

3-2. This section has operating and programming instructions for the -hp- Model 3336 Synthesizer/Level Generator. This section includes:

- Descriptions of the controls, annunciators and input/output connectors.
- Power and warm-up requirements.
- Manual and remote programming instructions.
- Operator verification procedures.
- Operator maintenance procedures.

3-3. The Table of Contents for this section is organized by subject for quick access to specific operating information.

3-4. PANEL FEATURES.

3-5. Figure 3-1 is a picture of the instrument with a brief description of all the controls, annunciators, and input/output connectors. A paragraph number where more detailed information about each feature is located, is supplied with each caption.

Paragraph	Page
3-4. Panel Features	3-1
3-6. Power Requirements	3-4
3-8. Warm-up	3-4
3-10. Initial (Turn-On) Conditions	3-4
3-12. Front Panel Signal Outputs	3-4
3-20. Sync Output	3-6
3-23. Ext Ref Input	3-6
3-25. 10 MHz Oven Output (Option 004)	3-7
3-29. Ref Output	3-7
3-31. Manual Programming	3-7
3-36. Programming Errors	3-8
3-45. 21-60 MHz Output	3-9
3-49. Amplitude Leveling	3-9
3-55. Amplitude Blanking	3-10
3-60. Frequency Sweep	3-11
3-85. Amplitude Modulation	3-15
3-90. Phase Modulation	3-15
3-94. Operating State Storage	3-15
3-97. Operator Maintenance	3-16
3-103. Remote Operation	3-16

APPENDICES

- A. Detailed Implementation of Bus Messages
- B. -hp- 3336A/B/C Programming Times
- C. -hp- 9825A Bus Message Implementation Table

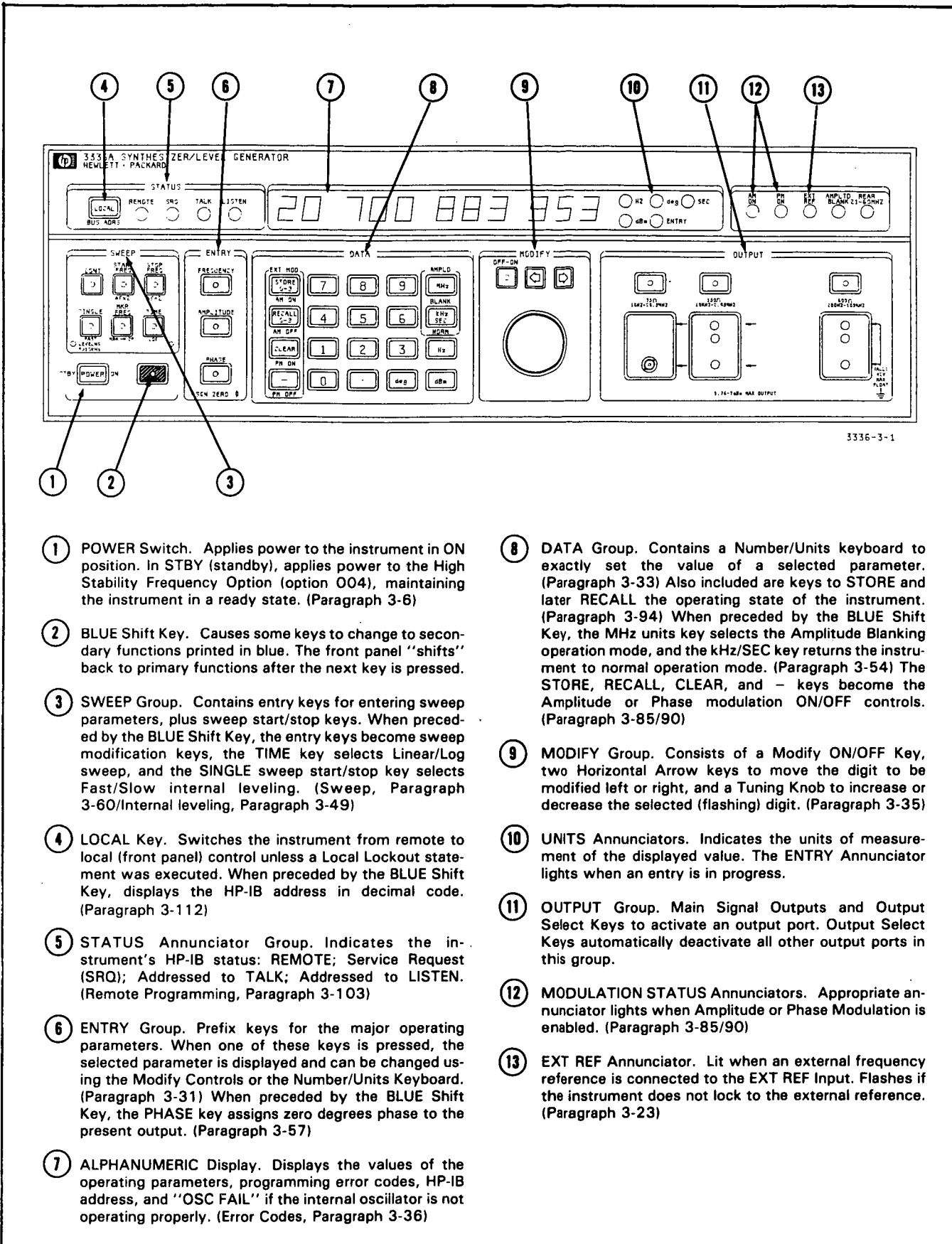

3336-3-1

- ① **POWER Switch.** Applies power to the instrument in ON position. In STBY (standby), applies power to the High Stability Frequency Option (option 004), maintaining the instrument in a ready state. (Paragraph 3-6)
- ② **BLUE Shift Key.** Causes some keys to change to secondary functions printed in blue. The front panel "shifts" back to primary functions after the next key is pressed.
- ③ **SWEEP Group.** Contains entry keys for entering sweep parameters, plus sweep start/stop keys. When preceded by the BLUE Shift Key, the entry keys become sweep modification keys, the TIME key selects Linear/Log sweep, and the SINGLE sweep start/stop key selects Fast/Slow internal leveling. (Sweep, Paragraph 3-60/Internal leveling, Paragraph 3-49)
- ④ **LOCAL Key.** Switches the instrument from remote to local (front panel) control unless a Local Lockout statement was executed. When preceded by the BLUE Shift Key, displays the HP-IB address in decimal code. (Paragraph 3-112)
- ⑤ **STATUS Annunciator Group.** Indicates the instrument's HP-IB status: REMOTE; Service Request (SRQ); Addressed to TALK; Addressed to LISTEN. (Remote Programming, Paragraph 3-103)
- ⑥ **ENTRY Group.** Prefix keys for the major operating parameters. When one of these keys is pressed, the selected parameter is displayed and can be changed using the Modify Controls or the Number/Units Keyboard. (Paragraph 3-31) When preceded by the BLUE Shift Key, the PHASE key assigns zero degrees phase to the present output. (Paragraph 3-57)
- ⑦ **ALPHANUMERIC Display.** Displays the values of the operating parameters, programming error codes, HP-IB address, and "OSC FAIL" if the internal oscillator is not operating properly. (Error Codes, Paragraph 3-36)
- ⑧ **DATA Group.** Contains a Number/Units keyboard to exactly set the value of a selected parameter. (Paragraph 3-33) Also included are keys to STORE and later RECALL the operating state of the instrument. (Paragraph 3-94) When preceded by the BLUE Shift Key, the MHz units key selects the Amplitude Blanking operation mode, and the kHz/SEC key returns the instrument to normal operation mode. (Paragraph 3-54) The STORE, RECALL, CLEAR, and - keys become the Amplitude or Phase modulation ON/OFF controls. (Paragraph 3-85/90)
- ⑨ **MODIFY Group.** Consists of a Modify ON/OFF Key, two Horizontal Arrow keys to move the digit to be modified left or right, and a Tuning Knob to increase or decrease the selected (flashing) digit. (Paragraph 3-35)
- ⑩ **UNITS Annunciators.** Indicates the units of measurement of the displayed value. The ENTRY Annunciator lights when an entry is in progress.
- ⑪ **OUTPUT Group.** Main Signal Outputs and Output Select Keys to activate an output port. Output Select Keys automatically deactivate all other output ports in this group.
- ⑫ **MODULATION STATUS Annunciators.** Appropriate annunciator lights when Amplitude or Phase Modulation is enabled. (Paragraph 3-85/90)
- ⑬ **EXT REF Annunciator.** Lit when an external frequency reference is connected to the EXT REF Input. Flashes if the instrument does not lock to the external reference. (Paragraph 3-23)

Figure 3-1. Panel Features.

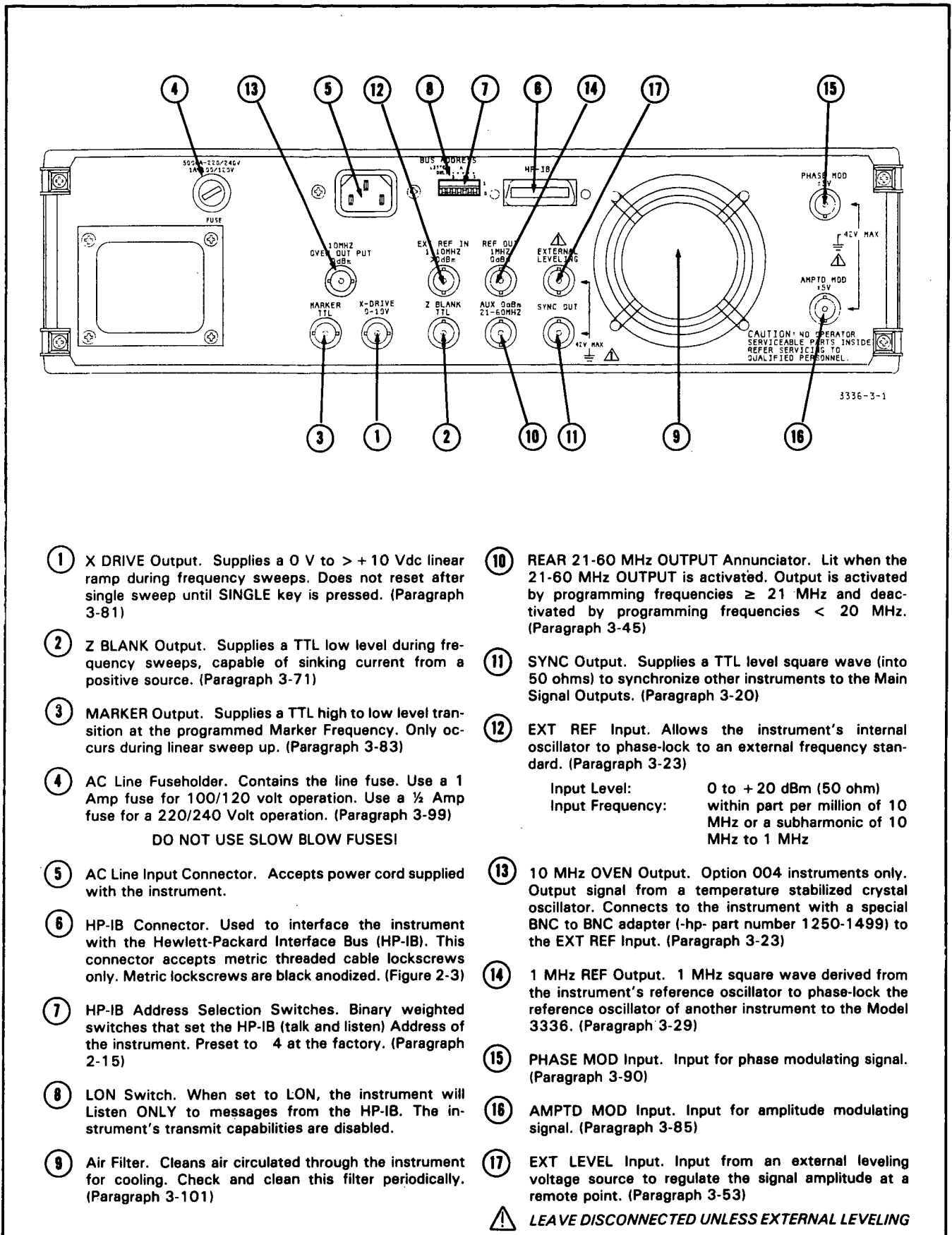

- ① X DRIVE Output. Supplies a 0 V to > + 10 Vdc linear ramp during frequency sweeps. Does not reset after single sweep until SINGLE key is pressed. (Paragraph 3-81)
- ② Z BLANK Output. Supplies a TTL low level during frequency sweeps, capable of sinking current from a positive source. (Paragraph 3-71)
- ③ MARKER Output. Supplies a TTL high to low level transition at the programmed Marker Frequency. Only occurs during linear sweep up. (Paragraph 3-83)
- ④ AC Line Fuseholder. Contains the line fuse. Use a 1 Amp fuse for 100/120 volt operation. Use a ½ Amp fuse for a 220/240 Volt operation. (Paragraph 3-99)
DO NOT USE SLOW BLOW FUSES!
- ⑤ AC Line Input Connector. Accepts power cord supplied with the instrument.
- ⑥ HP-IB Connector. Used to interface the instrument with the Hewlett-Packard Interface Bus (HP-IB). This connector accepts metric threaded cable lock screws only. Metric lock screws are black anodized. (Figure 2-3)
- ⑦ HP-IB Address Selection Switches. Binary weighted switches that set the HP-IB (talk and listen) Address of the instrument. Preset to 4 at the factory. (Paragraph 2-15)
- ⑧ LON Switch. When set to LON, the instrument will Listen ONLY to messages from the HP-IB. The instrument's transmit capabilities are disabled.
- ⑨ Air Filter. Cleans air circulated through the instrument for cooling. Check and clean this filter periodically. (Paragraph 3-101)
- ⑩ REAR 21-60 MHz OUTPUT Annunciator. Lit when the 21-60 MHz OUTPUT is activated. Output is activated by programming frequencies ≥ 21 MHz and deactivated by programming frequencies < 20 MHz. (Paragraph 3-45)
- ⑪ SYNC Output. Supplies a TTL level square wave (into 50 ohms) to synchronize other instruments to the Main Signal Outputs. (Paragraph 3-20)
- ⑫ EXT REF Input. Allows the instrument's internal oscillator to phase-lock to an external frequency standard. (Paragraph 3-23)
Input Level: 0 to + 20 dBm (50 ohm)
Input Frequency: within part per million of 10 MHz or a subharmonic of 10 MHz to 1 MHz
- ⑬ 10 MHz OVEN Output. Option 004 instruments only. Output signal from a temperature stabilized crystal oscillator. Connects to the instrument with a special BNC to BNC adapter (-hp- part number 1250-1499) to the EXT REF Input. (Paragraph 3-23)
- ⑭ 1 MHz REF Output. 1 MHz square wave derived from the instrument's reference oscillator to phase-lock the reference oscillator of another instrument to the Model 3336. (Paragraph 3-29)
- ⑮ PHASE MOD Input. Input for phase modulating signal. (Paragraph 3-90)
- ⑯ AMPTD MOD Input. Input for amplitude modulating signal. (Paragraph 3-85)
- ⑰ EXT LEVEL Input. Input from an external leveling voltage source to regulate the signal amplitude at a remote point. (Paragraph 3-53)
⚠ LEAVE DISCONNECTED UNLESS EXTERNAL LEVELING

Figure 3-1. Panel Features (Cont'd).

3-6. POWER REQUIREMENTS.

3-7. The Model 3336 requires a power source of 100, 120, 220 or 240 Vac, + 5% - 10%, 48 to 66 Hz, single phase. Instructions to change the line voltage selection are located in the Service Manual. Fuse replacement is described in the Operator Maintenance chapter of this section, Paragraph 3-97.

3-8. WARM-UP.

3-9. A standard instrument (without Option 004) requires 30 minutes to warm-up. Instruments with the High Stability Frequency Reference Option (Option 004) require 30 minutes to warm-up if power has been disconnected for less than 24 hours. If an Option 004 instrument is disconnected from its power source longer than 24 hours, the warm-up period may be as long as 72 hours.

3-10. INITIAL (Turn-On) OPERATING CONDITIONS.

3-11. When the instrument is turned on, its operating state will be:

FREQUENCY.....	10000 Hz
AMPLITUDE	Minimum
PHASE.....	0.0 deg
OUTPUT PHASE RELATIONSHIP	
TO FREQUENCY REFERENCE.....	Arbitrary
OUTPUT.....	75 ohm (Models A or B) 50 ohm (Model C)
SWEEP	
Start Frequency.....	1 MHz
Stop Frequency.....	10 MHz
Marker Frequency.....	5 MHz
Sweep Time.....	1 sec
AMPLITUDE BLANKING.....	Off
PHASE MODULATION.....	Off
AMPLITUDE MODULATION.....	Off
FAST LEVELING.....	Off

NOTE

If the instrument displays "OSC FAIL", the frequency synthesis circuits are not operating properly. Refer the instrument to qualified service personnel for repair.

3-12. FRONT PANEL SIGNAL OUTPUTS.



The maximum peak voltage that can be safely applied between the chassis and the outer conductor of any input or output is ± 42 volts.

3-13. The Model 3336 is manufactured as one of three models identified by the letters A, B or C following the model number. The difference between models is the configuration of the front panel outputs. The outputs on each model are:

Model	Outputs	Accepts Connector Type
3336A	75 ohm unbal 150 ohm bal 600 ohm bal	75 ohm BNC Siemens type 9REL STP—6AC Siemens type 9REL STP—6AC
3336A with Option 001	75 ohm unbal 150 ohm bal 600 ohm bal	Siemens type 1.6/5mm coaxial Siemens type 9REL STP—6AC Siemens type 9REL STP—6AC
3336B	75 ohm unbal 124 ohm bal 135 ohm bal 600 ohm bal	WECO type 439A or 440A WECO type 443A WECO type 241A WECO type 310
3336B with Option 001	75 ohm unbal 124 ohm bal 135 ohm bal 600 ohm bal	WECO type 358A WECO type 372A WECO type 241A WECO type 310
3336C	50 ohm unbal 75 ohm unbal	50 ohm BNC 75 ohm BNC

3-14. Frequency Limits.

3-15. It is possible to enter frequencies from 10 Hz to 20.999 999 999 MHz for any front panel output. The instrument specifications, however, apply only during operation within the following frequency limits:

Output	Lower Frequency Limit	Upper Frequency Limit
50 ohm unbal	10 Hz	20.9 MHz
75 ohm unbal	10 Hz	20.9 MHz
124 ohm bal	10 kHz	10.9 MHz
135 ohm bal	10 kHz	2.09 MHz
150 ohm bal	10 kHz	2.09 MHz
600 ohm bal	200 Hz	109 kHz

3-16. Frequency Resolution.

3-17. The frequency resolution for all outputs with programmable frequencies is:

- 1 μ Hz for frequencies below 100 kHz.
- 1 mHz for frequencies 100 kHz and above.

3-18. Level Limits.

3-19. Every front panel output has an amplitude range of 79.99 dB with 0.01 dBm resolution. The absolute maximum and minimum amplitudes, however, differ from output to output. The upper and lower output level limits for each output are:

Output	Lower Level Limit	Upper Level Limit
50 ohm unbal	- 71.23 dBm	+ 8.76 dBm
75 ohm unbal	- 72.99 dBm	+ 7.00 dBm
124 ohm bal	- 78.23 dBm	+ 1.76 dBm
135 ohm bal	- 78.23 dBm	+ 1.76 dBm
150 ohm bal	- 78.23 dBm	+ 1.76 dBm
600 ohm bal	- 72.99 dBm	+ 7.00 dBm

NOTE

When changing from one output to another, expect a level change equal to the difference of the output level limits. For example, when changing from the 50 ohm to the 75 ohm output, the output level will decrease 1.76 dB. Conversely, expect the level to increase when changing back to the 50 ohm output.

3-20. SYNC OUTPUT.

3-21. This rear panel output supplies a TTL level square wave for synchronizing other instruments to the signal from any front panel output. The phase relationship between the front panel signal and the Sync signal is always constant with the transition between levels occurring at the zero-crossing of the front panel signal.

3-22. When the SYNC Output is terminated with 50 ohms, the Sync Signal levels are:

Low Level = $\leq +0.2$ V

High Level = $\geq +1.2$ V

NOTE

If the SYNC Output is connected to a high impedance load, the voltage levels will be approximately twice the values given. The improper termination of a 50 ohm system, however, may cause ringing at the positive and negative transitions.

3-23. EXT REF INPUT.

3-24. The Model 3336's reference oscillator may be phase locked to an external frequency standard, transferring the standard's frequency accuracy and aging rate to the Model 3336. The input signal level must be: from 0 dBm to +20 dBm (50 ohm) and the frequency must be within 10 parts per million of 10 MHz or a submultiple of 10 MHz down to 1 MHz (10 MHz, 5 MHz, 3.3333 MHz, 2.5 MHz.....1 MHz). The EXT REF annunciator will light continuously when the instrument and an external frequency reference are phase-locked together. If they are not phase-locked but a signal is present, the annunciator will flash on and off.

3-25. 10 MHz OVEN OUTPUT (Option 004).

3-26. This output is available only on instruments equipped with Option 004. Option 004 is a temperature stabilized crystal oscillator with an aging rate specified at $\pm 5 \times 10^{-8}$ per week after 72 hours of operation. Option 004 is connected to the instrument with a BNC to BNC adapter, -hp- part number 1250-1499, connecting the 10 MHz OVEN Output to the EXT REF Input. The EXT REF annunciator will be on continuously when the instrument and Option 004 (or any frequency standard) are phase-locked together. If they are not locked, but a signal is present, the annunciator will flash on and off.

3-27. To reduce the warm-up time and realize the maximum performance from an instrument equipped with Option 004, always leave the instrument connected to a power source. Power is maintained to Option 004 whenever the instrument is plugged in. The warm-up time for an instrument equipped with Option 004 is 20 minutes if power has been interrupted for less than 24 hours. If, however, power is interrupted for longer than 24 hours, it may take as long as 72 hours before Option 004 will meet its aging rate specification.

3-28. The signal at the 10 MHz OVEN Output is a 0 dBm (50 ohms) square wave and is present when the Model 3336 is connected to a power source.

3-29. REF OUT (Frequency Reference Output).

3-30. This output supplies a 1 MHz, 0 dBm (50 ohm) square wave derived from the Model 3336's frequency reference. When this signal is applied to the external reference input of a compatible instrument, the reference oscillator of both instruments will be phase-locked together.

3-31. MANUAL PROGRAMMING.

3-32. Programming the Model 3336 from the front panel can be done in two ways. The value of the operating parameter may be set exactly using the Entry keys and the Number/Units keyboard, or the value can be modified using the Tuning Knob in the Modify group.

3-33. To exactly set the value of any operating parameter:

1. Press the key associated with the desired operating parameter (the light in the center of any Entry key indicates the active entry parameter).
2. Press the exact number sequence, including decimal point and minus sign, of the value to be assigned.
3. Press the appropriate Units key to execute the entry.

3-34. There are two operating rules to be aware of when modifying frequency.

1. If the last frequency entered with the Number/Units keyboard is within the specified frequency limits of the selected output, the frequency can be modified, using the Tuning control ONLY within those frequency limits.
2. Frequency can be modified from 10 Hz to 20.999 999 999 MHz if the last frequency entered with the Number/Units keyboard is outside the specified frequency limits of the selected output.

3-35. To modify the present value of any operating parameter:

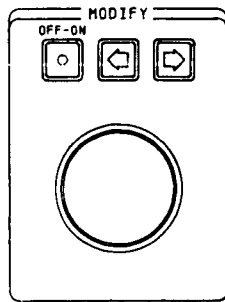

1. Turn the Modify group "ON" by pressing the ON/OFF key. "ON" status is indicated by the light in the center of this key.

2. Press one of the horizontal arrow keys to move the flashing digit to be modified one position to the left or right. This flashing digit is the least significant digit that will be modified.

3. Rotate the Tuning Knob clockwise to increase the flashing digit and counterclockwise to decrease it. This is a two speed control.

That is, if the Tuning Knob is rotated slowly, the flashing digit increases (decreases) by one. If, however, the Tuning Knob is rotated faster (> .5 rpm) the flashing digit will increase (decrease) by three.

NOTE

Attempts to enter or modify operating parameters beyond the capabilities of the instrument are ignored and result in the word ERROR followed by a number to be displayed for one second. Refer to the Error Code Messages to determined the exact nature of the programming problem.

3-36. Programming Errors.

3-37. The word "ERROR" followed by a number will be displayed for one second after a programming error occurs. Refer to the error code messages to determine the nature of the programming problem.

Error Code	Message
1	Value too large or too small
2	Incorrect units
3	---Not used---
4	Sweep time too long or too short.
5	---Not used---
6	Sweep bandwidth too small or start frequency greater than stop frequency in log sweep
7	Unrecognized HP-IB mnemonic received
8	Unrecognized HP-IB character received
9	Option does not exist

3-38. F. bound Err. For added flexibility, the actual programmable frequency limit of every front panel output is from 10 Hz to 20.999 999 999 MHz. However, the instrument may not meet its stringent specifications when operated outside the frequency limits of each output. As a warning, "F. bound Err" will be displayed for 1 second after a frequency is entered that exceeds these frequency limits. These limits are printed on the front panel just below each output select key and are listed in Paragraph 3-14.

3-39. Clear Display.

3-40. The  key causes the display to clear to zero. This key is useful when an error is made entering numerical data. This key has no effect on existing programs.

3-41. Output Selection.

3-42. Pressing the key above any front panel output, activates that output port and deactivates all other output ports in this group. The light in the center of these keys indicates the active port. When the 21-60 MHz AUX Output on the rear panel is active, all front panel outputs are deactivated. At this time, the light in the center of the Output Select key indicates the front panel output port to be activated if and when the 21-60 MHz AUX Output is deactivated. Any front panel output may be selected at any time.

NOTE

*When changing from one output to another, expect a level change relative to the different absolute amplitude ranges of each output.
(Paragraph 3-16)*

3-43. Frequency Entry.

3-44. To enter frequency, press the FREQUENCY Entry key (it is not necessary to press this key if the light in its center is lit indicating that it is already the entry function). Next, enter the number sequence, most significant digit first, including decimal point of the desired frequency and finally, press the appropriate Units key (MHz, kHz, Hz). Three units keys allow the frequency to be entered in the most convenient form, however, the instrument always displays the frequency in Hz.

3-45. 21-60 MHz Aux Output.

3-46. This rear panel output is activated by entering frequencies ≥ 21 MHz and deactivated by entering frequencies below 20 MHz. The nominal rear panel output level is 0 dBm into 50 Ohms.

3-47. Level Entry.

3-48. Output levels are entered by pressing the AMPLITUDE Entry key followed by the - key (if needed), the exact number sequence of the desired level (most significant digit first) including decimal point and the dBm Units key.

**3-49. Amplitude Leveling.**

3-50. Internal Amplitude Leveling. Internal Amplitude Leveling regulates the output power ensuring accurate output levels throughout the entire frequency range of the instrument. The Model 3336 has two leveling modes, Normal and Fast, with different settling times. The settling times are nominally 250 ms for the Normal mode and 1 ms for the Fast mode. At turn-on, the instrument is in the Normal Leveling Mode and this is the operating mode that should be used unless the advantage of faster settling time is needed. One advantage of the Fast Leveling Mode is improved flatness of frequency sweeps above 10 kHz.

NOTE

Use discretion when using the Fast Leveling Mode below 10 kHz. At frequencies below 10 kHz, the Fast Leveling circuit responds to the instantaneous amplitude changes of the output signal, resulting in distortion and degraded amplitude accuracy. As a warning "F. bound Err." will be displayed when frequencies below 10 kHz are entered while in the Fast Leveling Mode.

3-51. Amplitude Leveling Mode Selection. To change from one leveling mode to the other, press the BLUE shift key followed by . The light to the lower left of this key will be on when the instrument is in the Fast Leveling Mode. Fast Leveling Amplitude Modulation and Amplitude Blanking are mutually exclusive operating modes. That is, the instrument cannot have Fast Leveling, Amplitude Modulation or Amplitude Blanking enabled at the same time. For example, if the instrument is in the Fast Leveling Mode when Amplitude Modulation is programmed, the instrument will automatically return to the Normal Leveling Mode. Conversely, Amplitude Modulation will be automatically turned OFF when Fast Leveling is programmed.

3-52. Normal Amplitude Leveling and Amplitude Modulation. The Amplitude Leveling circuit senses an increase in output power as the percentage of modulation increases because of the presence of sideband energy. The Leveling circuit responds by reducing the signal (carrier and sidebands) until the TOTAL output power equals the amplitude setting of the instrument. This constant power regulation of the output causes what appears to be carrier compression.



3-53. External AMplitude Leveling. An external Amplitude Leveling input (located on the rear panel) allows regulation of the amplitude at a remote point. This input, marked EXT LEVEL, has a nominal input impedance of 1 k ohm and a +1 V change at this input causes a 1 dB, \pm .25 dB change at the signal output.

**CAUTION**

Terminating or connecting the EXT LEVEL input to circuits other than an active amplitude leveling voltage source will degrade the amplitude accuracy. Leave this input disconnected unless externally leveling the instrument.

3-54. Amplitude Blanking.

3-55. When the instrument is making a frequency change, the output signal does not instantaneously change to the new frequency. The potential exists in the Normal (no blanking) operating mode, to produce unwanted energy at intermediate frequencies during a frequency change. In the Amplitude Blanking mode, the output level is automatically reduced during the frequency change, resulting in the unwanted energy becoming insignificant. Amplitude Blanking reduces the output level to less than -85 dBm during the time the instrument is changing frequencies.

3-56. To select Amplitude Blanking, press the BLUE shift key and then press . The AMPTD BLANK annunciator will be lit when the instrument is in the Amplitude Blanking Mode. Even though the Amplitude Blanking Mode is selected, the output signal will not be affected if the frequency is changed using the Modify Group (tuning knob). Fast Leveling and Amplitude Blanking are mutually exclusive operating modes. That is, the instrument will automatically return to Normal Leveling when Amplitude Blanking is selected and, conversely, when Fast Leveling is selected, Amplitude Blanking is removed. To return to Normal operation, press the BLUE shift key followed by .

3-57. Phase Entry.

3-58. The phase of the output signal may be shifted up to $\pm 719.9^\circ$ with 0.1° resolution. To enter a phase shift, press the PHASE entry key, followed by the exact number sequence of the desired phase shift and then the  units key. Press the - key before entering the number of degrees for negative phase shifts.

3-59. After entering a phase shift, the new phase may be assigned the zero phase position. Subsequent changes in phase will be referenced to this point, extending the 719.9° offset limit. To assign zero phase, press the BLUE shift key followed by the PHASE entry key.

3-60. Frequency Sweep.

3-61. The Model 3336 produces phase continuous, logarithmic or linear, single or continuous frequency sweeps over its entire frequency range. Three auxiliary outputs provide sweep related X-axis drive, Z-axis blanking and frequency marking for X, Y axis presentations of the frequency sweep. A special "ZOOM" feature can quickly position and expand a point of interest in the sweep display.

NOTE

"F. bound Err." will be displayed for 1 second after a sweep is started if either the Start or Stop frequency is outside the specified frequency limits of the output selected.

3-62. At instrument Turn-on, the sweep parameters are:

Sweep Mode.....	Linear
Start Frequency.....	1 000 000.0 Hz
Stop Frequency.....	10 000 000.0 Hz
Marker Frequency.....	5 000 000.0 Hz
Time.....	1.0 Sec

3-63. Single Sweep Execution.

3-64. The Single Sweep has a two step execution cycle. To begin a Single Sweep:

Press  to set the output and display to the Start Frequency and reset the X-axis drive.

Press  again, to start the sweep. The light in the center of this key will be on when the instrument is sweeping.

After a Single Sweep stops, the output and display remain at the Stop Frequency until the cycle is initiated again. The X-axis drive remains at its maximum value (+ 10.5 Vdc).

NOTE

The actual stop frequency at the end of a single sweep may be slightly higher than the programmed value.

3-65. Sweep Entry.

3-66. To exactly set any of the sweep parameters, press the appropriate sweep parameter entry key, and then enter the numerical value followed by the appropriate units key. To change from linear to log or log to linear sweep mode, press the BLUE shift key followed by . The light to the lower right of this key will be on when the instrument is in the logarithmic sweep mode.

3-67. Continuous Sweep Execution.

3-68. Press  to start a continuous sweep. The light in the center of this key will be on when the instrument is sweeping. In the Linear Sweep Mode, the instrument will sweep from the Start Frequency to the Stop Frequency in the programmed time and then sweep back to the Start Frequency. In the Log Sweep Mode, the instrument will sweep from the Start Frequency to the Stop Frequency in the programmed time, immediately reset to the Start Frequency and continue the cycle.

NOTE

The Stop Frequency must be greater than Start Frequency when the instrument is in the Log Sweep Mode.

3-69. Log Sweep.

3-70. The Single Log Sweep is a logarithmic approximation made up of 10 linear segments per decade. The minimum log sweep width is one decade of frequency.

NOTE

The actual Stop Frequency at the end of a Single Log Sweep, will be higher than the programmed value because of computation time required by the control circuits. The actual value will always be within 0.25% of the programmed value and the error will decrease as the sweep time increases.

3-71. Sweep Time Limits.

3-72. The maximum sweep time for all sweep types and sweep modes is 99.99 sec. The sweep time resolution is 0.01 sec for sweep times ≥ 1 sec, and 0.001 sec for sweep times < 1 sec. The minimum sweep times are:

Linear Sweep	
Single.....	0.01 sec
Continuous.....	0.01 sec
Log Sweep	
Single.....	2.00 sec
Continuous.....	0.10 sec

NOTE

In Single Log Sweep, the sweep time is increased between segments. The time increase in seconds, is approximately equal to:

$$.045 (10 \log \frac{\text{Stop Frequency}}{\text{Start Frequency}}) \text{ seconds}$$

3-73. Sweep Bandwidth Limits.

3-74. The maximum sweep bandwidths are the specified frequency limits of each output. (See Paragraph 3-14) The minimum sweep limits are:

Log Sweep.....	1 decade
Linear Sweep.....	(.1 Hz/sec) x (sweep time)

3-75. Sweep Modification.

3-76. While the instrument is continuously sweeping, the Sweep Time, Start Frequency, Stop Frequency, Marker Frequency, Sweep Bandwidth and Output Amplitude can be modified. When a modification is entered, the sweep stops, resets to the Start Frequency and then, after a brief computation period, the sweep automatically restarts.

3-77. Sweep Bandwidth Modification. In Linear Sweep Mode, the sweep bandwidth can be doubled or halved by pressing the Blue shift key followed by $\Delta f \times 2$ or $\Delta f \div 2$. When **MKR** \rightarrow **cf** is used to set the sweep center frequency equal to the marker frequency in conjunction with these bandwidth modification keys, it is possible to "ZOOM" in on a specific point of the sweep. For example, during a continuous linear sweep from 1 MHz to 10 MHz while monitoring the Marker and the response of the swept device on an oscilloscope, an interesting response is noted at about 8 MHz. This point of interest, however, is too compressed to analyze properly. To "ZOOM" in on this point, center it in the display by (1) modifying the Marker frequency until the marker transition occurs at the same time as the point of interest and (2) pressing the Blue shift key followed by the **MKR** \rightarrow **cf**. The point of interest should now be in the center of the display. (3) Expand the display by using the Blue shift key and the $\Delta f \div 2$ key. Repeat these steps as necessary to modify the sweep until the desired display is produced.

3-78. Sweep Marker.

3-79. Sweep Marker Output. The Marker Output (located on the rear panel) produces a TTL high to low level transition at the programmed Marker Frequency during the linear sweep up. This signal resets to the high level at the end of sweep. The marker transition will not occur in the sweep down or Log sweep. Set the Marker Frequency by pressing followed by the desired frequency and finally the appropriate Units key. 

3-80. The Marker Frequency can be set anywhere in the sweep band, but, if it is set within 400 microseconds of the sweep stop, the Stop Frequency will be increased until it occurs approximately 400 microseconds after the Marker. The equation to determine the approximate maximum Marker Frequencies is:

$$\text{Max Marker Freq} = \text{Stop Freq} - \frac{.0004 \times \text{Bandwidth}}{\text{Sweep Time}}$$

3-81. X-axis Drive.

3-82. The X DRIVE Output (located on the rear panel) supplies the following signals:

Single Linear Sweep: 0 V at start frequency, increasing linearly to > +10 V dc at stop frequency. Remains at final voltage until reset prior to start of the next sweep.

Continuous Linear Sweep: Increases linearly from 0 V to > +10 V dc during sweep up. Resets and remains at 0 V during sweep down.

Log Sweep: 0 V at start frequency, increasing to > +10 V dc with the sweep segments.

The X DRIVE Output has a nominal voltage of +10.5 V dc at the end of a sweep to be compatible with oscilloscopes requiring +10.0 V for full screen horizontal deflection. At the end of Single Sweeps (no reset), the X DRIVE voltage decays toward 0 V at less than 10 mV per second.

3-83. Z-axis Blank.

3-84. The Z BLANK Output (located on the rear panel) produces TTL compatible voltage levels as follows:

Single Linear Sweep: Low level during sweep from Start to Stop Frequency. High level at all other times.

Continuous Linear Sweep: Low level during sweep up. High level during sweep down.

Single Log Sweep: Low level during sweep up. High level at all other times.

Continuous Log Sweep: Low level during sweep up. High level momentarily at end of sweep.

The Z BLANK Output low level is capable of sinking current from a positive voltage source through a pen-lift relay or other device. The Z BLANK Output ratings are:

Maximum Current.....	200 mA
Voltage Range.....	0 V to +45 V dc
Maximum Power (output voltage x current).....	1 Watt

3-85. AMPLITUDE MODULATION.

3-86. Amplitude Modulation Selection.

3-87. To program Amplitude Modulation, press the BLUE shift key followed by the AM ON (STORE) key. To disable Amplitude Modulation, press the BLUE shift key followed by the AM OFF (RECALL) key. The AMPTD MOD annunciator will light when Amplitude Modulation is enabled.

3-88. When Amplitude Modulation is enabled and no modulating signal is present, the output level is the programmed level. At 100% modulation, the maximum output amplitude will be twice the programmed level.

3-89. Amptd Mod Input. (Located on the rear panel) is the modulating signal input. This input is rated:

Maximum Input Voltage.....	± 5 V peak
Nominal Input Impedance.....	20 k ohm, 10 k ohm when Amplitude Modulation is OFF
Input Sensitivity.....	≈ 10 V p-p for 100% modulation
Frequency Range.....	50 Hz to 50 kHz
Envelope Distortion.....	- 30 dB to 80% modulation

3-90. PHASE MODULATION.

3-91. Phase Modulation Selection.

3-92. To program Phase Modulation press the BLUE shift key followed by the PM ON (CLEAR) key. The Phase Mod annunciator will light when Phase Modulation is enabled. To disable Phase Modulation, press the BLUE shift key followed by the PM OFF (-) key.

3-93. Phase Mod Input. The PHASE MOD Input (located on the rear panel) is the Phase Modulating Signal input. This input is rated:

Maximum Input Voltage.....	± 5 V peak
Nominal Input Impedance.....	10 k ohm
Input Frequency Range.....	dc to 5 kHz
Maximum θ Shift.....	± 850°
Input Sensitivity.....	≈ ± 170°/volt

3-94. OPERATING STATE STORAGE.

3-95. Up to ten entire instrument operating states (programs) may be saved for use in the future. Each instrument state is stored in a location identified by a number from 0 to 9. To

Store the current operating state, press the STORE 0-9 key followed by the number of the desired storage location. If two programs are stored in the same location, the first program is lost. To Recall an operating state, press the RECALL 0-9 key followed by the number of the location where the program is stored.

3-96. All stored information is lost when power is removed from the instrument or when the POWER switch is set to STBY. Any stored phase information is invalid because the phase of the output signal is arbitrary when recalled. The command to start a frequency sweep is not saved and therefore, either the CONT key or SINGLE key must be pressed after recalling a frequency sweep.

3-97. OPERATOR MAINTENANCE.

3-98. Maintenance performed by the operator is limited to checking and cleaning the air filter and replacing the line fuse.

3-99. Line Fuse Replacement.

3-100. To replace the line fuse (located in a fuseholder on the rear panel) disconnect the power cord and rotate the fuseholder's slotted cap 1/2 turn counterclockwise. Install the new line fuse in the fuseholder and secure it by rotating the slotted cap 1/2 turn clockwise. Generally, if the line fuse needs replacement, a malfunction exists in the instrument and it must be referred to qualified service personnel. The correct replacement fuse is:

Line Voltage	Fuse	-hp- Part No.
100/120 V	1 Amp	2110-0001
220/240 V	1/2 Amp	2110-0012



DO NOT USE SLOW BLOW FUSES

The use of SLOW BLOW fuses prevents the proper operation of an important protection circuit and may result in damage to the instrument.

3-101. Air Filter Replacement.

3-102. The Air Filter (located over the intake fan on the rear panel) should be inspected frequently and cleaned or replaced as necessary to allow a free flow of air through the instrument. To remove the filter, disconnect the instrument from power and remove the four thumbscrews from the filter retainer. Remove the filter and wash thoroughly using a mild soap, rinse clean and air dry. If the filter needs replacement, use -hp- Part No. 3150-0227.

3-103. REMOTE OPERATION.

3-104. Introduction.

3-105. The Model 3336 can be remotely operated via the Hewlett-Packard Interface Bus (HP-IB). This section describes how the Model 3336 responds to specific messages and how

to implement these messages over the HP-IB. Directions to interface the instrument with an HP-IB system are given in Section II. Since remote operation parallels manual (front panel) operation, the operator should be thoroughly familiar with the front panel operation of the instrument before attempting to operate it via the HP-IB.

3-106. The Hewlett-Packard Interface Bus. The Hewlett-Packard Interface Bus referred to as the HP-IB from now on, is a multi-wire parallel bus interconnecting up to 15 devices providing a means of communication between these devices. The ability to communicate between devices, program and coordinate instrument operation, transfer measurement data and manage the system, create new and powerful capabilities such as:

- unattended operation.
- data manipulation and storage.
- automatic generation of permanent records by using peripherals such as plotters and printers.
- the capabilities created by the coordinated operation of two or more devices.

In fact, it is not unusual to see all these capabilities used in a single application of the HP-IB.

NOTE

HP-IB is Hewlett-Packard's implementation of IEEE Std. 488-1978, "Standard Digital Interface for Programmable Instrumentation".

3-107. Special Operating Considerations. If possible, lock all instruments to a single frequency reference. This will greatly simplify the tuning subroutine in the controller's program. Use the most accurate frequency reference available. The -hp- 3336 aging rate is specified at less than $\pm 5 \times 10^{-6}$ per year. The -hp- 3336 with Option 004 aging rate is specified at less than $\pm 5 \times 10^{-8}$ per week.

3-108. HP-IB Operating Principles.

3-109. Talker. Any device that can, when addressed, send over the HP-IB is a TALKER. The -hp- 3336 is a talker since it can send messages indicating its operating state and the values of all its programmable functions.

3-110. Listener. Any device that can, when addressed, receive over the HP-IB is a LISTENER. The -hp- 3336 is a listener since it can receive messages that program its functions. Obviously, it is possible for a device to be both a talker and a listener, though not at the same time.

3-111. Controller. The device that directs which device will talk and which device or devices will listen is the CONTROLLER. The system controller (usually a calculator or computer) is the active controller most of the time. However, it may direct another device to become the active controller. The system controller is the only device which can unconditionally assume control of the bus.

3-112. Addressing. The active controller directs which device will talk and which device or devices will listen by specifically ADDRESSING those devices. Each device has a talk address and a listen address. Therefore, when a controller addresses a device, it also specifies whether the device will talk or listen. Some controllers require a decimal equivalent of the talk and listen addresses, called the DEVICE ADDRESS. The factory presets the device address (automatically assigning talk and listen addresses) to:

Device Address	4
Talk Address	D
Listen Address	\$

The device address may be changed if desired (see Section II of this manual). Actually, there is no reason to change it unless another device with the same address is added to the system.

3-113. Abridged Description of the HP-IB.

3-114. The HP-IB consists of 16 active signal lines that are used to interconnect up to 15 devices (e.g., instruments). The 16 signal lines are organized according to function. The categories are DATA, HANDSHAKE, and GENERAL INTERFACE MANAGEMENT lines. The structure of the HP-IB is illustrated in Figure 3-2.

3-115. Data Lines. Eight DATA lines are used to carry instrument addresses, instrument control instructions, measurement results and instruments status information in bit parallel, byte serial form. Ordinarily, a seven bit ASCII code represents each byte of DATA. The eighth bit is available for parity checking. DATA is sent over the DATA lines in both directions.

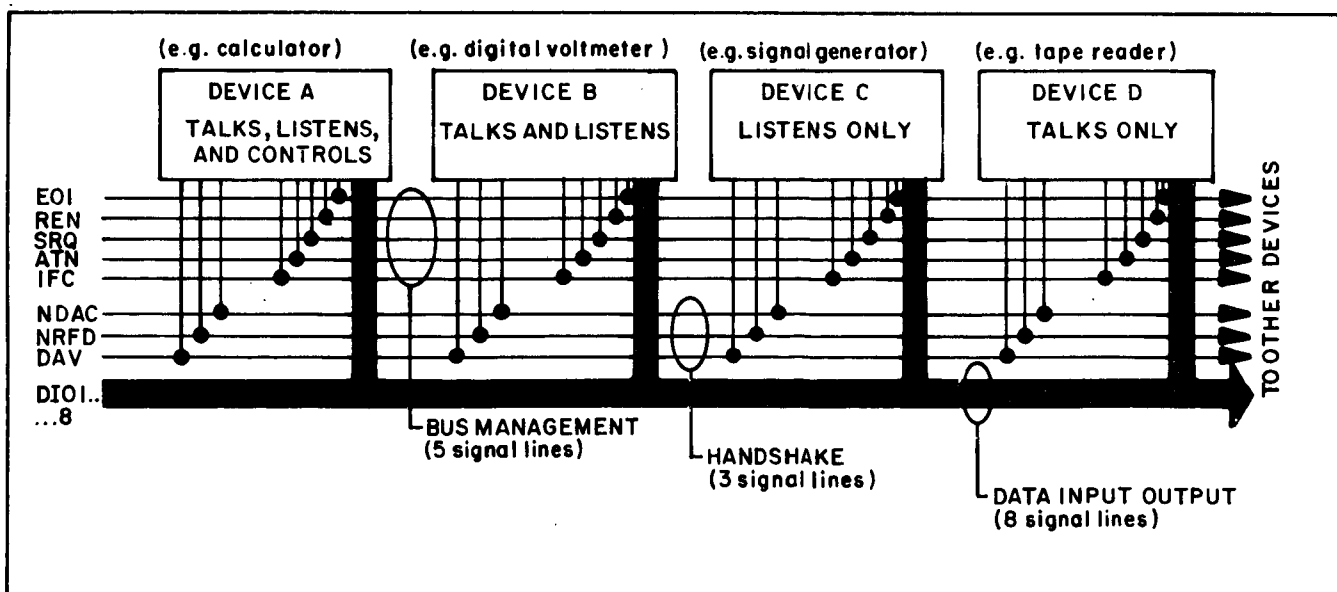

Figure 3-2. General Interface Management Lines.

3-116. Handshake Lines (DAV, NFRD, NDAC). Data is transferred between devices using an interlocked HANDSHAKE technique. This method causes the data to be moved at a rate determined by the slowest device involved in the transfer. The HANDSHAKE lines coordinate the asynchronous data transfer by communicating the status of the transfer to the device sending the data (talker), the device receiving the data (listener) and the device controlling the transfer (controller).

3-117. General Interface Management Lines. These five lines operate independently and in conjunction to send Bus Management Message to the devices connected to the HP-IB. Each line has a precise definition that is either sent or not sent depending on the truth state of the line. The lines are defined as follows:

Attention (ATN)—When TRUE, identifies ASCII characters on the DATA lines as commands. Identifies ASCII characters on the DATA lines as data when FALSE.

Remote Enable (REN)—Places the interface bus in the REMOTE mode.

Interface Clear (IFC)—Halts all activity on the HP-IB.

Service Request (SRQ)—A device on the bus uses this line to request service from the controller.

End or Identify (EOI)—Indicates the last character of a multi-byte message.

Also used with ATN (true) to indicate a parallel poll.

3-118. Producing Controller Statements for Instrument Operation.

3-119. The interface between the operator and the instrument is changed dramatically when an instrument is operated over the HP-IB. During non HP-IB operation, the operator actuates front panel controls that are labeled according to function. Often, only a single control is used to activate a function and getting the results of a measurement simply consists of reading the display! In contrast, during HP-IB operation, the operator typically faces an alpha-numeric keyboard. Neither the key functions nor their labels correspond to the instrument operation. The natural question arises:

“What instructions must be entered on the controller to cause a particular action in the instrument?”

This sub-section explains how to answer that question.

3-120. An ideal HP-IB operating section in an instrument manual would include specific instructions such as:

“To set the frequency of the -hp- 3336 to 19.5 MHz, enter wrt 704,
“FR19.5MH” on the controller.”

This instruction is very specific and leaves no room for error. Unfortunately, it is not possible to supply such specific instructions because it is not possible to predict which instruments and controllers will be used together. The instrument's operating instructions, therefore, can only describe how the instrument interfaces with the HP-IB. An analogous situation exists for the controller's operating instructions. Almost all statements sent over the HP-IB to operate an instrument, contain a portion that depends upon the individual instrument, and a portion that depends upon the controller used in the system. The operator must produce the required statement from information found partially in the controller documentation. The concept of Bus Messages, presented in the next paragraph, is a significant aid to this process.

3-121. Bus Messages. When all the bus operations are organized according to how they are physically implemented on the HP-IB, twelve unique Bus Messages are found:

	DATA
	Data Send (to -hp- 3336)
	Data Receive (from -hp- 3336)
	TRIGGER
System Management	REMOTE
	LOCAL
	LOCAL LOCKOUT
	CLEAR LOCKOUT/SET LOCAL
	CLEAR
	REQUIRE SERVICE
	STATUS BYTE
	PASS CONTROL
	ABORT
	STATUS BIT

The Data Message implements the primary purpose of the HP-IB. It is used to send the codes that activate instrument functions and transfer measurement data from one device to another. This message is subdivided into Data Send and Data Receive for operator convenience. Technically, there is no difference between Data Messages used to send and receive information. The Trigger Message causes simultaneous action in two or more devices on the bus. The action executed depends upon the design of the particular instrument. The -hp-3336 does not respond to the Trigger Message. The remaining ten Bus Messages are used to manage the system. Their only purpose is to facilitate the implementation of the Data Trigger Messages.

3-122. Implementing Bus Messages. Recall that the objective is to answer the question:

“What instructions must be entered on the controller to cause a particular action in the instrument?”

This question is answered by converting the Bus Messages into controller statements that cause the desired action in the instrument when executed by the controller. Since these twelve messages describe every possible HP-IB operation, converting them to controller statements will enable the operator to implement every possible HP-IB operation. A procedure for converting the Bus Messages to controller statements follows.

NOTE

If the controller used in your system is a -hp- 9825A, Desktop Computer, substitute the appropriate Bus Message Implementation Table in Appendix C for Table 3-1. The appropriate controller statements that implement each bus message are given in this table. If you do make this substitution, be sure to study the descriptions of the Bus Messages thoroughly. The information supplied is not restricted to that required to convert the Bus Messages.

3-123. *Step One.* Choose one of the Bus Messages for conversion. Begin with the System Management Messages since they are usually easier to convert to controller statements than the Trigger or Data Messages. Locate the description of the Bus Message in this manual. The description of each message contains the following information as applicable:

- the response of the -hp- 3336 to the message.
- the device dependent information required for the controller statement.
- any prerequisite operations.
- suggestions for optimizing the use of the message.

The device dependent information required for the controller statement is always found under the heading Implementation.

NOTE

1. *The Require Service Message originates at the instrument rather than at the controller. Consequently, there is no controller message that implements this message. This does not diminish the importance of this message to the operator. Study it carefully in turn.*

2. *The Status Bit, Pass Control, Abort, and Trigger Messages can not be implemented because the -hp- 3336 does not have the capacity or the need to respond to them.*

3-124. *Step Two.* Find the description of the selected Bus Message in the controller documentation. This description usually consists of the following information:

- one or more controller statements that implement the message.
- mnemonics for the controller statements.
- syntax of the controller statements.
- suggestions for optimizing the implementation of the message.

3-125. *Step Three.* Integrate the device dependent information, found in Step One, with the controller dependent information found in Step Two. The syntax of the controller statement explains how this should be done.

3-126. *Step Four.* Record the statements that implement each Bus Message in Table 3-1 as they are found. The operator needs to translate the Bus Messages only once. Table 3-1 can be used as a quick reference when writing programs in the future and should be included in your system documentation.

3-127. When searching for a message in the controller documentation, it is usually best to start with the Table of Contents. If the message is not referenced there, look in the Index. In order to use the twelve bus messages, the controller documentation must organize the Input/Output Operation programming statements according to the definitions of the twelve messages. It would be unusual for any manufacturer of controllers to do otherwise. The exact nomenclature, however, used to describe the Bus Messages may vary from one manufacturer to another.

NOTE

If your controller documentation does not contain a programmable statement for a particular Bus Message, the controller may not be capable of implementing the message.

Table 3-1. Bus Message Implementation Table.

		Controller	Instrument #1	Instrument #2
	Select Code		-hp- 3336	
	Device		7	
	Listen		04	
	Talk		\$	
			D	
Bus Message	Description	Sample Implementation		
Data	Output text and variables to single devices.		yes	
	Output single characters.		yes	
	Input data from a device.		yes	
	Input single characters.		yes	
	Specify addresses and send data in ASCII form.		yes	
	Output data to multiple listeners.		yes	
	Output data to multiple listeners.		yes	
	Transfer data from device to device.		yes	
Trigger	Send a "Group Execute Trigger" to all devices.		no	
	Send a "Group Execute Trigger" to selected devices.		no	
Clear	Clear all devices.		yes	
	Clear selected devices.		yes	
Remote	Enable remote mode on all devices. Device will remote when addressed.		yes	
	Set remote on selected devices.		yes	
Local	Return selected device to front panel control.		yes	
Local Lockout	Prevent all devices from returning to local mode.		yes	
Clear Lockout/ Set Local	Set local mode and disable local lockout on all devices.		yes	
Pass Control	Transfer bus management to another controller.		yes	
Serial Poll (Status Byte)	Input the Status Byte of a selected device.		yes	
Abort I/O	Clear all bus operations and return the bus management to the system controller.		no	
Require Service	Request Service from the controller.	Normally originates from the device.	yes*	

* Controllers can send the Requires Service message, however, normally this message originates from the device. The -hp- 3336 can send this message. It will not respond to a service request from another device or controller.

3-128. System Management Messages.

3-129. The purpose of the ten System Management Messages is to control the system so that Data and Trigger messages can be sent as desired.

3-130. Remote. When it is first turned on, the -hp- 3336 is in the Local mode and under front panel control. In order to be operated over the HP-IB, it must be switched to the Remote mode. The Remote Message switches the instrument to the Remote mode. In this mode, the only operational front panel controls are the Power switch and the Local key (see Local Lockout Message, Paragraph 3-134). All other instrument functions are activated over the HP-IB through the system controller. The instrument configuration does not change when switched to Remote.

3-131. Implementation. The syntax and mnemonics for the program statement(s) that implements the Remote Message are found in the controller documentation. Only the listen address, which is \$ for the -hp- 3336, must come from the instrument documentation. A technical description of the implementation of the Remote Message is presented in Figure 3-A-1 of Appendix A.

3-132. Local. The Local Message switches the -hp- 3336 from Remote to Local operation. The instrument is operated using front panel controls while in the Local mode. Another way to switch the instrument to the Local mode is to actuate the front panel Local control (see Local Lockout Message, Paragraph 3-134).

3-133. Implementation. The syntax and mnemonics for the program statement that implements the Local Message are found in the controller documentation. Only the listen address, which is \$ for the -hp- 3336, is taken from the instrument documentation. An instrument must be addressed to listen in order for it to enter the Local mode. A technical description of the Local Message implementation is presented in Figure 3-A-2 of Appendix A.

3-134. Local Lockout. The Local Lockout Message disables the Local control on the front panel of the -hp- 3336. All devices on the HP-IB with Local Lockout capability will respond when this message is sent. The instrument can be switched to Local mode by executing the Local Message. Local Lockout, however, will still be in effect if the instrument is switched back to the Remote mode. To remove Local Lockout, see Paragraph 3-136, Clear Lockout/Set Local Message.

3-135. Implementation. The entire program statement that implements the Local Lockout Message is found in the controller documentation. No part of the program statement depends on the individual instrument. A technical description of the Local Lockout Message implementation is presented in Figure 3-A-3 of Appendix A.

3-136. Clear Lockout/Set Local. This message switches all instruments on the HP-IB to the Local mode and clears all Local Lockout conditions. Other methods to accomplish the same thing are to disconnect the HP-IB cable, turn the controller off or turn the individual instruments off.

3-137. Implementation. The entire program statement that implements the Clear Lockout/Set Local Message is found in the controller documentation. No part of the program statement depends on the individual instrument. A technical description of the Clear Lockout/Set Local Message is presented in Figure 3-A-4 of Appendix A.

3-138. Clear. The Clear Message resets instruments to a predefined state. The predefined state of the -hp- 3336 is its turn on state (see Paragraph 3-10), except that stored instrument states are retained. The Clear Message can be a universal instruction, resetting all devices on the bus capable of responding, or an addressed instruction sent to selected devices only.

3-139. Implementation. When the Clear Message is a universal instruction, the entire program statement is found in the controller documentation. When it is an addressed instruction, the syntax and mnemonics of the program statement are found in the controller documentation. A technical description of the Clear Message implementation is presented in Figure 3-A-5 of Appendix A.

NOTE

The -hp- 3336 will respond to a universal Clear Message when it is in the Local operation mode.

3-140. Require Service. The Require Service Message is a request for service which is sent from a device on the HP-IB to the active controller. Any of the following conditions in the -hp- 3336 can, when enabled, generate a Require Service Message:

- Received an unrecognizable program string.
- Sweep started.
- Sweep stopped.
- System failure; External reference unlocked or main oscillator failure, "OSC FAIL"

All conditions that cause a Require Service Message from the -hp- 3336 are disabled (masked) at turn-on. The condition or conditions that will cause a Require Service Message are enabled using the Data Message, Paragraph 3-151. The Require Service Message is completely independent of all other bus activity. It is sent on a single line (wire) called the SRQ Line, whose state is either true or false. This line is shared by all devices on the HP-IB. If the controller is programmed to respond when a Require Service Message is received, the controller must determine which device or devices are requesting service. This is accomplished by conducting a Serial Poll. Each polled device responds by sending a Status Poll. Each polled device responds by sending a Status Byte which indicates, among other things, whether or not the device requested service. Serial Polling and Status Byte Messages are fully explained in the discussion of the Status Byte Message (see Paragraph 3-142, Status Byte). The Require Service Message will be cleared when the device sending it is polled or the condition causing it disappears. In some applications, the controller is programmed to interrupt its main program and respond to a Require Service Message immediately. In other applications, it may periodically check the status of the Service Request Line and respond when a request is discovered.

3-141. Implementation. The Require Service Message originates in the devices on the bus. A technical description of its implementation is presented in Figure 3-A-10 of Appendix A.

3-142. Status Byte. A Status Byte Message is sent by a device on the bus to the active controller. The individual bits of the Status Byte indicate the status of various instrument functions and whether the instrument requested service. Once the Status Byte of an instrument is in the controller, the status of the instrument functions may be determined by examining the truth state of each bit. The controller can be programmed to take the appropriate action based upon the functional status of the bus instruments. For example, if bit 6 of the -hp- 3336

Status Byte is true, the -hp- 3336 requests service. If bit 0 is also true, the reason it requested service is because the -hp- 3336 received a program string it could not recognize or respond to. In this case, the appropriate action may be to print a message advising the operator that the -hp- 3336 received an invalid instruction. Only the instrument status associated with bits 0 thru 3 can cause service requests. See Masking Service Requests.

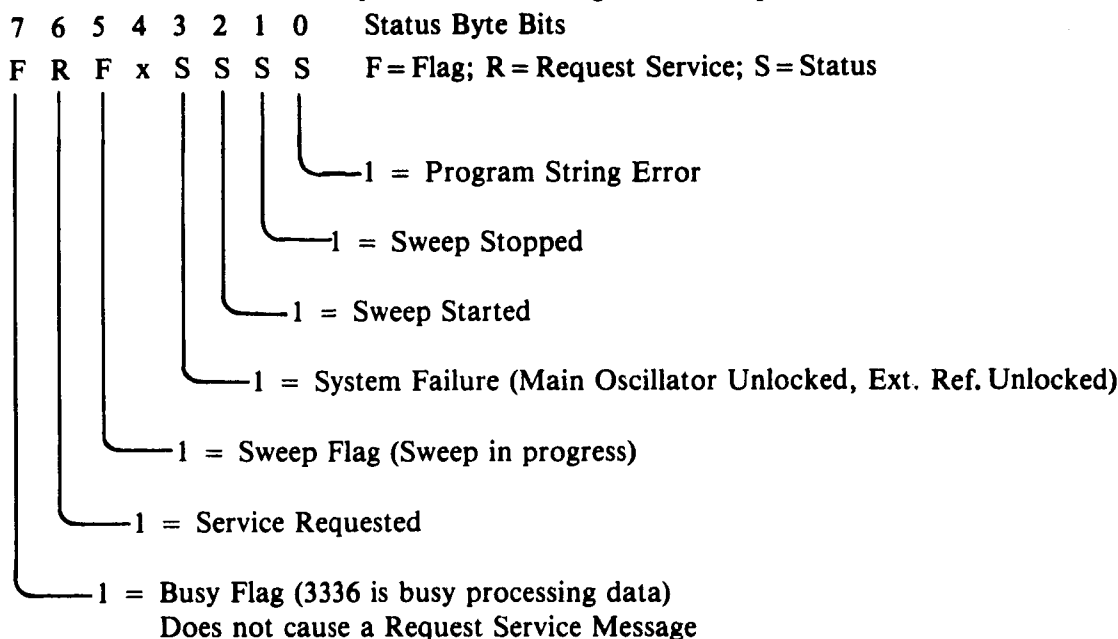

3-143. Status Bytes are requested by the controller by conducting a Serial Poll (see Paragraph 3-144, Serial Polling). Usually, a serial poll is conducted in response to a Require Service Message received from an instrument on the HP-IB. Occasionally, a Serial Poll is conducted even though a Require Service Message was not received. The programmer may wish to check the status of an instrument function that is encoded in the Status Byte but does not generate a Service Request. There are two and up to six such functions in the -hp- 3336. Bit 0 through bit 3 of the Status Byte are maskable. That is, the corresponding conditions of each bit will not cause a Service Request unless programmed to do so. Bit 7 of the Status Byte is the Busy Flag. This bit will be true (1) when the -hp- 3336 is processing instructions and is not capable of communicating, except for the Status Byte, over the HP-IB.

3-144. Serial Polling. A Serial Poll is a routine in the program that sequentially requests the Status Byte from some or all devices on the HP-IB. The structure of the routine depends on the way the controller implements the Serial Poll and the purpose of the poll. Some controllers have a single program statement that enables a Serial Poll, polls the addressed device and then disables the Serial Poll. In this case, a Serial Poll of a system consists of several Serial Polls (one for each device). Recall that Serial Polls are sometimes conducted on a single device to learn the status of an instrument that is encoded in the Status Byte but does not generate a Service Request.

3-145. Implementation. The syntax and mnemonics for the controller statements that implement a Serial Poll are found in the controller documentation. The structure of the Serial Poll (what instruments to be polled in what order) routine is developed in accord with the total system. Only the listen addresses of the devices to be polled and the definitions of the bits in the Status Byte are taken from the instrument documentation. The listen address of the -hp- 3336 is \$. A technical description of the Status Byte Message implementation is presented in Figure 3-A-8 of Appendix A.

3-146. Status Bit. The Status Bit Message is sent from a device on the bus to the active controller. It communicates the truth state of a predefined condition which may describe a specific instrument function or the entire instrument condition. The advantage of the Parallel Poll is that the status of up to eight devices can be checked at the same time. The -hp- 3336 does not respond to a Parallel Poll. Refer to the controller documentation or the documentation of an instrument with Parallel Poll capabilities for more information about the Status Bit.

3-147. Pass Control. The Pass Control Message transfers the management of the bus from the system controller to another device with controller capability in the system. The -hp-3336 does not have controller capability. See the controller documentation or the documentation of a device with controller capability for more information about the Pass Control Message.

3-148. Abort. The Abort Message is used by the system controller to regain control of the HP-IB from the active controller. See the system controller documentation for more information about the Abort Message.

3-149. Trigger. The Trigger Message causes a predefined response in each device receiving it. When more than one device receives the Trigger Message, the predefined response in all devices occurs simultaneously. The -hp- 3336 does not respond to the Trigger Message. See the controller documentation or the documentation of a device capable of responding for more information about the Trigger Message.

3-150. Remote Operation of the -hp- 3336.

3-151. Data. Almost every function of the -hp- 3336 can be activated remotely by sending Instrument Programming Codes over the HP-IB. The Instrument Programming Codes are sent using the Data Message.

3-152. Implementation. Usually, there are several controller statements that will implement the Data Message. Each statement will have some unique advantage. Thoroughly research this Bus Message in the controller documentation to be certain you are using the optimum statement for your application. The syntax and mnemonics for the controller statement come from the controller documentation. The instrument listen address, which is \$ for the -hp- 3336, and the Instrument Programming Codes come from the instrument documentation. The Instrument Programming Codes and their format are presented in the paragraphs that follow.

3-153. Instrument Programming Codes. All of the -hp- 3336 programming codes and their binary, octal, decimal, and hexadecimal values are presented in Table 3-2. Each programming code is an instruction to the instrument. In most cases, sending these instructions corresponds to pressing front panel controls during local operation. For instance, receiving the ASCII characters AM during remote operation has the same effect as pressing the AMPLITUDE entry key during local operation. There are exceptions to this one to one relationship. They are:

All "ON/OFF" and "FAST/SLOW" type controls have separate ASCII instructions to select each mode.

These front panel controls or operations are NOT available to the HP-IB programmer:

- Δ x2 —display BUS ADDRESS
- Δ f - 2 —all controls in the Modify Group
- MKR—CF —CLEAR display

These HP-IB operations are NOT available from the front panel:

- Data Transfer Mode Selection
- Service Request Masking
- Interrogation of Programming Errors

3-154. Data Transfer Mode Selection. The -hp- 3336 accepts Data Messages in one of two Data Transfer Modes.

a. Data Transfer Mode 1. The -hp- 3336 is in Data Transfer Mode 1 at turn-on and while in this mode, each Instrument Programming Code is processed when received. That is, the instrument immediately performs the instruction. The -hp- 3336 can NOT receive another character until the instrument has completely performed the previous instruction. The time required to transfer data has been extended by the time -hp- 3336 takes to perform the instruction. The advantage of Mode 1 is that it is less complicated to use but as your system sophistication increases, the advantage of faster programming time makes Data Transfer Mode 2 important.

b. Data Transfer Mode 2. The -hp- 3336 accepts and stores a string of Program Instruction Codes in an internal buffer when it is in Data Transfer Mode 2. These codes are NOT processed until the buffer is full (48 characters) or the EOS (End of String) character is received. The advantage of Data Transfer Mode 2 is that after a string of instructions is sent to the -hp- 3336, at the fastest rate the instrument can accept them (150-200 μ sec per character), communication can take place between other devices on the bus. A "Busy" flag, encoded into bit 7 of the Status Byte, indicates when the instrument is "Busy" processing a string of instructions. The instrument can NOT accept Data Messages during the time it is "Busy". If a string longer than 48 characters is sent, the instrument will "hold up" the bus until the first 48 characters are processed and the remaining characters are accepted. Therefore, to realize the maximum effectiveness, a program string longer than 48 characters should be divided and an EOS character sent after (or at a convenient place before) the 48th character. Data Transfer Mode 2 must be remotely programmed. The instrument will remain in Mode 2 until Mode 1 is programmed or the POWER switch is set to STBY.

Table 3-2. Instrument Programming Codes—Data Receive.

Instruction	ASCII Code	Binary Code	Octal Code	Decimal Code	Hexadecimal Code
Entry Parameters					
Frequency	F	01000110	106	70	46
	F	01000110	106	70	46
or	F	01000110	106	70	46
	R	01010010	122	82	52
Amplitude	A	01000001	101	65	41
	M	01001101	115	77	4D
Phase	P	01010000	120	80	50
	H	01001000	110	72	48
Sweep Start Frequency	S	01010011	123	83	53
	T	01010100	124	84	54
Sweep Stop Frequency	S	01010011	123	83	53
	P	01010000	120	80	50
Marker Frequency	M	01001101	115	77	4D
	F	01000110	106	70	46
Sweep Time	T	01010100	124	84	54
	I	01001001	111	73	49
Digits					
0	0	00110000	060	48	30
1	1	00110001	061	49	31
2	2	00110010	062	50	32
3	3	00110011	063	51	33
4	4	00110100	064	52	34
5	5	00110101	065	53	35
6	6	00110110	066	54	36
7	7	00110111	067	55	37
8	8	00111000	070	56	38
9	9	00111001	071	57	39
.	.	00101110	056	46	2E
+	+	00101011	053	43	2B
-	-	00101101	055	45	2D
Units					
Hertz	H	01001000	110	72	48
	H	01001000	110	72	48
or	H	01001000	110	72	48
	Z	01011010	132	90	9A
Kilo-Hertz	K	01001011	113	75	8B
	H	01001000	110	72	48
Mega-Hertz	M	01001101	115	77	4D
	H	01001000	110	72	48
dBm	D	01000100	104	68	44
	B	01000010	102	66	42
Degrees	D	01000100	104	68	44
	E	01000101	105	69	45
Seconds	S	01010011	123	83	53
	E	01000101	105	69	45

Table 3-2. Instrument Programming Codes—Data Receive (Cont'd).

Instruction	ASCII Code	Binary Code	Octal Code	Decimal Code	Hexadecimal Code
Leveling Loop Speed					
Fast Leveling Off	F	01000110	106	70	46
Leveling Off	L	01001100	114	76	4C
Off	Ø	00110000	060	48	30
Fast Leveling On	F	01000110	106	70	46
Leveling On	L	01001100	114	76	4C
On	1	00110001	061	49	31
Data Transfer Mode					
Mode 1	M	01001101	115	77	4D
	D	01000100	104	68	44
	1	00110001	061	49	31
Mode 2	M	01001101	115	77	4D
	D	01000100	104	68	44
	2	00110010	062	50	32
Sweep Mode					
Linear Sweep	S	01010011	123	83	53
	M	01001101	115	77	4D
	1	00110010	061	49	31
Log Sweep	S	01010011	123	83	53
	M	01001101	115	77	4D
	2	00110010	062	50	32
Assign Zero Phase	A	01000001	101	65	41
	P	01010000	120	80	50
*Start Single Sweep	S	01010011	123	83	53
Start Continuous Sweep	S	01010011	123	83	53
Store Program	C	01000011	103	67	43
	R	01010011	123	83	53
plus one digit (0 thru 9)	R	01010010	122	82	52
Recall Program	R	01010010	122	82	52
plus one digit (0 thru 9)	E	01000101	105	69	45
Masking Service Requests	M	01001101	115	77	4D
	S	01010011	123	83	53
and one of the following	@	01000000	100	64	40
	A	01000001	101	65	41
	B	01000010	102	66	42
	C	01000011	103	67	43
	D	01000100	104	68	44
	E	01000101	105	69	45
	F	01000110	106	70	46
	G	01000111	107	71	47
	H	01001000	110	72	48
	I	01001001	111	73	49
	J	01001010	112	74	4A
	K	01001011	113	75	4B
	L	01001100	114	76	4C
	M	01001101	115	77	4D
	N	01001110	116	78	4E
	O	01001111	117	79	4F
EOS (End of String)					
Line Feed	LF	00001010	12	10	A
or Asterisk	*	00101010	52	42	2A

*Start Single code must be sent twice "SSSS". The first "SS" resets the sweep to start conditions and the second "SS" starts the sweep.

Table 3-2. Instrument Programming Codes--Data Receive (Cont'd).

Instruction	ASCII Code	Binary Code	Octal Code	Decimal Code	Hexadecimal Code
Output Selection by Model					
Model 3336A					
75 ohm	0	01001111	117	79	4F
	1	01001001	111	73	49
	1	00110001	061	49	31
150 ohm	0	01001111	117	79	4F
	1	01001001	111	73	49
	2	00110010	116	78	4E
600 ohm	0	01001111	117	79	4F
	1	01001001	111	73	49
	3	00110011	063	51	33
Model 3336B					
75 ohm	0	01001111	117	79	4F
	1	01001001	111	73	49
	1	00110001	061	49	31
124 ohm	0	01001111	117	79	4F
	1	01001001	111	73	49
	2	00110010	062	50	32
135 ohm	0	01001111	117	79	4F
	1	01001001	111	73	49
	3	00110011	063	51	33
600 ohm	0	01001111	117	79	4F
	1	01001001	111	73	49
	4	00110100	064	52	34
Model 3336C					
50 ohm	0	01001111	117	79	4F
	1	01001001	111	73	49
	1	00110001	061	49	31
75 ohm	0	01001111	117	79	4F
	1	01001001	062	50	32
	2	00110010	062	50	32
Modulation					
Amplitude Modulation Off	M	01001101	115	77	4D
	A	01000001	101	64	41
	Ø	00110000	060	48	30
Amplitude Modulation On	M	01001101	115	77	4D
	A	01000001	101	64	41
	1	00110001	102	49	31
Phase Modulation Off	M	01001101	115	77	4D
	P	01010000	120	80	50
	Ø	00110000	060	48	30
Phase Modulation On	M	01001101	115	77	4D
	P	01010000	120	80	50
	1	00110001	061	49	31
Amplitude Blanking					
Amplitude Blanking Off	A	01000001	101	65	41
	B	01000010	102	66	42
	Ø	00110000	060	48	30
Amplitude Blanking On	A	01000001	101	65	41
	B	01000010	102	66	42
	1	00110001	061	49	31

3-155. Masking Service Requests. At instrument turn-on, all four SRQ conditions are masked (disabled) from generating a Request Service Message. The true states of these four conditions are encoded into the Status Byte (bits 0 thru 3). Any combination of these four conditions can be enabled by sending one of the following Program Instruction Codes:

Instrument Programming Codes (ASCII)	System Fail Bit 3	Sweep Start Bit 2	Sweep Stop Bit 1	Program Error Bit 0
MS@	Mask	Mask	Mask	Mask
MSA	Mask	Mask	Mask	Enable
MSB	Mask	Mask	Enable	Mask
MSC	Mask	Mask	Enable	Enable
MSD	Mask	Enable	Mask	Mask
MSE	Mask	Enable	Mask	Enable
MSF	Mask	Enable	Enable	Mask
MSG	Mask	Enable	Enable	Enable
MSH	Enable	Mask	Mask	Mask
MSI	Enable	Mask	Mask	Enable
MSJ	Enable	Mask	Enable	Mask
MSK	Enable	Mask	Enable	Enable
MSL	Enable	Enable	Mask	Mask
MSM	Enable	Enable	Mask	Enable
MSN	Enable	Enable	Enable	Mask
MSO	Enable	Enable	Enable	Enable

3-156. Formats for Instrument programming Codes. The format for the programming codes is identical to the front panel (manual) operation. A unique one, two or three ASCII character programming code is sent to the instrument to activate the same functions that are activated by front panel switches in manual operation. For example, the instruction AB1 programs Amplitude Blanking ON. While the characters comprising each programming code must be received in a certain order, the order in which the programming codes are received is not important. Sending "AB0, FL1, MP1" or "MP1, FL2, AB0" result in the activation of the same functions, Amplitude Blanking OFF, Fast Leveling ON, and Phase Modulation ON, but in reverse order. Note, the -hp- 3336 ignores commas and spaces. They are included for operator clarity.

3-157. When the -hp- 3336 is in the Local mode, certain instrument functions are set using SEVERAL front panel controls. For instance, to enter Frequency, the FREQUENCY key, the appropriate digits including the decimal point, and then the appropriate frequency UNITS key (MHz, kHz, Hz) is pressed. Obviously, the order in which the controls are actuated is important. When operating in the Remote mode, the same method is used to set the Entry Frequency except that ASCII characters are sent over the HP-IB to activate the instrument functions instead of pressing front panel controls. The ASCII character group "FR" activates the function controlled by the FREQUENCY key, ASCII digits correspond to the digit keys and the ASCII character groups "MH", "KH", "HZ" correspond to the MHz, kHz and Hz units keys. For example, to program the -hp- 3336 to output 12.534 763 MHz, the ASCII character group "FR12.534763MH" is sent. As before, the order within the character group is important, however, the character group can be placed anywhere within a larger group of instrument instructions.

3-158. Data (Receive). In addition to the information about the instrument encoded into the Status Byte (see Paragraph 3-142), the following instrument functions may be individually interrogated and the -hp- 3336 will return the value or state of the function using the Data message:

- Frequency
- Amplitude
- Phase
- Sweep Start Frequency
- Sweep Stop Frequency
- Sweep Marker Frequency
- Amplitude Blanking On/Off
- Sweep Time
- Output Impedance
- Programming Errors
- Sweep Mode (Log/Linear)
- Amplitude Modulation (On/Off)
- Phase Modulation (On/Off)
- Leveling Loop Speed (Fast/Slow)

3-159. Implementation. The interrogation of an instrument function is a two step process. That is, the instrument must be sent the Programming Code (IFR for instance) and then the instrument must be addressed to Talk. At this time the -hp- 3336 will return the data asked for. The syntax and mnemonics for the controller statements come from the controller documentation. In the first step, the instrument listen address, which is \$ for the -hp- 3336, and the Instrument Programming Codes come from the instrument documentation. In the second step, only the instrument Talk address, which is D for the -hp- 3336, comes from the instrument documentation. The Instrument Programming Codes and their binary, octal, decimal, and hexadecimal values are presented in Table 3-4.

NOTE

When using Data Transfer Mode 2 (see Paragraph 3-154), the Interrogate instruction must be placed at the end of the string of Programming Codes or programming errors will occur. Only one interrogating instruction may be sent in each string.

Table 3-3. Instrument Programming Codes—Data Send.

Instruction	ASCII Code	Binary Code	Octal Code	Decimal Code	Hexadecimal Code
Interrogation					
Frequency	I	01001001	111	73	49
	F	01000110	106	70	46
	R	01010010	122	82	52
or	I	01001001	111	73	49
	F	01000110	106	70	46
	F	01000110	106	70	46
Amplitude	I	01001001	111	73	49
	A	01000001	101	65	41
	M	01001101	115	77	4D
Phase	I	01001001	111	73	49
	P	01010000	120	80	50
	H	01001000	110	72	48
Sweep Start Frequency	I	01001001	111	73	49
	S	01010011	123	83	53
	T	01010100	124	84	54
Sweep Stop Frequency	I	01001001	111	73	49
	S	01010011	123	83	53
	P	01010000	120	80	50

Table 3-3. Instrument Programming Codes—Data Send (Cont'd).

Instruction	ASCII Code	Binary Code	Octal Code	Decimal Code	Hexadecimal Code
Sweep Marker Frequency	I	01001001	111	73	49
	M	01001101	115	77	4D
	F	01000110	106	70	46
Sweep Time	I	01001001	111	73	49
	T	01010100	124	84	54
	I	01001001	111	73	49
Output Impedance	I	01001001	111	73	49
	O	01001111	117	79	4F
	I	01001001	111	73	49
Sweep Type	I	01001001	111	73	49
	S	01010011	123	83	53
	M	01001101	115	77	4D
Amplitude Modulation State	I	01001001	111	73	49
	M	01001101	123	83	53
	A	01000001	101	65	41
Phase Modulation State	I	01001001	111	73	49
	M	01001101	123	83	53
	P	01010000	120	80	50
Error Codes	I	01001001	111	73	49
	E	01000101	105	69	45
	R	01010010	122	82	52
Amplitude Blanking State	I	01001001	111	73	49
	A	01000001	101	65	41
	B	01000010	102	66	42
Fast Leveling	I	01001001	111	73	49
	F	01000110	106	70	46
	L	01001100	114	76	4C
Carriage Return	CR	00001101	15	13	D
Line Feed	LF	00001010	12	10	A

3-160. Data Formats. The format of the data that is returned is illustrated in the following paragraphs. The characters that are used in the illustrations and their definitions are:

- D = ASCII digits 0 through 9
- 0 = ASCII digit 0 (zero)
- .
- = ASCII minus sign
- CR = ASCII carriage return
- LF&EOI = ASCII line feed concurrent with EOI message

All other characters are the actual ASCII characters used.

Spaces have been added to the illustrations for operator clarity but are not used by the instrument.

a. Frequency. After receiving "IFR" or "IFF", the -hp- 3336 will return its frequency, in Hz, formatted as follows:

FR DDDDD.DDDDDD HZ CR LF&EOI For frequencies with more than 3 significant digits after the decimal point.

or

FR DDDDDDDD.DDD HZ CR LF&EOI For frequencies with less than 3 significant digits after the decimal point.

b. Amplitude. After receiving "IAM", the -hp- 3336 will send its output amplitude, in dBm, formatted as follows:

AM ~~000000~~ DD.DD~~0~~ DB CR LF&EOI A minus sign will replace the first zero if the value is less than 0 dBm.

c. Phase. After receiving "IPH", the -hp- 3336 will send its phase shift, in degrees, formatted as follows:

PH ~~000000~~DDD.D~~00~~ DE CR LF&EOI A minus sign will replace the first zero if the phase shift is negative.

d. Sweep Start Frequency. After receiving "IST", the -hp- 3336 will send the frequency in Hz, formatted as follows:

ST DDDDD.DDDDDD HZ CR LF&EOI For frequencies with more than 3 significant digits after the decimal point.

or

ST DDDDDDD.DDD HZ CR LF&EOI For frequencies with 3 or less significant digits after the decimal point.

e. Sweep Stop Frequency. After receiving "ISP", the -hp- 3336 will send the frequency in Hz, formatted as follows:

SP DDDDD.DDDDDD HZ CR LF&EOI For frequencies with more than 3 significant digits after the decimal point.

or

SP DDDDDDD.DDD HZ CR LF&EOI For frequencies with 3 or less significant digits after the decimal point.

f. Sweep Marker Frequency. After receiving "IMF", the -hp- 3336 will send the frequency in Hz, formatted as follows:

MF DDDDD.DDDDDD HZ CR LF&EOI For frequencies with more than 3 significant digits after the decimal point.

or

MF DDDDDDD.DDD HZ CR LF&EOI For frequencies with 3 or less significant digits after the decimal point.

g. Sweep Time. After receiving "ITI", the -hp- 3336 will send the time in seconds, formatted as follows:

T1 ~~000000~~DD.DDD SE CR LF&EOI

h. Output Impedance. After receiving "IOI", the -hp- 3336 will send a digit indicating which output is active, formatted as follows:

IO D CR LF&EOI

The digit D returned varies with the instrument model.

3336A	75 ohm	D = 1
	150 ohm	D = 2
	600 ohm	D = 3

3336B	75 ohm	D = 1
	124 ohm	D = 2
	135 ohm	D = 3
	600 ohm	D = 4
3336C	50 ohm	D = 1
	75 ohm	D = 2

i. Programming Errors. After receiving "IER", the -hp- 3336 will send a digit indicating the type of programming error, formatted as follows:

ER D CR LF&EOI

The digit D has the following definitions:

- 1 = Entry parameter data is absolutely out of bounds.
- 2 = Invalid units.
- 4 = Sweep time too small.
- 6 = Sweep bandwidth too small.
 - Start frequency too small (log sweep).
 - Start frequency is greater than stop frequency (log sweep).
- 7 = Unrecognizable program code received from HP-IB.
- 8 = Unrecognizable character received.
- 9 = Option does not exist.
- 0 = No error has occurred since the last time errors were interrogated.

j. Sweep Mode. After receiving "ISM", the -hp- 3336 will send the digit 1 or 2 indicating the sweep mode is linear (1) or logarithmic (2) formatted as follows:

SM D CR LF&EOI

k. Amplitude Modulation. After receiving "IMA", the -hp- 3336 will send the digit 0 or 1 indicating amplitude modulation is Off (0) or On (1) formatted as follows:

MA D CR LF&EOI

l. Phase Modulation. After receiving "IMP", the -hp- 3336 will send the digit 0 or 1 indicating phase modulation is Off (0) or On (1) formatted as follows:

MP D CR LF&EOI

m. Amplitude Blanking. After receiving "IAB", the -hp- 3336 will send the digit 0 or 1 indicating amplitude blanking is Off (0) or On (1) formatted as follows:

AB D CR LF&EOI

n. Fast Leveling. After receiving "IFL", the -hp- 3336 will send the digit 0 or 1 indicating that fast leveling is Off (0) or On (1) formatted as follows:

FL D CR LF&EOI

APPENDIX A

Detailed Implementation of Bus Messages

3-A-1. Introduction.

3-A-2. This appendix contains technical descriptions of the implementation of the HP-IB messages. Included at the end are two timing diagrams describing the handshake technique. The figures that comprise this appendix are:

Message	Figure
Remote	3-A-1
Local	3-A-2
Local Lockout	3-A-3
Clear Lockout/Set Local	3-A-4
Clear	3-A-5
Data (send)	3-A-6
Data (receive)	3-A-7
Serial Poll (status byte)	3-A-8
Trigger	3-A-9
Require Service	3-A-10
Pass Control	3-A-11
Abort I/O	3-A-12
Handshake	
Functional Diagram	3-A-13
Timing Relationship	3-A-14

3-A-3. Codes used in these figures are:

T = True
F = False
X = don't care

The characters sent or received on the Data lines are ASCII. The logic on the HP-IB is low true, floating high for false.

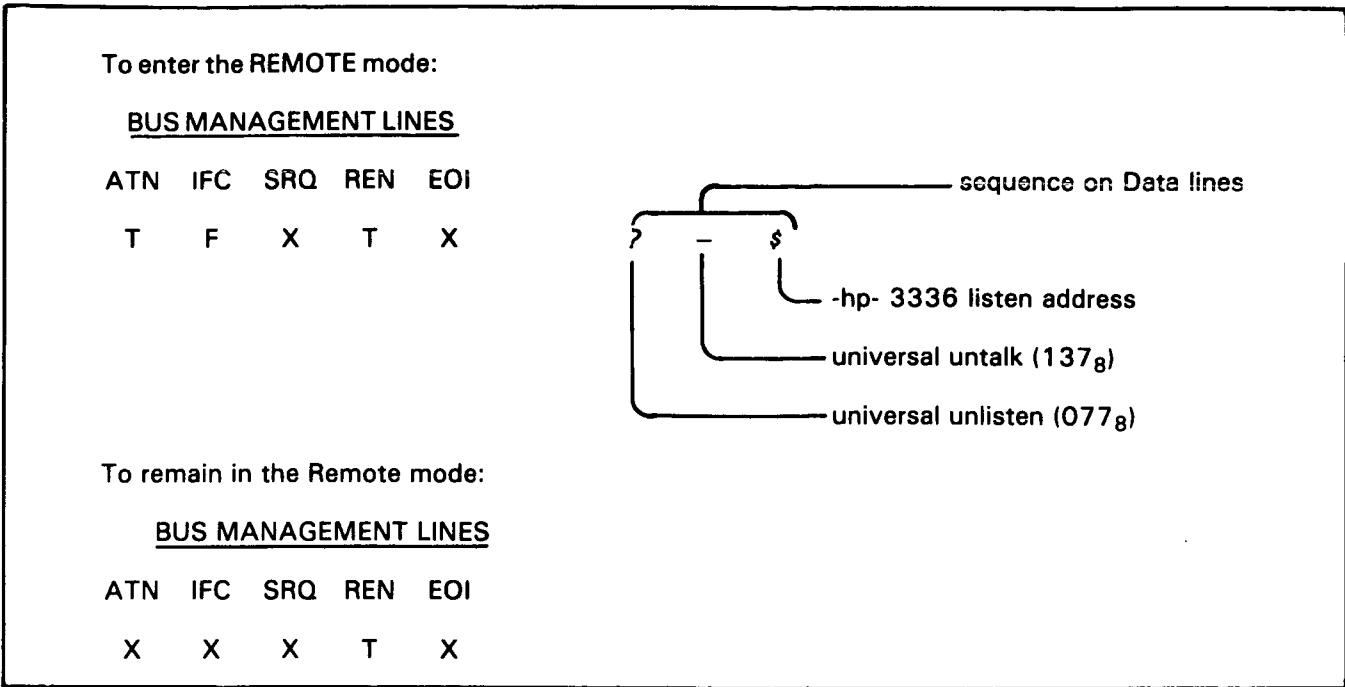

Figure 3-A-1. Remote Message.

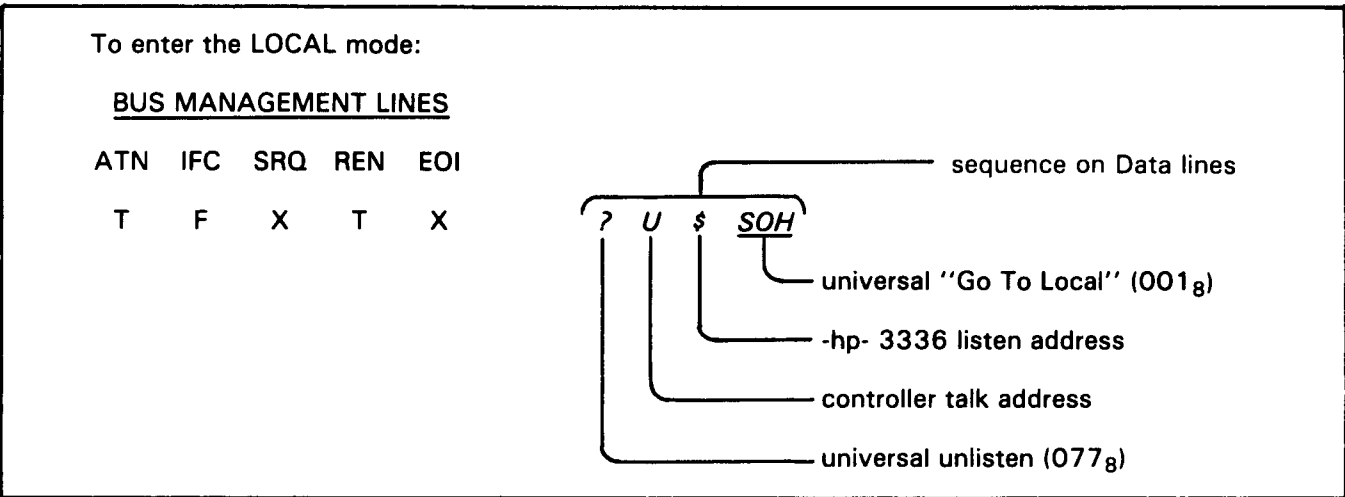

Figure 3-A-2. Local Message.

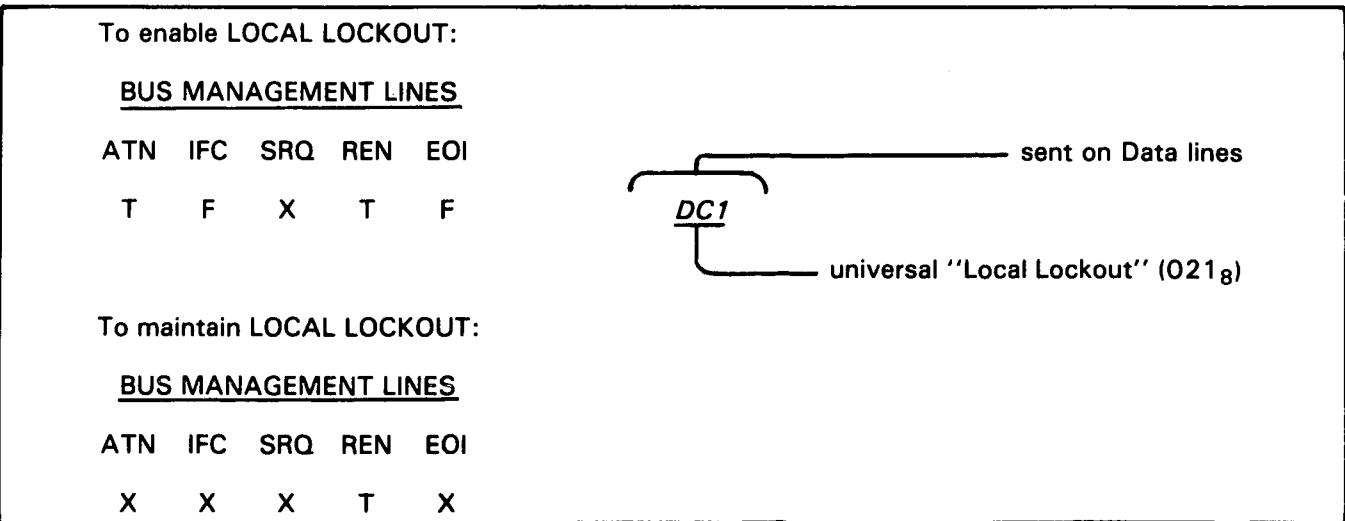

Figure 3-A-3. Local Lockout.

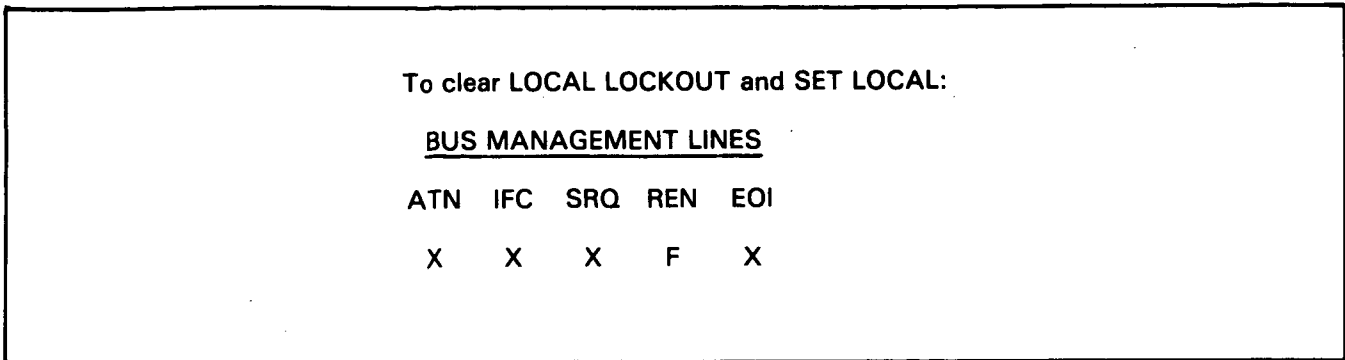

Figure 3-A-4. Clear Local Lockout/Set Local.

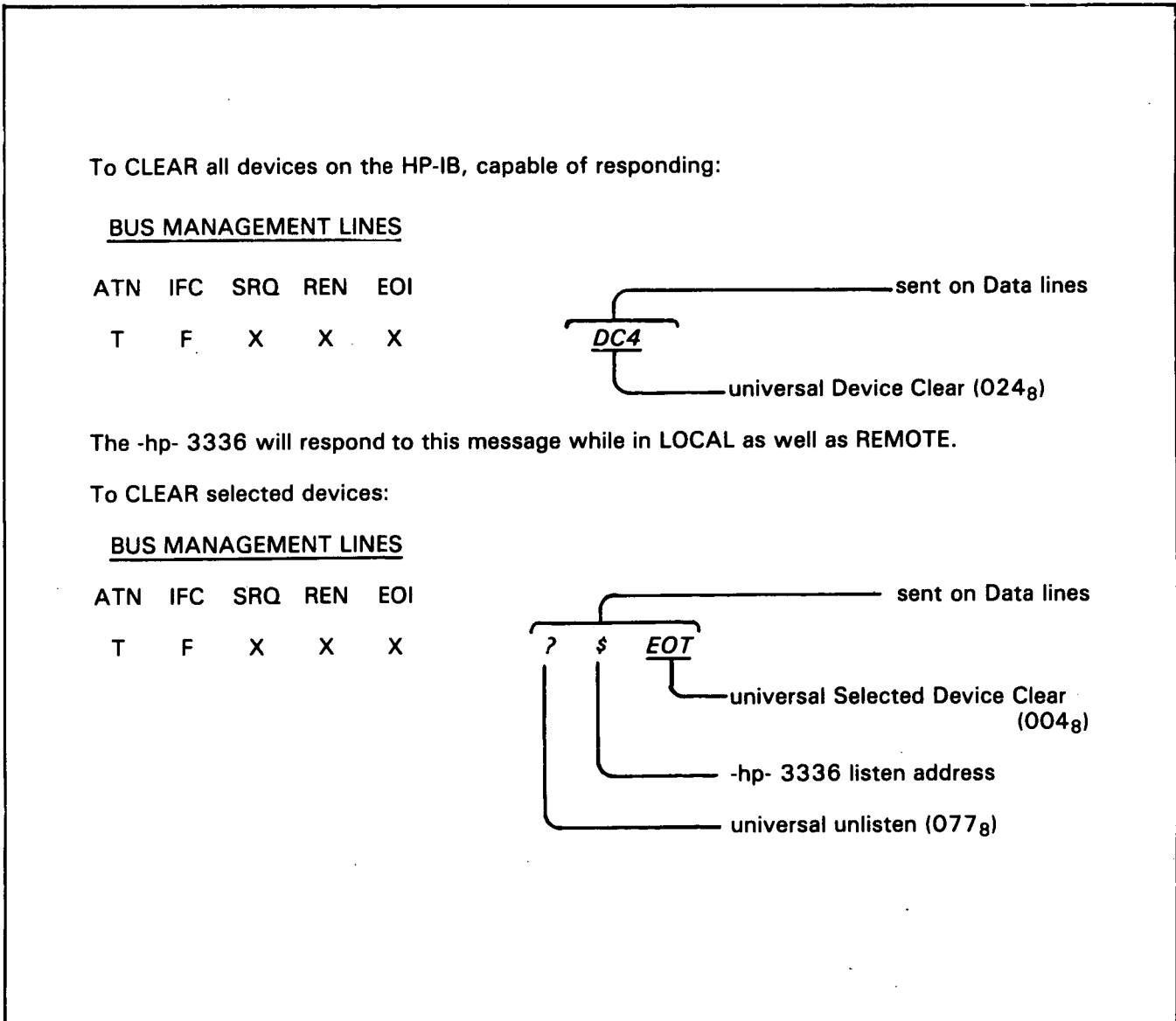

Figure 3-A-5. Clear.

To send specific programming instructions to the -hp- 3336 using the DATA message:

First:

BUS MANAGEMENT LINES

ATN	IFC	SRQ	REN	EOI
T	F	X	T	X

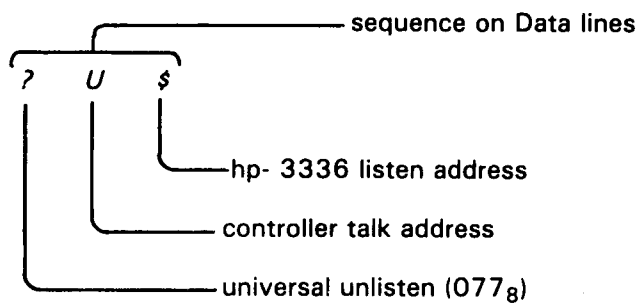

Second:

BUS MANAGEMENT LINES

ATN	IFC	SRQ	REN	EOI
F	F	X	T	X

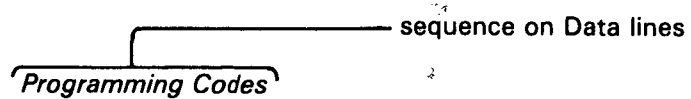

NOTE

The -hp- 3336 must already be in REMOTE.

Figure 3-A-6. Data (send).

To make the -hp- 3336 return specific information about its operating state:

First:

BUS MANAGEMENT LINES

ATN	IFC	SRQ	REN	EOI
T	F	X	T	X

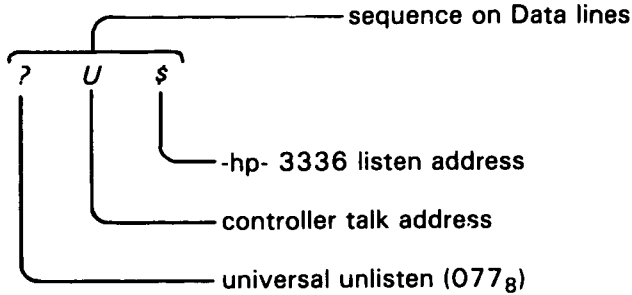

Second:

BUS MANAGEMENT LINES

ATN	IFC	SRQ	REN	EOI
F	F	X	T	X

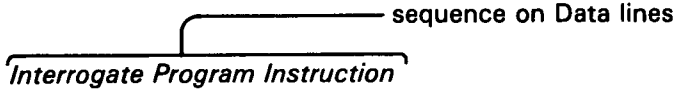

Third:

BUS MANAGEMENT LINES

ATN	IFC	SRQ	REN	EOI
T	F	X	T	X

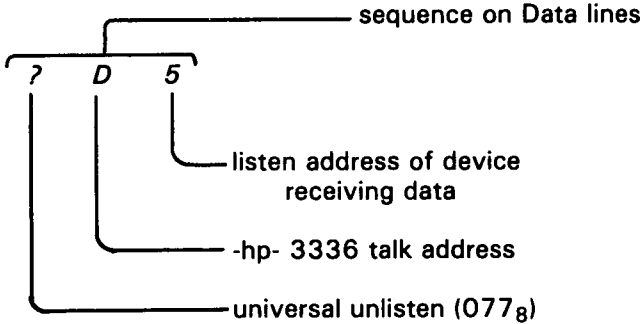

Fourth:

BUS MANAGEMENT LINES

ATN	IFC	SRQ	REN	EOI
F	F	X	T	F*

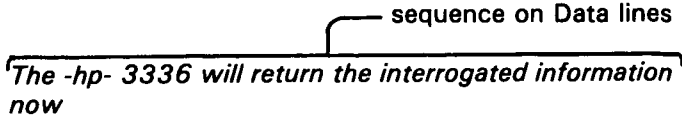

*Bus Management Line "EOI" will be true concurrent with the last character of a multi-byte message. The sending device sets this line.

Figure 3-A-7. Data (receive).

To SERIAL POLL the -hp- 3336:

First:

BUS MANAGEMENT LINES

ATN	IFC	SRQ	REN	EOI
T	F	X	X	X

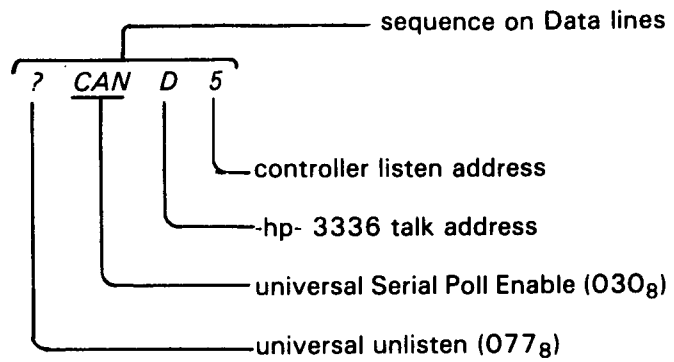

Second:

BUS MANAGEMENT LINES

ATN	IFC	SRQ	REN	EOI
F	F	X	X	X



Third:

BUS MANAGEMENT LINES

ATN	IFC	SRQ	REN	EOI
T	F	X	X	X

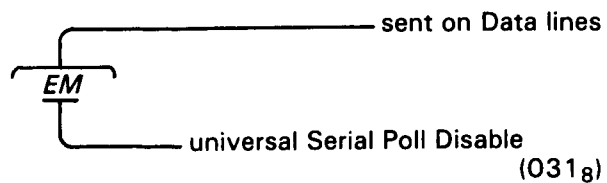

Figure 3-A-8. Serial Poll (obtaining the Status Byte).

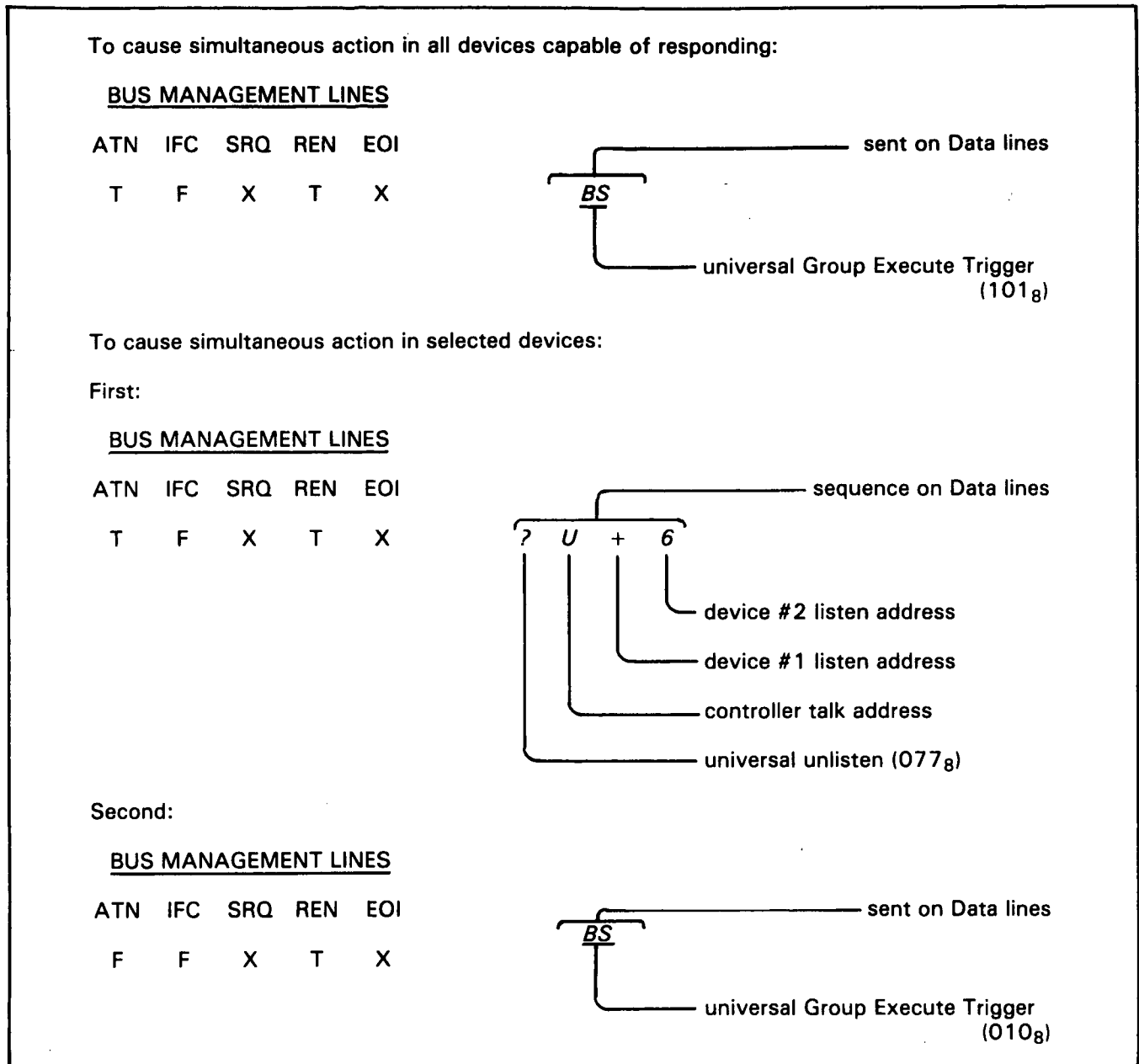

Figure 3-A-9. Trigger.

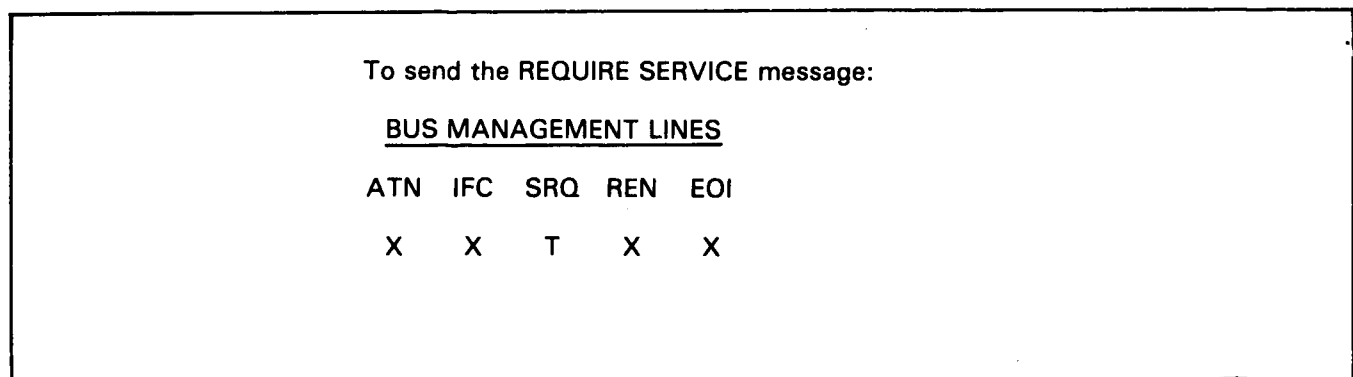

Figure 3-A-10. Require Service.

To PASS CONTROL of the HP-IB from one controller to another:

First:

BUS MANAGEMENT LINES

ATN	IFC	SRQ	REN	EOI
T	F	X	T	X

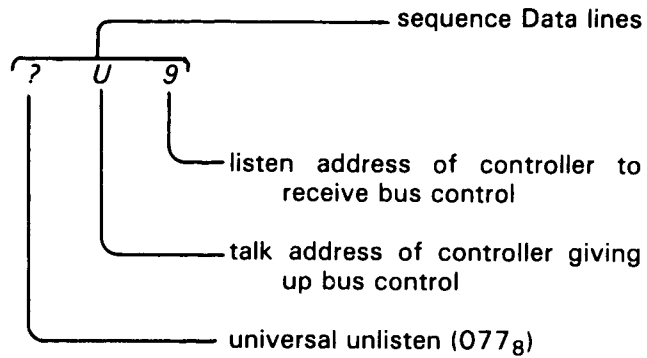

Second:

BUS MANAGEMENT LINES

ATN	IFC	SRQ	REN	EOI
F	F	X	T	X

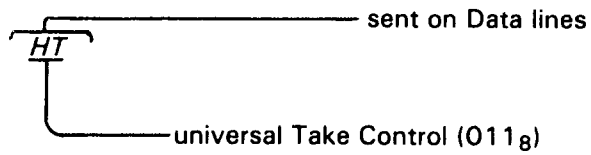

Figure 3-A-11. Pass Control.

To halt all activity and return bus control to the system controller.

BUS MANAGEMENT LINES

ATN	IFC	SRQ	REN	EOI
X	T	X	X	X

Only the system controller has this capability.

Figure 3-A-12. Abort I/O.

3-A-4. Handshake.

3-A-5. Every character on the Data Lines is asynchronously transferred among various devices using a three wire handshake technique. This technique coordinates the transfer by communicating the status of the transfer to the active controller, talker and listener. The speed of the transfer is determined by the slowest device involved in the transfer and, therefore, insures that data is not lost.

3-A-6. Figures 3-A-13 and 3-A-14 are presentations of the Handshake sequence. Handshake Lines NRFD and NDAC are controlled by the listener. The Data Lines and Handshake Line DAV are controlled by the talker.

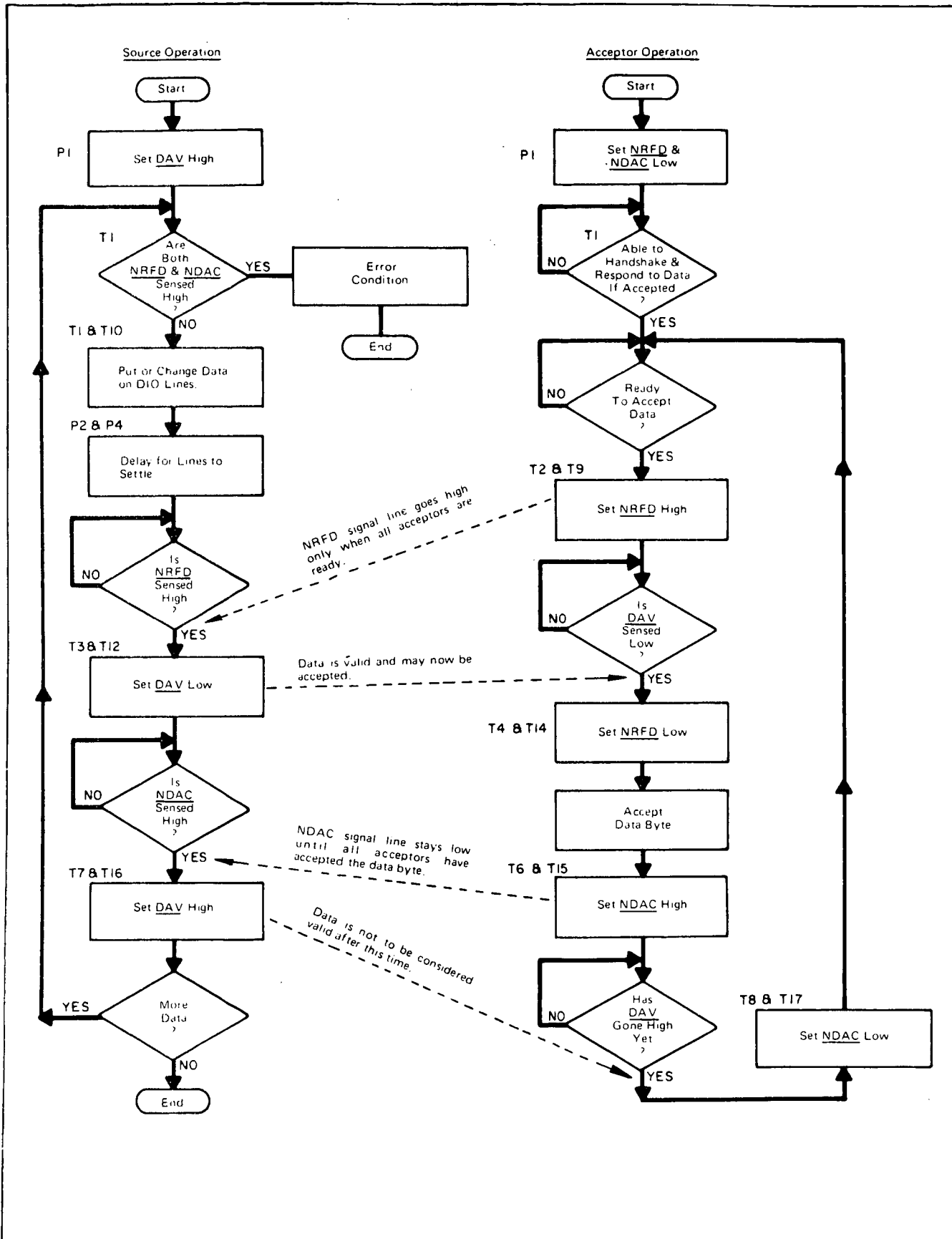

Figure 3-A-13. Handshake Functional Block Diagram.

The timing diagram illustrates the handshake process by indicating the actual waveforms on the DAV, NRFD, and NDAC lines. The NRFD and NDAC signals each represent composite waveforms resulting from two or more Listeners accepting the same data byte at slightly different times. This is usually due to variations in the transmission path length and individual instrument response rates (delays).

The flow chart represents the same sequence of events in a different form.

The subscripted letters on the flow chart and the timing diagram refer to the same event on the list of events.

HANDSHAKE line timing diagram for one talker and multiple listeners using the handshake process. Two cycles of the handshake sequence are shown. Also refer to the flow diagram and list of events on this figure.

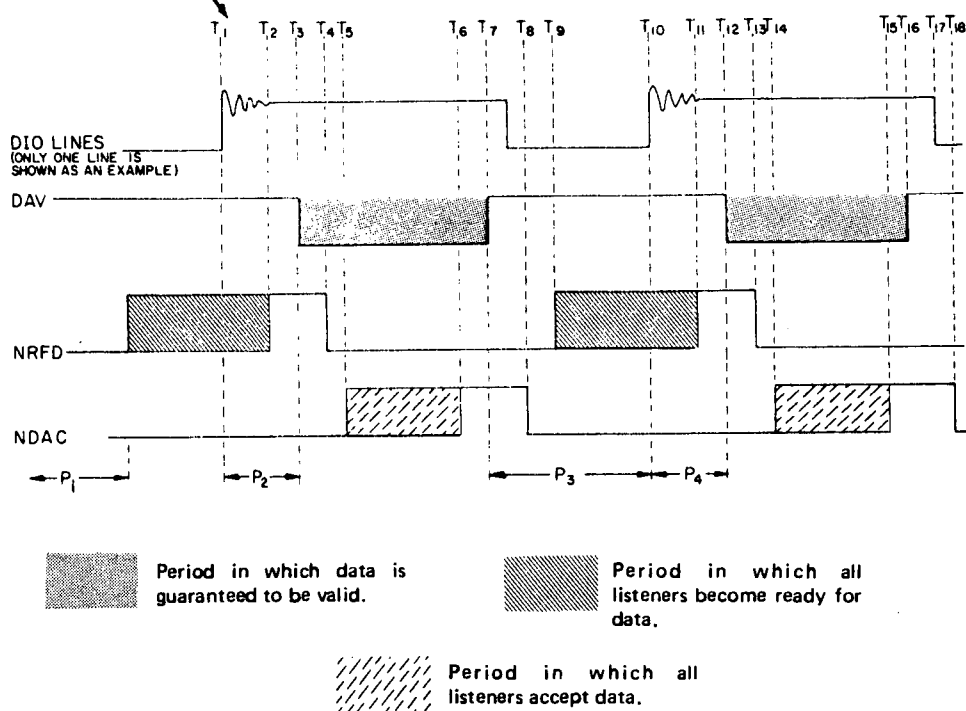

List of Events for Handshake Process

- Source initializes DAV to high (False - data not valid).
- P₁ - Acceptors initialize NRFD to low (True - none are ready for data), and set NDAC to low (True - none have accepted the data).
- T₁ Source checks for error condition (both NRFD and NDAC high), then places data byte on DIO lines.
- P₂ Source delays to allow data to settle on DIO lines.

Figure 3-A-14. Handshake Timing Relationship.

T ₂	Acceptors have all indicated readiness to accept first data byte; NRFD goes high.
T ₃	When the data is settled and valid, and the source has sensed NRFD high, DAV is set low.
T ₄	First acceptor sets NRFD low to indicate that it is no longer ready, then accepts the data. Other acceptors follow at their own rates.
T ₅	First acceptor sets NDAC high to indicate that it has accepted the data. (NDAC remains low due to other acceptors driving NDAC low).
T ₆	Last acceptor sets NDAC high to indicate that it has accepted the data; all have now accepted and NDAC goes high.
T ₇	Source, having sensed that NDAC is high, sets DAV high. This indicates to the acceptors that data on the DIO lines must now be considered not valid. Upon completion of this step, one byte of data has been transferred.
P ₃ (T ₇ –T ₁₀)	Source changes data on the DIO lines.
T ₈ *	Acceptors, upon sensing DAV high set NDAC low in preparation for next cycle. NDAC goes low as the first acceptor sets it low.
T ₉	First acceptor indicates that it is ready for the next data byte by setting NRFD high. (NRFD remains low due to other acceptors driving NRFD low).
T ₁₀	Source checks for error condition (both NRFD and NDAC high), then places data byte on DIO lines (as at T ₁).
P ₄ (T ₁₀ –T ₁₂)	Source delays to allow data to settle on DIO lines.
T ₁₁	Last acceptor indicates that it is ready for the next data byte by setting NRFD high; NRFD signal line goes high.
T ₁₂	Source, upon sensing NRFD high, sets DAV low to indicate that data on DIO lines is settled and valid.
T ₁₃	First acceptor sets NRFD low to indicate that it is no longer ready, then accepts the data.
T ₁₄	First acceptor sets NDAC high to indicate that it has accepted the data.
T ₁₅	Last acceptor sets NDAC high to indicate that it has accepted the data (as at T ₆).
T ₁₆	Source, having sensed that NDAC is high, sets DAV high (as at T ₇).
T ₁₇	Source removes data byte from DIO signal lines after setting DAV high.
T ₁₈ *	Acceptors, upon sensing DAV high, set NDAC low in preparation for next cycle.
	* Note that all three handshake lines return to their initialized states, as at T ₁ and T ₂ .

Table 3-A-1. ASCII Character Codes.

ASCII Char.	EQUIVALENT FORMS			ASCII Char.	EQUIVALENT FORMS			ASCII Char.	EQUIVALENT FORMS			ASCII Char.	EQUIVALENT FORMS		
	Binary	Octal	Dec		Binary	Octal	Dec		Binary	Octal	Dec		Binary	Octal	Dec
NULL	00000000	000	0	space	00100000	040	32	@	01000000	100	64		01100000	140	96
SOH	00000001	001	1	!	00100001	041	33	A	01000001	101	65	a	01100001	141	97
STX	00000010	002	2	"	00100010	042	34	B	01000010	102	66	b	01100010	142	98
ETX	00000011	003	3	#	00100011	043	35	C	01000011	103	67	c	01100011	143	99
EOT	00000100	004	4	\$	00100100	044	36	D	01000100	104	68	d	01100100	144	100
ENQ	00000101	005	5	%	00100101	045	37	E	01000101	105	69	e	01100101	145	101
ACK	00000110	006	6	&	00100110	046	38	F	01000110	106	70	f	01100110	146	102
BELL	00000111	007	7	'	00100111	047	39	G	01000111	107	71	g	01100111	147	103
BS	00001000	010	8	(00101000	050	40	H	01001000	110	72	h	01101000	150	104
HT	00001001	011	9)	00101001	051	41	I	01001001	111	73	i	01101001	151	105
LF	00001010	012	10	,	00101010	052	42	J	01001010	112	74	j	01101010	152	106
V _{tab}	00001011	013	11	+	00101011	053	43	K	01001011	113	75	k	01101011	153	107
FF	00001100	014	12	.	00101100	054	44	L	01001100	114	76	l	01101100	154	108
CR	00001101	015	13	-	00101101	055	45	M	01001101	115	77	m	01101101	155	109
SO	00001110	016	14	/	00101110	056	46	N	01001110	116	78	n	01101110	156	110
SI	00001111	017	15	/	00101111	057	47	O	01001111	117	79	o	01101111	157	111
DLE	00010000	020	16	0	00110000	060	48	P	01010000	120	80	p	01110000	160	112
DC ₁	00010001	021	17	1	00110001	061	49	Q	01010001	121	81	q	01110001	161	113
DC ₂	00010010	022	18	2	00110010	062	50	R	01010010	122	82	r	01110010	162	114
DC ₃	00010011	023	19	3	00110011	063	51	S	01010011	123	83	s	01110011	163	115
DC ₄	00010100	024	20	4	00110100	064	52	T	01010100	124	84	t	01110100	164	116
NAK	00010101	025	21	5	00110101	065	53	U	01010101	125	85	u	01110101	165	117
SYNC	00010110	026	22	6	00110110	066	54	V	01010110	126	86	v	01110110	166	118
ETB	00010111	027	23	7	00110111	067	55	W	01010111	127	87	w	01110111	167	119
CAN	00011000	030	24	8	00111000	070	56	X	01011000	130	88	x	01111000	170	120
EM	00011001	031	25	9	00111001	071	57	Y	01011001	131	89	y	01111001	171	121
SUB	00011010	032	26	:	00111010	072	58	Z	01011010	132	90	z	01111010	172	122
ESC	00011011	033	27	:	00111011	073	59	[01011011	133	91	{	01111011	173	123
FS	00011100	034	28	<	00111100	074	60	\	01011100	134	92	:	01111100	174	124
GS	00011101	035	29	=	00111101	075	61]	01011101	135	93	}	01111101	175	125
RS	00011110	036	30	>	00111110	076	62	^	01011110	136	94	~	01111110	176	126
US	00011111	037	31	?	00111111	077	63	_	01011111	137	95	DEL	01111111	177	127

APPENDIX B

-hp- 3336A/B/C Programming Times

3-B-1. Approximate Programming Times.

3-B-2. The -hp- 3336 processes each programming code as it is received when in Data Transfer Mode 1. The 3336 can not receive the next program code until the previous code has been processed. Approximate times are supplied so the operator can predict program times more accurately. This ability allows the program to be executed at its fastest rate without any loss of accuracy arising from not allowing for enough settling time. In Data Transfer Mode 2, these times still apply except, the Program Codes are not processed until the EOS character is received (see Paragraph 3-154).

3-B-3. In addition to the program times, each character requires 150 to 200 μ seconds to be received from the HP-IB. This is the transfer rate when Data Transfer Mode 2 is used. The processing times, however, still exist and processing starts when the EOS character is received. At this time, the controller is free to perform other function while the -hp- 3336 is processing program codes.

NOTE

These times are in addition to the settling times for frequency, amplitude and phase changes listed in Table 1-1.

Table 3-B-1. Programming Code Execution Time.

Numeric Data in Entry Parameter Strings		1.7 ms per digit
Frequency	FF,FR	6.5 ms
Delimiter	HH,HZ,KH,MH	10.9 ms
Start Frequency	ST	6.5 ms
Stop Frequency	SP	6.5 ms
Marker Frequency	MF	6.5 ms
Delimiter	HH,HZ,KH,MH	7.5 ms
Sweep Time	ST	5 ms
Delimiter	SE	5 ms
Amplitude	AM	6 ms
Delimiter	DB	165 ms
Phase	PH	5 ms
Delimiter	DE	28 ms
Output Impedance	OI	9 ms
Store (#)	SR	20 ms
Recall (#)	RE	975 ms
Assign Zero Phase	AP	10 ms
Start Single Sweep	SS	500 ms
Start Continuous Sweep	SC	500 ms
Interrogation	[(mnemonic)]	5 ms + (mnemonic time)
Mask Service Request	MS	2 ms
Sweep Mode	SM	3 ms
Programming Mode	MD	2 ms
Amplitude Blanking	AB	2.5 ms
Fast Leveling	FL	4.5 ms

APPENDIX C

-hp- 9825A Bus Message Implementation Table

		Controller	Instrument #1	Instrument #2
		-hp- 9825A	-hp- 3336	
	Select Code	7	7	
	Device	21	04	
	Listen	5	\$	
	Talk	U	D	
Bus Message	Description	Sample Implementation		
Data	Output text and variables to single devices.	wrt 704,"FR20.25MH"	yes	
	Output single characters.	wtb 704,A	yes	
	Input data from a device.	red 704,A	yes	
	Input single characters.	rdb (704)-A	yes	
	Specify addresses and send data in ASCII form.	cmd 7,"?U\$","FR20.25MH"	yes	
	Output data to multiple listeners.	wrt "SYN1,SYN2","AM-24.37DB"	yes	
		cmd 7,"?U\$1","AM-24.37DB"	yes	
	Transfer data from device to device.	cmd 7,"?D1"	yes	
Trigger	Send a "Group Execute Trigger" to all devices.	trg 7	no	
	Send a "Group Execute Trigger" to selected devices.	trg 711	no	
Clear	Clear all devices.	clr 7	yes	
	Clear selected devices.	clr 704	yes	
Remote	Enable remote mode on all devices. Device will remote when addressed.	rem 7	yes	
	Set remote on selected devices.	rem 704	yes	
Local	Return selected device to front panel control.	lcl 704	yes	
Local Lockout	Prevent all devices from returning to local mode.	llo 7	yes	
Clear Lockout/ Set Local	Set local mode and disable local lockout on all devices.	lcl 7	yes	
Pass Control	Transfer bus management to another controller.	pct 723	yes	
Serial Poll (Status Byte)	Input the Status Byte of a selected device.	rds (704)-A	yes	
Abort I/O	Clear all bus operations and return the bus management to the system controller.	cli 7	no	
Require Service	Request Service from the controller.	Originates from the device.	yes*	

*Controllers can send the Requires Service message, however, normally this message originates from the device. The -hp- 3336 can send this message. It will not respond to a service request from another device or controller.

SALES & SUPPORT OFFICES

Arranged alphabetically by country

1



Product Line Sales/Support Key

Key Product Line

- A Analytical
- CM Components
- C Computer Systems Sales only
- CH Computer Systems Hardware Sales and Services
- CS Computer Systems Software Sales and Services
- E Electronic Instruments & Measurement Systems
- M Medical Products
- MP Medical Products Primary SRO
- MS Medical Products Secondary SRO
- P Personal Computation Products
- Sales only for specific product line
- Support only for specific product line

IMPORTANT: These symbols designate general product line capability. They do not insure sales or support availability for all products within a line, at all locations. Contact your local sales office for information regarding locations where HP support is available for specific products.

HP distributors are printed in italics.

HEADQUARTERS OFFICES

If there is no sales office listed for your area, contact one of these headquarters offices.

NORTH/CENTRAL AFRICA

Hewlett-Packard S.A.
7, Rue du Bois-du-Lan
CH-1217 MEYRIN 2, Switzerland
Tel: (022) 83 12 12
Telex: 27835 hpse
Cable: HEWPACKSA Geneve

ASIA

Hewlett-Packard Asia Ltd.
6th Floor, Sun Hung Kai Centre
30 Harbour Rd.
G.P.O. Box 795

HONG KONG

Tel: 5-832 3211
After Jan. 1, 1984
47th Floor, China Resources Bldg.
26 Harbour Rd., Wanchai

HONG KONG

Telex: 66678 HEWPA HX
Cable: HEWPACK HONG KONG

CANADA

Hewlett-Packard (Canada) Ltd.
6877 Goreway Drive
MISSISSAUGA, Ontario L4V 1M8
Tel: (416) 678-9430
Telex: 610-492-4246

EASTERN EUROPE

Hewlett-Packard Ges.m.b.H.
Liebigasse 1
P.O.Box 72
A-1222 VIENNA, Austria
Tel: (222) 2365110
Telex: 1 3 4425 HEPA A

NORTHERN EUROPE

Hewlett-Packard S.A.
Uilenstede 475
P.O.Box 999
NL-1180 AZ AMSTELVEEN
The Netherlands
Tel: 20 437771

SOUTH EAST EUROPE

Hewlett-Packard S.A.
7, Rue du Bois-du-Lan
CH-1217 MEYRIN 2, Switzerland
Tel: (022) 83 12 12
Telex: 27835 hpse
Cable: HEWPACKSA Geneve

OTHER EUROPE

Hewlett-Packard S.A.
P.O. Box
150, Rte du Nant-D'Avril
CH-1217 MEYRIN 2, Switzerland
Tel: (022) 83 8111
Telex: 22486 hpsa
Cable: HEWPACKSA Geneve

MEDITERRANEAN AND MIDDLE EAST

Hewlett-Packard S.A.
Mediterranean and Middle East
Operations
Atrina Centre
32 Kifissias Ave.
Paradissos-Amarousion, ATHENS
Greece
Tel: 682 88 11
Telex: 21-6588 HPAT GR
Cable: HEWPACKSA Athens

EASTERN USA

Hewlett-Packard Co.
4 Choke Cherry Road
ROCKVILLE, MD 20850
Tel: (301) 258-2000

MIDWESTERN USA

Hewlett-Packard Co.
5201 Tollview Drive
ROLLING MEADOWS, IL 60008
Tel: (312) 255-9800

SOUTHERN USA

Hewlett-Packard Co.
2000 South Park Place
P.O. Box 105005
ATLANTA, GA 30348
Tel: (404) 955-1500

WESTERN USA

Hewlett-Packard Co.
3939 Lankershim Blvd.
P.O. Box 3919
LOS ANGELES, CA 91604
Tel: (213) 506-3700

OTHER INTERNATIONAL AREAS

Hewlett-Packard Co.
Intercontinental Headquarters
3495 Deer Creek Road
PALO ALTO, CA 94304
Tel: (415) 857-1501
Telex: 034-8300
Cable: HEWPACK

ANGOLA

Teletra
Empresa Técnica de Equipamentos
R. Barbosa Rodrigues, 41-1 DT.
Caixa Postal 6487
LUANDA
Tel: 35515,35516
E.P.

ARGENTINA

Hewlett-Packard Argentina S.A.
Avenida Santa Fe 2035
Martinez 1640 BUENOS AIRES
Tel: 798-5735, 792-1293
Telex: 17595 BIONAR
Cable: HEWPACKARG
A,E,CH,CS,P
Biotron S.A.C.I.M. e I.
Av Paseo Colon 221, Piso 9
1399 BUENOS AIRES
Tel: 30-4846, 30-1851
Telex: 17595 BIONAR
M

AUSTRALIA

Adelaide, South Australia Office

Hewlett-Packard Australia Ltd.
153 Greenhill Road
PARKSIDE, S.A. 5063
Tel: 272-5911
Telex: 82536
Cable: HEWPARD Adelaide
A*,CH,CM,,E,MS,P

Brisbane, Queensland Office

Hewlett-Packard Australia Ltd.
10 Payne Road
THE GAP, Queensland 4061
Tel: 30-4133
Telex: 42133
Cable: HEWPARD Brisbane
A,CH,CM,E,M,P

Canberra, Australia Capital Territory Office

Hewlett-Packard Australia Ltd.
121 Wollongong Street
FYSHWICK, A.C.T. 2609
Tel: 80 4244
Telex: 62650
Cable: HEWPARD Canberra
CH,CM,E,P

Melbourne, Victoria Office

Hewlett-Packard Australia Ltd.
31-41 Joseph Street
BLACKBURN, Victoria 3130
Tel: 895-2895
Telex: 31-024
Cable: HEWPARD Melbourne
A,CH,CM,CS,E,MS,P

Perth, Western Australia Office

Hewlett-Packard Australia Ltd.
261 Stirling Highway
CLAREMONT, W.A. 6010
Tel: 383-2188
Telex: 93859
Cable: HEWPARD Perth
A,CH,CM,E,MS,P

Sydney, New South Wales Office

Hewlett-Packard Australia Ltd.
17-23 Talavera Road
P.O. Box 308
NORTH RYDE, N.S.W. 2113
Tel: 887-1611
Telex: 21561
Cable: HEWPARD Sydney
A,CH,CM,CS,E,MS,P

AUSTRIA

Hewlett-Packard Ges.m.b.H.
Grottenhofstrasse 94
A-8052 GRAZ
Tel: (0316) 291 5 66
Telex: 32375
CH,E

Hewlett-Packard Ges.m.b.H.
Liebigasse 1
P.O. Box 72
A-1222 VIENNA
Tel: (0222) 23 65 11-0
Telex: 134425 HEPA A
A,CH,CM,CS,E,MS,P

BAHRAIN

Green Salon
P.O. Box 557
Manama
BAHRAIN
Tel: 255503-255950
Telex: 84419
P

Wael Pharmacy

P.O. Box 648
BAHRAIN
Tel: 256123
Telex: 8550 WAEL BN
E,C,M

BELGIUM

Hewlett-Packard Belgium S.A./N.V.
Blvd de la Woluwe, 100
Woluwedal
B-1200 BRUSSELS
Tel: (02) 762-32-00
Telex: 23-494 paloben bru
A,CH,CM,CS,E,MP,P

BRAZIL

Hewlett-Packard do Brasil I.e.C. Ltda
Alameda Rio Negro, 750
Alphaville
06400 BARUERI SP
Tel: (011) 421.1311
Telex: (011) 33872 HPBR-BR
Cable: HEWPACK Sao Paulo
A,CH,CM,CS,E,M,P
Hewlett-Packard do Brasil I.e.C. Ltda.
Avenida Epitacio Pessoa, 4664
22471 RIO DE JANEIRO-RJ
Tel: (021) 286.0237
Telex: 021-21905 HPBR-BR
Cable: HEWPACK Rio de Janeiro
A,CH,CM,E,MS,P*
ANAMED I.C.E.I. Ltda.
Rua Bage, 103
04012 SAO PAULO
Tel: (011) 570-5726
Telex: 021-21905 HPBR-BR
M

SALES & SUPPORT OFFICES

Arranged alphabetically by country



CANADA

Alberta

Hewlett-Packard (Canada) Ltd.
3030 3rd Avenue N.E.
CALGARY, Alberta T2A 6T7
Tel: (403) 235-3100
A,CH,CM,E*,MS,P*

Hewlett-Packard (Canada) Ltd.
11120A-178th Street
EDMONTON, Alberta T5S 1P2
Tel: (403) 486-6666
A,CH,CM,CS,E,MS,P

British Columbia

Hewlett-Packard (Canada) Ltd.
10691 Shellbridge Way
RICHMOND,

British Columbia V6X 2W7
Tel: (604) 270-2277
Telex: 610-922-5059
A,CH,CM,CS,E*,MS,P*

Manitoba

Hewlett-Packard (Canada) Ltd.
380-550 Century Street
WINNIPEG, Manitoba R3H 0Y1
Tel: (204) 786-6701
A,CH,CM,E,MS,P*

Nova Scotia

Hewlett-Packard (Canada) Ltd.
P.O. Box 931
900 Windmill Road
DARTMOUTH, Nova Scotia B2Y 3Z6
Tel: (902) 469-7820
CH,CM,CS,E*,MS,P*

Ontario

Hewlett-Packard (Canada) Ltd.
3325 N. Service Rd., Unit 6
BURLINGTON, Ontario P3A 2A3
Tel: (416) 335-8644
CS,M*

Hewlett-Packard (Canada) Ltd.
552 Newbold Street
LONDON, Ontario N6E 2S5
Tel: (519) 686-9181
A,CH,CM,E*,MS,P*

Hewlett-Packard (Canada) Ltd.
6877 Goreway Drive
MISSISSAUGA, Ontario L4V 1M8
Tel: (416) 678-9430
A,CH,CM,CS,E,MP,P

Hewlett-Packard (Canada) Ltd.
2670 Queensview Dr.
OTTAWA, Ontario K2B 8K1
Tel: (613) 820-6483
A,CH,CM,CS,E*,MS,P*

Hewlett-Packard (Canada) Ltd.
220 Yorkland Blvd., Unit #11
WILLOWDALE, Ontario M2J 1R5
Tel: (416) 499-9333
CH

Quebec

Hewlett-Packard (Canada) Ltd.
17500 South Service Road
Trans-Canada Highway
KIRKLAND, Quebec H9J 2M5
Tel: (514) 697-4232
A,CH,CM,CS,E,MP,P*

Hewlett-Packard (Canada) Ltd.
Les Galeries du Vallon
2323 Du Versant Nord
STE. FOY, Quebec G1N 4C2
Tel: (418) 687-4570
CH

CHILE

Jorge Calcagni y Cia. Ltda.
Av. Italia 634 Santiago
Casilla 16475
SANTIAGO 9
Tel: 222-0222
Telex: Public Booth 440001
A,CM,E,M

Olympia (Chile) Ltda.
Av. Rodrigo de Araya 1045
Casilla 256-V
SANTIAGO 21
Tel: (02) 22 55 044
Telex: 240-565 OLYMP CL
Cable: Olympiachile Santiagochile
CH,CS,P

CHINA, People's Republic of

China Hewlett-Packard Rep. Office
P.O. Box 418
1A Lane 2, Luchang St.
Beiwei Rd., Xuanwu District
BEIJING
Tel: 33-1947, 33-7426
Telex: 22601 CTSHP CN
Cable: 1920
A,CH,CM,CS,E,P

COLOMBIA

Instrumentación
H. A. Langebaek & Kier S.A.
Carrera 4A No. 52A-26
Apartado Aereo 6287
BOGOTA 1, D.E.
Tel: 212-1466
Telex: 44400 INST CO
Cable: AARIS Bogota
CM,E,M
Casa Humboldt Ltda.
Carrera 14, No. 98-60
Apartado Aereo 51283
BOGOTA 1, D.E.
Tel: 256-1686
Telex: 45403 CCAL CO.
A

COSTA RICA

Científica Costarricense S.A.
Avenida 2, Calle 5
San Pedro de Montes de Oca
Apartado 10159
SAN JOSE
Tel: 24-38-20, 24-08-19
Telex: 2367 GALGUR CR
CM,E,M

CYPRUS

Telexa Ltd.
P.O. Box 4809
14C Stassinou Avenue
NICOSIA
Tel: 62698
Telex: 2894 LEVIDO CY
E,M,P

DENMARK

Hewlett-Packard A/S
Datavej 52
DK-3460 BIRKEROD
Tel: (02) 81-66-40
Telex: 37409 hpas dk
A,CH,CM,CS,E,MS,P
Hewlett-Packard A/S
Røllighedsvej 32
DK-8240 RISSKOV, Aarhus
Tel: (06) 17-60-00
Telex: 37409 hpas dk
CH,E

DOMINICAN REPUBLIC

Microprog S.A.
Juan Tomás Mejía y Cotes No. 60
Arroyo Hondo
SANTO DOMINGO
Tel: 565-6268
Telex: 4510 ARENTA DR (RCA) P

ECUADOR

CYEDE Cia. Ltda.
Avenida Eloy Alfaro 1749
Casilla 6423 CCI
QUITO
Tel: 450-975, 243-052
Telex: 2548 CYEDE ED
CM,E,P

Hospitalar S.A.

Robles 625
Casilla 3590
QUITO
Tel: 545-250, 545-122
Telex: 2485 HOSPITAL ED
Cable: HOSPITALAR-Quito
M

EGYPT

International Engineering Associates
24 Hussein Hegazi Street
Kasr-el-Aini
CAIRO
Tel: 23829, 21641
Telex: IEA UN 93830
CH,CS,E,M
EGYPOR
P.O. Box 2558
42 El Zahraa Street
CAIRO, Egypt
Tel: 65 00 21
Telex: 93 337
P

EL SALVADOR

IPESA de El Salvador S.A.
29 Avenida Norte 1216
SAN SALVADOR
Tel: 26-6858, 26-6868
Telex: 20539 IPESASAL
A,CH,CM,CS,E,P

FINLAND

Hewlett-Packard Oy
Revontulentie 7
PL 24
SF-02101 ESPOO 10
Tel: (90) 4550211
Telex: 121563 hewpa sf
CH,CM,CS,P
Hewlett-Packard Oy
(Olarinluoma 7)
PL 24
02101 ESPOO 10
Tel: (90) 4521022
A,E,MS
Hewlett-Packard Oy
Aatoksenkatu 10-C
SF-40720-72 JYVASKYLA
Tel: (941) 216318
CH
Hewlett-Packard Oy
Kainuntie 1-C
SF-90140-14 OULU
Tel: (981) 338785
CH

FRANCE

Hewlett-Packard France
Z.I. Mercure B
Rue Berthelot
F-13763 Les Milles Cedex
AIX-EN-PROVENCE
Tel: 16 (42) 59-41-02
Telex: 410770F
A,CH,E,MS,P*

Hewlett-Packard France
64, rue Marchand Saillant
F-61000 ALENCON
Tel: 16 (33) 29 04 42

Hewlett-Packard France
Boite Postale 503
F-25026 BESANCON
28 rue de la Republique
F-25000 BESANCON
Tel: 16 (81) 83-16-22
CH,M

Hewlett-Packard France
13, Place Napoleon III
F-29000 BREST
Tel: 16 (98) 03-38-35

Hewlett-Packard France
Chemin des Mouilles
Boite Postale 162
F-69130 ECULLY Cedex (Lyon)
Tel: 16 (78) 833-81-25
Telex: 310617F
A,CH,CS,E,MP

Hewlett-Packard France
Tour Lorraine
Boulevard de France
F-91035 EVRY Cedex
Tel: 16 6 077-96-60
Telex: 692315F
E

Hewlett-Packard France
Parc d'Activite du Bois Briard
Ave. du Lac
F-91040 EVRY Cedex
Tel: 16 6 077-8383
Telex: 692315F
E

Hewlett-Packard France
5, avenue Raymond Chanas
F-38320 EYBENS (Grenoble)
Tel: 16 (76) 25-81-41
Telex: 980124 HP GRENOB EYBE
CH

Hewlett-Packard France
Centre d'Affaire Paris-Nord
Bâtiment Ampère 5 étage
Rue de la Commune de Paris
Boite Postale 300
F-93153 LE BLANC MESNIL
Tel: 16 (1) 865-44-52
Telex: 211032F
CH,CS,E,MS

Hewlett-Packard France
Parc d'Activités Cadera
Quartier Jean Mermoz
Avenue du Président JF Kennedy
F-33700 MERIGNAC (Bordeaux)
Tel: 16 (56) 34-00-84
Telex: 550105F
CH,E,MS

Hewlett-Packard France
Immuable "Les 3 B"
Nouveau Chemin de la Garde
ZAC de Bois Briand
F-44085 NANTES Cedex
Tel: 16 (40) 50-32-22
CH**



FRANCE (Cont'd)

Hewlett-Packard France
125, rue du Faubourg Bannier
F-45000 ORLEANS
Tel: 16 (38) 68 01 63

Hewlett-Packard France
Zone Industrielle de Courtaboeuf
Avenue des Tropiques
F-91947 Les Ulis Cedex ORSAY
Tel: (6) 907-78-25
Telex: 600048F
A,CH,CM,CS,E,MP,P

Hewlett-Packard France
Paris Porte-Maillet
15, Avenue de L'Amiral Bruix
F-75782 PARIS CEDEX 16
Tel: 16 (1) 502-12-20
Telex: 613663F
CH,MS,P

Hewlett-Packard France
124, Boulevard Tourasse
F-64000 PAU
Tel: 16 (59) 80 38 02

Hewlett-Packard France
2 Allée de la Bourgonnette
F-35100 RENNES
Tel: 16 (99) 51-42-44
Telex: 740912F
CH,CM,E,MS,P*

Hewlett-Packard France
98 Avenue de Bretagne
F-76100 ROUEN
Tel: 16 (35) 63-57-66
CH*,CS

Hewlett-Packard France
4 Rue Thomas Mann
Boite Postale 56
F-67033 STRASBOURG Cedex
Tel: 16 (88) 28-56-46
Telex: 890141F
CH,E,MS,P*

Hewlett-Packard France
Le Péripole
20, Chemin du Pigeonnier de la
Cépière
F-31083 TOULOUSE Cedex
Tel: 16 (61) 40-11-12
Telex: 531639F
A,CH,CS,E,P*

Hewlett-Packard France
9, rue Baudin
F-28000 VALENCE
Tel: 16 (75) 42 76 18

Hewlett-Packard France
Carolor
ZAC de Bois Briand
F-57640 VIGY (Metz)
Tel: 16 (8) 771 20 22
CH

Hewlett-Packard France
Immeuble Péricentre
F-59658 VILLENEUVE D'ASCO Cedex
Tel: 16 (20) 91-41-25
Telex: 160124F
CH,E,MS,P*

**GERMAN FEDERAL
REPUBLIC**

Hewlett-Packard GmbH
Geschäftsstelle
Kellstrasse 2-4
D-1000 BERLIN 30
Tel: (030) 24-90-86
Telex: 018 3405 hpbln d
A,CH,E,M,P

Hewlett-Packard GmbH
Geschäftsstelle
Herrenberger Strasse 130
D-7030 BOBLINGEN
Tel: (7031) 14-0
Telex:
A,CH,CM,CS,E,MP,P

Hewlett-Packard GmbH
Geschäftsstelle
Emanuel-Leutze-Strasse 1
D-4000 DUSSELDORF
Tel: (0211) 5971-1
Telex: 085/86 533 hpdd d
A,CH,CS,E,MS,P

Hewlett-Packard GmbH
Geschäftsstelle
Schleefstr. 28a
D-4600 DORTMUND-Aplerbeck
Tel: (0231) 45001

Hewlett-Packard GmbH
Vertriebszentrale Frankfurt
Berner Strasse 117
Postfach 560 140
D-6000 FRANKFURT 56
Tel: (0611) 50-04-1
Telex: 04 13249 hpfm d
A,CH,CM,CS,E,MP,P

Hewlett-Packard GmbH
Geschäftsstelle
Aussenstelle Bad Homburg
Louisenstrasse 115
D-6380 BAD HOMBURG
Tel: (06172) 109-0

Hewlett-Packard GmbH
Geschäftsstelle
Kapstadtring 5
D-2000 HAMBURG 60
Tel: (040) 63804-1
Telex: 021 63 032 hphh d
A,CH,CS,E,MS,P

Hewlett-Packard GmbH
Geschäftsstelle
Heidering 37-39
D-3000 HANNOVER 61
Tel: (0511) 5706-0
Telex: 092 3259
A,CH,CM,E,MS,P

Hewlett-Packard GmbH
Geschäftsstelle
Rosslauer Weg 2-4
D-6800 MANNHEIM
Tel: (0621) 70050
Telex: 0462105
A,C,E

Hewlett-Packard GmbH
Geschäftsstelle
Messerschmittstrasse 7
D-7910 NEU ULM
Tel: 0731-70241
Telex: 0712816 HP ULM-D
A,C,E*

Hewlett-Packard GmbH
Geschäftsstelle
Ehlicherstr. 13
D-8500 NÜRNBERG 10
Tel: (0911) 5205-0
Telex: 0623 860
CH,CM,E,MS,P

Hewlett-Packard GmbH
Geschäftsstelle
Eschenstrasse 5
D-8028 TAUFKIRCHEN
Tel: (089) 6117-1
Telex: 0524985
A,CH,CM,E,MS,P

GREAT BRITAIN

See United Kingdom

GREECE

Kostas Karayannis S.A.
8 Omirou Street
ATHENS 133
Tel: 32 30 303, 32 37 371
Telex: 215962 RKAR GR
A,CH,CM,CS,E,M,P

PLAISIO S.A.
G. Gerardos
24 Stournara Street
ATHENS
Tel: 36-11-160
Telex: 221871
P

GUATEMALA

IPESA
Avenida Reforma 3-48, Zona 9
GUATEMALA CITY
Tel: 316627, 314786
Telex: 4192 TELTRO GU
A,CH,CM,CS,E,M,P

HONG KONG

Hewlett-Packard Hong Kong, Ltd.
G.P.O. Box 795
5th Floor, Sun Hung Kai Centre
30 Harbour Road

HONG KONG
Tel: 5-8323211
Telex: 66678 HEWPA HX
Cable: HEWPACK HONG KONG
E,CH,CS,P

CET Ltd.
1402 Tung Wah Mansion
199-203 Hennessy Rd.
Wanchia, HONG KONG
Tel: 5-729376
Telex: 85148 CET HX
CM

Schmidt & Co. (Hong Kong) Ltd.
Wing On Centre, 28th Floor
Connaught Road, C.

HONG KONG
Tel: 5-455644
Telex: 74766 SCHMX HX
A,M

ICELAND

Elding Trading Company Inc.
Hafnarnvolf-Tryggvagotu
P.O. Box 895
IS-REYKJAVIK
Tel: 1-58-20, 1-63-03
M

INDIA

Computer products are sold through
Blue Star Ltd. All computer repairs and
maintenance service is done through
Computer Maintenance Corp.

Blue Star Ltd.
Sabri Complex II Floor
24 Residency Rd.
BANGALORE 560 025
Tel: 55660
Telex: 0845-430
Cable: BLUESTAR
A,CH*,CM,CS*,E

Blue Star Ltd.
Band Box House
Prabhadevi
BOMBAY 400 025
Tel: 422-3101
Telex: 011-3751
Cable: BLUESTAR
A,M

Blue Star Ltd.
Sahas
414/2 Vir Savarkar Marg
Prabhadevi
BOMBAY 400 025
Tel: 422-6155
Telex: 011-4093
Cable: FROSTBLUE
A,CH*,CM,CS*,E,M

Blue Star Ltd.
Kalyan, 19 Vishwas Colony
Alkapuri, BORODA, 390 005
Tel: 65235
Cable: BLUE STAR
A

Blue Star Ltd.
7 Hare Street
CALCUTTA 700 001
Tel: 12-01-31
Telex: 021-7655
Cable: BLUESTAR
A,M

Blue Star Ltd.
133 Kodambakkam High Road
MADRAS 600 034
Tel: 82057
Telex: 041-379
Cable: BLUESTAR
A,M

Blue Star Ltd.
Bhandari House, 7th/8th Floors
91 Nehru Place
NEW DELHI 110 024
Tel: 682547
Telex: 031-2463
Cable: BLUESTAR
A,CH*,CM,CS*,E,M

Blue Star Ltd.
15/16-C Wellesley Rd.
PUNE 411 011
Tel: 22775
Cable: BLUE STAR
A

Blue Star Ltd.
2-2-47/1108 Bolarum Rd.
SECUNDERABAD 500 003
Tel: 72057
Telex: 0155-459
Cable: BLUEFROST
A,E

Blue Star Ltd.
T.C. 7/603 Poomima
Maruthankuzhi
TRIVANDRUM 695 013
Tel: 65799
Telex: 0884-259
Cable: BLUESTAR
E

Computer Maintenance Corporation
Ltd.
115, Sarojini Devi Road
SECUNDERABAD 500 003
Tel: 310-184, 345-774
Telex: 031-2960
CH**



SALES & SUPPORT OFFICES

Arranged alphabetically by country

INDONESIA

BERCA Indonesia P.T.
P.O.Box 496/Jkt.

Jl. Abdul Muis 62
JAKARTA

Tel: 21-373009
Telex: 46748 BERSAL IA
Cable: BERSAL JAKARTA
P

BERCA Indonesia P.T.
P.O.Box 2497/Jkt
Antara Bldg., 17th Floor
Jl. Medan Merdeka Selatan 17
JAKARTA-PUSAT

Tel: 21-344-181
Telex: BERSAL IA
A,CS,E,M

BERCA Indonesia P.T.
P.O. Box 174/SBY.

Jl. Kutei No. 11
SURABAYA
Tel: 68172
Telex: 31146 BERSAL SB
Cable: BERSAL-SURABAYA
A*,E,M,P

IRAQ

Hewlett-Packard Trading S.A.
Service Operation
Al Mansoor City 9B/3/7

BAGHDAD
Tel: 551-49-73
Telex: 212-455 HEPAIRAQ IK
CH,CS

IRELAND

Hewlett-Packard Ireland Ltd.
82/83 Lower Leeson Street

DUBLIN 2
Tel: 0001 608800
Telex: 30439
A,CH,CM,CS,E,M,P

Cardiac Services Ltd.
Kilmore Road
Artane

DUBLIN 5
Tel: (01) 351820
Telex: 30439
M

ISRAEL

Eldan Electronic Instrument Ltd.
P.O.Box 1270

JERUSALEM 91000
16, Ohaliav St.

JERUSALEM 94467
Tel: 533 221, 553 242
Telex: 25231 AB/PAKRD IL
A

Electronics Engineering Division
Motorola Israel Ltd.

16 Kremenetski Street
P.O. Box 25016
TEL-AVIV 67899

Tel: 3 88 388
Telex: 33569 Motil IL
Cable: BASTEL Tel-Aviv
CH,CM,CS,E,M,P

ITALY

Hewlett-Packard Italiana S.p.A
Traversa 99C

Via Giulio Petroni, 19
I-70124 **BARI**

Tel: (080) 41-07-44
M

Hewlett-Packard Italiana S.p.A.

Via Martin Luther King, 38/III
I-40132 **BOLOGNA**
Tel: (051) 402394
Telex: 511630
CH,E,MS

Hewlett-Packard Italiana S.p.A.
Via Principe Nicola 43G/C
I-95126 **CATANIA**
Tel: (095) 37-10-87
Telex: 970291
C,P

Hewlett-Packard Italiana S.p.A.
Via G. Di Vittorio 9
I-20063 **CERNUSCO SUL NAVIGLIO**
(Milano)
Tel: (02) 923691
Telex: 334632

A,CH,CM,CS,E,MP,P
Hewlett-Packard Italiana S.p.A.
Via C. Colombo 49
I-20090 **TREZZANO SUL NAVIGLIO**
(Milano)
Tel: (02) 4459041
Telex: 322116
C,M

Hewlett-Packard Italiana S.p.A.
Via Nuova San Rocco a
Capodimonte, 62/A
I-80131 **NAPOLI**
Tel: (081) 7413544
Telex: 710698
A,CH,E

Hewlett-Packard Italiana S.p.A.
Viale G. Modugno 33
I-16156 **GENOVA PEGLI**
Tel: (010) 68-37-07
Telex: 215238
E,C

Hewlett-Packard Italiana S.p.A.
Via Pelizzo 15
I-35128 **PADOVA**
Tel: (049) 664888
Telex: 430315
A,CH,E,MS

Hewlett-Packard Italiana S.p.A.
Viale C. Pavese 340
I-00144 **ROMA EUR**
Tel: (06) 54831
Telex: 610514
A,CH,CM,CS,E,MS,P*

Hewlett-Packard Italiana S.p.A.
Via di Casellina 57/C
I-50018 **SCANDICCI-FIRENZE**
Tel: (055) 753863

Hewlett-Packard Italiana S.p.A.
Corso Svizzera, 185
I-10144 **TORINO**
Tel: (011) 74 4044
Telex: 221079
CH,E

JAPAN

Yokogawa-Hewlett-Packard Ltd.
152-1, Onna
ATSUGI, Kanagawa, 243
Tel: (0462) 28-0451
CM,C*,E

Yokogawa-Hewlett-Packard Ltd.
Meiji-Seimei Bldg. 6F
3-1 Hon Chiba-Cho
CHIBA, 280
Tel: 472 25 7701
E,CH,CS

Yokogawa-Hewlett-Packard Ltd.
Yasuda-Seimei Hiroshima Bldg.
6-11, Hon-dori, Naka-ku
HIROSHIMA, 730
Tel: 82-241-0611

Yokogawa-Hewlett-Packard Ltd.
Towa Building
2-3, Kaigan-dori, 2 Chome Chuo-ku
KOBE, 650
Tel: (078) 392-4791
C,E

Yokogawa-Hewlett-Packard Ltd.
Kumagaya Asahi 82 Bldg
3-4 Tsukuba
KUMAGAYA, Saitama 360
Tel: (0485) 24-6563
CH,CM,E

Yokogawa-Hewlett-Packard Ltd.
Asahi Shinbun Daiichi Seimei Bldg.
4-7, Hanabata-cho
KUMAMOTO, 860
Tel: (0963) 54-7311
CH,E

Yokogawa-Hewlett-Packard Ltd.
Shin-Kyoto Center Bldg.
614, Higashi-Shiokoji-cho
Karasuma-Nishiiru
Shiokoji-dori, Shimogyo-ku
KYOTO, 600
Tel: 075-343-0921
CH,E

Yokogawa-Hewlett-Packard Ltd.
Mito Mitsui Bldg
4-73, Sanno-maru, 1 Chome
MITO, Ibaraki 310
Tel: (0292) 25-7470
CH,CM,E

Yokogawa-Hewlett-Packard Ltd.
Sumitomo Seimei 14-9 Bldg.
Meieki-Minami, 2 Chome
Nakamura-ku
NAGOYA, 450
Tel: (052) 571-5171
CH,CM,CS,E,MS

Yokogawa-Hewlett-Packard Ltd.
Chuo Bldg.,
4-20 Nishinakajima, 5 Chome
Yodogawa-ku
OSAKA, 532
Tel: (052) 304-6021
Telex: YHPOSA 523-3624
A,CH,CM,CS,E,MP,P*

Yokogawa-Hewlett-Packard Ltd.
27-15, Yabe, 1 Chome
SAGAMIHARA Kanagawa, 229
Tel: 0427 59-1311

Yokogawa-Hewlett-Packard Ltd.
Daiichi Seimei Bldg.
7-1, Nishi Shinjuku, 2 Chome
Shinjuku-ku, **TOKYO** 160
Tel: 03-348-4611
CH,E

Yokogawa-Hewlett-Packard Ltd.
29-21 Takaido-Higashi, 3 Chome
Suginami-ku **TOKYO** 168
Tel: (03) 331-6111
Telex: 232-2024 YHPTOK
A,CH,CM,CS,E,MP,P*

Yokogawa-Hewlett-Packard Ltd.
Daiichi Asano Building
2-8, Odori, 5 Chome
UTSUNOMIYA, Tochigi 320
Tel: (0286) 25-7155
CH,CS,E

Yokogawa-Hewlett-Packard Ltd.
Yasuda Seimei Nishiguchi Bldg.
30-4 Tsuruya-cho, 3 Chome
YOKOHAMA 221
Tel: (045) 312-1252
CH,CM,E

JORDAN

Mouasher Cousins Company
P.O. Box 1387

AMMAN
Tel: 24907, 39907
Telex: 21456 SABCO JO
CH,E,M,P

KENYA

ADCOM Ltd., Inc., Kenya
P.O.Box 30070

NAIROBI
Tel: 331955
Telex: 22639
E,M

KOREA

Samsung Electronics HP Division
12 Fl. Kinam Bldg.

San 75-31, Yeoksam-Dong
Kangnam-Ku
Yeongdong P.O. Box 72
SEOUL

Tel: 555-7555, 555-5447
Telex: K27364 SAMSAN
A,CH,CM,CS,E,M,P

KUWAIT

Al-Khaldiya Trading & Contracting
P.O. Box 830 Safat

KUWAIT
Tel: 42-4910, 41-1726
Telex: 22481 Areeg kt
CH,E,M

Photo & Cine Equipment
P.O. Box 270 Safat

KUWAIT
Tel: 42-2846, 42-3801
Telex: 22247 Matin kt
P

LEBANON

G.M. Dolmadjian
Achrafieh
P.O. Box 165.167

BEIRUT
Tel: 290293
MP**

Computer Information Systems
P.O. Box 11-6274
BEIRUT
Tel: 89 40 73
Telex: 22259
C

LUXEMBOURG

Hewlett-Packard Belgium S.A./N.V.
Blvd de la Woluwe, 100

Woluwedal
B-1200 BRUSSELS
Tel: (02) 762-32-00
Telex: 23-494 paloben bru
A,CH,CM,CS,E,MP,P

MALAYSIA

Hewlett-Packard Sales (Malaysia)
Sdn. Bhd.

1st Floor, Bangunan British
American
Jalan Semantan, Damansara Heights
KUALA LUMPUR 23-03
Tel: 943022
Telex: MA31011
A,CH,E,M,P*



MAYLAISIA (Cont'd)

Protel Engineering
P.O.Box 1917
Lot 6624, Section 64
23/4 Pending Road
Kuching, **SARAWAK**
Tel: 36299
Telex: MA 70904 PROMAL
Cable: PROTELENG
A,E,M

MALTA

Philip Toledo Ltd.
Notabile Rd.
MRIEHEL
Tel: 447 47, 455 66
Telex: Media MW 649
E,P

MEXICO

Hewlett-Packard Mexicana, S.A.
de C.V.
Av. Periferico Sur No. 6501
Tepepan, Xochimilco
16020 MEXICO D.F.
Tel: 6-76-46-00
Telex: 17-74-507 HEWPACK MEX
A,CH,CS,E,MS,P
Hewlett-Packard Mexicana, S.A.
de C.V.
Ave. Colonia del Valle 409
Col. del Valle
Municipio de Garza Garcia
MONTERREY, Nuevo Leon
Tel: 78 42 41
Telex: 038 410
CH
ECISA
José Vasconcelos No. 218
Col. Condesa Deleg. Cuauhtémoc
MEXICO D.F. 06140
Tel: 553-1206
Telex: 17-72755 ECE ME
M

MOROCCO

Dolbeau
81 rue Karatchi
CASABLANCA
Tel: 3041-82, 3068-38
Telex: 23051, 22822
E

Gerep
2 rue d'Agadir
Boite Postale 156
CASABLANCA
Tel: 272093, 272095
Telex: 23 739
P

NETHERLANDS

Hewlett-Packard Nederland B.V.
Van Heuven Goedhartlaan 121
NL 1181KK **AMSTELVEEN**
P.O. Box 667
NL 1180 AR **AMSTELVEEN**
Tel: (020) 47-20-21
Telex: 13 216 HEPAC NL
A,CH,CM,CS,E,MP,P
Hewlett-Packard Nederland B.V.
Bongerd 2
NL 2906VK **CAPELLE A/D IJSSEL**
P.O. Box 41
NL 2900AA **CAPELLE A/D IJSSEL**
Tel: (10) 51-64-44
Telex: 21261 HEPAC NL
A,CH,CS,E

Hewlett-Packard Nederland B.V.
Pastoor Petersstraat 134-136
NL 5612 LV **EINDHOVEN**
P.O. Box 2342
NL 5600 CH **EINDHOVEN**
Tel: (040) 326911
Telex: 51484 hepae nl
A,CH* ,E,M

NEW ZEALAND

Hewlett-Packard (N.Z.) Ltd.
5 Owens Road
P.O. Box 26-189
Epsom, **AUCKLAND**
Tel: 687-159
Cable: HEWPACK Auckland
CH,CM,E,P*

Hewlett-Packard (N.Z.) Ltd.
4-12 Cruickshank Street
Kilbirnie, **WELLINGTON 3**
P.O. Box 9443
Courtenay Place, **WELLINGTON 3**
Tel: 877-199
Cable: HEWPACK Wellington
CH,CM,E,P

Northrop Instruments & Systems Ltd.
369 Khyber Pass Road
P.O. Box 8602
AUCKLAND
Tel: 794-091
Telex: 60605
A,M

Northrop Instruments & Systems Ltd.
110 Mandeville St.
P.O. Box 8388
CHRISTCHURCH
Tel: 486-928
Telex: 4203
A,M

Northrop Instruments & Systems Ltd.
Sturdee House
85-87 Ghuznee Street
P.O. Box 2406
WELLINGTON
Tel: 850-091
Telex: NZ 3380
A,M

NORTHERN IRELAND

See United Kingdom

NORWAY

Hewlett-Packard Norge A/S
Folke Bernadottes vei 50
P.O. Box 3558
N-5033 **FYLLINGSDALEN** (Bergen)
Tel: 0047/5/16 55 40
Telex: 16621 hpnas n
CH,CS,E,MS

Hewlett-Packard Norge A/S
Österndalen 16-18
P.O. Box 34
N-1345 **ÖSTERÅS**
Tel: 0047/2/17 11 80
Telex: 16621 hpnas n
A,CH,CM,CS,E,MP

OMAN

Khimjil Ramdas
P.O. Box 19
MUSCAT
Tel: 722225, 745601
Telex: 3289 BROKER MB MUSCAT
P
Suhail & Saud Bahwan
P.O.Box 169
MUSCAT
Tel: 734 201-3
Telex: 3274 BAHWAN MB

PAKISTAN

Mushko & Company Ltd.
1-B, Street 43
Sector F-8/1
ISLAMABAD
Tel: 5 1071
Cable: FEMUS Rawalpindi
A,E,M
Mushko & Company Ltd.
Oosman Chambers
Abdullah Haroon Road
KARACHI 0302
Tel: 524 131, 524 132
Telex: 2894 MUSKO PK
Cable: COOPERATOR Karachi
A,E,M,P*

PANAMA

Electrónico Balboa, S.A.
Calle Samuel Lewis, Ed. Alfa
Apartado 4929
PANAMA 5
Tel: 63-6613, 63-6748
Telex: 3483 ELECTRON PG
A,CM,E,MP

PERU

Cía Electro Médica S.A.
Los Flamencos 145, San Isidro
Casilla 1030
LIMA 1
Tel: 41-4325, 41-3703
Telex: Pub. Booth 25306
CM,E,M,P

PHILIPPINES

The Online Advanced Systems Corporation
Rico House, Amorsolo Cor. Herrera Street
Legaspi Village, Makati
P.O. Box 1510
Melro MANILA
Tel: 85-35-81, 85-34-91, 85-32-21
Telex: 3274 ONLINE
A,CH,CS,E,M
Electronic Specialists and Proponents Inc.
690-B Epifanio de los Santos Avenue
Cubao, **QUEZON CITY**
P.O. Box 2649 Manila
Tel: 98-96-81, 98-96-82, 98-96-83
Telex: 40018, 42000 ITT GLOBE
MACKAY BOOTH
P

PORTUGAL

Mundinter
Intercambio Mundial de Comércio
S.A.R.L.
P.O. Box 2761
Av. Antonio Augusto de Aguiar 138
P-LISBON
Tel: (19) 53-21-31, 53-21-37
Telex: 16691 munter p
M
Soquimica
Av. da Liberdade, 220-2
1298 **LISBOA** Codex
Tel: 56 21 81/2/3
Telex: 13316 SABASA
P

Telectra-Empresa Técnica de Equipamentos Eléctricos S.A.R.L.
Rua Rodrigo da Fonseca 103
P.O. Box 2531
P-LISBON 1
Tel: (19) 68-60-72
Telex: 12598
CH,CS,E,P

PUERTO RICO

Hewlett-Packard Puerto Rico
Ave. Muñoz Rivera #101
Esq. Calle Ochoa
HATO REY, Puerto Rico 00918
Tel: (809) 754-7800
Hewlett-Packard Puerto Rico
Calle 272 Edificio 203
Urb. Country Club
RIO PIEDRAS, Puerto Rico
P.O. Box 4407
CAROLINA, Puerto Rico 00628
Tel: (809) 762-7255
A,CH,CS

QATAR

Compulearbia
P.O. Box 2750
DOHA
Tel: 883555
Telex: 4806 CHPARB
P
Eastern Technical Services
P.O. Box 4747
DOHA
Tel: 329 993
Telex: 4156 EASTEC DH
Nasser Trading & Contracting
P.O.Box 1563
DOHA
Tel: 22170, 23539
Telex: 4439 NASSER DH
M

SAUDI ARABIA

Modern Electronic Establishment Hewlett-Packard Division
P.O. Box 22015
Thuobah
AL-KHOBAR
Tel: 895-1760, 895-1764
Telex: 671 106 HPMEEK SJ
Cable: ELECTA AL-KHOBAR
CH,CS,E,M
Modern Electronic Establishment Hewlett-Packard Division
P.O. Box 1228
Redec Plaza, 6th Floor
JEDDAH
Tel: 644 38 48
Telex: 4027 12 FARNAS SJ
Cable: ELECTA JEDDAH
CH,CS,E,M
Modern Electronic Establishment Hewlett-Packard Division
P.O.Box 22015
RIYADH
Tel: 491-97 15, 491-63 87
Telex: 202049 MEERYD SJ
CH,CS,E,M
Abdul Ghani El Ajou
P.O. Box 78
RIYADH
Tel: 40 41 717
Telex: 200 932 EL AJOU
P

SCOTLAND

See United Kingdom

SINGAPORE

Hewlett-Packard Singapore (Sales)
Pte. Ltd.
#08-00 Inchcape House
450-2 Alexandra Road
P.O. Box 58 Alexandra Rd. Post Office
SINGAPORE, 9115
Tel: 631788
Telex: HPSGSO RS 34209
Cable: HEWPACK, Singapore
A,CH,CS,E,MS,P

SALES & SUPPORT OFFICES

Arranged alphabetically by country



SINGAPORE (Cont'd)

Dynamar International Ltd.
Unit 05-11 Block 6
Kolam Ayer Industrial Estate
SINGAPORE 1334
Tel: 747-6188
Telex: RS 26283
CM

SOUTH AFRICA

Hewlett-Packard So Africa (Pty.) Ltd.
P.O. Box 120
Howard Place CAPE PROVINCE 7450
Pine Park Center, Forest Drive,
Pinelands
CAPE PROVINCE 7405
Tel: 53-7954
Telex: 57-20006
A,CH,CM,E,MS,P
Hewlett-Packard So Africa (Pty.) Ltd.
P.O. Box 37099
92 Overport Drive
DURBAN 4067
Tel: 28-4178, 28-4179, 28-4110
Telex: 6-22954
CH,CM

Hewlett-Packard So Africa (Pty.) Ltd.
6 Linton Arcade
511 Cape Road
Linton Grange
PORT ELIZABETH 6000
Tel: 041-302148
CH

Hewlett-Packard So Africa (Pty.) Ltd.
P.O. Box 33345
Glenstantia 0010 TRANSVAAL
1st Floor East
Constantia Park Ridge Shopping
Centre
Constantia Park
PRETORIA
Tel: 982043
Telex: 32163
CH,E

Hewlett-Packard So Africa (Pty.) Ltd.
Private Bag Wendywood
SANDTON 2144
Tel: 802-5111, 802-5125
Telex: 4-20877
Cable: HEWPACK Johannesburg
A,CH,CM,CS,E,MS,P

SPAIN

Hewlett-Packard Española S.A.
Calle Entenza, 321
E-BARCELONA 29
Tel: 322.24.51, 321.73.54
Telex: 52603 hpbee
A,CH,CS,E,MS,P

Hewlett-Packard Española S.A.
Calle San Vicente S/No
Edificio Albia II
E-BILBAO 1
Tel: 423.83.06
A,CH,E,MS

Hewlett-Packard Española S.A.
Ctra. de la Coruña, Km. 16, 400
Las Rozas
E-MADRID
Tel: (1) 637.00.11
CH,CS,M

Hewlett-Packard Española S.A.
Avda. S. Francisco Javier, S/no
Planta 10. Edificio Sevilla 2,
E-SEVILLA 5
Tel: 64.44.54
Telex: 72933
A,CS,MS,P

Hewlett-Packard Española S.A.
Calle Ramon Gordillo, 1 (Entlo.3)
E-VALENCIA 10
Tel: 361-1354
CH,P

SWEDEN

Hewlett-Packard Sverige AB
Sunnanvagen 14K
S-22226 LUND
Tel: (046) 13-69-79
Telex: (854) 17886 (via Spånga
office)
CH

Hewlett-Packard Sverige AB
Östra Tullgatan 3
S-21128 MALMÖ
Tel: (040) 70270
Telex: (854) 17886 (via Spånga
office)

Hewlett-Packard Sverige AB
Västra Vintergatan 9
S-70344 ÖREBRO
Tel: (19) 10-48-80
Telex: (854) 17886 (via Spånga
office)
CH

Hewlett-Packard Sverige AB
Skalholtsgatan 9, Kista
Box 19
S-16393 SPÅNGA
Tel: (08) 750-2000
Telex: (854) 17886
Telefax: (08) 7527781
A,CH,CM,CS,E,MS,P
Hewlett-Packard Sverige AB
Frötällsgatan 30
S-42132 VÄSTRA-FRÖLUNDA
Tel: (031) 49-09-50
Telex: (854) 17886 (via Spånga
office)
CH,E,P

SWITZERLAND

Hewlett-Packard (Schweiz) AG
Clarastrasse 12
CH-4058 BASEL
Tel: (61) 33-59-20
A

Hewlett-Packard (Schweiz) AG
7, rue du Bois-du-Lan
Case Postale 365
CH-1217 MEYRIN 2
Tel: (0041) 22-83-11-11
Telex: 27333 HPAG CH
CH,CM,CS

Hewlett-Packard (Schweiz) AG
Allmend 2
CH-8967 WIDEN
Tel: (0041) 57 31 21 11
Telex: 53933 hpag ch
Cable: HPAG CH
A,CH,CM,CS,E,MS,P

SYRIA

General Electronic Inc.
Nuri Basha Ahnaf Ebn Kays Street
P.O. Box 5781
DAMASCUS
Tel: 33-24-87
Telex: 411 215
Cable: ELECTROBOR DAMASCUS
E

Middle East Electronics
P.O. Box 2308
Abu Rummaneh
DAMASCUS
Tel: 33 4 5 92
Telex: 411 304
M

TAIWAN

Hewlett-Packard Far East Ltd.
Kaohsiung Office
2/F 68-2, Chung Cheng 3rd Road
KAOSHIUNG
Tel: (07) 241-2318
CH,CS,E

Hewlett-Packard Far East Ltd.
Taiwan Branch
8th Floor
337 Fu Hsing North Road
TAIPEI

Tel: (02) 712-0404
Telex: 24439 HEWPACK
Cable: HEWPACK Taipei
A,CH,CM,CS,E,M,P
Ing Lih Trading Co.
3rd Floor, 7 Jen-Ai Road, Sec. 2
TAIPEI 100
Tel: (02) 3948191
Cable: INGLIH TAIPEI
A

THAILAND

Unimesa
30 Palpong Ave., Suriwong
BANGKOK 5
Tel: 235-5727
Telex: 84439 Simonco TH
Cable: UNIMESA Bangkok
A,CH,CS,E,M
Bangkok Business Equipment Ltd.
5/5-6 Dejo Road
BANGKOK
Tel: 234-8670, 234-8671
Telex: 87669-BEQUIPT TH
Cable: BUSIQUIPT Bangkok
P

TRINIDAD & TOBAGO

Caribbean Telecoms Ltd.
50/A Jerningham Avenue
P.O. Box 732
PORT-OF-SPAIN
Tel: 62-44213, 62-44214
Telex: 235,272 HUGCO WG
CM,E,M,P

TUNISIA

Tunisie Electronique
31 Avenue de la Liberté
TUNIS
Tel: 280-144
E,P

Corema
1 ter. Av. de Carthage
TUNIS
Tel: 253-821
Telex: 12319 CABAM TN
M

TURKEY

Teknim Company Ltd.
Iran Caddesi No. 7
Kavaklidere, ANKARA
Tel: 275800
Telex: 42155 TKNM TR
E

E.M.A.
Medina Eldem Sokak No.41/6
Yüksel Caddesi
ANKARA
Tel: 175 622
Telex: 42 591
M

UNITED ARAB EMIRATES

Emilat Ltd.
P.O. Box 2711
ABU DHABI
Tel: 82 04 19-20
Cable: EMITAC ABUDHABI
Emilat Ltd.
P.O. Box 1641
SHARJAH
Tel: 591 181
Telex: 68136 Emilat Sh
CH,CS,E,M,P

UNITED KINGDOM

GREAT BRITAIN
Hewlett-Packard Ltd.
Trafalgar House
Navigation Road
ALTRINCHAM
Cheshire WA14 1NU
Tel: 061 928 6422
Telex: 668068
A,CH,CS,E,M,MS,P

Hewlett-Packard Ltd.
Elstree House, Elstree Way
BOREHAMWOOD, Herts WD6 1SG
Tel: 01 207 5000
Telex: 8952716
E,CH,CS,P

Hewlett-Packard Ltd.
Oakfield House, Oakfield Grove
Clifton BRISTOL, Avon BS8 2BN
Tel: 0272 736806
Telex: 444302
CH,CS,E,P

Hewlett-Packard Ltd.
Bridewell House
Bridewell Place
LONDON EC4V 6BS
Tel: 01 583 6565
Telex: 298163
CH,CS,P

Hewlett-Packard Ltd.
Fourier House
257-263 High Street
LONDON COLNEY
Herts. AL2 1HA, St. Albans
Tel: 0727 24400
Telex: 1-8952716
CH,CS

Hewlett-Packard Ltd.
Pontefract Road
NORMANTON, West Yorkshire WF6 1RN
Tel: 0924 895566
Telex: 557355
CH,CS,P

Hewlett-Packard Ltd.
The Quadrangle
106-118 Station Road
REDHILL, Surrey RH1 1PS
Tel: 0737 68655
Telex: 947234
CH,CS,E,P

SALES & SUPPORT OFFICES

Arranged alphabetically by country

7



GREAT BRITAIN (Cont'd)

Hewlett-Packard Ltd.
Avon House
435 Stratford Road
Shirley, SOLIHULL, West Midlands
B90 4BL

Tel: 021 745 8800
Telex: 339105
CH,CS,E,P

Hewlett-Packard Ltd.
West End House
41 High Street, West End
SOUTHAMPTON

Hampshire SO3 3DQ
Tel: 04218 6767
Telex: 477138
CH,CS,P

Hewlett-Packard Ltd.
Eskdale Rd.
Winnersh, **WOKINGHAM**
Berkshire RG11 5DZ
Tel: 0734 696622
Telex: 848884
E

Hewlett-Packard Ltd.
King Street Lane
Winnersh, **WOKINGHAM**
Berkshire RG11 5AR
Tel: 0734 784774

Telex: 847178
A,CH,CS,E,M,MP,P

Hewlett-Packard Ltd.
Nine Mile Ride
Easthampstead, **WOKINGHAM**
Berkshire, 3RG11 3LL
Tel: 0344 773100
Telex: 848805
CH,CS,E,P

IRELAND

NORTHERN IRELAND

Hewlett-Packard Ltd.
Cardiac Services Building
95A Finaghy Road South
BELFAST BT10 0BY
Tel: 0232 625-566
Telex: 747626
CH,CS

SCOTLAND

Hewlett-Packard Ltd.
SOUTH QUEENSFERRY
West Lothian, EH30 9TG
Tel: 031 331 1188
Telex: 72682
CH,CM,CS,E,M,P

UNITED STATES

Alabama

Hewlett-Packard Co.
700 Century Park South, Suite 128
BIRMINGHAM, AL 35226
Tel: (205) 822-6802
A,CH,M

Hewlett-Packard Co.
420 Wynn Drive
HUNTSVILLE, AL 35805
P.O. Box 7700
HUNTSVILLE, AL 35807
Tel: (205) 830-2000
CH,CM,CS,E,M*

Arizona

Hewlett-Packard Co.
8080 Pointe Parkway West
PHOENIX, AZ 85044
Tel: (602) 273-8000
A,CH,CM,CS,E,MS

Hewlett-Packard Co.
2424 East Aragon Road
TUCSON, AZ 85706
Tel: (602) 889-4631
CH,E,MS**

California

Hewlett-Packard Co.
99 South Hill Dr.
BRISBANE, CA 94005
Tel: (415) 330-2500
CH,CS

Hewlett-Packard Co.
P.O. Box 7830 (93747)
5060 E. Clinton Avenue, Suite 102
FRESNO, CA 93727
Tel: (209) 252-9652
CH,CS,MS

Hewlett-Packard Co.
P.O. Box 4230
1430 East Orangethorpe
FULLERTON, CA 92631
Tel: (714) 870-1000
CH,CM,CS,E,MP

Hewlett-Packard Co.
320 S. Kellogg, Suite B
GOLETA, CA 93117
Tel: (805) 967-3405
CH

Hewlett-Packard Co.
5400 W. Rosecrans Boulevard
LAWDALE, CA 90260
P.O. Box 92105
LOS ANGELES, CA 90009
Tel: (213) 970-7500
Telex: 910-325-6608
CH,CM,CS,MP

Hewlett-Packard Co.
3155 Porter Oaks Drive
PALO ALTO, CA 94304
Tel: (415) 857-8000
CH,CS,E

Hewlett-Packard Co.
4244 So. Market Court, Suite A
P.O. Box 15976
SACRAMENTO, CA 95852
Tel: (916) 929-7222
A*,CH,CS,E,MS

Hewlett-Packard Co.
9606 Aero Drive
P.O. Box 23333
SAN DIEGO, CA 92139
Tel: (619) 279-3200
CH,CM,CS,E,MP

Hewlett-Packard Co.
2305 Camino Ramon "C"
SAN RAMON, CA 94583
Tel: (415) 838-5900
CH,CS

Hewlett-Packard Co.
3005 Scott Boulevard
SANTA CLARA, CA 95050
Tel: (408) 988-7000
Telex: 910-338-0586
A,CH,CM,CS,E,MP

Hewlett-Packard Co.
5703 Corsa Avenue
WESTLAKE VILLAGE, CA 91362
Tel: (213) 706-6800
E*,CH*,CS*

Colorado

Hewlett-Packard Co.
24 Inverness Place, East
ENGLEWOOD, CO 80112
Tel: (303) 649-5000
A,CH,CM,CS,E,MS

Connecticut

Hewlett-Packard Co.
47 Barnes Industrial Road South
P.O. Box 5007
WALLINGFORD, CT 06492
Tel: (203) 265-7801
A,CH,CM,CS,E,MS

Florida

Hewlett-Packard Co.
2901 N.W. 62nd Street
P.O. Box 24210
FORT LAUDERDALE, FL 33307
Tel: (305) 973-2600
CH,CS,E,MP

Hewlett-Packard Co.
6177 Lake Ellenor Drive
P.O. Box 13910
ORLANDO, FL 32859
Tel: (305) 859-2900
A,CH,CM,CS,E,MS

Hewlett-Packard Co.
5750B N. Hoover Blvd., Suite 123
P.O. Box 15200
TAMPA, FL 33614
Tel: (813) 884-3282
A*,CH,CM,CS,E*,M*

Georgia

Hewlett-Packard Co.
2000 South Park Place
P.O. Box 105005
ATLANTA, GA 30348
Tel: (404) 955-1500
Telex: 810-766-4890
A,CH,CM,CS,E,MP

Hawaii

Hewlett-Packard Co.
Kawaiahao Plaza, Suite 190
567 South King Street
HONOLULU, HI 96813
Tel: (808) 526-1555
A,CH,E,MS

Illinois

Hewlett-Packard Co.
304 Eldorado Road
P.O. Box 1607
BLOOMINGTON, IL 61701
Tel: (309) 662-9411
CH,MS**

Hewlett-Packard Co.
1100 31st Street, Suite 100
DOWNERS GROVE, IL 60515
Tel: (312) 960-5760
CH,CS

Hewlett-Packard Co.
5201 Tollview Drive
ROLLING MEADOWS, IL 60008
Tel: (312) 255-9800
Telex: 910-687-1066
A,CH,CM,CS,E,MP

Indiana

Hewlett-Packard Co.
7301 No. Shadeland Avenue
P.O. Box 50807
INDIANAPOLIS, IN 46250
Tel: (317) 842-1000
A,CH,CM,CS,E,MS

Iowa

Hewlett-Packard Co.
1776 22nd Street, Suite 1
WEST DES MOINES, IA 50265
Tel: (515) 224-1435
CH,MS**

Kansas

Hewlett-Packard Co.
7804 East Funston Road, #203
WICHITA, KS 67207
Tel: (316) 684-8491
CH

Kentucky

Hewlett-Packard Co.
10300 Linn Station Road, #100
LOUISVILLE, KY 40223
Tel: (502) 426-0100
A,CH,CS,MS

Louisiana

Hewlett-Packard Co.
160 James Drive East
ST. ROSE, LA 70087
P.O. Box 1449
KENNER, LA 70063
Tel: (504) 467-4100
A,CH,CS,E,MS

Maryland

Hewlett-Packard Co.
3701 Koppers Street
BALTIMORE, MD 21227
Tel: (301) 644-5800
Telex: 710-862-1943
A,CH,CM,CS,E,MS

Hewlett-Packard Co.
2 Choke Cherry Road
ROCKVILLE, MD 20850
Tel: (301) 948-6370
A,CH,CM,CS,E,MP

Massachusetts

Hewlett-Packard Co.
1775 Minuteman Road
ANDOVER, MA 01810
Tel: (617) 682-1500
A,C,CH,CS,CM,E,MP,P*
Hewlett-Packard Co.
32 Hartwell Avenue
LEXINGTON, MA 02173
Tel: (617) 861-8960
CH,CS,E

Michigan

Hewlett-Packard Co.
4326 Cascade Road S.E.
GRAND RAPIDS, MI 49506
Tel: (616) 957-1970
CH,CS,MS

Hewlett-Packard Co.
1771 W. Big Beaver Road
TROY, MI 48084
Tel: (313) 643-6474
CH,CS

Minnesota

Hewlett-Packard Co.
2025 W. Larpenteur Ave.
ST. PAUL, MN 55113
Tel: (612) 644-1100
A,CH,CM,CS,E,MP

Missouri

Hewlett-Packard Co.
11131 Colorado Avenue
KANSAS CITY, MO 64137
Tel: (816) 763-8000
A,CH,CM,CS,E,MS

Hewlett-Packard Co.
13001 Hollenberg Drive
BRIDGETON, MO 63044
Tel: (314) 344-5100
A,CH,CS,E,MP



SALES & SUPPORT OFFICES

Arranged alphabetically by country

UNITED STATES (Cont'd)

Nebraska

Hewlett-Packard
10824 Old Mill Rd., Suite 3
OMAHA, NE 68154
Tel: (402) 334-1813
CM,MS

New Jersey

Hewlett-Packard Co.
120 W. Century Road
PARAMUS, NJ 07652
Tel: (201) 265-5000
A,CH,CM,CS,E,MP
Hewlett-Packard Co.
60 New England Av. West
PISCATAWAY, NJ 08854
Tel: (201) 981-1199
A,CH,CM,CS,E

New Mexico

Hewlett-Packard Co.
11300 Lomas Blvd., N.E.
P.O. Box 11634
ALBUQUERQUE, NM 87112
Tel: (505) 292-1330
CH,CS,E,MS

New York

Hewlett-Packard Co.
5 Computer Drive South
ALBANY, NY 12205
Tel: (518) 458-1550
A,CH,E,MS
Hewlett-Packard Co.
9600 Main Street
P.O. Box AC
CLARENCE, NY 14031
Tel: (716) 759-8621
CH

Hewlett-Packard Co.
200 Cross Keys Office Park
FAIRPORT, NY 14450
Tel: (716) 223-9950
CH,CM,CS,E,MS

Hewlett-Packard Co.
7641 Henry Clay Blvd.
LIVERPOOL, NY 13088
Tel: (315) 451-1820
A,CH,CM,E,MS

Hewlett-Packard Co.
No. 1 Pennsylvania Plaza
55th Floor
34th Street & 8th Avenue
MANHATTAN NY 10119
Tel: (212) 971-0800
CH,CS,E*,M*

Hewlett-Packard Co.
250 Westchester Avenue
WHITE PLAINS, NY 10604
Tel: (914) 684-6100
CM,CH,CS,E

Hewlett-Packard Co.
3 Crossways Park West
WOODBURY, NY 11797
Tel: (516) 921-0300
A,CH,CM,CS,E,MS

North Carolina

Hewlett-Packard Co.
5605 Roanne Way
P.O. Box 26500
GREENSBORO, NC 27420
Tel: (919) 852-1800
A,CH,CM,CS,E,MS

Ohio

Hewlett-Packard Co.
9920 Carver Road
CINCINNATI, OH 45242
Tel: (513) 891-9870
CH,CS,MS

Hewlett-Packard Co.
16500 Sprague Road
CLEVELAND, OH 44130
Tel: (216) 243-7300
A,CH,CM,CS,E,MS

Hewlett-Packard Co.
962 Crupper Ave.
COLUMBUS, OH 43229
Tel: (614) 436-1041
Eff: Nov. 25, 1983
675 Brooksedge Blvd.
WESTERVILLE, OH 43081
CH,CM,CS,E*

Hewlett-Packard Co.
330 Progress Rd.
DAYTON, OH 45449
Tel: (513) 859-8202
A,CH,CM,E*,MS

Oklahoma

Hewlett-Packard Co.
304 N. Meridian, Suite A
P.O. Box 75609
OKLAHOMA CITY, OK 73147
Tel: (405) 946-9499
A*,CH,E*,MS

Hewlett-Packard Co.
3840 S. 103rd E. Avenue, #100
P.O. Box 35747
TULSA, OK 74153
Tel: (918) 665-3300
A*,CH,CS,M*

Oregon

Hewlett-Packard Co.
9255 S. W. Pioneer Court
P.O. Box 328
WILSONVILLE, OR 97070
Tel: (503) 682-8000
A,CH,CS,E*,MS

Pennsylvania

Hewlett-Packard Co.
111 Zeta Drive
PITTSBURGH, PA 15238
Tel: (412) 782-0400
A,CH,CS,E,MP

Hewlett-Packard Co.
2750 Monroe Boulevard
P.O. Box 713
VALLEY FORGE, PA 19482
Tel: (215) 666-9000
A,CH,CM,E,M

South Carolina

Hewlett-Packard Co.
Brookside Park, Suite 122
1 Harbison Way
P.O. Box 21708
COLUMBIA, SC 29221
Tel: (803) 732-0400
CH,E,MS

Hewlett-Packard Co.
Koger Executive Center
Chesterfield Bldg., Suite 124
GREENVILLE, SC 29615
Tel: (803) 297-4120

Tennessee

Hewlett-Packard Co.
224 Peters Road, Suite 102
P.O. Box 22490
KNOXVILLE, TN 37922
Tel: (615) 691-2371
A*,CH,MS

Hewlett-Packard Co.
3070 Directors Row
MEMPHIS, TN 38131
Tel: (901) 346-8370
A,CH,MS

Texas

Hewlett-Packard Co.
4171 North Mesa
Suite C-110
EL PASO, TX 79902
Tel: (915) 533-3555
CH,E*,MS**

Hewlett-Packard Co.
10535 Harwin Drive
P.O. Box 42816
HOUSTON, TX 77042
Tel: (713) 776-6400
A,CH,CM,CS,E,MP

Hewlett-Packard Co.
930 E. Campbell Rd.
P.O. Box 1270
RICHARDSON, TX 75080
Tel: (214) 231-6101
A,CH,CM,CS,E,MP

Hewlett-Packard Co.
1020 Central Parkway South
P.O. Box 32993
SAN ANTONIO, TX 78216
Tel: (512) 494-9336
CH,CS,E,MS

Utah

Hewlett-Packard Co.
3530 W. 2100 South
SALT LAKE CITY, UT 84119
Tel: (801) 974-1700
A,CH,CS,E,MS

Virginia

Hewlett-Packard Co.
4305 Cox Road
GLEN ALLEN, VA 23060
P.O. Box 9669
RICHMOND, VA 23228
Tel: (804) 747-7750
A,CH,CS,E,MS

Washington

Hewlett-Packard Co.
15815 S.E. 37th Street
BELLEVUE, WA 98006
Tel: (206) 643-4000
A,CH,CM,CS,E,MP

Hewlett-Packard Co.
Suite A
708 North Argonne Road
SPOKANE, WA 99212
Tel: (509) 922-7000
CH,CS

West Virginia

Hewlett-Packard Co.
4604 MacCorkle Ave.
P.O. Box 4297
CHARLESTON, WV 25304
Tel: (304) 925-0492
A,MS

Wisconsin

Hewlett-Packard Co.
150 S. Sunny Slope Road
BROOKFIELD, WI 53005
Tel: (414) 784-8800
A,CH,CS,E*,MP

URUGUAY

*Pablo Ferrando S.A.C. e I.
Avenida Italia 2877
Casilla de Correo 370
MONTEVIDEO
Tel: 80-2586
Telex: Public Booth 901
A,CM,E,M*

VENEZUELA

Hewlett-Packard de Venezuela C.A.
3RA Transversal Los Ruices Norte
Edificio Segre 1, 2 & 3
Apartado 50933
CARACAS 1071
Tel: 239-4133
Telex: 251046 HEWPACK
A,CH,CS,E,MS,P

Hewlett-Packard de Venezuela C.A.
Calle-72-Entre 3H y 3Y, No. 3H-40
Edificio Ada-Evelyn, Local B
Apartado 2646
4001, MARACAIBO, Estado Zulia
Tel: (061) 80.304
C,E*

Hewlett-Packard de Venezuela C.A.
Calle Vargas Rondon
Edificio Seguros Carabobo, Piso 10
VALENCIA
Tel: (041) 51 385
CH,CS,P

*Bioelectronica Medica C.A.
Calle Buen Pastor
Edif. Cota Mil-Piso 2 y Semi Sotano 1
Boleita Norte
Apartado 50710 CARACAS 1050A
Tel: 239 84 41
Telex: 26518*

ZIMBABWE

*Field Technical Sales
45 Kelvin Road, North
P.B. 3458
SALISBURY
Tel: 705 231
Telex: 4-122 RH
C,E,M,P*

July 1983 5952-6900

Indicates main office

HP distributors are printed in italics.



**HEWLETT
PACKARD**

03336-90011



Printed in U.S.A.



HEWLETT
PACKARD

SERVICE MANUAL

MODEL 3336A/B/C

SYNTHESIZER/LEVEL GENERATOR

Serial Number 1930A00101 (3336A)
1931A00101 (3336B)
1932A00101 (3336C)

IMPORTANT NOTICE

This manual applies to instruments with the above serial numbers and greater. As changes are made in the instrument to improve performance and reliability, the appropriate pages will be revised to include this information.

WARNING

To prevent potential fire or shock hazard, do not expose equipment to rain or moisture.

Manual Part No. 03336-90001

Microfiche Part No. 03336-90051

©Copyright Hewlett-Packard Company 1979
P.O. Box 301, Loveland, Colorado 80537 U.S.A.

CERTIFICATION

Hewlett-Packard Company certifies that this product met its published specifications at the time of shipment from the factory. Hewlett-Packard further certifies that its calibration measurements are traceable to the United States National Bureau of Standards, to the extent allowed by the Bureau's calibration facility, and to the calibration facilities of other International Standards Organization members.

WARRANTY

This Hewlett-Packard product is warranted against defects in material and workmanship for a period of one year from date of shipment [except that in the case of certain components listed in Section I of this manual, the warranty shall be for the specified period] . During the warranty period, Hewlett-Packard Company will, at its option, either repair or replace products which prove to be defective.

For warranty service or repair, this product must be returned to a service facility designated by -hp-. Buyer shall prepay shipping charges to -hp- and -hp- shall pay shipping charges to return the product to Buyer. However, Buyer shall pay all shipping charges, duties, and taxes for products returned to -hp- from another country.

HP software and firmware products which are designated by HP for use with a hardware product, when properly installed on that hardware product, are warranted not to fail to execute their programming instructions due to defects in materials and workmanship. If HP receives notice of such defects during the warranty period, HP shall repair or replace software media and firmware which do not execute their programming instructions due to such defects. HP does not warrant that the operation of the software, firmware or hardware shall be uninterrupted or error free.

LIMITATION OF WARRANTY

The foregoing warranty shall not apply to defects resulting from improper or inadequate maintenance by Buyer, Buyer-supplied software or interfacing, unauthorized modification or misuse, operation outside of the environmental specifications for the product, or improper site preparation or maintenance.

NO OTHER WARRANTY IS EXPRESSED OR IMPLIED. HEWLETT-PACKARD SPECIFICALLY DISCLAIMS THE IMPLIED WARRANTIES OF MERCHANTABILITY AND FITNESS FOR A PARTICULAR PURPOSE.

EXCLUSIVE REMEDIES

THE REMEDIES PROVIDED HEREIN ARE BUYER'S SOLE AND EXCLUSIVE REMEDIES. HEWLETT-PACKARD SHALL NOT BE LIABLE FOR ANY DIRECT, INDIRECT, SPECIAL, INCIDENTAL, OR CONSEQUENTIAL DAMAGES, WHETHER BASED ON CONTRACT, TORT, OR ANY OTHER LEGAL THEORY.

ASSISTANCE

Product maintenance agreements and other customer assistance agreements are available for Hewlett-Packard products.

For any assistance, contact your nearest Hewlett-Packard Sales and Service Office.



SAFETY SUMMARY

The following general safety precautions must be observed during all phases of operation, service, and repair of this instrument. Failure to comply with these precautions or with specific warnings elsewhere in this manual violates safety standards of design, manufacture, and intended use of the instrument. Hewlett-Packard Company assumes no liability for the customer's failure to comply with these requirements. This is a Safety Class 1 instrument.

GROUND THE INSTRUMENT

To minimize shock hazard, the instrument chassis and cabinet must be connected to an electrical ground. The instrument is equipped with a three-conductor ac power cable. The power cable must either be plugged into an approved three-contact electrical outlet or used with a three-contact to two-contact adapter with the grounding wire (green) firmly connected to an electrical ground (safety ground) at the power outlet. The power jack and mating plug of the power cable meet International Electrotechnical Commission (IEC) safety standards.

DO NOT OPERATE IN AN EXPLOSIVE ATMOSPHERE

Do not operate the instrument in the presence of flammable gases or fumes. Operation of any electrical instrument in such an environment constitutes a definite safety hazard.

KEEP AWAY FROM LIVE CIRCUITS

Operating personnel must not remove instrument covers. Component replacement and internal adjustments must be made by qualified maintenance personnel. Do not replace components with power cable connected. Under certain conditions, dangerous voltages may exist even with the power cable removed. To avoid injuries, always disconnect power and discharge circuits before touching them.

DO NOT SERVICE OR ADJUST ALONE

Do not attempt internal service or adjustment unless another person, capable of rendering first aid and resuscitation, is present.

DO NOT SUBSTITUTE PARTS OR MODIFY INSTRUMENT

Because of the danger of introducing additional hazards, do not install substitute parts or perform any unauthorized modification to the instrument. Return the instrument to a Hewlett-Packard Sales and Service Office for service and repair to ensure that safety features are maintained.

DANGEROUS PROCEDURE WARNINGS

Warnings, such as the example below, precede potentially dangerous procedures throughout this manual. Instructions contained in the warnings must be followed.

WARNING

Dangerous voltages, capable of causing death, are present in this instrument. Use extreme caution when handling, testing, and adjusting.

SAFETY SYMBOLS

General Definitions of Safety Symbols Used On Equipment or In Manuals.



Instruction manual symbol: the product will be marked with this symbol when it is necessary for the user to refer to the instruction manual in order to protect against damage to the instrument.



Indicates dangerous voltage (terminals fed from the interior by voltage exceeding 1000 volts must be so marked).

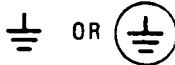

Protective conductor terminal. For protection against electrical shock in case of a fault. Used with field wiring terminals to indicate the terminal which must be connected to ground before operating equipment.



Low-noise or noiseless, clean ground (earth) terminal. Used for a signal common, as well as providing protection against electrical shock in case of a fault. A terminal marked with this symbol must be connected to ground in the manner described in the installation (operating) manual, and before operating the equipment.



Frame or chassis terminal. A connection to the frame (chassis) of the equipment which normally includes all exposed metal structures.



Alternating current (power line).



Direct current (power line).



Alternating or direct current (power line).

WARNING

The **WARNING** sign denotes a hazard. It calls attention to a procedure, practice, condition or the like, which, if not correctly performed or adhered to, could result in injury or death to personnel.











CAUTION

The **CAUTION** sign denotes a hazard. It calls attention to an operating procedure, practice, condition or the like, which, if not correctly performed or adhered to, could result in damage to or destruction of part or all of the product.

NOTE :

The **NOTE** sign denotes important information. It calls attention to procedure, practice, condition or the like, which is essential to highlight.

GENERAL SCHEMATIC NOTES

1. PARTIAL REFERENCE DESIGNATIONS ARE SHOWN. PREFIX WITH ASSEMBLY OR SUBASSEMBLY DESIGNATION(S) OR BOTH FOR COMPLETE DESIGNATION.
2. COMPONENT VALUES ARE SHOWN AS FOLLOWS UNLESS OTHERWISE NOTED.
 RESISTANCE IN OHMS
 CAPACITANCE IN MICROFARADS
 INDUCTANCE IN MILLIHENRYS
3.  DENOTES EARTH GROUND. USED FOR TERMINALS WITH NO LESS THAN A NO. 18 GAUGE WIRE CONNECTED BETWEEN TERMINAL AND EARTH GROUND TERMINAL OR AC POWER RECEPTACLE.
4.  DENOTES FRAME GROUND. USED FOR TERMINALS WHICH ARE PERMANENTLY CONNECTED WITHIN APPROXIMATELY 0.1 OHM OF EARTH GROUND.
5.  DENOTES GROUND ON PRINTED CIRCUIT ASSEMBLY. (PERMANENTLY CONNECTED TO FRAME GROUND).
6.  DENOTES ASSEMBLY.
7.  DENOTES MAIN SIGNAL PATH.
9.  DENOTES FEEDBACK PATH.
10.  DENOTES FRONT PANEL MARKING.
11.  DENOTES REAR PANEL MARKING.
12.  DENOTES SCREWDRIVER ADJUST.
13. * AVERAGE VALUE SHOWN, OPTIMUM VALUE SELECTED AT FACTORY. THE VALUE OF THESE COMPONENTS MAY VARY FROM ONE INSTRUMENT TO ANOTHER. THE METHOD OF SELECTING THESE COMPONENTS IS DESCRIBED IN SECTION V OF THIS MANUAL.
14.  DENOTES SECOND APPEARANCE OF A CONNECTOR PIN.
15. 924 DENOTES WIRE COLOR: COLOR CODE SAME AS RESISTOR COLOR CODE. FIRST NUMBER IDENTIFIES BASE COLOR, SECOND NUMBER IDENTIFIES WIDER STRIP, THIRD NUMBER IDENTIFIES NARROWER STRIP. (e.g. 924 = WHITE, RED, YELLOW.)
17. ALL RELAYS ARE SHOWN DEENERGIZED.

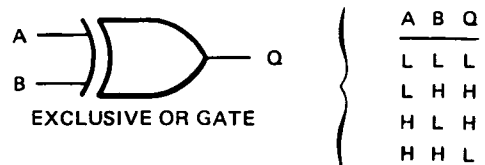
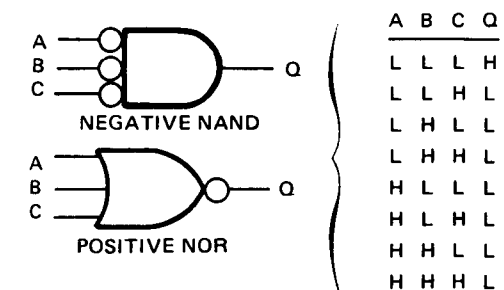
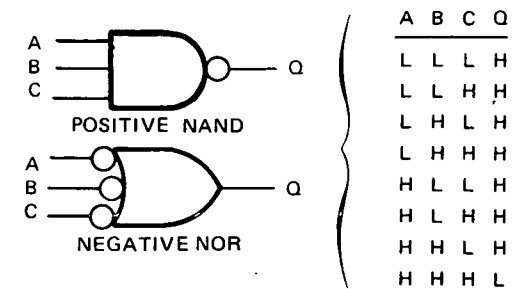
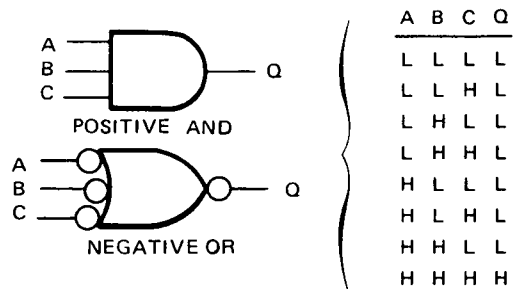
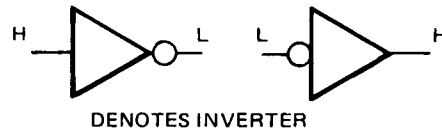
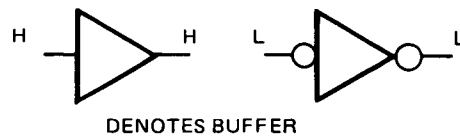

SECTION IV PERFORMANCE TEST

4-1. INTRODUCTION.

4-2. This section contains in cabinet test procedures to verify that the -hp- Model 3336 is operating properly. These performance tests compare the instrument's performance to its specifications, listed in Table 4-1. In most tests, the result is a measure of the actual performance of the instrument; in other tests, the result is a pass/fail indication.

Table 4-1. Specifications.

FREQUENCY		
Range:		
Model 3336A:	75 ohm unbalanced	10 Hz to 20.999 999 999 MHz
	150 ohm balanced	10 kHz to 2.099 999 999 MHz
	600 ohm balanced	200 Hz to 109.999 999 kHz
Model 3336B:	75 ohm unbalanced	10 Hz to 20.999 999 999 MHz
	124 ohm balanced	10 kHz to 10.999 999 999 MHz
	135 ohm balanced	10 kHz to 2.099 999 999 MHz
	600 ohm balanced	200 Hz to 109.999 999 kHz
Model 3336C:	50 ohm unbalanced	10 Hz to 20.999 999 999 MHz
	75 ohm unbalanced	10 Hz to 20.999 999 999 MHz
Resolution:		
1 μ Hz for frequencies < 100 kHz		
1 mHz for frequencies \geq 100 kHz		
Aging Rate: (instruments without Option 004)		
$\pm 5 \times 10^{-6}$ per year (20° to 30°C)		
Warm-Up Time:		
30 minutes		
AMPLITUDE		
Range:		
Model 3336A:	75 ohm output	- 72.99 to + 7.00 dBm
	150 ohm output	- 78.23 to + 1.76 dBm
	600 ohm output	- 72.99 to + 7.00 dBm
Model 3336B:	75 ohm output	- 72.99 to + 7.00 dBm
	124 ohm output	- 78.23 to + 1.76 dBm
	135 ohm output	- 78.23 to + 1.76 dBm
	600 ohm output	- 72.99 to + 7.00 dBm
Model 3336C:	50 ohm output	- 71.23 to + 8.76 dBm
	75 ohm output	- 72.99 to + 7.00 dBm
Absolute Accuracy: specified at 10 kHz for the 50, 75 and 600 ohm outputs; specified at 50 kHz for the 124, 135 and 150 ohm outputs, after 30 minutes warmup.		
$\pm .05$ dB, for the top 9.99 dB of amplitude range (20° to 30°C)		
$\pm .08$ dB, for the top 9.99 dB of amplitude range (0° to 55°C)		

Table 4-1. Specifications (Cont'd)

Flatness: referenced to amplitudes at 10 kHz for the 50, 75 and 600 ohm outputs; referenced to amplitudes at 50 kHz for the 124, 135 and 150 ohm outputs.

	10Hz	200	10K	50K	109K	2.09M	20.9MHz
Model 3336A							
75 ohm output	± .1 dB (± .07 dB with Option 005)						
150 ohm output	± .12 dB						
600 ohm output	± .25 dB						
Model 3336B	10Hz	200	10K	50K	109K	2.09M	10.9M 20.9MHz
75 ohm output	± .1 dB (± .07 dB with Option 005)						
124 ohm output	± .15 dB ± .1 dB						
135 ohm output	± .12 dB						
600 ohm output	± .25 dB						
Model 3336C	10Hz						20.9 MHz
50 and 75 ohm outputs	± .1 dB (± .07 dB with Option 005)						

Attenuator Accuracy: (instruments without Option 005)

Attenuation	10Hz	1 M	10M	20.9MHz
10 to 19.99 dB	± .1 dB	± .15 dB	± .2 dB	
20 to 39.99 dB	± .15 dB	± .2 dB	± .25 dB	
40 to 79.99 dB	± .2 dB	± .25 dB	± .3 dB	

NOTE

Amplitude Accuracy is the sum of Absolute Accuracy and, as needed, Flatness and Attenuator Accuracy.

Warm-Up Time:

30 minutes

MAIN SIGNAL OUTPUTS

On Carrier Return Loss:

	10Hz	10K	30K	2.09M	10.9M	20.9MHz
Model 3336A						
75 ohm output	> 30 dB					
150 ohm output	> 20 dB > 30 dB					
Model 3336B	10Hz	10K	30K	2.09M	10.9M	20.9MHz
75 ohm output	> 30 dB					
124 ohm output	> 20 dB > 30 dB					
135 ohm output	> 20 dB > 30 dB					
Model 3336C	10Hz	10K	30K	2.09M	10.9M	20.9MHz
50 ohm output	> 30 dB > 25 dB*					
75 ohm output	> 30 dB					

*Return Loss of 50 ohm output is > 30 dB to 20.9 MHz with Option 005.

Table 4-1. Specifications (Cont'd)

Balance:

Model 3336A	300Hz	10K	50 K	2.09MHz	
150 ohm output			> 36 dB		
600 ohm output	> 38 dB				
Model 3336B	300Hz	10K	50K	2.09M	10.9MHz
124 ohm output			> 30 dB		
135 ohm output			> 36 dB		
600 ohm output	> 38 dB				

SPECTRAL PURITY

Integrated Phase Noise:

Model 3336A and 3336B
 < - 72 dB, for a 3 kHz band, centered 2 kHz either side of a 20 MHz carrier.

Model 3336C
 < - 64 dB, for a 30 kHz band, centered on a 20 MHz carrier, excluding 1 Hz about the carrier.

Phase Jitter:

.3° peak to peak maximum, measured per Bell System Technical Reference PUB 41009, "Transmission Parameters Affecting Voiceband Data Transmission-Measuring Techniques May 1975" and per CCITT Orange Book, Volume IV.2 "Specifications of Measuring Equipment".

HARMONIC DISTORTION

No harmonically related signal will exceed these values with respect to the carrier:

10Hz	30	50	10K	100K	1M	5M	20.9MHz	
- 35dB	- 50dB		- 60dB		- 55dB	- 50dB		Fast Leveling Off
			- 50dB	- 60dB	- 55dB	- 50dB		Fast Leveling On

Spurious: (dc to 200 MHz except where noted)

All non-harmonically related signals from dc to 200 MHz will be more than 70 dB below the carrier or less than one of the following levels, whichever is greater.

Model 3336A	without Option 005	with Option 005
75 ohm output	- 100 dBm	- 115 dBm
150 ohm output	- 100 dBm (to 10 MHz)	- 100 dBm (to 10 MHz)
600 ohm output*	- 100 dBm (to 10 MHz)	- 100 dBm (to 10 MHz)
Model 3336B	without Option 005	with Option 005
75 ohm output	- 100 dBm	- 115 dBm
124 ohm output	- 100 dBm	- 115 dBm
135 ohm output	- 100 dBm	- 115 dBm
600 ohm output*	- 100 dBm	- 115 dBm
Model 3336C	without Option 005	with Option 005
50 ohm output	- 100 dBm	- 115 dBm
75 ohm output	- 100 dBm	- 115 dBm

* Line related signals from the 600 ohm outputs will be more than 70 dB below the carrier or - 83 dBm whichever is greater.

Amplitude Blanking:

Maximum signal output during amplitude blanking: < - 85 dBm
 Impulse Level in adjacent channels caused by amplitude blanking: > 22 dBm 0

Table 4-1. Specifications (Cont'd)

PHASE OFFSET**Range:**

$\pm 719.9^\circ$ with respect to arbitrary starting phase or assigned zero phase.

Resolution: 0.1°

Increment Accuracy: $\pm 0.2^\circ$

Ambient Stability: ± 1 degree of phase per degree C.

FREQUENCY SWEEP**Sweep Flatness:**

$\pm .15$ dB, Normal Leveling, 50 Hz to 1 MHz, .5s Sweep Time.

$\pm .15$ dB, Fast Leveling, 10 kHz to 20 MHz, .03s Sweep Time.

Sweep Time

Linear Sweep: .01 sec to 99.99 sec

Single Log Sweep: 2 sec to 99.99 sec

Continuous Log Sweep: .1 sec to 99.99 sec

Minimum Sweep Width

Log Sweep: 1 decade

Linear Sweep: Minimum Bandwidth (Hz) = $.1(\text{Hz/sec}) \times \text{Sweep Time (sec)}$

Phase Continuity:

Sweep is phase continuous over the full frequency range

AMPLITUDE MODULATION

Modulation Depth: 0 to 100 %

Modulation Frequency Range: 50 Hz to 50 kHz

Envelope Distortion: < -30 dBc to 80% modulation

Input Impedance: >20 k Ω

PHASE MODULATION

Range: 0 to $\pm 850^\circ$

Linearity: $< \pm .5\%$ of peak to peak deviation from best fit straight line.

Modulation Frequency Range: dc to 5 kHz

Input Sensitivity: ± 5 V peak for $\approx 850^\circ$ phase shift ($\approx 170^\circ/\text{volt}$)

Input Impedance: >20 k Ω

HP-IB CONTROL

Frequency Switching Time: (Time to settle to within 1 Hz to final value, exclusive of programming and processing time)

< 10 ms for 100 kHz step

< 25 ms for 1 MHz step

< 70 ms for 20 MHz step

Phase Switching Time: (to within 90° of phase lock, exclusive of programming and processing time)

< 15 ms

Amplitude Switching Time: (to within .1 dB of final value, exclusive of programming and processing time)

< 500 ms

Table 4-1. Specifications (Cont'd)

AUXILIARY OUTPUTS		
AUX 0 dBm: Frequency range is from 21 MHz to 60.999 999 999 MHz (underrange to 20.000 000 001 MHz). Amplitude is 0 dBm (50 ohm).		
SYNC OUT: Square wave with $V_{high} \geq 1.2 V$, $V_{low} \leq 0.2 V$ into 50 ohms, to synchronize other instruments to the Main Signal Outputs. Level transition occurs at Main Signal Output zero crossing.		
REF OUT: 0 dBm (50 ohm), 1 MHz signal for phase-locking additional instruments to the Model 3336.		
10 MHz OVEN OUT: Instruments with Option 004, only. 0 dBm (50 ohm), 10 MHz signal from a temperature stabilized, crystal oscillator for phase-locking the Model 3336 or other instruments.		
X DRIVE: 0 to > + 10 Vdc linear ramp proportional to the sweep frequency. Linearity, $\pm 1\%$ of final value, 10% to 90%, best fit straight line.		
Z BLANK: Sweep related TTL compatible voltage levels. Low level is capable of sinking current from a positive voltage source. Maximum Current = 200 mA Maximum Voltage = + 45 Vdc Maximum Power Dissipation = 1 W (V x A)		
MARKER: TTL compatible high to low level transition at the programmed Marker Frequency.		
AUXILIARY INPUTS		
EXT REF IN: For phase-locking the 3336A/B/C to an external frequency reference. Signal from 0 dBm to + 20 dBm (50 ohm). Signal frequency must be within 1×10^{-6} of a sub-harmonic of 10 MHz from 1 MHz to 10 MHz.		
AMPTD MOD: Amplitude modulation input (see AMPLITUDE MODULATION specifications)		
PHASE MOD: Phase modulation input (see PHASE MODULATION specifications)		
EXTERNAL LEVELING: Input from an External Leveling voltage source to regulate the signal amplitude at a remote point. Input Sensitivity: 1 dB/Volt, $\pm .25$ dB		
OPTION 004, HIGH STABILITY FREQUENCY REFERENCE		
Aging Rate: $\pm 5 \times 10^{-8}$ per week after 72 hours continuous operation. $\pm 1 \times 10^{-7}$ per month after 15 days continuous operation.		
Ambient Stability: $\pm 5 \times 10^{-8}$ maximum, 0° to 55°C		
Warm-Up Time: Reference frequency will be within 1×10^{-7} of the turn-off frequency, 20 minutes after turn-on, for an off time less than 24 hours.		
OPTION 005, HIGH ACCURACY ATTENUATOR		
Attenuation	10Hz	20 MHz
10 to 19.99 dB	± .035 dB	
20 to 39.99 dB	± .06 dB	
40 to 79.99 dB	± .1 dB	

Table 4-1. Specifications (Cont'd)

GENERAL
Operating Environment:
Temperature: 0° to 55°C
Relative Humidity: ≤ 85%, 0° to 40°C
Altitude: < 15,000 ft. (< 4600 meters)
Storage Environment:
Temperature: - 50° to + 65°C
Altitude: < 50,000 ft. (< 15,000 meters)
Power Requirements:
100/120, 220/240 V, + 5%, - 10%, 48 to 66 Hz, 60 VA (100 VA with all options), 10 VA standby.
Size: 132.6 mm (5 1/4 in) high x 425.5 mm (16-3/4) wide x 497.8 (19-5/8) deep
Weight: 10 kg (22 lbs.) net, 15.5 kg (34 lbs.) shipping

4-3. RECOMMENDED EQUIPMENT.

4-4. Each performance test lists the recommended equipment to complete that test. A complete list of the equipment used to perform all the tests is provided in Table 4-2. Substitute equipment may be used only if it meets or exceeds the critical specifications listed in the table. For this reason, some of the test procedures contain discussions of measurement techniques.

4-5. OPERATOR VERIFICATION.

4-6. A special sub-set of the Performance Tests, called the Operator Verification, is recommended for:

- a. Incoming inspection.
- b. General after-repair inspection.
- c. Instilling high confidence about the instruments operation when time and equipment resources are limited.

After repair, there may be one or more Performance Tests, not in this list, that will verify that the repair is complete. These should also be performed. In some cases, these additional tests are recommended in Section VIII.

4-7. The recommended Performance Tests that comprise the Operator Verification are:

Test	Paragraph No.
Frequency Accuracy	4-12
Absolute Amplitude Accuracy	4-14
Amplitude Flatness (75 ohm output only)	4-16
Harmonic Distortion	4-27
Spurious Response	4-29

Table 4-2. Recommended Test Equipment

INSTRUMENT	CRITICAL SPECIFICATION	REQUIRED FOR	RECOMMENDED MODEL
Electronic Counter	Frequency Measurements Range: to 20.9 MHz Resolution: 8 digits Accuracy: ± 1 part/10 ⁹ Time Interval Average Resolution: .1 ns	V = Oper. Ver. P = Performance Test T = Troubleshooting A = Adjustments V, P, A	-hp- Model 5328A with Options 010 and 040 or 041
Digital Voltmeter	dc Function Ranges: .1V, 1V, 10V, 100V Accuracy: $\pm .2\%$ Resolution: 4½ digits ac Function Ranges: 1V, 10V, 100V Accuracy: $\pm .5\%$ Resolution: 4 digits dc function Ranges: .1V, 1V, 10V, 100V Accuracy: $\pm .05\%$ Resolution: 6 digits ac Function Ranges: 1V, 10V, 100V Accuracy: $\pm .15\%$ at 10 and 50 kHz Resolution: 5 digits	T V, P, A	-hp- Model 3466A or -hp- Model 3455A w/Option 001 -hp- Model 3455A with Option 001 (Average Responding Converter) or -hp- Model 3490A
Wave Analyzer	Frequency Range: 15 Hz to 50 kHz Amplitude Accuracy: $\pm .5$ dB Spurious Response: ≤ -80 dBc Y-Axis output	V, P, A	-hp- Model 3581A or 3581C
Synthesizer	Frequency Range: 200 Hz to 20.9 MHz Amplitude Range: -60 to +13 dBm Phase Noise: ≤ 70 dBc @ 20MHz Spurious: ≤ -75 dBc	P	-hp- Model 3335A (-hp- Model 3325A is acceptable except for Phase Noise and Spurious Performance Tests)
Unbalanced Directional Couplers	50 ohm Frequency Range: .1 to 20.9 MHz Directivity: ≥ 40 dB 75 ohm Frequency Range: .1 to 20.9 MHz Directivity: ≥ 40 dB	P (3336C only) P (all models)	-hp- Model 8721A* -hp- Model 8721A* with Option 008
*Unbalanced Directional Couplers are also part of Transmission/Reflection kits: 50 Ω Transmission/Reflection Kit -hp- Model 11652A 75 Ω Transmission/Reflection Kit -hp- Model 11652A with Option 008			

Table 4-2. Recommended Test Equipment (Cont'd)

INSTRUMENT	CRITICAL SPECIFICATION	REQUIRED FOR	RECOMMENDED MODEL
Balanced Directional Couplers	124 ohm Frequency Range: .01 to 10.9 MHz Directivity: ≥ 40 dB	P (3336B only)	-hp- Part No. 5061-1137 -hp- Part No. 5061-1136 (Opt 001)
	150 ohm Frequency Range: .01 to 20.9 MHz Directivity: ≥ 40 dB	P (3336A only)	-hp- Part No. 5061-1135
DC Power Supply	Output Voltage: Output Current: ≥ 20 mA	P	-hp- Model 6214A
Double Balanced Mixer	Input/Output Z: 50 ohm Frequency Range: 1 to 20.9 MHz	P	-hp- Model 10534A or 10514A
Attenuators	Attenuation: 10 dB (fixed) VSWR: ≤ 1.02 , dc to 20.9 MHz Input/Output Z: 50 ohms	P	-hp- Model 8491A Option 010 (2 required)
	Attenuation: 0 to 70 dB Attenuation Step Size: 10 dB Input/Output Z: 50 ohm Certification required at 1 MHz, 10 MHz, 20.9 MHz	P	-hp- Model 355D
Spectrum Analyzer	Frequency Range: .1 to 100 MHz Amplitude Accuracy: ± 1 dB Harmonic Distortion: ≤ -65 dBc Spurious: ≤ -70 dBc	V, P, A	-hp- Model 141T/8553B/8552B
	Frequency Range: 10 Hz to 50 kHz Amplitude Accuracy: ± 1 dB Harmonic Distortion: ≤ -65 dBc Spurious: ≤ -70 dBc	V, P, A	-hp- Model 3580A
Thermal Converter	Input Z: 75 ohms Maximum Input: .5 V rms Flatness: Certification required at 10 kHz, 100 kHz, 1 MHz, 10 MHz and 20 MHz	V, P, A	-hp- Model 11051A/H07
Oscilloscope	Vertical Bandwidth: dc to 100 MHz Deflection: .01V to 10V/DIV Horizontal Sweep: .05 μ s to 1s/DIV Delayed Sweep	A, T	-hp- Model 1740A
Function Generator	Frequency: 1 and 10 kHz Functions: Sine, Squarewave Symmetry: Variable	P, A	-hp- Model 3312A
ac Voltmeter	Ranges: 1 mV to 1 V Frequency Range: 25 Hz to 1 MHz Scale: Logarithmic Accuracy: $\pm 2\%$, 100 Hz to 10 kHz	P	-hp- Model 400 E or EL
System Voltmeter	dc Voltage Range: ± 10 V Trigger: External Trigger Delay: Programmable	P	-hp- Model 3437A

Table 4-2. Recommended Test Equipment (Cont'd)

INSTRUMENT	CRITICAL SPECIFICATION	REQUIRED FOR	RECOMMENDED MODEL
1 MHz Low Pass Filter	Cut-Off Frequency: 1 MHz Stop-Band Frequency: 4 to 80 MHz	P	J903 TT Electronics Inc 2214 S. Barry Avenue Los Angeles, CA 90064 (213) 478-8224
15 kHz Low Pass Filter	Cut-Off Frequency: 15 kHz Consisting of Resistor: 10K ohm, ± 1% Capacitor: 1600 pF, ± 5%	P (3336C only)	
High Frequency Probe	Frequency Range: .1 to 20 MHz Accuracy: ± .5 dB (Diode Detector)	P	-hp- Model 11096B
Signature Analyzer	Signature: 4 digit Hexadecimal Characters: 0 thru 9, A, C, F, H, P, U Logic Threshold: + 2.2 V, high + .5 V, low	T	-hp- Model 5004A
Minimum Loss Impedance Matching Pads	50 - 75 ohm	V, P	-hp- Model 85428B
Terminations	50 ohm, ± .1% 75 ohm, ± .1%	V, P, A, T V, P, A, T	-hp- Model 11048C -hp- Model 11094B
Resistor	1 x 50Ω .1% .125W 4 x 62Ω .1% .125W 5 x 75Ω .1% .125W 9 x 135Ω 1 x 150Ω .1% .125W 1 x 225Ω 1% .5W 1 x 358Ω 1% .125W 8 x 600Ω .1% .125W 1 x 675Ω 1% .125W 1 x 10kΩ 1% .25W	V, P, A, T V, P, A, T V, P, A, T V, P, A, T V, P, A, T V, P, A, T V, P, A, T V, P, A, T V, P, A, T V, P, A, T V, P, A, T	-hp- Part No. 0698-6364 -hp- Part No. 0698-6800 -hp- Part No. 0698-7363 -hp- Part No. 0698-7364 -hp- Part No. 0698-6774 -hp- Part No. 0757-0980 -hp- Part No. 0698-3242 -hp- Part No. 0698-7408 -hp- Part No. 0698-4194 -hp- Part No. 0757-0340
Capacitors	1 x 1600pF 5% 300V	V, P, A, T	-hp- Part No. 0160-2223
Amplifier	Gain: 20 dB Frequency Range: .1 to 20.9 MHz Input/Output Z: 50 ohm	P	QB 300 Q-Bit Corp. P.O. Box 2208 Melbourne, Florida 32901 (305) 727-1838
Frequency Counter	Resolution: .1 Hz @ 20 MHz Aging Rate: <1 x 10-8/wk for standard instruments <5 x 10-9/wk for Option 004		-hp- Model 5328A w/Option 10 -hp- Model 5335A w/Option 10 -hp- Model 5345 w/o Option 001

Table 4-2. Recommended Test Equipment (Cont'd)

INSTRUMENT	CRITICAL SPECIFICATION	REQUIRED FOR	RECOMMENDED MODEL
Adapters	BNC (f) to WECO 440A (3336B only)	V, P, A, T	-hp- Part No. 1250-0556 (2 required)
	BNC (f) to WECO 358 (3336B only)	V, P, A, T	-hp- Part No. 1250-0591 (2 required)
	BNC (f) to WECO 347 (3336B only)	V, P, A, T	-hp- Part No. 1251-3759 (2 required)
	BNC (f) to 1.6/5.6 (m) (3336A with Option 001 only)	V, P, A, T	S 230 W & G Instruments Inc. 119 Naylon Avenue Livington, NJ 07039 (201) 994-0854 -hp- Part No. 1251-3757
	BNC (f) to WECO 310 (3336B only)	V, P, A, T	-hp- Part No. 1251-3757
	BNC (f) to TRIAX (m)	P	-hp- Part No. 1250-0595
	BNC (f) to Dual Banana Plug	V, P, A, T	-hp- Part No. 1250-2277
	BNC (m) to Dual Banana Post	V, P, A, T	-hp- Part No. 1250-1264
	Dual Banana Plug (used with termination resistors)	V, P, A	-hp- Part No. 1251-2816 (4 required)
	BNC (f) to Type N (m)	P	-hp- Part No. 1250-0780 (2 required)
	BNC (m) to Type N (f)	P	-hp- Part No. 1250-0077 (2 required)
Cables	50 ohm BNC (m) to BNC (m) 12" 24" 36"	V, P, A, T V, P, A, T V, P, A, T	-hp- Model 11170A (2 required) -hp- Model 11170B (2 required) -hp- Model 11170C (2 required)
	75 ohm BNC (m) to BNC (m) 6" 36"	V, P, A, T V, P, A, T	-hp- Part No. 15582-60010 (2 required) -hp- Part No. 15582-60020 (2 required)
	75 ohm BNC (m) to Siemens type 9 REL STP-6AC Consisting of Siemens type connector (m) BNC (m) connector 6", RG 59 coaxial cable (75 ohm)	V, P, A, T	-hp- Part No. 5060-4444 -hp- Part No. 1250-1448 -hp- Part No. 8120-1289

4-8. PERFORMANCE TEST RECORD.

4-9. A Performance Test Record is located at the end of this section to help you consolidate the test results, -hp- recommends that copies of the Performance Test Record be used. Copies of the Performance Test Record can be made at any time without written permission from Hewlett-Packard.

4-10. PERFORMANCE TESTS.

4-11. The following Performance Tests have been specifically developed to test the -hp- 3336:

Test	Paragraph No.
Frequency Accuracy	4-12
Absolute Amplitude Accuracy	4-14
Amplitude Flatness	4-16
Attenuator Accuracy	4-18
Phase Increment Accuracy	4-20
On Carrier Return Loss	4-22
Output Balance	4-25
Harmonic Distortion	4-27
Spurious Signals	4-29
Amplitude Modulation Envelope Distortion	4-31
Phase Modulation Linearity	4-33
X Drive Linearity	4-35
Integrated Phase Noise	4-37

4-12. Frequency Accuracy.

4-13. The frequency accuracy of the 3336 is not specified. However, the aging rate is. A standard 3336 should pass this test, one year after the frequency has been calibrated. A 3336 with Option 004 should pass this test, one week after the frequency has been calibrated.

Specification: (Aging Rate)

$\pm 5 \times 10^{-6}$ per year (20 to 30°C)

$\pm 5 \times 10^{-8}$ per week, Option 004

Required Equipment:

Electronic Counter

-hp- Model 5328A
with Option 010

75 ohm Feedthru Termination

-hp- Model 11094B

a. Connect the equipment as shown in Figure 4-1.

b. Set the 3336 (DUT) output amplitude to +7.00 dBm (75 ohm output). Set the output frequency to 20 MHz. If the 3336 has Option 004, disconnect the adapter between the 10 MHz OVEN Output and the EXT REF Input.

c. Set the electronic counter to measure frequency with .1 Hz resolution. (On the -hp- 5328A, the counter will overflow, however, the accuracy of the measurement is not affected.

To determine the overflow digit, measure the output frequency with 1 Hz resolution.)

- d. Enter the counter reading on the Performance Test Record.
- e. If the 3336 has Option 004, reconnect the adapter between the 10 MHz OVEN Output and the EXT REF Input.
- f. Measure the frequency again, and enter the reading on the Performance Test Record.

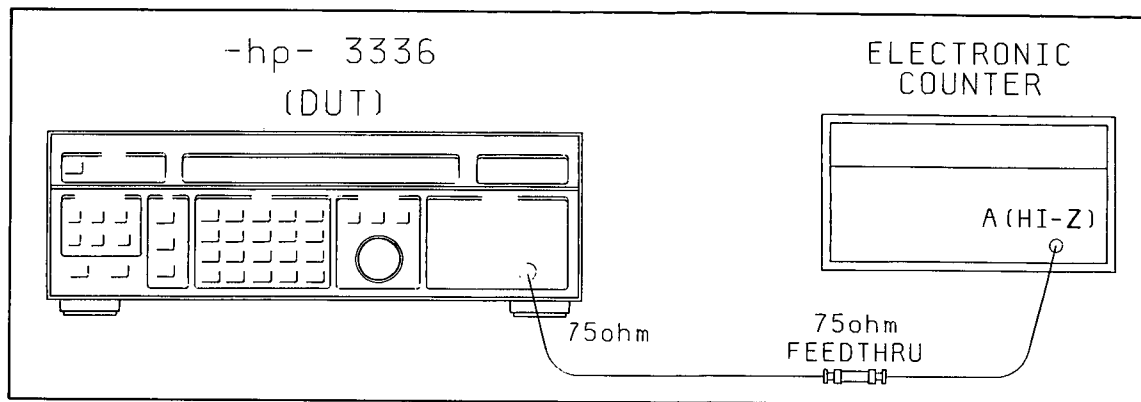

Figure 4-1. Frequency Accuracy Equipment Set Up.

4-14. Absolute Amplitude Accuracy.

4-15. This performance test verifies that the -hp- Model 3336 meets the Absolute Accuracy specification in Table 4-1.

Specification: Accuracy applies to the top 9.99 dB of amplitude range (20° to 30° C).

3336A	75 ohm output	$\pm .05$ dB at 10 kHz
	150 ohm output	$\pm .05$ dB at 50 kHz
	600 ohm output	$\pm .05$ dB at 10 kHz
3336B	75 ohm output	$\pm .05$ dB at 10 kHz
	124 ohm output	$\pm .05$ dB at 50 kHz
	135 ohm output	$\pm .05$ dB at 50 kHz
	600 ohm output	$\pm .05$ dB at 10 kHz
3336C	50 ohm output	$\pm .05$ dB at 10 kHz
	75 ohm output	$\pm .05$ dB at 10 kHz

Required Equipment:

AC Voltmeter

-hp- Model 3455A
with Option 001
(average responding)

Terminations: all 0.1% or better

3336A	75 ohm	-hp- Model 11094B
	150 ohm	-hp- Part No. 0757-0715
	600 ohm	-hp- Part No. 0698-5405
3336B	75 ohm	-hp- Model 11094B
	124 ohm	-hp- Part No. 0698-6284
	135 ohm	-hp- Part No. 0698-5197
	600 ohm	-hp- Part No. 0698-5405
3336C	50 ohm	-hp- Model 11048C
	75 ohm	-hp- Model 11094B

NOTE

The ac voltmeter used in this test must be accurate to $\pm .15\%$

- a. Connect the equipment as shown in Figure 4-2. Use the proper termination at the voltmeter's input. For example, if you are testing the 600 ohm output, use a 600 ohm termination.

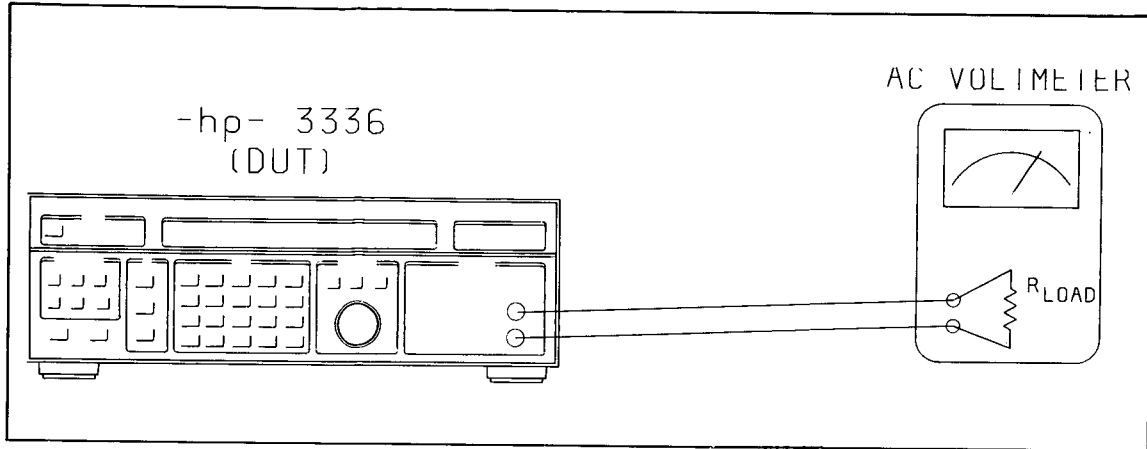

Figure 4-2. Absolute Amplitude Accuracy Equipment Set Up.

- b. Refer to the following table for Step c.

	OUTPUT	AMPLITUDE	FREQUENCY	NOMINAL	MINIMUM	MAXIMUM
3336A	75Ω	7.00 dBm	10 kHz	0.6131	0.6096	0.6166
	150Ω	1.76 dBm	50 kHz	0.4743	0.4716	0.4770
	600Ω	7.00 dBm	10 kHz	1.7341	1.7242	1.7441
3336B	75Ω	7.00 dBm	10 kHz	0.6131	0.6096	0.6166
	124Ω	1.76 dBm	50 kHz	0.4312	0.4288	0.4337
	135Ω	1.76 dBm	50 kHz	0.4500	0.4474	0.4526
	600Ω	7.00 dBm	10 kHz	1.7341	1.7242	1.7441
3336C	50Ω	8.76 dBm	10 kHz	0.6130	0.6095	0.6166
	75Ω	7.00 dBm	10 kHz	0.6131	0.6096	0.6166

- c. Set up the 3336 for each of test conditions above and enter the ac voltmeter readings on the Performance Test Record. Refer to the minimum and maximum values above to see if the measured values meet the specifications.

d. Refer to the following table for Step e.

	OUTPUT	AMPLITUDE	FREQUENCY	NOMINAL	MINIMUM	MAXIMUM
3336A	75Ω	-2.99 dBm	10 kHz	0.1941	0.1930	0.1952
	150Ω	-8.23 dBm	50 kHz	0.1502	0.1493	0.1510
	600Ω	-2.99 dBm	10 kHz	0.5490	0.5459	0.5522
3336B	75Ω	-2.99 dBm	10 kHz	0.1941	0.1930	0.1952
	124Ω	-8.23 dBm	50 kHz	0.1365	0.1357	0.1373
	135Ω	-8.23 dBm	50 kHz	0.1425	0.1416	0.1433
	600Ω	-2.99 dBm	10 kHz	0.5490	0.5459	0.5522
3336C	50Ω	-1.23 dBm	10 kHz	0.1941	0.1930	0.1952
	75Ω	-2.99 dBm	10 kHz	0.1941	0.1930	0.1952

e. Set up the 3336 for each of test conditions above and enter the ac voltmeter readings on the Performance Test Record. Refer to the minimum and maximum values above to see if the measured values meet the specifications.

4-16. Amplitude Flatness.

4-17. This performance test verifies that the -hp- Model 3336 meets the Amplitude Flatness specification in Table 4-1.

Specification:

Referenced to amplitudes at 10 kHz for the 50, 75 and 600 ohm outputs. Referenced to amplitudes at 50 kHz for the 124, 135 and 150 ohm outputs.

3336A	75 ohm output	± .1 dB (± .07 dB)*	10 Hz to 20.9 MHz
	150 ohm output	± .12 dB	10 kHz to 2.09 MHz
	600 ohm output	± .25 dB	200 Hz to 109 kHz
3336B	75 ohm output	± .1 dB (± .07 dB)*	10 Hz to 20.9 MHz
	124 ohm output	± .15 dB	10 kHz to 50 kHz
		± .1 dB	50 kHz to 10.9 MHz
	600 ohm output	± .25 dB	200 Hz to 109 kHz
3336C	50 ohm output	± .1 dB (± .07 dB)*	10 Hz to 20.9 MHz
	75 ohm output	± .1 dB (± .07 dB)*	10 Hz to 20.9 MHz

*NOTE

Specifications in parenthesis apply to instruments with Option 005.

Required Equipment:

75 ohm, .5 V Thermal Converter
DC Voltmeter

-hp- Model 11051A/H07
-hp- Model 3455A

Impedance Matching Pads

3336A	150 to 75 ohm R1 = 75 ohm 1%	-hp- Part No. 0698-7363
	600 to 75 ohm R1 = 225 ohm 1% R2 = 300 ohm 1%	-hp- Part No. 0757-0980 -hp- Part No. 0698-6319
3336B	124 to 75 ohm R1 = 358 ohm 1% R2 = 62 ohm 1%	-hp- Part No. 0698-3242 -hp- Part No. 0698-6800
	135 to 75 ohm R1 = 675 ohm R2 = 67.5 ohm (2 x 135)	-hp- Part No. 0698-4194 -hp- Part No. 0698-7364 (need 2)
	600 to 75 ohm R1 = 225 ohm 1% R2 = 300 ohm 1%	-hp- Part No. 0757-0980 -hp- Part No. 0698-6319
3336C	50 to 75 ohm	-hp- Model 85428B

a. Connect the equipment as shown in Figure 4-3. Connect the thermal converter directly to the 3336 (DUT), 75 ohm output. If this is not possible, use the shortest cables available. Use the appropriate impedance matching pad between the other 3336 outputs and the 75 ohm thermal converter.

b. Set the frequency and amplitude of the 3336 to the values in the following table. The 10 kHz measurement must be taken first because the thermal converter voltage at this frequency will be used as a reference for the other frequencies.

	OUTPUT	FREQUENCIES	AMPLITUDE	CONVERTER VOLTAGE
3336A	75Ω	10 Hz, 100 kHz, 1 MHz, 10 MHz, 20.9 MHz	5.00 dBm	0.487 V
	150Ω	10 kHz, 100 kHz, 1 MHz, 2.09 MHz	1.50 dBm	0.230 V
	600Ω	200 Hz, 109 kHz	6.50 dBm	0.205 V
3336B	75Ω	10 Hz, 100 kHz, 1 MHz, 10 MHz, 20.9 MHz	5.00 dBm	0.487 V
	124Ω	10 kHz, 100 kHz, 1 MHz, 10.9 MHz	1.50 dBm	0.209 V
	135Ω	10 kHz, 100 kHz, 1 MHz, 2.09 MHz	1.50 dBm	0.218 V
	600Ω	200 Hz, 109 kHz	6.50 dBm	0.205 V
3336C	50Ω	10 Hz, 100 kHz, 1 MHz, 10 MHz, 20.9 MHz	8.50 dBm	0.377 V
	75Ω	10 Hz, 100 kHz 1 MHz, 10 MHz,	5.00 dBm 20.9 MHz	0.487 V

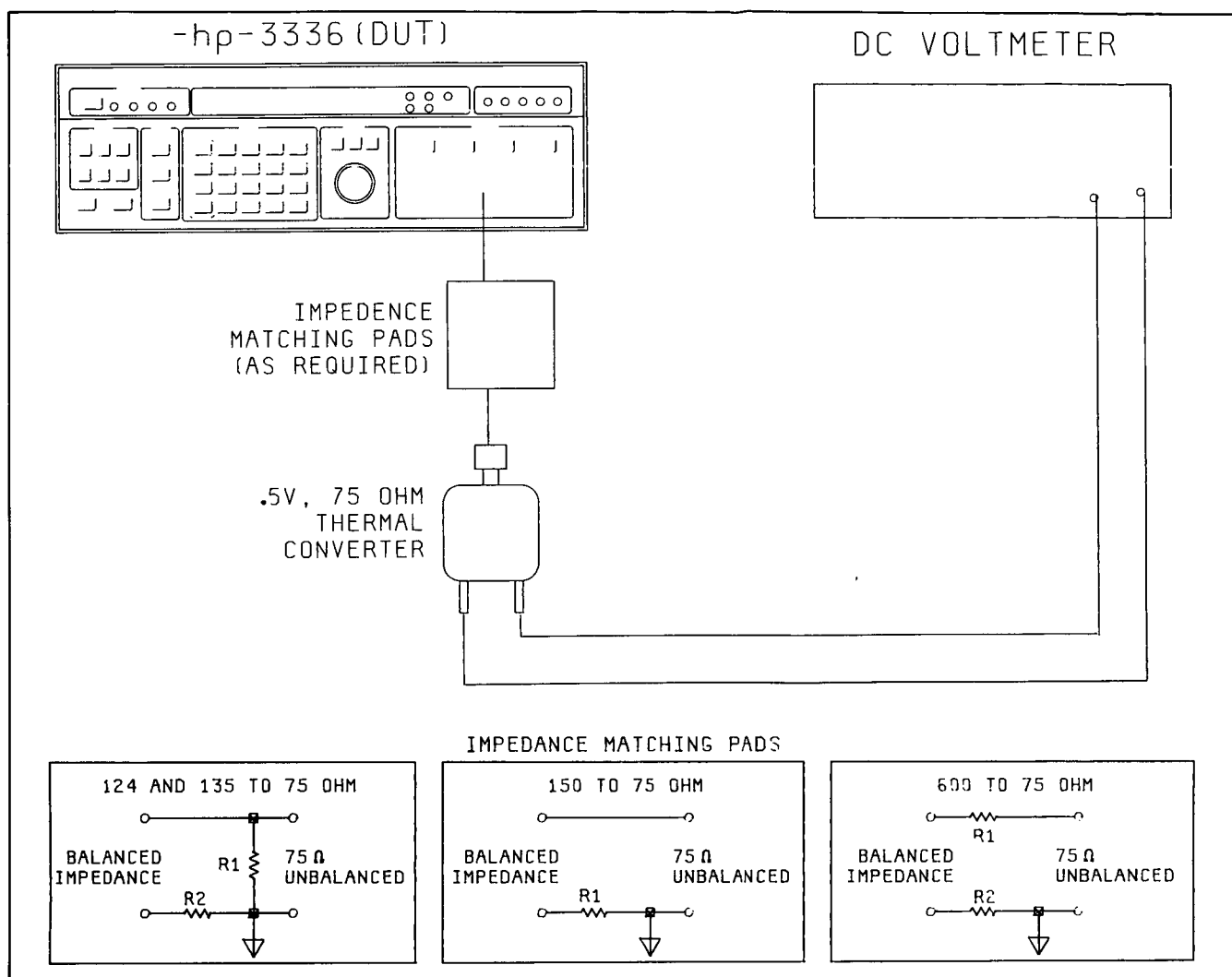

Figure 4-3. Amplitude Flatness Equipment Set Up.

c. Allow time for the thermal converter to settle before taking any measurements. The accuracy of this test is enhanced if the thermal converter is protected from drafts and other sources of temperature change. Measure and record the thermal converter's output with the 3336 programmed at 10 kHz.

CAUTION

Use extreme caution when making the following measurements at the 75 ohm output. The converter voltage will approach maximum, and the converter will be destroyed if care is not exercised.

d. Measure the thermal converter voltage for each output at the frequencies listed above. At each frequency setting, adjust the amplitude of the 3336 in .01 dBm steps until the converter voltage is equal to the reference voltage recorded at 10 kHz. When the converter level matches the reference level, record the amplitude setting of the 3336. Do not adjust the amplitude of the 3336 in increments larger than .01 dBm.

e. If the certified error of the thermal converter being used was given in dBm, enter this value in the Performance Test Record. If it was given as a percentage, convert it to dBm using the following formula:

$$\text{dBm} = 20\log(1 - \%error/1000)$$

f. Compute the amplitude flatness of the 3336 at each output and frequency setting using the following formula:

$$\begin{array}{r} \text{Reference level (from Step c)} \\ - \text{ 336 Amplitude setting (from Step d)} \\ + \text{ Thermal converter error (from step e)} \\ \hline = \text{ 3336 amplitude flatness} \end{array}$$

4-18. Attenuator Accuracy Verification.

4-19. This performance test verifies that the -hp- 3336 meets the attenuator accuracy specification listed in Table 4-1 using a "put and take" measurement system at four attenuator settings and three test frequencies. It is preferred that this test be performed in a screen room. If one is not available, an electrically "clean" environment is a must. It is important that the specified cables be used and that the test equipment be arranged as illustrated. Failure to follow the test procedures explicitly can result in erroneous data.

NOTE

A certification program is available to verify the 3336 attenuator specifications. To recertify, the attenuator must be returned to Hewlett-Packard. The recertified attenuator will be returned with the results of each attenuation setting. Contact your nearest Hewlett-Packard Sales Office for further details. A list of these offices is provided at the back of this manual.

Required Equipment:

Attenuator (10 dB, 20 dB, 40 dB, 70 dB attenuations) with Certification	-hp- Model 355D
(2) 10 dB, 50 ohm Coaxial Attenuators	-hp- Model 8491A Option 010
75 ohm to 50 ohm Minimum Loss Impedance Matching Pad	-hp- Model 85428B
50 ohm Feedthru Termination	-hp- Model 11048C
Mixer	-hp- Model 10514A
Synthesizer	-hp- Model 3325A
Wave Analyzer	-hp- Model 3581A/C
DC Voltmeter	-hp- Model 3455A
DC Power Supply	-hp- Model 6214A
20 dB Amplifier	Q Bit Corp. Model QB-300

Cables:

- (1) 50 ohm, 1 ft. -hp- 11170A
- (1) 50 ohm, 2 ft. -hp- 11170B
- (1) 50 ohm, 3 ft. -hp- 11170C

Adapters: 50 ohm

- (1) Type N (m) to BNC (m) -hp- 1250-0082
- (2) Type N (f) to BNC (m) -hp- 1250-0077
- (1) Type N (m) to BNC (f) -hp- 1250-0780
- (1) BNC (f) to Dual Banana -hp- 1251-2277
- (1) BNC (m) to BNC (m) -hp- 1250-0216

Adapters: 75 ohm

- (1) BNC (m) to BNC (m) -hp- 1250-1288

NOTE

Q Bit Corporation; P.O. Box 2208; Melbourne, Florida 32901.

- a. Connect the equipment electrically as shown in Figure 4-4 and physically as shown in Figure 4-5.

NOTE

The quality of the test results depends upon the equipment arrangement. It is important that the physical location of the instruments be as shown in Figure 4-5. Do not cross cables. Allow the Q-Bit Amplifier 30 minutes to warm-up.

- b. Set the 3336 (DUT) controls as follows:

Amplitude..... + 7.00 dBm (75 ohm output)
 Frequency..... 20 MHz

- c. Set the Reference Synthesizer as follows:

Amplitude..... + 7.00 dBm (50 ohm output)
 Frequency..... 20.008 MHz

- d. Set the Wave Analyzer controls as follows:

Scale..... Volts
 Resolution Bandwidth..... 100 Hz
 Sweep Mode..... Manual
 Amplitude Reference Level..... Normal
 Input Sensitivity (initially)..... 1V
 Input (3581C)..... Unbalanced
 AFC..... OUT; Tune Frequency to 8 kHz
 AFC..... Push IN after Tuning to 8 kHz

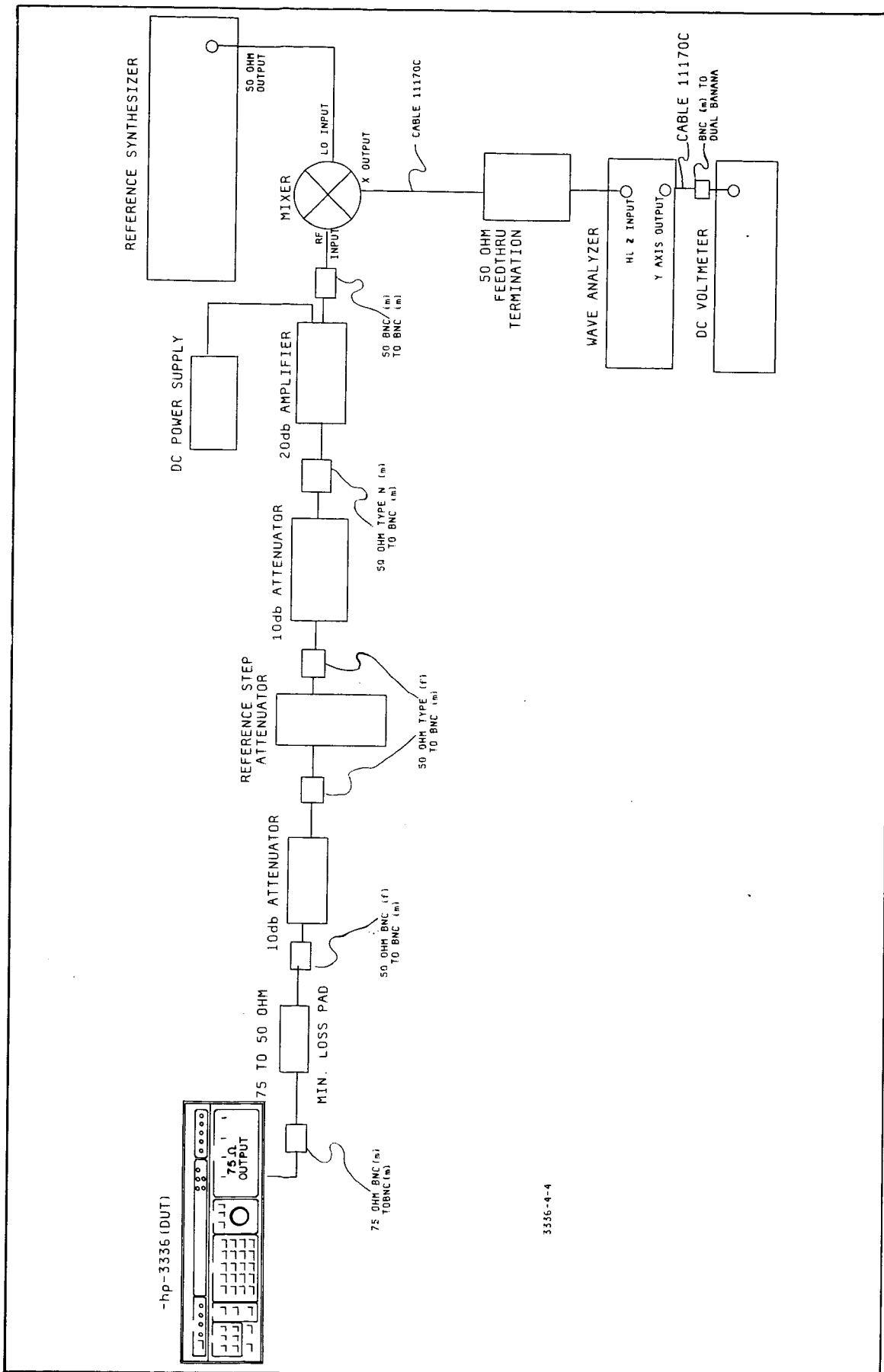

Figure 4-4. Equipment Set Up for Attenuator Accuracy Test

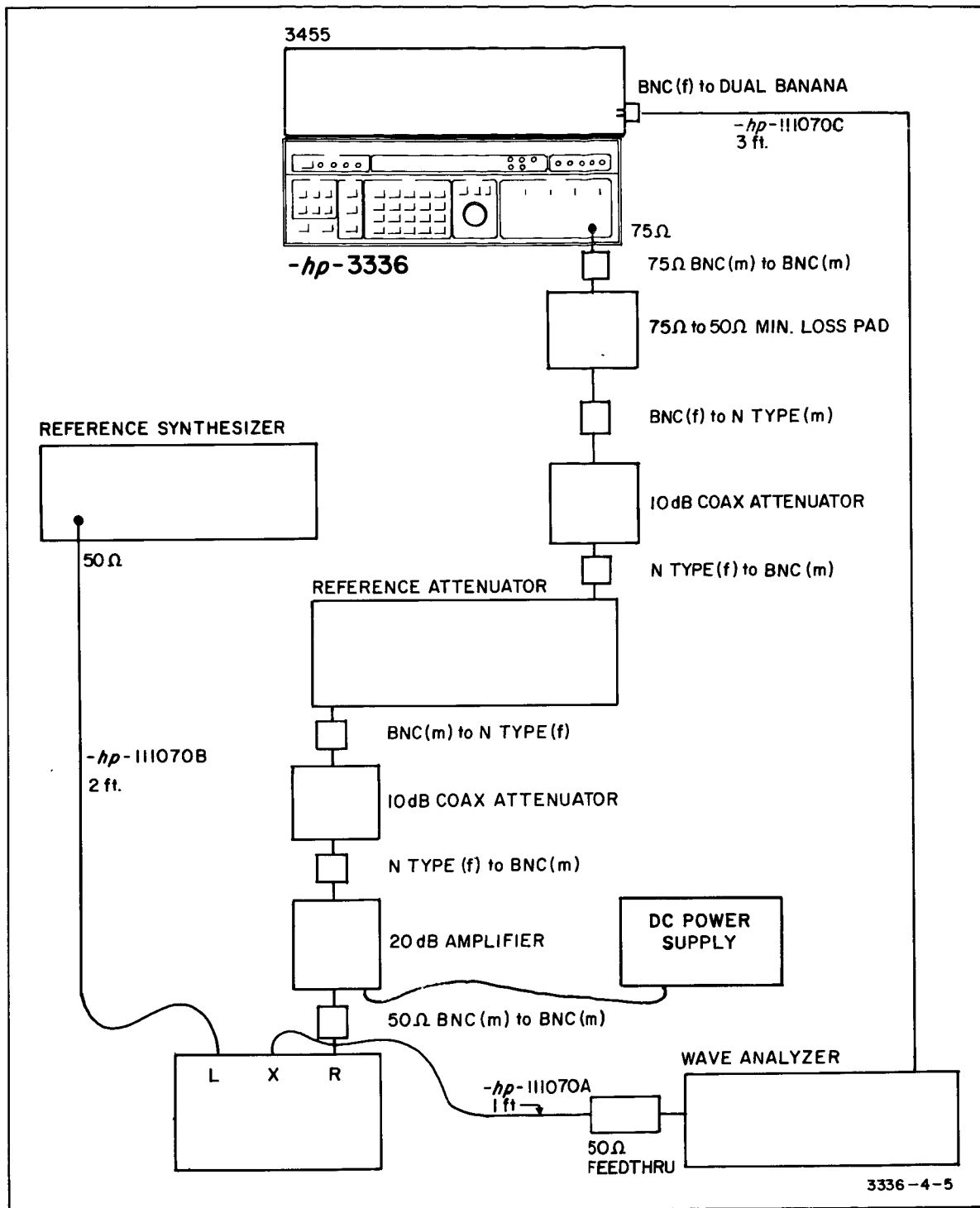

Figure 4-5. Physical Location for Attenuator Accuracy

e. The objective of this procedure is to compare the reference attenuator against the 3336 attenuator. The 3336 is tested at 10, 20, 40, and 70 dB attenuation levels. Begin each test by setting up the reference attenuator and the 3336 to the levels shown in the table below under Step e.

TEST	STEP E		STEP H	
	3336	REFERENCE	3336	REFERENCE
10 dB	7 dBm	10 dB	- 3 dBm	0 dB
20 dB	7 dBm	20 dB	- 13 dBm	0 dB
40 dB	7 dBm	40 dB	- 38 dBm	0 dB
70 dB	7 dBm	70 dB	- 63 dBm	0 dB

f. Adjust the wave analyzer sensitivity until the DVM reads approximately 4.6 volts.

g. Observe the DVM for several seconds to determine the average reading and record it in the Performance Test Record as V1.

h. Reduce the 3336 level to the value shown in the table above under Step h.

i. Adjust the reference attenuator to 0 dB.

j. Again observe the DVM and record the average value in the Performance Test Record, this time as V2.

k. Repeat Steps e - h until all four attenuation levels have been tested.

4-20. Phase Increment Accuracy.

4-21. This performance test verifies that the -hp- 3336 meets the Phase Increment Accuracy specification listed in Table 4-1.

Specification:

Any phase increment will be within 0.2° of the selected value.

Required Equipment:

Electronic Counter

-hp- Model 5328A with
Option 040 or Option 041

75 ohm Feedthru Termination

-hp- Model 11094B

a. Connect the REF OUT output, located on the 3336 (DUT) rear panel, to the B input of the electronic counter. This will be the reference source against which phase increments will be measured.

b. Connect the 3336 (DUT), 75 ohm output, to the A input of the electronic counter. Terminate this output with a 75 ohm feedthru termination at the counter's input.

c. Set the 3336 (DUT) output frequency to 1 MHz and output amplitude to +7.00 dBm.

- d. Set the electronic counter controls to measure the average time interval from input A to input B (T.I.AVG A→B). Set the counter to average 10^7 intervals. Note, the gate time to average 10^7 intervals will be 1 second. Do not use the first reading displayed after changing phase.
- e. Adjust the 3336 (DUT) output phase until the counter displays a time interval from 190 ns to 210 ns. Each degree incremented on the 3336 will cause a 2.8 ns change in the counter display.
- f. Assign zero phase to the 3336 signal output. This is a shifted function of the PHASE key.
- g. Record the electronic counter reading with no phase shift (T1).
- h. Change the phase of the 3336 output signal by one of these values:

$+1^\circ$	$+10^\circ$	$+100^\circ$
------------	-------------	--------------
- i. Record the electronic counter reading with the test phase shift (T2).
- j. Reset the 3336 output phase to zero degrees. The electronic counter should again display a time interval from 190 ns to 210 ns.
- k. Repeat Steps e thru j until each phase increment has been measured. Reading T1 may change slightly from test to test and a new value should be recorded for each test increment.
- l. Compute the actual time difference of each phase increment by subtracting T1 from T2. Record this value on the Performance Test Record and compare it to the upper and lower limits.

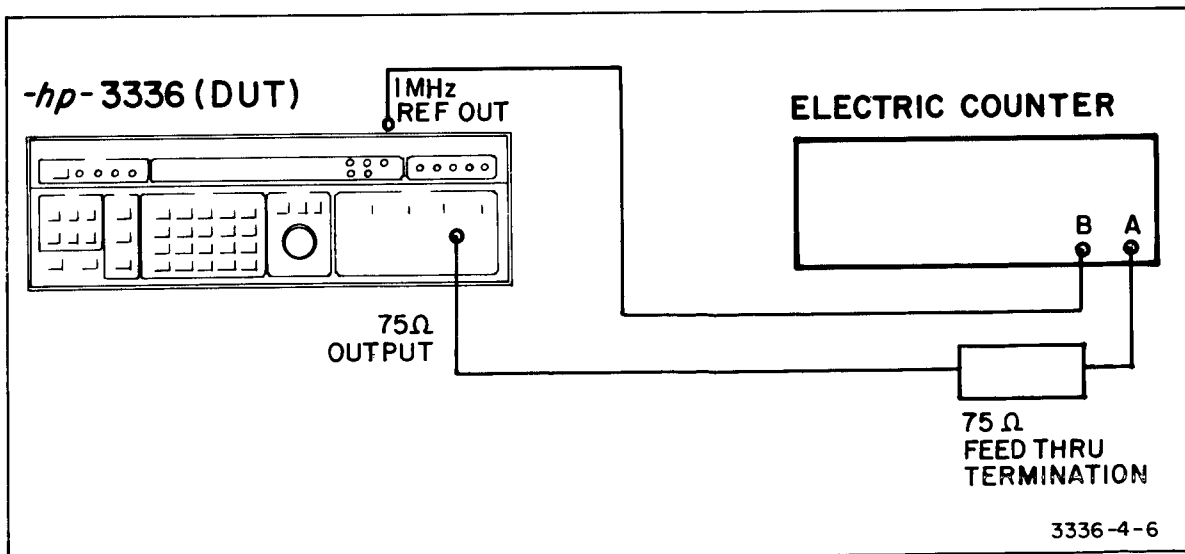

Figure 4-6. Phase Increment Accuracy Equipment Set Up.

4-22. On Carrier Return Loss.

4-23. This performance test verifies that the -hp- 3336 meets the On Carrier Return Loss specification in Table 4-1.

Specification:

	10Hz	10kHz	30kHz	2.09MHz	10.9MHz	20.9MHz
3336A						
75 ohm output	> 30 dB					
150 ohm output	> 20 dB		> 30 dB			
3336B						
75 ohm output	> 30 dB					
124 ohm output	> 20 dB		> 30 dB			
135 ohm output	> 20 dB		> 30 dB			
3336C						
50 ohm output	> 30 dB					> 25 dB*
75 ohm output	> 30 dB					

***NOTE**

50Ω Return Loss from 10 MHz to 20.9 MHz is > 30 dB with Option 005.

Required Equipment:

Synthesizer	-hp- Model 3325A or 3335A
Wave Analyzer	-hp- Model 3581A/C
High Frequency Probe (diode detector)	-hp- Model 11096B
50 - 75 ohm Minimum Loss Impedance Matching Pad	-hp- Model 85428B
75 ohm Directional Bridge**	-hp- Model 8721A/Option 008
50 ohm Directional Bridge (3336C only)**	-hp- Model 8721A
124 ohm Directional Coupler (3336B only)	-hp- Part No. 5061-1135
124 ohm Direction Coupler (3336B with Option 001)	-hp- Part No. 5061-1136
150 ohm Directional Coupler (3336A only)	-hp- Part No. 5061-1137
50 ohm Feedthru Termination (3336C only)	-hp- Model 11048C (2 required)
75 ohm Feedthru Termination	-hp- Model 11094B (2 required)
124 ohm Termination Resistor (3336B only) (2 × 248 ohm)	-hp- Part No. 0698-6793 (4 required)
150 ohm Termination Resistor (3336A only)	-hp- Part No. 0698-6774 (2 required)
Ohmmeter	-hp- Model 3455A

****NOTE**

Directional Bridges are also part of Transmission/Reflection Kits:

50 ohm Transmission/Reflection Kit -hp- Model 11652A

75 ohm Transmission/Reflection Kit -hp- Model 11652A

Option 008

a. Connect the equipment as shown in Figure 4-7. Use the appropriate impedance Directional Coupler and Termination for the output under test. For example, to test the 124 ohm output, use the 124 ohm Directional Coupler and 124 ohm Termination Resistors. To test the 75 ohm output, use the 75 ohm Direction Coupler and 75 ohm Feedthru Terminations.

NOTE

Make sure the frequency references of the synthesizer and the 3336 (DUT) are locked together.

b. Set the 3336 (DUT) output amplitude to maximum:

50 ohm – +8.76 dBm

75 ohm – +7.00 dBm

124 ohm – +1.76 dBm

150 ohm – +1.76 dBm

c. Set the 3336 (DUT) output frequency to one of the following test frequencies:

50 ohm – 100kHz, 1MHz, 10MHz, 20.9MHz

75 ohm – 100kHz, 1MHz, 10MHz, 20.9MHz

124 ohm – 100kHz, 1MHz, 10.9MHz

150 ohm – 100kHz, 1MHz, 2.09MHz

d. Turn Fast Leveling “ON”. This test will not produce valid results if Fast Leveling is “OFF”.

e. Set the reference synthesizer’s output amplitude to –10 dBm for all test setups except when testing the 3336’s 75 ohm output. Set the reference synthesizer’s output amplitude to –4 dBm when testing the 75 ohm outputs.

f. Set the reference synthesizer’s output frequency to the test frequency (selected in Step c) plus 15 Hz.

g. Tune the Wave Analyzer to lock to and measure the 15 Hz signal from the High Frequency Probe. Use a 3 Hz, or narrower, resolution bandwidth. If you have a -hp- Model 3581A/C Wave Analyzer, set the controls as follows:

SCALE.....90 dB
 RESOLUTION BANDWIDTH.....3 Hz
 SWEEP MODE.....Manual
 AMPLITUDE REFERENCE LEVEL.....Normal
 INPUT (3581C).....Unbalanced
 INPUT SENSITIVITY.....as required
 AFC.....OUT: Tune to 15 Hz
 AFC.....PUSH IN after tuning to 15 Hz

h. Create an impedance mismatch factor of two by inserting a feedthru termination between the load port of the directional coupler and the 3336 under test. If the output under test is a balanced output, create a mismatch by placing a termination resistor across the 3336 output. The value of this resistor must be the same as the impedance of the output under test. (e.g. use a 50 ohm termination when testing the 50 ohm output.)

i. In all cases, adjust the wave analyzer's input sensitivity controls until it displays -9.5 dB. If the impedance mismatch is a factor of two, all the mismatches produced in Step h have a return loss of 9.54 dB.

j. Remove the Feedthru Termination or Termination Resistor and connect the Directional Coupler directly to the 3336 output under test.

k. Record the Wave Analyzer reading on the Performance Test Record for the output and frequency tested.

NOTE

Make sure the Wave Analyzer is tuned to the 15 Hz signal before recording the reading.

l. Repeat Steps c thru k until the return loss at all the test frequencies listed in Step c has been measured.

m. Repeat Steps b thru l until the return loss of all the 3336's signal outputs has been measured.

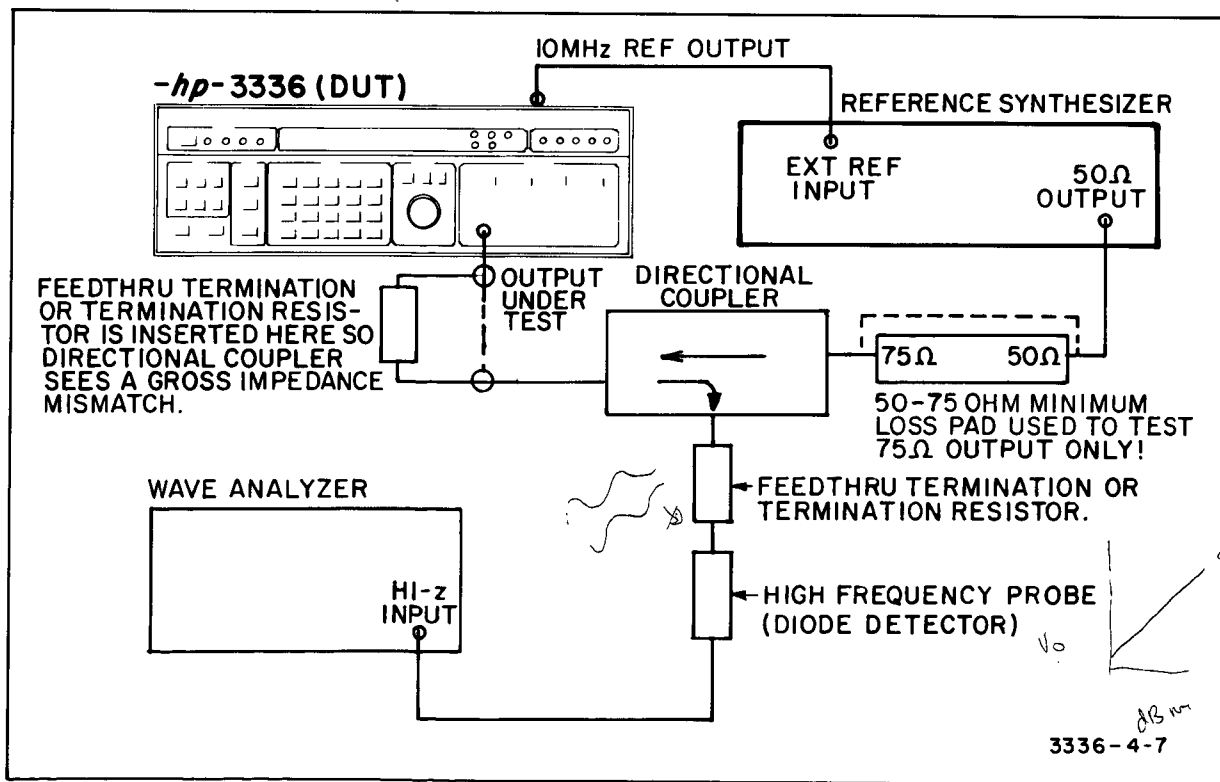

Figure 4-7. On Carrier Return Loss Equipment Set Up.

4-24. On Frequency Return Loss Measurement Technique.

Since this performance test is new, a brief conceptual discussion of the measure follows:

A small signal is launched, in the forward direction, into the active -hp- 3336 output. The addition of the 3336's output signal (f_c) and the small signal (f_o) at the 3336's output could be considered as the 3336 output signal with one sideband. Furthermore, this signal (the carrier and one sideband) is mathematically equivalent to the 3336 output signal (the carrier) with a pair of AM sidebands and a pair of PM sidebands, cancelling on one side of the carrier and reinforcing on the other side. The 3336's amplitude leveling circuits will compensate for any amplitude changes, and effectively cancel them at the Leveled Node (located on the other side of the output termination, inside the 3336). Since no AM components can exist at this Leveled Node, there will be no AM components reflected, either. Any reflected AM components seen at the output of the 3336 are solely due to the output termination impedance and, hence, are a measure of the "ON" Frequency Return Loss. A directional coupler introduces the small signal to the 3336's output and isolates the reflected signals. A diode detector recovers the AM components (recall that there are also PM sidebands) by demodulating the reflected signals and a wave analyzer, tuned to the modulating frequency, measures the relative magnitude of this signal and a signal from a known, gross impedance mismatch, used as a reference. To insure that the measurement is "ON" Frequency Return Loss, the frequency difference between f_c and f_o must be well within the bandwidth of the 3336's Amplitude Leveling circuits. When Fast Leveling is "ON", this bandwidth is from dc to 1 kHz. When Fast Leveling is OFF, this bandwidth is from dc to 1 Hz. In this particular procedure, the frequency difference is 10 Hz, therefore, Fast Leveling must be ON. Since the only difference between Fast Leveling ON and OFF is the bandwidth of the leveling circuits, results obtained with Fast Leveling ON apply to the instrument when Fast Leveling is OFF.

$$\text{Return loss} = 20\log|(Z_i - Z_o)/(Z_i + Z_o)|$$

where: Z_i is the ideal output impedance
 Z_o is the actual output impedance

4-25. Output Balance (3336A and 3336B only).

4-26. This performance test verifies that the -hp- 3336 meets the Balance specification in Table 4-1.

Specification:

Model 3336A

150 ohm output > 36 dB, 10 kHz to 2.09 MHz
 600 ohm output > 38 dB, 300 Hz to 50 kHz

Model 3336B

124 ohm output > 30 dB, 10 kHz to 10.9 MHz
 135 ohm output > 36 dB, 10 kHz to 2.09 MHz
 600 ohm output > 38 dB, 300 Hz to 50 kHz

Required Equipment:

AC Voltmeter -hp- Model 400E or EL
 Resistors (3 ea. required)
 R = 62 ohm (3336B only) (3 required) -hp- Part No. 0698-6800
 R = 67.5 ohm (3336B only) (3 required) -hp- Part No. 0698-7364 (2 in parallel)
 R = 75 ohm (3336A only) (3 required) -hp- Part No. 0698-7363
 R = 300 ohm (3336A/3336B) (6 required) -hp- Part No. 0698-6319

a. Connect the equipment as shown in Figure 4-8A. Neither voltmeter input can be connected to ground.

b. Set the 3336 frequency to 10 kHz.

c. Set the 3336 amplitude to maximum. The maximum output amplitudes by output are:

124 ohm + 1.76 dBm
 135 ohm + 1.76 dBm
 150 ohm + 1.76 dBm
 600 ohm + 7.00 dBm

d. Record the voltmeter reading, using the dB scale (V_{ref}).

e. Connect the equipment as shown in Figure 4-8B.

f. Set the 3336 frequency to each of the test frequencies listed below. For each frequency, take a voltage measurement, using the dB scale (V_{bal}).

OUTPUT	OUTPUT LEVEL	RESISTOR	TEST FREQUENCIES
124Ω	1.76 dBm	62Ω	10 kHz, 100 kHz, 1 MHz, 10 MHz
135Ω	1.76 dBm	67.5Ω	10 kHz, 100 kHz, 2.09 MHz
150Ω	1.76 dBm	75Ω	10 kHz, 100 kHz, 2.09 MHz
600Ω	7.00 dBm	300Ω	300 Hz, 10 kHz, 50 kHz

g. Subtract V_{bal} (Step d) from V_{ref} (Step f) and enter the results on the Performance Test Record for each test frequency.

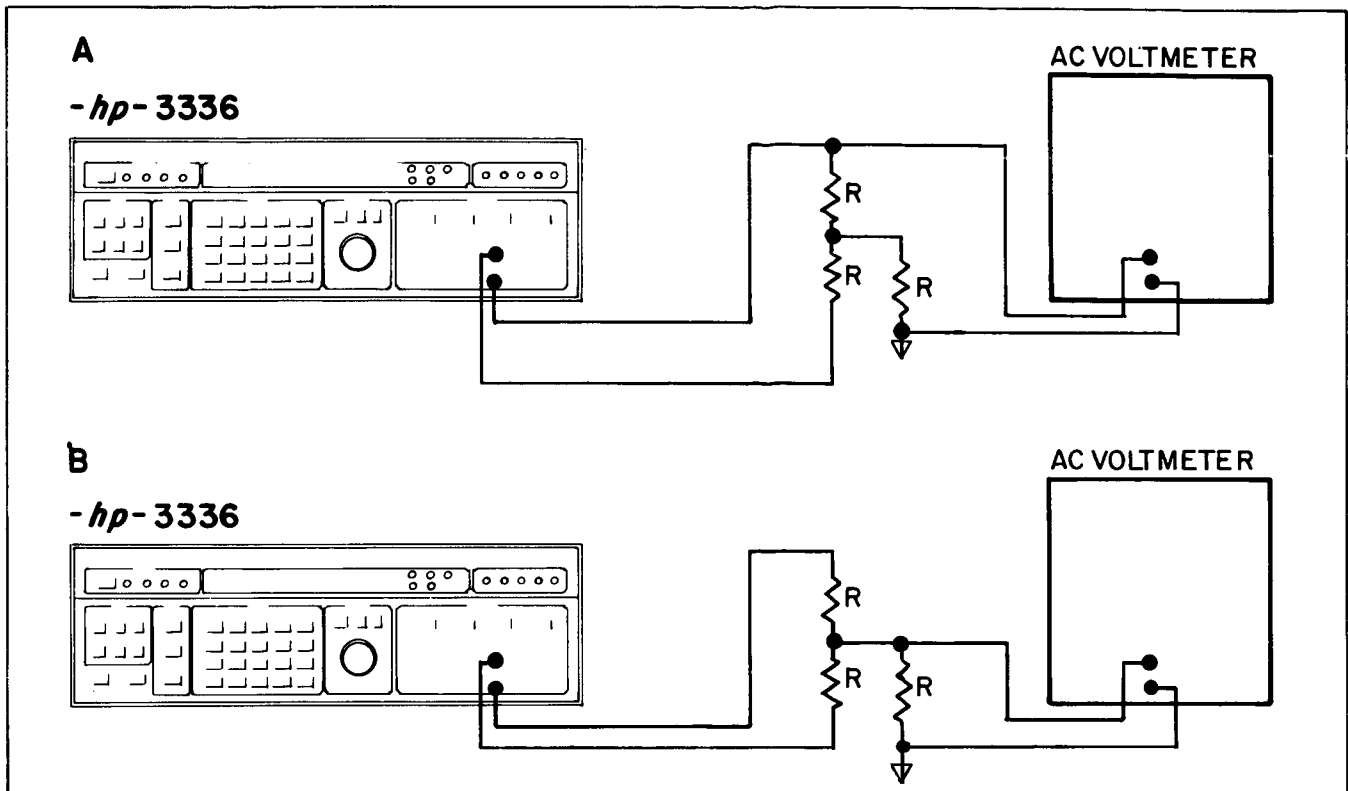

Figure 4-8. Equipment Set Up for Output Balance.

4-27. Harmonic Distortion.

4-28. This performance test verifies that the -hp- 3336 meets the Harmonic Distortion specification listed in Table 4-1.

Specification:

10Hz	30Hz	50Hz	10kHz	100kHz	1MHz	5MHz	20.9MHz	
-35dB	-50dB	-60dB			-55dB	-50dB		Fast Leveling OFF
			-50dB	-60dB	-55dB	-50dB		Fast Leveling ON

Required Equipment:

- | | |
|--|---------------------------------|
| Spectrum Analyzer (low frequency) | -hp- Model 3580A |
| Spectrum Analyzer (high frequency) | -hp- Model 141T/
8552B/8553B |
| 50 ohm Feedthru Termination | -hp- Model 11048C |
| 50-75 ohm Minimum Loss Impedance
Matching Pad | -hp- Model 85428B |

NOTE

When making harmonic distortion measurements with a spectrum analyzer, make sure that the analyzer's harmonic distortion does not mask the distortion of the device under test. One technique to ensure this is to increase the analyzer's input attenuation, which results in lower signal levels at the analyzer's input. This yields better intermodulation and harmonic distortion performance. Adjust the analyzer's reference level controls to obtain the proper display. For good harmonic distortion performance in the -hp- Model 141T/8552B/8553B, the signal level at its mixer must be less than -40 dBm. If you are using this analyzer, set its input attenuation to 40dB.

a. This test will require two different setups: one for frequencies equal to or less than 10 kHz and one for frequencies greater than 10 kHz.

b. Set the 3336 controls as follows:

OUTPUT75 ohm
 AMPLITUDE5.00 dBm
 FAST LEVELINGOFF

c. Perform Steps d through f for each configuration listed below.

3336 FREQUENCY	FAST LEVELING	SETUP
10 Hz	OFF	Figure 4-9A
30 Hz	OFF	
50 Hz	OFF	
10 kHz	OFF	
10 kHz	ON	
100 kHz	OFF	Figure 4-9B
100 kHz	ON	
1 MHz	OFF	
1 MHz	ON	
5 MHz	OFF	
5 MHz	ON	
20.9 MHz	OFF	
20.9 MHz	ON	

d. Tune the spectrum analyzer to display the fundamental frequency and at least four of its harmonics.

e. Adjust the analyzer's input sensitivity controls until the amplitude of the fundamental is 0 dB (full scale display).

- f. Measure the value of the largest harmonic, relative to the fundamental, and record this value in the Performance Test Record.
- g. Repeat Steps d - f until each of the conditions in the table above have been tested.

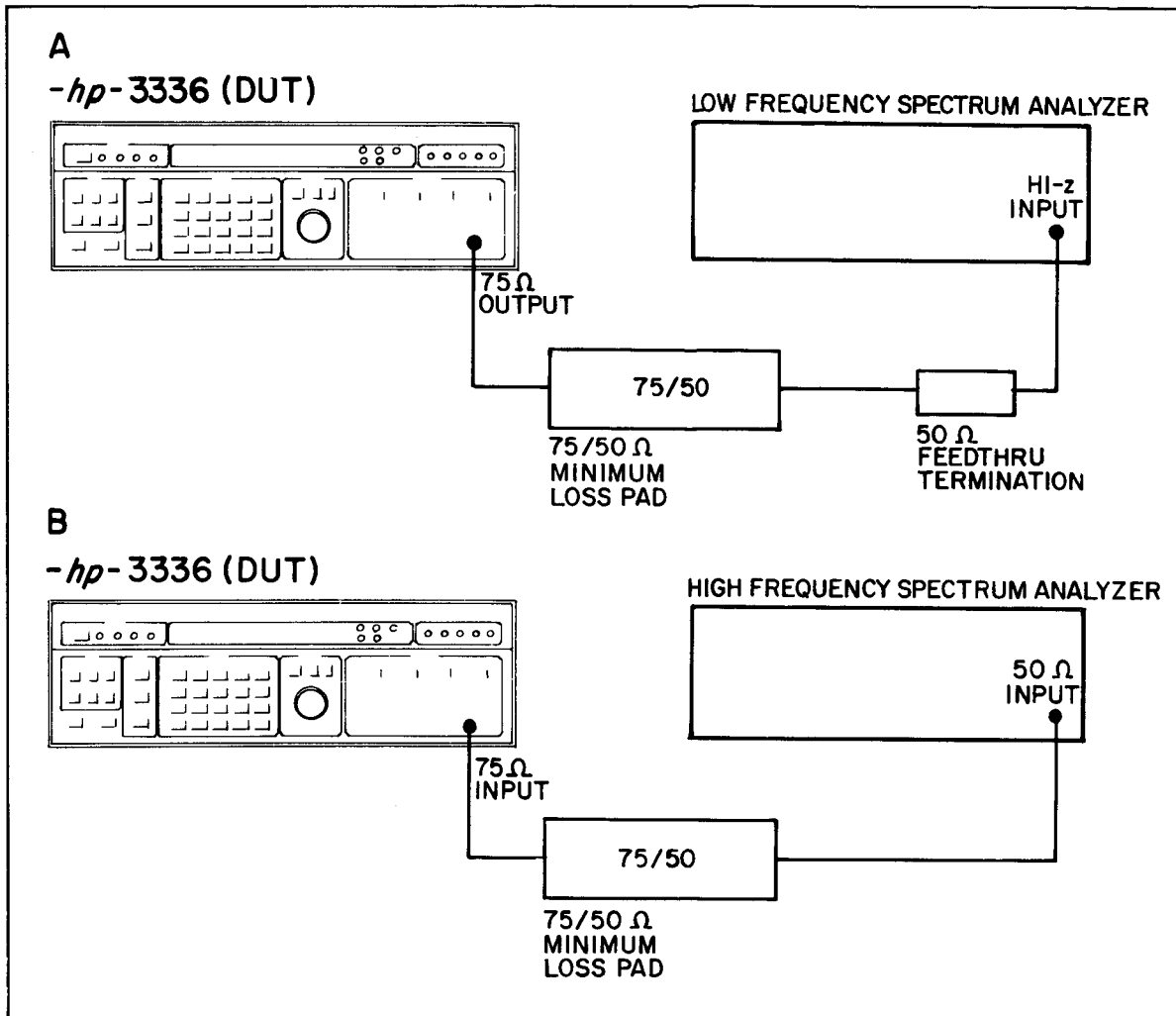

Figure 4-9. Harmonic Distortion Equipment Set Up.

4-29. Spurious Signal.

4-30. This performance test verifies that the -hp- 3336 meets the Spurious Signal specification in Table 4-1.

Specification: dc to 200 MHz except where noted.

All non-harmonically related signals from 0 Hz to 200 MHz will be more than 70 dB below the carrier or one of the following levels, whichever is greater:

Model 3336A	Without Option 005	With Option 005
75 ohm output	- 100 dBm	- 115 dBm
150 ohm output	- 100 dBm	- 100 dBm
	(to 10 MHz)	(to 10 MHz)
600 ohm output	- 100 dBm	- 100 dBm
	(to 10 MHz)	(to 10 MHz)
 Model 3336B		
75 ohm output	- 100 dBm	- 115 dBm
124 ohm output	- 100 dBm	- 115 dBm
135 ohm output	- 100 dBm	- 115 dBm
600 ohm output	- 100 dBm	- 115 dBm
 Model 3336C		
50 ohm output	- 100 dBm	- 115 dBm
75 ohm output	- 100 dBm	- 115 dBm

NOTE

Line related signals from the 600 ohm outputs will be more than 70 dB below the carrier or - 83 dBm whichever is greater.

Required Equipment:

Spectrum Analyzer (High Frequency)	-hp- Model 141T/ 8553B/8552B
Spectrum Analyzer (Low Frequency)	-hp- Model 3582A
Synthesizer	-hp- Model 3335A
Mixer	-hp- Model 10534A
DC Voltmeter	-hp- Model 3455A
75 to 50 ohm Minimum Loss Impedance Matching Pad	-hp- Model 85428B
50 ohm Feedthru Termination	-hp- Model 11054C
1 MHz Low Pass Filter	TT Electronics Model J903

- a. Connect the equipment as shown in Figure 4-10A.
- b. Set the 3336's amplitude of +7.00 dBm (75 ohm) and frequency to 20 MHz.
- c. Tune the spectrum analyzer to the 3336's output signal and set a 0 dB reference level.

d. Without changing any controls which will affect the reference level, tune the spectrum analyzer to the following frequencies and measure their relative amplitude:

100kHz 1MHz 2MHz 30MHz

e. All spurious signals should be more than 70 dB below the reference level.

f. Set the 3336 sweep controls as follows:

SWEEP START FREQUENCY.....11 MHz
 SWEEP STOP FREQUENCY.....19 MHz
 SWEEP TIME.....5 seconds

g. Set the spectrum analyzer controls as follows:

START FREQUENCY.....10 MHz
 SCAN WIDTH.....1 MHz/DIV
 BANDWIDTH.....30 kHz
 SCAN TIME.....20 ms/DIV

h. Press the 3336 "CONT" key.

i. Set the spectrum analyzer controls to display the 3336 output signal and a 2:1 mixer spur. As the 3336 output signal sweeps from 11 MHz to 19 MHz the 2:1 mixer spur will sweep from 19 MHz to 11 MHz. Measure the amplitude of the spur relative to the 3336 output signal (reference level).

j. All spurious signals should be more than 70 dB below the reference level.

k. Connect the equipment as shown in Figure 4-10B.

l. Set the 3336's amplitude to +7.00 dBm (75 ohm) and frequency to 1 kHz.

m. Tune the spectrum analyzer to the 3336 output signal at 1 kHz and set a 0 dB reference level. Using a battery powered spectrum analyzer enhances the accuracy of this part of the test.

n. Without changing any controls that will affect the reference level, tune the spectrum analyzer to the following frequencies and measure their amplitude relative to the 0 dB reference level:

60Hz 120Hz 180Hz

o. All spurious signals should be more than 70 dB below the reference level.

p. Connect the equipment as shown in Figure 4-10C.

q. Set the 3336's output amplitude to +2.7 dBm (75 ohm) and frequency to 20.001 MHz.

r. Make sure the frequency references of both synthesizers are locked together and set the reference synthesizer's output amplitude to +7.00 dBm (50 ohm) and frequency to 20 MHz.

s. Tune the spectrum analyzer to the 1 kHz signal from the mixer and low pass filter and set a 0 dB reference level.

- t. Change the reference synthesizer output frequency to 20.001 MHz.
- u. Increment the phase of the 3336's output signal until the dc output of the mixer is 0 Vdc, $\pm .01$ V.
- v. Disconnect the dc voltmeter to eliminate a possible noise source.
- w. Tune the spectrum analyzer to the following frequencies and measure their amplitude relative to the reference level set in Step s.

1kHz 2kHz 3kHz 4kHz

- x. Enter a Pass or Fail indication on the Performance Test Record. This test checked a number of the most important (largest) spurious signals. There may be other spurious signals present, however, they normally are well within the specification and need not be checked.

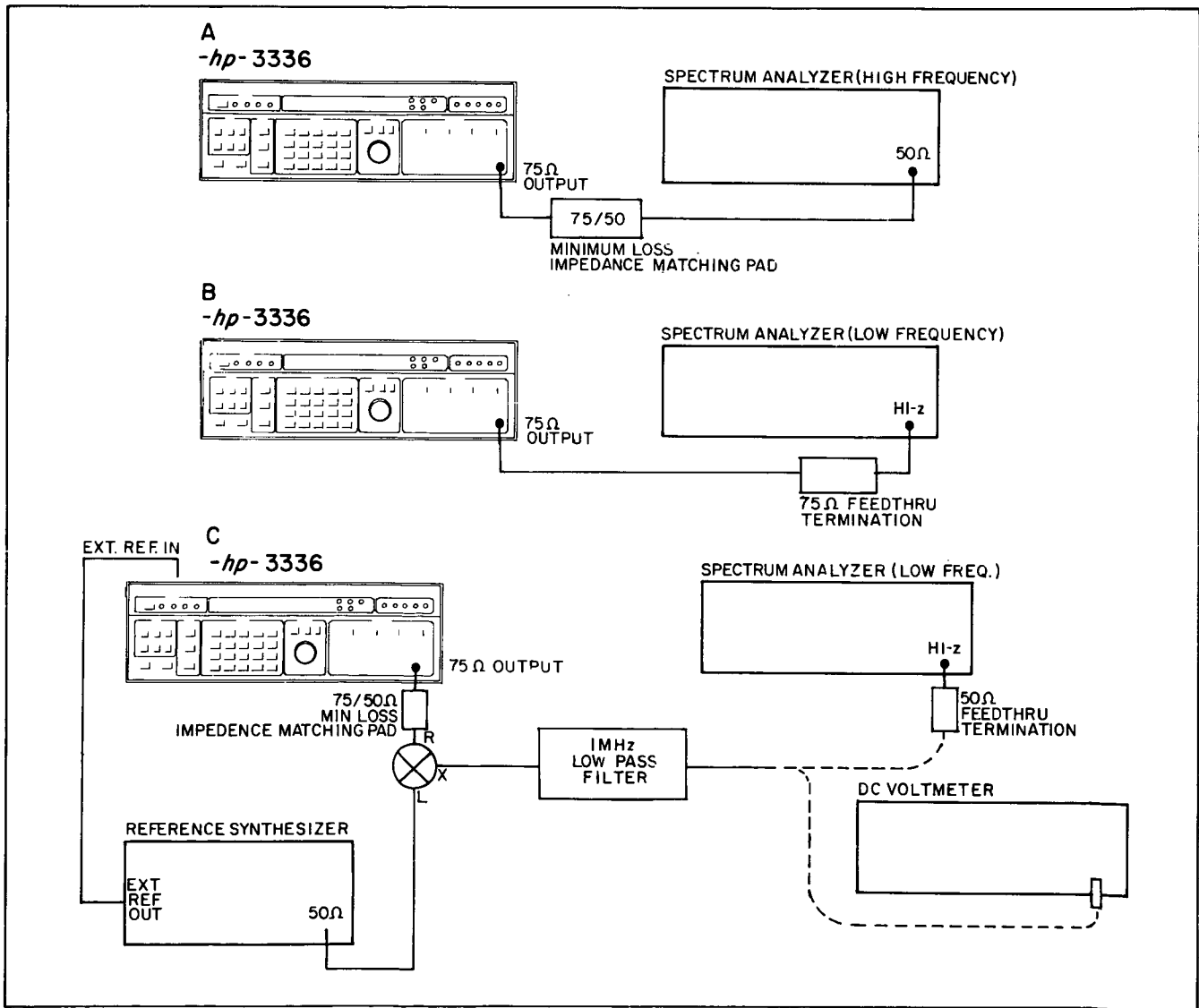

Figure 4-10. Spurious Signal Equipment Set Up.

4-31. Amplitude Modulation Envelope Distortion.

4-32. This procedure verifies that the -hp- 3336 meets the Amplitude Modulation Envelope Distortion specification listed in Table 4-1.

Specification:

All distortion related sidebands will be more than 30 dB below the first or fundamental sideband at 80% modulation. $f_c = 20$ MHz, $f_m = 10$ kHz.

Required Equipment:

Sine Wave Source	-hp- Model 3325A
Spectrum Analyzer	-hp- Model 141T/ 8552B/8553B
50-75 ohm Minimum Loss Impedance Matching Pad	-hp- Model 85428B

- a. Connect the equipment as shown in Figure 4-11.
- b. Set the 3336 (DUT) controls as follows:
 - SIGNAL OUTPUT.....75 ohm
 - AMPLITUDE..... +7.00 dBm
 - FREQUENCY.....20 MHz
 - AMPLITUDE MODULATION.....On
- c. Set the spectrum analyzer controls to display the carrier (center frequency = 20 MHz) and at least four orders of sidebands (frequency span = 100 kHz).
- d. Set the frequency of the modulating signal to 10 kHz. Adjust the amplitude of the modulating signal until the first sideband is 7.96 dB below the carrier amplitude. This sideband to carrier relationship corresponds to 80% amplitude modulation. Note, as the percent of modulation increases, the amplitude of the carrier will decrease slightly. This is normal and due to the 3336's leveling loop regulating the output power at a constant level.
- e. Measure the amplitude of the distortion related sidebands relative to the first or fundamental sideband. Enter this value on the Performance Test Record.

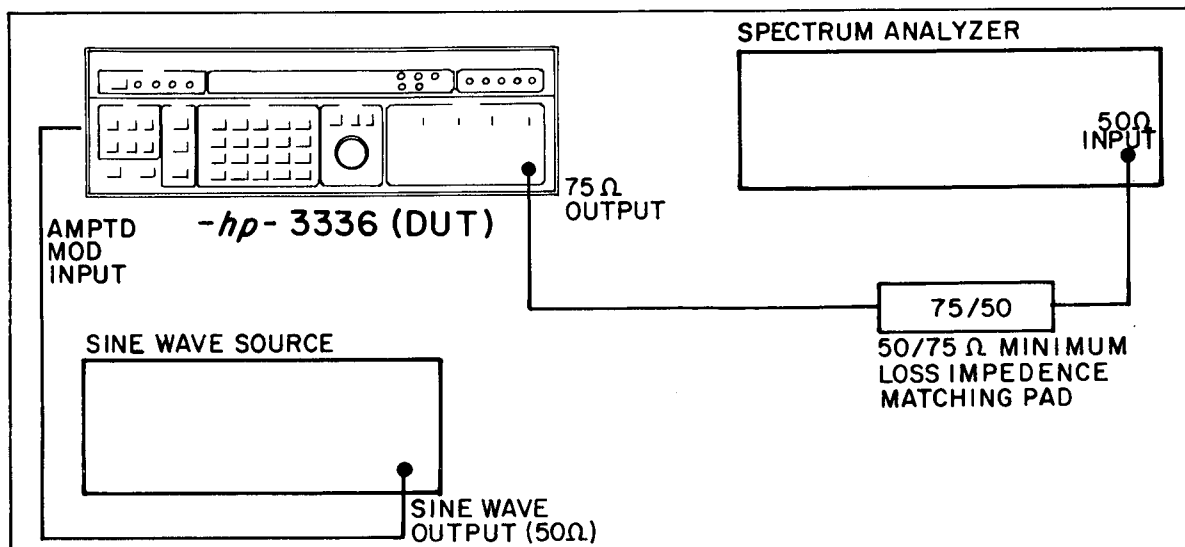

Figure 4-11. Amplitude Modulation Envelope Distortion Equipment Set Up.

4-33. Phase Modulation Linearity.

4-34. This performance test verifies that the -hp- Model 3336 meets the Phase Modulation Linearity specification in Table 4-1.

Specification:

The phase shift of the main signal, caused by the phase modulation input voltage, will be linear within .5% of the peak to peak phase deviation, compared to a best fit straight line.

Required Equipment:

dc Power Supply	-hp- Model 6216A
dc Voltmeter	-hp- Model 3455A
Electronic Counter	-hp- Model 5328A
75 ohm Feedthru Termination	-hp- Model 11094B

a. Connect the equipment as shown in Figure 4-12.

b. Set the 3336 controls as follows:

FREQUENCY.....1 MHz
 OUTPUT.....75 ohm
 AMPLITUDE..... +7.00 dBm
 PHASE MODULATION.....ON

c. Set the electronic counter controls to measure the average time interval between input A and input B (T.I. AVG A→B). Set the number of intervals averaged to 10⁶.

d. Set the power supply voltage to -5.000 V, ± .002 V. Use the dc voltmeter to adjust this voltage as precisely as possible. This is the first voltage (x₀) from the following list:

x ₀ = -5.000 V	x ₃ = -2.000 V	x ₆ = 1.000 V	x ₉ = 4.000 V
x ₁ = -4.000 V	x ₄ = -1.000 V	x ₇ = 2.000 V	x ₁₀ = 5.000 V
x ₂ = -3.000 V	x ₅ = 0.000 V	x ₈ = 3.000 V	

It may be easier to obtain an accurate 0.000 V by disconnecting the power supply and placing a short across the 3336's Phase Modulation input.

e. With the RPG, modify the phase of the 3336's main output until the electronic counter measures a time interval of 200 ns ± .5 ns. To achieve this accuracy, the final phase increments must be in .1° steps.

f. Without changing any other controls, set the dc power supply to the next voltage from the list in Step d. The voltages listed in Step d must be used in sequence and must be accurate to within .002 V.

g. Record the time interval (T_n) in column "T" of the work sheet at the end of this procedure.

h. Repeat Steps e thru g until time interval measurements have been taken for each voltage listed in Step d. The repeating sequence is:

1. Set the time interval to 200 ns.
2. Increment the dc voltage by 1 V.
3. Record the new time interval on the work sheet.

i. Each value entered in column "T" is the incremental time interval for a 1 volt input step, plus 200 ns. The accumulative time interval is the sum of all the preceding incremental time intervals, less 200 ns per time interval. Find the accumulative time intervals (y_n) and enter the results in column "C", and in the "Measured Results" column on the Performance Test Record. If, for example, all the incremental time intervals are 700 ns, the accumulative time intervals would be:

0, 500 ns, 1000 ns, 1500 ns, . . . 5000 ns

j. Total all the entries in column "C".

k. Multiply the corresponding entries in column "A" and column "C" together and enter the results to 5 decimal places in column "D".

l. Total all the entries in column "D".

m. The general equations to find the slope and y intercept for a "best fit straight line" are rather involved, however, in this particular procedure they reduce to:

$$m = \frac{D}{110} \qquad b = \frac{C}{11}$$

n. Using the values for C and D from the work sheet and the formula from the previous step, compute values for m and b.

o. Using the formula $y = mx + b$, with the specific values m and b just found, compute a value y for each x recorded in column "A". Enter the results in the "Specification" column on the Performance Test Record.

p. Take the last entry in the "Specification" column and multiply it by .005. Enter this number in all the spaces in the "Tolerance" column.

q. In order for the 3336 to pass this performance test, the "Measured Results" must equal the corresponding "Specification", plus or minus the "Tolerance".

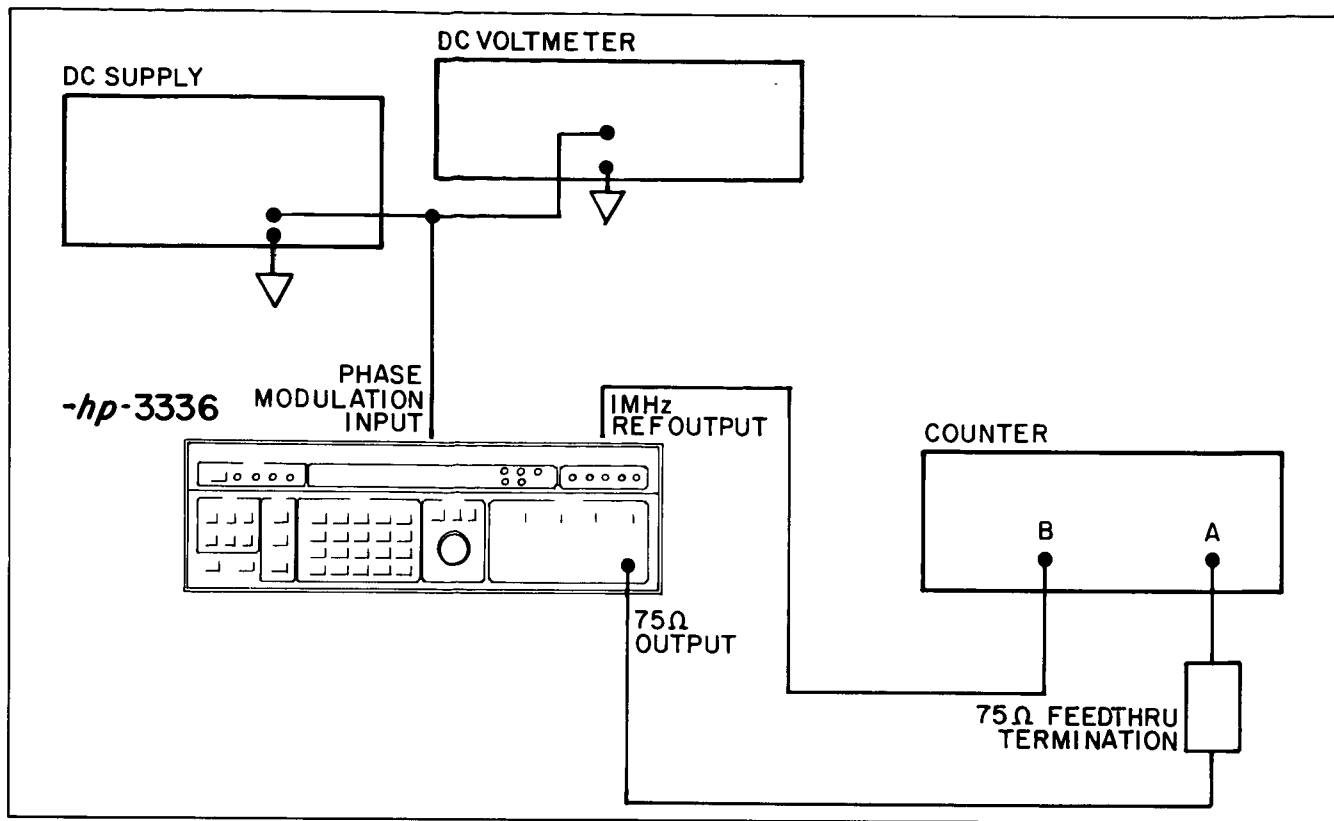

Figure 4-12. Phase Modulation Linearity Equipment Set Up.

4-35. X Drive Linearity.

4-36. This performance test verifies that the -hp- 3336 meets the X Drive Linearity specification in Table 4-1.

Specification:

The X Drive ramp will be linear within .1% of the final ramp voltage, from 10% to 90%, compared to a best fit straight line.

Required Equipment:

- | | |
|----------------------|-------------------------|
| System Voltmeter | -hp- Model 3437A |
| BNC to Triax Adapter | -hp- Part No. 1250-0595 |

a. Connect the equipment as shown in Figure 4-13.

b. Set the system voltmeter controls as follows:

- | | |
|-------------------------|------|
| RANGE..... | 10 V |
| NUMBER OF READINGS..... | 1 |
| TRIGGER | Ext |

NOTE

The -hp- 3437A triggers on the negative going edge of the 3336's Z Blank signal. This occurs at the start of each sweep up.

c. Starting with the 3336 in its "turn on" condition, set the Sweep Time to .01 seconds and press the CONT key.

d. Set the system voltmeter delay to each of the following times (x_n). For each delay time, record the voltage reading (y_n) in column C of the work sheet at the end of this procedure and on the Performance Test Record in the "Measured Results" column. In both places, record this voltage to 2 decimal places.

$$\begin{array}{lll} x_0 = .001s & x_3 = .004s & x_6 = .007s \\ x_1 = .002s & x_4 = .005s & x_7 = .008s \\ x_2 = .003s & x_5 = .006s & x_8 = .009s \end{array}$$

e. Total all the entries in column "C".

f. Multiply the corresponding entries in column "A" and column "C" together and enter the results to 5 decimal points in column "D".

g. Total all the entries in column "D".

h. The general equations to find the slope and y intercept for a "best fit straight line" are rather involved, however, in this particular procedure, they reduce to:

$$b = .527778C - 83.333D \qquad m = 16,667D - 83.333C$$

i. Using the values for C and D from the work sheet and the formula from the previous step, compute values for m and b.

j. Using the formula $y = mx + b$, with the specific values m and b just found, compute a value y for each x recorded in column "A". Enter the results in the "Specification" column on the Performance Test Record.

k. In order for the 3336 to pass this performance test, the "Measured Results" must equal the corresponding "Specification", plus or minus the "Tolerance".

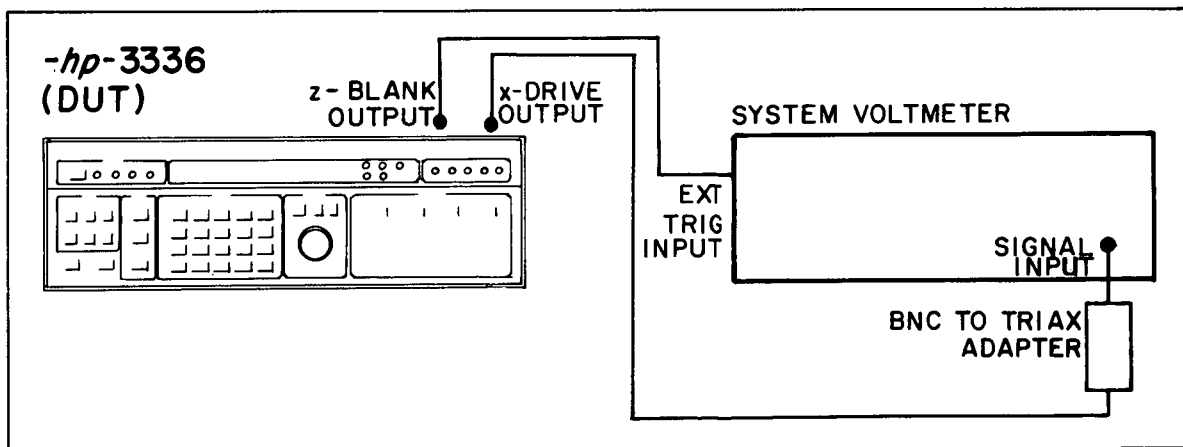

Figure 4-13. X-Drive Linearity Performance Test Equipment Set Up.

4-37. Integrated Phase Noise.

4-38. This performance test verifies that the -hp- 3336 meets the Integrated Phase Noise specification in Table 4-1.

Specification:

- 3336A/B: >72 dB for a 3kHz band centered 2 kHz either side of the 3336 carrier.
- 3336C: >60 dB for a 30 kHz band centered on the 3336 carrier, excluding 1 Hz about the carrier.

Required Equipment:

Low Phase Noise Synthesizer	-hp- Model 3335A
Mixer	-hp- Model 10534A
1 MHz Low Pass Filter	TT Electronics, Model J903
dc Voltmeter	-hp- Model 3455A
ac Voltmeter	-hp- Model 400FL
75 to 50 ohm Minimum Loss Impedance Matching Pad	-hp- Model 85428B
50 ohm Feedthru Termination	-hp- Model 11048C
15 kHz, noise equivalent, Low Pass Filter, consisting of:	
Resistor: 10 k ohm	-hp- Part No. 0757-0340
Capacitor: 1600 pF	-hp- Part No. 0160-2223

a. Connect the equipment as shown in Figure 4-14. Make sure that the frequency references of the 3336 and the reference synthesizer are locked together.

b. Set the reference synthesizer controls as follows:

FREQUENCY.....20.001 MHz
 AMPLITUDE..... + 7.00 dBm

c. Set the 3336 (DUT) controls as follows:

FREQUENCY.....20 MHz
 AMPLITUDE..... + 2.7 dBm (75 ohm)

d. Record the ac voltmeter reading, using the dB scale (V_{ref}).

e. Change the reference synthesizer's frequency to 20 MHz.

f. Disconnect the ac voltmeter and connect the dc voltmeter in its place.

g. Modify the phase of the 3336's output, using the Tuning control in the Modify group, until the dc voltmeter reads 0 V, \pm 10 mV.

h. Disconnect the dc voltmeter and reconnect the ac voltmeter.

i. Record the ac voltmeter reading, using the dB scale (V_{noise}).

j. Using the following formula, compute the integrated phase noise of the 3336:

$$V_{ref} - V_{noise} - 1.05 \text{ dB} - 3 \text{ dB} = \text{integrated phase noise}$$

NOTE

Subtract the 1.05 dB term in the formula above only if you are using an averaging voltmeter. Do not subtract 1.05 dB if you are using a true rms meter.

k. Enter the result in the Performance Test Record and compare it to the specification (>60 dB).

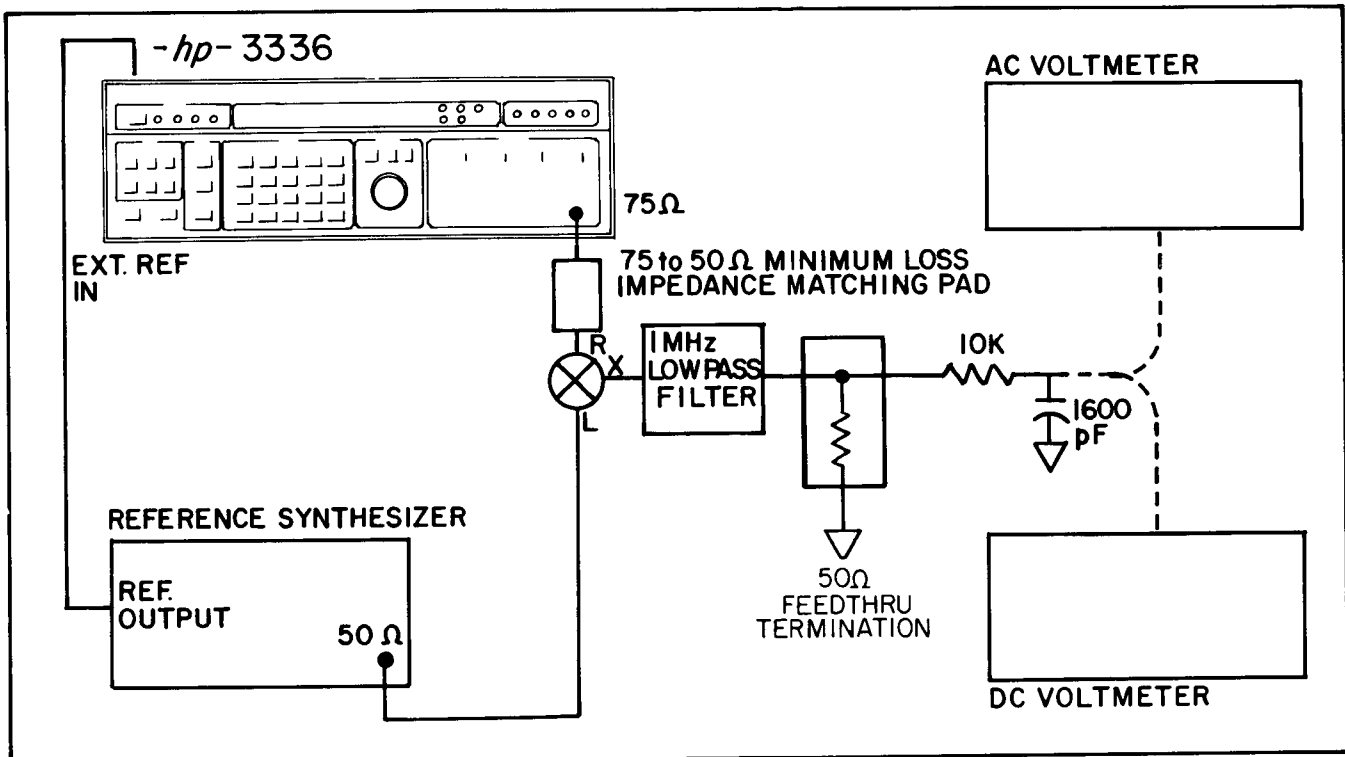

Figure 4-14. Integrated Phase Noise Equipment Set Up.

Phase Modulation Work Sheet

A	B	T	C	D
$x_0 = \underline{-5}$	$(x_0)^2 = \underline{25}$	$T_0 = \underline{200}$	$y_0 = \underline{0}$	$-5y_0 = \underline{0}$
$x_1 = \underline{-4}$	$(x_1)^2 = \underline{16}$	$T_1 = \underline{\hspace{2cm}}$	$y_1 = \underline{\hspace{2cm}}$ <small>$(y_1 = y_0 + T_1 - 200\text{ns})$</small>	$-4y_1 = \underline{\hspace{2cm}}$
$x_2 = \underline{-3}$	$(x_2)^2 = \underline{9}$	$T_2 = \underline{\hspace{2cm}}$	$y_2 = \underline{\hspace{2cm}}$ <small>$(y_2 = y_1 + T_2 - 200\text{ns})$</small>	$-3y_2 = \underline{\hspace{2cm}}$
$x_3 = \underline{-2}$	$(x_3)^2 = \underline{4}$	$T_3 = \underline{\hspace{2cm}}$	$y_3 = \underline{\hspace{2cm}}$ <small>$(y_3 = y_2 + T_3 - 200\text{ns})$</small>	$-2y_3 = \underline{\hspace{2cm}}$
$x_4 = \underline{-1}$	$(x_4)^2 = \underline{1}$	$T_4 = \underline{\hspace{2cm}}$	$y_4 = \underline{\hspace{2cm}}$ <small>$(y_4 = y_3 + T_4 - 200\text{ns})$</small>	$-1y_4 = \underline{\hspace{2cm}}$
$x_5 = \underline{0}$	$(x_5)^2 = \underline{0}$	$T_5 = \underline{\hspace{2cm}}$	$y_5 = \underline{\hspace{2cm}}$ <small>$(y_5 = y_4 + T_5 - 200\text{ns})$</small>	$0y_5 = \underline{0}$
$x_6 = \underline{+1}$	$(x_6)^2 = \underline{1}$	$T_6 = \underline{\hspace{2cm}}$	$y_6 = \underline{\hspace{2cm}}$ <small>$(y_6 = y_5 + T_6 - 200\text{ns})$</small>	$1y_6 = \underline{\hspace{2cm}}$
$x_7 = \underline{+2}$	$(x_7)^2 = \underline{4}$	$T_7 = \underline{\hspace{2cm}}$	$y_7 = \underline{\hspace{2cm}}$ <small>$(y_7 = y_6 + T_7 - 200\text{ns})$</small>	$2y_7 = \underline{\hspace{2cm}}$
$x_8 = \underline{+3}$	$(x_8)^2 = \underline{9}$	$T_8 = \underline{\hspace{2cm}}$	$y_8 = \underline{\hspace{2cm}}$ <small>$(y_8 = y_7 + T_8 - 200\text{ns})$</small>	$3y_8 = \underline{\hspace{2cm}}$
$x_9 = \underline{+4}$	$(x_9)^2 = \underline{16}$	$T_9 = \underline{\hspace{2cm}}$	$y_9 = \underline{\hspace{2cm}}$ <small>$(y_9 = y_8 + T_9 - 200\text{ns})$</small>	$4y_9 = \underline{\hspace{2cm}}$
$x_{10} = \underline{+5}$	$(x_{10})^2 = \underline{25}$	$T_{10} = \underline{\hspace{2cm}}$	$y_{10} = \underline{\hspace{2cm}}$ <small>$(y_{10} = y_9 + T_{10} - 200\text{ns})$</small>	$5y_{10} = \underline{\hspace{2cm}}$
A = <u>0</u>	B = <u>110</u>		C = <u> </u>	D = <u> </u>

X-Drive Linearity Work Sheet

A	B	C	D
$x_0 = \underline{\quad .001 \quad}$	$(x_0)^2 = \underline{\quad .000001 \quad}$	$y_0 = \underline{\quad \quad \quad}$	$.001y_0 = \underline{\quad \quad \quad}$
$x_1 = \underline{\quad .002 \quad}$	$(x_1)^2 = \underline{\quad .000004 \quad}$	$y_1 = \underline{\quad \quad \quad}$	$.002y_1 = \underline{\quad \quad \quad}$
$x_2 = \underline{\quad .003 \quad}$	$(x_2)^2 = \underline{\quad .000009 \quad}$	$y_2 = \underline{\quad \quad \quad}$	$.003y_2 = \underline{\quad \quad \quad}$
$x_3 = \underline{\quad .004 \quad}$	$(x_3)^2 = \underline{\quad .000016 \quad}$	$y_3 = \underline{\quad \quad \quad}$	$.004y_3 = \underline{\quad \quad \quad}$
$x_4 = \underline{\quad .005 \quad}$	$(x_4)^2 = \underline{\quad .000025 \quad}$	$y_4 = \underline{\quad \quad \quad}$	$.005y_4 = \underline{\quad \quad \quad}$
$x_5 = \underline{\quad .006 \quad}$	$(x_5)^2 = \underline{\quad .000036 \quad}$	$y_5 = \underline{\quad \quad \quad}$	$.006y_5 = \underline{\quad \quad \quad}$
$x_6 = \underline{\quad .007 \quad}$	$(x_6)^2 = \underline{\quad .000049 \quad}$	$y_6 = \underline{\quad \quad \quad}$	$.007y_6 = \underline{\quad \quad \quad}$
$x_7 = \underline{\quad .008 \quad}$	$(x_7)^2 = \underline{\quad .000064 \quad}$	$y_7 = \underline{\quad \quad \quad}$	$.008y_7 = \underline{\quad \quad \quad}$
$x_8 = \underline{\quad .009 \quad}$	$(x_8)^2 = \underline{\quad .000081 \quad}$	$y_8 = \underline{\quad \quad \quad}$	$.009y_8 = \underline{\quad \quad \quad}$
$A = \underline{\quad .045 \quad}$	$B = \underline{\quad .000285 \quad}$	$C = \underline{\quad \quad \quad}$	$D = \underline{\quad \quad \quad}$

PERFORMANCE TEST RECORD

HEWLETT-PACKARD MODEL 3336A/B/C

Tested By: _____

SYNTHESIZER/LEVEL GENERATOR

Location: _____

SERIAL NO. _____

Date: _____

FREQUENCY ACCURACY (4-12)

3336 19 999 900 Hz ≤ _____ ≤ 20 000 100 Hz (should pass for one year)
 3336 with Option 004 19 999 999.0 Hz ≤ _____ ≤ 20 000 001.0 Hz (should pass for one week)

ABSOLUTE AMPLITUDE ACCURACY (4-14)

	Full Output	Full Output - 9.99 dB	
3336A			
75 ohm output	.6096 ≤ _____ ≤ .6166	.1930 ≤ _____ ≤ .1952	
150 ohm output	.4716 ≤ _____ ≤ .4770	.1493 ≤ _____ ≤ .1510	
600 ohm output	1.7242 ≤ _____ ≤ 1.7441	.5459 ≤ _____ ≤ .5522	
3336B			
75 ohm output	.6096 ≤ _____ ≤ .6166	.1930 ≤ _____ ≤ .1952	
124 ohm output	.4288 ≤ _____ ≤ .4337	.1357 ≤ _____ ≤ .1373	
135 ohm output	.4474 ≤ _____ ≤ .4526	.1416 ≤ _____ ≤ .1433	
600 ohm output	1.7242 ≤ _____ ≤ 1.7441	.5459 ≤ _____ ≤ .5522	
3336C			
50 ohm output	.6095 ≤ _____ ≤ .6166	.1930 ≤ _____ ≤ .1952	
75 ohm output	.6096 ≤ _____ ≤ .6166	.1930 ≤ _____ ≤ .1952	

AMPLITUDE FLATNESS (4-16)

3336A	75 ohm	10 Hz	100 kHz	1 MHz	10 MHz	20.9 MHz
+ Reference Level	+ 5.00	+ 5.00	+ 5.00	+ 5.00	+ 5.00	+ 5.00
- Amplitude Setting		_____	_____	_____	_____	_____
+ <u>T.C. Error</u>		_____	_____	_____	_____	_____
= 3336 Flatness		_____	_____	_____	_____	_____
	150 ohm	10 kHz	100 kHz	1 MHz	2.09 MHz	
+ Reference Level		+ 1.50	+ 1.50	+ 1.50	+ 1.50	
- Amplitude Setting		_____	_____	_____	_____	
+ <u>T.C. Error</u>		_____	_____	_____	_____	
= 3336 Flatness		_____	_____	_____	_____	
	600 ohm	200 Hz	109 kHz			
+ Reference Level		+ 6.5	+ 6.5			
- Amplitude Setting		_____	_____			
+ <u>T.C. Error</u>		_____	_____			
= 3336 Flatness		_____	_____			

	3336B	75 ohm	10 Hz	100 kHz	1 MHz	10 MHz	20.9 MHz
+	Reference Level		+ 5.00	+ 5.00	+ 5.00	+ 5.00	+ 5.00
-	Amplitude Setting		_____	_____	_____	_____	_____
+	<u>T.C. Error</u>		=====	=====	=====	=====	=====
=	3336 Flatness		_____	_____	_____	_____	_____
		124 ohm	10 kHz	100 kHz	1 MHz	10.9 MHz	
+	Reference Level		+ 1.50	+ 1.50	+ 1.50	+ 1.50	
-	Amplitude Setting		_____	_____	_____	_____	
+	<u>T.C. Error</u>		=====	=====	=====	=====	
=	3336 Flatness		_____	_____	_____	_____	
		135 ohm	10 kHz	100 kHz	1 MHz	2.09 MHz	
+	Reference Level		+ 1.50	+ 1.50	+ 1.50	+ 1.50	
-	Amplitude Setting		_____	_____	_____	_____	
+	<u>T.C. Error</u>		=====	=====	=====	=====	
=	3336 Flatness		_____	_____	_____	_____	
		600 ohm	200 Hz	109 kHz			
+	Reference Level		+ 6.50	+ 6.50			
-	Amplitude Setting		_____	_____			
+	<u>T.C. Error</u>		=====	=====			
=	3336 Flatness		_____	_____			
	3336C	50 ohm	10 Hz	100 kHz	1 MHz	10 MHz	20.9 MHz
+	Reference Level		+ 8.50	+ 8.50	+ 8.50	+ 8.50	+ 8.50
-	Amplitude Setting		_____	_____	_____	_____	_____
+	<u>T.C. Error</u>		=====	=====	=====	=====	=====
=	3336 Flatness		_____	_____	_____	_____	_____
		75 ohm	10 Hz	100 kHz	1 MHz	10 MHz	20.9 MHz
+	Reference Level		+ 5.00	+ 5.00	+ 5.00	+ 5.00	+ 5.00
-	Amplitude Setting		_____	_____	_____	_____	_____
+	<u>T.C. Error</u>		=====	=====	=====	=====	=====
=	3336 Flatness		_____	_____	_____	_____	_____

ATTENUATOR ACCURACY (4-18)

				<u>10 dB</u>		
				<u>1 MHz</u>	<u>10 MHz</u>	<u>20 MHz</u>
V1	_____	_____	_____	_____	_____	_____
V2	_____	_____	_____	_____	_____	_____
20 log V1/V2	_____	_____	_____	_____	_____	_____
+ Ref Attenuator Errors	=====	=====	=====	=====	=====	=====
= 3336 Attenuator Error	_____	_____	_____	_____	_____	_____
				<u>20 dB</u>		
				<u>1 MHz</u>	<u>10 MHz</u>	<u>20 MHz</u>
V1	_____	_____	_____	_____	_____	_____
V2	_____	_____	_____	_____	_____	_____
20 log V1/V2	_____	_____	_____	_____	_____	_____
+ Ref Attenuator Errors	=====	=====	=====	=====	=====	=====
= 3336 Attenuator Error	_____	_____	_____	_____	_____	_____
				<u>40 dB</u>		
				<u>1 MHz</u>	<u>10 MHz</u>	<u>20 MHz</u>
V1	_____	_____	_____	_____	_____	_____
V2	_____	_____	_____	_____	_____	_____
20 log V1/V2	_____	_____	_____	_____	_____	_____
+ Ref Attenuator Errors	=====	=====	=====	=====	=====	=====
= 3336 Attenuator Error	_____	_____	_____	_____	_____	_____
				<u>70 dB</u>		
				<u>1 MHz</u>	<u>10 MHz</u>	<u>20 MHz</u>
V1	_____	_____	_____	_____	_____	_____
V2	_____	_____	_____	_____	_____	_____
20 log V1/V2	_____	_____	_____	_____	_____	_____
+ Ref Attenuator Errors	=====	=====	=====	=====	=====	=====
= 3336 Attenuator Error	_____	_____	_____	_____	_____	_____

PHASE INCREMENT ACCURACY (4-20)

Increment Size	Lower Limit	Measured Time (T2-T1)	Upper Limit
+ 1°	2.22 ns	≤ _____	≤ 3.33 ns
+ 10°	27.22 ns	≤ _____	≤ 28.33 ns
+ 100°	277.22 ns	≤ _____	≤ 278.33 ns

ON CARRIER RETURN LOSS (4-22)

	100 kHz	1 MHz	2.09 MHz	10 MHz	20.9 MHz
3336A					
75 ohm	_____ < -30	_____ < -30		_____ < -30	_____ < -30
150 ohm	_____ < -30	_____ < -30	_____ < -30		
3336B					
75 ohm	_____ < -30	_____ < -30		_____ < -30	_____ < -30
124 ohm	_____ < -30	_____ < -30	_____ < -30	_____ < -30	
3336C					
50 ohm	_____ < -30	_____ < -30		_____ < -30	_____ < -25*
75 ohm	_____ < -30	_____ < -30		_____ < -30	_____ < -30

* < -30 with Option 005.

BALANCE (4-25)

	SPEC	300 Hz	10 kHz	50 kHz	100 kHz	2.09 MHz	10 MHz
3336A							
150 ohm	> 36 dB		_____		_____	_____	
600 ohm	> 38 dB	_____	_____	_____			
3336B							
124 ohm	> 30 dB		_____		_____		_____
135 ohm	> 36 dB		_____		_____	_____	
600 ohm	> 38 dB	_____	_____	_____			

HARMONIC DISTORTION (4-27)

Fundamental Test Frequency	Largest Harmonic, Fast Leveling Off		Largest Harmonic, Fast Leveling On	
		Specification		Specification
10 Hz	_____	< -35 dB		
30 Hz	_____	< -50 dB		
50 Hz	_____	< -60 dB		
10 kHz	_____	< -60 dB	_____	< -50 dB
100 kHz	_____	< -60 dB	_____	< -60 dB
1 MHz	_____	< -60 dB	_____	< -60 dB
5 MHz	_____	< -55 dB	_____	< -55 dB
20.9 MHz	_____	< -50 dB	_____	< -50 dB

SPURIOUS SIGNAL (4-29)

Frequency	Source	all specs: < -70dB
100 kHz	Frequency Synthesis Clock	_____
1 MHz	Reference Output	_____
2 MHz	DAC Clock	_____
30 MHz	LO Feedthru	_____
60 Hz	Power Line	_____
120 Hz	Power Line	_____
180 Hz	Power Line	_____
1 kHz	API 1, 1st sideband	_____
2 kHz	API 1, 2nd sideband	_____
3 kHz	API 1, 3rd sideband	_____
4 kHz	API 1, 4th sideband	_____
19-11MHz	2:1 Mixer Spur	_____

AMPLITUDE MODULATION ENVELOPE DISTORTION (4-31)

Specification: > 30 dBc Result: _____

PHASE MODULATION LINEARITY (4-33)

Input Voltage	Specification	Tolerance	Measured Results
-5 V	_____	_____	_____
-4 V	_____	_____	_____
-3 V	_____	_____	_____
-2 V	_____	_____	_____
-1 V	_____	_____	_____
0 V	_____	_____	_____
+1 V	_____	_____	_____
+2 V	_____	_____	_____
+3 V	_____	_____	_____
+4 V	_____	_____	_____
+5 V	_____	_____	_____

X-DRIVE LINEARITY (4-35)

Specification (Tolerance)	Measured Results (Step d)
10% _____ ± .0105V	Y ₀ = _____
20% _____ ± .0105V	Y ₁ = _____
30% _____ ± .0105V	Y ₂ = _____
40% _____ ± .0105V	Y ₃ = _____
50% _____ ± .0105V	Y ₄ = _____
60% _____ ± .0105V	Y ₅ = _____
70% _____ ± .0105V	Y ₆ = _____
80% _____ ± .0105V	Y ₇ = _____
90% _____ ± .0105V	Y ₈ = _____

INTEGRATED PHASE NOISE (4-37)

Specification: > 60 dB Measured Result: _____

WARNING

Maintenance described herein is performed with power supplied to the instrument, and protective covers removed. Such maintenance should be performed only by service-trained personnel who are aware of the hazards involved (for example, fire and electrical shock). Where maintenance can be performed without power applied, the power should be removed.

SECTION V

ADJUSTMENTS

5-1. INTRODUCTION.

5-2. This section contains adjustment procedures required to make the -hp- 3336 meet its specifications listed in Table 4-1. These adjustments should be performed after repair and when the performance tests indicate a deficiency. To identify and locate the individual printed circuit assemblies inside the -hp-3336, refer to Figure 5-2 on page 5-13/14.

5-3. The equipment required to adjust the -hp- 3336 is listed in each adjustment procedure and in Table 4-2. Table 4-2 also gives the critical specifications for each piece of equipment. Other test equipment may be substituted if it meets or exceeds these critical specifications; however, the adjustment procedure may have to be modified slightly to account for the new equipment. For this reason, the adjustment procedures are in general terms and in some cases a discussion of the measurement technique is included.

5-4. If a series of adjustments must be performed, the order that they should be performed in is the order they are given in this section. An adjustment may affect one or more of the adjustments that follow it but should not affect those that precede it. It is recommended that a 30 minute warm-up precede any adjustment unless otherwise noted.

Adjustment	Paragraph
Power Supply Voltage	5-5
30 MHz Reference Oscillator Frequency	5-7
Option 004, High Stability Frequency Reference	5-9
VCO Range	5-11
API Current Sources	5-13
API Spur	5-15
Multiplier Input and Output Offset	5-17
2:1 Mixer Spur	5-19
- 10.2 Vdc Reference Voltage	5-21
DAC Offset Voltage	5-23
Leveling Loop Amplifier Zero	5-25
Leveling Loop Bias	5-27
75 ohm Level Accuracy	5-29
Output Amplifier Flatness	5-31
124/135/150/600 ohm Level Accuracy	5-33
X Drive Final Voltage	5-35

5-5. Power Supply Voltage Adjustment.

5-6. This adjustment sets all three supply voltages within the operating tolerances of the -hp-3336.

WARNING

AC power line voltage is present at the rear panel and on the power supply printed circuit board (A2). When the front panel power switch is in the STBY (standby) position, line voltage is still applied to the instrument.

Required Equipment:

dc Voltmeter

-hp- Model 3466A

a. Measure the dc voltage at the -15V test point on the A2 Power Supply printed circuit board.

b. Adjust A2R22 until the voltage is -15V, $\pm 0.03V$.

c. Measure the dc voltage at the +5V and +15V test points. These voltages should be +5V, $\pm 0.05V$ and $\pm 0.03V$, respectively.

d. If necessary, readjust A2R22 until all three voltages are within tolerance.

5-7. 30 MHz Reference Oscillator Frequency Adjustment.

5-8. This procedure sets the frequency accuracy of the 30 MHz Reference Oscillator to within 5 parts per million.

Required Equipment:

Electronic Counter

-hp- Model 5328A
with Option 010

75 ohm Feedthru Termination

-hp- Model 11094B

NOTE

The -hp- 3336 must be ON for at least 30 minutes before making this adjustment.

a. If the -hp- 3336 is equipped with Option 004, disconnect the special BNC to BNC adapter from the 10 MHz Oven Output and the Ext Ref Input.

b. Connect the 3336's 75 ohm output to the electronic counter using the 75 ohm Feedthru Termination at the electronic counter's Hi Z input.

c. Set the 3336 output amplitude to +7.00 dBm (maximum) and frequency to 20 MHz.

d. Adjust A3R30 until the counter reads 20 MHz as accurately as possible. The specification is 20 MHz, ± 100 Hz.

e. If necessary, reconnect the special adapter removed in Step a.

5-9. Option 004, High Stability Reference Frequency Accuracy.

5-10. This procedure sets the frequency accuracy of the High Stability Frequency Reference, Option 004, to within 1 part in 10 million.

Required Equipment:

Electronic Counter

-hp- Model 5328A
with Option 010

75 ohm Feedthru Termination

-hp- Model 11094B

NOTE

The -hp- 3336 must be connected to ac power for at least 72 hours before making this adjustment.

- a. Make sure the special BNC to BNC adapter, supplied with Option 004, is connected between the 10 MHz Ref Output and the Ext Ref Input, and that the EXT REF annunciator is ON.
- b. Connect the 3336's 75 ohm output to the electronic counter using the 75 ohm Feedthru Termination at the counter's Hi Z input.
- c. Set the 3336 output amplitude to +7.00 dBm (maximum) and frequency to 20 MHz.
- d. Set the electronic counter controls to resolve .1 Hz. On the -hp- 5328A, this may make the counter overflow. This overflow condition does not affect the accuracy of the measurement, and the overflow digit may be determined by changing the resolution to 1 Hz.
- e. Adjust A9R7 until the counter reads 20 MHz as accurately as possible. The specification is 20 MHz, ± 1 Hz.
- f. If A9R7 does not have enough range, remove the access screw from the Coarse Frequency Adjustment on the Oven assembly.
- g. Adjust A9R7 to mechanical center and then, using a non-conductive tool, adjust the Coarse Frequency Adjustment until the counter reads 20 MHz as accurately as possible.
- h. Replace the access screw and readjust A9R7.

5-11. Voltage Controlled Oscillator Range Adjustment.

5-12. This adjustment sets the low frequency tune voltage to the VCO and checks the VCO frequency versus tune voltage range.

Required Equipment:

dc Voltmeter

-hp- Model 3466A

- a. With the -hp- 3336 in its turn-on condition, measure the dc voltage at test point A21TP11
- b. Set the -hp- 3336 frequency to 60 MHz. Using a non-conductive tool, adjust A21L162 until the voltmeter reads $-3.00\text{Vdc} \pm .05\text{V}$.
- c. Set the frequency to 10 kHz. The voltmeter should read $10\text{V} \pm 2\text{V}$.

5-13. Analog Phase Interpolation (API) Current Source Adjustment.

5-14. This procedure adjusts the API current sources, reducing the corresponding API phase modulation sidebands to their minimum value.

Required Equipment:

Spectrum Analyzer (low frequency)	-hp- Model 3580A
1 to 1 Probe	-hp- Model 10007B

- a. Set the 3336 output frequency to 5 001 000 Hz.
- b. Connect the spectrum analyzer to test point A21TP11 using a 1:1 probe.
- c. Manually tune the spectrum analyzer to the 1kHz component. It may be necessary to misadjust A21R76 to find this signal; however, once it is found, the analyzer will not have to be retuned.
- d. Adjust A21R76 until the 1 kHz signal is at its minimum amplitude.
- e. Change the 3336 frequency to 5 000 100 Hz.
- f. Adjust A21R74 until the 1 kHz signal is at its minimum amplitude.
- g. Change the 3336 frequency to 5 000 001 Hz.
- h. Adjust A21R88 until the 1 kHz signal is at its minimum amplitude.
- i. The current sources that have been adjusted are API 1, API 2, and API 4. API 3 and API 5 are not adjustable.

5-15. Analog Phase Interpolation (API) Spur Adjustment.

5-16. This procedure minimizes the API 100 kHz spurs.

Required Equipment:

synthesizer	-hp- Model 3335A
impedance matching pad	-hp- Model 85428B
spectrum analyzer	-hp- Model 141T/ 8552B/8553B
DVM	-hp- Model 3466A or
	-hp- Model 3455A
1 MHz low pass filter	TT Electronics Inc.
	Model J903

- a. Set up the 3335A as follows:

amplitude	+ 7.00 dBm (75 ohm output)
frequency	20 MHz

- b. Set up the 3336 as follows:

amplitude	- 10 dBm
frequency	20 MHz

- c. Connect the DVM and adjust the phase of the 3336 to obtain 0 volts \pm 10 mV at the output of the filter, as shown in the following figure.

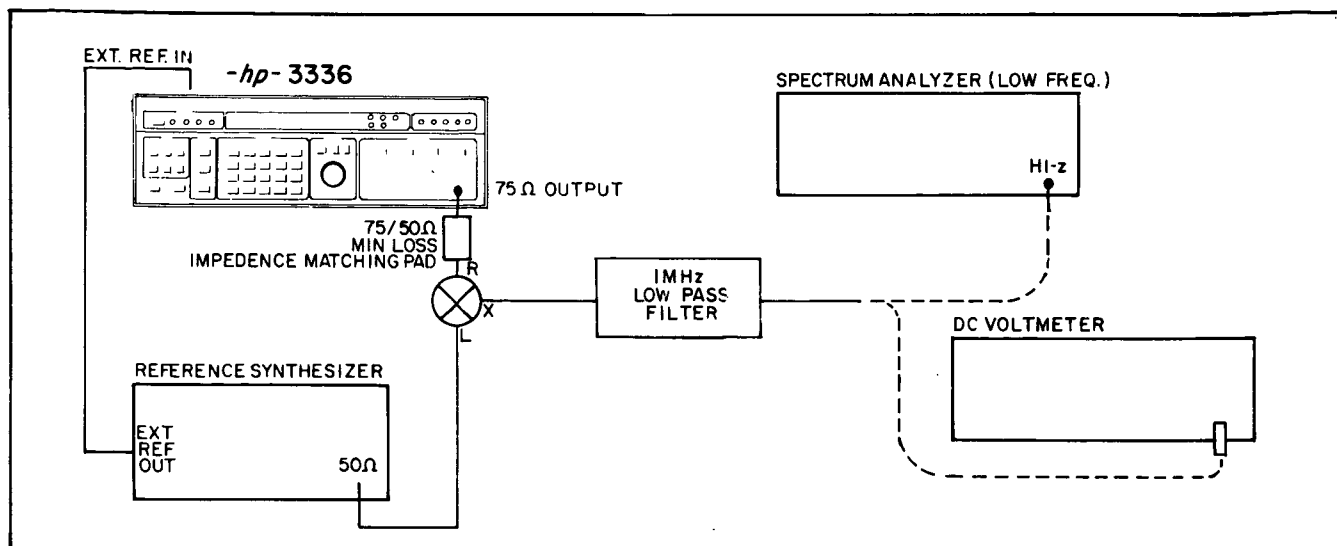

Figure 5-1. API 100 kHz Spur Adjustment Set Up

NOTE 1

This adjustment procedure applies only to newer -hp- 3336s with the A21 Frequency Synthesis board, not the original A1 board. On the old A1 assembly, R107 is not adjustable.

NOTE 2

Although A21TP11 is used as a monitoring point in the previous adjustment (API Current Source Adjustment), paragraph 5-13), it cannot be used with this adjustment set-up because the 141T/8552B/8553B has a 50 Ω input only.

d. Set up the spectrum analyzer as follows:

- range. 0 - 11 MHz
- center frequency 100 kHz
- scan width 20 kHz/div
- bandwidth 3 kHz
- scan time 10 msec/div
- video filter 10 kHz
- ref level -40 dBm

e. Misadjust A21R107 until the 100 kHz spur is clearly visible.

f. Zoom in on that spur by adjusting the center frequency and scan width then the bandwidth and scan time until the analyzer is adjusted to:

- center frequency ~ 100 kHz
- scan width 0.1 kHz/div
- bandwidth 0.03 kHz
- scan time 0.2 sec/div

- g. Switch the 8552B to manual scan mode and adjust the manual scan until the beam is on the spur.
- h. Switch the 141T to non-storage
- i. Adjust A21R107 to minimize the spur.
- j. Return the analyzer to storage and internal sweep modes to make certain that the beam was centered on the spur.
- k. It will not be possible to get the spur down into the noise floor, but it should be possible to get it down in the area of -60 dBm.

5-17 Multiplier Input and Output Offset Adjustment.

5-18 This procedure optimizes the balance of the voltage multiplier IC (A3U11).

Required Equipment:

oscilloscope	-hp- Model 1740A
function generator	-hp- Model 3312A
50 ohm feedthru termination	-hp- Model 11048C

- a. Set the -hp- 3312A as follows:

Range 1 kHz
 Dial 1
 Offset Cal
 Amplitude x10
 Ampl Vernier Center
 Sym Cal
 Function Square Wave

- b. Set the -hp- 1740A as follows:

Channel A
 Volts/Div 0.05V
 Main Trig Ext
 Time/Div 0.2msec
 DC Coupled

- c. Set the -hp- 3336A/B/C as follows:

Frequency 10 kHz
 Amplitude 7.00 dB

- d. Connect +5Vdc to the rear panel AMPTD MOD input on the 3336.
- e. Remove cable W23 on the A3 assembly.
- f. Connect the 3312A 50 ohm output to J23.

- g. Monitor A3 TP4 with the oscilloscope and a 10:1 scope probe.
- h. Press AM ON (press blue button, then STORE 0-9 button).
- i. Adjust A3R69 for minimum modulation.
- j. Disconnect the +5Vdc source from the 3336 AMPTD MOD input.
- k. Disconnect the 3312A from A3J23 and connect it to the AMPTP MOD input on the 3336.
- l. Connect the 50 ohm feedthru termination to A3J23.
- m. Adjust A3R33 for minimum modulation and adjust A3R68 for 0Vdc.
- n. Disconnect the 3312A and the 50 ohm termination from the 3336 and reconnect cable W23

5-19. 2:1 Mixer Spur Adjustment.

5-20. This procedure minimizes the 2:1 intermodulation products of the mixer. The 2:1 spur is a product of the second harmonic of the VCO and the reference fundamental.

Required Equipment:

impedance matching pad	-hp- Model 85428B
spectrum analyzer	-hp- Model 141T/8553B/8552B

- a. Set the 3336 as follows:

Frequency	10 MHz
Amplitude	- 2.99 dBm
Output	75 ohm

- b. Set the 141T/3583B/8582B as follows:

Range	0 - 11 MHz
Center frequency	10 MHz
Scan time	1 msec/div
Bandwidth	30 kHz
Scan width	0.05 MHz
Input attenuation	0 dB
Log ref level	- 10 dB 10 dB/div
Video filter	10 kHz

- c. Connect the impedance matching pad between the 75 ohm output on the 3336 and the spectrum analyzer's input.

- d. Adjust the center frequency of the spectrum analyzer to center the signal and adjust the log ref vernier to achieve a 0 dB signal.

e. while maintaining the signal in the center of the screen, adjust the spectrum analyzer as follows:

Bandwidth0.3 kHz
 Scan width2 kHz/div
 Scan time1 sec/div
 Video filter10 Hz

f. Program the 3336 to 20 MHz and set the log ref level on the spectrum analyzer to -30 dB.

g. Switch the spectrum analyzer to manual scan mode and move the beam to the 10 MHz spur in the center of the screen, then switch to non-storage.

h. Turn on PHASE entry with MODIFY at 1° on the 3336.

i. Adjust the phase through 360° and find the worst case spur.

j. Adjust A3R115 to minimize the worst case spur. Adjust the phase through a full 360° again and make sure that the worst case is < 50 dB on the screen (< 70 dB below the signal).

5-21. - 10.2 Vdc Reference Voltage Adjustment.

5-22. This procedure sets the dc reference voltage used in the DAC and the leveling loop.

Required Equipment:

dc voltmeter -hp- Model 3455A

a. Connect the dc voltmeter to test point A4TP208.

b. Adjust A4R269 until the dc voltage at test point A4TP208 is -10.202V , $\pm .001\text{V}$.

5-23. Digital-to-Analog Converter (DAC) Offset Voltage Adjustment

5-24. This adjustment compensates for the offset voltage in the DAC.

Required Equipment:

dc voltmeter -hp- Model 3455A

a. Connect the dc voltmeter to test point A4TP AMPL.

b. Set the output amplitude to maximum ($+8.76\text{dBm}$, 50 ohm output or $+7.00$ dBm, 75 ohm output).

OFFSET

c. Adjust A4R40 (located between A4J4 and A4J9 — labeled DAC ~~OS~~) until the dc voltmeter reads $+10.000\text{V}$, $\pm 1\text{mV}$.

5-25 Leveling Loop Amplifier Zero Adjustment.

5-26. This adjustment compensates for the voltage offsets of the leveling loop amplifier.

Required equipment:

oscilloscope -hp- Model 1740A

*Check Spur 5p6 on
A2 bd 1st.*

- a. Remove cable W24 from A4J24.
- b. Place jumper A4TP207, located midway between A4J2 and A4J23, in the test position (away from the A3 assembly).
- c. Place switches A4S1 and A4S2, located beside A4J2, to the test position (away from the A3 assembly).
- d. Connect an oscilloscope probe to A4TP AMP ZERO, located beside A4S1.
- e. Set the 1740A in the the ground mode with .005 volts/div and adjust the vertical position so that the trace is on the zero reference line in the center of the screen.
- f. Put the oscilloscope in the dc mode and adjust A4R208 (labeled AMP ZERO - located beside A4J23) for zero dc offset at A4TP AMP ZERO.
- g. Return switches A4S1 and A4S2 and jumper A4207 to their normal positions.

5-27. Leveling Loop Bias Adjustment.

5-28. This procedure balances the bias current to the thermal converter.

Required Equipment:

Oscilloscope

-hp- Model 1740A

NOTE

The 3336 must be on for 30 minutes before making this adjustment.

- a. Remove cable W24 from A4J24.
- b. Ground test point A4TP201.
- c. Connect the oscilloscope to test point A4TP AMP ZRO.
- d. Set the oscilloscope to dc coupled, zero center, and 1 volt/div.
- e. Adjust A4R212 (located between A4J40 and A4TP207) to center the signal and maintain it at the center of the screen.
- f. Increase the sensitivity of the oscilloscope and readjust A4R212.
- g. Repeat Step f until the oscilloscope is set at .005 Volts/div and the trace remains on the screen for at least 5 seconds.
- h. Remove the short from A4TP201 and reconnect W24.

5-29. ⁺⁵⁰ 75 ohm Output Level Accuracy Adjustment.

5-30. This adjustment sets the absolute amplitude accuracy of the unbalanced outputs by accurately setting the minimum and maximum values of the amplitude's dynamic range.

FOR ABSOLUTE
AMPLITUDE ACCURACY

These values are set by adjusting the dc offset and gain of the amplitude reference amplifier.

Required Equipment:

ac voltmeter	-hp- Model 3455A with Option 001 or -hp- Model 3490A
50 ohm feedthru termination	-hp- Model 11048C
75 ohm feedthru termination	-hp- Model 11094B
75 ohm cable	

NOTE

The 3336 must be ON 30 minutes before attempting this adjustment.

a. Connect the ac voltmeter to one of the unbalanced outputs, using the proper feedthru termination at the voltmeter's input.

b. Set the output amplitude to -1.23 dBm 50Ω using the 75 ohm output. Set the frequency to 10 kHz.

c. Adjust A4R259 until the ac voltmeter reads $.1585 \text{ V}_{\text{rms}} \pm .5 \text{ mV}$. $.1941 \text{ V}_{\text{rms}} \pm .5 \text{ mV}$.

d. Set the output amplitude to 8.76 dBm $+7.00 \text{ dBm}$.

e. Adjust A4R261 until the ac voltmeter reads $.5006 \text{ V}_{\text{rms}} \pm 1 \text{ mV}$. $.6130 \text{ V}_{\text{rms}} \pm 1 \text{ mV}$.

f. Repeat Steps b thru e until both voltages are within their tolerances. Go to Step h if it is not possible to set these voltages.

g. Set the output amplitude to 4.76 dBm (50Ω) $+3.00 \text{ dBm}$.

h. The ac voltmeter should read $.3159 \pm 1 \text{ mV}$ $.3868 \text{ V}_{\text{rms}} \pm 1 \text{ mV}$. If this voltage is out of tolerance, perform the following adjustments and then try this adjustment again.

- Multiplier Input and Output Offset (5-17)
- -10.2 Vdc Reference Voltage (5-21)
- DAC Offset Voltage (5-23)
- Leveling Loop Amplifier Zero (5-25)
- Leveling Loop Bias (5-27)

5-31. Output Amplifier Flatness Adjustment.

5-32. This adjustment optimizes the ac feedback in the output amplifier, insuring the flattest possible frequency response.

Required Equipment:

oscilloscope	-hp- Model 1740A
50 ohm feedthru termination	-hp- Model 11048C
75 ohm feedthru termination	-hp- Model 11094B

a. Set the -hp- 3336 controls as follows:

Active Output.....50 or 75 ohm
 AmplitudeMax (+ 7.00 dBm, 75 ohm)
 Sweep Start Frequency.....1 MHz
 Sweep Stop Frequency.....20.9 MHz
 Sweep Time.....0.01 seconds
 Sweep Type.....Linear
 Fast Leveling.....ON

b. Connect the oscilloscope to test point A4TP203 using an ac coupled 10 to 1 probe.

c. Adjust A4C109, using a non-conductive tool, until the error voltage is reduced to its minimum peak to peak amplitude with no discontinuities.

5-33. 124/135/150/600 ohm Output Level Accuracy Adjustment.

5-34. These adjustments set the absolute amplitude accuracy of the balanced outputs.

NOTE

Perform the 75 ohm Output Level Adjustment before adjusting these output levels.

Required Equipment:

ac voltmeter	-hp- Model 3455A with Option 001 or -hp- Model 3490A
termination resistors	
124 ohm, 3336B only	-hp- Part No. 0698-6284
135 ohm, 3336B only	-hp- Part No. 0698-5197
150 ohm, 3336A only	-hp- Part No. 0757-0715
600 ohm, 3336A and 3336B	-hp- Part No. 0698-5405

NOTE

The 3336 must be ON for 30 minutes before attempting this adjustment.

a. Terminate a balanced output with the corresponding termination resistor.

b. Connect the ac voltmeter to the terminated output.

c. Activate the output and use the following table to determine:

- the -hp- 3336 amplitude setting
- the -hp- 3336 frequency setting
- the component to adjust
- the ac output voltage to adjust to
- the ac output voltage tolerance

Output	Freq. Setting	Amplitude Setting	Component To Adjust	Output Voltage	Voltage Tolerance
124 ohm	50 kHz	+ 1.76 dBm	A4R257	.4312	± 1 mV
135 ohm	50 kHz	+ 1.76 dBm	A4R255	.4500	± 1 mV
150 ohm	50 kHz	+ 1.76 dBm	A4R257	.4743	± 1 mV
600 ohm	10 kHz	+ 7.00 dBm	A4R256	1.7341	± 7.4 mV

- e. Repeat Steps a thru c until all of the unbalanced outputs have been adjusted.

5-35. X Drive Final Voltage Adjustment.

5-36. This adjustment sets the final voltage of the X drive ramp to + 10.5 Vdc.

Required Equipment:

dc voltmeter

-hp- Model 3466A

- Connect the dc voltmeter to the -hp- 3336 X Drive output.
- Starting with the -hp- 3336 in turn-on condition, set the Sweep Time to .999 seconds.
- Press the -hp- 3336 SINGLE key twice. The first actuation resets the sweep to the start conditions and the second starts a single sweep.
- At the end of the sweep, the dc voltmeter should read + 10.5 Vdc, ± .05 V. If the voltmeter reads less than + 10.5 Vdc, adjust A4R6 slightly clockwise. If the voltmeter reads more than + 10.5 Vdc, adjust A4R6 slightly counterclockwise.

NOTE

The voltmeter will not respond directly to the adjustment of A4R6. The effect of the adjustment can only be seen after another single sweep.

- Press the SINGLE key twice to execute another single sweep.
- Readjust A4R6 and execute single sweeps as necessary until the end voltage is + 10.5 Vdc, ± .05 V.
- Check the decay rate of the X Drive voltage. The final voltage should decay at less than 10 mV/second.

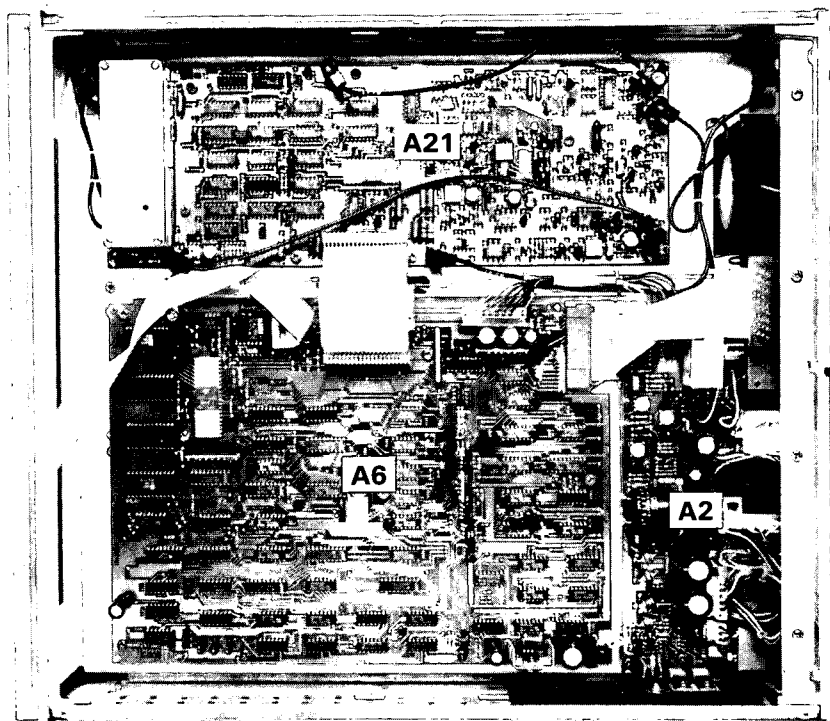

Top View

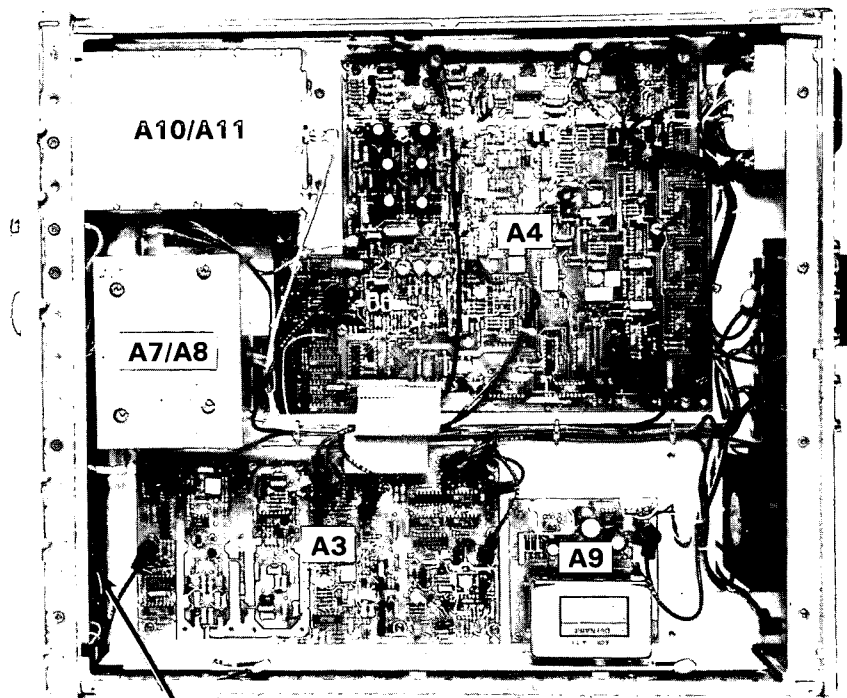

Bottom View

A5/A15/A25
(BEHIND FRONT PANEL)

Figure 5-2. Location of Printed Circuit Assemblies.