



OPERATING AND SERVICE MANUAL

MODEL 339A

DISTORTION MEASUREMENT SET

Serial Numbers: 1730A00266 and Greater

IMPORTANT NOTICE

This manual applies directly to instruments with serial number shown on this page. If changes have been made in the instrument since this manual was printed, a "Manual Changes" supplement supplied with this manual will define these changes. Be sure to record this information in your manual. Backdating information contained in Section VII adapts this manual to instruments having serial numbers lower than those shown on this page.

WARNING

To help minimize the possibility of electrical fire or shock hazards, do not expose this instrument to rain or excessive moisture.

Manual Part No. 00339-90001

Microfiche Part No. 00339-90051

Copyright Hewlett-Packard Company 1977
P.O. Box 301, Loveland, Colorado, 80537 U.S.A.

Printed: April 1978

SECTION I GENERAL INFORMATION

1-1. INTRODUCTION.

1-2. This Operating and Service Manual contains information necessary to install, operate, test, adjust, and service the Hewlett-Packard Model 339A Distortion Measurement Set.

1-3. This section of the manual contains the performance specifications and general operating characteristics of the Model 339A. Also listed are available options and accessories, and instrument and manual identification information.

1-4. SPECIFICATIONS.

1-5. Operating Specifications for the Model 339A are listed in Table 1-1. These specifications are the performance standards or limits against which the instrument is tested. Table 1-2 lists general operating characteristics of the instrument. These characteristics are not specifications but are typical operating characteristics included as additional information for the user.

1-6. INSTRUMENT AND MANUAL IDENTIFICATION.

1-7. Instrument identification by serial number is located on the rear panel. Hewlett-Packard uses a two-section serial number consisting of a four-digit prefix and a five-digit suffix separated by a letter designating the country in which the instrument was manufactured. (A = U.S.A.; G = West Germany; J = Japan; U = United Kingdom.) The prefix is the same for all identical instruments and changes only when a major instrument change is made. The suffix, however, is assigned sequentially and is unique to each instrument.

1-8. This manual applies to instruments with serial numbers indicated on the title page. If changes have been made in the instrument since the manual was printed, a yellow "Manual Changes" supplement supplied with the manual will define these changes and explain how to adapt the manual to the newer instruments. In addition, backdating information contained in Section VII adapts the manual to instruments with serial numbers lower than those listed on the title page.

1-9. Part numbers for the manual and the microfiche copy of the manual are also listed on the title page.

1-10. DESCRIPTION.

1-11. The Model 339A Distortion Measurement Set combines a low distortion signal source, a high resolution distortion analyzer, an rms responding voltmeter and a VU (volume units) meter in one unit.

1-12. The signal source used in the Model 339A is a "bridged-T" oscillator which provides a low distortion sine-wave signal from 10 Hz to 110 kHz. The output amplitude is variable from 1 mV rms to 3 V rms into a 600 ohm load and is maintained by an amplitude control circuit which minimizes amplitude variations even when changing frequency ranges.

1-13. The distortion analyzer section of the 339A contains a tracking notch filter which is tuned to the oscillator frequency. The analyzer measures total harmonic distortion (THD) from 100% full-scale to .01% full-scale in nine ranges and features both automatic "Set Level" and automatic "Nulling" to greatly simplify operation. The Auto Set Level feature automatically sets the reference level over a 10 dB range. If the input signal is outside this range, a LED on the front panel indicates whether the INPUT RANGE control setting must be increased or decreased to be within the "pull-in" range of the Auto Set Level. The Auto Nulling feature is fully automatic when the 339A internal oscillator is used as the signal source. When an external oscillator is used as the signal source, an LED on the front panel indicates which direction the FREQUENCY controls must be set to be within the Auto Nulling range. Distortion characteristics of the input signal can be monitored at the MONITOR OUTPUT terminals with external equipment (oscilloscope, voltmeter, spectrum analyzer, etc.) to provide additional analysis of the distortion products.

1-14. The Model 339A is equipped with an amplitude modulation (AM) detector which has a frequency response from 550 kHz to 1.6 MHz. The AM detector permits the measurement of modulation distortion.

1-15. The 339A contains three active filters, one high-pass and two low-pass, which enables the user to eliminate unwanted frequencies and noise to permit higher resolution measurements.

1-16. The ac voltmeter section of the 339A measures the rms value of input voltage from 1 mV full-scale to 300 V full-scale in twelve ranges. In the VU meter mode, the

meter response characteristics are changed to those of a volume units meter.

1-17. OPTIONS.

1-18. The following options are available for use with the Model 339A:

Option 907: Front Handle Kit

Option 908: Rack Mounting Kit
 Option 909: Front Handle and Rack Mounting Kit
 Option 910: Additional Operating and Service Manual

1-19. Recommended Test Equipment.

1-20. Equipment required to maintain the Model 339A is listed in Table 1-3. Other equipment may be substituted if it meets the critical requirements listed in the table.

Table 1-1. Specifications.

DISTORTION																					
<p>Fundamental Frequency Range:</p> <p>10 Hz to 110 kHz continuous frequency coverage in 4 decade ranges with 2-digit resolution. Distortion analyzer and oscillator are simultaneously tuned.</p> <p>Distortion Measurement Range:</p> <p>0.01% full scale to 100% full scale (-80 dB to 0 dB) in 9 ranges.</p> <p>Detection and Meter Indication:</p> <p>True rms detection for waveforms with crest factor ≤ 3. Meter reads dB and % THD (Total Harmonic Distortion). Meter response can be changed from NORMAL to VU ballistics with a front panel switch.</p> <p>Distortion Measurement Accuracy:</p> <table border="0"> <tr> <td>20 Hz to 20 kHz</td> <td>± 1 dB</td> </tr> <tr> <td>10 Hz to 50 kHz</td> <td>+1, -2 dB</td> </tr> <tr> <td>50 kHz to 110 kHz</td> <td>+1.5, -4 dB</td> </tr> </table> <p style="text-align: center;">NOTE</p> <p><i>The above specifications apply for harmonics < 330 kHz.</i></p> <p>Fundamental Rejection:</p> <table border="0"> <tr> <td>10 Hz to 20 kHz</td> <td>> 100 dB</td> </tr> <tr> <td>20 kHz to 50 kHz</td> <td>> 90 dB</td> </tr> <tr> <td>50 kHz to 110 kHz</td> <td>> 86 dB</td> </tr> </table> <p>Distortion Introduced by Instrument (Input > 1 V rms)</p> <table border="0"> <tr> <td>10 Hz to 20 kHz</td> <td>< -95 dB</td> </tr> <tr> <td>20 kHz to 30 kHz</td> <td>< -90 dB</td> </tr> <tr> <td>30 kHz to 50 kHz</td> <td>< -85 dB</td> </tr> <tr> <td>50 kHz to 110 kHz</td> <td>< -70 dB</td> </tr> </table> <p>Residual Noise (Fundamental frequency setting < 20 kHz, 80 kHz filter in, source resistance ≤ 1 kΩ shielded):</p> <p>< -92 dB referenced to 1 V.</p> <p>Input Level for Distortion Measurements:</p> <p>30 mV to 300 V rms (100 mV range minimum)</p> <p>Input Impedance:</p> <p>100 kΩ $\pm 1.0\%$ shunted by < 100 pF input High to Low.</p>	20 Hz to 20 kHz	± 1 dB	10 Hz to 50 kHz	+1, -2 dB	50 kHz to 110 kHz	+1.5, -4 dB	10 Hz to 20 kHz	> 100 dB	20 kHz to 50 kHz	> 90 dB	50 kHz to 110 kHz	> 86 dB	10 Hz to 20 kHz	< -95 dB	20 kHz to 30 kHz	< -90 dB	30 kHz to 50 kHz	< -85 dB	50 kHz to 110 kHz	< -70 dB	<p>DC Isolation:</p> <p>Input low may be connected to chassis ground or floated 30 V to reduce the effects of ground loops on the measurement.</p> <p>Auto Set Level:</p> <p>No set level adjustment required. Distortion measurements are made directly over 10 dB range selected by input range switch. Two LED annunciators provide a fast visual indication to change input range for valid distortion measurement. Correct range is indicated when both annunciators are extinguished.</p> <p>Auto Null:</p> <p>Using internal oscillators: No manual frequency tuning necessary when using internal oscillator as signal source. Oscillator frequency controls simultaneously tune the analyzer.</p> <p>Using external frequency source: Two LED annunciators provide a quick visual indication for the operator to increase or decrease the analyzer frequency controls. When the analyzer is rough tuned to within one least significant digit of the fundamental frequency, the indicator lights are extinguished and the 339A auto-null circuitry takes over to provide a fast accurate null without tedious operator tuning.</p> <p>Input Filters (usable on all functions):</p> <p>Low Pass</p> <p>30 kHz - 3 dB point at 30 kHz, + 2.6 kHz, - 3 kHz. Provides band limiting required by FCC for proof-of-performance broadcast testing.</p> <p>80 kHz - 3 dB point at 80 kHz, + 7 kHz, - 7.9 kHz. Normally used with fundamental frequencies < 20 kHz to reduce the effect of higher frequency noise present in the measured signal.</p> <p>High Pass</p> <p>400 Hz - 3 dB point at 400 Hz, + 35 Hz, - 40 Hz. Normally used with fundamental frequencies > 1 kHz to reduce the effect of hum components in the input signal.</p> <p>Monitor Output:</p> <p>Provides scaled presentation of input signal after</p>
20 Hz to 20 kHz	± 1 dB																				
10 Hz to 50 kHz	+1, -2 dB																				
50 kHz to 110 kHz	+1.5, -4 dB																				
10 Hz to 20 kHz	> 100 dB																				
20 kHz to 50 kHz	> 90 dB																				
50 kHz to 110 kHz	> 86 dB																				
10 Hz to 20 kHz	< -95 dB																				
20 kHz to 30 kHz	< -90 dB																				
30 kHz to 50 kHz	< -85 dB																				
50 kHz to 110 kHz	< -70 dB																				

Table 1-1. Specifications (Cont'd).

fundamental is removed for further analysis using oscilloscope or low frequency spectrum analyzer.

Output Voltage: 1 V rms $\pm 5\%$ open circuit for full

scale meter indication, proportional to meter deflection.

Output Resistance: 1 k Ω $\pm 5\%$.

VOLTMETER

Voltage Range:

1 mV rms full scale to 300 V rms full scale
(-60 dB to +50 dB full scale, meter calibrated in dBV and dBm into 600 Ω)

Monitor Output:

Provides scaled presentation of input signal for further analysis using oscilloscope or low frequency spectrum analyzer.

Frequency Range:

10 Hz to 110 kHz

Output Voltage: 1 V rms $\pm 5\%$ open circuit for full scale meter indication, proportional to meter deflection.

Accuracy (% of range setting)

20 Hz to 20 kHz $\pm 2\%$
10 Hz to 110 kHz $\pm 4\%$

Output Resistance: 1 k Ω $\pm 5\%$.

RELATIVE INPUT LEVEL

Provides a ratio measurement relative to an operator selected reference level with readout directly in dB V or dBm (600 Ω).

Voltage range, frequency range, accuracy specifications, and monitor are the same as in VOLTMETER mode. (Accuracy is relative to 0 dB set level input.)

Detection and Meter Indication

True rms detection for waveforms with crest factor ≤ 3 . Meter reads true rms volts, dB V, and dBm into 600 Ω .

Input Impedance:

100 k Ω $\pm 1.0\%$ shunted by <100 pF Input High to Low.

OSCILLATOR

Frequency Range:

10 Hz to 110 kHz in 4 overlapping decade ranges with 2 digit resolution. Frequency vernier provides continuous frequency tuning between 2nd digit switch settings.

Frequency Accuracy:

$\pm 2\%$ of selected frequency (with FREQUENCY VERNIER in CAL position).

Output Level:

Variable from < 1 mV to > 3 V rms into 600 Ω with 10 dB/step LEVEL control and 10 dB VERNIER adjustment.

Level Flatness:

20 Hz to 20 kHz ± 0.1 dB
10 Hz to 110 kHz ± 0.2 dB

OSC LEVEL position on function switch allows a quick check of oscillator level without disconnecting leads to device under test.

OFF position on Oscillator LEVEL control provides fast signal-to-noise measurement capability. Oscillator output terminals remain terminated in 600 Ω .

Distortion ($\geq 600 \Omega$ load, ≤ 3 V output):

10 Hz to 20 kHz < -95 dB (0.0018%) THD
20 kHz to 30 kHz < -85 dB (0.0056%) THD
30 kHz to 50 kHz < -80 dB (0.01%) THD
50 kHz to 110 kHz < -70 dB (0.032%) THD

Output Resistance:

600 Ω $\pm 5\%$

AM DETECTOR

Frequency Range:

Carrier frequencies: 550 kHz to 1.6 MHz.
Modulation frequencies: 20 Hz to 20 kHz.

Input Level

Maximum: 60 V peak
Modulation signal level:
2.0 V rms minimum
10 V rms maximum

Distortion introduced by AM Detector (with 30 kHz filter switched IN):

Up to 85% Modulation: < -36 dB (1.6%) THD
85% to 95% Modulation: < -30 dB (3%) THD

Monitor Output (with modulated RF carrier applied to AM Detector input):

Table 1-1. Specifications (Cont'd).

<p>Distortion mode: Provides scaled presentation of demodulated input signal after fundamental is removed.</p>	<p>Voltmeter and Relative Input mode: Provides scaled presentation of demodulated input signal.</p> <p>Output Voltage and Output Resistance are the same as in Distortion mode.</p>
--	---

Table 1-2. Typical Operating Characteristics.

GENERAL	
<p><i>Operating Environment:</i></p> <p>Temperature: 0°C to 50°C. Humidity Range: < 95%, 0°C to 40°C.</p> <p><i>Storage Temperature:</i></p> <p>- 40°C to +65°C.</p> <p><i>Power:</i></p> <p>100/120/220/240, +5%, -10%, 40 to 66 Hz, 200 mA max.</p>	<p><i>Weight:</i></p> <p>Net 8.2 kg (18 lbs.); shipping 11.3 kg (25 lbs.).</p> <p><i>Dimensions:</i></p> <p>426 mm wide x 146 mm high x 442 mm deep (16.75" wide x 5.75" high x 17.4" deep).</p>

Table 1-3. Recommended Test Equipments.

Instrument	Critical Specification	Recommended Model	Use
AC Calibrator	Frequency: 10 Hz - 110 kHz Output Level: 1 mV - 300 V rms Level Accuracy: ± .2% Output Impedance: ≤ 50 Ω	-hp- Model 745A AC Calibrator -hp- Model 746A High Voltage Amplifier	PAT
True RMS Voltmeter	Frequency Range: 10 Hz - 110 kHz Voltage Range: 1 mV - 10 V rms Measurement Accuracy: ± .5% Measurement Resolution: .1% of full-scale Crest Factor: ≥ 4	-hp- Model 3403C True RMS Voltmeter	PT
Pulse Generator	Pulse Output Amplitude: 10 V p-p Pulse Width: Variable, 1 msec - 10 μsec Repetition Rate: 100 Hz - 10 kHz	-hp- Model 8011A Pulse Generator	P
Oscilloscope	Bandwidth: DC - 2 MHz Sweep Time: .1 μs - .5 sec/div Sensitivity: .1 V/div.	-hp- Model 1221A Oscilloscope	PT

Table 1-3. Recommended Test Equipments (Cont'd).

Instrument	Critical Specification	Recommended Model	Use
Frequency Counter	Frequency Range: 10 Hz - 110 kHz Frequency Resolution: .1% of reading	-hp- Model 5300A Counter Mainframe -hp- Model 5302A Counter Module	P
Spectrum Analyzer	Frequency Range: 10 Hz - 330 kHz Frequency Resolution: .1 Hz Input Amplitude: 1 V Dynamic Range: 50 dB Measurement Resolution: ± .1 dB Minimum Bandwidth: 3 Hz	-hp- Model 3044A Spectrum Analyzer	PA
Tuneable Notch Filter	Frequency Range: 10 Hz - 110 kHz Notch Depth: ≥ -80 dB	-hp- Model 339A Distortion Measurement Set	P
Low Distortion Oscillator	Frequency Range: 10 Hz - 110 kHz Output Level: 3 V rms into 600 Ω THD: > -95 dB (10 Hz - 20 kHz) > -85 dB (20 kHz - 30 kHz) > -80 dB (30 kHz - 50 kHz) > -70 dB (50 kHz - 110 kHz)	-hp- Model 239A Oscillator	PAT
DC Digital Voltmeter	Input Range: 4 V dc Measurement Accuracy: ± .1% Resolution: .01% of full-scale	-hp- Model 3465A Digital Voltmeter	AT
Resistors	600 Ω Resistive Load	-hp- Accessory No. 11095A	PA
	600 Ω 1% Metal Film	-hp- Part No. 0698-5405	
	60 kΩ 1% Metal Film	-hp- Part No. 0698-5973	P
	100 kΩ .1% Metal Film	-hp- Part No. 0698-4158	
	1 kΩ 1% Metal Film	-hp- Part No. 0757-0280	

P = Performance Test

A = Adjustment Procedures

T = Troubleshooting

SECTION II INSTALLATION

2-1. INTRODUCTION.

2-2. This section of the manual contains information and instructions necessary to install the Model 339A Distortion Measurement Set. Also included are initial inspection procedures, power and grounding requirements, environmental information, and packaging instructions.

2-3. INITIAL INSPECTION.

2-4. This instrument was carefully inspected, both mechanically and electrically, before shipment. It should be free of marks and scratches and in perfect electrical order. The instrument should be inspected upon receipt for damage that might have occurred in transit. If the shipping container or cushioning material is damaged, it should be kept until the contents of the shipment have been checked for completeness and the instrument has been mechanically and electrically inspected. Procedures for testing the electrical performance of the Model 339A are given in Section IV of this manual. If the contents are incomplete, if there is mechanical damage or defect, or if the instrument does not pass the Performance Tests, notify the nearest Hewlett-Packard Office. (A list of the -hp- Sales and Service Offices is presented at the back of this manual.) If the shipping container is damaged, or the cushioning material shows signs of stress, notify the carrier as well as the Hewlett-Packard Office. Save the shipping materials for the carrier's inspection.

2-5. PREPARATION FOR USE.

2-6. Power Requirements.

2-7. The Model 339A requires a power source of 100, 120, 220, or 240 V ac (+5% - 10%), 48 Hz to 66 Hz single phase. Maximum power consumption is 48 VA.

2-8. Line Voltage Selection.

2-9. Before connecting ac power to the Model 339A make sure the rear panel line selector switches are set to correspond to the available power line voltage and that the proper fuse is installed, as shown in Figure 2-1. The instrument is shipped from the factory with the line voltage and fuse selected for 120 V ac operation.

2-10. Power Cable.

2-11. Figure 2-2 illustrates the standard configurations used for -hp- power cables. The number directly below each drawing is the -hp- part number for a power cable equipped with a connector of that configuration. If the

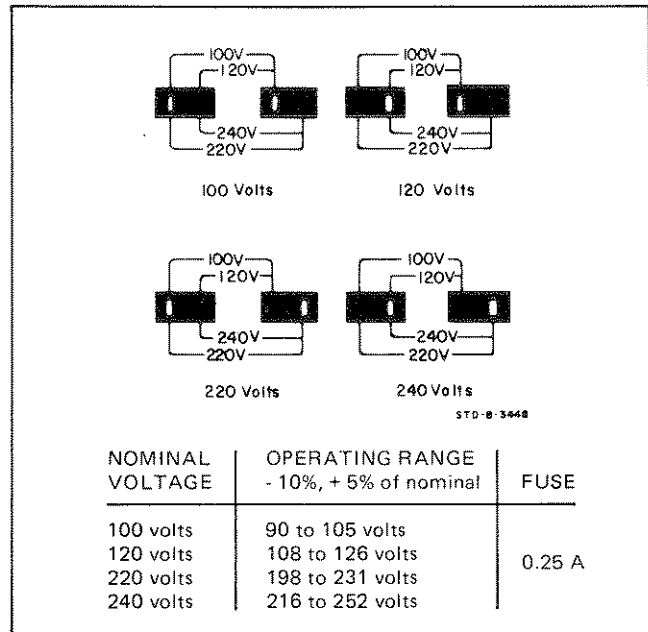

Figure 2-1. Line Voltage Selection.

appropriate power cable is not included with the instrument, notify the nearest -hp- Sales and Service Office and the proper cable will be provided.

2-12. Grounding Requirements.

2-13. To protect operating personnel, the National Electrical Manufacturer's Association (NEMA) recommends that the instrument cabinet and front panel be grounded. The Model 339A is equipped with a three

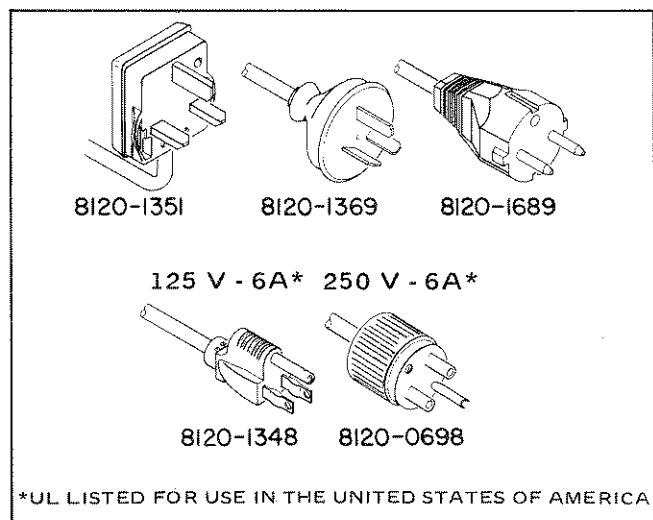

Figure 2-2. Power Cord Configurations.

conductor power cable which, when plugged into an appropriate receptacle, grounds the instrument.

2-14. Bench Use.

2-15. The Model 339A is shipped with plastic feet and tilt stands installed and is ready for use as a bench instrument. The plastic feet are shaped to permit "stacking" with other full-module Hewlett-Packard instruments. The tilt stands permit the operator to elevate the front of the instrument for operating and viewing convenience.

2-16. Rack Mounting.

2-17. The Model 339A may be rack mounted by adding rack mounting kit Option 908 or Option 909. Option 908 contains the basic hardware and instructions for rack mounting; Option 909 adds front handles to the basic rack mount kit. The rack mount kits are designed to permit the instrument to be installed in a standard 19 inch rack.

2-18. ENVIRONMENTAL REQUIREMENTS.

WARNING

To prevent electrical shock or fire hazard, do not expose the instrument to rain or moisture.

2-19. Operating and Storage Temperature.

2-20. In order to meet the specifications listed in Table 1-1, the instrument should be operated within an ambient temperature range of 0°C to +50°C (+32°F to +122°F).

2-21. The instrument may be stored or shipped where the ambient temperature range is within -40°C to +65°C (-40°F to +149°F). However, the instrument should not be stored or shipped where temperature fluctuations cause condensation within the instrument.

2-22. Humidity.

2-23. The instrument may be operated in environments with relative humidity of up to 95%. However, the instrument must be protected from temperature extremes which cause condensation within the instrument.

2-24. Altitude.

2-25. The instrument may be operated at altitudes up to 4572 meters (15,000 feet).

2-26. REPACKAGING FOR SHIPMENT.

NOTE

If the instrument is to be shipped to Hewlett-Packard for service or repair, attach a tag to the instrument identifying the owner and indicating the service or repair to be accomplished. Include the model number and full serial number of the instrument. In any correspondence, identify the instrument by model number and full serial number. If you have any questions, contact your nearest -hp-Sales and Service Office.

2-27. The following is a general guide for repackaging the instrument for shipment. If the original container is available, place the instrument in the container with appropriate packing material and seal well with strong tape or metal bands. If the original container is not available, proceed as follows:

- a. Wrap the instrument in heavy paper or plastic before placing it in an inner container.
- b. Place packing around all sides of the instrument and protect the front panel with cardboard strips or plastic foam.
- c. Place the instrument and inner container in a heavy carton and seal with strong tape or metal bands.
- d. Mark the shipping container "DELICATE INSTRUMENT", "FRAGILE", etc.

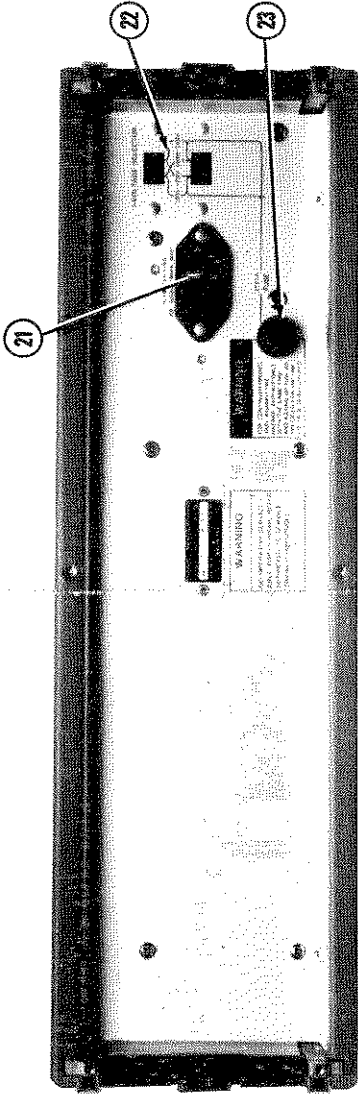
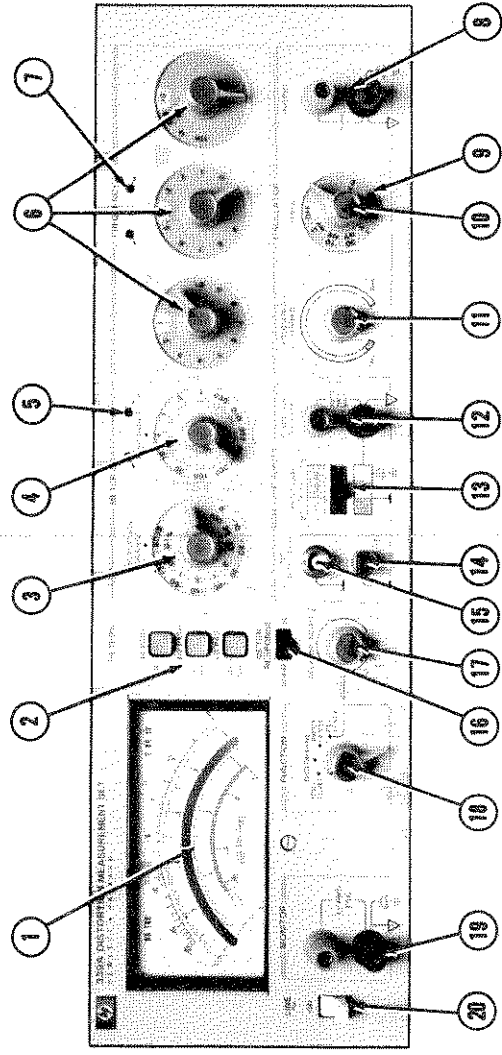

1. Meter indicates voltage level, distortion in dB or percent, or VU (volume units) in dB.
2. Filters permit the user to eliminate unwanted frequencies and noise from the measurement. The filters include a 400 Hz high-pass filter which is normally used to reject power-line related noise, a 30 kHz low-pass filter for use in making "proof of performance" measurements at AM broadcast stations, and an 80 kHz low-pass filter to eliminate high frequency noise.
3. DISTORTION RANGE control selects the gain of the distortion measurement circuits to the proper sensitivity for measuring the applied signal.
4. INPUT RANGE control sets the input range of the distortion and meter circuits to the proper sensitivity for measuring the applied signal.
5. Input Range indicators indicate the direction the INPUT RANGE control must be turned to select the correct range for the signal applied.
6. FREQUENCY controls determine the fundamental rejection frequency of the analyzer and the output frequency of the oscillator.

7. Frequency indicators indicate the direction the FREQUENCY controls must be turned to bring the analyzer circuits within "pull-in range" of the fundamental frequency of the applied signal. This applies only when using an external signal source.
8. OSCILLATOR OUTPUT terminals. Output impedance is 600 Ω .
9. OSCILLATOR LEVEL control changes the output level in 10 dBV steps from 3 mV rms to 3 V rms into 600 Ω . The LEVEL control also includes an OFF position which disconnects the oscillator output and terminates the output terminals with a 600 Ω resistive load.
10. Oscillator Level Vernier permits the output level to be varied below the level selected by the LEVEL control. This makes the oscillator output level continuously variable from less than 1 mV to greater-than 3 rms into 600 Ω .
11. OSCILLATOR FREQUENCY VERNIER. Frequency range of the vernier permits the oscillator output frequency to be increased above the frequency selected by the FREQUENCY controls. Frequency range of the vernier is approximately equal to one step on the center frequency control.

12. DISTORTION ANALYZER (and voltmeter) terminals provide connection for analyzer and voltmeter inputs.

13. ANALYZER (and voltmeter) INPUT/GND SELECT switch selects Distortion Analyzer input with either circuit or chassis ground or AM DETECTOR input with chassis ground only.

14. AM DETECTOR input terminal provides connection for amplitude modulated RF signals.

15. Ground Terminal provides connection to 339A Chassis.

16. METER RESPONSE switch selects normal or VU (volume units) meter response.

17. RELATIVE ADJUST permits the user to set a convenient reference level on the meter when using the voltmeter RELATIVE LEVEL FUNCTION.

18. FUNCTION control selects analyzer or voltmeter functions.

19. MONITOR terminals permit the signal applied to the meter circuitry to be monitored. The MONITOR output is 1 V rms for a full-scale meter deflection.

With an audio signal applied to the DISTORTION ANALYZER input the MONITOR output will be:

DISTORTION FUNCTION - Distortion products of the applied signal after the fundamental has been removed.

INPUT LEVEL - And Relative LEVEL FUNCTIONS. Scaled presentation of the applied signal.

With a modulated RF signal applied to the AM DETECTOR input the MONITOR output will provide:

DISTORTION FUNCTION - Scaled presentation of the demodulated input signal with the fundamental removed.

INPUT LEVEL and Relative LEVEL FUNCTIONS - Scaled presentation of the demodulated input signal.

The MONITOR terminals are disabled when using the OSCILLATOR LEVEL FUNCTION.

20. LINE switch applies ac power to the instrument.

21. AC LINE connector provides connection for ac power.

22. AC VOLTAGE SELECTOR switches set the instrument to operate from 100 V, 120 V, 220 V, or 240 V ac power source.

23. FUSE protects the instrument circuits from excessive current.

Figure 3-1. Control, Connector and Indicator Descriptions.

SECTION III OPERATION

3-1. INTRODUCTION.

3-2. This section contains information and instructions necessary for operation of the Model 339A Distortion Measurement Set. Included is a description of operating characteristics, a description of operating controls and indicators, and functional checks to be performed by the operator.

3-3. OPERATING CHARACTERISTICS.

3-4. General.

3-5. The Model 339A is designed to measure Total Harmonic distortion (THD) of signals having a fundamental frequency between 10 Hz and 110 kHz. The analyzer section of this instrument measures total harmonic distortion levels from 100% (0 dB) full-scale to .01% (-80 dB) full-scale in nine ranges as selected by the DISTORTION RANGE control. To simplify operation, the analyzer section features both automatic "set level" and automatic "nulling".

3-6. The Auto Set Level feature automatically sets the measurement reference level over a 10 dB V range. If the input signal is outside this range, an LED on the front panel indicates whether the INPUT RANGE control setting must be increased or decreased to be within the "pull-in" range of the Auto Set Level.

3-7. The Auto Nulling feature is fully automatic when the 339A internal oscillator is used as the signal source. When using an external signal source, an LED on the front panel indicates which direction the FREQUENCY controls must be rotated to be within the Auto Nulling range.

3-8. The Model 339A includes an AM detector which has a carrier frequency range of 550 kHz to 1.6 MHz. The AM detector permits the measurement of THD of a modulation signal.

3-9. The signal source used in the Model 339A is a "bridged T" oscillator which provides a low distortion sine-wave signal from 10 Hz to 110 kHz. The operating

frequencies of the oscillator and the analyzer notch filter are set simultaneously. The output level of the oscillator is variable from 1 mV rms full-scale to 3 V rms full-scale into a 600 Ω load.

3-10. The ac voltmeter section of the Model 339A measures the true rms value of input voltages from 1 mV full-scale to 300 V full-scale in twelve ranges. Frequency response of the meter section is 10 Hz to 110 kHz.

3-11. True RMS VS Average Responding Detection.

3-12. Since the 339A employs a true rms converter to detect the measurement signal, it is less susceptible to errors than average responding devices. Most average responding meters are calibrated to indicate the rms value of a pure sine-wave. When reading a pure sine-wave, both the true rms and average responding meters will give the correct indication. However, when reading complex signals the average responding meter may be in error. The amount of error depends upon the particular signal being measured.

As an example; when measuring a square-wave, the true rms meter will give the correct indication of the rms value. The average responding meter however, will read 11% high. The average responding meter is also affected by signals with harmonic content. The amount of error introduced by an average responding meter due to harmonics is dependent upon the relative amplitude, phase, and order of the harmonic. The third harmonic usually causes the greatest amount of error. For example, when measuring a signal with third harmonic content, an average responding meter can be in error by +5% to -20% depending upon the amplitude and phase of the harmonic, relative to the fundamental frequency. Due to the errors inherent in average responding meters, a distortion analyzer which employs this type of detector will also be subject to the same measurement errors. These errors can cause indicated distortion readings to be as much as 1.3 dB below the actual rms value for certain combinations of second and third harmonics. The Model 339A is not affected by the errors associated with average responding detectors and will provide more accurate measurement indications.

3-13. Turn-On and Warm-Up.

3-14. Before connecting ac power to the 339A, be certain the rear panel voltage selector switches are set to correspond to the voltage of the available power line and that the proper fuse is installed for the voltage selected. For rated measurement accuracy, the 339A should be allowed to "warm-up" for at least 15 minutes.

3-15. DISTORTION MEASUREMENT.

3-16. Distortion Measurement Using the 339A Internal Oscillator.

3-17. The Model 339A Distortion Measurement Set is designed to provide complete capability for measuring Total Harmonic Distortion by combining an automatic, high resolution distortion analyzer and a low distortion signal source. Figure 3-2 illustrates the fundamental application of the Model 339A. The figure shows the equipment configuration and includes an operating procedure for making THD measurements.

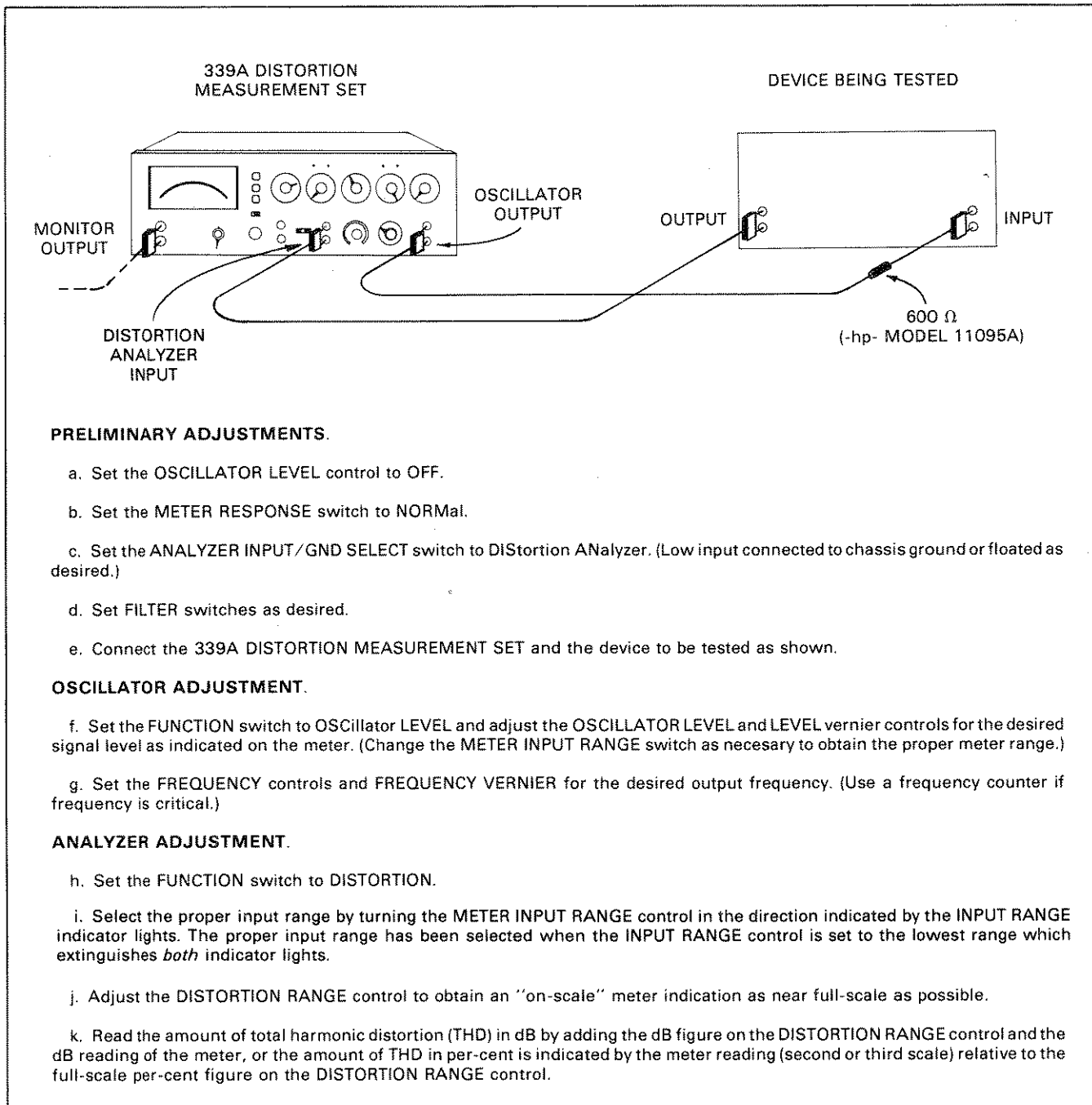

Figure 3-2. Distortion Measurement Using 339A Internal Oscillator.

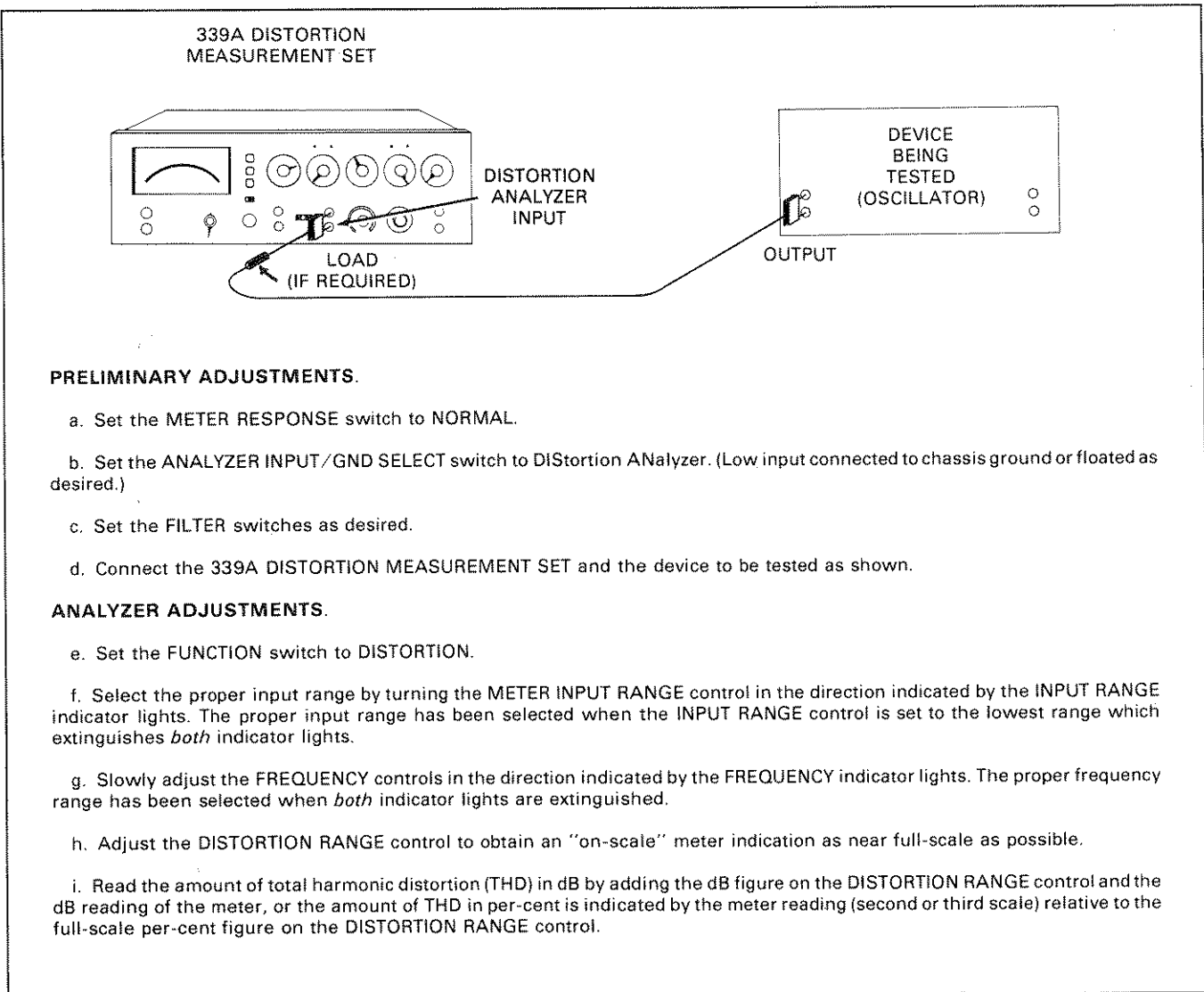

Figure 3-3. Distortion Measurement of an External Source.

3-18. Distortion Measurement of an External Source.

Figure 3-3 shows another measurement application. In this case the Model 339A is used to measure the THD of a signal source. The figure includes an illustration of the necessary equipment connections and an operating procedure for making the measurement.

3-20. AM DETECTOR.

3-21. The Model 339A includes an AM DETECTOR to permit the user to measure the total harmonic distortion of a modulation signal on an RF carrier. Equipment connection and measurement procedures are similar to those outlined in Figure 3-3 except the input is connected to the AM DETECTOR input.

3-22. VOLTMETER OPERATION.

3-23. The following procedures outline the operating procedures for the various voltmeter functions.

3-24. Normal Voltmeter Operation.

3-25. To use the Model 339A as a normal, true rms voltmeter, proceed as follows:

- Set the FUNCTION switch to INPUT LEVEL.
- Set the METER RESPONSE switch to NORMAL.
- Set the INPUT/GND SELECT switch to DIStortion ANalyzer (low input connected to chassis ground or floating as desired).

d. Set the FILTER switches off (out).

e. Connect the signal to be measured to the DISTORTION ANALYZER input connectors.

f. Adjust the INPUT RANGE control in the direction indicated by the INPUT RANGE indicator lights until an "on-scale" meter indication, as near full-scale as possible, is obtained. (Both indicator lights will be off.)

3-26. RELATIVE LEVEL OPERATION.

3-27. The RELATIVE LEVEL FUNCTION permits the user to adjust the meter gain of the 339A to set a convenient reference level on the meter (usually 0 dB). This function is convenient for measuring signal levels relative to a reference level. To use the RELATIVE LEVEL FUNCTION, proceed as follows:

a. Set the FUNCTION switch to RELative LEVEL.

b. Set the METER RESPONSE switch to NORMal.

c. Set the INPUT/GND SELECT switch to DISTortion ANalyzer. (Low input connected to chassis ground or floating as desired.)

d. Set the FILTER switches off (out).

e. Connect the reference signal to the DISTORTION ANALYZER input connectors.

f. Adjust the INPUT RANGE control in the direction indicated by the INPUT RANGE indicator lights until an "on-scale" meter indication is obtained.

g. Use the RELATIVE ADJUST control to set the meter to the desired reference level.

h. Measure other input levels relative to the reference just established. Do not change the RELATIVE ADJUST control.

3-28. Oscillator Level Operation.

3-29. In the OSCillator LEVEL function, the analyzer inputs and the MONITOR output is disabled and the 339A meter circuit is used to monitor the output level of the oscillator. To measure the oscillator output level, perform the following:

a. Set the FUNCTION switch to OSCillator LEVEL.

b. Set the METER RESPONSE switch to NOR-MAL.

c. Set the FILTER switches to off (out).

d. Adjust the INPUT RANGE control as necessary to obtain an "on-scale" meter indication as near full-scale as possible.

e. The meter reading, relative to the meter range selected by the INPUT RANGE control indicates the output level of the oscillator.

3-30. To adjust the oscillator output to a particular level, perform the following:

a. Set the FUNCTION switch to OSCillator LEVEL.

b. Set the METER RESPONSE switch to NOR-MAL.

c. Set the FILTER switches to off (out).

d. Set the INPUT RANGE control to the appropriate meter range for the oscillator output level desired.

e. Adjust the OSCILLATOR LEVEL control and LEVEL vernier until the desired output level is indicated on the meter.

3-31. VU MEASUREMENTS.

3-32. To measure volume units (VU), the meter response characteristics are changed to those of a VU meter by switching the METER RESPONSE switch to the VU position. VU measurements can be made in the INPUT LEVEL or RELative LEVEL functions. Measurement results are normally read on the dBm 600 ohms meter scale. Operating procedures for making VU measurements are the same as those listed for Normal Voltmeter Operation or Relative Level Operation.

3-33. Filters.

3-34. Three 60 dB/decade active filters, one high-pass and two low-pass, are included to permit the user to eliminate unwanted frequencies and noise. These filters may be selected individually or in any combination by means of the front panel FILTER switch. The frequencies labeled beside each switch indicate the 3 dB "roll-off" point of that particular filter.

3-35. Input Ground Select.

3-36. The ANALYZER Low input reference is selected by the INPUT/GND SELECT switch. When using the DISTORTION ANALYZER input, the input low is connected to chassis ground (center switch position) or allowed to float (right switch position). When using the AM DETECTOR input (left switch position) the input low is connected to chassis ground.



To prevent damage to the analyzer input circuits, do not float the low input terminal more than ± 30 V dc relative to earth ground.

3-37. Monitor Output.

3-38. The MONITOR output provides a means of driving external equipment to permit a more detailed analysis of the signal being measured. Instruments, such as an oscilloscope, wave analyzer, or spectrum analyzer can be used to determine the nature of the total harmonic distortion being measured. The monitor output level is 1 V rms for full-scale meter deflection. The MONITOR output is disabled when using the OSCILLATOR LEVEL FUNCTION.

3-39. OSCILLATOR OPERATION.**3-40. Frequency Selection.**

3-41. The oscillator frequency is determined by the setting of the FREQUENCY and FREQUENCY VERNIER controls. The units and tenths controls determine the first and second digits of the desired frequency. These numbers are then multiplied by the range selected on the multiplier control. As an example: to set the oscillator to a frequency of 5.6 kHz; set the units control to 5, the tenths control to .6, and the multiplier to X1K. (The FREQUENCY VERNIER should be set to the CAL position.) The FREQUENCY VERNIER provides continuous frequency tuning between steps of the tenths control to permit continuous frequency selection from 10 Hz to 110 kHz.

3-42. Output Level.

3-43. The oscillator output level is controlled by the OSCILLATOR LEVEL control and LEVEL vernier. The OSCILLATOR LEVEL control selects output levels from 3 mV rms full-scale to 3 V rms full-scale in 10 dB V steps (600 ohm load). The level vernier varies the output level from greater than 3 V rms to less than 1 mV rms (600 ohm load).

3-44. OPERATIONAL VERIFICATION CHECKS.

3-45. The following procedures are designed to test the operational capabilities of the Model 339A. If so desired, these tests can be substituted for the performance tests outlined in Section IV for incoming inspection tests or to check operation after calibration. Keep in mind however, these tests check only the operational capabilities of the Models 339A. They *do not* check the performance accuracy. If the instrument fails any of the following tests, refer service to qualified service personnel.

3-46. Preliminary Procedure.

3-47. Before connecting power to the 339A, perform the following:

a. Be certain that the rear panel VOLTAGE SELECTOR switches are set to correspond to the

available power line voltage and that the proper fuse is installed.

b. Connect power to the 339A and turn the LINE switch ON.

c. Set the FILTER switches off (out).

d. Set the METER RESPONSE switch to NORMAL.

3-48. OSCILLATOR.

3-49. This procedure checks the output level of the 339A oscillator for all frequency settings. Frequency accuracy is not checked. To check the oscillator proceed as follows:

a. Set the FUNCTION switch to OSCILLATOR LEVEL.

b. Set the INPUT RANGE control to the 10 volt range.

c. Set the FREQUENCY controls fully counterclockwise.

d. Set the OSCILLATOR LEVEL control and level vernier fully clockwise. The meter should indicate more than 6 volts.

e. Set the level vernier fully counterclockwise. The meter should indicate less than 2 volts.

f. Set the INPUT RANGE control to the +10 dBm range and adjust the level vernier for a 0 dBm meter indication (blue scale).

g. While observing the meter, set the FREQUENCY controls to each dial position. (Allow time for the meter reading to stabilize at each setting.) The meter indication should not vary more than 0.6 dBm from the original setting.

h. Set the FREQUENCY controls for a frequency of 1 kHz.

i. Adjust the level vernier for a meter indication 0 dBm.

j. Simultaneously down-range the OSCILLATOR LEVEL and INPUT RANGE controls to the next lower range. The meter should indicate 0 dBm.

k. Repeat Steps i and j for each position of the OSCILLATOR LEVEL control.

3-50. AC VOLTMETER.

3-51. The following procedure checks the ac voltmeter functions and ranges. Perform the following steps:

a. Set the FILTER switches off (out), the METER RESPONSE switch to NORMAL, and the INPUT/GND SELECT switch to the center position. (DISTORTION ANALYZER with input low connected to chassis ground.)

b. Set the FUNCTION switch to INPUT LEVEL.

c. Set the INPUT RANGE control to the 10 volt range.

d. Set the FREQUENCY controls for a frequency of 1 kHz.

e. Set the OSCILLATOR LEVEL control to the 3 volt range.

f. Connect a cable from the OSCILLATOR OUTPUT terminals to the DISTORTION ANALYZER input terminals.

g. Adjust the OSCILLATOR LEVEL vernier for a meter indication of 6 volts.

h. While observing the meter, set the INPUT RANGE control to the 30, 100, and 300 volts ranges. The meter should indicate 6 volts on the respective ranges. The left hand INPUT RANGE indicator light should be lit on all three ranges.

i. Set the INPUT RANGE switch to the 3 volt range. Observe that the right hand INPUT RANGE indicator is lit.

j. Down-range the OSCILLATOR LEVEL control to the next lower range and adjust the level vernier for a meter indication -10 dB V.

k. Down-range the INPUT RANGE control to the next lower range. The meter should indicate $0 \text{ dB V} \pm .2 \text{ dB V}$.

l. Repeat Steps j and k until all input ranges except the .001 V range have been checked.

m. Set the INPUT RANGE control to the 10 volt range and the OSCILLATOR LEVEL control to the 3 volt range.

n. Adjust the level vernier for a meter indication of -12 dB V.

o. Set the FUNCTION switch to the RELATIVE LEVEL position.

p. Vary the RELATIVE ADJUST control to verify an adjustment range of greater-than 10 dB V.

3-52. Distortion Analyzer.

3-53. The following procedure checks the distortion

analyzer ranges and distortion measurement capability. Perform the following steps:

a. Set the FILTER switches off (out), the METER RESPONSE switch to NORMAL, and the INPUT/GND SELECT switch to the center position (DISTORTION ANALYZER with input low connected to chassis ground).

b. Set the DISTORTION RANGE control to 0 dB.

c. Set the INPUT RANGE control to the 1 volt range.

d. Set the FREQUENCY controls to a frequency of 1 kHz.

e. Set the OSCILLATOR LEVEL control to the 3 volt range.

f. Connect a cable between the OSCILLATOR OUTPUT terminals and the DISTORTION ANALYZER input terminals.

g. Set the FUNCTION switch to the DISTORTION position.

h. Adjust the OSCILLATOR LEVEL vernier for a meter indication of -15 dB V.

i. Down-range the DISTORTION RANGE control to the next lower range. The meter should indicate approximately -5 dB V.

j. Repeat Steps h and i until all distortion ranges have been checked.

3-54. Filters.

3-55. The following procedure checks the "roll-off" of the filters.

a. Set the FUNCTION switch to OSCILLATOR LEVEL.

b. Set the INPUT RANGE control to the 3 volt range.

c. Set the OSCILLATOR LEVEL control to the 3 volt range and adjust the level vernier for a meter indication of 0 dB V.

d. Set the FREQUENCY controls for a frequency of 400 Hz.

e. Set the 400 Hz FILTER switch on (in). The meter should indicate $-3 \text{ dB V} \pm 1 \text{ dB}$. Return the filter switch to off (out).

f. Set the FREQUENCY controls for a frequency of 30 kHz. Readjust the level vernier for a meter indication 0 dB V if necessary.

g. Set the 30 kHz filter switch on (in). The meter

should indicate $-3 \text{ dB V} \pm 2 \text{ dB}$. Return the filter switch to off (out).

h. Set the FREQUENCY controls for a frequency of 80 kHz. Readjust the level vernier for a meter indication of 0 dB V if necessary.

i. Set the 80 kHz filter switch on (in). The meter should indicate $-3 \text{ dB V} \pm 2 \text{ dB}$. Return the filter switch to off (out).

3-56. OPERATOR'S MAINTENANCE.

3-57. Fuse Replacement.

3-58. The ac line fuse is located on the rear panel of the instrument. Before checking or replacing the fuse, disconnect the ac line cord from the instrument. The fuse used in the Model 339A is a 250 mA, normal-blow fuse.

WARNING

For continued protection against fire hazard, replace only with the same type and rating of fuse as specified for the line voltage being used.

3-59. Adjustment of Meter Mechanical Zero.

3-60. The meter is properly zero-set when the pointer rests over the zero calibration mark with the instrument in its normal operating environment and turned off. Zero-set the meter as follows to obtain maximum accuracy and mechanical stability:

a. Turn instrument on and allow it to operate for at least 20 minutes to let meter movement reach normal operating temperature.

b. Turn instrument off and allow 30 seconds for all capacitors to discharge.

c. Rotate zero adjustment screw clockwise until pointer is left of zero and moving upscale.

d. Continue rotating screw clockwise; stop when pointer is exactly at zero.

e. When pointer is exactly over zero, rotate adjustment screw slightly counterclockwise to relieve tension on pointer suspension. If pointer moves off zero, repeat Steps c through e, but make counterclockwise rotation less.

SECTION IV PERFORMANCE TEST

4-1. INTRODUCTION.

4-2. This section contains performance test procedures which can be used to verify that the Model 339A meets the specifications listed in Table I-1. All tests can be performed without access to the interior of the instrument. A simpler operational verification procedure, included in Section III, may be used to check the operational capability of the 339A. The operational procedures do not, however, check specified accuracy of the instrument.

4-3. EQUIPMENT REQUIRED.

4-4. The test equipment required for the performance tests is listed at the beginning of each procedure and in the Recommended Test Equipment Table in Section I. If the recommended equipment is not available, any equipment that meets the critical specifications given in the table may be substituted.

4-5. TEST RECORD.

4-6. A Performance Test Record is included at the end of this section for your convenience in recording performance data. This record may be removed from the manual and used as a permanent record of the incoming

inspection or of a routine performance test. The Performance Test Record may be reproduced without written permission of Hewlett-Packard.

4-7. CALIBRATION CYCLE.

4-8. The Model 339A requires periodic verification of performance. The performance should be tested as part of the incoming inspection and at 90 day or 6 month intervals, depending upon the environmental conditions and your specific accuracy requirements.

4-9. VOLTMETER PERFORMANCE TESTS.

4-10. The following procedures check the accuracy of the voltmeter section of the 339A. These procedures should be performed and the voltmeter accuracy verified before performing the Distortion Analyzer Performance Tests.

4-11. Full-Scale Accuracy and Frequency Response Test.

Equipment Required:

- AC Calibrator (-hp- Model 745A)
- High Voltage Amplifier (-hp- Model 746A)

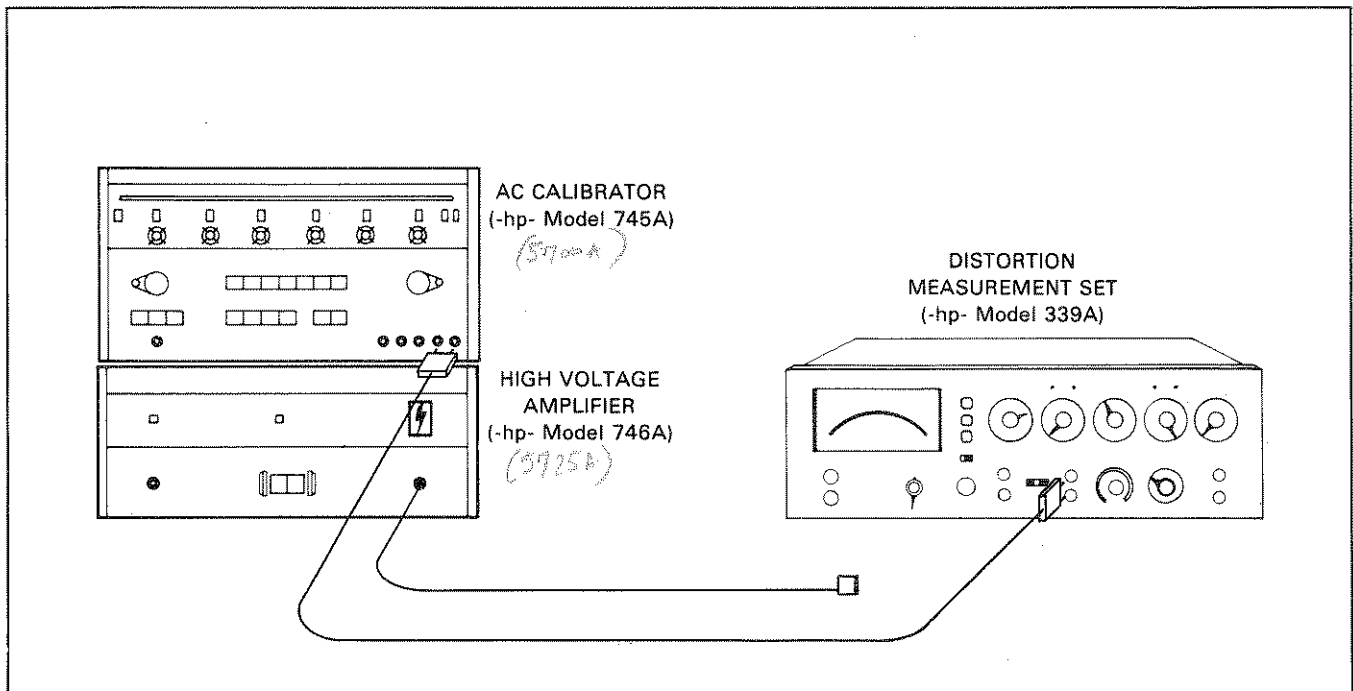

Figure 4-1. Full-Scale Accuracy and Frequency Response Test.

Table 4-1. Full-Scale Accuracy and Frequency Response Test Limits.

Input Range & Input Level	FREQUENCY						
	10 Hz	20 Hz	100 Hz	1 kHz	10 kHz	20 kHz	110 kHz
.001 V	.00096 - .00104			.00098 - .00102			.00096 - .00104
.003 V	.00288 - .00312			.00294 - .00306			.00288 - .00312
.01 V	.0096 - .0104			.0098 - .0102			.0096 - .0104
.03 V	.0288 - .0312			.0294 - .0306			.0288 - .0312
.1 V	.096 - .104			.098 - .102			.096 - .104
.3 V	.288 - .312			.294 - .306			.288 - .312
1 V	.96 - 1.04			.98 - 1.02			.96 - 1.04
3 V	2.88 - 3.12			2.94 - 3.06			2.88 - 3.12
10 V	9.6 - 10.4			9.8 - 10.2			9.6 - 10.4
30 V	28.8 - 31.2			29.4 - 30.6			28.8 - 31.2
100 V	96 - 104			98 - 102			96 - 104
300 V	288 - 312			294 - 306			288 - 312

a. Set the 339A controls as follows:

FUNCTION INPUT LEVEL
 FILTERS OFF (out)
 METER RESPONSE VU
 INPUT RANGE001 V
 INPUT/GND SELECT DIS. AN./⊥
 (center position)

b. Set the AC Calibrator controls for an output of 1 mV, 10 Hz.

c. Connect the output of the AC Calibrator to the 339A DISTORTION ANALYZER input.

d. The 339A 1 mV, 10 Hz meter indication should be within the Test Limits listed in Table 4-1.

e. Using the AC Calibrator and High Voltage Amplifier, verify the 339A Voltmeter accuracy for each Test Frequency, Input Level, and 339A Input Range listed in Table 4-1.

4-12. Meter Tracking and Monitor Output Accuracy Test.

Equipment Required:

- AC Calibrator (-hp- Model 745A)
- True RMS Voltmeter (-hp- Model 3403C)

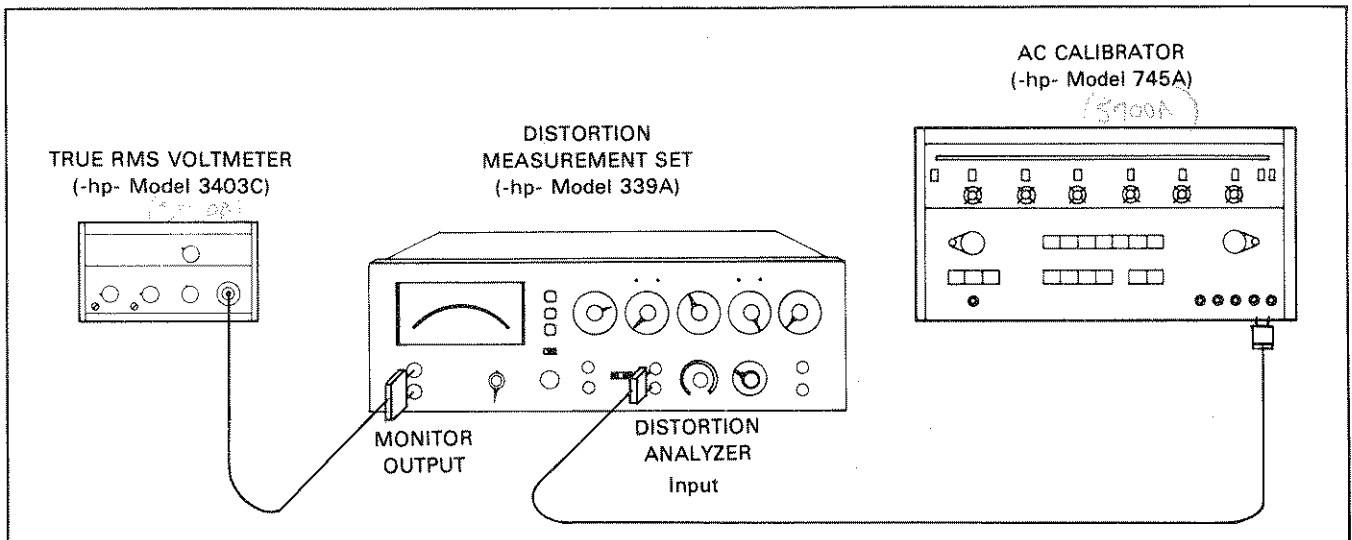

Figure 4-2. Meter Tracking and Monitor Output Accuracy Test.

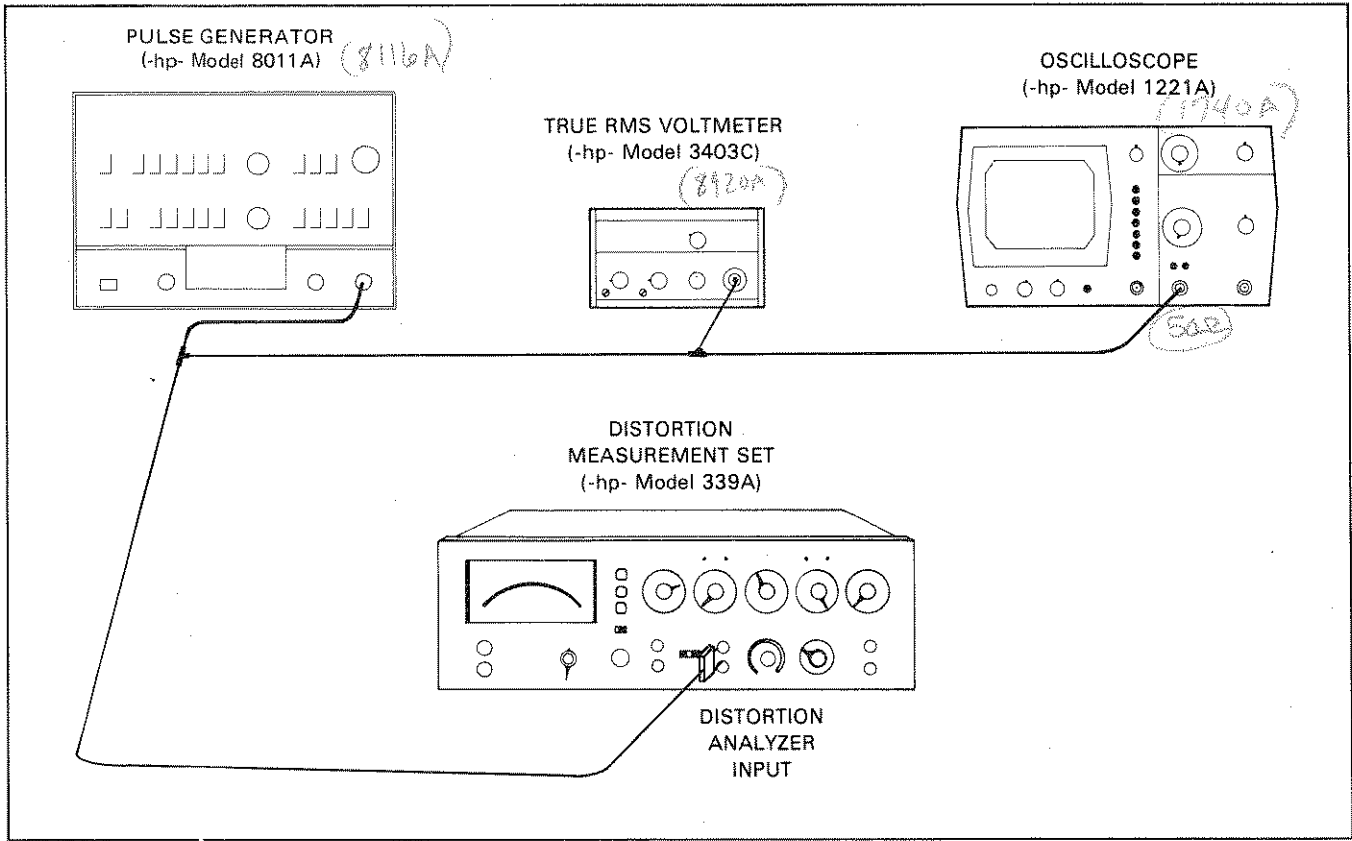

Figure 4-3. RMS Accuracy Test.

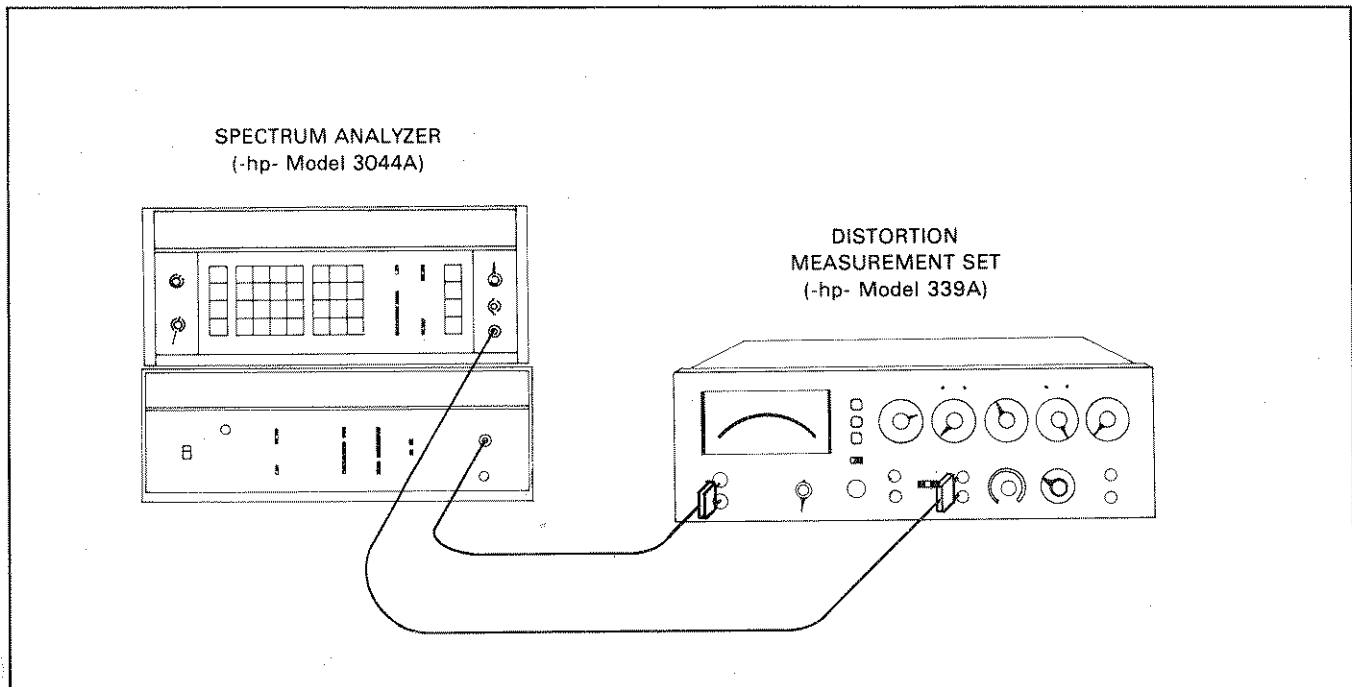

Figure 4-4. Filter Accuracy Test.

a. Set the 339A controls as follows:

FUNCTION INPUT LEVEL
 FILTERS OFF (out)
 METER RESPONSE VU
 INPUT RANGE 1 V
 INPUT/GND SELECT DIS. AN./⊥
 (center position)

b. Set the AC Calibrator controls for an output of 1 V, 1 kHz.

c. Set the True RMS Voltmeter to read AC Volts on the 1 V range.

d. Connect the equipment as shown in Figure 4-2.

e. The 339A 1 V meter indication and MONITOR output level should be within the Test Limits listed in Table 4-2.

f. Using the AC Calibrator, verify the 339A meter accuracy and MONITOR output accuracy for each input level listed in Table 4-2.

Table 4-2. Meter Tracking and MONITOR Output Accuracy Tests.

Input Level	Meter Indication	Monitor Output Level
1.0 V	.98 - 1.02	.95 - 1.05
.9 V	.88 - .92	.85 - .95
.8 V	.78 - .82	.75 - .85
.7 V	.68 - .72	.65 - .75
.6 V	.58 - .62	.55 - .65
.5 V	.48 - .52	.45 - .55
.4 V	.38 - .42	.35 - .45
.3 V	.28 - .32	.25 - .35
.2 V	.18 - .22	.15 - .25
.1 V	.08 - .12	.05 - .15

4-13. RMS Accuracy (crest factor) Test.

Equipment Required:

- Pulse Generator (-hp- Model 8011A)
- True RMS Voltmeter (-hp- Model 3403C)
- Oscilloscope (-hp- Model 1221A)

a. Set the 339A controls as follows:

FUNCTION INPUT LEVEL
 FILTERS OFF (out)
 METER RESPONSE VU
 INPUT RANGE 3 V
 INPUT/GND SELECT DIS. AN./⊥
 (center position)

b. Connect the equipment as shown in Figure 4-3.

c. Adjust the pulse generator for a 10 V peak-to-peak positive pulse with a repetition rate of 1 kHz (as observed on the oscilloscope).

d. Adjust the Pulse Generator symmetry until the true RMS voltmeter indicates 3.00 V rms.

NOTE

The pulse generator amplitude and symmetry controls may interact. Repeat adjustments as necessary to obtain a true rms meter indication of 3 V and an oscilloscope presentation of 10 V peak-to-peak.

e. The 339A meter indication must be 3 volts ± .06 volts.

f. Change the Pulse Generator repetition rate to 100 Hz. Readjust the amplitude and symmetry as necessary to obtain a true RMS meter indication of 3 V and a 10 V peak-to-peak oscilloscope presentation.

g. The 339A meter indication must be 3 V ± .06 volts.

h. Change the Pulse Generator repetition rate to 10 kHz. Readjust the amplitude and symmetry as necessary to obtain a True RMS meter reading of 3 V and a 10 V peak-to-peak oscilloscope presentation.

i. The 339A meter indication must be 3 V ± .12 volts.

4-14. Filter Accuracy Test.

Equipment Required:

- Spectrum Analyzer (-hp- Model 3044A)

5700A/3920A

a. Set the 339A controls as follows:

FUNCTION INPUT LEVEL
 FILTERS OFF (out)
 METER RESPONSE VU
 INPUT RANGE 1 V
 INPUT/GND SELECT DIS. AN./⊥
 (center position)

b. Connect the equipment as shown in Figure 4-4.

c. Set the Synthesizer (3330B) output frequency to 400 Hz and adjust the output level for a full-scale meter reading on the 339A.

d. Set the Spectrum Analyzer (3571A) controls for an input impedance of 1 MΩ, an input range of +10 dB V, a bandwidth of 3 Hz and a relative display reference.

e. Set the Spectrum Analyzers measurement reference by pressing the Enter Offset button. (The Spectrum Analyzer should display 00.00 dB.)

f. Set the 339A 400 Hz FILTER switch to ON (in).

g. Adjust the Synthesizer frequency until the Spectrum Analyzer indicates a reading of -3.00 dB. The Synthesizer frequency must be between 360 Hz and 435 Hz.

h. Set the 339A 400 Hz FILTER to OFF (out).

i. Set the Synthesizer output frequency to 30 kHz.

j. Set the Spectrum Analyzers measurement reference by pressing the Enter Offset button.

k. Set the 339A 30 kHz FILTER switch to ON (in).

l. Adjust the Synthesizer frequency as necessary to obtain a Spectrum Analyzer reading of -3.00 dB. The Synthesizer frequency must be between 27 kHz and 32.6 kHz.

m. Set the 339A 30 kHz FILTER to OFF (out).

n. Set the Synthesizer output frequency to 80 kHz.

o. Set the Spectrum Analyzers measurement reference by pressing the Enter Offset button.

p. Set the 339A 80 kHz FILTER switch to ON (in).

q. Adjust the Synthesizer frequency as necessary to obtain a Spectrum Analyzer reading of -3.00 dB. The Synthesizer frequency must be between 72.1 kHz and 87 kHz.

r. Set the 339A 80 kHz FILTER to OFF (out).

4-15. OSCILLATOR PERFORMANCE TESTS.

4-16. Output Level and Flatness Test.

Equipment Required:

True RMS Voltmeter (-hp- Model 3403C)
600 ohm Resistive Load (-hp- 11095A)

a. Set the 339A controls as follows:

FREQUENCY 1 kHz (1.0 x 1 K)
FREQUENCY VERNIER CAL
OSCILLATOR LEVEL 3 V
LEVEL vernier fully CW

b. Set the True RMS Voltmeter controls to measure AC Volts.

c. Connect the equipment as shown in Figure 4-5.

d. The True RMS Voltmeter indication must be greater than 3 V (typically > 3.4 V).

e. Adjust the 339A LEVEL vernier for a reading of 3.00 V as indicated on the True RMS Voltmeter.

f. Set the 339A to each FREQUENCY listed in Table 4-3 and verify that the output level is within the limits specified.

4-17. Output Impedance Test.

Equipment Required:

True RMS Voltmeter (-hp- Model 3403C)
600 ohm Resistive Load (-hp- Model 11095A)

a. Set the 339A controls as follows:

FREQUENCY 1 kHz (1.0 x 1 K)

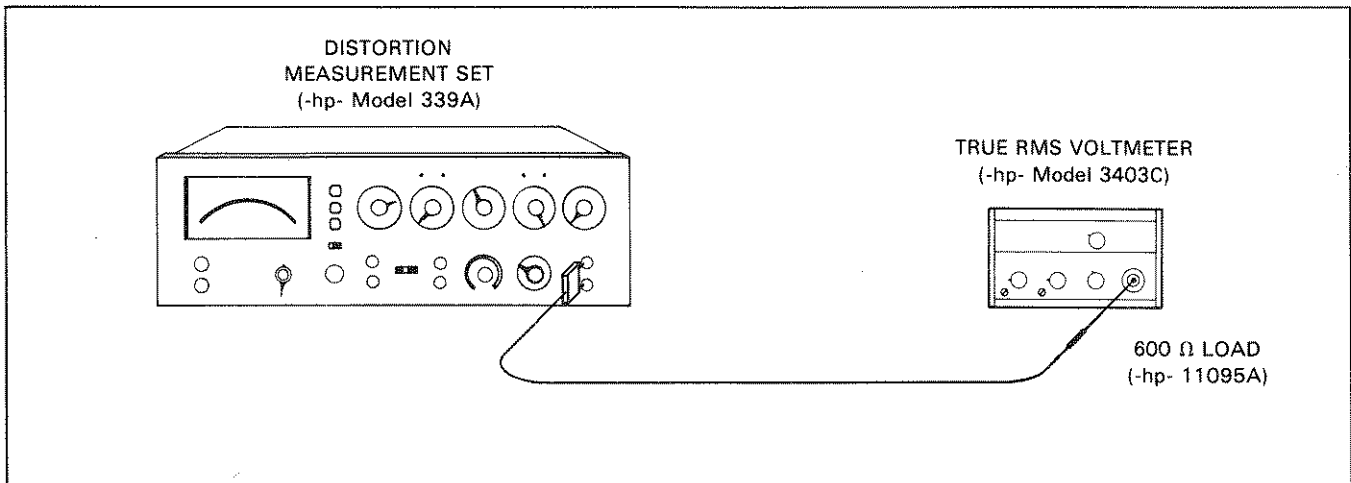

Figure 4-5. Oscillator Output Level and Flatness Test.

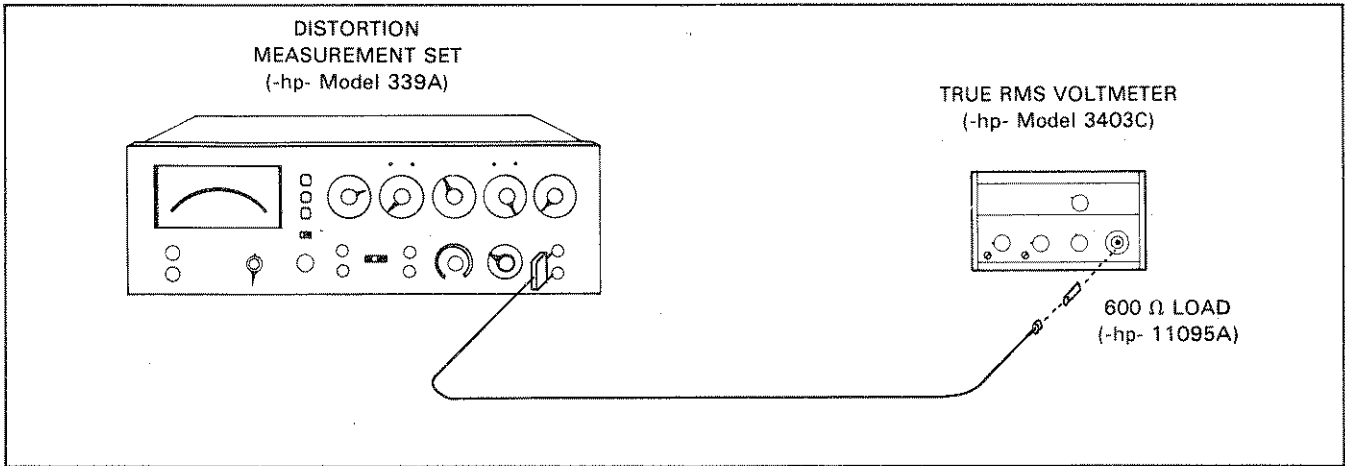

Figure 4-6. Oscillator Output Impedance Test.

FREQUENCY VERNIER CAL
 OSCILLATOR 3 V

b. Connect the equipment as shown in Figure 4-6 (without the 600 ohm load).

c. Adjust the True RMS Voltmeter controls to measure AC volts on the 10 V range.

d. Adjust the 339A LEVEL vernier control to obtain a reading of 6.00 V on the True RMS voltmeter.

e. Disconnect the cable from the True RMS Voltmeter and install the 600 ohm load as shown in Figure 4-6.

f. The True RMS Voltmeter reading must be between 2.927 and 3.077 V rms.

4-18. Oscillator Frequency Accuracy Test.

Equipment Required:

Frequency Counter (-hp- Model 5300A Mainframe, 5302A Frequency Module)
 600 ohm Resistive Load (-hp- 11095A)

a. Set the 339A controls as follows:

FREQUENCY 10 Hz (1.0 x 10)
 FREQUENCY VERNIER CAL
 OSCILLATOR LEVEL 3 V

Table 4-3. Oscillator Output Limits (Flatness Test).

Output Frequency	Output Level
10 Hz	2.930 - 3.070
20 Hz	2.965 - 3.035
100 Hz	2.965 - 3.035
10 kHz	2.965 - 3.035
20 kHz	2.965 - 3.035
110 kHz	2.930 - 3.070

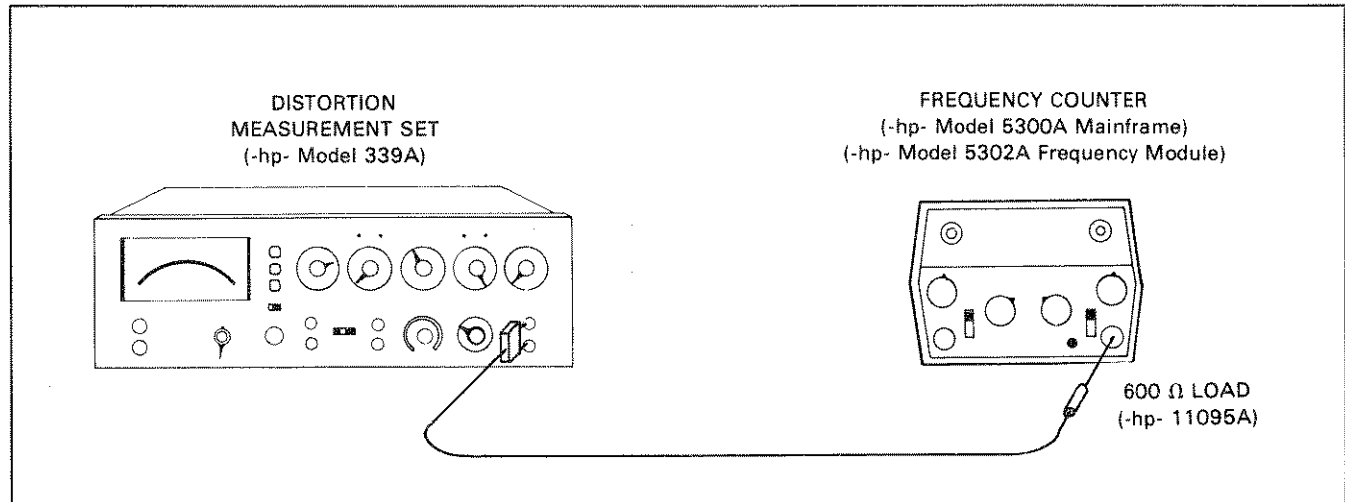

Figure 4-7. Oscillator Frequency Accuracy Test.

Table 4-4. Oscillator Frequency Accuracy Test.

Frequency	339A Frequency Range Setting	Frequency Counter Indication (Period)
10 Hz 20 Hz 50 Hz 100 Hz	X 10	102.04 mSec. - 98.04 mSec. 51.020 mSec. - 49.019 mSec. 20.408 mSec. - 19.608 mSec. 10.204 mSec. - 9.803 mSec.
100 Hz 200 Hz 500 Hz 1 kHz	X 100	10.204 mSec. - 9.803 mSec. 5.1020 mSec. - 4.9019 mSec. 2.0408 mSec. - 1.9608 mSec. 1.0204 mSec. - .9803 mSec.
1 kHz 1.1 kHz 1.2 kHz 1.3 kHz 1.4 kHz 1.5 kHz 1.6 kHz 1.7 kHz 1.8 kHz 1.9 kHz 2.0 kHz 3.0 kHz 4.0 kHz 5.0 kHz 6.0 kHz 7.0 kHz 8.0 kHz 9.0 kHz 10.0 kHz	X 1K	1020.4 μ Sec. - 980.3 μ Sec. 927.64 μ Sec. - 891.26 μ Sec. 850.34 μ Sec. - 816.99 μ Sec. 784.93 μ Sec. - 754.14 μ Sec. 728.86 μ Sec. - 700.28 μ Sec. 680.27 μ Sec. - 653.59 μ Sec. 637.75 μ Sec. - 612.74 μ Sec. 600.24 μ Sec. - 576.70 μ Sec. 566.89 μ Sec. - 544.66 μ Sec. 537.05 μ Sec. - 515.99 μ Sec. 510.20 μ Sec. - 490.19 μ Sec. 340.13 μ Sec. - 326.79 μ Sec. 255.10 μ Sec. - 245.09 μ Sec. 204.08 μ Sec. - 196.08 μ Sec. 170.06 μ Sec. - 163.39 μ Sec. 145.77 μ Sec. - 140.05 μ Sec. 127.55 μ Sec. - 122.54 μ Sec. 113.37 μ Sec. - 108.93 μ Sec. 102.04 μ Sec. - 98.039 μ Sec.
10 kHz 20 kHz 50 kHz 100 kHz 109 kHz	X 10 K	102.04 μ Sec. - 98.039 μ Sec. 51.020 μ Sec. - 49.019 μ Sec. 20.408 μ Sec. - 19.608 μ Sec. 10.204 μ Sec. - 9.8039 μ Sec. 9.3615 μ Sec. - 8.9944 μ Sec.

- b. Connect the equipment as shown in Figure 4-7.
- c. Adjust the Frequency Counter controls to measure period.
- d. The 339A 10 Hz frequency should be within the limits listed in Table 4-4.
- e. Verify the 339A Oscillator Frequency Accuracy for each frequency listed in Table 4-4.

4-19. Oscillator Total Harmonic Distortion Test.

Equipment Required:

- Spectrum Analyzer (-hp- Model 3044A)
- Tuneable Notch Filter (-hp- Model 339A)
- 600 ohm Resistive Load (-hp- 11095A)

- a. Set the 339A controls as follows:

FUNCTION OSCillator LEVEL
 FREQUENCY 10 Hz (1.0 x 10)
 FREQUENCY VERNIER CAL
 OSCILLATOR LEVEL 3 V

- b. Connect the equipment as shown in Figure 4-8.
- c. Adjust the 339A OSCILLATOR LEVEL vernier for an output level of 3 V rms as indicated on the 339A meter.
- d. Set the Tuneable Notch Filter (339A) Frequency to 10 Hz and set the Function to Input Level. Adjust the Input Range control as necessary to obtain an on-scale meter indication as near full-scale as possible.

- e. Set the Spectrum Analyzer (3571A) controls for an input impedance of 1 M Ω , an input range of +10 dB V, a bandwidth of 3 Hz, and a relative display reference.

- f. Tune the Spectrum Analyzer to the exact frequency of the 339A under test by varying the Synthesizer (3330B) frequency until the Spectrum Analyzer indicates maximum level. Enter this frequency as both the output frequency and step frequency of the Synthesizer.

- g. Reference the Spectrum Analyzer to the amplitude of the 339A fundamental frequency by pressing the Enter Offset button. (Observe a Spectrum Analyzer display of 00.00 dB.)

- h. Adjust the Tuneable Notch Filter controls as necessary to make a distortion measurement. (The purpose of this step is to null the fundamental frequency of the 339A Oscillator output. This puts the distortion products within the dynamic range of the Spectrum Analyzer.)

- i. Step the Synthesizer frequency to the second harmonic frequency of the 339A output.

- j. The amplitude of the second harmonic frequency, relative to the fundamental frequency is determined by adding the Spectrum Analyzer display reading and the range setting of the Notch Filter. (As an example: If the Notch Filter distortion range control is set to -80 dB and the Spectrum Analyzer display indicates -23 dB the amplitude of the second harmonic is -103 dB, relative to the fundamental.) Record the amplitude reading of the second harmonic.

- k. Step the Synthesizer frequency to the frequency of the third harmonic.

- l. Determine the relative amplitude of the third harmonic by adding the Spectrum Analyzer display reading and the range setting of the Notch Filter. Record the amplitude reading of the third harmonic.

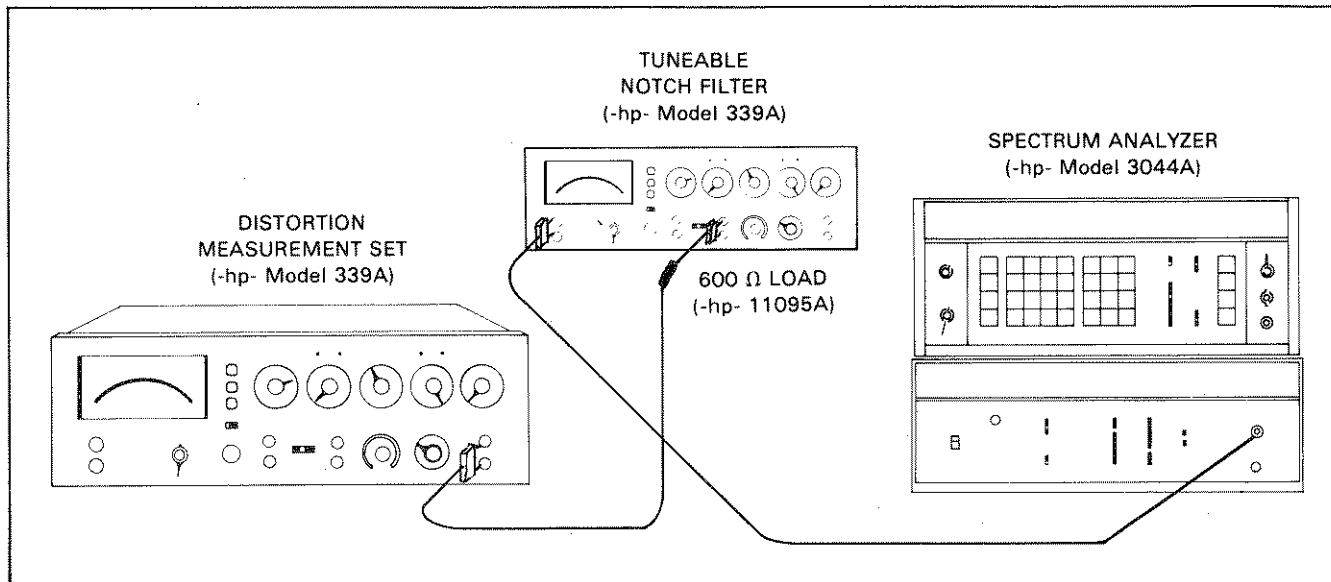

Figure 4-8. Oscillator Total Harmonic Distortion Test.

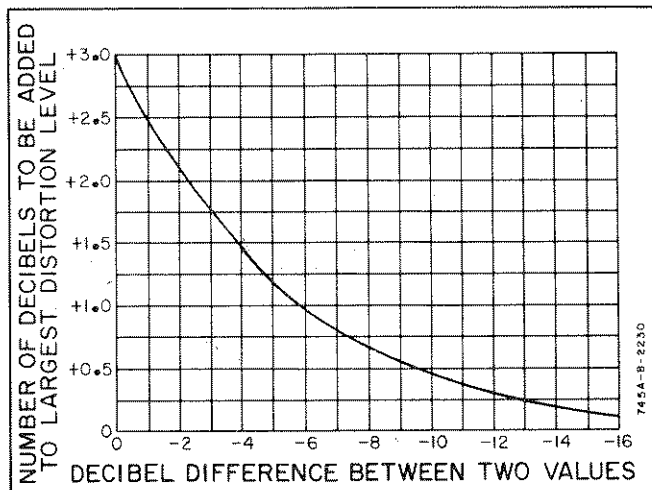

Figure 4-9. Logarithmic Addition of Harmonic Components.

Table 4-5. Oscillator Total Harmonic Distortion Test.

339A Frequency	THD Specification
10 Hz	> -95 dB
100 Hz	> -95 dB
1 kHz	> -95 dB
10 kHz	> -95 dB
20 kHz	> -95 dB
30 kHz	> -85 dB
50 kHz	> -80 dB
109 kHz	> -70 dB

m. Calculate the Total Harmonic Distortion using the graph shown in Figure 4-9. As an example: If the amplitude of the second harmonic is -110 dB and the third harmonic amplitude is -114 dB the dB difference between the two is -4 dB. Locate this number on the horizontal axis of the graph. The -4 line intersects the curve at approximately the +1.5 level on the vertical axis. The total harmonic distortion is therefore the amplitude of the largest harmonic (2nd harmonic) plus the number determined on the vertical axis (-110 dB + 1.5 dB = -108.5 dB).

n. The 339A should meet the 10 Hz THD specification listed in Table 4-5.

o. Repeat Steps f through m for each frequency listed in Table 4-5.

NOTE

It may be necessary to increase the Bandwidth of the Spectrum Analyzer at higher frequencies. Adjust as necessary to maintain a stable reading.

4-20. DISTORTION ANALYZER PERFORMANCE TESTS.

4-21. The Voltmeter Performance Tests, at the beginning of this section, should be performed and the Voltmeter accuracy verified before proceeding with the Distortion Analyzer Tests.

4-22. Fundamental Rejection and Induced Distortion Test.

4-23. The following test requires an exceptionally low

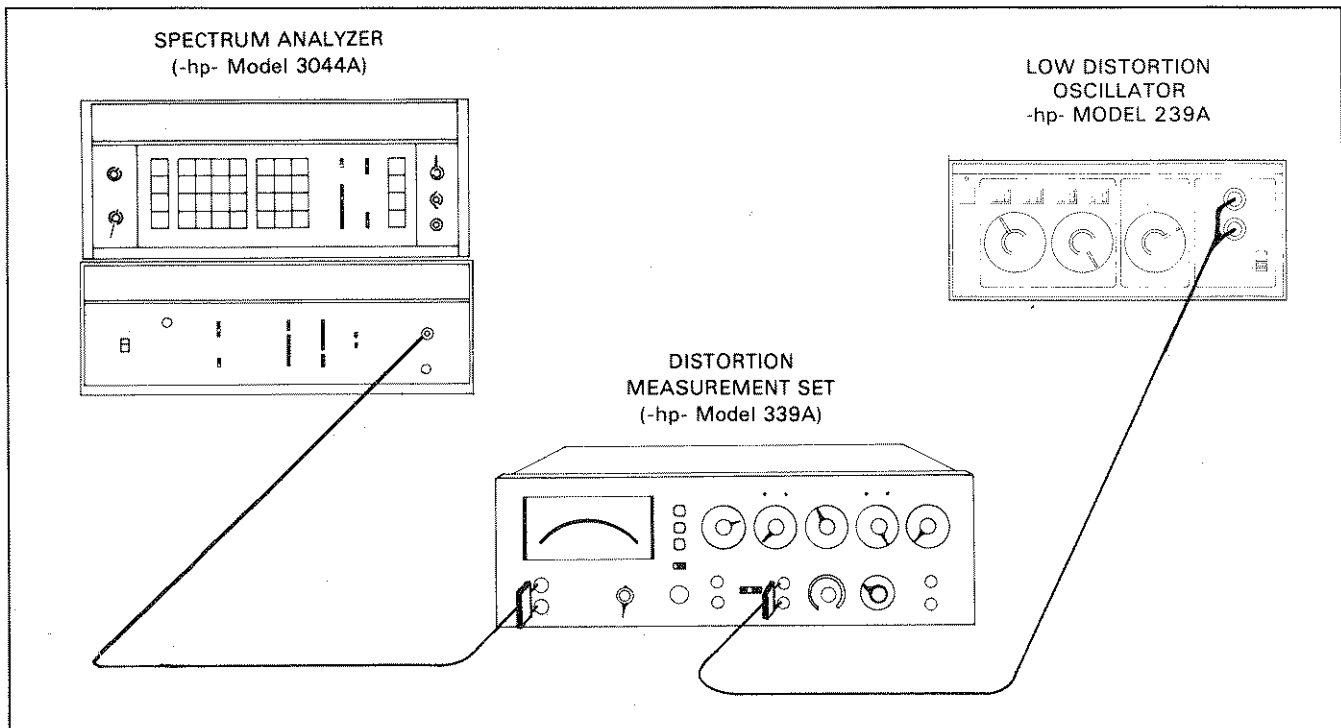

Figure 4-10. Fundamental Rejection and Induced Distortion Test.

distortion signal source. In most cases the Model 339A being used as a source will be sufficient. However, if the instrument under test does not meet the Induced Distortion specifications listed in Table 4-6, it must be determined whether the distortion is due to the signal source or the analyzer under test. In some cases this may be accomplished by exchanging the signal source with another. If this is not practical, low-pass filters may be constructed to enhance the signal purity of the source.

a. Set the 339A controls as follows:

- FUNCTION INPUT LEVEL
- FILTERS OFF (out)
- METER RESPONSE NORMAL
- INPUT RANGE 3 V
- INPUT/GND SELECT DIS. AN./⊥
(center position)
- FREQUENCY 10 Hz (1.0 x 10)

b. Connect the equipment as shown in Figure 4-10.

c. Set the Low Distortion Oscillator for an output frequency of 10 Hz. Adjust the output level for a full-scale (0 dB) meter indication on the 339A under test.

d. Adjust the frequency of the Synthesizer (3330B) for a maximum level indication on the Spectrum Analyzer (3571A). Enter this frequency as both the output frequency and step frequency of the synthesizer.

NOTE

When adjusting the frequency of the Synthesizer, use frequency steps equal to 10% of the fundamental frequency being measured. This insures adequate resolution.

e. Reference the Spectrum Analyzer to this level by pressing the enter offset button. The Spectrum Analyzer should indicate 00.00 dB.

f. Set the FUNCTION switch of the 339A under test to DISTORTION.

g. Adjust the DISTORTION RANGE control for an on-scale meter indication as near full-scale as possible.

h. Determine the fundamental rejection of the 339A under test by adding the display reading of the Spectrum Analyzer and the distortion range setting of the 339A under test. (As an example: If the 339A DISTORTION RANGE control is set to -80 dB and the Spectrum Analyzer display indicates -35 dB the fundamental rejection is -115 dB.)

i. The fundamental rejection level determined in the previous step must meet or exceed the specification listed in Table 4-6.

j. Step the Synthesizer frequency to the second harmonic frequency.

Table 4-6. Fundamental Rejection and Induced Distortion Test.

Test Frequency	Fundamental Rejection Specification	Induced Distortion Specification
10 Hz	> -100 dB	> -95 dB
100 Hz		
1 kHz		
10 kHz		
20 kHz		
30 kHz	> -90 B	> -90 dB
50 kHz		> -85 dB
110 kHz		> -70 dB

k. Determine the relative amplitude of the second harmonic by adding the Spectrum Analyzer display reading and the distortion range setting of the 339A under test. Record the amplitude reading of the second harmonic.

l. Step the Synthesizer frequency to the third harmonic frequency.

m. Determine the relative amplitude of the third harmonic by adding the Spectrum Analyzer display reading and the distortion range setting of the 339A under test. Record the amplitude reading of the third harmonic.

n. Calculate the Induced Harmonic Distortion using the graph shown in Figure 4-9.

o. The induced distortion measurement must meet or exceed the specification listed in Table 4-6.

p. Set the FUNCTION switch of the 339A under test to INPUT LEVEL.

q. Repeat Steps c through p for each frequency listed in Table 4-6.

4-24. Distortion Measurement Accuracy Test.

Equipment Required: *REFER to 8903A DISTORTION TEST USING 652A + 8920A + OUTPUT OF 339A AS STIMULUS.*

- Spectrum Analyzer (-hp- Model 3044A)
- Low Distortion Oscillator (-hp- Model 339A)
- 600 Ω 1% Metal Film Resistor (-hp- Part No. 0698-5405)
- 60 kΩ 1% Metal Film Resistor (-hp- Part No. 0698-5973)

a. Set the 339A controls as follows:

- FUNCTION INPUT LEVEL
- FILTERS OFF (out)
- DISTORTION RANGE -80 dB
- INPUT RANGE 1 V
- INPUT/GND SELECT DIS. AN./L
(center position)
- FREQUENCY 10 kHz (1.0 x 10 K)

b. Connect the equipment as shown in Figure 4-11.

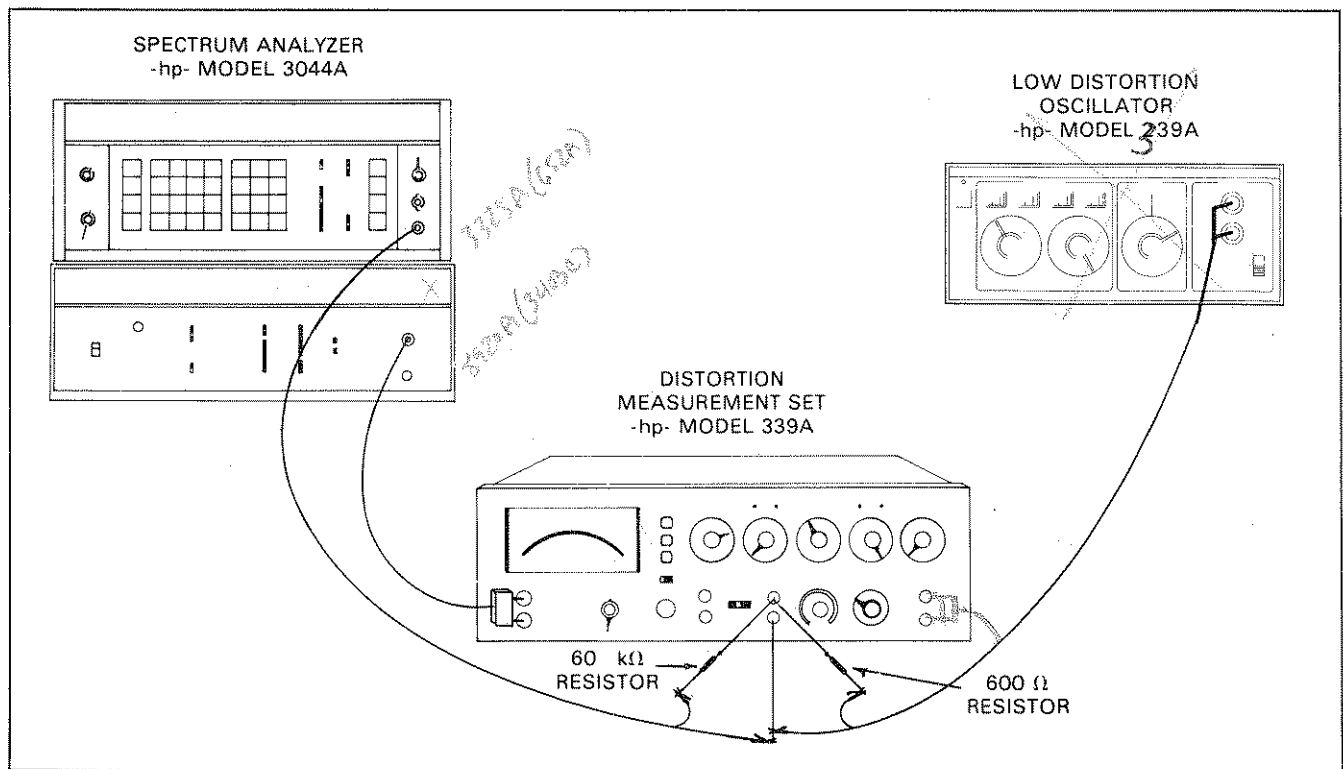

Figure 4-11. Distortion Measurement Accuracy Test.

Table 4-7. Distortion Measurement Accuracy Test.

Distortion Frequency	Accuracy Limits
10 Hz	+1.0 dB, -2.0 dB
20 Hz	±1.0 dB
100 Hz	±1.0 dB
20 kHz	±1.0 dB
50 kHz	+1.0 dB, -2.0 dB
100 kHz	+1.5 dB, -4.0 dB
330 kHz	+1.5 dB, -4.0 dB

c. Adjust the Synthesizer (3330B) controls for an output frequency of 1 kHz and an output amplitude of -40 dBm.

d. Set the Low Distortion Oscillator for an output frequency of 10 kHz. Adjust the output level for a meter indication of 1 V on the 339A under test.

e. Set the FUNCTION switch of the 339A under test to DISTORTION.

f. Adjust the Synthesizer amplitude as necessary to obtain a distortion reading of -80 dB on the 339A under test (full-scale meter indication).

g. Set the Spectrum Analyzer (3571A) to a 3 Hz bandwidth, an input range of +10 dB V, an input impedance of 1 MΩ, and a relative display reference. Reference the Spectrum Analyzer to the 339A measurement by pressing the Enter Offset button.

h. Set the Synthesizer to each frequency listed in Table 4-7, and verify that the Spectrum Analyzer reading is within the limits listed.

4-25. Residual Noise Test.

Equipment Required:

1 kΩ shielded load (Refer to Figure 4-12.)

a. Set the 339A controls as follows:

FUNCTION DISTORTION
 FILTERS 80 kHz ON (in)
 DISTORTION RANGE.....-80 dB
 INPUT RANGE 1 V
 FREQUENCY 20 kHz (2.0 x 10 K)
 INPUT/GND SELECT DIS. AN./⊥
 (center position)

b. Connect the 1 kΩ shielded load to the DISTORTION ANALYZER input terminals. (See Figure 4-12 for construction details of 1 kΩ load.)

c. The 339A measurement indication must be below -92 dB.

4-26. Input Impedance Test.

Equipment Required:

Spectrum Analyzer (-hp- Model 3044A)
 100 kΩ 0.1% Metal Film Resistor (-hp- Part No. 0698-4158)

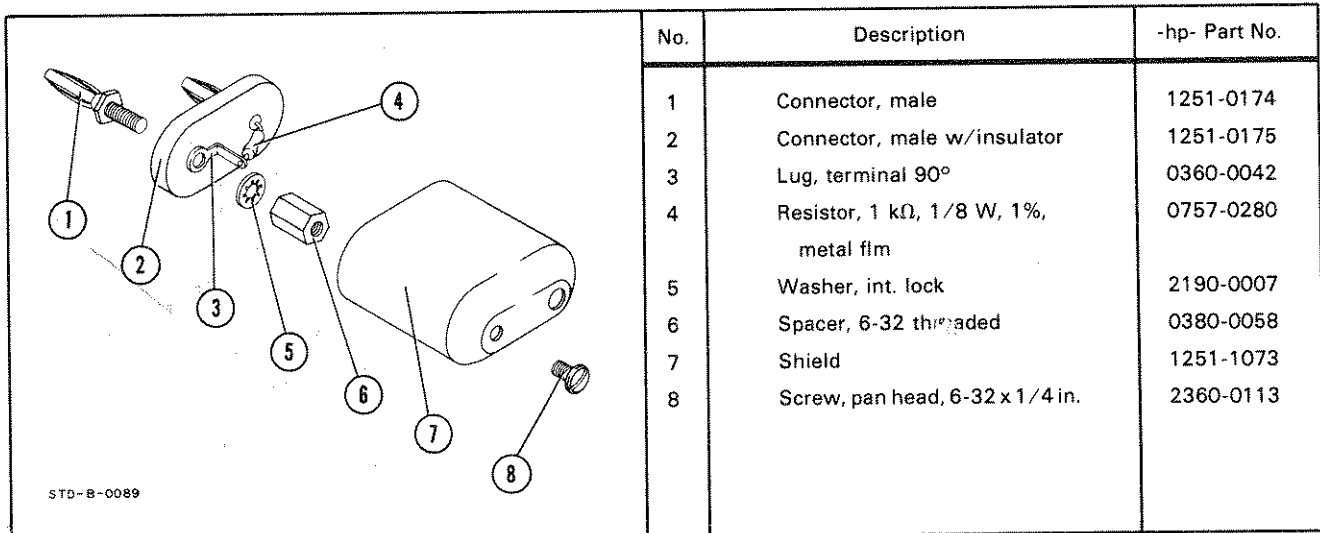

Figure 4-12. Shielded Load Assembly.

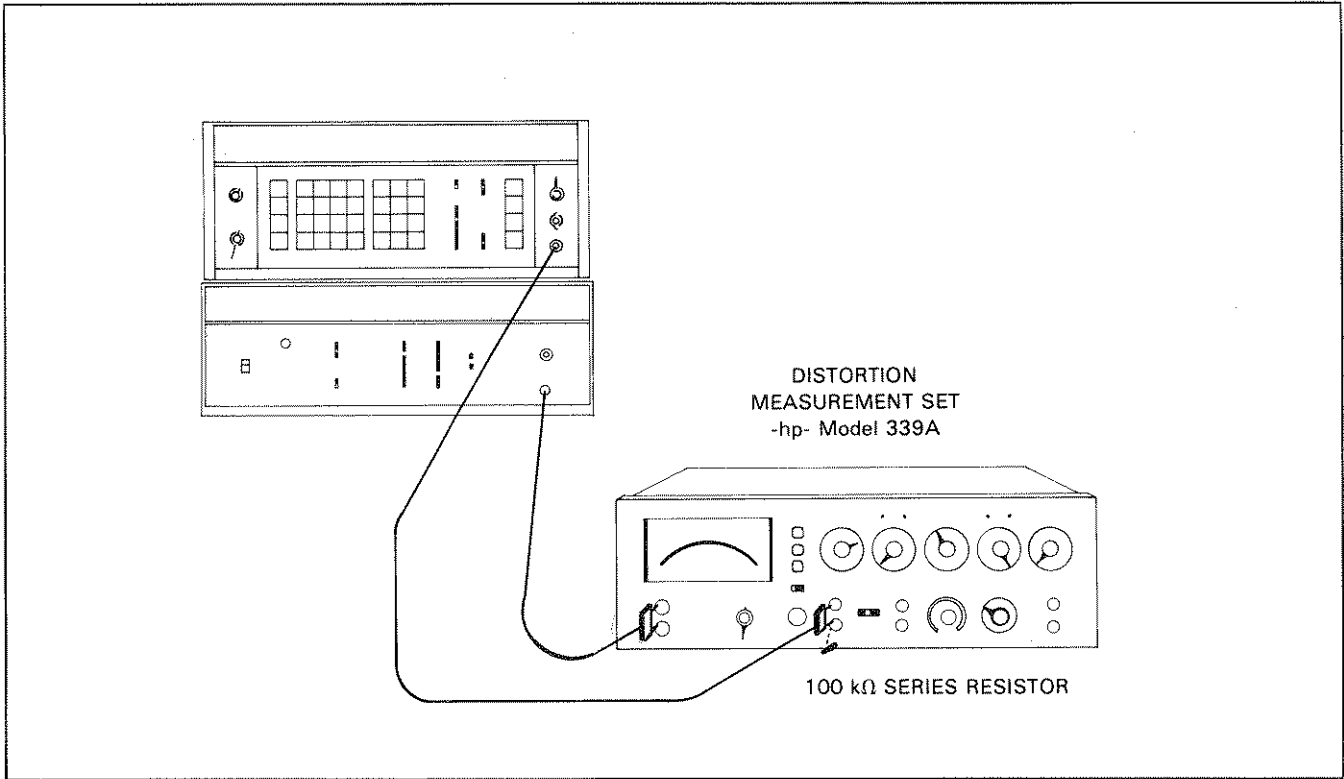

Figure 4-13. Input Impedance Test.

a. Set the 339A controls as follows:

FUNCTION INPUT LEVEL
 FILTERS OFF (out)
 INPUT RANGE 1 V
 INPUT/GND SELECT DIS. AN./⊥
 (center position)

b. Connect the equipment as shown in Figure 4-13.

c. Set the Synthesizer (3330B) for an output frequency of 1 kHz and adjust the amplitude as necessary to obtain a meter reading of 0 dB on the 339A.

d. Set the Spectrum Analyzer (3571A) reference by pressing the Enter Offset button. Observe a display reading of 00.00 dB.

e. Disconnect the cable from the 339A and insert the 100 kΩ resistor in series with the input. The Spectrum Analyzer must indicate -6.02 dB ± .05 dB.

f. Change the Synthesizer frequency to 17.000 kHz. The Spectrum Analyzer reading must be less than -9.00 dB indicating an input capacitance of less than 100 pF.

-6.02 to -9.00 (checklist)

PERFORMANCE TEST RECORD

Hewlett-Packard Model 339A

Tests Performed By: _____

Distortion Measurement Set

Date: _____

Serial No. _____

VOLTMETER PERFORMANCE

Full-Scale Accuracy and Frequency Response Test:

Input Level	339A Input Range	339A 10 Hz Reading	339A 110 KHz Reading	Test Limits	339A 20 Hz Reading	339A 100 Hz Reading	339A 1 kHz Reading	339A 10 kHz Reading	339A 20 kHz Reading	Test Limits
.001 V	.001 V	_____	_____	.00096 - .00104	_____	_____	_____	_____	_____	.00098 - .00102
.003 V	.003 V	_____	_____	.00288 - .00312	_____	_____	_____	_____	_____	.00294 - .00306
.01 V	.01 V	_____	_____	.0096 - .0104	_____	_____	_____	_____	_____	.0098 - .0102
.03 V	.03 V	_____	_____	.0288 - .0312	_____	_____	_____	_____	_____	.0294 - .0306
.1 V	.1 V	_____	_____	.096 - .104	_____	_____	_____	_____	_____	.098 - .102
.3 V	.3 V	_____	_____	.288 - .312	_____	_____	_____	_____	_____	.294 - .306
1 V	1 V	_____	_____	.96 - 1.04	_____	_____	_____	_____	_____	.98 - 1.02
3 V	3 V	_____	_____	2.88 - 3.12	_____	_____	_____	_____	_____	2.94 - 3.06
10 V	10 V	_____	_____	9.6 - 10.4	_____	_____	_____	_____	_____	9.8 - 10.2
30 V	30 V	_____	_____	28.8 - 31.2	_____	_____	_____	_____	_____	29.4 - 30.6
100 V	100 V	_____	_____	96 - 104	_____	_____	_____	_____	_____	98 - 102
300 V	300 V	_____	_____	288 - 312	_____	_____	_____	_____	_____	294 - 306

Meter Tracking and Monitor Output Accuracy Test:

Input Level	339A Meter Reading	Test Limits	Monitor Output Level	Test Limits
1.0 V	_____	.98 - 1.02	_____	.95 - 1.05
.9 V	_____	.88 - .92	_____	.85 - .95
.8 V	_____	.78 - .82	_____	.75 - .85
.7 V	_____	.68 - .72	_____	.65 - .75
.6 V	_____	.58 - .62	_____	.55 - .65
.5 V	_____	.48 - .52	_____	.45 - .55
.4 V	_____	.38 - .42	_____	.35 - .45
.3 V	_____	.28 - .32	_____	.25 - .35
.2 V	_____	.18 - .22	_____	.15 - .25
.1 V	_____	.08 - .12	_____	.05 - .15

PERFORMANCE TEST RECORD (Cont'd)

RMS Accuracy (crest factor) Test:

RMS Input Level	Repetition Rate	339A Meter Reading	Test Limits
3 V	100 Hz	_____	2.94 - 3.06
	1 kHz	_____	2.94 - 3.06
	10 kHz	_____	2.88 - 3.12

Filter Accuracy Test:

339A Filter	-3 dB Frequency	Test Limits
400 Hz	_____	360 Hz - 435 Hz
30 kHz	_____	27 kHz - 32.6 kHz
80 kHz	_____	72.1 kHz - 87 kHz

OSCILLATOR PERFORMANCE

Output Level and Flatness Test:

339A Output Frequency	Output Level	Test Limits
10 Hz	_____	2.930 - 3.070
20 Hz	_____	2.965 - 3.035
100 Hz	_____	2.965 - 3.035
10 kHz	_____	2.965 - 3.035
20 kHz	_____	2.965 - 3.035
110 kHz	_____	2.930 - 3.070

Maximum Output Level into 600 Ω = _____ (> 3 V rms)

Output Impedance Test:

With an unloaded output level of 6.00 V rms, the output level into a 600 Ω load = _____
(test limit 2.927 - 3.077 V rms).

Oscillator Frequency Accuracy Test:

339A Output Frequency	339A Frequency Range Setting	Frequency Counter Indication (Period)	Test Limits
10 Hz	X 10	_____	98.04 - 102.04 msec.
20 Hz		_____	49.019 - 51.020 msec.
50 Hz		_____	19.608 - 20.408 msec.
100 Hz		_____	9.803 - 10.204 msec.
100 Hz	X 100	_____	9.803 - 10.204 msec.
200 Hz		_____	4.9019 - 5.1020 msec.
500 Hz		_____	1.9608 - 2.0408 msec.
1 kHz		_____	.9803 - 1.0204 msec.

PERFORMANCE TEST RECORD (Cont'd)

Oscillator Frequency Accuracy Test (Cont'd):

339A Output Frequency	339A Frequency Range Setting	Frequency Counter Indication (Period)	Test Limits
1.0 kHz	X 1K		980.3 - 1020.4 μ sec.
1.1 kHz			891.26 - 927.64 μ sec.
1.2 kHz			816.99 - 850.34 μ sec.
1.3 kHz			754.14 - 784.93 μ sec.
1.4 kHz			700.28 - 728.86 μ sec.
1.5 kHz			653.59 - 680.27 μ sec.
1.6 kHz			612.74 - 637.75 μ sec.
1.7 kHz			576.70 - 600.24 μ sec.
1.8 kHz			544.66 - 566.89 μ sec.
1.9 kHz			515.99 - 537.05 μ sec.
2.0 kHz			490.19 - 510.20 μ sec.
3.0 kHz			326.79 - 340.13 μ sec.
4.0 kHz			245.09 - 255.10 μ sec.
5.0 kHz			196.08 - 204.08 μ sec.
6.0 kHz			163.39 - 170.06 μ sec.
7.0 kHz			140.05 - 145.77 μ sec.
8.0 kHz			122.54 - 127.55 μ sec.
9.0 kHz		108.93 - 113.37 μ sec.	
10 kHz		98.039 - 102.04 μ sec.	
10 kHz	X 10K		98.039 - 102.04 μ sec.
20 kHz			49.019 - 51.020 μ sec.
50 kHz			19.608 - 20.408 μ sec.
100 kHz			9.8039 - 10.204 μ sec.
109 kHz			9.3615 - 8.9944 μ sec.

Oscillator Total Harmonic Distortion Test:

339A Output Frequency	Calculated THD	Test Limit
10 Hz		-95 dB
100 Hz		
1 kHz		
10 kHz		
20 kHz		
30 kHz		-85 dB
50 kHz		-80 dB
109 kHz		-70 dB

PERFORMANCE TEST RECORD (Cont'd)

DISTORTION ANALYZER PERFORMANCE

Fundamental Rejection and Induced Distortion Test:

Test Frequency	339A Fundamental Rejection	Test Limit	339A Induced Distortion	Test Limit
10 Hz	_____	-100 dB	_____	-95 dB
100 Hz	_____		_____	
1 kHz	_____		_____	
10 kHz	_____		_____	
20 kHz	_____		_____	
30 kHz	_____	-90 dB	_____	-90 dB
50 kHz	_____		_____	-85 dB
110 kHz	_____		_____	-70 dB

Distortion Measurement Accuracy Test:

Distortion Frequency	Spectrum Analyzer Reading	Test Limit
10 Hz	_____	+1.0 dB, -2.0 dB
20 Hz	_____	±1.0 dB
100 Hz	_____	±1.0 dB
20 kHz	_____	±1.0 dB
50 kHz	_____	+1.0 dB, -2.0 dB
100 kHz	_____	+1.5 dB, -4.0 dB
330 kHz	_____	+1.5 dB, -4.0 dB

Residual Noise Test:

Residual Noise with 1 kΩ input load and 80 kHz Filter = _____ . Test Limit; below -92 dB.

Input Impedance Test:

Spectrum Analyzer indication for 100 kΩ resistance in series with 339A input, frequency -1 kHz = _____ .
Test Limit -5.97 to -6.07 dB.

Spectrum Analyzer indication for frequency of 17 kHz = _____ . Test Limit -6.02 to -9.00 dB.