

Operating Manual
HP 3577B Network Analyzer
HP 35677A/B S-Parameter Test Set



HP Part Number 03577-90035
Microfiche Part Number 03577-90235

Printed in U.S.A.
Print Date: October 1990

©Hewlett-Packard Company, 1989, 1990. All rights reserved.
8600 Soper Hill Road, Everett, Washington 98205-1298



CERTIFICATION

Hewlett-Packard Company certifies that this product met its published specifications at the time of shipment from the factory. Hewlett-Packard further certifies that its calibration measurements are traceable to the United States National Bureau of Standards, to the extent allowed by the Bureau's calibration facility, and the calibration facilities of other International Standards Organization Members.

WARRANTY

This Hewlett-Packard product is warranted against defects in material and workmanship for a period of one year from date of shipment. During the warranty period, Hewlett-Packard Company will, at its option, either repair or replace products which prove to be defective.

For warranty service or repair, this product must be returned to a service facility designated by HP. Buyer shall prepay shipping charges to HP and HP shall pay shipping charges to return the product to Buyer. However, Buyer shall pay all shipping charges, duties, and taxes for products returned to HP from another country.

HP software and firmware products which are designated by HP for use with a hardware product, when properly installed on the hardware product, are warranted not to fail to execute their programming instructions due to defects in materials and workmanship. If HP receives notice of such defects during their warranty period, HP shall repair or replace software media and firmware which do not execute their programming instructions due to such defects.

HP does not warrant that the operation of the software, firmware or hardware shall be uninterrupted or error free.

LIMITATION OF WARRANTY

The foregoing warranty shall not apply to defects resulting from improper or inadequate maintenance by Buyer, Buyer-supplied software or interfacing, unauthorized modification or misuse, operation outside of the environmental specifications for the product, or improper site preparation or maintenance.

NO OTHER WARRANTY IS EXPRESSED OR IMPLIED. HEWLETT-PACKARD SPECIFICALLY DISCLAIMS THE IMPLIED WARRANTIES OF MERCHANTABILITY AND FITNESS FOR PARTICULAR PURPOSE.

EXCLUSIVE REMEDIES

THE REMEDIES PROVIDED HEREIN ARE BUYER'S SOLE AND EXCLUSIVE REMEDIES. HEWLETT-PACKARD SHALL NOT BE LIABLE FOR ANY DIRECT, INDIRECT, SPECIAL, INCIDENTAL, OR CONSEQUENTIAL DAMAGES, WHETHER BASED ON CONTRACT, TORT, OR ANY OTHER LEGAL THEORY.

ASSISTANCE

Product maintenance agreements and other customer assistance agreements are available for Hewlett-Packard products.

For any assistance, contact your nearest Hewlett-Packard Sales and Service Office. Addresses are provided at the back of this manual.



SAFETY SUMMARY

The following general safety precautions must be observed during all phases of operation, service, and repair of this instrument. Failure to comply with these precautions or with specific warnings elsewhere in this manual violates safety standards of design, manufacture, and intended use of the instrument. Hewlett-Packard Company assumes no liability for the customer's failure to comply with these requirements. This is a Safety Class 1 instrument.

GROUND THE INSTRUMENT

To minimize shock hazard, the instrument chassis and cabinet must be connected to an electrical ground. The instrument is equipped with a three-conductor ac power cable. The power cable must either be plugged into an approved three-contact electrical outlet or used with a three-contact to two-contact adapter with the grounding wire (green) firmly connected to an electrical ground (safety ground) at the power outlet. The power jack and mating plug of the power cable meet International Electrotechnical Commission (IEC) safety standards.

DO NOT OPERATE IN AN EXPLOSIVE ATMOSPHERE

Do not operate the instrument in the presence of flammable gases or fumes. Operation of any electrical instrument in such an environment constitutes a definite safety hazard.

KEEP AWAY FROM LIVE CIRCUITS

Operating personnel must not remove instrument covers. Component replacement and internal adjustments must be made by qualified maintenance personnel. Do not replace components with power cable connected. Under certain conditions, dangerous voltages may exist even with the power cable removed. To avoid injuries, always disconnect power and discharge circuits before touching them.

DO NOT SERVICE OR ADJUST ALONE

Do not attempt internal service or adjustment unless another person, capable of rendering first aid and resuscitation, is present.

DO NOT SUBSTITUTE PARTS OR MODIFY INSTRUMENT

Because of the danger of introducing additional hazards, do not install substitute parts or perform any unauthorized modification to the instrument. Return the instrument to a Hewlett-Packard Sales and Service Office for service and repair to ensure the safety features are maintained.

DANGEROUS PROCEDURE WARNINGS

Warnings, such as the example below, precede potentially dangerous procedures throughout this manual. Instructions contained in the warnings must be followed.

Warning



Dangerous voltages, capable of causing death, are present in this instrument. Use extreme caution when handling, testing, and adjusting.

SAFETY SYMBOLS

General Definitions of Safety Symbols Used On Equipment or In Manuals.



Instruction manual symbol: the product will be marked with this symbol when it is necessary for the user to refer to the instruction manual in order to protect against damage to the instrument.



Indicates dangerous voltage (terminals fed from the interior by voltage exceeding 1000 volts must be so marked.)

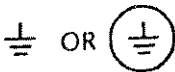

Protective conductor terminal. For protection against electrical shock in case of a fault. Used with field wiring terminals to indicate the terminal which must be connected to ground before operating equipment.



Low-noise or noiseless, clean ground (earth) terminal. Used for a signal common, as well as providing protection against electrical shock in case of a fault. A terminal marked with this symbol must be connected to ground in the manner described in the installation (operating) manual, and before operating the equipment.

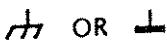

Frame or chassis terminal. A connection to the frame (chassis) of the equipment which normally includes all exposed metal structures.



Alternating current (power line.)



Direct current (power line.)



Alternating or direct current (power line.)

Warning



The **WARNING** sign denotes a hazard. It calls attention to a procedure, practice, condition or the like, which if not correctly performed or adhered to, could result in injury or death to personnel.

Caution



The **CAUTION** sign denotes a hazard. It calls attention to an operating procedure, practice, condition or the like, which, if not correctly performed or adhered to, could result in damage to or destruction of part or all of the product.

Note



The **NOTE** sign denotes important information. It calls attention to procedure, practice, condition or the like, which is essential to highlight.

Table of Contents

Introduction of the Network Analyzer HP 3577B and the HP 35677A/B S-Parameter Test Set

Front Panel Overview	I-2
Rear Panel Overview	I-4
New Features and Options of the HP 3577B	I-5
Compatibility with the HP 3577A	I-6
How To Use This Manual	I-6
Instrument Description	I-7
Initial Inspection	I-8

Chapter 1: Getting Started

Introduction	1-1
Instrument Turn On	1-2
“Hardkeys” & “Softkeys”	1-4
Definitions & Operating Hints	1-4
In Case Of Trouble	1-6
Confidence Test	1-7

Chapter 2: Making Measurements

Tuned Stub Notch Filter	2-3
Measurement Set Up	2-5
Making Measurements	2-9
Store Trace Data	2-14
Save Instrument State	2-16
Bandpass Filter	2-17
Measurement Set Up	2-19
Bandwidth Measurements	2-25
Passband Ripple	2-32
Passband Insertion Phase	2-35
Group Delay	2-37
Limit Test	2-39
Discrete Sweep Measurement	2-47
Amplifier	2-54
Gain Compression	2-54
Low Pass Filter	2-59
Measurement Set-up	2-61
Insertion Loss	2-64
Insertion Phase	2-65
Passband Ripple	2-67
Stopband Rejection	2-70

Table of Contents

Amplifier S-Parameters	2-72
Measurement Setup	2-74
S21, Forward Gain And Phase	2-77
S12 Reverse Loss	2-79
S11, Input Return Loss	2-82
Standing Wave Ratio	2-85
S22, Output Reflection Coefficient	2-86
Complex Output Impedance	2-88
Chapter 3: Remote Operation	
The Hewlett-Packard Interface Bus	3-1
The HP 3577B And The HP-IB	3-4
HP-IB Capability	3-4
Compatibility	3-4
Data Format Vs Transfer Rate	3-5
Direct Plotting	3-6
HP-IB Verification	3-6
HP-IB Diagnostic Mode	3-7
The HP 3577B HP-IB Address	3-8
Talk/listen Addresses	3-8
Viewing The HP-IB Address	3-8
Setting The HP-IB Address	3-9
Bus Messages	3-11
Bus Commands	3-11
Device Dependent Commands	3-15
Instrument Preset (default) Parameter Values	3-68
The Status Byte	3-72
“How To Go Fast” Example Program	3-74
Chapter 4: Key Reference	
Alphabetical Listing of Hardkeys	
Chapter 5: General Information	
Introduction	5-1
Initial Inspection	5-1
Power Requirements	5-2
Power Cable And Grounding Requirements	5-2
Operating Environment	5-4
Accessories Available	5-6
Accessories Supplied	5-7
Options	5-8
Installation	5-9
Display Alignment	5-12
HP-IB Connections	5-12
Programmable Input/Output Connector	5-15
Storage and Shipment	5-18
HP 3577B Specifications	5-19

HP 35677A/B Specifications	5-30
Appendix A: Special Topics Appendix A	
Data Processing And Structure	A-1
Optimizing Sweep Time	A-4
Appendix B: Remote Graphics Appendix B	
Digital Display Quick Reference Guide	B-1
Digital Display Commands	B-1
Appendix C: Screen Messages Appendix	
Appendix D: Programming Codes, Functional Index	
Appendix E: Programming Commands, Alphabetical Index	
Appendix F: Bibliography	
Sales Service Offices	

Introduction of the HP 3577B Network Analyzer¹ and the HP 35677A/B S-Parameter Test Set

1 The HP 3577B Option 002 Three-Channel Network Analyzer is recommended for use with the HP 35677A/B S-Parameter Test Set.

Front Panel Overview

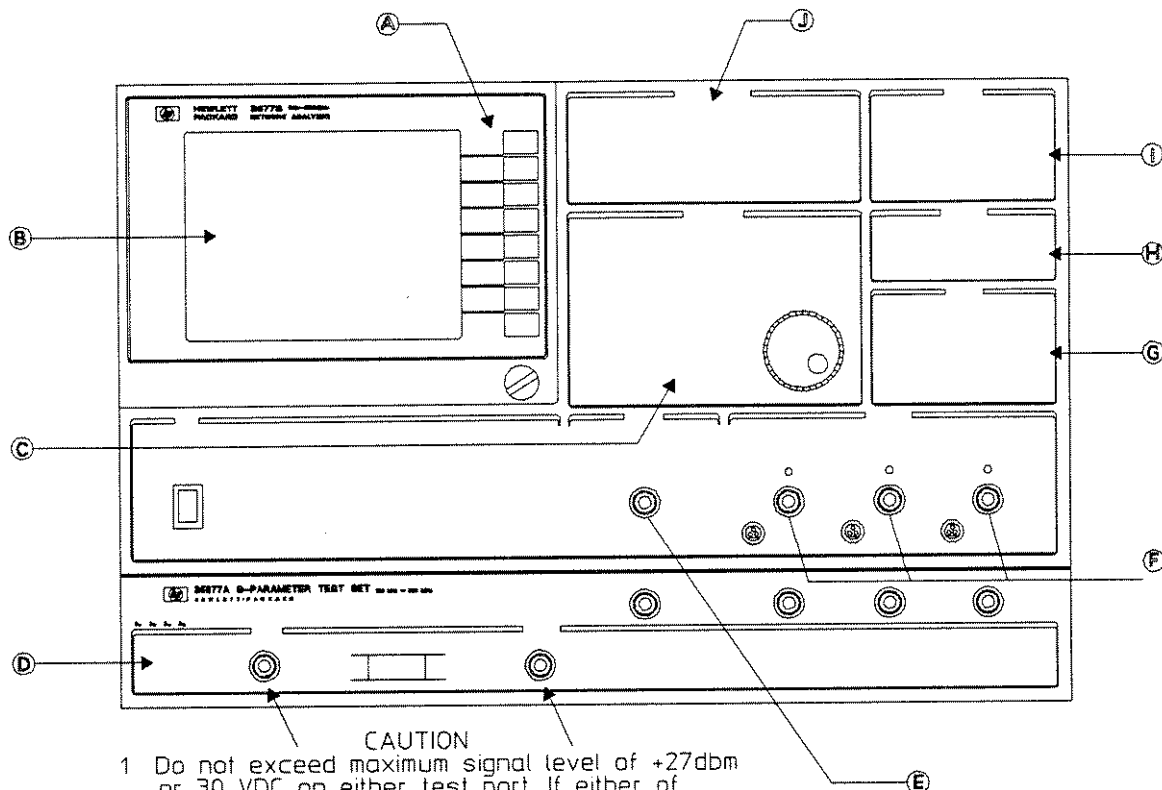

- CAUTION**
- 1 Do not exceed maximum signal level of +27dbm or 30 VDC on either test port. If either of these levels is exceeded, damage to the instrument may result.
 - 2 The HP 35677B has 75Ω type-N female connectors for test ports one and two. These connectors may be physically damaged if 50Ω type N connectors are used on the test ports.

A. Softkeys

Select items from the menus using these eight keys beside the display. Select a parameter for data entry, perform an immediate execution function, make a selection from a list, or display the next level menu.

B. Screen Areas

The TRACE hardkeys in the DISPLAY FORMAT section select the active trace. This trace and the associated measurement parameters are shown on the screen in several information blocks or areas.

- **Marker Information Block:** appears in the upper right-hand corner of the screen above the graticule. It describes the trace display function and input definition, and lists the marker position and measured value for each trace.
- **Scale Information Area:** appears in the upper left-hand corner of the screen above the graticule. It defines both the reference level (dashed line) and the vertical scale in units/division for each trace.

- **Data Entry Block:** appears when a data entry softkey is active or bright, and displays the current value of the parameter. When entering or modifying new data, it displays the new value.
- **Graticule:** is displayed in linear, log, or Smith Chart formats.
- **Menu Area:** is located on the right side of the screen, indicating the softkey labels of the chosen parameter.

C. Data Entry

The data entry section contains the numeric key pad and the knob. Turning the knob moves the marker or modifies a data entry. The key above the knob toggles between the marker and data entry modes. Correct an entry error by using the backspace key. The entry off key clears the menu, which effectively eliminates further data entry.

D. S-Parameter Test Set

The HP 35677A/B is a 100 kHz to 200 MHz scattering parameter test set built for use with the HP 3577B Option 002 Three-Receiver Network Analyzer S-Parameter Test Set. The HP 35677A provides signal, power, and control for the test set and provides a menu which includes S-parameter softkey selections S11, S21, S12, and S22.

E. Source Output

The source output has overvoltage protection circuitry that disconnects the output from the source when a signal is 4 V_{pk} or greater.

F. Receiver Inputs

Two standard receiver inputs (A and R) are provided and a third optional input B is available with Option 002. All inputs have overvoltage protection circuitry that senses signal levels greater than 1.1 V_{pk} and switches the input impedance to 1 M Ω . The inputs may be overloaded without switching if the signal level beyond the input attenuation exceeds -20 dBm, but does not exceed 1.1 V_{pk}.

G. System

- Special Functions: includes the HP 3577B confidence tests, beeper and graticule on/off, service diagnostics, INPUT menu S-parameters on/off and HP Instrument BASIC program management softkeys (used for Option 1C2).
- Save Instrument State: saves the current state in one of five registers.
- Recall Instrument State: recalls a saved instrument state or the state of the instrument at the last power down.
- Plot: controls all plotting parameters to an HP-IB plotter.
- Instrument Basic: is an optional feature that supports HP Instrument BASIC programs. It adds several program management softkeys in this front panel section.

H. Receiver

- Resolution Bandwidth: provides 1 kHz, 100 Hz, 10 Hz, and 1 Hz resolution filters. For discrete sweeps, resolution bandwidths may be selected for each measurement frequency.
- Averaging: selects a weighting value for exponential vector averaging.
- Input Attenuation and Impedance: Allows selection of attenuation (0 dB, 20 dB), and impedance (50 Ω or 1 M Ω ,) and clears receiver trip(s).
- Length: allows for data corrections for cable lengths in units of meters or seconds.

I. Source

- Sweep Type: selects linear frequency sweep, alternate sweep, log frequency sweep, amplitude sweep, CW, discrete sweep, or sweep direction up or down.
- Sweep Mode: selects continuous, single, or manual modes.
- Sweep Time: is selectable from 100 ms/span to 6553 s/span for linear sweep type. For discrete sweeps, the settling time can be set for each measurement frequency.
- Frequency: specifies the start, stop, and center frequencies, frequency span, center frequency step size, sweep resolution, and full sweep. For discrete sweeps, specify the individual frequencies to be measured.
- Amplitude: ranges from -49 dBm to +15 dBm in 0.1 dB increments. It can also clear a source trip.
- Trigger Mode: available in free run, line, external, and immediate.

J. Display Format

- Input: R, A, A/R or user defined inputs are standard. B, B/R, and four S-parameters are available with Option 002.
- Display Function: log magnitude, linear magnitude, phase, polar, real, imaginary, group delay and standing wave ratio.
- Scale: autoscale, reference level, /DIV, reference position, reference line on/off, copy scale, phase slope value, phase slope on/off.
- Marker: marker position, marker on/off, zero marker, marker offset on/off, marker offset (value), frequency offset (value), marker coupling on/off.
- Store Data: store data to one of twelve registers (X1-X8 & D1-D4), and mathematically define the way it is stored.
- Measurement Calibration: Normalize, normalize with a short, one port partial calibration, one port full calibration.
- Define Math: define seven complex constants (K1-K7), five functions (F1-F5), and use the j Ω register.
- Marker \rightarrow ...reference level, ...start frequency, ...stop frequency, ...center frequency, ...maximum, ...minimum, ...discrete, marker offset \rightarrow frequency span, marker search right or left for target value.
- Limit: define and test to limits for trace 1 and 2. PASS or FAIL results are displayed on screen and are indicated at the Programmable I/O Port.

1 The HP 3577B Option 002 Three-Channel Network Analyzer is recommended for use with the HP 35677A/B S-Parameter Test Set.

Rear Panel Overview

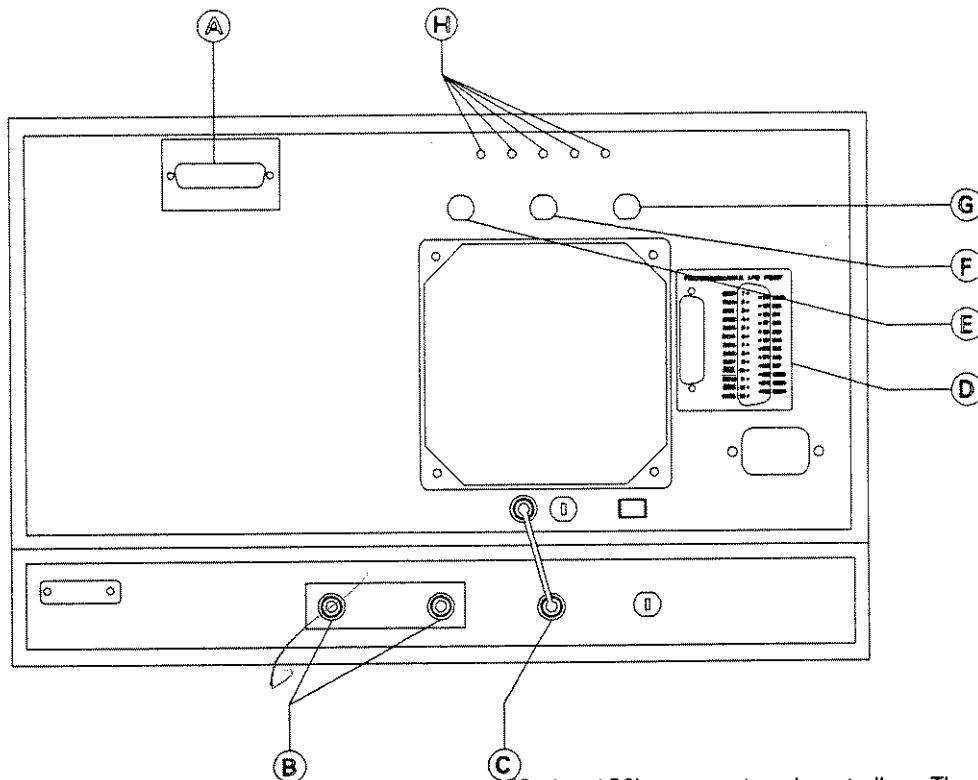

A. HP-IB Port:

Control operation of the HP 3577B from a remote controller or perform direct plots using the HP-IB port. With Option 1C2, the HP-IB port of the HP 3577B can control other HP-IB instruments. This connector uses metric fasteners and is not compatible with older cables using English fasteners. Metric fasteners are available from HP to upgrade older cables.

B. Port Bias 1 & 2:

Two inputs on the rear of the HP 35677A/B serve to connect a bias voltage to the front panel connections labeled PORT 1 or PORT 2.

C. Instrument Interconnect:

The HP 3577B is connected to the HP 35677A/B¹ S-Parameter Test Set at the rear panel with the interconnect cable. This cable supplies power to the test set, controls the configuration of the test set, and allows the HP 3577B to sense the presence of the test set, changing the INPUT menu.

D. Programmable I/O Port:

The 8-bit I/O portion of the connector is intended to interface with non-HP-IB compatible equipment or custom hardware. Load or write to the 8-bit I/O using HP Instrument BASIC

(Option 1C2) or an external controller. The female 25-pin connector also has three dedicated lines (END-OF-SWEEP, END-OF-MEASUREMENT, and FAIL) for operation of custom hardware designed to simplify component testing. Any version of the HP 3577B allows use of these three outputs.

E. External Trigger:

This input is used to trigger a measurement on the falling edge of a TTL signal or a switch closure to ground.

F. 10 MHz Output:

For Option 001, the frequency reference output provides a 0 dBm signal with stability of 0.05 ppm/day, 0 to 55° C

G. External Reference In:

This input is used to phase lock the HP 3577B to an external frequency reference. The signal applied should be between -7 and +15 dBm. The frequency of the external reference may be any subharmonic of 10 MHz, but greater than 100 kHz.

H. CRT Display Adjustments:

See Installation in the General Information section.

1 The HP 3577B Option 002 Three-Channel Network Analyzer is recommended for use with the HP 35677A/B S-Parameter Test Set.

New Features and Options of the HP 3577B

The feature set of the HP 3577B is a superset of the HP 3577A. Some hardware features have been made optional. The additional features and options are summarized in the following:

- Discrete sweep allows the HP 3577B to make a sequence of measurements at up to 51 discrete frequencies, with individually programmed settling times and resolution bandwidths. This allows decreased measurement time without compromising accuracy.
- Limit tests can be performed on measurements, making go/no-go testing easier. Each limit, upper and lower, is defined by the user and can be made of up to 20 line segments. Two limit tables (one for each trace) are available and automatically become part of the instrument state. Limit test results are displayed on screen and are sent to the FAIL pin of the I/O port for control of custom hardware designed to simplify component testing.
- A general purpose 8-Bit I/O port is provided on the rear panel of the HP 3577B allowing direct interface with external hardware. Load or write to the 8-bit I/O port using HP Instrument BASIC (Option 1C2) or an external HP-IB controller. In addition, the port has three dedicated lines usable on any version of the HP 3577B; (End Of Sweep, End Of Measurement, and FAIL). These outputs can control custom hardware such as a pass/fail light indicator for simplified component testing.
- Eight additional data registers, four additional math constants, and a jOmega register are available for building math functions, allowing more flexibility in the display of measurement results.
- Standing Wave Ratio (SWR) is available as a display function providing direct display of SWR for easy interpretation of reflection measurement results.

New Options:

- Instrument BASIC is available as Option 1C2. The option provides an additional 640 kBytes of random access memory (RAM) for running HP Instrument BASIC programs. Instrument BASIC provides the HP 3577B with the ability to internally run measurement programs that can take measurements, manipulate data, make decisions, and control other HP-IB components such as disc drives, switch drivers and power supplies, without the need for a controller. HP Instrument BASIC can be useful in applications requiring high security or “easy-to-execute” custom measurement routines.
- Input B, which was standard for an HP 3577A, is now optional for the HP 3577B for applications requiring the third receiver.
- The oven oscillator that was standard for an HP 3577A is now optional for the HP 3577B, reducing any unnecessary cost to those using an external system reference.

Compatibility with the HP 3577A

The HP 3577B enhancements were designed to improve the HP 3577A without sacrificing compatibility. In most cases, programs written for the HP 3577A can be used with the HP 3577B with no modification.

How To Use This Manual

The GETTING STARTED section is designed to help the first-time user. This section describes how to turn on the HP 3577B. It also defines some terms used in this manual, gives operating hints, and shows how to run the confidence test.

The MEASUREMENT section describes the use of the HP 3577B Network Analyzer and the HP 35677A/B S-Parameter Test Set in making typical measurements on several common devices. These measurements are examples that cover topics of general interest and demonstrate the capabilities of the HP 3577B and the HP 35677A/B.

The REMOTE OPERATION section describes the Hewlett-Packard Interface Bus and how it is used to operate the HP 3577B with a controller (computer). To use the HP 3577B under remote control, first become acquainted with front panel operation then refer to the REMOTE OPERATION section. When using Option 1C2 (HP Instrument BASIC) refer to "Using HP Instrument BASIC with the HP 3577B" for information on using this capability.

The REFERENCE section is an alphabetical listing of the front panel sections, hardkeys, and terms. Each hardkey topic shows its associated softkeys and describes each softkey command in detail.

Before proceeding, read Installation in the General Information section. This reading covers initial inspection, power requirements, power cable and grounding requirements, installation for the HP 3577B and the HP 35677A/B, and definition of the operating environment.

Instrument Description

The HP 3577B Network Analyzer is a two-receiver,¹ dual trace, 5 Hz–200 MHz programmable network analyzer². It features menu-driven operation, using eight softkeys located next to the menu display area of the CRT. A menu is a list of softkey labels that appears on the CRT next to the softkeys. Display a menu by pressing the hardkey for the parameter to be modified or the measurement to be made. This permits control of many features with a minimum number of front panel keys by redefining the softkeys with each new menu. Marker information and sweep parameters are displayed above and below the CRT graticule and give the current instrument status.

Trace information displayed on the HP 3577B CRT is digitally stored as complex data (real and imaginary) in trace memory. Using the storage and math processing capabilities of the HP 3577B, up to eight different display formats may be derived from the same trace data and changes in scale may be made without repeating the measurement.

All HP 3577B graticules are electronically generated on the screen as part of the display operation. Thus, no screen overlays are needed for polar or log graticules or the Smith chart. In log sweep the graticule changes to reflect changes in start and stop frequencies.

Other features of the HP 3577B include

- Electrical length correction/measurement
- Automatic plot routines for HP-GL plotters
- Limit line and test capability
- Discrete sweep
- User defined vector math
- Vector averaging
- 1 Hz resolution bandwidth
- Programmable I/O port for direct interface with external custom hardware
- Automatic self-protection on the source output and receiver inputs
- Extensive data storage
- The ability to save and recall six instrument states
- Optional HP Instrument BASIC capability for “custom” measurement routines and instrument control.

The HP 3577B has three functional blocks: SOURCE, RECEIVER, and DISPLAY FORMAT. The source and receivers work together to gather data and store it in trace memory. The display section takes the trace data and formats it for viewing.

¹ A third receiver input is available as Option 002.

² A temperature stabilized crystal reference oscillator is available as Option 001.

Initial Inspection

This instrument was carefully inspected both mechanically and electrically before shipment. It should meet published specifications. To confirm this, inspect the instrument for physical damage incurred in transit, inventory the supplied accessories (listed in Table 5-2), and test the electrical performance using the Confidence Test listed in the section on Getting Started. If there is physical damage, if the contents are incomplete or if the instrument does not pass the Confidence Test, notify the nearest HP Sales and Service Office. If the shipping container is damaged or the cushioning material shows signs of stress, notify the carrier as well as the Hewlett-Packard office. Keep the shipping material for the carrier's inspection.

Warning



The integrity of the protective earth ground may be interrupted if the HP 3577B is mechanically damaged. Under no circumstance should the HP 3577B be connected to power if it is damaged.

Getting Started

Introduction

This section is designed to get the first time user ready to make measurements. First, a description of the instrument turn-on procedure will be given, followed by a discussion of nomenclature used for hardkeys and softkeys in this manual. Then some operating hints and things to try in case of trouble.

Before turning on the instrument, make sure the HP 3577B is configured and fused for the available line voltage and is safely connected to the power line. As the instrument warms up, it runs a self test on internal RAM and ROM, and the front panel LED's light. By the time the CRT is warm enough to display a screen, normal operation has begun. For Option 001 (which adds the oven reference), approximately ten minutes after power is turned on, the beeper will sound again as the oven reference reaches operating temperature and switches in as the frequency reference for the HP 3577B Network Analyzer.

Instrument Turn On

1. Before connecting ac power to the HP 3577B
 - a. Set the rear panel VOLTAGE SELECTOR switch to the position that corresponds to the powerline voltage to be used:

Voltage Selector	Line Voltage
115V	86V to 127V at 48 Hz to 440 Hz
230V	195V to 253V at 48 Hz to 66 Hz

Warning



To avoid serious injury, be sure that the ac power cord is disconnected before removing or installing the ac line fuse.

- b. Verify that the proper line fuse is installed in the rear-panel FUSE holder:

Voltage Selector	Fuse Type	HP Part No.
115V	6A, 250V Normal Blo	2110-0056
230V	3A, 250V Normal Blo	2110-0003

Warning



To protect operating personnel, the 3577B chassis and cabinet must be grounded. The HP 3577B is equipped with a three-wire power cord which, when plugged into an appropriate receptacle, grounds the instrument. To preserve this protection feature the power plug should only be inserted in a three-terminal receptacle having a protective earth ground contact. The protective action must not be negated by the use of an extension cord or adapter that does not have the required earth ground connection. Grounding one conductor of a two-conductor outlet is not sufficient protection. Ensure that all devices connected to the HP 3577B are also connected to the protective earth ground.

- c. Set the front panel power switch to the OFF position.
- d. Connect the ac power cord to the rear panel LINE connector. Plug the other end of the power cord into a three-terminal grounded power outlet.
- e. Turn on the power to the instrument by pressing the LINE switch on the front panel to the ON position. Verify that all front panel LED's illuminate simultaneously soon after the HP 3577B is turned on.

Note



Each time the HP 3577B is powered ON a self-test of ROM and RAM is run and the results (pass/fail) are displayed on the screen. (Normally the CRT will not show these results because it hasn't warmed up). All front panel LED's should illuminate when the instrument is first turned on. The operator should visually verify that all LED's illuminate.

- f. Verify that the cooling fan on the rear panel is operating and that the SWEEP LED on the front panel is flashing about once per second.
- g. If the Option 001 (High Stability Frequency Reference) is used, approximately ten minutes after power-on the beeper will sound and the screen message "REFERENCE UNLOCKED" will appear very briefly. This indicates that the oven reference has reached operating temperature and has been selected as the frequency reference for the Voltage Controlled Crystal Oscillator (VCXO). When the switch occurs, the VCXO takes a moment to achieve phase lock which causes the screen message. Until this switch occurs the VCXO uses its own 10 MHz crystal as the frequency reference. If "REFERENCE UNLOCKED" remains on the screen, contact an authorized repair facility.

Note



If an external reference has not been connected, the internal oven will automatically become the frequency reference when it reaches operating temperature; no external connections are necessary. The jack on the rear panel marked EXTERNAL REFERENCE should not be connected to the 10 MHz REFERENCE OUTPUT beside it.

“Hardkeys” & “Softkeys”

Before using the analyzer, it is important to understand the difference between hardkeys and softkeys.

Hardkeys are front panel buttons whose functions are always the same. Most hardkeys have a label printed directly on the key. Throughout this book, they are printed like this: [**HARDKEY**]

Softkeys are keys whose functions change with the analyzer’s current menu selection. A softkey’s function is indicated by video label to the left of the key (on the edge of the analyzer’s screen). Throughout this book, they are printed like this: [**SOFTKEY**]

Definitions & Operating Hints

1. It is good practice to start a measurement setup by pressing [**INSTR PRESET**]. This is a quick way to set all parameters to known values (the PRESET state) and is used as the common starting point for measurements in this manual. For a listing of the PRESET state parameter values, see INSTRUMENT PRESET in the REFERENCE section.
-

Note



The PRESET state depends on whether an HP 35677A/B S-Parameter Test Set is connected to the HP 3577B. Making the connection without turning off power to the HP 3577B Network Analyzer, requires pressing [**INSTR PRESET**] to update the starting parameter values.

2. The recommended sequence for setting up a measurement is
 - [**INPUT**]
 - [**DISPLAY FCTN**]
 - [**FREQ**]
 - [**AMPTD**]

This sequence is a good, general start for setting up an instrument state and should be easy to remember. See the circled numbers in figure 1-1.

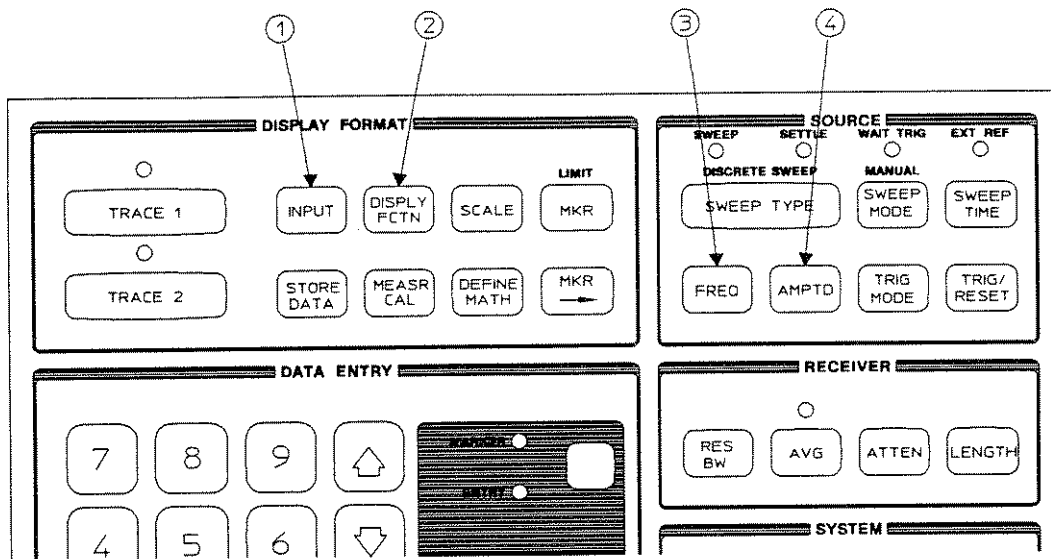

Figure 1-1. Set-Up Sequence

3. The HP 3577B is a menu-driven instrument. The hardkeys are used to display the various menus. To select another menu, press a different hardkey. Pressing a different hardkey interrupts any data entry made using the numeric keypad if no units key is pressed since data entries must be terminated by units (e.g. Hz, dBm).
4. The softkey labels will appear next to the eight softkeys, on the right-hand side of the screen. Each group of softkey labels is referred to as a "menu."
5. The beeper will sound when the HP 3577B displays a new screen message (unless the beeper has been turned off; see SPECIAL FUNCTIONS in the REFERENCE chapter).
6. If the HP 3577B is used as part of a measurement system, the frequency references of all instruments should be phase-locked to a common frequency standard. The HP 3577B will lock to a frequency reference applied to its External Reference Input located on the rear panel. The external reference must be between -7 and $+15$ dBm and its frequency must be ≥ 100 kHz (± 20 ppm) and the result of dividing 10 MHz by an integer. Conversely, if the HP 3577B Option 001 is used, it can serve as the system reference via its 10 MHz, 0 dBm Reference Output, also located on the rear panel. If the HP 3577B Option 001 is used as the standard, the aging rate is $\pm 5 \times 10^{-8}$ /day from 0° to 55°C .
7. The HP 3577B requires 60 minutes to warm up before all of the specifications will apply except the oven warm-up for Option 001 which requires 48 hours. However, the instrument is operable during this warm-up period.

In Case Of Trouble

8. If the HP 3577B fails to respond to front panel key presses, perform the following steps until normal operation is restored:
 - a. Verify that the HP-IB status indicator LED labeled "REMOTE" is not illuminated. It is possible that the instrument has been addressed over the HP-IB bus, in which case it will not respond to front panel operation until LOCAL control is restored with the [**LCL**] hardkey or via a controller issued comand. The [**LCL**] key will not restore LOCAL status if the controller has issued a LOCAL LOCKOUT command.
 - b. Press [**INSTR PRESET**].
 - c. Cycle the instrument's power by pressing [**LINE**] OFF and ON again.
-

Caution



The test described in the following step will erase the contents of all nonvolatile read/write memory on the main processor board. This resets all six instrument states, plot parameters, limit and discrete sweep tables, and the HP-IB parameters to their default parameters.

- d. If none of the previous steps have returned control to the front panel:
 - Turn power OFF
 - Hold down [**SAVE**] and [**RECALL**] simultaneously
 - Turn power ON

Continue to hold the keys down until all power-on tests are complete. This procedure will test parts of the main processor memory not normally tested and may reset a bad memory register, allowing normal operation to continue.

- e. Contact an authorized repair facility.

Confidence Test

After unpacking the instrument or whenever a quick check of basic operation is necessary, run the confidence test using the following keystrokes.

1. Press
[SPCL FCTN].

This key is located in the SYSTEM section of the front panel. This menu contains the softkey, [CONF TEST].

2. Press
[CONF TEST]

This selects the confidence test. Note that the screen displays a message to connect a cable between the output and the input to be tested. The menu contains commands to test any of the inputs (Option 002 adds a third input, receiver B).

Connect the cable as shown below.

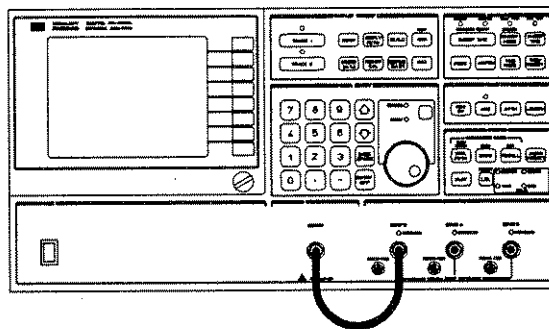

3. Press [TEST R] to begin the test of input R.

The HP 3577B will run nine tests and display pass/fail results of each. These tests are:

- Log Sweep signal level test
- Log Sweep flatness test
- Linear Sweep signal level
- Linear Sweep magnitude flatness
- Synthesizer and L.O. feed through
- Amplitude Sweep accuracy
- Output limiter linearity
- Receiver Impedance
- Receiver Attenuator

If any tests fail, the HP 3577B Network Analyzer will stop the testing and display a bright failure message. Testing may be continued by pressing [CONTINUE TEST].

Getting Started
Confidence Test

Inputs A and B may be tested in the same manner, by connecting the OUTPUT to the input to be tested and pressing the corresponding softkey. When testing is complete, press [**INSTR PRESET**] or any other hardkey to exit the [**CONF TEST**] menu and begin a measurement setup.

Note



If any of the HP 3577B CONFIDENCE TESTS fail, refer to the HP 3577B Service Manual for instructions.

Warning



Service procedures should be executed by trained service personnel, only. To avoid electrical shock, do not perform any servicing procedures unless qualified.

Making Measurements

This section contains step by step instructions demonstrating the use of the HP 3577B Network Analyzer and the HP 35677A/B S-Parameter Test Set to make measurements.

Using the HP 3577B by itself, characterize:

1. A tuned stub notch filter
 - a. Measurement set up
 - b. Using the marker to make measurements
 - c. Store trace data
 - d. Save Instrument State

2. A bandpass filter
 - a. Measurement set up
 - b. Measure -60 dB and -3 dB bandwidths (calculate shape factor)
 - c. Measure passband ripple
 - d. Measure passband insertion phase
 - e. Measure passband group delay
 - f. Create a limit table and run a limit test
 - g. Create a discrete sweep table and make a measurement

3. Gain compression of an amplifier
 - a. Measurement set up
 - b. Measure -3 dB gain compression point.

Making Measurements

Using the HP 35677A/B S-Parameter Test Set with the HP 3577B Option 002 Three-Channel Network Analyzer, characterize:

4. A low pass filter
 - a. Measurement set up
 - b. Measure insertion loss
 - c. Measure passband insertion phase
 - d. Measure passband ripple
 - e. Measure stopband rejection

5. S-parameters of an amplifier
 - a. Initial measurement set up
 - b. Measure S_{21} , forward gain and phase
 - c. Measure S_{12} , reverse loss
 - d. Measure S_{11} , input return loss and SWR
 - e. Measure S_{22} , output reflection coefficient
 - f. Conversion of reflection coefficient to complex impedance

These measurements cover topics of general interest and common usage such that most of the capabilities of the HP 3577B Network Analyzer and HP 35677A/B S-Parameter Test Set are demonstrated. For details on operating features see the REFERENCE section. The listing of the hardkeys in the REFERENCE section is alphabetical.

When reading this section, key presses and connection instructions appear in the left column and measurement descriptions and observations appear in the right column. Even if no device-under-test is available and nothing is connected to be tested, references to menus and data entry help teach operation of the HP 3577B Network Analyzer. It is important to start each measurement topic at the beginning (i. e., at [INSTR PRESET]). Use the front panel pictorial for locating hardkeys.

Note that most hardkeys are used only to display a menu of softkey labels. If a mistake is made in data entry or feature selection for data entry (such as forgetting to select [CENTER FREQ] before beginning to enter it), pressing the hardkey again will display the original menu.

Tuned Stub Notch Filter

Connect the cables and adapters as shown in figure 2-1. This configuration should result in a notch filter whose center frequency is related to the length of the open-ended cable. The notch filter is constructed from the following parts:

Qty	Description	Part Number
2	N(m) to BNC(f) adapters	HP 1250-0780
2	1 foot BNC cable	HP 8120-1838
1	BNC tee (f)(f)(m)	HP 1250-0781
1	BNC(f) to BNC(f) adapter	HP 1250-0080
1	2 foot BNC cable	HP 8120-1839

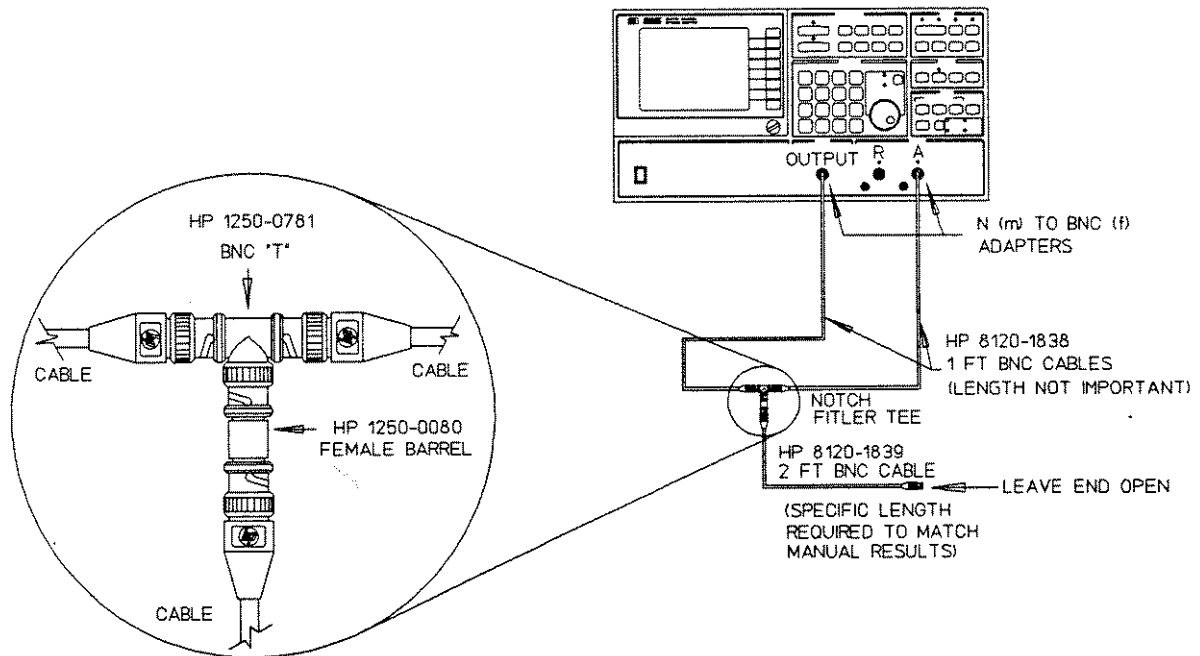

Figure 2-1. Circuit Configuration

Tuned Stub Notch Filter Making Measurements

This measurement exercise is designed to show:

1. How to set up the instrument state to make a measurement.
2. How to use the markers to make measurements.
3. How to store trace data.
4. How to save an instrument state.

Data entries require four steps: press a hardkey to display a menu, press a softkey (if not already active or bright) to select the parameter for data entry, enter data with the numeric key pad, and press a softkey to select units. Using the knob or arrow keys replaces the need to select units.

Either receiver input may be used for this example. Input R is defined as the default. For the following example uses receiver input A. To select input A, select it in the [**INPUT**] menu. Note that "receiver input" refers to front panel connections R and A, while [**INPUT**] refers to the softkey selection under the [**INPUT**] hardkey.

The following measurement will show how to select the proper **INPUT**, **DISPLAY FUNCTION**, **FREQUENCY**, and **AMPLITUDE**.

Measurement Set Up

1. Press
[INSTR PRESET]
in the SYSTEM section of the
front panel.
2. Note that the [INPUT] menu is
displayed.
3. Press
[A]
to select receiver input A as the
INPUT definition for the active
trace.

It presets the HP 3577B parameters to their default values. These are listed under INSTRUMENT PRESET in the REFERENCE section of this manual.

Note the LED above [TRACE 1] is illuminated, indicating that trace one is active. The screen should now appear as shown in figure 2-2. Note that input B and B/R appear in the menu even if input B is not present on the HP 3577B. This selection is included in case a third input is added later.

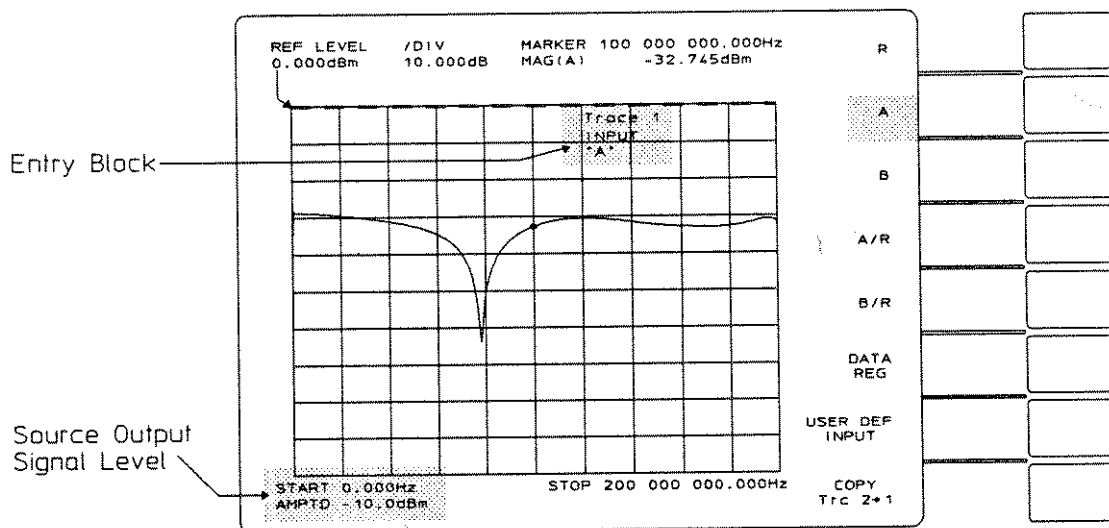

Figure 2-2. Log Magnitude of Input A

Tuned Stub Notch Filter
Making Measurements

4. Press
[TRACE 2]
in the DISPLAY FORMAT
section that selects trace two as
the active trace.
5. Select input A as the active input
for trace 2 by pressing
[A].
6. Press
[DISP FCTN]
in the DISPLAY FORMAT
section.
7. Press
[PHASE]
to select the phase display
function for the active trace.

Note that the [INPUT] menu shows [INPUT R] is active for trace two. Also, trace one and its alphanumeric information above the graticule dimmed slightly when trace two was selected.

When this key was pressed the beeper sounded and the screen message "WARNING: TRACE IS OFF" appeared. Now trace 2 will be turned on in the next step.

It displays a new menu listing the eight possible display function formats available for each trace.

Pressing this key turns trace two on and defines its display function to be phase. Note that trace two is brighter than trace one. This difference in trace intensity and the LEDs above the TRACE hardkeys indicate which trace is active. Any softkey commands given or data entered will affect the active trace. Note that when trace two was turned on, another set of alphanumeric information appeared above the graticule. This information applies to trace two and is the same intensity as the trace.

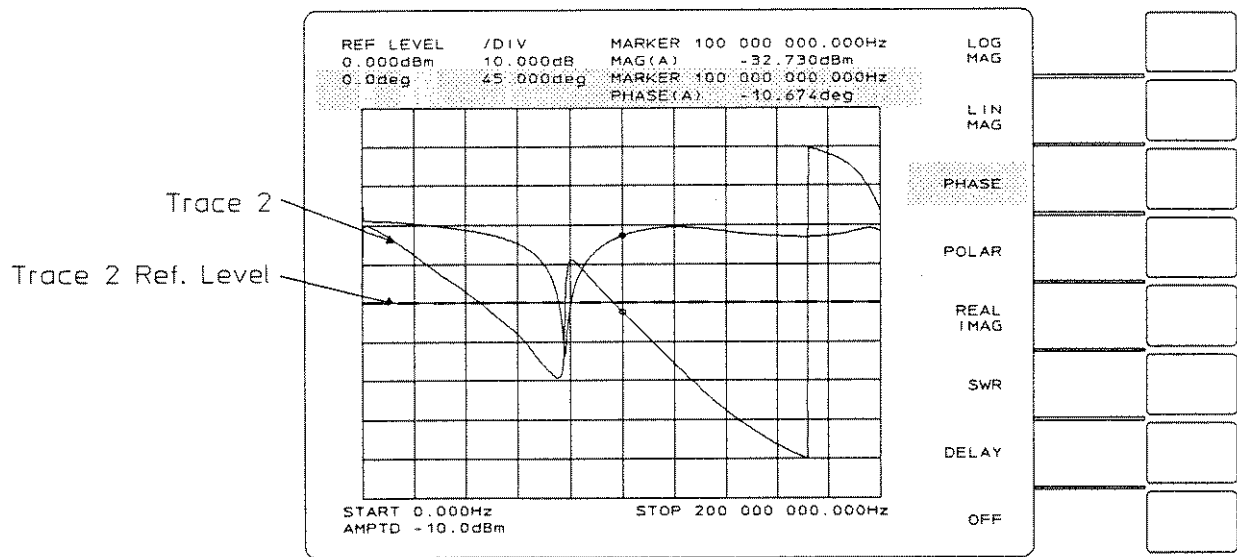

Figure 2-3. Log Magnitude and Phase of Input A

The screen should now appear as shown in figure 2-3.

8. Press **[FREQ]** in the SOURCE section.
9. Press **1** on the numeric keypad in the DATA ENTRY section. Then press **[MHz]**.
10. Now select the stop frequency by pressing **[STOP FREQ]** **1 5 0** **[MHz]**.

Note that **[START FREQ]** is active. Since this is the parameter to be modified, selection of a softkey parameter is not necessary.

Tuned Stub Notch Filter
Making Measurements

11. To set up the source amplitude, press [AMPTD].
12. Press [↓] to decrement the source amplitude by the step size.
13. Press [TRACE 1] [SCALE] [AUTO SCALE]. This select scale parameters that fit the active trace in the graticule.

Since the [AMPTD] softkey is already active, and this is the parameter to be modified, selection of a softkey parameter is not necessary. Note that the ENTRY BLOCK shows the current value of this parameter is - 10 dBm.

Note that the value in the ENTRY BLOCK and the alphanumeric at the lower left corner of the graticule show that the source amplitude is now - 11 dBm (i.e. STEP SIZE is 1 dB).

The screen should now appear as shown in figure 2-4.

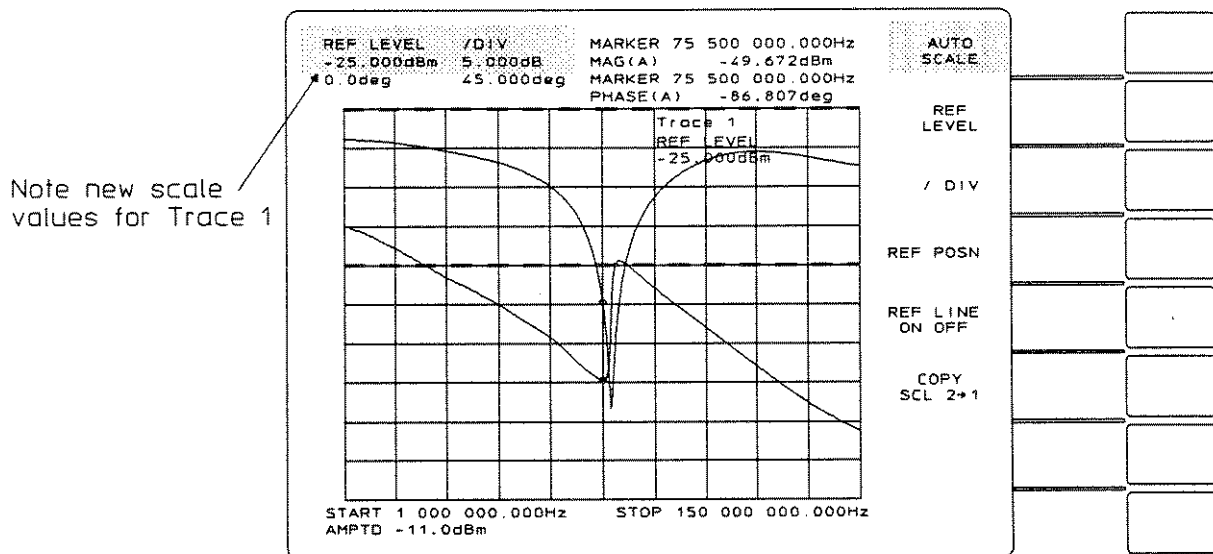

Figure 2-4. Changing Source and Scale Parameter Value

Now the measurement set up is complete and measurements can be taken.

Making Measurements

1. First, the 3 dB width of the notch filter will be measured. Turn the knob in the DATA ENTRY section and notice the marker's movement along the traces and change in information in the marker information block on the screen. Position the markers at the extreme left of the graticule.
2. Press [MKR] in the DISPLAY FORMAT section then press [ZERO MARKER].
3. Press [MKR →] to display the marker placement menu.
4. Press [MORE] to display a second level menu.
5. Press [MKR → R TARG] to search right for the target value.

The knob should be in the MARKER mode (indicated by the LEDs above the knob). The knob toggles between the MARKER mode and ENTRY mode using the unmarked key above the knob.

[ZERO MARKER] turns on the OFFSET MARKER feature and sets the [MARKER OFFSET] (which is a magnitude in this case) and [FREQ OFFSET] values to those of the regular marker.

Note that a triangular marker appears on top of the circular marker on trace one. This offset marker is now the reference for measurements taken with the marker on trace one. Note the change in the marker information block for trace one from "MARKER" to "OFFSET."

These keys may be used to make data entries with the marker after positioning it with the knob or to move the marker to maximum or minimum points on the trace.

Note that MARKER TARGET is the active (bright) softkey label and that its default value is -3.000 dB.

Note that the regular marker on trace two moves right until it reaches the first point on the trace where it is three dB below the OFFSET MARKER.

- Now the notch filter center frequency and rejection magnitude will be measured.

Press

[MKR]

[MKR OFST OFF].

- Press

[MKR →]

[MKR → MIN]

to move the marker to the lowest value on the trace. This point is the center frequency of the notch.

This is a push-push toggle type key; continued key presses will toggle the feature between ON and OFF. One keypress now turns it OFF. Note the return of the marker information block to MARKER.

Note that the marker information block now contains the notch center frequency and rejection magnitude as shown in figure 2-6.

Center Frequency &
Rejection Level of Notch

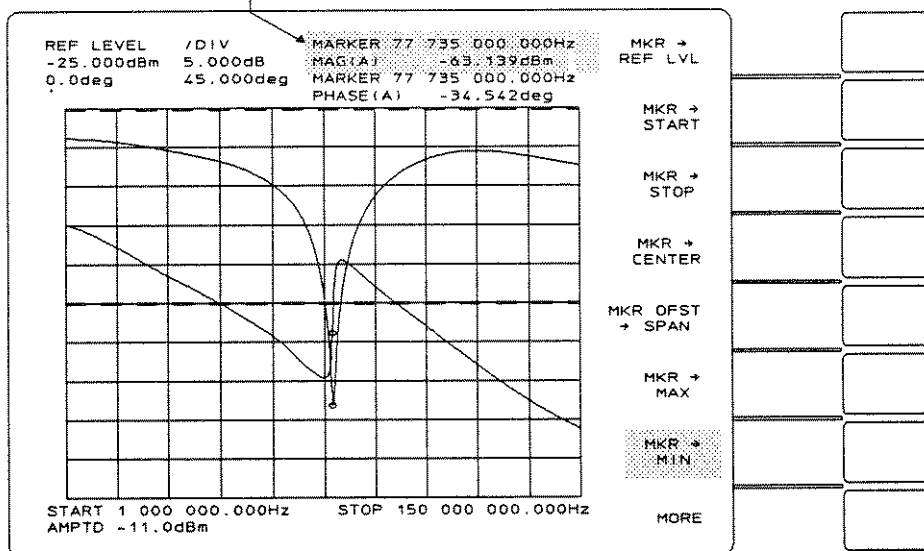
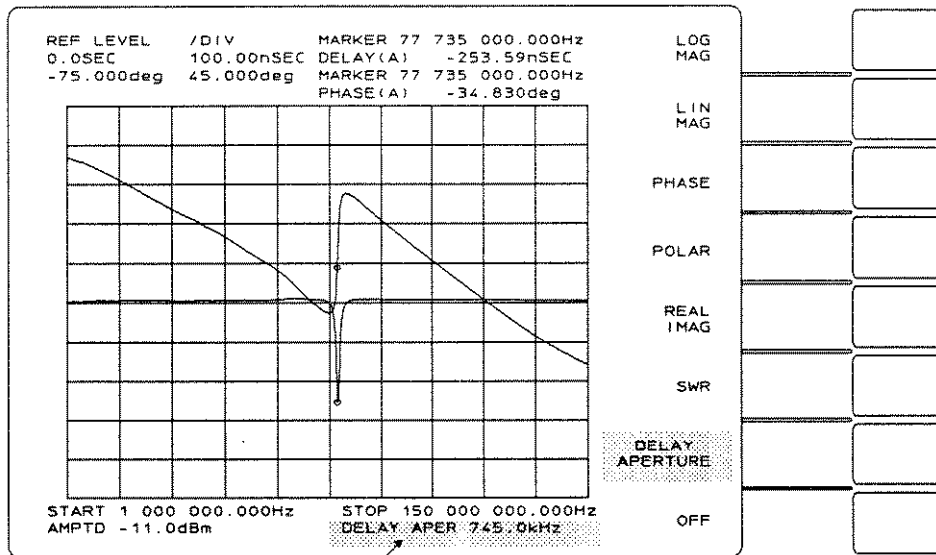

Figure 2-6. Notch Center Frequency

Tuned Stub Notch Filter
Making Measurements

9. Now the group delay will be measured. Press
 - [TRACE 2]
 - [SCALE]
 - 7 5
 - [deg].
 Then press
 - [TRACE 1]
 - [DISPLY FCTN]
 - [DELAY]
 to display group delay as the active trace.

Note that this softkey label changes to read [DELAY APERTURE] when pressed. Also note the DELAY APER alphanumeric data under the lower right corner of the graticule. See figure 2-7.



Corresponds to % of Span Selected for Aperature

Figure 2-7. Phase and Group Delay

10. Now the group delay will be displayed in polar form. First the delay aperture will be set for convenient viewing. Press
[DELAY APERTURE].

Note the menu of user selectable values for the delay aperture. The units are frequency in percent-of-span. Data entries are not allowed for this parameter.

11. Press
[1% OF SPAN]
Then Press
[DSPLY FCTN]
[POLAR]
[SCALE]
[AUTO SCALE].

The POLAR softkey selects POLAR as the display function for the active trace. Since only one trace is allowed in POLAR display function, the inactive trace will be turned off. See figure 2-8.

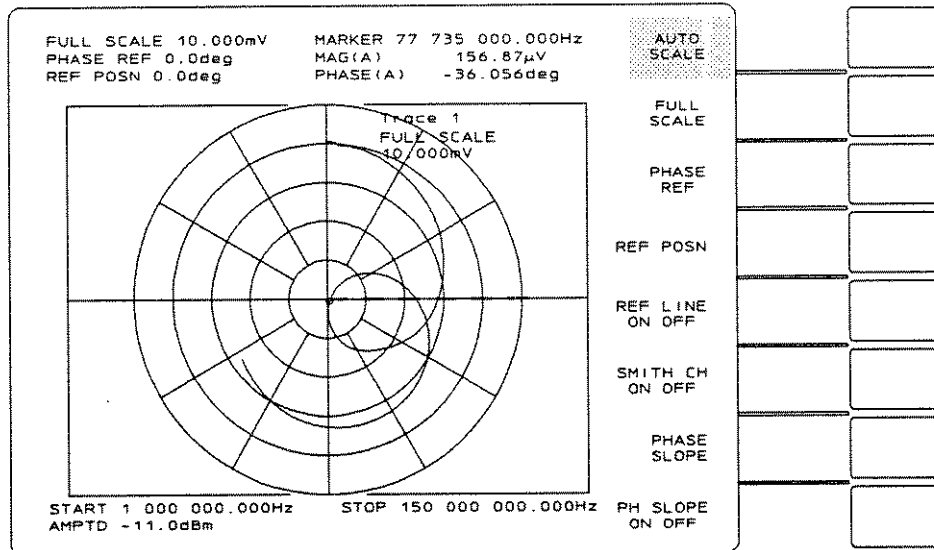

Figure 2-8. Polar Display Function

Now the measurements are complete and ready to be stored.

Store Trace Data

1. The measurement just made will now be stored in one of the twelve data storage registers, X1. Press **[STORE DATA]** in the DISPLAY FORMAT section and notice the storage menu as in figure 2-9.

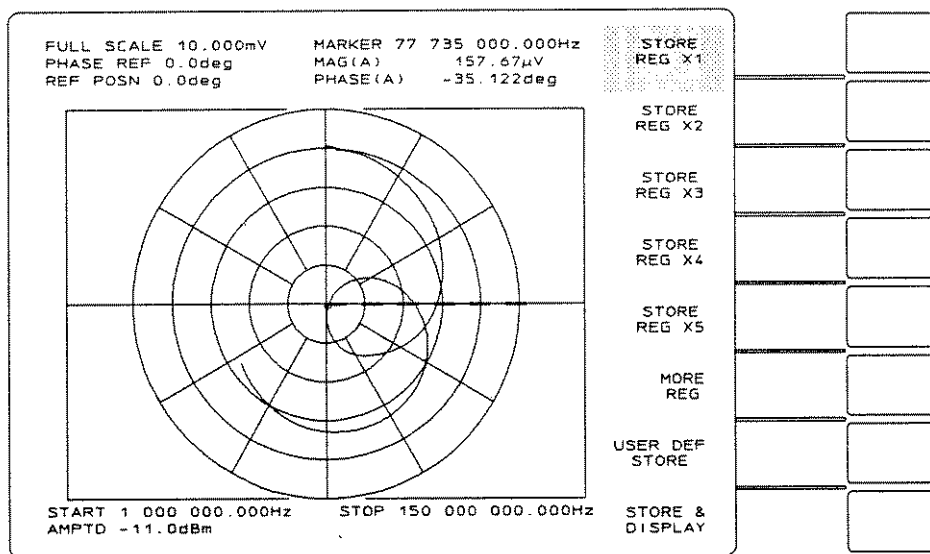
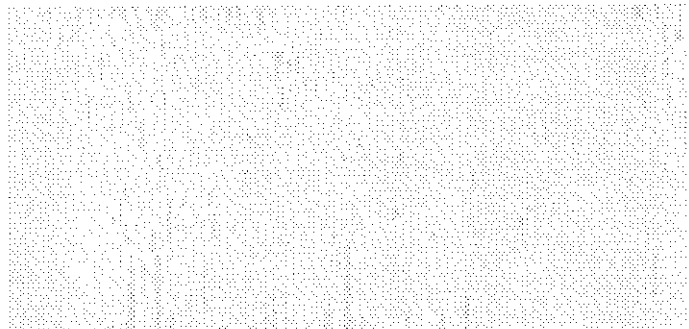

Figure 2-9. Store Data Menu

2. Press
[STORE REG X1].

Once data is stored, it can be viewed and manipulated without taking new measurements. To illustrate this, press
[INPUT]
[DATA REG]
[X1].

3. The data may be represented in any of eight display functions. For example, press
[DSPLY FCTN]
[LIN MAG]
to view the same data in linear magnitude form. Change it back by pressing:
[LOG MAG].

This stores the trace data of the active trace as defined under the INPUT key into data register X1. Since the INPUT of both traces is defined to be A, it doesn't matter which trace was active in this case. The current display function has no effect on what is stored. Note the screen message "STORE completed."

Note that a sweep dot still appears. Memory sweeps are still occurring but no new measurement is being displayed. *If new START and STOP frequencies are entered, this trace will not change.*

Save Instrument State

1. The instrument state used to set up the preceding measurement can also be saved. Press [**SAVE**] in the SYSTEM section. Then press [**SAVE REG 1**].
2. This state may be recalled by pressing [**RECALL**] [**RECALL REG 1**].

The menu for five state registers will appear as in figure 2-10. Note the screen message "INSTRUMENT STATE SAVED."

Cycling power or presetting the instrument will not affect this memory register.

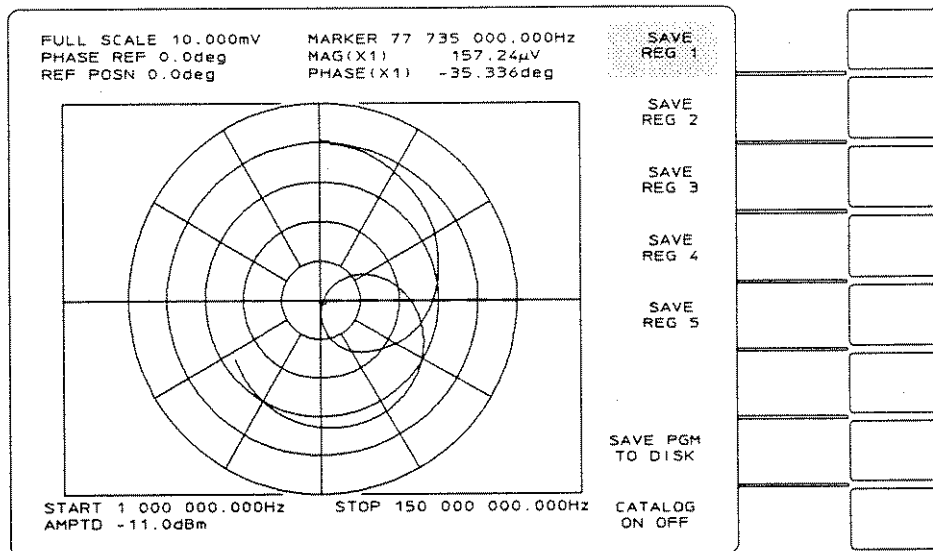

Figure 2-10. Save Instrument State Menu

Bandpass Filter

Connect the filter to the HP 3577B as shown in figure 2-11. The bandpass filter used in this example has a center frequency of 10.1875 MHz but the methods are the same for any bandpass filter.

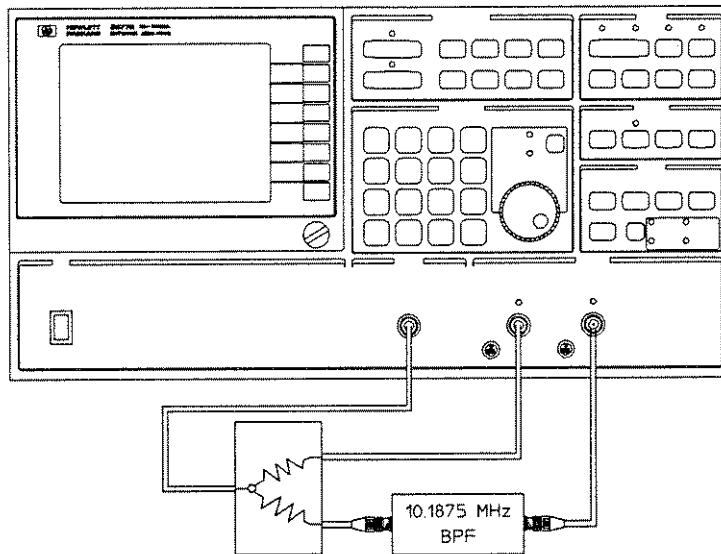

Figure 2-11.

The purpose of this measurement exercise is to demonstrate the use of the HP 3577B Network Analyzer to characterize a passband filter. The general organization is:

1. Set up the measurement
2. Measure the -60 dB and -3 dB bandwidths (calculate the shape factor)
3. Measure the passband ripple
4. Measure the passband insertion phase
5. Measure the passband group delay
6. Create a limit table and run a limit test
7. Create a discrete sweep table and make a measurement

Bandpass Filter
Making Measurements

The next section will illustrate the standard means of creating a measurement set up starting with

[INSTR PRESET]

and the four hardkeys:

[INPUT],
[DISPLY FCTN],
[FREQ], and
[AMPTD].

This set up will select

[INPUT] = A/R,
[DISPLY FCTN] = LOG MAG,
[CENTER FREQ] = 10.1875 MHz,
[FREQ SPAN] = 100 kHz

(equivalent to setting

[START FREQ] = 10.1375 MHz
[STOP FREQ] = 10.2375 MHz),

[AMPTD] = 0 dBm.

Different settings may be needed depending on the filter used.

Measurement Set Up

1. Press
[INSTR PRESET]
in the SYSTEM section.

This green key presets HP 3577B parameters to their default values. These are listed under INSTRUMENT PRESET in the REFERENCE section. Note that the [INPUT] menu is displayed when the HP 3577B is PRESET as shown in figure 2-12. If [INPUT] is pressed the menu will not change.

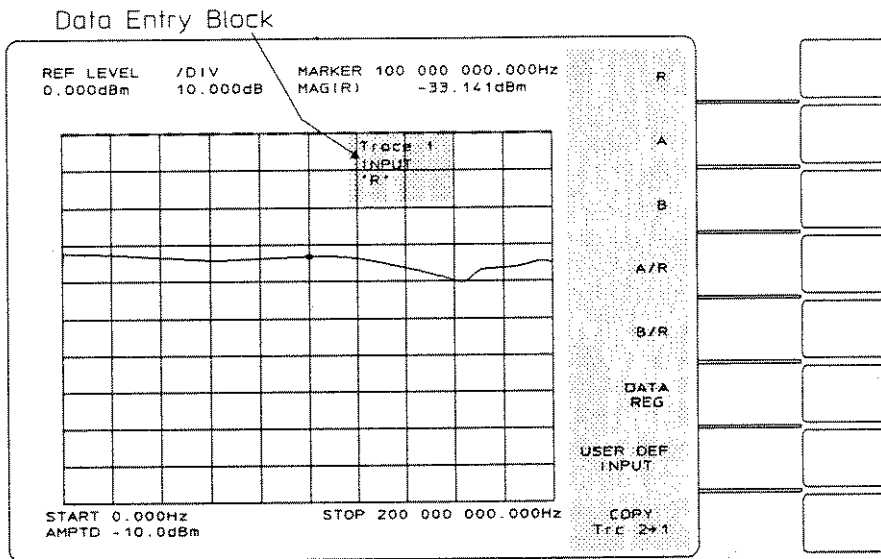

Figure 2-12. Default Menu

Bandpass Filter
Making Measurements

2. Press
[A/R]
to change the [INPUT] definition
to A/R.

3. Press
[DSPLY FCTN]
and notice the new softkey
menu. Since [LOG MAG] is the
desired display function, make no
change in this menu.

4. Press
[FREQ]
in the SOURCE section and
select
[CENTER FREQ]
from the menu shown in figure
2-13.

These softkeys represent the eight ways measured data can be presented by the HP 3577B. The default [DISPLY FNCTN] is Log Magnitude.

The default value for center frequency is 100 MHz.

Start Frequency Active

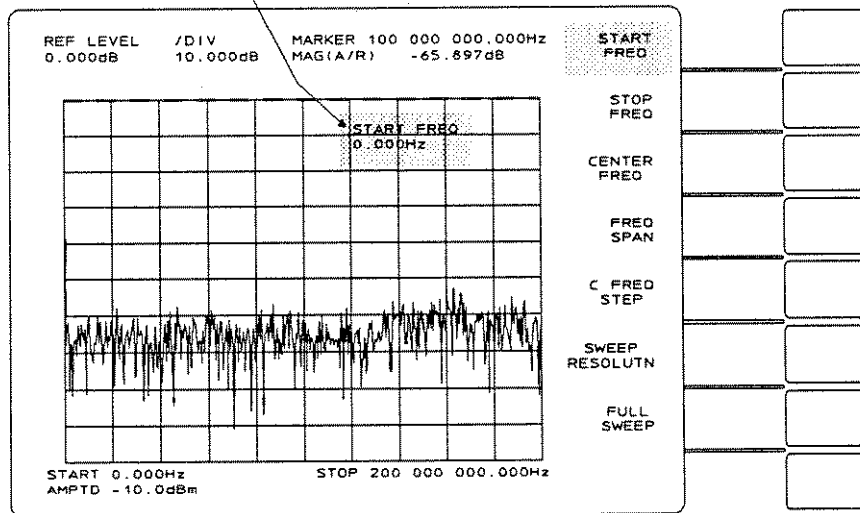

Figure 2-13. The Frequency Menu

5. Change the center frequency to 10.1875 MHz by pressing **1 0 . 1 8 7 5** on the numeric keypad, then press **[MHz]**.

6. The current frequency span is 200 MHz. Reduce the span to 100 kHz by pressing **[FREQ SPAN]**
1 0 0
[kHz].

7. The noise level of figure 2-14 will now be reduced by increasing the source amplitude and decreasing the attenuation applied to input A. Press **[AMPTD]** in the SOURCE section.

Note that the data entry is not complete until units are selected from the menu. A "sweep span limited" message should appear on the screen.

The default source amplitude is -10 dBm without the test set and $+15$ dBm with the test set.

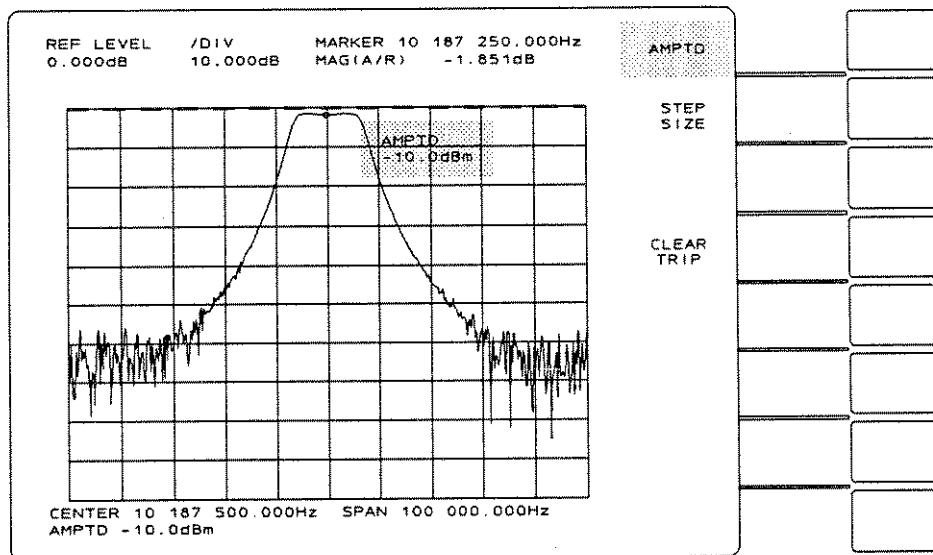

Figure 2-14. The Source Amplitude Menu

8. Press

0

[dBm].

9. Noise may be reduced further by selecting a receiver attenuation of 0 dB, as long as the input is not overdriven in the passband.

Before removing the 20 dB receiver attenuator from input A, check for a maximum signal level of < -20 dBm on input A by pressing

[INPUT]

[A].

Then read the marker amplitude by pressing

[MKR →]

[MKR → MAX].

Read the level in the marker information block at top of screen and make sure it is < -20 dBm. Press

[INPUT]

[A/R]

to return the input definition back to A/R. Select 0 dB attenuation by pressing

[ATTEN]

and toggle to

[ATTEN A **0 dB** 20 dB].

The noise-reduced trace is shown in figure 2-15. Compare it with figure 2-14.

The entry is effective when the dBm key is pressed. In this case, increasing the source amplitude 10 dB has decreased the noise level in the stopband by the same amount.

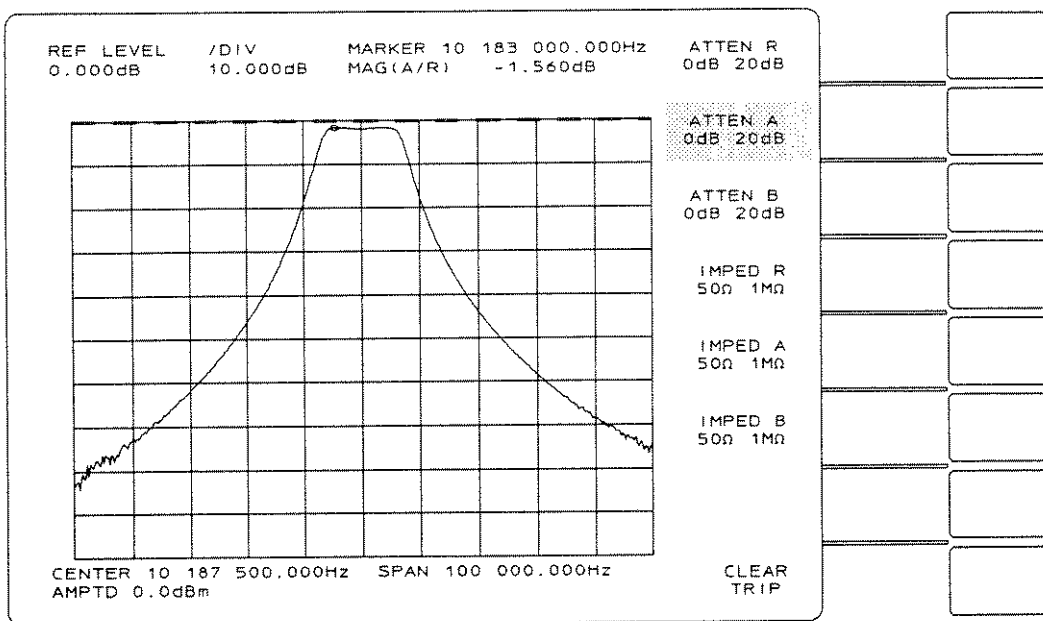

Figure 2-15. Optimizing Dynamic Range

$UDF = A/R/D1$

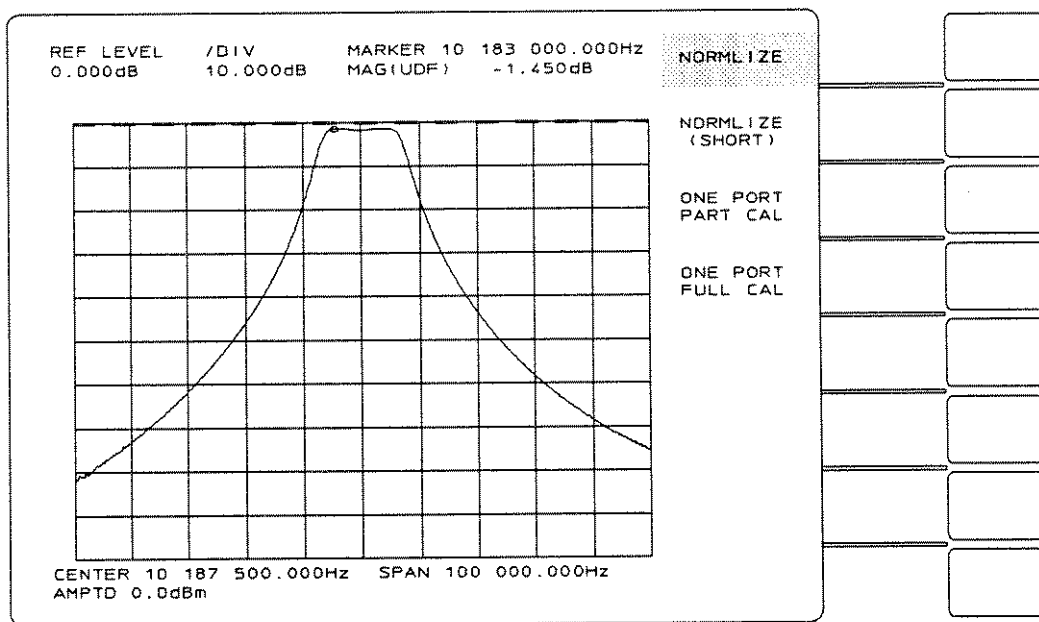

Figure 2-16. Normalized Bandpass Filter Response

Bandpass Filter
Making Measurements

10. The noise can be further reduced by using a narrower resolution bandwidth. Narrower resolution bandwidths also require longer sweep times. Press **[RES BW]** in the RECEIVER section and **[100 Hz]**.
11. Press **[SWEEP TIME]**
5
[SEC].
12. The measurement set up will now be normalized to correct for cable lengths, connectors, etc. Press **[MEAS CAL]** and replace the bandpass filter with a BNC barrel (BNC(f) to BNC(f) adapter) and wait for a complete sweep.
13. Press **[NORMLIZE]**.
14. Replace the BNC barrel with the bandpass filter.

Note that the current resolution bandwidth is 1 kHz.

Any time resolution bandwidth is reduced, an increase in sweep time may be required. See **OPTIMIZING SWEEP TIME** in Appendix A.

When pressed, this softkey stores the active trace in a data register (D1 for trace one and D2 for trace two) and then redefines the INPUT to be the previous INPUT definition divided by the data register that was just used. Now the INPUT for trace one is A/R/D1 (press the **[INPUT]** to see it in the ENTRY BLOCK). See figure 2-16.

Now the set up is complete and measurements can be taken. Most measurements are taken using the MARKER. This small circle may be moved along the trace in a number of ways, some of which will be demonstrated in the following steps.

Bandwidth Measurements

1. Use the knob to tune the marker to the center of the filter. The shape factor will now be measured, starting with the 60 dB bandwidth measurement. Press [MKR] [ZERO MARKER].

This softkey is used to turn on the OFFSET MARKER which is a triangle shaped marker. It has the same units as the regular marker (in this case, magnitude & frequency). Note that the marker information block above the graticule now shows OFFSET information. Note that the softkey MKR OFST ON/OFF shows the feature has been turned ON. This toggle type softkey may be used to return the marker to normal operation (OFFSET OFF) by pressing it once.

2. Press [MARKER OFFSET]

This softkey is used to display the magnitude of the [OFFSET MARKER]. New values may be entered with the numeric key pad or the current value may be modified with the arrow keys or the knob in the ENTRY mode when this softkey label is active (bright). See figure 2-17.

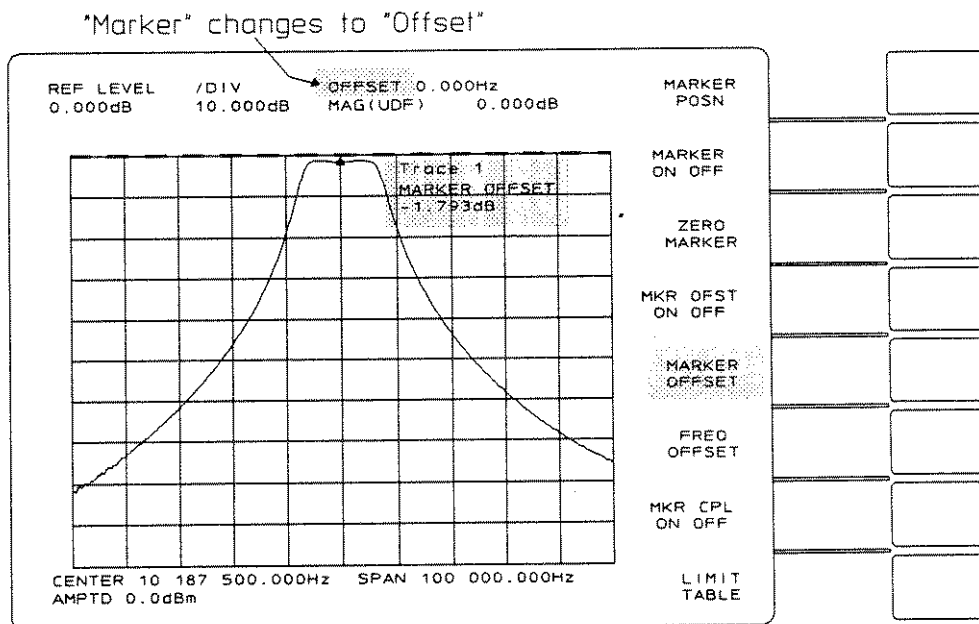

Figure 2-17. The Marker Menu

Making Measurements

3. Press
[FREQ OFFSET]
to display the frequency value of
the offset marker.
4. This instrument state will be
convenient to return to for
measurements taken later in this
example. Therefore, the
instrument state will be saved at
this time. Press
[SAVE]
[SAVE REG 1].
5. Proceeding with the 60 dB
bandwidth measurement, press
[MKR →]
[MORE].
6. To search for a value – 60 dB to
the left of the zero marker, press
– 6 0
on the numeric keypad and press
[dB].
Then press
[MKR → L TARG].
See figure 2-18.

[MORE] displays a second-level menu
[MARKER TARGET] is the active softkey. It is used to
search for specific values.

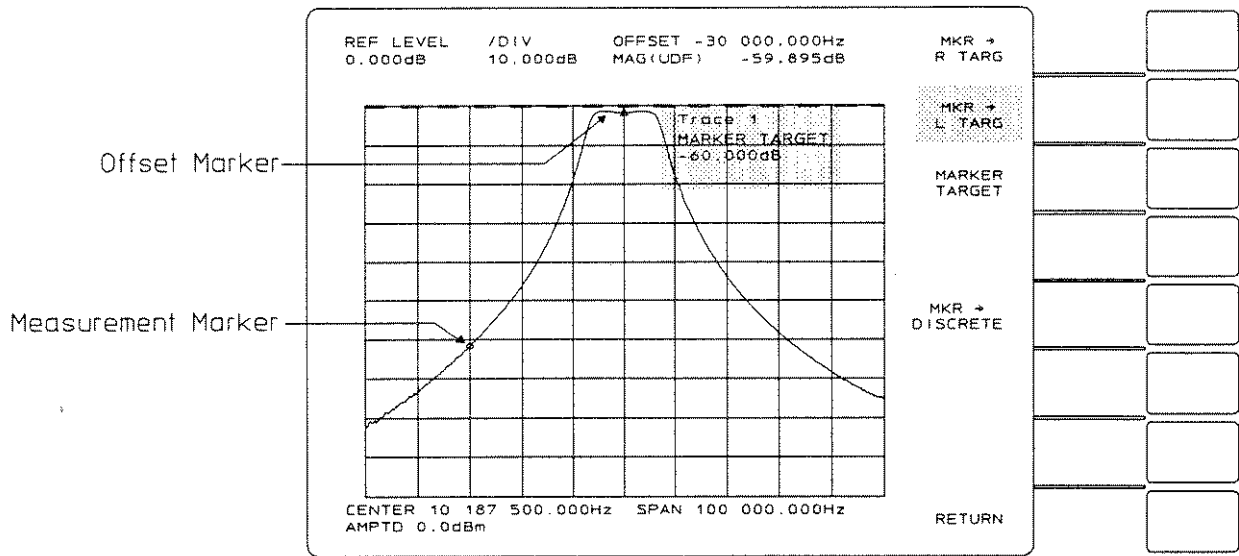

Figure 2-18. Marker Search

7. To look for the other 60 dB point, the [MARKER TARGET] key can be used again but this time the search criteria will be 0 dB. But first, the zero marker must be moved to the 60 dB point just found. To do this, press
 - [MKR]
 - [ZERO MARKER].
 Now to search for the other 60 dB point, press
 - [MKR →]
 - [MORE]
 - 0
 - [dB].
 Then press
 - [MKR → R TARG].
 The OFFSET frequency readout (between the two markers) is the 60 dB bandwidth. See figure 2-19.

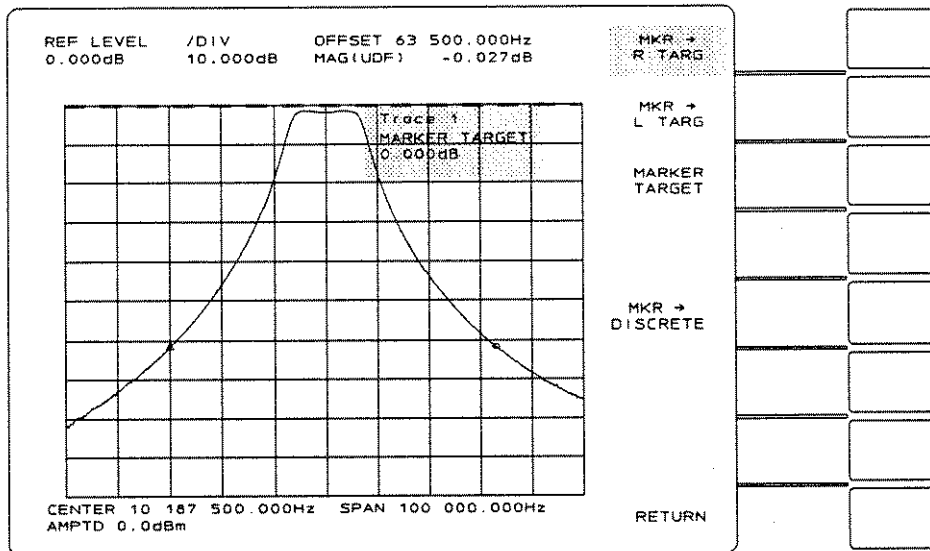
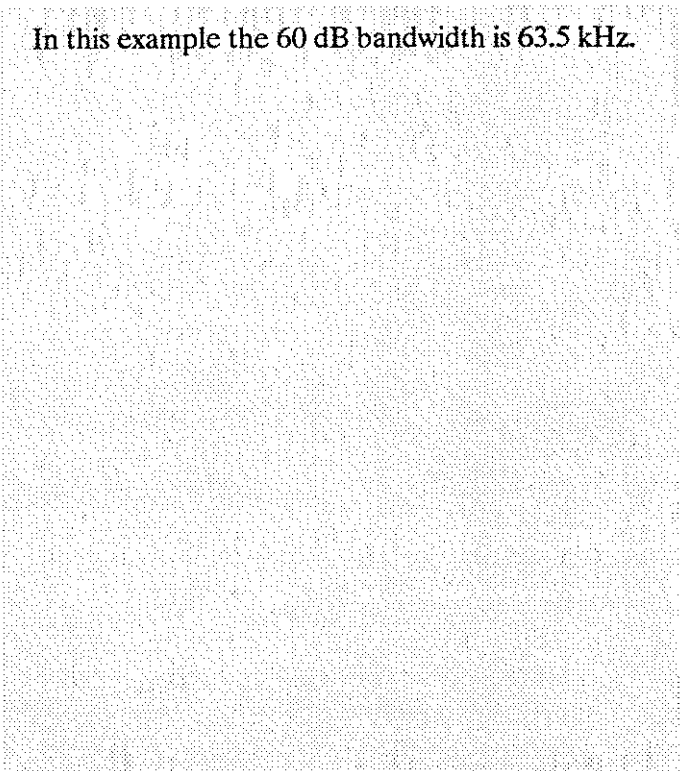

Figure 2-19. 60 dB Bandwidth

8. Now return to the instrument state stored earlier in preparation for measuring the 3 dB bandwidth. Press
 [RECALL]
 [RECALL REG 1].

9. Press
 [MKR→]
 [MORE].

10. Press
 [MKR → L TARG].
 To record the absolute frequency and amplitude of the marker, the marker offset needs to be turned off. To do this, press
 [MKR]
 and toggle to
 [MKR OFST ON **OFF**].
 Record the marker frequency and amplitude.

11. Marker Frequency = _____

12. Marker Amplitude = _____

13. Now turn the marker offset back on by pressing
 [ZERO MARKER].

[MARKER TARGET] will be used again to measure the 3 dB bandwidth. Also, as each 3 dB point is measured, record the absolute frequency and amplitude of both 3 dB points. These values are needed for a later example where limit lines will be constructed using the limit table.

Note that the target value is - 3.000 dB as shown on screen in the data entry block.

In this example, Marker Frequency is 10.18075 MHz and Marker Amplitude is - 4.534 dB (relative to the reference level).

Making Measurements

14. Then search for the other 3 dB point by pressing
 [MORE]
 and change the search criteria to
 0
 [dB].

15. Press
 [MKR → R TARG]
 and the offset marker readout
 shows the 3 dB bandwidth. See
 figure 2-20. Shape factor may
 now be calculated.

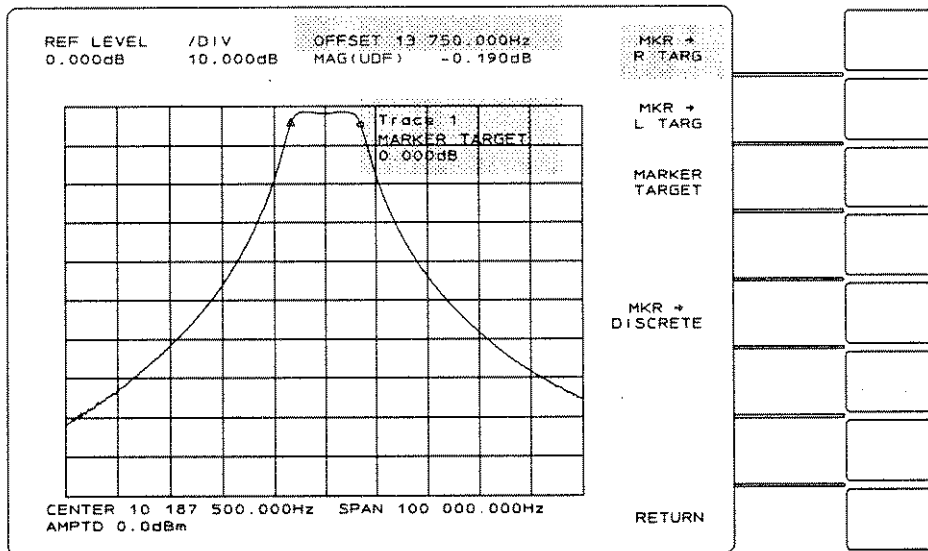
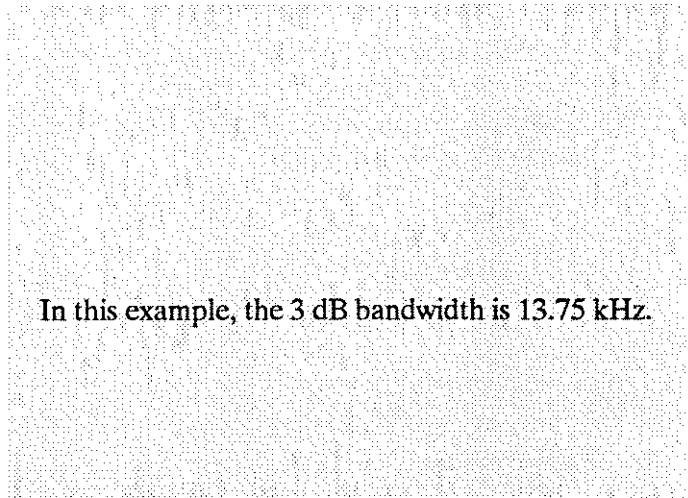

Figure 2-20. 3 dB Bandwidth

$$\text{Shape Factor} = \frac{-60 \text{ dB BW}}{-3 \text{ dB BW}} = \frac{63,500}{13,750} = 4.62$$

16. Record the absolute frequency and amplitude of the right 3 dB point by pressing [MKR] and toggle to [MKR OFST ON OFF].

17. Marker Frequency = _____

18. Marker Amplitude = _____

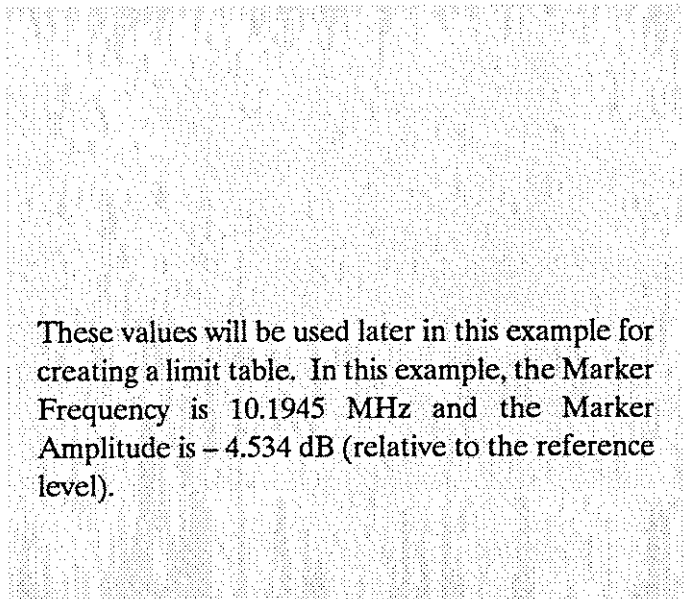

Passband Ripple

The next measurement is passband ripple. To make this measurement ALTERNATE SWEEP will be employed to retain the frequency span given to trace one while viewing a narrower span with trace two. When ALTERNATE SWEEP TYPE is selected, trace two starts out with preset values. This means a different measurement set up is required for trace two, as follows:

1. Press
[SWEEP TYPE]
in the SOURCE section. Then
press
[ALTERNATE SWEEP].
2. Press
[TRACE 2]
[INPUT]
[A/R].
3. To turn trace 2 on, press
[DISPLAY FCTN]
[LOG MAG].
4. Now trace two will be set to
similar settings as trace 1 except a
narrower frequency span will be
selected. Press
[AMPTD]
0
[dBm].

Alternate sweep allows each trace to have different values for start and stop frequencies, amplitude, sweep time, and resolution bandwidth.

Note the warning message "TRACE IS OFF" on the screen and that OFF is bright in the next menu.

Selecting any display function has the effect of turning the trace on. All parameters for trace two revert to default parameters including AMPTD = -10 dBm. Since AMPTD = 0 dBm for trace one, the HP 3577B will change the amplitude OUTPUT level at the beginning of each sweep. Note clicking of amplitude relays. The HP 3577B uses relays in the output circuit to determine output amplitude. If left running in a state that switches these relays regularly, the instrument will time out (switch to single sweep mode) after five minutes to reduce relay wear. See SWEEP MODE, SINGLE in the REFERENCE section.

The clicking of the output relays will stop when the amplitudes of the two traces are set equal.

5. Press

[**FREQ**]
 [CENTER FREQ]
10.1875
 [MHz].
 Then press
 [FREQ SPAN]
7.325
 [kHz].

This sets the frequency span to the center portion of the 3 dB bandwidth.

6. Press

[**SCALE**]
 and wait until trace two has
 completed a full sweep before
 pressing
 [AUTO SCALE].

[AUTO SCALE] will evaluate the values in all bins of the active trace to determine the new scale. When the SWEEP TYPE is ALTERNATE, these values are not updated until the next sweep of the trace. If a change is made that requires rescaling (and [AUTO SCALE] is executed again), wait for the sweep to finish before pressing [AUTO SCALE]. The trace on the screen will be updated on the sweep following the AUTOSCALE command.

7. Just to demonstrate the sweep direction feature, press

[**SWEEP TYPE**]
 and toggle to
 [SWP DIR UP **DOWN**].

This is a push-push toggle softkey. In this instance, selection of a different sweep direction is used only to demonstrate the use of the feature. It is useful for testing that the sweep time is not too fast. If the filter response changes on screen when the direction is changed, the sweep time needs to be longer. For other uses, see SWEEP DIRECTION listed under SWEEP TYPE in the REFERENCE section. Note that setting up a second trace is only required when alternate sweep is used.

Making Measurements

8. Now the measurement set up for the second trace is complete and the bandpass ripple measurement can be made. Press

- [MKR →]
- [MKR → MAX]
- [MKR]
- [ZERO MARKER]
- [MKR →]
- [MKR → MIN].

[ZERO MARKER] moves the triangular marker to the position of the regular marker. The magnitude information in the MARKER Block for trace two is now indicating the measured passband ripple for this filter. See figure 2-21.

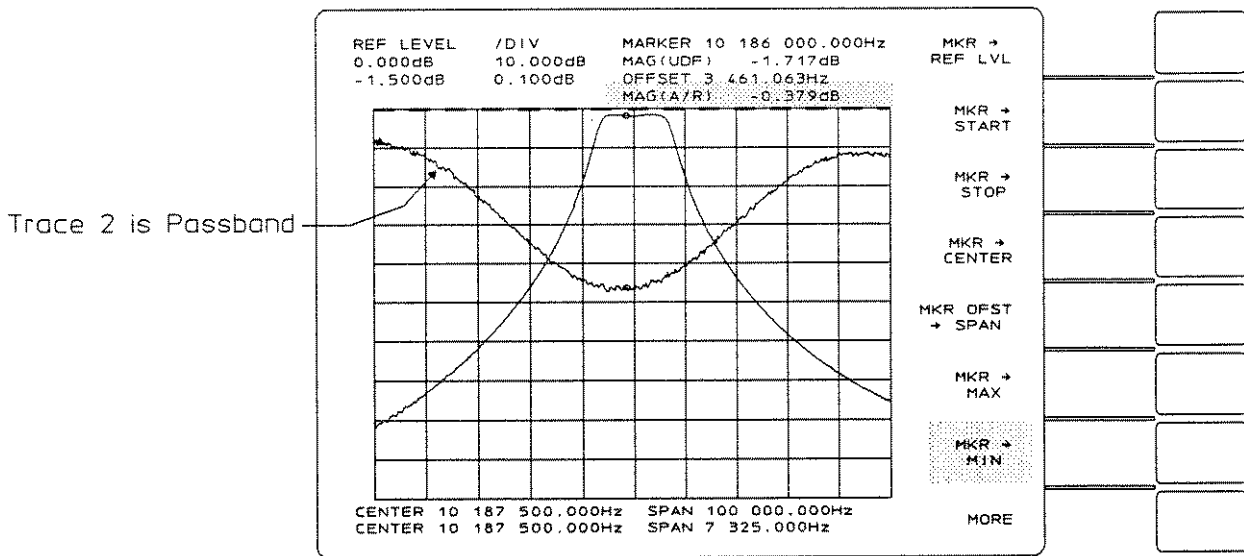

Figure 2-21. Passband Ripple

Passband Insertion Phase

The next measurement will be phase in the passband. To do this the sweep type will be returned to linear (the default type) so that the frequency span of trace two is the same as that of trace one.

1. Press
 [**SWEEP TYPE**]
 [**LIN FREQ SWEEP**].
2. To quickly set up trace two, the input definition for trace one will be copied to trace two. Press
 [**INPUT**]
 [**COPY Trc 1 → 2**].
3. Press
 [**MKR**]
 [**MKR OFST OFF**]
 [**DSPLY FCTN**]
 [**PHASE**].
4. Moving the marker (with the knob) allows phase measurements to be made at any point on the trace. Data may be read from the marker block for trace two. The vertical parts of the trace represent 360° phase wraps.

This also normalizes trace two.

The LED over [**TRACE 2**] indicates that trace two is active and therefore the keys just pressed effected trace two only. Trace 2 now shows the passband insertion phase.

Since the HP 3577B stores data in complex form, $\pm 180^\circ$ is the range these values may have when interpreted as phase information. Note that trace two will be noisy in the same area as trace one, due to extremely low signal levels. See figure 2-22.

Making Measurements

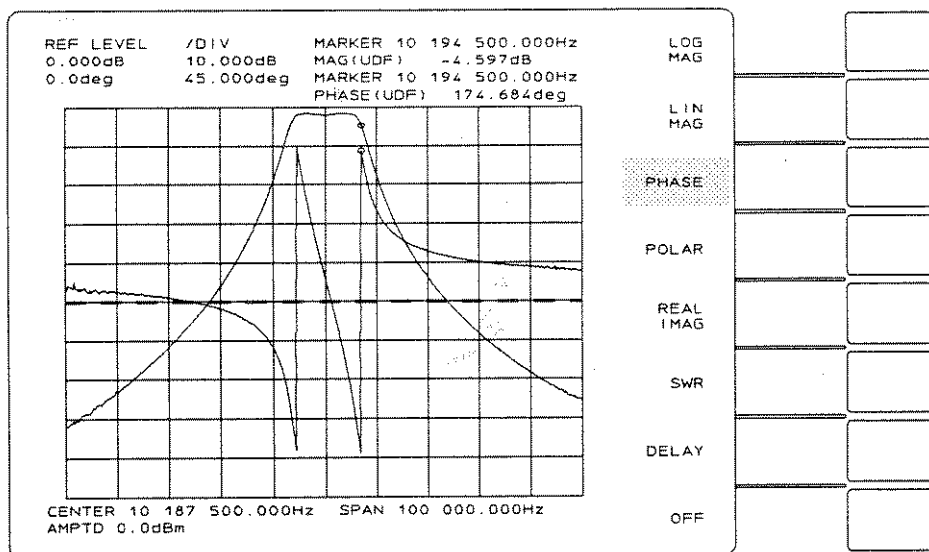

Figure 2-22. Bandpass Filter Magnitude & Phase Response

Group Delay

The next measurement is group delay. The DISPLAY FUNCTION menu should still be displayed.

1. Press
[DELAY].
2. Press
[SCALE]
[AUTO SCALE]
so that the trace appears as large as possible without clipping the upper and lower boundaries of the graticule.
3. Now press
[DSPLY FCTN]
[DELAY APERTURE]
[2% OF SPAN].

Note that the softkey labeled DELAY changes to DELAY APERTURE.

[DELAY APERTURE] displays the menu of selections for group delay aperture (the change in frequency over which the change in phase is measured).

DELAY aperture information (shown below the graticule) changes when different percent-of-span selections are made. The DELAY information will appear only when the trace whose display function is DELAY is selected. See figure 2-23.

Making Measurements

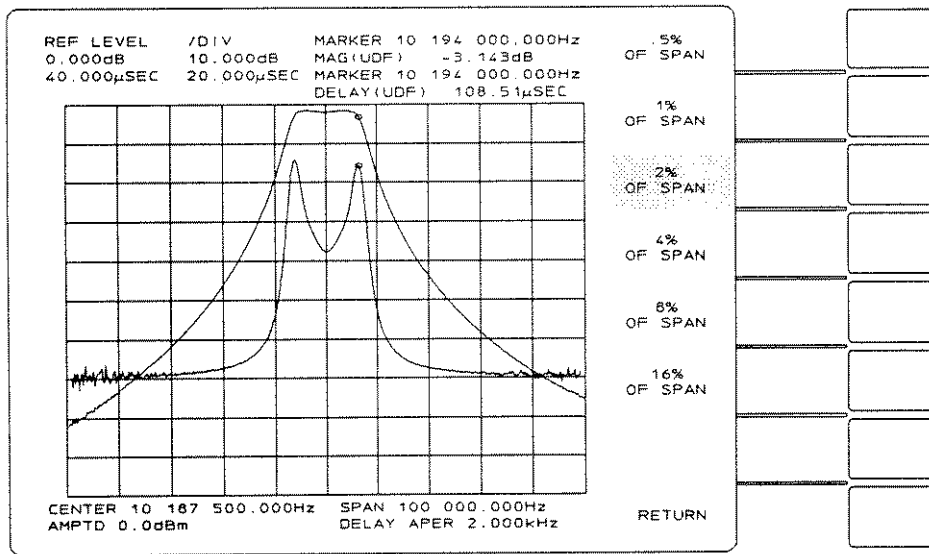

Figure 2-23. Bandpass Magnitude and Group Delay

$$\text{Group Delay } t_g = \frac{\Delta\Phi}{360 \times \Delta f} = \frac{\text{Delay}}{\text{Aperture}}$$

Note

The DISCRETE SWEEP and LIMIT features can be used together to quickly measure critical frequencies, compare those frequencies to a limit and set the PASS/FAIL indicator. This feature combination can be useful for reducing test and data transfer time to a computer. However, each feature is totally independent of the other.

The discrete sweep table developed in this example now becomes part of the instrument state and is preserved when [INSTR PRESET] is pressed. For more detail on DISCRETE SWEEP see the SWEEP TYPE section of the REFERENCE Chapter.

Amplifier

Gain Compression

Connect the amplifier to the HP 3577B Network Analyzer as shown in figure 2-33. The receiver inputs will begin to overload when the input signal level is ≥ 0.0 dBm receiver attenuation = 20 dB; overload occurs at input signal levels ≥ 20 dBm with receiver attenuation = 0 dB). The amplifier used in this example has a gain of approximately 30 dB so 30 dB of attenuation was added to the circuit between the amplifier and the receiver input.

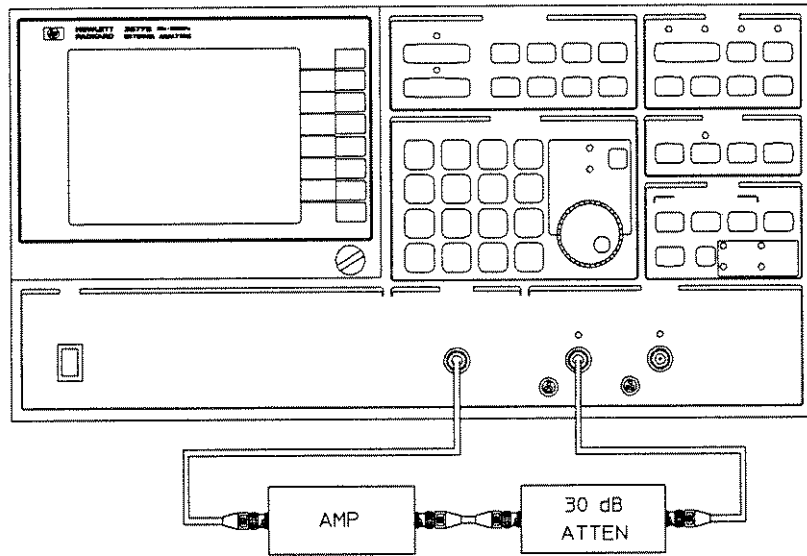

Figure 2-33.

Limit Test

This section will demonstrate how to test the bandpass filter to upper and lower limits. These limits are drawn on the display by entering values in a limit table where each row represents a line segment. In this example, an upper and a lower limit line will be drawn above and below the 3 dB passband of the filter using the 3 dB marker values recorded earlier in this example.

Creating a Limit Table

1. Before defining the limit table, trace two will be turned off and trace one will be made active.

Press

[TRACE 2]
 [DISPLY FNCTN]
 [OFF]
 [TRACE 1].

2. To create the limit table, press

[MKR]
 [LIMIT TABLE].

3. Start the limit table from scratch

by pressing
 [LIMIT CONFIG]
 [CLEAR TABLE]
 [RETURN].

The display should look like figure 2-24.

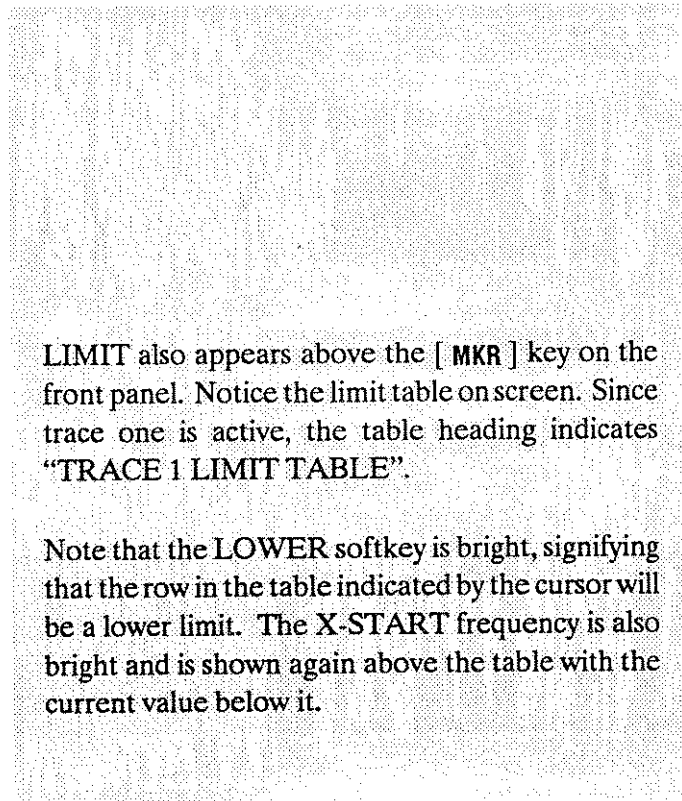

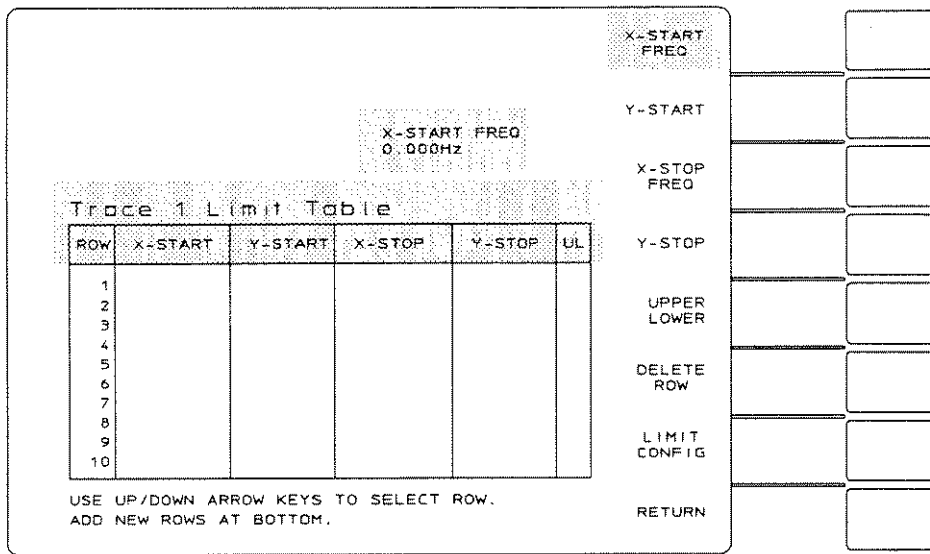

Figure 2-24. Trace 1 Limit Table

4. Change [X-START] to the first 3 dB point frequency recorded on page 2-29 plus 500 Hz. For the bandpass used in this example, the x-start frequency is **10.18125** [MHz].

5. Press [Y-START] and enter the recorded marker amplitude on page 2-29. For the filter used in this example, press **- 4.534** [UNITS] to terminate the entry.

For example, if the recorded marker frequency value on page 2-29 is 100 kHz, enter 100.5 kHz. Enter the value using the numeric keypad and the appropriate units softkey.

UNITS assumes the current y-axis scale of the trace specified for the limit. In this case the units are dB for TRACE 1.

6. Press [X-STOP] and enter the second 3 dB point frequency recorded on page 2-31 minus 500 Hz. For the bandpass filter used in this example, the x-stop is **10.194** [MHz].

7. Press [Y-STOP] and enter the same marker amplitude as [Y-START] (-4.534 units for this example).

8. Check for where the limit was drawn on the display by pressing [LIMIT CONFIG] and toggle to [LINES **ON** OFF]. Press [RETURN] (twice) and look for the limit on the display as in figure 2-25.

If no frequency and amplitude values were recorded earlier, measure them at this time. Absolute values need to be used as entries in the limit table. To record the absolute frequency and amplitude of the marker, the marker offset needs to be turned off. Repeat steps 9 through 18 of the Bandwidth Measurements section and record the absolute marker frequency and amplitude.

This assumes the bandpass filter used has a flat 3 dB passband. If it does not, enter the marker amplitude of the second 3 dB point recorded on page 2-31.

The limit line will appear as a small line just under the 3 dB passband of the filter.

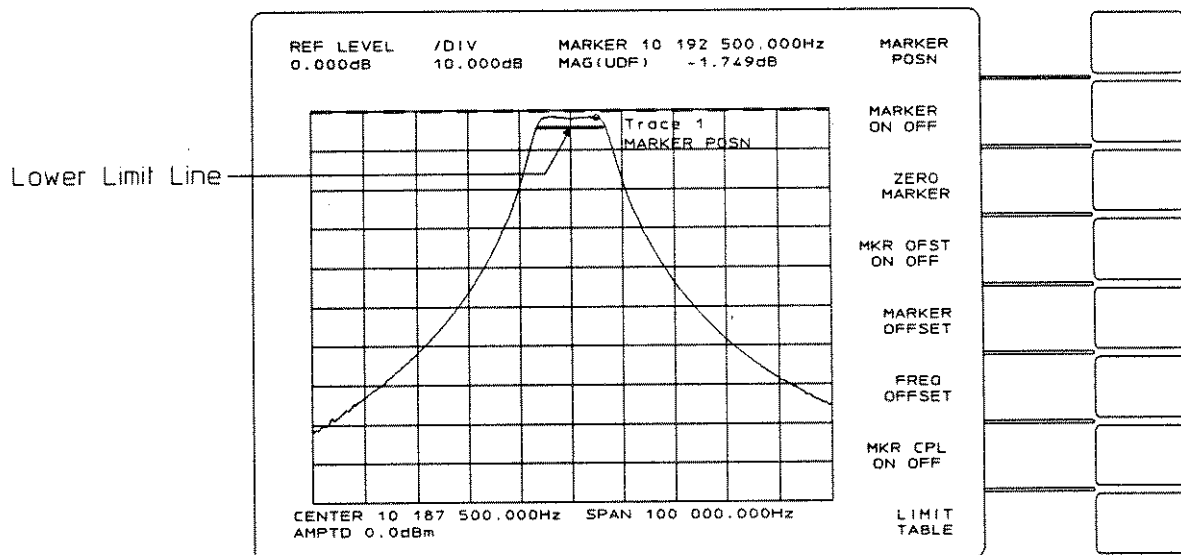

Figure 2-25. Lower Limit Line for 3 dB Passband

Making Measurements

9. If no limit line is seen, it may coincide with a graticule line making it hard to see. To check for this, turn off the graticule by pressing
[**SPCL FCTN**]
and toggle to
[**GRAT ON OFF**].

If a limit line still cannot be seen, check that the lines have been turned on by pressing
[**MKR**]
[**LIMIT TABLE**]
[**LIMIT CONFIG**]
and toggle to
[**LINES ON OFF**].

10. Now the upper limit will be entered in the limit table. Press
[**MKR**]
[**LIMIT TABLE**].
Use the
[**↓**]
key to move the table cursor to the next line down.

11. Press
[**UPPER**]
to define an upper passband limit. This limit will be drawn 6 dB above the one just drawn. Press
[**X-START**]
and enter the same value as the X-START frequency in the first row. Press
[**Y-START**]
and enter either an amplitude 6 dB higher than the amplitude in the previous row or 0 dB, whichever is lower. Press
[**Y-STOP**]
and enter the same amplitude value.

If the limit line just created is not drawn within the passband of the filter, modify the X-START/STOP and Y-START/STOP frequencies as needed.

Note that the [**X-STOP**] frequency from the row above is automatically entered as the [**X-START**] and [**X-STOP**] frequencies of the new row. These values are entered as a convenience for entering consecutive limit segment values for multi-segment limits. However, this example will simply demonstrate single-segment limit lines.

Note that [**X-STOP**] already has the desired value entered since it was copied from the row above.

12. Press
 [RETURN]
 and check for the new upper limit similar to the display shown in figure 2-26B. The graticule may have to be turned off again to view the new limit. To do this, press
 [SPCL FCTN]
 and toggle to
 [GRAT ON **OFF**].
 Turn the graticule back on after viewing the new limit.

The table is now complete as shown in figure 2-26A.

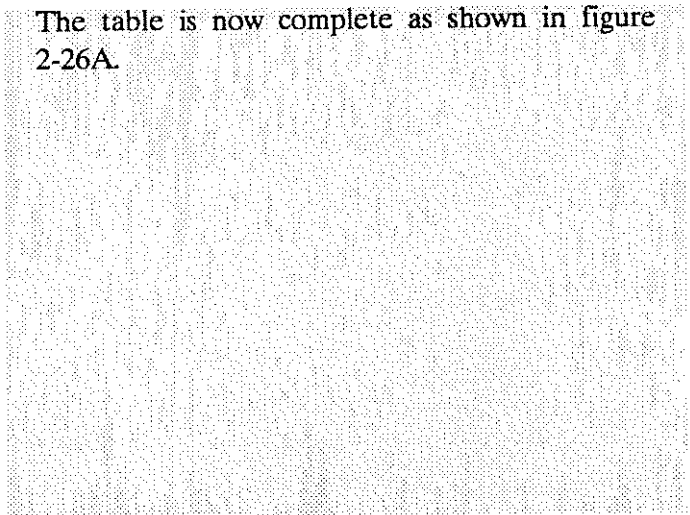

Making Measurements

Y-STOP
0.0000 UNITS

ROW	X-START	Y-START	X-STOP	Y-STOP	UL
1	10.181M	-4.534	10.194M	-4.534	LO
▷ 2	10.181M	0.000	10.194M	0.000	UP
3					
4					
5					
6					
7					
8					
9					
10					

USE UP/DOWN ARROW KEYS TO SELECT ROW.
ADD NEW ROWS AT BOTTOM.

X-START FREQ

Y-START

X-STOP FREQ

Y-STOP

UPPER LOWER

DELETE ROW

LIMIT CONFIG

RETURN

Figure 2-26A. Limit Table Complete

REF LEVEL
2.000dB

/DIV
10.000dB

MARKER 10 192 500.000Hz
MAG(UDF) -1.796dB

AUTO SCALE

CENTER 10 187 500.000Hz
AMPTD 0.0dBm

SPAN 100 000.000Hz

Trace 1
REF LEVEL
2.000dB

REF LEVEL

/ DIV

REF POSN

REF LINE ON OFF

COPY SCL 2+1

Figure 2-26B. Upper and Lower Limits Displayed

Limit Test Evaluation

- Now the filter will be tested to the upper and lower limits just created. Press
 [MKR]
 [LIMIT TABLE]
 [LIMIT CONFIG]
 and toggle to
 [EVALUATE **ON** OFF].
 To start the test, press
 [RETURN] twice.

Note the brief message "COMPUTING LIMITS" on the display. Then a "PASS" message should appear in the upper left corner of the display as in figure 2-27.

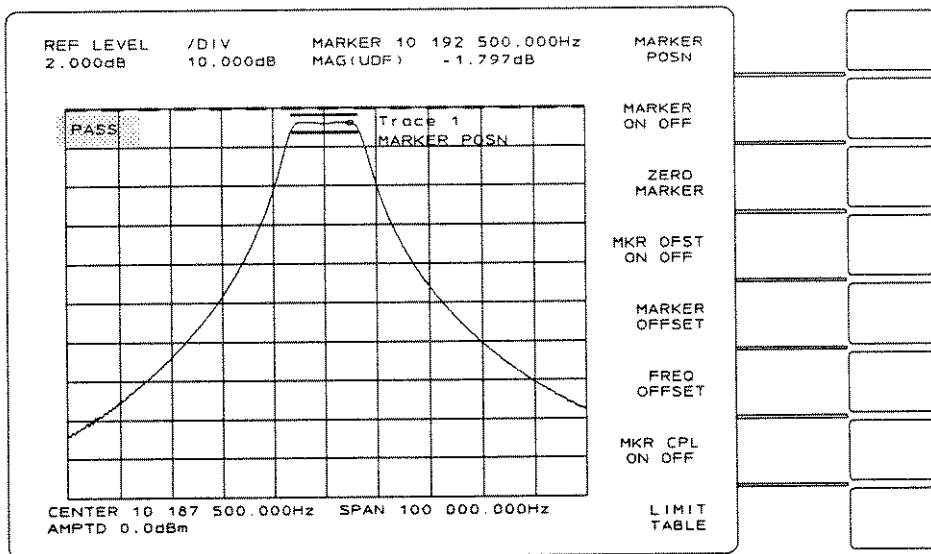

Figure 2-27. Bandpass Filter Passes Limit Test

Making Measurements

- If the filter passed the limits, cause it to artificially fail by pressing

[INPUT]

[A].

As the sweep completes, the analyzer should beep and display the "FAIL 1" message meaning TRACE 1 has failed as shown in figure 2-28. To cause it to pass again, press

[INPUT]

[USER DEF INPUT].

If the message says "FAIL 1" from the start, it means the limit lines have simply been drawn too close to the 3 dB passband of the particular filter being used for the example.

The Limit Table developed in this example now becomes part of the instrument state and is preserved when [INSTR PRESET] is pressed. Do not press [INSTR PRESET] if continuing to the next example. See the LIMIT section in the Reference Chapter for more information on limit testing.

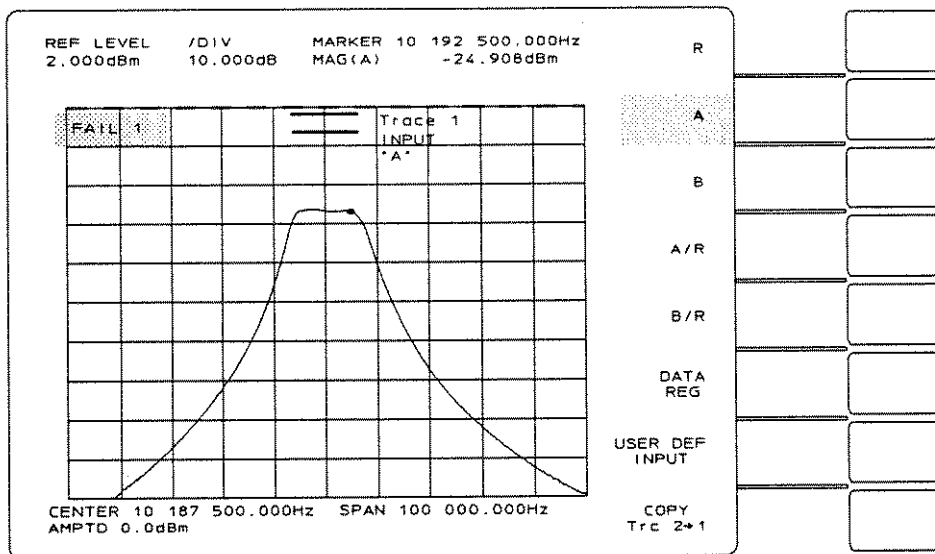

Figure 2-28. Trace 1 Fails Limit Test (Artificially Induced)

Discrete Sweep Measurement

The bandpass filter will be measured at several discrete points defined by the Discrete Sweep table. There are several ways to build a Discrete Sweep table and some of them will be illustrated in this example.

Creating a Discrete Sweep Table

1. Press
[SWEEP TYPE].

2. Press
[DISCRETE SWEEP]
and the [DISCRETE TABLE] key
appears below it. If the table is
clear of entries, the HP 3577B
display should look like figure
2-29.

Note the current sweep type is linear frequency sweep.

If the display looks different, the table probably has entries in it. To clear it, press

- [DISCRETE TABLE]
- [CLEAR TABLE]
- [CLEAR TABLE] (again).

Check the display again by pressing

- [SWEEP TYPE]
- and now the display should look like figure 2-30. The table defaults to two entries, both at 0 Hz.

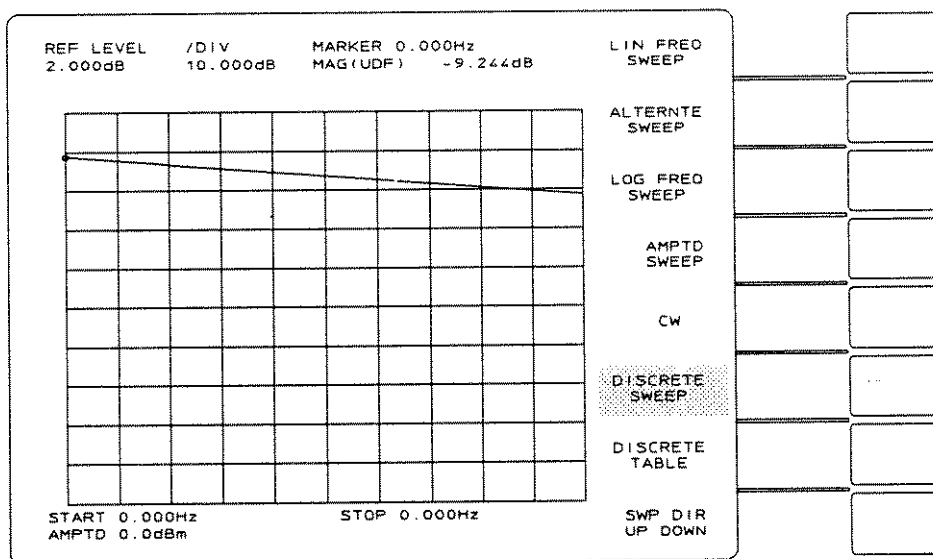

Figure 2-29. Display Resulting From a Clear Discrete Sweep Table

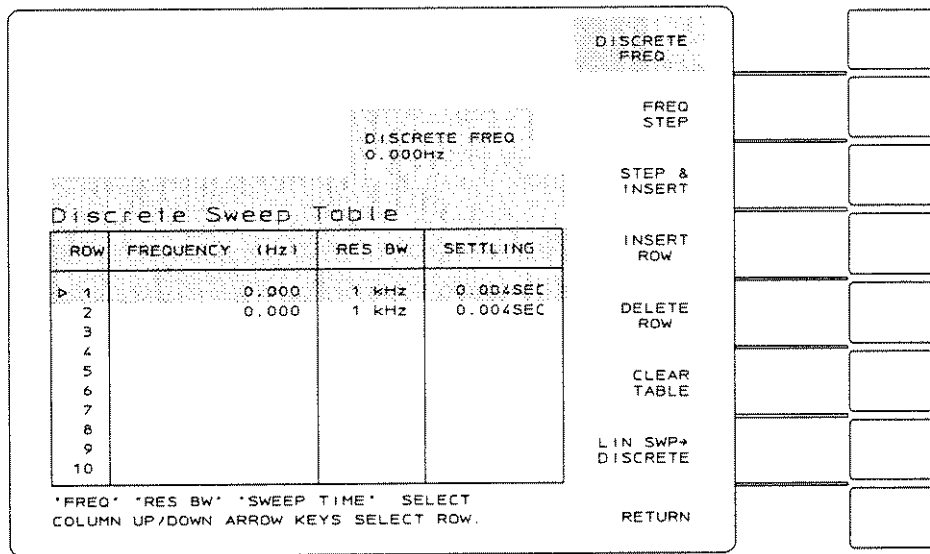
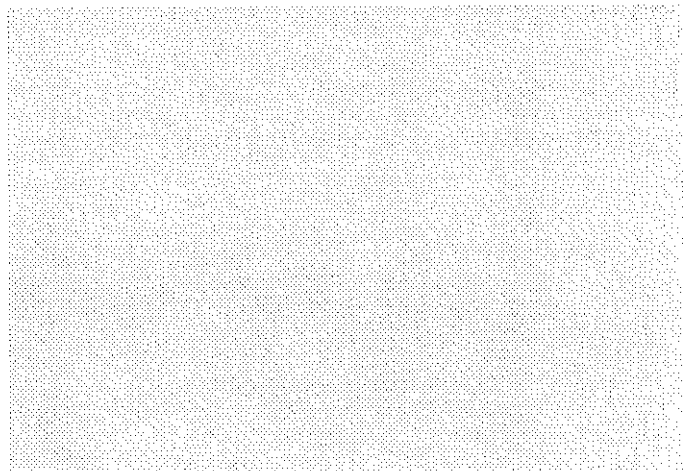

Figure 2-30. A Clear Discrete Sweep Table

- The Discrete Sweep table can be edited in several ways. To get a quick, coarse view of the trace, the [LIN SWP → DISCRETE] feature can be used. It fills the table with equally spaced frequency points between the linear sweep start and stop frequencies. Press [DISCRETE TABLE].



4. Press
 [LIN SWP → DISCRETE]
 and note the submenu that allows
 selection of the total number of
 frequencies or rows desired in the
 table. Press
 [11 POINTS]
 and observe the additional
 frequencies in the table as in
 figure 2-31A.

The RES BW and SETTLING columns are
 automatically selected as 100 Hz and .037 seconds,
 respectively. Narrower [RES BW] and shorter
 [DISCRETE SETTLING] times can also be entered
 manually. See the DISCRETE SWEEP section of
 the REFERENCE chapter for more information.

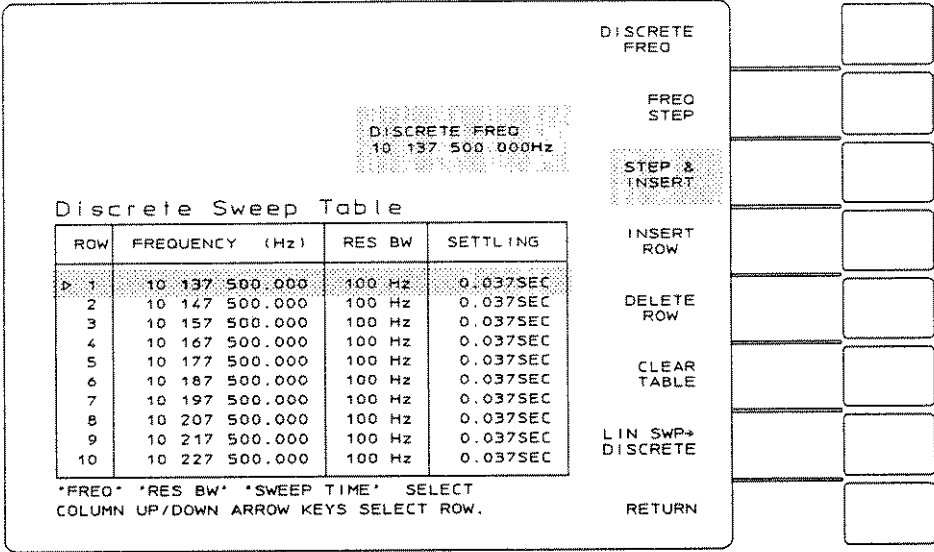

Figure 2-31A. Discrete Sweep Table with Entries
 Generated Using LIN SWP → Discrete

Making Measurements

5. Press [RETURN] and observe the discrete sweep display as shown in figure 2-31B.

Frequencies can also be entered manually by using [DISCRETE FREQ] and entering the desired frequency with the numeric keypad.

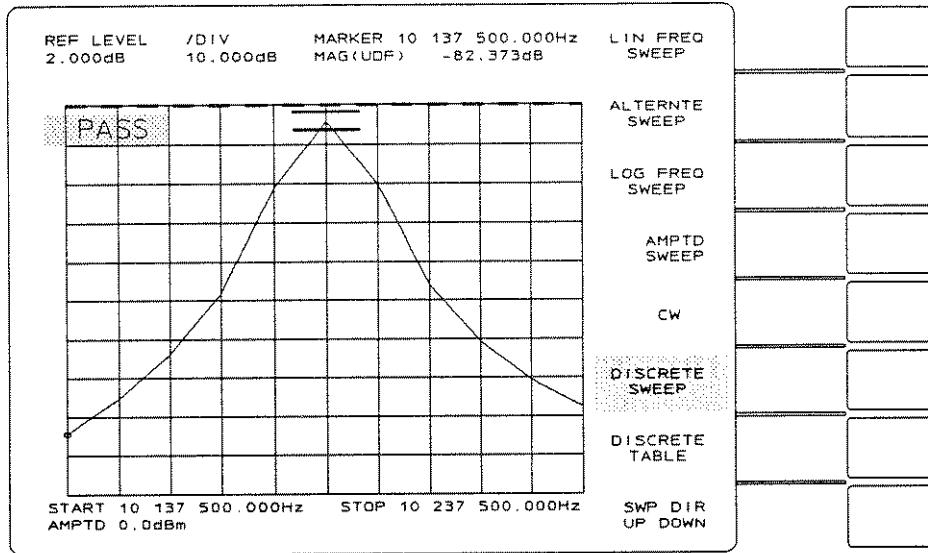

Figure 2-31B. Discrete Sweep Display

6. The next example will show another way to add frequencies that are equally spaced using [STEP & INSERT]. This key is closely tied with the [FREQ STEP] softkey which sets the spacing between new frequencies to be added with [STEP & INSERT].

7. Press
 [DISCRETE TABLE]
 [FREQ STEP]
 and enter
 2
 [kHz]
 using the numeric key pad. Press the
 [↓] key and note the movement of the cursor in the table. Move the cursor to any row.

8. Press
 [STEP & INSERT]
 and note the additional frequency in the table. Press
 [RETURN]
 and check for the additional point on the display as shown in figure 2-32A and 2-32B.

As the cursor is moved to the bottom, the table will scroll. Choose a [FREQ STEP] value that will show a noticeable frequency addition on screen.

Note that the limit lines defined in the previous section are still displayed and the PASS indicator is still valid. The limits are compared to each discrete sweep point only. The straight lines drawn between each point may cross a limit line but the test will not fail unless one of the discrete sweep points is outside the limits.

Making Measurements

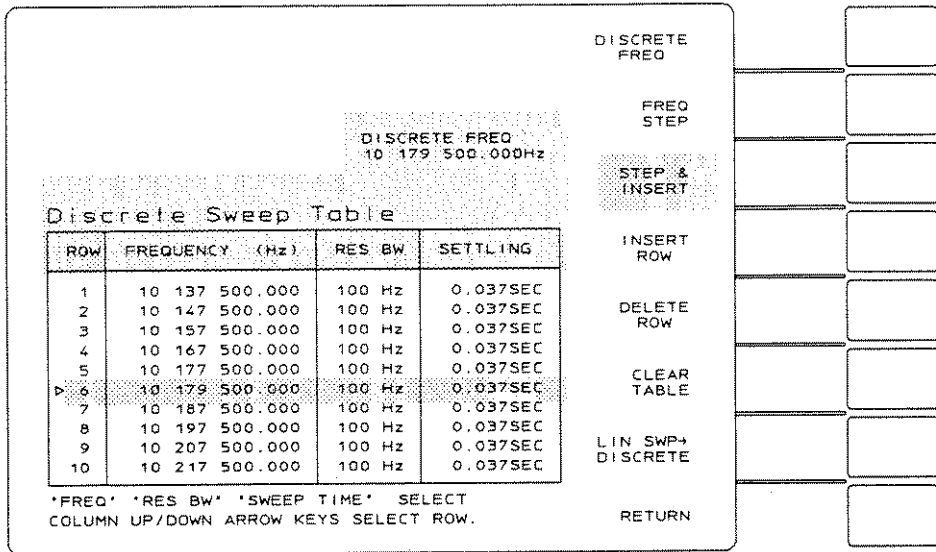

Figure 2-32A. Step & Insert Used to Add Frequency at Cursor

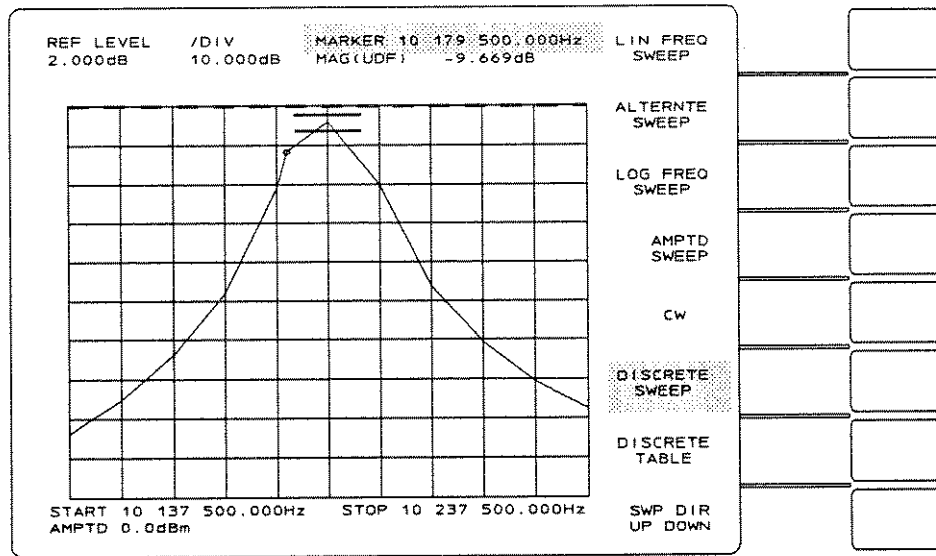

Figure 2-32B. Corresponding Frequency Added on the Display

- The amplifier will be swept with a ramping source amplitude from -40 dBm to 0.0 dBm at 100 MHz. Press
[INSTR PRESET]
[SWEEP TYPE]
[AMPTD SWEEP].

Note the alphanumeric information under the graticule.

Note



This feature will time out (change to **[SINGLE]** in the **[SWEEP MODE]** menu) after five minutes of continuous sweeping to extend the life of the switching relays in the output of the HP 3577B. Single sweeps may be triggered with the **[TRIG/RESET]** hardkey or **[CONT]** sweep may be selected for another five minutes.

- The plot shown in figure 2-34 is output level versus input level. To display gain compression (input versus gain), the trace must be normalized.

Note that gain compression causes the trace to level out. Normalization stores a measurement taken with a BNC barrel in place of the amplifier and then redefines the **[INPUT]** to be the old input definition divided by the stored trace. The trace is then displayed as gain versus input.

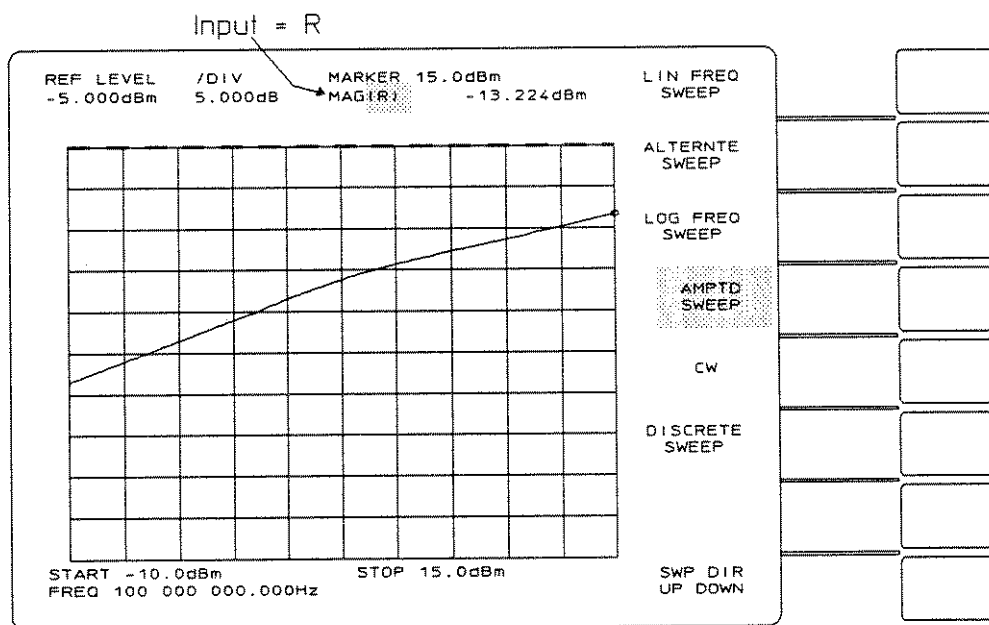

Figure 2-34. Amplitude Sweep of an Amplifier

Making Measurements
Amplifier

3. To normalize, press
[MEASR CAL]
in the DISPLAY FORMAT
section. Replace the amplifier
with a BNC barrel, and wait for a
full sweep.

4. Press
[NORMLIZE]
and replace the BNC barrel with
the amplifier.

5. Press
[SCALE]
[AUTO SCALE].

6. Press
[MKR →]
[MKR → MAX]
to move the marker to the point
on the trace with the largest gain
value. Now an offset marker will
be used to find the 3 db
compression point. Press
[MKR]
[ZERO MARKER]
[MKR →]
[MORE].

7. Press
[MKR → R TARG].

The gain is constant where the trace is level and is in compression where the trace rolls off. Now the marker will be used to measure the 3 dB compression point.

Note that the marker target value is -3 dB.

The marker information block now contains the span over which the amplifier has a gain compression of < 3 dB. See figure 2-35.

Compression Range
UDF = R/D1

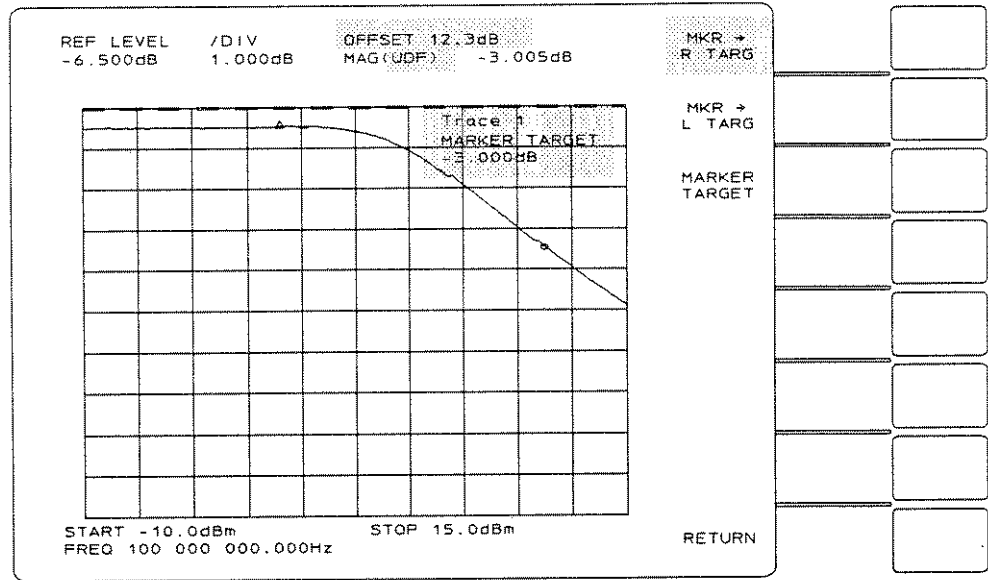

Figure 2-35. Gain Compression of an Amplifier

Making Measurements
Amplifier

8. To display the 3 dB compression point in absolute terms, press [MKR] and toggle to [MKR OFST ON OFF].

The marker information block will change from OFFSET to MARKER information. The MARKER magnitude is the input level at which the amplifier has a gain compression of 3 dB. See figure 2-36.

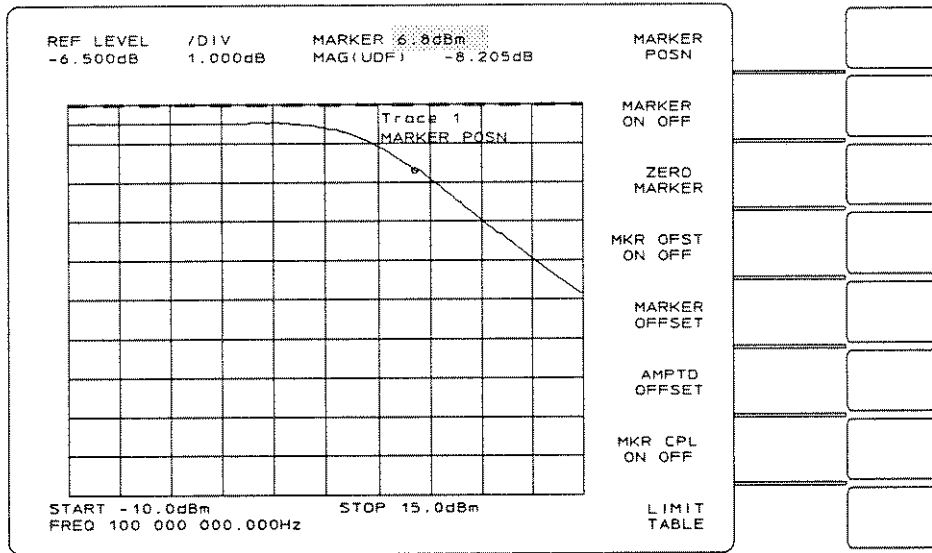

Figure 2-36. 3 dB Compression Level

This test may be run again at other frequencies for more thorough testing of the amplifier.

Low Pass Filter

Note



This section assumes use of the HP 3577B Option 002 Three-Channel Network Analyzer. This option is recommended for use with the HP 35677A/B S-Parameter Test Set.

Connect the HP 35677A/B S-Parameter Test Set to the HP 3577B Network Analyzer and connect the low pass filter to be tested to the HP 35677A/B as shown in figure 2-37. The low pass filter used in this example has a -3 dB frequency of 50 MHz, but the methods used to measure its characteristics are the same for any low pass filter.

The HP 35677A/B is a convenient accessory for making ratio measurements of transmission and reflection scattering parameters. The test set has two configurations: FORWARD and REVERSE, indicated by two LEDs on the upper left corner of the front panel. This configuration is controlled through the HP 3577B Network Analyzer by defining the INPUT. Figure 2-38 shows the test set block diagram for each of the two configurations.

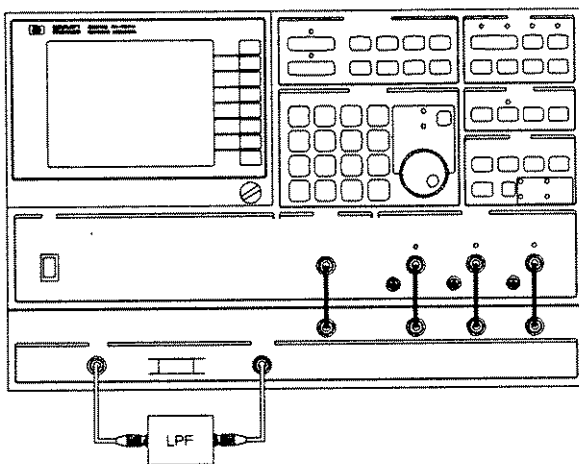

Front Panel Connections (4)

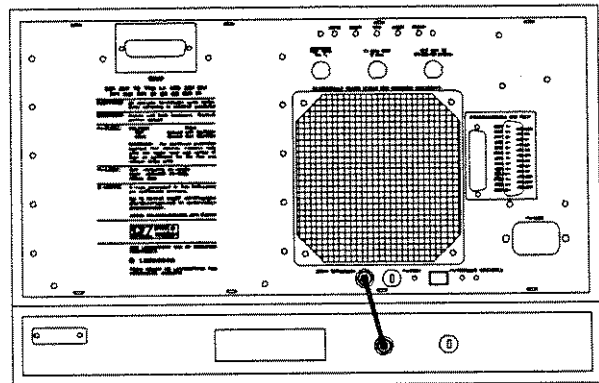

Rear Panel Connections (1)

Figure 2-37. HP 35677A/B Connections

Making Measurements
Low Pass Filter

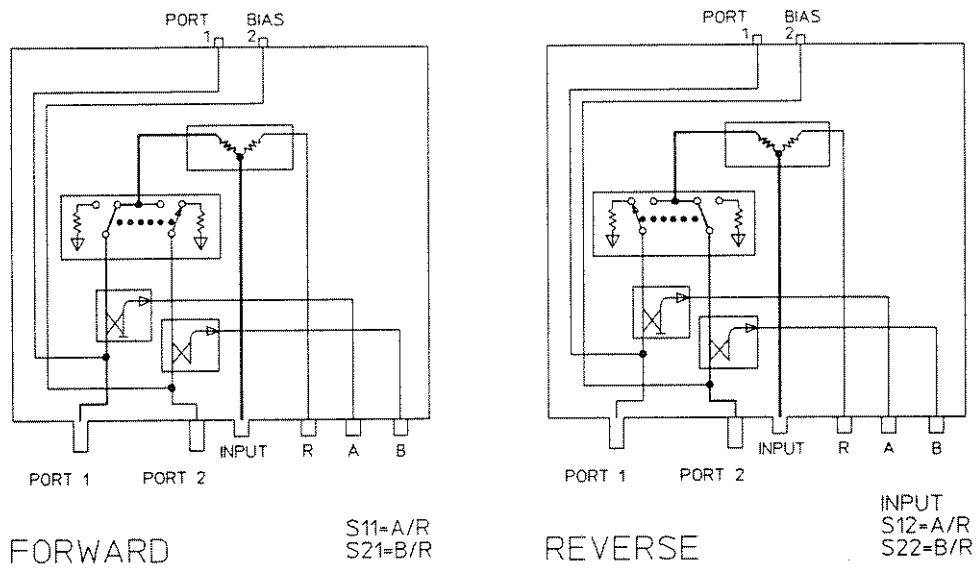

Figure 2-38. HP 35677A/B Configuration

The purpose of this measurement exercise is to demonstrate the use of the HP 35677A/B S-Parameter Test Set and the HP 3577B Network Analyzer to characterize a low pass filter. The test is organized as follows:

1. Set up the measurement
2. Measure the insertion loss
3. Measure the insertion phase
4. Measure the passband ripple
5. Measure the stop band rejection

Measurement Set-up

1. Press
[INSTR PRESET].

With the HP 35677A/B S-Parameter Test Set connected to the HP 3577B Option 002 via the rear panel cable, INSTR PRESET parameters differ as follows:

START FREQ	100 kHz
SOURCE AMPLITUDE	+15 dBm
INPUT (both traces)	S21 (same as B/R)
LENGTH R	1.300 meters

[INSTR PRESET] always displays the [INPUT] menu. Note that S₂₁ is bright in the menu. This indicates that it is the active INPUT definition of the selected trace. Also note the entry block showing that the input is B/R. This indicates that S₂₁ is the same as B/R with the test set in the FORWARD configuration. See figure 2-39.

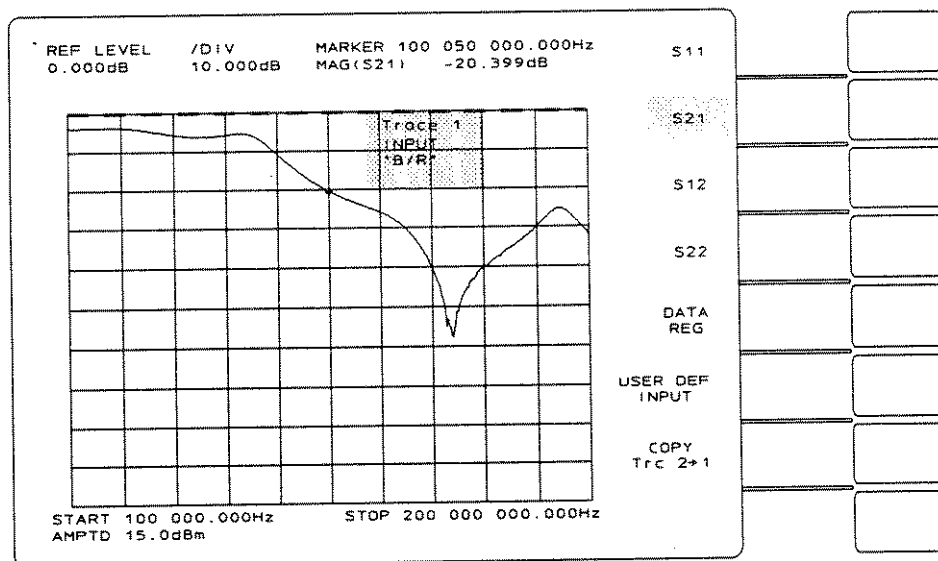

Figure 2-39. S-Parameter Input Menu

2. The low pass filter will be displayed using logarithmic frequency sweep. Press
[SWEEP TYPE]
[LOG FREQ SWEEP].

Note that the screen includes frequency annotation shown across the bottom of the graticule. See figure 2-40.

Making Measurements
Low Pass Filter

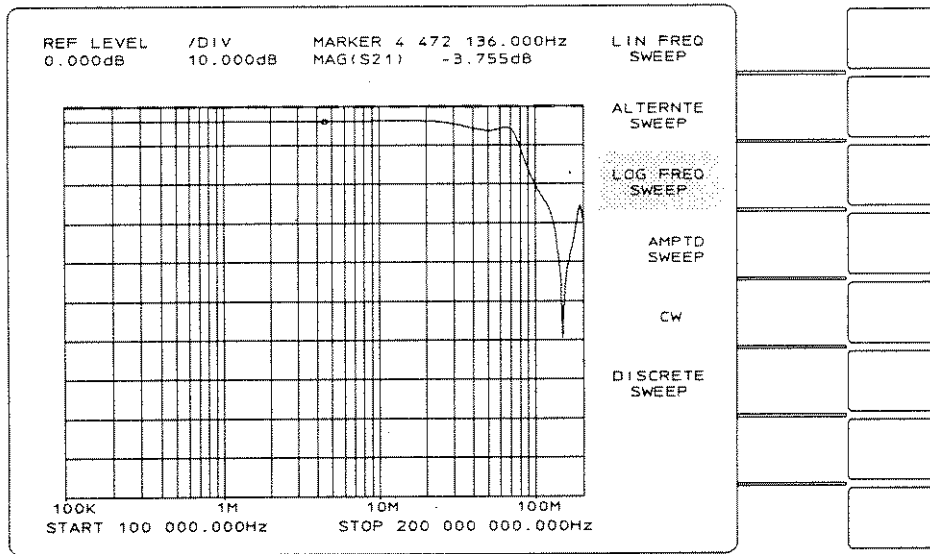

Figure 2-40. Log Frequency Sweep Type

Note



If the [FREQ] or [AMPTD] parameters are not giving a proper display, change them now so the display looks similar to figure 2-31. Only two data entry parameters exist in the [FREQ] menu when the [SWEEP TYPE] is [LOG FREQ]: [START FREQ] and [STOP FREQ]. (FULL SWEEP is an immediate execution command instead of a data entry command).

3. The trace will now be normalized. Press **[MEASR CAL]** and replace the device under test with a BNC “barrel” (BNC(f) to BNC(f) adapter). Wait until the next sweep is complete before executing the next step.
4. Press **[NORMLIZE]**.

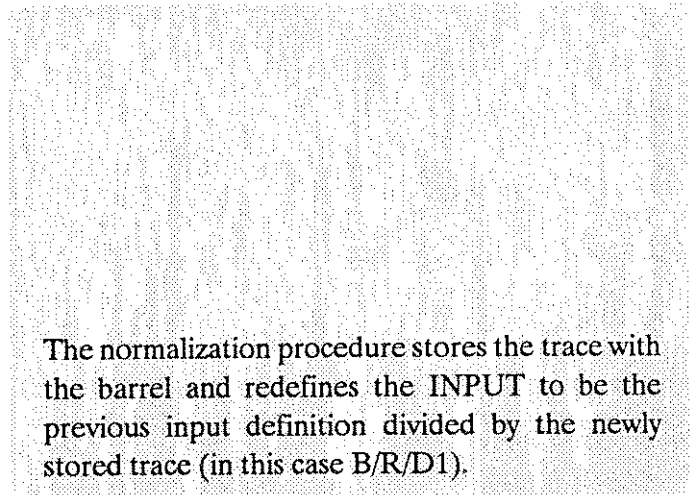

The normalization procedure stores the trace with the barrel and redefines the INPUT to be the previous input definition divided by the newly stored trace (in this case B/R/D1).

Insertion Loss

1. Replace the BNC barrel with the filter to be tested.
2. Move the marker to any part of the trace with the knob (must be in MARKER mode) to measure insertion loss. See figure 2-41.

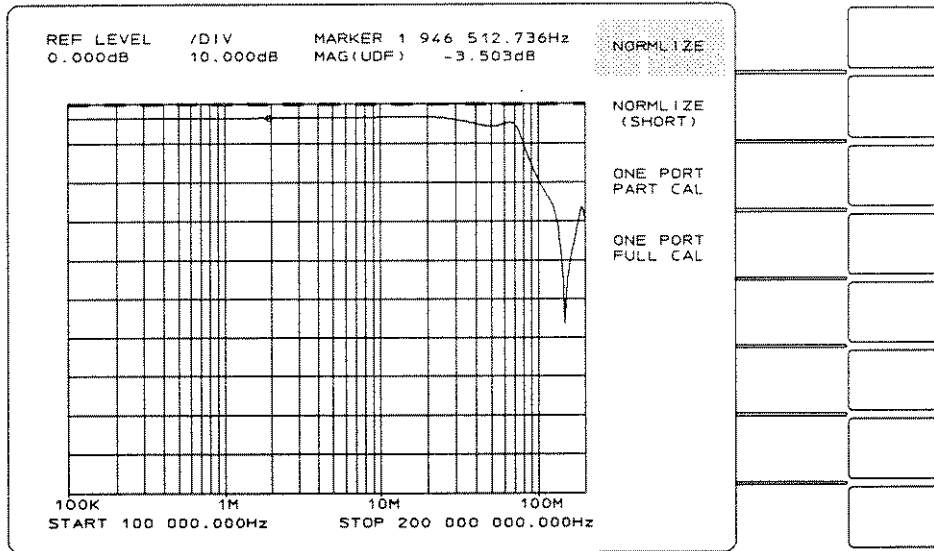
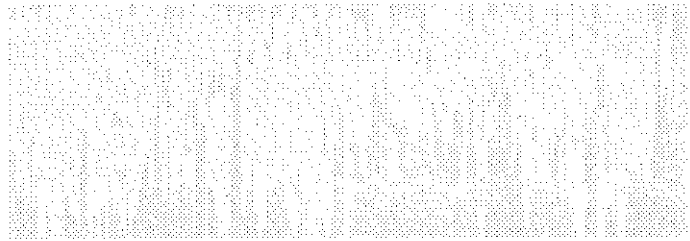

Figure 2-41. Measurement Calibration Menu

Insertion Phase

1. The insertion phase will now be measured using trace two. Press
[**DSPLY FCTN**]
[**TRACE 2**]
[**PHASE**].

Then press
[**INPUT**]
[**COPY Trc 1 → 2**]

2. Press
[**SCALE**].
3. The knob will now be used to redefine the value of REF LEVEL. Press the unlabeled key above the knob. This key press should put the knob in ENTRY mode, so that it may be used to modify the value of the active data entry softkey in the menu. Turn the knob counterclockwise.

Note that the trace appears immediately. No new data needs to be collected (no sweep is required) for trace two to be displayed as PHASE. Each vertical part of the phase trace represents a jump of 360° from -180° to $+180^\circ$. This is called phase wrap.

Note that REF LEVEL is bright in the menu. Reference level is the measured signal level represented by the dashed line. For PHASE, this line appears at midscreen. (It may be moved up or down by changing the value of REF POSN).

As the trace moves toward the top of the graticule, note the changing value of REF LEVEL in the entry block and above the upper left corner of the graticule.

Making Measurements
Low Pass Filter

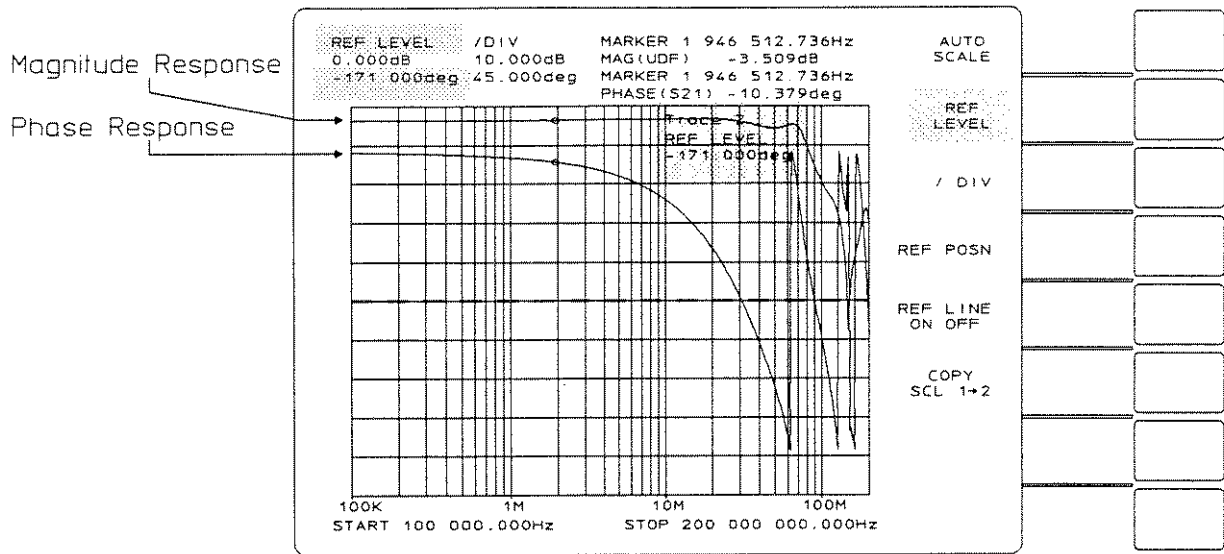

Figure 2-42. Low Pass Filter Log Magnitude and Phase Response

7. To clear the screen of the entry block and menu, press [**ENTRY OFF**] in the DATA ENTRY section.
8. The marker may be used to measure the passband ripple. Make sure the knob is in MARKER mode (see the LEDs above the knob).

This key may be used to disable data entry so that unintentional rotation of the knob (in ENTRY mode) does not modify a parameter.

Note that the [**↑**] and [**↓**] arrow keys may also be used to move the marker after pressing [**MKR**] and [**MARKER POSN**].

Stopband Rejection

1. The frequency span will now be widened so that the filter's stopband can be viewed beyond the 3 dB point. Press

[**FREQ**]
[**STOP FREQ**]
2 0 0
[**MHZ**].

2. The start frequency will now be changed to the -3 dB point. Press

[**MKR →**]
[**MORE**]
[**MKR → L TARG**].

This moves the marker left to the -3 dB point.

3. Press

[**RETURN**]
[**MKR → START**].

4. Press

[**SCALE**]
[**AUTO SCALE**].

Now the marker will be used to measure the maximum rejection of the filter. Press

[**MKR →**]
[**MKR → MIN**]

and the marker information block shows the desired measurement.

The display should look like figure 2-44.

This moves the start frequency to the present marker position (frequency). Note that the frequency scale changed from log to linear. This occurs any time **STOP FREQ** divided by **START FREQ** is ≤ 4 .

Rejection may be measured at any point by moving the marker to the point of interest and reading the value in the marker information block.

Passband Ripple

1. Returning to trace one, press
[**DSPLY FCTN**]
[**OFF**]
to turn off trace two. Then press
[**TRACE 1**].
2. Now a frequency span will be set
(using marker features) that
shows only the 3 dB passband of
the filter. Press
[**MKR**]
and move the marker to the left
edge of the screen. Press
[**MKR →**]
[**MORE**].
3. Press
[**MKR → R TARG**].
4. Press
[**RETURN**]
[**MKR → STOP**]
and the stop frequency is set to
the current marker position
(frequency).
5. To change the input definition
back to B/R, press
[**INPUT**]
[**S21**].

Note that [**MARKER TARGET**] is active and that its default value (shown in the **ENTRY BLOCK**) is -3 dB.

Note the new value of magnitude for the marker. If no such value had been found the marker would not have moved and the screen message "TARGET VALUE NOT FOUND" would appear.

Note that the graticule is redrawn and that the frequency annotation changes to match the new sweep. Also, note that this change in frequency requires renormalization or changing the [**INPUT**] definition back to B/R.

This step changes the [**INPUT**] definition from B/R/D1 to B/R. Since the frequency span has been changed, D1 should not be used in the definition until the measurement is re-normalized.

Making Measurements
Low Pass Filter

6. Press
[SCALE]
[AUTO SCALE]
and note the change in the /DIV
value in the upper left-hand
corner of the screen. See figure
2-43.

The trace displayed is the 3 dB passband of the low pass filter.

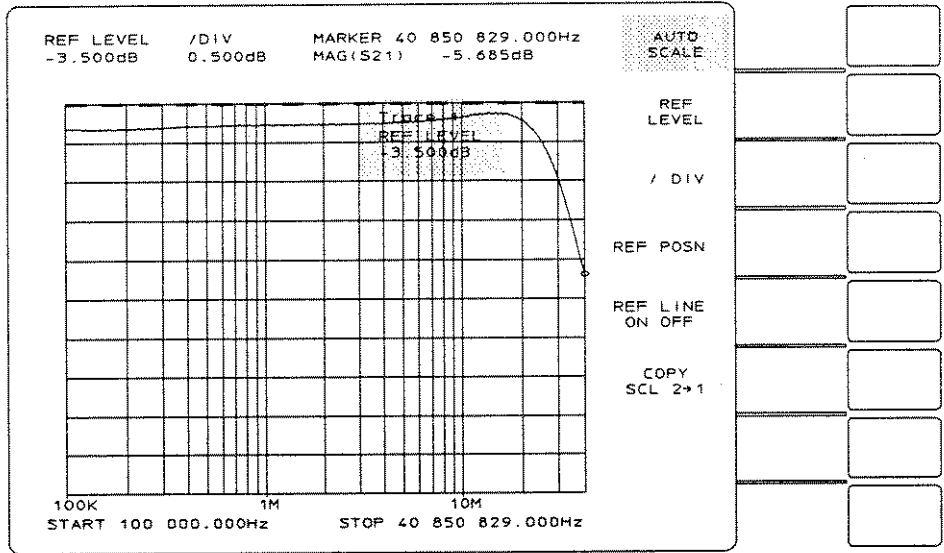

Figure 2-43. Low Pass Filter Pass Band Ripple

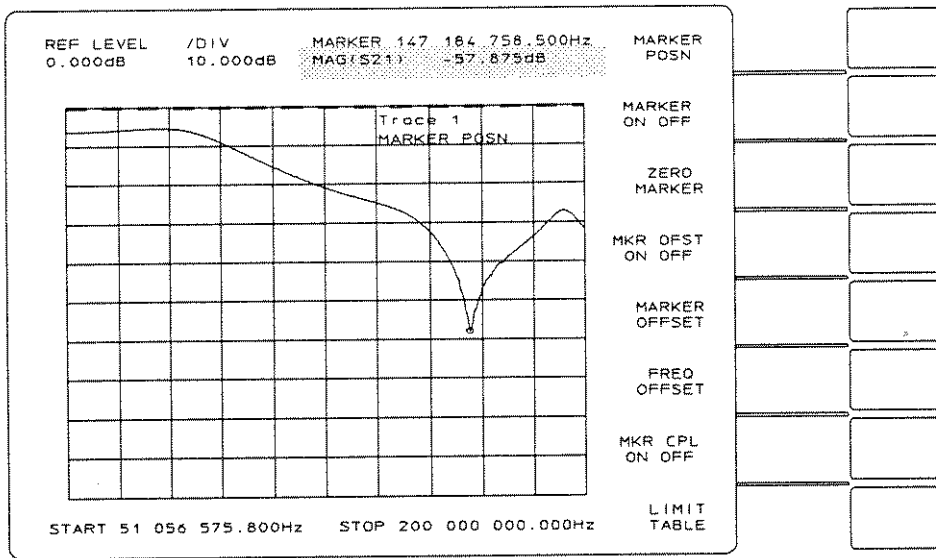

Figure 2-44. Low Pass Filter Stop Band Rejection

Amplifier S-Parameters

Note



This section assumes use of the HP 3577B Option 002 (Adds third receiver B). This is the recommended option for use with the HP 35677A/B.

Connect the amplifier to the HP 35677A/B as shown in figure 2-45. Fifteen volt power is supplied by an external power supply. The amplifier used in this example has a gain rating of +25 dB from 50 MHz to 180 MHz. A 10 dB attenuator is used at the amplifier output to avoid overloading the receiver input. The methods used here may be used to test amplifiers with different specifications.

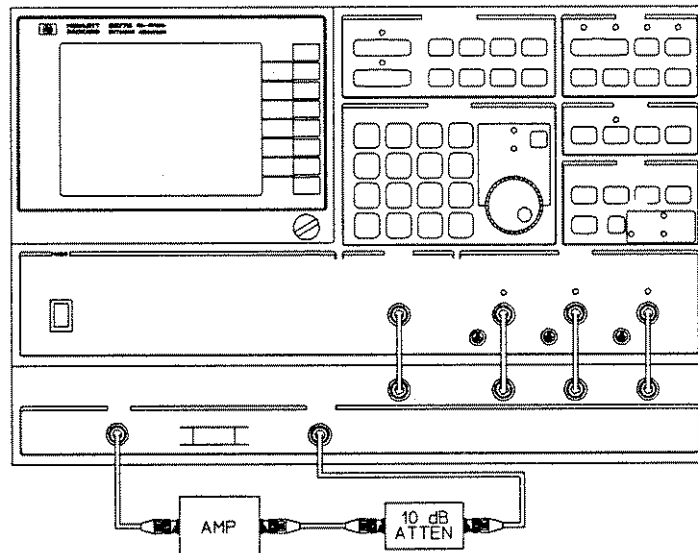

Figure 2-45.

The purpose of this measurement exercise is to demonstrate the use of the HP 3577B Option 002 Three-Channel Network Analyzer and the HP 35677A/B S-Parameter Test Set to characterize the scattering parameters of an RF amplifier. The exercise is organized as follows:

1. Initial measurement set up
2. Measure S_{21} , forward gain and phase
3. Measure S_{12} , reverse loss
4. Measure S_{11} , input return loss and standing wave ratio (SWR)
5. Measure S_{22} , output reflection coefficient
6. Conversion of reflection coefficient to complex impedance

Measurement Setup

1. Press
[INSTR PRESET].

Note that the default INPUT definition is S₂₁ (B/R & test set FORWARD) when the HP 35677A/B S-Parameter Test Set is connected to the HP 3577B Network Analyzer.

Note



If the amplifier was on when [INSTR PRESET] was pressed, one or more of the receiver inputs may have tripped or been overloaded. A receiver “trip” occurs when the receiver input switches to 1M Ω to protect itself from high input signal levels. This switch occurs for signals $\geq 1.1 V_{pk}$. The screen message:

INPUT_TRIPPED

Clear trip on [ATTEN] menu.

appears, lists the input(s) tripped and directs the user to change [ATTEN] to clear the condition. Note that the impedance softkeys in the [ATTEN] menu will not reflect the tripped condition. [CLEAR TRIP] will be used after the value of [AMPTD] is changed.

2. Press
[FREQ]
and note that [START FREQ] is
selected (ready for data entry).
Press
5 0
[MHz]
using the numeric keypad. Press
[AMPTD]
0
[dBm].

3. The trip on the receiver input
can now be cleared. Press
[ATTEN]
[CLEAR TRIP].



4. Next, the measurement will be normalized. Press
[MEAS CAL]
and replace the amplifier with a BNC barrel and wait for one complete sweep.

5. Press
[NORMLIZE].

6. Replace the BNC barrel with the amplifier.

7. Now the display scale will be modified to best show magnitude data for the amplifier. Press
[SCALE]
[REF POSN]
8 0
[%]
using the numeric keypad.

8. Press
[REF LEVEL]
1 5
[dB].

9. Change the graticule scale by pressing
[DIV]
5
[dB].

This stores a trace in data register D1 and redefines the [INPUT] to be the old definition divided by the stored trace. If trace two had been active, the store would have been to D2. If [INPUT] is pressed, the new INPUT definition, B/R/D1, can be seen in the entry block. Also note that the marker block has changed from MAG(S₂₁) to MAG(UDF), where UDF is the abbreviation for "user defined function."

Note that the dashed line moved from the top of the graticule down to the eighth division from the bottom.

Now trace one is completely set up.

Making Measurements
Amplifier S-Parameters

10. Trace two will be turned on and set up to display phase information. Press

[DSPLY FCTN]
[TRACE 2]
[PHASE].

11. Copy the input definition of trace one to trace 2 by pressing

[INPUT]
[COPY Trc 1 → 2].

12. Press

[SCALE]
[AUTO SCALE].

The display should look like figure 2-46.

Note that the ENTRY BLOCK shows trace two INPUT to be B/R/D1. This equation was created when trace one was normalized. Copying the INPUT definition also normalizes trace two.

A forward gain and phase measurement is next.

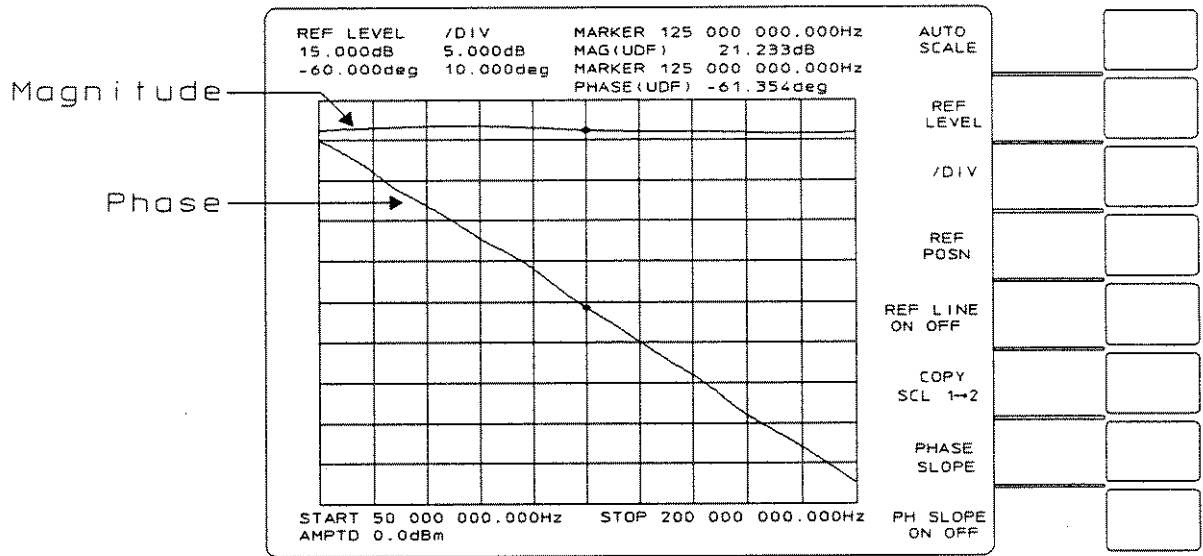

Figure 2-46. RF Amplifier Magnitude and Phase of S21

S21, Forward Gain And Phase

1. The display as shown in Figure 2-37 is the forward gain and phase of the amplifier under test. The markers will be used to measure the amplifier ripple using the offset markers.
2. First, the marker for trace one will be de-coupled from trace two. Press
[MKR]
and toggle to
[MKR CPL ON OFF].
3. Press
[TRACE 1]
[MKR →]
[MKR → MIN]
to move the marker to the point on the active trace with the lowest value.
4. Now the maximum point will be found relative to this minimum point. Press
[MKR]
[ZERO MARKER].
This initializes the offset marker at the position of the regular marker.
5. Press
[MKR →]
[MKR → MAX]
to move the marker to the point of maximum value on the active trace. The marker OFFSET represents the total amplifier ripple. See figure 2-47.

Turning the knob with marker coupling off will move only the marker on the active trace.

Note that the information in the marker block for trace one has changed from MARKER to OFFSET.

Making Measurements
 Amplifier S-Parameters

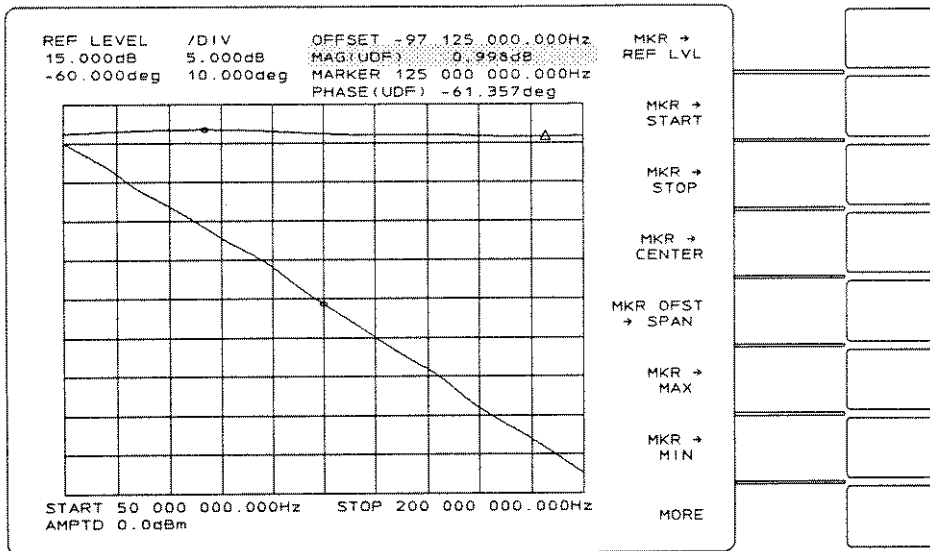

Figure 2-47. Measuring Amplifier Ripple

S₁₂ Reverse Loss

- To set up the HP 35677A/B for a reverse measurement, press

[INPUT]
[S12].

This causes the test set to change to the REVERSE configuration. See figure 2-48.

The screen message:

INCOMP. TESTSET POSITIONS
Trc2 chgd to agree with #1

will appear. This message (incomplete test set positions; trace two changed to agree with number one) is caused by the change of INPUT for trace one. The old trace two INPUT definition had the test set configured FORWARD. Since the test set can't be configured both ways at the same time, the HP 3577B Option 002 has changed the HP 35677A/B configuration to REVERSE and displayed a screen message to let the user know that the trace two INPUT definition has changed.

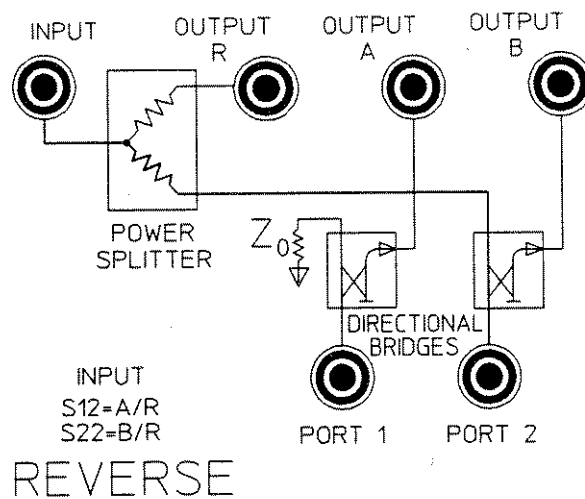

Figure 2-48. S-Parameter Test Set Reverse Configuration

Making Measurements
Amplifier S-Parameters

2. Now the measurement will be normalized and the display will be set up to show reverse loss and phase. Press
[**MKR**]
and toggle to
[**MKR OFST ON OFF**].
Press
[**MEAS CAL**]
and replace the amplifier with a BNC barrel.
3. Press
[**NORMLIZE**]
and wait for a full sweep.
Replace the BNC barrel with the amplifier.
4. Press
[**SCALE**]
[**AUTO SCALE**].
5. Next, trace two will be set up to display phase. Press
[**TRACE 2**]
to make trace two active. Press
[**INPUT**]
[**COPY Trc 1 → 2**].
6. Press
[**SCALE**]
[**AUTO SCALE**].

Trace one is set up for the magnitude display of reverse loss.

Note that the INPUT definition in the entry block has changed from B/R/D1 to A/R/D1. This normalizes trace two.

Both traces are ready to make measurements with the markers.

7. To make the markers for both traces move at the same frequency as the knob is turned, press **[MKR]** and toggle to **[MKR CPL ON OFF]**.

Use the markers to measure reverse loss and reverse phase angle. See figure 2-49.

8. Press **[TRACE 1]** to make it the active trace.

Notice the alphanumeric information above the screen of the active trace appears brighter on the screen than the other trace. This helps keep track of which data applies to which trace.

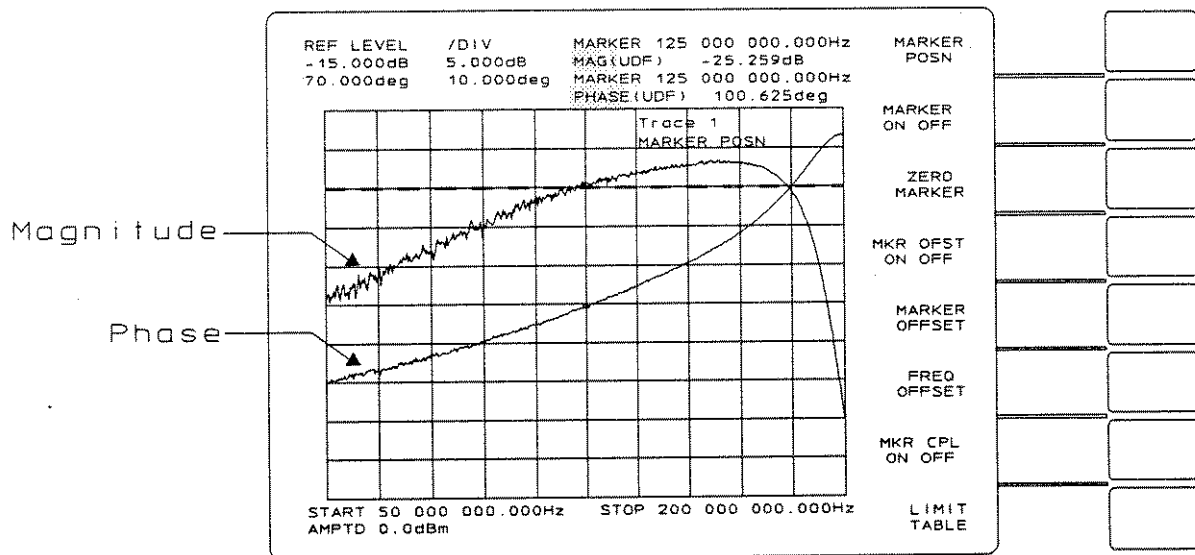

Figure 2-49. Normalized Reverse Loss and Phase

S₁₁, Input Return Loss

Next, input reflection will be examined. This is possible through the use of the directional bridges of the HP 35677A/B S-Parameter Test Set. In this example, full one-port calibration using three term error correction is employed for maximum measurement accuracy.

1. Press
 [INPUT]
 [S11].
 Then press
 [MEAS CAL]
 [ONE PORT FULL CAL].

Note the screen message LEAVE PORT 1 OPEN.
 See figure 2-50.

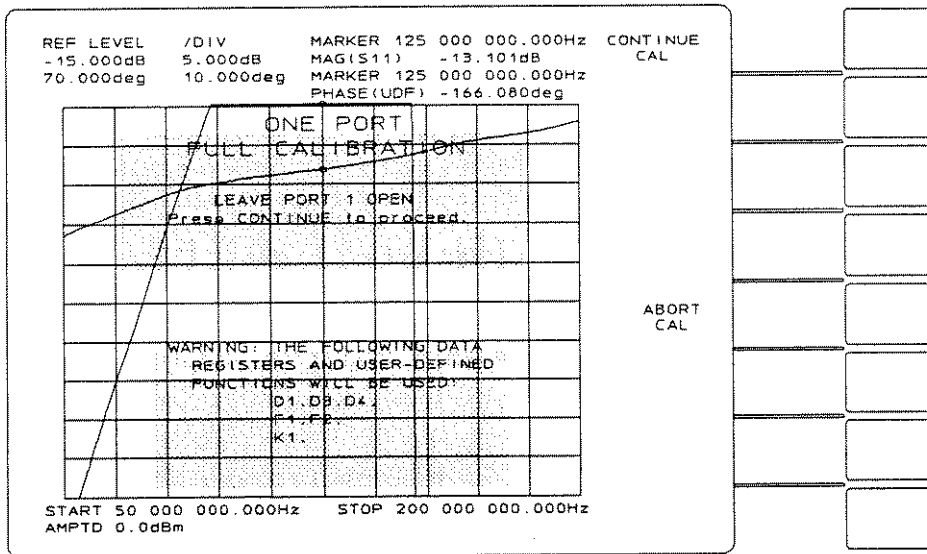

Figure 2-50. Screen Messages for One Port Full Calibration

2. Disconnect the device under test from its input cable. Then press [CONTINUE CAL].

After a sweep, note the screen message INSTALL SHORT ON PORT 1. Install a shorted termination on the input cable where the device under test has been connected. Press [CONTINUE CAL]

3. Replace the short termination with a reference load and press [CONTINUE CAL].

4. Connect the cable back to the input of the device and press [SCALE] [AUTO SCALE].

5. Now trace two will be set up to display return loss phase. Press [TRACE 2] [INPUT] [COPY Trc 1 → 2] [SCALE] [AUTO SCALE].

6. The maximum return loss (or best impedance match) can be measured on trace 1 by finding the minimum magnitude. Press [TRACE 1] [MKR →] [MKR → MIN].

After a complete sweep and some calculation time, note the screen message INSTALL REFERENCE LOAD ON PORT 1.

After a complete sweep and some more calculation time, note the screen message CALIBRATION COMPLETE INPUT= "F2": CALIBRATED REFLECTION This message means that the INPUT definition has been changed to the user defined function F2. See MEASUREMENT CALIBRATION in the REFERENCE section for more details.

Input return loss magnitude (trace one) and phase (trace two) is shown in figure 2-51. Measurements may be made with the markers by turning the knob to move them along the trace. Marker data appears in the marker information block above the graticule.

Making Measurements
 Amplifier S-Parameters

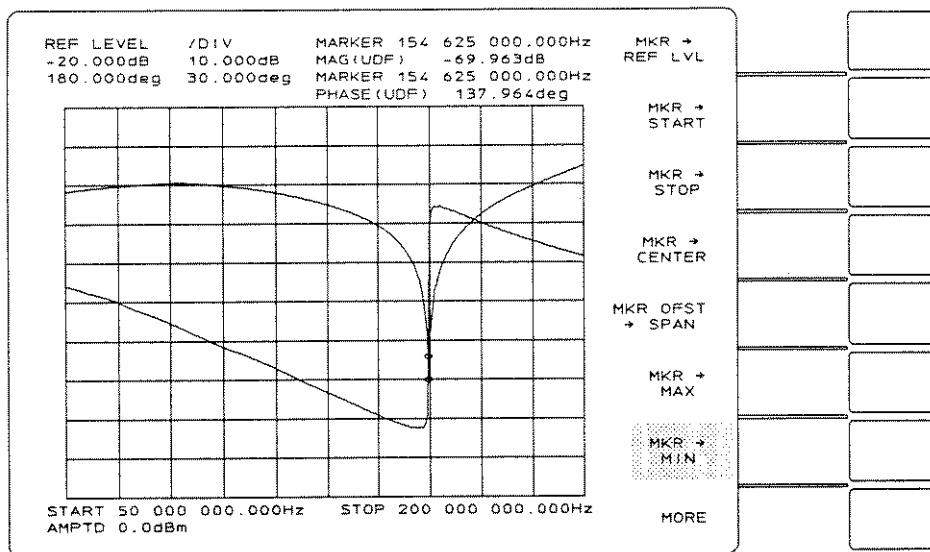

Figure 2-51. Calibrated Input Return Loss and Phase Response

Standing Wave Ratio

1. The return loss can be viewed in another form using [SWR]. Press [DSPLY FCTN] [SWR].

Notice the change in trace one. The reference level (dashed line) moved to the bottom graticule line. This line represents a SWR of 1 (or the best impedance match). SWR units range from 1 to 11. See figure 2-52.

In this case, SWR would be $(1 + |S_{11}|)/(1 - |S_{11}|)$ where $|S_{11}|$ is the magnitude of S_{11} .

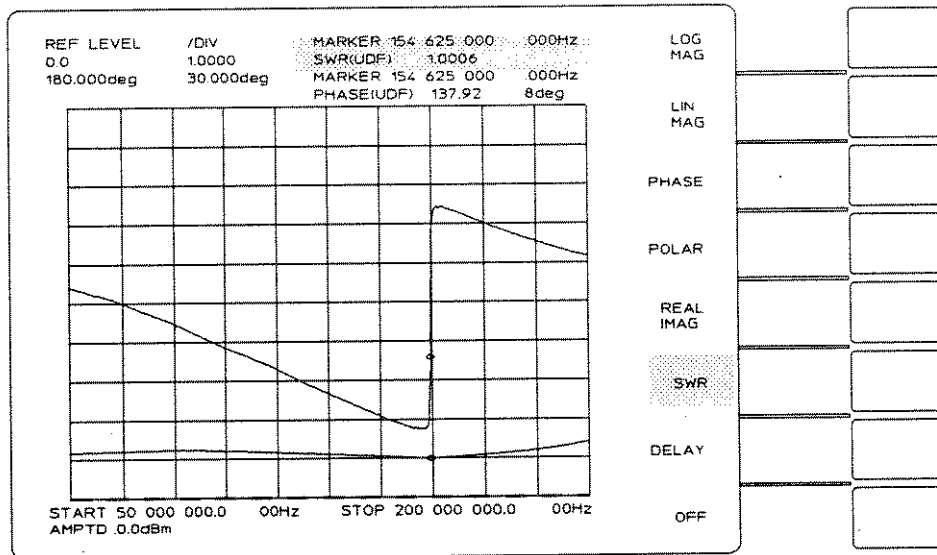

Figure 2-52. SWR Display

S22, Output Reflection Coefficient

1. Next, the output reflection coefficient will be measured using the HP 35677A/B in the REVERSE configuration.

2. Press
[INPUT]
[S22].

3. Press
[MEAS CAL]
and disconnect the cable from the amplifier output and leave the end of the cable open. Press
[NORMLIZE].

4. Reconnect the output of the amplifier to the PORT 2 cable. Press
[DSPLY FCTN]
[POLAR].

5. The display shows the reflection coefficient of the amplifier output from 50 MHz to 200 MHz.

This selects B/R as the input with the test set in the REVERSE configuration.

This feature may be used with an "open" termination for reflection measurements as well as with a BNC barrel for transmission measurements.

Note that only one trace may be on when using the POLAR display function. Trace two is turned off when POLAR is selected for trace one. See figure 2-53.

Note that the marker magnitude units are in linear units. The marker may be moved as described previously to make measurements on the trace.

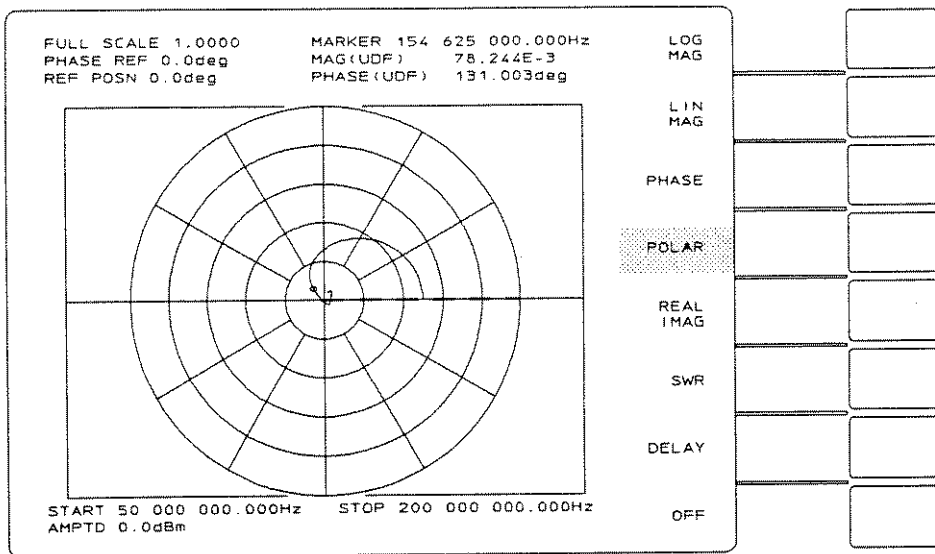

Figure 2-53. Polar Display Function of Normalized RF Amplifier Output Reflection

Complex Output Impedance

Next, the reflection coefficient will be converted to complex impedance using the Smith chart graticule. The marker units will also be changed from magnitude and phase to real and imaginary.

1. Press
[**SCALE**]
and toggle to
[SMITH CH **ON** OFF].

This softkey appears in the [**SCALE**] menu when the display function is [**POLAR**]. It toggles the Smith chart on and off. Note that the marker units change from **MAG** and **PHASE** to **Z MAG** and **Z PHASE**, or impedance magnitude and phase. This may be changed to read directly in real and imaginary units as shown next.

2. Press
[**MKR**]
and toggle to
[MARKER M,P **R,I**].

This softkey appears in the marker menu when the display function is **POLAR**. It toggles the marker units between **Magnitude & Phase** and **Real & Imaginary** units. Note the correspondence between the Smith chart graticule and the marker units. See figure 2-54.

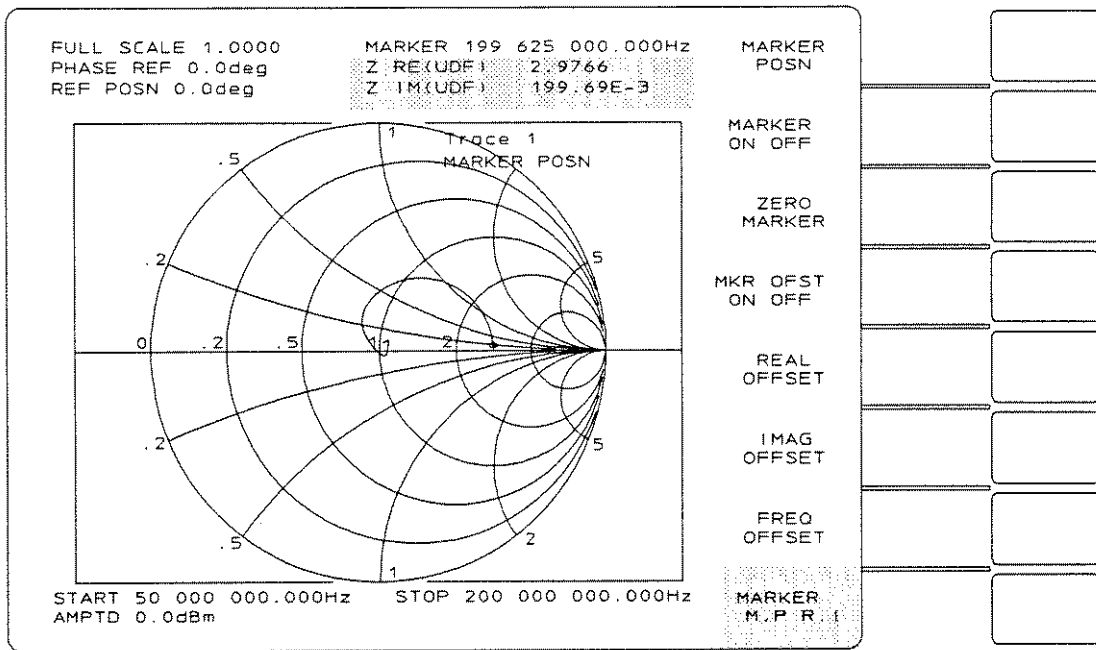

Figure 2-54. The Smith Chart

Note



The Smith chart graticule has a FULL SCALE value of 1.000 units. A warning message appears on screen if a different scale value is used saying that the graticule is not accurate. However, the marker information block remains accurate.

Remote Operation

The Hewlett-Packard Interface Bus

What Is The HP-IB?

The Hewlett-Packard Interface Bus (HP-IB) is an easy to use, high-performance bus structure that links the HP 3577B and other instruments, desktop computers, and minicomputers into automated measurement systems. The HP-IB is Hewlett-Packard's implementation of the IEEE Standard 488.1, ANSII Standard MC 1.1 and IEC Recommendation 625-1.

How Does The HP-IB Operate?

All of the active interface circuits are contained within the various HP-IB devices. The cable's role is limited to connecting all of the devices in parallel, so that data can be transferred from one device to another.

Every participating device must be able to perform at least one of the following roles: TALKER, LISTENER, or CONTROLLER. A talker transmits data to other devices called listeners. Most devices can perform both roles, but not at the same time. A controller manages the operation of the bus system by designating which device is to talk and which device(s) are to listen at any given time. The HP 3577B can be a talker, listener, or a controller.

An HP-IB controller participates in the measurement by being programmed to:

- Schedule measurement tasks
- Set up instruments
- Monitor the measurement
- Interpret and operate upon the results

HP-IB Specification Summary

Number Of Interconnected Devices:

A maximum of fifteen on one bus.

Interconnection Path/maximum Cable Length:

Total cable length equal to two meters times number of devices or twenty meters, whichever is less, with a maximum of three meters separating any two devices.

Message Transfer Scheme:

Byte-serial, eight bit-parallel asynchronous data transfer using a three wire handshake.

Data Rate:

One megabyte per second (maximum) over limited distances, actual data rate depends upon the capability of the slowest device involved in the transmission.

Address Capability:

Primary addresses: 31 talk, 31 listen. A maximum of one talker and fourteen listeners at one time.

Multiple controller capability:

In systems with more than one controller, only one can be active at a time. The active controller can pass control to another controller, but only the system controller can assume unconditional control. Only one system controller is allowed. The system controller is hard-wired to assume bus control after a power failure.

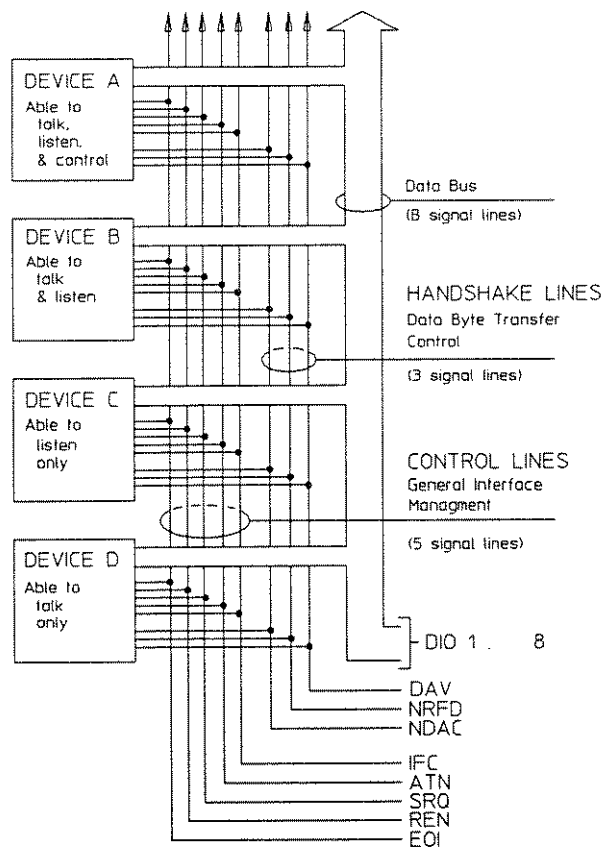

Figure 3-1. Bus Structure

Management (CONTROL) Lines

ATN — Attention. This line is used by the active controller to define how information on the data lines (DIO 1..8) will be interpreted by the other devices on the bus. When ATN is low (true) the HP-IB is in Command Mode and the data lines carry bus commands. When ATN is false the HP-IB is in Data Mode and the data lines carry device dependent commands. In the command mode the controller is active and all other devices are waiting for instructions.

SRQ — Service Request. This line is set low (true) by any instrument requesting service.

REN — Remote Enable. The system controller sets REN low and then addresses the devices to listen before they will operate under remote control.

IFC — Interface Clear. Only the system controller can activate this line. When IFC is set (true) all talkers, listeners, and active controllers go to their inactive states.

EOI — End Or Identify. This line is used to indicate the end of a multiple byte transfer sequence or, in conjunction with ATN, to execute a parallel polling sequence.

The HP 3577B And The HP-IB

HP 3577B HP-IB Capability

As defined by IEEE Standard 488-1978, the HP 3577B has these characteristics:

SH1	complete Source Handshake capability
AH1	complete Acceptor Handshake capability
T6	Basic Talker; serial poll; unaddress if MLA
TE0	no Extended Talker capability
L4	Basic Listener; unaddress if MTA; no Listen Only
LE0	no Extended Listener capability
SR1	complete Service Request capability
RL1	complete Remote/Local capability
PP1	Parallel Poll; remote configuration capability
DC1	complete Device Clear capability
DT1	complete Device Trigger capability
C1, C2, C3, C12	System Controller capability
E1	drivers are open-collector

This list of capabilities is printed on the rear panel near the HP-IB connector as follows:

SH1 AH1 T6 TE0 L4 LE0 SR1 RL1 PP1 DC1 DT1 C1 C2 C3 C12 E1

HP 3577A Compatibility

HP-IB programs written for the HP 3577A should work on the HP 3577B without modification.

Data Format Vs Transfer Rate

The HP 3577B offers three data formats for transferring certain types of data on the bus. Data format may be selected for the following I/O: trace dumps, register dumps and loads, marker data dumps, and marker position dumps. A trace is made up of real numbers and is defined by the INPUT key. Trace one or trace two may be dumped (output) in any of the three data formats. A register is made up of real and imaginary numbers. There will be twice as many numbers in a register I/O as there are for a trace dump with the same sweep resolution. Registers R, A, B, D1-D4, and X1-X8 may be dumped or loaded in any of the three data formats.

As described in the previous paragraph, not all HP 3577B dump and load commands may be done in more than one type data format. It is recommended that the ASCII format (FM1) be active unless one of these transfers is required. Each data format has a different data transfer rate. The figures listed for transfer rate are average times, shown here for comparison. They were taken such that the controller was not a limiting factor.

FM1 — Data format one is the default data format. When FM1 is active the HP 3577B transfers data using the ASCII format. Using this format the HP 3577B can dump a trace of 401 points in approximately 2.8 seconds. This format has the slowest data transfer rate of the three.

FM2 — Data format two is the 64 bit floating point binary specified in the ANSI/IEEE Standard 754-1985. The data rate for this format is faster than that of FM1 but slower than that of FM3. FM2 has the advantage of being the same format used by HP 9000 Series 300 Computers. Using this format the HP 3577B can dump a trace of 401 points in approximately 0.5 seconds.

FM3 — Data format three is the 32 bit floating point binary used by the HP 3577B fast processor. FM3 has the fastest data transfer rate of the three data formats. Using FM3 the HP 3577B can dump a trace of 401 points in approximately 0.3 seconds. When this format is active the HP 3577B does not have to convert data formats and requires half as many transfers per data value as FM2. This format may be used for data that is not processed outside the HP 3577B.

Direct Plotting

The HP 3577B can provide a hardcopy of the CRT screen without using a computer. It does this by directly controlling a digital plotter connected to the HP 3577B's HP-IB port located on the rear panel. The plotter (such as the HP 7475A) must accept Hewlett-Packard Graphic Language (HP-GL) commands. The HP 3577B must be the system controller. To enable this, press

[LCL]

and toggle to

[SYS CTLR ON OFF].

The HP 3577B must be the only controller connected to the HP-IB.

Also, set the [PLOTTER ADDRESS] to the switch address on the plotter. Press

[PLOTTER ADDRESS],

enter the address using the numeric keypad, and press

[ENTER].

Refer to LOCAL in the REFERENCE section.

HP-IB Verification

First make sure the HP 3577B is not the system controller by pressing

[LCL]

and toggle to

[SYS CTLR ON OFF].

Then refer to the computer operating manual and find the section describing the HP-IB REMOTE Message. When this message is sent to the HP 3577B, the REMOTE annunciator LED on the front panel will light. If this does not occur, recheck the cabling, the HP 3577B address, the syntax of the computer statement, and check that **OFF** has been selected.

Example:

REMOTE 711

HP 9000, Series 300; BASIC

HP-IB Diagnostic Mode

The Bus Diagnostic Modes (BD1 & BD2) may be used to find HP-IB program problems. When active, these modes cause the HP 3577B to display menus as though being operated from the front panel. In BD2 the programming code received by the HP 3577B over the bus will be left-shifted through the screen error block in a "ticker tape" fashion.

BD0 is the default mode. Bus diagnostics are off; no menus appear and bus codes are not displayed. Sweep dot does not appear unless sweep time is 1 second or more. This is the fastest programming mode.

BD1 displays all menus and updates the front panel as though the HP 3577B were being operated from the front panel. The HP-IB programming codes appear only when an error is encountered. When this occurs, processing of all bus commands will halt for three seconds to allow the programmer to read the code that caused the error before processing continues and secondary errors are generated.

BD2 is the same as BD1 except that the HP 3577B processes bus code at a reduced rate (one command per second) and all programming code received on the bus is left-shifted through the screen error block.

Note



The HP 3577B will interpret the carriage return (CR) as ←, linefeed as ↓, and EOI as ^. Binary loads (including the #I) and ASCII register loads are not shown on the screen.

Note



The HP 3577B's HP-IB buffer will hold a maximum of 100 characters. If the controller tries to send more than 100, it will have to wait for the HP 3577B to process some of the code before sending more. If the computer is waiting as just described, and the HP 3577B processes a dump command, it will wait to be addressed to talk. It is possible that both controller and HP 3577B could end up waiting for each other, halting all bus activity. Care should be taken in programming so that this does not occur.

The HP 3577B HP-IB Address

Talk/listen Addresses

Every HP-IB device has at least one address unless it is a totally transparent or a Talk-Only or Listen-Only device. Device addresses are used by the active controller in the COMMAND MODE (ATN true) to specify who talks (via a Talk Address) and who listens (via Listen Addresses). There may be only one talker addressed (by the controller) to talk at any time. Talk and Listen addresses are the same on the HP 3577B.

Viewing The HP 3577B HP-IB Address

The HP 3577B's HP-IB address is set to eleven (11) at the factory. To display the address of the HP 3577B:

Press

[LCL]

[ANALYZER ADDRESS].

The address will appear in the entry block. See figure 3-2.

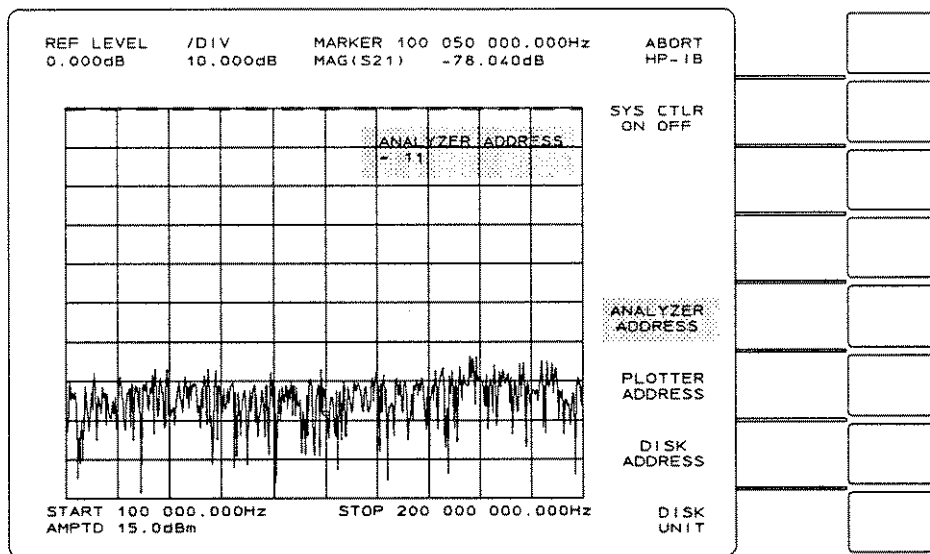

Figure 3-2.

Setting The HP 3577B HP-IB Address

The HP 3577B address can be set to any address from zero (0) to thirty (30), inclusive. When choosing an address, remember that the controller also has an address (typically 21). To change the HP-IB address:

1. Press
[LCL].
[ANALYZER ADDRESS]
to display the current HP-IB address.
2. Press the appropriate keys in the numeric keypad for the new address. Note the change in the entry block.
3. Press
[ENTER].

The HP 3577B HP-IB address is stored in a non-volatile memory; there are no address switches. If the contents of this memory are destroyed, the HP-IB address defaults to eleven (11). Under normal circumstances, the non-volatile memory should retain its data for up to five years. This time is not specified and no warranty is stated or implied.

Use the following table for controllers that require the talk and listen addresses.

Remote Operation
The HP 3577B HP-IB Address

HP-IB ADDRESSES		
DEVICE ADDRESSES	TALK	LISTEN
0	@	SPACE ‡
1	A	!
2	B	"
3	C	#
4	D	\$
5	E	%
6	F	&
7	G	'
8	H	(
9	I)
10	J	*
11‡‡	K	+
12	L	,
13	M	-
14	N	.
15	O	/
16	P	0
17	Q	1
18	R	2
19	S	3
20	T	4
21 ‡‡‡	U	5
22	V	6
23	W	7
24	X	8
25	Y	9
26	Z	:
27	[;
28	1/2	<
29]	=
30	^	>

‡ (ASCII character) ‡‡ (HP 3577B factory setting) ‡‡‡ (usually the controller)

The Talk and Listen addresses are ASCII characters. When a device receives one of these characters while ATN is true, it will become addressed. The ASCII character ? will unaddress all devices. The Device address (set from the HP 3577B front panel) is used by most newer HP-IB computers which automatically send the Talk and Listen address characters.

Bus Messages

The interface system operates in either of two modes: COMMAND MODE (ATN true) or DATA MODE (ATN false). If an HP computer is used, the bus management lines will be configured automatically and all necessary command strings will be issued. All examples in this section assume an HP 9000 Series 300 Computer is used, in BASIC.

Bus Commands

In the Command Mode special codes known as "bus commands" may be placed on the HP-IB. These commands have the same meaning in all HP-IB systems. Each device is designed to respond to those commands that have a useful meaning to the device and ignore other bus commands. The HP 3577B will respond to the following commands as described. The three-letter command abbreviations refer to IEEE 488 nomenclature.

Abort I/O

Abort Input/Output (IFC; interface clear) is an unconditional assumption of control of the bus by the system controller. All bus activity halts and the HP 3577B becomes unaddressed. This does not clear the HP 3577B HP-IB command buffer. The HP 3577B must NOT be configured as the system controller. To do this press

[LCL]
and toggle to
[SYS CTLR ON OFF].

Example:

ABORT 7

Clear Lockout/Set Local

This command removes all devices from the local lockout mode and returns them to local (front panel) control. The only difference between this bus message and the LOCAL message is how it is addressed.

Example:

LOCAL 7
(Clears LOCAL LOCKOUT and enables front panel keys).

Remote Operation Bus Messages

Device Clear

The CLEAR command may be addressed (SDC, selected device clear) or unaddressed (DCL; device clear). When this command is received by the HP 3577B it will clear the HP-IB command buffer, reset the SRQ line (if pulled low by the HP 3577B), and abort any data input or output. This interrupts bus activity and gains control of the analyzer, no matter what it may be doing. It does not preset the HP 3577B. It is good practice to begin programs with this command. See the examples that follow.

Examples:

```
CLEAR 7  
(UDC; clears all devices on computer port seven)  
CLEAR 711  
(SDC; clears device addressed eleven on port seven)
```

Local

LOCAL (GTL; go to local) returns control of the listening device to the local (front panel) state. The REMOTE LED on the front panel extinguishes if the instrument was in remote prior to the local command. The HP-IB buffer is not cleared on the HP 3577B. Also, any dump or load in progress will **not** be aborted.

Example:

```
LOCAL 711  
(Local lockout still active if returned to REMOTE).
```

Note



This command is **not** identical to pressing the LCL front panel key on the HP 3577A. Pressing the key will clear the HP-IB buffer of all pending commands.

Local Lockout

LOCAL LOCKOUT (LLO) disables the LOCAL key of all devices on the bus to secure the system from operator interference when in remote control. After this command is issued the only way to return to front panel operation from remote control is with a LOCAL command from the controller. Local lockout will not change the local/remote status of the instrument. Local lockout is disabled by a universal (unaddressed) LOCAL command on the bus.

Example:

```
LOCAL LOCKOUT 7
```

Parallel Poll

PARALLEL POLL is a command issued by the controller in response to the SRQ (service request) management line being pulled low (true). Since any instrument could have pulled SRQ the controller must poll them all to find which requested service. The parallel poll commands each device to send its Request Service bit (RQS; part of the Status Byte) on one of the eight data lines. The Parallel Poll Configure (PPC) command determines data line and logical sense used.

Example:

```
Var=PPOLL(7)
```

Parallel Poll Configure

The PARALLEL POLL CONFIGURE command (PPC) programs the logical sense and data line used by a specified device to respond to a parallel poll. The configure word is coded as shown in figure 3-3. The three least significant bits determine the data bus line for the response. The fourth bit determines the logical sense of the response.

Decimal	Binary
2	0 010
9	1 001

Figure 3-3

Example:

```
PPOLL CONFIGURE 711;2
(put RQS bit on DIO line 2 Sense: 0 = RQS true)
PPOLL CONFIGURE 711;9
(put RQS bit on DIO line 1 Sense: 1 = RQS true)
```

Pass Control

Pass Control (TCT; take control) shifts system control from one controller to another. If the HP 3577B HP Instrument BASIC Option 1C2 is used, the analyzer can respond to this command. HP Instrument BASIC lets the HP 3577B control other instruments if a program is written that executes control commands to other instruments. TCT is not useful without Option 1C2. See *Using HP Instrument BASIC with the HP 3577B* for more information on passing control using an HP Instrument BASIC program.

When TCT is executed, the **SYS CTLR** portion of the [**SYS CTLR ON OFF**] softkey appears bright. (This softkey appears under the [**LCL**] hardkey.) **SYS CTLR** remains bright any time the HP 3577B is the active controller and becomes dim when it is not. Therefore, when passing control, the brightness of **SYS CTLR** is the true indicator of the active controller status of the HP 3577B.

Remote Operation Bus Messages

See "Plotting Via HP-IB" in this chapter for information on plotting.

Remote

REMOTE may be used to address the HP 3577B to listen. When this command is issued, the REMOTE front panel LED illuminates and the front panel is disabled except for the LCL key. If LOCAL LOCKOUT is active the LCL front panel key is also disabled.

Examples:

```
REMOTE 7
(switches all devices on port seven from local to remote)
REMOTE 711
(switches device addressed eleven from local to remote)
```

Serial Poll

SERIAL POLL is a command to dump the status byte on the bus. Encoded in the eight bits of the status byte are the states of several HP 3577B operating conditions. See "THE STATUS BYTE" in this chapter

Examples:

```
Var=SPOLL(711)
IF Var THEN... (Checks for the zero state)
```

Another example:

```
BINAND(SPOLL(711),16) THEN... (Checks state of bit five)
```

Service Request

The Service Request(SRQ) line is one of the five bus management lines that go to every device on the bus, along with eight data lines and three handshake lines. It may be used by one or more devices to indicate the need for attention from the controller and can act as an interruption of the current sequence of events. Typically, SRQ indicates information is ready to transmit and/or an error condition exists. When the HP 3577B issues an SRQ it also sets bit #6 of the Status Byte. Bit 6 is the RQS (Require Service) bit, sometimes referred to as the "status bit" in connection with a poll.

If properly configured, the controller will stop and poll when it senses the SRQ. A serial poll returns each device's status byte, one device at a time. A parallel poll returns all (up to eight) device's status bits simultaneously; each instrument responding on one of the eight data lines. When the HP 3577B is polled it will clear the RQS bit and the SRQ line.

Any of the bits in the Status Byte may initiate an SRQ. To select which bits cause the HP 3577B to set the SRQ line, mask the Status Byte. (See "THE STATUS BYTE" in this chapter.)

Trigger

The HP 3577B responds to the TRIGGER bus command (GET; group execute trigger) as it would to any other external trigger; by beginning a sweep or, in the case of CW sweep type or manual sweep mode, taking a measurement. TRIGGER may be sent to a selected device or all devices addressed to listen on the HP-IB. The HP 3577B must be addressed to listen and in the "WAIT TRIG" state before the trigger message is sent. If the last statement left the HP 3577B addressed to listen and settling is complete, it's ready for a trigger. If not, or if several devices are to be triggered simultaneously, use a SEND command to address the listeners. See Bit B4 of The Status Byte.

Examples:

```
SEND 7;UNL MTA LISTEN 11, 17, 22  
TRIGGER 7
```

UNL = UNLISTEN; unaddresses all listeners
MTA = MY TALK ADDRESS; the controller addresses itself to talk
LISTEN 11, 17, 22; addresses devices whose addresses are 11, 17, and 22 to listen

Another example:

```
ASSIGN @Listeners TO 702, 707, 711  
TRIGGER @Listeners
```

Device Dependent Commands

In the Data Mode special codes known as "device dependent commands" may be placed on the HP-IB. These commands have meaning for a specific instrument. They can configure the instrument, tell it to take a measurement, dump or load data, or define error reporting conditions, and are meaningless for other instruments.

Device dependent commands and front panel key functions have a one-to-one relationship for all but the HP-IB-only commands. For example, DF5 is the remote equivalent of pressing the PHASE softkey in local. Exceptions to this rule are:

- Front panel functions not allowed in remote operation: HP-IB Address Viewing and Selection

HP-IB Only Commands are remote functions available only from computer control. These include:

- Data Dumps
- Load Data
- User defined graphics
- User defined annotation
- User defined menus
- Bus code diagnostics
- Control of Settling Time value

Remote Operation
Bus Messages

Device dependent commands may be sent to the HP 3577B by using the BASIC command "OUTPUT" as shown in the following examples:

```
OUTPUT 711;"FSW;"           (Full Sweep)
OUTPUT 711;"DF5;"           (Display Function 5 is PHASE)
OUTPUT 711;"FRA 2 MHZ;"     (Start Frequency = 2 MHz)
OUTPUT 711;"DRA;"           (Dump Register A)

OUTPUT 711;"DF7,FRA 1 MHZ,FRB 10 MHZ,SAM 0 DBM,TKM,DRA;"
```

*Display Function = Log Mag
Start Freq = 1 MHz
Stop Freq = 10 MHz
Source Amplitude = 0 dBm
Take measurement
Dump Register A

A delimiter should be used after all commands when there are multiple commands per line. Delimiters are semicolons (;), linefeeds (LF), and <EOI> (pulling the EOI bus management line). Separators, such as spaces and commas, may be used instead of delimiters, but using semicolons or LF characters between commands enables the HP 3577B to do a better job of error reporting. A delimiter is required to terminate a numeric entry. The HP 3577B accepts upper or lower case letters over the bus.

Definitions

A **SELECT COMMAND** is a two-letter prefix followed by a qualifier digit that selects a particular state of that function.

Example:

the HP-IB code for PHASE (display function 5) is DF5

IMMEDIATE EXECUTION COMMANDS execute a given operation when issued. They require no other data. Example: Instrument Preset is IPR.

DATA ENTRY COMMAND is a three part command that enters a value for one of the parameters. The three parts are: prefix (the parameter to be changed by the data entry), data (numbers), and suffix (units for the new value). Source amplitude (SAM) is an example of a data entry command.

Example:

```
OUTPUT 711; "SAM 0 DBM; "
```

HP 3577B Program Codes have been categorized into five distinct groups to help explain them. These are:

- DISPLAY FORMAT
- SOURCE
- RECEIVER
- SYSTEM
- HP-IB ONLY

DISPLAY FORMAT

Function	HP-IB code
TRACE 1	TR1
TRACE 2	TR2
DISPLAY FUNCTION	DSF *
SWR	DF8
Log Magnitude	DF7
Linear Magnitude	DF6
Phase	DF5
Polar	DF4
Real	DF3
Imaginary	DF2
Delay	DF1
Trace Off	DF0
Delay Aperture menu	DAP *
Aperture .5% of span	AP1
Aperture 1% of span	AP2
Aperture 2% of span	AP3
Aperture 4% of span	AP4
Aperture 8% of span	AP5
Aperture 16% of span	AP6
Return	RET *
INPUT	INP *
Input = R	INR
Input = A	INA
Input = B	INB
Input = A/R	IAR
Input = B/R	IBR
Input = D1	ID1
Input = D2	ID2
Input = D3	ID3
Input = D4	ID4
Input = X1	IX1
Input = X2	IX2

Function	HP-IB code
Input = X3	IX3
Input = X4	IX4
Input = X5	IX5
Input = X6	IX6
Input = X7	IX7
Input = X8	IX8
Return	RET *
User Defined Input	UDI
Input = S11	I11
Input = S21	I21
Input = S12	I12
Input = S22	I22
Copy Input	CPI
Test Set Forward	TSF
Test Set Reverse	TSR
SCALE	SCL *
Autoscale	ASL
Reference Level (entry)	REF
Scale/DIV (entry)	DIV
Reference Position (entry)	RPS
Reference Line Off	RLO
Reference Line On	RL1
Copy Scale	CPS
Phase Slope (entry)	PSL
Phase Slope Off	PS0
Phase Slope On	PS1
Polar Full Scale (entry)	PFS
Polar Phase Ref (entry)	PPR
Smith Chart Off	GTO
Smith Chart On	GT1
MARKER	MKR *
Marker Position (entry)	MKP

* The only Function of this code is to display a menu (if bus diagnostics are on).

DISPLAY FORMAT Continued

Function	HP-IB code
Marker Off	MRO
Marker On	MR1
Zero Marker	ZMK
Marker Offset Off	MO0
Marker Offset On	MO1
Marker Offset (entry)	MKO
Marker Offset Freq (entry)	MOF
Marker Offset Amp (entry)	MOA
Marker Coupling Off	CO0
Marker Coupling On	CO1
Polar Mag Offset (entry)	PMO
Polar Phase Offset (entry)	PPO
Polar Real Offset (entry)	PRO
Polar Imag Offset (entry)	PIO
Polar Marker Units (Re/Im)	MRI
Polar Marker Units (Mg/Ph)	MMP
LIMIT	
Limit Line Display Off	LL0
Limit Line Display On	LL1
Limit Test Evaluation Off	LE0
Limit Test Evaluation On	LE1
Beep On Limit Failure Off	LS0
Beep On Limit Failure On	LS1
Clear Limit Table	LMC
Define X-Start for Next Row(entry)	LBX
Define Y-Start for Next Row(entry)	LBY
Define X-Stop for Next Row(entry)	LEX
Define Y-Stop for Next Row(entry)	LEY
Select Upper for Next Row	LUP
Select Lower for Next Row	LDN
Insert or Add a Row	LMA
Display Limit Editing Menu	LTD*

Function	HP-IB code
Display Limit Configuration Menu	LTC*
MARKER →	MKG*
MKR → Reference Level	MTR
MKR → Start Frequency	MTA
MKR → Stop Frequency	MTB
MKR → Center Frequency	MTC
MKR Offset → Span	MOS
MKR → Max	MTX
MKR → Min	MTN
MORE menu	MSM *
MKR Target value (entry)	MTV
MKR → Right for Target	MRT
MKR → Left for Target	MLT
Return	RET *
MKR → Full Scale	MTP
MKR → Polar Phase Ref	MPF
MKR → Discrete	MKD
STORE DATA	ST0 *
Store in register X1	SX1
Store in register X2	SX2
Store in register X3	SX3
Store in register X4	SX4
Store in register X5	SX5
Store in register X6	SX6
Store in register X7	SX7
Store in register X8	SX8
Store in register D1	SD1
Store in register D2	SD2
Store in register D3	SD3
Store in register D4	SD4
Store and Display	STD
More (storage registers)	STX*

* The only Function of this code is to display a menu (if bus diagnostics are on).

DISPLAY FORMAT Continued

Function	HP-IB code
User Defined Store	UDS
Store to X1	TX1
Store to X2	TX2
Store to X3	TX3
Store to X4	TX4
Store to X5	TX5
Store to X6	TX6
Store to X7	TX7
Store to X8	TX8
Store to D1	TD1
Store to D2	TD2
Store to D3	TD3
Store to D4	TD4
MEASUREMENT CALIBRATION	CAL *
Normalize	NRM
Normalize (Short)	NRS
Calibrate, Partial	CPR
Calibrate, Full	CFL
Continue Calibration	CGO
DEFINE MATH	DFN *
Constant K1, Real(entry)	KR1
Constant K1, Imaginary(entry)	KI1
Constant K2, Real(entry)	KR2
Constant K2, Imaginary(entry)	KI2
Constant K3, Real(entry)	KR3
Constant K3, Imaginary(entry)	KI3
Constant K4, Real(entry)	KR4
Constant K4, Imaginary(entry)	KI4
Constant K5, Real(entry)	KR5
Constant K5, Imaginary(entry)	KI5
Constant K6, Real(entry)	KR6
Constant K6, Imaginary(entry)	KI6

Function	HP-IB code
Constant K7, Real(entry)	KR7
Constant K7, Imaginary(entry)	KI7
Define Function	DFC *
Function F1	UF1
Function F2	UF2
Function F3	UF3
Function F4	UF4
Function F5	UF5
Math term for input R	R
Math term for input A	A
Math term for input B	B
Math term for storage reg D	D
Math term for constant	K
Math term for function	F
Math term for jOmega	W
Math term for storage reg X	X
Math bracket	(
Math function plus	+
Math function minus	-
Math function multiply	*
Math function divide	/
Math bracket)
Return	RET *
DATA ENTRY SECTION COMMANDS	
Increment (up arrow)	IUP
Decrement (down arrow)	IDN
Continuous Entry (knob) Off	CE0
Continuous Entry (knob) On	CE1
Entry Off	HLD
DISPLAY FORMAT SUFFIX UNITS	
dBm	DBM
dBv (rms)	DBV

* The only Function of this code is to display a menu (if bus diagnostics are on).

DISPLAY FORMAT Continued

Function	HP-IB code
dB relative	DBR
Volt (rms)	V
milli-Volt (rms)	MV
micro-Volt (rms)	UV
nano-Volt (rms)	NV
degrees	DEG
degrees/span	DSP
radians	RAD
radians/span	RSP
seconds	SEC
milliseconds	MSC
microseconds	USC
nanoseconds	NSC
percent	%
degrees/span	DSP
radians/span	RAP
MHZ	MHZ
kHz	KHZ
Hz	HZ
exponent	E
units	; or <cr> <lf>

* The only Function of this code is to display a menu (if bus diagnostics are on).

USER DEFINED INPUT (UDI) uses the same terms and math functions as UDF (user defined function).

Example:

```
10 OUTPUT 711; "UDI (B/R)/(K1-B/R);"
```

COPY INPUT (CPI) will copy the INPUT definition of the inactive trace into that of the active trace as follows:

1. Trace one active
2. Output CPI
3. INPUT definition of trace one is now the same as trace two

TEST SET FORWARD AND REVERSE (TSF & TSR) are used to configure an HP 35677A/B S-Parameter Test Set connected to the HP 3577B. The INPUT definition should be user defined (to avoid an error message). If you wish to control the test set while using one of the standard input definitions, enter it under UDI.

Example:

```
10 OUTPUT 711; "UDI R; TSR; "
```

COPY SCALE (CPS) will copy reference level and /DIV parameters of the inactive trace into those of the active trace if the DISPLAY FUNCTION units of both traces are compatible.

MARKER POSITION (MKP) is a prefix for a data entry. The data will be a bin number. The number of bins in a sweep depends on the sweep resolution (in a frequency sweep) or number of steps (in an amplitude sweep). The default numbers of bins in a sweep are 401 (0 through 400) for frequency sweeps and 101 (0 through 100) for amplitude sweeps. MKP is the prefix used to position the marker at a specific bin. This bin number may be calculated using the following formula:

$$\text{Bin number} = \frac{f_{\text{bin}} - f_{\text{start}}}{\text{span}} \times (\text{points per sweep})$$

Where: f_{bin} is the frequency of the new marker position
 f_{start} is the start frequency
 f_{span} is the frequency span
points per sweep is the sweep resolution

This number *should* be an integer ≤ 401 . If the result is not an integer you probably picked a frequency for f_{bin} that is not one of the sampled frequencies for the sweep. The HP 3577B will round any fraction received with MKP. If the number is > 401 a "NUMBER OUT OF RANGE" error message will be generated.

LIMIT LINE DISPLAY OFF/ON (LL0 & LL1) turn the LIMIT lines of TRACE 1 and TRACE 2 off and on. Both the UPPER and LOWER limits will be displayed, as specified in the LIMIT table. To display the limits for one trace at a time, make sure only one trace is turned on. See line 60 in the sample program below.

LIMIT TEST EVALUATION OFF/ON (LE0 & LE1) turn the pass/fail indicator of TRACE 1 and TRACE 2 off and on. When a failure occurs for an upper or lower limit, bit 1 of status byte 3 will be set on for TRACE 1 and bit 2 of status byte 3 will be set on for TRACE 2. The program below builds a limit table for TRACE 1, takes a measurement and reads the result of the limit evaluation.

X/Y START/STOP FOR NEXT ROW (LBX, LBY, LEX, & LEY) define the limit lines of the next row in the LIMIT table. Units for X-START/STOP are specified in HZ, KHZ, or MHZ. Y-START/STOP are unitless in the LIMIT table and are interpreted according to the current amplitude scale.

The values set by the LBX, LBY, LEX, LEY, LUP, and LDN commands do not change the table immediately. The LMA command (insert a row) must be sent to add a new row. LMA will add one row, using the values last set by the LBX, LBY, LEX, LEY, and LUP or LDN commands.

Limit test evaluations will typically add a 10 to 120 msec delay between analyzer sweeps. For maximum programming speed:

1. The limit line display and test evaluation should be turned off (LL0 & LE0) while entering values in the table.
2. All existing rows should be deleted (LMC) and values should be entered row by row using LBX, LBY, LEX, LEY & LMA.

Remote Operation
Bus Messages

Example:

```

10 ! Example BASIC program to enter HP 3577B limit lines, and
20 ! test fail bits in status byte.
30 !
40 ASSIGN @Na TO 711                !HP-IB select code
50 !                                and HP 3577B address
60 OUTPUT @Na;"TR1"                 !select trace
70 OUTPUT @Na;"LLO; LEO"           !limit display & eval off
80 OUTPUT @Na;"LMC"                 !clear limit table
90 !
100 ! send each row of table
110 OUTPUT @Na;"LBX 0 HZ; LBY -40; LEX 123.456 MHZ; LEY -40; LUP; LMA"
120 OUTPUT @Na;"LBX 0 HZ; LBY -46; LEX 123.456 MHZ; LEY -46; LDN; LMA"
130 OUTPUT @Na;"LBX 150 MHZ; LBY -30.33; LEX 200 MHZ; LEY -40; LUP; LMA"
140 !
150 OUTPUT @Na;"LL1; LE1"           !limit display & eval on
160 !
170 DIM Message$(100)
180 INTEGER Status1, Status2, Status3
190 !
200 OUTPUT @Na;"TKM"                !take a measurement
210 OUTPUT @Na;"DMS"                !request status dump
220 ENTER @Na;Status1, Status2, Status3, Message$ !read status
230 !
240 !bits 1 and 2 of status byte 3 will be set on limit failures.
250 IF BIT(Status3,1) THEN PRINT "FAIL 1"
260 END

```

Table 3-1 Limit Table Built by Sample Program.

TRACE 1 LIMIT TABLE					
N	X-START	Y-START	X-STOP	Y-STOP	U/L
1	0.000Hz	- 40.000	123.456M	- 40.000	UP
2	0.000Hz	- 46.000	123.456M	- 46.000	LO
3	150.000M	- 30.33	200.000M	- 40.000	UP

To limit test TRACE 2, TR2 would be selected in line 60 instead of TR1. The result of a limit test for trace 2 is returned as bit 2 of status byte 3. Hence, the following program line would replace line 250 at the end of the sample program to return the result of TRACE 2.

Example:

```
250 IF BIT(Status3,2) THEN PRINT "FAIL2"
```

See the LIMIT section of the Reference Chapter for more information on limit testing.

USER DEFINED STORE (UDS) is used together with TX1-TX8 and TD1-TD4 to define and store data (traces). Since registers D1 through D4 are used for measurement normalization and for the store & display feature, registers X1 through X8 should be used in preference to registers D1 through D4 if the normalization and store & display features are going to be used.

Example:

```
10 OUTPUT 711; "UDS X3-A/R*D4 TX3; "
```

A register name may appear as part of the definition and as the destination register. A destination register (in this case TX3) must appear after the definition.

USER DEFINED FUNCTIONS 1 THROUGH 5 (UF1-UF5) are used to enter definitions as shown in the following:

Example:

```
10 OUTPUT 711; "UF3 D4*A/R+ D3; "  
20 OUTPUT 711; "UF4 (A/R-D2)/F3; "
```

Note that functions may be defined in terms of lower numbered functions. Thus F1 cannot be a function of another user defined function but F5 could be a function of any of the first four.

CONTINUOUS ENTRY OFF/ON (CEO & CE1) corresponds to the MARKER and ENTRY modes of the knob where CEO = MARKER and CE1 = ENTRY.

SOURCE

Function	HP-IB code	Function	HP-IB code
SWEEP TYPE	STY *	Sweep Time (entry)	SWT
Linear Sweep	ST1	Step Time (entry)	SMT
Alternate Sweep	ST2	Sample Time (entry)	MSR
Log Sweep	ST3	FREQUENCY	FRQ *
Amplitude Sweep	ST4	Source Frequency (entry)	SFR
CW	ST5	Start Frequency (entry)	FRA
Discrete Sweep	ST6	Stop Frequency (entry)	FRB
Sweep Direction Up	SUP	Center Frequency (entry)	FRC
Sweep Direction Down	SDN	Frequency Span (entry)	FRS
Discrete Sweep Commands		FRC Step size (entry)	CFS
Clear Discrete Sweep Table	DTC	Sweep Resolution menu	SRL *
Define Frequency for Next Row (entry)	DTF	Freq Swp Res 51 pts/span	RS1
Select 1 Hz Res BW for Next Row	DB1	Freq Swp Res 101 pts/span	RS2
Select 10 Hz Res BW for Next Row	DB2	Freq Swp Res 201 pts/span	RS3
Select 100 Hz Res BW for Next Row	DB3	Freq Swp Res 401 pts/span	RS4
Select 1 kHz Res BW for Next Row	DB4	Return	RET *
Define Settling Time for Next Row (entry)	DTS	Full Sweep	FSW
Lin Swp → Discr Swp Table, 11 points	DL1	Freq Step Size (entry)	FST
Lin Swp → Discr Swp Table, 21 points	DL2	AMPLITUDE	AMP*
Lin Swp → Discr Swp Table, 31 points	DL3	Source Amplitude (entry)	SAM
Lin Swp → Discr Swp Table, 41 points	DL4	Amp Step Size (entry)	AST
Lin Swp → Discr Swp Table, 51 points	DL5	Clear Trip, Source	CTS
Insert (Add) row to Discr Swp Table	DTA	Start Amplitude (entry)	AMA
MKR → Discrete	MKD	Stop Amplitude (entry)	AMB
SWEEP MODE	SMD*	Steps/Sweep menu	NST *
Continuous	SM1	Number of steps = 6	NS1
Single Sweep	SM2	Number of steps = 11	NS2
Manual Sweep	SM3	Number of steps = 21	NS3
Manual Frequency (entry)	MFR	Number of steps = 51	NS4
Manual Amplitude (entry)	MAM	Number of steps = 101	NS5
Marker → Manual	MTM	Number of steps = 201	NS6
SWEEP TIME	STM *	Number of steps = 401	NS7

* Use not required The only function of this code is to display a menu (if bus diagnostics are on).

Function	HP-IB code
Return	RET *
Full Sweep	FSW
TRIGGER MODE	TRM *
Free Run	TG1
Line Trigger	TG2
External Trigger	TG3
Immediate	TG4
SWEEP TRIGGER TRG/ SWEEP RESET RESET	TRG RST
SOURCE SUFFIX UNITS	
dBm	DBM
dBV (rms)	DBV
Volt (rms)	V
milli-Volt (rms)	MV
micro-Volt (rms)	UV
nano-Volt (rms)	NV
seconds	SEC
milliseconds	MSC
MHz	MHZ
kHz	KHZ
Hz	HZ
exponent	E

SELECT DISCRETE SWEEP (ST6) measures and displays each frequency entered in the discrete sweep table. Straight line segments connect each point. The start and stop frequencies are set by the frequency entries of the first and last rows in the table.

Each point is measured using a CW sweep associated with a resolution bandwidth. Therefore, the resolution bandwidth and settling time are also assigned to each row in the discrete sweep table (DB1 - DB4, & DTS). If no resolution bandwidth is specified, the current setting of the analyzer RES BW will be selected for all rows when the program is run. Default settling time values are chosen according to the table below.

Table 3-2. Default settling time for each resolution bandwidth.

Resolution Bandwidth	Settling Time
1 Hz	3.707 Sec
10 Hz	0.370 Sec
100 Hz	0.037 Sec
1 kHz	0.004 Sec

The sample program below shows a simple discrete sweep measurement setup. For maximum programming speed:

1. Single sweep mode (SM2) should be used to stop the sweep during programming.
2. Another sweep type, LINEAR in this case, is selected (ST2) while programming the Discrete Sweep Table. When programming is complete, discrete sweep is selected (ST6).
3. All existing rows should be deleted (DTC) and values should be entered row by row (DTA).

Example:

```

10 ! Example BASIC program to enter HP 3577B discrete sweep table.
20 !
30 ASSIGN @Na TO 711 !HP-IB select code and HP 3577B address
40 !
50 OUTPUT @Na;"ST1; SM2" !de-select discrete, single
60 OUTPUT @Na;"DTC" !clear table
70 !
80 ! send each row of table
90 OUTPUT @Na;"DTF 6.000000 MHZ; DB3; DTS 0.037 SEC; DTA"
100 OUTPUT @Na;"DTF 123.456789 MHZ; DB4; DTS 0.004 SEC; DTA"
110 OUTPUT @Na;"DTF 130.000000 MHZ; DB4; DTS 1.111 SEC; DTA"
120 OUTPUT @Na;"DTF 140.000000 MHZ; DB4; DTS 0.004 SEC; DTA"
130 OUTPUT @Na;"DTF 150.000000 MHZ; DB4; DTS 0.004 SEC; DTA"
140 !
150 OUTPUT @Na;"ST6" !select discrete sweep type
160 !
170 OUTPUT @Na;"TKM" !take a measurement
180 END

```

Table 3-3. Discrete Sweep table created by example program.

DISCRETE SWEEP TABLE			
N	FREQUENCY (Hz)	RES BW	SETTLING
1	6 000 000.000	100 Hz	0.037 SEC
2	123 456 789.000	1 kHz	0.004 SEC
3	130 000 000.000	1 kHz	1.111 SEC
4	140 000 000.000	1 kHz	0.004 SEC
5	150 000 000.000	1 kHz	0.004 SEC

The values set by the DTF, DB1-DB4, and DTS commands do not change the table immediately. The DTA command (add a row) must be sent to add a new row. DTA will add one row, using values set last by the DTF, DB1-DB4, and DTS commands.

The minimum measurement time for each frequency measured typically takes 10 msec, therefore, a discrete sweep of more than 20 frequencies may take longer than a linear sweep. However, since there are less data points, transfer times to a computer and limit check times will be shorter. Also, each frequency can be set more accurately than linear frequency sweeps.

STEP TIME (SMT) is a data entry prefix for sample time used for amplitude sweeps. The default value for this parameter is 0.05 seconds per step:

Example:

```

10 OUTPUT 711;"ST4;SMT .1 SEC;" ! ST4 is amptd sweep

```

Remote Operation
Bus Messages

SAMPLE TIME (MSR) is a data entry prefix for sample time for the manual sweep mode and CW sweep type. The default value for this parameter is 0.05 seconds per sample.

Example:

```
10 OUTPUT 711; "SM3;MSR .1 SEC;" ! SM3 = Manual sweep mode
```

FREQUENCY STEP SIZE (FST) is a data entry prefix used only when the source is operated at a single frequencies as with CW or amplitude sweep types or the manual frequency sweep mode.

TRIGGER AND RESET (TRG & RST) Where the front panel has one key, labeled TRIG/RESET, functioning as both trigger (for single sweeps) and reset, the HP-IB has separate commands for each function. Sweep control is done the same in remote as local. RST resets the sweep in all sweep modes, and TRG may be used to trigger single sweeps. RST also initiates settling even if more commands are waiting in the HP-IB buffer. Other commands do not initiate settling until the command buffer is empty. RST is useful for decreasing the time required to prepare for a sweep by overlapping settling and other HP-IB operations.

Example:

```

10 !
20 ! 'RST', 'TRG' Use of Reset and Trigger commands
30 !
40 ! This example program will take measurements at 1, 2, 3, 4, and
50 ! 5 MHz and dump the data to the computer.
60 !
70 ! First, set the instrument state and take a measurement
80 !
90 OUTPUT 711;"IPR;ST5;SM2;SFR 1 MHz;TKM;"           ! Set up 1st freq
100 FOR I=2 TO 5
110 LOOP
120   EXIT IF BINAND(SPOLL(711),4)                   ! 4=B2 of Status Byte
130   END LOOP                                       ! Loop until Meas is
140                                               ! Complete
150 !
160 OUTPUT 711;"SFR;" ; I;"MHz;RST;DM1;TRG;"       ! Start settling for
170 ENTER 711;Mkr_mag                               ! next meas and dump
180                                               ! data for previous
190                                               ! meas. This allows
200                                               ! settling to occur
210                                               ! during the data dump
220 !
230 PRINT "MARKER MAGNITUDE AT"; I-1;"MHz=";Mkr_mag;"dB"
240 !
250 NEXT I                                           ! When this FOR/NEXT
260                                               ! loop is done, 5 MHz
270                                               ! has been set up but
280                                               ! no data dumped.
290 LOOP
300   EXIT IF BINAND(SPOLL(711),4)                   ! Wait for Meas
310   END LOOP                                       ! Complete, again
320 OUTPUT 711;"DM1"                                ! Dump 5 MHz data
330 ENTER 711;Mkr_mag
340 PRINT "MARKER MAGNITUDE AT"; I-1;"MHz=";Mkr_mag;"dB"
350 END

```

Receiver

Function	HP-IB Code
RESOLUTION BW	RBW *
Resolution BW 1 Hz	BW1
Resolution BW 10 Hz	BW2
Resolution BW 100 Hz	BW3
Resolution BW 1 kHz	BW4
Auto Bandwidth Off	AU0
Auto Bandwidth On	AU1
AVERAGE	AVE *
Averaging Off	AV0
N=4	AV1
N=8	AV2
N=16	AV3
N=32	AV4
N=64	AV5
N=128	AV6
N=256	AV7
ATTENUATION	ATT *
Attenuation R = 0 dB	AR1
Attenuation R = 20 dB	AR2
Attenuation A = 0 dB	AA1
Attenuation A = 20 dB	AA2
Attenuation B = 0 dB	AB1
Attenuation B = 20 dB	AB2
Impedance R = 50Ω	IR1
Impedance R = 1 MΩ	IR2
Impedance A = 50Ω	IA1
Impedance A = 1 MΩ	IA2
Impedance B = 50Ω	IB1

Function	HP-IB Code
Impedance B = 1 MΩ	IB2
Clear Trip, Receiver	CTR
LENGTH	LEN *
Length R (entry)	LNR
Length R Off	LRO
Length R On	LR1
Length A (entry)	LNA
Length A Off	LAO
Length A On	LA1
Length B (entry)	LNB
Length B Off	LB0
Length B On	LB1
Length Step Size (entry)	LNS
RECEIVER SUFFIX UNITS	
meters	MET
centimeters	CM
seconds	SEC
milliseconds	MSC
microseconds	USC
nanoseconds	NSC
exponent	E

* Use not required. the only function of this code is to display a menu (if bus diagnostics are on.)

SYSTEM

Function	HP-IB Code
SPECIAL FUNCTIONS	SPC *
Confidence test menu	SLF *
Confidence test channel R	STR
Confidence test channel A	STA
Confidence test channel B	STB
Return	RET *
Beeper off	BP0
Beeper on	BP1
Graticule off	GR0
Graticule on	GR1
Service Diagnostics menu	SDG *
Source Leveling off	SL0
Source Leveling on	SL1
Settling Time off	SE0
Settling Time on	SE1
Synthesizer Diag off	SY0
Synthesizer Diag on	SY1
Display Test Pattern	DTP
Trace Memory Test	TMT
Fast Processor Test	FPT
Fast Bus Interface Test	PRT
More Serv Diag menu	MOR *
Display Memory Test	DST
Software Revision message	SRV
Return	RET *
S-Parameters Off	SP0
S-Parameters On	SP1
SAVE INSTRUMENT STATE	SAV *
Save state in register 1	SV1
Save state in register 2	SV2

Function	HP-IB Code
Save state in register 3	SV3
Save state in register 4	SV4
Save state in register 5	SV5
RECALL INSTRUMENT STATE	RCL *
Recall old (last) state	RLS
Recall register 1	RC1
Recall register 2	RC2
Recall register 3	RC3
Recall register 4	RC4
Recall register 5	RC5
INSTRUMENT PRESET	IPR
PLOT MENU	PLM *
Plot all	PLA
Plot trace 1	PL1
Plot trace 2	PL2
Plot graticule	PLG
Plot characters	PLC
Plot trace 1 marker	PM1
Plot trace 2 marker	PM2
Configure Plot menu	CPT *
Trace 1 linetype (entry)	T1L
Trace 2 linetype (entry)	T2L
Trace 1 pen number (entry)	T1P
Trace 2 pen number (entry)	T2P
Graticule pen no. (entry)	PGP
Pen speed fast (max)	PNM
Pen speed slow	PNS
Set plot config. to default	PLD
Plotter address (entry)	HBP
Return	RET *

* Use not required. the only function of this code is to display a menu (if bus diagnostics are on.)

Plotting Via HP-IB

HP-IB PLOT commands are a special programming case because the HP 3577B is not the active controller. To control a plotter directly, the HP 3577B must become a talker. Only one talker is allowed on the bus at a time so the computer must be programmed to release the bus. The HP 3577B must be manually configured with [SYST CTLR ON **OFF**], as with any remote control operation. The following examples execute a PLOT ALL command. They assume that the analyzer's address is eleven and the plotter's address is thirty.

Example for the HP 9000 Series 300 Computers:

```
10 SEND 7; UNL MTA LISTEN 11 DATA "PLA" UNL MTA TALK 11 LISTEN 30 DATA
```

SEND 7 – selects the HP-IB interface at address seven
UNL – unlisten, unaddresses all listeners
MTA – my talk address, controller addresses itself to talk, this command will also unaddress all talkers
LISTEN 11 – addresses device at address eleven to listen
DATA "PLA" – outputs the characters in quotes on the HP-IB
UNL – unlisten
MTA – my talk address
TALK 11 – addresses device at address eleven to talk
LISTEN 30 – addresses device at address thirty to listen
DATA – releases the bus for the data transfer

If the HP 3577B is unaddressed as the talker by the bus controller during a plot, the plotting process can be resumed if the HP 3577B is readdressed to talk and was NOT addressed to listen (with a byte transmitted) in the interim. It is the responsibility of the bus controller to transmit its UNTALK command so that the handshake in progress is completed and data is not lost. Actions that will terminate a PLOT are: addressing the HP 3577B to LISTEN (and sending a data byte), sending a Universal Clear, sending a Selective Device Clear, or an invalid handshake.

If the plot is aborted via the HP-IB, the plotter pen is left in the carriage at its most recent position. If the plot is aborted from the front panel, the pen is returned to its stall and the carriage moved to the P1 position, allowing full view of the plot on plotters that roll the paper in and out for one axis of movement.

PEN SPEED. The bus code PNM (pen speed fast) allows the plotter to run at its maximum (default) velocity. This speed is dependent on the plotter used. The bus code PNS (pen speed slow) causes the plotter pen velocity to be ten centimeters per second.

The following two example programs demonstrate methods used to recognize the end of a plot process. Either of two bits in the Status Byte are used to trigger SRQ; B0 (End Of Transfer) or B4 (Ready).

```

100 !
110 ! Controller responds to plot completion by polling the bus
120 ! CONTROL lines (SRQ=1024) pulled by the instrument 'End of Transfer ( EOT )
130 ! bit.
140 !
150 Adrs=711                ! HP 3577B address
160 Plotter=705            ! Plotter address
170 Done_bit=1             ! End Of Transfer bit (BO)=1
180 !
190 OUTPUT Adrs;"SQM";Done_bit    ! Unmask EOT bit
200 !
210 REPEAT
220   X=SPOLL(Adrs)          ! SPOLL to clear previous EOT bit
230   UNTIL NOT BINAND(X,Done_bit)
240 !
250 ! Next, start the plot.
260 !
270   SEND 7;UNL MTA LISTEN Adrs MOD 100 DATA "PLA" LISTEN Plotter MOD 100 TALK Adrs
MOD 100 DATA
280 !
290   DISP "WAITING FOR PLOT COMPLETION"
300   LOOP
310     STATUS 7,7;X          ! Read the bus control and data lines
320     EXIT IF BINAND(X,1024) ! Check for SRQ asserted
330   END LOOP
340 !
350   DISP "PLOT IS COMPLETE. "
360   BEEP
370   X=SPOLL(Adrs)          ! Clear SRQ
380   OUTPUT Adrs;"SQM 0"    ! Reset mask to default
390 !
400   END

```

Remote Operation
Bus Messages

```
100 !
110 ! Controller responds to plot completion using interrupts
120 ! and the instrument's 'Ready' bit
130 !
140 Adrs=711 !HP 3577B address
150 Plotter=705 ! Plotter address
160 Done_bit=16 ! 'Ready' = 16
170 !
180 OUTPUT Adrs;"SQM";Done_bit ! Unmask Ready bit
190 !
200 OUTPUT Adrs;"PLA" ! Get ready to plot. Plot won't start
210 ! until the HP 3577B is addressed to talk
220 !
230 REPEAT
240 X=SPOLL(Adrs) ! SPOLL to clear previous Ready
250 UNTIL NOT BINAND(X,Done_bit)
260 !
270 ! Next, enable the SRQ interrupt and start the plot.
280 !
290 ENABLE INTR 7;2 ! Allow Service Request to interrupt
300 ON INTR 7 GOTO Plot_done ! Turn interrupt 'ON'
310 SEND 7;UNL MTA LISTEN Plotter MOD 100 TALK Adrs MOD 100 DATA !Start plot
320 !
330 !
340 DISP "WAITING FOR PLOT COMPLETION"
350 LOOP
360 !
370 ! Wait indefinitely for plot completion
380 !
390 END LOOP
400 !
410 Plot_done: DISP "PLOT IS COMPLETE."
420 BEEP
430 X=SPOLL(Adrs) ! Clear interrupt condition
440 !
450 OUTPUT Adrs;"SQM 0" ! Reset mask to default
460 !
470 END
```

HP-IB ONLY COMMANDS

Function	HP-IB code
Settling Time Entry	STE
Dump register A	DRA
Dump register B	DRB
Dump register R	DRR
Dump register D1	DD1
Dump register D2	DD2
Dump register D3	DD3
Dump register D4	DD4
Dump register X1	DX1
Dump register X2	DX2
Dump register X3	DX3
Dump register X4	DX4
Dump register X5	DX5
Dump register X6	DX6
Dump register X7	DX7
Dump register X8	DX8
Dump jOmega, trace 1	DW1
Dump jOmega, trace 2	DW2
Dump trace 1	DT1
Dump trace 2	DT2
Dump marker 1	DM1
Dump marker 2	DM2
Dump marker 1 position	MP1
Dump marker 2 position	MP2
Dump state (learn mode out)	LMO
Dump complete state	DCS
Dump status	DMS
Dump average number	DAN
Dump key or knob	DKY
Dump characters	DCH
Dump Instrument ID	ID?
Channel B query	DMB

Function	HP-IB code
Read and dump 8-bit I/O port	DIO
HP Instr. Basic and Channel B Query	DOP
Load register A	LRA
Load register B	LRB
Load register R	LRR
Load register D1	LD1
Load register D2	LD2
Load register D3	LD3
Load register D4	LD4
Load register X1	LX1
Load register X2	LX2
Load register X3	LX3
Load register X4	LX4
Load register X5	LX5
Load register X6	LX6
Load register X7	LX7
Load register X8	LX8
Load state (learn mode in)	LMI
Load complete state	LCS
Load and write to 8-bit I/O port (entry)	LIO
Characters off	CH0
Characters on	CH1
Annotation off	ANO
Annotation on	AN1
Annotation Clear	ANC
Menu off	MNO
Menu on	MN1
Menu clear	MNC
ASCII data format	FM1
64 bit IEEE data format	FM2
32 bit HP 3577B binary	FM3
Bus diagnostics mode off	BDO

Remote Operation
Bus Messages

Function	HP-IB code
Bus diagnostics on, fast	BD1
Bus diagnostics on, slow	BD2
Enter Menu (user defined)	ENM
Enter Annotation	ENA
Enter Graphics	ENG
Clear Keyboard Buffer	CKB
Take Measurement	TKM
Set SRQ Mask (entry)	SQM
Error Reporting mode 0	ER0
Error Reporting mode 1	ER1
Error Reporting mode 2	ER2
Error Reporting mode 3	ER3
Send SRQ	SRQ
Dump time & date	DTI
Set time & date	STI

SETTLING TIME ENTRY (STE). Settling time may be entered over the HP-IB. Each bandwidth has a settling time associated with it. When a new bandwidth is selected its associated settling time will be active. These new values for settling time are not saved with instrument state and will be cleared by a PRESET or turning off power. The default values for settling time are shown in the following table:

Res BW = 1 kHz	22 ms
Res BW = 100 Hz	55 ms
Res BW = 10 Hz	370 ms
Res BW = 1 Hz	3.707 s

To enter a new value for the settling time parameter, select the resolution bandwidth before entering the new settling time. Settling time values may range from one millisecond to 16.383 seconds. For zero settling time, turn settling time off (SEO). The current value of the settling time parameter will appear in the data entry block if bus diagnostics mode one is used as follows:

Example:

```
OUTPUT 711; "BW3;BD1;STE 3 SEC;"
```

DUMP/LOAD REGISTER. The receiver input registers R, A, and B, and the storage registers X1 through X8 and D1 through D4 contain twice as many numbers as there are points in the active sweep resolution. Each point on the trace is derived from a register bin containing a complex number (represented by two real numbers). In the default sweep resolution of 401 points per sweep there will be 401 complex numbers. The HP 3577B will dump 401 real and 401 imaginary numbers in the form real (bin one), imaginary (bin one), real (bin two), imaginary (bin two),... The same methods apply for the "number of steps" sweep resolution used in amplitude sweeps and for the number of frequencies in the Discrete Sweep Table. Register I/O may use any of the three data formats FM1, FM2, or FM3. The example that follows shows how register data may be dumped to the computer/controller and loaded into the HP 3577B in each of the three data formats.

Remote Operation
Bus Messages

Example:

```
10 !
20 ! Dump and Load Registers using all 3 data transfer formats
30 !
40 REAL Real_array1(0:801),Real_array2(0:101)
50 INTEGER Integer_array(0:3,0:400)           ! array of 401 x 4 elements
60 ASSIGN @Na TO 711; FORMAT ON              ! Na = Network Analyzer
70 OUTPUT @Na;"IPR;SM2;DF5;TKM;"           ! TKM = take measurement
80 !
90 ! *****
100 !
110 ! FM1 = the ASCII data format
120 ! Next, Dump Register R using FM1
130 !
140 OUTPUT @Na;"FM1;DRR;"                   ! DRR = Dump Register R
150 ENTER @Na;Real_array1(*)
160 !
170 ! Real_array1 now contains the real and imaginary parts of
180 ! 401 complex numbers. Next, load the data into storage
190 ! register D1.
200 !
210 OUTPUT @Na;"LD1;",Real_array1(*)       ! LD1 = Load Register D1
220 !
230 ! Register D1 now contains the data held in Real_array1
240 !
250 OUTPUT @Na;"TR2;DF5;ID1;"              ! Display Register D1
260 PAUSE
270 !
280 ! *****
290 !
300 ! FM2 = 64 bit floating point binary (HP Series 200
310 ! computer real number) data format. Next, dump register
320 ! A using FM2. Note the use of reduced sweep resolution.
330 !
340 OUTPUT @Na;"RS1;TKM;FM2;DRA;"         ! Changing sweep res
350                                         ! clears registers, so new
360                                         ! TKM is required
370 !
380 ! Enter the leading bytes (#I) into an unused string
390 !
400 ENTER @Na USING "#,2A";Junk$
410 !
420 ! Enter the register data in data format FM2
430 !
440 ASSIGN @Na;FORMAT OFF                  ! FORMAT must be OFF to
450 ENTER @Na;Real_array2(*)              ! use data format FM2
460 ASSIGN @Na;FORMAT ON
```

```

470 !
480 ! Real_array2 now contains the real and imaginary part of
490 ! 51 complex numbers. Load this data into register D2:
500 !
510 OUTPUT @Na;"LD2;#I";           ! Last ";" prevents CR/LF
520 ASSIGN @Na;FORMAT OFF         ! Binary data must be
530 OUTPUT @Na;Real_array2(*)     ! preceded by "#I"
540 ASSIGN @Na;FORMAT ON
550 !
560 ! Register D2 now contains the data from Real_array2
570 !
580 OUTPUT @Na;"TR1;INA;TR2;ID2;ASL;"      ! Display data in D2
590 PAUSE
600 !
610 ! *****
620 !
630 ! FM3 = 32 bit floating point binary used by the HP 3577
640 ! internal processor. There are 4 bytes per real number in
650 ! data format 3. Next, take a measurement and store to D1:
660 !
670 OUTPUT @Na;"RS4;TR1;IBR;TKM;SD1;ASL;"
680 !
690 ! Now Dump D1 in data format FM3:
700 !
710 OUTPUT @Na;"FM3;DD1;"
720 !
730 ! Enter the leading bytes ("#I") into an unused string
740 ! then enter the data.
750 !
760 ENTER @Na USING "#,2A";Junk$
770 ASSIGN @Na;FORMAT OFF
780 ENTER @Na;Integer_array(*)       ! 401 x 4 bytes
790 ASSIGN @Na;FORMAT ON
800 !
810 ! Integer_array now contains the real and imaginary parts
820 ! of 401 complex numbers, each part filling a pair of
830 ! Series 200 Integers. Load this data into register D2:
840 !
850 OUTPUT @Na;"LD2;#I";           ! Binary data must be
860 ASSIGN @Na;FORMAT OFF         ! preceded by "#I"
870 OUTPUT @Na;Integer_array(*)
880 ASSIGN @Na;FORMAT ON
890 !
900 ! Register D1 now contains the data from Integer_array
910 !
920 OUTPUT @Na;"TR2;ID2;DF5;ASL;"      ! Display D1 as phase (DF5)
930 !
940 END

```

Remote Operation
Bus Messages

DUMP TRACE Traces may be dumped but not loaded. A trace is made up of real numbers as defined under the INPUT and DISPLAY FUNCTION keys and will have the same number of data points as defined in the current sweep resolution. This data is dumped using any of the three data formats with the following units:

Display Function	Absolute Units	Relative Units
	(e.g., INPUT = R)	(e.g., INPUT = B/R)
Log Mag	dBV	dB
Lin Mag	Volts	Units
Phase	Degrees	Degrees
Polar	Volts	Units
Delay	Seconds	Seconds
Real,Imag	Volts	Units

Phase trace data will be offset by the active Phase Reference Level. Delay data will be meaningless in some of the beginning and end bins due to the algorithm used to measure group delay. The number of bins affected will depend on the aperture and sweep resolution. When the HP 3577B dumps a delay trace, it will output large negative numbers in those bins whose data is thus affected. The example that follows shows how a trace may be dumped to the computer/controller.

Example:

```

10 !
20 ! Dump Trace example demonstrating use of all three
30 ! data transfer formats.
40 !
50 REAL Real_array1(0:400),Real_array2(0:50)
60 INTEGER Integer_array(0:1,0:400)           ! array of 401 x 2 elements
70 ASSIGN @Na TO 711; FORMAT ON              ! Na = Network Analyzer
80 OUTPUT @Na; " IPR; SM2; TKM; "          ! TKM = take measurement
90 !
100 ! *****
110 !
120 ! FM1 = the ASCII data format
130 ! Next, dump trace one.
140 !
150 OUTPUT @Na; " FM1; DT1; "                ! DT1 = Dump Trace one
160 ENTER @Na; Real_array1(*)
170 PAUSE
180 !

```

```

190 ! *****
200 !
210 ! FM2 = 64 bit floating point binary (HP 9000 Series 300
220 ! computer real number) data format. Next, dump trace
230 ! two using FM2. Note the use of reduced sweep resolution.
240 !
250 OUTPUT @Na; "RS1;TR2;DF5;TKM;FM2;DT2;"           ! RS1 = 51 pts/span
260 !
270 ! Enter the leading bytes ("#I") into array elements 0 & 1
280 !
290 ENTER @Na USING "#, (B)";Real_array2(0),Real_array2(1)
300 !
310 ! Prepare for an HP 9000 Series 300 internal real number format
320 ! data transfer and preform the entry.
330 !
340 ASSIGN @Na; FORMAT OFF                           ! FORMAT must be OFF to
350 ENTER @Na;Real_array2(*)                          ! use data format FM2
360 ASSIGN @Na; FORMAT ON                             ! Note that array elements
370 PAUSE                                             ! 0 & 1 are written over
380 !
390 ! *****
400 !
410 ! FM3 = 32 bit floating point binary used by the HP 3577B
420 ! internal processor. There are 4 bytes per real number in
430 ! data format 3. Next, take a measurement and dump trace 1
440 !
450 OUTPUT @Na; "RS4;TKM;FM3;DT1;"
460 !
470 ! Enter the #I as before, then the data.
480 !
490 ENTER @Na USING "#, 2A";Junk$
500 ASSIGN @Na; FORMAT OFF
510 ENTER @Na; Integer_array(*)
520 ASSIGN @Na; FORMAT ON
530 !
540 ! Integer_array now contains 401 real numbers from trace
550 ! one; each real number (32 bits) filling a pair of Series
560 ! 200 Integers (16 bits).
570 !
580 END

```

Remote Operation
Bus Messages

DUMP MARKER (DM1 & DM2). Except for the polar display function, this is Y-axis information for one bin. The units will match those of the trace dumps shown in the table on Page 3-50. If the display function is polar, two numbers will be output when a marker is dumped. These two numbers will be real and imaginary or magnitude and phase, respectively, depending on units selected for the marker. Any of the three data formats FM1, FM2, or FM3 may be used. The example that follows shows how a marker may be dumped and displayed.

Example: Non-polar display function

```
10 ! Example: Non-polar display function
20 OUTPUT 711;"IPR;TKM;FM1;DM1;"          ! DM1 = Dump Marker one
30 ENTER 711;Marker_amp
40 DISP "Magnitude=";Marker_amp
50 END
```

Example: Polar display function

```
10 ! Example: Polar display function
20 OUTPUT 711;"IPR;DF4;TKM;FM1;DM1;"      ! DF4 = polar
30 ENTER 711;Marker_amp,Marker_phase
40 PRINT "Magnitude=";Marker_amp
50 PRINT "Phase=";Marker_phase
60 END
```

MARKER POSITION (MP1 & MP2) dumps X-axis information for the appropriate trace marker. Any of the three data formats FM1, FM2, or FM3 may be used. The information units are:

LIN SWP	Frequency
LOG Swp	Frequency
ALT SWP	Frequency
AMP SWP	Source amplitude
CW	Frequency

Example:

```
10 OUTPUT 711;" IPR;TKM;MP1;"
20 ENTER 711;Mkr_freq
30 DISP "Marker frequency =";Mkr_freq
40 END
```

Note

If the frequency span is 0 Hz and the sweep time is less than 1000 seconds, the marker position is in units of time.

Dump and Load Instrument State

There are two ways to load and dump the instrument state; Dump and Load Complete State (DCS/LCS) and Learn Mode Out and In (LMO/LMI).

Dump Complete State (DCS) dumps the instrument state to a computer in binary, including the Limit Tables for Trace 1 and Trace 2, and the Discrete Sweep table. 3018 bytes are dumped including the first two bytes which are always #I. (#I is used to indicate that binary data is to follow.)

Load Complete State (LCS) loads the instrument state in binary, including the Limit Tables and the Discrete Sweep Table. It is used to configure the HP 3577B to a specific instrument state. Data dumped to the controller using DCS should not be changed outside the HP 3577B. LCS can be used to speed up reconfiguration if a large status change is necessary between tests.

Learn Mode Out (LMO) returns the instrument state in binary to be stored by a computer. This command should be used if the state will be reloaded in an HP3577A. 1100 bytes are dumped including the first two bytes which are #I. Limit Tables and the Discrete Sweep Table are not included.

Learn Mode In (LMI) loads the instrument state from a computer in binary. This command should be used to re-load a state that was dumped using LMO. It is recommended that the entire 1100 bytes (including the #I) be kept together after the dump as the same information needs to be returned to the HP 3577B when the LMI is used.

Remote Operation
Bus Messages

The example that follows shows how to dump a complete instrument state to a controller and load the complete instrument state back to the HP 3577B.

```
10 !
20 ! 'DCS', Dump Complete Instrument State
30 ! 'LCS', Load Complete Instrument State
40 ! Similar to LMO and LMI but includes Discrete Sweep Table
50 ! and Limit Tables, and other features not in the 3577A.
60 !
70 INTEGER Integer_array(0:1508)          !1509 16 bit words, or 3018 bytes
80 ASSIGN @Na TO 711
90 !
100 ! 3018 bytes will be dumped, 2 bytes per element of Integer_array.
110 !
120 OUTPUT @Na;"DCS"
130 ASSIGN @Na;FORMAT OFF
140 ENTER @Na;Integer_array(*)
150 ASSIGN @Na;FORMAT ON
160 PAUSE
170 !
180 ! This data may be reloaded as follows.
190 !
200 OUTPUT @Na;"IPR;LCS;"
210 ASSIGN @Na;FORMAT OFF
220 OUTPUT @Na;Integer_array(*)
230 ASSIGN @Na;FORMAT ON
240 !
250 END
```

The following program uses LMO and LMI to load and return the instrument state.

Example:

```

10 !
20 ! 'LMO', Learn Mode Out (dump instrument state)
30 ! 'LMI', Learn Mode In (load instrument state)
40 !
50 INTEGER Integer_array(0:549)      ! Array of 550 16 bit words
60 ASSIGN @Na TO 711; FORMAT ON
70 !
80 ! 1100 bytes will be dumped, 2 bytes per element of
90 ! Integer_array. Next, configure state and dump it.
100 !
110 OUTPUT @Na; "IPR; TR2; DF5; FRA 1 MHZ; SAM 15 DBM; ST3; LMO;"
120 ASSIGN @Na; FORMAT OFF
130 ENTER @Na; Integer_array(*)
140 ASSIGN @Na; FORMAT ON
150 PAUSE
160 !
170 ! Integer_array now contains 1100 bytes of instrument state
180 ! data. This data may be reloaded as follows.
190 !
200 OUTPUT @Na; "IPR; LMI;"
210 ASSIGN @Na; FORMAT OFF
220 OUTPUT @Na; Integer_array(*)
230 ASSIGN @Na; FORMAT ON
240 !
250 END

```

DUMP STATUS (DMS) This command dumps the Status Byte and two more bytes of instrument status information plus a screen message (the Serial Poll dumps only the Status Byte). In the following table, B7 is the most significant bit and B0 is the least significant bit. All data is in the ASCII format.

Remote Operation
Bus Messages

BYTE 1 The STATUS BYTE		
Bit Number	Bit Value	Function
B7	128	Instrument BASIC stopped or paused
B6	64	RQS (require service)
B5	32	Error bit
B4	16	Ready for HP-IB command
B3	8	Key pressed
B2	4	Measurement complete
B1	2	Data available
B0	1	Data transfer complete
BYTE 2		
B7	128	Power on
B6	64	Source tripped
B5	32	Reference unlocked
B4	16	No external reference
B3	8	Input A overload
B2	4	Input B overload
B1	2	Input R overload
B0	1	Input tripped
BYTE 3		
B7	128	Settling
B6	64	Waiting for trigger (TRG)
B5	32	Waiting for external trigger or line sync
B4	16	Sweeping
B3	8	End of sweep has occurred
B2	4	Trace 2 failed limit test
B1	2	Trace 1 failed limit test
B0	1	Not used

ASCII STRING

The ASCII String is a 26-character string containing an error, warning, or general information screen message. The error reporting mode selected determines the level of message (none, error only, warning and error, or all) that appears. Refer to MASKING THE STATUS BYTE for more on error reporting modes, and to Appendix C for a complete listing of these messages.

Bits 0, 1, 2, 3, 5, and 6 of byte two will cause error messages when they become set. If the error bit is unmasked and more than one of these conditions exist, the first to occur will be the only message dumped. If the error bit is masked, DMS will dump the most recent message. The following example program was run immediately after having preset the HP 3577B and pressed a numeric key in the DATA ENTRY section:

Example:

```
10 DIM A$(100)
20 OUTPUT 711;"DMS"
30 ENTER 711;A$
40 DISP "Response to DMS command is '" ;A$;"'"
50 END
```

Response to DMS command is:

```
' 16, 0, 16, ENTRY UNDEFINED'
```

Dumping status will clear the error string to all blanks. It also clears the Power on, RQS, and (if no permanent hardware errors remain set) the error bit. Its effect on the Status Byte is the same as a serial poll.

DUMP AVERAGE NUMBER (DAN) dumps the number of sweeps or samples taken since averaging was turned on. This number is not the user selection, N. The ASCII equivalent of the average number is returned terminated by <CR/LF> and <EOI>. The data format for DAN is *always* ASCII. The maximum value returned is 9999.

Example:

```
10 OUTPUT 711;"IPR;AV5;"      ! AV5 = averaging on (N=64)
20 WAIT 5
30 OUTPUT 711;"DAN;"
40 ENTER 711;Avg_no
50 DISP Avg_no
60 GOTO 20
70 END
```

Remote Operation
Bus Messages

CLEAR KEYBOARD BUFFER & DUMP KEY (CKB & DKY) These allow the controller to clear the keyboard buffer (which will hold as many as six keypresses) and monitor key presses and/or knob rotation. Note that an SRQ may be generated by front panel keys (see STATUS BYTE).

CKB clears the key buffer of key presses and the knob counter to zero. The key buffer holds a maximum of six key presses. The knob counter contains the first count, other than zero, taken by the counter since the last CKB command.

DKY dumps two numbers in ASCII format. The first number corresponds to a front panel hardkey and will range from 0 to 51 inclusive. The following table shows the keys and their corresponding number. If there has been no key pressed since the last CKB command, a - 1 will be returned. The second number is the knob counter which contains a number between - 15 and +15; negative numbers indicate counter-clockwise rotation and positive numbers indicate clockwise rotation. Zero indicates no rotation. The following example shows how the CKB and the DKY commands are used. Also, refer to the example for ENTER MENU and ENTER ANNOTATION.

Example

```
10 OUTPUT 711;"CKB;"
20 OUTPUT 711;"DKY;"
30 ENTER 711;Key,Knob
40 IF Key=-1 AND Knob=0 THEN 20
50 DISP "Key=";Key;" and Knob=";Knob
60 OUTPUT 711;"CKB;"
70 GOTO 20
80 END
```

Number	Key Name	Number	Key Name
0	zero	26	DECREMENT
1	one	27	TRACE 1
2	two	28	TRACE 2
3	three	29	FREQ
4	four	30	AMPTD
5	five	31	TRIG MODE
6	six	32	SWEEP TYPE
7	seven	33	Swp MODE
8	eight	34	Swp TIME
9	nine	35	DEFINE MATH
10	decimal	36	STORE DATA
11	minus	37	DISPLAY FCTN
12	backspace	38	INPUT
13	softkey 1 (top)	39	SCALE
14	softkey 2	40	MKR
15	softkey 3	41	MEASR CAL
16	softkey 4	42	(not used)
17	softkey 5	43	SAVE
18	softkey 6	44	RECALL
19	softkey 7	45	SPCL FCTN
20	softkey 8	46	RES BW
21	TRIG/RESET	47	AVG
22	ENTRY OFF	48	ATTEN
23	LOCAL	49	LENGTH
24	MARKER/ENTRY KEY	50	PLOT
25	INCREMENT	51	MKR →

Remote Operation
Bus Messages

DUMP CHARACTERS (DCH) Dumps the alphanumeric characters on the screen to determine values of certain parameters. Only information presently on the screen is returned on the bus. As soon as the instrument is addressed to talk the following ASCII information will be returned if the display is NOT in polar format:

1. Reference level for trace 1
2. Amplitude level for trace 1
3. Reference level for trace 1
4. Reference level for trace 2
5. Amplitude level for trace 2
6. Marker frequency for trace 1
7. Marker amplitude for trace 1
8. Marker frequency for trace 2
9. Marker amplitude for trace 2
10. Start frequency for trace 1
11. Stop frequency for trace 1
12. Start frequency for trace 2
13. Stop frequency for trace 2
14. Source amplitude (if not in alternate sweep)
15. Delay aperture (if DSPLY FCTN is DELAY) for the active trace
16. Entry block information (if bus diagnostics are enabled)

If the display format is POLAR, then the following ASCII information is returned:

1. Full scale level,
2. Phase reference
3. Reference position
4. <NULL>
5. Marker frequency
6. Marker amplitude
7. Marker phase
8. <NULL>
9. Start frequency for trace 1
10. Stop frequency for trace 1
11. Start frequency for trace 2
12. Stop frequency for trace 2
13. Source amplitude (if not in alternate sweep)
14. <NULL>
15. Entry block information

Each field will be separated by a comma; the last field will be delimited by a carriage return/linefeed. If the field is not defined currently on the CRT, an empty field will be returned.

Example

```
10 !
20 ! 'DCH', Dump Characters Program
30 !
40 DIM Bfr$(1:15)[40],U$(300),E$(26]
50 ASSIGN @Adrs TO 711
60 !
70 ! Polar Display Function
80 !
90 OUTPUT @Adrs;"IPR;ST1;TR1;DF4;TKM;DMS;"
100 ENTER @Adrs;X,Y,Z,E$           ! Status read to make sure all commands
110                               ! have been processed & sweep is done
120 !
130 OUTPUT @Adrs;"ASL;"           ! Auto scale the screen display
140 WAIT .1                       ! Allow time to update picture
150 !
160 GOSUB Get_characters
170 !
180 PRINT "Full Scale: ";Bfr$(1)
190 PRINT "Phase Reference: ";Bfr$(2)
200 PRINT "Reference Position: ";Bfr$(3)
210 PRINT
220 PRINT "Marker Frequency: ";Bfr$(5)
230 PRINT "Marker Amplitude: ";Bfr$(6)
240 PRINT "Marker Phase: ";Bfr$(7)
250 PRINT
260 PRINT "Start Frequency: ";Bfr$(9)
270 PRINT "Stop Frequency: ";Bfr$(10)
280 PRINT "Source Amplitude: ";Bfr$(13)
290 STOP
300 !
310 Get_characters: !
320 OUTPUT @Adrs;"DCH;"
330 ENTER @Adrs;U$
340 FOR I=1 TO 15
350 IF POS(U$,"") THEN
360   Bfr$(I)=U$[1,POS(U$,"")-1]
370   U$=U$[POS(U$,"")+1]
380 ELSE
390   Bfr$(I)=U$
400 END IF
410 NEXT I
420 RETURN
430 !
440 END
```

Remote Operation
Bus Messages

Result:

Full scale: FULL SCALE 2.5000
Phase reference: PHASE REF 0.0 deg.
Reference position: REF POSN 0.0 deg.

Marker frequency: MARKER 100 050 000.000 Hz
Marker amplitude: MAG(S21) 646.58E-3
Marker phase: PHASE(S21) - 45.208 deg.

Start frequency: START 100 000.000 Hz.
Stop frequency: STOP 200 000 000.000 Hz.
Source amplitude: AMPTD 15.0 dBm

SINGLE PARAMETER QUERY To query the value of a specific parameter returned by the DCH command, use the following program.

```
10 !
20 ! "QUERY_NA"
30 !
40 ASSIGN @Na TO 711
50 PRINT FNQuery_na$(@Na, "SWT")
60 !
70 END
80 DEF FNQuery_na$(@Na, Entry_code$)
90 ! This function will query the HP 3577B and return the value
100 ! of the item specified by Entry_code$. The string it returns
110 ! will be in the same format as the CRT display for the item.
120 !
130 ! For example,
140 ! FNQuery_na$(@Na, "SWT")
150 ! will return
160 ! "SWEEP TIME 1.000SEC"
170 !
180 DIM Reply$[300] !will contain the comma-separated
190 !DCH reply.
200 OUTPUT @Na;"BD1;";Entry_code$ !display the item on CRT
210 OUTPUT @Na;"DCH" !request character dump
220 ENTER @Na;Reply$ !read characters
230 OUTPUT @Na;"BD0" !turn off bus diagnostics
240 !
250 ! The entry field is the last field of Reply$.
251 ! Find the last comma by adding 1 to the length of the string
252 ! and subtracting the reverse of the string.
260 Last_comma=LEN(Reply$)+1-POS(REV$(Reply$),",")
270 RETURN Reply$[Last_comma+1]
280 FNEND
```

DUMP PRODUCT IDENTIFICATION (ID?) The HP 3577B responds with the following ASCII character string:

HP 3577B, TESTSET (or <NULL>< Software revision>

The TESTSET string is present if the HP 35677A or HP 35677B S-Parameter Test Set is connected to the HP 3577B.

CHANNEL B QUERY (DMB) returns one character; “0 <cr><lf>” when channel B is absent, and “1 <cr><lf>” when channel B is present. The HP 3577B Option 002 adds the third (channel B) receiver.

HP INSTRUMENT BASIC and CHANNEL B OPTIONS QUERY (DOP) The HP 3577B responds with the following ASCII character string:

002 (or 0), 1C2 (or 0).

If both options are present the reply is “002,1C2 <cr> <lf>.”

BUS DIAGNOSTIC MODES. There are three bus diagnostic modes:

1. BD0 = Bus Diagnostics Off, used for best programming speed.
2. BD1 = Bus Diagnostics On, Fast; menus appear, bus codes appear on screen for three seconds after an error is detected.
3. BD2 = Bus Diagnostics On, Slow; menus appear, bus codes appear and are decoded at the rate of one per second.

BD1 and BD2 are useful for debugging programs written to control the HP 3577B. When on, this mode will sequence through all menus and update the display as if the HP 3577B were being operated from the front panel.

DATA FORMATS. The HP 3577B offers three data formats used to transfer certain types of data on the bus. The data types that make use of all three formats are trace data, register data, marker data, and marker position.

FM1 is the ASCII data format. The ASCII floating point format will always transfer fifteen characters in the form - 12.3456789E +03 for each number (i.e., leading spaces or zeros are not suppressed). In FM1 data dumps, the HP 3577B outputs ASCII data points separated by commas and carriage return line feed (CR/LF) indicates the end of record. When transferring data, the complete set of data is referred to as a record. A record is composed of data and an end of record terminator. When loading data the HP 3577B accepts commas, CR and LF as delimiters between data points. No end of record symbol is required; the instrument will respond to EOI. No more than one delimiter is allowed between numbers; CR/LF is considered a single delimiter. Spaces between and within numbers will be ignored.

FM2 is the 64 bit floating point binary specified by ANSI/IEEE standard 754-1985. This is the same data format used by the HP 9000 Series 300 Computers. This format appears as follows:

SEEEEEEEEEEMFFF FFFFFFFFFFFFFFFFFF FFFFFFFFFFFFFFFFFF FFFFFFFFFFFFFFFFFFL

where:	M is the most significant bit of the fractional part
	F is an intermediate fractional bit
	L is the least significant fractional bit
	S is the sign bit of the fractional part
	E is the exponent part
and:	The exponent is offset by 127 (i.e. 127=0). This format represents 1.fff. All ones for f's represents ~ 2.0 (i.e., normalized to 2).

FM3 is the 32 bit floating point binary used by the HP 3577B fast processor. This format appears as follows:

MFFFFFFFFFFFFFFFF SFFFFFFFFLEEEEEEE

where:	M is the most significant bit of the fractional part
	F is an intermediate fractional bit
	L is the least significant fractional bit
	S is the sign of the fractional part
	E is the exponent part
and:	M should always be a "1"
	The exponent is offset by 128 (i.e., 128=0). This format represents .1ffff... All ones represents ~ 1.0 (i.e., normalized to 1).

In either of the the binary data formats the header #I must precede a binary load so that the HP 3577B can recognize the bytes following the header as binary data.

ABORTING A DUMP OR LOAD A dump or load will be aborted by any one of the following events:

1. End (EOI) sent by talker (FM2 or FM3 load only)
2. Sending non-numeric data (ASCII loads only)
3. Device Clear
4. Pressing the LOCAL front panel key
5. Addressing the HP 3577B to Listen and sending one or more bytes (dumps only).

Note that an Interface Clear (IFC) does not abort a dump or load over the bus. For unconditional control of the bus, it is recommended that Device Clear followed by Interface Clear be issued at the beginning of your program. The BASIC commands that correspond to these are CLEAR 7 and ABORT 7, respectively.

LENGTH OF RECORD The length of the data record (number of points transferred) will depend on the sweep type currently active. This is true for both register data and trace data. Note that in trace dumps of delay a certain number of first and last bins will be undefined. The total number of undefined bins equals half the aperature width. To protect the user from bad data, the HP 3577B will output a large negative numbers in these bins. Typical record lengths for each sweep type is given below:

- CW: 1
- LIN: Sweep Resolution
- LOG: 401
- ALT: 401
- AMP: Number of steps per sweep plus 1
- DISCR: Total number of rows in Discrete Sweep Table

Remote Operation
Bus Messages

END OF DATA The bus management line EOI (end or identify) will be pulled by the HP 3577B on the last byte of any data dump whether it is a binary or ASCII dump. Once the HP 3577B has pulled its EOI line it will not transmit any more data until receiving another message. When using ENG (enter graphics) to load graphics commands, EOI must be pulled on the handshake of the last byte. Using BASIC on HP computers, pulling the EOI line is done by putting ;END at the end of the data string as shown in the following example:

Example:

```
10 OUTPUT 711;"ENG #I";  
20 OUTPUT 711 USING "#,W" ;Cmnd_array(*) ;END
```

SET TIME & DATE/DUMP CURRENT TIME & DATE (STI, DTI). STI sets the time and date. The command requires a quoted string with 6 values representing the year, month, day, hour, minute, and second as shown in the example below. Separate each value with a comma, space, or colon.

Example:

```
OUTPUT 711;"STI ""1990,6,26,16:19:00"";"
```

Use the time and date clock for disk catalog entries or for Option 1C2's (HP Instrument BASIC) TIMEDATE function. The clock stops when the instrument's power is shut off.

DTI dumps the current time and date. It returns the 6 values defined in the STI command. Six zeros will return if the time and date have not been set since power on.

ENTER MENU (ENM) allows the user to label the eight softkeys. This feature may be used with commands that read the keyboard. It does not allow the user to redefine the key label corresponding to a HP 3577B softkey function. The user defined menu shares the same display memory with system menus. It is recommended that the bus diagnostic mode be kept off to avoid overwriting menus.

To label the softkeys use the following sequence:

ENM	Enter menu bus mnemonic.
▪	Opening quote indicates that text follows.
1-8	The softkey number on which to display the message. If the first character is not a number
text	Up to 16 characters of ASCII text. If the text is 8 characters or less a single line key-label will appear centered on the key. If the text is 9 to 16 characters the text will be divided into 2 lines with 8 characters on the first line and the remainder on the second line; the 2 lines will be centered on the key. A carriage return character is not acceptable and will be translated to a left arrow. Double quote marks (") may be included as characters by sending a pair of double quotes (") to the HP 3577B. Note that the computer may require entry of four quote marks for two quote marks to appear in the program line (resulting in one on the HP 3577B screen).
▪	Closing quote mark.
<delim>	This delimiter may be the characters; <CR/LF> space or the act of pulling <EOI> on the handshake of the last byte transferred.

Whenever the instrument returns to LOCAL mode and the front panel is enabled, the user defined menu will be overwritten with the present system definition of the softkeys. For an example program using ENM, refer to ENTER ANNOTATION. Additional functions to control the menu display memory:

Menu off	MNO
Menu on	MN1
Menu clear	MNC

Remote Operation
Bus Messages

ENTER ANNOTATION (ENA) This command allows the user to provide text strings and to specify on which of twelve lines it will appear. These lines are located in the graticule area; four near the top, four in the middle, and four near the bottom. They are located such that there is no interference with the message block in which errors and warnings are displayed.

The format to be used is as follows:

ENA	Enter annotation bus mnemonic.
▪	Opening quote indicates that text follows.
1-12	The display line number on which the annotation is to be displayed. If the first character is not numeric
text	Up to 40 characters of ASCII text. The carriage return character code is unacceptable and will be translated to a left arrow if used.
▪	Closing quote marks.
<delim>	This delimiter may be the characters: <CR/LF> space or the act of pulling <EOI> on the handshake of the last byte transferred.

Example:

```

10 !
20 ! 'ENA', 'ENM' Use of Enter Annotation and Enter Menu
30 ! 'CKB', 'DKY' Use of Clear Keyboard and Dump Key
40 !
50 Adrs=711
60 ASSIGN @Adrs TO Adrs
70 OUTPUT @Adrs;"ANC;MNC"           ! Clear annotation and menu
80 !
90 ! Next, define the annotation and menu
100 !
110 OUTPUT @Adrs;"ENA;"2      Special Test""
120 OUTPUT @Adrs;"ENA;"4  Select appropriate MENU KEY. ""
130 !
140 OUTPUT @Adrs;"ENM;"1CONTINUE""
150 OUTPUT @Adrs;"ENM;"4  TEST FAILED""
160 OUTPUT @Adrs;"ENM;"8  ABORT""
170 !
180 ! Note that a pair of double quotes must be used to send
190 ! one double quote mark (") at execution time. To get a
200 ! double quote to appear in the HP 3577B screen annotation,
210 ! 4 double quotes (""") must be written into the program.
220 !
230 LOOP
240 OUTPUT @Adrs;"MN1;AN1;"           ! Turn annotation and menu on
250 OUTPUT @Adrs;"CKB;"             ! Clear the keyboard buffer
260 LOOP
270 OUTPUT @Adrs;"DKY;"             ! Read the keyboard
280 ENTER @Adrs;Key,Knob
290 EXIT IF Key=13 OR Key=16 OR Key=20
300 IF Key=-1 THEN BEEP             ! -1 = no key pressed
310 END LOOP
320 OUTPUT @Adrs;"MNO;"             ! Turn menu off
330 SELECT Key
340 CASE 13
350 OUTPUT @Adrs;"ENA;"5  CONTINUE key pressed""
360 CASE 16
370 OUTPUT @Adrs;"ENA;"5  TEST FAILED key pressed""
380 CASE 20
390 OUTPUT @Adrs;"ENA;"5  ABORT key pressed""
400 END SELECT

```

Remote Operation
Bus Messages

```
410 !  
420 WAIT 2  
430 OUTPUT @Adrs;"ENA;"5"" ! Clears the message  
440 OUTPUT @Adrs;"MN1;" ! Turns the menu back on  
450 !  
460 END LOOP  
470 !  
480 END
```

ENTER GRAPHICS (ENG) The graphics mode allows the user to place alphanumeric information anywhere on the screen in different sizes, intensities and rotational positions, as well as draw vectors. Although this offers more flexibility than ENA, knowledge of the Digital Display Module command set is required. This information uses the same display memory as the ENA function, therefore the two functions cannot be used together.

The format to be used is as follows:

ENG	Enter Graphics bus mnemonic.
#1	Indicates binary words to follow.
<0-923>	Starting address within annotation block where digital display commands are to be placed. Sent as a 16 bit binary number
Digital Display Commands	Sent as 16 bit binary words, MSB first. The commands for the digital display are binary commands. When the ENG command is used the HP 3577B will pass these commands to the display section. Appendix B is a quick reference programming guide for the digital display. The JUMP command is not allowed. The carriage return character will be translated into a left arrow. Memory capacity is 924 commands.
<EOI>	End Or Identify will be sent with the last data byte to indicate the end of the sequence.

Example:

This program draws a square on the HP 3577B screen, writes a message on the screen and displays the HP logo at random locations.

```

1000 ! Use of Enter Graphics: This program draws a square on the HP 3577B
1010 ! screen, writes a message on the screen, and displays the HP logo
1020 ! at random locations.
1030 COM INTEGER Cmnd_array(0:20),Array_indx,Disp_adrs,Array_length,@Adrs
1040 INTEGER Plotx,Movey,Ploty,Set_cmnd,Text(1:5),Es
1050 INTEGER I,J
1060 Array_length=20
1070 Array_indx=1
1080 Disp_adrs=0
1090 Adrs=711
1100 ASSIGN @Adrs TO Adrs
1110 !
1120 OUTPUT @Adrs;"IPR;ANC;"      ! Clear state and annotation
1130 OUTPUT @Adrs;"AN1;"        ! Turn the display ON
1140 OUTPUT @Adrs;"TR1;DF0;GR0;CH0;"
1150 !
1160 ! Define the annotation commands
1170 !
1180 ! The PLOT command for the display: 000y pddd dddd dddd
1190 !
1200 !   Where: y = 0 for x definition; 1 for y definition
1210 !         p = 0 for 'pen up'; 1 for 'pen down'
1220 !         d = location in range 0 to 2047
1230 !
1240 !
1250 Plotx=0
1260 Ploty=6144
1270 Movey=4096
1280 !
1290 ! The SET CONDITIONS command for the display
1300 !
1310 ! 011i ixxl l0xw wxxx
1320 !
1330 !   Where: i defines the line intensity
1340 !         00 - blank
1350 !         01 - dim
1360 !         10 - half bright
1370 !         11 - full bright
1380 !   l defines the line type
1390 !         00 - solid line
1400 !         01 - intensified end points
1410 !         10 - long dashes
1420 !         11 - short dashes
1430 !   w defines the writing speed
1440 !         00 - 0.20 inches per microsecond
1450 !         01 - 0.15 inches per microsecond

```

Remote Operation
Bus Messages

```
1440 !      00 - 0.20 inches per microsecond
1450 !      01 - 0.15 inches per microsecond
1460 !      10 - 0.10 inches per microsecond
1470 !      11 - 0.05 inches per microsecond
1480 !      x = don't care
1490 !
1500 Set_cmnd=30744 ! full bright, solid line, & .05 in/us
1510 !
1520 ! The TEXT command: 010s srre cccc cccc
1530 !
1540 ! Where: s defines character size
1550 !      00 - 1.0X
1560 !      01 - 1.5X
1570 !      10 - 2.0X
1580 !      11 - 2.5X
1590 !      r defines rotation
1600 !      00 - 0 degrees
1610 !      01 - 90 degrees
1620 !      10 - 180 degrees
1630 !      11 - 270 degrees
1640 !      e - establish size of character
1650 !      0 - Use previous size and rotation
1660 !      1 - Use new size and rotation
1670 !      c - character code (see table in appendix)
1680 !
1690 Text(1)=16384 ! size is 1.0X and rotation is 0 degrees
1700 Text(2)=18944 ! size is 1.5X and rotation is 90 degrees
1710 Text(3)=21504 ! size is 2.0X and rotation is 180 degrees
1720 Text(4)=24064 ! size is 2.5X and rotation is 270 degrees
1730 Text(5)=22528 ! size is 2.5X and rotation is 0 degrees
1740 Es=256 ! "establish size and rotation" flag
1750 !
1760 ! Plot a square on the HP 3577B screen:
1770 !
1780 Sqr:DATA 100,100 ! x,y coordinate for lower left corner
1790 DATA 100,1000 ! upper left
1800 DATA 1000,1000 ! upper right
1810 DATA 1000,100 ! lower right
1820 !
1830 ! Since the display units are not equal (i.e., Y-axis
1840 ! units are 3/4 the size of the X-axis units on the
1850 ! display), the Y-axis units should be divided by .75
1860 ! to get a true square.
1870 !
1880 Y_axis_scale=.75
1890 READ X0,Y0 ! read the first point
```

```

1900 CALL Add_cmnd(Set_cmnd)           ! initialize SET COMMAND
1910 CALL Add_cmnd(X0+Plotx)          ! move to starting point
1920 CALL Add_cmnd(Y0/Y_axis_scale+Movey)
1930 FOR I=1 TO 3
1940 READ X,Y
1950 CALL Add_cmnd(X+Plotx)
1960 CALL Add_cmnd(Y/Y_axis_scale+Ploty)
1970 NEXT I
1980 CALL Add_cmnd(X0+Plotx)
1990 CALL Add_cmnd(Y0/Y_axis_scale+Ploty) ! plot to starting point
2000 !
2010 ! Now display the following message in the four different
2020 ! sizes and rotations.
2030 !
2040 Message$="HP3577 "
2050 !
2060 CALL Add_cmnd(550+Plotx)         ! define the start of characters
2070 CALL Add_cmnd(500+Movey)
2080 FOR I=1 TO 4
2090 CALL Add_cmnd(Text(I)+Es+NUM(Message$)) ! 1st character
2100                                     ! w/ Es asserted
2110 FOR J=2 TO LEN(Message$)
2120 CALL Add_cmnd(Text(I)+NUM(Message$[J]))
2130 NEXT J
2140 NEXT I
2150 !
2160 IF Array_indxl THEN CALL Transfer_cmnd ! transfer if necessary
2170 !
2180 Array_indx=1                       ! reinitialize buffer
2190 Cmnd_array(0)=100                  ! use address 100 for buffer
2200 CALL Add_cmnd(1500+Plotx)          ! define starting position for
2210 CALL Add_cmnd(1500+Movey)          ! loop
2220 CALL Add_cmnd(Text(5)+Es+1)        ! character "1" is HP logo
2230 OUTPUT @Adrs;"ENG#I";
2235 ASSIGN @Adrs;FORMAT OFF           ! switch to binary format
2240 OUTPUT @Adrs;Cmnd_array(*) ;END
2245 ASSIGN @Adrs;FORMAT ON            ! return to ASCII
2255 !
2260 ! The following steps will update the two commands which
2270 ! define the starting location of the HP logo. It
2280 ! demonstrates changing selected commands "on the fly".
2290 !
2300 LOOP
2310 Cmnd_array(1)=INT(1500*RND)+Plotx ! Update new starting
2320 Cmnd_array(2)=INT(1900*RND)+Movey ! position for logo.
2330 OUTPUT @Adrs;"ENG#I";             ! Update new x,y

```

Remote Operation
Bus Messages

```
2335 ASSIGN @Adrs;FORMAT OFF           ! switch to binary format
2340 OUTPUT @Adrs;Cmnd_array(0),Cmnd_array(1),Cmnd_array(2);END
2345 ASSIGN @Adrs;FORMAT ON           ! return to ASCII
2350 WAIT .1
2360 END LOOP
2370 !
2380 END
2390 !
2400 ! The following subroutine adds Digital Display commands to
2410 ! Cmnd_array until it contains 20 (Array_length) elements.
2420 !
2430 SUB Add_cmnd(INTEGER Value)
2440 COM INTEGER Cmnd_array(*),Array_indx,Disp_adrs,Array_length,@Adrs
2450 Cmnd_array(Array_indx)=Value
2460 Array_indx=Array_indx+1
2470 IF Array_indx>Array_length THEN
2480 CALL Transfer_cmnd
2490 Array_indx=1
2500 END IF
2510 SUBEND
2520 !
2530 ! Send the Cmnd_array to HP 3577B
2540 !
2550 SUB Transfer_cmnd
2560 COM INTEGER Cmnd_array(*),Array_indx,Disp_adrs,Array_length,@Adrs
2580 Cmnd_array(0)=Disp_adrs
2590 OUTPUT @Adrs USING "#,K";"ENG #I" ! Send ENG and #I
2595 ASSIGN @Adrs;FORMAT OFF           ! switch to binary format
2600 OUTPUT @Adrs;Cmnd_array(*);END    ! Send array
2605 ASSIGN @Adrs;FORMAT ON           ! return to ASCII
2610 FOR K=0 TO Array_length           ! Clear out Cmnd_array
2620 Cmnd_array(K)=0
2630 NEXT K
2640 Disp_adrs=Disp_adrs+Array_indx-1 ! Re-define display
2650                                     ! memory address for
2660 SUBEND                             ! next transfer.
```

ANNOTATION OFF (ANO) Turns off the Annotation/Graphics modes by disabling the display memory.

ANNOTATION ON (AN1) Enables the commands in display memory.

ANNOTATION CLEAR (ANC) Clear display memory back to NOP instructions.

Additional functions to control the screen are:

Graticule On	GR1
Graticule Off	GR0
Characters On	CH1
Characters Off	CH0 (screen messages will not be turned off)

The character fields controlled by the character commands are:

1. Information at the bottom of the screen.
2. The REF and /DIV messages and their values
3. The entry block
4. The marker data
5. The graticule

The following screen features have their own on/off commands:

1. Trace data (the traces themselves; **TR1 DF0** and **TR2 DF0**)
2. Trace reference lines (**TR1 RL0** and **TR2 RL0**)
3. Annotation
4. Menu

TAKE MEASUREMENT (TKM) When this command is received the HP 3577B settles and takes a measurement before processing the next bus command. TKM (followed by a dump command) guarantees that the measurement will be completed before data transfer begins. For faster measurements RST and TRG may be used as shown previously.

Instrument Preset (default) Parameter Values

The HP 3577B responds to the instrument preset (IPR) command configuring its parameters as defined in the following table:

FUNCTION	PRESET CONDITION	
	Without test set	With test set
TRACE 1	Active	same
TRACE 2	Off	same
DISPLAY FUNCTION	Log magnitude	same
INPUT def. (both traces)	R	S21 (B/R, test set FWD)
user defined input	F3	same
SCALE (log mag)		
Reference level	0.0 dBm	0.0 dB
/DIV	10.0 dB	same
Reference position	100 %	same
Reference line	On	same
SCALE (linear mag)		
Reference level	0.0 Volts	0.0 units
/DIV	100 mV	$100E^{-3}$ units
Reference position	0.0 %	same
Reference line	On	same
SCALE (phase)		
Reference level	0.0°	0.0°
/DIV	45 degrees	same
Reference position	50 %	same
Reference line	On	same
Phase slope (Trc 1&2)	On, 0.0°/span	same
SCALE (polar)		
Full scale	1.0 Volts	1.0 units
Phase reference	0.0°	same
Reference position	0.0°	same
Reference line	On	same
Phase slope (Trc 1&2)	On, 0.0°/span	same
SCALE (real & imaginary)		
Reference level	0.0 Volts	0.0 units

FUNCTION	PRESET CONDITION	
	Without test set	With test set
/DIV	200 mV	$200E^{-3}$ units
Reference position	50 %	same
Reference line	On	same
Phase slope (Trc 1&2)	On, 0.0%/span	same
SCALE (delay)		
Reference level	0.0 s	same
/DIV	100 ns	same
Reference position	50 %	same
Reference line	On	same
Phase slope (Trc 1&2)	On, 0.0%/span	same
SCALE (SWR)		
Reference level	0 units	same
/DIV	1.0 unit	same
Reference position	0 %	same
Reference line	On	same
MARKER (Both traces)		
Marker	On	same
Position	Bin 200	same
Offset (Mag, freq swp)	Off, 13.01 dBm	Off, 0.0 dB
Freq Offset (X-axis)	0.0 Hz	0.0 Hz
Offset (Mag, amptd swp)	Off, 13.01 dBm	Off, 0.0 dB
Amptd Offset (X-axis)	13.0 dBm	13.0 dBm
Target	10.01 dBm	- 3.0 dB
LIMIT TABLE (Both traces)	remains same	remains same
STORE		
User def equation	R	same
DEFINE MATH		
K1 real	1	same
K1 imaginary	0	same
DEFINE MATH, continued		
K2 real	50	same
K2 imaginary	0	same

Remote Operation
Bus Messages

FUNCTION	PRESET CONDITION	
	Without test set	With test set
K3 real	75	same
K3 imaginary	0	same
K4 real	0	same
K4 imaginary	1	same
K5 real	-1	same
K5 imaginary	0	same
K6 real	1.0×10^9	same
K6 imaginary	0	same
K7 real	1.0×10^{12}	same
K7 imaginary	0	same
F1	$(B/R)/(K1 - B/R)$	same
F2	A/R	same
F3	$(K1 + F2)/(K1 - F2)$	same
F4	$K2 * F3$	same
F5	$K3 * F3$	same
SWEEP TYPE	Linear (freq)	same
Sweep direction	Up (left to right)	same
Discrete Sweep Table	remains same	remains same
SWEEP MODE	Continuous	same
SWEEP TIME (linear swp)	1000 s	same
(amplitude swp)	0.050 s/step	same
(manual swp mode or CW)	0.050 s/step	same
FREQUENCY		
Start freq (linear swp)	0.000 Hz	100 kHz
Start freq (log sweep)	50.000 Hz	100 kHz
Stop frequency	200 MHz	same
Center frequency	100 MHz	100.05 MHz
Frequency span	200 MHz	199.9 MHz
Center freq step size	1.0 MHz	same
Freq sweep resolution	401 points/span	same
AMPLITUDE		
Source amplitude	- 10.0 dBm	+ 15.0 dBm

FUNCTION	PRESET CONDITION	
	Without test set	With test set
Amplitude step size	1.0 dBm	same
Start amplitude	- 40.0 dBm	same
Stop amplitude	0.0 dBm	+15.0 dBm
Steps/sweep	100	same
TRIGGER MODE	Free run	same
RESOLUTION BANDWIDTH	1 kHz	same
Setting time for:		
Res BW = 1 kHz	22 ms	same
Res BW = 100 Hz	55 ms	same
Res BW = 10 Hz	370 ms	same
Res BW = 1 Hz	3.707 s	same
AVERAGING	Off	same
INPUT ATTENUATION		
Input R	20 dB	same
Input A	20 dB	same
Input B	20 dB	same
INPUT IMPEDANCE		
Input R	50Ω	same
Input A	50Ω	same
Input B	50Ω	same
INPUT LENGTH		
Input R	On, 0.0 meters	On, 1.3 meters
Input A	On, 0.0 meters	same
Input B	On, 0.0 meters	same
Step size	1.0 meter	same

The Status Byte

The Status Byte is an 8 bit word that the HP 3577B will dump on the HP-IB when it is serially polled. The state of each bit indicates the status of an internal HP 3577B function.

BASIC example:

```
Var= SPOLL(711)
```

Status Byte Bit Numbers

B7 B6 B5 B4 B3 B2 B1 B0

B7:	Instrument BASIC stopped or paused. Set when an HP Instrument BASIC program stops running. This can be due to a PAUSE or STOP statement, a program error, or the PRS and PRP HP-IB commands. It can be unmasked to generate SRQ. It is cleared at power on and when an HP Instrument BASIC program is run or continued.
B6:	REQUIRE SERVICE, RQS. Set when the HP 3577B pulls the SRQ line Cleared along with the SRQ line when a serial poll is performed.
B5:	ERROR This bit reflects the logical OR of all error conditions in the instrument. An SRQ is generated on the rising edge of any of these error conditions. The error conditions include all HP-IB errors and all hardware error conditions. The hardware errors include input overloads, input tripped, source tripped, and reference unlocked. The error bit is cleared when the hardware error conditions have cleared and a serial poll is performed, if the error bit is unmasked. If the bit is masked it will clear whenever the error conditions clear (i.e., it won't stay set until the poll occurs). It is also cleared by a dump status command (DMS) when the user receives the error information (if all hardware error bits are clear). Four levels of masking are provided for the user to select what type of programming errors will be reported by the error bit. See MASKING THE STATUS BYTE.
B4:	READY (for HP-IB commands) Set when the HP-IB input buffer is completely empty, all commands have been completely processed, and (if the last command was RST) settling is complete. If a command is issued during a sweep, the ready bit will clear until command processing is complete.
B3:	KEY PRESSED/SRQ If unmasked, this bit will be set when a key is pressed. Also, this bit is set when the HP 3577B receives the "SRQ" command on the bus. The set condition is cleared by a serial poll.
B2:	MEASUREMENT COMPLETE Set when sweep completes Cleared by the start of a new sweep
B1:	DATA AVAILABLE Instrument will output data when addressed to talk. Cleared by the handshake of the last byte.
B0:	DATA TRANSFER COMPLETE Set after the HP 3577B handshakes the last data byte in a dump. Primarily designed for plotting. Cleared by a serial poll if it is unmasked

Any status bit that is unmasked will cause an SRQ (and set RQS) when the condition it represents is true. As long as the condition is true, the bit will stay set. The bit will reset when the condition has cleared and the instrument is serially polled.

If multiple bits are un-masked and more than one condition becomes true, two serial polls will be required to clear the SRQ. The first serial poll will indicate only the first condition to occur; the second serial poll will indicate other conditions.

Any status bit that is masked will follow the condition it represents, resetting without a serial poll whenever the condition clears.

Masking The Status Byte

A service request will be generated when any unmasked bit in the status byte becomes set. The SRQ mask may be loaded by sending SQM followed by the mask byte in ASCII. The mask byte definition is as follows:

SQM		If 0	If 1
B7	(HP Instr BASIC stop/pause)	mask B7	enable B7 SRQ
B6	(RQS)	—	not maskable
B5	(Error)	mask B5	enable B5 SRQ
B4	(Ready)	mask B4	enable B4 SRQ
B3	(Key/SRQ)	mask B3	enable B3 SRQ
B2	(MEAS DONE)	mask B2	enable B2 SRQ
B1	(DATA AVAIL)	mask B1	enable B1 SRQ
B0	(XFER DONE)	mask B0	enable B0 SRQ

In the default instrument state SQM = 0 (all bits masked). Pressing INSTR PRESET or sending IPR over the bus will set SQM = 0.

The user may choose the level of screen message that sets the SRQ line (and which level of message appears with DMS) by selecting one of the following four modes:

ER0	Nothing will be reported
ER1	Only errors will be reported
ER2	Errors and warnings will be reported
ER3	Errors warnings and messages will be reported

The default selection is ER1. If the error bit is unmasked, the following conditions will pull SRQ regardless of the error reporting mode selected:

Input(s) tripped
 Input(s) overloaded
 Reference unlocked
 Source tripped

"How To Go Fast" Example Program

This example program is written for the HP 9000 Series 300 computers. It uses Discrete Sweep and illustrates the fastest measurement technique for data measurement and transfer.

```
10 ! Example BASIC program to demonstrate fast HP 3577B measurements.
20 ! This program sets up a discrete sweep with 11 points, takes a
30 ! measurement, and transfers the 11 values into an array.
40 ! The following items are important for fast measurements:
50 ! Discrete Sweep, Single sweep mode, Transfer format 2,
60 ! and the TKM command.
70 !
80 ASSIGN @Na TO 711           ! HP-IB select code and HP 3577B address.
90 REAL Trc(0:10)            ! Array to hold 11 trace values.
100 !
110 CLEAR @Na                ! Initialize the HP-IB.
120 OUTPUT @Na;"IPR"         ! Preset the HP 3577B.
130 !
140 OUTPUT @Na;"CHO"         ! Turn off characters for maximum speed.
150 OUTPUT @Na;"FM2"        ! Select non-ASCII format for max speed.
160 !
170 OUTPUT @Na;"SM2"        ! Single sweep to stop any sweeping.
180 OUTPUT @Na;"DL1"        ! Create an 11-point discrete sweep table
190                          ! by copying the linear sweep.
200 !
210 OUTPUT @Na;"ST6"        ! Select discrete sweep type
220 !
230 LOOP
240 OUTPUT @Na;"TKM"        ! Take a measurement. The HP 3577B will start
250                          ! sweeping and will not respond with data
260                          ! until the sweep has completed. This is faster
270                          ! than polling the ready bit because it does not
280                          ! interrupt the HP 3577B processor.
290 !
300 OUTPUT @Na;"DT1"        ! Request trace dump. It will contain one value
310                          ! for each frequency in the discrete sweep table.
320 !
330 ENTER @Na USING "%,2A";Junk$ ! Read #I
340 ASSIGN @Na;FORMAT OFF   ! Switch to binary format
350 ENTER @Na;Trc(*)        ! Read 11 trace values
360 ASSIGN @Na;FORMAT ON   ! Switch back to ASCII format
370 !
380 PRINT Trc(*)
390 END LOOP
400 END
```

Key Reference

This reference is an alphabetical listing of the hardkeys, their menus, the front panel sections, and some of the terms used throughout this manual. This chapter is intended for experienced users.

Amplitude

AMPLITUDE is a hardkey in the SOURCE section of the front panel used to display either menu of softkey labels shown above. These softkeys may be used to change the signal level of the source output. The HP 3577B source amplitude range is from -49 dBm to $+15$ dBm in 0.1 dB steps; the default value at power-on is -10 dBm without a test set and $+15$ dBm with a test set.

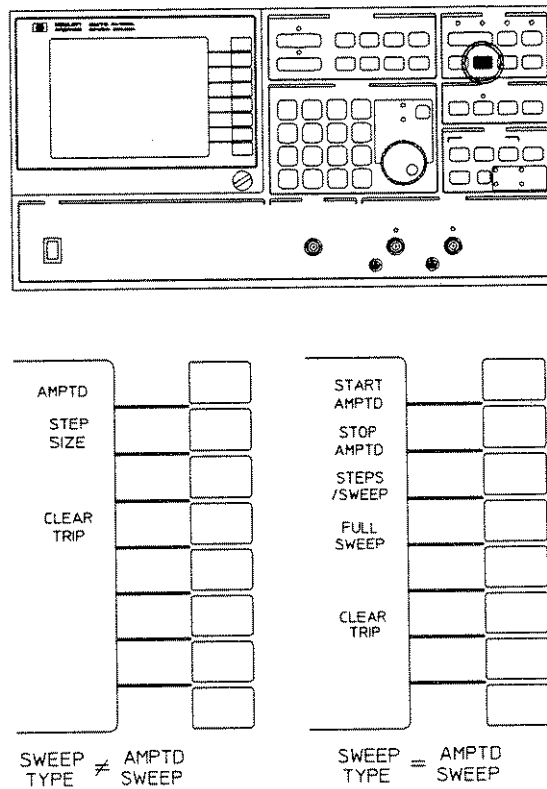

Figure 4-1

AMPLITUDE is also a softkey in the [**AMPTD**] menu used to change the value of the source amplitude. After power-on or [**INSTR PRESET**], this softkey is active. A bright label in the menu indicates softkey selection.

To change the value of [**AMPTD**]:

1. Press [**AMPTD**] to display the menu
2. Press [**AMPTD**] (softkey) if the label is not bright
3. Modify the value with the knob or arrow keys
OR
4. Enter a new value with the numeric key pad and select units from the menu (press softkey).

When [**SWEEP TYPE**] is [**ALTERNTE**], each trace may be given separate amplitude values. For more information see **SWEEP TYPE, ALTERNATE SWEEP** in this chapter.

STEP SIZE is a softkey used to change the value that the arrow keys (in the **DATA ENTRY** section) increase or decrease the output amplitude. [**STEP SIZE**] is adjustable from .1 dB to 64 dB in .1 dB steps. The default value for [**STEP SIZE**] is 1.0 dB.

To change the value of [**STEP SIZE**]:

1. Press [**AMPTD**] to display the menu
2. Press [**STEP SIZE**] (if label is not bright)
3. Modify the value with the knob or arrow keys
OR
4. Enter a new value with the numeric key pad and select units from the menu (press softkey).

CLEAR TRIP (Source) is a softkey in the [**AMPTD**] menu used to reset the **SOURCE TRIP**. The source is protected against large external signals applied to it by a relay in the output circuit which opens when the voltage is $4V_{pk}$. If the source TRIPs, the user is directed by a screen message to press [**AMPTD**] in the **SOURCE** section of the front panel. This displays the menu containing [**CLEAR TRIP**], which resets (closes) the relay in the source output. If the trip condition still exists the source trips again.

START AMPLITUDE is a softkey in the [**AMPTD**] menu when the [**SWEEP TYPE**] is [**AMPLITUDE SWEEP**]. [**START AMPLITUDE**] changes the source start amplitude. The default value is -40dBm . The allowable range is the same as the range of the source output amplitude, -49dBm to $+15\text{dBm}$. The value of start amplitude may be larger than the stop amplitude. Units used for data entry of new values for start and stop amplitude may be linear (volts) but the sweep is always logarithmic.

To view the menu shown in figure 4-1:

1. Press [**SWEEP TYPE**]
2. Press [**AMPTD SWEEP**]
3. Press [**AMPTD**]

To change the value of [**START AMPLITUDE**]:

1. Press [**START AMPTD**] (if the label is not bright)
2. Modify the value with the knob or arrow keys
OR
3. Enter a new value with the numeric key pad and select units from the menu (press softkey)

STOP AMPLITUDE is a softkey label in the [**AMPTD**] menu when the [**SWEEP TYPE**] is [**AMPLITUDE SWEEP**]. It changes the source stop amplitude. The default value for stop amplitude is 0.0dBm if no test set is connected to the HP 3577B. With a test set, the default value is $+15\text{dBm}$. The allowable range is the same as that of the source output amplitude, -49dBm to $+15\text{dBm}$. The value of stop amplitude value may be smaller than the start amplitude.

To change the value of **STOP AMPLITUDE**:

1. Press [**STOP AMPTD**]
2. Modify the value with the knob or arrow keys
OR
3. Enter a new value with the numeric key pad and select units from the menu (press softkey)

STEPS/SWEEP is a softkey used to change the number of amplitude data point measurements taken and plotted on the screen. When [**STEPS/SWEEP**] is pressed, a menu appears that contains all possible selections; they are 5, 10, 20, 50, 100, 200, and 400. The default number of steps is 100. A large number of **STEP/SWEEP** makes the trace smooth while a small number lowers the required sweep time.

Attenuation

ATTENUATION is a hardkey in the RECEIVER section of the front panel used to display the menu shown above. These softkeys may be used to select the input attenuation and input impedance for each of the receiver channels. Also, [CLEAR TRIP] for the receivers is included in this menu.

Each input channel has two possible input impedances (50Ω or 1 MΩ) and two possible input attenuations (0 dB or 20 dB). When the instrument is PRESET all channels revert to the default values: 50Ω input impedance and 20 dB input attenuation. All of the attenuation and impedance softkeys are the push-push toggle type. Each has two possible states; the bright part of the labels indicate which state is active. These parameters may be changed by softkey selection, only.

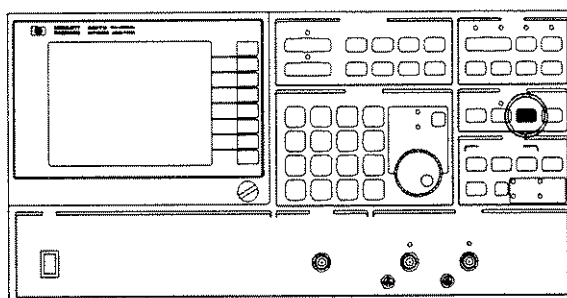

ATTEN R		
0dB 20dB		
ATTEN A		
0dB 20dB		
ATTEN B		
0dB 20dB		
IMPED R		
50Ω 1MΩ		
IMPED A		
50Ω 1MΩ		
IMPED B		
50Ω 1MΩ		
CLEAR TRIP		

Figure 4-2

The two input attenuation values may be thought of as measurement ranges. Normally the HP 3577B is in the high range, with 20 dB of input attenuation. To increase the HP 3577B's ability to measure low signal levels, change the input attenuation to 0 dB. The following table lists the signal levels at which overload occurs for any combination of input attenuation and impedance:

OVERLOAD SIGNAL LEVELS (> 10 kHz)		
INPUT ATTENUATION	INPUT IMPEDANCE	
	50 Ω	1 M Ω
20 dB	0 dBm	- 13 dBV (224 mV)
0 dB	- 20 dBm	- 33 dBV (22.4 mV)

All the front panel connections of the HP 35677A S-PARAMETER TEST SET have a characteristic impedance of 50 Ω . If a 75 Ω characteristic impedance is required, the HP 35677B is recommended.

To modify the impedance and attenuation parameters:

1. Press [**ATTEN**] to display the menu
2. Press the softkey of the desired parameter

CLEAR TRIP (RECEIVER) is a softkey used to reset a RECEIVER TRIP. A RECEIVER TRIP switches the input impedance to 1 M Ω when the signal level is $\geq 1.1V_{pk}$ at the input. When any receiver trips the screen message "INPUT TRIPPED: Chan_, Clear trip on ATTEN menu" appears. This change of impedance does not show in the [**ATTEN**] menu. The menu gives the user's selections including [**CLEAR TRIP**] which resets the TRIP condition. [**CLEAR TRIP**] clears any and all inputs that are tripped.

Average

AVERAGE is a hardkey in the RECEIVER section of the front panel. It displays the menu of softkeys shown in figure 4-3. These softkeys turn on the exponential averaging feature of the HP 3577B. The LED above [**AVG**] is turned on when averaging is on. Each softkey is a weighting factor called N.

[**AVG**] is useful for removing the effects of noise from a trace. If the device under test is going to be adjusted while the analyzer is sweeping, select a small N. A small N (e.g., 4) shows the adjustment changes faster than a large N. For a very good "final" picture of the measurement, pick 256 or another large value for N because a larger N reduces the noise. This feature can reduce trace noise as much as 24 dB (when N = 256). Another way to reduce trace noise when measuring low-level signals is by reducing the 20 dB RECEIVER attenuators to 0 dB. See ATTENUATION.

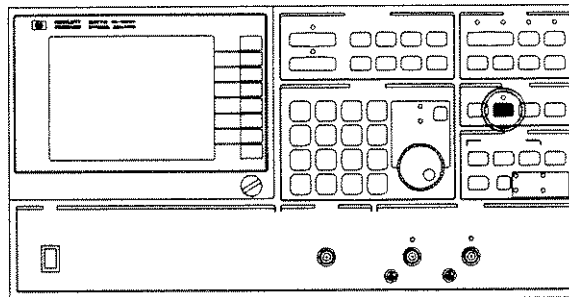

OFF	<input type="checkbox"/>
4	<input type="checkbox"/>
8	<input type="checkbox"/>
16	<input type="checkbox"/>
32	<input type="checkbox"/>
64	<input type="checkbox"/>
128	<input type="checkbox"/>
256	<input type="checkbox"/>

Figure 4-3

To use AVERAGE, press [**AVG**] in the RECEIVER section of the front panel. The softkey choices appear in the menu area of the display. If the feature is off the word OFF appears bright in the menu. If any other selection is made, the new selection becomes bright and [**AVG**] is on. The [**AVG**] weighting factor, N, may be changed by softkey selection, only. Averaging does not stop after N sweeps.

The averaging algorithm is a continuous process that begins when the feature is turned on. The number selected by the user is used in the equation below to yield an exponential average.

$$\text{NEXT VALUE} = \frac{1}{N} \times (\text{NEW VALUE}) + \frac{N-1}{N} \times (\text{CURRENT VALUE})$$

If N is 256, the new sweep data is weighted by 1/256 and the current data by 255/256. Therefore, each sweep does not change the trace significantly when N = 256. If N is 4, the new sweep data is weighted by 1/4 and the current data by 3/4, so new data changes the trace faster when N is small.

The HP 3577B stores the trace information in "bins." Each bin contains a measurement value taken at a discrete frequency in the sweep and is as wide as the selected bandwidth. As each new value is taken, the math processor weights (multiplies) it by 1/N, weights the old value by (N-1)/N, adds the two together and stores the result in the same bin the old value. Multiple traces are not stored. The effect of any single sample diminishes as each average weights its value at some factor less than one and adds it to new incoming data.

Before the analyzer has swept N times, the averaging algorithm cycles up through lower values of N until it reaches the user's selection. For example, let N = 256. The first value used in the equation for N is 4. After several sweeps a higher value of N is used and this process is repeated until 256 is reached. The HP 3577B uses this method because it displays a useable trace faster than if N were initially set to 256.

Note

After averaging with a large N for a long time (i.e., many sweeps) removing the device under test does not affect the trace noticeably.

The LED above [**AVG**] is on when the HP 3577B is averaging.

Continuous Entry

In the DATA ENTRY section of the front panel there are three ways to enter or modify data: the numeric keypad, the arrow keys, and the knob. CONTINUOUS ENTRY refers to the knob in ENTRY mode.

To use CONTINUOUS ENTRY the active (bright) softkey must be a softkey that allows data entry. When the key above the knob is pressed the LEDs marked "MARKER" and "ENTRY" toggle. The knob is capable of CONTINUOUS ENTRY when the ENTRY LED is lit. When in MARKER mode the knob moves the markers on the screen. Normally, the knob should be left in MARKER mode so that data modifications are not made when the knob is accidentally rotated. [ENTRY OFF] also turns off the knob ENTRY mode by removing the menu (and therefore any active softkey) from the screen.

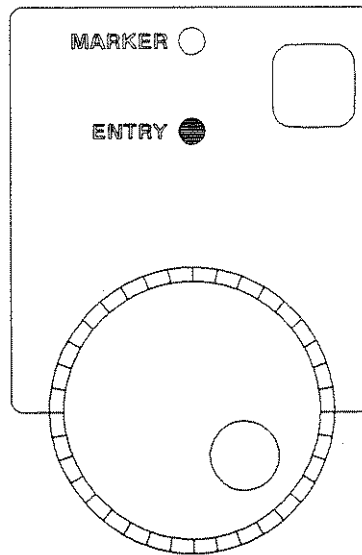

Figure 4-4

Data Entry

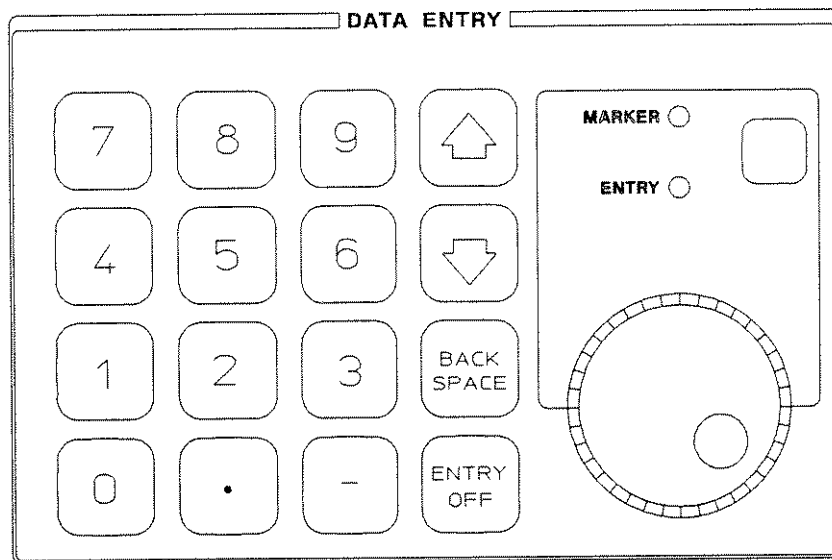

Figure 4-5

DATA ENTRY is a section of the front panel used for entering or modifying data. It contains a numeric keypad, increment/decrement (arrow) keys, [**BACKSPACE**], [**ENTRY OFF**] and the knob. To terminate a numeric keypad entry, use the units softkeys at the right side of the screen.

The **BACKSPACE** key allows the user to correct data entries or trace arithmetic equations. It moves the cursor in the entry block (text in the upper-right corner of the screen) back one space and erases the character. If an error is made in the data entry, the HP 3577B displays a screen message and beeps but the original entry is not erased. Use the backspace key to correct the entry or press another hardkey to abort the entry. An aborted entry returns the data in the entry block to the current definition of the parameter.

ENTRY OFF clears the screen of menus and messages. It also guards the user from inadvertently changing an **ENTRY** by accidentally moving the knob. [**ENTRY OFF**] also dims the graticule and characters and brightens the trace(s).

The **KNOB** has two modes: **MARKER** or **ENTRY**. The unmarked key above the knob toggles between these two modes. The **MARKER** and **ENTRY** LEDs show which mode the knob is in. The [**INSTR PRESET**] default is **MARKER** mode.

Key Reference
Data Entry

The **INCREMENT/DECREMENT** keys increment (↑) or decrement (↓) data for the selected (bright) softkey if it is an item that allows data entry. For example, sweep time allows increments but sweep type does not. When trying to modify a parameter that is not appropriate to modify, the message "ENTRY UNDEFINED" appears on screen. If held down for more than 1 second, the up/down keys auto-repeat. The amount of increment or decrement is determined by the step size of the parameter. Refer to the particular parameter in this section for more information on step size.

Data Registers

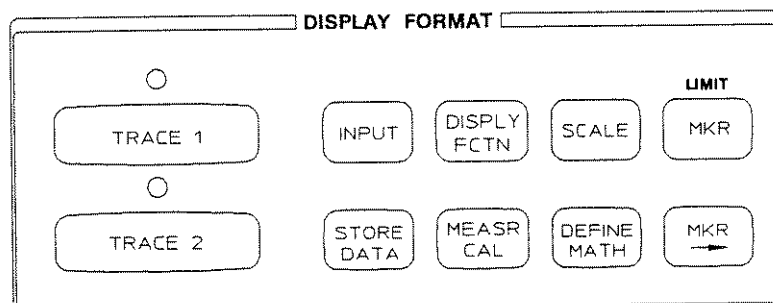

Figure 4-6.

Data registers are accessible from several places in the DISPLAY FORMAT section of the front panel. There are 12 registers used to manipulate and STORE trace DATA, X1 through X8 and D1 through D4. As a caution, the NORMALIZE, CALIBRATION, and STORE & DISPLAY functions store data in registers D1 through D4. To avoid writing over this data, use X1 through X8 in preference to D1 through D4.

Stored data maintains the same form (complex) created by the receivers and stored in trace memory. Therefore, any data register information may be recreated in any of the DISPLAY FUNCTION formats (LOG MAG, PHASE, GROUP DELAY, etc.). Refer to Appendix A for more information on DATA PROCESSING AND STRUCTURE.

The data stored in any of the data registers may be displayed by specifying the data register of interest as an input. Press [INPUT] and [DATA REG], then select the data register of interest from the menu. Refer to STORE DATA in this chapter.

Define Math

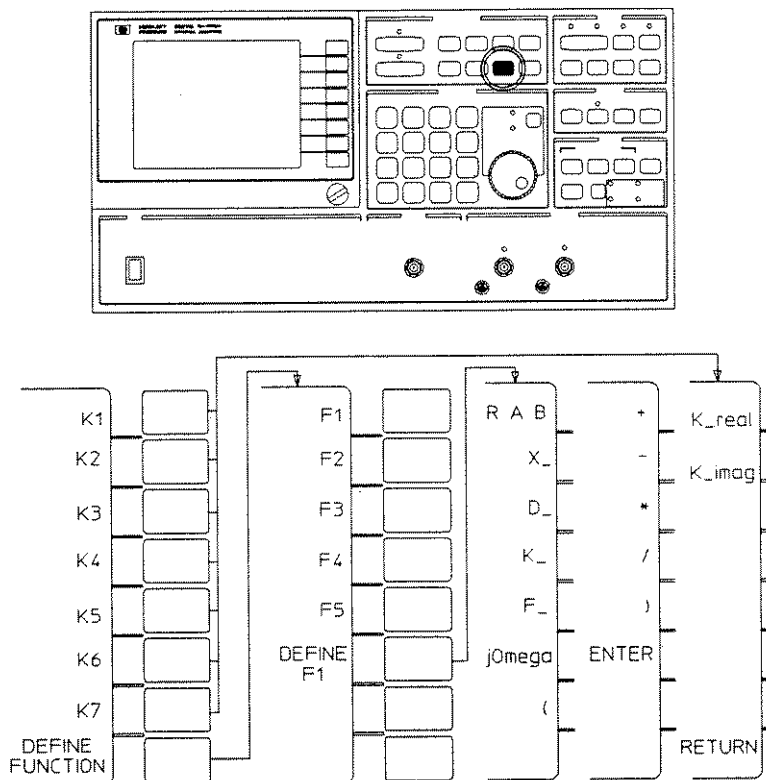

Figure 4-7

DEFINE MATH is a hardkey in the DISPLAY FORMAT section of the front panel. It displays the menu shown in figure 4-7. Define up to seven complex constants and five functions. Constants and functions may be used as terms in USER DEFINED INPUTs or USER DEFINED STOREs.

Complex constants (K1 through K7) appear in the menu under [**DEFINE MATH**]. To define each component, real and imaginary, press the softkey of interest and enter the desired value for each component using the numeric keypad. The entry appears in the entry block on the screen. To correct entry errors, use the backspace key.

[**DEFINE FUNCTION**] displays a new menu containing 1) the 5 user definable functions, [**F1**] through [**F5**], 2) a command to [**DEFINE F_**], and 3) [**RETURN**], which displays the previous menu. The entry block shows the current definition of the bright function and changes to show any new entries.

[**F_**] is one of the softkey labels under [**DEFINE F_**]. [**F_**] displays the equation being defined and changes the menu to allow selection of the first term in the definition. This softkey selection is shown in figure 4-7.

jOmega is a special register that contains zeros in the real part, and ω in the imaginary part. ω is defined as $2\pi f$, where f is the frequency of each bin. Therefore, displayed as a trace, jOmega appears as in imaginary linear ramp from $(2 \times \pi \times \text{start frequency})$ to $(2 \times \pi \times \text{stop frequency})$. jOmega appears as a "W" in trace math expressions. For example, "(A/R)/W".

To change a reflection measurement display (in the case below, A/R) to directly display capacitance in picofarads, use the following user defined function.

K7/W/F4

Where:

$$K7 = 1.0 \times 10^{12} + j0.0$$

$$W = j\Omega$$

$$F4 = K2 \times F3 = Z_0$$

$$F3 = (K1 + F2)/(K1 - F2) = Z_N$$

$$K2 = 50 + j0.0$$

$$K1 = 1.0 + j0.0$$

$$F2 = A/R$$

This user defined function assumes the default $K_$ and $F_$ values which are selected with [INSTR PRESET]. F4 converts normalized impedance (Z_N) to actual Impedance Z_0 ; (where $Z_0 = 50 \Omega$). F3 converts A/R to Z_N . Since

$$Z_0 = 1/j\omega C,$$

the $j\omega$ term cancels in the function and leaves

$$C \times 10^{-12}$$

or capacitance in picofarads. Similarly, a user defined function that divides impedance by jOmega displays inductance directly in Henrys (i.e. user defined function F4/W). A constant can be used to scale the inductance display.

Sub-menus appear under the $K_$, $F_$, $X_$, $D_$, and jOmega softkeys. These menus finish describing the term. While building an equation, the menu continues to change and the entry block shows each entry. Use the backspace key to correct entry errors. When the equation is finished, press [ENTER]. Character strings may not be longer than 17. If longer strings are necessary, divide them among as many user defined functions as necessary and then define an INPUT equation with them. See MEASUREMENT CALIBRATION for an example.

Key Reference
Define Math

There is no change in a displayed trace after pressing [ENTER] unless the [INPUT] has the new function as part of its definition. This new USER DEFINED FUNCTION may now be used in a user defined INPUT or STORE. The trace arithmetic capabilities of the HP 3577B make complicated error corrections or special conversions easy. See MEASUREMENT CALIBRATION for examples.



Note Pressing INSTR PRESET or cycling the power switch redefines all user defined functions. Be sure to SAVE instrument state if you wish to retain the USER DEFINED FUNCTIONS.

[INSTR PRESET] defaults the values of the constants and functions to the following values.

$K1 = 1.0 + j0.0$	$F1 = (B/R)/(K1 - B/R)$
$K2 = 50 + j0.0$	$F2 = A/R$
$K3 = 75 + j0.0$	$F3 = (K1 + F2)/(K1 - F2)$
$K4 = 0.0 + j1.0$	$F4 = K2 * F3$
$K5 = -1.0 + j0.0$	$F5 = K3 * F3$
$K6 = 1.0 \times 10^9 + j0.0$	
$K7 = 1.0 \times 10^{12} + j0.0$	

RECALL OLD STATE recovers the user defined functions as defined when power was last turned off or if there is a power failure.

Display Format

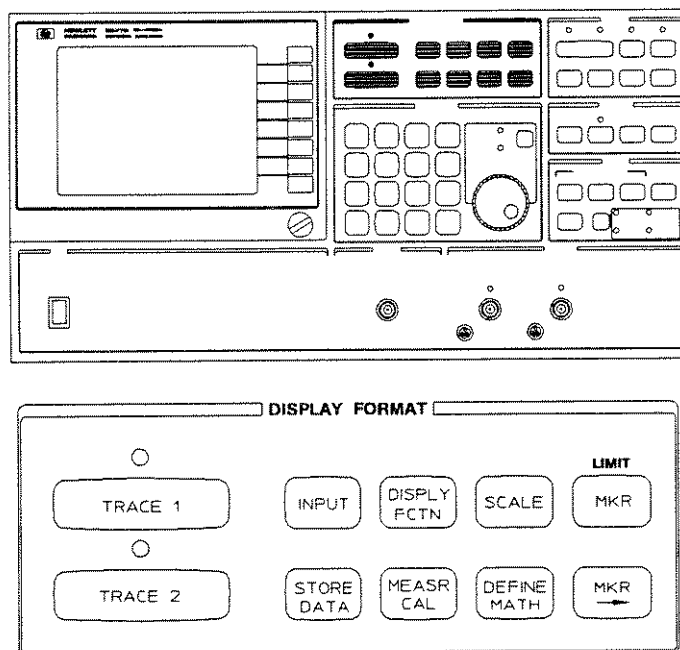
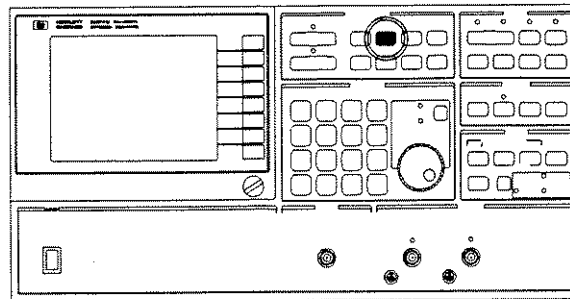

Figure 4-8

DISPLAY FORMAT is one of five front panel sections. The hardkeys in this section are in the following table.

[INPUT]	defines a trace in terms of receiver inputs, stored data, user defined constants, and user defined functions
[DISPLAY FCTN]	presents the complex measured data as trace data according to the specified parameter ([LOG MAG], [PHASE], [GROUP DELAY], etc.)
[SCALE]	defines the graticule scale ([REF LEVEL], [/DIV], etc.)
[MKR]	(marker) reads data from the displayed trace. It also allows limits to be defined and displayed
[MKR →]	places a marker at the designated point on the active trace.
[STORE DATA]	stores complex data as defined under the [INPUT] hardkey
[MEASR CAL]	normalizes or does a partial (two term) or full (three term) error correction of one-port measurements
[DEFINE MATH]	defines up to seven complex constants and five functions

Display Function



LOG MAG	<input type="checkbox"/>
LIN MAG	<input type="checkbox"/>
PHASE	<input type="checkbox"/>
POLAR	<input type="checkbox"/>
REAL IMAG	<input type="checkbox"/>
DELAY	<input type="checkbox"/>
SWR	<input type="checkbox"/>
OFF	<input type="checkbox"/>

Figure 4-9

DISPLAY FUNCTION is a hardkey in the DISPLAY FORMAT section. It displays the menu of softkeys shown in figure 4-9. These softkeys define how the complex measured data in trace memory is interpreted and displayed on screen. If any of the top 7 entries in the menu are bright, the trace is on. The trace is turned off with the [OFF] softkey.

Choosing a display function selects the math used to interpret the data in trace memory as the selected function. The data collected during the sweep does not depend on which function is selected. How the data is collected is determined by the source and receiver settings. See "DATA PROCESSING AND STRUCTURE" in Appendix A.

LOG MAGNITUDE is a softkey in the DISPLAY FUNCTION menu that selects the y-axis a log magnitude. It is the default display function for instrument preset or power-on. It does not accept data entry. The default SCALE parameters for LOG MAGNITUDE are:

REF LEVEL: 0 dBm
/DIV: 10 dB
REF POS: 100%

The REF LEVEL and/DIV parameters are listed on the screen above the graticule. The reference line is the dashed line. Its value is 0 dBm and it appears at the top graticule line (or 100% reference position). Check the REFERENCE POSITION by pressing [**SCALE**] and [REF POS]. Then enter the reference position using the numeric keypad.

LINEAR MAGNITUDE is a softkey in the DISPLAY FUNCTION menu that defines the y-axis as linear magnitude. It does not accept data entry from the numeric keypad. Selecting [**LINEAR MAG**] selects the following [**SCALE**] parameters:

REF LEVEL: 0.0V
/DIV: 100 mV
REF POS: 0.0%

PHASE is a softkey that defines the y-axis as phase information. [**PHASE SLOPE**] appears in the [**SCALE**] menu when [**PHASE**] is the current display function. Default SCALE parameters for PHASE are:

REF LEVEL: 0.0 deg
/DIV: 45 deg
REF POS: 50%

To use this feature, press [**TRACE 1**] or [**TRACE 2**] as the active trace for displaying the phase information. Press [**DSPLY FCTN**] and [**PHASE**]. The trace now displays phase information.

Key Reference
Display Function

POLAR is a softkey that displays measured data in polar format. In polar format, only one trace is displayed at a time. If both traces are displayed in a rectangular format when polar is selected, the non-active trace is turned off. The LEDs over [TRACE 1] and [TRACE 2] indicate which trace is active.

The polar format changes the menu listings of [SCALE], [MKR], and [MKR→] as shown in figure 4-10. Polar format cannot be used with discrete sweeps.

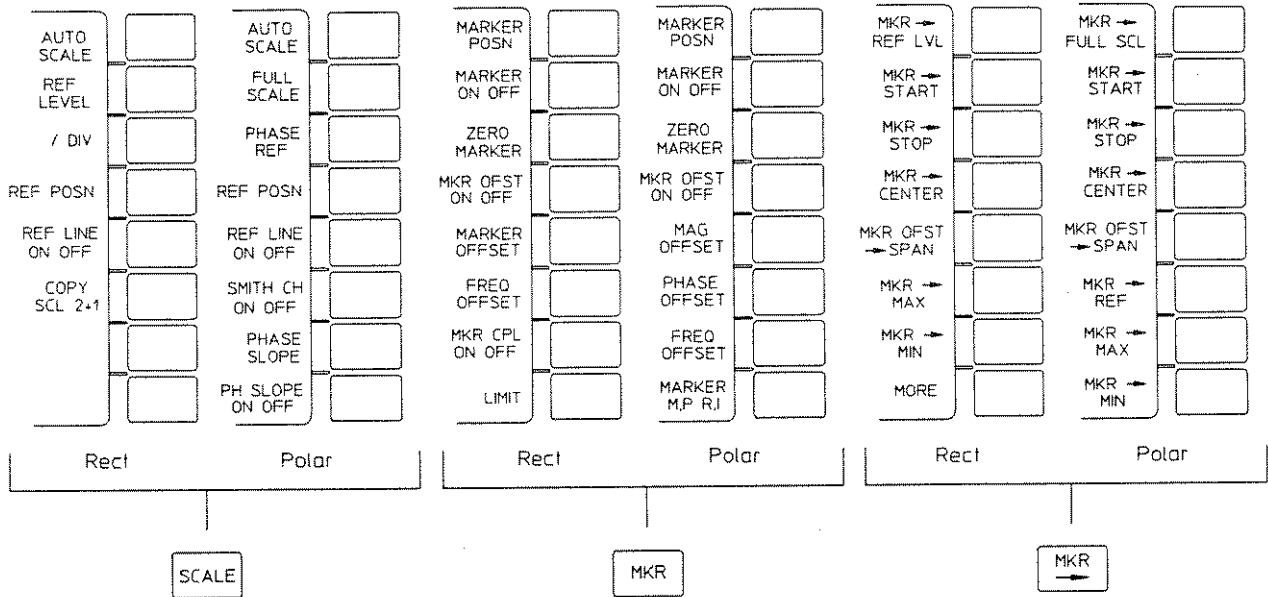

Figure 4-10

REAL/IMAG is a softkey that brings up the [REAL] and [IMAG] softkeys. [REAL] defines the y-axis as the real half of the complex measured data stored in trace memory. [IMAG] defines the y-axis as the imaginary half of the complex measured data. The unit of measure for the real and imaginary display functions is volts. See Appendix A for information on Data Processing and Structure.

SWR (Standing Wave Ratio) is a softkey that calculates $(1 + |\text{displayed data}|)/(1 - |\text{displayed data}|)$, where the displayed data represents a reflection measurement (i.e., S_{11}). [SWR] determines the impedance match of a component or group of components over the displayed frequency range. The default scale of the [SWR] display ranges from 1 to 11. A value of 1 represents the best impedance match.

DELAY (GROUP) is a softkey that selects group delay as the display function. Pressing [DELAY] changes the softkey label to [DELAY APERTURE] which changes the frequency span over which the analyzer evaluates phase and calculates group delay. See DELAY APERTURE in this chapter.

[DELAY] does not appear in the [DISPLY FCTN] menu if the [SWEEP TYPE] is [LOG SWEEP], [AMPLITUDE SWEEP], [CW] or if the [SWEEP MODE] is [MANUAL].

Group delay is the derivative of phase with respect to frequency ($d\phi/df$). In the HP 3577B this is approximated by using the function $\Delta\phi/(\Delta f \times 360)$. Multiplying by 360 converts degrees to cycles. The user selects [DELAY APERTURE] (Δf) in % of span (frequency) from a sub-menu. The HP 3577B calculates the change in phase for the specified aperture and divides $\Delta\phi$ by $\Delta f \times 360$.

The point plotted is calculated by using the data points surrounding the point. For example, the group delay for 100 Hz may be calculated by measuring the change in phase between 90 and 110 Hz.

No data is calculated for the endpoints of the trace. In the example, if the start frequency is 90 Hz, 100 Hz is the first point with group delay data. This results in a trace that does not extend to the edges of the screen. This becomes more noticeable as the delay aperture is made larger.

The unit of measure for group delay is time. The readings are in seconds or fractions of seconds from 0.01 nanoseconds to 1000.0 seconds. Larger apertures yield finer resolution of units because t_g (group delay) = $\Delta\phi$ (with fixed phase resolution) divided by Δf . Larger apertures (Δf), yield smaller t_g .

There are some important limitations if group delay measurements are made using the [DISCRETE SWEEP] sweep type. The same approximation for t_g is used but the delay aperture, Δf , is not specified as a percentage of frequency span. Instead, $2 \times$ the frequency spacing of the first two rows of the Discrete Sweep Table set the effective delay aperture.

Key Reference
 Display Function

Returning to the example, when [DISCRETE SWEEP] is selected, the group delay for 100 Hz is calculated by measuring the change in phase between 90 Hz and 110 Hz. Therefore, it is important to have 90 Hz, 100 Hz, and 110 Hz entered in the Discrete Sweep Table to measure the delay at 100 Hz. It is also important that the frequencies in the table be of equal spacing. When frequency spacings are different than the frequency spacing of the first two rows, no data is calculated. Frequencies of equal spacing are easily entered in the table using the [LIN SWP → DISCRETE] key. See DISCRETE SWEEP in the SWEEP TYPE section of this chapter for more information on this feature. As with other delay measurements, no data is calculated for the first and last frequencies in the Discrete Sweep Table.

When the display function is group delay (or any phase dependent function) the scale menu includes [PHASE SLOPE]. Initially, this feature is on and the default value is 0 deg/span. [PHASE SLOPE] is not available when using [DISCRETE SWEEP] but the [LENGTH] feature can be used to make similar data corrections. See LENGTH in this chapter for more information.

DELAY APERTURE is a softkey that appears in the [DISPLY FCTN] menu when [DELAY] is selected. Delay aperture is the frequency span over which the HP 3577B evaluates phase and calculate group delay. This frequency span is in percent-of-span; the selections include .5%, 1%, 2%, 4%, 8%, and 16%. The selected aperture appears below the lower-right corner of the graticule in Hertz when the active trace is group delay. See figure 4-11.

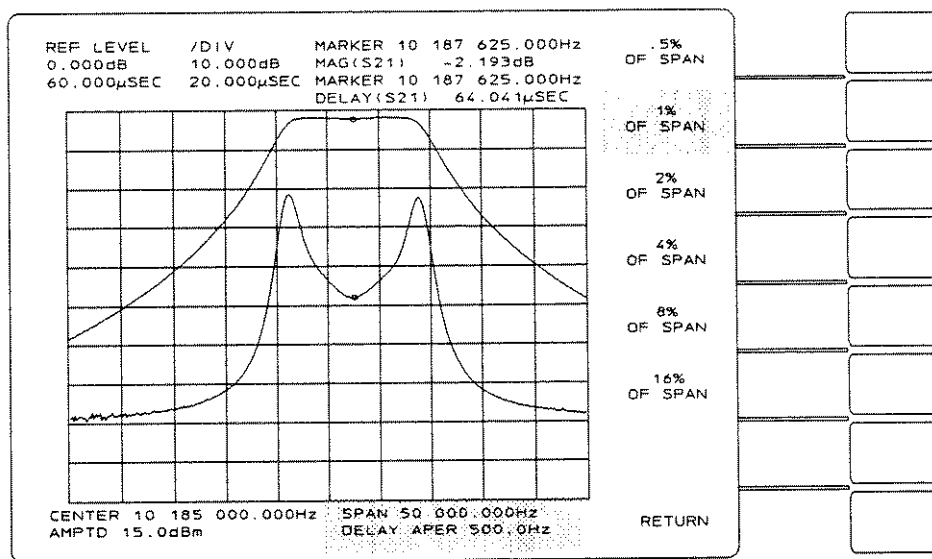

Figure 4-11

To find and/or modify [DELAY APERTURE], press [**DSPLY FCTN**] and then [DELAY]. Pressing [DELAY] changes the softkey to read [DELAY APERTURE]. Pressing [DELAY APERTURE] displays a sub-menu that lists a selection of apertures as a function of the current frequency span. Large apertures have more of a smoothing effect on the group delay trace than smaller apertures.

Delay aperture is also dependent upon sweep resolution (a softkey in the [**FREQ**] menu). When sweep resolution is 201, the delay aperture cannot be less than 1% of span. The HP 3577B automatically changes aperture from .5% to the larger value when sweep resolution is changed. Aperture is increased to 2% when a sweep resolution of 101 is selected, and is increased again to 4% when sweep resolution becomes 51. See the example for [**SWEEP RES**] in the **FREQUENCY** section of this chapter.

Entry Block

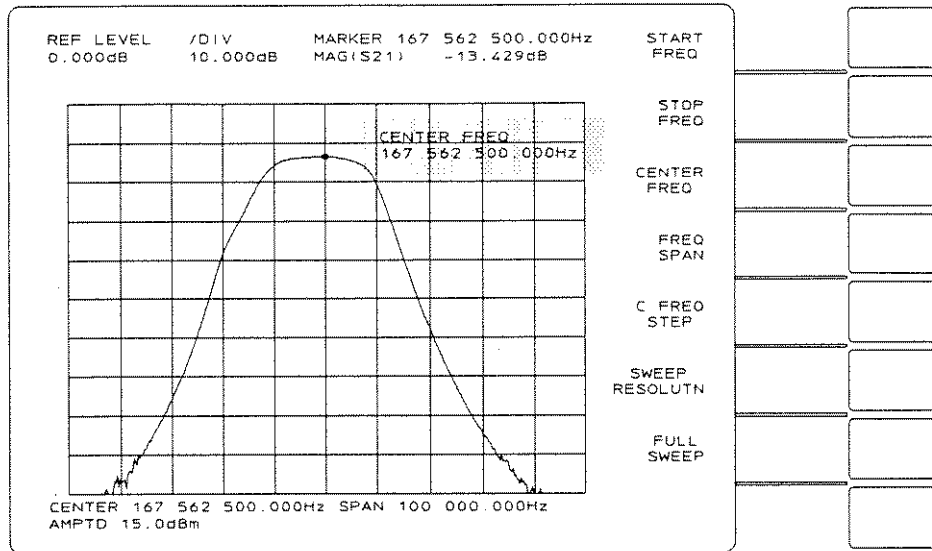

Figure 4-12

The ENTRY BLOCK is a portion of the screen where entry messages appear. These messages show the data entered or data being modified. Any time a new menu is selected and the active (bright) softkey label is a data entry item, its current value appears in the upper-center portion of the screen.

For example, pressing

[TRACE 1]

[SCALE]

[REF LEVEL]

results in the entry block on screen showing the current reference level setting since [REF LEVEL] is a data entry item.

If a key is not a data entry item, no message appears. For example, pressing [TRACE 2] when trace 2 is [OFF] results in no message in the entry block since [OFF] is not a data entry item.

External Reference

This input on the rear panel allows the HP 3577B to be connected to an external frequency reference. When a signal is present on this input the EXT REF LED in the upper right-hand corner of the front panel lights. The HP 3577B phaselocks to signals from -7 dBm to $+15$ dBm. The frequency of the external reference must be ≥ 100 kHz and must be the result of dividing 10 MHz by an integer, accurate to ± 20 ppm. If the source connected to the EXTERNAL REFERENCE varies more than this, the HP 3577B switches to its own internal reference. When this occurs, the EXT REF LED extinguishes and the HP 3577B beeps as phaselock is lost during the switch.

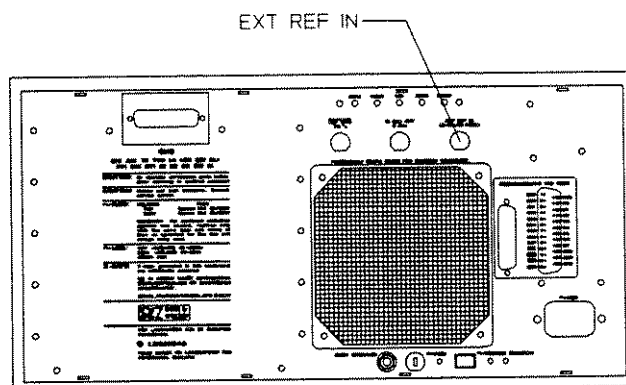
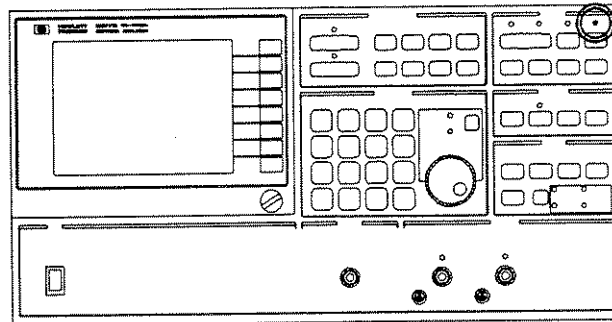

Figure 4-13

Frequency

FREQUENCY is a hardkey in the SOURCE section that displays the menu of softkeys shown in figure 4-14. These softkeys modify the frequency parameters. [START FREQ] is the default frequency parameter for [INSTR PRESET] or when cycling power.

The top 5 softkeys in this menu are data entry items. [SWEEP RESOLUTN] calls a sub-menu that selects the number of sampled frequencies or bins in the trace. FULL SWEEP is an immediate execution command that resets the start and stop frequencies to get a full sweep.

If the [SWEEP TYPE] is [LOG FREQ] the menu consists of the following:

START FREQ
STOP FREQ
FULL SWEEP

If the [SWEEP TYPE] is [CW] or [AMPTD] the menu consists of the following:

FREQ
STEP SIZE

If the [SWEEP TYPE] is [ALTERNTE], different frequency parameters may be entered for each of the two active traces. See SWEEP TYPE, ALTERNATE.

If the [SWEEP TYPE] is [DISCRETE SWEEP], the Discrete Sweep Table editing menu is displayed. See SWEEP TYPE, DISCRETE SWEEP.

START FREQ is a softkey used to enter data for the sweep start frequency. To enter a new start frequency:

1. Press [FREQ] to display the menu
2. Press [START FREQ] (if label is not bright)
3. Modify the value with the knob or arrow keys

OR

Enter a new value with the numeric key pad and select units from the menu

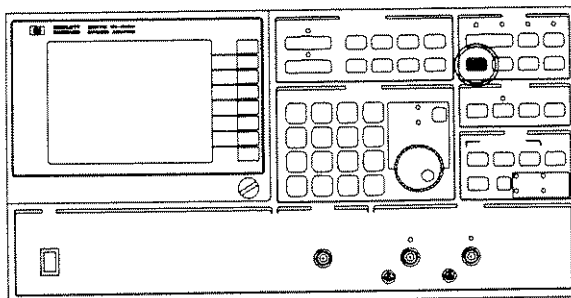

START FREQ		
STOP FREQ		
CENTER FREQ		
FREQ SPAN		
C. FREQ STEP		
SWEEP RESOLUTN		
FULL SWEEP		

Figure 4-14

STOP FREQ is a softkey that operates the same as [START FREQ] for entering data for the sweep stop frequency. The START and STOP FREQ values appear below the graticule.

CENTER FREQ is a softkey that operates the same as [START FREQ] for entering data for the sweep center frequency. There is no defined center frequency when the [SWEEP TYPE] is [LOG FREQ], [CW], or [AMPTD]. Pressing [CENTER FREQ] or [FREQ SPAN] changes the START and STOP information below the graticule changes to CENTER and SPAN.

FREQ SPAN is a softkey used in the same manner as START FREQ for entering data for the frequency span represented by the graticule. There is no frequency span when the when the [SWEEP TYPE] is [LOG FREQ], [CW], or [AMPTD]. If the frequency span is 0 Hz and sweep time is less than 1000 seconds, the marker position reads in units of time.

CENTER FREQ STEP is a softkey that enters data for the step size taken when incrementing or decrementing the center frequency using the arrow keys. Data entry for this parameter is accomplished in the same manner as for [START FREQ].

SWEEP RESOLUTION is a softkey used to change the number of sample frequencies measured by the HP 3577B. The default value for sweep resolution is 401 points. These correspond to the bins referred to in Appendix A. Each bin is as wide as the selected resolution bandwidth and has associated with it a bin number (position information) and measurement value. The user may select 401, 201, 101, or 51 points per sweep. The larger numbers provide a smoother trace while the lower number of points per sweep allow a shorter [**SWEEP TIME**]. To select a value for [**SWEEP RESOLUTN**], press [**FREQ**], [**SWEEP RESOLUTN**], and then press the softkey corresponding to the desired value.

Note



Changing [**SWEEP RESOLUTN**] or [**SWEEP TYPE**] erases registers R, A, and B in trace memory (sets all bins to zero).

When the display function is group delay, delay aperture is dependent on sweep resolution. Decreasing the sweep resolution may result in an automatic increase in the delay aperture. The screen message "DELAY APERTURE INCREASED" appears when the delay aperture is automatically increased.

- EXAMPLE
1. PRESET; Swp Res = 401, Aperture = .5% of span
 2. Change Swp Res to 201, Aperture changes to 1%
 3. Change Swp Res to 101, Aperture changes to 2%
 4. Return Swp Res to 401, Aperture does not change

FULL SWEEP is a softkey that resets the start/stop sweep parameters to their maximum values. Full sweep, in a linear sweep, is from 0 to 200 MHz. In log sweep, full sweep is from 5 Hz to 200 MHz. The presence of a test set does not affect full sweep.

Graticule

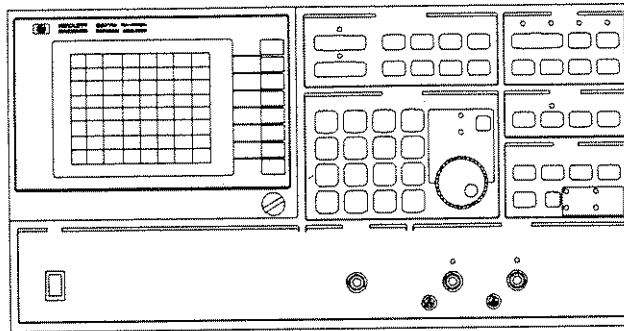

GRATICULE is a scale for measuring quantities displayed on the CRT. Turn it on and off by pressing

[**SPCL FCTN**]
and toggling between
[**GRAT ON OFF**] and
[**GRAT ON OFF**]

The HP 3577B has different graticules for LOG and Linear sweep types, the POLAR display function, and the Smith Chart scale. See figure 4-15.

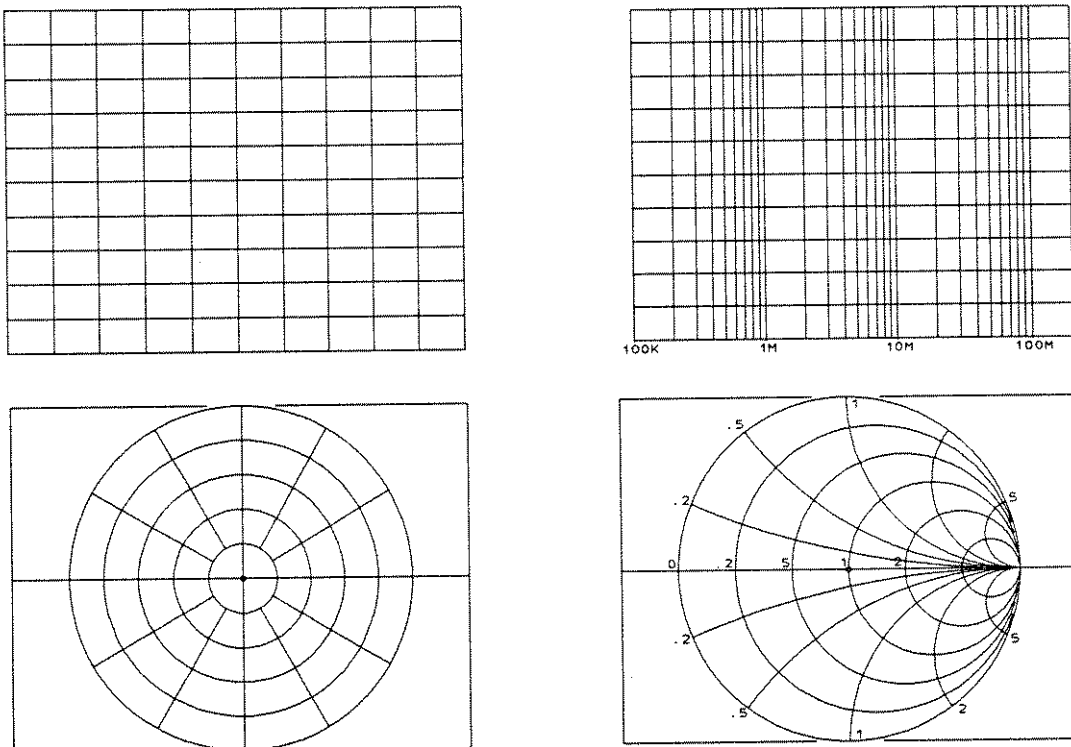

Figure 4-15.

Hardkey

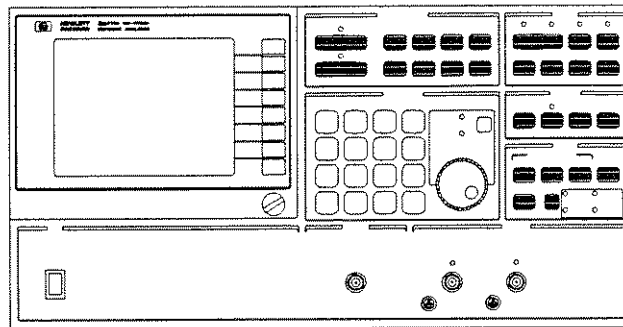

Figure 4-16

HARDKEY refers to all of the keys on the front panel that have command names printed on them. Most hardkeys display a menu of softkey labels. Exceptions to this are the keys in the DATA ENTRY section, [TRIG/RESET], [LCL], and the [INSTR PRESET].

Input

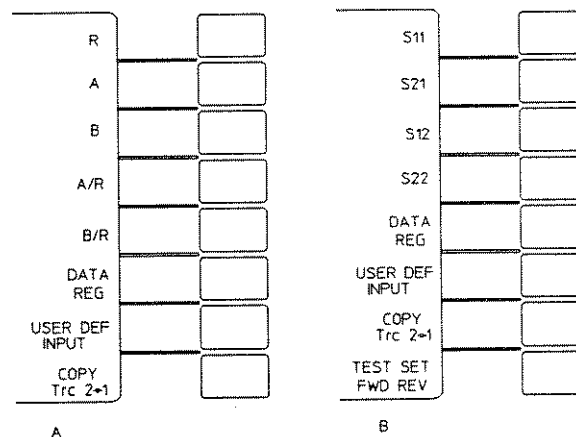
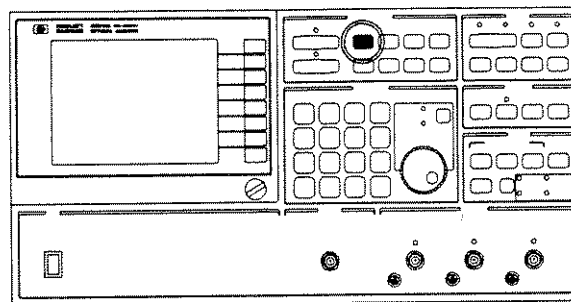

Figure 4-17A/B

INPUT is a hardkey in the **DISPLAY FORMAT** section that displays the menu of softkeys shown in figure 4-17. These softkeys define the active trace in terms of 1) receiver inputs, 2) data registers (that may contain stored traces), 3) user defined functions, and 4) user defined complex constants. Connecting an HP 35677A/B S-parameter Test Set to the HP 3577B changes this menu as shown in figure 4-17B. (The HP 35677A/B should be used with an HP 3577B Option 002 Three-Channel Network Analyzer.) If the test set is used, the S-parameters may be turned off with a softkey found under [**SPCL FCTN**]. When the S-parameters are turned off, the [**INPUT**] menu changes to that shown in figure 4-17A.

Without the test set, the default selection for [**INPUT**] is the R input. When the INPUT definition is R, A, or B, the trace appears as a display function of the signal at the selected input. If the [**INPUT**] is A/R (or B/R), the trace consists of the data at the A (or B) input divided by the data at R. This removes the response of the source from the trace if a power splitter is used as shown in figure 4-17C.

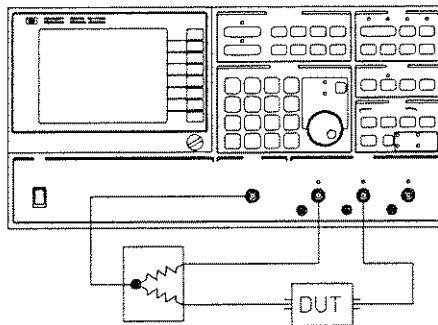

Figure 4-17C.

[DATA REG] softkey selects one of the twelve data registers as the [INPUT] definition. [USER DEF INPUT] allows construction of an equation using constants, data registers, inputs, and previously defined functions as terms. The user may also copy the input definition for the other trace into the definition of the active trace using the Copy Trace softkey.

With the S-parameter test set, the [INPUT] menu has most of the same features. In place of the selections for inputs R, A, B, A/R, and B/R are the S-parameters S11, S21, S12, and S22. When [USER DEF INPUT] is active the [TEST SET FWD/REV] softkey appears at the bottom of the menu.

DATA REGISTER is a softkey that displays the data stored in a data register. It calls a sub-menu that lists the twelve data registers, X1-X8 and D1-D4. Pressing one of these softkeys selects that data register as the trace INPUT. Be aware that the sweep parameters of the stored trace may be entirely different the current sweep parameters. [SCALE] parameters are the only values that affect the trace when the [INPUT] is defined to be a data register.

USER DEFINED INPUT is a softkey for creating an equation to define a trace INPUT that is more complicated than the common ones offered at the top of the menu. Choose from the following terms to define an INPUT equation.

1. The receiver inputs
2. Up to seven user defined complex constants
3. Up to twelve data registers
4. Up to five user defined functions

To make a USER DEFINED INPUT:

1. Press [INPUT] to display the menu
2. Press [USER DEF INPUT] (if label is not bright)
3. Press the softkey corresponding to a math term
4. Press the softkey corresponding to a math function
5. Repeat steps 3 and 4 until the equation is complete
6. Press [ENTER]

COPY Trc n → m is a softkey used to define the input of the active trace to be identical to the other trace input. Press [COPY INPUT 2 → 1] when TRACE 1 is active and press [COPY INPUT 1 → 2] when TRACE 2 is active.

TEST SET FWD/REV is a push-push toggle type softkey that selects PORT 1 or PORT 2 of the S-Parameter Test Set as the source. When FWD is bright PORT 1 is the signal source and when REV is bright PORT 2 is the source. This softkey appears only when [USER DEF INPUT] is active.

HP Instrument BASIC (Option 1C2 only)

HP Instrument BASIC is an optional feature (Option 1C2) that provides the HP 3577B with the ability to execute custom measurement routines without the need for a controller. Routines can be developed by the user via a controller or by pressing the desired keystroke combination.

For more information on this capability, refer to *Using HP Instrument BASIC with the HP3577B* (HP Part No. 03577-90030) and *HP Instrument BASIC Programming Reference* (HP Part No. E2083-90000).

Instrument Preset

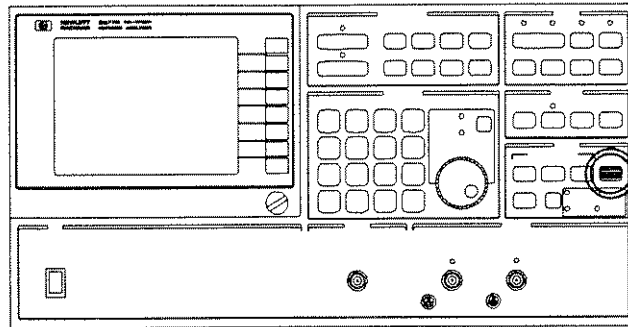

Figure 4-18

INSTRUMENT PRESET is a green hardkey in the SYSTEM section. This key resets the values of HP 3577B parameters to a known operating state. This operating state is especially useful as a reference condition. Immediately after preset or power-on, the HP 3577B parameters are set to their default values. These parameters and their preset conditions are shown in the following table.

Table 4-1

Function	Preset Condition	
	Without test set	With test set
Display function	Log magnitude	same
Input (both traces)	R input	S21
Active trace	Trace 1	same
Scale	10 dB /DIV	same
Reference level	0 dBm	same
Reference position	100% (for log mag)	same
Limit table	unchanged	unchanged
Start frequency	0 Hz	100 kHz
Stop frequency	200 MHz	same
Amplitude	- 10 dBm	+ 15 dBm
Amplitude step size	1 dB	same
Sweep type	Linear frequency	same
Sweep time	1 second	same
Sweep mode	Continuous	same
Sweep resolution	401 points/span	same
Discrete sweep table	unchanged	unchanged
Trigger mode	Free Run	same
Resolution bandwidth	1 kHz	same
Averaging	Off	same
Attenuation (input)	20 dB (all inputs)	same
Impedance (input)	50 ohms (all inputs)	same
Length R	On, 0 meters	On, 1.3 meters
Length A	On, 0 meters	same
Length B	On, 0 meters	same
User def constants	K1 = 1.0 + j0.0	same
	K2 = 50.0 + j0.0	same
	K3 = 75.0 + j0.0	same
	K4 = 0.0 + j1.0	same
	K5 = -1.0 + j0.0	same
	K6 = $1.0 \times 10^9 + j0.0$	same
	K7 = $1.0 \times 10^{12} + j0.0$	same
User def functions	F1 = (B/R) / (K1 - B/R)	same
	F2 = A/R	same
	F3 = (K1 + F2) / (K1 - F2)	same
	F4 = K2 * F3	same
	F5 = K3 * F3	same

Key Reference
Instrument Preset

F1 is useful for connecting between open-loop gain and closed-loop gain, F2 is input reflection (if the test set is configured forward). F3 converts the reflection measurement to normalized impedance for port 1 of the test set, F4 converts normalized impedance to actual impedance where $Z_o = 50\Omega$, and F5 converts normalized impedance to actual impedance where $Z_o = 75\Omega$. For a more complete listing of preset parameters, refer to the REMOTE OPERATION section.

Knob

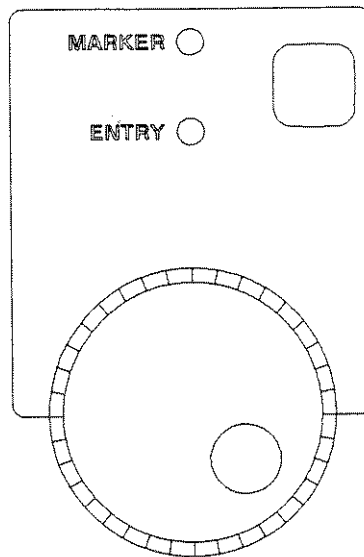
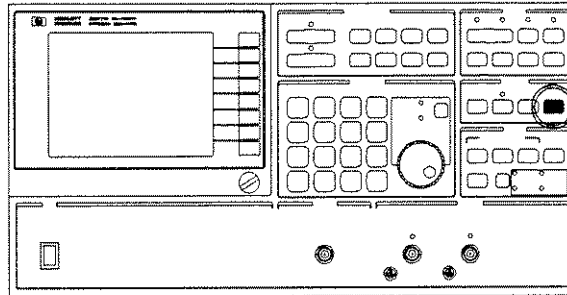

Figure 4-19

The KNOB in the DATA ENTRY section moves the marker or modifies data. The unmarked key above the knob toggles between the marker and data entry modes. The LED's above the knob indicate the current mode.

Length



LENGTH R		
LENGTH R ON OFF		
LENGTH A		
LENGTH A ON OFF		
LENGTH B		
LENGTH B ON OFF		
STEP SIZE		

Figure 4-20

LENGTH is a hardkey in the RECEIVER section of the front panel that displays the menu of softkey labels shown in figure 4-20. These softkeys select the electrical length of each of the receiver inputs to compensate for, or simulate cable lengths. Propagation velocity is assumed to be the speed of light. The actual cable length should be compensated for using a relative velocity. Each input's LENGTH feature may be turned off (i.e., set to 0).

To change the value of length for a receiver input:

1. Press [**LENGTH**] to display the menu
2. Press [**LENGTH_**] for the channel to be modified (if the label is not bright)
3. Modify the value with the knob or arrow keys
OR
4. Enter a new value with the numeric key pad and select units from the menu

The length affects phase functions only; there is no loss factor. If the current [**DISPLY FCTN**] is LOG or linear magnitude there is no change in the trace with changes in length.

Preset or default value: 0.0m, ON

Upper limit: 1 second or 300,000,000 meters

Lower limit: - 1 second or - 300,000,000 meters

Resolution: .001 ns or .1 cm

Menu Units: m, cm, SEC, mSEC, μ SEC, nSEC, EXP

Limit

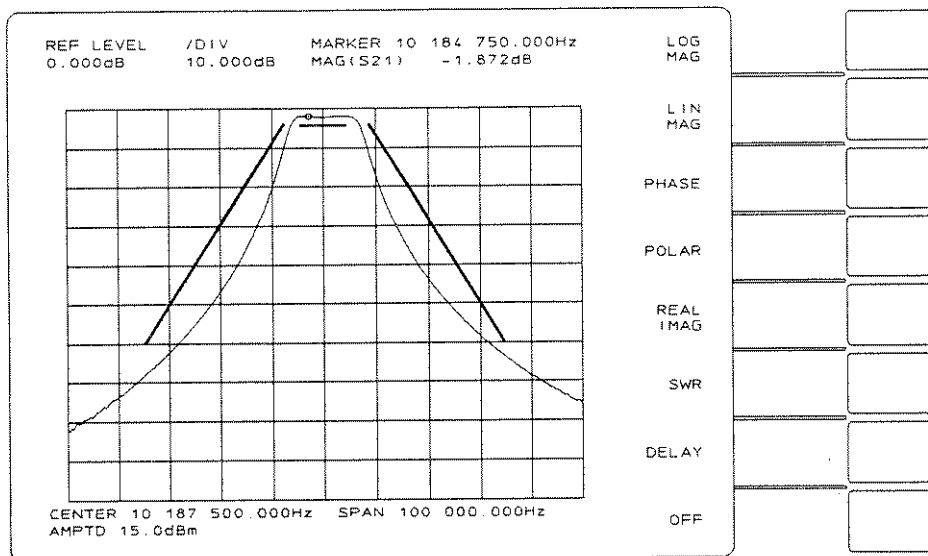

Figure 4-21

LIMIT testing compares measured data to a user defined limit. Define a limit by using a limit table which is a list of values referenced to their respective x- and y-coordinates. The analyzer compares these values with the displayed trace and reports a “PASS” or “FAIL 1 (or 2)” condition on the screen. The “FAIL” message indicates which trace failed.

A limit appears as a line defined by a series of line segments. These line segments are defined by points that are specified by the user for each limit table.

Each trace has its own limit table. Upper and lower limits can be created for each limit table. [EVALUATE ON] turns the limit test on and the analyzer indicates a “FAIL” condition if the displayed trace exceeds an upper limit (or goes below a lower limit). If the trace is within the limit lines, the test passes. Both upper and lower limit lines need not be used. For some types of testing, it may be more convenient to use only upper (or lower) limits.

Creating a Limit Table

To display the limit table, press [MKR] and [LIMIT TABLE]. When editing the limit table, use the [↑] and [↓] hardkeys to move to a particular segment. If there is more than one page of segments, the table scrolls until the bottom of the list is reached.

When adding a new segment, the [X-START] and [Y-START] values are copied from the [X-STOP] and [Y-STOP] values of the previous segment. This allows convenient entry of a connecting segment (i.e., there is no need to re-enter the [X-START] and [Y-START] values). Simply choose the [X-STOP] and [Y-STOP] values for the new segment as follows:

1. Press [X-STOP], enter the data from the numeric keypad, and choose a units softkey.
2. Press [Y-STOP], and enter the data from the numeric keypad. See figure 4-22.

X-START FREQ
10.183.000.000HZ

Trace 1 Limit Table

ROW	X-START	Y-START	X-STOP	Y-STOP	UL
1	10.183M	-4.000	10.192M	-4.000	LO
2	10.153M	-60.000	10.180M	-2.000	UP
3	10.196M	-4.000	10.222M	-60.000	UP
4					
5					
6					
7					
8					
9					
10					

USE UP/DOWN ARROW KEYS TO SELECT ROW.
ADD NEW ROWS AT BOTTOM.

Figure 4-22 Segment Entries in a Limit Table

Note



The analyzer does not store unit labels for the y-axis (Y-START/STOP points). For example, a y-value of -35 dBm is stored simply as “ -35 ”. Before using a limit table again, make sure the analyzer is set to use the same vertical units that were used when building the table initially. Otherwise, the limit test will not work properly. It is also a good idea to use the same frequency span.

Between 1 and 20 rows or line segments can be used per limit table. The x- and y-values in the table have better resolution than the analyzer display indicates.

To turn off limit testing, press

[**MKR**]
[LIMIT TABLE]
[LIMIT CONFIG]
and toggle to
[EVALUATE ON **OFF**].

For a detailed example on how to build a limit table, see the example “Limit Line Comparison Test on a Bandpass Filter” in the Making Measurements Chapter.

Hints

To compare a device-under-test to a reference device, use a normalized trace and set straight-line limits that test the test device variation from the reference device. To do this, store (using [STORE DATA]) the reference device trace in one of the X_ registers. Then select [**INPUT**] [USER DEF] and enter A/X_.

The normalized trace should appear as a straight line. Create a limit table that sets the limits to the desired variation tolerance (i.e. 3 dB above and below the normalized trace). See figure 4-23A.

Toggle to

[EVALUATE **ON** OFF]
and insert the new device to be tested. Deviations from the normalized line represent variations of the device under test from the reference device as shown in figure 4-23B.

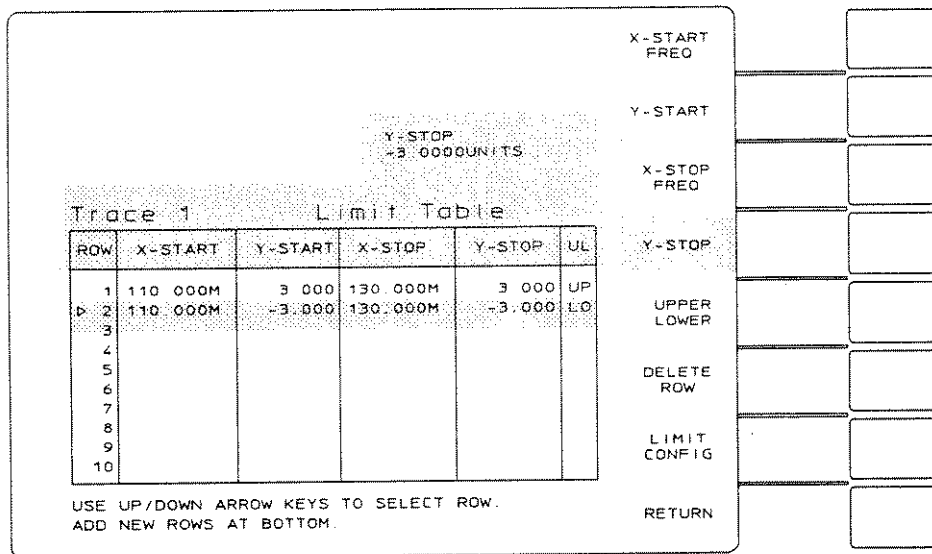

Figure 4-23A.

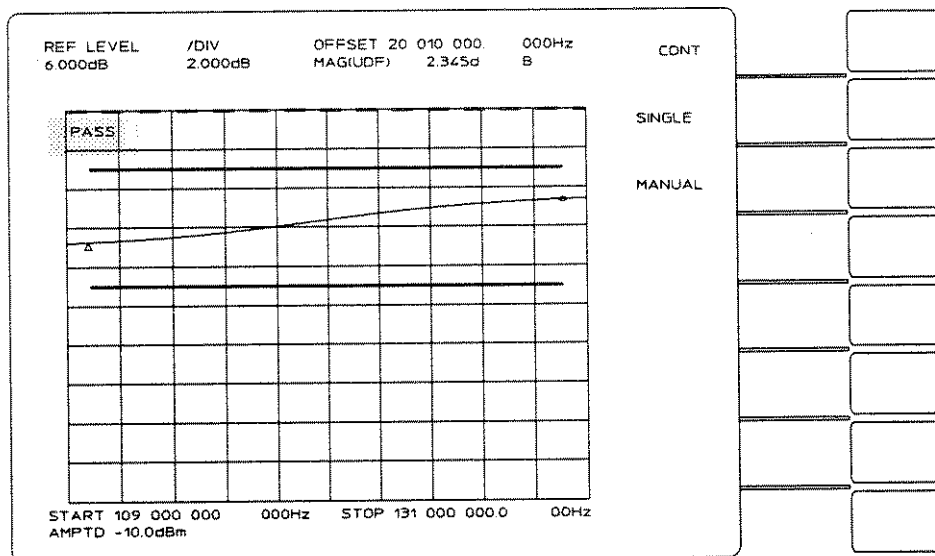

Figure 4-23B.

Results from any limit test are indicated at the Input/Output Port on the rear panel of the HP 3577B. A dedicated line of this connector (called **FAIL**) can help control custom hardware designed to simplify component testing in a manufacturing environment. For more information on this connector, see the Programmable Input/Output Port section of the General Information Chapter.

LIMIT Softkey Definitions

X-START specifies the x-axis starting point of a segment using the numeric keypad.

Y-START specifies the y-axis starting point of a segment using the numeric keypad.

X-STOP specifies the x-axis end point of a segment using the numeric keypad.

Y-STOP specifies the y-axis end point of a segment using the numeric keypad.

UPPER/LOWER specifies whether the segment being defined should be part of the upper limit or part of the lower limit. The right column of the limit table shows an "UP" for an upper limit and "LO" for a lower limit.

DELETE ROW deletes the row indicated by the cursor.

LIMIT CONFIG calls up a menu that allows the limit lines to be displayed, turns on the limit testing, turns on the limit test beeper, and deletes segments from the displayed limit table.

LINES ON/OFF specifies whether or not the limits are displayed.

EVALUATE ON/OFF turns the limit testing on or off. When testing is on, a "PASS" or "FAIL" label appears in the upper left portion of the display. A "1" or "2" will appear beside "FAIL" to indicate which trace has failed.

BEEP ON/OFF specifies whether the analyzer should beep if the limit test fails.

DELETE ALL ROWS deletes all segments from the displayed limit table.

RETURN selects the softkey menu that is the next level higher and exits the limit table display.

Interactions:

1. Instrument Preset:

Limit tables do not change after pressing [INSTR PRESET]. They become part of the instrument state and are also preserved in non-volatile memory after cycling power.

2. Display Function:

Limit lines can be used with any display function except [POLAR].

3. Scale:

Changing [REF LEVEL] will also move the limit lines such that the proper relation between trace data and the limit(s) is maintained.

4. Sweep Type:

Limit lines can be used with all sweep types, however, when used with the LOG FREQ SWEEP and AMPTD SWEEP, be aware of the following.

- a. Using the same limit lines for [LOG FREQ SWEEP] and [LIN FREQ SWEEP] may give different results since each limit segment is drawn as a straight line between points.
- b. Limit lines will work with AMPTD SWEEP, however, the [X-START] and [X-STOP] amplitude values must be entered as Hz. For example to start a limit line at -13 dBm, enter "-13.000 Hz" for [X-START].

5. Programmable Input/Output Port:

Results of a limit evaluation set pin 10 (FAIL) of the Programmable I/O Port on the back panel of the analyzer. This connector can be used to control custom hardware designed for simplified component testing. See the Programmable Input/Output Port section in the General Information Chapter.

Local

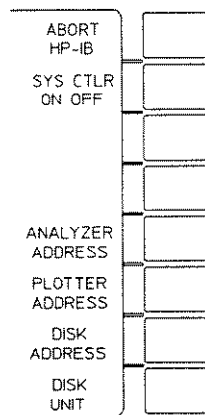
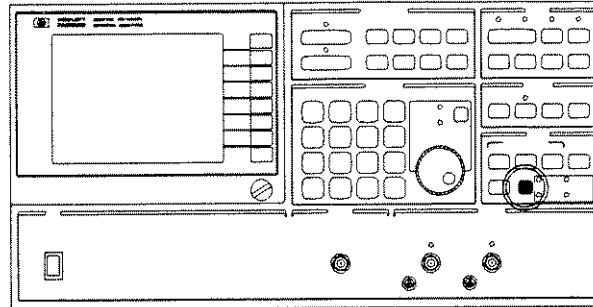

Figure 4-24

LOCAL is a hardkey in the SYSTEM section of the front panel that changes the HP-IB status of the HP 3577B from REMOTE to LOCAL if the LOCAL LOCKOUT command has not been issued.

[**LCL**] is part of the HP-IB STATUS block. This block has four LED indicators that show the HP-IB status for REMOTE, TALK, LISTEN, and SRQ. If the REMOTE LED is illuminated, none of the front panel keys have any effect until [**LCL**] returns LOCAL control (which turns off the REMOTE LED). If the HP-IB controller issues the LOCAL LOCKOUT command and the REMOTE LED is illuminated, pressing [**LCL**] does not gain LOCAL control. See the Remote Operation Chapter for more information.

Local also displays the menu shown in figure 4-24.

ABORT HP-IB sends an interface clear (IFC) to the HP-IB. IFC is needed when two controllers are present on the HP-IB. IFC is used to terminate all bus activity and reset the HP-IB interfaces of all devices on the bus.

SYSTEM CONTROLLER ON/OFF is a push-push toggle type softkey that changes the HP 3577B HP-IB status from being a controller to being a listener. Toggle to [**SYS CTLR ON OFF**] to control other HP-IB instruments such as a plotter. Toggle to [**SYS CTLR ON OFF**] when operating the analyzer from a computer.

ANALYZER ADDRESS is a softkey used to view and change the address of the HP 3577B on the HP-IB. This address is set at the factory to 11 and may be set to any whole number from 0 to 30, inclusive. Pressing [**INSTR PRESET**] or cycling power does not change this value. The address cannot be changed via the HP-IB; it can only be changed manually. To modify the HP-IB address:

1. Press [**LCL**] to display the menu
2. Press [**ANALYZER ADDRESS**]
3. Enter the new address with the numeric key pad
4. Press [**ENTER**]

PLOTTER ADDRESS is a softkey used to set the plotter address so that it matches the switch address of the HP-IB plotter. This address is set at the factory to 5 and may be set to any whole number from 0 to 30, inclusive. Pressing [**INSTR PRESET**] or cycling power does not change this value. To modify [**PLOTTER ADDRESS**]:

1. Press [**LCL**] to display the menu
2. Press [**PLOTTER ADDRESS**]
3. Enter the new address with the numeric key pad
4. Press [**ENTER**]

DISK ADDRESS is used only with Option 1C2 (HP Instrument BASIC Option). Use this softkey to set the disk drive address to the switch address of an HP-IB disk drive. It operates the same as [**PLOTTER ADDRESS**]. See *Using HP Instrument BASIC with the HP 3577B* for more information on how to control a disk drive with Option 1C2 and an HP Instrument BASIC program.

DISK UNIT is used only with Option 1C2 (HP Instrument BASIC Option). Use this softkey to set the drive number of the disk drive to the desired drive. [**DISK UNIT**] operates the same as [**PLOTTER ADDRESS**]. See *Using HP Instrument BASIC with the HP 3577B* for more information on how to control a disk drive with Option 1C2 and an HP Instrument BASIC program.

Marker

MARKER is a hardkey in the DISPLAY FORMAT section of the front panel that displays the menu of softkey labels shown in figure 4-25. These softkeys read data from the displayed trace. After pressing [INSTR PRESET], the knob is in the marker mode. When moving the marker with the knob, the data for that point appears in the MARKER BLOCK above the right half of the graticule. Note that the MARKER information is valid even though the trace may be clipped by the upper or lower edges of the graticule. If the frequency span is 0 Hz and the sweep time is less than 1000 seconds, the marker position reads out in units of time.

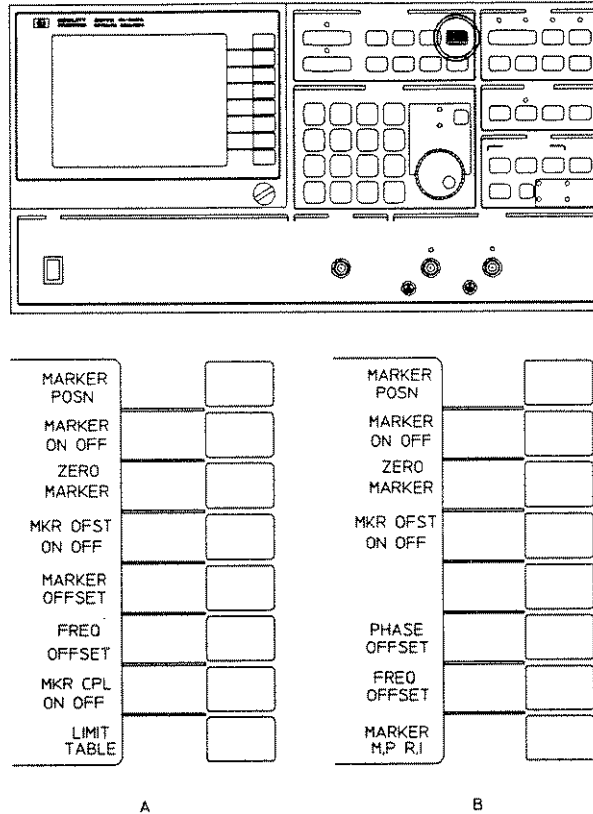

Figure 4-25

MARKER POSITION is a softkey that is the default marker mode. It allows the marker to be moved when the arrow keys are pressed. Note that when [**MARKER POSITION**] is bright the knob moves the marker in either the **MARKER** or **ENTRY** modes.

MARKER ON/OFF is a push-push toggle type softkey that turns the marker for the selected trace on and off. When the marker is on, the **MARKER BLOCK** in the upper right-hand portion of the screen is turned on. The default condition is on. Pressing [**MKR**] also turns the marker on.

ZERO MARKER is a softkey which turns on the offset marker and sets its X-Y coordinates (offset values) to those of the regular marker. The offset marker is a small triangle that appears on top of the regular marker. Pressing [**ZERO MARKER**] changes the marker information block above the graticule top **OFFSET** information. The offset marker becomes the reference for the regular marker.

MARKER OFFSET ON/OFF is a softkey that turns the offset marker on and off. When it is turned on, the offset marker is placed at the values represented by the [**MARKER OFFSET**] (magnitude) and [**FREQ OFFSET**] parameters. It is a push-push toggle type softkey. When on, the triangular offset marker appears on the screen (if its coordinates are on-scale) and the word "MARKER" changes to "OFFSET" in the marker block above the graticule.

MARKER OFFSET is a softkey used to enter a reference value for the Y-axis of the **OFFSET MARKER**. The default value for **MARKER OFFSET** is 0.0 dBm. To change this value:

1. Press [**MKR**] to display the menu
2. Press [**MARKER OFFSET**] (if label is not bright)
3. Modify the data with the knob or arrow keys

OR

Enter a new value with the numeric key pad and select units from the menu

FREQUENCY OFFSET is a softkey that enters a reference value for the X-axis of the **OFFSET MARKER**. The default value for [**FREQUENCY OFFSET**] is 0 Hz (in a frequency sweep). When [**SWEEP TYPE**] is [**AMPTD**] the softkey label changes to [**AMPTD OFFSET**]. This parameter may be modified in the same manner as [**MAG OFFSET**].

MARKER COUPLING ON/OFF is a push-push toggle type softkey used when two traces are on. In the default setting (ON) both markers move together when the knob is rotated. If **MARKER COUPLING** is turned OFF, turning the knob moves only the marker on the active trace.

LIMIT TABLE displays the limit table. See the **LIMIT** section in this chapter.

Markers for Polar Displays

When the DISPLAY FUNCTION is POLAR only one trace is active, so there is only one active marker. This marker has three values associated with it; frequency, magnitude and phase (or frequency, real, and imaginary). With the POLAR DISPLAY FUNCTION the MKR menu appears as shown in figure 4-25B. The following discussion of softkey features assumes that the active display function is POLAR. The top four softkey labels operate in the POLAR DISPLAY FUNCTION the same as they do in a rectangular display function.

MAGNITUDE OFFSET is a softkey for entering or modifying the value of magnitude for the offset marker. The default value of magnitude offset is 0.0 V without a test set and 0.0 units with a test set. Pressing [ZERO MARKER] resets this value to the current magnitude value of the regular marker. When [MARKER M,P **R,I**] is selected, [MAG OFFSET] changes to [REAL OFFSET]. To change the value of this parameter:

1. Press [**DSPLY FCTN**] to display a menu
2. Press [POLAR] (if label is not bright)
3. Press [**MKR**] to display a menu
4. Press [MAG OFFSET] (if label is not bright)
5. Modify the value with the knob or the arrow keys

OR

Enter a new value with the numeric key pad and select units from the menu

PHASE OFFSET is a softkey for data entry of phase data which places the offset marker relative to the regular marker. The procedure for entering this parameter is the same as described previously for [MAG OFFSET]. Enter [PHASE OFFSET] with the offset marker on or off. Pressing [ZERO MARKER] resets [PHASE OFFSET] to the current phase of the regular marker. Selecting [MARKER M,P **R,I**] changes [PHASE OFFSET] to [IMAG OFFSET].

FREQUENCY OFFSET is a softkey that operates the same in the polar as in the rectangular display function. Note that in polar, changing this value does not change the screen position of the offset marker. This parameter offsets the frequency readout in the marker information block.

MARKER M,P/R,I is a push-push toggle type softkey which changes the units of the marker information from magnitude & phase to real & imaginary. The default setting is magnitude and phase units. To change the units to real and imaginary, toggle to [MARKER M,P **R,I**]. The current units are indicated by the brightened M,P for magnitude and phase or R,I for real and imaginary.

When the marker offset is on, toggling to [MARKER M,P R,I] will change the units of the marker from magnitude and phase to real and imaginary as expected. However, with the marker offset on, this change in units is not defined by the standard polar-to-cartesian coordinate transformation rules. The coordinate transformation rules do not apply because the offsets of magnitude-phase-frequency or real-imaginary-frequency are calculated separately. They are treated as scalar quantities instead of vector quantities.

For example, if the marker is in magnitude/phase units,
OFFSET = MARKER FREQUENCY - FREQ OFFSET
MAG () = MARKER (MAG) - MAG OFFSET
PHASE () = MARKER (PHASE) - PHASE OFFSET

If the marker is in real/imaginary units,
OFFSET = MARKER FREQUENCY - FREQ OFFSET
REAL () = MARKER (REAL) - REAL OFFSET
IMAG () = MARKER (IMAG) - IMAG OFFSET

Marker →

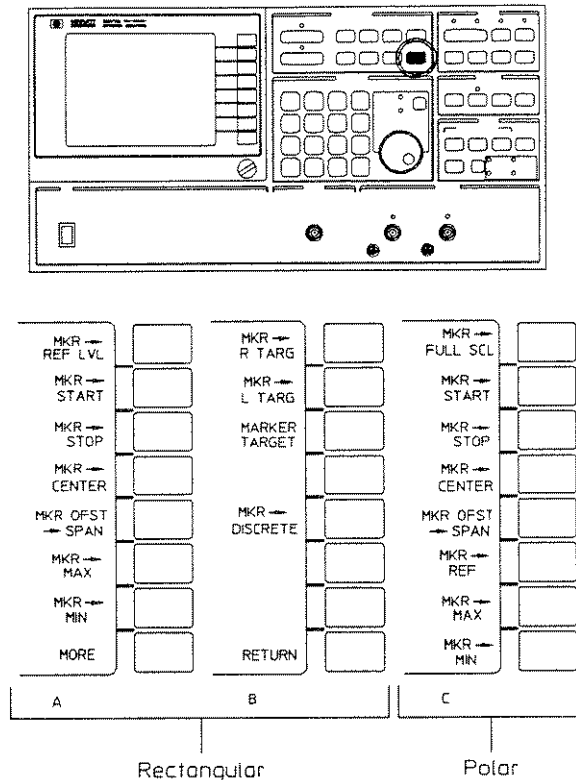

Figure 4-26

MARKER → is a hardkey in the DISPLAY FORMAT section of the front panel that displays the menus of softkeys shown in figure 4-26. Some of these softkeys are for entering data corresponding to the position of the marker. Others move the marker to points of interest.

MARKER → REFERENCE LEVEL is a softkey that changes the current value of reference level to the magnitude (position) of the marker. This redefines the level at the dashed line and moves the trace correspondingly so that the marker moves to the reference line. To use this feature:

1. Move the marker to the point of interest on the trace
2. Press [**MARKER →**] to display the menu
3. Press [**MARKER → REF LVL**]

MARKER → START FREQ is a softkey used to change the current value of start frequency to the frequency (position) of the marker. To use this feature:

1. Move the marker to the point on the trace that will be the new start frequency
2. Press [**MKR →**] to display the menu
3. Press [**MKR → START**]

MARKER → STOP FREQ is a softkey used to change the current value of stop frequency to the frequency (position) of the marker. To use this feature:

1. Move the marker to the point on the trace that will be the new stop frequency
2. Press [**MKR →**] to display the menu
3. Press [**MKR → STOP**]

MARKER → CENTER FREQ is a softkey that allows the present frequency of the marker to be entered into the center frequency value. To use this feature:

1. Move the marker to the point on the trace that will be the new center frequency
2. Press [**MKR →**] to display the menu.
3. Press [**MKR → CENTER**]

MARKER OFFSET → SPAN is a softkey used to select new START and STOP frequencies (i.e., frequency span). The start and stop frequencies are selected by positioning the offset marker and regular marker. To use this feature:

1. Move the marker to the point on the trace that will be one of the end frequencies
2. Press [**MKR**] to display a menu
3. Press [**ZERO MARKER**] to turn on the offset marker
4. Move the marker to the point on the trace that will be the other end frequency
5. Press [**MKR →**] to display the menu
6. Press [**MKR OFST → SPAN**]

Reference
Marker →

MARKER → MAX is a softkey used to move the marker to the bin containing the largest value. To use this feature:

1. Press [**MKR →**] to display the menu
2. Press [**MKR → MAX**]

MARKER → MIN is a softkey used to move the marker to the bin containing the smallest value. To use this feature:

1. Press [**MKR →**] to display the menu
2. Press [**MKR → MIN**]

Note that if future sweeps create maximum or minimum values in bins other than the position of the marker, the marker does not move to that bin. The marker remains at the position selected when [**MKR →**] was pressed.

MORE is a softkey that displays the menu shown in figure 4-26B. The active softkey in this menu is [**MARKER TARGET**].

MARKER → RIGHT TARGET is a softkey used to search to the right for the target value entered in [MARKER TARGET]. The default value of [MARKER TARGET] is 10.01 dBm without the test set and – 3 dB with the test set. To use this feature:

1. Press [MKR →] to display a menu
2. Press [MORE] to display the second menu
3. Press [MKR → R TARG]

If the target value does not exist to the right of the marker, the screen message “TARGET VALUE NOT FOUND” appears and the marker does not change position. If the value exists in more than one bin the marker moves to the first bin to the right that has the target value. (The bin value is not necessarily equal to the target value. Refer to the marker information block above the graticule for any discrepancies.)

MARKER → LEFT TARGET is a softkey used to search to the left for the target value entered in [MARKER TARGET]. The default value of [MARKER TARGET] is 10.01 dBm without a test set and – 3 dB with a test set. To use this feature:

1. Press [MKR →] to display a menu
2. Press [MORE] to display the second menu
3. Press [MKR → L TARG]

If the target value does not exist to the left of the marker, the screen message “TARGET VALUE NOT FOUND” appears and the marker does not change position. If the value exists in more than one bin the marker moves to the first bin to the right that has the target value. (The bin value is not necessarily equal to the target value. Refer to the marker information block above the graticule for any discrepancies.)

MARKER → DISCRETE adds the current marker frequency to the Discrete Sweep Table. The new frequency is automatically inserted in the table in order of ascending frequency. The resolution bandwidth and settling time are copied from the row above the new frequency. To use this feature:

1. Press [MKR] and move the marker to the desired frequency to be added to the Discrete Sweep Table using the knob or arrow keys
2. Press [MKR →] to display the menu
3. Press [MORE] to display the second menu
4. Press [MKR → DISCRETE]

Reference
Marker →

MARKER TARGET is a softkey used for entering the desired search value for the target markers. The default value of [MARKER TARGET] is 10.01 dBm without a test set and – 3 dB with a test set. To use this feature:

1. Press [**MKR →**] to display a menu
2. Press [**MORE**] to display the second menu
3. Modify the value with the knob or arrow keys

OR

Enter a new value with the numeric key pad and select units from the menu

RETURN is a softkey that displays the previous menu. This may also be done by pressing [**MKR →**].

MKR → for Polar Displays

When the DISPLAY FUNCTION is POLAR the MKR → menu appears with the softkey labels shown in figure 4-26C. The following softkey features assume that the display function is polar.

MARKER → FULL SCALE is a softkey that changes the value of FULL SCALE to the magnitude (position) of the marker. This sets the level of the outer circle of the polar graticule to the current magnitude of the marker which has the effect of changing the scale.

To use this feature:

1. Move the marker to the point that will be the outer circle of the polar graticule
2. Press [**MKR →**] to display the menu
3. Press [**MKR → FULL SCL**]

MARKER → START FREQUENCY is a softkey that also appears in the MKR menu for rectangular display formats. It works the same for polar formats. In POLAR there is only one trace and only one marker. The marker has three values associated with it: frequency, magnitude, and phase (or frequency, real, and imaginary). [**MKR → START**] assigns the present frequency value of the marker to the start frequency.

MARKER → STOP FREQUENCY is a softkey that works the same in polar as rectangular display formats.

MARKER → CENTER FREQUENCY is a softkey that works the same in polar as rectangular display formats.

MARKER OFFSET → FREQ SPAN is a softkey that works the same in polar as rectangular display formats.

MARKER → REFERENCE LEVEL is a softkey that puts the current phase value of the marker into the value of the reference line. The polar trace rotates as a result, leaving the marker on the dashed line. To use this feature:

1. Move the marker to the point on the trace that will be the new phase reference
2. Press [**MKR →**] to display the menu
3. Press [**MKR → REF**]

MARKER → MAX is a softkey that works the same in polar as rectangular display formats.

MARKER → MIN is a softkey that works the same in polar as rectangular display formats.

Measurement Calibration

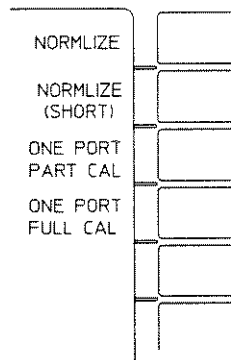
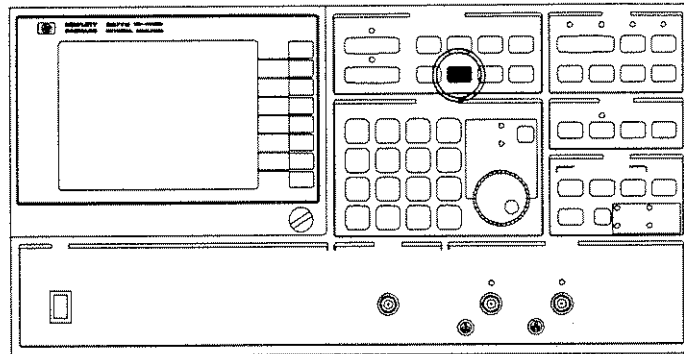

Figure 4-27

MEASUREMENT CALIBRATION is a hardkey in the DISPLAY FORMAT section of the front panel that displays the menu of softkeys shown in figure 4-27. These softkeys calibrate out the effects of measurement hardware imperfections. None of these softkey functions are operable if the sweep type is alternate sweep.

NORMALIZE is a softkey that is used to remove cable lengths and imperfections in the source flatness from simple measurements. To use this feature:

1. Set up the measurement
2. Replace the device under test with a through (barrel adapter)
3. Wait for a full sweep update of the trace
4. Press [MEASR CAL] to display the menu
5. Press [NORMLIZE]
6. Replace the barrel with the test device

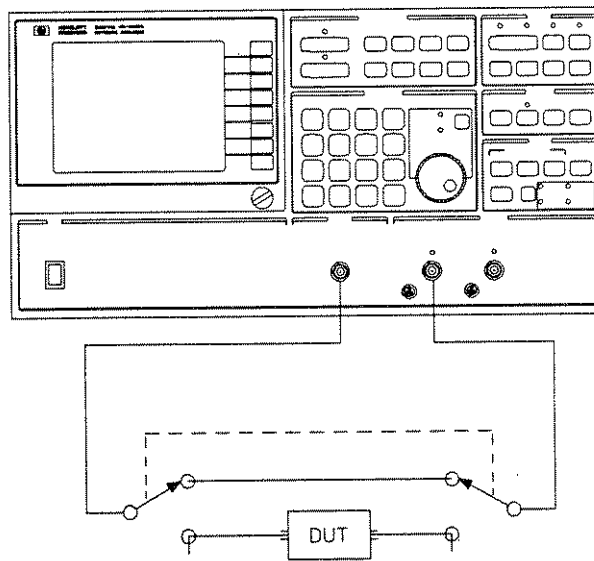

Figure 4-28

To normalize, the HP 3577B uses the INPUT definition to store the trace in register D1 (for trace 1) or D2 (for trace 2). Then it redefines the INPUT to be “old INPUT”/D1 or “old INPUT”/D2, for trace 1 and trace 2, respectively.

NORMALIZE is also used to calibrate a reflection measurement. The configuration shown in figure 4-29 should be used with an open as the standard. The procedure is the same as previously described except in step 2, disconnect the D.U.T. and connect it to a directional bridge that is open instead.

NORMALIZE (SHORT) is used for normalizing single port (reflection) measurements. The procedure is the same as [NORMLIZE] except connect a standard short to the directional bridge. See figure 4-29.

Reference
Measurement Calibration

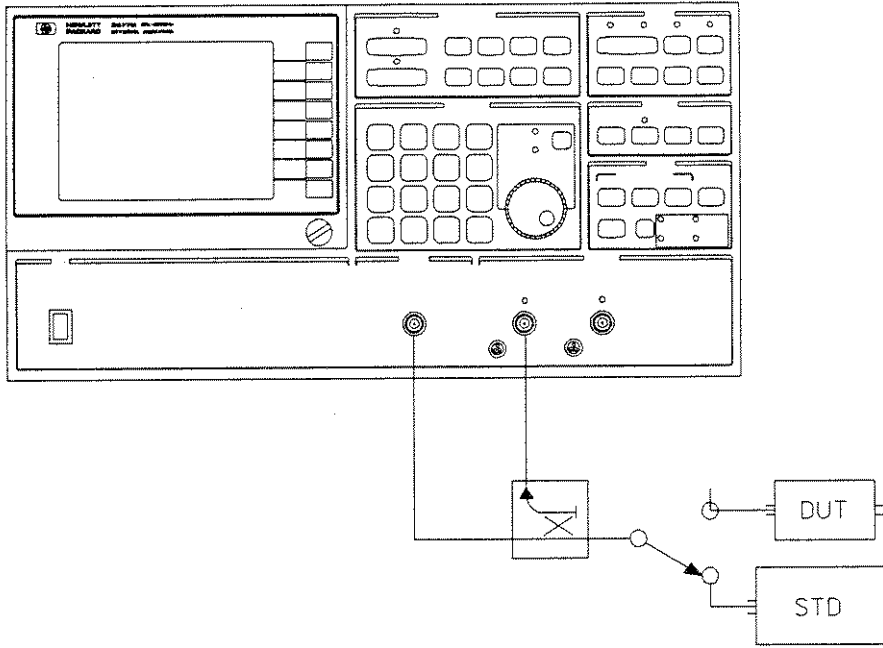

Figure 4-29



The HP 3577B allows normalization of INPUT expressions A, B, R, A/R, or B/R only.

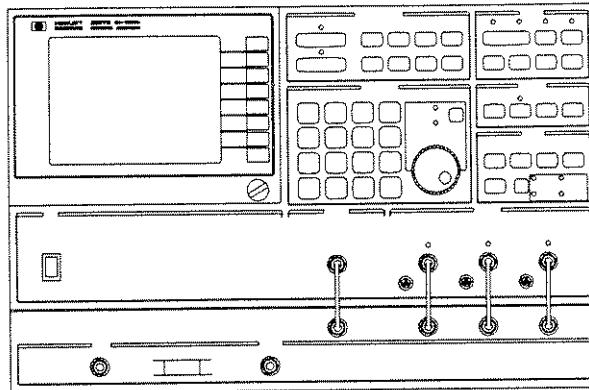

Figure 4-30

ONE PORT PARTIAL CAL is a softkey used to improve the accuracy of return loss measurements by doing two-term error correction. The HP 3577B Option 002 Three-Channel Network Analyzer and the HP 35677A/B S-Parameter Test Set are recommended for doing a one port calibration. Using this feature changes the contents of registers D3 and D4 and redefines the function F2 and the constant K1. To use this feature:

1. Set up the measurement ([INPUT], [FREQ], [AMPTD], [SWEEP TIME] etc.)
2. Press [MEASR CAL] to display the menu
3. The HP 3577B displays a screen message to "LEAVE PORT 1 OPEN"
4. Disconnect the cable to PORT 1
5. Press [CONTINUE CAL]
6. Wait for the HP 3577B to do a complete sweep
7. The HP 3577B displays a message to INSTALL REFERENCE LOAD ON PORT 1 of the HP 35677A/B S-Parameter test Set
8. Install a calibrated load of characteristic impedance on PORT 1 of the HP 35677A/B S-parameter test set
9. Press [CONTINUE CAL]
10. Wait for the message CALIBRATION COMPLETE
11. Reconnect the device to be tested to PORT 1

When calibration is complete notice the input definition is the user defined function F2, calibrated reflection. To display the normalized impedance function, select INPUT = F3 as follows:

1. Press [INPUT] to display the menu
2. Press [USER DEF INPUT]

Reference
Measurement Calibration

3. Press the F_ softkey
4. Press the 3 softkey (or 3 in the numeric key pad)
5. Press [ENTER]

To display the definition of F3:

1. Press [**DEFINE MATH**]
2. Press [DEFINE FUNCTION]
3. Press the F3 softkey and read “(K1+F2)/(K1-F2)” in the entry block portion of the screen

The error model expression is $M_{\text{meas}} = D + F \cdot M_{\text{actual}}$ where D is the directivity error term and F is the frequency response error term. When calibrated the HP 3577B displays $M_{\text{actual}} = (M_{\text{meas}} - D) / F$.

To solve for M_{actual} , the HP 3577B stores A/R measured with an open termination into D4. Then it stores the directivity error term D (with the standard load) in D3 and redefines D4 to be D4-D3, the frequency response error term F. The user defined function F2 is now the calibrated reflection function used to solve for M_{actual} ; $F2 = (A/R - D3) / D4$ which represents $M_{\text{actual}} = (M_{\text{meas}} - D) / F$.

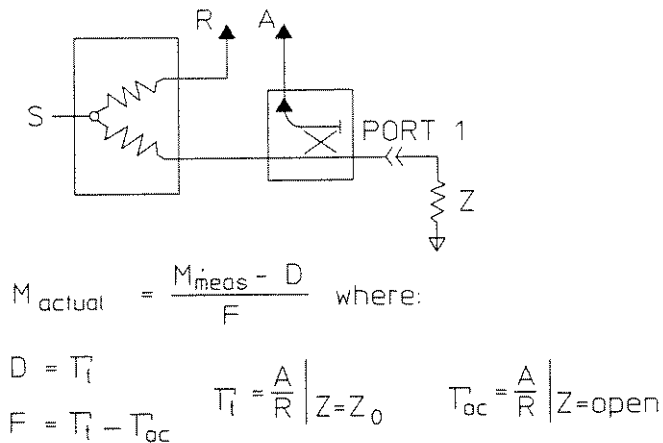

Figure 4-31

ONE PORT FULL CAL is a softkey label in the MEASUREMENT CALIBRATION menu used to improve return loss measurement accuracy. Use of this feature destroys the contents of data registers D1 (for trace 1) or D2 (for trace 2), D3, and D4, and redefines F1, F2, and K1.

Use of this feature is identical to that of the two-term error correction described previously, with the addition of a step requiring that PORT 1 of the S-parameter test set be terminated with a short. Messages on the screen ask the user to LEAVE PORT 1 OPEN, INSTALL SHORT ON PORT 1, and INSTALL REFERENCE LOAD ON PORT 1 (of the S-parameter test set). After each termination is connected, press [CONTINUE CAL] and the HP 3577B takes a sweep. When this sequence is complete, the displayed trace is F2 which is the calibrated reflection. Display the normalized impedance function by selecting F3 for the user defined INPUT, as previously described.

The error model expression used for the 3-term correction function is $M_{\text{meas}} = (D + T * M_{\text{actual}}) / (1 - S * M_{\text{actual}})$ where D is the correction factor for directivity, T is the correction factor for transmission and S is the factor for source match. When calibrated, the HP 3577B displays $M_{\text{actual}} = (M_{\text{meas}} - D) / (S * M_{\text{meas}} + T)$.

To solve for M_{actual} , the HP 3577B stores A/R measured with the open termination in D3. Then it requests the short termination and stores (A/R) + D3 in D4, stores (A/R) - D3 in D1 (or D2, for trace two) defines $K1 = 2 + j0$, and stores $K1 * A/R * D3$ in D3. Next, it requests a standard load and stores $D3 - A/R * D4$ in D3, stores $D3/D1$ (or D2) in D3 (which is now used as the error term B), stores $K1 * A/R - D4$ to D4, stores $D4/D1$ (or D2) to D4 (now equivalent to the error term C), and stores A/R in D1 (or D2) (which is A in the error model expression). Finally, it defines $F1 = D4 * A/R + D3$ and $F2 = (A/R - D2) / F1$.

Reference
Measurement Calibration

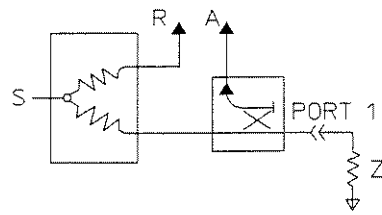

$$M_{\text{actual}} = \frac{M_{\text{meas}} - D}{S * M_{\text{meas}} + T} \text{ where:}$$

$$\Gamma_1 = \frac{A}{R} \Big|_{Z=Z_0} \quad D = \Gamma_1$$

$$\Gamma_{oc} = \frac{A}{R} \Big|_{Z=\text{open}} \quad T = \frac{2\Gamma_{sc}\Gamma_{oc} - \Gamma_1(\Gamma_{sc} + \Gamma_{oc})}{\Gamma_{sc} - \Gamma_{oc}}$$

$$\Gamma_{sc} = \frac{A}{R} \Big|_{Z=0} \quad S = \frac{2\Gamma_1 - \Gamma_{sc} + \Gamma_{oc}}{\Gamma_{sc} - \Gamma_{oc}}$$

Figure 4-32

Note



Changing the START or STOP frequencies destroys the calibration. Be sure to repeat normalization or calibration after any frequency modification.

Menu

A **MENU** is a list of softkey labels that is displayed on the CRT next to the column of softkeys. This part of the display is called the MENU AREA. See figure 4-33.

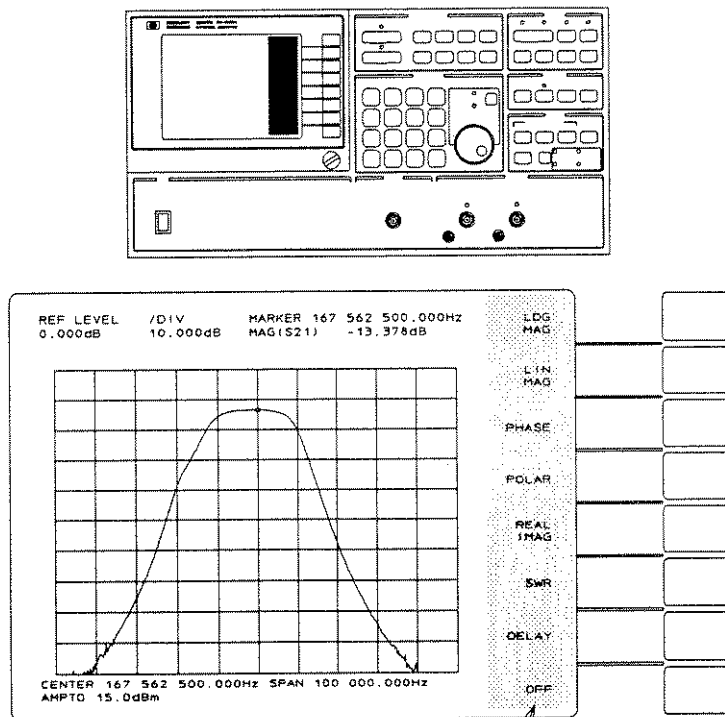

Menu
Figure 4-33

Reference
Menu

No menu contains more than eight softkey labels. Pressing the softkey beside each softkey label executes the command represented by the label. Menus change whenever a hardkey is pressed or if a sub-menu exists under a softkey. See figure 4-34.

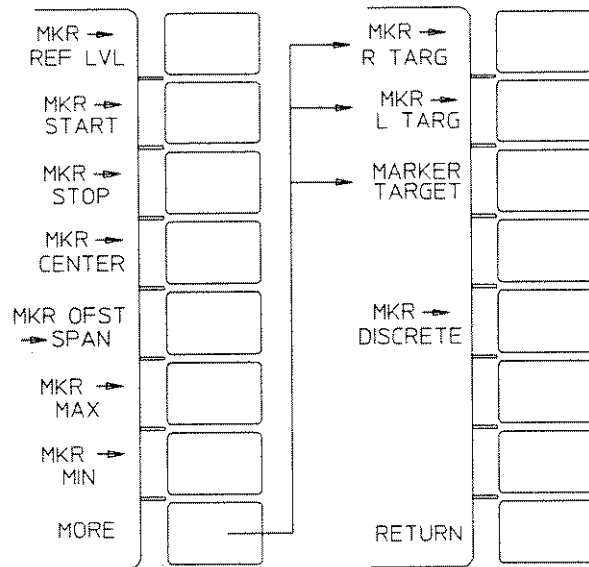

Figure 4-34

Hardkeys are the stenciled keys on the front panel that do not change definition. Hardkeys (excluding the DATA ENTRY section) are used to display menus of softkey labels. Four hardkeys that do not display a menu are [INSTR PRESET], [TRACE 1], [TRACE 2], and [TRIG/RESET].

Message Block

The **MESSAGE BLOCK** is the area of the graticule where messages to the user are written. See figure 4-35. These messages may be warning, error, or general information messages. For a listing of these messages see Appendix C.

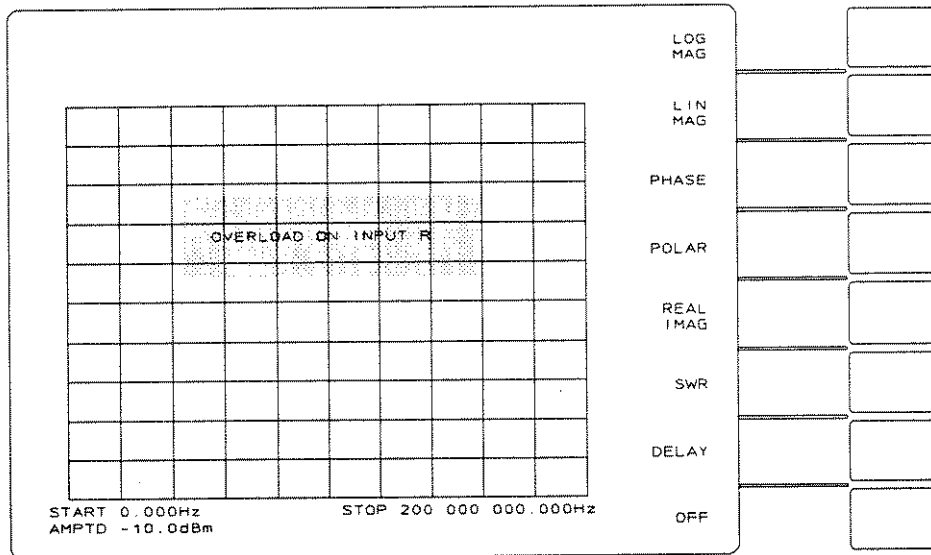

Figure 4-35

Output

The **OUTPUT** of the HP 3577B is the signal source. It is located at the lower center position on the front panel and is the left-most of the type-N connectors arranged along the bottom. The **OUTPUT** signal is controlled by the keys in the **SOURCE** section of the front panel. The characters across the bottom of the CRT show the status of the frequency and amplitude of the source. In **LOG** and **ALTERNATE** sweep types the amplitude information does not appear on the screen.

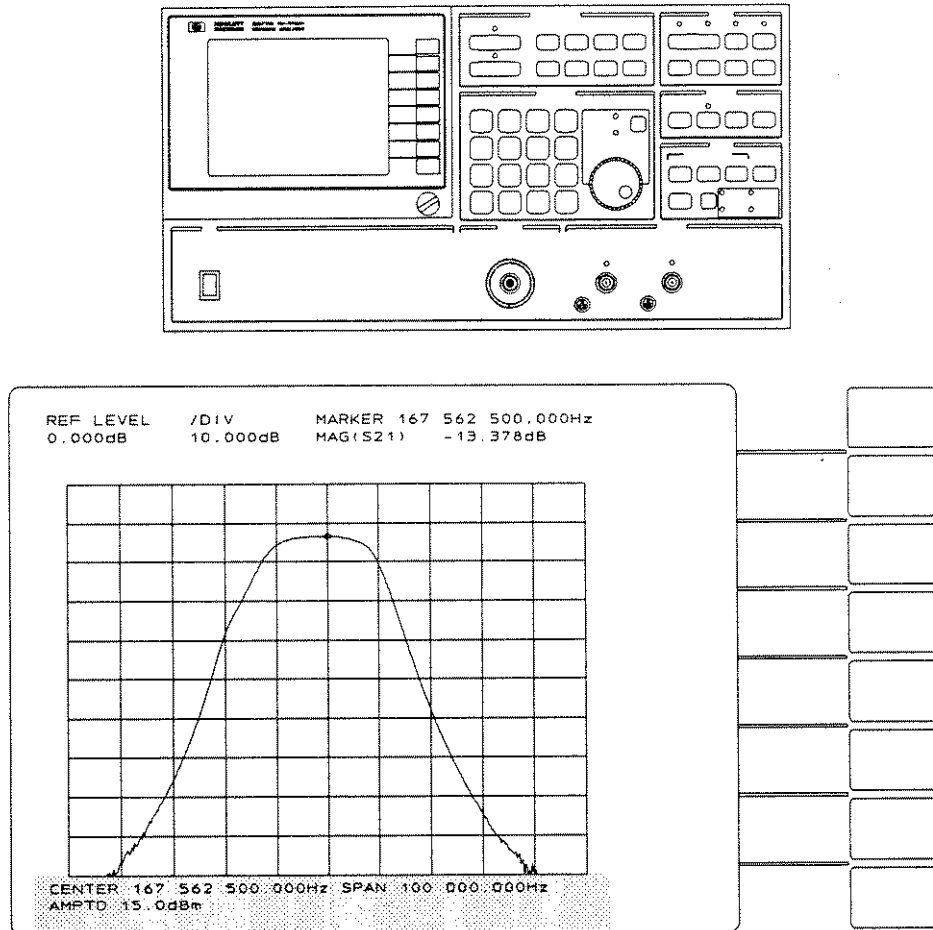

Figure 4-36 Output Signal Information

The **OUTPUT** has protection circuitry that opens the output path if a signal level greater than 4V appears on the connector. This open condition is called **TRIPPED**. The screen message “**SOURCE TRIPPED, Clear trip on AMPTD menu**” directs the user to to the **AMPTD** menu where the softkey **CLEAR TRIP** may be found.

Overload

OVERLOAD occurs when a signal level larger than 0.0 dBm (with ATTEN = 20 dB) or -20 dBm (with ATTEN = 0 dB) is applied to one of the receiver inputs. (If the frequencies of interest are below 10 kHz, these signal levels must be further reduced.) When an input is overloaded, reduce the input level to avoid degradation of the measurement accuracy. When an overload occurs, the HP 3577B sounds an audible alarm (if the beeper is ON), illuminates the OVERLOAD LED above the input being overloaded, and displays a warning message on the screen. The alarm LED is a real-time indication of an overload condition while the screen message remains until the beginning of a new sweep.

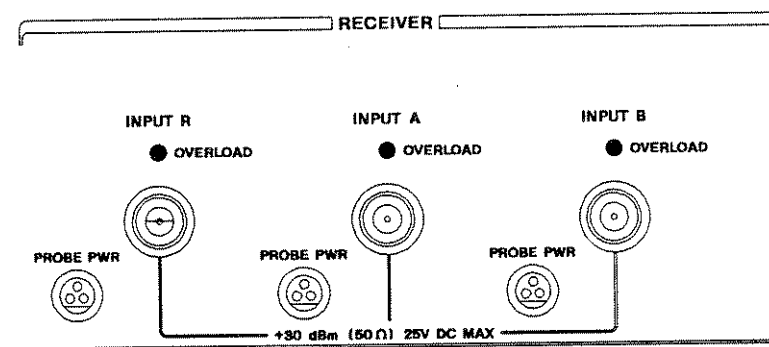

Figure 4-37

Note



If an overload occurs during a slow or single sweep, inaccurate trace data may remain on the screen. Take a new sweep with reduced input levels before taking measurements.

If the signal level is increased to 1.1V the receiver input TRIPs (changes to 1 M Ω impedance) to protect itself from damage. To reset the TRIP press the

[ATTEN]
[CLEAR TRIP].

Note that the TRIP changes the the impedance of the input but the ATTEN menu shows an impedance of 50 Ω . The impedance shown in the menu is a user selection, not the active impedance value.

Plot

PLOT is a hardkey in the SYSTEM section of the front panel that displays the menu shown in figure 4-38. These softkeys send commands to an HP-IB plotter which plots the screen of the analyzer. Set the plotter address so that it matches the HP-IB switch address on the plotter; press

[LCL]
[PLOTTER ADDRESS]

and enter the address with the numeric keypad. The HP 3577B must be the system controller. Press

[LCL]

and toggle to

[SYS CTRLR ON OFF].

Connect the HP-IB ports of the plotter and the HP 3577B with an HP-IB cable. (Refer to "INSTALLATION" in the GENERAL INFORMATION section). This procedure assumes the HP 3577B is the only controller on the HP-IB. If a computer is connected, it must be disconnected or see "Plotting Via HP-IB" in the Remote Operation Chapter.

PLOT ALL is a softkey that plots the active traces, the active markers, the graticule, the limit lines, and the alphanumerics above and below the graticule. Press PLOT ALL and the screen message PLOT IN PROGRESS appears. The menu changes to [ABORT] which allows the user to interrupt the plot. After a plot is aborted, it cannot be restarted where it stopped. Line types and pen numbers used are discussed under [CONFIG PLOT].

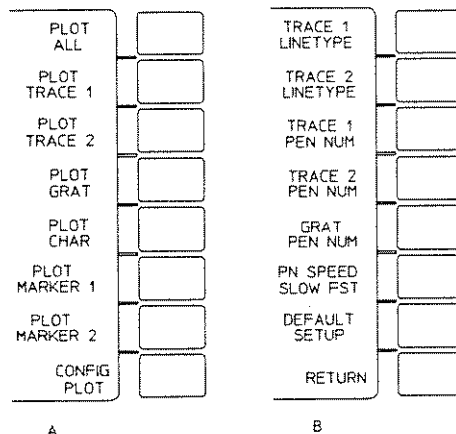
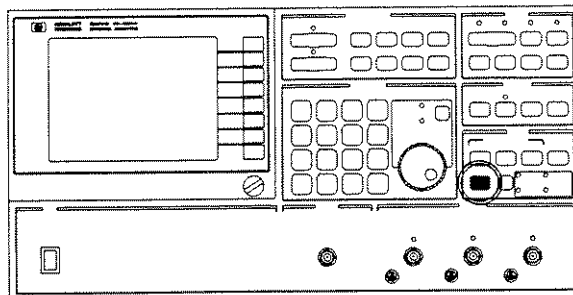

Figure 4-38

While the plot is in progress, [ABORT] is the only softkey label in the menu area. All other front panel keys (except INSTR PRESET) are ignored. [ABORT] may not stop the plot immediately. The delay depends on the time required for the plotter to execute the last command sent to it by the HP 3577B.

PLOT TRACE 1 is a softkey that plots trace one and any active markers on it. The plot may be interrupted by using [ABORT] as described in [PLOT ALL].

PLOT TRACE 2 is a softkey that plots trace two the same as described above for [PLOT TRACE 1].

PLOT GRATICULE is a softkey used to plot the active graticule, reference lines, and displayed limit lines. The reference lines are plotted using the pen (number) selected for plotting its associated trace. Pressing [ABORT] interrupts the plot. To avoid plotting the reference lines or limit lines, turn them off with softkeys in the SCALE and LIMIT menus, respectively.

PLOT CHARACTERS is a softkey that plots the alphanumeric above and below the graticule. Pressing [ABORT] interrupts the plot.

Reference
Plot

PLOT MARKER 1 and 2 are softkeys used to plot multiple markers. This allows the user to mark many points of interest on the plot. The “extra” markers appear as a cross hair on the trace and the marker block information is plotted next to it. See figure 4-39. If the marker is near one of the edges of the graticule the marker information is moved such that it all appears on the graticule. Information blocks may overwrite each other if the markers are close. To use this feature:

1. Move the marker to the point of interest on the trace
2. Press [**PLOT**] to display the menu
3. Press [**PLOT MARKER**] (1=trace 1, 2=trace 2)

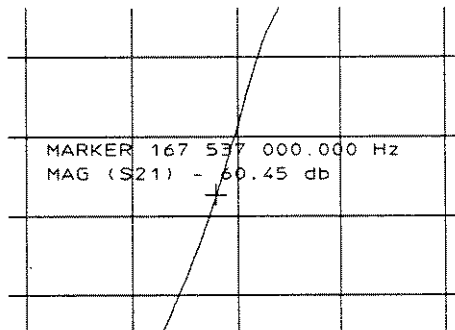
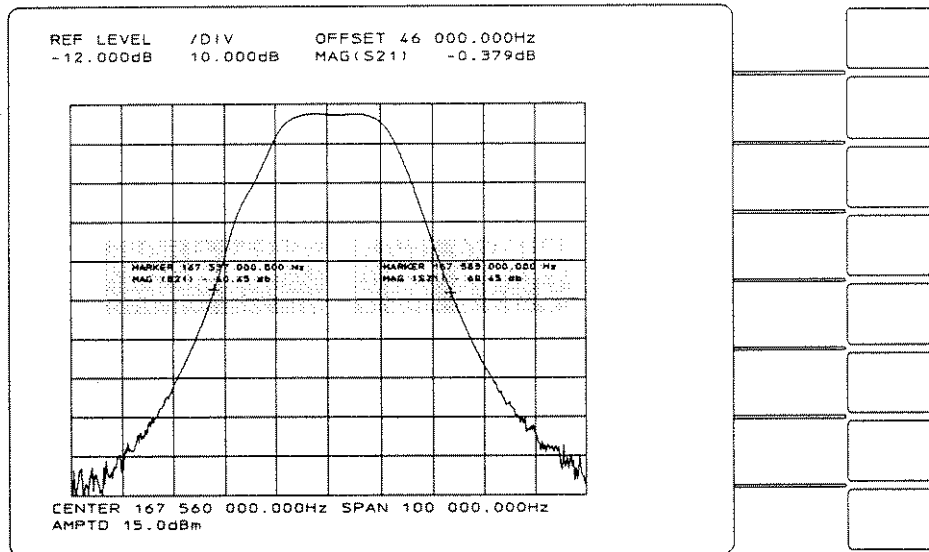

Figure 4-39

CONFIGURE PLOT is a softkey for selecting pens, line types and pen velocity. It brings up the sub-menu shown in figure 4-38B. These parameters are not changed when [INSTR PRESET] is pressed but are not saved with instrument state. See DEFAULT SETUP later in this discussion.

TRACE 1 LINETYPE is a softkey that selects the plotter line type (solid, dashes, dots, etc.) for trace 1. The line type available is dependent on the plotter. The default value is 7 (a solid line) and the range is 0-7. To select a line type:

1. Press the [PLOT] to display the menu
2. Press [CONFIG PLOT]
3. Press [TRACE 1 LINETYPE] (if label is not bright)
4. Modify the value with the knob or arrow keys

OR

Enter a new value with the numeric key pad and press
[UNITS]

TRACE 2 LINETYPE is a softkey selects the plotter line type for trace 2 as described for trace 1 above. The default value for TRACE 2 LINETYPE is 7 (solid).

TRACE 1 PEN NUMBER is a softkey that selects the plotter pen number for trace 1. This pen is also used to plot the alphanumeric information associated with trace 1. The default value for [TRACE 1 PEN NUMBER] is 1. The pen number is modified in the same manner as linetype. The range of pen numbers is 0-8.

TRACE 2 PEN NUMBER is a softkey used to select the plotter pen number for trace 2 as described for trace 1. The default value for [TRACE 2 PEN NUMBER] is 2.

GRATICULE PEN NUMBER is a softkey that selects the plotter pen number for the graticule, all alphanumeric information, and displayed limit lines. This information includes "REF" /DIV", start and stop or center and span frequencies (except in alternate sweep type), and source amplitude (except in alternate and LOG frequency sweep types). In alternate sweep, the frequency information is associated with a specific trace, so pen numbers selected by trace are used and amplitude information does not appear. In LOG frequency sweep, amplitude information does not appear at the bottom of the screen. The default value of GRATICULE PEN NUMBER is 2. Modify [GRAT PEN NUM] the same as linetype. The range of pen numbers is 0-8.

Reference
Plot

PEN SPEED SLOW/FAST is a toggle softkey that selects either a slow pen velocity or the maximum. The default setting is fast. The fast pen velocity depends on the plotter. The SLOW pen speed is

10 cm/s for plotting with marginal pens or transparencies. To modify the pen speed, press [**PLOT**], [**CONFIG PLOT**], and then toggle between [**PEN SPEED SLOW FST**] and [**PEN SPEED SLOW FST**].

DEFAULT SETUP is a softkey that resets the plot parameters to their default parameters:

```
TRACE 1 LINETYPE =7  
TRACE 2 LINETYPE =7  
TRACE 1 PEN NUMBER =1  
TRACE 2 PEN NUMBER =2  
GRATICULE PEN NUMBER =2  
PEN SPEED = FST
```

RETURN is a softkey that changes the menu listing back to the [**PLOT**] menu. This allows the user to plot after reconfiguration. The same thing is accomplished by pressing [**PLOT**].

Recall

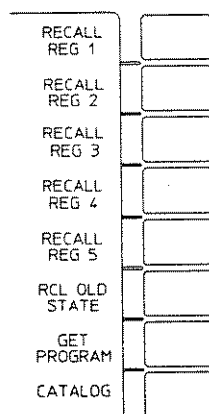
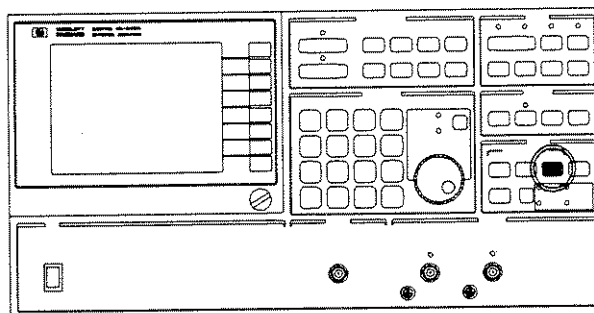

Figure 4-40

RECALL is a hardkey in the **SYSTEM** section that recalls up to five saved instrument states or the state of the HP 3577B when it was last turned off ([RCL OLD STATE]).

To use this feature:

1. Press [**RECALL**] to display the menu
2. Press [RECALL REG] (the corresponding softkey to the desired instrument state saved).

If [**SAVE**] and [**RECALL**] are held down when power is turned on, a special test of all main processor non-volatile memory is run that is not part of the regular power-on test. These two keys must be held down until the test messages appear on the screen. One message should be "TOTAL RAM TEST. NON-VOLATILE MEMORY LOST." This test erases all main processor memory resetting INSTRUMENT STATE, PLOT parameters, Limit and Discrete Sweep Tables, and the HP-IB to default parameters. For the HP-IB this means that [SYS CTLR ON **OFF**] has been toggled to OFF and the bus address is 11. This test may be used if the HP 3577B will not respond to key presses and pressing [**INSTR PRESET**] and cycling power do not solve the problem.

GET PROGRAM and **CATALOG** are softkeys that are only useful for Option 1C2 (HP Instrument BASIC Option). Refer to "Using HP Instrument BASIC with the HP 3577B" for more information.

Receiver

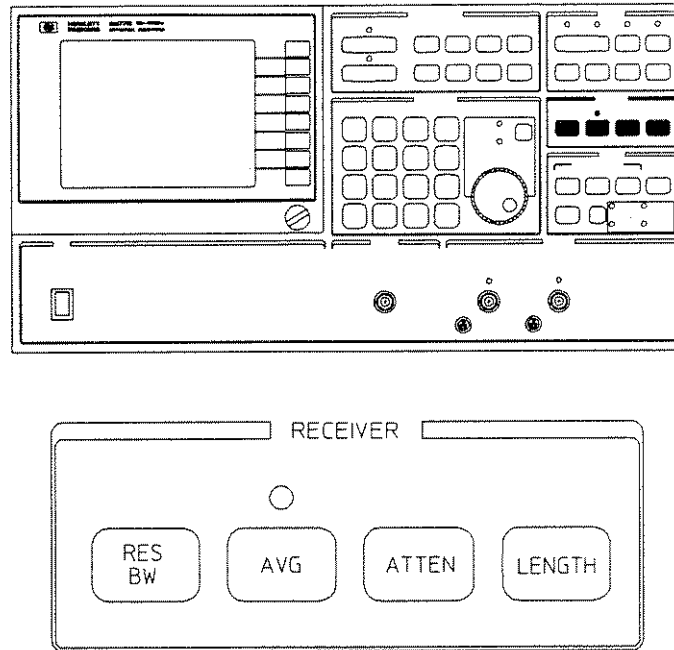

Figure 4-41

The **RECEIVER** section has four hardkeys which allow the user to control resolution bandwidth, vector averaging, attenuation, impedance, and length for each of the receiver inputs. For more information on the individual hardkey, refer to the item of interest.

Resolution Bandwidth

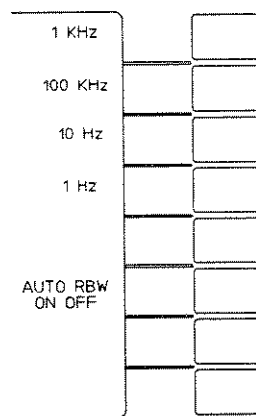
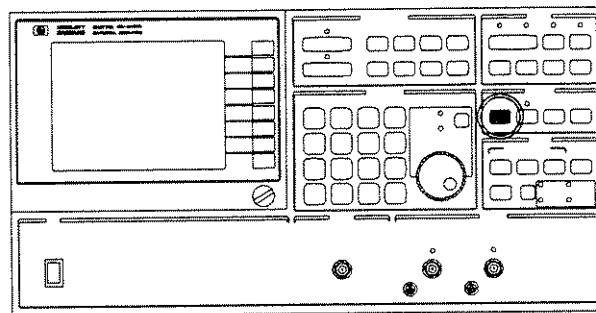

Figure 4-42

RESOLUTION BANDWIDTH is a hardkey in the RECEIVER section that displays the menu of softkeys shown in figure 4-42. Select from four resolution bandwidths for the receiver IF (intermediate frequency).

To select a resolution bandwidth, press the corresponding softkey. The bandwidth cannot be selected by entering the value using the numeric keypad. Narrow bandwidths usually require longer sweep times for accurate measurements. For more on optimizing sweep time, refer to “Optimizing Sweep Time” in Appendix A.

AUTOMATIC RESOLUTION BANDWIDTH ON/OFF is a softkey in the [RES BW] menu when the [SWEEP TYPE] is [LOG FREQ]. When it is toggled ON, [AUTO RBW ON/OFF] cycles up through the lower values of resolution bandwidth as the band is swept until it reaches the active (bright) RES BW. This prevents LO feedthrough at low frequencies and allows fast, accurate measurements at high frequencies. For example, with default parameters (sweeping 50 Hz to 200 MHz and RES BW = 1 kHz) the sweep starts at 50 Hz with a resolution bandwidth of 10 Hz. At 400 Hz the bandwidth changes to 100 Hz and at 4 kHz the bandwidth changes to 1 kHz. If FULL SWEEP is selected from the FREQ menu (or if START FREQ is changed to 5 Hz) AUTO RBW starts by waiting approximately 4 seconds for the source to settle. Then the sweep begins at 5 Hz with 1 Hz BW and changes to 10 Hz BW at 40 Hz. The cycle continues as described previously.

Reference
Resolution Bandwidth

When the [**SWEEP TYPE**] is [ALTERNATE], different resolution bandwidth can be selected for each of the two traces. In addition, different band sweeps, sweep times, and source amplitudes for each trace can also be selected.

Each resolution bandwidth has a settling time associated with it. Settling time is the time the source stays at the start frequency (or amplitude) before beginning a sweep. The following table lists the default values of settling time. Other values may be entered via HP-IB or when using Discrete Sweep. For more information on entering new values for settling time, refer to the STE command in the Remote Operation Chapter and the Discrete Sweep Table Editing section of Sweep Type in this chapter.

Res BW	Settling time
1 kHz	22 ms
100 HZ	55 ms
10 Hz	370 ms
1 Hz	3.707 s

S-Parameter Test Set

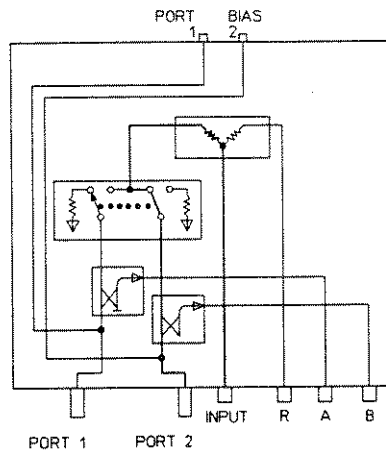
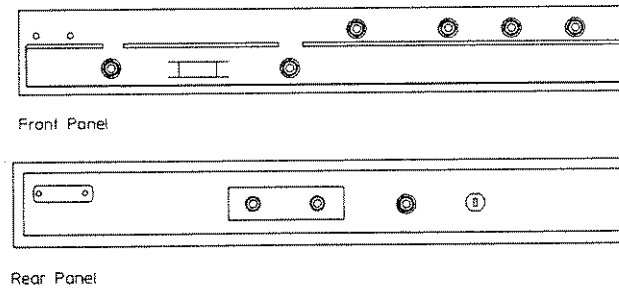

Figure 4-43

The HP 35677A/B is a scattering parameter test set built for use with the HP 3577B Option 002 Three-Channel Network Analyzer. The A model has 50 Ω ports and the B model has 75 Ω ports. Frequency response for the test set is from 100 kHz to 200 MHz. For complete specifications see the General Information section.

The test set has no internal power supply or HP-IB interface; it is powered and controlled by the HP 3577B. The two are connected together by an interconnection cable between the two instruments' rear panels and by four RF cables between the front panels. The rear panel cable supplies power and ground, control of the test set's coaxial switch and a sense line to indicate when the test set is connected to the analyzer (this changes the [**INPUT**] menu).

When the HP 35677A/B S-parameter Test Set is connected to the HP 3577B Option 002 Three-Channel Network Analyzer the [**INPUT**] menu consists of S-parameters S11, S21, S12, and S22. These are defined in terms of receiver inputs and test set direction in figure 2-29. Changing the test set direction effectively switches the signal source and termination of the device under test as though it were removed and reconnected to the test set in the reverse direction.

Reference
S-Parameter Test Set

Different S-parameters may be selected for each of the two traces. If this requires the test set to be configured in both directions at the same time, select [ALTERNATE SWEEP] in the [SWEEP TYPE] menu. In alternate sweep, each sweep updates one of the traces and then reconfigures the test set and sweeps the other trace. This switches the test set's relay between sweeps. After five minutes operation in this manner, the HP 3577B times out, changes to single sweep mode to limit wear on the test set relay. The user may change the sweep mode back to continuous for another five minutes of operation or make single sweeps by pressing [TRIG/RESET].

If alternate sweep is not used and the input of a trace is changed such that the test set must change directions, the input of the other trace is redefined also, since the test set can not be configured in both directions at the same time.

The direction of the S-parameter test set may be controlled directly by the user if a user defined input is being specified. This may be done in the following manner:

1. Press [INPUT] to display the menu
2. Press [USER DEF INPUT]
3. Enter the input equation as described in the INPUT section of this chapter.
4. Note the new softkey label that appears at the bottom of the menu [TEST SET FWD/REV]. This is a push-push toggle type key that directly controls the direction configuration of the test set. The change in configuration does not occur until the end of a sweep.

The ONE PORT calibration softkeys (PARTIAL and FULL CAL) found in the [MEASR CAL] menu are recommended for use with the HP 35677A/B S-Parameter Test Set or a similar configuration of power splitter and directional bridge.

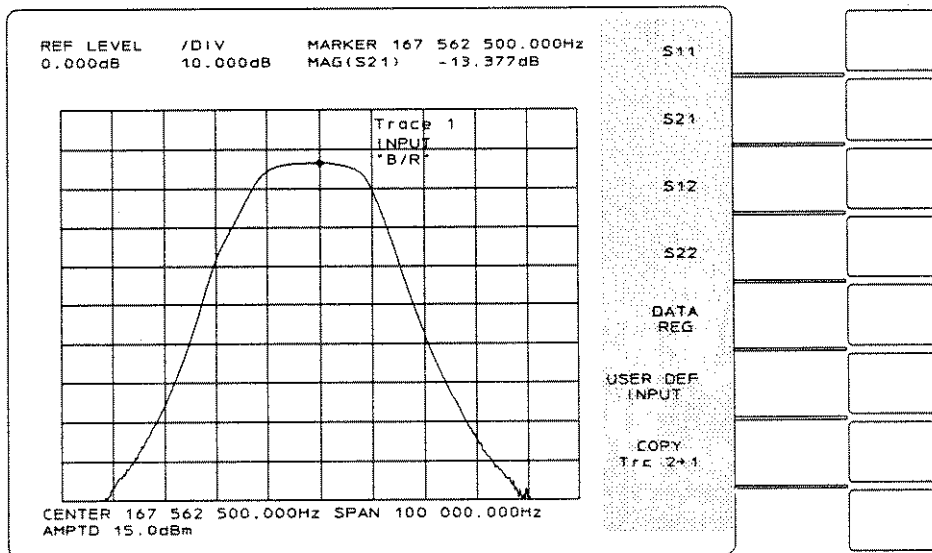

Figure 4-44

Save Instrument State

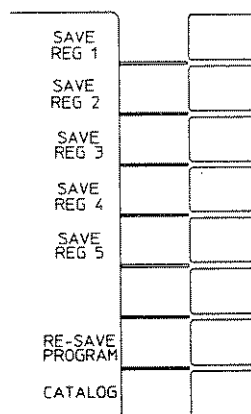
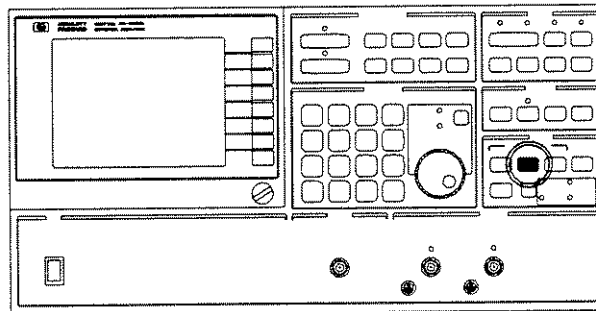

Figure 4-45

SAVE is a hardkey in the SYSTEM section of the front panel used to display the menu of softkeys shown in figure 4-45. These softkeys may be used to save 5 instrument states. An instrument state is the total set of instrument parameters. This feature is convenient for saving a complex and/or often-used test configuration for later recall.

To use this feature:

1. Press [**SAVE**] to display the menu
2. Press the softkey with the desired register number for saving the current instrument state

If **SAVE** and **RECALL** hardkeys are held down when power is turned on, a special test of all main processor non-volatile memory is run that is not part of the regular power-on test. These two keys must be held down until the test messages begin appearing on the screen. One message should be "TOTAL RAM TEST-NON-VOLATILE MEMORY LOST." This test erases all main processor memory resetting instrument state, plot parameters, Limit and Discrete Sweep Tables, and the HP-IB default parameters. For the HP-IB this means that [**SYS CTLR ON OFF**] is toggled to OFF and the bus address is 11. This test is used when the HP 3577B does not respond to key presses and when pressing [**INSTR PRESET**] and cycling power does not clear the problem.

Reference
Save Instrument State

RE-SAVE PROGRAM and **CATALOG** are softkeys used only for Option 1C2 (HP Instrument BASIC Option). Refer to "Using HP Instrument BASIC with the HP 3577B" for more information on these softkeys.

Scale

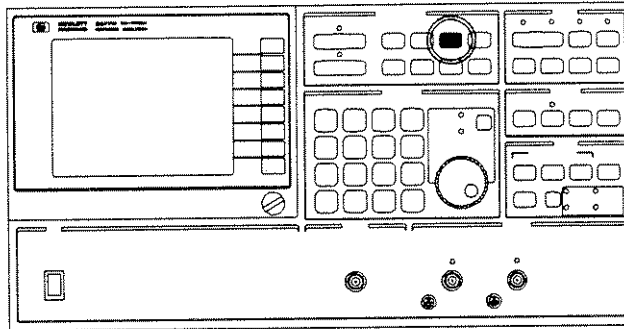

Figure 4-46

SCALE is a hardkey in the DISPLAY FORMAT section of the front panel that displays the menus of softkeys shown in figure 4-46. These softkeys modify the vertical axis scale and value of the reference line. None of the [**SCALE**] features require a new measurement sweep when their values change (except in [ALTERNATE SWEEP]). Each uses data stored in trace memory to reconfigure the screen.

REFERENCE LEVEL is a softkey for entering the value the dashed reference line represents. The default values for [REF LEVEL] are 0 dBm without the test set and 0 dB with the test set. The reference level value is valid and active even when the reference line is turned off.

Reference
Scale

To change the value of [REF LEVEL]:

1. Press [**SCALE**] to display the menu
2. Press [REF LEVEL] (if label is not bright)
3. Modify the value with the knob or arrow keys

OR

4. Enter a new value with the numeric key pad and select units from the menu

/DIV is a softkey for entering a value for the vertical scale. The value of [/DIV] is changed in the same manner as shown for [REF LEVEL].

REFERENCE POSITION is a softkey for entering a value that moves the dashed line to a different height on the graticule. For [LOG MAG] the default position is the top of the graticule, or 100%. For [PHASE] it is 50%, [LIN MAG] and [SWR] it is 0% (the bottom of the graticule). The value of [REF POSN] is changed in the same manner as shown for [REF LEVEL].

REFERENCE LINE ON OFF is a softkey that turns the dashed reference line off and back on. To use this feature, press [**SCALE**], and then [REF LINE ON OFF]. This is a push-push toggle type key function. The relative brightness of the ON and OFF labels indicate the current status of the feature.

COPY SCALE is a softkey used to copy the [**SCALE**] parameters, [REF LEVEL], and [/DIV] of the inactive trace into the active trace. The softkey label varies depending on which trace is selected. If trace 1 is selected it reads COPY SCALE 2 → 1; if trace 2 is selected it reads COPY SCALE 1 → 2.

AUTO SCALE is a softkey used to quickly scale the trace so that it fills the graticule without clipping the trace. To use this feature, press [**SCALE**] and then [**AUTO SCALE**].

PHASE SLOPE is a softkey that appears in the menu when the display function is [**PHASE**] or a function of phase (like [**DELAY**]). This softkey is used to add or subtract a phase shift term to the defined input. [**PHASE SLOPE**] units are degrees/SPAN or radians/SPAN. This is similar to the [**LENGTH**] function, except [**PHASE SLOPE**] is used for a trace and [**LENGTH**] is used for individual receiver inputs. [**PHASE SLOPE**] may be used as a phase flattener. Note that changes in frequency span require modification of [**PHASE SLOPE**] if it is to have the same effect on the new span. The value of [**PHASE SLOPE**] is changed the same way [**REF LEVEL**] is changed.

[**PHASE SLOPE**] is not available when using [**DISCRETE SWEEP**] but the [**LENGTH**] feature can be used to make similar data corrections. See the [**LENGTH**] feature in this chapter for more information.

One important difference between [**LENGTH**] and [**PHASE SLOPE**] is that [**LENGTH**] values are used to process incoming data when a measurement is being taken and affects values stored in trace memory. [**PHASE SLOPE**] processing uses data stored in trace memory to create a new trace for the screen and so does not affect stored data or require a measurement sweep when new **PHASE SLOPE** values are entered.

PHASE SLOPE ON OFF is a softkey that turns the phase slope feature feature off and on. This is a push-push toggle type softkey. Turning the feature off has the same effect on the measurement as if a value of 0 deg/SPAN was entered for [**PHASE SLOPE**].

FULL SCALE is a softkey used to change the value of magnitude represented by the outer ring of the polar graticule. If the display function is [**POLAR**], the menu shown when [**SCALE**] is pressed contains [**FULL SCALE**] instead of [**REF LEVEL**]. To change the value of [**FULL SCALE**]:

1. Press [**SCALE**] to display the menu
2. Press [**FULL SCALE**] (if label is not bright)
3. Modify the value with the knob or arrow keys

OR

Enter a new value with the numeric key pad and select units from the menu

Reference Scale

PHASE REFERENCE is a softkey for changing value of phase represented by the dashed line that exists between the center and outer circles of the polar graticule. Changing [PHASE REF] rotates the trace. The value of [PHASE REF] is changed in the same manner as [REF LEVEL].

REFERENCE POSITION is a softkey that repositions the dashed reference line on the polar graticule. Changing [REF POS] rotates the trace and reference line. The value of [REF POS] is changed in the same manner as [REF LEVEL].

REFERENCE LINE ON OFF is a softkey that turns the dashed reference line on and off. This is a push-push toggle type key. Turning the reference line off does not change the effect of reference position (i.e. a change in the [REF POS] value rotates the trace even if the reference line does not appear).

SMITH CHART ON OFF is a softkey that allows the user to overlay the polar graticule with a Smith Chart. This is a push-push toggle type key. The Smith chart is used to graphically convert reflection coefficient to normalized impedance. The marker information reads impedance when the Smith chart is on.

To use this feature, the input definition should be S11 (A/R) or S22 (B/R). The full scale is set to 1.0. The scale may be changed to a different value for a clearer view of data near the center (Z_0). The trace data and marker information block will be correct but the Smith Chart overlay will not change scale. If the scale is set to a different value, a "GRAT REQUIRES FULL SCALE = 1.0" message will be displayed.

Change the marker units from magnitude & phase to real & imaginary by pressing [MARKER M,P/ R,I] in the [MKR] menu.

Screen

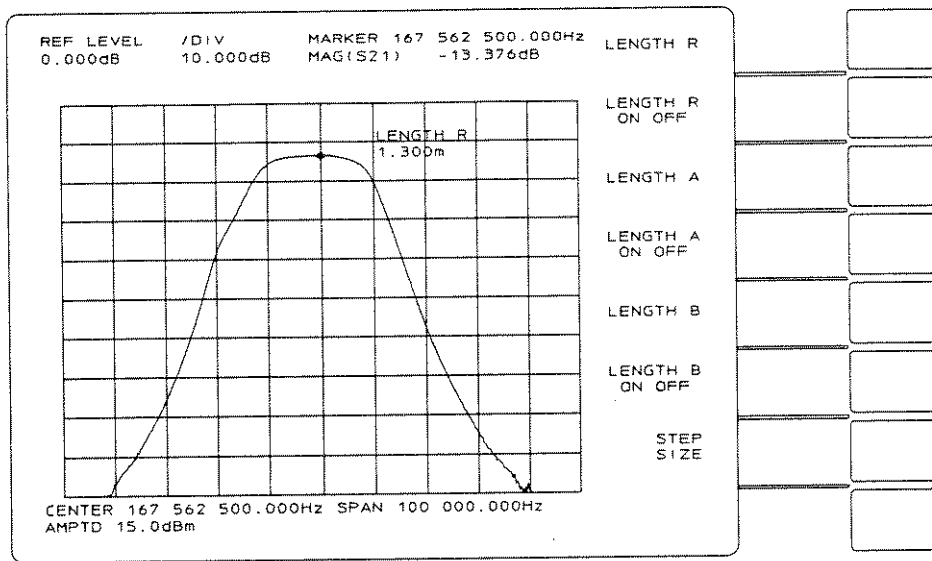
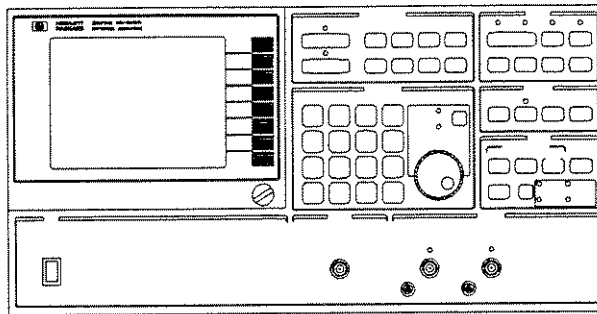

Figure 4-47

The **SCREEN** is the total CRT display area. It is composed of the graticule, the menu area (down the right side from top to bottom), and the alphanumeric characters which appear above and below the graticule. See figure 4-47.

Softkey



Softkeys



Figure 4-48

The eight keys with no stenciling next to the menu area of the screen are called **SOFTKEYS**. The lettered keys are referred to as **hardkeys**. The function of most hardkeys is to a menu of softkey labels. Exceptions are the keys in the **DATA ENTRY** section of the front panel, [**INSTR PRESET**], [**LCL**], and [**TRIG/RESET**]. See figure 4-48.

Source

The **SOURCE** section of the front panel contains the hardkeys that display menus of softkeys which control the parameters of the source. These parameters include [**SWEEP TYPE**] (linear, alternate, log, amplitude, discrete, or CW), [**SWEEP MODE**] (continuous, single, or manual), [**SWEEP TIME**], [**FREQ**], [**AMPTD**], [**TRIG MODE**] (free run, line, and external), and [**TRIG/RESET**]. For more information on individual functions refer to the hardkey of interest.

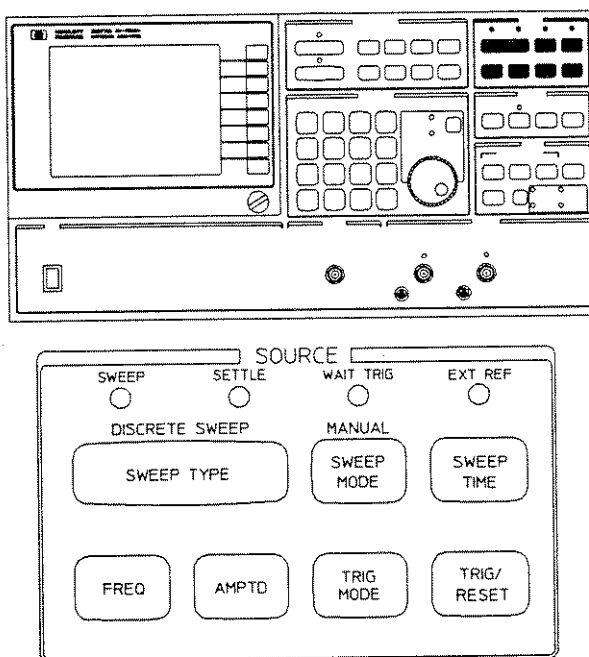

Figure 4-49

Special Functions

The **SPECIAL FUNCTIONS** hardkey in the SYSTEM section of the front panel contains the softkey menus for running a confidence test, turning the beeper and graticule on or off, service diagnostics, and special softkeys that are useful only for Option 1C2 (HP Instrument BASIC Option). These special softkeys define, run, and continue an HP Instrument BASIC program. See *Using HP Instrument BASIC with the HP 3577B* for more information on the [RUN PROGRAM], [CONTINUE PROGRAM], and [INSTRMNT BASIC] softkeys.

RUN PROGRAM	<input type="checkbox"/>	LEVELING ON OFF	<input type="checkbox"/>	DISPLAY MEM TEST	<input type="checkbox"/>
CONTINUE PROGRAM	<input type="checkbox"/>	SETTLING ON OFF	<input type="checkbox"/>	DISPLAY HP-IB	<input type="checkbox"/>
INSTRMNT BASIC	<input type="checkbox"/>	SYN DIAG ON OFF	<input type="checkbox"/>	HP-IB SIG ANAL	<input type="checkbox"/>
BEEPER ON OFF	<input type="checkbox"/>	TEST PATTERN	<input type="checkbox"/>	SOFTWARE REVISION	<input type="checkbox"/>
GRAT ON OFF	<input type="checkbox"/>	TRCE MEM TEST	<input type="checkbox"/>		<input type="checkbox"/>
S PARS ON OFF	<input type="checkbox"/>	FASTPROC TEST	<input type="checkbox"/>		<input type="checkbox"/>
CONF TEST	<input type="checkbox"/>	FAST BUS INT TEST	<input type="checkbox"/>		<input type="checkbox"/>
SERVICE DIAG	<input type="checkbox"/>	MORE	<input type="checkbox"/>	RETURN	<input type="checkbox"/>

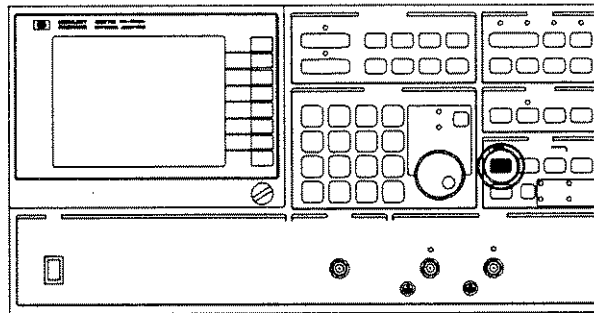

Figure 4-50

CONFIDENCE TEST checks each receiver channel for general pass/fail status. A screen message requests the user to put a cable between the source output and the receiver to be tested. Nine tests are run and the status of each (pass/fail) is displayed on the screen. Any test that fails, stops the test and highlights the screen message specifying the failure. The test may be continued from a failed test by pressing the [CONTINUE TEST]. The S-Parameter Test Set should not be connected to the receiver being tested during the confidence test. In the case of a test failure, refer the problem to a service repair facility.

BEEPER ON OFF is a push-push toggle type softkey used to turn the beeper off and back on. This is not reset by [INSTR PRESET].

GRATICULE ON OFF is a push-push toggle type softkey used to turn the graticule off and on. Turning the graticule off can be useful when viewing limit lines that may coincide with a graticule line.

SERVICE DIAGNOSTICS is a softkey which displays a menu used for diagnosing service problems with the HP 3577B. The menu items that follow are described briefly. For more details on these features and their uses refer to the HP 3577B Service Manual.

S PARMs ON OFF is a softkey that changes the [INPUT] menu between the S-parameter menu and the standard input menu.

LEVELING ON OFF is a softkey that disables the source leveling loop when OFF. This is used for service of the HP 3577B and should not be changed by an operator. This feature is reset to ON by INSTR PRESET or power on.

SETTLING ON OFF is a softkey that turns the digital filter settling on (default condition) or off. This is used for service of the HP 3577B and should not be changed by an operator. This feature is reset to ON by [INSTR PRESET] or power-on.

SYNTHESIZER DIAGNOSTICS ON OFF is a softkey used to turn on the fractional N synthesizer diagnostics for service of the HP 3577B and should not be changed by an operator. This feature is set to OFF by [INSTR PRESET] or power-on.

TEST PATTERN is a softkey that turns on the digital display test pattern. This feature is used for alignment of the screen area of the HP 3577B. To terminate the test pattern and return to the measurement state press [INSTR PRESET].

TRACE MEMORY TEST is a softkey that tests the RAM in trace memory. This test takes approximately 20 seconds to run during which time all other activity is suspended. This test may be interrupted by pressing [INSTR PRESET].

Note



This test clears all information stored in trace memory including D1, D2, D3, D4, R, A and B.

FAST PROCESSOR TEST is a softkey that runs a test on the fast processor board. This test should immediately display the message “FP SELF TEST PASSED.”

FAST BUS INTERFACE TEST is a softkey that tests the port between the main processor and the fast processor. This test should immediately display the message “MP/FP PORT TEST PASSED.”

DISPLAY MEMORY TEST is a softkey that tests the memory of the digital display unit. This test takes approximately 5 seconds to run, during which time the display is blank. The HP 3577B returns from the test in the preset condition.

DISPLAY HP-IB is a softkey that puts a picture of the HP-IB connector on the screen. Pin numbers and signal names are labeled on the figure and a bright dot appears on any pin that has a TRUE (low) signal state on it. This feature allows the user to display the status of the HP-IB lines of the HP 3577B and is used for troubleshooting only. Do not attempt to operate the instrument via HP-IB when in this mode.

HP-IB SIGNATURE ANALYSIS is a softkey that runs a program to allow signature analysis tests to be run on the HP 3577B's HP-IB board.

SOFTWARE REVISION is a softkey used to display a screen message which shows the revision status of the operating system.

Store Data

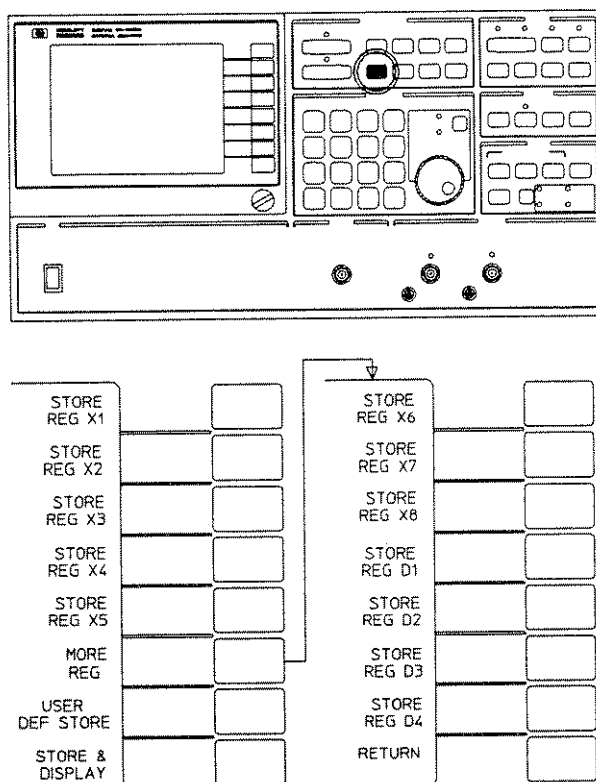

Figure 4-51

STORE DATA is a hardkey in the DISPLAY FORMAT front panel section used to display the menu of softkeys shown in figure 4-51. These softkeys may be used to store a trace as it is specified by the [INPUT] definition, store a trace defined by the user, or store and compare. The trace stored is independent of the active display function. The data stored is complex trace data identical to what is stored in trace memory registers R and A (and B for Option 002) when a measurement is taken.

There are twelve storage registers, X1 through X8 and D1 through D4. Since the calibration procedures and the [STORE & DISPLAY] feature use storage registers D1 through D4, use registers X1 through X8 for data storage in preference to registers D1 through D4.

The HP 3577B does not store the instrument state used to produce the data (such as INPUT definition or start and stop frequencies). To store this kind of information, use the [SAVE] and [RECALL] registers. When a storage register such as X1 is used in a user defined equation, take care that the parameters of all the terms in the equation are compatible. For example, for a user defined input of R/X1, R and X1 should both have the same start and stop frequencies, amplitude, and sweep type. Therefore, [SAVE] the instrument state at the same time that data is stored so that the instrument state can be recalled when the stored data is used.

To use this feature:

1. Press [**STORE DATA**] to display the menu
2. Choose a data register softkey. Press [**MORE REG**] to view the remaining data registers.

USER DEFINED STORE is a softkey used to define a function and have the results stored in the register of choice. This equation is constructed in the same way user defined functions and user defined inputs are constructed. Pressing [**USER DEFINED STORE**] changes the menu to a selection of the first term. Terms include five user defined functions, twelve data registers, seven user defined complex constants, a jOMEGA register, and the receiver inputs. After selecting the first term, a new menu displays the four possible math functions (+, -, *, and /) and the [**→ REG**] softkey. These two menus alternate until the destination register is selected using [**→ REG**]. The currently displayed trace is not affected unless the input definition of the trace is a function of the destination register just defined.

STORE & DISPLAY is a softkey used to store the active trace and compare the stored data with measurement data using one key press. The storage register used for the STORE depends on the active trace. If TRACE 1 is active, data is stored in data register D3; if trace two is active then data is stored in D4. After the STORE, the INPUT definition of the inactive trace is changed to display the data just stored. If TRACE 1 is active, the store goes into D3 and the INPUT definition of TRACE 2 becomes D3. If TRACE 2 is active, the store goes into D4 and the INPUT of TRACE 1 becomes D4.

Note



Because this feature writes to a data register, information stored there (such as calibration information) is overwritten and lost.

Sweep Mode

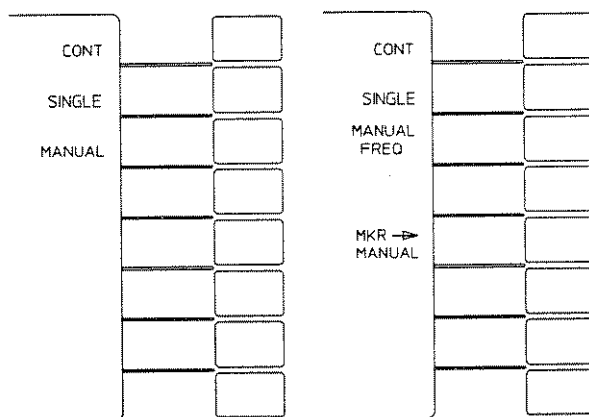
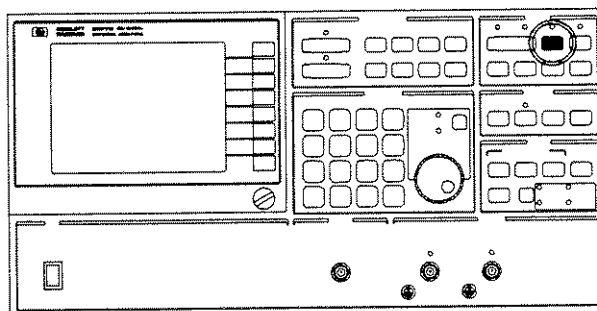

Figure 4-52

SWEEP MODE is a hardkey in the SOURCE section that displays the menus of softkeys shown in figure 4-52. Select from [CONTINUOUS], [SINGLE], or [MANUAL] sweeps. The default is [CONTINUOUS].

CONTINUOUS is a softkey that starts a new sweep after each sweep completion. [TRIG RESET] resets the sweep in progress by allowing settling to take place and starting the next sweep. For more information on settling time, refer to RESOLUTION BANDWIDTH.

SINGLE is a softkey that sweeps once each time the HP 3577B is triggered. To use this feature press [SWEEP MODE], and then [SINGLE]. The sweep in progress continues to the end but no new sweep begins. The WAIT TRIG LED illuminates until [TRIG RESET] is pressed which starts a new sweep. [TRIG RESET] can also stop a sweep in [SINGLE] sweep mode.

Settling is done for the next sweep immediately upon completion of the current sweep. Thus the sweep begins without delay when [TRIG RESET] is pressed and if the SETTLE LED is dark.

Reference
Sweep Mode

MANUAL is a softkey used to sweep the display manually using the knob or the arrow keys. To use this feature:

1. Press [**SWEEP MODE**] to display the menu
2. Press [**MANUAL**]. The label changes to [**MANUAL FREQ**] and the new label [**MKR → MANUAL**] appears in the menu. Also the marker information block changes to **MANUAL**.
3. Move the marker (in **MARKER** mode) to the point of interest on the trace
4. Press
[**MKR→ MANUAL**].
The sweep dot moves to the marker position and the marker information block shows the measurement being made.
5. Modify the frequency value with the knob (in **ENTRY** mode) or arrow keys. If the knob is used in **ENTRY** mode the marker moves to the sweep dot when the knob is first rotated.

Or

Enter a new value with the numeric key pad and select units from the menu

[**MANUAL**] sweep allows the user to make measurements at frequencies that would not be sampled in an automatic sweep of the same span. Any frequency from 0 to 200 MHz may be entered, to the nearest mHz, with the numeric keypad. If the offset marker is on in manual sweep, the marker information block displays **OFS MN**.

Sweep Time

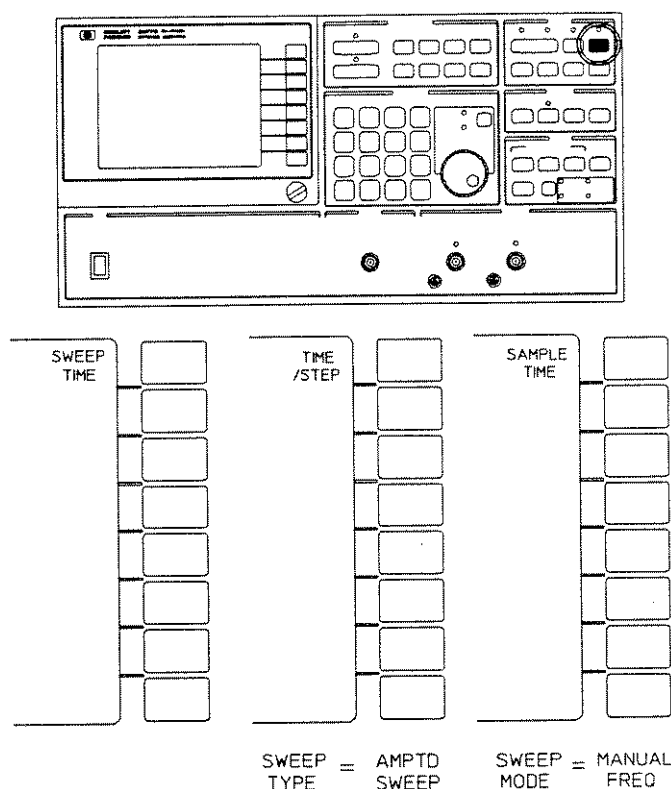

Figure 4-53

SWEEP TIME is a hardkey in the SOURCE section of the front panel that selects measurement times. Immediately after power-on or [INSTR PRESET], the sweep time for a linear frequency sweep is 1 second. If [SWEEP TYPE] is [AMPTD SWEEP] the default TIME/STEP is 0.050 seconds and the total sweep time depends upon the STEPS/SWEEP (found in the [AMPTD] menu). If the sweep mode is changed to MANUAL, the default SAMPLE TIME is 0.050 seconds. In a frequency sweep, the sweep dot appears if the sweep time is 1 second or more.

In an amplitude sweep the sweep dot appears if the time/step is 0.010 seconds or more. When the sweep type is [ALTERNATE SWEEP], different sweep times may be selected for each of two traces. For more information see ALTERNATE SWEEP listed under SWEEP TYPE. When the sweep type is [LOG FREQ SWEEP], the sweep time may appear to be greater than the value entered for sweep time, due to overhead time. The device under test is swept at an effective rate equal to the value of sweep time.

To change the value of [SWEEP TIME]:

1. Press [SWEEP TIME]
 2. Modify the value with the knob or the arrow keys
- OR*

Reference
Sweep Time

Enter a new value with the numeric keypad and select units from the menu (press a softkey)

Sweep time may be limited by the math processing load. When this occurs, the screen message "SWEEP TIME INCREASED" appears and the sweep time increases automatically. Refer to Appendix A for more information on HP 3577B data processing and sweep time optimization.

For discrete sweeps, pressing [**SWEEP TIME**] displays the Discrete Sweep Table and a menu allowing the settling time for each frequency to be changed. See the Discrete Sweep Table Editing section of Sweep Type in this chapter for more information.

Sweep Type

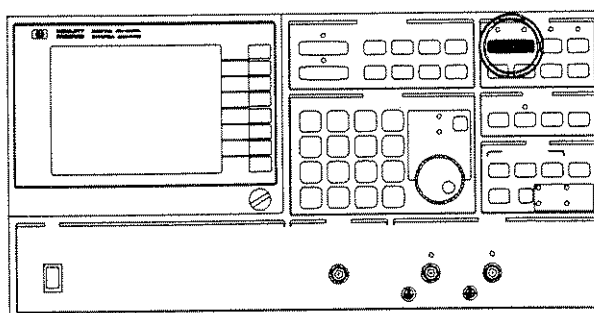

LIN FREQ SWEEP	<input type="checkbox"/>	<input type="checkbox"/>
ALTERNTE SWEEP	<input type="checkbox"/>	<input type="checkbox"/>
LOG FREQ SWEEP	<input type="checkbox"/>	<input type="checkbox"/>
AMPTD SWEEP	<input type="checkbox"/>	<input type="checkbox"/>
CW	<input type="checkbox"/>	<input type="checkbox"/>
DISCRETE SWEEP	<input type="checkbox"/>	<input type="checkbox"/>
DISCRETE TABLE	<input type="checkbox"/>	<input type="checkbox"/>
SWP DIR UP DOWN	<input type="checkbox"/>	<input type="checkbox"/>

Figure 4-54

SWEEP TYPE is a hardkey in the SOURCE section of the front panel used to display the menu of softkeys shown in figure 4-54. Select from six sweep types.

Note



Changing sweep type or sweep resolution (in the FREQ menu) erases registers R, A, and B in trace memory (sets all zeros).

LINEAR FREQUENCY SWEEP is the default sweep type. It sweeps continuously from the start frequency to the stop frequency. Since this is a mode selection, data entry is not necessary for this softkey.

Reference
Sweep Type

ALTERNATE SWEEP is a softkey that alternately sweeps trace 1 and trace 2. It allows assignment of separate frequency, amplitude, resolution bandwidth, and sweep time for each trace. The sweeps are linear and alternate. With other sweep types, trace 1 and 2 can have different display functions, inputs, and scales. With [**ALTERNATE SWEEP**], each trace may also have different frequency parameters (start/stop, center, span), source amplitudes, resolution bandwidths, and sweep times.

When the sweep type is alternate, stores are not allowed. This means that none of the [**MEASR CAL**] features may be used in alternate sweep. Averaging is turned off when alternate sweep is active. If trace 1 and trace 2 have different source amplitude values which cause the output relays to switch as the sweeps alternate, the HP 3577B times out after five minutes. Also, if the inputs selected for the two traces cause the S-parameter test set to switch configuration from forward to reverse, time out occurs after five minutes. Time out changes the sweep mode to single, the [**SWEEP MODE**] menu appears, and the WAIT TRIG LED illuminates. The user may trigger single sweeps by pressing [**TRIG RESET**] or change the sweep mode back to continuous for another five minutes of uninterrupted operation. Time out extends the life of the HP 3577B and HP 35677A/B relays.

To use this feature:

1. Set up trace 1 parameters (input, display function, frequency, source amplitude, scale, sweep time, and resolution bandwidth).
2. Turn on trace 2 by pressing [**TRACE 2**], [**DSPLY FCTN**], and selecting any menu item (except [**POLAR**] since it turns trace 1 off). Trace 2 turns on having the same start/stop frequencies, amplitude, bandwidth and sweep time as trace 1 and both traces are swept simultaneously.
3. Press [**SWEEP TYPE**], and [**ALTERNATE SWEEP**]. Trace 2 parameters revert to their previous settings (if the HP 3577B was just preset, these are the default parameters). This allows the alternate sweep trace to be turned off and back on without losing trace parameters.
4. Enter the new parameters for trace 2.

Interactions [**DSPLY FCTN**]: No [**POLAR**].

LOG FREQ SWEEP is a softkey that selects a log scale for the horizontal axis of the display. The logarithmic graticule has frequency values listed across the bottom of the screen. The graticule changes as the start and stop frequencies are changed. When the ratio of stop frequency and start frequency is less than four, the graticule changes back to a linear scale.

Interactions [FREQ]: When [LOG FREQ SWEEP] is active the [FREQ] menu contains only [START FREQ], [STOP FREQ], and [FULL SWEEP]. Default Sweep is from 50 Hz to 200 MHz. [FULL SWEEP] is from 5 Hz to 200 MHz.

[RES BW]: When [LOG FREQ SWEEP] is active the [RES BW] menu has an added item called [AUTO RBW] (for automatic resolution bandwidth) which is turned on. The sweep starts at 50 Hz and stops at 200 MHz and the resolution bandwidth changes during the sweep to reduce LO feedthrough at the lower frequencies. Selecting [FULL SWEEP] starts the sweep at 5 Hz and the 1 Hz resolution bandwidth is used from 5 Hz to 40 Hz (4 seconds of settling occurs before the sweep begins). Then the HP 3577B switches to 10 Hz BW until it reaches 400 Hz. Then the 100 Hz bandwidth is used until it reaches 4 kHz. Finally the 1 kHz bandwidth is used until the stop frequency is reached.

[DSPLY FCTN]: No [DELAY] measurements can be made.

[MKR →]: No [MKR → CENTER]

[SWEEP TYPE]: No [SWP DIR UP/DN]

AMPTD SWEEP is a softkey for using a logarithmic sweep of the source output amplitude. The default start and stop levels are -40 dBm and 0 dBm, respectively. Either start or stop amplitude may be from -49 dBm to +15 dBm. The start amplitude may be larger or smaller than the stop amplitude (unlike frequency sweeps).

If left running, [AMPTD SWEEP] times out after five minutes. This prolongs the life of the relays used to switch pads in the output circuitry. The time out condition switches the [SWEEP MODE] to [SINGLE] and displays an error message. The user may trigger single sweeps with [TRIG/RESET] or change the sweep mode back to continuous.

Interactions [SWEEP TYPE]: [DISCRETE SWEEP] is not allowed in amplitude sweep.

CW is a softkey that puts the HP 3577B in a single frequency measurement state. The display shows a single line from the bottom of the graticule to the height of the signal level at the specified frequency. Any frequency may be entered with the numeric key pad with millihertz resolution.

Interactions [FREQ]: The frequency menu contains only [FREQ] and [STEP SIZE].

[DSPLY FCTN]: No [DELAY] measurements can be made.

Reference
Sweep Type

DISCRETE SWEEP is used to measure a set of individual frequencies and consists of a list of frequency values and associated parameters to be swept. The "sweep" is a CW measurement at each of the discrete frequencies. [DISCRETE SWEEP] is useful for analyzing particular regions with better sweep resolution around the point(s) of interest without sacrificing total measurement time. Data transfer times to a computer can also be significantly decreased.

The HP 3577B has one Discrete Sweep Table consisting of between 2 and 51 rows. The first and last rows select the start and stop frequencies of the display. Each row represents one frequency and the desired resolution bandwidth and settling time for measuring that frequency. See the sample Discrete Sweep Table table in figure 4-55A.

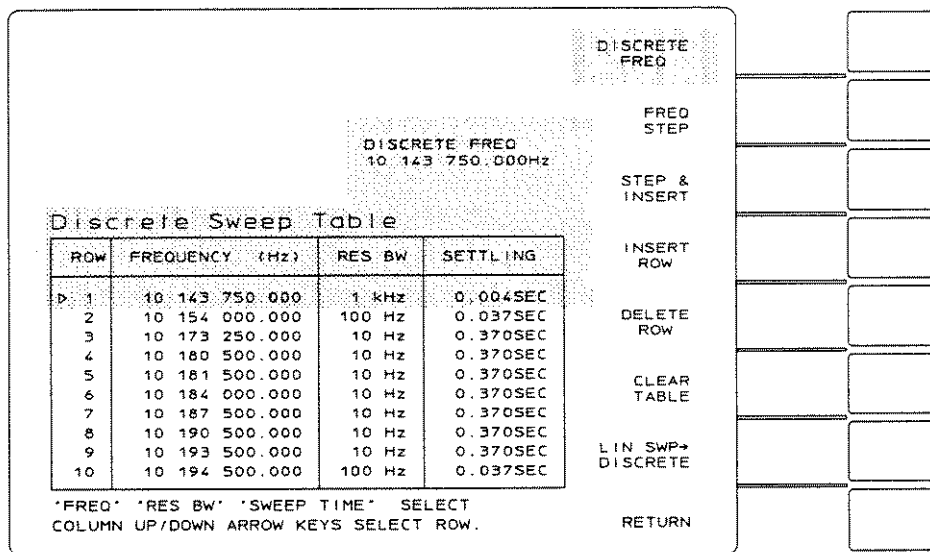

Figure 4-55A Discrete Sweep Table

The rows of the table are always displayed in order of increasing frequency values. Display and edit the table from the front panel or via HP-IB.

Since each frequency is measured using a CW sweep, a narrower resolution bandwidth can be selected without compromising sweep time. Only the frequency areas of interest are measured and straight lines are drawn between measured values. This makes the displayed trace look more “coarse” since fewer points are measured. See figure 4-55B.

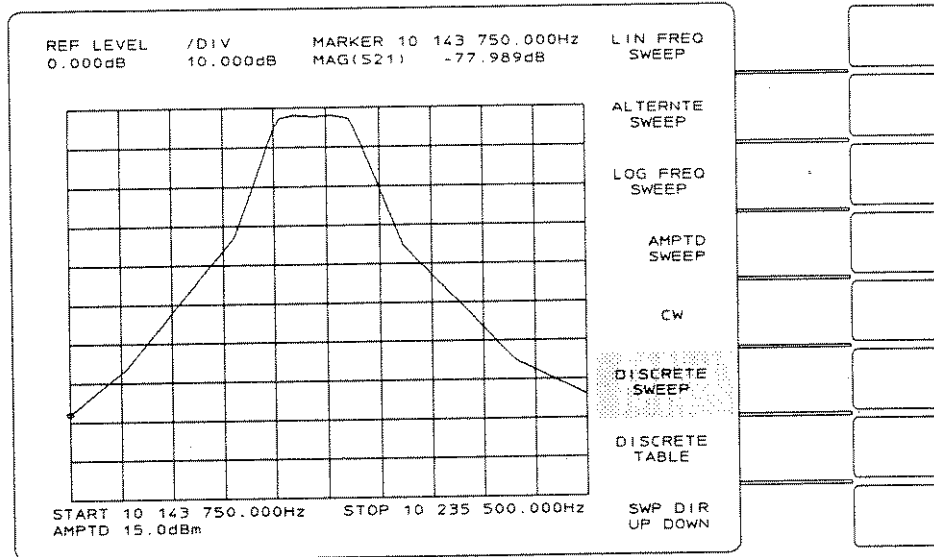

Figure 4-55B Discrete Sweep Measurement

The marker moves from point-to-point and trace math operations can be used as normal. Pressing [INSTR PRESET] and cycling power will not change the table. The Discrete Sweep Table is stored as part of the instrument state. However, when recalling a saved state, the recalled state will erase the current Discrete Sweep Table if the recalled state has a different table associated with it.

The menus for [FREQ], [RES BW], and [SWEEP TIME] are changed when [DISCRETE SWEEP] is pressed as shown in figure 4-56.

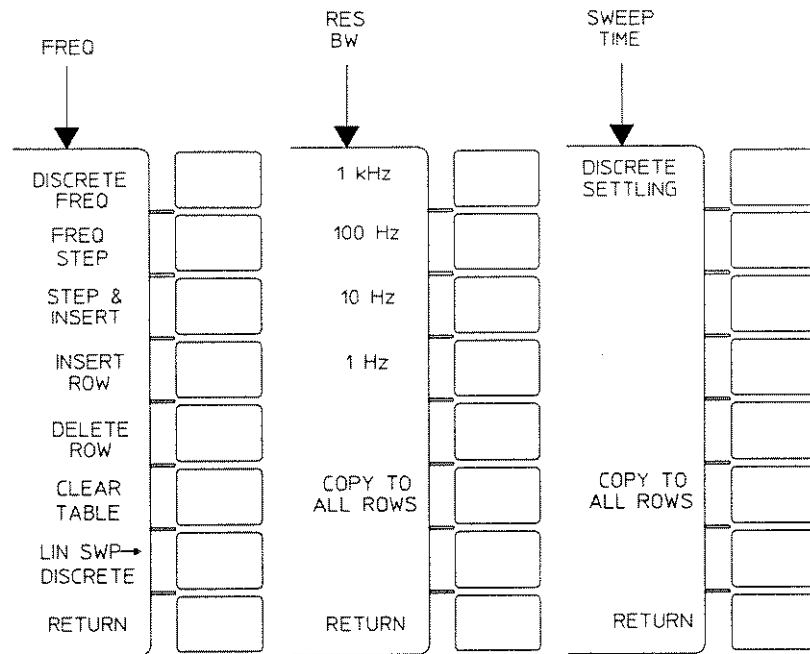

Figure 4-56 Modified Menus for Discrete Sweep

Discrete Sweep Table Editing:

1. To display the Discrete Sweep Table, press [SWEEP TYPE], and [DISCRETE TABLE]. When editing the Discrete Sweep Table, use the [↑] and [↓] keys to move to a particular row. If there is more than one page of frequencies, the table will scroll until the bottom of the list is reached.
2. There are three ways to add new frequencies to the DISCRETE SWEEP table.
 - a. Manual entry: After pressing [DISCRETE TABLE], use the [↑] and [↓] keys to move the cursor to any row. Press [INSERT ROW], enter the desired frequency using the numeric keypad, and choose a units softkey. The table is automatically sorted in order of increasing frequency which may result in an automatic scrolling of the table.

- b. To add several equally spaced frequency points one at a time, press [**SWEEP TYPE**],
 [**DISCRETE SWEEP**]
 which activates discrete sweep, and press
 [**FREQ**] (hardkey).
 Press
 [**FREQ STEP**]
 and enter the desired frequency spacing using the numeric keypad. Move the table cursor to
 the desired row and press
 [**STEP & INSERT**].
 The new frequency is the sum of the frequency of the current row plus the [**FREQ STEP**]
 value.
 The **RES BW** and **DISCRETE SETTling** time are copied from the current row to the
 new row. These values can also be entered manually.
- c. [**LIN SWP → DISCRETE**] fills the table all at once with equally spaced frequency points between
 the start and stop frequencies last used in linear frequency sweep. It displays a sub-menu for
 selecting the total number of points measured. The **RES BW** and **DISCRETE SETTling**
 times are automatically selected according to the current resolution bandwidth used in the
 linear frequency sweep. To use this, press
 [**SWEEP TYPE**]
 [**DISCRETE SWEEP**]
 [**FREQ**]
 [**LIN SWP → DISCRETE**]
 and notice the new frequencies automatically added in the table. To view the trace, press
 any hardkey.
3. The frequency in each row can use any of the resolution bandwidths and settling times for the
 discrete sweep measurement. Enter these values manually by pressing the [**RES BW**] and
 [**SWEEP TIME**] hardkeys and enter the desired values for the cursor row.

Narrower resolution bandwidths give increased measurement sensitivity and signal resolution
 but require longer settling times. If one bandwidth is desired for use in the entire table, press
 [**RES BW**]

[**COPY TO ALL ROWS**].

This softkey appears in the [**RES BW**] menu after [**DISCRETE SWEEP**] has been pressed in the
 [**SWEEP TYPE**] menu.

Listed below are the default **DISCRETE SETTling** times selected for each resolution
 bandwidth. For high Q devices, longer settling times may be required for accurate
 measurements. To assure the settling time is not too short, press

[**SWEEP TYPE**]

and toggle between

[**SWP DIR UP DN**] and

[**SWP DIR UP DN**].

4. If the response changes on the display, the settling time is too fast. Changes can be detected on the screen more accurately if a marker is placed on the screen. If the marker amplitude changes as the sweep direction is changed, the settling time is too fast. Continue choosing longer settling times until no change in marker amplitude is seen.

Table 4-2 Default Discrete Settling Times

Resolution Bandwidth	Discrete Settling Time
1 Hz	3.707 sec
10 Hz	0.370 sec
100 Hz	0.037 sec
1 kHz	0.004 sec

Hints:

Limit lines can be used with discrete sweep to measure critical frequencies, compare those frequencies to a limit and set the PASS/FAIL indicator ([EVALUATE ON]). This feature combination can be useful for reducing test time and data transfer to a computer. However, LIMIT and DISCRETE SWEEP are independent features.

If more than one DISCRETE SWEEP table is required, use the SAVE/RECALL registers to get the effect of multiple tables. More than 20 points per sweep may take more time to sweep than a linear sweep but data transfer times to a computer and limit check times will be shorter.

Discrete Sweep Softkey Definitions

DISCRETE SWEEP activates the sweep according to the Discrete Sweep table.

DISCRETE TABLE displays the discrete sweep table and calls up a menu that allows table editing.

DISCRETE FREQ modifies the frequency of the current row. When a row is modified the table is re-sorted so that it is always in order of increasing frequency. As a result, the table may scroll and leave the cursor at a new place in the table.

DISCRETE SETTLING modifies the settling time of the current row.

RES BW calls up a menu of resolution bandwidths for manual entry in a row using the numeric key pad.

INSERT ROW inserts a new row below the current row indicated by the cursor. The frequency, resolution bandwidth, and settling time of the row above the new frequency are copied to this row.

DELETE ROW deletes the current row indicated by the cursor.

FREQ STEP specifies the desired frequency spacing used with [STEP & INSERT].

STEP & INSERT adds a row to the table where the frequency is the sum of the frequency of the current row plus the [FREQ STEP] value. The resolution bandwidth and settling time are copied from the row above the new frequency.

MKR → DISCRETE adds the frequency of the marker to the discrete sweep table in order of increasing frequency. The resolution bandwidth and settling time are copied from the row above the new frequency.

CLEAR TABLE deletes all rows and sets the first two rows to 0 Hz. The first 2 rows cannot be deleted since the minimum table size is 2 rows.

LIN SWP → DISCRETE fills the table with equally spaced frequencies between the linear sweep start and stop frequencies. It calls up a menu for selection of the number of points (11, 21, 31, 41, 51). The resolution bandwidth and settling times are copied from the row above the new frequencies.

COPY TO ALL ROWS is a softkey that appears in the [RES BW] and [SWEEP TIME] menus when discrete sweep is used. In the [RES BW] menu, it copies the resolution bandwidth of the current row to all rows and adjusts settling times to the default values. In the [SWEEP TIME] menu, the discrete settling time of the current row is copied to all rows.

RETURN selects the softkey menu that is the next level higher.

Interactions [**INSTR PRESET**]: The Discrete Sweep Table does not change after pressing [**INSTR PRESET**] or cycling power. It becomes part of the instrument state.

[**SWEEP TYPE**]: If the sweep direction is toggled to [**SWP DIR UP DOWN**], the table is swept from the first row to the last. If it is toggled to [**SWP DIR UP DOWN**], it is swept from last to first.

[**SWEEP MODE**]: [**CONT**], [**SINGLE**], and [**MANUAL**] modes are all valid for discrete sweeps.

[**AVG**]: If averaging is on, the average occurs at each sweep, not at each frequency. Each complete sweep of the table is considered one average.

[**TRIG MODE**]: In [**EXT**] mode, each negative edge of the rear panel external trigger input causes discrete sweep to sweep through the table.

[**DSPLY FCTN**]: [**POLAR**] is not allowed in discrete sweep. [**DELAY**] is allowed but must be used with some caution. See **DELAY (GROUP)** in the **DISPLAY FUNCTION** section of this chapter for a detailed discussion. [**PHASE SLOPE**] is not available when using discrete sweep but the [**LENGTH**] feature can be used to make similar data corrections. See the **LENGTH** feature in this chapter for more information.

Changed Menus: When Discrete Sweep is selected, the softkey menus of the [**FREQ**], [**RES BW**], and [**SWEEP TIME**] hardkeys are changed. See figure 4-56.

SWEEP DIRECTION UP/DOWN is a push-push toggle type softkey that allows the user to change the direction of the sweep. The default direction is UP, or left to right. In an amplitude sweep the start amplitude may be larger than the stop amplitude, so amplitude may be swept from a higher to lower value without changing the **SWEEP DIRECTION**. Changing **SWEEP DIRECTION** to DOWN in an amplitude sweep causes the sweep dot to move from right to left.

Changing sweep direction during a frequency sweep is useful for determining whether the sweep time is long enough for the selected resolution bandwidth. Change the sweep direction while the sweep dot is on a steep part of the response. If the dot does not exactly retrace its path, the sweep time should be increased. See **Optimizing Sweep Time** in Appendix A. [**SWP DIR UP/DN**] is not offered in the CW sweep type.

System

SYSTEM is one of five front panel sections. The hardkeys in this section may be used to [**SAVE**] and [**RECALL**] the instrument state, [**INSTR PRESET**] the HP 3577B, [**PLOT**] what appears on the screen, monitor the HP-IB status of the HP 3577B, use the special functions, or define and execute an HP Instrument BASIC program (Option 1C2 only).

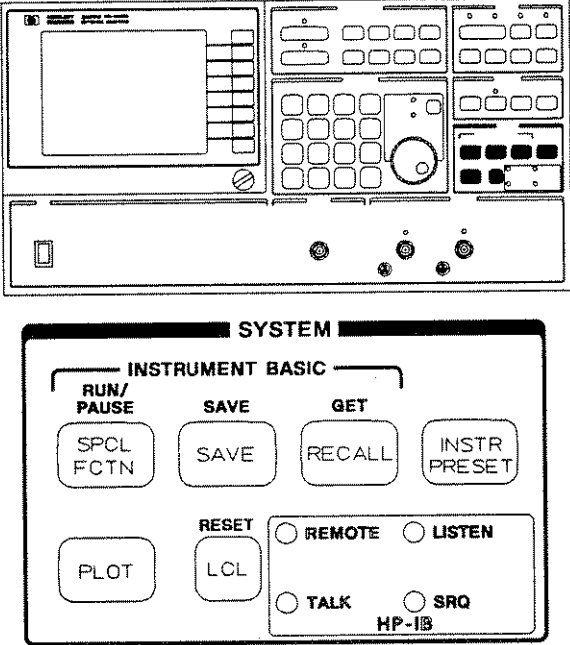

Figure 4-57

For more information on each feature in the SYSTEM section, refer to the hardkey of interest.

Trace 1 Trace 2

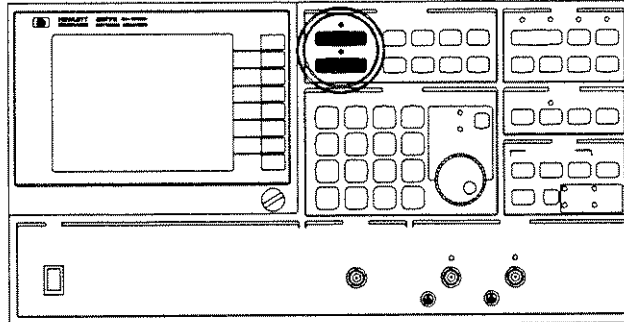

Figure 4-58

TRACE 1 and **TRACE 2** are two hardkeys in the DISPLAY FORMAT front panel section that select the active trace. The active trace is indicated by the illuminated LED over either the [**TRACE 1**] or [**TRACE 2**] key and by a bright trace and marker information block on the screen. Hardkeys in the DISPLAY FORMAT front panel section are used for data entry or mode selection for one of the two traces. If SWEEP TYPE is ALTERNATE SWEEP (in the SOURCE section) then [**FREQ**], [**AMPTD**], [**SWEEP TIME**], and [**RES BW**] data are also trace dependent. For these hardkeys, the data entered or mode selected affects only the active trace.

When the HP 3577B is preset or turned on, trace one is active and trace two is off. To turn on trace 2, press

[**TRACE 2**]

[**DSPLY FCTN**]

and press one of the softkeys other than [**OFF**]. Trace two and characters related to it (REF LEVEL, /DIV, and marker information) appear brighter than trace one when the [**TRACE 2**] LED is illuminated.

Trigger Mode

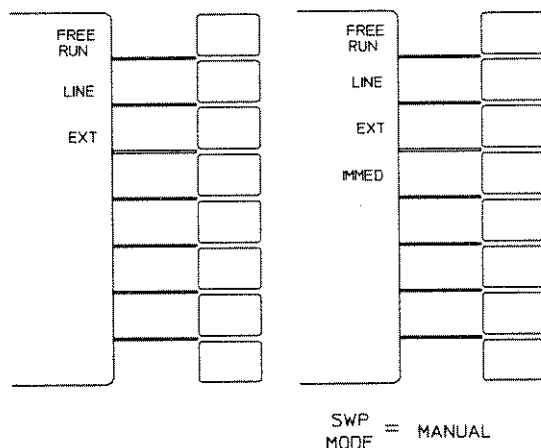
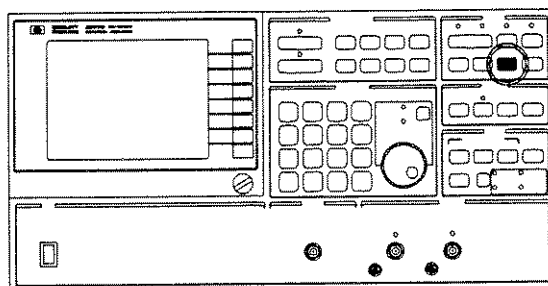

Figure 4-59

TRIGGER MODE is a hardkey in the SOURCE section of the front panel that displays the menu of softkeys shown in figure 4-58. Use these softkeys to select the type of triggering used by the HP 3577B to initiate measurement sweeps.

FREE RUN is a softkey that is the default trigger mode. In [FREE RUN], the HP 3577B triggers a new sweep as soon as the previous sweep ends and the source settles (settling is indicated by an LED in the SOURCE section). If the [SWEEP MODE] is [SINGLE], the next sweep does not begin until the user presses [TRIG/RESET].

LINE is a softkey that selects the power line as the trigger source. This results in the power line starting the sweep after the settling is complete. If the [SWEEP MODE] is [SINGLE], the next sweep does not begin until the user presses [TRIG/RESET] and the line trigger occurs.

Reference
Trigger Mode

EXTERNAL is a softkey used to select the external trigger input on the back panel as the trigger source. The trigger occurs after settling is complete and (if [**SWEEP MODE**] is [**SINGLE**]) when [**TRIG/RESET**] is pressed. The HP 3577B triggers a sweep on the high-to-low transition of a TTL logic signal or a switch closure to ground. When the HP 3577B is ready to be triggered the WAIT TRIG LED in the SOURCE section of the front panel is illuminated. If a trigger signal occurs when the WAIT TRIG LED is not illuminated the trigger is ignored. Each trigger requires a transition (edge) of the external trigger signal. Therefore, the trigger signal must return to the pre-trigger state before triggering again. Holding a closure to ground or to a low signal on the external trigger input does not continue triggering the HP 3577B. There is a delay of 250 to 500 microseconds from the time the trigger signal is received to the beginning of the sweep.

IMMEDIATE triggering is a softkey that appears in this menu only when the [**SWEEP MODE**] is [**MANUAL**]. If this method of triggering is selected, the operator triggers the HP 3577B to take a measurement by pressing [**TRIG/RESET**]. To use this feature:

1. Press [**SWEEP MODE**] to display a menu
2. Press [**MANUAL**]
3. Press [**TRIG MODE**] to display a menu
4. Press [**IMMED**]
5. Press [**SWEEP MODE**]
6. Move the marker to the point of interest
7. Press [**MKR → MANUAL**]. The **MANUAL FREQUENCY** changes to that of the marker but no measurement is taken
8. Press [**TRIG/RESET**] to take the measurement.

Trigger/Reset

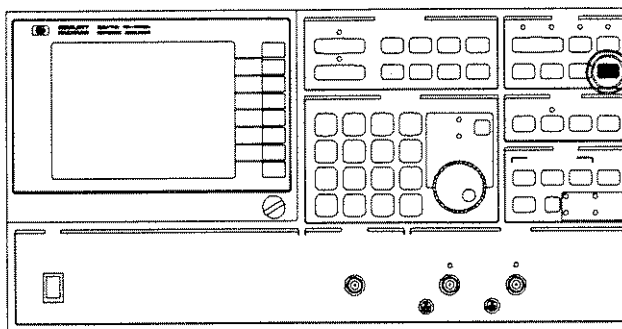

Figure 4-60

TRIGGER/RESET is a hardkey in the SOURCE section of the front panel that triggers or resets the HP 3577B in preparation for a measurement. It is an immediate execution function and does not display a menu.

When the [**SWEEP MODE**] is [**CONT**], [**TRIG/RESET**] stops the current sweep and initiates a new sweep. The new sweep starts as soon as settling is complete.

When the [**SWEEP MODE**] is [**SINGLE**], [**TRIG/RESET**] triggers the measurement if the WAIT TRIG LED is illuminated. If a sweep is in progress, pressing [**TRIG/RESET**] resets or stops the sweep, resets to the start frequency (or amplitude if the [**SWEEP TYPE**] is [**AMPTD**]), and then settles. After settling, the WAIT TRIG LED illuminates and pressing [**TRIG/RESET**] triggers the HP 3577B.

When the [**SWEEP MODE**] is [**MANUAL**] and the [**TRIG MODE**] is [**IMMED**], [**TRIG/RESET**] takes each measurement. See TRIGGER MODE, IMMEDIATE in this chapter for more information.

General Information

Introduction

This chapter contains instructions for installing and interfacing the HP 3577B Network Analyzer and the HP 35677A/B S-parameter Test Set. Included are initial inspection procedures, power and grounding requirements, operating environment, available accessories and options, installation instructions, HP-IB interfacing procedures, and instructions for repacking and shipment.

Initial Inspection

This instrument was carefully inspected both mechanically and electrically before shipment. It should meet all published specifications upon receipt. To confirm this, inspect the instrument for physical damage incurred in transit, inventory the supplied accessories (listed in Table 5-2), and test the electrical performance using the Confidence Test listed in the section on Getting Started. If there is physical damage, if the contents are incomplete or if the instrument does not pass the Confidence Test, notify the nearest HP Sales and Service Office. If the shipping container is damaged or the cushioning material shows signs of stress, notify the carrier as well as the Hewlett-Packard office. Keep the shipping material for the carrier's inspection.

Warning



The integrity of the protective earth ground may be interrupted if the HP 3577B is mechanically damaged. Under no circumstance should the HP 3577B be connected to power if it is damaged.

Power Requirements

Caution



Before applying ac line power to the HP 3577B, ensure the voltage selector switch on the back panel of the instrument is set for the proper line voltage and that the correct line fuse is installed in the rear panel fuse holder.

The HP 3577B can be operated from any single phase ac power source supplying:

1. 86 V to 127 V from 48 Hz to 440 Hz
(115 V Voltage Selector setting)
OR
2. 195 V to 253 V from 48 Hz to 66 Hz
(230 V Voltage Selector setting)

Power consumption is less than 450 VA.

Power Cable And Grounding Requirements

The HP 3577B is equipped with a three-conductor power cord which, when plugged into an appropriate receptacle, grounds the instrument cabinet. The type of power cable plug shipped with each instrument depends on the country of destination. Refer to figure 5-1 for the part number of the power cable and plug configurations available. If the appropriate power cable is not included with your instrument, contact the nearest HP Sales and Service Office and the proper cable will be provided.

Warning



The power cable plug must be inserted into a socket outlet provided with a protective earth ground terminal. Defeating the protection of the grounded instrument cabinet can subject the operator to lethal voltages.

<p>United Kingdom Option 900</p>  <p>PLUG*: BS 1363A CABLE*: HP 5041-5807</p> <p>220V - 5A OPERATION</p>	<p>Australia/New Zealand Option 901</p>  <p>PLUG*: NZSS 198/AS C112 CABLE*: HP 5041-5808</p> <p>220V - 6A OPERATION</p>
<p>Continental Europe Option 902</p>  <p>PLUG*: CEE7-V11 CABLE*: HP 5041-5809</p> <p>220V - 6A OPERATION</p>	<p>North America Option 903</p>  <p>PLUG*: NEMA 5-15P CABLE*: HP 5041-5819</p> <p>125V - 10A** OPERATION</p>
<p>North America Option 904</p>  <p>PLUG*: NEMA-G-15P CABLE*: HP 5041-5806</p> <p>250V - 6A** OPERATION</p>	<p>Japan Option 918</p>  <p>PLUG*: MITI 41-9692 CABLE*: HP 5041-5840</p> <p>125V - 12A OPERATION</p>
<p>Switzerland Option 906</p>  <p>PLUG*: SEV 1011.1959-24507 TYPE 12 CABLE*: HP 5041-5812</p> <p>220V - 6A OPERATION</p>	<p>Denmark Option 912</p>  <p>PLUG*: DHCR 107 CABLE*: HP 5041-5814</p> <p>220V - 6A OPERATION</p>

Figure 5-1. Power Cables

*The number shown for the plug is the industry identifier for the plug only, the number shown for the cable is an HP part number for a complete cable including the plug.

**UL listed for use in the United States of America.

Warning

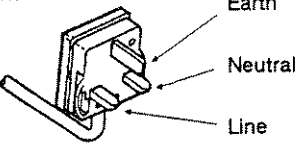
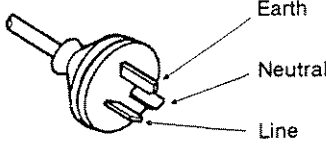
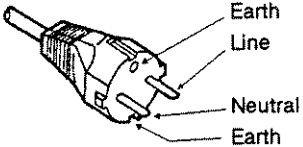
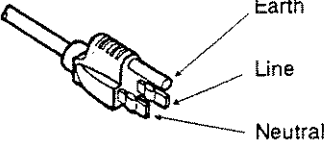
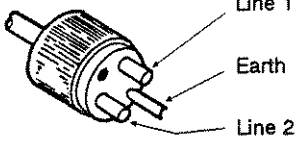
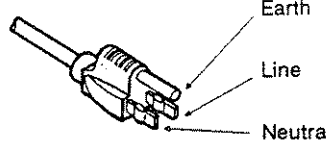
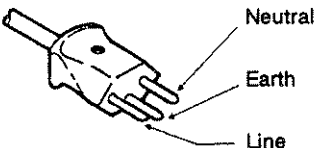
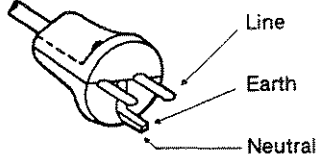

The power cable plug must be inserted into an outlet provided with a protective earth terminal. Defeating the protection of the grounded analyzer cabinet can subject the operator to lethal voltages.

Operating Environment

Warning



To prevent potential fire or shock hazard, do not expose the HP 3577B to rain or other excessive moisture.

Temperature The HP 3577B may be operated in temperatures from 0° C to +55° C. The HP 3577B performance specifications apply within this temperature range.

Humidity The instrument may be operated in environments with humidity up to 95%. However, the HP 3577B should be protected from temperature extremes which cause condensation.

Altitude The HP 3577B may be operated at altitudes up to 4,600 meters (15,000 feet).

Cooling System The HP 3577B is equipped with a forced-air cooling system to maintain the proper internal operating temperature. The cooling fan is mounted on the rear panel. Air, drawn through the rear panel fan filter, is circulated through the instrument and exhausted through holes in the side panels. The HP 3577B should be mounted to permit as much air circulation as possible, with at least one inch clearance at the rear and on each side. The filter for the cooling fan should be removed and cleaned at least once every 30 days. To clean the fan filter, flush it with soapy water, rinse, and then air dry.

Thermal Cutout The HP 3577B is equipped with a thermal cutout switch which automatically turns off the main power supply whenever the internal temperature is excessive. The temperature at which this occurs is dependent upon line voltage and airflow. With proper airflow and operating line voltage, thermal cutout does not occur at or below an ambient temperature of +55° C. The switch resets automatically when the instrument is turned off/on and after the temperature falls below the thermal cutout point. If a thermal cutout occurs, check for fan stoppage, clogged fan ports, and other conditions that can obstruct airflow or otherwise cause excessive heating.

Note



The thermal cutout will operate at any external temperature above +15° C if the airflow is blocked.

Table 5-1 Accessories Available

Description	50Ω Impedance			75Ω Impedance			High Impedance
	Transmission	Forward S-Parameters	Forward/Reverse S-Parameters	Transmission	Forward S-Parameters	Forward/Reverse S-Parameters	
NETWORK ANALYZER	HP 3577B	HP 3577B Option 002	HP 3577B Option 002	HP 3577B	HP 3577B Option 002	HP 3577B Option 002	HP 3577B
S-PARAMETER TEST SET/KIT		35676A	35677A		35676B	35677B	
ACCURACY ENHANCEMENT SOFTWARE			35675A		35675A		
TYPE N CALIBRATION KIT	35678A	35678A	35678A	35678B	35678B	35678B	
POWER SPLITTER (3 Resistor)	11850C			11850D			
POWER SPLITTER (2 Resistor)	11677A						
MINIMUM LOSS PAD AND ACCESSORY KITS							
50/75 Ω MINIMUM LOSS PAD				11852A ³			
TEST PORT EXTENSION CABLES	35679A ¹	35679A	35679A	35679B ¹	35679B	35679B	
TYPE N ACCESSORY KIT	11853A	11853A	11853A	11855A	11855A	11855A	
BNC ACCESSORY KIT	11854A	11854A	11854A	11856A	11856A	11856A	11854A
PROBES							
500 MHz ACTIVE PROBE							41800 ²
1:1 MINIATURE PROBE							10438A ²
10:1 MINIATURE PROBE							10430A ²

¹ 2 pair recommended

² 3 ea recommended

³ 4 ea recommended

⁴ Requires 2ea 11525A APC-7 to Type N Male adapters for use with the HP 35677A

Accessories Available

Table 5-1 lists the accessories available for the HP 3577B. These accessories may be obtained through your HP Sales and Service office.

The following HP products may also be useful accessories

External Disk Drives

Requires Option 1C2

9122C 3.5 inch micorfloppy

9153C 10, 20 and 40 MByte Winchester with optional 3.5 inch microfloppy

9127A Single Sided 5.25 inch microfloppy

7957B 81 MByte Winchester Disk

7958B 152 MByte Winchester Disk

7959B 304 MByte Winchester Disk

Plotters

7440A Eight-Pen A4 Plotter

7475A Six-Pen A3/B and A4/A Plotter

7550A High Speed Eight Pen A3/B and A4/A Plotter

External

Switch Systems

3488A Low-Cost Switch/control Unit

3235A High-Performance Switch/Control Unit

Accessories Supplied

Table 5-2 lists the accessories supplied with the HP 3577B Network Analyzer and the HP 35677A S-parameter test set.

Table 5-2

For the HP 3577B		
Power cord	Qty. 1	see figure 5-1
Type N(m)-to-BNC(f) adapters	Qty. 3 ¹	1250-0780
For the HP 35677A/B		
Interconnect cable	Qty. 1	35677-61620
190 mm (7.5 in) 50 Ω cable	Qty. 4	8120-4387
Cabinet lock foot kit	Qty. 1	5062-3999

¹ Qty. 4 with Option 002

Options

Table 5-3 lists the options available for the HP 3577B. These options are available when the instrument is ordered. For later installation, use the HP part number when ordering.

Table 5-3

Option	Description	HP Part Number
For the HP 3577B		
001	Add High Stability Frequency Reference	03577-88801
002	Add 3rd Receiver	HP 3577B Option K02
102	Add HP Instrument BASIC and 640 kBytes RAM	03577-88812
907	Front Handle Kit	5062-3991
908	Rack Mounting Kit	5062-3979
909	Front Handle & Rack Mount Kit	5062-3965
910	Additional Operating & Service Manual	03577-90029 03577-90028
911	Additional HP Instrument BASIC Programming References	E2083-90000 03577-90030
For the HP 35677A/B		
907	Front Handle Kit	5062-3988
908	Rack Mounting Kit	5062-3974
909	Front Handle & Rack Mount Kit	5062-3975
910	Additional Service Manual	35677-90010

Installation

The HP 3577B is shipped with plastic feet attached to the bottom panel, ready for use as a bench instrument. The feet are shaped to make full-width modular instruments self align when they are stacked. Because of its weight, the HP 3577B is not equipped with a tilt stand. It is recommended that a Front Handle Kit (Option 907, HP Part No. 5062-3991) be installed for ease of handling the instrument on the bench.

The HP 35677A/B S-parameter test set was designed to be mounted to the bottom of the HP 3577B Option 002 Three-Receiver Network Analyzer as follows:

1. Install the Rear Panel Lock foot kit (5062-3999) as indicated by the kit instructions. This fastens the two instruments together using four slide-together clips across the front edges and two lock feet mounted at the corners of the rear panels' common side.
2. Install the test set interconnect cable between the rear panels of both instruments as shown in figure 5-2. This cable
 1. supplies power and ground
 2. lets the analyzer sense the presence of the test set (changes the INPUT menu)
 3. controls the test set's coaxial switch.

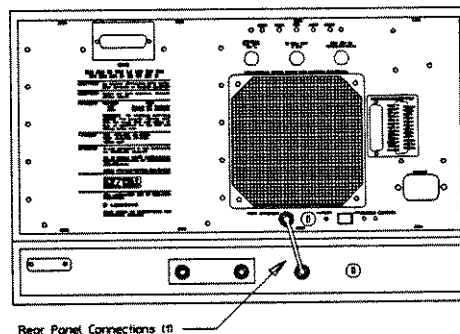

Figure 5-2 Rear panel interconnect cable installation

3. Install the four N-connector 50 Ω cables between the front panels of the two instruments as shown in figure 5-3.

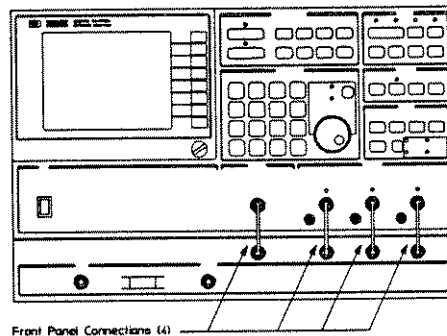

Figure 5-3 Front panel cable installation

General Information
Installation

The HP 3577B may be rack mounted in either of two ways; with or without slides. Both mountings may be utilized for maximum strength and safety.

To rack mount without slides:

1. Remove the plastic trim and front handles if so equipped.
2. Remove the plastic feet from the bottom of the HP 3577B.
3. Install the flange kit with or without handles according to instructions included with the kit:
Rack Flange Kit(no handles)...Option 908, HP P.N. 5062-3979
Rack Flange & Front Handle Kit...Option 909, HP P.N. 5062-3985
4. Install an Instrument Support Rail on each side of the instrument rack. (The Instrument Support Rails, used to support the weight of the instrument, are included with HP rack-mount cabinets.)

Warning



1. The weight Of the HP 3577B must be supported by Instrument Support Rails inside the instrument rack. Do not, under any circumstances, attempt to rack mount the HP 3577B using only the front flanges.
2. The HP 3577B is heavy (approximately 62 lbs, 28 kg.). Use extreme care when lifting it to avoid personal injury.

-
5. Using *two* people, lift the HP 3577B to its position in the rack on *top* of the Instrument Support Rails.
 6. Using the appropriate screws, fasten the HP 3577B's Rack-Mount Flanges to the front of the instrument rack.

To rack mount with slides, the following items are required:

Quantity	Description
1	Rack Flange Kit (Option 908, HP 5062-3979) OR Rack Flange & Handle Kit (Option 909, HP 5062-3985)
1	Heavy-Duty Slide Kit (HP Part Number 1494-0016)

Note



Instrument Support Rails are not absolutely necessary when rack mounting with slides. However, they do relieve a considerable amount of strain from the slides and provide an extra measure of safety.

1. Perform Steps 1 through 4 of the previous procedure.
2. Attach a slide inner-member bracket to each side of the HP 3577B.
3. Attach the slide's outer members to the instrument rack according to the instructions included with the slides.
4. If your instrument rack has extension legs on the front, be *sure* that they are extended at this time.
5. Using *two* people, lift the HP 3577B to its position in the rack and mate the two sections of the slides together. Do *not* rest the full weight of the HP 3577B on the extended slides until you are sure the instrument rack will not overturn.
6. Slide the HP 3577B into the rack. Using the appropriate screws, fasten the HP 3577B's Rack Mount Flanges to the front of the rack.

Display Alignment

If alignment of the display is necessary, perform the following:

1. Power ON.
2. Press [**SPCL FCTN**] and [**SERVICE DIAG**]
3. Press [**TEST PATTERN**]
4. Adjust **HORIZ** and **VERT** on the rear panel to center the pattern on the face of the CRT.
5. Adjust **ALIGN** on the rear panel (which rotates the display) until the bottom of the display is parallel to the bottom of the bezel.
6. Adjust **FOCUS** and **ASTIG** on the rear panel until the lines on the display are sharp and clear. It may be easier to align this using a dot on the screen; press [**INSTR PRESET**] and use one of the decimal points in the alphanumerics.

HP-IB Connections

The HP 3577B Network Analyzer is designed for use with the Hewlett-Packard Interface Bus (HP-IB).

Note



The HP-IB is Hewlett-Packard's implementation of IEEE standard 448-1978, "Standard Digital Interface for Programmable Instrumentation."

The HP 3577B is connected to the HP-IB by connecting an HP-IB interface cable to the HP-IB connector on the rear panel. Figure 5-4 illustrates a typical HP-IB system in interconnection.

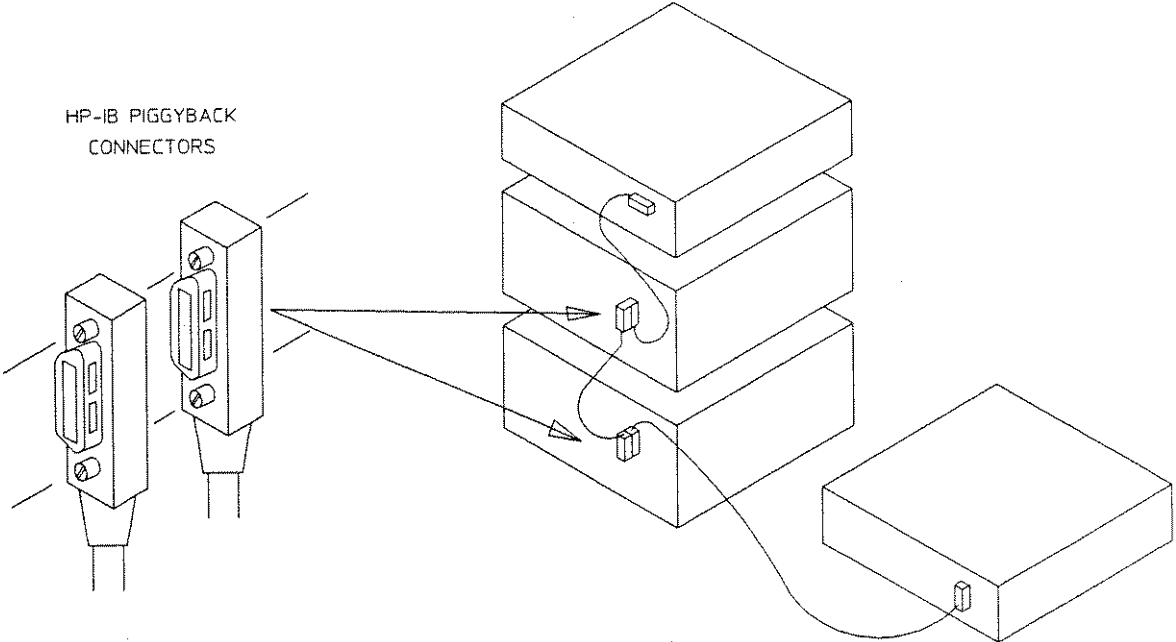
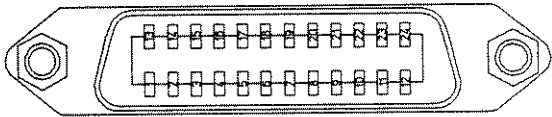

Figure 5-4 A typical HP-IB system Interconnection



Caution

The HP 3577B contains metric threaded HP-IB cable mounting studs as opposed to English threads. Metric threaded HP 10833A,B,C, or D HP-IB cable lockscrews must be used to secure the cable to the instrument. Identification of the two types of mounting studs and lockscrews is made by their color. English threaded fasteners are colored silver and metric threaded fasteners are colored black. DO NOT mate silver and black fasteners to each other or the threads of either or both will be destroyed.

PIN	LINE
1	D101
2	D102
3	D103
4	D104
13	D105
14	D106
15	D107
16	D108
5	E01
17	REN
6	DAV
7	NRFD
8	NDAC
9	IFC
10	SRQ
11	ATN
12	SHIELD-CHASSIS GROUND
18	P/O TWISTED PAIR WITH PIN 6
19	P/O TWISTED PAIR WITH PIN 7
20	P/O TWISTED PAIR WITH PIN 8
21	P/O TWISTED PAIR WITH PIN 9
22	P/O TWISTED PAIR WITH PIN 10
23	P/O TWISTED PAIR WITH PIN 11
24	ISOLATED DIGITAL GROUND

HP-IB Interconnect Cables	
PART NUMBER	LENGTH
10833A	1 m (3.3 ft)
10833B	2 m (6.6 ft)
10833C	4 m (13.2 ft)
10833D	0.5 m (1.6 ft)

THESE PINS ARE INTERNALLY GROUNDED

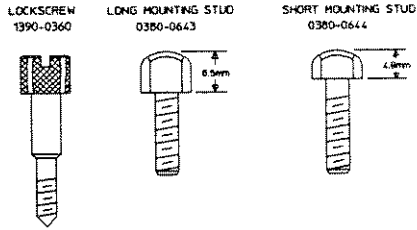

Figure 5-5 HP-IB Interfacing

Caution



The HP 3577B contains metric threaded HP-IB cable mounting studs as opposed to English threads. Metric threaded HP 10833A, B, C, or D HP-IB cable lockscrews must be used to secure the cable to the instrument. Identification of the two types of mounting studs and lockscrews is made by their color. English threaded fasteners are colored silver and metric threaded fasteners are colored black. **DO NOT** mate silver and black fasteners to each other or the threads of either or both will be destroyed.

With the HP-IB system, up to 15 HP-IB compatible instruments can be interconnected. The HP 10833 HP-IB cables have identical piggy-back connectors on each end so that several cables can be connected to a single source without special adapters or switch boxes. System components and devices can be connected in virtually any configuration as long as a path exists between each device and the controller. As a practical matter, avoid stacking more than three or four cables on any one connector. If the stack gets too long, force on the stack can produce sufficient leverage to damage the connector mounting. Be sure that each connector is firmly screwed in place to keep it from working loose during use. The HP 3577B uses all the available HP-IB lines; therefore, damage to any connector pin may adversely affect HP-IB operation. See figure 5-5.

To achieve design performance with the HP-IB, proper voltage levels and timing relationships must be maintained. If the system cable is too long, the lines cannot be driven properly and the system will fail to perform.

Total cable length for the system must be less than or equal to 20 meters (65 feet) or 2 meters (6 feet) times the total number of devices connected to the bus, whichever is less.

Programmable Input/Output Connector

The HP 3577B provides an 8-bit Input/Output port and three dedicated lines; $\overline{\text{EOS}}$ (End of Sweep), $\overline{\text{EOM}}$ (End of Measurement), and $\overline{\text{FAIL}}$ (for limit test). The connector is labeled "Programmable I/O Port" on the rear panel. Figure 5-6 shows the connector and pin assignments.

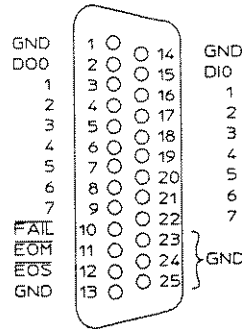

Figure 5-6 Programmable I/O Port

DI0 - DI7 and DO0 - DO7 are 8-bit parallel input and output ports, respectively. Inputs and outputs are TTL levels. Inputs are pulled up with 10 K Ω and outputs can drive three standard LS TTL loads. These I/O pins are intended for operation with a custom device, using an HP Instrument BASIC program. Therefore, the HP 3577B Option 1C2 (Instrument BASIC Option) is required to fully utilize the I/O pins. See the "Using HP Instrument BASIC with the HP 3577B" for more information on how to use this portion of the connector using an HP Instrument BASIC program.

The $\overline{\text{EOS}}$ and $\overline{\text{EOM}}$ are negative going, with approximately 1 μ sec duration. They have no direct relationship to the input and output pins. Figure 5-7 shows the output timing of the $\overline{\text{EOS}}$, $\overline{\text{EOM}}$, and $\overline{\text{FAIL}}$ signals.

General Information
 Programmable Input/Output Connector

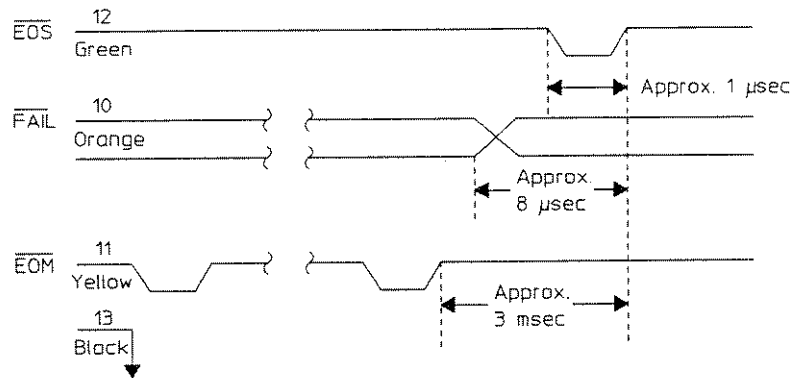

Figure 5-7
 $\overline{\text{EOS}}$, $\overline{\text{FAIL}}$, and $\overline{\text{EOM}}$ Output Timing (Typical)

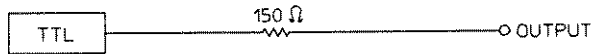

Figure 5-8
 $\overline{\text{EOS}}$, $\overline{\text{EOM}}$, and $\overline{\text{FAIL}}$ Equivalent Circuit

Figure 5-8 shows the equivalent circuit for the internal circuit of the $\overline{\text{EOS}}$, $\overline{\text{FAIL}}$, and $\overline{\text{EOM}}$ lines.

$\overline{\text{EOS}}$: Output. Normally high, pulses low for about 1 μsec at the end of each sweep.

$\overline{\text{EOM}}$: Output. Normally high, pulses low for about 1 μsec at the end of each measurement. Each frequency "bin" of a sweep is considered a measurement.

$\overline{\text{FAIL}}$: Output. When limit testing is in use, this output will be set low if either trace fails, or high if both traces pass. It changes state just before $\overline{\text{EOS}}$ is pulsed, so $\overline{\text{EOS}}$ can be used to clock $\overline{\text{FAIL}}$.

GND : Connected to chassis ground.

Storage and Shipment

Environment The HP 3577B and HP 35677A/B should be stored in a clean, dry environment. The following are environmental limitations that apply to both storage and shipment.

Temperature	- 40° C to +70° C
Humidity	Up to 95%relative
Altitude	Up to 15,300 meters (50,000 feet)

The instruments should also be protected from temperature extremes which cause condensation.

Original Packaging Containers and materials equivalent to those used in factory packaging are available through Hewlett-Packard Offices. If the instrument is being returned to Hewlett-Packard for service, attach a tag indicating the type of service required, return address, model number, and full serial number. Also, mark the container FRAGILE to ensure careful handling. In any correspondence, refer to the instrument by model number and full serial number.

Other Packaging The following general instructions should be followed for repackaging with commercially available materials:

1. Wrap the instrument in heavy paper or anti-static plastic. If the instrument is being shipped to a Hewlett-Packard office or service center, attach a tag to the instrument indicating type of service required, return address, model number, and full serial number.
2. Use a strong shipping container. A double-wall carton made of 350 pound test material is adequate.
3. Use a layer of shock absorbing material 70 to 100 mm (3 to 4 inches) thick around all sides of the instrument to provide firm cushioning and prevent movement inside the container. Protect the front panel with cardboard.
4. Seal shipping container securely.
5. Mark shipping container FRAGILE to ensure careful handling.
6. In any correspondence, refer to the instrument by model number and full serial number

Caution



Styrene pellets in any shape should not be used as packing material. The pellets do not adequately cushion the instrument and do not prevent the instrument from shifting in the carton. The pellets also create static electricity which can damage electronic components.

HP 3577B Network Analyzer Specifications

Source Characteristics

■ Frequency Characteristics

Frequency Range: 5 Hz to 200 MHz.

Frequency Resolution: 0.001 Hz.

Stability: for Option 001, $\pm 5 \times 10^{-8}$ /day, 0 to 55° C
(Applicable for instrument on continuously ≥ 48 hours.)

■ Output Characteristics

Level Range: +15 dBm to -49 dBm
(1.26 Vrms to 793 μ Vrms; 2 dBV to -62 dBV) into a 50 Ω load.

Resolution: 0.1 dB.

Entry Units: dBm, dBV, V.

Accuracy: ± 1 dB at +15 dBm and 100 kHz.
Below +15 dBm, add the greater of ± 0.02 dB/dB or 0.2 dB.

Flatness: 1.5 dBpp from 5 Hz to 200 MHz.

Impedance: 50 Ω ; > 20 dB return loss at all levels.

RF Output Connector: 50 Ω Type N female.

Spectral Purity:

Phase Noise (in 1 Hz Bandwidth):
< -70 dBc at offset frequencies from carrier of 100 Hz to 20 kHz.

Harmonics: < -30 dBc.

Non-Harmonic Spurious Signals:
< -50 dBc or -70 dBm whichever is greater.

Reverse Power Protection: Output is automatically opened at a signal level of approximately +22 dBm (50 Ω), or ± 4 Vdc, or greater applied to the source output. Source output is reconnected with the Clear Trip function.

■ Sweep Characteristics

Linear Frequency:

Range: 5 Hz to 200 MHz.

Entry: Start/stop or center/span frequencies.

Span: 0 Hz or 0.01 Hz to 200 MHz, phase continuous.

Sweep Time: 100 ms/span to 6553 s/span.

Direction: Increasing or decreasing frequency.

Log Frequency (segmented linear approximation):

Range: 5 Hz to 200 MHz.

Entry: Start/stop frequencies.

Span: 0.01 Hz to 200 MHz, phase continuous.

Log Accuracy: 2%.

Sweep Time: 200 ms/span to 6553 s/span.

Sweep Direction: Increasing frequency.

Alternate Frequency: Sweep alternates between two separate start/stop frequencies using linear sweep only.

CW: Frequency is fixed. Data is updated with a selectable sample time from 1 ms to 16 s.

Discrete: From 2 to 51 discrete frequencies at points of interest. Resolution bandwidth and settling time are individually settable. The minimum measurement time for each frequency is typically 10 ms. The discrete sweep table becomes part of the instrument state.

Sweep Direction: Increasing or decreasing frequency.

Log Amplitude (fixed frequency):

Range: +15 dBm to -49 dBm.

Entry: Start/stop level in dBm or dBV.

Sweep Time: 1 ms/step to 16 s/step. Total sweep time/span depends upon total number of steps and time/step.

Sweep Modes: Continuous, single, manual.

Trigger Modes: Free run, immediate, line, external.

Receiver Characteristics

Input Characteristics

Frequency Range: 5 Hz to 200 MHz.

Inputs: Two receiver inputs (A and R). Option 002 provides input B.

Input Impedance: Selectable 50Ω with > 25 dB return loss, or 1 MΩ in parallel with approximately 30 pF.

Full Scale Input Level:

Input Impedance	Input Attenuation	
	0 dB	20 dB
50Ω	-20 dBm	0 dBm
1 MΩ	-33 dBV (22.4 mV)	-13 dBV (224 mV)

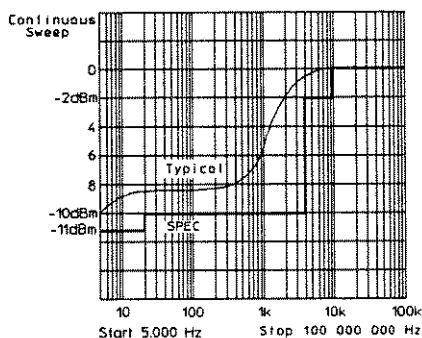
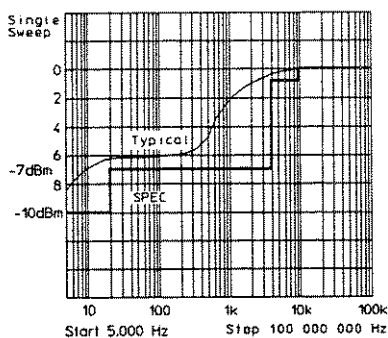

Input Damage Level (approximate):

50Ω: +30 dBm or 25 Vdc

1 MΩ: +16.9 dBV (7 Vrms) or 25 Vdc. The 50Ω input impedance automatically switches to 1 MΩ at approximately +20 dBm, and can be reset with the clear trip function.

Input Connectors: 50Ω Type N female.

Resolution Bandwidth: Selectable 1 kHz, 100 Hz, 10 Hz, or 1 Hz.

Sensitivity due to noise and internal crosstalk between source and receiver:

Sensitivity*					
Resolution Bandwidth	Minimum Freq.	Min. Freq. - 30 kHz (50 Ω)		30 kHz - 200 MHz (50Ω)	
		Min. Freq. - 300 kHz (1 MΩ)		300 kHz - 20 MHz (1 MΩ)	
		Full Scale Input		Full Scale Input	
		0 dBm -13 dBm (20 dB Atten)	-20 dBm -33 dBV (0 dB Atten)	0 dBm -13 dBV (20dB Atten)	-20 dBm -33 dBV (0 dB Atten)
1 Hz	100 Hz	-110 dBm	-130 dBm	-110 dBm	-130 dBm
10 Hz	100 Hz	-100 dBm	-120 dBm	-110 dBm	-130 dBm
100 Hz	500 Hz	-90 dBm	-110 dBm	-105 dBm	-125 dBm
1 kHz	5 kHz	-80 dBm	-100 dBm	-95 dBm	-115 dBm

*For 1 MΩ inputs, add 5 dB to the table.

Residual Responses: > 100 dB below full scale input, except for crosstalk error limits, L.O. feedthrough, and ac line and fan related spurious signals.

Crosstalk Error Limits:

(> 100 dB isolation between inputs.

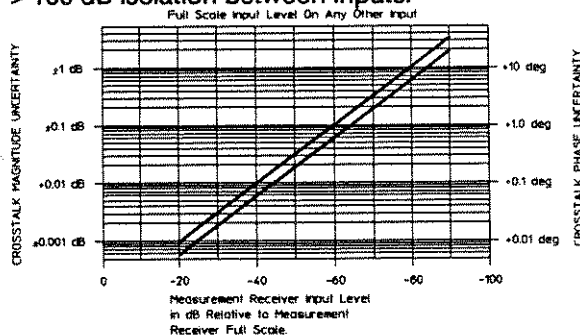

L.O. Feedthrough: < -33 dB below maximum input level.

AC Line and Fan Related Spurious Signals:

< -100 dBm, frequency < 1kHz.

Electrical Length/Reference Plane Extension:

Provides equivalent electrical line length, or delay at inputs A, R, and B (B for Option002 only).

Range: -3×10^8 m to $+3 \times 10^8$ m, or +1 s to -1 s.

Resolution: 5 digits or 0.1 cm (3.3 ps) whichever is greater.

Accuracy: ± 0.1 cm or $\pm 0.02\%$ whichever is greater.

Magnitude Characteristics

Range: Full Scale Input Level to Sensitivity.

Resolution:

Marker: 0.001 dB (log); 5 digits (linear).

Display: 0.01 dB/div to 20 dB/div (log absolute);
0.01 dB/div to 200 dB/div (log ratio);
0.1 nV/div to 10 V/div (linear absolute);
 10^{-10} /div to 10^{20} /div (linear ratio).

Display Units: dB, dBm, dBV, V, and linear ratio.

Accuracy (at 100 kHz, 25° C, and Full Scale Input):

Absolute (A,B,R): ± 0.2 dB.

Ratio (A/R,B/R,A/B): ± 0.15 dB (50 Ω); ± 0.2 dB (1 M Ω).

Accuracy and frequency response errors, and effects of different input attenuation can be calibrated out with normalization.

Dynamic Accuracy:

Error		Input Level Relative to Full Scale Input
Resolution Bandwidth		
1 kHz, 100 Hz, 10 Hz	1 Hz	
$\pm .04$ dB	$\pm .04$ dB	0 dB to - 10 dB
$\pm .02$ dB	$\pm .02$ dB	- 10 dB to - 50 dB
$\pm .05$ dB	$\pm .05$ dB	- 50 dB to - 60 dB
$\pm .15$ dB	$\pm .25$ dB	- 60 dB to - 80 dB
$\pm .75$ dB	$\pm .75$ dB	- 80 dB to - 90 dB
$\pm .75$ dB	± 3.00 dB	- 90 dB to - 100 dB

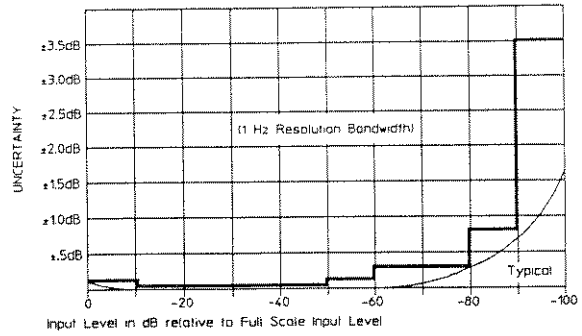
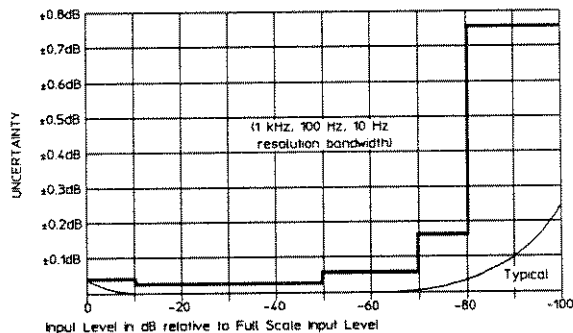

Frequency Response: Specifications apply when inputs are driven from a 50 Ω source impedance.

Absolute (A,B,R):

Frequency	Error	
	50 Ω Input	1 M Ω Input
20 Hz to 20 MHz	.3 dB pp	.5 dB pp
5 Hz to 200 MHz	.6 dB pp	—
5 Hz to 20 MHz	—	1 dB pp

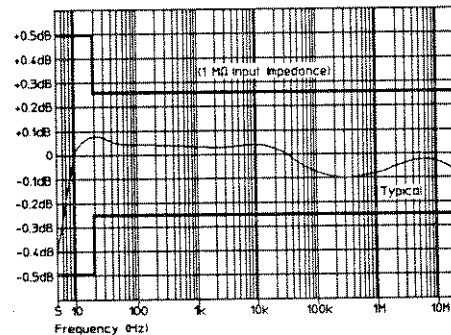
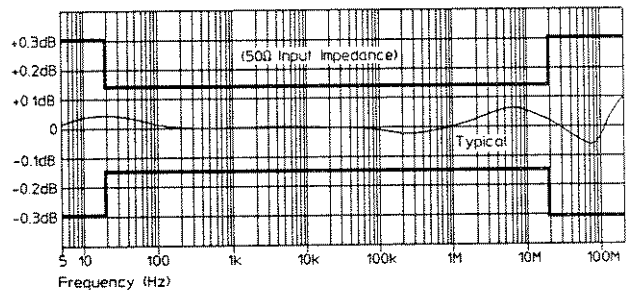

Ratio (A/R,B/R,A/B):

Frequency	Error*	
	50Ω Input	1 MΩ Input
20 Hz to 20 MHz	.3 dB pp	.3 dB pp
5 Hz to 200 MHz	.4 dB pp	—
5 Hz to 20 MHz	—	.6 dB pp

*For unequal 50Ω input attenuation add 0.15 dB pp (20 Hz to 20 MHz), 0.3 dB pp (5 Hz to 200 MHz). For unequal 1 MΩ input attenuation add 0.2 dB pp (20 Hz to 20 MHz), 0.4 dB pp (5 Hz to 20 MHz).

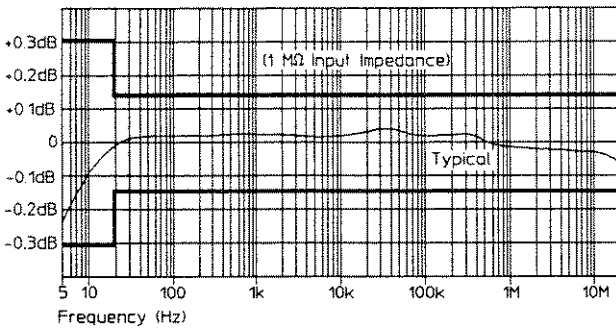
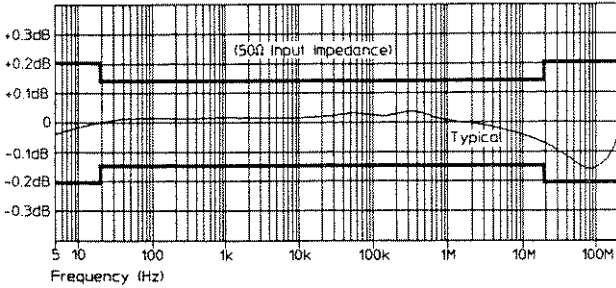

Reference Level:

Range: -207 dBm to +33 dBm
 (-220 dBV to +20 dBV) (log absolute);
 -400 dB to +400 dB (log ratio);
 0 V to 10 V (linear absolute);
 0 to 10²⁰ (linear ratio).
 Resolution: 0.001 dB (log); 5 digits (linear).

Stability:

Temperature: Typically < ± 0.02 dB/° C.
 Time: Typically < ± 0.05 dB/hour at 25° C.

Phase Characteristics (A/R,B/R,A/B):

Range: ± 180 deg.

Resolution:

Marker: 0.005 deg (0.0001 rad)
 Display: 0.01 deg/div to 200 deg/div
 (0.00018 rad/div to 3.49 rad/div).

Display Units: degrees, radians.

Accuracy (at 100 kHz, 25° C, and Maximum Input Level): ± 2.0 deg.

Accuracy and frequency response errors, and effects of different input attenuation can be calibrated out with normalization.

Dynamic Accuracy:

Error*	Input Level Relative to Maximum Allowable
± .4 deg	0 dB to -10 dB
± .2 deg	-10 dB to -50 dB
± .5 deg	-50 dB to -60 dB
± 1.5 deg	-60 dB to -80 dB
± 7.5 deg	-80 dB to -100 dB

*Specifications do not apply below -60 dB in a 1 Hz Resolution Bandwidth.

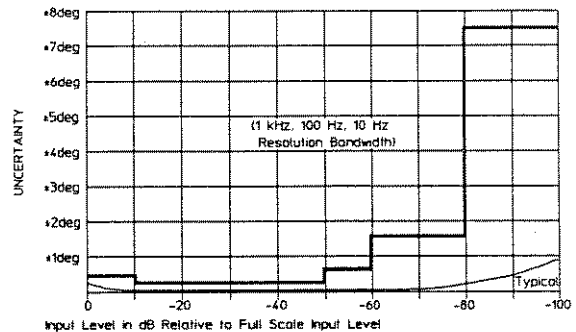

Frequency Response: Specifications apply when inputs are driven from a 50Ω source impedance.

Frequency	Error *	
	50Ω Input	1 MΩ Input
20 Hz to 20 MHz	2 deg pp	5 deg pp
5 Hz to 200 MHz	10 deg pp	—
5 Hz to 20 MHz	—	10 deg pp

*For unequal input attenuation add 8 deg pp.

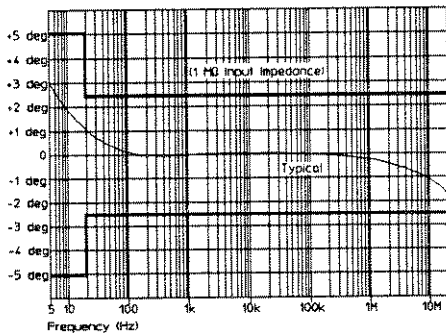
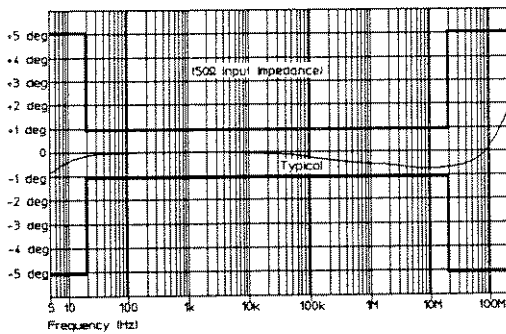

Crosstalk: Specified under Input Characteristics.

Reference Level:

Range: - 500 deg to + 500 deg (- 8.7 rad to + 8.7 rad)
Resolution: 0.01 deg.

Stability:

Temperature: Typically < ± 0.05 deg/° C.
Time: Typically ± 0.05 deg/hour at 25° C.

■ **Polar Characteristics**

Range, Resolution, Display Units, Dynamic Accuracy, Frequency Response, Uncertainty, Crosstalk, Reference Level, and Stability specifications are the same as the corresponding magnitude and phase characteristics.

Full Scale Magnitude Range:

Absolute(A,B,R): 0.1 nV to 10V
Ratio (A/R,B/R,A/B): 10⁻¹⁰ to 10²⁰

■ **Real/Imaginary Characteristics**

Range, Dynamic Accuracy, Frequency Response, Uncertainty, Crosstalk, Stability specifications are the same as the corresponding magnitude and phase characteristics.

Resolution:

Marker: 5 digits.
Display: 0.1 nV/div to 10 V/div for absolute;
10⁻¹⁰ to 10²⁰ for ratio.

Display Units: V and linear ratio.

Reference Level:

Range: ± 10 V for absolute; ± 10²⁰ for ratio.
Resolution: 5 digits.

■ **Delay Characteristics**

(Linear Frequency Sweep and Discrete Sweep with equal frequency point spacing; A/R, B/R, A/B; 50Ω Input Impedance)

Range: Group delay is a computed parameter, defined by the equation $t_g = -\frac{\Delta\phi}{2\pi\Delta f}$

Minimum: The minimum delay time is given by the expression

$$\frac{1.4 \times 10^{-5}}{\text{Aperture [Hz]}}$$

Maximum: The maximum delay is given by the expression $\frac{N - 1}{2 \times \text{Span [Hz]}}$ where N = number of points per sweep (51, 101, 201, 401 for linear sweep; 3 to 51 for discrete sweep).

Effective Range: 1 ps to 20,000 s.

Resolution:

Marker: Same as minimum delay time or 5 digits, whichever is greater.
Display: 0.01 ns/div to 1000 s/div.

Aperture: Selectable 0.5%, 1%, 2%, 4%, 8%, 16% of frequency span for linear sweep. For discrete sweep, aperture is two times the spacing between the first two frequency points.

Display Units: seconds

Accuracy: $\frac{.13 \text{ s}}{(\text{freq [Hz]})^2} \pm 2 \text{ ns or}$

$\frac{\text{Dynamic Phase Accuracy}}{360 \times \text{Aperture [Hz]}} \pm 2 \text{ ns whichever is greater.}$

The $\frac{.13 \text{ s}}{(\text{freq [Hz]})^2} \pm 2 \text{ ns}$

term can be calibrated out with normalization.

HP 3577B Network Analyzer Specifications
Source Characteristics

Crosstalk: Determined by the expression
$$\frac{\text{Phase Crosstalk}}{360 \times \text{Aperture [Hz]}}$$

Reference Level:

Range: $\pm 10^3$ s.
Resolution: 5 digits.

Stability:

Temperature: Determined by the expression
$$\frac{\text{Phase Temperature Stability}}{360 \times \text{Aperture [Hz]}}$$

Time: Determined by the expression
$$\frac{\text{Phase Time Stability}}{360 \times \text{Aperture [Hz]}}$$

Display Characteristics

Annotation: Start/stop, center/span or CW frequency, source level, scale/div, reference level, delay aperture, marker data, and soft key functions.

Graticules: Rectangular logarithmic and linear, polar, and Smith. All graticules are electronically generated.

Traces: Two simultaneous traces may be present with a rectangular graticule. One trace with polar or Smith graticules.

Markers: Each trace has one main marker and an offset marker. Markers indicate data at corresponding trace coordinates in the same units as used to set the Reference Level. Markers can be used to modify certain display parameters. Marker resolution is the same as horizontal display resolution.

Limit Lines: Each trace can have separate limit lines made of up to 20 line segments. Upper and lower limit lines can be defined for each trace. The limit table for each trace becomes part of the instrument state. A Pass/Fail indicator shows the results of a limit test on the screen. Also, the FAIL line on the Programmable I/O Port is set low for a failure, or high for pass just before the EOS is pulsed low. Limit tests typically add between 10 and 120 msec delay between sweeps.

Reference Line Position:

Rectangular Graticule: 0% to 100% full scale deflection in 0.05% increments.

Polar/Smith Chart Graticule: ± 500 deg in 0.001 deg increments.

Data Storage: Measured data can be stored in vector format in twelve non-volatile storage registers X1 through X8 and D1 through D4. Stored data can be displayed again later or operated on with Vector Math.

Vector Math: Input magnitude and phase data, stored data, a $j\omega$ register, and user defined constants and functions can be mathematically combined into expressions which define displayed or stored data. Mathematical operations are: add, subtract, multiply, and divide.

Calibration:

Normalization: Both traces can be normalized to measured data with full accuracy, and resolution. Scale factors can be changed after normalization without affecting calibration.

Normalize (Short): Compensates for frequency response errors. Requires a short termination.

One Port Part Cal: Compensates for directivity errors and frequency response errors. Requires open and load terminations.

One Port Full Cal: Compensates for directivity, frequency response and source match errors. Requires open, short, and load terminations.

Noise Averaging:

Type: Exponentially weighted vector averaging on successive sweep data.

Averaging Factor: Selectable 1 (off), 4, 8, 16, 32, 64, 128, 256.

The current trace A_n is always displayed and updated at the sweep rate according to the expression

$$A_n = S_n/F + (F - 1)(A_{n-1})/F$$
, where S_n = current input signal, F = averaging factor, A_{n-1} = previously averaged trace.

Averaging Factor is fixed at 1 in alternate sweep.

Linear Phase Slope Compensation:

Provides linear phase slope offset in deg/span.

Range: $-72,000$ deg./span to $+72,000$ deg./span (-1256 rad/span to $+1256$ rad/span).

Resolution: 5 digits or 0.001 deg whichever is greater.

Accuracy: 0.02%.

Autoscale: Automatically adjusts the reference level and scale/div. of the displayed measurement.

Measured No. of Points per Sweep:

Logarithmic frequency: 401

Linear frequency: 51, 101, 201, 401

CW frequency: 1

Discrete Sweep: between 2 and 51

Measured No. of Steps per Sweep:

Logarithmic Amplitude Sweep:

5, 10, 20, 50, 100, 200, 400

Display Resolution: Horizontal and vertical.

Rectangular: 1600 points.

Polar: 1200 points.

Programming Characteristics

HP-IB Capability: Remote programming is via the Hewlett-Packard Interface Bus (HP-IB)* for all HP 3577B front panel control functions except the ac line switch, display intensity, entry knob, HP-IB address and system controller on/off. The HP 35677A/B S-Parameter Test Sets are programmable through the HP 3577B interface only. The HP 3577B responds to all HP 3577A HP-IB programming commands.

Interface Functions: SH1,AH1,T6,TEØ, L4, LEØ,SR1,RL1,PP1,DC1,DT1,C1,C2,C3,C12,E1.

Output Data Transfer Time: 401 complex data points can be transferred directly to an HP 9000 Series 300 Computer in BASIC language as follows:

ASCII Mode: Typically 2800 ms.

Binary Floating Point Mode: Typically 310 ms.

HP Instrument BASIC Capability (Option 1C2): This option adds 640 kBytes of RAM to the HP 3577B and provides the capability to capture key sequences, customize parameter extractions, fully control the Programmable I/O Port, and control other HP-IB devices. Mass storage is accessed using a LIF or DOS disk in an external SS80 drive (subset of the CS80). One program can be in RAM at a time. Edit a program via an external controller. Load a program via an external disk drive or via HP-IB. 401 complex data points can be transferred to an HP Instrument BASIC program in 64-bit IEEE 754 binary floating-point mode in typically 130 msec.

* HP-IB is Hewlett-Packard's implementation of IEEE Standard 488.1

Option 1C2: HP Instrument BASIC Commands

Front panel commands	Trigonometric operations	Graphics control	Clock and calendar
LIST	ACS()	GCLEAR	TIMEDATE
SECURE	ASN()		
Error handling	ATN()	Graphics plotting	General device I/O
ERRLN()	COS()	DRAW	ASSIGN
ERRLN()	DEG	MOVE	BEEP
ERRM\$	RAD	Program control	CRT
ERRN	SIN()	CALL	DATA
Memory allocation	TAN()	CASE	DISP
COM	String operations	CASE ELSE	ENTER
DIM	&	CONT	IMAGE
INTEGER	CHR&()	DEF FN	INPUT
REAL	DVAL\$()	ELSE	OUTPUT
SCRATCH	DVAL()	END	PRINT
Relation operators	IVAL\$()	END IF	PRINTER IS
<, <=, <>	IVAL()	END LOOP	PRT
>=, =	LEN()	END SELECT	READ
General math	LWC\$()	END WHILE	RESTORE
×, +, -, /, ^	NUM()	EXIT IF	TAB()
ABS()	POS()	FN	TABXY()
DIV	REV\$()	FNEND	Binary functions
DROUND()	RPT\$()	FOR NEXT	BINAND()
EXP()	TRIM\$()	GOSUB	BINCMP()
FRACT()	UPC\$()	GOTO	BINEOR()
INT()	VAL\$()	IF THEN	BINIOR()
LET	VAL()	LOOP	BIT()
LGT()	HP-IB control	PAUSE	ROTATE()
LOG()	ABORT	REPEAT	SHIFT()
MAX()	CLEAR	UNTIL	Event-initiate branching
MAXREAL	LOCAL	RETURN	DISABLE
MIN()	LOCAL	RUN	DISABLE
MINREAL	LOCKOUT	SELECT	INTR
MOD	PASS	STOP	ENABLE
MODULO	CONTROL	SUB	ENABLE
PI	REMOTE	SUBEND	INTR
PROUND()	SROLL()	SUBEXIT	ON/OFF
RANDOMIZE	TRIGGER	WAIT	ERROR
RND	Mass storage	WHILE	ON/OFF INTR
SGN()	CAT	Logical operators	ON/OFF KEY
SQR()	COPY	AND	ON/OFF
SQRT()	CREATE ASCII	EXOR	TIMEOUT
	CREATE BDAT	NOT	
	CREATE (DOS FILE)	OR	
	CREATE DIR (DOS FILE)		
	GET		
	INITIALIZE		
	MSI		
	PURGE		
	RE-SAVE		
	RENAME		
	SAVE		

Graphics Capabilities:

Alphanumeric Characters: 12 lines of text with 40 characters per line can be displayed character set includes alphanumeric, special characters and line vectors.

Vector Display: Trace lines and alphanumeric characters can be drawn on the display between any two points with a resolution of 2048 points along the horizontal and vertical axes.

General Characteristics

Compatibility:

The HP 3577B (including Options 001 and 002) is form, fit and function compatible with the HP 3577A. The HP 3577B responds to all HP 3577A HP-IB commands.

External Reference Frequency Input:

Frequency: 10 MHz/N (N is an integer from 1 to 100).

Level: 0 dBm \pm 10 dB, nominal.

Impedance: 50 Ω , nominal.

Connector: BNC female, rear panel.

Reference Frequency Output:

Frequency: 10 MHz (nominal)

Level: Typically 0 dBm

Impedance: 50 Ω , nominal.

Connector: BNC female, rear panel.

External Trigger:

Triggers on negative TTL transition or contact closure to ground.

Minimum Pulse Width: Typically 1 μ sec.

Impedance: 50 Ω , nominal.

Connector: BNC female, rear panel.

Programmable Input/Output Connector:

Rear panel connector is a female D-SUB series D25. It has three dedicated outputs (EOS, EOM, and FAIL). The connector is intended to interface with non-HP-IB equipment or custom hardware. The eight input and output lines are accessible from HP Instrument BASIC or from external HP-IB control. Input and output are TTL levels. Inputs are pulled up with 10 K Ω and outputs can drive three standard LS TTL loads (typical 1 – 2 mA sink). They are accessible from HP Instrument BASIC or external HP-IB control.

Plotter Control:

Directly compatible with HP-IB graphics plotters that use Hewlett-Packard Graphics Language (HP-GL). Plotter may be controlled by the HP 3577B through the HP-IB connector without an external computer. The plotter address can be set from the HP 3577B front panel. Plotted data includes trace 1, trace 2, graticule, and annotation. Additional markers can be plotted, and pen numbers, pen speed, and line type can also be selected.

Display Adjustments:

Astigmatism, x-axis position, y-axis position, alignment, focus, and intensity.

Save/Recall:

Front panel setups can be stored in non-volatile memory locations 1 through 5. Last state is saved when power is removed.

Operating Conditions:

Temperature: 0° C to +55° C.

Relative Humidity: < 95% at 40° C.

Altitude: < 4,572 m (15,000 ft).

Non-Operating Conditions:

Temperature: – 40° C to +70° C.

Altitude: < 15,240 m (50,000 ft).

Accessories Included:

3ea. Type N male to BNC female Adapter with standard. (HP Part No. 1250-0780)

4 ea. with Option 002.

1 ea. Operating Manual. (HP Part No. 03577-90029).

1 ea. Service Manual. (HP Part No. 03577-90028).

Option 1C2 Accessories:

1 ea. *Using HP Instrument BASIC with the HP 3577B* (03577-90030)

1 ea. *HP Instrument BASIC User's Handbook* (E2083-90000)

Hardware Options:

Option 001; Internal Oven Frequency Reference. Adds 10 MHz oven stabilized frequency reference.

Stability: 5×10^{-8} /day, 0 to 55° C, after 48 hour warm-up period.

Option 002; Third Receiver.

Adds third input receiver (input B).

All receiver specifications apply.

Option 1C2; HP Instrument BASIC

See description in the Programming Characteristics section.

Power: 115V + 10%, - 25% (47 Hz to 440 Hz), or
230 V + 10%, - 15% (47 Hz to 66 Hz), 450 VA
maximum.

Weight: 31 kg (67 lbs) net. 41 kg (90 lbs) shipping.

Dimensions: 222 mm H × 426 mm W × 578 mm
D (8.75 in × 16.75 in × 22.75 in). Add 1 1/8 inch to
depth to include front panel controls and
connectors.

HP 35677A/B S-Parameter Test Set Specifications

All specifications apply without bias signals. Degrees are specified as deviation from linear phase. Frequency Response, Port Match, and Test Port Reciprocity specifications are equivalent values for ratio measurements, and errors can be calibrated out.

Frequency Range: 100 kHz to 200 MHz.

Test Port Impedance:

HP 35677A: 50Ω.
HP 35677B: 75Ω.

Directivity: > 40 dB.

Frequency Response:

Transmission (S_{21} , S_{12}): ± 1 dB, ± 5 deg.
Reflection (S_{11} , S_{22}): ± 1 dB, ± 5 deg.

Port Match:

Test Ports 1, 2: HP 35677A, > 26 dB;
HP 35677B, > 24 dB.
Test Ports 1, 2 Open/short ratio:
HP 35677A, ± 0.75 dB magnitude and ± 5 deg phase;
HP 35677B, ± 1 dB magnitude and ± 7.5 deg phase.
Input Port: > 20 dB return loss.
Output Ports A, B, and R: > 26 dB return loss.

Test Port Isolation: > 100 dB.

Insertion Loss:

RF Input to Test Port 1 or 2: HP 35677A, typically 13 dB; HP 35677B, typically 19 dB.
RF Input to Output Ports A, B, or R:
HP 35677A, typically 19 dB; HP 35677B, typically 31 dB.

Test Port Reciprocity:

Transmission (S_{21} , S_{12}): typically ± 0.5 dB magnitude and ± 5 deg phase.
Reflection (S_{21} , S_{12}): typically ± 0.5 dB magnitude and ± 5 deg phase.
Incident Power Ratio (Test Port 1 to Test Port 2): typically ± 1.5 dB.

RF Input Maximum Operating Level:

+ 25 dBm or ± 30 Vdc.

RF Input Damage Level: +27 dBm or ± 30 Vdc.

Port 1 or 2 Damage Level: +27 dBm or ± 30 Vdc.

Connectors:

Input Port and Output Ports A, B, and R: 50Ω Type N female.
Test Ports 1 and 2: HP 35677A, 50Ω Type N female; HP 35677B, 75Ω Type N female.
DC Bias Inputs: BNC female, rear panel.

DC Bias Range: Typically ± 30 Vdc and ± 20 mA with some degradation of RF specifications; 200 mA damage level.

Accessories Included:

4 ea. 190 mm (7.5 in.) 50Ω cables with Type N male connectors for connection to HP 3577B (HP Part No. 8120-4387).
1 ea. Test Set interconnect cable to HP 3577B (HP Part No. 35677-61620)
1 ea. Rear Panel Lock Foot Kit (HP Part No. 5061-0099).
1 ea. Service Manual (HP Part No. 35677-90010).*

Recommended Accessories:

HP 35677A: 35678A 50Ω Type N Calibration Kit; 35679A 50Ω Type N Test Port Extension Cables.
HP 35677B: 35678B 75Ω Type N Calibration Kit; 35679B 75Ω Type N Test Port Extension Cables.

Programming: The HP 35677A/B are completely controlled through the HP 3577B using the HP 3577B interconnect cable. All programming is accomplished through the HP 3577B HP-IB interface.

Power: All power is obtained through the HP 3577B interconnect cable.

Weight: 6 kg (13 lbs) net; 12 kg (26 lbs) shipping.

* Note operation information included in HP 3577B Operation Manual. (HP Part No. 03577-90029).

Dimensions: 90 mm H × 426 mm W × 584 mm D
(3.5 in × 16.75 in × 22.75 in). Add 1 1/8 inch to depth to include front panel connectors.

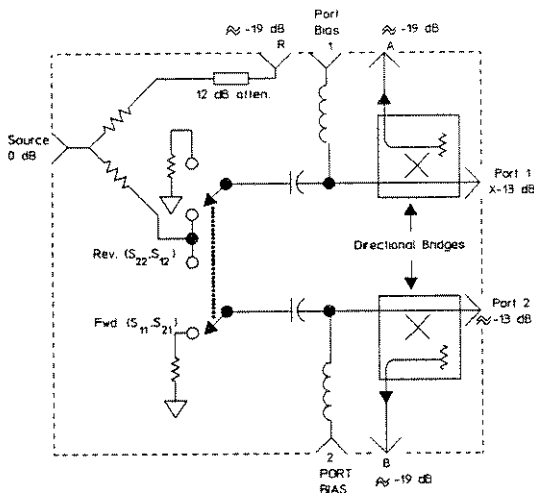

HP 35677A Block Diagram

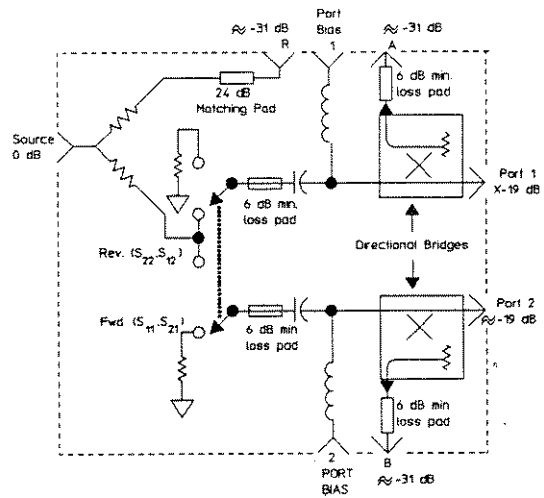

HP 35677B Block Diagram

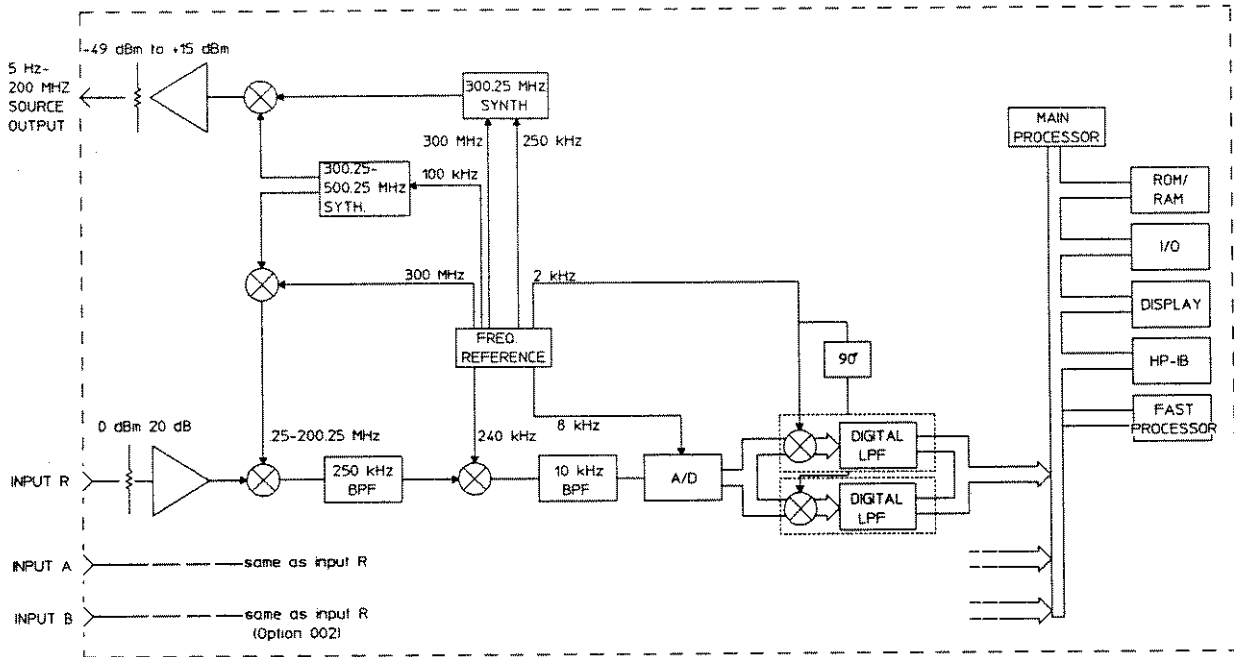

HP 3577B Block Diagram

Special Topics Appendix A

Data Processing And Structure

Knowing how the HP 3577B takes measurements and what it does with the data will increase measurement efficiency. This section presents and explains the operating system flow chart of the HP 3577B Network Analyzer. See Figure A-1.

The synthesized source sweeps the selected span continuously (when not in CW or discrete sweep type or manual sweep mode) while the receivers take measurements, digitize the data, and output the data. The processor accepts data from the receivers only at certain frequencies. These are usually 401 equally spaced "bins" in the sweep span, but 201, 101, or 51 points/sweep may be selected for the sweep resolution. Each bin is as wide as the selected resolution bandwidth and has a frequency number (position information) and measurement value associated with it. Bins do not always overlap.

The process shown in the flow chart in Figure A-1 operates on one bin at a time. The HP 3577B takes a data point and plots it on screen before sampling the next bin.

The receiver's output values are complex numbers of the form $(X + jY)$, where X is real and jY imaginary. Two numbers (X & Y) are transferred to the processor for each bin. Data is collected from the receivers simultaneously.

If the average or length features are in use, the processor implements those functions at this point and then stores the results in trace memory. Trace memory stores the complex numbers representing inputs R , A , B , and storage registers $X1$ through $X8$ and $D1$ through $D4$.

If length and average are inactive, the measurement data is stored in trace memory without change. This emphasizes the point that average and length change what is stored in trace memory. Consider the case of single sweep mode. After taking data, it may be formatted to a number of configurations, but changing length or average has no effect. Thus, changing the trace inputs, display functions, or scales is possible without taking another measurement. However, changing length or average requires a new measurement (sweep) before the screen can be updated. Any math processing that occurs after data has been stored in trace memory operates on this new complex data.

Next, the operating system executes a store if it has been requested. If [**STORE DATA**] is pressed, source sweep and receiver measurements are interrupted while a memory sweep of trace memory occurs. If a simple [**STORE REG X_n**] is executed (i.e. not [**USER DEF STORE**]) then the [**STORE DATA**] math is the same as the [**INPUT**] math; the trace is stored using the current [**INPUT**] definition. If a [**USER DEF STORE**] is pressed, the user defines the math (and the data stored is not displayed). Changes in display function do not change what is stored. The data in trace memory may be processed by any display function and displayed as magnitude, phase, delay, etc. information. After the storing the math, the data is stored in the register specified by the user.

Next, (for all but the last bin) the operating system continues the memory sweep, repeating this process for each bin. The displayed trace is not affected unless the input definition is a function of the storage register used.

If [**STORE DATA**] is not pressed, the next step is to do the math defined by the [**INPUT**] function. Then, if [**PHASE SLOPE**] is on and the value is non-zero, the [**PHASE SLOPE**] math is done. Complex numbers are the result of all processing done up to this point. This data is then processed according to the definition of [**DISPLY FCTN**], resulting in a high-precision, floating point, scalar number. This number is stored in main memory for readout as **MARKER** data. The same number is then processed according to [**SCALE**] definitions for placement on the display. These two scalar numbers provide 1) a trace that stays within the boundaries of the graticule and 2) good measurement data readout (via the marker) for all portions of the frequency span, even where the trace is off screen.

If a function change does not require new measurements to update the trace, a memory sweep occurs. The processor sweeps through the complex data in trace memory and updates the trace very quickly. The speed in which this happens is limited only by the rate at which the processor can manipulate numbers. If a lot of math is required (averaging, length, and complicated user definitions for two traces) the HP 3577B may choose a slower sweep speed to allow time for the number processing. The message "SWEEP TIME INCREASED" appears on the screen when this happens.

It is important to keep in mind how the HP 3577B does math and the form of the complex data in trace memory when defining user defined equations for inputs, stores, or functions. For example, to find the difference in phase between inputs R and A the [**INPUT**] definition should be A/R, not A-R. See Figure A-2.

if:

$$A = X + jY = Me^{j\theta_1}$$

$$R = S + jT = Ne^{j\theta_2}$$

then:

$$\text{INPUT} = A/R = (M/N)e^{j(\theta_1 - \theta_2)} \text{ where } (\theta_1 - \theta_2) \text{ is the phase displayed.}$$

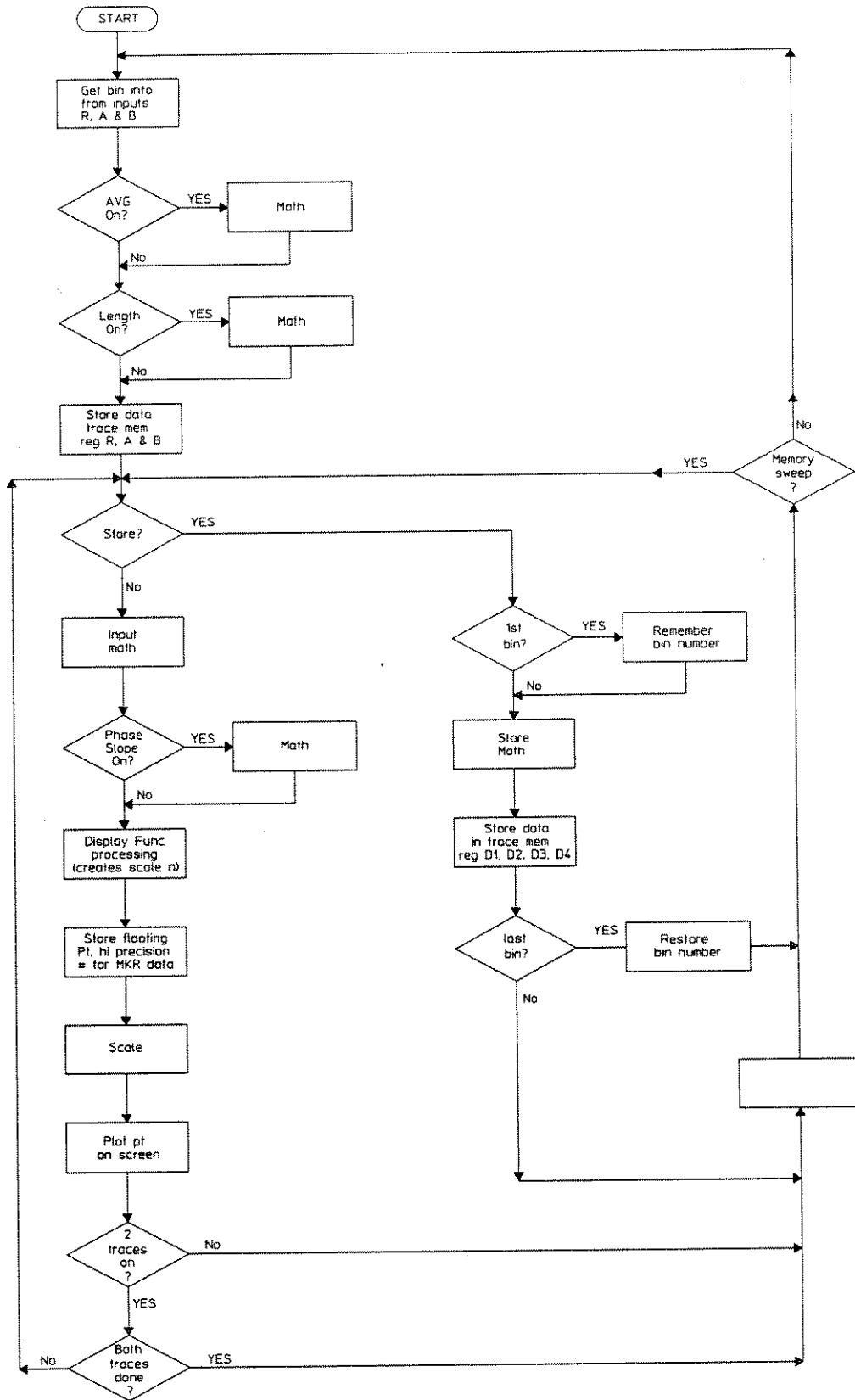

Figure A-1

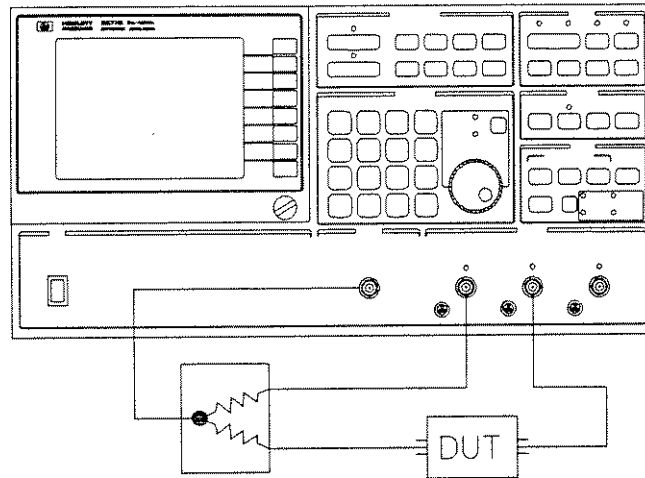

Figure A-2

Optimizing Sweep Time

The HP 3577B Network Analyzer has 4 selections for bandwidth: 1kHz, 100Hz, 10Hz, and 1 Hz. While each reduction in bandwidth lowers the noise floor, it also results in an increase in the pre-sweep settling time (done automatically) and may require selection of a longer [**SWEEP TIME**]. This discussion is to help the user find the optimum sweep time for a given resolution bandwidth.

Settling time is the time that the source holds at the start frequency before beginning the sweep. This is done to allow the source amplitude and filters time to stabilize before starting the measurement. While the HP 3577B is settling the SETTLE LED is illuminated. The settling time is 22 ms for a 1 kHz bandwidth and progressively longer for narrower bandwidths (see Resolution Bandwidth in the Reference chapter). Settling time changes automatically unless the user chooses to turn it off using the [**SPCL FCTN**] key.

There is no rigorous method for selecting [**SWEEP TIME**], given a certain [**RES BW**]; the response time of the device under test helps dictate the fastest sweep time. The filters of the HP 3577B have a finite response time as does the circuit being tested. If the [**SWEEP TIME**] is too short there is not enough time to allow both to respond fully to each sampled frequency. When the sweep direction is up (i.e., increasing frequency, the default condition) this phenomena is evident as a skewing of the trace to the right.

The goal is to make an accurate measurement with as short a [**SWEEP TIME**] as possible. There are several ways to decide whether or not the sweep time is too fast:

1. Increment (increase) the [**SWEEP TIME**] and look for a change in the trace shape. If there is, then the previous [**SWEEP TIME**] was too small. Continue incrementing until no change is seen.
2. Reverse the sweep direction when the sweep dot is on the steepest part of the response. If the [**SWEEP TIME**] is too fast the trace skews to the left (or right, depending on sweep direction) and the dot does not retrace its path. Increase [**SWEEP TIME**] and try again.
3. Let the HP 3577B sweep once and then select [**SWEEP MODE**] and [**MANUAL**]. Move the marker to the steepest part of the response and press [**MKR → MANUAL**]. If the marker is not on the trace the sweep time is too fast.

Remote Graphics Appendix B

To enter display graphics under remote control, display commands must be issued to the Digital Display Module using the ENA HP 3577B HP-IB code as described in this quick reference.

Digital Display Quick Reference Guide

Digital Display Commands

NOTE

Bit D15 is used only for vector memory board commands. For standard Digital Display commands D15 should be 0.

Digital Display 16 Bit Data Word.

MSB	D14	D13	D12	D11	D10	D9	D8	D7	D6	D5	D4	D3	D2	D1	LSB
	COMMAND		COMMAND MODIFIERS												

	Bit 14	Bit 13
Set Condition	1	1
Plot Command	0	0
Graph Command	0	1
Text Command	1	0

Set Condition Command

Set Condition Command:

MSB	D14	D13	D12	D11	D10	D9	D8	D7	D6	D5	D4	D3	D2	D1	LSB
															DO
	1	1	I ₁	I ₀	X	X	L ₁	L ₀	0	X	W ₁	W ₀	X	X	X

Note: Bit 6 (D6) must be zero.

Command Modifiers:

a. To Set Line Intensity:

I ₁	I ₀	Intensity
0	0	Blank
0	1	Dim
1	0	Half Brightness
1	1	Full Brightness

b. To Set Line Type:

L ₁	L ₀	Type
0	0	Solid Line
0	1	Intensified End Points on Solid Line
1	0	Long Dashes
1	1	Short Dashes

c. To Set Writing Speed:

W ₁	W ₀	Speed
1	1	0.05in. per μ s
1	0	0.10 in. per μ s
0	1	0.15 in. per μ s
0	0	0.20 in. per μ s

Plot Command

Plot Command:

MSB D14	D13	D12	D11	D10	D9	D8	D7	D6	D5	D4	D3	D2	D1	LSB D0
0	0	XY	PC	D10	D9	D8	D7	D6	D5	D4	D3	D2	D1	D0
				DATA										

Command Modifiers:

- XY Information (D12)
 - 0 = X coordinate (0-2047), specified by D0-D10
 - 1 = Y coordinate (0-2047), specified by D0-D10
- PC Beam Control Information (D11)
 - 0 = Beam OFF (move)
 - 1 = Beam ON (draw)

Programming Command Ranges

Programming Command Ranges		
Digital Display Command	Octal Range	Hexidecimal Range
a. Plot		
X	00000-07777	0000-0FFF
Y (beam off)	10000-13777	1000-17FF
Y (beam on)	14000-17777	1800-1FFF
b. Graph		
Set Delta-X	20000-27777	2000-27FF
Y (beam off)	30000-33777	3000-37FF
Y (beam on)	34000-37777	3800-3FFF
c. Text		
	40000-57777	4000-5FFF
d. Set Condition		
	60000-77777	6000-7FFF

Graph Command

Graph Command:

MSB D14	D13	D12	D11	D10	D9	D8	D7	D6	D5	D4	D3	D2	D1	LSB D0
0	1	XY	PC	D10	D9	D8	D7	D6	D5	D4	D3	D2	D1	D0

DATA

Command Modifiers:

- a. XY Information (D12)
 - 0 = Set Delta-X increment, specified by D0-D10 for all subsequent Y coordinates
 - 1 = Set Y coordinate, specified by D0-D10. The beam is to be moved to this Y in conjunction with the Delta X increment.
- b. PC Beam Control Information (D11)
 - 0 = Beam OFF (move)
 - 1 = Beam ON (draw)

Memory Board Commands

Vector Memory Word

M15	M14	M13	M12	M11	M10	M9	M8	M7	M6	M5	M4	M3	M2	M1	M0
0	B14	B13	B12	B11	B10	B9	B8	B7	B6	B5	B4	B3	B2	B1	B0

(SEE DATA BIT DEFINITIONS FOR DIGITAL DISPLAY COMMANDS)

Internal Jump

An internal jump does not affect the Vector Memory address pointer.

M15	M14	M13	M12	M11	M10	M9	M8	M7	M6	M5	M4	M3	M2	M1	M0
1	0	X	X	A11	A10	A9	A8	A7	A6	A5	A4	A3	A2	A1	A0

X = DON'T CARE

M15 = 1, M14 = 0; Internal jump to Vector Memory address specified by A11 thru A0 during refresh.

Address Pointer

M15	M14	M13	M12	M11	M10	M9	M8	M7	M6	M5	M4	M3	M2	M1	M0
X	X	X	X	A11	A10	A9	A8	A7	A6	A5	A4	A3	A2	A1	A0

X = DON'T CARE

A0 = 0; Set pointer register to the Vector Memory address value specified by A11 thru A0..

Digital Display Modified ASCII Character Set

DIGITAL DISPLAY MODIFIED ASCII CODE CONVERSION TABLE								
	MOST SIGNIFICANT CHARACTER							
	0	1	2	3	4	5	6	7
0		center *	SP	0	@	P	'	p
1	HP logo*	centered o*	!	1	A	Q	a	q
2	β	\uparrow	"	2	B	R	b	r
3		\leftarrow	#	3	C	S	c	s
4	upper-half tic*	\downarrow	\$	4	D	T	d	t
5	lower-half tic*	\rightarrow	%	5	E	U	e	u
6	left-half tic*	\surd	&	6	F	V	f	v
7	right-half tic*	π	'	7	G	W	g	w
8	back space	Δ	(8	H	X	h	x
9	1/2 shift down	μ)	9	I	Y	i	y
A	line feed	$^{\circ}$ (degree)	*	:	J	Z	j	z
B	inv. line feed	Ω	+	:	K	[k	{
C	1/2 shift up	ρ	,	<	L	\	l	
D	carriage return	Γ	-	=	M]	m	}
E	horizontal tic*	θ	.	>	N	^	n	\square
F	vertical tic*	λ	/	?	O	—	o	\triangleright

<u>EXAMPLES:</u>	
HP logo	= 01
A	= 41
i	= 69
\surd	= 16
\triangleright	= 7F
line feed	= 09

* Non - advancing characters.

Capabilities for Character and Vector Combinations

Conditions				
Average character drawing time: 16 sec				
Recommended refresh rate: 60 Hz ~ 16.6 msec				
Digital Display writing speed: 0.1 in/sec				
Vector dead time: 1 sec				
	NUMBER OF CHARACTERS TO BE DRAWN			
	0	100	200	300
Total frame time (msec)	16.67	16.67	16.67	16.67
Character writing time (msec)	0	1.6	3.2	4.80
Time left to draw vectors(msec)	16.67	15.07	13.47	11.87
AVERAGE VECTOR LENGTH	APPROXIMATE NUMBER OF VECTORS DRAWN			
0.1 in	8330	7530	6730	5930
0.5 in	2770	2510	2240	1970
2.0 in.	790	710	640	560
6.0 in.	270	240	220	190

Text Command

Text Command:

MSB														LSB
D14	D13	D12	D11	D10	D9	D8	D7	D6	D5	D4	D3	D2	D1	D0
1	0	S1	S0	R1	R0	ES	C7	C6	C5	C4	C3	C2	C1	C0

CHARACTER

Command Modifiers:

For C0-C7, see ASCII Conversion Table

- a. ES Establish Size of Character

0 = Use previous size and rotation

1 = Establish new size and rotation according to S1, S0, R1 and R0

- b. Rotate Character counter-clockwise

R1	R0	Rotation
0	0	0 degrees
0	1	90 degrees
1	0	180 degrees
1	1	270 degrees

- c. Character Size

S1	S0	Size	W × H (in addressable points)
0	0	1×	24 × 36
0	1	1.5×	36 × 54
1	0	2×	48 × 72
1	1	2.5×	60 × 90

4 PROGRAMMABLE CHARACTER SIZES:

- 1.0 × 56 characters per line, 29 horizontal lines possible.
- 1.5 × 37 characters per line, 19 horizontal lines possible.
- 2.0 × 28 characters per line, 14 horizontal lines possible.
- 2.5 × 22 characters per line, 11 horizontal lines possible.

Character Rotation

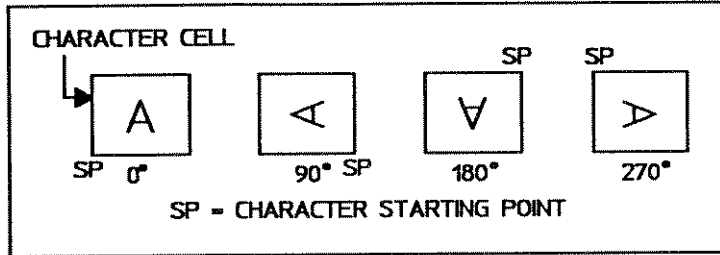

Screen Messages Appendix

The HP 3577B Network Analyzer displays operator messages to inform the user of various conditions. These fall into three categories: instructions or informative messages, warning messages, and error messages. Under remote control, the user may select the message category level that pulls SRQ and appears in the DUMP STATUS command as defined by the error reporting mode selected. Refer to "Masking the Status Byte" in the section on Remote Operation. In the following table W is used for warning, E is for error, and M for general information messages.

MESSAGE	W - Warning E - Error	DESCRIPTION
1 MHz FAILURE	E	Hardware failure.
1345A JUMP CMND DISALLOWED	E	HP-IB. Use of the HP 1345A display module command is illegal when entering graphics.
1 MHz & 8 kHz FAILURE	E	Hardware failure.
8 kHz FAILURE	E	Hardware failure.
ABORT CAL SOFTKEY ONLY	W	During MEASR CAL Sweeps and CAL processing, the only key to which the HP 3577B responds (besides INSTR PRESET) is ABORT CAL.
AMPLITUDE SWEEP TIMEOUT	E	Amplitude sweep operate in the CONTINUOUS SWEEP MODE for five minutes before changing to SINGLE, to prevent excessive wear on the output relays. See AMPLITUDE SWEEP TYPE.
AVG TURNED OFF IN ALT SWP	W	If AVERAGE is on and ALTERNATE SWEEP TYPE is selected, this message appears. It is not possible to use averaging with ALTERNATE SWEEP.
COMPUTING LIMITS	M	The Limit Table is being converted into a format that allows fast limit evaluation.
CONFIDENCE TEST FAILED	E	One or more of the confidence tests do not pass. Hardware failure.
CONFIDENCE TEST PASSED	M	All confidence tests passed.
CONT CAL NOT ALLOWED	E	HP-IB. Continue CAL not allowed unless in the MEASR CAL sequence,
COPY NEEDS "FROM" TRC ON	E	Both traces should be on to COPY SCALE. This message appeared because one is inactive.
DATA ERROR #_	E	HP-IB. User-entered data may cause data errors when, involved in trace arithmetic. This message may also indicate a hardware failure.

Screen Messages Appendix

MESSAGE	W - Warning E - Error	DESCRIPTION
DATA INPUT ABORTED	E	HP-IB. Data transfer to the HP 3577B has stopped.
DATA OUTPUT ABORTED	E	HP-IB. Data transfer from the HP 3577B has stopped.
DELAY APERTURE INCREASED	W	Delay aperture is increased automatically when necessary as the sweep resolution is decreased. This message appears when the display function is delay, aperture is small, and the user selects a reduced sweep resolution.
DISPLAY MEMORY TEST FAILED	E	Hardware failure.
DISPLAY MEMORY TEST PASSED	E	For more details refer to the Service Manual.
ENTRY SET TO 0.0	W	An extremely small number has been rounded to zero.
ENTRY TOO LONG	E	Data entered has too many characters. Limit is 17.
ENTRY UNDEFINED	E	Keys in the numeric key pad have been pressed when no data entry softkey is active in the menu.
EOI BEFORE INPUT COMPLETE	E	HP-IB. End Or Identify asserted (indicating end of data) when more data was expected.
EXPECTED "#I"	E	HP-IB. In the binary format, data to be loaded should be preceded by the characters #I.
FP CANNOT ACCESS TRACE MEM	E	Hardware failure.
FP CNTR/RCVR FAILURE	E	Hardware failure of either the Fast Processor counter or a receiver input channel.
FP LOGIC FAILURE	E	Fast Processor hardware failure.
FAST PROC NOT GRANTING BUS	E	Hardware failure.
FP SELF TEST PASSED	E	For more details, see the Service Manual.
FP-MP COMMUNICATION ERROR	E	Hardware failure.
FRONT PANEL DECODING ERROR	E	Hardware failure.
FRONT PANEL KEY STUCK	E	One of the front panel keys has been depressed for ten seconds or more or is stuck.
GRAT REQUIRES FULL SCALE = 1	M	The Smith Chart graticule should be used with a FULL SCALE value of 1.0 units. If FULL SCALE is not 1.0, this message appears as a warning that the graticule is not accurate. (The marker information block will continue to be accurate.)
IBasic NOT INSTALLED	W	Option 1C2 (HP Instrument BASIC) is required.
ILLEGAL "#" RECEIVED	E	HP-IB. # is a special character and may only be used for its intended function.
ILLEGAL SYMBOL	E	User defined math equation entry that is not a legal symbol.
INCOMPATIBLE DISPLAY FCTNS	E	Attempt to COPY SCALE between traces when display functions' units are incompatible.

MESSAGE	W - Warning E - Error	DESCRIPTION
INCOMPATIBLE FAST PROC	E	Fast processor ROM revision is incompatible with main processor ROMs.
INCOMP. TESTSET POSITIONS Trc_ chgd to agree with #_	W	Incompatible S-parameter test set positions, trace changed to agree with trace number (2 or 1)" (i.e. the HP 35677A/B can't be configured forward and reverse at the same time so the INPUT of the other trace has been changed).
INP MUST BE A,B,R,A/R,B/R	E	For NORMALIZATION, the INPUT must be defined as one of these RECEIVER input expressions.
INP SHOULD BE USER-DEFINED	E	HP-IB. Set INPUT to be USER DEF before attempting to directly change the configuration of the S- parameter test set over the bus.
INPUT(S) __ TRIPPED	E	One or more of the RECEIVER channels has switched to 1 MΩ impedance. (The message indicates which receiver inputs have tripped). This message is accompanied by a message to "Clear trip on ATTEN menu."
INVALID EXPRESSION	E	User defined equation not valid such as A/R. More common for HP-IB than front panel entries.
INVALID HPIB COMMAND	E	HP-IB. Code sent to HP 3577B not a valid HP 3577B HP-IB Code.
INVALID LEARN MODE DATA	E	HP-IB. The checksum of the instrument state just loaded is incorrect, possibly because the attempted to modify instrument state data outside the HP 3577B.
INVALID START ADDRESS	E	HP-IB. Start address for ENG must be an integer between 0 and 923.
INVALID SUFFIX	E	HP-IB. Code sent to HP 3577B for a data entry suffix is not appropriate for prefix parameter or instrument state.
KEY BUFFER FULL	W	The front panel key buffer can hold 6 key presses for processing.
KEY NOT APPLICABLE	E	When in MANUAL sweep mode and ALTERNATE sweep type with trace one active (and trace two is not off) this error message appears if MKR → MAN FREQ is used. This is permitted only for trace two in this situation.
KEY NOT IN MENU	E	HP-IB. Command issued over the bus is not allowed; if the label does not appear in the menu during local operation, it cannot be used over the bus (e.g., "Smith chart" in a rectangular display function).
MARKER FREQ ADDED TO TABLE	M	The current marker frequency has been added to the Discrete Sweep Table.
MARKER OFFSET IS OFF	E	Cannot use MKR OFST → SPAN if the OFFSET MARKER is OFF.
MARKER __ IS OFF	E	Request to plot one of the markers or execute a MKR → operation but the marker is not on.

Screen Messages Appendix

MESSAGE	W - Warning E - Error	DESCRIPTION
MEM FAIL--SAVED STATES LOST	E	A memory hardware failure has occurred and the instruments states which had been saved have been lost.
MP/FP PORT TEST FAILED	E	The test run on the port between the Main Processor and the Fast Processor has failed. Hardware failure.
MP/FP PORT TEST PASSED	E	For more details see the Service Manual.
NO CHARACTERS TO PLOT	E	HP-IB. Request to plot characters that have been turned off.
NO COMMA IN TRACE ARITH	E	HP-IB. Comma not allowed in trace arithmetic.
NO GRATICULE TO PLOT	E	HP-IB. Request to plot a graticule that has been turned off.
NO INPUTS ARE TRIPPED	W	Results from pressing CLEAR TRIP in the ATTEN menu when no inputs were tripped.
NO KEYBOARD ATTACHED	E	Hardware failure.
NO LISTENER ON BUS	E	User has requested data dump (such as PLOT ALL) and there is no listener on the bus.
NO RESPONSE FROM FP	E	Fast Processor didn't respond to self test. Hardware failure.
NO STORE & DISP IN POLAR	E	Illegal in polar display function.
NON-NUMERIC DATA RECEIVED	E	HP-IB. Data loaded was supposed to be ASCII number characters.
NOT ALLOWED IN ALT SWP	E	Functions not allowed when SWEEP TYPE is ALTERNATE are STORE, STORE & DISPLAY, and all CALIBRATION.
NOT ALLOWED IN LOG SWP	E	HP-IB. Display function DELAY is not allowed in LOG SWEEP.
NOT ENOUGHY ROWS IN TABLE	E	The Discrete Sweep Table must have at least two rows when Discrete Sweep is selected. From HP-IB
NOTHING TO PLOT	E	HP-IB. Request to plot after all screen features have been turned off.
NUMBER OUT OF RANGE	E	Data entry of a value beyond the capabilities of the HP 3577B such as SOURCE AMPLITUDE of 100 dBm.
ONLY SMALLER FCNTS ALLOWED	E	When entering user defined functions, other functions may be used as terms in the new function as long as their function number is smaller.
OSCILLATOR UNLOCKED	E	Hardware failure.
OUT OF MEMORY	E	No free RAM available.
OVERLOAD ON INPUT(S)_	E	One or more inputs are being overdriven by a large signal input but have not tripped. This warns the user that readings taken may be distorted.

MESSAGE	W - Warning E - Error	DESCRIPTION
RECALL FAILED-STATE IS BAD	E	The Instrument State the user tried to recall is bad so the recall failed. To clear the bad state, SAVE another state in the register. If this does not clear the problem cycle power while holding down SAVE and RECALL. This runs a special memory-clearing test that resets instrument state memory locations. See "In Case of Trouble" under Operating Hints in the Getting Started section.
RECEIVER B NOT INSTALLED	W	Option 002 required.
REFERENCE UNLOCKED	E	The internal VCXO is not locked to the external reference input, possibly due to a difference in frequency exceeding 20 ppm. This message appears briefly during warm-up when the oven reference switches on after reaching operating temperature (~ 10 minutes from power-on).
REFLECTION MEAS REQUIRED	W	Standing Wave Ratio (SWR) display function is only valid for reflection measurements.
SELECTED TRACE IS OFF	E	Can't perform the requested Operation because the trace is OFF (as with scale parameter changes).
SET HP-IB SYS CTLR ON	E	The HP 3577B must be active or the system controller for the requested operation. See [LCL] key.
SOURCE NOT TRIPPED	W	Results from pressing SOURCE CLEAR TRIP when the SOURCE wasn't tripped.
SOURCE TRIPPED	E	The Source Output is open (no power out). This is accompanied by a message to "Clear trip on AMPTD menu."
STOP MUST BE $\geq 1.05 \cdot \text{START}$	M	In log sweep the stop frequency must be greater than or equal to 1.05 X the start frequency.
STORED DATA D1-D4 LOST	E	Stored trace data in registers D1-D4 has been lost.
SWEEP MODE MUST BE MANUAL	E	HP-IB. User sent MKR \rightarrow MANUAL over the bus without first setting SWEEP MODE to MANUAL.
SWEEP RATE UNCALIBRATED	M	Selection of span and sweep time have resulted in a very slow sweep rate. Due to limited resolution of the frequency synthesis circuitry
SWEEP RESOLUTN TOO COARSE	E	DELAY APERTURE is limited by the selection of SWEEP RESOLUTION (in the FREQ menu). Coarse sweep resolution prohibits the use of small delay apertures. This message appears when the user tries to select a smaller aperture.
SWEEP SPAN LIMITED	M	This message appears when a center frequency and frequency span are selected such that the equivalent start or stop frequencies would be less than 0 Hz or greater than 200 MHz.
SWEEP TIME INCREASED	W	The sweep time has been increased automatically to allow enough time to do the required math processing.
SWEEP TIMING ERROR	E	Hardware failure.

Screen Messages Appendix

MESSAGE	W - Warning E - Error	DESCRIPTION
SYSTEM ERROR #__	E	Hardware failure.
TABLE FULL	E	Discrete Sweep or Limit table is full.
TARGET VALUE NOT FOUND	W	A marker search did not find a the target value.
TEST SET RELAY TIMEOUT	E	Same timeout as described for AMPLITUDE SWEEP. See S-PARAMETER TEST SET.
TEXT STRING TOO LONG	E	HP-IB. Text string for ENA or ENM is too long.
TIMER INTERRUPT FAILURE	E	Hardware failure.
TOO MANY GRAPHICS COMMANDS	E	HP-IB. Enter Graphics code too long. Memory is limited to 924 16-bit commands.
TRACE_ HAS BEEN TURNED OFF or TRC 1, 2, ARE NOW TURNED OFF	W	One or both traces were group delay and the user selected a sweep type that does not allow group delay. This message is accompanied by a message saying "NO DELAY IN LOG"
TRACE MEMORY TEST FAILED	E	Hardware failure.
TRACE MEMORY TEST PASSED	E	For more details refer to the Service Manual.
UNEXPECTED TEXT STRING	E	HP-IB. Received text in quotes with no prior command (such as enter annotation).
UNMATCHED "(" AND ")"	E	The user defined math equation is in error. There must be as many opening as closing parenthesis.
UP/DOWN OR KNOB ONLY	W	Only the arrow keys in the data entry section or the KNOB may be used to move the marker.
WAITING FOR "#"	W	HP-IB. Data load in the binary format is waiting for the starting sequence "#!".
WAITING FOR DATA TRANSFER	W	HP-IB. Waiting for a data-receiving device to handshake.
WAITING FOR INPUT DATA	W	HP-IB. Load ready and waiting for input data.
WARNING: TRACE IS OFF	W	This message appears when an operation is performed with the active trace OFF
XUNITS: dBm (DISREGARD Hz)	M	When editing a Limit Table while amplitude sweep is selected

HP 3577B Programming Codes, Functional Index

DISPLAY FORMAT

Function	HP-IB
TRACE 1	TR1
TRACE 2	TR2
DISPLAY FUNCTION	DSF *
SWR	DF8
Log Magnitude	DF7
Linear Magnitude	DF6
Phase	DF5
Polar	DF4
Real	DF3
Imaginary	DF2
Delay	DF1
Trace Off	DF0
Delay Aperture menu	DAP *
Aperture 5% of span	AP1
Aperture 1% of span	AP2
Aperture 2% of span	AP3
Aperture 4% of span	AP4
Aperture 8% of span	AP5
Aperture 16% of span	AP6
Return	RET *
INPUT	INP *
Input = R	INR
Input = A	INA
Input = B	INB
Input = A/R	IAR
Input = B/R	IBR
Input = D1	ID1
Input = D2	ID2
Input = D3	ID3
Input = D4	ID4
Input = X1	IX1
Input = X2	IX2
Input = X3	IX3

Function	HP-IB
Input = X4	IX4
Input = X5	IX5
Input = X6	IX6
Input = X7	IX7
Input = X8	IX8
Return	RET *
User Defined Input	UDI
Input = S11	I11
Input = S21	I21
Input = S12	I12
Input = S22	I22
Copy Input	CPI
Test Set Forward	TSF
Test Set Reverse	TSR
SCALE	SCL *
Autoscale	ASL
Reference Level (entry)	REF
Scale/DIV (entry)	DIV
Reference Position (entry)	RPS
Reference Line Off	RL0
Reference Line On	RL1
Copy Scale	CPS
Phase Slope (entry)	PSL
Phase Slope Off	PS0
Phase Slope On	PS1
Polar Full Scale (entry)	PFS
Polar Phase Ref (entry)	PPR
Smith Chart Off	GT0
Smith Chart On	GT1
MARKER	MKR *
Marker Position (entry)	MKP
Marker Off	MR0
Marker On	MR1

*Use not required The only function of this code is to display a menu (if bus diagnostics are on).

DISPLAY FORMAT Continued

Function	HP-IB
Zero Marker	ZMK
Marker Offset Off	MO0
Marker Offset On	MO1
Marker Offset (entry)	MKO
Marker Offset Freq (entry)	MOF
Marker Offset Amp (entry)	MOA
Marker Coupling Off	CO0
Marker Coupling On	CO1
Polar Mag Offset (entry)	PMO
Polar Phase Offset (entry)	PPO
Polar Real Offset (entry)	PRO
Polar Imag Offset (entry)	PIO
Polar Marker Units (Re/Im)	MRI
Polar Marker Units (Mg/Ph)	MMP
LIMIT	
Limit Line Display Off	LL0
Limit Line Display On	LL1
Limit Test Evaluation Off	LE0
Limit Test Evaluation On	LE1
Beep On Limit Failure Off	LS0
Beep On Limit Failure On	LS1
Clear Limit Table	LMC
Define X-Start for Next Row (entry)	LBX
Define Y-Start for Next Row (entry)	LBY
Define X-Stop for Next Row (entry)	LEX
Define Y-Store for Next Row (entry)	LEY
Select Upper for Next Row	LUP
Select Lower for Next Row	LDN
Insert or Add a Row	LMA
Display Limit Editing Menu	LTD
Display Limit Configuration Menu	LTC
MARKER →	MKG *
MKR→ Reference Level	MTR
MKR→ Start Frequency	MTA
MKR→ Stop Frequency	MTB
MKR→ Center Frequency	MTC
MKR Offset→ Span	MOS
MKR→ Max	MTX
MKR→ Min	MTN
MORE menu	MSM *
MKR Target Value (entry)	MTV

Function	HP-IB
MKR → Right for Target	MRT
MKR → Left for Target	MLT
Return	RET *
MKR → Full Scale	MTP
MKR → Polar Phase Ref	MPF
MKR → Discrete	MKD
STORE DATA	STO*
Store in register X1	SX1
Store in register X2	SX2
Store in register X3	SX3
Store in register X4	SX4
Store in register X5	SX5
Store in register X6	SX6
Store in register X7	SX7
Store in register X8	SX8
Store in register D1	SD1
Store in register D2	SD2
Store in register D3	SD3
Store in register D4	SD4
Store and Display	STD
More storage registers	STX*
User defined store	UDS
Store to X1	TX1
Store to X2	TX2
Store to X3	TX3
Store to X4	TX4
Store to X5	TX5
Store to X6	TX6
Store to X7	TX7
Store to X8	TX8
Store to D1	TD1
Store to D2	TD2
Store to D3	TD3
Store to D4	TD4
MEASUREMENT CALIBRATION	CAL *
Normalize	NRM
Normalize (Short)	NRS
Calibrate, Partial	CPR
Calibrate, Full	CFL
Continue Calibration	CGO
DEFINE MATH	DFN *

*Use not required The only function of this code is to display a menu (if bus diagnostics are on).

DISPLAY FORMAT Continued

Function	HP-IB
Constant K1, Real (entry)	KR1
Constant K1, Imaginary (entry)	KI1
Constant K2, Real (entry)	KR2
Constant K2, Imaginary (entry)	KI2
Constant K3, Real (entry)	KR3
Constant K3, Imaginary (entry)	KI3
Constant K4, Real (entry)	KR4
Constant K4, Imaginary (entry)	KI4
Constant K5, Real (entry)	KR5
Constant K5, Imaginary (entry)	KI5
Constant K6, Real (entry)	KR6
Constant K6, Imaginary (entry)	KI6
Constant K7, Real (entry)	KR7
Constant K7, Imaginary (entry)	KI7
Define Function	DFC *
Function F1	UF1
Function F2	UF2
Function F3	UF3
Function F4	UF4
Function F5	UF5
Math term for input R	R
Math term for input A	A
Math term for input B	B
Math term for storage reg	D
Math term for constant	K
Math term for function	F
Math term for jOmega	W
Math term for storage reg X	X
Math bracket	(
Math function plus	+
Math function minus	--
Math function multiply	*
Math function divide	/
Math bracket)
Return	RET*
DATA ENTRY SECTION COMMANDS	
Increment (up arrow)	IUP
Decrement (down arrow)	IDN
Continuous Entry (knob) Off	CE0
Continuous Entry (knob) On	CE1
Entry Off	HLD

Function	HP-IB
DISPLAY FORMAT SUFFIX UNITS	
dBm	DBM
dBV (rms)	DBV
dB relative	DBR
Volt (rms)	V
milli-Volt (rms)	MV
micro-Volt (rms)	UV
nano-Volt (rms)	NV
degrees	DEG
degrees/span	DSP
radians	RAD
radians/span	RSP
seconds	SEC
milliseconds	MSC
microseconds	USC
nanoseconds	NSC
percent	%
degrees/span	DSP
radians/span	RAP
MHz	MHZ
kHz	KHZ
Hz	HZ
exponent	E
units	;or <cr> <lf>

*Use not required The only function of this code is to display a menu (if bus diagnostics are on).

SOURCE

Function	HB-IB
SWEEP TYPE	STY *
Linear Sweep	ST1
Alternate Sweep	ST2
Log Sweep	ST3
Amplitude Sweep	ST4
CW	ST5
Discrete Sweep	ST6
Sweep Direction Up	SUP
Sweep Direction Down	SDN
Discrete Sweep Commands	
Clear Discrete Sweep Table	DTC
Define Frequency for next row (entry)	DTF
Select 1 Hz Res BW for next row	DB1
Select 10 Hz Res Bw for next row	DB2
Select 100 Hz Res BW for next row	DB3
Select 1 kHz Res BW for next row	DB4
Define Settling Time for next row (entry)	DTS
Lin Swp → Discr Swp Table, 11 points	DL1
Lin Swp → Discr Swp Table, 21 points	DL2
Lin Swp → Discr Swp Table, 31 points	DL3
Lin Swp → Discr Swp Table, 41 points	DL4
Lin Swp → Discr Swp Table, 51 points	DL5
Insert (Add) row to Discr Swp Table	DTA
MKR → Discrete	MKD
SWEEP MODE	SMD*
Continuous	SM1
Single Sweep	SM2
Manual Sweep	SM3
Manual Frequency (entry)	MFR
Manual Amplitude (entry)	MAM
Marker → Manual	MTM
SWEEP TIME	STM*
Sweep Time (entry)	SWT
Step Time (entry)	SMT
Sample Time (entry)	MSR
FREQUENCY	FRQ*
Source Frequency (entry)	SFR
Start Frequency (entry)	FRA
Stop Frequency (entry)	FRB
Center Frequency (entry)	FRC
Frequency Span (entry)	FRS

Function	HB-IB
FRC Step size (entry)	CFS
Sweep Resolution menu	SRL *
Freq Swp Res 51 pts/span	RS1
Freq Swp Res 101 pts/span	RS2
Freq Swp Res 201 pts/span	RS3
Freq Swp Res 401 pts/span	RS4
Return	RET*
Full Sweep	FSW
Freq Step Size (entry)	FST
AMPLITUDE	AMP *
Source Amplitude (entry)	SAM
Amp Step Size (entry)	AST
Clear Trip, Source	CTS
Start Amplitude (entry)	AMA
Stop Amplitude (entry)	AMB
Steps/Sweep menu	NST *
Number of steps = 6	NS1
Number of steps = 11	NS2
Number of steps = 21	NS3
Number of steps = 51	NS4
Number of steps = 101	NS5
Number of steps = 201	NS6
Number of steps = 401	NS7
Return	RET *
Full Sweep	FSW
TRIGGER MODE	TRM *
Free Run	TG1
Line Trigger	TG2
External Trigger	TG3
Immediate	TG4
SWEEP TRIGGER	TRG
SWEEP RESET	RST
SOURCE SUFFIX UNITS	
dBm	DBM
dBV (rms)	DBV
Volt (rms)	V
milli-Volt (rms)	MV
micro-Volt (rms)	UV
nano-Volt (rms)	NV
seconds	SEC
milliseconds	MSC

*Use not required The only function of this code is to display a menu (if bus diagnostics are on).

Function	HB-IB
MHz	MHZ
kHz	KHZ
Hz	HZ
exponent	E
units	; or <cr> <lf>

*Use not required The only function of this code is to display a menu (if bus diagnostics are on).

RECEIVER

Function	HP-IB
RESOLUTION BW	RBW *
Resolution BW 1 Hz	RW1
Resolution BW 10 Hz	RW2
Resolution BW 100 Hz	RW3
Resolution BW 1 kHz	BW4
Auto Bandwidth Off	AU0
Auto Bandwidth On	AU1
AVERAGE	AVE *
Averaging Off	AV0
N = 4	AV1
N = 8	AV2
N = 16	AV3
N = 32	AV4
N = 64	AV5
N = 128	AV6
N = 256	AV7
ATTENUATION	ATT *
Attenuation R = 0 dB	AR1
Attenuation R = 20 dB	AR2
Attenuation A = 0 dB	AA1
Attenuation A = 20 dB	AA2
Attenuation B = 0 dB	AB1
Attenuation B = 20 dB	AB2
Impedance R = 50	IR1
Impedance R = 1 M	IR2
Impedance A = 50 Ω	IA1
Impedance A = 1 MΩ	IA2
Impedance B = 50 Ω	IB1
Impedance B = 1 MΩ	IB2
Clear Trip, Receiver	CTR
LENGTH	LEN *
Length R (entry)	LNR
Length R Off	LR0
Length R On	LR1
Length A (entry)	LNA
Length A Off	LA0
Length A On	LA1
Length B (entry)	LNB
Length B Off	LB0
Length B On	LB1
Length Step Size (entry)	LNS

Function	HP-IB
RECEIVER SUFFIX UNITS	
meters	MET
centimeters	CM
seconds	SEC
milliseconds	MSC
microseconds	USC
nanoseconds	NSC
exponent	E
units	; or <cr><lf>

*Use not required The only function of this code is to display a menu (if bus diagnostics are on).

SYSTEM

Function	HP-IB
SPECIAL FUNCTIONS	SPC *
Confid. (self) test menu	SLF *
Self test channel R	STR
Self test channel A	STA
Self test channel B	STB
Return	RET*
Beeper off	BP0
Beeper on	BP1
Graticule off	GR0
Graticule on	GR1
Service Diagnostics menu	SDG *
Source Leveling off	SL0
Source Leveling on	SL1
Settling Time off	SE0
Settling time on	SE1
Synthesizer Diag off	SY0
Synthesizer Diag on	SY1
Display Test Pattern	DTP
Trace Memory Test	TMT
Fast Processor Test	FPT
Fast Bus Interface Test	PRT
More Serv Diag menu	MOR *
Display Memory Test	DST
Software Revision message	SRV
Return	RET *
S-Parameters Off	SP0
S-Parameters On	SP1
SAVE INSTRUMENT STATE	SAV *
Save state in register 1	SV1
Save state in register 2	SV2
Save state in register 3	SV3
Save state in register 4	SV4
Save state in register 5	SV5
RECALL INSTRUMENT STATE	RCL *
Recall old (last) state	RLS
Recall register 1	RC1
Recall register 2	RC2
Recall register 3	RC3
Recall register 4	RC4
Recall register 5	RC5
INSTRUMENT PRESET	IPR

Function	HP-IB
PLOT MENU	PLM*
Plot all	PLA
Plot trace 1	PL1
Plot trace 2	PL2
Plot graticule	PLG
Plot characters	PLC
Plot trace 1 marker	PM1
Plot trace 2 marker	PM2
Configure Plot menu	CPT *
Trace 1 linetype (entry)	T1L
Trace 2 linetype (entry)	T2L
Trace 1 pen number (entry)	T1P
Trace 2 pen number (entry)	T2P
Graticule pen no. (entry)	PGP
Pen speed fast (max)	PNM
Pen speed slow	PNS
Set plot config to default	PLD
Plotter address (entry)	HBP
Return	RET*

*Use not required The only function of this code is to display a menu (if bus diagnostics are on).

HP-IB ONLY COMMANDS

Function	HP-IB
Settling Time Entry	STE
Dump register A	DRA
Dump register B	DRB
Dump register R	DRR
Dump register D1	DD1
Dump register D2	DD2
Dump register D3	DD3
Dump register D4	DD4
Dump register X1	DX1
Dump register X2	DX2
Dump register X3	DX3
Dump register X4	DX4
Dump register X5	DX5
Dump register X6	DX6
Dump register X7	DX7
Dump register X8	DX8
Dump jOmega, trace 1	DW1
Dump jOmega, trace 2	DW2
Dump trace 1	DT1
Dump trace 2	DT2
Dump marker 1	DM1
Dump marker 2	DM2
Dump marker 1 position	MP1
Dump marker 2 position	MP2
Dump state (learn mode out)	LMO
Dump complete state	DCS
Dump status	DMS
Dump average number	DAN
Dump key or knob	DKY
Dump characters	DCH
Dump Instrument ID	ID?
Dump current time & date	DTI
Channel B query	DMB
HP Inst. BASIC & Channel B query	DOP
Read and Dump I/O Port	DIO
Load register A	LRA
Load register B	LRB
Load register R	LRR
Load register D1	LD1
Load register D2	LD2
Load register D3	LD3

Function	HP-IB
Load register D4	LD4
Load register X1	LX1
Load register X2	LX2
Load register X3	LX3
Load register X4	LX4
Load register X5	LX5
Load register X6	LX6
Load register X7	LX7
Load register X8	LX8
Load state (learn mode in)	LMI
Load complete state	LCS
Load and write to I/O port (entry)	LIO
Set time & date	STI
Characters off	CH0
Characters on	CH1
Annotation off	ANO
Annotation on	AN1
Annotation Clear	ANC
Menu off	MNO
Menu on	MN1
Menu clear	MNC
ASCII data format	FM1
64 bit IEEE data format	FM2
32 bit HP 3577B binary	FM3
Bus diagnostics mode off	BD0
Bus diagnostics on, fast	BD1
Bus diagnostics on, slow	BD2
Enter Menu (user defined)	ENM
Enter Annotation	ENA
Enter Graphics	ENG
Clear Keyboard Buffer	CKB
Take Measurement	TKM
Set SRQ Mask (entry)	SQM
Error Reporting mode 0	ERO
Error Reporting mode 1	ER1
Error Reporting mode 2	ER2
Error Reporting mode 3	ER3
Send SRQ	SRQ

*Use not required The only function of this code is to display a menu (if bus diagnostics are on).

HP 3577B Programming Commands, Alphabetical Index

HP-IB Code	Function
A	Math term for input A
AA1	Attenuation A = 0 dB
AA2	Attenuation A = 20 dB
AB1	Attenuation B = 0 dB
AB2	Attenuation B = 20 dB
AMA	Start Amplitude (entry)
AMB	Stop Amplitude (entry)
AMP	Amplitude1
AN0	Annotation Off
AN1	Annotation On
ANC	Annotation Clear
AP1	Aperature .5% of span
AP2	Aperature 1% of span
AP3	Aperature 2% of span
AP4	Aperature 4% of span
AP5	Aperature 8% of span
AP6	Aperature 16% of span
AR1	Attenuation R = 0 dB
AR2	Attenuation R = 20 dB
ASL	Autoscale
AST	Amp Step Size (entry)
ATT	Attenuation1
AU0	Auto Bandwidth Off
AU1	Auto Bandwidth On
AV0	Averaging Off
AV1	N=4
AV2	N=8
AV3	N=16
AV4	N=32
AV5	N=64
AV6	N=128

HP-IB Code	Function
AV7	N=256
AVE	Average1
B	Math term for input B
BA0	Program Auto Start off ²
BA1	Program Auto Start on ²
BCA	Disc catalog ²
BDO	Bus Diagnostics Mode Off
BD1	Bus Diagnostics On, Fast
BD2	Bus diagnostics On, Slow
BDO	Clear HP Inst. BASIC display ²
BLI	List program ²
BP0	Beeper Off
BP1	Beeper On
BSE	Secure HP Inst. BASIC program ²
BW1	Resolution BW 1 Hz
BW2	Resolution BW 10 Hz
BW3	Resolution BW 100 Hz
BW4	Resolution BW 1 kHz
CAL	Measurement Calibration ¹
CE0	Continuous Entry (knob) Off
CE1	Continuous Entry (knob) On
CFL	Calibrate
CFS	Center Frequency Step Size (entry)
CGO	Continue Calibration
CH0	Characters Off
CH1	Characters On
CKB	Clear Keyboard Buffer
CM	centimeters
CO0	Marker Coupling Off
CO1	Marker Coupling On
CPI	Copy Input

1. Use not required. The only function of this code is to display a menu(if bus diagnostics are on).
2. Option 1C2 (HP Instrument BASIC) command.

HP 3577B Programming Commands,
Alphabetical Index

HP-IB Code	Function
CPR	Calibrate, Partial
CPS	Copy Scale
CPT	Configure Plot Menu ¹
CTR	Clear Trip, Receiver
CTS	Clear Trip, Source
D	Math term for storage reg D
DAN	Dump Average Number
DAP	Delay Aperature Menu ¹
DB1	Select 1 Hz RBW for Next Row
DB2	Select 10 Hz RBW for Next Row
DB3	Select 100 Hz RBW for Next Row
DB4	Select 1 kHz RBW for Next Row
DBM	dBm
DBR	dB relative
DBV	dBV (rms)
DCH	Dump Characters
DCS	Dump Complete State (incl. tables)
DD1	Dump Register D1
DD2	Dump Register D2
DD3	Dump Register D3
DD4	Dump Register D4
DEG	degrees
DF0	Trace Off
DF1	Delay
DF2	Imaginary
DF3	Real
DF4	Polar
DF5	Phase
DF6	Linear Magnitude
DF7	Log Magnitude
DF8	Standing Wave Ratio
DFC	Define Function ¹
DFN	Define Math ¹
DIO	Read and dump 8-bit I/O port
DIV	Scale /DIV (entry)
DKY	Dump Key or Knob
DL1	LIN SWP → DISCRETE, 11 points
DL2	LIN SWP → DISCRETE, 21 points
DL3	LIN SWP → DISCRETE, 31 points
DL4	LIN SWP → DISCRETE, 41 points

HP-IB Code	Function
DL5	LIN SWP → DISCRETE, 51 points
DM1	Dump Marker 1
DM2	Dump Marker 2
DMB	Query Channel B (Option 002)
DMS	Dump Status
DOP	HP Inst. BASIC & Channel B options query
DPR	Dump HP Inst. BASIC program ²
DRA	Dump Register A
DRB	Dump Register B
DRI	Real/Imaginary menu ¹
DRR	Dump Register R
DSF	Display Function ¹
DSP	degrees/span
DST	Display Memory Test
DT1	Dump Trace 1
DT2	Dump Trace 2
DTA	Add Row to Discrete Sweep Table
DTC	Clear Discrete Sweep Table
DTF	Define Frequency for Next Row (entry)
DTI	Dump current time & date
DTP	Display Test Pattern
DTS	Define Settling Time for Next Row (entry)
DW1	Dump Trace 1 jOmega
DW2	Dump Trace 2 jOmega
DX1	Dump Register X1
DX2	Dump Register X2
DX3	Dump Register X3
DX4	Dump Register X4
DX5	Dump Register X5
DX6	Dump Register X6
DX7	Dump Register X7
DX8	Dump Register X8
E	exponent
ENA	Enter Annotation
ENG	Enter Graphics
ENM	Enter Menu (user defined)
ERO	Error Reporting Mode 0
ER1	Error Reporting Mode 1
ER2	Error Reporting Mode 2

1. Use not required. The only function of this code is to display a menu(if bus diagnostics are on).
2. Option 1C2 (HP Instrument BASIC) command.

Alphabetical Index

HP-IB Code	Function
ER3	Error Reporting Mode 3
F	Math term for function
FM1	ASCII Data Format
FM2	64 Bit IEEE Data Format
FM3	32 Bit HP 3577B binary
FPT	Fast Processor Test
FRA	Start Frequency (entry)
FRB	Stop Frequency (entry)
FRC	Center Frequency (entry)
FRQ	Frequency ¹
FRS	Frequency Span (entry)
FST	Frequency Step Size (entry)
FSW	Full Sweep
GR0	Graticule Off
GR1	Graticule On
GTO	Smith Chart Off
GT1	Smith Chart On
HBD	Disc HP-IB address (entry) ²
HBP	Plotter HP-IB address (entry)
HBU	Disc unit number (entry) ²
HLD	Entry Off
HZ	Hz
I11	Input = S11
I12	Input = S12
I21	Input = S21
I22	Input = S22
IA1	Impedance A = 50Ω
IA2	Impedance A = 1MΩ
IAR	Input = A/R
IB1	Impedance B = 50Ω
IB2	Impedance B = 1MΩ
IBR	Input = B/R
ID1	Input = D1
ID2	Input = D2
ID3	Input = D3
ID4	Input = D4
ID?	Dump Instrument ID
IDN	Decrement (↓)
INA	Input = A
INB	Input = B

HP-IB Code	Function
INP	Input ¹
INR	Input = R
IPR	Instrument Preset
IR1	Impedance R = 50Ω
IR2	Impedance R = 1 MΩ
IUP	Increment (↑)
IX1	Input = X1
IX2	Input = X2
IX3	Input = X3
IX4	Input = X4
IX5	Input = X5
IX6	Input = X6
IX7	Input = X7
IX8	Input = X8
K	Math term for constant
KHZ	kHz
KI1	Constant K1, Imaginary (entry)
KI2	Constant K2, Imaginary (entry)
KI3	Constant K3, Imaginary (entry)
KI4	Constant K4, Imaginary (entry)
KI5	Constant K5, Imaginary (entry)
KI6	Constant K6, Imaginary (entry)
KI7	Constant K7, Imaginary (entry)
KR1	Constant K1, Real (entry)
KR2	Constant K2, Real (entry)
KR3	Constant K3, Real (entry)
KR4	Constant K4, Real (entry)
KR5	Constant K5, Real (entry)
KR6	Constant K6, Real (entry)
KR7	Constant K7, Real (entry)
LA0	Length A Off
LA1	Length A On
LB0	Length B Off
LB1	Length B On
LBE	Ending line for listing ²
LBS	Start line for listing ²
LBX	Define X-start For Next Row (entry)
LBY	Define Y-start For Next Row (entry)
LCS	Load Complete State (incl. tables)
LD1	Load Register D1

1. Use not required. The only function of this code is to display a menu(if bus diagnostics are on).
2. Option 1C2 (HP Instrument BASIC) command.

HP 3577B Programming Commands,
Alphabetical Index

HP-IB Code	Function
LD2	Load Register D2
LD3	Load Register D3
LD4	Load Register D4
LDN	Select Lower For Next Row
LE0	Limit test Evaluation Off
LE1	Limit test Evaluation On
LEN	Length ¹
LEX	Define X-stop For Next Row (entry)
LEY	Define Y-stop For Next Row (entry)
LIO	Load value, write to 8-bit I/O port (entry)
LLO	Limit Line Display Off
LL1	Limit Line Display On
LMA	Insert Row In Limit Table
LMC	Clear Limit Table
LMI	Load State (learn mode in)
LMO	Dump State (learn mode out)
LNA	Length A (entry)
LNB	Length B (entry)
LNR	Length R (entry)
LNS	Length Step Size (entry)
LPR	Load HP Inst. BASIC program ²
LR0	Length R Off
LR1	Length R On
LRA	Load Register A
LRB	Load Register B
LRR	Load Register R
LS0	Beep On Limit Failure Off
LS1	Beep On Limit Failure On
LTC	Display Limit Configuration Menu ¹
LTD	Display Limit Editing Menu ¹
LUP	Select Upper For Next Row
LX1	Load Register X1
LX2	Load Register X2
LX3	Load Register X3
LX4	Load Register X4
LX5	Load Register X5
LX6	Load Register X6
LX7	Load Register X7
LX8	Load Register X8
MAM	Manual Amplitude (entry)

HP-IB Code	Function
MET	meters
MFR	Manual Frequency (entry)
MHZ	MHz
MKD	MKR → Discrete Sweep Table
MKG	MKR → ¹
MKO	Marker Offset (entry)
MKP	Marker Position (entry)
MKR	Marker ¹
MLT	MKR → Left for Target
MMP	Polar Marker Units (Mg/Ph)
MNO	Menu Off
MN1	Menu On
MNC	Menu Clear
MO0	Marker Offset Off
MO1	Marker Offset On
MOA	Marker Offset Amplitude
MOF	Marker Offset Freq (entry)
MOR	More Service Diagnostics Menu ¹
MOS	MKR Offset → Span
MP1	Dump Marker Position 1
MP2	Dump Marker Position 2
MPF	MKR → Polar Phase Ref
MR0	Marker Off
MR1	Marker On
MRI	Polar Marker Units (Re/Im)
MRT	MKR → Right for Target
MSC	milliseconds
MSM	Marker Search ¹
MSR	Sample Time (entry)
MTA	MKR → Start Frequency
MTB	MKR → Stop Frequency
MTC	MKR → enter Frequency
MTM	Marker → Manual
MTN	MKR → Min
MTP	MKR → Full Scale
MTR	MKR → Reference Level
MTV	MKR Target Value (entry)
MTX	MKR → Max
MV	milli-Volt (rms)
NRM	Normalize

1. Use not required. The only function of this code is to display a menu(if bus diagnostics are on).
2. Option 1C2 (HP Instrument BASIC) command.

Alphabetical Index

HP-IB Code	Function
NRS	Normalize (Short)
NS1	Number of steps = 6
NS2	Number of steps = 11
NS3	Number of steps = 21
NS4	Number of steps = 51
NS5	Number of steps = 101
NS6	Number of steps = 201
NS7	Number of steps = 401
NSC	nanoseconds
NST	Steps/Sweep menu ¹
NV	nano-Volt (rms)
PFS	Polar Full Scale (entry)
PGP	Graticule and Limit Line Pen no.(entry)
PIO	Polar Imag Offset (entry)
PL1	Plot Trace 1
PL2	Plot Trace 2
PLA	Plot All
PLC	Plot Characters
PLD	Set Plot Config to Default
PLG	Plot Graticule and Limit Lines
PLM	Plot Menu ¹
PM1	Plot Trace 1 Marker
PM2	Plot Trace 2 Marker
PMO	Polar Mag Offset (entry)
PNM	Pen Speed Fast (max)
PNS	Pen Speed Slow
PPO	Polar Phase Offset (entry)
PPR	Polar Phase Ref (entry)
PRC	CONTINUE HP Inst. BASIC program ²
PRM	HP Inst. BASIC memory size ²
PRO	Polar Real Offset (entry)
PRR	RUN HP Inst. BASIC program ²
PRP	PAUSE HP Inst. BASIC program ²
PRS	STOP HP Inst. BASIC program ²
PRT	Fast bus interface test
PS0	Phase Slope Off
PS1	Phase Slope On
PSL	Phase Slope (entry)
R	Math term for input R
RAD	radians

HP-IB Code	Function
RBW	Resolution Bandwidth ¹
RC1	Recall register 1
RC2	Recall register 2
RC3	Recall register 3
RC4	Recall register 4
RC5	Recall register 5
RCL	Recall Instrument State ¹
REF	Reference Level (entry)
RET	Return ¹
RLO	Reference Line Off
RL1	Reference Line On
RLS	Recall old (last) state
RPS	Reference Position (entry)
RS1	Freq Swp Res 51 pts/span
RS2	Freq Swp Res 101 pts/span
RS3	Freq Swp Res 201 pts/span
RS4	Freq Swp Res 401 pts/span
RSP	radians/span
RST	Sweep Reset
SAM	Source Amplitude (entry)
SAV	Save Instrument State ¹
SCA	HP Inst. BASIC SCRATCH A ²
SCC	HP Inst. BASIC SCRATCH C ²
SCL	Scale ¹
SCP	HP Inst. BASIC SCRATCH P ²
SD1	Store in register D1
SD2	Store in register D2
SD3	Store in register D3
SD4	Store in register D4
SDG	Service Diagnostics Menu ¹
SDN	Sweep Direction Down
SEO	Settling Time Off
SE1	Settling Time On
SEC	seconds
SFR	Source Frequency (entry)
SLO	Source Leveling Off
SL1	Source Leveling On
SLF	Confidence (self) Test Menu ¹
SM1	Continuous
SM2	Single Sweep

1. Use not required. The only function of this code is to display a menu(if bus diagnostics are on).
2. Option 1C2 (HP Instrument BASIC) command.

HP 3577B Programming Commands,
Alphabetical Index

HP-IB Code	Function
SM3	Manual Sweep
SMD	Sweep Mode ¹
SMT	Step Time (entry)
SP0	S-Parameters Off
SP1	S-Parameters On
SPC	Special Functions ¹
SQM	Set SRQ Mask (entry)
SRL	Sweep Resolution menu ¹
SRQ	Send SRQ
SRV	Software Revision Message
ST1	Linear Sweep
ST2	Alternate Sweep
ST3	Log Sweep
ST4	Amplitude Sweep
ST5	CW
ST6	Discrete Sweep
STA	Confidence Test Channel A
STB	Confidence Test Channel B
STD	Store and Display
STE	Settling Time Entry
STI	Set time & date
STM	Sweep Time ¹
STO	Store Data ¹
STR	Confidence Test Channel R
STX	Store data (more) ¹
STY	Sweep Type ¹
SUP	Sweep Direction Up
SV1	Save State in Register 1
SV2	Save State in Register 2
SV3	Save State in Register 3
SV4	Save State in Register 4
SV5	Save State in Register 5
SWT	Sweep Time (entry)
SX1	Store in register X1
SX2	Store in register X2
SX3	Store in register X3
SX4	Store in register X4
SX5	Store in register X5
SX6	Store in register X6
SX7	Store in register X7

HP-IB Code	Function
SX8	Store in register X8
SY0	Synthesizer Diagnostics Off
SY1	Synthesizer Diagnostics On
T1L	Trace 1 Linetype (entry)
T1P	Trace 1 Pen Number (entry)
T2L	Trace 2 Linetype (entry)
T2P	Trace 2 Pen Number (entry)
TD1	Store to D1
TD2	Store to D2
TD3	Store to D3
TD4	Store to D4
TG1	Free Run
TG2	Line Trigger
TG3	External Trigger
TG4	Immediate
TKM	Take Measurement
TMT	Trace Memory Test
TR1	Trace 1
TR2	Trace 2
TRG	Sweep Trigger
TRM	Trigger Mode ¹
TSF	Test Set Forward
TSR	Test Set Reverse
TX1	Store to X1
TX2	Store to X2
TX3	Store to X3
TX4	Store to X4
TX5	Store to X5
TX6	Store to X6
TX7	Store to X7
TX8	Store to X8
UDI	User Defined Input
UDS	User Defined Store
UF1	Function F1
UF2	Function F2
UF3	Function F3
UF4	Function F4
UF5	Function F5
USC	microseconds
UV	micro-Volt (rms)

1. Use not required. The only function of this code is to display a menu(if bus diagnostics are on).
2. Option 1C2 (HP Instrument BASIC) command.

Alphabetical Index

HP-IB Code	Function
V	Volt (rms)
W	Math term for jOmega register
X	Math term for storage reg X
ZMK	Zero Marker
;	Units
%	Percent
(Math bracket, open
)	Math bracket, close
*	Math function multiply
+	Math function plus
--	Math function minus
/	Math function divide

1. Use not required. The only function of this code is to display a menu(if bus diagnostics are on).
2. Option 1C2 (HP Instrument BASIC) command.

Bibliography

Fitzpatrick, J., "Error Models for Systems Measurements," Microwave Journal, May 1978.

The following are Hewlett-Packard publications:

- HP Publication #5952-9270, "Vector Measurements of High Frequency Networks."
- HP Application Note 95-1, "S-Parameter Techniques for Faster, More Accurate Network Design."
- HP Application Note 154, "S-Parameter Design."
- HP Product Note 3577A-1, "Users Guide to the HP 3577A Network Analyzer."

Index

A

- ABORT HP-IB (softkey) 4-44
- aborting
 - data transfer 3-57
- accessories
 - available 5-5
 - supplied 5-7
- address
 - talker/listener 3-8
 - viewing 3-9
- ALTERNTE SWEEP (softkey) 4-98
- amplifier
 - example measurements 2-54
 - S-parameters 2-73
- amplitude
 - sweep 2-55
- amplitude sweep example
 - See amplifier
- AMPTD (hardkey) 4-1
- AMPTD SWEEP (softkey) 4-99
- ANALYZER ADDRESS (softkey) 4-45
- annotation
 - changing 3-60
- ASCII string 3-49
- ATTEN (hardkey) 4-4
- AUTO RBW ON/OFF (softkey) 4-76
- AUTO SCALE (softkey) 4-83
- average
 - transferring number 3-49
 - weighting factor (N) 4-6
- AVG (hardkey) 4-6

B

- B (channel)
 - See options
 - See receiver
- backspace 4-9
- bandpass filter
 - example measurements 2-17
- bandwidth measurement
 - See bandpass filter
- BEEP ON/OFF (softkey)
 - for limit testing 4-42
- BEEPER ON/OFF (softkey) 4-89
- Bode plot
 - See amplifier
- bus capability 3-4
- bus commands 3-11
- bus diagnostic modes 3-56
- bus structure 3-2

C

- C FREQ STEP (softkey) 4-25
- calibration
 - one port full 4-61, 4-78
 - one port full example 2-82
 - one port partial 4-59, 4-78
- capacitance display 4-13
- Cartesian display
 - See graticule
- CATALOG (softkey) 4-73, 4-80
- CENTER FREQ (softkey) 4-25
- CENTER FREQ STEP (softkey) 4-25

Index

- center frequency
 - See bandpass filter
 - See notch filter
- characters
 - alphanumeric 3-52
- CLEAR TABLE (softkey) 4-105
- CLEAR TRIP (softkey) 4-67
 - receiver 4-5
 - source 4-2
- code
 - See commands
 - See HP-IB
 - See programming
- commands
 - device dependent 3-15
 - HP-IB 3-11
 - HP-IB only 3-15
 - types of 3-17
- compatibility
 - with HP 3577A 1-6, 3-4
- complex output impedance 2-88
- CONF TEST (softkey) 1-7, 4-89
- confidence test 1-7, 4-89
- CONFIG PLOT (softkey) 4-71
- configuration
 - equipment 5-5
- constants
 - default values 4-14
- CONT (softkey) 4-93
- CONTINUE PROGRAM (softkey) 4-88
- continuous entry 4-8
- controller 3-1
- COPY SCL n TO m (softkey) 4-82
- COPY TO ALL ROWS (softkey)
 - discrete sweep 4-105
- COPY Trc n TO m (softkey) 4-30
- CRT
 - adjustments 5-12
- CW (softkey) 4-99

D

- data
 - processing A-1
 - structure A-1
- data entry 4-8
- DATA REG (softkey) 4-30
- data registers 4-11
- data transfer
 - aborting 3-57
 - format 3-5, 3-56
 - last byte 3-58
 - of alphanumeric characters 3-52
 - of average number 3-49
 - of instrument state 3-45
 - of marker value 3-44
 - of product name 3-55
 - of product options 3-55
 - of register 3-39
 - of specific parameter 3-54
 - of time & date 3-58
 - of trace 3-42
 - rate 3-5
 - record length 3-57
- date 3-58
- decrement key 4-10
- DEFAULT SETUP (softkey) 4-72
- DEFINE FUNCTION (softkey) 4-12
- DEFINE MATH (hardkey) 4-12
- DELAY (softkey)
 - group 4-19
 - using DISCRETE SWEEP 4-20
- DELAY APER (softkey) 4-20
- DELETE ALL ROWS (softkey)
 - for limit table 4-42
- DELETE ROW (softkey)
 - discrete sweep table 4-105
 - for limit table 4-42
- delimiters 3-56
- digital display B-1
- direct plotting 3-6

- DISCRETE FREQ (softkey) 4-105
DISCRETE SETTling (softkey) 4-105
discrete sweep
 creating a table 2-47, 4-102
 example 2-47
 measurement time advantages 2-53, 3-29, 3-74
 use with limit testing 2-53
 via HP-IB 3-28
DISCRETE SWEEP (softkey) 4-100
DISCRETE TABLE (softkey) 4-105
DISK ADDRESS (softkey) 4-45
DISK UNIT (softkey) 4-45
DISPLAY FCTN (hardkey) 4-16
DISPLAY FORMAT 4-15
DISPLAY HP-IB (softkey) 4-90
DISPLAY MEM TEST (softkey) 4-90
dynamic range
 optimizing 2-21
- E**
- end of data 3-58
end-of-measurement 5-15
end-of-sweep 5-15
entry block 4-22
entry off key 4-9
EOM 5-15
EOS 5-15
error messages C-1
error model 4-61
error reporting levels 3-73
error term
 directivity 4-61
 frequency response 4-61
 source match 4-61
 transmission 4-61
EVALUATE ON/OFF (softkey) 4-42
EXT (softkey) 4-110
- EXT TRIG
 See EXT (softkey)
external reference 4-23
- F**
- F₋
 See functions
fail 5-15
FAST BUS INT TEST (softkey) 4-90
FAST PROC TEST (softkey) 4-90
features
 HP 3577B new 1-5
fixtures 5-5
flow chart
 data processing A-1
focus
 See CRT adjustments
forward
 gain and phase 2-77
 return loss 2-82
forward configuration
 See S-Parameter Test Set
FREE RUN (softkey) 4-109
FREQ (hardkey) 4-24
FREQ OFFSET (softkey) 4-47
FREQ SPAN (softkey) 4-25
FREQ STEP (softkey) 4-105
frequency reference 1-5
frequency response
 See bandpass filter
 See error term
 See notch filter
front panel
 overview 1-2
FULL SCALE (softkey) 4-83
FULL SWEEP (softkey) 4-26
functions
 user defined 4-13
fuse 1-2

Index

G

- gain compression
 - See amplifier
- gain/phase plot
 - See amplifier
- gamma
 - See output reflection coefficient
- GET PROGRAM (softkey) 4-73
- go no-go test
 - See limit test
- GP-IB
 - See HP-IB
- graphics 3-62
 - remote B-1
- GRAT ON/OFF (softkey) 4-89
- GRAT PEN NUM (softkey) 4-71
- grounding 1-2, 5-2
- group delay 2-12
 - See also DELAY (softkey)

H

- hardkeys 4-28
 - nomenclature 1-4
- horizontal
 - See CRT adjustments
- HP Instrument BASIC I-5, 3-72, 4-107
- HP-IB
 - address 3-9
 - commands 3-11
 - compatibility with HP 3577A programs 3-4
 - connections 5-12
 - definition 3-1
 - device dependent commands 3-15
 - diagnostic mode 3-7, 3-56
 - HP 3577B capability 3-4
 - management lines 3-3
 - only commands 3-15
 - operation 3-1
 - specification summary 3-2

- structure 3-2
- verification 3-6
- HP-IB SIG ANAL (softkey) 4-90

I

- identification
 - of product name 3-55
 - of product options 3-55
- IEEE-488
 - See HP-IB
- IMMED (softkey) 4-110
- impedance
 - complex output 2-88
 - normalized 4-13
- incoming inspection
 - See initial inspection
- increment key 4-10
- inductance display 4-13
- initial inspection I-8, 5-1
 - See also confidence test
- INPUT (hardkey) 4-29
- INSERT ROW (softkey)
 - discrete sweep table 4-105
- insertion loss
 - See low pass filter
- insertion phase
 - See bandpass filter
 - See low pass filter
- inspection
 - See initial inspection
- installation 5-9
- INSTR PRESET (hardkey) 4-32
- INSTRMNT BASIC (softkey) 4-88
- instrument
 - general description I-7
- instrument preset 4-32
 - default values 3-68, 4-32
- instrument state
 - dumping and loading 3-45

instrument status
 dumping 3-49
 instrument turn on 1-2
 interconnect
 with S-Parameter Test Set 5-9

J

jOmega register 4-13

K

K_
 See constants

keyboard 3-50
 numbers 3-50

kits 5-5
 knob 4-8, 4-35

L

LCL (hardkey) 4-44
 Lockout 1-6

LENGTH (hardkey) 4-36

LEVELING ON/OFF (softkey) 4-89

LIMIT CONFIG (softkey) 4-42

LIMIT TABLE (softkey) 4-38

limit test 4-38
 creating a table 2-39, 4-39
 example 2-39
 use with discrete sweep 2-53
 via HP-IB 3-23

LIN FREQ SWEEP (softkey) 4-97

LIN MAG (softkey) 4-17

LIN SWP TO DISCRETE (softkey) 4-105

LINE (softkey) 4-109

line voltage
 See voltage selector

LINES ON/OFF (softkey) 4-42

listener 3-1

address 3-8

loading
 See data transfer

local
 See LCL (hardkey)
 LOCKOUT 1-6, 3-12

locked front panel
 See local LOCKOUT

LOG FREQ SWEEP (softkey) 4-99

LOG MAG (softkey) 4-17

low pass filter
 example measurements 2-59

M

MAG OFFSET (softkey) 4-48

magnitude response
 See bandpass filter
 See also notch filter

making measurements 2-1

management lines 3-3

manual
 how to use 1-6

MANUAL (softkey) 4-94

marker 4-46
 dumping 3-44
 loading 3-22

marker mode
 See knob

MARKER OFFSET (softkey) 4-47

MARKER ON/OFF (softkey) 4-47

MARKER POSN (softkey) 4-47

MARKER TARGET (softkey) 4-54

MARKER TO (hardkey) 4-50

maximum rejection
 See notch filter

MEASR CAL (hardkey) 4-56

measurement calibration 4-56

measurement sequence
 See operating hints

Index

measurements
 making 2-1
 See also the type of measurement
menu 4-63
 changing 3-59
message block 4-65
messages C-1
 error reporting levels 3-73
MKR (hardkey) 4-46
MKR CPL ON/OFF (softkey) 4-47
MKR M,P/R,I (softkey) 4-48
MKR OFST ON/OFF (softkey) 4-47
MKR OFST TO SPAN (softkey) 4-51,
4-55
MKR TO CENTER (softkey) 4-51, 4-55
MKR TO DISCRETE (softkey) 4-53,
4-105
MKR TO FULL SCL (softkey) 4-55
MKR TO L TARG (softkey) 4-53
MKR TO MAX (softkey) 4-52, 4-55
MKR TO MIN (softkey) 4-52, 4-55
MKR TO R TARG (softkey) 4-53
MKR TO REF LVL (softkey) 4-50, 4-55
MKR TO START (softkey) 4-51, 4-55
MKR TO STOP (softkey) 4-51, 4-55
MKR→ MANUAL (softkey) 4-94
MORE (marker softkey) 4-52

N

NORMLIZE (SHORT) (softkey) 4-57
NORMLIZE (softkey) 4-57
notch filter
 example measurements 2-3
numeric keypad 4-9

O

offset markers
 example use of 2-26
ONE PORT FULL CAL (softkey) 4-61

ONE PORT PART CAL (softkey) 4-59
operating
 environment 5-4
operating hints 1-4
 See also measurements,making
options 5-8
 HP 3577B new 1-5
out-of-band rejection
 See low pass filter
output 4-66
output reflection coefficient 2-86
oven
 See frequency reference
 See also warm-up time
overload 4-67

P

packaging 5-18
pass/fail test
 See limit test
passband insertion phase
 See bandpass filter
passband ripple
 See bandpass filter
 See also low pass filter
/DIV (softkey) 4-82
PH SLOPE ON/OFF (softkey) 4-83
PHASE (softkey) 4-17
PHASE OFFSET (softkey) 4-48
PHASE REF (softkey) 4-84
phase response
 See bandpass filter
 See also notch filter
PHASE SLOPE (softkey) 4-20, 4-83
PLOT (hardkey) 4-68
PLOT ALL (softkey) 4-68
PLOT CHAR (softkey) 4-69
PLOT GRAT (softkey) 4-69
PLOT MARKER 1 (softkey) 4-70
PLOT MARKER 2 (softkey) 4-70

- PLOT TRACE 1 (softkey) 4-69
 - PLOT TRACE 2 (softkey) 4-69
 - PLOTTER ADDRESS (softkey) 4-45
 - plotting
 - direct 3-6
 - via HP-IB 3-34
 - PN SPEED SLOW/FST (softkey) 4-72
 - POLAR (softkey) 4-18
 - power
 - consumption 5-2
 - cord 1-2, 5-2
 - requirements 5-2
 - power splitters 5-5
 - power up
 - See instrument turn on
 - powerline voltage
 - See voltage selector
 - probes 5-5
 - programmable I/O port 1-5
 - dedicated lines 5-15
 - eight-bit 5-15
 - programming
 - code functional categories 3-17
 - data transfer formats 3-5
 - data transfer rates 3-5
 - problems 3-7
 - speeding up 3-74
- Q**
- query 3-54 - 3-55
- R**
- R (reference channel)
 - See receiver
 - rack mount 5-10
 - RCL OLD STATE (softkey) 4-73
 - RE-SAVE PROGRAM (softkey) 4-80
 - REAL/IMAG (softkey) 4-19
 - rear panel
 - overview 1-4
 - RECALL (hardkey) 4-73
 - receiver 4-74
 - receiver trip 4-5
 - record length 3-57
 - REF LEVEL (softkey) 4-81
 - REF LINE ON/OFF (softkey) 4-82, 4-84
 - REF POSN (softkey) 4-82, 4-84
 - reflection measurements
 - See return loss
 - registers
 - D_ 4-11, 4-91
 - dumping and loading 3-39
 - jOmega 4-13
 - X_ 4-11, 4-91
 - rejection
 - See low pass filter
 - See notch filter
 - RES BW (hardkey) 4-75
 - with discrete sweep 4-103
 - reset
 - hard 1-6, 4-73, 4-79
 - return loss 2-82
 - reverse
 - loss 2-79
 - output reflection coefficient 2-86
 - reverse configuration
 - See S-Parameter Test Set
 - rho
 - See output reflection coefficient
 - ripple
 - See bandpass filter
 - RUN PROGRAM (softkey) 4-88
- S**
- S PARS ON/OFF (softkey) 4-89
 - S-parameter test set 4-77
 - forward and reverse configurations 2-72
 - rear panel connection 5-9

Index

- S-parameters
 - of an amplifier 2-72
 - See also S-Parameter Test Set
- SAVE (hardkey) 4-79
- save instrument state example
 - See notch filter
- SCALE (hardkey) 4-81
- scattering matrix
 - See S-parameters
- scattering parameters
 - See S-parameters
- screen 4-85
 - messages C-1
- screen annotation
 - changing 3-60
- SERVICE DIAG (softkey) 4-89
- service request
 - triggering 3-34
- SETTLING ON/OFF (softkey) 4-89
- settling time 4-76
 - discrete 4-104
- shape factor measurement
 - See bandpass filter
- shipment 5-18
- SINGLE (softkey) 4-93
- SMITH CH ON/OFF (softkey) 4-84
- Smith Chart
 - example 2-88
- softkey
 - changing labels 3-59
- softkeys
 - nomenclature 1-4
 - See also particular key name
- SOFTWARE REVISION (softkey) 4-90
- source 4-66
 - front panel section 4-87
- source match
 - See error term
- source trip 4-2
- SPCL FCTN (hardkey) 4-88
- special functions 4-88
- specifications
 - HP 35677A/B S-Parameter Test Set 5-29
 - HP 3577B Network Analyzer 5-18
 - HP-IB 3-2
- standing wave ratio 2-85
- START AMPLITUDE (softkey) 4-3
- START FREQ (hardkey) 4-24
- status byte 3-49, 3-72
 - masking 3-73
- STEP & INSERT (softkey) 4-105
- STEP SIZE (softkey)
 - for AMPTD 4-2
 - for LENGTH 4-36
- STEPS/SWEEP (softkey) 4-3
- stimulus-response
 - See bandpass filter
- STOP AMPLITUDE (softkey) 4-3
- STOP FREQ (softkey) 4-25, 4-51
- stopband rejection
 - See low pass filter
- storage 5-18
- STORE & DISPLAY (softkey) 4-92
- STORE DATA (hardkey) 4-91
- STORE REG_ (softkey) 4-91
- store trace data example
 - See notch filter
- SWEEP MODE (hardkey) 4-93
- SWEEP RESOLUTN (softkey) 4-26
- SWEEP TIME (hardkey) 4-95
 - optimizing A-4
- SWEEP TYPE (hardkey) 4-97
- SWP DIR UP/DOWN (softkey) 4-106
- SWR 2-85
- SWR (softkey) 4-19
- SYN DIAG ON/OFF (softkey) 4-89
- SYS CTLR ON/OFF (softkey) 4-45
- system
 - front panel section 4-107
- system reference
 - See also external reference
 - HP 3577B as the 1-5

T

table
 discrete sweep 4-102
 limit 4-39
 talker 3-1
 address 3-8
 10 MHz OUT 1-5
 TEST PATTERN (softkey) 4-89
 TEST SET FWD/REV (softkey) 4-31
 3 dB width
 See notch filter
 time 3-58
 trace
 dumping and loading 3-42
 TRACE 1 (hardkey) 4-108
 TRACE 1 LINETYPE (softkey) 4-71
 TRACE 1 PEN NUM (softkey) 4-71
 TRACE 2 (hardkey) 4-108
 TRACE 2 LINETYPE (softkey) 4-71
 TRACE 2 PEN NUM (softkey) 4-71
 trace memory
 data A-2
 transfer function
 See forward gain and phase
 transmission
 See error term
 traveling waves
 See reflection measurements
 TRCE MEM TEST (softkey) 4-89
 TRIG/RESET (hardkey) 4-111
 TRIGGER MODE (hardkey) 4-109
 trip
 source 4-66
 trouble 1-6
 turn on
 See instrument turn on
 two-port device
 See S-parameters of an amplifier

U

UPPER/LOWER (softkey) 4-42
 USER DEF INPUT (softkey) 4-30
 USER DEF STORE (softkey) 4-92

V

VCXO
 See frequency reference
 verification
 HP-IB 3-6
 vertical
 See CRT adjustments
 voltage selector 1-2
 VSWR
 See SWR

W

warm-up time 1-5
 warning messages C-1

X

X-START (softkey) 4-42
 X-STOP (softkey) 4-42
 X_
 See data registers

Y

Y-START (softkey) 4-42
 Y-STOP (softkey) 4-42

Z

ZERO MARKER (softkey) 4-47
 Z_N (normalized impedance) 4-13

Hewlett-Packard Sales and Service Offices

To obtain Servicing information or to order replacement parts, contact the nearest Hewlett-Packard Sales and Service Office listed in HP Catalog, or contact the nearest regional office listed below:

In the United States

California

P.O. Box 4230
1421 South Manhattan Avenue
Fullerton 92631

Georgia

P.O. Box 105005
2000 South Park Place
Atlanta 30339

Illinois

5201 Tollview Drive
Rolling Meadows 60008

New Jersey

W. 120 Century Road
Paramus 07652

In Canada

Hewlett-Packard (Canada) Ltd.
17500 South Service Road
Trans-Canada Highway
Kirkland, Quebec H9J 2M5

In France

Hewlett-Packard France
F-91947 Les Ulis Cedex
Orsay

In German Federal Republic

Hewlett-Packard GmbH
Vertriebszentrale Frankfurt
Berner Strasse 117
Postfach 560 140
D-6000 Frankfurt 56

In Great Britain

Hewlett-Packard Ltd.
King Street Lane
Winnersh, Wokingham
Berkshire RG11 5AR

In Other European Countries

Switzerland

Hewlett-Packard (Schweiz) AG
7, rue du Bois-du-Lan
Case Postale 365
CH-1217 Meyrin

In All Other Locations

Hewlett-Packard Inter-Americas
3155 Porter Drive
Palo Alto, California 94304

