



**HEWLETT
PACKARD**

3577A NETWORK ANALYZER

35677A/B S-PARAMETER TEST SET

OPERATING MANUAL

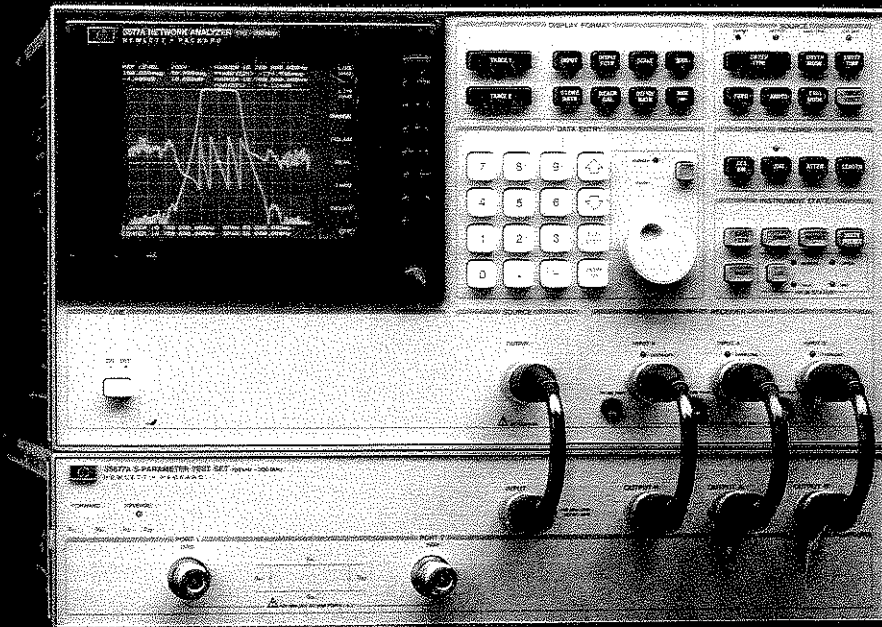

SOFTKEYS

These eight keys beside the display are used to select items from the menus. Softkeys may be used to select a parameter for data entry, select units for a data entry, perform an immediate execution function, make a selection from a list, or display the next level menu.

SCREEN AREAS

The active trace is selected with the TRACE hardkeys in the DISPLAY FORMAT section. This trace and its scale and marker information blocks will appear bright on the screen.

MARKER INFORMATION BLOCK: describes trace DISPLAY FUNCTION and INPUT definitions and lists the marker position and measured value for each trace

SCALE INFORMATION AREA: defines both the reference level (dashed line) value and the vertical scale in units/division for each trace

DATA ENTRY BLOCK: (Not shown) appears when a data entry softkey is active (bright), displaying the current value of the parameter; displays new value as data entry is made or modified

GRATICULE:

Linear, Log, Polar, or Smith (see "Graticule" in the REFERENCE section)

MENU AREA:

right side of the screen where menus of softkey labels appear

DATA ENTRY

The data entry section contains the numeric key pad and the knob. The knob may be used to move the marker or modify a data entry. It may be toggled between these two modes by pressing the key immediately above it. The default knob mode is marker position. Before a new value may be entered or modified, the parameter softkey label must be active (appear bright in the menu). The BACKSPACE key may be used to correct an entry error. The ENTRY OFF key clears the menu, which effectively eliminates further data entry.

S-PARAMETER TEST SET

The HP 35677A/B is a 100 kHz to 200 MHz scattering parameter test set built for use with the HP 3577A Network Analyzer. The A model has 50 Ω test ports and the B model has 75 Ω test ports. This test set provides a convenient method for making reflection and transmission measurements of one and two-port devices. The HP 3577A provides signal, power, and control for the test set. With the test set connected, the network analyzer's INPUT menu will include S-parameter softkey selections S_{11} , S_{12} , and S_{22} .

DISPLAY FORMAT

INPUT: R, A, B, A/R, B/R. User defined input; S_{11} , S_{12} , S_{21} , S_{22}

DISPLAY FUNCTION: Log magnitude, linear magnitude, phase, polar, real, imaginary, group delay

SCALE: Autoscale, reference level, DIV, reference position, reference line on/off, copy scale, phase slope value, phase slope on/off

MARKER: Marker position, marker on/off, zero marker, marker offset on/off, marker offset (value), frequency offset (value), marker coupling on/off

STORE DATA: store data to one of four registers, user defined store, store and compare

MEASUREMENT CALIBRATION: Normalize, normalize with a short, one port, partial calibration, one port full calibration

DEFINE MATH: User may define three complex constants (K1-K3) and five functions (F1-F5)

MARKER → ...reference level, ...start frequency, ...stop frequency, ...center frequency, marker offset → frequency span, ...maximum, ...minimum, marker search right or left for target value

SOURCE

SWEEP TYPE: Linear frequency sweep, alternate sweep, log frequency sweep, amplitude sweep, CW, sweep direction up/down

SWEEP MODE: Continuous, single, manual

SWEEP TIME: 100 ms/span to 6553 s/span for linear sweep type

FREQUENCY: Start, stop, center, frequency span, center frequency step size, sweep resolution, full sweep

AMPLITUDE: -49 dBm to +15 dBm in 0.1 dBm increments, clear source trip

TRIGGER MODE: free run, line, external, immediate

RECEIVER

RESOLUTION BANDWIDTH: 1 kHz, 100 Hz, 10 Hz, 1 Hz

AVERAGING: exponential vector averaging, select weighting value (see AVERAGE in the REFERENCE section of the manual)

INPUT ATTENUATION AND IMPEDANCE: impedance 50 Ω , 1 M Ω , attenuation 0 dB/20 dB, clear receiver trip(s)

LENGTH: Data entry for each input in units of meters or seconds

INSTRUMENT STATE

SPECIAL FUNCTIONS: HP-IB address, talk only on/off, confidence tests, beeper on/off, service diagnostics, INPUT menu S-parameter on/off

SAVE INSTRUMENT STATE: save current state in one of five registers

RECALL INSTRUMENT STATE: recall a saved instrument state or the state of the instrument at the last power down

PLOT: all, trace 1, trace 2, graticule, characters, marker 1, marker 2, configure line types and pen numbers

RECEIVER INPUTS

All three inputs have overvoltage protection circuitry that senses signal levels greater than 1.1 V_{pk} and switches the input impedance to 1 M Ω . This switch is called a receiver "trip." The inputs may be overloaded without tripping if the signal level beyond the input attenuation exceeds -20 dBm, but does not exceed 1.1 V_{pk}. This condition causes inaccurate information to be displayed and is indicated by an audible alarm, illumination of red alarm LEDs over each overloaded input and a warning message displayed on the screen.

▲ SOURCE OUTPUT

The source output has overvoltage protection circuitry that will disconnect the output from the source when a signal appears that is 4 V_{pk} or greater. This disconnect is called a source "trip."

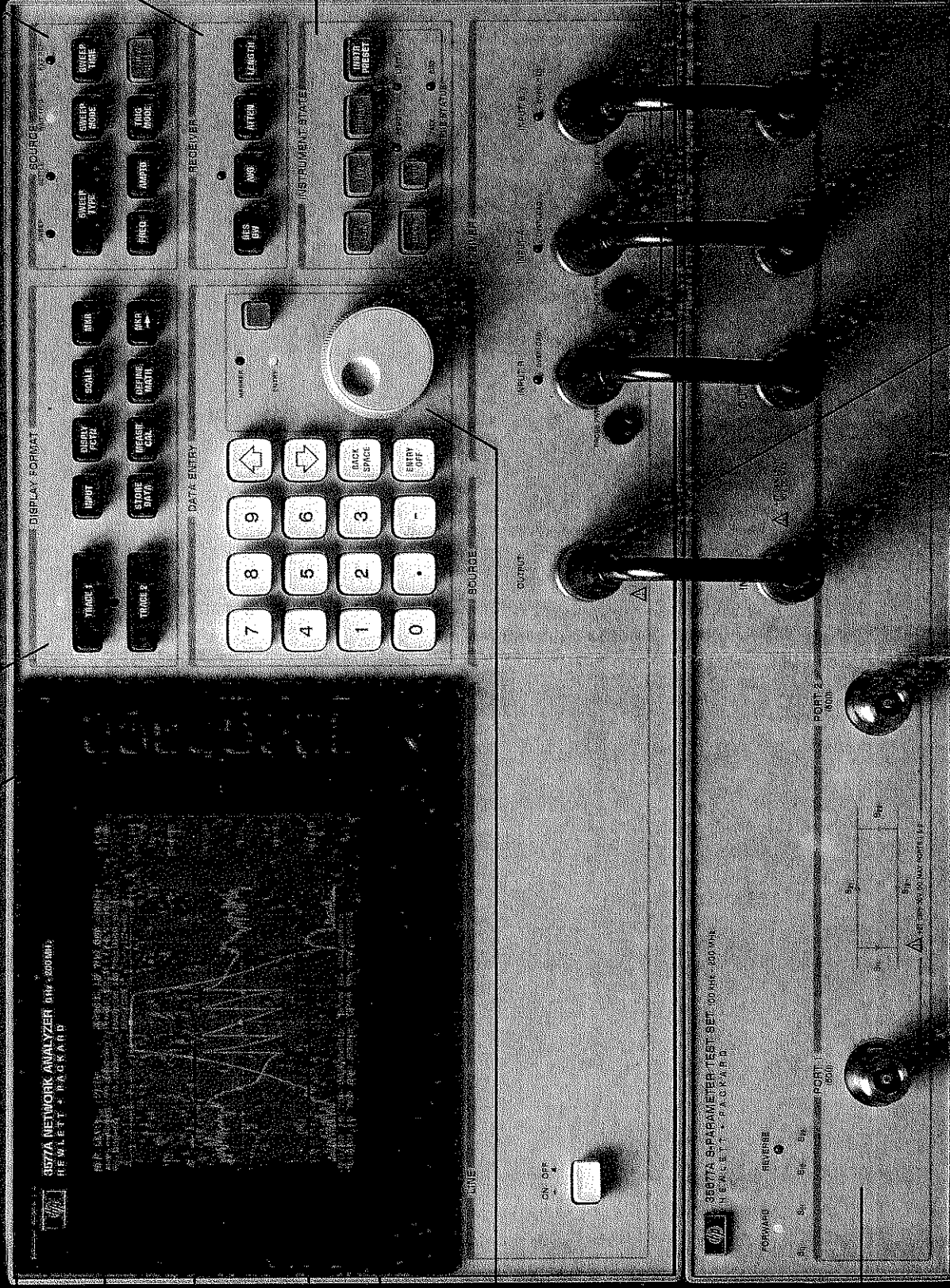

1. Do not exceed a maximum signal level of +27dBm or 30 VDC on either test port. If either of these levels is exceeded, damage to the instrument may result.

CAUTION

2. The B model has 75 Ω type-N female connectors for test ports one and two. These connectors may be physically damaged, if 50 Ω type-N connectors are used on the test ports.

THE HP 3577A NETWORK ANALYZER AND HP 35677A/B S-PARAMETER TEST SET REAR PANELS

HP-IB PORT

The HP-IB is used to control the operation of the HP 3577A from a remote controller. This connector uses metric fasteners and is not compatible with older cables using english fasteners. Metric fasteners are available from HP to upgrade older cables.

CRT DISPLAY ADJUSTMENTS

See INSTALLATION in the General Information section.

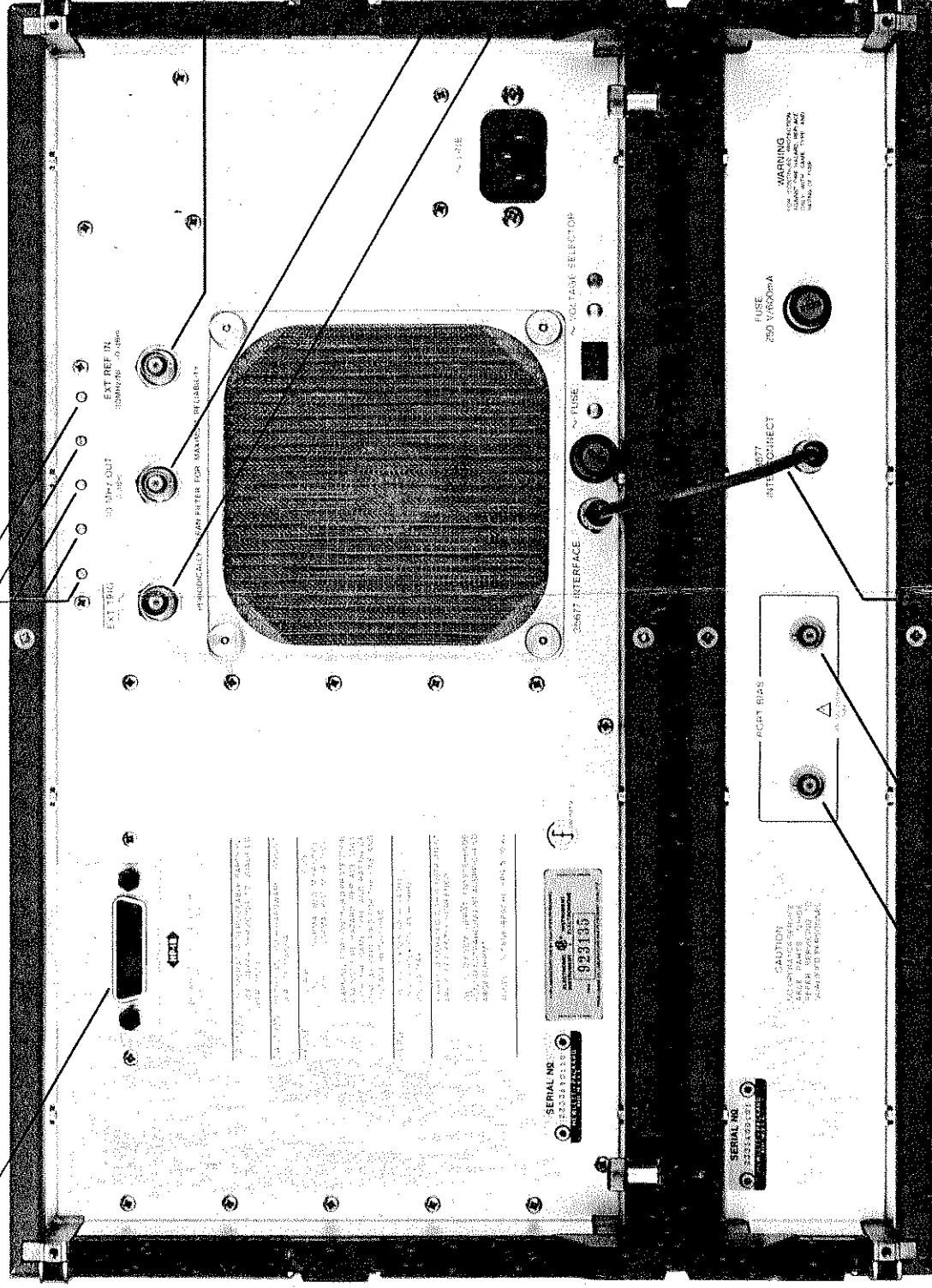

EXT REF IN

Used to phase lock the HP 3577A to an external frequency reference. The signal applied to this input should be between -7 and $+15$ dBm. The frequency of the external reference may be any subharmonic of 10 MHz greater than 100 kHz.

10 MHz OUT

A frequency reference output whose signal level is 0 dBm. The stability of this reference is .05 ppm per $^{\circ}\text{C}$.

EXT TRIG

This input is used to trigger a measurement on the falling edge of a TTL signal or a switch closure to ground. See "External" under TRIGGER MODE in the Reference section (page 4-36).

PORT BIAS 1 & 2

Two inputs on the rear of the HP 35677A/B used to connect a bias voltage to the front panel connections labeled PORT 1 or PORT 2.

INSTRUMENT INTERCONNECT

The HP 35677A/B is connected to the HP 3577A at the rear panel with the rear panel interconnect cable. This cable supplies power to the test set, controls the configuration of the test set, and allows the HP 3577A to sense the presence of the test set, changing the INPUT menu.

HOW TO USE THIS MANUAL

The **GETTING STARTED** section is designed to help the first-time user. This section describes how to turn on the HP 3577A, defines some terms used in the manual, gives some operating hints, and shows how to run the CONFIDENCE TEST.

The **MEASUREMENT** section describes the use of the HP 3577A Network Analyzer and the HP 35677A/B S-Parameter Test Set in making typical measurements on several common devices. These measurements were selected as examples to cover topics of general interest in a manner that demonstrates the capabilities of the HP 3577A and HP 35677A/B.

The **REMOTE OPERATION** section describes the Hewlett-Packard Interface Bus and how it is used to operate the HP 3577A with a controller (computer). To use the HP 3577A under remote control, first become acquainted with front panel operation and then refer to the REMOTE OPERATION section.

The **REFERENCE** section is an encyclopedia of front panel operation details. This section is an alphabetical listing of front panel sections, hardkeys, and terms. Each hardkey topic shows the menu of softkey labels it will display on the screen and describes each softkey command in detail.

The "Meet the HP 3577A" foldout was designed as part of the front cover to wrap around the back of the manual so that it will be visible to the right of the manual.

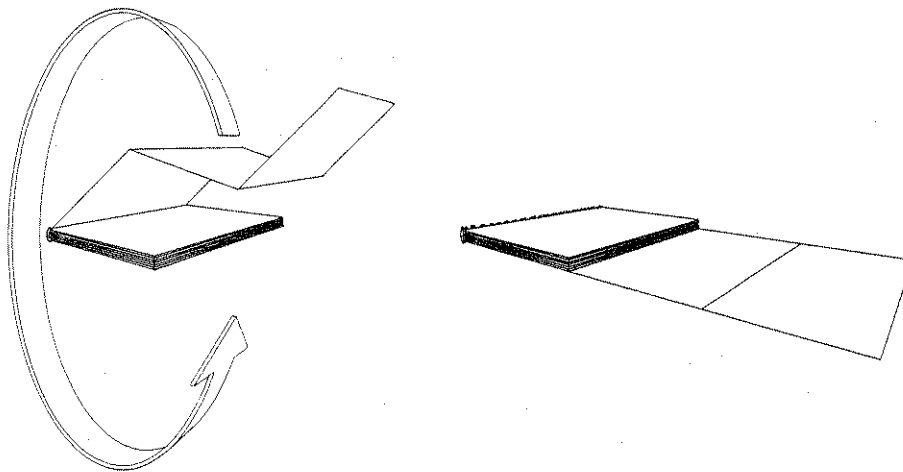

This makes it available for reference while the rest of the manual is in use.

Before proceeding further, it is recommended that the user read Installation in the General Information section. This reading covers initial inspection, power requirements, power cable and grounding requirements, installation for the HP 3577A and the HP 35677A, and definition of the operating environment.



HEWLETT
PACKARD

OPERATING MANUAL
MODEL 3577A
NETWORK ANALYZER
AND
MODEL 35677A/B
S-PARAMETER TEST SET

WARNING

*To prevent potential fire or shock hazard, do not
expose equipment to rain or moisture.*

Manual Part No. 03577-90000

Microfiche Part No. 03577-90050

© Copyright Hewlett-Packard Company 1983
P.O. Box 69, Marysville, Washington, 98270 U.S.A.

CERTIFICATION

Hewlett-Packard Company certifies that this product met its published specifications at the time of shipment from the factory. Hewlett-Packard further certifies that its calibration measurements are traceable to the United States National Bureau of Standards, to the extent allowed by the Bureau's calibration facility, and to the calibration facilities of other International Standards Organization members.

WARRANTY

This Hewlett-Packard product is warranted against defects in material and workmanship for a period of one year from date of shipment [except that in the case of certain components listed in this manual, the warranty shall be for the specified period]. During the warranty period, Hewlett-Packard Company will, at its option, either repair or replace products which prove to be defective.

For warranty service or repair, this product must be returned to a service facility designated by -hp-. Buyer shall prepay shipping charges to -hp- and -hp- shall pay shipping charges to return the product to Buyer. However, Buyer shall pay all shipping charges, duties, and taxes for products returned to -hp- from another country.

HP software and firmware products which are designated by HP for use with a hardware product, when properly installed on that hardware product, are warranted not to fail to execute their programming instructions due to defects in materials and workmanship. If HP receives notice of such defects during the warranty period, HP shall repair or replace software media and firmware which do not execute their programming instructions due to such defects. HP does not warrant that the operation of the software, firmware or hardware shall be uninterrupted or error free.

LIMITATION OF WARRANTY

The foregoing warranty shall not apply to defects resulting from improper or inadequate maintenance by Buyer, Buyer-supplied software or interfacing, unauthorized modification or misuse, operation outside of the environmental specifications for the product, or improper site preparation or maintenance.

NO OTHER WARRANTY IS EXPRESSED OR IMPLIED. HEWLETT-PACKARD SPECIFICALLY DISCLAIMS THE IMPLIED WARRANTIES OF MERCHANTABILITY AND FITNESS FOR A PARTICULAR PURPOSE.

EXCLUSIVE REMEDIES

THE REMEDIES PROVIDED HEREIN ARE BUYER'S SOLE AND EXCLUSIVE REMEDIES. HEWLETT-PACKARD SHALL NOT BE LIABLE FOR ANY DIRECT, INDIRECT, SPECIAL, INCIDENTAL, OR CONSEQUENTIAL DAMAGES, WHETHER BASED ON CONTRACT, TORT, OR ANY OTHER LEGAL THEORY.

ASSISTANCE

Product maintenance agreements and other customer assistance agreements are available for Hewlett-Packard products.

For any assistance, contact your nearest Hewlett-Packard Sales and Service Office. Addresses are provided at the back of this manual.

SAFETY SUMMARY

The following general safety precautions must be observed during all phases of operation, service, and repair of this instrument. Failure to comply with these precautions or with specific warnings elsewhere in this manual violates safety standards of design, manufacture, and intended use of the instrument. Hewlett-Packard Company assumes no liability for the customer's failure to comply with these requirements. This is a Safety Class 1 instrument.

GROUND THE INSTRUMENT

To minimize shock hazard, the instrument chassis and cabinet must be connected to an electrical ground. The instrument is equipped with a three-conductor ac power cable. The power cable must either be plugged into an approved three-contact electrical outlet or used with a three-contact to two-contact adapter with the grounding wire (green) firmly connected to an electrical ground (safety ground) at the power outlet. The power jack and mating plug of the power cable meet International Electrotechnical Commission (IEC) safety standards.

DO NOT OPERATE IN AN EXPLOSIVE ATMOSPHERE

Do not operate the instrument in the presence of flammable gases or fumes. Operation of any electrical instrument in such an environment constitutes a definite safety hazard.

KEEP AWAY FROM LIVE CIRCUITS

Operating personnel must not remove instrument covers. Component replacement and internal adjustments must be made by qualified maintenance personnel. Do not replace components with power cable connected. Under certain conditions, dangerous voltages may exist even with the power cable removed. To avoid injuries, always disconnect power and discharge circuits before touching them.

DO NOT SERVICE OR ADJUST ALONE

Do not attempt internal service or adjustment unless another person, capable of rendering first aid and resuscitation, is present.

DO NOT SUBSTITUTE PARTS OR MODIFY INSTRUMENT

Because of the danger of introducing additional hazards, do not install substitute parts or perform any unauthorized modification to the instrument. Return the instrument to a Hewlett-Packard Sales and Service Office for service and repair to ensure that safety features are maintained.

DANGEROUS PROCEDURE WARNINGS

Warnings, such as the example below, precede potentially dangerous procedures throughout this manual. Instructions contained in the warnings must be followed.

WARNING

Dangerous voltages, capable of causing death, are present in this instrument. Use extreme caution when handling, testing, and adjusting.

SAFETY SYMBOLS

General Definitions of Safety Symbols Used On Equipment or In Manuals.



Instruction manual symbol: the product will be marked with this symbol when it is necessary for the user to refer to the instruction manual in order to protect against damage to the instrument.



Indicates dangerous voltage (terminals fed from the interior by voltage exceeding 1000 volts must be so marked).

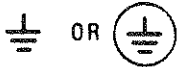

Protective conductor terminal. For protection against electrical shock in case of a fault. Used with field wiring terminals to indicate the terminal which must be connected to ground before operating equipment.



Low-noise or noiseless, clean ground (earth) terminal. Used for a signal common, as well as providing protection against electrical shock in case of a fault. A terminal marked with this symbol must be connected to ground in the manner described in the installation (operating) manual, and before operating the equipment.

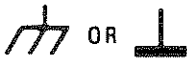

Frame or chassis terminal. A connection to the frame (chassis) of the equipment which normally includes all exposed metal structures.



Alternating current (power line).



Direct current (power line).



Alternating or direct current (power line).



The **WARNING** sign denotes a hazard. It calls attention to a procedure, practice, condition or the like, which, if not correctly performed or adhered to, could result in injury or death to personnel.



The **CAUTION** sign denotes a hazard. It calls attention to an operating procedure, practice, condition or the like, which, if not correctly performed or adhered to, could result in damage to or destruction of part or all of the product.

NOTE

The **NOTE** sign denotes important information. It calls attention to procedure, practice, condition or the like, which is essential to highlight.

TABLE OF CONTENTS

Instrument Description/Initial Inspection	vi
Specifications at a Glance	vii

GETTING STARTED

Introduction	1-1
Instrument Turn On	1-1
Definitions & Operating Hints	1-3
Confidence Test	1-5

MAKING MEASUREMENTS

Introduction	2-1
Tuned Stub Notch Filter	2-3
Bandpass Filter	2-13
Amplifier	2-27
Low Pass Filter	2-31
Amplifier S-Parameters	2-39

REMOTE OPERATION

The Hewlett Packard Interface Bus	3-1
The HP 3577A and the HP-IB	3-2
The HP 3577A's HP-IB Address	3-4
Bus Messages	3-5
Instrument Preset Parameter Values	3-31
** The Status Byte	3-33
"How To Go Fast" Examples	3-34

REFERENCE

Amplitude	4-1
Attenuation	4-2
Average	4-3
Continuous Entry	4-4
Data Entry	4-4
Data Register	4-5
Define Math	4-5
Display Format	4-6
Display Function	4-7
Entry Block	4-9
External Reference	4-9
Graticule	4-11
Hardkey	4-12
Input	4-12
Instrument Preset	4-13
Instrument State	4-13
Knob	4-14
Length	4-14
Local	4-15

PARAMS (DATA) - - - 3-34

Marker	4-15
Marker—	4-16
Measurement Calibration	4-18
Menu	4-21
Message Block	4-21
Output	4-21
Overload	4-22
Plot	4-22
Recall Instrument State	4-24
Receiver	4-25
Resolution Bandwidth	4-25
S-Parameter Test Set	4-26
Save Instrument State	4-27
Scale	4-27
Screen	4-29
Softkey	4-29
Source	4-29
Special Functions	4-30
Store Data	4-31
Sweep Mode	4-32
Sweep Time	4-33
Sweep Type	4-34
Trace 1, Trace 2	4-35
Trigger Mode	4-36
Trigger/Reset	4-36
Softkey Index	4-38

GENERAL INFORMATION

Introduction	5-1
Initial Inspection	5-1
Power Requirements	5-1
Power Cable and Grounding Requirements	5-1
Operating Environment	5-3
Accessories Available	5-4
Accessories Supplied	5-4
Options	5-4
Installation	5-4
HP-IB Connections	5-6
Storage and Shipment	5-6
Specifications	5-8

APPENDICES

Appendix A — Special Topics	A-1
Appendix B — Remote Graphics	B-1
Appendix C — Screen Messages	C-1
Appendix D — Programming Codes	D-1
Appendix E — Bibliography	E-1

INSTRUMENT DESCRIPTION

The HP 3577A Network Analyzer is a three-input, dual trace, synthesized, 5Hz-200MHz programmable network analyzer. It features menu-driven operation, using eight "softkeys" located next to the menu display area of the CRT. A menu is a list of softkey labels that appears on the CRT by the softkeys. Menus are displayed by pressing the hardkeys for the parameters to be modified or measurement to be made. This permits control of many features with a minimum number of front panel keys by redefining the softkeys with each new menu. Marker information and sweep parameters are displayed above and below the CRT graticule to give the operator the present instrument status.

Trace information displayed on the 3577A CRT is digitally stored as complex data (real + imaginary) in trace memory. Using this storage technique and the math processing capabilities of the HP 3577A, any of 7 different display formats may be derived from the same trace data and changes in scale may be made without repeating the measurement.

All 3577A graticules are electronically generated on the screen as part of the display operation. Thus, no screen overlays are needed for polar or log graticules or the Smith chart. In log sweep the graticule changes to reflect changes in start and stop frequencies.

Other features of the HP 3577A include electrical length correction/measurement, automatic plot routines for HP-GL plotters, user defined vector math, vector averaging, 1 Hz resolution bandwidth, automatic self-protection on the source output and receiver inputs, and the ability to save and recall six instrument states.

The HP 3577A is composed of three main functional blocks: **SOURCE**, **RECEIVER**, and **DISPLAY FORMAT**. The source and receivers work together to gather data and store it in trace memory. The display section takes the trace data and formats it for viewing.

INITIAL INSPECTION

This instrument was carefully inspected both mechanically and electrically before shipment. It should be free of marks and scratches and in perfect electrical order upon receipt. To confirm this, inspect the instrument for physical damage incurred in transit, inventory the supplied accessories (listed in Table 5-2), and test the electrical performance using the Confidence Test listed in the section on Getting Started. If there is physical damage, if the contents are incomplete or if the instrument does not pass the Confidence Test, notify the nearest HP Sales and Service Office. If the shipping container is damaged or the cushioning material shows signs of stress, notify the carrier as well as the Hewlett-Packard office. Keep the shipping material for the carrier's inspection.

WARNING

The integrity of the protective earth ground may be interrupted if the HP 3577A is mechanically damaged. Under no circumstance should the HP 3577A be connected to power if it is damaged.

SPECIFICATIONS AT A GLANCE

3577A NETWORK ANALYZER

Source Characteristics
Frequency Range: 5 Hz to 200 MHz.
Frequency Resolution: 0.001 Hz.
Output Level Range: +15 dBm to -49 dBm (1.26 Vrms to 793 μ Vrms).
Output Resolution: 0.1 dB.
Impedance: 50 Ω with >20 dB return loss.
Output Connector: 50 Ω Type N female.
Sweep Type: Linear, Alternate, Logarithmic and CW Frequency; Logarithmic Amplitude.
Sweep Mode: Continuous, Single, Manual.
Trigger Mode: Free Run, Immediate, Line, External.

Receiver Characteristics
Frequency Range: 5 Hz to 200 MHz.
Inputs: Three (A,B,R).
Impedance: 50 Ω with >25 dB return loss or 1 M Ω .
Input Connectors: Three, 50 Ω Type N female.

Magnitude Range (with 50 Ω input impedance and 20 dB input attenuation):

Resolution Bandwidth	5 Hz to 30 kHz Input Frequency	30 kHz to 200 MHz Input Frequency
1 Hz	0 dBm to -110 dBm	0 dBm to -110 dBm
1 kHz	0 dBm to -80 dBm	0 dBm to -95 dBm

Note: These levels shift 20 dB lower with 0 dB input attenuation.

Phase Range: ± 180 deg.
Group Delay Range: 1 ps to 20,000 s.
Resolution Bandwidth: 1 kHz, 100 Hz, 10 Hz, 1 Hz.

Dynamic Accuracy (in 1 kHz, 100 Hz, or 10 Hz resolution bandwidth):

Magnitude	Phase	Input Level Relative to Maximum Allowable Input
± 0.04 dB	± 0.4 deg	0 dB to -10 dB
± 0.02 dB	± 0.2 deg	-10 dB to -50 dB
± 0.05 dB	± 0.5 deg	-50 dB to -60 dB
± 0.15 dB	± 1.5 deg	-60 dB to -80 dB
± 0.75 dB	± 7.5 deg	-80 dB to -100 dB

Electrical Length: -3×10^6 m to $+3 \times 10^6$ m of equivalent electrical length at inputs A,B and R.

Display Characteristics

Measurement Functions: Log magnitude, linear magnitude, phase, real, imaginary and group delay.

Graticules: Rectangular (dual trace), polar and Smith chart.

Resolution:

	Display	Marker
Magnitude	0.01 dB/div	0.001 dB
Phase	0.01 deg/div	0.005 deg
Real/Imaginary	0.1 nV/div	5 digits
Group Delay	0.01 ns/div	1 ps

Measured No. Points/Sweep: Linear and Alternate Frequency, 51,101,201,401; Logarithmic Frequency, 401.

Measured No. Steps/Sweep: Logarithmic Amplitude Sweep, 5,10,20,50,100,200,400.

Noise Averaging: Exponentially weighted vector averaging on successive sweeps. Averaging factors are 1(off),4,8,16,32,64,128,256.

Vector Math: Vector addition, subtraction, multiplication, and division of measured data, stored data, constants and/or functions.

Calibration: Normalization and reflection vector error correction (removes effects of directivity, frequency response, and/or source match).

Graphics: HP-IB programmable alphanumeric and special characters, and line vectors.

Hard Copy: Direct plots using an HP graphics plotter without a computer.

Save/Recall Memory: Front panel setups can be stored and recalled using any of the five non-volatile memories.

35677A/B S-PARAMETER TEST SETS

Frequency Range: 100 kHz to 200 MHz

Test Port Impedance:

35677A: 50 Ω with >26 dB port match.

35677B: 75 Ω with >24 dB port match.

Connectors:

Input Port, Output Ports(A,B,R): 50 Ω Type N female.

Test Ports(1,2):

35677A: 50 Ω Type N female.

35677B: 75 Ω Type N female.

Directivity: >40 dB.

Typical Maximum Output Power (with 3577A Source Output Level at +15 dBm):

	Test Ports(1,2)	Output Ports(A,B,R)*
35677A	+2 dBm	-4 dBm
35677B	-4 dBm	-16 dBm

*with a direct through connection for transmission, or a short circuit for reflection at test ports.

GETTING STARTED

INTRODUCTION

This section is designed to get the first time user ready to make measurements. To do this the HP 3577A must be configured and fused for the available line voltage and safely connected to the power line before it is turned on. As the CRT warms up, a self test is run that sounds the beeper, illuminates all the front panel LED's and tests internal RAM and ROM. By the time the CRT is warm enough to display a screen, normal operation has begun. Approximately ten minutes after power is turned on, the beeper will sound again as the oven reference reaches operating temperature and switches in as the frequency reference for the HP 3577A Network Analyzer.

After the detailed turn-on procedure is a definition of some of the terms commonly used in this manual and some operating hints to help the new user establish good operating habits. "IN CASE OF TROUBLE" is included under operating hints.

INSTRUMENT TURN ON

A. Before connecting ac power to the HP 3577A:

- 1. Set the rear panel VOLTAGE SELECTOR switch to the position that corresponds to the power-line voltage to be used:

Voltage Selector	Line Voltage
115V	86V to 127V at 48 Hz to 440 Hz
230V	195V to 253V at 48 Hz to 66 Hz

WARNING

To avoid serious injury, be sure that the ac power cord is disconnected before removing or installing the ac line fuse.

- 2. Verify that the proper line fuse is installed in the rear-panel FUSE holder:

Voltage Selector	Fuse Type	HP Part No.
115V	7A, 250V Normal Blo	2110-0614
230V	4A, 250V Normal Blo	2110-0055

WARNING

To protect operating personnel, the 3577A chassis and cabinet must be grounded. The HP 3577A is equipped with a three-wire power cord which, when plugged into an appropriate receptacle, grounds the instrument. To preserve this protection feature the power plug should only be inserted in a three-terminal receptacle having a protective earth ground contact. The protective action must not be negated by the use of an extension cord or adapter that does not have the required earth ground connection. Grounding one conductor of a two-conductor outlet is not sufficient protection.

Ensure that all devices connected to the HP 3577A are also connected to the protective earth ground.

- B. Set the front panel power switch to the OFF position.
- C. Connect the ac power cord to the rear panel LINE connector. Plug the other end of the power cord into a three-terminal *grounded* power outlet.
- D. Turn on the power to the instrument by pressing the LINE switch on the front panel to the ON position. Verify that all front panel LED's illuminate simultaneously soon after the HP 3577A is turned on.

NOTE

Each time the HP 3577A is powered ON a self-test of ROM and RAM is run and the results (pass/fail) are displayed on the screen. (Normally the CRT will not show these results because it hasn't warmed up). The beeper will sound and all front panel LED's should illuminate when the instrument is first turned on. The operator should visually verify that all LED's illuminate.

- E. Verify that the cooling fan on the rear panel is operating and that the SWEEP LED on the front panel is flashing about once per second.
- F. Approximately ten minutes after power-on the beeper will sound and the screen message "REFERENCE UNLOCKED" will appear very briefly. This indicates that the oven reference has reached operating temperature and has been selected as the frequency reference for the Voltage Controlled Crystal Oscillator (VCXO). When the switch occurs, the VCXO takes a moment to achieve phase lock which causes the screen message. Until this switch occurs the VCXO uses its own 10 MHz crystal as the frequency reference. If "REFERENCE UNLOCKED" remains on the screen, contact an authorized repair facility.

NOTE

The internal oven will automatically become the frequency reference when it reaches operating temperature; no external connections are necessary. The jack on the rear panel marked EXTERNAL REFERENCE is not meant to be connected to the 10 MHz REFERENCE OUTPUT beside it.

DEFINITIONS & OPERATING HINTS

1. It is good practice to start a measurement setup by pressing INSTRUMENT PRESET. This is a quick way to set all parameters to known values (the PRESET state) and is used as the common starting point in this manual. For a listing of the PRESET state parameter values, see INSTRUMENT PRESET in the REFERENCE section.

NOTE

The PRESET state depends on whether an HP 35677 A/B S-Parameter Test Set is connected to the HP 3577A. If the connection is made without turning off power to the HP 3577A Network Analyzer, it is recommended that the INSTR PRESET hardkey be pressed to update the starting parameter values.

2. The recommended sequence for setting up a measurement is 1) **INPUT**, 2) **DISPLAY FCTN**, 3) **FREQ**, 4) **AMPTD**. This sequence is a good, general start for setting up an instrument state and should be easy to remember. See the circled numbers in Figure 1•1.

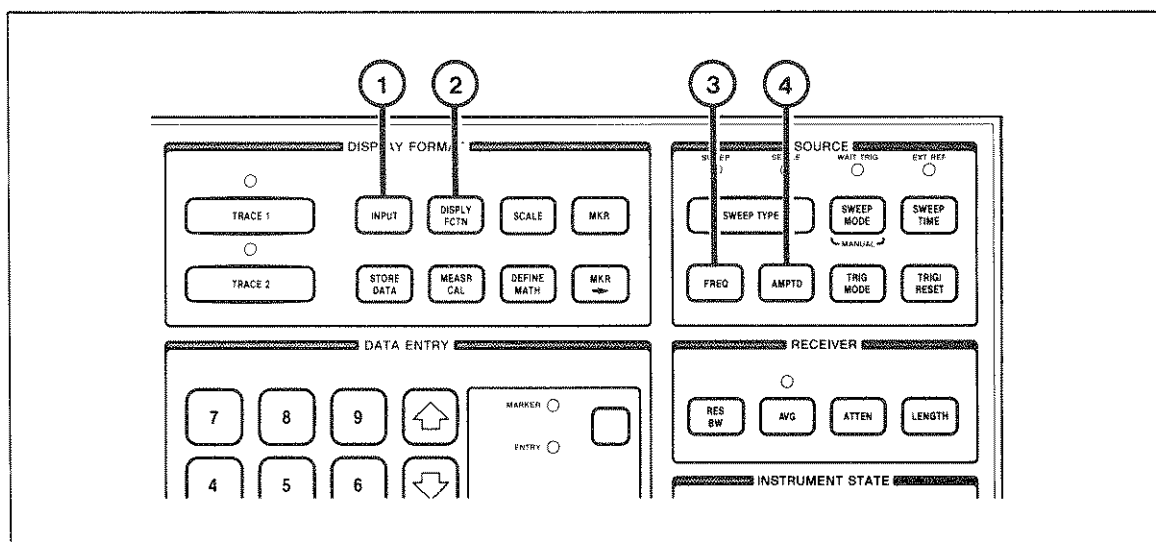

Figure 1•1 Setup Sequence

3. The HP 3577A is a menu-driven instrument. The hard keys (all keys with a function stenciled on them) are used to display the various menus. If the menu displayed is not what you wanted, press another hardkey to display another menu. If you decide not to make a data entry after beginning the entry on the numeric keypad, you may press another hardkey to exit. Since data entries must be terminated by selection of units (Hz, dBm, etc.), no entry is made if units are not selected.

4. The softkey labels will appear next to the eight softkeys, down the right side of the screen. Each group of softkey labels is referred to as a "menu."
5. The beeper will sound to attract the user's attention when the HP 3577A displays a new screen message (unless the beeper has been turned off; see SPECIAL FUNCTIONS in the REFERENCE).
6. If the HP 3577A is used as part of a measurement system, it is recommended that the frequency references of all instruments be phase locked to a common frequency standard. The HP 3577A will lock to a frequency reference applied to its External Reference Input if the signal is between -7 and $+15$ dBm and the frequency is the result of dividing 10 MHz by an integer and is above 100 kHz (± 20 ppm). Or, the HP 3577A can serve as the system reference via its 10 MHz, 0 dBm Reference Output. Both of these connections are located on the rear panel. If the HP 3577A is used as the standard, the stability will be .05 ppm per °C.
7. The HP 3577A requires 60 minutes to warm up before all of the specifications will apply; however, the instrument is operable during this warmup period.

IN CASE OF TROUBLE

8. If the HP 3577A fails to respond to front panel key presses perform the following steps until normal operation is restored:
 - a. Verify that the HP-IB status indicator LED labeled "REMOTE" is not illuminated. It is possible that the instrument has been addressed over the bus, in which case it will not respond to front panel operation until LOCAL control is restored with the LCL hardkey or via a controller issued comand. The LCL key will not restore LOCAL status if the controller has issued a LOCAL LOCKOUT command.
 - b. Press the INSTR PRESET hardkey.
 - c. Turn the 3577A power OFF and back ON.

NOTE



The test described in the following step will reset (i.e. erase) all non-volatile read/write memory on the main processor board. This resets all six instrument states, plot parameters, and the HP-IB parameters to their default parameters.





- d. If none of the previous steps have returned control to the front panel, 1) turn power OFF, 2) hold down the SAVE and RECALL hardkeys, and 3) turn power ON. Continue to hold the keys down until all power-on tests are complete. This procedure will test parts of the main processor memory not normally tested and may reset a bad memory register, allowing normal operation to continue.
- e. Contact an authorized repair facility.

CONFIDENCE TEST

The 3577A may be confidence tested with the following keystrokes. Use this test when the instrument is first unpackaged to ensure that the instrument is in an undamaged condition or whenever a quick check of basic operation parameters is necessary.

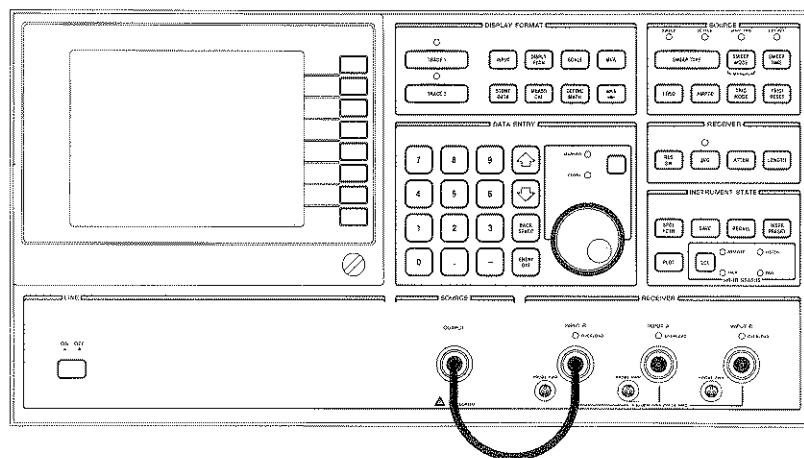
KEY	DESCRIPTION
	Hardkey in the INSTRUMENT STATE section used to display the SPECIAL FUNCTION menu. This menu contains the softkey "CONF TEST."
CONF TEST 	Softkey used to select the confidence test. Note that the screen displays a message to connect a cable between the output and the input to be tested. The menu contains commands to test any of the three inputs. Connect the cable as shown below.



TEST R 	Softkey that begins test of input R. The HP 3577A will run nine tests and display pass/fail results of each. These tests are: <ul style="list-style-type: none"> • LOG SWEEP signal level test • LOG SWEEP flatness test • LINEAR SWEEP signal level • LINEAR SWEEP magnitude flatness • Synthesizer and L.O. feed through • AMPLITUDE SWEEP accuracy • Output limiter linearity • RECEIVER IMPEDANCE • RECEIVER ATTENUATOR
---	--

If any tests fail, the HP 3577A Network Analyzer will stop the testing and display a failure message. Testing may be continued by pressing the CONT TEST softkey. Any screen listing of a failed test will be bright.

Inputs A and B may be tested in the same manner, by connecting the OUTPUT to the input to be tested and pressing the corresponding softkey. When testing is complete, press INSTR PRESET or any other hardkey to exit the CONFIDENCE TEST menu and begin a measurement setup.

NOTE

If any of the HP 3577A CONFIDENCE TESTS fail, refer to the HP 3577A Service Manual for instructions.

WARNING

Service procedures should be executed by trained service personnel, only. To avoid electrical shock, do not perform any servicing procedures unless you are qualified to do so.

MAKING MEASUREMENTS

This section contains step by step instructions demonstrating the use of the HP 3577A Network Analyzer and the HP 35677A/B S-Parameter Test Set to make measurements.

Using the HP 3577A by itself, characterize:

1. A tuned stub notch filter
 - a. Measurement set up
 - b. Using the marker to make measurements
 - c. STORE trace data
 - d. SAVE Instrument State
2. A bandpass filter
 - a. Measurement set up
 - b. Measure -60 dB and -3 dB bandwidths (calculate shape factor)
 - c. Measure passband ripple
 - d. Measure passband insertion phase
 - e. Measure passband group delay
3. Gain compression of an amplifier
 - a. Measurement set up
 - b. Measure -3 dB gain compression point

Using the HP 35677A/B S-Parameter Test Set with the HP 3577A, characterize:

4. A low pass filter
 - a. Measurement set up
 - b. Measure insertion loss
 - c. Measure passband insertion phase
 - d. Measure passband ripple
 - e. Measure stopband rejection
5. S-parameters of an amplifier *p. 2-39*
 - a. Initial measurement set up
 - b. Measure S_{21} , forward gain and phase
 - c. Measure S_{12} , reverse loss
 - d. Measure S_{11} , input return loss
 - e. Measure S_{22} , output reflection coefficient
 - f. Conversion of reflection coefficient to complex impedance

This list of measurements was selected to cover topics of general interest and common usage such that most of the capabilities of the HP 3577A Network Analyzer and HP 35677A/B S-Parameter Test Set are demonstrated. For details on operating features see the REFERENCE section. A Soft-key Index is on page 4-38. The listing of the hardkeys in the REFERENCE section is alphabetical.

As you read this section press the keys on the HP 3577A listed at the left of each page. Even if nothing is connected to be tested, references to menus and data entry exercises will help you learn to operate the HP 3577A Network Analyzer. It is important to start each topic at the beginning (i.e., at INSTRUMENT PRESET). Use the foldout pictorial for locating hardkeys. This page may be wrapped around the back of the manual so that it lays to the right face up while the rest of the manual is read.

Note that most hardkeys are used only to display a menu of softkey labels. If a mistake is made in data entry or feature selection for data entry (such as forgetting to select CENTER FREQ before beginning to enter it), pressing the hardkey again will display the original menu.

TUNED STUB NOTCH FILTER

Connect the cables and adapters as shown in Figure 2•1. This configuration should result in a notch filter whose center frequency is related to the length of the open-ended cable. The notch filter is constructed from the following parts:

- Qty 2, N(m) to BNC(f) adapters, HP 1250-0780
- Qty 2, 1 foot BNC cable, HP 11170A
- Qty 1, BNC tee (f)(f)(m), HP 1250-0781
- Qty 1, BNC(f) to BNC(f) adapter, HP 1250-0080
- Qty 1, 2 foot BNC cable, HP 11170B

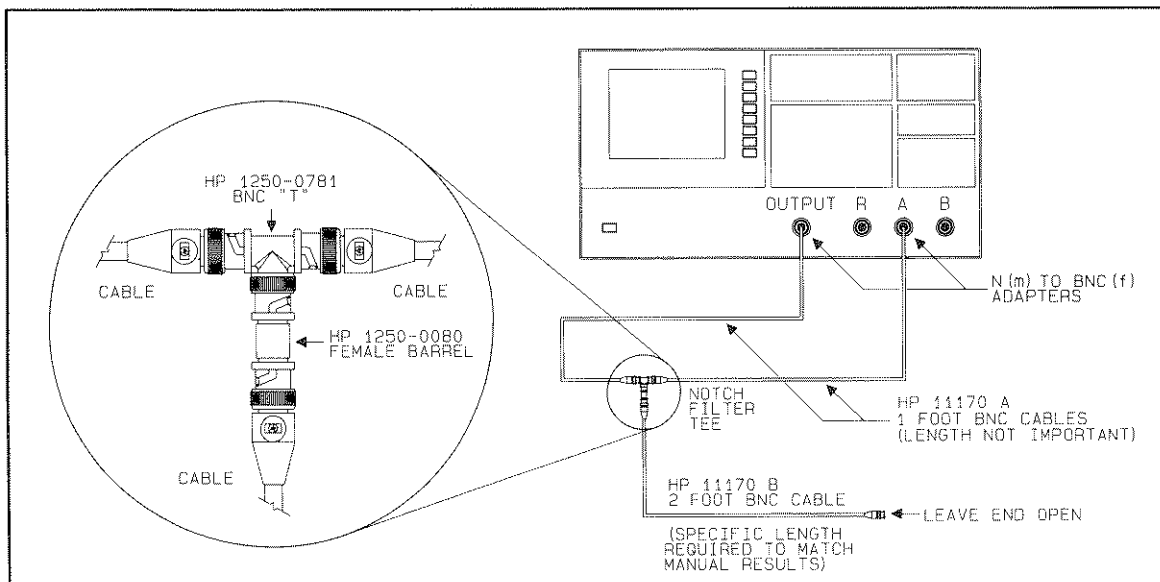

Figure 2•1 Circuit Configuration

This measurement exercise is designed to show:



1. How to set up the instrument state to make a measurement.
2. How to use the markers to make measurements.
3. How to STORE trace data.
4. How to SAVE an instrument state.

Data entries require four steps: press a hardkey to display a menu, press a softkey (if not already active or bright) to select the parameter for data entry, enter data with the numeric key pad, and press a softkey to select units. If the knob or arrow keys are used, unit selection is not necessary; since existing values are modified, units do not change.





Any of the three receiver inputs may be used for this example. If the operator wishes to use an input other than R (the default INPUT definition), connection should be made to that input and the corresponding selection should be made in the INPUT menu. Note that "receiver input" refers to front panel connections R, A, and B while "INPUT" (capitalized) refers to the definition of the screen trace under the INPUT hardkey.

This measurement set up begins, after INSTRUMENT PRESET, by defining INPUT, DISPLAY FUNCTION, FREQUENCY, and AMPLITUDE.

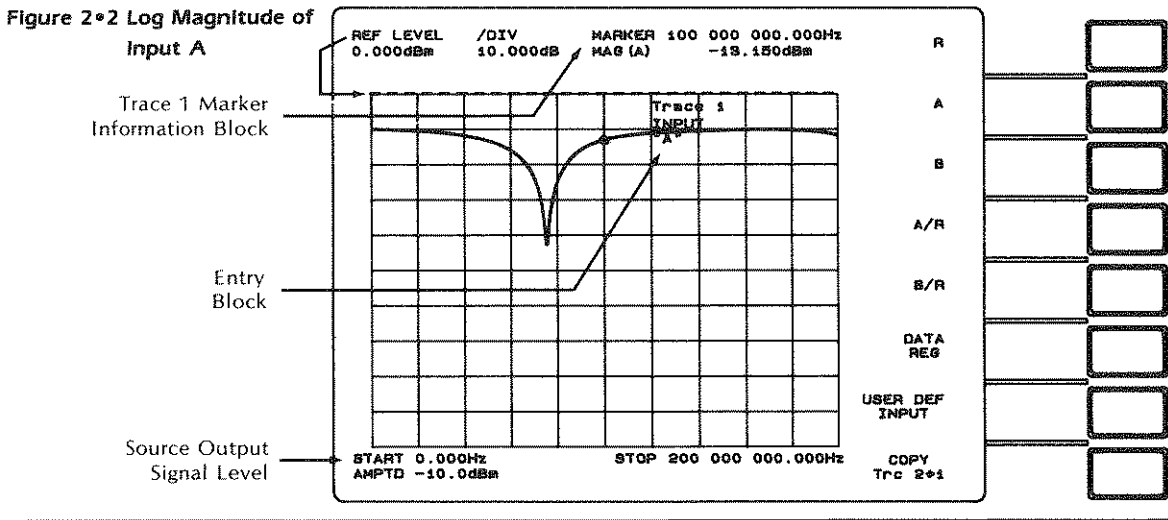
MEASUREMENT SET UP

KEY	DESCRIPTION
	This green hardkey in the INSTRUMENT STATE section of the front panel presets 3577A parameters to their default values. These are listed under INSTRUMENT PRESET in the REFERENCE section of this manual. Note that the INPUT menu is displayed.
A 	Softkey used to select receiver input A as the INPUT definition for the active trace. Note that the LED above the TRACE 1 hardkey is illuminated, indicating that trace one is active. The screen should now appear as shown in Figure 2*2.



	Hardkey in the DISPLAY FORMAT section that selects trace two as the active trace. Note that the INPUT menu shows that INPUT R is active for trace two. Note that trace one and its alphanumeric information above the graticule dimmed slightly when trace two was selected.
A 	Softkey that selects receiver input A as the active INPUT for trace two. When this key was pressed the beeper sounded and the screen message "WARNING: TRACE IS OFF" appeared.
	Hardkey in the DISPLAY FORMAT section that displays a new menu listing the seven possible display function formats available for each trace. Note that trace two is OFF.
PHASE 	Softkey used to select the phase display function for the active trace. Pressing this key turns trace two on and defines its display function to be phase. Note that trace two is brighter than trace one. This difference in trace intensity and the LEDs above the TRACE hardkeys indicate which trace is active. Any softkey commands given or data entered will affect the active trace. Note that when trace two was turned on, another set of alphanumeric information appeared above the graticule. This information applies to trace two and is the same intensity as the trace.

The screen should now appear as shown in Figure 2*3.

Figure 2*3 Log Magnitude and Phase of Input A

Trace 2 Information

Trace 2 Ref. Level

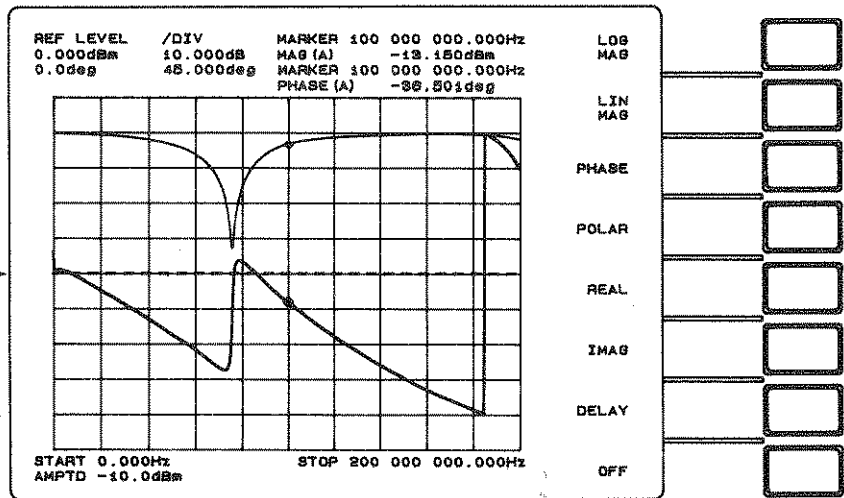

Hardkey in the **SOURCE** section used to display the FREQUENCY menu. Note that the softkey label START FREQ is active. Since this is the parameter to be modified, selection of a softkey parameter is not necessary.



Data entry done with the numeric key pad in the **DATA ENTRY** section.



Softkey used to select units for the data entry.



Softkey used to select the stop frequency parameter for modification or data entry of a new value.



Data entry done with the numeric key pad in the **DATA ENTRY** section.



Softkey used to select units for the data entry.



Hardkey in the **SOURCE** section used to display the AMPLITUDE menu. Note that the softkey label AMPTD is active. Since this is the parameter to be modified, selection of a softkey parameter is not necessary. Note that the ENTRY BLOCK shows the current value of this parameter is -10 dBm.



Down arrow key in the **DATA ENTRY** section used to decrement the active parameter by the STEP SIZE. Note that the value in the ENTRY BLOCK and the alphanumeric at the lower left corner of the graticule show that the source amplitude is now -11 dBm (i.e. STEP SIZE is 1 dB).



Hardkey in the **DISPLAY FORMAT** section that selects trace one as the active trace.



Hardkey in the **DISPLAY FORMAT** section that displays the SCALE parameter menu.



Softkey selection that selects scale parameters such that the active trace will fit in the graticule. The screen should now appear as shown in Figure 2*4.

Figure 2*4 Changing Source and Scale Parameter Values





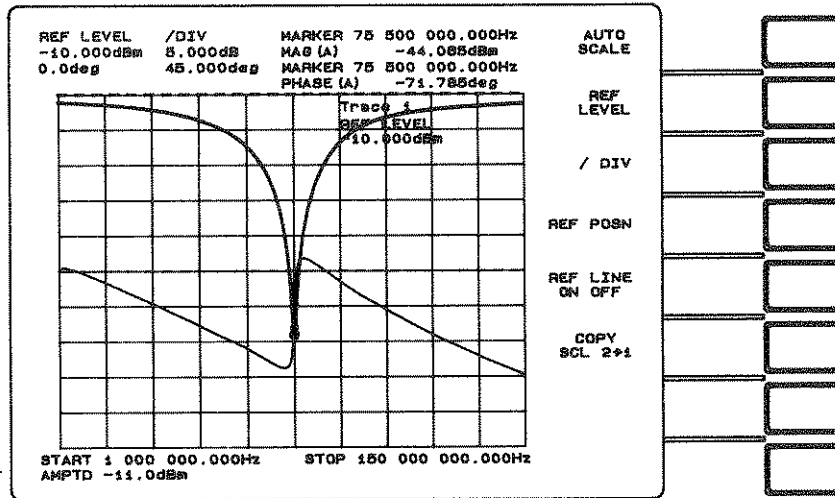



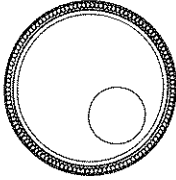

Note new scale values for Trace 1

Note new parameter values for both traces

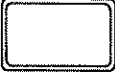

Now the measurement set up is complete. Next, we begin to take measurements.

MAKING MEASUREMENTS

KEY	DESCRIPTION
	The knob in the DATA ENTRY section should be in the MARKER mode (indicated by the LEDs above the knob and changed to modify data in the ENTRY mode with the key next to the LEDs). Turn the knob and notice the markers move along the traces and the change in information in the marker information block. Position the markers at the extreme left of the graticule.
	Hardkey in the DISPLAY FORMAT section used to display the MARKER menu.
ZERO MARKER 	Softkey used to turn on the OFFSET MARKER feature and set the MARKER OFFSET (which is a magnitude in this case) and FREQ OFFSET values to those of the regular marker. Note that a triangular marker appears on top of the circular marker on trace one. This OFFSET MARKER is now the reference for measurements taken with the marker on trace one. Note the change in the marker information block for trace one from "MARKER" to "OFFSET."
	Hardkey in the DISPLAY FORMAT section used to display the MARKER GOES INTO... menu. These keys may be used to make data entries with the marker after positioning it with the knob or to move the marker to maximum or minimum points on the trace.
MARKER SEARCH 	Softkey used to display the MARKER SEARCH menu, which is a second level menu. Note that MARKER TARGET is the active (bright) softkey label and that its default value is -3.000dB .
MKR - R TARG 	Softkey used to SEARCH RIGHT FOR TARGET value. Note that the regular marker on trace two moves right until it reaches the first point on the trace where it is three dB below the OFFSET MARKER .
	Hardkey described previously.
ZERO MARKER 	Softkey described previously. Note that the OFFSET MARKER moves to the position of the regular marker.
	Hardkey described previously.
MARKER SEARCH 	Softkey described previously.
	Data entry for a new MARKER TARGET value.

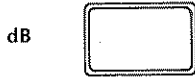

Softkey selection of units for the new MARKER TARGET value



Softkey used to SEARCH RIGHT FOR TARGET value. The MARKER information block now shows the 3 dB width of the notch filter as shown in Figure 2*5.

Figure 2*5 3dB Bandwidth

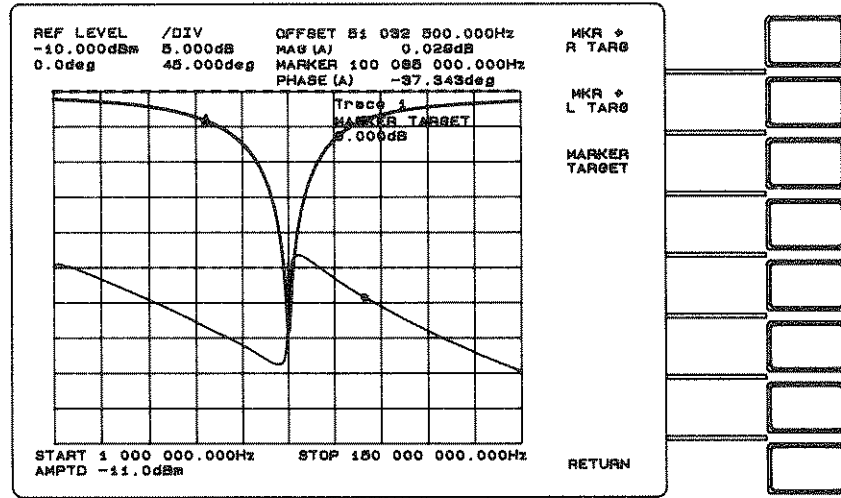

Hardkey described previously.



Softkey used to turn OFFSET MARKER on or off. This is a push-push toggle type key; continued key presses will toggle the feature between ON and OFF. One keypress now turns it OFF. Note the return of the marker information block to MARKER.



Hardkey described previously.

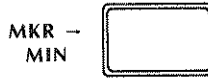

Softkey used to move the marker to the lowest value on the trace. This point is the center frequency of the notch. Note that the marker information block now contains the notch center frequency and rejection magnitude as shown in Figure 2*6.

Figure 2*6 Notch Center Frequency

Center freq. & rejection level of notch

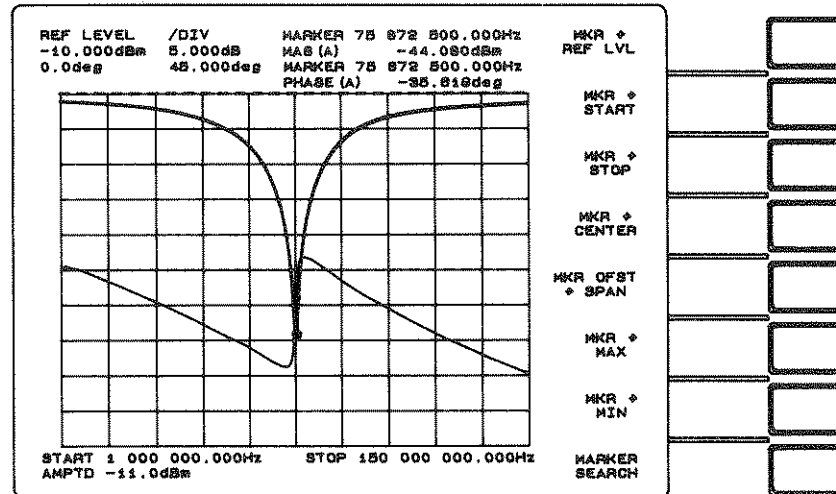

- Hardkey described previously.
- Hardkey described previously.
- Data entry.
- deg Softkey selection of units.
- Hardkey in the **DISPLAY FORMAT** section.
- Hardkey in the **DISPLAY FORMAT** section used to display the **DISPLAY FUNCTION** menu.
- DELAY Softkey selection of **GROUP DELAY** as the **DISPLAY FUNCTION** for the active trace. Note that this softkey label changes to read **DELAY APERTURE** when pressed. Also note the **DELAY APER** alphanumeric data under the lower right corner of the graticule. See Figure 2*7.

Figure 2*7 Phase and Group Delay

Corresponds to % of span selected for aperture

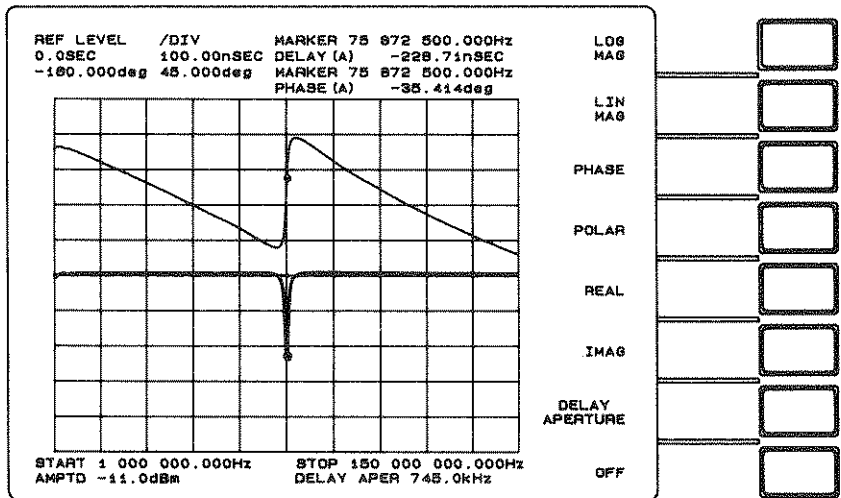

DELAY APERTURE

Softkey used to display the menu of user selectable values for the delay aperture. These value's units are frequency in percent-of-span. Data entries are not allowed for this parameter.

1% OF SPAN

Softkey used to select a delay aperture that is 1% of the total frequency span swept.

DISPLY FCTN

Hardkey described previously.

POLAR

Softkey used to select POLAR as the display function for the active trace. Since only one trace is allowed in POLAR display function, the inactive trace will be turned off.

SCALE

Hardkey described previously.

AUTO SCALE

Softkey described previously. See Figure 2*8.

Figure 2*8 Polar Display Function

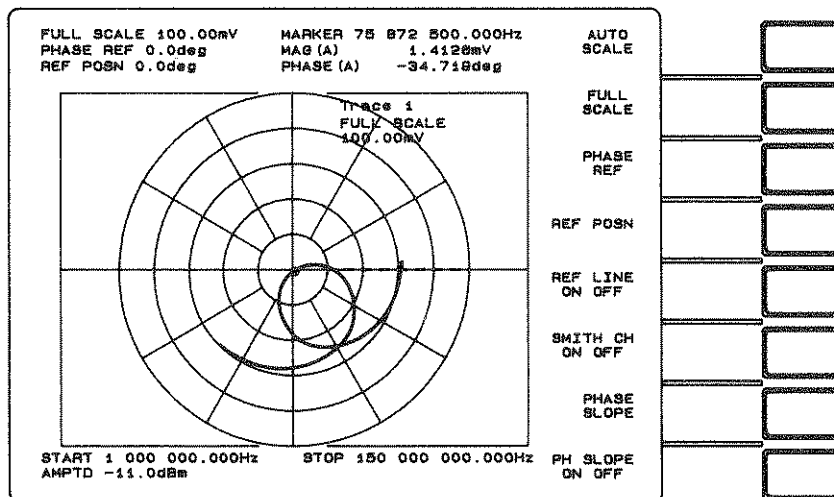

Now the measurements are complete. Next, we will STORE the trace data in one of four data storage registers.

STORE TRACE DATA

KEY

DESCRIPTION



Hardkey in the **DISPLAY FORMAT** section used to display the STORE menu. The menu should appear as shown in Figure 2*9.

Figure 2*9 Store Data Menu

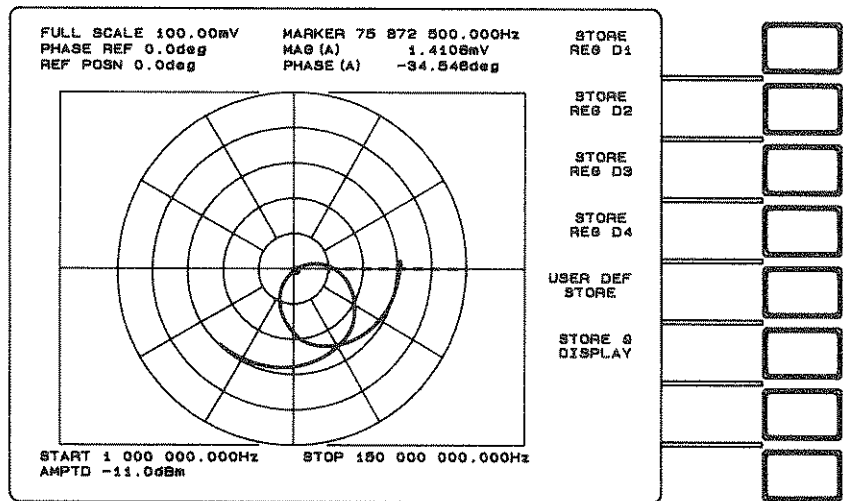

Softkey used to store the trace data of the active trace as defined under the INPUT key into data register D1. Since the INPUT of both traces is ddefined to be A, it didn't matter which trace was active. The current display function has no effect on what is stored. Note the screen message "STORE completed."



Hardkey in the **DISPLAY FORMAT** section. We're going to display the data register we just stored data in.



Softkey used to specify that the INPUT definition is a data register.



Softkey used to specify which data register is displayed. Note that a sweep dot still appears. Memory sweeps are still occurring but no new measurement is being displayed. *If new START and STOP frequencies are entered, this trace will not change.*



Hardkey in the **DISPLAY FORMAT** section. Trace data may be represented in any of the seven DISPLAY FUNCTIONS.



Any softkey in the menu may be selected to redefine the DISPLAY FUNCTION for the trace showing data stored in the data registers.

SAVE INSTRUMENT STATE



KEY	DESCRIPTION
	Hardkey in the INSTRUMENT STATE section used to display the menu used to save state into one of five state registers. This menu will appear as shown in Figure 2*10.

Figure 2*10 Save Instrument State Menu

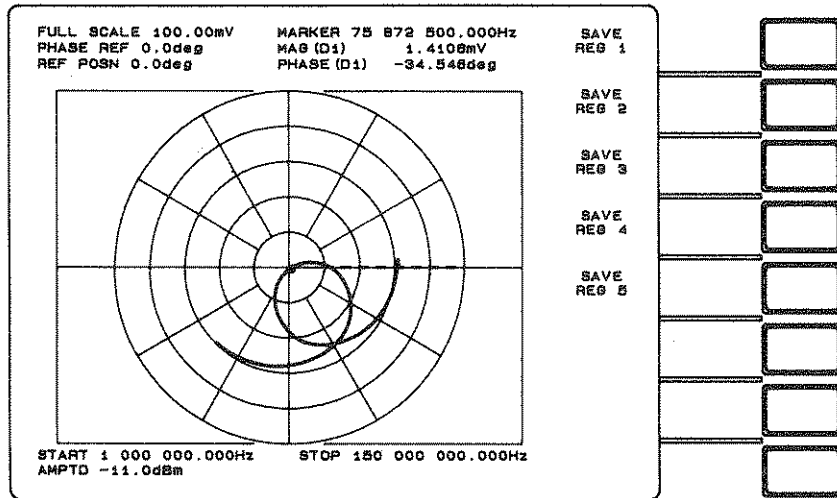

SAVE REG 1 	Softkey selection of instrument state register one. Note screen message "INSTRUMENT STATE SAVED." This state may be recalled by pressing the RECALL hardkey and then pressing the RECALL REG 1 softkey. Cycling power or presetting the instrument will not affect this memory register.
---	--

BANDPASS FILTER

Connect the filter to the HP 3577A as shown in Figure 2•11. The bandpass filter used in this example has a center frequency of 70 MHz but the methods are the same for any bandpass filter.

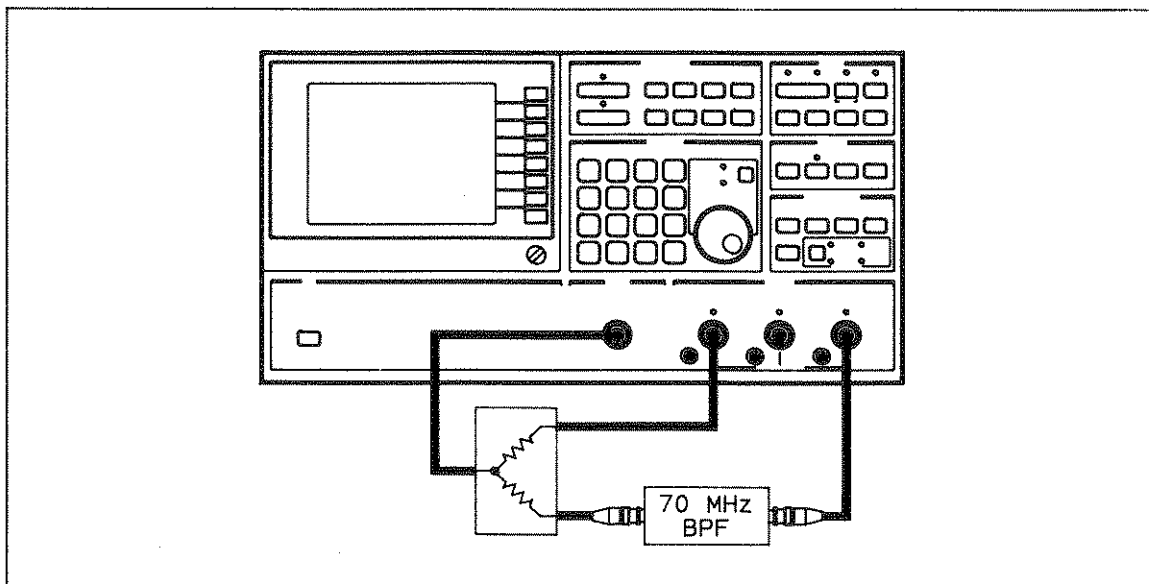

Figure 2•11

The purpose of this measurement exercise is to demonstrate the use of the HP 3577A Network Analyzer to characterize a passband filter. The general organization is:

1. Set up the measurement
2. Measure the -60 dB and -3 dB bandwidths (calculate the shape factor)
3. Measure the passband ripple
4. Measure the passband insertion phase
5. Measure the passband group delay

This measurement set up begins, after INSTRUMENT PRESET, with the four hardkeys: INPUT, DISPLY FCTN, FREQ, and AMPTD. This set up will be INPUT = B/R, DISPLAY FUNCTION = LOG MAG, CENTER FREQ = 70 MHz, FREQ SPAN = 100 kHz (equivalent to setting START FREQ = 69.95 MHz and STOP FREQ = 70.05 MHz), and AMPLITUDE = 0 dBm.

MEASUREMENT SET UP

KEY DESCRIPTION



This green hardkey in the **INSTRUMENT STATE** section of the front panel presets 3577A parameters to their default values. These are listed under INSTRUMENT PRESET in the REFERENCE section. Note that the INPUT menu is displayed when the HP 3577A is PRESET. See Figure 2•12 and the screen of your HP 3577A. If the INPUT hardkey is pressed the menu will not change.

Figure 2•12 Default Menu

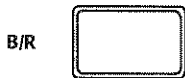
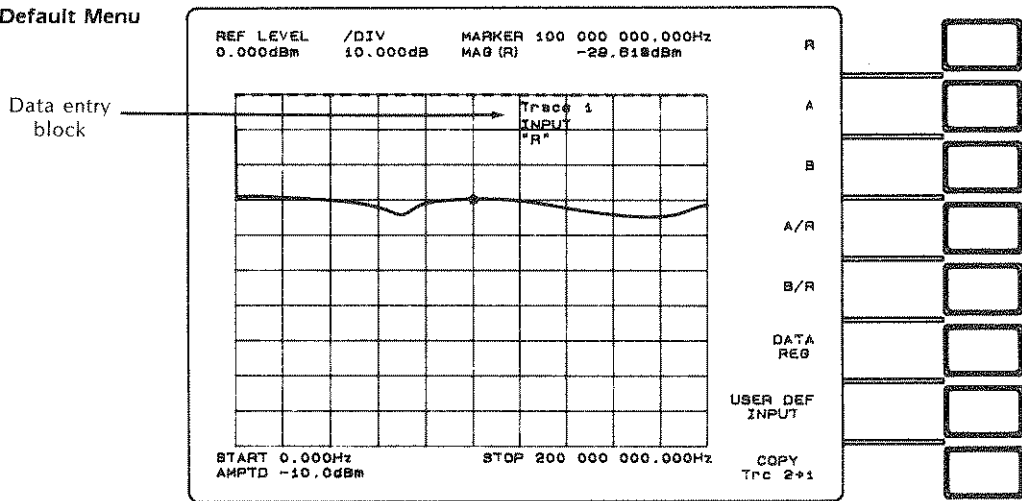

Softkey used to change the INPUT definition to B/R.



Hardkey in the **DISPLAY FORMAT** section. Note the new menu. These softkeys are the seven (eight, counting OFF) ways that the measurement data may be interpreted by the HP 3577A. Note that the current (and default) DISPLAY FUNCTION is Log Magnitude. Make no change in this menu.

Figure 2•13 The Frequency Menu

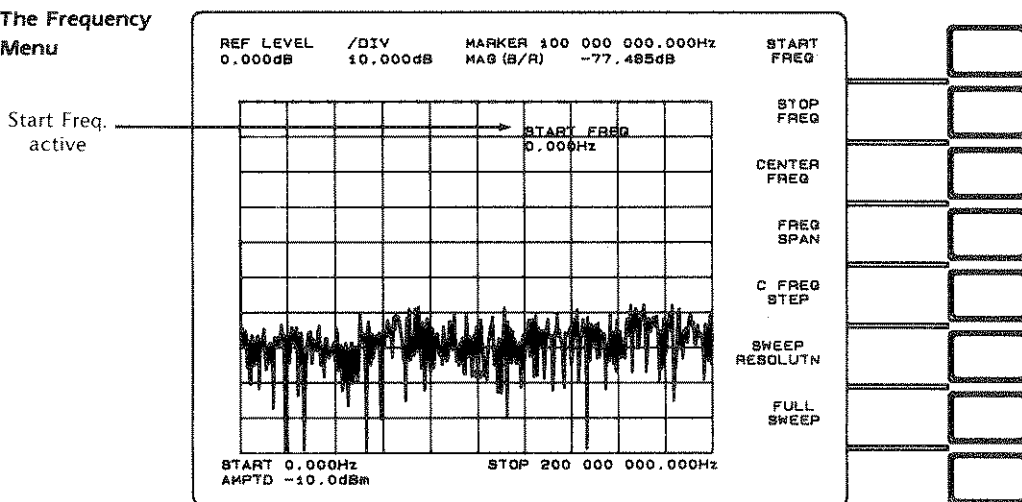



Hardkey in the SOURCE section used to display the menu of softkeys shown in Figure 2•13



Softkey used to select center frequency as the parameter for modification. Default value is 100 MHz.



Data entry



Softkey used to select megahertz as the units for the data entry. Note that the data entry is not complete until units are selected from the menu.



Softkey used to select frequency span as the parameter for modification. The DATA ENTRY block (on the screen) shows the current value is 200 MHz.



Data entry



Softkey used to select kHz as units for entry.



Hardkey in the SOURCE section used to display the menu of softkeys shown in Figure 2•14. Default value is -10 dBm without the test set and +15 dBm with the test set.

Figure 2•14 The Source Amplitude Menu

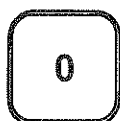
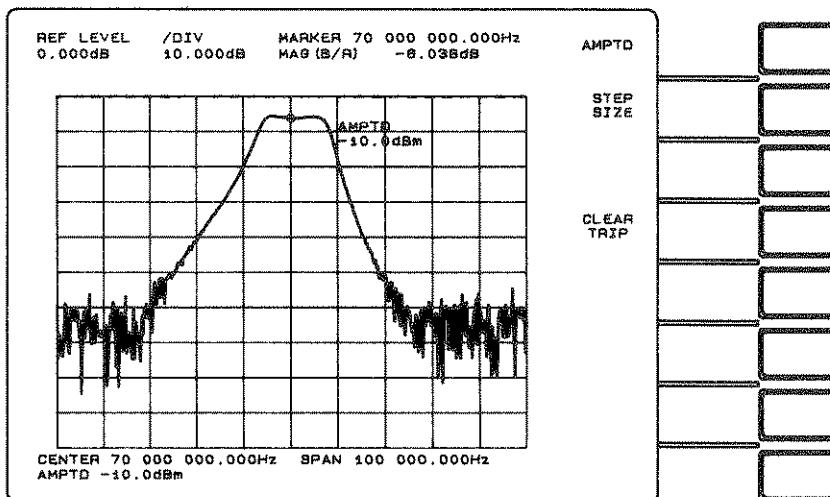

Data entry



Softkey used to select the units for the data entry. The entry is effective when this key is pressed.

In this case, increasing the source amplitude 10 dB has decreased the noise level in the stopband by the same amount. Noise may be reduced further by using higher source amplitudes and/or selecting a receiver attenuation of 0 dB, as long as the input is not overdriven in the passband. Before removing the 20 dB receiver attenuator from input B, check for a maximum signal level of < -20 dBm on input B by pressing:

1. hardkey INPUT
2. softkey B
3. hardkey MKR \rightarrow
4. softkey MKR \rightarrow max, read level in marker info block at top of screen

Change the INPUT definition back to B/R by pressing:

5. hardkey INPUT
6. softkey B/R

Select 0 dB attenuation by pressing:

7. hardkey ATTEN
8. softkey ATTEN B 0 dB 20 dB

These steps were taken and the results appear in Figure 2•15 for comparison with Figure 2•14.

Figure 2•15 Optimizing Dynamic Range

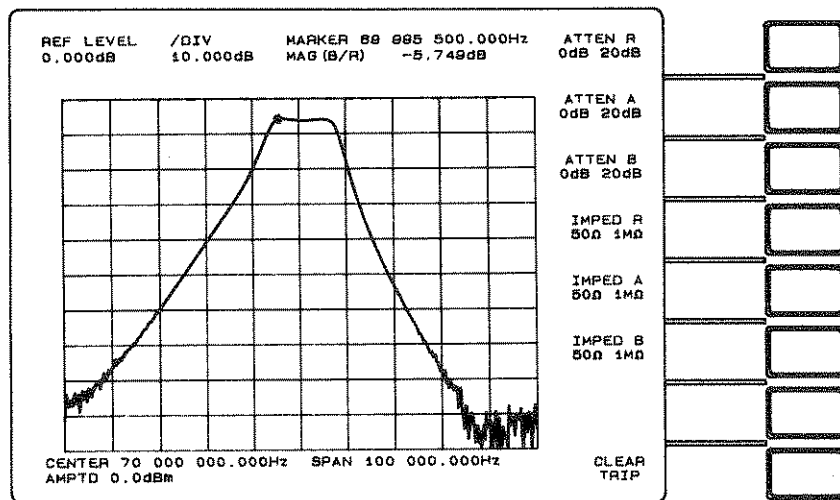

Hardkey in the **RECEIVER** section used to display the four possible selections for RESOLUTION BANDWIDTH. Note that the current selection is 1 kHz.



Softkey used to select a RESOLUTION BANDWIDTH of 100 Hz.



Hardkey in the **SOURCE** section used to select a new time. Any time resolution bandwidth is reduced, an increase in sweep time may be required. See OPTIMIZING SWEEP TIME in Appendix A.



Data entry.



Softkey used to select units for the data entry.



Hardkey in the **DISPLAY FORMAT** section used to display a menu listing the 3577A calibration features.

USER ACTION

Replace the Device Under Test with a BNC barrel (BNC(f) to BNC(f) adapter) and wait for a complete sweep.



Softkey command used to normalize the measurement. When pressed, this softkey stores the active trace in a data register (D1 for trace one and D2 for trace two) and then redefines the INPUT to be the previous INPUT definition divided by the data register that was just used. Now the INPUT for trace one is B/R/D1 (press the INPUT hardkey to see it in the ENTRY BLOCK). See Figure 2*16.

USER ACTION

Replace the BNC barrel with the bandpass filter.

Figure 2*16 Normalized Bandpass Filter Response

UDF = B/R/D1

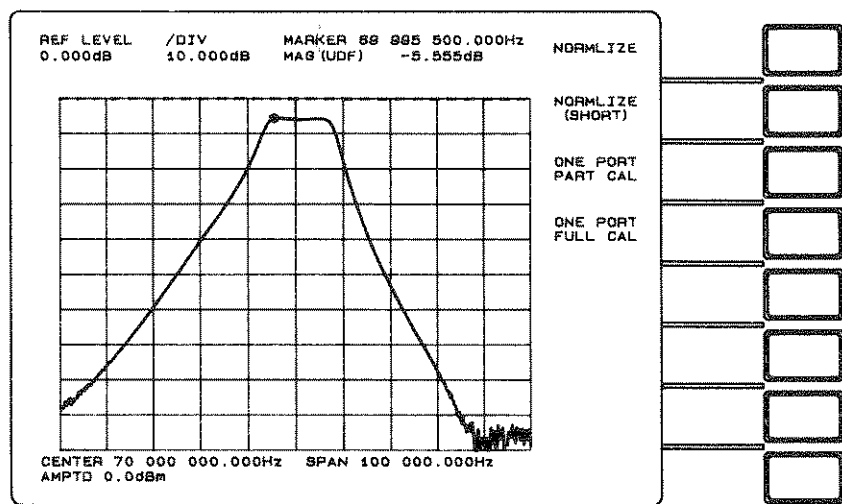

Now the set up is complete and measurements can be taken. Most measurements are taken using the MARKER. This small circle may be moved along the trace in a number of ways, some of which will be demonstrated in the following steps.

BANDWIDTH MEASUREMENTS







KEY	DESCRIPTION
	<p>Note that the marker dot appears at midscreen. The frequency in the Marker Information Block should be 70 MHz. If it is not, turn the knob until it is.</p>
	<p>Hardkey in the DISPLAY FORMAT used to display the MARKER menu of softkeys.</p>
<p>ZERO MARKER</p> 	<p>Softkey used to turn on the OFFSET MARKER. This triangle shaped marker will turn on with the same values as the regular marker (in this case, magnitude & frequency). Note that the marker information block above the graticule now shows OFFSET information. Note that the softkey MKR OFST ON/OFF shows the feature has been turned ON. This toggle type softkey may be used to return the marker to normal operation (OFFSET OFF) by pressing it once.</p>
<p>MARKER OFFSET</p> 	<p>Softkey used to display the magnitude value of the OFFSET MARKER in the ENTRY BLOCK. New values may be entered with the numeric key pad or the current value may be modified with the arrow keys or the knob in the ENTRY mode when this softkey label is active (bright). See Figure 2•17</p>

Figure 2•17 The Marker Menu

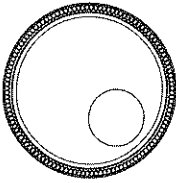
"Marker" changed to "Offset"

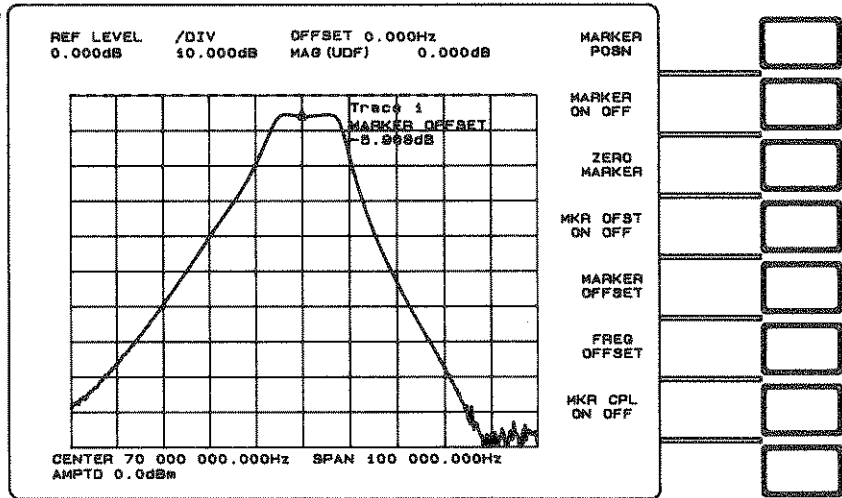

FREQ OFFSET



Softkey used to display the frequency value of the OFFSET MARKER in the ENTRY BLOCK. New values may be entered with the numeric key pad or the current value may be modified with the arrow keys or the knob in the ENTRY mode when this softkey label is bright.

SAVE



Hardkey in the **INSTRUMENT STATE** section used to display the SAVE STATE menu.



Softkey used to save the current instrument state in the first of five registers. This state will be recalled to begin another measurement later in this exercise.



Hardkey in the **DISPLAY FORMAT** section used to make data entries using the position of the marker. Also, → MAX, → MIN and MARKER SEARCH will move the marker to points of interest on the active trace.



Softkey that displays a second-level menu of softkeys used to search for specific values. Note that MARKER TARGET is active.



Data entry

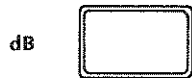

Softkey used to select units for MARKER TARGET.



Softkey used to search left for the user defined MARKER TARGET value. See Figure 2*18.

Figure 2*18 Marker Search

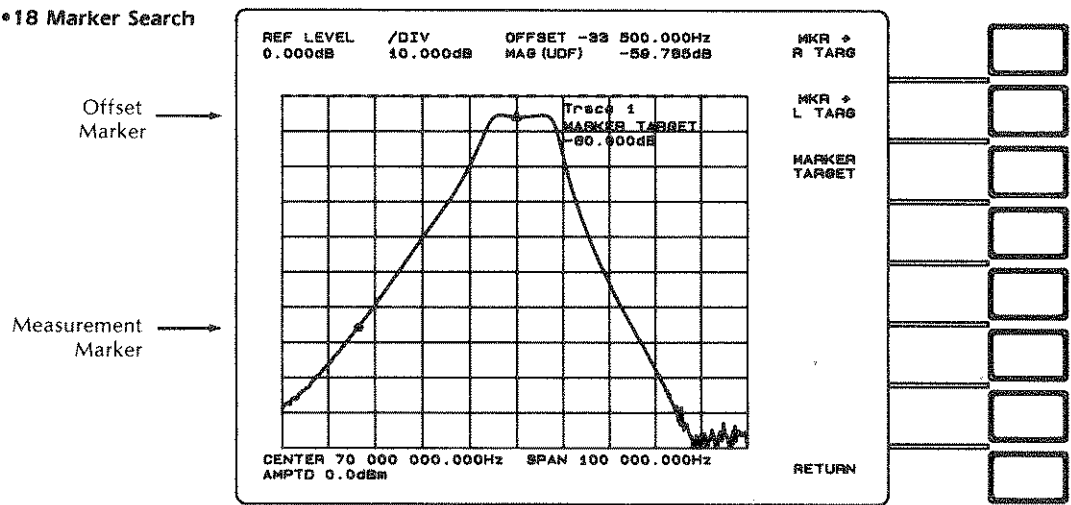

Hardkey in the **DISPLAY FORMAT** section.



Softkey; moves the OFFSET MARKER to the new marker position. This is in preparation for another MARKER SEARCH for a magnitude equal to the level at this marker position. The result will be the offset frequency (between the two markers).



Hardkey in the **DISPLAY FORMAT** section.



Softkey described previously.

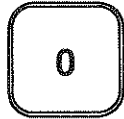

Data entry for a new MARKER TARGET value.

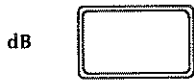

Softkey selection of units.



Softkey used to search right for the user defined MARKER TARGET value. The OFFSET reading in the marker block is the 60 dB bandwidth for this bandpass filter. See Figure 2*19.

Figure 2*19 60dB Bandwidth

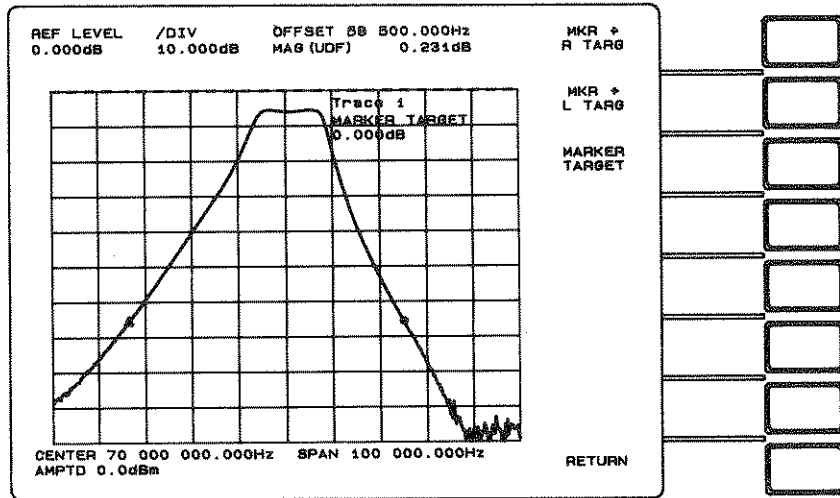

Hardkey in the **INSTRUMENT STATE** section used to display a new menu.



Softkey used to RECALL instrument state saved in register 1.



Hardkey in the **DISPLAY FORMAT** section.



Hardkey described previously. Note that the target value has returned to -3.000 dB as shown in the data entry block.



Softkey used to search left for the MARKER TARGET value.



Hardkey in the **DISPLAY FORMAT** section.



Softkey used to move the OFFSET MARKER to regular marker.



Hardkey in the **DISPLAY FORMAT** section.



Softkey described previously.

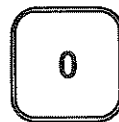

Data entry.



Softkey selection of units.

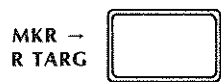

Softkey: searches right for target value. The OFFSET information above the graticule contains the -3 dB bandwidth for this filter. See Figure 2*20. Shape factor may now be calculated.



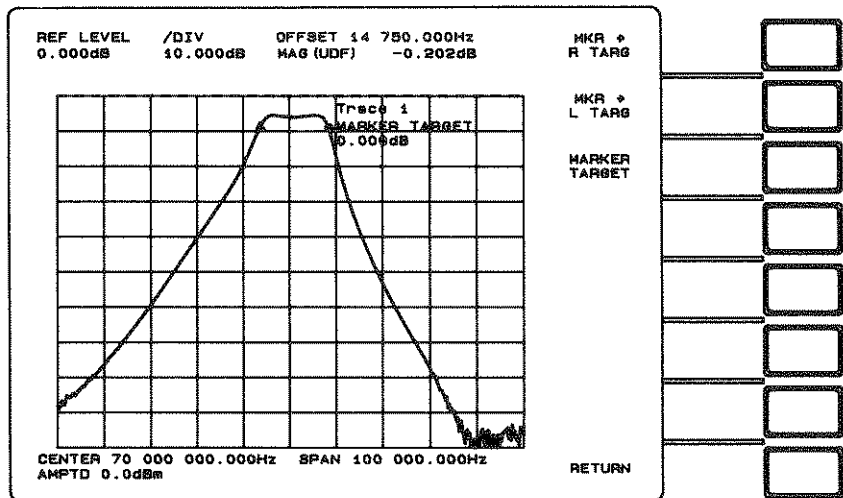





Figure 2*20 3 dB Bandwidth





$$\text{Shape Factor} = \frac{-60 \text{ dB BW}}{-3 \text{ dB BW}} = \frac{58,500}{14,750} = 3.97$$

PASSBAND RIPPLE

The next measurement is passband ripple. To make this measurement ALTERNATE SWEEP will be employed to retain the frequency span given to trace one while viewing a narrower span with trace two. When ALTERNATE SWEEP TYPE is selected, trace two starts out with preset values. This means another measurement set up is required for trace two, as follows:

KEY	DESCRIPTION
	Hardkey in the SOURCE section used to display the menu of softkeys which select the type of sweep.
ALTERNATE SWEEP 	Softkey used to select ALTERNATE sweep. This feature allows each trace to have different values for START & STOP or CENTER & SPAN frequencies, AMPTD, SWP TIME, and RES BW.
	Hardkey in the DISPLAY FORMAT section used to select trace two as the active trace.
	Hardkey in the DISPLAY FORMAT section.
B/R 	Softkey used to select B/R as the INPUT definition for the active trace. Note the warning message on the screen that this trace is off. Next we'll turn it on in the DISPLAY FUNCTION menu.
	Hardkey in the DISPLAY FORMAT section used to select the DISPLAY FUNCTION of the active trace. Note that OFF is bright in the menu, indicating that trace two is off.
LOG MAG 	Softkey used to select LOG MAGNITUDE as the DISPLAY FUNCTION for trace two, effectively turning the trace on. All parameters for trace two revert to default parameters including AMPTD = -10 dBm. Since AMPTD = 0 dBm for trace one, the HP 3577A will change the amplitude OUTPUT level at the beginning of each sweep. Note clicking of amplitude relays. The HP 3577A uses relays in the output circuit to determine output amplitude. If left running in a state that switches these relays regularly, the instrument will TIME OUT (switch to SINGLE SWEEP MODE) after five minutes to reduce relay wear. See SWEEP MODE, SINGLE in the REFERENCE section.
	Hardkey in the SOURCE section.
	Data entry.

dBm 





 **FREQ**

CENTER FREQ 

 

MHz 

FREQ SPAN 

    

kHz 

 **SCALE**

AUTO SCALE 

 **SWEEP TYPE**

SWP DIR UP DOWN 

Now the measurement set up for the second trace is complete. Note that this extra set up is required only when ALTERNATE SWEEP is used. The following key presses will make the bandpass ripple measurement.



Hardkey in the **DISPLAY FORMAT** section.

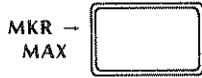

Softkey used to move the marker to the point on the trace that has the largest value.



Hardkey in the **DISPLAY FORMAT** section.



Softkey used to move the OFFSET MARKER (change the values of its position parameters) to the same position as the regular marker.



Hardkey in the **DISPLAY FORMAT** section.

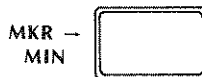

Softkey used to move the marker to the point on the trace that has the smallest value. The magnitude information in the MARKER Block for trace two is now indicating the measured passband ripple for this filter.

Figure 2*21 Passband Ripple

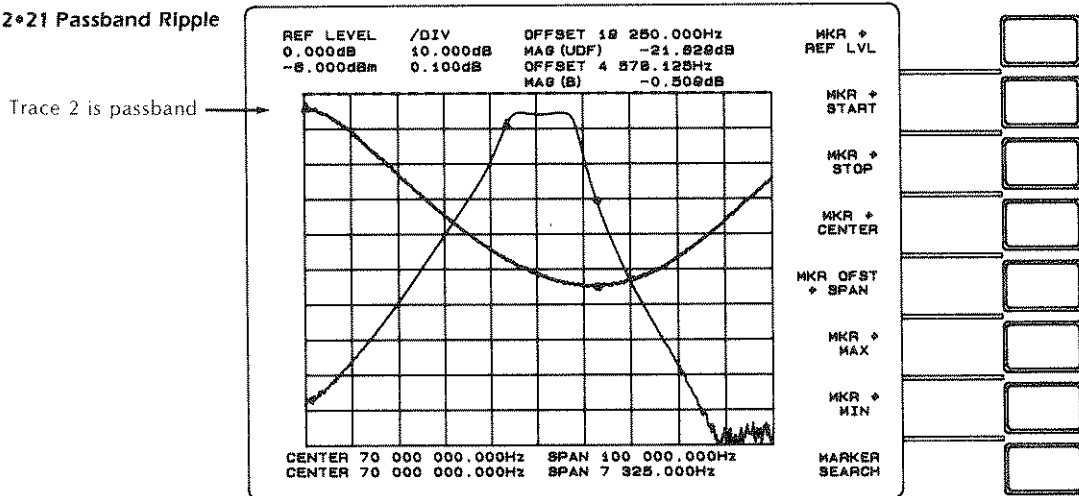

PASSBAND INSERTION PHASE

The next measurement will be phase in the passband. To do this the SWEEP TYPE will be returned to LINEAR (the default type) so that the frequency span of trace two is the same as that of trace one.

KEY

DESCRIPTION



Hardkey in the **SOURCE** section.

LIN FRQ SWEEP

Softkey used to select linear frequency sweep.

INPUT

Hardkey in the **DISPLAY FORMAT** section.

COPY Trc 1-2

Softkey used to copy the INPUT definition for trace one into trace two. This normalizes trace two.

MKR

Hardkey in the **DISPLAY FORMAT** section

MKR OFST ON OFF

Softkey used to toggle the MARKER OFFSET OFF for the active trace (which should be trace two). The same can be done for trace one after the TRACE 1 hardkey is pressed.

DSPLY FCTN

Hardkey in the **DISPLAY FORMAT** section which displays a menu of softkeys used to select the DISPLAY FUNCTION of the active trace (indicated by the LED over the TRACE 2 key).

PHASE

Softkey used to select PHASE as the DISPLAY FUNCTION for the active trace. Selection of any softkey in this menu (other than OFF) turns trace two ON.

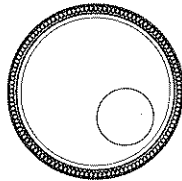

Moving the marker (with the knob) allows phase measurements to be made at any point on the trace. Data may be read from the marker block for trace two. The vertical parts of the trace represent 360° phase wraps. Since the HP 3577A stores data in complex form, ±180° is the range these values may have when interpreted as phase information. Note that trace two will be noisy in the same area as trace one, due to extremely low signal levels. See Figure 2*22.

Figure 2*22 Bandpass Filter Magnitude & Phase Response

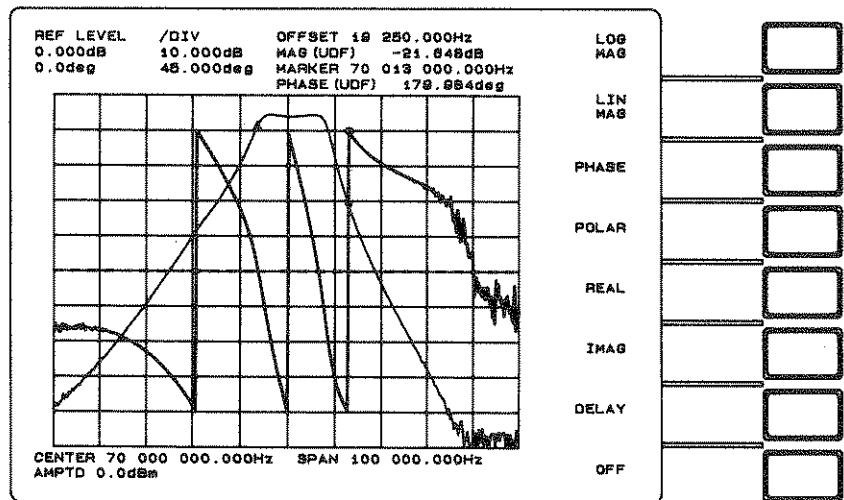

GROUP DELAY

The next measurement is group delay. The DISPLAY FUNCTION menu should still be displayed.







KEY	DESCRIPTION
DELAY 	Softkey used to select group delay as the DISPLAY FUNCTION. Note that the softkey labeled DELAY changes to DELAY APERTURE.
 SCALE	Hardkey in the DISPLAY FORMAT section.
AUTO SCALE 	Softkey used to set the SCALE parameters such that the trace appears as large as possible without clipping the upper and lower boundaries of the graticule.
 DSPLY FCTN	Hardkey used to recall the menu containing DELAY APERTURE.
DELAY APERTURE 	Softkey used to display the menu of selections for group delay aperture (the change in frequency over which the change in phase is measured).
2% OF SPAN 	Softkey used to select a different delay aperture. DELAY APERTURE information (shown below the graticule) changes when different percent-of-span selections are made. The DELAY APER information will appear only when the trace whose display function is DELAY is selected. See Figure 2*23.

Figure 2*23 Bandpass Magnitude and Group Delay



$$\text{Group Delay } \tau_g = \frac{\Delta\phi}{360 \times \Delta f} \quad \text{where } \Delta f = \text{Delay Aperture}$$

AMPLIFIER

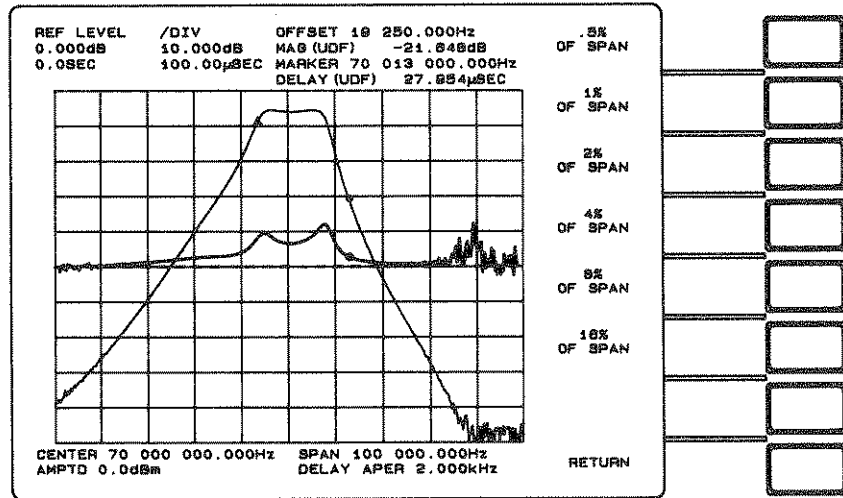
GAIN COMPRESSION

Connect the amplifier to the HP 3577A Network Analyzer as shown in Figure 2•24. The receiver inputs will begin to overload when the input signal level is ≥ 0.0 dBm (receiver attenuation = 20 dB; overload occurs at input signal levels ≥ -20 dBm with receiver attenuation = 0 dB). The amplifier used in this example has a gain of approximately 30 dB so 30 dB of attenuation was added to the circuit between the amplifier and the receiver input.

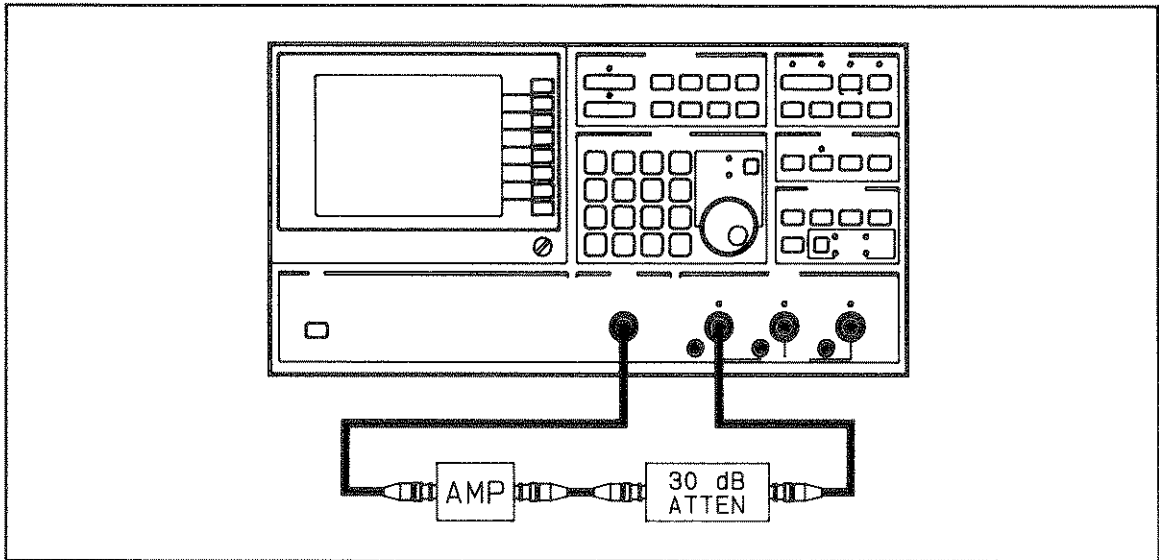





Figure 2•24

KEY	DESCRIPTION
	Hardkey in the INSTRUMENT STATE section that resets parameters to their initial values.
	Hardkey in the SOURCE section.
	Softkey that selects amplitude sweeps. Note the alphanumeric information under the graticule. The START amplitude is -40 dBm, the STOP amplitude is 0.0 dBm, and the source frequency is 100 MHz.

NOTE *This feature will time out (change to SINGLE in the SWEEP MODE menu) after five minutes of CONTINUOUS sweeping to extend the life of the switching relays in the output of the HP 3577A. SINGLE sweeps may be triggered with the TRIG/RESET hardkey or CONTINUOUS sweep may be selected for another five minutes.*

The plot shown in Figure 2*25 is output level versus input level. Note that gain compression causes the trace to level out. To display gain compression (input versus gain) we will normalize. Normalization stores a measurement taken with a BNC barrel in place of the amplifier and then redefines the INPUT to be the old INPUT definition divided by the stored trace. This makes the trace gain versus input.

Figure 2*25 Amplitude Sweep of an Amplifier

Input = R

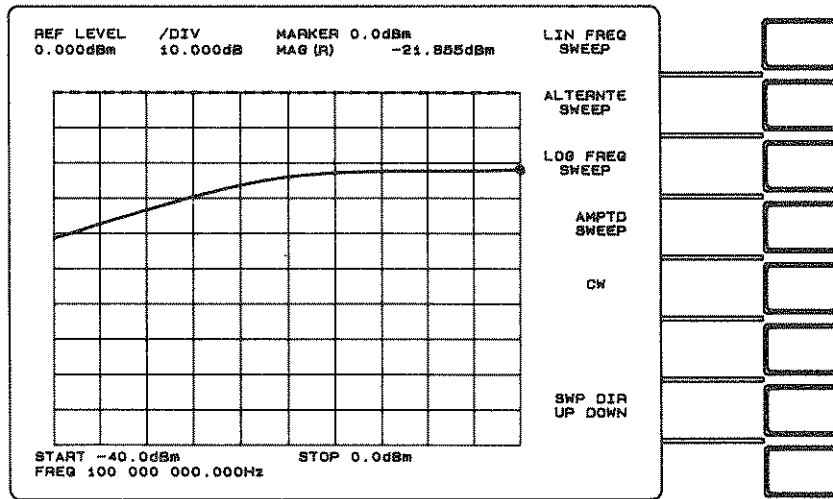

Hardkey in the **DISPLAY FORMAT** section.

USER ACTION

Replace the amplifier with a BNC barrel, and wait for a full sweep.



Softkey used to normalize the measurement.

USER ACTION

Replace the BNC barrel with the amplifier.



Hardkey in the **DISPLAY FORMAT** section.

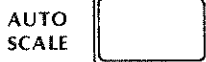

Softkey described previously.

Now the trace is amplifier input vs gain. The gain is constant where the trace is level and is in compression where the trace rolls off. Next we'll use the marker to search for the 3 dB compression point.



Hardkey in the **DISPLAY FORMAT** section.

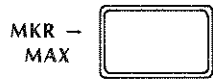

Softkey used to move the marker to the point on the trace with the largest gain value.



Hardkey in the **DISPLAY FORMAT** section.



Softkey used to turn the OFFSET MARKER on at the position of the regular marker.



Hardkey in the **DISPLAY FORMAT** section.



Softkey used to display the MARKER SEARCH menu. Note that the MARKER TARGET value is -3 dB.



Softkey used to search right for target. The marker information block now contains the span over which the amplifier has a gain compression of 3 dB. See Figure 2*26.

Figure 2*26 Gain Compression of an Amplifier

Compression Range
UDF = R/D1

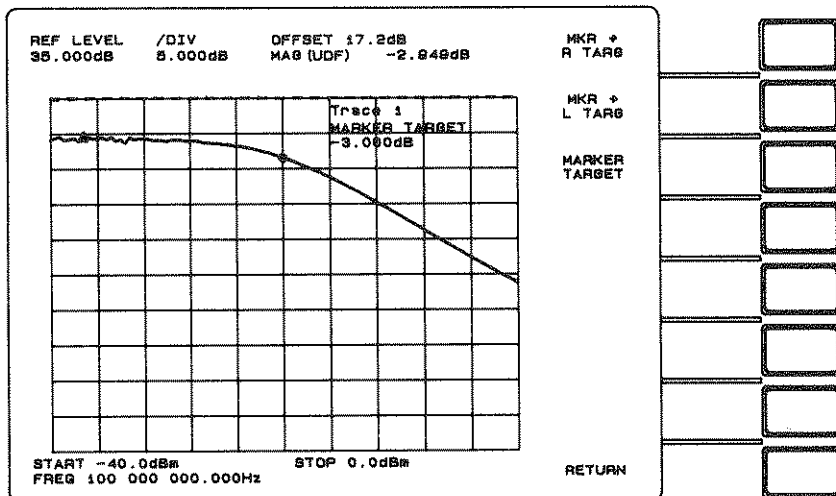

Hardkey in the **DISPLAY FORMAT** section.



Softkey used to turn the OFFSET MARKER off. The marker information block will change from OFFSET to MARKER information. The MARKER magnitude is the input level at which the amplifier has a gain compression of 3 dB. See Figure 2•27.

Figure 2•27 3 dB
Compression
Level

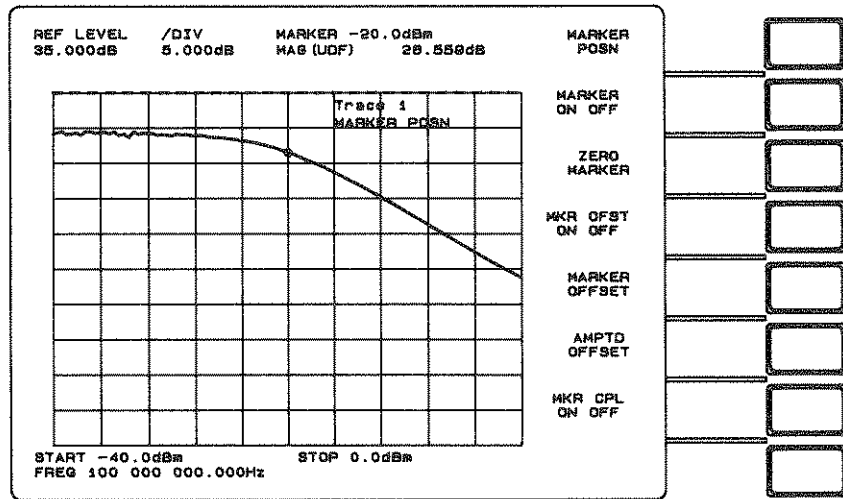

This test may be run again at other frequencies for more thorough testing of the amplifier.

LOW PASS FILTER

Connect the HP 35677A/B S-Parameter Test Set to the HP 3577A Network Analyzer and connect the low pass filter to be tested to the HP 35677A/B as shown in Figure 2•28. The low pass filter used in this example has a -3 dB frequency of 50 MHz, but the methods used to measure its characteristics are the same for any low pass filter.

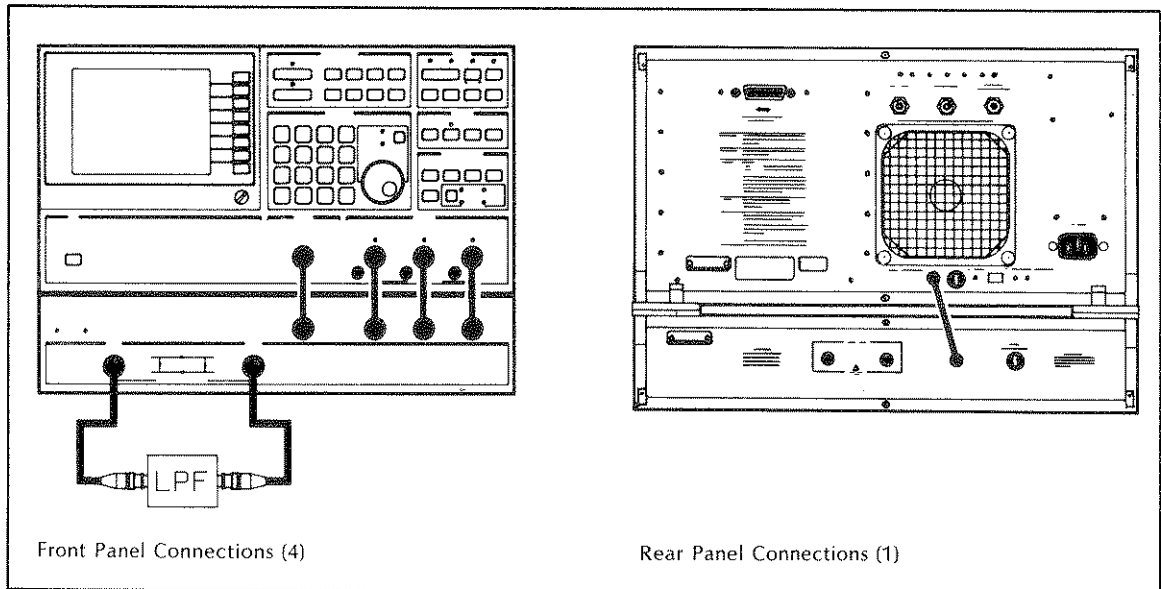

Figure 2•28 HP 3577A to HP 35677A/B Connections

The HP 35677A/B is a convenient accessory for making ratio measurements of transmission and reflection scattering parameters. The test set has two configurations: FORWARD and REVERSE, indicated by two LEDs on the upper left corner of the front panel. This configuration is controlled through the HP 3577A Network Analyzer by defining the INPUT. Figure 2•29 shows the test set block diagram for each of the two configurations.

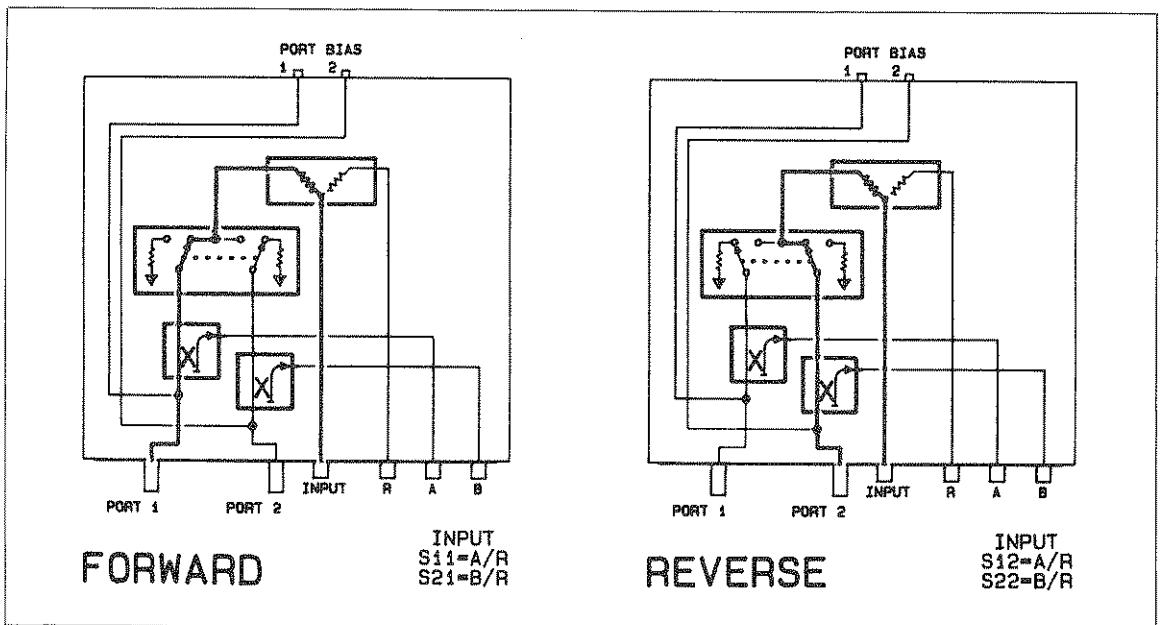

Figure 2•29 HP 35677A/B Configurations

The purpose of this measurement exercise is to demonstrate the use of the HP 35677A/B S-Parameter Test Set and the HP 3577A Network Analyzer to characterize a low pass filter. The general organization is:

1. Set up the measurement
2. Measure the insertion loss
3. Measure the insertion phase
4. Measure the passband ripple
5. Measure the stop band rejection

MEASUREMENT SET-UP

KEY DESCRIPTION



Hardkey in the **INSTRUMENT STATE** that presets the HP 3577A parameters to their default values. With the HP 35677A/B S-Parameter Test Set connected to the HP 3577A via the rear panel cable, INSTR PRESET parameters differ as follows:

START FREQ	100 kHz
SOURCE AMPLITUDE	+15 dBm
INPUT (both traces)	S21 (same as B/R)

INSTRUMENT PRESET always displays the INPUT menu. Note that S_{21} is bright in the menu. This indicates that it is the active INPUT definition of the selected trace. Also note the entry block showing that INPUT is B/R. This indicates that S_{21} is the same as B/R with the test set in the FORWARD configuration. See Figure 2*30.

Figure 2*30 S-Parameter Input Menu

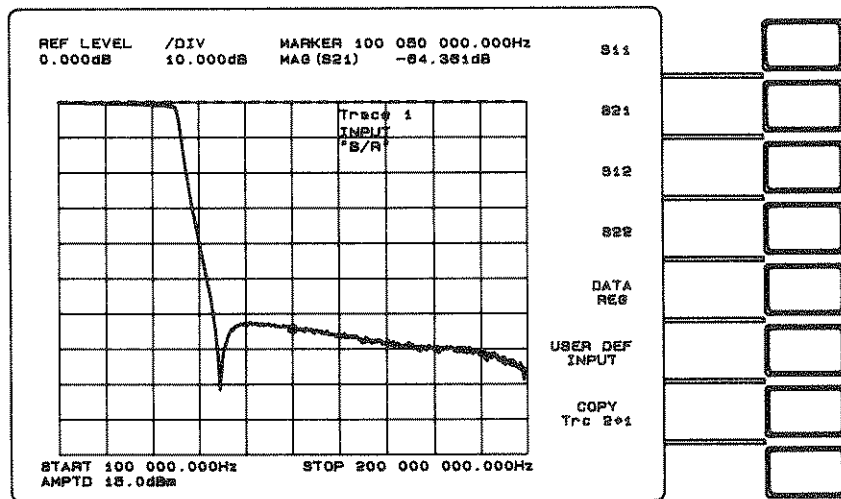

Hardkey in the **SOURCE** section

LOG FREQ SWEEP 

Softkey that selects a logarithmic frequency sweep. Note that the screen includes frequency annotation shown across the bottom of the graticule. See Figure 2*31.

Figure 2*31 Log Frequency Sweep Type

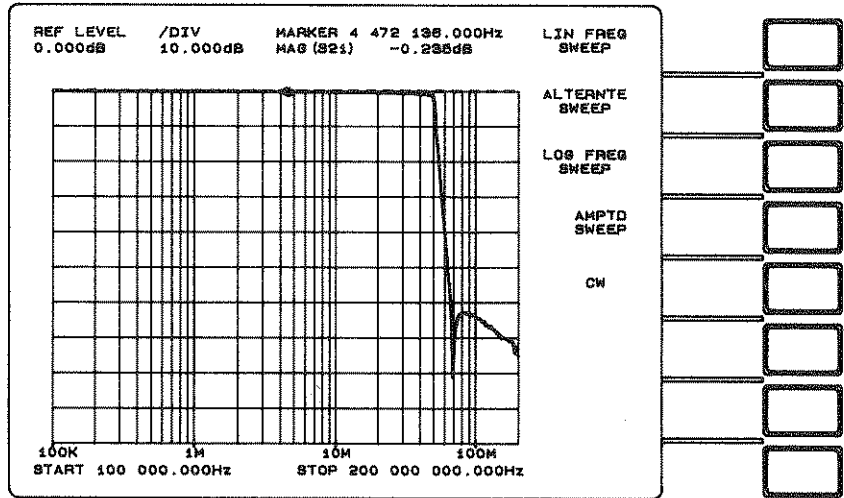

NOTE

If you need to change the FREQ or AMPTD parameters to get the correct measurement set up, do so at this point. Only two data entry parameters exist in the FREQUENCY menu when the SWEEP TYPE is LOG FREQ: START and STOP FREQ. (FULL SWEEP is an immediate execution command; not data entry).

MEASR CAL 

Hardkey in the **DISPLAY FORMAT** section used to display the MEASUREMENT CALIBRATION menu, which includes the softkey, NORMLIZE.

USER ACTION

Replace the device under test with a BNC "barrel" (BNC(f) to BNC(f) adapter). Be sure to wait until the next sweep is complete before executing the next step.

NORMLIZE 

Softkey used to normalize the measurement. The HP 3577A does this by storing the trace with the barrel and redefining the INPUT to be the previous definition divided by the stored trace (in this case B/R/D1).

INSERTION LOSS

USER ACTION

Replace the BNC barrel with the filter to be tested.

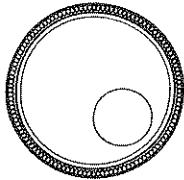

The marker may be moved to any part of the trace with the knob (must be in MARKER mode) to measure insertion loss. See Figure 2*32.

Figure 2*32 Measurement

Calibration Menu

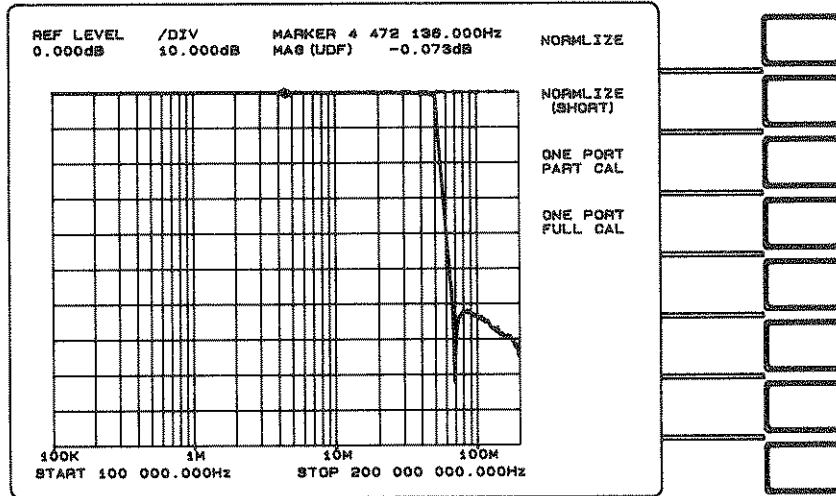

INSERTION PHASE

KEY

DESCRIPTION



Hardkey in the **DISPLAY FORMAT** section



Hardkey in the **DISPLAY FORMAT** section that redefines the menu displayed to operate on trace two. Note that the trace is OFF.



Softkey used to turn on trace two and define it to be phase information. Note that the trace appears immediately. No new data need be collected (no sweep is required) for trace two to be displayed as PHASE. Note the vertical parts of the phase trace. This is a jump of 360° from -180° to +180° called phase wrap.



Hardkey in the **DISPLAY FORMAT** section. Note that REF LEVEL is bright in the menu. Reference level is the measured signal level represented by the dashed line. For PHASE, this line will appear at midscreen. (It may be moved up or down by changing the value of REF POSN). Next, the knob will be used to redefine the value of REF LEVEL.

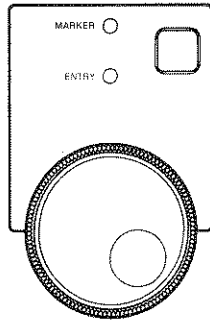

Press the unlabeled key above the knob. This key press should put the knob in ENTRY mode, so that it may be used to modify the value of the active data entry softkey in the menu.

Turn the knob counterclockwise. The trace moves toward the top of the graticule and the value of REF LEVEL in the ENTRY BLOCK and above the upper left corner of the graticule changes.

Figure 2-33 Low Pass Filter
Log Magnitude
and
Phase Response

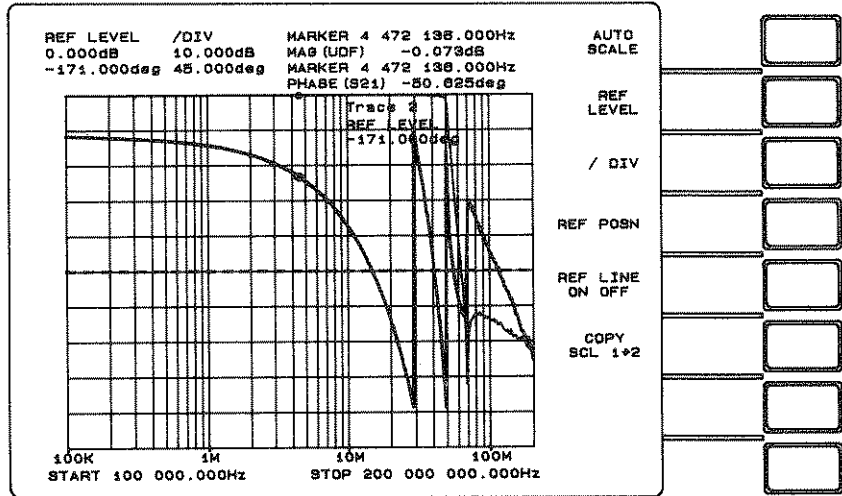

PASSBAND RIPPLE

KEY DESCRIPTION



Hardkey in the **DISPLAY FORMAT** section.

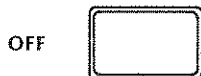

Softkey in the DSPLY FCTN menu used to turn the active trace (which should still be trace two) off.



Hardkey in the **DISPLAY FORMAT** section.



Hardkey in the **DISPLAY FORMAT** section.



Softkey that displays a second menu used to do marker searches. Note that **MARKER TARGET** is active and that its default value (shown in the **ENTRY BLOCK**) is -3 dB.



Softkey used to search right for the **MARKER TARGET** value. Note the new value of magnitude for the marker. If no such value had been found the marker would not have moved and the screen message "TARGET VALUE NOT FOUND" would appear.







- RETURN

Softkey used to move back to the primary menu. Note that the MKR → hardkey could have been used to display the same menu.
- MKR → STOP

Softkey used to redefine the STOP FREQ as the present marker position (frequency). Note that the graticule is redrawn and that the frequency annotation changes to match the new sweep. Also, note that this change in frequency requires renormalization or changing the INPUT definition back to B/R.
- INPUT

Hardkey described previously.
- S21

Softkey used to define S-parameter. This step changes the INPUT definition from B/R/D1 to B/R. Since the frequency span has been changed, D1 should not be used in the definition until the measurement is re-normalized.
- SCALE

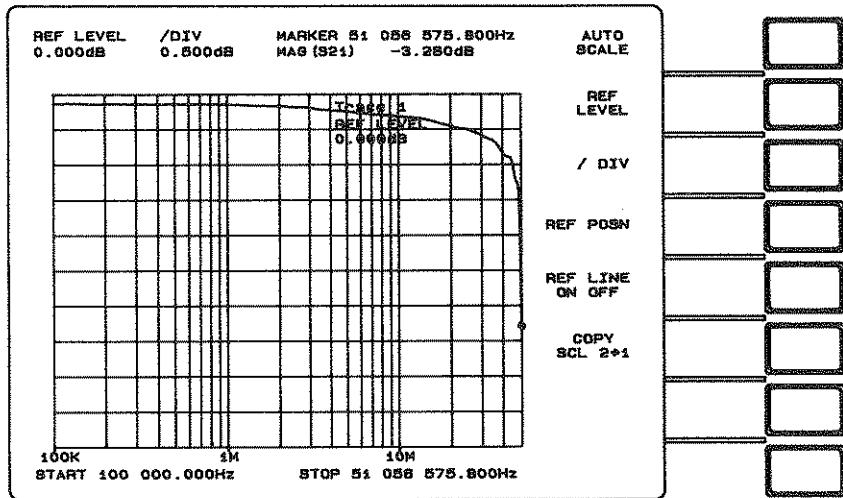
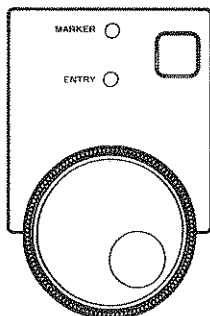
Hardkey in the **DISPLAY FORMAT** section.
- AUTO SCALE

Softkey. The trace displayed is of the passband. Note the change in the /DIV value in the upper left-hand corner of the screen. See Figure 2•34.

Figure 2•34 Low Pass Filter Pass Band Ripple

















ENTRY OFF

Hardkey in the **DATA ENTRY** section that clears the screen of the ENTRY BLOCK and the menu. This key may be used to disable data entry so that unintentional rotation of the knob (in ENTRY mode) does not modify a parameter.



The marker may be used to measure the passband ripple. The knob must be in MARKER mode to for it to be used to move the marker (see the LEDs above the knob). Note that the “up” and “down” arrow keys may also be used to move the marker.

STOPBAND REJECTION

KEY	DESCRIPTION
	Hardkey in the SOURCE section.
STOP FREQ 	Softkey used to select stop frequency as the parameter for data entry.
  	Data entry.
MHz 	Softkey used to select units for data entry.
	Hardkey in the DISPLAY FORMAT section.
MARKER SEARCH 	Softkey. Note that the target value is -3 dB.
MKR — L TARG 	Softkey used to move the marker left to the -3 dB point. This point will be used as the start frequency for sweeping the stopband.
RETURN 	Softkey used to return to the primary menu.
MKR — START 	Softkey used to redefine the START FREQ as the present marker position (frequency). Note that the graticule frequency scale changed from log to linear. This will occur any time STOP FREQ divided by START FREQ is ≤ 4 .
	Hardkey in the DISPLAY FORMAT section.
AUTO SCALE 	Softkey used to let the HP 3577A select the SCALE parameters for the graticule.
	Hardkey described previously.
MKR — MIN 	Softkey described previously.

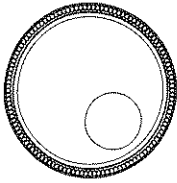

The trace on the screen in Figure 2•35 is the stopband. Rejection may be measured at any point by moving the marker to the point of interest and reading the value in the marker information block.

Figure 2•35 Low Pass Filter
Stop Band
Rejection

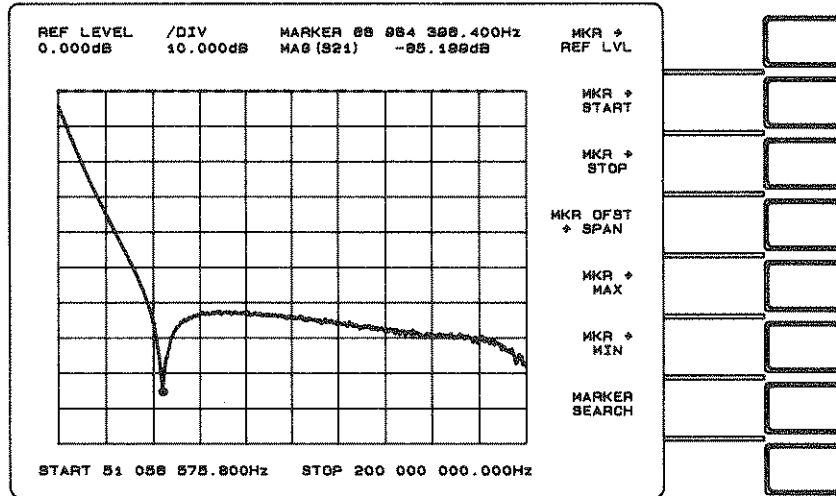

AMPLIFIER S-PARAMETERS

Connect the amplifier to the HP 35677A/B as shown in Figure 2•36. Fifteen volt power is supplied by an external power supply. The amplifier used in this example has a gain rating of +15 dB from 0.5 MHz to 100 MHz. The methods used here may be used to test amplifiers with different specifications.

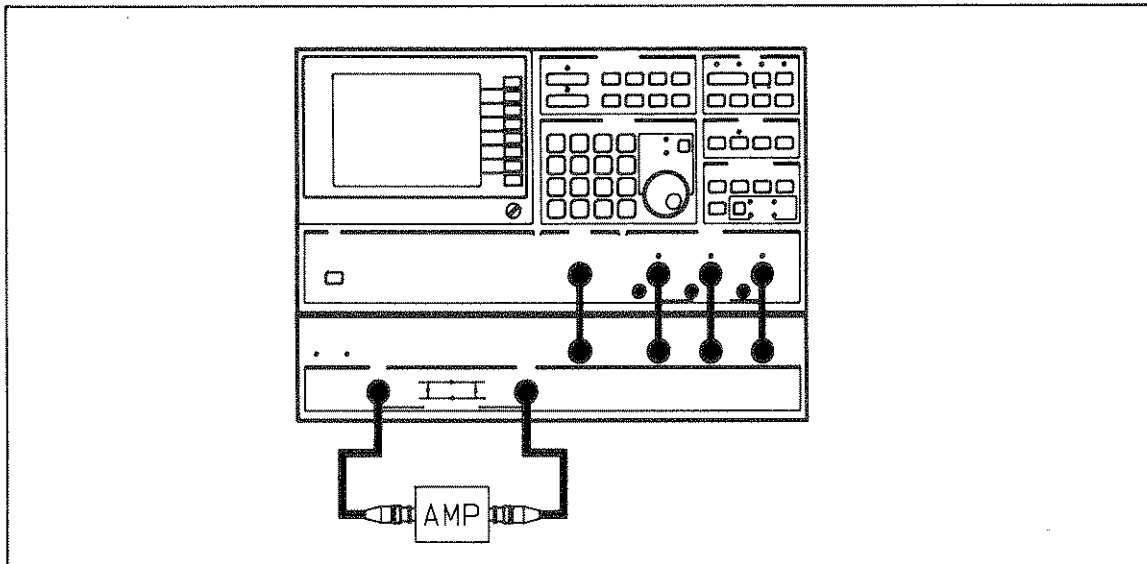





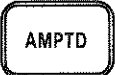





Figure 2•36

The purpose of this measurement exercise is to demonstrate the use of the HP 3577A Network Analyzer and the HP 35677A/B S-Parameter Test Set to characterize the scattering parameters of an RF amplifier. The organization of the exercise is:

1. Initial measurement set up
2. Measure S_{21} , forward gain and phase
3. Measure S_{12} , reverse loss
4. Measure S_{11} , input return loss
5. Measure S_{22} , output reflection coefficient
6. Conversion of reflection coef. to complex impedance

MEASUREMENT SETUP

KEY	DESCRIPTION
	Hardkey in the INSTRUMENT STATE section used to reset all parameters to their default values. The menu displayed on the screen is the INPUT menu. Note that the default INPUT definition is S_{21} (B/R & test set FORWARD) when the HP 35677A/B S-Parameter Test Set is connected to the HP 3577A Network Analyzer.
NOTE	If the amplifier was on when INSTR PRESET was pressed, one or more of the RECEIVER INPUTs may have tripped or been overloaded. A receiver "trip" is when the receiver input switches to $1M\Omega$ to protect itself from high input signal levels. This switch occurs for signals $\geq 1.1 V_{pk}$. The screen message: <p style="text-align: center;">INPUT _ TRIPPED Clear trip on ATTEN menu.</p> appears, listing the input(s) tripped and directing the user to the AT-TEN hardkey to clear the condition. Note that the impedance softkeys in the ATTEN menu will not reflect the tripped condition. We will clear the trip with the CLEAR TRIP softkey after the value of AMPTD is changed.
	Hardkey in the SOURCE section. Note that START FREQ is selected (ready for data entry).
  	Data entry
kHz 	Softkey selection of units for the data entry.
	Hardkey in the SOURCE section.
	Data entry.
dBm 	Softkey selection of units for the data entry.
	Hardkey in the RECEIVER section.
CLEAR TRIP 	Softkey used to reset a tripped RECEIVER INPUT.

Hardkey in the **DISPLAY FORMAT** section used to display the MEASUREMENT CALIBRATION menu.



USER ACTION

Replace the amplifier with a BNC barrel and wait for one complete sweep.



USER ACTION

Softkey used to normalize the measurement. This stores a trace in data register D1 and redefines the INPUT to be the old definition divided by the stored trace. If trace two had been active, the store would have been to D2. If you press the INPUT hardkey you can see in the entry block that the INPUT definition is B/R/D1. Also note that the marker block has changed from MAG(S₂₁) to MAG(UDF); UDF is the abbreviation for "user defined function."

Replace the BNC barrel with the amplifier.



Hardkey in the **DISPLAY FORMAT** section. We're going to change reference position, reference level, and scale (/DIV).



Softkey used to select REFERENCE POSITION for data entry.

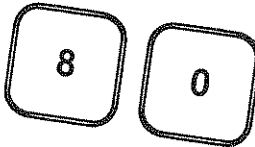

Data entry with the numeric key pad.

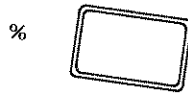

Softkey selection of units. Note that the dashed line moved from the top of the graticule down to the eighth division from the bottom.

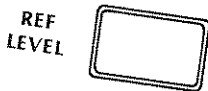

Softkey used to select REFERENCE LEVEL for data entry.

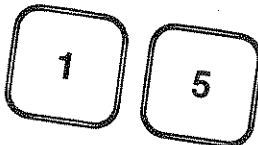

Data entry.

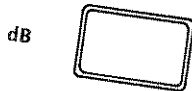

Softkey selection of units for the data entry.

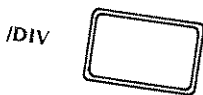

Softkey used to prefix a data entry for the graticule scale.

Handwritten notes:
980 down to 5th
...
...
...



Data entry.

dB



Softkey selection of units for the data entry.

Now trace one is completely set up. Next we'll turn on trace two as phase information and set it up.



Hardkey in the **DISPLAY FORMAT** section.



Hardkey in the **DISPLAY FORMAT** section.

PHASE



Softkey used to turn trace two on and make it phase information.



Hardkey in the **DISPLAY FORMAT** section.

COPY Trc 1-2



Softkey used to copy the INPUT definition for trace one into trace two. Note that the ENTRY BLOCK shows trace two INPUT to be B/R/D1. This equation was created when trace one was normalized. This copying of INPUT definition normalizes trace two.



Hardkey in the **DISPLAY FORMAT** section.

AUTO SCALE



Softkey previously described. See Figure 2*37.

Figure 2*37 RF Amplifier

Magnitude and Phase of S₂₁

Magnitude →
Phase →

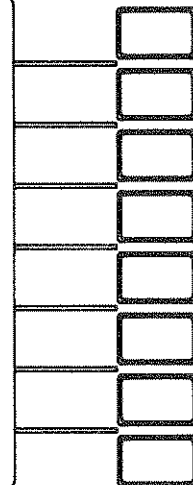
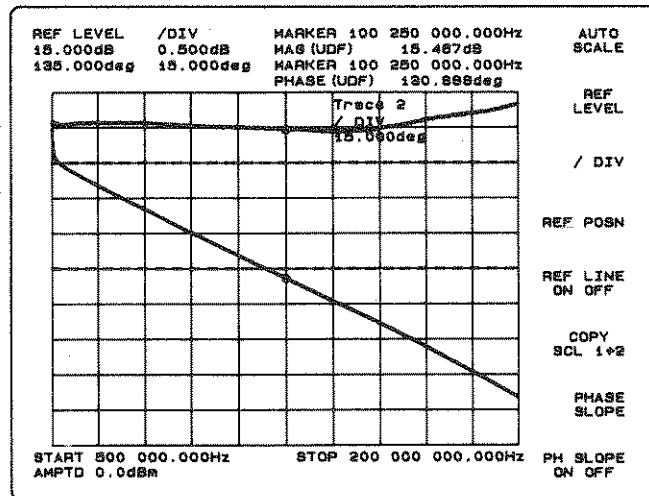

S₂₁ FORWARD GAIN AND PHASE

The display as shown in Figure 2•37 is the forward gain and phase of the amplifier under test. The markers may be used to make exact measurements at points along the traces and to make offset measurements.









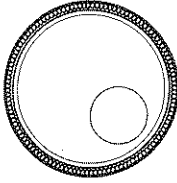

KEY	DESCRIPTION
	Hardkey in the DISPLAY FORMAT section.
MKR CPL ON OFF 	Softkey that toggles marker coupling between the ON and OFF conditions. This key press should leave OFF bright.
	Turning the knob with marker coupling off will move only the marker on the active trace.
	Hardkey in the DISPLAY FORMAT section.
	Hardkey in the DISPLAY FORMAT section.
MKR - MIN 	Softkey used to move the marker to the point on the active trace with the lowest value.
	Hardkey in the DISPLAY FORMAT section.
ZERO MARKER 	Softkey used to initialize the offset marker at the position of the regular marker. Note that the information in the marker block for trace one has changed from MARKER to OFFSET.
	Hardkey in the DISPLAY FORMAT section.
MKR - MAX 	Softkey used to move the marker to the point on the active trace with the largest value. The information in the marker block is now total amplifier ripple. See Figure 2•38.

Figure 2*38 Measuring Amplifier Ripple



S₁₂ REVERSE LOSS

KEY

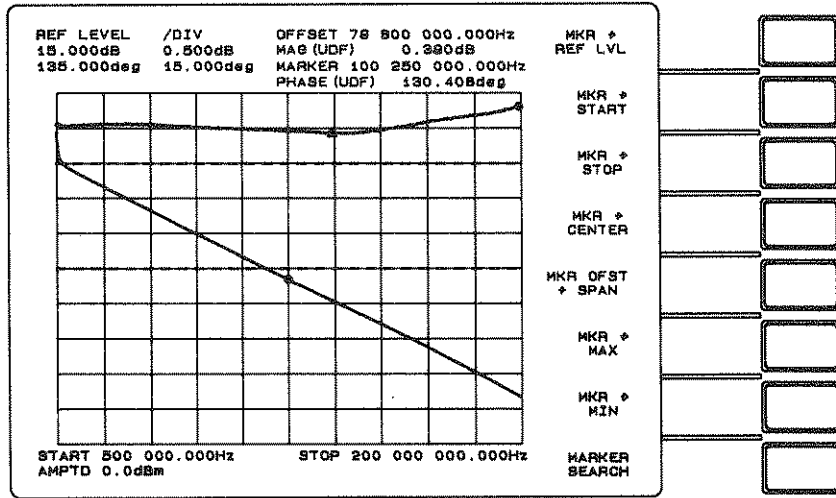
DESCRIPTION



Hardkey in the **DISPLAY FORMAT** section.



Softkey selection of a new INPUT definition. This causes the test set to change to the REVERSE configuration. See Figure 2*39.

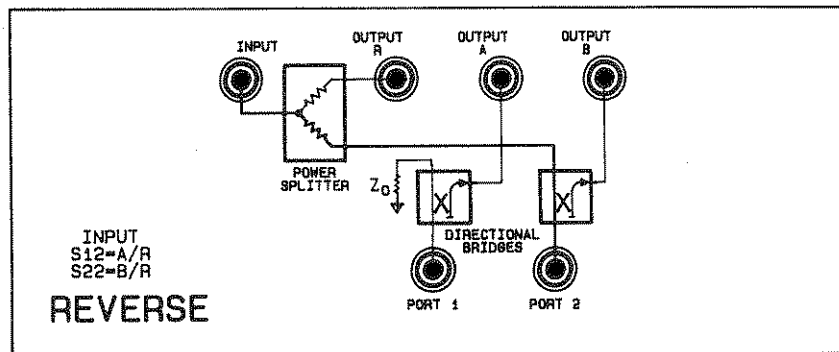

Figure 2*39 S-Parameter Test Set Reverse Configuration

The screen message

INCOMP. TESTSET POSITIONS
Trc2 chgd to agree with #1

will appear. This message (incomplete test set positions; trace two changed to agree with number one) is caused by the change of INPUT for trace one. The old trace two INPUT definition had the test set configured FORWARD. Since the test set can't be configured both ways at the same time, the HP 3577A has changed the HP 35677A/B configuration to REVERSE and displayed a screen message to let the user know that the trace two INPUT definition has changed.



Hardkey in the **DISPLAY FORMAT** section.



Softkey used here to turn OFF the OFFSET MARKER.



Hardkey in the **DISPLAY FORMAT** section.

USER ACTION

Replace the amplifier with a BNC barrel.



Softkey used to normalize the measurement as described previously.

USER ACTION

Replace the BNC barrel with the amplifier.



Hardkey in the **DISPLAY FORMAT** section.

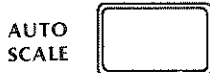

Softkey described previously.



Hardkey used to select trace two as the active trace.



Hardkey in the **DISPLAY FORMAT** section. Note that the current INPUT definition (listed in the entry block) is B/R/D1.



Softkey used to copy the INPUT definition for trace one into trace two. Note that the INPUT definition in the entry block has changed to A/R/D1. This normalizes trace two.



Hardkey in the **DISPLAY FORMAT** section.



Softkey described previously.



Hardkey in the **DISPLAY FORMAT** section.

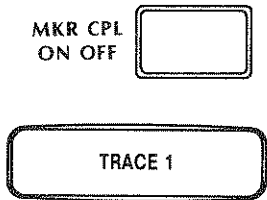

Softkey used here to turn marker coupling back ON. Note that both markers are now at the same frequency and will move together when the knob is turned.

Hardkey in the **DISPLAY FORMAT** used to select trace one as the active trace, making it and its alphanumeric information above the screen bright.

The markers may be used to measure reverse loss and reverse phase angle. See Figure 2*40.

Figure 2*40 Normalized Reverse Loss and Phase

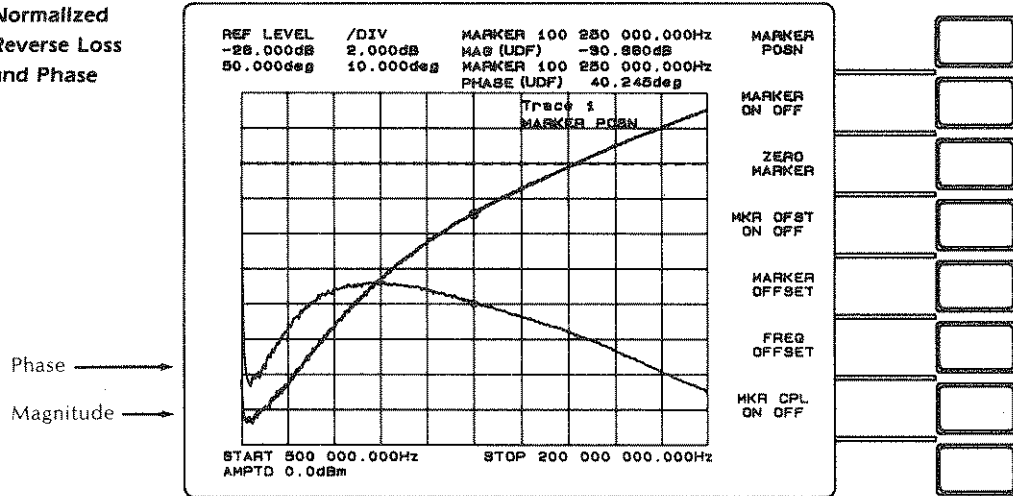

S₁₁ INPUT RETURN LOSS

Next, input reflection will be examined. This is possible through the use of the directional bridges of the HP 35677A/B S-Parameter Test Set. In this example, full one-port calibration using three term error correction is employed for maximum measurement accuracy.

KEY	DESCRIPTION
INPUT	Hardkey in the DISPLAY FORMAT section.
S11	Softkey selection of S-parameter S ₁₁ as the INPUT.
MEASR CAL	Hardkey in the DISPLAY FORMAT section.
ONE PORT FULL CAL	Softkey. Note the screen message LEAVE PORT 1 OPEN. See Figure 2*41.

Figure 2-41 Screen Messages for One Port Full Calibration

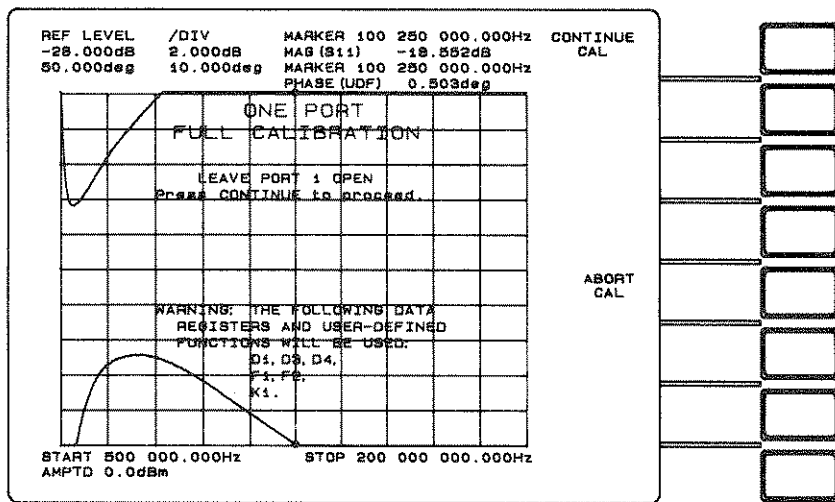

USER ACTION

Disconnect the device under test from its input cable.



Softkey. After a sweep, note the screen message **INSTALL SHORT ON PORT 1.**

USER ACTION

Install a shorted termination on the input cable where the device under test has been connected.



Softkey. After a complete sweep and some calculation time, note the screen message **INSTALL REFERENCE LOAD ON PORT 1.**

USER ACTION

Replace the short termination with a reference load.



Softkey. After a complete sweep and some more calculation time, note the screen message

CALIBRATION COMPLETE
INPUT="F2" : CALIBRATED REFLECTION

This message to the user says that the **INPUT** definition has been changed to the user defined function **F2**. See **MEASUREMENT CALIBRATION** in the **REFERENCE** section for more details.

USER ACTION

Connect the cable back to the input of the device.



Hardkey in the **DISPLAY FORMAT** section.



Softkey described previously.



Hardkey in the **DISPLAY FORMAT** section. Note that the SCALE menu is still displayed and selections made from it will affect trace two.



Hardkey described previously.

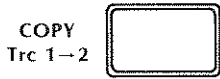

Softkey described previously.



Hardkey described previously.



Softkey described previously.



Hardkey in the **DISPLAY FORMAT** section.



Hardkey in the **DISPLAY FORMAT** section.

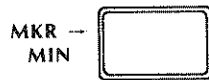

Softkey used to search for the minimum magnitude (in this case, maximum RETURN LOSS or best impedance match).

The display is now input return loss magnitude (trace one) and phase (trace two). Measurements may be made with the markers by turning the knob to move them along the trace. Marker data appears in the marker information block above the graticule. See Figure 2•42.

Figure 2•42 Calibrated Input Return Loss and Phase Response

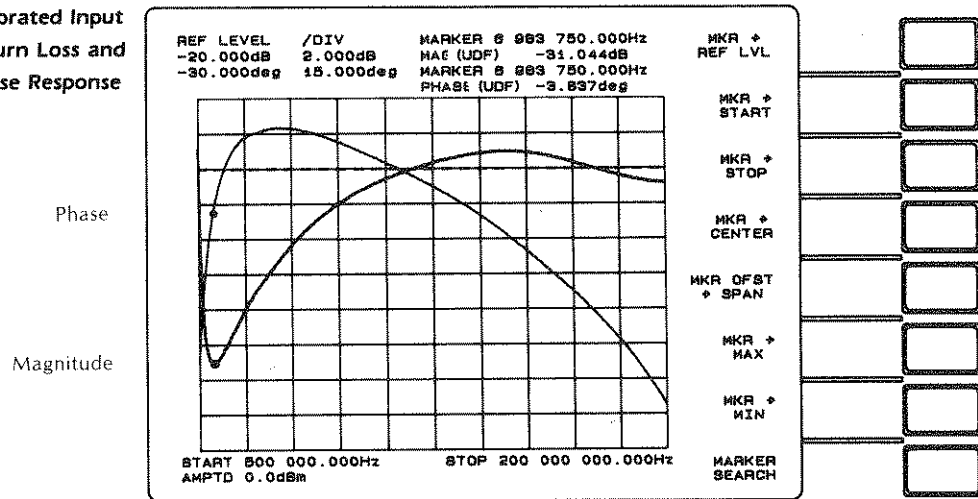

S₂₂' OUTPUT REFLECTION COEFFICIENT

Next we'll set up and measure S₂₂' output reflection coefficient, using the HP 35677A/B in the REVERSE configuration.

KEY	DESCRIPTION
<div style="border: 1px solid black; border-radius: 10px; padding: 5px; width: fit-content; margin-bottom: 20px;">INPUT</div>	Hardkey in the DISPLAY FORMAT section.
S22 <div style="border: 1px solid black; width: 60px; height: 30px; display: inline-block; margin-left: 10px;"></div>	Softkey used to select B/R as the INPUT with the test set in the REVERSE configuration.
<div style="border: 1px solid black; border-radius: 10px; padding: 5px; width: fit-content; margin-bottom: 20px;">MEAS CAL</div>	Hardkey in the DISPLAY FORMAT section.
USER ACTION	Disconnect the cable from the amplifier output and leave the end of the cable open.
NORMLIZE <div style="border: 1px solid black; width: 60px; height: 30px; display: inline-block; margin-left: 10px;"></div>	Softkey used to normalize the measurement as described previously. This feature may be used with an "open" termination for reflection measurements as well as with a BNC barrel for transmission measurements.
USER ACTION	Reconnect the output of the amplifier to the PORT 2 cable.
<div style="border: 1px solid black; border-radius: 10px; padding: 5px; width: fit-content; margin-bottom: 20px;">DISPLY FCTN</div>	Hardkey in the DISPLAY FORMAT section.
POLAR <div style="border: 1px solid black; width: 60px; height: 30px; display: inline-block; margin-left: 10px;"></div>	Softkey used to display trace information in a polar format. Note that only one trace may be on when using the POLAR display function. Trace two is turned off when POLAR is selected for trace one. See Figure 2•43.

Figure 2•43 Polar Display

Function of Normalized RF Amplifier Output Reflection

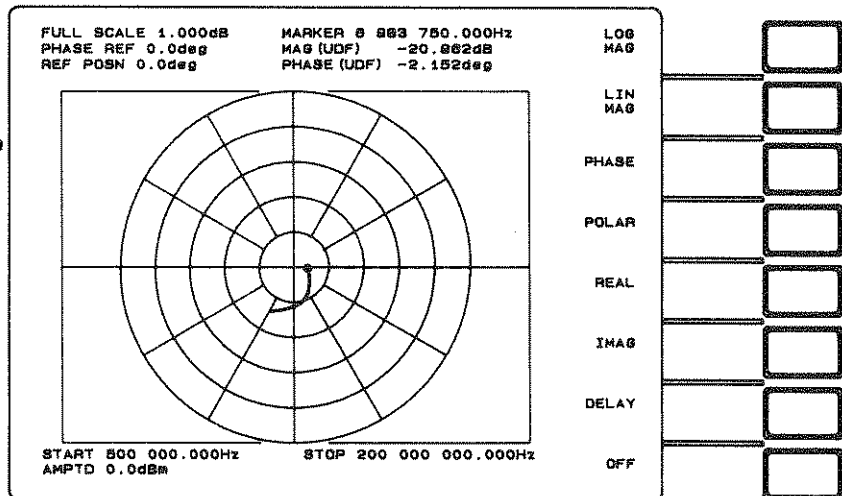

Now the display shows the trace of the reflection coefficient of the amplifier output from .5 MHz to 200 MHz. Note that the marker magnitude units are in linear units. The marker may be moved as described previously to make measurements on the trace.

COMPLEX OUTPUT IMPEDANCE

Next we'll use the Smith chart graticule to convert reflection coefficient to complex impedance and change the marker units from magnitude and phase to real and imaginary.





KEY	DESCRIPTION
	Hardkey in the DISPLAY FORMAT section.
	Softkey which appears in the SCALE menu when the DISPLAY FUNCTION is POLAR. This softkey toggles the Smith chart on and off. Note that the marker units change from MAG and PHASE to Z MAG and Z PHASE, or impedance magnitude and phase. This may be changed to read directly in real and imaginary units as shown next.
	Hardkey in the DISPLAY FORMAT section.
	Softkey that appears in the MARKER menu when the DISPLAY FUNCTION is POLAR. This softkey toggles the marker units between Magnitude & Phase and Real & Imaginary units. Note the correspondence between the Smith chart graticule and the marker units. See Figure 2•44.

Figure 2•44 The Smith Chart

Marker readout in complex impedance

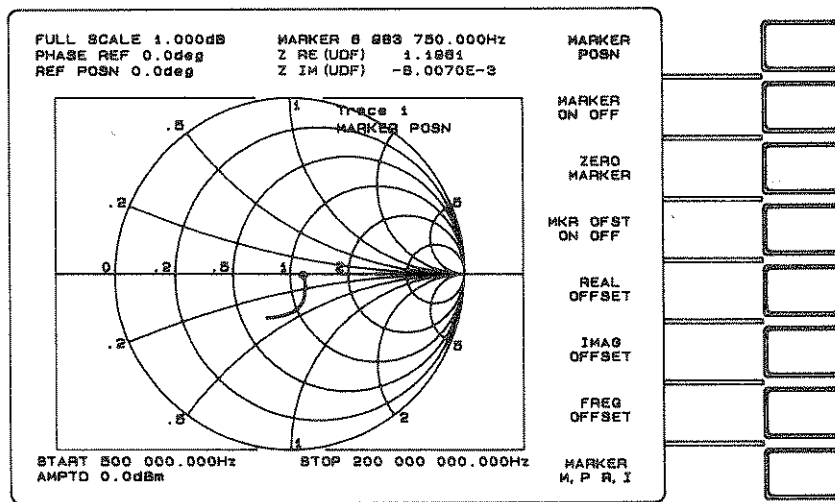

NOTE

The Smith chart graticule should be used with a FULL SCALE value of 1.000 units. If this scale is changed the graticule may not be used for conversion to complex impedance, but the data in the marker information block will continue to be accurate.

REMOTE OPERATION

THE HEWLETT PACKARD INTERFACE BUS

WHAT IS THE HP-IB?

The Hewlett Packard Interface Bus (HP-IB) is an easy to use, high performance bus structure that links the HP 3577A and other instruments, desktop computers and minicomputers into automated measurement systems. The HP-IB is Hewlett-Packard's implementation of the IEEE Standard 488-1978, ANSI Standard MC 1.1 and IEC Recommendation 625-1.

HOW DOES THE HP-IB OPERATE?

All of the active interface circuits are contained within the various HP-IB devices. The cable's role is limited to connecting all of the devices in parallel, so that data can be transferred from one device to another.

Every participating device must be able to perform at least one of the following roles: TALKER, LISTENER, or CONTROLLER. A talker transmits data to other devices called listeners. Most devices can perform both roles, but not at the same time. A controller manages the operation of the bus system by designating which device is to talk and which device(s) are to listen at any given time. The HP 3577A can be a talker or a listener. It has no controller capabilities.

The minimum HP-IB system consists of one talker and one listener without a controller. In this configuration, data transfer is limited to one direction because one device must be manually set to "TALK ONLY" and the other device must be manually set to "LISTEN ONLY". The HP 3577A can be set to talk only; it cannot be set to listen only.

The full flexibility and power of the HP-IB is realized when a controller is added to the system. An HP-IB

controller participates in the measurement by being programmed to:

- schedule measurement tasks
- set up instruments
- monitor the measurement
- interpret and operate upon the results

HP-IB SPECIFICATION SUMMARY

Number of Interconnected Devices:

A maximum of fifteen on one bus.

Interconnection Path/Maximum Cable Length:

Total cable length equal to two meters times number of devices or twenty meters, whichever is less, with a maximum of three meters separating any two devices.

Message Transfer Scheme:

Byte-serial, eight bit-parallel asynchronous data transfer using a three wire handshake.

Data Rate:

One megabyte per second (maximum) over limited distances, actual data rate depends upon the capability of the slowest device involved in the transmission.

Address Capability:

Primary addresses: 31 talk, 31 listen. A maximum of one talker and fourteen listeners at one time.

Multiple controller capability:

In systems with more than one controller, only one can be active at a time. The active controller can pass control to another controller, but only the system controller can assume unconditional control. Only one system controller is allowed. The system controller is hard-wired to assume bus control after a power failure.

BUS STRUCTURE

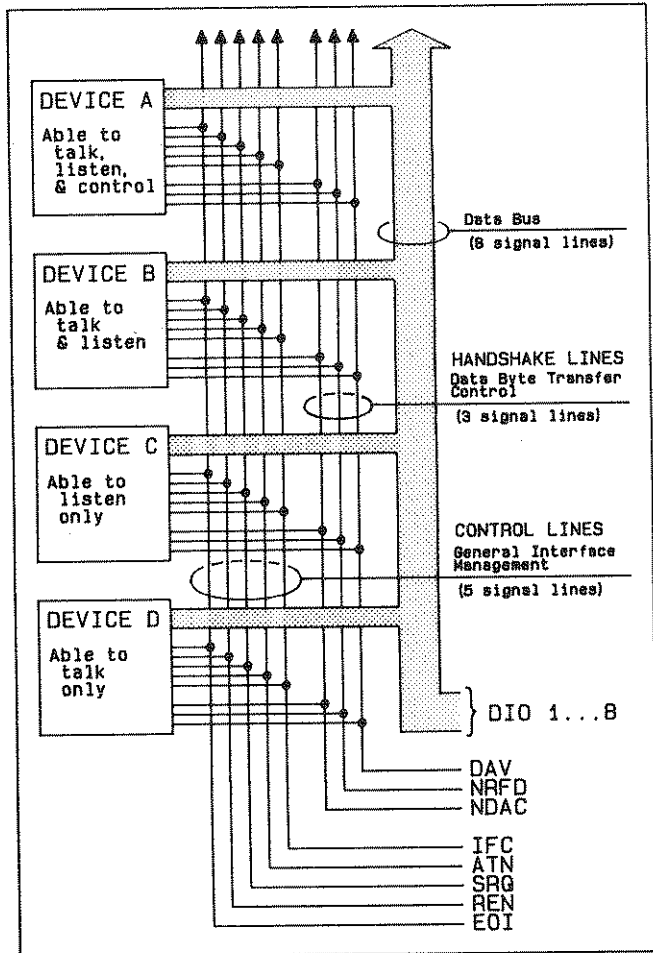

Figure 3-1

Management (CONTROL) Lines.

ATN-Attention. This line is used by the active controller to define how information on the data lines (DIO 1...8) will be interpreted by the other devices on the bus. When ATN is low (true) the HP-IB is in Command Mode and the data lines carry bus commands. When ATN is false the HP-IB is in Data Mode and the data lines carry device dependent commands. In the command mode the controller is active and all other devices are waiting for instructions.

SRQ-Service Request. This line is set low (true) by any instrument requesting service.

REN-Remote Enable. The system controller sets REN low and then addresses the devices to listen before they will operate under remote control.

IFC-Interface Clear. Only the system controller can activate this line. When IFC is set (true) all talkers, listeners, and active controllers go to their inactive states.

EO1-End Or Identify. This line is used to indicate the end of a multiple byte transfer sequence or, in conjunction with ATN, to execute a parallel polling sequence.

THE HP 3577A AND THE HP-IB

HP 3577A HP-IB CAPABILITY

As defined by IEEE Standard 488-1978, the HP 3577A has these characteristics:

- SH1** complete Source Handshake capability
- AH1** complete Acceptor Handshake capability
- T5** Basic Talker; serial poll; unaddress if MLA; Talk-Only
- TE0** no Extended Talker capability
- L4** Basic Listener; unaddress if MTA; no Listen Only
- LE0** no Extended Listener capability
- SR1** complete Service Request capability
- RL1** complete Remote/Local capability
- PP1** Parallel Poll; remote configuration capability
- DC1** complete Device Clear capability
- DT1** complete Device Trigger capability
- C0** no Controller capability
- E1** drivers are open-collector

This list of capabilities is printed on the rear panel near the HP-IB connector as follows:

SH1 AH1 T5 TE0 L4 LE0 SR1 RL1 PP1 DC1 DT1 C0 E1

DATA FORMAT VS TRANSFER RATE

The HP 3577A offers three data formats for transferring certain types of data on the bus. Data format may be selected for the following I/O: trace dumps, register dumps and loads, marker data dumps, and marker position dumps. A trace is made up of real numbers and is defined by the INPUT key. Trace one or trace two may be dumped (output) in any of the three data formats. A register is made up of real and imaginary numbers. There will be twice as many numbers in a register I/O as there are for a trace dump with the same sweep resolution. Registers R, A, B, D1, D2, D3, or D4 may be dumped or loaded in any of the three data formats.

As described in the previous paragraph, not all HP 3577A dump and load commands may be done in more than one type data format. It is recommended that the ASCII format (FM1) be active unless one of these

transfers is required. Each data format has a different data transfer rate. The figures listed for transfer rate are average times, shown here for comparison. They were taken such that the controller was not a limiting factor.

FM1 — Data format one is the default data format. When FM1 is active the HP 3577A transfers data using the ASCII format. Using this format the HP 3577A can dump a trace of 401 points in approximately 1.6 seconds. This format has the slowest data transfer rate of the three.

FM2 — Data format two is the 64 bit floating point binary specified in the IEEE draft standard P754. The data rate for this format is faster than that of FM1 but slower than that of FM3. FM2 has the advantage of being the same format used by HP Series 200 (98_6) computers. Using this format the HP 3577A can dump a trace of 401 points in approximately 0.16 seconds.

FM3 — Data format three is the 32 bit floating point binary used by the HP 3577A fast processor. FM3 has the fastest data transfer rate of the three data formats. Using FM3 the HP 3577A can dump a trace of 401 points in approximately 0.04 seconds. When this format is active the HP3577A does not have to convert data formats and requires half as many transfers per data value as FM2. This format may be used for data that is not processed outside the HP 3577A.

DIRECT PLOTTING

The HP 3577A can provide a hardcopy of the CRT screen without using a computer. It does this by directly controlling a digital plotter connected to the HP 3577A's HP-IB port located on the rear panel. The plotter (such as the HP 7470A) must accept Hewlett-Packard Graphic Language (HP-GL) commands. The HP 3577A must be configured in a Talk Only mode and the plotter must be configured as a Listen Only device. Refer to SPECIAL FUNCTIONS in the REFERENCE section.

HP-IB VERIFICATION

Refer to the computer operating manual and find the section describing the HP-IB REMOTE Message. When this message is sent to the HP 3577A, the REMOTE annunciator LED on the front panel will light. If this does not occur, recheck the cabling, the HP 3577A address, and the syntax of the computer statement. Here are some examples of the REMOTE message as implemented by HP computers:

REMOTE 711 HP Series 80, Series 200; BASIC
rem 711 HP 9825, Series 200; HPL

HP-IB DIAGNOSTIC MODE

The Bus Diagnostic Modes (BD1 & BD2) may be used to find HP-IB program problems. When active, these modes cause the HP 3577A to display menus as though being operated from the front panel. In BD2 the programming code received by the HP 3577A over the bus will be left-shifted through the screen error block in a "ticker tape" fashion.

BD0 is the default mode. Bus diagnostics are off; no menus appear and bus codes are not displayed. Sweep dot does not appear unless sweep time is 1 second or more. This is the fastest programming mode.

BD1 displays all menus and updates the front panel as though the HP 3577A were being operated from the front panel. The HP-IB programming codes appear only when an error is encountered. When this occurs, processing of all bus commands will halt for three seconds to allow the programmer to read the code that caused the error before processing continues and secondary errors are generated.

BD2 is the same as BD1 except that the HP 3577A processes bus code at a reduced rate (one command per second) and all programming code received on the bus is left-shifted through the screen error block.

NOTE

The HP 3577A will interpret the carriage return (CR) as \leftarrow , linefeed as \downarrow , and EOI as \wedge . Binary loads (including the #I) and ASCII register loads are not shown on the screen.

NOTE

The HP 3577A's HP-IB buffer will hold a maximum of 100 characters. If the controller tries to send more than 100, it will have to wait for the HP 3577A to process some of the code before sending more. If the computer is waiting as just described, and the HP3577A processes a dump command, it will wait to be addressed to talk. It is possible that both controller and HP 3577A could end up waiting for each other, halting all bus activity. Care should be taken in programming such that this does not occur.

THE HP 3577A's HP-IB ADDRESS

TALK/LISTEN ADDRESSES

Every HP-IB device has at least one address unless it's totally transparent or a Talk-Only or Listen-Only device. Device addresses are used by the active controller in the COMMAND MODE (ATN true) to specify who talks (via a Talk Address) and who listens (via Listen Addresses). There may be only one talker addressed (by the controller) to talk at any time. Talk and Listen addresses are the same on the HP 3577A.

VIEWING THE HP 3577A's HP-IB ADDRESS

The HP 3577A's HP-IB address is set to eleven (11) at the factory. To display the address of the HP 3577A:

- 1 Press the "SPCL FCTN" hardkey
- 2 Press the "HP-IB ADDRESS" softkey (top item in the display menu). The address will appear in the entry block. See Figure 3*2.

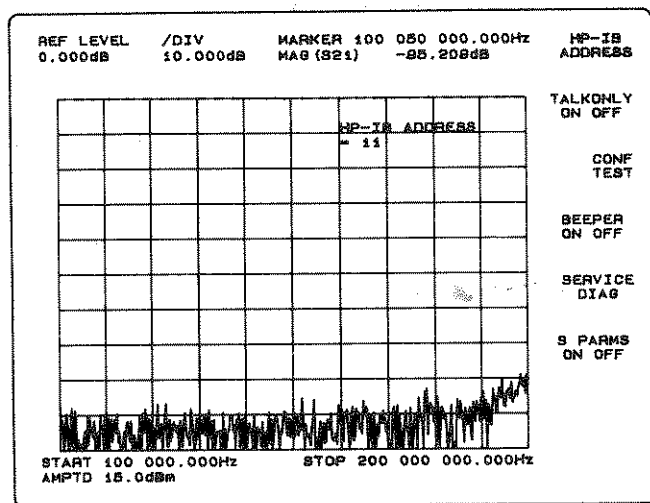

Figure 3*2

SETTING THE HP 3577A's HP-IB ADDRESS

Every device on the HP-IB must have a unique address. The HP 3577A address can be set to any address from zero (0) to thirty (30), inclusive. When choosing an address, remember that the controller also has an address (typically 21). To change the HP-IB address:

- 1 Press the "SPCL FCTN" hardkey
- 2 Press the "HP-IB ADDRESS" softkey to display the current HP-IB address.
- 3 Press the appropriate keys in the numeric keypad for the new address. Note the change in the entry block.

- 4 Press the "ENTER" softkey.

The HP 3577A's HP-IB address is stored in a non-volatile memory; there are no address switches. If the contents of this memory are destroyed, the HP-IB address defaults to eleven (11). Under normal circumstances, the non-volatile memory should retain its data for up to five years. This time is not specified and no warranty is stated or implied.

Use the following table if you are using a controller that requires the talk and listen addresses:

HP-IB ADDRESSES		
DEVICE ADDRESSES	TALK	LISTEN
0	@	SPACE ‡
1	A	!
2	B	"
3	C	#
4	D	\$
5	E	%
6	F	&
7	G	'
8	H	(
9	I)
10	J	*
11 ‡‡	K	+
12	L	,
13	M	-
14	N	.
15	O	/
16	P	0
17	Q	1
18	R	2
19	S	3
20	T	4
21 ‡‡‡	U	5
22	V	6
23	W	7
24	X	8
25	Y	9
26	Z	:
27	[;
28	½	<
29]	=
30	^	>

‡ (ASCII character)
 ‡‡ (HP 3577A factory setting)
 ‡‡‡ (usually the controller)

The Talk and Listen addresses are ASCII characters. When a device receives one of these characters while ATN is true, it will become addressed. The ASCII character ? will unaddress all devices. The Device address (set from the HP 3577A front panel) is used by most newer HP-IB computers which automatically send the Talk and Listen address characters.

BUS MESSAGES

The interface system operates in either of two modes: COMMAND MODE (ATN true) or DATA MODE (ATN false). If an HP computer is used, the bus management lines will be configured automatically and all necessary command strings will be issued.

BUS COMMANDS

In the Command Mode special codes known as "bus commands" may be placed on the HP-IB. These commands have the same meaning in all HP-IB systems. Each device is designed to respond to those commands that have a useful meaning to the device and ignore other bus commands. The HP 3577A will respond to the following commands as described. The three-letter command abbreviations refer to IEEE 488 nomenclature.

ABORT I/O

Abort Input/Output (IFC; interface clear) is an unconditional assumption of control of the bus by the system controller. All bus activity halts and the HP 3577A becomes unaddressed. This does **not** clear the HP 3577A HP-IB command buffer.

Example for HP Series 200 computers, in BASIC:

```
ABORT 7
```

CLEAR LOCKOUT/SET LOCAL

This command removes all devices from the local lockout mode and returns them to local (front panel) control. The only difference between this bus message and the LOCAL message is how it is addressed.

Example for HP Series 200 computers, in BASIC:

```
LOCAL 7 (Clears LOCAL LOCKOUT and enables front panel keys)
```

DEVICE CLEAR

The CLEAR command may be addressed (SDC; selected device clear) or unaddressed (DCL; device clear). When this command is received by the HP 3577A it will clear the HP-IB command buffer, reset the SRQ line (if pulled low by the HP3577A), and abort any data input or output. This interrupts bus activity and gains control of the analyzer, no matter what it may be doing. It does *not* preset the 3577A. It is good practice to begin programs with this command. See the examples that follow.

Examples for HP Series 200 computers, in BASIC:

```
CLEAR 7 (UDC; clears all devices on computer port seven)
```

```
CLEAR 711 (SDC; clears device addressed eleven on port seven)
```

LOCAL

LOCAL (GTL; go to local) returns control of the listening device to the local (front panel) state. The REMOTE LED on the front panel extinguishes if the instrument was in remote prior to the local command. The HP-IB buffer is not cleared on the HP 3577A. Also, any dump or load in progress will **not** be aborted.

Example for HP Series 200 computers, in BASIC:

```
LOCAL 711 (Local lockout still active if returned to REMOTE)
```

NOTE

*This command is **not** identical to pressing the LCL front panel key on the HP 3577A. Pressing the key will clear the HP-IB buffer of all pending commands.*

LOCAL LOCKOUT

LOCAL LOCKOUT (LLO) disables the LOCAL key of all devices on the bus to secure the system from operator interference when in remote control. After this command is issued the only way to return to front panel operation from remote control is with a LOCAL command from the controller. Local lockout will not change the local/remote status of the instrument. Local lockout is disabled by a universal (unaddressed) LOCAL command on the bus.

Example for HP Series 200 computers, in BASIC:

```
LOCAL LOCKOUT 7
```

PARALLEL POLL

PARALLEL POLL is a command issued by the controller in response to the SRQ (service request) management line being pulled low (true). Since any instrument could have pulled SRQ the controller must poll them all to find which requested service. The parallel poll commands each device to send its Request Service bit (RQS; part of the Status Byte) on

one of the eight data lines. The Parallel Poll Configure (PPC) command determines data line and logical sense used.

Example for HP Series 200 computers, in BASIC:

```
Var = PPOLL(7)
```

PARALLEL POLL CONFIGURE

The PARALLEL POLL CONFIGURE command (PPC) programs the logical sense and data line used by a specified device to respond to a parallel poll. The configure word is coded as shown in Figure 3•3. The three least significant bits determine the data bus line for the response. The fourth bit determines the logical sense of the response.

Decimal	Binary
2	0 010
9	1 001

└─┬─┘ data line number
└───┘ sense bit

Figure 3•3

Example for HP Series 200 computers, in BASIC:

```
PPOLL CONFIGURE 711;2 (put RQS bit on DIO line 2
Sense: 0 = RQS true)
PPOLL CONFIGURE 711;9 (put RQS bit on DIO line 1
Sense: 1 = RQS true)
```

PASS CONTROL

Pass Control (TCT; take control) shifts system control from one controller to another. Since the HP 3577A has no controller capability, it cannot respond.

REMOTE

REMOTE may be used to address the HP 3577A to listen. When this command is issued, the REMOTE front panel LED illuminates and the front panel is disabled except for the LCL key. If LOCAL LOCKOUT is active the LCL front panel key is also disabled.

Examples for HP Series 200 computers, in BASIC:

```
REMOTE 7 (switches all devices on port seven from
local to remote)
REMOTE 711 (switches device addressed eleven from
local to remote)
```

SERIAL POLL

SERIAL POLL is a command to dump the status byte on the bus. Encoded in the eight bits of the status byte are the states of several HP 3577A operating conditions. See "THE STATUS BYTE."

Examples for HP Series 200 computers, in BASIC:

```
Var = SPOLL(711)
IF Var THEN ... (Checks for the zero state)
```

Another example:

```
IF BINAND(SPOLL(711),16) THEN ... (Checks
state of bit five)
```

SERVICE REQUEST

The Service Request (SRQ) line is one of the five bus management lines that go to every device on the bus, along with eight data lines and three handshake lines. It may be used by one or more devices to indicate the need for attention from the controller and can act as an interruption of the current sequence of events. Typically, SRQ indicates information is ready to transmit and/or an error condition exists. When the HP 3577A issues an SRQ it also sets bit #6 of the Status Byte. Bit 6 is the RQS (Require Service) bit, sometimes referred to as the "status bit" in connection with a poll.

If properly configured, the controller will stop and poll when it senses the SRQ. A serial poll returns each device's status byte, one device at a time. A parallel poll returns all (up to eight) device's status bits simultaneously; each instrument responding on one of the eight data lines. When the HP 3577A is polled it will clear the RQS bit and the SRQ line.

Any of the bits in the Status Byte may initiate an SRQ. The Status Byte may be masked such the user may select which bits cause the HP 3577A to set the SRQ line (see the Status Byte).

TRIGGER

The HP 3577A responds to the TRIGGER bus command (GET; group execute trigger) as it would to any other external trigger; by beginning a sweep or, in the case of CW SWEEP TYPE or MANUAL SWEEP MODE, taking a measurement. TRIGGER may be sent to a selected device or all devices addressed to listen on the HP-IB. The HP 3577A must be addressed to listen and in the "WAIT TRIG" state before the trigger message is sent. If the last statement left the HP 3577A addressed to

listen and settling is complete, it's ready for a trigger. If not, or if several devices are to be triggered simultaneously, a SEND command may be used to address the listeners. See Bit B4 of The Status Byte.

Examples for HP Series 200 computers, in BASIC:

```
SEND 7;UNL MTA LISTEN 11,17,22
TRIGGER 7
```

UNL = UNLISTEN; unaddresses all listeners
 MTA = MY TALK ADDRESS; the controller addresses itself to talk
 LISTEN 11,17,22; addresses devices whose addresses are 11,17, and 22 to listen

Another example:

```
ASSIGN @Listeners TO 702,707,711
TRIGGER @Listeners
```

DEVICE DEPENDENT COMMANDS

In the Data Mode special codes known as "device dependent commands" may be placed on the HP-IB. These commands have meaning for a specific instrument. They can configure the instrument, tell it to take a measurement, dump or load data, or define error reporting conditions, and are meaningless for other instruments.

Device dependent commands and front panel key functions have a one-to-one relationship for all but the HP-IB-only commands. For example, DF5 is the remote equivalent of pressing the PHASE softkey in local. Exceptions to this rule are:

Front panel functions not allowed in remote operation:

HP-IB Address Viewing and Selection

Remote functions not allowed from the front panel:

- Data Dumps
- Load Data
- User defined graphics
- User defined annotation
- User defined menus
- Bus code diagnostics
- Control of Settling Time value

Device dependent commands may be sent to the HP 3577A by using the BASIC command "OUTPUT" as

shown in the following examples for HP Series 200 computers:

```
OUTPUT 711;"FSW;" (Full sweep)
OUTPUT 711;"DF5;" (Display Function 5 is PHASE)
OUTPUT 711;"FRA 2 MHZ;" (Start Frequency = 2 MHz)
OUTPUT 711;"DRA;" (Dump Register A)
```

```
OUTPUT 711;"DF7;FRA 1 MHZ;FRB 10 MHZ;SAM 0 DBM;TKM;DRA;"
```

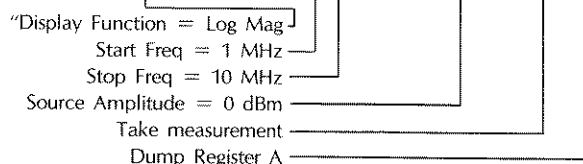

A delimiter should be used after all commands when there are multiple commands per line. Delimiters are semicolons (;), linefeeds (LF), and <EOI> (pulling the EOI bus management line). Separators, such as spaces and commas, may be used instead of delimiters, but using semicolons or LF characters between commands enables the HP 3577A to do a better job of error reporting. A delimiter is required to terminate a numeric entry. The HP 3577A accepts upper or lower case letters over the bus.

DEFINITIONS

A **SELECT COMMAND** is a two-letter prefix followed by a qualifier digit that selects a particular state of that function.

Example: the HP-IB code for PHASE (display function 5) is DF5.

IMMEDIATE EXECUTION COMMANDS execute a given operation when issued. They require no other data.

Example: Instrument Preset is IPR.

DATA ENTRY COMMAND is a three part command that enters a value for one of the parameters. The three parts are: prefix (the parameter to be changed by the data entry), data (numbers), and suffix (units for the new value). Source amplitude (SAM) is an example of a data entry command.

Example: OUTPUT 711;"SAM 0 DBM;"

HP 3577A Program Codes have been categorized into five distinct groups to help explain them. These are:

- SOURCE
- RECEIVER
- DISPLAY FORMAT
- INSTRUMENT STATE
- HP-IB ONLY

DISPLAY FORMAT

<u>Function</u>	<u>HP-IB code</u>
TRACE 1	TR1
TRACE 2	TR2
DISPLAY FUNCTION	DSF *
Log Magnitude	DF7
Linear Magnitude	DF6
Phase	DF5
Polar	DF4
Real	DF3
Imaginary	DF2
Delay	DF1
Trace Off	DF0
Delay Aperture menu	DAP *
Aperture .5% of span	AP1
Aperture 1% of span	AP2
Aperture 2% of span	AP3
Aperture 4% of span	AP4
Aperture 8% of span	AP5
Aperture 16% of span	AP6
Return	RET *
INPUT	INP *
Input = R	INR
Input = A	INA
Input = B	INB
Input = A/R	IAR
Input = B/R	IBR
Input = D1	ID1
Input = D2	ID2
Input = D3	ID3
Input = D4	ID4
Return	RET *
User Defined Input	UDI
Input = S_{11}	I11
Input = S_{21}	I21
Input = S_{12}	I12
Input = S_{22}	I22
Copy Input	CPI
Test Set Forward	TSF
Test Set Reverse	TSR
SCALE	SCL *
Autoscale	ASL
Reference Level (entry)	REF
Scale /DIV (entry)	DIV
Reference Position (entry)	RPS
Reference Line Off	RL0
Reference Line On	RL1
Copy Scale	CPS
Phase Slope (entry)	PSL
Phase Slope Off	PS0
Phase Slope On	PS1
Polar Full Scale (entry)	PFS
Polar Phase Ref (entry)	PPR
Smith Chart Off	GT0
Smith Chart On	GT1
MARKER	MKR *
Marker Position (entry)	MKP
Marker Off	MRO
Marker On	MR1

Zero Marker
 Marker Offset Off
 Marker Offset On
 Marker Offset (entry)
 Marker Offset Freq (entry)
 Marker Offset Amp (entry)
 Marker Coupling Off
 Marker Coupling On
 Polar Mag Offset (entry)
 Polar Phase Offset (entry)
 Polar Real Offset (entry)
 Polar Imag Offset (entry)
 Polar Marker Units (Re/Im)
 Polar Marker Units (Mg/Ph)

MARKER -
 MKR → Reference Level
 MKR → Start Frequency
 MKR → Stop Frequency
 MKR → Center Frequency
 MKR Offset → Span
 MKR → Max
 MKR → Min
 MARKER SEARCH menu
 MKR Target Value (entry)
 MKR → Right for Target
 MKR → Left for Target
 Return
 MKR → Full Scale
 MKR → Polar Phase Ref

STORE DATA
 Store in register D1
 Store in register D2
 Store in register D3
 Store in register D4
 Store and Display
 User defined store
 Store to D1
 Store to D2
 Store to D3
 Store to D4

MEASUREMENT CALIBRATION
 Normalize
 Normalize (Short)
 Calibrate, Partial
 Calibrate, Full
 Continue Calibration

DEFINE MATH
 Constant K1, Real
 Constant K1, Imaginary
 Constant K2, Real
 Constant K2, Imaginary
 Constant K3, Real
 Constant K3, Imaginary
 Define Function
 Function F1
 Function F2
 Function F3
 Function F4
 Function F5
 Math term for input R
 Math term for input A
 Math term for input B
 Math term for storage reg

ZMK
 MO0
 MO1
 MKO
 MOF
 MOA
 CO0
 CO1
 PMO
 PPO
 PRO
 PIO
 MRI
 MMP
 MKG *
 MTR
 MTA
 MTB
 MTC
 MOS
 MTX
 MTN
 MSM *
 MTV
 MRT
 MLT
 RET *
 MTP
 MPF
 STO *
 SD1
 SD2
 SD3
 SD4
 STD
 UDS
 TD1
 TD2
 TD3
 TD4
 CAL *
 NRM
 NRS
 CPR
 CFL
 CGO
 DFN *
 KR1
 KI1
 KR2
 KI2
 KR3
 KI3
 DFC *
 UF1
 UF2
 UF3
 UF4
 UF5
 R
 A
 B
 D

* Use not required. The only function of this code is to display a menu (if bus diagnostics are on).

Math term for constant
 Math term for function
 Math bracket
 Math function plus
 Math function minus
 Math function multiply
 Math function divide
 Math bracket
 Return

K
 F
 (
 +
 -
 *
 /
)
 RET *

DATA ENTRY SECTION COMMANDS

Increment (up arrow)
 Decrement (down arrow)
 Continuous Entry (knob) Off
 Continuous Entry (knob) On
 Entry Off

IUP
 IDN
 CE0
 CE1
 HLD

DISPLAY FORMAT SUFFIX UNITS

dBm
 dBV (rms)
 dB relative
 Volt (rms)
 milli-Volt (rms)
 micro-Volt (rms)
 nano-Volt (rms)
 degrees
 degrees/span
 radians
 radians/span
 seconds
 milliseconds
 microseconds
 nanoseconds
 percent
 degrees/span
 radians/span
 MHz
 kHz
 Hz
 exponent

DBM
 DBV
 DBR
 V
 MV
 UV
 NV
 DEG
 DSP
 RAD
 RSP
 SEC
 MSC
 USC
 NSC
 %
 DSP
 RAP
 MHZ
 KHZ
 HZ
 E

USER DEFINED INPUT (UDI) uses the same terms and math functions as **UDF** (user defined function).

Example:

10 OUTPUT 711;"UDI (B/R)(K1-B/R)"

COPY INPUT (CPI) will copy the INPUT definition of the inactive trace into that of the of the active trace as follows:

1. Trace one active
2. Output CPI
3. INPUT definition of trace one is now the same as trace two

TEST SET FORWARD AND REVERSE (TSF & TSR) are used to configure a HP 35677A/B S-Parameter Test Set connected to the HP 3577A. The INPUT definition should be user defined (to avoid an error message). If you wish to control the test set while using one of the standard input definitions, enter it under UDI.

Example:

10 OUTPUT 711;"UDI R;TSR;"

COPY SCALE (CPS) will copy reference level and /DIV parameters of the inactive trace into those of the active trace *if* the DISPLAY FUNCTION units of both traces are compatible.

MARKER POSITION (MKP) is a prefix for a data entry. The data will be a bin number. The number of bins in a sweep depends on the sweep resolution (in a frequency sweep) or number of steps (in an amplitude sweep). The default numbers of bins in a sweep are 401 (0 through 400) for frequency sweeps and 101 (0 through 100) for amplitude sweeps. MKP is the prefix used to position the marker at a specific bin. This bin number may be calculated using the following formula:

$$\text{Bin number} = \frac{f_{\text{bin}} - f_{\text{start}}}{\text{span}} \times (\text{points per sweep})$$

Where: f_{bin} is the frequency of the new marker position
 f_{start} is the start frequency
 span is the frequency span
 points per sweep is the sweep resolution

This number *should* be an integer ≤ 401 . If the result is not an integer you probably picked a frequency for f_{bin} that is not one of the sampled frequencies for the sweep. The HP 3577A will round any fraction received with MKP. If the number is > 401 a "NUMBER OUT OF RANGE" error message will be generated.

USER DEFINED STORE (UDS) and **TD1-TD4** are used together to define and store data (traces).

Example:

10 OUTPUT 711;"UDS D3-A/R*D4 TD3;"

Note that a register name may appear as part of the definition *and* as the destination register. A destination register *must* appear after the definition.

USER DEFINED FUNCTIONS 1 THROUGH 5 (UF1-UF5) are used to enter definitions as shown in the following:

Example:

10 OUTPUT 711;"UF3 D4*A/R + D3;"
 20 OUTPUT 711;"UF4 (A/R-D2)F3;"

Note that functions may be defined in terms of *lower* numbered functions. Thus F1 cannot be a function of another user defined function but F5 could be a function of any of the first four.

CONTINUOUS ENTRY OFF/ON (CE0 & CE1) corresponds to the MARKER and ENTRY modes of the knob where CE0 = MARKER and CE1 = ENTRY.

* Use not required. The only function of this code is to display a menu (if bus diagnostics are on).

SOURCE

<u>Function</u>	<u>HP-IB code</u>
SWEEP TYPE	STY *
Linear Sweep	ST1
Alternate Sweep	ST2
Log Sweep	ST3
Amplitude Sweep	ST4
CW	ST5
Sweep Direction Up	SUP
Sweep Direction Down	SDN
SWEEP MODE	SMD *
Continuous	SM1
Single Sweep	SM2
Manual Sweep	SM3
Manual Frequency (entry)	MFR
Manual Amplitude (entry)	MAM
Marker — Manual	MTM
SWEEP TIME	STM *
Sweep Time (entry)	SWT
Step Time (entry)	SMT
Sample Time (entry)	MSR
FREQUENCY	FRQ *
Source Frequency (entry)	SFR
Start Frequency (entry)	FRA
Stop Frequency (entry)	FRB
Center Frequency (entry)	FRC
Frequency Span (entry)	FRS
FRC Step size (entry)	CFS
Sweep Resolution menu	SRL *
Freq Swp Res 51 pts/span	RS1
Freq Swp Res 101 pts/span	RS2
Freq Swp Res 201 pts/span	RS3
Freq Swp Res 401 pts/span	RS4
Return	RET *
Full Sweep	FSW
Freq Step Size (entry)	FST
AMPLITUDE	AMP *
Source Amplitude (entry)	SAM
Amp Step Size (entry)	AST
Clear Trip, Source	CTS
Start Amplitude (entry)	AMA
Stop Amplitude (entry)	AMB
Steps/Sweep menu	NST *
Number of steps = 6	NS1
Number of steps = 11	NS2
Number of steps = 21	NS3
Number of steps = 51	NS4
Number of steps = 101	NS5
Number of steps = 201	NS6
Number of steps = 401	NS7
Return	RET *
Full Sweep	FSW
TRIGGER MODE	TRM *
Free Run	TG1
Line Trigger	TG2
External Trigger	TG3
Immediate	TG4
SWEEP TRIGGER	TRG
SWEEP RESET	RST

} TRG/
RESET

SOURCE SUFFIX UNITS

dBm	DBM
dBV (rms)	DBV
Volt (rms)	V
milli-Volt (rms)	MV
micro-Volt (rms)	UV
nano-Volt (rms)	NV
seconds	SEC
milliseconds	MSC
MHz	MHZ
kHz	KHZ
Hz	HZ
exponent	E

STEP TIME (SMT) is a data entry prefix for sample time used for amplitude sweeps. The default value for this parameter is 0.05 seconds per step.

Example:

10 OUTPUT 711; "ST4;SMT .1 SEC;" ! ST4 is amptd sweep

SAMPLE TIME (MSR) is a data entry prefix for sample time for the manual sweep mode and CW sweep type. The default value for this parameter is 0.05 seconds per sample.

Example:

10 OUTPUT 711; "SM3;MSR .1 SEC;" ! SM3 = Manual sweep mode

FREQUENCY STEP SIZE (FST) is a data entry prefix used only when the source is operated at a single frequencies as with CW or amplitude sweep types or the manual frequency sweep mode.

TRIGGER AND RESET (TRG & RST) Where the front panel has one key, labeled TRIG/RESET, functioning as both trigger (for single sweeps) and reset, the HP-IB has separate commands for each function. Sweep control is done the same in remote as local. RST resets the sweep in all sweep modes, and TRG may be used to trigger single sweeps. RST also initiates settling even if more commands are waiting in the HP-IB buffer. Other commands do not initiate settling until the command buffer is empty. RST is useful for decreasing the time required to prepare for a sweep by overlapping settling and other HP-IB operations.

* Use not required. The only function of this code is to display a menu (if bus diagnostics are on).

Example:

```

10  !
20  ! 'RST','TRG' Use of Reset and Trigger commands
30  !
40  ! This example program will take measurements at 1, 2, 3, 4, and
50  ! 5 MHz and dump the data to the computer.
60  !
70  ! First, set up the instrument state and take a measurement
80  !
90  OUTPUT 711;"IPR;ST5;SM2;SFR 1 MHZ;TKM;" ! Set up 1st freq
100 FOR I=2 TO 5
110     LOOP
120         EXIT IF BINAND(S POLL(711),4) ! 4=B2 of Status Byte
130     END LOOP ! Loop until Meas is
140         ! Complete
150 !
160 OUTPUT 711;"SFR";I;"MHZ;RST;DM1;TRG;" ! Start settling for
170 ENTER 711;Mkr_Mag ! next meas and dump
180         ! data for previous
190         ! meas. This allows
200         ! settling to occur
210         ! during the data dump
220 !
230 PRINT "MARKER MAGNITUDE AT";I-1;"MHz =";Mkr_Mag;"dB"
240 !
250     NEXT I ! When this FOR/NEXT
260         ! loop is done 5 MHz
270         ! has been set up but
280         ! no data dumped.
290     LOOP
300         EXIT IF BINAND(S POLL(711),4) ! Wait for Meas
310     END LOOP ! Complete, again
320 OUTPUT 711;"DM1;" ! Dump 5 MHz data
330 ENTER 711;Mkr_Mag
340 PRINT "MARKER MAGNITUDE AT";I-1;"MHz =";Mkr_Mag;"dB"
350 END

```

RECEIVER

<u>Function</u>	<u>HP-IB code</u>
RESOLUTION BW	RBW *
Resolution BW 1 Hz	BW1
Resolution BW 10 Hz	BW2
Resolution BW 100 Hz	BW3
Resolution BW 1 kHz	BW4
Auto Bandwidth Off	AU0
Auto Bandwidth On	AU1
AVERAGE	AVE *
Averaging Off	AV0
N=4	AV1
N=8	AV2
N=16	AV3
N=32	AV4
N=64	AV5
N=128	AV6
N=256	AV7
ATTENUATION	ATT *
Attenuation R = 0 dB	AR1
Attenuation R = 20 dB	AR2
Attenuation A = 0 dB	AA1
Attenuation A = 20 dB	AA2
Attenuation B = 0 dB	AB1
Attenuation B = 20 dB	AB2
Impedance R = 50 Ω	IR1
Impedance R = 1 MΩ	IR2
Impedance A = 50 Ω	IA1
Impedance A = 1 MΩ	IA2
Impedance B = 50 Ω	IB1
Impedance B = 1 MΩ	IB2
Clear Trip, Receiver	CTR
LENGTH	LEN *
Length R (entry)	LNR
Length R Off	LR0
Length R On	LR1
Length A (entry)	LNA
Length A Off	LA0
Length A On	LA1
Length B (entry)	LNB
Length B Off	LB0
Length B On	LB1
Length Step Size (entry)	LNS

RECEIVER SUFFIX UNITS

meters	MET
centimeters	CM
seconds	SEC
milliseconds	MSC
microseconds	USC
nanoseconds	NSC
exponent	E

INSTRUMENT STATE

<u>Function</u>	<u>HP-IB Code</u>
SPECIAL FUNCTIONS	SPC *
Confid. (self) test menu	SLF *
Self test channel R	STR
Self test channel A	STA
Self test channel B	STB
Return	RET *
Beeper off	BP0
Beeper on	BP1
Service Diagnostics menu	SDG *
Source Leveling off	SL0
Source Leveling on	SL1
Settling Time off	SE0
Settling time on	SE1
Synthesizer Diag off	SY0
Synthesizer Diag on	SY1
Display Test Pattern	DTP
Trace Memory Test	TMT
Fast Processor Test	FPT
I/O port test	PRT
More Serv Diag menu	MOR *
Display Memory Test	DST
Software Revision message	SRV
Return	RET *
S-Parameters Off	SP0
S-Parameters On	SP1
SAVE INSTRUMENT STATE	SAV *
Save state in register 1	SV1
Save state in register 2	SV2
Save state in register 3	SV3
Save state in register 4	SV4
Save state in register 5	SV5
RECALL INSTRUMENT STATE	RCL *
Recall old (last) state	RLS
Recall register 1	RC1
Recall register 2	RC2
Recall register 3	RC3
Recall register 4	RC4
Recall register 5	RC5
INSTRUMENT PRESET	IPR
PLOT MENU	PLM *
Plot all	PLA
Plot trace 1	PL1
Plot trace 2	PL2
Plot graticule	PLG
Plot characters	PLC
Plot trace 1 marker	PM1
Plot trace 2 marker	PM2
Configure Plot menu	CPT *
Trace 1 linetype (entry)	T1L
Trace 2 linetype (entry)	T2L
Trace 1 pen number (entry)	T1P
Trace 2 pen number (entry)	T2P
Graticule pen no. (entry)	PGP
Pen speed fast (max)	PNM
Pen speed slow	PNS
Set plot config to default	PLD
Return	RET *

* Use not required. The only function of this code is to display a menu (if bus diagnostics are on).

PLOTTING VIA HP-IB

HP-IB PLOT commands are a special programming case. To control a plotter directly, the HP 3577A must become a talker. Only one talker is allowed on the bus at a time so the controller must be programmed to release the bus. The HP 3577A must be manually configured with TALK ONLY OFF, as with any remote control operation. The following examples execute a PLOT ALL command. They assume that the analyzer's address is eleven and the plotter's address is thirty.

Example for the HP Series 200 computers:

```
10 SEND 7; UNL MTA LISTEN 11 DATA "PLA" UNL MTA TALK 11
LISTEN 30 DATA
```

Example for the HP Series 80 computers:

```
10 SEND 7; UNL MTA LISTEN 11 DATA "PLA" UNL MTA TALK 11
LISTEN 30
20 RESUME 7
```

- SEND 7 — selects the HP-IB interface at address seven
- UNL — unlisten; unaddresses all listeners
- MTA — my talk address; controller addresses itself to talk; this command will also unaddress all talkers
- LISTEN 11 — addresses device at address eleven to listen
- DATA "PLA" — outputs the characters in quotes on the HP-IB
- UNL — unlisten
- MTA — my talk address
- TALK 11 — addresses device at address eleven to talk
- LISTEN 30 — addresses device at address thirty to listen
- DATA — releases the bus for the data transfer (Series 200)
- RESUME 7 — releases the bus for the data transfer (Series 80)

If the HP 3577A is unaddressed as the talker by the bus controller during a plot, the plotting process can be resumed if the HP 3577A is readdressed to talk and was NOT addressed to listen (with a byte transmitted) in the interim. It is the responsibility of the bus controller to transmit its UNTALK command so that the handshake in progress is completed and data is not lost. Actions that will terminate a PLOT are: addressing the HP 3577A to LISTEN (and sending a data byte), sending a Universal Clear, sending a Selective Device Clear, or an invalid handshake.

If the plot is aborted via the HP-IB, the plotter pen is left in the carriage at its most recent position. If the plot is aborted from the front panel, the pen is returned to its stall and the carriage moved to the P1 position, allowing full view of the plot on plotters that roll the paper in and out for one axis of movement.

PEN SPEED. The bus code PNM (pen speed fast) allows the plotter to run at its maximum (default) velocity. This speed is dependent on the plotter used. The bus code PNS (pen speed slow) causes the plotter pen velocity to be ten centimeters per second.

HP-IB ONLY COMMANDS

<u>Function</u>	<u>HP-IB code</u>
Settling Time Entry	STE
Dump register A	DRA
Dump register B	DRB
Dump register R	DRR
Dump register D1	DD1
Dump register D2	DD2
Dump register D3	DD3
Dump register D4	DD4
Dump trace 1	DT1
Dump trace 2	DT2
Dump marker 1	DM1
Dump marker 2	DM2
Dump marker 1 position	MP1
Dump marker 2 position	MP2
Dump state (learn mode out)	LMO
Dump status	DMS
Dump average number	DAN
Dump key or knob	DKY
Dump characters	DCH
Dump Instrument ID	ID?
Load register A	LRA
Load register B	LRB
Load register R	LRR
Load register D1	LD1
Load register D2	LD2
Load register D3	LD3
Load register D4	LD4
Load state (learn mode in)	LMI
Graticule off	GR0
Graticule on	GR1
Characters off	CH0
Characters on	CH1
Annotation off	AN0
Annotation on	AN1
Annotation Clear	ANC
Menu off	MN0
Menu on	MN1
Menu clear	MNC
ASCII data format	FM1
64 bit IEEE data format	FM2
32 bit HP 3577A binary	FM3
Bus diagnostics mode off	BD0
Bus diagnostics on, fast	BD1
Bus diagnostics on, slow	BD2
Enter Menu (user defined)	ENM
Enter Annotation	ENA
Enter Graphics	ENG
Clear Keyboard Buffer	CKB
Take Measurement	TKM
Set SRQ Mask	SQM
Error Reporting mode 0	ER0
Error Reporting mode 1	ER1
Error Reporting mode 2	ER2
Error Reporting mode 3	ER3
Send SRQ	SRQ

REMOTE OPERATION

The following two example programs demonstrate methods used to recognize the end of a plot process. Either of two bits in the Status Byte are used to trigger SRQ; B0 (End Of Transfer) or B4 (Ready).

```

100 !
110 ! Controller responds to plot completion by polling the bus
120 ! CONTROL lines (SRQ=1024) pulled by the instrument's EOT
130 ! bit.
140 !
150 Adrs=711 ! 3577A address
160 Plotter=705 ! Plotter address
170 Done__bit=1 ! End Of Transfer bit (B0) = 1
180 !
190 OUTPUT Adrs;"SQM ";Done__bit ! Unmask EOT bit
200 !
210 REPEAT
220 X=SPOLL(Adrs) ! SPOLL to clear previous EOT bit
230 UNTIL NOT BINAND(X,Done__bit)
240 !
250 ! Next, start the plot.
260 !
270 SEND 7;UNL MTA LISTEN Adrs MOD 100 DATA "PLA" LISTEN Plotter MOD 100
TALK Adrs MOD 100 DATA
280 !
290 DISP "WAITING FOR PLOT COMPLETION"
300 LOOP
310 STATUS 7,7;X ! Read bus control and data lines
320 EXIT IF BINAND(X,1024) ! Check for SRQ asserted
330 END LOOP
340 !
350 Plot__done:DISP "PLOT IS COMPLETE."
360 BEEP
370 X=SPOLL(Adrs) ! Clear SRQ
380 OUTPUT Adrs;"SQM 0" ! Reset mask to default
390 !
400 END

```

```

100 !
110 ! Controller responds to plot completion using interrupts
120 ! and the instrument's 'Ready' bit
130 !
140 Adrs=711 ! 3577A address
150 Plotter=705 ! plotter address
160 Done__bit=16 ! 'Ready'=16
170 !
180 OUTPUT Adrs;"SQM ";Done__bit ! Unmask Ready bit
190 !
200 OUTPUT Adrs;"PLA" ! Get ready to plot. Plot won't start
210 ! until the 3577 is addressed to talk
220 !
230 REPEAT
240 X=SPOLL(Adrs) ! SPOLL to get rid of previous Ready
250 UNTIL NOT BINAND(X,Donebit)
260 !

```

```

270 ! Next, enable the SRQ interrupt and start the plot.
280 !
290 ENABLE INTR 7;2 ! Allow Service Request to interrupt
300 ON INTR 7 GOTO Plot__done ! Turn interrupt 'ON'
310 SEND 7;UNL MTA LISTEN Plotter MOD 100 TALK Adrs MOD 100 DATA ! Start
plotting
320 !
330 !
340 DISP "WAITING FOR PLOT COMPLETION"
350 LOOP
360 !
370 ! Wait indefinitely for plot completion
380 !
390 END LOOP
400 !
410 Plot__done:DISP "PLOT IS COMPLETE."
420 BEEP
430 X=SPOLL(Adrs) ! Clear the interrupt condition
440 !
450 OUTPUT Adrs;"SQM 0" ! Resets mask to default condition
460 !
470 END

```

SETTLING TIME ENTRY (STE). Settling time may be entered over the HP-IB. Each bandwidth has a settling time associated with it. When a new bandwidth is selected its associated settling time will be active. These new values for settling time are not saved with instrument state and will be cleared by a PRESET or turning off power. The default values for settling time are shown in the following table:

Res BW = 1 kHz	22 ms
Res BW = 100 Hz	55 ms
Res BW = 10 Hz	370 ms
Res BW = 1 Hz	3.707 s

To enter a new value for the settling time parameter, select the resolution bandwidth before entering the new settling time. Settling time values may range from one millisecond to 16.383 seconds. For zero settling time, turn settling time off (SE0). The current value of the settling time parameter will appear in the data entry block

if bus diagnostics mode one is used as follows:

Example: OUTPUT 711;"BW3;BD1;STE 3 SEC;"

DUMP/LOAD REGISTER. The receiver input registers R, A, and B, and the storage registers D1, D2, D3, and D4 contain twice as many numbers as there are points in the active sweep resolution. Each point on the trace is derived from a register bin containing a complex number (represented by two real numbers). In the default sweep resolution of 401 points per sweep there will be 401 complex numbers. The HP 3577A will dump 401 real and 401 imaginary numbers in the form real (bin one), imaginary (bin one), real (bin two), imaginary (bin two), ... The same methods apply for the "number of steps" sweep resolution used in amplitude sweeps. Register I/O may use any of the three data formats FM1, FM2, or FM3. The example that follows shows how register data may be dumped to the computer/controller and loaded into the HP 3577A in each of the three data formats.

Example:

```

10 !
20 ! Dump and Load Registers using all 3 data transfer formats
30 !
40 REAL Real__array1(0:801),Real__array2(0:101)
50 INTEGER Integer__array(0:3,0:400) ! array of 401x4 elements
60 ASSIGN @Na TO 711;FORMAT ON ! Na = Network Analyzer
70 OUTPUT @Na;"IPR;SM2;TKM;" ! TKM = take measurement

```

REMOTE OPERATION

```

75  !
80  ! *****
85  !
90  ! FM1 = the ASCII data format
100 ! Next, Dump Register R using FM1
110 !
120 OUTPUT @Na;"FM1;DRR;"          ! DRR = Dump Register R
130 ENTER @Na;Real__array1(*)
140 !
150 ! Real__array1 now contains the real and imaginary parts of
160 ! 401 complex numbers. Next, load the data into storage
170 ! register D1.
180 !
190 OUTPUT @Na;"LD1;"Real__array1(*) ! LD1 = Load Register D1
200 !
210 ! Register D1 now contains the data held in Real__array1
220 !
230 OUTPUT @Na;"TR2;DF7;ID1;"      ! Display register D1
240 PAUSE
245 !
250 ! *****
255 !
260 ! FM2 = 64 bit floating point binary (HP Series 200
270 ! computer real number) data format. Next, dump register
280 ! A using FM2. Note the use of reduced sweep resolution.
290 !
300 OUTPUT @Na;"RS1;TKM;FM2;DRA;"   ! Changing sweep res
310                                     ! clears registers, so new
320                                     ! TKM is required
330 !
340 ! Enter the leading bytes (#I) into an unused string
350 !
360 ENTER @Na USING "#,2A";Junk$
370 !
380 ! Enter the register data in data format FM2:
390 !
400 ASSIGN @Na;FORMAT OFF           ! FORMAT must be OFF to
410 ENTER @Na;Real__array2(*)       ! use data format FM2
420 ASSIGN @Na;FORMAT ON
430 !
440 ! Real__array2 now contains the real and imaginary parts of
450 ! 51 complex numbers. Load this data into register D2:
460 !
470 OUTPUT @Na;"LD2;#I;";          ! Last ";" prevents CR/LF
480 ASSIGN @Na;FORMAT OFF           ! Binary data must be
490 OUTPUT @Na;Real__array2(*)      ! preceded by "#I"
500 ASSIGN @Na;FORMAT ON
510 !
520 ! Register D2 now contains the data from Real__array2
530 !
540 OUTPUT @Na;"TR2;ID2;ASL;"      ! Display data in D2
550 PAUSE
555 !
560 ! *****
565 !

```

```

570 ! FM3 = 32 bit floating point binary used by the HP 3577A
580 ! internal processor. There are 4 bytes per real number in
590 ! data format 3. Next, take a measurement and store to D1:
600 !
610 OUTPUT @Na;"RS4;TR1;IBR;TKM;SD1;ASL;"
620 !
630 ! Now Dump D1 in data format FM3:
640 !
650 OUTPUT @Na;"FM3;DD;"
660 !
670 ! Enter the leading bytes (" #I") into an unused string
680 ! then enter the data.
690 !
700 ENTER @Na USING "#,2A";junk$
710 ENTER @Na USING "%,W";Integer__array(*) ! 401x2x4 bytes
720 !
730 ! Integer__array now contains the real and imaginary parts
740 ! of 401 complex numbers, each part filling a pair of
750 ! Series 200 Integers. Load this data into register D2:
760 !
770 OUTPUT @Na;"LDI;#I;"; ! Binary data must be preceded by
780 OUTPUT @Na USING "#,W";Integer__array ! "#I"
790 !
800 ! Register D1 now contains the data from Integer__array
810 !
820 OUTPUT @Na;"TR2;ID1;DF5;ASL;" ! Display D1 as phase (DF5)
830 !
840 END

```

DUMP TRACE. Traces may be dumped but not loaded. A trace is made up of real numbers as defined under the INPUT and DISPLAY FUNCTION keys and will have the same number of data points as defined in the current sweep resolution. This data is dumped using any of the three data formats with the following units:

Display Function	Absolute Units (e.g., INPUT = R)	Relative Units (e.g., INPUT = B/R)
Log Mag	dBV	dB
Lin Mag	Volts	Units
Phase	Degrees	Degrees
Polar	Volts	Units
Delay	Seconds	Seconds
Real,Imag	Volts	Units

Phase trace data will be offset by the active Phase Reference Level. Delay data will be meaningless in some of the beginning and end bins due to the nature of the measurement. The number of bins affected will depend on the aperture and sweep resolution. When the HP 3577A dumps a delay trace, it will output large negative numbers in those bins whose data is thus affected. The example that follows shows how a trace may be dumped to the computer/controller.

Example:

```

10 !
20 ! Dump trace example demonstrating use of all three
30 ! data transfer formats.
40 !
50 REAL Real__array1(0:400),Real__array2(0:50)
60 INTEGER Integer__array(0:1,0:400) ! array of 401x2 elements
70 ASSIGN @Na TO 711;FORMAT ON ! Na = Network Analyzer
80 OUTPUT @Na;IPR;SM2;TKM;" ! TKM = take measurement

```

REMOTE OPERATION

```

85 |
90 | *****
95 |
100 | FM1 = the ASCII data format.
110 | Next, dump trace one.
120 |
130 | OUTPUT @Na;"FM1;DT1;"          ! DT1 = dump trace one
140 | ENTER @Na;Real__array1(*)
150 | PAUSE
160 |
170 | Real__array1 now contains 401 real numbers from trace one
180 |
190 | *****
200 |
210 | FM2 = 64 bit floating point binary (HP Series 200
220 | computer real number) data format. Next, dump trace
230 | two using FM2. Note the use of reduced sweep res.
240 |
250 | OUTPUT @Na;"RS1;TKM;FM2;DT2;"    ! RS1 = 51 pts/span
260 |
270 | Enter the leading bytes (" #I ") into array elements 0 & 1
280 |
290 | ENTER @Na USING "#,2(B)";Real__array2(0),Real__array2(1)
300 |
310 | Prepare for a Series 200 internal real number format
320 | data transfer and perform the entry.
330 |
340 | ASSIGN @Na;FORMAT OFF          ! FORMAT must be OFF
350 | ENTER @Na;Real__array2(*)      ! to use data format FM2
360 | ASSIGN @Na;FORMAT ON          ! Note that array elements
370 | PAUSE
380 |
400 |
410 | *****
420 |
430 | FM3 = 32 bit floating point binary used by the HP 3577A
440 | internal processor. There are 4 bytes per real number
450 | data format 3. Next, take a measurement and dump trace 1
460 |
470 | OUTPUT @Na;"RS4;TKM;FM3;DT1;"
480 |
490 | Enter the #I as before, then the data.
500 |
510 | ENTER @Na USING "#,2A";Junk$
520 | ENTER @Na USING "%,W";Integer__array(*)
530 |
540 | Integer__array now contains 401 real numbers from trace
550 | one; each real number (32 bits) filling a pair of Series
560 | 200 Integers (16 bits).
570 |
580 | END

```

DUMP MARKER, (DM1 & DM2) Except for the polar display function, this is Y-axis information for one bin. The units will match those of the trace dumps shown in the table on Page 3-20. If the display function is two numbers will be output when a marker is dumped. These two numbers will be real and imaginary or

magnitude and phase, respectively, depending on units selected for the marker. Any of the three data formats FM1, FM2, or FM3 may be used. The example that follows shows how a marker may be dumped and displayed.

Example: Non-polar display function

```
10 OUTPUT 711;"IPR;TKM;FM1;DM1;"           ! DM1 = Dump Marker one
20 ENTER 711;Marker__amp
30 DISP "Magnitude = ";Marker__amp
40 END
```

Example: Polar display function

```
10 OUTPUT 711;"IPR;DF4;TKM;FM1;DM1;"       ! DF4 = polar
20 ENTER 711;Marker__amp,Marker__phase
30 DISP "Magnitude = ";Marker__amp
40 DISP "Phase = ";Marker__phase
50 END
```

MARKER POSITION (MP1 & MP2) dumps X-axis information for the appropriate trace marker. Any of the three data formats FM1, FM2, or FM3 may be used. The information units are:

- LIN SWP - Frequency
- LOG SWP - Frequency
- ALT SWP - Frequency
- AMP SWP - Source amplitude
- CW - Frequency

Note If the frequency span is 0 Hz and the sweep time is less than 1000 seconds, the marker position is in units of time.

Example:

```
10 OUTPUT 711;"IPR;TKM;MP1;"
20 ENTER 711;Mkr__freq
30 DISP "Marker frequency = ";Mkr__freq;"Hz"
40 END
```

DUMP AND LOAD INSTRUMENT STATE.

LMO (learn mode out) dumps the instrument state out in binary to be stored by the computer. 1100 bytes will always be dumped including the first two bytes which are always #I. #I is used to indicate that binary data is to follow.

LMI (learn mode in) loads instrument state in binary. It is used to configure the HP 3577A to a specific instrument state. This state should be configured on the HP 3577A and dumped to the controller using LMO. Data dumped with LMO should not be changed outside the HP 3577A. It is not possible to configure the instrument state with a computer. LMI can be used to speed up reconfiguration if a large status change is necessary between tests.

It is recommended that the entire 1100 bytes (including the #I) be kept together after the dump as the same information needs to be returned to the HP 3577A when the LMI is used. The example that follows shows how to dump instrument state to a computer/controller and load instrument state back to the HP 3577A.

Example:

```
10 !
20 ! 'LMO', Learn Mode Out (dump instrument state)
30 ! 'LMI', Learn Mode In (load instrument state)
40 !
50 INTEGER Integer__array(0:549)           ! Array of 550 16 bit words
60 ASSIGN @Na TO 711;FORMAT ON
```

```

70      !
80      ! 1100 bytes will be dumped, 2 bytes per element of
90      ! Integer__array. Next, configure state and dump it.
100     !
110     OUTPUT @Na;"IPR;TR2;DF5;FRA 1 MHZ;SAM 15 DBM;ST3;LMO;"
120     ENTER @Na USING "%,W";Integer__array(*)
130     PAUSE
140     !
150     ! Integer__array now contains 1100 bytes of instrument state
160     ! data. This data may be reloaded as follows:
170     !
180     OUTPUT @Na;"IPR;LMI;"
190     OUTPUT @Na USING "#,W";Integer__array(*)
200     !
210     END
    
```

DUMP STATUS (DMS) This command dumps the Status Byte and two more bytes of instrument status information plus a screen message (the Serial Poll dumps only the Status Byte). In the following table, B7 is the most significant bit and B0 is the least significant bit. All data is in the ASCII format.

BYTE 1 -The STATUS BYTE

- B7- Not used
- B6- RQS (require service)
- B5- Error bit
- B4- Ready for HP-IB command
- B3- Key pressed
- B2- Measurement complete
- B1- Data available
- B0- Data transfer complete

BYTE 2

- B7- Power on
- B6- Source tripped
- B5- Reference unlocked
- B4- No external reference
- B3- Input A overload
- B2- Input B overload
- B1- Input R overload
- B0- Input tripped

BYTE 3

- B7- Settling
- B6- Waiting for trigger (TRG)
- B5- Waiting for external trigger or line sync
- B4- Sweeping
- B3- End of sweep has occurred
- B2- Not used
- B1- Not used
- B0- Not used

ASCII STRING

A 26-character string containing an error, warning,

or general information screen message. The error reporting mode selected will determine the level of message (none, error only, warning and error, or all) that will appear here. Refer to MASKING THE STATUS BYTE for more on error reporting modes, and to Appendix D for a complete listing of these messages.

Bits 0, 1, 2, 3, 5, and 6 of byte two will cause error messages when they become set. If the error bit is unmasked and more than one of these conditions exist, the first to occur will be the only message dumped. If the error bit is masked, DMS will dump the most recent message. The following example program was run immediately after having preset the HP 3577A and pressed a numeric key in the DATA ENTRY section:

Example:

```

10  DIM A$(100)
20  OUTPUT 711;"DMS"
30  ENTER 711;A$
40  DISP "Response to DMS command is "";A$;""
50  END
    
```

Response to DMS command is

' 16, 0, 16, ENTRY UNDEFINED '

Dumping status will clear the error string to all blanks. It also clears the Power on, RQS, and (if no permanent hardware errors remain set) the error bit. Its effect on the Status Byte is the same as a serial poll.

DUMP AVERAGE NUMBER (DAN) dumps the number of sweeps or samples taken since averaging was turned on. This number is not the user selection, N. The ASCII equivalent of the average number is returned terminated by <CR/LF> and <EOI>. The data format for DAN is always ASCII. The maximum value returned is 9999.

Example:

```

10 OUTPUT 711;"IPR;AV5;"
20 WAIT 5
30 OUTPUT 711;"DAN;"
40 ENTER 711; Avg__no
50 DISP Avg__no
60 GOTO 20
70 END
    
```

! AV5 = averaging on (N = 64)

CLEAR KEYBOARD BUFFER & DUMP KEY (CKB & DKY)

These allow the controller to clear the keyboard buffer (which will hold as many as ten keypresses) and monitor key presses and/or knob rotation. Note that an SRQ may be generated by front panel keys (see STATUS BYTE)

CKB clears the key buffer of key presses and the knob counter to zero. The key buffer holds a maximum of six key presses. The knob counter contains the first count, other than zero, taken by the counter since the last CKB command.

DKY dumps two numbers in ASCII format. The first number corresponds to a front panel hardkey and will range from 0 to 51 inclusive. The following table shows the keys and their corresponding number. If there has been no key pressed since the last CKB command, a -1 will be returned. The second number is the knob counter which contains a number between -15 and +15; negative numbers indicate counter-clockwise rotation and positive numbers indicate clockwise rotation. Zero indicates no rotation. The following example shows how the CKB and the DKY commands are used. Also, refer to the example for ENTER MENU and ENTER ANNOTATION.

Number	Key Name
0	zero
1	one
2	two
3	three
4	four
5	five
6	six
7	seven
8	eight
9	nine
10	decimal
11	minus
12	backspace
13	softkey 1 (top)
14	softkey 2
15	softkey 3
16	softkey 4
17	softkey 5
18	softkey 6
19	softkey 7
20	softkey 8
21	TRIG/RESET
22	ENTRY OFF
23	LOCAL
24	MARKER/ENTRY KEY
25	INCREMENT
26	DECREMENT
27	TRACE 1
28	TRACE 2
29	FREQ
30	AMPTD
31	TRIG MODE
32	SWEEP TYPE
33	SWP MODE
34	SWP TIME
35	DEFINE MATH
36	STORE DATA
37	DISPLAY FCTN
38	INPUT
39	SCALE
40	MKR
41	MEASR CAL
42	(not used)
43	SAVE
44	RECALL
45	SPCL FCTN
46	RES BW
47	AVG
48	ATTEN
49	LENGTH
50	PLOT
51	MKR -

Example:

```

10 OUTPUT 711;"CKB;"
20 OUTPUT 711;"DKY;"
30 ENTER 711;Key,Knob
40 IF Key=-1 AND Knob=0 THEN 20
50 DISP "Key=";Key;" and Knob =";Knob
60 OUTPUT 711;"CKB;"
70 GOTO 20
80 END
    
```

! Enter two numbers

DUMP CHARACTERS (DCH) Dumps the alphanumeric characters on the screen to determine values of certain parameters. Only information presently on the screen is returned on the bus. As soon as the instrument is addressed to talk the following ASCII information will be returned if the display is NOT in polar format:

- 1) Reference level for trace 1
- 2) Amplitude level for trace 1
- 3) Reference level for trace 2
- 4) Amplitude level for trace 2
- 5) Marker frequency for trace 1
- 6) Marker amplitude for trace 1
- 7) Marker frequency for trace 2
- 8) Marker amplitude for trace 2
- 9) Start frequency for trace 1
- 10) Stop frequency for trace 1
- 11) Start frequency for trace 2
- 12) Stop frequency for trace 2
- 13) Source amplitude (if not in alternate sweep)
- 14) Delay aperture (if DSPLY FCTN is DELAY) for the active trace
- 15) Entry block information (if bus diagnostics are enabled)

If the display format is POLAR, then the following ASCII information is returned:

- 1) Full scale level
- 2) Phase reference
- 3) Reference position
- 4) <null>
- 5) Marker frequency
- 6) Marker amplitude
- 7) Marker phase
- 8) <null>
- 9) Start frequency for trace 1
- 10) Stop frequency for trace 1
- 11) Start frequency for trace 2
- 12) Stop frequency for trace 2
- 13) Source amplitude (if not in alternate sweep)
- 14) <null>
- 15) Entry block information

Each field will be separated by a comma; the last field will be delimited by a carriage return/linefeed. If the field is not defined currently on the CRT, an empty field will be returned.

Example:

```

10      !
20      ! 'DCH', Dump Characters program
30      !
40      DIM Bfr$(1:15)[40],U$(300),E$(26)
50      Adrs = 711
60      ASSIGN @Adrs TO 711
70      !
80      ! --POLAR DISPLAY FUNCTION
90      !
100     OUTPUT @Adrs;"IPR;ST1;TR1;DF4;TKM;DMS;"
110     ENTER @Adrs;X,Y,Z,E$           ! Status read to make sure all commands
120                                           ! have been processed & sweep is done
130     !
140     OUTPUT @Adrs;"ASL;"           ! Auto scale the screen display
150     WAIT .1                         ! Allow time to update picture
160     !
170     GOSUB Get__characters
180     !
    
```

```

190 PRINT "Full scale: ";Bfr$(1)
200 PRINT "Phase Reference: ";Bfr$(2)
210 PRINT "Reference position: ";Bfr$(3)
220 PRINT
230 PRINT "Marker frequency: ";Bfr$(5)
240 PRINT "Marker amplitude: ";Bfr$(6)
250 PRINT "Marker phase: ";Bfr$(7)
260 PRINT
270 PRINT "Start frequency: ";Bfr$(9)
280 PRINT "Stop frequency: ";Bfr$(10)
290 PRINT "Source amplitude: ";Bfr$(13)
300 STOP
310 !
320 Get_characters: !
330 OUTPUT @Adrs;"DCH;"
340 ENTER @Adrs;U$
350 FOR I=1 TO 15
360 IF POS(U$,"'") THEN
370 Bfr$(I)=U$[1,POS(U$,"'")-1]
380 U$=U$[POS(U$,"')+1]
390 ELSE
400 Bfr$(I)=U$
410 END IF
420 NEXT I
430 RETURN
440 !
450 END

```

Result:

```

Full scale: FULL SCALE 2.5000
Phase reference: PHASE REF 0.0deg
Reference position: REF POSN 0.0deg

Marker frequency: MARKER 100 050 000.000Hz
Marker amplitude: MAG(S21) 646.58E-3
Marker phase: PHASE(S21) -45.208deg

Start frequency: START 100 000.000Hz
Stop frequency: STOP 200 000 000.000Hz
Source amplitude: AMPTD 15.0dBm

```

DUMP PRODUCT IDENTIFICATION (ID?) The HP 3577A responds with the following ASCII character string:

HP3577A, TESTSET (or <NULL>),
<Software revision>

The "TESTSET" string is present if the HP 35677A or HP 35677B S-Parameter Test Sets are connected to the HP 3577A.

BUS DIAGNOSTIC MODES There are three bus diagnostic modes. They are: 1) BD0 = Bus Diagnostics Off; used for best programming speed. 2) BD1 = Bus Diagnostics On, Fast; menus appear, bus codes appear on screen for three seconds after an error is detected. 3) BD2 = Bus Diagnostics On, Slow; menus appear, bus codes appear and are decoded at the rate of one per second. BD1 and BD2 are useful for debugging programs written to control the HP 3577A. When on, this mode will sequence through all menus and update the display as if the HP 3577A were being operated from the front panel.

DATA FORMATS. The HP 3577A offers three data formats used to transfer certain types of data on the bus. The data types that make use of all three formats are trace data, register data, marker data, and marker position.

-1E38 =

FM1 is the ASCII data format. The ASCII floating point format will always transfer fifteen characters in the form -12.3456789E+03 for each number (i.e., leading spaces or zeros are not suppressed). In FM1 data dumps, the HP 3577A outputs ASCII data points separated by commas and carriage return line feed (CR/LF) indicates the end of record. When transferring data, the complete set of data is referred to as a record. A record is composed of data and an end of record terminator. When loading data the HP 3577A accepts commas, CR and LF as delimiters between data points. No end of record symbol is required; the instrument will respond to EOI. No more than one delimiter is allowed between numbers; CR/LF is considered a single delimiter. Spaces between and within numbers will be ignored.

FM2 is the 64 bit floating point binary specified by IEEE draft standard P754. This is the same data format used by the HP Series 200 computers. This format appears as follows:

SEEEEEEEEEEMFFF FFFFFFFFFFFFFFFFF FFFFFFFFFFFFFFFFF FFFFFFFFFFFFFFFFF

where : M is the most significant bit of the fractional part
F is an intermediate fractional bit
L is the least significant fractional bit
S is the sign bit of the fractional part
E is the exponent part

and: M is a "1"
The exponent is offset by 127 (i.e., 127=0) This format represents 1.fff... All ones for f's represents ~ 2.0 (i.e., normalized to 2)

FM3 is the 32 bit floating point binary used by the HP 3577A fast processor. This format appears as follows:

MFFFFFFFFFFFFFFF SFFFFFFFFLEEEEEEEEE

where: M is the most significant bit of the fractional part
F is an intermediate fractional bit
L is the least significant fractional bit
S is the sign of the fractional part
E is the exponent part

and: M should always be a "1"
The exponent is offset by 128 (i.e., 128=0). This format represents .1fffff... All ones represents ~ 1.0 (i.e., normalized to 1).

In either of the the binary data formats the header #I must precede a binary load so that the HP 3577A can recognize the bytes following the header as binary data.

ABORTING A DUMP OR LOAD. A dump or load will be aborted by any one of the following events:

- 1) End (EOI) sent by talker (FM2 or FM3 load only)
- 2) Sending non-numeric data (ASCII loads only)
- 3) Device Clear
- 4) Pressing the LOCAL front panel key
- 5) Addressing the HP 3577A to Listen and sending one or more bytes (dumps only).

Note that an Interface Clear (IFC) does not abort a dump or load over the bus. For unconditional control of the bus, it is recommended that Device Clear followed by Interface Clear be issued at the beginning of your program. The BASIC commands that correspond to these are CLEAR 7 and ABORT 7, respectively.

LENGTH OF RECORD The length of the data record (number of points transferred) will depend on the sweep type currently active. This is true for both register data and trace data. Note that in trace dumps of delay, the aperture/2 first and last bins will be undefined; the HP 3577A will output a large negative number in an attempt to protect the user from bad data. Examples of record length:

```
CW: 1
LIN: Sweep Resolution
LOG: 401
ALT: 401
AMP: Number of steps/sweep plus 1
```

END OF INFORMATION The bus management line EOI (end or identify) will be pulled by the HP 3577A on the last byte of any data dump whether it is a binary or ASCII dump. Once the HP 3577A has pulled its EOI line it will not transmit any more data until receiving another message. When using ENG (enter graphics) to load graphics commands, <EOI> must be pulled on the handshake of the last byte. Using BASIC on HP computers, such as the 9836, pulling the EOI line is done by putting ;END at the end of the data string as shown in the following example:

Example:

```
10 OUTPUT 711;"ENG #I ";
20 OUTPUT 711 USING "#,W";Cmnd__array(*)END
```

ENTER MENU (ENM) allows the user to label the eight softkeys. This feature may be used with commands that read the keyboard. It does not allow the user to redefine the key label corresponding to a HP 3577A softkey function. The user defined menu shares the same display memory with system menus. It is recommended that the bus diagnostic mode be kept off to avoid overwriting menus.

To label the softkeys use the following sequence:

- | | |
|---------|--|
| ENM | Enter menu bus mnemonic. |
| " | Opening quote indicates that text follows. |
| 1-8 | The softkey number on which to display the message. If the first character is not a number, 1 is assumed. |
| text | Up to 16 characters of ASCII text. If the text is 8 characters or less a single line key-label will appear centered on the key. If the text is 9 to 16 characters the text will be divided into 2 lines with 8 characters on the first line and the remainder on the second line; the 2 lines will be centered on the key. A carriage return character is not acceptable and will be translated to a left arrow. Double quote marks (") may be included as characters by sending a pair of double quotes (""") to the HP 3577A. Note that the computer may require four quote marks be entered to get two in its program line (resulting in one on the HP 3577A screen). |
| " | Closing quote mark. |
| <delim> | This delimiter may be the characters ; <CR/LF> space or the act of pulling <EOI> on the handshake of the last byte transferred. |

Whenever the instrument returns to LOCAL mode and the front panel is enabled, the user defined menu will be overwritten with the present system definition of the softkeys. For an example program using ENM, refer to ENTER ANNOTATION. Additional functions to control the menu display memory:

```
Menu off    MN0
Menu on     MN1
Menu clear  MNC
```

ENTER ANNOTATION (ENA) This command allows the user to provide text strings and to specify on which of twelve lines it will appear. These lines are located in the graticule area; four near the top, four in the middle, and four near the bottom. They are located such that there is no interference with the message block in which errors and warnings are displayed.

The format to be used is as follows:

ENA	Enter annotation bus mnemonic.		
"	Opening quote indicates that text follows.	"	Closing quote marks.
		<delim >	This delimiter may be the characters ; <CR/LF> space or the act of pulling <EOI> on the handshake of the last byte transferred.

1-12

The display line number on which the annotation is to be displayed. If the first character is not numeric, line 1 will be assumed.

text

Up to 40 characters of ASCII text. The carriage return character code is unacceptable and will be translated to a left arrow if used.

"

Closing quote marks.

<delim >

This delimiter may be the characters ; <CR/LF> space or the act of pulling <EOI> on the handshake of the last byte transferred.

Example:

```

10  !
20  ! 'ENA','ENM' Use of Enter Annotation and Enter Menu
30  ! 'CKB','DKY' Use of Clear Keyboard and Dump Key
40  !
50  Adrs=711
60  ASSIGN @Adrs TO Adrs
70  OUTPUT @Adrs;"ANC;MNC;"          ! Clear annotation and menu
80  !
90  ! Next, define the annotation and menu
100 !
110 OUTPUT @Adrs;"ENA;""2          Special Test""""
120 OUTPUT @Adrs;"ENA;""4          Select appropriate MENU KEY. """"
130 !
140 OUTPUT @Adrs;"ENM;""1 CONTINUE""""
150 OUTPUT @Adrs;"ENM;""4          TEST FAILED""""
160 OUTPUT @Adrs;"ENM;""8 ABORT""""
170 !
180 ! Note that a pair of double quotes must be used to send
190 ! one double quote mark (") at execution time. To get a
200 ! double quote to appear in the HP 3577A screen annotation,
210 ! 4 double quotes (""""") must be written into the program.
220 !
230 LOOP
240 OUTPUT @Adrs;"MN1;AN1;"          ! Turn annotation & menu on
250 OUTPUT @Adrs;"CKB;"              ! Clear the keyboard buffer
260 LOOP
270 OUTPUT @Adrs;"DKY;"              ! Read the keyboard
280 ENTER @Adrs;Key,Knob
290 EXIT IF Key=13 OR Key=16 OR Key=20
300 IF Key < >-1 THEN BEEP          ! -1 = no key pressed
310 END LOOP
320 OUTPUT @Adrs;"MN0;"              ! Turn menu off
330 SELECT Key
340 CASE 13
350 OUTPUT @Adrs;"ENA;""5          CONTINUE key pressed""""
360 CASE 16
370 OUTPUT @Adrs;"ENA;""5          TEST FAILED key pressed""""

```

```

380      CASE 20
390      OUTPUT @Adrs;"ENA;"5      ABORT key pressed""
400      END SELECT
410      !
420      WAIT 2
430      OUTPUT @Adrs;"ENA;"5""      ! Clears the message
440      OUTPUT @Adrs;"MN1;"      ! Turn the menu back on
450      !
460      END LOOP
470      !
480      END

```

ENTER GRAPHICS (ENG) The graphics mode allows the user to place alphanumeric information anywhere on the screen in different sizes, intensities and rotational positions, as well as draw vectors. Although this offers more flexibility than ENA, knowledge of the HP 1345A Digital Display command set is required. This information uses the same display memory as the ENA function, therefore the two functions cannot be used together.

1345A commands Sent as 16 bit binary words, MSB first. The commands for the HP 1345A Digital Display are binary commands. When the ENG command is used the HP 3577A will pass these commands to the display section. Appendix B is a quick reference programming guide for the HP 1345A. The JUMP command is not allowed. The carriage return character will be translated into a left arrow. Memory capacity is 924 commands.

The format to be used is as follows:

ENG Enter Graphics bus mnemonic.

#I Indicates binary words to follow.

<0-923> Starting address within annotation block where 1345A commands are to be placed. Sent as a 16 bit binary number, MSB first.

<EOI> End Or Identify will be sent with the last data byte to indicate the end of the sequence.

Example:

```

1000      !
1010      !   Use of Enter Graphics
1020      !
1030      COM INTEGER Cmnd__array(0:20),Array__indx,Disp__adrs,Array__ length,@Adrs
1040      INTEGER Plotx,Movey,Ploty,Set__cmdnd,Text(1:5),Es
1050      INTEGER I,J,K
1060      Array__length= 20
1070      Array__indx= 1
1080      Disp__adrs= 0
1090      Adrs= 711
1100      ASSIGN @Adrs TO Adrs
1110      !
1120      OUTPUT @Adrs;"IPR;ANC;"      ! Clear state and annotation
1130      OUTPUT @Adrs;"AN1;"      ! Turn the display ON
1140      OUTPUT @Adrs;"TR1;DF0;GR0;CH0;"
1150      !
1160      !   Define the annotation commands
1170      !
1180      !   The PLOT command for the display: 000y pddd dddd dddd
1190      !
1200      !   Where: y = 0 for x definition; 1 for y definition
1210      !           p = 0 for 'pen up'; 1 for 'pen down'
1220      !           d = location in range 0 to 2047

```

REMOTE OPERATION

```

1230 !
1240 Plotx=0
1250 Ploty=6144
1260 Movey=4096
1270 !
1280 ! The SET CONDITIONS command for the display:
1290 !
1300 ! 011i i-l l0-w w--
1310 !
1320 ! Where: i defines the line intensity
1330 ! 00 - blank
1340 ! 01 - dim
1350 ! 10 - half bright
1360 ! 11 - full bright
1370 ! 1 defines line type
1380 ! 00 - solid line
1390 ! 01 - intensified end points
1400 ! 10 - long dashes
1410 ! 11 - short dashes
1420 ! w defines writing speed
1430 ! 00 - 0.20 inches per microsecond
1440 ! 01 - 0.15 " " "
1450 ! 10 - 0.10 " " "
1460 ! 11 - 0.05 " " "
1470 !
1480 Set__cmd=30744 ! full bright, solid line, & .05 in/us
1490 !
1500 ! The TEXT command: 010s srre cccc cccc
1510 !
1520 ! Where: s defines character size
1530 ! 00 - 1.0X
1540 ! 01 - 1.5X
1550 ! 10 - 2.0X
1560 ! 11 - 2.5X
1570 ! r defines rotation
1580 ! 00 - 0 degrees
1590 ! 01 - 90 degrees
1600 ! 10 - 180 degrees
1610 ! 11 - 270 degrees
1620 ! e - establish size of character
1630 ! 0 - Use previous size and rotation
1640 ! 1 - Use new size and rotation
1650 ! c - character code (see table in appendix)
1660 !
1670 Text(1)=16384 ! size is 1X and rotation is 0 deg
1680 Text(2)=18944 ! size is 1.5X and rotation is 90 deg
1690 Text(3)=21504 ! size is 2.0X and rotation is 180 deg
1700 Text(4)=24064 ! size is 2.5X and rotation is -90 deg
1710 Text(5)=22528 ! size is 2.5X and rotation is 0 deg
1720 Es=256 ! "establish size and rotation" flag
1730 !
1740 ! Plot a square on the HP 3577A screen:
1750 !
1760 Sqr:DATA 100,100 ! x,y coordinate for lower left corner
1770 DATA 100,1000 ! upper left

```



```

1780      DATA 1000,1000          ! upper right
1790      DATA 1000,100        ! lower right
1800 !
1810 ! Since the display units are not equal (i.e., Y-axis
1820 ! units are ¾ the size of the X-axis units on the
1830 ! display), the Y-axis units should be divided by .75
1840 ! to get a true square.
1850 !
1860      Y__axis__scale=.75
1870      READ X0,Y0              ! read the first point
1880      CALL Add__cmnd(Set__cmnd) ! initialize SET CONDITION
1890      CALL Add__cmnd(X0+Plotx) ! move to starting point
1900      CALL Add__cmnd(Y0/Y__axis__scale+Movey)
1910      FOR I=1 TO 3
1920          READ X,Y
1930          CALL Add__cmnd(X+Plotx)
1940          CALL Add__cmnd(Y/Y__axis__scale+Ploty)
1950      NEXT I
1960      CALL Add__cmnd(X+Plotx)
1970      CALL Add__cmnd(Y0/Y__axis__scale+Ploty) ! plot to starting pt
1980 !
1990 ! Now display the following message in the four different
2000 ! sizes and rotations
2010 !
2020      Message$="HP3577 "
2030 !
2040      CALL Add__cmnd(550+Plotx) ! define the start of characters
2050      CALL Add__cmnd(500+Movey)
2060      FOR I=1 TO 4
2070          CALL Add__cmnd(Text(I)+Es+NUM(Message$)) ! 1st character
2080                                                  ! w/ Es asserted
2090          FOR J=2 TO LEN(Message$)
2100              CALL Add__cmnd(Text(I)+NUM(Message$[J]))
2110          NEXT J
2120      NEXT I
2130 !
2140      IF Array__indx <> 1 THEN CALL Transfer__cmnd transfer if
2150 !                                                  necessary
2160      Array__indx=1 ! reinitialize buffer
2170      Cmdn__array(0)=100 ! use address 100 for this buffer
2180      CALL Add__cmnd(1500+Plotx) ! define starting position for
2190      CALL Add__cmnd(1500+Movey) ! loop
2200      CALL Add__cmnd(Text(5)+Es+1) ! character "1" is HP logo
2210      OUTPUT @Adrs;"ENG #I";
2220      OUTPUT @Adrs USING "W";Cmdn__array(*);END
2230 !
2240 ! The following steps will update the two commands which
2250 ! define the starting location of the HP logo. It
2260 ! demonstrates changing selected commands "on the fly."
2270 !
2280      LOOP
2290          Cmdn__array(1)=INT(1500*RND)+Plotx ! Update new starting
2300          Cmdn__array(2)=INT(1900*RND)+Movey ! position for logo.
2310          OUTPUT @Adrs;"ENG #I"; ! Update new x,y

```

```

2320     OUTPUT @Adrs USING "#,W,W,W";Cmnd__array(0),Cmnd__array(1)
        ,Cmnd__array(2);END
2330     WAIT .1
2340     END LOOP
2350     !
2360     STOP
2370     !
2380     END
2390     !
2400     ! The following subroutine adds 1345A Display commands to
2410!     Cmnd__array until it contains 20 (Array__length) elements.
2420     !
2430     SUB Add__cmnd(INTEGER Value)
2440         COM INTEGER Cmnd__array(*),Array__indx,X,Array__length,@ Adrs
2450         Cmnd__array(Array__indx)= Value
2460         Array__indx= Array__indx+ 1
2470         IF Array__indx>Array__length THEN
2480             CALL Transfer__cmnd
2490             Array__indx=1
2500         END IF
2510     SUBEND
2520     !
2530     ! Send Cmnd__array to HP 3577A
2540     !
2550     SUB Transfer__cmnd
2560     COM INTEGER Cmnd__array(*),Array__indx,Disp__adrs,Array__
        leng th,@ Adrs
2570     Cmnd__array(0)= Disp__adrs
2580     OUTPUT @Adrs;"ENG #I";                ! Send ENG and #I
2590     OUTPUT @Adrs USING "#,W";Cmnd__array(*);END! send array
2600     FOR K=0 TO Array__length                ! Clear out Cmnd__array
2610     Cmnd__array(K)=0
2620     NEXT K
2630     Disp__adrs= Disp__adrs+ Array__indx-1    ! Redefine display
2640                                           ! memory address for
2650     SUBEND                                    ! next transfer.

```

ANNOTATION OFF (AN0) Turns off the Annotation/Graphics modes by disabling the display memory.

ANNOTATION ON (AN1) Enables the commands in display memory.

ANNOTATION CLEAR (ANC) Clear display memory back to NOP instructions.

Additional functions to control the screen are:

Graticule On	GR1
Graticule Off	GR0
Characters On	CH1
Characters Off	CH0 (screen messages will not be turned off)

The character fields controlled by the CH commands are:

- 1) Information at the bottom of the screen.
- 2) The REF and /DIV messages and their values

- 3) The entry block
- 4) The marker data

The following screen features have their own on/off commands:

- 1) Trace data (the traces themselves; **TR1 DF0** and **TR2 DF0**)
- 2) Trace reference lines (**TR1 RL0** and **TR2 RL0**)
- 3) Annotation
- 4) Menu

TAKE MEASUREMENT (TKM) When this command is received the HP 3577A settles and takes a measurement before processing the next bus command. TKM (followed by a dump command) guarantees that the measurement will be completed before data transfer begins. For faster measurements RST and TRG may be used as shown previously.

INSTRUMENT PRESET (DEFAULT) PARAMETER VALUES

The HP 3577A responds to the instrument preset (IPR) command configuring its parameters as defined in the following table:

FUNCTION	PRESET CONDITION	
	<i>Without test set</i>	<i>With test set</i>
TRACE 1	Active	same
TRACE 2	Off	same
DISPLAY FUNCTION	Log magnitude	same
INPUT def. (both traces)	R	S21 (B/R, test set fwd)
user defined input	F3	same
SCALE (log mag)		
Reference level	0.0 dBm	0.0 dB
/DIV	10.0 dB	same
Reference position	100 %	same
Reference line	On	same
SCALE (linear mag)		
Reference level	0.0 Volts	0.0 units
/DIV	100 mV	100E-3 units
Reference position	0.0 %	same
Reference line	On	same
SCALE (phase)		
Reference level	0.0°	0.0°
/DIV	45 degrees	same
Reference position	50 %	same
Reference line	On	same
Phase slope (Trc 1&2)	On, 0.0°/span	same
SCALE (polar)		
Full scale	1.0 Volts	1.0 units
Phase reference	0.0°	same
Reference position	0.0°	same
Reference line	On	same
Phase slope (Trc 1&2)	On, 0.0°/span	same
SCALE (real & imaginary)		
Reference level	0.0 Volts	0.0 units
/DIV	200 mV	200E-3 units
Reference position	50 %	same
Reference line	On	same
Phase slope (Trc 1&2)	On, 0.0°/span	same
SCALE (delay)		
Reference level	0.0 s	same
/DIV	100 ns	same
Reference position	50 %	same
Reference line	On	same
Phase slope (Trc 1&2)	On, 0.0°/span	same
MARKER (Both traces)		
Marker	On	same
Position	Bin 200	same
Offset (Mag, freq swp)	Off, 13.01 dBm	Off, 0.0 dB
Freq Offset (X-axis)	0.0 Hz	0.0 Hz
Offset (Mag, amptd swp) Off,	13.01 dBm	Off, 0.0 dB
Amptd Offset (X-axis)	13.0 dBm	13.0 dBm
Target	10.01 dBm	-3.0dB

STORE

User def equation R same

DEFINE MATH

K1 real 1 same
 K1 imaginary 0 same
 K2 real 50 same
 K2 imaginary 0 same
 K3 real 75 same
 K3 imaginary 0 same
 F1 (B/R)/(K1-B/R) same
 F2 A/R same
 F3 (K1 + F2)/(K1-F2) same
 F4 K2*F3 same
 F5 K3*F3 same

SWEEP TYPE

Linear (freq) same

Sweep direction Up (left to right) same

SWEEP MODE

Continuous same

SWEEP TIME (linear swp)

1.000 s same

(amplitude swp) 0.050 s/step same

(manual swp mode or CW) 0.050 s/step same

FREQUENCY

Start freq (linear swp) 0.000 Hz 100 kHz
 Start freq (log sweep) 50.000 Hz 100 kHz
 Stop frequency 200 MHz same
 Center frequency 100 MHz 100.05 MHz
 Frequency span 200 MHz 199.9 MHz
 Center freq step size 1.0 MHz same
 Freq sweep resolution 401 points/span same

AMPLITUDE

Source amplitude -10.0 dBm +15.0 dBm
 Amplitude step size 1.0 dBm same
 Start amplitude -40.0 dBm same
 Stop amplitude 0.0 dBm +15.0 dBm
 Steps/sweep 100 same

TRIGGER MODE

Free run same

RESOLUTION BANDWIDTH

1 kHz same

Settling time for:

Res BW = 1kHz 22 ms same
 Res BW = 100 Hz 55 ms same
 Res BW = 10 Hz 370 ms same
 Res BW = 1 Hz 3.707 s same

AVERAGING

Off same

INPUT ATTENUATION

Input R 20 dB same
 Input A 20 dB same
 Input B 20 dB same

INPUT IMPEDANCE

Input R 50Ω same
 Input A 50Ω same
 Input B 50Ω same

INPUT LENGTH

Input R On, 0.0 meters On, 1.3 meters
 Input A On, 0.0 meters same
 Input B On, 0.0 meters same
 Step size 1.0 meter same

THE STATUS BYTE

The Status Byte is an 8 bit word that the HP 3577A will dump on the HP-IB when it is serially polled. The state of each bit indicates the status of an internal HP 3577A function.

BASIC example: HPL example:
 Var=SPOLL(711) rds(711)→S

STATUS BYTE BIT NUMBERS

B7 B6 B5 B4 B3 B2 B1 B0

- B7:** Not used
- B6:** **REQUIRE SERVICE, RQS.** Set when the HP 3577A pulls the SRQ line. Cleared along with the SRQ line when a serial poll is performed.
- B5:** **ERROR** This bit reflects the logical OR of all error conditions in the instrument. An SRQ is generated on the rising edge of any of these error conditions. The error conditions include all HP-IB errors and all hardware error conditions. The hardware errors include input overloads, input tripped, source tripped, and reference unlocked. The error bit is cleared when the hardware error conditions have cleared and a serial poll is performed, if the error bit is unmasked. If the bit is masked it will clear whenever the error conditions clear (i.e., it won't stay set until the poll occurs). It is also cleared by a dump status command (DMS) when the user receives the error information (if all hardware error bits are clear). Four levels of masking are provided for the user to select what type of programming errors will be reported by the error bit. See MASKING THE STATUS BYTE.
- B4:** **READY** (for HP-IB commands) Set when the HP-IB input buffer is completely empty, all commands have been completely processed, and (if the last command was RST) settling is complete. If a command is issued during a sweep, the ready bit will clear until command processing is complete.
- B3:** **KEY PRESSED/SRQ** If unmasked, this bit will be set when a key is pressed or the knob is turned. Also, this bit is set when the HP 3577A receives the "SRQ" command on the bus. The set condition is cleared by a serial poll.
- B2:** **MEASUREMENT COMPLETE** Set when sweep completes. Cleared by the start of a new sweep.
- B1:** **DATA AVAILABLE** Instrument will output data when addressed to talk. Cleared by the handshake of the last byte.

B0: **DATA TRANSFER COMPLETE** Set after the HP 3577A handshakes the last data byte in a dump. Primarily designed for plotting. Cleared by a serial poll if it is unmasked, or upon B1 being set.

Any status bit that is unmasked will cause an SRQ (and set RQS) when the condition it represents is true. As long as the condition is true, the bit will stay set. The bit will reset when the condition has cleared and the instrument is serially polled.

Any status bit that is masked will follow the condition it represents, resetting without a serial poll whenever the condition clears.

MASKING THE STATUS BYTE

A service request will be generated when any unmasked bit in the status byte becomes set. The SRQ mask may be loaded by sending SQM followed by the mask byte in ASCII. The mask byte definition is as follows:

	0	1
B7 (not used)		
B6 (RQS)		not maskable
B5 (Error)	mask B5	enable B5 SRQ
B4 (Ready)	mask B4	enable B4 SRQ
B3 (Key/SRQ)	mask B3	enable B3 SRQ
B2 (MEAS DONE)	mask B2	enable B2 SRQ
B1 (DATA AVAIL)	mask B1	enable B1 SRQ
B0 (XFER DONE)	mask B0	enable B0 SRQ

In the default instrument state SQM = 0 (all bits masked). Pressing INSTR PRESET or sending IPR over the bus will set SQM = 0.

The user may choose the level of screen message that sets the SRQ line (and which level of message appears with DMS) by selecting one of the following four modes:

- ER0** Nothing will be reported
- ER1** Only errors will be reported
- ER2** Errors and warnings will be reported
- ER3** Errors, warnings, and messages will be reported

The default selection is ER1. If the error bit is unmasked, the following conditions will pull SRQ regardless of the error reporting mode selected:

- Input(s) tripped
- Input(s) overloaded
- Reference unlocked
- Source tripped

"HOW TO GO FAST" EXAMPLE PROGRAMS

These two example programs are written for the HP Series 200 computers. The first program demonstrates the fastest measurement technique for any display function except group delay (with the appropriate changes in line 300 to

change from DF7 (default) to DF___, and line 610 to print the correct units after the value of the data dumped). The second program is an example demonstrating the fastest way to make group delay measurements.

```

10  ! This program demonstrates the fastest possible single-
20  ! point (CW) measurements that the HP 3577A is capable of.
30  !
40  ASSIGN @Na TO 711
50  ASSIGN @Na__nofmt TO 711;FORMAT OFF
60  Meas__complete=4
70  Pass=0
80  CLEAR @Na                ! Initialize the bus
90  OUTPUT @Na,"IPR;"        ! Preset the instrument
100 !
110 ! Turn characters and bus diagnostics off to improve speed
120 !
130 OUTPUT @Na,"CH0;BD0;"
140 !
150 ! Set the data transfer format to 64 bit binary (IEEE)
160 !
170 OUTPUT @Na,"FM2;"
180 !
190 ! Select single sweep mode to improve speed
200 !
210 OUTPUT @Na,"SM2;"
220 !
230 ! Select CW sweep type (fastest method for making single
240 ! point measurements)
250 !
260 OUTPUT @Na,"ST5;"
270 !
280 ! Set up measurement conditions
290 !
300 OUTPUT @Na,"SAM -6 DBM;TR1;BW4;UDI B/R;TSF;"
310 Freq=RND*2.00E+8          ! Select a random frequency
320 OUTPUT @Na,"SFR";Freq;"HZ;"
330 OUTPUT @Na,"TKM;"        ! 1st meas is done with TKM
340 LOOP
350   Starttime=TIMEDATE
360   Oldfreq=Freq
370   Freq=RND*2.00E+8       ! Select next random frequency
380   !
390   ! Next, go to the new frequency and begin settling,
400   ! then dump the marker data from the last measurement.
410   !
420   OUTPUT @Na,"SFR";Freq;"HZ;RST;DM1;TRG;"
430   !
440   ! Note that TRG (trigger the new measurement) will not
450   ! occur until settling is complete.
460   !
470   ENTER @Na USING "%,2A";Junk$    ! gets "#I" characters
480   ENTER @Na__nofmt;Y             ! gets marker data for Oldfreq

```

```

490 Start__meas=TIMEDATE
500 !
510 ! Next, wait for the data to be taken. Data analysis
520 ! may be performed here, while waiting.
530 !
540 REPEAT
550     Stat=SPOLL(711)
560 UNTIL BINAND(Stat,Meas__complete)
570 Stoptime=TIMEDATE
580 Measure__time=INT((Stop__time-Start__meas)*1000+.5)
590 Time=INT((Stoptime-Start__time)*1000+.5)
600 DISP "PASS ";Pass," TOTAL TIME=";Time;"msec Measurement =";Measure__time;"msec"
610 PRINT "FREQ: ";Oldfreq/1.E+6;"MHz, Y: ";Y;" dB"
620     Pass=Pass+1
630 END LOOP
640 END

```

```

10 ! This program demonstrates the fastest possible 5-point
20 ! group delay measurements possible on the HP 3577A.
30 !
40 ! Data can be dumped by moving the marker or dumping the
50 ! trace.
60 !
70 OPTION BASE 0
80 DIM Mkr(5) ! Array holding the 5 marker values for the
90 ! filter to be tested
100 DIM Trace(100) ! Array holding the 100 trace data points.
110 ASSIGN @Na TO 711
120 ASSIGN @Na__nofmt TO 711; FORMAT OFF
130 Ready__bit=16
140 Meas__complete=4
150 Pass=0
160 Answer$="M"
170 INPUT "Dump Trace (T) or Dump Marker (M): ";Answer$
180 IF (Answer$[1,1]="T") OR (Answer$[1,1]="t") THEN
190     PRINT "Will use Dump Trace"
200     Dump__trace=1
210 ELSE
220     PRINT "Will use Marker Dump"
230     Dump__trace=0
240 END IF
250 Startuptime=TIMEDATE
260 CLEAR @Na
270 OUTPUT @Na;"IPR;" ! Preset the instrument
280 !
290 ! Turn off characters and bus diagnostics for greater speed
300 !
310 OUTPUT @Na;"CH0;BD0;"
320 IF Dump__trace THEN
330     OUTPUT @Na;"FM2;" ! Use 64 bit binary data format
340 ELSE
350     OUTPUT @Na;"FM1;" ! The marker will be dumped in ASCII
360 END IF
370 !
380 ! Select single, linear sweep and delay (display fctn. 1)

```

```

390 !
400 OUTPUT @Na;"SM2;ST1;TR1;DF1;"
410 OUTPUT @Na;"SAM 0 DBM;TR1;BW4;UDI B/R" ! Measurement set up
420 OUTPUT @Na;"RS2;" ! Reduced sweep res improves speed.
430 ! HP 3577A will change its delay
440 ! aperature to 2% of span and beep.
450 !
460 ! Set up the freq definition for a 10.7 MHz bandpass filter
470 !
480 OUTPUT @Na;"FRC 10.7 MHZ;FRS 45 KHZ;STM 0.1 SEC;"
490 OUTPUT @Na;"TKM;ASL;" ! Sweep and autoscale for onlookers
500 REPEAT ! Wait for end of measurement
510 Stat=SPOLL(711)
520 UNTIL BINAND(Stat,Ready__bit)
530 OUTPUT @Na;"TKM;"
540 Starttime=TIMEDATE
550 PRINT "Initialization time: "INT((TIMEDATE-Startuptime)* 1000);"msec"
560 LOOP
570 REPEAT ! Wait for end of measurement
580 Stat=SPOLL(711)
590 UNTIL BINAND(Stat,Ready__bit)
600 Swptime=TIMEDATE
610 !
620 ! Now the data is taken and a new filter may be selected
630 ! for testing. This selection may occur while this data
640 ! is being dumped
650 !
660 IF Dump__trace THEN
670 !
680 ! Dump the entire trace. Assume that the program
690 ! processes the data during the Donemkr interval that
700 ! currently displays how long this took.
710 !
720 OUTPUT @Na;"DT1;TKM;" ! dump trace & take new meas
730 ENTER @Na USING "%,2A";Junk$ ! Gets the "#1"
740 ENTER @Na__nofmt;Trace(*) ! Gets the trace data
750 !
760 ! The "Take Measurement" command in line 720 is
770 ! executed as soon as the "Dump Trace" is complete
780 ! (when the computer has entered it; i.e., now).
790 !
800 ELSE
810 ! Send the commands to dump data at 5 marker
820 ! postions. Then enter them one at a time.
830 !
840 OUTPUT @Na;"MKP 23;DM1;MKP 33;DM1;MKP 50;DM1;MKP 67;
DM1;MKP 77;DM1;TKM;"
850 ENTER @Na;Mkr(1)
860 ENTER @Na;Mkr(2)
870 ENTER @Na;Mkr(3)
880 ENTER @Na;Mkr(4)
890 ENTER @Na;Mkr(5)
900 END IF

```



```
910   Donemkr:
920     Stoptime = TIMEDATE
930     Time__to__sweep = INT((Swptime-Starttime)*1000)
940     Time__to__dump = INT((Stoptime-Swptime)*1000)
950     Time__total = INT((Stoptime-Starttime)*1000)
960     DISP "PASS ";Pass;", SWEEP TIME = ";Time__to__sweep;"msec
Dump = ";Time__to__dump;"msec TOTAL = ";Time__total;"msec"
970     Pass = Pass + 1
980     Starttime = Stoptime
990     END LOOP
995   END
```

REFERENCE

This section of the manual is an alphabetical listing of the hardkeys and their menus, the front panel sections and some of the terms used throughout this manual. It is assumed that the operator is an experienced user and is referring to this section for details.

AMPLITUDE

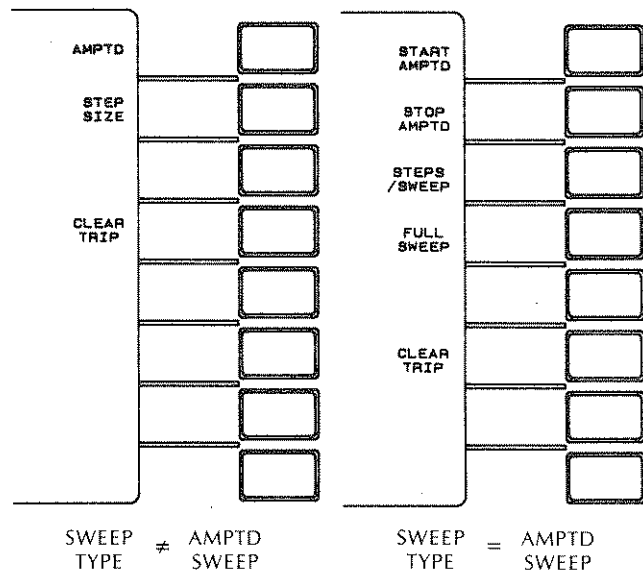
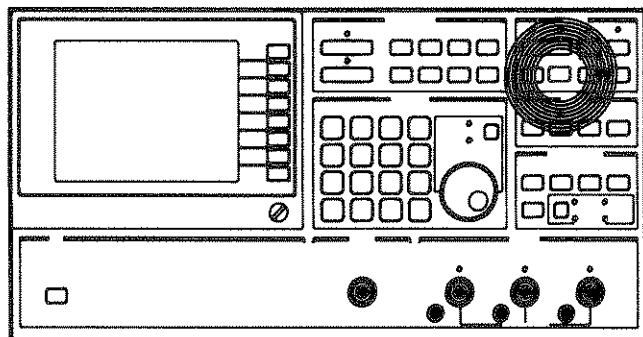

Figure 4-1

AMPLITUDE is a hardkey in the SOURCE section of the front panel used to display either menu of softkey labels shown above. These softkeys may be used to change the signal level of the source output. The HP 3577A source amplitude range is -49 dBm to $+15$ dBm in $.1$ dBm steps; the default value at power-on is -10 dBm without a test set and $+15$ dBm with a test set.

AMPLITUDE is also a softkey in the AMPLITUDE menu used to change the value of source AMPLITUDE. After power turn-on or INSTRUMENT PRESET, this softkey is active. A bright label in the menu indicates softkey selection.

To change the value of AMPLITUDE:

1. Press the AMPTD hardkey to display the menu
2. Press the AMPTD softkey (if label is not bright)
3. Modify the value with the knob or arrow keys

OR

3. Enter a new value with the numeric key pad
4. Select units from the menu (press softkey)

When the SWEEP TYPE is ALTERNATE, each trace may be given separate AMPLITUDE values. For more information see SWEEP TYPE, ALTERNATE SWEEP.

STEP SIZE is a softkey used to change the value that the arrow keys (in the DATA ENTRY section) increase or decrease the output amplitude. STEP SIZE is adjustable from $.1$ dB to 64 dB in $.1$ dB steps. The default value for STEP SIZE is 1.0 dB.

To change the value of STEP SIZE:

1. Press the AMPTD hardkey to display the menu
2. Press the STEP SIZE softkey (if label is not bright)
3. Modify the value with the knob or arrow keys

OR

3. Enter a new value with the numeric key pad
4. Select units from the menu (press softkey)

CLEAR TRIP (Source) is a softkey in the AMPTD menu used to reset the SOURCE TRIP. The source is protected against large external signals applied to it by a relay in the output circuit which opens when the voltage is $\geq 4V_{pk}$. If the source TRIPs, the user is directed by a screen message to press the AMPTD hardkey in the SOURCE section of the front panel. This displays the menu containing the softkey label "CLEAR TRIP." Pressing CLEAR TRIP resets (closes) the relay in the source output. If the trip condition still exists the source trips again.

START AMPLITUDE is a softkey in the AMPTD menu (when the SWEEP TYPE is AMPLITUDE SWEEP) used to change the value of the sweep parameter START AMPLITUDE. The default value for start amplitude is -40dBm . The allowable range is the same as the range of the source output amplitude, -49 dBm to $+15\text{ dBm}$. The value of start amplitude may be larger than the stop amplitude. Units used for data entry of new values for start and stop amplitude may be linear (volts) but the sweep is always logarithmic.

To view the menu shown in Figure 4*1:

1. Press the SWEEP TYPE hardkey
2. Press the AMPTD SWEEP softkey
3. Press the AMPTD hardkey

To change the value of START AMPLITUDE:

1. Press the START AMPTD softkey (if the label is not bright)
2. Modify the value with the knob or arrow keys

OR

2. Enter a new value with the numeric key pad
3. Select units from the menu (press softkey)

STOP AMPLITUDE is a softkey label in the AMPTD menu (when the SWEEP TYPE is AMPLITUDE SWEEP) used to change the value of the sweep parameter STOP AMPLITUDE. The default value for stop amplitude is 0.0 dBm if no test set is connected to the HP 3577A. With a test set, the default value is $+15\text{ dBm}$. The allowable range is the same as that of the source output amplitude, -49 dBm to $+15\text{ dBm}$. The value of stop amplitude value may be smaller than the start amplitude.

To change the value of STOP AMPLITUDE:

1. Press the STOP AMPTD softkey
2. Modify the value with the knob or arrow keys

OR

2. Enter a new value with the numeric key pad
3. Select units from the menu (press softkey)

STEPS/SWEEP is a softkey used to change the number of amplitude data point measurements taken and plotted on the screen. The value may be changed by softkey selection, only. When STEPS/SWEEP softkey is pressed, a menu appears that contains all possible selections. They are 5, 10, 20, 50, 100, 200, and 400. The default number is 100. A large number of STEP/SWEEP makes the trace smooth while a small number lowers the required SWEEP TIME.

ATTENUATION

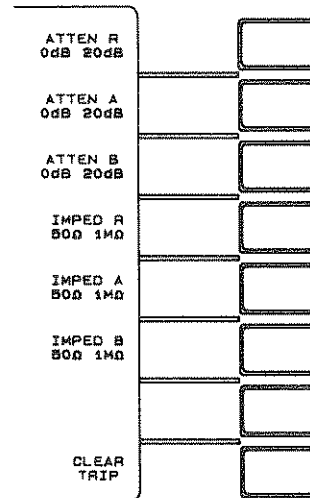
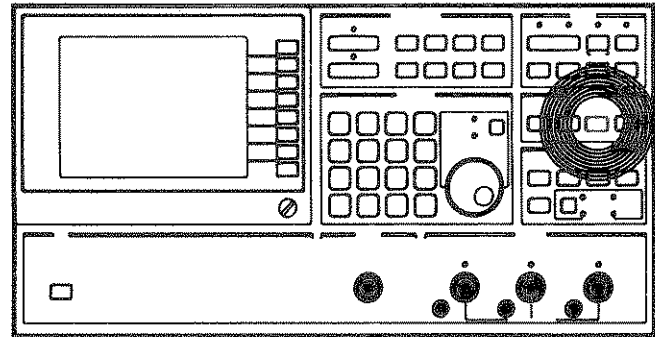

Figure 4*2

ATTENUATION is a hardkey in the RECEIVER section of the front panel used to display the menu shown above. These softkeys may be used to select the input attenuation and input impedance for each of the three receiver channels. Also, the CLEAR TRIP for the receivers is included in this menu.

Each input channel has two possible input impedances (50Ω or $1M\Omega$) and two possible input attenuations (0dB or 20dB). When the instrument is PRESET all channels revert to the default values: 50Ω input impedance and 20dB input attenuation. All of the attenuation and impedance softkeys are the push-push toggle type. Each

has two possible states; the bright part of the labels indicate which state is active. These parameters may be changed by softkey selection, only.

The two input attenuation values may be thought of as measurement ranges. Normally the HP 3577A is in the high range, with 20dB of input attenuation. To increase the HP 3577A's ability to measure very small signal levels, change the input attenuation to 0dB. The following table lists the signal levels at which overload occurs for any combination of input attenuation and impedance:

OVERLOAD SIGNAL LEVELS		
INPUT ATTENUATION	INPUT IMPEDANCE	
	50Ω	1MΩ
20 dB	0 dBm	-13 dBV (224 mV)
0 dB	-20 dBm	-33 dBV (22.4 mV)

All the front panel connections of the HP 35677A S-PARAMETER TEST SET have a characteristic impedance of 50Ω. If a 75Ω characteristic impedance is required, we recommend using the HP 35677B.

To modify the impedance and attenuation parameters:

1. Press the ATTEN hardkey to display the menu
2. Press the softkey of the parameter you wish to change

CLEAR TRIP (RECEIVER) is a softkey used to reset a RECEIVER TRIP. A RECEIVER TRIP is input voltage protection that switches the input impedance to 1 MΩ when the signal level is $\geq 1.1V_{pk}$. When any receiver trips the screen message "INPUT TRIPPED: Chan __, Clear trip on ATTEN menu" appears. This change of impedance does not show in the ATTEN menu. The menu shows the user's selections and has the CLEAR TRIP softkey which should be used to reset the TRIP condition. The CLEAR TRIP softkey clears any and all inputs that are tripped.

AVERAGE

AVERAGE is a hardkey in the RECEIVER section of the front panel used to display the menu of softkeys shown in Figure 4*3. Selection of any of the numbered softkeys turns on the exponential averaging feature of the HP 3577A. When averaging is on the LED above the AVG hardkey is illuminated. The number selected by the user from the menu is a weighting factor called N in the following discussion.

Averaging is useful for removing the effects of noise from a trace. It is best to select a small N if you wish

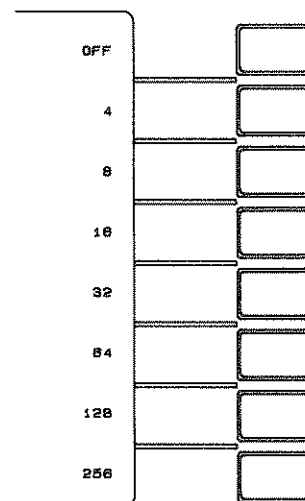
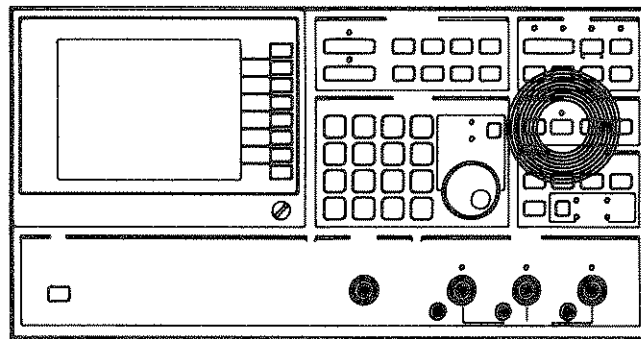

Figure 4*3

to adjust the response of the device under test while sweeping. A small N (like 4) shows the response changes faster than a large N. If you want a very good "final" picture, pick 256 (or other large value for N). The larger N is, the more noise is reduced. This feature is capable of reducing trace noise as much as 24 dB (N=256). Another way to reduce trace noise when measuring weak signals is to switch out the 20 dB RECEIVER attenuators. See ATTENUATION.

To use AVERAGE, press the hardkey labeled AVG in the RECEIVER section of the front panel. The list of choices appears in the menu area of the display. If the feature is off the word OFF appears bright in the menu. If any other selection is made, the new selection becomes bright and AVERAGE is on. The AVERAGE weighting factor N may be changed by softkey selection, only. Averaging does not stop after N sweeps.

The averaging algorithm is a continuous process that begins when the feature is turned on (N is selected). The number selected by the user (N) is used in the equation below to yield an exponential average.

$$\text{NEXT VALUE} = \frac{1}{N} \times (\text{NEW VALUE}) + \frac{N-1}{N} \times (\text{CURRENT VALUE})$$

If N is 256, the new sweep data is weighted by 1/256 and the current data by 255/256. You can see that each sweep does not change the trace much when N = 256. If N is 4, the new sweep data is weighted by 1/4 and the current data by 3/4; so new data changes the trace faster when N is small.

The HP 3577A stores the trace information in "bins". Each bin contains a measurement value taken at a discrete frequency in the sweep and is as wide as the selected bandwidth. As each new value is taken, the math processor weights (multiplies) it by 1/N, weights the old value by (N-1)/N, adds the two together and stores the result in the same bin the old value was in. Multiple traces are not stored. In this manner, the effect of any single sample diminishes as each average weights its value at some factor less than one and adds it to new incoming data.

The preceding discussion has described how the averaging feature works after N sweeps (samples). Until that time, the averaging algorithm cycles up through lower values of N until it reaches the user's selection. For example, let N = 256. The first value used in the equation for N is 4. After several sweeps a higher value of N is used and the process repeated until 256 is reached. The HP 3577A uses this method because it displays a useable trace faster than if N were large and constant.

NOTE

After averaging with a large N for a long time (i.e. many sweeps) removing the device under test does not affect the trace noticeably. The LED above the AVG key is on when the HP 3577A is averaging.

CONTINUOUS ENTRY

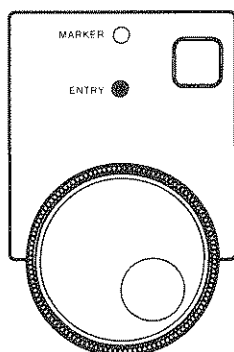

Figure 4•4

In the DATA ENTRY section of the front panel there are three ways to enter or modify data: the keypad, the arrow keys, and the knob. **CONTINUOUS ENTRY** refers to the knob in ENTRY mode.

To use CONTINUOUS ENTRY the active (bright) softkey must be a type that allows data entry. When the key above the knob is pressed the LEDs marked "MARKER" and "ENTRY" toggle. The knob is capable of CONTINUOUS ENTRY when the ENTRY LED is lit. When in MARKER mode the knob moves the markers on the screen. It is recommended that the knob be left in MARKER mode so that data modifications are not made when the knob is accidentally rotated. The ENTRY OFF hardkey also turns off the knob ENTRY mode by removing the menu (and therefore any active softkey) from the screen.

DATA ENTRY

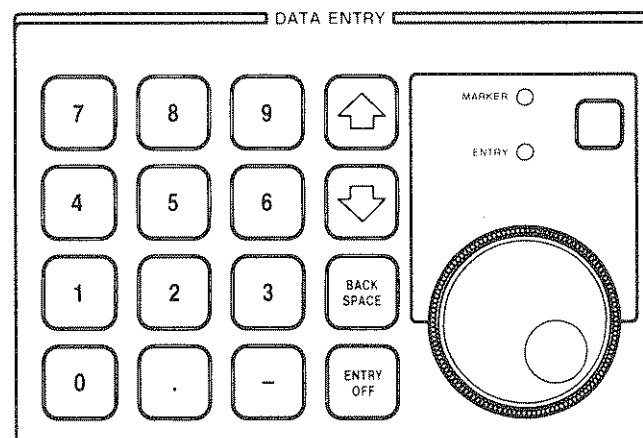

Figure 4•5

DATA ENTRY is a section of the front panel used for entering or modifying data. It contains a numeric keypad, increment/decrement (arrow) keys, a BACKSPACE key, ENTRY OFF key and the knob. If new entries are made with the keypad, units must be entered with the softkeys at the right side of the screen before the new entry is complete.

The **BACKSPACE** key is used to correct data entries or trace arithmetic equations. When the backspace key is pressed, the cursor in the entry block (text in the upper-right corner of the screen) backs up one space, erasing that character. If an error is made in the data entry, the HP 3577A displays a screen message and beeps; the original entry is not erased. The new entry must be backspaced over before new data may be entered. Another alternative is to begin again with the hardkey. This replaces your data in the entry block with the current definition of the parameter.

ENTRY OFF is used to keep the knob from changing an ENTRY value or to clear the screen of menus and messages. The graticule and all characters are displayed at low intensity and the trace(s) are bright.

The **KNOB** is used in one of two modes: to move the MARKER or for (continuous) ENTRY (i.e. data modification). It toggles between these two modes when the key above it is pressed. Two LEDs, marked MARKER and ENTRY show which mode the knob is in. When preset, the knob is in the MARKER mode. It is good operating practice to keep it in MARKER so that accidental rotation of the knob does not modify whatever entry currently appears in the menu. Also, note that when MARKER POSITION (in the MKR menu) is bright, the knob moves the marker in either MARKER or ENTRY mode (the entry would be MARKER POSITION).

The **INCREMENT/DECREMENT** keys are used to increment (up-arrow) or decrement (down-arrow) data for the selected (bright) softkey if it is an item that allows data entry; you can increment a sweep time but not a sweep type. The message "ENTRY UNDEFINED" appears if you try to modify a softkey for which data entry is not appropriate. If held down for more than 1 second, the up/down keys auto-repeat. The amount of change is determined by the step size of the parameter to be modified and may be a data entry, itself. Refer to the particular parameter in this section for more information on its STEP SIZE.

DATA REGISTER

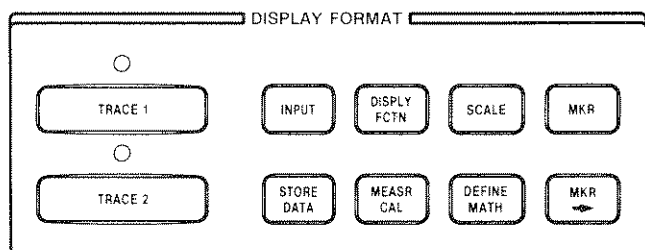

Figure 4-6

There are four registers used to STORE trace DATA. They are called D1, D2, D3, and D4. Stored data is in the same form (complex) created by the receivers and stored in trace memory. Therefore, any data register information may be recreated in any of the DISPLAY FUNCTION formats (LOG MAG, PHASE, GROUP DELAY, etc.). Refer to Appendix A for more information on DATA PROCESSING AND STRUCTURE.

The data stored in any of the data registers may be displayed by specifying the data register of interest as an INPUT. Press the INPUT hardkey and the softkey labeled DATA REG, then select the data register of interest from the menu. Refer to STORE DATA.

DEFINE MATH

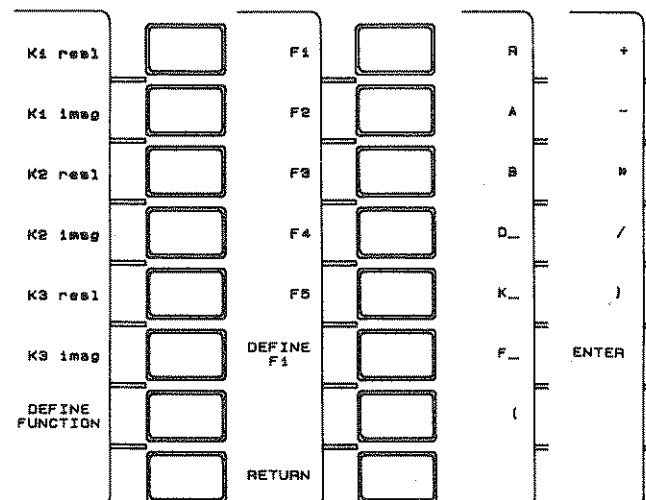
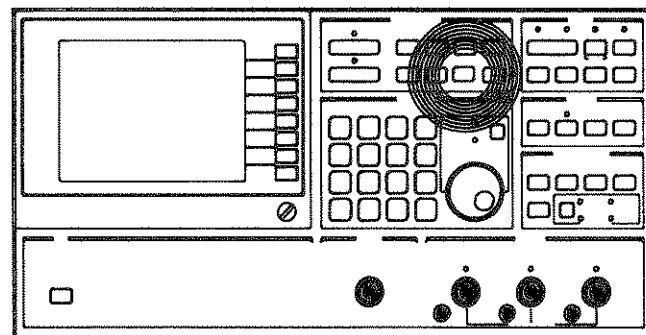

Figure 4-7

DEFINE MATH is a hardkey in the DISPLAY FORMAT section of the front panel used to display the menu shown above (left). These softkeys may be used to define three complex constants and five functions. Constants and functions may be used as terms in USER DEFINED INPUTS or USER DEFINED STORES.

The constants are displayed in the menu as soon as the DEFINE MATH key is pressed. Each component, real and imaginary, of each constant, K1 through K3, may be defined by pressing the appropriate softkey and making a data entry with the numeric keypad. The entry appears in the entry block on the screen as it is entered. To correct entry errors use the backspace key in the DATA ENTRY section.

The functions may be defined by pressing the DEFINE FUNCTION softkey. This displays a new menu containing 1) the 5 user definable functions, F1 through F5, 2) a command to DEFINE F___, and 3) RETURN, which displays the previous menu. Also displayed is an entry message (on the screen) showing the current definition of the bright function. This message changes to show the new entry as it is entered.

One of the F___ softkey labels is bright and appears in the DEFINE F___ softkey label. Selecting another F___ changes the DEFINE F___ command. When the DEFINE F___ key is pressed the entry block shows the equation being defined and the menu changes to a selection of the first term to be used. This list includes the three input channels (R, A, and B), the four data registers (D___), the three constants (K___), the other functions (only lower numbered functions may be used to define this function), and parenthesis to be used in constructing the equation.

When a softkey is pressed the menu changes to the list of math functions or (if K___, F___, or D___ was the first selection) a list of numbers to finish describing the term. The menu continues to change as the equation is built and the entry block shows what is being entered. If errors are made they may be erased by backspacing over them. When finished, one of the softkey labels should allow the function to be ENTERed. Character strings may not be longer than 17; if longer strings are necessary you may divide them among as many user defined functions as necessary and then define an INPUT equation with them. See MEASUREMENT CALIBRATION for an example. The default constant and function definitions are listed in the following table.

K1 = 1.0 + 0.0j	F1 = (B/R)/(K1-B/R)
K2 = 50 + 0.0j	F2 = A/R
K3 = 75 + 0.0j	F3 = (K1 + F2)/(K1-F2)
	F4 = K2*F3
	F5 = K3*F3

When the function is ENTERed there is no change in the trace unless the INPUT is a function of the term just defined. This new USER DEFINED FUNCTION may now be used in a user defined INPUT or STORE. The trace arithmetic capabilities of the HP 3577A make complicated error corrections or special conversions easy. See MEASUREMENT CALIBRATION for examples.

NOTE

Pressing INSTR PRESET or cycling the power switch redefines all user defined functions. Be sure to SAVE instrument state if you wish to retain the USER DEFINED FUNCTIONS.

RECALL OLD STATE may be used to recover the user defined functions as they were defined when power was last turned off or in case of power failure.

DISPLAY FORMAT

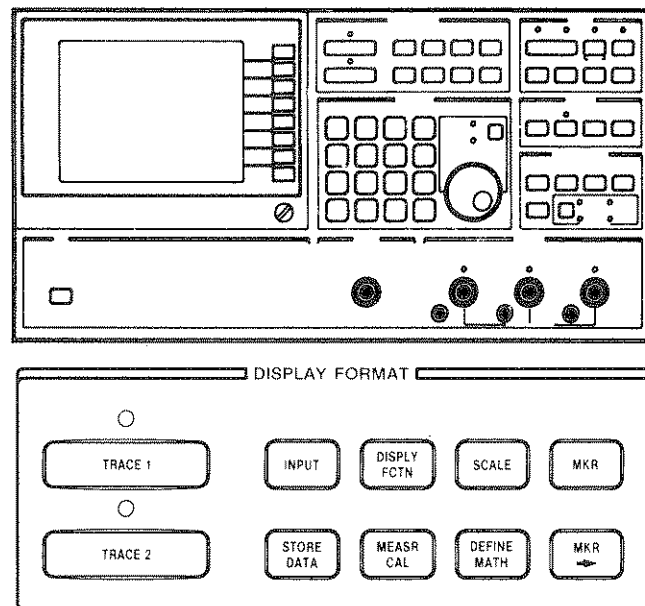

Figure 4•8

DISPLAY FORMAT is one of five front panel sections. The hardkeys in this section display menus of softkeys used to:

- INPUT define screen trace in terms of receiver inputs, stored data, user defined constants, and user defined functions
- DISPLAY FCTN define screen trace in terms of how the complex data is interpreted (LOG MAG, PHASE, GROUP DELAY, etc.)
- SCALE define graticule scale (REF LEVEL, /DIV, etc.)
- MKR (marker) read data from the displayed trace

MKR →	(marker goes into) enter data using the position of the marker
STORE DATA	store complex data as defined under the INPUT hardkey
MEASR CAL	normalize or do partial (two term) or full (three term) error correction of one-port measurements
DEFINE MATH	define three constants and five functions

DISPLAY FUNCTION

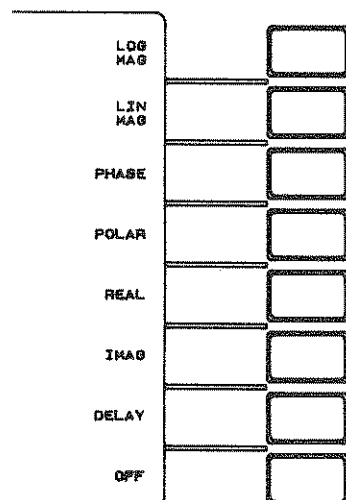
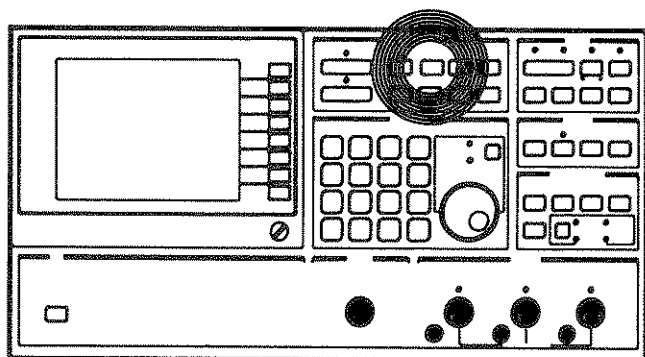

Figure 4*9

DISPLAY FUNCTION is a hardkey in the DISPLAY FORMAT section of the front panel used to display the menu of softkeys shown above. These softkeys may be used to define the screen trace in terms of how the complex data in trace memory is interpreted. If any of the top 7 entries in the menu are bright, the trace is on. The trace may be turned off with the bottom softkey.

LOG MAGNITUDE is a softkey in the DISPLAY FUNCTION menu. Immediately after preset or power-on, LOG MAG is the active DISPLAY FUNCTION. If not already bright, pressing this softkey defines the y-axis as log

magnitude. It does not accept data entry. The default SCALE parameters for LOG MAGNITUDE are:

REF LEVEL: 0dBm
/DIV : 10dBm
REF POS : 100%

The REFERENCE LEVEL and /DIVISION parameters are listed on the screen above the graticule. Reference refers to the dashed line; its value is 0dBm and its position on the screen is top or 100%. The REFERENCE POSITION may be checked by pressing the hardkey SCALE, and then the softkey REF POS. At this point data may be entered for the reference position.

LINEAR MAGNITUDE is a softkey in the DISPLAY FUNCTION menu used to define the y-axis as linear magnitude. It does not accept data entry from the keypad. When LINEAR MAG is selected the SCALE parameters change to the following:

REF LEVEL: 0.0V
/DIV: 100 mV
REF POS: 0.0%

PHASE is a softkey used to define the y-axis as PHASE information. The softkey label PHASE SLOPE appears in the SCALE menu when PHASE is the current display function. Default SCALE parameters for PHASE are:

REF LEVEL: 0.0 deg
/DIV: 45 deg
REF POS: 50%

To use this feature, select the trace you wish to be a phase trace by pressing either the TRACE 1 or TRACE 2 hardkey, press the DSPLY FCTN hardkey, and then press the PHASE softkey. The selected trace is now phase information.

POLAR is a softkey used to display trace information in a polar format. In the polar format, only one trace is displayed so if both traces are on in a rectangular format when polar is selected, the non-active trace is turned off. The active trace is indicated by the LEDs over the TRACE 1 and TRACE 2 hardkeys.

The polar format changes the menu listings of the SCALE, MKR, and MKR→ hardkeys as shown in Figure 4*10.

REAL is a softkey used to define the y-axis as real. The unit of measure for the real and imaginary display functions is volts. When this display function is selected the HP 3577A displays the real half of the complex data stored in trace memory. See Appendix A on Data Processing and Structure.

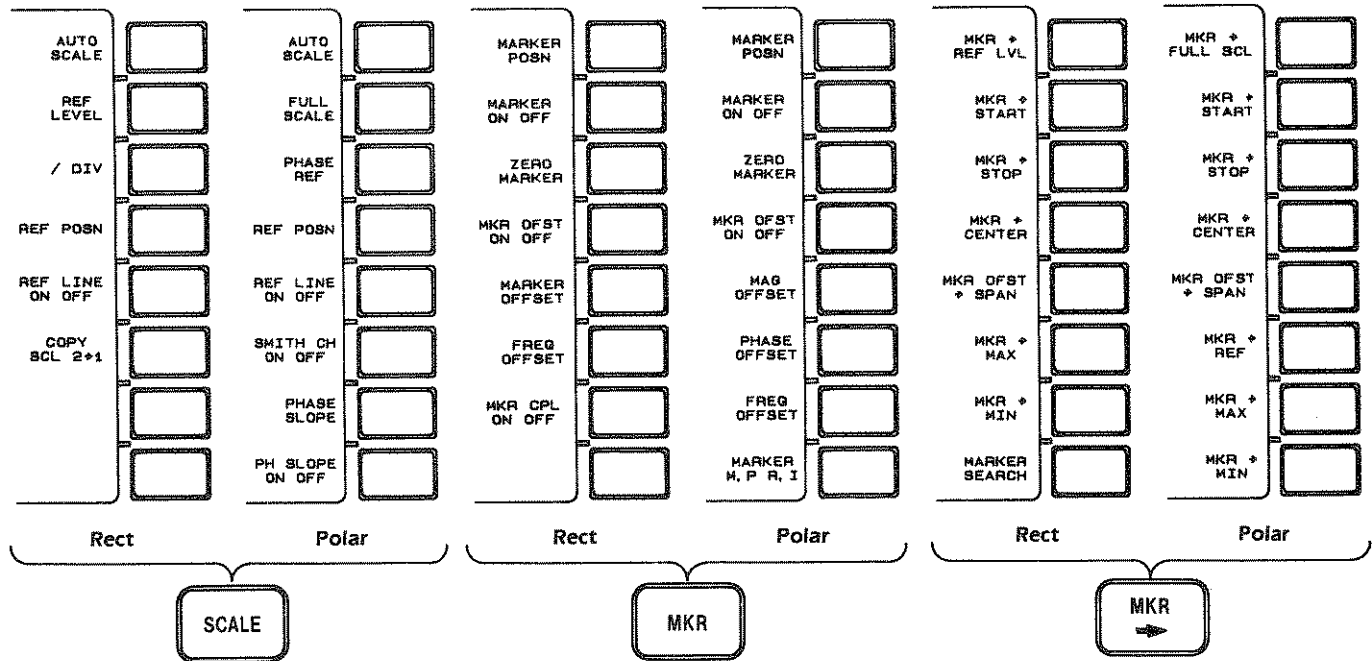

Figure 4*10

IMAGINARY is a softkey used to define the y-axis as imaginary. The unit of measure for the imaginary and real display functions is volts. When this display function is selected the HP 3577A displays the imaginary half of the complex data stored in trace memory.

DELAY (GROUP) is a softkey used to select group delay as the display function. When selected, this softkey label changes to DELAY APERTURE. DELAY APERTURE activates a menu which allows the user to change the delay aperture.

Choosing a display function selects the math used to interpret the data in trace memory as the selected function. The data collected during the sweep does not depend on which function is selected. How the data is collected is determined by the source and receiver settings. See "DATA PROCESSING AND STRUCTURE" in Appendix A.

The DELAY display function does not exist in the DISPLAY FUNCTION menu if the sweep type is LOG SWEEP, AMPLITUDE SWEEP, CW or if the sweep mode is MANUAL.

Group delay is the derivative of phase with respect to frequency ($d\phi/df$). In the HP 3577A this is approximated by using the function $\Delta\phi/(\Delta f \times 360)$. The user selects the DELAY APERTURE (Δf) in % of span (frequency) from a menu. The HP 3577A calculates the change in phase for the specified aperture and divide $\Delta\phi$ by $\Delta f \times 360$.

The point plotted is between data points used to calculate it. For example, the group delay for 100 Hz may

be calculated by measuring the change in phase between 90 and 110 Hz. Therefore, no data is calculated for the endpoints of the trace. If you had specified a start frequency of 90 Hz, 100 Hz would be the first point with group delay data. This results in a trace that does not extend to the edges of the screen (more noticeable as the delay aperture is made larger).

The unit of measure for group delay is time. The readings are in seconds or fractions of seconds from 0.01 ns to 1000.0 seconds. Larger apertures yield finer resolution of units because τ_g (group delay) = $\Delta\phi$ (with fixed phase resolution) divided by Δf . The larger the aperture (Δf), the smaller τ_g is.

When the display function is group delay (or any phase dependent function) the scale menu includes "PHASE SLOPE". Initially this feature is on and the default value is 0 deg/span.

DELAY APERTURE is a softkey label that is created in the DISPLAY FUNCTION menu when DELAY is selected. Delay aperture is the frequency span over which the HP 3577A evaluates phase and calculate group delay. This frequency span is in percent-of-span; the selections include .5%, 1%, 2%, 4%, 8%, and 16%. The selected aperture appears below the lower-right corner of the graticule in Hertz when the active trace is group delay. See Figure 4*11.

To find and/or modify DELAY APERTURE press DSPLY FCTN and then DELAY. The softkey DELAY changes to read DELAY APERT when pressed. Pressing this key displays the list of apertures in the menu area. Large

apertures have more of a smoothing effect on the trace than smaller apertures.

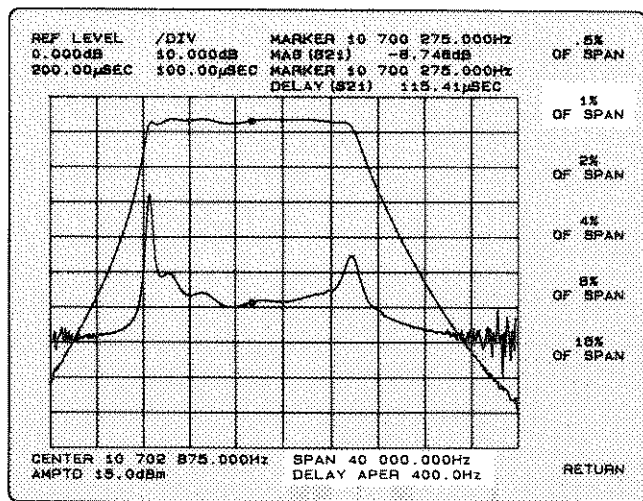

Figure 4*11

Delay aperture is somewhat dependent upon sweep resolution (a softkey in the FREQ menu). When sweep resolution is 201, the delay aperture cannot be less than 1% of span. The HP 3577A automatically changes aperture from .5% to the larger value when sweep resolution is changed. Aperture is increased to 2% when a sweep resolution of 101 is selected, and is increased again to 4% when sweep resolution becomes 51. See the example for SWEEP RES under the FREQ hardkey.

ENTRY BLOCK

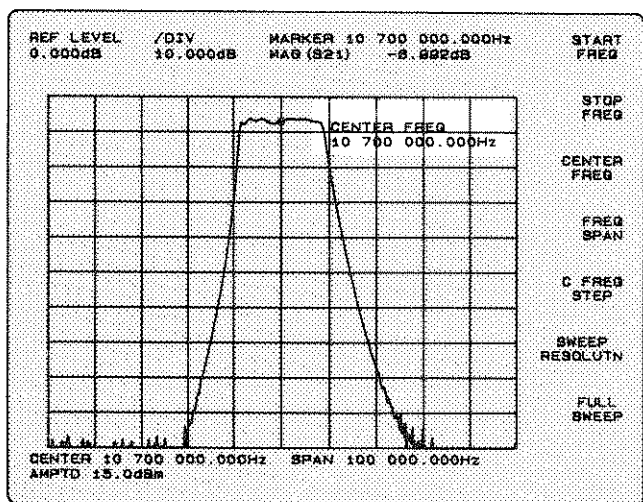

Figure 4*12

The **ENTRY BLOCK** is a portion of the screen where entry messages appear. These messages show the data

entered or modified. Any time a new menu is selected and the active (bright) softkey label is a data entry item, its current value appears in the upper-center portion of the screen. If the selected trace is changed to 2 and trace 2 is off, no message appears.

Example: Trace 1
Press SCALE hardkey REF LEVEL
0.000dBm

EXTERNAL REFERENCE

This input on the rear panel allows the HP 3577A to be connected to an external frequency reference. When a signal is present on this input the EXT REF LED in the upper right hand corner of the front panel lights. The HP 3577A phaselocks to signals from -7 dBm to +15 dBm at any frequency that is the result of dividing 10 MHz by an integer and is above 100 kHz, accurate to ±20 ppm. If the source connected to the EXTERNAL REFERENCE varies more than this, the HP 3577A switches to its own internal reference. When this occurs, the EXT REF LED extinguishes and the HP 3577A beeps as phaselock is lost during the switch.

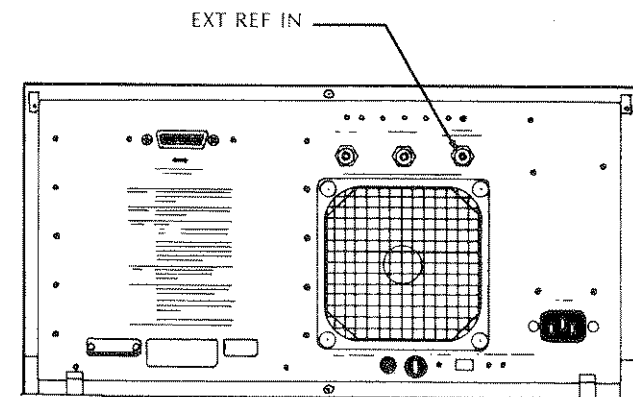
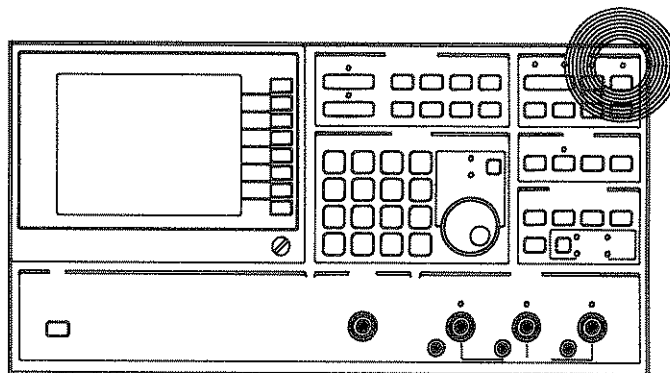

Figure 4*13

FREQUENCY

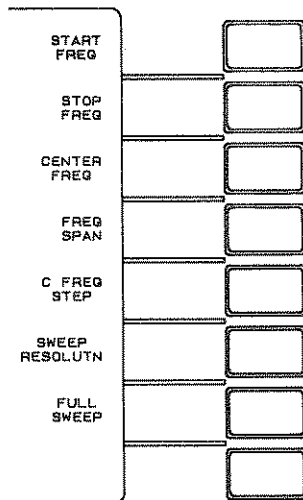
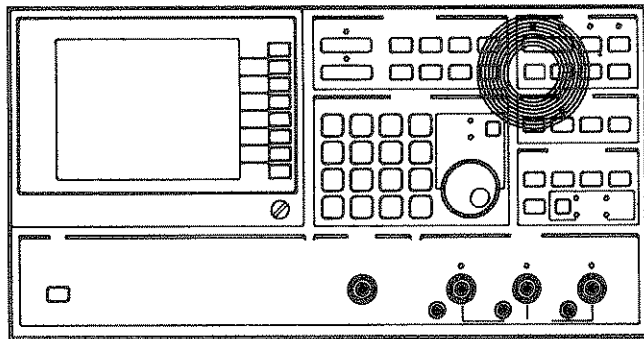

Figure 4-14

FREQUENCY is a hardkey in the SOURCE section used to display the menu of softkeys shown above. These softkeys are used to modify the frequency parameters. Immediately after pressing INSTR PRESET or cycling power, START FREQ is the active (bright) softkey.

The top 5 softkeys in this menu allow data entry. SWEEP RESOLUTION calls another menu used to select the number of sampled frequencies or bins that are the data points of the trace. FULL SWEEP is an immediate execution command that resets the START FREQUENCY and STOP FREQUENCY to get a full sweep; or you may think of it as resetting the CENTER FREQUENCY and the FREQUENCY SPAN.

If the SWEEP TYPE is LOG FREQ the menu consists of the following:

- START FREQ
- STOP FREQ
- FULL SWEEP

If the SWEEP TYPE is CW or AMPTD the menu consists of the following:

- FREQ
- STEP SIZE

If the SWEEP TYPE is ALTERNATE, different frequency parameters may be entered for each of the two active traces. See SWEEP TYPE, ALTERNATE.

START FREQ is a softkey used to enter data for the sweep start frequency. To enter a new start frequency:

1. Press the FREQ hardkey to display the menu
2. Press the START FREQ softkey (if label is not bright)
3. Modify the value with the knob or arrow keys

OR

3. Enter a new value with the numeric key pad
4. Select units from the menu (press a softkey)

STOP FREQ is a softkey used in the same manner as START FREQ for entering data for the sweep stop frequency. The START and STOP FREQ values appear below the graticule.

CENTER FREQ is a softkey used in the same manner as START and STOP FREQ for entering data for the sweep center frequency. There is no defined center frequency when the SWEEP TYPE is LOG FREQ, CW, or AMPTD. The START and STOP information below the graticule changes to CENTER and SPAN when either of the latter two are selected.

FREQ SPAN is a softkey used in the same manner as START FREQ for entering data for the frequency span represented by the graticule. There is no frequency span when the when the SWEEP TYPE is LOG FREQ, CW, or AMPTD. If the frequency span is 0 Hz and sweep time is less than 1000 seconds, the marker position reads in units of time.

CENTER FREQ STEP is a softkey used to enter data for the step size taken when the increment/decrement arrows are used to modify the center frequency value. Data entry for this parameter is accomplished in the same manner as for START FREQ.

SWEEP RESOLUTION is a softkey used to change the number of sample frequencies measured by the HP 3577A. The default value for sweep resolution is 401 points. These correspond to the bins referred to in Appendix A. Each bin is as wide as the selected resolution bandwidth and has associated with it a bin number (position information) and measurement value. The user may select 401, 201, 101, or 51 points per sweep. The

larger numbers provide a smoother trace while the lower number of points per sweep allow a shorter SWEEP TIME. To select a value for SWEEP RESOLUTION, press the **FREQ** hardkey, **SWEEP RESOLUTION** softkey, and then press the softkey corresponding to the desired value.

NOTE

Changing SWEEP RESOLUTION or SWEEP TYPE erases registers R, A, and B in trace memory (sets all zeros).

When the display function is group delay, delay aperture is somewhat dependent on sweep resolution. If the sweep resolution is decreased, the HP 3577A automatically increases the delay aperture and displays the screen message "DELAY APERTURE INCREASED."

- EXAMPLE: 1. PRESET; Swp Res = 401, Aperture = .5% of span
2. Change Swp Res to 201, Aperture changes to 1%
 3. Change Swp Res to 101, Aperture changes to 2%
 4. Return Swp Res to 401, Aperture does not change

FULL SWEEP is a softkey used to reset the start/stop sweep parameters to their maximum values. Full sweep, in a linear sweep, is from 0 to 200 MHz. In log sweep, full sweep is from 5 Hz to 200 MHz. The presence of a test set does not affect full sweep.

GRATICULE

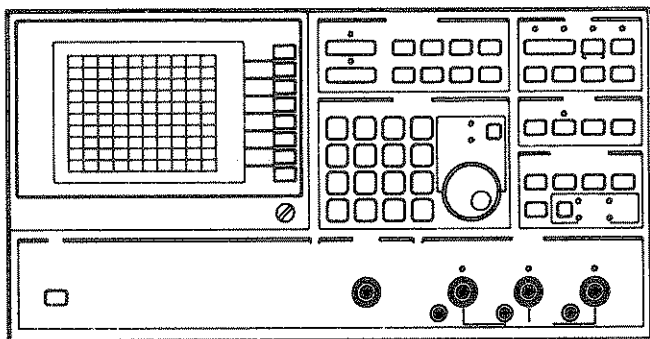

GRATICULE is a scale for measuring quantities displayed on the CRT (referred to as the display screen). The HP 3577A has different graticules for LOG and LINEAR sweep types, POLAR display function and changes the POLAR display graticule to a SMITH chart with a softkey in the SCALE menu.

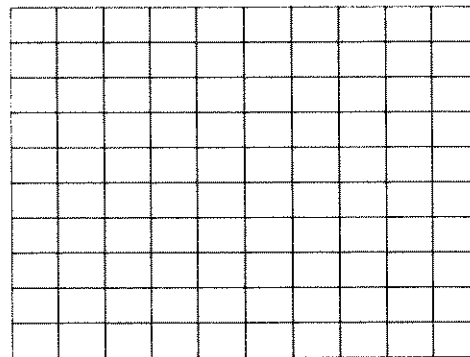

Rectangular, Linear

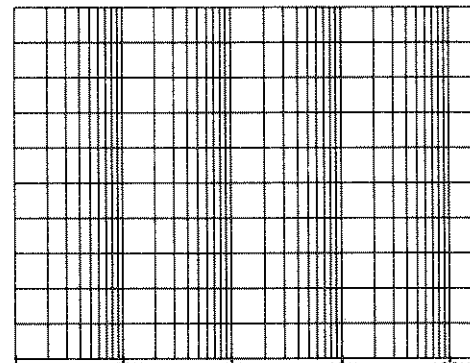

Rectangular, Log

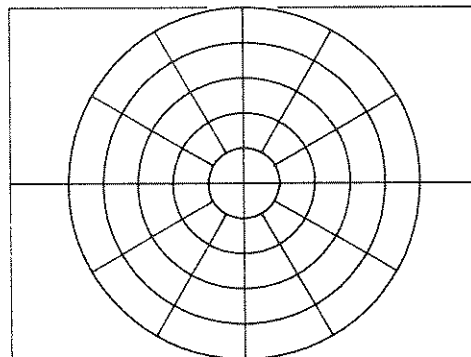

Polar: Smith Chart Off

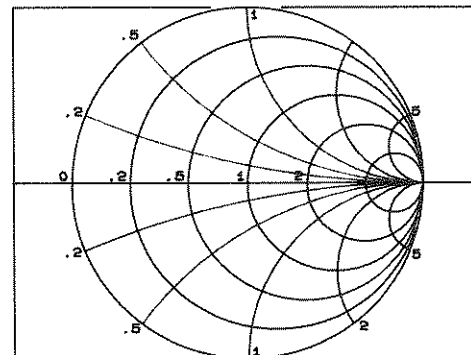

Polar: Smith Chart On

Figure 4•15

HARDKEY

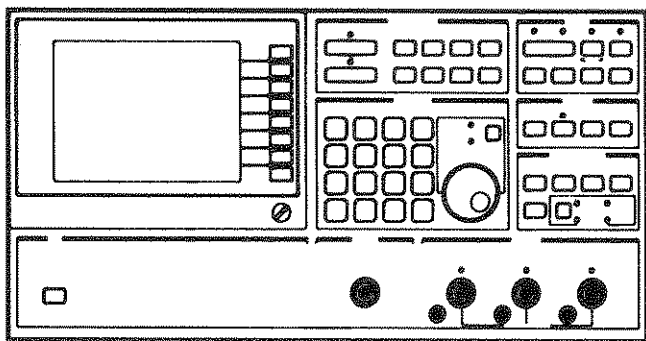
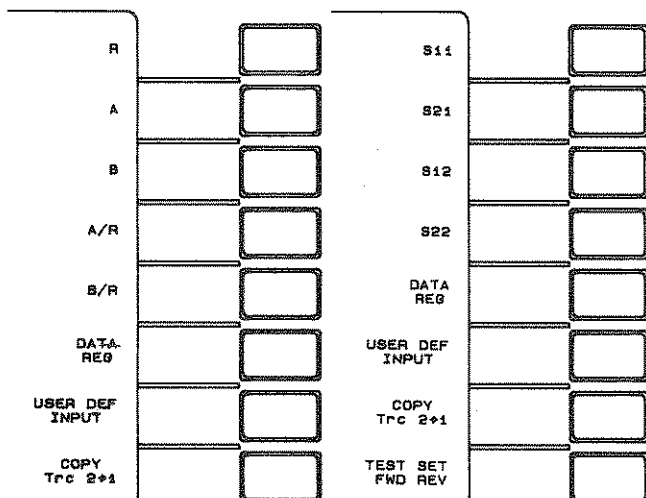
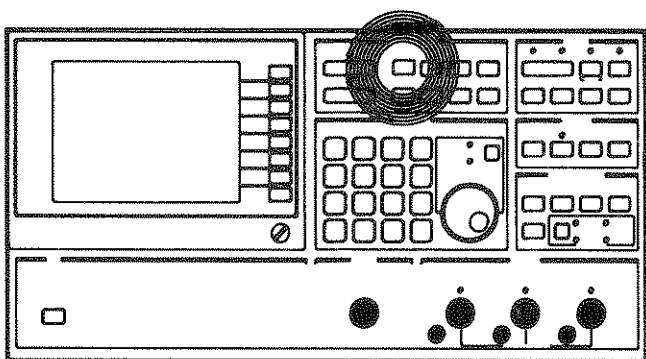

Figure 4-16

HARDKEY refers to all of the keys on the front panel that have command names printed on them. Most hardkeys are used to display a menu of softkey labels. Exceptions to this are the keys in the DATA ENTRY section, the TRIG/RESET key, the LCL key, and the INSTRUMENT PRESET key.

INPUT



4-17A

4-17B

Figure 4-17

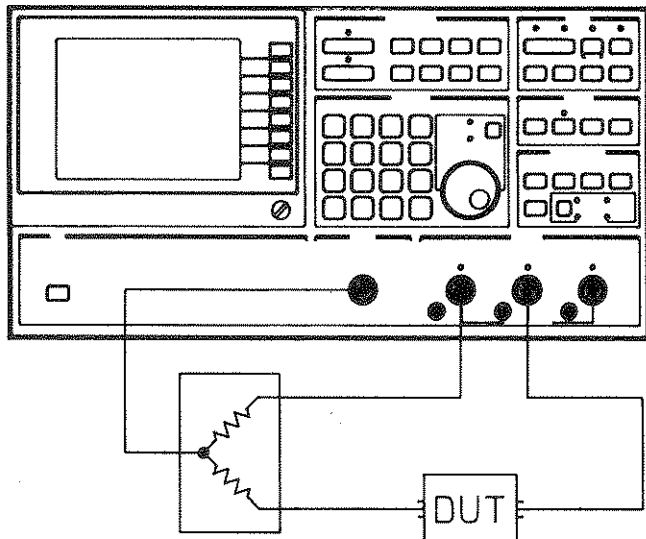

4-17C

INPUT is a hardkey in the DISPLAY FORMAT section used to display the menus of softkeys shown in Figure 4-17. These softkeys may be used to define the active trace in terms of 1) receiver inputs, 2) data registers (contain stored traces), 3) user defined functions, and 4) user defined complex constants. Connecting an HP 35677A/B S-parameter Test Set to the HP 3577A changes this menu as shown in Figure 4-17B. If the test set is used, the S-parameters may be turned off with a softkey found under the SPCL FCTN hardkey. When the S-parameters are turned off, the INPUT menu changes to that shown in Figure 4-17A.

Without the test set, the default selection for INPUT is the R input. When the INPUT definition is R, A, or B, the trace appears as a display function of the signal at the selected input. The three inputs are identical. If A/R or B/R are selected as the INPUT then the trace consists of the data at the A or B input divided by the data at R. This may be used to remove the response of the source from the trace by using a power splitter as shown in Figure 4-17C.

The DATA REG softkey may be used to select one of the four data registers as the INPUT definition. The USER DEFINED INPUT softkey may be used to construct an equation using constants, data registers, inputs, and previously defined functions as terms. The user may also copy the INPUT definition for the other trace into the definition of the active trace using the COPY TRACE softkey.

With the S-parameter test set the INPUT menu has most of the same features. In place of the selections for inputs R, A, B, A/R, and B/R are the S-parameters S11, S21, S12, and S22. When the USER DEFINED INPUT is active the softkey label TEST SET FWD/REV appears at the bottom of the menu.

DATA REGISTER is a softkey used to select a trace stored in a data register as the displayed trace. Pressing this softkey changes the menu to a list of the four data registers, D1-D4. Pressing one of these softkeys accomplishes the selection of that data register as the trace INPUT. Be aware that the sweep parameters of the stored trace may be entirely different from those in effect now. SCALE parameters are the only values that affect the trace when the INPUT is defined to be a data register.

USER DEFINED INPUT is a softkey used to create an equation to define a trace INPUT that is more complicated than the common ones offered at the top of the menu. The user may use 1) the three receiver inputs, 2) three user defined complex constants, 3) four data registers, and 4) five user defined functions as terms in this equation.

To make a USER DEFINED INPUT:

1. Press the INPUT hardkey to display the menu
2. Press the USER DEF INPUT softkey (if label is not bright)
3. Press the softkey corresponding to a math term
4. Press the softkey corresponding to a math function
5. Repeat steps 3 and 4 until the equation is complete
6. Press the ENTER softkey

COPY Trc n→m is a softkey used to define the INPUT of the active trace to be identical to the other trace INPUT. The softkey label is COPY INPUT 2→1 when TRACE 1 is selected and COPY INPUT 1→2 when TRACE 2 is selected.

TEST SET FWD/REV is a push-push toggle type softkey used to select which of the two S-parameter test set ports is the source. When FWD is bright PORT 1 is the signal source and when REV is bright PORT 2 is the source. This softkey appears only when the USER DEF INPUT softkey is active.

INSTRUMENT PRESET

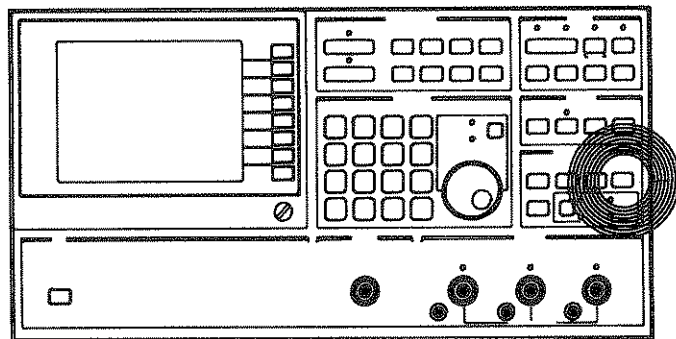

Figure 4•18

INSTRUMENT PRESET is a green hardkey in the INSTRUMENT STATE section. This key resets the values of HP 3577A parameters to a known state. This operating state is especially useful as a reference condition. Immediately after preset or power-on, the HP 3577A parameters are set to their default values. These parameters and their preset conditions are shown in the following table.

Table 4•1

Function	Preset Condition	
	Without test set	With test set
Display function	Log magnitude	same
Input (both traces)	R input	S21
Active trace	Trace 1	same
Scale	10 dB /DIV	same
Reference level	0 dBm	same
Reference position	100% (for log mag)	same
Start frequency	0 Hz	100 kHz
Stop frequency	200 MHz	same
Amplitude	-10 dBm	+15 dBm
Amplitude step size	1 dB	same
Sweep type	Linear frequency	same
Sweep time	1 second	same
Sweep mode	Continuous	same
Sweep resolution	401 points/span	same
Trigger mode	Free Run	same
Resolution bandwidth	1 kHz	same
Averaging	Off	same
Attenuation (input)	20 dB (all 3 inputs)	same
Impedance (input)	50 ohms (all 3 inputs)	same
Length R	On, 0 meters	On, 1.3 meters
Length A	On, 0 meters	same
Length B	On, 0 meters	same
User def constants	K1 = 1.0 + j0.0	same
	K2 = 50.0 + j0.0	same
	K3 = 75.0 + j0.0	same
User def functions	F1 = (B/R) / (K1-B/R)	same
	F2 = A/R	same
	F3 = (K1+F2) / (K1-F2)	same
	F4 = K2*F3	same
	F5 = K3*F3	same

where F1 converts closed loop gain to open loop gain, F2 is input reflection (if the test set is configured forward), F3 converts the reflection measurement to normalized impedance for port 1 of the test set, F4 converts normalized impedance to actual impedance where $Z_o = 50\Omega$, and F5 converts normalized impedance to actual impedance where $Z_o = 75\Omega$. For a more complete listing of preset parameters, refer to the REMOTE OPERATION section.

INSTRUMENT STATE

INSTRUMENT STATE is one of five front panel sections. The hardkeys in this section may be used to SAVE and RECALL instrument state, PRESET the HP 3577A, PLOT what appears on the screen, monitor the HP-IB

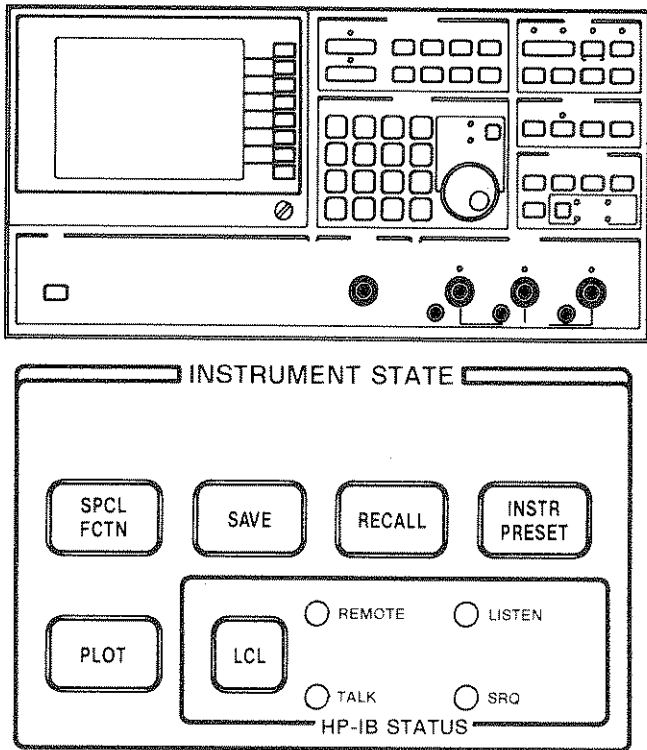

Figure 4-19

status of the HP 3577A, or use the SPECIAL FUNCTIONS.

SPECIAL FUNCTIONS include changing the HP-IB address, confidence testing the HP 3577A, turning the beeper on and off, service diagnostics, and INPUT menu S-parameter control.

INSTRUMENT STATE is also a term that refers to the state or values of all parameters. This state may be SAVED and later RECALLED. For more information on the features described here, refer to the hardkey of interest.

KNOB

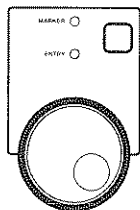

Figure 4-20

The **KNOB** in the DATA ENTRY section is used to move the marker or modify data. It is toggled between these two modes with the unmarked key above it. The current mode of the knob is indicated by the LED's above it. The knob may not be used to change the HP-IB address.

LENGTH

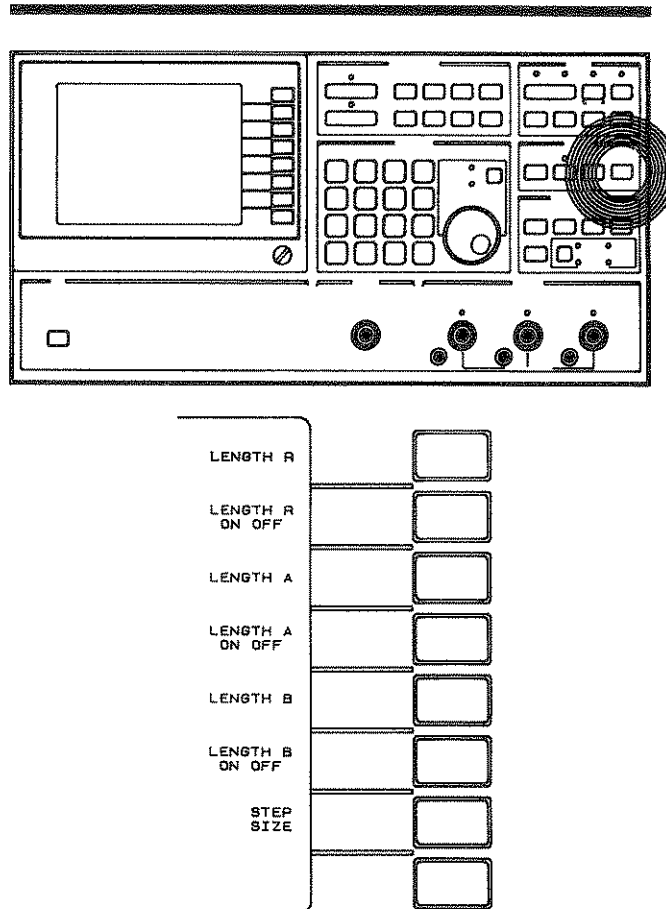

Figure 4-21

LENGTH is a hardkey in the RECEIVER section of the front panel used to display the menu of softkey labels shown above. These softkeys may be used to select the electrical length of each of the receiver inputs to compensate for, or simulate cable lengths. Propagation velocity is assumed to be the speed of light. The actual cable length should be compensated for using a relative velocity. Each input's LENGTH feature may be turned off, which is equivalent to setting its value to 0.

To change the value of length for a receiver input:

1. Press the LENGTH hardkey to display the menu
 2. Press the softkey LENGTH for the channel to be modified (if the label is not bright)
 3. Modify the value with the knob or arrow keys
- OR
3. Enter a new value with the numeric key pad
 4. Select units from the menu (press a softkey)

LENGTH affects phase functions only; there is no loss factor. If the current DISPLAY FUNCTION is LOG or LIN MAG there is no change in the trace with changes in LENGTH.

Preset or default value: 0.0m, ON
 Upper limit: 1 second or 300,000,000 meters
 Lower limit: -1 second or -300,000,000 meters
 Resolution: .001 ns or .1 cm
 Menu Units: m, cm, SEC, mSEC, μ SEC, nSEC, EXP

LOCAL

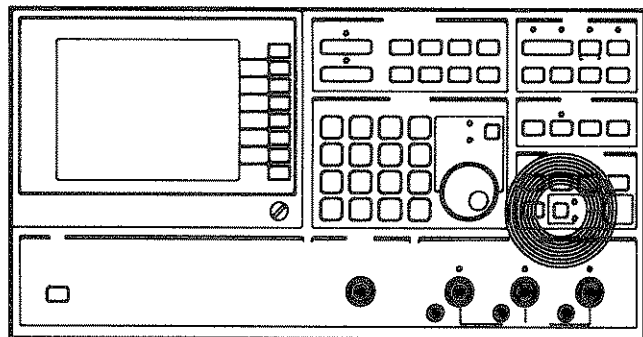

Figure 4-22

LOCAL is a hardkey in the INSTRUMENT STATE section of the front panel used to change the HP-IB status of the HP 3577A from REMOTE to LOCAL if the LOCAL LOCKOUT command has not been issued.

The **LCL** key is part of the HP-IB STATUS block. This block has four LED indicators that show the HP-IB status for REMOTE, TALK, LISTEN, and SRQ. If the REMOTE LED is illuminated, none of the front panel keys have any effect until the LCL key returns LOCAL control (which extinguishes the REMOTE LED). If the HP-IB controller has issued the LOCAL LOCKOUT command and the REMOTE LED is illuminated, the LCL key cannot gain LOCAL control. See the section on remote operation.

MARKER

MARKER is a hardkey in the DISPLAY FORMAT section of the front panel used to display the menus of softkey labels shown in Figure 4-23. These softkeys may be used to read data from the displayed trace. After being PRESET the HP 3577A's knob is in the MARKER position mode. The marker (small circle) may be moved to any part of the trace with the knob and the data for that point appears in the MARKER BLOCK above the right half of the graticule. Note that the MARKER information is valid even though the trace may be clipped by the upper or lower edges of the graticule. The arrow keys may also be used to move the marker across the trace. If the frequency span is 0 Hz and the sweep time is less than 1000 seconds, the marker position reads out in units of time.

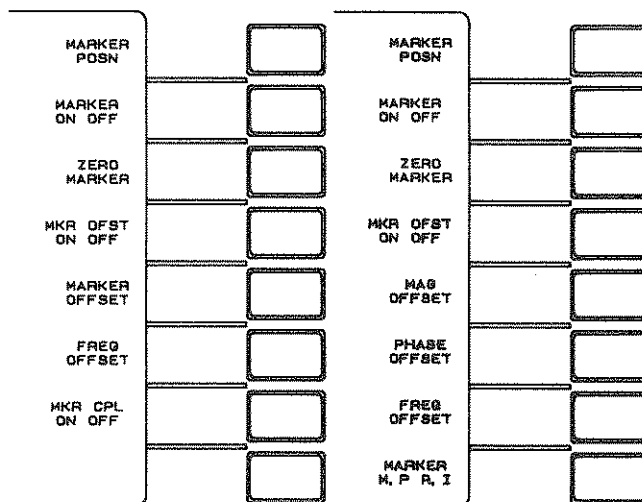
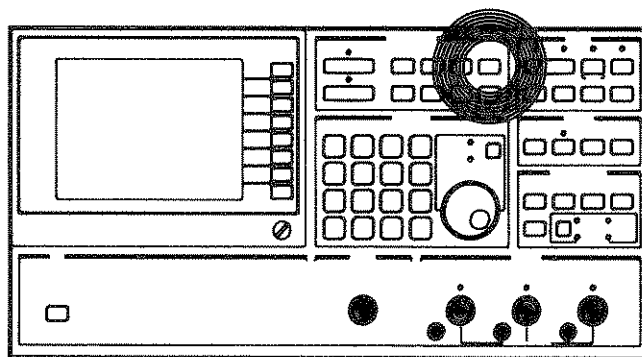

4-23A Rectangular

4-23B Polar

Figure 4-23

MARKER POSITION is a softkey which must be selected when the arrow keys are used to move the marker. Note that when MARKER POSITION is bright the knob moves the marker in either the MARKER or ENTRY modes.

MARKER ON/OFF is a push-push toggle type softkey used to turn the marker and the MARKER BLOCK off and back on. The default condition is on. If the marker is off, pressing the MKR hardkey turns it on.

ZERO MARKER is a softkey which turns on the OFFSET MARKER and sets its X-Y coordinates (OFFSET values) to those of the regular marker. This marker appears as a small triangle on top of the regular marker (which is a small circle). When ZERO MARKER is activated the marker information block above the graticule contains OFFSET information. The OFFSET MARKER becomes the reference for the regular marker.

MARKER OFFSET ON/OFF is a softkey used to turn on the OFFSET MARKER at the values represented by the MARKER OFFSET (magnitude) and FREQ OFFSET parameters. This is a push-push toggle type softkey. When ON the triangular OFFSET MARKER appears on

the screen (if its coordinates are on-scale) and the word "MARKER" changes to "OFFSET" in the marker block above the graticule.

MARKER OFFSET is a softkey used to enter a reference value for the Y-axis of the OFFSET MARKER. The default value for MARKER OFFSET is 0.0 dBm. To change this value:

1. Press the MKR hardkey to display the menu
 2. Press the MARKER OFFSET softkey (if label is not bright)
 3. Modify the data with the knob or arrow keys
- OR
3. Enter a new value with the numeric key pad
 4. Select units from the menu (press a softkey)

FREQUENCY OFFSET is a softkey that allows the user to enter a reference value for the X-axis of the OFFSET MARKER. The default value for FREQUENCY OFFSET is 0 Hz (in a frequency sweep). When SWEEP TYPE is AMPLITUDE this softkey label reads "AMPLITUDE OFFSET." This parameter may be modified in the same manner as MAGNITUDE OFFSET.

MARKER COUPLING ON/OFF is a push-push toggle type softkey used when two traces are on. In the default setting (ON) both markers move together when the knob is rotated. If MARKER COUPLING is turned OFF, turning the knob moves only the marker on the active trace.

When the DISPLAY FUNCTION is POLAR only one trace is active, so there is only one active marker. This marker has three values associated with it; frequency, magnitude and phase (or frequency, real, and imaginary). With the POLAR DISPLAY FUNCTION the MKR menu appears as shown in Figure 4-23B. The following discussion of softkey features assumes that the active display function is POLAR. The top four softkey labels operate in the POLAR DISPLAY FUNCTION the same as they do in a rectangular display function.

MAGNITUDE OFFSET is a softkey used to enter or modify the value of magnitude for the offset marker. The default value of magnitude offset is 0.0 V without a test set and 0.0 units with a test set. Pressing the ZERO MARKER softkey resets this value to the current magnitude value of the regular marker. This softkey label changes to read "REAL OFFSET" when the selected units are changed with the MARKER M,P R,I softkey. To change the value of this parameter:

1. Press DSPLY FCTN hardkey to display a menu
2. Press the POLAR softkey (if label is not bright)
3. Press the MKR hardkey to display a menu

4. Press the MAG OFFSET softkey (if label is not bright)
 5. Modify the value with the knob or the arrow keys
- OR
5. Enter a new value for MAG OFFSET with the numeric key pad
 6. Select units from menu (press a softkey)

PHASE OFFSET is a softkey which allows data entry of the phase data to place the OFFSET MARKER as a reference for the regular marker. This parameter value may be entered or modified in the same manner as described previously for MAGNITUDE OFFSET. The OFFSET MARKER may be on or off when this is done. Pressing the ZERO MARKER softkey resets this data to the current phase of the regular marker. The softkey label changes to IMAGINARY OFFSET when the units are changed with the softkey at the bottom of the menu from magnitude & phase to real & imaginary. This is described later in this discussion.

FREQUENCY OFFSET is a softkey that operates the same in the POLAR as in a rectangular display function. Note that in polar display function, changing this value does not change the screen position of the offset marker. The value of this parameter may be modified to offset the frequency readout in the marker information block.

MARKER M,P R,I is a push-push toggle type softkey which changes the units of the marker information from magnitude & phase to real & imaginary. The default setting is magnitude and phase units. To change the units to real and imaginary, press the MARKER M,P R,I softkey once. Pressing it a second time returns the units to magnitude and phase. The selected unit type is indicated by bright letters M,P for magnitude and phase or bright letters R,I for real and imaginary.

MARKER →

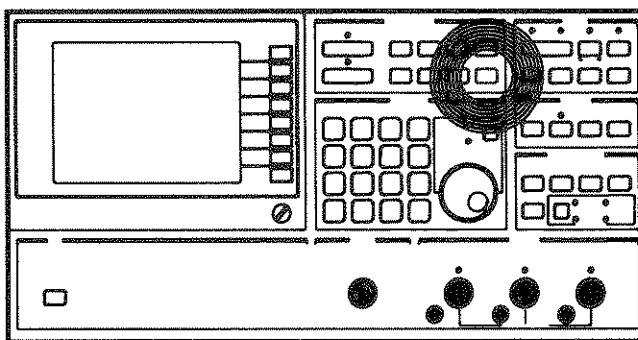

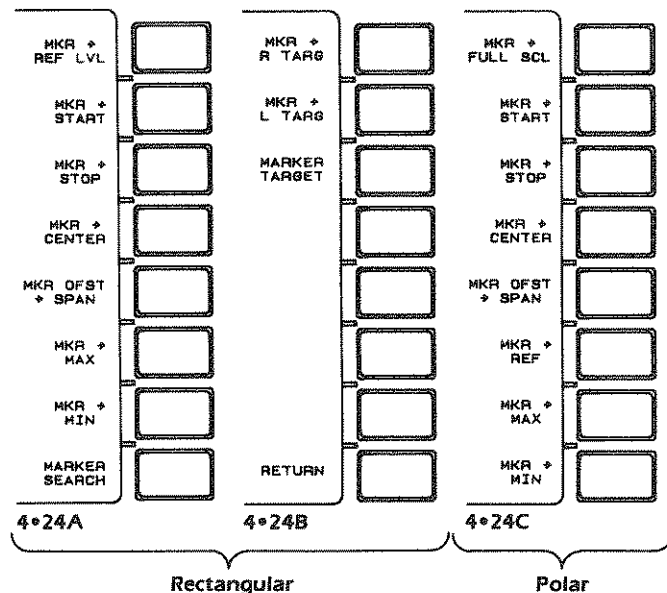

Figure 4-24

MARKER → is a hardkey in the DISPLAY FORMAT section of the front panel used to display the menus of softkeys shown above. Some of these softkeys may be used to enter data corresponding to the position of the marker. Others move the marker to points of interest.

MARKER → REFERENCE LEVEL is a softkey used to change the current value of REFERENCE LEVEL to the magnitude (position) of the marker. This redefines the level at the dashed line such that the trace moves up or down putting the marker on the reference line. To use this feature:

1. Move the marker to the point on the trace whose magnitude you wish to be the new reference level (dashed line value)
2. Press the MKR → hardkey to display the menu
3. Press the MKR → REF LVL softkey

MARKER → START FREQ is a softkey used to change the current value of START FREQUENCY to the frequency (position) of the marker. To use this feature:

1. Move the marker to the point on the trace that you wish to be the new start frequency
2. Press the MKR → hardkey to display the menu
3. Press the MKR → START softkey

MARKER → STOP FREQ is a softkey used to change the current value of STOP FREQUENCY to the frequency (position) of the marker. To use this feature:

1. Move the marker to the point on the trace that you wish to be the new stop frequency
2. Press the MKR → hardkey to display the menu
3. Press the MKR → STOP softkey

MARKER → CENTER FREQ is a softkey that allows the present frequency of the marker to be entered into the CENTER FREQUENCY value. To use this feature:

1. Move the marker to the point on the trace that you wish to be the new center frequency
2. Press the MKR → hardkey to display the menu
3. Press the MKR → CENTER softkey

MARKER OFFSET → SPAN is a softkey used to select new START and STOP frequencies (i.e., frequency span). The start and stop frequencies are selected by positioning the reference and regular markers. To use this feature:

1. Move the marker to the point on the trace that you wish to be one of the end frequencies
2. Press the MKR hardkey to display a menu
3. Press the ZERO MARKER softkey to turn on the OFFSET MARKER
4. Move the marker to the point on the trace that you wish to be the other end frequency
5. Press the MKR → hardkey to display the menu
6. Press the MKR OFST → SPAN softkey

MARKER → MAX is a softkey used to move the marker to the bin containing the largest value. To use this feature:

1. Press the MKR → hardkey to display the menu
2. Press the MKR → MAX softkey

MARKER → MIN is a softkey used to move the marker to the bin containing the smallest value. To use this feature:

1. Press the MKR → hardkey to display the menu
2. Press the MKR → MIN softkey

Note that if future sweeps create maximum or minimum values in bins other than the position of the marker, the marker does not move to that bin. The marker remains at the position selected through the use of the last MKR → MIN or MKR → MAX softkey.

MARKER SEARCH is a softkey used to search for a target value defined by the user. Pressing this softkey displays a new menu shown in Figure 4-24B. The active softkey in this menu is MARKER TARGET.

MARKER → RIGHT TO TARGET is a softkey used to search to the right for the TARGET value entered by the user. The default value of the MARKER TARGET is 10.01 dBm without the test set and -3 dB with the test set. To use this feature:

1. Press MKR → hardkey to display a menu
2. Press the MARKER SEARCH softkey to display the second menu
3. Press the MKR → R TARG softkey

If the target value does not exist to the right of the marker, the screen message "TARGET VALUE NOT FOUND" appears and the marker does not change position. If the value exists in more than one bin the marker moves in the selected direction to the first bin containing the the value closest to the target value. Refer to the marker information block above the graticule.

MARKER → LEFT TO TARGET is a softkey used to search to the left for the TARGET value entered by the user. The default value of the MARKER TARGET is 10.01 dBm without a test set and -3 dB with a test set. To use this feature:

1. Press the MKR→ hardkey to display a menu
2. Press the MARKER SEARCH softkey to display the second menu
3. Press the MKR→ L TARG softkey

If the target value does not exist to the left of the marker, the screen message "TARGET VALUE NOT FOUND" appears and the marker does not change position. If the value exists in more than one bin the marker moves to the closest bin containing the target value. The bin value is not necessarily exactly equal to the target value. Refer to the marker information block above the graticule.

MARKER TARGET is a softkey used to enter a value to search for with the marker. The default value of the TARGET is 10.01 dBm without a test set and -3 dB with a test set. To use this feature:

1. Press the MKR→ hardkey to display a menu
2. Press the MARKER SEARCH softkey to display the second menu
3. Modify the value with the knob or arrow keys

OR

3. Enter a new value with the numeric key pad
4. Select units from the menu (press a softkey)

RETURN is a softkey that displays the previous menu. This may also be done by pressing the MKR → hardkey.

When the DISPLAY FUNCTION is POLAR the MKR→ menu appears with different softkey labels than when the DISPLAY FUNCTION is one of the rectangular formats as shown in Figure 4-24C. The following discussions of softkey features assume that the active DISPLAY FUNCTION is POLAR.

MARKER → FULL SCALE is a softkey used to change the value of FULL SCALE to the magnitude (position) of the marker. This sets the level of the outer ring of the polar graticule to the current magnitude of the marker which has the effect of changing the scale.

To use this feature:

1. Move the marker to the point you wish to be on the outer ring of the polar graticule
2. Press the MKR→ hardkey to display the menu
3. Press the MKR→ FULL SCL softkey

MARKER → START FREQUENCY is a softkey that also appears in the MKR→ menu for rectangular display formats. It works the same for polar formats. In POLAR there is only one trace and only one marker. The marker has three values associated with it: frequency, magnitude, and phase (or frequency, real, and imaginary). The MKR→START FREQ softkey puts the present frequency value of the marker into the START FREQ value.

MARKER → STOP FREQUENCY is a softkey that works the same in polar as rectangular display formats.

MARKER → CENTER FREQUENCY is a softkey that works the same in polar as rectangular display formats.

MARKER OFFSET → FREQ SPAN is a softkey that works the same in polar as rectangular display formats.

MARKER → REFERENCE is a hardkey that puts the current phase value of the marker into the value of the reference line. This has the effect of rotating the polar trace, leaving the marker on the dashed line. To use this feature:

1. Move the marker to the point on the trace that you wish to be the new phase reference
2. Press the MKR→ hardkey to display the menu
3. Press the MKR→ REF softkey

MARKER → MAX is a softkey that works the same in polar as rectangular display formats.

MARKER → MIN is a softkey that works the same in polar as rectangular display formats.

MEASUREMENT CALIBRATION

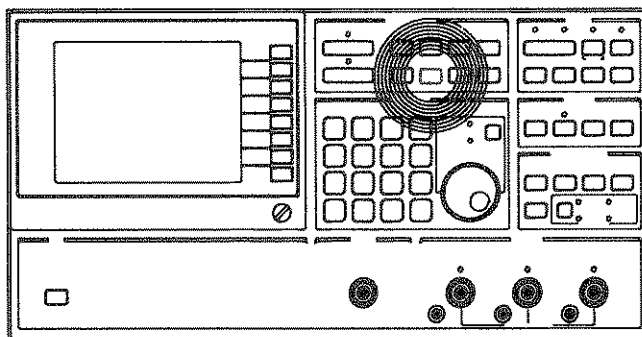

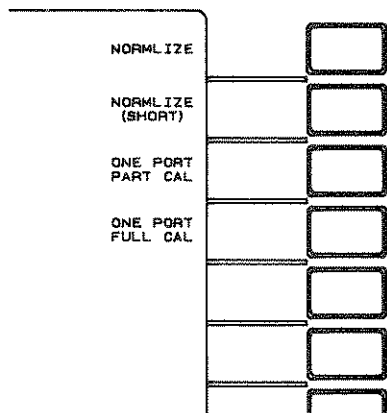

Figure 4-25

MEASUREMENT CALIBRATION is a hardkey in the DISPLAY FORMAT section of the front panel used to display the menu of softkeys shown in the figure above. Items in the MEASR CAL menu help the user calibrate out the effects of measurement hardware imperfections. None of these softkey functions are operable if the active sweep type is ALTERNATE SWEEP.

NORMALIZE is a softkey that is used to remove cable lengths and imperfections in the source flatness from simple measurements. To use this feature:

1. Set up the measurement
2. Replace the device under test with a through (barrel adapter)
3. Wait for a full sweep update of the trace
4. Press the MEASR CAL hardkey to display the menu
5. Press the NORMLIZE softkey
6. Replace the barrel with the test device

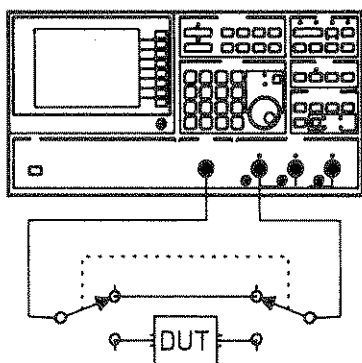

Figure 4-26

To normalize, the HP 3577A uses the INPUT as it is originally defined to store the trace in register D1 (for trace 1) or D2 (for trace 2). Then it redefines the INPUT to be "old INPUT"/D1 or "old INPUT"/D2, whichever applies (dependent on trace being operated on).

NORMALIZE may also be used to calibrate a reflection measurement. The configuration shown in Figure 4-27 should be used with an open as the standard. The procedure is the same as previously described except that, instead of replacing the device under test with a through, the D.U.T. should be disconnected and the connection to the directional bridge left open.

NORMALIZE (SHORT) may be used in the same manner as **NORMALIZE** for normalizing single port (reflection) measurements. The standard used should be a short.

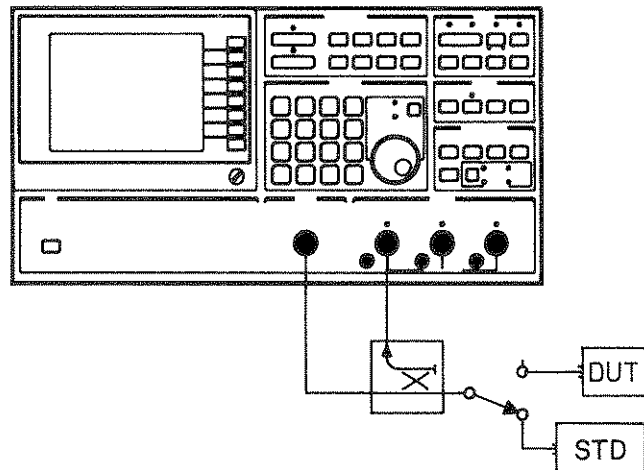

Figure 4-27

NOTE

The HP 3577A does not allow normalization of INPUT expressions other than A,B,R,A/R, or B/R.

ONE PORT PARTIAL CAL is a softkey label in the MEASUREMENT CALIBRATION menu used to improve accuracy of return loss measurements by doing two-term error correction. Use of this feature destroys the contents of registers D3 and D4 and redefines the function F2 and the constant K1. To use this feature:

1. Set up the measurement (INPUT, FREQ, AMPTD, SWEEP TIME etc.)
2. Press the MEASR CAL hardkey to display the menu
3. The HP 3577A displays a screen message to LEAVE PORT 1 OPEN
4. Disconnect the cable to PORT 1
5. Press the CONTINUE CAL softkey
6. Wait for the HP 3577A to do a complete sweep
7. The HP 3577A displays a message to INSTALL REFERENCE LOAD ON PORT 1 of the HP 35677A/B S-parameter test set

8. Install a calibrated load of characteristic impedance on PORT 1 of the HP 35677A/B S-parameter test set
9. Press the CONTINUE CAL softkey
10. Wait for the message CALIBRATION COMPLETE
11. Reconnect the device to be tested to PORT 1

When calibration is complete the INPUT is the user defined function F2, CALIBRATED REFLECTION. To display the NORMALIZED IMPEDANCE FUNCTION select INPUT = F3 as follows:

1. Press the INPUT hardkey to display the menu
2. Press the USER DEF INPUT softkey
3. Press the F__ softkey
4. Press the 3 softkey (or 3 in the numeric key pad)
5. Press the ENTER softkey

To display the definition of F3:

1. Press the DEFINE MATH hardkey
2. Press the DEFINE FUNCTION softkey
3. Press the F3 softkey and read "(K1 + F2)/(K1-F2)" in the entry block portion of the screen

The error model expression is $M_{meas} = D + F * M_{actual}$ where D is the directivity error term and F is the frequency response error term. When calibrated the HP 3577A displays $M_{actual} = (M_{meas} - D) / F$.

To solve for M_{actual} , the HP 3577A stores A/R measured with an open termination into D4. Then it stores the directivity error term D (with the standard load) in D3 and redefines D4 to be $D4 - D3$, the frequency response error term F. The user defined function F2 is now the calibrated reflection function used to solve for M_{actual} ; $F2 = (A/R - D3) / D4$ which represents $M_{actual} = (M_{meas} - D) / F$.

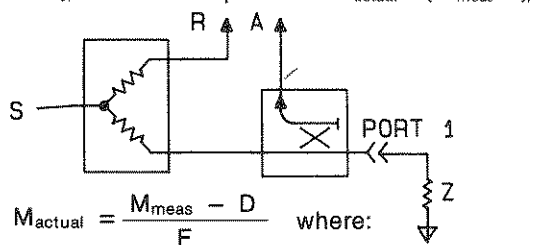

$$D = \Gamma_t$$

$$F = \Gamma_{oc} - \Gamma_t \quad \Gamma_t = \frac{A}{R} \Big|_{Z=Z_0} \quad \Gamma_{oc} = \frac{A}{R} \Big|_{Z=open}$$

Figure 4*28

ONE PORT FULL CAL is a softkey label in the MEASUREMENT CALIBRATION menu used to improve return loss measurement accuracy. Use of this feature destroys the contents of data registers D1 (for trace 1) or D2 (for trace 2), D3, and D4, and redefine F1, F2, and K1.

Use of this feature is identical to that of the two-term error correction described previously, with the addition of a step requiring that PORT 1 of the S-parameter test set be terminated with a short. Messages on the screen

ask the user to LEAVE PORT 1 OPEN, INSTALL SHORT ON PORT 1, and INSTALL REFERENCE LOAD ON PORT 1 (of the S-parameter test set). After each termination is connected, the CONTINUE CAL softkey is pressed and the HP 3577A collects data by sweeping (during which sweep time we must patiently wait). When this sequence is complete, F2 is the displayed trace and has been defined to be the CALIBRATED REFLECTION. The normalized impedance function may be displayed by selecting F3 for the user defined INPUT, as previously described.

The error model expression used for the 3-term correction function is $M_{meas} = (D + T * M_{actual}) / (1 - S * M_{actual})$ where D is the correction factor for directivity, T is the correction factor for transmission and S is the factor for source match. When calibrated, the HP 3577A displays $M_{actual} = (M_{meas} - D) / (S * M_{meas} + T)$.

To solve for M_{actual} , the HP 3577A stores A/R measured with the open termination in D3. Then it requests the short termination and stores $(A/R) + D3$ in D4, stores $(A/R) - D3$ in D1 (or D2, depending on the active trace) defines $K1 = 2 + j0$, and stores $K1 * A/R * D3$ in D3. Next, it requests a standard load and stores $D3 - A/R * D4$ in D3, stores $D3 / D1$ (or D2) in D3 (which is now used as the error term B), stores $K1 * A/R - D4$ to D4, stores $D4 / D1$ (or D2) to D4 (now equivalent to the error term C), and stores A/R in D1 (or D2) (which is A in the error model expression). Finally, it defines $F1 = D4 * A/R + D3$ and $F2 = (A/R - D2) / F1$.

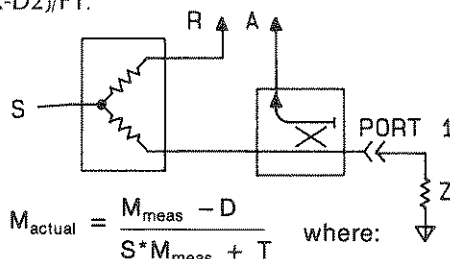

$$\Gamma_t = \frac{A}{R} \Big|_{Z=Z_0} \quad D = \Gamma_t$$

$$\Gamma_{oc} = \frac{A}{R} \Big|_{Z=open} \quad T = \frac{2\Gamma_{sc} \Gamma_{oc} - \Gamma_t (\Gamma_{sc} + \Gamma_{oc})}{\Gamma_{sc} - \Gamma_{oc}}$$

$$\Gamma_{sc} = \frac{A}{R} \Big|_{Z=0} \quad S = \frac{2\Gamma_t - \Gamma_{sc} + \Gamma_{oc}}{\Gamma_{sc} - \Gamma_{oc}}$$

Figure 4*29

NOTE

Changing either START or STOP frequencies destroys the calibration. Be sure to repeat normalization after any frequency modification.

MENU

A **MENU** is a list of softkey labels that is displayed on the CRT next to the column of softkeys. This part of the display is called the MENU AREA

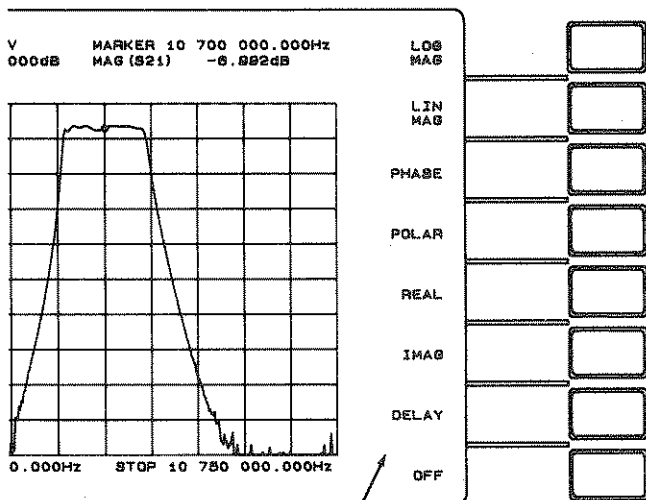
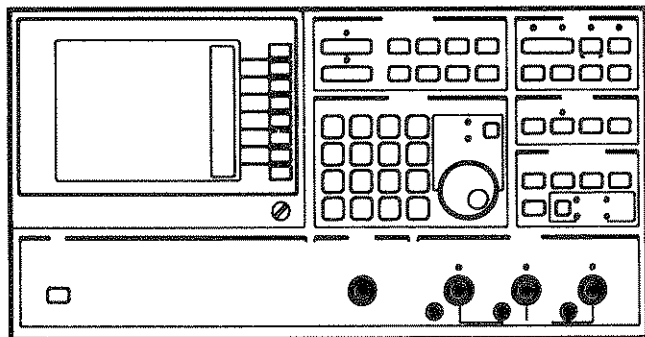

Menu

Figure 4*30

No menu contains more than eight softkey labels. Each softkey label is associated with the softkey beside it such that pressing its softkey effects the command represented by the softkey label.

Menus change whenever a hardkey is pressed or (if a menu is more than one level deep) when certain softkeys are pressed (see Figure 4*31).

Hardkeys are the stenciled keys on the front panel that do not change definition. Hardkeys (excluding the DATA ENTRY section) are used to display menus of softkey labels. Three hardkeys that do not display a menu are INSTR PRESET, LCL, and TRIG/RESET.

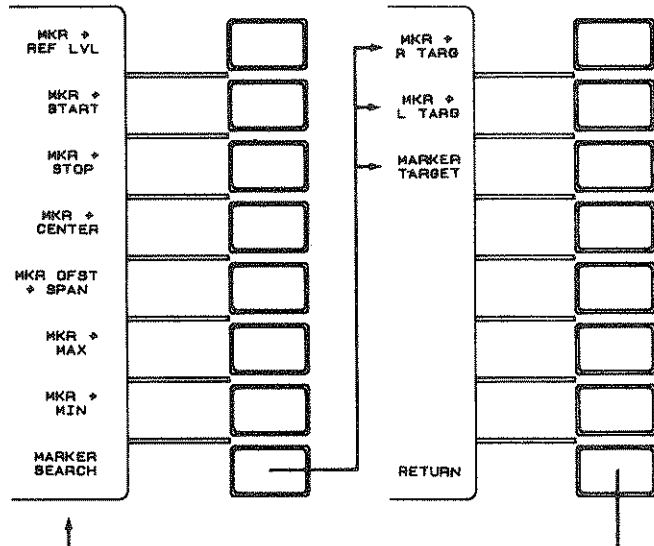

Figure 4*31

MESSAGE BLOCK

The **MESSAGE BLOCK** is the area within the graticule in which messages appear. See Figure 4*32. These messages may be warning, error, or general information messages. For a listing of these messages see Appendix C.

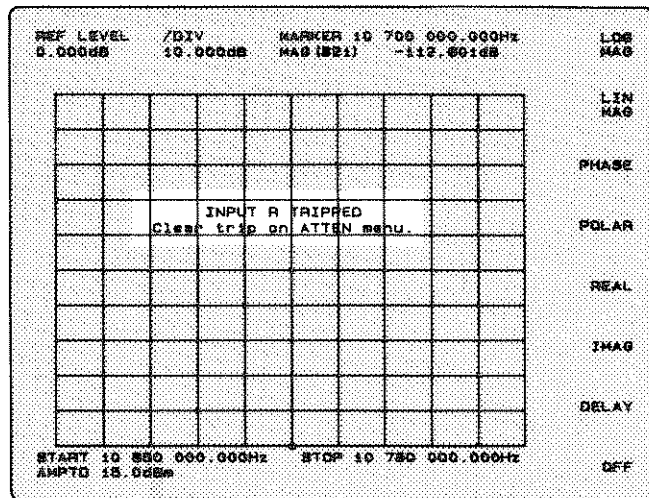

Figure 4*32

OUTPUT

The **OUTPUT** of the HP 3577A is the signal source. It is located at the lower center position on the front panel

and is the left-most of the four type-N connectors arranged along the bottom. The OUTPUT signal is controlled by the keys in the SOURCE section of the front panel. The characters across the bottom of the CRT show the status of the frequency and amplitude of the source. In LOG and ALTERNATE sweep types the amplitude information does not appear on the screen.

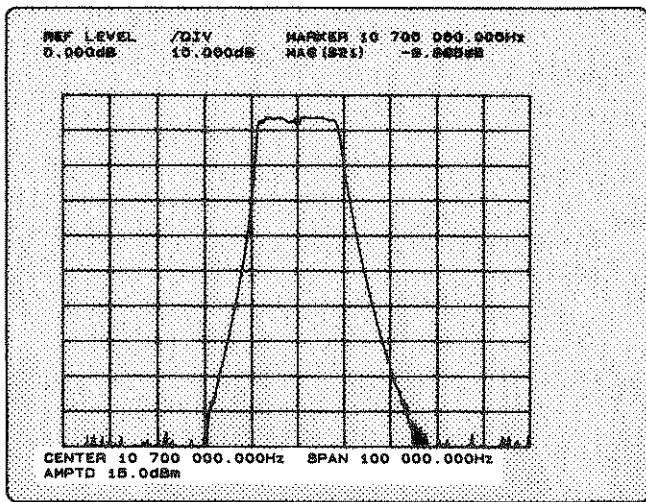
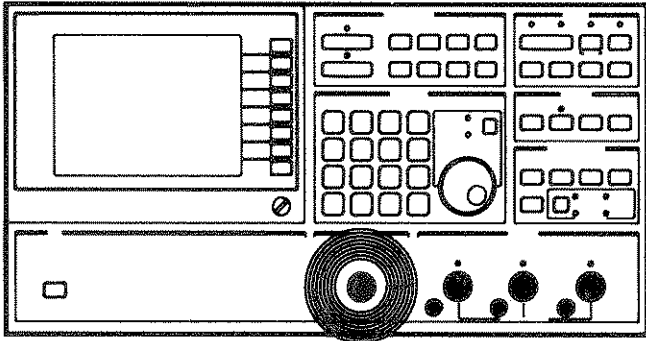

Figure 4*33 Output Signal Information

The OUTPUT has protection circuitry that opens the output path if a signal level greater than 4V appears on the connector. This open condition is called TRIPPED. The screen message "SOURCE TRIPPED, Clear trip on AMPTD menu" directs the user to the AMPTD menu where the softkey CLEAR TRIP may be found.

OVERLOAD

OVERLOAD occurs when a signal level larger than 0.0 dBm (with ATTEN = 20 dB) or -20 dBm (with ATTEN = 0 dB) is applied to one of the three receiver inputs. (If the frequencies of interest are below 1 kHz, reduce these signal levels 6 dB). When an input is overloaded the measurement accuracy is degraded and action should be taken to reduce the input level. When an

overload occurs, the HP 3577A sounds an audible alarm (if the beeper is ON), illuminates the red OVERLOAD LED above the input being overloaded, and displays a warning message on the screen. The red alarm LED is a real-time indication of an overload condition while the screen message remains until the beginning of a new sweep.

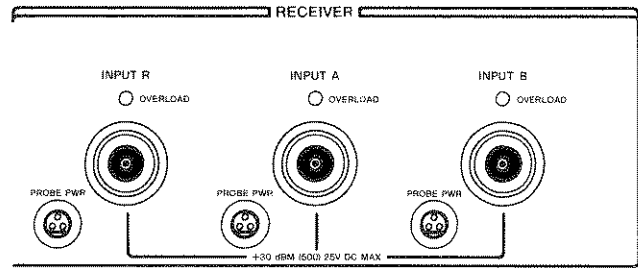

Figure 4*34

NOTE

If an overload occurs during a slow or single sweep, inaccurate trace data may remain on the screen. It is recommended that a new sweep be taken with reduced input levels before measurement values are taken.

If the signal level is increased to 1.1V the receiver input TRIPs (changes to 1 MΩ impedance) to protect itself from damage. To reset the TRIP press the ATTEN hardkey and then the CLEAR TRIP softkey. Note that the TRIP changes the impedance of the input but the ATTEN menu shows an impedance of 50 Ω. The impedance shown in the menu is a user selection, not the active impedance value.

PLOT

PLOT is a hardkey in the INSTRUMENT STATE section of the front panel used to display the menus of softkeys shown in Figure 4*35A. These softkeys are used to reproduce the display screen on paper, using an HP-IB

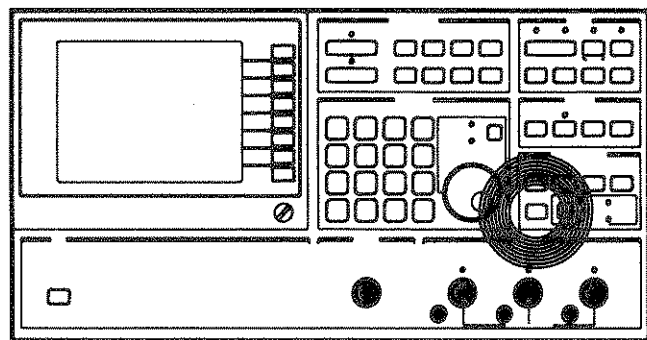

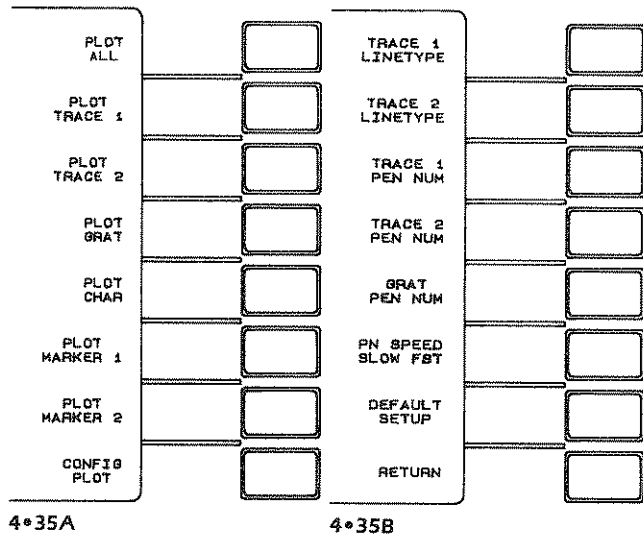

Figure 4*35

plotter. The plotter must be configured to LISTEN ONLY and the HP 3577A must be in the TALK ONLY mode (press SPCL FCTN hardkey, then the TALKONLY ON/OFF softkey so that "ON" is bright). Connect the HP-IB ports of the printer and the HP 3577A with an HP-IB cable. (Refer to "INSTALLATION" in the GENERAL INFORMATION section).

PLOT ALL is a softkey used to plot the active traces, the active markers, the graticule, and the alphanumeric above and below the graticule. When pressed, the plot begins, the screen message PLOT IN PROGRESS appears, and the menu changes to ABORT PLOT. Line types and pen numbers used are discussed under CONFIGURE PLOT. ABORT PLOT allows the user to interrupt the plot and the original menu returns. After a plot is aborted, it cannot be restarted where it stopped.

While the plot is in progress, ABORT PLOT is the only softkey label in the menu area. All other front panel keys (except INSTR PRESET) are ignored. ABORT PLOT may not stop the plot immediately. The delay depends on the time required for the plotter to execute the last command sent to it by the HP 3577A.

PLOT TRACE 1 is a softkey used to plot only TRACE 1. When pressed, trace 1 and any active markers on it are plotted. The plot may be interrupted by using the ABORT PLOT softkey as described in PLOT ALL.

PLOT TRACE 2 is a softkey that plots TRACE 2 exactly as described above for PLOT TRACE 1.

PLOT GRATICULE is a softkey used to plot the active graticule and reference lines. The reference lines are plotted using the pen (number) selected for plotting its associated trace. Pressing ABORT PLOT interrupts the

plot. If you don't want to plot the reference lines, turn them off with softkeys in the SCALE menu.

PLOT CHARACTERS is a softkey that plots the alphanumeric above and below the graticule. Pressing ABORT PLOT interrupts the plot.

PLOT MARKER 1 or 2 are softkeys used to plot multiple markers. This allows the user to mark many points of interest on the plot. The "extra" markers appear as a cross hair on the trace and the marker block information is plotted next to it. If the marker is near one of the edges of the graticule the marker information is moved such that it all appears on the graticule. Information blocks may overwrite each other if the markers are close. See Figure 4*36. To use this feature:

1. Move the marker to the point of interest on the trace
2. Press the PLOT hardkey to display the menu
3. Press the PLOT MARKER ___ softkey (1 = trace 1, 2 = trace 2)

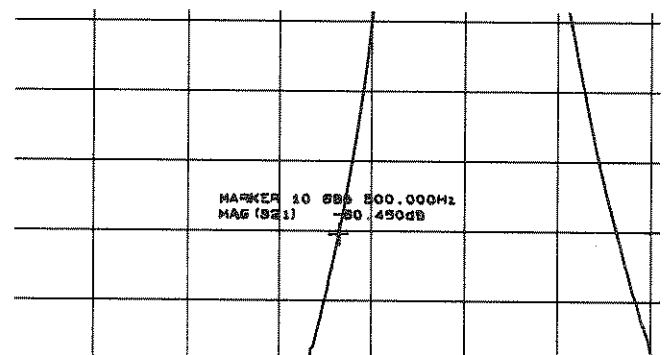
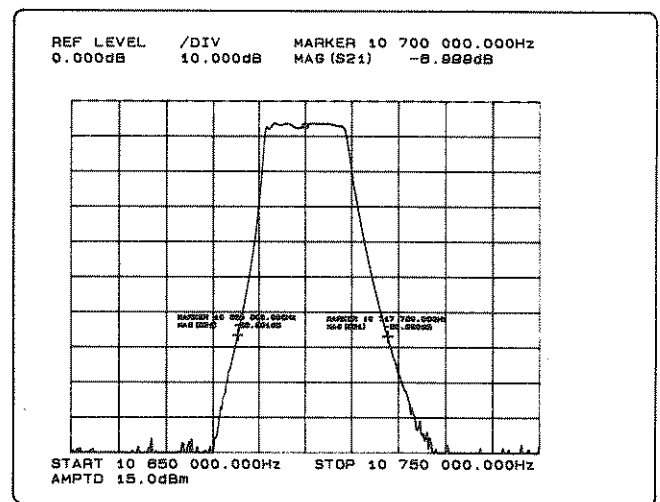

Figure 4*36

CONFIGURE PLOT is a softkey used to select pens, line types and pen velocity. Pressing this softkey changes the menu listing as shown in Figure 4*35B. These parameters are not affected by use of the INSTR PRESET

hardkey and are not saved with instrument state. See DEFAULT SETUP later in this discussion.

TRACE 1 LINETYPE is a softkey used to select the plotter line type (solid, dashes, dots, etc.) for trace 1. The line type available is dependent on the plotter. The default value is 7 (a solid line) and the range is 0-7. To select a line type:

1. Press the PLOT harkey to display the menu
2. Press the CONFIGURE PLOT softkey
3. Press the TRACE 1 LINETYPE (if label is not bright)
4. Modify the value with the knob or arrow keys

OR

4. Enter a new value with the numeric key pad
5. Press the UNITS softkey

TRACE 2 LINETYPE is a softkey used to select plotter line type for trace 2 as described for trace 1 above. The default value for TRACE 2 LINETYPE is 7 (solid).

TRACE 1 PEN NUMBER is a softkey used to select the plotter pen number for trace 1. This pen is also used to plot the alphanumeric information associated with trace 1. The default value for TRACE 1 PEN NUMBER is 1. PEN NUMBER is modified in the same manner as LINETYPE. The range of pen numbers is 0-8.

TRACE 2 PEN NUMBER is a softkey used to select the plotter pen number for trace 2 as described for trace 1. The default value for TRACE 2 PEN NUMBER is 2. PEN NUMBER is modified in the same manner as LINETYPE in the range 0-8.

GRATICULE PEN NUMBER is a softkey used to select the plotter pen number for the graticule and any alphanumeric information that is associated with both traces. This information includes "REF", "/DIV", start and stop or center and span frequencies (when not in ALTERNATE SWEEP TYPE), and source amplitude (when not in ALTERNATE or LOG SWEEP TYPE). In ALTERNATE SWEEP the frequency information is associated with a specific trace, so pen numbers selected by trace are used and amplitude information does not appear. In LOG FREQ SWEEP, amplitude information does not appear at the bottom of the screen. The default value of GRATICULE PEN NUMBER is 2. This parameter may be modified in the same manner as LINETYPE. The range of numbers allowed as data for this entry is 0-8.

PEN SPEED SLOW/FST is a softkey used to select either a slow pen velocity or the maximum. The default setting is FST. This pen velocity is dependent on the plotter in use. The SLOW pen speed is 10 cm/s for plotting with marginal pens or transparencies. This softkey is a

toggle selection. To modify this parameter, press the PLOT hardkey, and then the CONFIG PLOT softkey. The current setting of PEN SPEED appears bright. To change to the other selection of PEN SPEED, press the PEN SPEED softkey once.

DEFAULT SETUP is a softkey that resets the plot parameters to their default parameters:

- TRACE 1 LINETYPE = 7
- TRACE 2 LINETYPE = 7
- TRACE 1 PEN NUMBER = 1
- TRACE 2 PEN NUMBER = 2
- GRATICULE PEN NUMBER = 2
- PEN SPEED = FST

RETURN is a softkey that changes the menu listing back to the PLOT menu. This allows the user to plot after reconfiguration. The same thing is accomplished by pressing the PLOT hardkey.

RECALL INSTRUMENT STATE

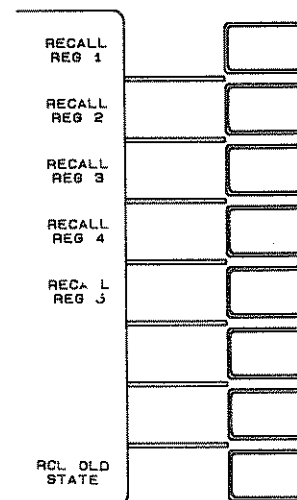
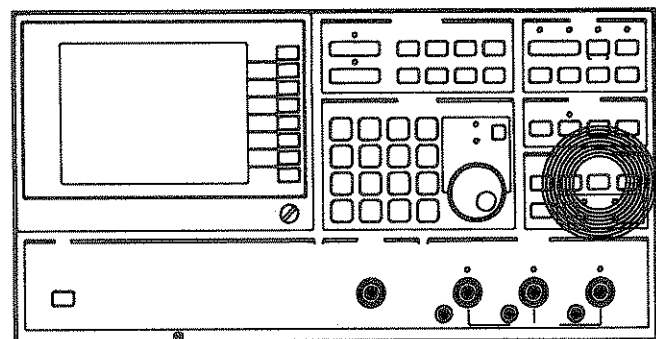

Figure 4-37

RECALL is a hardkey in the INSTRUMENT STATE section of the front panel used to recall 5 SAVED states

or the state of the HP 3577A when it was last turned off (RCL OLD STATE).

To use this feature:

1. Press the RECALL hardkey to display the menu
2. Press the softkey corresponding to the instrument state you wish to recall

If SAVE and RECALL hardkeys are held down when power is turned on, a special test of all main processor non-volatile memory is run that is not part of the regular power-on test. These two keys must be held down until the test messages begin appearing on the screen. One message should be "TOTAL RAM TEST. NON-VOLATILE MEMORY LOST." This test erases all main processor memory resetting INSTRUMENT STATE, PLOT parameters, and the HP-IB to default parameters. For the HP-IB this means that TALK ONLY is OFF and the bus address is 11. This test may be used if the HP 3577A won't respond to key presses and INSTRUMENT PRESET and cycling power has not cleared the problem.

RECEIVER

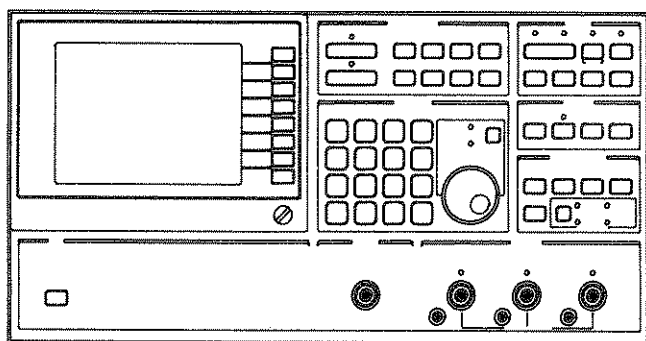

Figure 4-38

The **RECEIVER** section is one of five front panel sections. This section has four hardkeys which allow the user to control resolution bandwidth, vector averaging, attenuation, impedance, and length for each of the three receiver inputs. For more information on the individual hardkey, refer to the item of interest.

RESOLUTION BANDWIDTH

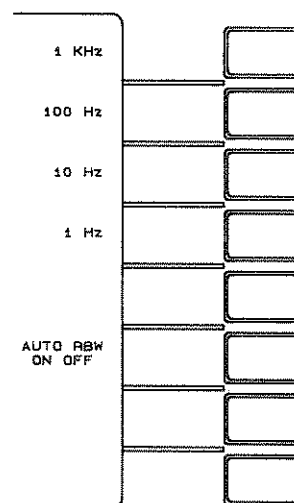
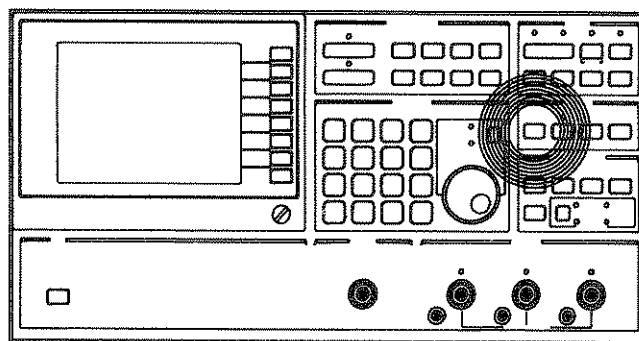

Figure 4-39

RESOLUTION BANDWIDTH is a hardkey in the RECEIVER front panel section used to display the menu of softkeys shown above. These softkeys may be used to select one of four resolution bandwidths for the receiver IF.

The top four softkey labels in this list are the only valid selections for resolution bandwidth. No data entry is appropriate. Narrow bandwidths usually require more sweep time for accurate measurements. For more on optimizing sweep time for a given bandwidth, refer to "Optimizing Sweep Time" in Appendix A.

AUTOMATIC RESOLUTION BANDWIDTH ON/OFF is a fifth softkey in the RES BW menu when the SWEEP TYPE is LOG FREQ. AUTO RBW is a feature that cycles up through the lower values of resolution bandwidth as the band is swept until it reaches the active (bright) RES BW. This prevents LO feedthru at low frequencies and allows fast, accurate measurements at high frequencies. With default parameters (sweeping 50 Hz to 200 MHz and RES BW = 1 kHz) the sweep starts at 50 Hz with a resolution bandwidth of 10 Hz. At 400 Hz the bandwidth changes to 100 Hz and at 4 kHz the bandwidth changes to 1 kHz. If FULL SWEEP is selected from the FREQ menu (or if START FREQ is changed to 5 Hz) AUTO RBW starts by waiting approximately 4

seconds for the source to settle. Then the sweep begins at 5 Hz with 1 Hz BW and changes to 10 Hz BW at 40 Hz. The cycle continues as described previously. When the SWEEP TYPE is ALTERNATE, the user may select a different resolution bandwidth for each of the two traces. This is in addition to being able to select different band sweeps, sweep times, and source amplitudes for each trace.

Each of the four resolution bandwidths has a settling time associated with it. Settling time is the time the source stays at the start frequency (or amplitude) before beginning a sweep. The following table lists the default values of settling time. Values other than these may be entered only through the use of the HP-IB and a computer controller. For more information on entering new values for settling time refer to the section on remote operation.

Res BW	Settling time
1 kHz	22 ms
100 Hz	55 ms
10 Hz	370 ms
1 Hz	3.707 s

S-PARAMETER TEST SET

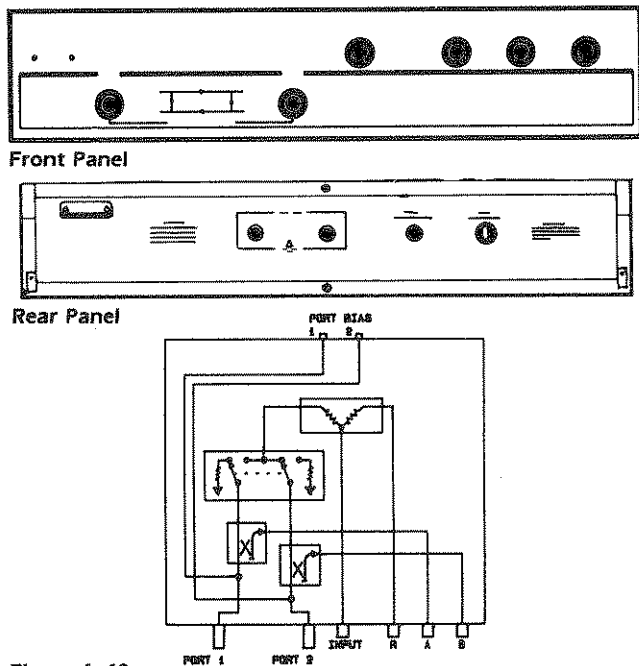

Figure 4*40

The HP 35677A/B is an S-parameter test set built for use with the HP 3577A Network Analyzer. The A model has 50 Ω ports and the B model has 75 Ω ports. Frequency response for the test set is from 100 kHz to 200 MHz. For complete specifications see the General Information section.

The test set has no internal power supply or HP-IB interface; it is powered and controlled by the HP 3577A. The two are connected together by an interconnection cable between the two instruments' rear panels and by four RF cables between the front panels. The rear panel cable supplies power and ground, control of the test set's coaxial switch and a sense line to indicate when the test set is connected to the analyzer (this changes the INPUT menu).

When the HP 35677A/B S-parameter test set is connected to the HP 3577A Network Analyzer the INPUT menu consists of S-parameters S11, S21, S12, and S22. These are defined in terms of receiver inputs and test set direction in Figure 2*29. Changing the test set direction effectively switches the signal source and termination of the device under test as though it were removed and reconnected to the test set in the reverse direction.

Different S-parameters may be selected for each of the two traces. If this requires the test set to be configured in both directions at the same time, ALTERNATE SWEEP TYPE must be used. In ALTERNATE SWEEP each sweep updates one of the traces and then reconfigures the test set and sweeps the other trace. This switches the test set's relay between sweeps. After five minutes operation in this manner, the HP 3577A times out, changes to SINGLE SWEEP MODE to limit wear on the test set relay. The user may change the SWEEP MODE back to CONTINUOUS for another five minutes of operation or make single sweeps by pressing the TRIG/RESET hardkey.

If ALTERNATE SWEEP is not used and the INPUT of a trace is changed such that the test set must change directions, the other trace INPUT is redefined also, since the test set can't be configured in both directions at the same time.

The direction of the S-parameter test set may be controlled directly by the user if a USER DEFINED INPUT is being specified. This may be done in the following manner:

1. Press the INPUT hardkey to display the menu
2. Press the USER DEF INPUT softkey
3. Enter the INPUT equation as described under the INPUT listing found earlier in this section.
4. Note the new softkey label that appears at the bottom of the menu TEST SET FWD/REV. This is a push-push toggle type key that directly controls the direction configuration of the test set. The change in configuration does not occur until the end of a sweep.

The ONE PORT calibration softkeys (PARTIAL and FULL CAL) found in the MEASR CAL menu are meant to be

used with the HP 35677A/B S-parameter test set or a similar configuration of power splitter and directional bridge.

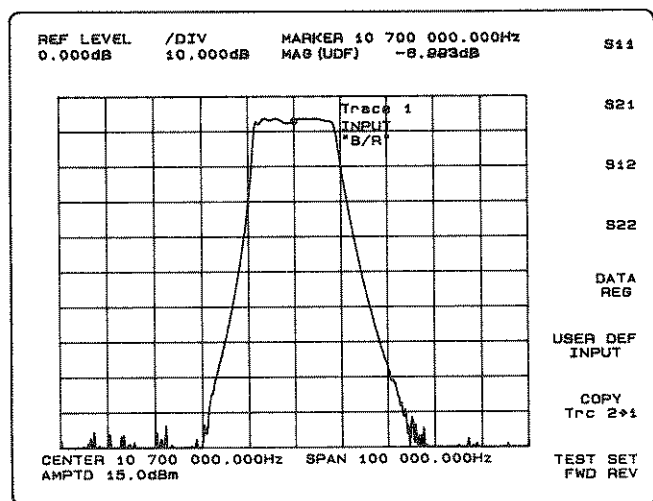

Figure 4*41

SAVE INSTRUMENT STATE

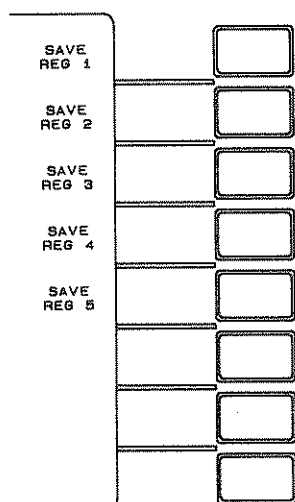
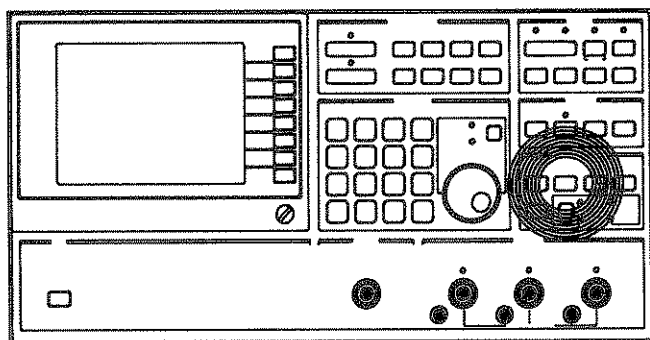

Figure 4*42

SAVE is a hardkey in the INSTRUMENT STATE section of the front panel used to display the menu of softkeys shown above. These softkeys may be used to save 5 instrument states. An INSTRUMENT STATE is the total set of instrument parameters. This feature is convenient for saving a complex and/or often-used test configuration and RECALLing it for use at a later time.

To use this feature:

1. Press the SAVE hardkey to display the menu
2. Press the softkey corresponding to the register in which you wish to save the current instrument state

If SAVE and RECALL hardkeys are held down when power is turned on, a special test of all main processor non-volatile memory is run that is not part of the regular power-on test. These two keys must be held down until the test messages begin appearing on the screen. One message should be "TOTAL RAM TEST. NON-VOLATILE MEMORY LOST". This test erases all main processor memory resetting INSTRUMENT STATE, PLOT parameters, and the HP-IB to default parameters. For the HP-IB this means that TALK ONLY is OFF and the bus address is 11. This test may be used if the HP 3577A won't respond to key presses and INSTRUMENT PRE-SET and cycling power have not cleared the problem.

SCALE

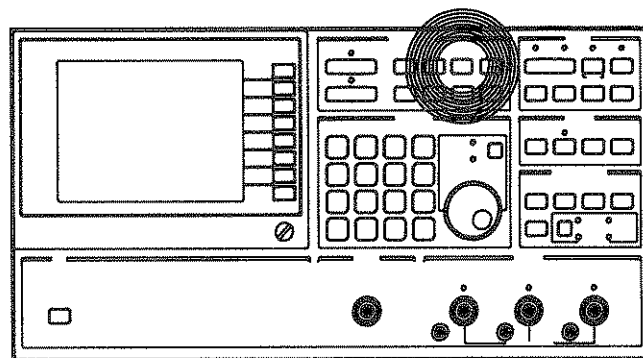

Figure 4*43A

SCALE is a hardkey in the DISPLAY FORMAT section of the front panel used to display the menus of softkeys shown in Figure 4*43B. These softkeys may be used to modify the vertical axis scale and value of the reference line. None of the SCALE features require a new measurement sweep when their values change (unless in Alternate sweep). Each uses data stored in trace memory to reconfigure the screen.

REFERENCE LEVEL is a softkey used to enter the value the dashed reference line represents. The default values for REFERENCE LEVEL are 0 dBm without and 0 dB with

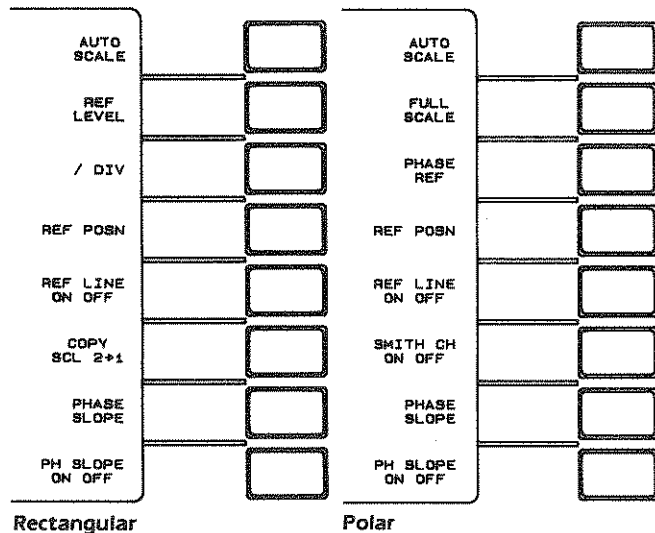

Figure 4-43B

the test set. The REFERENCE LEVEL value is valid and active even when the REFERENCE LINE has been turned off.

To change the value of REFERENCE LEVEL:

1. Press the SCALE hardkey to display the menu
2. Press the REF LEVEL softkey (if label is not bright)
3. Modify the value with the knob or arrow keys

OR

3. Enter a new value with the numeric key pad
4. Select units from the menu (press a softkey)

/DIV is a softkey used to to enter a value for the vertical scale. The value of /DIV may be changed in the same manner as shown for REFERENCE LEVEL.

REFERENCE POSITION is a softkey used to enter a value that moves the dashed line to a different height on the graticule. For LOG MAG the default position is the top of the graticule, or 100%. PHASE REFERENCE POSITION is 50%, LIN MAG REF POS is 0% (the bottom of the graticule). The value of REF POS may be changed in the same manner as shown for REFERENCE LEVEL.

REFERENCE LINE ON/OFF is a softkey used to turn the dashed reference line off and back on. To use this feature, press the SCALE hardkey, and then the REF LINE ON/OFF softkey. This is a push-push toggle type key function. Each time the softkey is pressed the softkey label changes from OFF to ON or ON to OFF. The current status of the feature is indicated by the relative brightness of the ON or OFF in the label.

COPY SCALE is a softkey used to copy the SCALE parameters REF LEVEL, and /DIV of the inactive trace into

the active trace. The softkey label varies depending on which trace is selected. If trace 1 is selected it reads COPY SCALE 2→1; if trace 2 is selected it reads COPY SCALE 1→2.

AUTO SCALE is a softkey used to quickly scale the trace so that it fills the graticule without clipping the trace. To use this feature, press the SCALE hardkey and then the AUTO SCALE softkey.

PHASE SLOPE is a softkey that appears in the menu when the DISPLAY FUNCTION is PHASE or a function of phase (like delay). This softkey is used to add or subtract a phase shift term to the defined input. PHASE SLOPE units are degrees/SPAN or radians/SPAN. This is somewhat like the LENGTH for use with a trace instead of individual receiver inputs and may be used as a phase flattener. Note that changes in frequency span require modification of PHASE SLOPE if it is to have the same effect on the new span. The value of PHASE SLOPE may be changed in the same manner as shown for REFERENCE LEVEL.

One important difference between LENGTH and PHASE SLOPE is that LENGTH values are used to process incoming data when a measurement is being taken and affects values stored in trace memory. PHASE SLOPE processing uses data stored in trace memory to create a new trace for the screen and so does not affect stored data or require a measurement sweep when new PHASE SLOPE values are entered.

PHASE SLOPE ON/OFF is a softkey used to turn the PHASE SLOPE feature off and back on. This is a push-push toggle type softkey. Turning the feature off has the same effect on the measurement as if a value of 0 deg/SPAN was entered for PHASE SLOPE.

FULL SCALE is a softkey used to change the value of magnitude represented by the outer ring of the polar graticule. If the DISPLAY FUNCTION is POLAR, the menu shown when the hardkey SCALE is pressed contains FULL SCALE instead of REF LEVEL. To change the value of FULL SCALE:

1. Press the SCALE hardkey to display the menu
2. Press the FULL SCALE softkey (if label is not bright)
3. Modify the value with the knob or arrow keys

OR

3. Enter a new value with the numeric key pad
4. Select units from the menu (press a softkey)

PHASE REFERENCE is a softkey used to change the value of phase represented by the dashed line that exists between the center and outer ring of the graticule. Changing the PHASE REFERENCE has the effect of

rotating the trace. The value of PHASE REF may be changed in the same manner as shown for REFERENCE LEVEL.

REFERENCE POSITION is a softkey used to reposition the dashed reference line on the polar graticule. Changing the REF POS has the effect of rotating the trace and reference line. The value of REF POS may be changed in the same manner as shown for REFERENCE LEVEL.

REFERENCE LINE ON/OFF is a softkey used to turn the dashed reference line off and back on. This is a push-push toggle type key. Turning the reference line off does not change the effect of reference position (i.e. a change in the REF POS value rotates the trace even if the reference line does not appear).

SMITH CHART ON/OFF is a softkey that allows the user to overlay the polar graticule with a Smith Chart. This is a push-push toggle type key. The Smith chart is used to graphically convert reflection coefficient to normalized impedance. The marker information reads impedance when the Smith chart is on.

To use this feature, the INPUT definition should be S11 (A/R) or S22 (B/R) and the full scale value should be 1.0. If full scale is a value other than 1.0, the trace values cannot be read directly from the Smith chart but the marker information is still valid. Note that the marker units may be toggled between magnitude & phase and real & imaginary by pressing the MARKER M,P R,I softkey in the MKR menu.

SCREEN

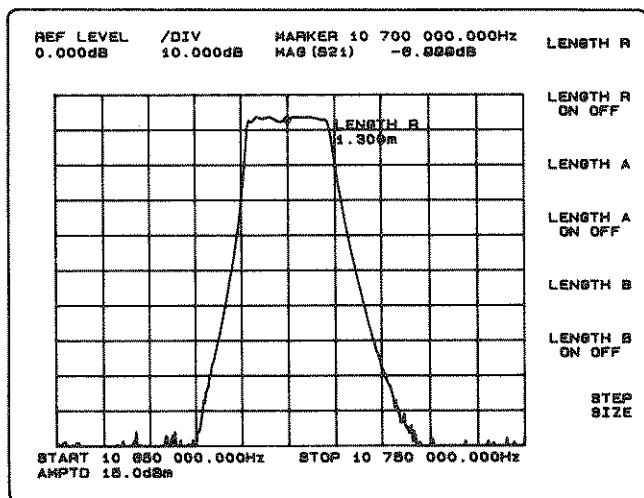
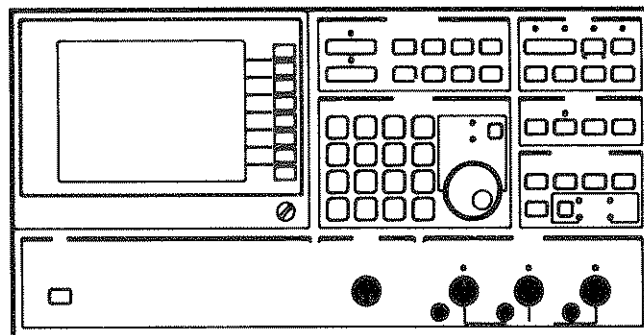

Figure 4-44

The **SCREEN** is the total CRT display area. It is composed of the graticule, which takes up most of the

screen in the center, the menu area (down the right side from top to bottom), and the alphanumeric characters which appear above and below the graticule. See Figure 4-44.

SOFTKEY



Softkeys



Figure 4-45

The eight keys with no stenciling next to the menu area of the screen are called **SOFTKEYS**. The lettered keys are referred to as **HARDKEYS**. Most hardkeys only function is to display a menu of softkey labels. Exceptions are the keys in the DATA ENTRY section of the front panel and the INSTR PRESET, LCL, and TRIG/RESET hardkeys. See Figure 4-45.

SOURCE

The **SOURCE** section of the front panel contains the hardkeys that display menus of softkeys which control the parameters of the source. These parameters include SWEEP TYPE (linear, alternate, log, amplitude, or CW), SWEEP MODE (continuous, single, or manual), SWEEP TIME, FREQUENCY, AMPLITUDE, TRIGGER MODE

(free run, line, and external), and TRIGGER/RESET. For more information on individual functions refer to the hardkey of interest.

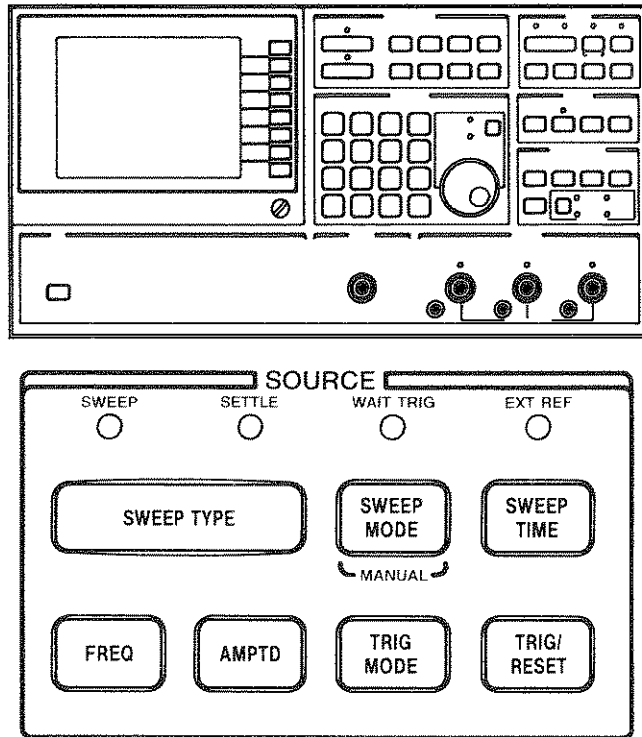

Figure 4-46

SPECIAL FUNCTIONS

The **SPECIAL FUNCTIONS** hardkey in the INSTRUMENT STATE front panel section contains the softkey menus for viewing and modifying the HP-IB address, running a CONFIDENCE TEST, turning the beeper on or off, and many service diagnostics.

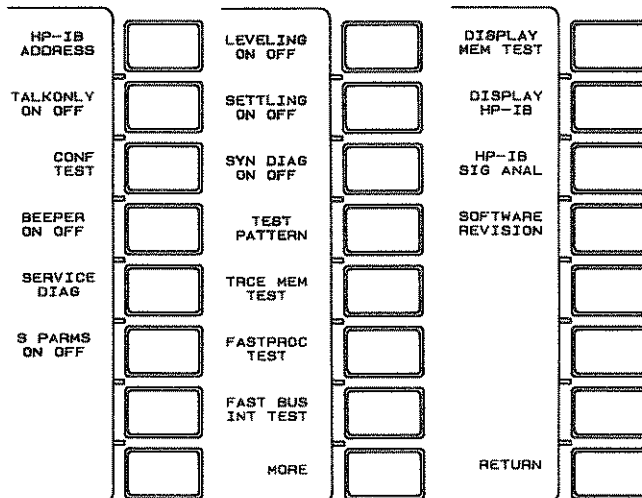

Figure 4-47A

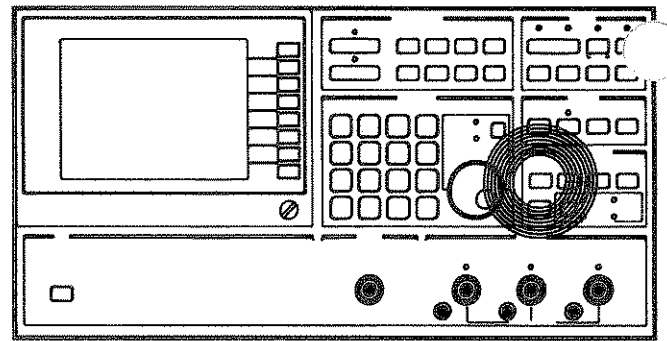

Figure 4-47B

HP-IB ADDRESS is a softkey used to view and change the address of the HP 3577A on the Hewlett-Packard Interface Bus. This address is set at the factory to 11 and may be set to any whole number from 0 to 30, inclusive. INSTR PRESET does not change this value, nor does cycling power. This number cannot be changed via the HP-IB; it can only be changed manually. To modify the HP-IB address:

1. Press the SPCL FCTN hardkey to display the first menu
2. Press the HP-IB ADDRESS softkey
3. Enter the new address with the numeric key pad
4. Press the ENTER softkey

TALK ONLY ON/OFF is a push-push toggle type softkey that changes the HP-IB configuration to TALK ONLY (ON) for driving a plotter. TALK ONLY should be turned OFF when the HP 3577A is controlled via HP-IB.

CONFIDENCE TEST is used to check each receiver channel for general pass/fail status. A screen message requests the user to put a cable between the source output and the receiver to be tested. Nine tests are run and the status of each (pass/fail) is displayed on the screen as the results are determined. Any test that fails, stops the test and highlights the screen message specifying the failure. The test may be continued from a failed test by pressing the softkey "CONTINUE TEST." The S-parameter test set should not be connected to the receiver being tested during the CONFIDENCE TEST. In the case of a test failure, refer the problem to a service repair facility.

BEEPER ON/OFF is a push-push toggle type softkey used to turn the beeper off and back on. This is not reset by INSTR PRESET.

SERVICE DIAGNOSTICS is a softkey which displays a menu used for diagnosing service problems with the HP 3577A. The menu items that follow are described briefly. For more details on these features and their uses refer to the HP 3577A Service Manual.

S PARSMS ON/OFF is a softkey used to change the INPUT definition menu between the S-parameters menu to the standard INPUT menu.

LEVELING ON/OFF is a softkey that disables the source leveling loop when OFF. This is used for service of the HP 3577A and should not be changed by an operator. This feature is reset to ON by INSTR PRESET or power-on.

SETTLING ON/OFF is a softkey that turns the digital filter settling on (default condition) or off. This is used for service of the HP 3577A and should not be changed by an operator. This feature is reset to ON by INSTR PRESET or power-on.

SYNTHESIZER DIAGNOSTICS ON/OFF is a softkey used to turn on the fractional N synthesizer diagnostics for service of the HP 3577A and should not be changed by an operator. This feature's status is reset to OFF by INSTR PRESET or power-on.

TEST PATTERN is a softkey that turns on the digital display test pattern. This feature is used for alignment of the screen area of the HP 3577A. To terminate the test pattern and return to the measurement state press the INSTR PRESET hardkey.

TRACE MEMORY TEST is a softkey that tests the RAM in TRACE MEMORY when pressed. This test takes approximately 20 seconds to run during which time all other activity is suspended. This test may be interrupted by pressing INSTR PRESET.

NOTE

This test clears all information stored in trace memory including D1, D2, D3, D4, R, A and B.

FAST PROCESSOR TEST is a softkey that runs a test on the fast processor board. This test should immediately display the message "FP SELF TEST PASSED."

FAST BUS INTERFACE TEST is a softkey that tests the port between the main processor and the fast processor. This test should immediately display the message "MP/FP PORT TEST PASSED."

DISPLAY MEMORY TEST is a softkey that tests the memory of the digital display unit. This test takes approximately 5 seconds to run, during which time the display is blank. The HP 3577A returns from the test in the preset condition.

DISPLAY HP-IB is a softkey that puts a picture of the HP-IB connector on the screen. Pin numbers and signal

names are labeled on the figure and a bright dot appears on any pin that has a TRUE (low) signal state on it. This feature allows the user to display the status of the HP-IB lines of the HP 3577A.

HP-IB SIGNATURE ANALYSIS is a softkey that runs a program to allow signature analysis tests to be run on the HP 3577A's microprocessor systems.

SOFTWARE REVISION is a softkey used to display a screen message which shows the revision status of the operating system.

STORE DATA

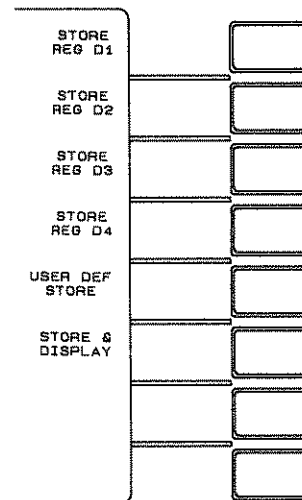
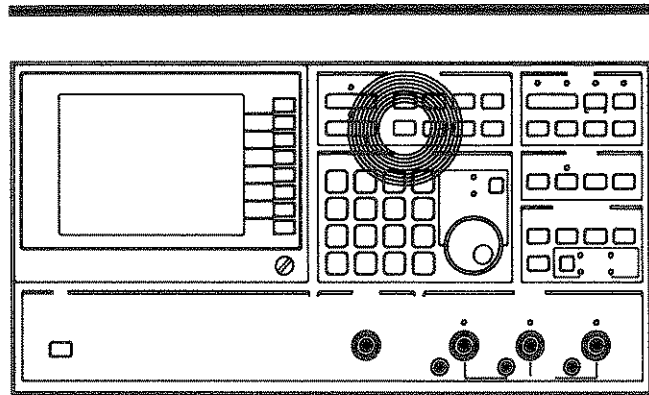

Figure 4-48

STORE DATA is a hardkey in the DISPLAY FORMAT front panel section used to display the menu of softkeys shown above. These softkeys may be used to store a trace as it's specified by the INPUT definition, store a trace defined by the user, or store and compare. The trace stored is independent of the active display function. The data stored is complex trace data identical to what is stored in trace memory registers R, A, and B when a measurement is taken.

The HP 3577A does not "remember" the instrument state (such as INPUT definition or start and stop

frequencies) active when the data was stored. If the stored information is used in a user defined equation, care should be taken that the parameters of all terms are compatible. For example, for a user defined INPUT of R/D1 (where D1 is data register one), R and D1 should both have the same start and stop frequencies, amplitude, and sweep type. The user may SAVE instrument state at the same time that data is STORED to be able to recall the state used to store data.

To use this feature:

1. Press the STORE DATA hardkey to display the menu
2. Press the softkey corresponding to the register you wish the active trace to be stored in

USER DEFINED STORE is a softkey used to define a function and have the results stored in the register of choice. This equation is constructed in the same manner as done for user defined functions and user defined inputs. When selected, the menu changes to the first term selection menu. Terms include five user defined functions, four data registers, three user defined complex constants, and the three receiver inputs: R, A, and B. After the first term is selected, a new menu is displayed containing the four possible math functions (+, -, *, and /) and the STORE IN REGISTER D__ command. These two menus alternate until you finish the definition and use the → D__ command to select the register to store into. This store occurs without affecting the trace on the screen unless the active INPUT definition is a function of the register stored to.

STORE & DISPLAY is a softkey used to store the currently selected trace and compare the stored data with measurement data using one key press. The storage register used for the STORE depends on the active trace. If TRACE 1 is active, data is stored in data register D3; if trace two is active then data is stored in D4. After the STORE, the INPUT definition of the inactive trace is changed to display the data just stored. If TRACE 1 is active the store goes into D3 and the INPUT definition of TRACE 2 becomes D3. If TRACE 2 is active when STORE & DISPLAY is pressed the store goes into D4 and the INPUT of TRACE 1 becomes D4.

NOTE

Because this feature writes to a data register, information stored there is overwritten and lost.

SWEEP MODE

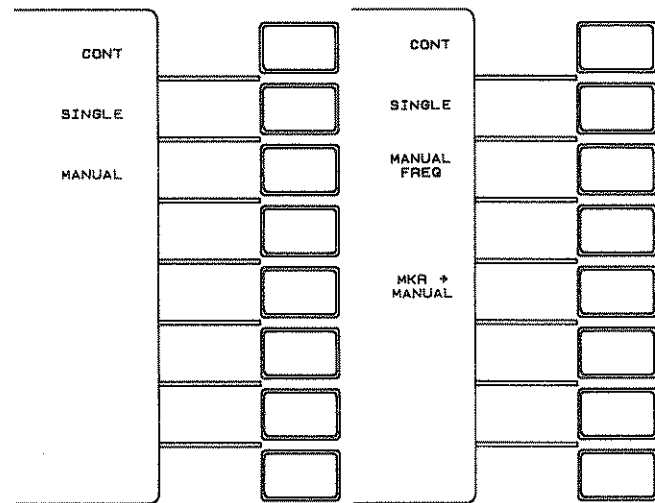
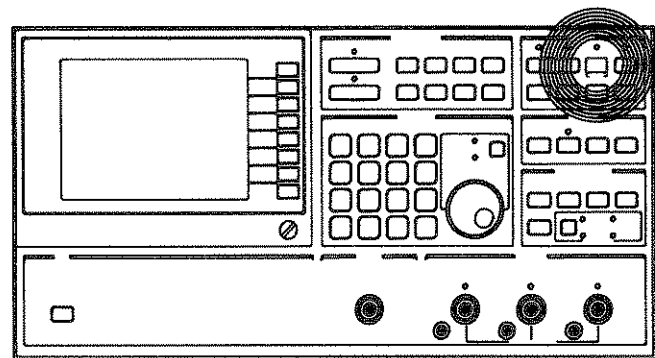

Figure 4-49

SWEEP MODE is a hardkey in the SOURCE section used to display the menus of softkeys shown above. These softkeys may be used to select CONTINUOUS, SINGLE, or MANUAL sweeps. The default selection is CONTINUOUS.

CONTINUOUS is a softkey that selects a sweep mode which starts a new sweep after each sweep completion. The TRIG/RESET hardkey resets the sweep in progress; after which settling takes place and the next sweep begins. For more information on settling time, refer to RESOLUTION BANDWIDTH.

SINGLE is a softkey that selects a sweep mode which sweeps once each time the HP 3577A is triggered. To use this feature press SWP MODE hardkey, and then the SINGLE softkey. The sweep in progress continues but no new sweep begins when the current sweep ends. The WAIT TRIG LED illuminates until the TRIG RESET hardkey is pressed to start a new sweep. The TRIG/RESET hardkey may also be used to stop a sweep in SINGLE SWEEP MODE.

Settling is done for the next sweep immediately upon completion of the present sweep. Thus the sweep begins without delay on the next TRIG/RESET key press if the SETTLE LED is dark.

MANUAL is a softkey used to sweep the display manually using the knob or the arrow keys. To use this feature:

1. Press the SWEEP MODE hardkey to display the menu
2. Press the MANUAL softkey. The label changes to MANUAL FREQ and the new label MKR → MANUAL appears in the menu. Also the MARKER in the marker information block changes to MANUAL.
3. Move the marker (in MARKER mode) to the point of interest on the trace
4. Press the MKR → MANUAL softkey. The sweep dot moves to the marker position and the marker information block shows the measurement being made.
5. Modify the frequency value with the knob (in ENTRY mode) or arrow keys. If the knob is used in ENTRY mode the marker moves to the sweep dot when the knob is first rotated.

OR

5. Enter a new value with the numeric key pad
6. Select units from the menu (press a softkey)

MANUAL SWEEP allows the user to make measurements at frequencies that would not be sampled in an automatic sweep of the same span. Any frequency from 0 to 200 MHz may be entered, to the nearest mHz, with the numeric keypad. If the OFFSET MARKER is on in MANUAL SWEEP the marker information block displays OFS MN instead of MANUAL, MARKER, or OFFSET.

SWEEP TIME

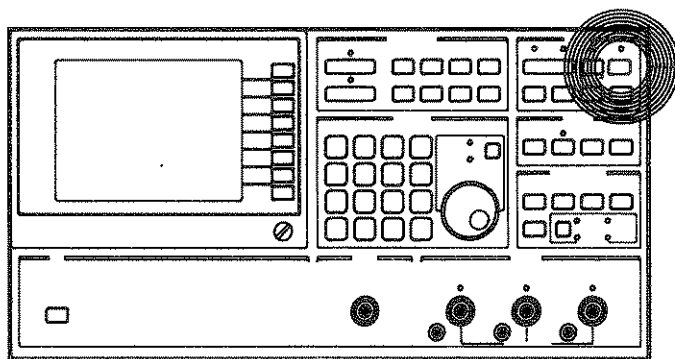

Figure 4*50A

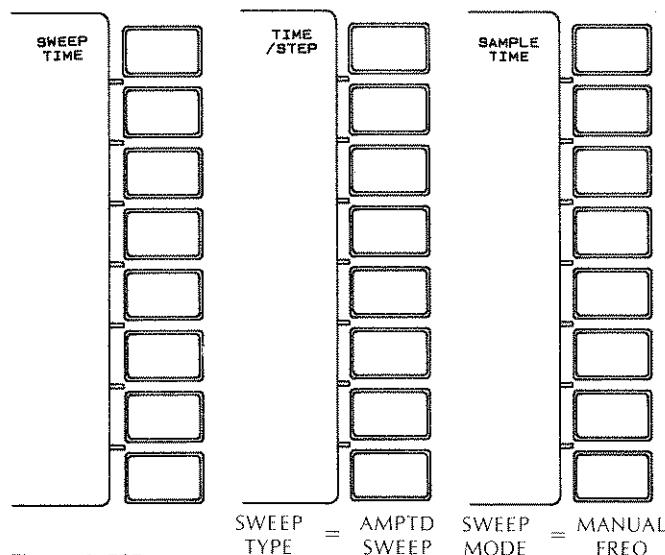

Figure 4*50B

SWEEP TIME is a hardkey in the SOURCE section of the front panel used to select measurement times. Immediately after power-on or INSTRUMENT PRESET, the SWEEP TIME for a linear frequency sweep is 1 second. If the SWEEP TYPE is changed to AMPTD SWEEP the default TIME/STEP is 0.050 seconds and the total sweep time depends upon the STEPS/SWEEP (found in the AMPTD menu). If the SWEEP MODE is changed to MANUAL, the default SAMPLE TIME is 0.050 seconds. In a frequency sweep, the sweep dot appears if the sweep time is 1 second or more.

In an amplitude sweep the sweep dot appears if the time/step is 0.010 seconds or more. When the sweep type is ALTERNATE SWEEP, different sweep times may be selected for each of two traces. For more information see ALTERNATE SWEEP listed under SWEEP TYPE. When the sweep type is LOG SWEEP, the sweep time may appear to be greater than the value entered for sweep time, due to overhead time. The device under test is swept at an effective rate equal to the value of sweep time.

To change the value of SWEEP TIME:

1. Press the SWEEP TIME hardkey
2. Modify the value with the knob or the arrow keys

OR

2. Enter a new value with the numeric keypad
3. Select units from the menu (press a softkey)

Sweep time may be limited by the math processing load. When this occurs, the screen message "SWEEP TIME INCREASED" appears and the sweep time increases automatically. Refer to Appendix A for more information on HP 3577A data processing and sweep time optimization.

SWEEP TYPE

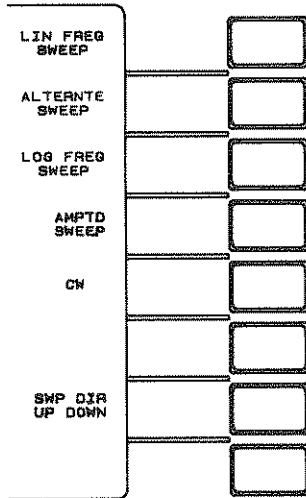
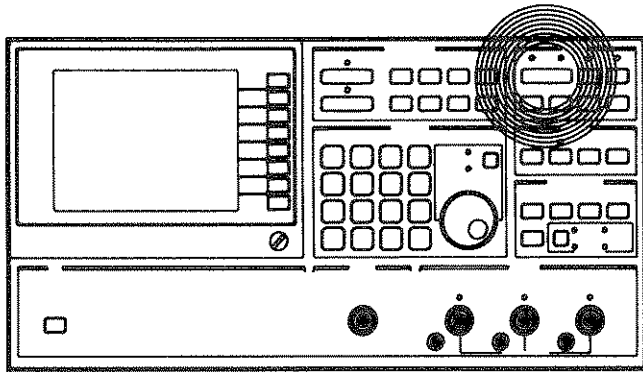

Figure 4-51

SWEEP TYPE is a large hardkey in the SOURCE section of the front panel used to display the menu of softkeys shown above. These softkeys may be used to select from five sweep types.

NOTE

Changing sweep type or sweep resolution (in the FREQ menu) erases registers R, A, and B in trace memory (sets all zeros).

LINEAR FREQUENCY SWEEP is the default sweep type. The graticule displayed on the screen has ten equal divisions. This softkey is a mode select type of key; data entry is not appropriate.

ALTERNATE SWEEP is a softkey used to assign separate FREQ, AMPTD, RES BW and SWP TIME parameters for each trace. The sweeps are linear and alternate. Without using ALTERNATE SWEEP the user may define different DISPLAY FUNCTIONS, INPUTS, and SCALES for each

trace. With ALTERNATE SWEEP each trace may also have different frequency parameters (start/stop, center, span), source amplitudes, resolution bandwidths, and sweep times.

When the sweep type is alternate, stores are not allowed. This means that none of the MEAS CAL features may be used in alternate sweep. Averaging is turned off when alternate sweep is active. If two amplitude values selected cause the output relays to switch as the sweeps alternate, the HP 3577A times out after five minutes. Also, if the INPUTs selected for the two traces cause the S-parameter test set to switch configuration from forward to reverse, time out occurs after five minutes. Time out changes SWEEP MODE to SINGLE, changes the menu to SWP MODE and the WAIT TRIG LED illuminates. The user may trigger single sweeps with the TRIG/RESET key or change the sweep mode back to continuous for another five minutes of uninterrupted operation. Time out extends the life of the HP 3577A and HP 35677A/B relays.

To use this feature:

- 1) set up trace 1 parameters (input, display function, frequency, source amplitude, scale, sweep time, and resolution bandwidth).
- 2) Turn on trace 2 by pressing hardkeys TRACE 2, DSPLY FCTN, and selecting any menu item (use of POLAR turns trace 1 off). Trace 2 turns on having the same start/stop frequencies, amplitude, bandwidth and sweep time as trace 1 and both traces are swept simultaneously.
- 3) Press SWEEP TYPE hardkey, and ALTERNTE SWEEP softkey. Trace 2 parameters revert to their previous settings (if the HP 3577A was just preset, these are the default parameters). This allows the ALTERNATE SWEEP trace to be turned off and back on without losing trace parameters.
- 4) Enter the new parameters for trace 2.

LOG FREQ SWEEP is a softkey that selects a log scale for the horizontal axis of the display. The logarithmic graticule has frequency values listed across the bottom of the screen. The graticule changes as the START and STOP frequencies are changed. When the ratio of STOP FREQ/START FREQ is less than four, the graticule changes back to a linear scale.

When LOG FREQ SWEEP is active the FREQ menu contains only START FREQ, STOP FREQ, and FULL SWEEP. There are no CENTER FREQ, FREQ SPAN, or SWEEP RESOLUTION softkeys as in LIN FREQ SWEEP. Default sweep is from 50Hz to 200MHz. FULL SWEEP is from 5Hz to 200MHz.

When LOG FREQ SWEEP is active the RES BW menu has an added item called AUTO RBW (for automatic resolution bandwidth) which is ON. The sweep starts at 50Hz and stops at 200MHz and the resolution bandwidth changes during the sweep to reduce LO feedthru at the lower frequencies. If FULL SWEEP is selected, the sweep starts at 5Hz and the 1Hz RES BW is active from 5Hz to 40Hz (4 seconds of settling occurs before the sweep begins). Then the HP 3577A switches to 10Hz BW until it reaches 400Hz when it changes to 100Hz. The last switch is at 4kHz where it switches to 1kHz RES BW. When AUTO RBW is ON the RES BW selected (bright) is the widest bandwidth the AUTO RBW progresses to; if 100Hz RES BW is selected and AUTO RBW is ON, the HP 3577A does not switch to 1kHz RES BW at 4kHz as it would if 1kHz RES BW were selected.

Other menus that are changed by selecting LOG FREQ SWEEP are:

DISPLAY FUNCTION: no DELAY
 MKR→ : no MKR→ CENTER freq
 SWEEP TYPE : no SWP DIR

AMPTD SWEEP is a softkey label in the SWEEP TYPE menu. It is a logarithmic sweep of the source output amplitude. The default start and stop levels are -40 dBm and 0 dBm, respectively. Either start or stop amplitude may be larger or smaller than stop amplitude (unlike frequency sweeps).

If left running, the amplitude sweep times out after five minutes. This is to prolong the life of the relays used to switch pads in the output circuitry in and out. The time out condition switches the SWEEP MODE from CONTINUOUS to SINGLE and displays an error message. The user may trigger single sweeps with the TRIG/RESET key or change the sweep mode back to continuous.

CW is a softkey that puts the HP 3577A in a single frequency measurement state. When the SWEEP TYPE is CW the frequency menu contains only the menu items FREQ and STEP SIZE. The display shows a single line from the bottom of the graticule to the height of the signal level at the specified frequency. Any frequency may be entered with the numeric key pad with millihertz resolution. Group delay is not available on the DISPLAY FUNCTION menu when CW is selected.

SWEEP DIRECTION UP/DOWN is a push-push toggle type softkey that allows the user to change the direction of the sweep. The default direction is UP, or left to right. In frequency sweeps left to right is always up because the start frequency cannot be larger than the stop frequency. In an amplitude sweep the start

amplitude may be larger than stop amplitude, so amplitude may be swept from a higher to lower value without changing the SWEEP DIRECTION. Changing SWEEP DIRECTION to DOWN in an amplitude sweep causes the sweep dot to move from right to left.

Changing sweep direction during a frequency sweep is useful for determining whether the sweep time is large enough for the selected resolution bandwidth. If you change the sweep direction while the sweep dot is on a steep part of the response and the dot does not exactly retrace its path, the sweep time should be increased. See Optimizing Sweep Time in Appendix A. The SWEEP DIRECTION selection is not offered in the CW sweep type.

TRACE 1 TRACE 2

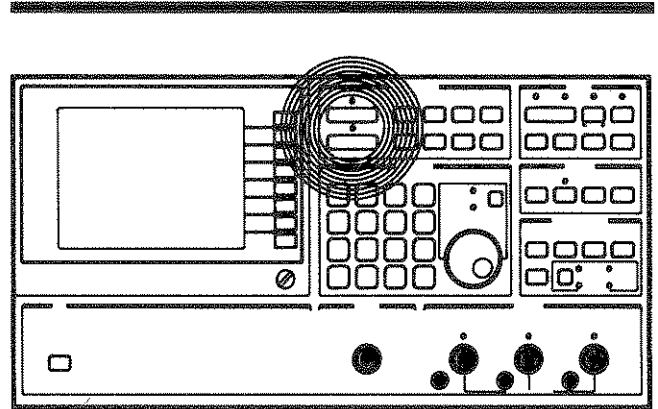

Figure 4-52

TRACE 1 and **TRACE 2** are two hardkeys in the DISPLAY FORMAT front panel section that are used to select the active trace. The active trace is indicated by the illuminated LED over either the TRACE 1 or TRACE 2 key and by a bright trace and marker information block on the screen. Hardkeys in the DISPLAY FORMAT front panel section are used for data entry or mode selection for one of the two traces. If SWEEP TYPE is ALTERNATE SWEEP (in the SOURCE section) then FREQ, AMPTD, SWP TIME, and RES BW data is also trace dependent. For these hardkeys, the data entered or mode selected affects only the selected trace.

When the HP 3577A is preset or turned on, trace one is LOG MAGNITUDE and active and trace two is off. To turn on trace 2, press TRACE 2 hardkey, DSPLY FCTN hardkey), and press one of the softkeys other than OFF. Trace two and characters related to it (REF, /DIV, and marker information) appear brighter than trace one when the TRACE 2 LED is illuminated.

TRIGGER MODE

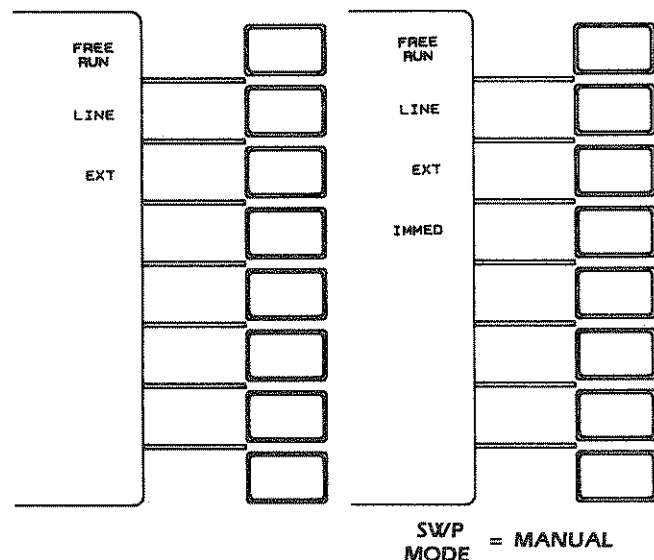
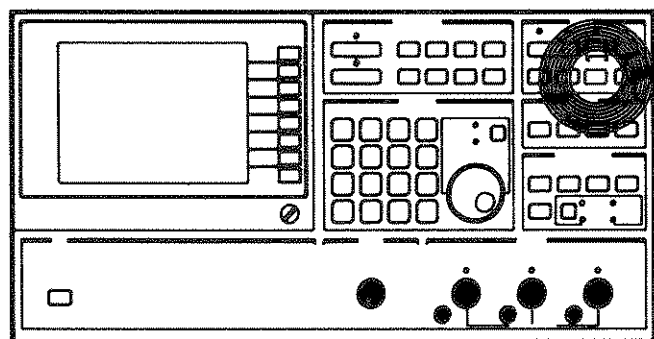

Figure 4-53

TRIGGER MODE is a hardkey in the SOURCE section of the front panel used to display the menu of softkeys shown above. These softkeys may be used to select the type of triggering used by the HP 3577A to initiate measurement sweeps.

FREE RUN is a softkey that is the default TRIGGER MODE selection. In FREE RUN the HP 3577A triggers a new sweep as soon as the previous sweep ends and the source settles (settling is indicated by an LED in the SOURCE section). If the SWEEP MODE is SINGLE, the next sweep does not begin until the user presses the TRIG/RESET hardkey.

LINE is a softkey that selects the power line as the trigger source. This results in the power line starting the sweep after the settling is complete. If SWEEP MODE is SINGLE the next sweep does not begin until the user presses the TRIG RESET hardkey and the line trigger occurs.

EXTERNAL is a softkey used to select the external trigger input on the back panel as the trigger source. The

trigger occurs after settling is complete and (if SWEEP MODE = SINGLE) the TRIGGER RESET hardkey is pressed. The HP 3577A triggers a sweep on the high-to-low transition of a TTL logic signal or a switch closure to ground. When the HP 3577A is ready to be triggered the WAIT TRIG LED in the SOURCE section of the front panel is illuminated. If a trigger signal occurs when the WAIT TRIG LED is not illuminated the trigger is ignored. Each trigger requires a transition (edge) of the external trigger signal so the trigger signal must return to the pre-trigger state before triggering again; holding a closure to ground or low signal on the external trigger input does not continue triggering the HP 3577A. There is a delay of 250 to 500 microseconds from the time the trigger signal is received to the beginning of the sweep.

IMMEDIATE triggering is a softkey that appears in this menu only when the SWEEP MODE is MANUAL. If this method of triggering is selected, the operator triggers the HP 3577A to take a measurement by pressing the TRIG/RESET hardkey. To use this feature:

1. Press the SWP MODE hardkey to display a menu
2. Press the MANUAL softkey
3. Press the TRIG MODE hardkey to display a menu
4. Press the IMMED softkey
5. Press the SWP MODE hardkey
6. Move the marker to the point of interest
7. Press the MKR → MANUAL softkey. The MANUAL FREQUENCY changes to that of the marker but no measurement is taken
8. Press the TRIG/RESET hardkey to take the measurement

OR

7. Enter a new value with the numeric key pad
8. Select units from the menu (press a softkey)
9. Press the TRIG/RESET hardkey to take the measurement

TRIGGER/RESET

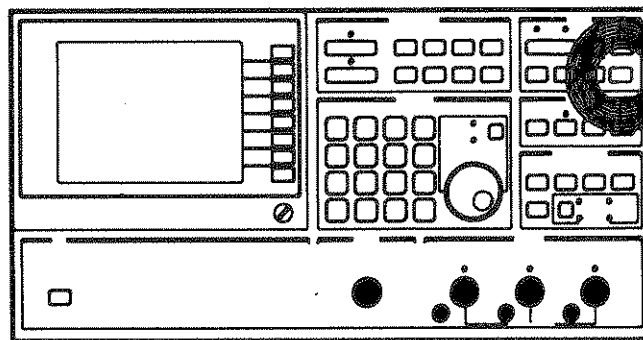

Figure 4-54

graticule and 2) good measurement data readout (via the marker) for all portions of the frequency span, even where the trace is off screen.

If a function change does not require new measurements to update the trace, a memory sweep occurs. The processor sweeps through the complex data in trace memory and updates the trace very quickly. The speed in which this happens is limited only by the rate at which the processor can manipulate numbers. If the processor is given a lot of math to do (averaging, length, and complicated user definitions for two traces) the HP 3577A may choose a slower sweep speed to allow time for the number processing. The message "SWEEP TIME INCREASED" appears on the screen when this happens.

It is important to keep in mind how the HP 3577A does math and the form of the complex data in trace memory when defining user defined equations for INPUTs, STOREs, or functions. For example, to find the difference in phase between inputs R and A the INPUT definition should be A/R, not A-R. See Figure A*2.

$$\text{if: } A = X + jY = Me^{j\phi_1}$$

$$R = S + jT = Ne^{j\phi_2}$$

$$\text{then: INPUT} = A/R = (M/N)e^{j(\phi_1 - \phi_2)}$$

where $(\phi_1 - \phi_2)$ is the phase displayed

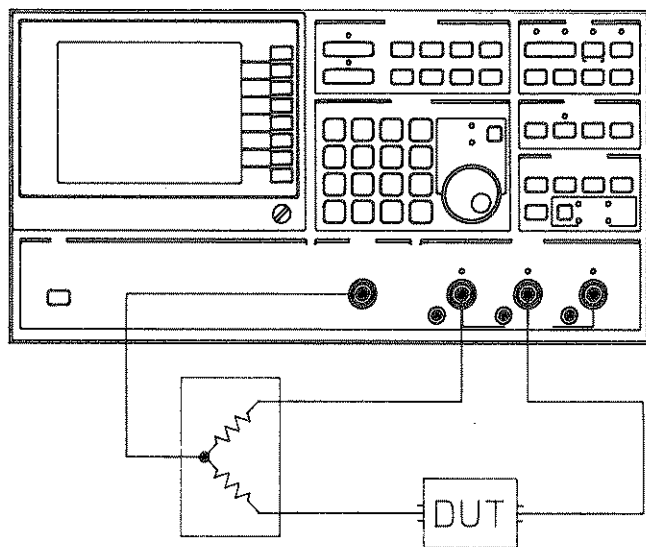

Figure 4-2.

OPTIMIZING SWEEP TIME

The HP 3577A Network Analyzer has 4 selections for bandwidth: 1kHz, 100Hz, 10Hz, and 1Hz. While each reduction in bandwidth lowers the noise floor, it also results in an increase in the pre-sweep SETTLING time (done automatically) and may require selection of a longer SWEEP TIME. This discussion is to help the user find the optimum Sweep Time for a given Resolution Bandwidth.

SETTLING time is the time that the source holds at the START frequency before beginning the sweep. This is done to allow the SOURCE amplitude and filters time to stabilize before starting the measurement. While the HP 3577A is settling the **SETTLE** LED is illuminated. The SETTLING time is 22 ms for a 1 kHz bandwidth and progressively longer for narrower bandwidths (see Resolution Bandwidth in the Reference section). SETTLING time changes automatically unless the user chooses to turn it off using the SPCL FCTN key.

There is no rigorous method for selecting SWEEP TIME, given RES BW; too much depends on the response time of the device under test. The filters of the HP 3577A have a finite response time as does the circuit being tested. If the SWEEP TIME is too short there is not enough time to allow both to respond fully to each sampled frequency. When the SWEEP DIRECTION is UP (i.e., increasing frequency, the default condition) this phenomena is evident as a skewing of the trace to the right.

The object is to make an accurate measurement with as short a SWEEP TIME as possible. There are several ways to decide whether or not the SWEEP TIME is too small:

- 1) Increment (increase) the SWEEP TIME and look for a change in the trace shape. If there is, then the previous SWEEP TIME was too small. Continue incrementing until no change is seen.
- 2) Reverse the SWEEP DIRECTION when the sweep dot is on the steepest part of the response. If the SWEEP TIME is too small the trace skews to the left (or right, depending on sweep direction) and the dot does not retrace its path. Increment the SWEEP TIME and try again.
- 3) Let the HP 3577A sweep once and then select MANUAL FREQUENCY SWEEP MODE. Move the marker to the steepest part of the response and press the MKR → MANUAL softkey. If the marker is not on the trace the SWEEP TIME is too small.

TRIG/RESET is a hardkey in the SOURCE section of the front panel that is used by the operator to either TRIGGER or RESET in preparation for a measurement. This is one of three hardkeys that do not display a menu. It executes its function immediately when pressed.

When the SWEEP MODE is CONTINUOUS, the TRIGGER RESET hardkey stops the current sweep and initiates a new sweep. The new sweep starts as soon as settling is complete.

When the SWEEP MODE is SINGLE, the TRIGGER RESET triggers the measurement, if the WAIT TRIG LED

is illuminated. If a sweep is in progress, pressing TRIGGER RESET resets or stops the sweep, resets to the start frequency (or amplitude if SWEEP TYPE is AMPTD), and then settles. After settling, the WAIT TRIG LED illuminates and pressing TRIGGER RESET triggers the HP 3577A.

When the SWEEP MODE is MANUAL and the TRIGGER MODE is IMMED, the TRIGGER RESET hardkey is used to take each measurement. See TRIGGER MODE, IMMEDIATE for more information.

SOFTKEY INDEX

SOFTKEY	page	SOFTKEY	page	SOFTKEY	page
/DIV	4-28	LEVELING ON OFF	4-31	PLOT MARKER	4-23
ALTERNTE SWEEP	4-34	LIN FREQ SWEEP	4-34	PLOT TRACE	4-23
AMPTD (amplitude)	4-1	LIN MAG (linear magnitude)	4-7	POLAR	4-7
AMPTD SWEEP	4-35	LINE (trigger)	4-36	RCL OLD STATE	4-25
ATTEN (attenuation)	4-2	LOG FREQ SWEEP	4-34	REAL	4-7
AUTO RBW ON OFF	4-25	LOG MAG (log magnitude)	4-7	RECALL REG <u> </u>	4-24
AUTO SCALE	4-28	MAG OFFSET	4-16	REF LEVEL	4-27
BEEPER ON OFF	4-30	MANUAL (sweep mode)	4-33	REF LINE ON OFF	4-28, 29
C FREQ STEP	4-10	MANUAL FREQ	4-33	REF POSN	4-28, 29
CENTER FREQ	4-10	MARKER M,P R,I	4-16	RETURN	4-18, 24
CLEAR TRIP (receiver)	4-3	MARKER OFFSET	4-16	S PARMs ON OFF	4-31
CLEAR TRIP (source)	4-2	MARKER ON OFF	4-15	SAMPLE TIME	4-33
CONF TEST	4-30	MARKER POS	4-15	SAVE REG <u> </u>	4-27
CONFIG PLOT	4-23	MARKER SEARCH	4-17	SERVICE DIAG	4-30
CONTINUOUS SWEEP	4-32	MARKER TARGET	4-18	SETTLING ON OFF	4-31
COPY SCL	4-28	MKR OFST ON OFF	4-15	SINGLE (sweep mode)	4-32
COPY Trc	4-13	MKR → CENTER	4-17, 18	SMITH CH ON OFF	4-29
CW	4-35	MKR → FULL SCL	4-18	SOFTWARE REVISION	4-31
DATA REG	4-13	MKR → L TARG	4-18	START AMPLITUDE	4-2
DEFAULT SETUP (plot)	4-24	MKR → MANUAL	4-33	START FREQ	4-10
DEFINE FUNCTION	4-6	MKR → MAX	4-17, 18	STEP SIZE (amplitude)	4-1
DELAY (GROUP)	4-8	MKR → MIN	4-17, 18	STEP SIZE (length)	4-14
DELAY APERTURE	4-8	MKR → R TARG	4-17	STEPS/SWEEP	4-2
DISPLAY HP-IB	4-31	MKR → REF	4-18	STOP AMPTD	4-2
DISPLAY MEM TEST	4-31	MKR → REF LVL	4-17	STOP FREQ	4-10
EXT (trigger)	4-36	MKR → START	4-17, 18	STORE & DISPLAY	4-32
FAST BUS INTERFACE TEST	4-31	MKR → STOP	4-17, 18	STORE REG <u> </u>	4-31
FASTPROC TEST	4-31	MKR CPL ON OFF	4-16	SWEEP RESOLUTN	4-10
FREE RUN (trigger)	4-36	MKR OFST → SPAN	4-17, 18	SWEEP TIME	4-33
FREQ OFFSET	4-16	NORMLIZE	4-19	SWP DIR UP DOWN	4-35
FREQ SPAN	4-10	NORMLIZE (SHORT)	4-19	SYN DIAG ON OFF	4-31
FULL SCALE	4-28	ONE PORT FULL CAL	4-20	TALKONLY ON OFF	4-30
FULL SWEEP	4-11	ONE PORT PART CAL	4-19	TEST PATTERN	4-31
GRAT PEN NUM	4-24	PEN SPEED SLOW FST	4-24	TEST SET FWD/REV	4-13
GROUP DELAY	4-8	PHASE	4-7	TIME/STEP	4-33
HP-IB ADDRESS	4-30	PHASE OFFSET	4-16	TRACE LINETYPE	4-24
HP-IB SIG ANAL	4-31	PHASE REFERENCE	4-28	TRACE PEN NUM	4-24
IMAG	4-8	PHASE SLOPE	4-28	TRCE MEM TEST	4-31
IMMEDIATE (trigger)	4-36	PHASE SLOPE ON OFF	4-28	USER DEF INPUT	4-13
IMPEDANCE <u> </u> 50Ω/1 MΩ	4-2	PLOT ALL	4-23	USER DEF STORE	4-32
LENGTH	4-14	PLOT CHAR	4-23	ZERO MARKER	4-15
LENGTH ON OFF	4-14	PLOT GRAT	4-23		

GENERAL INFORMATION

INTRODUCTION

This chapter contains instructions for installing and interfacing the HP 3577A Network Analyzer and the HP 35677A/B S-parameter Test Set. Included are initial inspection procedures, power and grounding requirements, operating environment, available accessories and options, installation instructions, HP-IB interfacing procedures, and instructions for repacking and shipment.

INITIAL INSPECTION

This instrument was carefully inspected both mechanically and electrically before shipment. It should be free of marks and scratches and in perfect electrical order upon receipt. To confirm this, inspect the instrument for physical damage incurred in transit, inventory the supplied accessories (listed in Table 5•2), and test the electrical performance using the Confidence Test listed in the section on Getting Started. If there is physical damage, if the contents are incomplete or if the instrument does not pass the Confidence Test, notify the nearest HP Sales and Service Office. If the shipping container is damaged or the cushioning material shows signs of stress, notify the carrier as well as the Hewlett-Packard office. Keep the shipping material for the carrier's inspection.

WARNING

The integrity of the protective earth ground may be interrupted if the HP 3577A is mechanically damaged. Under no circumstance should the HP 3577A be connected to power if it is damaged.

POWER REQUIREMENTS

CAUTION

Before applying ac line power to the HP 3577A, ensure the voltage selector switch on the back panel of the instrument is set for the proper line voltage and that the correct line fuse is installed in the rear panel fuse holder.

The HP 3577A can be operated from any single phase ac power source supplying:

86V to 127V from 48 Hz to 440 Hz
(115V Voltage Selector setting)

or

195V to 253 from 48 Hz to 66 Hz
(230V Voltage Selector setting)

Power consumption is less than 450 VA.

POWER CABLE AND GROUNDING REQUIREMENTS

The HP 3577A is equipped with a three-conductor power cord which, when plugged into an appropriate receptacle, grounds the instrument cabinet. The type of power cable plug shipped with each instrument depends on the country of destination. Refer to Figure 5•1 for the part number of the power cable and plug configurations available. If the appropriate power cable is not included with your instrument, contact the nearest HP Sales and Service Office and the proper cable will be provided.

WARNING

The power cable plug must be inserted into a socket outlet provided with a protective earth ground terminal. Defeating the protection of the grounded instrument cabinet can subject the operator to lethal voltages.

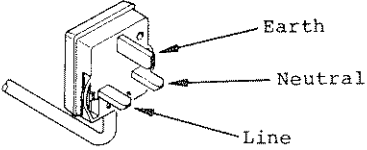
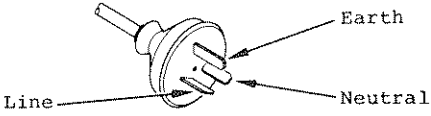
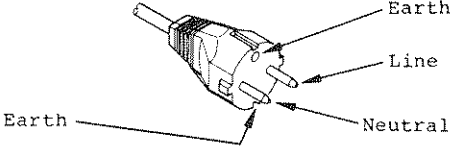
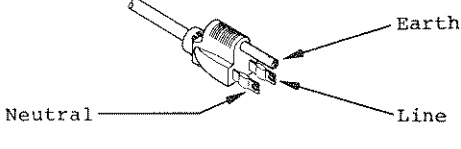
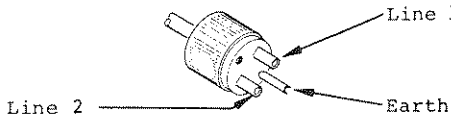
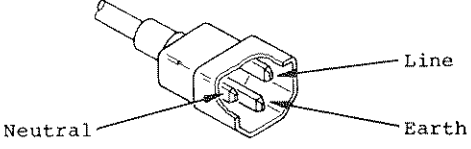
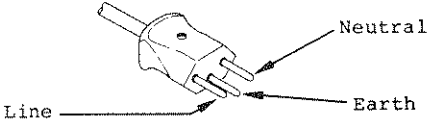
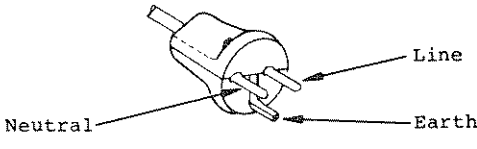
<p>OPTION 900 United Kingdom</p>  <p>PLUG*: BS 1363A CABLE*: HP 8120-1703</p> <p>250 V OPERATION</p>	<p>OPTION 901 Australia/New Zealand</p>  <p>PLUG*: NZSS 198/AS C112 CABLE*: HP 8120-0696</p> <p>250 V OPERATION</p>
<p>OPTION 902 European Continent</p>  <p>PLUG*: CEE7-V11 CABLE*: HP 8120-1692</p> <p>250 V OPERATION</p>	<p>OPTION 903 U.S./Canada</p>  <p>PLUG*: NEMA 5-15P CABLE*: HP 8120-1621</p> <p>125 V - 6A**</p>
<p>OPTION 904 U.S./Canada</p>  <p>PLUG*: NEMA G-15P CABLE*: HP 8120-0896</p> <p>250 V - 6A**</p>	<p>OPTION 905 Any country</p>  <p>PLUG*: CEE22-V1 CABLE*: HP 8120-1860</p> <p>250 V OPERATION</p>
<p>OPTION 906 Switzerland</p>  <p>PLUG*: SEV 1011.1959-24507 TYPE 12 CABLE*: HP 8120-2104</p> <p>250 V OPERATION</p>	<p>OPTION 912 Denmark</p>  <p>PLUG*: DHCR 107 CABLE*: HP 8120-2956</p> <p>250 V OPERATION</p>

*The number shown for the plug is the industry identifier for the plug only.
The number shown for the cable is an HP part number for a complete cable including the plug.
**UL listed for use in the United States of America

Figure 5•1

OPERATING ENVIRONMENT

WARNING

To prevent potential fire or shock hazard, do not expose the HP 3577A to rain or other excessive moisture.

Temperature The HP 3577A may be operated in temperatures from 0° C to +55° C. The HP 3577A performance specifications apply within this temperature range.

Humidity The instrument may be operated in environments with humidity up to 95%. However, the HP 3577A should be protected from temperature extremes which cause condensation.

Altitude The HP 3577A may be operated at altitudes up to 4,600 meters (15,000 feet).

Cooling System The HP 3577A is equipped with a forced-air cooling system to maintain the proper internal operating temperature. The cooling fan is mounted on the rear panel. Air, drawn through the rear panel fan filter, is circulated through the instrument and exhausted through holes in the side panels. The HP 3577A should be mounted to permit as much air circulation as possible, with at least one inch clearance at the rear and on each side. The filter for the cooling fan should be removed and cleaned at least once every 30 days. To clean the fan filter, flush it with soapy water, rinse, and then air dry.

Thermal Cutout The HP 3577A is equipped with a thermal cutout switch which automatically turns off the main power supply whenever the internal temperature is excessive. The temperature at which this occurs is dependent upon line voltage and airflow. With proper airflow and operating line voltage, thermal cutout does not occur at or below an ambient temperature of +55° C. The switch resets automatically when the instrument is turned off/on. If a thermal cutout occurs, check for fan stoppage, clogged fan ports, and other conditions that can obstruct airflow or otherwise cause excessive heating.

Table 5•1 Accessories Available

DESCRIPTION	50 Ω IMPEDANCE		75 Ω IMPEDANCE		HIGH IMPEDANCE
	TRANSMISSION	S-PARAMETERS	TRANSMISSION	S-PARAMETERS	TRANSFER FUNCTIONS
MINIMUM CONFIGURATION					
NETWORK ANALYZER	3577A	3577A	3577A	3577A	3577A
S-PARAMETER TEST SET		35677A		35677B	
TYPE N CALIBRATION KIT		35678A		35678B	
TYPE N TEST PORT EXTENSION CABLES	35679A ¹	35679A	35679A ¹	35679B	
POWER SPLITTERS	11850A or 11667A		11850B		
MINIMUM LOSS PAD AND ACCESSORY KITS					
TYPE N MINIMUM LOSS PAD			11852A ³		
TYPE N ACCESSORY KIT	11853A	11853A	11855A	11855A	
BNC ACCESSORY KIT	11854A	11854A	11856A	11856A	11854A
TRANSISTOR FIXTURES					
TO-18/TO-72 TRANSISTOR FIXTURE		11600B			
TO-5/TO-12 TRANSISTOR FIXTURE		11602B			
TRANSISTOR FIXTURE ADAPTER		11858A ⁴			
PROBES					
CURRENT PROBE					1110B
500 MHz ACTIVE PROBE					1120A ²
1:1 MINIATURE PROBE					10021A ²
10:1 MINIATURE PROBE					10040A ²
Notes:					
(1) 2 ea. recommended.					
(2) 3 ea recommended.					
(3) 4 ea recommended.					
(4) Requires 2ea 11525A APC-7 to Type N male adapters for use with the 35677A.					

NOTE

The thermal cutout will operate at any external temperature above +15 °C if the airflow is blocked.

ACCESSORIES AVAILABLE

Table 5•1 lists the accessories available for the HP 3577A. These accessories may be obtained through your HP Sales and Service office.

ACCESSORIES SUPPLIED

Table 5•2 lists the accessories supplied with the HP 3577A Network Analyzer and the HP 35677A S-parameter test set.

Table 5•2

For the HP 3577A		
Power cord	(Qty. 1)	see Figure 5•1
Type N(m)-to-BNC(f) adapters	(Qty. 4)	1250-0780
For the HP 35677A/B		
Interconnect cable	(Qty. 1)	35677-61620
190 mm (7.5 in) 50Ω cable	(Qty. 4)	8120-2289
Cabinet lock foot kit	(Qty. 1)	5061-0099

OPTIONS

Table 5•3 lists the options available for the HP 3577A. These options are available either when the instrument is ordered or for later installation.

Table 5•3

Option	Description	HP Part Number
For the HP 3577A		
907	Front Handle Kit	5061-0091
908	Rack Mounting Kit	5061-0079
909	Front Handle & Rack Mount Kit	5061-0085
910	Additional Service Manual	03577-90010
For the HP 35677A/B		
907	Front Handle Kit	5061-0088
908	Rack Mounting Kit	5061-0074
909	Front Handle & Rack Mount Kit	5061-0075
910	Additional Service Manual	035677-90010
For either instrument		
910	Additional Operating Manual	03577-90000

INSTALLATION

The HP 3577A is shipped with plastic feet attached to the bottom panel, ready for use as a bench instrument. The feet are shaped to make full-width modular instruments self align when they are stacked. Because of its weight, the HP 3577A is not equipped with a tilt stand. It is recommended that a Front Handle Kit (Option 907, HP Part No. 5061-0091) be installed for ease of handling the instrument on the bench.

The HP 35677A/B S-parameter test set was designed to be mounted to the bottom of the HP 3577A Network Analyzer as follows:

- Install the Rear Panel Lock foot kit (5061-0099) as indicated by the kit instructions. This fastens the two instruments together using four slide-together clips across the front edges and two lock feet mounted at the corners of the rear panels' common side.
- Install the test set interconnect cable between the rear panels of both instruments as shown in Figure 5•2. This cable 1) supplies power and ground, 2) lets the analyzer sense the presence of the test set (changes the INPUT menu), and 3) controls the test set's coaxial switch.

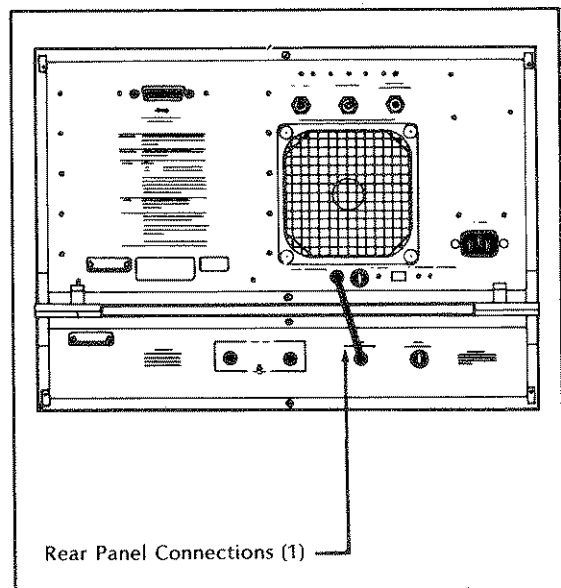

Figure 5•2 Rear panel interconnect cable installation

- Install the four N-connector 50Ω cables between the front panels of the two instruments as shown in Figure 5•3

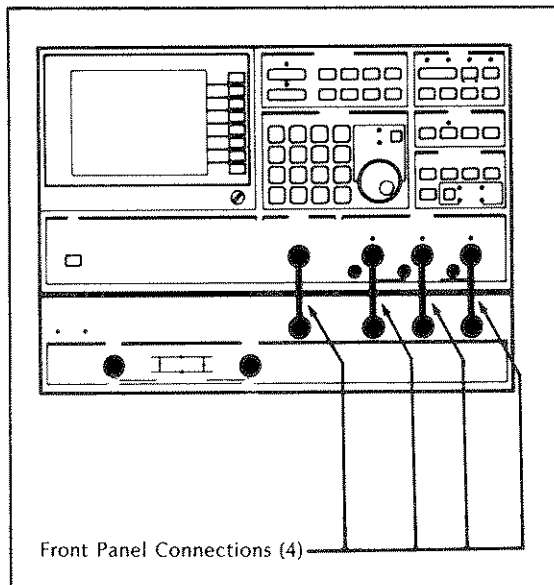

Figure 5*3 Front panel cable installation

The HP 3577A may be rack mounted in either of two ways; with or without slides. Both mountings may be utilized for maximum strength and safety.

To rack mount without slides:

- a. Remove the plastic trim and front handles if so equipped.
- b. Remove the plastic feet from the bottom of the HP 3577A.
- c. Install the flange kit with or without handles according to instructions included with the kit:
 - Rack Flange Kit (no handles). . .Option 908, HP P.N. 5061-0079
 - Rack Flange & Front Handle Kit. . .Option 909, HP P.N. 5061-0085
- d. Install an Instrument Support Rail on each side of the instrument rack. (The Instrument Support Rails, used to support the weight of the instrument, are included with HP rack-mount cabinets.)

WARNING

1. The weight of the HP 3577A must be supported by Instrument Support Rails inside the instrument rack. Do not, under any circumstances, attempt to rack mount the HP 3577A using only the front flanges.
2. The HP 3577A is heavy (approximately 62 lbs, 28 kg.). Use extreme care when lifting it to avoid personal injury.

- e. Using two people, lift the HP 3577A to its position in the rack on top of the Instrument Support Rails.
- f. Using the appropriate screws, fasten the HP 3577A's Rack-Mount Flanges to the front of the instrument rack.

To rack mount with slides, the following items are required:

Quantity	Description
1	Rack Flange Kit (Option 908, HP 5061-0079) OR Rack Flange & Handle Kit (Option 909, HP 5061-0085)
1	Heavy-Duty Slide Kit (HP Part Number 1494-0016)

NOTE

Instrument Support Rails are not absolutely necessary when rack mounting with slides. However, they do relieve a considerable amount of strain from the slides and provide an extra measure of safety.

- a. Perform steps a thru d of the previous procedure.
- b. Attach a slide inner-member bracket to each side of the HP 3577A.
- c. Attach the slide's outer members to the instrument rack according to the instructions included with the slides.
- d. If your instrument rack has extension legs on the front, be sure that they are extended at this time.
- e. Using two people, lift the HP 3577A to its position in the rack and mate the two sections of the slides together. Do not rest the full weight of the HP 3577A on the extended slides until you are sure the instrument rack will not overturn.
- f. Slide the HP 3577A into the rack. Using the appropriate screws, fasten the HP 3577A's Rack Mount Flanges to the front of the rack.

If alignment of the display is necessary, perform the following:

- a. Power ON
- b. Press the SPCL FCTN hardkey
- c. Press the TEST PATTERN softkey.
- d. Adjust HORIZ and VERT on the rear panel to center the pattern on the face of the CRT.
- e. Adjust ALIGN on the rear panel (which rotates the display) until the bottom of the display is parallel to the bottom of the bezel.
- f. Adjust FOCUS and ASTIG on the rear panel until the lines on the display are sharp and clear. It may be easier to align this using a dot on the screen; press INSTR PRESET and use one of the decimal points in the alphanumerics.

HP-IB CONNECTIONS

The HP 3577A Network Analyzer is designed for use with the Hewlett-Packard Interface Bus (HP-IB).

NOTE

The HP-IB is Hewlett-Packard's implementation of IEEE standard 448-1978, "Standard Digital Interface for programmable Instrumentation."

The HP 3577A is connected to the HP-IB by connecting an HP-IB interface cable to the HP-IB connector on the rear panel. Figure 5•4 illustrates a typical HP-IB system interconnection.

With the HP-IB system, up to 15 HP-IB compatible instruments can be interconnected. The HP 10833 HP-IB cables have identical piggy-back connectors on each end so that several cables can be connected to a single source without special adapters or switch boxes. System components and devices can be connected in virtually any configuration as long as a path exists between each device and the controller. As a practical matter, avoid stacking more than three or four cables on any one connector. If the stack gets too long, force on the stack can produce sufficient leverage to damage the connector mounting. Be sure that each connector is firmly screwed in place to keep it from working loose during use. The HP 3577A uses all the available HP-IB lines; therefore, damage to any connector pin may adversely affect HP-IB operation. See Figure 5•5.

To achieve design performance with the HP-IB, proper voltage levels and timing relationships must be maintained. If the system cable is too long, the lines cannot be driven properly and the system will fail to perform. Total cable length for the system must be less than or equal to 20 meters (65 feet) or 2 meters (6 feet) times the total number of devices connected to the bus, whichever is less.

STORAGE AND SHIPMENT

Environment The HP 3577A and HP 35677A/B should be stored in a clean, dry environment. The following are environmental limitations that apply to both storage and shipment.

- Temperature -40° C to +75° C
- Humidity Up to 95% relative
- Altitude Up to 15,300 meters (50,000 feet)

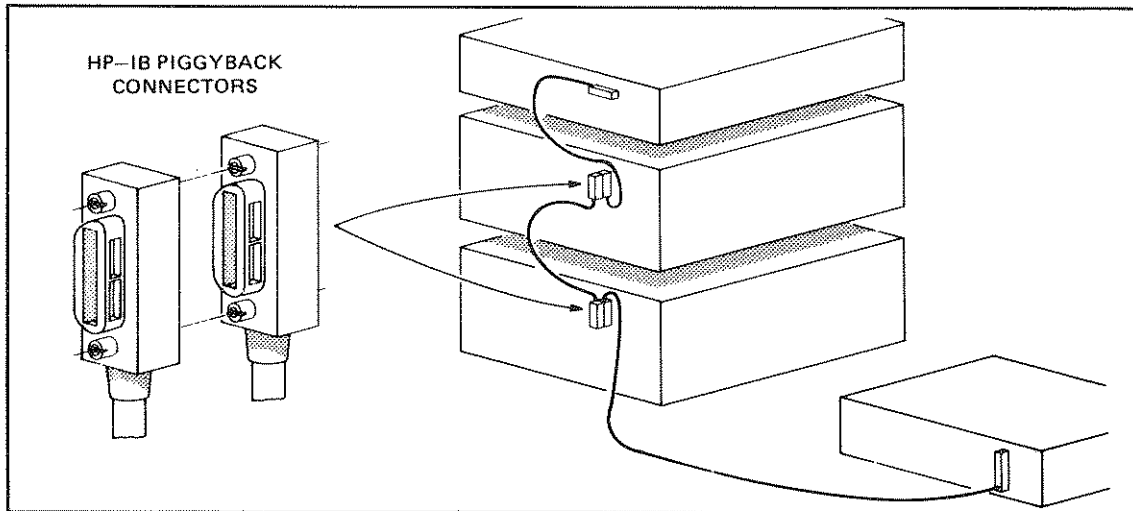

Figure 5•4 A typical HP-IB system Interconnection

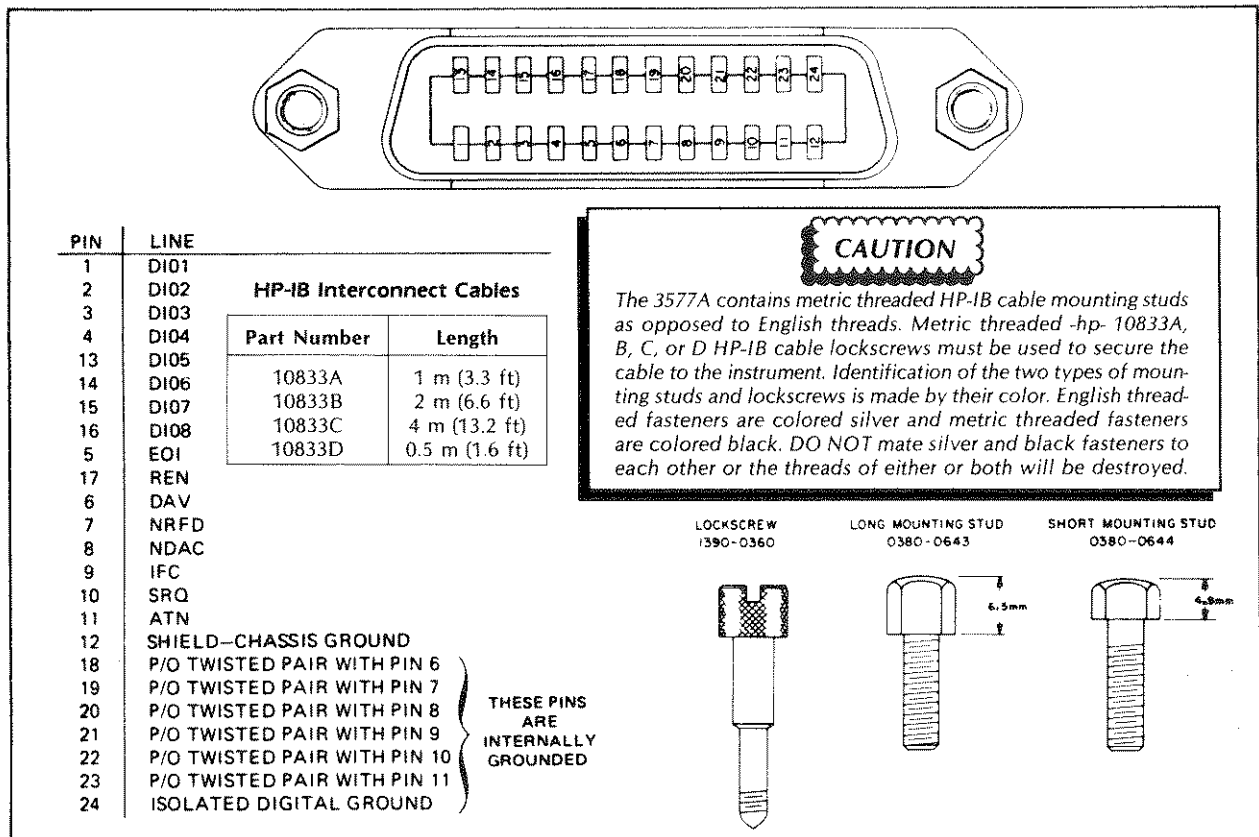

Figure 5•5 HP-IB Interfacing

The instruments should also be protected from temperature extremes which cause condensation.

Original Packaging Containers and materials equivalent to those used in factory packaging are available through Hewlett-Packard offices. If the instrument is being returned to Hewlett-Packard for service, attach a tag indicating the type of service required, return address, model number, and full serial number. Also, mark the container FRAGILE to ensure careful handling. In any correspondence, refer to the instrument by model number and full serial number.

Other Packaging The following general instructions should be followed for repackaging with commercially available materials:

- a. Wrap the instrument in heavy paper or anti-static plastic. If the instrument is being shipped to a Hewlett-Packard office or service center, attach a tag to the instrument indicating type of service required, return address, model number, and full serial number.
- b. Use a strong shipping container. A double-wall carton made of 350 pound test material is adequate.

- c. Use a layer of shock absorbing material 70 to 100 mm (3 to 4 inches) thick around all sides of the instrument to provide firm cushioning and prevent movement inside the container. Protect the front panel with cardboard.

CAUTION

Styrene pellets in any shape should not be used as packing material. The pellets do not adequately cushion the instrument and do not prevent the instrument from shifting in the carton. The pellets also create static electricity which can damage electronic components.

- d. Seal shipping container securely.
- e. Mark shipping container FRAGILE to ensure careful handling.
- f. In any correspondence, refer to the instrument by model number and full serial number.

3577A Network Analyzer Specifications

SOURCE CHARACTERISTICS

Frequency Characteristics

Frequency Range: 5 Hz to 200 MHz.
Frequency Resolution: 0.001 Hz.
Stability: $\pm 5 \times 10^{-8}$ /day, 0 to 55°C.

Output Characteristics

Level Range: +15 dBm to -49 dBm (1.26 Vrms to 793 μ Vrms; 2 dBV to -62 dBV) into a 50 Ω load.
Resolution: 0.1 dB.
Entry Units: dBm, dBV, V.
Accuracy: ± 1 dB at +15 dBm and 100 kHz. Below +15 dBm, add the greater of ± 0.02 dB/dB or 0.2 dB.
Flatness: 1.5 dBp-p from 5 Hz to 200 MHz.
Impedance: 50 Ω ; >20 dB return loss at all levels.
RF Output Connector: 50 Ω Type N female.
Spectral Purity:
Phase Noise (in 1 Hz Bandwidth):
 < -70 dBc at offset frequencies from carrier of 100 Hz to 20 kHz.
Harmonics: < -30 dBc.
Non-Harmonic Spurious Signals:
 < -50 dBc or -70 dBm whichever is greater.
Reverse Power Protection: Output is automatically opened at a signal level of approximately +22 dBm (50 Ω), or ± 4 Vdc, or greater applied to the source output. Source output is reconnected with the Clear Trip function.

Sweep Characteristics

Linear Frequency:

Range: 5 Hz to 200 MHz.
Entry: Start/stop or center/span frequencies.
Span: 0 Hz or 0.01 Hz to 200 MHz, phase continuous.
Sweep Time: 100 ms/span to 6553 s/span.
Direction: Increasing or decreasing frequency.

Log Frequency (segmented linear approximation):

Range: 5 Hz to 200 MHz.
Entry: Start/stop frequencies.
Span: 0.01 Hz to 200 MHz, phase continuous.

Log Accuracy: 2%.

Sweep Time: 200 ms/span to 6553 s/span.
Sweep Direction: Increasing frequency.

Alternate Frequency: Sweep alternates between two separate start/stop frequencies using linear sweep only.

CW: Frequency is fixed. Data is updated with a selectable sample time from 1ms to 16 s.

Log Amplitude (fixed frequency):

Range: +15 dBm to -49 dBm.
Entry: Start/stop level in dBm or dBV.
Sweep Time: 1 ms/step to 16 s/step. Total sweep time/span depends upon total number of steps and time/step.

Sweep Modes: Continuous, single, manual.

Trigger Modes: Free run, immediate, line, external.

3577A Block Diagram

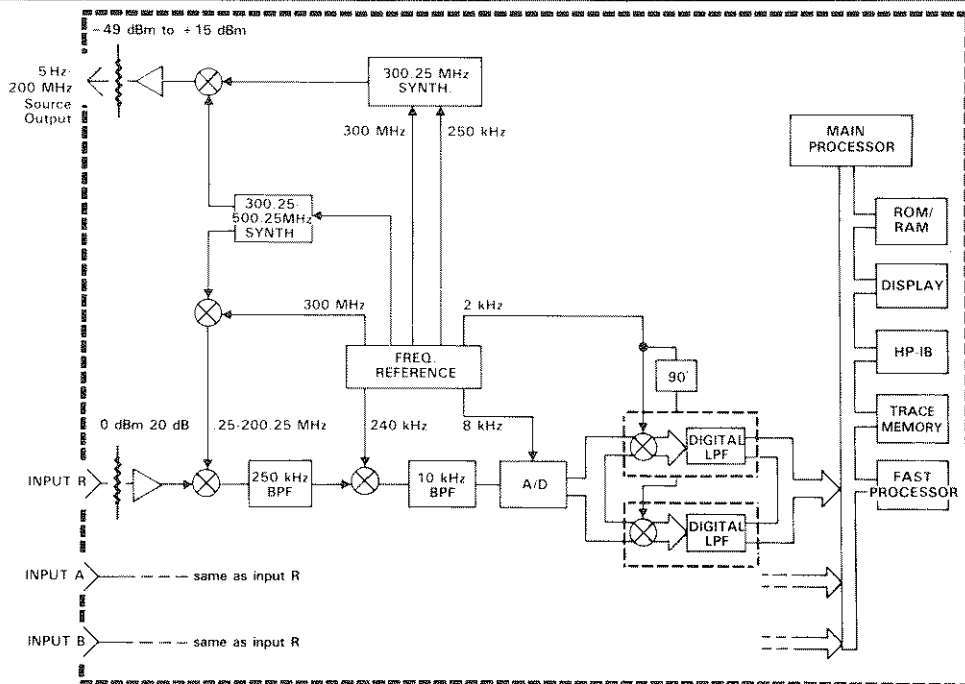

Frequency Response: Specifications apply when inputs are driven from a 50 Ω source impedance.

Frequency	Error*	
	50 Ω Input	1 MΩ Input
20 Hz to 20 MHz	2 deg pp	5 deg pp
5 Hz to 200 MHz	10 deg pp	----
5 Hz to 20 MHz	----	10 deg pp

*For unequal input attenuation add 8 deg pp.

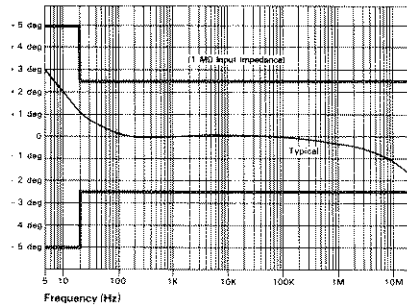
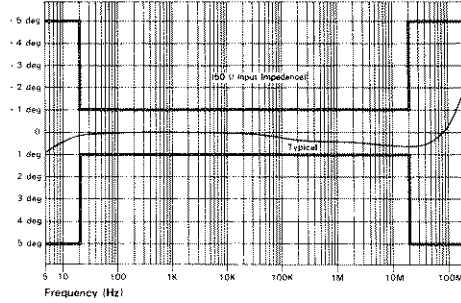

Crosstalk: Specified under Input Characteristics.

Reference Level:

Range: -500 deg to +500 deg (-8.7 rad to +8.7 rad)

Resolution: 0.01 deg.

Stability:

Temperature: Typically < ±0.05 deg/°C.

Time: Typically < ±0.05 deg/hour at 25°C.

Polar Characteristics

Range, Resolution, Display Units, Dynamic Accuracy, Frequency Response, Uncertainty, Crosstalk, Reference Level, and Stability specifications are the same as the corresponding magnitude and phase characteristics.

Full Scale Magnitude Range:

Absolute (A,B,R): 0.1 nV to 10 V.

Ratio (A/R,B/R,A/B): 10⁻¹⁰ to 10²⁰.

Real/Imaginary Characteristics

Range, Dynamic Accuracy, Frequency Response, Uncertainty, Crosstalk, Stability specifications are the same as the corresponding magnitude and phase characteristics.

Resolution:

Marker: 5 digits.

Display: 0.1 nV/div to 10 V/div for absolute; 10⁻¹⁰ to 10²⁰ for ratio.

Display Units: V and linear ratio.

Reference Level:

Range: ±10 V for absolute; ±10²⁰ for ratio.

Resolution: 5 digits.

Delay Characteristics (Linear Frequency Sweep; A/R, B/R, A/B; 50 Ω input impedance)

Range: Group delay is a computed parameter, defined by the equation

$$t_g = - \frac{\Delta\phi}{2\pi\Delta f}$$

Minimum: The minimum delay time is given by the expression

$$\frac{1.4 \times 10^{-5}}{\text{Aperture [Hz]}}$$

Maximum: The maximum delay is given by the expression

$$\frac{N - 1}{2 \times \text{Span [Hz]}}$$

where N = number of points per sweep (51,101,201,401).

Effective Range: 1 ps to 20,000 s.

Resolution:

Marker: Same as minimum delay time or 5 digits, whichever is greater.

Display: 0.01 ns/div to 1000 s/div.

Aperture: Selectable 0.5%, 1%, 2%, 4%, 8%, 16% of frequency span.

Display Units: s.

Accuracy:

$$\frac{.13 \text{ s}}{(\text{freq [Hz]})^2} \pm 2 \text{ ns}$$

or

$$\frac{\text{Dynamic Phase Accuracy}}{360 \times \text{Aperture [Hz]}} \pm 2 \text{ ns}$$

whichever is greater.

The $\frac{.13 \text{ s}}{(\text{freq [Hz]})^2} \pm 2 \text{ ns}$ term can be

calibrated out with normalization.

Crosstalk: Determined by the expression

$$\frac{\text{Phase Crosstalk}}{360 \times \text{Aperture [Hz]}}$$

Reference Level:

Range: ±10³ s.

Resolution: 5 digits.

Stability:

Temperature: Determined by the expression

$$\frac{\text{Phase Temperature Stability}}{360 \times \text{Aperture [Hz]}}$$

Time: Determined by the expression

$$\frac{\text{Phase Time Stability}}{360 \times \text{Aperture [Hz]}}$$

3577A Network Analyzer Specifications

DISPLAY CHARACTERISTICS

Annotation: Start/stop, center/span or CW frequency, source level, scale/div, reference level, delay aperture, marker data, and soft key functions.

Graticules: Rectangular logarithmic and linear, polar, and Smith. All graticules are electronically generated.

Traces: Two simultaneous traces may be present with a rectangular graticule. One trace with polar or Smith graticules.

Markers: Each trace has one main marker and an offset marker. Markers indicate data at corresponding trace coordinates in the same units as used to set the Reference Level. Markers can be used to modify certain display parameters. Marker resolution is the same as horizontal display resolution.

Reference Line Position:

Rectangular Graticule: 0% to 100% full scale deflection in 0.05% increments.

Polar/Smith Chart Graticule: ± 500 deg in 0.001 deg increments.

Data Storage: Measured data can be stored in vector format in non-volatile storage registers D1,D2,D3,D4. Stored data can be redisplayed later or operated on with Vector Math.

Vector Math: Input Magnitude and Phase Data, Stored Data, and User Defined Constants and Functions can be mathematically combined into expressions which define displayed or stored data. Mathematical operations are: add, subtract, multiply, and divide.

Calibration:

Normalization: Both traces can be normalized to measured data with full accuracy, and resolution. Scale factors can be changed after normalization without affecting calibration.

Normalize(Short): Compensates for frequency response errors.

Requires a short termination.

One Port Part Cal: Compensates for directivity errors and frequency response errors. Requires open and load terminations.

One Port Full Cal: Compensates for directivity, frequency response and source match errors. Requires open, short, and load terminations.

Noise Averaging:

Type: Exponentially weighted vector averaging on successive sweep data.

Averaging Factor: Selectable 1(off), 4,8,16,32,64,128,256.

The current trace A_n is always displayed and updated at the sweep rate according to the expression

$A_n = S_n/F + (F-1)(A_{n-1})/F$, where S_n = current input signal, F = averaging factor, A_{n-1} = previously averaged trace.

Averaging Factor is fixed at 1 in alternate sweep.

Linear Phase Slope Compensation: Provides linear phase slope offset in deg/span.

Range: $-72,000$ deg./span to $+72,000$ deg./span (-1256 rad/span to $+1256$ rad/span).

Resolution: 5 digits or 0.001 deg whichever is greater.

Accuracy: 0.02%.

Autoscale: Automatically adjusts the reference level and scale/div. of the displayed measurement.

Measured No. of Points per Sweep:

Logarithmic frequency, 401;
linear frequency, 51,101,201,401;
CW frequency, 1.

Measure No. of Steps per Sweep:

Logarithmic Amplitude Sweep, 5,10,20,
50,100,200,400.

Display Resolution: Horizontal and vertical.

Rectangular: 1600 points.

Polar: 1200 points.

PROGRAMMING CHARACTERISTICS

Capability: Remote programming is via the Hewlett-Packard Interface Bus (HP-IB)* for all 3577A front panel control functions, except the ac line switch, display intensity, entry knob, HP-IB address and talk-only on/off. The 35677A/B S-Parameter Test Sets are programmable through the 3577A interface only.

Interface Functions: SH1,AH1,T5,TE \emptyset ,L4,LE \emptyset ,SR1,RL1,PP1,DC1,DT1,C \emptyset ,E1.

Output Data Transfer Time: 401 data points (single parameter) can be transferred directly to an HP 200 series computer in Basic language as follows:

ASCII Mode: Typically 1500 ms.

Binary Floating Point Mode: Typically 160 ms.

Graphics Capabilities:

Alphanumeric Characters: 12 lines of text with 40 characters per line can be displayed. Character set includes alphanumerics special characters and line vectors.

Vector Display: Trace lines can be drawn on the display between any two points with a resolution of 2048 points along the horizontal and vertical axes.

*HP-IB is Hewlett-Packard's implementation of IEEE Standard 488-1978.

RECEIVER CHARACTERISTICS

Input Characteristics

Frequency Range: 5 Hz to 200 MHz.
Inputs: Three receiver inputs (A, B and R).
Input Impedance: Selectable 50 Ω with >25 dB return loss, or 1 MΩ in parallel with approximately 30 pF.

Maximum Input Level:

Input Impedance	Input Attenuation	
	0 dB	20 dB
50 Ω	-20 dBm	0 dBm
1 MΩ	-33 dBV (22.4 mV)	-13 dBV (224 mV)

Input Damage Level (approximate):
 50 Ω: +30 dBm or 25 Vdc.
 1 MΩ: +16.9 dBV (7 Vrms) or 25 Vdc.
 The 50 Ω input impedance automatically switches to 1 MΩ at approximately +20 dBm, and can be reset with the clear-trip function.
Input Connectors: 50 Ω Type N female.
Resolution Bandwidth: Selectable 1 kHz, 100 Hz, 10 Hz, or 1 Hz.
Sensitivity (Due to noise and internal crosstalk between source and receiver inputs):

Resolution Bandwidth	Minimum Freq.	Minimum Freq. - 30 kHz		30 kHz - 200 MHz (50 Ω) 30 kHz - 20 MHz (1 MΩ)	
		Maximum Input Level		Maximum Input Level	
		0 dBm -13 dBV (20 dB atten)	-20 dBm -33 dBV (0 dB atten)	0 dBm -13 dBV (20 dB atten)	-20 dBm -33 dBV (0 dB atten)
1 Hz	100 Hz	-110 dBm	-130 dBm	-110 dBm	-130 dBm
10 Hz	100 Hz	-100 dBm	-120 dBm	-110 dBm	-130 dBm
100 Hz	500 Hz	-90 dBm	-110 dBm	-105 dBm	-125 dBm
1 kHz	5 kHz	-80 dBm	-100 dBm	-95 dBm	-115 dBm

Residual Responses: > 100 dB below maximum input level, except for crosstalk error limits, L.O. feedthrough, and ac line and fan related spurious signals.

Crosstalk Error Limits: (> 100 dB isolation between inputs)

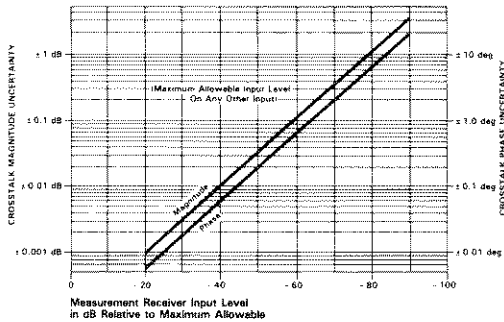

L.O. Feedthrough: < -33 dB below maximum input level.
AC Line and Fan Related Spurious Signals: < -100 dBm below 1 kHz input frequency.

Electrical Length/Reference Plane

Extension: Provides equivalent electrical line length, or delay at inputs A, B and R.
Range: -3 × 10⁸ m to +3 × 10⁸ m, or +1 s to -1 s.
Resolution: 5 digits or 0.1 cm (3.3 ps) whichever is greater.
Accuracy: ±0.1 cm or ±0.02% whichever is greater.

Magnitude Characteristics

Range: Maximum Input Level to Sensitivity.
Resolution:
Marker: 0.001 dB (log); 5 digits (linear).
Display: 0.01 dB/div to 20 dB/div (log absolute); 0.01 dB/div to 200 dB/div (log ratio); 0.1 nV/div to 10 V/div (linear absolute); 10⁻¹⁰/div to 10²⁰/div (linear ratio).
Display Units: dB, dBm, dBV, V, and linear ratio.
Accuracy (at 100 kHz, 25° C, and Maximum Input Level):
Absolute (A,B,R): ±0.2 dB.
Ratio (A/R,B/R,A/B): ±0.15 dB (50 Ω); ±0.2 dB (1 MΩ).
 Accuracy and frequency response errors, and effects of different input attenuation can be calibrated out with normalization.

Dynamic Accuracy:

Error		Input Level Relative to Maximum Allowable
Resolution Bandwidth		
1 kHz, 100 Hz, 10 Hz	1 Hz	
±.04 dB	±.04 dB	0 dB to -10 dB
±.02 dB	±.02 dB	-10 dB to -50 dB
±.05 dB	±.05 dB	-50 dB to -60 dB
±.15 dB	±.25 dB	-60 dB to -80 dB
±.75 dB	±.75 dB	-80 dB to -90 dB
±.75 dB	±3.00 dB	-90 dB to -100 dB

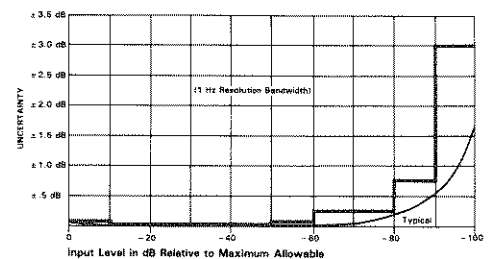
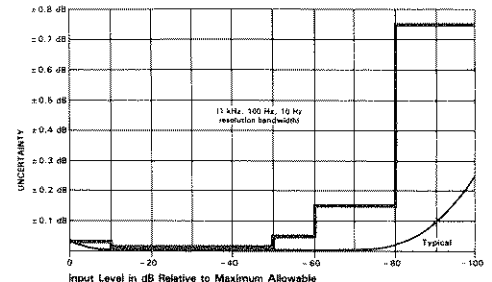

3577A Network Analyzer Specifications

Frequency Response: Specifications apply when inputs are driven from a 50 Ω source impedance.

Absolute (A,B,R):

Frequency	Error	
	50 Ω Input	1 MΩ Input
20 Hz to 20 MHz	.3 dB pp	.5 dB pp
5 Hz to 200 MHz	.6 dB pp	----
5 Hz to 20 MHz	----	1 dB pp

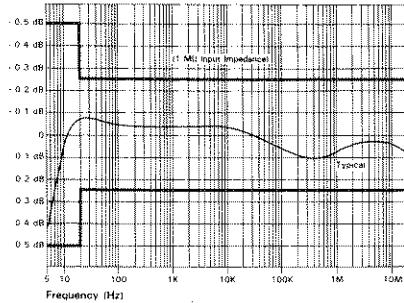
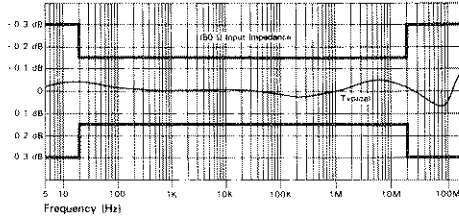

Ratio (A/R,B/R,A/B):

Frequency	Error*	
	50 Ω Input	1 MΩ Input
20 Hz to 20 MHz	.3 dB pp	.3 dB pp
5 Hz to 200 MHz	.4 dB pp	----
5 Hz to 20 MHz	----	.6 dB pp

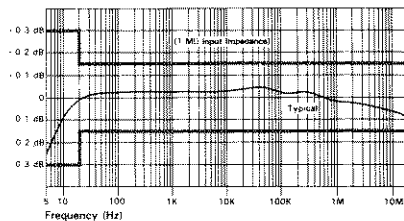
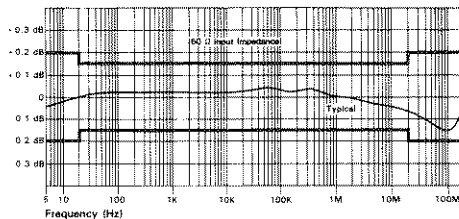

*For unequal 50 Ω input attenuation add 0.15 dB pp (20 Hz to 20 MHz), 0.3 dB pp (5 Hz to 200 MHz). For unequal 1 MΩ input attenuation add 0.2 dB pp (20 Hz to 20 MHz), 0.4 dB pp (5 Hz to 20 MHz).

Reference Level:

Range: -207 dBm to +33 dBm (-220 dBV to +20 dBV) (log absolute); -400 dB to +400 dB (log ratio); 0 V to 10 V (linear absolute); 0 to 10²⁰ (linear ratio).

Resolution: 0.001 dB (log); 5 digits (linear).

Stability:

Temperature: Typically < ±0.02 dB/°C.
Time: Typically < ±0.05 dB/hour at 25°C.

Phase Characteristics (A/R,B/R,A/B):

Range: ±180 deg.

Resolution:

Marker: 0.005 deg (0.0001 rad)
Display: 0.01 deg/div to 200 deg/div (0.00018 rad/div to 3.49 rad/div).

Display Units: degrees, radians.

Accuracy (at 100 kHz, 25°C, and Maximum Input Level): ±2.0 deg.

Accuracy and frequency response errors, and effects of different input attenuation can be calibrated out with normalization.

Dynamic Accuracy:

Error*	Input Level Relative to Maximum Allowable
±.4 deg	0 dB to -10 dB
±.2 deg	-10 dB to -50 dB
±.5 deg	-50 dB to -60 dB
±1.5 deg	-60 dB to -80 dB
±7.5 deg	-80 dB to -100 dB

*Specifications do not apply below -60 dB in a 1 Hz Resolution Bandwidth.

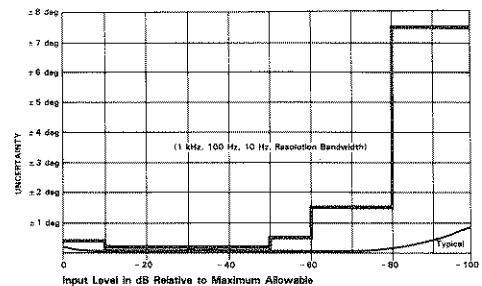

SPECIAL TOPICS

APPENDIX A

DATA PROCESSING AND STRUCTURE

Knowing how the HP 3577A takes measurements and what it does with the data will increase your effectiveness as a user. This section presents and explains the operating system flow chart of the HP 3577A Network Analyzer. For the following discussion refer to the flow chart in Figure A*1

The synthesized source sweeps the selected span continuously (when not in CW sweep type or MANUAL sweep mode) while the 3 receivers take measurements, digitize them, and output the data. The processor accepts data from the receivers only at certain frequencies. These are usually 401 equally spaced "bins" in the sweep span, but 201, 101, or 51 points/sweep may be selected for the sweep resolution. Each bin is as wide as the selected resolution bandwidth and has associated with it a frequency number (position information) and measurement value. Bins do not always overlap.

The process shown in the flow chart operates on one bin at a time. Data is taken and a point plotted on the screen before the next bin is sampled.

The receiver's output values are complex numbers of the form $(X + jY)$, where X is real and jY imaginary. Two numbers (X & Y) are transferred to the processor for each bin. Data is collected from all three receivers simultaneously.

If the AVERAGE or LENGTH features are in use, the processor implements those functions at this point and then stores the results in trace memory. Trace memory is used to store the complex numbers representing inputs R, A, B, and storage registers D1, D2, D3, and D4. If LENGTH and AVERAGE are inactive, the measurement data is stored in trace memory without change. This point is emphasized because the AVERAGE and LENGTH functions change what is stored in trace memory. Consider the case of single sweep mode. After the data is taken it may be formatted to any of a number of configurations, but changing LENGTH or

AVERAGE has no effect. TRACE INPUTS, DISPLAY FUNCTIONS, or SCALE may be changed and the display updated from trace memory without taking another measurement. If LENGTH or AVERAGE are changed, a new measurement (sweep) must be taken and data stored in trace memory before the screen can be updated. Any math processing that occurs after data has been stored in trace memory registers R, A, and B, operates on this complex data.

Next, the operating system executes a store if it been requested. If a STORE is executed, source sweep and receiver measurements are interrupted while a memory sweep of trace memory occurs. If a simple "STORE REG D_" is executed (i.e. not USER DEF STORE) then the STORE math is the same as the INPUT math; the trace is stored using the current INPUT definition. If a USER DEF STORE command is given, the user defines the math done (and the data stored is not displayed). Changes in display function do not change what is stored. The data in trace memory may be processed by any display function and displayed as MAGNITUDE, PHASE, DELAY, etc. information. After the STORE math is complete the data is stored in the register specified by the user (D1-D4).

Next, (unless this was the last bin) the operating system continues the memory sweep, repeating this process for each bin. The displayed trace is not affected unless the INPUT definition is a function of the storage register used.

If a STORE is not requested, the next step is to do the math defined by the INPUT function. Then, if PHASE SLOPE is on and the value is non-zero, the PHASE SLOPE math is done. Complex numbers are the result of all processing done up to this point. This data is then processed according to the definition of DISPLAY FUNCTION, resulting in a high-precision, floating point, scalar number. This number is stored in main memory for readout as MARKER data. The same number is then processed according to the SCALE definitions for placement on the display. These two scalar numbers provide 1) a trace that stays within the boundaries of the

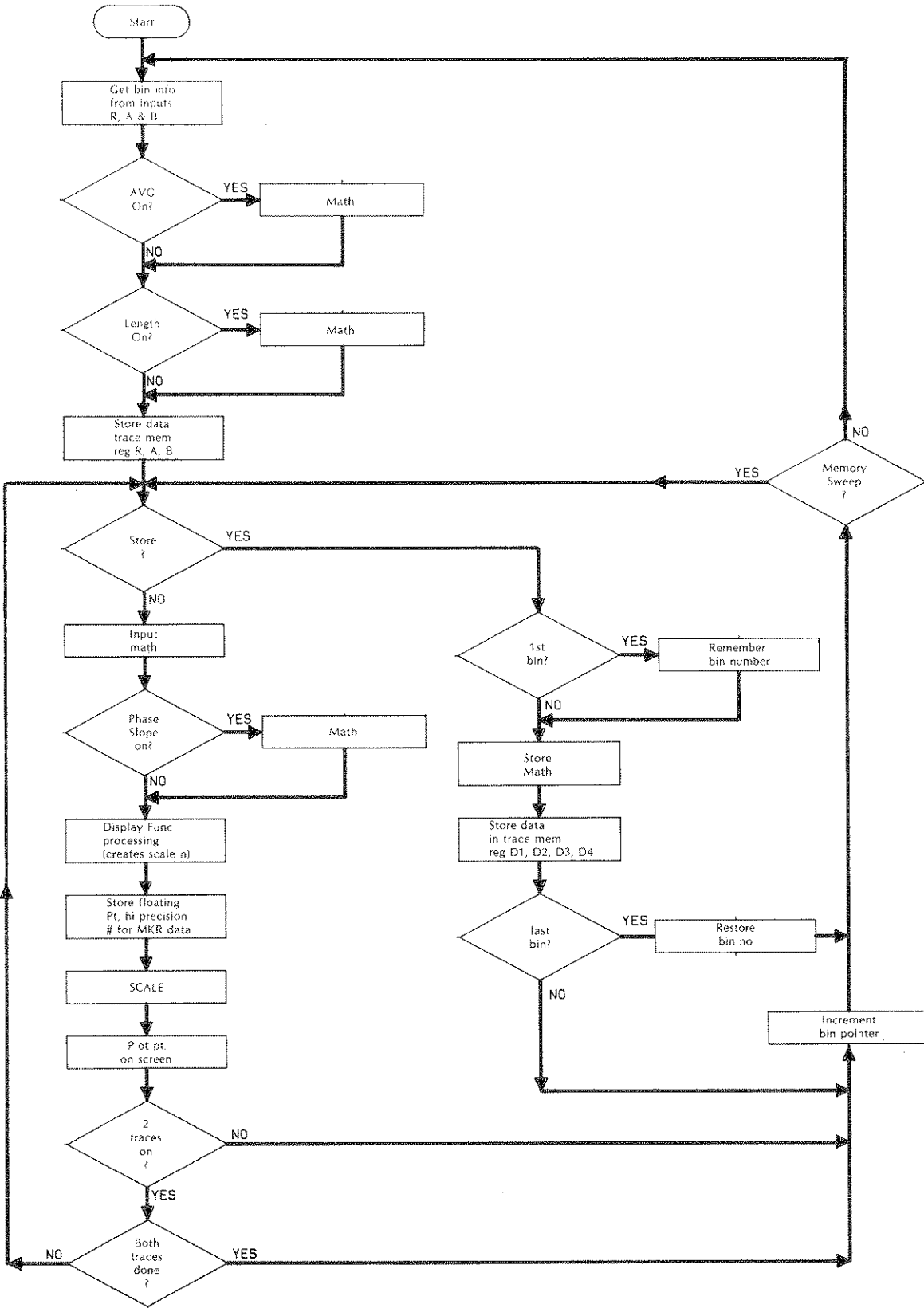

Figure A-1.

REMOTE GRAPHICS

APPENDIX B

To enter display graphics under remote control, display commands must be issued to the 1345A display module using the ENA 3577A HP-IB code as described in this quick reference

For more details, refer to the Operation Section of the 1345 Service Manual or the "Designers Manual for the 1345A Digital Display Module," number 01345-90902.

1345A QUICK REFERENCE GUIDE

1345A COMMANDS.

NOTE: Bit D15 is used only for vector memory board commands. For standard 1345A commands, D15 should be 0.

1345A 16 Bit Data Word.

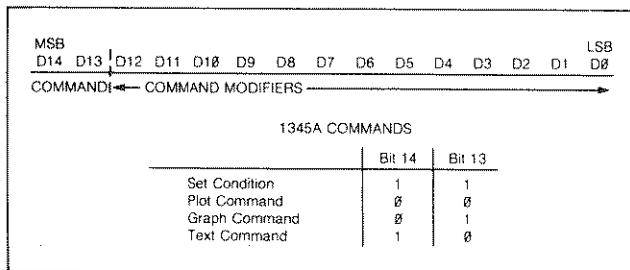

Set Condition Command.

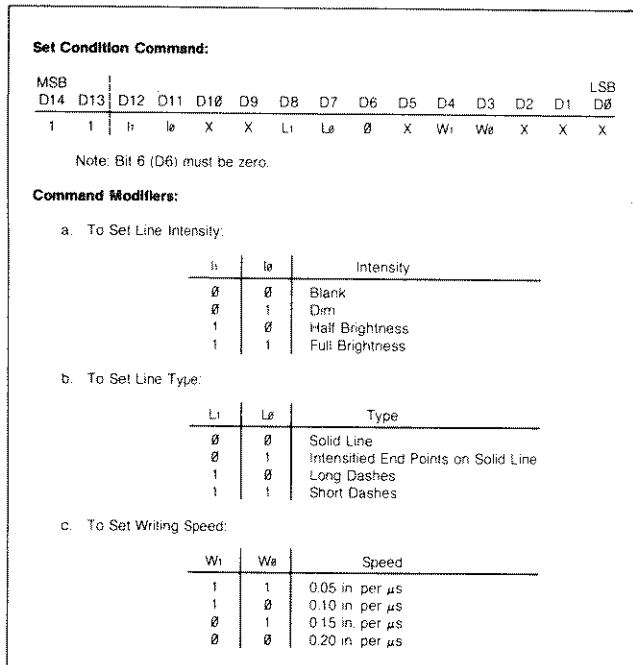

Plot Command.

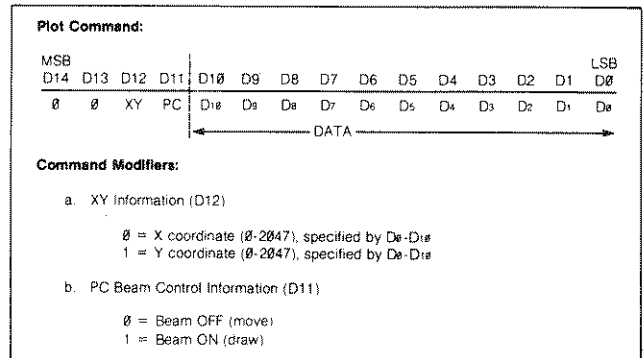

Programming Command Ranges.

PROGRAMMING COMMAND RANGES OF THE 1345A		
1345A Command	Octal Range	Hexadecimal Range
a. Plot		
X	00000-07777	0000-0FFF
Y (beam off)	10000-13777	1000-17FF
Y (beam on)	14000-17777	1800-1FFF
b. Graph		
Set Delta-X	20000-27777	2000-2FFF
Y (beam off)	30000-33777	3000-37FF
Y (beam on)	34000-37777	3800-3FFF
c. Text	40000-57777	4000-5FFF
d. Set Condition	60000-77777	6000-7FFF

Graph Command.

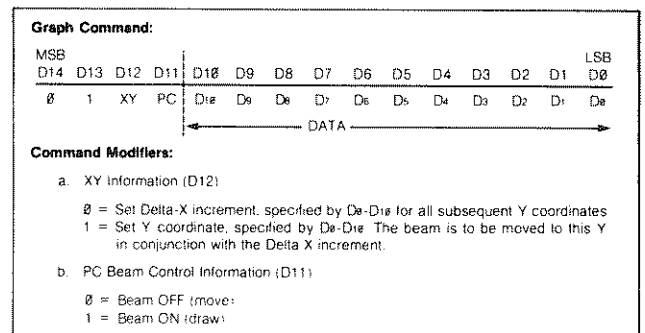

MEMORY BOARD COMMANDS.

Vector Memory Word.

M15	M14	M13	M12	M11	M10	M9	M8	M7	M6	M5	M4	M3	M2	M1	M0
0	B14	B13	B12	B11	B10	B9	B8	B7	B6	B5	B4	B3	B2	B1	B0

(SEE DATA BIT DEFINITIONS FOR 1345A COMMANDS)

Internal Jump.

An internal jump does not affect the Vector Memory address pointer.

M15	M14	M13	M12	M11	M10	M9	M8	M7	M6	M5	M4	M3	M2	M1	M0
1	0	X	X	A11	A10	A9	A8	A7	A6	A5	A4	A3	A2	A1	A0

X = DONT CARE
 M15 = 1, M14 = 0. Internal jump to Vector Memory address specified by A11 thru A0 during refresh.

Address Pointer.

M15	M14	M13	M12	M11	M10	M9	M8	M7	M6	M5	M4	M3	M2	M1	M0
X	X	X	X	A11	A10	A9	A8	A7	A6	A5	A4	A3	A2	A1	A0

X = DONT CARE
 A0 = 0. Set pointer register to the Vector Memory address value specified by A11 thru A0.

1345A Modified ASCII Character Set.

		1345A MODIFIED ASCII CODE CONVERSION TABLE							
		MOST SIGNIFICANT CHARACTER							
		0	1	2	3	4	5	6	7
LEAST SIGNIFICANT CHARACTER	0		centered *	SP	0	@	P	.	p
	1	HP logo	centered o	!	1	A	Q	a	q
	2	β	l	-	2	B	R	b	r
	3		—	#	3	C	S	c	s
	4	upper-half tic	l	\$	4	D	T	d	t
	5	lower-half tic	—	%	5	E	U	e	u
	6	left-half tic	√	&	6	F	V	f	v
	7	right-half tic	π	—	7	G	W	g	w
	8	back space	Δ	!	8	H	X	h	x
	9	1/2 shift down	μ	!	9	I	Y	i	y
	A	line feed	° (degree)	.	.	J	Z	j	z
	B	inv. line feed	ρ	+	.	K		k	
	C	1/2 shift up	ρ	+	.	L	\	l	
	D	carriage return	!'	.	.	=	M		m
	E	horizontal tic	θ	.	.	>	N	^	n
	F	vertical tic	λ	/	?	O	—	o	▶

EXAMPLES

HP logo = 01
 A = 41
 l = 69
 √ = 16
 ▶ = 7F
 line feed = 09

Text Command.

Text Command:

MSB	D14	D13	D12	D11	D10	D9	D8	D7	D6	D5	D4	D3	D2	D1	D0	LSB
	1	0	Sr	Sp	Rr	Re	ES	Cr	Cs	Cl	C4	C3	C2	C1	C0	

CHARACTER →

Command Modifiers:

For Ca-C7, see modified ASCII conversion table

- ES Establish Size of Character
 - 0 = Use previous size and rotation
 - 1 = Establish new size and rotation according to Sr, Sp, Rr and Re
- Rotate Character CCW

Rr	Re	Rotation
0	0	0 degrees
0	1	90 degrees
1	0	180 degrees
1	1	270 degrees

Sr	Sp	Size	W X H (in addressable points)
0	0	1X	24 X 36
0	1	1.5X	36 X 54
1	0	2X	48 X 72
1	1	2.5X	60 X 90

4 PROGRAMMABLE CHARACTER SIZES:

- 1.0 x 56 characters per line, 29 horizontal lines possible.
- 1.5 x 37 characters per line, 19 horizontal lines possible.
- 2.0 x 28 characters per line, 14 horizontal lines possible.
- 2.5 x 22 characters per line, 11 horizontal lines possible.

Character Rotation.

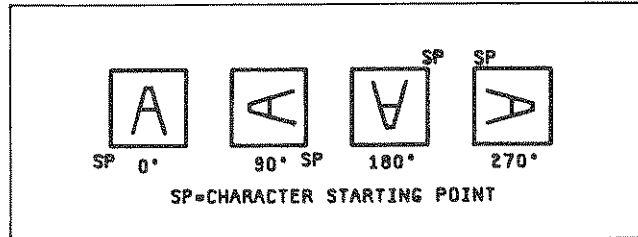

Capabilities for Character and Vector Combinations.

Conditions.				
Average character drawing time: 16 -sec				
Recommended refresh rate: 60 Hz ~ 16.6 msec				
1345A writing speed: 0.1 in./-sec				
Vector dead time: 1 -sec				
	NUMBER OF CHARACTERS TO BE DRAWN			
	0	100	200	300
Total frame time (msec)	16.67	16.67	16.67	16.67
Character writing time (msec)	0	1.60	3.20	4.80
Time left to draw vectors (msec)	16.67	15.07	13.47	11.87
AVERAGE VECTOR LENGTH	APPROXIMATE NUMBER OF VECTORS DRAWN			
0.1 in.	8330	7530	6730	5930
0.5 in.	2770	2510	2240	1970
2.0 in.	790	710	640	560
6.0 in.	270	240	220	190

SCREEN MESSAGES

APPENDIX C

The HP 3577A Network Analyzer displays operator messages to inform the user of various conditions. These fall into three categories: instructions or informative messages, warning messages, and error messages. Under remote control, the user may select the message category level that pulls SRQ and appears in the DUMP STATUS command as defined by the error reporting mode selected. Refer to "Masking the Status Byte" in the section on Remote Operation. In the following table W is used for warning, E is for error, and M for general information messages.

MESSAGE	DESCRIPTION
1 MHz FAILURE	E Hardware failure.
1345A JUMP CMND DISALLOWED	E HP-IB. Use of the HP 1345 display module command is illegal when entering graphics.
1 MHz & 8 kHz FAILURE	E Hardware failure.
8 kHz FAILURE	E Hardware failure.
ABORT CAL SOFTKEY ONLY	W During MEASR CAL sweeps and CAL processing, the only key to which the HP 3577A responds (besides INSTR PRESET) is ABORT CAL.
AMPLITUDE SWEEP TIMEOUT	E Amplitude sweep operate in the CONTINUOUS SWEEP MODE for five minutes before changing to SINGLE, to prevent excessive wear on the output relays. See AMPLITUDE SWEEP TYPE.
AVG TURNED OFF IN ALT SWP	W If AVERAGE is on and ALTERNATE SWEEP TYPE is selected, this message appears. It is not possible to use averaging with ALTERNATE SWEEP.
CONFIDENCE TEST FAILED	E One or more of the confidence tests do not pass. Hardware failure.
CONFIDENCE TEST PASSED	M All confidence tests passed.
CONT CAL NOT ALLOWED	E HP-IB. Continue CAL not allowed unless in the MEASR CAL sequence.
COPY NEEDS "FROM" TRC ON	E Both traces should be on to COPY SCALE. This message appeared because one is inactive.
DATA ERROR #__	E HP-IB. User-entered data may cause data errors when involved in trace arithmetic. This message may also indicate a hardware failure.
DATA INPUT ABORTED	E HP-IB. Data transfer to the HP 3577A has stopped.
DATA OUTPUT ABORTED	E HP-IB. Data transfer from the HP 3577A has stopped.
DELAY APERTURE INCREASED	W Delay aperture is increased automatically when necessary as the sweep resolution is decreased. This message appears when the display function is delay, aperture is small, and the user selects a reduced sweep resolution.

MESSAGE	DESCRIPTION
DISPLAY MEMORY TEST FAILED	E Hardware failure.
DISPLAY MEMORY TEST PASSED	E For more details refer to the Service Manual.
ENTRY SET TO 0.0	W An extremely small number has been rounded to zero.
ENTRY TOO LONG	E Data entered has too many characters. Limit is 17.
ENTRY UNDEFINED	E Keys in the numeric key pad have been pressed when no data entry softkey is active in the menu.
EOI BEFORE INPUT COMPLETE	E HP-IB. End Or Identify asserted (indicating end of data) when more data was expected.
EXPECTED "#I"	E HP-IB. In the binary format, data to be loaded should be preceded by the characters #I.
FP CANNOT ACCESS TRACE MEM	E Hardware failure.
FP CNTR/RCVR FAILURE	E Hardware failure of either the Fast Processor counter or a receiver input channel.
FP LOGIC FAILURE	E Fast Processor hardware failure.
FAST PROC NOT GRANTING BUS	E Hardware failure.
FP SELF TEST PASSED	E For more details, see the Service Manual.
FP-MP COMMUNICATION ERROR	E Hardware failure.
FRONT PANEL DECODING ERROR	E Hardware failure.
FRONT PANEL KEY STUCK	E One of the front panel keys has been depressed for ten seconds or more or is stuck.
ILLEGAL "#" RECEIVED	E HP-IB. # is a special character and may only be used for its intended function.
ILLEGAL SYMBOL	E User defined math equation entry that is not a legal symbol.
INCOMPATIBLE DISPLAY FCTNS	E Attempt to COPY SCALE between traces when display functions' units are incompatible.
INCOMP. TESTSET POSITIONS Trc__ chgd to agree with #__	W "Incompatible S-parameter test set positions, trace changed to agree with trace number (2 or 1)" (i.e. the HP 35677A/B can't be configured forward and reverse at the same time so the INPUT of the other trace has been changed).
INP MUST BE A,B,R,A/R,B/R	E For NORMALIZATION, the INPUT must be defined as one of these RECEIVER input expressions.
INP SHOULD BE USER-DEFINED	E HP-IB. Set INPUT to be USER DEF before attempting to directly change the configuration of the S-parameter test set over the bus.
INPUT(S) __ TRIPPED	E One or more of the RECEIVER channels has switched to 1 M Ω impedance. (The message indicates which receiver inputs have tripped). This message is accompanied by a message to "Clear trip on ATTEN menu."
INVALID EXPRESSION	E User defined equation not valid such as A//R. More common for HP-IB than front panel entries.
INVALID HPIB COMMAND	E HP-IB. Code sent to HP 3577A not a valid HP 3577A HP-IB Code.
INVALID LEARN MODE DATA	E HP-IB. The checksum of the instrument state just loaded is incorrect, possibly because the attempted to modify instrument state data outside the HP 3577A.
INVALID START ADDRESS	E HP-IB. Start address for ENG must be an integer between 0 and 923.

MESSAGE	DESCRIPTION
INVALID SUFFIX	E HP-IB. Code sent to HP 3577A for a data entry suffix is not appropriate for prefix parameter or instrument state.
KEY BUFFER FULL	W The front panel key buffer can hold 6 key presses for processing.
KEY NOT APPLICABLE	E When in MANUAL sweep mode and ALTERNATE sweep type with trace one active (and trace two is not off) this error message appears if MKR → MAN FREQ is used. This is permitted only for trace two in this situation.
KEY NOT IN MENU	E HP-IB. Command issued over the bus is not allowed; if the label does not appear in the menu during local operation, it cannot be used over the bus (e.g., "Smith chart" in a rectangular display function).
MARKER OFFSET IS OFF	E Cannot use MKR OFST → SPAN if the OFFSET MARKER is OFF.
MARKER ___ IS OFF	E Request to plot one of the markers or execute a MKR → operation but the marker is not on.
MEM FAIL- SAVED STATES LOST	E A memory hardware failure has occurred and the instruments states which had been saved have been lost.
MP/FP PORT TEST FAILED	E The test run on the port between the Main Processor and the Fast Processor has failed. Hardware failure.
MP/FP PORT TEST PASSED	E For more details see the Service Manual.
NO CHARACTERS TO PLOT	E HP-IB. Request to plot characters that have been turned off.
NO COMMA IN TRACE ARITH	E HP-IB. Comma not allowed in trace arithmetic.
NO GRATICULE TO PLOT	E HP-IB. Request to plot a graticule that has been turned off.
NO INPUTS ARE TRIPPED	W Results from pressing CLEAR TRIP in the ATTEN menu when no inputs were tripped.
NO KEYBOARD ATTACHED	E Hardware failure.
NO LISTENER ON BUS	E User has requested data dump (such as PLOT ALL) and there is no listener on the bus.
NO RESPONSE FROM FP	E Fast Processor didn't respond to self test. Hardware failure.
NO STORE & DISP IN POLAR	E Illegal in polar display function.
NON-NUMERIC DATA RECEIVED	E HP-IB. Data loaded was supposed to be ASCII number characters.
NOT ALLOWED IN ALT SWP	E Functions not allowed when SWEEP TYPE is ALTERNATE are STORE, STORE & DISPLAY, and all CALIBRATION.
NOT ALLOWED IN LOG SWP	E HP-IB. Display function DELAY is not allowed in LOG SWEEP.
NOTHING TO PLOT	E HP-IB. Request to plot after all screen features have been turned off.
NUMBER OUT OF RANGE	E Data entry of a value beyond the capabilities of the HP 3577A such as SOURCE AMPLITUDE of 100 dBm.
ONLY SMALLER FCNTS ALLOWED	E When entering user defined functions, other functions may be used as terms in the new function as long as their function number is smaller.
OSCILLATOR UNLOCKED	E Hardware failure.

MESSAGE	DESCRIPTION
OVERLOAD ON INPUT(S)___	E One or more inputs are being overdriven by a large signal input but have not tripped. This warns the user that readings taken may be distorted.
RECALL FAILED-STATE IS BAD	E The Instrument State the user tried to recall is bad so the recall failed. To clear the bad state, SAVE another state in the register. If this does not clear the problem, cycle power while holding down SAVE and RECALL. This runs a special memory-clearing test that resets instrument state memory locations. See "In Case of Trouble" under Operating Hints in the GETTING STARTED section.
REFERENCE UNLOCKED	E The internal VCXO is not locked to the external reference input, possibly due to a difference in frequency exceeding 20 ppm. This message appears briefly during warmup when the oven reference switches on after reaching operating temperature (~10 minutes from power-on).
SELECTED TRACE IS OFF	E Can't perform the requested operation because the trace is OFF (as with scale parameter changes).
SET HP-IB TO TALKONLY MODE	E Before plotting, TALKONLY ON/OFF (in the SPCL FCTN menu) must be turned ON.
SOURCE NOT TRIPPED	W Results from pressing SOURCE CLEAR TRIP when the SOURCE wasn't tripped.
SOURCE TRIPPED	E The Source Output is open (no power out). This is accompanied by a message to "Clear trip on AMPTD menu."
STOP MUST BE $\geq 1.05 \times$ START	M In log sweep the stop frequency must be greater than or equal to $1.05 \times$ the start frequency.
STORED DATA D1-D4 LOST	E Stored trace data in registers D1-D4 has been lost.
SWEEP MODE MUST BE MANUAL	E HP-IB. User sent MKR→MANUAL over the bus without first setting SWEEP MODE to MANUAL.
SWEEP RATE UNCALIBRATED	M Selection of span and sweep time have resulted in a very slow sweep rate. Due to limited resolution of the frequency synthesis circuitry, the source is in error (off frequency) by more than one bin at the end of the sweep for a linear sweep or at arbitrary points in a log sweep. Increasing the span or decreasing the sweep time is recommended.
SWEEP RESOLUTN TOO COARSE	E DELAY APERTURE is limited by the selection of SWEEP RESOLUTION (in the FREQ menu). Coarse sweep resolution prohibits the use of small delay apertures. This message appears when the user tries to select a smaller aperture.
SWEEP SPAN LIMITED	M This message appears when a center frequency and frequency span are selected such that the equivalent start or stop frequencies would be less than 0 Hz or greater than 200 MHz.
SWEEP TIME INCREASED	W The sweep time has been increased automatically to allow enough time to do the required math processing.
SWEEP TIMING ERROR	E Hardware failure.
SYSTEM ERROR #___	E Hardware failure.
TALK ONLY MODE SELECTED	E HP-IB. The HP 3577A has been manually set to TALKONLY (probably to plot). When addressed the HP 3577A must listen even though the softkey setting is TALKONLY.

MESSAGE	DESCRIPTION
TARGET VALUE NOT FOUND	W A marker search did not find a the target value.
TEST SET RELAY TIMEOUT	E Same timeout as described for AMPLITUDE SWEEP. See S-PARAMETER TEST SET.
TEXT STRING TOO LONG	E HP-IB. Text string for ENA or ENM is too long.
TIMER INTERRUPT FAILURE	E Hardware failure.
TOO MANY GRAPHICS COMMANDS	E HP-IB. Enter Graphics code too long. Memory is limited to 924 16-bit commands.
TRACE___ HAS BEEN TURNED OFF or TRC 1,2, ARE NOW TURNED OFF	W One or both traces were group delay and the user selected a SWEEP TYPE that does not allow group delay. This message is accompanied by a message that "DELAY IN LIN,ALT SWEEP ONLY." (Not LOG, CW or AMPTD)
TRACE MEMORY TEST FAILED	E Hardware failure.
TRACE MEMORY TEST PASSED	E For more details refer to the Service Manual.
UNEXPECTED TEXT STRING	E HP-IB. Received text in quotes with no prior command (such as enter annotation).
UNMATCHED "(" AND ")"	E The user defined math equation is in error. There must be as many opening as closing parenthesis.
UP/DOWN OR KNOB ONLY	W Only the arrow keys in the data entry section or the KNOB may be used to move the marker.
WAITING FOR "#"	W HP-IB. Data load in the binary format is waiting for the starting sequence "#I".
WAITING FOR DATA TRANSFER	W HP-IB. Waiting for a data-receiving device to handshake.
WAITING FOR INPUT DATA	W HP-IB. Load ready and waiting for input data.
WARNING: TRACE IS OFF	W This message appears when an operation is performed with the active trace OFF, warning the user, who may be trying to modify parameters for the wrong trace.

3577A PROGRAMMING CODES

APPENDIX D

DISPLAY FORMAT

Function	HP-IB code		
TRACE 1	TR1	Phase Slope (entry)	PSL
		Phase Slope Off	PSO
		Phase Slope On	PS1
		Polar Full Scale (entry)	PFS
		Polar Phase Ref (entry)	PPR
		Smith Chart Off	GT0
		Smith Chart On	GT1
DISPLAY FUNCTION	DSF *	MARKER	MKR *
Log Magnitude	DF7	Marker Position (entry)	MKP
Linear Magnitude	DF6	Marker Off	MR0
Phase	DF5	Marker On	MR1
Polar	DF4	Zero Marker	ZMK
Real	DF3	Marker Offset Off	MO0
Imaginary	DF2	Marker Offset On	MO1
Delay	DF1	Marker Offset (entry)	MKO
Trace Off	DF0	Marker Offset Freq (entry)	MOF
Delay Aperture menu	DAP *	Marker Offset Amp (entry)	MOA
Aperture .5% of span	AP1	Marker Coupling Off	CO0
Aperture 1% of span	AP2	Marker Coupling On	CO1
Aperture 2% of span	AP3	Polar Mag Offset (entry)	PMO
Aperture 4% of span	AP4	Polar Phase Offset (entry)	PPO
Aperture 8% of span	AP5	Polar Real Offset (entry)	PRO
Aperture 16% of span	AP6	Polar Imag Offset (entry)	PIO
Return	RET *	Polar Marker Units (Re/Im)	MRI
		Polar Marker Units (Mg/Ph)	MMP
INPUT	INP *	MARKER --	MKG *
Input = R	INR	MKR --Reference Level	MTR
Input = A	INA	MKR --Start Frequency	MTA
Input = B	INB	MKR --Stop Frequency	MTB
Input = A/R	IAR	MKR --Center Frequency	MTC
Input = B/R	IBR	MKR Offset --Span	MOS
Input = D1	ID1	MKR --Max	MTX
Input = D2	ID2	MKR --Min	MTN
Input = D3	ID3	MARKER SEARCH menu	MSM *
Input = D4	ID4	MKR Target Value (entry)	MTV
Return	RET *	MKR -- Right for Target	MRT
User Defined Input	UDI	MKR -- Left for Target	MLT
Input = S ₁₁	I11	Return	RET *
Input = S ₂₁	I21	MKR -- Full Scale	MTP
Input = S ₁₂	I12	MKR -- Polar Phase Ref	MPF
Input = S ₂₂	I22		
Copy Input	CPI	STORE DATA	STO *
Test Set Forward	TSF	Store in register D1	SD1
Test Set Reverse	TSR	Store in register D2	SD2
		Store in register D3	SD3
		Store in register D4	SD4
		Store and Display	STD
		User defined store	UDS
		Store to D1	TD1
		Store to D2	TD2
		Store to D3	TD3
		Store to D4	TD4
SCALE	SCL *		
Autoscale	ASL		
Reference Level (entry)	REF		
Scale /DIV (entry)	DIV		
Reference Position (entry)	RPS		
Reference Line Off	RL0		
Reference Line On	RL1		
Copy Scale	CPS		

* Use not required. The only function of this code is to display a menu (if bus diagnostics are on).

MEASUREMENT CALIBRATION

Normalize
 Normalize (Short)
 Calibrate, Partial
 Calibrate, Full
 Continue Calibration

DEFINE MATH

Constant K1, Real
 Constant K1, Imaginary
 Constant K2, Real
 Constant K2, Imaginary
 Constant K3, Real
 Constant K3, Imaginary
 Define Function
 Function F1
 Function F2
 Function F3
 Function F4
 Function F5
 Math term for input R
 Math term for input A
 Math term for input B
 Math term for storage reg
 Math term for constant
 Math term for function
 Math bracket
 Math function plus
 Math function minus
 Math function multiply
 Math function divide
 Math bracket
 Return

DATA ENTRY SECTION COMMANDS

Increment (up arrow)
 Decrement (down arrow)
 Continuous Entry (knob) Off
 Continuous Entry (knob) On
 Entry Off

DISPLAY FORMAT SUFFIX UNITS

dBm
 dBV (rms)
 dB relative
 Volt (rms)
 milli-Volt (rms)
 micro-Volt (rms)
 nano-Volt (rms)
 degrees
 degrees/span
 radians
 radians/span
 seconds
 milliseconds
 microseconds
 nanoseconds
 percent
 degrees/span
 radians/span
 MHz
 kHz
 Hz
 exponent

CAL *
 NRM
 NRS
 CPR
 CFL
 CGO

DFN *
 KR1
 KI1
 KR2
 KI2
 KR3
 KI3
 DFC *
 UF1
 UF2
 UF3
 UF4
 UF5
 R
 A
 B
 D
 K
 F
 (
 +
 -
 *
 /
)
 RET*

IUP
 IDN
 CE0
 CE1
 HLD

DBM
 DBV
 DBR
 V
 MV
 UV
 NV
 DEG
 DSP
 RAD
 RSP
 SEC
 MSC
 USC
 NSC
 %
 DSP
 RAP
 MHZ
 KHZ
 HZ
 E

SOURCE

Function

HP-IB code

SWEEP TYPE

Linear Sweep
 Alternate Sweep
 Log Sweep
 Amplitude Sweep
 CW
 Sweep Direction Up
 Sweep Direction Down

STY *
 ST1
 ST2
 ST3
 ST4
 ST5
 SUP
 SDN

SWEEP MODE

Continuous
 Single Sweep
 Manual Sweep
 Manual Frequency (entry)
 Manual Amplitude (entry)
 Marker — Manual

SMD *
 SM1
 SM2
 SM3
 MFR
 MAM
 MTM

SWEEP TIME

Sweep Time (entry)
 Step Time (entry)
 Sample Time (entry)

STM *
 SWT
 SMT
 MSR

FREQUENCY

Source Frequency (entry)
 Start Frequency (entry)
 Stop Frequency (entry)
 Center Frequency (entry)
 Frequency Span (entry)
 FRC Step size (entry)
 Sweep Resolution menu
 Freq Swp Res 51 pts/span
 Freq Swp Res 101 pts/span
 Freq Swp Res 201 pts/span
 Freq Swp Res 401 pts/span
 Return
 Full Sweep
 Freq Step Size (entry)

FRQ *
 SFR
 FRA
 FRB
 FRC
 FRS
 CFS
 SRL *
 RS1
 RS2
 RS3
 RS4
 RET *
 FSW
 FST

AMPLITUDE

Source Amplitude (entry)
 Amp Step Size (entry)
 Clear Trip, Source
 Start Amplitude (entry)
 Stop Amplitude (entry)
 Steps/Sweep menu
 Number of steps = 6
 Number of steps = 11
 Number of steps = 21
 Number of steps = 51
 Number of steps = 101
 Number of steps = 201
 Number of steps = 401
 Return
 Full Sweep

AMP *
 SAM
 AST
 CTS
 AMA
 AMB
 NST *
 NS1
 NS2
 NS3
 NS4
 NS5
 NS6
 NS7
 RET *
 FSW

* Use not required. The only function of this code is to display a menu (if bus diagnostics are on).

TRIGGER MODE

- Free Run
- Line Trigger
- External Trigger
- Immediate

SWEEP TRIGGER } TRG/
SWEEP RESET } RESET

SOURCE SUFFIX UNITS

- dBm
- dBV (rms)
- Volt (rms)
- milli-Volt (rms)
- micro-Volt (rms)
- nano-Volt (rms)
- seconds
- milliseconds
- MHz
- kHz
- Hz
- exponent

TRM *

- TG1
- TG2
- TG3
- TG4

TRG
RST

- DBM
- DBV
- V
- MV
- UV
- NV
- SEC
- MSC
- MHZ
- KHZ
- HZ
- E

- Length A (entry)
- Length A Off
- Length A On
- Length B (entry)
- Length B Off
- Length B On
- Length Step Size (entry)

- LNA
- LA0
- LA1
- LNB
- LB0
- LB1
- LNS

RECEIVER SUFFIX UNITS

- meters
- centimeters
- seconds
- milliseconds
- microseconds
- nanoseconds
- exponent

- MET
- CM
- SEC
- MSC
- USC
- NSC
- E

INSTRUMENT STATE

RECEIVER

Function

HP-IB code

RESOLUTION BW

- Resolution BW 1 Hz
- Resolution BW 10 Hz
- Resolution BW 100 Hz
- Resolution BW 1 kHz
- Auto Bandwidth Off
- Auto Bandwidth On

- RBW *
- BW1
- BW2
- BW3
- BW4
- AU0
- AU1

AVERAGE

- Averaging Off
- N=4
- N=8
- N=16
- N=32
- N=64
- N=128
- N=256

- AVE *
- AV0
- AV1
- AV2
- AV3
- AV4
- AV5
- AV6
- AV7

ATTENUATION

- Attenuation R = 0 dB
- Attenuation R = 20 dB
- Attenuation A = 0 dB
- Attenuation A = 20 dB
- Attenuation B = 0 dB
- Attenuation B = 20 dB
- Impedance R = 50 Ω
- Impedance R = 1 MΩ
- Impedance A = 50 Ω
- Impedance A = 1 MΩ
- Impedance B = 50 Ω
- Impedance B = 1 MΩ
- Clear Trip, Receiver

- ATT *
- AR1
- AR2
- AA1
- AA2
- AB1
- AB2
- IR1
- IR2
- IA1
- IA2
- IB1
- IB2
- CTR

LENGTH

- Length R (entry)
- Length R Off
- Length R On

- LEN *
- LNR
- LR0
- LR1

Function

HP-IB Code

SPECIAL FUNCTIONS

- Confid. (self) test menu
- Self test channel R
- Self test channel A
- Self test channel B
- Return
- Beeper off
- Beeper on
- Service Diagnostics menu
- Source Leveling off
- Source Leveling on
- Settling Time off
- Settling time on
- Synthesizer Diag off
- Synthesizer Diag on
- Display Test Pattern
- Trace Memory Test
- Fast Processor Test
- I/O port test
- More Serv Diag menu
- Display Memory Test
- Software Revision message
- Return
- S-Parameters Off
- S-Parameters On

- SPC *
- SLF *
- STR
- STA
- STB
- RET *
- BP0
- BP1
- SDG *
- SL0
- SL1
- SE0
- SE1
- SY0
- SY1
- DTP
- TMT
- FPT
- PRT
- MOR *
- DST
- SRV
- RET *
- SP0
- SP1

SAVE INSTRUMENT STATE

- Save state in register 1
- Save state in register 2
- Save state in register 3
- Save state in register 4
- Save state in register 5

- SAV *
- SV1
- SV2
- SV3
- SV4
- SV5

RECALL INSTRUMENT STATE

- Recall old (last) state
- Recall register 1
- Recall register 2
- Recall register 3
- Recall register 4
- Recall register 5

- RCL *
- RLS
- RC1
- RC2
- RC3
- RC4
- RC5

* Use not required. This code's only function is to display a menu (if but diagnostics are on).

INSTRUMENT PRESET

PLOT MENU

- Plot all
- Plot trace 1
- Plot trace 2
- Plot graticule
- Plot characters
- Plot trace 1 marker
- Plot trace 2 marker
- Configure Plot menu
- Trace 1 linetype (entry)
- Trace 2 linetype (entry)
- Trace 1 pen number (entry)
- Trace 2 pen number (entry)
- Graticule pen no. (entry)
- Pen speed fast (max)
- Pen speed slow
- Set plot config to default
- Return

IPR

- PLM ***
- PLA**
- PL1**
- PL2**
- PLG**
- PLC**
- PM1**
- PM2**
- CPT ***
- T1L**
- T2L**
- T1P**
- T2P**
- PGP**
- PNM**
- PNS**
- PLD**
- RET ***

- Dump average number
- Dump key or knob
- Dump characters
- Dump Instrument ID
- Load register A
- Load register B
- Load register R
- Load register D1
- Load register D2
- Load register D3
- Load register D4
- Load state (learn mode in)
- Graticule off
- Graticule on
- Characters off
- Characters on
- Annotation off
- Annotation on
- Annotation Clear
- Menu off
- Menu on
- Menu clear

- DAN**
- DKY**
- DCH**
- ID?**
- LRA**
- LRB**
- LRR**
- LD1**
- LD2**
- LD3**
- LD4**
- LMI**
- GR0**
- GR1**
- CH0**
- CH1**
- AN0**
- AN1**
- ANC**
- MN0**
- MN1**
- MNC**

HP-IB ONLY COMMANDS

Function

HP-IB code

- Settling Time Entry
- Dump register A
- Dump register B
- Dump register R
- Dump register D1
- Dump register D2
- Dump register D3
- Dump register D4
- Dump trace 1
- Dump trace 2
- Dump marker 1
- Dump marker 2
- Dump marker 1 position
- Dump marker 2 position
- Dump state (learn mode out)
- Dump status

- STE**
- DRA**
- DRB**
- DRR**
- DD1**
- DD2**
- DD3**
- DD4**
- DT1**
- DT2**
- DM1**
- DM2**
- MP1**
- MP2**
- LMO**
- DMS**

- ASCII data format
- 64 bit IEEE data format
- 32 bit HP 3577A binary
- Bus diagnostics mode off
- Bus diagnostics on, fast
- Bus diagnostics on, slow
- Enter Menu (user defined)
- Enter Annotation
- Enter Graphics
- Clear Keyboard Buffer
- Take Measurement
- Set SRQ Mask
- Error Reporting mode 0
- Error Reporting mode 1
- Error Reporting mode 2
- Error Reporting mode 3
- Send SRQ

- FM1**
- FM2**
- FM3**
- BD0**
- BD1**
- BD2**
- ENM**
- ENA**
- ENG**
- CKB**
- TKM**
- SQM**
- ER0**
- ER1**
- ER2**
- ER3**
- SRQ**

* Use not required. The only function of this code is to display a menu (if bus diagnostics are on).

BIBLIOGRAPHY

APPENDIX E

Fitzpatrick, J., "Error Models for Systems Measurements," Microwave Journal, May 1978.

The following are Hewlett-Packard publications:

HP Publication #01345-90902, "1345A Digital Display Module Designer's Manual."

HP Publication #5952-9270, "Vector Measurements of High Frequency Networks."

HP Application Note 95-1, "S-Parameter Techniques for Faster, More Accurate Network Design."

HP Application Note 154, "S-Parameter Design."

HP Product Note 3577A-1, "Users Guide to the HP 3577A Network Analyzer."

S-parameters - p. 2-4, 3
Normalize - p. 4-19
Status byte - p. 3-33
Trig/Reset - p. 3-10
CW Example - p. 3-60
Formulas (DATA) - p. 3-24
DUMP STATUS BYTES - 3-30
SOFTKEY INDEX 4-38
Dump/Load ^{PARAMETER} STATE - 3-19
Save/Recall States - 4-24, 4-27, 4-13



GENERAL CHARACTERISTICS

External Reference Frequency Input:

Frequency: 10 MHz/N (N is an integer from 1 to 100).

Level: 0 dBm \pm 10 dB, nominal.

Impedance: 50 Ω , nominal.

Connector: BNC female, rear panel.

Reference Frequency Output:

Frequency: 10 MHz.

Level: Typically 0 dBm.

Impedance: 50 Ω , nominal.

Connector: BNC female, rear panel.

External Trigger: Triggers on negative TTL transition or contact closure to ground.

Minimum Pulse Width: Typically 1 μ s.

Impedance: 50 Ω , nominal.

Connector: BNC female, rear panel.

Plotter Control: Directly compatible with HP-IB graphics plotters that use Hewlett-Packard Graphics Language (HP-GL) with listen only capability. Plotter may be controlled by the 3577A through the HP-IB connector without an external computer.

Plotted data includes trace 1, trace 2, graticule, are annotation. Additional markers can be plotted, and pen numbers, pen speed, and line type can also be selected.

Display Adjustments: Astigmatism, x-axis position, y-axis position, alignment, focus, and intensity.

Save/Recall: Front panel setups can be stored in non-volatile memory locations 1 through 5. Last state is saved when power is removed.

Operating Conditions:

Temperature: 0°C to +55°C.

Relative Humidity: <95% at 40°C.

Altitude: <4,572 m (15,000 ft).

Non-Operating Conditions:

Temperature: -40°C to +75°C.

Altitude: <15,240 m (50,000 ft).

Accessories Included:

4ea. Type N male to BNC female Adapter. (HP Part No. 1250-0780.)

1 ea. Operating Manual. (HP Part No. 03577-90000).

1 ea. Service Manual. (HP Part No. 3577-90010).

Power: 115V +10%, -25% (47 Hz to 440 Hz), or 230 V +10%, -15% (47 Hz to 66 Hz), 450 VA maximum.

Weight: 31 kg (67 lbs) net. 41 kg (90 lbs) shipping.

Dimensions: 222 mm H \times 426 mm W \times 578 mm D (8.75 in \times 16.75 in \times 22.75 in). Add 1 1/8 inch to depth to include front panel controls and connectors.

35677A/B S-Parameter Test Set Specifications

All specifications apply without bias signals. Degrees are specified as deviation from linear phase. Frequency Response, Port Match, and Test Port Reciprocity specifications are equivalent values for ratio measurements, and errors can be calibrated out.

Frequency Range: 100 kHz to 200 MHz.
Test Port Impedance:
 35677A: 50 Ω .
 35677B: 75 Ω .
Directivity: >40 dB.
Frequency Response:
 Transmission(S_{21}, S_{12}): ± 1 dB, ± 5 deg.
 Reflection(S_{11}, S_{22}): ± 1 dB, ± 5 deg.
Port Match:
 Test Ports 1,2: 35677A, > 26 dB;
 35677B, >24 dB.
Test Ports 1,2 open/short ratio:
 35677A, $< \pm 0.75$ dB magnitude and $< \pm 5$ deg phase;
 35677B, $< \pm 1$ dB magnitude and $< \pm 7.5$ deg phase.
Input Port: >20 dB return loss.
Output Ports A, B, and R: >26 dB return loss.
Test Port Isolation: >100 dB.
Insertion Loss:
 RF Input to Test Port 1 or 2: 35677A, typically 13 dB; 35677B, typically 19 dB.
 RF Input to Output Ports A, B, or R: 35677A, typically 19 dB; 35677B, typically 31 dB.
Test Port Reciprocity:
 Transmission (S_{21}, S_{12}): typically $< \pm 0.5$ dB magnitude and $< \pm 5$ deg phase.
 Reflection (S_{11}, S_{22}): typically $< \pm 0.5$ dB magnitude and $< \pm 5$ deg phase.
Incident Power Ratio (Test Port 1 to Test Port 2): typically $< \pm 1.5$ dB.
RF Input Maximum Operating Level: +25 dBm or ± 30 Vdc.

RF Input Damage Level: +27 dBm or ± 30 Vdc.
Port 1 or 2 Damage Level: +27 dBm or ± 30 Vdc.
Connectors:
 Input Port and Output Ports A, B, and R: 50 Ω Type N female.
 Test Ports 1 and 2: 35677A, 50 Ω Type N female; 35677B, 75 Ω Type N female.
DC Bias Inputs: BNC female, rear panel.
DC Bias Range: Typically ± 30 Vdc and ± 20 mA with some degradation of RF specifications; 200 mA damage level.
Accessories Included:
 4 ea. 190 mm(7.5 in.) 50 Ω cables with Type N male connectors for connection to 3577A (HP Part No. 8120-4387).
 1 ea. Test Set interconnect cable to 3577A (HP Part No. 35677-61620)
 1 ea. Rear Panel Lock Foot Kit (HP Part No. 5061-0099).
 1 ea. Service Manual (HP Part No. 35677-90010). *
Recommended Accessories:
35677A: 35678A 50 Ω Type N Calibration Kit; 35679A 50 Ω Type N Test Port Extension Cables.
35677B: 35678B 75 Ω Type N Calibration Kit; 35679B 75 Ω Type N Test Port Extension Cables.
Programming: The 35677A/B are completely controlled through the 3577A using the 3577A interconnect cable. All programming is accomplished through the 3577A HP-IB interface.
Power: All power is obtained through the 3577A interconnect cable.
Weight: 6 kg(13 lbs) net; 12 kg (12 lbs) shipping.
Dimensions: 90 mm H x 426 mm W x 584 mm D (3.5 in x 16.75 in x 22.75 in).
 Add 1 1/8 inch to depth to include front panel connectors.

35677A
Block Diagram

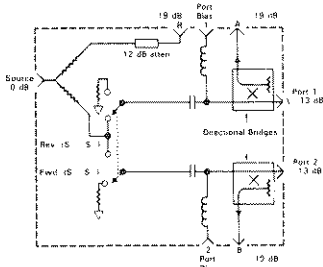

35677B
Block Diagram

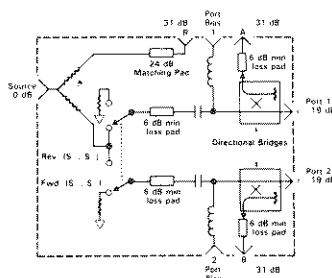

* Note operation information included in 3577A Operation Manual. (HP Part No. 03577-90000).



Product Line Sales/Support Key

Key Product Line

- A Analytical
- CM Components
- C Computer Systems
- CP Computer Systems Primary Service Responsible Office (SRO)
- CS Computer Systems Secondary SRO
- E Electronic Instruments & Measurement Systems
- M Medical Products
- MP Medical Products Primary SRO
- MS Medical Products Secondary SRO
- P Personal Computing Products
- * Sales only for specific product line
- ** Support only for specific product line

IMPORTANT: These symbols designate general product line capability. They do not insure sales or support availability for all products within a line, at all locations. Contact your local sales office for information regarding locations where HP support is available for specific products.

HP distributors are printed in italics.

ANGOLA

Telectra
Empresa Técnica de Equipamentos
Eléctricos, S.A.R.L.
R. Barbosa Rodrigues, 41-I DT.
Caixa Postal 6487
LUANDA
Tel: 355 15,355 16
A,E,M,P*

ARGENTINA

Hewlett-Packard Argentina S.A.
 Avenida Santa Fe 2035
 Martínez 1640 BUENOS AIRES
Tel: 798-5735, 792-1293
Telex: 122443 AR CIGY
 Cable: HEWPACARG
 A,E,CP,P

Bioltron S.A.C.I.y.M

Avenida Paseo Colon 221
9 Piso
1399 BUENOS AIRES
Tel: 30-4846, 30-1851, 30-8384
Telex: (33)17595 BIONAR
 Cable: BIOTRON Argentina
 M

Fate S.A. Electronica

Bartolomeu Mitre 833
1036 BUENOS AIRES
Tel: 74-41011, 74-49277,
74-43459
Telex: 18137, 22754
 P

AUSTRALIA**Adelaide, South Australia Pty. Ltd.**

Hewlett-Packard Australia Pty.Ltd.
 153 Greenhill Road
 PARKSIDE, S.A. 5063
Tel: 272-5911
Telex: 82536
 Cable: HEWPARD Adelaide
 A*,CM,CS,E,MS,P

Brisbane, Queensland Office

Hewlett-Packard Australia Pty.Ltd.
 5th Floor
 Teachers Union Building
 495-499 Boundary Street
 SPRING HILL, Queensland 4000
Tel: 229-1544
Telex: 42133
 Cable: HEWPARD Brisbane
 A,CM,CS,E,MS,P

Canberra, Australia Capital Office

Hewlett-Packard Australia Pty.Ltd.
 121 Wollongong Street
 Fyshwick, A.C.T. 2069
Tel: 804244
Telex: 62650
 Cable: HEWPARD Canberra
 A*,CM,CS,E,MS,P

Melbourne, Victoria Office

Hewlett-Packard Australia Pty.Ltd.
 31-41 Joseph Street
 BLACKBURN, Victoria 3130
Tel: 89-6351
Telex: 31-024
 Cable: HEWPARD Melbourne
 A,CM,CP,E,MS,P

Perth, Western Australia Office

Hewlett-Packard Australia Pty.Ltd.
 141 Stirling Highway
 NEDLANDS, W.A. 6009
Tel: 386-5455
Telex: 93859
 Cable: HEWPARD Perth
 A,CM,CS,E,MS,P

Sydney, New South Wales Office

Hewlett-Packard Australia Pty.Ltd.
 17-23 Talavera Road
 NORTH RYDE, N.S.W. 2113
 P.O. Box 308
Tel: 887-1611
Telex: 21561
 Cable: HEWPARD Sydney
 A,CM,CP,E,MS,P

AUSTRIA

Hewlett-Packard Ges.m.b.h.
 Grottenhofstrasse 94
 Verkaufsburo Graz
 8052 GRAZ
Tel: 21-5-66
Telex: 32375
 CM,C*,E*
 Hewlett-Packard Ges.m.b.h.
 Wehlstrasse 29
 P.O. Box 7
 A-1205 VIENNA
Tel: (222) 35-16-210
Telex: 135823/135066
 A,CM,CP,E,MS,P

BAHRAIN

Green Salon
P.O. Box 557
BAHRAIN
Tel: 5503
Telex: 88419
 P

Wael Pharmacy

P.O. Box 648
BAHRAIN
Tel: 54886, 56123
Telex: 8550 WAEL GJ
 M

BELGIUM

Hewlett-Packard Belgium S.A./N.V.
 Blvd de la Woluwe, 100
 Woluwedal
 B-1200 BRUSSELS
Tel: (02) 762-32-00
Telex: 23-494 paloben bru
 A,CM,CP,E,MP,P

BRAZIL

Hewlett-Packard do Brasil I.e.C. Ltda.
 Alameda Rio Negro, 750
 ALPHAVILLE 06400 Barueri SP
Tel: 421-1311
Telex: 011 23602 HPBR-BR
 Cable: HEWPACK Sao Paulo
 A,CM,CP,E,MS
 Hewlett-Packard do Brasil I.e.C. Ltda.
 Avenida Epitacio Pessoa, 4664
 22471 RIO DE JANEIRO-RJ
Tel: 286-0237
Telex: 021-21905 HPBR-BR
 Cable: HEWPACK Rio de Janeiro
 A,CM,E,MS,P*

BURUNDI

Typomeca S.P.R.L.
B.P. 553
BUJUMBURA
Tel: 2659
 P

CANADA

Alberta
 Hewlett-Packard (Canada) Ltd.
 210, 7220 Fisher Street S.E.
 CALGARY, Alberta T2H 2H8
Tel: (403) 253-2713
Telex: 610-821-6141
 A,CM,CP,E*,MS,P*

Hewlett-Packard (Canada) Ltd.
 11620A-168th Street
 EDMONTON, Alberta T5M 3T9
Tel: (403) 452-3670
Telex: 610-831-2431
 A,CM,CP,E,MS,P*

British Columbia

Hewlett-Packard (Canada) Ltd.
 10691 Shellbridge Way
 RICHMOND, British Columbia
 V6X 2W7
Tel: (604) 270-2277
Telex: 610-922-5059
 A,CM,CP,E*,MS,P*

Manitoba

Hewlett-Packard (Canada) Ltd.
 380-550 Century Street
 WINNIPEG, Manitoba R3H 0Y1
Tel: (204) 786-6701
 A,CM,CS,E,MS,P*

Nova Scotia

Hewlett-Packard (Canada) Ltd.
 P.O. Box 931
 900 Windmill Road
 DARTMOUTH, Nova Scotia B2Y 3Z6
Tel: (902) 469-7482
Telex: 610-271-4482
 CM,CP,E*,MS,P*

Ontario

Hewlett-Packard (Canada) Ltd.
 552 Newbold Street
 LONDON, Ontario N6E 2S5
Tel: (519) 686-9181
Telex: 610-352-1201
 A,CM,CS,E*,MS,P*

Hewlett-Packard (Canada) Ltd.
 6877 Goreway Drive
 MISSISSAUGA, Ontario L4V 1M8
Tel: (416) 678-9430
Telex: 610-492-4246
 A,CM,CP,E,MP,P

Hewlett-Packard (Canada) Ltd.
 1020 Morrison Drive
 OTTAWA, Ontario K2H 8K7
Tel: (613) 820-6483
Telex: 610-563-1636
 A,CM,CP,E*,MS,P*

Quebec

Hewlett-Packard (Canada) Ltd.
 17500 South Service Road
 Trans-Canada Highway
 KIRKLAND, Quebec H9J 2M5
Tel: (514) 697-4232
Telex: 610-422-3022
 A,CM,CP,E,MP,P*

CHILE

Jorge Calcagni y Cia. Ltda.
Arturo Burtle 065
Casilla 16475
SANTIAGO 9
Tel: 220222
Telex: JCALCAGNI
 A,CM,E,M
Olympia (Chile) Ltd.
Rodrico de Araya 1045
Casilla 256-V
SANTIAGO 21
Tel: 25-50-44
Telex: 40-565
 C,P

COLOMBIA

Instrumentación
H. A. Langebaek & Kier S.A.
Apartado Aéreo 6287
BOGOTÁ 1, D.E.
Carrera 7 No. 48-75
BOGOTÁ, 2 D.E.
Tel: 287-8877
Telex: 44400
 Cable: AARIS Bogota
 A,CM,E,M,P

COSTA RICA

Cientifica Costarricense S.A.
Avenida 2, Calle 5
San Pedro de Montes de Oca
Apartado 10159
SAN JOSÉ
Tel: 24-38-20, 24-08-19
Telex: 2367 GALGUR
 Cable: GALGUR
 CM,E,M

CYPRUS

Telexa Ltd.
P.O. Box 4809
14C Stassinios Avenue
NICOSIA
Tel: 45628
Telex: 2894
 E,M,P

CZECHOSLOVAKIA

Hewlett-Packard
Obchodni Zastupitelstvi v CSSR
Post. schranka 27
CS-118 01 PRAHA 011
Tel: 66-296
Telex: 121353 IHC

DENMARK

Hewlett-Packard A/S
 Datavej 52
 DK-3460 BIRKEROD
Tel: (02) 81-66-40
Telex: 37409 hpas dk
 A,CM,CP,E,MS,P

Hewlett-Packard A/S
 Navervej 1
 DK-8600 SILKEBORG
Tel: (06) 82-71-66
Telex: 37409 hpas dk
 CM,CS,E

ECUADOR

CYEDE Cia. Ltda.
P.O. Box 6423 CCI
Avenida Eloy Alfaro 1749
QUITO
Tel: 450-975, 243-052
Telex: 2548 CYEDE ED
 Cable: CYEDE-Quito
 A,CM,E,P
Hospitalar S.A.
Casilla 3590
Robles 625
QUITO
Tel: 545-250, 545-122
 Cable: HOSPITALAR-Quito
 M

EGYPT

Samitro
SANTIAGO 9
Tel: 220222
Telex: JCALCAGNI
 A,CM,E,M
Olympia (Chile) Ltd.
Rodrico de Araya 1045
Casilla 256-V
SANTIAGO 21
Tel: 25-50-44
Telex: 40-565
 C,P

International Engineering Associates
 24 Hussein Hegazi Street
 Kasr-el-Aini
CAIRO
Tel: 23-829
Telex: 93830
 E,M
Informatic For Computer Systems
 22 Talaat Harb Street
CAIRO
Tel: 759006
Telex: 93938 FRANK UN
 C

EL SALVADOR

IPESA
Boulevard de los Heroes
Edificio Sarah 1148
SAN SALVADOR
Tel: 252787
 A,C,CM,E,P

FINLAND

Hewlett-Packard Oy
 Revontulentie 7
 SF-02100 ESPOO 10
Tel: (90) 455-0211
Telex: 121563 hewpa sf
 A,CM,CP,E,MS,P

FRANCE

Hewlett-Packard France
 Le Ligoures
 Bureau de Vente de
 Aix-en-Provence
 Place Romée de Villeneuve
 F-13090 AIX-EN-PROVENCE
Tel: (42) 59-41-02
Telex: 410770F
 A,CM,CS,E,MS,P*



SALES & SUPPORT OFFICES

Arranged alphabetically by country

FRANCE (Cont.)

Hewlett-Packard France
Boite Postale No. 503
F-25026 BESANCON
28 Rue de la Republique
F-25000 BESANCON
Tel: (81) 83-16-22
C,M

Hewlett-Packard France
Bureau de Vente de Lyon
Chemin des Mouilles
Boite Postale No. 162
F-69130 ECULLY Cédex
Tel: (78) 33-81-25
Telex: 310617F
A,CM,CP,E,MP

Hewlett-Packard France
Immeuble France Evry
Tour Lorraine
Boulevard de France
F-91035 EVRY Cédex
Tel: (60) 77-96-60
Telex: 692315F
CM,E

Hewlett-Packard France
5th Avenue Raymond Chanas
F-38320 EYBENS
Tel: (76) 25-81-41
Telex: 980124 HP GRENOB EYBE
CM,CS

Hewlett-Packard France
Bâtiment Ampère
Rue de la Commune de Paris
Boite Postale 300
F-93153 LE BLANC MESNIL
Tel: (01) 865-44-52
Telex: 211032F
CM,CP,E,MS

Hewlett-Packard France
Le Montesquieu
Avenue du President JF Kennedy
F-33700 MERIGNAC
Tel: (56) 34-00-84
Telex: 550105F
CM,CP,E,MS

Hewlett-Packard France
32 Rue Lothaire
F-57000 METZ
Tel: (87) 65-53-50
CM,CS

Hewlett-Packard France
F-91947 Les Ulis Cédex ORSAY
Tel: (1) 907-78-25
Telex: 600048F
A,CM,CP,E,MP,P

Hewlett-Packard France
Paris Porte-Maillot 13, 15 25
Boulevard De L'Amiral Bruix
F-75782 PARIS Cédex 16
Tel: (01) 502-12-20
Telex: 613663F
CM,CP,MS,P

Hewlett-Packard France
2 Allee de la Bourgonette
F-35100 RENNES
Tel: (99) 51-42-44
Telex: 740912F
CM,CS,E,MS,P*

Hewlett-Packard France
4 Rue Thomas Mann
Boite Postale 56
F-67200 STRASBOURG
Tel: (88) 28-56-46
Telex: 890141F
CM,CS,E,MS,P*

Hewlett-Packard France
20 Chemin de la Cèpière
F-31081 TOULOUSE Cédex
Tel: (61) 40-11-12
Telex: 531639F
A,CM,CS,E,P*

Hewlett-Packard France
Bureau de Vente de Lille
Immeuble Péricentre
Rue Van Gogh
F-59650 VILLENEUVE D'ASQ
Tel: (20) 91-41-25
Telex: 160124F
CM,CS,E,MS,P*

GERMAN FEDERAL REPUBLIC

Hewlett-Packard GmbH
Technisches Büro Berlin
Keithstrasse 2-4
D-1000 BERLIN 30
Tel: (030) 24-90-86
Telex: 018 3405 hpbm d
A,CM,CS,E,X,M,P

Hewlett-Packard GmbH
Technisches Büro Böblingen
Herrenberger Strasse 110
D-7030 BOBLINGEN
Tel: (07031) 667-1
Telex: 07265739 bbn or 07265743
A,CM,CP,E,MP,P

Hewlett-Packard GmbH
Technisches Büro Dusseldorf
Emanuel-Leutze-Strasse 1
D-4000 DUSSELDORF
Tel: (0211) 5971-1
Telex: 085/86 533 hppd d
A,CM,CP,E,MS,P

Hewlett-Packard GmbH
Vertriebszentrale Frankfurt
Bernier Strasse 117
Postfach 560 140
D-6000 FRANKFURT 56
Tel: (0611) 50-04-1
Telex: 04 13249 hpfm d
A,CM,CP,E,MP,P

Hewlett-Packard GmbH
Technisches Büro Hamburg
Kapstadtring 5
D-2000 HAMBURG 60
Tel: (040) 63804-1
Telex: 21 63 032 hphh d
A,CM,CP,E,MS,P

Hewlett-Packard GmbH
Technisches Büro Hannover
Am Grossmarkt 6
D-3000 HANNOVER 91
Tel: (0511) 46-60-01
Telex: 092 3259
A,CM,CS,E,MS,P

Hewlett-Packard GmbH
Technisches Büro Mannheim
Rosslauer Weg 2-4
D-6800 MANNHEIM
Tel: (621) 70050
Telex: 0462105
A,C,E

Hewlett-Packard GmbH
Technisches Büro Neu Ulm
Messerschmittstrasse 7
D-7910 NEU ULM
Tel:
Telex:
C,E

Hewlett-Packard GmbH
Technisches Büro Nürnberg
Neumeyerstrasse 90
D-8500 NURNBERG
Tel: (0911) 56-30-83
Telex: 0623 860
CM,CS,E,MS,P

Hewlett-Packard GmbH
Technisches Büro München
Eschenstrasse 5
D-8021 TAUFKIRCHEN
Tel: (089) 6117-1
Telex: 0524985
A,CM,CP,E,MS,P

GREAT BRITAIN

Hewlett-Packard Ltd.
Trafaigar House
Navigation Road
ALTRINCHAM
Cheshire WA14 1NU
Tel: (061) 928-6422
Telex: 668068
A,C,E,M

Hewlett-Packard Ltd.
Oakfield House, Oakfield Grove
Clifton
BRISTOL BS8 2BN
Tel: 36806
Telex: 444302
P

Hewlett-Packard Ltd.
14 Wesley Street
CASTLEFORD
Yorkshire WF10 1AE
Tel: (0977) 550016
Telex: 5557355
C

Hewlett-Packard Ltd.
Fourier House
257-263 High Street
LONDON COLNEY
Herts., AL2 1HA
Tel: (0727) 24400
Telex: 1-8952716
C,E

Hewlett-Packard Ltd
Tradax House, St. Mary's Walk
MAIDENHEAD
Berkshire, SL6 1ST
Tel: (0628) 39151
E,P

Hewlett-Packard Ltd.
308/314 Kings Road
READING, Berkshire
Tel: 61022
Telex: 84-80-68
CM,P

Hewlett-Packard Ltd.
Quadrangle
106-118 Station Road
REDHILL, Surrey
Tel: (0737) 68655
Telex: 947234 C,E

Hewlett-Packard Ltd.
Westminster House
190 Stratford Road
SHIRLEY, Solihull
West Midlands B90 3BJ
Tel: (021) 7458800
Telex: 339105
C

Hewlett-Packard Ltd.
King Street Lane
WINNERSH, Wokingham
Berkshire RG11 5AR
Tel: (0734) 784774
Telex: 847178
A,C,E,M

GREECE

Kostas Karayannis
8 Omirou Street
ATHENS 133
Tel: 32-30-303, 32-37-371
Telex: 21 59 62 RKAR GR
E,M,P

"Plaiso"
G. Gerados
24 Stournara Street
ATHENS
Tel: 36-11-160
Telex: 21 9492
P

GUATEMALA

IFESA
Avenida Reforma 3-48
Zona 9
GUATEMALA CITY
Tel: 316627, 314786, 664715
Telex: 4192 Teletro Gu
A,C,CM,E,M,P

HONG KONG

Hewlett-Packard Hong Kong, Ltd.
G.P.O. Box 795
5th Floor, Sun Hung Kai Centre
30 Harbour Road
HONG KONG
Tel: 5-8323211
Telex: 66678 HEWPA HX
Cable: HP ASIA LTD Hong Kong
E,CP,P

Schmidt & Co. (Hong Kong) Ltd.
Wing On Centre, 28th Floor
Connaught Road, C.

HONG KONG

Tel: 5-455644
Telex: 74766 SCHMX HX
A,M

ICELAND

Elding Trading Company Inc.
Hafnarmvohi Tryggvagotu
P.O. Box 895
IS-REYKJAVIK
Tel: 1-58-20, 1-63-03
M

INDIA

Blue Star Ltd.
Bhavdeep
Stadium Road
AHMEDABAD 380 014
Tel: 42932
Telex: 012-234
Cable: BLUEFROST
E

Blue Star Ltd.
11 Magarath Road
BANGALORE 560 025
Tel: 55668
Telex: 0845-430
Cable: BLUESTAR
A,CM,C,E

Blue Star Ltd.
Band Box House
Prabhadevi
BOMBAY 400 025
Tel: 422-3101
Telex: 011-3751
Cable: BLUESTAR
A,M

Blue Star Ltd.
Sahas
41/2 Vir Savarkar Marg
Prabhadevi
BOMBAY 400 025
Tel: 422-6155
Telex: 011-4093
Cable: FROSTBLUE
A,CM,C,E,M

Blue Star Ltd.
7 Hare Street
CALCUTTA 700 001
Tel: 12-01-31
Telex: 021-7655
Cable: BLUESTAR
A,M

Blue Star Ltd.
Meenakshi Mandiram
XXXXV/1379-2 M. G. Road
COCHIN 682-016
Tel: 32069
Telex: 085-514
Cable: BLUESTAR
A*

Blue Star Ltd.
133 Kodambakkam High Road
MADRAS 600 034
Tel: 82057
Telex: 041-379
Cable: BLUESTAR
A,M

Blue Star Ltd.
Bhandari House, 7th/8th Floors
91 Nehru Place
NEW DELHI 110 024
Tel: 682547
Telex: 031-2463
Cable: BLUESTAR
A,CM,C,E,M

Blue Star Ltd.
1-1-117/1 Sarojini Devi Road
SECUNDERABAD 500 033
Tel: 70126
Telex: 0155-459
Cable: BLUEFROST
A,E

Blue Star Ltd.
T.C. 7/603 Poonima
Maruthankuzhi
TRIVANDRUM 695 013
Tel: 65799
Telex: 0884-259
Cable: BLUESTAR
E

INDONESIA

BERCA Indonesia P.T.
P.O.Box 496/Jkt.
Jin. Abdul Muis 62
JAKARTA
Tel: 373009
Telex: 31146 BERSAL IA
Cable: BERSAL JAKARTA
A,C,E,M,P

BERCA Indonesia P.T.
P.O. Box 174/Sby.
J.L. Kutei No. 11
SUBAEE-SURABAYA
Tel: 68172
Telex: 31146 BERSAL SD
Cable: BERSAL-SURABAYA
A*,E,M,P

IRAQ

Hewlett-Packard Trading S.A.
Mansoor City 9B/3/7
BAGHDAD
Tel: 551-49-73
Telex: 2455 HEPARAO IK
CP

IRELAND

Hewlett-Packard Ireland Ltd.
Kestrel House
Clanwilliam Court
Lower Mount Street
DUBLIN 2, Eire
Tel: 680424, 680426
Telex: 30439
A,C,CM,E,M,P
Cardiac Services Ltd.
Kilmore Road
Artane
DUBLIN 5, Eire
Tel: (01) 351820
Telex: 30439
M



ISRAEL

Electronics Engineering Division
Motorola Israel Ltd.
 16 Kremenetski Street
 P.O. Box 25016
 TEL-AVIV 67899
 Tel: 338973
 Telex: 33569 Motil IL
 Cable: BASTEL Tel-Aviv
 A,C,M,C,E,M,P

ITALY

Hewlett-Packard Italiana S.p.A.
 Traversa 99C
 Giulio Petrone, 19
 I-70124 BARI
 Tel: (080) 41-07-44
 M

Hewlett-Packard Italiana S.p.A.
 Via Martin Luther King, 38/111
 I-40132 BOLOGNA
 Tel: (051) 402394
 Telex: 511630
 CM,CS,E,MS

Hewlett-Packard Italiana S.p.A.
 Via Principe Nicola 43G/C
 I-95126 CATANIA
 Tel: (095) 37-10-87
 Telex: 970291
 C,P

Hewlett-Packard Italiana S.p.A.
 Via G. Di Vittorio 9
 I-20063 CERNUSCO SUL NAVIGLIO
 Tel: (2) 903691
 Telex: 334632
 A,CM,CP,E,MP,P

Hewlett-Packard Italiana S.p.A.
 Via Nuova san Rocco A
 Capodimonte, 62/A
 I-80131 NAPOLI
 Tel: (081) 7413544
 A,CM,CS,E

Hewlett-Packard Italiana S.p.A.
 Viale G. Modugno 33
 I-16156 GENOVA PEGLI
 Tel: (010) 68-37-07 E,C

Hewlett-Packard Italiana S.p.A.
 Via Turazza 14
 I-35100 PADOVA
 Tel: (49) 664888
 Telex: 430315
 A,CM,CS,E,MS

Hewlett-Packard Italiana S.p.A.
 Viale C. Pavese 340
 I-00144 ROMA
 Tel: (06) 54831
 Telex: 610514
 A,CM,CS,E,MS,P*

Hewlett-Packard Italiana S.p.A.
 Corso Giovanni Lanza 94
 I-10133 TORINO
 Tel: (011) 682245, 659308
 Telex: 221079
 CM,CS,E

JAPAN

Yokogawa-Hewlett-Packard Ltd.
 Inoue Building
 1348-3, Asahi-cho
 ATSUGI, Kanagawa 243
 Tel: (0462) 24-0451
 CM,C*,E

Yokogawa-Hewlett-Packard Ltd.
 3-30-18 Tsuruya-cho
 Kanagawa-ku, Yokohama-Shi
 KANAGAWA, 221
 Tel: (045) 312-1252
 Telex: 382-3204 YHP YOK
 CM,CS,E

Yokogawa-Hewlett-Packard Ltd.
 Sannomiya-Daichi Seimei-Bldg. 5F
 69 Kyo-Machi Ikuta-Ku
 KOBE CITY 650 Japan
 Tel: (078) 392-4791
 C,E

Yokogawa-Hewlett-Packard Ltd.
 Kumagaya Asahi Yasoji Bldg 4F
 4-3 Chome Tsukuba
 KUMAGAYA, Saitama 360
 Tel: (0485) 24-6563
 CM,CS,E

Yokogawa-Hewlett-Packard Ltd.
 Mito Mitsui Building
 4-73, San-no-maru, 1-chome
 MITO, Ibaragi 310
 Tel: (0292) 25-7470
 CM,CS,E

Yokogawa-Hewlett-Packard Ltd.
 Sumitomo Seimei Bldg.
 11-2 Shimo-sasajima-cho
 Nakamura-ku
 NAGOYA, Aichi 450
 Tel: (052) 581-1850
 CM,CS,E,MS

Yokogawa-Hewlett-Packard Ltd.
 Chuo Bldg., 4th Floor
 5-4-20 Nishinakajima, 5-chome
 Yodogawa-ku, Osaka-shi
 OSAKA, 532

Yokogawa-Hewlett-Packard Ltd.
 Tel: (06) 304-6021
 Telex: YHPOSA 523-3624
 A,CM,CP,E,MP,P*

Yokogawa-Hewlett-Packard Ltd.
 29-21 Takaido-Higashi 3-chome
 Suginami-ku TOKYO 168
 Tel: (03) 331-6111
 Telex: 232-2024 YHPTOK
 A,CM,CP,E,MP,P*

JORDAN

Mouasher Cousins Company
 P.O. Box 1387
 AMMAN
 Tel: 24907, 39907
 Telex: 21456 SABCO JO
 E,M,P

KOREA

Samsung Electronics
 4759 Shinkil, 6 Dong
 Youngdeungpo-Ku,
 SEOUL
 Tel: 8334311, 8334312
 Telex: SAMSAN 27364
 A,C,E,M,P

KUWAIT

Al-Khalidya Trading & Contracting
 P.O. Box 830 Safat
 KUWAIT
 Tel: 42-4910, 41-1726
 Telex: 2481 Areeg kt
 A,E,M

Photo & Cine Equipment
 P.O. Box 270 Safat
 KUWAIT
 Tel: 42-2846, 42-3801
 Telex: 2247 Matin
 P

LUXEMBOURG

Hewlett-Packard Belgium S.A./N.V.
 Blvd de la Woluwe, 100
 Woluwedal
 B-1200 BRUSSELS
 Tel: (02) 762-32-00
 Telex: 23-494 paloben bru
 A,CM,CP,E,MP,P

MALAYSIA

Hewlett-Packard Sales (Malaysia)
 Sdn. Bhd.
 Suite 2.2 1/2 22
 Bangunan Angkasa Raya
 Jalan Ampang
 KUALA LUMPUR
 Tel: 483544
 Telex: MA31011
 A,CP,E,M,P*

Protel Engineering
 Lot 319, Satok Rd.
 P.O. Box 1917
 KUCHING, SARAWAK
 Tel: 535-44
 Telex: MA 70904 Promal
 Cable: Proteleng
 A,E,M

MEXICO

Hewlett-Packard Mexicana, S.A. de
 C.V.
 Avenida Periferico Sur No. 6501
 Tepepan, Xochimilco
 MEXICO CITY 23, D.F.
 Tel: (905) 676-4600
 Telex: 017-74-507
 A,CP,E,MS,P

Hewlett-Packard Mexicana, S.A. de
 C.V.
 Rio Volga 600
 Colonia del Valle
 MONTERREY, N.L.
 Tel: 78-42-93, 78-42-40, 78-42-41
 Telex: 038-410
 CS

MOROCCO

Dolbeau
 81 rue Karatchi
 CASABLANCA
 Tel: 3041-82, 3068-38
 Telex: 23051, 22822
 E
Gerep
 2 rue d'Agadir
 Boite Postale 156
 CASABLANCA
 Tel: 272093, 272095
 Telex: 23 739
 P

NETHERLANDS

Hewlett-Packard Nederland B.V.
 Van Heuven Goedhartlaan 121
 NL 1181KK AMSTELVEEN
 P.O. Box 667
 NL 1080 AR AMSTELVEEN
 Tel: (20) 47-20-21
 Telex: 13 216
 A,CM,CP,E,MP,P
 Hewlett-Packard Nederland B.V.
 Bongerd 2
 NL 2906VK CAPPELLE, A/D IJssel
 P.O. Box 41
 NL2900 AA CAPELLE, IJssel
 Tel: (10) 51-64-44
 Telex: 21261 HEPAC NL
 A,CM,CP

NEW ZEALAND

Hewlett-Packard (N.Z.) Ltd.
 169 Manukau Road
 P.O. Box 26-189
 Epsom, AUCKLAND
 Tel: 68-7159
 Cable: HEWPACK Auckland
 CM,CS,E,P*

Hewlett-Packard (N.Z.) Ltd.
 4-12 Cruickshank Street
 P.O. Box 9443
 Kilbirnie, WELLINGTON 3
 Tel: 877-199
 Cable: HEWPACK Wellington
 CM,CP,E,P
Northrop Instruments & Systems
 Ltd.
 Eden House, 44 Khyber Pass Road
 P.O. Box 9682
 Newmarket, AUCKLAND
 Tel: 794-091
 A,M
Northrop Instruments & Systems
 Ltd.
 Terrace House, 4 Oxford Terrace
 P.O. Box 8388
 CHRISTCHURCH
 Tel: 64-165
 A,M
Northrop Instruments & Systems
 Ltd.
 Slurdee House
 85-87 Ghuznee Street
 P.O. Box 2406
 WELLINGTON
 Tel: 850-091
 Telex: NZ 3380
 A,M

NIGERIA

The Electronics Instrumentations
 Ltd.
 N6B/S70 Oyo Road
 Oluseun House
 P.M.B. 5402
 IBADAN
 Tel: 461577
 Telex: 31231 TEIL NG
 A,E,M,P
The Electronics Instrumentations
 Ltd.
 144 Agege Motor Road, Mushin
 P.O. Box 6645
 Mushin, LAGOS
 A,E,M,P

NORTHERN IRELAND

Cardiac Services Company
 95A Finaghy Road South
 BELFAST BT 10 0BY
 Tel: (0232) 625-566
 Telex: 747626
 M
The Electronics Instrumentations
 Ltd.
 144 Agege Motor Road, Mushin
 P.O. Box 6645
 Mushin, LAGOS
 A,E,M,P

NORWAY

Hewlett-Packard Norge A/S
 Folke Bernadottelstvei 50
 P.O. Box 3558
 N-5033 FYLLINGSDALEN (BERGEN)
 Tel: (05) 16-55-40
 Telex: 16621 hpnas n
 CM,CS,E
 Hewlett-Packard Norge A/S
 Oesterndalen 18
 P.O. Box 34
 N-1345 OESTERAAS
 Tel: (02) 17-11-80
 Telex: 16621 hpnas n
 A*,CM,CP,E,MS,P

OMAN

Khimji Ramdas
 P.O. Box 19
 MUSCAT
 Tel: 72-22-17, 72-22-25
 Telex: 3289 BROKER MB MUSCAT
 P

PAKISTAN

Mushko & Company Ltd.
 10, Bazar Road
 Sector G-6/4
 ISLAMABAD
 Tel: 28624
 Cable: FEMUS Rawalpindi
 A,E,M
Mushko & Company Ltd.
 Oosman Chambers
 Abdullah Haroon Road
 KARACHI 0302
 Tel: 511027, 512927
 Telex: 2894 MUSHKO PW
 Cable: COOPERATOR Karachi
 A,E,M,P*

PANAMA

Electrónico Balboa, S.A.
 Apartado 4929
 Panama 5
 Calle Samuel Lewis
 Edificio "Alta" No. 2
 CIUDAD DE PANAMA
 Tel: 64-2700
 Telex: 3480380
 Cable: ELECTRON Panama
 A,CM,E,M,P
Foto Internacional, S.A.
 P.O. Box 2068
 Free Zone of Colon
 COLON 3
 Tel: 45-2333
 Telex: 3485126
 Cable: IMPORT COLON/Panama
 P

PERU

Cómpania Electro Médica S.A.
 Los Flamencos 145, San Isidro
 Casilla 1030
 LIMA 1
 Tel: 41-4325
 Telex: Pub. Booth 25424 SISIDRO
 Cable: ELMED Lima
 A,CM,E,M,P

PHILIPPINES

The Online Advanced Systems
 Corporation
 Rico House, Amoroso Cor. Herrera
 Street
 Legaspi Village, Makati
 P.O. Box 1510
 Metro MANILA
 Tel: 85-35-81, 85-34-91, 85-32-21
 Telex: 3274 ONLINE
 A,C,E,M
Electronic Specialists and
Proponents Inc.
 690-B Epifanio de los Santos
 Avenue
 Cubao, QUEZON CITY
 P.O. Box 2649 Manila
 Tel: 98-96-81, 98-96-82, 98-96-83
 Telex: 742-40287
 P

POLAND

Buro Informacji Technicznej
 Hewlett-Packard
 Ul Stawki 2, 6P
 PL00-950 WARSZAWA
 Tel: 39-59-62, 39-67-43
 Telex: 812453 hepa pl

SALES & SUPPORT OFFICES

Arranged alphabetically by country

PORTUGAL

Telectra-Empresa Técnica de Equipamentos Eléctricos S.a.r.l.
Rua Rodrigo da Fonseca 103
P.O. Box 2531
P-LISBON 1
Tel: (19) 68-60-72
Telex: 12598
A,C,E,P
Mundinter
Intercambio Mundial de Comércio S.a.r.l.
P.O. Box 2761
Avenida Antonio Augusto de Aguiar 138
P-LISBON
Tel: (19) 53-21-31, 53-21-37
Telex: 16691 munter p
M

PUERTO RICO

Hewlett-Packard Puerto Rico
P.O. Box 4407
CAROLINA, Puerto Rico 00630
Calle 272 Edificio 203
Urb. Country Club
RIO PIEDRAS, Puerto Rico 00924
Tel: (809) 762-7255
Telex: 345 0514
A,CP

QATAR

Nasser Trading & Contracting
P.O. Box 1563
DOHA
Tel: 22170
Telex: 4439 NASSER
M
Scitecharabia
P.O. Box 2750
!DOHA
Tel: 329515
Telex: 4806 CMPARB
P

ROMANIA

Hewlett-Packard Reprezentanta
Boulevard Nicolae Balcescu 16
BUCURESTI
Tel: 130725
Telex: 10440

SAUDI ARABIA

Modern Electronic Establishment
P.O. Box 193
AL-KHOBAR
Tel: 44-678, 44-813
Telex: 670136
Cable: ELECTA AL-KHOBAR
C,E,M,P
Modern Electronic Establishment
P.O. Box 1228, Baghdadiyah Street
JEDDAH
Tel: 27-798
Telex: 401035
Cable: ELECTA JEDDAH
C,E,M,P
Modern Electronic Establishment
P.O. Box 2728
RIYADH
Tel: 62-596, 66-232
Telex: 202049
C,E,M,P

SCOTLAND

Hewlett-Packard Ltd.
Royal Bank Buildings
Swan Street
BRECHIN, Angus, Scotland
Tel: 3101, 3102
CM,CS

Hewlett-Packard Ltd.
SOUTH QUEENSFERRY
West Lothian, EH30 9TG
GB-Scotland
Tel: (031) 3311000
Telex: 72682
A,CM,E,M

SINGAPORE

Hewlett-Packard Singapore (Pty.) Ltd.
P.O. Box 58 Alexandra Post Office
SINGAPORE, 9115
6th Floor, Inchcape House
450-452 Alexandra Road
SINGAPORE 0511
Tel: 631788
Telex: HPSGSO RS 34209
Cable: HEWPACK, Singapore
A,CP,E,MS,P

SOUTH AFRICA

Hewlett-Packard South Africa (Pty.) Ltd.
P.O. Box 120
Howard Place
Pine Park Center, Forest Drive,
Pinelands
CAPE PROVINCE 7450
Tel: 53-7955, 53-7956, 53-7957
Telex: 57-0006
A,CM,CS,E,MS,P
Hewlett-Packard South Africa (Pty.) Ltd.
P.O. Box 37066
Overport
DURBAN 4067
Tel: 28-4178, 28-4179, 28-4110
CM,CS
Hewlett-Packard South Africa (Pty.) Ltd.
P.O. Box 33345
Glenstantia 0010
TRANSSVAAL
1st Floor East
Constantia Park Ridge Shopping Centre
Constantia Park
PRETORIA Tel: 98-1126 or 98-1220
Telex: 32163
C,E
Hewlett-Packard South Africa (Pty.) Ltd.
Daphny Street
Private Bag Wendywood
SANDTON 2144
Tel: 802-5111, 802-5125
Telex: 89-84782
Cable: HEWPACK Johannesburg
A,CM,CP,E,MS,P

SPAIN

Hewlett-Packard Española S.A.
c/Entenza, 321
E-BARCELONA 29
Tel: (3) 322-24-51, 321-73-54
Telex: 52603 hpbee
A,CM,CP,E,MS,P
Hewlett-Packard Española S.A.
c/San Vicente S/N
Edificio Albia II,7 B
E-BILBAO 1
Tel: (944) 423-8306, 423-8206
A,CM,E,MS
Hewlett-Packard Española S.A.
Calle Jerez 3
E-MADRID 16
Tel: 458-2600
Telex: 23515 hpe
A,CM,E,MP,P

Hewlett-Packard Española S.A.
Colonia Mirasierra
Edificio Juban
c/o Costa Brava 13, 2.
E-MADRID 34
Tel: 734-8061, 734-1162
CM,CP

Hewlett-Packard Española S.A.
Av Ramón y Cajal 1-9
Edificio Sevilla 1,
E-SEVILLA 5
Tel: 64-44-54, 64-44-58
Telex: 72933
A,CM,CS,MS,P
Hewlett-Packard Española S.A.
C/Ramon Gordillo, 1 (Entfo.3)
E-VALENCIA 10
Tel: 361-1354, 361-1358
CM,CS,P

SWEDEN

Hewlett-Packard Sverige AB
Ernighetsvägen 3, Fack
P.O. Box 20502
S-16120 BROMMA
Tel: (08) 730-0550
Telex: (854) 10721 MESSAGES
Cable: MEASUREMENTS
STOCKHOLM
A,CM,CP,E,MS,P
Hewlett-Packard Sverige AB
Sunnanvagen 14K
S-22226 LUND
Tel: (46) 13-69-79
Telex: (854) 10721 (via BROMMA office)
CM,CS
Hewlett-Packard Sverige AB
Vastra Vintergatan 9
S-70344 OREBRO
Tel: (19) 10-48-80
Telex: (854) 10721 (via BROMMA office)
CM,CS
Hewlett-Packard Sverige AB
Fröfallsgatan 30
S-42132 VÄSTRA-FRÖLUNDA
Tel: (031) 49-09-50
Telex: (854) 10721 (via BROMMA office)
CM,CS,E,P

SWITZERLAND

Hewlett-Packard (Schweiz) AG
Clarastrasse 12
CH-4058 BASLE
Tel: (61) 33-59-20
A,CM
Hewlett-Packard (Schweiz) AG
47 Avenue Blanc
CH-1202 GENEVA
Tel: (022) 32-30-05, 32-48-00
CM,CP
Hewlett-Packard (Schweiz) AG
29 Chemin Château Bloc
CH-1219 LE LIGNON-Geneva
Tel: (022) 96-03-22
Telex: 27333 hpag ch
Cable: HEWPACKAG Geneva
A,CM,E,MS,P
Hewlett-Packard (Schweiz) AG
Zürcherstrasse 20
Allmend 2
CH-8967 WIDEN
Tel: (57) 50-111
Telex: 59933 hpag ch
Cable: HPAG CH
A,CM,CP,E,MS,P

SYRIA

General Electronic Inc.
Nuri Basha-Ahmad Ebn Kays Street
P.O. Box 5781
DAMASCUS
Tel: 33-24-87
Telex: 11215 ITIKAL
Cable: ELECTROBOR DAMASCUS
E
Sawah & Co.
Place Azmé
Boite Postale 2308
DAMASCUS
Tel: 16-367, 19-697, 14-268
Telex: 11304 SATACO SY
Cable: SAWAH, DAMASCUS
M

TAIWAN

Hewlett-Packard Far East Ltd.
Kaohsiung Branch
68-2, Chung Cheng 3rd Road
Shin Shin, Chu
KAOHSIUNG
Tel: 24-2318, 26-3253
CS,E,MS,P
Hewlett-Packard Far East Ltd.
Taiwan Branch
5th Floor
205 Tun Hwa North Road
TAIPEI
Tel: (02) 751-0404
Cable:HEWPACK Taipei
A,CP,E,MS,P
Hewlett-Packard Far East Ltd.
Taichung Branch
#33, Cheng Yih Street
10th Floor, Room 5
TAICHUNG
Tel: 289274
Ing Lih Trading Co.
3rd Floor 18, Po-la Road
TAIPEI
Tel:
Telex:
Cable: INGLIH TAIPEI
A

THAILAND

UNIMESA Co. Ltd.
Elcom Research Building
2538 Sukhumvit Ave.
Bangchak, BANGKOK
Tel: 393-2387, 393-0338
Telex: TH81160, 82938, 81038
Cable: UNIMESA Bangkok
A,C,E,M
Bangkok Business Equipment Ltd.
5/5-6 Dejo Road
BANGKOK
Tel: 234-8670, 234-8671,
234-8672
Cable: BUSIUPT Bangkok
P

TRINIDAD & TOBAGO

Caribbean Telecoms Ltd.
P.O. Box 732
50/A Jerningham Avenue
PORT-OF-SPAIN
Tel: 624-4213, 624-4214
A,CM,E,M,P

TUNISIA

Tunisie Electronique
31 Avenue de la Liberté
TUNIS
Tel: 280-144
E,P

Corema
1 ter. Av. de Carthage
TUNIS
Tel: 253-821
Telex: 12319 CABAM TN
M

TURKEY

Teknim Company Ltd.
Riza Sah Pehievi
Caddesi No. 7
Kavaklidere, ANKARA
Tel: 275800
Telex: 42155
E
EMA, Muhendislik Kolektif Sirketi
Mediha Eldem
Sokak 41/6
Yüksel Caddesi, ANKARA
Tel: 17-56-22
Cable: Emaltrade
M

UNITED ARAB EMIRATES

Emitag Ltd.
P.O. Box 1641
SHARJAH
Tel: 354121, 354123
Telex: 68136
E,M,P,C

UNITED KINGDOM

see: GREAT BRITAIN
NORTHERN IRELAND
SCOTLAND

UNITED STATES

Alabama
Hewlett-Packard Co.
700 Century Park South
Suite 128
BIRMINGHAM, AL 35226
Tel: (205) 822-6802
CM,CS,MP
Hewlett-Packard Co.
P.O. Box 4207
8290 Whitesburg Drive, S.E.
HUNTSVILLE, AL 35802
Tel: (205) 881-4591
CM,CP,E,M*

Alaska
Hewlett-Packard Co.
1577 "C" Street, Suite 252
ANCHORAGE, AK 99510
Tel: (206) 454-3971
CM,CS**

Arizona
Hewlett-Packard Co.
2336 East Magnolia Street
PHOENIX, AZ 85034
Tel: (602) 273-8000
A,CM,CP,E,MS
Hewlett-Packard Co.
2424 East Aragon Road
TUCSON, AZ 85702
Tel: (602) 889-4631
CM,CS,E,MS**

Arkansas
Hewlett-Packard Co.
P.O. Box 5646
Brady Station
LITTLE ROCK, AR 72215
Tel: (501) 376-1844, (501)
664-8773
CM,MS



UNITED STATES (Cont.)

California

Hewlett-Packard Co.
7621 Canoga Avenue
CANOGA PARK, CA 91304
Tel: (213) 702-8300
A,CM,CP,E,P

Hewlett-Packard Co.
1579 W. Shaw Avenue
FRESNO, CA 93771
Tel: (209) 224-0582
CM,MS

Hewlett-Packard Co.
1430 East Orangethorpe
FULLERTON, CA 92631
Tel: (714) 870-1000
CM,CP,E,MP

Hewlett-Packard Co.
5400 W. Rosecrans Boulevard
LAWDALE, CA 90260
P.O. Box 92105
LOS ANGELES, CA 90009
Tel: (213) 970-7500
CM,CP,MP

Hewlett-Packard Co.
3939 Lankershim Blvd.
NORTH HOLLYWOOD, CA 91604
Tel: (213) 877-1282
Regional Headquarters

Hewlett-Packard Co.
3200 Hillview Avenue
PALO ALTO, CA 94304
Tel: (415) 857-8000
CM,CP,E

Hewlett-Packard Co.
646 W. North Market Boulevard
SACRAMENTO, CA 95834
Tel: (916) 929-7222
A*,CM,CP,E,MS

Hewlett-Packard Co.
9606 Aero Drive
P.O. Box 23333
SAN DIEGO, CA 92123
Tel: (714) 279-3200
CM,CP,E,MP

Hewlett-Packard Co.
3003 Scott Boulevard
SANTA CLARA, CA 95050
Tel: (408) 988-7000
A,CM,CP,E,MP

Hewlett-Packard Co.
454 Carlton Court
SO. SAN FRANCISCO, CA 94080
Tel: (415) 877-0772
CM,CP

Colorado

Hewlett-Packard Co.
24 Inverness Place, East
ENGLEWOOD, CO 80112
Tel: (303) 771-3455
A,CM,CP,E,MS

Connecticut

Hewlett-Packard Co.
47 Barnes Industrial Road South
P.O. Box 5007
WALLINGFORD, CT 06492
Tel: (203) 265-7801
A,CM,CP,E,MS

Florida

Hewlett-Packard Co.
P.O. Box 24210
2727 N.W. 62nd Street
FORT LAUDERDALE, FL 33309
Tel: (305) 973-2600
CM,CP,E,MP

Hewlett-Packard Co.
4080 Woodcock Drive, #132
Brownett Building
JACKSONVILLE, FL 32207
Tel: (904) 398-0663
CM,C*,E*,MS**

Hewlett-Packard Co.
P.O. Box 13910
6177 Lake Elenor Drive
ORLANDO, FL 32809
Tel: (305) 859-2900
A,CM,CP,E,MS

Hewlett-Packard Co.
6425 N. Pensacola Blvd.
Suite 4, Building 1
PENSACOLA, FL 32575
Tel: (904) 476-8422
A,CM,MS

Hewlett-Packard Co.
110 South Hoover, Suite 120
Vanguard Bldg.
TAMPA, FL 33609
Tel: (813) 872-0900
A*,CM,CS,E*,M*

Georgia

Hewlett-Packard Co.
P.O. Box 105005
2000 South Park Place
ATLANTA, GA 30339
Tel: (404) 955-1500
Telex: 810-766-4890
A,CM,CP,E,MP

Hewlett-Packard Co.
Executive Park Suite 306
P.O. Box 816
AUGUSTA, GA 30907
Tel: (404) 736-0592
CM,MS

Hewlett-Packard Co.
P.O. Box 2103
1172 N. Davis Drive
WARNER ROBINS, GA 31098
Tel: (912) 922-0449
CM,E

Hawaii

Hewlett-Packard Co.
Kawaiahao Plaza, Suite 190
567 South King Street
HONOLULU, HI 96813
Tel: (808) 526-1555
A,CM,CS,E,MS

Idaho

Hewlett-Packard Co.
11311 Chinden Boulevard
BOISE, ID 83707
Tel: (208) 376-6000
CM,CS,M*

Illinois

Hewlett-Packard Co.
211 Prospect Road
BLOOMINGTON, IL 61701
Tel: (309) 663-0383
CM,CS,MS**

Hewlett-Packard Co.
1100 31st Street
DOWNERS GROVE, IL 60515
Tel: (312) 960-5760
CM,CP

Hewlett-Packard Co.
5201 Toiview Drive
ROLLING MEADOWS, IL 60008
Tel: (312) 255-9800
A,CM,CP,E,MP

Indiana

Hewlett-Packard Co.
P.O. Box 50807
7301 No. Shadeland Avenue
INDIANAPOLIS, IN 46250
Tel: (317) 842-1000
A,CM,CS,E,MS

Iowa

Hewlett-Packard Co.
2415 Heinz Road
IOWA CITY, IA 52240
Tel: (319) 351-1020
CM,CS,E*,MS

Kansas

Hewlett-Packard Co.
1644 S. Rock
WICHITA, KA 67207
Tel: (316) 265-5200
CM,CS

Kentucky

Hewlett-Packard Co.
10170 Linn Station Road
Suite 525
LOUISVILLE, KY 40223
Tel: (502) 426-0100
A,CM,CS,MS

Louisiana

Hewlett-Packard Co.
P.O. Box 1449
3229 Williams Boulevard
KENNER, LA 70062
Tel: (504) 443-6201
A,CM,CS,E,MS

Maryland

Hewlett-Packard Co.
7121 Standard Drive
HANOVER, MD 21076
Tel: (301) 796-7700
A,CM,CP,E,MS

Hewlett-Packard Co.
2 Choke Cherry Road
ROCKVILLE, MD 20850
Tel: (301) 948-6370
Telex: 710-828-9685
A,CM,CP,E,MP

Massachusetts

Hewlett-Packard Co.
32 Hartwell Avenue
LEXINGTON, MA 02173
Tel: (617) 861-8960
A,CM,CP,E,MP

Michigan

Hewlett-Packard Co.
23855 Research Drive
FARMINGTON HILLS, MI 48024
Tel: (313) 476-6400
A,CM,CP,E,MP

Hewlett-Packard Co.
4326 Cascade Road S.E.
GRAND RAPIDS, MI 49506
Tel: (616) 957-1970
CM,CS,MS

Minnesota

Hewlett-Packard Co.
2025 W. Larpenteur Ave.
ST. PAUL, MN 55113
Tel: (612) 644-1100
A,CM,CP,E,MP

Mississippi

Hewlett-Packard Co.
P.O. Box 5028
322 N. Mart Plaza
JACKSON, MS 39216
Tel: (601) 982-9363
CM,MS

Missouri

Hewlett-Packard Co.
11131 Colorado Avenue
KANSAS CITY, MO 64137
Tel: (816) 763-8000
Telex: 910-771-2087
A,CM,CS,E,MS

Hewlett-Packard Co.
1024 Executive Parkway
ST. LOUIS, MO 63141
Tel: (314) 878-0200
A,CM,CP,E,MP

Nebraska

Hewlett-Packard
7101 Mercy Road
Suite 101, IBX Building
OMAHA, NE 68106
Tel: (402) 392-0948
CM,MS

Nevada

Hewlett-Packard Co.
Suite D-130
5030 Paradise Blvd.
LAS VEGAS, NV 89119
Tel: (702) 736-6610
CM,MS**

New Jersey

Hewlett-Packard Co.
Crystal Brook Professional Building
Route 35
EATONTOWN, NJ 07724
Tel: (201) 542-1384
A*,CM,C*,E*,P*

Hewlett-Packard Co.
W120 Century Road
PARAMUS, NJ 07652
Tel: (201) 265-5000
A,CM,CP,E,MP

Hewlett-Packard Co.
60 New England Avenue West
PISCATAWAY, NJ 08854
Tel: (201) 981-1199
A,CM,CP,E

New Mexico

Hewlett-Packard Co.
P.O. Box 11634
11300 Lomas Blvd., N.E.
ALBUQUERQUE, NM 87123
Tel: (505) 292-1330
Telex: 910-989-1185
CM,CP,E,MS

New York

Hewlett-Packard Co.
5 Computer Drive South
ALBANY, NY 12205
Tel: (518) 458-1550
Telex: 710-444-4691
A,CM,CS,E,MS

Hewlett-Packard Co.
9600 Main Street
CLARENCE, NY 14031
Tel: (716) 759-8621
Telex: 710-523-1893

Hewlett-Packard Co.
200 Cross Keys Office
FAIRPORT, NY 14450
Tel: (716) 223-9950
Telex: 510-253-0092
CM,CP,E,MS

Hewlett-Packard Co.
No. 1 Pennsylvania Plaza
55th Floor
34th Street & 8th Avenue
NEW YORK, NY 10119
Tel: (212) 971-0800
CM,CP,E*,M*

Hewlett-Packard Co.
5858 East Molloy Road
SYRACUSE, NY 13211
Tel: (315) 455-2486
A,CM,CS,E,MS

Hewlett-Packard Co.
3 Crossways Park West
WOODBURY, NY 11797
Tel: (516) 921-0300
Telex: 510-221-2183
A,CM,CP,E,MS

North Carolina

Hewlett-Packard Co.
P.O. Box 15579
2905 Guess Road (27705)
DURHAM, NC 27704
Tel: (919) 471-8466
C,M

Hewlett-Packard Co.
5605 Roanne Way
GREENSBORO, NC 27409
Tel: (919) 852-1800
A,CM,CP,E,MS

Ohio

Hewlett-Packard Co.
9920 Carver Road
CINCINNATI, OH 45242
Tel: (513) 891-9870
CM,CP,MS

Hewlett-Packard Co.
76500 Sprague Road
CLEVELAND, OH 44130
Tel: (216) 243-7300
Telex: 810-423-9430
A,CM,CP,E,MS

Hewlett-Packard Co.
962 Crupper Ave.
COLUMBUS, OH 43229
Tel: (614) 436-1041
CM,CP,E*

Hewlett-Packard Co.
330 Progress Rd.
DAYTON, OH 45449
Tel: (513) 859-8202
A,CM,CP,E*,MS

Oklahoma

Hewlett-Packard Co.
P.O. Box 366
1503 W. Gore Blvd., Suite #2
LAWTON, OK 73502
Tel: (405) 248-4248
C

Hewlett-Packard Co.
P.O. Box 32008
304 N. Meridan Avenue, Suite A
OKLAHOMA CITY, OK 73107
Tel: (405) 946-9499
A*,CM,CP,E*,MS

Hewlett-Packard Co.
Suite 121
9920 E. 42nd Street
TULSA, OK 74145
Tel: (918) 665-3300
A**,CM,CS,M*

Oregon

Hewlett-Packard Co.
1500 Valley River Drive, Suite 330
EUGENE, OR 97401
Tel: (503) 683-8075
C

Hewlett-Packard Co.
9255 S. W. Pioneer Court
WILSONVILLE, OR 97070
Tel: (503) 682-8000
A,CM,CP,E*,MS

Pennsylvania

Hewlett-Packard Co.
1021 8th Avenue
King of Prussia Industrial Park
KING OF PRUSSIA, PA 19406
Tel: (215) 265-7000
Telex: 510-660-2670
A,CM,CP,E,MP

Hewlett-Packard Co.
111 Zeta Drive
PITTSBURGH, PA 15238
Tel: (412) 782-0400
A,CM,CP,E,MP

South Carolina

Hewlett-Packard Co.
P.O. Box 6442
6941-0 N. Trenholm Road
COLUMBIA, SC 29260
Tel: (803) 782-6493
CM,CS,E,MS



SALES & SUPPORT OFFICES

Arranged alphabetically by country

UNITED STATES (Cont.)

South Carolina (Cont.)

Hewlett-Packard Co
814 Wade Hampton Blvd
Suite 10
GREENVILLE, SC 29609
Tel: (803) 232-0917
C

Tennessee

Hewlett-Packard Co
P.O. Box 22490
224 Peters Road
Suite 102
KNOXVILLE, TN 37922
Tel: (615) 691-2371
A*, CM, MS

Hewlett-Packard Co
3070 Directors Row
MEMPHIS, TN 38131
Tel: (901) 346-8370
A, CM, CS, MS

Hewlett-Packard Co
Suite 103
478 Craighead Street
NASHVILLE, TN 37204
Tel: (615) 383-9136
CM, MS**

Texas

Hewlett-Packard Co.
Suite 310W
7800 Shoal Creek Blvd.
AUSTIN, TX 78757
Tel: (512) 459-3143
CM, E

Hewlett-Packard Co.
Suite C-110
4171 North Mesa
EL PASO, TX 79902
Tel: (915) 533-3555
CM, CS, E*, MS**

Hewlett-Packard Co.
5020 Mark IV Parkway
FORT WORTH, TX 76106
Tel: (817) 625-6361
CM, C*

Hewlett-Packard Co.
P.O. Box 42816
10535 Harwin Street
HOUSTON, TX 77036
Tel: (713) 776-6400
A, CM, CP, E, MP

Hewlett-Packard Co.
3309 67th Street
Suite 24
LUBBOCK, TX 79413
Tel: (806) 799-4472
M

Hewlett-Packard Co.
P.O. Box 1270
930 E Campbell Rd.
RICHARDSON, TX 75081
Tel: (214) 231-6101
A, CM, CP, E, MP

Hewlett-Packard Co.
205 Billy Mitchell Road
SAN ANTONIO, TX 78226
Tel: (512) 434-8241
CM, CS, E, MS

Utah

Hewlett-Packard Co.
3530 W. 2100 South Street
SALT LAKE CITY, UT 84119
Tel: (801) 974-1700
A, CM, CP, E, MS

Virginia

Hewlett-Packard Co.
P.O. Box 9669
2914 Hungary Spring Road
RICHMOND, VA 23228
Tel: (804) 285-3431
A, CM, CP, E, MS

Hewlett-Packard Co.
P.O. Box 4786
3110 Peters Creek Road, N.W.
ROANOKE, VA 24015
Tel: (703) 563-2205
CM, CS, E**

Hewlett-Packard Co
P.O. Box 12776
5700 Thurston Avenue
Suite 111
VIRGINIA BEACH, VA 23455
Tel: (804) 460-2471
CM, CS, MS

Washington

Hewlett-Packard Co.
15815 S.E. 37th Street
BELLEVUE, WA 98006
Tel: (206) 643-4000
A, CM, CP, E, MP

Hewlett-Packard Co.
Suite A
708 North Argonne Road
SPOKANE, WA 99206
Tel: (509) 922-7000
CM, CS

West Virginia

Hewlett-Packard Co.
4604 MacCorkle Ave., S.E.
CHARLESTON, WV 25304
Tel: (304) 925-0492
A, CM, MS

Wisconsin

Hewlett-Packard Co.
150 S. Sunny Slope Road
BROOKFIELD, WI 53005
Tel: (414) 784-8800
A, CM, CS, E*, MP

URUGUAY

Pablo Ferrando S.A.C. e.l.
Avenida Italia 2877
Castilla de Correo 370
MONTEVIDEO
Tel: 403102
Telex: 901 Public Booth Para Pablo
Ferrando 919520
Cable: RADIUM Montevideo
A, CM, E, M

Guillermo Kraft del Uruguay S.A.
Avda. Libertador Brig. Gral.
Lavalleja 2083
MONTEVIDEO
Tel: 234588, 234808, 208830
Telex: 6245 ACTOUR UY
P

U.S.S.R.

Hewlett-Packard Co.
Representative Office
Pokrovsky Blvd. 4/17 KV12
MOSCOW 101000 Tel: 294-2024
Telex: 7825 HEWPACK SU

VENEZUELA

Hewlett-Packard de Venezuela C.A.
Apartado 50933
3A Transversal Los Ruices Norte
Edificio Segre 2Y3
CARACAS 1071
Tel: 239-4133, 239-4777,
239-4244
Telex: 25146 HEWPACK
Cable: HEWPACK Caracas
A, CP, E, MS, P

YUGOSLAVIA

Iskra-Commerce-Representation of
Hewlett-Packard
Sava Centar Delegacija 30
Milentija Popovica 9
11170 BEOGRAD
Tel: 638-762
Telex: 12042, 12322 YU SAV CEN

Iskra-Commerce-Representation of
Hewlett-Packard
Kopraska 46
61000 LJUBLJANA
Tel: 321674, 315879
Telex.

ZAMBIA

R. J. Tilbury (Zambia) Ltd.
P.O. Box 2792
LUSAKA
Tel: 81243
A.E.M.P

ZIMBABWE

Field Technical Sales
45 Kelvin Road, North
P.B. 3458
SALISBURY
Tel: 81243
C.E.M.P

FOR COUNTRIES AND AREAS NOT LISTED:

CANADA

Ontario
Hewlett-Packard (Canada) Ltd.
6877 Goreway Drive
MISSISSAUGA, Ontario L4V 1M8
Tel: (416) 678-9430
Telex: 610-492-4246

EASTERN USA

Maryland
Hewlett-Packard Co.
4 Choke Cherry Road
Rockville, MD 20850
Tel: (301) 258-2000

MIDWESTERN USA

Illinois
Hewlett-Packard Co.
5201 Tollview Drive
ROLLING MEADOWS, IL 60008
Tel: (312) 255-9800

SOUTHERN USA

Georgia
Hewlett-Packard Co.
P.O. Box 105005
450 Interstate N. Parkway
ATLANTA, GA 30339
Tel: (404) 955-1500

WESTERN USA

California
Hewlett-Packard Co.
3939 Lankersim Blvd.
LOS ANGELES, CA 91604
Tel: (213) 877-1282

EUROPEAN AREAS NOT LISTED, CONTACT

SWITZERLAND

Hewlett-Packard S.A.
7 Rue du Bois-du-Lan
CH-1217 MEYRIN 2, Switzerland
Tel: (022) 83-81-11
Telex: 27835 hpse
Cable: HEWPACKSA Geneve

EAST EUROPEAN AREAS NOT LISTED, CONTACT

AUSTRIA

Hewlett-Packard Ges.m.b.H.
Wehlstrasse 29
P.O. Box 7
A-1205 VIENNA
Tel: (222) 35-16-210
Telex: 135823/135066

MEDITERRANEAN AND MIDDLE EAST AREAS NOT LISTED, CONTACT

GREECE

Hewlett-Packard S.A.
Mediterranean & Middle East
Operations
35, Kolokotroni Street
Platia Kefallariou
GR Kithissia, ATHENS, Greece
Tel: 808-0359, 808-0429
Telex: 21-6588
Cable: HEWPACKSA Athens

INTERNATIONAL AREAS NOT LISTED, CONTACT

OTHER AREAS

Hewlett-Packard Co.
Intercontinental Headquarters
3495 Deer Creek Road
PALO ALTO, CA 94304
Tel: (415) 857-1501
Telex: 034-8300
Cable: HEWPACK