

# HP 3852A Data Acquisition/Control Unit

## Getting Started Guide



©Copyright Hewlett-Packard Company 1986

Manual Part Number: 03852-90012  
Microfiche Part Number: 03852-99012

Printed: FEBRUARY 1987 Edition 1  
Printed in U.S.A. E0287



# Printing History

---

New editions are complete revisions of the manual. Update packages, which are issued between editions, contain additional and replacement pages to be merged into the manual by the customer. The dates on the title page change only when a new edition or a new update is published. No information is incorporated into a reprinting unless it appears as a prior update; the edition does not change when an update is incorporated.

Many product updates and fixes do not require manual changes and, conversely, manual corrections may be done without accompanying product changes. Therefore, do not expect a one-to-one correspondence between product updates and manual updates.

Edition 1.....FEBRUARY 1987



**Herstellerbescheinigung**

Hiermit wird bescheinigt, daß das Gerät/System HP 3852A  
in Übereinstimmung mit den Bestimmungen von Postverfügung 1046/84 funkentstört ist.

Der Deutschen Bundespost wurde das Inverkehrbringen dieses Gerätes/Systems angezeigt und die Berechtigung zur Überprüfung der Serie auf Einhaltung der Bestimmungen eingeräumt.

**Zusatzinformation für Meß- und Testgeräte**

Werden Meß- und Testgeräte mit ungeschirmten Kabeln und/oder in offenen Meßaufbauten verwendet, so ist vom Betreiber sicherzustellen, daß die Funk-Entstörbestimmungen unter Betriebsbedingungen an seiner Grundstücksgrenze eingehalten werden.

**Manufacturer's declaration**

This is to certify that the equipment HP 3852A  
is in accordance with the Radio Interference Requirements of Directive FTZ 1046/84. The German Bundespost was notified that this equipment was put into circulation, the right to check the series for compliance with the requirements was granted.

**Additional Information for Test- and Measurement Equipment**

If Test- and Measurement Equipment is operated with unscreened cables and/or used for measurements on open set-ups, the user has to assure that under operating conditions the Radio Interference Limits are still met at the border of his premises.

**NOTICE**

The information contained in this document is subject to change without notice.

HEWLETT-PACKARD MAKES NO WARRANTY OF ANY KIND WITH REGARD TO THIS MATERIAL, INCLUDING, BUT NOT LIMITED TO, THE IMPLIED WARRANTIES OF MERCHANTABILITY AND FITNESS FOR A PARTICULAR PURPOSE. Hewlett-Packard shall not be liable for errors contained herein or for incidental or consequential damages in connection with the furnishing, performance or use of this material.

Hewlett-Packard assumes no responsibility for the use or reliability of its software on equipment that is not furnished by Hewlett-Packard.

This document contains proprietary information which is protected by copyright. All rights are reserved. No part of this document may be photocopied, reproduced or translated to another language without the prior written consent of Hewlett-Packard Company.

Copyright © 1985 by HEWLETT-PACKARD COMPANY



**HEWLETT  
PACKARD**

### **CERTIFICATION**

*Hewlett-Packard Company certifies that this product met its published specifications at the time of shipment from the factory. Hewlett-Packard further certifies that its calibration measurements are traceable to the United States National Bureau of Standards, to the extent allowed by the Bureau's calibration facility, and to the calibration facilities of other International Standards Organization members.*

### **WARRANTY**

This Hewlett-Packard instrument product is warranted against defects in materials and workmanship for a period of one year from date of shipment. During the warranty period, Hewlett-Packard Company will, at its option, either repair or replace products which prove to be defective.

For warranty service or repair, this product must be returned to a service facility designated by -hp-. Buyer shall prepay shipping charges to -hp- and -hp- shall pay shipping charges to return the product to Buyer. However, Buyer shall pay all shipping charges, duties, and taxes for products returned to -hp- from another country.

Duration and conditions of warranty for this instrument may be superceded when the instrument is integrated into (becomes a part of) other -hp- instrument products.

Hewlett-Packard warrants that its software and firmware designated by -hp- for use with an instrument will execute its programming instructions when properly installed on that instrument. Hewlett-Packard does not warrant that the operation of the instrument, or software, or firmware will be uninterrupted or error free.

### **LIMITATION OF WARRANTY**

The foregoing warranty shall not apply to defects resulting from improper or inadequate maintenance by Buyer, Buyer-supplied software or interfacing, unauthorized modification or misuse, operation outside of the environmental specifications for the product, or improper site preparation or maintenance.

**NO OTHER WARRANTY IS EXPRESSED OR IMPLIED. HEWLETT-PACKARD SPECIFICALLY DISCLAIMS THE IMPLIED WARRANTIES OF MERCHANTABILITY AND FITNESS FOR A PARTICULAR PURPOSE.**

### **EXCLUSIVE REMEDIES**

**THE REMEDIES PROVIDED HEREIN ARE BUYER'S SOLE AND EXCLUSIVE REMEDIES. HEWLETT-PACKARD SHALL NOT BE LIABLE FOR ANY DIRECT, INDIRECT, SPECIAL, INCIDENTAL, OR CONSEQUENTIAL DAMAGES, WHETHER BASED ON CONTRACT, TORT, OR ANY OTHER LEGAL THEORY.**

### **ASSISTANCE**

*Product maintenance agreements and other customer assistance agreements are available for Hewlett-Packard products.*

*For any assistance, contact your nearest Hewlett-Packard Sales and Service Office. Addresses are provided at the back of this manual.*



**HEWLETT  
PACKARD**

## **SAFETY SUMMARY**

The following general safety precautions must be observed during all phases of operation, service, and repair of this instrument. Failure to comply with these precautions or with specific warnings elsewhere in this manual violates safety standards of design, manufacture, and intended use of the instrument. Hewlett-Packard Company assumes no liability for the customer's failure to comply with these requirements.

### **GROUND THE INSTRUMENT**

To minimize shock hazard, the instrument chassis and cabinet must be connected to an electrical ground.

### **DO NOT OPERATE IN AN EXPLOSIVE ATMOSPHERE**

Do not operate the instrument in the presence of flammable gases or fumes. Operation of any electrical instrument in such an environment constitutes a definite safety hazard.

### **KEEP AWAY FROM LIVE CIRCUITS**

Operating personnel must not remove instrument covers. Component replacement and internal adjustments must be made by qualified maintenance personnel. Under certain conditions, dangerous voltages may exist even with the instrument switched off. To avoid injuries, always disconnect input voltages and discharge circuits before touching them.

### **DO NOT SERVICE OR ADJUST ALONE**

Do not attempt internal service or adjustment unless another person, capable of rendering first aid and resuscitation, is present.

### **DO NOT SUBSTITUTE PARTS OR MODIFY INSTRUMENT**

Because of the danger of introducing additional hazards, do not install substitute parts or perform any unauthorized modification to the instrument. Return the instrument to a Hewlett-Packard Sales and Service Office for service and repair to ensure that safety features are maintained.

# Operating and Safety Symbols

## Symbols Used On Products And In Manuals

~ LINE

AC line voltage input receptacle.



Instruction manual symbol affixed to product. Cautions the user to refer to respective instruction manual procedures to avoid possible damage to the product.



Indicates dangerous voltage – terminals connected to interior voltage exceeding 1000 volts.

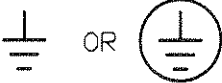

Protective conductor terminal. Indicates the field wiring terminal that must be connected to earth ground before operating equipment – protects against electrical shock in case of fault.



Clean ground (low-noise). Indicates terminal that must be connected to earth ground before operating equipment – for single common connections and protection against electrical shock in case of fault.

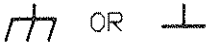

Frame or chassis ground. Indicates equipment chassis ground terminal – normally connects to equipment frame and all metal parts.



Affixed to product containing static sensitive devices – use anti-static handling procedures to prevent electrostatic discharge damage to components.

---

### NOTE

**NOTE**

*Calls attention to a procedure, practice, or condition that requires special attention by the reader.*

---

---

### CAUTION

**CAUTION**

*Calls attention to a procedure, practice, or condition that could possibly cause damage to equipment or permanent loss of data.*

---

---

### WARNING

**WARNING**





*Calls attention to a procedure, practice, or condition that could possibly cause bodily injury or death.*

---

## WARNING, CAUTION, and NOTE Symbols

Some labels on the HP 3852A, HP 3853A, and plug-in accessories include an international warning symbol (triangle with subscripted number) which refers the reader to the manuals for further information. This table shows the warning symbols used for the HP 3852A/3853A and plug-in accessories. Refer to the manual set for specific information on WARNINGS, CAUTIONS, or NOTES referenced with a warning symbol.

### HP 3852A WARNING, CAUTION, and NOTE Symbols

Symbol	Meaning	Location
	Shock hazard originating outside the instrument (field wiring)	<ul style="list-style-type: none"> <li>. Analog Extender Connector on Power Supply Modules</li> <li>. Terminal modules on plug-in accessories</li> <li>. Component module covers on plug-in accessories</li> </ul>
	Treat all channels as "one circuit" for safety purposes.	<ul style="list-style-type: none"> <li>. Inside terminal modules on plug-in accessories</li> <li>. Metal cover on component modules of plug-in accessories</li> </ul>
	Maximum number of certain plug-in accessories to be installed into an HP 3852A or HP 3853A.	<ul style="list-style-type: none"> <li>. HP 44701A, HP 44702A/B, HP 44727A/B/C plug-in accessories</li> </ul>
	If High-Speed FET multiplexers are used with the HP 44702A/B, ribbon cable may be connected.	<ul style="list-style-type: none"> <li>. HP 44711A, 44712A, 44713A (referenced on HP 44702A and HP 44702B)</li> </ul>
	The instrument should not be operated at a line frequency of 440 Hz with a line voltage of 200 V or greater as the AC leakage current may exceed 3.5 mA.	<ul style="list-style-type: none"> <li>. HP 3852A, HP 3853A Power Supply Modules</li> </ul>



# Contents

## Chapter 1 Getting Started

Introduction	1-1
What's In This Guide?	1-1
Getting Started Sequence	1-2
Unpacking and Inspection	1-3
Unpack Mainframe Carton	1-3
Unpack Accessory Cartons	1-3
Assemble the Manuals	1-4
Inspect Equipment	1-6
HP 3852A Description	1-7
HP 3852A Mainframe	1-7
HP 3853A Extender	1-7
Plug-In Accessories	1-7

## Chapter 2 Configuring the HP 3852A

Introduction	2-1
Initial Setup	2-1
Check Line Selector Switch	2-1
Install Fuse	2-3
Install AC Power Cord	2-3
Connect HP-IB Cable	2-3
System Checkout	2-4
Power-On Sequence	2-4
Checking HP-IB Communication	2-4

## Chapter 3 Front Panel Operation

Introduction	3-1
Front Panel Tour	3-1
The Keyboard	3-1
The Display	3-3
Entering Commands	3-3
Command Format	3-3
Shifted/Unshifted Entries	3-3
Entering Numbers	3-6
Display Control	3-6
Controlling the Display	3-6
Correcting Entry Errors	3-8

## Chapter 4 Programming the HP 3852A

Introduction	4-1
Programming Overview	4-1
HP-IB Communication	4-1
HP 3852A Addressing	4-2
HP 3852A Command Format	4-3

## Chapter 4 (Cont'd)

Programming Examples	4-5
Example 1: Check HP 3852A Address	4-5
Example 2: Check Mainframe ID	4-5
Example 3: HP 3852A Self-Test	4-6

## Chapter 5 Measurement/Control Exercises

Introduction	5-1
Setting Up For The Exercises	5-2
Connecting Field Wiring	5-2
Installing Accessories	5-5
Measurement Exercises	5-8
Exercise 1: Voltage Measurements	5-8
Exercise 2: Resistance Measurements	5-15
Exercise 3: Temperature Measurements	5-20
Counting/Control Exercises	5-26
Exercise 4: Count Switch Closures	5-27
Exercise 5: Read Switch State	5-29
Exercise 6: Light an LED	5-32

## Chapter 6 Managing Data

Introduction	6-1
Data Destinations and Formats	6-3
Data Destinations	6-3
Data Formats	6-3
Example 4: Changing Data Formats	6-4
Storing Data in Memory	6-6
Declaring Variables and Arrays	6-6
Example 5: Declaring Arrays and Variables	6-7
Entering Data Into Memory	6-7
Example 6: Enter Address Into Memory	6-7
Reading/Writing Stored Data	6-8
Reading Data in Memory	6-8
Example 7: Reading Stored Address	6-9
Writing Data to Memory	6-9
Example 8: Writing Data to Memory	6-9
Downloading Subroutines	6-10
Subroutine Definitions	6-10
Example 9: Downloading Subroutine	6-11

## Chapter 7 The Manual Set

Introduction	7-1
Manual Set Description	7-1

## Index

Index	1-1
-------	-----



# **Chapter 1**

## **Getting Started**

# CONTENTS

	Page
Introduction .....	1-1
What's In This Guide? .....	1-1
Getting Started Sequence .....	1-2
Unpacking and Inspection .....	1-3
Unpack Mainframe Carton .....	1-3
Unpack Mainframe Manuals Carton .....	1-3
Unpack Accessory Cartons .....	1-4
Assemble the Manuals .....	1-4
Inspect Equipment .....	1-6
HP 3852A Description .....	1-7
HP 3852A Mainframe .....	1-7
HP 3853A Extender .....	1-7
Plug-In Accessories .....	1-7

## Introduction

This Getting Started Guide has been designed to help you learn about the HP 3852A Data Acquisition and Control Unit and to get you started programming the instrument. Before you connect the HP 3852A to your system or begin programming, we highly recommend that you use this guide to learn about the HP 3852A and see how to program the instrument for some measurement and control functions.

This guide is not intended to be a complete tutorial or reference manual for the HP 3852A. If you want more detail on any subject discussed in the guide, please refer to the HP 3852A manual set. You'll find a list of these manuals in Table 1-1 in this chapter.

---

### NOTE

*The program examples in this guide use syntax applicable for HP Series 200/300 controllers. Modify the syntax as required for the controller you use.*

---

### What's In This Guide?

The guide has seven chapters: Getting Started; Configuring the HP 3852A; Front Panel Operation; Programming the HP 3852A; Measurement/Control Exercises; Managing Data; and The Manual Set. A brief description of each chapter follows.

#### Chapter 1 - Getting Started

This chapter shows how the guide is organized, shows how to unpack and inspect the instrument, and briefly describes the HP 3852A and its plug-in accessories.

## **Chapter 2 - Configuring the HP 3852A**

This chapter shows how to configure the HP 3852A for initial operation, how to connect the HP-IB (Hewlett-Packard Interface Bus) cable, and how to check HP-IB communication between an HP Series 200/300 controller and the HP 3852A. (HP-IB is Hewlett-Packard's implementation of IEEE Standard 488-1978 and ANSI MC1.1.)

## **Chapter 3 - Front Panel Operation**

This chapter summarizes the front panel keyboard and display functions. It also shows how to enter commands from the front panel and how to control the display.

## **Chapter 4 - Programming the HP 3852A**

This chapter summarizes command/data flow between the HP 3852A and a controller and shows how to enter commands into the HP 3852A.

## **Chapter 5 - Measurement/Control Exercises**

This chapter lists some sample programs to measure voltage, temperature, and resistance; to totalize input counts; to determine input state; and to control the state of an LED.

## **Chapter 6 - Managing Data**

This chapter defines data formats and destinations, shows how to store data in mainframe memory, how to read and write stored data, and how to download subroutines.

## **Chapter 7 - The Manual Set**

This chapter introduces the rest of the HP 3852A manual set and provides an overview of the content of each manual.

## **Getting Started Sequence**

To get started learning about the HP 3852A and begin programming the instrument, we suggest you read through each chapter in this guide in sequence. For example, whether you plan to program the HP 3852A with your controller over HP-IB or plan to use the front panel only, you should read both Chapters 3 and 4.

As you read through the guide, we recommend you configure the equipment and enter the example keystroke sequences and programs shown so you can get "hands-on" experience.

---

## WARNING

*When you enter the example commands or programs in this guide, be sure the HP 3852A is not connected to any external system since commands entered may set the system to an undesired state.*

---

## Unpacking and Inspection

Since you are reading this guide, you have obviously opened the manuals carton and the box containing this Getting Started Guide. To complete unpacking and inspection, use the steps in the following paragraphs.

### Unpack Mainframe Carton

Open the HP 3852A shipping carton. The carton should contain an HP 3852A, an HP 3852A power cord, and a plastic bag containing HP 3852A power line fuses. The fuse bag is usually taped to the top of the HP 3852A mainframe.

Remove the HP 3852A, power cord, and fuses from the mainframe carton. Store the carton and shipping materials in a dry place. (If you have to return the instrument to Hewlett-Packard, you'll need the shipping cartons.)

---

## NOTE

*If you ordered an HP 3853A Extender, it was shipped in a separate carton. You won't need to open this carton yet, since there are no manuals shipped in the carton nor is the extender used for any of the examples or exercises in this guide.*

---

### Unpack Mainframe Manuals Carton

Next, unpack the manuals in the mainframe manuals carton (the carton with this Getting Started Guide in it). The box containing this Getting Started Guide should also contain a plastic bag labeled "03852-67901 Getting Started Kit". Put this kit aside as it will be used in the Measurement/Control Exercises in Chapter 5. Also, unpack the other manual boxes in the mainframe manuals carton. Store all cartons and shipping materials in a dry place.

## **Unpack Accessory Cartons**

Depending on the number of HP 447XXX plug-in accessories you ordered, you received one or more plug-in accessory cartons. Each accessory carton contains one or more plug-in accessory boxes. Each accessory box, in turn, contains a plug-in accessory and associated plug-in manual. Remove the accessories and plug-in manuals from the boxes.

---

### **CAUTION**

*When removing the accessory from its anti-static pouch, avoid touching the edge connectors contacts. Touching the contacts can subject the components to static discharges that could damage them.*

---

## **Assemble the Manuals**

When all manuals are removed from their boxes, remove the shrink-wrapping and insert the manual into the appropriate binder. Note that an empty binder (part number 03852-90018) is supplied to store the plug-in accessory manuals. Table 1-1 lists mainframe manuals for the HP 3852A. Your shipment should include the mainframe manuals (03852-900XX) shown plus an accessory manual (447XX-90001 or 447XX-90002) for each plug-in accessory ordered.



**Table 1-1. HP 3852A Mainframe Manuals**

Part Number	Description
03852-90011	HP 3852A Assembly Level Service Manual
03852-90012	HP 3852A Getting Started Guide
03852-90015	HP 3852A Mainframe Configuration and Programming Manual
03852-90016	HP 3852A Command Reference Manual
03852-90017	HP 3852A Quick Reference Guide

## Inspect Equipment

When you have unpacked the mainframe, plug-in accessories, and the manuals, the next step is to inspect the equipment. First, check the fuse package and the Getting Started Kit.

The fuse package should contain two fuses and a fuseholder. As shown in Figure 1-1, the Getting Started Kit contains a breadboard, a 9V battery, a push-button switch, an LED, a 1000 ohm resistor, a 10,000 ohm thermistor, a screwdriver, battery snap-on leads, and three 20" (500 mm) wires. We'll use the Getting Started Kit in the Measurement/Control Exercises in Chapter 5.

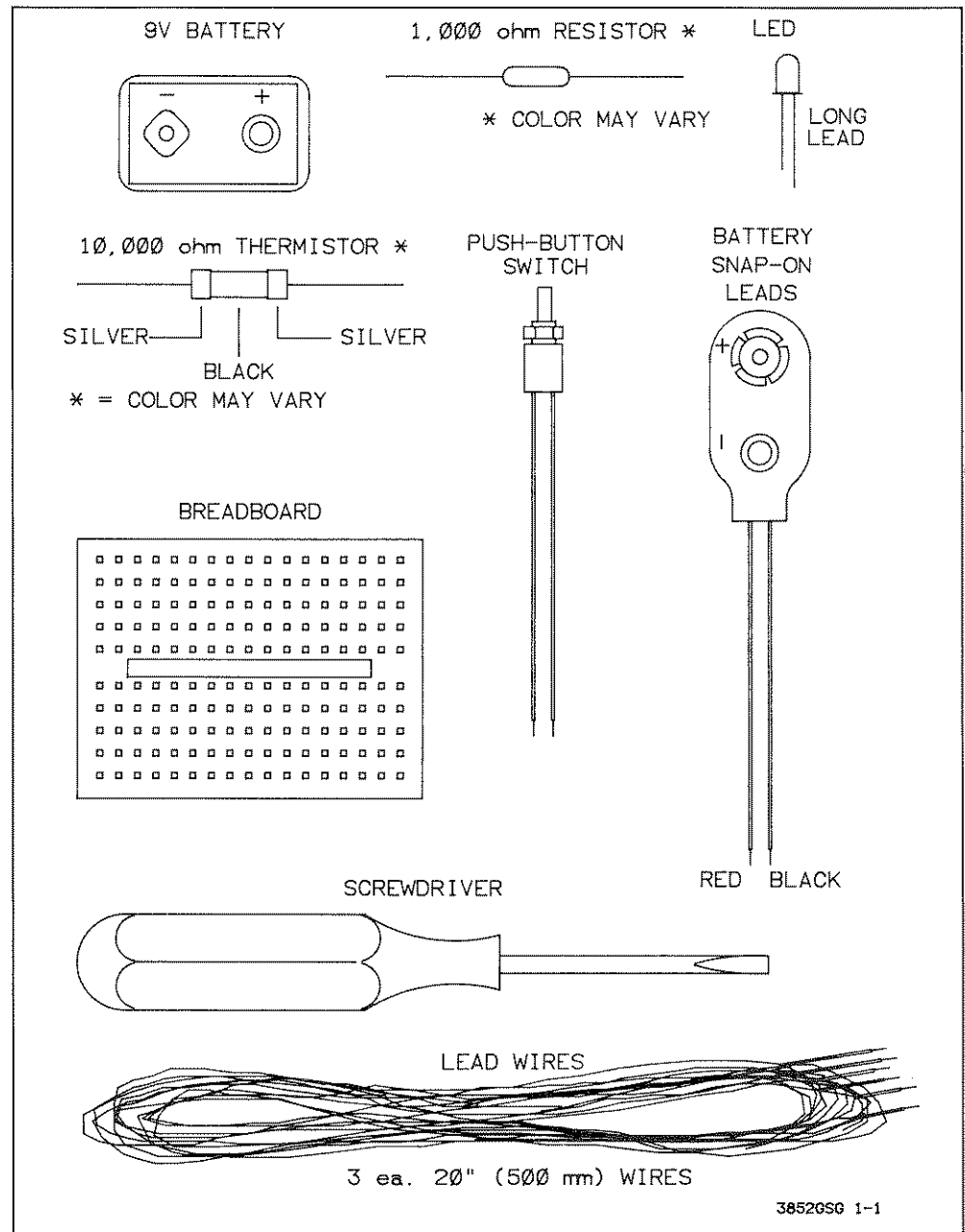

Figure 1-1. HP 3852A Getting Started Kit Contents

Inspect the shipping cartons, the HP 3852A, the plug-in accessories, and the manuals for damage and/or for missing parts. Then, check the equipment received against the packing list. If equipment or manuals are missing, notify the Order Administration Department of your local Hewlett-Packard Sales and Support Office.

If any equipment is damaged, have the freight carrier record the damage, then notify the Service Department of your local Hewlett-Packard Sales and Support Office. A list of these offices is at the back of the HP 3852A Mainframe Configuration and Programming Manual.

## HP 3852A Description

Now that you have unpacked the equipment, let's take a minute to get acquainted with the HP 3852A before setting it up and programming it. The HP 3852A family of equipment consists of an HP 3852A Mainframe, HP 3853A Extenders, and HP 447XXX series of Plug-In Accessories. Up to seven HP 3853A Extenders can be added to a single HP 3852A to provide a maximum of 78 slots for plug-in accessories.

### HP 3852A Mainframe

The HP 3852A mainframe includes a front panel with keyboard and display and an 8-slot cardcage to install plug-in accessories. Figure 1-2 shows the front panel of the HP 3852A and describes some of the instrument's capabilities. Figure 1-3 shows the HP 3852A rear panel and summarizes rear panel features.

### HP 3853A Extender

Each HP 3853A Extender provides ten slots for plug-in accessories. Up to seven extenders can be used with a mainframe, so a maximum of 78 slots are available for a single mainframe. Except for the HP 44702A/B High-Speed Voltmeter, any plug-in accessory can be installed in any slot. (Because of a metal support, the HP 44702A/B can't be installed in slots 3 and 4 of the mainframe or in slots 5 and 6 of an extender.)

### Plug-In Accessories

There are several plug-in accessories which can be used with the HP 3852A to provide the interface between the user application and the HP 3852A. Without the plug-in accessories, the HP 3852A cannot acquire data and has very limited control capabilities.

There are two main configurations for plug-in accessories. All accessories, except the HP 44701A Integrating Voltmeter and the HP 44702A/B High-Speed Voltmeters, consist of a component module and a terminal module. Each voltmeter is contained in a single module.

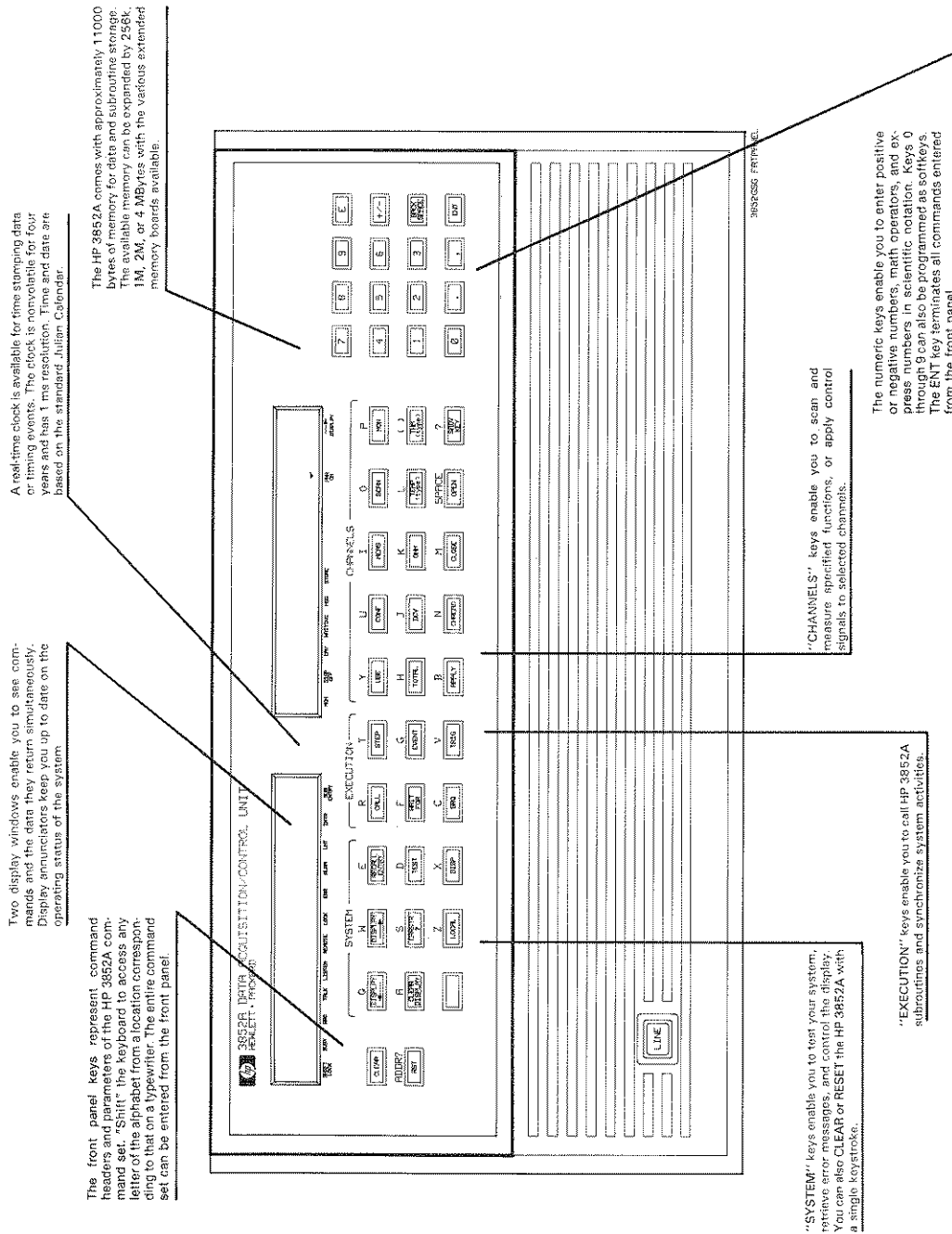

Figure 1-2. HP 3852A Front Panel

The Analog Extender port enables you to extend the HP 3852A's backplane analog bus. Connect the ports of the mainframe and extenders to route analog signals from multiplexer accessories installed in the extenders to voltmeter accessories installed in the mainframe or other extenders. Multiplexers can also be linked to an external voltmeter via this port. The analog port terminals include chassis ground (CH), guard (GU), high and low sense (H.L.O.), and high and low current source (H.L.C.) current source.

The HP 3852A detects the line frequency and automatically configures the mainframe for 50 Hz or 60 Hz operation.

Install up to eight accessories with an accessory in any slot. The plastic slot latch prevents the accessory from being pulled out from the backplane edge connector when the terminal module is removed for configuration and wiring.

Use the Digital Extender Out port to connect up to seven HP 3852A extenders to the HP 3852A mainframe. The digital extender cable routes data and programming information between the mainframe and the accessories installed in the extenders.

Use this port and an HP-IB cable to connect the HP 3852A to a controller. The HP 3852A has a factory set HP-IB address of 9.

Use the BNC ports to trigger and synchronize operation with external devices such as the multiplexer for interfacing system activities. All BNC input ports are TTL compatible and require pulse widths > 0.5  $\mu$ sec.

Enable the EVENT IN port with the WAITFOR EVENT command then initiate system operation using an external device.

Enable the CHANNEL ADVANCE port with the STRIG CHADV command then input a signal to initiate a backplane scan and measurement of a list of channels. Enable the port with the SADV CHADV command then input a signal to advance to the next channel during a scan.

The CHANNEL CLOSED port outputs a low going pulse when a channel is closed. Use the port to trigger an external voltmeter to start a measurement.

The SYSTEM TRIGGER IN port provides an easy way to trigger several plug-in accessories simultaneously.

The PACER OUT port provides a low-going pulse with nominal 500 ns pulse width. Period is programmable from 1  $\mu$ sec to 4.19 seconds in 250 ns steps. Output a continuous stream of pulses or a fixed number from 1 to 65535 to synchronize an external event.

Enable the PACER TRIGGER IN port with the PTRIG EXT command then trigger the PACER port to output a continuous stream or fixed number of pulses. PTRIG EXT allows the PACER port to be hardware-triggered for greatest timing precision.

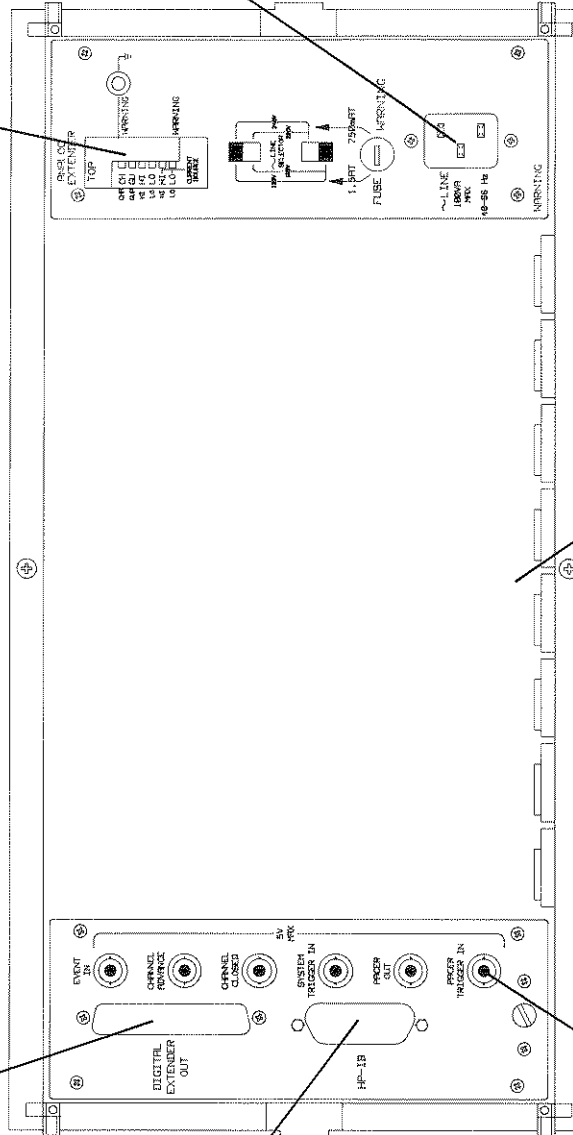

Figure 1-3. HP 3852A Rear Panel



**Chapter 2**  
**Configuring the HP 3852A**

# CONTENTS

	Page
Introduction .....	2-1
Initial Setup .....	2-1
Check Line Selector Switch .....	2-1
Install Fuse .....	2-3
Install AC Power Cord .....	2-3
Connect HP-IB Cable .....	2-3
System Checkout .....	2-4
Power-On Sequence .....	2-4
Checking HP-IB Communication .....	2-4



# Configuring the HP 3852A

---

## Introduction

Now that you have had a chance to see what the HP 3852A looks like and know some of its capabilities, the next step is to set up the instrument for operation and programming. This chapter shows how to configure the HP 3852A for initial operation and describes a way to check HP-IB communication.

## Initial Setup

Setting up the HP 3852A for initial operation is quite simple. All you need to do is to check the LINE SELECTOR switch setting, install a fuse, and connect the AC line cord and HP-IB cable. See Figure 2-1 for switch, fuse, and line plug locations. See Figure 2-2 for typical HP-IB connections.

---

### NOTE

*Figure 2-1 shows LINE SELECTOR, FUSE, and LINE cord locations for two versions of the HP 3852A. HP 3852As with power supply part number 03852-66212 were shipped after 1 December 1987, while HP 3852A with power supply part number 03852-66202 were shipped before 1 December 1987. Use the applicable diagram in Figure 2-1 for your instrument.*

---

## Check Line Selector Switch

Depending on the position of the LINE SELECTOR switch, HP 3852A mainframes with power supply part number 03852-66212 can be set to operate at 90-132 Vac @ 48-440 Hz or at 198-250 Vac @ 48-66 Hz. Mainframes with power supply part number 03852-66202 can be set to operate at 100 Vac, 120 Vac, 220 Vac, or 240 Vac (all RMS) at 48-66 Hz.

Make sure the LINE SELECTOR switches are set for your line voltage. If they are not, use a flat-bladed screwdriver to move the switch(es) to the correct position. See Figure 2-1 for switch location and settings.

---

### NOTE

*The HP 3852A automatically sets itself for the line frequency (50 Hz or 60 Hz) which is present, so you won't need to set any line frequency switches.*

---

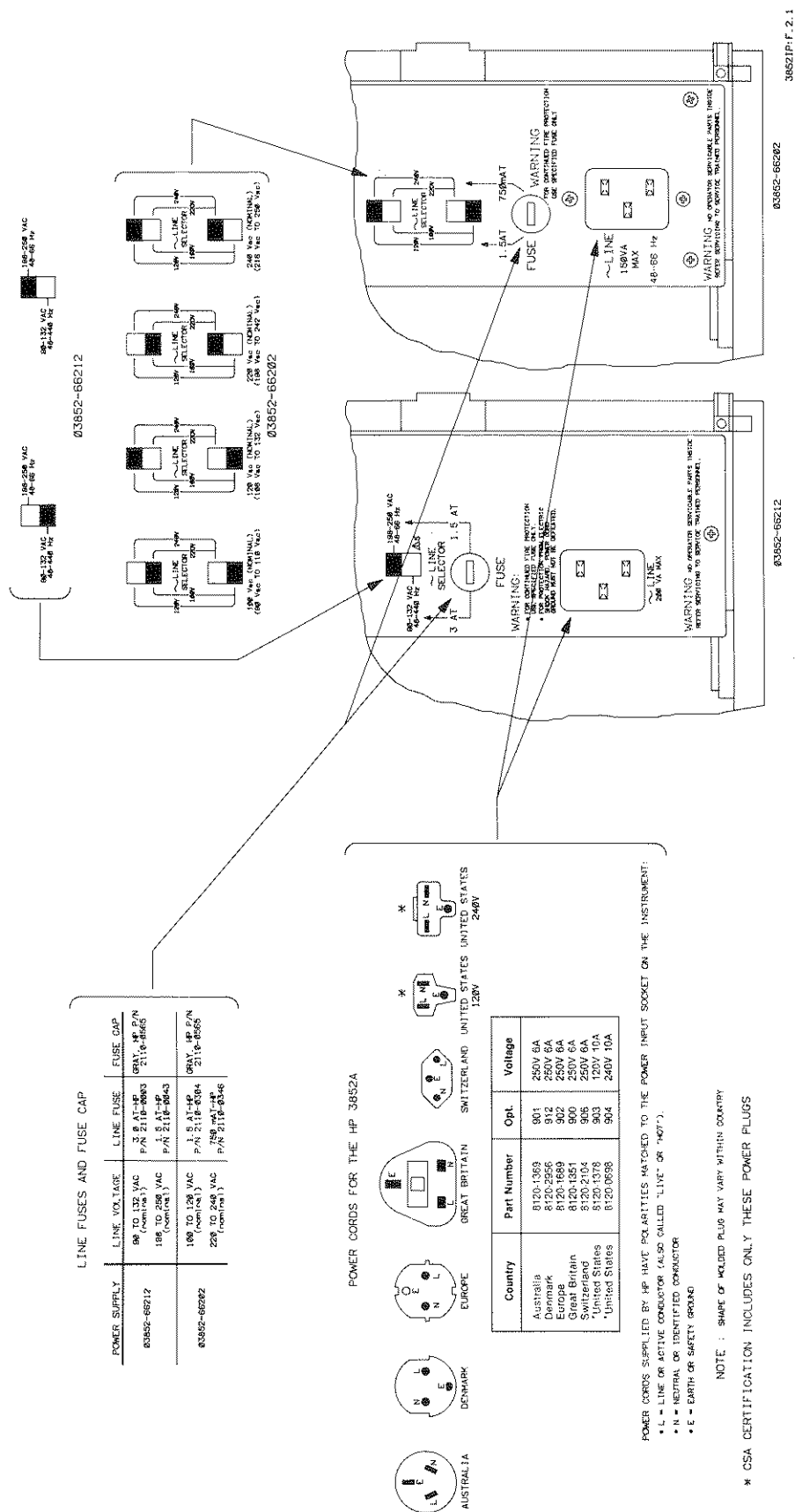

Figure 2-1. Fuse/Line Selector/Line Plug Locations

## Install Fuse

The line fuse holder (FUSE) is located below the LINE SELECTOR switch(es) (see Figure 2-1). For HP 3852A mainframes with power supply part number 03852-66212, install the 3.0 AT fuse for operation at 90-132 Vac or install the 1.5 AT fuse for operations at 198-250 Vac. For HP 3852A mainframes with power supply part number 03852-66202, install the 1.5 AT fuse for operation at 100-120 Vac or install the 750 mA fuse for operation at 220-240 Vac.

Both fuses and a fuse cap are in a plastic bag which you previously unpacked. (Refer to "Unpacking and Inspection" in Chapter 1.) Place one end of the correct fuse in the fuse cap and install the fuse in the FUSE holder. Press the fuse cap until the cap is even with the rim. Then, turn the cap clockwise to lock the fuse in place.

## Install AC Power Cord

Be sure you received the correct power cord for your AC line voltage requirements. (See Figure 2-1 for power cord descriptions by country.) Set the LINE switch on the front of the HP 3852A to the "O" (OFF) position. Plug the cord into the LINE plug, but don't connect the cord to your AC power yet.

## Connect HP-IB Cable

If you plan to program the HP 3852A from a controller over HP-IB, connect the HP-IB cable to the HP-IB port on the left rear panel of the HP 3852A and tighten the connector to the port with the thumbscrews. Then, connect the other end of the HP-IB cable to your controller. Figure 2-2 shows typical connections to an HP 9000 Series 200 controller. See your controller manual for connections to the controller.

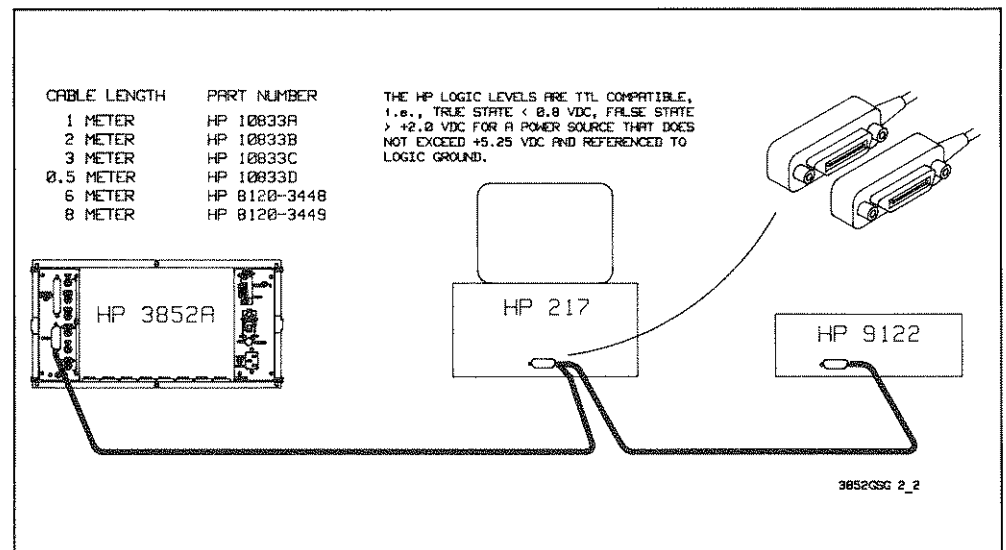

Figure 2-2. Typical HP-IB Connections

# System Checkout

When the HP 3852A has been set for initial operation, you can check the instrument operation with the power-on test. You can also check communication over HP-IB with the ID? command.

---

## WARNING

*Before entering the commands or example programs in this guide, be sure the HP 3852A is not connected to any external system since commands entered may set the system to an undesired state.*

---

### Power-On Sequence

To turn on the HP 3852A, plug the AC power cord into your AC line and press the LINE switch on the front panel to the "1" (ON) position. At power-on, you should hear a "BEEP" and the front panel display should cycle through the sequence shown in Figure 2-3. If an error message is displayed or the instrument does not turn on, refer to the HP 3852A Mainframe Configuration and Programming Manual, Chapter 3.

### Checking HP-IB Communication

If you are programming the HP 3852A over HP-IB, one way to check communication between your controller and the HP 3852A is to send the ID? command. A typical program for HP 9000 Series 200/300 controllers follows for an HP 3852A set to HP-IB address 9 (factory-set address). Modify the syntax and address as necessary.

```
10 OUTPUT 709;"ID?"      !Query HP 3852A identity
20 ENTER 709;A$          !Enter HP 3852A identity
30 PRINT A$              !Display HP 3852A identity
40 END
```

When this program executes, the controller CRT should display HP3852A. Also, the mainframe front panel display should show ID? in the left window and HP3852A in the right window. If the power-on test and ID? command return correct results, you can be reasonably sure the equipment is operating properly. After this program completes, press the LOCAL key on the front panel keyboard to return the HP 3852A to local (front-panel) operation. Now, let's take a look at front panel operation.

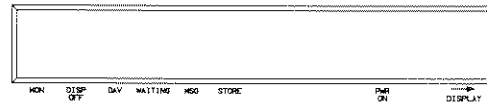
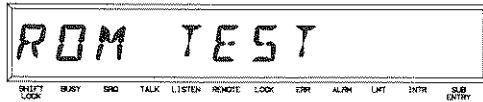

Tests the mainframe's read only memory



Tests the mainframe's read/write memory

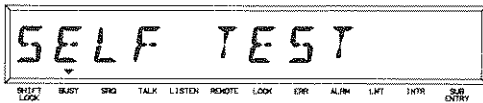

Tests the mainframe's controller module and front panel

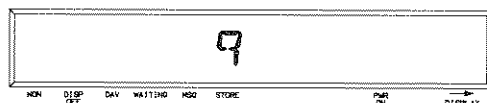

Displays the mainframe's HP-IB address. (The factory set address is 9.)

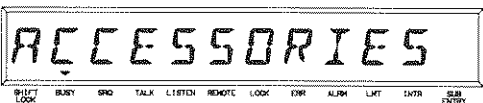

Indicates the number of accessories installed in the mainframe and extender (s)

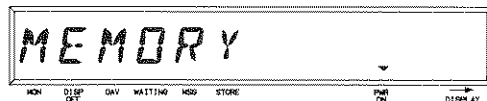

Indicates whether or not an extended memory board is installed.

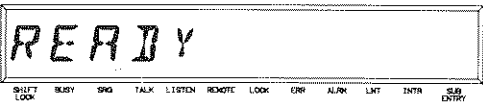

The mainframe completes its power-on sequence and is "READY" to accept commands.

3852099 2.3

Figure 2-3. HP 3852A Power-On Sequence



**Chapter 3**  
**Front Panel Operation**

# CONTENTS

	Page
Introduction .....	3-1
Front Panel Tour .....	3-1
The Keyboard .....	3-1
The Display .....	3-3
Entering Commands .....	3-3
Command Format .....	3-3
Shifted/Unshifted Entries .....	3-3
Entering Numbers .....	3-6
Display Control .....	3-6
Controlling the Display .....	3-6
Correcting Entry Errors .....	3-8



# Front Panel Operation

---

## Introduction

This chapter shows how to enter commands from the front panel of the HP 3852A. It includes a tour of the front panel keyboard and display and shows some sample keystroke sequences to enter commands and control the display.

## Front Panel Tour

The HP 3852A front panel consists of a keyboard, two display windows, and a LINE (ON/OFF) switch. You can enter commands from the keyboard and can see the results on the display.

### The Keyboard

As shown in Figure 3-1, the front panel keyboard has four groups of keys: SYSTEM, EXECUTION, CHANNELS, and NUMERIC. Several keys have a shifted and unshifted function. The unshifted function is printed in black on the key and the shifted function is printed in blue above the key. Note that the shifted functions are arranged in a standard typewriter (QWERTY) format.

Keys are set to the shifted function by pressing the blue (SHIFT) key at the lower left-hand corner of the SYSTEM group of keys. For example, in the unshifted mode, pressing the TEST key enters the TEST command. Pressing the blue key and then the TEST key enters the letter D (the shifted function).

Although commands are entered into the HP 3852A by the keyboard keys, you must press the grey (ENT) key at the lower right-hand corner of the NUMERIC key group to execute most commands entered. If you are interested in the details of the functions of the keys, refer to Chapter 4, "Front Panel Operation," in the HP 3852A Mainframe Configuration and Programming Manual.

### 3-2 Front Panel Operation

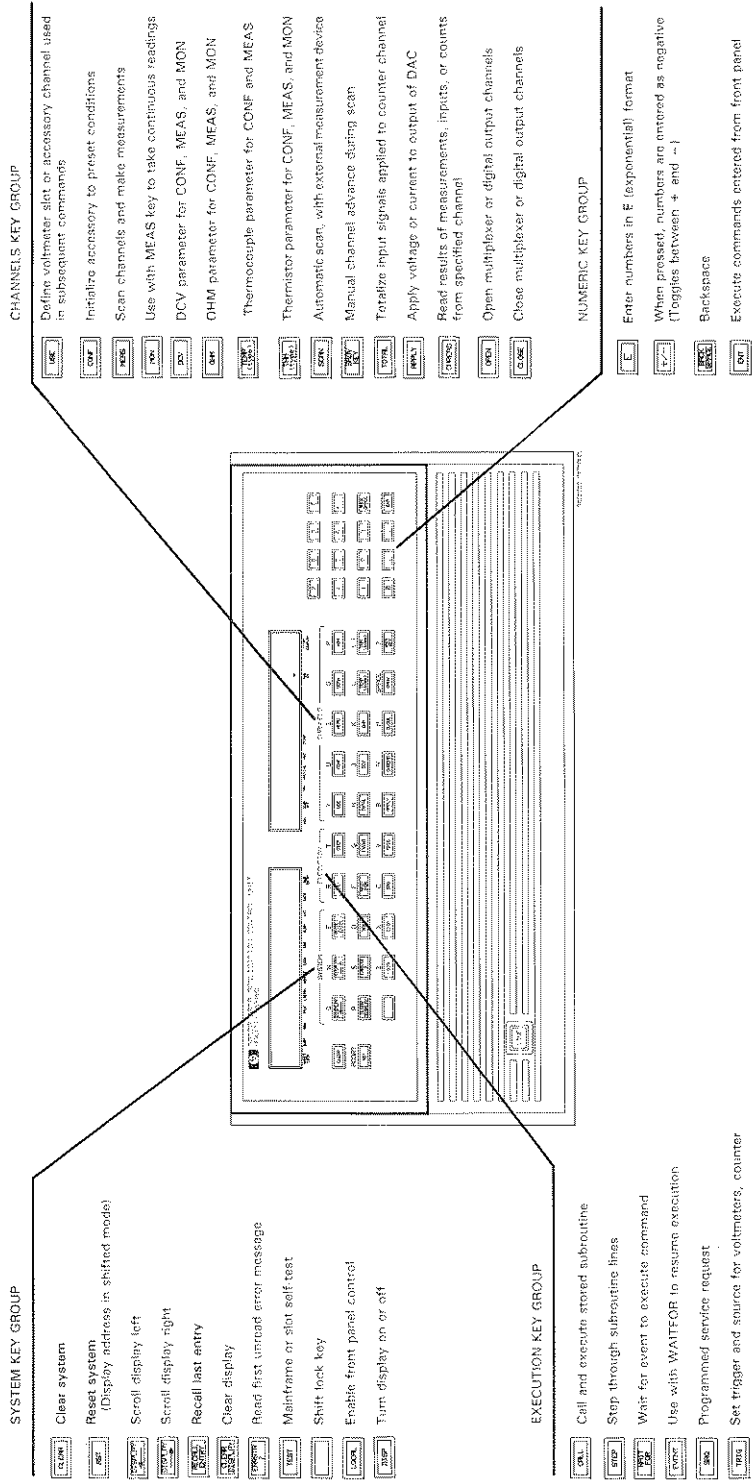

Figure 3-1. HP 3852A Front Panel Keyboard

## The Display

As shown in Figure 3-2, the front panel display has two windows. The left display window shows commands entered into and executed by the HP 3852A. It also shows channel numbers for associated commands and parts of error messages. The right display window shows the data returned as commands are executed and is also used to display error messages and user-displayed messages.

The display has 20 annunciators, listed under the display windows, which show the current operating condition of the HP 3852A. Figure 3-2 also summarizes the annunciator functions.

## Entering Commands

Now, let's see how to enter commands into the HP 3852A from the keyboard. In this section, we'll show some example keystroke sequences to enter commands in both shifted and unshifted mode and show how to enter numbers. In the next section "Display Control", we'll show how to use the keyboard to control the display and to correct keystroke entry errors. We'll begin with the HP 3852A command format.

### Command Format

HP 3852A commands consist of a command header followed (usually) by one or more parameters. Parameters may be required or optional. For example, the CLR command has a command header (CLR) but no parameters. The DISABLE *event* command has command header DISABLE and required parameter *event*. The BEEP [*mode*] command has command header BEEP and optional parameter *mode*. Optional parameters are indicated in text by brackets, but the brackets are not part of the command.

You can use a space, a comma, or any combination of spaces or commas between the command header and a parameter or between any two parameters. From the front panel, the ENT key terminates a command and causes command execution.

### Shifted/Unshifted Entries

There are two ways to enter commands from the keyboard: unshifted mode or shifted mode. Some keys, such as TEST, enter the command header in unshifted mode. However, for other commands, you must enter the command header and/or parameters by spelling out the letters with the shifted mode keys. Let's try some example sequences to enter commands in both shifted and unshifted mode.

### 3-4 Front Panel Operation

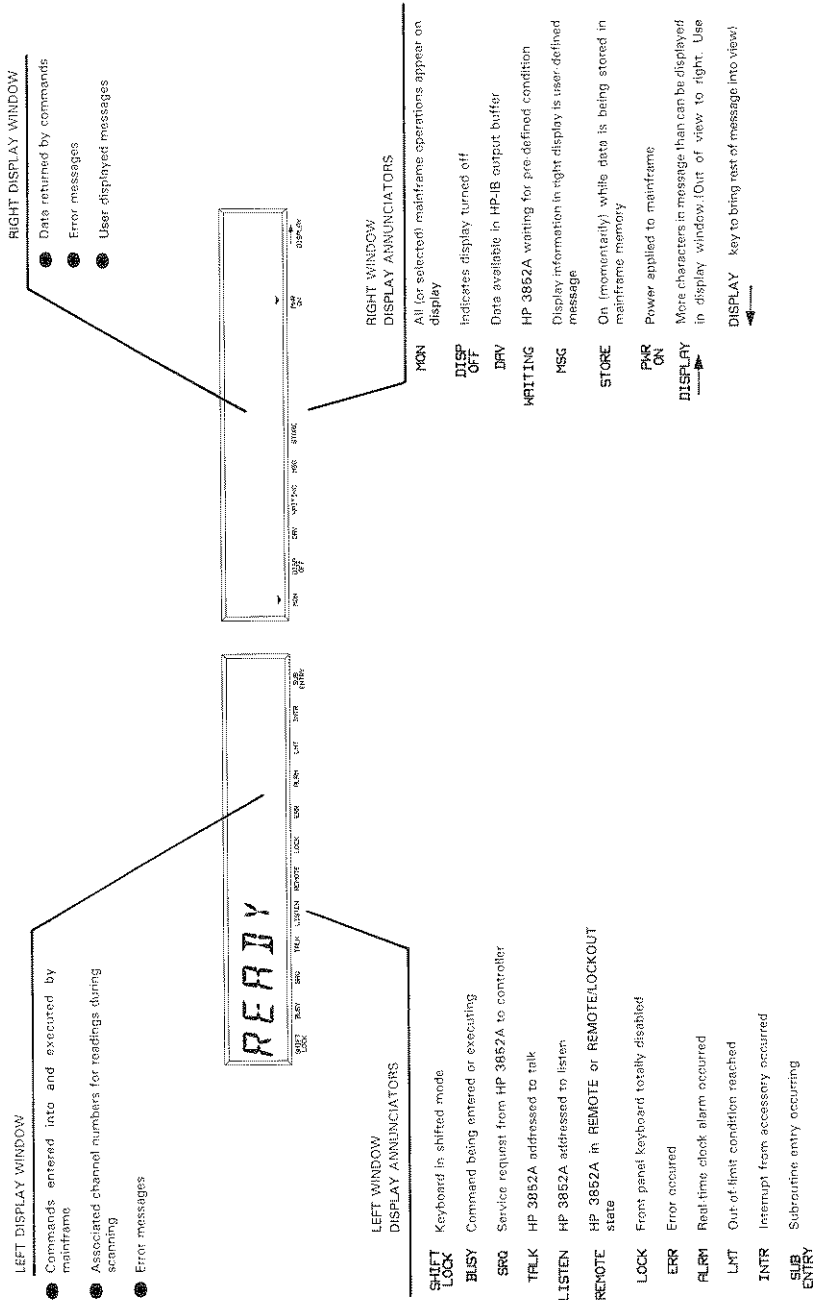

Figure 3-2. HP 3852A Front Panel Display

Before you enter the following example command sequences, press the LOCAL key and then the RST key so that the instrument starts in a known state. If you enter a wrong command, press the CLEAR DISPLAY key and then enter the correct command.

### Example: Unshifted Mode Keystroke Entries

The command to execute a partial self-test of the mainframe is TEST. We'll enter this command in two ways, first using the unshifted mode and then using the shifted mode. To begin, press the RST key. When the reset sequence is complete, the left window display should show READY and the right window should be blank.

To enter the TEST command using unshifted mode, use the following keystroke sequence:

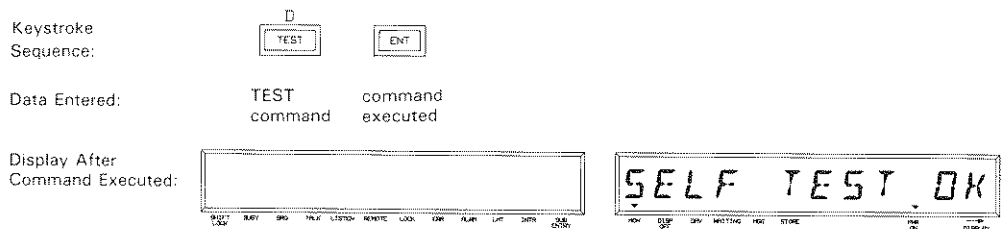

### Example: Shifted Mode Keystroke Entries

To enter the TEST command using shifted mode, use the following keystroke sequence:

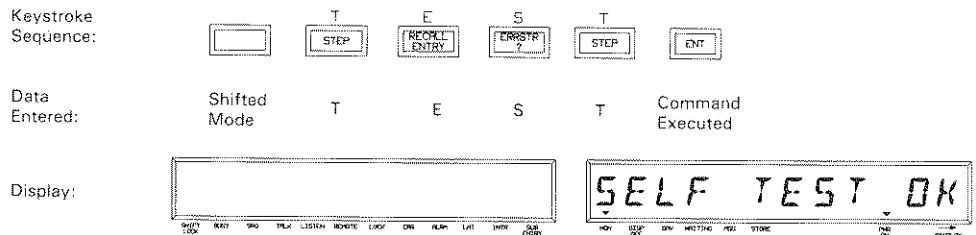

## Entering Numbers

By using the NUMERIC key group, you can enter numbers into the HP 3852A. For example, the number 15 can be entered as 15, 015, 000015, 0.15E+2, etc. Numbers are entered as positive (+) unless the +/- key is pressed. When the +/- key is pressed, a - is placed before the first digit in the number.

### Example: Entering Numbers

We'll use the PACER *period* [count] command to demonstrate how to enter positive and negative numbers. We'll set *period* = 2.5  $\mu$ sec and use the default value for [count]. (Since the *count* parameter is optional, we don't need to specify its value. A default value will be assigned.) Use the following keystroke sequence:

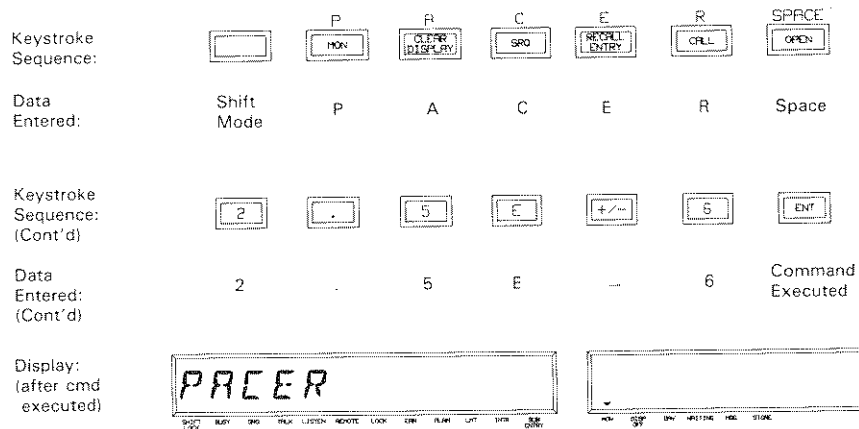

## Display Control

This section shows how to use the keyboard to control the display and some ways to correct errors in front panel entries.

### Controlling the Display

There are six keys which can be used to control the display: DISPLAY (left arrow); DISPLAY (right arrow); RECALL ENTRY; CLEAR DISPLAY; DISP; and BACK SPACE. See Figure 3-1 for location.





The display windows can display up to 24 alphanumeric characters, but the display buffer can hold up to 50 characters. You can read the complete message by scrolling the display to the left with DISPLAY (left arrow) or to the right with DISPLAY (right arrow), as required.

The DISPLAY keys scroll the left display window when commands are entered and scroll both displays when an error message is displayed as a result of an error. The keys scroll the right display window when command results are shown and when an error message is displayed as a result of an error or the ERRSTR? command.



You can use the RECALL ENTRY key to recall the last command executed from the front panel. Use the BACK SPACE key to move the cursor to the left, erasing a character at the same time. By using these keys, you can recall and modify commands.

### Example: Display Control

To show one way to control the display, we'll enter the TEST 500 command to initiate a self-test of the plug-in accessory in slot 5 of the mainframe. Since we haven't installed any plug-in accessories yet, this command will return an error message.

Keystroke Sequence:					
Data Entered:	TEST	5	0	0	Command Executed

Display:		
----------	--	---

As advertised, the display shows an error message. However, note that the triangular DISPLAY annunciator light (under the E in ACCE) is on, which says that there is more to the error message than meets the eye. To find out what the rest of the message is, press the DISPLAY (left arrow) key until the annunciator turns off. Then, the display shows:

	
--	---

So, the entire message is ERROR 32: TEST: NO ACCESSORY PRESENT. You can also scroll the display to the right by pressing the DISPLAY (right arrow) key.

# Correcting Entry Errors

If you try to enter an incorrect command, the HP 3852A will BEEP at you and display an error message. In this case, you'll need to correct the sequence and enter the correct command. One way to correct an entry error is to use the CLEAR DISPLAY key. However, that wipes out the entire command and you have to start over. Another way to correct entry errors is to use the BACK SPACE key if you haven't entered the command. Let's look at an example.

## Example: Correcting Errors Before Entering Command

For example, suppose you want to enter the TEST 500 command, but you actually key in TEST 5 . , instead. If you discover the mistake before you enter the command, you can use the BACK SPACE key to erase the period and the comma and then enter the correct sequence, as shown.

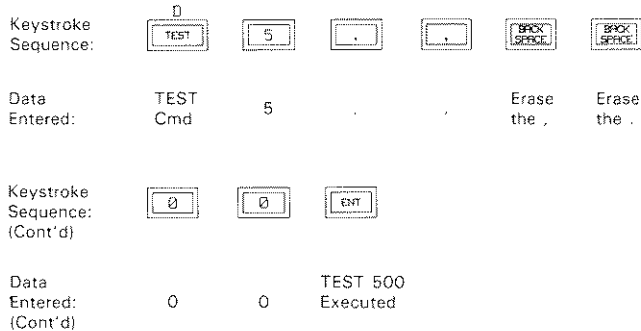



### Example: Correcting Errors After a Command is Entered

If you don't discover your mistake before you enter the command, the HP 3852A may display an error message. However, you can correct the entry by using the RECALL ENTRY key and then the BACK SPACE key. So, for this example sequence, key in TEST 5 . , as before and press the ENT key. In this case, the display is:

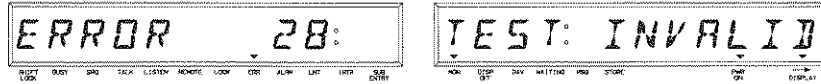

By scrolling the display with the DISPLAY (left arrow) key, the complete error message is shown to be ERROR 28: TEST: INVALID SLOT. To correct the entry errors, press the RECALL ENTRY key to display the last command entered (TEST 5 . ). Then, use the BACK SPACE key to erase the incorrect entries ( . ) and press the 0 key twice to enter the correct numbers (0 0) as shown in the previous example.



**Chapter 4**  
**Programming the HP 3852A**

# CONTENTS

	Page
Introduction .....	4-1
Programming Overview .....	4-1
HP-IB Communication .....	4-1
HP 3852A Addressing .....	4-2
HP 3852A Command Format .....	4-3
Programming Examples .....	4-5
Example 1: Check HP 3852A Address .....	4-5
Example 2: Check Mainframe ID .....	4-5
Example 3: HP 3852A Self-Test .....	4-6

# Programming the HP 3852A

## Introduction

The HP 3852A can be programmed from the front panel or from a controller over HP-IB. In this chapter, we'll see how to program the HP 3852A over HP-IB using an HP Series 200/300 controller. If you use a different controller, you may need to modify the syntax in the example programs.

## Programming Overview

Before we begin programming the HP 3852A, we'll summarize HP-IB communication between a controller and the HP 3852A, HP 3852A addressing, and HP 3852A command formats.

### HP-IB Communication

As shown in Figure 4-1, the HP 3852A is programmed over HP-IB by sending commands with an OUTPUT statement and data is returned from the HP 3852A to the controller with an ENTER statement. In Figure 4-1, note that the HP-IB address of the HP 3852A is 9, which is the factory-preset address. All program examples use HP-IB address 09, Interface Select Code (ISC) 7, and device selector 709.

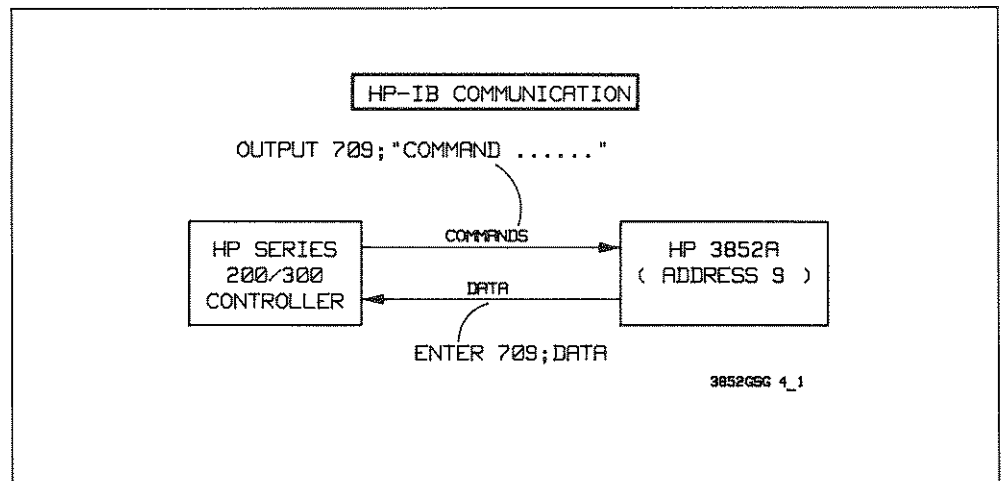

Figure 4-1. HP-IB Communication

# HP 3852A Addressing

Many HP 3852A commands require that a specific slot or channel be addressed by the command parameters. The HP 3852A uses an ESCC addressing scheme, where E = extender number (mainframe = 0), S = slot number, and CC = channel number. In the ESCC format, as with all numbers, leading zeroes are ignored and it is not necessary to enter them.

Since up to seven extenders can be connected to a single mainframe, the range of E = 0 through 7, where the mainframe = extender 0. The mainframe has eight slots (0 through 7), so the range of S for the mainframe = 0 through 7. Each extender has ten slots (0 through 9), so the range of S for the extenders = 0 through 9. When a parameter addresses a slot, the form is ES00, where trailing zeroes are required.

The channel number (CC) range depends on the accessory installed in the slot addressed. For example, the channel number range for some multiplexers is from 00 through 59 and 90 through 94, depending on the multiplexer installed. When a parameter addresses a channel number or channel list, the form is ESCC.

Some commands use a channel list. A channel list can be a channel number, a channel number range, or a combination of channel numbers and channel number ranges. A channel number range is a sequence of channel numbers separated by a dash in the form ESCC-ESCC. Table 4-1 shows HP 3852A addressing conventions and some examples.

Table 4-1. HP 3852A Addressing

<b>Definitions:</b>	
Addressing commands may have a slot, channel, or channel list as a parameter. Slots have form ES00, channels have form ESCC, channel lists have form ESCC [- ESCC] [ESCC [- ESCC]...].	
E = extender number where accessory installed, S = slot number in extender "E" where accessory installed, and CC = channel number in accessory. Range of E = 0-7, where mainframe = 0. Range of S = 0-7 for mainframe, 0-9 for extenders.	
<b>Example: Parameter is slot (form = ES00)</b>	
0200	Slot 2 in mainframe
3400	Slot 4 in extender 3
0	Slot 0 in mainframe
OUTPUT 709; "ID? 3500"	Request ID of accessory in slot 5 of extender 3.
<b>Example: Parameter is channel (form = ESCC)</b>	
1315	Extender 1, slot 3, channel 15
5	Mainframe, slot 0, channel 5
2409	Extender 2, slot 4, channel 9
OUTPUT 709; "MON 102"	Display readings from mainframe slot 1, channel 2.

Table 4-1. HP 3852A Addressing (Cont'd)

Example: Parameter is ch_list (form = ESCC [- ESCC] [ESCC [- ESCC]...])	
1305	Extender 1, slot 3, channel 5.
1310-1305	Extender 1, slot 3, channels 10 through 5.
1305-1310,1312	Extender 1, slot 3, channels 5 through 10 and channel 12.
1302,1305-1310,1312	Extender 1, slot 3, channels 2, 5 through 10, and 12.
OUTPUT 709; "CLOSE? 0-1312"	Check states of mainframe, slot 0, channel 0 through extender 1, slot 3, channel 12.

## HP 3852A Command Format

Figure 4-2 is a “railroad diagram” representation of HP 3852A commands. As shown in Figure 4-2, HP 3852A commands consist of a command header followed (usually) by parameters. Parameters can be required or optional. The command format has the form **HEADER** *parameter* [*parameter*], where brackets indicate an optional parameter.

You can use a comma, space, or any combination of commas and spaces between the command header and a parameter or between any two parameters. More than one command can be sent in a single OUTPUT message if commands are separated by a semi-colon (;).

### NOTE

*In the text, optional parameters are enclosed by brackets. However, the brackets are not part of the command syntax.*

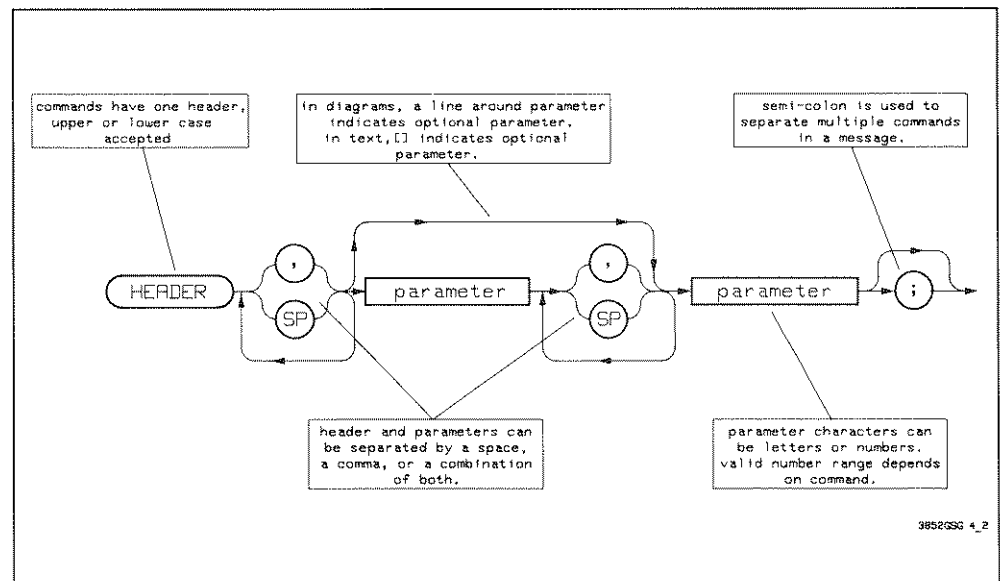
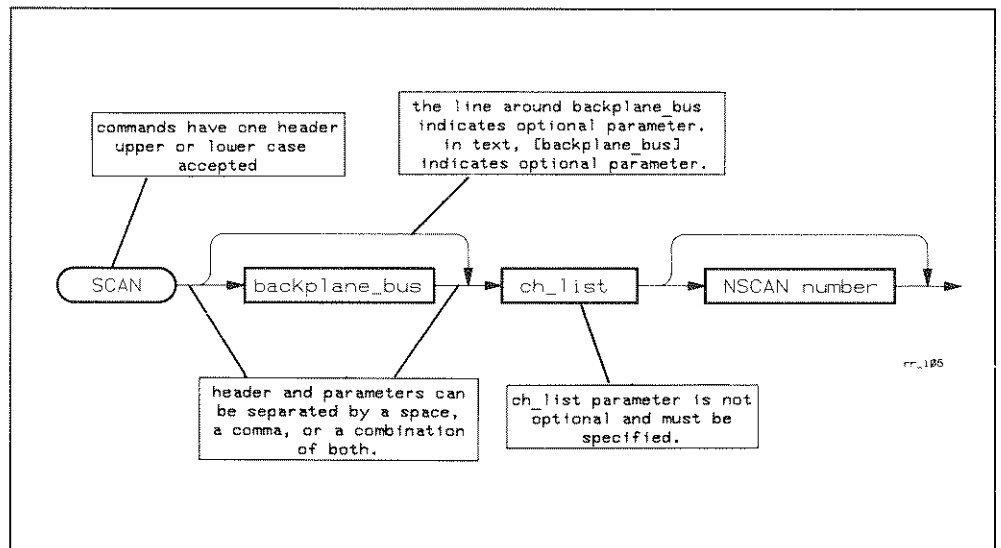

Figure 4-2. HP 3852A Command Format

Although you can use any combination of commas and/or spaces between the header and parameters or between parameters, for simplicity we'll use a line between the command header and a parameter or between parameters to represent a comma, a space, or a combination of commas and spaces.

For example (see Figure 4-3), in the command `SCAN [backplane_bus] ch_list`, `SCAN` is the command header, `[backplane_bus]` is an optional parameter, and `ch_list` is a required parameter.

For this command, you can use any combination of commas and/or spaces between the command header (`SCAN`) and the `[backplane_bus]` parameter, between `SCAN` and the `ch_list` parameter, and between the `[backplane_bus]` and the `ch_list` parameters.



**Figure 4-3. Command Format Example: SCAN Command**

If commands are separated by a semi-colon (;), more than one command may be sent with a single `OUTPUT` message. For example, in the following program lines, line 10 sends a single command, while line 20 sends multiple commands.

A few things to notice about the commands in lines 10 and 20. First, since the Interface Select Code (ISC) is assumed to be 7 and the HP-IB address to be 9, the device selector used in the commands is 709. Second, the command string must be enclosed in quote (") marks. Third, multiple commands in a string must be separated by semicolons (;).

10 OUTPUT 709; "APPLY DCV, 5.000"	!Single Command
20 OUTPUT 709; "BEEP; CLOSE 302"	!Multiple Commands



# Programming Examples

Now that we have introduced command and data flow, addressing, and command formats, let's run a few example programs to send commands. Obviously, these examples only provide an introduction to programming the HP 3852A. However, we suggest you work through them before starting the Measurement/Control Exercises in Chapter 5 to see how the instrument responds to commands and how data is returned.

---

## NOTE

*To execute commands, the HP 3852A requires a linefeed (LF) or semicolon (;) as an end-of-command character. If you don't use an HP Series 200/300 or equivalent controller, add the appropriate end-of-command character as required in the following example programs.*

---

### Example 1: Check HP-IB Address

For this example, we'll send the ADDR? command to return the HP-IB address of the HP 3852A. This, of course, is somewhat trivial since we are sending a command to address 9 and asking "What is your address?". However, the program does get us started communicating with the HP 3852A.

```
10 OUTPUT 709;"ADDR?"      !Requests HP-IB address
20 ENTER 709;A             !Return address to controller
30 PRINT A                 !Display address on CRT
40 END
```

A typical controller display when the HP 3852A is set for address 9 follows. Also, note that the command ADDR? is displayed on the HP 3852A left window and the number 9 is displayed on the right window.

9

### Example 2: Check Main- frame ID

This program uses the ID? command to check the identity of the HP 3852A mainframe.

```
10 OUTPUT 709;"ID?"      !Requests mainframe ID
20 ENTER 709;Id$         !Returns mainframe ID
30 PRINT Id$             !Display ID
40 END
```

A typical display on the controller CRT follows. In addition, the HP 3852A displays the ID? command on the left window and displays HP3852A on the right window.

HP3852A

### **Example 3: HP 3852A Self-Test**

You can use the TEST command to self-test the HP 3852A or a plug-in accessory. In this example, we'll issue the TEST command to the mainframe.

10 DIM Test\$(60)	!Dimension Test\$
20 OUTPUT 709;"RST"	!Reset HP 3852A
30 OUTPUT 709;"TEST;ERRSTR?"	!Self-Test, Error Check
40 ENTER 709;Test\$	!Enter Self-Test Results
50 PRINT Test\$	!Display Results
60 END	

A typical display on the controller CRT when the self-test passes follows. In addition, when the self-test passes, ERRSTR? is displayed in the HP 3852A left window and 0: NO ERR is displayed in the right window. (Use the DISPLAY (left arrow) key to show the entire message of 0: NO ERROR.)

" 0: NO ERROR "

**Chapter 5**  
**Measurement/Control Exercises**

# CONTENTS

	Page
Introduction .....	5-1
Setting Up For The Exercises.....	5-2
Connecting Field Wiring.....	5-2
Installing Accessories.....	5-5
Measurement Exercises.....	5-8
Exercise 1: Voltage Measurements.....	5-8
Exercise 2: Resistance Measurements.....	5-15
Exercise 3: Temperature Measurements.....	5-20
Counting/Control Exercises.....	5-26
Exercise 4: Count Switch Closures.....	5-27
Exercise 5: Read Switch State.....	5-29
Exercise 6: Light an LED.....	5-32

# Measurement/Control Exercises

---

## Introduction

Now that you are familiar with programming concepts for the HP 3852A, let's do some exercises to show how the HP 3852A performs basic measurement and control functions. The exercises in this chapter are divided into two categories: Measurement Exercises (Exercises 1, 2, and 3) and Counting/Control Exercises (Exercises 4, 5, and 6).

Each exercise is self-contained, so you need do only those of interest to you. However, we encourage you to do as many of the exercises as possible to become more familiar with the instrument.

Before you start any exercise, you should first read the next section "Setting Up For The Exercises" to see how to connect field wiring and how to install plug-in accessories.

---

### **WARNING**

*To avoid personal injury or equipment damage, do not touch the back panel of the HP 3852A mainframe, the back panel of an HP 3853A Extender, or any plug-in accessory installed in the HP 3852A or the HP 3853A until a qualified, service-trained person aware of the hazards involved has removed all external power sources from the instrument.*

*Only qualified, service-trained persons aware of the hazards involved should install, remove, or configure the plug-in accessories for this instrument. DO NOT PERFORM ANY OF THE EXERCISES IN THIS GUIDE IF ANY EXTERNAL POWER SOURCES ARE CONNECTED TO THE HP 3852A, HP 3853A, OR PLUG-IN ACCESSORIES.*

---

# Setting Up For The Exercises

Up to this point, we've used only the HP 3852A mainframe for programming examples. However, to measure or control external (user) systems, the system must be connected to the mainframe by field wires connected to plug-in accessories. The exercises in this chapter give you an opportunity to connect external systems to plug-in accessories and to make typical measurements of the system.

To do the exercises, you'll need to connect components (from the Getting Started Kit) to a plug-in accessory. This part of the chapter describes the plug-in accessories, shows how to connect field wiring to an accessory, and how to install accessories in a slot in the mainframe.

## Connecting Field Wiring

All HP 3852A plug-in accessories (except the voltmeters) consist of a component module and a terminal module. External (user) systems are connected with field wiring to the terminal module. To make these connections, first separate the terminal module from the component module and then remove the terminal module cover. See Figure 5-1.

When the terminal module cover is removed, connect field wiring from the user system to the terminals on the terminal module. When you connect the field wires, route the wires under the strain relief clamp as shown in Figure 5-2. Tighten the clamp screw to reduce the chances of the wires being pulled out.

TERMINAL MODULE AND COMPONENT MODULE

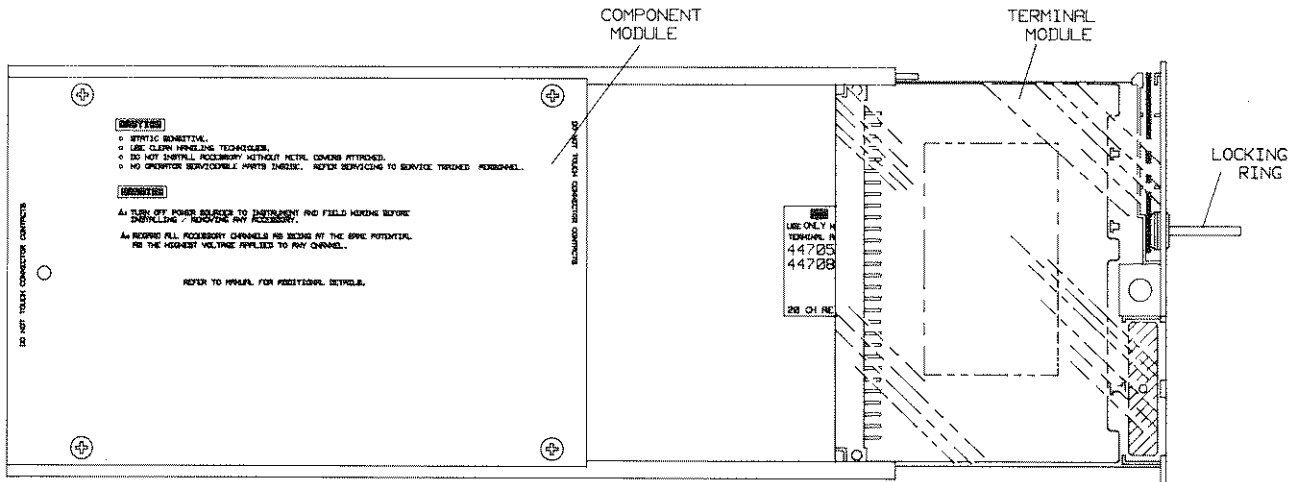

REMOVING THE TERMINAL MODULE COVER

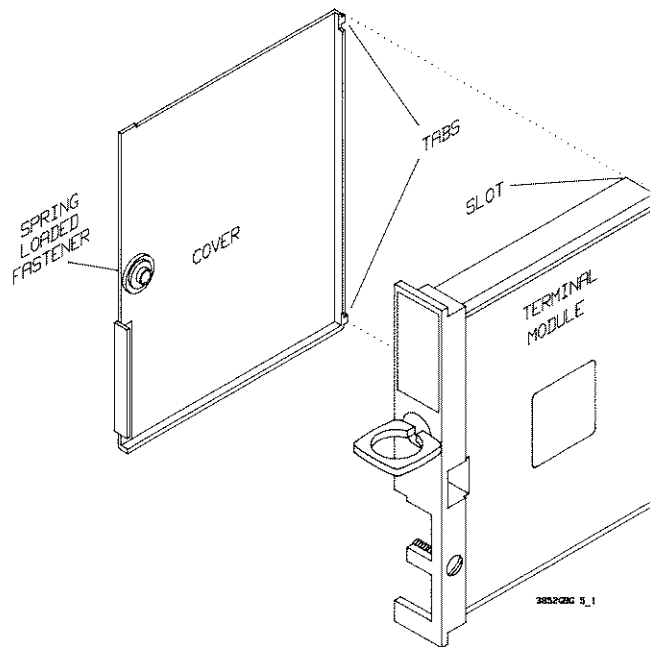

- To separate modules, turn locking ring on terminal module to UNLOCK position, hold component module with one hand and pull on locking ring with other hand.
- To remove terminal module cover, separate terminal module from component module. Use flat-bladed screwdriver to turn spring-loaded fastener 1/4 turn counterclockwise. Lift cover from terminal module.
- To replace terminal module cover, insert tabs on cover into module slots. Lower cover to module, press down on spring-loaded fastener and turn 1/4 turn clockwise to close.

Figure 5-1. Removing Terminal Module and Cover

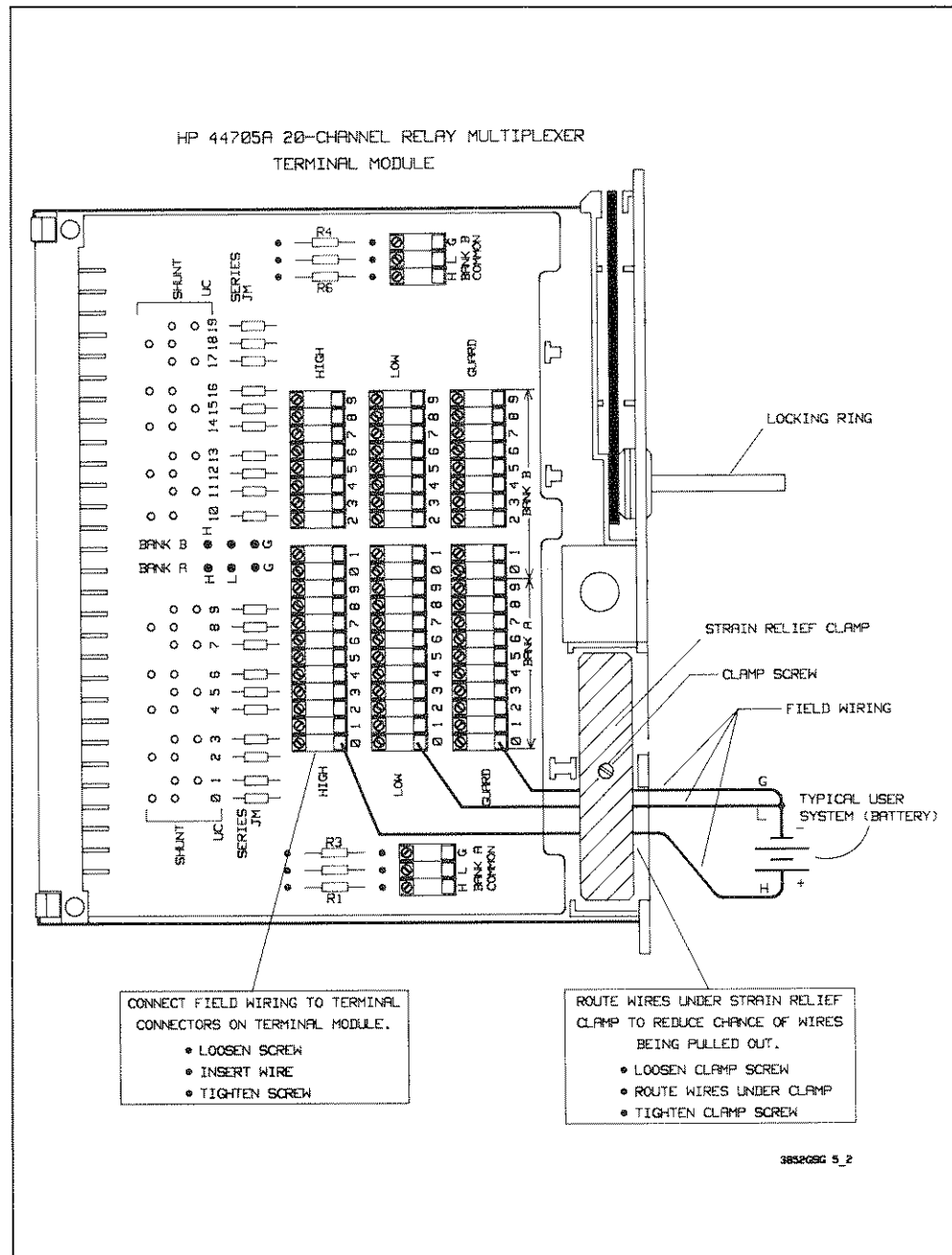

Figure 5-2. Connecting Field Wiring



## Installing Accessories

When you have connected field wiring to the terminal module, replace the terminal module cover, re-connect the terminal module to the component module, and install the accessory in a desired slot.

For the exercises in this chapter, we'll install accessories only in the mainframe. There are eight slots in the mainframe, numbered 0 through 7 left-to-right. The slot numbers are identified by a number at the front of the slot.

All accessories except the HP 44702A/B High-Speed Voltmeter use one slot. The HP 44702A/B uses two slots. For programming the HP 44702A/B, use the lower slot number for addressing. For example, if an HP 44702A/B is installed in slots 6 and 7, use slot 6 as the slot address.

Figure 5-3 shows how to install and remove all accessories except voltmeters. Figure 5-4 shows how to install and remove the HP 44701A or HP 44702A/B voltmeter. You may want to practice installing and removing an accessory.

---

### NOTE

*If an accessory self test is performed, the test may fail if the accessory was installed while the HP 3852A (or HP 3853A) was turned on. To prevent the test from "failing" and for safety, ensure that the HP 3852A (HP 3853A) is turned off before you install any accessories.*

---

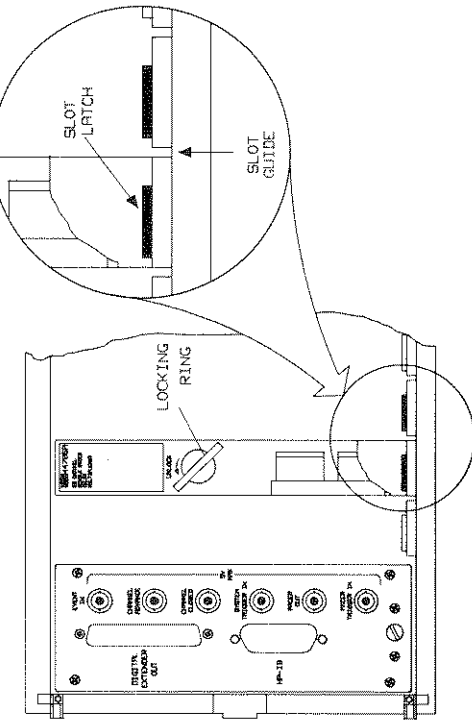

### Installing an Accessory

1. Connect the terminal module to the component module and turn the locking ring to the right to lock the terminal module to the component module.
2. Line up the ridges on the top and bottom rails of the accessory with the slot guides to the left of the slot number on the mainframe. Make sure the terminal module cover is facing left.
3. Slide the accessory into the slot and press firmly on the terminal to lock the accessory in the slot. You'll hear a click when the accessory locks.

### Removing an Accessory

1. Turn the locking ring to the UNLOCK position and pull on the ring to remove the terminal module. The component module will remain in the slot.
2. To remove the component module, place your right forefinger in the hole in the top rail of the component module and your left forefinger on the slot latch in the bottom rail of the component module.
3. Press down on the slot latch while pulling firmly on the component module. BE CAREFUL — you can easily pinch your left forefinger between the slot latch and the bottom plastic rail of the component module.

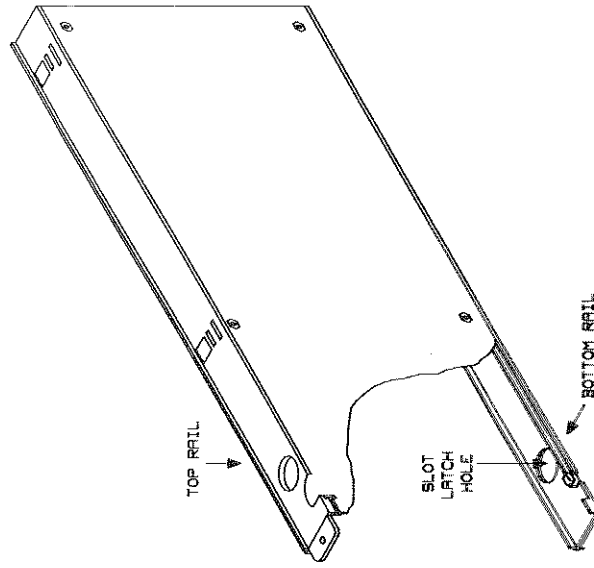
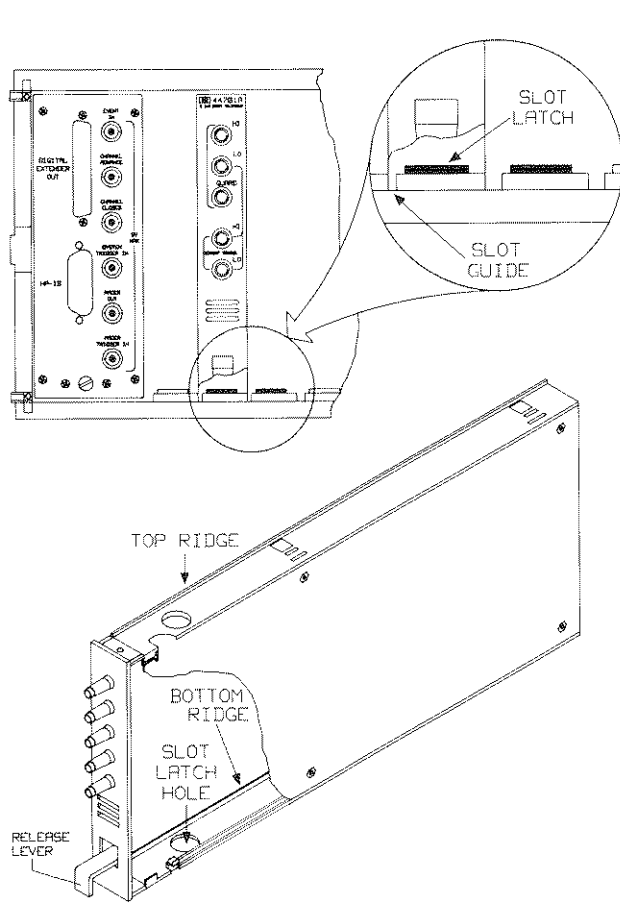

FIGURE 5-3

Figure 5-3. Installing Accessories (Except Voltmeters)



#### Installing the HP 44701A Voltmeter

1. Line up the ridges on the top and bottom rails of the accessory with the slot guides to the left of the slot number on the mainframe.
2. Slide the voltmeter into the slot and press firmly to lock the voltmeter in the slot. You'll hear a click when the voltmeter locks.

#### Removing the HP 44701A Voltmeter

To remove the voltmeter, lift the release lever FIRST. Then, firmly pull the voltmeter from the slot. If you try to pull the voltmeter from the slot before you lift the release lever, you may jam the mechanism.

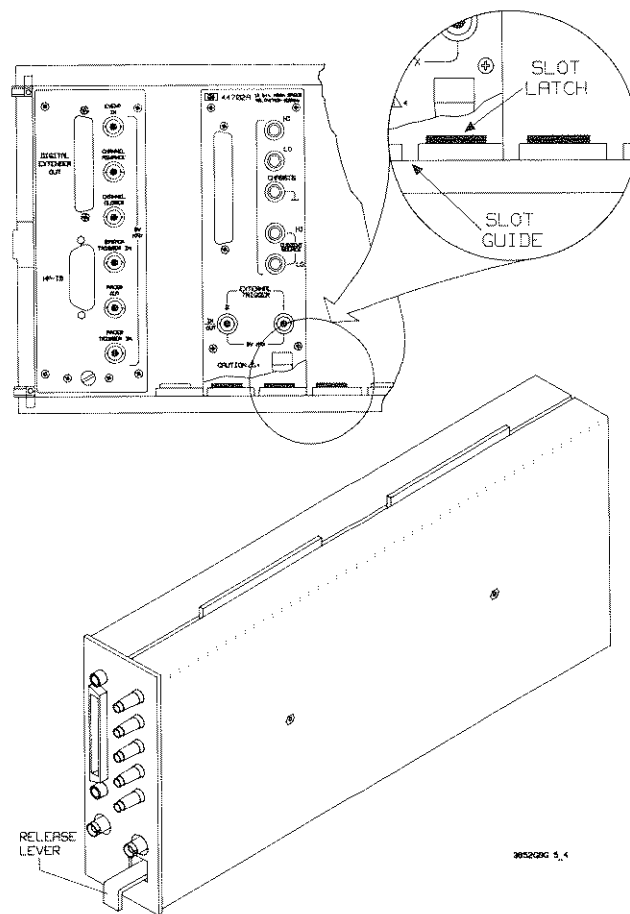

#### Installing the HP 44702A/B Voltmeter

1. The HP 44702A/B voltmeter requires two slots. Because of a metal support in the mainframe, the voltmeter can't be installed in slots 3 and 4.
2. Line up the ridges on the top and bottom center of the accessory with the slot guide between the two slots the voltmeter is to occupy. For example, to install the voltmeter in the slots 6 and 7, line up the ridges with the guide between slots 6 and 7.

3. Slide the voltmeter into the slots and press firmly to lock the voltmeter in the slot. You'll hear a click when the voltmeter locks.

#### Removing the HP 44702A/B Voltmeter

To remove the voltmeter, lift the release lever FIRST. Then, firmly pull the voltmeter from the slot. If you try to pull the voltmeter from the slot before you lift the release lever, you may jam the mechanism.

Figure 5-4. Installing Voltmeter Accessories

# Measurement Exercises

Three exercises follow to show some ways that the HP 3852A can be used to make voltage, resistance, and temperature measurements. Table 5-1 summarizes the three exercises and shows the accessories used for each.

---

## NOTE

*Each measurement exercise shows an HP 44701A Integrating Voltmeter and HP 44705A 20-Channel Relay Multiplexer for illustration. However, you can also use an HP 44702A/B High-Speed Voltmeter. In most cases, you can use other multiplexers for these exercises.*

---

**Table 5-1. Measurement Exercises**

Exercise	Title	Description
1	Voltage Measurements	Measure DC voltage of 9V battery using HP 44701A Integrating Voltmeter and HP 44705A 20-Channel Relay Multiplexer.
2	Resistance Measurements	Measure resistance of 1k ohm resistor (2-wire ohms) using HP 44701A Integrating Voltmeter and HP 44705A 20-Channel Relay Multiplexer.
3	Temperature Measurements	Measure temperature of 10k ohm thermistor using HP 44701A Integrating Voltmeter and HP 44705A 20-Channel Relay Multiplexer.

## Exercise 1: Voltage Measurements

In this exercise, we'll make simple DC voltage measurements of a 9V battery using an HP 44701A Integrating Voltmeter and an HP 44705A 20-Channel Relay Multiplexer. You can use the HP 44702A/B High-Speed Voltmeter as the voltmeter. Also, any of the HP 447XXX multiplexers can be used with either voltmeter.

The measurements to be made will be: (1) single-channel, single measurements; (2) single-channel, multiple measurements; and (3) scanning measurements.

### Equipment Required

- HP 44701A or HP 44702A/B voltmeter
- HP 44705A Relay Multiplexer (or other multiplexer)
- HP 3852A Getting Started Kit

## Connections

See Figure 5-5 and use the following steps to configure the HP 3852A for this exercise.

- Make sure LINE switch is OFF.
- Connect lead wires to multiplexer terminal module channel 0.
- Replace multiplexer terminal module cover.
- Connect multiplexer terminal module to component module.
- Install multiplexer in slot 1.
- Install voltmeter in slot 6.
- Connect 9V battery and lead wires to breadboard.
- Press LINE switch ON.

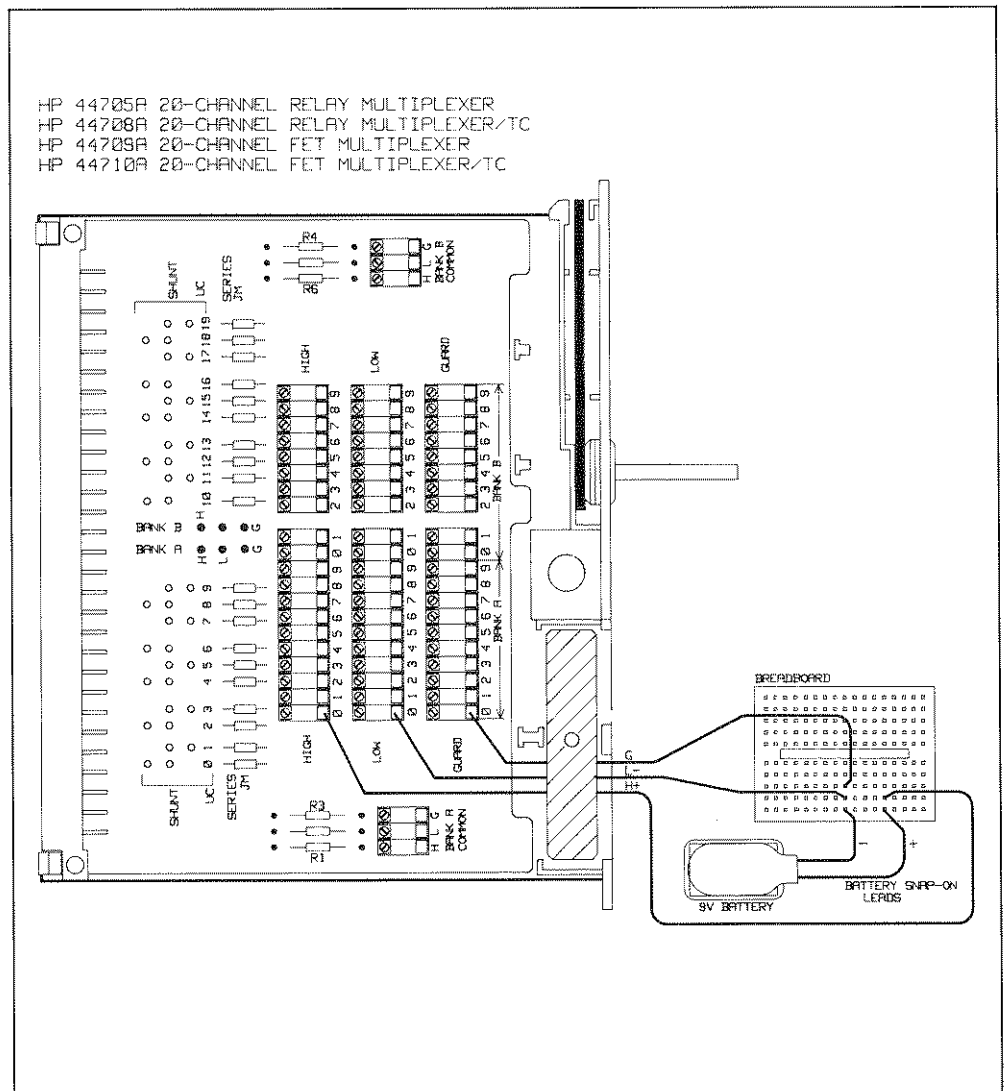

Figure 5-5. Exercise 1: Voltage Measurements - HP 44705A/05H/08A/08H/09A/10A Connections

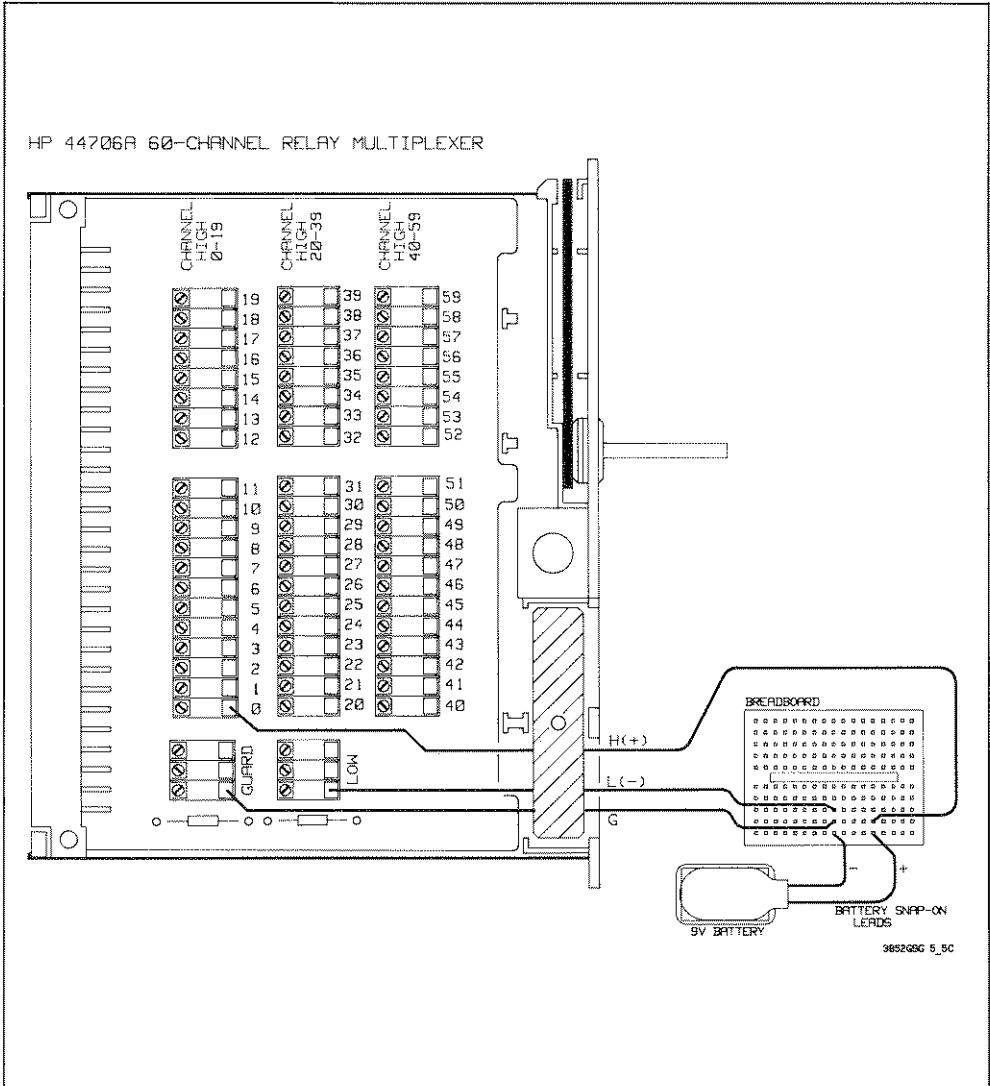

Figure 5.5. Exercise 1: Voltage Measurements - HP 44706A Connections

HP 44711A 24-CHANNEL HIGH-SPEED FET MULTIPLEXER  
 HP 44713A 24-CHANNEL HIGH-SPEED FET MULTIPLEXER/TC

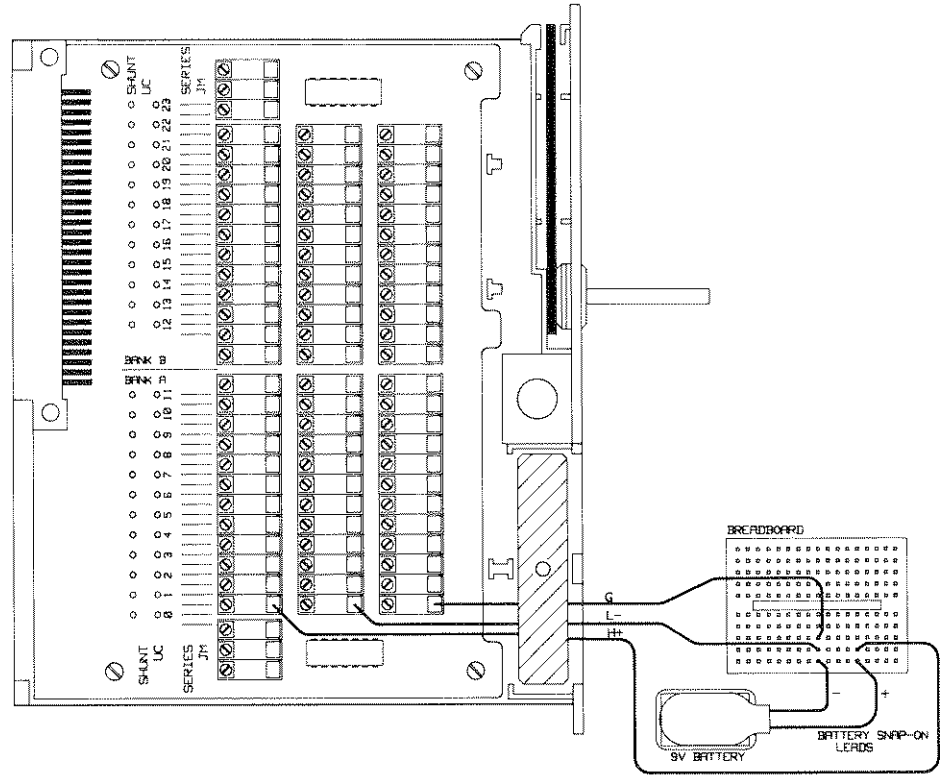

Figure 5-5. Exercise 1: Voltage Measurements -  
 HP 44711A/13A Connections

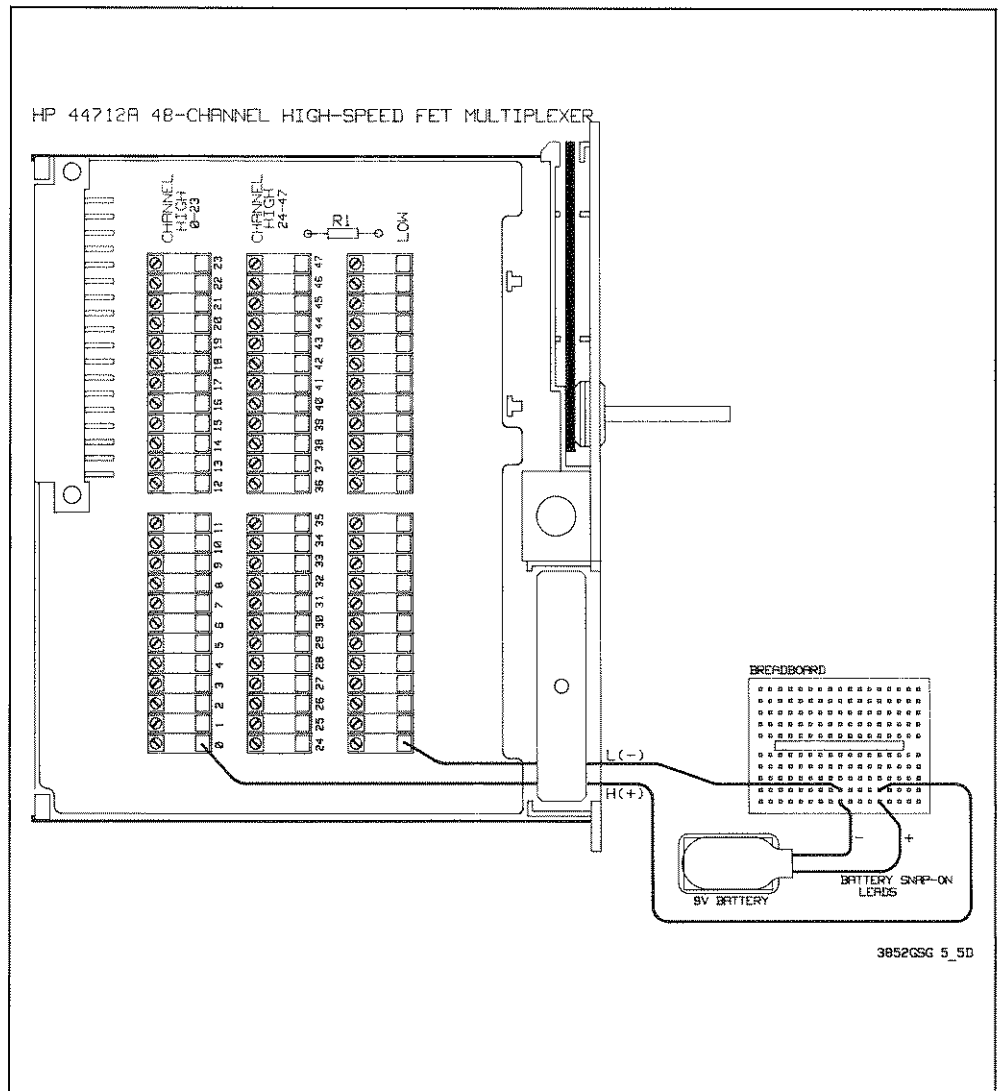

Figure 5-5. Exercise 1: Voltage Measurements - HP 44712A Connections

### Example Programs

Three voltage measurement programs follow. All measurements are made using the CONFMEAS command. The CONFMEAS command CONFIGures the voltmeter for the function specified then performs the MEASurement. This command is the most frequently used and easiest method for making measurements with the HP 3852A. The syntax of the CONFMEAS command is given below:

**CONFMEAS** *function* *ch\_list* [GAIN *corr*] [NSCAN *number*] [USE *ch*] [INTO *name*] or [*fmt*]



For these programs, the function specified is DCV, the channel the voltage will be measured on is channel 0 of the multiplexer accessory in slot 1 (100), and the voltmeter to be USEed is in slot 6 (600). Since the data returned will not be stored in the mainframe nor is any particular data format required, neither **INTO** *name* or *fmt* are specified.

### Single Channel - Single Measurement

This program makes a single measurement of the voltage on channel 0 of a multiplexer in slot 1, using the voltmeter in slot 6. The result is displayed on the controller CRT. (If an HP 44702A/B is used, although the HP 44702A/B occupies slots 6 and 7, slot 6 is used for programming.)

```
10 OUTPUT 709; "CONFMEAS DCV,100,USE 600"      !Conf/meas DC volts
20 ENTER 709;A                                  !Enter result
30 PRINT "Channel 0 voltage = ";A; "volts"      !Display result
40 END
```

Since we're measuring the voltage of a 9V battery, a typical display is:

Channel 0 voltage = 8.69753 volts

### Single Channel - Multiple Measurements

By changing the *ch\_list* parameter, you can use the CONFMEAS command to make repeated measurements of a channel. This program makes three voltage measurements on channel 0 of the multiplexer in slot 1, using the voltmeter in slot 6.

```
10 REAL Volts (0:2)                             !Dim REAL array Volts
20 OUTPUT 709;"CONFMEAS DCV,100,100,100, USE 600" !Conf/meas DC volts
30 ENTER 709;Volts(*)                           !Enter results
40 PRINT Volts(*)                               !Display results
50 END
```

A typical display (values in volts) is:

8.69567 .            8.69426            8.69345

## Scanning Measurements

By changing the *ch\_list* parameter in a second way, you can scan channels (the channels do NOT have to be sequential). For example, the command CONFMEAS DCV 100-103, 105, 107-109, USE 600 measures the voltage on channels 0 through 3, channel 5, and channels 7 through 9 of a multiplexer in slot 1 of the mainframe using the voltmeter in slot 6 of the mainframe. The following program scans channels 0 through 9 of the multiplexer in slot 1, using the voltmeter in slot 6.

```
10 REAL Volts(0:9)                !Dim REAL array Volts
20 OUTPUT 709;"CONFMEAS DCV,100-109,USE 600" !Conf/meas DC volts
30 PRINT "Channel      Voltage"
40 PRINT
50 FOR I = 0 TO 9
60 ENTER 709; Volts (I)           !Enter results
70 PRINT I;TAB (15);Volts (I)    !Display results
80 NEXT I
90 END
```

A typical display (values in volts) follows. For channels 1 through 9, since no external voltage is connected, the numbers indicate typical noise voltage on the channel. When the program completes, the HP 3852A display shows the measurement function and channel number of the last channel measured (DCV 109) in the left window and the measurement result for the channel (such as 2.156158E+00) in the right window.

Channel	Voltage
0	8.653943
1	1.232322
2	1.663778
3	1.749855
4	1.827543
5	1.921722
6	1.996387
7	1.996387
8	2.108535
9	2.156158

## Exercise 2: Resistance Measurements

In this exercise, we'll make 2-wire resistance measurements of a 1000 ohm resistor using an HP 44701A Integrating Voltmeter and an HP 44705A 20-Channel Relay Multiplexer. You can also use an HP 44702A/B High-Speed Voltmeter and can use an HP 44706A or HP 44708A multiplexer with either voltmeter.

---

### NOTE

*Using FET multiplexers (HP 44709A, HP 44710A, HP 44711A, HP 44712A, or HP 44713A) to do two-wire resistance measurements can cause measurement errors of thousands of ohms. Therefore, we recommend you do NOT use a FET multiplexer for this exercise (or for any 2-wire resistance measurement).*

---

The measurements to be made will be: (1) single-channel, single measurements; (2) single-channel, multiple measurements; and (3) scanning measurements.

### Equipment Required

- HP 44701A or HP 44702A/B voltmeter
- HP 44705A, HP 44706A, or HP 44708A multiplexer
- HP 3852A Getting Started Kit

### Connections

See Figure 5-6 and use the following steps to configure the HP 3852A for this exercise.

- Make sure LINE switch is OFF.
- Connect lead wires to multiplexer terminal module channel 0.
- Replace multiplexer terminal module cover.
- Connect multiplexer terminal module to component module.
  
- Install multiplexer in slot 1.
- Install voltmeter in slot 6.
- Connect 1000 ohm resistor and lead wires to breadboard.
- Press LINE switch ON.

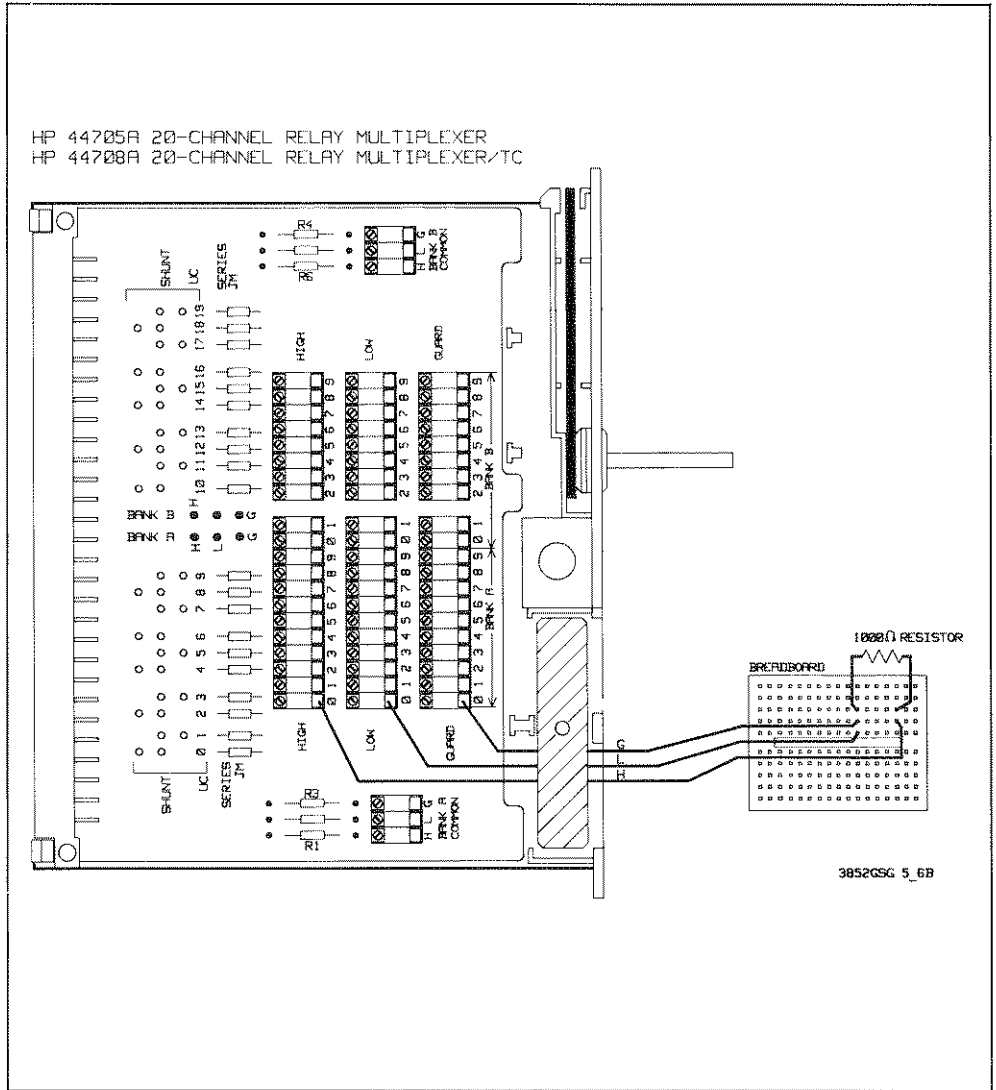

Figure 5-6. Exercise 2: Resistance Measurements - HP 44705A/05H/08A/08H Connections

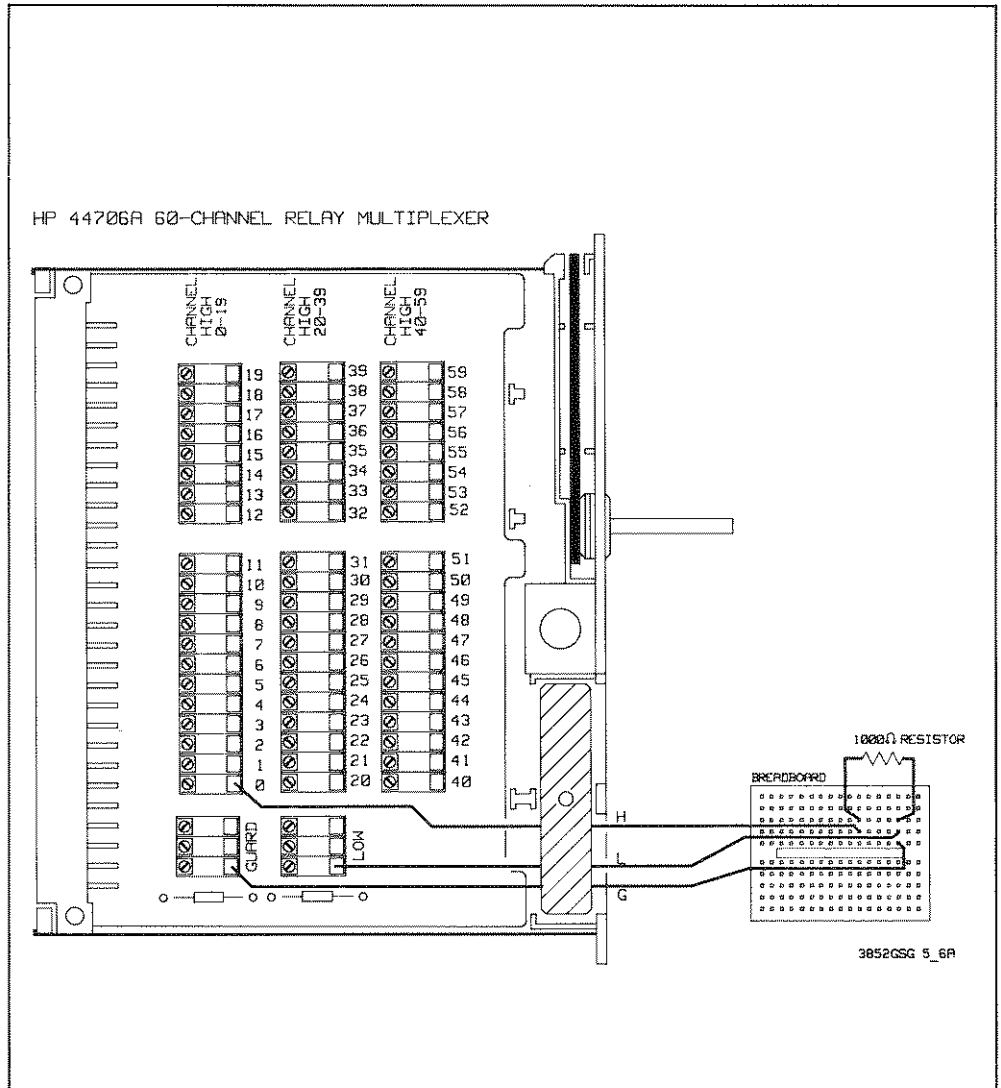

Figure 5-6. Exercise 2: Resistance Measurements - HP 44706A Connections

### Example Programs

Three resistance measurement programs follow. All measurements are made using the CONFMEAS command. The CONFMEAS command CONFIGures the voltmeter for the function specified then performs the MEASurement. This command is the most frequently used and easiest method for making measurements with the HP 3852A. The syntax of the CONFMEAS command is given below:

**CONFMEAS** *function* *ch\_list* [**GAIN** *corr*] [**NSCAN** *number*][**USE** *ch*] [**INTO** *name*] or [*fmt*]

For these programs, the function specified is OHM, the channel the resistance will be measured on is channel 0 of the multiplexer accessory in slot 1 (100), and the voltmeter to be USEed is in slot 6 (600). Since the data returned will not be stored in the mainframe nor is any particular data format required, neither **INTO** *name* or *fmt* are specified.

### Single Channel - Single Measurement

This program makes a single measurement of the resistance on channel 0 of a multiplexer in slot 1, using the voltmeter in slot 6. The result is displayed on the controller CRT. (If an HP 44702A/B is used, although the HP 44702A/B occupies slots 6 and 7, slot 6 is used for programming.)

```
10 OUTPUT 709; "CONFMEAS OHM,100,USE 600"      !Conf/meas resistance
20 ENTER 709;A                                  !Enter result
30 PRINT "Channel 0 resistance = ";A; "ohms"      !Display result
40 END
```

A typical display when an HP 44705A, HP 44706A, or HP 44708A multiplexer is used follows.

Channel 0 resistance = 999.124 ohms

### Single Channel - Multiple Measurements

By changing the *ch\_list* parameter, you can use the CONFMEAS command to make repeated measurements of a channel. This program makes three resistance measurements on channel 0 of a multiplexer in slot 1, using the voltmeter in slot 6.

```
10 REAL Ohms (0:2)                              !Dim REAL array Ohms
20 OUTPUT 709; "CONFMEAS OHM,100,100,100, USE 600" !Conf/meas resistance
30 ENTER 709;Ohms(*)                             !Enter results
40 PRINT Ohms(*)                                  !Display results
50 END
```

A typical display (values in ohms) when an HP 44705A, HP 44706A, or HP 44708A multiplexer is used follows.

999.107            999.106            999.102

## Scanning Measurements

By changing the *ch\_list* parameter in a different way, you can scan channels (channels do NOT have to be sequential). For example, the command CONFMEAS OHM, 100-103, 105, 107-109, USE 600 measures the resistance in channels 0 through 3, channel 5, and channels 7 through 9 of a multiplexer in slot 1 of the mainframe using the voltmeter in slot 6 of the mainframe.

As an example of sequential scanning resistance measurements, the following program scans channels 0 through 9 of a multiplexer in slot 1, using the voltmeter in slot 6.

```
10 REAL Ohms (0:9)                                !Dim REAL array Ohms
20 OUTPUT 709; "CONFMEAS OHM,100-109,USE 600"      !Conf/meas resistance
30 PRINT "Channel          Ohms"
40 PRINT
50 FOR I = 0 TO 9
60 ENTER 709;Ohms (I)                              !Enter results
70 PRINT I;TAB(15);Ohms (I)                        !Display results
80 NEXT I
90 END
```

A typical controller display (values in ohms) when an HP 44705A, HP 44706A, or HP44708A multiplexer is used follows. Since no external resistance is connected to channels 1 through 9, the channels are open and the value of 1.E+38 is the overload reading for the channel.

When the program completes, the HP 3852A display shows the measurement function and channel number of the last channel measured (OHM 109) in the left window and the measurement result for the channel (1.000000E+38) in the right window.

Channel	Ohms
0	999.124
1	1.E+38
2	1.E+38
3	1.E+38
4	1.E+38
5	1.E+38
6	1.E+38
7	1.E+38
8	1.E+38
9	1.E+38

## Exercise 3: Temperature Measurements

In this exercise, we'll make temperature measurements using a 10,000 ohm thermistor, an HP 44701A Integrating Voltmeter, and an HP 44705A 20-Channel Relay Multiplexer. You can use an HP 44702A/B High-Speed Voltmeter and can use an HP 44706A or HP 44708A multiplexer with either the HP 44701A or the HP 44702A/B voltmeter.

---

### NOTE

*Using a FET multiplexer (HP 44709A, HP 44710A, HP 44711A, HP 44712A, and HP 44713A) to do 2-wire ohms measurements can cause measurement errors of thousands of ohms. Therefore, we recommend you do NOT use a FET multiplexer for this exercise (or for any two-wire resistance or temperature measurement).*

---

The measurements to be made will be: (1) single-channel, single measurements; (2) single-channel, multiple measurements; and (3) scanning measurements.

### Equipment Required

- HP 44701A or HP 44702A/B voltmeter
- HP 44705A, HP 44706A, or HP 44708A multiplexer
- HP 3852A Getting Started Kit

### Connections

See Figure 5-7 and use the following steps to configure the HP 3852A for this exercise.

- Make sure LINE switch is OFF.
- Connect lead wires to multiplexer terminal module channel 0.
- Replace multiplexer terminal module cover.
- Connect multiplexer terminal module to component module.
  
- Install multiplexer in slot 1.
- Install voltmeter in slot 6.
- Connect 10,000 ohm thermistor and lead wires to breadboard.
- Press LINE switch ON.



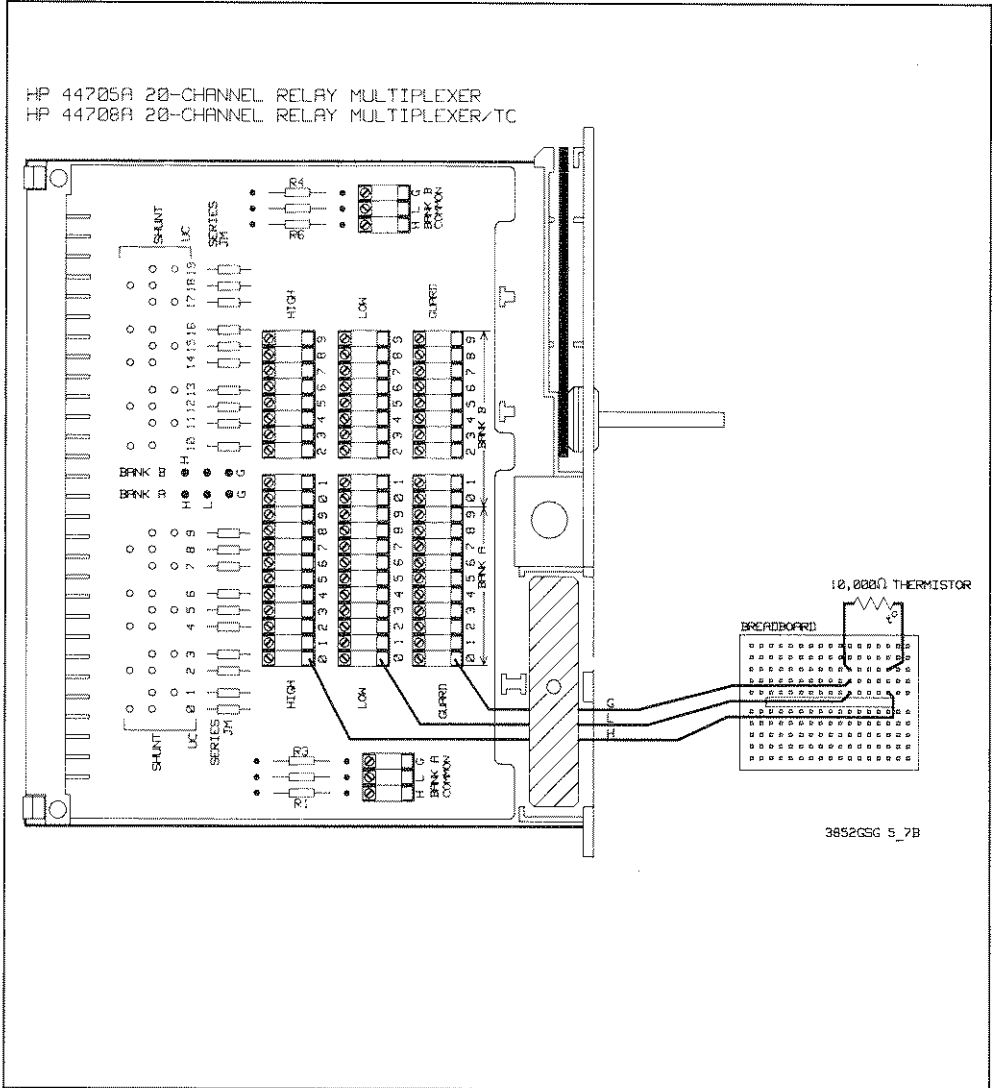

Figure 5-7. Exercise 3: Temperature Measurements - HP 44705A/05H/08A/08H Connections

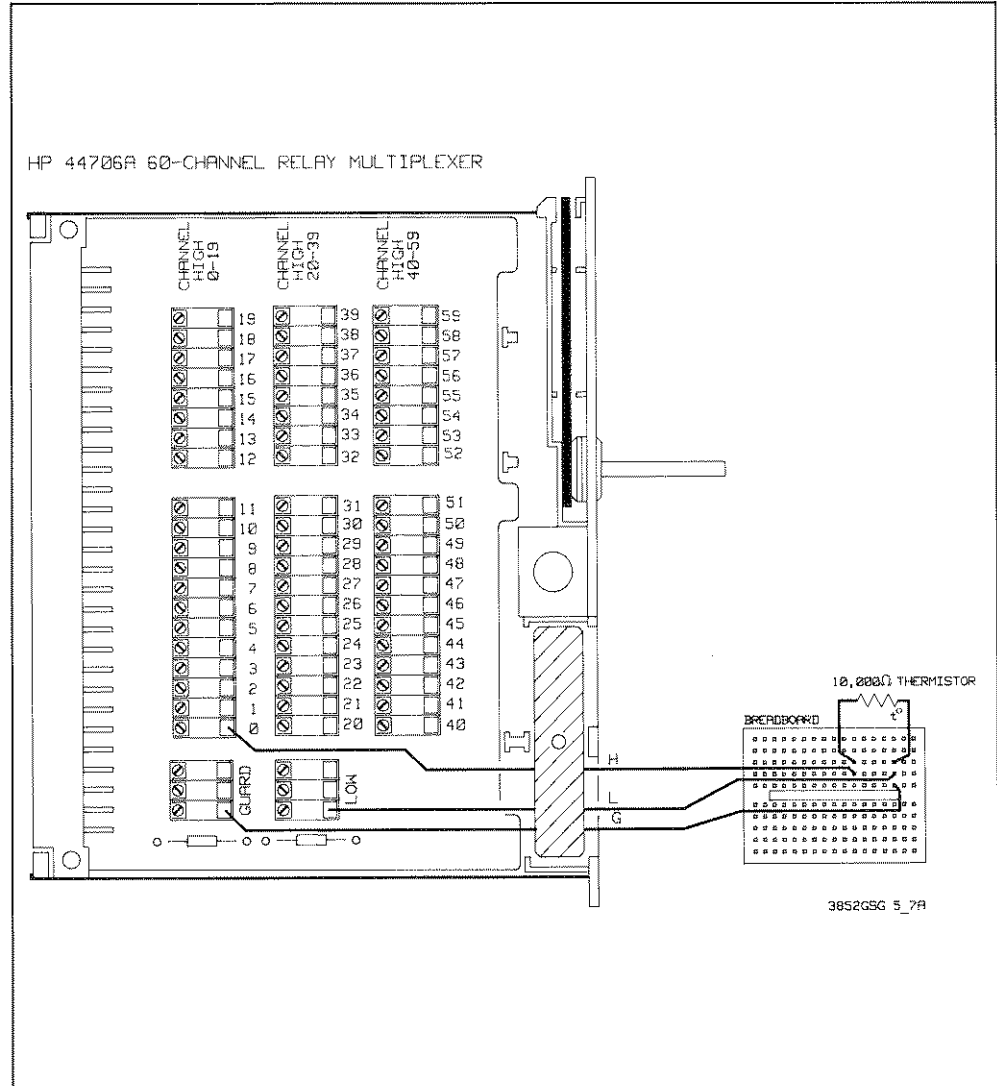

Figure 5-7. Exercise 3: Temperature Measurements - HP 44706A Connections

## Example Programs

Three temperature measurement programs follow. The first and third programs make measurements using the CONFMEAS command. The CONFMEAS command CONFIGures the voltmeter for the function specified then performs the MEASurement. This command is the most frequently used and easiest method for making measurements with the HP 3852A. The syntax of the CONFMEAS command is given below:

```
CONFMEAS function ch_list [GAIN corr] [NSCAN number] [USE ch] [INTO name] or [fmt]
```

For these programs, the function specified is THM10K, the channel the temperature will be measured on is channel 0 of the multiplexer accessory in slot 1 (100), and the voltmeter to be USEed is in slot 6 (600). Since the data returned will not be stored in the mainframe nor is any particular data format required, neither **INTO** *name* or *fmt* are specified.

In the second program, the temperature is continuously monitored on channel 0. The commands used to perform this measurement are CONF and MONMEAS which have the following syntax:

```
CONF function [USE ch]
```

```
MONMEAS function ch_list [USE ch]
```

The CONF command CONFIGures the voltmeter for the function specified and MONMEAS MONitors the readings on the channel.

### Single Channel - Single Measurement

This program makes a single measurement of the resistance on channel 0 of a multiplexer in slot 1, using the voltmeter in slot 6. The result is automatically converted to degrees C and is displayed on the controller CRT. (If an HP 44702A/B is used, although the HP 44702A/B occupies slots 6 and 7, slot 6 is used for programming.)

```
10 OUTPUT 709; "CONFMEAS THM10K,100,USE 600"      !Conf/meas temp
20 ENTER 709;A                                     !Enter result
30 PRINT "Channel 0 temperature = ";A; "Deg C"      !Display result
40 END
```

A typical display (for thermistors at room temperature) when a HP 44705A, HP 44706A, or HP 44708A multiplexer is used follows.

```
Channel 0 temperature = 23.84561 Deg C
```

## Single Channel - Multiple Measurements

You can use the MONMEAS command to continuously monitor the temperature of a channel input. The result of the measurement is displayed on the front panel display. The following program continuously takes measurements of channel 0 in slot 1, using the voltmeter in slot 6, and displays the results on the front panel. Note that the voltmeter must first be configured with the CONF command for the MONMEAS command to work.

```
10 OUTPUT 709; "CONF THM10K,USE 600"           !Config for 10k thermocouple
20 OUTPUT 709; "MONMEAS THM10K,100,USE 600"     !Display results
30 END
```

A typical display on the front panel (temperature in degrees C) when an HP 44705A, HP 44706A, or HP 44708A multiplexer is used follows. You may want to touch the thermistor for 5 to 10 seconds and watch as the temperature changes on the display.



### NOTE

*The MONMEAS command locks the HP 3852A to this function. To enter another command, you must press the CLEAR key on the front panel or send the CLR (CLEAR) command over the HP-IB to release the display and allow new commands to be entered.*

### Scanning Measurements

By changing the CONFMEAS *ch\_list* parameter in a different way, you can scan channels (channels do NOT have to be sequential). For example, the command CONFMEAS THM10K, 100-103, 105, 107-109, USE 600 measures the temperature of channels 0 through 3, channel 5, and channels 7 through 9 of a multiplexer in slot 1 of the mainframe, using the voltmeter in slot 6 of the mainframe.

As an example of sequential scanning measurements, the following program scans channels 0 through 9 of a multiplexer in slot 1, using the voltmeter in slot 6. If you ran the previous program using the MONMEAS command, press the CLEAR key on the front panel before running this program.

```

10 REAL Temp(0:9)                                !Dim REAL array Temp
20 OUTPUT 709;"CONFMEAS THM10K,100-109,USE 600"  !Conf/meas temp
30 PRINT "Channel          Temp (Deg C)"
40 PRINT
50 FOR I = 0 TO 9
60 ENTER 709;Temp(I)                              !Enter results
70 PRINT I;TAB(15);Temp(I)                        !Display results
80 NEXT I
90 END

```

A typical display (values in degrees C) when an HP 44705A, HP 44706A, or HP 44708A multiplexer is used follows. In channels 1 through 9, since no thermistor is connected, the value of 1.E+38 shows that the measurement is out of range for the voltmeter.

Also, when the program completes, the HP 3852A display shows the measurement function and channel number of the last channel measured (THM10K 109) in the left window and the measurement result for the channel (1.000000E+38) in the right window.

Channel	Temp (Deg C)
0	23.95675
1	1.E+38
2	1.E+38
3	1.E+38
4	1.E+38
5	1.E+38
6	1.E+38
7	1.E+38
8	1.E+38
9	1.E+38

## Counting/Control Exercises

This section includes three counting and control exercises. Exercise 4 counts and totals switch closures, Exercise 5 reads the state (open or closed) of a switch, and Exercise 6 controls the state (on or off) of an LED. Table 5-2 summarizes the three exercises and shows the accessories used.

**Table 5-2. Counting/Control Exercises**

Exercise	Title	Description
4	Count Switch Closures	Count and totalize number of switch closures using HP 44715A 5-Channel Counter/Totalizer.
5	Read Switch State	Read state (open or closed) of a switch using HP 44721A 16-Channel Digital Input.
6	Light an LED	Control the state (on or off) of an LED using HP 44724A 16-Channel Digital Output.

## **Exercise 4: Count Switch Closures**

In this exercise, we'll count and totalize the number of switch closures using an HP 44715A 5-Channel Counter.

### **Equipment Required**

- HP 44715A 5-Channel Counter
- HP 3852A Getting Started Kit

### **Connections**

See Figure 5-8 and use the following steps to configure the HP 3852A for this exercise.

- Make sure LINE switch is OFF.
- Configure counter terminal module.
- Connect lead wires to CH 3 on terminal module.
- Replace terminal module cover.
- Connect terminal module to component module.
  
- Install counter in slot 4.
- Connect 9V battery, switch, and lead wires to breadboard.
- Place breadboard on top of HP 3852A mainframe.
- Press LINE switch ON.

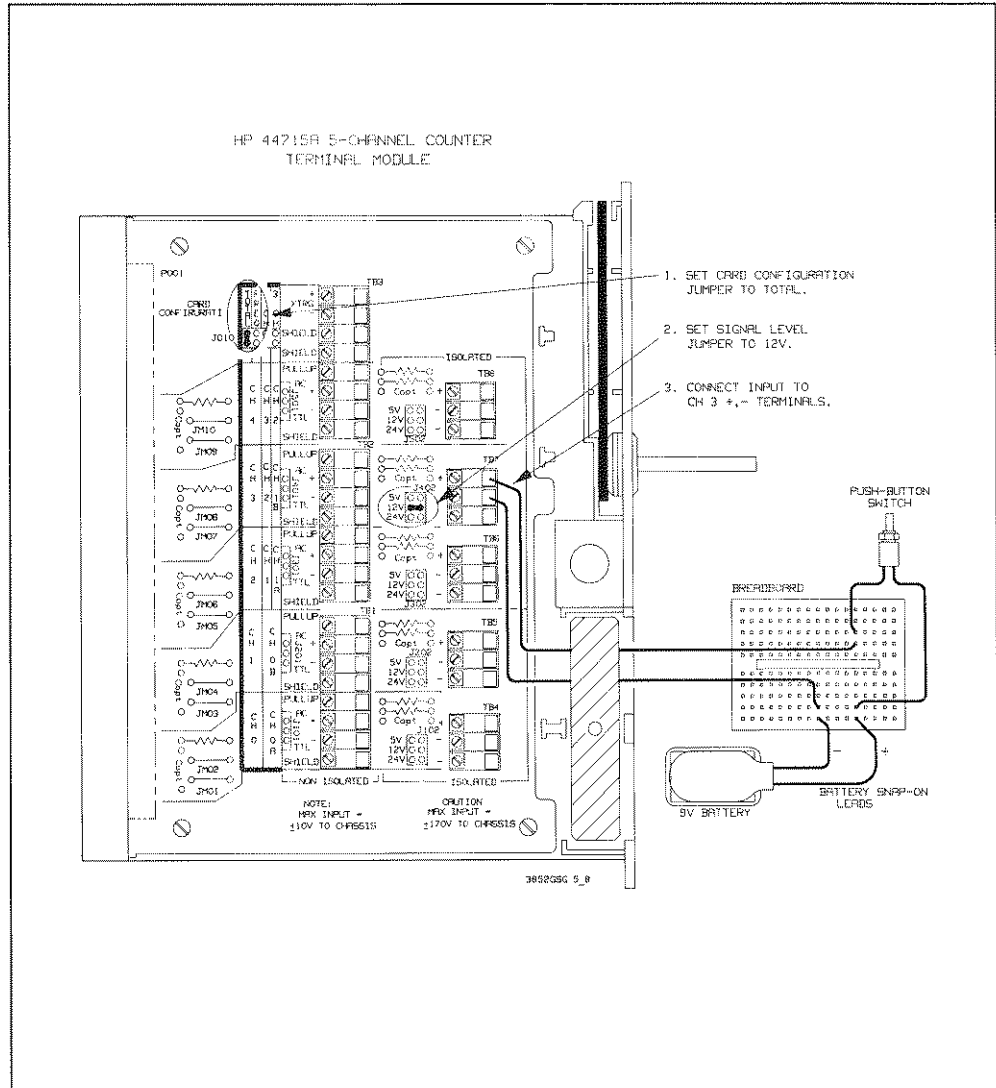

**Figure 5-8. Exercise 4: Count Switch Closures - Connections**

### Example Program

The HP 44715A counter has several functions. One important function is counting and totaling input events (states). The following program counts and totals the number of times a push-button switch is closed. The counter ignores the high-to-low switch transitions (switch openings).

In line 10, USE 403 sets channel 3 in slot 4 of the mainframe as the channel to use for the following commands. In line 20, TRIG HOLD ensures that the counter is not triggered before we're ready and EDGE LH sets the counter to count low-to-high input transitions (switch closures). In line 30, FUNC TOTAL sets the channel to total input counts and TRIG SGL single-triggers the counter.



---

## NOTE

*This program configures channel 3 of a counter in slot 4 of the mainframe to total switch closures, waits 5 seconds, then displays the total count. To see how the program operates, you may want to press the push-button switch as many times as you can during the 5 second wait time.*

---

```
10 OUTPUT 709;"USE 403"           !Use channel 3
20 OUTPUT 709;"TRIG HOLD;EDGE LH" !Set trig hold, LH transitions
30 OUTPUT 709;"FUNC TOTAL;TRIG SGL" !TOTAL function, single-trigger
40 WAIT 5                          !Wait 5 seconds
50 OUTPUT 709;"CHREAD 403"        !Read channel counts
60 ENTER 709;Counts               !Enter counts
70 PRINT "Counts on channel 3 = ";Counts !Display counts
80 END
```

A typical readout when the push-button switch is pressed seven times follows. You may get a reading which appears to be greater than the number of times you pushed the switch. This is not an error in the instrument, but is due to switch bounce which causes multiple closures with one push of the button.

```
Counts on channel 3 = 7
```

## Exercise 5: Read Switch State

In this exercise, we'll use the HP 44721A 16-Channel Digital Input to sense the state (open or closed) of a switch.

### Equipment Required

- HP 44721A 16-Channel Digital Input
- HP 3852A Getting Started Kit

## Connections

See Figure 5-9 and use the following steps to configure the HP 3852A for this exercise.

- Make sure LINE switch is OFF.
- Configure digital input terminal module.
- Replace terminal module cover.
- Connect terminal module to component module.
  
- Install digital input in slot 3.
- Connect 9V battery, switch, and lead wires to breadboard.
- Place breadboard on top of HP 3852A mainframe.
- Press LINE switch ON.

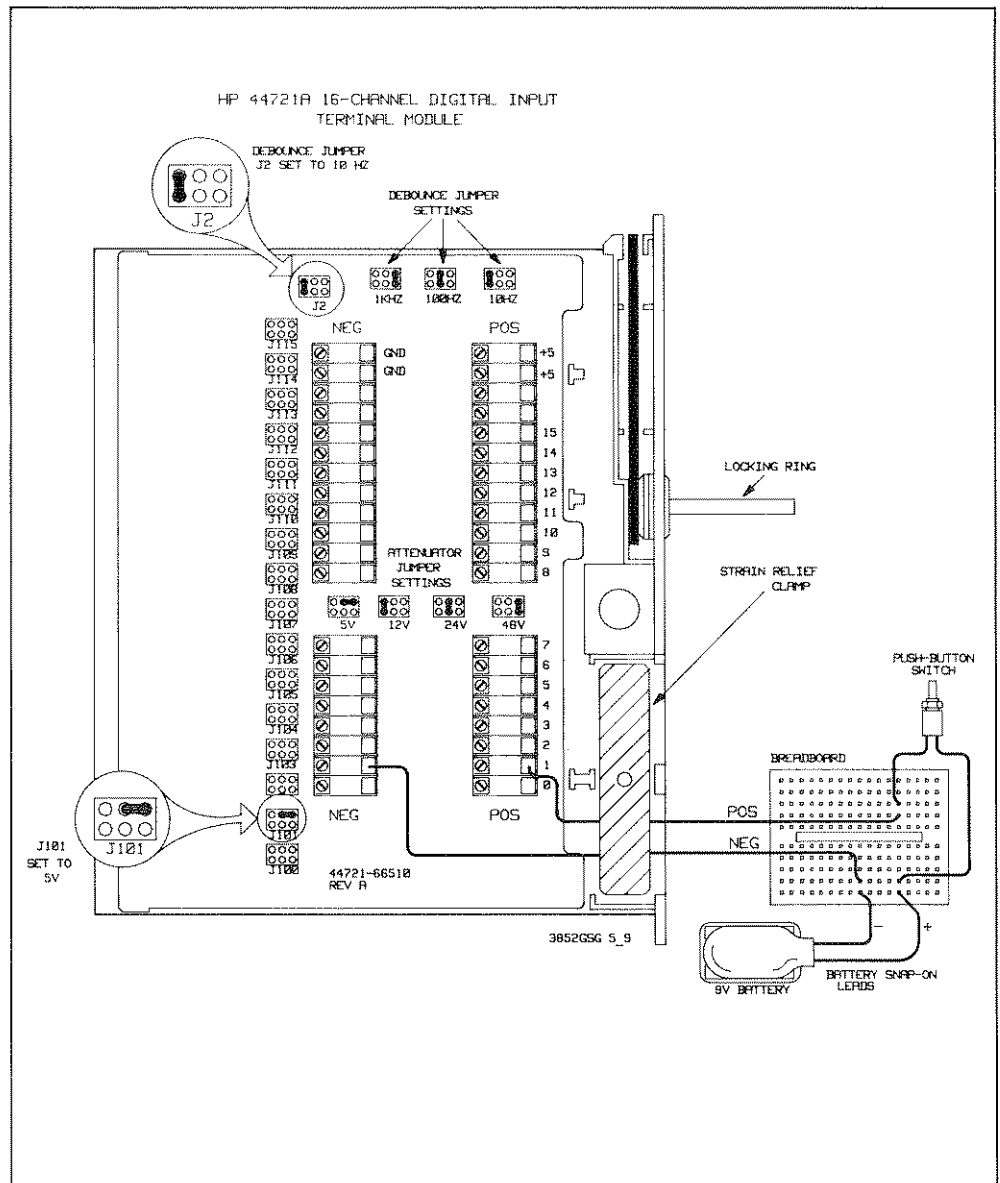

Figure 5-9. Exercise 5: Read Switch State - Connections

### Example Program

This program reads the state (open or closed) of the push-button switch connected to channel 1 of a digital input accessory in slot 3. Since each channel of a digital input has both a counting function and a sensing function, line 10 of the program uses the logical channel number 17 to sense the state of channel 1. (CHREAD 301 would read the number of counts on channel 1.)

You may want to first run the program with the push-button switch open, then hold the switch closed and run the program again. When the switch is open, the program returns a "0". When the switch is closed, the program returns a "1".

```
10 OUTPUT 709;"CHREAD 317"           !Read ch 1 state
20 ENTER 709;State                     !Enter state
30 PRINT "Channel 1 switch state = ";State !Display state
40 END
```

A typical display when the push-button switch is closed is:

```
Channel 1 switch state = 1
```

## **Exercise 6: Light an LED**

In this exercise, we'll use the HP 44724A 16-Channel Digital Output to act as a switch to turn an LED on and off.

### **Equipment Required**

- HP 44724A 16-Channel Digital Output
- HP 3852A Getting Started Kit

### **Connections**

See Figure 5-10 and use the following steps to configure the HP 3852A for this exercise.

- Make sure LINE switch is OFF.
- Connect lead wires to digital output terminal module.
- Replace terminal module cover.
- Connect terminal module to component module.
  
- Install digital output in slot 2.
- Connect LED, resistor, battery, and lead wires to breadboard.
- Place breadboard on top of HP 3852A mainframe.
- Press LINE switch ON.

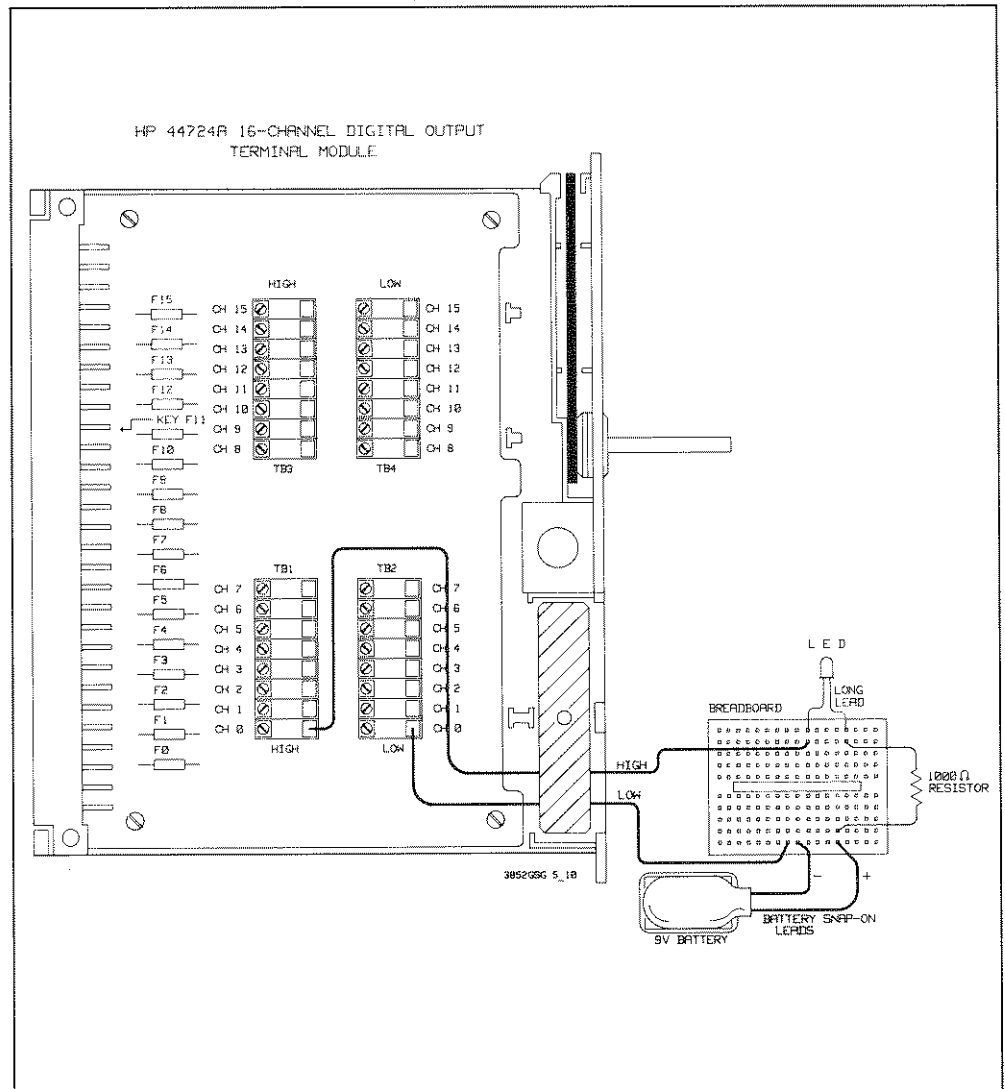

**Figure 5-10. Exercise 6: Light an LED - Connections**

### Example Program

The following program uses the CLOSE command to close channel 0 (turns the LED on), waits 1 second, and then uses the OPEN command to open the channel (turns the LED off). The cycle is repeated 5 times.

```

10 FOR I = 1 TO 5
20 OUTPUT 709;"CLOSE 200"           !Close channel 0 in slot 2
30 WAIT 1                          !Wait 1 second
40 OUTPUT 709;"OPEN 200"           !Open channel 0
50 WAIT 1                          !Wait 1 second
60 NEXT I
70 END

```



# **Chapter 6**

## **Managing Data**

# CONTENTS

	Page
Introduction .....	6-1
Data Destinations and Formats .....	6-3
Data Destinations .....	6-3
Data Formats .....	6-3
Example 4: Changing Data Formats .....	6-4
Storing Data in Memory .....	6-6
Declaring Variables and Arrays .....	6-6
Example 5: Declaring Arrays and Variables .....	6-7
Entering Data Into Memory .....	6-7
Example 6: Enter Address Into Memory .....	6-7
Reading/Writing Stored Data .....	6-8
Reading Data in Memory .....	6-8
Example 7: Reading Stored Address .....	6-9
Writing Data to Memory .....	6-9
Example 8: Writing Data to Memory .....	6-9
Downloading Subroutines .....	6-10
Subroutine Definitions .....	6-10
Example 9: Downloading Subroutine .....	6-11



## Introduction

In the previous chapters, all data was returned to the controller or to the front panel. However, you can also store data in the HP 3852A mainframe memory and you can download subroutines from your controller to the mainframe memory.

This chapter defines HP 3852A data destinations and formats, shows how to store data in mainframe memory, and introduces ways to use subroutines. The chapter also shows how to write data directly to memory and how to read data stored in memory.

Figure 6-1 summarizes the main data management topics covered in this chapter. You may want to refer back to this figure as you read through each topic.

**Data Destination and Formats**

**Data Destinations:**

Data is stored in mainframe memory when [INTO name] parameter used. When [fmt] parameter used, data is output to HP-IB in format specified by [fmt].

**Data Formats:**

HP 3852A uses ASCII (DASC, RASC, LASC, and IASC) and binary (PACK, RL64, and IN16) formats.

**Storing Data In Memory**

**Declaring Variables and Arrays:**

Declare variables and arrays in mainframe memory with DIM, REAL, INTEGER, and PACKED commands.

**Entering Data Into Memory:**

Enter data into memory by using the INTO name] parameter. Data is entered into variable or array previously declared by the DIM, REAL, INTEGER, or PACKED command.

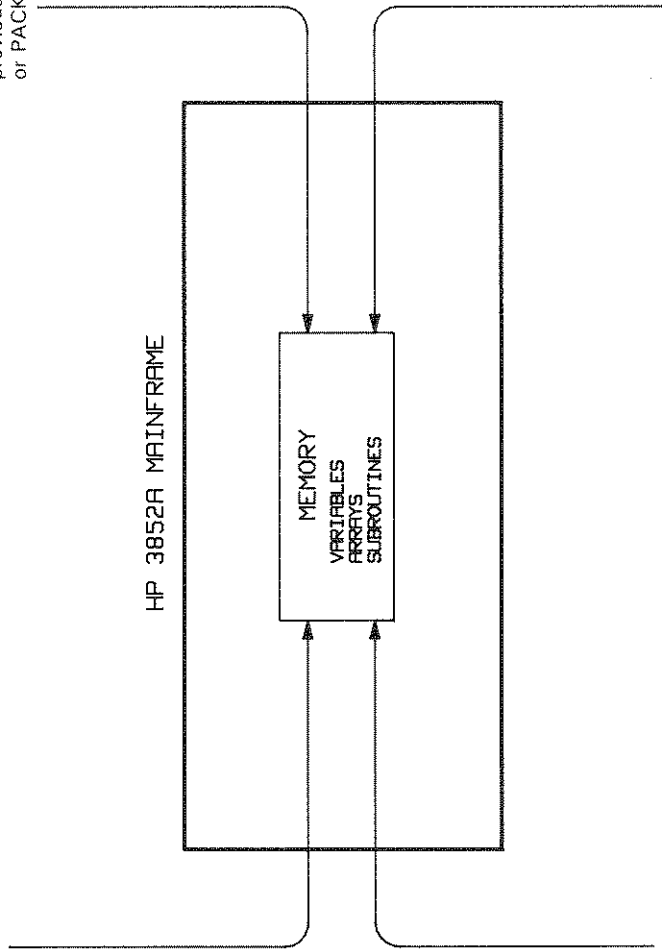

**Reading/Writing Stored Data**

**Reading Data in Memory:**

Use VREAD command to read array, array element, or variable value.

**Writing Data to Memory:**

Use the VWRITE command to write data to an array, array element, or variable. Use the [LET] command to assign a value to an array element or variable. Variables and arrays must be previously declared with the DIM, REAL, and INTEGER commands. VWRITE and [LET] do not work with PACKED arrays.

**Downloading Subroutines**

Define subroutines with the SUB and SUBEND commands. Use the CALL command to execute downloaded subroutine.

**Figure 6-1. Mainframe Data Management**

# Data Destinations and Formats

Before we begin discussing HP 3852A data management, we'll first look at data destinations and formats.

## Data Destinations

Many HP 3852A commands which return data have optional [INTO *name*] or [*fmt*] parameters. These optional parameters can be used to specify data formats or destinations. For example, the full syntax for the ADDR? command is ADDR? *ch* [INTO *name*] or [*fmt*].

You can specify the [INTO *name*] or the [*fmt*] parameter or no parameter (as we did for all the previous example programs). As shown in Table 6-1, if you specify the [INTO *name*] parameter, data is stored in mainframe memory in one of three binary types (INTEGER, REAL, or PACKED).

If you specify the [*fmt*] parameter, the data is not stored in memory but is converted to the format specified. If the command is entered from the front panel, the data is returned to the display in the format specified. If the command is sent over the HP-IB, the data is returned to the HP-IB output buffer and display. Note that only ASCII formats (IASC, LASC, RASC, DASC) can be displayed by the HP 3852A and only binary formats (IN16, RL64, PACK) are stored. Data in any of the seven formats, however, can be returned to the output buffer.

Table 6-1. HP 3852A Data Destinations/Formats

Parameter	Data Destination	Data Format
[INTO <i>name</i> ]	Stored in mainframe memory in variable or array declared by DIM, REAL, INTEGER, or PACKED command.	INTEGER, REAL, or PACKED.
[ <i>fmt</i> ]	ASCII formatted data sent to HP-IB output buffer if command is issued over the HP-IB. Also displayed on front panel. Binary data sent to HP-IB output buffer only.	Binary (RL64, IN16, or PACK) or ASCII (DASC, IASC, LASC, or RASC) as set by [ <i>fmt</i> ] parameter.
none	Sent in default format to HP-IB output buffer if command is issued over the HP-IB. ASCII formats are also displayed on front panel. Binary formats are not displayed.	Default format (usually one of the ASCII formats)

## Data Formats

The HP 3852A uses two types of data formats: ASCII and binary. ASCII formats are IASC, DASC, LASC, and RASC and binary formats are RL64, IN16, and PACK. Table 6-2 shows each of these formats and their representations.

Table 6-2. HP 3852A Data Formats

Format	Name	Representation
<b>ASCII</b>		
IASC	Short Integer	$\pm 12345$
LASC	Long Integer	$\pm 1234567890$
RASC	Real Number	$\pm 1.234567E + 12$
DASC	Double Real Number	$\pm 1.234567890123456E + 123$
<b>Binary</b>		
PACK	Packed	Depends on accessory
RL64	64-Bit Real	
IN16	16-Bit 2's Complement integer	

**Example 4:  
Changing  
Data  
Formats**

From Table 6-2, note that the HP 3852A can output data in one of seven formats: four ASCII (IASC, LASC, RASC, or DASC) or three binary (RL64, IN16, or PACK). In this example, we'll store a number in REAL (RL64) type and return the data in the six different formats to show how the instrument handles format conversions. In the next section, "Storing Data in Memory," we'll show how to define mainframe memory storage.

**NOTE**

*PACK is not a fixed format. The specific format depends on the command requesting data and on the plug-in accessory returning data. For this reason, the following program does not return a PACKed format. Refer to the HP 3852A Mainframe Configuration and Programming Manual for a discussion of PACK formats.*

```

10 DIM Ascii_data$(23)
20 OUTPUT 709;"RST" !Reset HP 3852A
30 OUTPUT 709;"REAL A" !Declares A as REAL (RL64) variable
40 OUTPUT 709;"A = 255.6789" !Stores 255.6789 in A
50 OUTPUT 709;"VREAD A, IASC" !Converts REAL to IASC format
60 ENTER 709;Ascii_data$ !Enter data in IASC format
70 PRINT "IASC Format =";Ascii_data$ !Print data in IASC format
80 OUTPUT 709;"VREAD A, LASC" !Converts REAL to LASC format
90 ENTER 709;Ascii_data$
100 PRINT "LASC Format =";Ascii_data$
110 OUTPUT 709;"VREAD A, RASC" !Converts REAL to RASC format
120 ENTER 709;Ascii_data$
130 PRINT "RASC Format =";Ascii_data$
140 OUTPUT 709;"VREAD A, DASC" !Converts REAL to DASC format
150 ENTER 709;Ascii_data$
160 PRINT "DASC Format =";Ascii_data$
170 ASSIGN @HP 3852 TO 709;FORMAT OFF !Causes HP 200/300 to expect binary
180 REAL RI64
190 OUTPUT 709;"VREAD A, RL64" !Reads A in REAL format
200 ENTER @HP 3852;RI64
210 PRINT "REAL Format =";RI64
220 OUTPUT 709;"VREAD A, IN16" !Converts REAL to INTEGER format
230 INTEGER In16
240 ENTER @HP 3852;In16
250 PRINT "INTEGER Format =";In16
260 END

```

A typical display for the six formats follows:

```

IASC Format = 256
LASC Format = 256
RASC Format = 2.556789E+02
DASC Format = 2.55678900000000E+002
REAL Format = 255.6789
INTEGER Format = 256

```

# Storing Data in Memory

From Figure 6-1, we noted that data is sent to the mainframe memory when the command requesting data uses the [INTO *name*] parameter. However, to actually store the data in memory, you must first declare an array or a variable.

## Declaring Variables and Arrays

To store data in mainframe memory, you must first declare an array variable or a scalar variable (which we'll call arrays and variables, respectively) with a DIM, REAL, INTEGER, or PACKED command. Then, when INTO *name* is specified in a command, the data is stored in the array or variable *name*.

The name of the array and its maximum index (*max\_\_index*) are specified by the DIM, REAL, INTEGER, and PACKED commands. The maximum index of REAL and INTEGER arrays is the maximum number of readings that can be stored in the array. The maximum index of a PACKED array is the number of bytes required to store a given number of readings in the desired packed format.

Arrays declared by the DIM, REAL, INTEGER, and PACKED commands have a starting index of 0. This means element 0 (or byte 0 for PACKED arrays) is the first element in the array. Thus, for example, a REAL array with a maximum index of 9 can store 10 readings (elements 0 through 9).

The DIM and REAL commands declare REAL variables and arrays and have the following syntax:

```
DIM name (max__index) [name (max__index)]
```

```
REAL name [(max__index)] [name [(max__index)]...]
```

Note that DIM declares arrays only. Executing REAL without specifying *max\_\_index* declares a REAL variable. More than one variable, array, or combination can be declared with a single DIM or REAL command.

The INTEGER command declares INTEGER variables and arrays. The INTEGER command has the syntax:

```
INTEGER name [(max__index)] [name [(max__index)]...]
```

Executing INTEGER without *max\_\_index* declares an INTEGER variable. More than one variable, array, or combination can be declared with a single INTEGER command.

The PACKED command declares PACKED arrays only. The syntax of the PACKED command is:

```
PACKED name (max__index) [name (max__index)]
```

More than one array can be declared with a single PACKED command.

When specifying the *max\_\_index* of a PACKED array, you should first determine the number of bytes/reading for the packed format you plan to store (see Chapter 6 in the Mainframe Manual). Then, given the number of readings you plan to take, you multiply that number by the bytes/reading of the format, which equals the minimum number of bytes you need to specify for the maximum index.

An example follows showing how various arrays and variables are declared.

### Example 5: Declaring Arrays and Variables

The following program lines declare variables and arrays. Line 100 declares a REAL array of 11 elements, line 110 declares a REAL variable B, line 120 declares an INTEGER variable C, and line 130 declares a PACKED array of 100 bytes.

```
100 OUTPUT 709;"DIM A (10)"           !Declares REAL array A of 11 elements
110 OUTPUT 709;"REAL B"               !Declares REAL variable B
120 OUTPUT 709;"INTEGER C"           !Declares INTEGER variable C
130 OUTPUT 709;"PACKED D (99)"       !Declares PACK array D of 100 bytes
```

### Entering Data Into Memory

An example of how data is entered into memory follows.

### Example 6: Enter Address Into Memory

In Example 1 (Chapter 4), we read the HP-IB address of the HP 3852A by using the ADDR? command but without using the [INTO *name*] or [*fmt*] parameters. Since these parameters were not used, data was returned directly to the controller and was not stored in mainframe memory. In this example, we'll store the address in the mainframe memory in INTEGER variable Adrs. In Example 7 (in the next section), we'll show how to read the address stored in the memory.

When this program executes, note that the ADDR? command appears in the left window display, but the data result (9) does NOT appear in the right display window as it would if ADDR? was sent without the [INTO *name*] parameter. This indicates the data has been stored internally.

```
10 OUTPUT 709;"INTEGER Adrs"         !Declares Adrs as INTEGER variable
20 OUTPUT 709;"ADDR? INTO Adrs"     !Stores address in variable Adrs
30 END
```

# Reading/Writing Stored Data

This part of the chapter shows how to read data stored in mainframe memory and how to write data to the memory.

## Reading Data in Memory

The command used to read the data in a variable or array is the VREAD command. The syntax of the VREAD command is:

**VREAD** *array* [*index*] or *variable* or *number* [**INTO** *name* ] or [*fmt*]

Based on the syntax, when *array* is specified the entire contents of the array are retrieved. When *array (index)* is specified, only the reading in the array element specified by *index* is retrieved. Specifying *variable* returns the value of the variable. When *number* is specified, the numeric expression is evaluated.

Notice the VREAD command also contains the [**INTO** *name*] parameter. This means that the contents of an entire array or specific array element can be copied to another array. Variables can be transferred also. You can transfer data from one REAL array to another, or from a REAL array to an INTEGER array. The same applies to INTEGER arrays. Data in a PACKED array can be transferred to another PACKED array or to a REAL/INTEGER array. When *number* is specified, the result of the expression after it has been evaluated is stored.

When the [*fmt*] parameter is specified in the VREAD command, the data is retrieved from the buffer and converted to that particular format. If the VREAD command is entered from the front panel, the data is returned to the front panel. If the command is entered over the HP-IB, the data is returned to the display and the HP-IB output buffer.

Since [**INTO** *name*] and [*fmt*] are optional parameters, if neither is specified the data is returned in the default format RASC to either the HP-IB output buffer and/or display depending on where the VREAD command was issued.



## Example 7: Reading Stored Address

In Example 6, we stored the HP 3852A HP-IB address (9) in mainframe memory in variable Adrs. In this example, we'll repeat storing the address and then read the address with the VREAD command.

When this program executes, 9 is displayed on the controller CRT. The front panel displays VREAD in the left window and 9.000000E+00 in the right window.

```
10 OUTPUT 709;"INTEGER Adrs"           !Declares Adrs as INTEGER variable
20 OUTPUT 709;"ADDR? INTO Adrs"        !Store HP-IB address into Adrs
30 OUTPUT 709;"VREAD Adrs"            !Read contents of Adrs
40 ENTER 709;Address                    !Enter Adrs contents
50 PRINT Address                        !Display Adrs contents
60 END
```

## Writing Data to Memory

In the previous section we mentioned that you could use the VREAD command to transfer data from one array to another. Data can also be written to an array or variable using the VWRITE and [LET] commands whose syntax is given below:

**VWRITE** *array item\_\_list* or *array (index) number* or *array(d) [(index)]*  
*array(s) [(index)]* or *variable number* or *variable(d) variable(s)*

**[LET]** *variable* or *array (index)* = *number*

When *array item\_\_list* is specified in the VWRITE command, the data in the item list is written to elements in the array. VWRITE can also write data to a single array element (*array (index) number*) or variable (*variable number*). Notice from the syntax that you can transfer data between arrays (*array(d) [(index)] array(s) [(index)]*) and variables (*variable(d) variable(s)*), where (*d*) is the destination array/variable and (*s*) is the source array/variable.

The [LET] command enables you to assign a value (*number*) to a specific array element (*array(index)*) or variable (*variable*). The command header LET is optional. Thus the command can be executed as *variable* or *array (index) = number*.

Example 8 shows how the VWRITE command is used to write data to an array.

## Example 8: Writing Data to Memory

In this example, we'll declare A as a 10 element REAL array and store data in specific elements of the array. Then, we'll use the VREAD command to retrieve the data.

10 DIM B (0:9)	!Dimension B for 10 elements
20 OUTPUT 709;"RST"	!Reset HP 3852A
30 OUTPUT 709;"REAL A (9)"	!Declare REAL array A of 10 elements
40 OUTPUT 709;"VWRITE A, 1.2"	!Write 1.2 to element A(0)
50 OUTPUT 709;"VWRITE A (3), 3.4"	!Write 3.4 to element A(3)
60 OUTPUT 709;"VWRITE A, 4.5"	!Write 4.5 to element A(4)
70 OUTPUT 709;"VREAD A"	!Read all elements of array A
80 ENTER 709;B(*)	!Enter array A values into B
90 PRINT B(*)	!Display array A values
100 END	

When this program executes, the data displayed on the controller CRT is:

```

1.2  0  0  3.4  4.5  0  0  0
0    0

```

As expected, line 40 stores 1.2 in element 0 (the starting element) of array A, and line 50 stores 3.4 in element 3 of the array. Notice that line 60 writes 4.5 to array element 4. This is because every array declared in the mainframe contains an index pointer. The index pointer indicates the next element in the array in which data will be stored and is shifted each time data is stored in an element.

## Downloading Subroutines

In addition to storing data in memory, you can also download subroutines into memory. Subroutines, variables, and arrays all share memory space.

### Subroutine Definitions

An efficient way to use the HP 3852A for repetitive tasks or to perform a specialized task on request is to download a subroutine into the mainframe memory. The subroutine will remain in memory until deleted (scratched) or until a RST (reset) command is issued or power is cycled.

The commands used for downloading and calling subroutines are SUB, SUBEND, CALL, and ON. The syntax of each command is given below:

```

SUB name
SUBEND
CALL name [number]
ON event CALL name

```

The first line of a subroutine must begin with the SUB command where *name* is the name of the subroutine. The last line of the subroutine must be the SUBEND command.

The CALL command is used to execute the subroutine. *name* is the subroutine that is called and *number* is the number of times it is called. If number is not specified, the subroutine is called once. Subroutines are also called with the ON command. This command is used to call a subroutine after an interrupt (*event*) has occurred.

Data generated by a subroutine is returned to where the CALL or ON command originated (front panel, HP-IB). Also, it should be noted that all arrays and variables are global. Thus, arrays and variables declared inside a subroutine can be used outside a subroutine or within another subroutine, and vice versa.

### Example 9: Downloading Subroutine

In this example program, the subroutine BEEPER is downloaded into the HP 3852A mainframe memory and is executed (the HP 3852A beeps once) when the CALL BEEPER command is issued (5 seconds after the subroutine is downloaded).

---

#### NOTE

*If you try to run the following program twice without erasing BEEPER after it executes the first time, two errors will occur: ERROR 59: SUB ALREADY EXISTS and ERROR 5: SUBEND WITHOUT SUB. The first error occurs because the subroutine BEEPER is already defined. The second error occurs because the mainframe recognizes the SUBEND command but not SUB since the name has been defined.*

---

10 OUTPUT 709;"SUB BEEPER"	!Create subroutine BEEPER
20 OUTPUT 709;"BEEP"	
30 OUTPUT 709;"SUBEND"	!End of subroutine
40 WAIT 5	!Wait 5 seconds
50 OUTPUT 709;"CALL BEEPER"	!Call BEEPER - HP 3852A BEEPS once
60 END	



**Chapter 7**  
**The Manual Set**

# CONTENTS

	Page
Introduction .....	7-1
Manual Set Description .....	7-1

# The Manual Set

---

---

## Introduction

You have now completed the getting started sequence for the HP 3852A. You have had an opportunity to learn about some of the HP 3852A's features and how the instrument is operated. The manual also presented several measurement and control exercises.

This chapter introduces the rest of the HP 3852A manual set and briefly describes the content of each manual.

## Manual Set Description

As shown in Chapter 1 (Table 1-1), the HP 3852A manual set consists of reference manuals and guides. Reference manuals include the Mainframe Configuration and Programming Manual, The Command Reference Manual, the individual plug-in accessory manuals, and the Assembly Level Service Manual. The guides include the Getting Started Guide and the Quick Reference Guide.

A brief description of each manual and guide in the set follows. You may want to review the table of contents of the manual for more information on what it contains.

## **Mainframe Configuration and Programming Manual**

The mainframe manual covers HP 3852A installation, front panel operation, and HP-IB programming. The manual also includes information on data management and storage; methods of data acquisition, timing, pacing, and interrupts; data processing; and system status and identification.

## **Plug-In Accessory Manuals**

The plug-in accessory manuals contain configuration and programming information for a specific plug-in accessory. In certain instances, similar accessories are covered in the same manual such as the HP 44705A, HP 44705H, HP 44706A, HP 44708A, and HP 44708H. (Table 1-1 identifies the accessories covered by the respective manuals.) The manuals are "stand alone" regarding accessory description, configuration, programming, and applications. The manuals will generally have to be used with the mainframe manual when data management, data processing, etc., is involved.

## **Command Reference Manual**

The command reference manual contains an alphabetical listing of all commands in the HP 3852A command set. Each command includes a description, prerequisites, command syntax and parameters, remarks, and typical program examples. The manual also includes a summary of commands by function, a glossary of terms, and a list of error messages.

## **Quick Reference Guide**

The quick reference guide is divided into nine main sections: Addressing Conventions, Syntax Rules, Using Subroutines, Data Destinations and Formats, Command Reference, Commands by Functional Group, Using Interrupts, Useful Tables, and Error Messages. Each section contains reference information in a summary format.



## **Getting Started Guide**

This guide shows how to get started using the HP 3852A and how to make some simple measurements. It includes initial setup, front panel operation, introductory programming, some measurement and control exercises, and introduction to data management.

## **Assembly Level Service Manual**

This manual has two main sections: mainframe and plug-in accessories. Chapters 1 through 5 discuss operating information, performance tests, replaceable parts, and problem isolation for the HP 3852A mainframe and HP 3853A extenders. Each accessory chapter (6 through 18) contains a technical description of the accessory, specifications, performance tests, and assembly level replaceable parts lists.

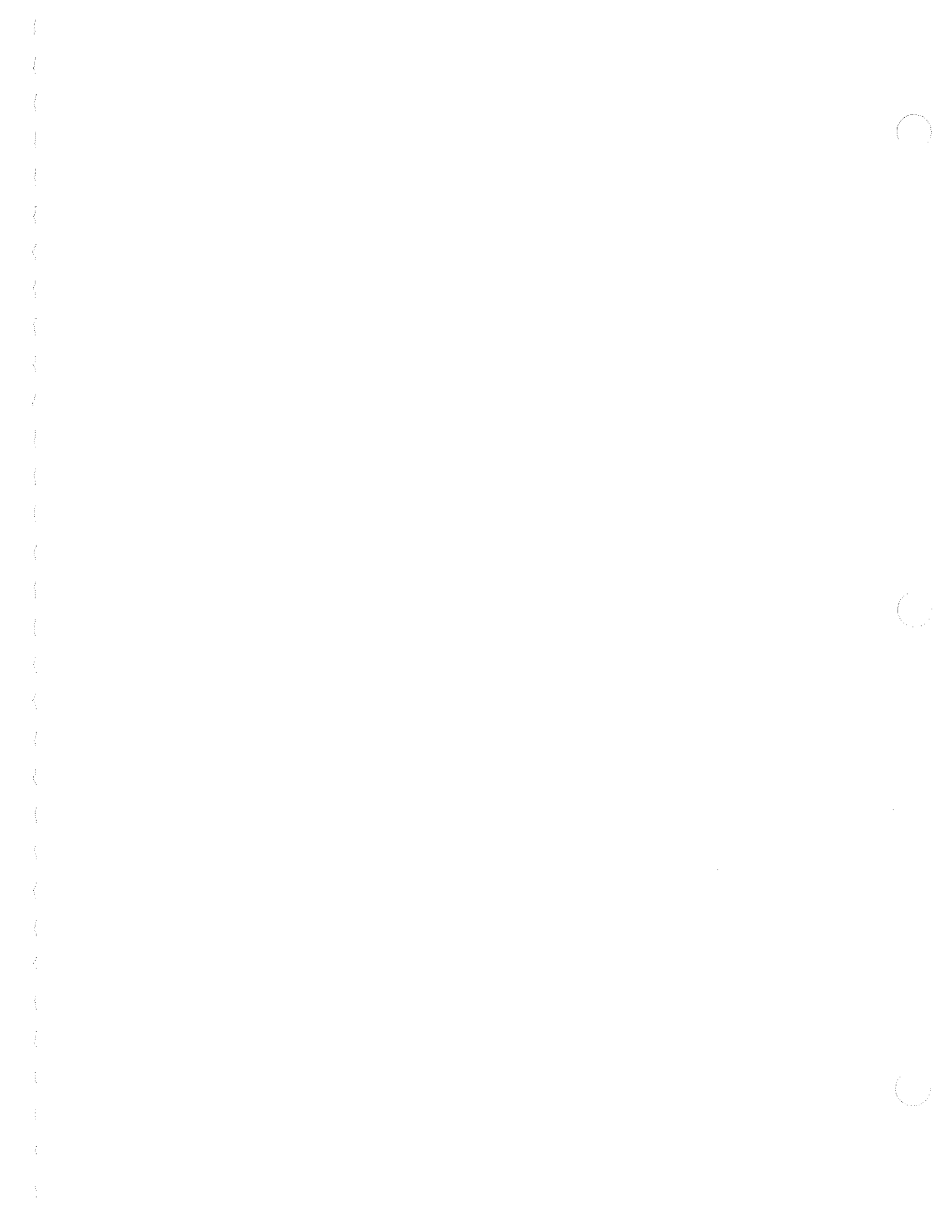

## **Index**

# CONTENTS

	Page
Index .....	I-I

# INDEX

- Accessories:
  - installing, 5-5
  - plug-in, 1-7
- Address:
  - check HP 3852A, 4-6
  - reading stored, 6-9
- Addressing, HP 3852A, 4-2
- Arrays/variables, declaring, 6-6
- Arrays, declaring variables and, 6-6
- Cable, connect HP-IB, 2-3
- Cartons:
  - unpack mainframe, 1-3
  - unpack accessories, 1-3
- Changing data formats, 6-4
- Check:
  - HP 3852A address, 4-5
  - line selector switch, 2-1
  - mainframe ID, 4-5
- Checking HP-IB communication, 2-4
- Checkout, system, 2-4
- Command format, 3-3, 4-3
- Commands, entering, 3-3
- Communication, HP-IB, 4-1
- Connect HP-IB cable, 2-3
- Connecting field wiring, 5-2
- Control, display, 3-6
- Cord, install AC power, 2-3
- Correcting entry errors, 3-8
- Counting/control exercises, 5-26
- Data:
  - destinations, 6-3
  - formats, 6-3
- Data formats, changing, 6-4
- Declaring variables and arrays, 6-6
- Definitions, subroutine, 6-10
- Description:
  - HP 3852A, 1-7
  - manual set, 7-1
- Destinations, data, 6-3
- Display control, 3-6
- Downloading subroutines, 6-10
- Enter address into memory, 6-7
- Entering:
  - commands, 3-3
  - data into memory, 6-7
  - numbers, 3-6
- Entries, shifted/unshifted, 3-3
- Entry errors, correcting, 3-8
- Equipment, inspect, 1-6
- Example 1: check HP 3852A address, 4-5
- Example 2: check mainframe ID, 4-5
- Example 3: HP 3852A self-test, 4-6
- Example 4: changing data formats, 6-4
- Example 5: declaring arrays/variables, 6-6
- Example 6: enter address in memory, 6-7
- Example 7: reading stored address, 6-9
- Example 8: writing data to memory, 6-9
- Example 9: downloading subroutine, 6-11
- Examples, programming, 4-5
- Exercise 1: voltage measurements, 5-8
- Exercise 2: resistance measurements, 5-15
- Exercise 3: temperature measurements, 5-20
- Exercise 4: count switch closures, 5-27
- Exercise 5: read switch state, 5-29
- Exercise 6: light an LED, 5-32
- Exercises:
  - counting/control, 5-26
  - measurement, 5-8
  - setting up for, 5-2
- Extender, HP 3853A, 1-7
- Field wiring, connecting, 5-2
- Format, command, 3-3, 4-3
- Formats, data, 6-3
- Front panel tour, 3-1
- Fuse, install, 2-3
- Getting started sequence, 1-2
- HP-IB:
  - communication, 4-1
  - checking, 2-4
- HP 3852A:
  - addressing, 4-2
  - description, 1-7
  - mainframe, 1-7
  - self-test, 4-6
- HP 3853A extender, 1-7
- ID, check mainframe, 4-5
- Initial setup, 2-1
- Inspect equipment, 1-6
- Inspection, unpacking and, 1-3
- Install:
  - AC power cord, 2-3
  - fuse, 2-3
- Installing accessories, 5-5
- Keyboard, 3-1
- Light an LED, 5-32
- Mainframe, HP 3852A, 1-7
- Manual set:
  - description, 7-1
- Measurement exercises, 5-8
- Measurements:
  - resistance, 5-15
  - temperature, 5-20
  - voltage, 5-8
- Memory:
  - enter address into, 6-7
  - entering data into, 6-7
  - reading data in, 6-8
  - storing data in, 6-6
  - writing data to, 6-9
- Numbers, entering, 3-6
- Overview, programming, 4-1
- Plug-in accessories, 1-7
- Power-on sequence, 2-4
- Programming:
  - examples, 4-5
  - overview, 4-1
- Read switch state, 5-29
- Reading/writing stored data, 6-8
- Reading:
  - data in memory, 6-8
  - stored address, 6-9
- Resistance measurements, 5-15
- Self-test, HP 3852A, 4-6
- Sequence:
  - getting started, 1-2
  - power-on, 2-4
- Setting up for exercises, 5-2
- Setup, initial, 2-1
- Shifted/unshifted entries, 3-3
- Stored data, reading/writing, 6-8
- Storing data in memory, 6-6
- Subroutine definitions, 6-10
- Subroutines, downloading, 6-10
- Switch, check line selector, 2-1
- Switch closures, count, 5-27
- Switch state, read, 5-29
- System checkout, 2-4
- Temperature measurements, 5-20
- Tour, front panel, 3-1
- Unpack:
  - accessories cartons, 1-3
  - mainframe carton, 1-3
  - manuals, 1-4
- Unpacking and inspection, 1-3
- Variables/arrays, declaring, 6-6
- Voltage measurements, 5-8
- Writing data to memory, 6-9

