

Agilent 41800A Active Probe

Operation Note

Third Edition

SERIAL NUMBERS

This manual applies directly to Agilent 41800A Active Probe with serial number prefix 2850J.

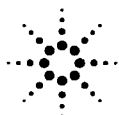

Agilent Technologies

Innovating the HP Way

Agilent Part No. 41800-90010

December 1999

Printed in Japan

Caution

The 41800A is sensitive to electrostatic discharge (ESD). The followings must be adhered to when using the 41800A.

- Do NOT touch the pin of the probe.
- Eliminate ESD on your body.
- Eliminate ESD on the work surface.
- Hold the probe by the protective sleeve.
- Do NOT introduce ESD into the DUT while the probe is in use.

Agilent 41800A Active Probe

MANUAL IDENTIFICATION

Model Number: Agilent 41800A
Date Printed: December 1999
Part Number: 41800-90010

Operation Note

This supplement contains information for correcting manual errors and for adapting the manual to newer instruments that contains improvements or modifications not documented in the existing manual.

To use this supplement

1. Make all ERRATA corrections
2. Make all appropriate serial-number-related changes listed below

SERIAL PREFIX OR NUMBER CHANGES	MAKE MANUAL
All	1

◆ New Item

SERIAL PREFIX OR NUMBER CHANGES	MAKE MANUAL

ERRATA

CHANGES 1

CHANGE 1 contains the information needed to adapt the 41800A's manual.

Page 1-5 Table 1-3. Specifications (2 of 3)

Change the 'Maximum Allowable Input (DC+AC):' as follows.

Maximum Allowable Input:

AC+DC: ± 40 V (probe alone)
AC: 0.5Vrms (probe alone)
AC: 0.5Vrms (with 1:1 divider)
AC: 5Vrms (with 10:1 divider)
AC: 30Vrms (with 100:1 divider)

NOTE

Manual change supplement are revised as often as necessary to keep manuals as current and accurate as possible. Agilent Technologies recommends that you periodically request the latest edition of this supplement. Free copies are available from all Agilent Technologies offices. When requesting copies, quote the manual identification information from your supplement, or the model number and print date from the title page of the manual.

Date/Div: December,1999/33

Page 1 of 1

PRINTED IN JAPAN

Notices

The information contained in this document is subject to change without notice.

This document contains proprietary information that is protected by copyright. All rights are reserved. No part of this document may be photocopied, reproduced, or translated to another language without the prior written consent of the Agilent Technologies.

Agilent Technologies Japan, Ltd.

Component Test PGU-Kobe

1-3-2, Murotani, Nishi-Ku, Kobe-shi, Hyogo, 651-2241 Japan

Copyright © Agilent Technologies Japan, Ltd. 1988,1998,1999

Manual Printing History

The manual's printing date and part number indicate its current edition. The printing date changes when a new edition is printed. (Minor corrections and updates that are incorporated at reprint do not cause the date to change.) The manual part number changes when extensive technical changes are incorporated.

December 1988 First Edition (part number: 41800-90000)

November 1998 Second Edition (part number: 41800-90010)

December 1999 Third Edition (part number: 41800-90010)

Safety Summary

The following general safety precautions must be observed during all phases of operation, service, and repair of this instrument. Failure to comply with these precautions or with specific WARNINGS elsewhere in this manual may impair the protection provided by the equipment. In addition it violates safety standards of design, manufacture, and intended use of the instrument.

Agilent Technologies assumes no liability for the customer's failure to comply with these requirements.

- **Ground The Instrument**

To avoid electric shock hazard, the instrument chassis and cabinet must be connected to a safety earth ground by the supplied power cable with earth blade.

- **DO NOT Operate In An Explosive Atmosphere**

Do not operate the instrument in the presence of flammable gasses or fumes. Operation of any electrical instrument in such an environment constitutes a definite safety hazard.

- DO NOT Substitute Parts Or Modify Instrument

Because of the danger of introducing additional hazards, do not install substitute parts or perform unauthorized modifications to the instrument. Return the instrument to a Agilent Technologies Sales and Service Office for service and repair to ensure that safety features are maintained.

- Dangerous Procedure Warnings

Warnings, such as the example below, precede potentially dangerous procedures throughout this manual. Instructions contained in the warnings must be followed.

Safety Symbol

General definitions of safety symbols used on the instrument or in manuals are listed below.



Instruction Manual symbol: the product is marked with this symbol when it is necessary for the user to refer to the instrument manual.



Alternating current.



Direct current.



On (Supply).



Off (Supply).



In position of push-button switch.



Out position of push-button switch.



Frame (or chassis) terminal. A connection to the frame (chassis) of the equipment which normally include all exposed metal structure.

WARNING

This warning sign denotes a hazard. It calls attention to a procedure, practice, condition or the like, which, if not correctly performed or adhered to, could result in injury or death to personnel.

CAUTION

This Caution sign denotes a hazard. It calls attention to a procedure, practice, condition or the like, which, if not correctly performed or adhered to, could result in damage to or destruction of part or all of the product.

NOTE

Note denotes important information. It calls attention to a procedure, practice, condition or the like, which is essential to highlight.

Certification

Agilent Technologies certifies that this product met its published specifications at the time of shipment from the factory. Agilent Technologies further certifies that its calibration measurements are traceable to the United States National Institute of Standards and Technology, to the extent allowed by the Institution's calibration facility, or to the calibration facilities of other International Standards Organization members.

Warranty

This Agilent Technologies instrument product is warranted against defects in material and workmanship for a period corresponding to the individual warranty periods of its component products. Instruments are warranted for a period of one year. Fixtures and adapters are warranted for a period of 90 days. During the warranty period, Agilent Technologies will, at its option, either repair or replace products that prove to be defective.

For warranty service or repair, this product must be returned to a service facility designated by Agilent Technologies. Buyer shall prepay shipping charges to Agilent Technologies and Agilent Technologies shall pay shipping charges to return the product to Buyer. However, Buyer shall pay all shipping charges, duties, and taxes for products returned to Agilent Technologies from another country.

Agilent Technologies warrants that its software and firmware designated by Agilent Technologies for use with an instrument will execute its programming instruction when properly installed on that instrument. Agilent Technologies does not warrant that the operation of the instrument, or software, or firmware will be uninterrupted or error free.

Limitation of Warranty

The foregoing warranty shall not apply to defects resulting from improper or inadequate maintenance by Buyer, Buyer-supplied software or interfacing, unauthorized modification or misuse, operation outside the environmental specifications for the product, or improper site preparation or maintenance.

IMPORTANT

No other warranty is expressed or implied. Agilent Technologies specifically disclaims the implied warranties of merchantability and fitness for a particular purpose.

Exclusive Remedies

The remedies provided herein are buyer's sole and exclusive remedies. Agilent

Technologies shall not be liable for any direct, indirect, special, incidental, or consequential damages, whether based on contract, tort, or any other legal theory.

Assistance

Product maintenance agreements and other customer assistance agreements are available for Agilent Technologies products.

For any assistance, contact your nearest Agilent Technologies Sales and Service Office. Addresses are provided at the back of this manual.

Typeface Conventions

Bold

Boldface type is used when a term is defined. For example: **icons** are symbols.

Italic

Italic type is used for emphasis and for titles of manuals and other publications.

[Hardkey]

Indicates a hardkey labeled "Hardkey."

Softkey

Indicates a softkey labeled "Softkey."

[Hardkey] - Softkey1 - Softkey2

Indicates keystrokes **[Hardkey] - Softkey1 - Softkey2**.

TABLE OF CONTENTS

SECTION 1:

GENERAL INFORMATION

INTRODUCTION	1-1
PRODUCT DESCRIPTION	1-1
COMPATIBLE INSTRUMENTS	1-1
SAFETY CONSIDERATIONS	1-1
UNITS COVERED BY THIS OPERATION NOTE	1-2
PRODUCT CONTENTS	1-3
SPECIFICATIONS	1-3
ACCESSORIES AVAILABLE	1-3

SECTION 2:

INSTALLATION

SECTION CONTENTS	2-1
INITIAL INSPECTION	2-1
POWER REQUIREMENTS	2-3
MATING CONNECTORS	2-3
ENVIRONMENTAL REQUIREMENTS	2-3
PACKAGING	2-4
Original Packaging	2-4
Other Packaging	2-4

SECTION 3:

OPERATION

SECTION CONTENTS	3-1
OVERVIEW	3-1
OPERATING PRECAUTIONS	3-5
Anti-static Precautions	3-5
Maximum Allowable Level	3-6
Discharging The Probe	3-6
PREPARATION FOR USE	3-7
Operating Check Using The HP 4195A	3-8
Operating Check Using Network Analyzer	3-10
Operating Check Using Spectrum Analyzer	3-11
10:1 / 100:1 Divider Adjustments	3-12
TYPICAL MEASUREMENT SETUPS	3-14
Network Measurements	3-15
Spectrum Measurements	3-18
PROBE PIN REPLACEMENT	3-20

SECTION 4: PERFORMANCE TEST

INTRODUCTION	4-1
EQUIPMENT REQUIRED	4-1
CALIBRATION CYCLE	4-2
PREPARATION	4-2
PROBE GAIN/FREQUENCY RESPONSE TESTS	4-3
1 dB GAIN COMPRESSION TEST	4-8

SECTION 5: ADJUSTMENTS

INTRODUCTION	5-1
EQUIPMENT REQUIRED	5-1
PREPARATION	5-1
LF GAIN/FLATNESS ADJUSTMENT	5-2

SECTION 6: SERVICE

INTRODUCTION	6-1
REPLACEABLE PARTS	6-1
DISASSEMBLY	6-5
THEORY OF OPERATION	6-10
TROUBLESHOOTING GUIDE	6-10

GENERAL INFORMATION

INTRODUCTION This section provides the specifications and the information necessary for receiving, performing an incoming inspection, and preparing the HP 41800A for use.

PRODUCT DESCRIPTION The HP 41800A is an Active Probe used with network and spectrum analyzers for circuit signal analysis. The following are the main features of the HP 41800A.

- Wide frequency range; 5 Hz to 500 MHz
- High input impedance; 100 k Ω , 3 pF
- Used for both spectrum and network analyzers
- Protective sleeve (to protect the probe tip from ESD and physical damage)

COMPATIBLE INSTRUMENTS The HP 41800A can be used with the spectrum and network analyzers listed in Table 1-1 which provide a probe power supply.

Table 1-1. Compatible instruments

Network/Spectrum Analyzer	Spectrum Analyzer	Network Analyzer
HP 4195A	HP 3585A/B HP 8568B HP 71100A	HP 3577A HP 8753A/B

SAFETY CONSIDERATIONS The HP 41800A Active Probe conforms to the safety requirements for IEC 348, and CSA 556B rated instruments, and is shipped from the factory in a safe condition. This operation note contains information, **CAUTIONS** and **WARNINGS** which must be followed by the user to ensure safe operation.

**UNITS COVERED BY
THIS OPERATION
NOTE**

Hewlett-Packard uses a two-part, nine character serial number which is stamped on the serial number plate (see Figure 1-1) attached to the probe. The first four digits and a letter are the prefix and the last five digits are the suffix of the serial number. The letter in the serial number identifies the country where the instrument was manufactured. The prefix is same for all identical instruments, it changes only when a change is made to the instrument. The suffix, however, is assigned sequentially and is different for each instrument. This operation note applies to instruments with serial number prefixes listed under **Serial Numbers** on the title page.



Figure 1-1. Serial Number Plate

Units manufactured after this operation note was printed may have a serial number prefix which is not listed on the title page. An unlisted serial number prefix indicates that the instrument may be different from those described in this operation note. Operation notes for new instruments may be accompanied by a yellow Manual Supplement page, or have a different part number. This supplement contains "Change Information" explaining how to adapt this operation note to newer instruments.

In addition to change information, the supplement may contain information for correcting errors (Errata) in previous operation notes. To keep this operation note as current and accurate as possible, Hewlett-Packard recommends that you periodically request the latest Manual Change supplements. The supplement for this operation note is identified by the **Print Date** and **Part Number**, both of which appear on the operation note's title page.

For information concerning the serial number prefixes not listed on the title page or in the Manual Change supplements, contact your nearest Hewlett-Packard sales office.

**PRODUCT
CONTENTS**

Table 1-2 lists the contents of the HP 41800A. Refer to Figure 2-1 for details.

Table 1-2. Contents of the HP 41800A

Description	Qty.
Probe Assembly	1
HP 10218A Probe-BNC (m) Adapter	1
10:1 Divider	1
100:1 Divider	1
Slip-on Spanner Ground Tip	1
Ground Clip (flexible)	1
Probe Tip Nut Driver (3/32 inch)	1
HP 10229A Hook Tip Adapter	1
Spare Probe Pin Set	1
Carrying Case	1

SPECIFICATIONS

The specifications for the HP 41800A Active Probe are listed in Table 1-3. The specifications are performance standards or limits. The HP 41800A meets all of the specifications listed in Table 1-3 when it is shipped from the factory.

**ACCESSORIES
AVAILABLE**

For making certain types of measurements and for convenience in connecting samples, the accessories listed in Table 1-4 are available.

Table 1-4. Available Accessories

Description	HP Model Number
Probe Power Supply	HP 1122A
N (m) Adapter	HP 11880A
Probe Power Divider	HP 41801A

Table 1-3. Specifications (1 of 3)

- Specifications describe the instrument's warranted performance over the temperature range of $23 \pm 5^\circ\text{C}$ (except where noted).
- The following performance is specified when the probe is terminated with an HP 11880A Type N Adapter.
- Supplemental characteristics are intended to provide information useful in applying the instrument by giving non-warranted performance parameters. These are denoted as "typical", "nominal", or "approximate".

Bandwidth: 5 Hz to 500 MHz

Probe Gain:

Probe Alone: 0 dB \pm 0.5 dB at 50 MHz
 With 10:1 Divider (Typical): -20 dB \pm 1 dB at 50 MHz
 With 100:1 Divider (Typical): -40 dB \pm 1.5 dB at 50 MHz

Input R, C (Typical):

Probe Alone: 100 K Ω , 3 pF
 With 10:1 Divider: 1 M Ω , 1.5 pF
 With 100:1 Divider: 1 M Ω , 1 pF

Frequency Response Relative to 50 MHz:

Probe Alone: +1/-2 dB at <50 Hz
 \pm 1 dB at 50 Hz to 200 MHz
 +1.5/-2 dB at >200 MHz
 With 10:1 Divider (Typical): +1.5/-2.5 dB at <50 Hz
 \pm 1.5 dB at 50 Hz to 200 MHz
 +2/-2.5 dB at >200 MHz
 With 100:1 Divider (Typical): +2/-3 dB at <50 Hz
 \pm 2 dB at 50 Hz to 200 MHz
 +2.5/-3 dB at >200 MHz

Table 1-3. Specifications (2 of 3)

Average Noise Level (Typical): 10 nV/ $\sqrt{\text{Hz}}$ at ≥ 300 kHz
 +3 dB/Oct at < 300 kHz
 (Refer to the following figure.)

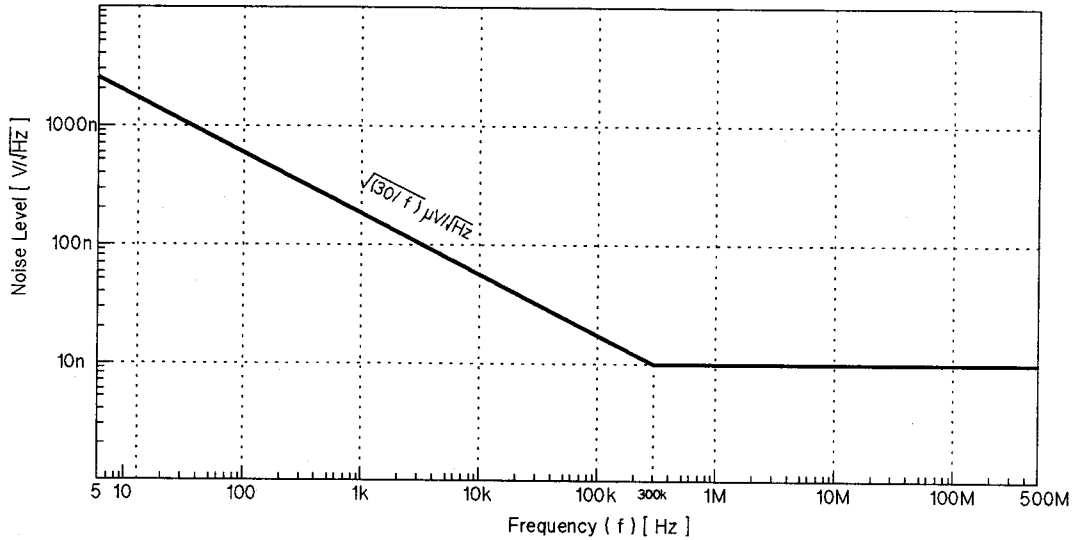

2nd Harmonic Distortion (Typical): < -50 dBc at -20 dBm (250 MHz) input

3rd Order Intermodulation Distortion (Typical): < -70 dBc at -26 dBm two signals input (400 MHz, 400.5 MHz)

1 dB Gain Compression: $> +3$ dBm input at 500 MHz

Maximum Allowable Input (DC+AC): ± 50 V (probe alone)
 ± 200 V (with divider)

Table 1-3. Specifications (3 of 3)

Output Connector:	50 Ω Type N male
Power:	+15 V/60 mA, -12.6 V/60 mA
Weight:	0.3 kg (probe alone) 2 kg (included accessories)
Length:	approximately 1.2 m
Operating Temperature Humidity:	0 °C to 55 °C, RH \leq 95 % (40 °C)
Furnished Accessories:	HP 10218A Probe-BNC (m) Adapter 10:1 Divider 100:1 Divider Slip-on Spanner Ground Tip Ground Clip (flexible) Probe Tip Nut Driver (3/32 inch) HP 19229A Hook Tip Adapter Spare Probe Pin Set Carrying Case

INSTALLATION

SECTION CONTENTS

This section contains the following information.

- Initial Inspection
- Power Requirements
- Mating Connector
- Environmental Requirements
- Packaging

INITIAL INSPECTION

CAUTION

Electrostatic Discharge (ESD) can damage the HP 41800A probe's highly sensitive input amplifier. **NEVER** touch the probe pin!

The HP 41800A Active Probe meets all of the specifications listed in Table 1-4. Upon receipt, inspect the shipping container for damage. If the shipping container or the cushioning material has been damaged, keep the container and packing material until the contents have been checked for completeness and the HP 41800A has been mechanically and electrically checked out. Figure 2-1 shows the product overview of the HP 41800A. The procedures for checking the general electrical operation are given in **SECTION 4, PERFORMANCE TEST**.

If anything is missing, damaged (scratches, dents, broken connectors, etc.), or if performance does not meet the specified performance test limits, notify the nearest HP sales office (see the list at the back of this operation note). The HP sales office will immediately arrange for repair or replacement without waiting for a claim settlement.

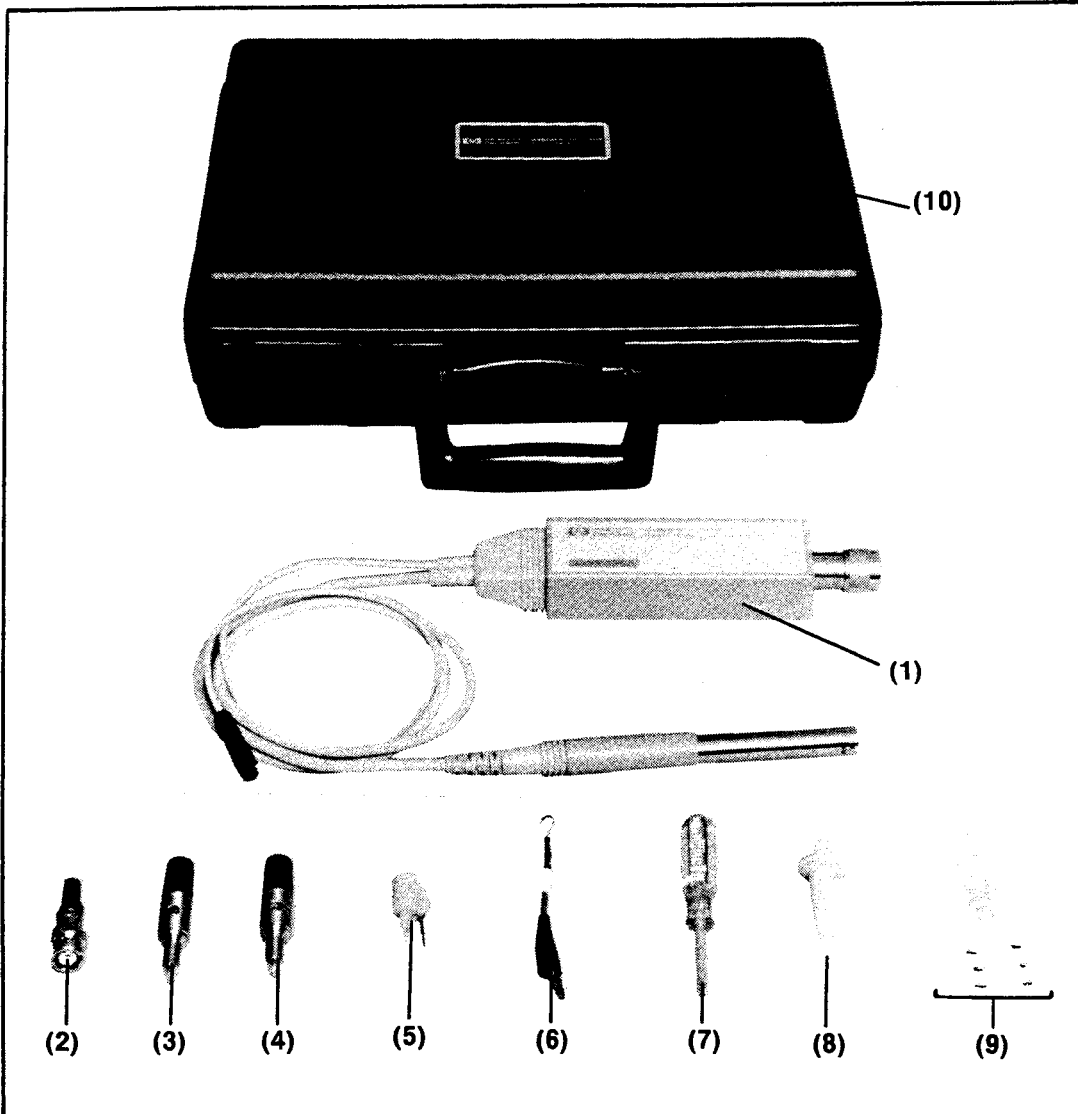

No.	Description	HP Part Number	Qty.
(1)	Probe Assembly	PN 41800-61001 ¹	1
(2)	Probe-BNC (m) Adapter	HP 10218A	1
(3)	10:1 Divider	PN 41800-60011	1
(4)	100:1 Divider	PN 41800-60012	1
(5)	Slip-on Spanner Ground Tip	PN 5060-0549	1
(6)	Ground Clip (flexible)	PN 01123-61302	1
(7)	Probe Tip Nut Driver (3/32 inch)	PN 8710-1806	1
(8)	HP 10229A Hook Tip Adapter	HP 10229A	1
(9)	Spare Probe Pin Set (12 mil pin x3, 30 mil pin x3)	PN 41800-60021	1
(10)	Carrying Case	PN 41800-60001	1

¹ Agilent internal-only part number.

Figure 2-1. Product Overview

POWER REQUIREMENTS

Power for the HP 41800A is supplied by the Compatible Instruments listed in Table 1-1 by connecting the HP 41800A's power plug to the probe power jack on the instrument. If the instrument used with the HP 41800A does not have a probe power supply, use a separate power supply which meets the requirements listed in Table 2-1. The HP 1122A Probe Power Supply meets these requirements and it accepts the HP 41800A's probe power plug directly.

Table 2-1. Probe Power Requirements

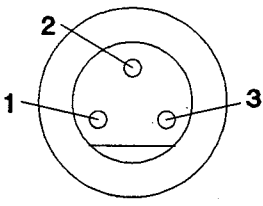
	Pin	Voltage	Current
	1	-12.6 V \pm 20%	60 mA
	2	GND	
	3	+15 V \pm 5%	60 mA

As looking into the probe's power plug.

MATING CONNECTORS

The output connector of the HP 41800A probe is a 50 Ω N-type male connector. Trying to mate this 50 Ω N-type connector to a 75 Ω N-type connector will result in damage to both connectors.

Keep the N-type output connector clean.

ENVIRONMENTAL REQUIREMENTS

The HP 41800A may be stored or shipped under the following environmental conditions.

- Temperature : -40 $^{\circ}$ C to +70 $^{\circ}$ C

The unit must be protected from temperature extremes which can cause condensation.

PACKAGING

This paragraph describes how to repackage the HP 41800A for shipment when necessary.

Original Packaging

Containers and packing material identical to those used in factory packaging are available from Hewlett-Packard. If the unit is being returned to Hewlett-Packard for servicing, attach a tag indicating the type of service required, return address, model number and full serial number.

Other Packaging

The following general instructions should be used for repacking with commercially available materials.

1. Wrap the unit in heavy paper or plastic. If shipping to a HP sales office or service center, attach a tag indicating the type of service required, return address, model number, and full serial number.
2. Use a strong shipping container. A double-walled carton made of 350 pound test material is adequate.
3. Use enough shock absorbing material (a 3 to 4 inch layer) around all sides of the unit to provide a firm cushion and to prevent the unit from moving around inside the container.
4. Securely seal the shipping container.
5. Mark the shipping container **FRAGILE** to ensure careful handling.
6. In any correspondence, refer to unit by its model number and its full serial number.

OPERATION

SECTION CONTENTS

This section provides the following information.

- Overview
- Operation Precautions
- Preparation For Use
- Typical Measurement Setups
- Probe Pin Replacement

OVERVIEW

This paragraph provides a description of the probe assembly and each of its furnished accessories including their usage. Figure 3-1 shows an overview of the HP 41800A probe assembly and Figure 3-2 shows the accessories furnished with the HP 41800A.

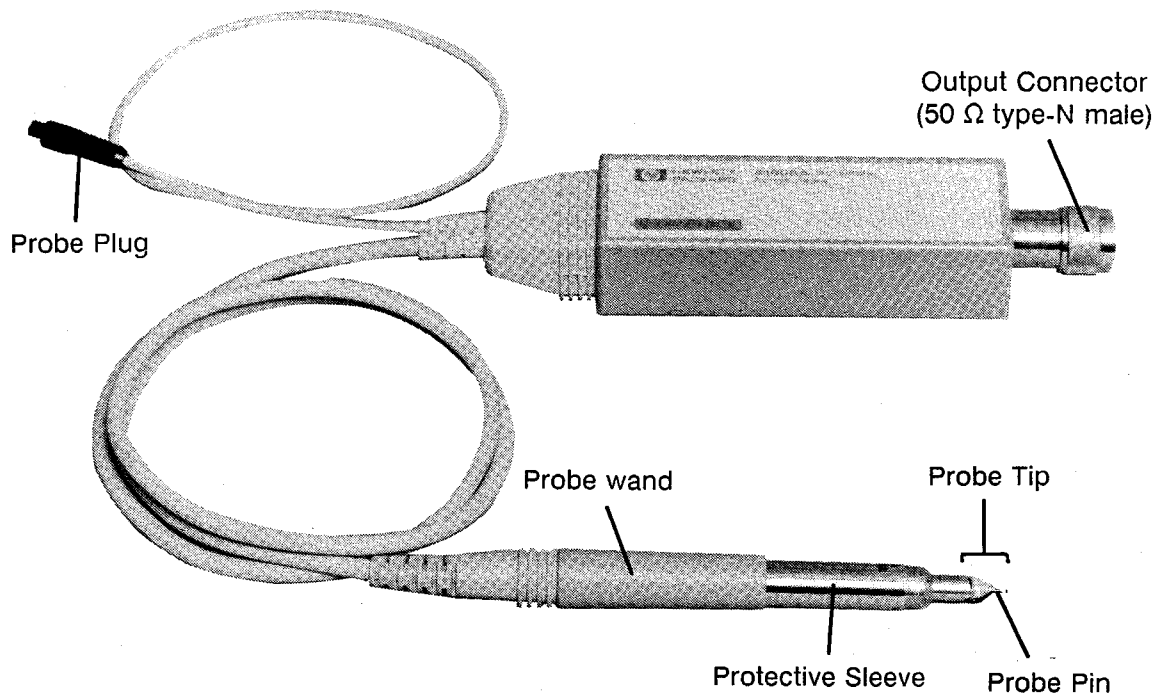

Figure 3-1. HP 41800A Probe Assembly

Probe Assembly

[Protective Sleeve]

The HP 41800A probe assembly is equipped with a grounded protective sleeve to protect the probe tip from mechanical abuse and to reduce the chance of ESD damage. Extend the protective sleeve when not actually making measurements.

To retract the protective sleeve of the probe, perform the following procedure.

1. Hold the probe wand, pointing the pin away from you, and grasp the protective sleeve in your other hand.
2. Turn the protective sleeve counter-clockwise a little.
3. Pull the sleeve slowly toward you.
4. Turn the sleeve clockwise a little to lock it in position.

To extend the protective sleeve, perform the above steps in reverse order.

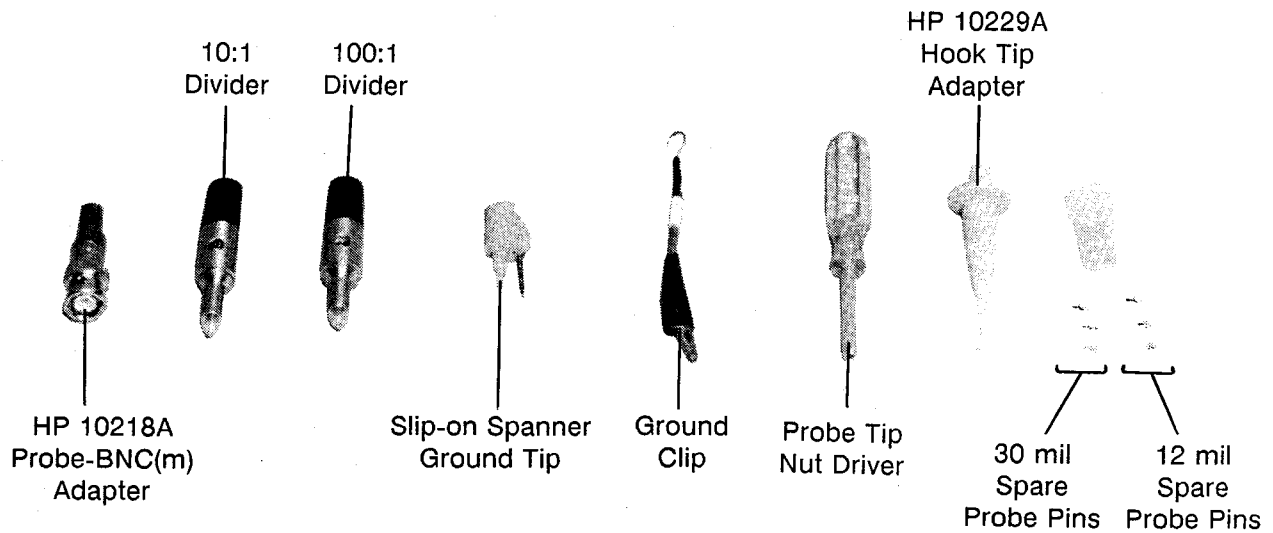

Figure 3-2. HP 41800A Furnished Accessories

**HP 10218A
Probe-BNC(m)
Adapter**

This is used to change the probe input to BNC(m) connector. To change the probe input to the BNC 50Ω system, insert the probe into this adapter and connect a 50Ω feed-through termination.

10:1 Divider

This is used to divide the probe input level by a factor of 10. Before using this divider, the divider adjustment should be performed (refer to page 3-7, **PREPARATION FOR USE**).

100:1 Divider

This is used to divide the probe input level by a factor of 100. Before using this divider, the divider adjustment should be performed (refer to page 3-7, **PREPARATION FOR USE**).

**Slip-on Spanner
Ground Tip**

This is used to ground the probe. Put this ground tip on the probe to probe a test point and a ground point simultaneously.

Ground Clip

This is used to ground the probe. When a test point and a ground point cannot be probed simultaneously, put this ground clip on the probe and connect the alligator clip of the ground clip to a ground point.

NOTE

Select the grounding devices (slip-on spanner ground tip and ground clip) for as short a ground path as possible. The effects of improper grounding become greater as the frequency increases. For optimum measurements in a factory environment, design your circuits with ground plane feedthroughs next to each test point.

**Probe Tip
Nut Driver**

This is used to replace the probe pin. Refer to page 3-22, **PROBE PIN REPLACEMENT**.

**HP 10229A
Hook Tip Adapter**

This is used to hook on to the test point of the device under test.

Probe Pins

Two kinds of probe pins, 12 mil pin and 30 mil pin, are available for the HP 41800A. Three 12 mil pins and three 30 mil pins are furnished with the HP 41800A as spare probe pin set. The HP 41800A is shipped from the factory with a 30 mil pin installed.

The 30 mil probe pin must be used, when using with the HP 10218A probe-BNC(m) adapter, the 10:1 / 100:1 dividers, the slip-on spanner ground tip, the hook tip adapter or the HP 11880A probe-N(m) adapter. To replace the probe pin, refer to page 3-22, **PROBE PIN REPLACEMENT**.

OPERATING PRECAUTIONS

This paragraph describes precautions for using the HP 41800A to prevent from damage on the HP 41800A and your Device Under Test (DUT).

Anti-static Precautions

The HP 41800A is sensitive to electrostatic discharge (ESD). The followings must be adhered to when using the HP 41800A.

- **Do NOT touch the probe pin:**
The probe input circuit is highly susceptible to damage by ESD introduced through the probe pin.
- **Eliminate ESD on your body:**
Wear a snug-fitting ground strap that is connected to earth ground through a 1 M Ω resistor. Refer to Table 3-1 which lists the available anti-static products.
- **Eliminate ESD on the work surface:**
A grounded anti-static bench mat is recommended. Optional floor mats provide an extra measure of protection, especially in areas with floor carpet. Do NOT use the HP 41800A on a carpeted work surface.
- **Hold the probe by the protective sleeve:**
Always hold the probe by the retracted ground protective sleeve to eliminate residual ESD on your body.
- **Do NOT introduce ESD into the DUT while the probe is in use:**
If an unprotected person touches a part of the DUT, a static surge could damage the DUT as well as the probe.

Table 3-1. Anti-static Products Available

Description	Part Number
Liquid Anti-static Agent (1 Qt. Spray)	PN 8500-3397
Static Control Table Mat (2'x 4') with 15-foot Ground Cord	PN 9300-0797
Small Wrist Strap with 7-foot Ground Cord	PN 9300-1099
Medium Wrist Strap with 7-foot Ground Cord	PN 9300-1117
Large Wrist Strap with 7-foot Ground Cord	PN 9300-1242

**Maximum Allowable
Level**

Maximum allowable level (ac+dc) to the probe is $\pm 50V$ ($\pm 200V$ when used with a divider).

**Discharging
The Probe**

Measuring a node having a DC voltage potential charges the blocking capacitors inside the HP 41800A probe. Ground the probe pin after measuring such nodes to discharge probe capacitor. Failure to do this could result in damage to sensitive circuits in the DUT, especially if it is an active device.

**PREPARATION
FOR USE**

This paragraph provides the HP 41800A operating check procedure and the 10:1 / 100:1 divider adjustment procedure.

The HP 41800A operating check procedure checks the probe gain using the network/spectrum analyzer (HP 4195A), a network analyzer, or a spectrum analyzer. These operating check procedures are only intended to ensure that the HP 41800A is functional. If the HP 41800A fails this check, it should be repaired. To verify that the HP 41800A meets its specifications, perform the **PERFORMANCE TEST** described in **SECTION 4**.

The 10:1 /100:1 divider adjustments should be performed to minimize the frequency response error due to the 10:1/100:1 dividers (furnished with the HP 41800A). Performing these adjustments are recommended before using the 10:1 and 100:1 dividers.

**Operating Check
Using The
HP 4195A**

Figure 3-3 shows the operating check setup using the HP 4195A network/spectrum analyzer.

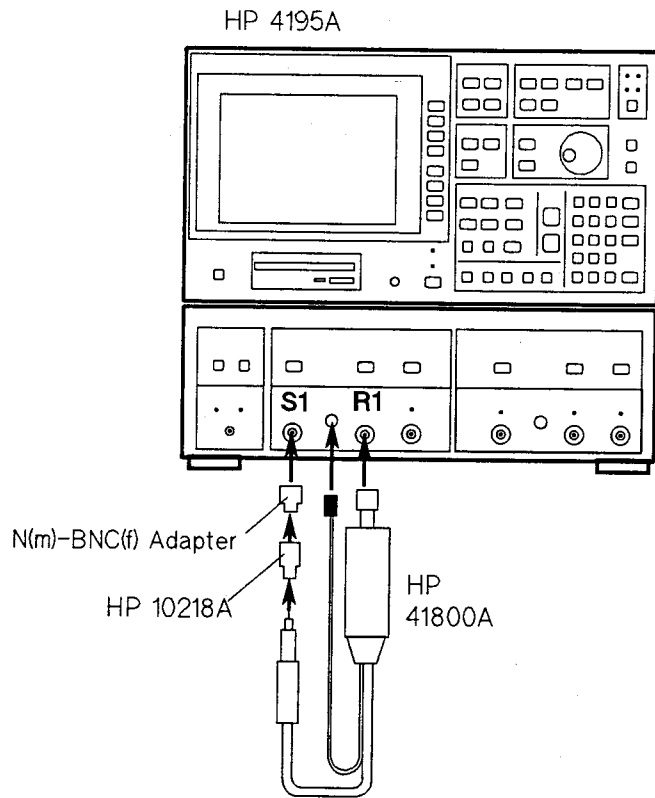

Figure 3-3. Operating Check Setup Using The HP 4195A

[Equipment]

- Network/Spectrum Analyzer HP 4195A
- Probe-BNC(m) Adapter HP 10218A
- Adapters as necessary

[Procedure]

1. Connect the equipment as shown in Figure 3-3.
2. Set up the HP 4195A as follows.

CONFIG	:	SPECTRUM
PORT SELECT	:	SOURCE CH1 on
CENTER	:	50 MHz
SPAN	:	0 Hz
AMPLITUDE (S1)	:	-26 dBm
REF ATTEN (R1)	:	10 dB

3. Confirm that the signal level is **-20 dBm ± 5 dB**.

NOTE

The HP 11880A probe-N(m) adapter can be used instead of the N(m)-BNC(f) adapter and the HP 10218A probe-BNC(m) adapter. The signal level should be **-26 dBm ± 5 dB** when the HP 11880A probe-N(m) adapter is used.

**Operating Check
Using Network
Analyzer**

Figure 3-4 shows the operating check setup using a network analyzer. To check the probe gain, absolute power amplitude measurement mode should be selected.

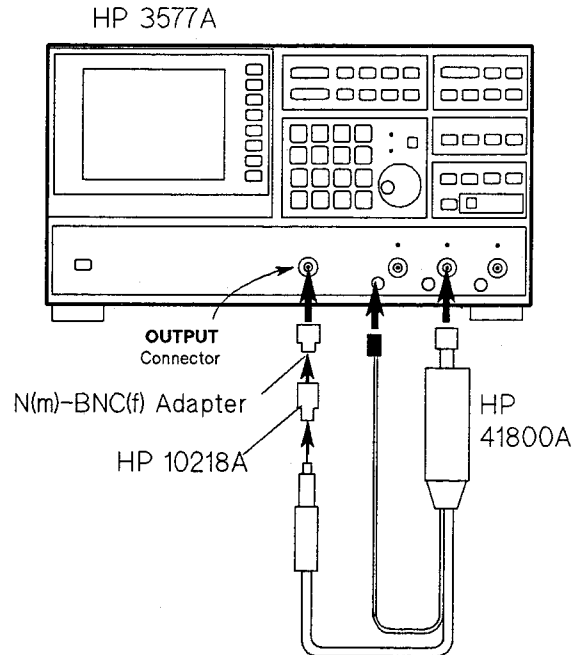

Figure 3-4. Operating Check Setup Using Network Analyzer

[Equipment]

- Network Analyzer Any Compatible
- Probe-BNC(m) Adapter HP 10218A
- Adapters as necessary

[Procedure]

1. Connect the equipment as shown in Figure 3-4.
2. Set the network analyzer as follows.

Measurement Mode	: R, A, or B (absolute amplitude measurement)
Center Frequency	: 50 MHz
Span	: 0 Hz
Output Level	: -10 dBm

3. Confirm that the signal level is $-4 \text{ dBm} \pm 5 \text{ dB}$.

NOTE

The HP 11880A probe-N(m) adapter can be used instead of the N(m)-BNC(f) adapter and the HP 10218A probe-BNC(m) adapter. The signal level should be $-10 \text{ dBm} \pm 5 \text{ dB}$ when the HP 11880A probe-N(m) adapter is used.

Operating Check Using Spectrum Analyzer

Figure 3-5 shows the operating check setup using a spectrum analyzer.

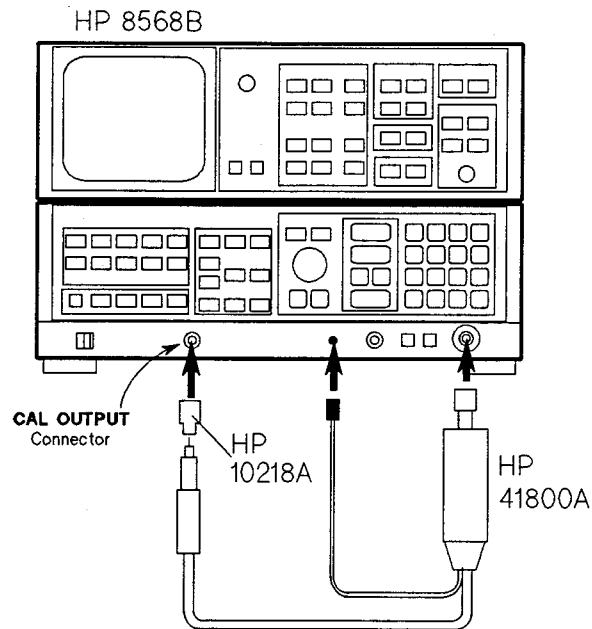

Figure 3-5. Operating Check Setup Using Spectrum Analyzer

[Equipment]

- Spectrum Analyzer Any Compatible
- Probe-BNC(m) Adapter HP 10218A
- Adapters as necessary

[Procedure]

1. Connect the equipment as shown in Figure 3-5.

NOTE

If the spectrum analyzer has a tracking generator output, use the tracking generator output connector instead of the calibration output connector. Then set the output level to ≤ -10 dBm.

2. Setup the spectrum analyzer as follows.

Center Frequency	:	same	as	Calibration	Output
				frequency	
Span	:	0	Hz		
Attenuation	:	40	dB		

3. Confirm that the signal level is (calibration output level + 6 dB) \pm 5 dB.

**10:1 / 100:1
Divider
Adjustments**

This adjustment procedure is used to adjust the 10:1 / 100:1 divider's gain. This adjustment requires the HP 4195A, any compatible Network Analyzer, or any compatible Spectrum Analyzer.

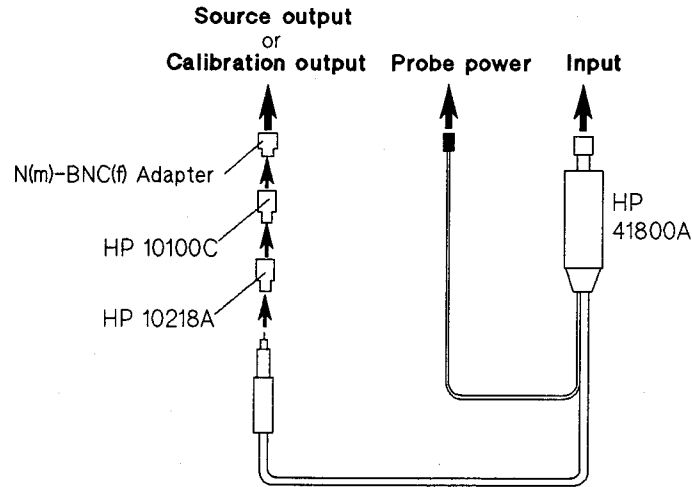

Figure 3-6. Divider Adjustment Setup

[Equipment]

- | | |
|---------------------------------------|----------------|
| • Network or Spectrum Analyzer | Any Compatible |
| • Probe-BNC(m) Adapter | HP 10218A |
| • 50 Ω Feedthrough Termination | HP 10100C |
| • Adapters | as necessary |
| • Alignment Tool (- ; minus) | as necessary |

[Procedure]

1. If you use the HP 4195A:
Set CONFIG to SPECTRUM.
Set SOURCE CH1 on.
Set CENTER to 50 MHz, SPAN to 0 Hz.
Connect the adapter, feedthrough and probe adapter to the S1 connector.

If you use the Network Analyzer:
Select the absolute power amplitude measurement mode (R, A or B).
Set CENTER to 50 MHz, SPAN to 0 Hz.
Connect the adapter, feedthrough and probe adapter to the source output connector.

If you use the Spectrum Analyzer:
Set CENTER to the calibration output frequency.
Set SPAN to 0 Hz.
Connect the feedthrough and probe adapter to the calibration output connector.

NOTE

If the spectrum analyzer has the tracking generator output, use the tracking generator output connector instead of the calibration output connector.

2. Connect the HP 41800A's OUTPUT connector to the instrument's Input connector.
3. Insert the HP 41800A's probe tip into the probe adapter.
4. Note the measured value, and remember it as data R. Data R is used in steps 7 and 9.

Data R = _____ dBm

5. Disconnect the HP 41800A from the probe adapter.

<< 10:1 Divider Adjustment >>

6. Connect the 10:1 divider to the HP 41800A's probe tip, and insert it into the probe adapter on the instrument's input connector.
7. Adjust the trimmer component from the opening of the divider, shown in Figure 3-7, so that the data measured by the instrument is approximately 20 dB less than data R.

<< 100:1 Divider Adjustment >>

8. Connect the 100:1 divider to the HP 41800A's probe tip, and insert it into the probe adapter on the instrument's input connector.
9. Adjust the trimmer component on 100:1 divider so that the data measured by the instrument is approximately 40 dB less than data R.

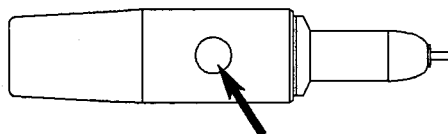

Figure 3-7. 10:1 / 100:1 Divider Adjustment Component Location

TYPICAL MEASUREMENT SETUPS

This paragraph provides typical measurement setups using the HP 41800A. The following setups are described.

- Network Measurement Setups
 - Using one HP 41800A
 - Using one HP 41800A with a transmission/reflection test set
 - Using two HP 41800A
- Spectrum Measurement Setups
 - Using the HP 41800A with an instrument which has a type-N input connector
 - Using the HP 41800A with an instrument which has a BNC input connector

CAUTION

Electrostatic Discharge (ESD) can damage the HP 41800A's highly sensitive input amplifier. **Never touch the probe pin!**

Do not apply a ac+dc level which exceeds $\pm 50V$ ($\pm 200V$ when using a divider) to the probe.

Do not mate the output connector of the probe assembly (50Ω type-N connector) to 75Ω type-N connectors or damage may result.

NOTE

The 30 mil probe pin must be used to adapt to the HP 10218A probe-BNC(m) adapter, the 10:1 / 100:1 dividers, the slip-on spanner ground tip, the hook tip adapter, or the HP 11880A probe-N(m) adapter.

**Network
Measurements**

[Using one HP 41800A]

Figure 3-8 shows a typical measurement setup for the network measurements. Place the probe tip as close to the input of the device under test, and perform a normalize (through) calibration to compensate the frequency response error.

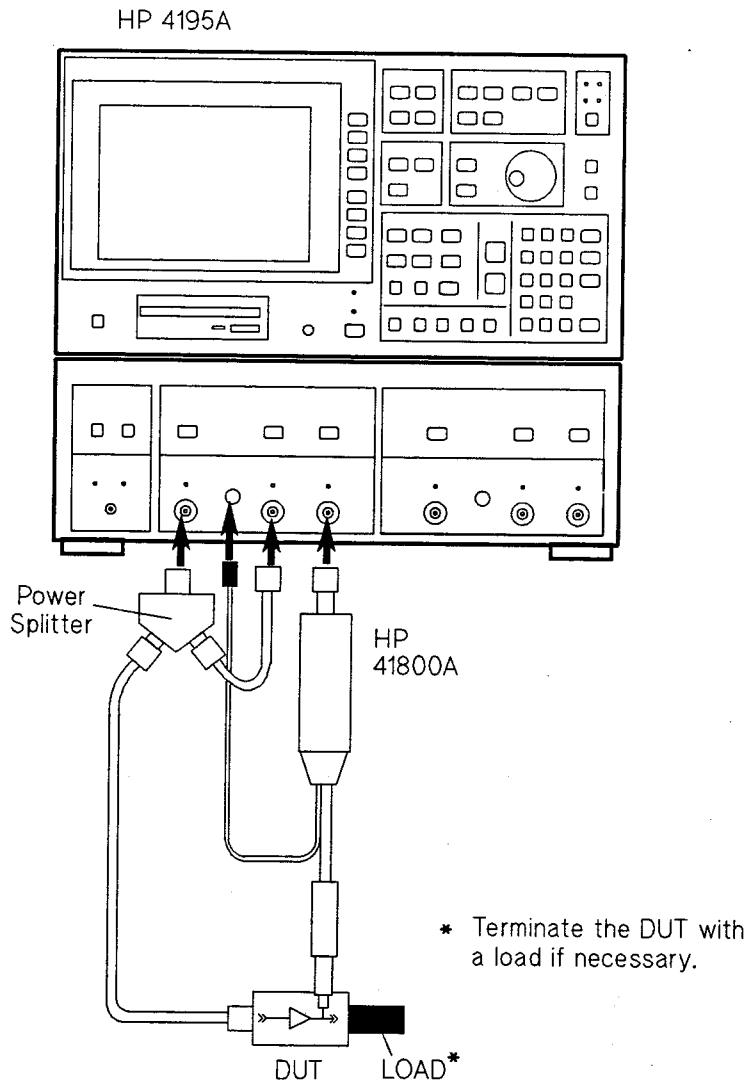

**Figure 3-8. Network Measurement Setup Example
(Using One HP 41800A)**

[Using one HP 41800A with a transmission/reflection test set]

Figure 3-9 shows typical measurement setup for the network measurements using with a transmission/reflection test set. Place the probe tip as close to the input of the device under test, and perform a normalize (through) calibration to compensate the frequency response error.

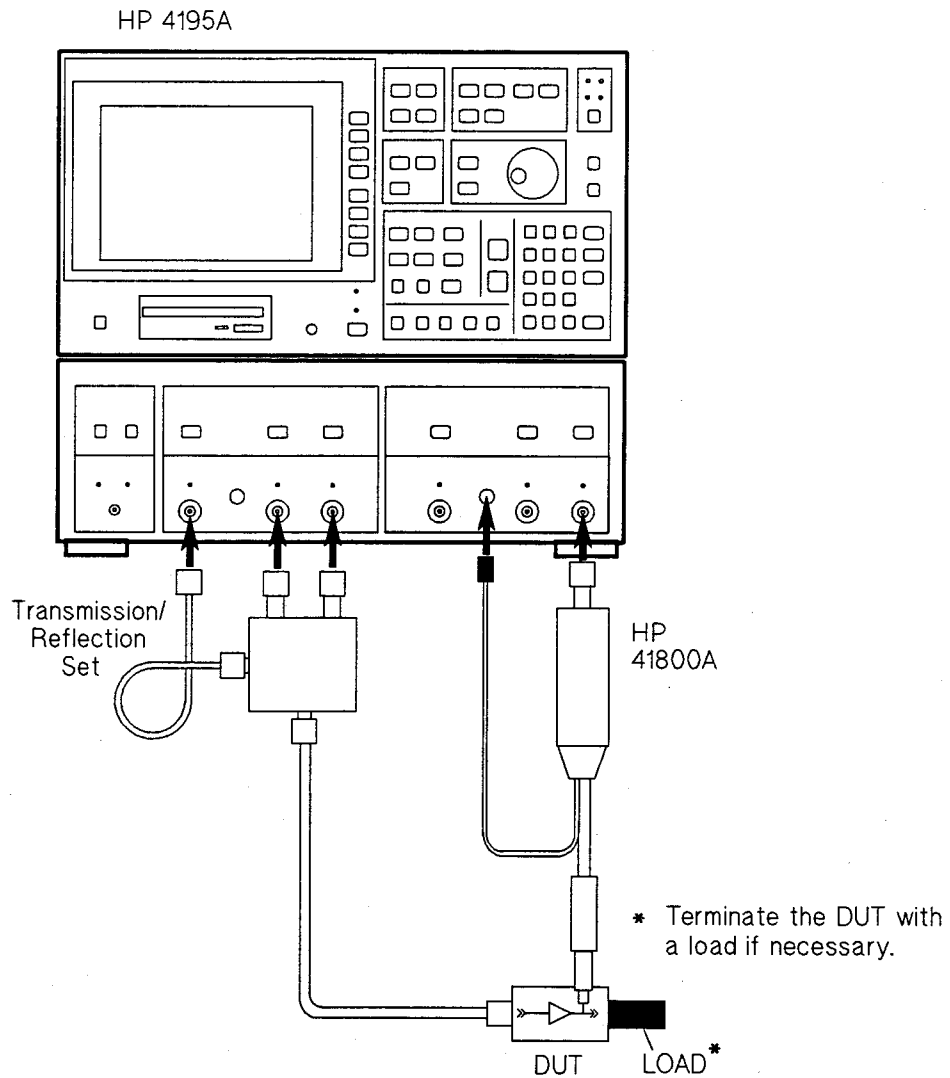

**Figure 3-9. Network Measurement Setup Example
(Using With A Transmission/Reflection Test Set)**

[Using two HP 41800As]

Figure 3-10 shows typical measurement setup for the network measurements using two probes. Place the probe tip as close to the input of the device under test, and perform a normalize (through) calibration to compensate the frequency response error.

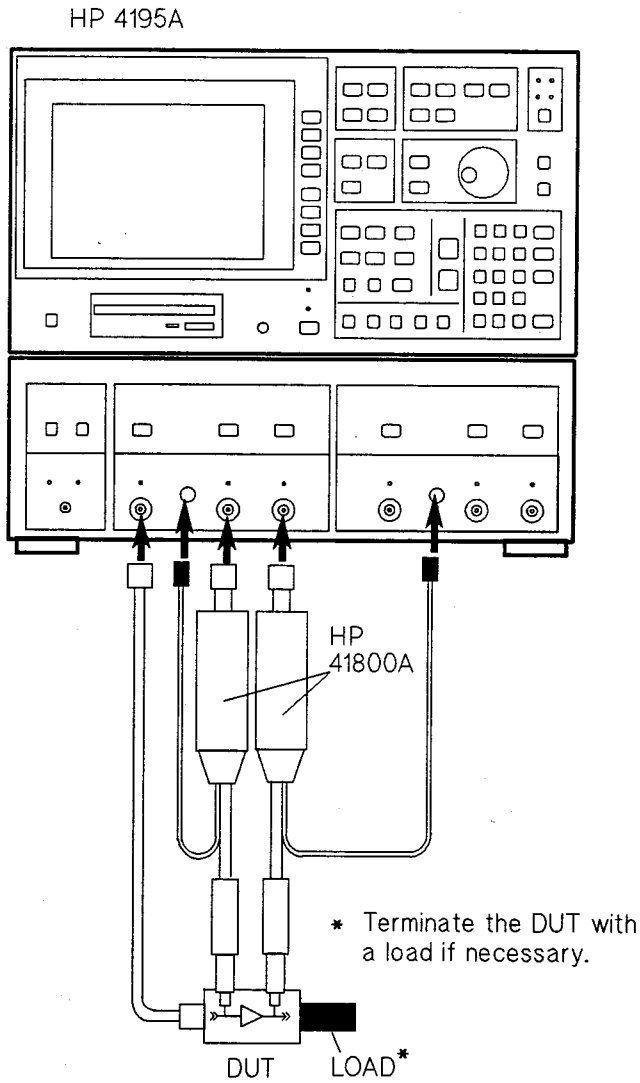
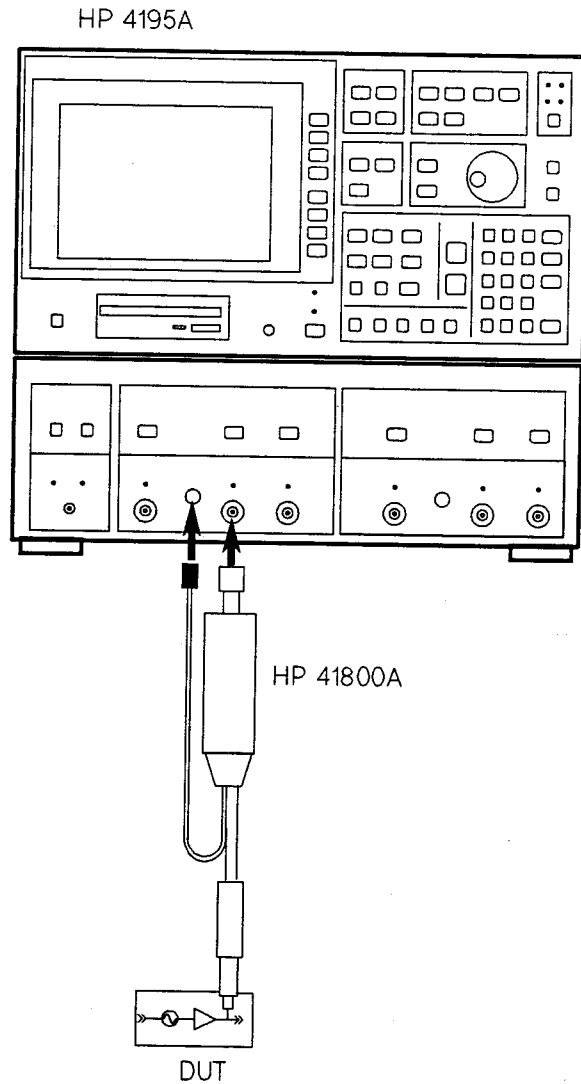

**Figure 3-10. Network Measurement Setup Example
(Using Two HP 41800As)**

**Spectrum
Measurements**

[Using HP 41800A with instruments which have type-N connectors]

Figure 3-11 shows typical measurement setup using a spectrum analyzer which has a type-N input connector.



**Figure 3-11. Spectrum Measurement Setup Example
(Type-N Input Connector)**

[Using HP 41800A with instruments which have BNC connectors]

Figure 3-12 shows typical measurement setup using a spectrum analyzer which has a BNC input connector. A BNC(m) cable and N(f)-BNC(f) adapter are recommended to use for connecting the HP 41800A to the spectrum analyzer. Do not use an unflexible adapter such as a BNC(m)-N(f) adapter instead of the cable and N(f)-BNC(f) adapter, otherwise the overweight caused by the HP 41800A may damage the spectrum analyzer's connector.

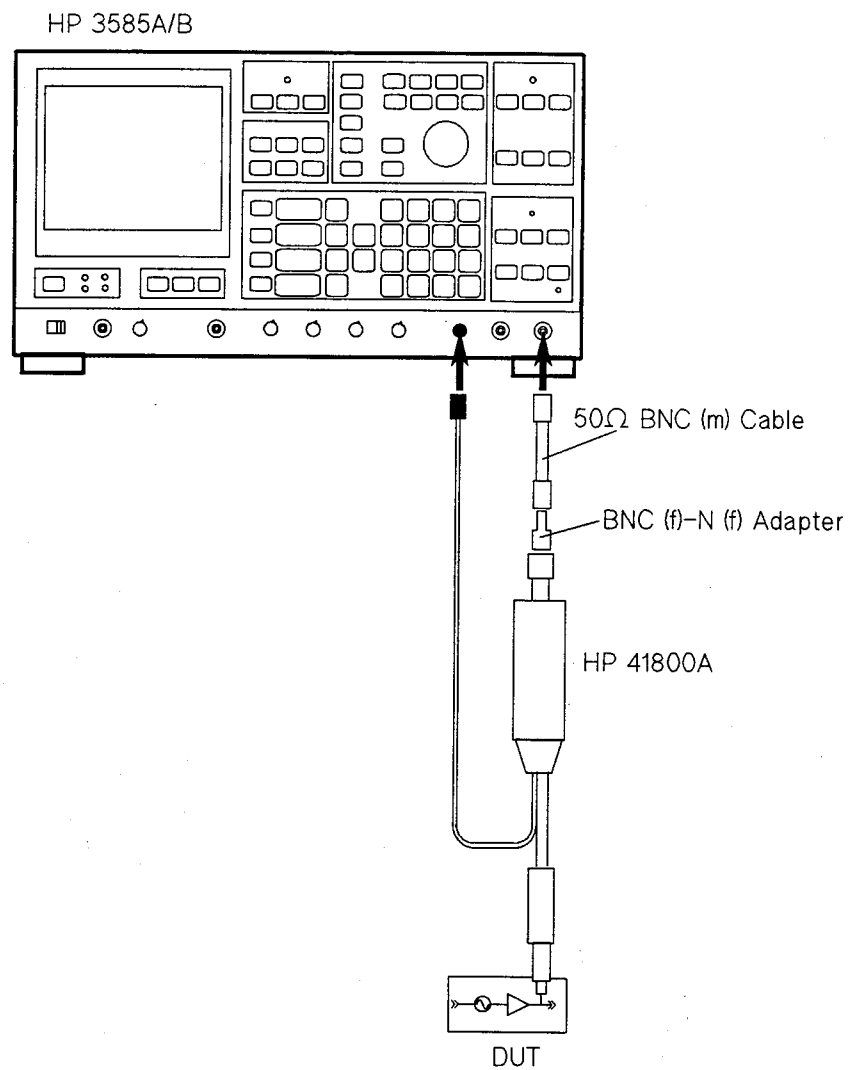

**Figure 3-12. Spectrum Measurement Setup Example
(BNC Input Connector)**

**PROBE PIN
REPLACEMENT**

This paragraph describes how to replace the probe pin.

CAUTION

Electrostatic Discharge (ESD) can damage the HP 41800A's highly sensitive input amplifier. Wear a snug-fitting ground strap to touch the probe pin. Do not touch the probe pin directly.

NOTE

The 30 mil probe pin must be used to adapt to the HP 10218A probe-BNC(m) adapter, the 10:1 / 100:1 dividers, the slip-on spanner ground tip, the hook tip adapter, or HP 11880A probe-N(m) adapter.

1. Unscrew the probe pin slowly using the probe tip nut driver (HP PN 8710-1806 ; furnished with the HP 41800A).
2. Screw in the new pin with the driver.

NOTE

A spare probe pin set (HP PN 41800-60021), includes 12 mil pins (3 ea.) and 30 mil pins (3 ea.), is available from your nearest Hewlett-Packard office.

PERFORMANCE TESTS

INTRODUCTION

This section provides performance test procedures to ensure that the HP 41800A meets the specifications listed in Table 1-3, Specifications. The performance test can be performed without accessing the interior of the HP 41800A.

The test results should be recorded into the Performance Test Record which is located at the end of this section.

EQUIPMENT REQUIRED

The equipment required for performance testing is listed in Table 4-1. Substitutions can be made if the substitution equipment meets or exceeds the specifications listed in the Requirements column.

Table 4-1. Recommended Test Equipment

Equipment Recommended Model	Qty.	Requirements	Use
Network Analyzer HP 4195A	1	No substitute	P,A,T
Power Meter HP 436A or 438A	1	Accuracy: ≤ 0.1 dB Frequency: 500 MHz	P
Power Sensor HP 8482A	1	Frequency: 500 MHz Compatible with the HP 436A or 438A	P
Power Splitter HP 11667A	1	Frequency Range: 5 Hz to 500 MHz	P,A
Probe Adapter HP 11880A	1	No substitute	P,A,T
Cable HP 11500B	2	N(m)-N(m), 50 Ω , 61 cm	P,A
Adapter	1	N(f)-N(f), 50 Ω	P,A
	1	N(m)-N(m), 50 Ω	P,A
Active Probe HP 41800A	1	Frequency: 50 MHz	T

Note: P, A, and T mean the Performance Test, Adjustment, and Troubleshooting, respectively.

CALIBRATION CYCLE

The HP 41800A requires periodic performance verification. The HP 41800A should be checked out using the performance test at least once a year or more depending on its frequency of use. Preventive maintenance should be performed at least twice a year to keep down-time to a minimum, and to insure optimum operation.

PREPARATION

This paragraph provides the information which you should know and the steps that you should perform before starting the performance test.

1. The test equipment must be allowed to warm-up and stabilize for at least 30 minutes.
2. A HP 4195A is required to test the HP 41800A. In the remainder of this manual, softkeys are indicated in boldface type and enclosed in single quotes (e.g., '**NETWORK**' softkey), and keys are indicated in boldface type only (e.g. **PRESET** key).

PROBE GAIN/FREQUENCY RESPONSE TESTS

DESCRIPTION:

The Probe Gain/Frequency Response Test checks the probe gain at 50 MHz, and the frequency response relative to 50 MHz.

SPECIFICATIONS: (at 23 °C ±5 °C)

PROBE GAIN: 0 dB ±0.5 dB at 50 MHz

FREQUENCY RESPONSE: +1 dB/-2 dB at <50 Hz
 ±1 dB at 50 Hz to 200 MHz
 +1.5 dB/-2 dB at >200 MHz

SETUP:

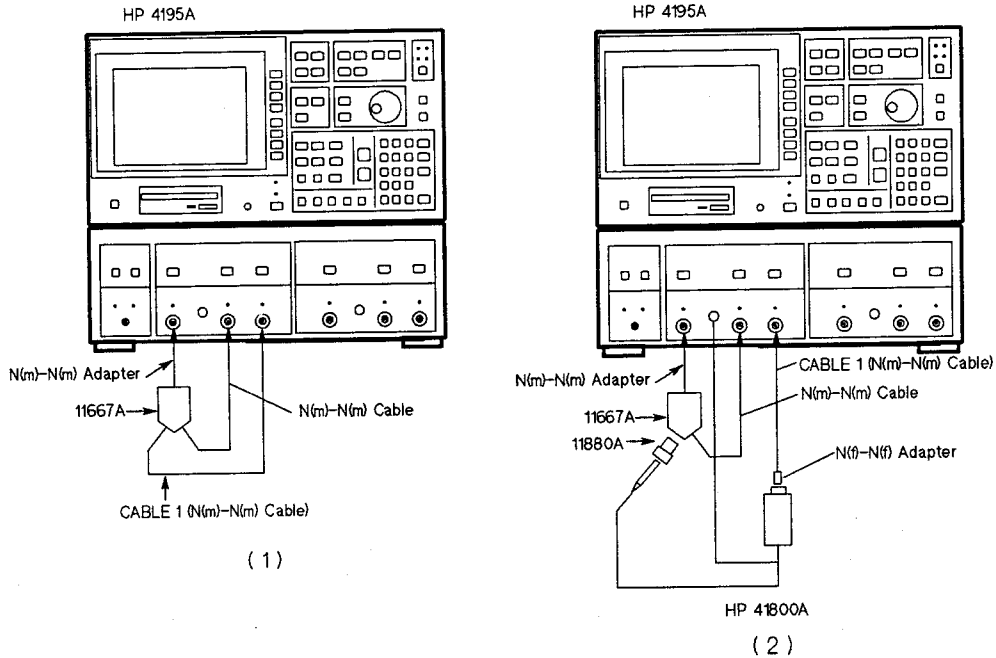

Figure 4-1. Probe Gain/Frequency Response Test Setup

EQUIPMENT:

- | | |
|-----------------------|--------------|
| Network Analyzer | HP 4195A |
| Power Splitter | HP 11667A |
| Probe to N(m) Adapter | HP 11880A |
| N(m)-N(m) Cable | HP 11500B |
| N(f)-N(f) Adapter | PN 1250-0777 |
| N(m)-N(m) Adapter | PN 1250-0778 |

PERFORMANCE TESTS

PROCEDURE:

1. Connect the power splitter to the HP 4195A as shown in Figure 4-1 (1).
2. Sequentially press the following HP 4195A front panel keys, to set the HP 4195A to the Probe Gain/Frequency Response test settings.

CONFIG, 'NETWORK', PRESET

AMPLITUDE (CHANNEL 1 side), - , 1 , 4 , ENTER/EXECUTE

REF ATTEN (CHANNEL 1 side), 0 , ENTER/EXECUTE

TEST ATTEN (CHANNEL 1 side), 0 , ENTER/EXECUTE

START, 1 , 0 , Hz/dB μ V

STOP, 5 , 0 , 0 , MHz/V

MENU, 'TRIGGER menu', 'SINGLE mode', 'return'

'RESOLUTN menu', 'No. of POINTS', 1 , 0 , 1 , ENTER/EXECUTE

'return', 'TYPE lin log'

("log" in the 'TYPE lin log' softkey will change to intensified green.)

DISPLAY, 'TRACE B on off'

("off" in the 'TRACE B on off' softkey will change to intensified green.)

AUTO

(The yellow LED in the **AUTO** key will turn on.)

PERFORMANCE TESTS

3. Sequentially press the following HP 4195A front panel keys to set the HP 4195A's programmed points table, and to activate its program sweep measurement capability.

MENU, 'PROGRAM sweep', 'PROG TBL set up'

(Confirm that the displayed table is empty. If the table is not empty, press the **'TABLE No.'** softkey repeatedly until an empty table is displayed, or press the **'TABLE ALL CLR'** softkey and **ENTER/EXECUTE** key.)

(Confirm that the table sweep parameter is frequency. If it is not frequency, press the **'SWP select'** softkey repeatedly until it changes to frequency.)

'X REG dump'

(move the cursor to the N = 96 position by pressing the down arrow key)

CLR LINE, 2 , 0 , 0 , MHz/V, ENTER/EXECUTE

(move the cursor to the N = 88 position)

CLR LINE, 5 , 0 , MHz/V, ENTER/EXECUTE

(move the cursor to the N = 10 position)

CLR LINE, 5 , 0 , Hz/dB μ V, ENTER/EXECUTE, 'set end',

'PROG SWP on off' ("on" in this softkey will change to intensified green.)

4. Sequentially press the following HP 4195A front panel keys to perform a normalize (thorough) calibration, and wait until the message "Cal completed" is displayed.

CAL, 'TRANS CAL menu', 'NORMLIZE (THRU)', 'THRU', ENTER/EXECUTE

5. Press the HP 4195A's **CAL** key and the **'CORRECTN on off'** softkey to activate the HP 4195A's correction capability. The "on" in this softkey will change to intensified green.

6. Disconnect CABLE 1 (see Figure 4-1 (1)) from the power splitter, and connect the HP 41800A between the power splitter and CABLE 1 as shown in Figure 4-1 (2).

<<PROBE GAIN TEST>>

7. Press the HP 4195A's **TRIG/RESET** key to make a single sweep measurement.
8. Press the **SCALE REF** key and the **'A AUTO SCALE'** softkey for auto scaling.
9. Move the o marker on the HP 4195A's display to the 50 MHz sweep point by rotating the rotary knob on the HP 4195A's front panel.

PERFORMANCE TESTS

10. Confirm that the T/R data displayed in the upper right corner of the HP 4195A's display is $0 \text{ dB} \pm 0.5 \text{ dB}$.

<<FREQUENCY RESPONSE>>

11. Enter the HP 4195A "A=A-A(88)" command using the following key stroke sequence to have the HP 4195A display the frequency response test results.

CLR LINE, blue shiftkey, **A**, = , **A**, - , **A**, **MATH OPERATOR**,

' (' , 8 , 8 , ') ' , ENTER/EXECUTE

12. Sequentially press the following keys to set the HP 4195A's analysis range.

MORE, **'ANA RNG'**

(move the * marker to the 50 Hz point)

'active oMKR *MKR' ("oMKR" in this softkey will change to intensified green)

(move the o marker to the 10 Hz point)

'STORE ANA RNG'

'PART ANA on off' ("on" in this softkey will change to intensified green)

13. Press the **MKR→** key and the **'MKR→MAX'** softkey to move the o marker to the maximum point between 10 Hz and 50 Hz. And confirm that the T/R data displayed on the upper right corner of the HP 4195A's display is within $+1 \text{ dB}/-2 \text{ dB}$.

14. Press the **'MKR→MIN'** softkey to move the o marker to the minimum point between 10 Hz and 50 Hz. And confirm that the T/R data displayed in the upper right corner of the HP 4195A's display is within $+1 \text{ dB}/-2 \text{ dB}$.

15. Sequentially press the following keys to change the HP 4195A's analysis range.

MORE, **'ANA RNG'**

(move the o marker to the 200 MHz point)

'STORE ANA RNG'

16. Press the **MKR→** key and the **'MKR→MAX'** softkey to move the o marker to the maximum point between 50 Hz and 200 MHz, and confirm that the T/R data is within $\pm 1 \text{ dB}$.

17. Press the **'MKR→MIN'** softkey to move the o marker to the minimum point between 50 Hz and 200 MHz, and confirm that the data T/R is within $\pm 1 \text{ dB}$.

PERFORMANCE TESTS

18. Sequentially press the following keys to change the HP 4195A's analysis range.

MORE, 'ANA RNG'

(move the o marker to the 200 MHz point)

'active oMKR *MKR' ("*MKR" in this softkey will change to intensified green)

(move the * marker to the 500 MHz point)

'STORE ANA RNG'

19. Press the **MKR→** key and the **'MKR→MAX'** softkey to move the * marker to the maximum point between 200 MHz and 500 MHz, and confirm that the data T/R is within +1.5 dB/-2 dB.
20. Press the **'MKR→MIN'** softkey to move the * marker to the minimum point between 200 MHz and 500 MHz, and confirm that the T/R data is within +1.5 dB/-2 dB.

PERFORMANCE TESTS

1 dB GAIN COMPRESSION TEST

DESCRIPTION:

The 1 dB Gain Compression Test checks the gain compression of the probe amplifier.

SPECIFICATIONS: (at 23 °C ±5 °C)

> +3 dBm at 500 MHz

SETUP:

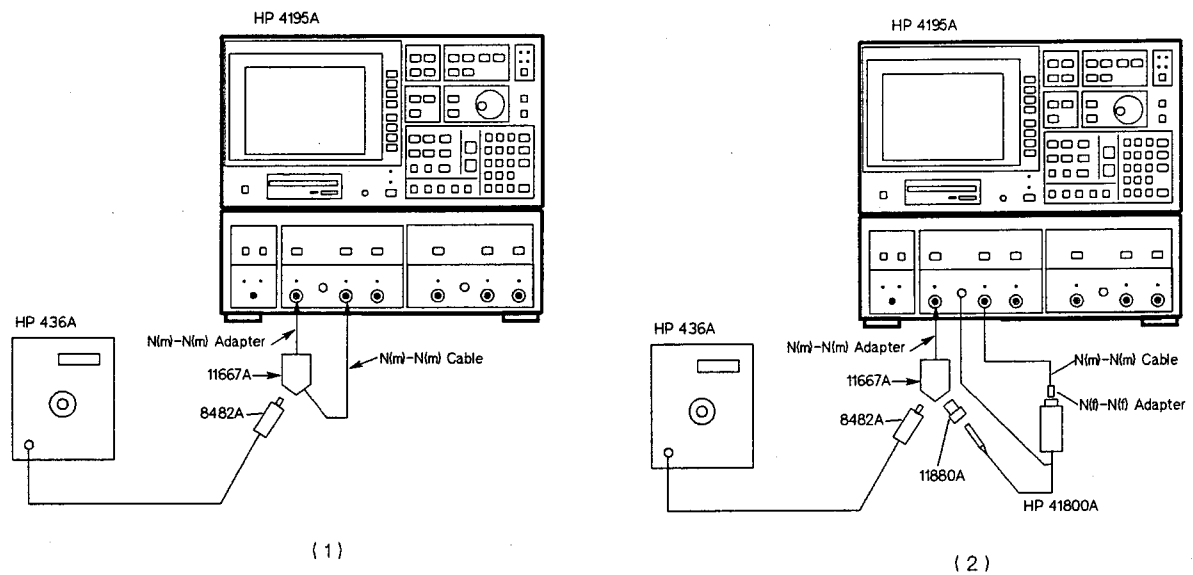

Figure 4-2. 1 dB Gain Compression Test Setup

EQUIPMENT:

Spectrum Analyzer	HP 4195A
Power Meter	HP 436A
Power Sensor	HP 8482A
Power Splitter	HP 11667A
Probe to N(m) Adapter	HP 11880A
N(m)-N(m) Cable	HP 11500B
N(f)-N(f) Adapter	PN 1250-0777
N(m)-N(m) Adapter	PN 1250-0778

PROCEDURE:

1. Connect the power sensor to the power meter.
2. Calibrate the power meter for the power sensor.

PERFORMANCE TESTS

3. Set the power meter to the dBm mode, and set the CAL FACTOR % knob to the value required by the power sensor at 500 MHz, and zero the meter.
4. Connect the power splitter to the HP 4195A, and connect the power sensor to the power splitter as shown in Figure 4-2 (1).
5. Sequentially press the following HP 4195A front panel keys to set the HP 4195A to the 1 dB Gain Compression test setting.

CONFIG, 'SPECTRUM', PRESET

MENU, 'PRMTR menu', 'OSC LVL [dBm]', 'SPOT FREQ', 5 , 0 , 0 , MHz/V

'return', 'TRIGGER menu', 'SINGLE mode'

START, - , 1 , 1 , ENTER/EXECUTE

STOP, 1 , 5 , ENTER/EXECUTE

RES BW, 1 , kHz/dBm

REF ATTEN (CHANNEL 1 side), 4 , 0 , ENTER/EXECUTE

CONFIG, 'PORT SELECT', 'SOURCE CH1'

6. Press the HP 4195A's TRIG/RESET key to make a single sweep measurement.
7. Enter the HP 4195A "C=A" command using the following key sequence.

CLR LINE, blue shiftkey, C, = , A, ENTER/EXECUTE

8. Disconnect N(m)-N(m) Cable from the power splitter, and connect the HP 41800A between the power splitter and N(m)-N(m) Cable, as shown in Figure 4-2 (2).
9. Press the HP 4195A's TRIG/RESET key to make a single sweep measurement.
10. Enter the HP 4195A "A=A-C" command using the following key sequence.

CLR LINE, blue shiftkey, A, = , A, - , C, ENTER/EXECUTE

11. Enter the HP 4195A "A=A-A(1)" command using the following key sequence.

**CLR LINE, blue shiftkey, A, = , A, - , A, MATH OPERATOR,
'(, 1 , ')', ENTER/EXECUTE**

12. Press the **SCALE REF** key and the **'A AUTO SCALE'** softkey for auto scaling.
13. Move the o marker to the point at which the **MAG** (data A) displayed in the upper right corner of the HP 4195A's display indicates approximately -1 dBm.
14. Sequentially press the HP 4195A's **MENU** key, and the **'TRIGGER menu'** and **'MANUAL mode'** softkeys.
15. Conform that the power meter reading is greater than 3 dBm.

NOTES

PERFORMANCE TEST RECORD

Hewlett-Packard
Model 41800A
Active Probe

Tested by _____
Date _____
Serial No. _____
Temperature _____
Humidity _____

PROBE GAIN (at 50 MHz):

Specification	Actual
0 dB \pm 0.5 dB	_____ dB

FREQUENCY RESPONSE (relative to 50 MHz):

	Specification	Actual
Max. at 10 Hz \leq f < 50 Hz:	+1 dB/-2 dB	_____ dB
Min. at 10 Hz \leq f < 50 Hz:	+1 dB/-2 dB	_____ dB
Max. at 50 Hz \leq f \leq 200 MHz:	\pm 1 dB	_____ dB
Min. at 10 Hz \leq f \leq 200 MHz:	\pm 1 dB	_____ dB
Max. at f > 200 MHz:	+1.5 dB/-2 dB	_____ dB
Min. at f > 200 MHz:	+1.5 dB/-2 dB	_____ dB

1 dB GAIN COMPRESSION:

Specification	Actual
>3 dBm	_____ dBm

NOTES

ADJUSTMENT

INTRODUCTION

This section describes the adjustments required to return the HP 41800A to the specifications listed in Table 1-3, Specifications, if the HP 41800A failed the performance test, or after it has been repaired. If proper performance cannot be achieved after these adjustments, refer to Section 6, Service.

EQUIPMENT REQUIRED

Table 4-1 lists the equipment required for adjustment.

PREPARATION

This paragraph provides the information which you should know, and the procedures that you must perform before starting the adjustments.

1. The test equipment must be allowed to warm-up and stabilize for at least 30 minutes.
2. A HP 4195A is required to test the HP 41800A. The HP 4195A's front panel keys and softkeys are indicated as in the following example in this manual.

ex)

PRESET key
NETWORK softkey

PRESET
'NETWORK'

ADJUSTMENT

LF GAIN/FLATNESS ADJUSTMENT

DESCRIPTION:

The LF Gain/Flatness Adjustment adjusts the HP 41800A gain and frequency response.

SETUP:

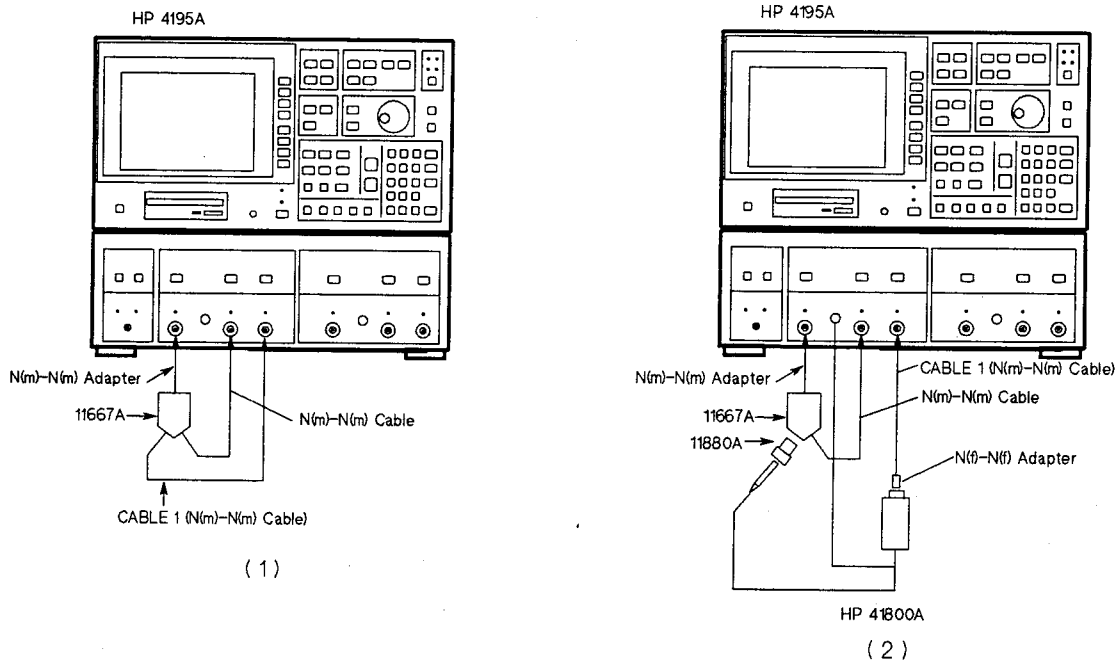

Figure 5-1. LF Gain/Flatness Adjustment Setup

EQUIPMENT:

Network Analyzer
Power Splitter
Probe to N(m) Adapter
N(m)-N(m) Cable
N(f)-N(f) Adapter
N(m)-N(m) Adapter

HP 4195A
HP 11667A
HP 11880A
HP 11500B
PN 1250-0777
PN 1250-0778

ADJUSTMENT

PROCEDURE:

1. Connect the power splitter to the HP 4195A as shown in Figure 5-1 (1).
2. Sequentially press the following HP 4195A front panel keys to set the HP 4195A to the adjustment settings.

CONFIG, 'NETWORK', PRESET

AMPLITUDE (CHANNEL 1 side), - , 1 , 4 , ENTER/EXECUTE

REF ATTEN (CHANNEL 1 side), 0 , ENTER/EXECUTE

TEST ATTEN (CHANNEL 1 side), 0 , ENTER/EXECUTE

START, 1 , 0 , Hz/dB μ V

STOP, 5 , 0 , MHz/V

MENU, 'TRIGGER menu', 'SINGLE mode', 'return'

'RESOLUTN menu', 'No. of POINTS', 2 , 1 , ENTER/EXECUTE

'return', 'TYPE lin log' ("log" in the 'TYPE lin log' softkey will change to intensified green.)

DISPLAY, 'TRACE B on off' ("off" in the 'TRACE B on off' softkey will change to intensified green.)

AUTO (The yellow LED in the **AUTO** key will turn ON.)

3. Sequentially press the following keys to perform a normalize (thorough) calibration, and wait until the message "Cal completed" is displayed.

CAL, 'TRANS CAL menu', 'NORMLIZE (THRU)', 'THRU', ENTER/EXECUTE

4. Press the **CAL** key and '**CORRECTN on off**' softkey to activate the HP 4195A's correction capability. "on" in this softkey will change to intensified green.
5. Disconnect **CABLE 1** (see Figure 5-1 (1)) from the power splitter, and connect the HP 41800A between the power splitter and **CABLE 1** as shown in Figure 5-1 (2).
6. Press the HP 4195A's **TRIG/RESET** key to make a single sweep measurement.
7. Enter the "REF=A(21)+0.5" command and "DIV=0.1" command to set the scale of the HP 4195A's display, using the following key sequence.

SCALE REF, 'A REF LEVEL', blue shiftkey, A, MATH OPERATOR,

'(, 2 , 1 , ')', '+', 0 , . , 5 , ENTER/EXECUTE

SCALE REF, 'A /DIV', 0 , . , 1 , ENTER/EXECUTE

ADJUSTMENT

- Press the **TRIG/RESET** key, and the '**CONT mode**' softkey to select the continuous sweep mode.
- Adjust **R18 (LF GAIN)** and **R25 (FLATNESS)** so that the T/R data displayed by the HP 4195A is within ± 0.5 dB for the data at 50 MHz, as shown in Figure 5-3.

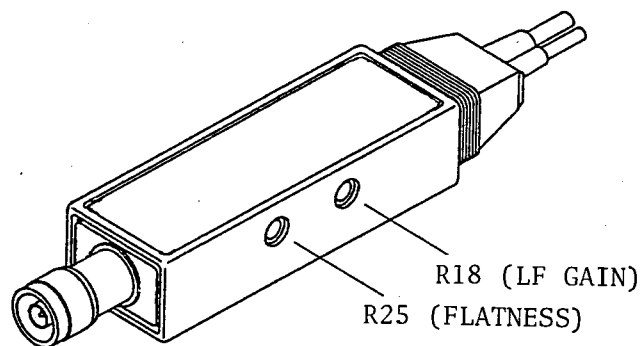

Figure 5-2. Adjustment Component Locations

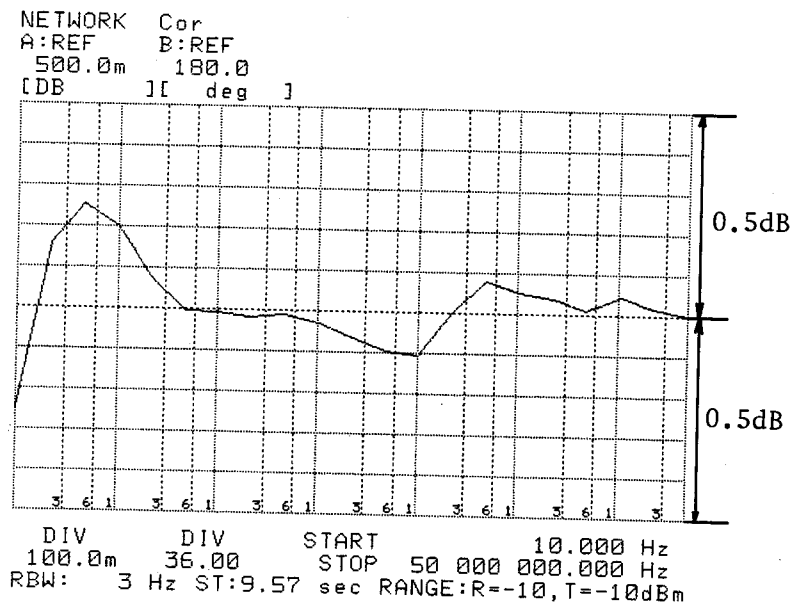

Figure 5-3. Adjustment Example

SERVICE

INTRODUCTION

This section contains the replaceable parts information, disassembly procedures, and troubleshooting and repair information.

REPLACEABLE PARTS

The HP 41800A's replaceable parts are listed in Table 6-1, Replaceable Parts. Table 6-1 gives the Hewlett-Packard part number, quantity (Qty.), and description.

To order a part listed in Table 6-1, indicate the Hewlett-Packard part number and the quantity desired. Address your order to the nearest Hewlett-Packard office.

Table 6-1. Replaceable Parts (1 of 3)

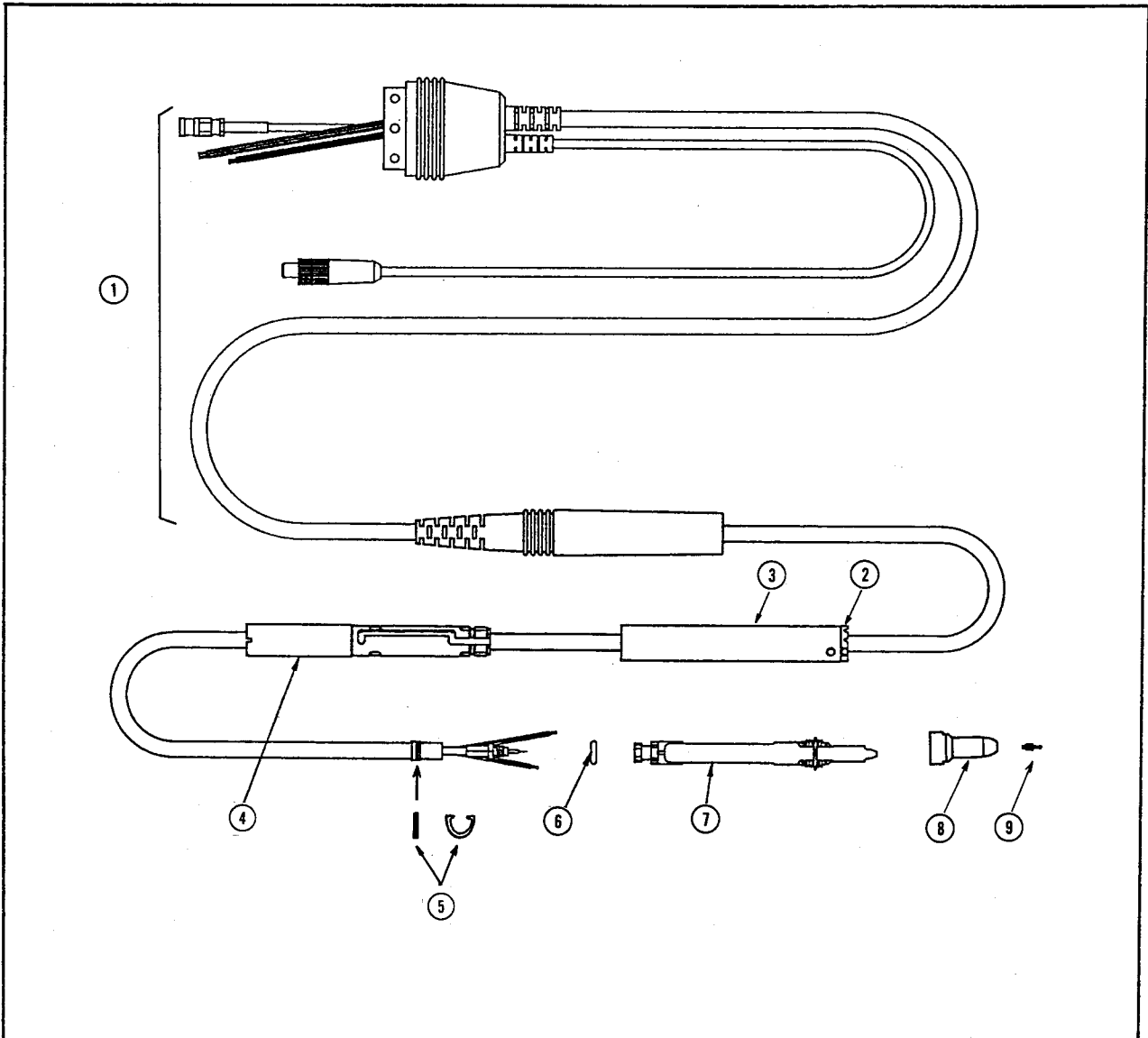

Reference Designator	Part Number	Qty.	Description
1	41800-61601	1	Cable Assembly
2	41800-40005	1	Support Shield
3	41800-24012	1	Protective Sleeve
4	41800-24010	1	Outer Tube Probe
5	0510-1325	1	Retainer CE Ring
6	0905-1150	1	O Ring
7	41800-60005	1	PC Board/Heatsink Assembly
8	41800-60002	1	Nose Assembly
9	41800-60003	1	12 mil Probe Pin Assembly
	41800-60004	1	30 mil Probe Pin Assembly

Table 6-1. Replaceable Parts (2 of 3)

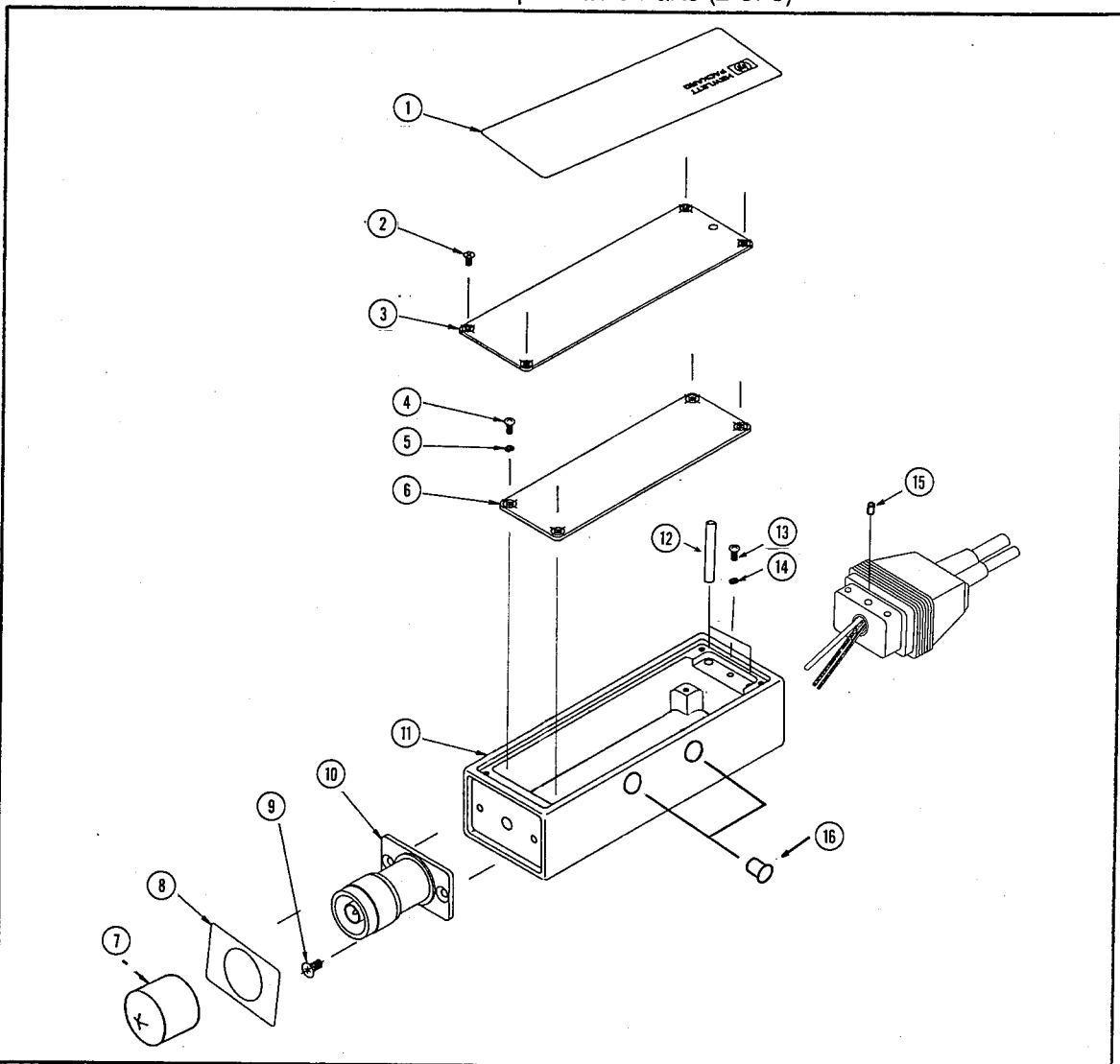

Reference Designator	Part Number	Qty.	Description
1	41800-87111	1	Label
2	0515-1873	4	Screw Metric
3	41800-04001	1	Cover
4	0515-0976	5	Screw M2 L6
5	2190-0654	5	Washer
6	41800-66502	1	Amplifier/Regulator Board Assembly
7	1401-0214	1	PVC Cap
8	41800-87112	1	Label
9	0515-0914	2	Screw-Mach M3×0.5
10	1250-2229	1	Connector N-PR-237
11	41800-20001	1	Case
12	41800-23003	2	Shaft
13	0515-0976		Screw M2 L6
14	2190-0654		Washer
15	41800-24004	1	Spacer
16	6960-0147	2	Plug Hole

Table 6-1. Replaceable Parts (3 of 3)

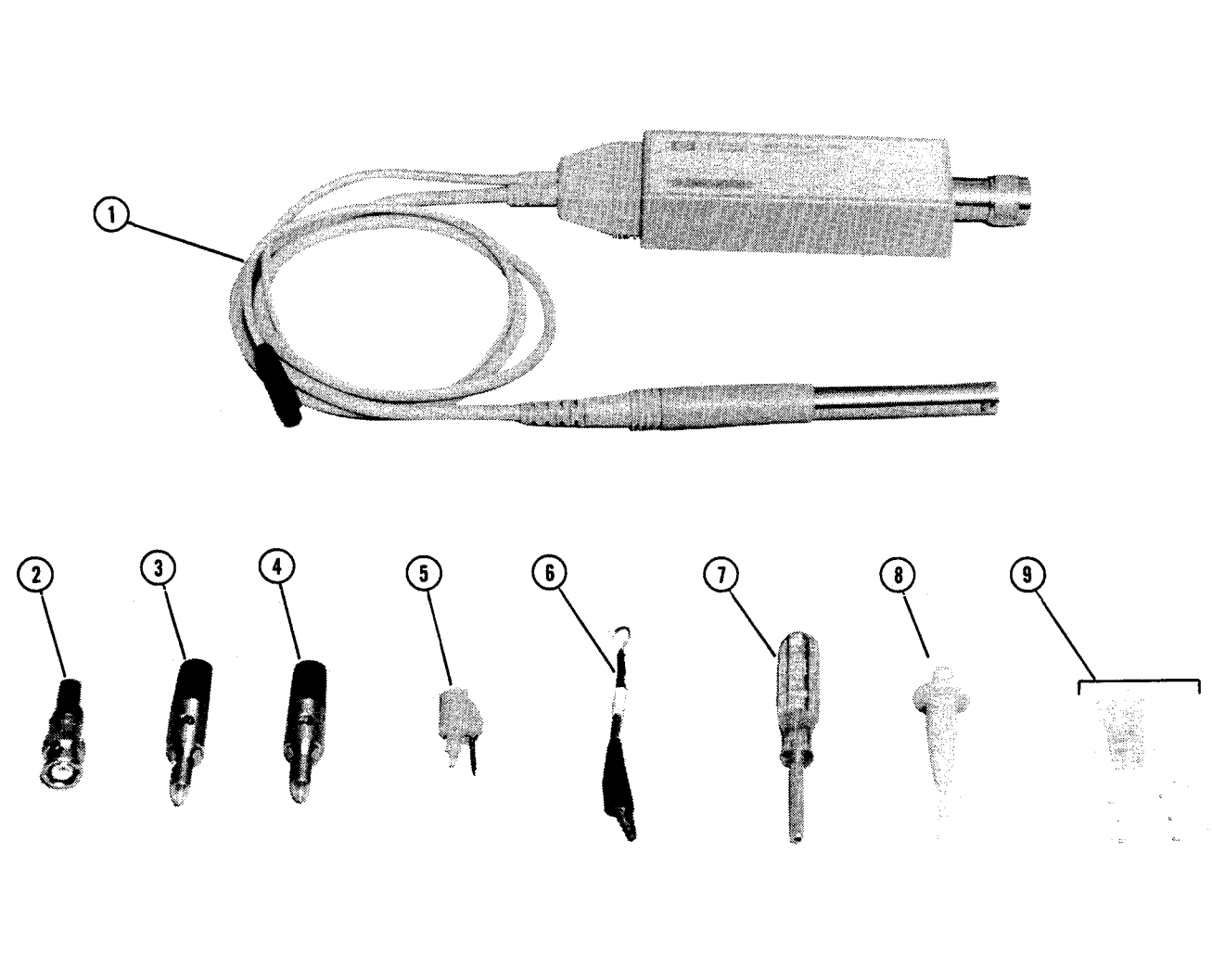

Reference Designator	Part Number	Qty.	Description
1	41800-6100 ¹	1	Probe Assembly
2	10218A	1	Probe-BNC(m) Adapter
3	41800-60011	1	10:1 Divider Assembly
4	41800-60012	1	100:1 Divider Assembly
5	5060-0549	1	Slip-on Spanner Ground Tip
6	01123-61302	1	Ground Clip (flexible)
7	8710-1806	1	Probe Tip Nut Driver (3/32 inch)
8	10229A	1	Hook Tip Adapter
9	41800-60021	1	Spare Probe Pin Set (12 mil pin×3, 30 mil pin×3)

¹ Agilent internal-only part number.

DISASSEMBLY

This paragraph describes the procedures for removing the Amplifier/Regulator Board Assembly (PN 41800-66502), and the PC Board/Heatsink Assembly (PN 41800-60005).

Removing the Amplifier/Regulator Board Assembly requires removing the labels on the HP 41800A. The labels will be damaged when you remove them. Use new labels after reassembling the HP 41800A (you must order the labels).

Amplifier/Regulator Board Assembly Removal:

1. Remove LABEL 1 from the COVER, and remove LABEL 2 from the N(m) Connector.

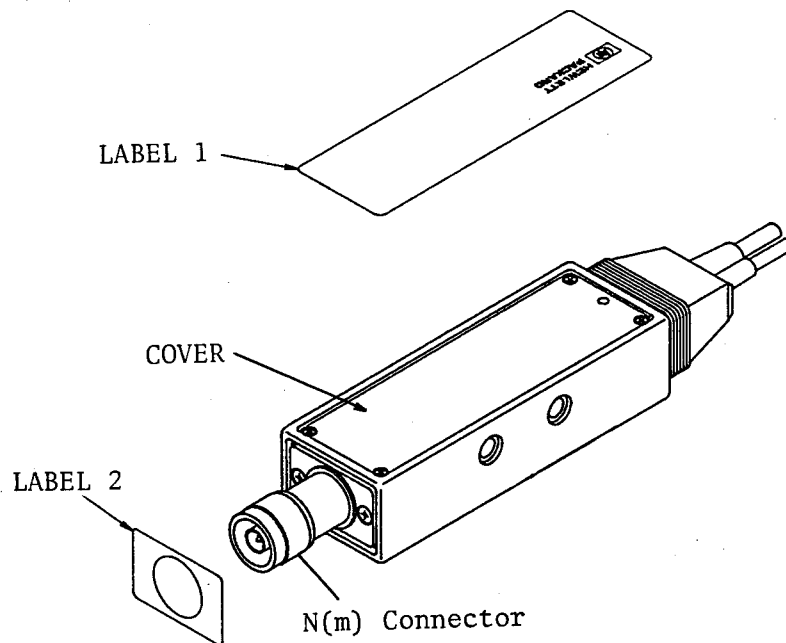

Figure 6-1. Label/Cover Removal

2. Remove the four screws holding the COVER and remove the COVER.
3. Remove the two screws holding the N(m) connector.

4. Remove the two SHAFTs and the screw as shown in Figure 6-2.

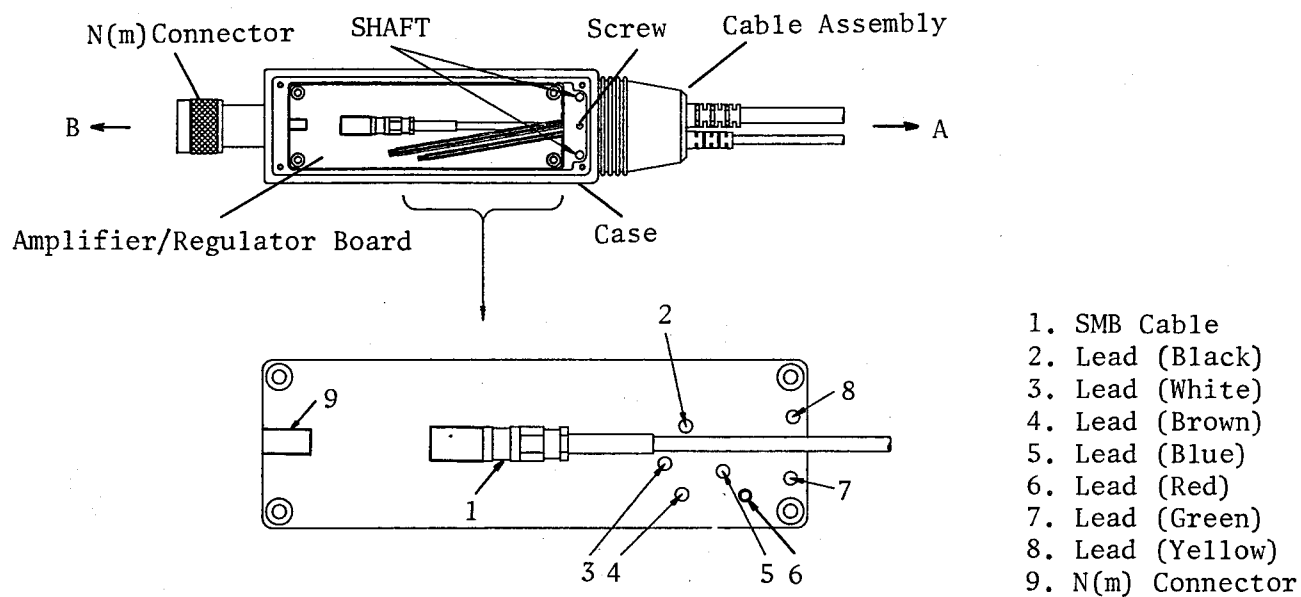

Figure 6-2. Amplifier/Regulator Board Disassembly

5. Disconnect the coaxial cable (item 1 in Figure 6-2) from the SMB connector on the Amplifier/Regulator Board assembly.
6. Remove the leads, item 2 through 8 on Figure 6-2, from the Amplifier/Regulator Board assembly.
7. Draw the coaxial cable and leads, a part of cable assembly PN 41800-61601, from the CASE toward the arrow A as shown in Figure 6-2.
8. Remove the solder at point 9 as shown in Figure 6-2.
9. Remove the N(m) connector from the CASE toward the arrow B shown Figure 6-2, while holding the soldering iron at point 9 as shown in Figure 6-2.
10. Remove the four screws holding the Amplifier/Regulator Board assembly in place.
11. Remove the Amplifier/Regulator Board assembly from the CASE.

PC Board/Heatsink Assembly Disassembly:

1. Remove the cable strain relief BOOT using the following procedure.
 - a. Hold the probe by hand at position **A** as shown in Figure 6-3.
 - b. Remove the BOOT by rotating it in the direction of arrow **B** as shown in Figure 6-3.
 - c. Slide the BOOT in the direction of arrow **C** as shown in Figure 6-3.

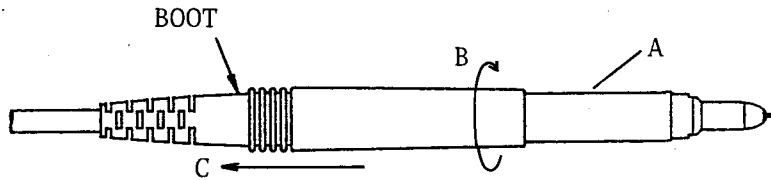

Figure 6-3. Boot Removal

2. Slide the SLEEVE in the direction of arrow **A** as shown in Figure 6-4.

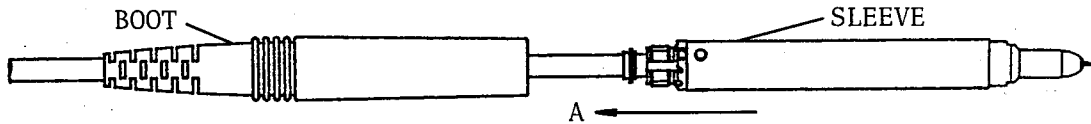

Figure 6-4. Sleeve Removal

3. Pull out the CE RING in the direction of arrow **A** as shown in Figure 6-5.

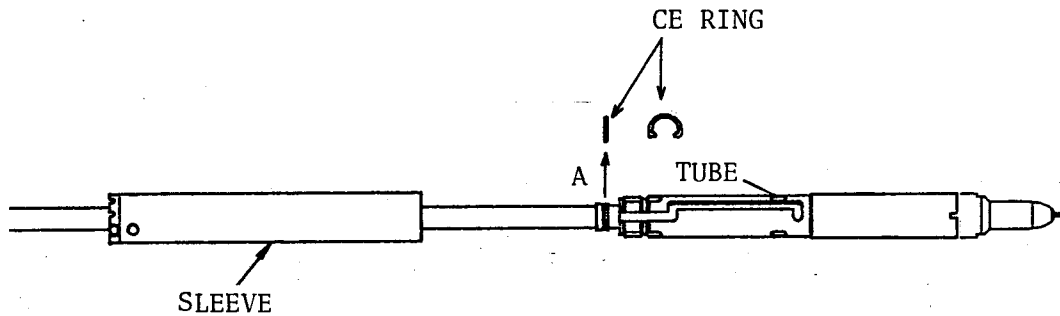

Figure 6-5. CE Ring Removal

4. Remove the probe NOSE piece using the following procedure.
 - a. Use a wrench to hold the NOSE piece at position **A** as shown in Figure 6-6.
 - b. Remove the NOSE piece by rotating it in the direction of arrow **B** as shown in Figure 6-6.
 - c. Remove the NOSE piece.

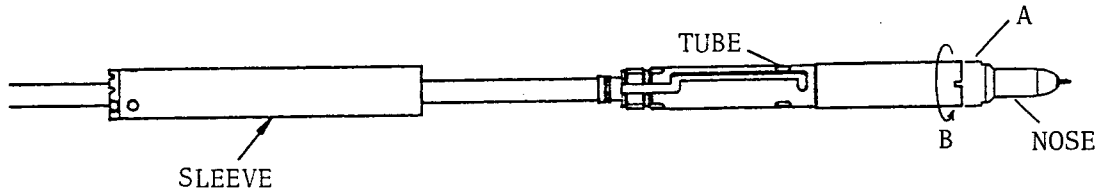

Figure 6-6. NOSE Removal

5. Remove the TUBE using the following procedure.
 - a. Hold the probe with a wrench at position **A** as shown in Figure 6-7.
 - b. Remove the TUBE by rotating it in the direction of arrow **B** as shown in Figure 6-7.
 - c. Slide the TUBE in the direction of arrow **C** as shown in Figure 6-7.

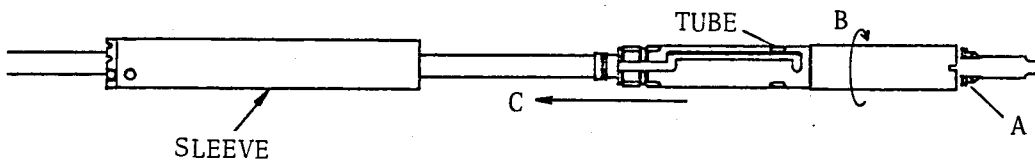

Figure 6-7. Tube Removal

6. Slide the O RING in direction A as shown in Figure 6-8.

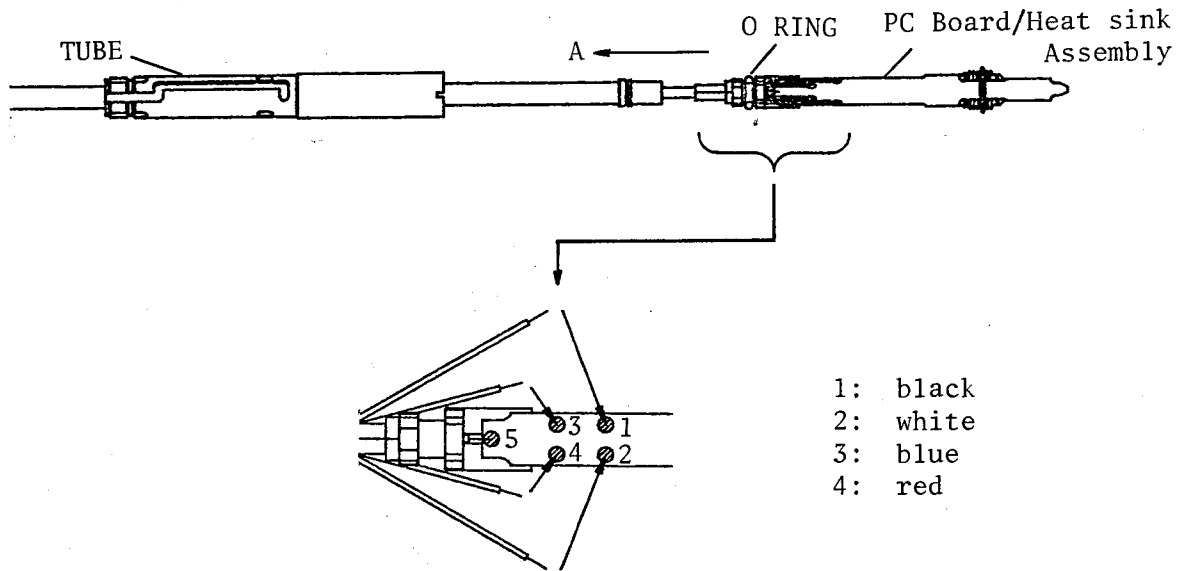

Figure 6-8. O Ring and Lead Removal

7. Remove leads No. 1 through 5 as shown in Figure 6-8, from the PC Board/Heatsink assembly.

8. Remove the PC Board/Heatsink Assembly using the following procedure.

a. Hold the probe at positions A and B as shown in Figure 6-9 using pliers or a wrench.

b. Remove the PC Board/Heatsink assembly by rotating it in the direction of arrow C as shown in Figure 6-9.

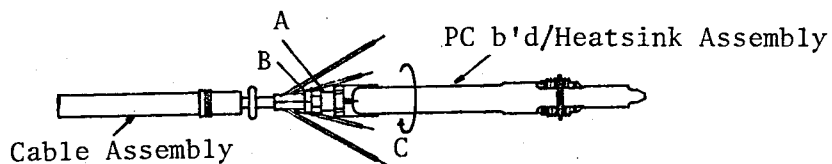

Figure 6-9. PC Board/Heatsink Assembly Removal

THEORY OF OPERATION

The HP 41800A active probe consists of amplifiers and regulators. The amplifiers provide unity gain. The amplifiers are on the PC board/Heatsink assembly and the Amplifier/Regulator Board assembly.

The regulators convert the dc voltage (+15 V and -12.6 V) supplied from the host instrument, and supply the regulated dc voltages (+15 V, +9 V, -7 V, and -12 V) to the amplifiers. The regulators are on the Amplifier/Regulator Board assembly.

TROUBLESHOOTING GUIDE

Troubleshooting should begin during the performance test. If the HP 41800A fails the performance test, perform the following procedure.

1. Check the voltage supplied by the host instrument. Refer to Figure 2-1, Probe Power Requirements for the required voltage.
2. Check the probe tip for damage. If the probe tip is defective, replace the probe tip.
3. Confirm that the gain of the PC board/Heatsink assembly is approximately -6 dB. The probing point is shown in Figure 6-10. If the gain is wrong, replace the PC board/Heatsink assembly.

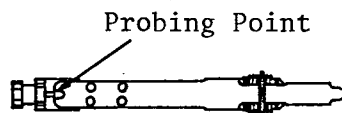

Figure 6-10. PC Board/Heatsink Assembly Check

4. Check the Cable assembly for damage. If it is defective, replace it.

Lead assignment:

- | | |
|---|--------------------------------------|
| 1 | -12.6 V (from Host Instrument) |
| 2 | +15 V (from Host Instrument) |
| 3 | +9 V (to PC Board/Heatsink Assembly) |
| 4 | -7 V (to PC Board/Heatsink Assembly) |
| 5 | GND (from Host Instrument) |
| 6 | S (from PC Board/Heatsink Assembly) |
| 7 | R (from PC Board/Heatsink Assembly) |

- | | |
|---|---------------------------------------|
| A | R (to Amplifier/Regulator Board) |
| B | S (to Amplifier/Regulator Board) |
| C | -7 V (from Amplifier/Regulator Board) |
| D | +9 V (from Amplifier/Regulator Board) |
| E | (coaxial cable) |

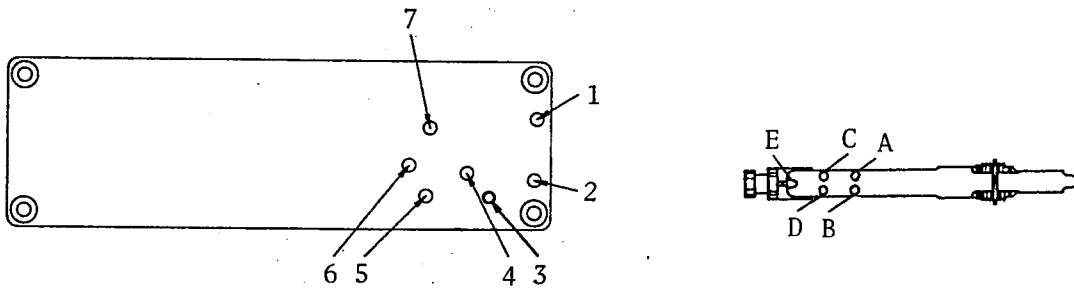

Figure 6-11. Lead Assignment

5. If the PC board/Heatsink assembly and the Cable assembly is ok, the Amplifier/Regulator board is defective.

NOTES

REGIONAL SALES AND SUPPORT OFFICES

For more information about Agilent Technologies test and measurement products, applications, services, and for a current sales office listing, visit our web site: <http://www.agilent.com/find/tmdir>. You can also contact one of the following centers and ask for a test and measurement sales representative.

11/29/99

United States:

Agilent Technologies
Test and Measurement Call Center
P.O.Box 4026
Englewood, CO 80155-4026
(tel) 1 800 452 4844

(fax) (61 3) 9272 0749
(tel) 0 800 738 378 (New Zealand)
(fax) (64 4) 802 6881

Canada:

Agilent Technologies Canada Inc.
5150 Spectrum Way
Mississauga, Ontario
L4W 5G1
(tel) 1 877 894 4414

Asia Pacific:

Agilent Technologies
24/F, Cityplaza One, 1111 King's Road,
Taikoo Shing, Hong Kong
(tel) (852)-3197-7777
(fax) (852)-2506-9284

Europe:

Agilent Technologies
Test & Measurement
European Marketing Organization
P.O.Box 999
1180 AZ Amstelveen
The Netherlands
(tel) (31 20) 547 9999

Japan:

Agilent Technologies Japan Ltd.
Call Center
9-1, Takakura-Cho, Hachioji-Shi,
Tokyo 192-8510, Japan
(tel) (81) 426 56 7832
(fax) (81) 426 56 7840

Latin America:

Agilent Technologies
Latin American Region Headquarters
5200 Blue Lagoon Drive, Suite #950
Miami, Florida 33126
U.S.A.
(tel) (305) 267 4245
(fax) (305) 267 4286

Australia/New Zealand:

Agilent Technologies Australia Pty Ltd
347 Burwood Highway
Forest Hill, Victoria 3131
(tel) 1-800 629 485 (Australia)