



**HEWLETT
PACKARD**

260141

OPERATION AND SERVICE MANUAL

MODEL 4277A

LCZ METER

(Including Options 001 and 002)

SERIAL NUMBERS

This manual applies directly to instruments with
serial numbers prefixed 2228J.

© COPYRIGHT: YOKOGAWA-HEWLETT-PACKARD, LTD., 1982
9-1, TAKAKURA-CHO, HACHIOJI-SHI, TOKYO, JAPAN

MANUAL PART NO. 04277-90000
Microfiche Part No. 04277-90050

Printed: JAN. 1984

M A N U A L C H A N G E S

4277A

LCZ METER

260141

MANUAL IDENTIFICATION

Model Number:	4277A
Date Printed:	JAN. 1984
Part Number:	04277-90000

This supplement contains important information for correcting manual errors and for adapting the manual to instruments containing improvements made after the printing of the manual.

To use this supplement:
 Make all ERRATA corrections.
 Make all appropriate serial number related changes indicated in the tables below.

SERIAL PREFIX OR NUMBER	MAKE MANUAL CHANGES	SERIAL PREFIX OR NUMBER	MAKE MANUAL CHANGES
2517J01271 and above	1		
2228J01030 and above	2		
2515J01618 and above	3		

► NEW ITEM

ERRATA

Page 3-49, Figure 3-22, External Trigger Pulse:
 Change the Input Level limits to read as follows.

$$\begin{aligned} \text{Input Levels: } & V_{IL} \leq 0.4V \\ & 2.4V \leq V_{IH} \leq 5V \end{aligned}$$

Page 3-74, Figure 3-32, Internal DC Bias Voltage Monitor (Sheet 1 of 2):
 In item 1. (i), change the equation for R to read as follows.

$$R_z = (V_K - V_H) \cdot R_0 / (V_H - V_L)$$

Page 4-A, Table 4-1, Recommended Equipment (Sheet 1 of 2):
 Change the Recommended Model for the 61cm test cable from HP 11170B to PN 8120-1839.

Change the Recommended Model for the 30cm test cable from HP 11170A to PN 8220-1838.

NOTE

Manual change supplements are revised as often as necessary to keep manuals as current and accurate as possible. Hewlett-Packard recommends that you periodically request the latest edition of this supplement. Free copies are available from all HP offices. When requesting copies quote the manual identification information from your supplement, or the model number and print date from the title page of the manual.

Date/Div: Aug. 14, 1986/33

Page 1 of 3



Pages 4-6 and 4-7, Paragraphs 4-9, Test Frequency Accuracy Test, and 4-11, Test Signal Level Accuracy Test:

Under EQUIPMENT, change the model number of the BNC-to-BNC cable from HP 11170A to PN 8120-1838.

Page 5-8, Paragraph 5-21, Test Signal Level Adjustment:

Under EQUIPMENT, change the model number of the BNC-to-BNC cable from HP 11170B to PN 8120-1839.

Page 6-7, Table 6-3, Replaceable Parts:

Change the part numbers and descriptions of A2Q6 through Q10 to read as follows.

Q6 and Q10: 1854-1041, TRANSISTOR NPN

Q2, Q3, and Q4: 1855-0571, TRANSISTOR FET

Page 6-18, Table 6-3, Replaceable Parts:

Change the part number of item 50 to 1510-0130.

Page 8-65, Figure 8-41, A1 LOGIC Board Troubleshooting Flow Diagram:

Delete pin 23 and the associated signature from Signature Set 8-1.

Page 8-67, Figure 8-41, A1 LOGIC Board Troubleshooting Flow Diagram:

In Signature Set 9-2, change the signature of A22U2 pin 15 to 810P.

CHANGE 1

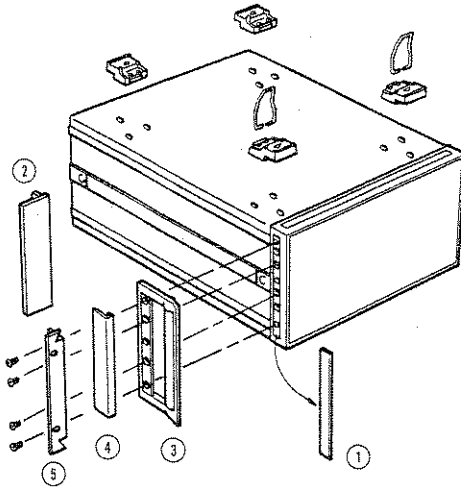
Page 2-5, Figure 2-3;

Change the Figure as shown on the next page.

CHANGE	Page	NOTE	Reference Designation	HP Part Number	Description
2	6-6	► C	A2C97	0160-4833	CAPACITOR-FXD .022 μ F 10%
3	6-6	► C	A2C100	0160-5493	CAPACITOR-FXD .1 μ F 10% 63V

►: New Item A: Add D: Delete C: Change

Option	Description	Kit Part Number
907	Handle Kit	5061-9690
908	Rack Flange Kit	5061-9678
909	Rack Flange & Handle Kit	5061-9684



1. Remove adhesive-backed trim strips ① from side at right and left front of instrument.
2. HANDLE INSTALLATION : Attach front handle ③ to sides at right and left front of instrument with screws provided and attach trim ④ to handle.
3. RACK MOUNTING : Attach rack mount flange ② to sides at right and left front of instrument with screws provided.
4. HANDLE AND RACK MOUNTING : Attach front handle ③ and rack mount flange ⑤ together to sides at right and left front of instrument with screws provided.
5. When rack mounting (3 and 4 above), remove all four feet (lift bar at inner side of foot, and slide foot toward the bar).

Figure 2-3. Rack Mount Kit.

SECTION I GENERAL INFORMATION

1-1. INTRODUCTION

1-2. This operation and service manual contains the information required to install, operate, test, adjust, and service the Hewlett-Packard Model 4277A LCZ Meter. Figure 1-1 shows the instrument and its supplied accessories. This section covers specifications, instrument identification, description, options, accessories, and other basic information.

1-3. Listed on the title page of this manual is a microfiche part number. This number can be used to order 4 x 6 inch microfilm transparencies of the manual. Each microfiche contains up to 60 photo-duplicates of the manual pages. The microfiche package also includes the latest manual changes supplement as well as all pertinent service notes. To order an additional manual, use the part number listed on the title page of this manual.

1-4. DESCRIPTION

1-5. The HP Model 4277A LCZ Meter is a fully automatic, high performance test instrument designed to measure the inductance, capacitance, dissipation factor, quality factor, conductance, equivalent series resistance, impedance magnitude, and phase of electronic components and devices. Its built-in test signal source covers the frequency range of 10kHz to 1MHz and provides 701 spot frequencies. Test frequency resolution is 100Hz (maximum), and frequency accuracy is $\pm 0.01\%$ of the selected spot frequency. Frequently used spot frequencies--10kHz, 100kHz, and 1MHz--can be quickly selected by the SPOT key. Test signal level is selectable at 1Vrms (HIGH) or 20mVrms (LOW). The instrument's state-of-the-art 4-terminal pair configuration provides a basic measurement accuracy of 0.1% over a wide measurement range.

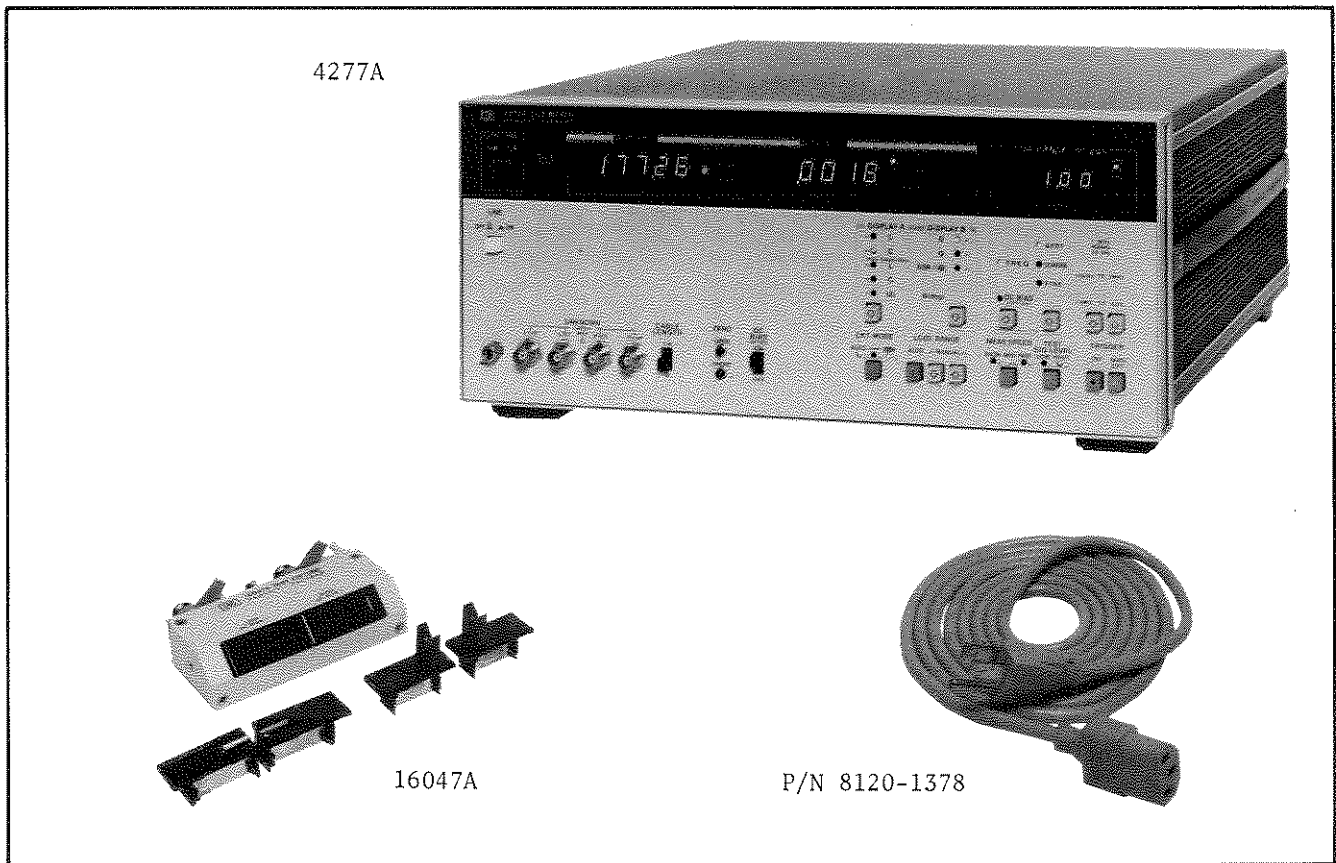


Figure 1-1. Model 4277A and Accessories.

1-6. The 4277A has three measurement speed modes: SLOW, MED, and FAST. When MED mode is selected, total time required for a C-D or L-Q measurement is approximately 70ms (at 1MHz). FAST mode measurement time is approximately 25 percent shorter than that of MED mode. Also, the HIGH SPEED C and HIGH SPEED L measurement functions reduce measurement time to approximately half that of a normal C-D or L-Q measurement. Shortest measurement time is approximately 35ms (HIGH SPEED C or L, FAST mode, at 1MHz). The 4277A is equipped with a Δ (delta) measurement function to permit temperature dependency or dc bias dependency measurements.

1-7. All instrument operations--measurement, front panel control settings, ranging, triggering, HP-IB, displays, self test, continuous memory, etc.--are controlled by a Z80 microprocessor. The built-in self test function can be initiated at any time to verify correct operation of the instrument's basic capabilities. The 4277A is also equipped with a continuous memory function that is automatically activated when the instrument is turned off or experiences a power failure. All front panel control settings (except dc bias), zero offset data, and comparator limits (Option 002) are memorized and automatically recalled when the instrument is turned on again.

1-8. The Hewlett-Packard Interface Bus (HP-IB) is standard on the 4277A. All of the instrument's standard and optional functions (except power on/off and DC BIAS ON/OFF) can be remotely controlled from an HP-IB compatible controller. When set to TALK ONLY mode, the 4277A can send measurement data to an external device (a printer, for example) without a controller.

1-9. The 4277A can be equipped with two special options: Option 001 Internal DC Bias and Option 002 Comparator/Handler Interface. Refer to paragraph 1-21 for a brief description of these options.

1-10. A wide selection of accessories--test fixtures and test leads--is available. All accessories are useable with HP's other four-terminal-pair type instruments. A description of furnished accessories is given in paragraph 1-30. For details on available accessories, refer to paragraph 1-32.

1-11. SPECIFICATIONS

1-12. Complete specifications of the Model 4277A are given in Table 1-1. These specifications are the performance standards or limits against which the instrument is tested. The test procedures for verifying the specifications are covered in Section IV, Performance Tests. Table 1-2 lists supplemental performance characteristics. Supplemental performance characteristics are not specifications but are typical characteristics included as additional information for the operator. When the 4277A is shipped from the factory, it meets the specifications listed in Table 1-1.

1-13. SAFETY CONSIDERATIONS

1-14. The Model 4277A has been designed to conform to the safety requirements of an IEC (International Electromechanical Committee) Safety Class I instrument and is shipped from the factory in a safe condition.

1-15. This operating and service manual contains information, cautions, and warnings which must be followed by the user to ensure safe operation and to maintain the instrument in a safe condition.

1-16. INSTRUMENTS COVERED BY MANUAL

1-17. Hewlett-Packard uses a two-section nine character serial number which is stamped on the serial number plate (Figure 1-2) attached to the instrument's rear-panel. The first four digits and the letter are the serial prefix and the last five digits are the suffix. The letter placed between the two sections identifies the country where the instrument was manufactured. The prefix is the same for all identical instruments; it changes only when a change is made to the instrument. The suffix, however, is assigned sequentially and is different for each instrument. The contents of this manual apply to instruments with the serial number prefix(es) listed under SERIAL NUMBERS on the title page.

1-18. An instrument manufactured after the printing of this manual may have a serial number prefix that is not listed on the title page. This unlisted serial number prefix indicates the instrument is different from the one described in this manual. The manual for this newer instrument may be accompanied by a yellow Manual Changes supplement or have a different manual part number. This supplement contains "change information" that explains how to adapt the manual to the newer instrument.

1-19. In addition to change information, the supplement may contain information for correcting errors (called Errata) in the manual. To keep this manual as current and accurate as possible, Hewlett-Packard recommends that you periodically request the latest Manual Changes supplement. The supplement for this manual is identified with this manual's print date and part number, both of which appear on the manual's title page. Complimentary copies of the supplement are available from Hewlett-Packard. If the serial prefix or number of an instrument is lower than that on the title page of this manual, see Section VII, Manual Changes.

1-20. For information concerning a serial number prefix that is not listed on the title page or in the Manual Change supplement, contact the nearest Hewlett-Packard office.

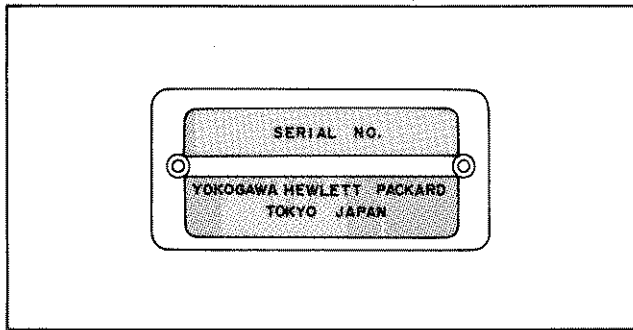


Figure 1-2. Serial Number Plate.

1-21. OPTIONS

1-22. Options are modifications to the standard instrument that implement the user's special requirements for minor functional changes. The 4277A has two options:

Option 001 : Internal DC Bias Supply
(0 -- $\pm 40V$)

Option 002 : Comparator/Handler Interface

1-23. OPTION 001

1-24. Option 001 equips the standard 4277A with a built-in dc voltage source for biasing the device under test. Output voltage is user-selectable from 0 to $\pm 40V$ with 10mV (0V to $\pm 9.99V$ range) or 100mV ($\pm 10V$ to $\pm 40V$ range) setting resolution, and can be keyed in directly from the front panel or remotely programmed via the HP-IB. Maximum display resolution is 3 digits.

1-25. OPTION 002

1-26. Option 002 equips the standard 4277A with the 16064A Comparator/Handler Interface for go/no-go testing and automatic bin sorting. Up to nine sets of HIGH/LOW limits for one DISPLAY A function (L, C, or |Z|) and one set of HIGH/LOW limits for one DISPLAY B function (D, Q, ESR, or G) can be manually keyed in from the 16064A, or entered from a remote controller via the HP-IB. Comparison results--HIGH, IN, or LOW--for each measurement parameter are indicated by LED lamps on the 16064A and by open collector (TTL level voltages) output from the handler interface connector.

HIGH: Measured value exceeds the HIGH limit.

IN : Measured value is within the HIGH and LOW limits, inclusive.

LOW : Measured value is lower than the LOW limit.

1-27. OTHER OPTIONS

1-28. The following options provide the mechanical parts necessary for rack mounting and hand carrying:

Option 907 : Front Handle Kit. Furnishes carrying handles for both ends of the front-panel.

Option 908 : Rack Flange Kit. Furnishes flanges for rack mounting.

Option 909 : Rack Flange and Front Handle Kit. Furnishes front handles (Opt. 907) and rack flanges (Opt. 908).

Installation instructions for these options are given in Section II.

1-29. Option 910 adds an extra copy of the Operation and Service Manual.


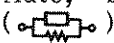
Table 1-1. Specifications (Sheet 1 of 17)

SPECIFICATIONS



Parameters Measured:

C (capacitance), L (inductance), $|Z|$ (impedance), D (dissipation factor), Q (quality factor), ESR (equivalent series resistance), G (conductance), θ (phase angle), HIGH SPEED C (at 1MHz only), HIGH SPEED L (at 1MHz only), Δ (deviation).

Measurement Circuit Modes:

Auto, Series () and Parallel ()

Parameter Combinations:

Circuit Mode	Parameter Combination
Series 	C-D, C-Q, C-ESR, L-D, L-Q, L-ESR, $ Z -\theta$, HIGH SPEED C, HIGH SPEED L
Parallel 	C-D, C-Q, C-G, L-D, L-Q, L-G, $ Z -\theta$, HIGH SPEED C, HIGH SPEED L

Measurement Speed Modes:

SLOW, MED, and FAST

Displays:

Measurement Speed Mode	Display Digits	Maximum Display
SLOW	4 1/2	19999 counts
MED		
FAST	3 1/2	1999 counts

Note: Number of display digits depends on the test frequency, the test signal level, and the measurement range.

Measurement Terminals:

4-terminal-pair configuration with guard terminal

Ranging Modes:

Auto and Manual (UP/DOWN keys)

Test Frequencies:

Test Frequency Range	Resolution
10kHz to 20kHz	100Hz
20kHz to 50kHz	200Hz
50kHz to 100kHz	500Hz
100kHz to 200kHz	1kHz
200kHz to 500kHz	2kHz
500kHz to 1MHz	5kHz

Frequency Control Modes:

SPOT (10kHz, 100kHz, 1MHz)
COARSE (10 freq. points/decade)
FINE (maximum resolution)

Frequency Accuracy: $\pm 0.01\%$

Test Signal Level:

HIGH (1Vrms) or LOW (20mVrms)

Level Accuracy:

Test Signal Level	Test Frequency	
	1MHz	10kHz to 995kHz
HIGH	$\pm 10\%$	$\pm 10\%$
LOW		$\pm 15\%$

Output Impedance: $100\Omega \pm 10\%$

Deviation Measurement:

Calculates and displays the difference between a stored reference values and measured values.

Self Test:

Checks the 4277A's basic operation when the instrument is turned on or when the SELF TEST key is pressed. If an abnormality is detected, an error code is displayed on DISPLAY A.

Table 1-1. Specifications (Sheet 2 of 17)

Zero Offset Adjustment:

Compensation for residual impedance and stray admittance of the test fixture connected to the UNKNOWN terminals is automatically done by the ZERO OPEN/SHORT buttons.

Compensation frequencies:

10k, 20.2k, 50.5k, 100k, 202k, 505k, 700k, 900k, and 1MHz

Compensation at other frequencies is automatically done by secondary interpolation.

Maximum Offset Values:

C: Up to 20pF	} (open)
G: Up to 2µs	
L: up to 2µH	} (short)
R: up to 2Ω	

CABLE LENGTH:

1m or 0m. Use 0m for direct attachment type test fixtures; use 1m for test leads.

Trigger:

Internal, External, Manual, or HP-IB remote control

External DC Bias:

Up to ±40V dc can be applied to the DUT from an external voltage source connected to the EXT INT/INT MONITOR BNC connector on the rear panel. Output impedance is 1040Ω±10%.

HP-IB (Hewlett-Packard Interface Bus):

Data output and remote control. Based on IEEE Std. 488 and ANSI-MC1.1.

Interface Capabilities:

SH1, AH1, T5, L4, SR1, RL1, DC1, DT1, and E1

Remote Control:

All front panel control settings (except power switch, DC BIAS (ON/OFF switch, and CABLE LENGTH switch) and all 16064A Comparator/Handler-Interface settings (option 002).

Data Output:

Parameter measured
Equivalent circuit mode
Display status
Measured values
Comparator output

Output Format:

ASCII format or Binary format

Continuous Memory:

Memorizes all front panel control settings (except DC BIAS voltage setting), zero offset adjustment data, Δ reference values, and comparator limits (option 002) when the instrument is turned off or experiences a power failure. Settings and data are recalled when the instrument is turned on.

Warm-up Time:

Minimum 30 minutes

Ambient Temperature:

23 °C±5 °C (at 0 °C to 55 °C, error doubles)

General Specifications

Operating Temperature: 0 °C to 55 °C

Relative Humidity: 95% at 40 °C

Storage Temperature: -40 °C to +70 °C

Power Requirements:

90V to 132V, 198V to 250V. 48Hz to 66Hz.

Power Consumption:

75VA max. with any option

Dimensions:

425.5 (W) x 188 (H) x 430 (D)mm

Weight: Approximately 8.5kg

Table 1-1. Specifications (Sheet 3 of 17)

Capacitance Measurement Accuracy

C-D Measurement Accuracy:

C Accuracy: $\pm[(\% \text{ of reading}) + (\text{error in farads}) + (\text{number of counts})]$, see Tables A-1 and A-2.

D Accuracy: $\pm[(\% \text{ of reading}) + (\text{D error}) + (\text{number of counts})]$, see Tables A-1 and A-2.

Note: Use Table A-1 when the test frequency is 10kHz, 100kHz, or 1MHz.
Use Table A-2 for all other frequencies.

Note: Accuracies obtained from Tables A-1 and A-2 are valid only for measurements made with the CABLE LENGTH switch set to 0m. When the CABLE LENGTH switch is set to 1m, add the errors listed in Table A-3 to the accuracies obtained from Tables A-1 and A-2.

Table A-1. C-D Accuracies (10kHz, 100kHz, 1MHz only)

Capacitance Range	Test Frequency		
	10kHz	100kHz	1MHz
10 μ F			
1 μ F		$(1 + \alpha)\% + \frac{3}{2}$ $1\% + .03 + \frac{3}{2}$	
100nF	$.1\% + 30\text{pF} + \frac{5}{\alpha}$ $.5\% + .0005/\alpha + .0006 + \frac{5}{\alpha}$	$(.3 + .5\alpha)\% + \frac{3}{2}$ $.3\% + .003\alpha + .002 + \frac{3}{2}$	
10nF	$.1\% + 3\text{pF} + \frac{5}{\alpha}$ $.5\% + .0005/\alpha + .0006 + \frac{5}{\alpha}$	$.1\% + 3\text{pF} + \frac{5}{\alpha}$ $.3\% + .0005/\alpha + .0006 + \frac{5}{\alpha}$	$(.3 + .5\alpha)\% + \frac{3}{2}$ $.3\% + .003\alpha + .002 + \frac{3}{2}$
1nF	$.1\% + .3\text{pF} + \frac{5}{\alpha}$ $.5\% + .0005/\alpha + .0006 + \frac{5}{\alpha}$	$.1\% + .3\text{pF} + \frac{5}{\alpha}$ $.3\% + .0005/\alpha + .0006 + \frac{5}{\alpha}$	
100pF	$.3\% + 30\text{fF} + \frac{10}{\alpha}$ $.5\% + .0005/\alpha + .003 + \frac{5}{\alpha}$	$.1\% + 30\text{fF} + \frac{5}{\alpha}$ $.3\% + .0005/\alpha + .0006 + \frac{5}{\alpha}$	$.1\% + \frac{5}{\alpha}$ $.3\% + .0005/\alpha + .0006 + \frac{5}{\alpha}$
10pF		$.3\% + 3\text{fF} + \frac{10}{\alpha}$ $.5\% + .0005/\alpha + .003 + \frac{5}{\alpha}$	
1pF			$.3\% + .3\text{fF} + \frac{10}{\alpha}$ $.5\% + .0005/\alpha + .003 + \frac{5}{\alpha}$

*: When LOW test signal level (20mVrms) is used, C accuracy is as follows:

$$.1\% + \frac{10}{\alpha}$$

Table 1-1. Specifications (Sheet 4 of 17)

Capacitance Range	Test Frequency Range					
	10.1kHz to 20kHz	20.2kHz to 50kHz	50.5kHz to 99.5kHz	101kHz to 200kHz	202kHz to 500kHz	505kHz to 995kHz
10µF						
1µF						
100nF	$(1 + \alpha)\% + \frac{3}{1\% + .05 + \frac{3}{2}}$					
10nF	$(.5 + .5\alpha)\% + \frac{3}{.3\% + .003\alpha + .002 + \frac{3}{5}}$					
1nF	$.1\% + 80\text{pF} + \frac{5}{.3\% + .0005/\alpha + .0016 + \frac{5}{5}}$	$.1\% + 12\text{pF} + \frac{5}{.3\% + .0005/\alpha + .0024 + \frac{5}{5}}$	$.1\% + 6\text{pF} + \frac{5}{.3\% + .0005/\alpha + .0012 + \frac{5}{5}}$	$.1\% + 8\text{pF} + \frac{5}{.3\% + .0005/\alpha + .0016 + \frac{5}{5}}$		
100pF	$.1\% + 8\text{pF} + \frac{5}{.3\% + .0005/\alpha + .0016 + \frac{5}{5}}$	$.1\% + 1.2\text{pF} + \frac{5}{.3\% + .0005/\alpha + .0024 + \frac{5}{5}}$	$.1\% + .6\text{pF} + \frac{5}{.3\% + .0005/\alpha + .0012 + \frac{5}{5}}$	$.1\% + .8\text{pF} + \frac{5}{.3\% + .0005/\alpha + .0016 + \frac{5}{5}}$		
10pF	$.1\% + 80\text{fF} + \frac{10}{.5\% + .0005/\alpha + .003 + \frac{5}{5}}$	$.1\% + .12\text{pF} + \frac{5}{.3\% + .0005/\alpha + .0024 + \frac{5}{5}}$	$.1\% + 60\text{fF} + \frac{5}{.3\% + .0005/\alpha + .0012 + \frac{5}{5}}$	$.1\% + 80\text{fF} + \frac{5}{.3\% + .0005/\alpha + .0016 + \frac{5}{5}}$	$.1\% + .12\text{pF} + \frac{5}{.3\% + .0005/\alpha + .0024 + \frac{5}{5}}$	$.1\% + 60\text{fF} + \frac{5}{.3\% + .0005/\alpha + .0012 + \frac{5}{5}}$
1pF						
	10kHz	20kHz	50kHz	100kHz	200kHz	500kHz 1MHz

Equations in Tables A-1 and A-2 represent:

C Accuracy
D Accuracy

α : Full-scale factor (= measured C value ÷ full-scale C value). For example, when the measured C value is 850pF on the 1000pF range, α is 0.85.

Note 1: Tables A-1 and A-2 are applicable under the following conditions:

- (1) CABLE LENGTH: 0m
- (2) Test Signal Level: HIGH (1Vrms)
- (3) Sample's D Value: ≤ 0.1
- (4) Zero offset adjustment has been performed with the OPEN and SHORT terminations of the Model 16074A.

Note 2: Error doubles when LOW test signal level (20mVrms) is used.

Table A-3. Additional Measurement Error for C-D at 1MHz

C Range	1MHz
100nF	.1% of reading
10nF	.001/ α
1nF	.06% of reading .0003 α
100pF	.03% of reading .0002 α
10pF	.05% of reading .0003 α
1pF	.4% of reading .001 α

Note 1: Table A-3 is applicable under the following conditions:

- (1) Test Frequency: 1MHz
- (2) CABLE LENGTH: 1m
- (3) Test Signal Level: HIGH (1Vrms)
- (4) Sample's D Value: ≤ 0.1
- (5) Test Leads: Model 16048A or 16048B
- (6) Zero offset adjustment has been performed with the OPEN and SHORT terminations of the Model 16074A.

Note 2: Error doubles when LOW test signal level (20mVrms) is used.

Table 1-1. Specifications (Sheet 5 of 17)

C-Q Measurement Accuracy:

C Accuracy: $\pm[(C \text{ accuracy of C-D measurement})]$

Q Accuracy: $\pm[(D \text{ accuracy} \div \text{measured D value} \times 100)\% \text{ of Q reading} + 1 \text{ count}]$

Note: Q is the reciprocal of D.

Note: Q accuracy is calculated from the measured D value. Refer to Figure 3-19.

HIGH SPEED C Measurement Accuracy:

C Accuracy: $\pm[(C \text{ accuracy of C-D measurement})]$

Note: HIGH SPEED C accuracy is specified on the ranges enclosed in the dotted line in Table A-1.

Note: Table A-1 is applicable under the following condition:

(1) Sample's D Value: ≤ 0.01

C-ESR/G Measurement Accuracy:

C Accuracy: $\pm[(C \text{ accuracy of C-D measurement})]$

ESR Accuracy: $\pm[(\% \text{ of reading}) + (\text{ESR error in ohms}) + (\text{number of counts})]$, see Tables A-4 and A-5.

G Accuracy: $\pm[(\% \text{ of reading}) + (\text{G error in siemens}) + (\text{number of counts})]$, see Tables A-4 and A-5.

Note: Use Table A-4 when the test frequency is 10kHz, 100kHz, or 1MHz. Use Table A-5 for all other frequencies.

Note: ESR range and G range depend on the selected C range and test frequency. Refer to Table A-7.

Note: Accuracies obtained from Tables A-4 and A-5 are valid only for measurements made with the CABLE LENGTH switch set to 0m. When the CABLE LENGTH switch is set to 1m, add the errors listed in Table A-6 to the accuracies obtained from Tables A-4 and A-5.

Note: DISPLAY B function, when ESR/G is selected, depends on the CIRCUIT MODE.

Table 1-1. Specifications (Sheet 6 of 17)

Table A-4. C-ESR/G Accuracies (10kHz, 100kHz, 1MHz only)

ESR/G Range		Test Frequency		
		10kHz	100kHz	1MHz
ESR	1MΩ	ESR: See Note 1. G : .3% + 4αnS + 20nS + <u>5</u>		
G	10μS			
ESR	100kΩ	ESR: See Note 1. G : .1% + 60αnS + 20nS + <u>5</u>		
G	100μS			
ESR	10kΩ	ESR: See Note 1. G : .1% + .6αμS + 0.2μS + <u>5</u>		
G	1mS			
ESR	1kΩ	ESR: See Note 1. G : .1% + 6αμS + 2μS + <u>5</u>		
G	10mS			
ESR	100Ω	ESR: .2% + 30αmΩ + 20mΩ + <u>5</u> G : See Note 2.		
G	100mS			
ESR	10Ω	ESR: .5% + 5αmΩ + 6mΩ + <u>5</u> G : See Note 2.		
G	1S			

Table A-5. C-ESR/G Accuracies

ESR/G Range		Test Frequency Range				
		10.1kHz to 20kHz	20.2kHz to 99.5kHz	101kHz to 200kHz	202kHz to 995kHz	
ESR	1MΩ	See Note 1. .3% + 12αnS + 60nS + <u>5</u>	See Note 1. .3% + 6αnS + 30nS + <u>5</u>	See Note 1. .3% + 12αnS + 60nS + <u>5</u>	See Note 1. .3% + 6αnS + 30nS + <u>5</u>	
G	10μS					
ESR	100kΩ	See Note 1. .1% + .18αμS + 60nS + <u>5</u>	See Note 1. .1% + 90αnS + 30nS + <u>5</u>	See Note 1. .1% + .18αμS + 60nS + <u>5</u>	See Note 1. .1% + 90αnS + 30nS + <u>5</u>	
G	100μS					
ESR	10kΩ	See Note 1. .1% + 1.8αμS + .6 μS + <u>5</u>	See Note 1. .1% + .9αμS + .3μS + <u>5</u>	See Note 1. .1% + 1.8αμS + .6μS + <u>5</u>	See Note 1. .1% + .9αμS + .3μS + <u>5</u>	
G	1mS					
ESR	1kΩ	See Note 1. .1% + 18αμS + 6μS + <u>5</u>	See Note 1. .1% + 9αμS + 3μS + <u>5</u>	See Note 1. .1% + 18αμS + 6μS + <u>5</u>	See Note 1. .1% + 9αμS + 3μS + <u>5</u>	
G	10mS					
ESR	100Ω	.2% + 30αmΩ + 60mΩ + <u>5</u> See Note 2.	.2% + 30αmΩ + 30mΩ + <u>5</u> See Note 2.	.2% + 30αmΩ + 60mΩ + <u>5</u> See Note 2.	.2% + 30αmΩ + 30mΩ + <u>5</u> See Note 2.	
G	100mS					
ESR	10Ω	.5% + 5αmΩ + 18mΩ + <u>5</u> See Note 2.	.5% + 5αmΩ + 18mΩ + <u>5</u> See Note 2.	.5% + 5αmΩ + 18mΩ + <u>5</u> See Note 2.	.5% + 5αmΩ + 9mΩ + <u>5</u> See Note 2.	
G	1S					
		10kHz	20kHz	100kHz	200kHz	1MHz

Table 1-1. Specifications (Sheet 7 of 17)

Equations in Tables A-4 and A-5 represent:

ESR Accuracy
G Accuracy

α : Full-scale factor (= measured C value \div full-scale C value). For example, when the measured C value is 850pF on the 1000pF range, α is 0.85.

Note 1: ESR accuracy is $\pm[2$ (C accuracy \div measured C \times 100)% of ESR reading + (G accuracy \div measured G \times 100)% of ESR reading + 1 count].

Note 2: G accuracy is $\pm[2$ (C accuracy \div measured C \times 100)% of G reading + (ESR accuracy \div measured ESR \times 100)% of G reading + 1 count].

Note 3: Tables A-4 and A-5 are applicable under the following conditions:

- (1) CABLE LENGTH: 0m
- (2) Test Signal Level: HIGH (1Vrms)
- (3) Sample's D Value: ≤ 0.1
- (4) Zero offset adjustment has been performed with the OPEN and SHORT terminations of the Model 16074A.

Note 4: Error doubles when LOW test signal level (20mVrms) is used.

Table A-6. Additional Measurement Error for ESR and G at 1MHz

ESR/G Range	1MHz
10 Ω	.1% of reading
100 Ω	.06% of reading
10mS	.06% of reading + 3 μ S
1mS	.04% of reading of .2 μ S
100 μ S	.05% of reading + 30nS
10 μ S	.4% of reading + 10nS

Note 1: Table A-6 is applicable under the following conditions:

- (1) Test Frequency: 1MHz
- (2) CABLE LENGTH: 1m
- (3) Test Signal Level: HIGH (1Vrms)
- (4) Sample's D Value: ≤ 0.1
- (5) Test Lead: Model 16048A or 16048B
- (6) Zero offset adjustment has been performed with the OPEN and SHORT terminations of the Model 16074A.

Note 2: Error doubles when LOW test signal level (20mVrms) is used.

Table 1-1. Specifications (Sheet 8 of 17)

Table A-7. ESR/G Range Selection

Capacitance Range		Test Frequency Range		
		10kHz to 20kHz	20.2kHz to 200kHz	202kHz to 1MHz
10 μ F	ESR			
	G			
1 μ F	ESR		10 Ω 1S	
	G			
100nF	ESR		100 Ω 100mS	
	G			
10nF	ESR		1k Ω 10mS	
	G			
1nF	ESR		10k Ω 1mS	
	G			
100pF	ESR		100k Ω 100 μ S	
	G			
10pF	ESR		1M Ω 10 μ S	
	G			
1PF	ESR			
	G			

Table 1-1. Specifications (Sheet 9 of 17)

Inductance Measurement Accuracy

L-D Measurement Accuracy:

L Accuracy: $\pm[(\% \text{ of reading}) + (\text{L error}) + (\text{number of counts})]$, see Tables B-1 and B-2.

D Accuracy: $\pm[(\% \text{ of reading}) + (\text{D error}) + (\text{number of counts})]$, see Tables B-1 and B-2.

Note: Use Table B-1 when the test frequency is 10kHz, 100kHz, or 1MHz. Use Tables B-2 for all other frequencies.

Note: Accuracies obtained from Tables B-1 and B-2 are valid only for measurements made with the CABLE LENGTH switch set to 0m. When the CABLE LENGTH switch is set to 1m, add the errors listed in Table B-3 to the accuracies obtained from Tables B-1 and B-2.

Table B-1. L-D Accuracies (10kHz, 100kHz, 1MHz only)

Inductance Range	Test Frequency		
	10kHz	100kHz	1MHz
1H			
100mH			
10mH		$1\% + \frac{5}{\alpha}$ $1\% + .02 + \frac{3}{\alpha}$	
1mH	$.2\% + .4\mu\text{H} + \frac{5}{\alpha}$ $.3\% + .0005/\alpha + .0008 + \frac{5}{\alpha}$	$.5\% + \frac{5}{\alpha}$ $.5\% + .005\alpha + .005 + \frac{5}{\alpha}$	
100μH	$.3\% + 40\text{nH} + \frac{10}{\alpha}$ $.5\% + .0005/\alpha + .005 + \frac{5}{\alpha}$	$.2\% + 40\text{nH} + \frac{5}{\alpha}$ $.3\% + .0005/\alpha + .0008 + \frac{5}{\alpha}$	
10μH		$.3\% + 4\text{nH} + \frac{10}{\alpha}$ $.5\% + .0005/\alpha + .005 + \frac{5}{\alpha}$	$.2\% + 4\text{nH} + \frac{5}{\alpha}$ $.3\% + .0005/\alpha + .0008 + \frac{5}{\alpha}$
1μH			$.3\% + .4\text{nH} + \frac{10}{\alpha}$ $.5\% + .0005/\alpha + .005 + \frac{5}{\alpha}$

Table 1-1. Specifications (Sheet 10 of 17)

Table B-2. L-D Accuracies

Inductance Range	Test Frequency Range					
	10.1kHz to 20kHz	20.2kHz to 50kHz	50.5kHz to 99.5kHz	101kHz to 200kHz	202kHz to 500kHz	505kHz to 995kHz
1H						
100mH						
10mH	$1\% + \frac{5}{\alpha}$ $1\% + .02 + \frac{5}{\alpha}$			$1\% + \frac{5}{\alpha}$ $1\% + .02 + \frac{5}{\alpha}$		
1mH	$.5\% + \frac{5}{\alpha}$ $.5\% + .005\alpha + .005 + \frac{5}{\alpha}$			$.5\% + \frac{5}{\alpha}$ $.5\% + .005\alpha + .005 + \frac{5}{\alpha}$		
100µH	$.2\% + .12\mu\text{H} + \frac{5}{\alpha}$ $.3\% + .0005/\alpha + .0024 + \frac{5}{\alpha}$	$.2\% + 80\text{nH} + \frac{5}{\alpha}$ $.3\% + .0005/\alpha + .0016 + \frac{5}{\alpha}$	$.2\% + 60\text{nH} + \frac{5}{\alpha}$ $.3\% + .0005/\alpha + .0012 + \frac{5}{\alpha}$	$.5\% + \frac{5}{\alpha}$ $.5\% + .005\alpha + .005 + \frac{5}{\alpha}$		
10µH	$.3\% + 12\text{nF} + \frac{10}{\alpha}$ $.5\% + .0005/\alpha + .005 + \frac{5}{\alpha}$	$.3\% + 8\text{nH} + \frac{10}{\alpha}$ $.5\% + .0005/\alpha + .005 + \frac{5}{\alpha}$	$.3\% + 6\text{nH} + \frac{10}{\alpha}$ $.5\% + .0005/\alpha + .005 + \frac{5}{\alpha}$	$.2\% + 12\text{nH} + \frac{5}{\alpha}$ $.3\% + .0005/\alpha + .0024 + \frac{5}{\alpha}$	$.2\% + 8\text{nH} + \frac{5}{\alpha}$ $.3\% + .0005/\alpha + 0.0016 + \frac{5}{\alpha}$	$.2\% + 6\text{nH} + \frac{5}{\alpha}$ $.3\% + .0005/\alpha + .0012 + \frac{5}{\alpha}$
1µH	$.3\% + 1.2\text{nH} + \frac{10}{\alpha}$ $.5\% + .0005/\alpha + .005 + \frac{5}{\alpha}$			$.3\% + .8\text{nH} + \frac{10}{\alpha}$ $.5\% + .0005/\alpha + .005 + \frac{5}{\alpha}$		
	10kHz	20kHz	50kHz	100kHz	200kHz	500kHz 1MHz

Equations in Tables B-1 and B-2 represent:

L Accuracy
D Accuracy

α : Full-scale factor (= measured L value ÷ full-scale L value). For example, when the L value is 850nH on the 1000nH range, α is 0.85.

Note 1: Tables B-1 and B-2 are applicable under the following conditions:

- (1) CABLE LENGTH: 0m
- (2) Test Signal Level: HIGH (1Vrms)
- (3) Sample's D Value: ≤ 0.1
- (4) Zero offset adjustment has been performed with the OPEN and SHORT terminations of the Model 16074A.

Note 2: Error doubles when LOW test signal level (20mVrms) is used.

Table B-3. Additional Measurement Error for L and D at 1MHz

L Range	1MHz
10mH	$.1\%$ of reading $.001/\alpha$
1mH	
100µH	
10µH	$.06\%$ of reading $.0003\alpha$
1µH	$.1\%$ of reading $.001\alpha$

Note 1: Table B-3 is applicable under the following conditions:

- (1) Test Frequency: 1MHz
- (2) CABLE LENGTH: 1m
- (3) Test Signal Level: HIGH (1Vrms)
- (4) Sample's D Value: ≤ 0.1
- (5) Test Lead: Model 16048A and 16048B
- (6) Zero offset adjustment has been performed with the OPEN and SHORT terminations of the Model 16074A.

Note 2: Error doubles when LOW test signal level (20mVrms) is used.

Table 1-1. Specifications (Sheet 11 of 17)

L-Q Measurement Accuracy

L Accuracy: $\pm[(L \text{ accuracy of L-D measurement})]$

Q Accuracy: $\pm[(D \text{ accuracy} \div \text{measured D value} \times 100)\% \text{ of Q reading} + 1 \text{ count}]$

Note: Q value is the reciprocal of D.

Note: Q accuracy is calculated from the measured D value. Refer to Figure 3-19.

HIGH SPEED L Measurement Accuracy:

L Accuracy: $\pm[(L \text{ accuracy of L-D measurement})]$

Note: HIGH SPEED L accuracy is specified in the range enclosed in the dotted line in Table B-1.

Note: Table B-1 is applicable under the following condition:

(1) Sample's D Value: ≤ 0.01

L-ESR/G Measurement Accuracy

L Accuracy: $\pm[(L \text{ accuracy of L-D measurement})]$

ESR Accuracy: $\pm[(\% \text{ of reading}) + (\text{ESR error in ohms}) + (\text{number of counts})]$, see Tables B-4 and B-5.

G Accuracy: $\pm[(\% \text{ of reading}) + (\text{G error in siemens}) + (\text{number of counts})]$, see Tables B-4 and B-5.

Note: Use Table B-4 when the test frequency is 10kHz, 100kHz, or 1MHz. Use Table B-5 for all other frequencies.

Note: ESR range and G range depend on the selected L range and test frequency. Refer to Table B-7.

Note: Accuracies obtained from Tables B-4 and B-5 are valid only for measurements made with the CABLE LENGTH switch set to 0m. When the CABLE LENGTH switch is set to 1m, add the errors listed in Table B-6 to the accuracies obtained from Tables B-4 and B-5.

Note: DISPLAY B function, when ESR/G is selected, depends on the CIRCUIT MODE.

Table 1-1. Specifications (Sheet 12 of 17)

Table B-4. L-ESR/G Accuracies (10kHz, 100kHz, 1MHz only)

ESR/G Range		Test Frequency		
		10kHz	100kHz	1MHz
ESR	100kΩ	ESR: See Note 1. G : 1% + 50αnS + 40nS + <u>5</u>		
G	100μS			
ESR	10kΩ	ESR: See Note 1. G : 1% + .5αμS + .4μS + <u>5</u>		
G	1mS			
ESR	1kΩ	ESR: See Note 1. G : .3% + 5αμS + 2μS + <u>5</u>		
G	10mS			
ESR	100Ω	ESR: .1% + .05αΩ + <u>5</u> G : See Note 2.		
G	100mS			
ESR	10Ω	ESR: .3% + .5αΩ + <u>5</u> G : See Note 2.		
G	1S			

Table B-5. L-ESR/G Accuracies

ESR/G Range		Test Frequency Range	
		10.1kHz to 99.5kHz	101kHz to 995kHz
ESR	100kΩ	ESR: See Note 1. G : 1% + 50αnS + 60nS + <u>5</u>	
G	100μS		
ESR	10kΩ	ESR: See Note 1. G : 1% + .5αμS + .6μS + <u>5</u>	
G	1mS		
ESR	1kΩ	ESR: See Note 1. G : .3% + 5αμS + 3μS + <u>5</u>	
G	10mS		
ESR	100Ω	ESR: .1% + 50αmΩ + 30mΩ + <u>5</u> G : See Note 2.	
G	100mS		
ESR	10Ω	ESR: .3% + 5αmΩ + 6mΩ + <u>5</u> G : See Note 2.	
G	1S		

Table I-1. Specifications (Sheet 13 of 17)

Equations in Tables B-4 and B-5 represent:

ESR Accuracy
G Accuracy

α : Full-scale factor (= measured L value \div full-scale L value). For example, when measured C value is 850nH on the 1000nH range, α is 0.85.

Note 1: ESR accuracy is $\pm[2 (L \text{ accuracy} \div \text{measured L} \times 100)\% \text{ of ESR reading} + (G \text{ accuracy} \div \text{measured G} \times 100)\% \text{ of ESR reading} + 1 \text{ count}]$.

Note 2: G accuracy is $\pm[2 (L \text{ accuracy} \div \text{measured L} \times 100)\% \text{ of G reading} + (\text{ESR accuracy} \div \text{measured ESR} \times 100)\% \text{ of G reading} + 1 \text{ count}]$.

Note 3: Tables B-4 and B-5 are applicable under the following conditions:

- (1) CABLE LENGTH: 1m
- (2) Test Signal Level: HIGH (1Vrms)
- (3) Sample's D Value: ≤ 0.1
- (4) Zero offset adjustment has been performed with the OPEN and SHORT terminations of the Model 16074A.

Note 4: Error doubles when LOW test signal level (20mVrms) is used.

Table B-6. Additional Measurement Error for ESR and G at 1MHz

ESR/G	1MHz
10 Ω	.1% of reading + 10 α m Ω
100 Ω	.06% of reading + 30 α m Ω
10mS	.1% of reading
1mS	
100 μ S	

Note 1: Table B-6 is applicable under the following conditions:

- (1) Test Frequency: 1MHz
- (2) CABLE LENGTH: 1m
- (3) Test Signal Level: HIGH (1Vrms)
- (4) Sample's D Value: ≤ 0.1
- (5) Test Lead: Model 16048A or 16048B
- (6) Zero offset adjustment has been performed with the OPEN and SHORT terminations of the Model 16074A.

Note 2: Error doubles when LOW test signal level (20mVrms) is used.

Table 1-1. Specifications (Sheet 14 of 17)

Table B-7. ESR/G Range Selection

Inductance Range		Test Frequency Range		
		10kHz	10.1kHz to 100kHz	101kHz to 1MHz
1H	ESR			
	G			
100mH	ESR		100kΩ 100μS	
	G			
10mH	ESR		10kΩ 1mS	
	G			
1mH	ESR		1kΩ 10mS	
	G			
100μH	ESR		100Ω 100mS	
	G			
10μH	ESR		10Ω 1S	
	G			
1μH	ESR			
	G			

Table I-1. Specifications (Sheet 15 of 17)

Impedance Measurement Accuracy

$|Z| - \theta$ Measurement Accuracy:

$|Z|$ Accuracy: $\pm[(\% \text{ of reading}) + (\text{number of counts})]$, see Tables C-1 and C-2.

θ Accuracy: $\pm[(\theta \text{ error in degrees}) + (\text{number of counts})]$, see Tables C-1 and C-2.

Note: Use Table C-1 when the test frequency is 10kHz, 100kHz, or 1MHz.
Use Table C-2 for all other frequencies.

Note: Accuracies obtained from Tables C-1 and C-2 are valid only for measurements made with the CABLE LENGTH switch set to 0m. When the CABLE LENGTH switch is set to 1m, add the errors listed in Table C-3 to the accuracies obtained from Tables C-1 and C-2.

Table C-1. $|Z| - \theta$ Accuracies
(10kHz, 100kHz, 1MHz only)

$ Z $ Range	Test Frequency		
	10kHz	100kHz	1MHz
1M Ω	$2\% + \frac{3}{3^\circ} + \frac{3}{3\alpha^\circ} + \underline{2}$		
100k Ω	$.1\% + .2\alpha\% + \frac{3}{.3^\circ} + .3\alpha^\circ + \underline{2}$		
10k Ω			
1k Ω			
100 Ω	$.1\% + \frac{5}{.1^\circ} + \frac{1}{.1/\alpha^\circ} + \underline{2}$		
10 Ω	$.3\% + \frac{10}{.3^\circ} + \frac{1}{.2/\alpha^\circ} + \underline{2}$		

Table C-2. $|Z| - \theta$ Accuracies

$ Z $ Range	Test Frequency Range	
	10.1kHz to 99.5kHz	101kHz to 995kHz
1M Ω	$2\% + \frac{3}{3^\circ} + \frac{3}{3\alpha^\circ} + \underline{2}$	
100k Ω	$.1\% + .2\alpha\% + \frac{3}{.3^\circ} + .3\alpha^\circ + \underline{2}$	
10k Ω		
1k Ω		
100 Ω	$.1\% + \frac{5}{.1^\circ} + \frac{1}{.1/\alpha^\circ} + \underline{2}$	
10 Ω	$.3\% + \frac{10}{.3^\circ} + \frac{1}{.2/\alpha^\circ} + \underline{2}$	

Table 1-1. Specifications (Sheet 16 of 17)

Equations in Tables C-1 and C-2 represent:

Z Accuracy
θ Accuracy

α : Full-scale factor (= measured |Z| value \div full-scale |Z| value). For example, when measured |Z| value is 850 Ω on the 1000 Ω range, α is 0.85.

Note 1: Tables C-1 and C-2 are applicable under the following conditions:

- (1) CABLE LENGTH: 0m
- (2) Test Signal Level: HIGH (1Vrms)
- (3) Sample's D Value: ≤ 0.1
- (4) Zero offset adjustment has been performed with the OPEN and SHORT terminations of the Model 16074A.

Note 2: Error doubles when LOW test signal level (20mVrms) is used.

Table C-3. Additional Measurement Error for |Z| and θ at 1MHz

Z Range	1MHz
1M Ω	.5% .1/ α $^\circ$
100k Ω	.1% .1/ α $^\circ$
10k Ω	
1k Ω	
100 Ω	.06% .03 α $^\circ$
10 Ω	.1% .1 α $^\circ$

Note 1: Table C-3 is applicable under the following conditions:

- (1) Test Frequency: 1MHz
- (2) CABLE LENGTH: 0m
- (3) Test Signal Level: HIGH (1Vrms)
- (4) Sample's D Value: ≤ 0.1
- (5) Test Lead: Model 16048A and 16048B
- (6) Zero offset adjustment has been performed with the OPEN and SHORT terminations of the Model 16074A.

Note 2: Error doubles when LOW test signal level (20mVrms) is used.

Table 1-1. Specifications (Sheet 17 of 17)

OPTIONS

Option 001:

Internal DC Bias. Equips the standard 4277A with a variable 0 to ±40V dc voltage source for biasing DUTs connected to the UNKNOWN terminals. Output voltage can be set from the front panel or via the HP-IB.

Bias Control Range and Accuracy:

Voltage Range	Step	Temperature	Accuracy
10.0 - 40.0V	100mV	23°C±5°C	±(0.5% of rdg + 35mV)
		0°C - 55°C	±(1% of rdg + 70mV)
.00 - 9.99V	10mV	23°C±5°C	±(0.3% of rdg + 10mV)
		0°C - 55°C	±(1% of rdg + 20mV)
-9.99 - -.01V	10mV	23°C±5°C	±(1% of rdg + 10mV)
		0°C - 55°C	±(2% of rdg + 20mV)
-40.0 - -10.0V	100mV	23°C±5°C	±(1% of rdg + 35mV)
		0°C - 55°C	±(2% of rdg + 70mV)

Output Impedance: 1040Ω±10%

Bias Voltage Monitor:

Bias voltage across the DUT can be monitored at the EXT INPUT/INT MONITOR BNC connector on the rear panel. INT MONITOR output impedance is approximately 730Ω.

Output Characteristics:

Voltage Range	Output Current
0 - ±25V	5mAmax.
±25 - ±40V	1mAmax.

Note: Measurement accuracies are guaranteed when output current is maximum.

Option 002: COMPARATOR/HANDLER INTERFACE

Contents:

Model 16064A COMPARATOR/HANDLER INTERFACE (Includes the 16064-66502 interface board assembly and 1251-0084 36-pin male Amphenol connector)

Comparator Function:

Compares measured values to 9 sets (Bins) of stored high/low limits. Displays LOW/IN/HIGH judgements and bin number.

Handler Interface Function: Outputs comparison results and handler control signals (open-collectors, TTL). Detects KEY LOCK and EXT TRIGGER signals sent from component handler.

Option 907: Front handle kit (Part No. 5061-0090)

Option 908: Rack flange kit (Part No. 5061-0078)

Option 909: Rack flange and handle kit (Part No. 5061-0084)

Option 910: Extra manual

Accessories Supplied

Test Fixture:

16047A Test Fixture. Includes three kinds of contact inserts

Power Cord: HP Part No. 8120-1378

Fuse:

Part No. 2110-0007 (100V/120V)
Part No. 2110-0360 (220V/240V)

Protective Fuse:

Part No. 2110-0011 (for dc bias input)

Accessories Available

HP-IB Cable:

10833A (1m) 10833C (4m)
10833B (2m) 10833D (0.5m)

Test Fixtures and Test Leads:

Refer to Table 1-3.

Table 1-2. Supplemental Performance Characteristics (Sheet 1 of 2)

Supplemental Performance Characteristics

Measurement Accuracies:

Applicable at all test frequencies except 1MHz

Additional Error for 1m CABLE LENGTH Mode:

Add the errors listed in Table 1.

Table 1.

Measurement Function	Additional Error
L, C, Z	.05f ² % of reading
D	.0005αf
θ	.05αf°
ESR, G	5αf x 10 ^{β-4} counts

where,

α : Full-scale factor
 β : Number of display digits
 f : Test frequency in MHz

Note: Error doubles when LOW test signal level (20mVrms) is used.

Use Table 2 for C measurements on the 1pF range.

Table 2.

Measurement Parameter	Additional Error
C	.4f ² % of reading
D	αf x 10 ⁻³
ESR, G	10αf counts

α : Full-scale factor
 β : Number of display digits
 f : Test frequency in MHz

Note: Table 2 does not apply when LOW test signal level (20mVrms) is used.

Use Table 3 for |Z| measurements on the 1MΩ range.

Table 3.

Measurement Function	Additional Error
Z	f ² % of reading
θ	.1αf°

α : Full-scale factor
 f : Test frequency in MHz

Note: Table 2 does not apply when LOW test signal level (20mVrms) is used.

Use Table 4 when 2-meter cables are used to connect the DUT to the UNKNOWN terminals.

Table 4.

Measurement Function	Additional Error
L, C, Z	.2f ² % of reading
D	.002αf
θ	.2αf°
ESR, G	20αf x 10 ^{β-4} counts

α : Full-scale factor
 β : Number of display digits
 f : Test frequency in MHz

Note: Table 4 does not apply when

- (1) C measurement is made on the 1pF range.
- (2) C measurement is made on the 10pF range and LOW test signal level is used.
- (3) |Z| measurement is made on the 1MΩ range.

Note: Error doubles when LOW test signal level (20mVrms) is used.

Table 1-2. Supplemental Performance Characteristics (Sheet 2 of 2)

Additional Measurement Error of Test Fixtures:
 Maximum additional errors attributable to the test fixtures:

Model	Residual Impedance
16047A, 16047C, 16048A, 16048B, 16048D, 16065A	-
16048C	C<App. 5pF L<App. 200nH R<App. 10mΩ
16034B	C<App. 0.02pF L<App. 30nH R<App. 50mΩ

Additional Measurement Error when $D > 0.01$:
 Add 5D% (when LOW test signal level is used, 10D%) to the accuracies for HIGH SPEED C and HIGH SPEED L.

Additional Measurement Error when $D > 0.1$:
 Multiply C, L, or D accuracy by $(1 + D^2)$

Settling Time after measurement range change:
 Approximately 60ms

Settling Time after frequency change:
 Approximately 300ms

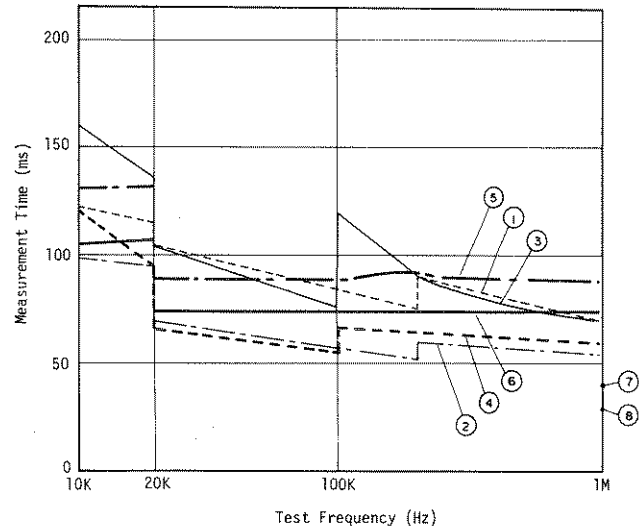
Settling Time after Test Signal Level Change:
 Approximately 60ms

Test Signal Settling Time in DC Bias applications:
 The same as dc bias voltage settling time

DC Bias Voltage Settling Time:
 Typical value for C measurement ($C < 2000\text{pF}$)

Bias Voltage	Settling Time
99% of setting	7.5ms
99.9% of setting	25ms
99.99% of setting	40ms

Measurement Time:
 Typical characteristics are shown in the figure below:



Number	Measurement Function	Measurement Speed Mode
1	C	MED
2	C	FAST
3	L	MED
4	L	FAST
5	Z	MED
6	Z	FAST
7	HIGH SPEED C. HIGH SPEED L	MED
8	HIGH SPEED C HIGH SPEED L	FAST

Continuous Memory: Approximately 2 weeks
 (at 23 °C ± 5 °C)

1-30. ACCESSORIES SUPPLIED

1-31. The standard HP Model 4277A LCZ Meter, along with its furnished accessories, is shown in Figure 1-1. The furnished accessories are also listed below:

16047A Test Fixture
(Refer to Table 1-3 for a brief description)

Power Cable HP Part No. 8120-1378

Fuse HP Part No. 2110-0007
or 2110-0360

1-32. ACCESSORIES AVAILABLE

1-33. In addition to the furnished 16047A Test Fixture, seven special purpose test fixtures and test leads are available. Each is intended for a particular measurement or DUT type, and all were designed with careful consideration to accuracy, reliability, ease of use, and compatibility with other HP instruments. A brief description of each available accessory is given in Table 1-3.

Table 1-3. Accessories Available (Sheet 1 of 3)

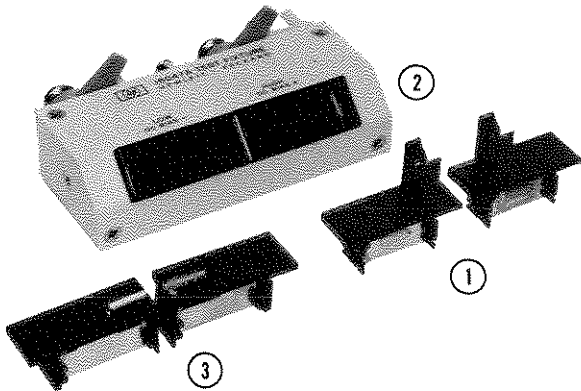
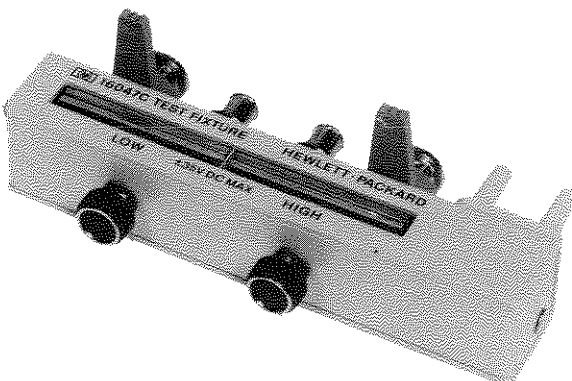
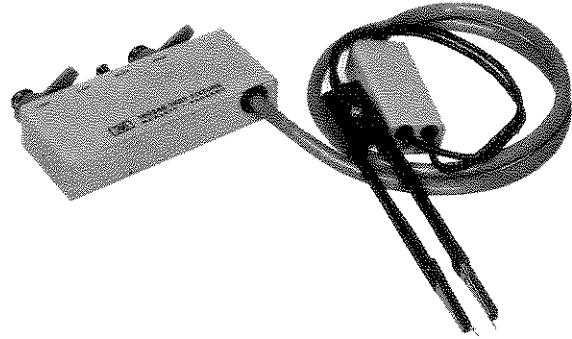
Model	Description
<p>16047A (furnished)</p> 	<p>Test Fixture (direct attachment type) for measurement of either axial-or radial-lead components. Three kinds of contact inserts are furnished:</p> <ul style="list-style-type: none"> ① For axial-lead components, (HP P/N: 16061-70022) ② For general radial-lead components, (HP P/N: 16061-70021) ③ For radial short-lead components, (HP P/N: 16047-65001) <p>DC bias up to $\pm 40V^*$ can be applied.</p>
<p>16047C</p> 	<p>Test Fixture (direct attachment type) designed especially for high frequency measurements requiring high accuracy. Two screw knobs facilitate and ensure optimum contact between the test fixture electrodes and the sample leads.</p> <p>DC bias up to $\pm 40V^*$ can be applied.</p>
<p>16034B</p> 	<p>Test Fixture (tweezer type) for measurement of miniature leadless components such as chip capacitors. Employs a three terminal configuration tweezer probe suitable for high impedance (above 50Ω) measurements.</p> <p>DC bias up to $\pm 40V^*$ can be applied.</p> <p>Cable length: 1m</p>

Table 1-3. Accessories Available (Sheet 2 of 3)

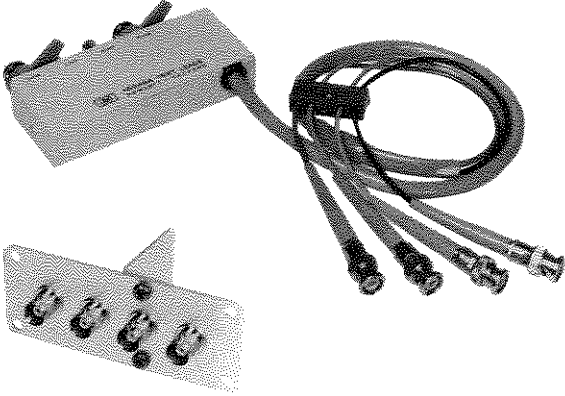
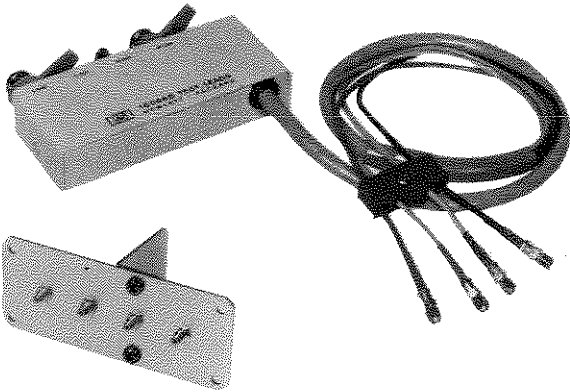
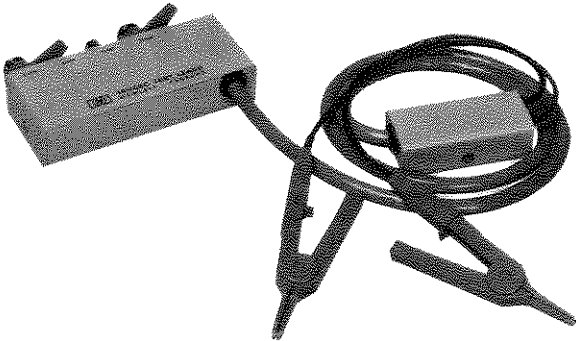
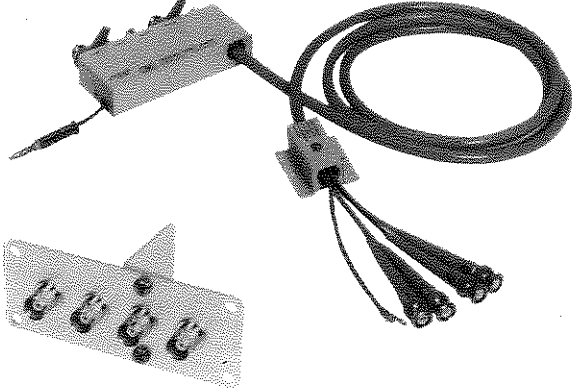
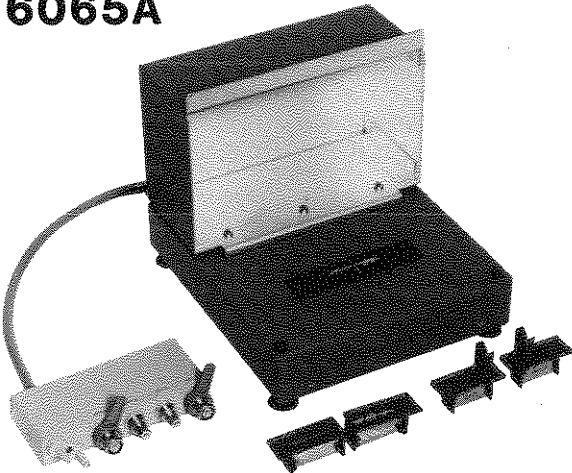
Model	Description
<p>16048A</p> 	<p>Test Leads (four terminal pair) with BNC connectors for connecting user-fabricated test fixtures.</p> <p>DC bias up to $\pm 40V^*$ can be applied.</p> <p>Cable length: 1m</p>
<p>16048B</p> 	<p>Test Leads (four terminal pair) with miniature RF connectors suitable for connecting user-fabricated test fixtures in systems applications.</p> <p>DC bias up to $\pm 40V^*$ can be applied.</p> <p>Cable length: 1m</p>
<p>16048C</p> 	<p>Test Leads with dual alligator clips for testing components of non-standard shapes and sizes at frequencies below 100kHz.</p> <p>Applicable measurement ranges:</p> <ul style="list-style-type: none"> Capacitance > 1000pF Inductance > 100μH <p>DC bias up to $\pm 40V^*$ can be applied.</p> <p>Cable length: 1m</p>

Table 1-3. Accessories Available (Sheet 3 of 3)

Model	Description
<p>16048D</p> 	<p>Double-shielded Test Leads (four terminal pair) with BNC connectors for connecting user-fabricated test fixtures.</p> <p>DC bias up to $\pm 40V^*$ can be applied.</p> <p>Cable length: 2m</p>
<p>16065A</p> 	<p>Test Fixture (cable connection type) for measurement of either axial- or radial-lead components at frequencies between 50Hz and 2MHz. Three kinds of contact inserts are furnished (same as those for the 16047A Test Fixture).</p> <p>DC bias up to $\pm 200V$ can be applied (a protective cover provides for operator safety).</p> <p>Cable length: Approximately 40cm</p>

* Though " $\pm 35V$ DC MAX" is indicated on the test fixtures, they are capable of handling dc bias voltages up to $\pm 40V$ when used with the 4277A.

SECTION II INSTALLATION

2-1. INTRODUCTION

2-2. This section provides installation instructions for the Model 4277A LCZ Meter. It also includes information on initial inspection and damage claims, preparation for using the 4277A, and packaging, storage, and shipment.

2-3. INITIAL INSPECTION

2-4. The 4277A LCZ Meter, as shipped from the factory, meets all the specifications listed in Table 1-1. Upon receipt, inspect the shipping container for damage. If the shipping container or cushioning material is damaged, it should be kept until the contents of the shipment have been checked for completeness and the instrument has been checked mechanically and electrically. The contents of the shipment should be as shown in Figure 1-1. The procedures for checking the general electrical operation are given in Section III (Paragraph 3-5 SELF TEST) and the procedures for checking the 4277A LCZ Meter against its specifications are given in Section IV. First, do the self test. If the 4277A is electrically questionable, then do the Performance Tests to determine whether the 4277A has failed or not.

If the contents are incomplete, if there is mechanical damage or defects (scratches, dents, broken switches, etc.), or if the performance does not meet the self test or performance tests, notify the nearest Hewlett-Packard office (see list at back of this manual). The HP office will arrange for repair or replacement without waiting for claim settlement.

2-5. PREPARATION FOR USE

2-6. POWER REQUIREMENTS

2-7. The 4277A requires a power source of 100, 120, 220 Volts ac $\pm 10\%$, or 240 Volts ac $+5\%-10\%$, 48 to 66Hz single phase; power consumption is 75VA maximum.

WARNING

IF THE INSTRUMENT IS TO BE ENERGIZED VIA AN EXTERNAL AUTOTRANSFORMER UNIT FOR VOLTAGE REDUCTION, BE SURE THAT THE COMMON TERMINAL IS CONNECTED TO THE NEUTRAL POLE OF THE POWER SUPPLY.

2-8. Line Voltage and Fuse Selection

CAUTION

BEFORE TURNING THE 4277A LINE SWITCH TO ON, VERIFY THAT THE INSTRUMENT IS SET TO THE VOLTAGE OF THE POWER TO BE SUPPLIED.

2-9. Figure 2-1 provides instructions for line voltage and fuse selection. The line voltage selection switch and the proper fuse are factory installed for the voltage appropriate to instrument destination.

CAUTION

USE PROPER FUSE FOR LINE VOLTAGE SELECTED.

CAUTION

MAKE SURE THAT ONLY FUSES FOR THE REQUIRED RATED CURRENT AND OF THE SPECIFIED TYPE ARE USED FOR REPLACEMENT. THE USE OF MENDED FUSES AND THE SHORT-CIRCUITING OF FUSE-HOLDERS MUST BE AVOIDED.

2-10. POWER CABLE

2-11. To protect operating personnel, the National Electrical Manufacturer's Association (NEMA) recommends that the instrument panel and cabinet be grounded. The Model 4277A is equipped with a three-conductor power cable which, when plugged into an appropriate receptacle, grounds the instrument. The offset pin on the power cable is the ground wire.

2-12. To preserve the protection feature when operating the instrument from a two contact outlet, use a three prong to two prong adapter (HP Part No. 1251-8196) and connect the green pigtail on the adapter to power line ground.

CAUTION

THE MAINS PLUG MUST ONLY BE INSERTED IN A SOCKET OUTLET PROVIDED WITH A PROTECTIVE EARTH CONTACT. THE PROTECTIVE ACTION MUST NOT BE NEGATED BY THE USE OF AN EXTENSION CORD (POWER CABLE) WITHOUT PROTECTIVE CONDUCTOR (GROUNDING).

2-13. Figure 2-2 shows the available power cords, which may be used in various countries including the standard power cord furnished with the instrument. HP Part number, applicable standards for power plug, power cord color, electrical characteristics and countries using each power cord are listed in the figure. If assistance is needed for selecting the correct power cable, contact the nearest Hewlett-Packard office.

2-14. INTERCONNECTIONS

2-15. When an external dc bias source is used, set the DC BIAS select switch on the rear panel to EXT. The output from the external bias source should be connected to EXT INPUT/INT MONITOR connector. The external dc bias fuse is installed in EXT DC BIAS FUSE Holder on rear panel to protect the instrument from excessive current. Fuse rating is as follows:

1/16A, 250V (HP Part No: 2110-0011)

CAUTION

MAKE SURE THAT ONLY FUSES OF THE REQUIRED RATED CURRENT AND OF THE SPECIFIED TYPE ARE USED FOR REPLACEMENT. THE USE OF MENDED FUSES AND THE SHORT-CIRCUITING OF FUSE-HOLDERS MUST BE AVOIDED.

2-16. OPERATING ENVIRONMENT

2-17. Temperature. The instrument may be operated in temperatures from 0 °C to +55 °C.

2-18. Humidity. The instrument may be operated in environments with relative humidities to 95% at 40 °C. However, the instrument must be protected from temperature extremes which cause condensation within the instrument.

2-19. INSTALLATION INSTRUCTIONS

2-20. The HP Model 4277A can be operated on the bench or in a rack mount. The 4277A is ready for bench operation as shipped from the factory. For bench operation a two-leg instrument stand is used. For use, the instrument stands are designed to be pulled towards the front of instrument.

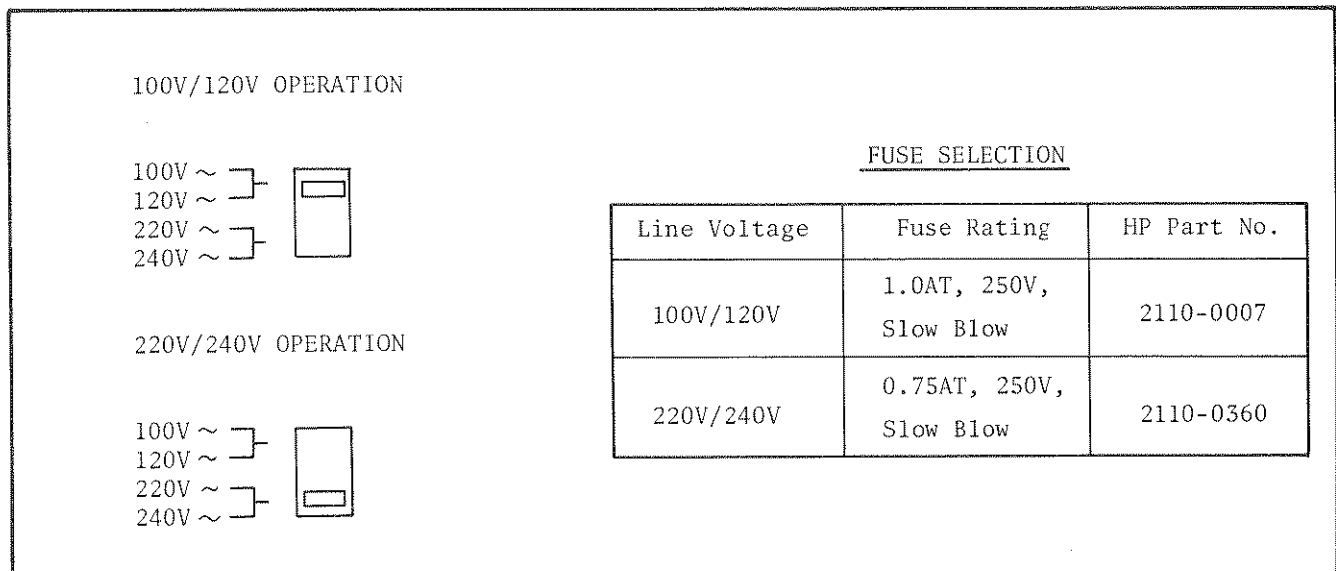


Figure 2-1. Voltage and Fuse Selection.

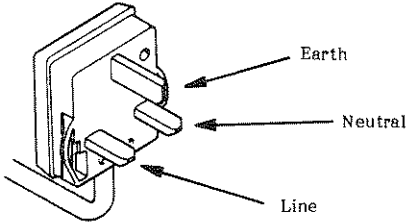
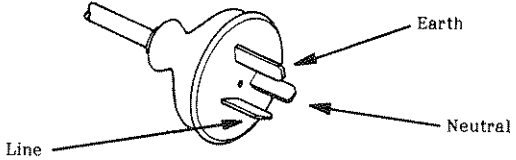
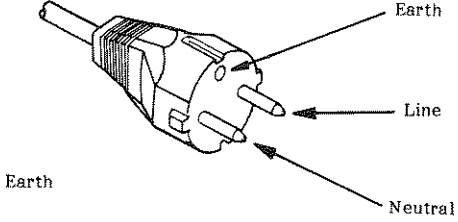
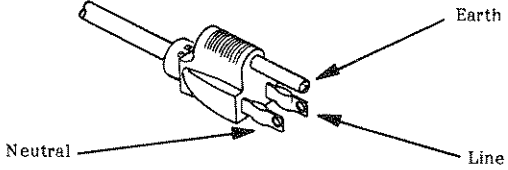
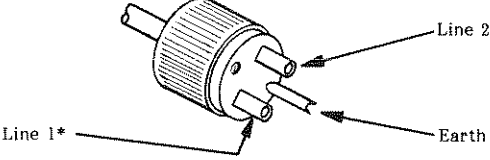
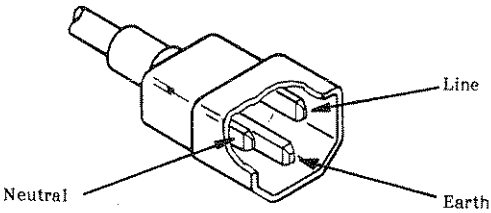
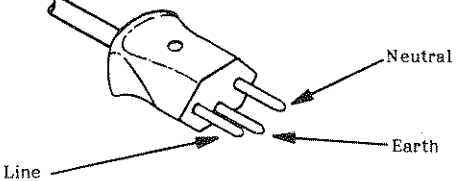
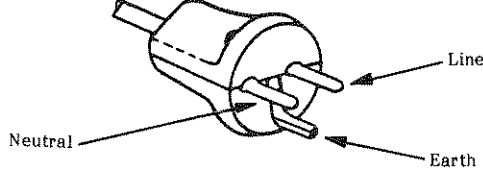
<p>OPTION 900 United Kingdom</p>  <p>Plug : BS 1363A, 250V Cable : HP 8120-1703</p>	<p>OPTION 901 Australia/New Zealand</p>  <p>Plug : NZSS 198/AS C112, 250V Cable : HP 8120-0696</p>
<p>OPTION 902 European Continent</p>  <p>Plug : CEE-VII, 250V Cable : HP 8120-1692</p>	<p>OPTION 903 U.S./Canada</p>  <p>Plug : NEMA 5-15P, 125V, 15A Cable : HP 8120-1521</p>
<p>OPTION 904 U.S./Canada</p>  <p>Plug : NEMA 6-15P, 250V, 6A Cable : HP 8120-0698</p>	<p>OPTION 905** Any country</p>  <p>Plug : CEE 22-VI, 250V Cable : HP 8120-1860</p>
<p>OPTION 906 Switzerland</p>  <p>Plug : SEV 1011.1959-24507 Type 12, 250V Cable : HP 8120-2104</p>	<p>OPTION 912 Denmark</p>  <p>Plug : DHCR 107, 220V Cable : HP 8120-2956</p>
<p>NOTE : Each option number includes a ' family ' of cords and connectors of various materials and plug body configurations (straight, 90 ° etc.).</p> <p>* In the U.S.A. a 230-volt mains might not include a neutral conductor. In this case it is recommended that the blue conductor of the standard power cord be connected to the terminal normally used for neutral (line 1).</p>	

Figure 2-2. Power Cables Supplied.

2-21. Installation of Options 907, 908 and 909.

2-22. The 4277A can be installed in a rack and be operated as a component of a measurement system. Rack mounting information for the 4277A is presented in Figure 2-3.

2-23. STORAGE AND SHIPMENT

2-24. ENVIRONMENT

2-25. The instrument may be stored or shipped in environments within the following limits:

Temperature -40 °C to +70 °C
Humidity to 95% at 40 °C

The instrument must be protected from temperature extremes which cause condensation inside the instrument.

2-26. PACKAGING

2-27. Original Packaging. Containers and materials identical to those used in factory packaging are available from Hewlett-Packard. If the instrument is being returned to Hewlett-Packard for servicing, attach a tag indicating the type of service required, return address, model number, and full serial number. Also mark the container FRAGILE to assure careful handling. In any correspondence, refer to the instrument by model number and full serial number.

2-28. Other Packaging. The following general instructions should be used for re-packing with commercially available materials:

- a. Wrap instrument in heavy paper or plastic. If shipping to Hewlett-Packard office or service center, attach tag indicating type of service required, return address, model number, and full serial number.
- b. Use strong shipping container. A double-wall carton made of 350 pound test material is adequate.
- c. Use enough shock absorbing material (3 to 4 inch layer) around all sides of instrument to provide firm cushion and prevent movement inside container. Protect control panel with cardboard.
- d. Seal shipping container securely.
- e. Mark shipping container FRAGILE to ensure careful handling.

- f. In any correspondence, refer to instrument by model number and full serial number.

2-29. OPTION INSTALLATION

2-30. Installation procedures for DC Bias option (Option 001) and Comparator/Handler Interface option (Option 002) are given in Figure 2-4.

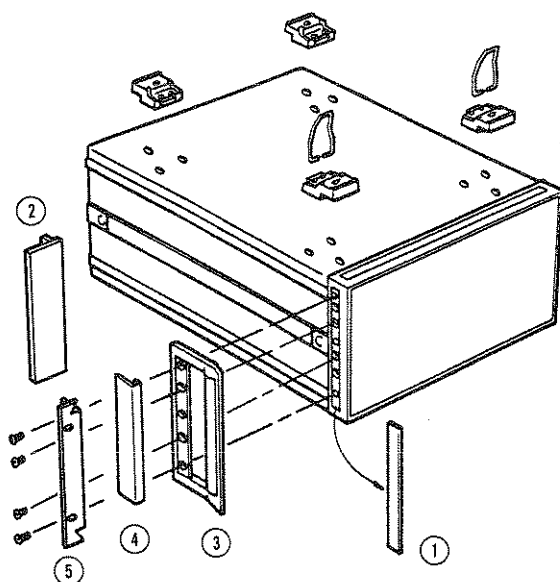
2-31. POWER FAILURE MONITOR INSTALLATION

2-32. To use the power failure monitor signal, you must solder two wires to a jumper on the mother board, remove a cap from a hole on the rear panel, and bring the wires out through the hole. The procedure is given below. A simplified drawing of the open collector circuit, a timing diagram, and the locations of the jumper and hole are shown in Figure 2-6. Refer to paragraph 2-114 for a description of the power failure monitor signal.

Procedure:

1. Turn off the 4277A.
2. Disconnect the 4277A from the ac power source.
3. Remove the top cover.
4. Disconnect the brown 4-terminal connector from the A5 board.
5. Remove the two screws that secure the A5 board to the chassis.
6. Remove the A5 board.
7. Solder a wire to each terminal of A6J3. The location of A6J3 is shown in Figure 2-6 (c).
8. Remove the cap from the access hole in the rear panel, as shown in Figure 2-6 (d).
9. Thread the wires first through the teflon clamp (securing the wires from A6J1) on the A6 board, and then through the access hole in the rear panel.
10. Reinstall the A5 board, reconnect the brown 4-terminal connector to the A5 board, and replace the top cover.

Option	Kit Part Number	Parts Included	Part Number	Q'ty	Remarks
907	Handle Kit 5061-0090	Front Handle Trim Strip X8-32 x 3/8 Screw	③ 5060-9900 ④ 5020-8897 2510-0195	2 2 8	9.525mm
908	Rack Flange Kit 5061-0078	Rack Mount Flange X8-32 x 3/8 Screw	② 5020-8863 2510-0193	2 8	9.525mm
909	Rack Flange & Handle Kit 5061-0084	Front handle Rack Mount Flange X8-32 x 3/8 Screw	③ 5060-9900 ⑤ 5020-8875 2510-0194	2 2 8	15.875mm



1. Remove adhesive-backed trim strips ① from side at right and left front of instrument.
2. HANDLE INSTALLATION : Attach front handle ③ to sides at right and left front of instrument with screws provided and attach trim ④ to handle.
3. RACK MOUNTING : Attach rack mount flange ② to sides at right and left front of instrument with screws provided.
4. HANDLE AND RACK MOUNTING : Attach front handle ③ and rack mount flange ⑤ together to sides at right and left front of instrument with screws provided.
5. When rack mounting (3 and 4 above), remove all four feet (lift bar at inner side of foot, and slide foot toward the bar).

Figure 2-3. Rack Mount Kit.

11. Connect the pull-up resistor and external voltage source as shown in Figure 2-6 (a).

Note

A +5V is recommended but higher voltage can be used as long as the current through AlT5 and AlQ4 does not exceed 25mA.

CAUTION: BEFORE PROCEEDING WITH INSTALLATION OF OPTION(S), TURN OFF THE INSTRUMENT AND DISCONNECT THE AC POWER CORD.

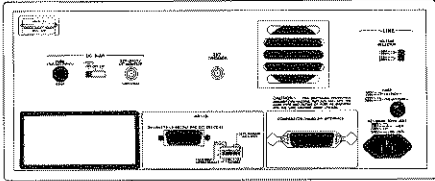
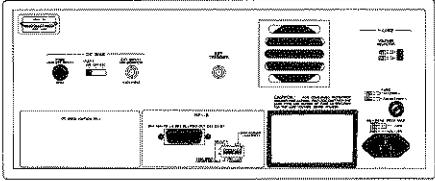
	OPTION 001 DC BIAS SUPPLY (0 to $\pm 40V$)	OPTION 002 COMPARATOR/ HANDLER INTERFACE
Option Parts	Board Assembly A22 04276-66522	Comparator 16064A Includes: Interface Board Assembly 16064-66502 and 36-pin male Amphenol connector 1251-0084
Installation Procedure (after removing top cover)	<ol style="list-style-type: none"> 1. Remove the rear panel access plate shown below.  <ol style="list-style-type: none"> 2. Insert the dc bias board (P/N: 04276-66522) into the access hole. 3. Insert the male edge connector of the interface board into the female edge connector of the 4277A mother board and push firmly until the interface board is completely seated. 4. Reinstall the screws removed in step (1). 	<ol style="list-style-type: none"> 1. Remove the rear panel access plate shown below.  <ol style="list-style-type: none"> 2. Insert the interface board (P/N: 16064-66502) into the access hole. 3. Insert the male edge connector of the interface board into the female edge connector of the 4277A mother board and push firmly until the interface board is completely seated. 4. Reinstall the screws removed in step 1. 5. Connect the 16064A keyboard cable to the connector on the interface board (installed in step 3). 6. Adjust the power supply in accordance with the procedure given in Figure 2-5.

Figure 2-4. Option Installation.

1. Connect the 4277A to the ac power line.
2. Turn on the instrument. ("16064" should be displayed on DISPLAY B.)
3. Connect a DVM (HP 3478A is recommended) to AITP1 and GND as shown below.
4. Adjust "V-ADJ" on the A4 board until the reading on the DVM is $5.10V \pm 0.02V$.

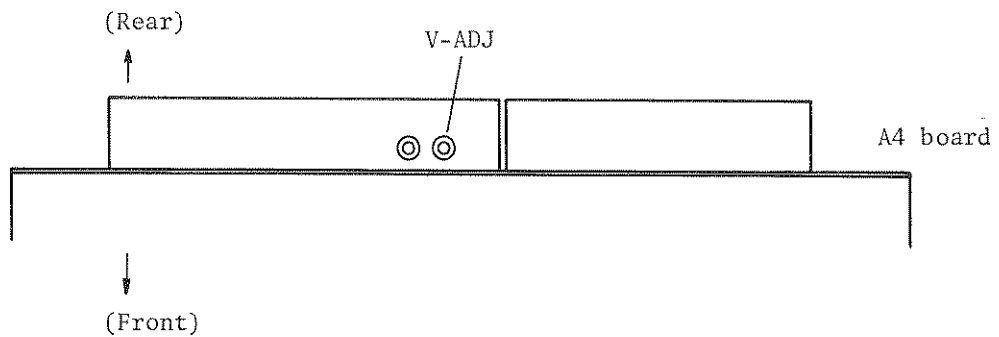
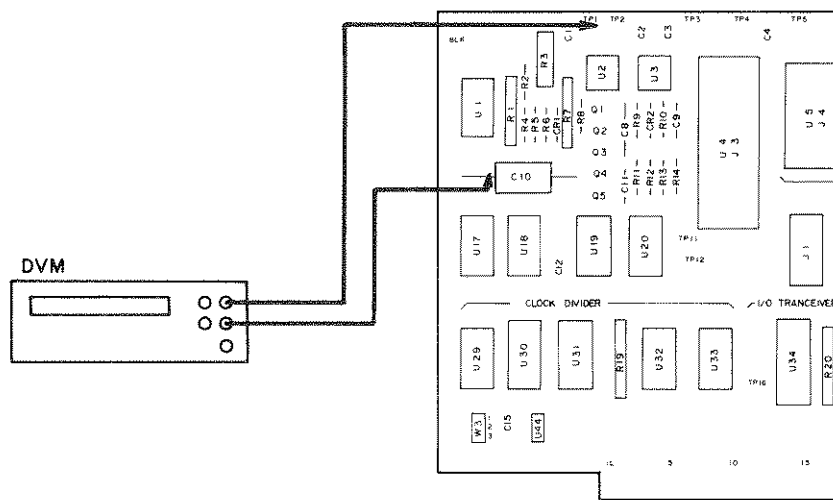


Figure 2-5. Power Supply Adjustment After Installing Option 002.

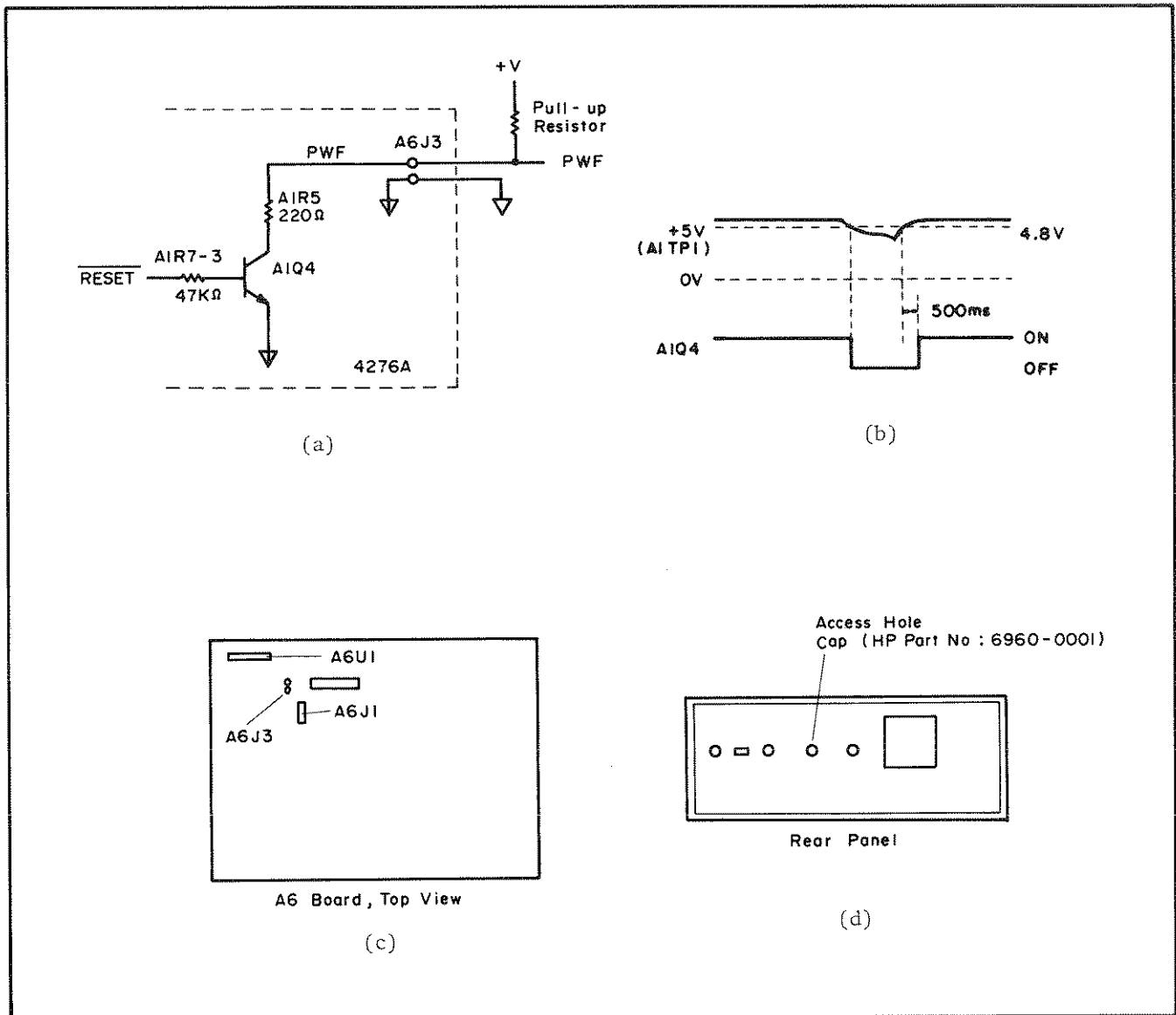


Figure 2-6. Power Failure Monitor Installation.

SECTION III OPERATION

3-1. INTRODUCTION

3-2. This section provides all the information necessary to operate the Model 4277A LCZ Meter. Included are descriptions of the front- and rear-panels, displays, lamps and connectors; discussions on operating procedures and measuring techniques for various applications; and instructions on the instrument's SELF TEST function. Warnings, Cautions, and Notes are given throughout; they should be observed to insure the safety of the operator and the serviceability of the instrument.

WARNING

BEFORE THE INSTRUMENT IS SWITCHED ON, ALL PROTECTIVE EARTH TERMINALS, EXTENSION CORDS, AUTO-TRANSFORMERS AND DEVICES CONNECTED TO IT SHOULD BE CONNECTED TO A PROTECTIVE EARTH GROUNDED SOCKET. ANY INTERRUPTION OF THE PROTECTIVE EARTH GROUNDING WILL CAUSE A POTENTIAL SHOCK HAZARD THAT COULD RESULT IN SERIOUS PERSONAL INJURY.

ONLY FUSES WITH THE REQUIRED RATED CURRENT AND OF THE SPECIFIED TYPE SHOULD BE USED. DO NOT USE REPAIRED FUSES OR SHORTED FUSEHOLDERS. TO DO SO COULD CAUSE A SHOCK OR FIRE HAZARD.

CAUTION

BEFORE THE INSTRUMENT IS SWITCHED ON, IT MUST BE SET TO THE VOLTAGE OF THE POWER SOURCE (MAINS), OR DAMAGE TO THE INSTRUMENT MAY RESULT.

3-3. PANEL FEATURES

3-4. Figures 3-1 and 3-2 identify and briefly describe the purpose of each key, indicator, and connector on the front panel and rear panel, respectively. More detailed information on front panel displays and controls is given starting in paragraph 3-5.

3-5. SELF TEST

3-6. The self test function confirms correct operation of the instrument's basic functions and facilitates troubleshooting. It consists of three parts: (1) ROM/RAM Test, (2) Display Test, and (3) Analog Circuit Test. Each is described in paragraphs 3-7 through 3-11.

3-7. ROM/RAM TEST

3-8. The ROM/RAM Test is performed each time the instrument is turned on. During this test, all ROMs and RAMs in the instrument's digital control section are tested using a check-sum test and a read/write test (RAMs only). If a malfunction is detected, the test will stop and an error-code will be displayed on DISPLAY A. If the ROMs and RAMs are functioning properly, the instrument will display the HP-IB address (or output data format if the HP-IB control switch is set to TALK ONLY) on DISPLAY A and the option annunciations on DISPLAY B and the FREQUENCY/DC BIAS DISPLAY. Error-codes are described in paragraph 3-20.

Note

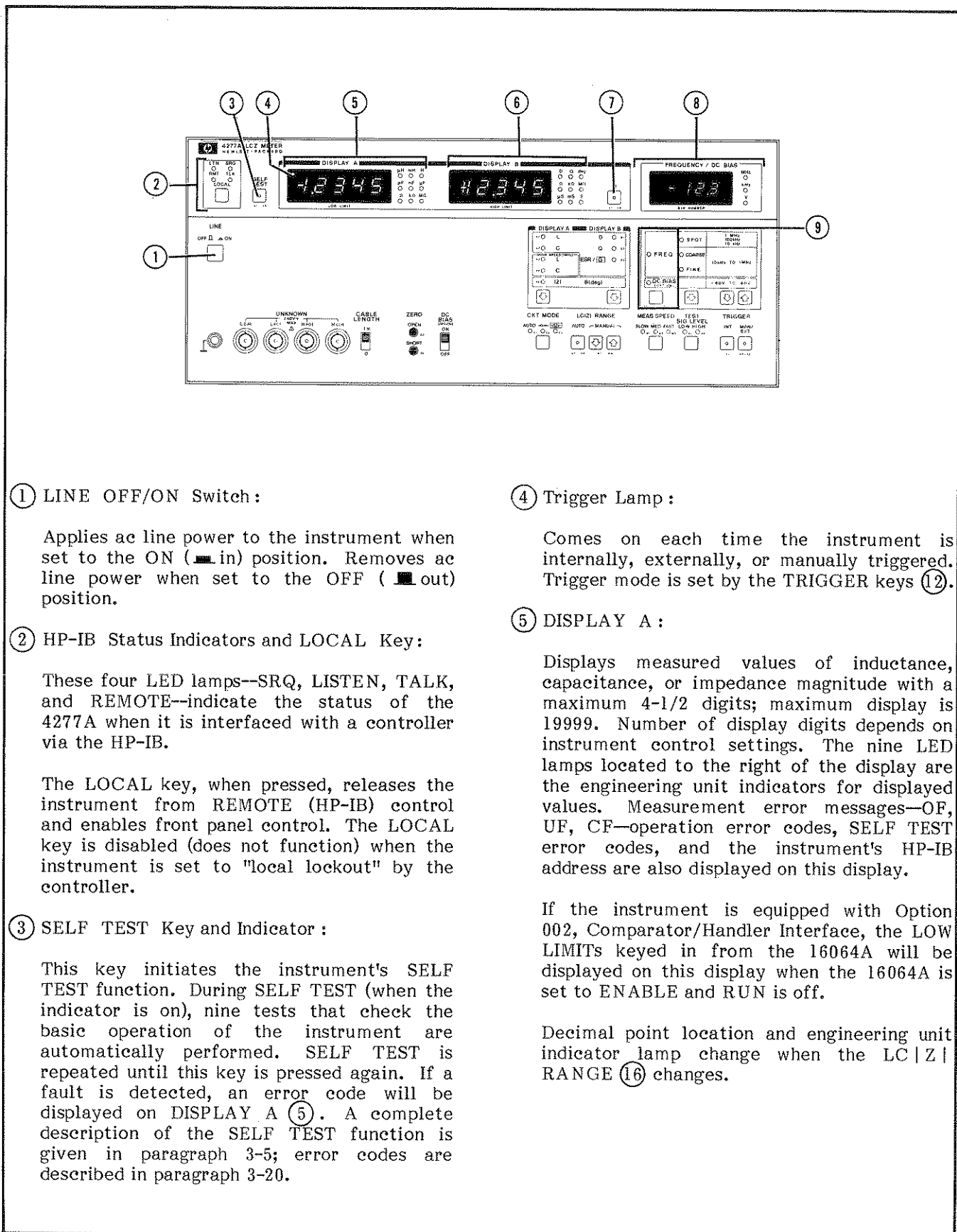
If a ROM/RAM test error code, E61 through E68, appears on DISPLAY A when the instrument is turned on, contact the nearest Hewlett-Packard Sales or Service Office for repairs.

Note



ROM/RAM test error code E68 indicates that the instrument's continuous memory feature is not functioning properly. All other instrument functions, including measurement, are not affected.

3-9. DISPLAY TEST

3-10. All LED lamps and 7-segment displays on the front panel are lit for approximately one second when the instrument's self-test function is initiated from the front panel or via the HP-IB. This test is repeated until the self-test function is turned off.



① LINE OFF/ON Switch :

Applies ac line power to the instrument when set to the ON ( in) position. Removes ac line power when set to the OFF ( out) position.

② HP-IB Status Indicators and LOCAL Key :

These four LED lamps--SRQ, LISTEN, TALK, and REMOTE--indicate the status of the 4277A when it is interfaced with a controller via the HP-IB.

The LOCAL key, when pressed, releases the instrument from REMOTE (HP-IB) control and enables front panel control. The LOCAL key is disabled (does not function) when the instrument is set to "local lockout" by the controller.

③ SELF TEST Key and Indicator :

This key initiates the instrument's SELF TEST function. During SELF TEST (when the indicator is on), nine tests that check the basic operation of the instrument are automatically performed. SELF TEST is repeated until this key is pressed again. If a fault is detected, an error code will be displayed on DISPLAY A (⑤). A complete description of the SELF TEST function is given in paragraph 3-5; error codes are described in paragraph 3-20.

④ Trigger Lamp :

Comes on each time the instrument is internally, externally, or manually triggered. Trigger mode is set by the TRIGGER keys (⑫).

⑤ DISPLAY A :

Displays measured values of inductance, capacitance, or impedance magnitude with a maximum 4-1/2 digits; maximum display is 19999. Number of display digits depends on instrument control settings. The nine LED lamps located to the right of the display are the engineering unit indicators for displayed values. Measurement error messages--OF, UF, CF--operation error codes, SELF TEST error codes, and the instrument's HP-IB address are also displayed on this display.

If the instrument is equipped with Option 002, Comparator/Handler Interface, the LOW LIMITs keyed in from the 16064A will be displayed on this display when the 16064A is set to ENABLE and RUN is off.

Decimal point location and engineering unit indicator lamp change when the LC|Z| RANGE (⑮) changes.

Figure 3-1. Front Panel Features (Sheet 1 of 6).

⑥ DISPLAY B

Displays measured values of dissipation factor, quality factor, equivalent series resistance, conductance or impedance phase angle with a maximum 4-1/2 digits; maximum display is 10000 for quality factor, 18000 for phase, and 19999 for all other parameters. Number of display digits depends on instrument control settings. The nine LED lamps located to the right of the display are the engineering unit indicators for displayed values.

Measurement error messages--OF, UF, and CF--are also displayed on this display. When the DISPLAY A Function ⑮ is set to HIGH SPEED L or HIGH SPEED C, or when an error code is displayed on DISPLAY A ⑤, this display is blanked (turned off) by the microprocessor.

If the instrument is equipped with Option 002, Comparator/Handler Interface, and if the 16064A comparator is connected, the number 16064 will be displayed on this display when the instrument is turned on. Also, the HIGH LIMITS keyed in from the 16064A will be displayed on this display when the 16064A is set to ENABLE and RUN is off.

⑦ Δ Key and Indicator :

This key enables deviation (Δ) measurements on both displays. When this key is pressed, the values displayed on DISPLAY A ⑤ and DISPLAY B ⑥ are stored as reference values. The difference between values obtained in subsequent measurements and the stored reference values is calculated and displayed on each display. The formula used to calculate the deviation is

$$A-B$$

Where A is the measured value of the device under test and B is the stored reference value.

LC | Z | RANGE ⑯ is set to MANUAL when this key is pressed.

Also, the deviation measurement function is turned off by pressing this key again, or by changing the DISPLAY A function ⑮, DISPLAY B function ⑰, LC | Z | RANGE ⑯, or CIRCUIT MODE ⑰. It may be turned off also if the test frequency is changed when the DISPLAY B function is ESR/G.

⑧ FREQUENCY/DC BIAS Display :

Displays test frequency or DC bias voltage (Option 001 only) with 3 digits. The three LED lamps located to the right of the display are unit indicators for displayed values. On instruments equipped with Option 002, Comparator/Handler Interface, bin numbers are displayed on this display when the comparator is set to RUN. Also, on Option 001 instruments, the number 001 is briefly displayed here when the instrument is turned on.

⑨ FREQUENCY/DC BIAS Select Key and Indicators :

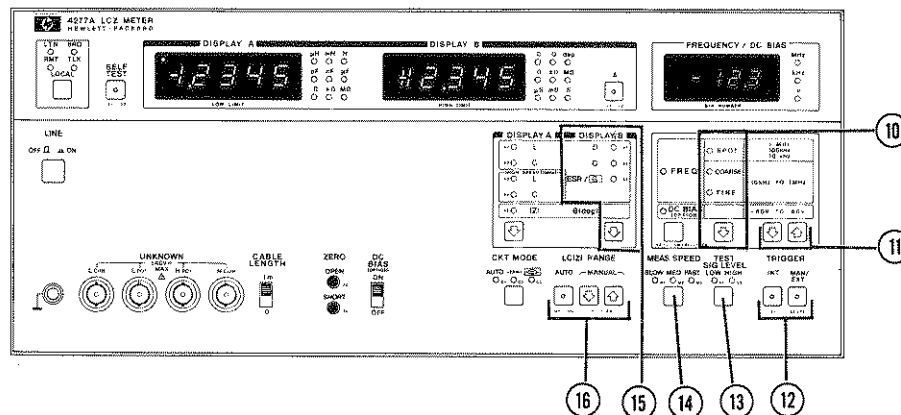
This key sets the FREQUENCY/DC BIAS Display ⑧, the SPOT/COARSE/FINE Select key ⑩, and the FREQUENCY/DC BIAS Step Control Keys ⑪ to FREQUENCY control mode or DC BIAS control mode. The selected control mode is indicated by the corresponding LED lamp.

FREQ: When this LED lamp is on, frequency is displayed on the FREQUENCY/DC BIAS Display and is controlled by the SPOT/COARSE/FINE Key and the FREQUENCY/DC BIAS Step Control Keys.

DC BIAS: When this LED lamp is on, DC bias voltage is displayed on the FREQUENCY/DC BIAS Display and is controlled by the FREQUENCY/DC BIAS Step Control Keys.

FREQUENCY control mode and DC BIAS control mode are mutually exclusive, and DC BIAS can be selected only if the instrument is equipped with Option 001.

Figure 3-1. Front Panel Features (Sheet 2 of 6).



⑩ SPOT/COARSE/FINE Select Key and Indicators:

This key selects the SPOT, COARSE, or FINE vernier mode for frequency changes mode by the FREQUENCY/DC BIAS Step Control Keys ⑪. The selected vernier mode is indicated by the corresponding LED lamp. Frequencies possible in each vernier mode are listed below:

SPOT: 10kHz, 100kHz, 1MHz

COARSE: 10kHz to 100kHz in 10kHz Steps
100kHz to 1MHz in 100kHz steps

FINE: 10kHz to 20kHz in 100Hz steps
20kHz to 50kHz in 200Hz steps
50kHz to 100kHz in 500Hz steps
100kHz to 200kHz in 1kHz steps
200kHz to 500kHz in 2kHz steps
500kHz to 1MHz in 5kHz steps

Note

When the DISPLAY A Function ⑱ is set to HIGH SPEED L or HIGH SPEED C, or when the FREQUENCY/DC BIAS Select Key ⑨ is set to DC BIAS mode, this key is disabled and the SPOT, COARSE, and FINE indicators are turned off.

⑪ FREQUENCY/DC BIAS Step Control Keys:

These keys— \square and \square —are used in conjunction with the FREQUENCY/DC BIAS Select Key ⑨ and the SPOT/COARSE/FINE Select Key ⑩ to set the test frequency and DC bias voltage (Option 001 instruments only). When FREQUENCY mode is selected by the FREQUENCY/DC BIAS Select Key ⑨, test frequency is increased in accordance with the selected vernier mode (SPOT, COARSE, FINE) each time the \square is pressed, and is decreased each time the \square key is pressed. These keys control DC bias in a similar manner when DC BIAS mode is selected by the FREQUENCY/DC BIAS Select Key ⑨.

When either of these keys is pressed and held, the value displayed on the FREQUENCY/DC BIAS Display will continuously change in the indicated direction. The actual value, however, will not change until the key is released.

Figure 3-1. Front Panel Features (Sheet 3 of 6).

12 TRIGGER Keys :

These keys select the trigger mode for triggering measurement (Internal or Manual/External):

INT : Internal trigger signal enables instrument to make repeated automatic measurements.

MAN/EXT : Measurement is triggered each time this key is pressed. Measurement data is held until the next time the key is pressed. Or in this mode measurement is triggered by an external trigger signal applied to the rear panel EXT TRIGGER connector (4) in Figure 3-2).

13 TEST SIGNAL LEVEL Selector Key and Indicators :

This key selects two test signal levels : HIGH and LOW. HIGH level is 1Vrms and LOW level is 20mVrms. The selected test signal level is indicated by the corresponding LED lamp.

14 MEASUREMENT SPEED Select Key and Indicators :


This key selects three measurement speeds: SLOW, MEDIUM or FAST. Actual measurement speed depends on test frequency, LC|Z| range (16), DISPLAY A Function (18), and the value of the device under test. The selected measurement speed mode is indicated by the corresponding LED lamp.

SLOW : Measurement speed is approximately 1/4 that of medium measurement speed.

MED : Measurement speed is approximately 14 measurements per second in C-G measurement mode.



FAST : Measurement speed is approximately one and a half that of medium measurement speed.

15 DISPLAY B Function Select Key and Indicators :

This key, , selects the measurement parameter for display on DISPLAY B (6). The selected parameter is indicated by the corresponding LED lamp. Pressing this key shifts the selected parameter in a top-to-bottom sequence. Selectable parameters are as follows:

D : Measures the dissipation factor of the DUT. DISPLAY A Function (18) must be set to L (inductance) or C (capacitance).

Q : Measures the quality factor of the DUT. DISPLAY A Function (18) must be set to L (inductance) or C (capacitance). Q values are calculated as the reciprocal dissipation factor.

ESR/G : Measures the equivalent series resistance or conductance of the DUT. DISPLAY A Function (18) must be set to L (inductance) or C (capacitance). ESR is selected when CIRCUIT MODE (17) is set to ; G is selected when CIRCUIT MODE (17) is set to .



16 LC|Z| RANGE Selector Keys and Indicator :

These keys select the measurement range and the ranging method for inductance, capacitance and impedance measurements.

AUTO (when indicator is lit):

Optimum range for the DUT's value is automatically selected.

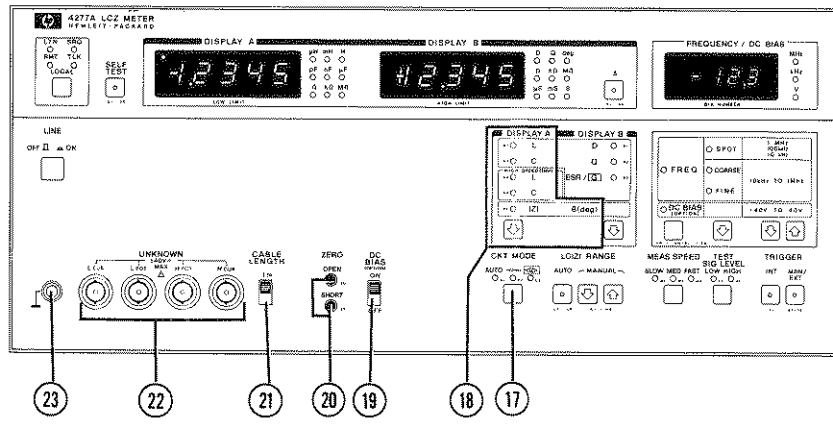
MANUAL (when indicator is not lit):

Measurement range is fixed (even when the DUT is changed). Manual ranging is done by pressing the adjacent DOWN () or UP () key.

Note



Pressing the DOWN or UP key sets the ranging mode to MANUAL even if the ranging mode was initially set to AUTO.



Figure 3-1. Front Panel Features (Sheet 4 of 6).




17 CIRCUIT MODE Select Key and Indicators:

This key selects the measurement circuit mode to be used during measurement. The selected circuit mode is indicated by the corresponding LED lamp.

AUTO: Automatically selects the equivalent circuit (parallel or series) most appropriate for the DUT's value. When $LC|Z|$ RANGE 16 is set to the 100Ω range or lower, circuit mode is set to . When $LC|Z|$ RANGE 16 is set to the 1kΩ range or higher, circuit mode is set to .

- : Selects equivalent series circuit.
- : Selects equivalent parallel circuit.

18 DISPLAY A Function Select Key and Indicators:

This key, , selects the measurement parameter for display on DISPLAY A 5. The selected parameter is indicated by the corresponding LED lamp. Pressing this key shifts the selected parameter in a top-to-bottom sequence. The selectable parameters are as follows:

L: Measures inductance and—depending on the setting of DISPLAY B Function 15—D (dissipation factor), Q (quality factor), or ESR/G (equivalent series resistance or equivalent parallel conductance).

C: Measures capacitance and—depending on the setting of DISPLAY B Function 15—D (Dissipation factor), Q (quality factor), or ESR/G (equivalent series resistance or equivalent parallel conductance).

HIGH SPEED L (1MHz):
Measures only inductance at 1MHz, which is set automatically when this function is selected.

HIGH SPEED C (1MHz):
Measures only capacitance at 1MHz, which is set automatically when this function is selected.

$|Z| - \theta$ (deg):
Measures impedance magnitude and phase angle. The results are displayed on DISPLAY A ($|Z|$) and DISPLAY B (θ) to provide a polar representation ($|Z| \angle \theta$) of the DUT's impedance.

Figure 3-1. Front Panel Features (Sheet 5 of 6).

①9 DC BIAS SWITCH:

On instruments equipped with Option 001, DC BIAS, this switch turns the internal DC bias source on and off. When this switch is set to ON and the DC BIAS Select Switch (②) in Figure 3-2) on the rear panel is set to INT, the DC voltage selected by the FREQUENCY/DC BIAS Step Control Keys (①) is output from the H_{CUR} UNKNOWN terminal (②). When set to OFF, this switch turns off the internal DC bias source; no DC voltage is output from the H_{CUR} UNKNOWN terminal (②), and "OFF" will be briefly displayed on the FREQUENCY/DC BIAS Display (⑧) each time a new DC bias voltage is set by the FREQUENCY/DC BIAS Step Control Keys (①) or via the HP-IB.

Note

This switch controls the internal DC bias source only. It does not control external DC bias voltage applied to the EXT INPUT/INT MONITOR connector (③) in Figure 3-2) on the rear panel. Also, this switch is not HP-IB programmable.

②0 ZERO Offset :

These buttons perform ZERO offset compensation (OPEN and SHORT) for the residuals of the test fixture, test leads, and measurement circuit. ZERO offset is performed at the following spot frequencies:

1MHz, 900kHz, 700kHz, 505kHz, 202kHz, 100kHz, 50.5kHz, 20.2kHz, and 10kHz.

OPEN : If this button is pressed when the test fixture or test leads are terminated open, measured values at this time are stored as residual admittance data.

SHORT : If this button is pressed when the test fixture or test leads are shorted, measured values at this time are stored as residual impedance data.

②1 CABLE LENGTH Switch :

This switch facilitates balancing of the measuring bridge circuit and minimizes measurement errors when the standard 1 meter test leads are used.

1m : Set the switch to this position when using the standard 1 meter test leads. Appropriate compensation is made for propagation delay and phase error caused by the test leads in high frequency measurements.

0 : Set the switch to this position when using a direct attachment type test fixture, such as the 16047A (connects to the UNKNOWN terminals (②)).

Note

This switch is not HP-IB programmable.

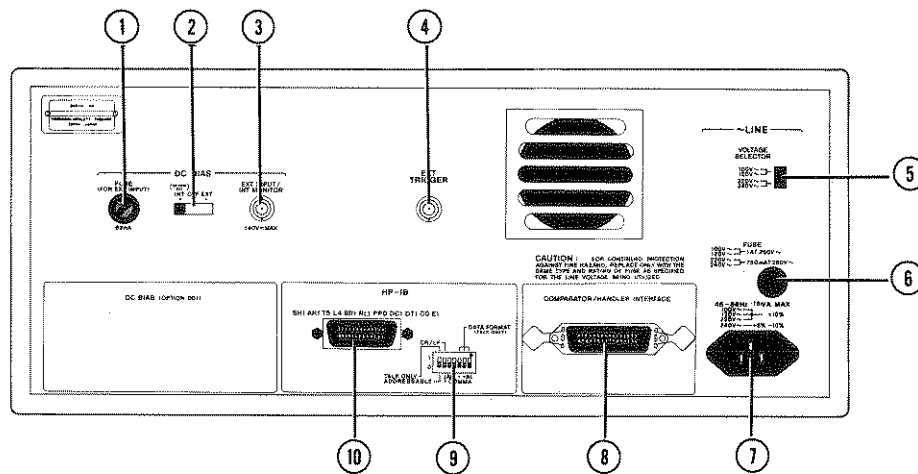
②2 UNKNOWN Terminals :

These four BNC connectors provide the means to connect DUT's in a four-terminal pair configuration: High current terminal (H_{CUR}), High potential terminal (H_{POT}), Low potential terminal (L_{POT}), and Low current terminal (L_{CUR}). Four-terminal pair test fixtures attach directly to these terminals.

②3 GUARD Terminal :

This terminal is tied to the instrument's chassis and can be used in measurements that require guarding.

Figure 3-1. Front Panel Features (Sheet 6 of 6).



① EXT DC BIAS FUSE Holder :

External DC bias fuse is installed in this holder. The fuse must be installed when an external bias source is used. Fuse rating is 1/16A, 250V (HP P/N: 2110-0011).

② DC BIAS Select Switch :

This switch selects the DC bias source that will be used for biasing DUTs connected to the UNKNOWN terminals.

INT: On instruments equipped with Option 001, DC BIAS, the DC voltage output from the internal DC bias source will be applied to the DUT when the DC BIAS Switch (②) in Figure 3-2) is set to ON.

OFF: No DC bias voltage will be applied to the DUT.

EXT: DC voltage provided by an external voltage source connected to the EXT INPUT/INT MONITOR Connector (③) will be applied to the DUT regardless of the setting of the DC BIAS Switch (②) in Figure 3-2). Maximum allowable voltage is $\pm 40V$.

③ EXT INPUT/INT MONITOR Connector :

The function of this connector depends on the setting of the DC BIAS Select Switch (②). When the DC BIAS Select Switch (②) is set to EXT, this connector is the input terminal for an external DC voltage source. When the DC BIAS Select Switch (②) is set to INT, this connector is the monitor output terminal for the internal DC bias source (Option 001 instruments only).

④ EXT TRIGGER Connector :

This connector is for external trigger input. TRIGGER key on front panel should be set to MAN/EXT. Specific information is provided in paragraph 3-74.

⑤ ~LINE VOLTAGE SELECTOR Switch :

This switch selects the appropriate ac operating voltage. Selectable voltages are 100V/120V $\pm 10\%$ and 220V $\pm 10\%$ /240V $\pm 5\%$ -10% (48 - 66Hz).

Figure 3-2. Rear Panel Features (Sheet 1 of 2).

⑥ ~ LINE FUSE Holder :

Instrument's power-line fuse is installed in this holder.

100V/120V operation :
1AT, 250V
(HP P/N : 2110-0007)

220V/240V operation :
750mA T, 250V
(HP P/N : 2110-0360)

⑦ ~ LINE Input Receptacle :

AC power cord connects to this receptacle.

⑧ COMPARATOR/HANDLER INTERFACE Connector :

Thirty-six pin connector, Option 002 instruments only, connects the 16064A COMPARATOR/HANDLER INTERFACE to the instrument.

⑨ HP-IB Control Switch :

This switch sets the instrument's HP-IB address (0 - 30), data output format (F1 - F6), and interface capability (Addressable or Talk Only). Specific information on this switch is given in paragraph 3-86.

⑩ HP-IB Connector :

Twenty-four pin connector; connects the instrument to an HP-IB controller or other HP-IB instruments via an HP-IB cable.

Figure 3-2. Rear Panel Features (Sheet 2 of 2).

Note

If an LED lamp or 7-segment display fails to light during the Display test, contact the nearest Hewlett-Packard Sales or Service Office for repairs.

Note

If the instrument is equipped with Option 002, Comparator/Handler Interface, and if the 16064A Comparator/Handler Interface is connected to the instrument, all 16064A LED lamps except D/Q/ESR/G and LIMIT LOW lamps will be lit during the Display test.

3-11. ANALOG CIRCUIT TEST

3-12. The Analog Circuit test is performed when the instrument's self-test function is initiated from the front panel or via the HP-IB. It is performed after the Display test, described in paragraph 3-9, and it confirms correct operation of the instruments analog circuits. Like the Display test, this test is repeated until the self-test function is turned off. The test lasts approximately three seconds. If a malfunction is detected, an error-code will be displayed on DISPLAY A. Refer to Table 3-4.

Note

The Analog Circuit test must be performed with an open-terminated (no DUT) test fixture (e.g., 16047A) connected to the UNKNOWN terminals.

Note



If one or more of the error codes listed in Table 3-4 appear on DISPLAY A during the Analog Circuit test, contact the nearest Hewlett-Packard Sales or Service Office for repairs.

3-13. MEASUREMENT FUNCTIONS

3-14. Values displayed on DISPLAY A and DISPLAY B are for the parameters selected by the DISPLAY A and DISPLAY B function keys. Inductance (L), capacitance (C), or impedance magnitude ($|Z|$) values are displayed on DISPLAY A; dissipation factor (D), quality factor (Q), equivalent series resistance (ESR), conductance (G), or impedance phase (θ) values are displayed on DISPLAY B. The DISPLAY B measurement function depends on the selected DISPLAY A function and the selected CKT MODE, as listed in Table 3-1. When DISPLAY A



function is HIGH SPEED C or HIGH SPEED L, DISPLAY B is always blank.



Table 3-1. Measurement Functions

		DISPLAY B	
DISPLAY A	Circuit Mode		
			
L	D, Q, or ESR	D, Q, or G	
C	D, Q, or ESR	D, Q, or G	
HIGH SPEED L	_____	_____	
HIGH SPEED C	_____	_____	
$ Z $	θ	θ	

3-15. DISPLAYS

3-16. The 4277A has three front panel displays: DISPLAY A, DISPLAY B, and FREQUENCY/DC BIAS. Each is described in paragraphs 3-17 through 3-19, respectively.

3-17. DISPLAY A provides direct readout of measured C, L, or $|Z|$, with 4 1/2-digit display resolution. The actual number of display digits depends on measurement range, test frequency, and test signal level. The least significant digit may be displayed as a small zero, , or may be blank, , to indicate that the digit does not provide a specified value. Maximum number of counts is ± 19999 . DISPLAY A also displays error-codes, operational annunciators, and the HP-IB address or output data format.

3-18. DISPLAY B provides direct readout of measured D, Q, ESR, G, or θ , with 4 1/2-digit display resolution. The actual number of display digits depends on measurement range, test frequency, test signal level, and number of DISPLAY A counts. The least significant digit may be displayed as a small zero, , or may be blank, , to indicate that the digit does not provide a specified value. Maximum number of display counts depends on the DISPLAY B function. Refer to Table 3-2. DISPLAY B also displays error-codes, operational annunciators, and option annunciation 16064 when the instrument is equipped with Option 002. When the DISPLAY A function is HIGH SPEED C or HIGH SPEED L, DISPLAY B is blank.

Note

Option annunciation 16064 appears only when the 16064A Comparator is connected to the rear panel.

Note

If one of the error-codes listed in Table 3-3 or Table 3-4 is displayed, contact the nearest Hewlett-Packard Sales or Service Office for repairs.

Table 3-2. Number of Counts on DISPLAY B

Measurement Function	Display Counts
D	Max. 1.9999
Q	Max. 10000
ESR/G	- 19999 to 19999 counts
θ	- 180.00° to 180.00°

3-19. The FREQUENCY/DC BIAS display provides direct readout of test frequency and, if the instrument is equipped with Option 001, the voltage output from the internal dc bias source. If Option 001 is installed, option annunciation 001 is displayed on this display each time the instrument is turned on. If the DC BIAS ON/OFF switch is set to OFF when the dc bias voltage is changed, OFF will be briefly displayed on this display after the new value has been set. Refer to paragraph 3-24. Also, if the instrument is equipped with Option 002, BIN numbers are displayed on this display when the 16064A Comparator is enabled.

3-20. ERROR-CODES

3-21. Error-codes related to the ROM/RAM test (see paragraph 3-7) are listed in Table 3-3. If one of these errors is displayed on DISPLAY A when the instrument is turned on, measurements can not be made.

Note

If E68 is displayed, measurements can be. The instrument's continuous memory function, however, is disabled.

3-22. Error-codes related to the Analog Circuit test (see paragraph 3-11) are listed in Table 3-4. If one or more of these errors are displayed on DISPLAY A during Self Test, the specifications listed in Table 1-1 are not guaranteed.

3-23. Error-codes related to operator errors are listed in Table 3-6. Corrective action for each error is also given in the table.

3-24. OPERATIONAL ANNUNCIATION

3-25. On instruments equipped with Option 001, DC BIAS, the annunciation shown in Table 3-5 may briefly appear on the FREQUENCY/DC BIAS display after a new dc bias voltage has been set. It indicates that the DC BIAS ON/OFF switch on the front panel is set to OFF. This switch must be set to ON if voltage from the internal dc bias source is to be applied to the DUT.

Note

For applications using the internal dc bias source, the DC BIAS select switch on the rear panel must be set to INT.

Table 3-3. Error-Codes for ROM/RAM Self Test









Error Code	Meaning
	A1U5 ROM is faulty.
	A1U6 ROM is faulty.
	A1U7 ROM is faulty.
	A1U8 ROM is faulty.
	A1U9 ROM is faulty.
	A1U10 ROM is faulty.
	A1U12 RAM is faulty.
	A1U12 RAM or A6BT1 is faulty.

Table 3-4. Error-Codes for Analog Circuit Self Test


Display	Meaning
	Analog Circuit is not functioning properly.

Table 3-5. Operation Error Codes Displayed on FREQUENCY/DC BIAS Display




DISPLAY A	DISPLAY B	FREQ/DC BIAS	Meanings	Treatment
 (any reading)	 (any reading)		Illegal INTERNAL DC BIAS operation (Option 001). The internal dc bias voltage was set manually or via the HP-IB when the DC BIAS ON/OFF switch on the front panel was set to OFF.	Set the DC BIAS switch to ON. Note Make sure that the DC BIAS switch on the rear panel is set to INT.

Table 3-6. Operation Error Codes Displayed on DISPLAY A/B (Sheet 1 of 3)

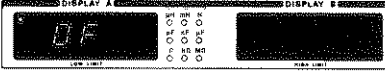



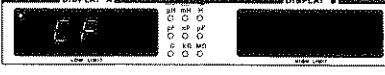

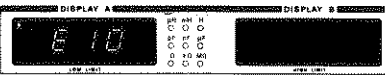
ERROR CODE	Meaning	Treatment
	Overflow - The inductance, capacitance, or impedance of the DUT is too high to be measured on the selected LC Z RANGE.	Select a higher LC Z RANGE.
 (any reading)	Overflow - The dissipation factor, quality factor, ESR, or conductance of the DUT is too high.	Change the DISPLAY B function, or change the DISPLAY A function to Z .
	Underflow -The inductance, capacitance, or impedance of the DUT is too low to be measured on the selected LC Z RANGE.	Select a lower LC Z RANGE.
 (any reading)	Underflow -The dissipation factor, quality factor, ESR, or conductance of the DUT is too low.	Change the DISPLAY B function, or change the DISPLAY A function to Z .
	Change Function -The selected parameter cannot be measured with the present control settings.	Change the DISPLAY A function to another parameter.
 (any reading)		Change the DISPLAY B function, or change the DISPLAY A function to Z .
	Zero Offset Adjustment error. The residuals of the test fixture or test leads are too high to be offset, or nothing is connected to the UNKNOWN terminals. Previous Zero Offset data are unchanged.	Use a different test fixture or test leads; or, if nothing is connected to the UNKNOWN terminals, connect an appropriate test fixture or test leads. Refer to paragraph 3-50 for details on Zero Offset Adjustments.

Table 3-6. Operation Error Codes Displayed on DISPLAY A/B (Sheet 2 of 3)


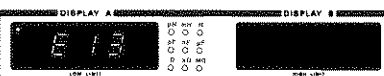

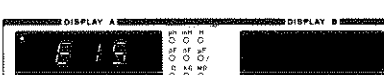

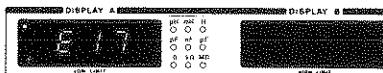

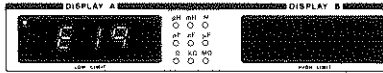
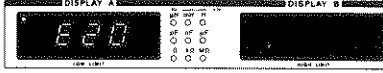
ERROR CODE	Meaning	Treatment
	Illegal LC Z RANGE, DISPLAY A, FREQ, or TEST SIG LEVEL setting.	The instrument will automatically select the correct setting.
	Illegal DC BIAS or COMPARATOR operation. Internal dc bias voltage was set via the HP-IB, but the instrument is not equipped with Option 001; or the comparator enable code (E1) was sent via the HP-IB; but the instrument is not equipped with Option 002.	Install the desired option. Refer to Section II.
	Illegal COMPARATOR operation. The D/Q/ESR/G key on the 16064A was pressed or was set via the HP-IB while the DISPLAY A function was set to HIGH SPEED C, HIGH SPEED L, or Z .	D, Q, ESR, or G comparison cannot be performed. The instrument is set to HIGH SPEED L or HIGH SPEED C measurement mode.
	Illegal COMPARATOR operation. One of the 4277A's front panel keys (except TRIGGER, LOCAL, or DC BIAS) was pressed or was set via the HP-IB.	To change a front panel control setting on the 4277A, first disable (turn off) the 16064A. Press the COMPARATOR ENABLE key (the lamp at the center of the key should go off).
	Illegal COMPARATOR operation. One of the 16064A's keys (except the COMPARATOR ENABLE key) was pressed or was set via HP-IB while the 16064A was disabled.	To operate the COMPARATOR, first enable (turn on) the 16064A. Press the COMPARATOR ENABLE key (the lamp at the center of the key should come on).

Table 3-6. Operation Error Codes Displayed on DISPLAY A/B (Sheet 3 of 3)

ERROR CODE	Meaning	Treatment
	<p>Illegal COMPARATOR operation. The 4277A's front panel control settings are different from those that existed when the present bin limits were entered.</p>	<p>Reset the front panel controls to the previous settings, or clear the stored bin limits by pressing the ERASE button.</p>
	<p>Illegal COMPARATOR operation. The RUN key on the 16064A was pressed or was set via HP-IB when no bin limits were entered, or a bin's LOW LIMIT is higher than its HIGH LIMIT.</p>	<p>Enter LOW and HIGH limits, or correct the displayed LOW and HIGH LIMITS.</p>
	<p>Illegal parameter setting. The test frequency setting, internal dc bias setting, or a bin limit setting is outside the specified limits.</p>	<p>Reset the incorrect parameter.</p>
	<p>Illegal HP-IB address. The HP-IB address switches on the rear panel were set to 31 (11111) when the instrument was turned on.</p>	<p>Turn off the instrument and set the HP-IB address to one between 0 (00000) and 30 (11110).</p>
	<p>Illegal deviation measurement operation. The Δ key on the front panel was pressed or was set via HP-IB when CF, UF, or CF was displayed on DISPLAY A or DISPLAY B.</p>	<p>Only valid reference values can be used for deviation measurement.</p>

3-26. TEST FREQUENCY

3-27. There are six test frequency ranges, as listed in Table 3-7. Frequency accuracy is 0.01% of the value displayed on the FREQUENCY/DC BIAS display.

Table 3-7. Test Frequency Ranges and Resolution

Test Frequency Range	Resolution
10.0kHz - 20.0kHz	100Hz
20.0kHz - 50.0kHz	200Hz
50.0kHz - 100kHz	500Hz
100kHz - 200kHz	1kHz
200kHz - 500kHz	2kHz
500kHz - 1.00MHz	5kHz

3-28. TEST SIGNAL LEVEL

3-29. The 4277A has two test signal levels: HIGH (1Vrms) and LOW (20mVrms). Accuracy for each level is listed in Table 3-8. The output impedance of the test signal source is 100Ω±10%, so the voltage across the DUT depends on the DUT's impedance. Refer to Figure 3-3.

Table 3-8. Test Signal Level Accuracy

Freq. Level	1MHz	Other Frequencies
HIGH	±10%	±10%
LOW		±15%

3-30. MEASUREMENT RANGE

3-31. Measurement range depends on the test frequency. The ranges which can be selected at each test frequency and the range resistor used on each range are shown in Figure 3-5. Each range allows a 100% overrange of the 10000 full scale counts (maximum 19999 counts). Figure 3-4 shows the number of display digits for each measurement functions. Measurement range is selected by the LC | Z | RANGE keys. When the LC | Z | RANGE control is set to AUTO, the optimum range is automatically selected for each measurement. Manual ranging is also possible. When an inappropriate range is selected, OF or UF is displayed on DISPLAY A or DISPLAY B.

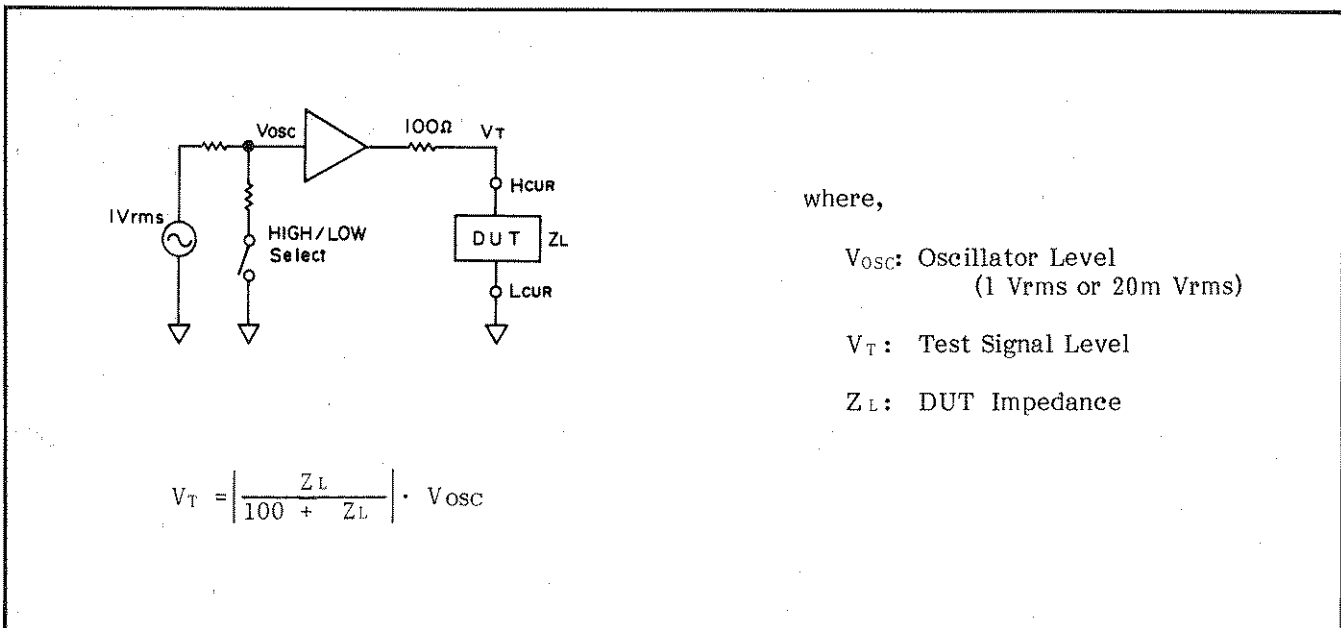
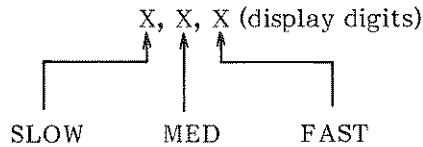


Figure 3-3. Equivalent Circuit of the Test Signal Source.

NUMBER OF DISPLAY DIGITS

Tables 1 through 12 show the number of significant digits displayed for each of the 4277A's measurement parameters. The three-number combinations given in the tables indicate the number of display digits for the respective measurement range and test frequency for each measurement speed. For example, if MED measurement speed is selected, use the middle number; if FAST is selected, use the right most number.



The number of display digits is defined as follows:

4 digits		to	
3 digits		to	
2 digits		to	
1 digits		to	

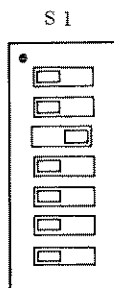
A full-scale factor is used in Figure A through Figure N. It is defined as follows:

$$\text{Full-scale factor} = (\text{measured value} \div \text{full-scale value}) \text{ of } C, L, \text{ or } |Z|$$

For example, when the measured C value is 9.5nF on the 10nF range, full-scale factor is 0.95.

Note

SA SELECT SW



To obtain more display digits on ranges where the number of display digits is less than 3-1/2, set the SA SELECT switch (S1) on the A1 (logic) board as shown in the figure. However, display fluctuation will be more than that in normal operation. The setting of this switch can be changed only when the instrument is turned off.

Figure 3-4. Measurement Ranges and Number of Display Digits (Sheet 1 of 16).

NUMBER OF DISPLAY DIGITS FOR CAPACITANCE

1 Test Signal Level: HIGH

Capacitance Range	Test Frequency (Hz)		
	10.0k to 20.0k	20.2k to 200k	202k to 1.00M
10 μ F	See Figure B		
1 μ F	See Figure A	See Figure B	
100nF		See Figure A	See Figure B
10nF			See Figure A
1nF			
100pF		4·4·3	
10pF			
1pF			

Note: Shaded areas indicate that measurement cannot be performed.

2 Test Signal Level: LOW

Capacitance Range	Test Frequency (Hz)								
	10.0k	10.1k to 18.0k	18.1k to 19.9k	20.0k	20.2k to 99.5k	100k	101k to 200k	202k to 995k	1.00M
10 μ F	See Figure B								
1 μ F	See Figure A				See Figure B				
100nF					See Figure A			See Figure B	
10nF	4·4·3	4·3·3	3·3·3		4·3·3	4·4·3		See Figure A	
1nF									
100pF	3·3·2	3·2·2					4·3·3		4·4·3
10pF					3·2·2	3·3·2	3·2·2		
1pF								3·2·2	3·3·2

Note: Shaded areas indicate that measurement cannot be performed.

Figure 3-4. Measurement Ranges and Number of Display Digits (Sheet 2 of 16).

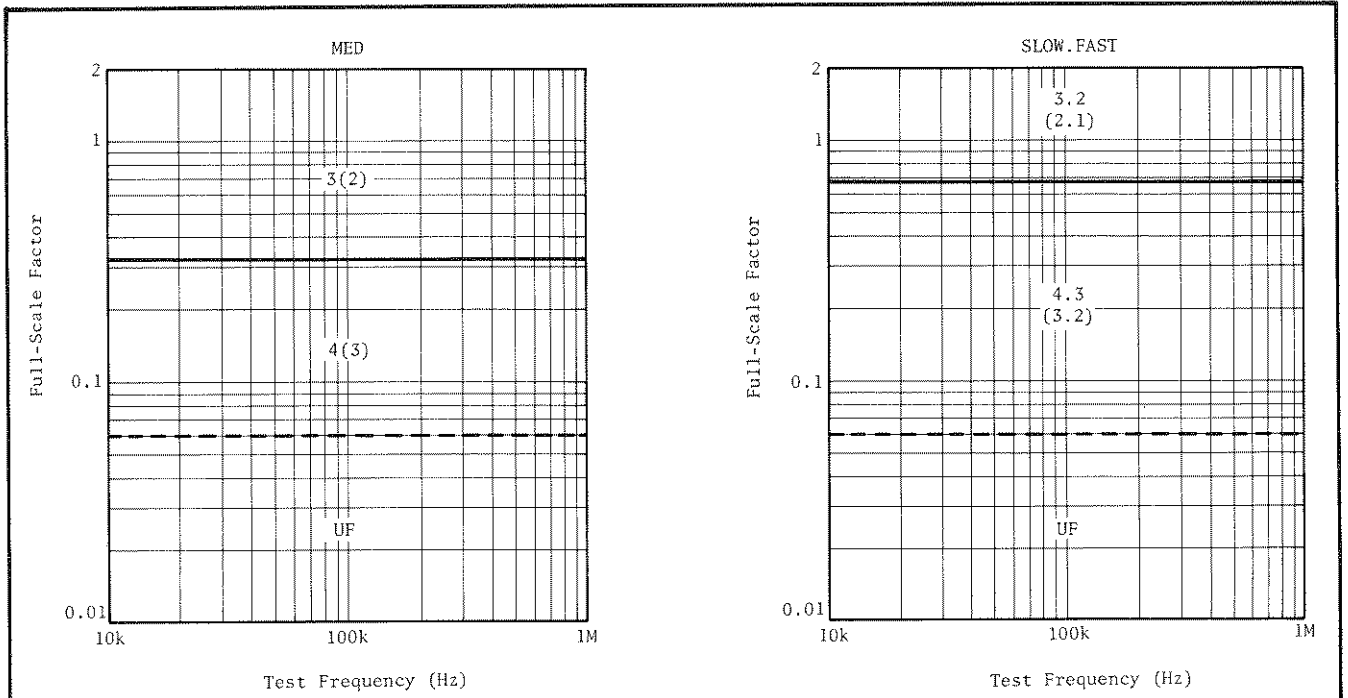


Figure A

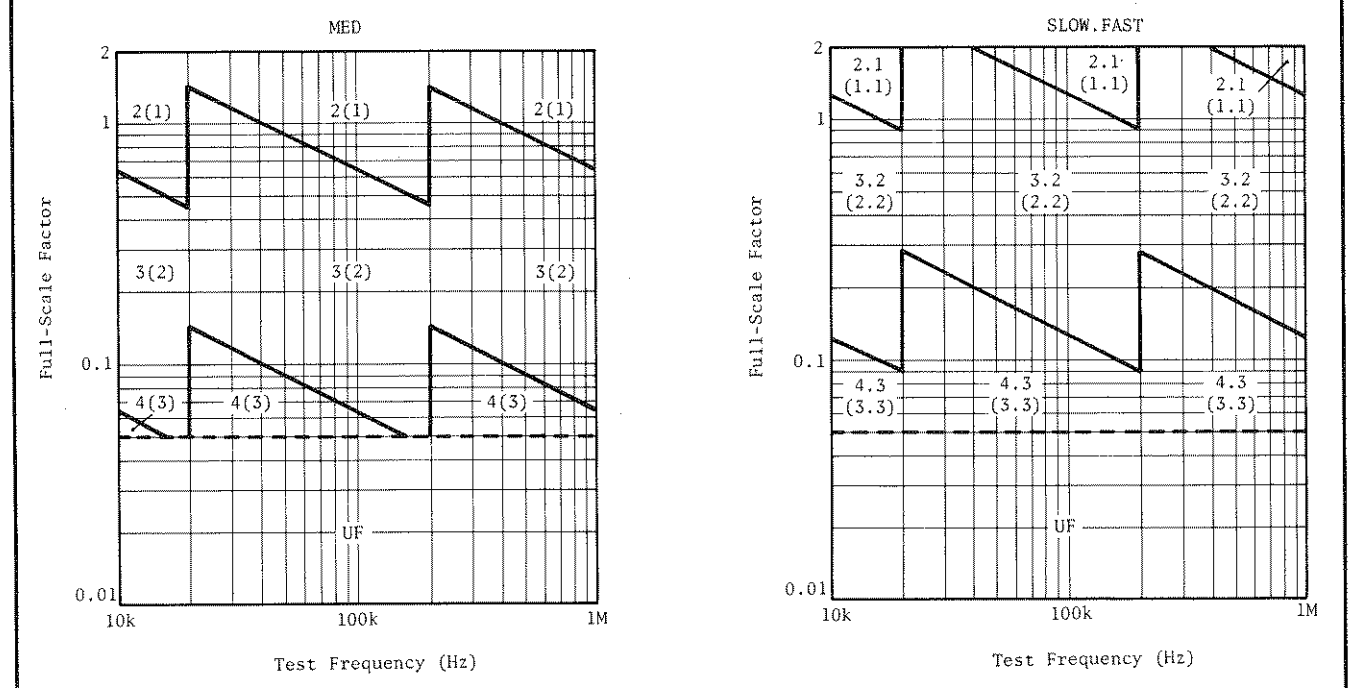


Figure B

Note: Numbers not enclosed in parentheses apply when Test Signal Level is HIGH; numbers enclosed in parentheses apply when Test Signal Level is LOW.

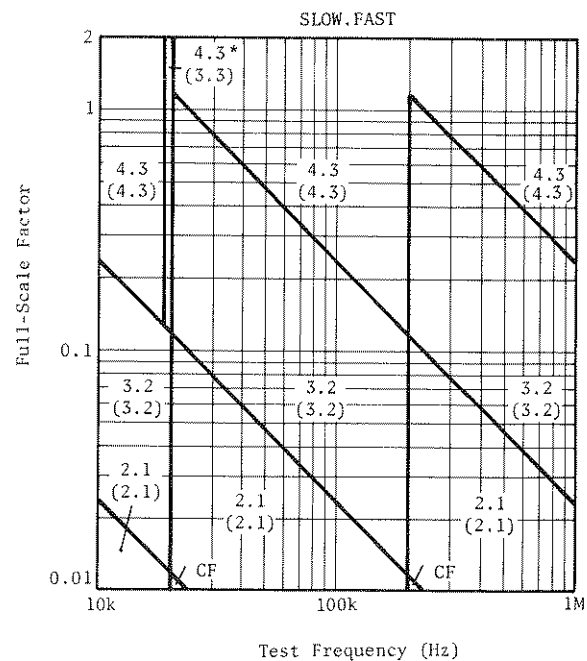
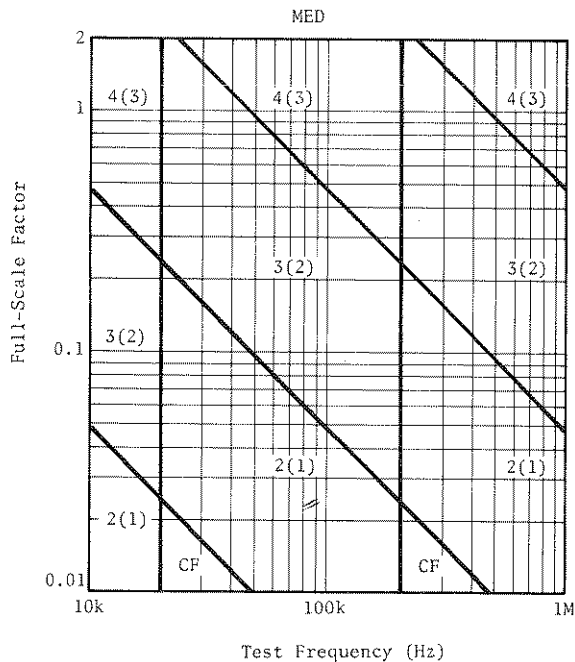
Figure 3-4. Measurement Ranges and Number of Display Digits (Sheet 3 of 16).

NUMBER OF DISPLAY DIGITS FOR DISSIPATION FACTOR IN C-D MEASUREMENT

3

Capacitance Range	Test Frequency (Hz)		
	10.0k to 20.0k	20.2k to 200k	202k to 1.00M
10 μ F	See Figure E		
1 μ F	3.3.2 (2.2.2)*	See Figure E	
100nF		3.3.2 (2.2.2)*	See Figure E
10nF			3.3.2 (2.2.2)*
1nF		See Figure C	
100pF	See Figure D		
10pF		See Figure D	
1pF			See Figure D

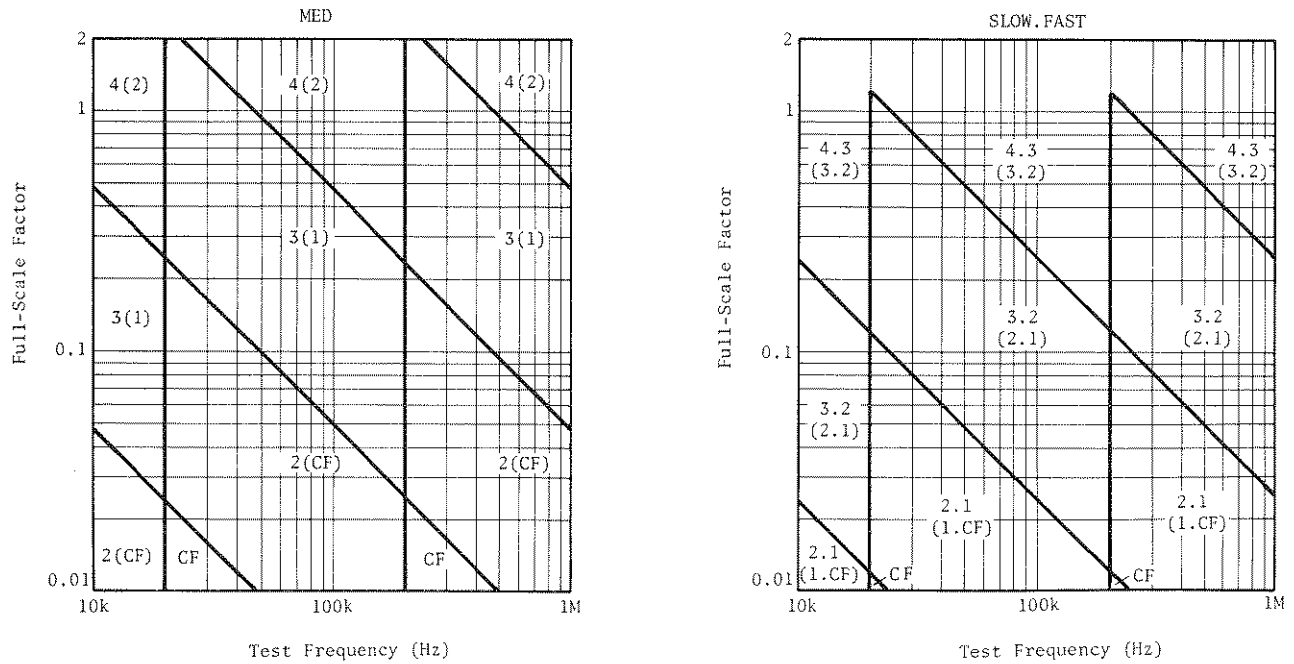
- Note: 1) Numbers not enclosed in parentheses apply when Test Signal Level is HIGH; numbers enclosed in parentheses apply when Test Signal Level is LOW.
- 2) Shaded areas indicate that measurement cannot be performed.
- 3) *When the measured C value is less than 5% of full scale, D measurement cannot be performed.



- Note: 1) Add one digit at 10k, 100k, and 1MHz when Test Signal Level is LOW.
- 2) *Frequency range is 18.1kHz to 19.9kHz.
- 3) Numbers not enclosed in parentheses apply when Test Signal Level is HIGH; numbers enclosed in parentheses apply when Test Signal Level is LOW.

Figure C

Figure 3-4. Measurement Ranges and Number of Display Digits (Sheet 4 of 16).



Note: Add one digit at 10k, 100k, and 1MHz when Test Signal Level is LOW.

Figure D

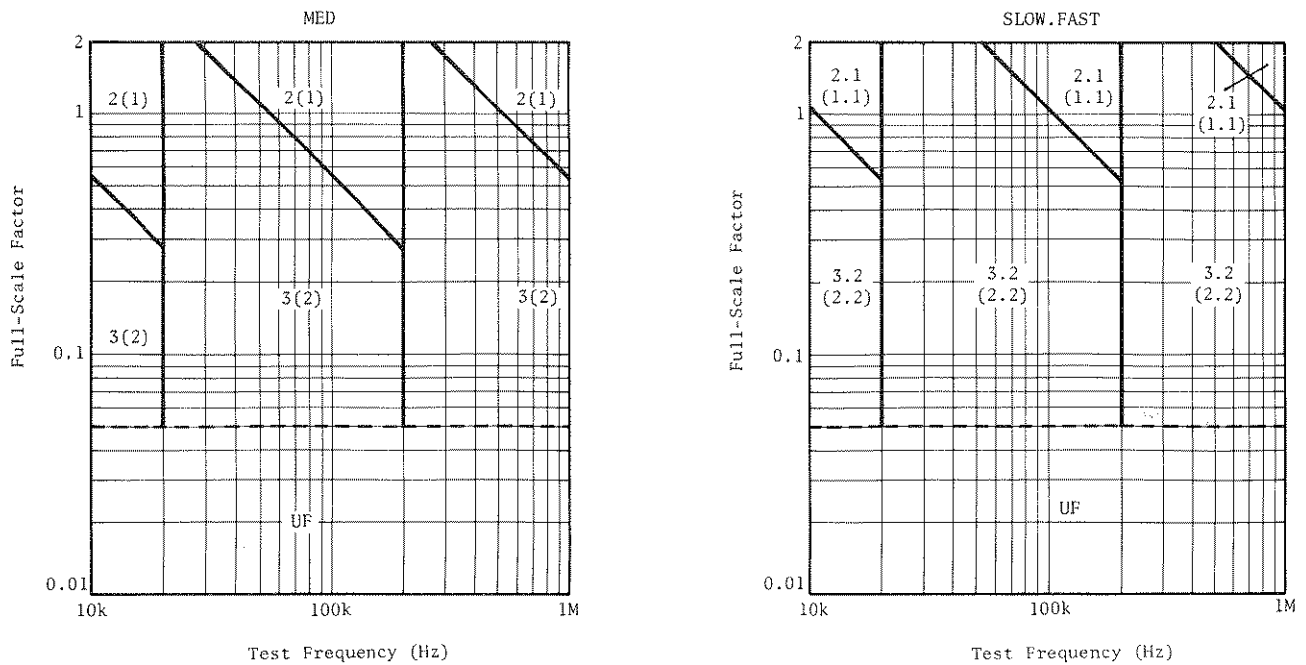


Figure E

Note: In Figures D and E numbers not enclosed in parentheses apply when Test Signal Level is HIGH; numbers enclosed in parentheses apply when Test Signal Level is LOW.

Figure 3-4. Measurement Ranges and Number of Display Digits (Sheet 5 of 16).

NUMBER OF DISPLAY DIGITS FOR INDUCTANCE

4 Test Signal Level: HIGH

Inductance Range	Test Frequency (Hz)						
	10.0k	10.1k to 20.0k	202.k to 99.5k	100k	101k to 200k	202k to 995k	1.00M
1H	See Figure G ₁						
100mH							
10mH	See Figure F	See Figure G ₂		See Figure G ₁	See Figure G ₂		See Figure G ₁
1mH	4.4.3	See Figure F					See Figure F
100μH			4.3.3	4.4.3	See Figure F		
10μH					4.3.3	4.4.3	
1μH							4.3.3

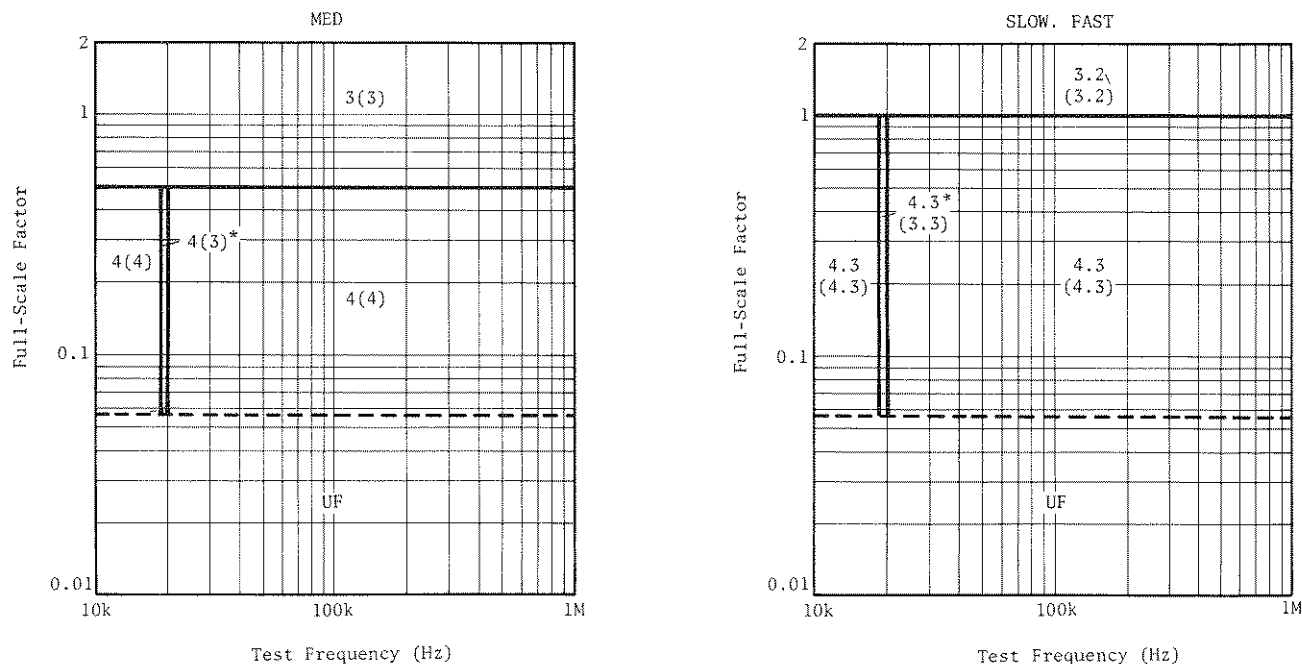
Note: Shaded areas indicate that measurement cannot be performed.

5 Test Signal Level: LOW

Inductance Range	Test Frequency (Hz)						
	10.0k	10.1k to 20.0k	20.2k to 99.5k	100k	101k to 200k	202k to 995k	1.00M
1H	See Figure G ₁						
100mH							
10mH	See Figure F	See Figure G ₂		See Figure G ₁	See Figure G ₂		See Figure G ₁
1mH	4.4.3	See Figure F					See Figure F
100μH	3.3.2	3.3.3	4.3.3	4.4.3	See Figure F		
10μH		2.2.2	3.2.2	3.3.2	3.3.3	4.3.3	4.4.3
1μH						2.2.2	3.2.2

Note: Shaded areas indicate that measurement cannot be performed.

Figure 3-4. Measurement Ranges and Number of Display Digits (Sheet 6 of 16).



Note: * Frequency range is 18.1kHz to 19.9kHz.

Figure F

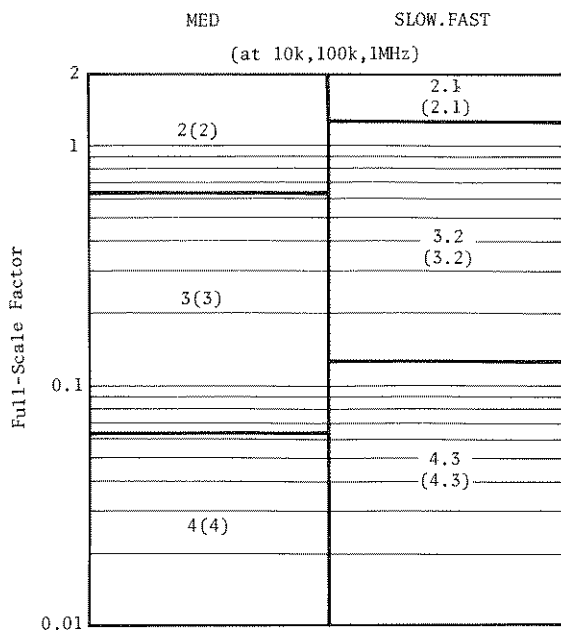
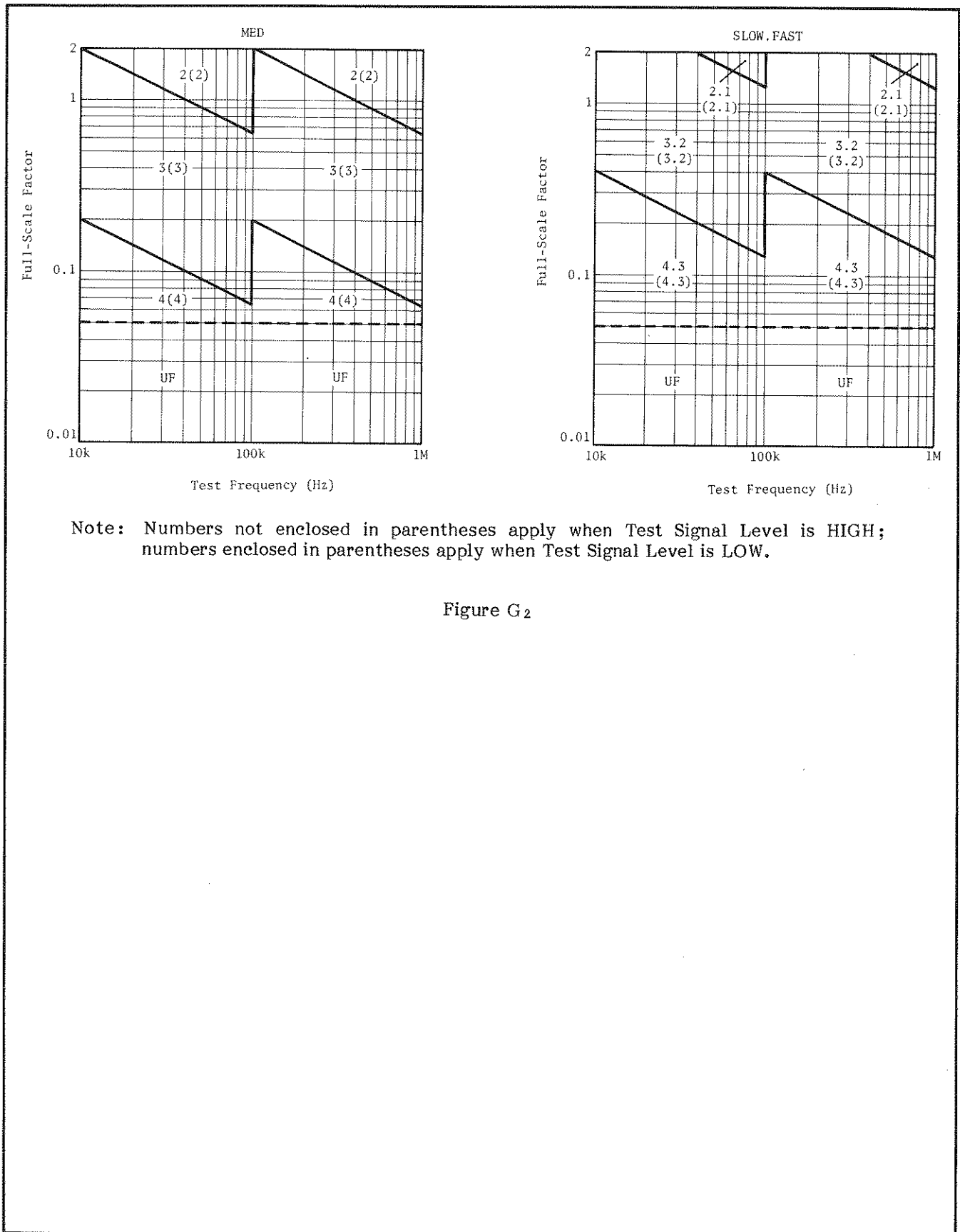


Figure G₁

Figure G₁

Note: In Figures F and G₁ numbers not enclosed in parentheses apply when Test Signal Level is HIGH; numbers enclosed in parentheses apply when Test Signal Level is LOW.

Figure 3-4. Measurement Ranges and Number of Display Digits (Sheet 7 of 16).



Note: Numbers not enclosed in parentheses apply when Test Signal Level is HIGH; numbers enclosed in parentheses apply when Test Signal Level is LOW.

Figure G₂

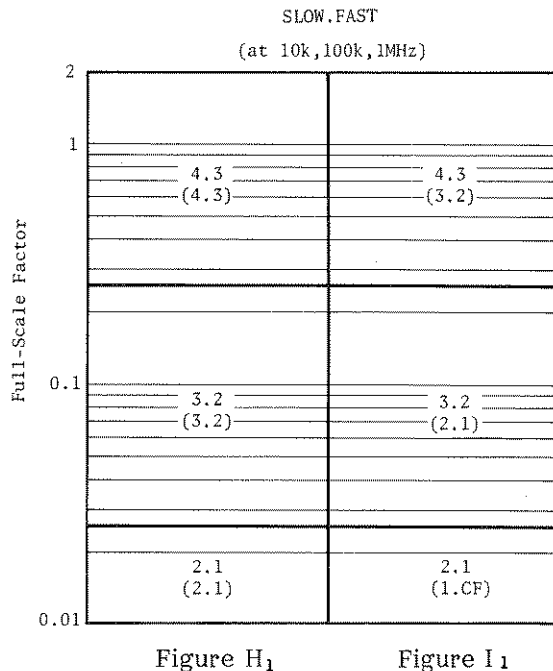
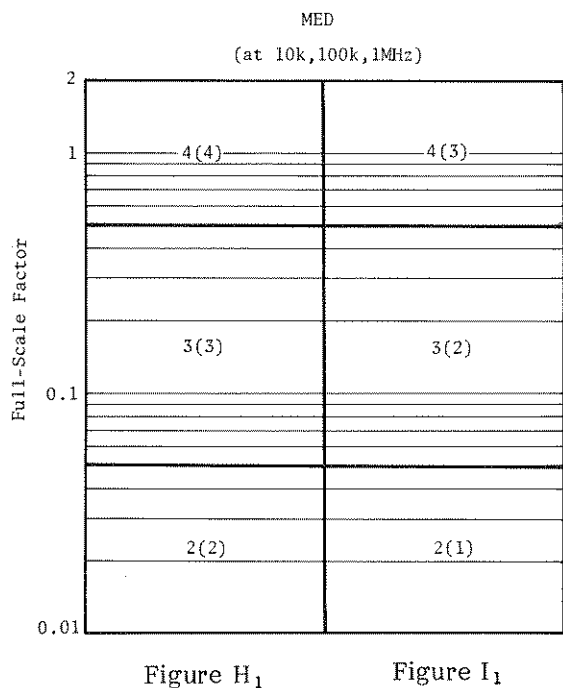
Figure 3-4. Measurement Ranges and Number of Display Digits (Sheet 8 of 16).

NUMBER OF DISPLAY DIGITS FOR DISSIPATION FACTOR IN L-D MEASUREMENT

6

Inductance Range	Test Frequency (Hz)				
	10.0k	10.1k to 99.5k	100k	101k to 995k	1.00M
1H	See Figure J				
100mH	See Figure J				
10mH	3·3·2 (3·3·2)*	See Figure J			See Figure J
1mH	See Figure H ₁	3·3·2 (3·3·2)*		See Figure J	
100μH	See Figure I ₁	See Figure H ₂	See Figure H ₁	3·3·2 (3·3·2)*	
10μH	See Figure J	See Figure I ₂	See Figure I ₁	See Figure H ₂	See Figure H ₁
1μH	See Figure J			See Figure I ₂	See Figure I ₁

- Note: 1) Numbers not enclosed in parentheses apply when Test Signal Level is HIGH; numbers enclosed in parentheses apply when Test Signal Level is LOW.
- 2) Shaded areas indicate that measurement cannot be performed.
- 3) *When the measured L value is less than 5.6% of full scale, D measurement cannot be performed.



Note: Numbers not enclosed in parentheses apply when Test Signal Level is HIGH; numbers enclosed in parentheses apply when Test Signal Level is LOW.

Figure 3-4. Measurement Ranges and Number of Display Digits (Sheet 9 of 16).

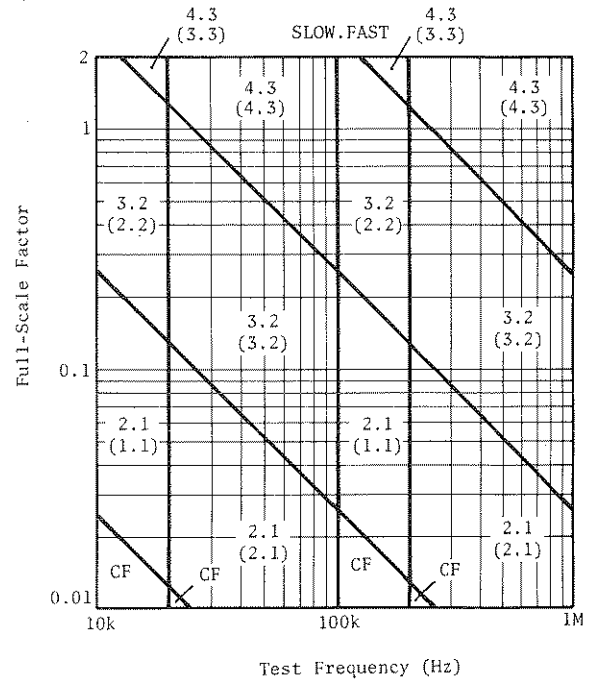
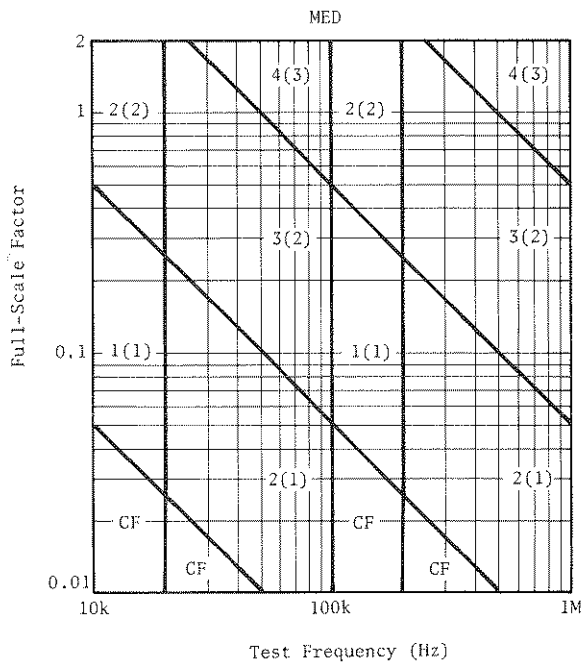


Figure H₂

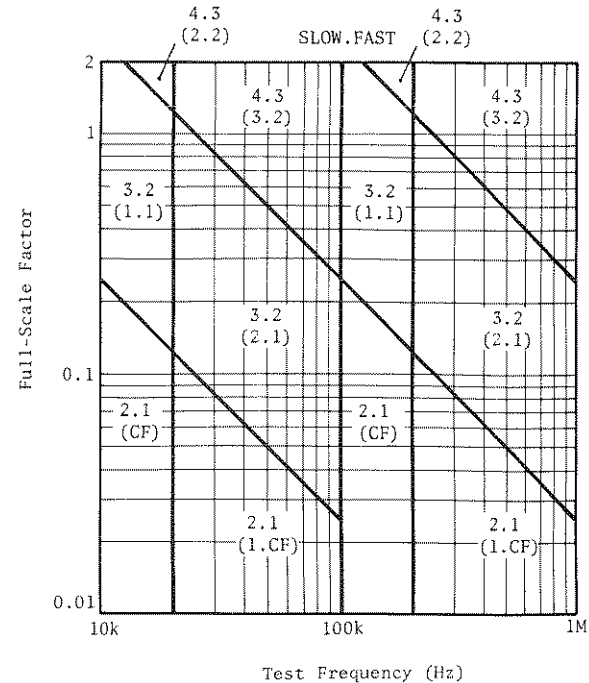
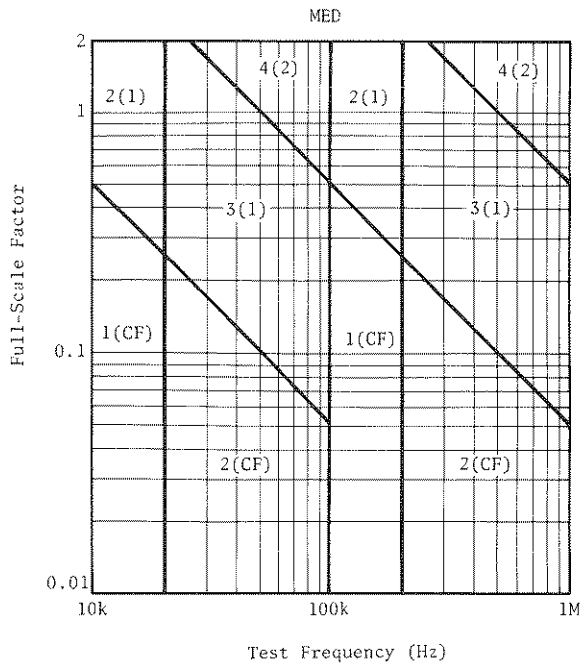
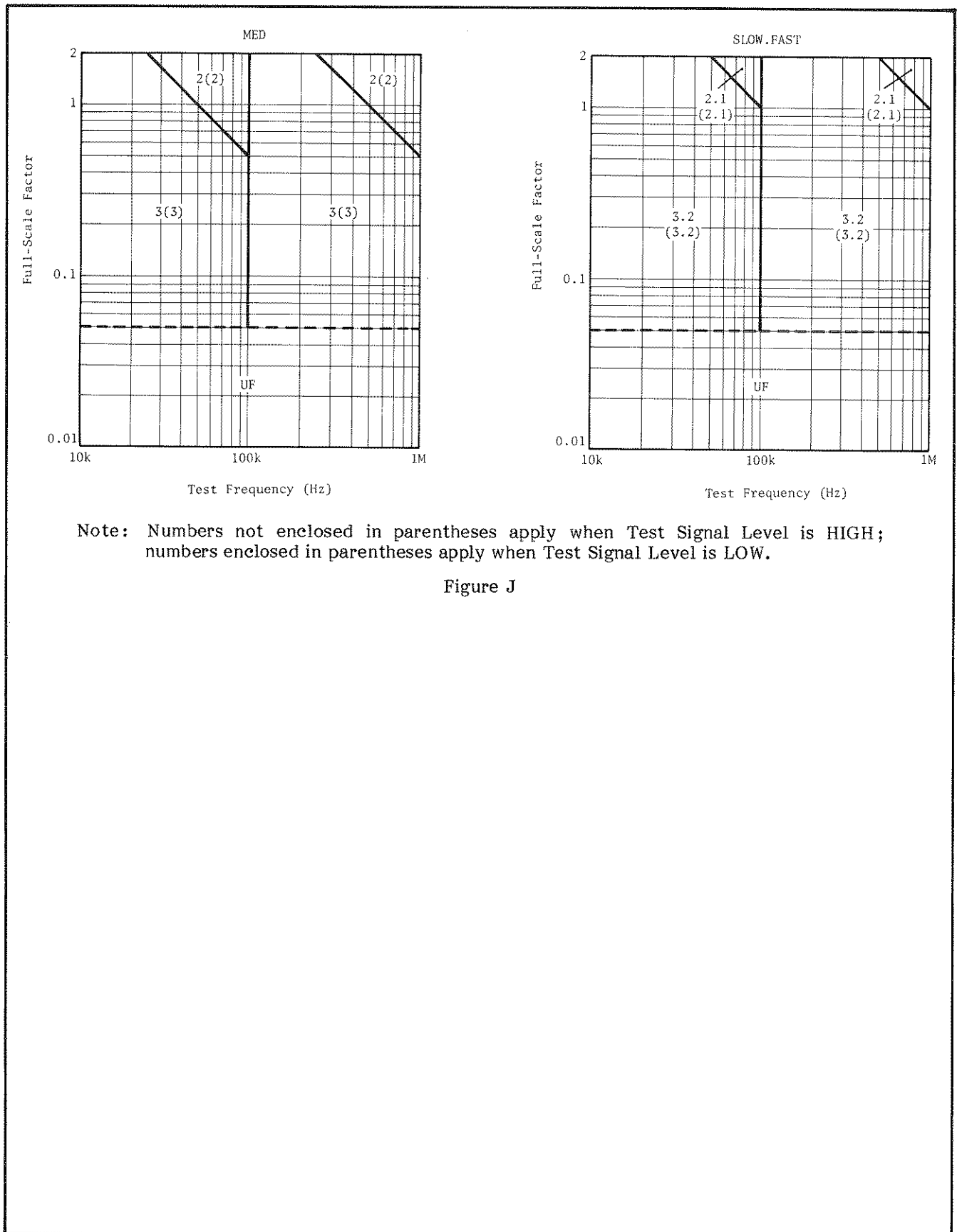


Figure I₂

Note: Numbers not enclosed in parentheses apply when Test Signal Level is HIGH; numbers enclosed in parentheses apply when Test Signal Level is LOW.

Figure 3-4. Measurement Ranges and Number of Display Digits (Sheet 10 of 16).



Note: Numbers not enclosed in parentheses apply when Test Signal Level is HIGH; numbers enclosed in parentheses apply when Test Signal Level is LOW.

Figure J

Figure 3-4. Measurement Ranges and Number of Display Digits (Sheet 11 of 16).

**NUMBER OF DISPLAY DIGITS FOR ESR AND G
IN C-ESR/G MEASUREMENT**

ESR/G Range	Test Frequency (Hz)		
	10.0k to 18.0k	18.1k to 19.9k	20.0k to 1.00M
1M Ω /10 μ S	4.4.3 (3.3.2)		
100k Ω /100 μ S	4.4.3 (4.4.3)	4.4.3 (3.3.3)	4.4.3 (4.4.3)
10k Ω /1mS			
1k Ω /10mS			
100 Ω /100mS	3.3.2 (3.3.2)		
10 Ω /1S			

- Note: 1) ESR and G ranges depend on the selected C range.
- 2) Numbers not enclosed in parentheses apply when Test Signal Level is HIGH; numbers enclosed in parentheses apply when Test Signal Level is LOW.

**NUMBER OF DISPLAY DIGITS FOR ESR AND G
IN L-ESR/G MEASUREMENT**

ESR/G Range	Test Frequency (Hz)		
	10.0k to 18.0k	18.1k to 19.9k	20.0k to 1.00M
100k Ω /100 μ S	3.3.2 (3.3.2)		
10k Ω /1mS			
1k Ω /10mS			
100 Ω /100mS	4.4.3 (4.4.3)	4.4.3 (3.3.3)	4.4.3 (4.4.3)
10 Ω /1S	4.4.3 (3.3.2)		

- Note: 1) ESR and G ranges depend on the selected L range.
- 2) Numbers not enclosed in parentheses apply when Test Signal Level is HIGH; numbers enclosed in parentheses apply when Test Signal Level is LOW.

Figure 3-4. Measurement Ranges and Number of Display Digits (Sheet 12 of 16).

DISPLAY INDICATION FOR QUALITY FACTOR

9 D: 4 digits

D	Q	Display
.0001 to .0009	10000 to 1111	DF
.0010 to .0033	1000 to 303	1000. to 300.
.0034 to .0099	294 to 101	290. to 100.
.0100 to .0333	100 to 30	100. to 30.
.0334 to 1.9999	29.9 to 0.5	29.9 to 0.5

Note: Q is the reciprocal of D.

10 D: 3 digits

D	Q	Display
.001 to .003	1000 to 333	DF
.004 to .010	250 to 100	300. to 100.
.011 to .033	90.9 to 30.3	90. to 30.
.034 to 1.999	29.4 to 0.5	30. to 0.5

Note: Q is the reciprocal of D.

Figure 3-4. Measurement Ranges and Number of Display Digits (Sheet 13 of 16).

NUMBER OF DISPLAY DIGITS FOR IMPEDANCE

Z Range	Test Frequency (Hz)			
	10.0k to 18.0k	18.1k to 19.9k	20.0k to 99.5k	100k to 1.00M
1M Ω	See Figure L			
100k Ω	See Figure K			
10k Ω				
1k Ω				
100 Ω	4.4.3 (4.3.3)	4.4.3 (3.3.3)	4.4.3 (4.3.3)	4.4.3 (4.4.3)
10 Ω	4.4.3 (3.3.2)			

Note: Numbers not enclosed in parentheses apply when Test Signal Level is HIGH; numbers enclosed in parentheses apply when Test Signal Level is LOW.

NUMBER OF DISPLAY DIGITS FOR PHASE ANGLE

Z Range	Test Frequency (Hz)
	10.0k to 1.00M
1M Ω	See Figure L
100k Ω	See Figure K
10k Ω	
1k Ω	
100 Ω	See Figure M
10 Ω	See Figure N

Figure 3-4. Measurement Ranges and Number of Display Digits (Sheet 14 of 16).

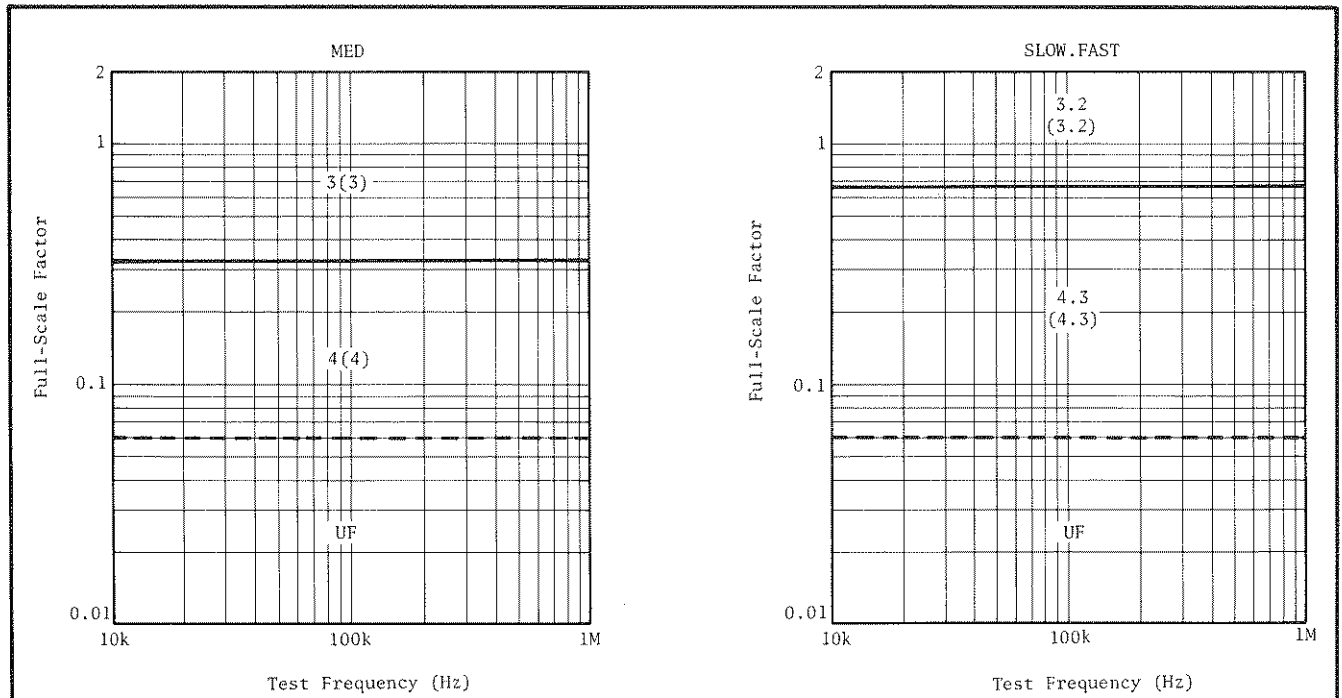


Figure K

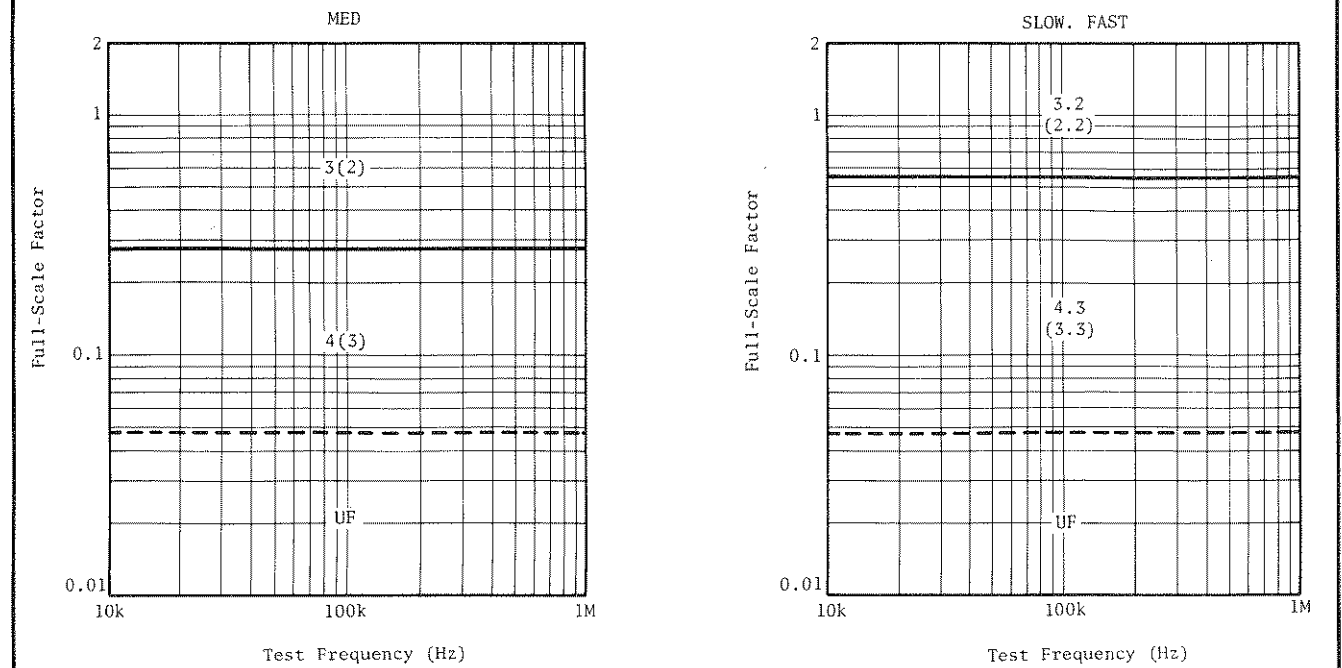
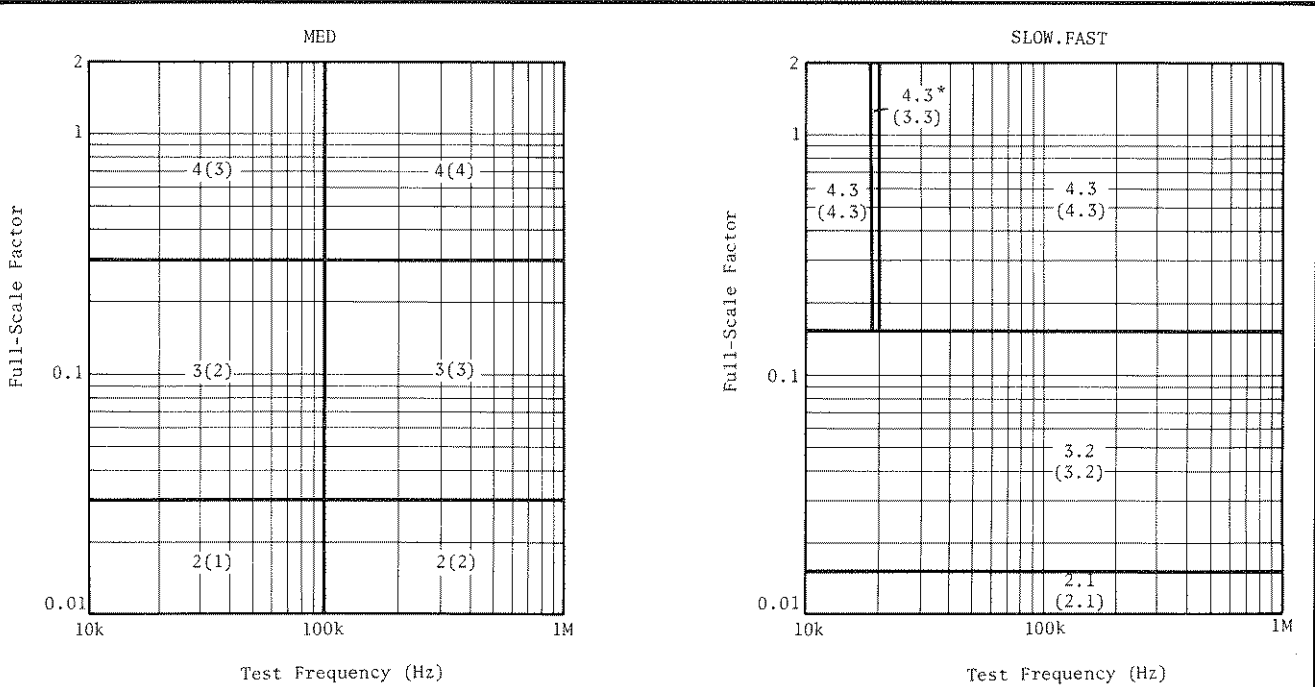


Figure L

Note: Numbers not enclosed in parentheses apply when Test Signal Level is HIGH; numbers enclosed in parentheses apply when Test Signal Level is LOW.

Figure 3-4. Measurement Ranges and Number of Display Digits (Sheet 15 of 16).



Note: * Frequency range is 18.1kHz to 19.9kHz.

Figure M

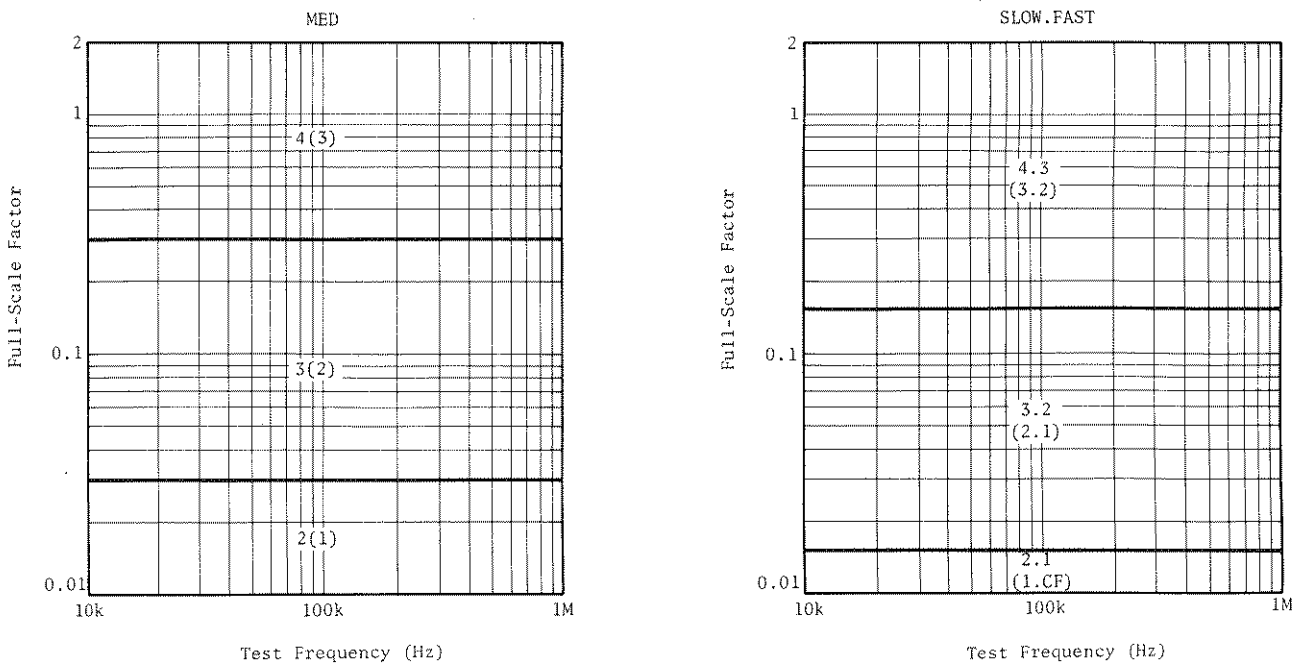


Figure N

Note: In Figures M and N numbers not enclosed in parentheses apply when Test Signal Level is HIGH; numbers enclosed in parentheses apply when Test Signal Level is LOW.

Figure 3-4. Measurement Ranges and Number of Display Digits (Sheet 16 of 16).

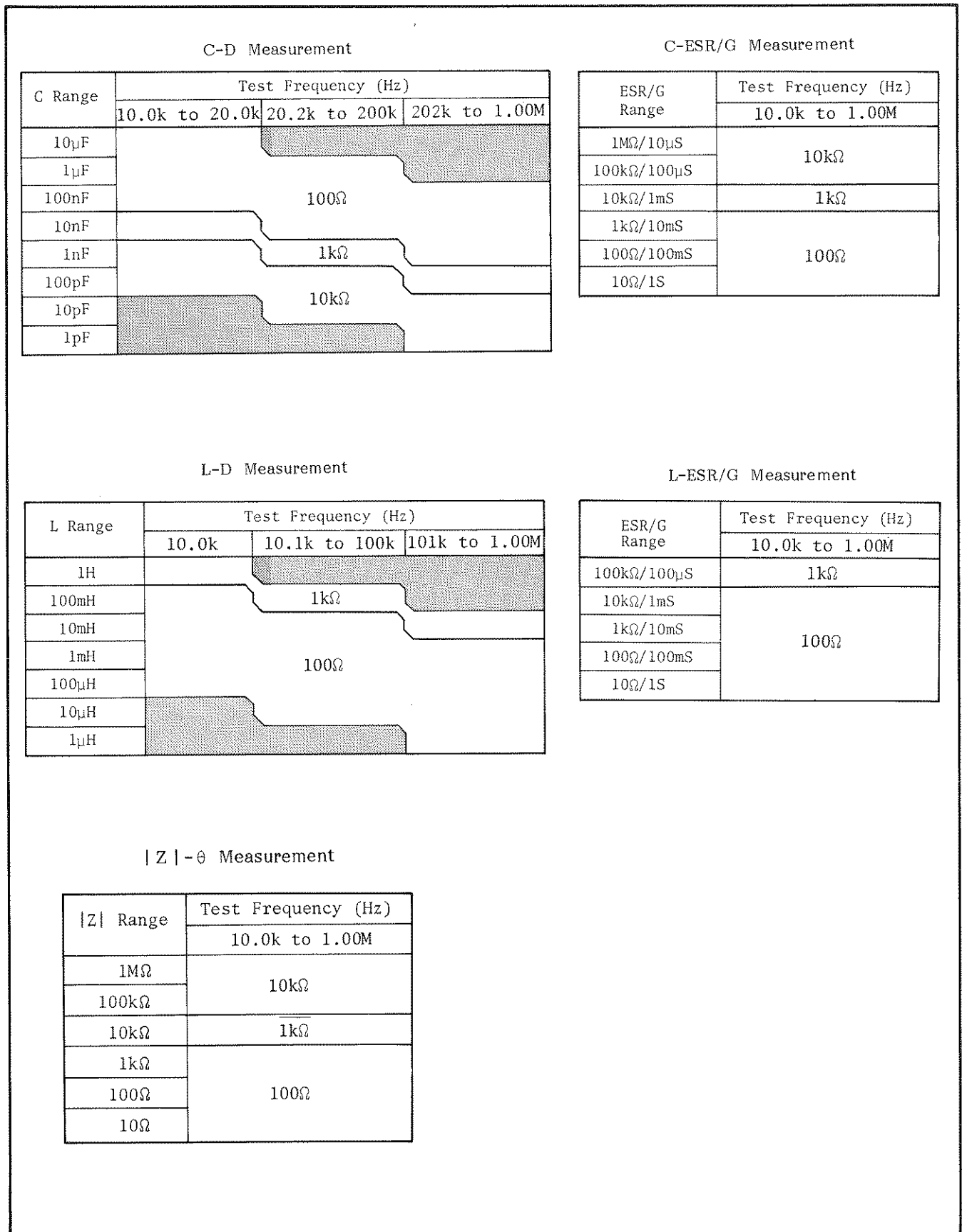



Figure 3-5. Measurement Ranges and Range Resistors.

Note

When a C-D measurement is made with the instrument controls set as follows, the number of display counts depends on frequency, as shown in Figure 3-6.

CIRCUIT MODE.....AUTO ()
 LC|Z| RANGE.....MANUAL
 Test Frequency 15.9kHz - 20.0kHz
 or 159kHz - 200kHz

As an example, suppose you're measuring a 180pF capacitor on the 100pF range at 17kHz, and the measured value is 175.62pF. If the test frequency is increased to 19kHz, OF will be displayed on DISPLAY A because the maximum number of counts at this higher frequency is only 17000, as shown in Figure 3-6.

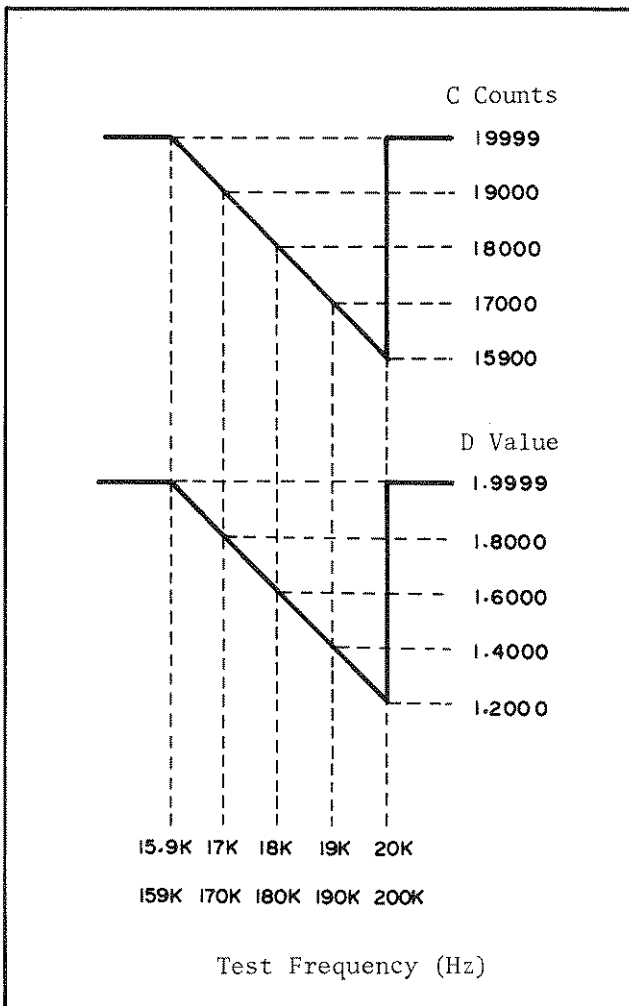
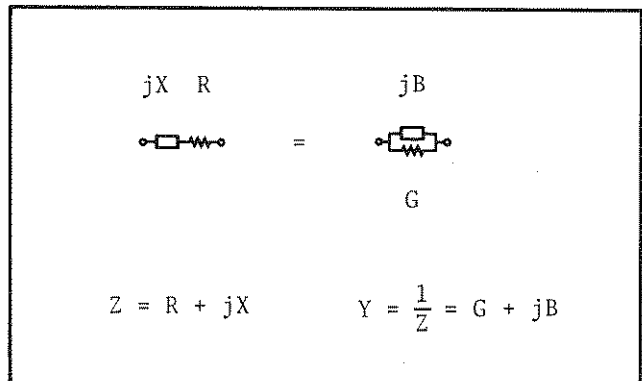


Figure 3-6. Number of Counts vs Frequency.

3-32. CIRCUIT MODE

3-33. An impedance can be represented by a simple series or parallel equivalent circuit consisting of resistive and reactive elements. This is possible because both equivalent circuits have identical impedances at a given test frequency by properly establishing the values of the equivalent circuit elements. The equivalent circuit measurement mode is selected by setting the CIRCUIT MODE control. When the CIRCUIT MODE is set to AUTO, the 4277A will automatically select the circuit mode most appropriate for the range and function settings. Equivalent series circuit mode is automatically selected when the measurement range is 100Ω or below. Equivalent parallel circuit mode is automatically selected when the measurement range is 1kΩ or above. By setting CIRCUIT MODE manually, either circuit mode can be selected, regardless all measurement ranges.

3-34. Capacitance and inductance measurements can be performed in either equivalent series circuit mode or equivalent parallel circuit mode. However, measured values obtained in each mode are different. The difference in measured values is related to the loss factor of the sample being measured. The impedance of a sample measured in both series and parallel circuit mode is the same at a particular frequency. Therefore, the following equations are satisfied:



$$G + jB = \frac{1}{R + jX}$$

$$= \frac{R}{R^2 + X^2} - j \frac{X}{R^2 + X^2}$$

Expanding the above equation, we have

$$G + j\omega C_p = \frac{R}{R^2 + \frac{1}{\omega^2 C_s^2}} + j \frac{\frac{1}{\omega C_s}}{R^2 + \frac{1}{\omega^2 C_s^2}}$$

where, $C_s (= -\frac{1}{\omega X})$: equivalent series circuit capacitance

$C_p (= \frac{B}{\omega})$: equivalent parallel circuit capacitance

Obviously, if no series resistance (R) or parallel conductance (G) are present, the equivalent series circuit capacitance (Cs) and equivalent parallel circuit capacitance (Cp) are identical. Likewise, if R and G are not present, the equivalent series circuit inductance (Ls) and equivalent parallel circuit inductance (Lp) are identical.

However, a sample value measured in a parallel measurement circuit can be correlated with that of a series circuit by a simple conversion formula which considers the effect of dissipation factor. See Table 3-9. Figure 3-7 graphically shows the relationships of parallel and series parameters for various dissipation factor values. Applicable diagrams and equations are given in the chart. For example, a parallel capacitance (Cp) of 1000pF with a dissipation factor of 0.5 is equivalent to a series capacitance (Cs) of 1250pF with an identical dissipation factor. As shown in Figure 3-7, inductance or capacitance values for parallel and series equivalents are nearly equal when the dissipation factor is less than 0.03. The dissipation factor of a component always has the same value at a given frequency for both parallel and series equivalents.

In ordinary LCR measuring instruments, the measurement circuit is set (automatically or manually) to a predetermined equivalent circuit with respect to either the selected range or to the dissipation factor value of the sample. The wider circuit mode selection capability of the 4277A, which is free from these restrictions, permits taking measurements in the desired circuit mode and of comparing such measured values directly with those obtained by another instrument. This obviates the inconvenience and necessity of employing instruments capable of taking measurements with the same equivalent circuit to assure measurement result correspondence.

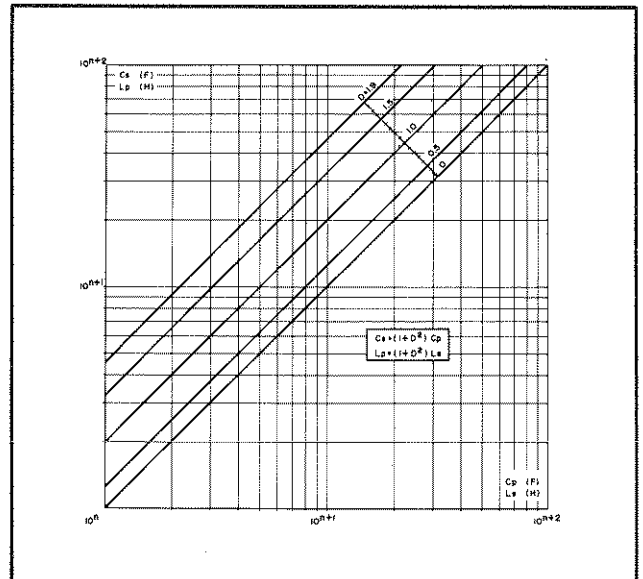






Figure 3-7. Parallel and Series Parameter Relationship.

Table 3-9. Dissipation Factor Equations and Equivalent Circuit Conversion Formulas

Circuit Mode	Dissipation Factor	Conversion to Other Modes
C		$D = \frac{G}{\omega C_p} = \frac{1}{Q}$
		$D = \omega C_s R = \frac{1}{Q}$
L		$D = \omega L_p G = \frac{1}{Q}$
		$D = \frac{R}{\omega L_s} = \frac{1}{Q}$

3-35. INITIAL DISPLAY AND INDICATIONS

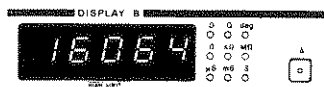
3-36. Each time the instrument is turned on, the option codes for installed options and the HP-IB address are displayed on the front panel for approximately two seconds. The HP-IB address is displayed on DISPLAY A, as shown below. The factory set address is 17 (10001), but any address from 0 (00000) to 30 (11110) can be set. Refer to the HP-IB discussion starting in paragraph 3-76.



Note

If the instrument is set to TALK ONLY mode, the output data format number (see paragraph 3-90) will appear on DISPLAY A instead of the HP-IB address.

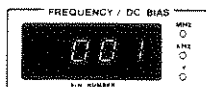
The following option code is displayed on DISPLAY B if the instrument is equipped with Option 002, Comparator/Handler Interface.



Note

The above option code will not be displayed if the 16064A Comparator/Handler Interface is not connected to the instrument.

The following option code is displayed on the FREQUENCY/DC BIAS display if the instrument is equipped with Option 001, Internal DC Bias.



3-37. After the HP-IB address and option codes have been displayed, the continuous memory function automatically recalls the front panel control settings that existed when the instrument was turned off.

Note

Output from the internal dc bias source (option 001 instruments) is automatically set to 0V at instrument power on as a safety precaution.

3-38. INITIAL CONTROL SETTINGS

3-39. The 4277A is automatically set to the control settings listed below when the continuous memory function (refer to paragraph 3-40) is reset as described in paragraph 3-43.

- DISPLAY A Function C
- DISPLAY B Function G
- CIRCUIT MODE AUTO
- LC | Z | RANGE AUTO
- MEASUREMENT SPEED MED
- TEST SIGNAL LEVEL HIGH
- TRIGGER INT
- SELF TEST OFF
- Δ OFF
- FREQ/DC BIAS FREQ
- SPOT/COARSE/FINE SPOT
- Frequency 1.00kHz
- OPEN ZERO DATA 0Ω
- SHORT ZERO DATA OS

When the instrument is equipped Option 001 :

- DC BIAS00V

When the instrument is equipped Option 002, control settings of the 16064A Comparator are as follows:

- ENABLE OFF
- LC | Z | //D/Q/ESR/G L/C/ | Z |
- LIMIT LOW/HIGH LOW
- BIN NUMBER 1
- RUN OFF
- BIN LIMITS blank

3-40. CONTINUOUS MEMORY

3-41. The continuous memory function of the 4277A automatically memorizes all front panel control settings when the instrument is turned off or experiences a power failure. When the instrument is turned on, the memorized settings are automatically recalled. Continuous memory is powered by a rechargeable 2.4V nickel-cadmium battery that lasts for approximately 2 weeks when the instrument is turned off. The battery is recharged while the 4277A is turned on.

Note

When turned on, the 4277A automatically performs a Check Sum Test as part of its turn-on Self Test. The Check Sum Test checks the contents of memory. If incorrect, E68 will be displayed on DISPLAY A and memory will be cleared. The instrument will be set to the initial control settings (refer to paragraph 3-38).

3-42. OPEN and SHORT Zero Offset values (refer to paragraph 3-51) and reference values for deviation measurements (refer to paragraph 3-60) are also memorized by the continuous memory function. On instruments equipped with the Comparator/Handler Interface option (Option 002), all high and low limits and all 16064A control settings (except RUN) are memorized. DC bias voltage (Option 001) settings, however, are not memorized.

3-43. RESETTING CONTINUOUS MEMORY

3-44. To reset, or clear, continuous memory, proceed as follows:

- (1) Turn off the 4277A.
- (2) Press and hold both FREQ/DC BIAS Step Control Keys (\square \square).
- (3) Turn on the 4277A.

3-45. UNKNOWN TERMINALS

3-46. Generally, the mutual inductance between test leads, noise from nearby equipment, and the residuals and strays of conventional connection methods significantly affect the accuracy of impedance measurements made at high frequencies. To minimize these error sources and thereby ensure optimum measurement accuracy, the 4277A employs a four-terminal pair connection method. The UNKNOWN terminals consist of four BNC female connectors: H_{CUR} (high current), H_{POT} (high potential), L_{POT} (low potential), and L_{CUR} (low current). The current terminals (H_{CUR} and L_{CUR}) provide the test signal current, and the potential terminals (H_{POT} and L_{POT}) detect the voltage across the DUT (device under test). To connect a sample, the four-terminal pair configuration must be converted to a two-terminal configuration. This is done by connecting the outer conductors of the terminals to each other and then H_{CUR} to H_{POT} and L_{CUR} to L_{POT} , as shown in Figure 3-8. The principle of the four-terminal pair measurement is illustrated in Figure 3-9.

At first glance, the arrangement appears to be an expanded four terminal method with a built-in guard structure. This is true. Thus, the four-terminal pair method combines the advantages of the four terminal method in low impedance measurements while providing the shielding required for high impedance measurements. The distinctive feature of the four-terminal pair configuration is that the outer shield works as the return path for the test signal current. The same current flows through both the center conductors and the outer shield conductors (in opposite directions), yet no external magnetic fields are generated around the conductors (the magnetic fields produced by the currents through the inner and outer conductors completely cancel each other). Because the measurement signal current does not develop an inductive magnetic field, the test leads do not contribute additional measurement errors due to mutual-inductance between the individual leads. Hence, the four-terminal pair method provides best measurement accuracy while minimizing the effects of stray capacitance and residual inductance inherent in the test leads or test fixture.

Note

Because test leads have residual inductance, the resultant additional measurement error increases in capacitance measurements in proportion to the square of the test frequency.

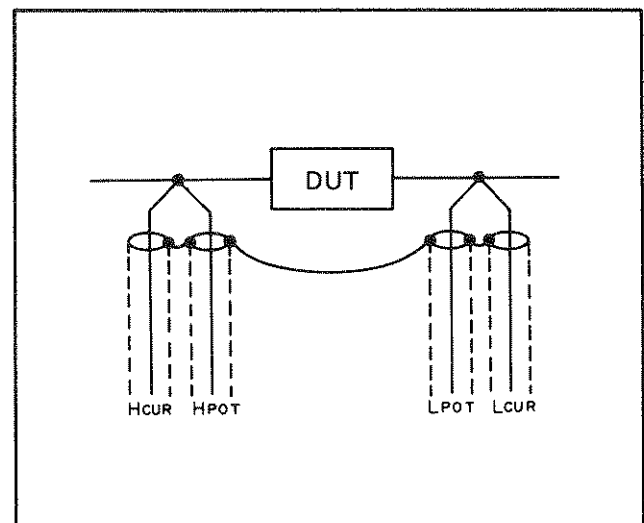


Figure 3-8. Four Terminal Pair DUT Connections.

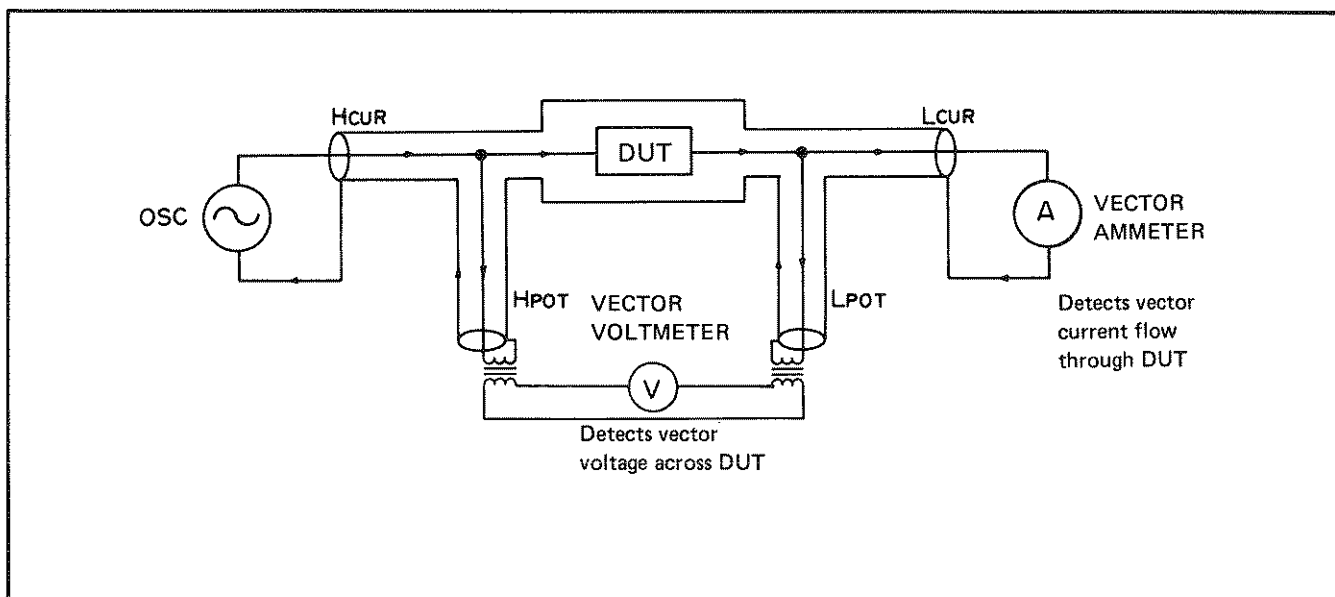


Figure 3-9. Four Terminal Pair Measurement Principle.

3-47. MEASUREMENT OF GROUNDED SAMPLES

3-48. Samples which have one terminal (except GROUND terminal) grounded to earth cannot normally be measured by the 4277A. Such measurement conditions are, for example, the distributed capacitance measurement of a coaxial cable with a grounded shield conductor or the input/output impedance measurement of a single ended amplifier. When a one-side-grounded sample is connected for measurement, the 4277A may display a measurement error message or incorrect measurement results. This is because the bridge section cannot achieve a balance with any measurement terminal grounded and, additionally, any grounding modifies the four terminal pair measurement architecture (other than an internal connection of the shield conductor to instrument chassis at one point).

Note

If one terminal is grounded, a signal current of equal magnitude (an operating condition of the four terminal pair configuration measurement) will not flow in the inner and outer conductors of the measurement cable.

3-49. SELECTION OF TEST CABLE LENGTH

3-50. The propagation signal in a transmission line will develop a change in phase between two points on the line as illustrated in Figure 3-10. The difference in phase corresponds to the ratio of the distance between the two points to the wavelength of the propagating signal. Consequently, owing to their length, test cables used to connect a sample to the UNKNOWN terminals will cause a phase shift and a propagation loss of the test signal. For example, the wavelength of a 1MHz test signal is 300 meters which is 300 times as long as the 1m standard test cables. Here, the phase of the test signal at the end of the test cable will be shifted by about 1.2 degrees ($360^\circ \div 300$) in reference to the phase at the other end of the cable. Since the effect of test cables on measurements and the resultant measurement error increase in proportion to the test frequency, cable length must be taken into consideration when making high frequency measurements. The CABLE LENGTH switch must be selected so as to provide the correct phase compensation for measurements made with the 1m standard test cables or for a test fixture attached directly to the UNKNOWN terminals. When standard test cables (1m or 2m) are used, the CABLE LENGTH switch must be set to the 1m position to minimize additional measurement errors. The 0 position is for direct attachment type test fixtures.

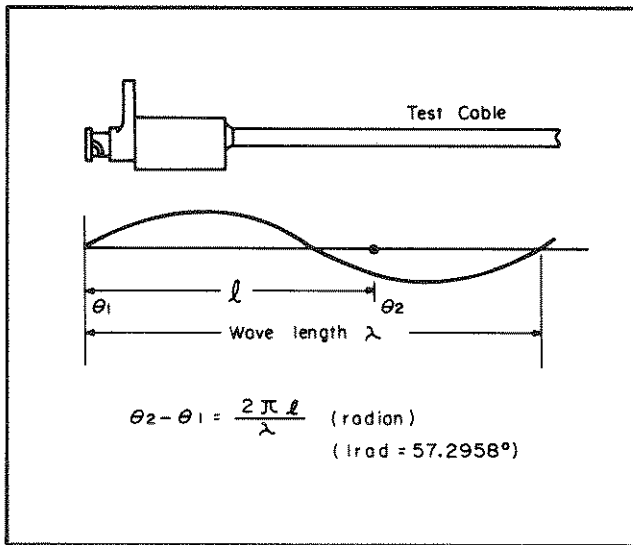


Figure 3-10. Test Signal Phase on Test Cables.

Note

When the HP 16065A, EXT Voltage Bias Fixture, is used with the 4277A, set the CABLE LENGTH switch to the 1m position.

Note

When the HP 16048D Test Leads (standard 2m test cable) is used with the 4277A, the CABLE LENGTH switch must be set to the 1m position and the SA SELECT switch (S1) on the A1 (Logic) board must be set as shown in Figure 3-11. The setting of this switch can be changed only when the instrument is turned off.

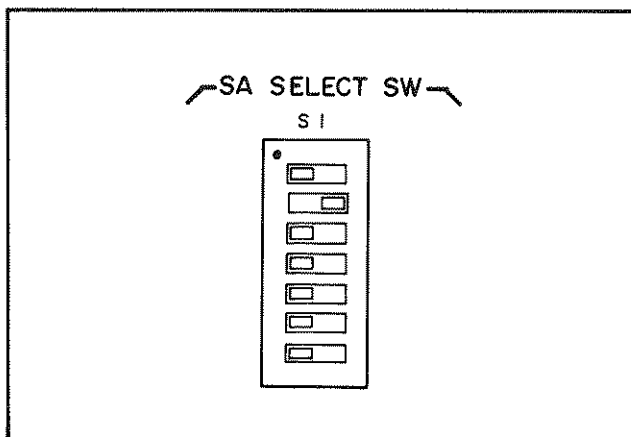


Figure 3-11. SA SELECT Switch Settings for 2m Test Leads.

Note

If test leads longer or shorter than the standard 1m or 2m test leads are used, the additional error is proportional to the square of the frequency. As the characteristic impedance of the test leads is also a factor in the propagation loss and phase shift (and of resultant measurement error), use of different type test leads must be avoided. Use only the standard test leads available from Hewlett-Packard.

3-51. ZERO OFFSET ADJUSTMENT

3-52. The test fixtures and test leads used to connect samples to the instrument's UNKNOWN terminals have inherent residual impedance and stray admittance which, unless compensated for in some way, affect measurement accuracy. To minimize the effects of these residuals and strays, the 4277A is equipped with OPEN and SHORT Zero Offset Adjustment functions that can be executed from the front panel or via the HP-IB. Each Zero Offset Adjustment is performed at the following frequencies:

1MHz	900kHz	700kHz	505kHz	202kHz
100kHz	50.5Hz	20.2Hz	10kHz	

Zero Offset data for test frequencies other than those listed above are calculated from the Zero Offset data obtained at the above test frequencies by using second degree interpolation. Thus, Zero Offset is provided for measurements made at all test frequencies. Brief descriptions of the Zero Offset Adjustments (OPEN and SHORT) are given below.

ZERO OPEN:

The procedure for performing OPEN Zero Offset Adjustment is as follows:

- (1) Connect the test fixture or test leads to the instrument's UNKNOWN terminals.

Note

If test leads are used, you must convert the four-terminal pair configuration to a two-terminal configuration. Refer to paragraph 3-45 and Figure 3-8.

- (2) Connect nothing as the DUT.
- (3) Press the ZERO OPEN button.

When the ZERO OPEN button is pressed, the instrument will be automatically set to C-G measurement mode. It will then measure the test fixture's stray admittance at each of the previously mentioned test frequencies. The measured values are stored in the instrument's internal memory. When offset adjustment is completed, DISPLAY A and DISPLAY B will be blank for 1 or 2 seconds, after which the front panel controls will be reset to the settings that existed when the ZERO OPEN button was pressed.

The purpose of OPEN Zero Offset Adjustment is to measure the test fixture's stray admittance, which, as shown in Figure 3-12 (a), consists of G_0 and C_0 . (This stray admittance is equivalent to a high impedance, which will "swamp out" a high impedance DUT connected to the test fixture.) The residual impedance of the test fixture-- R_0 and L_0 in Figure 3-12 (a)--is negligibly low and therefore does not affect the accuracy of OPEN Zero Offset Adjustments.

ZERO SHORT:

The procedure for performing SHORT Zero Offset Adjustment is as follows:

- (1) Connect the test fixture or test leads to the instrument's UNKNOWN terminals.

Note

If test leads are used, you must convert the four-terminal configuration to a two-terminal configuration. Refer to paragraph 3-45 and Figure 3-8.

- (2) Connect a low impedance shorting-bar to the test fixture. If you're using test leads, simply connect the ends of the leads together.
- (3) Press the ZERO SHORT button.

When the ZERO SHORT button is pressed, the instrument will be automatically set to L-ESR measurement mode. It will then measure the test fixture's residual impedance at each of the previously mentioned test frequencies. The measured values are stored in the instrument's internal memory. When offset adjustment is completed, DISPLAY A and DISPLAY B will be blank for 1 or 2 seconds, after which the front panel controls will be reset to the settings that existed when the ZERO SHORT button was pressed. The purpose of SHORT Zero Offset

Adjustment is to measure the test fixture's (or test lead's) residual impedance, which, as shown in Figure 3-12 (b), consists of R_0 and L_0 . This residual impedance, although small, degrades the accuracy of low impedance measurements. The stray admittance of the test fixture-- G_0 and C_0 in Figure 3-12 (b)-- is shunted by the low impedance shorting-bar and therefore is not measured.

Once OPEN and SHORT Zero Offset Adjustments have been made, the instrument automatically compensates all subsequent measurements for the residuals and strays of the test fixture or test leads. The values displayed on the front panel are the actual values of the DUT. Also, because the Zero Offset data is maintained by the instrument's continuous memory function, OPEN and SHORT Zero Offset Adjustments do not have to be repeated each time the instrument is turned on. You need to repeat Zero Offset Adjustments only when you change test fixtures (the residuals and strays of one test fixture are different from those of another). Maximum values that can be offset are listed below.

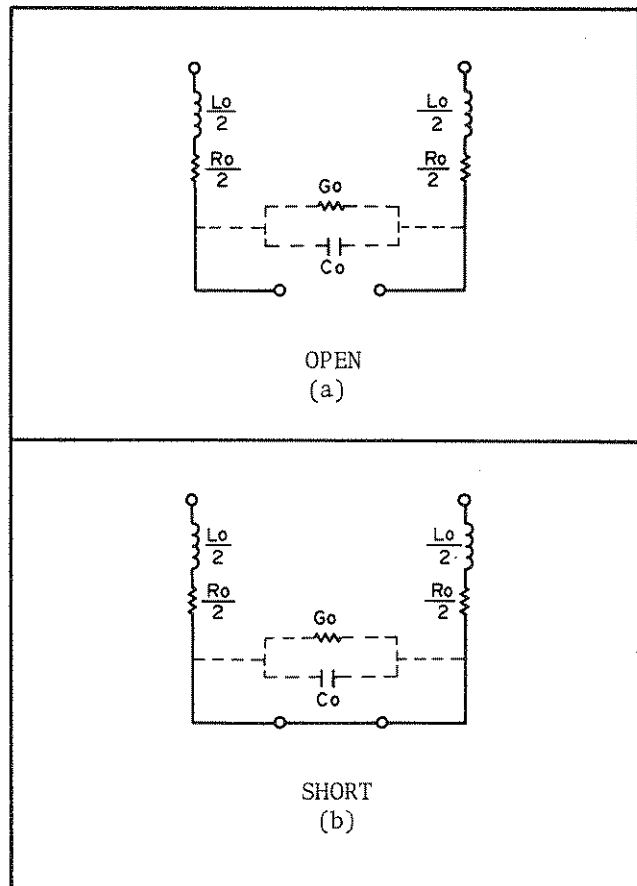


Figure 3-12. Equivalent Circuits for Zero Offset Adjustment.

Capacitance: Up to 20pF } OPEN
 Conductance: Up to 2μS }
 Inductance: Up to 2μH } SHORT
 Resistance: Up to 2Ω }

Note

During Zero Offset Adjustment, OF or CF may appear on DISPLAY A or DISPLAY B. Zero Offset Adjustment, however, is performed correctly unless error code "E10" is displayed.

Note

After Zero Offset Adjustments, CF and 0000 may be alternately displayed on DISPLAY A if the measurement mode is other than C-G and nothing is connected to the test fixture. This is normal; it is not a malfunction.

Note

OPEN and SHORT Zero Offset Adjustments cannot be performed without a test fixture.

3-53. ACTUAL MEASUREMENT EQUIVALENT CIRCUIT

3-54. The test fixture or test leads used to connect a sample to the instrument's UNKNOWN terminals becomes part of the sample which the instrument measures. The four-terminal pair configuration employed in the 4277A minimizes residual impedance circuit. The residual impedance, inherent in the test fixture or test leads, can be eliminated by the 4277A's ZERO offset function (refer to paragraph 3-51).

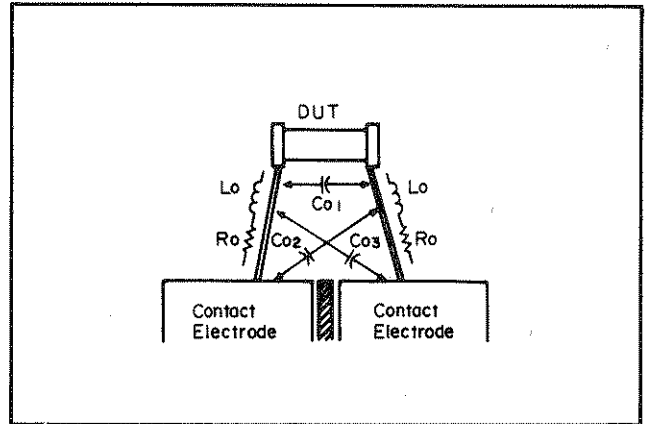


Figure 3-13. Parasitic Impedances Incident to DUT Connections.

However, the four-terminal pair measurement system must be converted to a two terminal configuration at the sample because most components have only two terminals. Moreover, additional stray capacitance is introduced when the sample is connected to the test fixture. Figure 3-13 illustrates lead impedance and the stray capacitances between the component's leads.

3-55. Diverse parasitic elements present between the sample and the UNKNOWN terminals will affect measurement results. These parasitic elements are series resistive and reactive elements and parallel conductive and susceptible elements. Figure 3-14 shows the equivalent circuit of the samples parasitic elements ($R + jX$ is the sample's impedance). In Figure 3-14, L_0 represents the residual inductance of the component's leads, and R_0 is lead resistance. G_0 is the conductance between the leads, and C_0 is the sum of all stray capacitances shown in Figure 3-13. Reactive factors in the residual impedance and susceptible factors in the stray admittance have a greater effect on measurements made at higher frequencies.

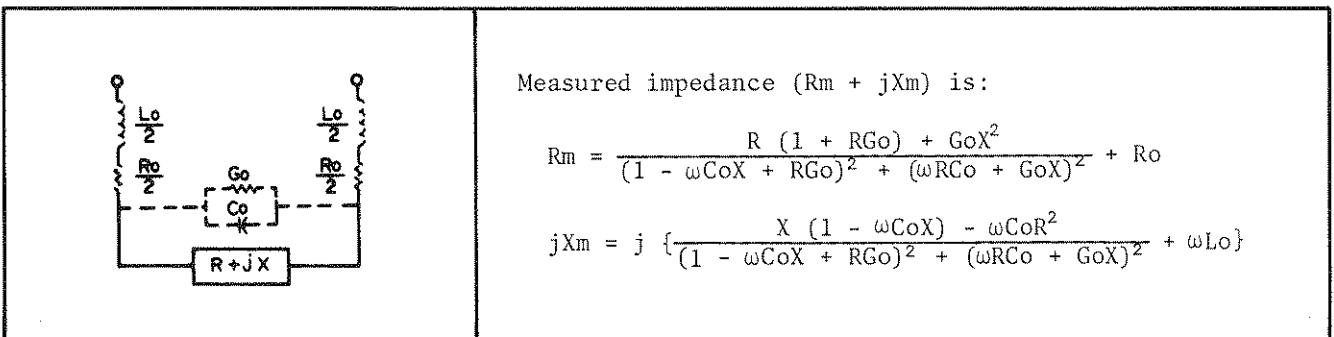


Figure 3-14. Equivalent Circuit Including Residual Impedance.

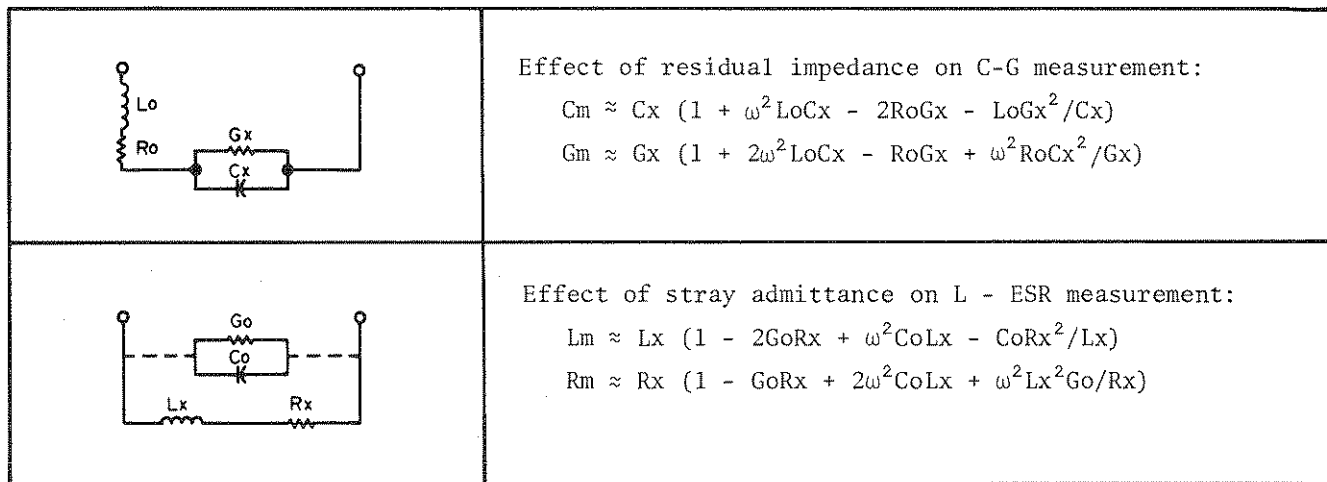


Figure 3-15. Effects of Residual Impedance.

3-56. Figure 3-15 shows the effect of residual impedance on C-G measurement and the effect of stray admittance on L-R measurement. Generally, L_0 resonates with the capacitance of the sample (series resonance) and C_0 resonates with the inductance of the sample (parallel resonance), respectively, at a specific high frequency. Thus, the impedance of the test sample will have a minimum value corresponding to resonant peaks, as shown in Figure 3-16. The presence of L_0 and C_0 causes measurement errors, as the phase of the test signal current varies over a broad frequency region around the resonant frequencies. Additional errors, due to the resonance, increase in proportion to the square of the measurement frequency (below resonant frequency) and can be theoretically approximated as follows:

$$C \text{ ERROR} \approx \omega^2 L_0 C_x \cdot 100 (\%)$$

$$L \text{ ERROR} \approx \omega^2 C_0 L_x \cdot 100 (\%)$$

where,

- $\omega = 2\pi f$ (f: test frequency)
- $C_x =$ Capacitance value of sample
- $L_x =$ Inductance value of sample

At low frequencies, L_0 and C_0 affect measured inductance and capacitance values, respectively, as simple additive errors. These measurement errors cannot be fully eliminated by the ZERO offset adjustment (which compensates for residual factors inherent in the test fixture). This is because L_0 and C_0 are peculiar to the component being measured. Their values depend on component lead length and on the distance between the sample and test fixture. The measurement results, then, are substantially the sample values including the parasitic impedances present under the conditions necessary to connect and hold the sample.

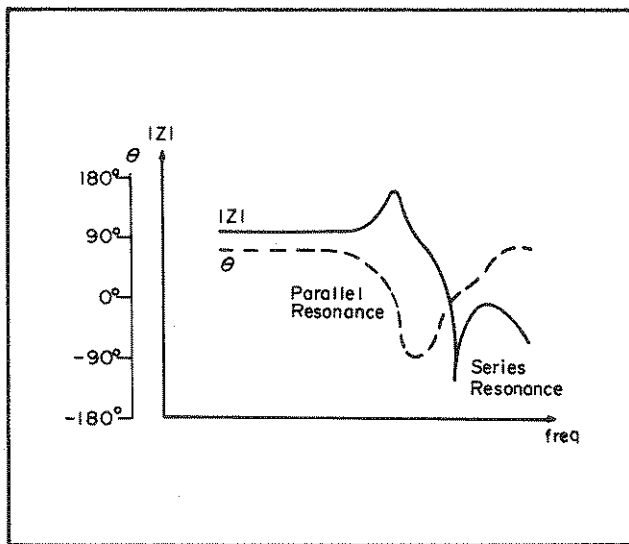


Figure 3-16. Effect of Resonance in Sample (Example).

3-57. MEASURED VALUES AND BEHAVIOR OF COMPONENTS

3-58. A component's measured value and its nominal value can, and often do, differ considerably because of various electromagnetic effects; for example, skin-effect of a conductor, the ferromagnetic properties of inductors, and the effects of dielectric materials in capacitors. Here, we'll discuss only the effects which result from the interaction of the reactive elements (L, C, etc.) of a component.

3-59. The impedance of a component can be graphically represented in vector form as shown in Figure 3-17. In such representation, the effective resistance and effective reactance correspond to the projections of the impedance vector $|Z| \angle \theta$; that is, the real (R) axis and the imaginary (jX) axis, respectively, as shown below:

$$\begin{aligned} Re &= |Z| \cos \theta \\ Xe &= |Z| \sin \theta \\ D &= \frac{\cos \theta}{\sin \theta} = \frac{1}{\tan \theta} \end{aligned}$$

- where, Re: Effective resistance
- Xe: Effective reactance
- Z: Impedance of the sample (Re + jXe).
- D: Dissipation factor

When the phase angle, θ , changes, both Re and Xe change in accordance with the definitions above. As component measurement parameters L, C, R, D, etc., are also representations of components related to the impedance vector, the phase angle dominates their values. Consider, for example, the inductance and the loss of an inductive component at frequencies around its self-resonant frequency. Figure 3-18 shows the equivalent circuit of the inductor. The inductance, L_x , resonates with the distributed capacitance C_0 at frequency f_0 . The phase angle (θ) of the impedance vector approaches 0 degrees (the vector approaches the R axis) when the frequency is close to the resonant frequency. Thus, the inductance of this component decreases while the resistive factor (loss) increases. At the resonant frequency, f_0 , this component is purely resistive. The effective resistance increases at resonance even if the inductor has no resistance (ideal inductor) at dc. Consequently, the loss factor varies sharply at frequencies around the resonant point.

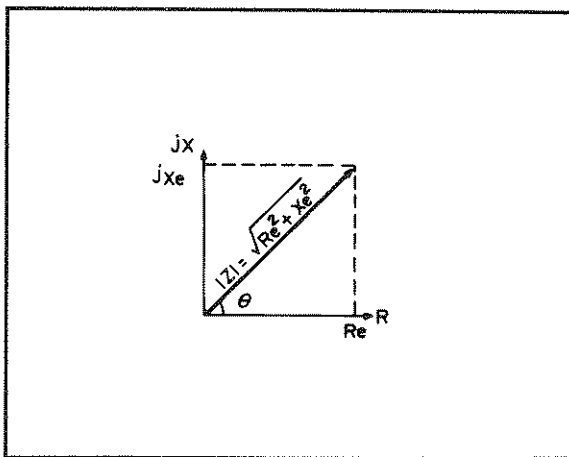


Figure 3-17. Impedance Vector Representation.

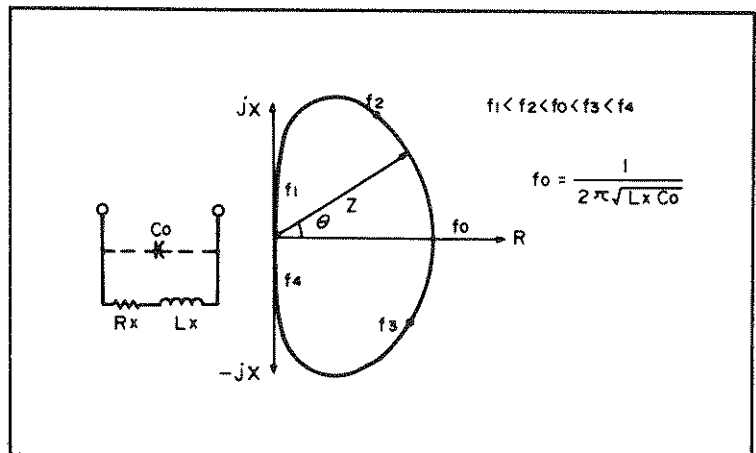


Figure 3-18. Typical Impedance Locus of an Inductor.

3-60. DEVIATION MEASUREMENT FUNCTION

3-61. When many components of similar value are to be tested, it may be more practical to measure the difference between the value of the component and a predetermined, or ideal, reference value than measuring the DUT value itself. When the purpose of the measurement is to observe the change of a component's value versus changes in temperature, frequency, bias, etc., a direct measurement of this change (deviation) makes examination more meaningful and easier.

3-62. When the Δ key is pressed, the values (measurement results) displayed on DISPLAY A and DISPLAY B are stored in the instrument's memory and are then used as the reference values for all subsequent measurements. The value displayed on each display is not the sample's measured value, it is the difference between the stored reference value and the measured value. Stored reference values are maintained by the 4277A's continuous memory function when the instrument is turned off. The deviation measurement function is automatically turned off when the DISPLAY A function, DISPLAY B function, LC | Z | RANGE, or CKT MODE is changed. It may be turned off also if the test frequency is changed when the DISPLAY B function is ESR/G, because the measurement range for ESR and G is frequency dependent.

3-63. CHARACTERISTICS OF TEST FIXTURES

3-64. Characteristics and applicable measurement ranges of the HP test fixtures and test leads for the 4277A are summarized in Table 3-10. To facilitate measurement and to minimize measurement errors, a test fixture appropriate for the measurement should be chosen from among HP's standard accessories. Select the test fixture or leads that have the desired performance characteristics.

Table 3-10. Typical Characteristics of Test Fixtures and Leads

Model	Applicable Measurement Ranges		Reading Error at 1MHz	
	Parameter Value	Measurement Frequency	Parameter Reading Error	D Offset Value
16047A	Full range	Full range	$\pm 0.05\%$	± 0.0002
16047C	Full range	Full range	$\pm 0.01\%$	± 0.0001
16048A 16048B	Full range	Full range	$\pm 0.05\%$	± 0.0005
16048C	C > 1000pF L > 100 μ H	Below 100kHz	Residual Parameter Values: C < 5pF, L < 200nH, R < 10m Ω	
16048D	Full range	Full range	$\pm 0.20\%$	± 0.0020
16034B	Ranges satisfied Z > 50 Ω	Full range	$\pm 0.05\%$	± 0.0005
			Residual Parameter Values: C < 0.02pF, L < 30nH, R < 50m Ω	
16065A	Full range	50Hz to 2MHz	—————	—————

3-65. MEASUREMENT ACCURACY

3-66. The measurement reference plane for the accuracies specified in Section I is the UNKNOWN terminals. The measurement accuracy of the 4277A is guaranteed at the UNKNOWN terminals. The conditions under which accuracy is specified are described in Table 1-1. An example of the how to calculate measurement accuracy is shown in Figure 3-19.

3-67. GENERAL COMPONENT MEASUREMENT

3-68. The procedures for measuring general components--inductors, capacitors, resistors--are given in Figure 3-20. Almost any discrete component, except for those having special shapes or dimensions, can be measured with this setup. Special components may be measured by using test leads 16048A, 16048B, 16034B, etc., or by using specially designed user-built fixtures instead of the 16047A Test Fixture.

3-69. SEMICONDUCTOR DEVICE MEASUREMENT

3-70. As an example of a typical semiconductor measurement, the procedures for measuring the base-collector junction capacitance (C_{ob}) of an NPN transistor are given in Figure 3-21.

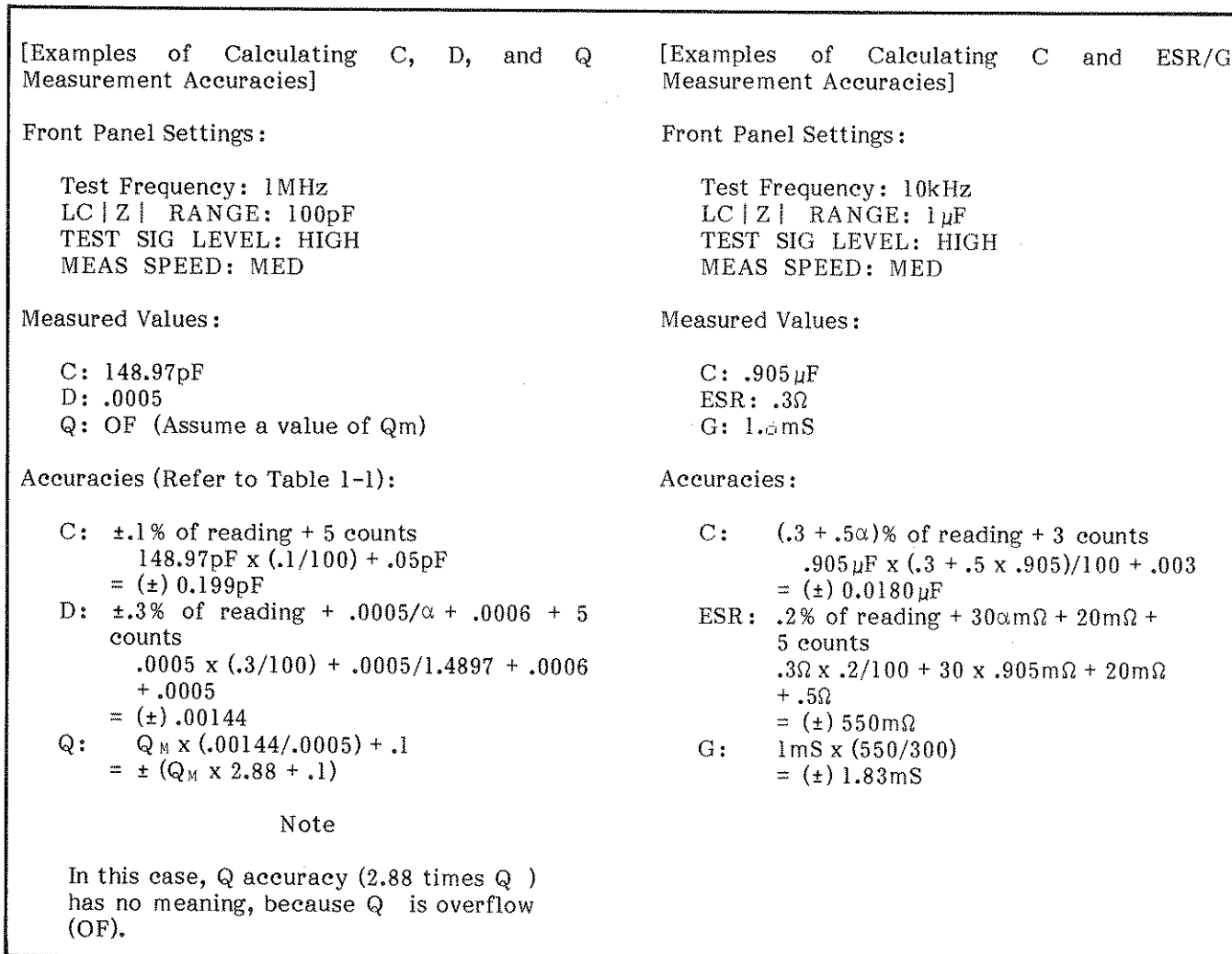
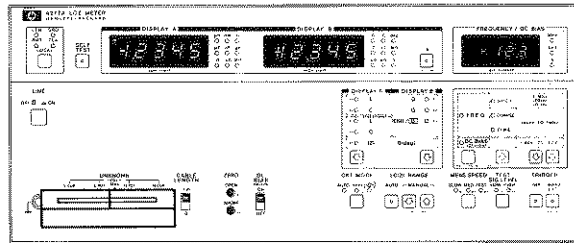


Figure 3-19. How to Calculate Measurement Accuracies.



1. Connect the 16047A Test Fixture to the UNKNOWN terminals.
2. Turn on the 4277A.
3. Verify that the HP-IB address and option codes (16064 and 001) are displayed on DISPLAY A, DISPLAY B, and the FREQUENCY/DC BIAS display, respectively.



Note

Option codes are displayed only if the corresponding option is installed.

Note

The HP-IB address is set to 17 (10001) when the instrument is shipped from the factory.

4. Press the SELF TEST key to verify that the instrument is functioning properly. Refer to paragraph 3-5, SELF TEST. If no error-codes are displayed, press the SELF TEST key again to turn off the SELF TEST function.
5. Select the measurement functions for DISPLAY A and DISPLAY B.
6. Set the test frequency, test signal level, and measurement speed.

Note

SLOW measurement speed minimizes display fluctuation.

Note

Best measurement accuracy is obtained when test signal level is set to HIGH and measurement speed is set to MED.

7. Perform OPEN and SHORT Zero Offset adjustments as described in paragraph 3-51.
8. Connect the device to be measured to the test fixture.
9. Read the measured values from DISPLAY A and DISPLAY B.

Note

Refer to paragraph 3-20 for the meaning of any error-codes that may appear on DISPLAY A.

Note

When the instrument is set to C-D or C-Q measurement mode and nothing is connected to the measurement terminals, CF and .0000 may be alternately displayed on DISPLAY A. This is not a malfunction, however.

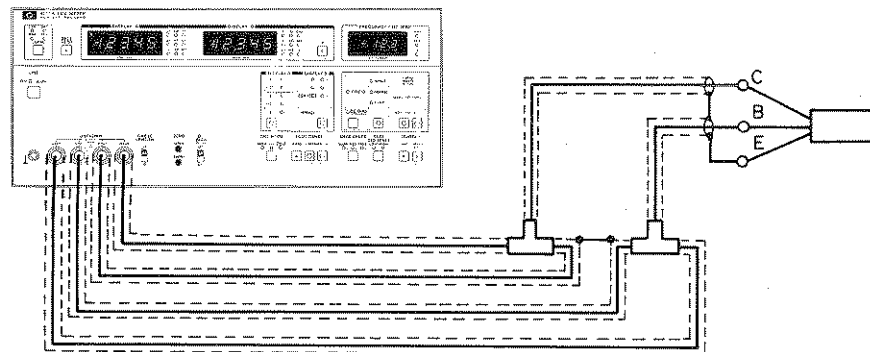
Note

For C or L measurement, if the dissipation factor of the DUT is higher than 0.1, C, L, and D measurement accuracy tolerances increase by a factor of $1 + D^2$. If D is higher than 1, AUTO ranging cannot be performed correctly. |Z| measurement mode should be selected.

Figure 3-20. General Component Measurements.

Parameters of semiconductor devices have a strong dependency on the applied voltage and device temperature. Because of the non-linear impedance characteristics of semiconductor devices, a semiconductor measurement is subject to exact establishment of the test conditions to make measured values meaningful. For a detailed analysis of the device under its

operating test conditions, a low level test signal is employed in order to obtain measured values with respect to a local region around the operating test point selected for plotting characteristic parameter curves of the sample. A typical procedure for measuring semiconductor junction capacitance in P-N and MOS junction devices is outlined below.



Measurement Setup:

The figure above shows a typical test setup for measuring the base-collector junction capacitance (C_{ob}) of an NPN transistor. For this measurement, the test fixture may be user designed. A 4277A equipped with option 001 is ideal for controlling the dc bias required for the measurement. If dc bias is not necessary, setup and procedures associated with this measurement may be deleted.

PROCEDURE:

1. Connect the test fixture or test cables to the UNKNOWN terminals of the 4277A.
2. Turn on the 4277A.
3. Set the 4277A's front panel controls as follows:
 - DISPLAY A: C
 - DISPLAY B: G
 - Test Freq.: 1MHz
 - TEST SIG LEVEL: LOW
4. Perform OPEN and SHORT Zero Offset adjustments as described in paragraph 3-51.

5. Set the DC BIAS SELECT switch on the rear panel to INT.

Note

If an external voltage source is used for dc biasing, set the DC BIAS SELECT switch to EXT, and connect the voltage source output to the EXT INPUT/INT MONITOR connector on the rear panel.

Note

DC bias voltage, whether supplied from the internal bias source or from an external bias source, should be set to 0V at this time.

Note

Use the HP Model 16065A EXTERNAL VOLTAGE BIAS FIXTURE for high voltage bias applications up to $\pm 200V$.

6. Connect the transistor to the measurement terminals.

Figure 3-21. Semiconductor Device Measurement (Sheet 1 of 2).

7. Monitor the bias voltage actually applied to the transistor.

Note

If the 16065A is used, close the lid after you connect the transistor to the measurement terminals. Measurement cannot be made while the lid is open.

8. Set the DC BIAS ON/OFF switch on the front panel to ON, and set the desired bias voltage.

Note

If the P-N junction becomes forward biased at either peak of the test signal, correct measurement cannot be made.

9. Read the capacitance value from DISPLAY A.

Figure 3-21. Semiconductor Device Measurement (Sheet 2 of 2).

3-71. EXTERNAL DC BIAS

3-72. The special biasing circuits and procedures for using external voltage or current bias (required for certain capacitance or inductance measurements) are given in Figure 3-23. The figures show sample circuits appropriate for 4277A applications. When applying a dc voltage to capacitors, be sure the applied voltage does not exceed the maximum specified voltage of the capacitor and that the capacitor is connected with correct polarity. Note that the externally applied bias voltage is present at the H_{POT} and H_{CUR} terminals.

3-73. Bias Voltage Settling Time: When a measurement with dc bias voltage superposed is performed, it takes some time for the voltage across sample to reach a certain percentage of the applied (desired) voltage. Typical values of dc bias voltage settling time are listed in Table 1-2 as reference data.

3-74. EXTERNAL TRIGGERING

3-75. The 4277A can be externally triggered by connecting an external triggering device to the EXT TRIGGER connector on the rear panel and setting the TRIGGER control on the front panel to MAN/EXT on front panel. The instrument is triggered (measurement is made) each time a positive-going TTL level pulse is applied to this connector (refer to Figure 3-22). External triggering can be also done by alternately shorting and opening the center conductor of the EXT TRIGGER connector to ground (chassis).

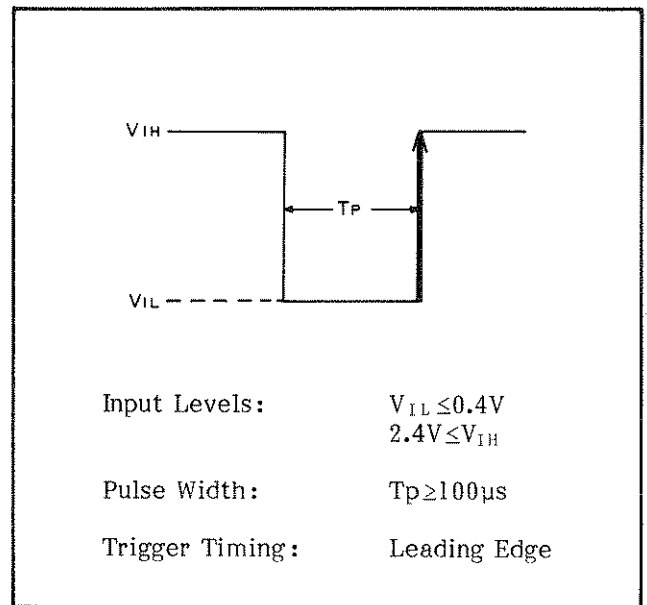
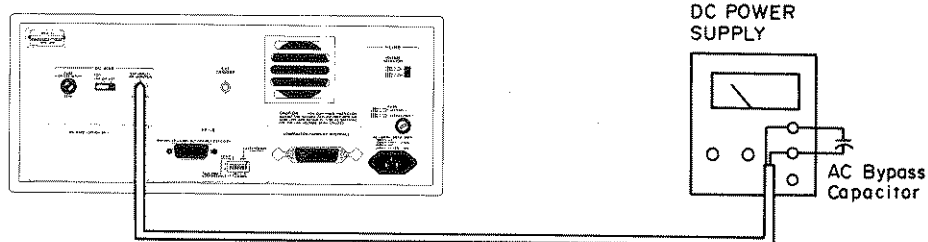


Figure 3-22. External Trigger Pulse.

EXTERNAL DC BIAS OPERATION ($\leq \pm 40V$)

To make capacitance measurements using externally supplied dc bias voltages up to $\pm 40V$, connect a dc voltage source to EXT INPUT/INT MONITOR connector on the rear panel as shown in the diagram.

CAUTION

DO NOT APPLY GREATER THAN $\pm 40V$ TO THE 4277A'S EXT INPUT/INT MONITOR CONNECTOR. IF THE APPLIED VOLTAGE EXCEEDS $\pm 40V$, THE 4277A MAY BE DAMAGED.

CAUTION

BE SURE THE CORRECT FUSE (HP P/N 2110-0011) IS INSTALLED IN THE DC BIAS FUSE HOLDER ON THE REAR PANEL.

PROCEDURE:

1. Set DC BIAS select switch on rear panel to EXT.
2. Connect the test fixture or test leads to the UNKNOWN terminals of the 4277A.
3. Turn on the instruments.
4. Set the 4277A's controls as described in steps 5 through 7 of Figure 3-20. Set the DISPLAY A function to "C" measurement mode.
5. Perform OPEN and SHORT Zero Offset Adjustments as described in paragraph 3-51.
6. Connect a sample to the test fixture or test leads.

CAUTION

DO NOT SHORT THE HIGH AND LOW TERMINALS.

CAUTION

WHEN A POSITIVE BIAS VOLTAGE IS USED, THE POSITIVE TERMINAL OF ELECTROLYTIC CAPACITORS MUST BE CONNECTED TO THE INSTRUMENT'S HIGH TERMINAL. WHEN USING A NEGATIVE BIAS VOLTAGE, CONNECT THE CAPACITOR'S NEGATIVE TERMINAL TO THE INSTRUMENT'S HIGH TERMINAL.

7. Set the external dc voltage source to the desired output voltage.
8. Read the measured values. Wait until the applied dc bias across the sample becomes stable.
9. Reset the external voltage source to 0V.
10. Remove the sample from test fixture or test leads.

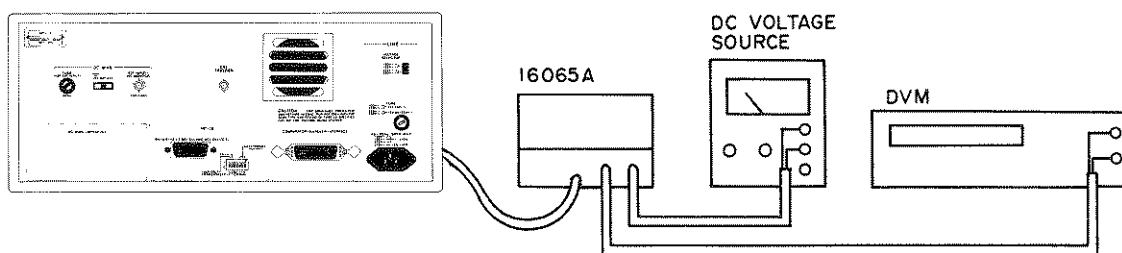
Note

Use a stable dc voltage source.

Note

To make stable measurements, connect an ac bypass capacitor (approximately $1\mu F$) between positive terminal and negative terminal of the external dc voltage source.

Figure 3-23. External DC Bias (Sheet 1 of 4).

EXTERNAL DC BIAS OPERATION ($\leq \pm 200V$)

To make capacitance measurements using externally supplied dc bias voltages up to $\pm 200V$, use the HP 16065A Test Fixture. Connect a dc voltage source to the 16065A as shown in the diagram.

CAUTION

DO NOT APPLY GREATER THAN $\pm 40V$ TO THE 4277A'S EXT INPUT/INT MONITOR CONNECTOR. IF THE APPLIED VOLTAGE EXCEEDS $\pm 40V$, THE 4277A MAY BE DAMAGED.

PROCEDURE:

1. Set DC BIAS select switch on rear panel to OFF.
2. Set CABLE LENGTH switch on the front panel to 1m.
3. Connect the 16065A to the UNKNOWN terminals of the 4277A.
4. Connect the dc voltage source to DC BIAS INPUT connector of the 16065A.
5. Connect a DVM or an oscilloscope to the DC BIAS MONITOR connector of the 16065A.
6. Turn on the instruments.
7. Set the 4277A's controls as described in steps 5 through 7 of Figure 3-20. Set the DISPLAY A function to "C" measurement mode.
8. Perform OPEN and SHORT Zero Offset Adjustments.

9. Connect a sample to the 16065A test fixture.

CAUTION

DO NOT SHORT THE HIGH AND LOW TERMINALS.

CAUTION

WHEN A POSITIVE BIAS VOLTAGE IS USED, THE POSITIVE TERMINAL OF ELECTROLYTIC CAPACITORS MUST BE CONNECTED TO THE INSTRUMENT'S HIGH TERMINAL. WHEN USING A NEGATIVE BIAS VOLTAGE, CONNECT THE CAPACITOR'S NEGATIVE TERMINAL TO THE INSTRUMENT'S HIGH TERMINAL.

10. Set the external dc voltage source to the desired output voltage and close the cover of the 16065A.
11. Read the measured values. Wait until the monitored voltage becomes stable.
12. Open the cover of the 16065A.

Note

When the cover of the 16065A is opened, the charge on the sample is discharged through two paralleled 20Ω resistors.

Figure 3-23. External DC Bias (Sheet 2 of 4).

13. Remove the sample from the 16065A.

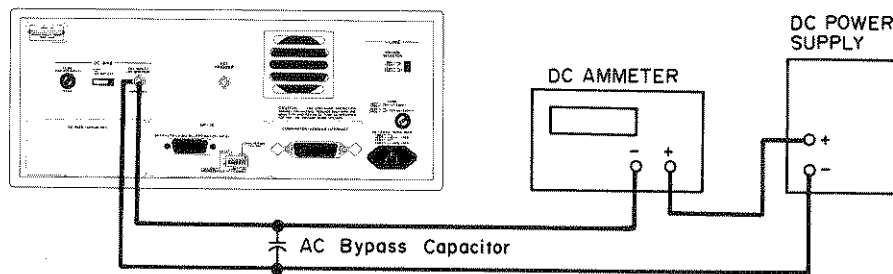
Note

Use a stable dc voltage source.

Note

The test signal will appear at the DC BIAS MONITOR connector. This does not affect measurement results, however.

EXTERNAL DC CURRENT BIAS OPERATION ($\leq 35\text{mA}$)



DC bias current can be applied to the sample through the UNKNOWN terminals by connecting a dc voltage source to the instrument. The procedure for making inductance measurements using current biasing is given below.

PROCEDURE:

1. Set the DC BIAS select switch on the rear panel to EXT.
2. Connect an external dc voltage source and a dc ammeter (for current monitoring) to the EXT INPUT/INT MONITOR connector on the rear panel, as shown in the diagram.
3. Connect a test fixture or test leads to the UNKNOWN terminals of the 4277A.
4. Turn on the instruments.
5. Set the 4277A's controls as described in steps 5 through 7 of Figure 3-20. Set the DISPLAY A function to "L" measurement mode.
6. Perform OPEN and SHORT Zero Offset Adjustments.

7. Connect the sample to the test fixture or test leads.

8. Gradually increase the dc voltage source output voltage until the desired bias current, as indicated on the dc ammeter, is obtained.

CAUTION

DO NOT ALLOW THE BIAS CURRENT TO EXCEED 35mA AND DO NOT ALLOW THE OUTPUT VOLTAGE FROM THE EXTERNAL DC VOLTAGE TO EXCEED SOURCE $\pm 40\text{V}$. IF CURRENT EXCEEDS 35mA OR IF VOLTAGE EXCEEDS $\pm 40\text{V}$, THE INSTRUMENT MAY BE DAMAGED.

Note

DC bias current flowing through sample can be calculated by the following equation:

$$I_{DC} = \frac{E_{\text{bias}}}{R_x + 1} \quad (\text{mA})$$

Figure 3-23. External DC Bias (Sheet 3 of 4).

where E_{bias} is the bias voltage (V) applied to EXT INPUT/INT MONITOR connector and R_x is the dc resistance ($k\Omega$) of the sample.

9. Read the measured values.
10. Gradually decrease the dc voltage source output voltage until the dc bias current is 0mA, then remove the sample from the test fixture or test leads.

Note

To make stable measurements, connect an ac bypass capacitor (near $1\mu F$) between the positive terminal and the negative terminal of the dc voltage source.

Note

Maximum allowable current depends on the bridge circuit's range resistor, as listed in the table below.

Range Resistor	Maximum Output Current
100 Ω	35mA
1k Ω and 10k Ω	10mA

Refer to Figure 3-5 for details on the relation between range resistor and measurement range. Note that measurement accuracies, as specified in Section I, are not guaranteed if bias current is allowed to exceed the limits given in the above table.

Figure 3-23. External DC Bias (Sheet 4 of 4).

3-76. HP-IB INTERFACE

3-77. The 4277A can be remotely controlled via the HP-IB, a carefully defined instrument interface which simplifies integration of programmable instruments and a calculator or computer into a system.

Note

HP-IB is Hewlett-Packard's implementation of IEEE Std. 488, "Standard Digital Interface for Programmable Instrumentation."

3-78. HP-IB INTERFACE CAPABILITIES

3-79. The 4277A has eight HP-IB interface functions, as listed in Table 3-11.

Table 3-11. HP-IB Interface Capabilities

Code	Interface Function * (HP-IB Capabilities)
SH1**	Source Handshake
AH1	Acceptor Handshake
T5	Talker (basic talker, serial poll, talk only mode, unaddress to talk if addressed to listen)
L4	Listener (basic listener, unaddress to listen if addressed to talk)
SR1	Service Request
RL1	Remote/local (with local lockout)
DC1	Device Clear
DT1	Device Trigger

* Interface functions provide the means for a device to receive, process, and transmit messages over the bus.

** The numeric suffix of the interface code indicates the limitation of the function, as defined in Appendix C of IEEE Std. 488. 1978.

3-80. CONNECTION TO HP-IB

3-81. The 4277A can be connected into an HP-IB bus configuration with or without a controller (i.e., with or without an HP calculator). In an HP-IB system without a controller, the instrument functions as a "talk only" device (refer to paragraph 3-86).

3-82. HP-IB STATUS INDICATORS

3-83. The HP-IB Status Indicators are four LED lamps located on the front panel. When lit, these lamps show the existing status of the 4277A in the HP-IB system as follows:

SRQ: SRQ signal from the 4277A to the controller is on the HP-IB line. Refer to paragraph 3-104.

LISTEN: The 4277A is set to listener.

TALK: The 4277A is set to talker.

REMOTE: The 4277A is under remote control.

3-84. LOCAL KEY

3-85. The LOCAL key releases the 4277A from HP-IB remote control and allows measurement conditions to be set from the front-panel. The REMOTE lamp will go off when this key is pressed. LOCAL control is not available when the 4277A is set to "local lockout" status by the controller.

3-86. HP-IB CONTROL SWITCH

3-87. The HP-IB Control Switch, located on the rear panel, has seven bit switches. See Figure 3-24. Each bit switch has two settings: logical 0 (down position) and logical 1 (up position). The left-most bit switch, bit 7, determines whether the instrument will be addressed by the controller in a multidevice system, or will function as a "talk only" device to output measurement data and/or instructions to an external "listener," e.g., printer.

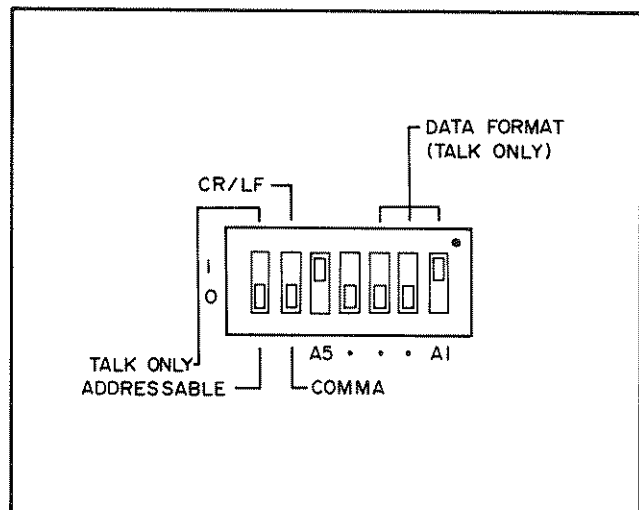


Figure 3-24. HP-IB Control Switch.

When bit switch 7 is set to 0, the instrument is in ADDRESSABLE mode and bit switches 1 through 5 determine the instrument address. When this bit switch is set to 1, however, the instrument is in TALK ONLY mode.

Bit switch 6 determines the output data delimiter. When this bit switch is set to 0, the delimiter is a comma (,); when set to 1, the delimiter is a carriage return and line feed (CR/LF).

Note

The HP-IB Control Switch, as set at the factory, is shown in Figure 3-24.

Note

The HP-IB Control Switch setting is memorized only at instrument turn on. Thus, even if the HP-IB Control Switch setting is changed while the instrument is turned on, the memorized setting is not changed until the instrument is turned off and on.

3-88. ADDRESSABLE MODE

3-89. When bit switch 7 of the HP-IB Control Switch is set to ADDRESSABLE (i.e., set to 0), bit switches 1 through 5 represent the HP-IB address of the instrument, in binary. These switches are set to 10001 (decimal 17) when the instrument leaves the factory but can be set to any desired address between 0 and 30.

Note

When the instrument is turned on, the HP-IB address is displayed, in decimal, on DISPLAY A. For example, the factory-set address (10001) is displayed as "17."

Note

HP-IB address 11111 (decimal 31) cannot be used. If this address is set, E19 will be displayed on DISPLAY A (after 31 has been displayed) when the instrument is turned on.

3-90. TALK ONLY MODE

3-91. When bit switch 7 of the HP-IB Control Switch is set to TALK ONLY (i.e., set to 1), the instrument functions as a "talker," outputting data to a "listener" (e.g., printer). In TALK ONLY mode, bit switches 1, 2, and 3 determine the format in which data is output. There are six formats, F1 through F6, and the bit switch setting for each format is shown in Table 3-12. Refer to paragraph 3-98 for details on the output data formats.

Note

If the instrument is set to TALK ONLY mode, the Output Data Format number will be briefly displayed on DISPLAY A (instead of the HP-IB address) when the instrument is turned on. The displayed number, however, will be the format number plus 50. For example, if the Output Data Format is F3, the number displayed on DISPLAY A at turn on will be 53.

Note

When the instrument is used in TALK ONLY mode, devices connected to the instrument must be set to LISTEN ONLY mode.

Table 3-12. Output Data Formats Selectable in TALK ONLY Mode

Bit Switch Settings			Output Data Format
Bit 3	Bit 2	Bit 1	
0	0	0	F1
0	0	1	F2
0	1	0	F3
0	1	1	F4
1	0	0	F5
1	0	1	F6
1	1	0	F1
1	1	1	F2

Note: Refer to paragraph 3-98 for details.

3-92. REMOTE PROGRAM CODES

3-93. Remote program codes for the 4277A are listed in Table 3-13.

Table 3-13. Remote Program Codes (Sheet 1 of 2)


Item	Control	Program Code	Description												
DISPLAY A Function	L C HIGH SPEED L HIGH SPEED C Z*	A1 A2 A3 A4 A5	DISPLAY A and DISPLAY B combinations are listed in the table below: <table border="1" style="margin: 10px auto;"> <thead> <tr> <th style="border: none;">A \ B</th> <th>1</th> <th>2</th> <th>3</th> </tr> </thead> <tbody> <tr> <th>1</th> <td>L-D</td> <td>L-Q</td> <td>L-ESR/G</td> </tr> <tr> <th>2</th> <td>C-D</td> <td>C-Q</td> <td>C-ESR/G</td> </tr> </tbody> </table>	A \ B	1	2	3	1	L-D	L-Q	L-ESR/G	2	C-D	C-Q	C-ESR/G
A \ B	1	2		3											
1	L-D	L-Q	L-ESR/G												
2	C-D	C-Q	C-ESR/G												
DISPLAY B Function	D Q ESR/G	B1 B2 B3	* When DISPLAY A is set to Z, DISPLAY B is automatically set to θ .												
CKT MODE	AUTO 	C1 C2 C3													
MEAS SPEED	SLOW MED FAST	M1 M2 M3													
Auto Range	OFF ON	U0 U1	: Range is fixed. : Range is automatically selected.												
LC Z Range	1 μ H/1pF 10 μ H/10pF 100 μ H/100pF/10 Ω 1mH/1nF/100 Ω 10mH/10nF/1k Ω 100mH/100nF/10k Ω 1H/1 μ F/100k Ω 10 μ F/1M Ω	R1 R2 R3 R4 R5 R6 R7 R8	If the instrument is set to a range which cannot make the measurement, range is automatically reset to the nearest range capable of making the measurement.												
Test Signal Level	LOW HIGH	V1 V2													
Trigger Mode	INT MAN/EXT	T1 T2	This code only sets the trigger mode; it does not trigger the instrument.												
Execute		EX	This code is used to trigger the instrument.												
Self Test	OFF ON	S0 S1													
Deviation Measurement	OFF ON	X0 X1													
Zero Offset	OPEN SHORT	Z0 ZS													

Table 3-13. Remote Program Codes (Sheet 2 of 2)

Item	Control	Program Code	Description
Data Ready	OFF ON	D0* D1	If Data Ready is set to ON, an SRQ signal is output when the measurement is completed.
Comparator Enable	OFF ON	E0* E1	If the instrument is not equipped with Option 002, an error will result if E1 is sent via the HP-IB.
Comparator Run	OFF ON	G0* G1	
Comparator Limit	L/C/Z input D/Q/ESR/G input	L1* L2	
Comparator Bin Number	BIN1 BIN2 BIN3 BIN4 BIN5 BIN6 BIN7 BIN8 BIN9	N1* N2 N3 N4 N5 N6 N7 N8 N9	These codes are used when setting L/C/ Z limits.
Comparator Limit Recall		LR	Refer to paragraph 3-102.
Comparator Limit Erase		ER	Comparator limits stored in all bins are cleared.
Output Data Abort		DA	HP-IB output data are erased from the output buffer.
Output Data Format	Displays A/B or Comparator Displays A/B/Comparator Display A or Comparator Display A/Comparator	F1* F2 F3 F4	Refer to paragraph 3-98 and Table 3-16.
Learn Mode		LN	Refer to paragraph 3-100.
Output Data Mode	ASCII BINARY	P0* P1	
Note: * indicates an initial control setting (Refer to paragraph 3-38.)			

3-94. DATA OUTPUT

3-95. Measurement and status data are output to external devices in bit parallel, byte serial format via the eight DIO signal lines of the HP-IB. Data can be output in ASCII mode or PACKED BINARY mode. Each mode is described below.

[1] ASCII mode

Output data in this mode includes status data, key status (function) data, and measurement data (including range) for DISPLAY A and DISPLAY B. If the instrument is equipped with Option 002, comparison data (LOW, IN, HIGH) for L/C/|Z| and D/Q/ESR/G, and BIN number data can be output, too. The output format is shown in Figure 3-25. All characters are coded in accordance with ASCII coding conventions.

[2] PACKED BINARY mode

Output data in this mode is output as one or two binary bytes, rather than as a character representation. This data output format is for high speed data transfer. Contents of output data, however, is less than that of ASCII mode. Output data in this mode includes status data for DISPLAY A and DISPLAY B, measurement range data as an 8-bit byte, and measurement data of DISPLAY A and DISPLAY B (not including unit and decimal point) as a 16-bit, 2's complement binary word. If the instrument is equipped with Option 002, comparison data (LOW, IN, HIGH) for L/C/|Z| and D/Q/ESR/G, and BIN number data can be output as an 8-bit byte. The displayed data is output as the equivalent decimal values of the resulting words. The output format is shown in Figure 3-25.

3-96. PARAMETER SETTING

3-97. Test frequency, DC bias (Option 001), and bin limits (Option 002) can be set via remote programming.

[1] Test Frequency Setting

$$\text{FR } \frac{\text{XXX.X}}{(1)} \text{ EN}$$

(1) Setting value, in kHz.

Note

When an illegal frequency that is within the instrument's frequency range is set, the frequency below the illegal setting is automatically selected. For example:

"FR75.9EN": 75.5kHz displayed on
FREQUENCY/DC BIAS
DISPLAY

[2] DC Bias Setting (Option 001 only)

$$\text{BI } \frac{\pm\text{XX.X}}{(1)} \text{ EN}$$

(1) Setting value, in volts.

Note

If not set, polarity sign is automatically set to plus (+).

[3] Comparator Limit Setting (Option 002 only)

(Low Limit) LL $\frac{\text{XX.XXX}}{(1)}$ EN

(High Limit) LH $\frac{\text{XX.XXX}}{(1)}$ EN

(1) Setting value. The position of the decimal point must agree with the measurement range. Unit is in accordance with the unit indicators of DISPLAY A or DISPLAY B.

[1] ASCII mode (Set using HP-IB remote program code "P0")

① DISPLAY A/B

X X X ±NN.NNN E±NN ,
 (1) (2) (3) (4) (5) (6)

X X ±N.NNNN E±NN CR LF
 (7) (8) (9) (10) (11)

- (1) Measurement circuit mode
- (2) Status of DISPLAY A
- (3) Function of DISPLAY A
- (4) Value of DISPLAY A (position of decimal point is coincident with display)
- (5) Unit of DISPLAY A
- (6) Comma (data delimiter)
- (7) Status of DISPLAY B
- (8) Function of DISPLAY B
- (9) Value of DISPLAY B (position of decimal point is coincident with display)
- (10) Unit of DISPLAY B
- (11) Data Terminator

② COMPARATOR (Option 002 only)

X X N CR LF
 (1) (2) (3) (4)

- (1) Status of L/C / | Z |
- (2) Status of D/Q/ESR/G
- (3) BIN number
- (4) Data Terminator

Note

Status and function data of DISPLAY A and DISPLAY B, and status of Comparator are each represented as one alphabetic character, as listed in Table 3-14.

Note

When measurement error code, OF, UF, CF or blank, is indicated on DISPLAY A or DISPLAY B, value of DISPLAY A or DISPLAY B ((4) or (9)) is output as follows:

OF (overflow).....+19999E+20
 UF (underflow).....+00000E-20
 CF (change function)/
 blank+00000E-30

Note

DISPLAY A and DISPLAY B ranges are expressed as an exponent as follows:

10⁻¹²(p) E-12
 10⁻⁹(n) E-09
 10⁻⁶(μ) E-06
 10⁻³(m) E-03
 10⁰ E+00
 10³(k) E+03
 10⁶(M) E+06

Note

The data delimiter, bit switch 6 on the HP-IB Control Switch, is set at the factory to comma (,). This causes the instrument to output all data (DISPLAY A data, DISPLAY B data, and, if Comparator is used, Comparator data) as a continuous string. When the data delimiter is set to CR/LF, a carriage return and line feed signal is output after each field. This is useful when outputting data to certain peripherals, such as a printer.

Note

The EOI signal is output with the LF signal.

Figure 3-25. Data Output Format for the 4277A (Sheet 1 of 2).

[2] PACKED BINARY mode (Set using HP-IB remote program code "P1")

② COMPARATOR (Option 002 only)

① DISPLAY A/B

$\frac{BB}{(1)} \quad \frac{BB}{(2)} \quad \frac{BBBB}{(3)}$

1st byte 2nd byte 3rd byte
 $\frac{BB}{(1)} \quad \frac{BB}{(2)} \quad \frac{BBBB}{(3)} \quad \frac{BBBBBBBB \quad BBBBBBBB}{(4)}$

- (1) Status of L/C/|Z|
- (2) Status of D/Q/ESR/G
- (3) BIN number

4th byte 5th byte
 $\frac{BBBBBBBB \quad BBBBBBBB}{(5)}$

Note

Status data of DISPLAY A and DISPLAY B, measurement range, and status and BIN number data of Comparator are each represented as a number, as listed in Table 3-15.

(B: 0 or 1)

Note

- (1) Status of DISPLAY A
- (2) Status of DISPLAY B
- (3) Measurement Range
- (4) Value* of DISPLAY A (not including decimal point and unit)
- (5) Value* of DISPLAY B (not including decimal point and unit)

Values displayed on DISPLAY A and DISPLAY B are output as number of counts. Actual measured values are obtained with measurement range and output data values.

Note

* Output data is the binary equivalent of the measured value.

The EOI signal is output with the last data byte.

Note

The first byte includes DISPLAY A status, DISPLAY B status, and measurement range. The value of the byte is output in decimal. For example, DISPLAY A status is OF (1), DISPLAY B status is "blank" (3), and measurement range is 5 (see Table 3-15), the byte will be as shown below.

$\frac{01}{1} \quad \frac{11}{3} \quad \frac{0101}{5}$

The decimal equivalent of this is 117. This is the value that will be output.

Figure 3-25. Data Output Format for the 4277A (Sheet 2 of 2).

Table 3-14. Data Output Codes for ASCII Mode



Item	Information	Code
Circuit Mode		P
		S
Data Status of DISPLAY A/B	Normal Normal on Deviation Measurement Overflow Underflow Change Function Blank (used only for DISPLAY B)	N D O U C B
Function of DISPLAY A	L C HIGH SPEED L HIGH SPEED C Z	L C L C Z
Function of DISPLAY B	D Q ESR G θ HIGH SPEED L* ¹ HIGH SPEED C* ¹	D Q R G T N
Data Status of L/C/ Z for Comparator	Bin IN HIGH LOW Embedded Undefined	I H L E* ² U* ³
Data Status of D/Q/ESR/G for Comparator	Limit IN HIGH LOW Undefined	I H L U* ³
Bin Number	Out of Bin BIN1 BIN2 BIN3 BIN4 BIN5 BIN6 BIN7 BIN8 BIN9	0 1 2 3 4 5 6 7 8 9
<p>*¹ HIGH SPEED C and HIGH SPEED L have the same output codes.</p> <p>*² This code appears when the measurement value is between two continued bins.</p> <p>*³ This code appears when DISPLAY A or B indicates "CF" or blank.</p>		

Table 3-15. Data Output Codes for PACKED BINARY Mode

Item	Information	Code
Data Status of DISPLAY A/B	Normal Overflow Underflow Change Function or Blank	0 1 2 3
Measurement Range	1 μ H/1pF 10 μ H/10pF 100 μ H/100pF/10 Ω 1mH/1nF/100 Ω 10mH/10nF/1k Ω 100mH/100nF/10k Ω 1H/1 μ F/100k Ω 10 μ F/1M Ω	1 2 3 4 5 6 7 8
Data Status of L/C/ Z for Comparator	Bin IN HIGH LOW Embedded or Undefined	0 1 2 3
Data Status of D/Q/ESR/G for Comparator	Bin IN HIGH LOW Undefine	0 1 2 3
Bin Number	Out of Bin BIN1 BIN2 BIN3 BIN4 BIN5 BIN6 BIN7 BIN8 BIN9	0 1 2 3 4 5 6 7 8 9

3-98. OUTPUT DATA FORMAT

Note

3-99. The 4277A can output measurement data to a controller or can output data directly to an external "listener" device (i.e., printer). There are six Output Data Formats, F1 through F6. The contents of the output data for each format are listed in Table 3-16.

Comparator data is output when the comparator is in RUN mode. When F1, F3, or F5 is selected, if comparator is not in RUN mode, or if the comparator is not connected to the instrument, contents of output data is Type I.

Note

In ADDRESSABLE mode, only F1 through F4 can be set by HP-IB remote control. Output data can be in either ASCII mode or PACKED BINARY mode. Also, in ADDRESSABLE mode, bit switch settings have no relation to Output Data Format.

Note

If the instrument is set to TALK ONLY mode, the Output Data Format number will be briefly displayed on DISPLAY A (instead of the HP-IB address) when the instrument is turned on. The displayed number, however, will be the format number plus 50. For example, if the Output Data Format is F3, the number displayed on DISPLAY A at turn on will be 53.

Note

In TALK ONLY mode, any Output Data Format, F1 through F6, can be set by HP-IB Control Switch settings (bit 1 through bit 3). Also, in TALK ONLY mode, data can be output in ASCII mode only.

Table 3-16. Output Data Formats

Format	Output Data				Output Mode	
		Display A	Display B	Comparator	ASCII	PACKED BINARY
F1	I	Yes	Yes	No	Yes	Yes
	II	No	No	Yes		
F2	I	Yes	Yes	No	Yes	Yes
	II	Yes	Yes	Yes		
F3	I	Yes	No	No	Yes	Yes
	II	No	No	Yes		
F4	I	Yes	No	No	Yes	Yes
	II	Yes	No	Yes		
F5	I	No	Yes	No	Yes	No
	II	No	No	Yes		
F6	I	No	Yes	No	Yes	No
	II	No	Yes	Yes		

3-100. LEARN MODE DATA

3-101. All front panel settings and comparator key settings are output from the 4277A when the program code "LN" is used (refer to Figure 3-28). The data is output in the following format:

$$\frac{\text{FRnnnnnEN}}{(1)} \quad \frac{\text{An}}{(2)} \quad \frac{\text{Bn}}{(3)} \quad \frac{\text{Cn}}{(4)} \quad \frac{\text{Dn}}{(5)} \quad \frac{\text{Fn}}{(6)} \quad \frac{\text{Mn}}{(7)} \quad \frac{\text{Pn}}{(8)}$$

$$\frac{\text{Rn}}{(9)} \quad \frac{\text{Sn}}{(10)} \quad \frac{\text{Tn}}{(11)} \quad \frac{\text{Un}}{(12)} \quad \frac{\text{Vn}}{(13)} \quad \frac{\text{Xn}}{(14)}$$

$$\frac{\text{BI±nnnnnEN}}{(15)} \quad \frac{\text{En}}{(16)} \quad \frac{\text{Gn}}{(17)} \quad \frac{\text{Ln}}{(18)} \quad \frac{\text{Nn}}{(19)} \quad \frac{\text{CR LP}}{(20)}$$

- (1) Test Frequency Setting
- (2) A1 - A5: DISPLAY A Function
- (3) B1 - B3: DISPLAY B Function
- (4) C1 - C3: Circuit Mode
- (5) D0, D1: Data Ready
- (6) F1 - F4: Output Data Format
- (7) M1 - M3: Measurement Speed
- (8) P0, P1: Output Data Mode (ASCII or Packed Binary)
- (9) R1 - R8: LC | Z | Range
- (10) S0, S1: Self Test
- (11) T1, T2: Trigger Mode
- (12) U0, U1: Auto Range
- (13) V1, V2: Test Signal Level
- (14) X0, X1: Deviation Measurement
- (15) DC Bias Setting
- (16) E0, E1: Comparator Enable
- (17) G0, G1: Comparator Run
- (18) L1, L2: Comparator Limit Input
- (19) N1 - N9: Comparator Bin Number for L/C/ | Z |
- (20) Data Terminator

Note

DC Bias data is not output when DC Bias option (Option 001) is not installed. Similarly, when the comparator (Option 002) is not installed, comparator data is not output.

Note

Don't open the UNKNOWN terminals no test fixture or test leads when LEARN mode data is output in AUTO range. If so, measurement range is not fixed in some cases. There is no problem when a test fixture is connected to the UNKNOWN terminals or when measurement range is set to MANUAL mode.

3-102. RECALL COMPARATOR LIMIT DATA

3-103. Low and high bin limits can be output from the 4277A when the program code "LR" is used (refer to Figure 3-30). The L/C/ | Z | limits for the designated bin are output when program code "L1" is used. When program code "L2" is used, D/Q/ESR/G limits are output. The data is output in the following format:

$$\frac{\text{LLXX.XXXEN}}{(1)} \quad \frac{\text{LHXX.XXXEN}}{(2)} \quad \frac{\text{CR LP}}{(3)}$$

- (1) Value of Low Limit (position of decimal point is coincident with display)
- (2) Value of High Limit (position of decimal point is coincident with display)
- (3) Data Terminator

3-104. SERVICE REQUEST STATUS BYTE

3-105. The 4277A outputs an RQS (Request Service) signal whenever it is set to one of the five possible service request states. Figure 3-26 shows the contents of the Status Byte.

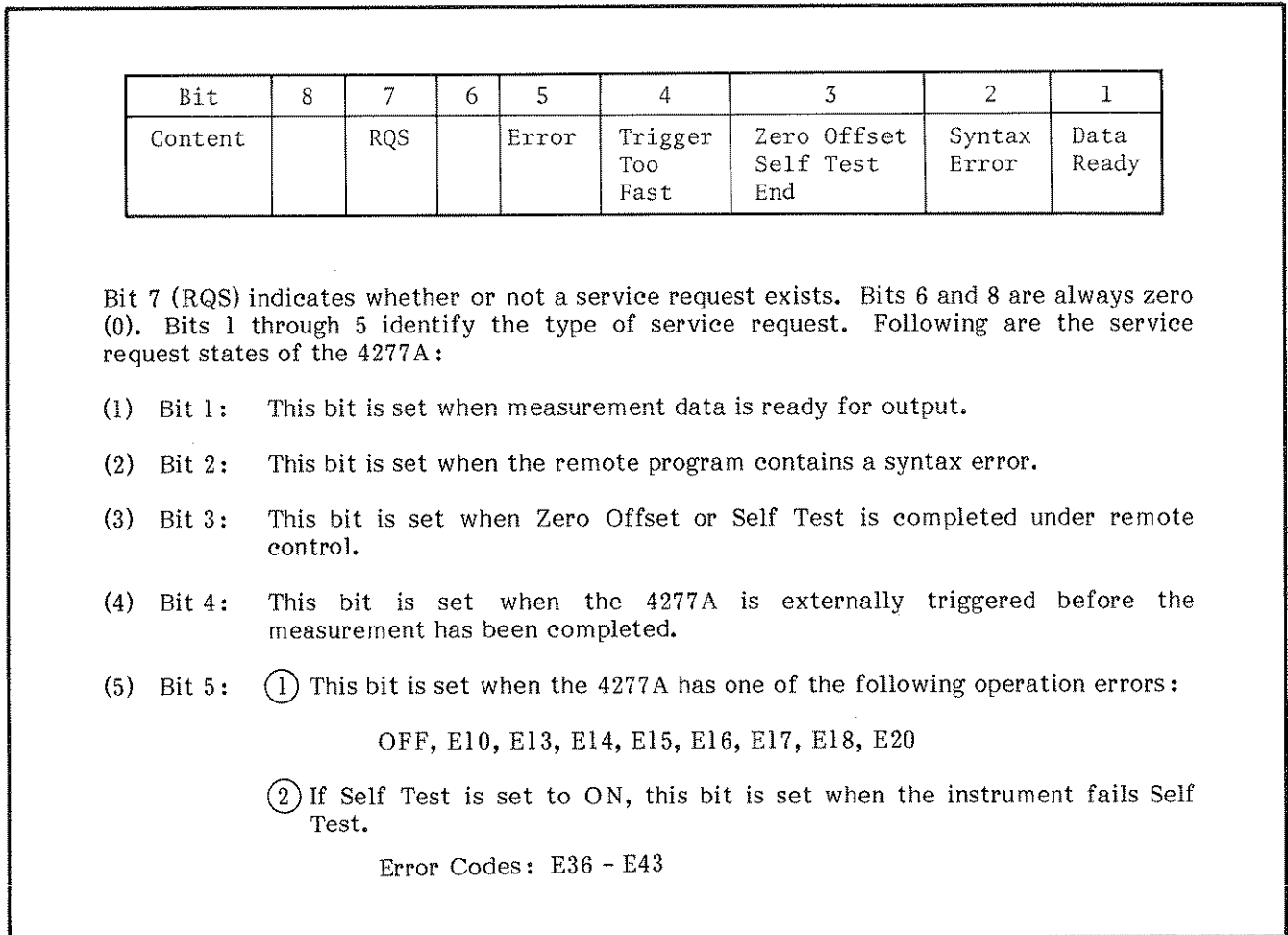


Figure 3-26. Status Byte for the 4277A.

3-106. PROGRAMMING GUIDE FOR 4277A

3-107. Sample programs that can be run on the HP-85, 9835A/B, 9845B, 9826A, or 9836A are given in Figures 3-27 through 3-30. These programs are listed in Table 3-17.

Note

Controller-specific HP-IB programming information is given in the controller's programming manual.

Note

Following equipment is required to run the sample programs:

- (1) 4277A LCZ Meter
- (2) HP-85 Personal Computer
00085-15003 I/O ROM
- (3) 82937A HP-IB INTERFACE

or

- (2) 9835A/B Desktop Computer
98332A I/O ROM
- (3) 98034A HP-IB INTERFACE
CARD

or

- (2) 9845B Desktop Computer
98412A I/O ROM
- (3) 98034A HP-IB INTERFACE
CARD

or

- (2) 9826A Desktop Computer

or

- (2) 9836A Desktop Computer

Table 3-17. Sample Programs

Sample Program	Figure	Description
1	3-27	Remote control and data output program
2	3-28	How to use remote program code "LN."
3	3-29	How to input low and high bin limits for the Comparator.
4	3-30	How to use remote program code "LR."

Sample Program 1

Description:

This program has three capabilities:

- (1) Control of the 4277A via the HP-IB
- (2) Trigger of the 4277A via the HP-IB
- (3) Data output from the 4277A via the HP-IB

Program:

```

10 REMOTE 717
20 CLEAR 717
30 DIM A$(50)
40 OUTPUT 717; "A2B1T2P0F1"
      (1)(2)      (3)
50 OUTPUT 717; "FR100 EN"
      (4)
60 OUTPUT 717; "EX"
      (5)
70 ENTER 717; A$
80 DISP A$
90 PRINT A$
100 END

```

- (1) HP-IB INTERFACE Select Code (82937A or 98034A)
- (2) HP-IB Address of the 4277A
- (3) Program codes for the 4277A (refer to Table 3-13)
- (4) Program codes for parameter setting of the 4277A (refer to paragraph 3-96)
- (5) This is equivalent to: TRIGGER 717

Figure 3-27. Sample Program 1 (Sheet 1 of 2).

If program code "P1" is used, refer to the following program :

Program :

```

10 REMOTE 717
20 CLEAR 717
30 OUTPUT 717 ; "A2B1T2P1F1"
40 OUTPUT 717 ; "EX"
50 ENTER 717 USING "%, B, W, W" ; A, B, C
      (1) (2) (3) (3)
60 DISP A ; B ; C
70 PRINT A ; B ; C
80 END

```

- (1) ENTER terminator. "#" can also be used.
- (2) Specifier for entering one byte (8-bit) of binary data
- (3) Specifier for entering two bytes (16-bit) of binary data

Figure 3-27. Sample Program 1 (Sheet 2 of 2).

Sample Program 2

Description:

The remote program code "LN" can be used to read the front panel control settings and comparator settings. This program shows how to use "LN."

Program :

```

10 REMOTE 717
20 CLEAR 717
30 DIM A$[60]
40 OUTPUT 717 ; "LN"
50 ENTER 717 ; A$
60 DISP A$
70 PRINT A$
80 END

```

Figure 3-28. Sample Program 2.

Sample Program 3

Description:

This program shows how to input low and high bin limits via the HP-IB when the instrument is equipped with Option 002.

Program:

```
10 REMOTE 717
20 CLEAR 717
30 DIM A$(50)
40 OUTPUT 717; "A2B1R4T2P0F2"
      (1)
50 OUTRUT 717; "FR100EN"
60 OUTPUT 717; "E1G0ER"
      (2)
70 OUTPUT 717; "L1N1LL.995ENLH.998EN"
      (2)      (3)
80 OUTPUT 717; "N2LL1ENLH1.1EN"
90 OUTPUT 717; "N3LL1.0001ENLH1.2EN"
100 OUTPUT 717; "L2LL0ENLH.001EN"
110 OUTPUT 717; "G1"
120 OUTPUT 717; "EX"
130 ENTER 717; A$
140 DISP A$
150 PRINT A$
160 END
```

- (1) Measurement range must be set.
- (2) Program codes for comparator setting
- (3) Program codes for inputting low and high bin limits

Figure 3-29. Sample Program 3.

Sample Program 4**Description**

The remote program code "LR" can be used to recall the high and low limits for each bin. This program shows how to use "LR."

Program :

```
10 REMOTE 717
20 DIM A$(30)
30 OUTPUT 717;"E1G0"
40 FOR I=1 TO 9
50 OUTPUT 717;"L1N";I,"LR"
60 ENTER 717;A$
70 PRINT A$
80 NEXT I
90 OUTPUT 717;"L2LR"
100 ENTER 717;A$
110 PRINT A$
120 END
```

Figure 3-30. Sample Program 4.

3-108. OPTIONS

3-109. Options are standard modifications to the instrument that implement user's special requirements for minor functional changes. Operating instructions for the 4277A's options (except rack mount and handle installation kit options) and associated information are described in the following paragraphs.

3-110. Two options are available, as listed in the following tables:

Option No.	Option Name
001	Internal DC Bias
002	Comparator/Handler Interface

Option contents are as follows:

Option No.	Contents
001	A22 Internal DC Bias Board Assembly
002	Comparator/Handler Interface Kit

3-111. OPTION 001 INTERNAL DC BIAS (-40V to +40V)

3-112. Option 001 adds an internal dc bias supply variable from .00 volts to ± 40.0 volts. The dc bias voltage can be controlled manually from the front-panel or remotely via the HP-IB. Manual control and dc bias applications under HP-IB control are described in Figure 3-31. The internal dc bias source has two ranges and a maximum resolution of 10mV. Refer to Table 3-18. Output from the bias source is automatically set to 0V each time the instrument is turned on or when the CLEAR command is sent via the HP-IB. DC bias voltage is applied to the DUT only when the DC BIAS select switch on the rear panel is set to INT and the DC BIAS ON/OFF switch on the front panel is set to ON. If the DC BIAS ON/OFF switch is set to OFF, OFF will be briefly displayed on the FREQUENCY/DC BIAS display each time a new bias voltage is set. The dc bias voltage actually applied to the DUT depends on the impedance of the DUT and in most cases will be less than the voltage value displayed on the FREQUENCY/DC BIAS display. By connecting a DVM or an oscilloscope to the EXT INPUT/INT MONITOR connector on the rear panel, the dc bias voltage actually applied across the DUT can be monitored. Refer to Figure 3-32.

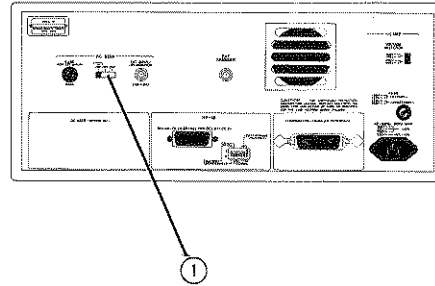
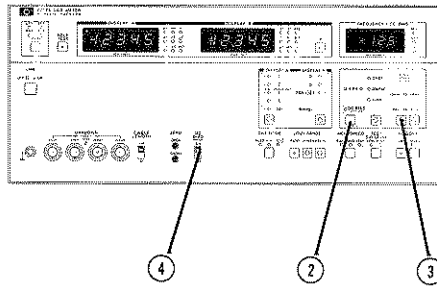
Table 3-18. Bias Voltage Resolution

Bias Voltage Range	Resolution
0V to ± 9.99 V	10mV
± 10.0 V to ± 40.0 V	100mV

Note

For the option 001 operation, set the DC BIAS select switch on the rear-panel to INT.

OPTION 001 INTERNAL DC BIAS OPERATION



1. Set the DC BIAS select switch (1) to INT.

2. Connect the 16047A Test Fixture to the UNKNOWN terminals.

Note

Any of the test fixtures and test leads listed in Table 1-3 can be used for measurements requiring dc bias.

3. Turn on the 4277A.

4. Perform OPEN and SHORT Zero Offset adjustments as described in paragraph 3-51.

5. Set the instrument's front panel controls as appropriate for the desired measurement.

6. Press the FREQ/DC BIAS select key (2). The DC BIAS lamp will come on.

7. Set the desired voltage by pressing the appropriate FREQ/DC BIAS control key (3). The voltage value will be displayed on the FREQUENCY/DC BIAS display.

Note

OFF will be briefly displayed on the FREQUENCY/DC BIAS display when the FREQ/DC BIAS control key is released, if the DC BIAS ON/OFF switch (4) is set to OFF.

8. Connect the DUT to the test fixture.

CAUTION

DO NOT CONNECT A CHARGED DUT TO THE TEST FIXTURE. DOING SO MAY DAMAGE THE INSTRUMENT.

9. Set the DC BIAS ON/OFF switch (4) to ON.

10. If you're measuring a capacitive DUT, allow sufficient time for the DUT to charge up to the applied voltage.

11. Read the measured values displayed on DISPLAY A and DISPLAY B.

12. Set the DC BIAS ON/OFF switch (4) to OFF.

13. Wait until the voltage across the DUT returns to 0V.

14. Remove the DUT from the test fixture.

Note

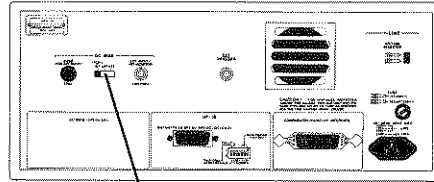
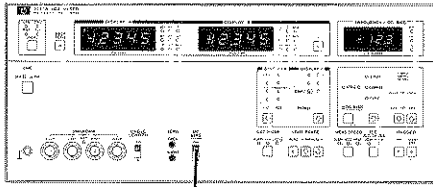
For reasons of safety and measurement accuracy, the voltage actually applied to the DUT should be monitored. Refer to Figure 3-32.

Note

When the DC BIAS switch on the front panel has been set to ON and the desired bias voltage is entered, the instrument automatically takes a wait time of approximately 0.8 seconds before outputting the bias voltage (after completion of the bias data input). Accordingly, it takes approximately (0.8 seconds + bias settling time) for the bias voltage to be applied to the DUT as well as to be settled after the bias data has been set. For the bias settling time, refer to Table 1-2 Supplemental Performance Characteristics.

Figure 3-31. Option 001 Internal DC Bias (Sheet 1 of 3).

[HP-IB Operation]



The following procedure is an example of dc bias remote control via the HP-IB.

1. Set the DC BIAS select switch (1) to INT.
2. Connect the 16047A Test Fixture to the UNKNOWN terminals.

Note

Any of the test fixtures and test leads listed in Table 1-3 can be used for measurements requiring dc bias.

3. Turn on the 4277A.
4. Perform OPEN and SHORT Zero Offset adjustments as described in paragraph 3-51.
5. Set the DC BIAS ON/OFF switch (2) to ON.

Note

The dc bias voltage is automatically set to 0V each time the instrument is turned on.

6. Set the front panel control via the HP-IB.
 - * Example of setting the instrument for a C-D measurement at 10kHz, external trigger.

```
REMOTE 717
CLEAR 717
OUTPUT 717; "A2B1FR10ENF1T2"
```

7. Connect the DUT to the test fixture.
8. Set the desired dc bias voltage via the HP-IB.
 - * Example of setting a dc bias voltage of +10V.

```
OUTPUT 717; "BI10EN"
```

9. Wait until the dc bias voltage settles.
 - * Example of programming a 10ms wait.

```
WAIT 10
```

10. Trigger the instrument via the HP-IB.

```
OUTPUT 717; "EX"
```

or

```
TRIGGER 717
```

11. Read and print the measured values.

```
ENTER 717; A, B
PRINT A, B
```

Figure 3-31. Option 001 Internal DC Bias (Sheet 2 of 3).

12. Set the bias voltage to 0V via the HP-IB.

```
OUTPUT 717; "BI0EN"
```

13. Wait until the dc bias voltage returns to 0V.

* Example of programming a 10ms wait.

```
WAIT 10
```

14. Remove the DUT from the test fixture.

Note

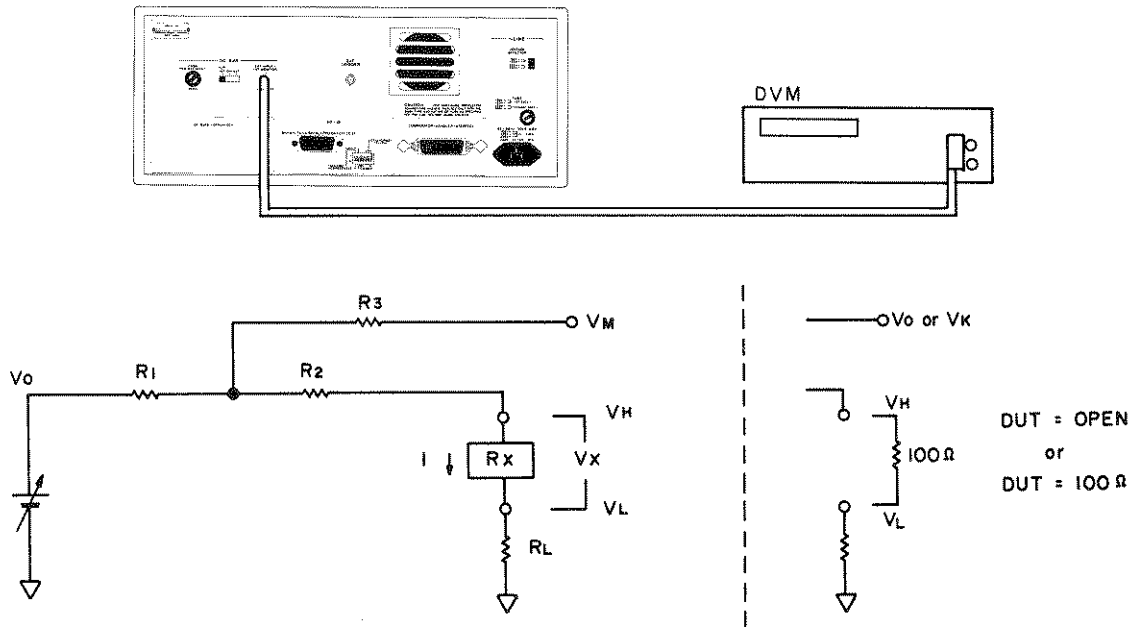
The above remote programming examples can be used on the HP Model 85 (with 00085-15003 I/O ROM), Model 9835A, Model 9845B/C, Model 9826A, and Model 9836A.

Note

In the above examples, HP-IB address 17 was used.

Figure 3-31. Option 001 Internal DC Bias (Sheet 3 of 3).

INTERNAL DC BIAS VOLTAGE MONITOR



The internal dc bias voltage is monitored by a DVM or an oscilloscope at the EXT INPUT/INT MONITOR connector on the rear panel.

Note

The dc bias voltage monitored at the EXT INPUT/INT MONITOR connector may contain a small ac component.

When the DUT impedance is higher than 100k Ω , the monitored voltage is equal to the dc voltage source voltage, and to the voltage applied to the DUT. These voltages, however, are different when the DUT impedance is less than 100k Ω . The following paragraph describes how to measure the actual bias voltage across the DUT.

1. $R_1/R_2/R_L$ Detection

- (a) Set the TEST SIG LEVEL to LOW.
- (b) Set the LC |Z| range so that the range resistor value will be 100 Ω . Refer to Figure 3-5.
- (c) Set the DC BIAS voltage to +5V on the FREQUENCY/DC BIAS display.
- (d) Connect nothing to the test fixture.

- (e) Set the DC BIAS switch on the front panel to ON.
- (f) Measure the monitor voltage (V_0) at the EXT INPUT/INT MONITOR connector.
- (g) Connect a reference resistor (R_0) (e.g., 100 $\Omega \pm 1\%$) to the test fixture.
- (h) Measure the dc voltages at the HIGH and LOW terminals of the test fixture and at the EXT INPUT/INT MONITOR connector (V_H , V_L , and V_K).

Note

Connect the LOW terminal of the DVM or the oscilloscope to the GUARD terminal of the instrument.

- (i) Calculate the resistances, R_1 , R_2 , and R_L , using the following equations:

$$R_1 = (V_0 - V_K) \cdot R_0 / (V_H - V_L)$$

$$R_2 = (V_K = V_H) \cdot R_0 / (V_H - V_L)$$

$$R_L = V_L \cdot R_0 / (V_H - V_L)$$

Figure 3-32. Internal DC Bias Voltage Monitor (Sheet 1 of 2).

2. Actual Bias Voltage/Current Measurement

- (a) Connect nothing to the test fixture.
- (b) Measure the monitor voltage (V_0).
- (c) Connect the desired sample to the test fixture.
- (d) Measure the monitor voltage (V_M).

- (e) Calculate the actual voltage applied to the DUT (V) or the actual current through the DUT (I) using the following equations:

$$I = (V_0 - V_M)/R_1$$
$$V = V_0 - (R_1 + R_2 + R_L) \cdot I$$

Note

Repeat step 2 each time the DUT is changed since the monitor voltage (V_M) depends on the DUT impedance.

Figure 3-32. Internal DC Bias Voltage Monitor (Sheet 2 of 2).

3-113. OPTION 002 COMPARATOR/HANDLER INTERFACE

3-114. Option 002 equips the standard 4277A with a comparator function and a handler (component sorter) interface capability. The comparator provides go/no-go testing and ten-bin sorting. The handler interface is for control of an automatic component handler.

3-115. Up to nine sets of high/low limits for L, C, or |Z| measurement, and one set of high/low limits for D, Q, ESR, or G measurement can be keyed in from the 16064A keyboard or entered via the HP-IB. When measurement is made, the comparator compares the measured values displayed on DISPLAY A and DISPLAY B with the stored high/low limits. If the measured values fit any set of limits, the bin number for that set is displayed on the FREQUENCY/DC BIAS display. If the measured values do not fit any of the limits, zero (0), the number for the out-of-limits bin, is displayed. Go/no-go decisions are indicated by two sets of LOW/IN/HIGH LED lamps on the 16064A keyboard. Comparator/Handler Interface operation is described in Figures 3-34.

3-116. The 16064A has a 36-pin female Amphenol connector for interfacing with an automatic component handler. The 16064A sends comparison results--LOW/IN/HIGH decisions and bin number--to the handler, and receives control signals via a user-fabricated interface cable constructed using the furnished 36-pin male Amphenol connector (P/N 1251-0084). Pin assignments are given in Figure 3-33. For complete information, refer to the 16064A Operation Note.

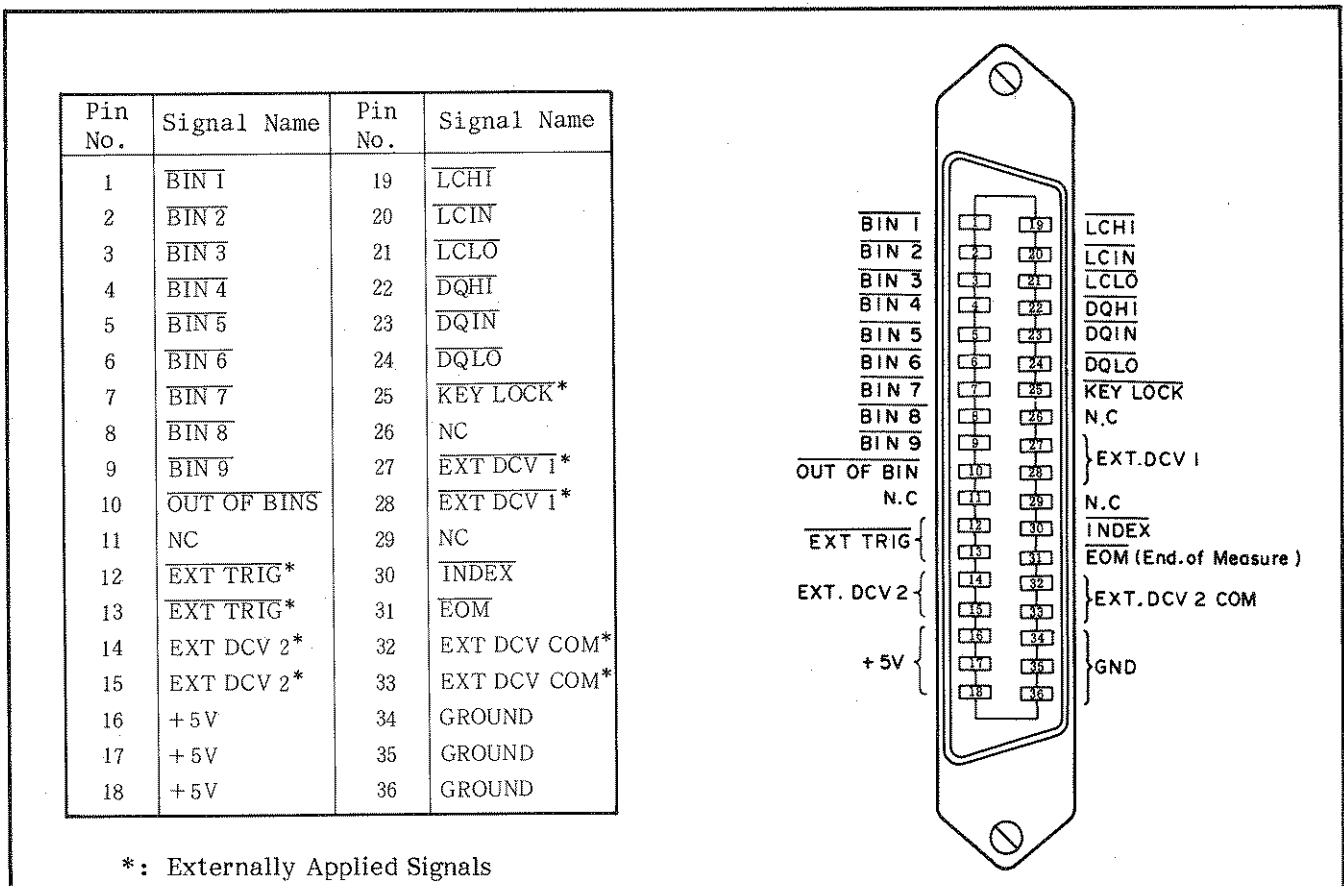
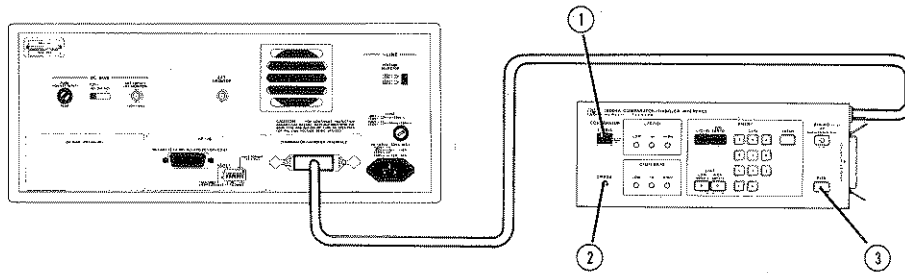


Figure 3-33. Pin Assignments for the Handler Interface Connector (HP 16064A).

OPTION 002 COMPARATOR OPERATION



1. Connect the Model 16064A COMPARATOR/HANDLER INTERFACE to the COMPARATOR/HANDLER INTERFACE connector on the 4277A's rear-panel.
2. Connect the desired test fixture to UNKNOWN terminals.
3. Turn on the instrument.
4. Perform OPEN and SHORT Zero Offset adjustments as described in paragraph 3-51.
5. Set the front panel controls as appropriate for the desired measurement.
6. Press the ENABLE key ① on the 16064A. The LED lamp at the center of the key should come on.

Note

If E16 is displayed or DISPLAY A, press the ERASE button ② on the 16064A to erase previously stored limits.

7. Enter the high/low limits for L/C/|Z| or D/Q/ESR/G.
8. Press the RUN key ③ on the 16064A. The comparator will then begin comparing all measured values with the high/low limits entered in step 6. The appropriate LED lamps—LOW, IN, HIGH—will be lit and the number of the bin whose high/low limits fit the measured values will be displayed on the FREQUENCY/DC BIAS display.

Example:

If the bin limits listed in Tables A and B are entered, the measured values listed in Table C will cause the comparison results shown in Table D.

Note

LOW and HIGH limits are inclusive; that is, if the measured value is exactly equal to the LOW or HIGH limit of a bin, the measured value fits the limits for that bin. Also, if a measured value fits the limits of more than one bin (bin limits overlap), the comparator selects the bin with the lower number. An example follows.

Bin 1: 100pF to 200pF
 Bin 2: 150pF to 250pF
 Measured Value: 190pF
 Selected Bin: Bin 1

Note

If the LOW/HIGH limits for D/Q/ESR/G are not entered, or when the instrument is set to HIGH SPEED L or HIGH SPEED C, the IN lamp for D/Q/ESR/G will be always lit. D/Q/ESR/G comparison is not performed, however.

Figure 3-34. Option 002 Comparator (Sheet 1 of 7).

Table A. Limits for L/C/|Z|

BIN No.	LOW Limit	HIGH Limit
1	1 nF	1.1 nF
2	1.1 nF	1.2 nF
3	1.2 nF	1.3 nF
4	1.3 nF	1.4 nF
5	1.4 nF	1.5 nF
6	2 nF	2.5 nF
7	2.5 nF	3 nF

Table B. Limits for D/Q/ESR/G

LOW Limit	HIGH Limit
.01	.05

Table C. Measured Values

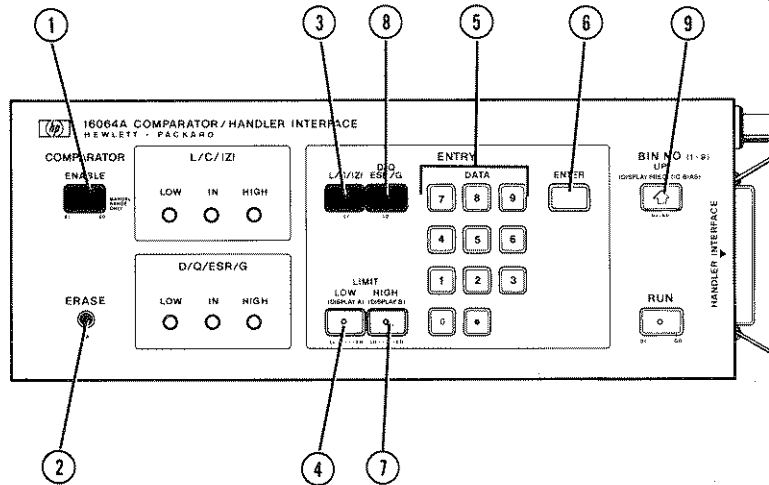
Sample No.	Measured Data	Sample No.	Measured Data
1	C 1.22 nF	6	C 1.1 nF
	D .013		D .02
2	C 1.08 nF	7	C 1.18 nF
	D .005		D .071
3	C .8 nF	8	C 4.1 nF
	D .025		D .033
4	C 2.75 nF	9	C 1.5 nF
	D .06		D .029
5	C .95 nF	10	C 1.72 nF
	D .055		D .025

Table D. Comparison Results

Sample No.	L/C/ Z Lamp	D/Q/ESR/G Lamp	FREQUENCY /DC BIAS Display
	LOW IN HIGH	LOW IN HIGH	
1	● ☉ ●	● ☉ ●	3
2	● ☉ ●	☉ ● ●	0
3	☉ ● ●	● ☉ ●	0
4	● ☉ ●	● ● ☉	0
5	☉ ● ●	● ● ☉	0
6	● ☉ ●	● ☉ ●	1
7	● ☉ ●	● ● ☉	0
8	● ● ☉	● ☉ ●	0
9	● ☉ ●	● ☉ ●	5
10	☉ ● ☉	● ☉ ●	0

Figure 3-34. Option 002 Comparator (Sheet 2 of 7).

COMPARATOR LIMIT SETTING



1. Press the ENABLE key ①. The LED lamp at the center of the key should come on.
2. Press the ERASE button ② to erase previously stored limits. One (1) will be displayed on the FREQUENCY/DC BIAS display.

[L/C/|Z| Limit Entry]

3. Press the L/C/|Z| key ③.
4. Press the LIMIT LOW key ④.
5. Key in the desired LOW limit using the DATA keys ⑤. The LOW limit value will be displayed on DISPLAY A.
6. Press the ENTER key ⑥. The LOW limit will be stored for bin 1. Also, the maximum allowable value that can be entered for the HIGH limit on the present LC|Z| RANGE will be displayed on DISPLAY B.

Note

If the LOW or HIGH limit is higher than the full scale value of the existing LC|Z| RANGE, E18 will be briefly displayed on DISPLAY A when the ENTER key is pressed. Re-enter the limits correctly.

7. Press the LIMIT HIGH key ⑦.

8. Key in the desired HIGH limit using the DATA keys ⑤. The HIGH limit value will be displayed on DISPLAY B.
9. Press the ENTER key ⑥. The HIGH limit will be stored for bin 1.
10. Press the BIN NO UP key ⑨. Two (2) will be displayed on the FREQUENCY/DC BIAS display.
11. Repeat steps 4 through 9 to enter the LOW and HIGH limits for bin 2.
12. Repeat steps 10 and 11 for bins 3 through 9.

[D/Q/ESR/G Limit Entry]

13. Press the D/Q/ESR/G key ⑧.

Note

When D/Q/ESR/G limits are being entered, no bin number is displayed on the FREQUENCY/DC BIAS display.

14. Press the LIMIT LOW key ④.
15. Key in the desired LOW limit using the DATA keys ⑤. The LOW limit value will be displayed on DISPLAY A.

Figure 3-34. Option 002 Comparator (Sheet 3 of 7).

16. Press the ENTER key (6). The LOW limit will be stored. Also, the maximum allowable value that can be entered for the HIGH limit will be displayed on DISPLAY B.

Note

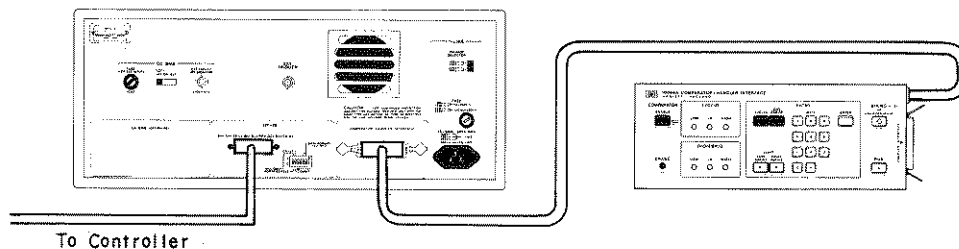
If the LOW or HIGH limit is higher than the full scale value of the existing DISPLAY B range, E18 will be briefly displayed on DISPLAY A when the ENTER key is pressed. Re-enter the limits correctly.

17. Press the LIMIT HIGH key (7).
 18. Key in the desired HIGH limit using the DATA keys (5). The HIGH limit value will be displayed on DISPLAY B.
 19. Press the ENTER Key (6).

Note

Press the ERASE button (2), erases the high/low limits of all bins.

[HP-IB OPERATION]



1. Connect the Model 16064A COMPARATOR/HANDLER INTERFACE to the COMPARATOR/HANDLER INTERFACE connector on the 4277A's rear-panel.
2. Connect the desired test fixture to the UNKNOWN terminals.
3. Turn on the instrument.
4. Perform OPEN and SHORT Zero Offset Adjustments.
5. Set the front panel controls as appropriate for the desired measurement and enable the 16064A via the HP-IB.

* Example of setting C-D measurement, 1nF range, and 100kHz test frequency

```
REMOTE717
CLEAR 717
OUTPUT 717;"A2B1FR100ENR4T2"
OUTPUT 717;"E1ER"
```

6. Enter the LOW/HIGH limits for L/C/|Z| via the HP-IB.

* Example of setting a low limit of .950nF and a high limit = 1.1nF

```
OUTPUT 717;"LL.95ENLH1.1EN"
```

If necessary, enter the limits for the next bin (Bin 2).

Figure 3-34. Option 002 Comparator (Sheet 4 of 7).

* Example of setting bin 2's low limit to 1.1001nF and high limit to 1.2nF

```
OUTPUT 717;"N2"
OUTPUT 717;"LL1.1001ENLH1.2EN"
```

Note

The same setting can be made by the following program :

```
OUTPUT 717;"N2"
OUTPUT 717;"LH1.2EN"
```

7. Enter the limits for D/Q/ESR/G via the HP-IB.

* Example of setting a low limit of .0000 and a high limit of .005

```
OUTPUT 717;"L2"
OUTPUT 717;"LLOENLH.005EN"
```

Note

The same setting can be made by the following program :

```
OUTPUT 717;"L2"
OUTPUT 717;"LH.005EN"
```

Note

Comparator operations can be done without high/low limits for D/Q/ESR/G.

8. Start the comparator operation by HP-IB program.

* Example of starting the comparator operation:

```
OUTPUT 717;"G1"
```

9. Connect the DUT to the test fixture.

10. Trigger the instrument via the HP-IB.

* Example of triggering the instrument :

```
OUTPUT 717;"EX"
```

or

```
TRIGGER 717
```

If necessary, read the comparison results via the HP-IB.

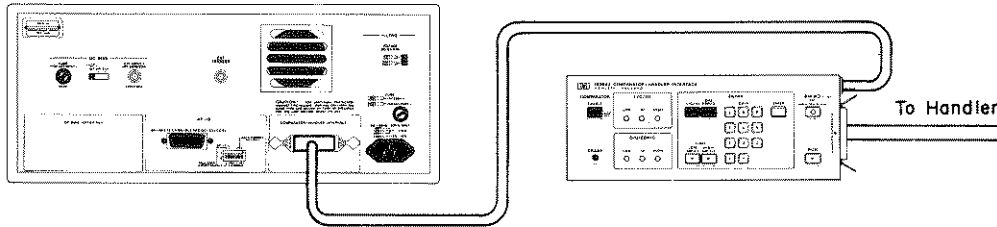
```
ENTER 717;A$
PRINT A$
```

Note

The HP-IB address code in the above examples is 17 (10001).

Figure 3-34. Option 002 Comparator (Sheet 5 of 7).

OPTION 002 HANDLER INTERFACE OPERATION



The 16064A outputs four types of signals to the component handler.

- (1) Comparison result signals ($\overline{\text{LCHI}}$, $\overline{\text{LCIN}}$, $\overline{\text{LCLO}}$, $\overline{\text{DQHI}}$, $\overline{\text{DQIN}}$, $\overline{\text{DQLO}}$)
- (2) Bin number signals ($\overline{\text{BIN1}}$... $\overline{\text{BIN9}}$, $\overline{\text{OUT-OF-BIN}}$)
- (3) DUT change signal ($\overline{\text{INDEX}}$)
- (4) Comparison complete signal ($\overline{\text{EOM}}$)

Type (1) signals correspond to the LOW/IN/HIGH LED lamps on the 16064A keyboard. Type (1) signals are divided into two groups of three. When the signal line corresponding to the lit LED lamp goes LOW, the other signal lines in that group stay HIGH.

Type (2) signals correspond to the bin numbers displayed on the FREQUENCY/DC BIAS display. When the signal line corresponding to the displayed bin number goes LOW, the other signal lines stay HIGH.

The type (3) signal, $\overline{\text{INDEX}}$, goes LOW when the 4277A has completed the analog portion of the measurement. The DUT can be disconnected from the measurement terminals and the next one can be connected. Comparison results, however, are not yet valid.

The type (4) signal, $\overline{\text{EOM}}$, goes LOW when the 4277A has completed the measurement and the comparator has made a judgement. Comparison results are now valid.

All signals are negative true, and all are from TTL open-collector outputs. Pull-up resistors are installed. TTL voltage levels or higher voltages (up to 30V) are possible by changing a few jumper settings inside the 16064A. Refer to the 16064A Operating Note for details.

Signals sent from the external component handler to the 16064A are a trigger signal ($\overline{\text{EXT TRIG}}$) that starts measurement and a key lock signal ($\overline{\text{KEY LOCK}}$) that disables all control keys during comparator operation. To trigger the 4277A, apply a LOW signal (at least 100 μs duration) to the $\overline{\text{EXT TRIG}}$ line. To disable the control keys of the 4277A and 16064A, apply a LOW signal to the $\overline{\text{KEY LOCK}}$ line.

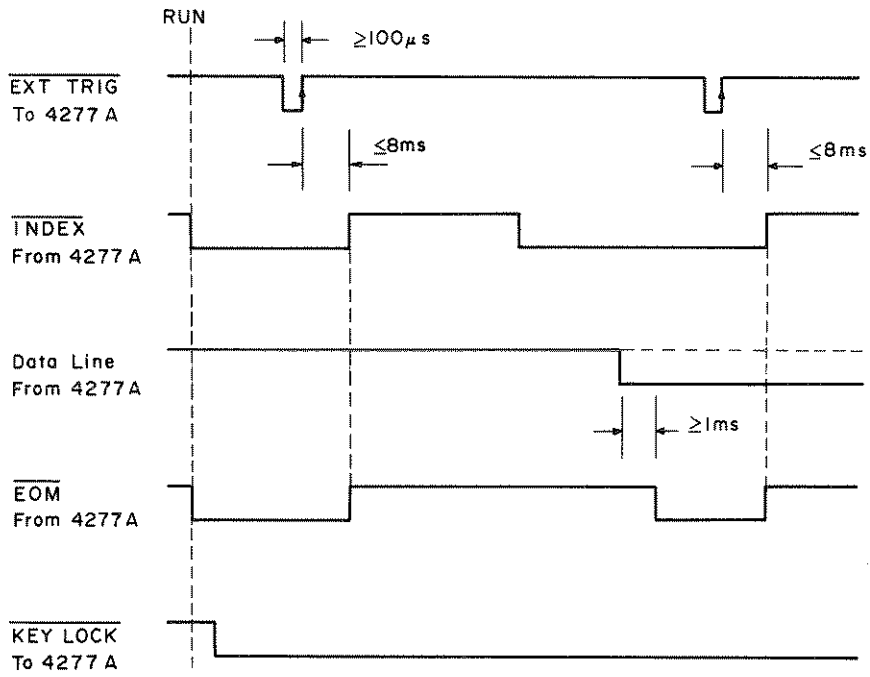
Note

The $\overline{\text{INDEX}}$ and $\overline{\text{KEY LOCK}}$ signals are not mandatory for comparator/handler interface applications.

Note

More information on the Option 002 Handler Interface is given in the 16064A Operating Note.

Figure 3-34. Option 002 Comparator (Sheet 6 of 7).



Timing Diagram

Figure 3-34. Option 002 Comparator (Sheet 7 of 7).



Table 4-1. Recommended Equipment (Sheet 1 of 2)

Equipment	Critical Specifications	Recommended Model/Note	Use*
Digital Voltmeter	Voltage range: 10mV to 100Vf.s. Resolution: 0.1mV Accuracy: 0.05% Input impedance: >10M Ω	HP 3478A	P, A, T
RF Voltmeter	Voltage range: 10mV to 3Vrms f.s. Bandwidth: 10kHz to 1MHz Accuracy: 1%	HP 400E and HP 3403C	P, A
Frequency Counter	Maximum frequency: >1MHz Accuracy: 0.001% Trigger level: Adjustable	HP 5314A	P, A, T
DC Power Supply	Maximum output voltage: >50V Resolution: <100mV	HP 6206B	P
Oscilloscope	Bandwidth: 100MHz Sensitivity: 5mV/DIV	HP 1740A	A, T
Oscillator	Frequency: 1kHz Output voltage: 1mV	HP 652A	T
Signature Analyzer		HP 5004A	T
Test Cables	BNC (m)-to-BNC (m), 61cm long, 1 ea.	HP 11170B	P, A
	BNC (m)-to-BNC (m), 10cm long, 1 ea.		A, T
	BNC (m)-to-BNC (m), 30cm long, 2 ea.	HP 11170A	T
	BNC (m)-to-Dual Banana Plug, 1 ea.	HP 11001A	P, A
	Dual Banana Plug-to-Alligator Clip, 1 ea.	HP 11002A	P, A, T
	BNC (m)-to-Dual Alligator Clip, 10cm long, 2 ea.	Refer to the troubleshooting diagram A2-17.	T
	Alligator Clip-to-Alligator Clip, 20cm long, 1 ea.		T
Adaptors	BNC (f)-to-BNC (f), 5 ea.	HP P/N 1250-0080	P, T
Oscilloscope Probes	10:1 Divider Probe Input impedance: 10M Ω	HP 10004D	A, T
	1:1 probe	HP 10007B	A
Test Leads		HP 16048A	P, T

*P = Performance Test, A = Adjustment, T = Troubleshooting

Table 4-1. Recommended Equipment (Sheet 2 of 2)

Equipment	Critical Specifications	Recommended Model/Note	Use*
Capacitance Standards	1pF±0.03% 10pF±0.03% 100pF±0.03% 1000pF±0.03% Useable frequency: Up to 1MHz	HP 16381A HP 16382A HP 16383A HP 16384A	P, A, T
Resistance Standards	0Ω 10Ω 100Ω±0.03% 1kΩ±0.03% 10kΩ±0.03% 100kΩ±0.03% OPEN termination SHORT termination	HP 16074A Standard Resistor Set	P, A, T
Capacitors	1nF±5%	HP P/N 0160-2218	T
Resistors	4.7Ω±5% 1/4W	HP P/N 0683-0475	T
	560Ω±5% 1/4W	HP P/N 0683-5615	T
	1kΩ±5% 1/2W	HP P/N 0757-0159	T
	10kΩ±1% 1/2W	HP P/N 0757-0839	T
	100kΩ±1% 1/8W	HP P/N 0757-0465	T
HP-IB Controller		HP-85/ w 00085-15003/ w 82936A/ w 82937A	A

*P = Performance Test, A = Adjustment, T = Troubleshooting

SECTION IV PERFORMANCE TESTS

4-1. INTRODUCTION

4-2. This section provides the tests and the procedures used to verify the 4277A specifications listed in Table 1-1. All tests can be performed without access to the interior of the instrument. A simpler operational test is presented in Section III under Self Test. The performance tests can be used when performing incoming inspection of the instrument and when verifying that the instrument meets performance specifications after troubleshooting or adjustment or both. If the performance tests indicate that the instrument is operating outside specified limits, check to see if the controls on the instrument used in the test and the test setup itself are correct and then proceed with adjustments or troubleshooting or both.

Note

To ensure proper test results and instrument operation, Hewlett-Packard recommends a 30-minute warm-up and stabilization period before performing any of the performance tests.

Note

All performance tests except for the HP-IB Interface Test should be performed in an ambient temperature range of $23^{\circ}\text{C} \pm 5^{\circ}\text{C}$.

4-3. EQUIPMENT REQUIRED

4-4. Equipment required to perform all of the performance tests is listed in Table 4-1. Any equipment that satisfies or exceeds the critical specifications listed in the table may be used as a substitute for the recommended models.

Accuracy checks described in this section use the HP 16380A series standard capacitors (16381A, 16382A, 16383A and 16384A) and 16074A Standard Resistor Set. The characteristics of the equipment satisfy the performance requirements for the accuracy checks and are especially suited for use as the 4277A's accuracy test standards.

Note

Components used as standards should be calibrated by an instrument whose specifications are traceable to NBS or an equivalent standards group; or calibrated directly by an authorized calibration organization such as NBS. The calibration cycle should be in accordance with the stability specifications for each component.

4-5. TEST RECORD

4-6. Performance test results can be recorded on the Test Record at the completion of the test. The Test Record is at the end of this section and it lists all the tested specifications and their acceptable limits. Test results recorded at incoming inspection can be used for comparison in periodic maintenance, troubleshooting, and after repair or adjustment.

4-7. CALIBRATION CYCLE

4-8. This instrument requires periodic verification of performance. Depending on the conditions under which the instrument is used, e.g., environmental conditions or frequency of use, the instrument should be checked with the performance tests described here at least once a year. To keep instrument down-time to a minimum and to insure optimum operation, preventive maintenance should be performed at least twice a year.

ACCURACY TEST CONSIDERATIONS

This paragraph discusses how the 4277A accuracy is tested and verified. As the 4277A has wider measurement capabilities in regard to the selectable measurement parameters, frequency, measurement range and accuracy, the performance tests include some critical measuring regions where accuracy is difficult to verify directly by measuring available standards.

Measurement accuracy is tested by measuring standard capacitors, resistors and other reference devices. The standards must have been calibrated and certified by transfer of values of national standards. However, a portion of the measurement range of the 4277A is out of the applicable ranges of the available standards. The method then, is to check accuracies by comparison with references on the specific ranges at which the standards are applicable, and to apply alternative tests for verification of accuracies on the other ranges.

Theoretical Background of Accuracy Checks

The 4277A, in accordance with its measurement principles, determines the vector impedance (or its reciprocal value: admittance) of the unknown device under test. The various measurement data provided, with respect to the 8 selectable measurement parameters (L, C, D, etc.), are arithmetically derived from measured values of the orthogonal vector components (resistance and reactance). For example, the capacitance value of a DUT is calculated by the following equation relative to the capacitance-to-reactance values:

$$C_x = \frac{1}{2\pi f X_m}$$

where, C_x is capacitance value of DUT,
 f is test frequency,
 X_m is measured reactance value of DUT.

As stated above, each measurement parameter is interrelated with the impedance (or admittance) value; consequently, the accuracies on all ranges can be verified if the instrument satisfies specified accuracies for each one of its resistive and reactive measurement parameters; that is, resistance and capacitance from the lowest through the highest test frequencies.

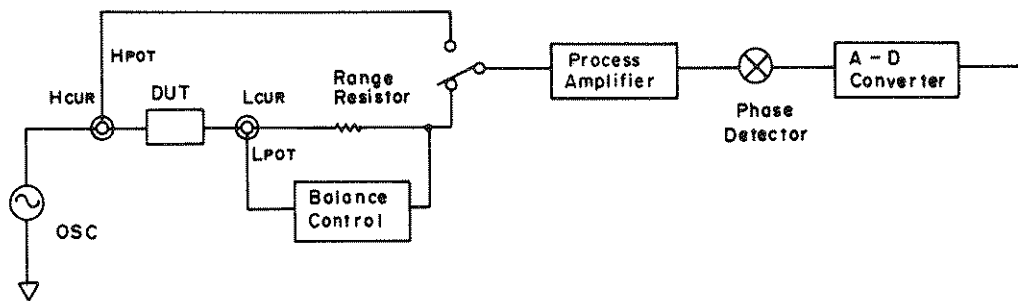
The technician should note that accuracy here is based on arithmetic relationships as are the parameter relationships. Therefore, the accuracy tests can be done by simplified procedures instead of time-consuming tests on the approximately 250000 possible combinations of the fundamental test parameters such as measurement parameter, frequency, and range.

Verification Check Considerations

The measurement accuracy test can be made by using calibrated standards on specific ranges only. On other ranges, which would be uncertifiable because of the limitations of the standards, the test takes the method proven to be theoretically and experimentally practicable for verification of accuracy. If the results of these checks meet all the individual test limits, the instrument should satisfy its specified accuracy across its entire range. How then can these methods be explained? Let us look at the performance test articles.

Accuracy test procedures include checks for the following circuit sections:

- 1) Range Resistors
- 2) Process Amplifier
- 3) Bridge Balance Control
- 4) Phase Detector
- 5) A-D (Analog to Digital) Converter



4277A Measurement Section

CAPACITANCE ACCURACY TEST verifies Range Resistor accuracy for reactive impedance measurements from the lowest through the highest test frequencies. Balance Control linearity and normal operation of the Phase Detector and A-D Converter are also verified.

RESISTANCE ACCURACY TEST is similar to the Capacitance Accuracy test, but for resistive impedance measurements. Thus, accuracy for both reactive and resistive components of the vector impedance is verified.

SELF-OPERATING TEST verifies the accuracy of the Process Amplifier which extends the measurement ranges. The A-D Converter accuracy is also checked by this combined self-test function which enables automatic check of each one of these circuits.

PHASE ACCURACY TEST verifies phase-flatness characteristics (minimum phase shift) of the overall measurement section and Phase Detector phase accuracy from the lowest through the highest test frequencies.

Note

A set of detection phases, each different by 90 degrees, is used in the Phase Detector. If the relative phase difference between the detection phases is exactly 90 degrees, the Phase Detector is operated at the maximum detection accuracy.

The accuracy of the right-angle detection phases is verified by both this test and dissipation factor checks associated with the Capacitance Accuracy Test.

ACCURACY TEST STANDARDS

1) Standard Capacitors

The HP 16380A Series Standard Capacitors, featuring the four terminal pair configuration, are recommended for use as performance test standards. The four standard capacitors, 16381A (1pF), 16382A (10pF), 16383A (100pF) and 16384A (1000pF) are calibrated at 0.01% accuracy at 1kHz (and have capacitances within 0.1% of their nominal values). For values up to 10MHz, an extrapolation of the calibrated values at 1kHz is used. This is based on the careful consideration of their inherent residual parameter values and on the actual test measurement to verify the frequency dependency of the values. Capacitance values at frequencies up to 10MHz are read from the graph given on the data sheet of each standard.

Note

A high capacitance standard, useable in high frequency region, is unavailable. This is because a 10 μ F capacitor, for example, has a low impedance value of 0.16 Ω at 100kHz. A capacitance standard would have, in addition, residual impedance which could not be disregarded when compared to the pure impedance of 0.16 Ω . Thus, an attempt to conduct tests which would use the standard capacitor at the higher operating frequency ranges is not practicable.

2) Standard Resistors

The standard resistors used for accuracy checks should be nearly pure resistances and should maintain an extremely low residual reactance at frequencies to 1MHz. The HP 16074A Standard Resistor Set, especially designed as standards useable over a broad frequency region, with thin film resistors and four terminal pair configurations, is suitable for the accuracy checks. Because of low residual inductance and less skin effect of the thin film resistors, the 16074A provides the standard resistance values of 0 Ω , 0.1 Ω , 1 Ω and 10 Ω at $\pm 10\%$ and 100 Ω , 1k Ω , 10k Ω and 100k Ω at $\pm 0.01\%$ calibration accuracies to 10MHz (1MHz at 100k Ω). Open (OS) and Short terminations, which facilitate optimum zero offset adjustment, and two quasi-inductors are included in the 16074A.

Note

The 0 Ω and 10 Ω resistors are used as the (pure resistance) reference device in the Phase Accuracy Test. The 0.1 Ω , 1 Ω and the quasi-inductors are not used in the 4277A performance tests.

3) Inductance Accuracy Test

The 4277A inductance accuracy is theoretically certified if the capacitance accuracy meets the specifications. Generally, inductors have unwanted parasitic impedances such as coil resistance and distributed capacitance. As these residuals significantly affect the inductance values at high frequencies, inductance standards useable in the RF region above 100kHz are substantially unavailable. Inductors with higher inductance values have lower frequency limits.

GENERAL

The standards should be of four terminal pair configuration design to provide compatibility with the instrument. This minimizes reduction in reliability of the values due to the effects of the residuals associated with cabling and connections.

PERFORMANCE TESTS

4-9. **TEST FREQUENCY ACCURACY TEST**

4-10. This test verifies that test signal frequencies for the 4277A meet the specified frequency accuracy of 0.01 %.

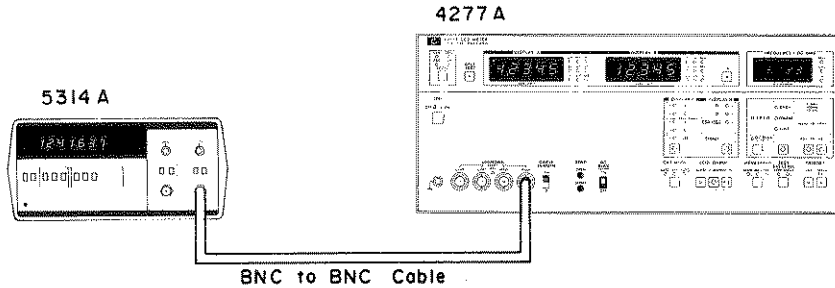


Figure 4-1. Test Frequency Accuracy Test Setup.

EQUIPMENT:

- Frequency Counter HP 5314A
- BNC to BNC cable HP 11170A

PROCEDURE:

1. Connect the frequency counter to the 4277A UNKNOWN HCUR terminal as shown in Figure 4-1.
2. Set the 4277A's controls as follows:
 - TEST SIG LEVEL HIGH
 - DC BIAS switch OFF
 - Test Frequency 10kHz
 - Other controls Any setting
3. Verify that the frequency reading on the 5314A is 10.000kHz±1Hz.
4. Set the test frequency in the sequence given in Table 4-2. Verify that the frequency readings on the 5314A are within the test limits given in the table.

Table 4-2. Test Frequency Accuracy Test

Frequency Setting	Test Limits
10.0kHz	9.999 to 10.001kHz
100kHz	99.99 to 100.01kHz
202kHz	201.98 to 202.02kHz
500kHz	499.95 to 500.05kHz
1.00MHz	0.9999 to 1.0001MHz

Note

- 1) Test limits in the table do not account for tolerance dependent on the specified accuracy of the 5314A.
- 2) If this test fails, the instrument requires troubleshooting.

PERFORMANCE TESTS

4-11. TEST SIGNAL LEVEL ACCURACY TEST

4-12. This test verifies that test signal level for the 4277A meets the specified level accuracy of 10%.

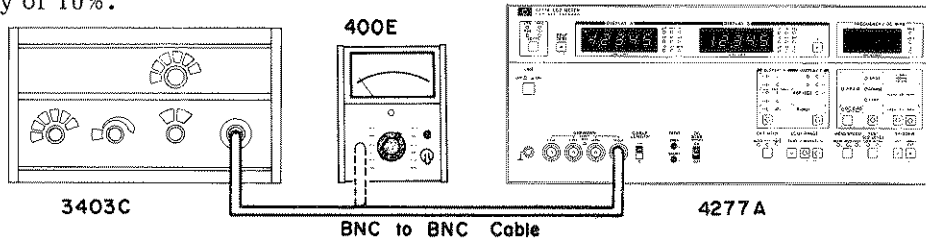


Figure 4-2. Test Signal Level Accuracy Test Setup.

EQUIPMENT:

- RF Voltmeter HP 3403C and HP 400E
- BNC to BNC Cable HP 11170A

Note

Use RF Voltmeter calibrated for frequency response of 10kHz to 1MHz.

PROCEDURE:

1. Connect the 3403C to the 4277A UNKNOWN HCUR terminal as shown in Figure 4-2.
2. Set the RANGE control of the 3403C as appropriate to measure 1Vrms.
3. Set the 4277A's controls as follows:
 - DC BIAS switch OFF
 - Test Frequency 10kHz
 - TEST SIG LEVEL HIGH
 - Other controls Any setting
4. The 3403C should read between 0.9V and 1.1Vrms.
5. Successively change the test frequency setting to 100kHz and 1MHz. The voltage readings on the 3403C should be within the test limits given in Table 4-3.
6. Replace the 3403C with the 400E. Set the TEST SIG LEVEL to LOW.
7. Set the test frequency in accordance with Table 4-3. Verify that the voltage readings on the 400E meet the test limits given in the table.

Table 4-3. Test Signal Level Accuracy Test

Level \ Frequency	Test Limits			Equipment
	10kHz	100kHz	1MHz	
High (1Vrms)	0.9 to 1.1Vrms	0.9 to 1.1Vrms	0.9 to 1.1Vrms	HP 3403C
Low (20mVrms)	17 to 23mVrms	17 to 23mVrms	18 to 22mVrms	HP 400E

PERFORMANCE TESTS

4-13. SELF-OPERATING TEST

4-14. The self-operating test checks operating conditions of the circuits which are critical to maintaining the specified accuracies. To verify that these circuits satisfy the performance requirements for ensuring specified accuracies, the values displayed in the Self Test are compared with test limits. Because basic circuit operating conditions related to accuracy are verified in this test, the instrument should be initially checked with this test.

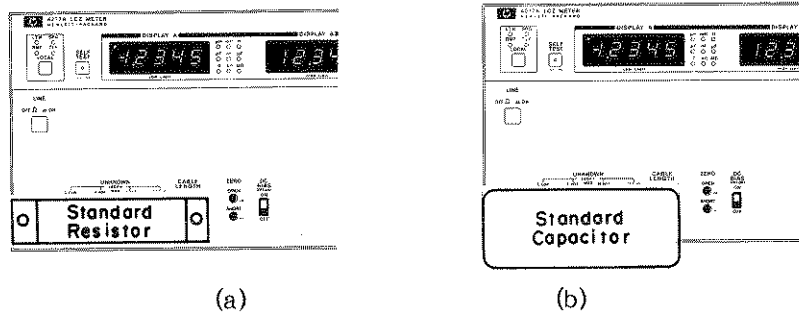


Figure 4-3. Self-Operating Test Setup.

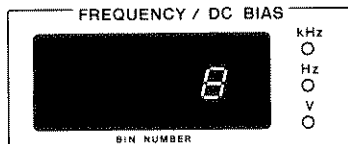
EQUIPMENT:

- Standard Capacitors 10pF: HP 16382A
 100pF: HP 16383A
 1000pF: HP 16384A
- Standard Resistor 100Ω: }
 Termination Open (0S): } HP 16074A Standard Resistor Set

PROCEDURE:

1. Connect Open (0S) termination directly to the 4277A UNKNOWN terminals as shown in Figure 4-3 (a).
2. Set the 4277A's controls as follows:
 - TEST SIG LEVEL HIGH
 - Test Frequency 10kHz
 - MEAS SPEED MED
 - TRIGGER INT
 - DC BIAS switch OFF
 - CABLE LENGTH switch 0
 - Other controls Any setting


3. Press the SELF TEST key and then the FREQUENCY/DC BIAS selector key.
4. Press the FREQUENCY/DC BIAS step control \square (or \square) key several times until self test item number "8" appears in the FREQUENCY/DC BIAS display as shown below:



PERFORMANCE TESTS

5. The values displayed on DISPLAY A and DISPLAY B should be within the following test limits:

DISPLAY A: 0.0020 to 0.0048
 DISPLAY B: -0.0020 to -0.0048

6. Set the test frequency to 100kHz and repeat step 5.
7. Set the test frequency to 1MHz and repeat step 5.
8. Press the FREQUENCY/DC BIAS step control  key to select self test item 9.
9. Press the FREQUENCY/DC BIAS selector key and set the 4277A controls as listed in step 2. Leave the SELF TEST function set to on.
10. The values displayed on DISPLAY A and DISPLAY B should be within the following test limits:

DISPLAY A: -0.9990 to -1.0010
 DISPLAY B: -0.0010 to 0.0010

11. Set the TEST SIG LEVEL and MEAS SPEED in accordance with Table 4-4, and verify that the displayed values are within the test limits given in the table.

Table 4-4. Self-operating Test (Item 9)

Measurement Speed	Test Limits			
	MED		FAST	
Test Signal Level	Display A	Display B	Display A	Display B
High	-1±0.0010	0±0.0010	-1±0.0050	0±0.0050
Low	-1±0.0020	0±0.0020	-1±0.0100	0±0.0100

12. Set the test frequency to 100kHz and 1MHz, and repeat steps 10 and 11 for each frequency.
13. Press the SELF TEST key to release the self test function, and set the 4277A's controls as follows:

Test frequency 1MHz
 TEST SIG LEVEL HIGH
 MEAS SPEED MED
 TRIGGER INT
 DISPLAY A function C
 DISPLAY B function G
 C RANGE 1pF
 DC BIAS switch OFF
 CABLE LENGTH 0
 Other controls Any setting

PERFORMANCE TESTS

14. Set the self test item "3" using the procedure described in steps 3 and 4. The value displayed on the DISPLAY A should be within 0 and -200 counts.
15. Disconnect the Open (0S) termination and connect a 10pF standard capacitor directly to the UNKNOWN terminals as shown in Figure 4-3 (b).
16. Set the DISPLAY B function to "D" and press the LC | Z | RANGE selector key once to select the 10pF range.

Note

To verify the selected range, temporarily release the self test function and read the measured value and unit indicator. Thereafter, reset the self test function and select the test item "3."

17. The value displayed on DISPLAY A should be between 0 and -200 counts.
18. Repeat steps 15, 16 and 17 with the 100pF and 1000pF standard capacitors. Set the range (step 16) as listed in Table 4-5.

Table 4-5. Self-Operating Test (Item 3)

Standard Resistor Capacitor	Function	Range	Test Limits (Display A)
Open (0S)	C-G	1pF	0 to -200 counts
10pF	C-D	10pF	0 to -200 counts
100pF	C-D	100pF	0 to -200 counts
1000pF	C-D	1nF	0 to -200 counts

Note

Only self test items 3, 8 and 9 are used in this test.

PERFORMANCE TESTS

4-15. **OPEN/SHORT TEST**

4-16. This test checks that the Zero Offset function is operating correctly.

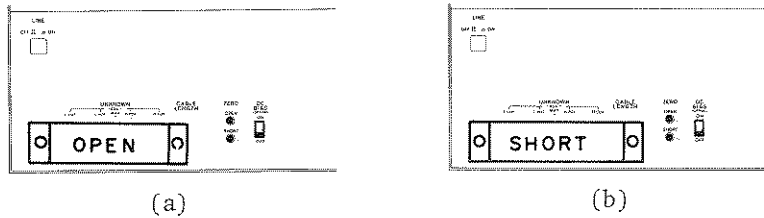


Figure 4-4. Open/Short Test Setups.

EQUIPMENT:

Terminations	Open (0S)	} HP 16074A Standard Resistor Set
	Short	

PROCEDURE:

1. Connect Open (0S) termination directly to the 4277A UNKNOWN terminals as shown in Figure 4-4 (a).
2. Set the 4277A's controls as follows :

DISPLAY A function	C
DISPLAY B function	ESR/G
Test Frequency	10kHz
C RANGE	1nF
TEST SIG LEVEL	HIGH
CIRCUIT MODE	AUTO
MEAS SPEED	MED
TRIGGER	INT
CABLE LENGTH switch	0
DC BIAS switch	OFF

3. Press the ZERO OPEN button to perform "open" offset adjustment and wait approximately 10 seconds. (Offset values are displayed on both DISPLAY A and B.)

4. The values displayed on the 4277A should be within the following test limits:

DISPLAY A: $0 \pm 0.0008nF$
 DISPLAY B: $0 \pm 0.07\mu s$

5. Set the TEST SIG LEVEL and test frequency in accordance with Table 4-6 (a). The values displayed on the 4277A should be within the test limits given in the table.

PERFORMANCE TESTS

6. Connect Short termination directly to 4277A UNKNOWN terminals as shown in Figure 4-6 (b).
7. Press the ZERO SHORT button and wait a few seconds.
8. Set the 4277A's controls as follows:

DISPLAY A function	L
DISPLAY B function	ESR/G
Test Frequency	10kHz
L RANGE	1mH
TEST SIG LEVEL	HIGH
9. The values displayed on the 4277A should be within the following test limits:

DISPLAY A:	$0 \pm 0.0009\text{mH}$
DISPLAY B:	$0 \pm 0.05\Omega$
10. Successively set the TEST SIG LEVEL, test frequency and LC|Z| RANGE in accordance with Table 4-6 (b). The values displayed on the 4277A should be within the test limits given in the table.

Table 4-6 (a). Open/Short Tests (Open)

Test Frequency	Test Limits			
	TEST SIG LEVEL HIGH		TEST SIG LEVEL LOW	
	DISPLAY A	DISPLAY B	DISPLAY A	DISPLAY B
10kHz	$0 \pm 0.0008\text{nF}$	$0 \pm 0.07\mu\text{S}$	$0 \pm 0.0016\text{nF}$	$0 \pm 0.14\mu\text{S}$
20kHz	$0 \pm 0.0013\text{nF}$	$0 \pm 0.11\mu\text{S}$	$0 \pm 0.012\text{nF}$	$0 \pm 0.22\mu\text{S}$
20.2kHz	$0 \pm 0.0017\text{nF}$	$0 \pm 0.0008\text{mS}$	$0 \pm 0.012\text{nF}$	$0 \pm 0.0016\text{mS}$
50.5kHz	$0 \pm 0.0011\text{nF}$	$0 \pm 0.0008\text{mS}$	$0 \pm 0.011\text{nF}$	$0 \pm 0.0016\text{mS}$
100kHz	$0 \pm 0.0008\text{nF}$	$0 \pm 0.0007\text{mS}$	$0 \pm 0.0016\text{nF}$	$0 \pm 0.0014\text{mS}$
200kHz	$0 \pm 0.0013\text{nF}$	$0 \pm 0.0011\text{mS}$	$0 \pm 0.012\text{nF}$	$0 \pm 0.0022\text{mS}$
202kHz	$0 \pm 0.0017\text{nF}$	$0 \pm 0.008\text{mS}$	$0 \pm 0.012\text{nF}$	$0 \pm 0.016\text{mS}$
505kHz	$0 \pm 0.0011\text{nF}$	$0 \pm 0.008\text{mS}$	$0 \pm 0.011\text{nF}$	$0 \pm 0.016\text{mS}$
1MHz	$0 \pm 0.0005\text{nF}$	$0 \pm 0.007\text{mS}$	$0 \pm 0.0010\text{nF}$	$0 \pm 0.014\text{mS}$

Table 4-6 (b). Open/Short Tests (Short)

Test Frequency	L RANGE	Test Limits			
		TEST SIG LEVEL HIGH		TEST SIG LEVEL LOW	
		DISPLAY A	DISPLAY B	DISPLAY A	DISPLAY B
10kHz	1mH	$0 \pm 0.0009\text{mH}$	$0 \pm 0.05\Omega$	$0 \pm 0.0018\text{mH}$	$0 \pm 0.10\Omega$
20kHz	100μH	$0 \pm 0.6\mu\text{H}$	$0 \pm 0.08\Omega$	$0 \pm 1.2\mu\text{H}$	$0 \pm 0.16\Omega$
20.2kHz	100μH	$0 \pm 0.13\mu\text{H}$	$0 \pm 0.08\Omega$	$0 \pm 1.2\mu\text{H}$	$0 \pm 0.16\Omega$
50.5kHz	100μH	$0 \pm 0.11\mu\text{H}$	$0 \pm 0.08\Omega$	$0 \pm 1.1\mu\text{H}$	$0 \pm 0.16\Omega$
100kHz	100μH	$0 \pm 0.09\mu\text{H}$	$0 \pm 0.05\Omega$	$0 \pm 0.18\mu\text{H}$	$0 \pm 0.10\Omega$
200kHz	10μH	$0 \pm 0.06\mu\text{H}$	$0 \pm 0.08\Omega$	$0 \pm 0.12\mu\text{H}$	$0 \pm 0.16\Omega$
202kHz	10μH	$0 \pm 0.013\mu\text{H}$	$0 \pm 0.08\Omega$	$0 \pm 0.12\mu\text{H}$	$0 \pm 0.16\Omega$
505kHz	10μH	$0 \pm 0.011\mu\text{H}$	$0 \pm 0.08\Omega$	$0 \pm 0.11\mu\text{H}$	$0 \pm 0.16\Omega$
1MHz	10μH	$0 \pm 0.009\mu\text{H}$	$0 \pm 0.05\Omega$	$0 \pm 0.018\mu\text{H}$	$0 \pm 0.10\Omega$

PERFORMANCE TESTS

4.17. CAPACITANCE ACCURACY TEST

4-18. This test checks capacitance measurement accuracy for various combinations of test signal frequency, test signal level and cable length. The capacitance accuracy checks are made by connecting a standard capacitor to the instrument and comparing measurement results with the calibrated values of the standard. Accuracies for dissipation factors near zero are also checked in this test.

Capacitance accuracy check ranges (cable length = 0m)

Freq. Range	10kHz	20kHz	20.2kHz	50.5kHz	100kHz	200kHz	202kHz	500kHz	1MHz
1pF	X	X	X	X	X	X			
10pF	X	X							
100pF									
1000pF									

□ Tested range

⊗ Non-applicable range for recommended capacitance standard

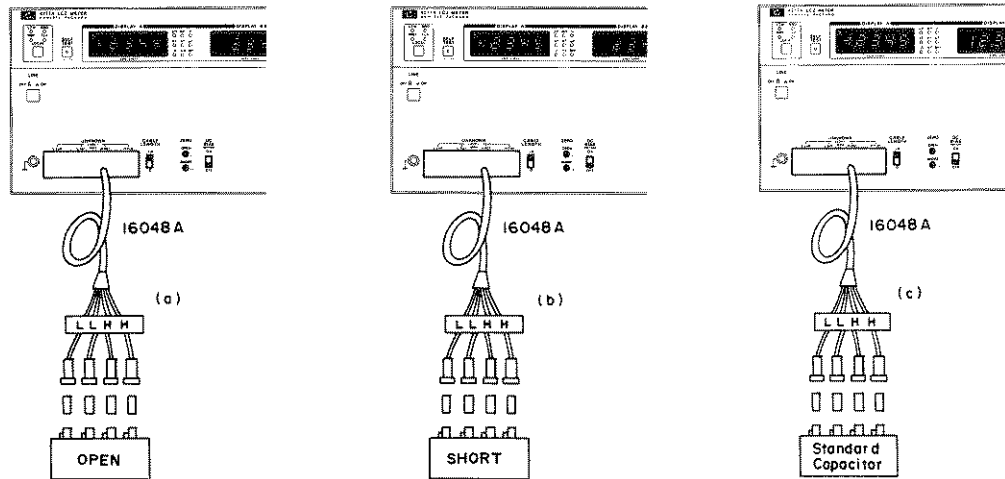


Figure 4-5. Capacitance Accuracy Test Setups (CABLE LENGTH: 1m).

EQUIPMENT:

- Standard Capacitors 1pF: HP 16381A
 10pF: HP 16382A
 100pF: HP 16383A
 1000pF: HP 16384A
- Terminations OPEN (0S) } HP 16074A
 Short } Standard Resistor Set
- Test leads with BNC connector HP 16048A
- BNC (f)-(f) adapter HP P/N 1250-0080 4 ea.

PERFORMANCE TESTS

Note

- 1) Use the BNC (f)-(f) adapters furnished with the HP 16380A standard capacitor set.
- 2) If the 16048A Test Leads are not available, use the 1m Test Leads (HP P/N 16074-61600) furnished with the HP 16074A standard resistor set.

PROCEDURE:

1. Set the 4277A's controls as follows:

DISPLAY A function	C
DISPLAY B function	D
CIRCUIT MODE	AUTO
LC Z RANGE	AUTO
MEAS SPEED	MED
TRIGGER	INT
DC BIAS switch	OFF
CABLE LENGTH switch	0
Other controls	Any setting

Note

If Open/Short Test (paragraph 4-15) has not been performed before doing this test, perform zero offset adjustment as described in steps 1, 3, 6 and 7 of paragraph 4-15.

2. Connect a 1pF standard capacitor directly to the UNKNOWN terminals as shown in Figure 4-3 (b).
3. Set the test frequency and TEST SIG LEVEL in accordance with Table 4-7 (a). Capacitance and dissipation factor readings should be within the test limits given in the table.
4. Change the standard capacitor to 10pF, 100pF and 1000pF in that order and verify that the capacitance readings are within the test limits given in Table 4-7 (a).
5. Set the CABLE LENGTH switch to 1m.
6. Disconnect the standard capacitor and connect the 16048A Test Leads to the UNKNOWN terminals. Connect Open termination as shown in Figure 4-5 (a). Use the BNC (f)-(f) adapters to permit connection of the termination. Press ZERO OPEN button to perform "open" offset adjustment.
7. Disconnect Open termination and connect Short termination as shown in Figure 4-5 (b). Press the ZERO SHORT button to perform "short" offset adjustment.
8. Disconnect Short termination and connect a 1pF standard capacitor as shown in Figure 4-5 (c).
9. Set the test frequency to 1MHz and set the TEST SIG LEVEL in accordance with Table 4-7 (b). Capacitance and dissipation factor readings should be within the test limits given in the table.

PERFORMANCE TESTS

10. Change the standard capacitor to 10pF, 100pF and 1000pF in that order, and verify that the capacitance and dissipation factor readings are within the test limits given in Table 4-7 (b).

Table 4-7 (a). Capacitance Accuracy Tests (CABLE LENGTH = 0)

Test Frequency	Standard Capacitance 1pF			
	TEST SIG LEVEL HIGH		TEST SIG LEVEL LOW	
	C Test Limits	D Test Limits	C Test Limits	D Test Limits
202kHz	C.V.±0.0052pF	0±0.009	C.V.±0.21pF	0±1.0
505kHz	C.V.±0.0046pF	0±0.0040	C.V.±0.21pF	0±0.11
1MHz	C.V.±0.0043pF	0±0.0040	C.V.±0.027pF	0±0.017

C.V. = Calibrated Value of Standard Capacitor

Table 4-7 (a). Capacitance Accuracy Tests (CABLE LENGTH = 0, continued)

Test Frequency	Standard Capacitance 10pF			
	TEST SIG LEVEL HIGH		TEST SIG LEVEL LOW	
	C Test Limits	D Test Limits	C Test Limits	D Test Limits
20.2kHz	C.V.±0.052pF	0±0.009	C.V.±2.1pF	0±1.0
50.5kHz	C.V.±0.046pF	0±0.0040	C.V.±2.1pF	0±0.11
100kHz	C.V.±0.043pF	0±0.0040	C.V.±0.27pF	0±0.017
200kHz	C.V.±0.048pF	0±0.0040	C.V.±2.1pF	0±0.11
202kHz	C.V.±0.027pF	0±0.008	C.V.±0.14pF	0±0.11
505kHz	C.V.±0.021pF	0±0.0022	C.V.±0.13pF	0±0.013
1MHz	C.V.±0.015pF	0±0.0016	C.V.±0.020pF	0±0.0032

C.V. = Calibrated Value of Standard Capacitor

Table 4-7 (a). Capacitance Accuracy Tests (CABLE LENGTH = 0, continued)

Test Frequency	Standard Capacitance 100pF			
	TEST SIG LEVEL HIGH		TEST SIG LEVEL LOW	
	C Test Limits	D Test Limits	C Test Limits	D Test Limits
10kHz	C.V.±0.43pF	0±0.0040	C.V.±2.7pF	0±0.017
20kHz	C.V.±0.48pF	0±0.0040	C.V.±20pF	0±0.11
20.2kHz	C.V.±0.27pF	0±0.079	C.V.±1.4pF	0±0.10
50.5kHz	C.V.±0.21pF	0±0.0022	C.V.±1.3pF	0±0.013
100kHz	C.V.±0.18pF	0±0.0016	C.V.±0.36pF	0±0.0032
200kHz	C.V.±0.23pF	0±0.0026	C.V.±1.3pF	0±0.014
202kHz	C.V.±0.27pF	0±0.008	C.V.±1.4pF	0±0.11
505kHz	C.V.±0.21pF	0±0.0022	C.V.±1.3pF	0±0.013
1MHz	C.V.±0.15pF	0±0.0016	C.V.±0.20pF	0±0.0032

C.V. = Calibrated Value of Standard Capacitor

PERFORMANCE TESTS

Table 4-7 (a). Capacitance Accuracy Tests (CABLE LENGTH = 0, continued)

Test Frequency	Standard Capacitance 1000pF			
	TEST SIG LEVEL HIGH		TEST SIG LEVEL LOW	
	C Test Limits	D Test Limits	C Test Limits	D Test Limits
10kHz	C.V.±0.0018nF	0±0.0016	C.V.±0.0036nF	0±0.0032
20kHz	C.V.±0.0023nF	0±0.0026	C.V.±0.014nF	0±0.014
20.2kHz	C.V.±0.0027nF	0±0.008	C.V.±0.014nF	0±0.11
50.5kHz	C.V.±0.0021nF	0±0.0022	C.V.±0.013nF	0±0.013
100kHz	C.V.±0.0018nF	0±0.0016	C.V.±0.0036nF	0±0.0032
200kHz	C.V.±0.0023nF	0±0.0026	C.V.±0.014nF	0±0.014
202kHz	C.V.±0.0027nF	0±0.008	C.V.±0.014nF	0±0.11
505kHz	C.V.±0.0021nF	0±0.0022	C.V.±0.013nF	0±0.013
1MHz	C.V.±0.0015nF	0±0.0016	C.V.±0.0020nF	0±0.0032

C.V. = Calibrated Value of Standard Capacitor

Table 4-7 (b). Capacitance Accuracy Tests
(CABLE LENGTH = 1m, test frequency = 1MHz)

Standard Capacitor	TEST SIG LEVEL HIGH		TEST SIG LEVEL LOW	
	C Test Limits	D Test Limits	C Test Limits	D Test Limits
1pF	C.V.±0.0083pF	0±0.0050	C.V.±0.035pF	0±0.019
10pF	C.V.±0.020pF	0±0.0019	C.V.±0.030pF	0±0.0038
100pF	C.V.±0.18pF	0±0.0018	C.V.±0.26pF	0±0.0036
1000pF	C.V.±0.0021nF	0±0.0019	C.V.±0.0032nF	0±0.0038

C.V. = Calibrated Value of Standard Capacitor

PERFORMANCE TESTS

4-19. RESISTANCE ACCURACY TEST

4-20. This test checks resistance measurement accuracy for various combinations of test signal frequency and test signal level. The resistance accuracy checks are made by connecting a standard resistor to the instrument and comparing the measurement results with the calibrated values of the standard.

EQUIPMENT:

Standard Resistors	100Ω	} HP 16074A Standard Resistor Set
	1kΩ	
	10kΩ	
	100kΩ	
Terminations	OPEN (0S)	
	Short	

PROCEDURE:

1. Set the 4277A's controls as follows:

DISPLAY A and B function	Z - θ
CIRCUIT MODE	AUTO
LC Z RANGE	AUTO
MEAS SPEED	MED
TRIGGER	INT
DC BIAS switch	OFF
CABLE LENGTH switch	0
Other controls	Any setting

2. Perform Open and Short zero offset adjustments as described in steps 1, 3, 6 and 7 of paragraph 4-15.
3. Connect the 100Ω standard resistor directly to the UNKNOWN terminals as shown in Figure 4-3 (a).
4. Set test frequency and TEST SIG LEVEL in accordance with Table 4-8. Absolute values of the impedance readings should be within the test limits given in the table.
5. Change the standard resistor to 1kΩ, 10kΩ and 100kΩ in that order, and verify that the impedance readings are within the test limits given in Table 4-8.

PERFORMANCE TESTS

Table 4-8. Resistance Accuracy Tests

Standard Resistor	Test Limits			
	100 Ω		1k Ω	
LEVEL FREQ.	HIGH	LOW	HIGH	LOW
10kHz	C.V. $\pm 0.15\Omega$	C.V. $\pm 1.2\Omega$	C.V. $\pm 0.006k\Omega$	C.V. $\pm 0.012k\Omega$
20kHz	C.V. $\pm 0.15\Omega$	C.V. $\pm 1.2\Omega$	C.V. $\pm 0.006k\Omega$	C.V. $\pm 0.012k\Omega$
50.5kHz	C.V. $\pm 0.15\Omega$	C.V. $\pm 1.2\Omega$	C.V. $\pm 0.006k\Omega$	C.V. $\pm 0.012k\Omega$
100kHz	C.V. $\pm 0.15\Omega$	C.V. $\pm 0.30\Omega$	C.V. $\pm 0.006k\Omega$	C.V. $\pm 0.012k\Omega$
200kHz	C.V. $\pm 0.15\Omega$	C.V. $\pm 0.30\Omega$	C.V. $\pm 0.006k\Omega$	C.V. $\pm 0.012k\Omega$
505kHz	C.V. $\pm 0.15\Omega$	C.V. $\pm 0.30\Omega$	C.V. $\pm 0.006k\Omega$	C.V. $\pm 0.012k\Omega$
1MHz	C.V. $\pm 0.15\Omega$	C.V. $\pm 0.30\Omega$	C.V. $\pm 0.006k\Omega$	C.V. $\pm 0.012k\Omega$

C.V. = Calibrated Value of Standard Resistor

Table 4-8. Resistance Accuracy Tests (continued)

Standard Resistor	Test Limits			
	10k Ω		100k Ω	
LEVEL FREQ.	HIGH	LOW	HIGH	LOW
10kHz	C.V. $\pm 0.06k\Omega$	C.V. $\pm 0.12k\Omega$	C.V. $\pm 0.6k\Omega$	C.V. $\pm 1.2k\Omega$
20kHz	C.V. $\pm 0.06k\Omega$	C.V. $\pm 0.12k\Omega$	C.V. $\pm 0.6k\Omega$	C.V. $\pm 1.2k\Omega$
50.5kHz	C.V. $\pm 0.06k\Omega$	C.V. $\pm 0.12k\Omega$	C.V. $\pm 0.6k\Omega$	C.V. $\pm 1.2k\Omega$
100kHz	C.V. $\pm 0.06k\Omega$	C.V. $\pm 0.12k\Omega$	C.V. $\pm 0.6k\Omega$	C.V. $\pm 1.2k\Omega$
200kHz	C.V. $\pm 0.06k\Omega$	C.V. $\pm 0.12k\Omega$	—————	—————
505kHz	C.V. $\pm 0.06k\Omega$	C.V. $\pm 0.12k\Omega$	—————	—————
1MHz	C.V. $\pm 0.06k\Omega$	C.V. $\pm 0.12k\Omega$	—————	—————

C.V. = Calibrated Value of Standard Resistor

PERFORMANCE TESTS

4-21. **PHASE ACCURACY TEST**

4-22. This test checks to the accuracy of phase measurements over the full frequency range. The phase accuracy test is made by connecting a resistor with extremely low reactive elements and by reading the displayed phase angle (almost zero) to verify that the impedance vector (phase angle) of the DUT has been accurately detected.

EQUIPMENT:

Standard Resistors	10Ω	} HP 16074A
	0Ω	
Termination	OPEN (0S)	} Set

Note

The resistors used as references in this test have been designed to maintain an extremely low (residual) reactance at frequencies up to 1MHz. The 0Ω termination has been specially designed for use with the 0.1Ω, 1Ω, and 10Ω standard resistors and provides an optimum termination impedance for the "short" offset adjustment to be made before performing tests with these standards.

PROCEDURE:

1. Set the 4277A's controls as follows:

DISPLAY A function	Z
CIRCUIT MODE	AUTO
LC Z RANGE	AUTO
MEAS SPEED	MED
TRIGGER	INT
CABLE LENGTH switch	0
DC BIAS switch	OFF
Other controls	Any setting

2. Perform OPEN and SHORT zero offset Adjustment as described in steps 1, 3, 6 and 7 of paragraph 4-15.

Note

Be sure to use the OPEN and 0Ω termination of the 16074A for zero offset Adjustment. DO NOT use the Short termination.

3. Disconnect the 0Ω termination and connect the 10Ω standard Resistor directly to the UNKNOWN terminals.
4. Set the test frequency and TEST SIG LEVEL in accordance with Table 4-9. Phase angle readings should be within the test limits given in the table.

PERFORMANCE TESTS

Table 4-9. Phase Accuracy Tests

Test Frequency	Phase (DISPLAY B) Test Limits	
	TEST SIG LEVEL HIGH	TEST SIG LEVEL LOW
10kHz	0±0.52 deg.	0±1.4 deg.
20kHz	0±0.52 deg.	0±1.4 deg.
50.5kHz	0±0.52 deg.	0±1.4 deg.
100kHz	0±0.52 deg.	0±1.4 deg.
200kHz	0±0.52 deg.	0±1.4 deg.
505kHz	0±0.52 deg.	0±1.4 deg.
1MHz	0±0.52 deg.	0±1.4 deg.

4-23. **INT DC BIAS VOLTAGE ACCURACY TEST (OPTION 001)**

4-24. This test verifies that Option 001 Internal DC BIAS Supply applies the specified bias voltages to the device under test.

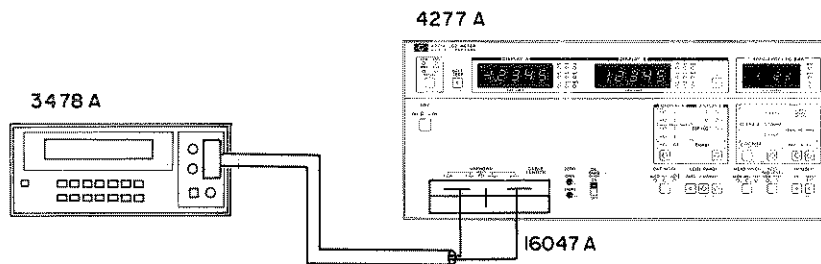


Figure 4-6. Option 001 INT DC Bias Accuracy Test Setup.

EQUIPMENT:

DC Voltmeter HP 3478A
 Test Fixture HP 16047A

PROCEDURE:

1. Interconnect the 4277A, 16047A, and 3478A as shown in Figure 4-6.

Note

Do not connect a DUT to the 16047A.

CAUTION

BEFORE OPERATING DC BIAS SWITCH, VERIFY THAT DC BIAS VOLTAGE IS SET TO ZERO VOLTS.

PERFORMANCE TESTS

2. Set the 4277A's controls as follows :

- DC BIAS selector switch (rear panel) INT (OPTION 001)
- DC BIAS switch (front panel) ON
- TEST SIG LEVEL LOW
- Other controls Any setting

3. Set the dc bias voltage in accordance with Table 4-10. The voltage readings on the 3478A should be within the test limits given in the table.

Table 4-10. INT DC Bias Voltage Test Limits

DC Bias Setting	Test Limits
-0.01V	0.1mV to -20.1mV
6.82V	6.7895V to 6.8505V
-9.99V	-9.8801V to -10.0999V
10V	9.915V to 10.085V
-12.7V	-12.538V to -12.862V
40V	39.765V to 40.235V
-40V	-39.565V to -40.435V

PERFORMANCE TESTS

4-25. **16064A COMPARATOR/HANDLER INTERFACE TEST (OPTION 002)**

4-26. This test verifies the functions of the 16064A Comparator/Handler Interface.

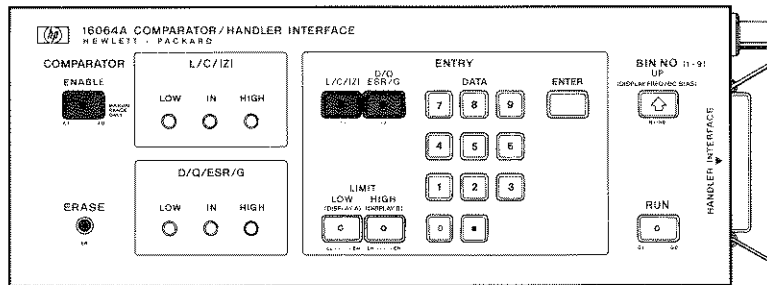


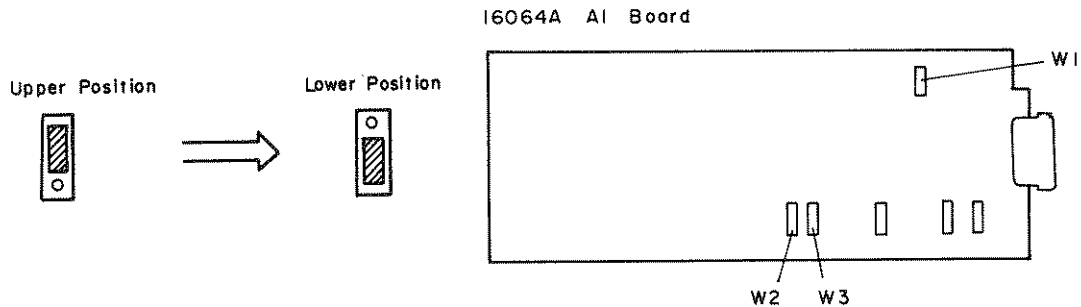
Figure 4-7. 16064A Comparator/Handler Interface.

EQUIPMENT:

- Digital Multimeter HP 3478A
- 100kΩ Standard resistor HP 16074A
- 1000pF Standard capacitor HP 16384A

PROCEDURE:

1. Set jumpers A1 W1/W2/W3 in the 16064A to the lower position as shown below:



2. Connect the 16064A to the COMPARATOR/HANDLER INTERFACE connector on the rear panel of the 4277A.
3. Turn on the 4277A. "16064" should be displayed on DISPLAY B.
4. Set the 4277A's controls as follows:

- DISPLAY A/B functions C-G
- Test Frequency 1.00kHz
- DC BIAS OFF
- CKT MODE
- LC | Z | RANGE 1nF
- MEAS SPEED MED
- TEST SIG LEVEL HIGH
- TRIGGER INT

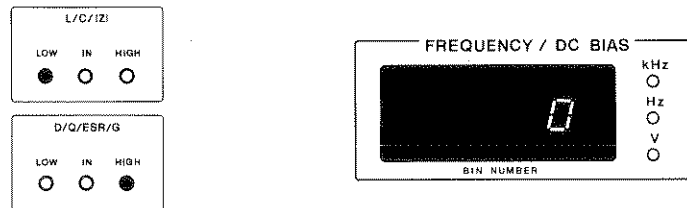
- Set the 3478A's controls as follows :

Function DCV
 RANGE 300V
 Display 3 1/2 digits

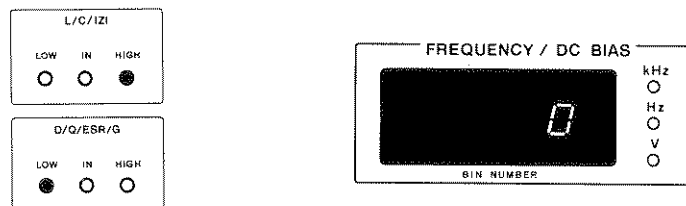
- Connect the 3478A's LO input to the 4277A's GUARD terminal.
- Press the 16064A's ERASE key and set the following comparator limits :

L/C/|Z| LOW LIMIT (BIN1) : .3
 L/C/|Z| HIGH LIMIT (BIN1) : .9
 D/Q/ESR/G LOW LIMIT : 2
 D/Q/ESR/G HIGH LIMIT : 8

- Connect the 100kΩ standard resistor to the 4277A's UNKNOWN terminals.
- Press the RUN key on the 16064A's control panel.
- Verify that the L/C/|Z| LOW and D/Q/ESR/G HIGH lamps light, and "0" is displayed on the 4277A's FREQUENCY/DC BIAS DISPLAY.



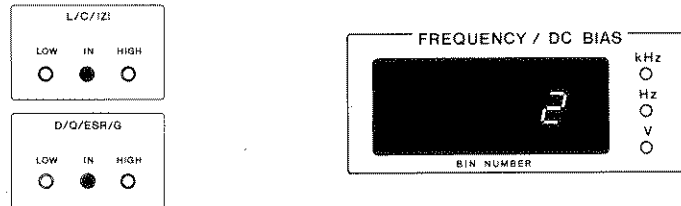
- Check the states of the comparison data output (TTL) at the HANDLER INTERFACE connector using the 3478A. The pin assignments and the data states are shown in Figure 4-8 and Table 4-11.
- Disconnect the 100kΩ resistor and connect a 1000pF standard capacitor.
- Verify that the L/C/|Z| HIGH and D/Q/ESR/G LOW lamps light, and "0" is displayed on the 4277A's FREQUENCY/DC BIAS DISPLAY.



PERFORMANCE TESTS

14. Check the comparison data output at the HANDLER INTERFACE connector by comparing it with the Data States shown in Table 4-11.
15. Press the ERASE key and set the following comparator limits:

L/C/ Z HIGH LIMIT	BIN1: .9
	BIN2: 1.1
	BIN3: 1.9999
D/Q/ESR/G HIGH LIMIT:	.1
16. Press the RUN key on the 16064A's control panel.
17. Verify that the L/C/|Z| IN and D/Q/ESR/G IN lamps light, and "2" is displayed on the 4277A's FREQUENCY/DC BIAS DISPLAY.



18. Check the comparison data output at the HANDLER INTERFACE connector by comparing it with the Data States shown in Table 4-11.

Table 4-11. Handler Interface Output Data States

TEST STEP	Connector Pin Numbers															
	1	2	3	4	5	6	7	8	9	10	19	20	21	22	23	24
10	H	H	H	H	H	H	H	H	H	L	H	H	L	L	H	H
13	H	H	H	H	H	H	H	H	H	L	L	H	H	H	H	L
17	H	L	H	H	H	H	H	H	H	H	H	L	H	H	L	H

H: Approximately 5V
L: Approximately 0V

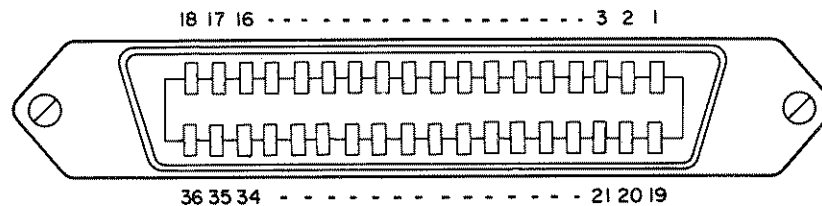


Figure 4-8. Handler Interface Connector Pin Assignments.

PERFORMANCE TESTS

4-27. **HP-IB INTERFACE TEST**

4-28. This test verifies the instrument's HP-IB capabilities.

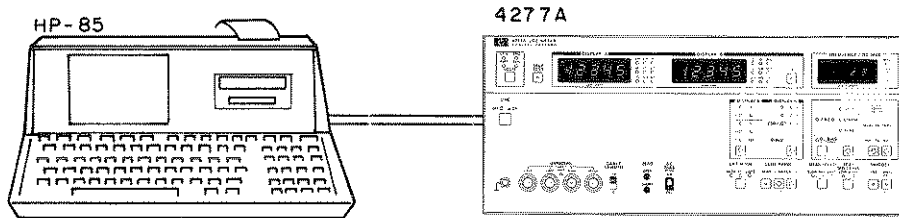


Figure 4-9. HP-IB Interface Test Setup.

EQUIPMENT:

Personal Computer	HP-85
I/O ROM	HP 00085-15003
ROM Drawer	HP 82936A
HP-IB Interface	HP 82937A
100pF Standard	HP 16383A

PROCEDURE:

1. Turn off the 4277A and the HP-85 off.
2. Connect the 82937A HP-IB Interface between the HP-85 and the 4277A as shown in Figure 4-9, and install the I/O ROM in the ROM Drawer of the HP-85.
3. Set the 4277A's HP-IB Control Switch, located on the rear panel, as follows:

bits 5-1	:	10001 (17 ₁₀)
bit 6	:	0
bit 7	:	0
4. Turn on the 4277A and the HP-85.
5. Load one of the three test programs into the personal computer. Test programs are listed on pages 4-26, and 4-28 and 4-30.
6. Execute the program and follow the prompts and instructions that are output by the HP-85. Details on the controller's (personal computer) instructions and the appropriate operator response are given in Tables 4-12 through 4-14.

PERFORMANCE TESTS

TEST PROGRAM 1

PURPOSE:

This test verifies that the 4277A has the following HP-IB capabilities:

- (1) Remote/Local Capability
- (2) Local Lockout
- (3) Talk Disable
- (4) Listen Disable

PROGRAM LISTING:

```

10 ! 4277A HP-IB TEST No.1
20 ! REMOTE/LOCAL TEST
30 DIM A$(1)
40 N=0 @ M=7 @ M1=717
50 S=SPOLL(M1)
60 CLEAR
70 PRINT "*** 4277A HP-IB TEST No.1 ***"
80 DISP "REMOTE/LOCAL TEST"
90 REMOTE M
100 OUTPUT M1 ;"T1"
110 DISP "LISTEN=1,TALK=0,REMOTE=1"
120 GOSUB 580
130 ABORTIO M
140 DISP "LISTEN=0,TALK=0,REMOTE=1"
150 GOSUB 580
160 LOCAL M
170 DISP "LISTEN=0,TALK=0,REMOTE=0"
180 GOSUB 580
190 REMOTE M1
200 DISP "LISTEN=1,TALK=0,REMOTE=1"
210 GOSUB 580
220 LOCAL LOCKOUT M
230 DISP "PRESS LOCAL KEY"
240 DISP "LISTEN=1,TALK=0,REMOTE=1"
250 GOSUB 580
260 LOCAL M1
270 DISP "LISTEN=1,TALK=0,REMOTE=0"
280 GOSUB 580
290 REMOTE M1
300 OUTPUT M1 ;"T1"
310 DISP "LISTEN=1,TALK=0,REMOTE=1"
320 GOSUB 580
330 IF N=1 THEN 340 ELSE 370
340 PRINT "REMOTE/LOCAL TEST FAIL"
350 DISP "REMOTE/LOCAL TEST FAIL"
360 GOTO 390
370 PRINT "REMOTE/LOCAL TEST PASS"
380 DISP "REMOTE/LOCAL TEST PASS"
390 N=0
400 DISP "LISTEN/TALK TEST"
410 ENTER M1 ; A
420 DISP "LISTEN=0,TALK=1,REMOTE=1"
430 GOSUB 580
440 OUTPUT M1 ;"T1"
450 DISP "LISTEN=1,TALK=0,REMOTE=1"
460 GOSUB 580
470 IF N=1 THEN 480 ELSE 510
480 PRINT "LISTEN/TALK TEST FAIL"
490 DISP "LISTEN/TALK TEST FAIL"
500 GOTO 530
510 PRINT "LISTEN/TALK TEST PASS"
520 DISP "LISTEN/TALK TEST PASS"
530 PRINT "END"
540 DISP "END"
550 CLEAR M
560 LOCAL M
570 END
580 INPUT A$
590 IF A$="N" THEN N=1
600 RETURN

```

PERFORMANCE TESTS

Table 4-12. Controller Instructions and Operator Responses for Test Program 1

Controller Instructions		Operator Response
Displays	Printout	
	*** 4277A HP-IB TEST NO.1 ***	
REMOTE/LOCAL TEST		
LISTEN=1*, TALK=0, REMOTE=1 LISTEN=0, TALK=0, REMOTE=1 LISTEN=0, TALK=0, REMOTE=0 LISTEN=1, TALK=0, REMOTE=1		If the 4277A HP-IB Status Indicators and Controller Display are the same, press <input type="checkbox"/> Y , and <input type="checkbox"/> END LINE . If not, press <input type="checkbox"/> N , and <input type="checkbox"/> END LINE .
PRESS LOCAL KEY		Press Local Key.
LISTEN=1, TALK=0, REMOTE=1 LISTEN=1, TALK=0, REMOTE=1 LISTEN=1, TALK=0, REMOTE=1		If the 4277A HP-IB Status Indicators and Controller Display are the same, press <input type="checkbox"/> Y , and <input type="checkbox"/> END LINE . If not, press <input type="checkbox"/> N , and <input type="checkbox"/> END LINE .
REMOTE/LOCAL TEST PASS	REMOTE/LOCAL TEST PASS	If all steps are correct, this message is output.
REMOTE/LOCAL TEST FAIL	REMOTE/LOCAL TEST FAIL	If any step fails, this message is output.
LISTEN/TALK TEST		
LISTEN=0, TALK=1, REMOTE=1 LISTEN=1, TALK=0, REMOTE=1		If the 4277A HP-IB Status Indicators and Controller Display are the same, press <input type="checkbox"/> Y , and <input type="checkbox"/> END LINE . If not, press <input type="checkbox"/> N , and <input type="checkbox"/> END LINE .
LISTEN/TALK TEST PASS	LISTEN/TALK TEST PASS	If both steps are correct, this message is output.
LISTEN/TALK TEST FAIL	LISTEN/TALK TEST FAIL	If any step fails, this message is output.
END	END	

*1 indicates ON; 0 indicates OFF.

PERFORMANCE TESTS

TEST PROGRAM 2

PURPOSE:

This test verifies that the 4277A has the following HP-IB capabilities:

- (1) Talker
- (2) Device Trigger

PROGRAM LISTING:

```

10 ! 4277A HP-IB TEST No.2
20 ! TALKER TEST
30 DIM A$(100),B$(11)
40 M=7 @ M1=717
50 S=SFOLL(M1)
60 PRINT "*** 4277A HP-IB TEST No.2 ***"
70 CLEAR
80 DISP "TALKER TEST"
90 DISP "CONNECT 100pF"
100 BEEP
110 PAUSE
120 DISP "DATA OUTPUT TEST"
130 REMOTE M
140 ABORTIO M
150 CLEAR M1
160 OUTPUT M1 ;"A2B1F1T2"
170 DISP "TEST FREQUENCY IN kHz ";
180 INPUT F
190 OUTPUT M1 ;"FR",F,"EN"
200 TRIGGER M1
210 ENTER M1 ; A,B
220 DISP A*1.E12;"pF",B
230 DISP "IS OUTPUT DATA CORRECT (Y or N) ";
240 INPUT B$
250 IF B$="N" THEN 260 ELSE 290
260 PRINT "DATA OUTPUT TEST FAIL"
270 DISP "DATA OUTPUT TEST FAIL"
280 GOTO 310
290 PRINT "DATA OUTPUT TEST PASS"
300 DISP "DATA OUTPUT TEST PASS"
310 DISP "COMPLETE DATA OUTPUT TEST"
320 TRIGGER M1
330 ENTER M1 ; A$
340 DISP A$
350 DISP "IS OUTPUT DATA CORRECT (Y or N) ";
360 INPUT B$
370 IF B$="N" THEN 380 ELSE 410
380 PRINT "COMPLETE DATA OUTPUT TEST FAIL"
390 DISP "COMPLETE DATA OUTPUT TEST FAIL"
400 GOTO 430
410 PRINT "COMPLPETE DATA OUTPUT TEST PASS"
420 DISP "COMPLETE DATA OUTPUT TEST PASS"
430 PRINT "END"
440 DISP "END"
450 CLEAR M
460 LOCAL M
470 END

```

PERFORMANCE TESTS

Table 4-13. Controller Instructions and Operator Responses for Test Program 2

Controller Instructions		Operator Responses
Displays	Printout	
	*** 4277A HP-IB TEST No.2 ***	
TALKER TEST		
CONNECT 100pF		Connect the 16383A (100pF Standard) to the UNKNOWN terminals.
DATA OUTPUT TEST TEST FREQUENCY IN kHz ?		Key in desired test frequency value, from 10 to 1000, and press END LINE .
[Capacitance] [Dissipation Factor] IS OUTPUT DATA CORRECT (Y or N) ?		If the output data is the same as the values displayed on each 4277A display, press Y and END LINE . If not, press N and END LINE .
	DATA OUTPUT TEST PASS	DATA OUTPUT TEST result.
	DATA OUTPUT TEST FAIL	
COMPLETE DATA OUTPUT TEST		
PNC[Capacitance],ND[Dissipation Factor] IS OUTPUT DATA CORRECT (Y or N) ?		If the output data is the same as the left values, press Y and END LINE . If not, press N and END LINE .
	COMPLETE DATA OUTPUT TEST PASS	COMPLETE DATA OUTPUT TEST result.
	COMPLETE DATA OUTPUT TEST FAIL	
	END	

PERFORMANCE TESTS

TEST PROGRAM 3

PURPOSE:

This test program verifies that the 4277A has the following HP-IB capabilities:

- (1) Service Request
- (2) Serial Poll

PROGRAM LISTING:

```

10 ! 4277A HP-IB TEST No.3
20 ! SRQ TEST
30 S=0 @ M=7 @ M1=717
40 ON INTR 7 GOSUB 560
50 CLEAR
60 PRINT "*** 4277A HP-IB TEST No.3 ***"
70 PRINT "SRQ TEST"
80 DISP "SRQ TEST"
90 REMOTE M
100 ABORTIO M
110 CLEAR M1
120 DISP "DATA READY SRQ TEST"
130 OUTPUT M1 ;"D1T2"
140 TRIGGER M1
150 GOSUB 480
160 PRINT "DATA READY SRQ TEST PASS"
170 S=0
180 DISP "SYNTAX ERROR SRQ TEST"
190 OUTPUT M1 ;"D0A6DA"
200 GOSUB 480
210 PRINT "SYNTAX ERROR SRQ TEST PASS"
220 S=0
230 DISP "SELF TEST END SRQ TEST"
240 OUTPUT M1 ;"S1"
250 DISP "SELF TEST in progress"
260 GOSUB 480
270 IF BIT(S,2)=0 THEN GOSUB 480
280 OUTPUT M1 ;"S0"
290 PRINT "SELF TEST END SRQ TEST PASS"
300 S=0
310 DISP "TRIGGER TOO FAST SRQ TEST"
320 DISP "MOMENTARILY GROUND"
330 DISP "EXT TRG CONNECTOR"
340 GOSUB 510
350 GOSUB 480
360 PRINT "TRG TOO FAST SRQ TEST PASS"
370 S=0
380 DISP "OPERATIONAL ERROR SRQ TEST"
390 OUTPUT M1 ;"N1N2"
400 GOSUB 480
410 PRINT "OPERATIONAL ERROR SRQ TEST PASS"
420 PRINT "SRQ TEST END"
430 CLEAR M1
440 ABORTIO M
450 LOCAL M
460 DISP "END"
470 END
480 ENABLE INTR 7;8
490 IF S>0 THEN DISP S @ RETURN
500 GOTO 480
510 OUTPUT M1 ;"F1T2DA"
520 TRIGGER M1
530 ENTER M1 ; A,B
540 IF S=0 THEN 510
550 RETURN
560 S=SPDLL(M1) @ STATUS 7,1 ; 2
570 IF BIT(S,6)=1 THEN 590
580 DISP "OTHER DEVICE SRQ"
590 ENABLE INTR 7;8
600 RETURN

```

PERFORMANCE TESTS

Table 4-14. Controller Instructions and Operator Responses for Test Program 3

Controller Instructions		Operator Response
Displays	Printout	
	*** 4277A HP-IB TEST No.3 ***	
SRQ TEST	SRQ TEST	
DATA READY SRQ TEST 65	DATA READY SRQ TEST PASS	SRQ Status Byte data should be 65 [=01000001].
SYNTAX ERROR SRQ TEST 66	SYNTAX ERROR SRQ TEST PASS	SRQ Status Byte data should be 66 [=01000010].
SELF TEST END SRQ TEST SELF TEST in progress 68	SELF TEST END SRQ TEST PASS	SRQ Status Byte data should be 68 [=01000100]. If the instrument fails SELF TEST, it should be 84 [=01010100].
TRIGGER TOO FAST SRQ TEST MOMENTARILY GROUND EXT TRG CONNECTOR 72* ¹	TRG TOO FAST SRQ TEST PASS	Ground EXT TRG Connector on rear panel momentarily. SRQ Status Byte data should be 72 [=01001000].
OPERATIONAL ERROR SRQ TEST 80* ²	OPERATIONAL ERROR SRQ TEST PASS	SRQ Status Byte data should be 80 [=01010000].
	SRQ TEST END	

*₁: SRQ Status Byte data may be 73 [=01001001] due to the timing of connecting the EXT TRG pin to ground.

*₂: SRQ Status Byte data may be 81 [=01010001] due to the timing of connecting the EXT TRG pin to ground.

PERFORMANCE TEST RECORD

Hewlett-Packard

Model 4277A
LCZ METER

Serial Number _____

Tested by _____

Date _____

Paragraph Number	TEST	Results		
		Minimum	Actual	Maximum
4-9	TEST FREQUENCY ACCURACY TEST Frequency setting 10.0kHz 100kHz 202kHz 500kHz 1.00MHz	9.999kHz 99.99kHz 201.98kHz 499.95kHz 0.9999MHz	_____ _____ _____ _____ _____	10.001kHz 100.01kHz 202.02kHz 500.05kHz 1.0001MHz
4-11	TEST SIGNAL LEVEL ACCURACY TEST Test Signal Level: HIGH Frequency 10kHz 100kHz 1MHz Test Signal Level: LOW Frequency 10kHz 100kHz 1MHz	Vrms 0.9 0.9 0.9 mVrms 17 17 18	_____ _____ _____ _____ _____ _____ _____	Vrms 1.1 1.1 1.1 mVrms 23 23 22
4-13	SELF-OPERATING TEST SELF TEST #8 Frequency 10kHz DISPLAY A DISPLAY B 100kHz DISPLAY A DISPLAY B 1MHz DISPLAY A DISPLAY B	0.0020 -0.0048 0.0020 -0.0048 0.0020 -0.0048	_____ _____ _____ _____ _____ _____	0.0048 -0.0020 0.0048 -0.0020 0.0048 -0.0020

PERFORMANCE TEST RECORD

Paragraph Number	TEST	Results		
		Minimum	Actual	Maximum
4-13	SELF-OPERATING TEST (Cont'd)			
	SELF TEST #9			
	Frequency: 10kHz			
	Measurement Speed: MED			
	Test Signal Level:			
	HIGH DISPLAY A	-1.0010	_____	-0.9990
	DISPLAY B	-0.0010	_____	0.0010
	LOW DISPLAY A	-1.0020	_____	-0.9980
	DISPLAY B	-0.0020	_____	0.0020
	Measurement Speed: FAST			
	Test Signal Level:			
	HIGH DISPLAY A	-1.0050	_____	-0.9950
	DISPLAY B	-0.0050	_____	0.0050
	LOW DISPLAY A	-1.0100	_____	-0.9900
	DISPLAY B	-0.0100	_____	0.0100
	Frequency: 100kHz			
	Measurement Speed: MED			
	Test Signal Level:			
	HIGH DISPLAY A	-1.0010	_____	-0.9990
	DISPLAY B	-0.0010	_____	0.0010
	LOW DISPLAY A	-1.0020	_____	-0.9980
	DISPLAY B	-0.0020	_____	0.0020
	Measurement Speed: FAST			
	Test Signal Level:			
HIGH DISPLAY A	-1.0050	_____	-0.9950	
DISPLAY B	-0.0050	_____	0.0050	
LOW DISPLAY A	-1.0100	_____	-0.9900	
DISPLAY B	-0.0100	_____	0.0100	

PERFORMANCE TEST RECORD

Paragraph Number	TEST	Results		
		Minimum	Actual	Maximum
4-13	SELF-OPERATING TEST (Cont'd)			
	Frequency: 1MHz			
	Measurement Speed: MED			
	Test Signal Level:			
	HIGH DISPLAY A	-1.0010	_____	-0.9990
	DISPLAY B	-0.0010	_____	0.0010
	LOW DISPLAY A	-1.0020	_____	-0.9980
	DISPLAY B	-0.0020	_____	0.0020
	Measurement Speed: FAST			
	Test Signal Level:			
	HIGH DISPLAY A	-1.0050	_____	-0.9950
	DISPLAY B	-0.0050	_____	0.0050
	LOW DISPLAY A	-1.0100	_____	-0.9900
	DISPLAY B	-0.0100	_____	0.0100
SELF TEST #3				
Standard				
Open (0S)	-200 counts	_____	0	
10pF	-200 counts	_____	0	
100pF	-200 counts	_____	0	
1000pF	-200 counts	_____	0	
4-15	OPEN, SHORT TEST			
	[OPEN]			
	Test Signal Level: HIGH			
	Frequency			
	10kHz C	-0.0008nF	_____	0.0008nF
	G	-0.07µS	_____	0.07µS
	20kHz C	-0.0013nF	_____	0.0013nF
	G	-0.11µS	_____	0.11µS
	20.2kHz C	-0.0017nF	_____	0.0017nF
	G	-0.0008mS	_____	0.0008mS
	50.5kHz C	-0.0011nF	_____	0.0011nF
	G	-0.0008mS	_____	0.0008mS
	100kHz C	-0.0008nF	_____	0.0008nF
	G	-0.0007mS	_____	0.0007mS

PERFORMANCE TEST RECORD

Paragraph Number	TEST	Results		
		Minimum	Actual	Maximum
4-15	OPEN, SHORT TEST (Cont'd)			
	200kHz	C	-0.0013nF	0.0013nF
		G	-0.0011mS	0.0011mS
	202kHz	C	-0.0017nF	0.0017nF
		G	-0.008mS	0.008mS
	505kHz	C	-0.0011nF	0.0011nF
		G	-0.008mS	0.008mS
	1MHz	C	-0.0005nF	0.0005nF
		G	-0.007mS	0.007mS
	Test Signal Level: LOW			
	Frequency			
	10kHz	C	-0.0016nF	0.0016nF
		G	-0.14μS	0.14μS
	20kHz	C	-0.012nF	0.012nF
		G	-0.22μS	0.22μS
	20.2kHz	C	-0.012nF	0.012nF
		G	-0.0016mS	0.0016mS
	50.5kHz	C	-0.011nF	0.011nF
		G	-0.0016mS	0.0016mS
	100kHz	C	-0.0016nF	0.0016nF
		G	-0.0014mS	0.0014mS
	200kHz	C	-0.012nF	0.012nF
		G	-0.0022mS	0.0022mS
	202kHz	C	-0.012nF	0.012nF
		G	-0.016mS	0.016mS
	505kHz	C	-0.011nF	0.011nF
		G	-0.016mS	0.016mS
	1MHz	C	-0.0010nF	0.0010nF
		G	-0.014mS	0.014mS
	[SHORT]			
	Test Signal Level: HIGH			
	Frequency			
	10kHz	L	-0.0009mH	0.0009mH
	ESR	-0.05Ω	0.05Ω	
20kHz	L	-0.6μH	0.6μH	
	ESR	-0.08Ω	0.08Ω	

PERFORMANCE TEST RECORD

Paragraph Number	TEST	Results		
		Minimum	Actual	Maximum
4-15	OPEN, SHORT TEST (Cont'd)			
	20.2kHz	L ESR	-0.13μH -0.08Ω	0.13μH 0.08Ω
	50.5kHz	L ESR	-0.11μH -0.08Ω	0.11μH 0.08Ω
	100kHz	L ESR	-0.09μH -0.05Ω	0.09μH 0.05Ω
	200kHz	L ESR	-0.06μH -0.08Ω	0.06μH 0.08Ω
	202kHz	L ESR	-0.013μH -0.08Ω	0.013μH 0.08Ω
	505kHz	L ESR	-0.011μH -0.08Ω	0.011μH 0.08Ω
	1MHz	L ESR	-0.009μH -0.05Ω	0.009μH 0.05Ω
	Test Signal Level: LOW			
	Frequency			
	10kHz	L ESR	-0.0018mH -0.10Ω	0.0018mH 0.10Ω
	20kHz	L ESR	-1.2μH -0.16Ω	1.2μH 0.16Ω
	20.2kHz	L ESR	-1.2μH -0.16Ω	1.2μH 0.16Ω
	50.5kHz	L ESR	-1.1μH -0.16Ω	1.1μH 0.16Ω
	100kHz	L ESR	-0.18μH -0.10Ω	0.18μH 0.10Ω
	200kHz	L ESR	-0.12μH -0.16Ω	0.12μH 0.16Ω
	202kHz	L ESR	-0.12μH -0.16Ω	0.12μH 0.16Ω
	505kHz	L ESR	-0.11μH -0.16Ω	0.11μH 0.16Ω
	1MHz	L ESR	-0.018μH -0.10Ω	0.018μH 0.10Ω

PERFORMANCE TEST RECORD

Paragraph Number	TEST	Results			
		Minimum	Actual	Maximum	
4-17	CAPACITANCE ACCURACY TEST				
	1pF Range				
	Test Signal Level: HIGH				
	Frequency				
	202kHz	C	C.V.-0.0052pF	_____	C.V.+0.0052pF
		D	-0.009	_____	0.009
	505kHz	C	C.V.-0.0046pF	_____	C.V.+0.0046pF
		D	-0.0040	_____	0.0040
	1MHz	C	C.V.-0.0043pF	_____	C.V.+0.0043pF
		D	-0.0040	_____	0.0040
	Test Signal Level: LOW				
	Frequency				
	202kHz	C	C.V.- 0.21pF	_____	C.V.+ 0.21pF
		D	-1.0	_____	1.0
	505kHz	C	C.V.- 0.21pF	_____	C.V.+ 0.21pF
		D	-0.11	_____	0.11
	1MHz	C	C.V.- 0.027pF	_____	C.V.+ 0.027pF
		D	-0.017	_____	0.017
	10pF Range				
	Test Signal Level: HIGH				
	Frequency				
	20.2kHz	C	C.V.- 0.052pF	_____	C.V.+ 0.052pF
		D	-0.009	_____	0.009
	50.5kHz	C	C.V.- 0.046pF	_____	C.V.+ 0.046pF
	D	-0.0040	_____	0.0040	
100kHz	C	C.V.- 0.043pF	_____	C.V.+ 0.043pF	
	D	-0.0040	_____	0.0040	
200kHz	C	C.V.- 0.048pF	_____	C.V.+ 0.048pF	
	D	-0.0040	_____	0.0040	
202kHz	C	C.V.- 0.027pF	_____	C.V.+ 0.027pF	
	D	-0.008	_____	0.008	
505kHz	C	C.V.- 0.021pF	_____	C.V.+ 0.021pF	
	D	-0.0022	_____	0.0022	
1MHz	C	C.V.- 0.015pF	_____	C.V.+ 0.015pF	
	D	-0.0016	_____	0.0016	

C.V. = Caribrated Value

PERFORMANCE TEST RECORD

Paragraph Number	TEST	Results			
		Minimum	Actual	Maximum	
4-17	CAPACITANCE ACCURACY TEST (Cont'd)				
	Test Signal Level: LOW				
	Frequency				
	20.2kHz	C	C.V.- 2.1pF	_____	C.V.+ 2.1pF
		D	-1.0	_____	1.0
	50.5kHz	C	C.V.- 2.1pF	_____	C.V.+ 2.1pF
		D	-0.11	_____	0.11
	100kHz	C	C.V.- 0.27pF	_____	C.V.+ 0.27pF
		D	-0.017	_____	0.017
	200kHz	C	C.V.- 2.1pF	_____	C.V.+ 2.1pF
		D	-0.11	_____	0.11
	202kHz	C	C.V.- 0.14pF	_____	C.V.+ 0.14pF
		D	-0.11	_____	0.11
	505kHz	C	C.V.- 0.13pF	_____	C.V.+ 0.13pF
		D	-0.013	_____	0.013
	1MHz	C	C.V.-0.020pF	_____	C.V.+0.020pF
		D	-0.0032	_____	0.0032
	100pF Range				
	Test Signal Level: HIGH				
	Frequency				
	10kHz	C	C.V.- 0.43pF	_____	C.V.+ 0.43pF
		D	-0.0040	_____	0.0040
	20kHz	C	C.V.- 0.48pF	_____	C.V.+ 0.48pF
		D	-0.0040	_____	0.0040
	20.2kHz	C	C.V.- 0.27pF	_____	C.V.+ 0.27pF
		D	-0.079	_____	0.079
	50.5kHz	C	C.V.- 0.21pF	_____	C.V.+ 0.21pF
		D	-0.0022	_____	0.0022
	100kHz	C	C.V.- 0.18pF	_____	C.V.+ 0.18pF
		D	-0.0016	_____	0.0016
200kHz	C	C.V.- 0.23pF	_____	C.V.+ 0.23pF	
	D	-0.0026	_____	0.0026	
202kHz	C	C.V.- 0.27pF	_____	C.V.+ 0.27pF	
	D	0.008	_____	0.008	
505kHz	C	C.V.- 0.21pF	_____	C.V.+ 0.21pF	
	D	-0.0022	_____	0.0022	

C.V. = Caribrated Value

PERFORMANCE TEST RECORD

Paragraph Number	TEST		Results		
			Minimum	Actual	Maximum
4-17	CAPACITANCE ACCURACY TEST (Cont'd)				
	1MHz	C D	C.V.- 0.15pF -0.0016	_____	C.V.+ 0.15pF 0.0016
	Test Signal Level: LOW				
	Frequency				
	10kHz	C D	C.V.- 2.7pF -0.017	_____	C.V.+ 2.7pF 0.017
	20kHz	C D	C.V.- 20pF -0.11	_____	C.V.+ 20pF 0.11
	20.2kHz	C D	C.V.- 1.4pF -0.10	_____	C.V.+ 1.4pF 0.10
	50.5kHz	C D	C.V.- 1.3pF -0.013	_____	C.V.+ 1.3pF 0.013
	100kHz	C D	C.V.- 0.36pF -0.0032	_____	C.V.+ 0.36pF 0.0032
	200kHz	C D	C.V.- 1.3pF -0.014	_____	C.V.+ 1.3pF 0.014
	202kHz	C D	C.V.- 1.4pF -0.11	_____	C.V.+ 1.4pF 0.11
	505kHz	C D	C.V.- 1.3pF -0.013	_____	C.V.+ 1.3pF 0.013
	1MHz	C D	C.V.- 0.20pF -0.0032	_____	C.V.+ 0.20pF 0.0032
	1000pF Range				
	Test Signal Level: HIGH				
	Frequency				
	10kHz	C D	C.V.-0.0018nF -0.0016	_____	C.V.+0.0018nF 0.0016
	20kHz	C D	C.V.-0.0023nF -0.0026	_____	C.V.+0.0023nF 0.0026
	20.2kHz	C D	C.V.-0.0027nF -0.008	_____	C.V.+0.0027nF 0.008
	50.5kHz	C D	C.V.-0.0021nF -0.0022	_____	C.V.+0.0021nF 0.0022

C.V. = Caribrated Value

PERFORMANCE TEST RECORD

Paragraph Number	TEST		Results			
			Minimum	Actual	Maximum	
4-17	CAPACITANCE ACCURACY TEST (Cont'd)					
	100kHz	C	C.V. -0.0018nF		C.V. +0.0018nF	
		D	-0.0016		0.0016	
	200kHz	C	C.V. -0.0023nF		C.V. +0.0023nF	
		D	-0.0026		0.0026	
	202kHz	C	C.V. -0.0027nF		C.V. +0.0027nF	
		D	-0.008		0.008	
	505kHz	C	C.V. -0.0021nF		C.V. +0.0021nF	
		D	-0.0022		0.0022	
	1MHz	C	C.V. -0.0015nF		C.V. +0.0015pF	
		D	-0.0016		0.0016	
	Test Signal Level: LOW					
	Frequency					
	10kHz	C	C.V. -0.0036nF		C.V. +0.0036nF	
		D	-0.0032		0.0032	
	20kHz	C	C.V. - 0.014nF		C.V. + 0.014nF	
		D	-0.014		0.014	
	20.2kHz	C	C.V. - 0.014nF		C.V. + 0.014nF	
		D	-0.11		0.11	
	50.5kHz	C	C.V. - 0.013nF		C.V. + 0.013nF	
		D	-0.013		0.013	
	100kHz	C	C.V. -0.0036nF		C.V. +0.0036nF	
		D	-0.0032		0.0032	
200kHz	C	C.V. - 0.014nF		C.V. + 0.014nF		
	D	-0.014		0.014		
202kHz	C	C.V. - 0.014nF		C.V. + 0.014nF		
	D	-0.11		0.11		
505kHz	C	C.V. - 0.013nF		C.V. + 0.013nF		
	D	-0.013		0.013		
1MHz	C	C.V. -0.0020nF		C.V. +0.0020nF		
	D	-0.0032		0.0032		

C.V. = Calibrated Value

PERFORMANCE TEST RECORD

Paragraph Number	TEST		Results		
			Minimum	Actual	Maximum
4-17	CAPACITANCE ACCURACY TEST (Cont'd)				
	CABLE LENGTH: 1m				
	1pF Range				
	Test Signal Level:				
	HIGH	C	C.V. -0.0083pF	_____	C.V. +0.0083pF
		D	-0.0050	_____	0.0050
	LOW	C	C.V. - 0.035pF	_____	C.V. + 0.035pF
		D	-0.019	_____	0.019
	10pF Range				
	HIGH	C	C.V. - 0.020pF	_____	C.V. + 0.020pF
		D	-0.0019	_____	0.0019
	LOW	C	C.V. - 0.030pF	_____	C.V. + 0.030pF
		D	-0.0038	_____	0.0038
	100pF Range				
	HIGH	C	C.V. - 0.18pF	_____	C.V. + 0.18pF
		D	-0.0018	_____	0.0018
LOW	C	C.V. - 0.26pF	_____	C.V. + 0.26pF	
	D	-0.0036	_____	0.0036	
1000pF Range					
HIGH	C	C.V. -0.0021nF	_____	C.V. +0.0021nF	
	D	-0.0019	_____	0.0019	
LOW	C	C.V. -0.0032nF	_____	C.V. +0.0032nF	
	D	-0.0038	_____	0.0038	
4-19	RESISTANCE ACCURACY TEST				
	100Ω Range				
	Frequency	Test Signal Level			
	10kHz	HIGH	C.V. - 0.15Ω	_____	C.V. + 0.15Ω
		LOW	C.V. - 1.2Ω	_____	C.V. + 1.2Ω
	20kHz	HIGH	C.V. - 0.15Ω	_____	C.V. + 0.15Ω
		LOW	C.V. - 1.2Ω	_____	C.V. + 1.2Ω
	50.5kHz	HIGH	C.V. - 0.15Ω	_____	C.V. + 0.15Ω
		LOW	C.V. - 1.2Ω	_____	C.V. + 1.2Ω
	100kHz	HIGH	C.V. - 0.15Ω	_____	C.V. + 0.15Ω
	LOW	C.V. - 0.30Ω	_____	C.V. + 0.30Ω	

C.V. = Calibrated Value

PERFORMANCE TEST RECORD

Paragraph Number	TEST		Results		
			Minimum	Actual	Maximum
4-19	RESISTANCE ACCURACY TEST (Cont'd)				
	200kHz	HIGH	C.V. - 0.15Ω	_____	C.V. + 0.15Ω
		LOW	C.V. - 0.30Ω	_____	C.V. + 0.30Ω
	505kHz	HIGH	C.V. - 0.15Ω	_____	C.V. + 0.15Ω
		LOW	C.V. - 0.30Ω	_____	C.V. + 0.30Ω
	1MHz	HIGH	C.V. - 0.15Ω	_____	C.V. + 0.15Ω
		LOW	C.V. - 0.30Ω	_____	C.V. + 0.30Ω
	1kΩ Range				
		Frequency	Test Signal Level		
	10kHz	HIGH	C.V. -0.006kΩ	_____	C.V. +0.006kΩ
		LOW	C.V. -0.012kΩ	_____	C.V. +0.012kΩ
	20kHz	HIGH	C.V. -0.006kΩ	_____	C.V. +0.006kΩ
		LOW	C.V. -0.012kΩ	_____	C.V. +0.012kΩ
	50.5kHz	HIGH	C.V. -0.006kΩ	_____	C.V. +0.006kΩ
		LOW	C.V. -0.012kΩ	_____	C.V. +0.012kΩ
	100kHz	HIGH	C.V. -0.006kΩ	_____	C.V. +0.006kΩ
		LOW	C.V. -0.012kΩ	_____	C.V. +0.012kΩ
	200kHz	HIGH	C.V. -0.006kΩ	_____	C.V. +0.006kΩ
		LOW	C.V. -0.012kΩ	_____	C.V. +0.012kΩ
	505kHz	HIGH	C.V. -0.006kΩ	_____	C.V. +0.006kΩ
		LOW	C.V. -0.012kΩ	_____	C.V. +0.012kΩ
	1MHz	HIGH	C.V. -0.006kΩ	_____	C.V. +0.006kΩ
		LOW	C.V. -0.012kΩ	_____	C.V. +0.012kΩ
	10kΩ Range				
		Frequency	Test Signal Level		
	10kHz	HIGH	C.V. - 0.06kΩ	_____	C.V. + 0.06kΩ
		LOW	C.V. - 0.12kΩ	_____	C.V. + 0.12kΩ
	20kHz	HIGH	C.V. - 0.06kΩ	_____	C.V. + 0.06kΩ
		LOW	C.V. - 0.12kΩ	_____	C.V. + 0.12kΩ
	50.5kHz	HIGH	C.V. - 0.06kΩ	_____	C.V. + 0.06kΩ
LOW		C.V. - 0.12kΩ	_____	C.V. + 0.12kΩ	
100kHz	HIGH	C.V. - 0.06kΩ	_____	C.V. + 0.06kΩ	
	LOW	C.V. - 0.12kΩ	_____	C.V. + 0.12kΩ	
200kHz	HIGH	C.V. - 0.06kΩ	_____	C.V. + 0.06kΩ	
	LOW	C.V. - 0.12kΩ	_____	C.V. + 0.12kΩ	

C.V. = Calibrated Value

PERFORMANCE TEST RECORD

Paragraph Number	TEST		Results		
			Minimum	Actual	Maximum
4-19	RESISTANCE ACCURACY TEST (Cont'd)				
	50.5kHz	HIGH	C.V.- 0.06kΩ	_____	C.V.+ 0.06kΩ
		LOW	C.V.- 0.12kΩ	_____	C.V.+ 0.12kΩ
	1MHz	HIGH	C.V.- 0.06kΩ	_____	C.V.+ 0.06kΩ
		LOW	C.V.- 0.12kΩ	_____	C.V.+ 0.12kΩ
	100kΩ Range				
	Frequency	Test Signal Level			
	10kHz	HIGH	C.V. - 0.6kΩ	_____	C.V. + 0.6kΩ
		LOW	C.V. - 1.2kΩ	_____	C.V. + 1.2kΩ
	20kHz	HIGH	C.V. - 0.6kΩ	_____	C.V. + 0.6kΩ
		LOW	C.V. - 1.2kΩ	_____	C.V. + 1.2kΩ
	50.5kHz	HIGH	C.V. - 0.6kΩ	_____	C.V. + 0.6kΩ
		LOW	C.V. - 1.2kΩ	_____	C.V. + 1.2kΩ
	100kHz	HIGH	C.V. - 0.6kΩ	_____	C.V. + 0.6kΩ
LOW		C.V. - 1.2kΩ	_____	C.V. + 1.2kΩ	
4-21	PHASE ACCURACY TEST				
	Frequency	Test Signal Level			
	10kHz	HIGH	0.52 deg	_____	-0.52 deg
		LOW	1.4	_____	-1.4
	20kHz	HIGH	0.52	_____	-0.52
		LOW	1.4	_____	-1.4
	50.5kHz	HIGH	0.52	_____	-0.52
		LOW	1.4	_____	-1.4
	100kHz	HIGH	0.52	_____	-0.52
		LOW	1.4	_____	-1.4
	200kHz	HIGH	0.52	_____	-0.52
		LOW	1.4	_____	-1.4
	505kHz	HIGH	0.52	_____	-0.52
		LOW	1.4	_____	-1.4
1MHz	HIGH	0.52	_____	-0.52	
	LOW	1.4	_____	1.4	

C.V. = Calibrated Value

PERFORMANCE TEST RECORD

Paragraph Number	TEST	Results		
		Minimum	Actual	Maximum
4-23	INT DC BIAS SUPPLY TEST			
	DC Bias Setting			
	-0.01V	-20.1mV	_____	0.1mV
	6.82V	6.7895V	_____	6.8505V
	-9.99V	-10.0999V	_____	-9.8801V
	10V	9.915V	_____	10.085V
	-12.7V	-12.862V	_____	-12.538V
	40V	39.765V	_____	40.235V
	-40V	-40.435V	_____	-39.565V

