

HP 4945A Transmission Impairment Measuring Set Operating Manual

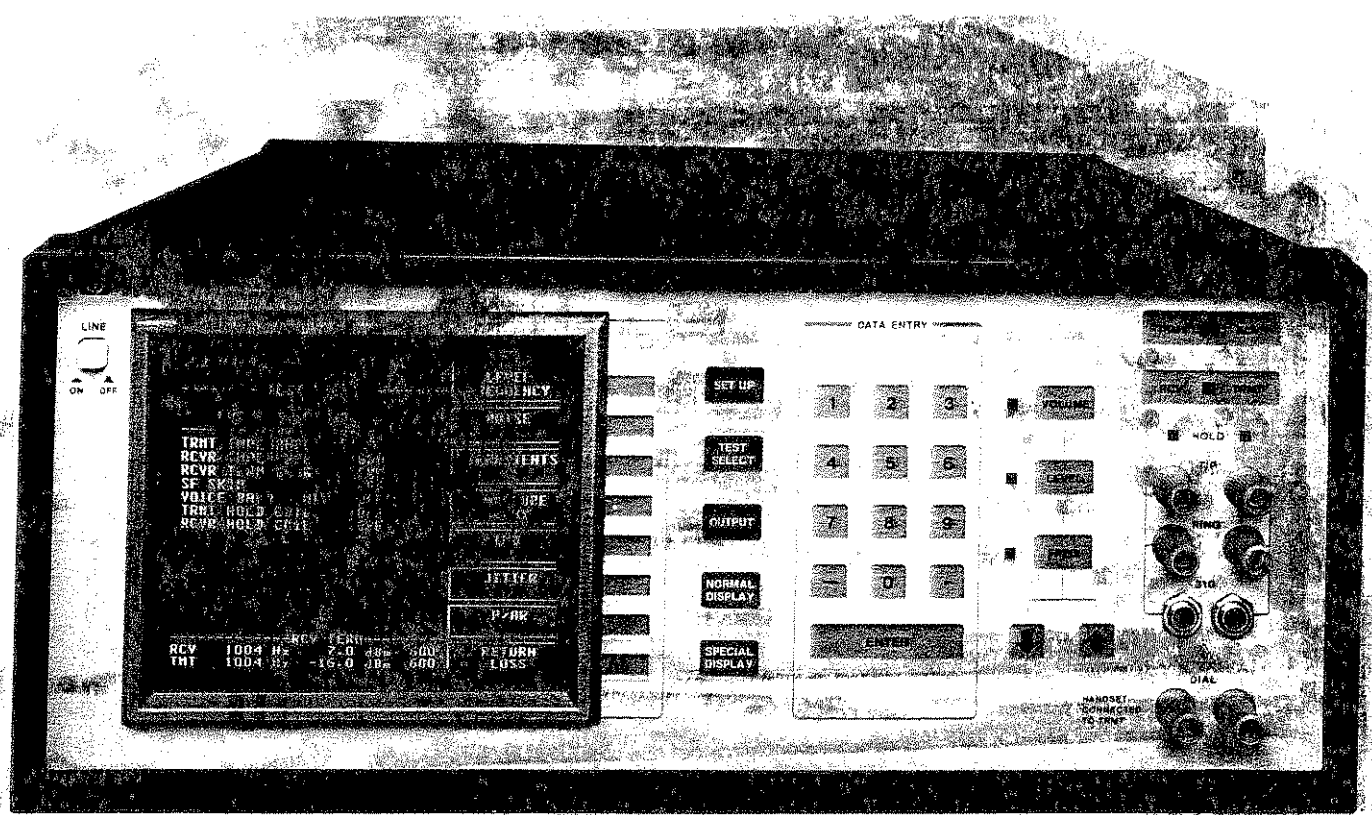

OPERATING MANUAL

HP 4945A TRANSMISSION IMPAIRMENT MEASURING SET

SERIAL NUMBERS

This manual applies directly to instruments with serial numbers prefixed 2521A.

For additional important information about serial numbers, see INSTRUMENTS COVERED BY THIS MANUAL in Section I.

Copyright Hewlett-Packard Company/Colorado Telecommunications Division 1985
5070 Centennial Blvd., P.O. Box 7050, Colorado Springs, CO 80933
All Right Reserved

Manual Part No. 04945-90023
Printed Pages Part No. 5957-4454
Binder Part No. 9282-0987
Microfiche Part No. 04945-90024

Printed May 1985
Printed in U.S.A.

PRINTING HISTORY

New editions of this manual will incorporate all material updated since the previous editions. Update packages may be issued between editions and contain replacement and additional pages to be merged into the manual by the user. Each update page will be indicated by a revision date at the bottom of the page. A vertical line in the margin indicates the changes on each page. Pages which are rearranged due to changes on a previous page are not considered revised.

The manual printing date and part number indicate its current edition. The printing date changes when a new edition is printed. The manual part number changes when extensive technical changes are incorporated.

November 1983 - First Edition

May 1985 - Second Edition

TABLE OF CONTENTS

Chapter	Page
I. GENERAL INFORMATION	
Introduction.....	1-1
Specifications.....	1-1
Safety Considerations.....	1-1
Instruments Covered by This Manual.....	1-1
Description.....	1-2
HP-IB (Hewlett-Packard Interface Bus).....	1-2
HP-IL (Hewlett-Packard Interface Loop).....	1-3
RS-232C.....	1-3
Accessories.....	1-3
Options.....	1-3
II. INSTALLATION	
Introduction.....	2-1
Initial Inspection.....	2-1
Preparation for Use.....	2-1
Power Requirements.....	2-1
Line Voltage Selection.....	2-1
Power Cable.....	2-2
Storage and Shipment.....	2-2
Environment.....	2-2
Original Packaging.....	2-2
Other Packaging.....	2-3
III. OPERATION	
HP 4945A Features.....	3-2
Front Panel Description.....	3-2
Rear Panel Description.....	3-4
CRT Display Functions.....	3-5
Operating the HP 4945A.....	3-7
Data Entry Procedure.....	3-7
Power on Self Check.....	3-11
Set Up and Turn On Procedure.....	3-12
Level and Frequency.....	3-21
Noise.....	3-26
Transients.....	3-31
Envelope Delay Distortion.....	3-34
Intermodulation Distortion Measurement.....	3-42
Jitter.....	3-45
P/AR (Peak-to-Average Ratio) Measurement.....	3-48
Return Loss.....	3-50
How to Dump the Display to a Printer Using the Output Hardkeys.....	3-56
Display Messages.....	3-59

TABLE OF CONTENTS (con't)

Chapter	Page
III. OPERATION (con't)	
Master/Slave.....	3-62
General Information	3-62
How to Configure the Instrument for Master/Slave Operation.....	3-65
Master/Slave When Using an HP 4943A or an HP 4944A with the HP 4945A.....	3-66
Master/Slave Error Messages.....	3-68
DTMF Signaling Capabilities.....	3-74
IV. MEASUREMENT PRINCIPLES	
Introduction.....	4-1
Input-output Switching.....	4-1
Data Level.....	4-3
Level and Frequency Measurement.....	4-3
1000 Hz Loss.....	4-4
Frequency Shift.....	4-4
Gain Slope.....	4-4
Noise Measurements.....	4-5
Noise.....	4-5
Noise With Tone.....	4-10
Signal to Noise.....	4-10
Noise to Ground Measurement.....	4-11
Transients Measurements.....	4-12
Impulse Noise.....	4-12
Phase Hits, Gain Hits and Dropouts.....	4-12
Simultaneous Measurement of Impluse Noise, Hits and Dropouts....	4-15
Jitter Measurements.....	4-17
Phase Jitter.....	4-17
Amplitude Jitter.....	4-17
Envelope Delay Measurement.....	4-21
Relating Phase Shift to Envelope Delay.....	4-21
Envelope Delay Distortion Measurement.....	4-23
Intermodulation Distortion Measurement.....	4-26
Peak to Average Ratio Measurement.....	4-28
Return Loss.....	4-31

TABLE OF CONTENTS (con't)

Chapter	Page
V. HP-IB OPERATION	
Introduction.....	5-1
Normal Mode.....	5-1
Talk Only Mode.....	5-1
HP 4944A Mode.....	5-1
Specifications.....	5-1
Installation.....	5-2
Description.....	5-3
Communication Capability.....	5-5
Data Input and Output Modes.....	5-5
Using the HP 4945A as an HP 4944A or an HP 4943A.....	5-6
HP-IB Addressing.....	5-7
HP-IB Device Functions.....	5-8
Message Definition.....	5-9
Serial Poll Operation.....	5-14
Controlling the HP HP 4945A.....	5-16
Example Program When Using the HP 9816A, HP 9826A, or HP 9836A.....	5-16
VI. HP-IL OPERATION	
Introduction.....	6-1
Normal Mode.....	6-1
Talk Only Mode.....	6-1
Specifications.....	6-1
Description.....	6-1
Installation.....	6-2
Select Code (Address).....	6-3
Communication Capability.....	6-3
Data Input and Output Modes.....	6-4
HP-IL Device Functions.....	6-5
Serial Poll Operation.....	6-9
Parallel Poll Operation.....	6-9
Using the HP-41C as the Controller.....	6-10
Sample Program Using the HP-41C - Voiceband Frequency Run.....	6-10
VII. RS-232C OPERATION	
Introduction.....	7-1
Specifications.....	7-1
Installation.....	7-1
Full Duplex.....	7-3
No Handshake.....	7-3
Full Handshake.....	7-4

Chapter	Page
VII. RS-232 OPERATION (con't)	
Half Duplex.....	7-4
No Handshake.....	7-4
Full Handshake.....	7-5
Software Handshake.....	7-5
Echo.....	7-6
Local Lockout.....	7-6
Status Reporting.....	7-6
Controlling the HP 4945A	7-7
VIII. I/O MODULE CODES	
Introduction.....	8-1
Output Format to the Controlling Interface.....	8-1
Output Sequences.....	8-4
I/O Mnemonic Commands.....	8-14
APPENDIX A	
Introduction.....	A-1
Power-on Self Check.....	A-1
Error Codes.....	A-2
Mainframe Error Codes.....	A-2
Interface Error Codes.....	A-5
Diagnostics.....	A-6

LIST OF ILLUSTRATIONS

Figure		Page
3-1.	Front Panel Controls, Connectors and Indicators.....	3-2
3-2.	Rear Panel Controls, Connectors and Features.....	3-4
3-3.	Display Features.....	3-5
3-4.	Data Entry, Level, Frequency, and Volume Hardkeys.....	3-7
3-5.	Level Softkey Selections.....	3-7
3-6.	Frequency Softkey Selections.....	3-9
3-7.	Volume Softkey Selections.....	3-10
3-8.	Set Up Menu.....	3-13
3-9.	Transmitter an Receiver Set Up Menu.....	3-14
3-10.	Clock Set Up Menu.....	3-17
3-11.	Dial Hold Set Up Menu.....	3-18
3-12.	The Level Frequency Measurement Menu.....	3-21
3-13.	Programmable Sweep Menu for Level Frequency Measurement.....	3-22
3-14.	The Noise Measurement Menu.....	3-26
3-15.	The Noise Filters Menu.....	3-27
3-16.	The Transients Measurement Menu.....	3-31
3-17.	The Envelope Delay Test Set Up.....	3-34
3-18.	The Envelope Delay Measurement Menu.....	3-35
3-19.	The Programmable Sweep Menu for Envelope Delay Distortion.....	3-36
3-20.	The Intermodulation Distortion Measurement Menu.....	3-42
3-21.	The Jitter Measurement Menu.....	3-45

LIST OF ILLUSTRATIONS (con't)

Figure	Page
3-22. The P/AR Measurement Menu.....	3-48
3-23. The Return Loss Measurement Menu.....	3-50
3-24. The Programmable Sweep Menu for Return Loss.....	3-52
3-25. Master/Slave Test Set Up.....	3-62
4-1. Input-Output Switching.....	4-2
4-2. Level and Frequency Measurement.....	4-3
4-3. Message Circuit Noise Measurement.....	4-6
4-4. C-message Weighting Characteristics.....	4-7
4-5. 3 kHz Flat Weighting Characteristics.....	4-8
4-6. 15 kHz Flat Filter Weighting Characteristics.....	4-8
4-7. Program Filter Characteristic.....	4-9
4-8. 50 Kbit Filter Characteristics.....	4-9
4-9. Notch Filter Characteristics.....	4-10
4-10. Noise-to-Ground Related to Message Circuit Noise.....	4-11
4-11. Impulse Noise, Hits, and Dropouts Waveforms.....	4-14
4-12. Impulse Noise, Hits, and Dropouts	4-16
4-13. Effects of Phase Jitter and Amplitude on Holding Tone.....	4-19
4-14. Phase and Amplitude Jitter Measurement.....	4-20
4-15. Phase Versus Frequency Relationship.....	4-21
4-16. Envelope Delay Waveforms.....	4-22
4-17. AM Signal Frequency Spectrum.....	4-23
4-18. Relating Phase Shift to Envelope Delay.....	4-24
4-19. Envelope Delay Measurement.....	4-25

LIST OF ILLUSTRATIONS (con't)

Figure	Page
4-20. Intermodulating Distortion Signal Frequency Spectrum.....	4-27
4-21. P/AR Transmit Signal Frequency Spectrum.....	4-30
4-22. P/AR Transmit Signal Envelope.....	4-30
4-23. Filter Shapes for ERL, SRL Low, and SRL High.....	4-31
5-1. HP 18162A Interface Installation.....	5-2
5-2. Interface Connections and Bus Structure.....	5-4
6-1. HP 18165A Interface Installation.....	6-2
7-1. HP 18163A Interface Installation.....	7-1

LIST OF TABLES

Table		Page
1-1.	Specifications.....	1-4
2-1.	Line Fuse Part Numbers.....	2-2
3-1.	Circuit Control Settings.....	3-20
4-1.	Filter Noise Ranges.....	4-5
4-2.	Transient Phenomena Summary.....	4-16
4-3.	Measurement Definitions.....	4-16
4-4.	Harmonics and Intermodulation Products of a Multiple Frequency Signal (f1 and f2).....	4-28
5-1.	General Interface Management Lines.....	5-3
5-2.	HP-IB Messages and HP 4945A Responses.....	5-9
6-1.	HP-IL Loop Messages and Module Responses.....	6-6
8-1.	Measurement Results and Headers.....	8-2
A-1.	Diagnostic Modes.....	A-6
A-2.	Stop-on Condition.....	A-7

CHAPTER I. GENERAL INFORMATION

INTRODUCTION

This Operating Manual contains information required to install and operate the HP 4945A Transmission Impairment Measuring Set (TIMS). Figure 1-1 shows the HP 4945A and the accessories supplied with the instrument. Throughout the remainder of this manual the HP 4945A will be referred to as the HP 4945A or the instrument.

Listed on the title page of this manual is a microfiche part number. This number can be used to order 4-X 6-inch microfiche transparencies of this manual. Each microfiche contains up to 96 photo-duplicates of the manual pages. The microfiche package also includes the latest Manual Changes supplement.

SPECIFICATIONS

Instrument specifications are listed in Table 1-1. These specifications are the instrument's warranted performance. Supplemental characteristics shown in italics are intended to provide information useful in applying the instrument by giving typical, but non-warranted, performance parameters.

SAFETY CONSIDERATIONS

This product is a Safety Class 1 instrument (provided with a protective earth terminal). The instrument and the manual should be reviewed for safety markings and instructions before operation.

INSTRUMENTS COVERED BY THIS MANUAL

Attached to the instrument is a serial number plate. The serial number is in the form: 0000A00000. It is in two parts; the first four digits and the letter are the serial prefix and the last five digits are the suffix.

The prefix is the same for all identical instruments; it changes only when a change is made to the instrument. The suffix however, is assigned sequentially and is different for each instrument. The contents of this manual apply to instruments with the serial number prefix listed under SERIAL NUMBERS on the title page.

An instrument manufactured after the printing date of this manual may have a serial number prefix that is not listed on the title page. This unlisted serial number prefix indicates the instrument is different from those described in this manual. The manual for this newer instrument is accompanied by a yellow Manual Changes

supplement. This supplement contains "change information" that explains how to adapt the manual to the newer instrument.

To keep this manual as current and accurate as possible, Hewlett-Packard recommends that you periodically request the latest Manual Changes supplement. Free copies of the supplement are available from Hewlett-Packard.

For information concerning a serial number prefix that is not listed on the title page or in the Manual Changes supplement, contact your nearest Hewlett-Packard office.

To verify the latest version, perform the SET UP and TURN ON procedure in Chapter III. Then perform the following steps:

- Press CALIBRATE/SELF-CHECK softkey
- Press TEST PATTERN softkey

The software version code will be shown at the bottom of the CRT display.

DESCRIPTION

The HP 4945A is a multifunction test set that is used to measure the quality of voice grade, program, and wideband data communications channels. The instrument is designed for problem isolation on high-speed data transmission circuits. The instrument has mounting feet on the rear panel and the right side, as well as on the bottom panel. This allows the instrument to be set vertically or horizontally as required. A rack mounting option is also available.

The HP 4945A interfaces are RS-232C, HP-IB, and HP-IL. The front panel contains a membrane switch-type keyboard. Measurement results are displayed on a nonglare CRT.

The HP 4945A incorporates master-slave provisions for use on 4-wire circuits. Measurement control for both directions of transmission is at one end of the circuit. At the control end is the master unit. At the remotely controlled end is the slave unit. All test results for both directions are displayed at the master unit. Choice of the direction of test (i.e., master to slave, or slave to master) is by switch selection at the master unit.

Once the slave unit is set up it can be left unattended. Another HP 4945A can be used as the slave, or any existing TMS that has the master/slave function (such as HP 4945A and HP 4944A) can be used.

HP-IB (Hewlett-Packard Interface Bus)

The HP-IB is Hewlett-Packard's implementation of the IEEE Standard 488-1978. For a description of the operation of the bus refer to Chapter V of this manual.

HP-IL (Hewlett-Packard Interface Loop)

The HP-IL is a two-wire loop. Communications over the loop is asynchronous and serial with the data traveling from one device to the next around the loop in only one direction. In this configuration each device receives the message, acts up on it if required, and retransmits it to the next device until the message returns to the originator. For further information refer to Chapter VI of this manual.

RS-232C

The RS-232C interface allows the HP 4945A to be controlled remotely from an external device that is configured for RS-232C serial communications. The interface also allows the HP 4945A to control other RS-232C devices such as printers. For further information refer to Chapter VII of this manual.

ACCESSORIES

The following accessories are available and can be ordered through your local HP Sales and Service Office. The addresses are located at the back of this manual.

HP-IB Interface	HP 18162A
RS-232C Interface	HP 18163A
HP-IL	HP 18165A
HP-IB Cable 1 metre.....	HP 10833A
RS-232C Terminal Cable.....	HP 13242N
RS-232C Modem Cable.....	HP 13242G
36-inch 310 to 310 Cable.....	HP 15513A
Rack Mounting Kit 19-inch.....	HP 18169A
Soft Carrying Case.....	HP 18170A
23-inch Rack Adapter.....	HP 18176A
Rugged Transit Case.....	HP 9211-2650

OPTIONS

The following option is available and can be ordered through your local HP Sales and Service Office. The addresses are located at the back of this manual.

Service Manual.....	Option 915
100/200 Volt Operation.....	Option 001

Table 1-1. Specifications

GENERAL

Power Requirements:	115/230 Vac \pm 11%, 48 to 63 Hz 150 watts maximum.
Dimensions: (excluding feet)	Height: 18.4 cm (7.25 in) Width: 45.1 cm (17.75 in) Depth: 48.9 cm (19.25 in)
Weight:	15 Kg (33 lbs)
Operating Environment:	Temperature: 0° to +50° C (+32° to 122° F) Humidity: 10% to 90%, non-condensing Altitude: up to 4600 m (15,000 ft) Warm-up time: 5 minutes for stated accuracy
Interfaces:	HP-IB (IEEE 488), RS-232C, HP-IL
HP-IB Capabilities:	AH1, SH1, CO, L4, T5, SR1, RL1, PP1, DC1, DT0
RS-232C Capabilities:	Bit Rates: 50, 75, 110, 150, 300, 600, 1200, 2400, 4800, 9600 bps. Asynchronous half or full duplex. 7 or 8 bit word. Parity: none, odd, even, mark or space.
HP-IL Capabilities:	R, AH, SH, D, T1-T5, L1, AA1, CO, DC2, DT0, PP1, SR2, RL2, PD0, DD0
Termination Impedance: (receiver and transmitter)	135, 600, 900 or 1200 ohm
Hold Circuits:	Two circuits, each independent; > 20 mA for applied open circuit voltages from 42.5 to 105 volts dc, either polarity, through an external resistance of \leq 1700 ohms. Nominal: 23 mA, 48 V, 1300 ohms.
Return Loss: (receiver and transmitter)	>20 dB from 20 Hz to 110 kHz >30 dB from 800 Hz to 110 kHz at 135 ohms >30 dB from 200 Hz to 20 kHz

Table 1-1. Specifications (cont.)

Bridging Loss: (receiver)	< 0.2 dB
Longitudinal Balance: (receiver and transmitter)	>90 dB, 50 Hz to 120 Hz decreasing 6 dB per octave above 120 Hz
Maximum dc blocking:	150 volts

Transmitter Frequency

Range:	20 Hz to 110 Hz; selected by keypad or six programmable steps.
Resolution:	1 Hz from 20 Hz to 9999 Hz; 10 Hz from 10 kHz to 110 kHz
Accuracy:	+-.01 % of output frequency
Sweep:	Automatic (single or repetitive) or manual.
Step Size:	Automatic: Programmable from 10 Hz to 10kHz. Manual: Selectable 10, 50, 100, 1000 Hz.
Step Rate:	0.3, 1, or 3 steps per second.
SF Skip:	Skips a band from 2450 to 2750 Hz
Holding Tone:	1004 Hz +-0.1 Hz

Transmitter Level

Range:	-60 to +13 dBm (600, 900, 1200 ohm) -60 to +5 dBm (135 ohm)
Resolution:	0.1 dB
Accuracy:	+ - 0.1 dB at 1004 Hz, -20 to 0 dBm + - 0.2 dB at 1004 Hz, -60 to +10 dBm

Table 1-1. Specifications (cont.)

Flatness:

20 Hz	200 Hz	15 kHz	85 kHz	110 kHz
+/- 0.5 dB	+/- 0.2 dB	+/- 0.5 dB	+/- 1.0 dB	

Flatness is not specified below 200 Hz when using the 135 ohm termination.

Total Distortion:

100 Hz to 3 kHz, ≥ 50 dB down from fundamental, measured in 3 dB bandwidth up to 12 kHz (for signal levels -40 dBm to +10 dBm)

3 kHz to 20 kHz, ≥ 40 dB down from fundamental, measured in 3 dB bandwidth up to 80 kHz (for signal levels -40 dBm to +10 dBm)

20 kHz to 110 kHz, ≥ 40 dB down from fundamental, measured in 3 dB bandwidth up to 440 kHz (for signal levels -30 dBm to +10 dBm)

Receiver Frequency

- Range: 20 Hz to 110 kHz
- Resolution: 1 Hz from 20 Hz to 9999 Hz; 10 Hz from 10 kHz to 110 kHz
- Accuracy: for signal levels > -50 dBm at > 20 dB signal-to-noise ratio
- 1 Hz from 20 Hz to 9999 Hz
- 10 Hz from 10 kHz to 110 kHz

Receiver Level

- Range: -60 to +13 dBm
- Resolution: .1 dB
- Detector: full wave average

Table 1-1. Specifications (cont.)

Accuracy (in dB): -50 dBm to +13 dBm

20 Hz	200Hz	15 kHz	110 kHz
+/-0.5 dB	+/-0.2 dB	+/-0.5 dB	

-60 dBm to -50 dBm

20 Hz	200 Hz	15 kHz	110 kHz
+/-1.0 dB	+/-0.5 dB	+/-1.0 dB	

1004 Hz holding tone accuracy is +/-0.1 dB from -20 to 0 dBm

accuracy is not specified below 200 Hz when using the 135 ohm termination

Filters Available: 60 Hz highpass, 10 kHz lowpass (Voiceband limit)

MESSAGE CIRCUIT NOISE MEASUREMENT

Transmitter: quiet termination

Receiver

Weighting Filters: C-message, 3 kHz flat, 15 kHz flat, 50 kbit or Program

Range: +10 to +90 dBm

Resolution: 1 dB

Accuracy: +/- 1 dB

Detector: True rms

Table 1-1. Specifications (cont.)

NOISE WITH TONE MEASUREMENT

Transmitter

Frequency: 1004 Hz (fixed)

Receiver

Weighting Filters: C-message, 3 kHz flat, 15 kHz flat, 50 kbit or Program

Notch Filter: >60 dB rejection from 995 to 1025 Hz

Range: +10 to +90 dBm

Resolution: 1 dB

Detector: True rms

Accuracy: +- 1 dB

SIGNAL-TO-NOISE RATIO MEASUREMENT

Transmitter

Frequency: 1004 Hz (fixed)

Receiver

Weighting Filters: C-message, 3kHz flat, 15 kHz flat, 50 kbit or Program

Notch Filter: > 60 dB rejection from 995 to 1025 Hz

Ratio Range: 10 dB to 45 dB

Resolution: 1 dB

Signal level range: -40 to +13 dBm at 600, 900, and 1200 ohms.
-34 to +13 dBm at 135 ohms.

Detector: full wave average and true rms

Accuracy: + or - 1 dB (10 dB to 40 dB)
+ or - 2 dB (41 dB to 45 dB)

Table 1-1. Specifications (cont.)

NOISE-TO-GROUND MEASUREMENT

Transmitter:	quiet termination
Receiver	
Weighting Filters:	C-message, 3 kHz flat, 15 kHz flat 50 kbit or Program
Range:	40 to 130 dBrn (C-Message, 3 kHz) 50 to 130 dBrn (Program, 15 kHz, 50 kbit)
Resolution:	1 dB
Accuracy:	+/- 1.5 dB
Detector:	True rms

INTERMODULATION DISTORTION MEASUREMENT

Transmitter

Signal Spectrum:	four tone, non-linear distortion two tone, noise check
Level Range:	-40 dBm to 0 dBm (not specified at 135 ohms)

Receiver

Signal Level Range:	-40 dBm to 0 dBm
Resolution:	1 dB
Accuracy:	+/- 1 dB
Filters:	Second order centered at 520 Hz and 2240 Hz Third order centered at 1900 Hz
Distortion Range:	10 to 55 dB (not specified at 135 ohms)

PEAK TO AVERAGE RATIO MEASUREMENT (P/AR)

Transmitter

Signal Spectrum:	meets Bell System PUB 41009 specifications and IEEE Std 743-1984
Level Range:	-40 to 0 dBm
Level Resolution:	0.1 dB

Table 1-1. Specifications (cont.)

Receiver

Signal Level Range:	-40 to 0 dBm
P/AR Range:	0 to 120 units
Accuracy:	+ - 2 P/AR units over range of 40 to 110 units + - 4 P/AR units elsewhere
Resolution:	1 P/AR unit

PHASE AND AMPLITUDE JITTER MEASUREMENTS

Transmitter

Frequency: 1004 Hz (fixed)

Receiver

Level Range:	-40 to +10 dBm (-34 dBm to +10 dBm at 135 ohms)
Bandwidths:	20 to 300 Hz, 4 to 20 Hz and 4 to 300 Hz
Phase Jitter:	0.0 to 30.0 degrees peak-to-peak, + or - 5 percent of reading plus + or - 0.2 degrees peak-to-peak.
Amplitude Jitter:	0.0 to 30.0 percent peak-to-peak, + or - 5 percent of measured value plus + or - 0.5 percent of peak.
Outputs:	Demodulated carrier and jitter available

TRANSIENTS MEASUREMENT

Transmitter

Frequency: 1004 Hz (fixed) and quiet termination
are selectable

Receiver

Holding Tone:	995 Hz to 1025 Hz: -40 dBm to 10 dBm at 600, 900, and 1200 ohms. -34 dBm to 10 dBm at 135 ohms.
Count Rate:	7, 8 or 100 counts per second
Count Range:	0 to 9999 for all count indicators
Timer:	1 to 9,999 minutes, or continuous

Table 1-1. Specifications (cont.)

Note: The following accuracy specifications apply to the 7 and 8 counts per second rates only.

Impulse Noise: low, 30 to 110 dBrn in 1 dB steps

Threshold Range: medium, programmable, 2, 3, 4, 5 or 6 dB above low
high, programmable, 2, 3, 4, 5 or 6 dB above medium

Threshold Accuracy: ± 1 dB

Phase Hits

Threshold Level: 5 to 45 degrees in 5 degree steps
(Hit Guard Interval : Nominal 4 msec.)

Reference: HP 4945A set for Impulse Threshold ≤ 90 dBrn

Threshold Accuracy: ± 0.5 degrees, $\pm 10\%$ of threshold setting (10 to 45 degrees)

Gain Hits

Threshold Range: 2 to 10 dB in 1 dB steps
(Hit Guard Interval : Nominal 4 msec.)

Reference: HP 4945A set for Impulse Threshold ≤ 90 dBrn

Threshold Accuracy: ± 0.5 dB

Dropouts

Threshold: ≥ 12 dB

Threshold Accuracy: ± 1 dB

Duration: Nominal 4 msec.

Reference: HP 4945A set for Impulse Threshold ≤ 90 dBrn

Table 1-1. Specifications (cont.)

ENVELOPE DELAY MEASUREMENT

Transmitter

Level Range: -40 to 0 dBm
Modulation Frequency: 83 1/3 Hz, +-0.1%

Receiver

Level Range: -40 to +10 dBm
Measurement Range: -3000 to +9000 microseconds
Resolution: 1 microsecond
Accuracy: +- 10 usec from 600 to 4000 Hz
+- 30 usec from 300 to 600 Hz

RETURN LOSS MEASUREMENT

Modes: ERL, SRL-High, SRL-Low and Sine Wave

Two-Wire Return Loss

Level Range: -10 to -2 dBm
Measurement Range: 0 dB to 40 dB
Resolution: 0.1 dB
Reference Impedance: 600 or 900 ohms (+-1%) in series with 2.16 microfarads (+-1%), or External

Four-Wire Return Loss

Transmitter

Level Range: -10 to -2 dBm

Receiver

Range: 0 dB to 50 dB
Accuracy: +- 0.5 dB
Resolution: 0.1 dB

Transhybrid Loss

Compensation: -10 to +30 dB

CHAPTER II. INSTALLATION

INTRODUCTION

This section contains installation instructions for the HP 4945A. This section also includes information about initial inspection and damage claims, preparation for use, packaging for shipment, and storage requirements.

INITIAL INSPECTION

WARNING

To avoid hazardous electrical shock, do not perform electrical tests when there are signs of shipping damage to any portion of the outer enclosure (covers, panels, CRT, etc.).

Inspect the shipping container for damage. If the shipping container or cushioning material is damaged, it should be kept until the contents of the shipment have been checked for completeness and the instrument has been checked mechanically and electrically.

If the contents of the shipment is incomplete, if there is mechanical damage or defect, or if the instrument does not pass the Self-check and Performance Test, notify the nearest Hewlett-Packard office.

If the shipping container or the cushioning material shows signs of stress, notify the carrier as well as the Hewlett-Packard office. Keep the shipping material for carrier's inspection. The HP office will arrange for repair or replacement (at HP option) without waiting for claim settlement.

PREPARATION OR USE

Power Requirements

The HP 4945A requires a power source of either 115-or 230-Vac, 48-to 63-Hz, single phase. Maximum 150 watts.

Line Voltage Selection

The voltage selector switch is located on the rear panel. Verify that the switch is set to the local operating line voltage. Also located on the rear panel is the line fuse. Verify that the fuse rating corresponds to the line voltage. Refer to table 2-1 for fuse rating and part numbers.

Table 2-1. Line Fuse Part Numbers

Line Voltage	Fuse Rating	HP Part Number
115 volts ac	3 amp SB	2110-0381
230 volts ac	1.5 amp SB	2110-0304

Power Cable

This instrument is equipped with a three-wire power cable. When connected to an appropriate ac power receptacle, this cable grounds the instrument cabinet. The type of power cable plug shipped with each instrument depends on the country of destination.

STORAGE AND SHIPMENT

Environment

The HP 4945A may be stored or shipped in environments within the following limits:

- Temperature -40° to +75° C (-40° to +167° F)
- Humidity 10% to 90% noncondensing
- Altitude 4600 m (15,000 ft)

The instrument should also be protected from temperature extremes which cause condensation within the instrument.

Original Packaging

Use original packaging if available. Containers and material identical to those used in the factory are available through Hewlett-Packard offices. If the instrument is being returned to Hewlett-Packard for servicing, attach a tag indicating the type of service required, return address, model number and full serial number. Also mark the container FRAGILE to ensure careful handling. In any correspondence, refer to the instrument by model number and full serial number.

Other Packaging

The following general instructions should be used for repackaging with commercially available materials:

1. Wrap the instrument in heavy paper or plastic.
2. Use a strong shipping container. A double-walled carton made of 350-pound test material is adequate.
3. Use a layer of shock-absorbing material 70-to 100-mm (3-to 4-inch) thick around all sides of the instrument to provide firm cushioning and prevent movement inside container.
4. Seal shipping container securely.
5. Mark shipping container FRAGILE to ensure careful handling.
6. In any correspondence, refer to instrument by model number and full serial number.

CHAPTER III. OPERATION

This chapter contains both general information about the instrument and specific information on how to use it for making measurements on your network. Below is a brief synopsis of the main features of this chapter.

HP 4945A Features

This contains front panel, rear panel, and display descriptions.

Data Entry Procedure

This contains instructions on how to change the transmit level, frequency, or volume of the instrument. It also covers changing parameters which are located inside a menu.

Set Up and Turn On Procedure

This covers how to initially set up your instrument. Some of the areas covered are: termination impedance selection, calibration, hold coils, and data/time settings.

Measurements

Each measurement is covered separately. Each section contains a general description of the measurement menu and specific instructions on how to perform the measurement. Following the measurements are instructions on how to use the OUTPUT hardkey to dump your results to a printer. Also in this chapter is a brief description of all of the messages that appear on the display.

Master/Slave

The final section contains information on Master/Slave. It includes a description of what it is, how it works, how to use it, and all the error messages. Also included are notes on operation when using an HP 4943A or an HP 4944A with the HP 4945A.

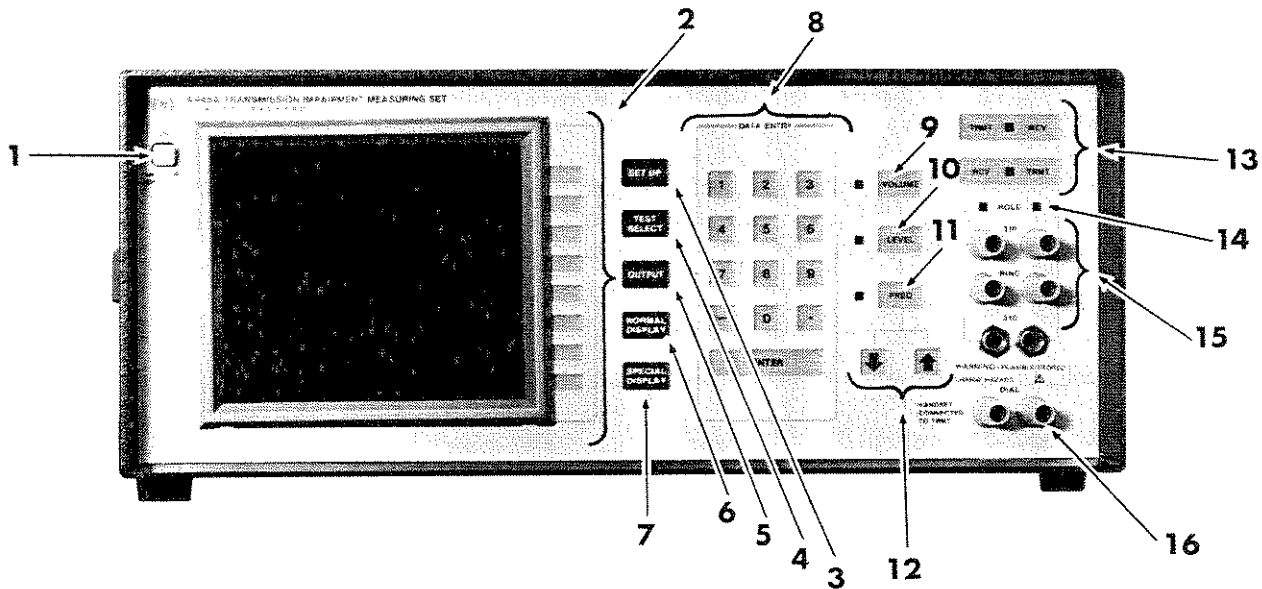

Figure 3-1. Front Panel Controls, Connectors, and Indicators

HP 4945A Features

FRONT PANEL DESCRIPTION

1. LINE ON/OFF - When pressed IN, the instrument is powered ON. When pressed again, the power is turned on.
2. SOFTKEYS - The function of each softkey is labelled on the screen. When a selection is made, the next level of choices appears.
3. SET UP Hardkey - Pressing this key presents all of the set-up choices. All of the set-up parameters can be changed from the menu selections available on the screen.
4. TEST SELECT Hardkey - Pressing this key presents all of the measurements selections.
5. OUTPUT Hardkey - Pressing this key will automatically print the data on the screen to a printer which is connected through any of the optional I/O interfaces.
6. NORMAL DISPLAY - This returns the display to the normal display mode after being in special display mode.
7. SPECIAL DISPLAY - Pressing this key enables the bold mode. This mode displays the measurement data in characters five times larger than normal display and in inverse video. The special display mode can be used when the measurement data becomes difficult to read (because of ambient light conditions or because of the distance from the display screen). The SPECIAL DISPLAY is designed to be used in the local mode. When a controller is being used with the HP 4945A the measurements should be viewed in NORMAL DISPLAY.

8. DATA ENTRY Keys - These keys are used to enter numeric values when prompted by the DATA ENTRY block on the display. After the desired value has been keyed in, the ENTER key must then be pressed to end the data entry mode.
9. VOLUME Hardkey - The volume level can be adjusted by the data entry keys or the up/down arrow keys. Also, the keyboard beep can be turned ON or OFF.
10. LEVEL Hardkey - Pressing this key enables you to change the existing output level by a number of methods: Along the right side of the screen, 5 programmable levels and a quiet termination selection are labelled. By pressing any of these, the level automatically changes to the desired value. In addition, the data entry block, which is in inverse video, indicates that the data entry keys are active. The up/down arrow keys allow you to step to the desired level. The step size used is set on softkey #7 on this menu.
11. FREQUENCY Hardkey - Pressing this key allows you to change the transmit frequency by a number of methods: Along the right side of the screen, 6 programmable frequencies are labelled. Pressing any of these changes the frequency to the desired value. In addition, the data entry block, which is in inverse video, indicates that the data entry keys are active. The up/down arrow keys allow you to step to the desired level. The step size used is set on softkey #7 on this menu.
12. UP/DOWN Arrow Keys - These are active when in DATA ENTRY mode. These will increment or decrement the value of each press of the hardkey.
13. TRMT/RCY Hardkeys (or normal/reverse keys) - The LED illuminated determines which terminals are connected to the transmitter and which are connected to the receiver. To reverse the connections, simply press the alternate hardkey.
14. HOLD Coil LEDs - These LEDs are directly associated with the jacks located below them. These indicate that the hold coils are active (LED illuminated) on the left and/or right set of terminals.
15. Transmitter and Receiver Jacks - Connections can be made using either the standard Western Electric 310 jacks or the binding posts. The LEDs noted (13) indicate which terminals are the transmitter and which are the receiver.
16. DIAL Posts - These posts are provided for connection of a linesman's handset. The dial post, when activated, are connected to the transmit terminals.

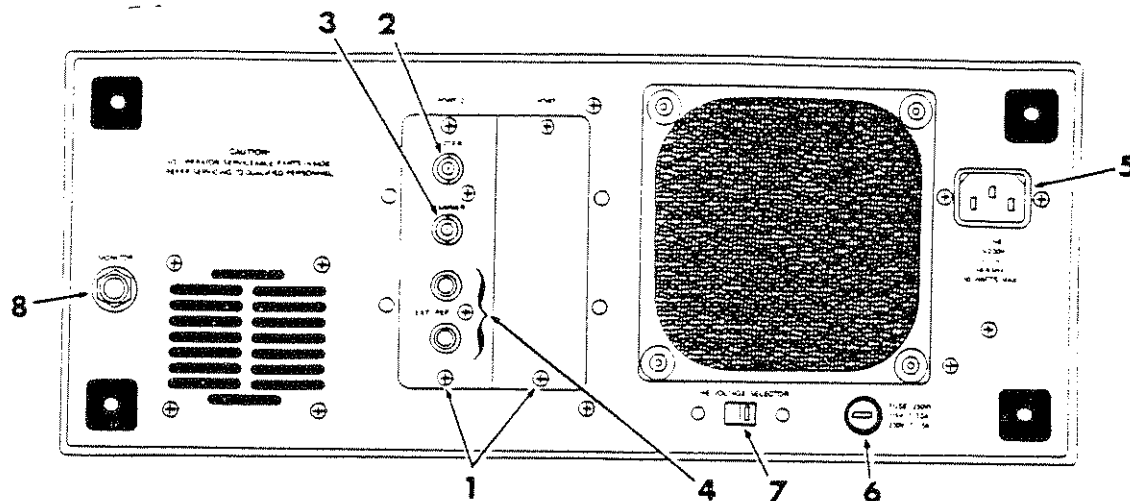

Figure 3-2. Rear Panel Control, Connectors, and Features

REAR PANEL DESCRIPTION

1. I/O Module Panels - These panels can be removed and the I/O modules can be inserted in their place.
2. Jitter Output - This is the demodulated jitter output. By using this output you are able to directly observe what is causing the jitter impairment (60 Hz, random noise, etc.). This output is directly affected by the jitter bandwidth selected.

Note

If both amplitude and phase jitter are on, this will not be a stable output.

3. CARRIER Output - The CARRIER output provides a square-wave output signal whose frequency corresponds to the received carrier signal.
4. EXTERNAL REFERENCE - This is active only in 2-wire return loss. The HP 4945A has the capability of using an external reference in place of the standard 600 ohms or 900 ohms, which are in series with a 2.16 uF capacitor. This option is selected using the softkeys in the Return Loss measurement set up menu.
5. Ac power line connector
6. Fuse
7. Voltage selector switch, 115 or 230 VAC
8. Monitor Jack - External headphones or speaker can be connected to this jack. When the headphone jack is inserted, the internal speaker is disabled.

CRT DISPLAY FUNCTIONS

The HP 4945A display screen is divided into functional areas that allow for quick and accurate interpretation of the displayed data. Figure 3-3 identifies these functional areas.

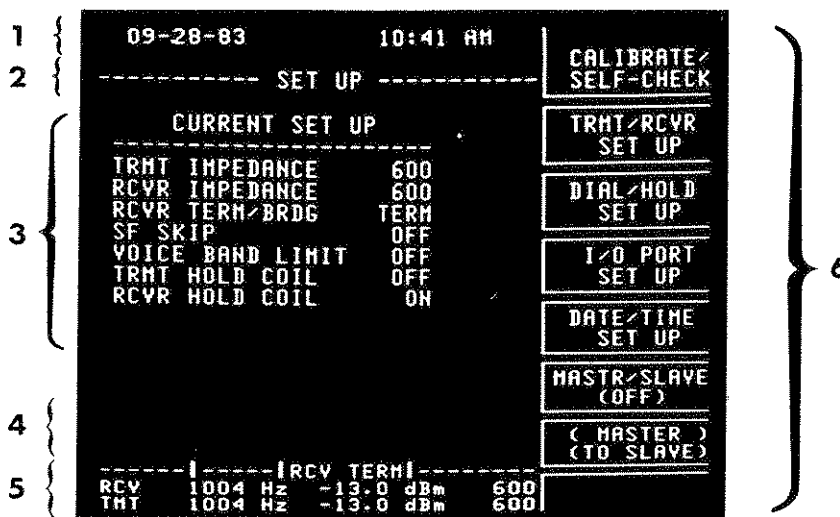

Figure 3-3. Display Features

Area 1

This line is dedicated to the date and time. In the 24 hour clock mode, the AM/PM indication is not displayed.

Area 2

This area contains three lines. The middle line labels the menu you are in and designates the softkeys to specific functions. The other two lines are designated for informational messages.

Area 3

This area is reserved for the measurement data or set-up information.

Area 4

This area contains three lines. The types of messages that may be found here are data entry messages, power-on messages, calibrate/self-check messages.

Area 5

Referring to this area will quickly tell you the transmitter and receiver configuration.

HP 4945A
Operation

Area 6

This area defines the functions of each of the softkeys. Since the HP 4945A is menu driven, each of these softkeys are redefined when a new selection is made.

OPERATING THE HP 4945A

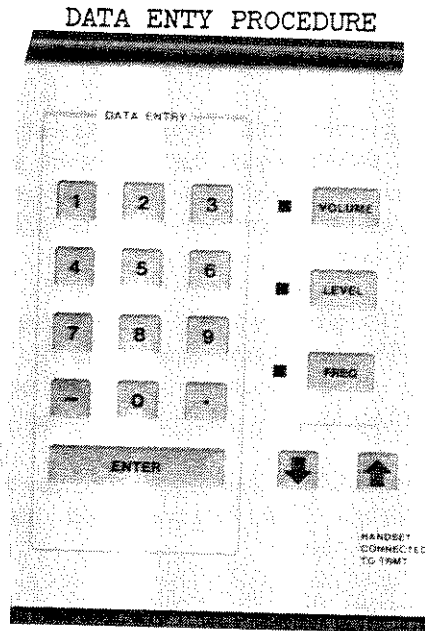



Figure 3-4. Data Entry, Level, Frequency, Volume Hardkeys

Level 

To change the transmitter's level, press the LEVEL hardkey. The following selections will appear.

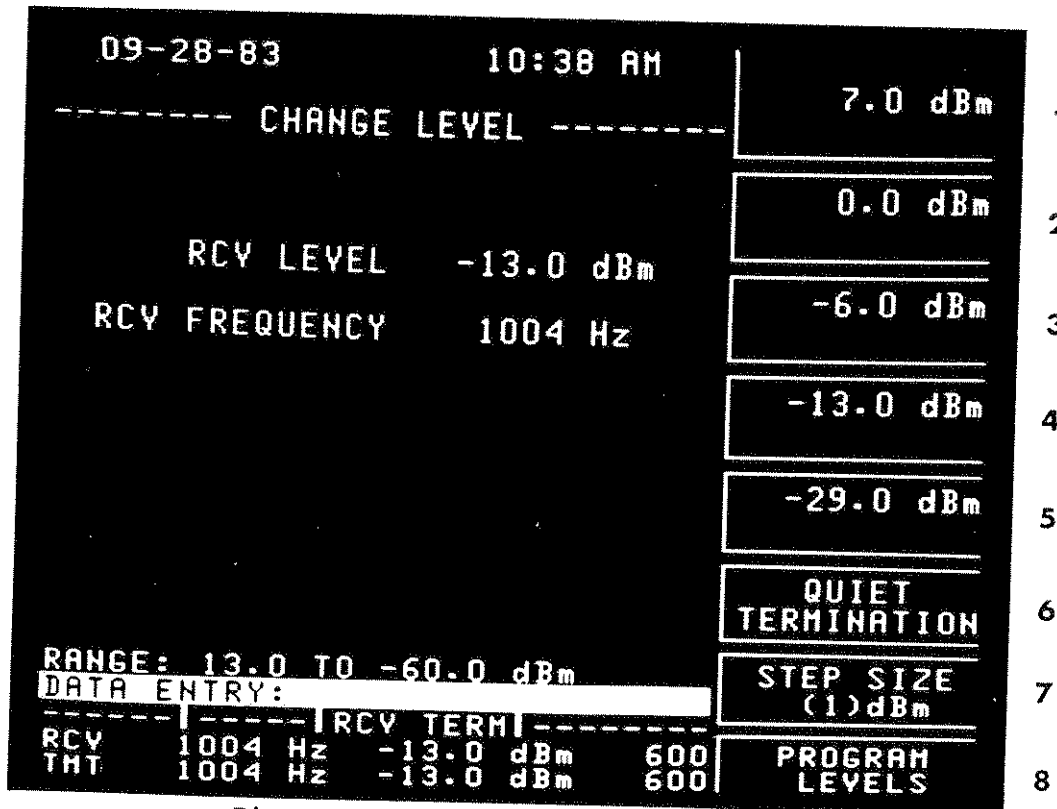

Figure 3-5. Level Softkey Selections

HP 4945A
Operation

Notice that the LED next to the hardkey will illuminate when this key is active. There are three ways of changing the level of the instrument. They are: The DATA ENTRY keys, the up/down arrow keys, or selection of one of the preprogrammed levels. The procedure for each of these is discussed below.

DATA ENTRY Keys - When making a specific entry, first press the LEVEL hardkey; the DATA ENTRY lock will come up on the screen in inverse video with an acceptable entry range on the line above it. Next, press the appropriate keys on the keypad to make the level entry. The entries will show up in the DATA ENTRY block. To finalize your selection, press the ENTER key.

Up/Down Arrow Keys - These are located right below the LEVEL, FREQUENCY, and VOLUME hardkeys on the front panel. The up/down arrow keys can single step up or down a value. The amount of the step size is set in this menu by pressing the STEP SIZE softkey (#7). The choices available are .1, .5, 1 dBm.

Programmable Levels - When the LEVEL hardkey is pressed, the softkey selections shown in figure 3-5 appear (Note: The values may be different). To change the level, press the corresponding softkey.

The values shown that correspond to softkeys #1 - #5 can be reprogrammed as follows:

- Press softkey #8 which is labelled PROGRAM LEVELS. Notice that each of the levels is in parentheses.
- To change any of the values, press the corresponding softkeys. Now, use the data entry keys or the up/down arrow keys to change it to the desired value.

Frequency FREQ

Changing the frequency is very similar to changing the level. When the FREQUENCY hardkey is pressed, the following selections appear:

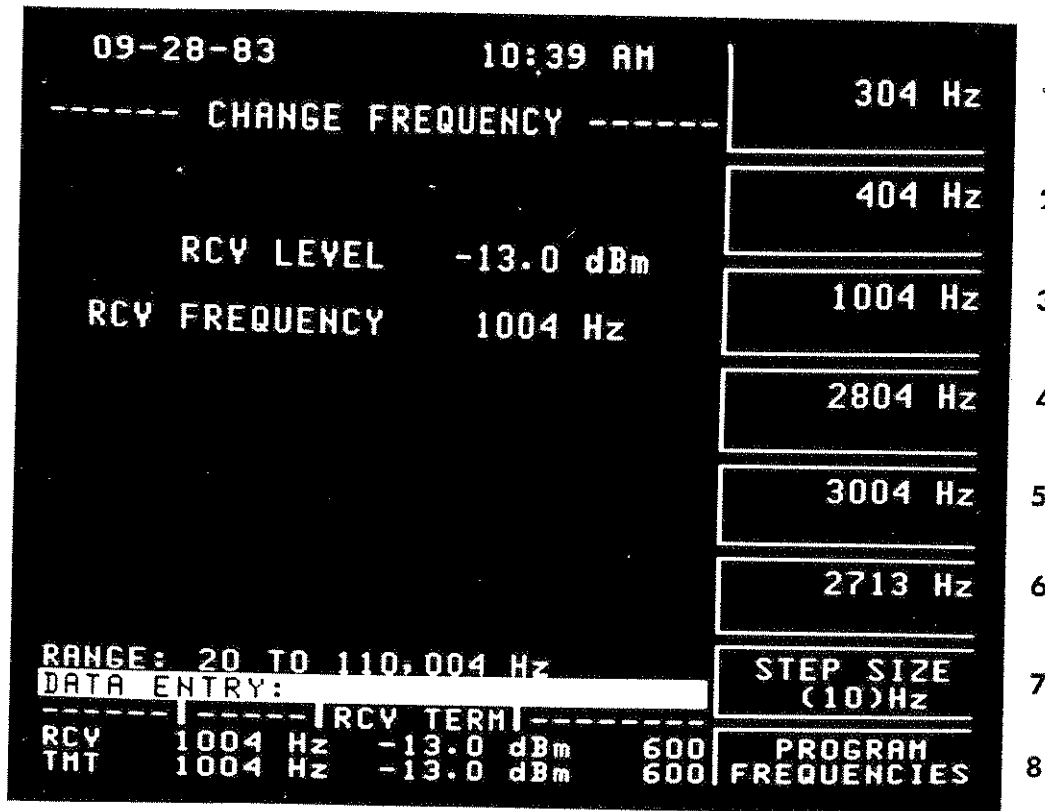

Figure 3-6. Frequency Softkey Selections

Notice that the LED next to the hardkey will illuminate when this key is active. There are three ways of changing the frequency of the instrument. They are: the Data ENTRY keys, the up/down arrow keys, or selection of one of the preprogrammed frequencies. The procedure for each of these is discussed below.

DATA ENTRY Keys - When making a specific entry, first press the FREQUENCY hardkey: the DATA ENTRY block will come up on the screen in inverse video with an acceptable entry range on the line above it. Next, press the appropriate keys on the keypad to make the frequency entry. The entries will show up in the DATA ENTRY block. To finalize your selection, press the ENTER key.

Up/Down Arrow Keys - These are located right below the LEVEL, FREQUENCY and VOLUME hardkeys on the front panel. The up/down arrow keys can single step up or down a value. The amount of the step size is set in this menu by pressing the Step Size softkey (#7). The choices available are 10, 50, 100, and 1000 Hz.

Programmable Frequencies - When the FREQUENCY hardkey is pressed, the softkey selections shown in figure 3-6 appear (Note: The values may be different). To change the frequency, press the corresponding softkey.

The values shown that correspond to softkeys #1 - #6 can be programmed as follows:

- Press softkey #8 which is labelled PROGRAM FREQUENCIES. Notice that each of the frequencies is in parentheses.
- To change any of the values, press the corresponding softkey. Now, use the data entry keys or the up/down arrow keys to change it to the desired value.

Volume

To control the speaker volume or the keyboard beep, press the VOLUME hardkey. The following selections will appear.

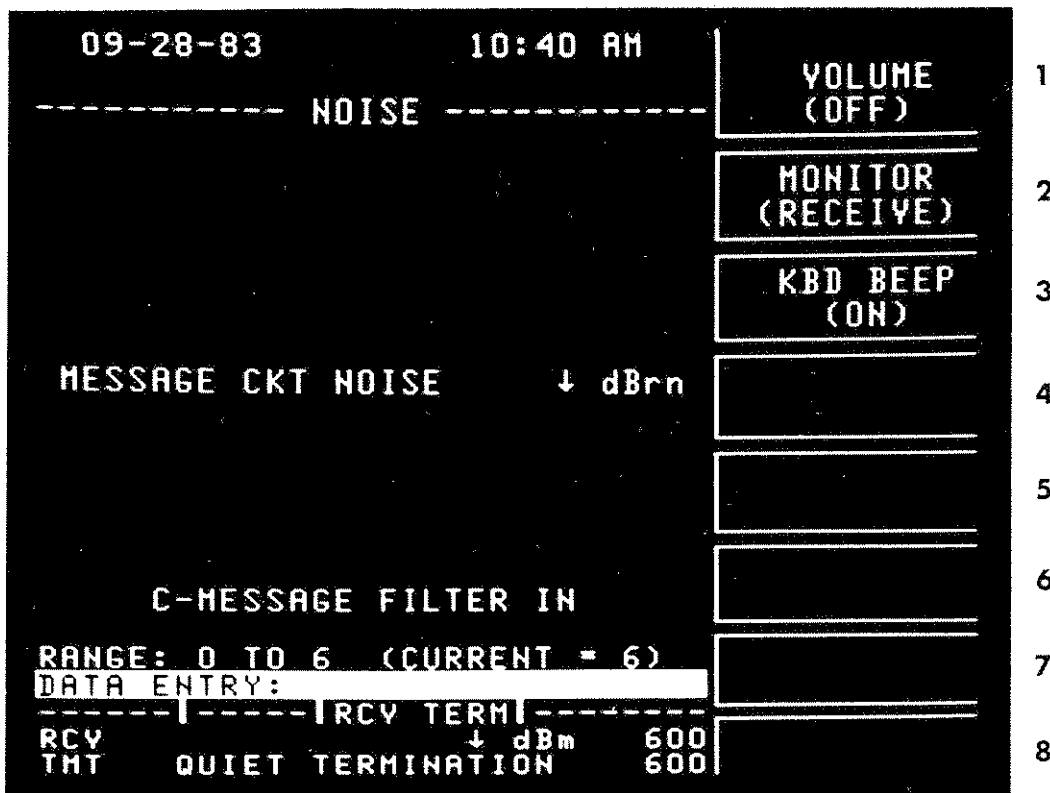

Figure 3-7. Volume Softkey Selections

Notice that the LED next to the hardkey will illuminate when this key is active.

Use softkey #1 to turn the VOLUME ONE. The volume range is from 0 to 6, with 6 being the loudest. The level can be changed by using either the up/down arrow keys or the DATA ENTRY keys.

Softkey #2 (MONITOR) selects whether the speaker is connected to the receiver or the transmitter.

Softkey #3 selects whether the keyboard beep is ON or OFF. This does not affect warning beeps.

Changing Parameters Located Inside a Menu (thresholds, timers, etc.)

Any parameter which has the option of being changed will be inside parentheses. If the parameter has a pre-determined set of choices, then when the softkey is pressed it will cycle through the selections. If there is a range that exists for that parameter, then when the softkey is pressed a data entry block will appear on the screen. You can now make either a numerical entry using the keypad or use the up/down arrow keys to change the parameter. To end the entry mode, either press the ENTER key or any key other than the DATA ENTRY keys.

POWER-ON SELF CHECK

The HP 4945A performs an automatic self check on power-on. During power-on a series of beeps will indicate that the self check is in progress. In addition to the beeps, the LED indicators located on the front panel will flash.

The power-on self check verifies the performance of the major circuitry. In the event of a hardware failure, an error code(s) will be displayed on the screen. Error codes are listed and explained in the HP 4945A Service Manual in Section VIII.

If power-on self-check errors are displayed, it may still be possible to continue using the instrument by pressing any key. The cause of the errors, however, should be corrected as soon as possible.

SET UP AND TURN ON PROCEDURE

General

1. Connect the power cord to the receptacle on the rear panel of the instrument.
2. Press the LINE button in to turn the instrument on. A series of beeps at power on indicates that the self-check is in progress.

CAUTION

Do not operate the instrument inside the carrying case. Restriction of air from the fan can cause overheating and damage to the test set.

3. Select the terminals that will be used for transmit and receive by using the appropriate hardkey located above the terminals.
4. Connect the HP 4945A to the circuit under test.
5. To initially configure the instrument, press the SET UP hardkey. The following menu will appear.

Note

The HP 4945A contains nonvolatile memory which "saves" your set up information after power-down. It does not retain your hold coil settings or measurement results. If you are in master/slave mode when you power-down, you will return to normal operation upon power-up.

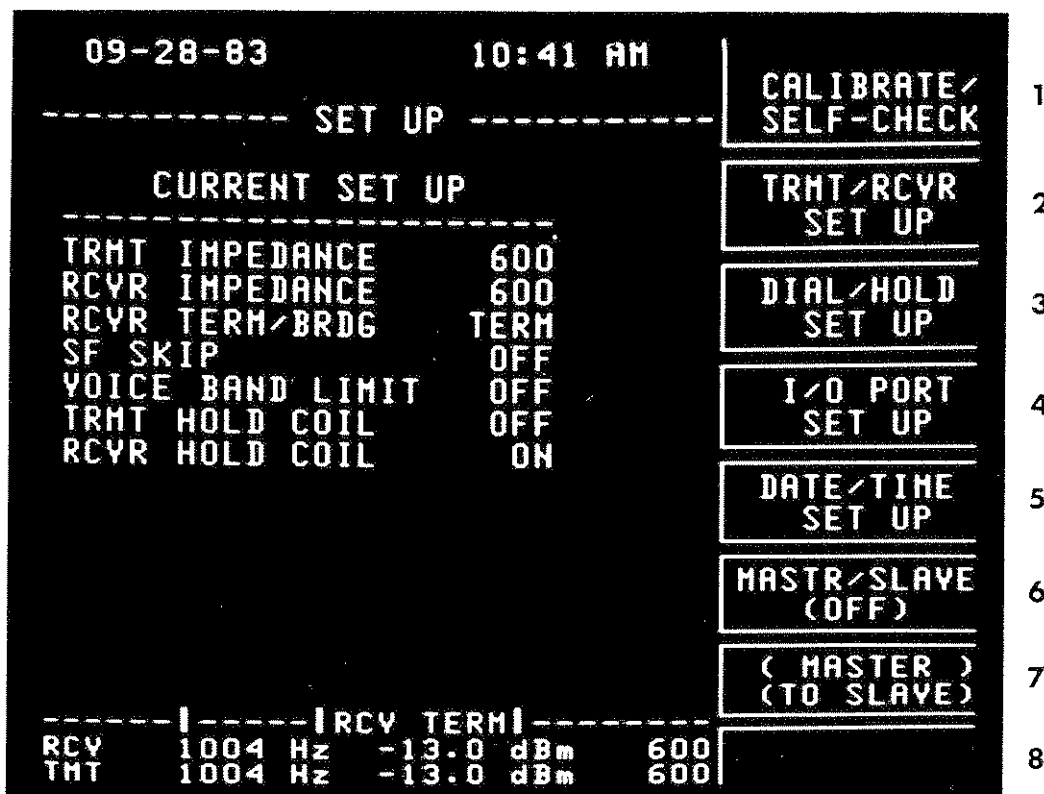

Figure 3-8. Set Up Menu

1. This softkey accesses the menu to run the calibration and self check routines.
2. This softkey accesses the menu to configure the transmitter and receiver.
3. This softkey accesses the menu for the dial/talk, talk battery and holding capabilities.
4. This softkey accesses the menu to set up the I/O ports.
5. This softkey accesses the menu to set the date and and time shown at the top of the display.
6. This softkey selects the mode of operation (e.g. OFF, MASTER or SLAVE).
7. If master/slave mode is selected, this softkey will determine the direction of test (e.g. MASTER TO SLAVE or SLAVE TO MASTER).
8. Not Used

Calibration

The HP 4945A has the capability of calibrating the major circuitry in the instrument. To perform the calibration procedure:

- Press the SET UP hardkey.
- Press the CALIBRATE/SELF-CHECK softkey (#1).
- Press the CALIBRATE softkey (#6). The message CALIBRATING will flash on the display while this is in progress. If there are any problems, refer to the Service Manual.

To Set Up the Transmitter and Receiver Configuration

1. Set the MASTER/SLAVE softkey (#6) to read OFF in the parentheses.
2. Press the TRMT/RCVR SET UP softkey (#2). The menu shown below will appear. Set each of the softkeys to the appropriate settings.

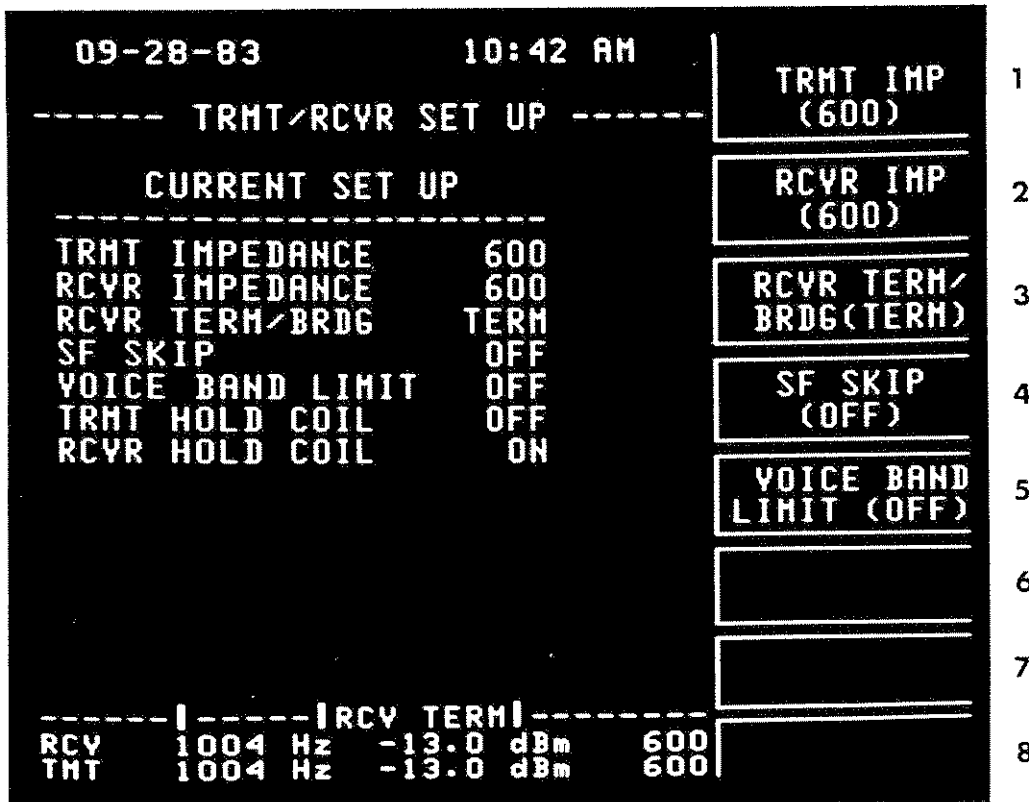

Figure 3-9. Transmitter and Receiver Set Up Menu

1. This softkey sets the transmitter termination impedance. The selections it cycles through are 135, 600, 900, and 1200 ohms. Select the impedance that matches the line to which the transmitter is connected.
2. This softkey sets the receiver termination impedance. The selections it cycles through are 135, 600, 900, and 1200 ohms. Select the impedance that matches the line to which the receiver is connected.
3. Set this softkey to TERM if the instrument is to be used to terminate the receive line. If the instrument is to bridge across the receive line, select BRIDGE. When the receiver is bridged, it presents a high impedance to the line. This ensures that the test set will not disturb the circuit which is under test.
4. Turn SF SKIP ON if transmitting over a dial up network where single frequency signalling units are used. SF SKIP prevents the instrument from transmitting frequencies between 2450 to 2750 Hz.
5. This softkey turns the VOICE BAND LIMIT function ON or OFF. When ON, it limits the high end output frequency to 3904 Hz and sets the current output frequency to 1004 Hz. This is used on N3 carrier facilities to prevent interference with 4 kHz pilot tones.
6. Not Used
7. Not Used
8. Not Used

Transmitter and Receiver Set Up When in Master/Slave

In master/slave, the slave's configuration can be set at the master unit. If you are configured for master/slave operation, then when the TRMT/RCVR SET UP softkey (#2) is pressed, the additional choices shown below will appear. Set each of these to the appropriate setting.

Note

These keys will not appear when operating with an HP 4943A or an HP 4944A slave unit.

SLAVE TRMT
IMP

6. This softkey sets the slave unit's transmitter IMP termination impedance. The selections it cycles through are 135, 600, 900, and 1200 ohms. Select the impedance that matches the line to which the slave's transmitter is connected.

HP 4945A
Operation

SLAVE RCVR IMP 7. This softkey sets the slave unit's receiver IMP termination impedance. The selections it cycles through are 135, 600, 900, and 1200 ohms. Select the impedance that matches the line to which the slave's receiver is connected.

SLAVE TERM/ BRDG 8. This softkey selects whether the receiver on the slave unit is BRIDGED or TERMinated. If the slave's receiver is bridged, it presents a high impedance to the line. This ensures that the test set will not disturb the circuit which is under test.

If desired, the slave can be configured at the slave box. Upon initial link, the master will display the slave's set-up configuration. It will not change unless one of the softkeys #6 - #8 are pressed.

You should be aware that the following actions will cause you to lose link:

- Running the diagnostic self check routine
- Running the calibration routine
- Reversing the transmit and receive lines using the hardkeys located above the terminals.

In order to recover, you must go through the initial link-up process again.

4. The HP 4945A will supply the handset with +15 Vdc to energize the microphone.
5. Not Used
6. Not Used
7. Not Used
8. Not Used

Refer to Table 3-1 for the proper control settings for your application.

<i>Table 3-1. Circuit Control Settings</i>			
Mode	2-Wire Wet (DDD)	2-Wire Dry	4-Wire Dry
Dial (through butt-in)	TRMT HOLD (OFF) RCVR HOLD (OFF) DIAL/TALK (ON) TALK BAT (OFF)		
Talk (through butt-in)	TRMT HOLD (OFF) RCVR HOLD (OFF) DIAL/TALK (ON) TALK BAT (OFF)	TRMT HOLD (OFF) RCVR HOLD (OFF) DIAL/TALK (ON) TALK BAT (ON)	TRMT HOLD (OFF) RCVR HOLD (OFF) DIAL/TALK (ON) TALK BAT (ON)
Listen (through butt-in)	TRMT HOLD (OFF) RCVR HOLD (OFF) DIAL/TALK (ON) TALK BAT (OFF)	TRMT HOLD (OFF) RCVR HOLD (OFF) DIAL/TALK (ON) TALK BAT (ON)	TRMT HOLD (OFF) RCVR HOLD (OFF) DIAL/TALK (ON) TALK BAT (ON)
Test	TRMT HOLD (ON) RCVR HOLD (ON) DIAL/TALK (OFF) TALK BAT (OFF)	TRMT HOLD (OFF) RCVR HOLD (OFF) DIAL/TALK (OFF) TALK BAT (OFF)	TRMT HOLD (OFF) RCVR HOLD (OFF) DIAL/TALK (OFF) TALK BAT (OFF)
Next, press the TEST SELECT hardkey and proceed with the measurement.			

Note

The hold coils do not switch lines with the line reverse switch. This is to prevent the line from being dropped.

LEVEL AND FREQUENCY

Description

This section describes the following types of level and frequency measurements:

- 1000 Hz Loss Measurement
- Frequency Shift Measurement
- Attenuation Distortion
- Gain Slope Measurement

To enter the Level Frequency menu, press the TEST SELECT hardkey and then the LEVEL FREQUENCY softkey (#1). The following menu will appear:

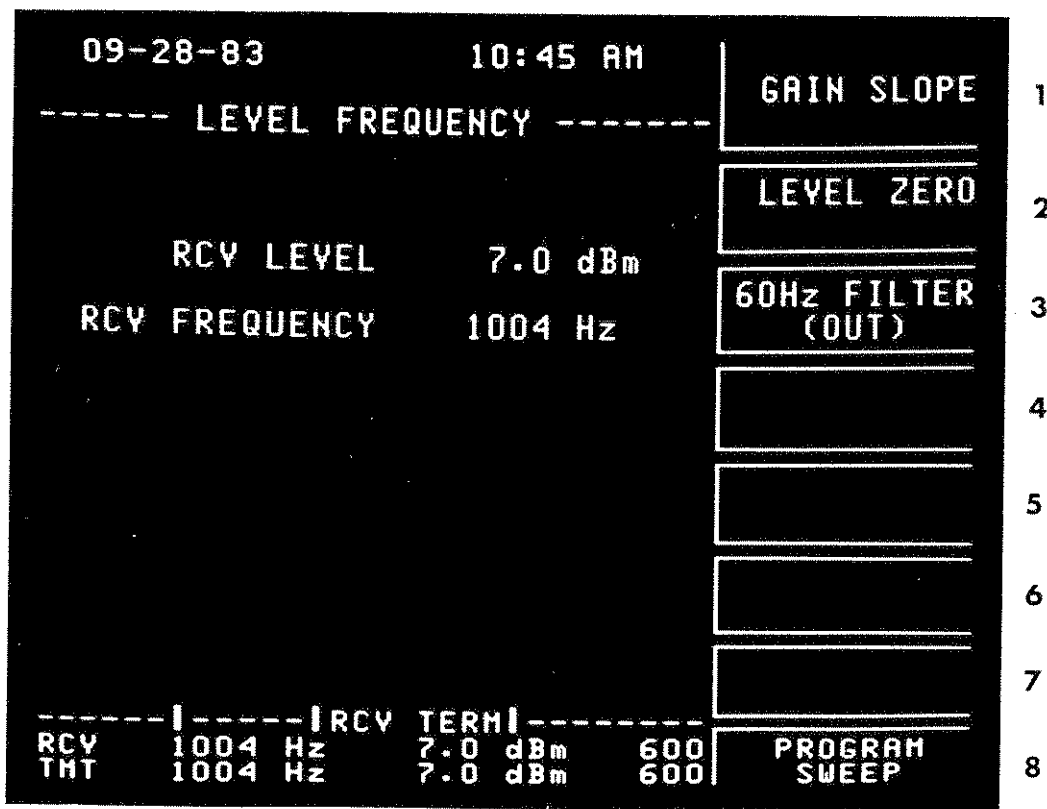

Figure 3-12. The Level Frequency Measurement Menu

1. This softkey begins the GAIN SLOPE measurement.
2. This softkey establishes a zero reference at the current level reading.

HP 4945A
Operation

3. This softkey inserts a 60 Hz high pass filter in the receive path. This attenuates 60 Hz by at least 20 dB without affecting the holding tone (1004 Hz) measurements.
4. Not Used
5. Not Used
6. Not Used
7. Not Used
8. This softkey accesses the programmable frequency sweep menu.

To set up a programmable frequency sweep when making the Level Frequency measurement, press the PROGRAM SWEEP softkey (#8). The menu is shown below with explanations of each of the selections. After setting up softkeys #2 through #6 to the appropriate settings, start the sweep by pressing softkey #1 until it reads SWEEPING in parentheses.

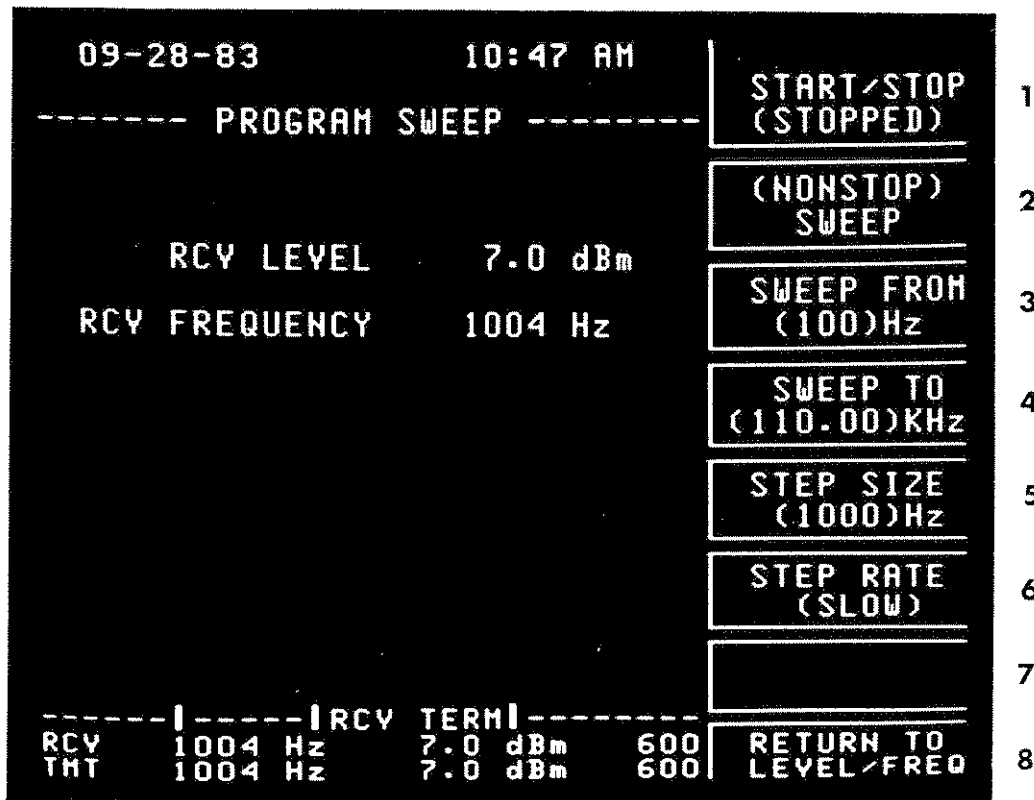

Figure 3-13. Programmable Sweep Menu for Level Frequency Measurement

1. This softkey starts and stops the sweep. It toggles between STOPPED and SWEEPING.
2. This softkey toggles between SINGLE and NONSTOP. NONSTOP allows you to continuously sweep.
3. Enter the frequency you want the sweep to start from.
4. Enter the frequency you want the sweep to end on.
5. Enter the step size you want between the frequencies.
6. Select how fast you want the sweep to step. This key cycles through slow (.3 steps/second), medium (1 step/second), and fast (3 steps/second).
7. Not Used
8. This softkey will return you to the level frequency menu.

General Instructions - Transmitter

1. Press the TEST SELECT hardkey.
2. Press the LEVEL FREQUENCY softkey (#1). The Level Frequency menu will appear.

Note

The transmitter is automatically set to 1004 Hz when entering the Level Frequency menu.

3. Adjust the level to the "Data Level".

Note

All transmission measurements should be made at Data Level. The Data Level for all presently specified data circuits is a power of 13 dB below the Transmission Level Point (TLP). For example, if the TLP is -16 dB, the Data Level would be -29 dBm. Therefore, an output level of -29 dBm would be applied in this case.

4. When requested by the receiver operator, transmit the agreed upon test frequencies. The frequency can be changed by entering a specific frequency, using the up/down arrow keys (both of these methods are explained in Data Entry Procedure Section) or by using the programmable sweep capability shown on softkey #8 above (refer to the Description Section).

Gain Slope Measurement

If you press GAIN SLOPE (softkey #1 in the Level Frequency menu), the transmitter will automatically cycle through 404 Hz, 1004 Hz, and 2804 Hz (2 seconds/step).

General Instructions - Receiver

1. Press the TEST SELECT hardkey.
2. Press the LEVEL FREQUENCY softkey (#1). The Level Frequency menu will be displayed.

1000 Hz Loss Measurement

3. Instruct transmitter operator to send 1004 Hz tone.
4. Observe RCV LEVEL and RCV FREQUENCY in center of the display.
5. Press 60 Hz FILTER softkey until IN appears in parentheses. If the received level changes more than ± 0.2 dBm, the 60 Hz filter should be left IN throughout the measurement. This will eliminate the effect of a 60 Hz signal interfering with your measurement.

Frequency Shift Measurement

6. Observe the received frequency while communicating with the transmitter operator, comparing any difference between the transmitted and received frequencies.

Note

The transmitting test set must be a test set capable of transmitting a signal which is known within ± 0.5 Hz. .

Attenuation Distortion

7. Instruct the transmitter operator to send 1004 Hz tone. If you want this measurement to be made in absolute dBm, then skip to step #9.
8. Press the LEVEL ZERO softkey. This establishes a 0 dB reference at the current frequency (1004 Hz).
9. Observe RCV LEVEL and RCV FREQUENCY in the center of the display while the agreed upon frequencies are transmitted. +dB indicates more loss and -dB indicates less loss, relative to the reference frequency.

Gain Slope Measurement

10. Select the GAIN SLOPE measurement softkey (#1). If the transmitting test set is not an HP 4945A, then the transmitter operator must transmit the tones (404 Hz, 1004 Hz, and 2804 Hz) individually. The receiving HP 4945A will recognize each of the frequencies and display the relative level to 1004 Hz on the screen.

Note

The transmitted frequencies can be sent in any order, but the relative level (dB) cannot be calculated until 1004 Hz is sent. As soon as the receiver recognizes 1004 Hz, it displays the relative levels of the tones it has previously received, if any. The measurement is continuously updated using the last 1004 Hz reference.

NOISE

Description

The noise measurements which can be performed with the HP 4945A are:

- Noise-with-Tone
- Signal-to-Noise Ratio
- Message Circuit Noise
- Noise-to-Ground
- Single Frequency Interference

Along with these measurements, there are five filters which can be selected. They are:

- C-message
- 3 kHz flat
- 15 kHz flat
- Program
- 50 kBit

To enter the noise menu, press the TEST SELECT hardkey and then the NOISE softkey (#2). The following menu will appear.

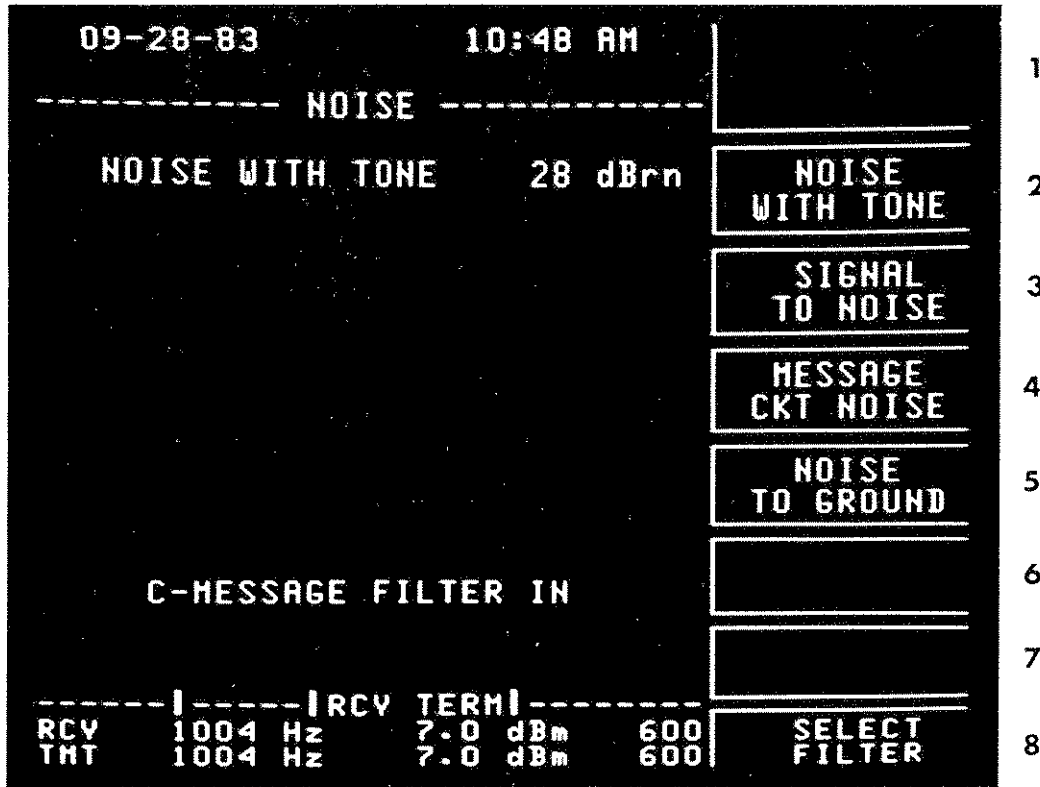

Figure 3-14. The Noise Measurement Menu

1. Not Used
2. This softkey selects the noise-with-tone measurement. It measures the telephone circuit noise (in dBrn) in the presence of a 1004 Hz tone.
3. When this softkey is pressed, the signal-to-noise ratio of the circuit is calculated.
4. This softkey selects the message circuit noise measurement. It measures the telephone circuit noise with the line quiet terminated.
5. This softkey selects the noise-to-ground measurement. This can be used as an indication of line balance.
6. Not Used
7. Not Used
8. This softkey accesses the noise filters menu.

If you press softkey #8 (SELECT FILTER), you will access the following menu.

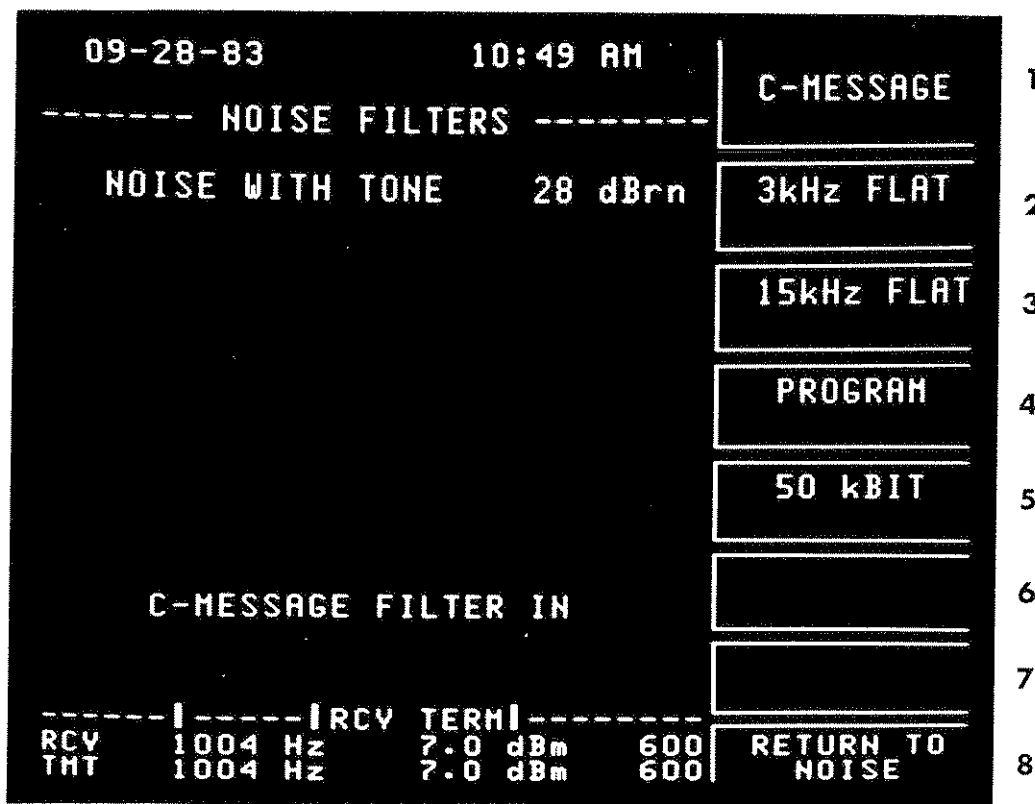

Figure 3-15. The Noise Filters Menu

HP 4945A
Operation

1. This softkey selects the C-message filter. This filter weights the noise to simulate what the human ear would detect.
2. This softkey selects the 3 kHz flat filter. This filter is used to detect the presence of low frequency noise on voice circuits.
3. This softkey selects the 15 kHz flat filter. This filter is used when making unweighted measurements of noise on program circuits.
4. This softkey selects the Program filter. This filter is used for the weighted measurement noise on program circuits which have bandwidths up to 8 kHz.
5. This softkey selects the 50 kHz filter. This filter is used on circuits which handle wideband data and DDS circuits.
6. Not Used
7. Not Used
8. This softkey returns you to the measurement menu.

General Instructions - Transmitter

1. Press the TEST SELECT hardkey.
2. Press the NOISE softkey (#2). The Noise menu will be displayed.

Message Circuit Noise

3. Press the MESSAGE CKT NOISE softkey (#4). This will quiet terminate the transmitter.

Signal-to-Noise Ratio

4. Press the SIGNAL TO NOISE softkey (#3). The transmitter is now transmitting a 1004 Hz holding tone.
5. Adjust the output level to the "Data Level" using the LEVEL hardkey.

Note

All transmission measurements should be made at Data Level. Data Level for all presently specified data circuits is a power of 13 dB below the Transmission Level Point (TLP). For example, if the TLP is -16 dB, the Data Level would be -29 dBm. Therefore, an output level of -29 dBm would be applied in this case.

Noise-to-Ground

The HP 4945A must be properly grounded for valid noise to ground measurements. Ground can be established through the power cord ground if there is a reliable power line bond or through the sleeve connections on the 310 transmit/receive jacks.

6. Press the NOISE TO GROUND softkey (#5). The transmitter is now quiet terminated.

Noise-With-Tone

7. Press the NOISE WITH TONE softkey (#2). The transmitter is now transmitting a 1004 Hz holding tone.
8. Adjust the output level to the "Data Level" using the LEVEL hardkey (refer to "Data Level" above).

General Instructions - Receiver

1. Press the TEST SELECT hardkey.
2. Press the NOISE softkey (#2).
3. The current filter selected is displayed on the lower portion of the screen. If you want to change to another filter, press the SELECT FILTER softkey (#8) and select the desired weighting or press the RETURN TO NOISE softkey (#8).

Message Circuit Noise

4. Press the MESSAGE CKT NOISE softkey (#4). The reading in dBm will be displayed.

Single Frequency Interference

While performing a message circuit noise measurement, a single frequency interference check can be done.

5. Press the VOLUME hardkey.
6. Press the VOLUME softkey (#1) until ON appears in parentheses.

7. Adjust the volume level by using either the up/down arrow keys or the DATA ENTRY keys.
8. Press the MONITOR softkey (#2) until RECEIVE appears in parentheses. Listen for any predominant tone which will indicate a potential single frequency interference problem. A LEVEL FREQUENCY measurement can be made (Don't change the transmitter - keep it quiet terminated) to further analyze the tone. Press VOLUME hardkey to end the entries.

Signal-to-Noise Ratio

9. Press the SIGNAL TO NOISE softkey (#3). The HP 4945A will automatically display the signal-to-noise ratio.

Noise-to-Ground

10. Press the NOISE TO GROUND softkey (#5) and observe the dBrn reading on the display.

Line Balance Calculation

The relative line balance of an end loop can be calculated by message circuit noise (Nm) and noise to ground (Ng) and applying the following formula:

$$\text{Balance in dB} = N_m - N_g$$

Note

This calculation is only valid if the measurements are made on a physical pair and if it is assumed that the message circuit noise is caused by longitudinal noise converted to message circuit noise by a line imbalance. It is recommended that both of these measurements be made using the 3 kHz flat filter to account for the effects of power line related noise.

Noise-With-Tone

11. Press the NOISE WITH TONE softkey (#2) and observe the dBrn reading on the display.

TRANSIENTS

Description

The HP 4945A performs the following transient measurements:

- Impulse Noise (3 level)
- Phase Hits
- Gain Hits
- Dropouts

The HP 4945A will also perform a noise with tone measurement and latch the results to aid you in setting the impulse noise thresholds. The noise with tone measurement is always in progress whenever the transients measurement is STOPPED.

To enter the transients menu, press the TEST SELECT hardkey and then the TRANSIENTS softkey (#3). The following menu will appear.

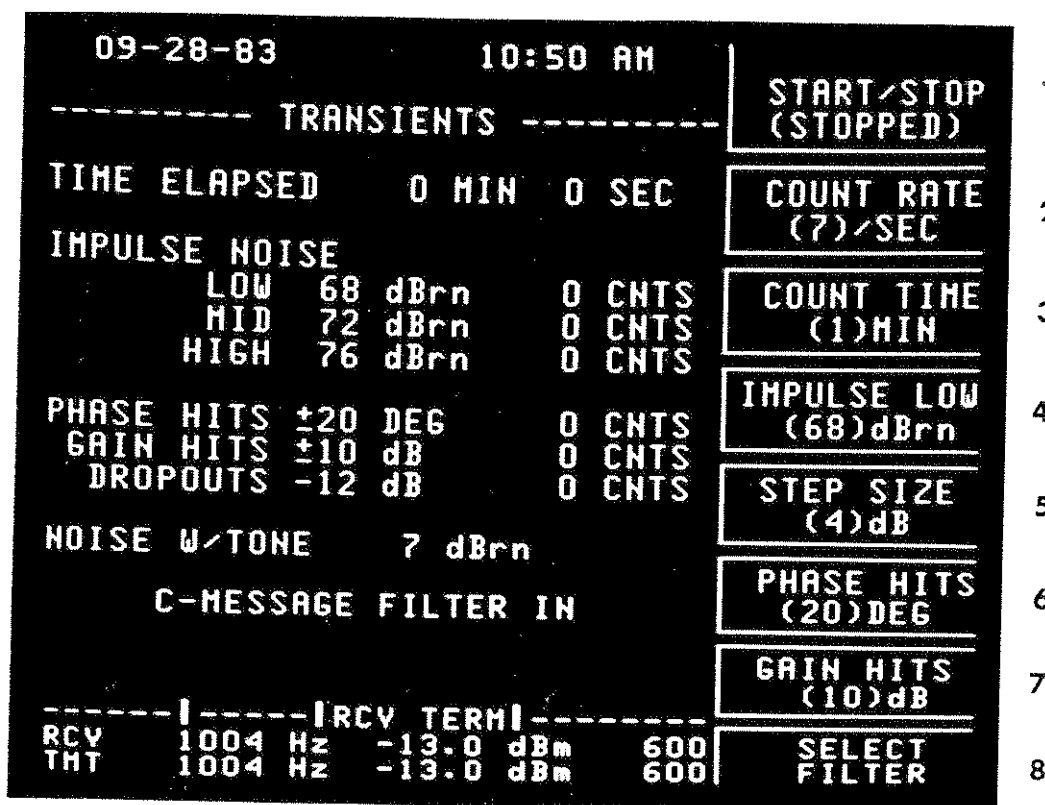

Figure 3-16. The Transients Measurement Menu

1. This softkey starts and stops the timer on the transients measurement. It toggles between STOPPED and RUNNING.

2. This softkey sets the count rate for transient measurements. It cycles through 7, 8, and 100 counts per second.
3. This softkey sets the timer for the transient measurement. The range is programmable from 0 (nonstop) to 9999 minutes.
4. This softkey sets the LOW threshold for impulse noise. The range is programmable from 30 to 110 dBm.
5. This softkey sets the step size between the LOW to MID and MID to HIGH impulse noises thresholds. It cycles through 2, 3, 4, 5 and 6 dB.
6. This softkey sets the phase hits threshold. It cycles through 5, 10, 15, 20, 25, 30, 35, 40 and 45 degrees.
7. This key sets the gain hits threshold. It cycles through 2, 3, 4, 5, 6, 7, 8, 9, and 10 dB.
8. This softkey accesses the noise filters menu. For further explanation of this menu, refer to the NOISE measurement section. The noise filter selected affects the impulse noise measurement only.

General Instructions - Transmitter

1. Press the TEST SELECT hardkey.
2. Press the TRANSIENTS softkey (#3). The transmitter is now transmitting a 1004 Hz holding tone.
3. Adjust the output level to the "Data Level" using the LEVEL hardkey

Note

All transmission measurements should be made at Data Level. The Data Level for all presently specified data circuits is a power of 13 dB below the Transmission Level Point (TLP). For example, if the TLP is -16 dBm, the Data Level would be -29 dBm. Therefore, an output level of -29 dBm would be applied in this case.

General Instructions - Receiver

1. Press the TEST SELECT hardkey.
2. Press the TRANSIENTS softkey (#3).
3. Press the COUNT RATE softkey (#2) until the desired rate appears in parentheses. It cycles through 7, 8, and 100 counts per second.

4. Press the COUNT TIME softkey (#3) and set the timer for the desired limit using the DATA ENTRY keys or the up/down arrow keys. The allowable range is from 0 to 9999 minutes with 0 being nonstop. The up/down arrow keys will step in 5 minute steps.
5. Press IMP THLD LO softkey (#4). Enter the desired low threshold for impulse noise using the DATA ENTRY keys or the up/down arrow keys (1 dBrn step).
6. Press the IMP THLD STEP softkey (#5) until the desired step size between the impulse noise thresholds appears. Your choices are 2, 3, 4, 5, and 6 dB.
7. Press the PHASE HITS THLD softkey (#6) until the desired phase hit threshold is obtained. This key cycles in 5 degree steps from 5 to 45 degrees.
8. Press the GAIN HITS THLD softkey (#7) until the desired gain hits threshold is obtained. This key cycles in 1 dB steps from 2 to 10 dB.
9. The current filter which is selected for the noise measurements is displayed on the lower portion of the screen. If you want to change to another filter, press the SELECT FILTER softkey and select the desired weighting or press the RETURN TO TRANSIENTS softkey (#8).
10. Press the VOLUME hardkey. Press the VOLUME softkey (#1) until ON appears in parentheses.
11. Press the MONITOR softkey (#2) until RECEIVE appears in parentheses.
12. Using the DATA ENTRY keys or the up/down arrow keys, change the volume to the desired level. Listen for any predominant noise which can provide a clue as to the noise source. If you decide not to change the volume level, press the VOLUME hardkey again to return to the measurement menu.
13. Start the measurement by pressing the START/STOP softkey (#1) until RUNNING appears in parentheses. The current status of the counters can be observed on the screen. When the timer is done, STOPPED will appear in the parentheses under softkey (#1). Any softkey change will restart the measurement.

Note

The noise-with-tone reading will be latched while the transients measurement is running.

ENVELOPE DELAY DISTORTION

Description

The HP 4945A performs the envelope delay distortion measurement, which is an indirect method of measuring the phase response of a channel. It has a programmable frequency sweep capability to aid you in characterizing a line.

The following figure is included to quickly familiarize you with the measurement procedure and terms.

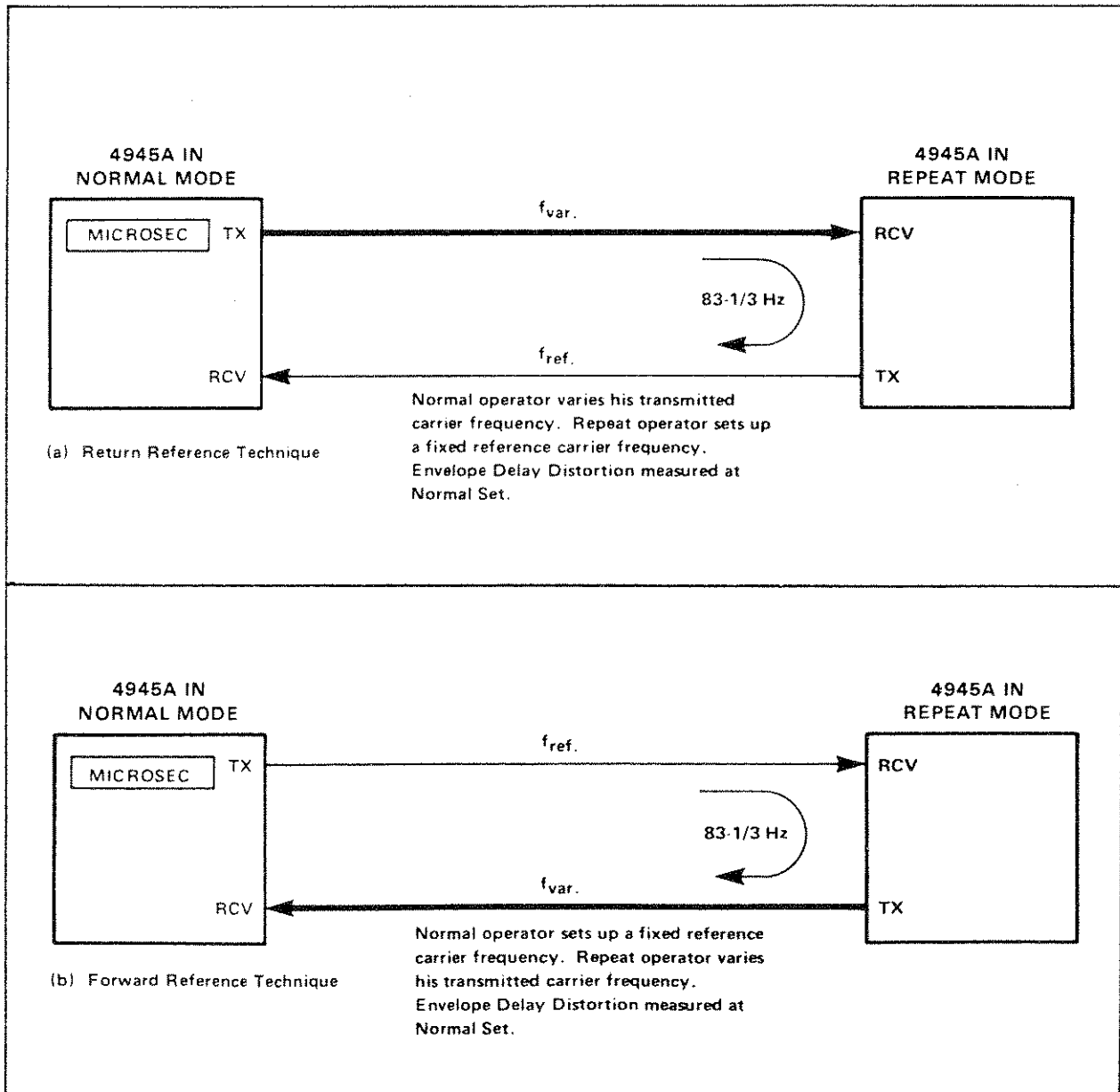

Figure 3-17. The Envelope Delay Test Set Up

To enter the envelope delay menu, press the TEST SELECT hardkey and then the ENVELOPE DELAY softkey (#4). The following menu will appear.

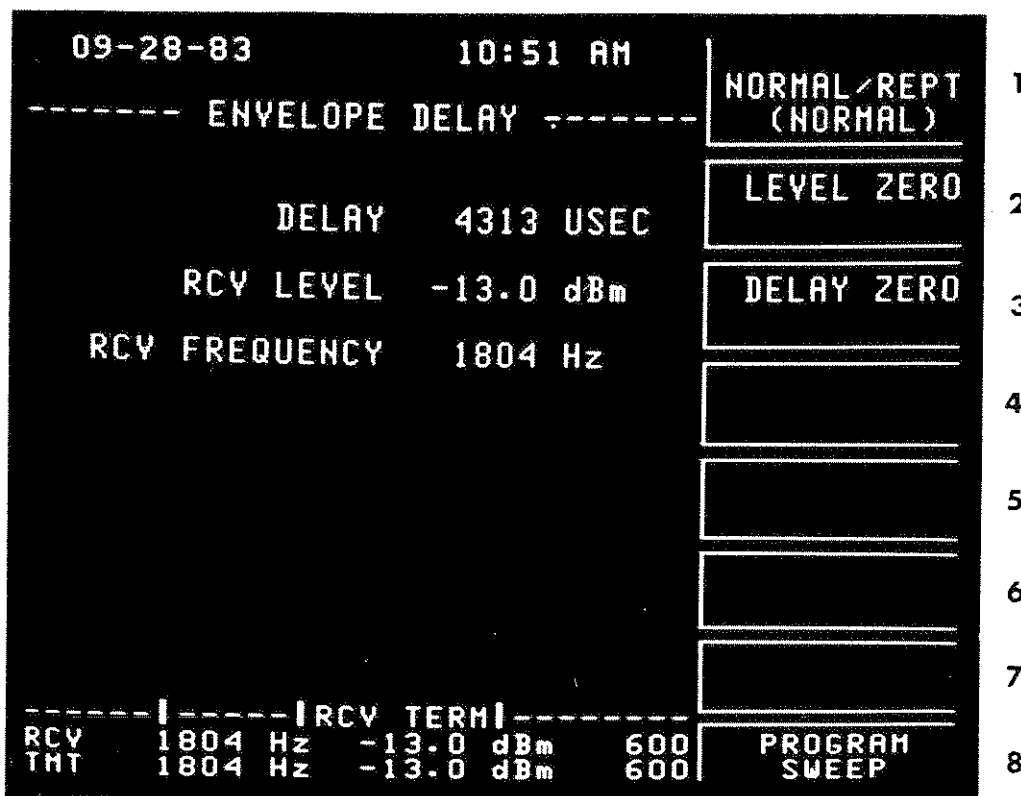

Figure 3-18. The Envelope Delay Measurement Menu

1. This softkey sets up the instrument as the NORMAL or as the REPEAT test set. This key is blanked in master/slave mode.
2. This softkey establishes a zero reference at the current level reading.
3. This softkey establishes a zero reference at the current delay reading.
4. In master/slave mode this softkey is labelled LEVEL/FREQ DATA (ON). This feature allows you to choose whether or not to view the slave's level and frequency readings. If you do not have a need to view this data, set the softkey to OFF. By choosing not to view the remote readings, the measurement cycle is significantly faster.
5. Not Used
6. Not Used
7. Not Used
8. This softkey accesses the programmable frequency sweep menu.

To set up a programmable frequency sweep when making the envelope delay measurement, press the PROGRAM SWEEP softkey (#8). The menu is shown below with explanations of each of the selections. After setting up softkeys #2 through #6 to the appropriate settings, start the sweep by pressing softkey #1 until it reads SWEEPING in parentheses.

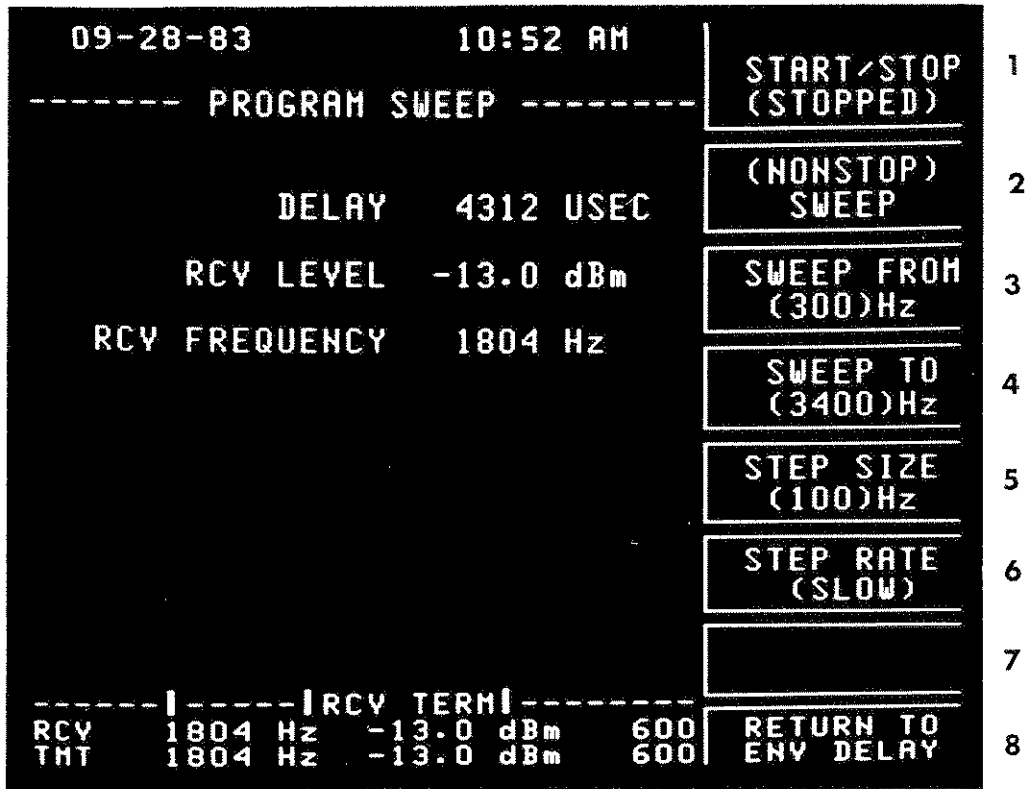

Figure 3-19. The Programmable Sweep Menu for Envelope Delay Distortion

1. This softkey starts and stops the sweep. It toggles between STOPPED and SWEEPING.
2. This softkey toggles between SINGLE and NONSTOP. NONSTOP allows you to continuously sweep.
3. Enter the frequency you want the sweep to start from.
4. Enter the frequency you want the sweep to end on.
5. Enter the step size you want between the frequencies.
6. Select how fast you want the sweep to step. The key cycles through slow (.3 steps/second), medium (1 step/second), and fast (3 steps/second).
7. Not Used

8. This softkey will return you to the envelope delay menu.

Note

Due to the amount of time the receiver of the HP 4945A needs to correctly measure a level and frequency, some points will not be displayed when using the medium or fast sweep rates.

Master/Slave Operation

When using the instrument in master/slave mode, the STEP RATE softkey (#6) will be blank. The step rate is not selectable in this mode of operation.

General Instructions - Return Reference - Normal Test Set

1. Press the TEST SELECT hardkey.
2. Press the ENVELOPE DELAY softkey (#4). The Envelope Delay menu will be displayed.
3. Press the NORMAL/REPT softkey (#1) until NORMAL appears in parentheses.
4. Connect the pair to be tested to the TRMT terminals. Connect the return reference pair to the RCV terminals.
5. Adjust the output level to the "Data Level" using the LEVEL hardkey.

Note

All transmission measurements should be made at Data Level. The Data Level for data circuits is a power of 13 dB below the Transmission Level Point (TLP). For example, if the TLP is -16 dB, the Data Level would be -29 dBm. Therefore, an output level of -29 dBm would be applied in this case.

6. When the Repeat Test Set operator has completed step 6, continue to step 7.
7. Observe the RCV LEVEL (in dBm) on the display. For valid measurements, this level must be greater than or equal to -40 dBm.
8. Adjust the transmit frequency to the reference frequency (e.g., 1804 Hz, or the frequency of minimum delay) using the FREQUENCY hardkey.

Note

The transmitter of the HP 4945A is automatically set to 1804 Hz when the envelope delay menu is accessed.

Note

If SF signaling units are used in the network under test, SF SKIP should be ON (refer to the Set Up Procedure).

9. Observe the delay reading on the display. Arrows will be displayed until the reading stabilizes. Press the DELAY ZERO softkey (#3). This establishes a zero reference at the reference frequency. This can be verified by noting the display under ZERO REFERENCE.
10. If you want a zero reference for the received level, press the LEVEL ZERO softkey (#2). The level which you selected as the reference is displayed under ZERO REFERENCE on the lower portion of the display.
11. Transmit the desired test frequencies using the FREQUENCY hardkey or the programmable sweep capability.
12. At each test frequency, observe the relative delay in microseconds. If the readings vary, take the average.

General Instructions - Return Reference - Repeat Test Set

1. Press the TEST SELECT hardkey.
2. Press the ENVELOPE DELAY softkey (#4). The envelope delay menu will be displayed.
3. Press the NORMAL/REPT softkey (#1) until REPEAT appears in parentheses.
4. Connect the pair to be tested to the RCV terminals. Connect the return reference pair to the TRMT terminals.
5. Adjust the output level to the "Data Level" using the LEVEL hardkey.

Note

All transmission measurements should be made at data level. The Data Level for data circuits is a power of 13 dB below the Transmission Level Point (TLP). For example, if the TLP is -16 dB, the Data Level would be -29 dBm. Therefore, an output level of -29 dBm would be applied in this case.

6. Adjust the transmit frequency to the reference frequency (e.g., 1804 Hz or the frequency of minimum delay) using the FREQUENCY hardkey.

Note

The transmitter of the HP 4945A is automatically set to 1804 Hz when the envelope delay menu is accessed.

7. Notify the Normal Test Set operator that you have completed Step 6.

General Instructions - Forward Reference - Normal Test Set

1. Press the TEST SELECT hardkey.
2. Press the ENVELOPE DELAY softkey (#4). The envelope delay menu will be displayed.
3. Press the NORMAL/REPT softkey until NORMAL appears in parentheses.
4. Connect the pair to be tested to the RCV terminals. Connect the reference pair to the TRMT terminals.
5. Adjust the output level to the "Data Level" using the LEVEL hardkey.

Note

All transmission measurements should be made at Data Level. The Data Level for data circuits is a power of 13 dB below the Transmission Level Point (TLP). For example, if the TLP is -16 dB, the data level would be -29 dBm. Therefore, an output level of -29 dBm would be applied in this case.

6. Adjust the transmit frequency to the reference frequency (e.g. 1804 Hz, or the frequency of minimum delay) using the FREQUENCY hardkey.

Note

The transmitter of the HP 4945A is automatically set to 1804 Hz when the envelope delay menu is accessed.

7. When the Repeat Test Set operator has completed step 6, continue to step 8.
8. Observe the RCV LEVEL (in dBm) on the display. For valid measurements, this level must be greater than or equal to -40 dBm.
9. Observe the delay reading on the display. Arrows will be displayed until the reading stabilizes. Press the DELAY ZERO softkey (#3). This establishes a reference at the reference frequency. This can be verified by noting the display under ZERO REFERENCE.
10. If you want a zero reference for the received level, press the LEVEL ZERO softkey (#2). The level which you selected as the reference is displayed under ZERO REFERENCE on the lower portion of the display.
11. Notify the repeat test set operator to begin sending the agreed upon test frequencies.
12. At each test frequency, observe the relative delay in microseconds. If the readings vary, take the average.

General Instructions - Forward Reference - Repeat Test Set

1. Press the TEST SELECT hardkey.
2. Press the ENVELOPE DELAY softkey (#4). The envelope delay menu will be displayed.
3. Press the NORMAL/REPT softkey until REPEAT appears in parentheses.
4. Connect the pair to be tested to the TRMT terminals. Connect the reference pair to the RCV terminals.
5. Adjust the output level to the "Data Level" using the LEVEL hardkey.

Note

All transmission measurements should be made at Data Level. The Data Level for data circuits is a power of 13 dB below the Transmission Level Point (TLP). For example, if the TLP is -16 dB, the Data Level would be -29 dBm. Therefore, an output level of -29 dBm would be applied in this case.

6. Adjust the transmit frequency to the reference frequency (e.g. 1804 Hz, or the frequency of minimum delay) using the FREQUENCY hardkey.

Note

The transmitter of the HP 4945A is automatically set to 1804 Hz when the envelope delay menu is accessed.

Note

If SF signaling units are used in the network under test, SF SKIP should be ON (refer to the Set Up Procedure).

7. Notify the normal test operator that you have completed step 6.
8. When the Normal Test operator has notified you step 10 has been completed, transmit the desired test frequencies using the FREQUENCY hardkey or the programmable sweep capability.

INTERMODULATION DISTORTION MEASUREMENT

Description

The HP 4945A performs the intermodulation distortion measurement using the 4-tone technique.* This measurement determines the effect of line nonlinearities on the transmitted signal. The HP 4945A will transmit a multifrequency signal and measure the second and third order distortion products. The HP 4945A has the capability to run a signal-to-noise check and correct the readings based on the results. This option is enabled when you select CHECK SIGNAL in the IMD menu.

To enter the intermodulation distortion menu, press the TEST SELECT hardkey and then the IMD/NLD softkey (#5). The following menu will appear.

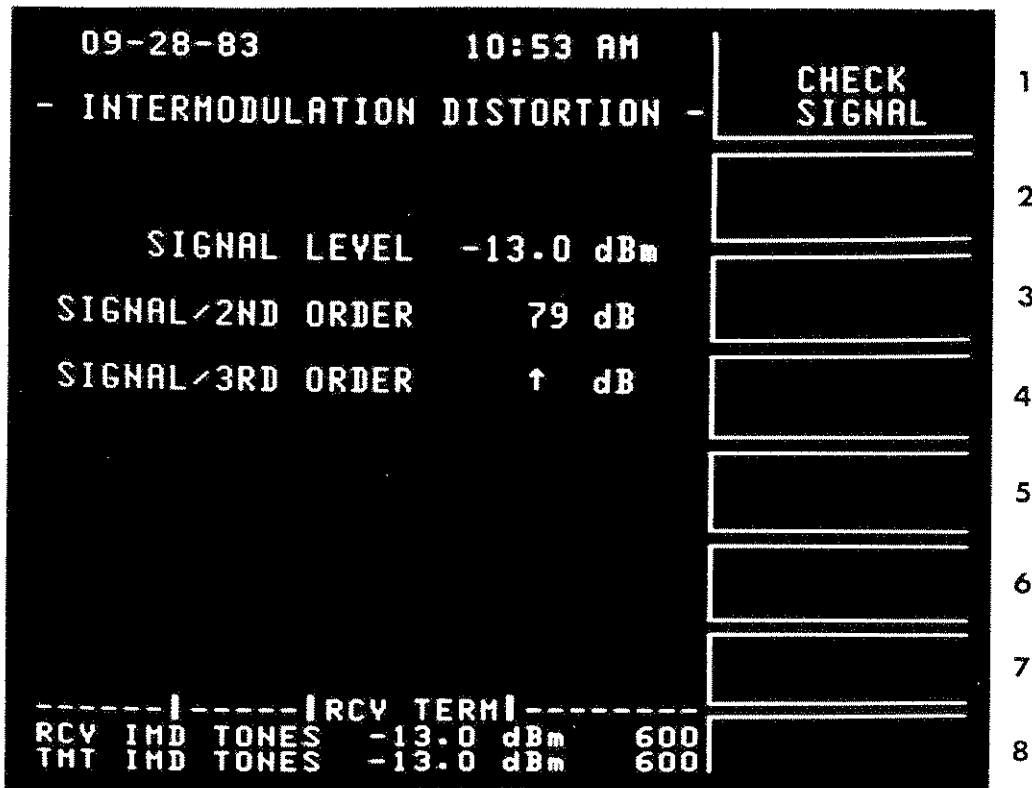

Figure 3-20. The Intermodulation Distortion Measurement Menu

1. This softkey enables a 12 second check signal with each press which is used to determine the signal-to-noise correction factor.

*Licensed under Hekimian Laboratories, Inc. U.S. Patent No. 3,862,380 for nonlinear distortion analyzer.

2. Not Used
3. Not Used
4. Not Used
5. Not Used
6. Not Used
7. Not Used
8. Not Used

General Instructions - Transmitter

1. Press the TEST SELECT hardkey.
2. Press the IMD/NLD softkey (#5). The IMD menu will be displayed.
3. Adjust the output level to the "Data Level" using the LEVEL hardkey.

Note

All transmission measurements should be made at Data Level. The Data Level for data circuits is a power of 13 dB below the Transmission Level Point (TLP). For example, if the TLP is -16 dB, the Data Level would be -29 dBm. Therefore, an output level of -29 dBm would be applied in this case.

4. When requested by the receiver operator, press the CHECK SIGNAL softkey (#1). This will transmit the check signal for 12 seconds. Each press of this key will add an additional 12 seconds to the transmission time.

General Instructions - Receiver

1. Press the TEST SELECT hardkey.
2. Press the IMD/NLD softkey (#5). The IMD menu will be displayed.
3. Instruct the transmitter operator to send the check signal. When this is in progress the status line of your display will read RCV CHECK SIG (in Area 5). When it is done, the message NOISE CORRECTED will appear on your screen. This indicates that the data is now automatically corrected for noise.
4. Observe the readings on the display. Note that the 2nd and 3rd order products are displayed in dB relative to the SIGNAL LEVEL.

HP 4945A
Operation

Master/Slave Operation

The instrument will automatically alternate between the CHECK SIGNAL and the IMD signal. Therefore, the CHECK SIGNAL softkey (#1) will be blank when in master/slave operation.

JITTER

Description

The HP 4945A performs both amplitude and phase jitter measurements in three different bandwidths. They are 20 to 300 Hz (Bell), 4 to 300 Hz (Bell + Low Frequency), and 4 to 20 Hz (Low Frequency). The jitter measurements can be made individually; or, using the measure-all feature, you can make both measurements in all three bandwidths sequentially.

To enter the jitter menu, press the TEST SELECT hardkey and then the JITTER soft key (#6). The following menu will appear.

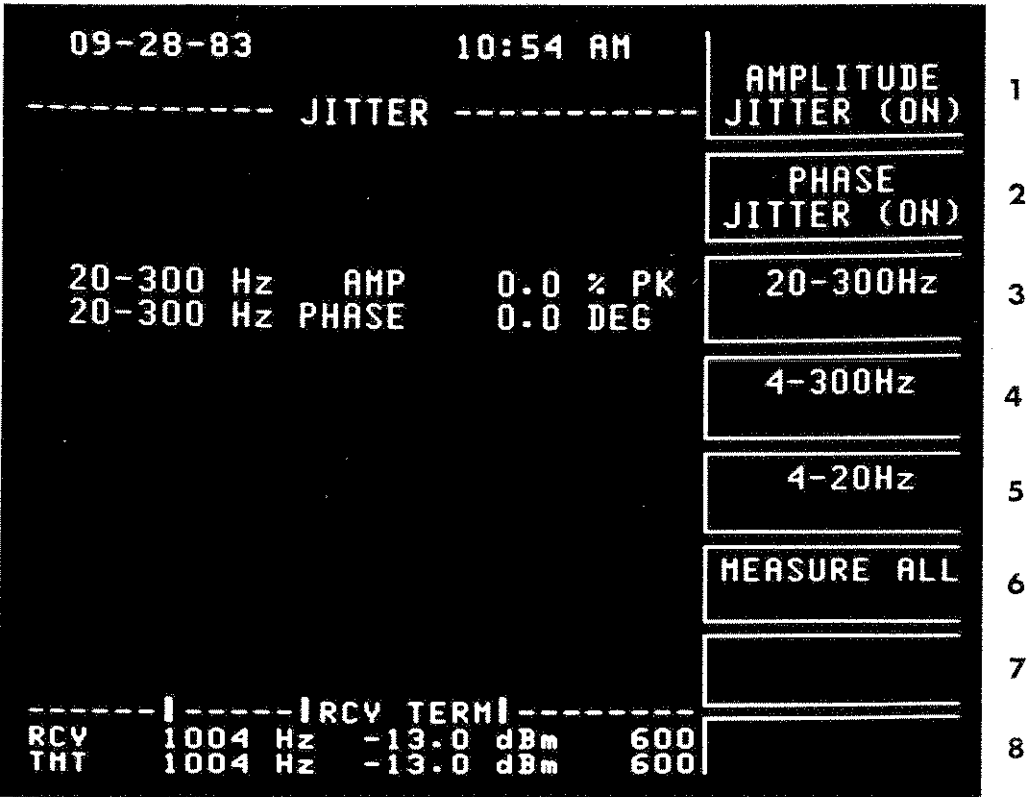

Figure 3-21. The Jitter Measurement Menu

HP 4945A
Operation

1. This softkey enables the amplitude jitter measurement. When it is ON, the amplitude jitter measurement will be displayed in the selected bandwidths.
2. This softkey enables the phase jitter measurement. When it is ON, the phase jitter measurement will be displayed in the selected bandwidths.
3. This softkey selects jitter in the 20 to 300 Hz bandwidth.
4. This softkey selects jitter in the 4 to 300 Hz bandwidth.
5. This softkey selects jitter in the 4 to 20 Hz bandwidth.
6. This softkey selects the desired jitter measurement in all three bandwidths.
7. Not Used
8. Not Used

**General Instructions - Transmitter
(Same for both amplitude and phase jitter)**

1. Press the TEST SELECT hardkey.
2. Press the JITTER softkey (#6). The Jitter menu will be displayed.

Note

The transmitter of the HP 4945A will be automatically set to 1004 Hz when this menu is accessed. No further adjustment is needed here.

3. Adjust the output level to the "Data Level" using the LEVEL hardkey.

Note

All transmission measurements should be made at Data Level. The Data Level for data circuits is a power of 13 dB below the Transmission Level Point (TLP). For example, if the TLP is -16 dB, the Data Level would be -29 dBm. Therefore, an output level of -29 dBm would be applied in this case.

General Instructions - Receiver

1. Press the TEST SELECT hardkey.
2. Press the JITTER softkey (#6). The Jitter menu will be displayed.
3. To perform the amplitude jitter measurement, press softkey #1 until ON appears in parentheses.
4. To perform the phase jitter measurement, press softkey #2 until ON appears in parentheses.
5. To perform the selected measurement in all three bandwidths, press the MEASURE ALL softkey (#6) and skip to step 7.
6. Select the desired measurement bandwidth by pressing the appropriate softkey, #3 (20-300Hz), #4 (4-300Hz) or #5 (4-20Hz).
7. Observe the jitter readings on the display. If the readings vary, take the average.

P/AR (PEAK-TO-AVERAGE RATIO) MEASUREMENT

Description

P/AR should not be used as a conclusive troubleshooting tool but only as a quick check of a line's performance. The P/AR signal is sensitive to attenuation distortion, phase distortion and noise.

To enter the P/AR menu, press the TEST SELECT hardkey and then the P/AR softkey (#7). The following menu will appear.

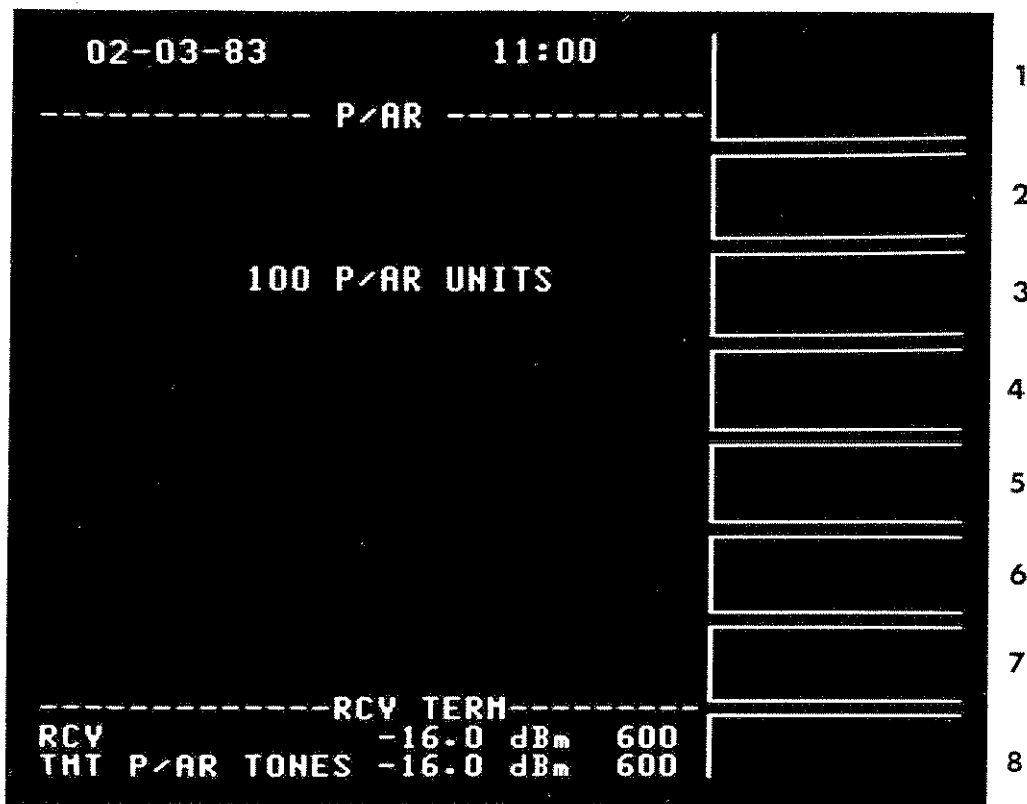

Figure 3-22. The P/AR Measurement Menu

1. Not Used
2. Not Used
3. Not Used
4. Not Used
5. Not Used
6. Not Used
7. Not Used
8. Not Used

There are no softkey selections for this measurement.

General Instructions - Transmitter

1. Press the TEST SELECT hardkey.
2. Press the P/AR softkey (#7). The P/AR menu will be displayed.
3. Adjust the output level to the "Data Level" using the LEVEL hardkey.

Note

All transmission measurements should be made at Data Level. The Data Level for data circuits is a power of 13 dB below the Transmission Level Point (TLP). For example, if the TLP is -16 dB, the Data Level would be -29 dBm. Therefore, an output level of -29 dBm would be applied in this case.

General Instructions - Receiver

1. Press the TEST SELECT hardkey.
2. Press the P/AR softkey. The P/AR menu will be displayed.
3. Observe the P/AR UNITS on the display.

RETURN LOSS

Description

The HP 4945A performs both 2- and 4-wire return loss. In 2-wire return loss you have the capability of using an external reference impedance in addition to the standard 600 and 900 ohm selections. In 4-wire return loss, there is an adjustment for transhybrid loss. You can perform the return loss measurement using one of the noise waveforms (ERL, SRL HIGH, SRL LOW) or using a single frequency tone. To facilitate characterizing a line, you can run a programmable frequency sweep over the band of interest in sine wave return loss.

Note

This measurement is not available when operating in master/slave mode.

To enter the return loss menu, press the TEST SELECT hardkey and then the RETURN LOSS softkey (#8). The following menu will appear.

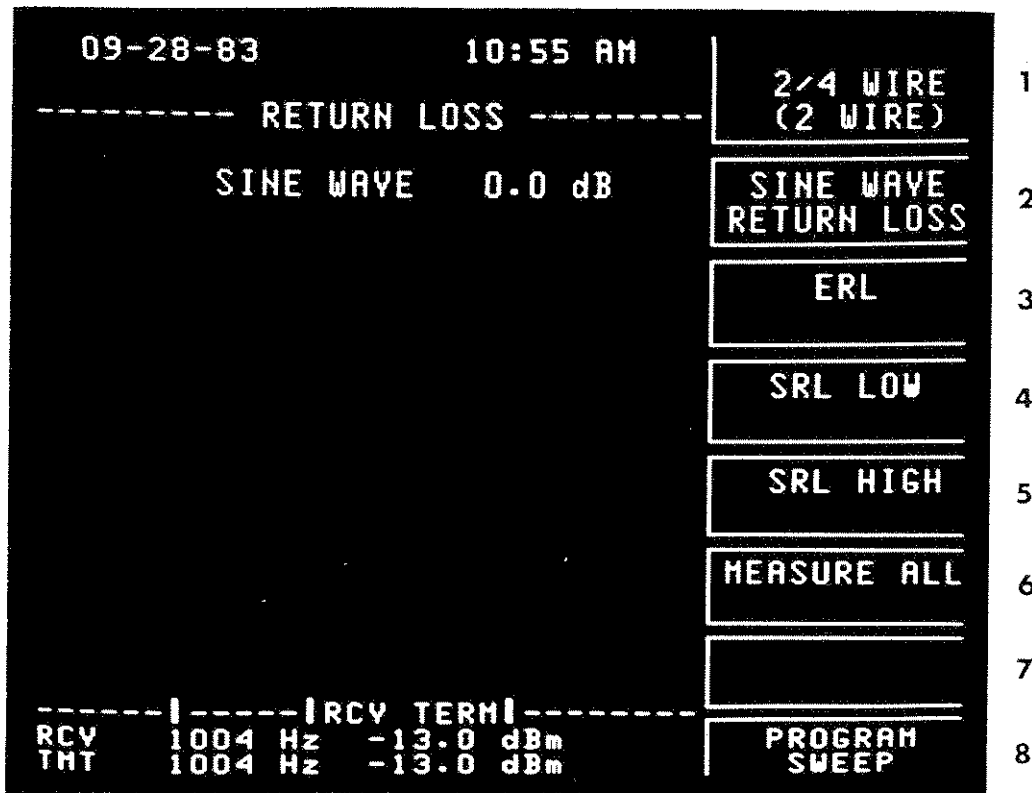

Figure 3-23. The Return Loss Measurement Menu

1. This softkey cycles through 2 WIRE, 4W 0 TLP, 4W -16 TLP. It selects 2- or 4-wire and adjusts the levels according to the point in the circuit you are testing at.
2. This softkey selects sine wave return loss.
3. This softkey selects echo return loss (ERL).
4. This softkey selects singing return loss - low (SRL LOW).
5. This softkey selects singing return loss - high (SRL HIGH).
6. This softkey selects ERL, SRL LOW, and SRL HIGH simultaneously.
7. What is displayed on this softkey depends on whether you have selected 2- or 4-wire mode on softkey #1.

If you are in 2-wire mode, this key is labelled REFERENCE IMP. It sets the reference impedance of the internal hybrid. It cycles through 600, 900 ohms and EXT. EXT means that you can use an external reference impedance which can be connected to the jacks on the rear panel.

If you are in 4-wire mode, this softkey is labelled HYBRID LOSS. You can enter the transhybrid loss of your network using the DATA ENTRY keys.

8. This softkey is displayed with SINE WAVE return loss only (softkey #2). It accesses the programmable frequency sweep menu.

When you select SINE WAVE (softkey #2) in the Return Loss menu, softkey #8 becomes PROGRAM SWEEP. When this is pressed the menu shown below is displayed. After setting softkeys #2 through #6, start the sweep by pressing softkey #1 until it reads SWEEPING in parentheses.

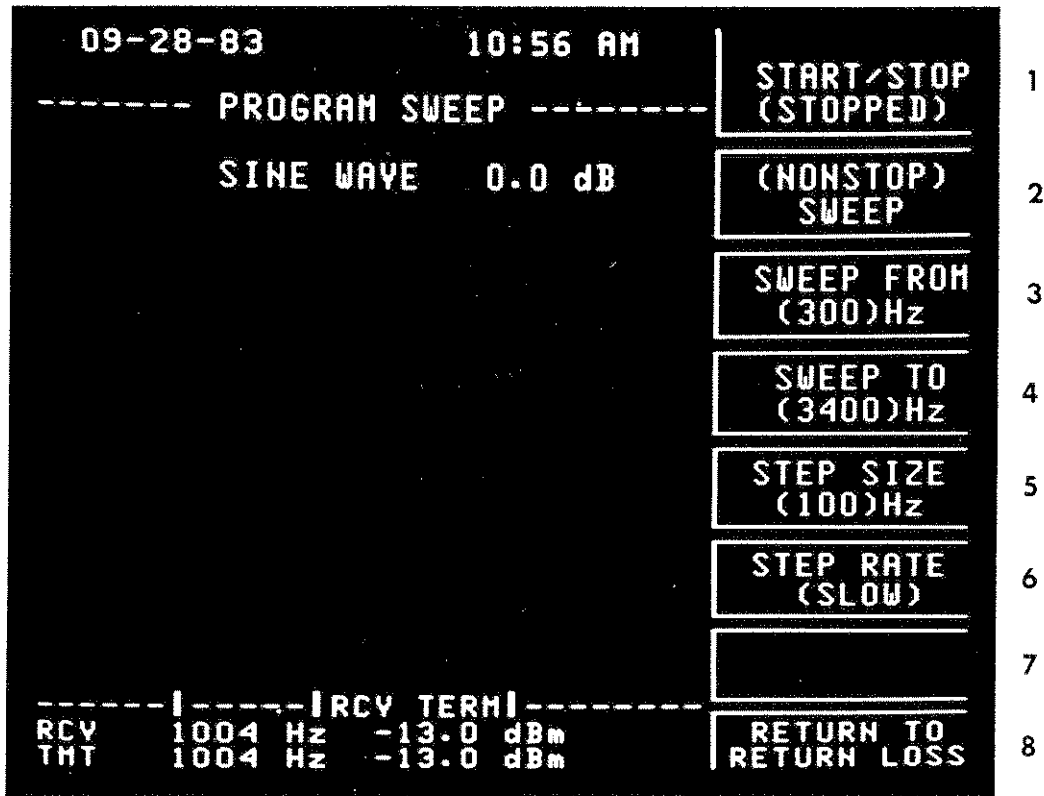

Figure 3-24. Programmable Sweep Menu for Return Loss

1. This softkey starts and stops the sweep. It toggles between STOPPED and SWEEPING.
2. This softkey toggles between SINGLE and NONSTOP. NONSTOP allows you to continuously sweep.
3. Enter the frequency that you want the sweep to start from.
4. Enter the frequency you want the sweep to end on.
5. Enter the step size you want between the frequencies.
6. Select how fast you want the sweep to step. The key cycles through slow (.3 steps/second), medium (1 step/second), and fast (3 steps/ second).
7. Not Used

8. This softkey will return you to the return loss menu.

Note

Due to the amount of time the receiver of the HP 4945A needs to correctly measure return loss, some points will not be displayed when using the medium or fast sweep rates.

General Instructions - 2-Wire Return Loss

The HP 4945A contains an internal resistive hybrid which is used to measure the impedance mismatch of a 2-wire circuit. The internal hybrid is on the transmit side of the HP 4945A

1. Connect the line under test to the TRMT terminals.
2. Press the TEST SELECT hardkey.
3. Press the RETURN LOSS softkey (#8). The Return Loss menu will be displayed.
4. Press the 2/4 WIRE softkey (#1) until 2 WIRE appears in parentheses.
5. Select the appropriate reference impedance by pressing REFERENCE IMP (softkey #7) until the desired selection appears in parentheses. If you want to use your own reference impedance, press the softkey until EXT appears in parentheses. The reference impedance should be connected to the jacks on the rear panel of the instrument.

Note

The 600 and 900 ohm selections are each in series with a 2.16 uF capacitor.

Note

When using either of the internal reference impedances, the EXTERNAL reference jacks are connected in parallel with the internal reference. This is for the purpose of adding shunt capacitance (e.g. NBO - Network Build-Out capacitance).

WARNING

DO NOT place a dc voltage across the external reference jacks; or a dc path using internal reference.

6. Adjust the output level using the LEVEL hardkey.

Note

The HP 4945A uses the reference impedance selected on softkey #7 to determine the level in dBm. If you have selected the external reference impedance option, it uses the impedance which was previously selected for the transmitter.

7. Select the desired test signal by choosing between softkeys #2 through #6. If performing sine wave return loss, select the measurement frequency using the FREQUENCY hardkey.

Note

The HP 4945A automatically begins transmitting a 2150 Hz tone when SINE WAVE return loss is accessed. This will disable any echo suppressors on the line. Also, the HP 4945A has the programmable sweep capability which comes up on softkey #8 after SINE WAVE return loss has been selected. This is explained in the previous section. The return loss readings will be displayed on the screen.

General Instruction - 4-Wire Return Loss

1. Connect the TRMT and RCV terminals to the hybrid under test.
2. Press the TEST SELECT hardkey.
3. Press the RETURN LOSS softkey (#8). The return loss menu will be displayed.
4. The HP 4945A has two different four-wire selections on softkey #1. The selections are labelled 4W-0 TLP and 4W-16 TLP. Select the one which matches the transmit TLP at the point you are going to test in the circuit.

Note

When testing at a -16 dBm0 TLP point, a receive TLP at +7 dBm0 is assumed, and the return loss results are adjusted accordingly.

5. Select the desired test signal by choosing between softkeys #2 through #6. If performing sine wave return loss, select the measurement frequency using the FREQUENCY hardkey.

Note

The HP 4945A automatically begins transmitting a 2150 Hz tone when SINE WAVE return loss is accessed. This will disable any echo suppressors on the line. Also, the HP 4945A has the programmable sweep capability which comes up on softkey #8 after SINE WAVE return loss has been selected. This is explained in the previous section.

6. Adjust the output level using the LEVEL hardkey to the level desired in dBm0 (referenced to TLP).
7. If the transhybrid loss of the circuit is known, press HYBRID LOSS and enter the appropriate value using the DATA ENTRY keys. If it isn't known, short the 2-wire arm of the hybrid under test. Note the reading on the display and enter this reading as indicated above. Don't forget to remove this short before proceeding.
8. Observe the readings displayed.

If you are using 2 instruments to perform this measurement:

If you are using 2 instruments to perform this test, you must set the transmit level on both, even though only one transmitter is being used. The HP 4945A at the receive side must know what the transmit level was in order to perform the return loss calculation.

Also, make sure the impedances on both instruments are set to the same values; otherwise you will receive erroneous readings.

If you want to run a frequency sweep between the 2 instruments only, set up the sweep function (softkey #8) on the transmitting instrument. The receiving instrument should be set up for SINE WAVE return loss. The receiving instrument will recognize the incoming frequencies and display the return loss reading.

HOW TO DUMP THE DISPLAY TO A PRINTER USING THE OUTPUT HARDKEY

Using the OUTPUT hardkey, an image of the display can be sent to a printer. The only part of the screen that will not be printed are the softkey selections. On your printout there will be a line of *'s, and then the display will be printed followed by another line of *'s. While it is printing, the word PRINTING will be flashing at the bottom portion of the screen. The instrument will still be making measurements even though the screen is frozen while printing. When the printing process is finished, the screen will automatically update the results on the screen. Pressing any key on the front panel will stop the printing action. Also, because there is not an ASCII equivalent to the up and down arrows which are displayed occasionally, + and - signs will be printed in their place. Notes for each of the different types of printers are contained below.

When using an HP-IL printer:

If your printer is already connected to the HP-IL module on your HP 4945A, skip to step 3.

1. With the HP 4945A turned OFF, insert the HP-IL module (HP-18165A) into one of the ports on the rear panel.
2. Connect the cables between the module and the printer.
3. Press the LINE button IN to power ON the instrument.
4. After the POWER ON SELF-CHECK has PASSED, then proceed to step 5.
5. Press the SET UP hardkey.
6. Next, press the I/O PORT SET UP softkey (#4). If you plugged the module into PORT 2, then press PORT 2 SET UP softkey (#8). The module should now be identified at the top of the screen.
7. Press I/O MODE softkey (#1) until OUTPUT appears in parentheses. .
8. Configure your printer for LISTEN ALWAYS mode.

Note

For the HP 82162A printer, hold the PRINT button and the PAPER ADVANCE button down while powering on.

Your instrument is now ready to print any display by simply accessing the display (perform the measurement) and then pressing the OUTPUT hardkey.

Note

Since the print buffer on the HP 82162A printer cannot hold all of the information on one line on the HP 4945A display, some of the information will wrap around and be printed on the next line.

When using an HP-IB printer:

If your printer is already connected to the HP-IB module on your HP 4945A then skip to step 3.

1. With the HP 4945A turned OFF, insert the HP-IB module (HP-18162A) into one of the ports on the rear panel.
2. Connect the cables between the module and the printer.
3. Press the LINE button IN to power ON the instrument.
4. After the POWER ON SELF CHECK has PASSED then proceed to step 5.
5. Press the SET UP hardkey.
6. Next, press the I/O PORT SET UP softkey (#4). If you plugged the module into PORT 2, then press PORT 2 SET UP softkey (#8). The module should now be identified at the top of the screen.
7. Press I/O MODE softkey (#1) until OUTPUT appears in parentheses. The HP-IB ADDRESS set on softkey #2 is ignored when you set the instrument into this mode.
8. Configure your printer for LISTEN ALWAYS mode.

Your instrument is now ready to print any display by simply accessing the display (perform the measurement) and then pressing the OUTPUT hardkey.

When using an RS-232SC printer:

If your printer is already connected to the RS-232C module on your HP 4945A, skip to step 3.

1. With the HP 4945A turned OFF, insert the RS-232C module (HP-18163A) into one of the ports on the rear panel.
2. Connect the cables between the module and the printer.
3. Press the LINE button IN to power ON the instrument.
4. After the POWER ON SELF CHECK has PASSED, then proceed to step 5.
5. Press the SET UP hardkey.

HP 4945A
Operation

6. Next, press the I/O PORT SET UP softkey (#4). If you plugged the module into PORT 2, then press PORT 2 SET UP softkey (#8). The module should now be identified at the top of the screen.
7. Press I/O MODE softkey (#1) until OUTPUT appears in parentheses.
8. Set up softkeys #2 through 7 to reflect your situation.

Your instrument is now ready to print any display by simply accessing the display (perform the measurement) and then press the OUTPUT hardkey.

DISPLAY MESSAGES

Following is a list of messages with their explanations. It is divided by the area on the display where it occurs.

AREA 2 MESSAGES

REMOTE - This will be displayed in inverse video when a controller has control of the instrument.

REMOTE WITH LOCAL LOCKOUT - This is displayed when a controller has control of the instrument and the keyboard is locked out.

SERVICE REQUEST - Refer to chapter 5, 6, or 7.

NO HOLDING TONE - In a measurement where a holding tone is used (e.g., Jitter) , a loss of tone will cause the warning message NO HOLDING TONE to appear in inverse video. "Loss of Tone" is defined as a receive level below -40 dBm or a receive frequency that is not between 995-1025 Hz.

IMD SIGNAL NOT RECEIVED - In the intermodulation distortion measurement, the receiver will check to see if a valid IMD signal is being received. If not, the above warning message will be displayed in inverse video.

NO MODULE, HP-IB, RS-232, HP-IL - In the I/O port set up menu, the display will identify what module, if any, is plugged in.

2ND ORDER DIST/NOISE < 2dB

3RD ORDER DIST/NOISE < 2dB

2ND, 3RD ORDER DIST/NOISE < 2dB - These messages indicate that the distortion level is within 2 dB of the background noise.

MASTER/SLAVE WARNING MESSAGES - Refer to the master/slave section.

AREA 4 MESSAGES

POWER ON SELF-CHECK PASSED - This means that the instrument has successfully completed the power on self-check with no errors. This message will disappear after the first key press.

POWER ON SELF-CHECK FAILED - If the instrument fails power on self-check, the entire display is blanked and the above message will appear with a list of the failures. You may be able to continue using the instrument by pressing any key.

RECEIVER NOT CALIBRATED - This warning message indicates that the receiver is not calibrated. The instrument will still operate using default values. This can be corrected by running the calibration routine with no errors in the diagnostic self check menu.

LAST SET UP NOT RETAINED - This indicates that there is a problem with the HP 4945A's nonvolatile memory. The instrument will still operate, but the set up parameters have been reset to default values. If the problem continues, refer to Section 8 of the Service Manual.

DATA ENTRY - Whenever making a data entry, this message will appear in inverse video. This indicates that both the data entry keypad and the up/down arrow keys are active.

FREQ. CHANGE NOT ALLOWED HERE - In certain measurements, the definition of the measurement defines the frequency or frequencies used (e.g. P/AR). In these cases, the above warning message will be displayed with a warning beep if you attempt to change the frequency.

RANGE: XX TO XX/XX OUT OF RANGE - When making a data entry, the HP 4945A automatically displays the allowable range for that parameter. If you try to exceed this range, the XX OUT OF RANGE indication appears with a warning beep.

TURN DIAL TALK OFF TO EXIT - If you are in DIAL/HOLD SET UP menu, you are not allowed to exit unless you turn DIAL TALK OFF. This is to prevent you from making a measurement without the instrument connected to the line.

NO I/O MODULE IN OUTPUT MODE - This indicates that the OUTPUT hardkey was pressed, but an I/O module is not installed or was not set up in output mode.

PRINTING - This occurs when data is being sent out to a printer.

The HP 4945A is equipped with self-diagnostics and self-calibration capability. When running either of these routines one of the following messages will be displayed.

CALIBRATING - This message is displayed when running the calibration routine.

SINGLE (or REPEATING) CHECK IN PROGRESS - This message is displayed when running the diagnostic self-check.

LINKING - PLEASE WAIT - This message indicates that it is performing the initial master/slave linkup.

AREA 5 MESSAGES

SELF-CHECKS PASSED/SELF-CHECKS FAILED - These messages are displayed in the diagnostic self-check mode. They are followed by the number of times it has passed and/or failed.

RCV TERM or RCV BRDG - This indicates whether your receiver is bridged or terminated.

SF SKP - This indicates that the SF (signalling frequency) SKIP is active.

VOICE - This indicates that the voice band limit function is active.

RCV (or TMT) MNTR - If the volume is on, this indicates whether you are listening to the receiver or the transmitter.

MS TO SL or SL TO MS - When in Master/Slave, this indicates the direction of the test that is selected.

LINKING - This message will flash while the instrument is re-linking while in master/slave mode.

LOOPBACK - This indicates that the slave unit is repeating the received signal at the level selected. This only occurs in master/slave mode.

The lower two lines contain the current level (in dBm), frequency and terminating impedance of both the transmitter and receiver. If the handset terminals are active on the front panel then the message HANDSET will be displayed on the transmitter line.

MASTER/SLAVE GENERAL INFORMATION

What is it?

Master/Slave is a method for remotely controlling a distant TIMS using the lines under test. Master/Slave can only be utilized on 4-wire circuits. This technique virtually eliminates the need for another person at the far end after the instrument is powered up. Another direct advantage is that a separate dial up link isn't required for communication purposes. Also, testing time is reduced by eliminating the coordination time needed when running a test using two people. Testing can be done on either pair of the four wire circuit. The "handshaking" that takes place between the two instruments is transparent to the user. The details of how it actually works and how to use it are contained in the following sections.

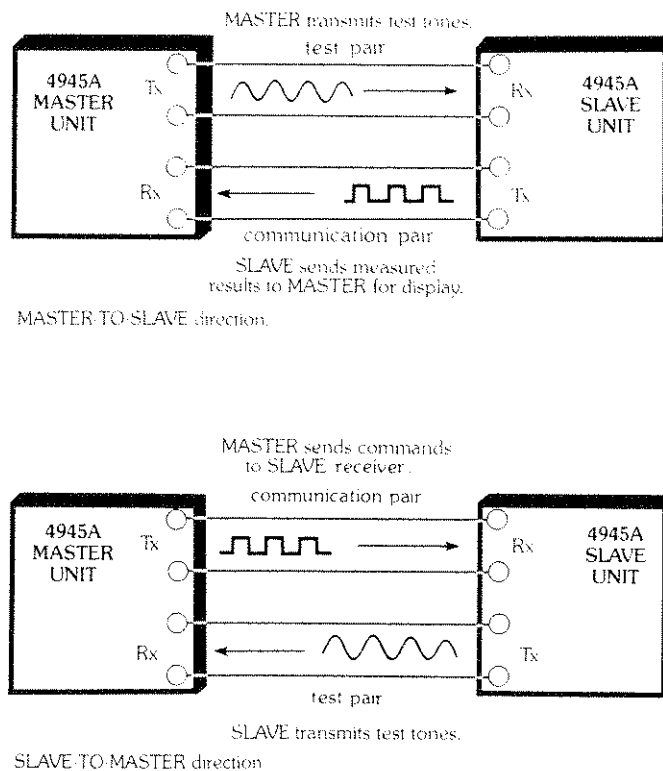

Figure 3-25. Master/Slave Test Set Up

FSK Technique

The two units communicate their information using internal lowspeed modems. The modems employ a technique called frequency shift keying (FSK) to code the data going over the line. They transmit 800 Hz to represent a "space" or a 0, and 1200 Hz to represent a "mark" or a 1. In addition a 1990 Hz pilot tone (also referred to as the "carrier") is used to alert the receiving unit that FSK data is coming. This is to prevent "noise" from being interpreted as data.

Direction of Test

This term is only applicable when you are performing a measurement. "Direction of test" refers to the direction that the measurement is taking place. "Master-to-Slave" means that the Master unit will transmit the test signals and the Slave unit will receive them and perform the measurement. "Slave-to-Master" is just reversed. An easy way to think about it is to visualize the test signal moving in the direction that is listed. "Master-to-Slave" means that the test signal is being generated (transmitted) at the "Master" end and is being received at the "Slave" end.

Initial Link-up

In the initial link-up, the Master requests identification from the Slave. The HP 4945A needs to know if it is interfacing with another HP 4945A, or an HP 4943A or HP 4944A, so it can configure itself accordingly. (Note that Master/Slave operation with the last two instruments mentioned is covered at the end of this chapter). Next, the Slave sends back the type of instrument it is and what its current parameters are. These parameters consist of its current level, impedances, and measurement information. During this process the message "LINKING - PLEASE WAIT" will be displayed on the screen. If an error or "no response" is detected in any of the above transmissions then the process will start over. If a link is not established after a reasonable length of time, then the message "UNABLE TO COMPLETE M/S LINK" will be displayed. The Master will continue trying to link until it is taken out of Master/Slave mode.

Re-link

Once linked, when an action takes place which affects the Slave, a "re-link" takes place. The message "LINKING" will flash on the screen. This will happen when entering a measurement, changing the Slave's impedances, changing the direction of test, etc. When entering a measurement, the Master will request the Slave to enter a specific measurement, designate the direction of test, and will include any setup parameters associated with that measurement. The Slave in turn will send back whether or not it has the capability to perform the measurement (if not it will go into "loopback" mode) and its level and frequency ranges for that measurement. After the re-link process is done, the measurement takes place.

Communication Pair vs Test Pair

During the link-up process, communication takes place over both pairs as was discussed above. When performing a measurement, the test is being run over one pair, which is referred to as the test pair. The other pair is used for communication between the Master and the Slave. In the Master-to-Slave direction, the Slave will send back the measurement results over the communication pair. In the Slave-to-Master direction, the Master will be sending measurement commands to the Slave over the communication pair. Communication is done using the FSK technique described earlier.

Envelope Delay Distortion

Since the envelope delay distortion measurement requires four wires, it is handled slightly different. Following is a brief description of what takes place when in the Master/Slave mode.

Master to Slave (Return Reference)

The Master sends an FSK signal requesting the Slave to perform a level and frequency measurement. Next, it sends the envelope delay signal using a variable frequency carrier.



The Slave performs level and frequency measurement and sends the information to the Master. Next, it shifts the received modulation to a fixed frequency carrier (1804 Hz) and sends it back to the Master.



The Master receives the current level and frequency, information, performs the delay measurement, and updates the screen.

Slave to Master (Forward Reference)

The Master sends an FSK signal telling the Slave the carrier frequency it should use. Next, it sends the envelope delay signal using a fixed frequency carrier (1804 Hz).



The Slave shifts the received modulation to the carrier frequency requested by the Master. This signal is sent to the Master.



The Master performs a level, frequency and delay measurement on the incoming signal and displays the results.

Note

An FSK signal will be sent from the Master unit to the Slave unit everytime you change the frequency.

HOW TO CONFIGURE THE INSTRUMENT FOR MASTER/SLAVE OPERATION

Let's look at how you put the instrument in Master/Slave mode.

First, press the SET UP hardkey to enter the Set Up menu.

Notice that softkeys #6 and #7 control Master/Slave operation. Softkey #6, which is labelled MASTR/SLAVE, cycles between OFF (normal operation) MASTER and SLAVE. Select the operating mode for your instrument. If you select MASTER, the initial linking process will begin.

Note

To act as the slave in Master/Slave, the unit does not need to be set to SLAVE. This will automatically happen when the unit at the far end is set to MASTER. This is called "capturing" the slave. This avoids the need to have a person at the Slave site. You will not be able to "capture" an instrument that is in calibration, self-check, or 2-wire return loss mode.

Note

On the Master unit, all keys except the MASTER/SLAVE softkey on the front panel will be locked out during initial link-up.

Note

The FSK signal level will track the measurement signal level down to -29 dBm. Below that the FSK signal level will remain at -29 dBm regardless of the measurement signal level which is set.

Softkey #7 toggles between (MASTER TO SLAVE) and (SLAVE TO MASTER). This is setting the "direction of test" as shown in figure 3-25. You should set this to the desired testing configuration. Notice that changing this setting causes the instruments to re-link.

Now, you can proceed through the normal operating sections. This manual is organized so that any additional notes pertaining to Master/Slave operation are included at the end of each section. Basically, you operate the instrument just as you would in normal operation.

Note

If you are using the HP 4945A with either an HP 4943A or an HP 4944A, then refer to the next Section for additional information.

MASTER/SLAVE WHEN USING AN HP 4943A OR AN HP 4944A WITH THE HP 4945A

Why is it Different?

The HP 4943A and HP 4944A are the original Hewlett-Packard instruments designed with the Master/Slave capability. Each contains only a subset of the HP 4945A's measurements. Also, they have LED displays and their front panels have switches and knobs. Due to these constraints, they are unable to display error messages in plain English (they display H codes) and some of their switches are not programmable through Master/Slave operation.

What is "Loopback mode"?

As mentioned before, the measurement capability is limited when using an HP 4943A or HP 4944A. When an HP 4943A or HP 4944A is instructed to perform a function that is beyond its capabilities, it will go into loopback mode. This means that the incoming signal to the Slave will be looped around and sent back to the master at the level which has been set on the Slave unit. To get out of loopback mode, press a different key and the instruments will re-link.

Configuration Considerations When Master is an HP 4943A or HP 4944A and Slave is an HP 4945A.

In this configuration the HP 4945A is limited to the capabilities of the Master.

Examples of these limitations are:

- Frequency and level range limitations of the HP 4943A or HP 4944A
- No amplitude jitter measurements
- No automatic gain slope measurement
- 7 counts/sec in impulse noise
- No phase hits, gain hits or dropouts measurements

The following items must be set on the HP 4945A Slave before it is put into Master/Slave mode:

- Transmitter and Receiver Impedances
- Transmitter and Receiver Hold Coils
- Receiver BRIDGED or TERMINATED Setting
- The VOLUME Control
- Impulse Noise Thresholds
- Transmitter Level

Note

If the HP 4945A transmit level is outside the range of the HP 4943A or HP 4944A then the two instruments will not be able to establish a link-up.

During the initial link-up, error codes may appear momentarily. First, the error code H-01 will appear which signifies that no response was received from the Slave. This occurs because the HP 4945A must take time to verify that it is configured as another HP 4943A or HP 4944A (depending on which unit you are using for the Master). This code will disappear if everything is functioning correctly and another error code may appear momentarily if you are set up in MASTER TO SLAVE direction of test. This may be either an H-09 or an H-10. This occurs because the HP 4945A will not send back test results until it has valid data. These error codes should all disappear and the Master/Slave operation should be no different than it would be with an HP 4943A or an HP 4944A acting as the Slave.

Configuration Considerations When Master is an HP 4945A and Slave is an HP 4943A or an HP 4944A

The following items must be set on the HP 4943A or HP 4944A slave unit before it is in Master/Slave mode:

- Transmitter/receiver impedance setting
- Hold coils
- Receiver BRIDGED or TERMINATED setting
- Impulse noise threshold
- Transmitter level

Note

If the HP 4945A transmit level is outside the range of the HP 4943A or HP 4944A then the two instruments will not be able to establish link-up.

DIRECTION OF TEST = MASTER TO SLAVE

You are limited to the range limitations of the HP 4943A or HP 4944A since it is performing the measurement (receive end).

The receiver's (Slave) frequency field will always be blank.

The HP 4945A will only display counts in the impulse noise low area since the HP 4943A or HP 4944A only has one threshold setting (which must be set manually).

When doing the envelope delay measurement, you do not have the capability of performing a LEVEL ZERO. This calculation must be done manually.

If you enter a menu with a parameter set to an illegal choice then the slave will go into loopback mode. Always set up all parameters before entering into Master/Slave mode.

DIRECTION OF TEST = SLAVE TO MASTER

In this configuration you have additional capabilities. You are limited to the receivers capabilities. Therefore, you are able to do the following:

- Amplitude jitter
- All 3 jitter bandwidths
- Noise-to-ground measurement
- 3 level impulse noise
- Phase hits, gain hits, and dropouts measurements

MASTER/SLAVE ERROR MESSAGES

Why Do They Occur?

What could cause the Master/Slave errors to occur? There may be an operational problem with your test set. In this case you should run through the self-diagnostic capabilities of each unit which is being used. Also, it is recommended that you use the test set at transmission levels > -40 dBm and a S/N ratio > 20 dB since impairments on the lines being used could disturb your Master/Slave operation. Always check your connections to ensure continuity.

Descriptions

All error messages (along with the equivalent H-code used by the HP 4943A and HP 4944A) are contained in this section. These messages are generated by the master unit. This section is organized to highlight some of the key differences between each of the error messages. Below is a brief explanation of each of the areas.

When? - This refers to whether the error will occur while linking is in progress (LINKING is flashing on the display) or after link-up.

Pilot Tone? - This will tell you whether you are receiving the pilot tone (1990 Hz).

Data? - Data refers to the FSK information which is being sent between the instruments on the communications pair. This will tell you if the error message is being caused because no data is being received by the Master from the Slave.

Direction of Test? - This is only applicable after link-up. Certain messages are susceptible to the direction of test which was selected. This will list whether it will only happen when the instrument is making a measurement in a certain direction or if it occurs independent of the direction of test setting.

Problem Channel? - Occasionally you can isolate the problem to a specific channel. The channel we refer to here is the pair and the transmitter and receiver connected to that pair.

No Answer Received From Slave (H-02)

When? - During link-up or re-link only.

Pilot tone? - Yes.

Data? - No.

Direction of Test? - Either direction.

Problem Channel? - Either channel.

Additional Comments - When you receive this message you are receiving the pilot tone back but not any data. This message is only displayed during the linking process.

Data Errors In Slave Response (H-03)

When? - Anytime.

Pilot Tone? - Yes.

Data? - The data received has parity and/or framing errors.

Direction of Test? - During Link-up - Either. After Link-up M - S only.

Problem Channel? - If it occurs during link-up then either channel may be causing a problem. After link-up has taken place the error is being caused on the communications channel.

Additional Comments - In this case we are receiving data back from the slave but it contains parity and/or framing errors.

Bad Data In Slave Response (H-04)

When? - During link-up or re-link only.

Pilot Tone? - Yes.

Data? - Yes.

Direction of Test? - Either.

Problem Channel? - Either.

Additional Comments - This error will occur if the master receives a negative acknowledge (NAK), a bad block of data, or the incorrect response from the initial inquiry sent to the slave unit.

Incorrect Response From Slave* (H-05)

When? - During link-up or re-link only.

Pilot Tone? - Yes.

Data? - It is good in terms of parity and framing but it is the incorrect response.

Direction of Test? - Either.

Problem Channel? - Either.

Additional Comments - In this case, the master has requested the slave to enter a measurement mode and the slave did not respond correctly.

Slave Fails To Execute Command* (H-06)

When? - During link-up or re-link only.

Pilot Tone? - Yes.

Data? - Yes.

Direction of Test? - Either.

Problem Channel? - Communications Channel.

Additional Comments - This error message occurs if the master receives no response from the initial inquiry sent to the slave.

Slave Looped Back (H-07)

When? - After link-up.

Pilot Tone? - Yes.

Data? - Slave is in loopback mode.

Direction of Test? - Either.

Problem Channel? - No.

Additional Comments - This error occurs when the master requests the slave to perform a measurement which is beyond its capabilities. The slave will automatically go into loopback mode. This occurs when interfacing with an HP 4943A or an HP 4944A because of their limited measurement capability.

* Applicable only if using an HP 4943A or an HP 4944A.

No Data Received From Slave (H-09)

When? - After link-up.

Pilot Tone? - Yes.

Data? - No.

Direction of Test? - M - S only.

Problem Channel? - Communications Channel.

Additional Comments - In this case, the master unit is expecting a response from the slave but it is only receiving the pilot tone.

Receiver Level Out of Range (H-10)

When? - After link-up.

Pilot Tone? - Yes.

Data? - No.

Direction of Test? - Either.

Problem Channel? - Test Channel.

Additional Comments - This error means that the instrument acting as the receiver is unable to perform the measurement because the test signal is out of range.

No Carrier Received From Slave (H-11)

When? - During link-up only.

Pilot Tone? - No.

Data? - ---

Direction of Test? - During link-up - Either.

Problem Pair? - Either.

Additional Comments - The master unit in this case is receiving a signal but it is not the correct frequency (1990 Hz).

Slave Initiated M/S Link Abort (H-13)

When? - Anytime.

Pilot Tone? - Yes.

Data? - Yes.

Direction of Test? - Either.

Problem Channel? - No.

Additional Comments - This message occurs if the slave sends an "abort" to the master. This only happens when the slave is taken out of slave mode at the far end.

Dropout > 1 Sec - Test Aborted* (H-14)

When? - After link-up.

Pilot Tone? - Yes.

Data? - No.

Direction of Test? - Either.

Problem Channel? - Test Channel.

Additional Comments - This error will only occur when you are in impulse noise and you lose the holding tone (100⁴ Hz). The instruments will terminate the test.

Phase Jitter Overrange* (H-15)

When? - After Link Up.

Pilot Tone? - Yes.

Data? - No.

Direction of Test? - Either.

Problem Channel? - Test Channel.

Additional Comments - This message is displayed only if the HP 4943A is making the phase jitter measurement and the reading is greater than 40 degrees.

* Applicable only if using an HP 4943A or an HP 4944A.

Invalid Test Signal* (H-16)

When? - After link-up.

Pilot Tone? - Yes.

Data? - ?

Direction of Test? - Either.

Problem Pair? - Either.

Additional Comments - In certain measurements the instrument is able to detect if it is receiving the correct test signal. These measurements are impulse noise, IMD, and the jitter measurements.

Unable To Complete M/S Link

When? - During initial link-up or re-link

Pilot Tone? - Maybe.

Data? - Maybe.

Direction of Test? - Either.

Problem Channel? - Either.

Additional Comments - This message is displayed if the instruments are unable to establish a link after a reasonable period of time. You may not be receiving the pilot tone or data because of one of the other errors causing a problem.

Slave Not Capable*

When? - After link-up

Pilot Tone? - Yes.

Data? - Yes.

Direction of Test? - See comments below.

Problem Channel? - No.

Additional Comments - This message will occur in two situations, both when using an HP 4943A or an HP 4944A as a Slave. The first is when you are set up in the Slave-to-Master direction of test and you try to change the Slave's transmit level.

The other situation is when you are set up in the Master to Slave direction of test and you try to change the impulse noise threshold settings.

* Applicable only if using an HP 4943A or an HP 4944A.

Slave Unable To Do Measurement

When? - After link-up

Pilot Tone? - Yes

Data? - Yes

Direction of Test? - Either

Problem Channel? - No

Additional Comments - This error occurs when the Master requests the Slave to perform a measurement which is beyond its capabilities. The Slave will not go into loopback mode.

DTMF SIGNALING CAPABILITIES

The HP 4945A provides Dual Tone Multi-Frequency (DTMF) signaling. This feature allows touch tone dialing. The following table lists the segments and their corresponding function.

Segment	Function
1	1
2	2
3	3
4	4
5	5
6	6
7	7
8	8
9	9
10	0
11	*
12	#
13	Erases memory
14	Adds pause to dialing
15	Resumes dialing after pause
16	Dials number automatically

To access the feature, enter the diagnostics self-check menu and select SEGMENT self-check, MODE 99. Then set the segment number to SEGMENT 13 and press the START/STOP key.

SEGMENT 13 clears out any previous number stored in the memory. A telephone number of up to 50 digits can be entered in memory.

Each digit is entered by selecting the SEGMENT for that digit and pressing START/STOP.

After the entire number has been entered, select segment 16 and press START/STOP. The number will then be dialed automatically.

A controller can be set up in a programming loop to dial the number automatically. Following is a sample command that would dial the number 9-(pause)1-800-987-6543.

```
SC399;SC413;SC1;EXC
<ENDST 0>
SC49;SC1;EXC
<ENDST 0>
SC414;SC1;EXC
<ENDST 0>
SC41;SC1;EXC
<ENDST 0>
SC48;SC1;DXC
<ENDST 0>
SC410;SC1;EXC
<ENDST 0>
SC410;SC1;EXC
<ENDST 0>
SC49;SC1;EXC
<ENDST 0>
SC48;SC1;EXC
<ENDST 0>
SC47;SC1;EXC
<ENDST 0>
SC46;SC1;EXC
<ENDST 0>
SC45;SC1;EXC
<ENDST 0>
SC44;SC1;EXC
<ENDST 0>
SC43;SC1;EXC
<ENDST 0>
```

To dial the number, the controller would then send:

```
SC416;SC1;EXC
<ENDST 0>
[WAIT FOR PBX RESPONSE]
SC415;SC1;EXC
<ENDST 0>
```

CHAPTER IV. MEASUREMENT PRINCIPLES

INTRODUCTION

This section describes the principles of all measurements made by the HP 4945A. Included are explanations of the need for the measurements, plus the effect of certain voice channel parameters on data transmission. Block diagrams and functional descriptions are provided to explain the HP 4945A input-output switching and the different measurements that the test set make.

For further information concerning the voice channel measurements described in this section, refer to the following Bell System Technical References: PUB 41008, Analog Parameters Affecting Voiceband Data Transmission - Description of parameters, and PUB 41009, Transmission Parameters Affecting Voiceband Data Transmission - Measuring Techniques. These publications are available from District Manager - information American Telephone and Telegraph Co., P.O. Box 915, Florham Park, New Jersey 07932.

INPUT-OUTPUT SWITCHING

The RECEIVE/TRANSMIT JACKS provide for interconnection of the HP 4945A to the circuit under test. See Figure 4-1. The RECEIVE/TRANSMIT switch provides for selection of either the transmit or receive function for the left jacks and simultaneously selects the opposite for the right jacks. Both the left and right sets of jacks provide parallel connections, the standard five-way binding posts on top and the Western Electric 310 type jacks on the bottom. Either the binding posts or the 310 jacks may be used; they will not normally be used at the same time.

The hold current coil allows the application of a 23-mA current source to both the right and left set of jacks (TIP and RING connections). This allows for latching of telephone switching equipment. Either the right or left set of jacks may be used for 2-wire dry circuit. If a 4-wire circuit is under test, the left jacks may be used for either transmit or receive, and the right set for the opposite.

The transmit and receive impedance of the HP 4945A is selectable at 135, 600, 900, or 1200 ohms (termination resistors figure 4-1), which are standard telephone circuit values. The impedance of the test set must be selected to match the circuit under test, or erroneous measurement values will be obtained.

The receive input may be terminated or bridged across the circuit under test. The termination mode provides a resistive termination on the receive circuit to provide proper loading. When a termination is provided by some other device, it is not necessary to provide a termination. In this case the receiver input should be used in the bridged mode.

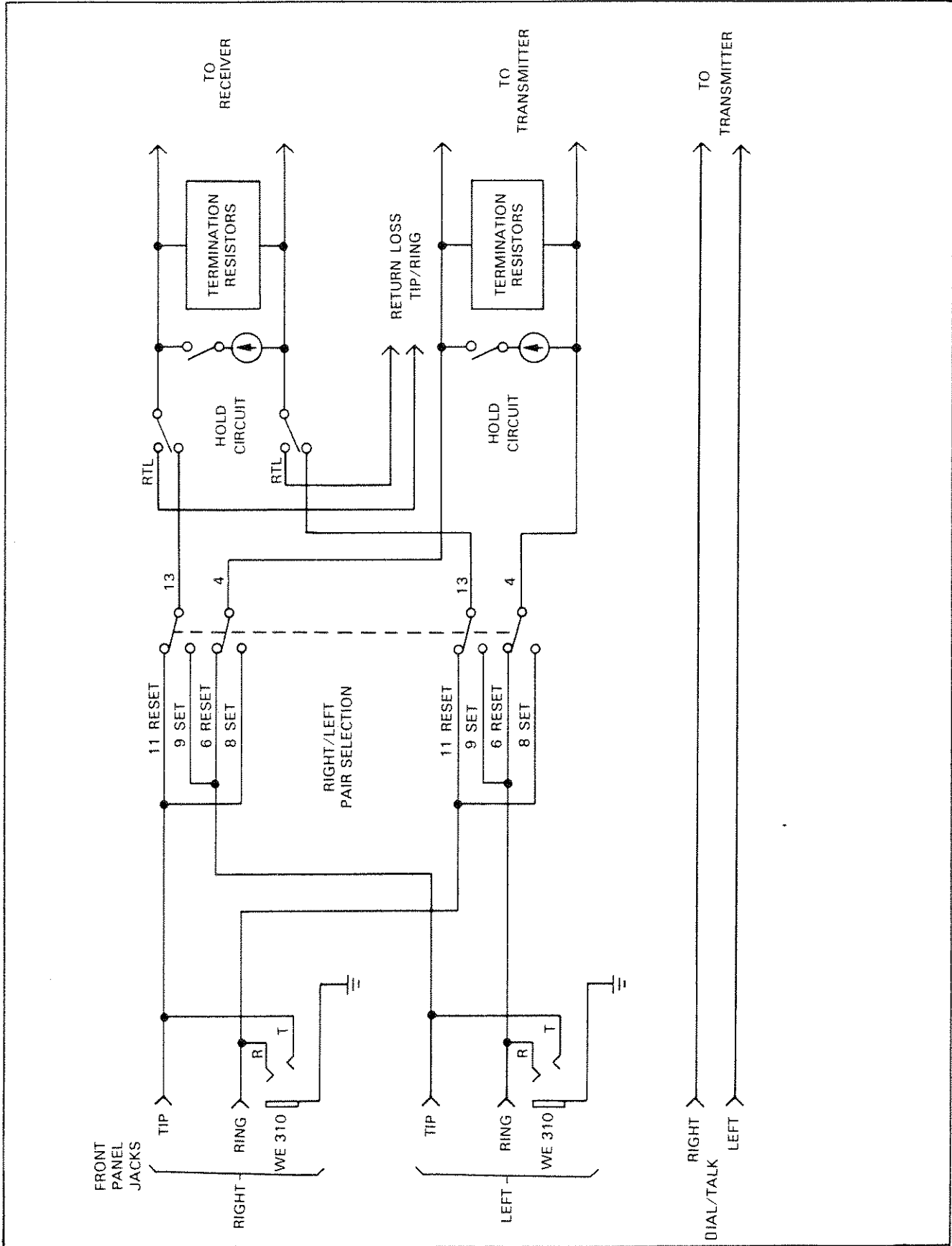

Figure 4-1. Input-Output Switching

The HP 4945A input and output circuits are balanced to match standard telephone voice channel lines. A balanced line is one that is electrically symmetrical; the two sides of the line have equal series resistance, series inductance, shunt capacitance, and leakage to ground. Only test sets (or other devices) with balanced inputs and outputs will operate properly when connected to a balance line.

To allow dialing, talking, and listening over the circuit under test, handset terminals are provided for the connection of a lineman's handset. In addition, talk battery is selectable for use on dry circuits (circuits which do not incorporate a power source to provide direct current flow for the microphone).

DATA LEVEL

Transmission measurements on data circuits use test signals applied at data level (the standard Bell System data level is -13 dBm). Data level is used to prevent overload on carrier systems. Data level is a power 13 dB below the transmission level point (TLP) where the tests are being made. For example, at a -16 dB TLP, the data level would be -29 dBm ($-16 - 13 = -29$). A test power of -29 dBm would be applied here. At the zero transmission level point (0 TLP), the data level would be -13 dBm, or -13 dBm0.

LEVEL AND FREQUENCY MEASUREMENTS

The level and frequency mode allows measurement of 1000 Hz loss, attenuation distortion, and gain slope. These measurements define the amplitude versus frequency response of a voice channel. The level and frequency mode also allows measurement of frequency shift. Figure 4-2 illustrates the basic setup for these measurements.

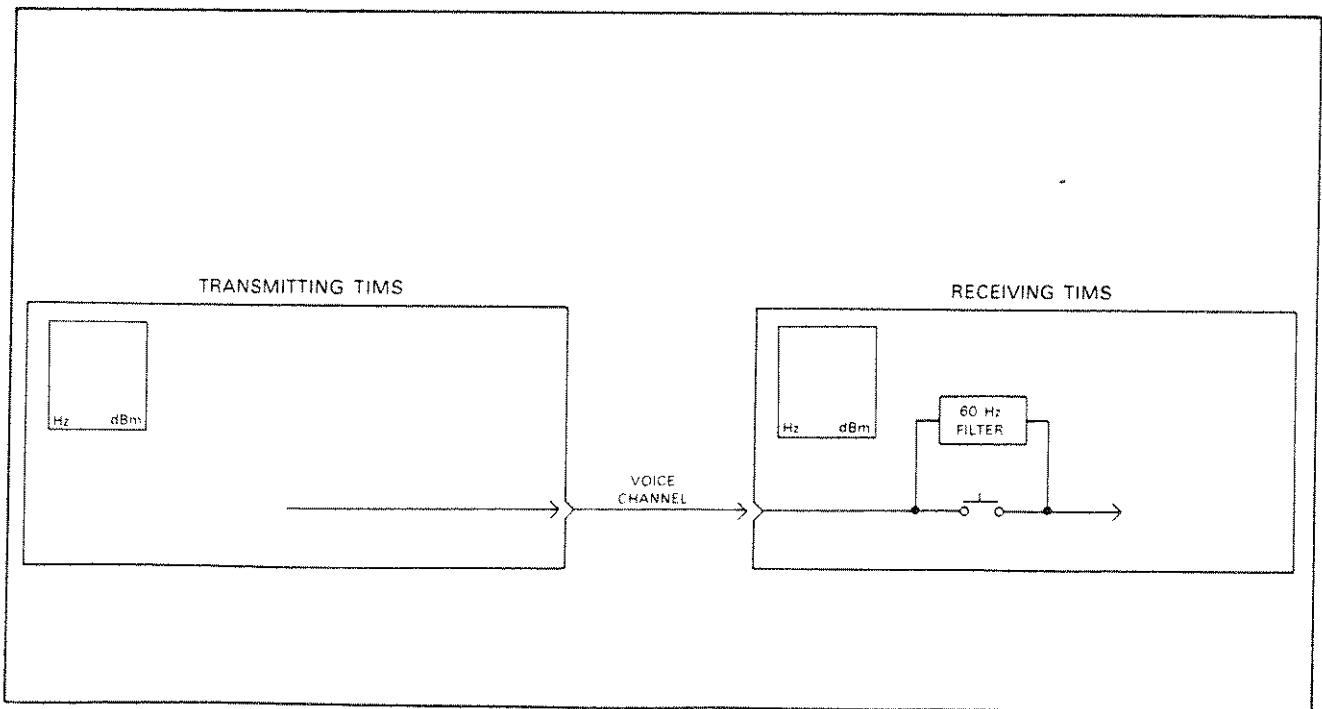

Figure 4-2. Level and Frequency Measurement

1000 Hz Loss

The 1000 Hz loss measurement determines the point-to-point loss (or gain) of a 1000 Hz test tone transmitted over a voice channel. To make this measurement, a 1004 Hz test frequency is transmitted at data level. At the receiving TIMS, the received power is measured (in dBm) and subtracted from the transmitted level to determine 1000 Hz loss (in dB).

The transmitted frequency is actually 1004 Hz (not 1000 Hz), to prevent measurement errors which would occur over T-carrier systems. This 4 Hz offset avoids measurement errors caused by test frequencies which are submultiples of the T-carrier sampling rate. This measurement error is not representative of actual conditions which are present when multiplexed signals like voice and data are transmitted over voice channels.

The accuracy of the received power measurement depends on the tolerance of the receiving and resistive termination. A terminating resistance of 0.1 percent tolerance is required to assure accurate measurements. Therefore, received level measurements should generally be made using the HP 4945A internal termination.

A switch-selectable 60 Hz high-pass receiving filter is provided for use with the level and frequency measurements. The 60-Hz filter is used to detect and remove excessive 60 Hz interference. The filter has an attenuation characteristic greater than 20 dB at 60 Hz, and a 4-dB attenuation characteristic at 180 Hz (3rd harmonic of 60 Hz).

Frequency Shift

The frequency shift measurement checks for any difference in the received frequency with reference to the transmitted frequency (frequency translation) as caused by carrier facilities. To make this measurement, a test tone of known frequency is transmitted. At the receiving end, the received frequency is observed and compared with the transmitted frequency. Any difference between transmitted and received frequencies indicates a frequency shift in the test signal. This measurement is not valid when on looped around carrier facilities, since the frequency shift in one direction (near-end to far-end) may be cancelled by the frequency shift in the other direction (far-end to near-end).

GAIN SLOPE

This is a measurement of the loss of received level versus frequency. Gain slope is the measurement of the received level at 404 Hz, 1004 Hz, and 2804 Hz. Gain slope is calculated by taking the difference between levels at 2804 Hz and 1004 Hz. This measurement determines the usable bandwidth of the voice channel. To make this measurement the transmitter automatically steps through 1004 Hz, 404 Hz, and 2804 Hz at 2 seconds per step. The frequency received must be within + or -26 Hz in order to be displayed on the CRT.

The gain slope or relative loss will then be displayed after the 1004 Hz reference is measured. The loss at 404 Hz and 2804 Hz will be displayed once all three frequencies have been received. The gain slope measurement runs continuously.

The SF (single-frequency) SKIP setup softkey is provided to automatically prevent the test set from transmitting frequencies within the range of 2450 Hz to 2750 Hz. This feature is used to prevent loss of voice channel connection when transmitting over a dial-up network incorporating single frequency signaling units.

NOISE MEASUREMENTS

The noise measurements determine the interfering effects of background noise and tones. Figure 4-3 illustrates the basic setup for these measurements.

Noise

The message circuit noise mode measures the noise present on a voice channel, which has a quiet termination on one end (supplied by transmitting TMS) and a weighted measuring device on the other end (received TMS). The quiet termination is a simple resistive termination on the wire pair and the transmitter is off.

At the measurement end of the voice channel a choice of frequency weighting filters is available. The filters that can be selected are; C-message, 3-kHz flat, 15-kHz flat, 50 Kbit, or program(see figures 4-4 thru 4-8). The required measurement range for noise is a function of the type of filter selected. Table 4-1 list the filter noise range. The C-message filter allows measurement of only those noise signals that are of annoyance to the "typical" subscriber of standard telephone service. The C-message weighting is also used to evaluate the effects of noise on voice grade data circuits. The C-weighting is valid for data transmission since the response characteristic is relatively flat over most of the frequency range of concern for data transmission (600 to 3000 Hz).

Table 4-1. Filter Noise Ranges

Filter	Noise (dBrn)	Noise-to-Ground (dBrn)
C-message	10 to 90	40 to 130
3-kHz Flat	10 to 90	40 to 130
15-kHz Flat	10 to 90	
C-notched noise	10 to 90	
50 Kbit (135 ohm impedance)	10 to 90	

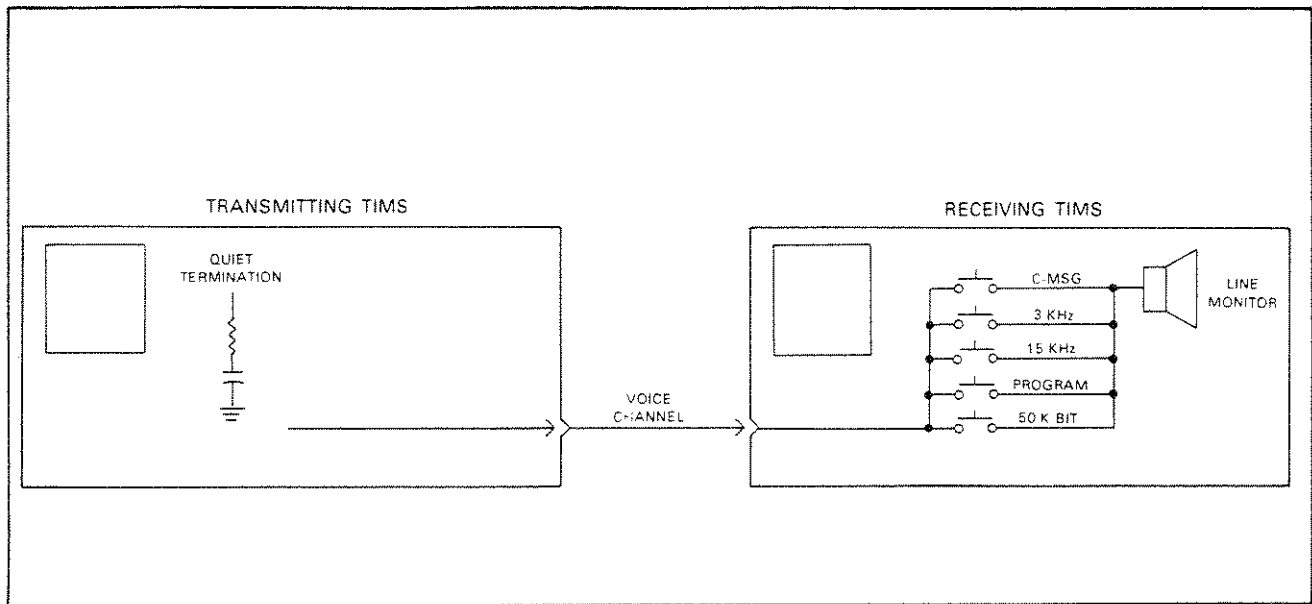

Figure 4-3. Message Circuit Noise Measurement

The 3-kHz flat filter has a response that provides much less attenuation to the low frequencies (60 Hz to 500 Hz) than the C-message filter. By comparing a 3-kHz flat noise measurement to a C-message noise measurement, the relative influence of low frequency noise (60-Hz commercial power, 20-Hz ring, etc.) can be determined.

The program filter is used for weighted measurements of noise on program circuits that have bandwidths up to approximately 8 kHz. It is not used on voice message circuits.

The 15-kHz flat filter is used when making unweighted measurements of noise on program circuits. It is a 15-kHz, low pass filter and it is not ordinarily used on voice message circuits.

The 50-Kbit filter is used to measure noise on facilities using up to 56-Kbit data service. The filters are used on wideband data circuits at an impedance of 135 ohms.

Received noise levels are displayed in units of dBrn, (dB with respect to noise where 0 dBrn = -90 dBm). For example, a noise reading of 20 dBrn has an RMS power of -70 dBrn (20-90 = -70). With the C-message filter selected, displayed readings are interpreted as being in units of dBrnC (noise level in dBrn with a C-message weighted measuring device).

Single frequency interference refers to unwanted steady tones which may appear on voice channels. Occasional burst of low level tones which may occur from crosstalk of multifrequency signaling, for example, do not fall in this category. Single frequency tones may interfere with certain data signals, particularly narrowband signals which are multiplexed onto a voiceband channel.

A simple audio monitoring arrangement will usually detect this interference, since tones exceeding acceptable levels are easily heard if the C-message noise is within limits. The single frequency interference check is made with the set up as shown in Figure 4-3. After the receiver noise signal passes through the C-message filter, the resultant signal is applied to the line monitor speaker. The TIMS operator listens for any predominant tone, which may indicate a single frequency interference problem.

If a single frequency tone (or tones) of long duration is heard, single frequency interference may be present and should be measured. To precisely determine the frequency and level of the interfering tone, a frequency selective voltmeter or spectrum analyzer must be used. The requirement for single frequency interference is that, when measured through a C-message filter, it will be at least 3 dB below C-message noise limits.

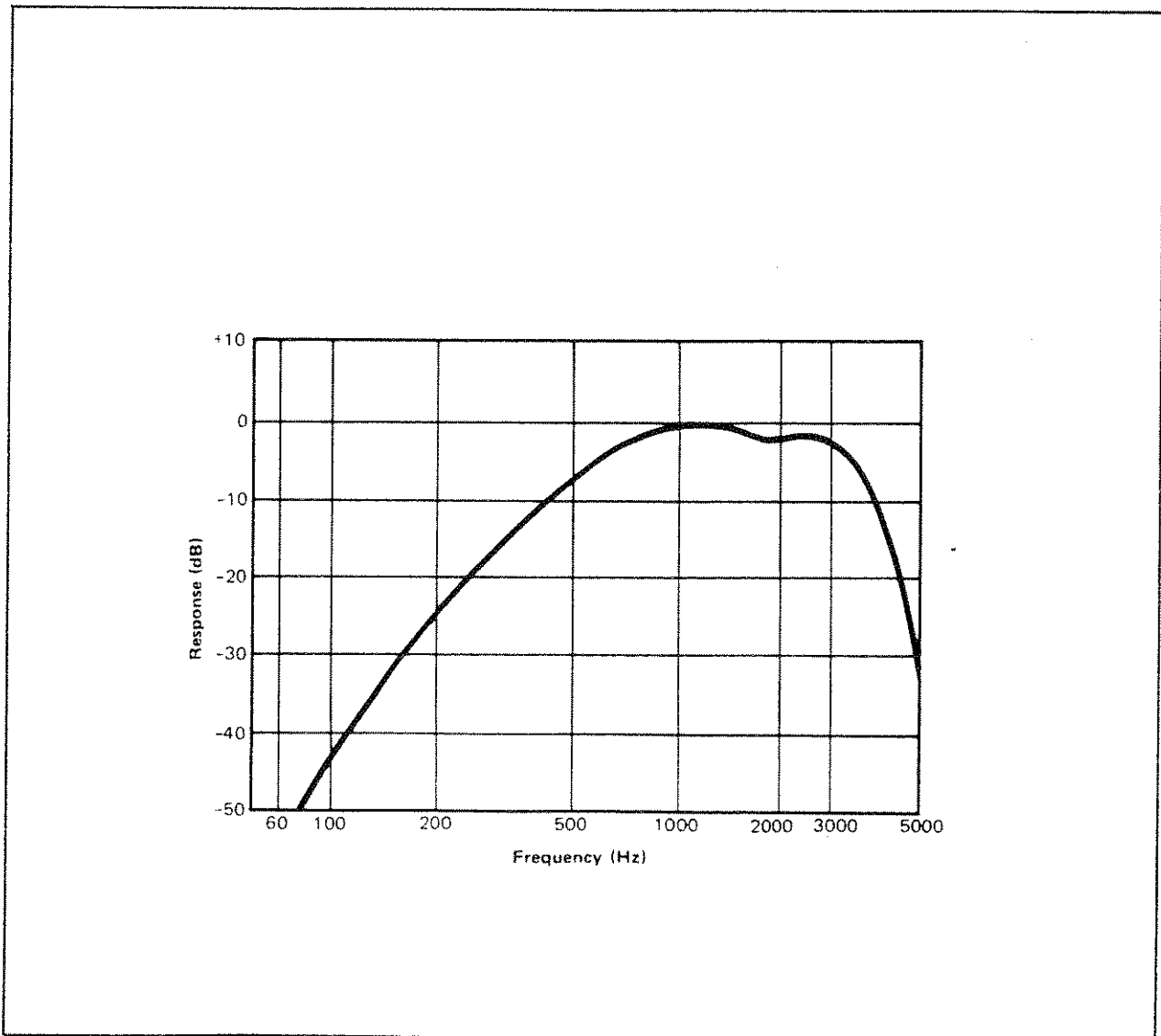

Figure 4-4. C-message weighting characteristic

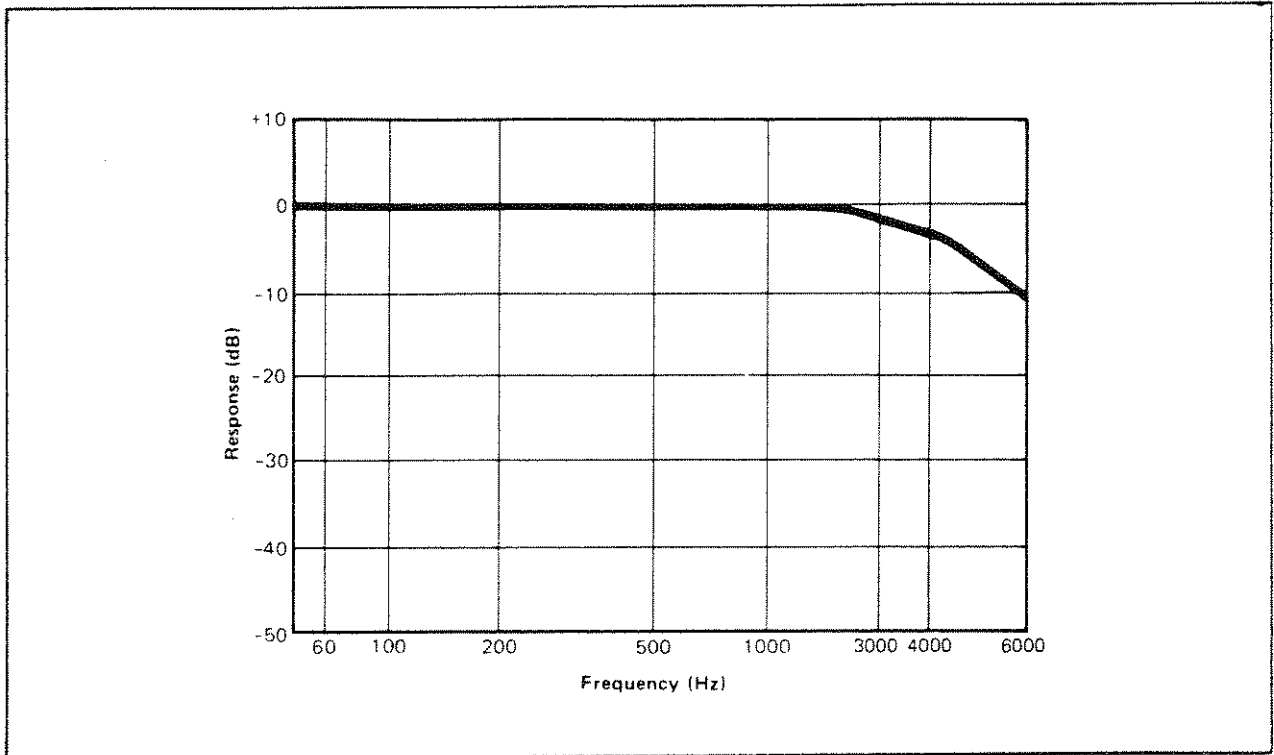

Figure 4-5. 3-kHz Flat Filter Weighting Characteristic

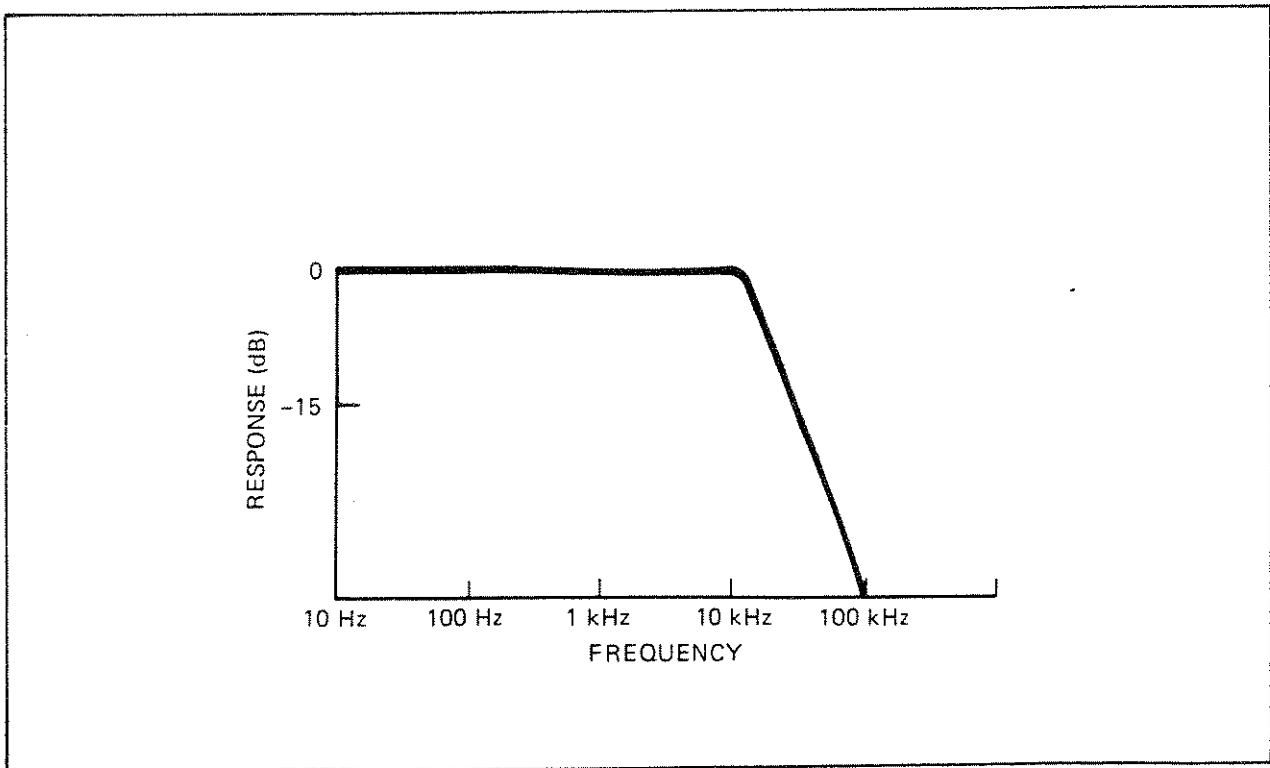

Figure 4-6. 15-kHz Flat Filter Weighting Characteristic

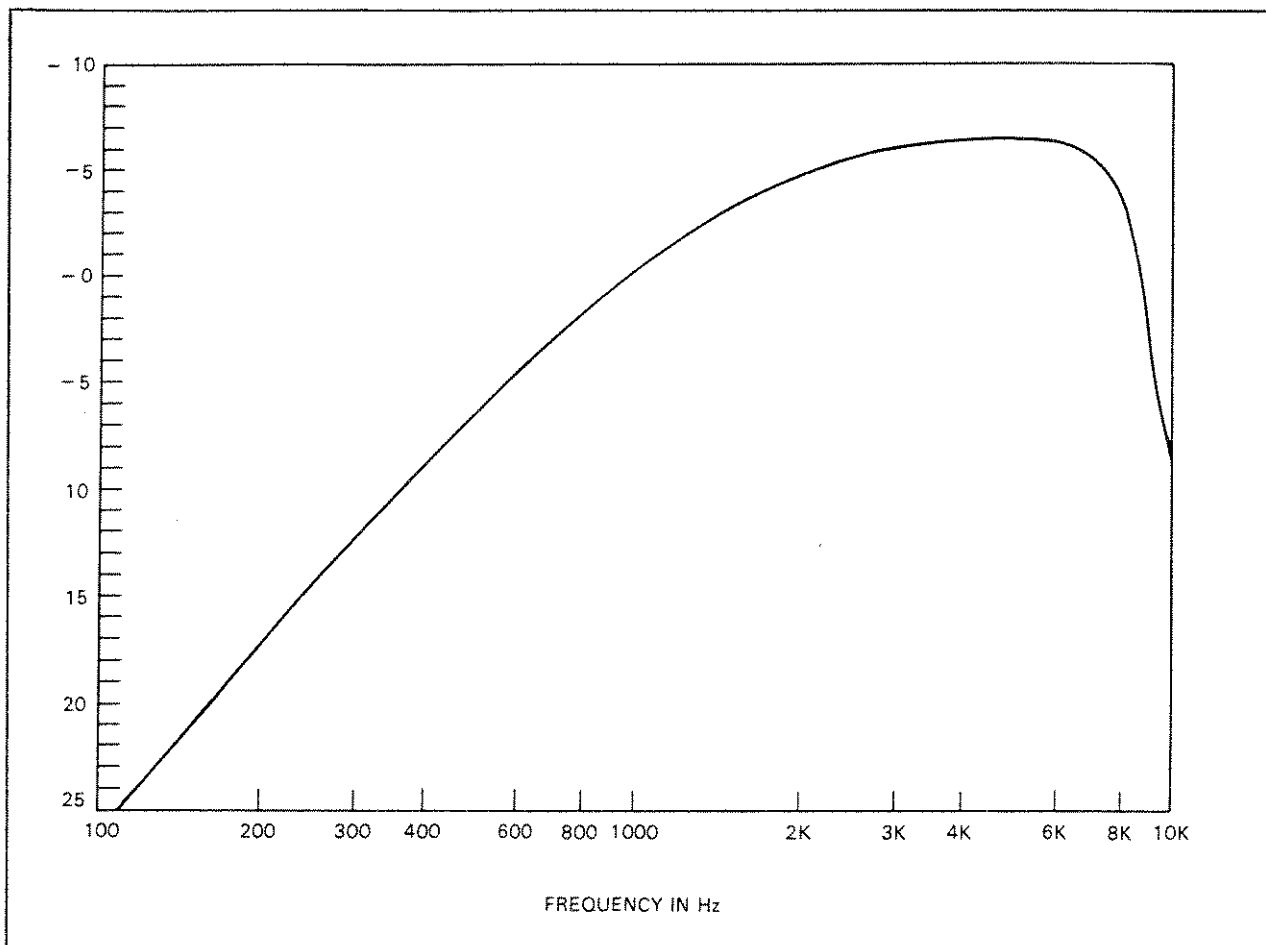

Figure 4-7. Program Filter Characteristic

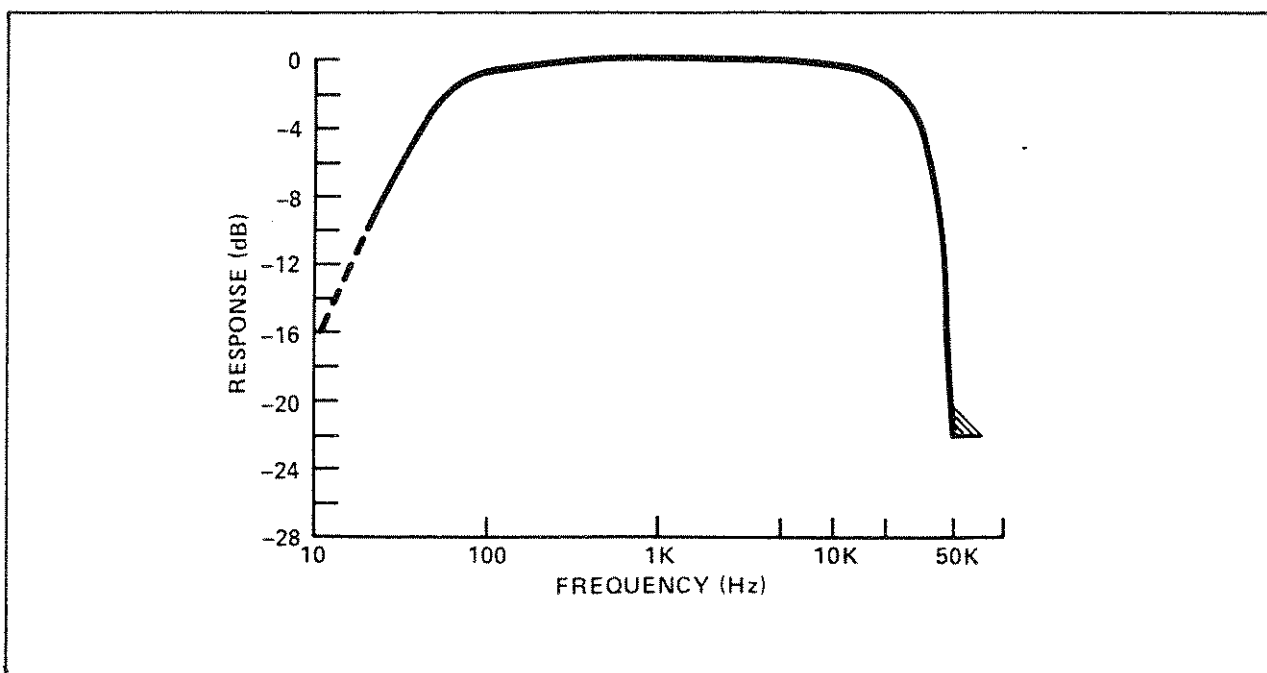

Figure 4-8. 50-Kbit Filter Characteristic

Noise-With-Tone

The noise-with-tone mode allows measurement of signal-to-noise ratio. The noise with-tone measurement is used to condition compandors and quantizers in the transmission system to their normal operating levels for continuous data signals. Therefore, noise levels are received which duplicate levels present under operating conditions.

To make this measurement, a 1004-Hz test frequency (holding tone) is transmitted at data level. At the receiving TMS, the 1004-Hz holding tone is selectively attenuated by >50 dB using a notch filter (all frequencies between 995 Hz and 1025 Hz are attenuated by >50 dB). The remaining received signal (noise) is passed through one of the weighting filters for measurement. The received noise level is displayed in units of dBm. Figure 4-9 illustrates the notch filter characteristic.

Signal-To-Noise Ratio

The signal-to-noise ratio of the voice channel under test is determined by comparing the noise-with-tone level with the holding tone level. This measurement is done automatically by the HP 4945A. Pressing the SIGNAL-TO-NOISE softkey will display the signal-to-noise ratio.

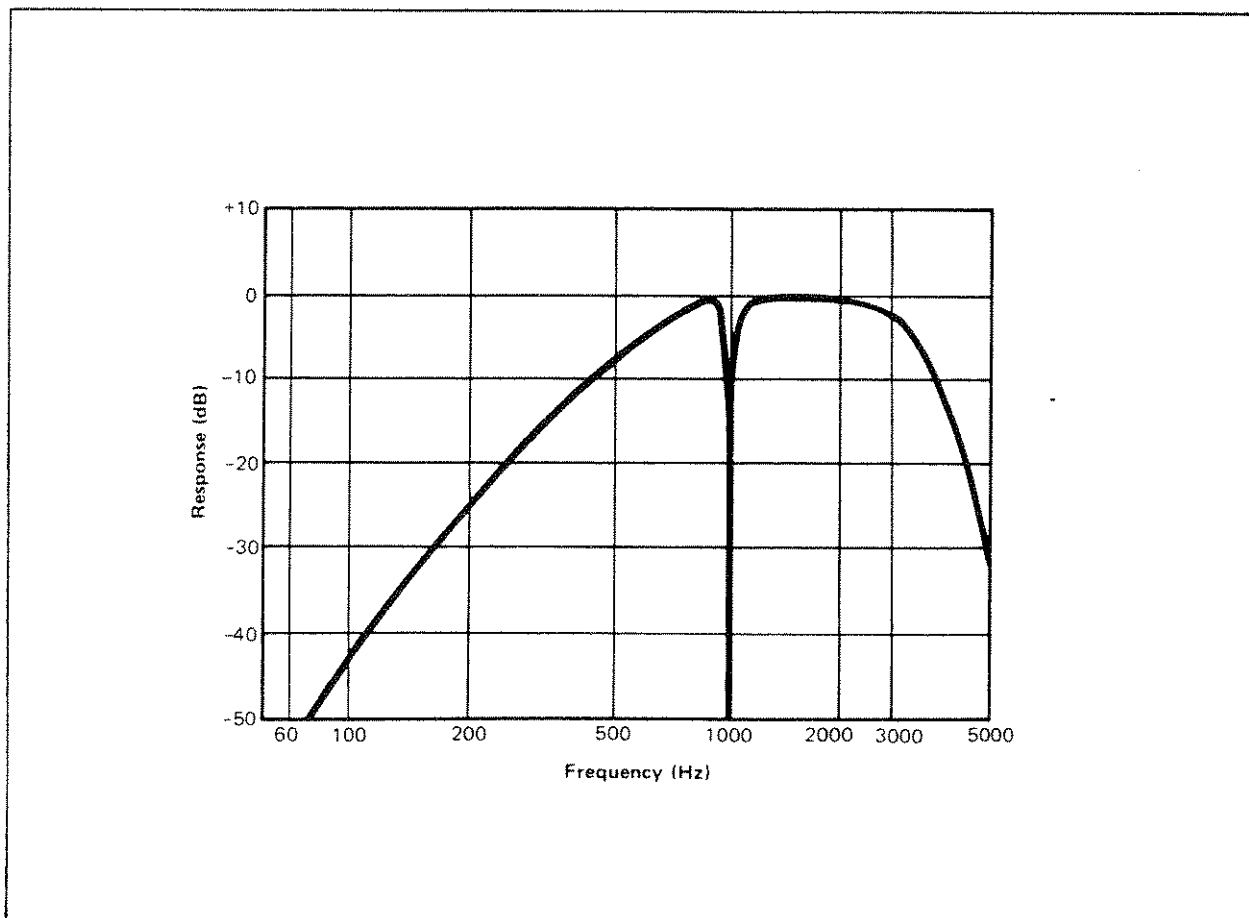

Figure 4-9. Notch Filter Characteristic

NOISE TO GROUND MEASUREMENT

The noise to ground mode allows measurements of the longitudinal noise present on a voice channel, with reference to ground. The transmitting TMS provides a quiet termination at one end of the voice channel, and the receiving TMS provides a frequency weighted filter and detector at the other end. The basic measurement technique for the noise to ground measurement is very similar to the message circuit noise measurement. The main difference lies in the use of a ground reference. Figure 4-10 illustrates this difference.

Noise to ground measurements are usually made for troubleshooting purposes and to measure the magnitude of longitudinal signals, which may indicate the susceptibility of a cable pair to electrical coupling from external sources.

The relative line balance of an end loop can be calculated by subtracting the measured noise to ground (N_g) value from the measured message circuit noise (N_m) value. It is recommended that both message circuit noise and noise to ground be measured with the 3-kHz flat weighted filter to include the effects of power line related noise.

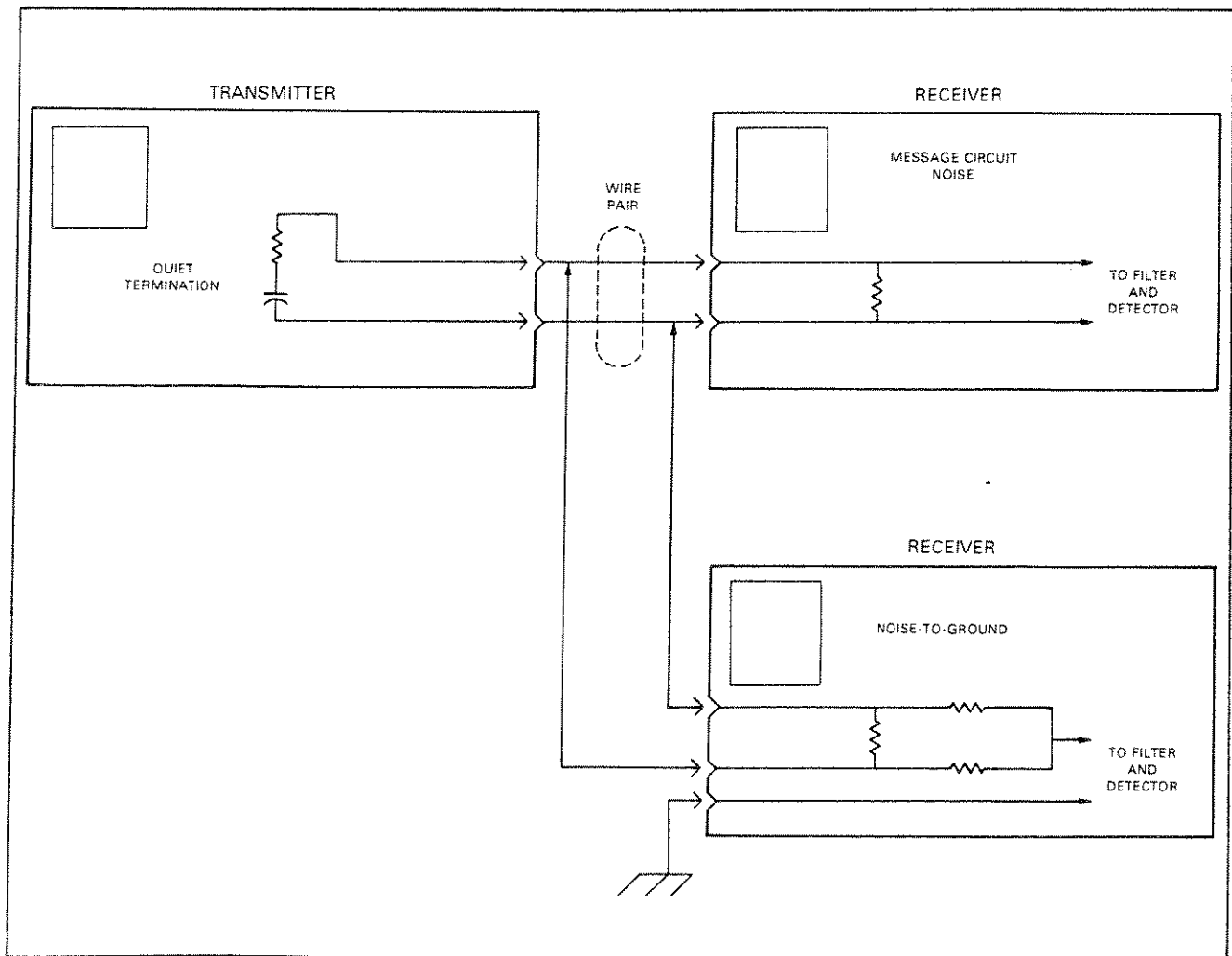

Figure 4-10. Noise-to-Ground Related to Message Circuit Noise

TRANSIENTS MEASUREMENTS

The 3-level impulse noise, hits and dropouts mode measures the interfering effects of transients phenomena. These transient phenomena can cause data transmission errors and interruptions to data communication systems. This measurement mode allows simultaneous determination of: impulse noise counts at three different thresholds, phase hit counts, gain hit counts, and dropout count. The simultaneous measurement of these transient phenomena allows the HP 4945A to reliably differentiate between each of them.

Impulse Noise

Impulse noise is that component of the received noise signal which is much greater in amplitude than the normal peaks of the message circuit noise, and that occurs as short duration spikes or burst of energy. Studies by Bell Telephone Laboratories have shown that the impulse noise spikes have duration of less than one millisecond, and that all significant effects of the noise spikes disappear within four milliseconds. Waveform (b) in Figure 4-11 illustrates a received holding tone (or test signal) that includes interfering impulse noise spikes. The impulse noise measurement allows determination of impulse noise count on a voice channel, given a specified measurement period (all are selectable on the HP 4945A).

Customers initiating and terminating calls cause relays and switches to operate and release, giving rise to impulse noise from the associated electrical transients. Normal installation and repair activities also introduce impulse noise.

Impulse noise affects data transmission by causing the loss of the information signal which results in errors. In slow data rate systems few errors occur due to impulse noise because the receiving device can distinguish a data pulse from an impulse noise pulse. As the data rate of a system increases, it becomes more difficult for the receiving device to distinguish the data pulse from the noise; resulting in impulse noise caused errors.

Phase Hits, Gain Hits, and Dropouts

A phase hit is a sudden change (increase or decrease) in the received signal phase (or frequency). Phase hits may be as small as tenths of a degree or as large as 360 degrees. The phase of the received signal may return to its original value in a short time, or it may remain indefinitely at a changed value. Waveform (c) in figure 4-11 illustrates a received holding tone that includes interfering phase hits.

Some of the more common causes of phase hits (and also gain hits and dropouts) are automatic switching to standby facilities or carrier supplies, patching out working facilities to perform maintenance, and noise transients coupled into carrier frequency sources.

Two common modulation techniques used by data modems are phase and frequency modulation. Phase hits create errors by appearing like information carried by data signal. For example, in a system using an 8-phase modulation technique (45 degrees between states), frequent 25-degree phase hits would make it very difficult for the receiving modem to distinguish between the interfering phase hits and the phase modulation; resulting in phase hits caused errors.

A gain hit is a sudden change (increase or decrease) in the received signal level. Gain hits can be less than a dB or as large as several dBs. The level of the received signal can return to its original value in a short time, or it can remain indefinitely at the changed value. Waveform (d) in Figure 4-11 illustrates received holding tone that includes interfering gain hits.

Amplitude modulation of a carrier signal is another common technique used by modems to transmit data. Because the information is contained in the level of the signal, gain hits can appear like the information carrier by the data signal; resulting in gain hit caused errors.

A dropout is a sudden drop in received signal level (>12 dB). During a dropout, the signal often becomes undetectable. Some dropouts are difficult to observe because the background noise can rise to a level near the original signal level. The level of the received signal can return to its original value in a short time or remain undetectable indefinitely. Waveform (e) in figure 4-11 illustrates a received holding tone that includes interfering dropouts.

All communication ceases during a dropout and data can be lost. The receiving mode must re-reference itself to the signal before data communication can resume. Most modems can track the received signal to a level as low as 12 dB below their normal receiving power. Beyond 12 dB the information signal is considered lost.

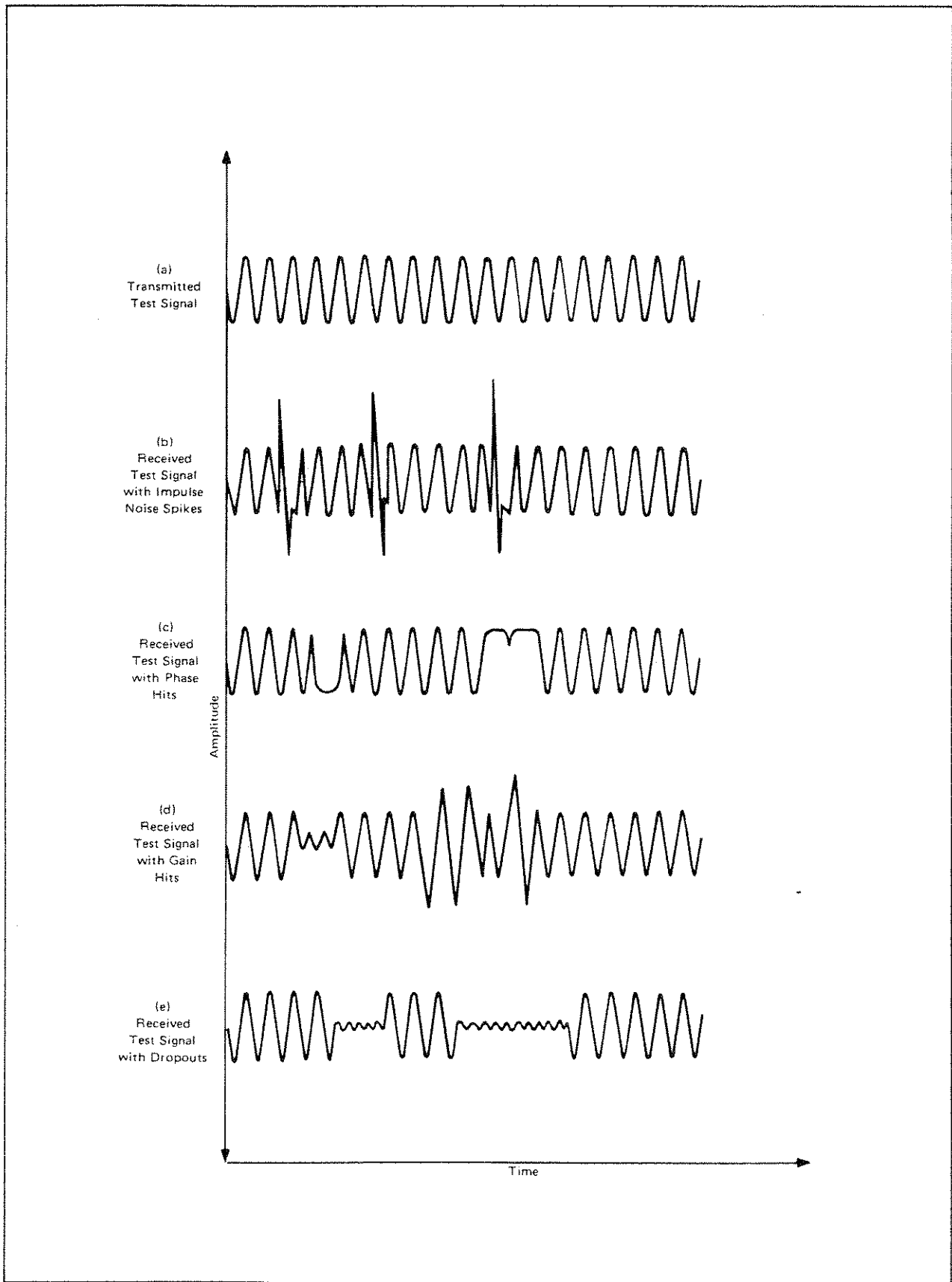

Figure 4-11. Impulse Noise, Hits, and Dropouts Waveforms

Simultaneous Measurement of Impulse Noise, Hits and Dropouts

The relationship between each of the transient disturbances is summarized in table 4-2. The best way to distinguish impulse noise from dropouts is the 4 ms maximum duration of the impulse noise. Phase hits can be distinguished from gain hits and dropouts because phase hits cause change in phase. Dropouts have to be distinguished from gain hits by definition, since dropouts are a special case of gain hits. Table 4-3 summarizes the measurement definitions necessary for implementing a practical measuring instrument.

The information needed about each disturbance is how often they occur. The measuring instrument is required to total each disturbances over a specified time. The nominal count rate for electromechanical counters is 7 counts per second with a blanking interval of 143 milliseconds. The nominal fast counting rate is 100 counts per second with a blanking interval of 10 milliseconds. All of the transients can occur at any time because they are caused by random sources. They can also occur in clusters with only a few milliseconds between each impulse noise spike.

Because not all disturbances are of sufficient magnitude to cause data communication problems, it is necessary to be able to set thresholds that will discriminate against small disturbances. The thresholds in the HP 4945A are adjustable so that measurements can be made at different test level points; and also so that the test set can be made to be susceptible to certain disturbances depending on the effect those disturbances have on current data communications.

This test set is capable of identifying all four disturbances simultaneously. Each is counted individually as shown in Figure 4-12.

Table 4-2. Transient Phenomena Summary

DISTURBANCE	SIGNAL RELATED	CHARACTERISTIC	DURATION
Impulse noise	No	Level and Phase	<0.1ms to 4ms
Phase hit	Yes	Phase	<0.1ms to >hours
Gain hit	Yes	Level	<0.1ms to >hours
Dropout	Yes	Level	~ms to >hours

Table 4-3. Measurement Definitions

DISTURBANCE	SIGNAL RELATION	DURATION
Impulse noise	Level change not related to signal	Less than 4ms
Phase hit	Phase change to the signal	Greater than 4ms
Gain hit	Level change to the signal	Greater than 4ms
Dropout	Decrease in signal level of 12 dB	Greater than 4ms

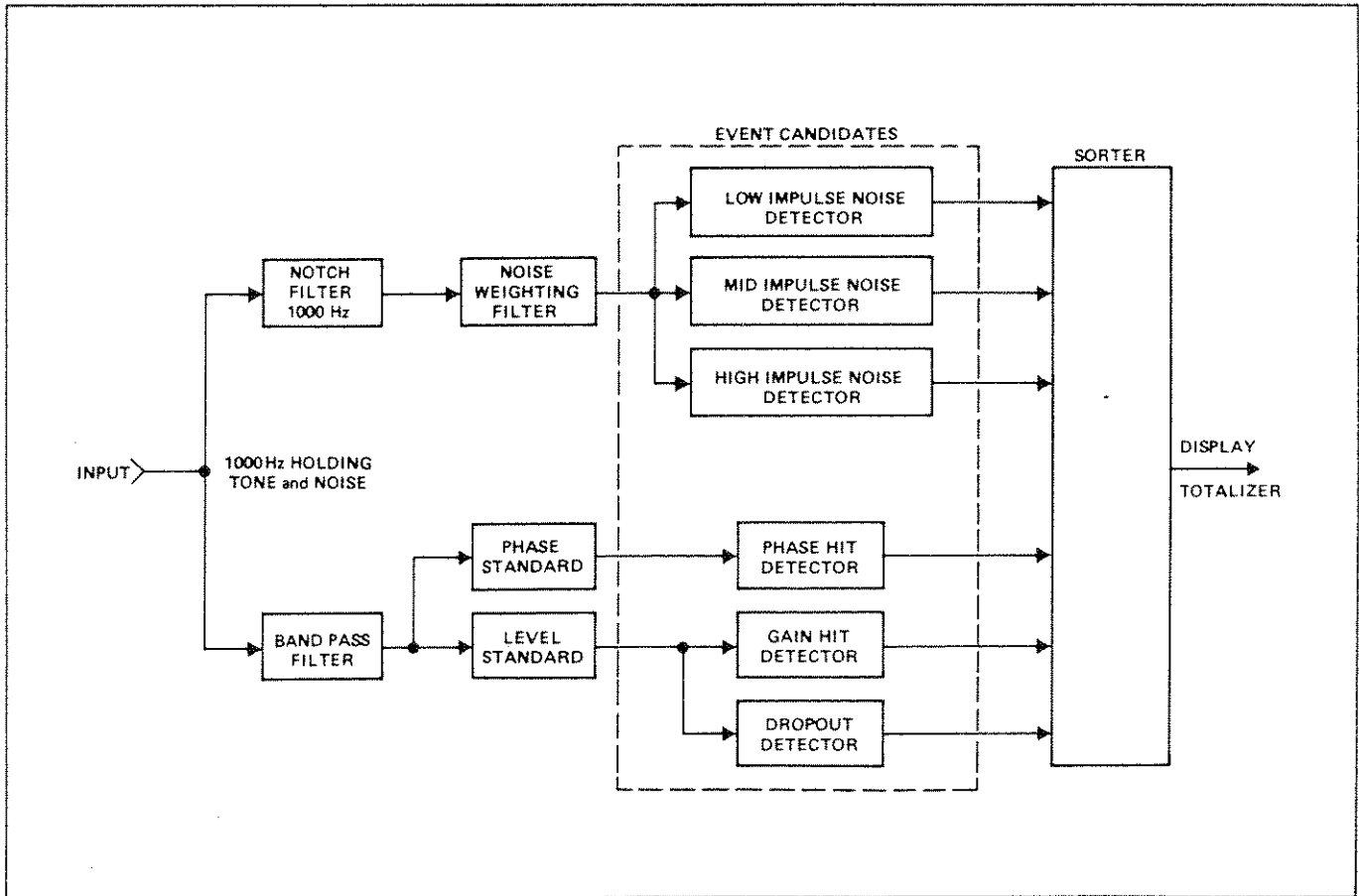

Figure 4-12. Impulse Noise, Hits, and Dropouts

JITTER MEASUREMENTS

Phase Jitter

The phase jitter mode allows measurement of the peak-to-peak phase deviation of a 1004 Hz holding tone on a voice channel. Phase jitter is unwanted phase (or frequency) modulation that a signal may pick up as it traverses a communication channel.

Phase jitter has an insignificant effect on voice transmission, however phase jitter can seriously affect data transmission. Phase jitter is especially interfering to data communications systems that use phase modulation as the transmission scheme. If large phase variations occur, one data pulse can occupy the allotted time slot of another pulse (intersymbol interference), causing an error to occur. Figure 4-13a illustrates the effect of phase jitter on a reference holding tone.

Different sources cause the instantaneous phase of a signal to jitter at rates normally less than 300 Hz. Phase jitter is typically caused by ripple in the dc power supply of the master oscillator of long haul carriers. Some phase jitter can also occur in short haul systems from incomplete filtering of image sidebands. The most commonly found frequency components of phase jitter are 20 Hz (ringing current), 60 Hz (commercial power), and the harmonics of these. A bandwidth of about 800 Hz centered about a carrier near 1 kHz will recover the major suspected phase jitter without incurring large amounts of uncorrelated interference.

To measure phase jitter, a 1004-Hz holding tone is transmitted at data level. At the receiving end of the voice channel is the test set configured to measure phase jitter. Figure 4-14a illustrates the receiving TIMS functional configuration. The received signal passes through the 600 to 1400 Hz band-pass filter. This filter reduces the effective measurement bandwidth to approximately one-fourth the total channel width, centered on the test tone frequency. This in turn reduces the effects of noise and other interference on the jitter measurement.

The phase-locked loop will not follow fast phase changes that occur at a rate greater than 20 Hz. The slow response amplifier will not react fast enough to change the oscillator frequency to match the received frequency. Fast phase change will cause an error to be generated by the phase detector.

The error signal appearing after the 300-Hz low-pass filter is limited in frequency between 20 Hz and 300 Hz. This pass band is a Bell Standard and includes the phase jitter interference caused by 20-Hz ringing and 60-Hz power, plus their first several harmonics. Phase jitter components rarely occur above 300 Hz. When they do, they are normally accompanied by large amounts of jitter below 300 Hz, which allows detection by the HP 4945A.

In addition to the Bell Standard, 20-to 300-Hz band, the HP 4945A also measures phase jitter in the low frequency (LF) 4- to 20-Hz band and in the Bell Standard plus LF 4- to 300- Hz.

Amplitude Jitter

Amplitude jitter is the summation of incidental amplitude modulation and the effects of interference and noise. Amplitude jitter is measured by examining amplitude disturbances on a 1004 Hz test tone. Figure 4-13b shows the effects of amplitude jitter on the 1004-Hz.

The most commonly found signal-frequency components of amplitude jitter are 20 Hz (ringing), 60 Hz (commercial power), and their second through fifth harmonics. A bandwidth of about 600 Hz centered about a carrier near 1 kHz will recover the major suspected amplitude jitter without incurring large amounts of uncorrelated interference.

Because group delay distortion of a channel can cause amplitude jitter to be created from phase jitter, and vice versa, amplitude jitter should be measured in conjunction with phase jitter. Also noise can cause what would appear to be amplitude jitter, so a C-notch weighted noise measurement should always be made in conjunction with amplitude jitter measurements.

Amplitude jitter is measured in the Bell standard 20 to 300 Hz band, the low frequency (LF) 4-20 Hz band and in the Bell standard plus LF 4 to 300 Hz band. Figure 4-14b shows the functional configuration of amplitude jitter measurements.

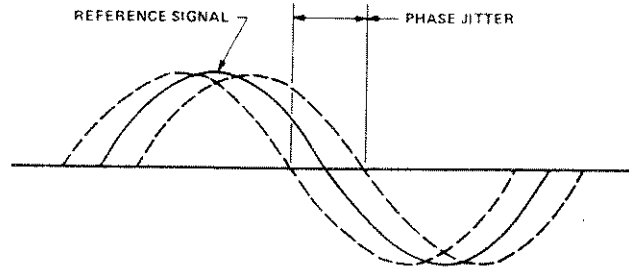

(a) Effects of phase jitter on 1004-Hz holding tone

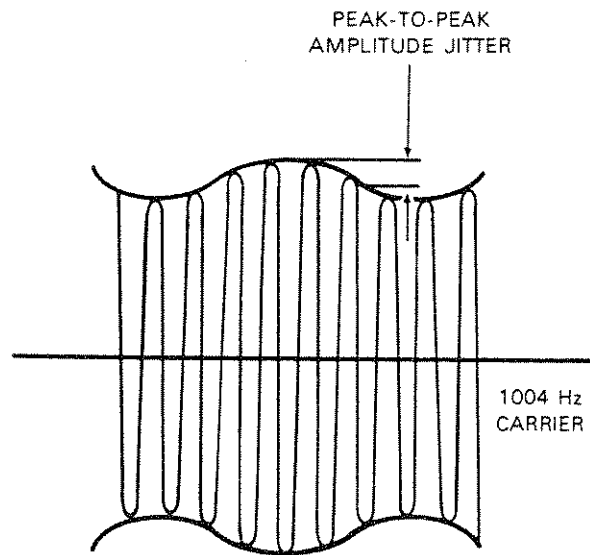

(b) Effects of amplitude jitter on 1004-Hz holding tone

Figure 4-13. Effects of Phase and Amplitude Jitter on Holding Tone

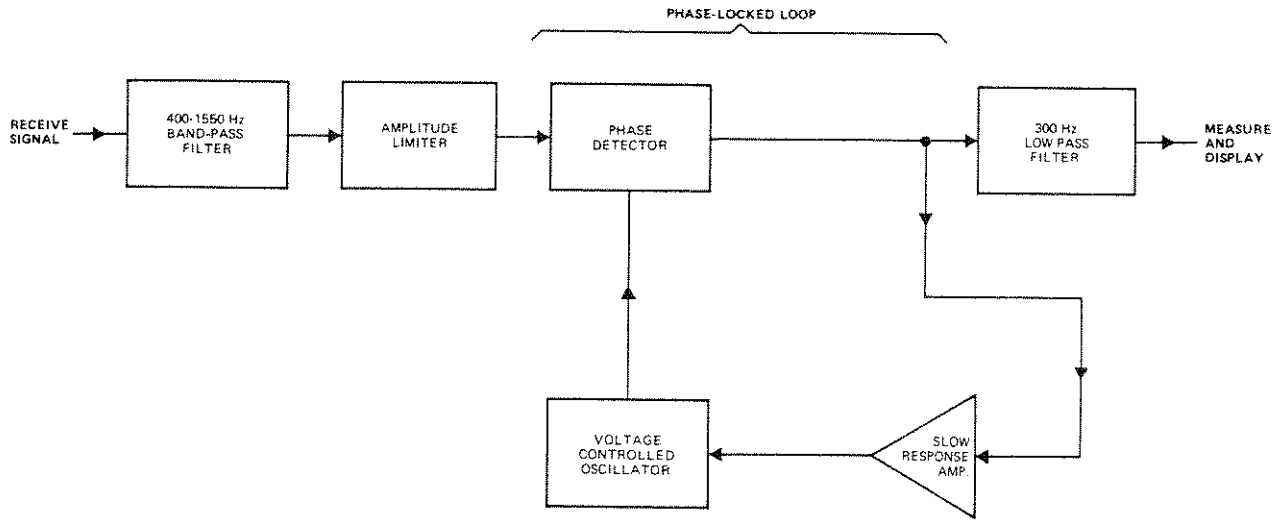

(a) Phase jitter measurement

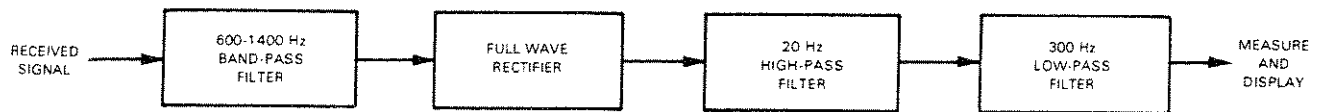

(b) Amplitude jitter measurement

Figure 4-14. Phase and Amplitude Jitter Measurements

ENVELOPE DELAY MEASUREMENT

The envelope delay mode allows measurement of the linearity of the phase versus frequency of a voice channel.

Phase information has an insignificant effect on voice transmission, but can seriously affect data transmission. At data transmission greater than 2400 bits per second, over a voice channel without proper delay compensation, the data bits tend to smear out in time and overlap each other causing inter symbol interference which produces errors.

An ideal circuit which has a linear phase shift characteristic will produce a straight line slope (a linear relationship between a change in frequency and a corresponding change in phase) as shown in Figure 4-15a. The practical circuit is never ideal and will produce a nonlinear phase shift characteristic (phase distortion) as shown in Figure 4-15b.

Conventional measurement techniques make it difficult to measure the phase characteristic of a transmission system, because a phase reference is difficult to establish at the receiving end of the circuit. It is possible however, to measure relative phase shift at the receiving end using the envelope delay measurement technique. This technique makes it possible to measure the envelope delay distortion of a voice channel, which provides a relative measure of the phase linearity (or nonlinearity) of the circuit.

Relating Phase Shift to Envelope Delay

Amplitude modulating a low frequency sine wave (f_m) onto a carrier frequency (f_c) produces an amplitude modulated (am) signal as shown by waveforms (a), (b), and (c) in Figure 4-16. The envelope of the AM signal is the outline (or shape) of the peak excursions of the modulated signal as shown in waveform (d) of Figure 4-16. The AM process produces a signal whose spectrum consist of the carrier frequency plus an upper sideband ($f_c + f_m$) and a lower sideband ($f_c - f_m$). Figure 4-17 illustrates this relationship. Since the upper sideband is of a higher frequency than the carrier, it undergoes a greater phase shift than the carrier; since the lower sideband is of a lower frequency, it undergoes less phase shift.

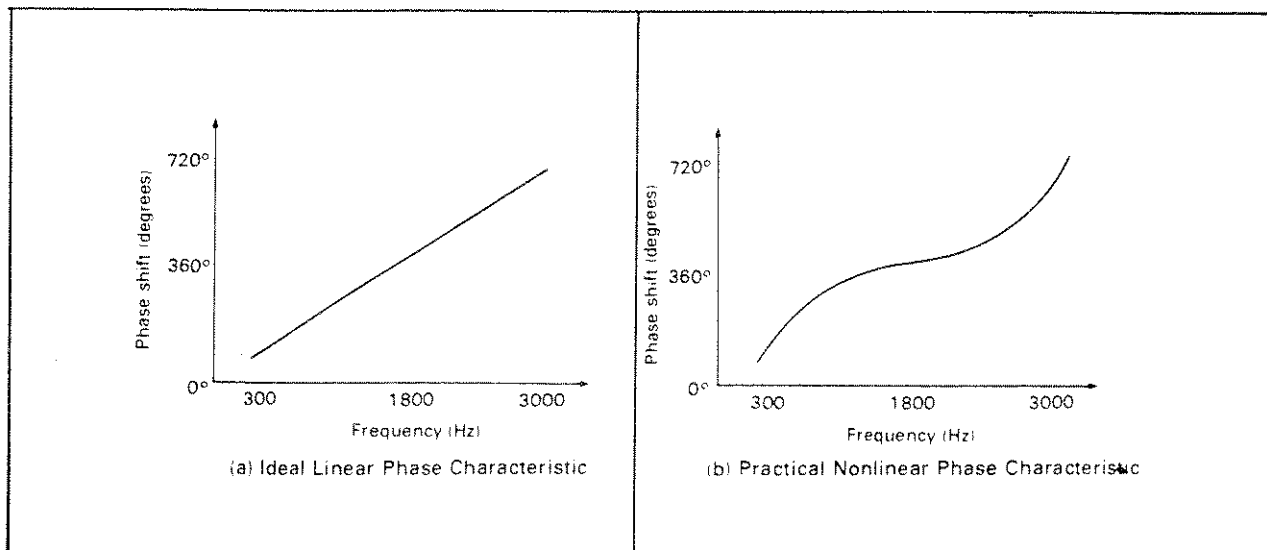

Figure 4-15. Phase Versus Frequency Relationship

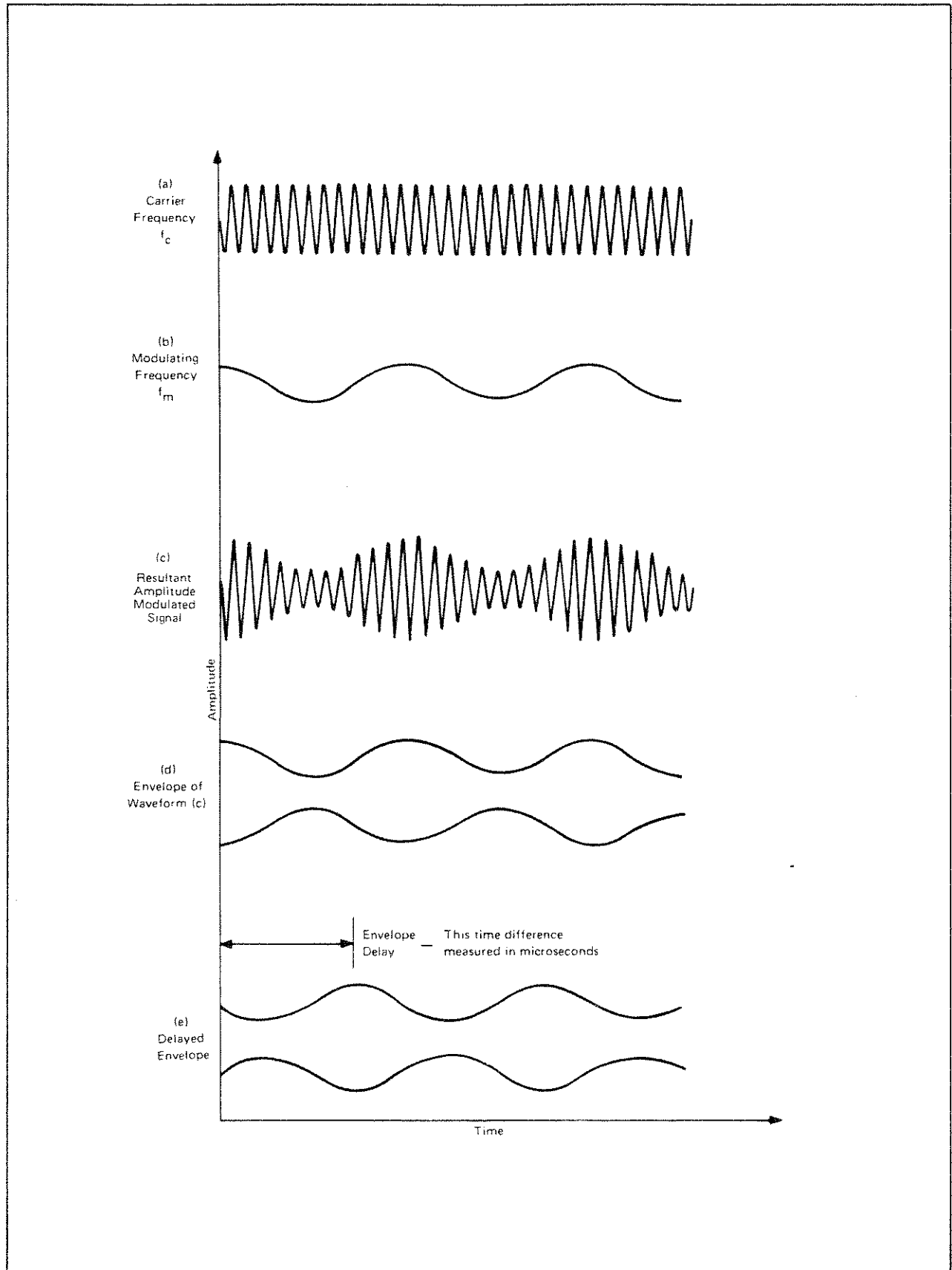

Figure 4-16. Envelope Delay Waveforms

If the AM signal is passed through a circuit having a phase shift characteristic which increases linearity with frequency (figure 4-15), the envelope of the AM signal experiences a shift in time (or delay) as shown in waveforms (d) and (e) of Figure 4-16. This occurs because the lower sideband experiences less phase shift than the carrier, while the upper sideband encounters more. The net result of these phase shifts is that the modulation envelope is shifted in phase (or delayed) when traversing a transmission medium.

The amount of envelope delay is related to the difference in phase between the two sidebands. If the phase versus frequency characteristic of the transmission medium is linear, then any carrier frequency used (with a fixed modulation frequency) will produce a constant envelope delay value. Plots (a) and (b) in Figure 4-18 illustrates this relationship. However, if the phase versus frequency characteristic is nonlinear, then the different carrier frequencies will produce different values. Plots (c) and (d) in Figure 4-18 illustrate this relationship. When different values of envelope delay occur, the difference between delay values at two different carrier frequencies is termed "envelope delay distortion".

Envelope Delay Distortion Measurement

To make this measurement, two TIMS are used in the configuration shown in Figure 4-19. The TIMS normal test set transmits a test signal over the voice channel under test to the TIMS repeat test set. The repeat set responds by transmitting envelope delay information back to the normal set over the return reference voice channel. The normal set compares its received signal with its transmitted signal to determine envelope delay distortion values.

The normal set transmits an amplitude modulated test signal consisting of a various frequency carrier (300-to 65004-Hz) and a fixed modulation frequency (83 1/3 Hz). The carrier frequency is varied over the band of interest, usually in 100 Hz steps. The test signal traverses the voice channel under test and is received by the repeat set. The receiver of the repeat set amplitude demodulates the incoming test signal to produce the AM envelope. Changing the carrier frequency as mentioned above will result in a change in the delay of the 83 1/3 Hz envelope at the repeat set, if envelope distortion exists. The envelope delay values received at the repeat set must now be transmitted back to the normal set without the introduction of a changing envelope delay, as would be introduced by changing the return reference carrier frequency.

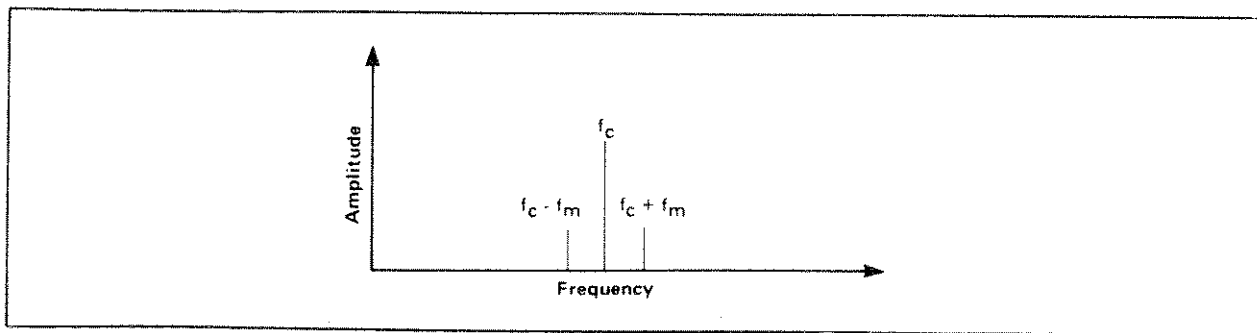
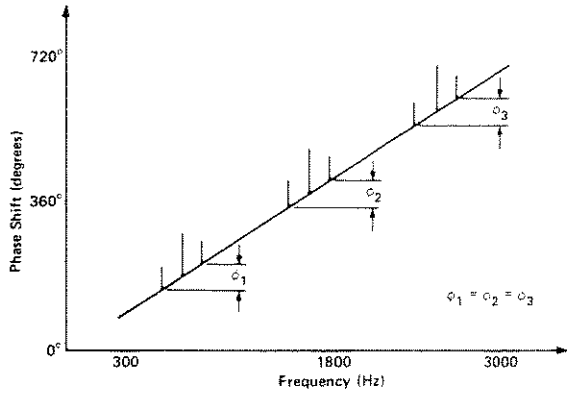
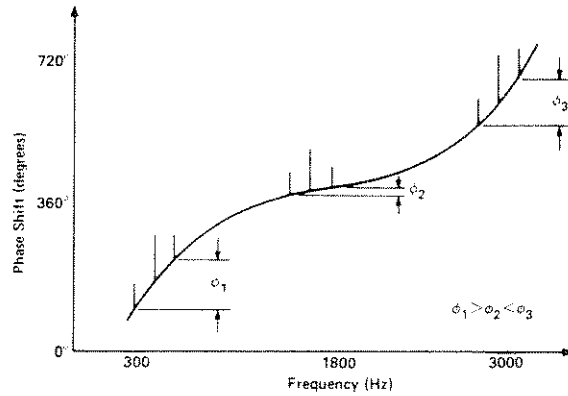

Figure 4-17. AM signal frequency spectrum



(a) Linear Phase Characteristic with Superimposed AM Signal Components



(c) Nonlinear Phase Characteristic with Superimposed AM Signal Components

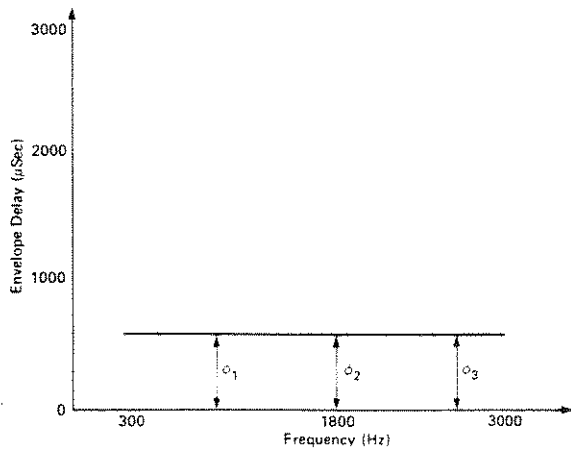

(b) Envelope Delay Characteristic of (a) above.

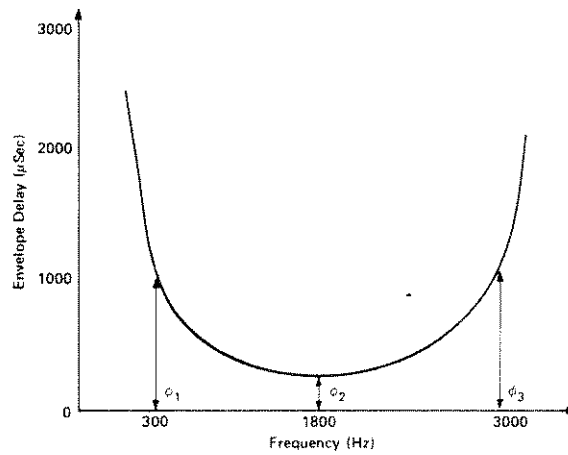

(d) Envelope Delay Characteristic of (c) above.

NOTE: The symbol phi (ϕ) represents the difference in phase between the upper and lower sidebands of the AM signal superimposed on the phase characteristic plots.

Figure 4-18. Relating Phase Shift to Envelope Delay

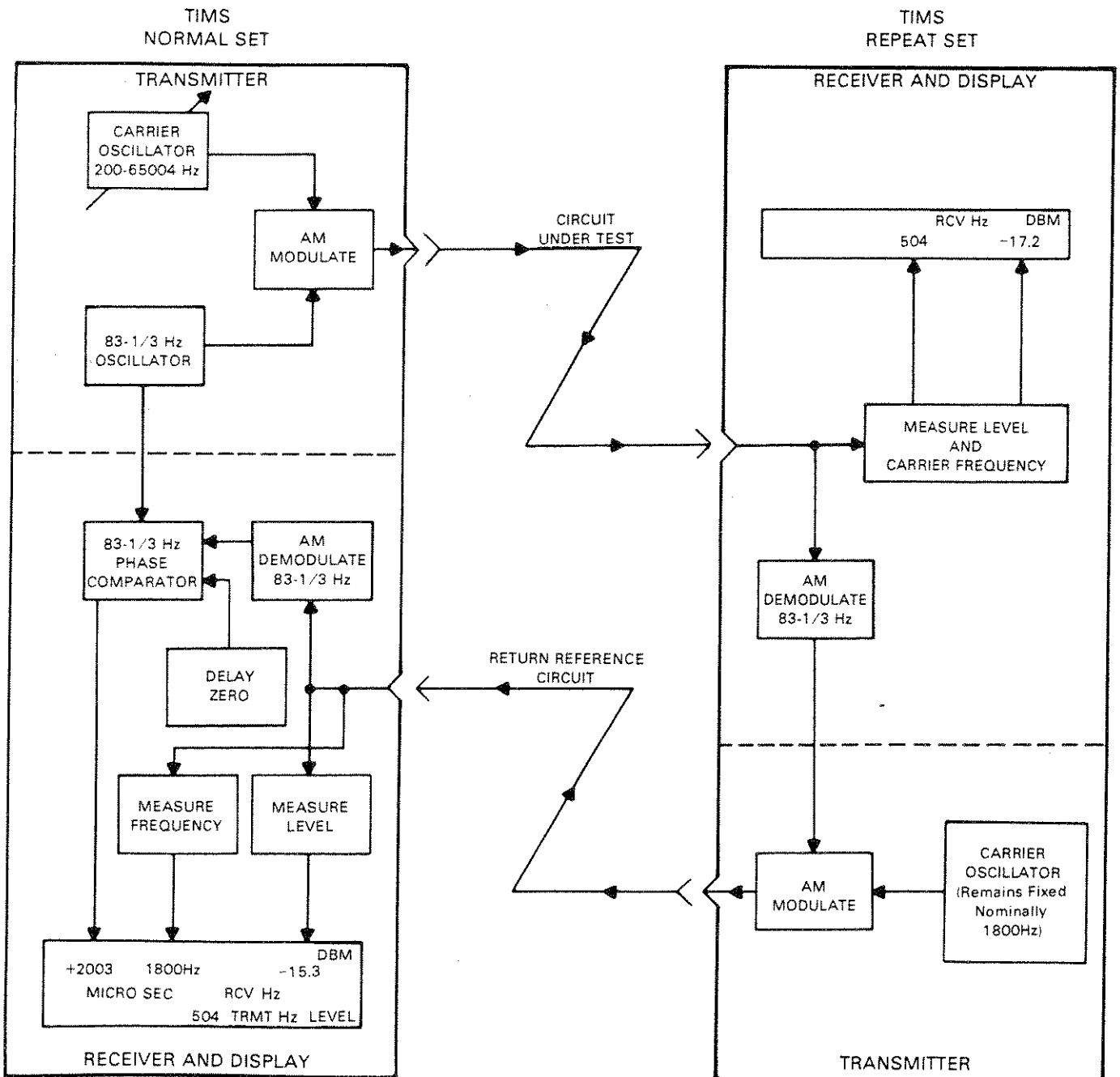

Figure 4-19. Envelope Delay Measurement

In the repeat set, the demodulated AM signal is used to amplitude modulate the fixed frequency carrier that is transmitted back to the normal set. The carrier oscillator in the repeat set remains fixed at one frequency during the envelope delay measurement. The carrier frequency is usually selected at midband (normally 1800 Hz) because envelope delay characteristics are fairly constant and attenuation distortion characteristics are fairly flat. Because a constant return reference carrier frequency is used by the repeat set, there will be no envelope delay distortion encountered by the return signal (although there will be a fixed envelope delay). Therefore, the envelope delay value received at the normal set will represent the envelope delay value received at the repeat set, plus the constant envelope delay of the return reference channel.

The receiver of the normal set amplitude demodulates the incoming return reference signal. The phase of the incoming return reference envelope is then compared to the original $83 \frac{1}{3}$ Hz oscillator signal to determine the difference in phase (envelope delay) between the two signals.

To measure the change in envelope delay from the normal set to the repeat set (with a change in carrier frequency), a delay zero control is used to "zero out" the envelope delay of the entire measurement loop. The delay zero control sets the phase difference (or envelope delay) between the $83 \frac{1}{3}$ Hz oscillator and the demodulated return reference envelope to zero when set. By changing the normal set carrier frequency from the delay zero reference value, the only changing envelope delay (envelope delay distortion) occurring in the measurement loop is that incurred by the test signal traversing the voice channel under test.

The delay zero function is usually implemented at a normal set carrier frequency of around 1800 Hz. For some tests it is convenient to set an arbitrary zero and vary the test frequency while looking for the largest negative envelope delay value. By setting a new zero value at this frequency of minimum delay, all other envelope delay measurements (on the channel under test) will have positive values of power line related noise.

INTERMODULATION DISTORTION MEASUREMENT

The intermodulation distortion mode allows measurement of the second and third order intermodulation distortion products of two test tone pairs transmitted over a voice channel. The test tone pairs are selected to closely approximate the nonlinear distortion properties encountered by data signals; to minimize the effects of channel roll-off phase jitter, frequency translation; and to avoid inaccurate readings on PCM carrier systems. Figure 4-20 illustrated the spectrum of the transmitted intermodulation distortion test signal.

Intermodulation distortion is the generation of new signal components not present in the original transmitted signal. This usually happens when a channel's loss is nonlinear with respect to input level. The main cause of nonlinear distortion are electronic devices such as modulators, demodulators, companders, and amplifiers.

With a single frequency (f_1) applied to the input of a nonlinear device, the nonlinear distortion appears as harmonics of the input frequency, such as $2f_1$, $3f_1$, $4f_1$, etc. This type of distortion is termed "harmonic distortion". With a multiple frequency signal (f_1 and F_2) applied to the device input, the nonlinear distortion appears as harmonics of the individual input frequencies plus intermodulation (or mixing) products of the input frequencies, as listed in Table 4-4. This type of distortion is termed "intermodulation distortion" or "nonlinear distortion", and is the type measured by the HP 4945A.

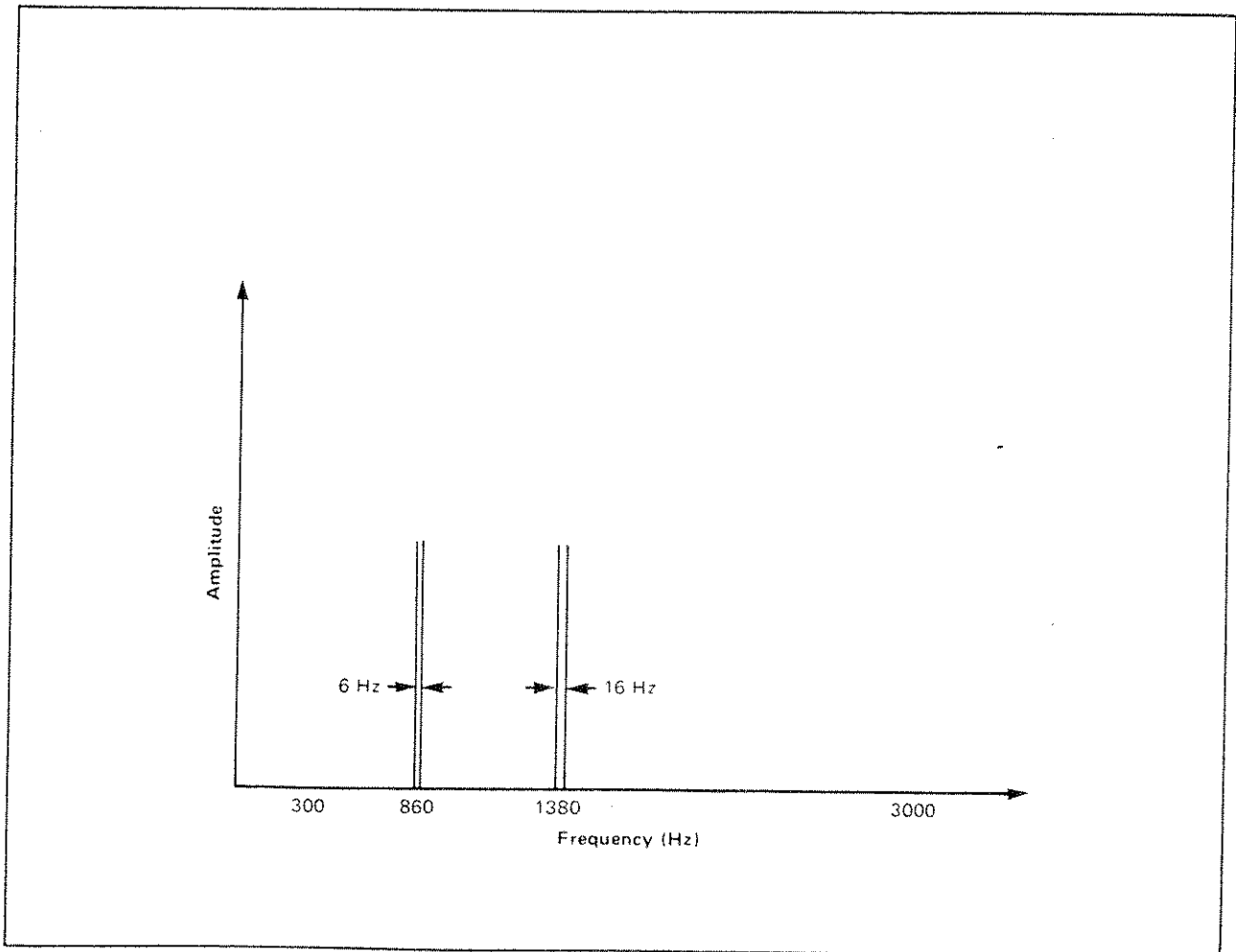

Figure 4-20. Intermodulation Distortion Signal Frequency Spectrum

Table 4-4 shows the harmonics of a multiple frequency signal (f_1 and f_2).

Table 4-4. Harmonics and Intermodulation Products of a Multiple Frequency Signal (f_1 and f_2)

TYPE OF DISTORTION	OUTPUT DISTORTION THRU THE THIRD ORDER
Harmonics	$2f_1, 3f_1, 2f_2, 3f_2$
Intermodulation Products	$f_1 + f_2, f_2 - f_1, 2f_1 + f_2, 2f_1 - f_2, 2f_2 + f_1, 2f_2 - f_1$

Intermodulation distortion and harmonic distortion measurement techniques will yield the same value for second and third order distortion in the simple case involving only one source of distortion. However, with a telephone channel there are normally multiple sources of distortion joined together by linear networks with delay distortion. This creates measurement problems in obtaining valid distortion values. Bell Telephone Laboratory studies have shown that the intermodulation distortion technique is less susceptible to these measurement problems.

The check signal provision is included in the HP 4945A to permit correction of error caused by the presence of high background noise, an interfering tone, or T-carrier quantizing noise. When the CHECK SIGNAL softkey is pressed the second tone pair shown in Figure 4-20 (as centered at 1380 Hz) is suppressed, and the lower tone pair is doubled in power. This allows the channel to be checked with a test signal of the same power. Without the two tone pairs being generated, the intermodulation process (as measured by the HP 4945A) does not occur. The receiving TMS looks for the second and third order products, but since these are not present, the measured received signals consist of noise. The second and third order products as measured with the two tone pairs may then be corrected accordingly to achieve accurate values.

PEAK-TO-AVERAGE RATIO MEASUREMENT

The peak-to-average ratio (P/AR) mode allows measurement of the channel dispersion (spreading in time of signal amplitude) due to transmission imperfections. The test signal has a peak-to-average ratio and a spectral content that approximates a data signal. As the P/AR signal traverses a dispersive medium, the peak-to-average ratio will deteriorate. Then by measuring the peak-to-average ratio at the receiving end, a simple measure of dispersion is obtained. Figure 4-21 illustrates the frequency spectrum of the transmitted P/AR test signal, and Figure 4-22 illustrates the signal envelope.

The P/AR rating is a single number rating of the fidelity of a channel and is a weighted measure of the total attenuation, phase distortion, and noise. The P/AR rating is derived by comparing the P/AR of an ideal signal with the P/AR of the output signal of the system under test. The P/AR measurement is most sensitive to envelope delay distortion and is also affected by noise, bandwidth reduction, gain ripples, nonlinearities such as compression and clipping, and other impairments. The P/AR rating is an indication of the general transmissions quality of the voice-band channel. If the P/AR signal were received entirely undistorted, the P/AR rating would be 100, while a circuit that causes a 10 percent reduction in the peak-to-average ratio has a P/AR rating of 90.

The P/AR measurement provides little information about the nature of the fault condition of any particular case. However, since P/AR is a figure of merit for the channel, it can be used as a benchmark for future reference. After other measurements are made and a channel is considered acceptable, the P/AR rating can be recorded for future reference. In case of a suspected trouble on the channel, P/AR may be measured first and be compared to the benchmark P/AR value. Deviations in excess of + or -4 P/AR units from an initial P/AR value provides sufficient reason to suspect that some channel characteristic has changed significantly.

The P/AR rating can also be useful in trouble-shooting on the DDD network where a number of connections are to be surveyed and full data recorded on only the worst connections experienced. In private line circuits, P/AR can help to identify the worst transmission direction (near to far, or far to near) such that measurement of the parameters in the worst direction can be completed first, since it is more probably that any transmission impairment will be in that direction.

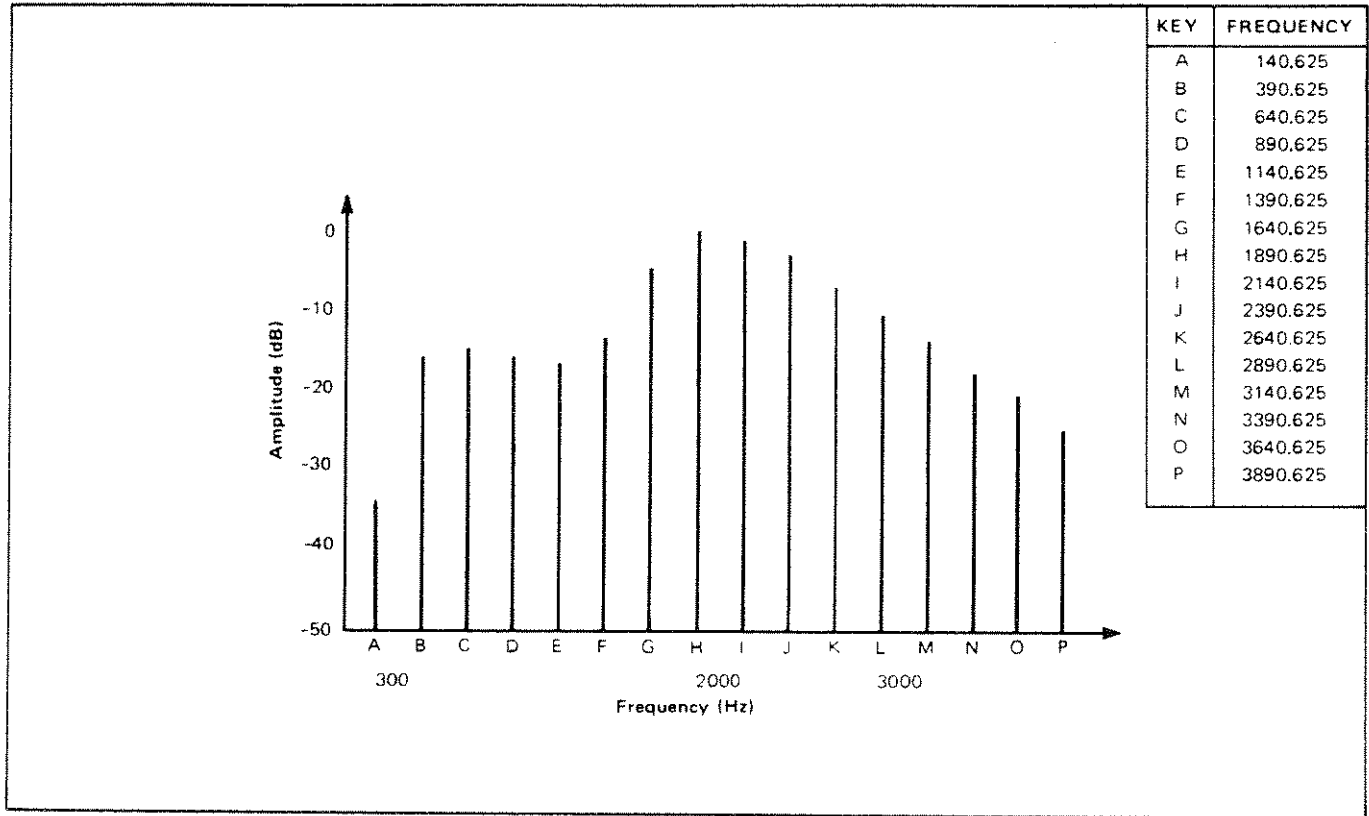

Figure 4-21. P/AR Transmit Signal Frequency Spectrum

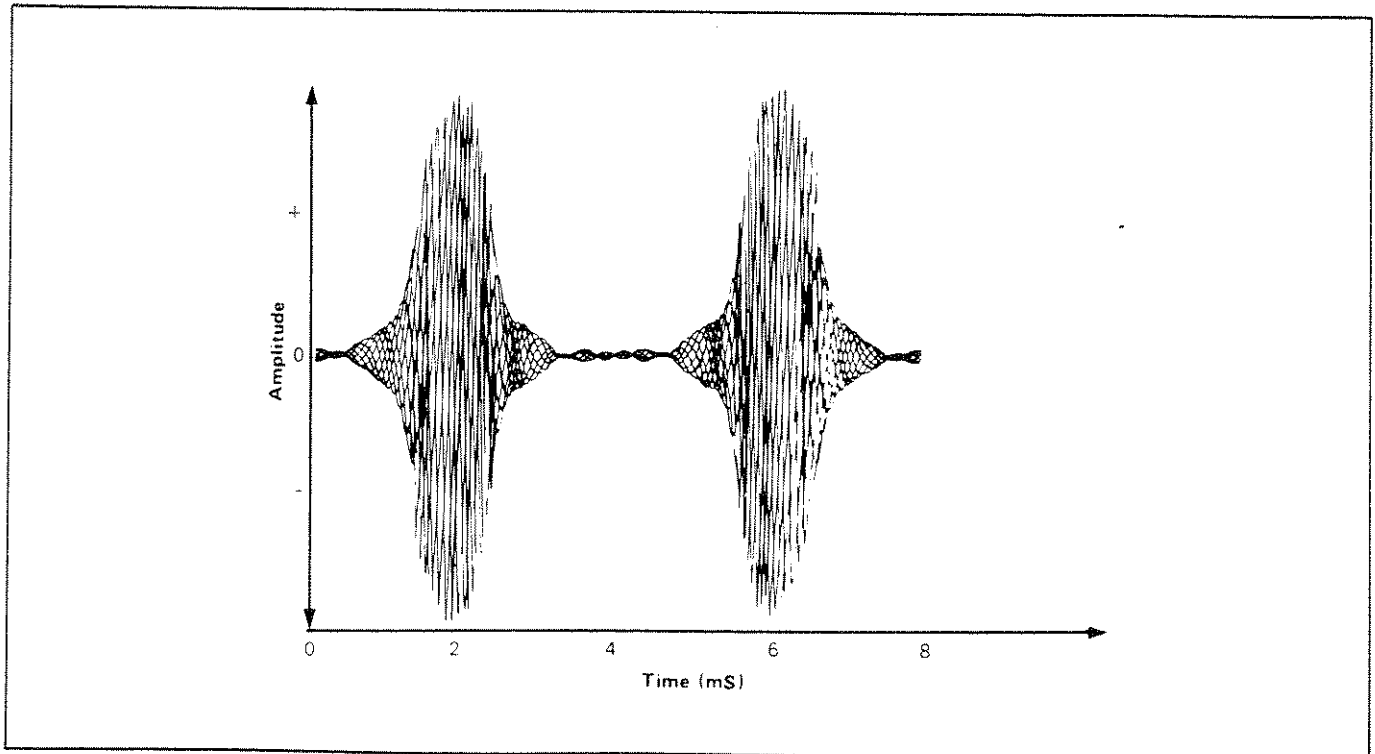

Figure 4-22. P/AR Transmit Signal Envelope

RETURN LOSS

Return loss is the ratio, in decibels, of the power incident upon a transmission system discontinuity to the power reflected from the discontinuity. Return loss measurements are made on both 2-wire and 4-wire circuits. The measurement indicates how well the input and the output impedances are matched throughout a circuit.

Four measurements are made when measuring return loss: echo return loss (ERL), singing return loss low (SRL low), singing return loss high (SRL high), and sine wave return loss (SWL). ERL is the most critical of the four measurements. SRL low and SRL high are designed to protect against circuit instability. Figure 4-23 shows the filter shapes for the measurements.

Echo return loss (ERL) and singing return loss (SRL) are band average return loss measurements made with a band limited noise signal.

Sine wave return loss is measured by transmitting a single frequency and then measuring the difference between the transmitted frequency and the received frequency. A series of single frequencies can also be transmitted by using the SINE WAVE SWEEP function of the HP 4945A.

Return loss measurements require a quiet termination at the distant end of the circuit.

The result of a single frequency return loss measurement must specify the measurement frequency. Return loss as a measure of impedance match is usually specified as the minimum for any frequency within a specified band.

Average return loss over a specified band of frequencies may be measured using a sweep frequency. The average return loss over the band is a power average noise signal.

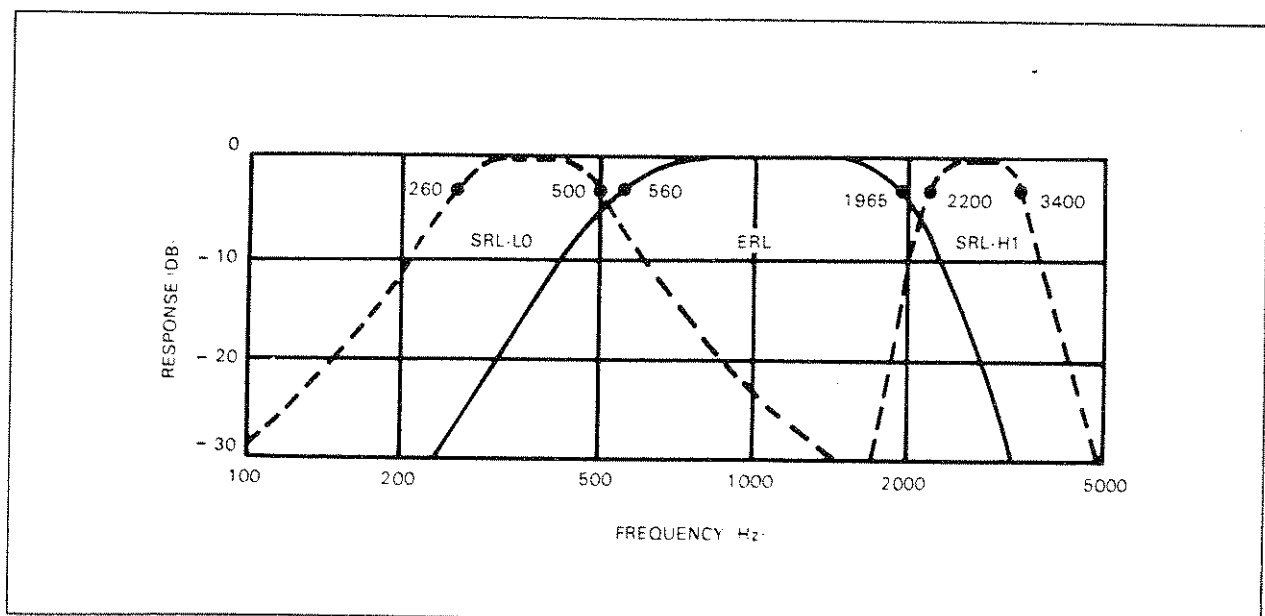

Figure 4-23. Filter Shapes for ERL, SRL low, and SRL high

CHAPTER V. HP-IB OPERATION (Model 18162A)

INTRODUCTION

The HP 18162A interface allows remote control of the HP 4945A with an external controller on the HP-IB bus. The HP-IB interface is Hewlett Packard's implementation of the IEEE Standard 488-1978.

Normal Mode

In normal operation, commands from the controller are sent to the HP 18162A Interface where they are converted into keystroke sequences to set up the HP 4945A. Data from the HP 4945A is sent to the interface and then to the controller.

Talk Only Mode

When the module is in talk only (I/O output) mode, pressing the output key on the front panel will cause an image of the display to be sent out on the interface to a printer which must be in listen always mode.

HP 4944A Mode

When the module is in this mode, it responds to all of the two character mnemonics used by the HP 4944A. All data returning to the controller will be sent in the format used by the HP 4944A, which is an image of its display.

SPECIFICATIONS

Dimensions:

Height: 33 mm (1.32 inches)
Width : 99 mm (3.91 inches)
Depth : 1880 mm (7.12 inches)

Maximum Cable Length: 20m (65 feet)

Operating Temperature: 0 to + 50 C (+32 to +122 F)

Storage Temperature: -40 to + 75 C (-40 to +167 F)

Power Requirements: Supplied by HP 4945A. Do not install interface with power on. Operating power must be off.

INSTALLATION

The HP 18162A Interface connects to one of the I/O slots on the HP 4945A rear panel. An HP-IB cable connects to the other HP 18162A connector as shown in figure 5-1.

WARNING

The HP 4945A operating power must be off. Do not install interface with power on.

The interface receives its power from the HP 4945A. No external power source is required.

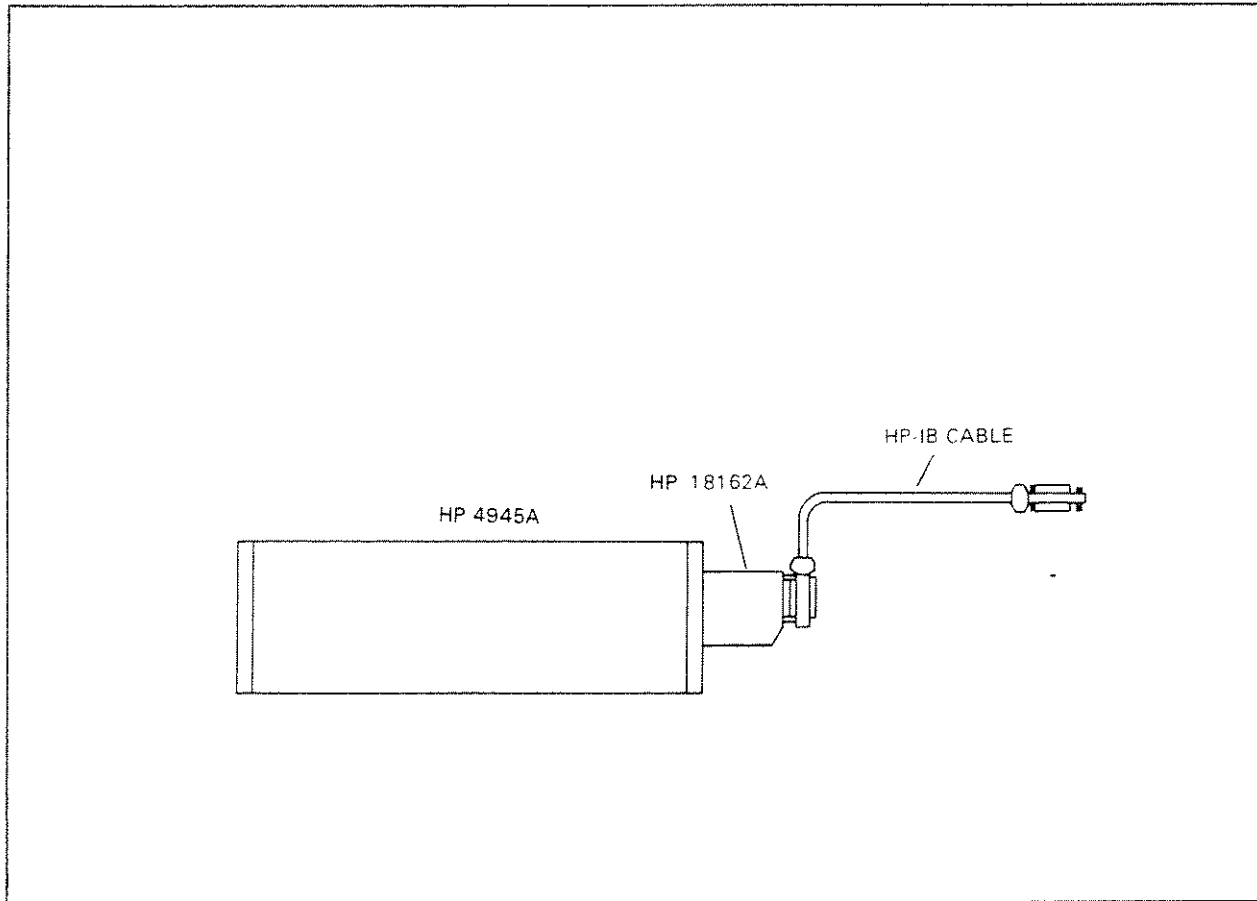

Figure 5-1. HP 18162A Interface Installation

DESCRIPTION

The HP-IB is a parallel bus of 16 active signal lines grouped into three sets according to function, to interconnect up to 15 instruments. Figure 5-2 is a diagram of the interface connections and bus structure.

One set of signal lines is the eight data lines. These lines carry coded messages which represent addresses, program data, measurements and status bytes. The data lines are used for both input and output messages in bit parallel, byte-serial form. Normally, a seven-bit ASCII code represents each byte of data, leaving the eighth bit available for parity checking.

There are three data byte transfer control lines. Data transfer is controlled by means of an interlocked handshake technique that permits data transfer (asynchronously) at the rate of the slowest device participating on the bus.

There are five general interface management lines which are used to activate all the connected devices at once, (i.e., clear the interface). Table 5-1 defines each of the management lines.

Table 5-1. General Interface Management Lines

Name	Mnemonic	Description
Attention	ATN	Enables a device to interpret data on the bus as a controller command (command mode) or data transfer (data mode).
Interface Clear	IFC	Initializes the HP-IB system to an idle state by unaddressing all talkers and listeners.
Service Request	SRQ	Alerts the controller to a need for communication.
Remote Enable	REN	Places devices under remote program control.
End or Identify	EOI	Indicates the last data byte in a data transfer sequence. Used with ATN to poll devices for their status.

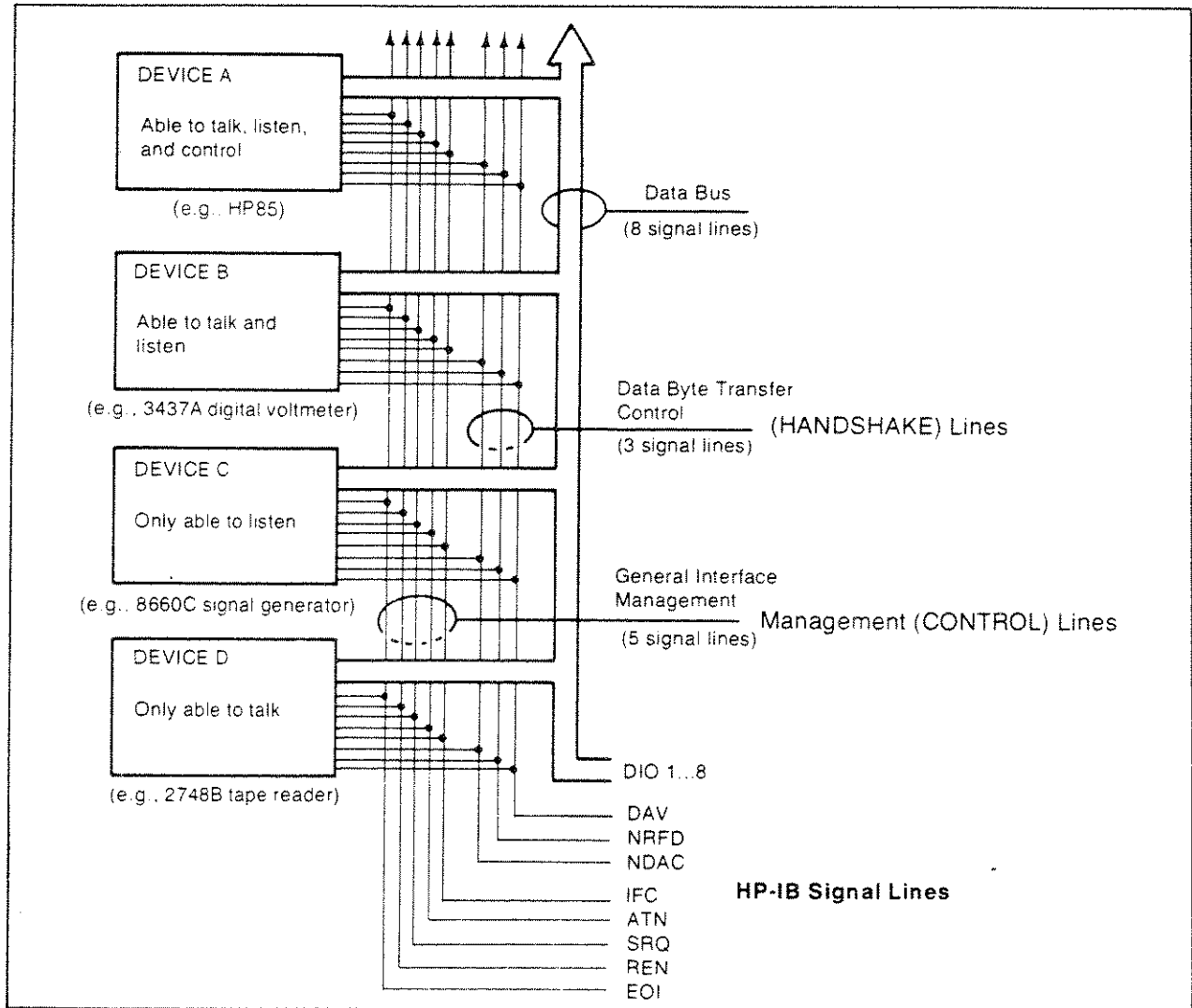

Figure 5-2. Interface Connections and Bus Structure

COMMUNICATION CAPABILITY

Devices on the bus fall into three basic categories: talkers, listeners, and controller.

Talkers are devices which send information on the bus when they have been addressed. Only one talker at a time can be on the bus.

Listeners are devices which receive information sent on the bus when they have been addressed. There can be multiple listeners on the bus.

Controllers are devices that can specify the talker and listener(s) for an information transfer. The controller can be an active controller or a system controller. The active controller is the current controlling device on the bus. The system controller can take control of the bus even if it is not the active controller. Each system can have only one system controller, even if several controllers have system control capability.

DATA INPUT AND OUTPUT MODES

There are four commands that control the output of data and the input of commands. These commands are the OUX; commands.

The OU0; command is a mask service request when data is available command. The Ready bit in the serial poll register is set when there is data ready and reset when there is none. This is the default state of the interface.

The OU1; command will cause the I/O module to make a service request when it has data available for the controller. Both the service request and the Ready bit in the serial poll register will be reset when the output queue empties unless there was a previous error, in which case only the Ready bit will be reset.

The OU2; command causes the module to hold off the HP-IB bus handshake after the line feed (following a command string from the controller) until all mnemonics have been decoded and accepted by the HP 4945A. This is the default state of the module.

The OU3; command causes the module to release the data handshake on the HP-IB bus as soon as the mnemonic commands have been received. This mode enables parallel operation of many instruments without waiting for each to accept the codes before programming the next. When using this mode it takes one to two seconds for each mnemonic to be decoded and accepted.

For example, in an application where the HP 4945A transmitter is being used and another TIMS receiver is being used to make the reading, the transmitter output may not be the expected value if there is insufficient delay before the reading.

USING THE HP 4945A AS AN HP 4944A OR AN HP 4943A

To enter this mode, all that it is necessary to do is to send one or more of the HP 4944A mnemonics. The mode of operation and the instrument set up will not change. A device clear command must be sent to the HPIB module prior to or just after entering HP 4944A mode to put the instrument in a known state, to remove any data from the output queue, and to reset the status register. This mode will be exited if a HP 4945A mnemonic is received, if the selected device clear is received or if a semicolon is received. As the HP 4944A does not respond to selected device clear, the HP 4944A mnemonics do not contain semicolons and are a different format than HP 4945A mnemonics, this transition should not occur unless there is an error in the program. When the HP 4944A mode is exited one of the clear commands, device clear or selected device clear, must be sent to reset the status register and to clear the output queue of any data.

CAUTION

It is very important to send one of the clear commands when entering the HP 4944A mode. If the HP 4945A is making a measurement that the HP 4944A cannot do, or is making a measurement outside the frequency range of the HP 4944A, the bus may lockup when the controller tries to input data.

In this mode, measurement data is returned from the HP 4945A in the same format as the HP 4944A returns it. In addition to HP 4944A mnemonics another mnemonic, M8, has been included in the set of mnemonics so that existing HP 4943A programs can be altered to also operate the HP 4945A. The HP 4943A uses the code M7 for phase jitter 20-300 Hz, while the HP 4944A uses M7 for nonlinear distortion. The HP 4945A interprets M8 code as phase jitter 20- 300 Hz, and returns the data in HP 4943A format. Replacing all occurrences of M7 with M8 in an HP 4943A program will allow it to run with the HP 4945A.

The codes C0 and C1, self check, have not been implemented and must be removed from any program which uses them before the program in question will run.

One important difference between the HP 4945A and the HP 4944A or HP 4943A is that functions that are not remotely programmable on the HP 4944A/HP 4943A, are programmable via HP-IB on the HP 4945A. When the HP 4945A executes a device clear, these functions are reinitialized default values. Understanding this difference is important when using the device clear. The following table is a summary of these differences.

HP 4944A Function

HP 4945A DCL State

Power

no change

Set up switches:

Normal test/dial talk

Normal test

Hold coils on/off

Off

Talk battery on/off

Off

Term/bridge

Term

600 ohms/900 ohms

600 ohms

SF skip on/off

Off

Normal test/self check

Normal test

Transmitter level

-16.0 dBm

Impulse noise threshold

68 dB

Line monitor volume

3, receive monitor

Analog output

Not present

RCV-TRMT switch

TRMT-RCV

HP-IB ADDRESSING

The HP-IB address is programmable from the front panel via the I/O Port Set Up menu. The default address is 10.

To change the HP-IB address, use the following procedure.

Press: SET UP I/O PORT SET UP

Press HP-IB Address key, and enter the desired address using data entry keys, and then press ENTER key.

HP-IB DEVICE FUNCTIONS

The HP 18162A Interface has the following HP-IB device capabilities which are compatible with IEEE Standard 488-1978.

AH1	Acceptor handshake
SH1	Source handshake
C0	No controller capability
L4	Listen and unlisten if talk addressed
T5	Full talker capability
SR1	Serial poll capability
RL1	Full remote local capability
PP1	Complete parallel poll ability
DC1	Full device clear implementation
DT0	No device trigger capability

MESSAGE DEFINITIONS

Information is transferred on the HP-IB from one device to one or more other devices in quantities called "messages". Some messages consist of two basic parts, an address portion and an information portion. Others are general messages to all devices. There are also messages which are referred to as "meta messages". The HP-IB bus messages and module responses are listed and defined in table 5-2. The HP 4945A response to the message (if any) is described after each definition.

Note

A meta message is not a program code or an HP-IB command. It is only intended as a tool to translate a program written as an algorithm into the controller's code.

Table 5-2. HP-IB Messages and HP 4945A Responses

Message	Definition and Response
Data	<p>The actual information (bytes) sent from a talker to one or more listeners. The information or data can be in numeric form or a string of characters.</p> <p>The HP 4945A accepts data messages when addressed to listen.</p> <p>The HP 4945A can send data messages when addressed to talk.</p>
Trigger	<p>Causes the listening device(s) to perform a device dependent action.</p> <p>The HP 4945A ignores this message.</p>
Clear	<p>Causes devices to return to a pre-defined device dependent state.</p>

Table 5-2. HP-IB Messages and HP 4945A Responses (con't)

Message	Definition and Response
Selected device clear (SDC) commands returns the HP 4945A to the following conditions:	
Menu:	Test Select
RCV:	TERM
TMT/RCV IMP:	600
Hold Coils:	OFF
SF Skip:	OFF
Voice Limit:	OFF
Master/Slave:	NORMAL (OFF), Master-to-Slave mode
Talk Battery:	OFF
Self Check:	Full, Mode 1, Segment 1, stop on end check
Noise:	Noise with tone C-MSG Filter IN 60 Hz Filter OUT
Sweep:	Stopped, Single, from 204 Hz to 3904 Hz Step = 100 Hz, Rate = Fast
Measurement:	Level/Freq, Quiet Termination, 1004 Hz
Jitter:	20 - 300 Hz, Amplitude and Phase jitter
Return Loss:	Measure All, 2-wire, Hybrid loss = 00.0
EDD:	Normal
Transients:	Stopped, 8 per sec, 15 min., 4 dB step, 68 dB threshold, 20 degrees, 10 dB gain hit Reference impedance = 600
Level keys:	Default values: 7.0, 0.0, -6.0, -13.0, -29.0
Freq Keys:	Default values: 304, 404, 1004, 2804, 3004, 2713
Volume:	OFF, Level 3, Monitor Receiver, Beep ON

Table 5-2. HP-IB Messages and HP 4945A Responses (con't)

Message	Definition and Response
	<p>Device clear (DCL) returns the HP 4945A to the same state as selected device clear with the following exceptions:</p> <p>Menu: Level Frequency</p> <p>Transients: Count is continuous</p> <p>Mode: HP 4944A or Normal (remains the same)</p>
<p>TRMT/RCV: (switch)</p> <p>Remote (REN)</p> <p>Local (GTL)</p> <p>Local Lockout (LLO)</p> <p>Clear Lockout Set Local</p> <p>Require Service</p>	<p>TRMT/RCV</p> <p>Causes the listening device(s) to switch from local front front panel control, to remote program control. This message remains in effect so that subsequent devices addressed to listen go into remote operation.</p> <p>The Remote Enable command (REN) with the HP 4945A listen address puts the HP 4945A in the remote state.</p> <p>Clears the remote message from the listening devices and returns the devices to local panel control.</p> <p>The Go To Local command (GTL) with the HP 4945A listen address puts the HP 4945A in the local state.</p> <p>Prevents the device operator from manually inhibiting remote program control.</p> <p>The Local Lockout command (LLO) puts the HP 4945A in the lockout state if REN is true.</p> <p>If REN goes false, the device goes local immediately.</p> <p>All devices are removed from local lockout and returned to local. The remote message for all devices is cleared.</p> <p>A device sends this message any time it needs some type of interaction with the controller. The message is cleared by the device's status byte message if it no longer requires service.</p> <p>The HP 4945A sets the Service Request line (SRQ) true when it requires service.</p>

Table 5-2. HP-IB Messages and HP 4945A Responses (con't)

Message	Definition and Response
Status Byte	A byte that represents the status of a single device. One bit indicates whether the device sent the required service message and the remaining seven bits indicate the operational status defined by the device. This byte is sent from the talking device in response to a serial poll operation performed by the controller.
Serial Poll	The HP 4945A sends its current status on the data bus.
Parallel Poll Configure (PPC)	Puts module into a state where parallel poll response may be programmed.
Parallel Poll Enable (PPE)	If the last command was the parallel poll configure, programs the parallel poll response.
Parallel Poll Disable (PPD)	If the last command was the parallel poll configure, disables the parallel poll response.
Parallel Poll Unconfigure (PPU)	Disables the Parallel Poll response.
Parallel Poll	Returns service request status if enabled, otherwise passive false is sent on data bus.
Listen Address (LAD)	If it equals the modules address, then it becomes listener active.
Unlisten (UNL)	Unaddresses module if listener active.
Talk Address (TAD)	If equal to modules address, then it becomes talker active, otherwise it is unaddressed if active talker.
Untalk Command (UNT)	The module is unaddressed if active talker. Group Execute (GET) This command is ignored.
Status Bit	<p>A byte that represents the operational conditions of a group of devices on the bus. Each device responds on a particular bit of the byte thus identifying a device dependent condition. This bit is sent by devices in response to a Parallel Poll operation.</p> <p>The HP 4945A returns service request status on the specified bit, if enabled.</p>

Table 5-2. HP-IB Messages and HP 4945A Responses (con't)

Message	Definition and Response
Pass Control	<p>Transfers the bus management responsibilities from the active controller to another controller.</p>
Abort	<p>The system controller sends this message to unconditionally take control of the bus from the active controller. The message terminates all bus communications but does not implement the clear message.</p> <p>When the Interface Clear line (IFC) is true, the HP 4945A does the following:</p> <ul style="list-style-type: none">The interface is unaddressed.Data in the queues is retained.Command decoding is aborted if in progress.Normal Mode on the HP 4944A is retained.

SERIAL POLL OPERATION

In the normal mode of operation, the serial poll register has the following configuration:

BIT	7	6	5	4	3	2	1	0
-----	---	---	---	---	---	---	---	---

	PON	RQS	ERR	READY	ddc	ddc	ddc	ddc
--	-----	-----	-----	-------	-----	-----	-----	-----

Bit 7	PON	Power on self check failed
Bit 6	RQS	This device requested service
Bit 5	ERR	Error occurred
Bit 4	READY	Data ready for output
Bit 3	ddc	Device dependent code
Bit 2	ddc	Device dependent code
Bit 1	ddc	Device dependent code
Bit 0	ddc	Device dependent code

Bit zero is set in conjunction with ERR when there has been a keycode or mnemonic error. Bit 1 is set in conjunction with ERR when the module has been locked out by another module. Bit 2 is set in conjunction with ERR when the front panel has been accessed in remote mode. It tells the controller that the instrument is now in local state and the set up of the instrument is now unknown to the controller. When the status is updated, the contents of the serial poll register are ORed with the new status message, so many combinations of status message are possible. Bit 3 is set when initial link is in progress, or when the instrument is in slave mode.

To clear the serial poll register it is necessary to send one of the clear commands, DCL or SDC, to reset the status bits. The one exception to this is the case of data available, when the data available bit is reset when the controller has read in all the data currently available. (The service request is also de-asserted if there are no errors.)

When a device fails, an incorrect mnemonic, or an incorrect keycode is detected, a SERVICE REQUEST message replaces the REMOTE or the REMOTE WITH LOCKOUT message across the top of the display. This message is not displayed for any other service request condition, although the SRQ line may be asserted on the bus to tell the controller that the device state has changed.

Decimal	Binary	Meaning
16	00010000	Data available in no request mode
80	01010000	Data available with service request
97	01100001	Incorrect mnemonic or invalid keycode
98	01100010	Module locked out by other module
100	01100100	Front panel accessed in remote state
224	11100000	Device failure

CONTROLLING THE HP 4945A

Commands can be sent from the controller to the HP 4945A to control the HP 4945A setup. Following is an example command line:

```
OUTPUT <select code> ; <command> <data> <; or LF>
```

The command is a three character code that is translated into key sequences by the HP 4945A. Data is not required on all commands.

Output mode is used when printed output is desired and a controller is not available. The mode is entered and exited from the HP 4945A front panel. HP-IB commands have no affect when in this mode. When the HP 4945A is in the printed page mode a copy of the display is printed when the output key is pressed.

EXAMPLE PROGRAM WHEN USING THE HP 9816A, HP 9826A, or HP 9836A

```
10      ! Frequency run program
20      ! This program will do a frequency run between two user specified
30      ! frequencies, with a user specified step and reference frequency.
40      ! The program also inputs the transmit and receive impedances.
50      ! This program has a limit of 1000 points which is a function of
60      ! the array size.
70      !
80      DIM A$[32]           ! String into which data is read from the HP 4945A
90      DIM Level(1000)     ! Array in which relative level is stored
100     DIM Freq(1000)      ! Array in which frequency data is stored
110     !
120     OUTPUT 2;CHR$(255) &"K" ! Clear screen
130     PRINTER IS 1        ! Print on the screen
140     ! Prompt for HP 4945A address
150     BEEP
160     INPUT "AT WHAT ADDRESS IS THE 4945A",Tims      ! Enter the HP 4945A address
170     IF Tims>700 AND Tims<731 THEN GOTO 200        ! Is it >700 and <731?
180     IF NOT <Tims>0 and Tims <31> THEN GOTO 150    ! Did they enter 1 to 30?
190     Tims=Tims+700                                  ! Using interface 7, add 700
200     ASSIGN @Tims TO Tims                          ! @Tims is now the address of
                                                    ! the HP 4945A
210     !
220     ON TIMEOUT 7,30 GOTO 1350                    ! Set a 30 second timeout
230     ABORT 7                                       ! Clear the bus
240     CLEAR @Tims                                   ! Clear the instrument
250     REMOTE @Tims                                  ! Put it into REMOTE state
260     LOCAL LOCKOUT 7                              ! Lock out the front panel
270     !
280     ! Prompt the user for transmit
           ! impedance
```

Example Program (con't)

```

290 BEEP
300 INPUT "WHAT IS THE TRANSMIT IMPEDANCE";Tr_imp
310 IF NOT (Tr_imp=135 OR Tr_imp=600 OR Tr_imp=900 OR Tr_imp=1200)
    THEN GO TO 290 ! The entered transmit impedance
    ! must be 135,
    ! 600, 900, or 1200 ohms

320 !
330 IF Tr_imp=135 THEN OUTPUT @Tims;"TR0" ! Program the HP 4945A to
340 IF Tr_imp=600 THEN OUTPUT @Tims;"TR1" ! the proper transmitter
350 IF Tr_imp=900 THEN OUTPUT @Tims;"TR2" ! impedance
360 IF Tr_imp=1200 THEN OUTPUT @Tims;"TR3" !
370 !
380 ! Prompt the user for receiver
    ! impedance

390 BEEP !
400 INPUT "WHAT IS THE RECEIVER IMPEDANCE";Rec_imp !
410 IF NOT (Rec_imp=135 OR Rec_imp=600 OR Rec_imp=900 OR
    Rec_imp=1200)THEN GOTO 390 ! The entered receive
    ! impedance must be 135,
    ! 600, 900, or 1200 ohms

420 !
430 IF REC_imp=135 THEN OUTPUT @Tims;"TR4" ! Program the 4945A to
440 IF Rec_imp=600 THEN OUTPUT @Tims;"TR5" ! the proper receiver
450 IF Rec_imp=900 THEN OUTPUT @Tims;"TR6" ! impedance
460 IF Rec_imp=1200 THEN OUTPUT @Tims;"TR7" !
470 !
480 ! Prompt the user for reference frequency
490 BEEP

500 INPUT "WHAT IS THE REFERENCE FREQUENCY";Ref_fre
510 !
520 !Test to see if the frequency is in the range of the HP 4945A
530 !
540 IF NOT (Ref_fre>=20 AND Ref_fre<=110004) THEN GOTO 490
550 IF NOT Tr_imp=135 THEN GOTO 590 !
560 IF NOT (Ref_fre>=200 AND Ref_fre<=110004) THEN GOTO 490
570 !
580 ! Prompt the user for start frequency
590 BEEP !

600 INPUT "WHAT IS THE STARTING FREQUENCY";Start_fre
610 !
620 ! Do a range test on the start frequency
630 !
640 IF NOT (Start_fre>=20 AND Start_fre<=110004) THEN GOTO 590
650 IF NOT Tr_imp=135 THEN GOTO 690 !
660 IF NOT (Start_fre>=200 AND Start_fre<=110004) THEN GOTO 590
670 !
680 ! Prompt the user for stop frequency
690 BEEP !

```

Example Program (con't)

```

700 INPUT "WHAT IS THE STOPPING FREQUENCY";Stop_fre !
710 !
720 ! Do a range test on the stop frequency
730 !
740 IF NOT (Stop_fre>=20 AND Stop_fre<=110004) THEN GOTO 690
750 IF NOT Tr_imp=135 THEN GOTO 810 !
760 IF NOT (Stop_fre>=200 AND Stop_fre<=110004) THEN GOTO 690
770 !
780 ! Then do a test to assure that the stop frequency is larger than
790 ! the start frequency

800 !
810 IF NOT Start_fre>Stop_fre THEN GOTO 590 ! If start>stop,
820 ! re-enter
830 ! Prompt the user for the step size
840 BEEP !
850 INPUT "WHAT IS THE STEP FREQUENCY";Step_fre !
860 Size=INT((Stop_fre-Start_fre)/Step_fre) ! Calculate the
870 IF Size=0 THEN GOTO 840 ! number of points
880 IF NOT Size>1000 THEN GOTO 940 ! in the run, must
890 DISP "SORRY, ONLY 1000 POINTS ALLOWED" ! be 1 to 1000
900 GOTO 840 !

910 !
920 !
930 !
940 OUTPUT @Tims;"LFO;FR0";Ref_fre ! Go to level frequency at
950 WAIT 5 ! reference, settle, and
960 OUTPUT @Tims;"ZLV;EXC" ! zero the level
970 !
980 !This is the measurement loop itself
990 !
1000 FOR I=0 TO Size !
1010 Frequency=Start_fre+I*Step_fre ! Compute frequency
1020 OUTPUT @Tims;"FR0";Frequency;"EXC" ! Change frequency, ask
1030 ! for a set of data
1040 GOSUB Get_string ! Get a piece of data
1050 IF A$[1,5]<>"RLLVL" THEN GOTO 1040 ! Is it relative level
1060 Level(I)=VAL(A$[6]) ! Then store it in the array
1070 !
1080 GOSUB Get_string ! Get a piece of data
1090 IF A$[1,5]<>"FRQCY" THEN GOTO 1080 ! Is it frequency?
1100 Freq(I)=VAL(A$[6]) ! Then store it in the array
1110 !
1120 GOSUB Get_string ! Get a piece of data
1130 IF A$[1,5]<>"ENDST" THEN GOTO 1120 ! Is it end of set?
1140 !
1150 NEXT I ! Make the next measurement
1160 !
1170 LOCAL 7 ! Return HP 4945A to LOCAL state
1180 GOTO 1370 ! End
1190 !

```

Example Program (con't)

```
1200 Get_string:           !
1210 S=SPOLL(@Tims)       ! Do a serial poll
1220 IF NOT BIT (S,4) THEN GOTO 1270 ! Is bit 4 of the status set
1230                       ! Then data is available
1240 ENTER @Tims;A$       ! Read in a piece of data
1250 RETURN               ! and return with it
1260                       !
1270 IF S=0 THEN GOTO 1210 ! If status is zero, then
1280                       ! everything is OK
1290 BEEP                 ! If bit 4 is not set, and
1300 DISP "ERROR; STATUS IS ";S ! status is not 0 then error
1310 CLEAR @Tims         ! Clear the instrument

1320 LOCAL 7              ! Return it to local control
1330 GOTO 1370           !

1340                       !
1350 DISP "ERROR; TIMEOUT ON THE HP-IB BUS"! Timeout routine
1360                       !
1370 END
```

CHAPTER VI. HP-IL OPERATION (Model 18165A)

INTRODUCTION

The HP 18165A interface allows an external controller to remotely control the HP 4945A through the HP-IL (Hewlett-Packard Interface Loop).

Normal Mode

In normal operation, commands from the controller are sent to the HP 18165A Interface where they are converted into keystroke sequences to set up the HP 4945A. Data from the HP 4945A is sent to the interface and then to the controller.

Talk Only Mode

When the module is in the talk only (I/O output) mode, pressing the OUTPUT pushbutton on the front panel will cause an image of the display to be sent out on the interface to a printer which must be in listen always mode.

SPECIFICATIONS

Dimensions:

Height: 33 mm (1.30 inches)
Width: 99 mm (3.90 inches)
Depth: 180 mm (7.09 inches)

Maximum Cable Length: 10 m (33 feet) between devices with standard cable.

Operating Temperature: 0 to 50 C (32 to 122 F)

Storage Temperature: -40 C to 75 C (-40 to 167 F)

Connectors: Two-pin

Signal Level: 1.5 Vac

Power Requirements: Supplied by HP 4945A. The HP 4945A operating power must be off. Do not install interface with power on.

DESCRIPTION

The HP-IL is a two-wire loop. Communication over the loop is asynchronous and serial, with digital messages traveling from one device to the next around the loop in only one direction.

INSTALLATION

The HP 18165A Interface connects to one of the I/O slots on the HP 4945A rear panel. The HP-IL cables connect to the other HP 18165A connectors as shown in Figure 6-1.

WARNING

The HP 4945A operating power must be off. Do not install interface with power on.

The interface receives its power from the HP 4945A. No external power source is required.

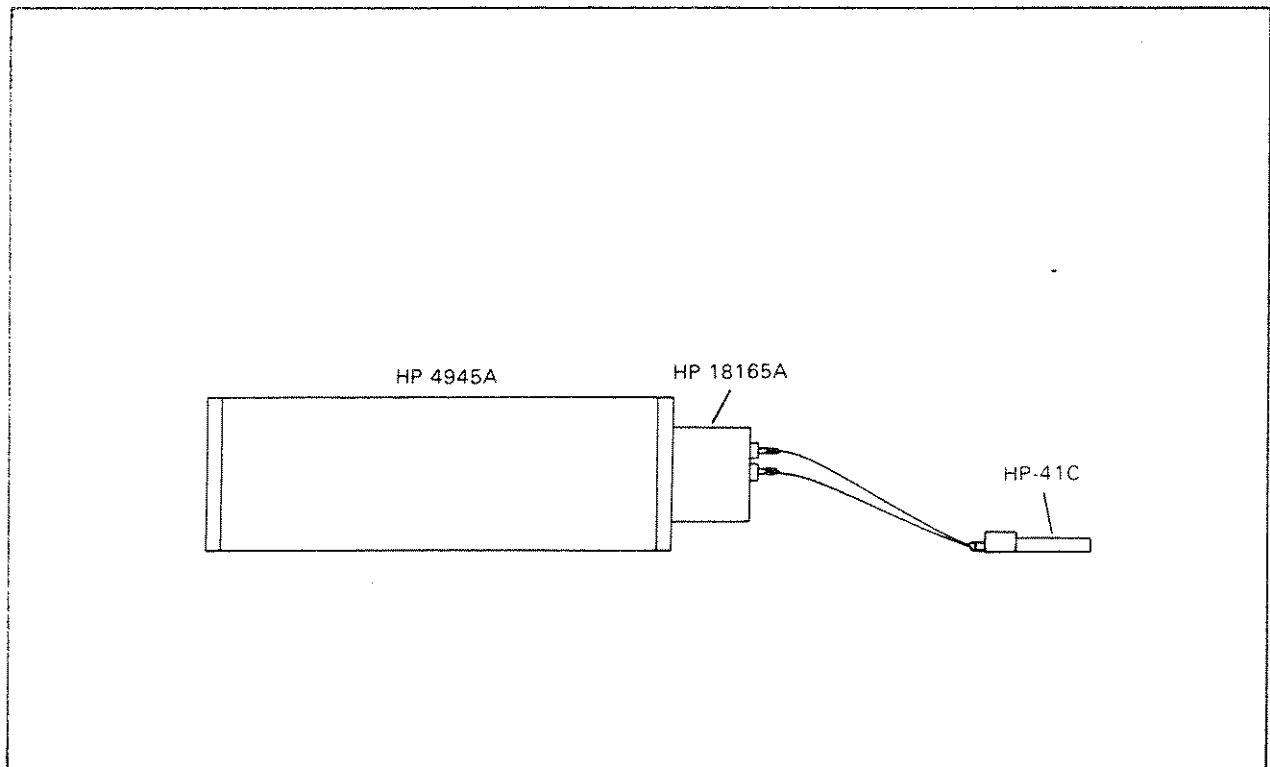

Figure 6-1. HP 18165A Interface Installation

SELECT CODE (address)

The interface select code is used in programming to designate the interface to which output is sent by the controller. The default select code for the HP-IL interface is "1" (two devices in the loop). When more than two devices are connected in the loop, the select code of the interface changes with its position in the loop (e.g., the fourth device in a loop is select code 4, etc.).

COMMUNICATION CAPABILITY

Loop functions provide the capability for a loop device to send, receive and process messages if the device has the functional capability to do so. Some of the common functions are described below.

Handshake - A technique used by devices to synchronize information transfer.

Listener - A device with listen capability that is listener active. As such, it is ready to receive data sent by the active talker device.

Talker - A device with talker capability that is talker active. As such, it is ready to send data to one or more active listeners. There can only be one device acting as a talker at a given time.

System Controller - At power-on, only one device on HP-IL can assume the role of system controller. The system controller resets the loop at power on and becomes controller active. The system controller can reset the loop and become controller active at any time, even if control has been passed to another loop device. The HP 4945A can not be system controller.

Controller Active - The controller active device configures the loop for the exchange of data by sending commands that designate one talker and one or more listeners. It can also send commands to cause specific actions to occur within a device, such as a test setup or clear. The controller active device may be able to pass control to any other loop device capable of receiving control.

Serial Poll - The controller active device can serially poll another device to obtain its status byte. The status byte denotes the device's present status and whether or not it requested service.

Parallel Poll - The controller active device can conduct a parallel poll to obtain a status bit from devices on the loop that are properly configured.

DATA INPUT AND OUTPUT MODES

There are four commands that control the output of data and the input of commands. These commands are the OUX; commands.

The OU0; command is a mask service request when data is available command. The data available message will be put in the status register when data is ready and removed when there is none.

The OU1; command will cause the I/O module to make a service request when it has data available for the controller. Both the service request bit and the data available message bits in the status register are set when data is available and a service request is made. The bits are reset when there is no more data.

The OU2; command causes the module to hold off the HP-IL loop handshake after a line feed (which terminates a mnemonic command) until all mnemonics have been decoded and accepted by the HP 4945A. This is the default state of the module.

The OU3; command causes the module to release the data handshake on the HP-IL loop as soon as the codes have been received. This mode enables parallel operation of many instruments without waiting for each to accept the codes before programming the next. When using this mode, it takes one to two seconds for each mnemonic to be decoded and accepted.

For example, in an application where the HP 4945A transmitter is being used and another TIMS receiver is being used to take the reading, the transmitter output may not be the expected value if there is insufficient delay before the reading.

HP-IL DEVICE FUNCTIONS

The HP 18165A Interface has the following HP-IL capabilities.

AA1	Automatic Address
AH	Acceptor handshake
CO	No controller capability
D	Driver
DD0	No device dependent commands implemented
DC2	Full device clear implementation
DT0	No device trigger capability
L1	Listen and unlisten if talk addressed
PDO	No power down capability
PP1	Complete parallel poll ability
R	Receiver
RL2	Full remote local capability
SH	Source handshake
SR1	Serial poll capability
T1 thru T5	Full talker capability

Information is transferred on the HP-IL from one device to another in quantities called messages. The loop messages and module response to the message are listed in table 6-1.

Table 6-1. HP-IL Loop Messages and Module Responses

Message	Response
Interface Clear (IFC)	Unaddresses the module. Data sustained in queues is retained. This command must be sent when there has been a time-out error.
SDC, selected device clear or DCL, device clear returns the HP 4945A to this state: Menu: Frequency: Display Level: TMT/RCV Imp: RCV: Hold coils: SF skip: Voice limit: Master/slave: Talk battery: Self check: Noise: Sweep: Measurement: Jitter: Return loss: Envelope delay: Transients:	clear or DCL, device clear returns the HP 4945A to this state: Set Up 1004 Hz Envelope Delay <in 4944A mode> 600 ohms Term Off Off Off Off, Master to slave Off Full, Mode 1, Segment 1, Stop on end check Noise with tone C-msg filter in 60 Hz filter out Stopped, single, from 204 to 3904 Hz Step = 100 Hz, Rate = Fast Level Frequency, Quiet term, 1004 Hz 20-300 Hz band, Amplitude and Phase Measure All, 2-wire, Hybrid loss = 00.0 Normal Stopped, 8 per sec, 15 min., 4 dB step, 68 dB threshold, 20 degrees, 10 dB gain hit, Ref imp. 600 ohms

Table 6-1. HP-IL Loop Messages and Module Responses (con't)

Message	Response
Level softkeys:	Defaults: 7.0, 0.0, -6.0, -13.0, -29.0
Frequency softkeys:	Defaults: 304, 404, 1004, 2804, 3004, 2713
Volume:	Off, Level 3, Monitor Receive, Beep on.
TRMT/RCV switch:	TRMT/RCV
SDC or DCL:	Resets the queues, stops any measurement in process. Mode of instrument goes to normal, direct mode is exited.
Remote enable (REN)	Puts the HP 4945A into remote enabled state.
Go To Local (GTL)	Puts the HP 4945A into local state if listen addressed.
Local Lockout (LLO)	If Remote enabled, puts the HP 4945A into lockout states.
Not Remote Enable (NRE)	Returns the HP 4945A to local state, no lockout.
Serial Poll	Module sends its current status over the loop.
Parallel Poll Configure (PPC)	Puts module into a state where parallel poll response may be programmed.
Parallel Poll Enable (PPE)	If the last command was the parallel poll configure, programs the parallel poll response.
Parallel Poll Disable (PPD)	If the last command was the parallel poll configure, disables the parallel poll response.
Parallel Poll (PPU)	Disables the parallel poll response. Unconfigure
Parallel Poll	Returns service request status if enabled, otherwise the parallel poll byte is unmodified.
Listen Address (LAD)	If it equals the modules address, then it becomes listener active. If remote enabled, goes to Remote state.

Table 6-1. HP-IL Loop Messages and Module Responses (con't)

Message	Response
Unlisten Command (UNL)	Unaddresses module if listener active.
Talk Address (TAD)	If equal to modules address, then it becomes talker active, otherwise it is unaddressed if active talker.
Untalk Command (UNT)	The module is unaddressed if active talker.
GET, group execute trigger	This command is ignored.
Enable Asynchronous Request (EAR)	This command will cause the modules, on reception of data from the HP 4945A, to source an asynchronous IDY frame. This mode is disabled if any other command is received.
Loop Power Down (LPO)	This command is ignored.

SERIAL POLL OPERATION

All messages sent over the serial poll mechanism are system status messages. These are characterized by bit 7, which is set. This is a group of general purpose messages that has been devised to allow simple controllers to better manage the loop, regardless of device type and function. Bit six is reserved to show whether or not the device requested service, it being set if service was requested. The lower six bits encode the various messages. Bit five is low when an event has occurred and the status is reset when a serial poll is made. When bit five is set, the status reflects a state, such as ready, not ready. The state is not affected by serial polling, but will only be affected by the changing state of the instrument, for example, when data is no longer available, the data ready message is replaced by the all OK message.

The HP 18165A Interface responses to a serial poll are listed below.

Decimal	Binary	Meaning
128	10000000	Nothing wrong, no service requested
163	10100011	Master/Slave initial link in progress or slave state
196	11000100	Device is in an invalid state
198	11000110	Self test failure
199	11000111	Command error
201	11001001	Front Panel service request
162 or 226	1x100010	Ready to send data

The contents of the serial poll register are updated when the HP 4945A status is updated.

PARALLEL POLL OPERATION

The HP 18165A Interface responds to a parallel poll if it is configured. The interface is configured for parallel poll from the controller.

The parallel poll configure is done with the parallel poll enable command, 1001000SBBB.

The S bit indicates the sense of a devices response. If S is a 1, the interface sets its bit if it needs service. If S is a 0, the interface sets its bit if it does not need service.

The interface bit is identified by BBB; 000 is bit 0 and 111 is bit 7. The interface must be listen addressed to be able to respond to this command.

Either the parallel poll disable or the parallel poll unconfigure can be used to disable parallel polls. The listen address devices respond to the PPD, while all devices repond to the PPU command.

USING THE HP-41C AS A CONTROLLER

An HP-41C with the HP 82160A HP-IL module can be used to control the HP 4945A. The HP 82183A Extended I/O module is useful to allow more general loop operation when there are several devices in the loop.

SAMPLE PROGRAM USING THE HP-41C - VOICEBAND FREQUENCY RUN

The following is a sample HP 41C program designed to do a frequency run over the voiceband, from 304 Hz to 3904 Hz in 100 Hz steps, and print the results on an HP 82162A thermal printer which is also on the HP-IL loop. For this program to work properly, the HP 4945A should be the first device on the loop, and the HP 82162A should be the second. Comments to the program listing have been added (following the !) for clarity. A bar code program for use with an HP 82153A Wand and HP 41C is also shown.

Set Up Section

```
01 LBL "FRQRUN"           ! Program name
02 CF 29                 ! Delete commas from numeric data > 999
03 FIX 1                 ! Only need 0.1 resolution
04 STOP10               ! Reset the loop
05 1                     ! The HP 4945A is the first device on the
06 SELECT               ! loop=> address one
07 REMOTE               ! Put the HP 4945A in remote state
08 ADV                  ! Linefeed the 82162A thermal printer
09 "RST:TR2:TR6"       ! Default conditions, set the transmit
10 OUTA                 ! and receive impedances to 900 ohms
11 "LFO"                ! Go to level frequency
12 OUTA
13 "FREQUENCY RUN"     ! Print the label for the printout
14 PRA
15 ADV                  ! Linefeed the printer
16 "REL. LEVEL"        ! Label the columns
17 ACA
18 FMT                  ! Right and left justify columns
19 "FREQUENCY"
20 ACA
21 ADV                  ! Print the labels
22 ADV                  ! Linefeed
23 PSE                  ! Wait a moment to get reference settled
24 "ZLV"               ! Zero the level
25 OUTA
26 .03601              ! Set up the number of loops and the
27 STO 01               ! increment in register 00
28 204                 ! Set up th starting frequency - 100 Hz
29 STO 01               ! in register 01
```

Sample Program (con't)

Measurement loop

```

30 LBL "FLOOP"           ! Loop 37 times
31 "FRO"                 ! Program frequency
32 RCL 01                 ! to a value equal to the
33 ENTER                 ! contents of register 01
34 100                   ! plus 100 Hz
35 +
36 STO 01                ! Load new value back into register 01
37 FIX 0                 ! Get rid of tenths
38 STO 02                ! Store the frequency in register 02
39 ARCL 02               ! and append it as an alpha string into
40 OUTA                  ! the alpha register.  Program frequency.
41 "EXC"
42 OUTA                  ! Ask for a set of data
43 FIX 1                 ! Need dB in tenths
44 IND                   ! Relative level
45 ACX                   ! Put it in the print buffer
46 FMT                   ! Justify into columns right and left
47 IND                   ! Level zero reference level
48 IND                   ! Level zero reference frequency
49 IND                   ! Frequency
50 ACX                   ! Append it to the print buffer
51 ADV                   ! And print the line
52 IND                   ! Status field level
53 IND                   ! Status field frequency
54 IND                   ! Warning message
55 ENTER                 ! To Y register
56 0                     ! Load X register with 0
57 X#Y?                  ! X not equal Y?
58 GOTO "ERROR"         ! Then error occurred
59 IND                   ! End of set
60 ISG 00                ! Loop 37 times, get data from 37
61 GOTO "FLOOP"         ! frequencies, 304 Hz to 3904 Hz

```

Program is done, do cleanup

```

62 ADV                   ! Do three linefeeds
63 ADV
64 ADV
65 LOCAL                 ! Go back to local control
66 GOTO "END"           ! End of program

```

HP 4945A
HP-IL Operation

Sample Program (con't)

Error Routine to Catch Non-zero Messages

```
67 LBL "ERROR"           ! Got a nonmessage warning message
68 ADV                   ! Linefeed
69 "ERROR:"              ! Print "ERROR:"
70 PRA
71 "WARNING "            ! Print "WARNING X OCCURRED"
72 ACA
73 X<>Y
74 ACX
75 " OCCURRED"
76 ACA
77 ADV
78 ADV                   ! Linefeed
79 IND                   ! Input end of set string
80 ISG 00                ! If not done, then continue
81 GTO "FLOOP"
```

End of program

```
82 LBL "END"             ! Else end
83 END                   ! Program done
```

BAR CODE PROGRAM

ROW 1 (1:3)



ROW 2 (3:9)



ROW 3 (9:11)



ROW 4 (11:13)



ROW 5 (13:16)



ROW 6 (16:19)



ROW 7 (19:24)



ROW 8 (24:28)



ROW 9 (28 : 31)



ROW 10 (31 : 39)



ROW 11 (39 : 44)



ROW 12 (45 : 51)



ROW 13 (52 : 58)



ROW 14 (58 : 61)



ROW 15 (61 : 67)



ROW 16 (67 : 69)



ROW 17 (69 : 72)



ROW 18 (73 : 75)



ROW 19 (76 : 81)



ROW 20 (81 : 83)



CHAPTER VII. RS-232C OPERATION (HP 18163A)

INTRODUCTION

The HP 18163A RS-232C Interface allows the HP 4945A to be controlled remotely from an external device that is configured for RS-232C serial communication. Figure 7-1 shows the interface installation.

The HP 18163A Interface communicates asynchronously with external devices and is configured as a DTE (Data Terminal Equipment).

SPECIFICATIONS

Dimensions:

Height: 33 mm (1.30 inches)
Width : 99 mm (3.90 inches)
Depth : 180 mm (7.09 inches)

Operating Temperature: 0 degrees to +50 degrees C (32 degrees to 122 degrees F)

Storage Temperature: -40 degrees to +75 degrees C (-40 degrees to 167 degrees F)

Power Requirements: Supplied by the HP 4945A. Do not install interface with power on. Operating power must be off.

INSTALLATION

WARNING

The HP 4945A operating power must be off before installing the interface. Damage to the instrument or to the HP 18163A can result.

The HP 18163A Interface connects to one of the I/O (slots on the HP 4945A rear panel). An RS-232C cable connects to the female D connector.

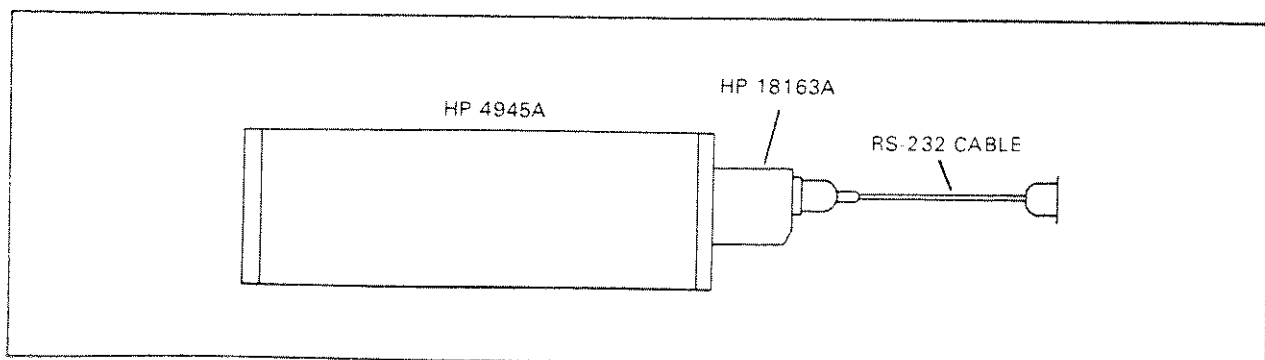

Figure 7-1. HP 18163A Interface Installation

HP 4945A
RS-232C Operation

The signal lines and the connector pins used by the interface are listed below.

Pin	Signal	EIA Code	Direction
1	Protective Ground	AA	
2	Transmitted Data (TX)	BA	To External Device
3	Received Data (RX)	BB	From External Device
4	Request to Send (RTS)	CA	To External Device
5	Clear to Send (CTS)	CB	From External Device
6	Data Set Ready (DSR)	CC	From External Device
7	Signal Ground	AB	
8	Received line detect (CD)	CF	From External Device
20	Data Terminal Ready (DTR)	CD	To External Device

The interface receives its power from the HP 4945A. No external power source is required.

Several RS-232C functions must be defined so that the interface is compatible with the system. The following functions can be set from the front panel of the HP 4945A via the I/O PORT SET UP menu:

Bit Rates: 50, 75, 110, 150, 300, 600, 1200, 4800, 9600

Duplex: Half, Full

Modem Handshake: ON, OFF

Software Handshake: ENQ/ACK, XON/XOFF (DC1/DC3), NONE

Parity: None, Even, Odd, Mark, Space

Stop Bits: 1, 2

Word Length: 7, 8

To change or check the function settings, press the SET UP key and then select the I/O PORT SET UP.

Press the appropriate softkey until the desired selection appears. The selection changes each time the softkey is pressed.

The following functions are programmable via mnemonic commands from an external device.

Echo: On, Off

Local Lockout: In effect, Local

Device Status

Device Identification

FULL DUPLEX

No Handshake

This handshake uses only Transmitted Data, Received Data, and Signal Ground. Both the I/O module and the external device are ready to receive data at all times. The normal command string length however, must never exceed the buffer size of 128 characters. Data Terminal Ready and Request to Send will be asserted. Data Set Ready, Clear To Send, and Received Line Signal Detected (carrier detected) will be ignored.

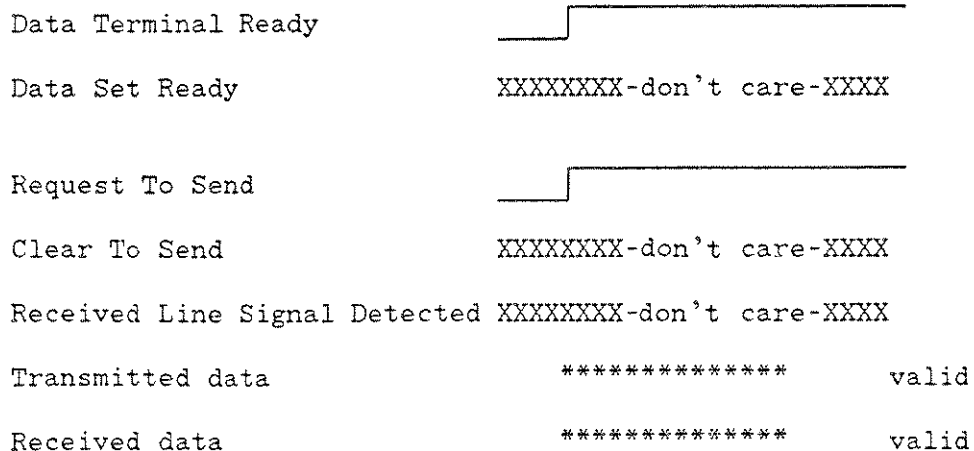

Full Handshake

This handshake uses Transmitted Data, Received Data, Signal Ground Data Terminal Ready, Data Set Ready, Request To Send and Clear To Send.

When the module is ready to operate, it will send Data Terminal true. When the modem is ready, it sets Data Set Ready true. These two leads show the status of the hardware. Once the hardware is ready, the module sets the Request To Send true. When the modem responds with Clear To Send true, data transfer can begin.

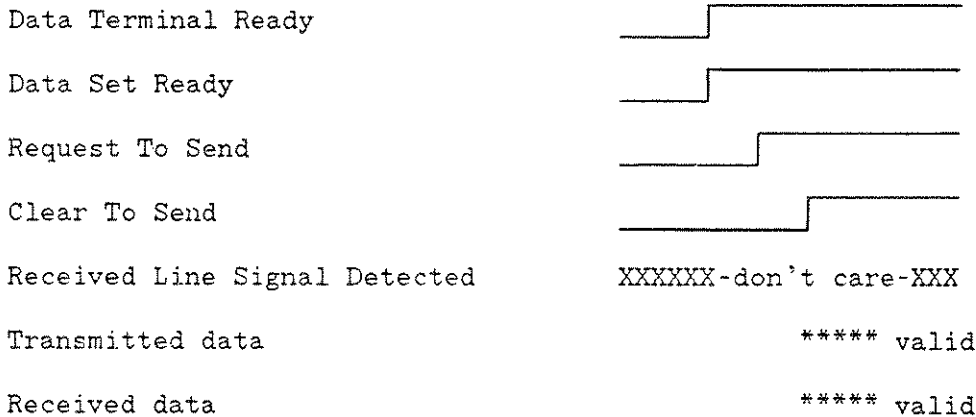

HALF DUPLEX

No Handshake

This handshake uses only Transmitted Data, Received Data, and Signal Ground. Both the I/O module and the external device are ready to receive data at all times. The normal command string length must never exceed the buffer size. Data Terminal Ready and Request to Send will be asserted. Data Set Ready, Clear To Send, and Received Line Signal Detected will be ignored.

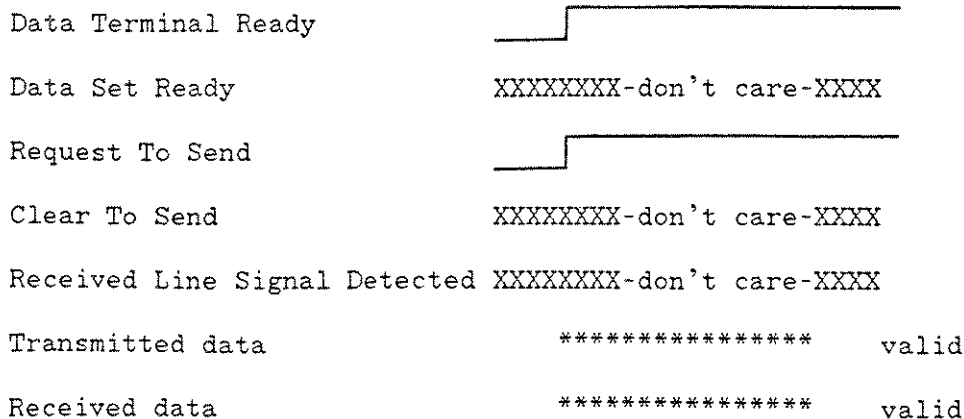

Full Handshake

This handshake uses Transmitted Data, Received Data, Signal Ground Lines, Data Terminal Ready, Data Set Ready, Request To Send, Clear To Send, and Received Line signal Detect.

When the module is ready to operate, it will send Data Terminal true. The external device sets Data Set Ready true when it is ready to send and receive data. If Data Set Ready and Data Terminal Ready are not true, no data transfer can occur, as these lines mirror the status of the hardware.

To send data, the module sets Request To Send true. When the modem has control of the line it will set Clear To Send true and set Receive Line Signal Detect false. The HP 18163A will begin to transmit data. When the transmission is complete the module will set Request To Send false. Request To Send will not be asserted again unless Clear To Send and Received Line Signal Detect are false. Receive Line Signal Detect must be true and Request to Send must be false for data to be accepted.

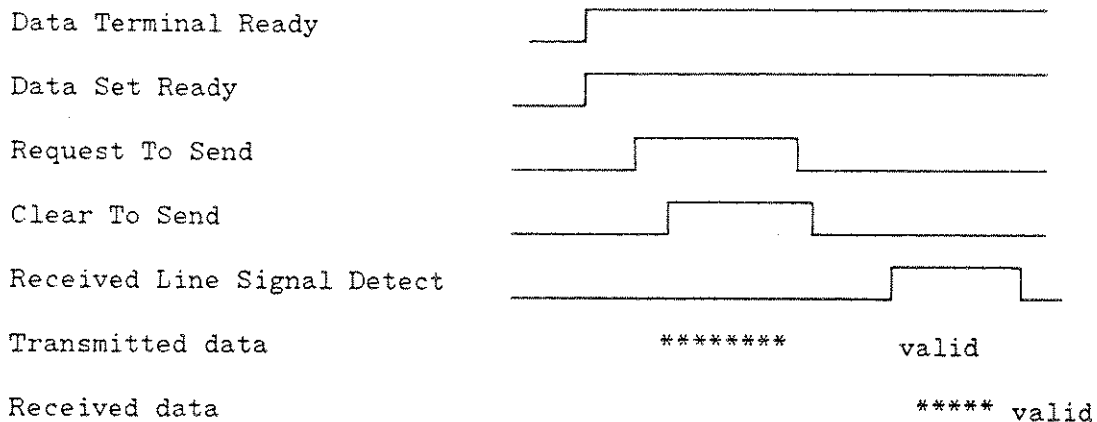

SOFTWARE HANDSHAKE

Besides the hardware handshake, a software handshake may be used to control the flow of information. For example, in the common three-wire configuration, the hardware is assumed to be ready at all times and a software handshake is required. The interface uses either the ENQ/ACK (DC1) or the Xon/Xoff (DC3) handshakes.

The ENQ/ACK handshake is called transmitter protocol because the transmitter is responsible for controlling the handshake. The transmitter sends an ENQ when it wants to send a block of information. Upon receiving an ACK from the receiver, the transmitter sends its block of information. This process is repeated for each block. A block can be up to 96 characters, so there must be enough room in the receive buffer before the ACK is sent. This protocol is used with either full or half duplex. This protocol is used with either full or half duplex.

The Xon/Xoff handshake is called receiver protocol because the receiver controls the handshake. The interface monitors its buffer. When there are 32 characters in the buffer, the interface sends an Xoff to the transmitter to stop the data flow. This allows room for one more block of 96 characters from the transmitter. When the buffer empties to ten characters or less, the interface sends an Xon to start the transmitter data flow. The interface must be full duplex to use Xon/Xoff protocol.

The external device controls the data flow when the interface is transmitting. The 18163A will transmit at most two characters after it receives a XOFF.

Echo

The interface is put into echo mode when the external device sends the mnemonic ONE; command. In full-duplex operation, characters are echoed as they are received. In half-duplex operation the interface waits for an ENQ (if it is using the ENQ/ACK handshake) or a line feed (if not in ENQ/ACK) before turning the line around and echoing the entire string. In half-duplex operation all command strings should be followed by <CrLF>. Echo mode can be exited by sending mnemonic OFE;.

Note

Echo, Lockout, and Direct Control Mode are exited if power is cycled.

Local Lockout

When the ONL; command is sent to the interface, front panel inputs and inputs from another interface are locked out. The lockout is disabled by sending the OFL; command.

STATUS REPORTING

When an error is detected a request for service message is displayed just above the menu line. The RS-232C interface does not have a serial poll or service request mechanism. When an error in operation is detected by the I/O module a corresponding bit is set in the status register. The controller can read the status of the register by sending an OE; command. The status is then sent, in decimal, to the controller. The decimal value and the meaning of the error bits are listed below.

Decimal Value	Bit No.	Meaning
0	0	Invalid keycode error
1	1	Locked out by other I/O module
4	2	Initial link in progress, or in slave mode
8	3	Front panel accessed
16	4	Overrun error
32	5	Parity error
64	6	Framing error

Any OR combination of 8 bits are possible. The format of the status string is

STSWD_ddd_CrLf

where ddd is a three digit number. When there are fewer than three digits leading spaces are inserted.

Example: STSWD_ _ _ 0_CrLf

The status word is reset to zero everytime it is read.

CONTROLLING THE HP 4945A

Commands can be sent from the controller to the HP 4945A to control the HP 4945A setup. Following is an example command line using BASIC as the programming language.

OUTPUT <select code> ; <command> <data><; or Lf>

The command is a three character code that is translated into key sequences by the HP 4945A. Data is not required on all the commands.

The mnemonics and the function that enable the HP 4945A to make each measurement are listed in Chapter VIII.

CHAPTER VIII. I/O MODULE CODES

INTRODUCTION

This chapter identifies and lists the interface control codes and formats necessary for communications between the HP 4945A and the following I/Os:

HP 18162A Option 101
HP 18163A Option 102
HP 18165A Option 103

OUTPUT FORMAT TO THE CONTROLLING INTERFACE

Each piece of data is preceded by a header and a space. The numeric data as received from the HP 4945A follows the header and space. This data may contain leading and trailing spaces, depending on the data itself and the size of the responding data field in the display.

The numeric data is followed by the suffix, which is the same as that displayed on the CRT with the following exceptions: all characters are converted to upper case, frequency is in units of hertz, and the mu sign (in microseconds) is replaced with capital U.

The up and down arrows, representing overrange, underrange, and unstable data, are changed to numbers before outputting. The UP arrow is replaced by 9.9E9, The DOWN arrow is replaced with -9.9E9, and the UP DOWN arrow is replaced with 9.9E8. When these numbers replace the arrows, the length of the string is increased by four-to six-characters, so that string dimensions at the beginning of the user programs should reflect the possibility of receiving these values. String dimensions of 32 characters will handle any strings sourced by the HP 4945A.

The last characters of each string are a carriage return and a linefeed. The carriage return linefeed pair is used to terminate an enter statement.

Each measurement returns a number of these data strings. To determine when there is a complete set of data for the measurement in question, the end of set data type is used with dummy data. The end of set string is "ENDST 0". To start another measurement, the EXC; command should now be sent, as no more data should be forthcoming.

Table 8-1 list the measurements and the header that precedes that measurement. Also listed in the table are the measurement units.

Table 8-1. Measurement Results and Headers

MEASUREMENT RESULT	HEADER	UNITS
Frequency (receiver status)	STFRQ	HZ
Level (receiver status)	STLVL	DBM
Noise	NOIS	DBRN
Noise to ground	NSTOG	DBRN
Noise with tone	NOTCH	DBRN
Signal to noise ratio	SG/NS	DB
Peak to average ratio	PAR	P/AR UNITS
Sine wave return loss	SINRL	DB
Relative level	RLLVL	DB
Delay	DLAY	USEC
Second product	SCDPR	DB
Third product	THDPR	DB
Frequency high (receive status)	STFRQ	HZ
No. self check mode in execution	MDNUM	
Transients drop out count	DPOUT	CNTS
Transients gain hit count	GNHIT	CNTS
Transients phase hit count	PHHIT	CNTS
Impulse noise high	IMPHI	CNTS
Impulse noise mid	IMPMD	CNTS
Impulse noise low	IMPLO	CNTS
Echo return loss	CHORL	DB
Singing return loss high	SRLHI	DB
Singing return loss low	SRLLO	DB
Delay zero ref. frequency low	DZRFR	HZ
Level zero ref. frequency low	LZRFR	HZ
Level zero reference level	LZRLV	DBM

Table 8-1. Measurement Results and Headers (cont'd)

MEASUREMENT RESULTS	HEADER	UNITS
Amplitude jitter 20-300 Hz	AMPJH	% PK
Phase jitter 20-300 Hz	PHJHI	DEG
Amplitude jitter 4-300 Hz	AJFUL	% PK
Phase jitter 4-300 Hz	PJFUL	DEG
Amplitude jitter 4-20 Hz	AMPJL	% PK
Phase jitter 4-20 Hz	PHJLO	DEG
Transients running/stopped	TRANS	
Receive status	RCVST	
End of a set of data	ENDST	
Noise correction factor, second	NCFSD	DB
Noise correction factor, third	NCFTD	DB
No. of times self check passed	NUMPS	
Average level (measurement fld)	AVGLV	DBM
Frequency low (measurement fld)	FRQCY	HZ
Frequency high (measurement fld)	FRQCY	HZ
Level zero ref. frequency high	LZRFR	HZ
Self check pass/fail	SLFCK	
No. of first test mode to fail	FSTMF	
Delay zero ref. freq. high	DZRFR	HZ
TLP Level (status fld return loss)	TLPLV	DBMO
No. of segment being executed	PATH	
No. of times self check has failed	NUMFL	
No. of times self check has passed	NUMPS	
No. of first test mode to fail	FSTMF	
Elapsed time minutes	TIMMN	MIN
Elapsed time seconds	TIMSC	SEC

For the self test results the following format is used:

<LN><line no in ASCII><space><data><suffix><CR><LF>

The header consists of LN (the line number) and a space. It is always six characters long, which is the same as the normal data type headers. Data types 96 through 185 all have the header SCMOD.

DT1I - DT16I	LN 1 - LN 16	64 - 79
DT1D - DT16D	LN 1 - LN 16	80 - 95
DT01 - DT90	SCMOD	96 - 185

The following warning messages will appear on the display (in the warning field) when the limits of a parameter are exceeded.

HEADING	MESSAGE
WARNG 0	= <BLANK WARNING FIELD>
WARNG 1	= NO HOLDING TONE
WARNG 2	= NOISE WITHIN 12 dB LO THRESH
WARNG 3	= IMD SIGNAL NOT RECEIVED
WARNG 4	= 2nd ORDER DIST/NOISE < 2dB
WARNG 5	= 3rd ORDER DIST/NOISE < 2dB
WARNG 6	= 2nd, 3rd ORDER DIST/NOISE <2dB
WARNG 8	= NO ANSWER RECEIVED FROM SLAVE
WARNG 9	= DATA ERRORS IN SLAVE RESPONSE
WARNG 10	= BAD DATA IN SLAVE RESPONSE
WARNG 11	= INCORRECT RESPONSE FROM SLAVE
WARNG 12	= SLAVE FAILS TO EXECUTE COMMAND
WARNG 13	= SLAVE LOOPED BACK
WARNG 15	= NO DATA RECEIVED FROM SLAVE
WARNG 16	= RECEIVED LEVEL OUT OF RANGE
WARNG 17	= NO CARRIER RECEIVED FROM SLAVE
WARNG 19	= SLAVE INITIATED A MASTER/SLAVE LINK ABORT
WARNG 20	= DROPOUT OF > 1 SECOND, TEST ABORTED
WARNG 22	= INVALID TEST SIGNAL
WARNG 23	= UNABLE TO COMPLETE MASTER/SLAVE LINK
WARNG 24	= SLAVE UNABLE TO DO MEASUREMENT

OUTPUT SEQUENCES

These are the result strings in the order in which they may be expected for each of the measurements that the HP 4945A makes where * represents a numeric character.

LEVEL FREQUENCY

No level zero

AVGLV ***.* DBM	Average level
FRQCY ***** HZ	Frequency
STLVL ***.* DBM	Status field level
STFRQ ***** HZ	Status field frequency
WARNG XX	Warning message (Highest priority)
ENDST 0	End of set

LEVEL FREQUENCY (con't)

With level zero

RLLVL ***.* DB	Relative level
LZRLV ***.* DBM	Level zero reference level
LZRFR ***** HZ	Level zero reference frequency
FRQCY ***** HZ	Frequency
STLVL ***.* DBM	Status field level
STFRQ ***** HZ	Status field frequency
WARNG XX	Warning message (Highest priority)
ENDST 0	End of set

NOISE WITH TONE

NOTCH ** DERN	Noise with tone
STLVL ***.* DBM	Status field level
STFRQ ***** HZ	Status field frequency
WARNG XX	Warning message (Highest priority)
ENDST 0	End of set

SIGNAL TO NOISE

SG/NS ** DB	Signal to noise
STLVL ***.* DBM	Status field level
STFRQ ***** HZ	Status field frequency
WARNG XX	Warning message (Highest priority)
ENDST 0	End of set

NOISE

NOIS ** DERN	Noise
STLVL ***.* DBM	Status field level
WARNG XX	Warning message (Highest priority)
ENDST 0	End of set

NOISE TO GROUND

NSTOG ** DERN	Noise to ground
STLVL ***.* DBM	Status field level
WARNG XX	Warning message (Highest priority)
ENDST 0	End of set

TRANSIENTS

In process

TRANS 1	Transients running
TIMMN ** MIN	Elapsed time minutes
TIMSC ** SEC	Elapsed time seconds
NOTCH ** DBRN	Noise with tone
IMPLO **** CNTS	Impulse noise low
IMPMD **** CNTS	Impulse noise mid
IMPHI **** CNTS	Impulse noise high
PHHIT **** CNTS	Phase hits
GNHIT **** CNTS	Gain hits
DPOUT **** CNTS	Drop outs
STLVL ***.* DBM	Status field level
STFRQ ***** Hz	Status field frequency
WARNG XX	Warning message (Highest priority)
ENDST 0	End of set

Count period complete

TRANS 0	Transients stopped
TIMMN ** MIN	Elapsed time minutes
TIMSC ** SEC	Elapsed time seconds
NOTCH ** DBRN	Noise with tone
IMPLO **** CNTS	Impulse noise low
IMPMD **** CNTS	Impulse noise mid
IMPHI **** CNTS	Impulse noise high
PHHIT **** CNTS	Phase hits
GNHIT **** CNTS	Gain hits
DPOUT **** CNTS	Drop outs
STLVL ***.* DBM	Status field level
STFRQ ***** HZ	Status field frequency
WARNG XX	Warning message (Highest priority)
ENDST 0	End of set

ENVELOPE DELAY

No zero

DLAY **** USEC	Delay
AVGLV ***.* DBM	Average level
FRQCY ***** HZ	Frequency
STLVL ***.* DBM	Status field level
STFRQ ***** HZ	Status field frequency
WARNG XX	Warning message (Highest priority)
ENDST 0	End of set

ENVELOPE DELAY (con't)

Level zero

DLAY **** USEC	Delay
RLLVL ***.* DB	Relative level
LZRLV ***.* DBM	Level zero reference level
LZRFR ***** HZ	Level zero reference frequency
FRQCY ***** HZ	Frequency
STLVL ***.* DBM	Status field level
STFRQ ***** HZ	Status field frequency
WARNG XX	Warning message (Highest priority)
ENDST 0	End of set

Delay zero

DLAY **** USEC	Delay
AVGLV ***.* DBM	Average level
DZRFR ***** HZ	Delay zero reference frequency
FRQCY ***** HZ	Frequency
STLVL ***.* DBM	Status field level
STFRQ ***** HZ	Status field frequency
WARNG XX	Warning message (Highest priority)
ENDST 0	End of set

Delay and level zero

DLAY **** USEC	Delay
RLLVL ***.* DB	Relative level
DZRFR ***** HZ	Delay zero reference frequency
LZRLV ***.* DBM	Level zero reference level
LZRFR ***** HZ	Level zero reference frequency
FRQCY ***** HZ	Frequency
STLVL ***.* DBM	Status field level
STFRQ ***** HZ	Status field frequency
WARNG XX	Warning message (Highest priority)
ENDST 0	End of set

INTERMODULATION DISTORTION

Four tone, no noise correction

RCVST 2	Receive status (four tones)
NCFMS 0	Noise correction factor message(not corrected)
NCFSD ***.* DB	Noise correction factor, second order
SCDPR ** DB	Second product
NCFTD ***.* DB	Noise correction factor, third order
THDPR ** DB	Third product
AVGLV ***.* DBM	Average level
STLVL ***.* DBM	Status field level
WARNG XX	Warning message (Highest priority)
ENDST 0	End of set

INTERMODULATION DISTORTION (con't)

Four tone, noise corrected

RCVST 2	Receive status (four tones)
NCFMS 1	Noise correction factor message (corrected)
NCFSD ***.* DB	Noise correction factor, second order
SCDPR ** DB	Second product
NCFTD ***.* DB	Noise correction factor, third order
THDPR ** DB	Third product
AVGLV ***.* DBM	Average level
STLVL ***.* DBM	Status field level
WARNG XX	Warning message (Highest priority)
ENDST 0	End of set

Two tone

RCVST 3	Receive status (two tones)
NCFMS 0	Noise correction factor message(not corrected)
NCFSD ***.* DB	Noise correction factor, second order
SCDPR ** DB	Second product
NCFTD ***.* DB	Noise correction factor, third order
THDPR ** DB	Third product
AVGLV ***.* DBM	Average level
STLVL ***.* DBM	Status field level
WARNG XX	Warning message (Highest priority)
ENDST 0	End of set

No tones received

RCVST 4	Receive status (no tones)
NCFMS X	Noise correction factor message
NCFSD ***.* DB	Noise correction factor, second order
SCDPR ** DB	Second product
NCFTD ***.* DB	Noise correction factor, third order
THDPR ** DB	Third product
AVGLV ***.* DBM	Average level
STLVL ***.* DBM	Status field level
WARNG XX	Warning message (Highest priority)
ENDST 0	End of set

JITTER

20-300 Hz Amplitude and phase

AMPJH ***.* % PK	Amplitude jitter 20-300 Hz (If amp jitter is on)
PHJHI ***.* DEG	Phase jitter 20-300 Hz (If phase jitter is on)
STLVL ***.* DBM	Status field level
STFRQ ***** HZ	Status field frequency
WARNG XX	Warning message (Highest priority)
ENDST 0	End of set

JITTER (con't)

20-300 Hz Amplitude

AMPJH **. * % PK Amplitude jitter 20-300 Hz (If amp jitter is on)
STLVL **.* DBM Status field level
STFRQ ***** HZ Status field frequency
WARNG XX Warning message (Highest priority)
ENDST 0 End of set

20-300 Hz Phase

PHJHI **. * DEG Phase jitter 20-300 Hz (If phase jitter is on)
STLVL **.* DBM Status field level
STFRQ ***** HZ Status field frequency
WARNG XX Warning message (Highest priority)
ENDST 0 End of set

20-300 Hz neither amplitude or phase

STLVL **.* DBM Status field level
STFRQ ***** HZ Status field frequency
WARNG XX Warning message (Highest priority)
ENDST 0 End of set

4-300 Hz Amplitude and phase

AJFUL **. * % PK Amplitude jitter 4-300 Hz (If amp jitter is on)
PJFUL **. * DEG Phase jitter 4-300 Hz (If phase jitter is on)
STLVL **.* DBM Status field level
STFRQ ***** HZ Status field frequency
WARNG XX Warning message (Highest priority)
ENDST 0 End of set

4-300 Hz Amplitude

AJFUL **. * % PK Amplitude jitter 4-300 Hz (If amp jitter is on)
STLVL **.* DBM Status field level
STFRQ ***** HZ Status field frequency
WARNG XX Warning message (Highest priority)
ENDST 0 End of set

4-300 Hz Phase

PJFUL **. * DEG Phase jitter 4-300 Hz (If phase jitter is on)
STLVL **.* DBM Status field level
STFRQ ***** HZ Status field frequency
WARNG XX Warning message (Highest priority)
ENDST 0 End of set

JITTER (con't)

4-300 Hz neither amplitude or phase

STLVL	***.* DBM	Status field level
STFRQ	***** HZ	Status field frequency
WARNG	XX	Warning message (Highest priority)
ENDST	0	End of set

4-20 Hz Amplitude and phase

AMPJL	**.* % PK	Amplitude jitter 4-20 Hz (If amp jitter is on)
PHJLO	**.* DEG	Phase jitter 4-20 Hz (If phase jitter is on)
STLVL	***.* DBM	Status field level
STFRQ	***** HZ	Status field frequency
WARNG	XX	Warning message (Highest priority)
ENDST	0	End of set

4-20 Hz Amplitude

AMPJL	**.* % PK	Amplitude jitter 4-20 Hz (If amp jitter is on)
STLVL	***.* DBM	Status field level
STFRQ	***** HZ	Status field frequency
WARNG	XX	Warning message (Highest priority)
ENDST	0	End of set

4-20 Hz Phase

PHJLO	**.* DEG	Phase jitter 4-20 Hz (If phase jitter is on)
STLVL	***.* DBM	Status field level
STFRQ	***** HZ	Status field frequency
WARNG	XX	Warning message (Highest priority)
ENDST	0	End of set

4-20 Hz neither amplitude or phase

STLVL	***.* DBM	Status field level
STFRQ	***** HZ	Status field frequency
WARNG	XX	Warning message (Highest priority)
ENDST	0	End of set

Measure all, Amplitude and phase

AMPJH	**.* % PK	Amplitude jitter 20-300 Hz (If amp jitter is on)
PHJHI	**.* DEG	Phase jitter 20-300 Hz (If phase jitter is on)
ANFUL	**.* % PK	Amplitude jitter 4-300 Hz (If amp jitter is on)
PJFUL	**.* DEG	Phase jitter 4-300 Hz (If phase jitter is on)
AMPJL	**.* % PK	Amplitude jitter 4-20 Hz (If amp jitter is on)
PHJLO	**.* DEG	Phase jitter 4-20 Hz (If phase jitter is on)
STLVL	***.* DBM	Status field level
STFRQ	***** HZ	Status field frequency
WARNG	XX	Warning message (Highest priority)
ENDST	0	End of set

JITTER (con't)

Measure all, Amplitude

AMPJH	***.* % PK	Amplitude jitter 20-300 Hz (If amp jitter is on)
AJFUL	***.* % PK	Amplitude jitter 4-300 Hz (If amp. jitte
AMPJL	***.* % PK	Amplitude jitter 4-20 Hz (If amp. jitter
STLVL	***.* DBM	Status field level
STFRQ	***** HZ	Status field frequency
WARNG	XX	Warning message (Highest priority)
ENDST	0	End of set

Measure all, Phase

PHJHI	***.* DEG	Phase jitter 20-300 Hz (If phase jitter is on)
PJFUL	***.* DEG	Phase jitter 4-300 Hz (If phase jitter is on)
PHJLO	***.* DEG	Phase jitter 4-20 Hz (If phase jitter is on)
STLVL	***.* DBM	Status field level
STFRQ	***** HZ	Status field frequency
WARNG	XX	Warning message (Highest priority)
ENDST	0	End of set

Measure all, neither amplitude or phase

STLVL	***.* DBM	Status field level
STFRQ	***** HZ	Status field frequency
WARNG	XX	Warning message (Highest priority)
ENDST	0	End of set

PAR

PAR	*** P/AR UNITS	P/AR reading
STLVL	***.* DBM	Status field level
WARNG	XX	Warning message (Highest priority)
ENDST	0	End of set

RETURN LOSS, STL

Sine wave

SINRL	***.* DB	Sine wave return loss
STLVL	***.* DBM	Status field level
STFRQ	***** HZ	Status field frequency
WARNG	XX	Warning message (Highest priority)
ENDST	0	End of set

Echo

CHORL	***.* DB	Echo return loss
STLVL	***.* DBM	Status field level
WARNG	XX	Warning message (Highest priority)
ENDST	0	End of set

RETURN LOSS, STL (con't)

Low singing

SRLLO **.* DB	Low singing return loss
STLVL **.* DBM	Status field level
WARNG XX	Warning message (Highest priority)
ENDST 0	End of set

High singing

SRLHI **.* DB	High singing return loss
STLVL **.* DBM	Status field level
WARNG XX	Warning message (Highest priority)
ENDST 0	End of set

Measure all

CHORL **.* DB	Echo return loss
SRLLO **.* DB	Low singing return loss
SRLHI **.* DB	High singing return loss
STLVL **.* DBM	Status field level
WARNG XX	Warning message (Highest priority)
ENDST 0	End of set

RETURN LOSS, -16 TLP

Sine wave

SINRL **.* DB	Sine wave return loss
TLPLV **.* DBMO	Status field level
STFRQ ****.* HZ	Status field frequency
WARNG XX	Warning message (Highest priority)
ENDST 0	End of set

Echo

CHORL **.* DB	Echo return loss
TLPLV **.* DBMO	Status field level
WARNG XX	Warning message (Highest priority)
ENDST 0	End of set

Low singing

SRLLO **.* DB	Low singing return loss
TLPLV **.* DBMO	Status field level
WARNG XX	Warning message (Highest priority)
ENDST 0	End of set

RETURN LOSS, -16 TLP (con't)

High singing

SRLHI	***.*	DB	High singing return loss
TLPLV	***.*	DBMO	Status field level
WARNG	XX		Warning message (Highest priority)
ENDST	0		End of set

Measure all

CHORL	***.*	DB	Echo return loss
SRLLO	***.*	DB	Low singing return loss
SRLHI	***.*	DB	High singing return loss
TLPLV	***.*	DBMO	Status field level
WARNG	XX		Warning message (Highest priority)
ENDST	0		End of set

SELF CHECK

NUMPS	**		Number of times self check has passed	
NUMFL	**		Number of times self check has failed	
	.			
MDNUM	zz		Number of mode being executed is zz	
PATH	1		Number of segment being executed = 1	
LN	1	*****	PASS	Each segment has at least one, and
LN	2	*****	FAIL	sometimes more pieces of data. The
	.			suffix tells whether the data is inside
	.			the limits or not.
PATH	2			Segment 2
LN	1	*****	PASS	Data
	.			
PATH	nn			Segment nn
	.			
SCMOD	zz	PASS (or FAIL)		Self check mode zz passed or failed
	.			
	.			
NUMPS	**			Number of times self check has passed
NUMFL	**			Number of times self check has failed
ENDST	0			

I/O MNEMONIC COMMANDS

The following list of mnemonics are the codes that the HP 4945A will respond to over the three interfaces. They are three-character mnemonics (plus any data entry) and a delimiter, which will be a semicolon or linefeed (HP-IL may use a colon also). Embedded spaces and carriage returns will have no affect on the decoding of the mnemonics. Any time a semicolon or a linefeed is received the module attempts to decode a mnemonic and the decoder is reset.

Syntax Explanation of Keystroke Sequences

The following strings are for illustration purposes only. To program the instrument the mnemonics must be used.

The @ code is used to specify the state of a softkey, for example, @h1 sets softkey 8 to state 1.

The data entry keys on the front panel are encoded as ASCII 0 through 9, -, and . and are represented in the table of mnemonics as an * when data is to be entered.

At the end of a data entry sequence, (delimited with ; or Lf), the code for enter (E) is sent.

Those mnemonics followed by a plus sign (+) can be accessed from more than one menu. Therefore, the last measurement made using a specific mnemonic must be known. If the last measurement made uses the already selected mnemonic, the test select menu cannot be accessed. Rather it is assumed that the correct menu is displayed and the proper softkeys have been sent. Otherwise the mnemonic is ignored.

HP 4945A MNEMONICS

Mnemonic	Function	Data Entry?
CLOCK SET UP		
CL0 <year>;	Set year	yes
CL1 <month>;	Set month	yes
CL2 <day>;	Set day	yes
CL3 <hour>;	Set hours	yes
CL4 <minute>;	Set minutes	yes
CL5;	AM	no
CL6;	PM	no
CL7;	12 hour	no
CL8;	24 hour	no
DATA ENTRY		
DAT<num. exp.>;	Sends the numeric expression the HP 4945A and follows it with an enter code.	yes
DIAL - HOLD SET UP		
DH0;	Transmitter hold off	no
DH1;	Transmitter hold on	no
DH2;	Receiver hold off	no
DH3;	Receiver hold on	no
DH4;	Dial talk off	no
DH5;	Dial talk on	no
DH6;	Talk bat off	no
DH7;	Talk bat on	no
ENVELOPE DELAY		
ED0;	E.D. normal set	no
ED1;	E.D. repeat	no
ED2;	E.D. with freq. data	no
ED3;	E.D. without freq. data	no

Mnemonic	Function	Data Entry?
----------	----------	-------------

EXECUTE

EXC;	Begin measurement	no
------	-------------------	----

This command will cause the HP 4945A to make a measurement and pass the data back to the controller. It is not necessary to send this command to cause execution of a mnemonic, the semicolon or linefeed will do that. Some commands, such as OI; or TIM; cause data that is not measurement data to be passed back to the controller. Commands of this type do not require that EXC; command be sent for them to be executed and do not return the end of set data type, ENDST.

Examples are TIM (all); OI (HP-IB); and OE (RS-232)

Note that these commands will cause data to be sent to the controller, but the data will not be terminated by the ENDST string, this being reserved for data measured by the receiver.

CHANGE FREQUENCY COMMAND

FR0 <freq.>;	Change transmitter frequency	yes
FR1;	Frequency 1	no
FR2;	Frequency 2	no
FR3;	Frequency 3	no
FR4;	Frequency 4	no
FR5;	Frequency 5	no
FR6;	Frequency 6	no
FR7;	Step size =10 Hz	no
FR8;	Step size =50 Hz	no
FR9;	Step size =100 Hz	no
FRA;	Step size =1000 Hz	no
FRB <freq.>;	Program frequency 1	yes
FRC <freq.>;	Program frequency 2	yes
FRD <freq.>;	Program frequency 3	yes
FRE <freq.>;	Program frequency 4	yes
FRF <freq.>;	Program frequency 5	yes
FRG <freq.>;	Program frequency 6	yes

INTERMODULATION DISTORTION

IMO;	Normal test	no
IM1;	Check signal	no

Mnemonic	Function	Data Entry?
IMPULSE NOISE (TRANSIENTS)		
IN0;	Stop	no
IN1;	Start	no
IN2;	Count rate 7/second	no
IN3;	Count rate 8/second	no
IN4;	Count rate 100/second	no
IN5;	Impulse threshold spread = 2 dB	no
IN6;	Impulse threshold spread = 3 dB	no
IN7;	Impulse threshold spread = 4 dB	no
IN8;	Impulse threshold spread = 5 dB	no
IN9;	Impulse threshold spread = 6 dB	no
INA;	Phase hit threshold = 5 deg.	no
INB;	Phase hit threshold = 10 deg.	no
INC;	Phase hit threshold = 15 deg.	no
IND;	Phase hit threshold = 20 deg.	no
INE;	Phase hit threshold = 25 deg.	no
INF;	Phase hit threshold = 30 deg.	no
ING;	Phase hit threshold = 35 deg.	no
INH;	Phase hit threshold = 40 deg.	no
INI;	Phase hit threshold = 45 deg.	no
INJ;	Gain hit threshold = 2 dB	no
INK;	Gain hit threshold = 3 dB	no
INL;	Gain hit threshold = 4 dB	no
INM;	Gain hit threshold = 5 dB	no
INN;	Gain hit threshold = 6 dB	no
INO;	Gain hit threshold = 7 dB	no
INP;	Gain hit threshold = 8 dB	no
INQ;	Gain hit threshold = 9 dB	no
INR;	Gain hit threshold = 10 dB	no
INS <cnt time>;	Duration of test	yes
INT <thrshld>;	Low impulse threshold	yes

I/O SET UP COMMANDS

IO0;	Normal mode	no
IO1;	Output mode	no
IO2 <address>;	HP-IB address entry	yes
IO3;	RS-232 ENQ/ACK protocol	no
IO4;	RS-232 TX-on/off protocol	no
IO5;	RS-232 No software prototcol	no
IO6;	RS-232 Auto handshake	no
IO7;	RS-232 No handshake	no

Mnemonic	Function	Data Entry?
I/O SET UP COMMANDS (con't)		
IO8;	Set baud rate = 50	no
IO9;	Set baud rate = 75	no
IOA;	Set baud rate = 110	no
IOB;	Set baud rate = 150	no
IOC;	Set baud rate = 300	no
IOD;	Set baud rate = 600	no
IOE;	Set baud rate = 1200	no
IOF;	Set baud rate = 2400	no
IOG;	Set baud rate = 4800	no
IOH;	Set baud rate = 9600	no
IOI;	No parity	no
IOJ;	Even parity	no
IOK;	Odd parity	no
IOL;	Mark parity	no
IOM;	Space parity	no
ION;	Half duplex	no
IOO;	Full duplex	no
IOP;	1 stop bit, length 7	no
IOQ;	2 stop bits, length 7	no
IOR;	1 stop bit, length 8	no
IOS;	2 stop bits, length 8	no
JITTER		
JT0;	Amplitude jitter off	no
JT1;	Amplitude jitter on	no
JT2;	Phase jitter off	no
JT3;	Phase jitter on	no
JT4;	20-300 Hz	no
JT5;	3-300 Hz	no
JT6;	3-20 Hz	no
JT7;	Measure all	no
LEVEL FREQUENCY		
LF0;	Level frequency	no
LF1;	60 Hz filter out	no
LF2;	60 Hz filter in	no

Mnemonic	Function	Data Entry?
LEVEL		
LV0 <level>;	Program transmitter level	yes
LV1;	Level 1	no
LV2;	Level 2	no
LV3;	Level 3	no
LV4;	Level 4	no
LV5;	Level 5	no
LV6;	Quiet termination	no
LV7;	Step size = .1	no
LV8;	Step size = .5	no
LV9;	Step size = 1	no
LVA <level>;	Program level 1	yes
LVB <level>;	Program level 2	yes
LVC <level>;	Program level 3	yes
LVD <level>;	Program level 4	yes
LVE <level>;	Program level 5	yes

MASTER/SLAVE SET UP

MS0;	M/S mode off	no
MS1;	Master & Master to Slave	no
MS2;	Master & Slave to Master	no
MS3;	Slave	no

NOISE FILTER COMMANDS

NF0;	C-message filter	no
NF1;	3 KHz flat	no
NF2;	15 KHz flat	no
NF3;	Program	no
NF4;	50 Kbit	no

If one of the noise filter commands is selected when starting to make transient measurements, the transient measurement will be replaced with noise with tone. To avoid this replacement send at least one other transient control command after selecting noise filter.

NORMAL DISPLAYS HARDKEY

NMD;	Normal displays	no
------	-----------------	----

Mnemonic	Function	Data Entry?
NOISE COMMANDS		
NO0;	Noise with tone	no
NO1;	Signal to noise	no
NO2;	Noise	no
NO3;	Noise to ground	no
OUTPUT ERROR (RS-232 only)		
OE;	Output the string "STSWD ddd CrLf" where ddd is a three character ASCII number, including leading spaces.	
OUTPUT IDENTIFICATION		
OI;	Output the string "HP4945A" when talk addressed	no
ECHO ON/OFF (RS-232 only)		
ONE;	Echo mode on	no
OFE;	Echo mode off	no
LOCKOUT ON/OFF (RS-232 only)		
ONL;	Enter remote with local lockout mode	no
OFL;	Enter local mode	no
OUTPUT COMMANDS (HP-IB and HP-IL only)		
OU0;	Mask SRQ on data available	no
OU1;	Generate SRQ on data ready	no
OU2;	Hold off linefeeds until ready	no
OU3;	Release linefeeds	no
OUTPUT HARDKEY		
OUT;	Same as output hardkey	no

Mnemonic	Function	Data Entry?
PEAK TO AVERAGE RATIO		
PAR;	P/AR	no
RETURN LOSS		
RL0;	Two wire	no
RL1;	Four wire, 0 TLP	no
RL2;	Four wire, -16 TLP	no
RL3;	Sine wave	no
RL4;	Echo	no
RL5;	Low singing	no
RL6;	High singing	no
RL7;	Measure all	no
RL8;	600 ohm reference impedance	no
RL9;	900 ohm reference impedance	no
RLA;	External standard impedance in	no
RLB <loss>;	Enter hybrid loss	yes
RESET		
RST;	Reset	no

The HP 4945A goes to the following state:

Menu	Test select
Frequency	1004 Hz
Display Level	(on HP 4944A Envelope Delay mode)
TMT/RCV Imp	600 ohms
Rcv Term hold coils	off
SF skip	off
Voice limit	off
Master/slave Direction	off master to slave
Talk bat.	off
Self check	full
Mode	1
Segment	1
Stop on	check end

HP 4945A
I/O Module Codes

Mnemonic	Function	Data Entry
RESET (con't)		
Noise	noise with tone	
C-msg filter	in	
60 Hz filter	out	
Sweep	stopped	
Single		
From	204 To 3904	
Step	100	
Rate	fast	
Measurement	level frequency	
	Quiet term	
	1004 Hz	
Jitter	20-300 Hz band Amp. and phase	
Return loss	measure all 2 wire Hybrid loss	00.0 dB
Envelope delay	normal	
Transients	stopped	
	8/sec	
	15 min.	
	4 dB step	
	68 dB threshold	
	20 deg. threshold	
	10 dB gain hit	
	Imp 600 ohms	
Level softkeys defaults	7.0,0.0,-6.0,-13.0,-29.0	
Frequency softkey defaults	304,404,1004,2804,3004,2713	
Volume	off	
Level	3	
Monitor	receive	
Beep	on	
TRMT-RCV switch	TRMT-RCV	
Resets the queues, stops any measurement in process. Mode of instrument goes to normal, direct mode is exited.		
Receive/Transmit, Transmit/Receive hardkeys		
RXM;	Recieve - transmit	no
XMR;	Transmit - recieve	no

Mnemonic	Function	Data Entry?
SELF CHECK		
SC0;	Stop full diagnostics	no
SC1;	Start full diagnostics	no
SC2;	Full self check	no
SC3<mode>;	Mode self check	no
SC4<seg>;	Segment self check	no
SC5;	Nonstop	no
SC6;	Check end	no
SC7;	Fail mode	no
SC8;	Fail end	no
SC9;	Calibrate	no

SPECIAL DISPLAYS COMMANDS

SPD;	Special displays hardkey	no
------	--------------------------	----

SOFT KEY STATES

These mnemonics will place the softkeys into state s, where s is one numeric ASCII character. If an invalid state is specified, state 0 is selected. These mnemonics should only be used to program retrofitable options, since mnemonics to program everything else have been provided.

SK1 s;	Program softkey 1 to state s	Yes
SK2 s;	Program softkey 2 to state s	Yes
SK3 s;	Program softkey 3 to state s	Yes
SK4 s;	Program softkey 4 to state s	Yes
SK5 s;	Program softkey 5 to state s	Yes
SK6 s;	Program softkey 6 to state s	Yes
SK7 s;	Program softkey 7 to state s	Yes
SK8 s;	Program softkey 8 to state s	Yes

SWEEP SET UP

SW2;	Single sweep	no
SW3;	Continuous sweep	no
SW4;	Step rate = .3/second	no
SW5;	Step rate = 1/second	no
SW6;	Step rate = 3/second	no

Mnemonic	Function	Data Entry?
SWEEP SESTUP (con't)		
SW7 <freq.>;	Set lower limit	yes
SW8 <freq.>;	Set upper limit	yes
SW9 <step >;	Enter step size	yes

REAL TIME CLOCK

Note

This command will be executed without sending the EXC; command since this is not measurement data. No ENDST data type will be returned for the same reason.

TIM;	Read real time clock	no
Time and date output format: MO-DY-YR , HH:MM <AM or PM or >		

TRANSMITTER/RECEIVER SET UP

TR0;	Transmitter imp. = 135 ohms	no
TR1;	Transmitter imp. = 600 ohms	no
TR2;	Transmitter imp. = 900 ohms	no
TR3;	Transmitter imp. = 1200 ohms	no
TR4;	Reciever imp. = 135 ohms	no
TR5;	Reciever imp. = 600 ohms	no
TR6;	Reciever imp. = 900 ohms	no
TR7;	Reciever imp. = 1200 ohms	no
TR8;	Term	no
TR9;	Bridge	no
TRA;	SF skip off	no
TRB;	SF skip on	no
TRC;	Voice band limit off	no
TRD;	Voice band limit on	no
TRE;	Slave transmit imp. = 135 ohms	no
TRF;	Slave transmit imp. = 600 ohms	no
TRG;	Slave transmit imp. = 900 ohms	no
TRH;	Slave transmit imp. = 1200 ohms	no
TRI;	Slave Recieve imp. = 135 ohms	no
TRJ;	Slave recieve imp. = 600 ohms	no
TRK;	Slave recieve imp. = 900 ohms	no
TRL;	Slave recieve imp. = 1200 ohms	no
TRM;	Slave term	no
TRN;	Slave bridge	no

Mnemonic	Function	Data Entry?
VOLUME PROGRAMMING		
VL0;	Volume level 0	no
VL1;	Volume level 1	no
VL2;	Volume level 2	no
VL3;	Volume level 3	no
VL4;	Volume level 4	no
VL5;	Volume level 5	no
VL6;	Volume level 6	no
VL7;	Speaker off	no
VL8;	Speaker on	no
VL9;	Monitor receiver	no
VLA;	Monitor transmitter	no
VLB;	Keyboard beep off	no
VLC;	Keyboard beep on	no
ZERO FUNCTION		
ZLV;	Level zero	no
ZDL;	Delay zero	no

APPENDIX A. OPERATING VERIFICATION

INTRODUCTION

This appendix contains procedures to verify the operation of the HP 4945A and can be used as an incoming inspection check. The verification is divided into two procedures, Power-On Self Check and Diagnostics. The Power-On Self Check is automatically performed when the instrument is first turned on. The Diagnostic tests can manually be run after that.

POWER-ON SELF CHECK

At power-on, the HP 4945A executes a series of self tests on the digital and analog circuits. Error codes are displayed in the event of a hardware failure. The instrument also beeps and lights the front panel LEDs to indicate the passage of some digital tests and to serve as an indication in case the display hardware is not functional.

Power-on LED and Beep Sequence:

1. A10 CR1-LED on.
2. Seven front panel LEDs all come on briefly, then flash and go off. These LEDs are located next to VOLUME, LEVEL, FREQ., TRMT/RCV, RCV/TRMT, and HOLD.
3. A11 passes - VOLUME LED on and 1 beep.
4. A12 passes - LEVEL LED and 2 beeps.
5. A13 passes - FREQ. LED on and 3 beeps.
6. VOLUME, LEVEL, FREQ. LED off.
7. A10 CR1 LED off.
8. TRMT/RCV LED on.
9. A10 CR1 LED flashes.
10. Display.

Error Codes

Power-on self check errors are displayed as they occur. The test program discovers and displays as many errors as possible before arriving at a point where further testing is pointless. If a key is pressed when the test program has stopped, the instrument attempts to go on with the tests.

An example error code display is shown below.

```
POWER-ON SELF CHECK ERRORS

008  013  113  213  404
605  606  700  Etc.
```

The error codes are three digits and are divided into several error groups as shown below.

Error Code Groups

```
0XX - ROM checksum errors
1XX - ROM location code errors
2XX - ROM revision code errors
3XX - RAM write/read errors
4XX - System peripheral hardware errors
5XX - System IRQ line errors
6XX - Receiver digital hardware errors
7XX - Analog hardware errors
8XX - Interface errors, port 1
9XX - Interface errors, port 2
```

Following is a summary of the self check error codes, a description of each circuit tested, and the possible failure.

Mainframe Error Codes

Code	Circuit tested/failure
000	A11 U604, System start-up ROM - bad checksum
001	A12 U100, Main ROM #1 (6000-9FFF) - bad checksum
002	A12 U200, Main ROM #2 (A000-DFFF) - bad checksum
003	A12 U300, Bank 1 ROM (2000-5FFF) - bad checksum
004	A12 U400, Bank 2 ROM (2000-5FFF) - bad checksum
005	A12 U102, Bank 3 ROM (2000-5FFF) - bad checksum
006	A12 U202, Bank 4 ROM (2000-5FFF) - bad checksum

007 U12 U302, Bank 5 ROM (2000-5FFF) - bad checksum
008 U12 U104, Bank 6 ROM (2000-5FFF) - bad checksum
009 U12 U204, Bank 7 ROM (2000-5FFF) - bad checksum
011 A10 U607, Receiver ROM #1 (E000-FFFF) - bad checksum
012 A10 U507, Receiver ROM #2 (C000-DFFF) - bad checksum
013 A10 U407, Receiver ROM #3 (A000-BFFF) - bad checksum
014 A10 U308, Receiver ROM #4 (8000-9FFF) - bad checksum
015 A10 U307, Receiver ROM #5 (6000-7FFF) - bad checksum
016 A10 U306, Receiver ROM #6 (4000-5FFF) - bad checksum
017 A10 U305, Receiver ROM #7 (2000-3FFF) - bad checksum
018 A9 U400, Transients Board ROM - checksum error

100 A11 U604, System start-up ROM - bad loc. code
101 A12 U100, Main ROM #1 (6000-9FFF) - bad loc. code
102 A12 U200, Main ROM #2 (A000-DFFF) - bad loc. code
103 A12 U300, Bank 1 ROM (2000-5FFF) - bad loc. code
104 A12 U400, Bank 2 ROM (2000-5FFF) - bad loc. code
105 A12 U102, Bank 3 ROM (2000-5FFF) - bad loc. code
106 A12 U202, Bank 4 ROM (2000-5FFF) - bad loc. code
107 A12 U302, Bank 5 ROM (2000-5FFF) - bad loc. code
108 A12 U104, Bank 6 ROM (2000-5FFF) - bad loc. code
109 A12 U204, Bank 7 ROM (2000-5FFF) - bad loc. code
111 A10 U607, Receiver ROM #1 (E000-FFF) - bad loc. code
112 A10 U507, Receiver ROM #2 (C000-DFFF) - bad loc. code
113 A10 U407, Receiver ROM #3 (A000-BFFF) - bad loc. code
114 A10 U308, Receiver ROM #4 (8000-9FFF) - bad loc. code
115 A10 U307, Receiver ROM #5 (6000-7FFF) - bad loc. code
116 A10 U306, Receiver ROM #6 (4000-5FFF) - bad loc. code
117 A10 U305, Receiver ROM #7 (2000-3FFF) - bad loc. code
118 A9 U400, Transients Board ROM - bad loc. code

200 A11 U604, System start-up ROM - bad rev. code
201 A12 U100, Main ROM #1 (6000-9FFF) - bad rev. code
202 A12 U200, Main ROM #2 (A000-DFFF) - bad rev. code
203 A12 U300, Bank 1 ROM (2000-5FFF) - bad rev. code
204 A12 U400, Bank 2 ROM (2000-5FFF) - bad rev. code
205 A12 U102, Bank 2 ROM (2000-5FFF) - bad rev. code
206 A12 U202, Bank 4 ROM (2000-5FFF) - bad rev. code
207 A12 U302, Bank 5 ROM (2000-5FFF) - bad rev. code
208 A12 U104, Bank 6 ROM (2000-5FFF) - bad rev. code
209 A12 U204, Bank 7 ROM (2000-5FFF) - bad rev. code
211 A10 U607, Receiver ROM #1 (E000-FFFF) - bad rev. code
212 A10 U507, Receiver ROM #2 (C000-DFFF) - bad rev. code
213 A10 U407, Receiver ROM #3 (A000-BFFF) - bad rev. code
214 A10 U308, Receiver ROM #4 (8000-9FFF) - bad rev. code
215 A10 U307, Receiver ROM #5 (6000-7FFF) - bad rev. code
216 A10 U306, Receiver ROM #6 (4000-5FFF) - bad rev. code
217 A10 U305, Receiver ROM #7 (2000-3FFF) - bad rev. code
218 A9 U400, Transients board ROM - bad rev. code
219 Receiver software (overall) - bad rev. code

HP 4945A
Operating Verification

300 A11 U404, System STACK RAM (0000-07FF) - R/W error
301 A10 U503, System SHARED RAM (0800-0FFF) - R/W error
304 A12 U500, System RAM (E000-E7FF) - R/W error
305 A12 U402, System RAM (E800-EFFF) - R/W error
306 A10 U503, Receiver SHARED RAM (0000-07FF) - R/W error
307 A10 U405, Receiver RAM (0800-0FFF) - R/W error
308 A10 U505, Receiver STACK RAM (1000-17FF) - R/W error
309 A10 U503, System/receivr SHARED RAM - dynamic R/W error
310 A11 U204, System RAM (bank 0, 2000-27FF) - R/W error
311 A13 U502, Character RAM (bank 0, 2800-2BFF) - R/W error
312 A13 U503, Attribute RAM (bank 0, 2C00-2FFF) - R/W error
313 A13 U306, Display RAM (bank 0, 3000-37FF) - R/W error
314 A13 U206, Display RAM (bank 0, 3800-3FFF) - R/W error
315 A13 U305, Display RAM (bank 0, 4000-47FF) - R/W error
316 A13 U205, Display RAM (bank 0, 4800-4FFF) - R/W error
317 A13 U203, Display RAM (bank 0, 5000-57FF) - R/W error
318 A13 U102, Display RAM (bank 0, 5800-5FFF) - R/W error
319 A9 U600, Transients RAM - R/W error
320,321 A12 U404, System RAM (1400-1BFF) - R/W error
322 A12 U106, U107, System RAM (1C00-1FFF) - R/W error

400 A11 U606, Programmable timer error
401 A11 U703, PIA error
402 Not used
403 A12 U308, Real time clock error
404 A13 U702, CRT controller error

500 System IRQ error - system IRQ line is held low
501 Receiver fails to write anything into SHARED RAM (A10 U503)
502 Receiver writes incorrectly into SHARED RAM (A10 U503)
503 Receiver does not respond by pulling on the system IRQ
line (P1 pin 9 on A10 and A11)
504 System IRQ error - system IRQ line (driven by A10)
does not function properly (P1 pin 9 on A10 and A11)
505 Power-on self check data received from the receiver
processor was sent with a bad checksum

600 Receiver digital bus bad - cannot talk to boards A4
through A7 and A9
604 Receiver cannot talk to A4
605 Receiver cannot talk to A5
606 Receiver cannot talk to A6
607 Receiver cannot talk to A7
609 Receiver cannot talk to A9 (handshake error)
610 Receiver cannot talk to input buffer (A9 U502)
611 Receiver cannot read output buffer (A9 U402)
612 Receiver cannot read output buffer (A9 U302)

700 Analog hardware error

Interface Error Codes

Port 1

800	RS-232 I/O processor internal RAM read/write error
801	RS-232 ROM checksum error
802	RS-232 External RAM error (U202)
803	RS-232 UART internal loopback error
804	HP-IL I/O processor internal RAM read/write error
805	HP-IL ROM checksum error
806	HP-IL system cannot read/write to HP-IL chip
807	HP-IB I/O processor internal RAM read/write error
808	HP-IB ROM Checksum error
820	Invalid code read from interface
821	Status bit fails to go true after 55 hex written
822	55 hex code written to I/O, AA hex code not read back
823	Status bit fails to go true after AA hex written
824	AA hex written to I/O, 55 hex not written back

Port 2

900	RS-232 I/O processor internal RAM read/write error
901	RS-232 ROM checksum error
902	RS-232 External RAM error (U202)
903	RS-232 UART internal loopback error
904	HP-IL I/O processor internal RAM read/write error
905	HP-IL ROM checksum error
906	HP-IL system cannot read/write to HP-IL chip
907	HP-IB I/O processor internal RAM read/write error
908	HP-IB ROM checksum error
920	Invalid code read from interface
921	Status bit fails to go true after 55 hex written
922	55 hex code written to I/O, AA hex code not read back
923	Status bit fails to go true after AA hex written
924	AA hex written to I/O, 55 hex not written back

DIAGNOSTICS

The diagnostic checks allow you to verify the instrument operation. If a faulty segment is found, the instrument may still be functional for the other measurements.

To access the diagnostic modes (see Table A-1), press the SETUP hardkey and then press the CALIBRATE SELF-CHECK softkey.

You now have the choice to run all the diagnostic modes, a specific mode, or a specific path within a mode. You can also specify the trigger condition on which the test can be stopped. See Table A-2.

To run all the modes, select FULL SELF-CHECK and then press START/STOP.

To run a specific mode, select MODE SELF-CHECK, press MODE and then enter the mode number from the keyboard and press ENTER. Press the START/STOP key to start the mode test.

To run a particular path within a mode, first select the mode and then select (SEGMENT) SELF-CHECK. Press SEGMENT and enter the data segment number associated with that path from the keyboard. Press ENTER and then press START/STOP to start the path test.

Table A-1. Diagnostic Modes

Mode Number	Title
1	Detector Digital and ADC Check (A5)
2	Detector Calibration Check (A5)
3	Basic Transmitter Check (A5, A15)
4	Wideband Autorange Amplifier Check (A4, A15, A17)
5	Narrowband Autorange Amplifier Check (A4, A15, A17)
6	Frequency Counter and Crystal Check (A4, A8, A14, A15)
7	Transmitter Single Tone Check (A4, A8, A14, A15)
8	Transmitter Multi-Tone Check (A4, A8, A14, A15)
9	Transmitter Filter Sweep (A4, A15)
10	Transmitter Alternate Channel Check (A4, A8, A15)
11	Wideband Filter Calibration (A1, A2, A4, A12, A17)
12	A2 Filter Sweeps (A2, A4, A5, A17)
13	A2 Filter Sweeps Continued (A2, A4, A5, A17)
14	A1 and A18 Check (A1, A2, A4, A5, A17, A18)
15	IMD Hardware Check (A2, A3, A4, A5, A17, A18)
16	IMD Filter Calibration (A2, A3, A4, A17)
17	Jitter Digital and Phase Lock Loop Check (A1, A6)
18	Jitter Calibration (A6)
19	Envelope Delay Hardware Check (A4, A5, A7, A14, A17)
20	Envelope Delay Calibration (A1, A2, A4, A7, A17)
21	Transient Measurements Check (A1, A2, A4, A8, A9, A17)
22	A3 FSK Demodulation Check (A1, A2, A3, A14, A17)

Table A-2. Stop-on Conditions

Condition	Description
CHECK END	- Stops at the end of the selected test (i.e., at the end of the selected mode or at the end of all modes when FULL is selected).
FAIL-MODE	- Stops at the end of the mode in which a failure has occurred. This mode runs non-stop if no error occurs.
FAIL-END	- Stops after running all the modes when a failure occurs.
NON-STOP	- Run the selected tests continually.

When the test stops because of one of these conditions, press START/STOP to start the test over again.

Press START/STOP to manually stop the test.

Diagnostics - Mode 1

MODE 1. Detector Digital and ADC Check (A5)

This mode checks the digital circuits and the analog to digital converter on the A5 Detector board.

The first six segments verify the digital circuits around the analog to digital converter and measure the time period of the A5 calibration signal.

The last five tests check the accuracy of the analog to digital converter and the functions of the detector multiplexer switch.

Following is a summary of the Mode 1 tests.

Data Segment	Test	Results Displayed Should Be	Path
1	Board Presence Test	0 +- 0	1
2	Walking Ones Test	0 +- 0	2
3	not used		
4	Comparator Tests	0 +- 0	3
5	not used		
6	Tracking ADC Tests	0 +- 0	4
7	Peak Detector Tests	0 +- 0	5
8	Cal Signal Digital Tests	0 +- 0	6
9	Count Up Period Test	4096 +- 20	6
10	Count Down Period Test	4096 +- 20	6
11	not used		
12	Tracking ADC Accuracy	188 +- 18mV	7
13	not used		
14	Voltage Reference Test	909 +- 11 mV	8
15	not used		
16	Receiver +5.0 V CLN	5000 +- 250	9

Diagnostics - Mode 2

MODE 2. Detector Calibration Check (A5)

This mode calibrates the A5 detectors and then checks the calibration constants against known limits. A check of the A5 analog circuits is also done.

Each detector's input/output characteristic is a linear function with slope and intercept values. The dc offset refers to the intercept and the gain constant refers to the slope; each is expressed times 1000. The dc offset is in millivolts and the gain constant is in dc volts output divided by the ac volts input (displayed in the appropriate measure of ac; e.g., average, rms or peak).

The comparator dc offset is an intentional dc offset in the A to D converter which measures all detector outputs. The offset lets the ADC measure detector offsets that are less than 0 volts. Thus, the input voltage range of the ADC is 10 volts wide but is shifted by the negative dc offset voltage of the comparator.

Note: Data segment 1 must be run before any other path since the data acquired in data segment 1 is used by the other data segments.

Following is a summary of the Mode 2 tests.

Data Segment	Test	Results Displayed Should Be	Path
1	190 mV dc offset ADC comparator	188 +-18 mV	1
2	not used		
3	0 dc offset rms detector	0 +-10 mV	2
4	1000 gain constant rms detector (X1000)	1000 +-20	3
5	not used		
6	0 dc offset FWA wideband detector	0 +-170 mV	4
7	2000 gain constant FWA wideband det.(X1000)	2000 +-20	5
8	0 dc offset FW rectified path	0 +-40 mV	6
9	909 gain constant FW rectified path	909 +-5	7
10	not used		
11	0 dc offset FWA narrowband detector	0 +-70 mV	8
12	2000 gain constant FWA narrowband det(X1000)	2000 +-20	9
13	0 dc offset FW rectified path	0 +-15 mV	10
14	909 gain constant FW rectified path (X1000)	909 +-5	11
15	not used		
16	not used		

MODE 3: Basic Transmitter Check (A5, A15)

This mode connects the self test signal (ST16) from A15 directly to the A5 input multiplexer. A 1024 Hz, .775 Vrms sine wave is transmitted and measured with the FWA wideband and RMS detectors (Paths 1 and 2). The same signal is then transmitted with an additional 10 dB of loss introduced by the fine attenuator on A15 and again measured by the two detectors (Paths 3 and 4). In the last segment (Path 5), the signal is set to .775 Vrms and a rough frequency check is made by setting the A5 comparator threshold to .33 V and measuring the time between threshold crossings by the FW rectified signal.

Following is a summary of the Mode 3 tests.

Data Segment	Test	Results Displayed Should Be	Path
1	FWA voltage in mV	698 +- 20	1
2	RMS voltage in mV	775 +- 20	2
3	not used		
4	FWA voltage -10 dB	221 +- 20	3
5	RMS voltage -10 dB	245 +- 20	4
6	not used		
7	Time in microseconds	1024 +- 30	5

8 thru 16 not used

Diagnostics - Mode 4

MODE 4: Wideband Autorange Amplifier Check (A4, A15, A17)

This mode checks the transmitter course attenuator on A17, the transmitter fine attenuator on A15 and the wideband autorange amplifier on A4.

The displayed numbers represent the rms voltage output of the wideband autorange channel under all gain conditions. The rms voltage can be verified with an external rms voltmeter at A4 TP5. A single failure can be located by observing the pattern of failures on the display.

Following is a summary of the Mode 4 tests including the attenuator and gain settings.

Data Segment	Output (mV)	XMTR Course Atten.	XMTR Fine Atten.	Wideband Auto Amp. Gain	Results Displayed Should Be
1	1199	-10dB	0dB	-10dB	-10000 +-100
2	1199	0dB	-10dB	-10dB	-10000 +-100
3	1199	-20dB	0dB	0dB	0 +-100
4	1199	-10dB	-10dB	0dB	0 +-100
5	1199	-30dB	0dB	+10dB	10000 +-100
6	1199	-20dB	-10dB	+10dB	10000 +-100
7	1199	-40dB	0dB	+20dB	20000 +-100
8	1199	-30dB	-10dB	+20dB	20000 +-100
9	1199	-50dB	0dB	+30dB	30000 +-100
10	1199	-40dB	-10dB	+30dB	30000 +-100
11	1199	-60dB	0dB	+40dB	40000 +-200
12	1199	-50dB	-10dB	+40dB	40000 +-200
13	1199	-70dB	0dB	+50dB	50000 +-2500
14	1199	-60dB	-10dB	+50dB	50000 +-2500
15	1199	-80dB	0dB	+60dB	60000 +10000 -5000
16	1199	-70dB	-10dB	+60dB	60000 +10000 -5000

Diagnostics - Mode 5

MODE 5: Narrowband Autorange Amplifier Check (A4, A15, A17)

This mode checks the receiver fine attenuator and the narrowband autorange amplifier on A4.

Following is a summary of the Mode 5 tests including the attenuator and gain settings.

Data Segment	Output (mV)	XMTR Course Atten.	RCVR Fine Atten.	Narrowband Auto Amp. Gain	Results Displayed Should Be
1	1199	-10dB	0dB	-10dB	-10000 +-200
2	1199	0dB	-10dB	-10dB	-10000 +-200
3	1199	-20dB	0dB	0dB	0 +-200
4	1199	-10dB	-10dB	0dB	0 +-200
5	1199	-30dB	0dB	+10dB	10000 +-200
6	1199	-20dB	-10dB	+10dB	10000 +-200
7	1199	-40dB	0dB	+20dB	20000 +-200
8	1199	-30dB	-10dB	+20dB	20000 +-200
9	1199	-50dB	0dB	+30dB	30000 +-200
10	1199	-40dB	-10dB	+30dB	30000 +-200
11	1199	-60dB	0dB	+40dB	40000 +-200
12	1199	-50dB	-10dB	+40dB	40000 +-200
13	1199	-70dB	0dB	+50dB	50000 +-5000
14	1199	-60dB	-10dB	+50dB	50000 +-5000
15	1199	-80dB	0dB	+60dB	60000 +2000/-5000
16	1199	-70dB	-10dB	+60dB	60000 +2000/-5000

Diagnostics - Mode 6

MODE 6: Frequency Counter and Crystal Check (A4, A8, A14, A15)

This mode connects the self test signal ST16 from A15 directly to the A4 input multiplexer. A 625 Hz, .775 Vrms sine wave is transmitted and measured by the A8 frequency counter. The transmitter is then driven in sequence by the following clock signals.

- A 10 kHz clock derived from the 1 MHz system clock
- The 16 kHz clock from A11
- The 131 kHz clock from A14
- The 16 kHz from A11
- The 131 kHz from a crystal on A14
- The 524 kHz from the crystal on A14
- The 1 MHz from the crystal on A14

This helps to isolate bad oscillators as well as verifying A8 operation. Since the transmitter output is 1000 Hz with the 16 kHz clock, it is measured in both narrowband and wideband channels.

Following is a summary of the Mode 6 tests.

Data Segment	Test	Results Displayed Should Be	Path
1	625 Hz from A15 (wide)	625 +- 1	1
2	1000 Hz from A15 (narrow)	1000 +- 1	2
3	1000 Hz from A15 (wide)	1000 +- 1	3
4	8192 Hz from A15 (wide)	8192 +- 1	4
5	32768 Hz from A15 (wide)	3276 +1/-0	5
6	65536 Hz from A15 (wide)	6553 +1/-0	6

7 thru 16 not used

A signal from A15 sets the transmitter to the frequency for the particular segment. The signal level is .775 Vrms. The signal is input to the receiver at the A1 multiplexer. The frequency is read at the A8 wideband channel for paths 1 and 3 through 6. The narrowband channel is used for path 2.

Diagnostics - Mode 7

MODE 7: Transmitter Single Tone Check (A4, A8, A14, A15)

This mode connects the self test signal output from A15 directly to the A4 input multiplexer. A 32 Hz, .775 Vrms sine wave is transmitted and measured by the A8 frequency counter. The bits in the transmitter frequency counter are changed one at a time to produce higher subsequent frequencies. Any errors in the fractional-N synthesizer show up as frequency offsets during the test. The frequencies change in the order listed below.

Following is a summary of the Mode 7 tests.

Data Segment	Frequency and Results Displayed Should Be
1	32 +- 0
2	33 +- 0
3	34 +- 0
4	36 +- 0
5	40 +- 0
6	48 +- 0
7	64 +- 0
8	128 +- 0
9	256 +- 0
10	512 +- 0
11	1024 +- 0
12	2048 +- 0
13	4096 +- 0
14	8192 +- 0
15	16384 (display 1638 +0 -1)
16	32768 (display 3276 +1 -0)

The transmitter transmits frequencies sequentially in the order listed above. The signal level from A15 is .775 Vrms. The signal is input to A4 and is measured on the A8 wideband channel.

Diagnostics - Mode 8

MODE 8: Transmitter Multi-tone Check (A4, A8, A14, A15)

This mode connects the A15 self test signal output directly to the A4 input multiplexer. Four frequencies are sequentially applied to A14 U402, U403, U404 and U405 with latch address 2 (01) selected. The test then repeats using latch addresses three (10) and four (11). These frequencies are read by the A8 frequency counter. Any errors in the multi-tone system appear as frequency offsets.

Following is a summary of the Mode 8 tests.

Data Segment	Test	Results Displayed Should be	Path
1	Latch Add. 2, 15 Hz	15 +- 0	1
2	Latch Add. 2, 240 Hz	240 +- 0	2
3	Latch Add. 2, 3840 Hz	3840 +- 0	3
4	Latch Add. 2, 61440 Hz	6144 +- 0	4
5	not used		
6	Latch Add. 3, 15 Hz	15 +- 0	5
7	Latch Add. 3, 240 Hz	240 +- 0	6
8	Latch Add. 3, 3840 Hz	3840 +- 0	7
9	Latch Add. 3, 61440 Hz	6144 +- 0	8
10	not used		
11	Latch Add. 4, 15 Hz	15 +- 0	9
12	Latch Add. 4, 240 Hz	240 +- 0	10
13	Latch Add. 4, 3840 Hz	3840 +- 0	11
14	Latch Add. 4, 61440 Hz	6144 +- 0	12

15, 16 not used

MODE 9: Transmitter Filter Sweep (A4, A15)

This mode connects the A15 self test signal output (ST16) to the A4 input multiplexer. Two frequencies are applied to the two A15 low pass filters and three frequencies are applied to the A15 IMD band-pass filter. These signals are at a .775 Vrms level. The level of each frequency is measured at the filter output to verify the filter performance. Errors in the midband gain and errors in the filter shapes should show up as level errors. Frequency errors indicate severe filter distortion or failure to pass the signal.

Following is a summary of the Mode 9 tests.

Data Segment	Test	Results Displayed Should Be	Path
1	2500 Hz	2500 +- 0	1
2	0.0 dBm	0.0 +- .5	1
3	10000 Hz	10000 +- 10	2
4	-18.0 dBm	-18 +- 1	2
5	not used		
6	1200 Hz	1200 +- 10	3
7	1.5 dBm	+1.5 +- .5	3
8	4800 Hz	4800 +- 10	4
9	-21.0 dBm	-21 +- 1	4
10	not used		
11	500 Hz	500 +- 10	5
12	-30.0 dBm	-30 +- 2	5
13	1120 Hz	1120 +- 10	6
14	0.0 dBm	0.0 +- .5	6
15	1600 Hz	1600 +- 10	7
16	-9.0 dBm	-9 +- 1	7

Diagnostics - Mode 10

MODE 10: Transmitter Alternate Channel Check (A4, A8, A15)

This mode connects the A15 self test signal directly to the A4 input multiplexer. A sine wave at 1000 Hz, .775 Vrms is output through the alternate channel amp (U305) and the 20 dB attenuator (U505) in the transmitter's alternate channel. Then the FSK low pass filter U405 is checked at three frequencies to insure proper attenuation of the mark and space frequencies as well as the high frequency roll-off. Any alternate channel problems should appear in at least one of the test paths.

Following is a summary of the Mode 10 tests.

Data Segment	Test	Results Displayed Should be	Path
1	1000 Hz	1000 +- 10	1
2	-18.5 dBm	-18.5 +- .5	1
3	Not Used		
4	800 Hz	800 +- 10	2
5	-3.0 dBm	-3.0 +- 1	2
6	1200 Hz	1200 +- 10	3
7	-3.0 dBm	-3.0 +- 1	3
8	2000 Hz	2000 +- 10	4
9	-13.0 dBm	-13 +- 1	4

10 thru 16 not used

Diagnostics - Mode 11

MODE 11: Wideband Filter Calibration (A1, A2, A4, A12, A17)

A gain constant is generated for the PAR, Program and C-message filters on A2. The A17 test signal (ST17) is routed through the appropriate A2 filter, (except for data segment 4) through the A4 wideband autorange, and then to the FWA detector. A reference measurement is made with no A2 filter to determine the absolute level variation. This reference value is subtracted from all filter measurements. The measured A2 filter constants are stored in non-volatile RAM on the A12 board.

Note: This mode is a calibration only mode and not intended for troubleshooting. Mode 12 provides more information if one of the filters fail. If mode 11 fails, mode 12 should also fail.

Following is a summary of the Mode 11 tests.

Data Segment	Test	Results Displayed Should Be	Path
1	1004 Hz, 0 dBm (600) PAR	0.0 +-1.0 dB	1
2	1004 Hz, 0 dBm (600) PRGM	0.0 +-1.0 dB	2
3	1004 Hz, 0 dBm (600) CMSG	0.0 +-1.0 dB	3
4	1004 Hz, 0 dBm (600)	0.0 +-1.0 dB	4

5 thru 16 not used

Diagnostics - Mode 12

MODE 12: A2 Filter Sweeps (A2, A4, A5, A17)

This mode does an abbreviated sweep of the A2 filters. The transmitter signal from A17 goes through the A2 multiplexer (U706) and through the selected filter. The signal goes through the A4 wideband autorange and then to the FWA detector on A5. All measurements are made relative to data segment 1.

Following is a summary of the Mode 12 tests. All tests are done at a 0 dBm level and 600 ohm termination impedance.

Data Segment	Results Displayed Should Be	Test	Filter	Path
1	0.0 +-1.0 dB	1000 Hz	No filter	1
2	-3.0 +-1.8 dB	3000 Hz	3 kHz	2
3	-12.3 +-3.0 dB	6000 Hz	3 kHz	3
4	-3.0 +-1.8 dB	15.0 kHz	15 kHz	4
5	-12.3 +-3.0 dB	30.0 kHz	15 kHz	5
6	-1.1 +-1.0 dB	100 Hz	50 k-bit	6
7	0.0 +-1.0 dB	1000 Hz	50 k-bit	7
8	-8.3 +-2.0 dB	40.0 kHz	50 k-bit	8
9	-11.6 +-2.0 dB	300 Hz	Program	9
10	0.0 +-1.0 dB	1000 Hz	Program	10
11	7.2 +-2.0 dB	4000 Hz	Program	11
12	-16.3 +-2.0 dB	300 Hz	C-message	12
13	0.0 +-1.0 dB	1000 Hz	C-message	13
14	-15.0 +-2.0 dB	4000 Hz	C-message	14
15	-14.1 +-1.0 dB	800 Hz	P/AR	15
16	-3.0 +-1.0 dB	1526 Hz	P/AR	16

Diagnostics - Mode 13

MODE 13: A2 Filter Checks Continued (A2, A4, A5, A17)

This mode continues the A2 filter checks. The signal is routed from A17 through A2. After passing through the selected filter, the signal goes through the A4 wideband autorange and then to the FWA detector on A5. For the phase jitter filter, the narrowband autorange path is used. All measurements are made relative to data segment 1.

Following is a summary of the Mode 13 tests. All tests are done with a 600 ohm termination impedance.

Data Segments	Results Displayed Should Be	Test	Filter	Path
1	0.0 +- 1.0 dB	1000 Hz	No filter	1
2	-55.0 +0/-99.0 dB	1010 Hz	Notch	2
3	-0.5 +- 1.0 dB	862 Hz	Notch	3
4	-0.5 +- 1.0 dB	1182 Hz	Notch	4
5	-2.7 +- 0.8 dB	10.0 kHz	10 kHz	5
6	-12.2 +- 1.0 dB	20.0 kHz	10 kHz	6
7	-21.0 +- 1.0 dB	60 Hz	60 Hz	7
8	0.0 +- 0.5 dB	400 Hz	60 Hz	8
9	0.0 +- 0.5 dB	1000 Hz	10 dB	9
10	-2.0 +- 0.5 dB	400 Hz	Phase Jitter	10
11	0.0 +- 0.5 dB	1000 Hz	Phase Jitter	11
12	-1.0 +- 0.5 dB	1450 Hz	Phase Jitter	12
13	-3.0 +- 0.5 dB	700 Hz	Transient	13
14	0.0 +- 0.5 dB	1000 Hz	Transient	14
15	-3.0 +- 0.5 dB	1300 Hz	Transient	15
16	not used			

Diagnostics - Mode 14

MODE 14: A1 and A18 Check (A1, A2, A4, A5, A17, A18)

This mode tests the amplifier, attenuators, input stage and terminations on A1 and the RTL transformer and RTL bridge on A18. Segments 1, 2 and 3 use the A17 test signal as the signal source. The other segments use the two-wire return loss path from the transmitter. The signal is then routed through A2 (no filters), A4 (wideband autorange) and A5 (FWA wideband detector). Since the transmit signal from the return loss bridge has not been tested, the termination test is also an A18 output check. This signal is routed from A18 to A1 without going through the active output, therefore the active output stage on A18 requires separate testing.

Following is a summary of the Mode 14 tests.

All tests use a 1000 Hz transmit frequency.

Data Segment	Results Displayed Should Be	Test (signal at A17TP2)	Path
1	0.0 +-1.0 dB	0.0 dBm (600) 0 Atten	1
2	0.0 +-1.0 dB	-20 dBm (600) 20dB Amp	2
3	-20.0 +-1.0 dB	0.0 dBm (600) 20 Atten	3
4	-15.7 +-1.0 dB	0.0 dBm (600) 135 Ohm	4
5	-11.3 +-1.0 dB	0.0 dBm (600) 600 Ohm	5
6	-10.7 +-1.0 dB	0.0 dBm (600) 900 Ohm	6
7	-10.4 +-1.0 dB	0.0 dBm (600) 1200 Ohm	7
8	-0.2 +-1.0 dB	0.0 dBm (600) Bridge	8
9	-12.4 +-1.0 dB	0.0 dBm (600) 900 Ref	9

10 thru 16 not used

Diagnostics - Mode 15

MODE 15: IMD Hardware Check (A2, A3, A4, A5, A17, A18)

This mode tests the A3 circuits. The signal is routed from A17 through A2 (with no A2 filters in) and through A3 where the signal can be picked off from the mixer input or after the 520 Hz bandpass filter. The A4 wideband autorange is used and the signal is detected with the A5 FWA wideband detector. Frequency is measured on A8.

Following is a summary of the Mode 15 tests.

Data Segment	Results Displayed Should Be	Test (signal at A17TP2)	Filter	Path
1	-15 +/-90 dB	1380 Hz, 0 dBm(600)	Notch	1
2	-15 +/-90 dB	860 Hz, 0 dBm(600)	Notch	2
3	-30 +/-90 dB	2940 Hz, 0 dBm(600)	Notch	3
4	-30 +/-90 dB	3280 Hz, 0 dBm(600)	Notch	4
5	5.0 +/-2.0 dB	490 Hz, 0 dBm(600)	BPF	5
6	5.4 +/-2.0 dB	520 Hz, 0 dBm(600)	BPF	6
7	4.9 +/-2.0 dB	550 Hz, 0 dBm(600)	BPF	7
8	5.4 +/-2.0 dB	520 Hz, -30 dBm(600)	Mixer	8
9	1.7 +/-2.0 dB	1900 Hz, 0 dBm(600)	Mixer	9
10	520 +/-5 Hz	1900 Hz, 0 dBm(600)	Mixer	9
11	3.1 +/-2.0 dB	2240 Hz, 0 dBm(600)	Mixer	10
12	520 +/-5 Hz	2240 Hz, 0 dBm(600)	Mixer	10
13	see Note	No detect/detect at 1380 Hz		1
14	see Note	No detect/detect at 860 Hz		2

15, 16 not used

Note: For Data Segments 13 and 14;

- 0 = no tones detected
- 1 = 1380 Hz tone detected
- 2 = 860 Hz tone detected
- 3 = both tones detected

Diagnostics - Mode 16

MODE 16: IMD Filter Calibration (A2, A3, A4, A17)

This mode tests the gain constant of the three bandpass filters used in IMD, and the noise floor of each filter. There is actually only one bandpass filter which is preceeded by the A3 mixer. The mixer can generate a 520 Hz component from a 1990 or 2240 Hz signal. The resultant 520 Hz component has an amplitude proportional to the 1900 or 2240 Hz signal (depending on the mixing signal). Thus, there are three different passband frequencies, the noise floors of each filter are not equal.

For Data Segments 1 - 3

The transmit signal is sent from A17 to the A2 input multiplexer, through A2 on the IMDI line to A3. The signal level is measured with the wideband autorange and the rms detector. All level measurements are made relative to the level measured when the appropriate frequency tone is sent from A2 directly to the wideband autorange (bypassing A3).

For Data Segments 4 - 6

The 4 tone IMD signal at 40 dBm is routed through each of the IMD bandpass filter. The signal then follows the usual IMD measurement path to the wideband autorange and RMS detector. The result displayed is the negative value of the noise plus one (for example, 114 displayed is -115 dB 600).

Following is a summary of the Mode 16 tests.

Data Segment	Results Displayed Should Be	Test	Filter	Path
1	5.4 +-1.0 dB	520 Hz, 0.0 dBm(600)	520 Hz BPF	1
2	1.7 +-1.0 dB	1900 Hz, 0.0 dBm(600)	1900 Hz BPF	2
3	3.1 +-1.0 dB	2240 Hz, 0.0 dBm(600)	2240 Hz BPF	3
4	113.5 +-13.5 dB	IMD , -40 dBm (600)	520 Hz noise	4
5	113.5 +-13.5 dB	IMD , -40 dBm (600)	1400 Hz noise	4
6	113.5 +-13.5 dB	IMD , -40 dBm (600)	2240 Hz noise	4

7 thru 16 not used

Diagnostics - Mode 17

MODE 17: Jitter Digital and Phase Lock Loop Check (A1, A6)

This mode checks the communication path on A6 (read/write test). The A6 A to D converter is also checked. The phase lock loop, lock time is measured and the capture range of the phase jitter phase lock loop is checked.

Following is a summary of the mode 17 tests.

Data Segment	Test	Results Displayed Should Be	Path
1	Read/Write Test 1=PASS, 0=FAIL	1	1
2	not used		
3	N/A	128 +-10	1
4	N/A	128 +-10	1
5	N/A	255 +0/-10	1
6	not used		
7	20Hz PLL Lock	0 +50/-0	2
8	4Hz PLL Lock	0 +50/-0	2
9	not used		
10	not used		
11	not used		
12	20Hz PLL Lock	0 +50/-0	3
13	4Hz PLL Lock	0 +50/-0	3
14	not used		
15	20Hz PLL Lock	0 +50/-0	4
16	4Hz PLL Lock	0 +50/-0	4

Diagnostics - Mode 18

MODE 18: Jitter Calibration (A6)

This mode calibrates the jitter circuits with signals from the transmitter and then checks the resulting calibration constants to within reasonable limits. This test is a functional test as opposed to a performance test.

Following is a summary of the Mode 18 tests.

Data Segment	Test	Results Displayed	Should Be	Path
1	AJ OFFSET 4-300HZ	0	+10/-0	1
2	PJ OFFSET 4-300HZ	0	+10/-0	2
3	AJ OFFSET 20-300HZ	0	+10/-0	3
4	PJ OFFSET 20-300HZ	0	+10/-0	4
5	AJ OFFSET 4-20HZ	0	+10/-0	5
6	PJ OFFSET 4-20HZ	0	+10/-0	6
7	AJ GAIN 4-300HZ	1485	+/-100	7
8	PJ GAIN 4-300HZ	688	+/-125	8
9	AJ GAIN 20-300HZ	1485	+/-100	9
10	PJ GAIN 20-300HZ	688	+/-125	10
11	AJ GAIN 4-20HZ	1485	+/-100	11
12	PJ GAIN 4-20HZ	688	+/-125	12

13 thru 16 not used

Diagnostics - Mode 19

MODE 19: Envelope Delay Hardware Check (A4, A5, A7, A14, A17)

This mode verifies the A7 hardware and its accuracy. A transmit signal from A17 is sent to the A4 input multiplexer. The signal is sent through the A4 wideband amplifier to A7 where it goes through the HI-Q filter and then to the A5 FWA wideband detector. Be sure to run Mode 2 (detector calibration) before running this mode.

If inconsistent calibration data is used (e.g., default calibration constants), this mode is sensitive enough to have errors occur. This sensitivity is due to the fact that the A7 output signals route directly to A5 with no autoranging done.

Diagnostics - Mode 19

Following is a summary of the Mode 19 tests.

Data Segment	Results Displayed Should Be *	Transmit Signal	Test	Path
1	6.6 +- 2.0 dB	EDD CAL, 9 dBm(600)	HI-Q/CAL	1
2	10.3 +- 2.0 dB	41.75 Hz, 0 dBm(600)	HI-Q/AGC	2
3	0.0 +-0.5 dB	41.75 Hz, 5 dBm(600)	HI-Q/AGC	3
4	-6.0 +-1.0 dB	41.0 Hz, 0 dBm(600)	HI-Q	4
5	-5.0 +-1.0 dB	42.25 Hz, 0 dBm(600)	HI-Q	5
6	-13.25 +-1.5 dB	40.75 Hz, 0 dBm(600)	TUNING	6
7	not used			
8	.03 +-2.5 dB	2000 Hz, -34 dBm(600)	FSK BPF	7
9	-3.5 +-1.0 dB	1845 Hz, -34 dBm(600)	FSK BPF	8
10	-3.5 +-1.0 dB	2166 Hz, -34 dBm(600)	FSK BPF	9
11	not used			
12	0 +12000/-0 usec	ED/1 kHz, 0 dBm(600)	Delay	10
13	-3000 +-30 usec	ED/1 kHz 0 dBm(600)	Delay	10
14	-3000 +-30 usec	ED/1 kHz 0 dBm(600)	Delay	10
15	-3000 +-30 usec	ED/1 kHz 0 dBm(600)	Delay	10
16	-3000 +-30 usec	ED/1 kHz 0 dBm(600)	Delay	10

* NOTE:

If the entire Mode 19 is run, the results listed in the previous table should be displayed. If segments 3 through 6 are run individually, the results displayed will be approximately 10 dB down. This is because when these segments are run individually the system software does not set the AGC DAC (U503).

Diagnostics - Mode 20

MODE 20: Envelope Delay Calibration (A1, A2, A4, A7, A17)

Envelope delay calibration is software compensation for the HP 4945's receiver and transmitter deviation from linear phase. The deviation is measured by comparing the delay at 1804 Hz to the delays at frequencies from 200 to 840 Hz at 64 Hz intervals. These values are stored in a table and used to correct envelope delay measurements taken at frequencies covered in the table. Interpolation is used to calculate intermediate values. The correction provides a delay flatness of +-4 microseconds. At frequencies above 840 Hz, delay flatness is assumed not to be a problem.

The transmitter signal is routed from A17 to the A1 multiplexer, through A2 and A4 (wideband autorange) and then to A7.

Following is a summary of the Mode 20 tests. The results displayed are in microseconds.

Data Segment	Results Displayed Should Be	Test (signal at A17TP2)	Path
1	0 +- 70	200 Hz, 0 dBm(600)	1
2	0 +- 50	264 Hz, 0 dBm(600)	2
3	0 +- 40	328 Hz, 0 dBm(600)	3
4	0 +- 30	392 Hz, 0 dBm(600)	4
5	0 +- 30	456 Hz, 0 dBm(600)	5
6	0 +- 20	520 Hz, 0 dBm(600)	6
7	0 +- 20	584 Hz, 0 dBm(600)	7
8	0 +- 20	648 Hz, 0 dBm(600)	8
9	0 +- 10	712 Hz, 0 dBm(600)	9
10	0 +- 10	776 Hz, 0 dBm(600)	10
11	0 +- 10	840 Hz, 0 dBm(600)	11
12 thru 16	not used		

Diagnostics - Mode 21

MODE 21: Transient Measurements Check (A1, A2, A4, A8, A9, A17)

A 1004 Hz, .775 Vrms sine wave from A17 is sent to the A1 input multiplexer. Impulse noise is monitored through the wideband autorange with the C-message filter and the 1010 Hz notch filter switched in and measured on A8. Gain hits, phase hits and dropouts are monitored through the narrowband autorange with the bessel filter switched in. Phase impairments are generated by programming frequency transitions into the transmitter and checked with the 20 degree phase hit detector. The gain hits detector is checked at the 2 dB and 6 dB threshold settings and checked against the receiver fine attenuator. The 12 dB dropout detector is also checked against the fine attenuator. The transmitter is then set to 1800 Hz to bypass the notch filter and the impulse noise thresholds are checked at 2 dB and 6 dB levels. In this case, the transmitter fine attenuator provides the reference. The fast count rate is checked by allowing a five second impulse noise count at 100 counts per second on a signal which should count all the time.

Following is a summary of the Mode 21 tests.

Data Segment	Test	Results Displayed Should Be	Path
1	PLL Balance Constant	0 +- 2	1
2	+20 Degree P.H. Constant	10 +- 2	1
3	-20 Degree P.H. Constant	10 +- 2	1
4	+2 dB Gain Hit Constant	82 +- 10	2
5	-2 dB Gain Hit Constant	82 +- 10	2
6	-6 dB Gain Hit Constant	50 + 35/-15	3
7	+6 dB Gain Hit Constant	50 + 35/-15	3
8	12 dB Dropout Constant	62 +- 10	4
9	95 dBrn I.N. HI Constant	10 +- 6	5
10	93 dBrn I.N. MID Constant	21 +- 5	5
11	91 dBrn I.N. LOW Constant	30 +- 4	5
12	101 dBrn I.N. HI Constant	10 +- 7	6
13	95 dBrn I.N. MID Constant	64 +- 6	6
14	89 dBrn I.N. LOW Constant	91 +- 4	6
15	100 Counts/sec Constant	500 +- 20	7
16	not used		

Diagnostics - Mode 22

Mode 22: A3 FSK Demodulation Check (A1, A2, A3, A14, A17)

The transmitter signal on A17 is connected to A18 using the 2W XMT line. From A18 the RTL-T and RTL-R signal is hardwired to A1. On A1 the signal goes through the differential input, and then goes to A3 on the FSK SIGNAL line. The FSK signal at .775 Vrms is sent through the FSK demodulator on A3. Data is sent by the transmitter through the ACIA chip on A14. The data is decoded and compared to ensure a match. If the demodulation circuit is not working, an error shows as an unmatched data pair or an error flag indicating bad parity, overrun or framing.

Following is a summary of the Mode 22 tests.

Data Segment	Test	Results Displayed Should Be
1	01 ACIA Data	1
2	02 ACIA Data	2
3	04 ACIA Data	4
4	08 ACIA Data	8
5	10 ACIA Data	16
6	20 ACIA Data	32
7	40 ACIA Data	64
8	80 ACIA Data	128
9	FE ACIA Data	254
10	FD ACIA Data	253
11	FB ACIA Data	251
12	F7 ACIA Data	247
13	EF ACIA Data	239
14	DF ACIA Data	223
15	BF ACIA Data	191
16	7F ACIA Data	127

Diagnostics - Mode 46

PERFORMANCE VERIFICATION AND SERVICE AID MODES

Several modes of operation are available within the HP 4945A receiver to assist in evaluating the HP 4945A performance and troubleshooting the receiver measurements. As with the diagnostic self-checks, these modes are accessed through the self-test menu. These modes allow high resolution measurements through the receiver, independent of the HP 4945A measurement restrictions. These modes allow static setup conditions for troubleshooting.

Mode 46: Filter Response Checks

This performance verification mode uses the receiver as a voltmeter and uses a different filter for each path. An external signal is input to the receiver. Depending on the path selected, one of the HP 4945A filters is switched into the signal path. By varying the signal frequency, the response of the filter can be checked by comparing the dB readings displayed with the values given in the response charts. The true voltage and power of the signal are given. These measurements assume ideal termination impedances within the receiver.

To use this mode, refer to the individual filter tests in Section IV of the HP 4945A Service Manual (Performance Tests 4-9 through 4-15).

Diagnostics - Modes 47 and 48

Mode 47: DC Offset Settling Time (narrowband)

This mode checks the dc offset settling times in the narrowband autorange amplifier when the gain is being switched in 10 dB steps. The receiver input at the A1 multiplexer is set to ground as well as the input to the A4 narrowband autorange amplifier.

When running the whole test, paths 1 through 8 evaluate the true settling time of the amplifier by waiting 500 msec between gain switching. Segments 9 through 16 use the programmed settling times to ensure that the times in paths 1 through 8 are correct.

When running a particular segment, the receiver enters a loop within the path that repeatedly switches the gain between two states.

Mode 48: DC Offset Settling Time (wideband)

This mode checks the dc offset settling times in the wideband autorange amplifier when the gain is being switched in 10 dB steps. The receiver input at the A1 multiplexer is set to ground as well as the input to the A4 wideband autorange amplifier.

When running the whole test, paths 1 through 8 evaluate the true settling time of the amplifier by waiting 500 msec between gain switching. Segments 9 through 16 use the programmed settling times to ensure that the times in paths 1 through 8 are correct.

When running a particular segment, the receiver enters a loop within the path that repeatedly switches the gain between two states.

Diagnostics - Mode 49

Mode 49: Filter Path Checks

This performance verification mode uses the receiver as a voltmeter and uses a different filter for each path. The signal level measured is referred to the receiver input weighted by the appropriate filter. The ac signal is measured for peak, average or rms value. The true voltage and power of the signal are given. These measurements assume ideal termination impedances within the receiver. Only some of the detector readings are displayed.

Following is a summary of the Mode 49 tests.

Path	Channel Filters	
	Wideband	Narrowband
1	Flat	Flat
2	P/AR	P/AR
3	1010 Hz notch	Flat 15 kHz
4	50 kbit	Flat
5	15 kHz	Flat
6	3 kHz	Flat
7	Program	Flat
8	C-message	Flat
9	Phase Jitter	Phase Jitter
10	IMD 520 Hz	Flat
11	IMD 1900 Hz	Flat
12	IMD 2240 Hz	Flat
13	IMD notch	Flat
14	10 kHz LP	10 kHz LP
15	60 Hz HP	60 Hz HP 3 kHz
16	Flat	Transients filter

Diagnostics - Modes 49, 50, and 51

Following is a summary of the information displayed on the various display lines.

Line	Display
1	XXXXXX rms voltage (wideband channel)
2	XXXXXX rms power (wideband channel)
4	XXXXXX average voltage (wideband channel)
5	XXXXXX rms equivalent power (wideband channel)
7	XXXXXX average voltage (narrowband channel)
8	XXXXXX rms equivalent power (narrowband channel)
10	XXXXXX peak voltage (wideband channel)
11	XXXXXX peak power in dBm (wideband channel)
14	XXXXXX peak power (narrowband channel)
15	XXXXXX peak power in dBm (narrowband channel)

Mode 50: Super P/AR

This performance mode gives you a P/AR measurement with much higher resolution and accuracy than the standard measurement. This mode evaluates the hardware/software performance in measuring the P/AR value. The displayed results are in thousandths of a P/AR unit.

Mode 51: Receiver Troubleshooting

This mode can assist you in troubleshooting the receiver. The receiver is used as a voltmeter and each path sets a different autorange amplifier gain so the autoranging is held at one static gain condition. This is useful for checking detector linearity and signal path continuity. Voltages are displayed if the detectors need to be checked.

Following is a summary of the Mode 51 tests.

Path	Gain (both amplifiers)
1	-10 dB
2	0 dB
3	10 dB
4	20 dB
5	30 dB
6	40 dB
7	50 dB
8	60 dB

Diagnostics - Modes 51 and 52

Following is a summary of the information displayed on the various display lines.

Line	Display
1	XXXXXX rms voltage (wideband channel)
2	XXXXXX rms power (wideband channel)
4	XXXXXX average voltage (wideband channel)
5	XXXXXX rms equivalent power (wideband channel)
7	XXXXXX average voltage (narrowband channel)
8	XXXXXX rms equivalent power (narrowband channel)
10	XXXXXX peak voltage (wideband channel)
11	XXXXXX peak power in dBm (wideband channel)
14	XXXXXX peak power (narrowband channel)
15	XXXXXX peak power in dBm (narrowband channel)

Mode 52: IMD Relative Tone Adjustment

Level measurements are taken internally for the 1380 Hz tone pair and the 860 Hz tone pair. The two levels are subtracted and the results are displayed.

This mode can be used for adjusting the tone pairs to the same relative level (IMD Flatness). The level can be set to within ± 0.1 dB of each other.

When the level difference is ± 0.5 dB or greater, the difference is displayed in inverse video to indicate a gross failure.

