

OPERATING AND SERVICE MANUAL

5150A
THERMAL PRINTER

(Including Options 001, 002, 003, 004, and 005)

SERIAL NUMBERS

This manual applies directly to instruments with Serial Number prefixed 1552A.

With changes described in Section VII, this manual also applies to instruments with Serial Numbers prefixed 1428, 1436, 1444, and 1528.

For additional important information about the Serial Numbers, see Instrument Identification and Manual Changes in Section I.

© COPYRIGHT HEWLETT-PACKARD COMPANY 1976
5301 STEVENS CREEK BLVD., SANTA CLARA, CA. 95050

MANUAL PART NO. 05150-90003
Microfiche Part No. 05150-90004
Operating Information Supplement Part No. 05150-90005

Printed: JUNE 1976

SAFETY

This instrument has been designed and tested according to IEC Publication 348, "Safety Requirements for Electronic Measuring apparatus." This is a Safety Class I instrument. To ensure safe operation and to keep the instrument safe, the information, cautions, and warning in this manual must be heeded. Refer to Section I for general safety considerations applicable to this instrument.

CERTIFICATION

Hewlett-Packard Company certifies that this instrument met its published specifications at the time of shipment from the factory. Hewlett-Packard Company further certifies that its calibration measurements are traceable to the United States National Bureau of Standards, to the extent allowed by the Bureau's calibration facility, and to the calibration facilities of other International Standards Organization members.

WARRANTY AND ASSISTANCE

This Hewlett-Packard product is warranted against defects in materials and workmanship for a period of one year from the date of shipment. Hewlett-Packard will, at its option, repair or replace products which prove to be defective during the warranty period provided they are returned to Hewlett-Packard, and provided the preventive maintenance procedures in this manual are followed. Repairs necessitated by misuse of the product are not covered by this warranty. **NO OTHER WARRANTIES ARE EXPRESSED OR IMPLIED, INCLUDING, BUT NOT LIMITED TO, THE IMPLIED WARRANTIES OF MERCHANTABILITY AND FITNESS FOR A PARTICULAR PURPOSE. HEWLETT-PACKARD IS NOT LIABLE FOR CONSEQUENTIAL DAMAGES.**

Service contracts or customer assistance agreements are available for Hewlett-Packard products.

For any assistance, contact your nearest Hewlett-Packard Sales and Service Office. Addresses are provided at the back of this manual.

Model 5150A
General Information

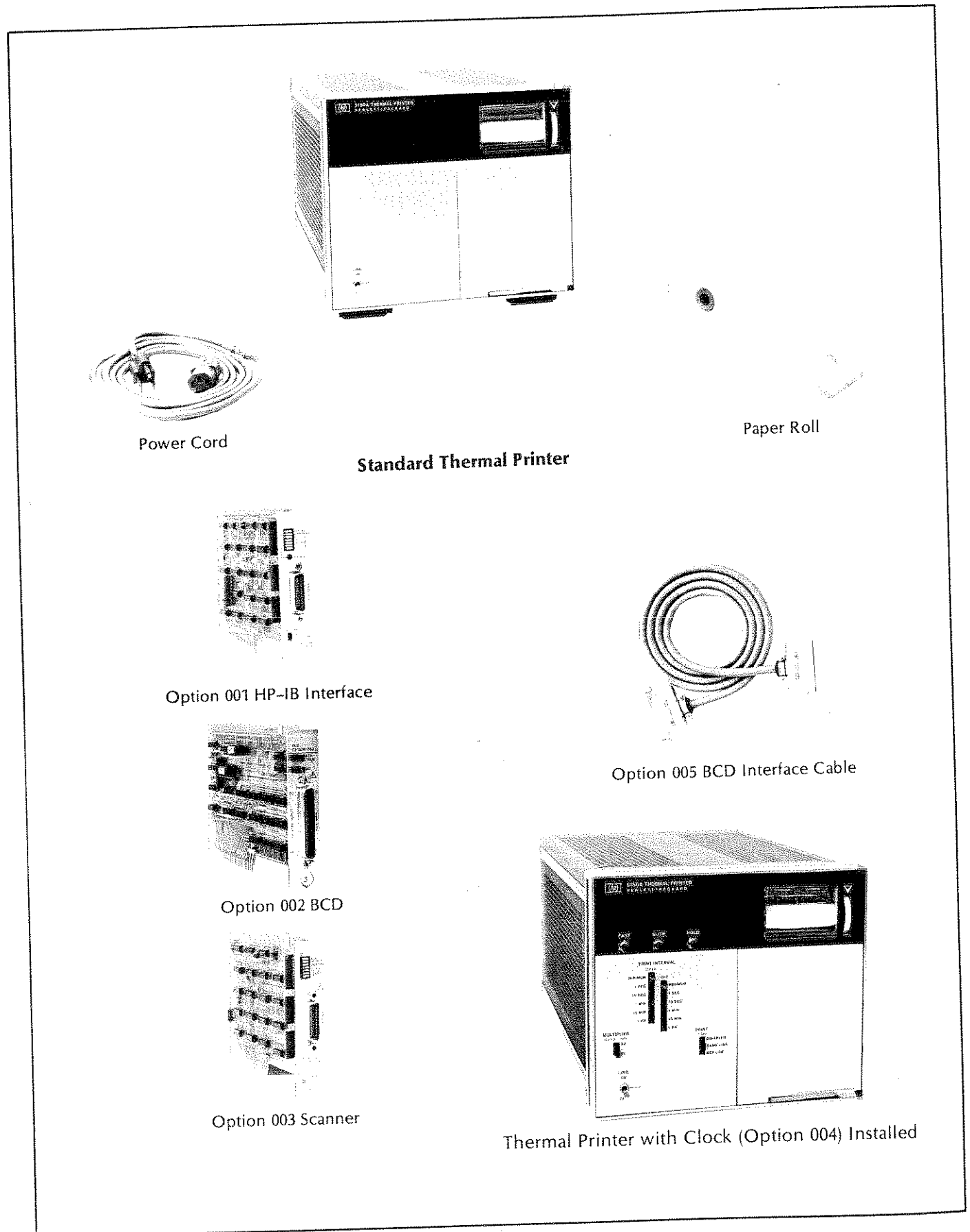

Figure 1-1. 5150A Thermal Printer

SECTION I GENERAL INFORMATION

1-1. SCOPE OF MANUAL

1-2. This manual provides operating and service information for the Hewlett-Packard Model 5150A Thermal Printers. *Figure 1-1* provides a visual packing slip of the 5150A Thermal Printer with available options and included accessories. The manual is organized as follows:

	SECTION	CONTENTS
OPERATOR INFORMATION	I	General Thermal Printer description, including supplied items, options, instrument compatibility, and specifications.
	II	Installation information including inspection procedures, power requirements, mounting hardware, interface cables, and option installation.
	III	Operating and programming information for all configurations; including interface information and paper loading procedures.
	IV	Theory of operation covering the basic Thermal Printer configurations. An overview block diagram description, and more detailed functional block/schematic level descriptions are included.
MAINTENANCE INFORMATION	V	Maintenance information; including test equipment recommendations, performance tests, adjustments, and assembly/disassembly procedures.
	VI	Replaceable parts listing covering all standard and optional Thermal Printer items.
	VII	Manual changes and their applicability.
	VIII	Schematic and functional block diagrams.

1-3. Supplied with this manual is an Operating Supplement. The supplement is a copy of the first three sections of the manual, and should be kept with the instrument for use by the operator. This Operating Information Supplement may be ordered from HP using number 05150-90005.

1-4. MICROFICHE NUMBER

1-5. On the title page of this manual, below the manual part number, is a microfiche part number. This number may be used to order the 4x6-microfilm transparencies of the manual from HP Customer Service, Palo Alto. This microfiche package also includes the latest manual changes supplement, as well as all pertinent service notes.

1-6. INSTRUMENT IDENTIFICATION AND MANUAL CHANGES

1-7. Hewlett-Packard instruments have a 10-character serial number, e.g., 0000A00000, which is located on the rear panel. The 4-digit serial prefix identifies a group of identical instruments. This prefix changes when changes are made to the instrument. The 5-digit suffix is a serial number unique to each instrument. If the serial prefix of your instrument differs from that listed on the title page of this manual, there are differences between this manual and your instrument. Instruments having lower serial prefixes than that listed on the title page are documented in Section VII, and higher serial prefixes are covered with manual change sheets included with the manual. If the change sheet is missing, contact the nearest Hewlett-Packard Sales and Service Office listed on the inside rear cover of this manual.

1-8. INSTRUMENT DESCRIPTION

1-9. The 5150A Thermal Printer responds to character data and command inputs from either a binary coded decimal (BCD), or a Hewlett-Packard Interface Bus (HP-IB) data source. The Printer is capable of printing up to 20 characters per line, at a rate of three lines per second on 2 $\frac{1}{4}$ inch wide thermal print paper. Depending on configuration, the data input operation may be controlled by:

- The data source sending the character (BCD or HP-IB);
- A controller such as an HP-IB compatible desk top calculator;
- A "built-in" controller called a Scanner (Option 003);
- A "built-in" controller called a Clock (Option 004).

1-10. The major parts of the 5150A are: The Main Frame, the Motherboard, the Print Mechanism, and the Main Control Board. To acquire characters from the data source, a board Option 001 HP-IB Interface, or an Option 002 BCD Interface must also be installed. Option 003 is a Scanner Board which serves as a limited built-in controller for the HP-IB. Option 004 is the Clock installation which provides selectable inhibit interval between data print operations, and between the time-of-day print operation. Option 005 is the BCD Interface cable. Table 1-1 lists the standard equipment supplied with the 5150A Thermal Printer. Table 1-2 lists those accessories which may be ordered in addition to the standard Thermal Printer.

Table 1-1. Equipment Supplied with Standard 5150A Printer

Quantity	Description	HP Model or Part Number
1	Instruction Manual	(see Title Page)
1	Fuse, 1A Timed (for 100-120 Vac)	2110-0007
1	Fuse, .5A Timed (for 220-240 Vac)	2110-0202
1	Cable, Power	(see Figure 2-4 in Section II)
1	Paper Roll, Thermal Print 76 metres (~250 feet)	9281-0401

Table 1-2. Accessories Available for 5150A Printer

Description	HP Part No.
BOARD OPTIONS	
HP-IB Interface (Option 001)	05150-60002
BCD Interface (Option 002)	05150-60005
Scanner (Option 003)	05150-60008
Clock (Option 004) 2 Boards Controller (Installable in HP Service Center) Display Only	05150-60006
CABLES	
HP-IB, one metre (~3 feet)	10631A
HP-IB, two metres (~6 feet)	10631B
HP-IB, four metres (~12 feet)	10631C
BCD General Purpose (Option 005)	562A-16C
BCD for HP 5300A System	10533A
PAPER	
Thermal Print Paper Roll, 76 metres (~250 feet), 6 rolls minimum	9281-0401
Thermal Sensitive Fan Folded Paper, 76 metres (~250 feet), 4 packs minimum	9270-0431
NOTE	
Only paper purchased from or approved by Hewlett-Packard is recommended for use with the printer.	

1-11. MAIN CONTROL AND OPTION BOARDS

1-12. Figure 1-2 shows the Main Control Board, the Option Boards, and briefly describes the functions of each.

<p>MAIN CONTROL/DRIVER</p>  <p>(05150-60001)</p>	<p>This board provides timing and control for the print operation. Timing and control signals are generated for acquisition of data from the BCD or HP-IB Interface Boards. This data is then translated into characters understood by the print mechanism. This board controls the print head and paper advance mechanism.</p>
<p>OPTION 001</p>  <p>(05150-60002)</p>	<p>This option interfaces the printer to HP-IB compatible data sources, providing data acquisition capability from either systems or instruments. A 20-column, 64-character alphanumeric readout provides flexible data print-out from data applied directly to the HP-IB board from the measurement source.</p>

Figure 1-2. Thermal Printer Plug-In Boards

OPTION 002 BCD

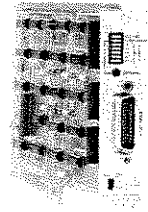
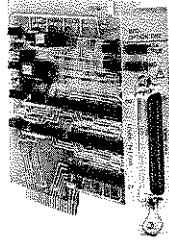

(05150-60005)

BCD $\pm 8 4 2 1$ coded instruments interface with the Printer through 10-column inputs, and up to two Option 002 interfaces may be installed. Along with a standard 16-character alphanumeric set, the user may select various combinations of special character and column formats. Special 16 character sub-sets are orderable from the 64-character ASCII set to provide user-defined choices.

OPTION 003 SCANNER

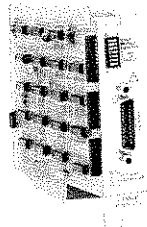

(05150-60008)

Up to 13 ASCII-coded instruments may be scanned on the HP-IB with Option 003 using Option 001 to transmit the data. The Scanner acts as a system controller, providing automatic data acquisition capability. Additionally, the Scanner provides data source alpha identifiers on the printout, assuring that data is easily correlated.

OPTION 004 CLOCK/CONTROLLER

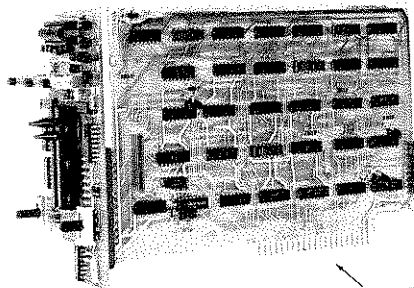

CLOCK DISPLAY BOARD
(05150-60007)

CLOCK CONTROL BOARD
(05150-60006)

05150-60007

05150-60006

Useable with ASCII and/or BCD measurement systems, the clock may provide hours, minutes, and seconds time printout (00:00:00 to 23:59:59) along with data at preselected intervals from 3 per second to one every 2 hours. A frequency of either 50 or 60 Hz may be selected by a switch on the clock display panel (HP Part No. 05150-60007). Selectable via a switch on the top front of the Clock/Controller board is the HOLD or RELEASE mode. With the Clock in HOLD a data source is held off from taking a measurement until completion of the preselected Data Print Interval. In the RELEASE mode the instrument is free to continually update its data.

Figure 1-2. Thermal Printer Plug-In Board (Continued)

1-13. INSTRUMENT COMPATIBILITY

1-14. The Thermal Printer is compatible with all HP-IB instruments and with $\pm 8 4 2 1$ BCD instruments which operate at TTL levels.

CAUTION

ENSURE THAT ALL DATA SOURCES SENDING TO THE 5150A USE TTL LEVELS. LEVELS THAT EXCEED +5.5 VOLTS MAY DAMAGE THE INPUT CIRCUITS OF THE HP-IB AND BCD INTERFACE BOARDS.

1-15. Figure 1-3 provides examples of various clock print choices. Notice an instrument identifier (printed with Scanner option installed) is overwritten by the time information if same line time print is chosen.

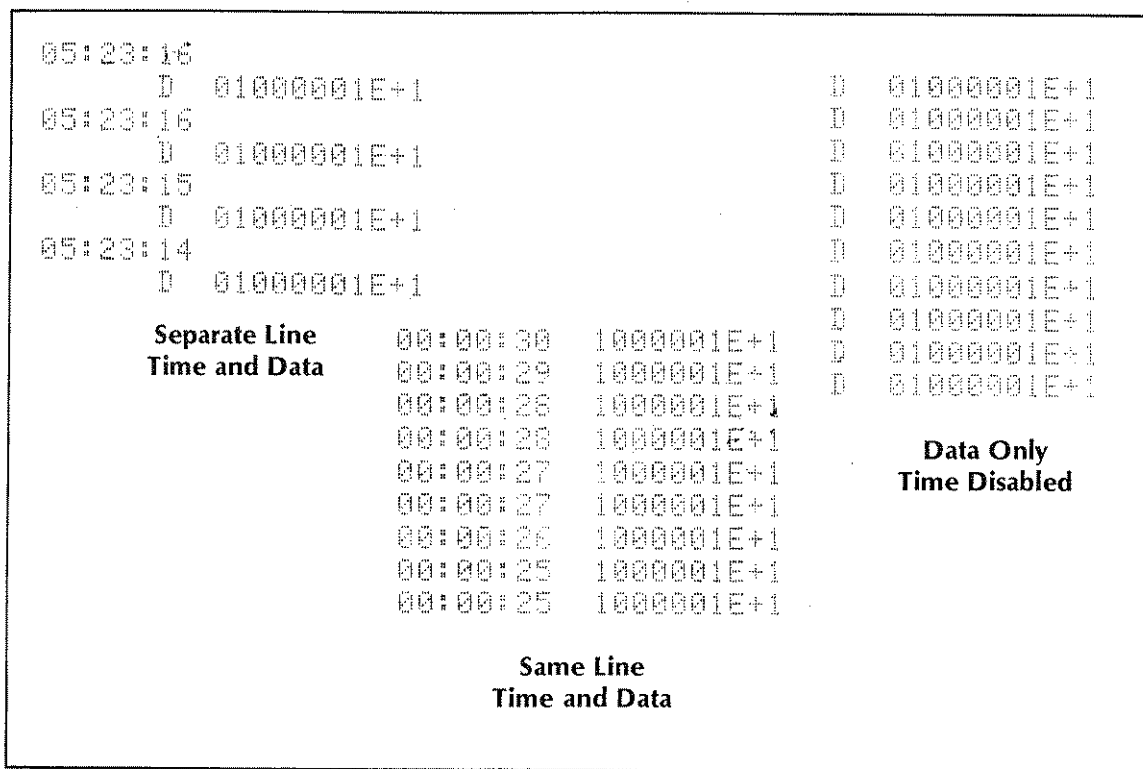

Figure 1-3. Thermal Printer Output

1-16. SPECIFICATIONS

1-17. Table 1-3 lists the specifications for the 5150A Thermal Printer.

Table 1-3. Thermal Printer Specifications

MAINFRAME

PRINCIPLE: Thermal Print
CHARACTER PRINT: 5 x 7 dot matrix
PRINTING RATE: 3 lines per second
LINE SPACING: 2 lines per cm (~5 lines per inch)
PAPER ADVANCE MECHANISM: Direct drive, stepping motor
PAPER: Thermal sensitive, in rolls or fan-folded
OPERATING ENVIRONMENT: 0°C to 50°C temperature; 95% relative humidity (85% RH with fan-folded paper)
POWER: 100, 120, 220, or 240 volts, -10% to +5%, 48 to 440 Hz (50 or 60 Hz needed for Option 004), 100 VA
DIMENSIONS: Half-rack module; 216 mm W x 178 mm H x 356 mm D (8½" x 7" x 14¼")
WEIGHT: Approximately 7 kg (16 lbs.) (5150A + 1 option)
STORAGE ENVIRONMENT LIMITS:
 Temperature Range: -40°C to +75°C
 Minimum Air Pressure (altitude): 275 mm of mercury (25,000 feet or 7500 metres)
 Relative Humidity (maximum): 95%

OPTION 001 HP-IB INTERFACE

COLUMNS: 20
PRINTED CHARACTER SET: 64 ASCII characters (columns 2, 3, 4, and 5 of ANSI X3.4 - 1968 except "↑" in column 5, row 14)
INPUT:
 Logic Levels: TTL (Low <.4V, High >2.4V)
 Data Format: Byte-serial with storage, negative true, compatible with HP-IB (7-bit ASCII character codes used)
 Inhibit (output): Holds NREFD line of HP-IB low following receipt of either CR or LF (selectable) until print is completed. This interval is approximately 250 ms, or the duration of Option 004 Clock data print interval with clock in HOLD mode.

OPTION 002 BCD

COLUMNS: 10 (20 columns with two Option 002's installed)
CHARACTER SET: 0 through 9, +, -, V, A, R, and (blank). Special character sets available.
INPUT:
 Logic Levels: TTL (Low <.4V, High >2.4V)
 Data Format: Parallel BCD (8-4-2-1); switch selects + or - true logic
 Print Command: Positive or negative TTL transition. 2 kΩ input impedance
 Inhibit (output): + and - available, same levels as above; remains at true level until print is completed (approximately 250 ms) or during Option 004 Clock data print interval with Clock in HOLD mode.

Table 1-3. Thermal Printer Specifications (Continued)

OPTION 003 SCANNER	
INSTRUMENTS SCANNED:	1 to 13
CYCLE TIME OF SCAN:	Limited by the slowest of (a) response of instruments scanned, subject to protect feature, or (b) 3 samples per second, or (c) DATA PRINT INTERVAL setting on Option 004 Clock.
COMPATIBILITY:	HP-IB
IDENTIFIER:	Labels data line of each instrument with letter from A through M in 20th column; defeatable via switch.
PROTECT FEATURE:	Bypasses non-responding instrument after approximately three (3) seconds; defeatable via switch.
OPTION 004 CLOCK	
DATA PRINT INTERVAL:	Selectable by front panel switches: Minimum (3/sec), 1 sec, 2 sec, 10 sec, 20 sec, 1 min, 2 min, 10 min, 20 min, 1 hour, 2 hours. Print interval will be that of input device if it is slower than the selected interval.
TIME PRINT FORMAT:	Selectable by front panel switch, same intervals as above (intervals shorter than data interval prevented).
TIME PRINT FORMAT:	Selectable by front panel switch: Disabled, Same Line as data, or Separate Line from data.
DISPLAY:	Six-digit, seven-segment LED display of hours, minutes, seconds (00:00:00 to 23:59:59); settable via front panel switches.
TIME BASE:	Line frequency (50 or 60 Hz, selectable by switch on Clock Display board.
INHIBIT:	Source instrument is inhibited until completion of data print interval (HOLD mode) with either BCD or HP-IB Interface; defeatable via switch.

1-18. RECOMMENDED TEST EQUIPMENT

1-19. Table 1-4 lists those test instruments that are recommended for in-cabinet performance tests and for maintenance of the 5150A Thermal Printer. Where special test fixtures are suggested, a diagram is referenced which shows the fixture and lists the required parts.

Table 1-4. Recommended Test Equipment

Equipment HP Part No.	Description	Used with all Boards Except where Specific Board Given	Use*
K08-59992A	HP Bus Exerciser	HP-IB 05150-60002	P, T
10525T	Logic Probe	ALL	P, T
10526T	Logic Pulser	ALL	P, T
10528A	Logic Clip	ALL	P, T
05050-6024	Extender Board	HP-IB, BCD, Scanner	P, T
Circuitry and parts list Figure 5-2	BCD Test Box	BCD 05150-60005	P, T
*P = Performance Test, T = Troubleshooting			

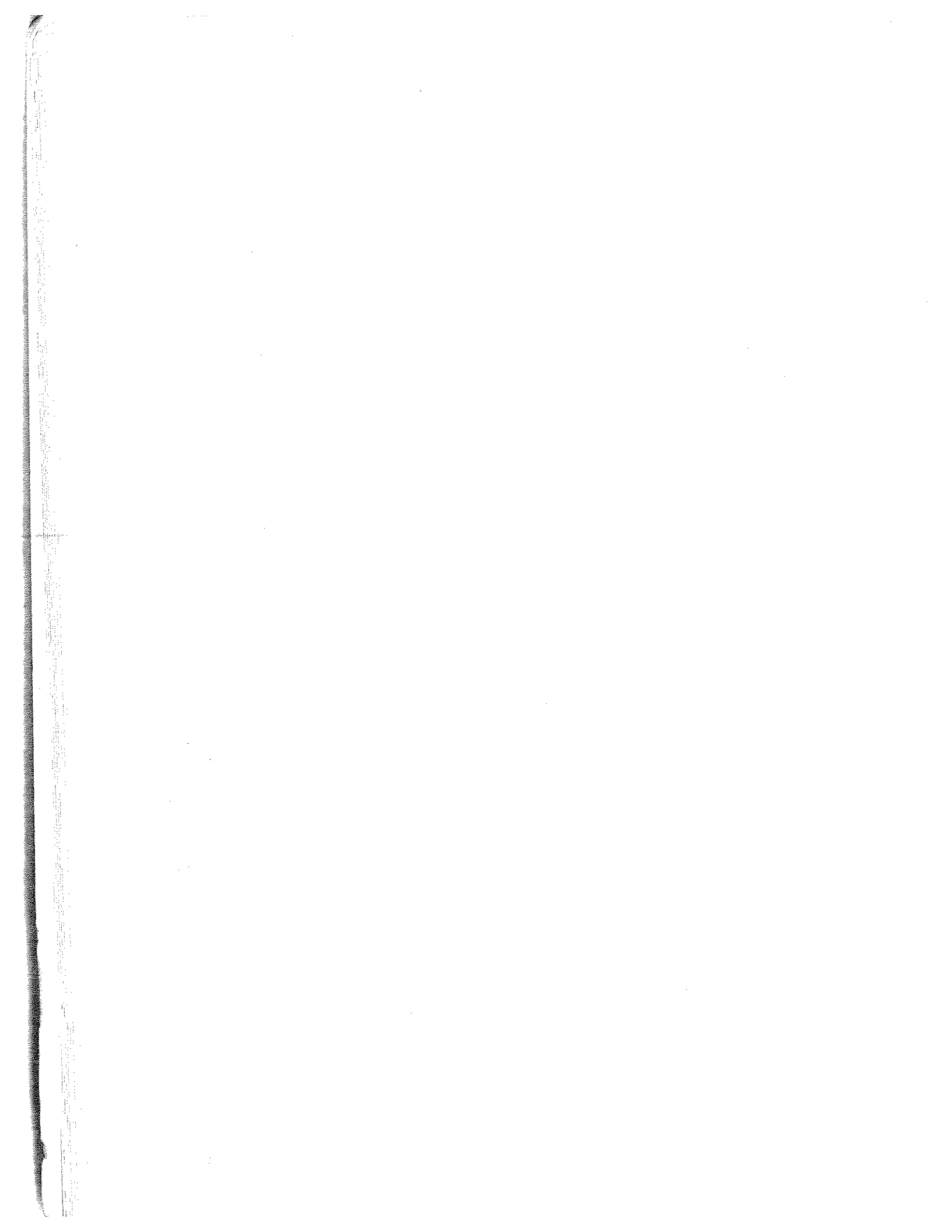

SECTION II

INSTALLATION

2-1. INTRODUCTION

2-2. This section provides information for inspecting, repackaging, and installing the 5150A Thermal Printer. Also included are power and option cable requirements, and Option Board installation procedures.

2-3. INITIAL INSPECTION

2-4. Inspect the shipping container for damage. If the container is damaged, or the cushioning material shows signs of stress, keep these items until you have thoroughly inspected the instrument. Check all ordered items to ensure that your shipment is complete. Use the appropriate performance test listed in Section V (the performance test depends on the installed option) to verify proper Thermal Printer operation. If the shipment is incomplete, damaged, or electrically defective, notify the nearest Hewlett-Packard Sales or Service office. If the shipping container or cushioning material appears to be damaged, also notify the carrier. Keep all material for the carrier's inspection. The HP office will arrange for repair or at HP's option replacement of the instrument without waiting for a claim settlement.

2-5. PACKAGING

2-6. Original packaging containers and materials identical with those used in the factory are available through Hewlett-Packard offices. If the instrument is being returned to HP for servicing, attach a tag indicating the type of service required, return address, model number, and full serial number. Also, mark the container FRAGILE to assure careful handling. In any correspondence, refer to the instrument by model number and full serial number.

2-7. Packaging Procedure

2-8. The following general instructions should be followed when repackaging the instrument:

- a. Wrap the instrument in heavy paper or plastic.
- b. Use a strong shipping container. A 1225 N/m² (~275 lb. bursting strength) corrugated single-wall box is sufficient.
- c. Use enough shock-absorbing material (75—100 mm layer, ~3 to 4-inch layer) around all sides of the instrument to provide a strong cushion and prevent movement inside the container.
- d. Protect the front and rear control panels with cardboard.
- e. Seal the shipping container securely.
- f. Make sure that the shipping container is marked FRAGILE.

2-9. Bench Operation

2-10. The instrument cabinet has plastic feet and a foldaway tilt stand for convenience in bench operation. The tilt stand permits inclining the instrument for ease in using front panel controls and indicators. The plastic feet are shaped to provide clearance for air circulation and to make modular cabinet width instruments self-aligning when stacked.

2-11. Rack Mounting

2-12. The 5150A can be rack-mounted in three different configurations as shown in Figures 2-1 through 2-3. The figures include the HP numbers of required rack-mounting kits. To rack-mount, proceed as follows:

- a. Remove the appropriate front trim strips (depending on the rack mounting configuration).
- b. The following is applicable when mounting two instruments:
 1. Install front lock links.
 2. If mounting the instruments in a vertical configuration, remove the front feet of the top instrument.
 3. Join the two instruments by mating the forward lock links.
 4. Install the rear lock links.
- c. Install the appropriate flanges and/or adapters.

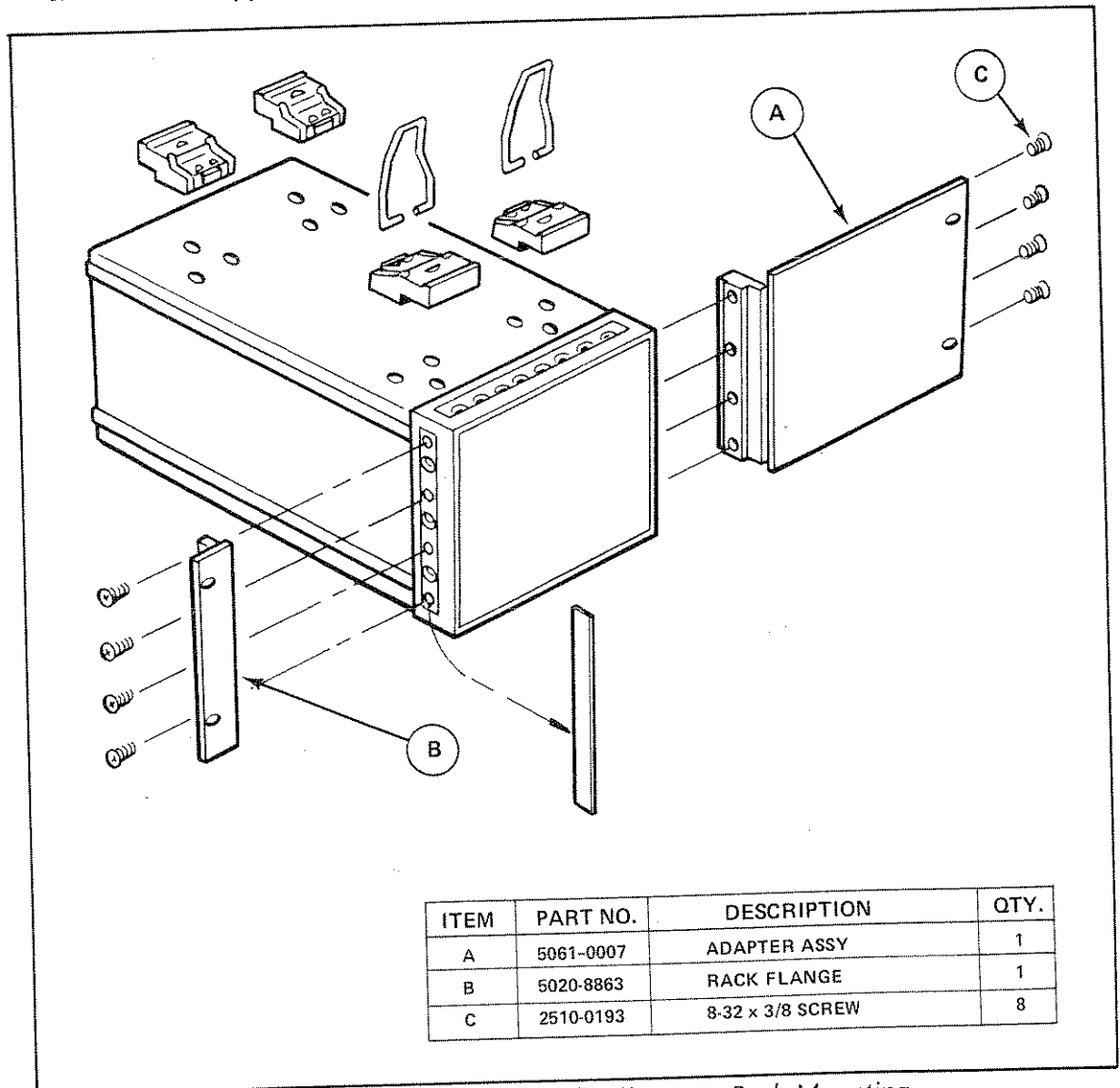

Figure 2-1. Single Module, Off-Center Rack Mounting

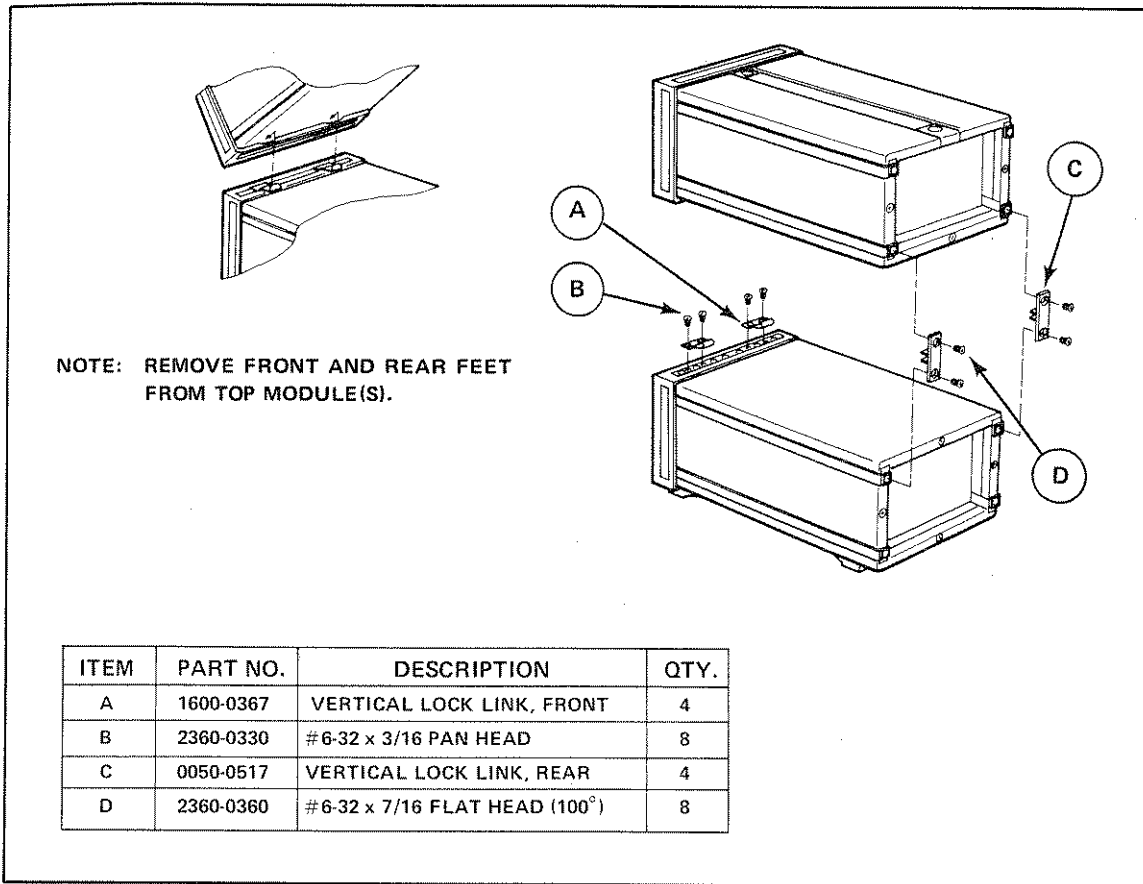

Figure 2-2. Two or Three Modules, Vertical Rack Mounting

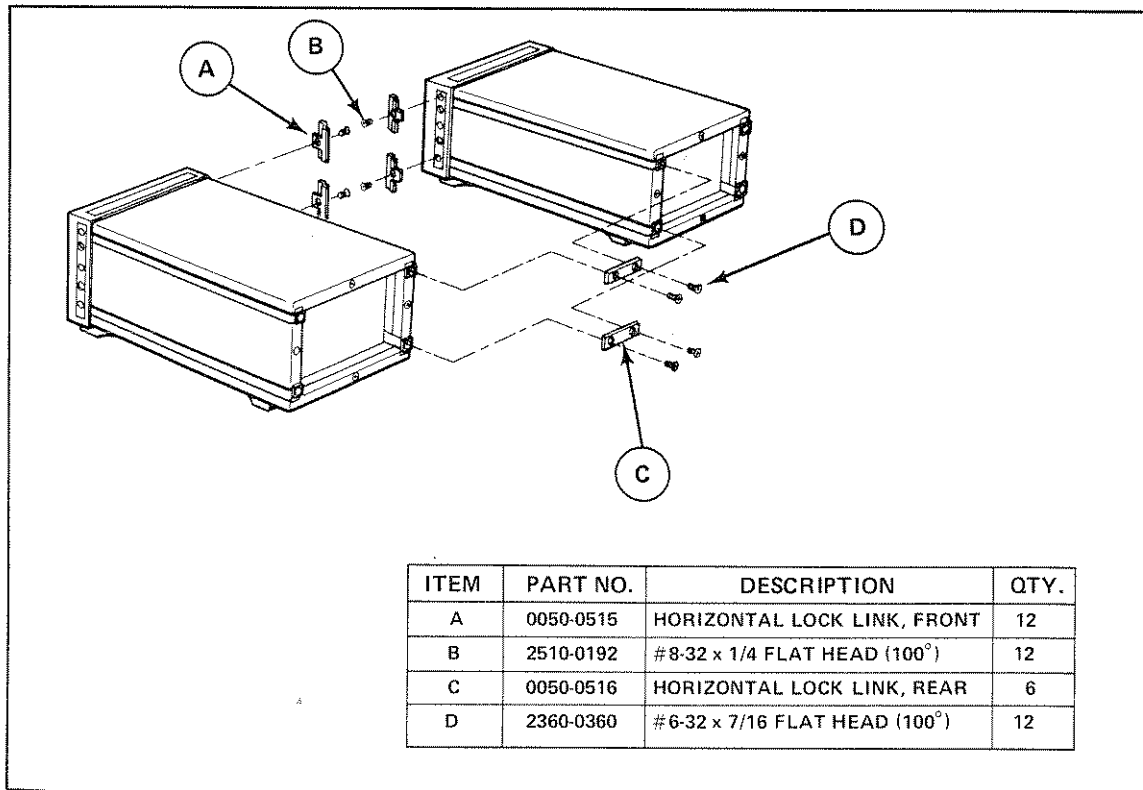

Figure 2-3. Two to Four Modules, Horizontal Rack Mounting

2-13. PREPARATION FOR USE

2-14. After the 5150A is unpacked and mounted, the following items should be considered prior to operating the instrument.

2-15. Power Requirements

2-16. Except for printers equipped with Option 004, the 5150A operates on single-phase power sources over the frequency range of 48 to 440 Hz. The Clock Option 004 requires a line frequency of 50 or 60 Hz. All Thermal Printers can operate on power sources of 100, 120, 220, or 240 Vac. The maximum power rating of this instrument is 100 VA.

2-17. Power Cables (Refer to Figure 2-4)

WARNING

TO PROTECT OPERATING AND SERVICE PERSONNEL, THIS INSTRUMENT IS EQUIPPED WITH A THREE-PIN POWER RECEPTACLE. THE CENTER PIN OF THIS RECEPTACLE CONNECTS THE INSTRUMENT CHASSIS AND PANELS TO EARTH GROUND WHEN USED WITH A PROPERLY WIRED THREE-CONDUCTOR OUTLET AND POWER CABLE. IMPROPERLY GROUNDED EQUIPMENT CAN RESULT IN HAZARDOUS POTENTIALS ON THE INSTRUMENT.

2-18. To accommodate the different power receptacles throughout the world, one of the power cable terminators (shown in Figure 2-4) is provided with the Thermal Printer. The cable supplied for use in the United States meets the specifications established by the International Electrotechnical Commission (IEC). The male connector of this cable is a NEMA type, and the female connector is a CEE-22 type, both recognized by the Underwriter's Laboratory. The 5150A is a Safety Class 1 instrument. Connect the power cable to a power source receptacle that has a grounded third conductor. If the power receptacle is a two-pin type, use a two-to-three pin adapter (HP Part No. 1251-0048 for USA applications) and connect the green lead of the adapter to earth.

2-19. Line Voltage and Fuse Selection

CAUTION

TO AVOID DAMAGING THE INSTRUMENT, MAKE THE PROPER LINE VOLTAGE SELECTION AT THE REAR PANEL BEFORE CONNECTING THE LINE POWER CABLE.

2-20. Select the appropriate line voltage and install proper fuse at the rear panel in the following manner:

- a. Determine the line voltage.
- b. At the instrument's rear panel, select the closest line voltage (line voltage selections are 100, 120, 220, or 240 Vac). The line voltage must be within -10% to +5% of the rear panel setting.
- c. Check that the correct fuse is installed. For 100/120V operation, use a 1 Ampere Timed Fuse, HP Part Number 2110-0007. For 220/240V operation, use a 500 Milliampere Timed Fuse, HP Part Number 2110-0202.
- d. Connect the power cable to the instrument's ac power receptacle.



HP Part Number	Plug Configuration (view of plug face)	Product Rating		Plug Rating and Ref. Spec.	For Use In:
		Voltage Nominal	Current Maximum		
8120-1689		220V	10.0A	1 ϕ , 250V, 10/16A CEE 7-V11	East and West Europe, Saudi Arabia, United Arab Republic (unpolarized in many nations)
8120-1351		240V	10.4A	1 ϕ , 250V, 13A BS 1363A	Great Britain, Cyprus, Nigeria, Rhodesia, Singapore, So. Africa, India
8120-1369		240V	10.0A	1 ϕ , 250V 10A N.Z.S.S. 198 AS C112	Australia, New Zealand
8120-1378		120V	12.0A	1 ϕ , 125V, 15A NEMA 5-15P	United States, Canada
8120-2104		220V	10.0A	1 ϕ , 250V, 10A, SEV 1011.1959 24507, type 12	Switzerland

Figure 2-4. Power Cables

2-21. OPTION BOARD INSTALLATION

2-22. Option Boards 001 (HP-IB), Option 002 (BCD), and Option 003 (HP-IB Scanner) may be purchased separately and field-installed. Option 004 (Clock) however, must be installed by Hewlett-Packard. Table 2-1 lists the option boards and indicates the 5150A receptacle into which they are installed.

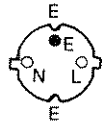
Table 2-1. Option Board Positions

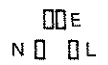
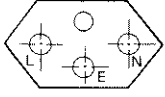
OPTION BOARD	POSITION (Refer to Figure 2-5)
*Option 001 (ASCII - coded HP-IB)	A2
*Option 002 (BCD)	A2 or A4
Option 003 (HP-IB Scanner)	A4
**Option 004 (Clock)	A3

*For proper combined HP-IB and BCD (i.e., Bilingual) operation, the HP-IB Board must be in the A2 position, and the BCD Board must occupy the A4 position.
 **Option 004 must be installed by authorized HP personnel, either as part of the initial purchase order, or retro-fitted at an authorized HP service office. This Option requires either a 50 Hz or 60 Hz ac power source. The 50 Hz/60 Hz switch at the rear of the Clock Display Board must be positioned to match the power source frequency.

2-23. Figure 2-5 shows the board installation positions within the 5150A and provides a general procedure for installing the option boards.

CAUTION

REMOVE POWER FROM THE 5150A PRIOR TO INSTALLING THE OPTION BOARDS OR DAMAGE TO THE INSTRUMENT MAY RESULT.

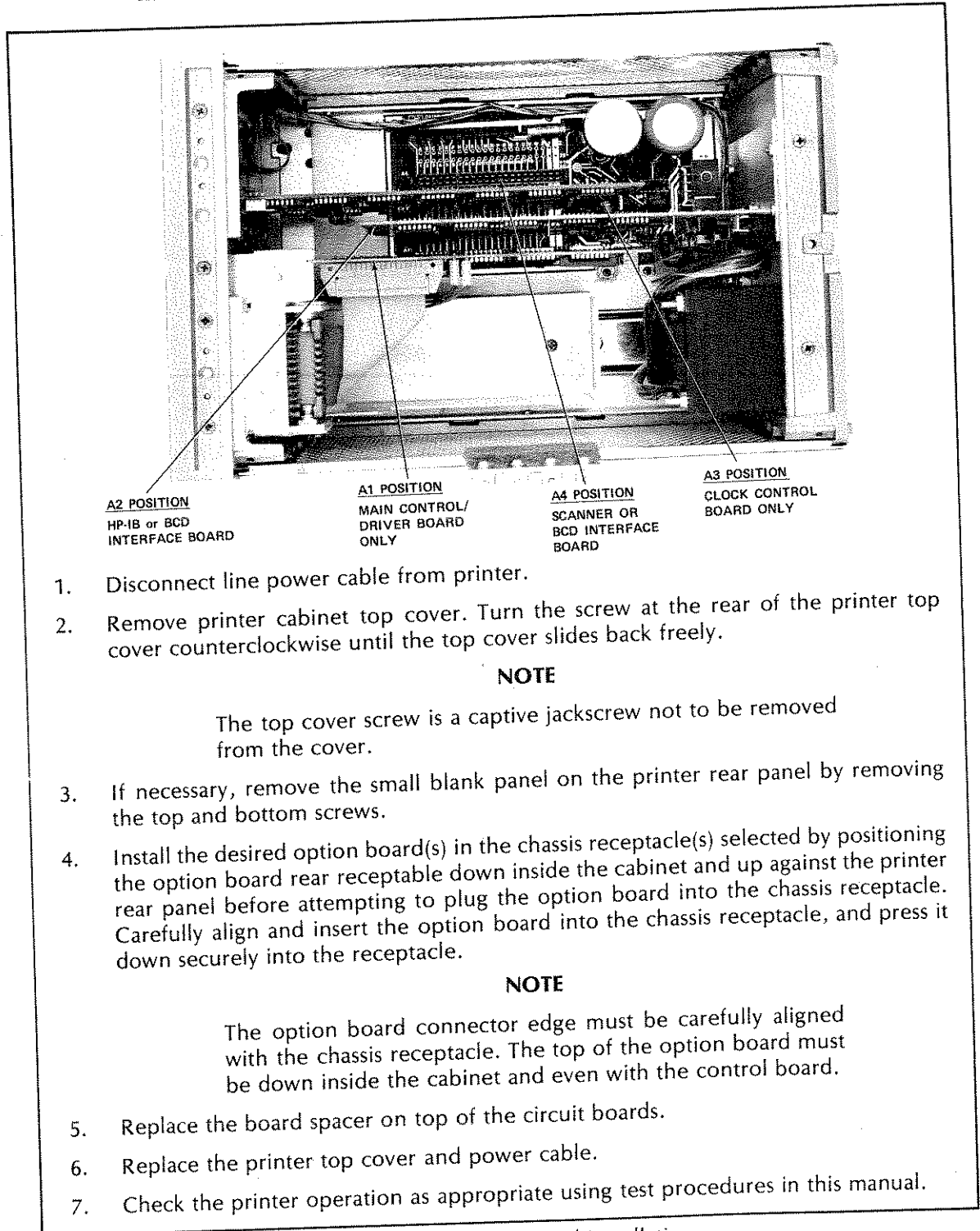

Figure 2-5. Option Board Installation

2-24. INTERFACE CABLES

2-25. Two interface cables are available for the Thermal Printer: an HP-IB cable, and a BCD cable. These cables are plugged into corresponding 5150A interface boards at the rear panel of the instrument. Figures 2-6 and 2-7 show the pin locations on the cable connectors.

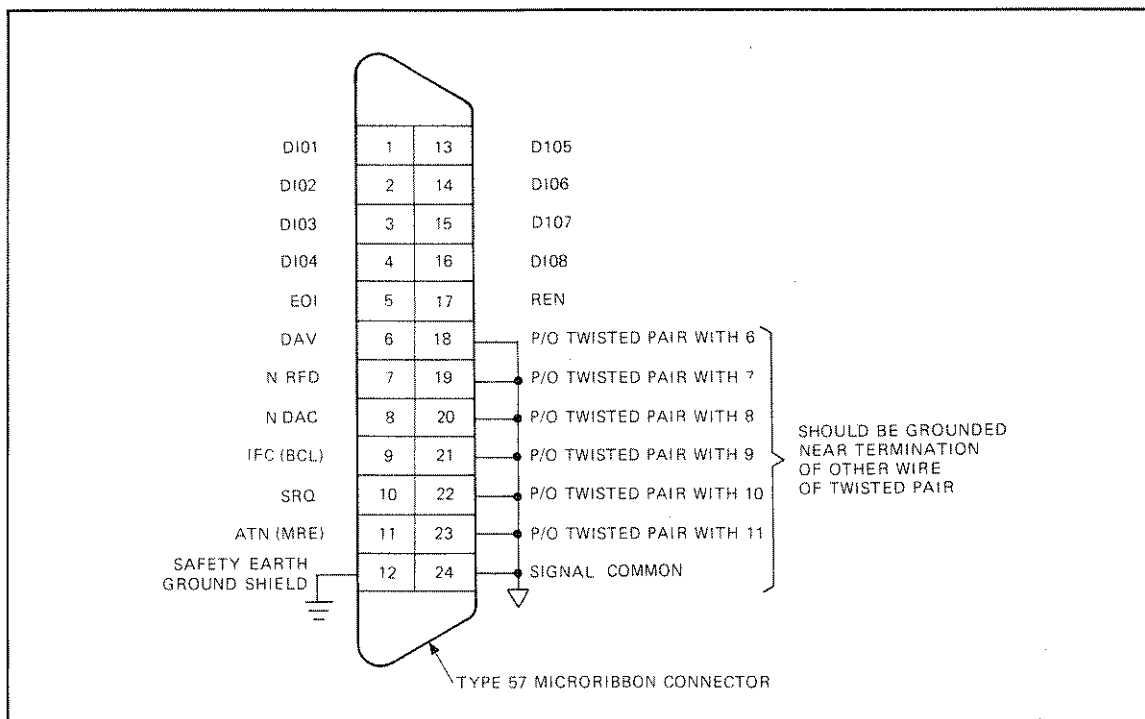

Figure 2-6. HP-IB Interface Cable Connector (Used with Options 001 and 003 Boards)

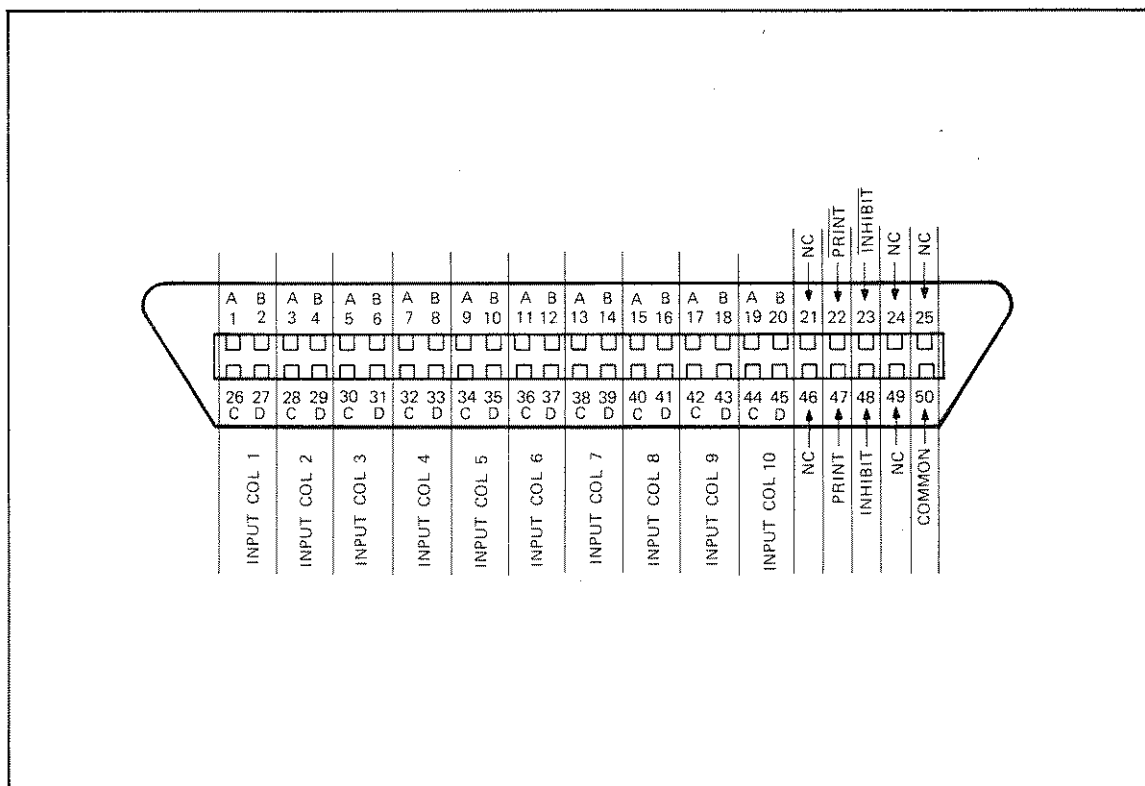
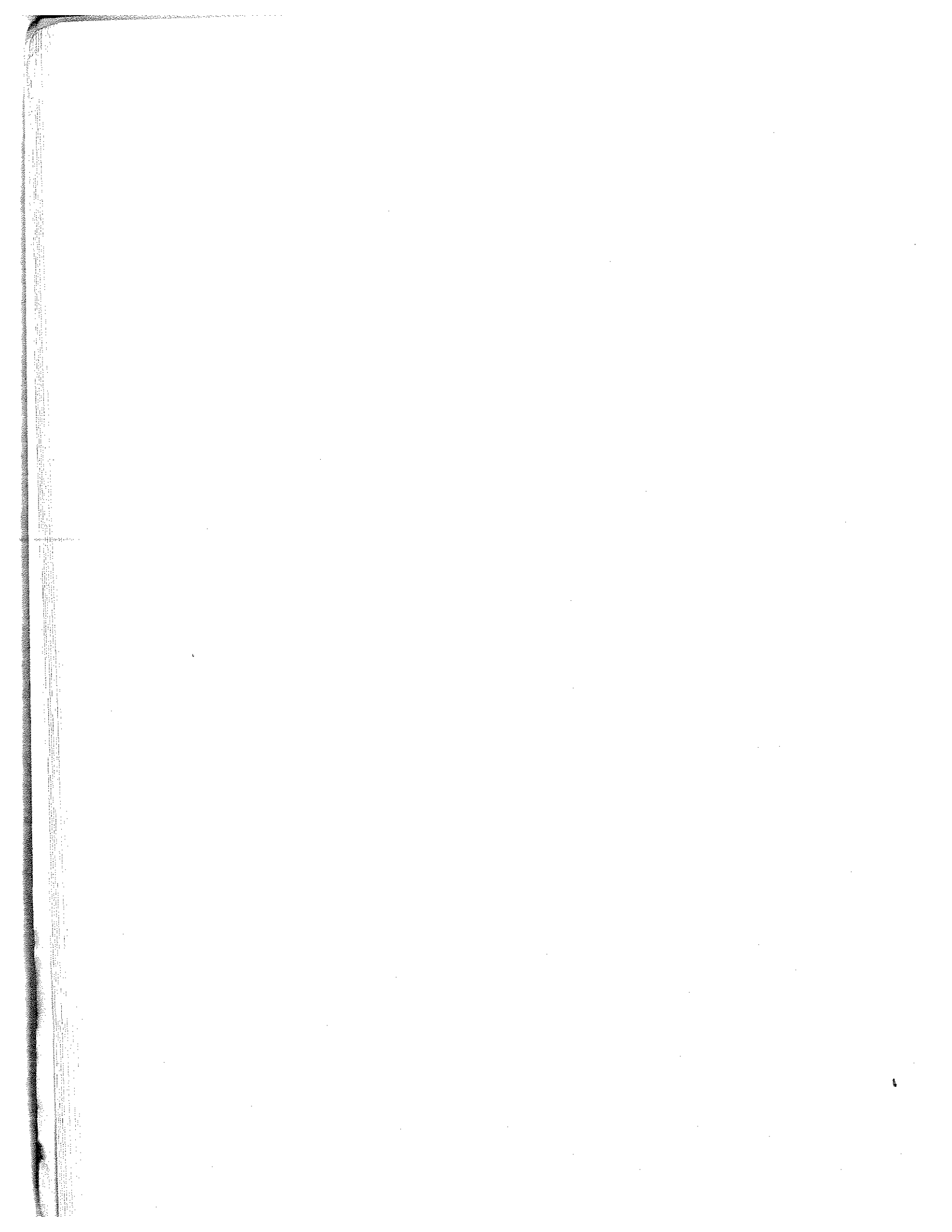

Figure 2-7. BCD Interface Cable Connector (Used with Option 002 Boards)



SECTION III

OPERATING AND PROGRAMMING INFORMATION

3-1. INTRODUCTION

3-2. This section provides operating information for each of the possible 5150A option combinations. The section is organized as follows:

Overview	3-3 through 3-7
Option 001 HP-IB	3-8 through 3-26
Option 002 BCD Interface	3-27 through 3-40
Option 001 and 002 Bilingual	3-41 through 3-42
Option 003 Scanner	3-43 through 3-55
Option 004 Clock	3-56 through 3-63
Option 005 BCD Cable	3-64 through 3-65
Thermal Print Paper Loading	3-66 through 3-72

NOTE

The 5150A Thermal Printer uses TTL levels. Data sent should not exceed +5.5 volts.

3-3. Switch Settings and Connectors

3-4. Each data source used with the Thermal Printer has rear panel switches which must be set. When the source is used one-to-one with the Thermal Printer, the data source Talker should have switches set to the Talk Always mode. When used with other data sources, unique addresses must be assigned via the rear panel switches on each source. The Thermal Printer option board switches must also be set. Check the appropriate paragraphs in Section III.

3-5. A Talker may contain switches to control the cycle rate of the printout. If a Talker does not have such switches and does not have an internally generated cycle rate, the Thermal Printer with clock (Option 004) can initiate a data gathering cycle over the range of three data outputs per second to 2 hours between initiations of the data gathering cycle.

3-6. The printer front and rear panel controls and indicators are illustrated and described by Option in this Section III.

3-7. The pin connections on the HP-IB connector are given in *Figure 2-6*. The BCD Interface pin connections are given in *Table 3-1*, with a drawing of the connector shown in *Figure 2-7*.

3-8. OPTION 001, HP-IB INTERFACE

3-9. This option provides Thermal Printer compatibility with instruments that use the HP-IB.

3-10. This option requires the installation of the HP-IB Interface (Option 001, Part Number 05150-60002) into the 5150A A2 position, and at least one HP-IB cable (Part No. 10631A,B, or C).

Table 3-1. BCD Interface Cable Pin Connections

OPTION 002 INPUT 40-PIN CONNECTOR			
1251-0086 50-Pin Connector		Cable Part Number 562A-16C	
PINS	PRINTER COLUMN	BCD WEIGHT	WEIGHT
1	1	1	10 ⁰ Col. 1
2	1	2	10 ¹ Col. 2
3	2	1	10 ² Col. 3
4	2	2	10 ³ Col. 4
5	3	1	10 ⁴ Col. 5
6	3	2	10 ⁵ Col. 6
7	4	1	10 ⁶ Col. 7
8	4	2	10 ⁷ Col. 8
9	5	1	10 ⁸ Col. 9
10	5	2	10 ⁹ Col. 10
11	6	1	
12	6	2	
13	7	1	
14	7	2	
15	8	1	
16	8	2	
17	9	1	
18	9	2	
19	10	1	
20	10	2	
21	—	—	NC
22 (Sh)	—	—	+Inhibit
23 (Sh)	—	—	+Print Command
24	—	—	NC
25	—	—	NC
26	1	4	10 ⁰ Col. 1
27	1	8	10 ¹ Col. 2
28	2	4	10 ² Col. 3
29	2	8	10 ³ Col. 4
30	3	4	10 ⁴ Col. 5
31	3	8	10 ⁵ Col. 6
32	4	4	10 ⁶ Col. 7
33	4	8	10 ⁷ Col. 8
34	5	4	10 ⁸ Col. 9
35	5	8	10 ⁹ Col. 10
36	6	4	
37	6	8	
38	7	4	
39	7	8	
40	8	4	
41	8	8	
42	9	4	
43	9	8	
44	10	4	
45	10	8	
46	—	—	NC
47 (Sh)	—	—	-Inhibit
48 (Sh)	—	—	-Print Command
49	—	—	NC
50	—	—	Ground

NC = No connection
 (SH) = Shielded

3-11. Print Format

3-12. The 5150A has a total of 64 print characters which includes 26 upper-case alphabetic characters. See *Table 3-2* (columns 2 through 5 rows, 0 through 15) for a list of the print characters.

3-13. The Thermal Printer may print a maximum of 20 characters for each print command (CR or LF) received. Twenty characters fill the HP-IB Interface Board Register and are subsequently printed on their thermal print paper as follows:

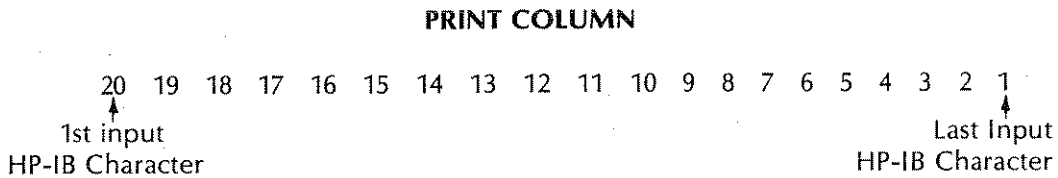

3-14. The Thermal Printer is structured for right-justified print operations. For example, if only 10 HP-IB characters are sent, the first input character is printed in column 10; while the last HP-IB character received is printed in column one. Columns 11 through 20 will remain blank. If more than 20 HP-IB characters are applied, the HP-IB Interface Board Register will overflow, and the first input characters will be lost. For example, if 22 characters precede the print command, the first and second characters are lost and all subsequent characters are printed with the third character printed in column 20 and the last (22nd) HP-IB character printed in column one.

3-15. In addition to ASCII-coded character data, the HP-IB Interface exchanges address, command, and Bus management information.

3-16. Controls and Indicators

3-17. *Figure 3-1* shows the controls and indicators of the Option 001 Board and provides a brief description of the functions of each.

Table 3-2. American Standard Code for Information Interchange (ASCII)

The 5150A uses only those commands and characters that are shaded.

NOTE
Negative true logic codes:

1 <.4 Volts
0 >2.4 volts

STANDARD CODE	DATA LINE	ADDRESS SWITCH
b ₁ =	DIO1 =	A1
b ₂ =	DIO2 =	A2
b ₃ =	DIO3 =	A3
b ₄ =	DIO4 =	A4
b ₅ =	DIO5 =	A5
b ₆ =	DIO6 =	A6
b ₇ =	DIO7 =	A7

USA STANDARD CODE FOR INFORMATION INTERCHANGE

BITS					0 0 0	0 0 1	0 1 0	0 1 1	1 0 0	1 0 1	1 1 0	1 1 1
b ₄	b ₃	b ₂	b ₁	COLUMN ROW	0	1	2	3	4	5	6	7
0	0	0	0	0	NUL	DLE	SP	0	@	P	\	p
0	0	0	1	1	SOH	DC1	!	1	A	Q	a	q
0	0	1	0	2	STX	DC2	"	2	B	R	b	r
0	0	1	1	3	ETX	DC3	#	3	C	S	c	s
0	1	0	0	4	EOT	DC4	\$	4	D	T	d	t
0	1	0	1	5	ENQ	NAK	%	5	E	U	e	u
0	1	1	0	6	ACK	SYN	&	6	F	V	f	v
0	1	1	1	7	BEL	ETB	'	7	G	W	g	w
1	0	0	0	8	BS	CAN	(8	H	X	h	x
1	0	0	1	9	HT	EM)	9	I	Y	i	y
1	0	1	0	10	LF	SUB	*	.	J	Z	j	z
1	0	1	1	11	VT	ESC	+	,	K	[k	{
1	1	0	0	12	FF	FS	.	<	L	\	l	
1	1	0	1	13	CR	GS	-	=	M]	m	}
1	1	1	0	14	SO	RS	.	>	N	↑	n	~
1	1	1	1	15	SI	US	/	?	O	—	o	DEL

UNIVERSAL ADDRESS COMMANDS

LISTEN ADDRESSES

TALK ADDRESSES

*When ATN is low:
 “?” becomes an UNLISTEN command
 “_” becomes an UNTALK command
 †“LF” and “CR” are print commands (ATN must be high and the 5150A must be “Listening” to the Bus). They are the only Universal Address Commands used.

DATA WHEN ATN IS HIGH.
 ADDRESSES WHEN ATN IS LOW.

NOTE

In a multi-instrument single-bussed situation, each instrument requires an address for bus identification. Bits A5, A4, A3, A2, and A1 provide 29 unique addresses. All ones, all zeros and 00001 are not permitted as instrument addresses.

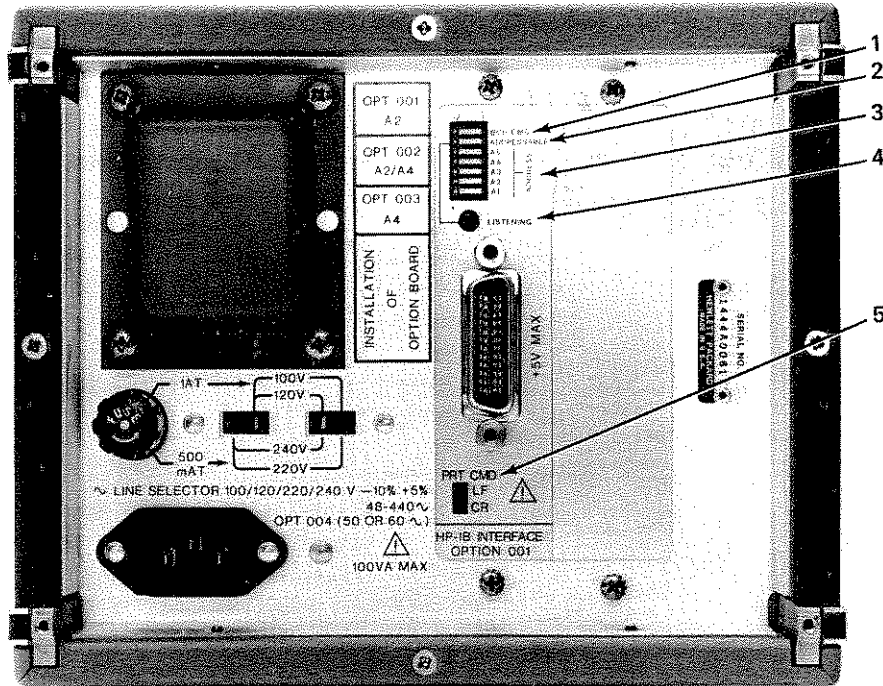

	CONTROL/INDICATOR	POSITION	FUNCTION
1	BCD CMD Switch	"1" or "0"	Used for combined HP-IB and BCD operation (Bilingual). Selects which print command the 5150A responds to. With just Option 001, BCD CMD switch position is irrelevant.
2	ADDRESSABLE Switch	"1"	The 5150A will respond to input commands and data only after the correct listen address is applied. The correct address matches the settings of ADDRESS switches A1 through A5.
		"0"	The 5150A is always "listening" to the HP-IB. As a result, the instrument responds to ASCII data and HP-IB command inputs without a prerequisite listen address.

Figure 3-1. Option 001 HP-IB Interface Board Controls and Indicators

	CONTROLS/INDICATOR	POSITION	FUNCTION
3	ADDRESS Switches	"1" or "0"	<p>These switches provide the Thermal Printer with a unique five-bit listen address which usually is used when more than one listener is on the HP-IB. In this multi-instrument single-bussed situation, each instrument requires an address for bus identification. In this parallel connected HP-IB system more than one instrument may be assigned the same listen address. Up to 31 HP-IB listen addresses are available to the 5150A user (refer to <i>Table 3-2</i> columns 2 and 3).</p> <p style="text-align: center;">NOTE</p> <ol style="list-style-type: none"> 1. These switches affect 5150A/HP-IB operation only when the ADDRESS-ABLE switch is in the "1" position. 2. When the 5150A uses the Scanner Option (Option 003), the ADDRESS-ABLE switch is placed in the "0" position, and these ADDRESS switches are not used.
4	LISTENING Lamp	ON	<p>Indicates that the 5150A is receptive to HP-IB data and commands as a result of either of the following conditions:</p> <ol style="list-style-type: none"> a. The ADDRESSABLE switch is in the "0" position. b. The correct listen address has been received.
		OFF	<p>Indicates the the 5150A is not receptive to HP-IB data and commands because the ADDRESS-ABLE switch is in the "1" position and the correct listen address has not been received.</p>
5	PRT CMD Switch	LF	<p>The 5150A prints as a result of an ASCII "LF" character input.</p>
		CR	<p>The 5150A prints as a result of an ASCII "CR" character input.</p> <p style="text-align: center;">NOTE</p> <p>These are the only two options available to indicate end of character input.</p>

Figure 3-1. Option 001 HP-IB Interface Board Controls and Indicators (Continued)

3-18. HP-IB Systems

3-19. For the purpose of illustration two basic systems using an HP-IB configured 5150A Thermal Printer are examined. The first system deals with the data source and the 5150A on a one-to-one basis. Figure 3-2 provides an example of this configuration and describes typical set-up considerations. Figure 3-3 shows a general multidata sources arrangement, with a desk top calculator acting as system controller and the 5150A recording solicited data. Also described are typical desk top calculators (9820A and 9830A) command formats for programming the transferring and printing of characters from the data sources to the HP-IB configured Thermal Printer.

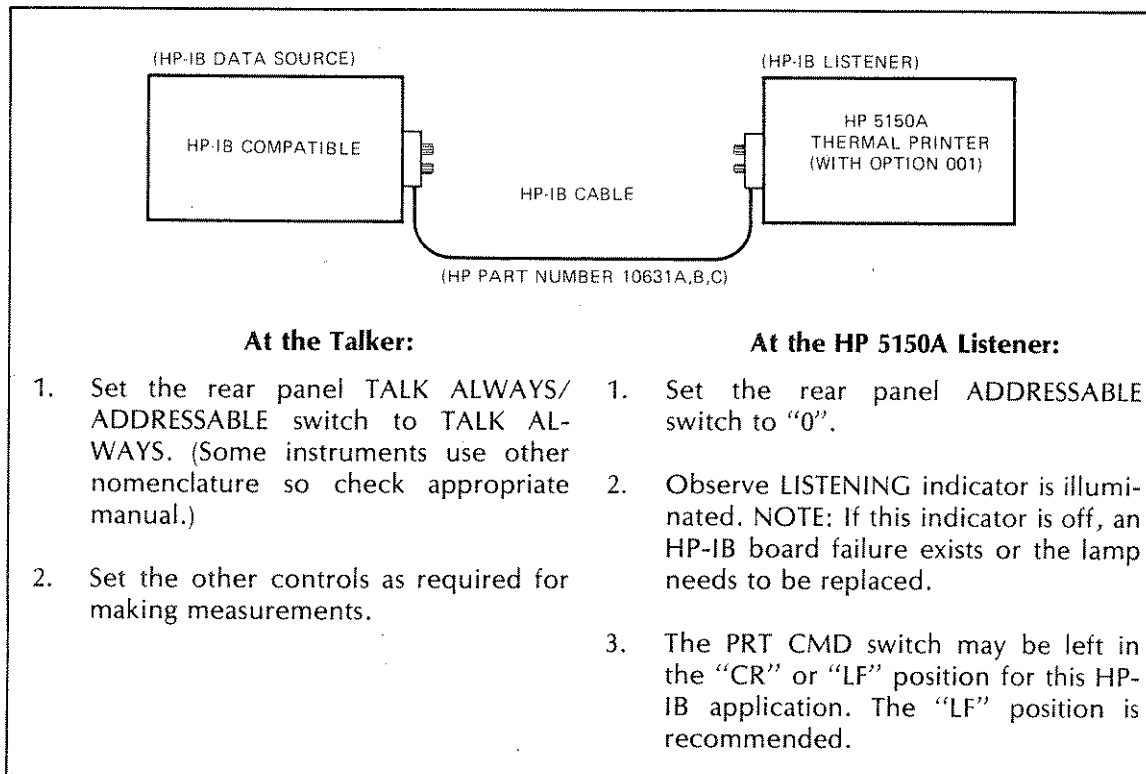

Figure 3-2. HP-IB Compatible Data Source with 5150A Thermal Printer as Listener

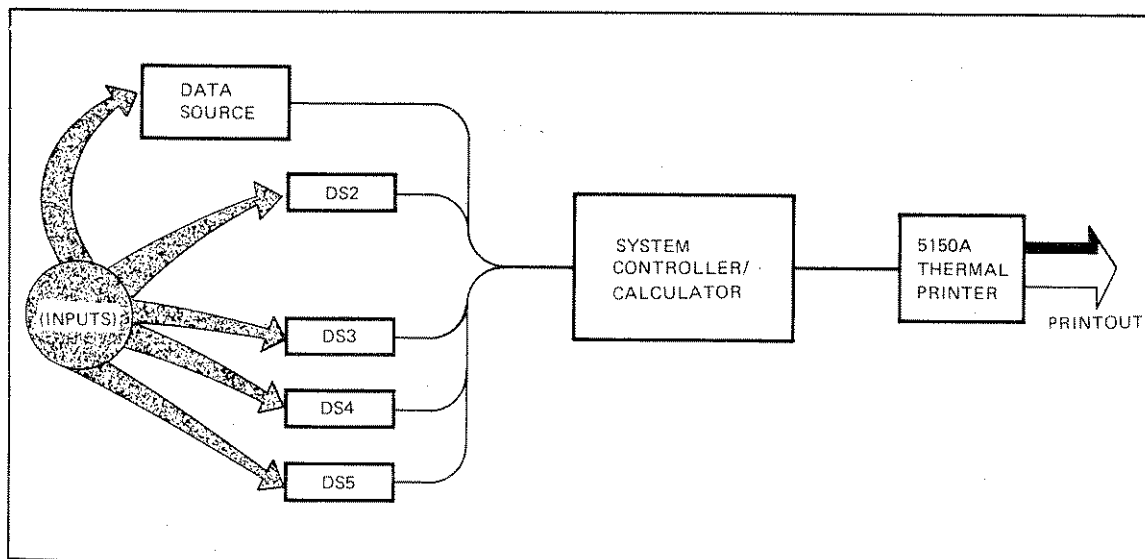

Figure 3-3. HP-IB Compatible Data Sources Controlled by Desk Top Calculator Used with 5150A Thermal Printer

3-20. System Configuration

3-21. HP-IB system devices may be interconnected in any configuration. The only requirement is that there must be some path from the calculator through bus cables to every device that will operate on the bus.

3-22. HP-IB Cable

3-23. Cable length restrictions imposed by the HP-IB electronics dictate that on the average no more than two metres of cable length connect any two instruments and that no more than 20 metres of HP-IB cable be in any one system. For example, in the system of *Figure 3-3* seven instruments restrict the total cable length to 14 metres.

3-24. The HP-IB cables use the same piggyback connection on both ends (see *Figure 3-4* for details of connector). They are easily stacked on another to allow more than one cable to connect to a single source without the need for special Y's, T's, or switch boxes.

NOTE

Avoid stacking more than three cables on any one connector. A stack produces leverage on the connector and can damage the connector mounting.

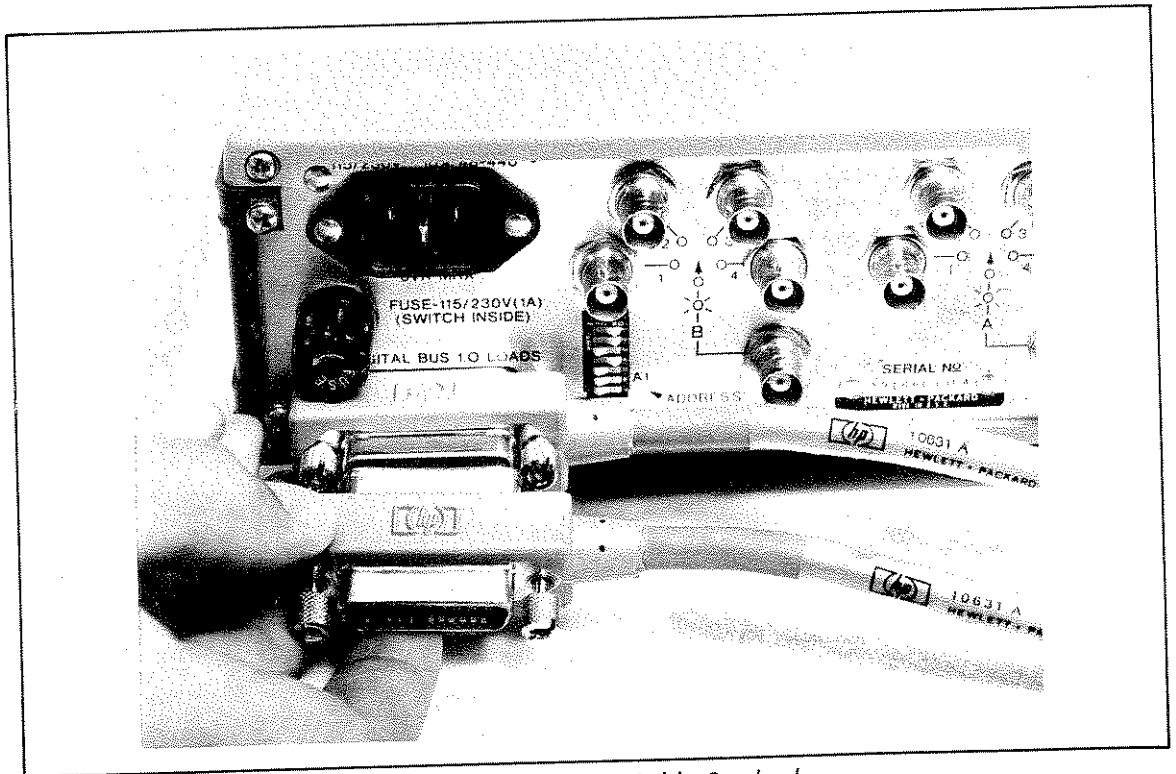

Figure 3-4. HP-IB Cable Stacked

3-25. The cables are available in lengths of 1, 2, and 4 metres with HP Part Numbers 10631A, B, and C, respectively.

3-26. A sample 9830A calculator program to control an HP-IB compatible instrument (Talker) and the 5150A Thermal Printer (Listener) is explained in *Table 3-3*. If a Talker is unavailable *Table 3-4* provides a program using just the 5150A with a 9830A calculator. Either set-up will test the Thermal Printer.

Table 3-3. Sample 9830A Program to Control HP-IB Talker and Thermal Printer

10 CMD "?E5"

"?" is the UNLISTEN command that clears all listeners from the Bus. "E" addresses Talker E to send data. Talker E has had its addressable switch set true and its five address switches are set to E in ASCII code

(0 0 1 0 1)
A5 A4 A3 A2 A1

"5" address Listener 5 (always Calculator-Controller) to listen (i.e., accept data).

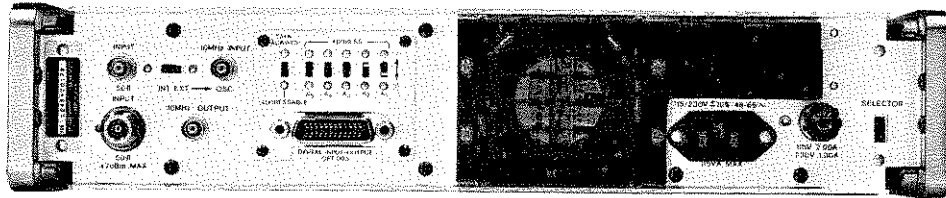

Figure 3-5. Switch Panel on 5340A

20 FORMAT 2B, E12.5

The format statements specifics will depend on the output from the Talker. The Talker's output format must be known. B accepts an alpha byte. E12.5 is a floating point number with a total of 12 digits, 5 digits to the right of the decimal point. (A field at least as large as the expected data string is necessary).

30 ENTER (13,20) A, B, C

Receive from Talker via HP-IB (13) data for the calculator according to format statement 20 and store the three bytes into calculator registers A, B, and C.

40 PRINT A, B, C

If uncertain what is being stored into calculator, use PRINT to list contents of storage registers.

50 CMD "?U1"

After clearing all LISTENERS from the Bus by "?", the Calculator is addressed to be LISTENER ("U" always reserved for Calculator listen address) and the Thermal Printer with switches set as in Figure 3-6 is addressed to be LISTENER.

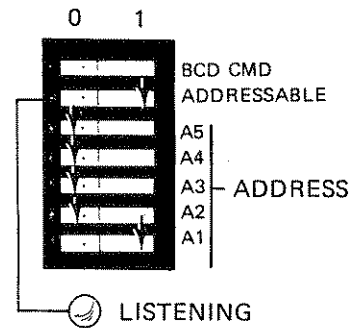

Figure 3-6. 5150A Rear Panel Switch Settings

Table 3-3. Sample 9830A Program to Control HP-IB Talker and Thermal Printer (Continued)

60 FORMAT "1234X FREQ ="	If you wish the Talker instrument be labeled on the Thermal Printer output use the format statement with what you wish to appear on the printout in quotation marks. (Note character restrictions in Calculator programming manual.)
70 OUTPUT (13,90) A, C	Send to LISTENER via HP-IB (13) the information stored in registers listed according to Format statement 90. (NOTE: the Format statement may occur before or after the output statement which uses it.)
80 OUTPUT (13,60)	Send to LISTENER via HP-IB the Format statement listed. NOTE: the command to print the instrument name follows the data from that instrument so that the identifier will be printed above the data. The Thermal Printer prints from bottom to top of paper output. (See output example below.)
90 FORMT B, E18.9	The second alpha stored from Talker is not printed. The E field is at least as large as field used to record data originally.
100 END	All Calculator programs must be terminated with an END statement.

For a 5340A frequency counter used with the 5150A Thermal Printer and the 9830A Calculator a sample program follows in Figure 3-7.

THE OUTPUT
FROM THIS
PROGRAM IS

```
10 CMD "?E5"
20 FORMAT 20,E12.5
30 ENTER (13,20)A,B,C
40 PRINT A,B,C
50 CMD "?U1"
60 FORMAT "5340A FREQ ="
70 OUTPUT (13,90)A,C
80 OUTPUT (13,60)
90 FORMAT B,E18.9
100 END
```

5340A FREQ =
3.020091000E+09

Figure 3-7. 9830A Program to Exercise 5150A with HP-IB Compatible Instrument

Table 3-4. 9830A Program to Exercise 5150A

5150A must be in Listening mode (ADDRESSABLE switch set to "0")		
<pre> 10 CMD "?U" 20 X=1 30 OUTPUT (13)+X 40 X=X+1 50 WAIT 3000 60 GOTO 30 70 END </pre>	<pre> 07:31:26 07:31:23 07:31:21 07:31:18 07:31:16 07:31:13 07:31:10 07:31:08 </pre>	<pre> 8 7 6 5 4 3 2 1 </pre>
9830A Program to exercise 5150A		Printout

3-27. OPTION 002 BINARY CODED DECIMAL (BCD)

3-28. This option provides Thermal Printer compatibility with instruments that use the $\pm 8 4 2 1$ BCD.

3-29. Hardware Requirements

3-30. This option requires the installation of at least one BCD Board (Option 002, part number 05150-60005) and one BCD cable (part number 562A-16C). When only one BCD board is installed, the A2 or A4 position may be used. With two BCD boards for 20 columns of output, the A4 position outputs data to the 10 left columns (i.e., columns 11 through 20) of the thermal print paper and the A2 position outputs the BCD data to columns 1-10. A full 20-column print format as shown below requires two BCD boards, and two BCD cables. Cross reference this illustration with Figure 2-7 (Section II of this manual) to find specific BCD cable pin allocations for a given input column.

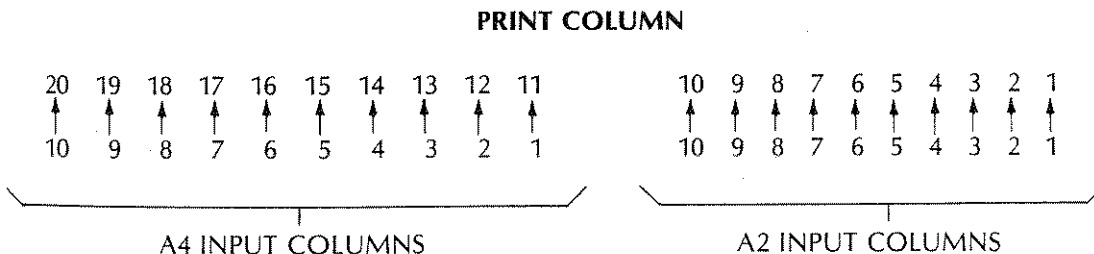

3-31. Print Format

3-32. Table 3-5 lists the standard characters that are printed in response to the 4-bit binary code input. (Special characters necessitate ordering special BCD translator ROMs from HP.) The BCD board accommodates both positive true or negative true 8 4 2 1 logic as determined by the rear panel switches (see Controls in Figure 3-8).

3-33. BCD Bus data transfer is accomplished with a handshake comprised of two command lines:

- a. PRINT — This line permits the Data Source to initiate the 5150A print operation. The 5150A responds to either a positive true, or negative true PRINT command.
- b. INHIBIT — This line is driven true by the 5150A to prevent the instrument (i.e., Data Source) from changing the BCD data while the print operation is being performed. The Thermal Printer drives the INHIBIT signal false allowing the Data Source to renew the data input. The 5150A provides both negative true and positive true INHIBIT signals.

3-34. Unlike the HP-IB bit parallel, byte serial character transmission, the BCD sends ALL characters simultaneously to the 5150A. With two BCD boards installed, 20 characters are applied to the Thermal Printer input simultaneously.

3-35. Special BCD Format; Firmware Options

3-36. For a BCD user who wants data recorded in a special pattern on the thermal print paper, or who requires characters that are not part of the standard code shown on Table 3-5; special options are available. Specially ordered BCD boards may be configured to provide:

- a. Placement of the input data into any selected print column or columns. For example, a character applied to input column 10 of A4 may be printed in column 2 of the thermal print paper or in more than one column (a standard BCD Board prints this character in column 20 of the thermal print paper).
- b. Special interpretations of the input code into any one of 64 available ASCII characters (see Table 3-2 for permitted characters).

Table 3-5. Standard BCD Character Codes

STANDARD PRINT CHARACTER	*CODE			
	D	C	B	A
0	0	0	0	0
1	0	0	0	1
2	0	0	1	0
3	0	0	1	1
4	0	1	0	0
5	0	1	0	1
6	0	1	1	0
7	0	1	1	1
8	1	0	0	0
9	1	0	0	1
+	1	0	1	0
-	1	0	1	1
V	1	1	0	0
A	1	1	0	1
R	1	1	1	0
BLANK	1	1	1	1

* Negative True Logic:
 1 = approx. <.4 volts
 0 = approx. >.4 volts

Positive True Logic:
 1 = approx. >.4 volts
 0 = approx. <.4 volts

Bit Weight:
 D C B A
 2^3 2^2 2^1 2^0
 8 4 2 1

3-37. BCD Controls

3-38. Figure 3-8 shows the controls of the BCD Interface board and provides a brief description of each.

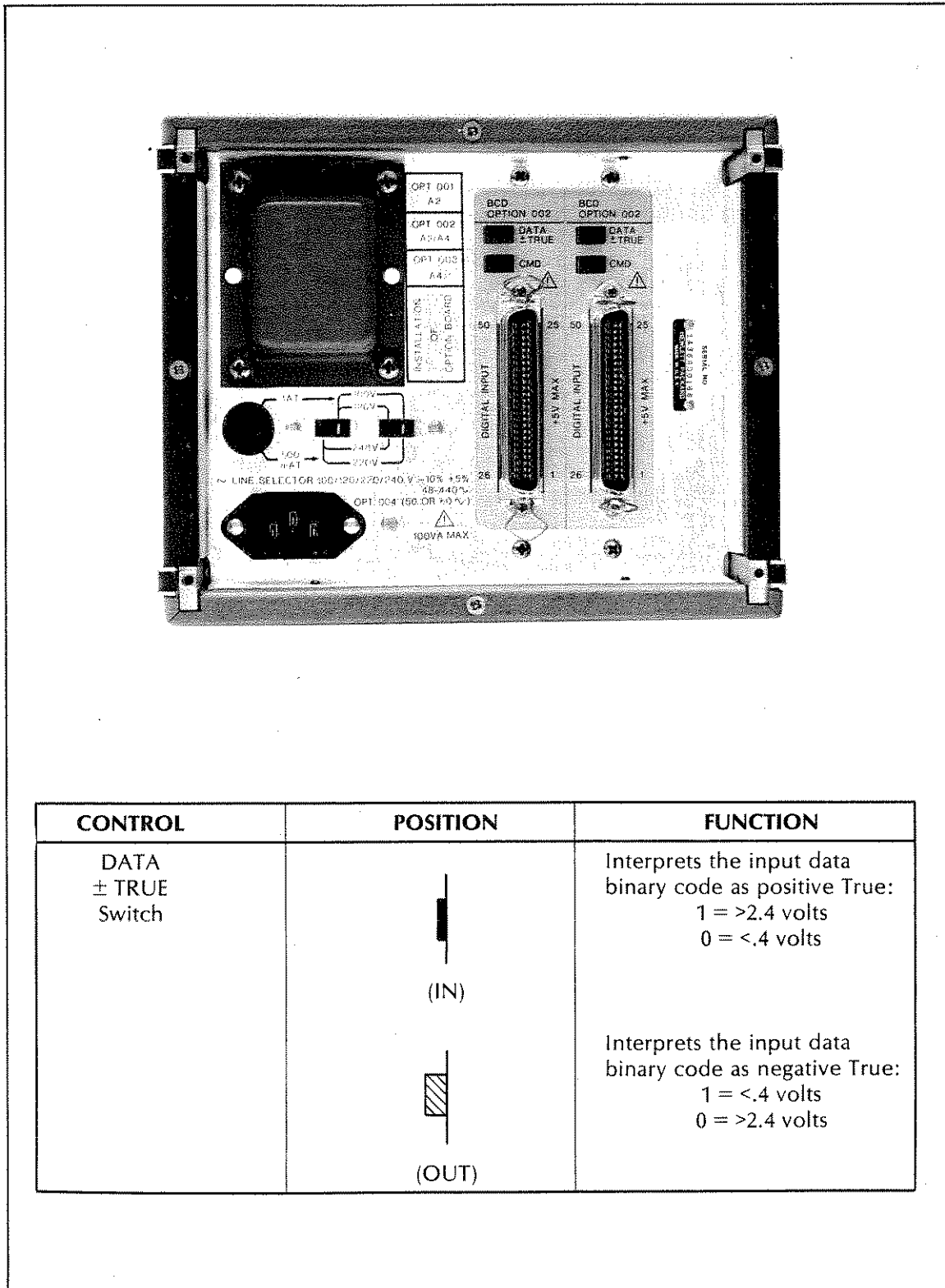











CONTROL	POSITION	FUNCTION
DATA ± TRUE Switch	 (IN)	Interprets the input data binary code as positive True: 1 = >2.4 volts 0 = <.4 volts
	 (OUT)	Interprets the input data binary code as negative True: 1 = <.4 volts 0 = >2.4 volts

Figure 3-8. Option 002 BCD Board Controls

CONTROL	POSITION		FUNCTION
	A2 BOARD	A4 BOARD	
CMD Switch	 (OUT)	 (OUT)	The print operation is initiated by an input PRINT command to <i>either</i> BCD Interface Board
	 (OUT)	 (IN)	The print operation is initiated by an input PRINT command to the A2 BCD Interface Board <i>ONLY</i> .
	 (IN)	 (OUT)	The print operation is initiated by an input PRINT command to the A4 BCD Interface Board <i>ONLY</i> .
	 (IN)	 (IN)	The print operation is initiated only when input PRINT commands are applied to <i>BOTH</i> the A2 and A4 BCD Interface Boards. (Both switches in the IN position are normal for use with two BCD options boards.)

NOTE

It is possible for the instrument sending to the A2 position (or A4 position) to be inhibited from new data measurements until the other instrument sending data to A4 (or A2) sends a print command.

NOTE: With only one Option 002 the CMD switch setting is irrelevant

Figure 3-8. Option 002 BCD Interface Board Controls (Continued)

3-39. BCD Systems

3-40. Any 10-column BCD $\pm 8 4 2 1$ compatible instrument may be used with 5150A Thermal Printer. Configured with two Option 002 boards and two BCD general purpose cables (Option 005), two BCD either $\pm 8 4 2 1$ compatible instruments may be used.

3-41. COMBINED HP-IB (OPTION 001)/BCD (OPTION 002), BILINGUAL OPERATION

3-42. The HP-IB Board and the BCD Board may be installed to provide bilingual operation. This operation allows data from an HP-IB data source to be printed with data from a BCD data source. Bilingual operation requires that the BCD board be installed in the A4 position, and the HP-IB Interface board be installed in the A2 position. *Figure 3-11* shows the Interface board controls including the switch arrangements that determine which data source initiates the print operation. *Figure 3-9* shows the bilingual print format and *Figure 3-10* illustrates a typical bilingual system configuration.

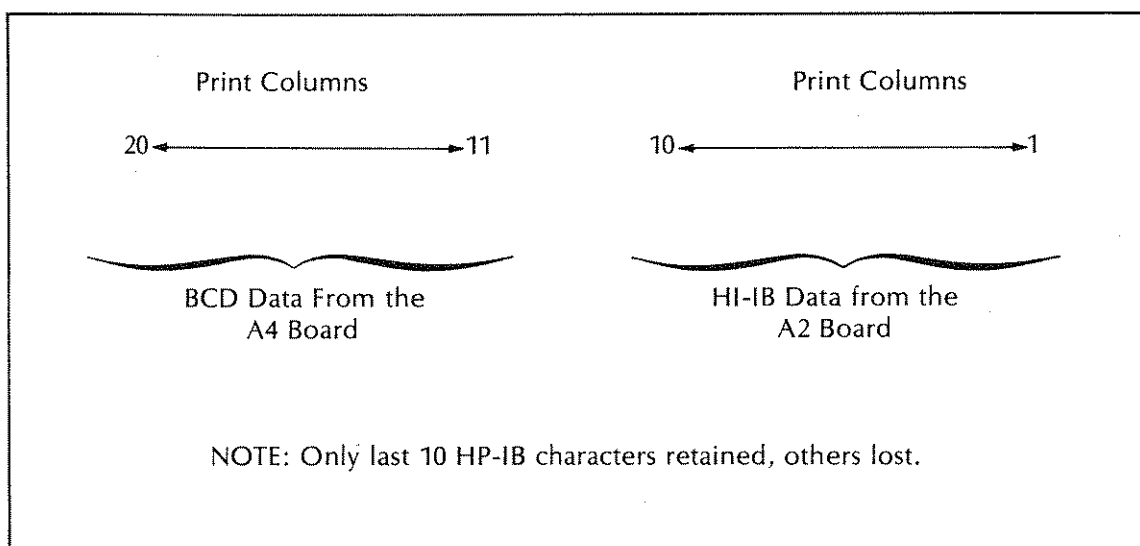

Figure 3-9. Bilingual Print Format

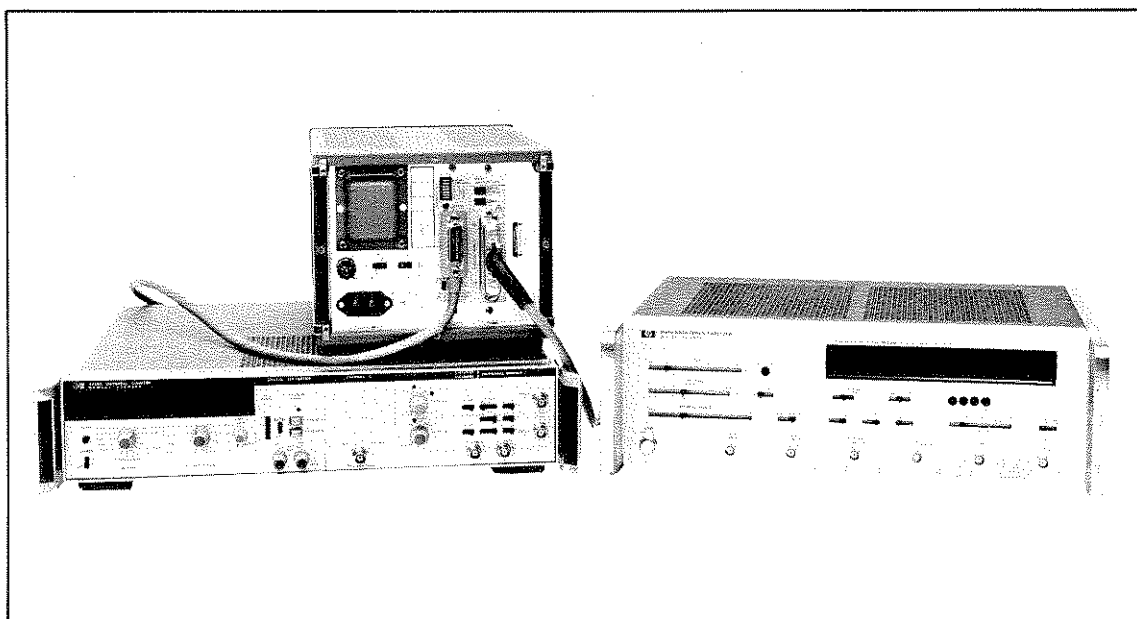
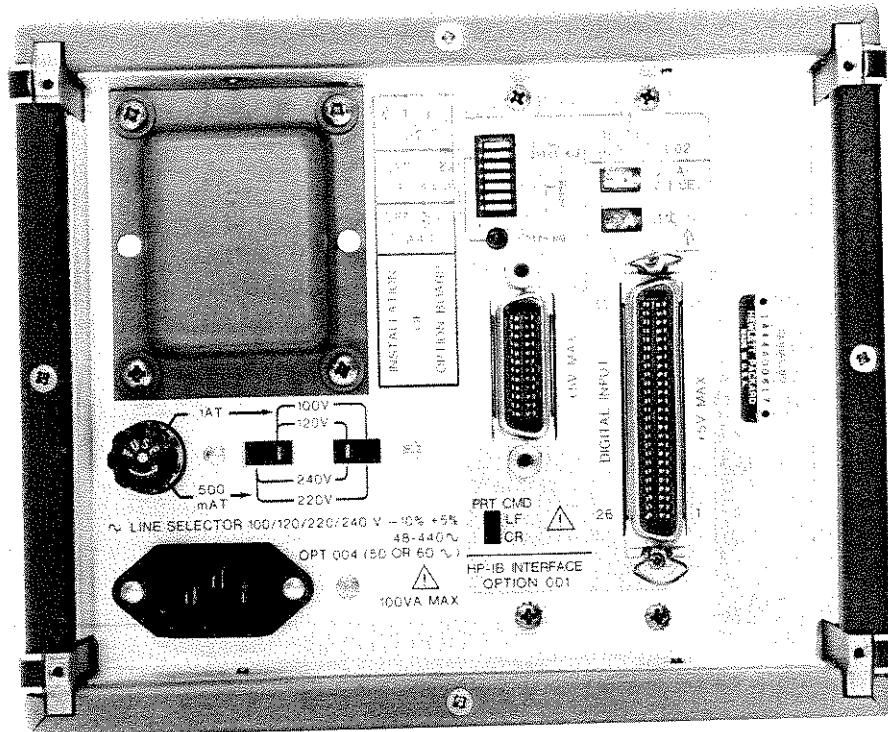

Figure 3-10. Typical Bilingual System Configuration



**A2 HP-IB Interface
 Board Control
 BCD CMD Switch**

**A4 BCD Interface
 Board Control
 CMD Switch**

Remarks

"1"

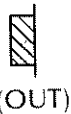

Print operation initiated by either HP-IB or BCD input print command.

"1"



Print operation initiated upon receipt of the HP-IB print command only.

"0"



Print operation initiated upon receipt of the BCD print command only.

"0"



Print operation initiated only when both BCD and HP-IB Interface print commands received. BCD print command must be received before HP-IB command or another HP-IB print command must occur.

Figure 3-11. Combined HP-IB (Option 001)/BCD (Option 002) Bilingual Print Control

3-43. OPTION 003 SCANNER

3-44. The Option 003 Scanner Board may be added to the HP-IB Interface-configured Thermal Printer to provide an automatic bus addressing and bus management capability. This combination of Option 003 with Option 001 (HP-IB Interface) provides an economical alternative to a calculator-controlled system. The Scanner Board however does not provide:

- a. A detailed printout that can be provided by a calculator. For example, the calculator can provide the literal "5340A FREQ=" (see *Figure 3-7*) whereas the Scanner is limited to identifying the data source with one alphabetic character printed in column 20 of the thermal print paper.
- b. Flexibility in processing of data source information prior to printing. For example, a calculator may combine parameter variables from a multi-instrument system and send the arithmetic solutions to the 5150A for printing.

NOTE

The HP Interface Bus cannot accommodate two controllers simultaneously. Therefore, do not connect a Calculator Controller and a Scanner Board to the bus at the same time.

3-45. The scanning mode is asynchronous; that is, the Scanner does not trigger each instrument's measurement but rather waits for the instrument to provide data within its own measurement cycle. When a scan begins, the Scanner will address the first instrument, wait for data from that instrument, print the data, and then address the next instrument. After the last instrument in the configuration has been interrogated, the Scanner will return to the first instrument again. The length of a scan cycle is therefore determined by the response of the instruments in the system. If an instrument fails to respond when interrogated, the Scanner may be instructed via the PROTECT switch to wait for 3 seconds and then go to the next instrument. If the PROTECT switch is not set, the Scanner will wait until the instrument responds. If the Clock options is installed the Data Print Interval setting will affect the scan cycle. Paragraph 3-47 explains in detail.

3-46. The Scanner Board allows the user to sequentially address and accept data from up to 13 instruments on the HP Interface Bus. In this way, it acts as a data acquisition controller on the Bus. No other controller is allowed on the Bus when the Scanner is used. *Figure 3-12* below shows a typical data logging system employing the Scanner.

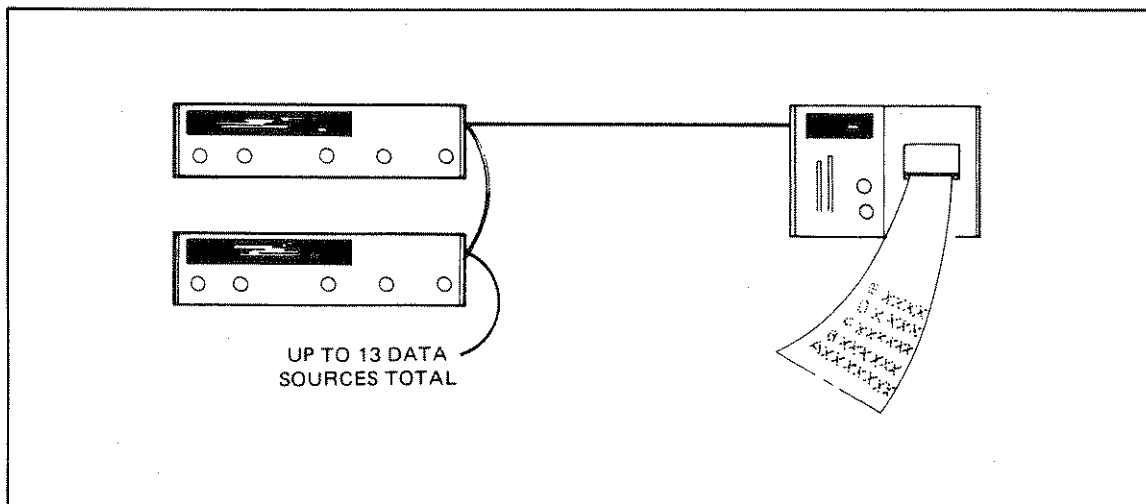

Figure 3-12. 5150A Thermal Printer with Option 003 Scanner Operates as a Data Logging System on the HP Interface Bus

3-47. With the Option 004 Clock installed, the Thermal Printer with Scanner becomes a versatile data acquisition system. A time interval may be set on the Clock using the Data Print Interval switch. This controls initiation of the scanning cycle. This interval ranges from three printouts per second to one printout every 2 hours. There is a case in which the scanning cycle would not be initiated at the time interval set on the clock front panel. This would occur when the time necessary to complete the Scan is greater than the interval set by the clock. For example, if the clock is set to initiate a scan cycle every 10 seconds and the actual time necessary to complete the cycle is 12 seconds, then a scan cycle would be initiated every 20 seconds. With the same 10 second clock interval, if the scanning operation took exactly 1 hour, a scan cycle would be initiated every 1-hour and 10 seconds.

3-48. The clock time is printed at the conclusion of the scan cycle unless it is disabled by the front panel control switch. It occupies columns 13-20 and blanks columns 11 and 12.

3-49. If the operator wishes to distinguish data from various sources, the Scanner can print an alpha identifier next to the data from each source.

3-50. Scanner System

3-51. The scanner board may address up to 13 data sources. The data sources are:

- a. TTL compatible.
- b. HP-IB compatible.
- c. Capable of sending data when addressed.
- d. Capable of sending a "LF" or "CR" signal at the end of the data message.
- e. Able to disconnect from the bus when no longer addressed.

3-52. Scanner Board Operation

3-53. The Scanner Board generates a sequence of either all odd, or all even Talk Addresses. As a result, data sources controlled by the Scanner must have their address switches set to all odd, or all even numbers, as shown in *Table 3-6*. All zeros and decimal 1 are illegal so the first permitted even address is "00010", decimal 2, and the first legal odd address is "00011", decimal 3.

NOTE

Set the Even/Odd switch at the rear of the 5150A Scanner Board according to whether data source addresses are even (0) or odd (1).

Table 3-6. Scanner System Data Source Address Selection

SEQUENCE OF DATA SOURCES (IDENT PRINTOUT)	CORRECT DATA SOURCE ADDRESS (EQUIVALENT ASCII CHARACTER IS IN PARENTHESIS)											SCANNER BOARD "NO. OF INPUTS"				
	ODD ADDRESSES					EVEN ADDRESSES						SWITCH SETTINGS				
	A5	A4	A3	A2	A1		A5	A4	A3	A2	A1		A4	A3	A2	A1
1st (A)	0	0	0	1	1	(C)	0	0	0	1	0	(B)	0	0	0	1
2nd (B)	0	0	1	0	1	(E)	0	0	1	0	0	(D)	0	0	1	0
3rd (C)	0	0	1	1	1	(G)	0	0	1	1	0	(F)	0	0	1	1
4th (D)	0	1	0	0	1	(I)	0	1	0	0	0	(H)	0	1	0	0
5th (E)	0	1	0	1	1	(K)	0	1	0	1	0	(J)	0	1	0	1
6th (F)	0	1	1	0	1	(M)	0	1	1	0	0	(L)	0	1	1	0
7th (G)	0	1	1	1	1	(O)	0	1	1	1	0	(N)	0	1	1	1
8th (H)	1	0	0	0	1	(Q)	1	0	0	0	0	(P)	1	0	0	0
9th (I)	1	0	0	1	1	(S)	1	0	0	1	0	(R)	1	0	0	1
10th (J)	1	0	1	0	1	(U)	1	0	1	0	0	(T)	1	0	1	0
11th (K)	1	0	1	1	1	(W)	1	0	1	1	0	(V)	1	0	1	1
12th (L)	1	1	0	0	1	(Y)	1	1	0	0	0	(X)	1	1	0	0
13th (M)	1	1	0	1	1	([1	1	0	1	0	(Z)	1	1	0	1

These addresses are illegal when using the Scanner Board:

CHARACTER	A5	A4	A3	A2	A1
@	0	0	0	0	0
A	0	0	0	0	1

3-54. Set the ADDRESSABLE switch on the HP-IB Interface Board to "0". This causes the HP-IB Interface Board "LISTENING" indicator to be illuminated at all times and the printer is capable of accepting data whenever sent.

3-55. Scanner Board switches, as well as related HP-IB Interface switches are shown in Figure 3-13. Also included are brief descriptions of the functions these switches provide. Figure 3-14 shows a typical four-talker data acquisition system. Figure 3-15 gives the details of the thermal printer board and the data sources boards setup.

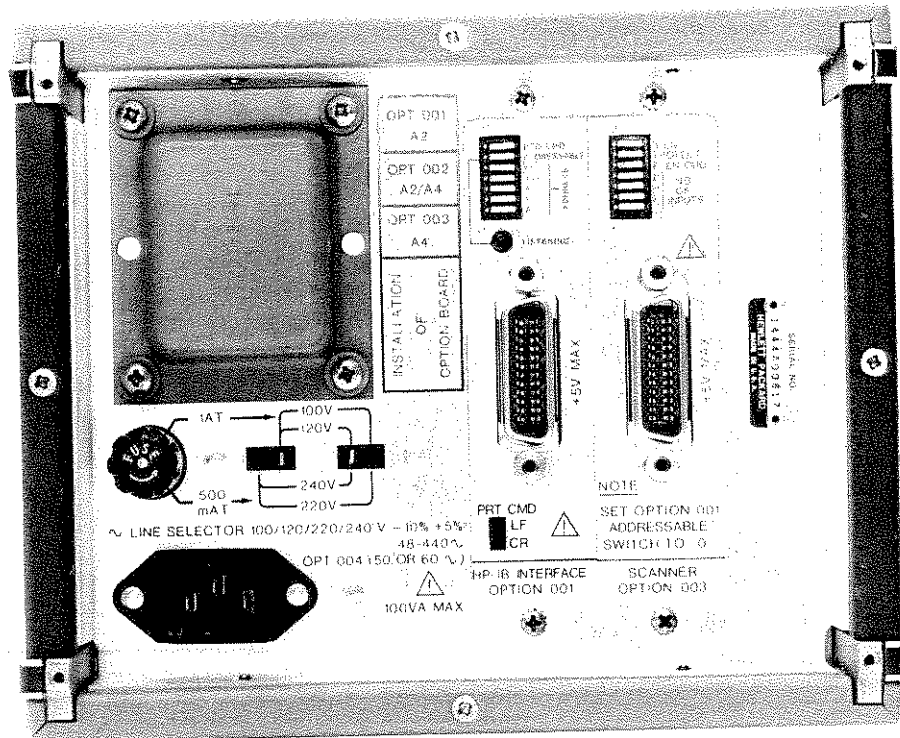

CONTROL	POSITION	FUNCTION
Scanner Board IDENT Switch	"1"	Provides an alphabetic character (in print column 20) to identify the data source on the thermal paper. NOTE The data source character normally printed in column 20 is pre-empted by the ident character.
	"0"	Defeats the ident function described above. Print column 20 will have the data source character.
Scanner Board PROTECT Switch	"1"	Provides a 3-second "waiting period" after a data source (talker) is addressed. If after the "waiting period", a print command is not received from this data source, the 5150A generates its own print command, then addresses the next sequential data source to talk.
	"0"	Defeats the protect function described above. Failure to receive a print command from a data source now stops the HP-IB scanner operation.
Scanner Board EVEN/ODD Switch	"1"	ODD — Sets the least significant bit of all talk addresses (i.e., the A ₁ bit) to a fixed binary "1". As a result, all generated talk addresses will be odd.
	"0"	EVEN — Sets the least significant bit of all talk addresses to a fixed binary "0". As a result, all generated talk addresses will be even.

Figure 3-13. Option 003 (HP-IB) Scanner and Option 001 HP-IB Interface Board Controls

CONTROL	POSITION	FUNCTION										
Scanner Board NO. OF INPUTS Switches 8 4 2 1	"1" or "0"	These switches are set to the binary equivalent of the number of talkers (i.e., data sources) to be addressed by the scanner. For example, if 12 talkers are applying data to the 5150A, then: <table data-bbox="776 411 1247 548" style="margin-left: auto; margin-right: auto;"> <thead> <tr> <th>SWITCH</th> <th>POSITION</th> </tr> </thead> <tbody> <tr> <td>"8"</td> <td>"1"</td> </tr> <tr> <td>"4"</td> <td>"1"</td> </tr> <tr> <td>"2"</td> <td>"0"</td> </tr> <tr> <td>"1"</td> <td>"0"</td> </tr> </tbody> </table> The maximum number of scanner-controlled talkers is 13. <p style="text-align: center;">NOTE</p> The ODD talk address of "A" (00001), or the EVEN talk address of "@" (00000) are illegal when the scanner board is used, and must not be assigned to a data source.	SWITCH	POSITION	"8"	"1"	"4"	"1"	"2"	"0"	"1"	"0"
SWITCH	POSITION											
"8"	"1"											
"4"	"1"											
"2"	"0"											
"1"	"0"											
HP-IB Interface Board "ADDRESS-ABLE" Switch	"0"	This switch must be in the "0" position when the Scanner Board controls the HP-IB for correct operation. <p style="text-align: center;">NOTE</p> As a result, the "LISTENING" indicator is on all the time.										
HP-IB Interface Board "PRT CMD"	"LF"	This is the recommended switch position when the Scanner Board controls the HP-IB. <p style="text-align: center;">NOTE</p> "CR" may be used to indicate the print command but with some instruments old data may be recorded. "LF" is suggested as print command.										

Figure 3-13. Option 003 (HP-IB) Scanner and HP-IB Interface Board Controls (Continued)

Model 5150A
 Operating and Programming Information

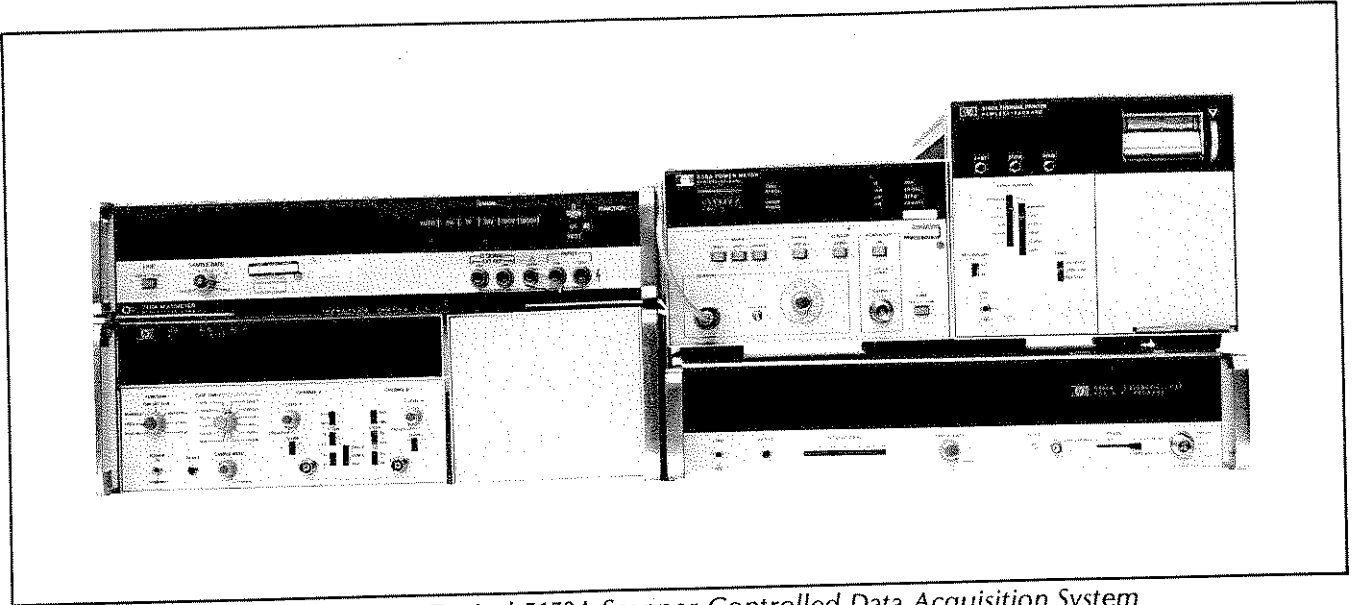

Figure 3-14. A Typical 5150A Scanner Controlled Data Acquisition System With Four Talkers

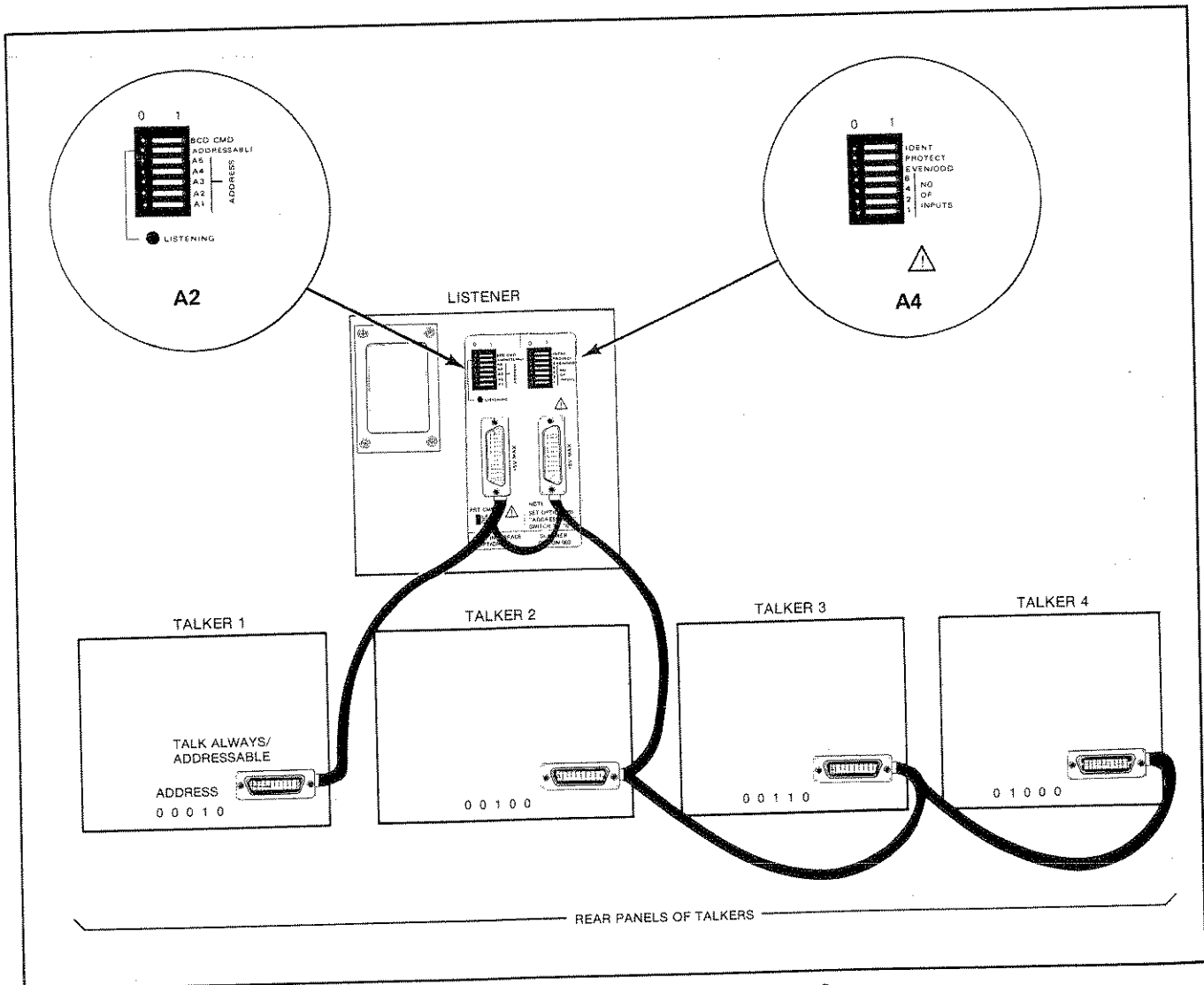

Figure 3-15. 5150A Multidata Source/Scanner System

SETUP OF THERMAL PRINTER BOARDS

HP-IB Interface Board

1. Plug HP-IB Board into A2 location in Thermal Printer.
2. BCD CMD switch either "1" or "0".
3. Set Addressable switch to "0" (Listening).
4. Switches A5-A1 any combination.
5. Set PRT CMD to "LF" or "CR".

Scanner Board

1. Plug Scanner Board into A4 location in Thermal Printer.
2. If the 20th column of data is unused, and you wish sources identified, set the IDENT switch to "1" (alpha identifiers will be printed in 20th column of thermal print paper output).
3. If you wish a nonresponding instrument skipped, set the PROTECT switch to "1" (after 3 seconds the Thermal Printer will initiate a print command causing a blank line of data with alpha identifier to be printed).
4. Set EVEN/ODD switch to "0" if chosen addresses are even, to "1" if addresses are odd.
5. Set the 8-4-2-1 Number of input switches in binary to the number of instruments to be scanned from 1 through 13.

SETUP OF TALKERS

1. Set Talk Always/Addressable switch to Addressable.
2. Set all Talker addresses to even or odd sequential addresses (see Table 3-6 for addresses and sequence of data source printouts).
3. Provide an HP-IB cable path linking all instruments with Thermal Printer. NOTE: System is capable of handling 20 metres of HP-IB cable or an average of 2 metres per instrument whichever is less. To exceed this length restriction is to potentially degrade the system.

OUTPUT

Thermal Printer output will label Talkers as example shows:

Scanner output alpha identifier corresponding to Talker address from lowest to highest instrument address.

```

04:24:35
D
C
B
A      D  00100000E+2

04:24:26
D
C
B
A      D  00100000E+2
    
```

Figure 3-15. 5150A Multidata Source/Scanner System (Continued)

3-56. OPTION 004 CLOCK

3-57. The Clock Option (Option 004) may be combined with any other 5150A option to add a timing capability to the data logging function. This option requires modification of the Thermal Printer (including a different front panel), and its installation should be accomplished either at the factory (upon initial order), or by an authorized Hewlett-Packard Sales and Service Office (for retrofit).

NOTE

The clock option requires that the ac power source frequency be either 50 Hz or 60 Hz.

3-58. The Option implements a 24-hour clock cycle to provide the following:

- a. A front panel LED Time-of-Day display (00:00:00 to 23:59:59:).
- b. The capability to print the Time-of-Day information with the recorded data.
- c. Selectable time intervals between data print operations. This time interval selection ranges from minimum, 3 prints per second to a maximum of 2 hours between time printouts.
- d. A selectable time interval between Time-of-Day prints. (This interval selection may be equal to or greater than the data print interval.)

3-59. Controls and Indicators

3-60. Figure 3-16 shows the various clock controls and indicators, and briefly describes the function of each.

3-61. The effect on HP-IB and BCD board operation of the clock HOLD/RELEASE switch is discussed in Table 3-7.

Table 3-7. Clock HOLD/RELEASE Switch Settings*

Action in HOLD Position	
BCD Board	ASCII Board
INHIBIT signal sent to data source until clock panel PRINT INTERVAL DATA switch time setting passes.	NRFID line set LOW until PRINT INTERVAL DATA switch time setting passes.
Action in RELEASE Position (NOTE: This position is typical.)	
BCD Board	ASCII Board
INHIBIT signal sent to data source for only a short time (approximately 200 milliseconds). Data not printed until PRINT INTERVAL DATA switch time setting passes. (Some measurements may not be transferred.)	NRFID line set LOW for only a short time (approximately 200 milliseconds). Then pseudo handshake (NDAC set HIGH, NRFID set HIGH) given. Data not printed until PRINT INTERVAL DATA switch time setting passes. (Some measurements may not be transferred.)

*This switch is inside the printer cabinet and accessible when the top cover is removed.

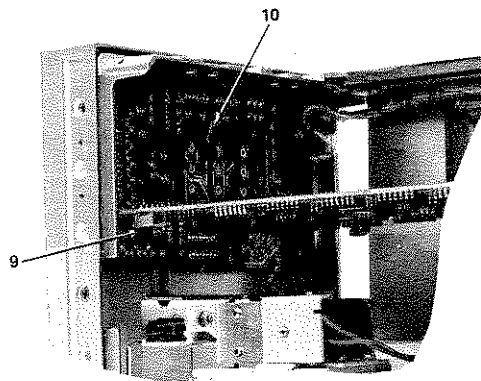
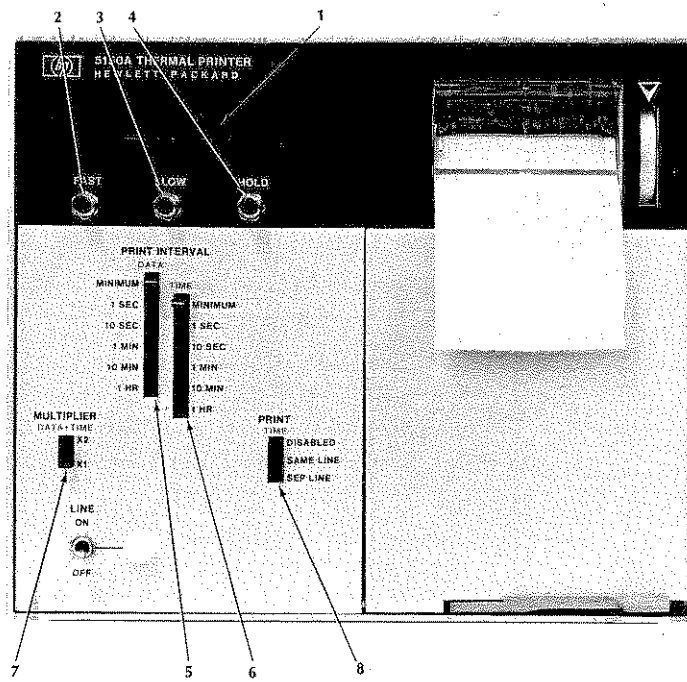

CLOCK DISPLAY BOARD (REAR VIEW)

CONTROL/INDICATOR		POSITION	FUNCTION (Items in parentheses are for 50 Hz operation)
1	Time-of-Day Display		Light Emitting Diode Time Display in hours, minutes, and seconds.
2	FAST SWITCH	Depressed	Used for setting clock. Slews at a 3600 Hz rate.
3	SLOW SWITCH	Depressed	Used for setting clock. Slews at a 60 Hz rate. (Slews at 50 Hz rate.)
4	HOLD SWITCH	Depressed	Stops the Clock.
5	PRINT INTERVAL, Data Switch	Minimum through 1 Hour	Sets the time interval between data print operations. The minimum rate is approximately one line every 300 milliseconds or the input speed of the data source, whichever is slower.

Figure 3-16. Option 004 Clock Controls and Indicators

CONTROL/INDICATOR		POSITION	FUNCTION
6	PRINT INTERVAL, Time Switch	Minimum through 1 Hour	Sets the time interval between printing of clock information. This switch is mechanically linked to the PRINT INTERVAL DATA switch so that the time print interval can never be shorter than the data print interval.
7	MULTIPLIER DATA-TIME Switch	X1	Allows the data and time print interval to be as set by the respective DATA and TIME PRINT INTERVAL switches.
		X2	Doubles the length of time between the set data and time print intervals.
8	PRINT TIME Switch	DISABLE	Suppresses printing of Time-of-Day information.
		SAME LINE	Prints Time-of-Day information on the same line as the data. NOTE Time-of-Day information is printed in columns 13 through 20 of the thermal paper. Data normally printed in these columns, as well as columns 11 and 12 are not printed. Data intended for columns 1 through 10 are printed as usual. When Scanner is used, columns 13-20 on the data line from the last instrument addressed contain the clock output.
		SEP LINE	Prints Time-of-Day information on the next line after a data line is printed. As a result, 20 columns of data is printed, the paper is advanced, and the Time-of-Day information is printed above the data. When Scanner is used, clock output is printed after (above) last instrument scanned.
9	50/60 Hz Switch NOTE Internal switch, located on rear, upper right of Clock Display Board. (Earlier instruments used jumpers to select 50 or 60 Hz freq.)	50 Hz or 60 Hz	Provides compatibility between the clock timing circuits and a 50 Hz or 60 Hz power source.
10	Internal switch right side, located on top, toward front of Clock Control Board with board properly in Thermal Printer slot A3.	HOLD	Depending on the instrument sending information the data may be up to the print interval length of time old at the time of printing. The choice between "LF" and "CR" may affect the outcome. Choosing "LF" usually provides output of data just taken.
		RELEASE	Constantly updates characters from the data source. When the selected print interval elapses, the most recently received characters are printed. With Scanner (Option 003) the clock is always in release position

Figure 3-16. Option 004 Clock Controls and Indicators (Continued)

3-62. Clock Print Format

3-63. Figure 3-17 shows the print format spacings which result from some interval selection combinations. The restraint on time printing is that one may not print time more frequently than data is printed. A choice the user must make is whether to disable the time print or if a record of the time is wished, whether the same line or the line above the data is to contain the time printout.

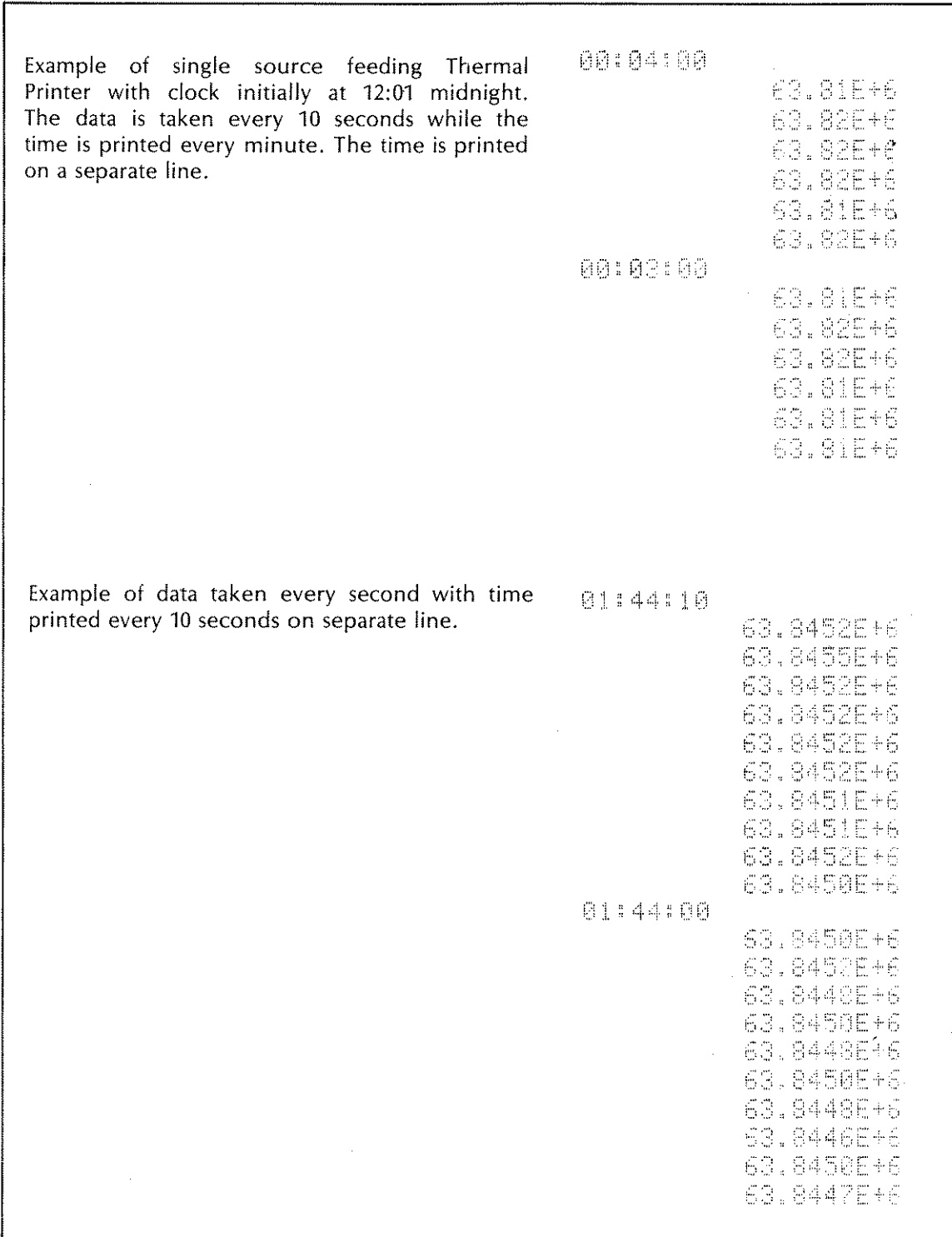

Figure 3-17. Clock Print Formats

Example of data and time recorded every 10 seconds on same line.

```
01:45:00 63.8465E+6
01:44:50 63.8462E+6
01:44:40 63.8461E+6
01:44:30 63.8457E+6
```

Example of data recorded every 10 seconds with time every minute.

```
01:38:00
63.8353E+6
63.8352E+6
63.8347E+6
63.8345E+6
63.8341E+6
63.8340E+6
```

Example of data and time every 10 seconds recorded on separate lines.

```
01:43:20
63.8436E+6
01:43:10
63.8438E+6
01:43:00
63.8435E+6
01:42:50
63.8431E+6
01:42:40
63.8430E+6
01:42:30
63.8426E+6
```

```
01:37:00
63.8336E+6
63.8332E+6
63.8330E+6
63.8326E+6
63.8324E+6
63.8320E+6
```

```
01:36:00
63.8317E+6
63.8315E+6
63.8312E+6
63.8311E+6
63.8307E+6
63.8302E+6
```

Example of data only.

Example of data and time recorded every second.

```
01:45:18 63.8478E+6
01:45:17 63.8471E+6
01:45:16 63.8471E+6
01:45:15 63.8467E+6
01:45:14 63.8467E+6
01:45:13 63.8467E+6
01:45:12 63.8471E+6
01:45:11 63.8467E+6
01:45:10 63.8468E+6
01:45:09 63.8468E+6
01:45:08 63.8467E+6
01:45:07 63.8467E+6
01:45:06 63.8468E+6
01:45:05 63.8465E+6
```

```
63.81E+6
63.81E+6
63.79E+6
63.81E+6
63.81E+6
63.80E+6
63.80E+6
63.81E+6
63.81E+6
63.81E+6
63.80E+6
63.80E+6
63.81E+6
63.81E+6
63.80E+6
63.80E+6
63.81E+6
```

Figure 3-17. Clock Print Formats (Continued)

3-64. OPTION 005 BCD CABLE

3-65. For each BCD board a BCD cable (HP Part Number 562A-16A, B, or C) is necessary.

3-66. PRINT PAPER

3-67. Two types of thermal print paper are available for the 5150A; rolled (Part Number 9281-0401) and fan-folded (Part Number 9270-0431). (Fan-folded paper will refold after data is printed and is more easily examined than long, rerolled paper.) A clip to store the spindle roller is fastened to the left side of the paper tray.

NOTE

PAPER IS SENSITIVE ON ONE SIDE ONLY

3-68. The recommended print paper is thermally sensitive on one side only. Usually the tape is wound with the printing surface on the outside of the roll. Identify the printing surface by running the edge of a fingernail across the paper surface with the paper held against a flat-hard surface. A thin, blue line will appear on the thermal sensitive side of the paper only. Thermal print paper that remains stationary in the printer for several hours may have a light blue stripe across the area where the advance roller has pressed. This is normal.

3-69. To install print paper refer to *Figure 3-18* and perform the following steps:

1. Push the latch level down and pull it and paper tray out.

NOTE

The image side of the paper must face away from you when you thread the paper up into the print head.

2. The paper roll is held together by some adhesive on the underside of the beginning tape. Separate this band and tear off the first foot of tape. This will eliminate any problems when running the adhesive portion through the print head.
3. Place the paper roll or flat package in the paper tray with the sensitive side oriented correctly.
4. Fold the end of the paper diagonally.
5. Thread the diagonally folded end of the paper up into the print head. Use the knurled manual paper advance knob to start the paper through the print head.
6. Check that the paper's sensitive side is exposed (up) when the paper comes out of the clear plastic viewer.
7. Check that the paper is centered. No rippling of the side of the paper should be evident.
8. Push the paper tray into the printer and push latch lever to its lock position.

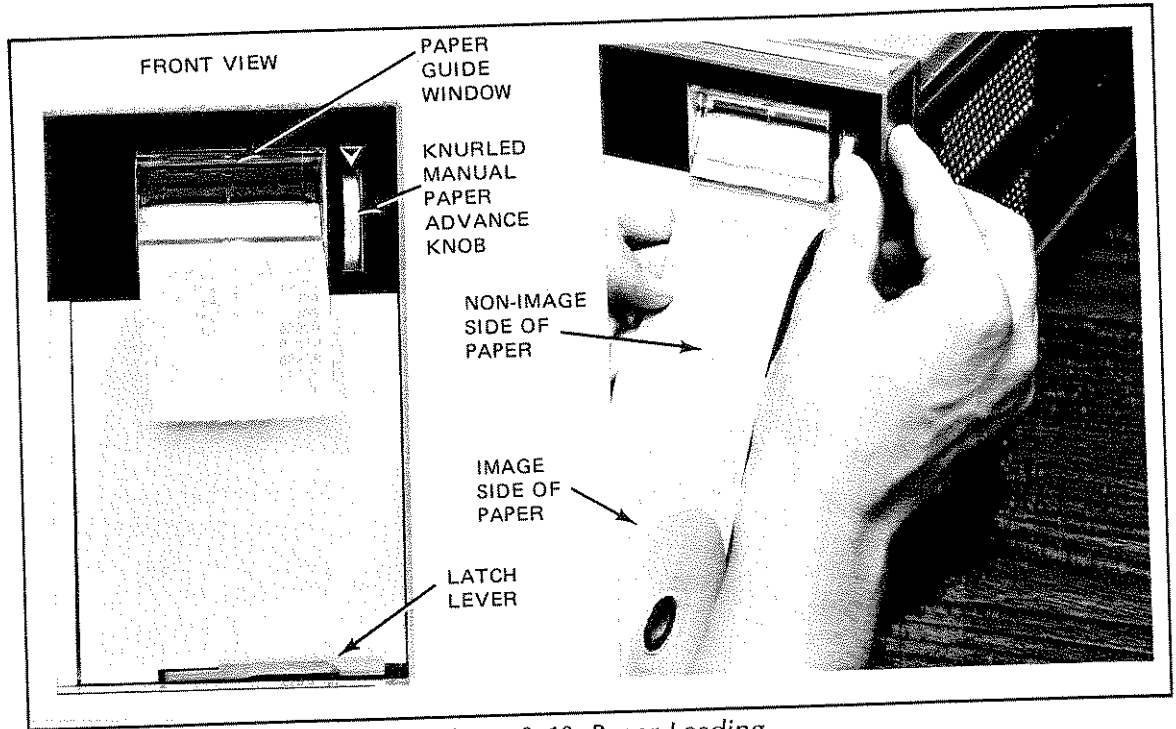

Figure 3-18. Paper Loading

3-70. To remove the printed portion of the tape, first roll the thumbwheel knob downward until all printed matter is below the clear plastic shield. Then lift the paper by one side and pull the tape across the plastic edge toward the opposite side as shown in Figure 3-19.

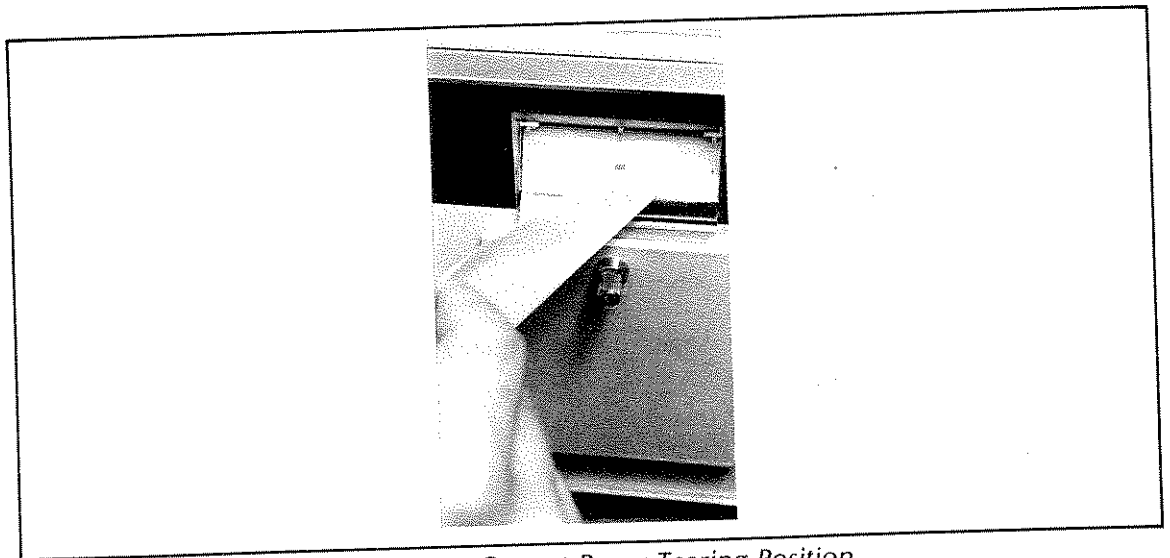

Figure 3-19. Correct Paper Tearing Position

3-71. Be sure to use the thumbwheel knob when advancing the paper. Pulling on the tape may cause the paper to bind on the edges. If so, the next printout may appear compressed and/or angled on the printout.

3-72. Each roll of paper tape is about 250 feet long. The last 5 or 6 feet will have a green line running down the right side to indicate that the tape is nearing the end. When the green line stops, there will be about 2 feet of tape left.

