

OPERATING AND SERVICE MANUAL

5315A/B

100 MHz Universal Counter

SERIAL PREFIX: 2538A

This manual applies to instruments with Serial Prefix 2538A unless accompanied by a Manual Change Sheet.

OLDER INSTRUMENTS

For Serial Prefixes 2536A and below, refer to Section VII for manual backdating.

Valuetronics International, Inc.
1-800-552-8258
MASTER COPY

© Copyright HEWLETT-PACKARD COMPANY 1986
5301 STEVENS CRK. BLVD., SANTA CLARA, CALIFORNIA 95051-7299

MANUAL PART NUMBER 05315-90028
Microfiche Part Number 05315-90029

Printed SEPT 1986



**HEWLETT
PACKARD**

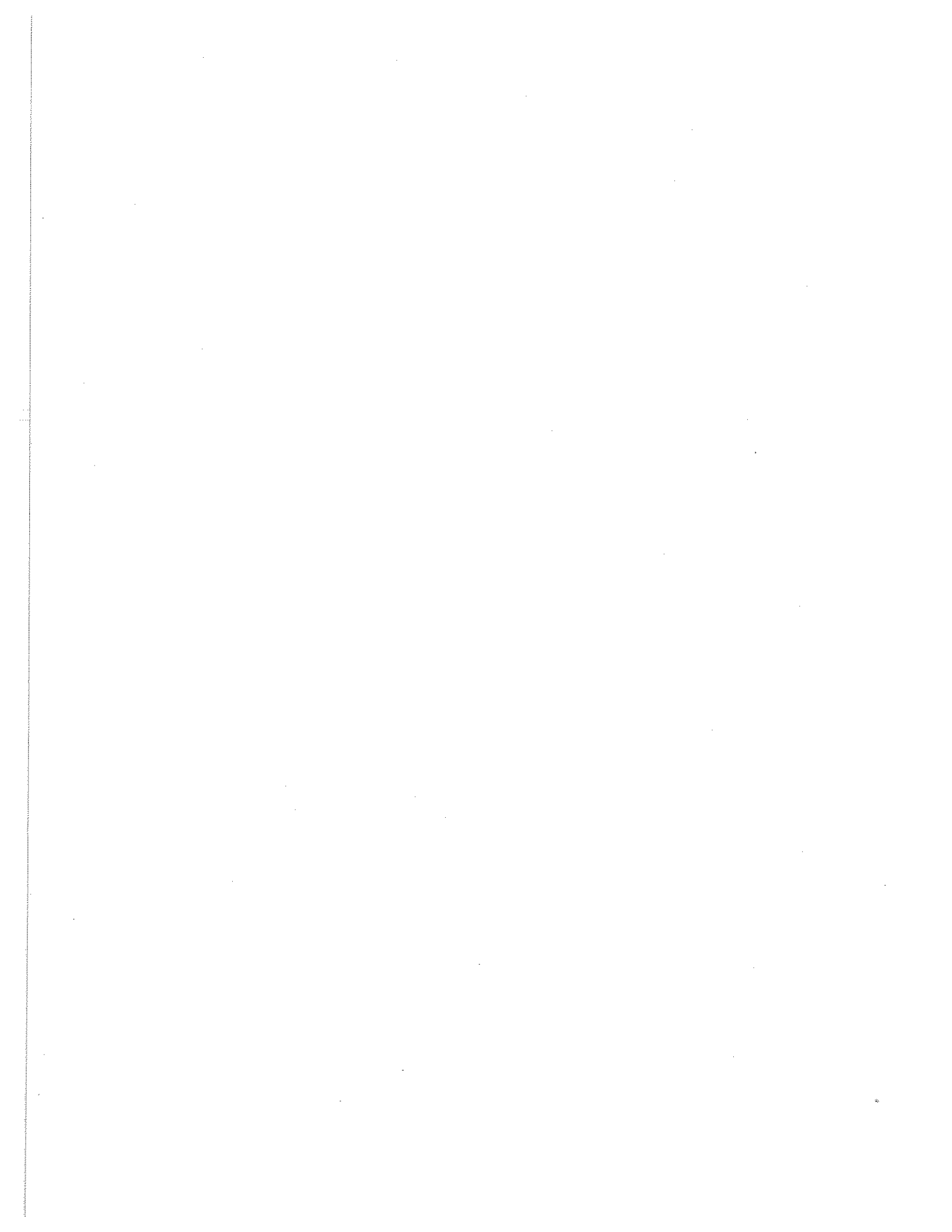

SAFETY CONSIDERATIONS

GENERAL

This product and related documentation must be reviewed for familiarization with safety markings and instructions before operation.

This product is a Safety Class I instrument (provided with a protective earth terminal).

BEFORE APPLYING POWER

Verify that the product is set to match the available line voltage and the correct fuse is installed. Refer to Section II, Installation.

SAFETY EARTH GROUND

An uninterruptible safety earth ground must be provided from the mains power source to the product input wiring terminals or supplied power cable.

SAFETY SYMBOLS



Instruction manual symbol; the product will be marked with this symbol when it is necessary for the user to refer to the instruction manual.



Indicates hazardous voltages.

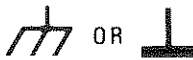

OR



Indicates terminal is connected to chassis when such connection is not apparent.



Alternating current.



Direct current.

WARNING

The **WARNING** sign denotes a hazard. It calls attention to a procedure, practice, or the like, which, if not correctly performed or adhered to, could result in personal injury. Do not proceed beyond a **WARNING** sign until the indicated conditions are fully understood and met.

CAUTION

The **CAUTION** sign denotes a hazard. It calls attention to an operating procedure, practice, or the like, which, if not correctly performed or adhered to, could result in damage to or destruction of part or all of the product. Do not proceed beyond a **CAUTION** sign until the indicated conditions are fully understood and met.

SAFETY INFORMATION

WARNING

Any interruption of the protective grounding conductor (inside or outside the instrument) or disconnecting the protective earth terminal will cause a potential shock hazard that could result in personal injury. (Grounding one conductor of a two conductor outlet is not sufficient protection.)

Whenever it is likely that the protection has been impaired, the instrument must be made inoperative and be secured against any unintended operation.

If this instrument is to be energized via an autotransformer (for voltage reduction) make sure the common terminal is connected to the earthed pole terminal (neutral) of the power source.

Instructions for adjustments while covers are removed and for servicing are for use by service-trained personnel only. To avoid dangerous electric shock, do not perform such adjustments or servicing unless qualified to do so.

For continued protection against fire, replace the line fuse(s) only with 250V fuse(s) of the same current rating and type (for example, normal blow, time delay). Do not use repaired fuses or short circuited fuseholders.



5315A
(Option 003 Shown)



5315B
(Option 003 Shown)

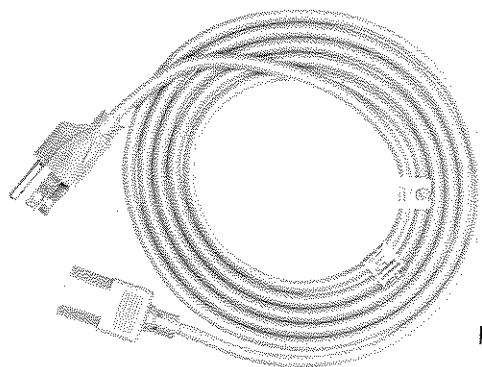

Power Cord
Part No. 8120-1378

Figure 1-1. Models 5315A and 5315B Universal Counters

SECTION I GENERAL INFORMATION

1-1. INTRODUCTION

1-2. This manual provides information about installation, operation, testing, adjustments, and servicing the Hewlett-Packard Model 5315A and 5315B Universal Counters, shown in *Figure 1-1*.

1-3. The 5315B is functionally identical to the 5315A. The major difference is that the 5315B is designed for rack mounting or stacking and features a metal cabinet to minimize electro-magnetic interference. (The 5315A has a high-strength plastic cabinet.)

1-4. This manual has eight sections, each covering a particular topic for using and servicing the 5315A and 5315B. The topics by section number are:

Section	Topic
I	General Information
II	Installation
III	Operation
IV	Performance Tests
V	Adjustments
VI	Replaceable Parts
VII	Manual Changes
VIII	Service

1-5. DESCRIPTION

1-6. The HP 5315A and 5315B are universal counters, measuring signals over a range from 0.1 Hz to 100 MHz. The 5315A and 5315B measure frequency, period, time interval, time interval average, time interval holdoff (delay), and ratio. A totalize function with manual or external gating is also provided. All measurements except totalize are displayed in scientific notation with up to eight digits of resolution.

1-7. Two independent input channels provide time interval measurements. Each input channel has an attenuator (X1, X20), trigger slope selector, trigger level and sensitivity control, and AC-DC coupling. A switchable low-pass filter on Channel A and three-state trigger lights are also provided.

1-8. Option 003, 1 GHz third or "C" input channel for the 5315A/B, provides frequency measurements from 50 MHz to 1 GHz. The input sensitivity is 15 mV for frequencies between 50 and 650 MHz, and 75 mV for frequencies between 650 MHz and 1 GHz. The C Channel is a 50-ohm input with a dynamic input range of 1V rms. The input is prescaled by 10 to achieve a 1 GHz frequency range. Complete specifications for the Option 003 are listed in *Table 1-1*.

1-9. SPECIFICATIONS

1-10. The instrument specifications are listed in *Table 1-1*. These specifications are the performance standards or limits against which the instrument may be tested.

Table 1-1. 5315A/B Specifications*

INPUT CHARACTERISTICS: (Channel A and Channel B)

Range:

DC coupled, 0 to 100 MHz.
AC coupled, 30 Hz to 100 MHz.

Sensitivity:

10 mV rms sine wave to 10 MHz.
25 mV rms sine wave to 100 MHz.
75 mV peak-to-peak pulse at minimum pulse width of 5 ns.

Sensitivity can be varied continuously up to 500 mV rms **NOMINAL** by adjusting SENSITIVITY control. In SENSITIVITY mode, trigger level is automatically set to 0V **NOMINAL**.

Dynamic Range:

30 mV to 5V peak-to-peak, 0 to 10 MHz.
75 mV to 5V peak-to-peak, 10 to 100 MHz.

Signal Operating Range: +2.5V DC to -2.5V DC.

Coupling: AC or DC, switchable.

Filter: Low pass, switchable in or out of Channel A.
3 dB point of **NOMINALLY** 100 kHz.

Impedance: 1 MΩ **NOMINAL** shunted by less than 40 pF.

Attenuator: X1 or X20 **NOMINAL**.

Trigger Level: Variable between +2.5V DC and -2.5V DC.

Slope: Independent selection of + or - slope.

Common Input: All specifications are the same for

Common A except the following:

Sensitivity: 20 mV rms to 10 MHz, 50 mV rms to 100 MHz,
150 mV peak-to-peak.

Dynamic Range: 60 mV-5V peak-to-peak 0-10 MHz,
150 mV-5V peak-to-peak 10-100 MHz.

Impedance: 500 kΩ (Nom) shunted by less than 70 pF.

Damage Level:

AC&DC × 1:

DC to 2.4 kHz 250V (DC + AC rms)
2.4 kHz to 100 kHz 6 × 10⁵V rms Hz/FREQ
>100 kHz 6V rms

AC&DC × 20:

DC to 28 kHz 500V (DC + AC peak)
28 kHz to 100 kHz 1 × 10⁷V rms Hz/FREQ
>100 kHz 100V rms

FREQUENCY (Channel A)

Range: 0.1 Hz to 100 (burst or cw).

NOTE

Between 0.1 Hz and 0.14 Hz, the resolution is one millihertz.

LSD Displayed: 10 Hz to 1 nHz depending upon gate time and input signal. At least 7 digits displayed per second of gate time.

****Resolution:**

± LSD† ± 1.4 × $\frac{\text{Trigger Error}}{\text{Gate Time}} \times \text{FREQ}$, FREQ < 10 MHz.

± LSD†, ≥ 10 MHz.

Accuracy: ± Resolution ± (time base error) × FREQ.

****Best Case Resolution for 1 Second Gate**

	100 Hz	1 kHz	10 kHz	100 kHz	1 MHz	10 MHz	100 MHz
50 mV rms	±.0004 Hz	±.00048 Hz	±0.0014 Hz	±0.01 Hz	±0.1 Hz	±1 Hz	±10 Hz
100 mV rms	±.0002 Hz	±.00029 Hz	±0.0012 Hz	±0.01 Hz	±0.1 Hz	±1 Hz	±10 Hz
500 mV rms	±.00005 Hz	±.00014 Hz	±0.0011 Hz	±0.01 Hz	±0.1 Hz	±1 Hz	±10 Hz
1V rms	±.00003 Hz	±.00012 Hz	±0.0010 Hz	0.01 Hz	±0.1 Hz	±1 Hz	±10 Hz

This chart shows best case frequency reduction versus input sinewave rms amplitude. This is best case because noise from the signal source is assumed to be zero; the trigger error is produced only by the counter's noise (i.e., 120 μV rms).

PERIOD

Range: 10 ns to 10⁵ s.

LSD Displayed: 100 ns to 1 fs depending upon gate time and input signal. At least 7 digits displayed per second of gate time.

Resolution:

± LSD† ± 1.4 × $\frac{\text{Trigger Error}}{\text{Gate Time}} \times \text{PER}$, PER > 100 ms.

± LSD†, PER ≤ 100 ns.

Accuracy: ± Resolution ± (time base error) × PER.

TIME INTERVAL

Range: 100 ns to 10⁵ s.

LSD Displayed: 100 ns.

Resolution: ± LSD ± Start Trigger Error ± Stop Trigger Error.

Accuracy: ± Resolution ± (time base error) × TI.

TIME INTERVAL AVERAGE

Range: 0 ns to 10⁵ s.

LSD Displayed: 100 ns to 10 ps depending upon gate time and input signal. See table in Definitions section.

Resolution:

± LSD ± $\frac{\text{Start Trigger Error}}{\sqrt{N}} \pm \frac{\text{Stop Trigger Error}}{\sqrt{N}}$

Accuracy: ± Resolution ± (time base error) × TI ± 4 ns.

Number of intervals averaged (N): N = Gate Time × FREQ.

Minimum Dead Time (stop to start): 200 ns.

TIME INTERVAL DELAY (Holdoff)

Front panel gate time knob inserts a variable delay of **NOMINALLY** 500 μs to 20 ms between START (Channel A) and enabling of STOP (Channel B). Electrical inputs during delay time are ignored. Delay time may be digitally measured by simultaneously pressing T.I. Averaging, T.I. Delay, and blue key. Other specifications of T.I. Delay are identical to Time Interval.

RATIO

Range: 0.1 Hz to 100 MHz, both channels.

LSD:

$\frac{2.5 \times \text{Period A}}{\text{Gate Time}} \times \text{Ratio}$. (rounded to nearest decade)

Resolution:

± LSD ± $\frac{B \text{ Trigger Error}}{\text{Gate Time}} \times \text{Ratio}$.

Accuracy: Same as resolution. Highest frequency input is connected to Channel A to achieve specified accuracy.

TOTALIZE

Manual:

Range: 0 to 100 MHz.

A Gated by B:

Totalizes input A between two events of B. Instrument must be reset to make new measurement. Gate opens on A slope, closes on B slope.

Range: 0 to 100 MHz.

Resolution: ± 1 count.

Accuracy: ± 1 count ± B Trigger Error × Frequency A.

*Specifications describe the instrument's warranted performance. Supplemental characteristics are intended to provide information useful in applications of the instrument by giving **TYPICAL** or **NOMINAL**, but nonwarranted performance parameters. Definition of terms is provided at the end of the specification section. For a more detailed explanation, see HP Application Note 200-4 "Understanding Frequency Counter Specifications".

Table 1-1. 5315A/B Specifications (Continued)

TIME BASE	WARRANTY
<p>Frequency: 10 MHz. Aging Rate: <3 parts in 10⁷/mo. Temperature: $\leq \pm 5$ parts in 10⁶, 0 to 50°C. Line Voltage: $\leq \pm 1$ part in 10⁷ for $\pm 10\%$ variation.</p>	<p>ALL COMPONENTS IN OPTION 002, EXCEPT THE BATTERY, ARE WARRANTED FOR ONE FULL YEAR. BATTERY BT-1, (HP PART NO. 1400-0253) IS NOT WARRANTED.</p>
<p>GENERAL</p>	<p>Option 003: C Channel</p>
<p>Check: Counts internal 10 MHz reference frequency over gate time range NOMINALLY 500 μs to 20 ms. Error Light: LED warning light activated if logic error is found during instrument turn-on self-check. Display: 8-digit amber LED display, with engineering units annunciator. Overflow: Only frequency and totalize measurements will overflow. In case of overflow, eight least significant digits will be displayed and amber front panel overflow LED will be actuated. All other measurements which would theoretically cause a display of more than 8 digits will result in the display of the 8 most significant digits. Gate Time: Continuously variable, NOMINALLY from 60 ms to 10 s or 1 period of the input, whichever is longer. Sample Rate: Up to 5 readings per second NOMINAL except in time interval mode, where it is continuously variable NOMINALLY from 4 readings per second to 1 reading every 10 seconds via Gate Time control. Operating Temperature: 0° to 50°C. Power Requirements: Internally switch selectable 100, 120, 220, or 240V (+5%, -10%) 48-66 Hz; 15 VA maximum. Weight: Net, 2.2 kg (4 lbs. 12 oz.); Shipping, 4.1 kg (9 lbs.). Dimensions: 238 mm W \times 98 mm H \times 276 mm D (9$\frac{3}{8}$ \times 3$\frac{7}{8}$ \times 10$\frac{7}{8}$ in.).</p>	<p>Input Characteristics: Range: 50 to 1000 MHz, prescaled by 10. Sensitivity: 15 mV rms sine wave (-23.5 dBm) to 650 MHz. 75 mV rms sine wave (-9.5 dBm) to 1000 MHz. Sensitivity can be decreased continuously by up to 20 dB NOMINAL, 50 to 500 MHz and 10 dB NOMINAL, 500 to 1000 MHz by adjusting sensitivity control. Trigger level is fixed at 0V NOMINAL. Dynamic Range: 15 mV to 1V rms (36 dB), 50 to 650 MHz. 75 mV to 1V rms (20 dB), 650 to 1000 MHz. Signal Operating Range: +5 Vdc to -5 Vdc. Coupling: AC. Impedance: 50Ω NOMINAL (VSWR, <2.5:1 TYPICAL) Damage Level: ± 8V (DC + AC peak), fuse protected. Fuse located in BNC connector.</p>
<p>OPTIONS</p>	<p>Frequency: Range: 50 to 1000 MHz (burst or cw). LSD Displayed: 100 Hz to 1 Hz depending upon gate time. At least 7 digits per second of gate time. LSD, Resolution and Accuracy: Same formulas as for Frequency A except "Gate Time" term becomes "(Gate Time)/10".</p>
<p>Option 001: Temperature Compensated Time Base (TCXO) Frequency: 10 MHz. Aging Rate: <1 part in 10⁷/mo. Temperature: ± 1 part in 10⁶, 0° to 40°C ref to 25°C if offset frequency is used. Line Voltage: <1 part in 10⁸ for $\pm 10\%$ variation.</p>	<p>Option 004 (for 5315A): High Stability Time Base (Oven Oscillator) Frequency: 10 MHz. Aging Rate: <3 parts in 10⁻⁸/mo. (after 30 days continuous operation. AC power applied, in OFF or ON position). Temperature: ± 1 part in 10⁻⁷, 0° to 50°C. Line Voltage: <1 part in 10⁻⁸ for $\pm 10\%$ variation.</p>
<p>Option 002: Battery (5315A only) Type: Rechargeable lead-acid (sealed). Capacity: TYPICALLY 4 hours of continuous operation at 25°C. Recharging Time: TYPICALLY 16 hours to 98% of full charge, instrument nonoperating. Charging circuitry included with Option. Batteries not charged during instrument operation.</p>	<p>Option 004 (for 5315B): High Stability Time Base (Oven Oscillator) Frequency: 10 MHz. Aging Rate: <3 parts in 10⁻⁸/mo after 30 days continuous operation. Temperature: ± 2 parts in 10⁻⁸, 0° to 50°C. Line Voltage: <1 part in 10⁻⁹ for $\pm 10\%$ variation.</p>
<p>Low Voltage Indicator: Instrument turns itself off automatically when low battery conditions exists. Discharge LED flashes slowly when this happens. Discharge LED is on whenever battery is supplying power to instrument. Charge LED indicates state of charge of battery during charging only and is on whenever battery is charged to 95% NOMINAL of capacity. Charge LED flashes when 90% NOMINAL of charge taken out is replaced. Charge LED is off if charge is less than 70% NOMINAL of capacity.</p>	<p>5315B: Rack and stack metal case with rear panel, switchable AC power line module. Specifications same as 5315A except as follows: Rack Mount Kit: 5061-0072 recommended. Oscillator Output: 10 MHz, 50 mV p-p into 50Ω load on rear panel.</p>
<p>Line Failure Protection: Instrument automatically switches to battery in case of line failure. Weight: Option 002 adds 1.4 kg (3 lbs.) to weight of instrument.</p>	<p>External Frequency Standard Input: 10 MHz, 1V rms into 500Ω on rear panel. Requires internal selection. Dimensions: 212 mm W \times 81 mm H \times 345 mm D (8$\frac{3}{8}$ \times 3$\frac{1}{2}$ \times 13$\frac{3}{4}$ in.). Weight: Net, 3.2 kg (7 lbs. 2 oz.); Shipping, 4.5 kg (10 lbs.).</p>

Table 1-1. 5315A/B Specifications (Continued)

DEFINITIONS

Resolution: Smallest discernible change of measurement result due to a minimum change in the input.

Accuracy: Deviation from the actual value as fixed by universally accepted standards of frequency and time.

Least Significant Digit (LSD) Displayed: Frequency:

$$\frac{2.5 \times 10^{-7}}{\text{Gate Time}} \times \text{FREQ}, \quad \text{FREQ} < 10 \text{ MHz.}$$

$$\frac{2.5}{\text{Gate Time}} \quad \text{FREQ} \geq 10 \text{ MHz.}$$

Period:

$$\frac{2.5 \times 10^{-7}}{\text{Gate Time}} \times \text{PER}, \quad \text{PER} > 100 \text{ ns.}$$

$$\frac{2.5}{\text{Gate Time}} \times \text{PER}^2, \quad \text{PER} \leq 100 \text{ ns.}$$

All above calculations should be rounded to nearest decade (i.e., 0.5 Hz will become 10 Hz and 0.4 ns will be 0.1 ns).

Time Interval Average

	LSD
1 to 25 intervals	100 ns
25 to 2500 intervals	10 ns
2500 to 250,000	1 ns
250,000 to 25,000,000 intervals	100 ps
>25,000,000 intervals	10 ps

Time Interval Average is a statistical process. LSD displayed is calculated for 1 standard deviation (σ) confidence level.

Trigger Error:

$$\frac{\sqrt{(120 \times 10^{-6})^2 + e_n^2}}{(\text{Input slew rate at trigger point})} \quad \text{seconds rms}$$

where e_n is the rms noise voltage of the input for a 100 MHz bandwidth.

NOTES:

†Due to arithmetic truncation, quantization error will be ± 1 or ± 2 counts of the LSD as follows:

$$\pm 2 \text{ counts of LSD if } \frac{\text{LSD}}{\text{FREQ or PER}} < 1 \times 10^{-7} \text{ FREQ} < 10 \text{ MHz.}$$

$$\pm 2 \text{ counts of LSD if } \frac{\text{LSD}}{\text{FREQ or PER}} < \frac{1/(\text{Gate Time})}{\text{FREQ}} \text{ FREQ} \geq 10 \text{ MHz.}$$

± 1 count of LSD for all other cases.

1-11. OPTIONS

1-12. The options available for the 5315A/B are listed below. Specifications for the options are given in *Table 1-1* and full descriptions begin with paragraph 3-62. If an option is included in the initial order, it will be installed at the factory and will be ready for operation upon receipt. Options 002 and 006 are available as retrofit kits for field installation. For field installation of Options 001, 002, 003, and 004, refer to the appropriate installation instructions in Section II. The Option 006 retrofit kit contains installation instructions.

Option	Description
001	Temperature Compensated Time Base TCXO*
002	Battery and Charger (for Model 5315A only)
003	C Channel 1 GHz Input
004	High Stability Time Base—Oven-Contained Oscillator*
006	Offset/Normalizer (Used with Model 5315B only)

*Only one of either Option 001 or 004 can be installed.

NOTE

For Model 5315A (only), one of the following options *must* be included with each order.

- Option 100: 90-105 VAC; 48-66 Hz
- Option 120: 108-126 VAC; 48-66 Hz
- Option 220: 198-231 VAC; 48-66 Hz
- Option 240: 216-252 VAC; 48-66 Hz

1-13. SAFETY CONSIDERATIONS

1-14. The 5315A/5315B Universal Counters are Safety Class I instruments, designed according to international safety standards. This operating and service manual contains information, cautions, and warnings which must be followed by the user to ensure safe operation and keep the instrument in safe condition.

1-15. INSTRUMENT IDENTIFICATION

1-16. Hewlett-Packard instruments have 2-section, 10-character serial numbers (0000A00000), usually on the rear panel. The four-digit serial prefix identifies instrument changes. If the serial prefix of your instrument differs from that listed on the title page of this manual, there are differences between this manual and your instrument. Instruments having higher serial prefixes are covered with a "Manual Changes" sheet included with this manual. If the change sheet is missing, contact the nearest Hewlett-Packard Sales and Service Office listed at the back of this manual. Instruments having a lower serial prefix number than that listed on the title page are covered in Section VII.

1-17. ACCESSORIES

1-18. Table 1-2 lists accessory equipment supplied and Table 1-3 lists accessories available.

Table 1-2. Accessories Supplied

Description	HP Part Number
Detachable Power Cord, 229 cm (7½ feet)	8120-1378

Table 1-3. Accessories Available

Description	HP Part Number
Rack Mount Kit (5315B Only)	5061-0072

1-19. RECOMMENDED TEST EQUIPMENT

1-20. The test equipment listed in Table 1-4 is recommended for use during performance tests, adjustments, and troubleshooting. Substitute test equipment may be used if it meets the critical specifications listed in the table.

Table 1-4. Recommended Test Equipment

Instrument	Critical Specifications	Recommended Model	Use
Oscilloscope	100 MHz Bandwidth	HP 1740A	A,T
Synthesizer/Function Generator	0.1—10 MHz, 5—120 mVrms Sine and Square wave output	HP 3325A	P,A,T
Signal Generator	10—100 MHz, 5—100 mVrms	HP 8654A	P
Synthesized Generator	50—1000 MHz, +1 to -14 dBm	HP 8660C/86602A	P
DC Voltmeter	20V Range, 0.05V Resolution	HP 3465A	A,T
50Ω Feedthrough (2 required)	BNC Type		P,A,T
Tee Connector	BNC Type	1250-0781	A,T
Power Splitter	50 MHz—1 GHz; Calibrated Output	HP 11667A	P
Cables (3)	4 BNC 50Ω	11170C	A,T
Power Meter/Sensor	50 MHz—1 GHz; -9 to -24 dBm	HP 436A/8481A	P
10 dB Attenuator		HP 8491A	P
Adapter, Coaxial (2 required)	Type N (male)-to- BNC (female)	1250-0780	P
Adapter, Coaxial	Type N (male)-to- BNC (male)	1250-0082	P

*P = Performance Tests, A = Adjustments, T = Troubleshooting

SECTION II INSTALLATION

2-1. INTRODUCTION

2-2. This section contains information for unpacking, inspection, storage, and installation.

2-3. UNPACKING AND INSPECTION

2-4. If the shipping carton is damaged, inspect the instrument for visible damage (scratches, dents, etc.). If the instrument is damaged, notify the carrier and the nearest Hewlett-Packard Sales and Service Office immediately (offices are listed at the back of this manual.) Keep the shipping carton and packing material for the carrier's inspection. The Hewlett-Packard Sales and Service Office will arrange for repair or replacement of your instrument without waiting for the claim against the carrier to be settled.

2-5. PREPARATION FOR USE

2-6. Power Requirements

2-7. The HP 5315A/B requires a power source of 100-, 120-, 220-, or 240-volt ac, +5%, -10%, 48 to 66 Hz single phase. Power consumption is approximately 12 watts. The 5315A (only) may also be powered by the Option 002 Battery Pack. See Section I, Specifications and Section VIII, paragraph 8-65, for description.

2-8. Line Voltage Selection

CAUTION

Before connecting the instrument to ac power lines, be sure that the voltage selector is properly positioned as described below.

2-9. The 5315A is preset at the factory to one of four line voltage selections. Refer to the rear panel label (see *Figure 2-1*) to determine which of the following settings is preselected:

- Option 100: 90 to 105 VAC; 48-66 Hz
- Option 120: 108 to 126 VAC; 48-66 Hz
- Option 220: 198 to 231 VAC; 48-66 Hz
- Option 240: 216 to 252 VAC; 48-66 Hz

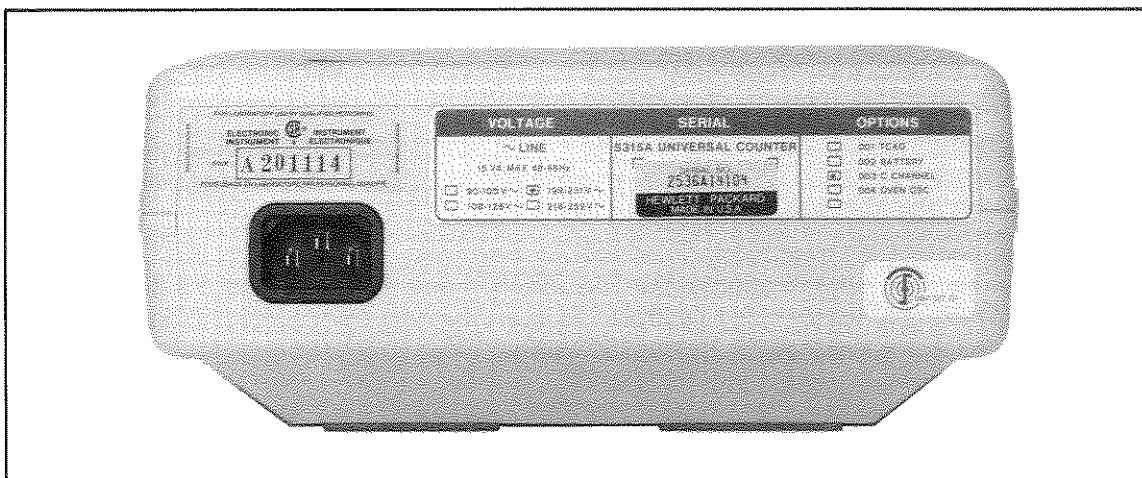

Figure 2-1. 5315A Line Voltage Selection Label

2-10. Changing the 5315A power line voltage selector requires opening the cabinet. Instructions for changing the line voltage setting are given in Section V.

2-11. The 5315A has a rear-panel power module that contains a printed-circuit line voltage selector to select 100-, 120-, 220-, or 240-volt ac operation (see Figure 2-2). Before applying power, the pc selector must be set to the correct position and the correct fuse must be installed as described below.

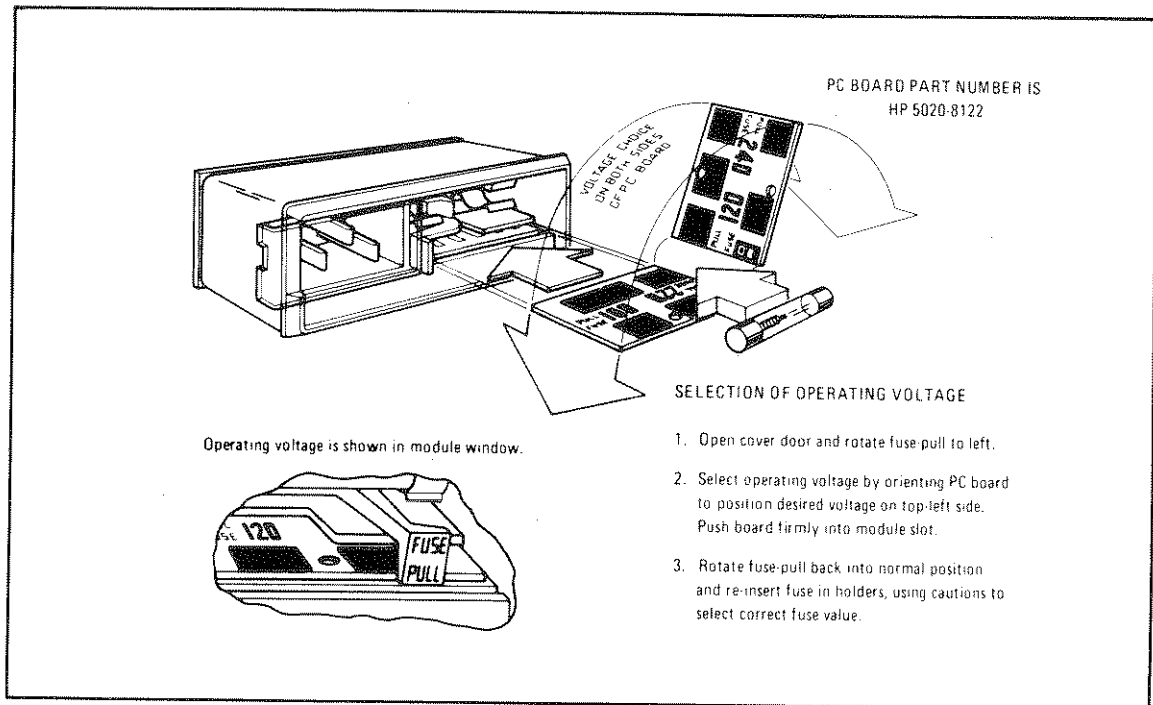

Figure 2-2. 5315B Line Voltage Selection Card

2-12. Power line voltage connections are selected by the position of the plug-in circuit card in the module. When the card is plugged in to the module, the only visible markings on the card indicate the line voltage to be used. The correct value of line fuse, with a 250-volt rating, must be installed after the card is inserted. This instrument uses a 0.25A fuse (HP Part No. 2110-0201) for 100/120-volt operation; a 0.12A fuse (HP Part No. 2110-0318) for 220/240-volt operation.

2-13. To convert from one line voltage to another, the power cord must be disconnected from the power module before the sliding window covering the fuse and card compartment can be moved to expose the fuse and circuit card.

2-14. Pull on the fuse lever to remove the fuse and then pull the card out of the module. The fuse lever must be held to one side to extract and insert the card. Insert the card so the marking that agrees with the line voltage to be used is visible.

2-15. Return fuse lever to normal position, insert correct fuse, slide plastic window over the compartment, and connect the power cord to complete the conversion.

2-16. Power Cable

WARNING

BEFORE SWITCHING ON THIS INSTRUMENT, THE PROTECTIVE EARTH TERMINALS OF THIS INSTRUMENT MUST BE CONNECTED TO THE PROTECTIVE CONDUCTOR OF THE (MAINS) POWER CORD. THE MAINS PLUG SHALL ONLY BE INSERTED IN A SOCKET OUTLET PROVIDED WITH A PROTECTIVE EARTH CONTACT. THE PROTECTIVE ACTION MUST NOT BE NEGATED BY THE USE OF AN EXTENSION CORD (POWER CABLE) WITHOUT A PROTECTIVE CONDUCTOR (GROUNDING).

2-17. The 5315A/B is shipped with a three-wire power cable. When the cable is connected to an appropriate ac power source, this cable connects the chassis to earth ground. The type of power cable plug shipped with each instrument depends on the country of destination. Refer to Figure 2-3 for the part numbers of the power cable and plug configurations available.

2-18. Operating Environment

2-19. TEMPERATURE. The 5315A/B may be operated in temperatures from 0°C to 50°C.

2-20. HUMIDITY. The 5315A/B may be operated in environments with humidity up to 95%. However, it should be protected from temperature extremes which cause condensation in the instrument.

2-21. ALTITUDE. The 5315A/B may be operated at altitudes up to 4,600 metres (15,000 feet).

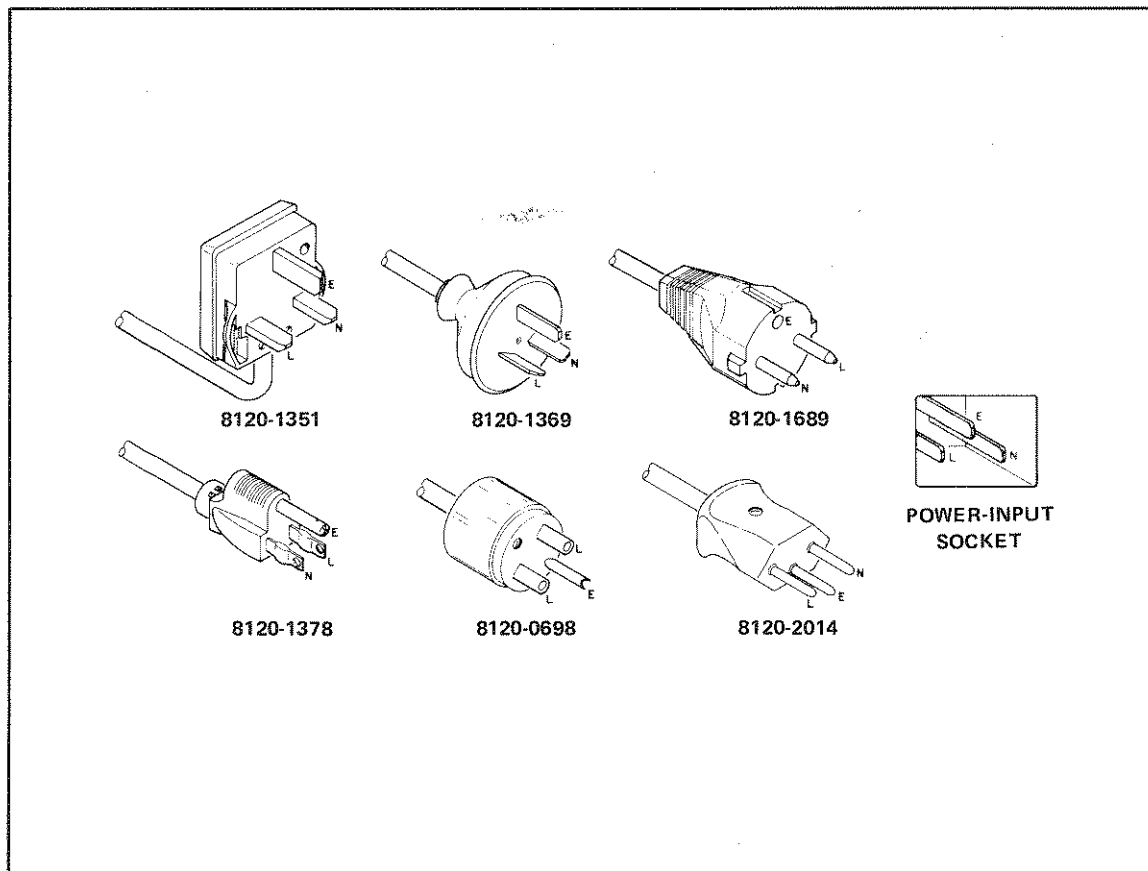

Figure 2-3. Power Cable HP Part Numbers versus Mains Plugs Available

2-22. STORAGE AND SHIPMENT

2-23. Environment

2-24. The instrument may be stored or shipped in environments with the following limits:

Temperature	-40°C to +75°C
Humidity	Up to 95%
Altitude	7,620 metres (25,000 feet)

2-25. The instrument should also be protected from temperature extremes which cause condensation within the instrument.

2-26. Packaging

2-27. ORIGINAL PACKAGING. Containers and materials identical to those used in factory packaging are available through Hewlett-Packard offices. If the instrument is being returned to Hewlett-Packard for servicing, attach a tag indicating the type of service required, return address, model number, and full serial number. Also, mark the container FRAGILE to ensure careful handling. In any correspondence, refer to the instrument by model number and full serial number.

2-28. OTHER PACKAGING. The following general instructions should be used for repacking with commercially available materials:

- a. Wrap instrument in heavy paper or plastic. (If shipping to Hewlett-Packard office or service center, attach a tag indicating type of service required, return address, model number, and full serial number.)
- b. Use a strong shipping container. A double-wall carton made of 2.4 MPa (350 psi) test material is adequate.
- c. Use a layer of shock-absorbing material 70 to 100 mm (3- to 4-inches) thick around all sides of the instrument to provide firm cushioning and prevent movement inside the container. Protect control panel with cardboard.
- d. Seal the shipping container securely.
- e. Mark the shipping container "FRAGILE" to ensure careful handling.
- f. In any correspondence, refer to the instrument by model number and full serial number.

2-29. FIELD INSTALLATION OF OPTIONS

2-30. The following paragraphs provide instructions for field installation of Options 001, 002, 003, and 004. Any of the options may be installed after the purchase of the Model 5315A or 5315B by ordering the appropriate parts listed in *Table 2-1* and performing the installation procedure for that option. Field installation instructions for the Model 5315B Option 006 are contained in the Installation and Service Manual.

2-31. Part Numbers for Ordering Option Kits

2-32. To obtain the necessary parts for installation of an option, order by part number as listed below (refer to Section VI for ordering information).

Table 2-1. Option Parts for Field Installation

Option	Description	HP Part Number
001	Temperature Compensated Time Base*	05315-60007
002	Battery Pack Retrofit Kit For 5315A with serial numbers prefixed 2120A and above	05315-60113
	For 5315A with serial numbers prefixed 1812A through 2032A	05315-60105
003	Channel C (Input to 1 GHz)	
	Channel C Assembly A9	05315-60009
	Special BNC Connector	05305-60205
	Teflon Insulator	05305-20105
	Hex Nut	0590-0038
	Lockwasher	2190-0124
	Connector	05305-60206
	Fuse .125A	2110-0301
	Front Panel (5315A; serial numbers prefixed 2120A and above)	05315-00027
	Front Panel (5315A; serial numbers prefixed 1812A through 2032A)	05315-00004
	Front Panel (5315B; serial numbers prefixed 2120A and above)	05315-00029
	Front Panel (5315B; serial numbers prefixed 1812A and 2032A)	05315-00008
	Screws 6-32 X .250" Pan Head Pozidriv (4 each)	2360-0113
Reset Cable Assembly (W2); used on instruments with serial numbers prefixed 1812A to 1920A.	05315-60106	
Connector Body	05305-20104	
004; 5315A	Oven-Contained Time Base*	05315-60017
004; 5315B	Oven-Contained Time Base*	05315-60112
	Screws securing Oscillator Mounting Bracket to left side frame and A1 motherboard.	2360-0115
	6-32 X .312" Pan Head Pozidriv w/lock (4 each)	2360-0113
006; 5315B	Offset/Normalizer Module Retrofit Kit**	05315-60110

*The mounting hardware for the standard oscillator is used to mount Options 001 and 004 (5315A), or the A15A1 Assembly of Option 004 (5315B).

**Includes installation instructions, parts and hardware.

2-33. Installation of TCXO Option 001

2-34. Option 001 consists of a Temperature Compensated Crystal Oscillator, which replaces the standard oscillator. To install Option 001, proceed as follows:

- a. Remove the AC power cord.
- b. Remove the instrument top cover. For Model 5315A, this requires removal of the four screws accessible from the cabinet bottom. For Model 5315B, loosen the single screw on the top rear center of the top cover and slide top backwards.
- c. Remove the A1 Motherboard by removing the three screws located on either side of transformer T1, and center of the board. Save the four plastic spacers.
- d. Remove the two screws that secure the existing reference oscillator; remove the oscillator circuit board.
- e. Insert the A7 TCXO assembly, with components facing to the outside of the instrument, into J2 of the A1 Motherboard assembly. See *Figure 5-3*.
- f. Secure the assembly by installing the two screws through L-brackets with lockwashers and hex nuts.
- g. Perform Option 001 adjustment as described in Section V.
- h. Replace A1 Motherboard, the four spacers and the top cover.

2-35. Installation of Battery Pack and Charger Option 002

2-36. Option 002 consists of a rechargeable battery and charger assembly (A6), which are installed in the top cover of Model 5315A. To install Option 002, proceed as follows:

NOTE

Option 002 may be installed only in Model 5315A. Installation should be performed by qualified service personnel only.

- a. Remove the AC power cord.
- b. Remove the instrument top cover by removing the four screws accessible from the cabinet bottom.
- c. Position the bracket assembly, with A6 and BT1 installed, onto the six mounting posts on the inside top cover, placing the charger toward the front and the battery toward the rear of the instrument. Secure with six press-on retainers supplied. The "ground clip" should be positioned as shown in *Figure 5-4*.
- d. Connect J1 of the A6 Charger assembly to J4 of the A1 Motherboard assembly using cable harness supplied. Position cable negative battery terminal lead beside the battery cover (refer to *Figure 5-3*).

NOTE

Connectors on this harness are polarized; do not force the connectors.

- e. If the oven oscillator (Option 004) is installed, add a short insulated jumper wire at A1W1 (refer to the 5315A A1 Assembly Schematic).
- f. Perform the Option 002 adjustment as described in Section V.
- g. Replace the top cover. Position the cable harness so the cable will not be pinched by the cover.

2-37. Installation of C Channel Option 003

2-38. Option 003 consists of a 1 GHz Channel Assembly (A9) which plugs into an existing motherboard connector. Procedures are provided for the installation of Option 003 in Model 5315A (paragraph 2-39) and Model 5315B (paragraph 2-40).

NOTE

If Option 003 is to be installed in a 5315A/B with a Serial Prefix of 1920A or earlier, the following modifications *must* be performed.

1. On A1 Motherboard, using diagonal pliers, clip off pin 1 of A1J6.
2. On A9 C Channel, install the RESET CABLE W2 (HP Part No. 05315-60106), by soldering the end (opposite the connector pin) into the vacant printed circuit pad next to pin 1 of P1.
3. Perform the following installation procedure. When finished, insert the connector end of RESET CABLE W2 into A1J7, pin 15 to complete the installation.

2-39. To install Option 003 in HP Model 5315A, proceed as follows:

- a. Remove the AC power cord.
- b. Remove the instrument top cover (MP 12) by removing the four screws accessible from the cabinet bottom.
- c. Remove the LEVEL/SENS and GATE TIME control knobs.
- d. Remove the three screws which secure the motherboard to cabinet bottom. Remove the handle (MP 3) and the four black spacers (MP 4) and lift the entire instrument straight up and out.
- e. Remove the front panel hex nuts on the CHANNEL A and B BNC's and the three control hex nuts.
- f. Remove the 1/4" hex nut on the left rear side of the A2 Display Assembly. Pull the front panel (MP6) forward until it clears the control shafts and input jacks. Note the spacer between the front panel and A2 Assembly.

NOTE

If the old front panel has bezels installed in the holes, transfer them to the replacement panel.

- g. Remove the four screws securing the A4 Input Amplifier.
- h. Remove the A3/A4 assembly by gently lifting on the rear edge of A4, until the pins come free of motherboard connector A1 J5.
- i. Position the A9 C Channel assembly, component side up and protruding connector pins toward rear of instrument, over A1 motherboard jack J6. Install by gently pressing the row of connector pins into J6 until the assembly rests on the spacers mounted on A1. Secure with four screws provided.
- j. Install the Special Input BNC (provided) in the INPUT C position (center) of the 5315A replacement front panel (provided) as illustrated in Section III, *Figure 3-12*.
- k. Connect the SMC connector on A9 W1 to the INPUT C BNC; loosely install the new front panel; set the instrument into the cabinet bottom.

- l. Perform Option 003 adjustment as described in Section V.
 - m. Remove the instrument from the cabinet bottom and replace the A3/A4 Input Amplifier.
 - n. Position the front panel, and reinstall the CHANNEL A and B BNC and three control hex nuts. Replace the LEVEL/SENS and GATE TIME control knobs.
 - o. Reinstall the instrument into the cabinet bottom and secure with three screws. Replace the handle and four black spacers. Replace the cabinet top cover.
- 2-40. To install Option 003 in HP Model 5315B proceed as follows:
- a. Remove the AC power cord.
 - b. Remove the instrument top cover (MP 12) by removing the screw which secures the carrying handle (MP 11) at rear of instrument. Slide the cover backward until free.
 - c. Remove the gray trim strip (MP 16) from top of the instrument front frame (MP 17).
 - d. Remove the four screws which secure the front panel (MP 21). The front feet of the instrument must be removed to access the two screws on the frame bottom.

NOTE

Steps e & f apply only to instruments with serial numbers prefixed 1812A through 2032A. For all instruments, continue with step g.

- e. Remove the two screws which secure the support bracket, on the left side of A1 motherboard, to the instrument side frame.
- f. Remove the two screws and bracket which secure the A1 power supply heat sink to the instrument side frame.
- g. Remove the two screws at the rear edge of A1 motherboard.
- h. Disconnect the three power transformer secondary wires (BLU, BLU, WHT-BLU) from the A1 Motherboard, by pulling the push-on connectors straight up and off the test pins. Remove the OSC OUT wire which connects J8 to A1 Motherboard in the same manner.

NOTE

HP 5315B instruments with serial number 1832A00001 to 1832A00120 do not have "push on" connectors on the transformer secondary terminals or EXT REF wires. Carefully unsolder and resolder the wires on these instruments to complete installation.

- i. Carefully pull the entire instrument straight forward, through the front frame, and clear of the cabinet.
- j. Remove the LEVEL/SENS and GATE TIME front panel control knobs.
- k. Remove the front panel hex nuts on CHANNEL A and B INPUT BNC's and the three control hex nuts.
- l. Remove the 1/4" hex nut on the left side (back) of the A2 Display Assembly, and pull the front panel (MP21) straight forward, until clear. Note the spacer between the front panel and the A2 assembly.
- m. Remove the A3/A4 assembly by gently lifting on the rear edge of A4, until the pins come free of motherboard connector A1 J5.
- n. Position the A9 C Channel assembly, component side up with the protruding connector pins toward rear of instrument, over A1 motherboard jack J6. Install by gently pressing the row of connector pins into J6 until the assembly tests on the spacers mounted on A1. Secure with four screws provided.

- o. Install the Special Input BNC (provided) in the INPUT C position (center) of the 5315B replacement front panel (provided) as illustrated in Section III, *Figure 3-12*.
- p. Connect the SMC connector on A9W1 to the INPUT C BNC, and loosely install the new front panel.
- q. Position the cabinet and A1 motherboard assembly side by side, with the cabinet facing to the rear. Route the three power transformer secondary wires through the cabinet side frame and reconnect to A1 motherboard test pins. Ensure the wire colors match the pins as labeled.
- r. Carefully replace AC power cord, and perform Option 003 adjustment as described in Section V.
- s. Disconnect the power transformer secondary wires. Reinstall the A3/A4 Input Amplifier assembly.
- t. Reinstall the instrument into the cabinet by reversing steps a through l. Be sure that the A1 motherboard fits into the board guides.

2-41. Installation of Oven Oscillator Option 004 (5315A)

2-42. Option 004 consists of an oven-contained oscillator assembly (A14), which plugs into the reference oscillator connector J2 on the motherboard. Option 004 replaces the standard oscillator assembly (A13) or the TCXO assembly. To install Option 004 in the 5315A, proceed as follows:

- a. Remove the AC power cord.
- b. Remove the instrument top cover by removing the four screws accessible from the cabinet bottom.
- c. If battery pack Option 002 is installed, disconnect the 11-conductor cable assembly W4 at the motherboard connector.
- d. Remove the four spacers (MP4) and the three screws used to secure the A1 motherboard. Two of the screws are located on either side of transformer T1 with the other in the center of the board.
- e. Remove the two screws which secure the existing reference oscillator assembly. Remove the assembly.
- f. Position the A14 oven oscillator assembly with the components facing the left side of the instrument. Insert A14P2 into the motherboard jack (A1J2) from which the previous assembly was removed.
- g. Secure the assembly to the motherboard by installing the two screws through the L-brackets.
- h. If battery Option 002 is also installed, add a short insulated jumper wire on the A1 motherboard at the location labeled "W1."
- i. Perform the 5315A Option 004 adjustment as described in Section V.
- j. Install and secure A1 motherboard with the three screws. Replace the four spacers. Reconnect the battery option cable (if necessary). Install and secure the top cover with the four screws.

2-43. Installation of Oven Oscillator Option 004 (5315B)

2-44. Option 004 consists of an Oven Module Assembly (A15) with mounting bracket and an interconnect board, which plugs into the reference oscillator connector J2 on the A1 motherboard. This assembly replaces the standard oscillator assembly (A13) or the Option 001 TCXO assembly (A7). To install Option 004 in the 5315B, proceed as follows:

- a. Disconnect the 5315B power cord.
- b. Remove the instrument top cover (MP12) by removing the carrying handle screw (MP11) at rear of instrument. Slide the cover toward the rear until free.
- c. Remove the bottom cover (MP8) by loosening the captive screw (at the rear edge of the cover). Slide cover toward the rear until free.
- d. Remove the two screws which secure the existing reference oscillator assembly. Remove the assembly.
- e. Position the oven module and bracket assembly with the flat surface of the bracket facing the left side strut and the foot of the bracket over the hole near the center of the motherboard. Guide the bracket into place against the side strut. The lower edge of the bracket should be inserted in the space between the edge of the motherboard and the side strut, (between the rear deck and board guide).
- f. Secure the bracket to the side strut using three 6-32 × 3/8 inch screws; secure to motherboard using a similar screw.
- g. Insert the interconnect board (A15A1) into connector A1J2 of the motherboard assembly. The components should face the left side of instrument.
- h. Secure the interconnect board by installing the two 6-32 × 1/4 inch screws through the L-brackets.
- i. Perform Option 004 adjustment as described in Section V.
- j. Replace the bottom and top covers.

SECTION III OPERATION

3-1. INTRODUCTION

3-2. This section provides operating information for the 5315A/B Universal Counter. Descriptions of all front panel controls, connectors, and indicators as well as an operator's check, operating instructions, and operator's maintenance are provided.

3-3. OPERATING CHARACTERISTICS

3-4. The 5315A/B is a 100 MHz and 100 ns full universal counter, capable of Frequency, Period, Time Interval, Ratio, and Totalize type measurements. To maximize resolution, the 5315A/B uses a reciprocal counting technique for frequencies below 10 MHz, automatically switching to conventional frequency counting for frequencies above 10 MHz. The gate time is continuously adjustable from 50 ms to 10 s, on the front panel. The internal microcomputer performs the calculations, and automatically compensates for the arbitrary gate time. The display is given in scientific notation (i.e., exponents of blank, ± 3 , ± 6 , or ± 9). The input amplifiers are optimized for both time interval and frequency measurements.

3-5. When the optional third input channel is installed, the ("C") frequency range of the counter is extended to 1 GHz. The input sensitivity can be decreased, continuously, up to 20 dB nominally (in the range of 50 to 500 MHz) and 10 dB nominally (in the range of 500 to 1000 MHz).

3-6. MODES OF OPERATION

3-7. The 5315A/B provides ten modes of operation and two check functions. The resolution and accuracy for each mode except A Armed by B is provided in *Table 1-1*. The modes of operation are described in the following paragraphs:

- FREQ A (Frequency A)
- PER A (Period A)
- T.I. A→B [Time Interval A (start)-to-B (stop)]
- T.I. AVG. A→B (Time Interval Average A-to-B)
- T.I. DELAY (Holdoff)
- RATIO A/B (Ratio A-to-B)
- A BY B (Gated Totalize)
- A-Armed-By-B Mode
- FREQ C (Option 003)
- TOT (Manual Totalize)
- CHECK
- Display Check

3-8. FREQ A (Frequency A Mode)

3-9. Frequency measurements are made by connecting a signal (up to 100 MHz) to INPUT A, and pressing the FREQ A key (with the Blue shift key out). Select the appropriate input signal conditioning and adjust the LEVEL/SENS control (with TRIGGER LEVEL/SENSITIVITY key to TRIGGER LEVEL) to optimum trigger point. The optimum trigger point may be determined by centering the LEVEL/SENS control within the triggering range, indicated by the flashing trigger light. The GATE TIME control determines the resolution of the measurement, and may be displayed by pressing the GATE TIME function key and Blue shift key. The gate time range when FREQ A is pressed is 60 ms to 10 s, typical. However a gate time range of 500 μ s to 30 ms is available by pressing T.I. DELAY and TOT STOP/START simultaneously. When the Blue Shift key is OUT, the 5315A/B will be in FREQ A. When the Blue Shift key is IN, the 5315A/B will be in PER A. PER A is discussed in the following paragraph.

3-10. PER A (Period A Mode)

3-11. The Period A mode allows single period measurements to be made with periods of 100,000 seconds (28 minutes) to 10.0 nanoseconds into INPUT A. Select the appropriate input signal conditioning and Trigger Level/Sensitivity.

3-12. T.I. A-B |Time Interval A (start)-to-B (stop)| Mode

3-13. T.I. A→B measures the time interval between a START signal at INPUT A and a STOP signal at INPUT B. If both the START and STOP signals are derived from the same signal, connect the signal to INPUT A and set the SEP/COM A key to the COM A position (IN). Separate slope and Level/Sensitivity controls for each channel allow variable triggering on either positive or negative going slope. A single-shot time interval measurement may be made over a range of 100 nanoseconds up to 8 digits and 100,000 seconds after 9 digits.

3-14. T.I. AVG A-B (Time Interval Average A-to-B) Mode

3-15. The T.I. Average mode provides greater resolution of time interval measurements than single-shot T.I. mode. In the T.I. AVG mode, the gate time control varies the number of events of time intervals averaged (approximately GATE TIME × REP RATE). The resolution of the measurement is improved by the \sqrt{N} , where N is the number of time intervals averaged. A limited range of negative T.I. measurements (i.e., B triggers before A) are possible in T.I. AVG mode.

3-16. In the T.I. AVG mode, there must be at least 200 ns dead time. Dead time occurs between the preceding time interval stop event and the current time interval start event, as shown in Figure 3-1. This means that in T.I. AVG mode, the repetition rate must be less than 5 MHz.

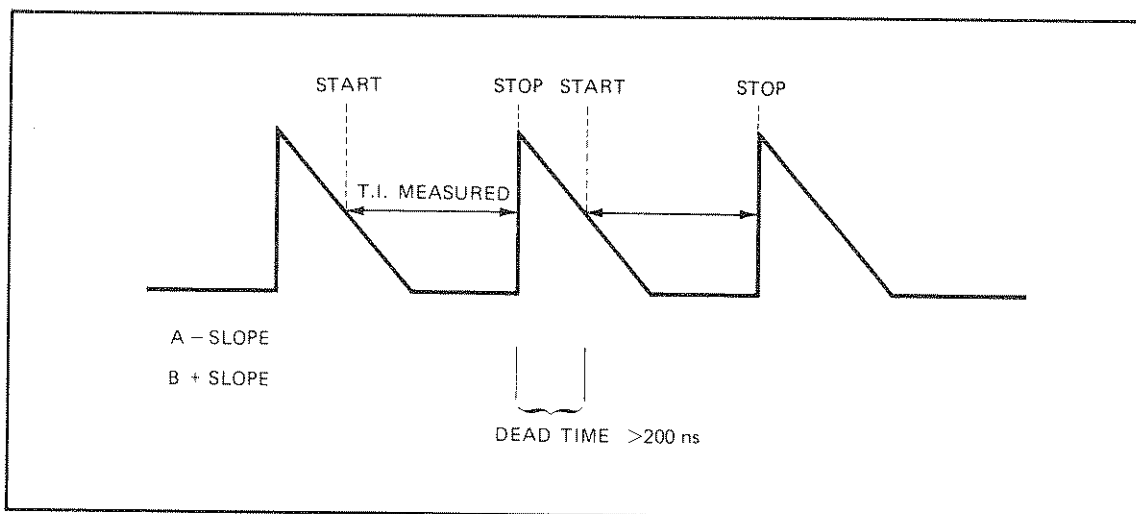

Figure 3-1. T.I. Average Dead Time

3-17. T.I. DELAY (Holdoff) Mode

3-18. The T.I. DELAY mode of operation is similar to T.I. A→B, but with the following additional control: The front panel GATE TIME control inserts a variable delay (from 500 μ s nominal to >20 ms between the START (INPUT A) event and the enabling of the STOP (INPUT B) event. Potential STOP events are ignored during the specified delay or holdoff. The amount of delay time may be continuously measured and displayed by simultaneously pressing the T.I. A→B, T.I. DELAY, and Blue shift keys. Figure 3-2 illustrates the T.I. DELAY function.

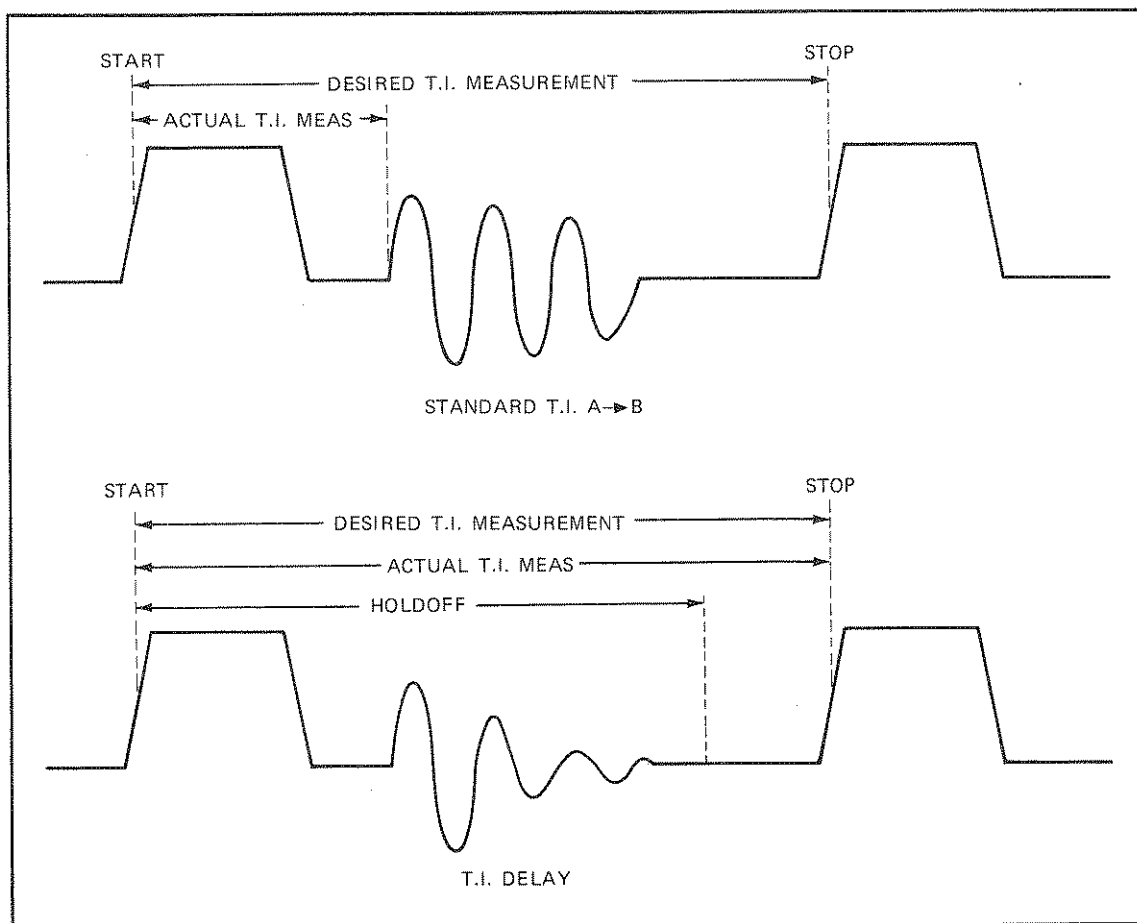

Figure 3-2. Timing of Time Interval Delay Mode

3-19. RATIO A/B

3-20. The RATIO A/B mode of operation measures and displays the frequency ratio of signals on INPUT A to signals on INPUT B. The GATE TIME control determines the resolution by selecting the number of cycles of the INPUT B signal over which the ratio A/B is measured. Increasing the gate time (towards MAX) or increasing the frequency of INPUT B results in an increased resolution of the measurement. Frequencies up to 100 MHz on both channels are allowed.

3-21. A BY B (Gated Totalize)

3-22. A BY B (A gated by B) is a totalize mode of operation (see *Figure 3-3*), in which events on INPUT A (up to 100 MHz) are counted for a duration determined by INPUT B. The gate is "OPENED" on the slope of Input B selected by the Channel A Slope switch, and "CLOSED" on the slope of Input B selected by the Channel B Slope switch. This allows any one of four discrete gate durations from a given signal on Input B. The Channel A slope switch also determines which slope of the events signal is counted on INPUT A. A BY B is a single-shot mode of operation. The RESET button must be pressed to clear the display and allow the initiation of a new measurement.

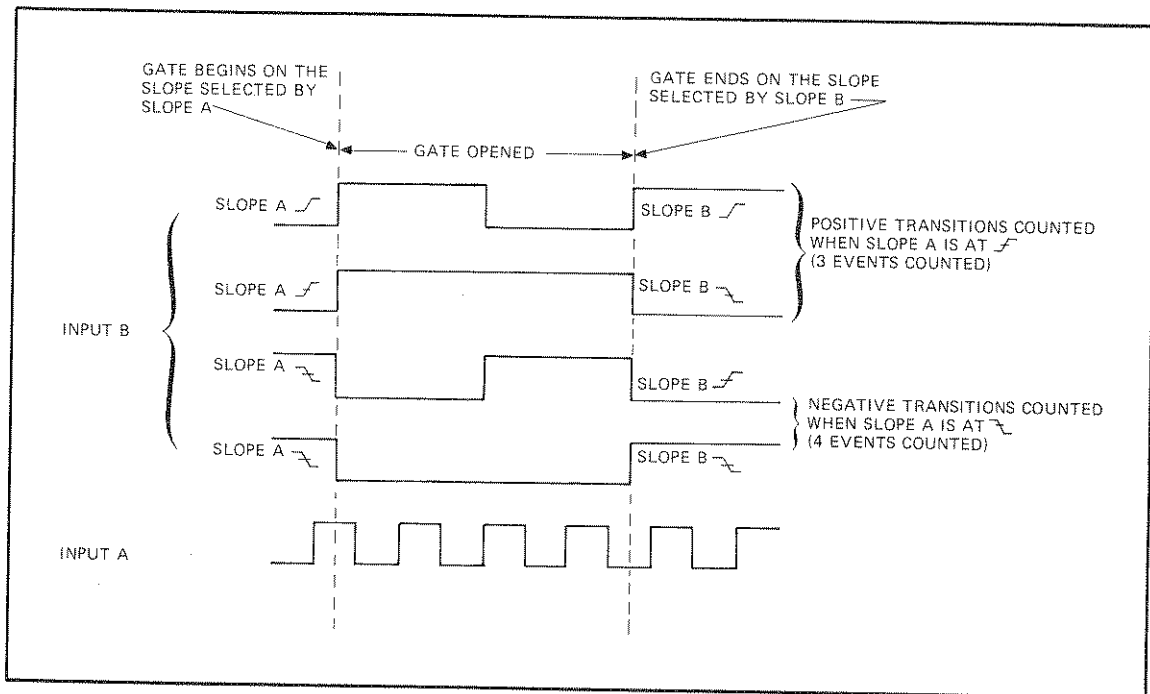

Figure 3-3. Timing of Totalize A by B Mode

3-23. A-ARMED-BY-B Mode

3-24. The 5315 has a measurement function, frequency-A-Armed-By-B, Averaged, for frequency averaging. Called "A ARMED BY B", this function allows the 5315 to average together multiple frequency measurements. To do this, a sampling signal synchronized with and of pulse width less than the signal bursts must be applied to the Channel B input. This signal performs two functions: one, it tells the 5315 when to count the incoming bursts and when to ignore the dead time between bursts; and two, it opens the 5315 gate. The measurement interval is set from the front panels and its length determines the number of bursts to be averaged. *Figure 3-4* shows an example of function A-Armed-By-B. In this example, 1 MHz bursts, 10 μ s wide, at a 10 kHz repetition rate are applied to Channel A input. A sampling signal of equal repetition rate and shorter pulse width is applied to Channel B. This sampling signal must be synchronized with the Channel A frequency burst signal. When the first burst occurs, the sampling signal at Channel B opens the gate, and tells the 5315 to begin counting the events at Channel A. When the sampling signal disappears, the 5315 stops counting the events at Channel A. If the gate is still open and another burst occurs, the 5315 will add these "new" events to the previous events counted. This will continue until the measurement interval runs out. On the next sampling pulse, after the gate closes, the 5315 will compute the average frequency of the signal during the burst (in this example 1 MHz). A final sampling pulse **must** occur after the measurement interval ends to terminate the measurement. The events that occurred during this final pulse are not averaged in the displayed amount.

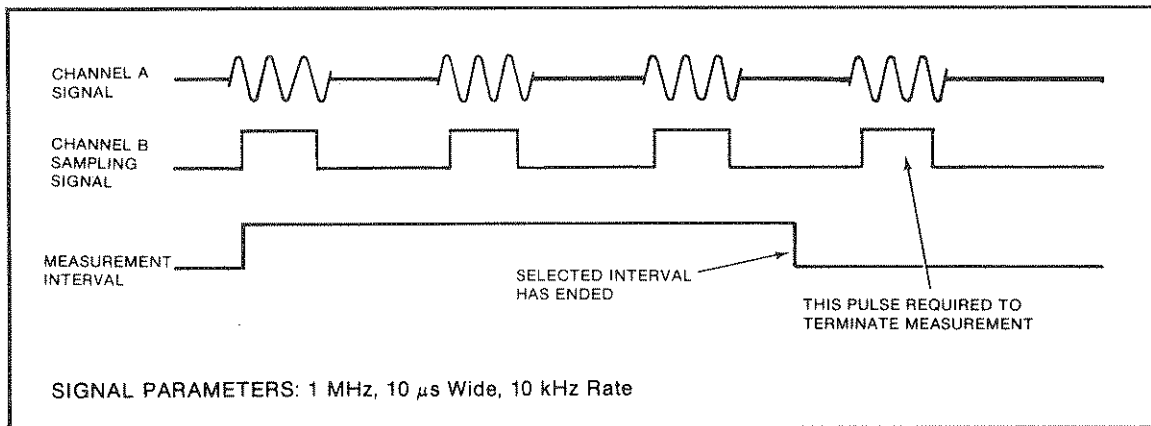

Figure 3-4. A ARMED BY B

3-25. The length of the measurement interval and signal repetition rate determine how many bursts will be averaged. Faster burst repetition rates allow shorter measurement intervals for a given number of averages. The main limit is that no more than 100 million "events" can be counted (either input signal cycles or time base counts). In the case of Figure 3-4, each burst contains 10 "events", with 10 thousand occurring in 1 second for 100 thousand "events" per second. Since 100 million events is the limit, the 5315 could average for 1000 seconds before the events counter would overflow. And, since the measurement interval determines the number of averages, a 1000-second measurement interval would be necessary before the events count or time base count would overflow. This, of course, is longer than that obtainable from the 5315 (maximum measurement interval of about 10 seconds). A specific case where the 5315 would overflow would be a 50 MHz signal pulsed for 200 ns at a 2 MHz rate. In this case 10 "events" occur during each burst, with 2 million bursts per second, or 20 million "events" in 1-second. So, the 5315 would overflow in 5 seconds, thus the gate time must be less than 5 seconds, and 10 million bursts would be averaged. If the 100 million events limit is exceeded the displayed answer will be inaccurate.

3-26. A ARMED BY B has two modes (two different measurement interval ranges) and is not labeled on the front panel. For a measurement interval range of 500 μ s-30 ms, press T.I. DELAY and RATIO A/B together. The measurement interval may be displayed by selecting the GATE TIME mode for the LONG interval or by pressing T.I. A-B, T.I. DELAY, and Blue Shift key simultaneously for the SHORT interval. For a measurement interval range of 60 ms to 10 seconds, press FREQ A and TOT STOP together. The Channel A Trigger Slope is set by the front panel Channel A Slope switch. The sampling signal enable slope (begin counting) is determined by the Blue Shift key. In the OUT position the counting will be enabled on the sampling signal positive slope. In the IN position, the counting will be enabled on the sampling signal negative slope. The gate will also be opened on the same slope as determined by the Blue Shift key. The disable slope is determined by the Channel B front panel slope switch. The measurement interval is controlled, as normal, by the front panel GATE TIME control. The gate will close once the selected time has passed. There is no problem if the gate should close in the middle of counting a burst. The following limits do exist in this mode:

1. 200 ns minimum dead time between bursts.
2. 100 ns minimum burst width.
3. The enable slope can only be negative when using the short measurement interval (500 μ s-30 ms).

Resolution increases with the square root of the number of samples averaged, N.

$$\text{Resolution} \sim \frac{(10^{-7}) \times (\text{INPUT FREQ})}{(\text{Sampling Signal Width}) \times (\sqrt{N})} \text{ Hz}$$

$$N \sim \frac{\text{Measurement Interval}}{\text{Gate signal repetition rate}}$$

From Figure 3-4, the sampling signal is 10 μ s wide at a 10 kHz repetition rate with a measurement interval of 1-second. With a single-shot measurement:

$$\text{resolution} = \frac{100 \times 10^{-9}}{10 \times 10^{-6}} \times \frac{1 \times 10^6}{\sqrt{1}} = 10^4 \text{ or } 10 \text{ kHz resolution}$$

but with average N = 10000 (1 second measurement interval):

$$\text{resolution} = \frac{100 \times 10^{-9}}{10 \times 10^{-6}} \times \frac{10^6}{\sqrt{10000}} = 100 \text{ Hz (100 times better)}$$

Accuracy: The actual measurement interval is shorter than the correct value by about 1 nanosecond. With short sample pulse widths and large N values the displayed answer will not be perfectly accurate:

$$\text{Ultimate accuracy} = \frac{10^{-9}}{\text{measurement interval}} \times (\text{Input FREQ})$$

With a 10 μ s sample pulse width, accuracy can be as good as 100 Hz if enough events are averaged.

3-27. **FREQ C** (Frequency C Mode, Option 003)

3-28. To make a frequency measurement on a CW signal in the range of 50 MHz to 1 GHz, select FREQ C function and connect the signal to INPUT C.

NOTE

If the amplitude of the signal exceeds the 1V rms dynamic range, the measurement may be incorrect.

Set the GATE TIME control to MIN (but not hold). Set the SENS C control to MIN. Slowly move the SENS C control in a clockwise direction (toward MAX) until the counter begins to gate. This represents the optimum trigger sensitivity. To increase the displayed resolution, move the GATE TIME control toward MAX. Pressing either slope switch will reset the counter.

NOTE

The Trigger Lights for INPUT A and INPUT B are inoperative and extinguished when functions FREQ C or GATE TIME are selected. This is normal. However, pressing either Channel A or B Slope switches will reset the counter.

3-29. **TOT STOP/START** (Totalize Start-Stop Mode)

3-30. Totalize STOP/START is a manually gated, totalize mode of operation. Pressing the blue shift key (IN position) opens the main gate, allowing INPUT A events to be counted. Pressing the shift key again (OUT position) closes the gate, stopping the count. The count is continuously displayed, and cumulative from gate cycle to gate cycle. The RESET button clears the counter and resets the display to zero.

3-31. **CHECK** (Mode)

3-32. The Check mode applies 10 MHz from the internal (or external for 5315B) reference oscillator to the MRC. It is used to verify the basic operation of the counter, GATE light and GATE TIME control.

3-33. Display Check (Mode)

3-34. The Display Check mode is unlabeled; it cycles the display through a routine that exercises all digits and most annunciators. With the POWER switch to ON, and all function switches to the "OUT" position, a rolling display, corresponding to Table 3-1, will result.

Table 3-1. Display Check

All Displays	OVFL	ERROR	—	Hz	S	GATE	dp1	dp2	dp3
00000000 0							•		
11111111-1	•		•					•	
22222222 2	•				•				•
33333333-3	•		•		•				
44444444 4	•			•					
55555555-5	•	•	•	•					
66666666 6	•			•	•				
77777777-7	•		•	•	•				
88888888 8	•					•			
99999999-9	•		•			•			
BLANK	•		•	•	•	•			

3-35. FRONT AND REAR PANEL FEATURES AND CONTROLS

3-36. The following paragraphs describe the features and controls of the function selection, signal conditioning, and display sections of the front panel. Front and rear panel controls are individually located and described in Figures 3-7 and 3-8).

NOTE

Except RESET all front panel key switches "latch" in and stay when pushed. A second push releases latched keys. The six keys between RESET and the blue "shift" key are interconnected so that pushing one will release another latched key.

3-37. FUNCTION SELECTION CONTROLS

3-38. The function (mode) selection section of the front panel contains the POWER (Stby/On), Reset keys, Function Mode keys group (within the border outline), and Gate Time/Delay control.

3-39. The POWER key sets the 5315A/B either to ON or STBY (Standby). In the ON position (in power is supplied to entire instrument. In the STBY position (OUT) unregulated DC is supplied only to battery-pack charging circuits (Option 002). The RESET key clears and updates the display for continuous measurement modes, and resets the counter in totalize modes.

3-40. Each of the keys within the outlined function group can select one of two functions: With the blue shift key in the "OUT" position, the other six keys select the function labeled above (i.e., FREQ A, T.I. A→B, etc.). With the shift key in the "IN" position, the keys select the function labeled in blue below (i.e., PER A, T.I. AVG A→B, etc.).

3-41. The GATE TIME/DELAY control determines the amount of gate time per measurement, and it is continuously adjustable over a range of 50 ms to 10 seconds. The selected gate time may be displayed by pressing the GATE TIME function key, and the blue shift key. In the T.I. DELAY mode of operation the control determines the amount of time the Start Channel is held off or "delayed" (see paragraph 3-17). The amount of "delay" may be displayed by pressing the T.I. A→B, T.I. DELAY, and blue shift key simultaneously. In the T.I. A→B mode of operation, the GATE TIME/DELAY control determines the sample rate.

3-42. SIGNAL CONDITIONING CONTROLS

3-43. A full complement of signal conditioning controls are provided for each channel (A and B) input (see Figure 3-6). These controls allow the selection of Attenuation (X1, X20), Slope (positive or negative) and input coupling (AC or DC). The SEP/COM A switch allows the selection of separate Channel A and B inputs in the SEP position. The COM A position disconnects the Channel B Input BNC, and connects both Channel A and Channel B input amplifiers to the Channel A input.

3-44. A low pass filter for Channel A input is provided. With the FILTER NORM key "in" frequencies above 100 kHz are effectively attenuated. With the FILTER NORM key "out" there is no filtering.

3-45. TRIGGER LEVEL/SENSITIVITY CONTROLS

3-46. The Trigger Level/Sensitivity controls provided for each channel operate as follows: With the TRIGGER LEVEL/SENSITIVITY key "out", the LEVEL/SENS control adjusts the trigger level (over a range of ± 2.5 volts DC in ATTN X1, or ± 50 volt DC in ATTN X20). With the TRIGGER LEVEL/SENSITIVITY key "in", the LEVEL/SENS control adjusts the input sensitivity from MAX (10 mV up to 10 MHz, 25 mV up to 100 MHz) with control fully clockwise to MIN (greater than 500 mV) with control fully counterclockwise (see Figure 3-5).

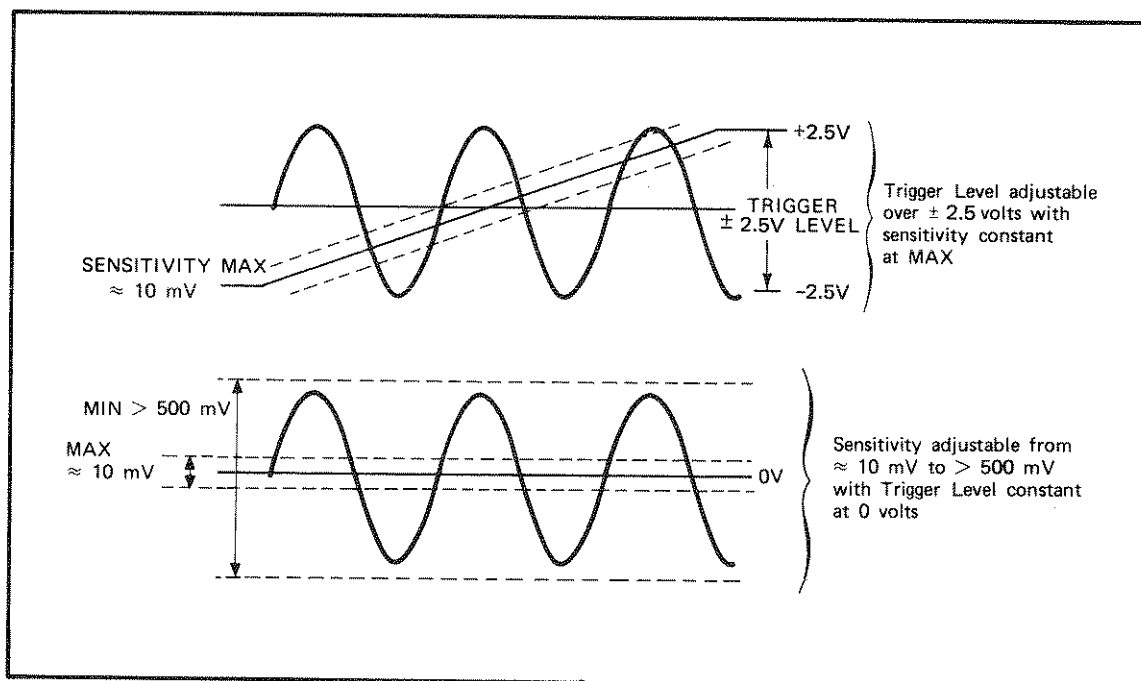

Figure 3-5. Trigger Level/Sensitivity Controls

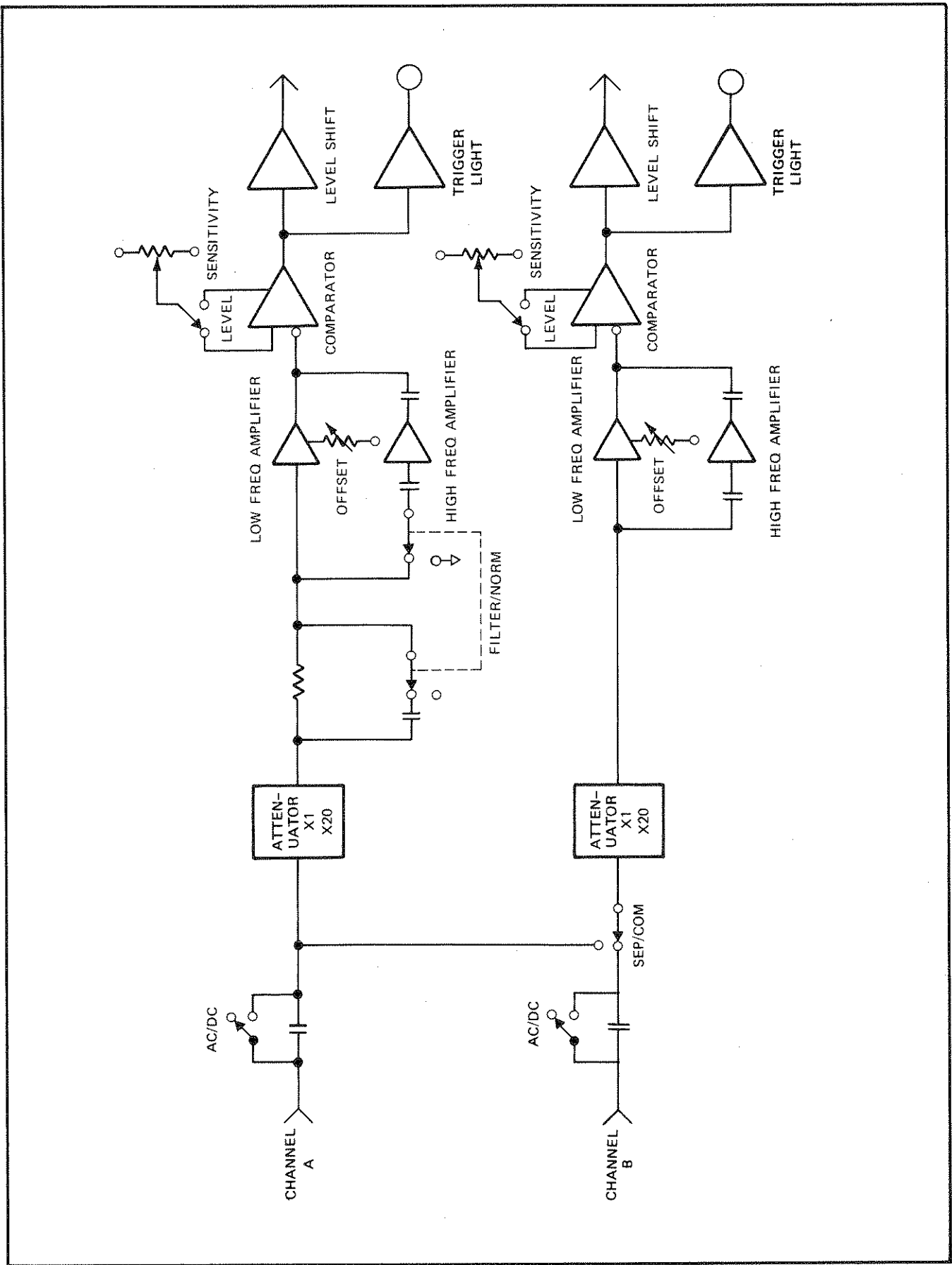
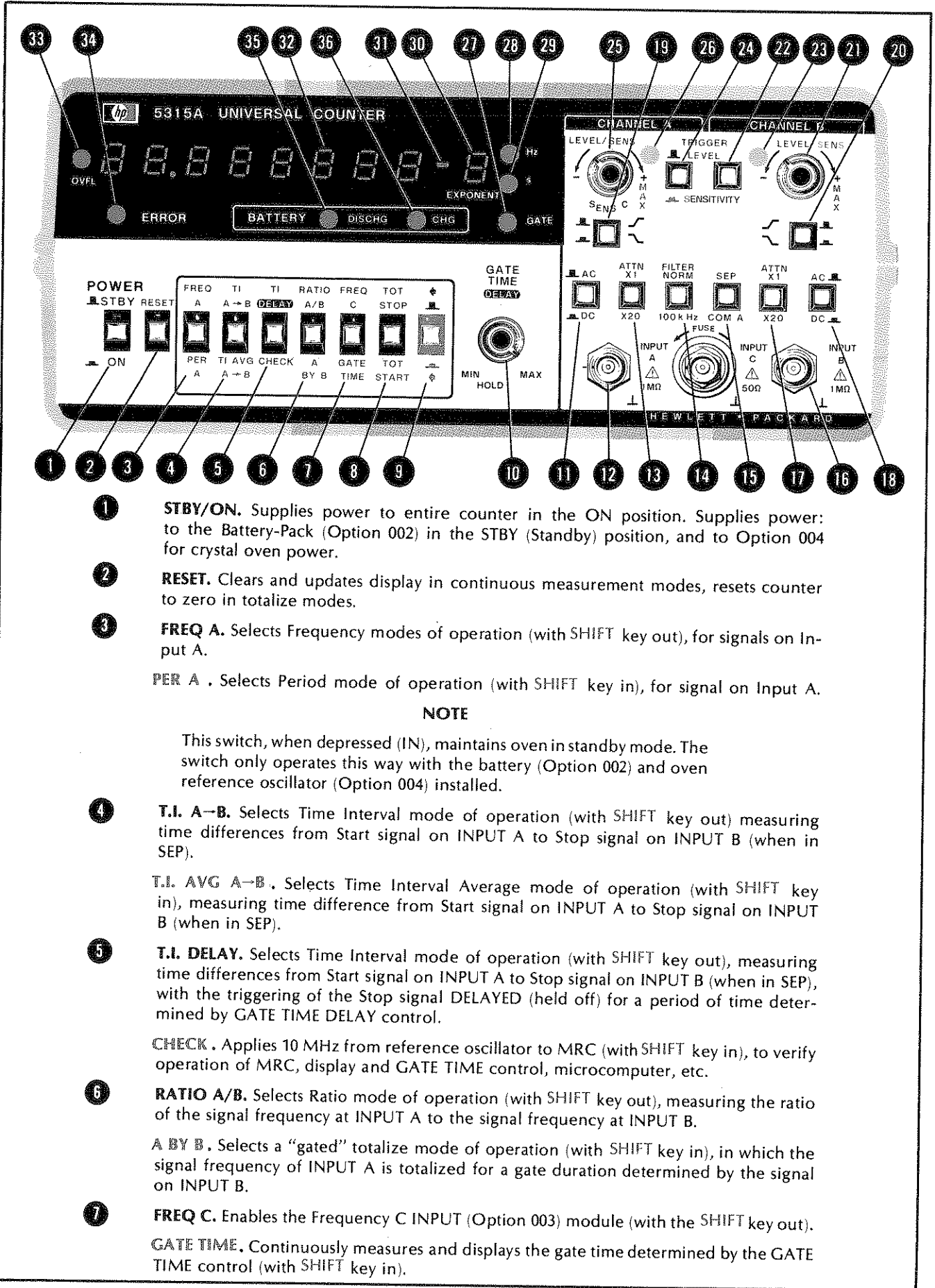

Figure 3-6. 5315A/B Front End Block Diagram



- 1 **STBY/ON.** Supplies power to entire counter in the ON position. Supplies power: to the Battery-Pack (Option 002) in the STBY (Standby) position, and to Option 004 for crystal oven power.
- 2 **RESET.** Clears and updates display in continuous measurement modes, resets counter to zero in totalize modes.
- 3 **FREQ A.** Selects Frequency modes of operation (with SHIFT key out), for signals on Input A.
PER A . Selects Period mode of operation (with SHIFT key in), for signal on Input A.

NOTE

This switch, when depressed (IN), maintains oven in standby mode. The switch only operates this way with the battery (Option 002) and oven reference oscillator (Option 004) installed.

- 4 **T.I. A-B.** Selects Time Interval mode of operation (with SHIFT key out) measuring time differences from Start signal on INPUT A to Stop signal on INPUT B (when in SEP).
- T.I. AVG A-B.** Selects Time Interval Average mode of operation (with SHIFT key in), measuring time difference from Start signal on INPUT A to Stop signal on INPUT B (when in SEP).
- 5 **T.I. DELAY.** Selects Time Interval mode of operation (with SHIFT key out), measuring time differences from Start signal on INPUT A to Stop signal on INPUT B (when in SEP), with the triggering of the Stop signal DELAYED (held off) for a period of time determined by GATE TIME DELAY control.
- CHECK.** Applies 10 MHz from reference oscillator to MRC (with SHIFT key in), to verify operation of MRC, display and GATE TIME control, microcomputer, etc.
- 6 **RATIO A/B.** Selects Ratio mode of operation (with SHIFT key out), measuring the ratio of the signal frequency at INPUT A to the signal frequency at INPUT B.
A BY B . Selects a "gated" totalize mode of operation (with SHIFT key in), in which the signal frequency of INPUT A is totalized for a gate duration determined by the signal on INPUT B.
- 7 **FREQ C.** Enables the Frequency C INPUT (Option 003) module (with the SHIFT key out).
GATE TIME . Continuously measures and displays the gate time determined by the GATE TIME control (with SHIFT key in).

Figure 3-7. Front Panel Features

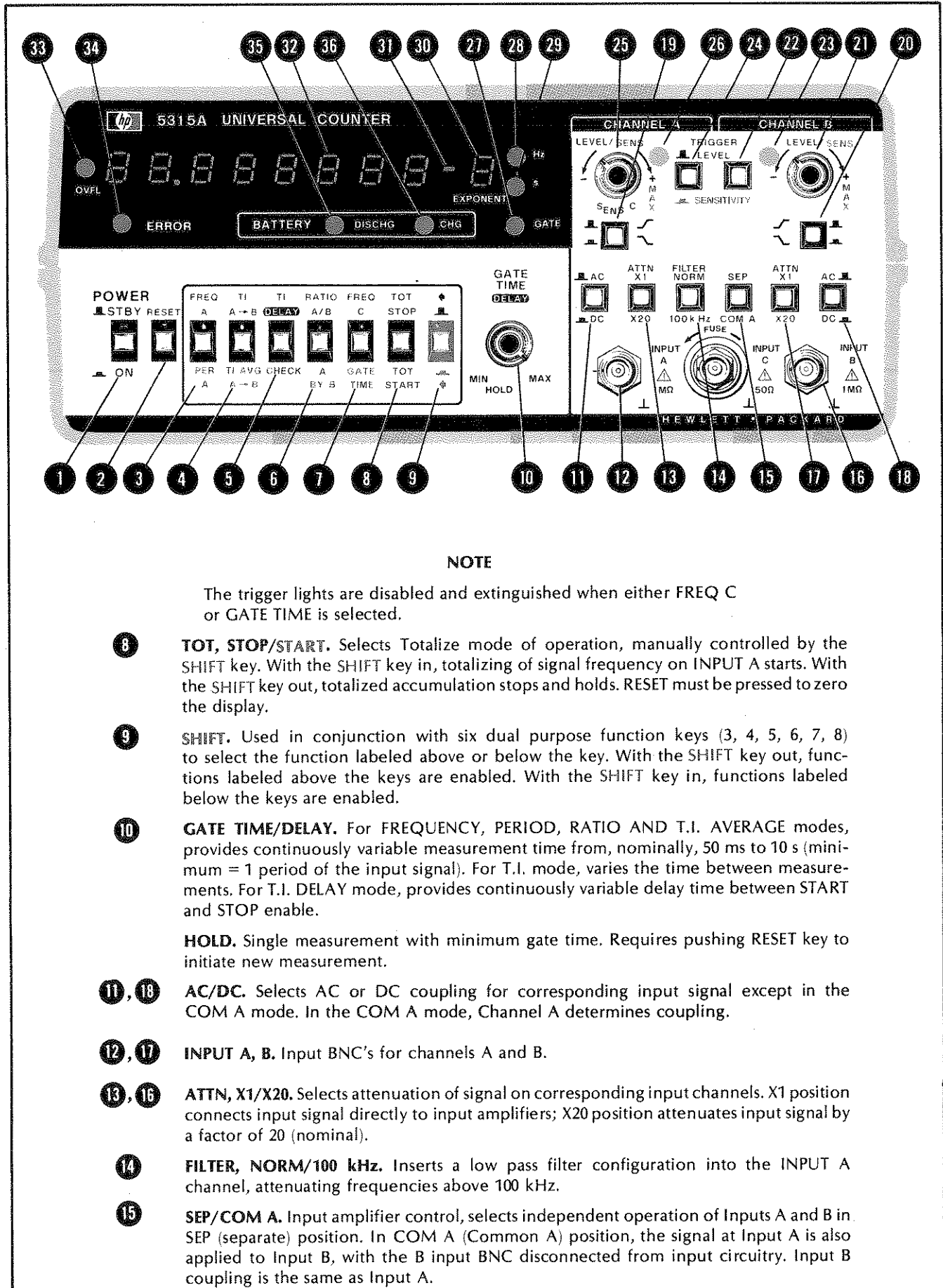

NOTE

The trigger lights are disabled and extinguished when either **FREQ C** or **GATE TIME** is selected.

- 8** **TOT, STOP/START.** Selects Totalize mode of operation, manually controlled by the SHIFT key. With the SHIFT key in, totalizing of signal frequency on INPUT A starts. With the SHIFT key out, totalized accumulation stops and holds. RESET must be pressed to zero the display.
- 9** **SHIFT.** Used in conjunction with six dual purpose function keys (3, 4, 5, 6, 7, 8) to select the function labeled above or below the key. With the SHIFT key out, functions labeled above the keys are enabled. With the SHIFT key in, functions labeled below the keys are enabled.
- 10** **GATE TIME/DELAY.** For FREQUENCY, PERIOD, RATIO AND T.I. AVERAGE modes, provides continuously variable measurement time from, nominally, 50 ms to 10 s (minimum = 1 period of the input signal). For T.I. mode, varies the time between measurements. For T.I. DELAY mode, provides continuously variable delay time between START and STOP enable.

HOLD. Single measurement with minimum gate time. Requires pushing RESET key to initiate new measurement.
- 11, 18** **AC/DC.** Selects AC or DC coupling for corresponding input signal except in the COM A mode. In the COM A mode, Channel A determines coupling.
- 12, 17** **INPUT A, B.** Input BNC's for channels A and B.
- 13, 16** **ATTN, X1/X20.** Selects attenuation of signal on corresponding input channels. X1 position connects input signal directly to input amplifiers; X20 position attenuates input signal by a factor of 20 (nominal).
- 14** **FILTER, NORM/100 kHz.** Inserts a low pass filter configuration into the INPUT A channel, attenuating frequencies above 100 kHz.
- 15** **SEP/COM A.** Input amplifier control, selects independent operation of Inputs A and B. In SEP (separate) position. In COM A (Common A) position, the signal at Input A is also applied to Input B, with the B input BNC disconnected from input circuitry. Input B coupling is the same as Input A.

Figure 3-7. Front Panel Features (Continued)

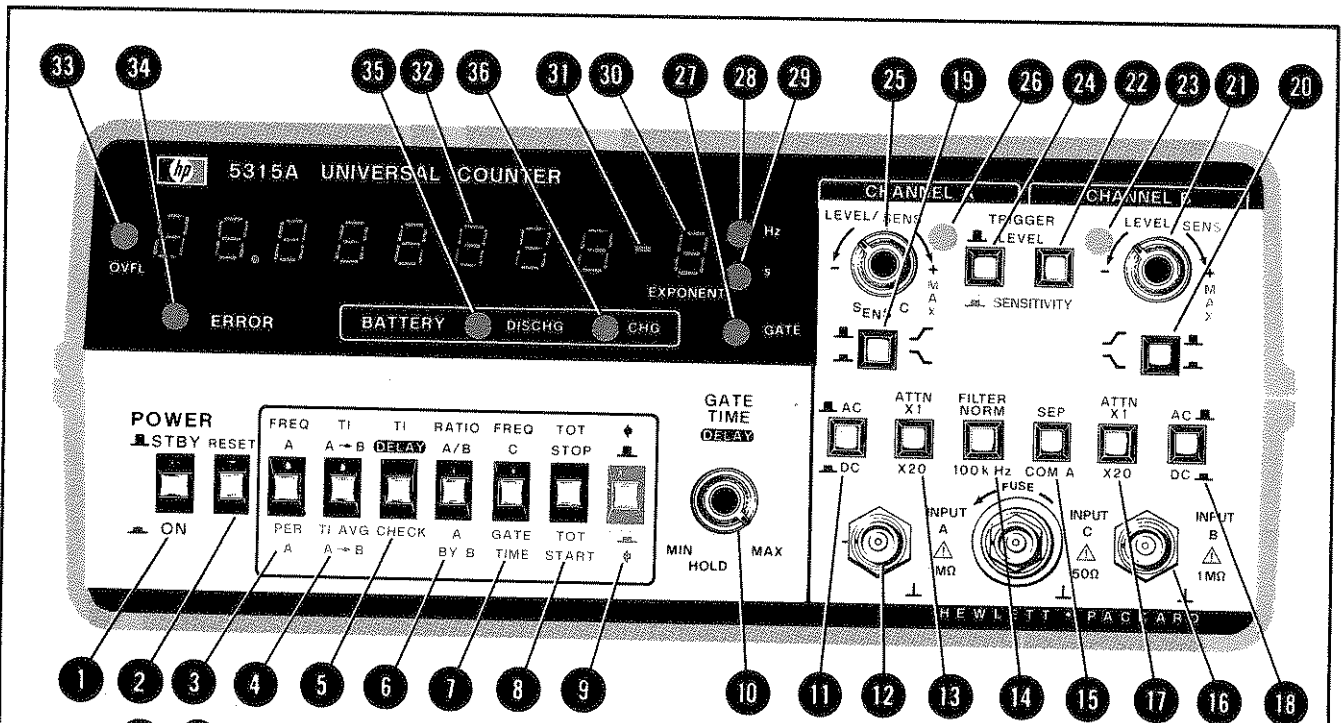

- 19, 20 **SLOPE.** Selects triggering on either positive f or negative \bar{f} slope of the corresponding input channel.
- 25 **LEVEL/SENS.** When in TRIGGER LEVEL, controls the voltage at which CHANNEL A input will trigger, variable over ± 2.5 volt X ATTN setting. When in SENSITIVITY, varies the sensitivity from MAX (≈ 10 mV) up to 500 mV. In FREQ C, controls the input sensitivity for INPUT C from MAX (≈ 15 mV up to 650 MHz, 75 mV up to 1 GHz) up to MIN (20 dB NOMINAL).
- 21 **LEVEL/SENS.** When in TRIGGER LEVEL, controls the voltage at which CHANNEL B input will trigger, variable over ± 2.5 volt X ATTN setting. When in SENSITIVITY, varies the sensitivity from MAX (≈ 10 mV) up to 500 mV.
- 22, 24 **TRIGGER LEVEL/SENSITIVITY.** Sets the function of corresponding LEVEL/SENS control to either Trigger Level or Sensitivity mode. In TRIGGER LEVEL mode, sensitivity is preset to maximum. In SENSITIVITY mode, trigger level is preset to 0 volts.
- 23, 26 **TRIGGER LIGHT.** 3-state trigger lights; blinks when channel is triggering; OFF when input signal is below trigger level setting; ON when input signal is above trigger level setting.
- 27 **GATE.** Gate light (when ON), indicates the counter's main gate is open and a measurement is in progress.
- 28 **Hz.** Hz (Hertz) annunciator, indicates displayed data is in frequency domain, in units of Hertz.
- 29 **s.** s (seconds) annunciator, indicates displayed data is in time domain, in units of seconds.
- 30 **EXPONENT.** Displays the value of the exponent of the measurement. Measurements are displayed in engineering notation, with exponents of blank (\emptyset), ± 3 , ± 6 , ± 9 .
- 31 **EXPONENT SIGN.** Indicates the polarity of the displayed exponent; ON (-) if negative, OFF if positive.
- 32 **DISPLAY.** Eight-digit red LED display.
- 33 **OVFL.** OVFL (Overflow) annunciator, indicates that one or more of the most significant digits are not displayed.
- 34 **ERROR.** Lights and remains lit when an error is detected during power-up.
- 35 **DISCHG.** Indicates instrument or reference oscillator oven is under battery operation; flashes when charge level is critically low and counter is disabled.
- 36 **CHGD.** Indicates the operating status of the charging circuits on Option 002.

Figure 3-7. Front Panel Features (Continued)

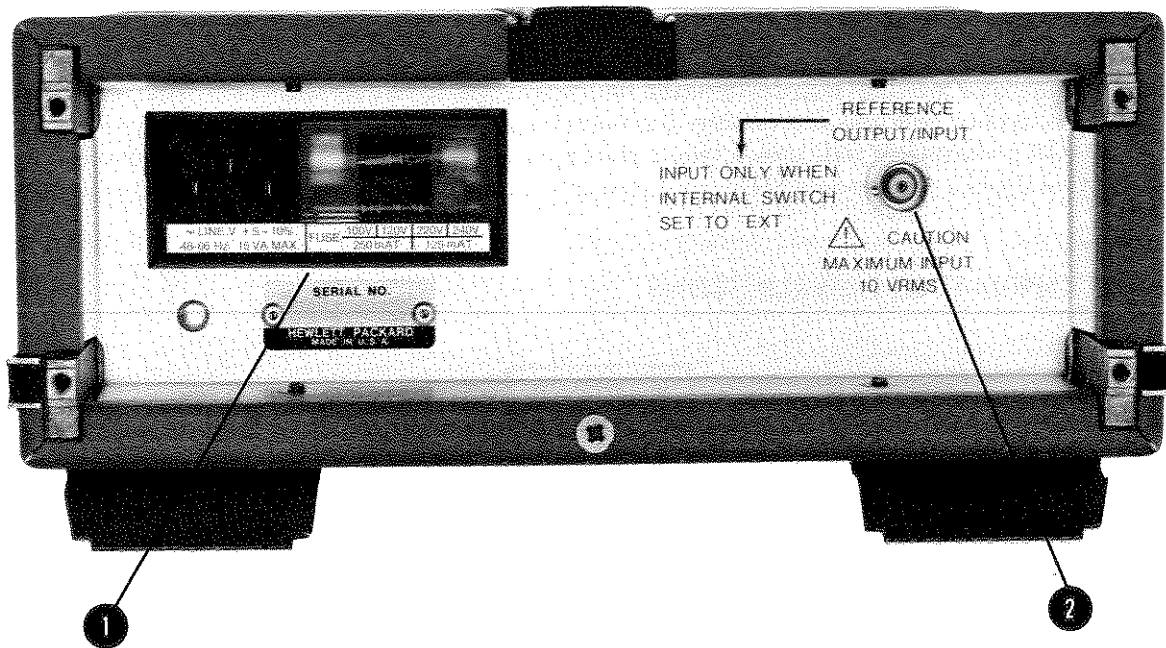

- 1 AC power input module permits operation from 100, 120, 220, or 240 volts AC. The number visible in the window indicates nominal line voltage to which instrument must be connected (see Figure 2-2). Protective grounding conductor connects to the instrument through this module.

WARNING

ANY INTERRUPTION OF THE PROTECTIVE (GROUNDING) CONDUCTOR INSIDE OR OUTSIDE THE INSTRUMENT OR DISCONNECTING OF THE PROTECTIVE EARTH TERMINAL IS LIKELY TO MAKE THE INSTRUMENT DANGEROUS. (See Section II.)

- 2 REFERENCE OUTPUT/INPUT jack (J8). Allows 5315B (only) to be operated with an external frequency standard of 10 MHz with drive of 1 volt rms across 500 Ω , when INT/EXT switch A1S3 (located on A1 Motherboard) is in the EXT position. With A1S3 in INT, the internal 10 MHz standard operates the counter, and is output for external use through J8.

Figure 3-8. 5315B Rear Panel Features

3-47. DISPLAY

3-48. The 5315A/B counter display has nine, seven-bar LED's, providing eight digits of resolution and a one-digit exponent. All measurements are displayed in scientific notation (i.e., exponents of blank, ± 3 , ± 6 , or ± 9) with automatic decimal point location. Annunciators for indicating the measurement units Hz, for Hertz, and s, for seconds are provided. The OVFL annunciator indicates that the left-most significant digits have overflowed the displayed. The GATE annunciator indicates the counter has been triggered and a measurement is in progress. The ERROR annunciator indicates a failure during power-up self-check. Battery annunciators DISCHG and CHG (on Models 5315A only) are active only when Option 002 is installed.

3-49. OPERATING INSTRUCTIONS

WARNING

BEFORE THE INSTRUMENT IS SWITCHED ON, ALL PROTECTIVE EARTH TERMINALS, EXTENSION CORDS, AUTOTRANSFORMERS, AND DEVICES CONNECTED TO IT SHOULD BE CONNECTED TO A PROTECTIVE EARTH GROUNDED SOCKET. ANY INTERRUPTION OF THE PROTECTIVE EARTH GROUNDING WILL CAUSE A POTENTIAL SHOCK HAZARD THAT COULD RESULT IN PERSONAL INJURY.

WARNING

ONLY FUSES WITH THE REQUIRED RATED CURRENT AND SPECIFIED TYPE SHOULD BE USED. DO NOT USE REPAIRED FUSES OR SHORT CIRCUITED FUSE-HOLDERS. TO DO SO COULD CAUSE A SHOCK OR FIRE HAZARD.

CAUTION

Before the instrument is turned on, it must be set to the voltage of the power source, or damage to the instrument could result.

3-50. OPERATOR'S CHECKS

3-51. A procedure for verifying the basic operation of the 5315A/B is provided in *Figure 3-9*. This check utilizes the instrument self-calibration cycle and visual verification of front panel controls by front panel indicators. No additional equipment is required.

NOTE

This check is not intended to verify the accuracy or performance specifications of the instrument.

3-52. POWER-UP SELF CHECK

3-53. When the 5315A/B is turned on, a power-up reset and self-check cycle is automatically initiated. This is approximately a 2-second cycle, indicated by the following display:

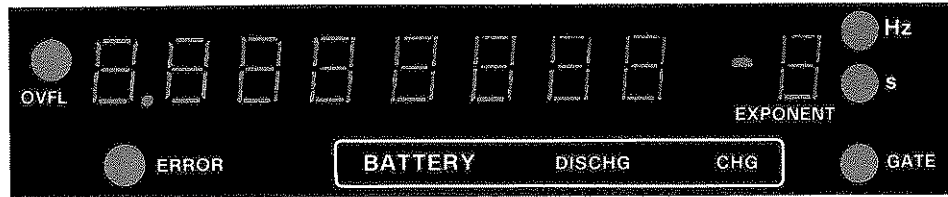

3-54. During this cycle, the microcomputer performs a check sum of the internal program in ROM and a bit pattern written into RAM. Additionally, a partial check of the MRC and I/O ports is performed. Any failure during the cycle will produce a numbered error message, momentarily displayed, and will latch the ERROR annunciator ON. Refer to Error Messages, paragraph 3-55.

NOTE

During the power-up self-check routine the ERROR state is undefined. Therefore, the ERROR annunciator may or may not be lit.

3-55. ERROR MESSAGES

3-56. Failures during the power-up self-check routine will result in a (momentary) display of a numbered error message. In addition, the ERROR annunciator will light and remain lit until the error is cleared and the instrument restarted. There are three numbered Error Messages:

ERROR	MESSAGE
E1	Possible Failure in Microcomputer
E2	Possible Failure in I/O Ports
E3	Possible Failure in MRC or No Oscillator Signal

3-57. If the ERROR annunciator is lit, verify the error number (1, 2, or 3) by repeating the power-up self-check, and refer to Section VIII, Troubleshooting. Power-up self-check is initiated when the POWER switch is changed from STBY to ON.

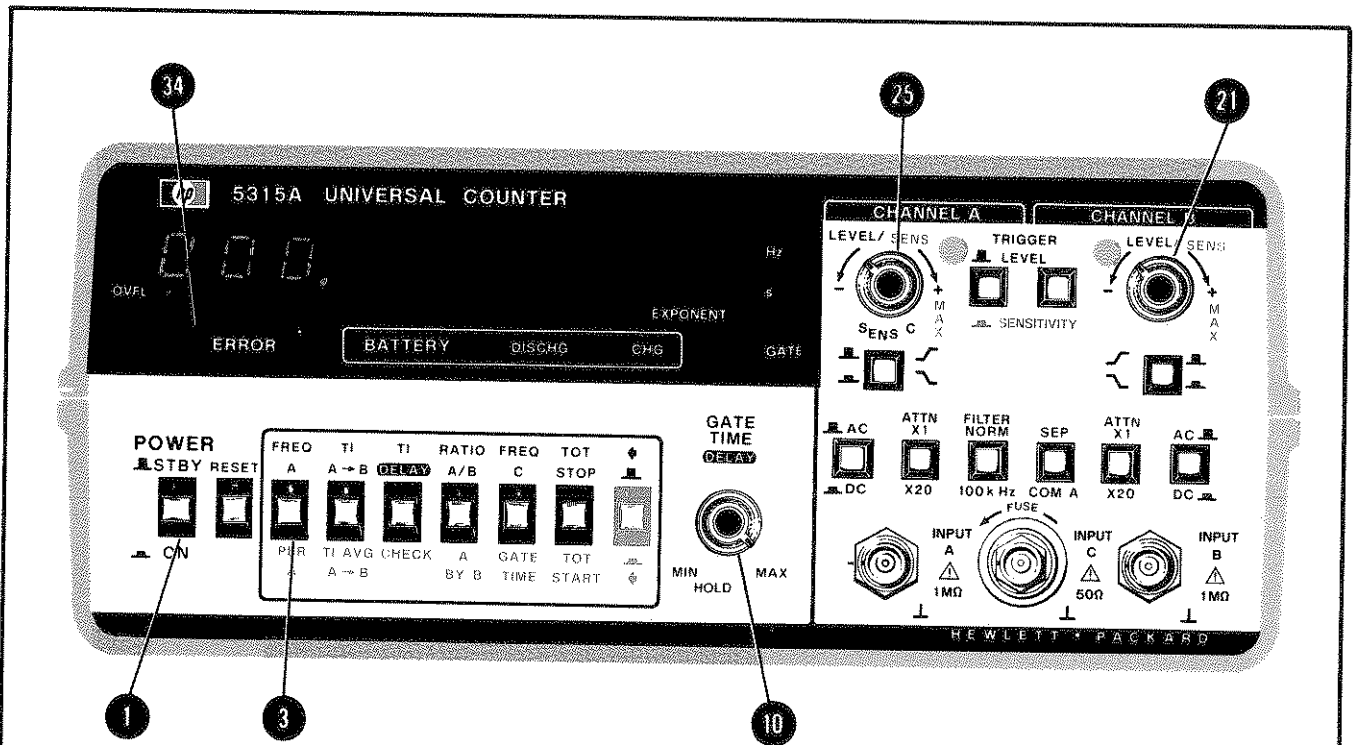

CAUTION

Before switching on the instrument, ensure that the power transformer primary is matched to the available line voltage, the correct fuse is installed and the safety precautions are taken. Refer to Power Requirements, Line Voltage Selection, Power Cables, and associated warnings and cautions in Section II of this manual.

1. Press FREQ A/PER A switch **3**, and adjust LEVEL/SENS controls **21** **25** fully ccw. Set all other switches to the OUT position.
2. Adjust GATE TIME control **10** to minimum.
3. Set POWER switch **1** to the ON position and observe the power-up self-check. Verify all segments of the display; decimal point after MSD; and the OVFL, Hz, S, and GATE annunciators light momentarily, followed by a display of 000. The ERROR annunciator may or may not light. Verify both trigger lights are lit.

NOTE

When the instrument is first turned on, the microcomputer performs a self-check. If, during power-up self-check, an error is detected, a numbered error message will flash momentarily and the Error annunciator **34** will light and remain lit. Verify the error number by repeating power-up self-check and refer to paragraph 3-59 Error Messages.

4. Verify Display Check routine by placing all function select switches in the OUT position. This may be accomplished by pressing any gray multi-function switch partially in, thereby releasing the function switch that is locked in. Observe the cycling of the display from all zero's to all one's, two's, three's . . . etc., to all blank. Refer to paragraph 3-33.

NOTE

The Display Check routine is an unlabeled function, used to verify the operation, digits and most annunciators within the Display assembly.

Figure 3-9. Operator's Check

3-58. MEASUREMENT PROCEDURES

3-59. Figures 3-13 through 3-21 show general operating procedures with the HP Model 5315A/B Universal Counter in typical measurement setups. Description numbers match the locator illustrations. The following paragraphs provide recommended operating guidelines to assist in making the most accurate measurement possible.

3-60. Frequency, Period, and Ratio Measurements

1. For cw sine wave or symmetrical waveforms (triangle, square, etc.) use AC coupling and the sensitivity mode.
2. For asymmetrical waveforms (pulse trains, TTL, ECL signals, ramps, etc.) use a combination of DC coupling, Trigger Level, and fixed attenuator. AC coupling these types of signals tends to distort them slightly, due to the charging of the capacitor. More important, the position of the signal on the zero preset trigger level is determined by the average DC level of the input. Depending on the pulse width and duty cycle, this DC average may be low enough to allow the base line noise to trigger the counter, producing extra counts (see Figure 3-10.) DC coupling fixes the DC level of the input signal, which allows the adjustable Trigger Level to be positioned at the optimum point. Set the Trigger Level control to the approximate center of the triggering range indicated by the trigger light (see Figure 3-11).

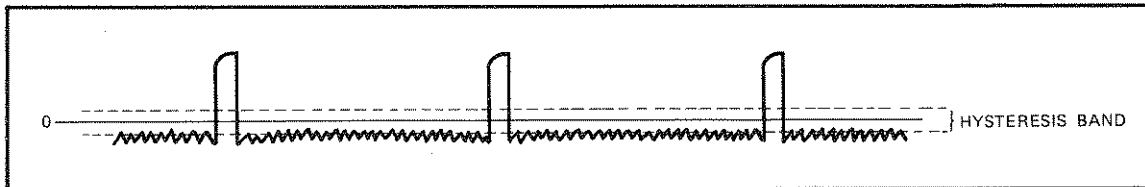

Figure 3-10. AC Coupled Measurements

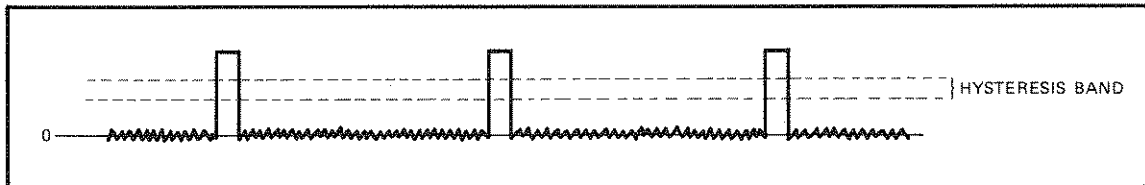

Figure 3-11. DC Coupled Measurements

3. When input loading is a problem (i.e., $1\text{ M}\Omega$ load or cable capacitance) or when a more convenient method of probing is desirable, use a 10:1 Scope Probe. A probe is recommended for all logic applications.
4. For sine wave measurements 100 kHz and below, always use the low pass filter, selectable on the front panel. Normally the input signal is integrated over the entire 100 MHz bandwidth. Use of the filter effectively removes noise and harmonics (above 100 kHz) that may affect the correct measurement.

WARNING

WHEN MEASURING POWER LINE FREQUENCIES, BE EXTREMELY CAREFUL AND ALWAYS USE A STEP-DOWN ISOLATION TRANSFORMER (WITH ABOUT 10V OUTPUT). THE COUNTER'S PANEL IS TYPICALLY AT SIGNAL GROUND, SO NEVER TRY TO MEASURE THE 50 OR 60 Hz LINE WITHOUT AN ISOLATION TRANSFORMER.

5. Be very careful with input levels at higher frequencies (greater than 5 MHz). The counter front end can withstand only 6 volts rms at these frequencies.

3-61. Time Interval Measurements

1. To ensure waveform fidelity during T.I. measurements, always use DC coupling.
2. Measurements of pulse width, and time between pulses, are more conveniently made in the COM A (common) position.
3. Measuring extremely fast rise times is not recommended because of the difficulty of setting precise trigger levels.
4. T.I. Average measurements of synchronous frequencies (any 10 MHz, or harmonic of, with stability similar or better than the internal clock) are not recommended because of a possible lock-up condition.
5. In general, use the GATE TIME control to vary the amount of resolution displayed. This control does not affect accuracy. It basically trades off longer measurement time for more resolution.

3-62. OPTIONS

3-63. The operating characteristics of the 5315A/B are affected by the addition of any of the options described in the following paragraphs. Only one time base (Option 001 or 004) can be used in an instrument. The time base option replaces the standard time base.

3-64. Temperature Compensated Time Base OPTION 001

3-65. Option 001 provides a temperature-compensated-crystal-oscillator (TCXO) providing higher accuracy than the Standard Time base. The TCXO is a 10 MHz oscillator, capable of making minor frequency corrections to compensate for offsets due to temperature variations.

3-66. Battery and Charger OPTION 002

3-67. Option 002 provides for battery operation of HP Model 5315A. The option includes the battery, and circuitry required for recharging. The operation of the battery charger circuitry is monitored by front panel BATTERY indicators. See paragraph 8-79 for a complete description of battery operation and indicators. This option is available for Model 5315A only.

3-68. C Channel OPTION 003

3-69. Option 003 extends the frequency counting range of the 5315A/B from 100 MHz (in Channel A) to 1 GHz (in Channel C). The input sensitivity and gate time are adjustable by front panel controls. See *Table 1-1* for complete specifications of Option 003.

3-70. Oven Contained Time Base OPTION 004

3-71. Option 004 is an oven stabilized oscillator for the 5315A/B which results in greater measurement accuracy. The oven oscillator generates a higher stability 10 MHz signal over the full operating temperature range than achieved by a standard or Option 001 time base.

3-72. The 5315A Option 004 consumes less power than the 5315B Option 004 and is compatible with battery operation. The 5315B Option 004, however, offers the greatest accuracy. Option 004 is available only for HP Models 5315A/B having serial numbers prefixed 2120A and above.

3-73. Offset/Normalizer OPTION 006

3-74. Option 006 allows the operator to mathematically manipulate the 5315B display. Option 006 is described in its own installation and service manual, HP Part Number 05315-90011. This option is available for Model 5315B only.

3-75. OPERATOR'S MAINTENANCE

3-76. The only maintenance the operator should normally perform is the replacement of the primary power fuse on a standard 5315B. This fuse is located within the Line Module Assembly. For instructions on changing the fuse, refer to Section II, Line Voltage Selection.

CAUTION

Make sure that only fuses with the required rated current and of the slow-blow type are used for replacement. The use of repaired fuses and the short-circuiting of fuse-holders must be avoided.

3-77. When Option 003 C Channel is installed, the operator may be required to replace the input BNC fuse. This is a 1/8A fuse (HP Part No. 2110-0301) which is located within the INPUT C BNC connector (see *Figure 3-12.* for details). To replace the fuse, disconnect the power cord, unscrew the special BNC barrel (P/N 05305-60205) and, with needle-nose pliers, remove and replace the fuse. Reinstall the BNC barrel, and tighten using a BNC cable connector. Be careful not to overtighten.

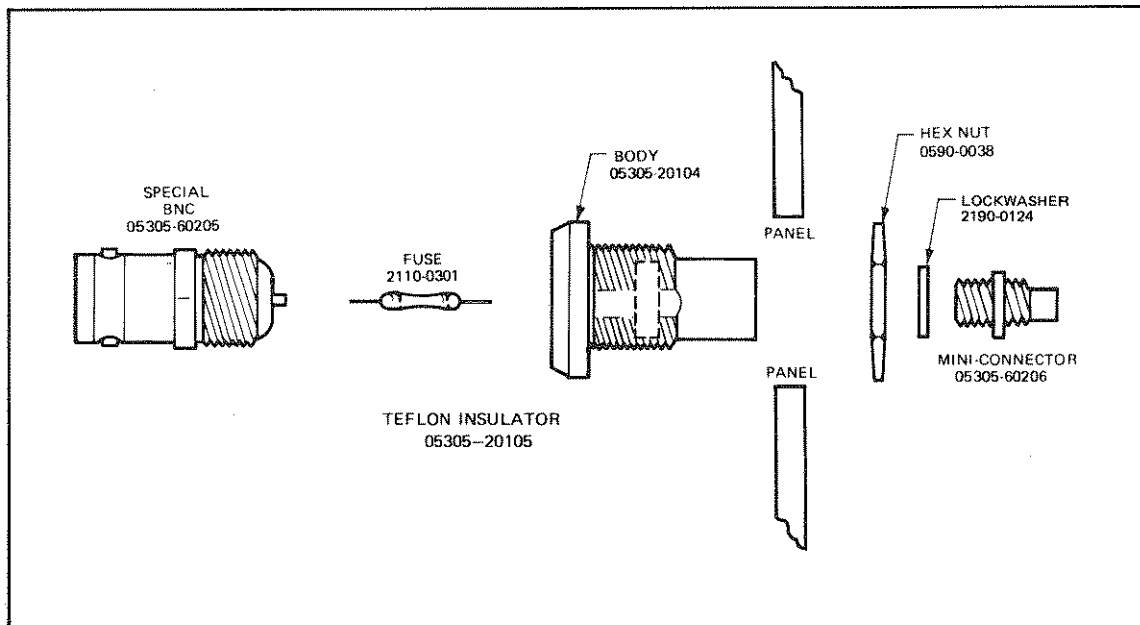

Figure 3-12. Details of Input Connector J1 and Fuse Mounting

3-78. POWER/WARM UP

3-79. The HP Model 5315A/B requires a power source of 100, 120, 220, or 240V AC, +5%, -10%, 48 to 66 Hz single phase. The selection of line voltage and input power fuse is described in Section II, paragraph 2-5, Preparation for Use.

3-80. The 5315A/B has a two-position power switch, STBY and ON. For 5315A models with Option 002, it is important that the instrument remain connected to the power source in the STBY mode when not in use. This supplies power to the battery charging circuitry.

WARNING

POWER IS ALWAYS PRESENT AT THE STBY/ON (LINE) SWITCH AND TRANSFORMER, AND UNREGULATED DC IS PRESENT WHENEVER THE LINE CORD IS ATTACHED. UNPLUGGING THE POWER CORD IS NECESSARY TO REMOVE ALL POWER FROM THE INSTRUMENT.

3-81. The Option 004 time base oven is supplied power whenever line (Mains) power is connected to the instrument. For a 5315A with both Options 002 and 004 installed, the oven receives standby power from the battery when the FREQ A/PER A switch is depressed.

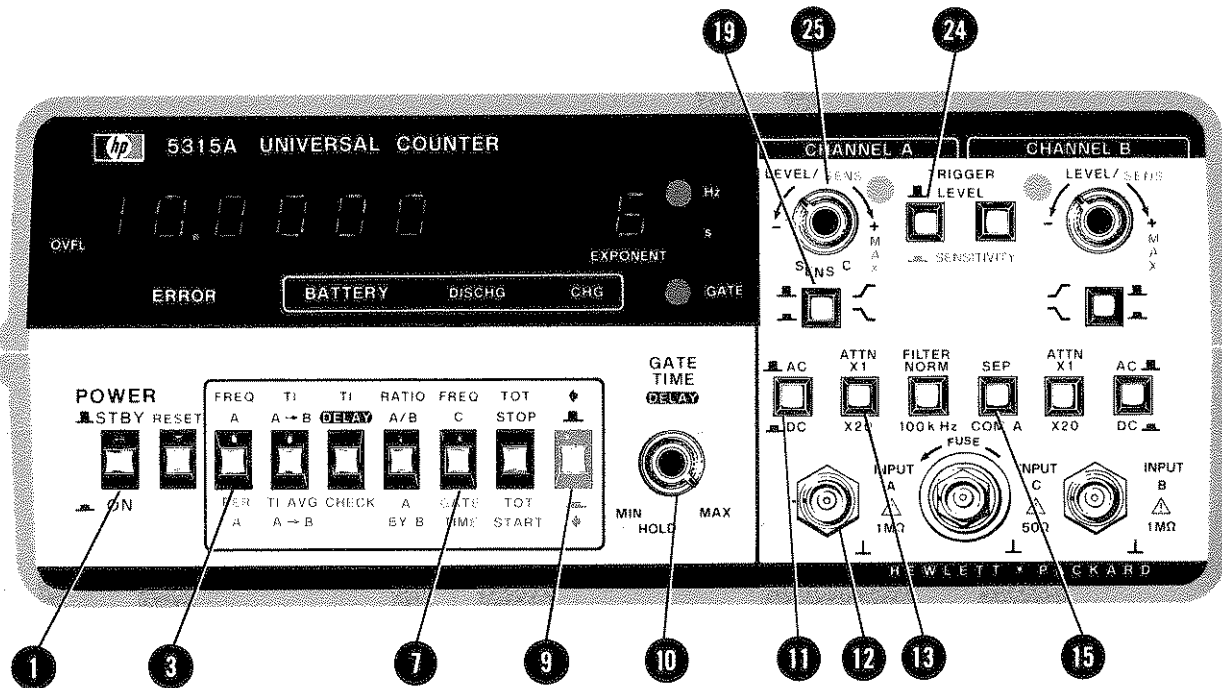

NOTE

For specifications concerning bandwidth, accuracy, and amplitude on input signals, refer to *Table 1-1*.

1. Set POWER switch **1** to the ON position.
2. Set SEP/COM A switch **15** to SEP position.
3. Connect the input signal to INPUT A jack **12**.
4. Press FREQ A/PER A switch **3**, and set the Blue SHIFT key **9** in the out position for FREQ A, or the in position for Period A.
5. Set AC/DC **11**, ATTN **13** and Slope **19** switches to appropriate positions.
6. Set GATE TIME control **10** to min.
7. Set TRIGGER LEVEL/SENSITIVITY switch **24** to SENSITIVITY position, and LEVEL/SENS control **25** fully ccw. This sets the trigger level at 0 volts (nominally) and sensitivity to minimum.
8. Adjust the LEVEL/SENS control **25** in a clockwise direction until a stable reading is obtained.
9. Adjust the GATE TIME control **10** for desired resolution. The gate time may be displayed by pressing the GATE TIME switch **7** and the Blue SHIFT key **9**.

Figure 3-13. Frequency A/Period A Measurements

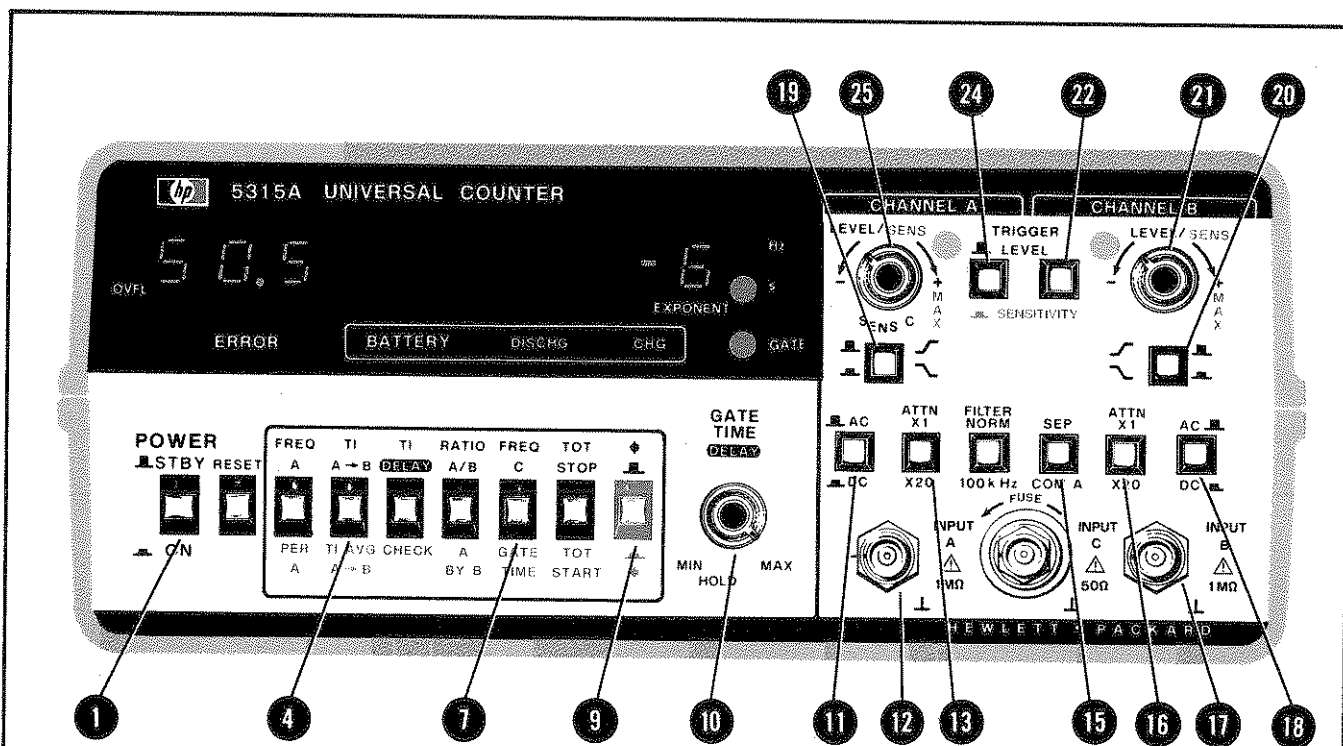

NOTE

For specifications concerning bandwidth, accuracy, and amplitude on input signals, refer to Table 1-1.

1. Set POWER switch **1** to the ON position.
2. Set GATE TIME control **10** to min.
3. If the Start and Stop signals are from separate sources, connect the Start signal to INPUT A jack **12**, the Stop signal to INPUT B jack **17**, and set the SEP/COM A switch **15** to SEP position. If the Start and Stop signals are from a common source, connect to INPUT A jack **12** and set the SEP/COM A switch **15** to COM A position.
4. Press T.I. A→B switch **4**, and ensure the Blue SHIFT key **9** is in the out position, to select time interval function.
5. Set AC/DC **11** **18**, ATTN **13** **16**, and Slope **19** **20** switches to desired positions.

NOTE

When the SEP/COM A switch is set to COM A, only the CHANNEL A AC/DC switch **11** is effective. However, all Attenuator, Slope, and LEVEL/SENS controls are effective.

6. Set TRIGGER LEVEL/SENSITIVITY switches **22** **24** to TRIGGER LEVEL position. This sets the sensitivity to maximum (typically ≤ 10 mV for frequencies ≤ 10 MHz) and allows variable selection of trigger levels.
7. Adjust the LEVEL/SENS controls **21** **25** for optimum triggering, usually the middle of the range over which the trigger light flashes.
8. Adjust the GATE TIME control **10** for the desired sample rate, variable nominally from 50 ms to 10 s. The selected gate time may be displayed by pressing the GATE TIME switch **7** and the Blue SHIFT key **9**.

NOTE

The first measurement is not displayed until the gate time delay is up. For slow sample rates, use HOLD and the RESET switch.

Figure 3-14. Time Interval Measurement

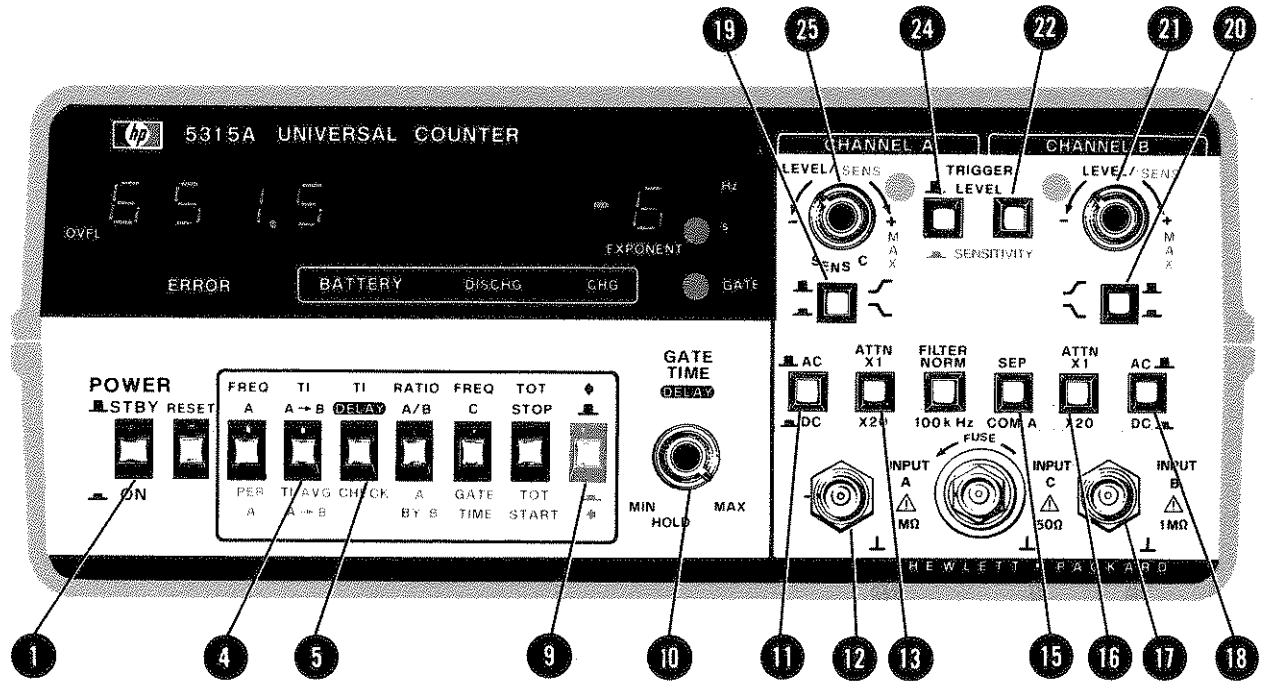

NOTE

For specifications concerning bandwidth, accuracy, and amplitude on input signals, refer to Table 1-1.

1. Set POWER switch **1** to the ON position.
2. If the Start and Stop signals are from separate sources, connect the Start signal to INPUT A jack **12**, the Stop signal to INPUT B jack **17**, and set the SEP/COM A switch **15** to SEP position. If the Start and Stop signals are from a common source, connect to INPUT A jack **12** and set the SEP/COM A switch **15** to COM A position.
3. Press T.I. DELAY switch **5**, and ensure the Blue SHIFT key **9** is in the out position, to select time interval function.
4. Set AC/DC **11** **18**, ATTN **13** **16**, and Slope **19** **20** switches to desired positions.

NOTE

When the SEP/COM A switch is set to COM A, only Channel A AC/DC switch **11** is effective. However, all ATTENUATOR, SLOPE, and LEVEL/SENS controls are effective.

5. Set TRIGGER LEVEL/SENSITIVITY switches **22** **24** to TRIGGER LEVEL position. This sets the sensitivity to maximum (typically ≤ 10 mV) and allows variable selection of trigger levels.
6. Adjust the LEVEL/SENS controls **21** **25** for optimum triggering (i.e., the middle of the range over which the trigger light flashes).
7. Adjust the GATE TIME/DELAY control **10**, for the desired holdoff, (variable nominally from $500 \mu\text{s}$ to 20 ms) between the Start on Channel A and the enabling of Stop on Channel B. Inputs during the delay time are ignored. The selected delay time may be displayed by pressing T.I. A→B **4**, T.I. DELAY **5** and Blue SHIFT key **9** to their in positions.

Figure 3-15. Time Interval Delay Measurement

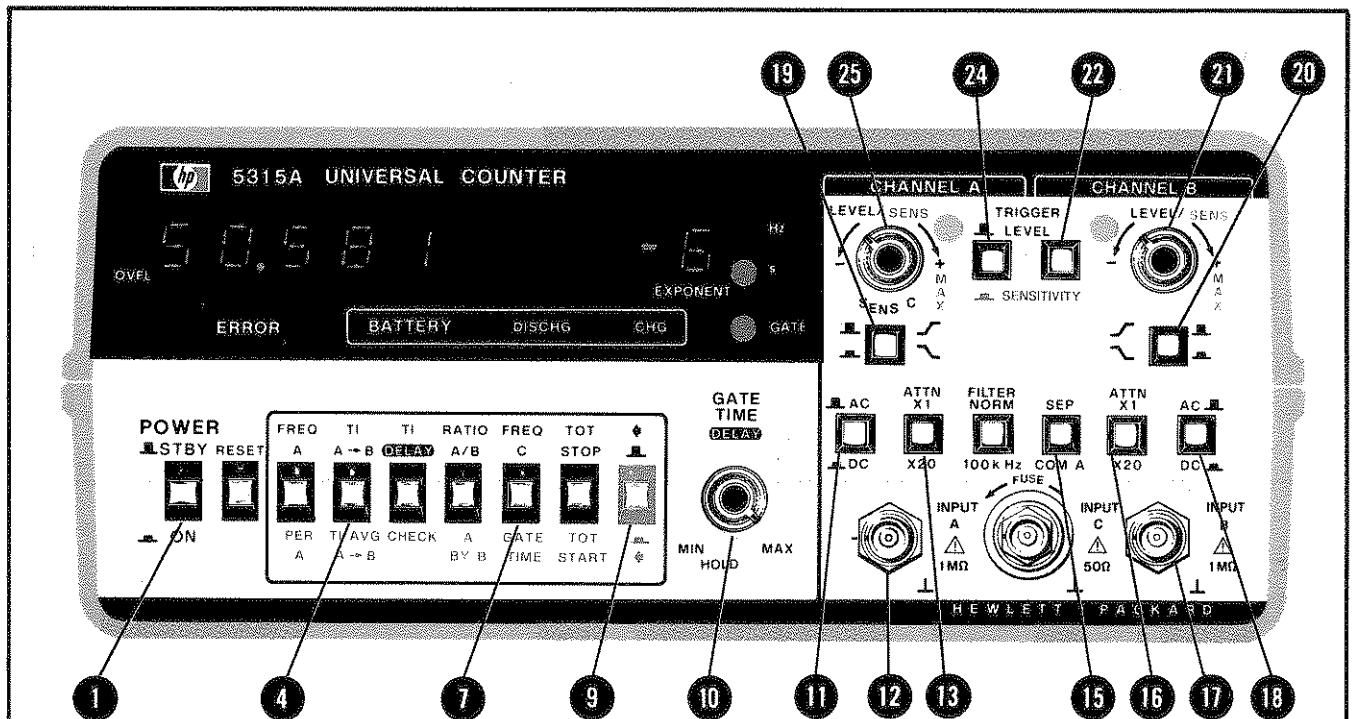

NOTE

For specifications concerning bandwidth, accuracy, and amplitude on input signals, refer to Table 1-1.

1. Set POWER switch 1 to the ON position.

NOTE

There must be at least 200 ns between the Stop pulse and the next Start pulse. When measuring the time interval between the same polarity slope of two pulses from a single source, the PER A mode should be used.

2. If the Start and Stop signals are from separate sources, connect the Start signal to INPUT A jack 12, the Stop signal to INPUT B jack 17, and set the SEP/COM A switch 15 to SEP position. If the Start and Stop signals are from a common source, connect to INPUT A jack 12 and set the SEP/COM A switch 15 to COM A position.
3. Press T.I. A→B switch 4, and the Blue SHIFT key 9, to select time interval average function.
4. Set AC/DC 11 18, ATTN 13 16, and Slope 19 20 switches to desired positions.

NOTE

When the SEP/COM A switch is set to COM A, only the Channel A AC/DC switch 11 is effective. However, all ATTENUATOR, SLOPE, and LEVEL/SENS controls are effective.

5. Set TRIGGER LEVEL/SENSITIVITY switches 22 24 to TRIGGER LEVEL position. This sets the sensitivity to maximum (≤ 10 mV) and allows variable selection of trigger levels.
6. Adjust the LEVEL/SENS controls 21 25 for optimum triggering (i.e., the middle of the range over which the trigger light flashes).
7. Adjust the GATE TIME control 10 for the desired resolution. The selected gate time may be displayed by setting the GATE TIME switch 7 and the Blue SHIFT key 9 to the "in" position.

NOTE

The T.I. Average A→B mode of operation will measure time intervals from 10^5 seconds down to 0 ns, with up to 1 ns resolution. A display of up to "-1 or 2 ns, indicating a negative time interval is possible (i.e., Channel B event occurred before Channel A event).

Figure 3-16. Time Interval Average A→B

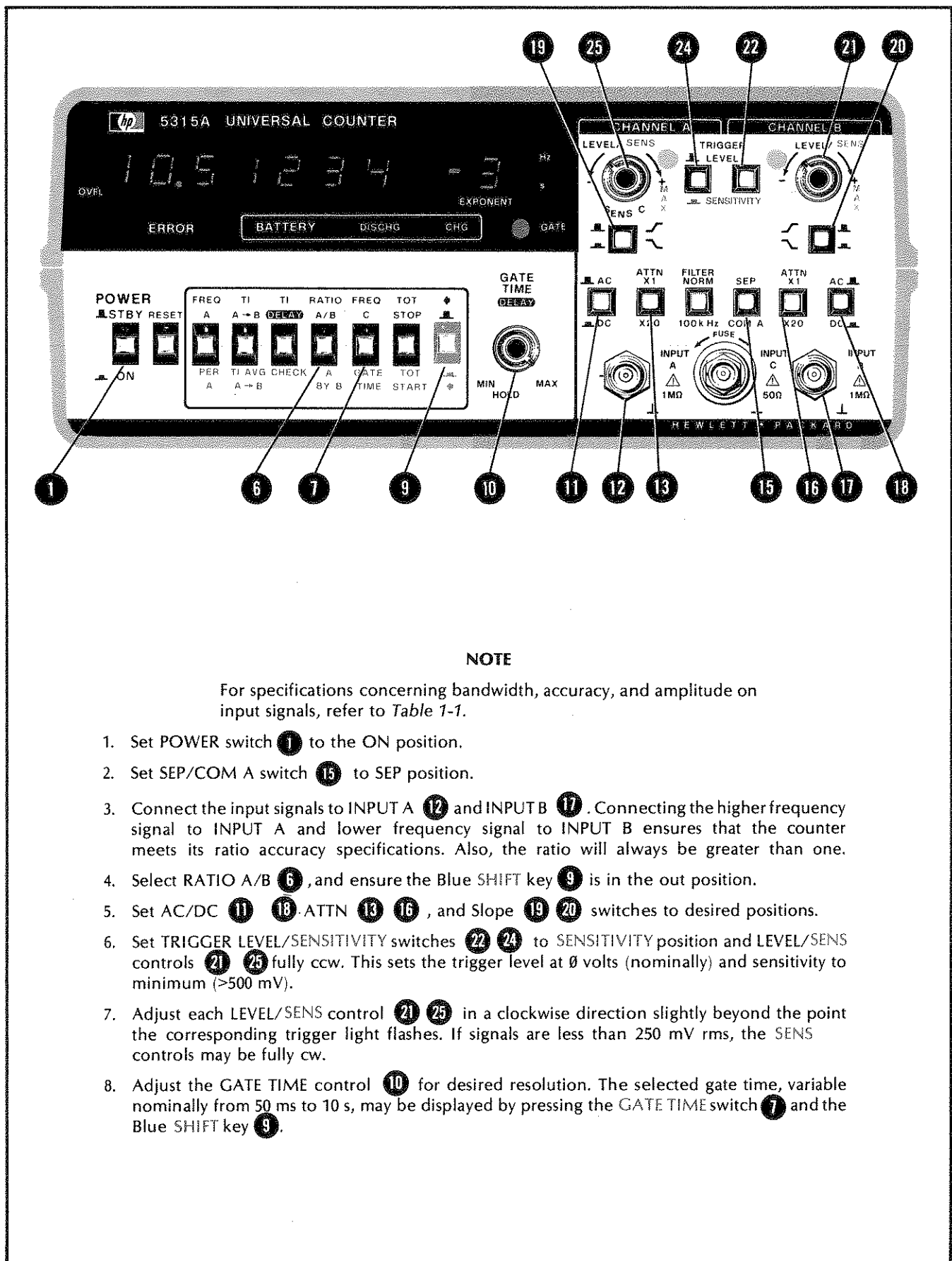

NOTE

For specifications concerning bandwidth, accuracy, and amplitude on input signals, refer to *Table 1-1*.

1. Set POWER switch **1** to the ON position.
2. Set SEP/COM A switch **15** to SEP position.
3. Connect the input signals to INPUT A **12** and INPUT B **17**. Connecting the higher frequency signal to INPUT A and lower frequency signal to INPUT B ensures that the counter meets its ratio accuracy specifications. Also, the ratio will always be greater than one.
4. Select RATIO A/B **6**, and ensure the Blue SHIFT key **9** is in the out position.
5. Set AC/DC **11** **18** ATTN **13** **16**, and Slope **19** **20** switches to desired positions.
6. Set TRIGGER LEVEL/SENSITIVITY switches **22** **24** to SENSITIVITY position and LEVEL/SENS controls **21** **25** fully ccw. This sets the trigger level at 0 volts (nominally) and sensitivity to minimum (>500 mV).
7. Adjust each LEVEL/SENS control **21** **25** in a clockwise direction slightly beyond the point the corresponding trigger light flashes. If signals are less than 250 mV rms, the SENS controls may be fully cw.
8. Adjust the GATE TIME control **10** for desired resolution. The selected gate time, variable nominally from 50 ms to 10 s, may be displayed by pressing the GATE TIME switch **7** and the Blue SHIFT key **9**.

Figure 3-17. Ratio A/B Measurements

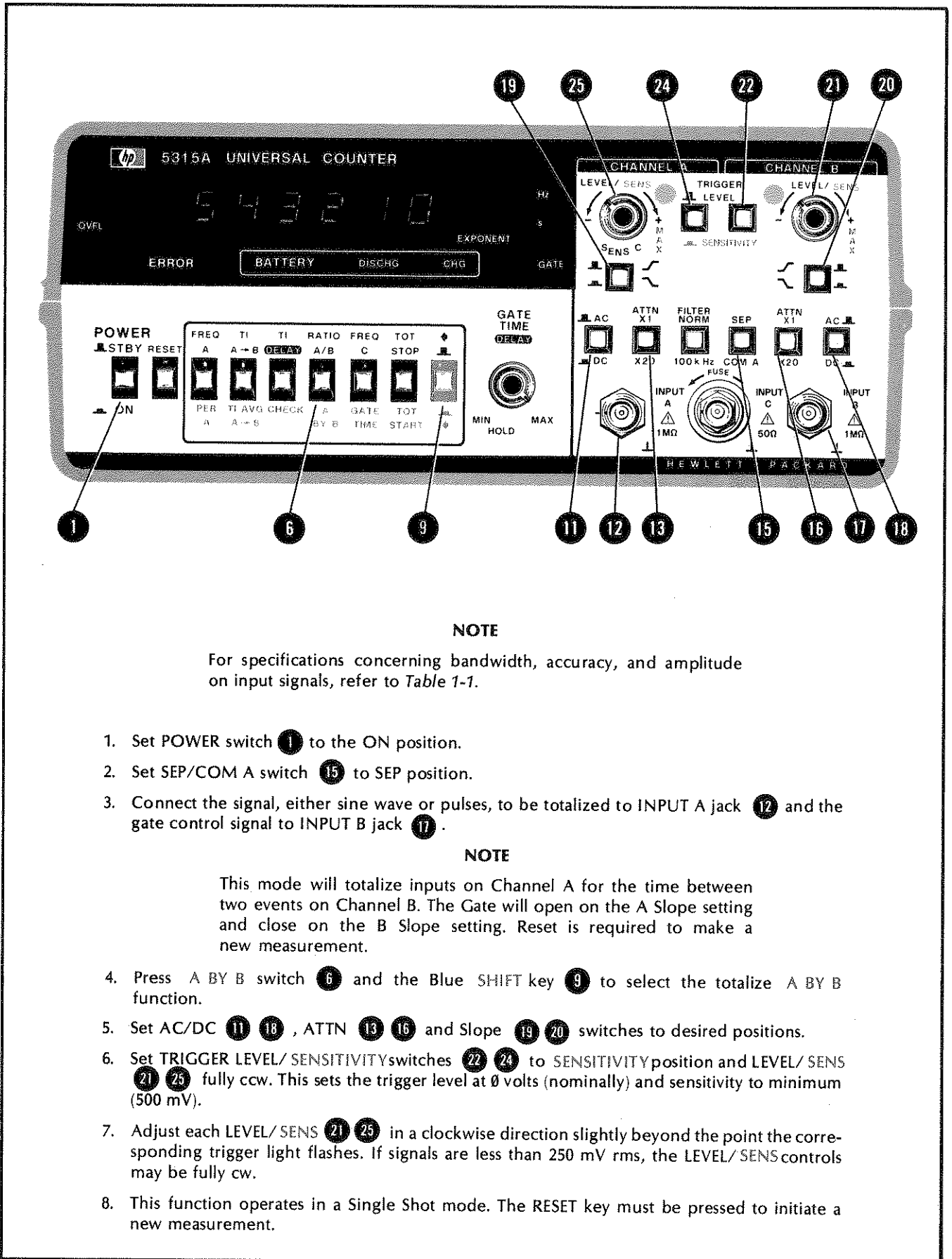

NOTE

For specifications concerning bandwidth, accuracy, and amplitude on input signals, refer to *Table 1-1*.

1. Set POWER switch **1** to the ON position.
2. Set SEP/COM A switch **15** to SEP position.
3. Connect the signal, either sine wave or pulses, to be totalized to INPUT A jack **12** and the gate control signal to INPUT B jack **17**.

NOTE

This mode will totalize inputs on Channel A for the time between two events on Channel B. The Gate will open on the A Slope setting and close on the B Slope setting. Reset is required to make a new measurement.

4. Press A BY B switch **6** and the Blue SHIFT key **9** to select the totalize A BY B function.
5. Set AC/DC **11** **18**, ATTN **13** **16** and Slope **19** **20** switches to desired positions.
6. Set TRIGGER LEVEL/ SENSITIVITY switches **22** **24** to SENSITIVITY position and LEVEL/ SENS **21** **25** fully ccw. This sets the trigger level at 0 volts (nominally) and sensitivity to minimum (500 mV).
7. Adjust each LEVEL/ SENS **21** **25** in a clockwise direction slightly beyond the point the corresponding trigger light flashes. If signals are less than 250 mV rms, the LEVEL/ SENS controls may be fully cw.
8. This function operates in a Single Shot mode. The RESET key must be pressed to initiate a new measurement.

Figure 3-18. A BY B Measurements

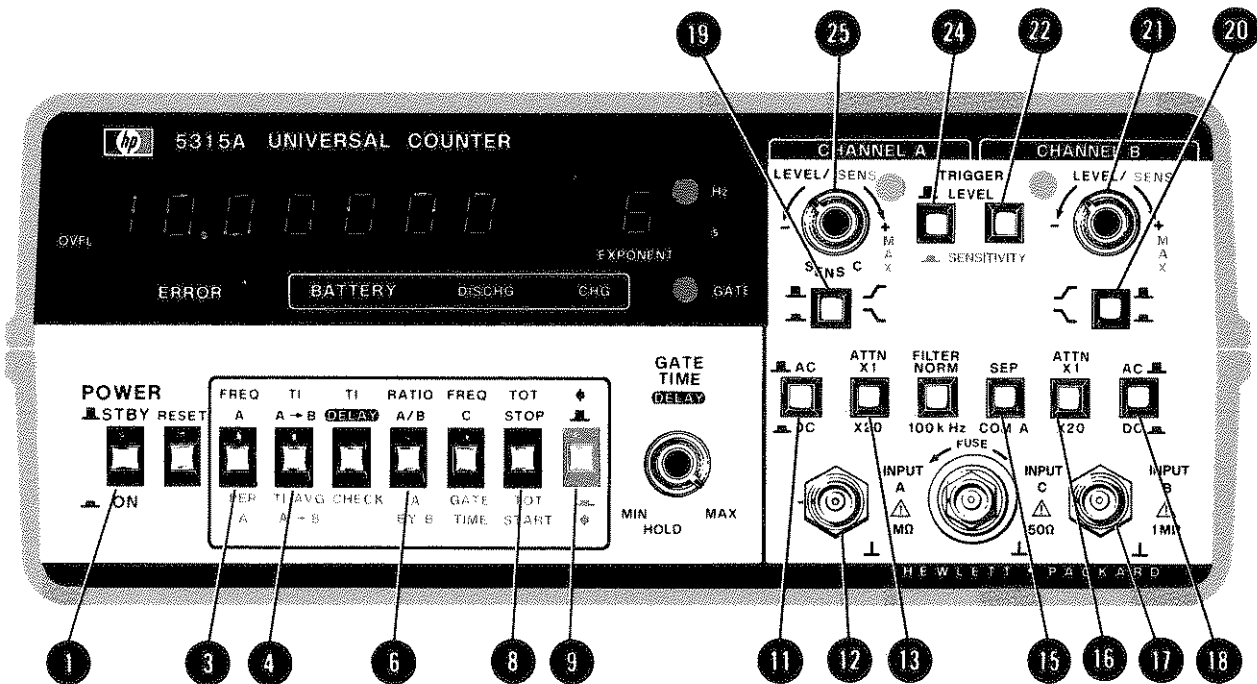

1. Set POWER switch **1** to the ON position.
2. Set SEP/COM A switch **15** to SEP position.
3. Connect the frequency burst signal to be averaged to INPUT A jack **12** and the sampling signal to INPUT B jack **17**. The sampling signal must be synchronized with, and of pulse width less than the burst.

NOTE

This mode will average together multiple frequency bursts and display the average frequency of the signal within the burst. *Due to the complexity of this function it is recommended that the user thoroughly read paragraph 3-23 before attempting to use this function.*

4. Press T.I. DELAY, CHECK switch **4** and RATIO A/B, A BY B switch **6** together for a gate time of 500 μ s-30 ms or FREQ A, PER A switch **3** and TOT STOP, TOT START switch **8** for a gate time of 60 ms-10 s.
5. Set AC/DC **11** **18**, ATTN **13** **16** to the desired positions.
6. Set the Blue Shift key **9** for the desired sampling/measurement interval enable slope: OUT for a positive enable slope, IN for a negative enable slope (negative slope only using SHORT measurement interval).
7. Set the A Channel SLOPE switch **19** to the desired trigger slope. Set the B Channel SLOPE switch **20** for the desired disable slope.
8. Set the TRIGGER/SENSITIVITY switches **22** **24** to SENSITIVITY position and LEVEL/SENS controls **21** **25** fully ccw. This sets the trigger level at 0 volts (nominally) and sensitivity to minimum (500 mV).
9. Adjust each LEVEL/SENS **21** **25** in a clockwise direction slightly beyond the point the corresponding trigger light flashes. If the signals are less than 250 mV, the LEVEL/SENS controls may be fully cw.

Figure 3-19. FREQ A Armed by B Measurements

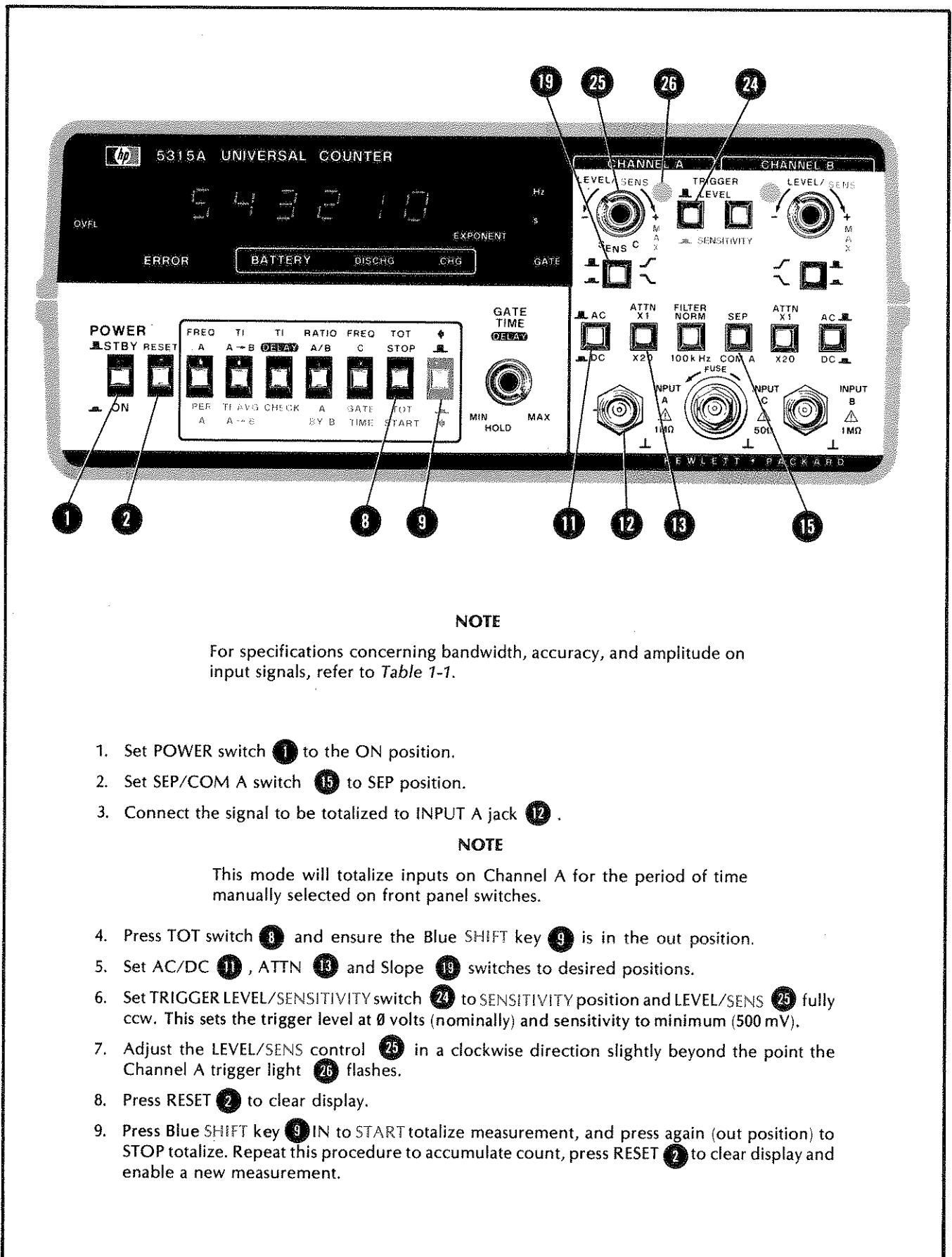

NOTE

For specifications concerning bandwidth, accuracy, and amplitude on input signals, refer to *Table 1-1*.

1. Set POWER switch **1** to the ON position.
2. Set SEP/COM A switch **15** to SEP position.
3. Connect the signal to be totalized to INPUT A jack **12**.

NOTE

This mode will totalize inputs on Channel A for the period of time manually selected on front panel switches.

4. Press TOT switch **8** and ensure the Blue SHIFT key **9** is in the out position.
5. Set AC/DC **11**, ATTN **13** and Slope **19** switches to desired positions.
6. Set TRIGGER LEVEL/SENSITIVITY switch **24** to SENSITIVITY position and LEVEL/SENS **25** fully ccw. This sets the trigger level at 0 volts (nominally) and sensitivity to minimum (500 mV).
7. Adjust the LEVEL/SENS control **25** in a clockwise direction slightly beyond the point the Channel A trigger light **26** flashes.
8. Press RESET **2** to clear display.
9. Press Blue SHIFT key **9** IN to START totalize measurement, and press again (out position) to STOP totalize. Repeat this procedure to accumulate count, press RESET **2** to clear display and enable a new measurement.

Figure 3-20. Totalize Measurement

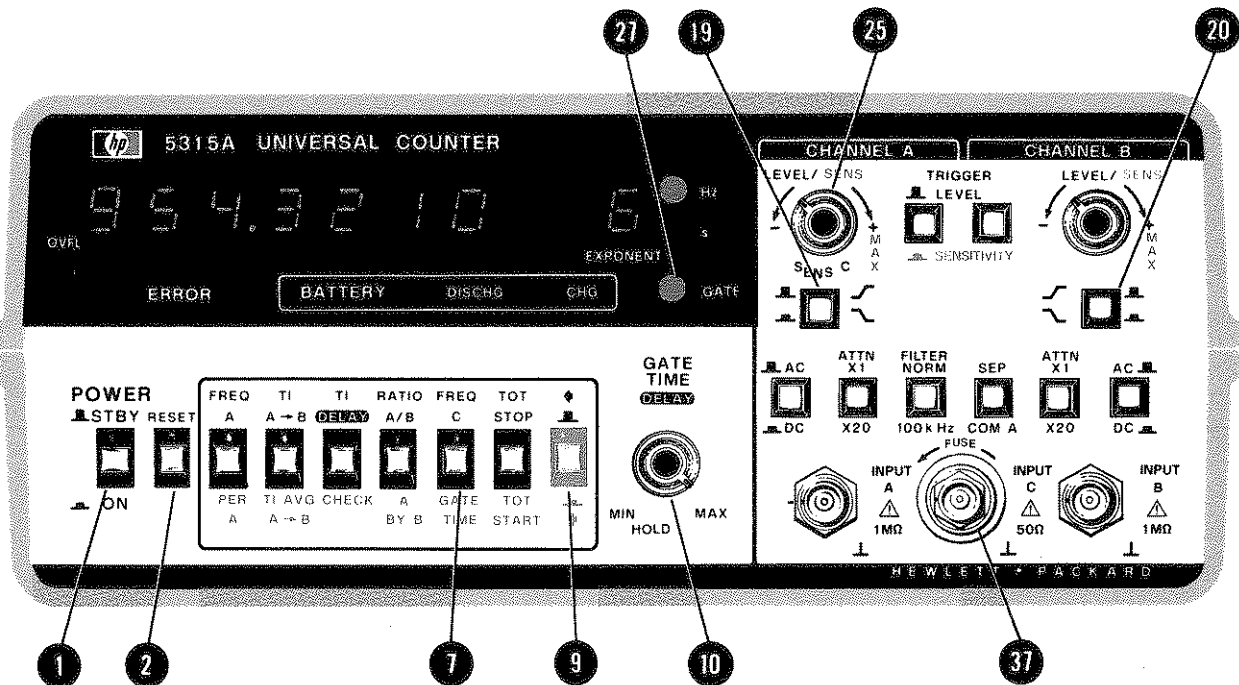

NOTE

For specifications concerning bandwidth, accuracy, and amplitude on input signals, refer to Table 1-1.

1. Set POWER switch 1 to ON position.
2. Set GATE TIME control 10 to MIN.
3. Select FREQ C and be sure that the blue SHIFT key is in the OUT position.

CAUTION

Be sure that the Input C signal does not exceed 1 V rms into 50 ohms.

4. Connect the input signal to INPUT C jack 37.

NOTE

The INPUT Connector is a special fused BNC. The in-line fuse within the connector is accessible from the front panel. Refer to the Operator's Maintenance section, paragraph 3-77, for replacement of fuse.

5. Set SENS C control 25 to min. Slowly rotate the control in a cw direction until the GATE light 27 just turns on.
6. Adjust the GATE TIME control 10 for the desired resolution. The actual gate time may be displayed by pressing the GATE TIME function switch 7 and the Blue SHIFT key 9. Moving the GATE TIME control 10 fully ccw into detent will HOLD the measurement display. In HOLD, single-shot measurements with minimum gate time can be made by pressing the RESET 2 key.

NOTE

The only controls active in FREQ C function mode are GATE TIME 10, RESET 2, and SENS C 25. However, pressing either Channel A 19 or B 20 scope switches will reset the counter. All other controls have no effect.

Figure 3-21. Frequency C Measurement (Option 003)

