

5370B
UNIVERSAL TIME INTERVAL COUNTER

OPERATING AND SERVICE MANUAL

SERIAL PREFIX: 2316A

This manual applies to Serial Prefix 2316A, unless accompanied by a Manual Change Sheet indicating otherwise.

First Edition — May 1983

©Copyright 1983
by
HEWLETT-PACKARD COMPANY
5301 Stevens Creek Boulevard
Santa Clara, California 95050

All Rights Reserved

MANUAL PART NUMBER 05370-90020
Microfiche Part Number 05370-90021



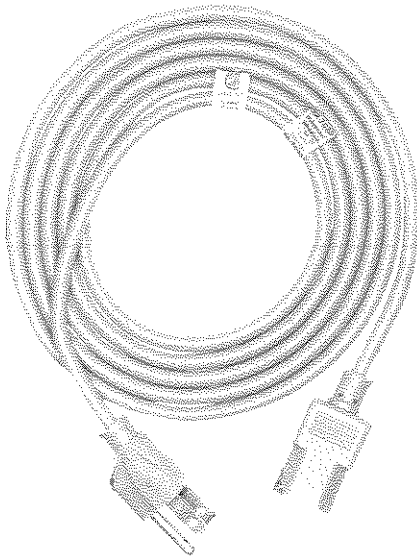
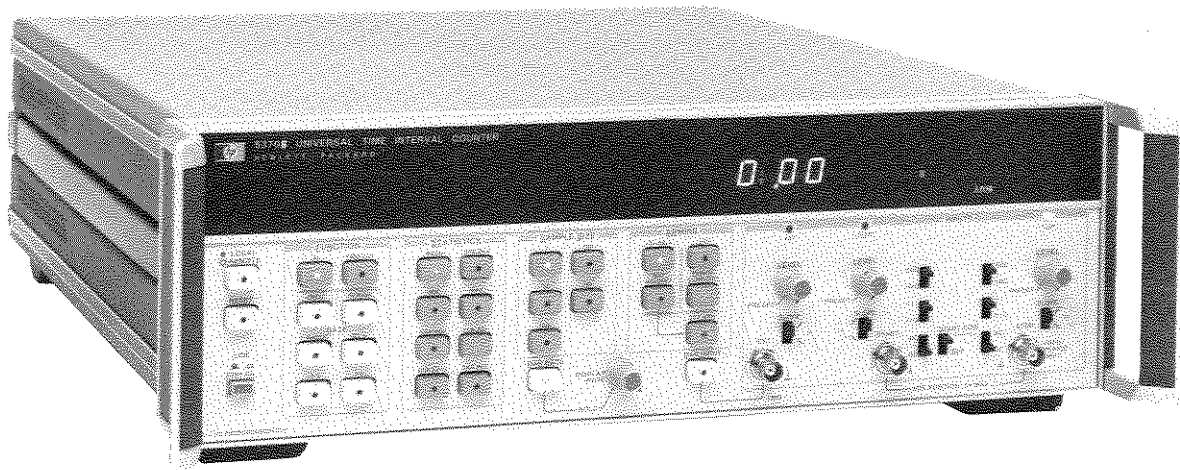

Figure 1-1. HP Model 5370A Universal Time Interval Counter and Accessories Supplied

SECTION I GENERAL INFORMATION

1-1. INTRODUCTION

1-2. This manual provides information pertaining to the installation, operation, testing, adjustment, and maintenance of the HP Model 5370B Universal Time Interval Counter. *Figure 1-1* shows the 5370B with accessories supplied.

1-3. This manual is divided into eight sections, each covering a particular topic for the operating and service of the HP Model 5370B. The topics by section number are:

Section	Topic
I	General Information
II	Installation
III	Operating and Programming
IV	Performance Tests
V	Adjustments
VI	Replaceable Parts
VII	Manual Changes
VIII	Service

1-4. SPECIFICATIONS

1-5. Instrument specifications are listed in *Table 1-1*. These specifications are the performance standards or limits against which the instrument may be tested.

1-6. INSTRUMENTS COVERED BY MANUAL

1-7. If the serial number of your instrument is lower than the serial number on the title page of this manual, you must modify your manual for agreement with your instrument. Refer to Section VII, Manual Changes, for the information that will adapt this manual to your instrument.

1-8. The 5370B Options 908, 910, and 913 are documented in this manual. The differences are noted in the appropriate locations such as Options in Section I, and the Replaceable Parts List in Section VI.

1-9. This instrument has a two-part serial number. The first four digits and the letter comprise the serial number prefix. The last five digits form the sequential suffix that is unique to each instrument. The contents of this manual apply directly to instruments having the same serial number prefix(es) as listed under Serial Prefix on the title page.

1-10. An instrument manufactured after the printing of this manual may have a serial prefix that is not listed on the title page. This unlisted prefix indicates that the instrument is different from those documented in this manual. The manual for this instrument is supplied with a yellow Manual Changes supplement which contains change information that documents the differences.

1-11. In addition to change information, the supplement may contain information for correcting errors in the manual. To keep this manual as current and accurate as possible, Hewlett-Packard recommends that you periodically request the latest Manual Changes supplement. The supplement for this manual is keyed to the manual's print date and part number, both of which appear on the title page. Complimentary copies of the supplement are available from Hewlett-Packard.

Table 1-1. HP Model 5370B Specifications

INPUT AMPLIFIERS

SEPARATE INPUTS

Sensitivity: 100 mV p-p, 35 mV rms sine wave times attenuator setting.

Impedance: Selectable 1 MΩ || <45 pF⁽¹⁾ or 50Ω **NOMINAL.**

Trigger Level: Adjustable from -2V to +2V with 10 mV displayed resolution.

Trigger Slope: Independent selection of + or - slope.

Attenuators: ÷1 and ÷10 **NOMINAL.**

Dynamic Range (preset):

- 50Ω ÷1 100 mV to 4V p-p pulse
 - ÷10 1V to 7V p-p pulse
 - 1 MΩ ÷1 100 mV to 4V p-p pulse
 - ÷10 1V to 10V p-p pulse
- Dynamic range for rms sine wave is one-third of the above values.

Signal Operating Range:

- 50Ω ÷1 -4V to +4V
- ÷10 -7V to 7V
- 1 MΩ ÷1 -4V to +4V
- ÷10 -25V to 10V

Coupling: AC or DC switch selectable.

Minimum Pulse Width: 5 ns

Maximum Input:

- 50Ω ÷1 ±7V DC
- 7V rms below 5 MHz
- 3.5V rms (+24 dBm) above 5 MHz
- ÷10 ±7V DC, 7V rms (+30 dBm)
- 1 MΩ ÷1 ±350V DC
- 250V rms to 20 kHz decreasing to 3.5V rms above 5 MHz
- ÷10 ±350V
- 250V rms to 20 kHz decreasing to 35V rms above 5 MHz.

COMMON INPUT

All specifications are the same as for separate operation with the following differences:

Impedance: 1 MΩ becomes 500 KΩ shunted by <80 pF. 50Ω same as in separate.

Sensitivity (preset):

- 50Ω ÷1 200 mV p-p, 70 mV rms sine
- ÷10 2V p-p, 700 mV rms sine
- 1 MΩ Same as in separate

Dynamic Range (preset):

- 50Ω ÷1 200 mV to 5V p-p pulse
- ÷10 2V to 5V p-p pulse
- 1 MΩ Same as in separate

Maximum Input:

- 50Ω ±5V DC or 5V rms
- 1 MΩ same as in separate

Attenuators: Becomes ÷2 and ÷20 for 50Ω **NOMINAL.**

TIME INTERVAL MEASUREMENTS

TIME INTERVAL RANGE:

- ± **Mode:** -10 seconds to +10 seconds including 0 seconds.
- + **Only Mode:** 10 ns to 1 second.

Sample Size (N): 1, 100, 1000, 10,000, 100,000
1 to 16777215 via HP-IB

Statistics: Mean, Standard Deviation, Maximum, Minimum. Time between measurements ≈330 μs; minimum rise time 1 ns.

Least Significant Digit Displayed:

$$20 \text{ ps}/\sqrt{N}$$

Resolution⁽²⁾:

$$\pm \frac{100 \text{ ps rms}}{\sqrt{N}} \pm \frac{\text{Start Trigger Error}}{\sqrt{N}} \pm \frac{\text{Stop Trigger Error}}{\sqrt{N}}$$

Accuracy⁽³⁾: ±Resolution ± Time Base Error × Time Interval ± Trigger Level Timing Error ± 1 ns Systematic⁽⁴⁾.

Differential Linearity: ±20 ps

Trigger Error:

$$\frac{\sqrt{(150 \mu\text{V})^2 + e_n^2}}{\text{Input voltage slew rate at trigger points (V/s)}} \text{ seconds rms}$$

where 150 μV is the **TYPICAL** rms input amplifier noise on the 5370B and e_n is the rms noise of the input signal for a 500 MHz bandwidth.

Trigger Level Timing Error:

$$\frac{25 \text{ mV}}{\text{Input voltage slew rate at trigger point (V/s)}}$$

FREQUENCY MEASUREMENTS

FREQUENCY RANGE: 0.1 Hz to 100 MHz

TIMED GATES:

Internal Gate Time: 1 period, 0.01, 0.1, 1 seconds.

Least Significant Digit Displayed:

$$\frac{20 \text{ ps}}{\text{Gate Time}} \times \text{FREQ}$$

Resolution:

$$\pm \frac{100 \text{ ps rms}}{\text{Gate Time}} \times \text{FREQ} \pm 1.4 \frac{\text{Trigger Error}}{\text{Gate Time}} \times \text{FREQ}$$

Accuracy: ± Resolution ± (Time Base Error) × FREQ

$$\pm \frac{100 \text{ ps Systematic}}{\text{Gate Time}} \times \text{FREQ}$$

Statistics: Mean

SAMPLE MODE (single period):

Sample Size: Same as Time Interval

Least Significant Digit Displayed:

$$20 \text{ ps}/\sqrt{N} \times \text{FREQ}$$

Resolution:

$$\pm \frac{100 \text{ ps rms}}{\text{Gate Time}} \times \text{FREQ} \pm 1.4 \frac{\text{Trigger Error}}{\text{Period } \sqrt{N}} \times \text{FREQ}$$

where gate time is the period of the input signal.

Accuracy: ± Resolution ± (Time Base Error) × FREQ

$$\pm \frac{100 \text{ ps Systematic}}{\text{Period}} \times \text{FREQ}$$

Statistics: Mean, Standard Deviation, Maximum, Minimum.

EXTERNAL GATE:

Gate Input: 20 ns to 10 seconds

Resolution and accuracy estimates may be made with the same specifications as Timed Gates above.

PERIOD MEASUREMENTS

PERIOD RANGE: 10 ns to 10 seconds.

TIMED GATES:

Internal Gate Time: 1 period, 0.01, 0.1, 1 seconds

Least Signification Digit Displayed:

$$\frac{20 \text{ ps}}{\text{Gate Time}} \times \text{PERIOD}$$

Resolution:

$$\pm \frac{100 \text{ ps rms}}{\text{Gate Time}} \times \text{PERIOD} \pm 1.4 \frac{\text{Trigger Error}}{\text{Gate Time}} \times \text{PERIOD}$$

Accuracy: ± Resolution ± Time Base Error × PERIOD

$$\pm \frac{100 \text{ ps Systematic}}{\text{Gate Time}} \times \text{PERIOD}$$

SAMPLE MODE (single period):

Sample Size (N): Same as Time Interval.

Least Significant Digit Displayed: 20 ps/√N

Resolution: ±100 ps rms/√N ± 1.4 Trigger Error/√N

Accuracy: ± Resolution ± Time Base Error × PERIOD

$$\pm 100 \text{ ps Systematic}$$

Statistics: Mean, Standard Deviation, Maximum, Minimum.

EXTERNAL GATE:

Gate Input: 20 ns to 10 seconds

Resolution and Accuracy estimates may be made with the same specifications as timed measurements above.

Table 1-1. HP Model 5370B Specifications (Continued)

GENERAL	
<p>EXTERNAL GATE Input Impedance: 1 MΩ 10 pF NOMINAL. Slope: Selectable + or - Level: Continuously adjustable -2V to +2V, preset 0V. Sensitivity: 10 mV Minimum Pulse Width: 20 ns External Gate Range: 20 ns to 10 s/sample size</p> <p>TRIGGER OUTPUTS (rear panel) Start: Edge going from 0 to -0.7V NOMINAL into 50Ω in sync with the opening of the start channel. Stop: 0 to -0.7V edge into 50Ω in sync with the closing of the stop channel.</p> <p>FREQUENCY STANDARD INPUT (rear panel) 5 or 10 MHz >1.0V p-p into 1 KΩ. Maximum Input 10V.</p> <p>FREQUENCY STANDARD OUTPUT (rear panel) 10 MHz 1V p-p into 50Ω in sync with time base chosen (INT or EXT)</p> <p>DISPLAY: 16 digits + sign, suppressed leading zeros. DISPLAY RATE: 10 ms to 5 s or hold.</p> <p>MINIMUM TIME BETWEEN MEASUREMENTS: 330 μs 165 μs (in the fast binary)</p> <p>OPERATING TEMPERATURE: 0° to 50°C.</p> <p>POWER REQUIREMENTS: 100, 120, 220, or 240 Vac +5% -10%, 48 to 66 Hz, less than 250 VA.</p>	<p>DIMENSIONS: 425 mm (16$\frac{3}{4}$") wide, 133 mm (5$\frac{1}{4}$") high, 457 mm (18") deep</p> <p>WEIGHT: 14.55 kg (32 lbs.).</p> <p>TIME BASE: Crystal Frequency: 10 MHz. Stability: Aging Rate: <5 \times 10⁻¹⁰(5) per month Short Term: <1 \times 10⁻¹⁰ rms for 1 s average Temperature: <7 \times 10⁻⁹ 0°C to 50°C Line Voltage: <1 \times 10⁻¹⁰(6), \pm10% from NOMINAL.</p> <p>(1)Use of 10013A (or equivalent) probes is recommended for time interval measurements in the 1 MΩ position. (2)Typically 35 ps rms. (3)For precise time interval measurements, the input signal and trigger levels must comply with the following criteria in order to remain in the linear operating range of the input amplifiers: the peak input signal (Vs) must be at least 150 mV but not greater than 1.75V above or below the trigger voltage (VTL), i.e., $.15 V < V_S - V_{TL} < 1.75 V$ (4)Typical systematic error =300 ps. With recommended warmup time of 20 minutes and use of the SET REF feature, systematic error can be reduced to <30 ps. (5)For oscillator off time less than 24 hours. (6)15 minutes after change.</p> <p>Specifications describe the instrument's warranted performance. Supplemental characteristics are intended to provide information useful in applying the instrument by giving TYPICAL or NOMINAL, but nonwarranted performance parameters.</p>

1-12. For information concerning a serial number prefix not listed on the title page or in the Manual Changes supplement, contact your nearest Hewlett-Packard office.

1-13. HP-IB INTERFACING, AND PROGRAMMING INFORMATION

1-14. Section II of this manual contains instructions for interfacing the Model 5370B with the HP-IB. A brief description of the sequence of events comprising the transfer of data by the HP-IB is provided in Section III, followed by programming information. Information concerning the design criteria of the bus is available in IEEE Standard 488-1975, titled "IEEE Standard Digital Interface for Programmable Instrumentation".

1-15. SAFETY CONSIDERATIONS

1-16. This product is a Safety Class I instrument (provided with a protective earth terminal). Safety information pertinent to the operation and servicing of this instrument is included in appropriate sections of this manual.

1-17. DESCRIPTION

1-18. The Hewlett-Packard Model 5370B Universal Time Interval (T.I.) Counter is capable of making single-shot T.I. measurements with \pm 20 ps resolution. It uses a phase-locked vernier interpolating technique in which the interpolating oscillators are locked to the time base, thus retaining its basic accuracy at all times. The technique also allows positive, zero, and negative time interval measurements, and a resident microprocessor extends the usefulness of the instrument by offering statistical data such as mean, standard deviation, max, min, etc., for repetitive time intervals.

1-19. Other features include pushbutton user-defined time interval reference for systematic error cancellation; "hysteresis" in arming circuitry eliminates possible random fluctuations between + and - measurements in repetitive time intervals. In addition to time interval, high resolution frequency and period measurements can be made with gates from one period to 1 second. Both time and event information are provided for interrogating complex waveforms.

1-20. The HP 5370B has a sensitive high-speed input amplifier with digital trigger level set, and a precision quartz crystal oscillator for accurate long T.I. measurements.

1-21. OPTIONS

1-22. The following is a list of equipment and accessory options available with the 5370B.

Option	Description
908	Rack Mount Flange Kit/Front Handle Assembly
910	Extra Operating and Service Manual
913	Rack Mount Flange Kit

1-23. For more information concerning these options, contact your local Hewlett-Packard Sales and Support Office. A list of HP Sales and Support offices is provided at the end of this manual.

1-24. ACCESSORIES SUPPLIED

1-25. The HP Model 5370B is supplied with a power cord (HP Part Number 8120-1378) as shown in *Figure 1-1*.

1-26. EQUIPMENT AVAILABLE

1-27. A service accessory kit for the HP Model 5370B is available for convenience of troubleshooting and repairing the instrument. The service accessory kit contains extender boards and a service aid board. The accessory kit may be obtained from Hewlett-Packard by ordering Service Accessory Kit Part Number 10870A.

1-28. RECOMMENDED TEST EQUIPMENT

1-29. Equipment required to maintain the HP Model 5370B is listed in *Table 1-2*. Other equipment can be substituted if it meets or exceeds the critical specifications listed in the table.

Table 1-2. Recommended Test Equipment

Equipment	Required Characteristics	Used For			Recommended HP Model
		Perf. Tests	Adjust.	Trouble-shooting	
Service Kit Consists of:			X	X	10870A
Service Board	No Substitute			X	05370-60014
Extender Board	30 Pin X2			X	5060-0049
Extender Board	22 Pin X2			X	5060-0630
Extender Board	For A22 Arming (No Substitute)			X	05370-60074
Extender Board	For A7 Oscillator Power Supply (6 Pin X2)			X	05370-60076
Extender Board	For Digital Section (A9 through A17)			X	05370-60075
Extender Board	For 5359A Use			X	05359-60078
Extender Board	For Analog Section (A18 through A21)			X	05370-60077
Time Synthesizer	<20 ns Rise Time	X			5359A
Pulse Generator	<5 ns Rise Time		X		8082A
Function Generator	0.1 Hz to 1 MHz	X			3312A
Signal Generator	100 MHz Signal		X		8640B
Frequency Synthesizer	100 MHz Signal	X			8660C
Oscilloscope	200 MHz		X	X	1725A
Sampling Oscilloscope	1 GHz Bandwidth		X		182C
Sampling Plug-In			X		1810A
Oscilloscope	100 MHz	X			1740A
Spectrum Analyzer	200 MHz Center Fre- quency with >100 MHz Bandwidth		X		141T/8552A/ 8554L
Active Probe			X	X	1120A
Probe P.S.			X	X	1122A
Signature Analyzer	No Substitute			X	5005A/5006A
DMM	3½ Digit with 0.1% Accuracy		X	X	3435A
Controller	No Substitute	X		X	9825A
Logic Probe				X	545A
Pulser				X	546A
Current Tracer				X	547A
Cables (7)	4' BNC 50Ω Cables (2 matched length within ½")	X	X X	X	11170C
Tuning Wand	Ceramic		X		8730-0013
Tuning Wand	Long Plastic		X		8730-0011

SECTION II INSTALLATION

2-1. INTRODUCTION

2-2. This section provides all information necessary to install the HP 5370B. Covered in this section are initial inspection, power requirements, line voltage selection, interconnection, mounting, storage, and repackaging for shipment.

2-3. INITIAL INSPECTION

2-4. Inspect the shipping container for damage. If the shipping container or cushioning material is damaged, it should be kept until the contents of the shipment have been checked for completeness and the shipment has been checked mechanically and electrically. The contents of the shipment should be as shown in *Figure 1-1*. If the contents are incomplete, if there is mechanical damage or defect, or if the instrument does not pass the electrical performance test, notify the nearest Hewlett-Packard office. Procedures for checking electrical performance are given in Section IV. If the shipping container is damaged, or the cushioning material shows signs of stress, notify the carrier as well as the Hewlett-Packard office. Keep the shipping material for the carrier's inspection.

2-5. PREPARATION FOR USE

2-6. Power Requirements

2-7. The HP 5370B requires a power source of 100, 120, 220, or 240V ac, +5%, -10%, 48 to 66 Hz single phase. Power consumption is approximately 200 watts nominal.



WARNING

IF THIS INSTRUMENT IS TO BE ENERGIZED VIA AN AUTO-TRANSFORMER FOR VOLTAGE REDUCTION, MAKE SURE THE COMMON TERMINAL IS CONNECTED TO THE EARTHED POLE OF THE POWER SOURCE.

2-8. Line Voltage Selection



CAUTION

BEFORE SWITCHING ON THIS INSTRUMENT, make sure the instrument is set to the voltage of the power source.

2-9. *Figure 2-1* provides instructions for the line voltage and fuse selection. The line voltage selection card and the proper fuse are factory installed for 120V ac operation.

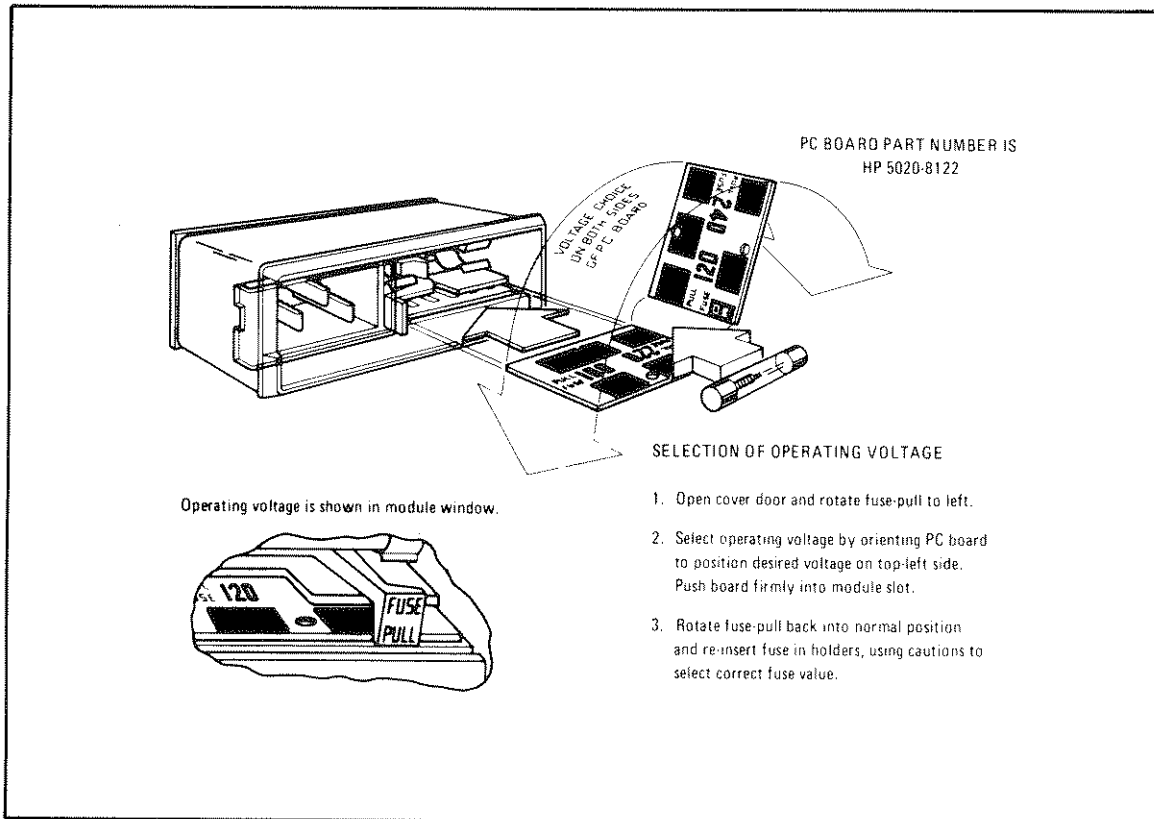

Figure 2-1. Line Voltage Selection

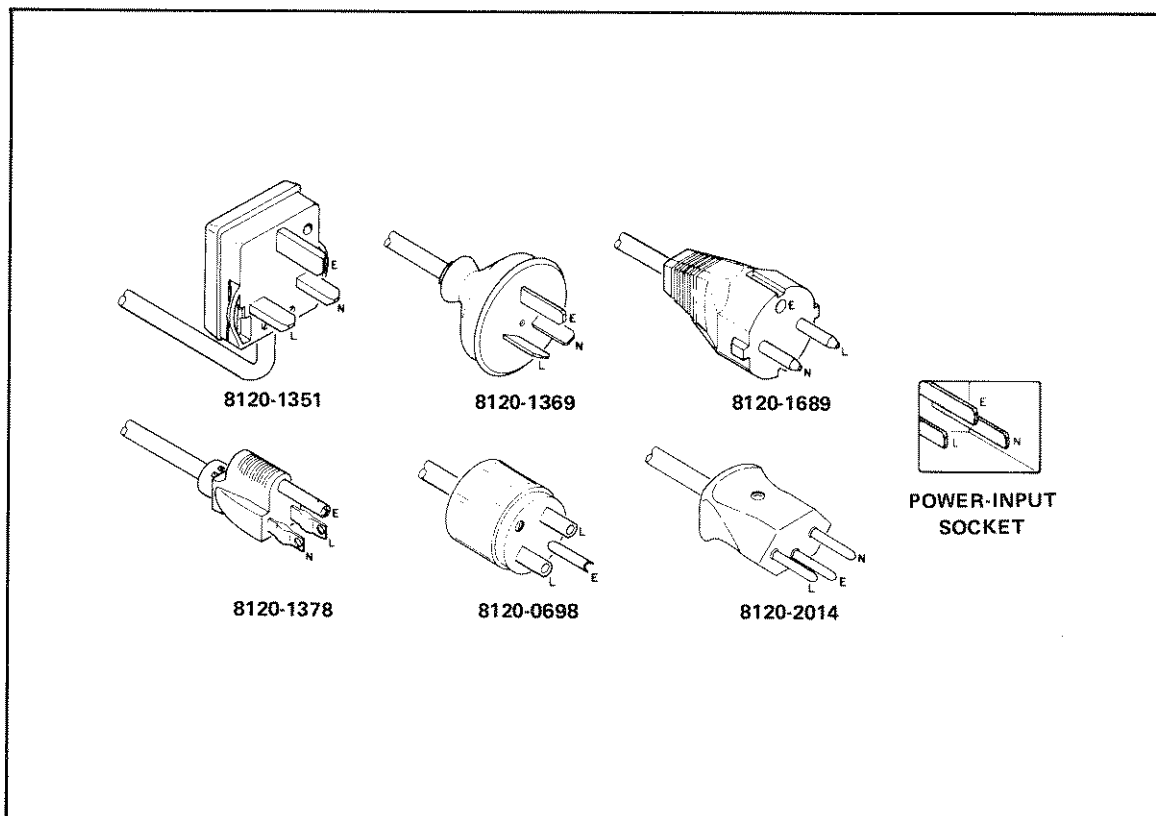

Figure 2-2. Power Cable HP Part Numbers versus Mains Plugs Available

2-10. Power Cable

WARNING

BEFORE SWITCHING ON THIS INSTRUMENT, THE PROTECTIVE EARTH TERMINALS OF THIS INSTRUMENT MUST BE CONNECTED TO THE PROTECTIVE CONDUCTOR OF THE (MAINS) POWER CORD. THE MAINS PLUG SHALL ONLY BE INSERTED IN A SOCKET OUTLET PROVIDED WITH A PROTECTIVE EARTH CONTACT. THE PROTECTIVE ACTION MUST NOT BE NEGATED BY THE USE OF AN EXTENSION CORD (POWER CABLE) WITHOUT A PROTECTIVE CONDUCTOR (GROUNDING).

2-11. The 5370B is shipped with a three-wire power cable. When the cable is connected to an appropriate ac power source, this cable connects the chassis to earth ground. The type of power cable plug shipped with each instrument depends on the country of destination. Refer to *Figure 2-2* for the part numbers of the power cable and plug configurations available.

2-12. Interconnections

2-13. HEWLETT-PACKARD INTERFACE BUS. Interconnection data concerning the rear panel HP-IB connector is provided in *Figure 2-3*. This connector is compatible with the HP 10631A/B/C/D HP-IB Cables. With the HP-IB system, you can interconnect up to 15 (including the controller) HP-IB compatible instruments. The HP-IB cables have identical "piggyback" connectors on both ends so several cables can be connected to a single source without special adapters or switch boxes. You can interconnect system components and devices in virtually any configuration you desire. There must, of course, be a path from the calculator (or other controller) to every device operating on the bus. As a practical matter, avoid stacking more than three or four cables on any one connector. If the stack gets too large, the force on the stack produces leverage which can damage the connector mounting. Be sure each connector is firmly screwed in place to keep it from working loose during use.

2-14. CABLE LENGTH RESTRICTIONS. To achieve design performance with the HP-IB, proper voltage levels and timing relationships must be maintained. If the system cable is too long, the lines cannot be driven properly and the system will fail to perform properly. Therefore, when interconnecting an HP-IB system, it is important to observe the following rules:

- a. The total cable length for the system must be less than or equal to 20 metres (65 feet).
- b. The total cable length for the system must be equal to or less than 2 metres (6.6 feet) times the total number of devices connected to the bus.
- c. The total number of instruments connected to the bus must not exceed 15.

2-15. 5370B Listen Address

2-16. The 5370B contains a rear panel HP-IB Instrument ADDRESS SELECTION switch. There are five switches designated (5, 4, 3, 2, 1) which are used to select the address. Instructions for setting and changing the listen address are provided in Section III of this manual along with 5370B programming codes.

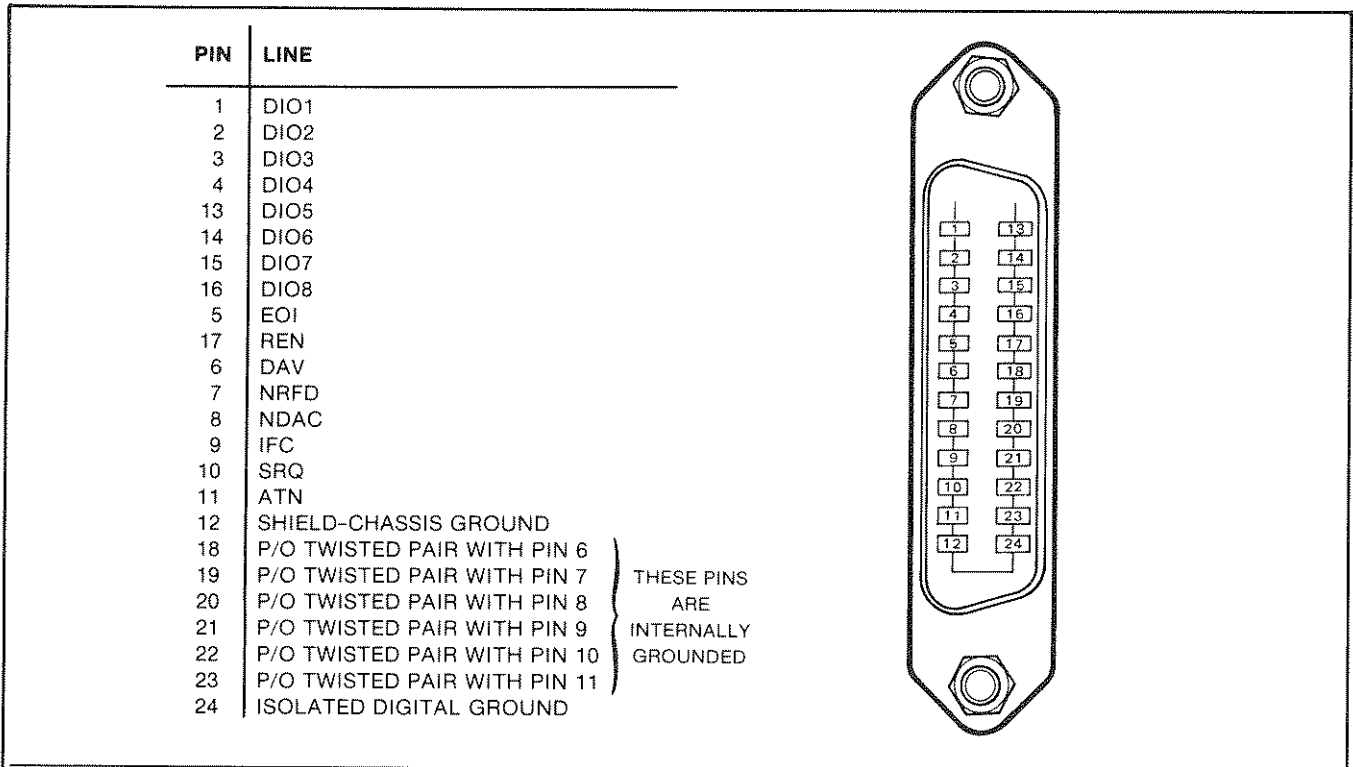

CAUTION

The 5370B contains metric threaded HP-IB cable mounting studs as opposed to English threads. Metric threaded HP 10631A, B, C, or D HP-IB cable lockscrews must be used to secure the cable to the instrument. Identification of the two types of mounting studs and lockscrews is made by their color. English threaded fasteners are colored silver and metric threaded fasteners are colored black. DO NOT mate silver and black fasteners to each other or the threads of either or both will be destroyed. Metric threaded HP-IB cable hardware illustrations and part numbers follow.

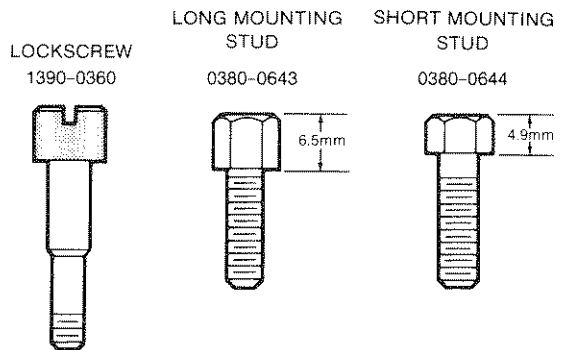

Logic Levels

The Hewlett-Packard Interface Bus logic levels are TTL compatible, i.e., the true (1) state is 0.0V dc to 0.4V dc and the false (0) state is +2.5V dc to +5.0V dc.

Programming and Output Data Format

Refer to Section III, Operation

Mating Connector

HP 1251-0293; Amphenol 57-30240.

Mating Cables Available

HP 10631A, 1 metre (3.3 ft.), HP 10631B, 2 metres (6.6 ft.),
HP 10631C, 4 metres (13.2 ft.), HP 10631D, 1/2 metre (1.6 ft.).

Cabling Restrictions

1. A Hewlett-Packard Interface Bus System may contain no more than 2 metres (6.6 ft.) of connecting cable per instrument.
2. The maximum accumulative length of connecting cable for any Hewlett-Packard Interface Bus System is 20.0 metres (65.6 ft.).
3. The maximum number of instruments in one system is fifteen.

Figure 2-3. Hewlett-Packard Interface Bus Connection

2-17. HP-IB Description

2-18. A description of the HP-IB is provided in Section III of this manual. A study of this information is necessary if you are not familiar with the HP-IB concept. Additional information concerning the design criteria and operation of the bus is available in IEEE Standard 488-1975, titled "IEEE Standard Digital Interface for Programmable Instrumentation".

2-19. Bench Operation

2-20. The instrument has plastic feet and a foldaway tilt stand for convenience in bench operation. The tilt stand raises the front of the instrument for easier viewing of the control panel. The plastic feet are shaped to make full width modular instruments self-aligning when stacked.

2-21. OPERATING ENVIRONMENT

2-22. Operating and Storage Temperature

2-23. In order for the 5370B to meet the specifications listed in *Table 1-1*, the operating environment must be within the following limits:

Temperature	0° to +50°C
Humidity	<80% relative
Altitude	<15,000 feet

2-24. Cooling System

2-25. A forced air cooling system is used to maintain the operating temperature required by the instrument. The cooling fan is located on the left-side of the rear panel (while looking at the rear panel). When operating the 5370B, choose a location that provides at least 8 cm (3 inches) of clearance at the rear and at least 2 cm (1 inch) for each side. Failure to provide adequate air clearance will result in excessive temperature reducing instrument reliability. The clearances provided by the plastic feet in bench stacking and the filler strip in rack mounting allow air passage across the top and bottom cabinet surfaces.

2-26. STORAGE AND SHIPMENT

2-27. Environment

2-28. The instrument should be stored in a clean, dry environment. The following environmental limitations apply to both storage and shipment:

Temperature	-40°C to +75°C
Humidity	<95% relative
Altitude	<50,000 feet

2-29. Packaging

2-30. ORIGINAL PACKAGING. Containers and materials equivalent to those used in factory packaging are available through Hewlett-Packard offices. If the instrument is being returned to Hewlett-Packard for servicing, attach a tag indicating the type of service required, return address, model number, and full serial number. Also, mark the container FRAGILE to assure careful handling. In any correspondence, refer to the instrument by model number and full serial number.

2-31. OTHER PACKAGING. The following general instructions should be used for repackaging with commercially available materials.

- a. Wrap the instrument in heavy paper or plastic. (If shipping to a Hewlett-Packard office or service center, attach a tag indicating the type of service required, return address, model number, and full serial number.)
- b. Use a strong shipping container. A doublewall carton made of 250 pound test material is adequate.
- c. Use enough shock-absorbing material (3- to 4-inch layer) around all sides of the instrument to provide firm cushion and prevent movement inside the container. Protect the control panel with cardboard.
- d. Seal the shipping container securely.
- e. Mark the shipping container FRAGILE to assure careful handling.

SECTION III OPERATING AND PROGRAMMING

3-1. INTRODUCTION

3-2. This section provides complete operating and programming information needed for the HP Model 5370B Universal Time Interval Counter. This section includes a description of all front and rear panel controls, connectors and indicators, operator's check, operating instructions both manually and remotely, and operator's maintenance.

3-3. OPERATING CHARACTERISTICS

3-4. The following paragraphs describe the operating ranges, resolution, and accuracy for Frequency, Period, and Time Interval modes.

3-5. Frequency Mode

3-6. All frequency measurements are made through the STOP channel input. The frequency range is 0.1 Hz to 100 MHz with a minimum input level of 100 mV p-p, or 35 mV rms sine wave times attenuator setting. The 5370B has 12 digits resolution with a 1-second measurement time. The accuracy is described using the following formula:

$$\text{Accuracy} = \frac{100 \text{ ps rms} \pm \text{trigger error}}{\text{gate time}} \pm \text{time base}$$

3-7. Period Mode

3-8. The 5370B makes period measurements from 10 nanoseconds to 10 seconds with a minimum input signal level of 100 mV p-p, or 35 mV rms sine wave times the attenuator setting. All period measurements are made through the STOP channel input jack. The 5370B gives 12 digits resolution using a 1-second measurement (gate time). The resolution is described using the following formula:

$$\text{Resolution} = \frac{20 \text{ ps}}{\text{gate time}}$$

The accuracy is the same as for the frequency measurements as described in paragraph 3-6.

3-9. Time Interval Mode

3-10. The 5370B measures time intervals from 10 nanoseconds to 10 seconds in +T.I. ONLY, and -10 seconds to +10 seconds in \pm T.I. The minimum input level for a two source T.I. measurement is 100 mV p-p times the attenuator setting. For a one source measurement, the input signal must be input to the START channel input jack, the SEP/COM switch in COM, both attenuators must be set to the same impedance, and the minimum input level is double that for two source measurements. That is 200 mV p-p times the attenuator setting. The resolution is given using the following formula:

$$\text{Resolution} = \frac{\pm 20 \text{ ps}}{\sqrt{\text{sample size}}} \pm 2 \text{ ps}$$

The accuracy is described using the following formula: Accuracy = jitter \pm 1 ns systematic \pm time base $\frac{\pm \text{trigger error}}{\sqrt{N}}$ where jitter equals 35 ps typical, trigger error equals $\frac{\pm 2 \times \text{noise peak voltage}}{\text{Signal Slope V}/\mu\text{s}}$ microseconds and N equals sample size.

NOTE:

To make accurate Time Interval measurements at 1 M Ω input impedance the following HP 10013A probe compensation procedure should be done.

1. Set the HP 1725A Oscilloscope input coupling to dc.
2. Set the HP 8082A Pulse Generator to obtain a square wave pulse that is 100 kHz, 3V p-p, and has a 1 ns transition time.
3. Connect the 10013A probe to the oscilloscope input and probe the output of the 8082A Pulse Generator. Observe the square wave on the 1725A Oscilloscope display.
4. Adjust the 10013A probe's compensation capacitor for the under compensation (observed from the display).
5. Connect the same 10013A probe to the HP 5370B. Probe the output of the 8082A and adjust the 5370B LEVEL pot until the trigger LED starts flashing. Now, adjust pot back until trigger LED just turns off.
6. Adjust the 10013A compensation capacitor on the probe until the trigger LED on the 5370B starts flashing again.

The 10013A probe is now correctly calibrated.

3-11. PANEL FEATURES

3-12. Front and rear panel features of the HP Model 5370B are described in *Figure 3-1* and *Figure 3-2*, respectively. These figures contain a description of the controls and connectors. Front panel indicators are described in *Figure 3-3*. Description numbers match the numbers on the illustrations.

3-13. OPERATOR'S CHECKS

3-14. A procedure for verifying the major functions of the HP Model 5370B is provided in *Figure 3-4*. The only accessory needed for the verification procedure is a 4-foot length coaxial BNC cable HP Part Number 10503A or equivalent and a 5 kHz oscilloscope.

3-15. OPERATING INSTRUCTIONS

WARNING

BEFORE THE INSTRUMENT IS SWITCHED ON, ALL PROTECTIVE EARTH TERMINALS, EXTENSION CORDS, AUTOTRANSFORMERS, AND DEVICES CONNECTED TO THE INSTRUMENT SHOULD BE CONNECTED TO A PROTECTIVE EARTH GROUNDED SOCKET. ANY INTERRUPTION OF THE PROTECTIVE EARTH GROUNDING WILL CAUSE A POTENTIAL SHOCK HAZARD THAT COULD RESULT IN PERSONAL INJURY.

WARNING

ONLY FUSES WITH THE REQUIRED RATED CURRENT AND SPECIFIED TYPE SHOULD BE USED. DO NOT USE REPAIRED FUSES OR SHORT CIRCUITED FUSEHOLDERS. TO DO SO COULD CAUSE A SHOCK OR FIRE HAZARD.



BEFORE THE INSTRUMENT IS TURNED ON, it must be set to the voltage of the power source, or damage to the instrument could result.

3-16. Figures 3-5, 3-6, 3-7, and 3-8 show general operating procedures with the HP Model 5370B Universal Time Interval Counter connected in a typical measurement test setup. Many other applications are possible but not shown because the general operating procedure is the same. Description numbers match the group containing the particular designated switch.

3-17. External Arming/External Holdoff

3-18. The EXTERNAL Input jack (front panel) allows the 5370B to be externally armed and held off. The input works in conjunction with the EXT HOLDOFF, EXT ARM, and MAN INPUT switches. The specifications for the input signal are in Table 1-1.

3-19. EXTERNAL ARMING. To operate the counter in the EXTERNAL ARM mode, press the EXT ARM switch on the front panel. The selected trigger edge at the external input then arms the counter. The next START or STOP input pulse begins the measurement as illustrated in the diagram.

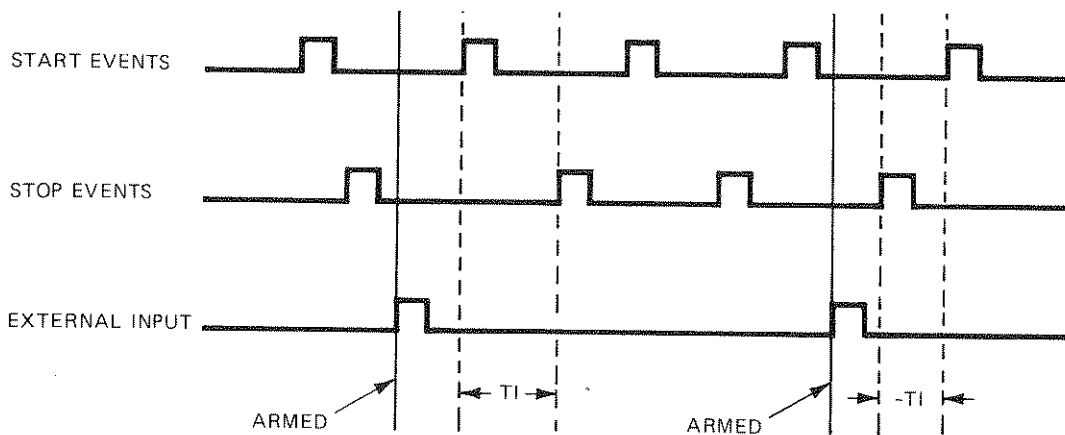

3-20. EXTERNAL ARM/EXTERNAL HOLDOFF. To operate the counter in the EXTERNAL HOLD-OFF mode, press the EXT HOLDOFF switch on the front panel. The selected trigger edge at the external input then arms the counter. The next START input pulse begins the measurement. The STOP pulses are held off as long as the external input holdoff is present as illustrated in the diagram.

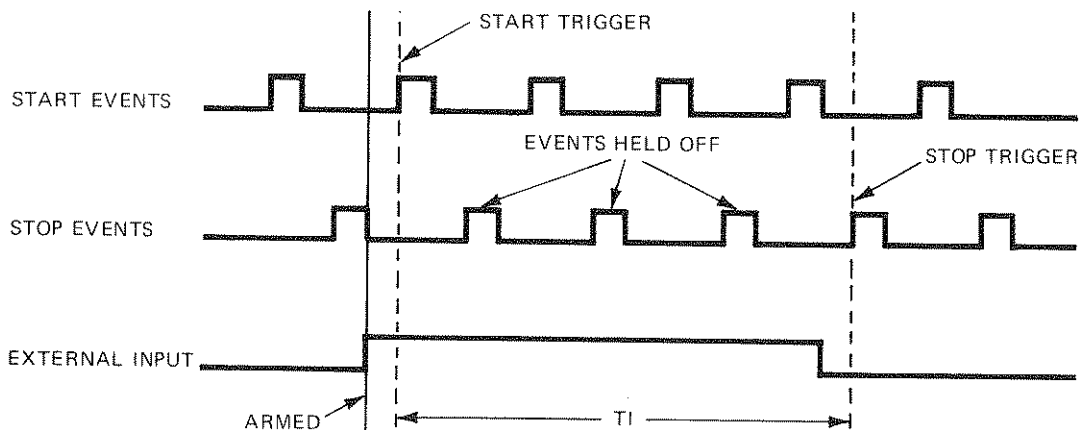

The number of events held off are counted and stored by the 5370B and can be displayed by pressing the DSP EVTS switch on the front panel.

3-21. **EXTERNAL GATE.** The 5370B may be operated in the External Gate mode for Frequency and Period measurements. To do this, press the EXT HOLDOFF switch on the front panel. The selected trigger edge at the external input then opens the main gate. The next edge then closes the gate. The diagram on page 3-4 illustrates the gate times for external gates with the 5370B front panel SLOPE switch set to *positive* and *negative*, respectively.

NOTE

Regardless of the length of the external gate, the 5370B displays 12 digits.

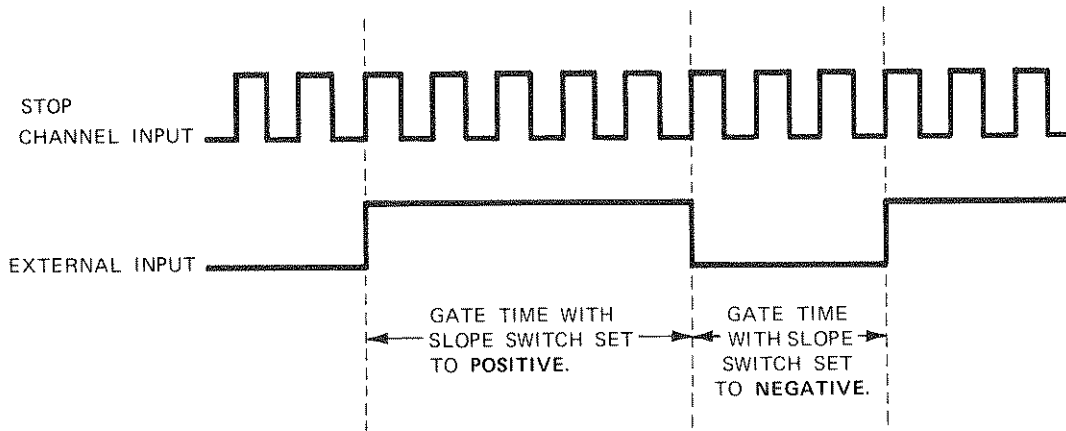

3-22. Error Messages

3-23. Under certain conditions, the 5370B will display an Error message (number). There are eight messages in all as listed below. Errors 6.n and 7.n pertain to power-up only. The remaining messages occur under certain operating conditions. In remote operation, the error message remains in the Status Byte until the initiation of the next measurement.

ERROR	MESSAGE
Error 0	A measurement has been completed and the 5370B has not yet been addressed.
Error 1	Indicates an illegal remote command or an undefined function (HP-IB) sent to 5370B.
Error 2	Data out of range (overrange).
Error 3	Illegal key combination (local or HP-IB).
Error 4	Phase-locked-loop out of lock.
Error 5	Undefined key (hardware problem).
Error 6.n	RAM error — processor writes into RAM (checker board pattern) and verifies error in RAM n.
Error 7.n	ROM error — processor computes check sum; error in ROM (U3) on A9 Processor board.

3-24. OPERATOR'S MAINTENANCE

3-25. The only maintenance the operator should normally perform is replacement of the primary power fuse located within the Line Module Assembly (A24). For instructions on how to change the fuse, refer to Section II, Line Voltage Selection.



Make sure that only fuses with the required rated current and of the slow-blow type are used for replacement. The use of repaired fuses and the short-circuiting of fuse-holders must be avoided.

3-26. Power/Warm-Up

3-27. The HP Model 5370B requires a power source of 100, 120, 220, or 240 Vac, +5%, -10%, 48 to 66 Hz single phase. The selection of line voltage and input power fuse is described in Section II, paragraph 2-5, Preparation for Use.

3-28. The 5370B has a two-position power switch, STBY and ON. It is important that the instrument remain connected to the power source in the STBY mode when not in use. This supplies power to the crystal oven maintaining a constant oven temperature thus eliminating the need for a warm-up period. When the STBY mode is not used and power is disconnected from the instrument, allow 30 minutes from the application of external power in the ON mode for the instrument (crystal oven) to warm-up.



POWER IS ALWAYS PRESENT AT THE LINE SWITCH AND TRANSFORMER, AND UNREGULATED DC IS PRESENT WHENEVER THE LINE CORD IS ATTACHED. UNPLUGGING THE POWER CORD IS NECESSARY TO REMOVE ALL POWER FROM THE INSTRUMENT.

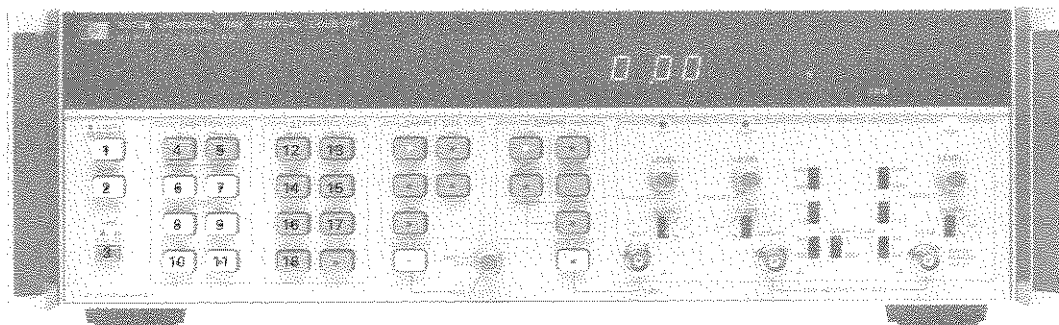

- | | | |
|---|---------------------|--|
| 1 | LOCAL REMOTE | Returns control from HP-IB to front panel. |
| 2 | RESET | Aborts current sample, performs lamp test, clears display, prepares machine to accept new samples and disarms instrument if manually armed. It does not destroy REFERENCE, EVENTS HOLDOFF, or the machine configuration. |
| 3 | STBY ON | Supplies power to entire machine in the ON position. Supplies power only to the oscillator oven in the STBY (standby) position. |
| 4 | T.I. | Time Interval function measures time differences from START channel to STOP channel. |
| 5 | TRIG LVL | Measures the voltage of the trigger levels of the START and STOP input channels and simultaneously displays them continuously. |
| 6 | FREQ | Measures frequency of the STOP channel signal by taking the reciprocal of a period average. START channel is ignored. |
| 7 | PERIOD | Measures a period average of STOP channel input events. START channel is ignored. Input amplifier control switch must be set to SEP. |
| 8 | 1 PERIOD | Measures one period of the input signal of the STOP channel and displays it as either frequency or period depending on the chosen function. 1 PERIOD is disabled when machine is in Time Interval function. |

NOTE

Gate Times 9 , 10 , and 11 are for frequency and period measurements only.

- | | | |
|----|-----------------|---|
| 9 | 0.01 s | Gate time of 0.01 second is enabled. |
| 10 | 0.1 s | Gate time of 0.1 second is enabled. |
| 11 | 1 s | Gate time of 1 second is enabled. |
| 12 | MEAN | Causes counter to measure and display the mean estimate which is the sample average from N time interval measurements minus a constant REFERENCE value. |
| 13 | STD DEV | Displays the standard deviation estimate for the selected sample size. |
| 14 | MIN | Displays the minimum time interval within the sample minus the REFERENCE. |
| 15 | MAX | Displays the maximum time interval within the sample minus the REFERENCE. |
| 16 | DSP REF | Displays the current value of REFERENCE stored. This value remains constant until changed by switch SET REF or by switch CLR REF. The power-up value of REFERENCE is zero. |
| 17 | CLR REF | Sets REFERENCE value to zero. |
| 18 | DSP EVTS | Displays the number of events input to the STOP channel which were held off during the sample measurement window. If HOLDOFF signal is not present, it displays the number of samples that have occurred per display cycle. |

Figure 3-1. Front Panel Controls, Indicators, and Connectors

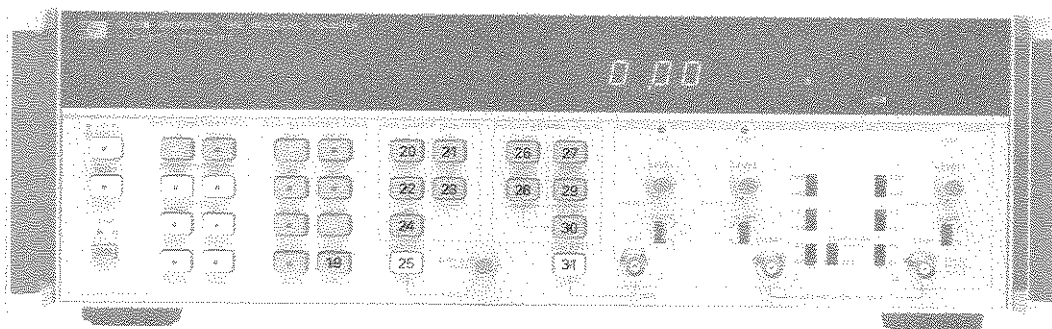

- 19 **SET REF** Establishes a new REFERENCE value equal to the average time interval of the latest sample.
- 20 **1** Instrument makes one measurement and displays result.
- 21 **100** Instrument makes one hundred measurements and displays result.
- 22 **1K** Instrument makes one thousand measurements and displays result.
- 23 **10K** Instrument makes ten thousand measurements and displays result.
- 24 **100K** Instrument makes one hundred thousand measurements and displays result.

NOTE

SAMPLE SIZE operates only with 1 PERIOD GATE. When gates other than 1 PERIOD are selected, SAMPLE SIZE is disabled. When a SAMPLE SIZE is selected, the 5370B automatically goes to 1 PERIOD mode.

- 25 **MAN RATE** Initiates a new sample for measurement when DISPLAY RATE control is in HOLD position. Old measurement value remains on display until replaced by new value. Also see DISPLAY RATE 32.
- 26 **+T.I. ONLY** In the +T.I. ONLY mode, all STOP channel events are ignored until the arrival of the START event. The counter is armed internally.
- 27 **±T.I.** In the ±T.I. mode, START event occurring before STOP event will automatically be assigned as a positive time interval and vice versa as a negative time interval. First incoming signal (either START or STOP) arms the counter.
- 28 **EXT HOLDOFF** Used in conjunction with EXT ARM mode switch; it enables the EXTERNAL HOLDOFF signal to inhibit STOP channel input signal.
- 29 **PERIOD COMPLMNT** When the PERIOD COMPLMNT switch is activated repeatedly, the measurement will switch from +T.I. to -T.I. or vice versa in a toggle fashion. Period Complement is operational only in the ±T.I. mode. Once a mode is selected, the ±T.I. range holds and the reading will not flicker between the two results. This switch has no effect when the instrument is externally armed, or when the T.I. is less than 10 nanoseconds.
- 30 **EXT ARM** In ±T.I. mode, the START and STOP channels are simultaneously armed after the arrival of the EXT input signal. As soon as the channels are armed, the time interval defined by the first event occurring in each channel is measured, regardless of the order of arrival. In +T.I. ONLY mode the START channel is armed after the arrival of the EXT input. Time Interval is defined by the first event in the START channel and the first event in the STOP channel arriving **after** the first event in the START channel.
- 31 **MAN INPUT** EXT INPUT signals for EXT ARM and/or EXT HOLDOFF functions can be generated manually through the MAN INPUT switch.

Figure 3-1. Front Panel Controls, Indicators, and Connectors (Continued)

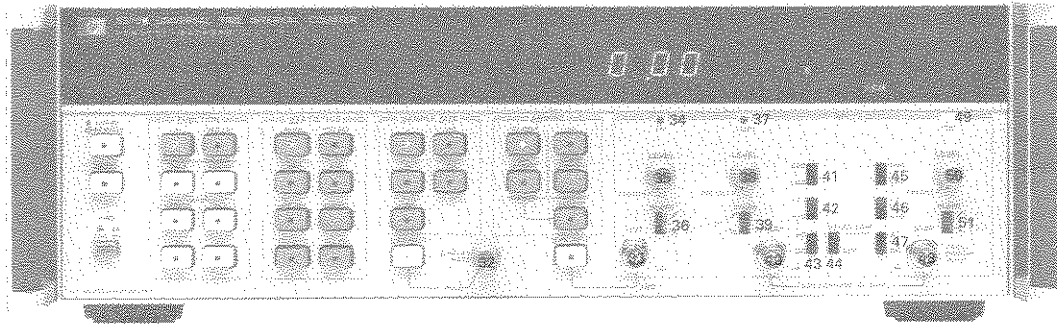

- 32 DISPLAY RATE** Determines time between sample measurements. Rotating this control more counter-clockwise will add more time between measurements which in turn, displays previous measurements longer and gives a more stable display.
- When the DISPLAY RATE control is in the HOLD position, a new measurement can be initiated in several ways:
1. Pressing MAN RATE (25)
 2. Changing functions (4 through 7)
 3. Changing gate times (8 through 11)
 4. Changing sample size (20 through 24)
 5. Changing arming mode (\pm T.I. to +T.I. or reverse)
- 33 J1** Input BNC connector for the EXT HOLDOFF and/or EXT ARM signals with an input load impedance of 1 megohm. See *Table 1-1* for specifications.
- 34 EXT** LED indicator which when blinking, indicates that the external signal is triggering.
- 35 LEVEL** Trigger level control for the external input signal.
- 36 1 SE** This switch setting determines which slope of the external input signal will be used as the triggering slope.
2
- 37 49** LED indicators which when blinking, indicate that the START and/or STOP channel is triggering the machine.
- 38 50** LEVEL controls used in conjunction with attenuator switches 42,46 to select voltage at which triggering occurs.
- 39 1 SA** This switch setting determines which slope of the START channel input signal will be used as the triggering slope.
2
- 51 1 SO** This switch setting determines which slope of the STOP channel input signal will be used as the triggering slope.
2
- 40 48** Input BNC connectors for the START and STOP channel signal inputs.
- 41 45** Input impedance switches used to select an input impedance of 50 Ω or 1 Meg Ω shunted by less than 30 pF.
- 42 46** Selects attenuation for input signal. Used in conjunction with LEVEL control to set trigger point. Input level is not affected in \pm 1 position. Input signal amplitude is reduced by a factor of 10 in \pm 10 position.
- 43 47** Coupling switches used to select direct or capacitor coupling for input signal.
- 44** Input Amplifier Control switch.
- a. **START COM** — Operationally connects START and STOP channels in parallel. Used for single source time interval measurement. STOP channel jack is not active. START and STOP input impedance switches must be set to same position.
 - b. **SEP** — Allows independent operation of START and STOP channels.

Figure 3-1. Front Panel Controls, Indicators, and Connectors (Continued)

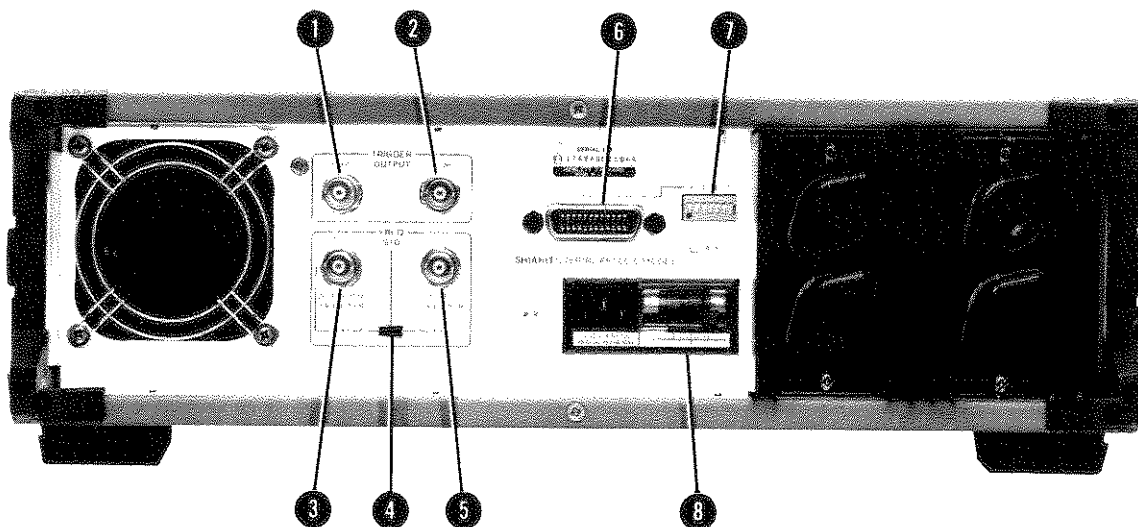

- ① **TRIGGER OUTPUT START** jack. Edge going from 0 to -0.7 volt nominal into 50Ω in sync with the opening of the START channel.
- ② **TRIGGER OUTPUT STOP** jack. Edge going from 0 to -0.7 volt nominal into 50Ω in sync with the closing of the STOP channel.
- ③ **FREQ STD INPUT** jack. Allows 5370B to be operated synchronous with an external standard of either 5 or 10 megahertz with drive of 1 volt rms across 1 kilohms. FREQ STD select switch ④ must be set to EXT position.
- ④ **FREQ STD** select switch.
 - a. INT allows the 5370B to operate with the internal time base standard.
 - b. EXT allows the 5370B to operate with an external time base standard.
- ⑤ **FREQ STD OUTPUT** jack. Provides 10 megahertz internal standard signal for external use. Amplitude is 1 volt rms into 50 ohms. FREQ STD select switch ④ set to INT position, provides output of the internal 10 MHz clock. EXT position provides a buffered output of the external time base standard being used.
- ⑥ Interface connector for 5370B connection to HP-IB remote interface.
- ⑦ **ADDRESS** switch cluster containing address switch A₁ through A₅ and TALK ONLY switch A₇. Switch A₆ is not internally connected. See programming in this section for detailed explanation.
- ⑧ AC power input module permits 5370B operation from 100, 120, 220, or 240 volts ac. The number visible in the window indicates nominal line voltage to which instrument must be connected (see Figure 2-1). Protective ground conductor connects to the instrument through this module.

WARNING

ANY INTERRUPTION OF THE PROTECTIVE (GROUNDING) CONDUCTOR INSIDE OR OUTSIDE THE INSTRUMENT OR DISCONNECTING OF THE PROTECTIVE EARTH TERMINAL IS LIKELY TO MAKE THE INSTRUMENT DANGEROUS. (See Section II.)

Figure 3-2. Rear Panel Features

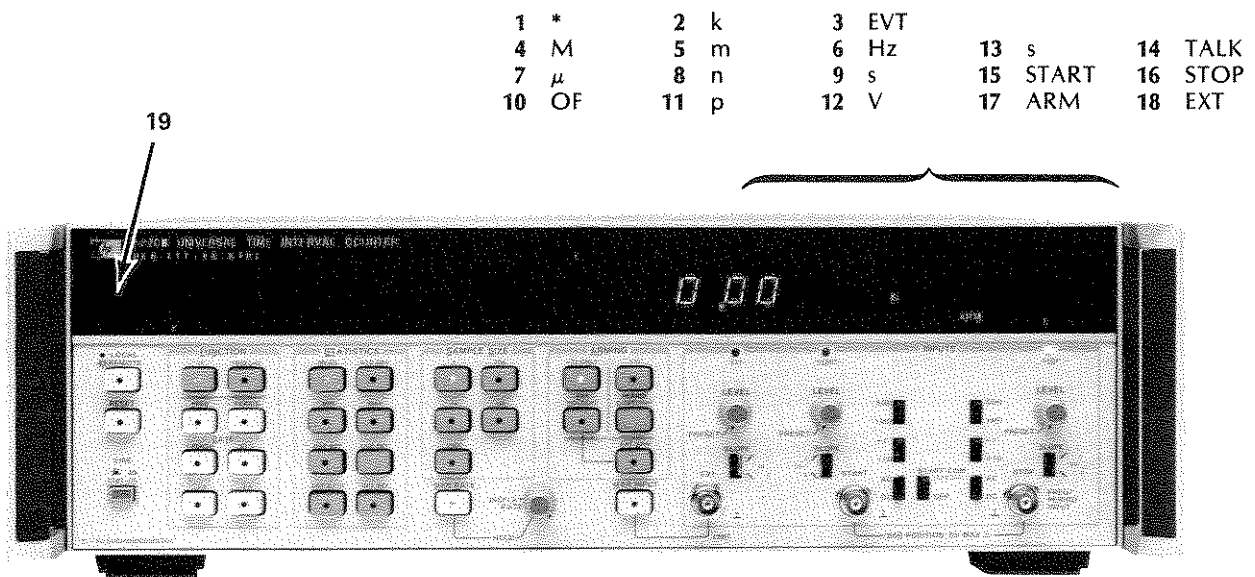

1 *	2 k	3 EVT		
4 M	5 m	6 Hz	13 s	14 TALK
7 μ	8 n	9 s	15 START	16 STOP
10 OF	11 p	12 V	17 ARM	18 EXT

Number	Symbol	Description
1	*	ASTERISK — Indicates crystal oscillator oven is below operating temperature (cold), as is the case when the 5370B is first plugged into the line supply.
2	k	kilo (10^3)
3	EVT	Events
4	M	Mega (10^6)
5	m	milli (10^{-3})
6	Hz	Hertz
7	μ	Micro (10^{-6})
8	n	nano (10^{-9})
9	s	seconds
10	OF	Overflow
11	p	pico (10^{-12})
12	V	Volts
13	LSTN	Listen — Active when 5370B is programmed to listen.
14	TALK	Active when 5370B is programmed to talk.
15	START	Active when Time Interval measurement is armed by START channel signal input in the \pm T.I. mode.
16	STOP	Active when Time Interval measurement is armed by STOP channel signal input in the \pm T.I. mode.
17	ARM	Indicates 5370B is armed (ready to measure input signal). ARM light is actually flickering while measuring N samples but so fast as to appear to be continually on. ARM light may not appear lit for single samples of narrow events. Light stays on during measurement time.
18	EXT	Indicates machine is in the EXTERNAL ARM mode.
19		Oscillator clock loss indicator. Indicates loss of internal clock signal, possibly due to setting of rear panel FREQ STD switch. Once clock signal is returned, the 5370B power may need to be turned off and on again before internal circuits can operate properly.

Figure 3-3. Front Panel Display Indicators

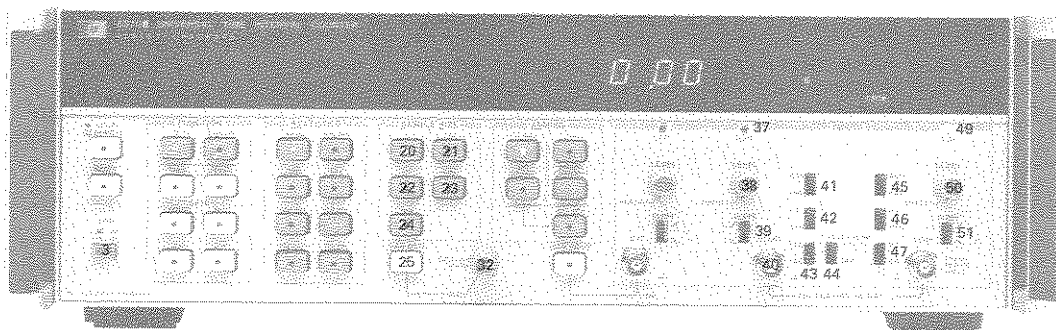

1. Before switching on the instrument, ensure that the power transformer primary is matched to the available line voltage, the correct fuse is installed, and the safety precautions are taken. See Power Requirements, Line Voltage Selection, Power Cables, and associated warnings and cautions in Section II of this manual. Description numbers match the numbers in *Figure 3-1* and *Figure 3-2*.
2. Connect a 4-foot BNC cable, such as HP 10503A, from the rear panel FREQ STD OUTPUT jack to the front panel START input jack 40.
3. Set the rear panel Frequency Select switch to INT.
4. Set the input impedance switches 41 45 to the 50 Ω position.
5. Set the attenuator switches 42 46 to the $\div 1$ position.
6. Set the AC, DC switches 43 47 to the DC position.
7. Set the input slope switches 39 51 to the 1 (positive going slope) position.
8. Set the LEVEL controls 38 50 to the preset position.
9. Set the COM, SEP switch 44 to the START COM position.
10. Adjust DISPLAY RATE 32 to maximum (full cw).
11. Press the LINE switch 3 to turn on the 5370B.

NOTE

When instrument is first turned on, the processor performs a self-check routine on the ROM's and RAM's. If, when power is first applied, or during operation, an error message is displayed, refer to paragraph 3-22 ERROR MESSAGES in this section for error explanation.

12. For the first second after the instrument is turned on, the display will remain blank. For the next second, all segments and decimal points and all annunciator lights (except START, STOP, and ARM) in the display will be lit as well as all LED's in all the front panel switches.
13. After this initial power-up reset, the 5370B will be in the T.I. FUNCTION, MEAN STATISTICS, SAMPLE SIZE 1, and +T.I. ONLY. The display should indicate 100.00 nanoseconds ± 1.0 nanosecond with both the START and STOP channel trigger LED's 37 49 flashing. Also, because of the sample size of one, the ARM light will not be visible in the display.
14. Press SAMPLE SIZE 100 switch 21. The least significant digit (LSD) will be one-digit greater (1 picosecond), the ARM light will be visible and flashing and the LED in the MAN RATE switch 25 will be flashing at approximately the same rate as the ARM light. Press SAMPLE SIZE 1K switch 22 and display will have same LSD (1 picosecond) with ARM light and MAN RATE switch flashing about twice per second. Press SAMPLE SIZE 10K 23 and display LSD will be 100 femtoseconds with ARM light flashing about once every four seconds. Press SAMPLE SIZE 100K switch 24 and the ARM light will flash about once every 40 seconds. Press SAMPLE SIZE 1 20.

Figure 3-4. Operators Checks

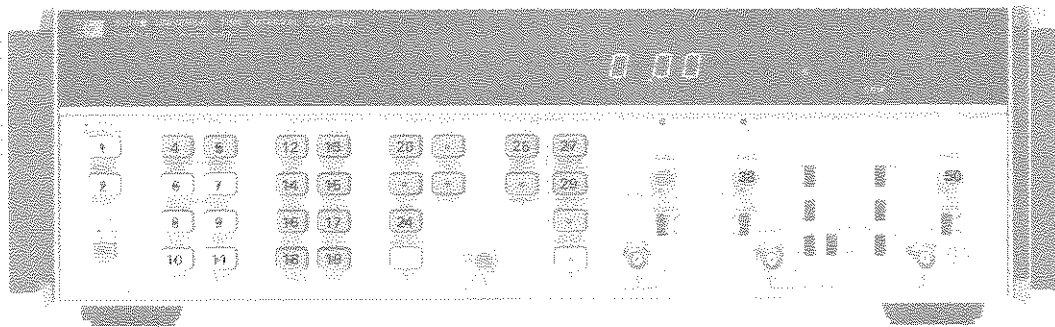

15. Press STD DEV 13 and \pm T.I. switch 27. Display should read less than 100 ps (this reading is the instrument's jitter). Notice that SAMPLE SIZE automatically goes to 100. For STD DEV measurements, SAMPLE SIZE must be ≥ 100 . Press MIN switch 14 and minimum T.I. should be displayed. Press MAX switch 15 and the maximum T.I. should be displayed. Press \pm T.I. ONLY 26.
16. Press DSP REF switch 16 and three zeros should be displayed. Press SET REF switch 19 and approximately 100 nanoseconds should be displayed. This reference is the MEAN T.I. Press CLR REF switch 17 and six zeros should be displayed (if 99.99X ns is displayed, CLR REF will give five zeros), three zeros on either six of the decimal point. Press DSP EVTS switch 18 and 100 should be in the display. This number corresponds to the SAMPLE SIZE. Notice also EVT is displayed in the right hand side of the window.
17. Press MEAN switch 12 and SAMPLE SIZE 1 switch 20. Press \pm T.I. switch 27 and the display should show less than 1 nanosecond. The STOP or START light in the display will also be on. Press PERIOD COMPLMNT switch 29 and the display should be the same except the other (STOP or START) light will be on in the display. Press the PERIOD COMPLMNT switch again and the first arming channel light should come back on. This switch operation is identical to a toggle switch.
18. Press TRIG LVL 5. There will be two groups displayed, three digits each, on the left and the right of the display. They indicate the DC trigger level voltage on the START and STOP channel inputs, respectively. Rotate the LEVEL controls 38 50 and note the voltage should change from approximately -2 to +2 volts. Turn both LEVEL controls fully counterclockwise until they click in the preset position. The display should show zero volts for both inputs.
19. Press FREQ switch 6. Press 0.01 s switch 9 and display should read approximately 10.000 000X MHz. Press 0.1 s switch 10 and display should read approximately 10.000 000 0X MHz. Press 1 s switch 11 and display should read approximately 10.000 000 0XX MHz. Press 1 PERIOD switch 8.
20. Press PERIOD switch 7. Display should indicate approximately 100 nanoseconds.
21. Press Function switch T.I. 4, 100K SAMPLE SIZE 24, rotate DISPLAY RATE control maximum cw and check the rear panel START and STOP outputs 1 and 2 using an oscilloscope. Both signals should be $\geq -0.7V$ (into 50 Ω) and approximately 320 μs wide as shown below.

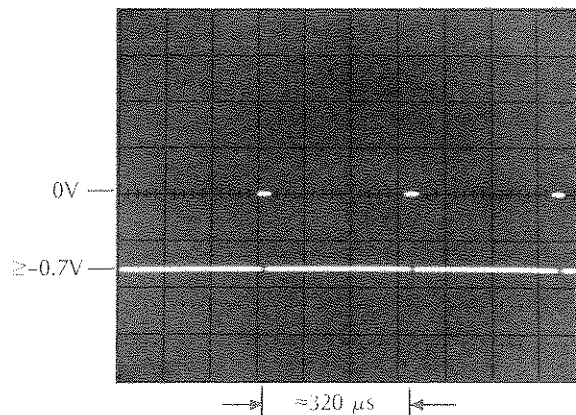
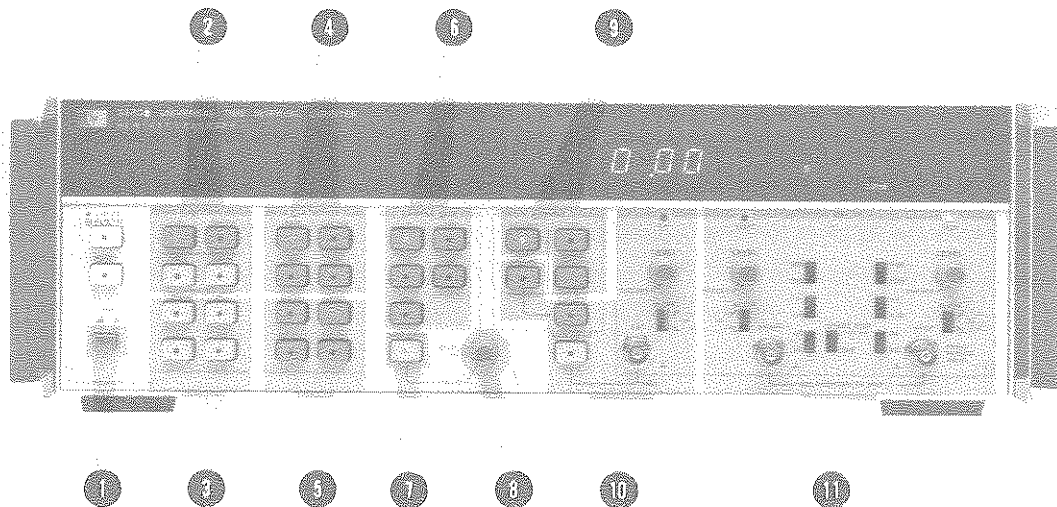

Figure 3-4. Operators Checks (Continued)



NOTE

See *Table 1-1* for specifications on all input signals concerning bandwidth, accuracy, and amplitude.

1. Set LINE switch ① to ON position.

NOTE

All GATE switches are disabled when 5370B is in T.I. FUNCTION.

2. Set START and STOP input impedance, attenuation, and coupling switches to desired position; see specifications in *Table 1-1*.
3. Set START COM/SEP switch ③ to START COM position. When START COM/SEP switch is set to START COM, impedance switches must be set to the same impedance.
4. Connect input signal to START channel input jack.
5. Set START channel slope switch SA ④ to 1 for triggering on positive slope or to 2 for triggering on negative slope.
6. Set STOP channel slope switch SO ⑤ to 1 for triggering on positive slope or to 2 for triggering on negative slope.
7. Set START LEVEL control to start measurement at desired voltage level. Press TRIG LVL (trigger level) to display triggering voltage (if desired).
8. Set STOP LEVEL control to stop measurement at desired voltage level. Press T.I. FUNCTION.
9. Press desired STATISTICS ⑨. When STD DEV is pressed in T.I. FUNCTION, the 5370B automatically goes to SAMPLE SIZE of 100 (unless SAMPLE SIZE is greater than 100). EXT HOLDOFF ⑩ and DSP EVT ⑥ will not operate when 5370B is set for \pm T.I. ARMING ⑪.
10. Press desired SAMPLE SIZE ⑩.
11. Press desired ARMING mode ⑪. See *Table 1-1* for specifications on EXT input signal used for EXT HOLDOFF and/or EXT ARM.
12. Adjust DISPLAY RATE control ⑧ for a convenient interval between measurements.
13. If more than one piece of information is desired for a sample, turn DISPLAY RATE control ⑧ fully counterclockwise until it clicks in the HOLD position. Then press the MAN RATE (manual rate) switch ⑦ to start measurement. At the end, different statistical information for that one sample can be obtained by pressing the appropriate switches. Press ⑦ again for a new sample. For measurement of single-shot signal, set input conditioning as desired. Press T.I., MEAN, SAMPLE SIZE 1, EXT ARM MAN INPUT (or use external arming signal via EXT input) and DISPLAY RATE to HOLD. The instrument is now ready for the single-shot signal.

Figure 3-5. One Source Time Interval Measurement

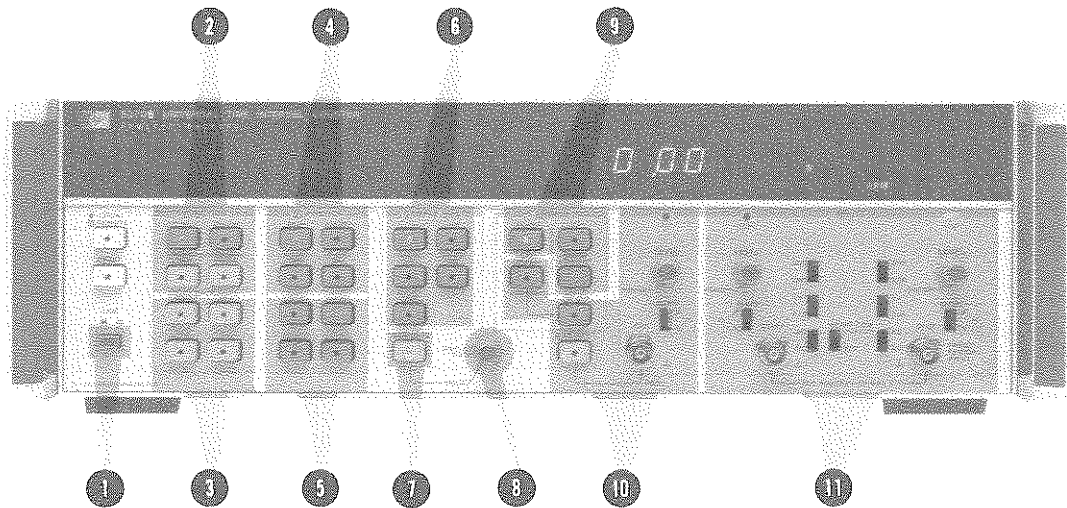

NOTE

See *Table 1-1* for specifications on all input signals concerning bandwidth, accuracy, and amplitude.

1. Set LINE SWITCH **1** to ON position.

NOTE

All GATE switches are disabled when the 5370B is in T.I. FUNCTION.

2. Set START and STOP input impedance, attenuation, and coupling switches **2** to desired position; see specifications in *Table 1-1*.
3. Set START COM/SEP switch **3** to SEP position.
4. Connect START signal to START input jack and STOP signal to STOP input jack.
5. Set START channel slope switch SA **5** to 1 for triggering on positive slope or to 2 for triggering on negative slope.
6. Set STOP channel slope switch SO **6** to 1 for triggering on positive slope or to 2 for triggering on negative slope.
7. Set START LEVEL control to start measurement at desired voltage level. Press TRIG LVL to display triggering voltage (if desired).
8. Set STOP LEVEL control to stop measurement at desired voltage level. Press T.I. FUNCTION.
9. Press desired STATISTICS **9**. When STD DEV is pressed in T.I. FUNCTION, the 5370B automatically goes to SAMPLE SIZE of at least 100. EXT HOLDOFF **10** and DSP EXT **5** will not operate when 5370B is set for \pm T.I. ARMING **9**.
10. Press desired SAMPLE SIZE **10**.
11. Press desired ARMING mode **11**. See *Table 1-1* for specifications on EXT input signal used for EXT HOLDOFF and/or EXT ARM. See also paragraphs 3-17 through 3-21.
12. Adjust DISPLAY RATE control **8** for a convenient interval between measurement.
13. For one-shot measurements, see step 13 in *Figure 3-5*.

Figure 3-6. Two Source Time Interval Measurement

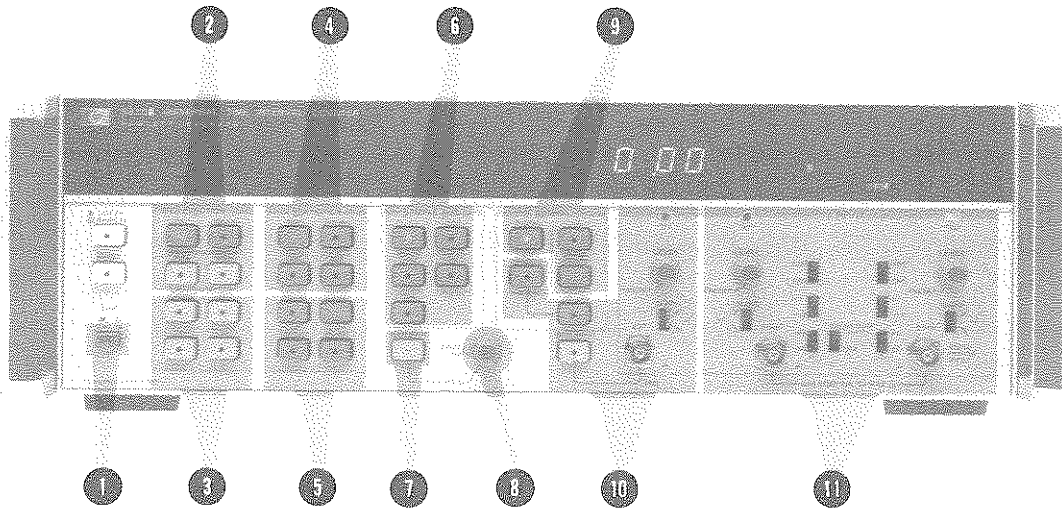

NOTE

See *Table 1-1* for specifications on all input signals concerning bandwidth, accuracy, and amplitude.

1. Set LINE switch ① to ON position.
2. Set STOP LEVEL control to trigger measurement at desired voltage level. Press TRIG LVL ② to display actual DC voltage of trigger level. Use PRESET for sine waves.
3. Set START COM/SEP switch ③ to SEP position.
4. Set STOP impedance, attenuation, and coupling switches ④ to desired position; see specifications in *Table 1-1* for details.
5. Connect input signal to STOP channel input jack ⑤ .
6. Press FREQ switch in FUNCTION group ⑥ .
7. Press GATE switch, group ⑦ , for desired integration time or press desired SAMPLE SIZE ⑧ .
8. Press desired STATISTICS switch ① .
9. Adjust DISPLAY RATE control ⑧ for a convenient interval between measurements. If one-shot measurements are desired, see step 13 in *Figure 3-5*.

Figure 3-7. Frequency Measurements

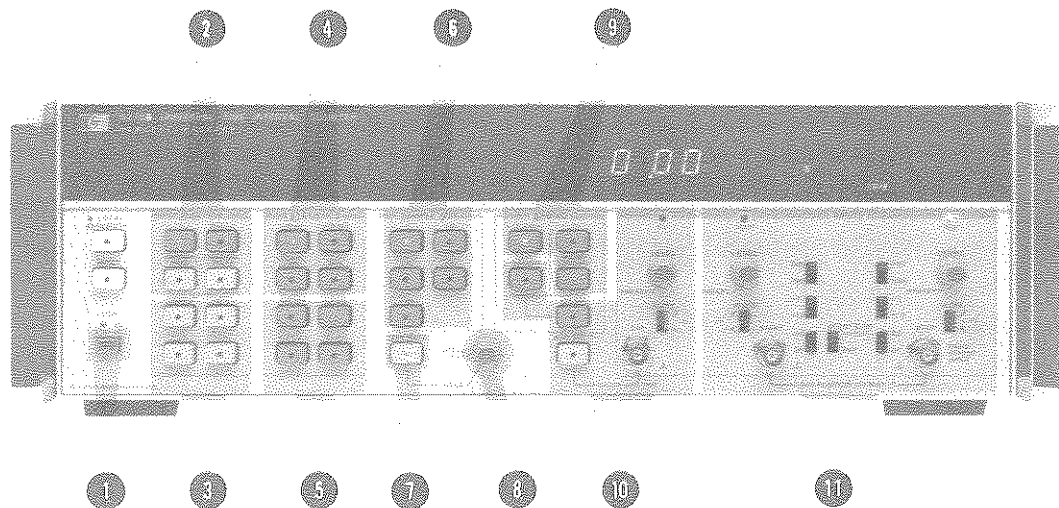

NOTE

See *Table 1-1* for specifications on all input signals concerning bandwidth, accuracy, and amplitude.

1. Set LINE switch ① to ON position.
2. Press PERIOD switch in FUNCTION group ② .
3. Set STOP impedance, attenuation, and coupling switches ③ to desired position; see specifications in *Table 1-1* for details.
4. Set STOP LEVEL control to trigger measurement at desired voltage level. Press TRIG LVL, group ⑤ , to display actual DC voltage of trigger level; press PERIOD again. Use PRESET for sine waves.
5. Set START COM/SEP switch ① to SEP position.
6. Connect input signal to STOP channel input jack ⑥ .
7. Press desired SAMPLE SIZE switch ⑦ or GATE time switch ⑧ . If STD DEV (standard deviation) is to be displayed, SAMPLE SIZE must be ≥ 100 .
8. Press desired STATISTICS switch ⑨ ; statistics can only be performed while machine is in the 1 PERIOD ② mode.
9. +T.I. is the only ARMING mode ⑨ usable in the PERIOD function.
10. Press desired switch for EXT ARM and/or EXT HOLDOFF ⑩ . See *Table 1-1* for specifications for External Gate input signal. See also paragraphs 3-17 through 3-21.
11. Adjust DISPLAY RATE control ⑪ for a convenient interval between measurements. If one-shot measurements are desired, see step 13 in *Figure 3-5*.

Figure 3-8. Period Measurements

3-29. PROGRAMMING

3-30. Introduction

3-31. The 5370B Universal Time Interval Counter is fully compatible with the Hewlett-Packard Interface Bus (HP-IB). The bus capability is installed as standard equipment and allows the counter to respond to remote control instructions and output measurement results via the HP-IB. At the simplest level, the 5370B can output data to other devices such as the 5150A Thermal Printer or the 59303A Digital-to-Analog Converter. In more sophisticated systems, a computing controller or other controllers can remotely program the 5370B to perform a specific type of measurement, trigger the measurement, and read the results.

NOTE

HP-IB is Hewlett-Packard's implementation of IEEE Standard 488-1975, "Standard Digital Interface for Programmable Instrumentation".

3-32. This section describes how to use the HP 9825A and HP 9830A Calculators on the HP-IB bus as computing controllers to program the 5370B. Before starting to operate a system, it is helpful to be familiar with the selected calculator, the capabilities of the HP-IB, and the manual operation and capabilities of the 5370B. The following HP manuals provide useful background information:

- HP-IB Users Guide, 9830A (P/N 59300-90002)
- Hewlett-Packard 9825A Calculator General I/O Programming (P/N 09825-90024)
- Abbreviated Description of Hewlett-Packard Interface Bus (P/N 5955-2903)
- HP-IB Quick Reference (P/N 5955-2902)
- Hewlett-Packard 9825A Calculator Extended I/O Programming (09825-90025)

3-33. The capability of a device connected to the bus is specified by its interface functions. Table 3-1 lists the 5370B Interface Functions using the terminology of the IEEE Std. 488-1975. These functions are also listed below the rear panel HP-IB connector. The number following the interface function code indicates the particular capability of that function as listed in Appendix C of IEEE Std. 488-1975. Interface functions provide the means for a device to receive, process, and send messages over the bus.

Table 3-1. HP-IB Interface Capability

CODE	INTERFACE FUNCTION
SH1	Source Handshake capability
AH1	Acceptor Handshake capability
T1	Talker (basic talker, serial poll, talk only mode)
L2	Listener (basic listener)
SR1	Service Request capability
RL1	Remote/Local capability
PP0	No Parallel Poll capability
DC1	Device Clear capability
DT1	Device Trigger capability
C0	No Controller capability
E1	One Unit Load

Table 3-2. Bus Message Usage

Message	Description	5370B Use	Sample 9825A Statements (5370B Set to Address 03)
Data	Transfers device-dependent information from one device to one or more devices on the Bus.	Input: Accepts program codes. See Table 3-4 for program code set Output: Sends measurement data. Output format is TI = SD.DDDDDDDDDDESDD	wrt 703, "SS3AR2" red 703, A
Trigger	Causes a group of selected devices to simultaneously initiate a set of device-dependent actions.	Starts a new measurement. Equivalent to the "MR" (manual rate) remote command.	trg 7 or trg 703
Clear	Causes an instrument to be set to a predefined state (a certain range, function, etc.).	Same as front panel reset. Generates lamp test, clears status byte, followed by "MR". Does not set counter to predefined function.	clr 7 or clr 703
Remote	Permits selected devices to be set to remote operation, allowing parameters and device characteristics to be controlled by Bus Messages.	Causes counter to go to remote operation if REN is true and counter is addressed to listen. In absence of program data, remote operation is according to state of front panel settings just prior to going to remote. Locks out all pushbuttons except Local (RTL).	rem 703
Local	Causes selected devices to return to local (front panel) operation.	Returns 5370B to front panel control.	lcl 703
Local Lockout	Disables local (front panel) controls of selected devices	Disables local (RTL) pushbutton.	ll07
Clear Lockout and Local	Returns all devices to local (front panel) control and simultaneously clears the Local Lockout Message.	Returns counter to local (front panel) control and clears the local lockout message.	lcl7
Require Service	Indicates a device's need for interaction with the controller.	Used to flag an error condition or to indicate that measurement is complete. Error message is coded in status byte.	rds (703)→A
Status Byte	Presents status information of a particular device; one bit indicates whether or not the device currently requires service, the other 7 bits (optional) are used to indicate the type of service required.	Bit 8 is set if device is running debug monitor (diagnostic tool). Bit 7 is set if service is requested. Bit 6 is set if oven heater is on. Bit 5 is set if an external time base is used. Bits 1-4 indicate error message if bit 7 is used. Error 0: Measurement is complete and counter is ready to output. Error 1: Illegal remote command. Error 2: Overrange (TI is too long or statistics overflow). Error 3: Undefined routine. Error 4: Out of lock (refers to internal phase lock loop). Error 5: Undefined key (indicates a hardware problem). Error 6: Fault in RAM storage. Error 7: Fault in ROM storage.	rds (703)→A ↑ ↓ rds (703)→A
Status Bit	A single bit of device-dependent status information which may be logically combined with status bit information from other devices by the controller.	Does not use.	—
Pass Control	Passes bus controller responsibilities from the current controller to a device which can assume the Bus supervisory role.	Does not use	—
Abort	Unconditionally terminates Bus communications and returns control to the system controller.	Clears Talk, Listen, and Serial Poll Enable registers on 5370B HP-IB Interface. Front panel setup does not change.	cli 7

3-34. Messages are the means by which devices exchange control and measurement information. These messages permit communication and/or control between: 1) controller and device(s); 2) device and device(s); and 3) controller and controller(s). *Table 3-2* lists the Bus Messages and gives a brief description of each.

3-35. Setting the Address Switches

3-36. To use the 5370B in an HP-IB system, the first step is to set the rear panel address switches as shown in *Table 3-3*. The leftmost switch sets the counter to the ADDRESSABLE mode or the TALK ONLY mode. ADDRESSABLE mode is used whenever a calculator or other controller is used within the system. TALK ONLY mode is used when the counter is operating under its own control (no controller on bus) and outputs its measured result to another device on the bus, such as a printer.

3-37. The five right-hand switches, A₅ through A₁, set the talk and listen addresses of the 5370B when it is used in the ADDRESSABLE mode. *Table 3-3* shows the possible address settings and the corresponding ASCII codes for talk and listen.

3-38. The examples listed in this section assume an address setting of 00011, which is a 5-bit binary code for the decimal number three. This number is important when using an HP 9825A calculator, since the calculator addresses the 5370B to talk and listen by using the code 703. (The "03" being the 5370B address.) The ASCII characters for this same switch setting are "C" for a talk address and "#" for a listen address. These characters are used when the computing controller is an HP 9830A calculator.

3-39. Program Codes

3-40. There are effectively three types of program codes that are used to remotely program the counter's functions. The first type uses two letters of the particular function, e.g., FN for FuNction, and a number associated with the specific function, see *Figure 3-9*. For example, selecting FN3 as the program code programs the frequency function. Notice that for commands such as FN, the front panel controls are numbered 1 through n, left to right and then top to bottom.

3-41. Other codes have only two functions, coded 0 and 1. The "0" indicates the selected function is **off** or disabled and the "1" indicates **on** or enabled. For example, EA0 is the code for EXT ARM disable.

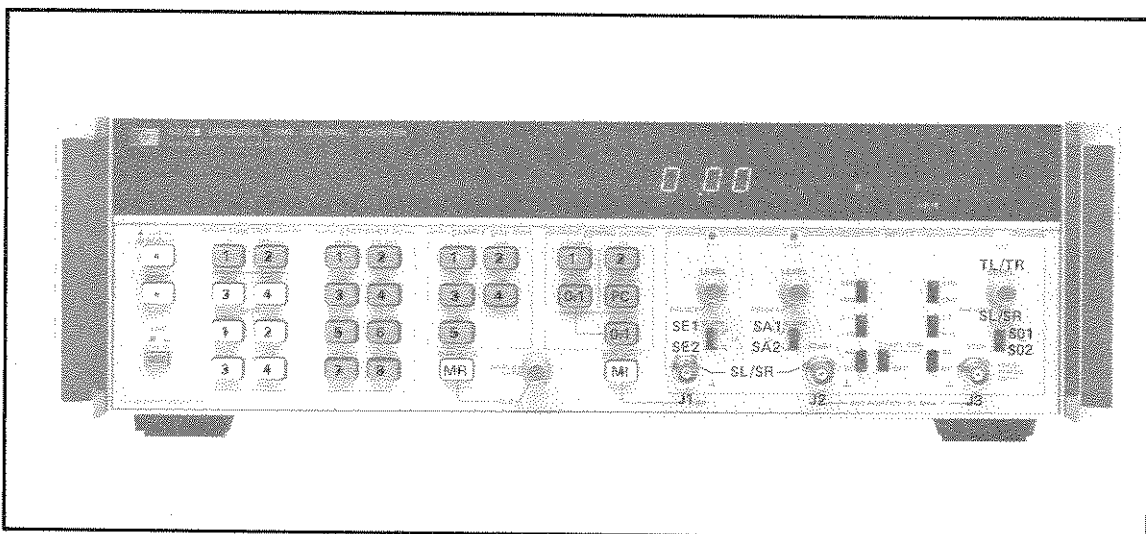
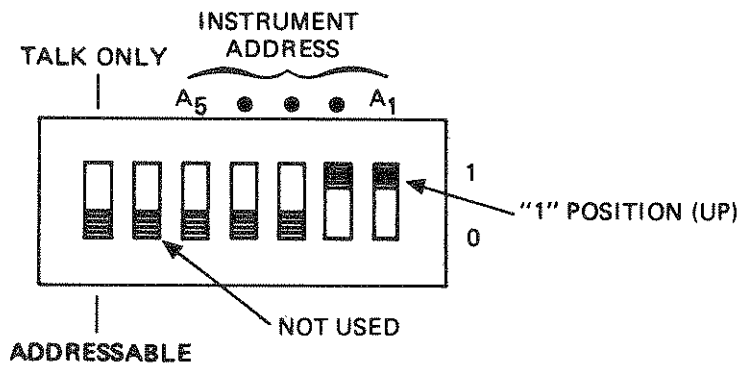

Figure 3-9. Program Codes Relating to Switch Functions

Table 3-3. Address Selection



ASCII CODE CHARACTER		ADDRESS SWITCHES					DECIMAL EQUIVALENT OF BINARY SWITCH SETTING
LISTEN	TALK	A ₅	A ₄	A ₃	A ₂	A ₁	
SP	@	0	0	0	0	0	00
!	A	0	0	0	0	1	01
"	B	0	0	0	1	0	02
#	C	0	0	0	1	1	03
\$	D	0	0	1	0	0	04
%	E	0	0	1	0	1	05
&	F	0	0	1	1	0	06
'	G	0	0	1	1	1	07
(H	0	1	0	0	0	08
)	I	0	1	0	0	1	09
*	J	0	1	0	1	0	10
+	K	0	1	0	1	1	11
,	L	0	1	1	0	0	12
-	M	0	1	1	0	1	13
.	N	0	1	1	1	0	14
/	O	0	1	1	1	1	15
Ø	P	1	0	0	0	0	16
1	Q	1	0	0	0	1	17
2	R	1	0	0	1	0	18
3	S	1	0	0	1	1	19
4	T	1	0	1	0	0	20
5	U	1	0	1	0	1	21
6	V	1	0	1	1	0	22
7	W	1	0	1	1	1	23
8	X	1	1	0	0	0	24
9	Y	1	1	0	0	1	25
:	Z	1	1	0	1	0	26
;	[1	1	0	1	1	27
<	\	1	1	1	0	0	28
=]	1	1	1	0	1	29
>	~	1	1	1	1	0	30

3-42. The third type of function selection places portions of the front panel to either remote or local operation. For example, program code SR sets the slope switches to remote programming control. Program code SA1 or SA2 must now be programmed to choose the particular slope, positive or negative, for the START channel. These are the basic types of function codes for remote programming. Those that require special consideration are described in *Table 3-4, Program Code Set*.

3-43. Output Formats

3-44. The 5370B can output data in three different formats. Two of the formats are described in detail, in the back of this section, in Examples 2 and 5. Example 2 describes the Display All output format which outputs not only the resultant measurement but all related statistics. Example 5 describes in detail, the Binary Output or Computer Dump format. The third format is the Standard Output format and is described in the following paragraph.

3-45. The standard output byte contains 22 characters per measurement. The characters are arranged as follows:

AAAASD.DDDDDDDDDDESDD

where

A = TI = for Time Interval
FREQ = for Frequency
PER = for Period
S = Sign of measurement or exponent (space for positive and - for negative)
D = Digits
E = Exponent

The output byte is followed by a CR (carriage return) and LF (line feed).

Table 3-4. Program Code Set

Codes shown in **bold face** are start-up conditions. These conditions are set when the instrument powers up on turn-on. They cannot be selected by using the bus commands of Device Clear or Selected Device Clear.

1. **FUNCTION**
 - FN1 **Time Interval**
 - FN2 Trigger Levels
 - FN3 Frequency
 - FN4 Period
2. **GATE TIME** (for FREQUENCY or PERIOD mode)
 - GT1 **Single Period**
 - GT2 0.01 second
 - GT3 0.1 second
 - GT4 1 second
3. **STATISTICS**
 - ST1 **Mean**
 - ST2 Standard Deviation (requires ≥ 100 sample size)
 - ST3 Minimum
 - ST4 Maximum
 - ST5 Display Reference
 - ST6 Clear Reference (immediate execution)
 - ST7 Display Events
 - ST8 Set Reference (immediate execution)
4. **SAMPLE SIZE**
 - SS1 **Sample Size = 1**
 - SS2 Sample Size = 100
 - SS3 Sample Size = 1K
 - SS4 Sample Size = 10K
 - SS5 Sample Size = 100K

See also "SB", Sample Size Binary in this table.
5. **MODE**
 - MD1 **Front Panel Display Rate Control is Functional.** Output only if addressed.
 - MD2 Display Rate Hold Until "MR" command (or GET) (Display Rate control is locked out). Wait until addressed. Changing functions while in MD2 mode causes the first measurement output data to be invalid. With the new function programmed, the first data output will be the previous measurement data in terms of the new function. For example, with 5370B in frequency and a measurement of 1 MHz taken, if a new function was programmed, say Period, then the first output data will be $1 \mu\text{s}$ (which is the previous Frequency measurement of 1 MHz converted to the new function of Period).
 - MD3 Display Rate Fast (Display Rate control is locked out). Only if addressed.
 - MD4 Display Rate Fast (Display Rate control is locked out). Wait until addressed.
6. **INPUT SELECTION** (see Example 3)
 - IN1 **Input selection for normal time interval operation.** START event = START channel input, STOP event = STOP channel input.

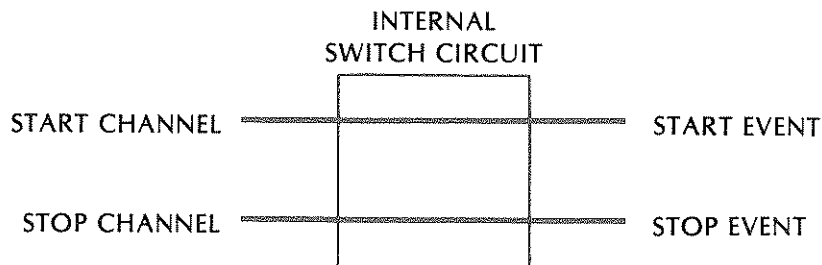

3-46. EXAMPLE PROGRAMS

3-47. Seven example programs are given as follows:

```
0: wrt 703, "FN3
  GT3MD2"
1: wrt 703, "MR";
  red 703, A; dsp
  A; wait 500
2: sto 1
*1132
```

EXAMPLE 1. TYPICAL MEASUREMENT FORMAT

This program forces the counter to perform a simple frequency measurement (FN3) with a 0.1 s gate time (GT3). The MD2 code prevents the counter from taking a measurement until the MR command is reached. The counter takes a measurement and reads it into the A register. The result is displayed by the calculator. After waiting 500 ms, the program loops back to the next "take a measurement" command (MR) and the process is repeated.

EXAMPLE 2. DISPLAY ALL STATISTICS

```
10 DIM C#[30]
20 OUTPUT 703 ; "MD2"
30 OUTPUT 703 ; "ST1"
40 ENTER 703 ; C#0 PRINT C#
50 OUTPUT 703 ; "ST2"
60 ENTER 703 ; C#0 PRINT C#
70 OUTPUT 703 ; "ST3"
80 ENTER 703 ; C#0 PRINT C#
90 OUTPUT 703 ; "ST4"
100 ENTER 703 ; C#0 PRINT C#
110 OUTPUT 703 ; "ST5"
120 ENTER 703 ; C#0 PRINT C#
130 OUTPUT 703 ; "ST7"
140 ENTER 703 ; C#0 PRINT C#
150 OUTPUT 703 ; "MD1"
160 END
TI = 9.997500000000E-08
STD = 1.680000000000E-11
MIN = 9.994000000000E-08
MAX = 1.000400000000E-07
REF = 0.000000000000E-10
EVT = 1.000000000000E+02
```

This is an example program written in basic that allows the counter to display all statistical data available for a Time Interval measurement per sample size. Step 10 dimensions a string variable in the calculator to accept the forthcoming data. Step 20 programs the counter to hold data and prevents the counter from being updated by the next set of data (in other words, the front panel DISPLAY RATE CONTROL is disabled). Step 30 puts the counter in the Mean mode; while, Step 40 causes the counter to read into the string and print the contents of the string. Step 50 programs the counter into the Standard Deviation mode. Step 60 causes it to read into the string and print the contents of the string. Programming statements in Step 70 through 140 causes the counter to execute in the same manner described in Steps 30 through 60 (for program codes ST3, ST4, ST5, and ST7). Step 150 causes the front panel DISPLAY RATE CONTROL to be functional. The counter automatically selected 100 samples because a standard deviation was programmed. The output format for a Time Interval measurement is as follows:

```
T.I. = <CR LF>
STD = <CR LF>
MIN = <CR LF>
MAX = <CR LF>
REF = <CR LF>
EVT = <CR LF>
```

where

```
T.I. = Time Interval
STD = Standard Deviation
MIN = Minimum
MAX = Maximum
REF = Reference
EVT = Events
<CR LF> = Carriage Return, Line Feed
```

```
0: flt 6
1: wrt 703, "FN1
  IN3"
2: red 703, A;
  dsp A; wait 2000
3: wrt 703, "FN3"
4: red 703, A;
  dsp A; wait 2000
5: sto 1
*31746
```

EXAMPLE 3. INPUT SELECTION

To demonstrate the input selection feature, connect signals of different frequencies to the input channels and set the START COM/SEP switch to SEP. Program Step 1 causes the counter to make a period measurement on the START channel signal. This is read and displayed in Step 2, along with a 2-second wait. Program Step 3 causes the counter to make a frequency measurement on the STOP channel signal. Step 4 duplicates Step 2, and Step 5 repeats the two measurements.

EXAMPLE 4. TEACH/LEARN

The following program serves as an example of the TEACH/LEARN mode. For demonstration purposes, perform the following steps:

1. Load the program into the 9825A Desk Top Computer.
2. Power up the 5370B.
3. On 5370B, push FREQ, MIN, and SAMPLE SIZE of 1K.
4. On 9825A, push RUN. The 5370B will teach the 9825A.
5. Turn 5370B power off, then on again. The counter will power up in T.I., MEAN, SAMPLE SIZE of 1, and +T.I.
6. On 9825A, push CONTINUE.
7. 5370B will learn from the 9825A and the front panel will indicate FREQ, MIN, and SAMPLE SIZE of 1K.

```
0: dim A#[50]
1: buf "BIN", A#,
  3
2: wtb 703, "te"
3: tfr 703, "BIN"
  ,21
4: if rds("BIN")
  <0; sto +0
5: wrt 703, "nr"
6: dsp "5370B+98
  25A"; beep; sto
7: wrt 703, "ln",
  A#[1,21]
8: dsp "9825A+53
  70B"; beep; sto
*16965
```

The program sets the dimension of the A\$ string variable and names the buffer into which data will be read (BIN). It then specifies size of buffer (A\$) and selects the type of buffer: 3 equals fast read/write buffer. Step 2 programs 5370B to the TEACH mode. Step 3 transfers 21 bytes of information into buffer and step 4 ensures transfer is complete before continuing. Step 5 initiates a measurement. Step 6 displays message to indicate "TEACH" is complete. Step 7 generates the "LEARN" function, and step 8 gives a display to indicate the process is complete.

Table 3-4. Program Code Set (Continued)

IN2 Normal input selection for frequency or period measurement. START event = STOP channel input, STOP event = STOP channel input.

NOTE

In this selection only STOP channel input selections are being used for both START and STOP events

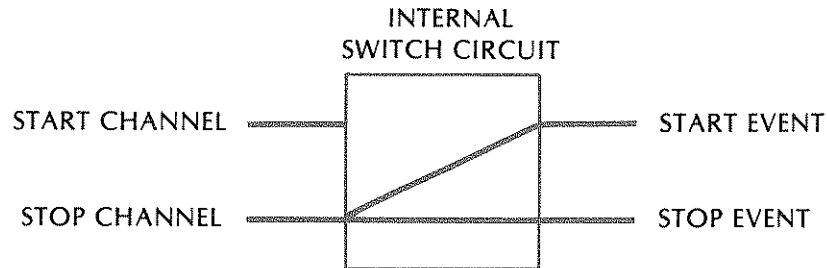

IN3 Input selection for operator convenience in switching input to different channels. START event = START channel input, STOP event = START channel input.

NOTE

In this selection only START channel input selections are being used for both START and STOP events.

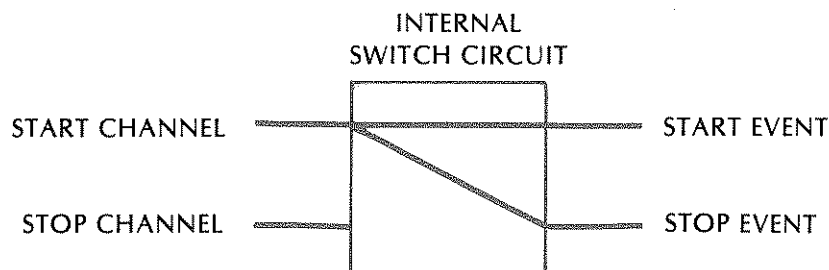

IN4 Input selection for operator convenience in switching input to different channels. START event = STOP channel input, STOP event = START channel input.

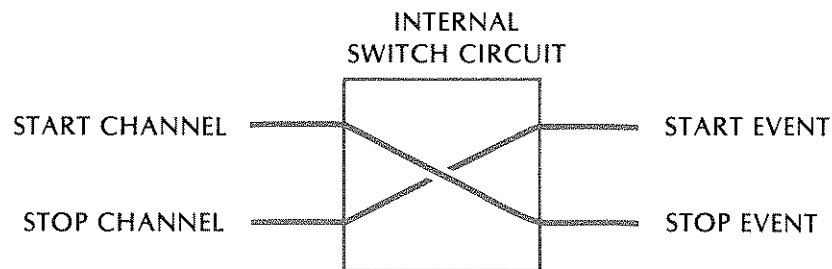

7. **START CHANNEL SLOPE SELECT**
SA1 Start Channel Slope: Positive
SA2 Start Channel Slope: Negative
8. **STOP CHANNEL SLOPE SELECT**
SO1 Stop Channel Slope: Positive
SO2 Stop Channel Slope: Negative
9. **EXTERNAL ARM SLOPE SELECT**
SE1 External Arm Slope: Positive
SE2 External Arm Slope: Negative
10. **ARM SELECT**
AR1 +T.I. Arming Only
AR2 ±T.I. Arming

Table 3-4. Program Code Set (Continued)

- 11. **EXTERNAL HOLDOFF**
 EH0 External Holdoff Disable
 EH1 External Holdoff Enable (must also use EA1 and AR1)
- 12. **EXTERNAL ARM**
 EA0 External Arm Disable
 EA1 External Arm Enable
- 13. **INTERNAL ARM**
 Used with \pm T.I. Arm Mode only. Forces counter to arm on either START or STOP channel always, regardless of input phase relation. Disables internal phase detection circuit.
 IA1 Internal Arm Auto
 IA2 Start Channel Arm
 IA3 Stop Channel Arm

The following terse commands have also been defined.

- 1. MR Manual Rate. Used to initiate a sample of measurements. Typically used with MD2. MR must be sent at least 10 ms after the previous program command. For example, a typical 9825A program should be:
 - a. wrt 703, "FN1ST1SS1MD2IN1SA1SO2TRSR"
 - b. wait 10; wrt 703 "MR"
- 2. MI Manual Input. Same operation as front panel MANUAL INPUT. Used to manually arm the counter. Use wtb calculator command.
- 3. SL **Slope Local.** Set slope switches to local (front panel) operation.
- 4. SR Slope Remote. Sets slope switches to remote operation.
- 5. TL **Trigger Local.** Sets trigger level controls to front panel operation.
- 6. TR Trigger Remote. Set trigger level controls to remote operation.
- 7. TE Teach. When addressed to talk, the 5370B transfers all front panel information (or remotely programmed information) from its memory into the controller's memory. See Example 4.
- 8. PC Period Complement. Performs the same operation as the front panel switch.
- 9. TB0 Disable Time Interval Binary Output.
- 10. TB1 Time Interval Binary Output. For short time intervals of $<320 \mu\text{s}$. Counter does not perform any type of statistical measurement (mean, standard deviation, etc.). Instead, counter outputs raw data: N0(ST), N1N2(CT1), N1N2(CT2), N0(CT1), and N0(CT2) in that order, and places "-----" in display. Measurements occur at up to a 6 kHz rate. See Example 5. NOTE — Intended for use with plus or minus time interval arming mode only.

The following binary commands have also been defined.

- 1. SB Sample Size Binary. Allows a theoretical setting of sample sizes from 1 to 16,777,215. Must be entered in binary form. See Example 6. Use wtb calculator command.
- 2. LN Learn. Enters program information into 5370B (RAM memory) that was stored into the calculator with an earlier TEACH (TE) command. See Example 4.

The following decimal commands have also been defined.

- 1. TA Trigger Start. Sets the trigger level of the START channel from -2V to +2V (-0.00 is an illegal trigger level input). See Example 7.
- 2. TO Trigger Stop. Sets the trigger level of the STOP channel from -2V to +2V. See Example 7.

NOTE

To output the trigger level setup data from the 5370B to the controller, program the 5370B to Trigger Level function (FN2) and "red (counter talk address)". The output format is as follows:

$STA = SD.DD, \quad STO = SD.DD \quad <CR LF>$

where

- STA = START channel Trigger level
- S = Polarity of Trigger voltage
- D = Digit value
- STO = STOP Channel Trigger level

EXAMPLE 5. TIME INTERVAL BINARY OUTPUT (COMPUTER DUMP)

NOTE — Intended for use with plus or minus time interval arming mode only.

The 5370B outputs raw measurement data in the following order: $N_0(ST)$, $N_{1N2}(CT1)$, $N_{1N2}(CT2)$, $N_0(CT1)$, and $N_0(CT2)$; where CT stands for count and ST stands for status. N_{1N2} is an 18-bit 2's complement quantity consisting of $N_{1N2}(CT1)$, $N_{1N2}(CT2)$, and the two least significant bits of $N_0(ST)$.

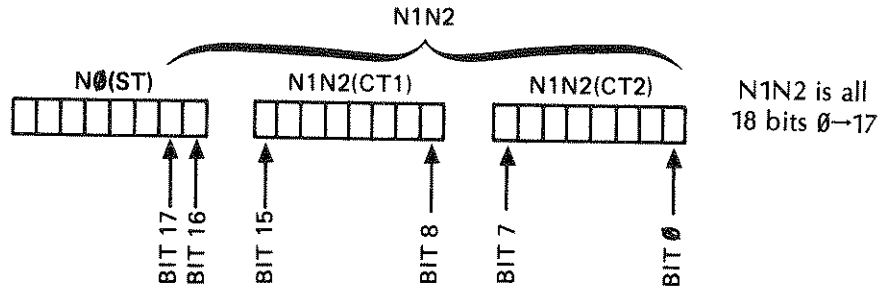

N_{1N2} actually represents the internal calculation of $257(N_1 - N_2)$. This is done in preparation of solving the equation: T.I. 5 $\left[\frac{257}{256} (N_1 - N_2) + N_0 \right]$ ns. The number 257 in $257(N_1 - N_2)$ is part of the ratio 257/256.

$N_0(ST)$ contains the following status bits:

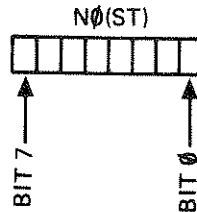

- Bit 7 = Event counter range flag
- Bit 6 = End of measurement
- Bit 5 = Sign of N_0 (High=+)
- Bit 4 = Armed flag
- Bit 3 = PLL out of lock flag
- Bit 2 = N_0 range flag
- Bit 1 = Bit 17 of N_{1N2}
- Bit 0 = Bit 16 of N_{1N2}

N_0 is a 16-bit quantity consisting of $N_0(CT1)$ and $N_0(CT2)$. It is expressed in sign-magnitude binary, **not** in 2's complement. To be complete, N_0 requires a sign, which is contained in bit 5 of $N_0(ST)$.

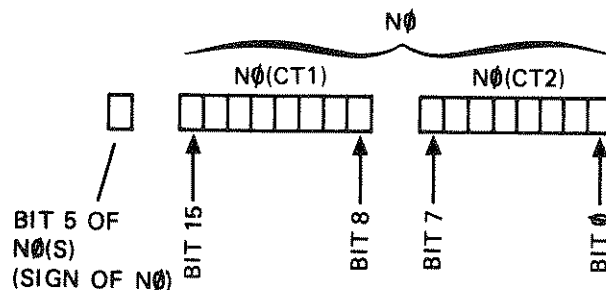

These five bytes of data will give the measured time interval when combined in the following equation:

$$T.I. = [N1N2/256 + N0] 5 \text{ ns}$$

This can be rewritten for the 9825A example shown on the next page, by letting

$$N1N2 = B$$

$$N0 = N$$

$$\text{Sign of } N0 = Q$$

$$\therefore T.I. = (B/256 + N \cdot Q) 5e-9$$

9825A EXAMPLE PROGRAM. The following program causes the counter to output in the fast binary output mode, store the five bytes of data in a buffer, perform the calculation, and display the result. Data is entered into the following string variables.

```

A$(1) = N0(ST)
A$(2) = N1N2(CT1)
A$(3) = N1N2(CT2)
A$(4) = N0(CT1)
A$(5) = N0(CT2)
0: flt 6
1: dim A$(21);
  buf "ti",A$,3
2: wrt 703,"tb1"
3: buf "ti";tfr
  703,"ti",5
4: if rds("ti") <
  0;sto +0
5: num(A$(4))*
  256+num(A$(5))+
  N
6: 1+0
7: if bit(5,num(
  A$(1)))=0;-1+0
8: band(num(A$(1
  )),3)*65536+
  num(A$(2))*256+
  num(A$(3))+B
9: if B>=131072;
  B-262144+B
10: (B/256+N*Q)*
  5e-9+T;dsp T
11: wait 500;
  sto 3
  *25017
  
```

PROGRAM STEP

PURPOSE

- 0: Sets up floating point format for 6 digits.
- 1: Sets up string variable (A\$) and specifies its size (21)*. Names buffer into which data will be read (ti) and specifies size of buffer (A\$). Selects type of buffer: 3 = fast read/write buffer.
- 2: Programs 5370B to "fast binary output" mode (tb1).

*In 9825A, always allow for 16 bytes of "overhead"; then, allow for the number of bytes to be transferred. One sample = 16 + 5 = 21; one hundred sample = 16 + 5 (5 x 100) = 516.

- 3: Initializes buffer "ti" prior to inputting data. Transfer five bytes of data from 5370B into buffer "ti".
- 4: Reads status of transfer. Stays in transfer mode as long as status remains -1. When status goes to "5", program advances to next step.
- 5: Sets the two N0 bytes next to each other in their proper binary order and places that value in the variable N.
- 6: Assigns variable Q the value of 1.
- 7: Examines the sign of N0 bit (bit 5 of N0(ST)). If bit 5 is 0, the variable Q is given a negative number.
- 8: Removes bits 0 and 1 from N0(ST) and positions them and N1N2(CT1) and N1N2(CT2) in their proper binary order. Places that values in the variable B.
- 9: Tests the N1N2 number to determine if it is positive or negative. If number in B is less than $(2^{18})/2$, go to step 10. If number in B is equal to or greater than $(2^{18})/2$, subtract 2^{18} from B and place result in B. This converts B into a negative number.
- 10: Performs proper mathematical operation on data and displays result as time interval.
- 11: Wait half a second and repeat program.

HP-85 EXAMPLE PROGRAM. The following example program is in basic using a HP-85 controller. The program causes the counter to output in the fast binary output mode; store 500 bytes of data in a buffer; perform the calculation; and print the result.

```

10 C=0
20 M=0
30 DIM A$(500),Z$(500)
40 IOBUFFER Z$
50 OUTPUT 703;"SS1TB1"
60 TRANSFER 703 TO Z$ FHS
70 ENTER Z$ USING "#, #K"; A$
80 FOR I=1 TO 500 STEP 5
90 Q=1
100 N=NUM(A$(I+3)) *256+NUM(A$(I+
4))
110 IF BIT(NUM(A$(I)),5)=0 THEN
Q=-1
120 B=BINAND(NUM(A$(I)),3)*65536
+NUM(A$(I+1))*256+NUM(A$(I+2
))
130 IF B>=131072 THEN B=B-262144
140 T=(B/256+N*Q)*.000000005
150 M=M+T
160 C=C+1
170 NEXT I
180 M=M/C
190 PRINT "MEAN OF SAMPLE SIZE":
C;" IS";M
200 END

```

PROGRAM STEP	PURPOSE
10	Assigns variable C the value of 0. (C is the variable for SAMPLE SIZE).
20	Assigns variable M the value of 0. (M is the variable for storing sum of the TIME INTERVALS.
30	Sets up string variables A\$ and Z\$ and specifies there size*.
40	Sets up Z string as I/O buffer.
50	Programs 5370B to SAMPLE SIZE 1 (SS1) and to "fast binary output" mode (TB1).
60	Transfer 500 bytes of data from 5370B to the buffer Z string.
70	Enters data from buffer Z string to A string.
80	Sets up a loop (100 times).
90	Assigns variable Q the value 1.
100	Sets the two N0 bytes next to each other in their proper binary order and places the value in the variable N.
110	Examines the sign of N0 bit (bit 5 of N0(ST)). If bit 5 is 0, the variable Q is given a negative number.
120	Removes bits 0 and 1 from N0(ST) and positions them and N1N2(CT1) and N1N2(CT2) in their proper binary order. Places the value in the variable B.
130	Tests the N1N2 number to determine if it is positive or negative. If number in B is less than $(2^{18})/2$, go to step 140, if number in B is equal to or greater than $(2^{18})/2$, subtract 2^{18} from B and place result in B. This converts B into a negative number.
140	Equation for calculating Time Interval.
150	Accumulates total of 100 Time Intervals.
160	Counts number of Time Interval samples.
170	Increments loop.
180	Calculates the MEAN.
190	Prints the MEAN.

EXAMPLE 6. SAMPLE SIZE BINARY

```
0: wrt 703, "FN3
  ST7"
1: 568→S
2: wtb 703, "SB",
  int(S/65536),
  int((S-int(S/
  65536)*65536)/
  256), Smod256
3: stp
*4534
```

This program permits the selection of any sample size from 1 to a theoretical maximum of 16, 777, 215. "ST7" causes the counter to display the programmed sample size, assuming the counter is taking measurements. Step 1 indicates that, for this example, 568 samples are being requested. Change this number to change the sample size. Step 2 must always be programmed to allow proper data entry to the counter.

* In HP-85, always allow for 8 bytes of "overhead".

EXAMPLE 7. REMOTE TRIGGER LEVELS

```
0: wrt 703, "FN2
  TR"
1: wrt 703, "TA
  -2"
2: wrt 703, "TO
  2"
3: end
*9047
```

This program causes the counter to display its trigger level (FN2) on the front panel and allows these levels to be set remotely (TR). "TA -2" sets the start channel trigger level (TA) to -2V; while "TO 2" sets the stop channel trigger level (TO) to 2V. Changing FN2 to FN1 will cause the counter to make a T.I. measurement at the programmed trigger levels.

This is an alternate program using a variable (T) for entering data.

```
0: wrt 703, "fn2t
  r"
1: -2+T
2: fmt f5.2
3: wrt 703, "ta",
  T
4: 2+T;wrt 703,
  "to",T
5: end
*30013
```

