Getting Started Guide

HP 54111D Digitizing Oscilloscope
HP 54112D Digitizing Oscilloscope



© Copyright Hewlett-Packard Company 1987

Publication 5954-2669

Printed in U.S.A. June 1987

Printing History

First Edition September 1987

Printed in U.S.A.

1
2
3
4
5
6
7
8
9
10
11
12
13
14
15
16
17
18
19
20
21
22
23
24
25
26
27
28
29
30
31
32
33
34
35
36
37
38
39
40
41
42
43
44
45
46
47
48
49
50
51
52
53
54
55
56
57
58
59
60
61
62
63
64
65
66
67
68
69
70
71
72
73
74
75
76
77
78
79
80
81
82
83
84
85
86
87
88
89
90
91
92
93
94
95
96
97
98
99
100

Introduction

About this book...

There's a lot of power packed inside the HP 54111D and HP 54112D digitizing oscilloscopes, and we want to make sure you get the most out of whichever one you have. That's why we'd like you to invest some time going through this *Getting Started Guide*. Whether you're a novice oscilloscope user or just new to these models, this book will give you a working knowledge of the HP 54111D and HP 54112D so you can start using them to solve your measurement problems. It covers:

- front-panel layout
- how to apply power to the instrument
- how to set up the scope to make a measurement
- how to use and interpret the display
- how to use the basic features

To make this book easier to use we have put the names of keys (**AUTO – SCALE**, **TIME/DIV**), as well as key labels in bold type. And, we have highlighted actions (rotate the knob, press the **AUTO – SCALE** key) in color.

Because the HP 54111D and HP 54112D have so many features, and many of them overlap, we have included both oscilloscopes in one *Getting Started Guide*. Don't be alarmed if you are using one and seeing pictures of the other in the following pages. The front panels are very similar and performances, in many cases, are the same. When there are evident differences, we'll point them out to you.

If you have never used this type of instrument, we recommend you read *Feeling Comfortable with Digitizing Scopes*. However, if you are very familiar with digitizing oscilloscopes you can probably "skim" through the first nine chapters. Starting with chapter 8 we'll guide you through some actual measurements and special HP 54111D and HP 54112D features. These exercises will make you more comfortable with the instruments, as well as demonstrate how they differ.

We didn't try to cover everything these oscilloscopes can do for you. That's the job of your *Front-Panel Operation Reference*.

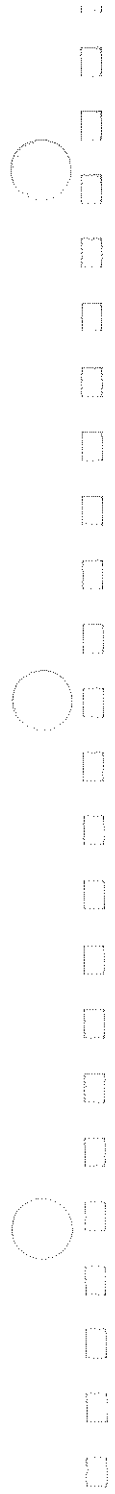

Table of Contents

Introduction

Chapter 1: What Can They Do?

- 1-1 Key Features
 - 1-2 What's the Difference?
-

Chapter 2: Applying Power

- 2-1 How to Power Up
 - 2-2 Power-up Self Test
 - 2-3 Instrument Preset
-

Chapter 3: Becoming Familiar with the Front Panel

- 3-1 Introduction
 - 3-2 System Control
 - 3-3 Display/Selection
 - 3-4 Entry Devices
 - 3-5 Inputs
-

Chapter 4: Connecting a Signal

- 4-1 Input
- 4-1 Signal Source

Table of Contents (Continued)

Chapter 5: **Setting Up the Instrument with Auto-scale**

- 5-1 What Is Auto-scale?
 - 5-2 Getting a Signal to the Input
 - 5-3 When a Signal Is Found
 - 5-3 Trigger Source
 - 5-4 If No Signal Is Found
-

Chapter 6: **Using the Display**

- 6-1 Color Display
-

Chapter 7: **Making Automatic Parameter Measurements**

- 7-1 Introduction
 - 7-2 Setting Up the Measurement
 - 7-4 Using the Measure Menu
 - 7-5 Making a Rise Time Measurement
 - 7-6 Making Other Auto Parameter Measurements
-

Chapter 8: **Making Voltage Measurements**

- 8-1 Introduction
 - 8-2 Automatic Voltage Measurements
 - 8-6 Manual Voltage Measurements
-



Table of Contents (Continued)

Chapter 9:

Making Time Interval Measurements

- 9-1 Introduction
 - 9-2 Automatic Time Measurements
 - 9-4 Manual Time Measurements
 - 9-6 Measuring Complex Signals
 - 9-7 Setting Up the Oscilloscope
 - 9-8 Measuring Time between Bursts
-

Chapter 10:

Trigger Operation

- 10-1 Introduction
 - 10-1 Connecting the Equipment
 - 10-2 Setting Up the Function Generator
 - 10-2 Setting Up the Oscilloscope
 - 10-4 Edge Trigger Mode
-

Chapter 11:

Display Memory Operation

- 11-1 Introduction
- 11-1 Setting Up the Signal Generator
- 11-2 Setting Up the Oscilloscope
- 11-3 Memory Operation
- 11-5 Deep Memory

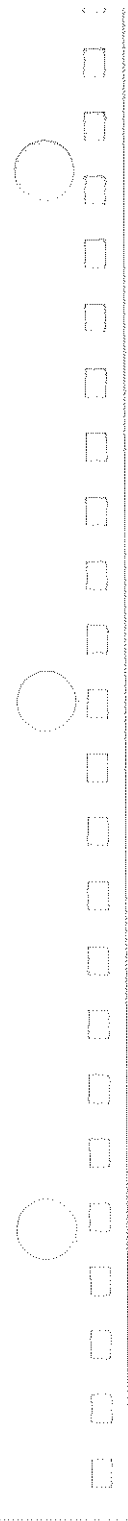

What Can They Do?

Key Features

The HP 54111D and the HP 54112D Digitizing Oscilloscopes have been developed to satisfy the need for single shot acquisition. Many signals have not been captured and evaluated because they only appeared once and the conditions were destroyed. Or the conditions never appeared again. Perhaps, a glitch appears only during initialization of certain loops of a program. A design engineer attempts to develop timing circuitry with four synchronized circuits. A technician tries to isolate a handshake error in a serial transmission line.

All are prime applications for the HP 54111D or the HP 54112D. If you need two-channel capability at extremely fast acquisition speeds, your answer is the HP 54111D. If you need four channel simultaneous acquisition with very deep memory, your solution is the HP 54112D.

Some of the key features common to both instruments are:

- Automatic parametric measurements
- Automatic waveform scaling
- Pre- and post-trigger viewing capability
- General purpose input coupling
- Full color display
- Hardcopy output to a printer or plotter
- Trigger delay by time or events
- Delta V and Delta t cursor measurements
- Front panel setup Save/Recall registers
- Waveform functions (A + B, A - B, invert)

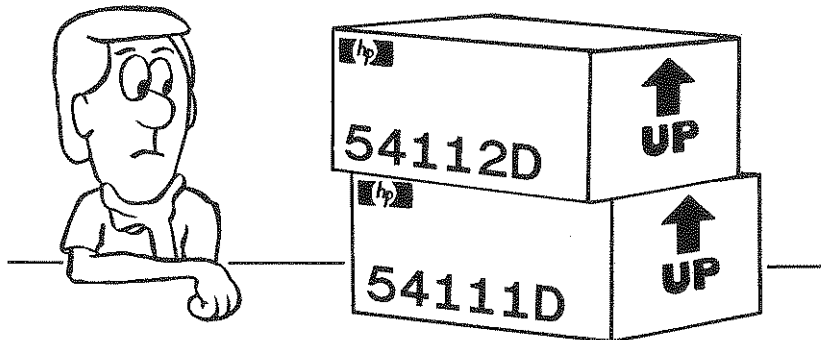

What Can They Do?

What's the Difference?

HP 54111D

- 1 gigasample/second digitizing rate
- Real-time bandwidth of 250 MHz
- Random repetitive bandwidth of 500 MHz
- 2 channel simultaneous acquisition
- 8k point memory depth per channel
- 2 external selectable triggers
- Selectable vertical resolution up to 8 bits
- Horizontal sensitivity from 500 ps to 1 s/div
- Vertical deflection from 1 mV to 5 V/div

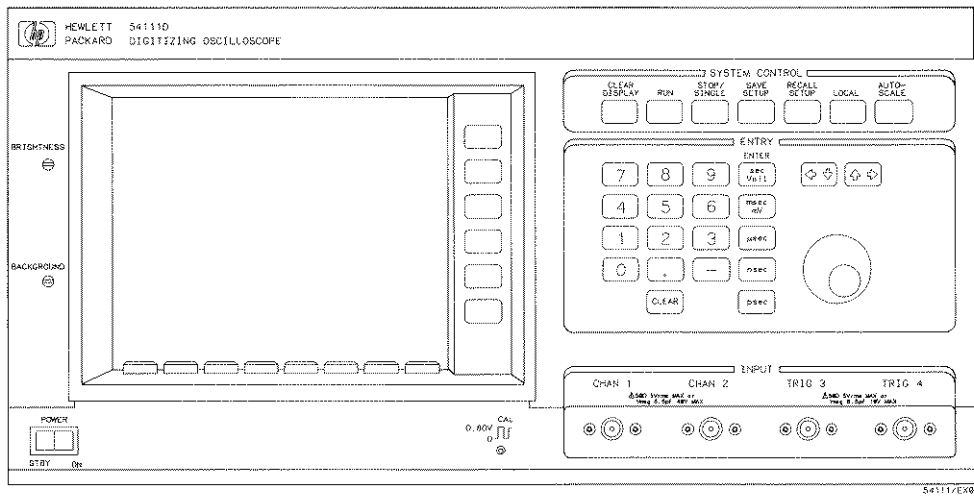

What Can They Do?

1-2

HP 54112D

- 400 megasample/second digitizing rate
- Real-time and repetitive bandwidth of 100 MHz
- 4 channel simultaneous acquisition
- 8k or 64k point deep memory per channel
- 1 external trigger
- Horizontal sensitivity from 2 ns to 1 sec/div
- Vertical deflection from 5 mV to 5 V/div

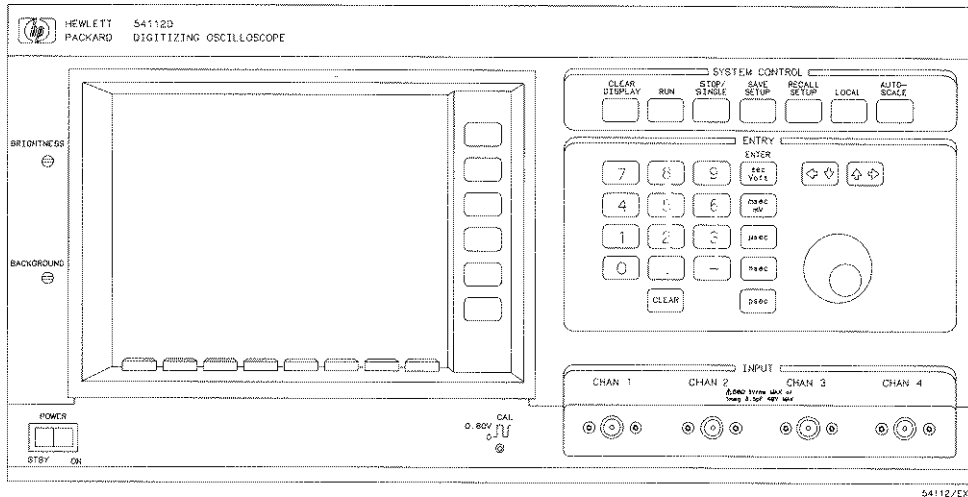

What Can They Do?
1-3

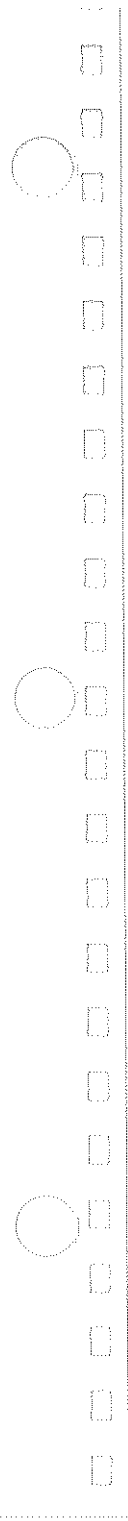

2

Applying Power

How to Power-up

To ensure safe operation, the following items should be checked before power is applied to the instrument.

- Before connecting the instrument to an ac power source, ensure that the line select switch at the rear of the instrument is set to the appropriate position (110 or 220 V).
- Make sure you have the correct power cord and it provides chassis ground for your instrument when it is plugged into the power receptacle.

After the power cord has been connected to the instrument and to an appropriate power source, the front panel power switch and the rear panel circuit breaker must be in the ON position for the unit to operate. (0 indicates OFF and 1 indicates ON).

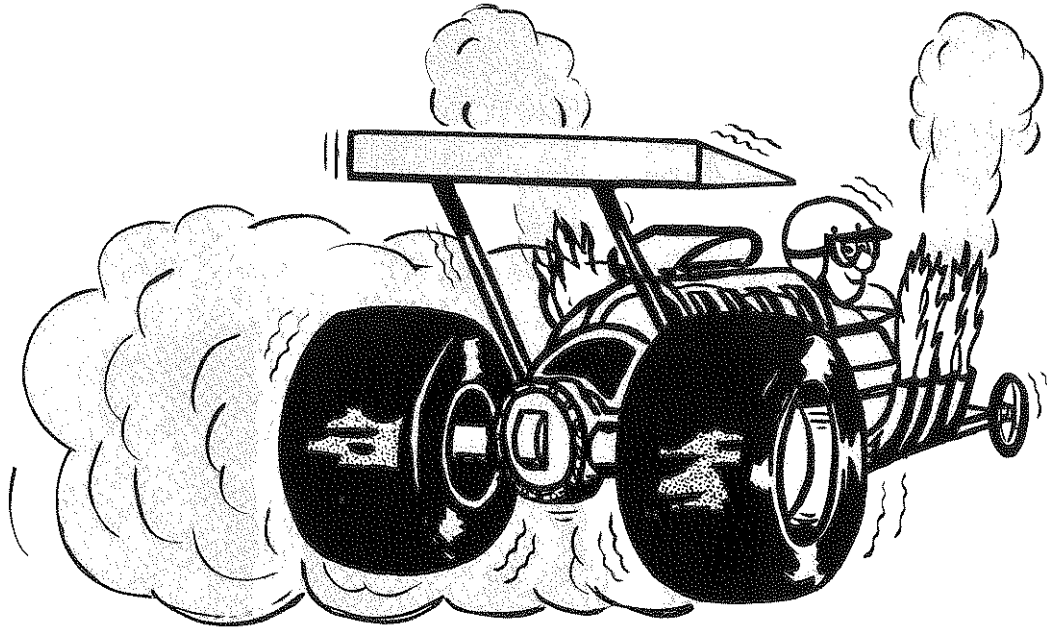

Power-up Self-Test

After the power switch is set to ON, a self-test of the oscilloscope is performed. While the self-test is in progress, several different patterns are displayed on the CRT which are meaningless to the user. When the oscilloscope completes the self-test, a message is displayed that tells you whether the oscilloscope has passed or failed the self-test.

- The message "Powerup Self Test Passed !" means you can continue and use the instrument.
- The message "Instrument Warm-up in Progress 15:00" means the instrument was not calibrated during self-test. Although you can use the instrument during this time, some measurements might not be properly calibrated. During the 15:00 minute warm-up, the instrument will attempt to calibrate itself.
- If at the end of the 15:00 minute warm-up, the instrument still did not pass the self-test, the message "Powerup Self Test Failed !" will be displayed. This may indicate the instrument requires service. Refer to the *Front Panel Operation Reference*, Utility Menu, or the service manual Self Test/Troubleshooting section.

Instrument Preset

The one key-down power-up operation is an instrument preset. This simply means that the instrument will power up in a known state. It is not important for you to understand these conditions, however, you must complete this operation to ensure the state of the instrument is known for these exercises.

To do a key-down power-up, turn the front panel power switch to STBY. Now press and hold the bottom function selection key. This is the bottom key on the right side of the instrument. This key **MUST** be held down until all test patterns have been completed and the "Power-up Self Test Passed" message is displayed on the CRT.

While holding the key down, turn the power switch to ON.

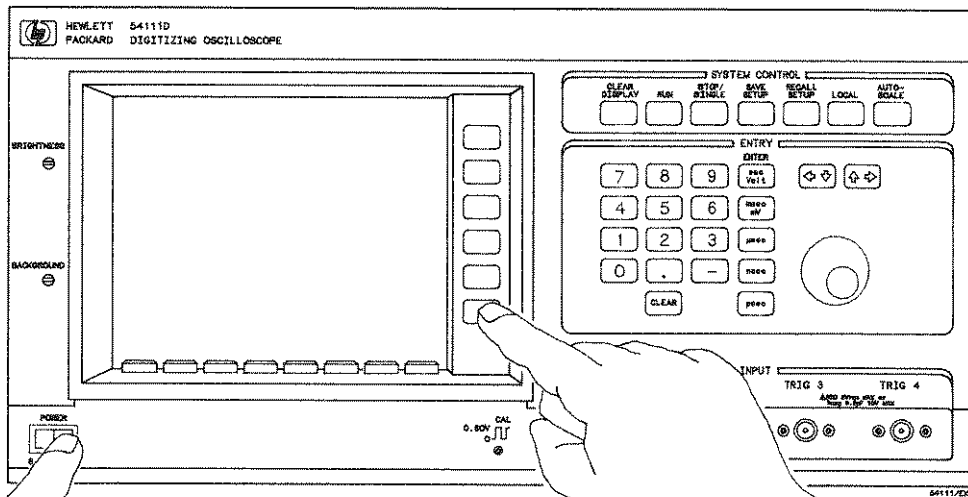

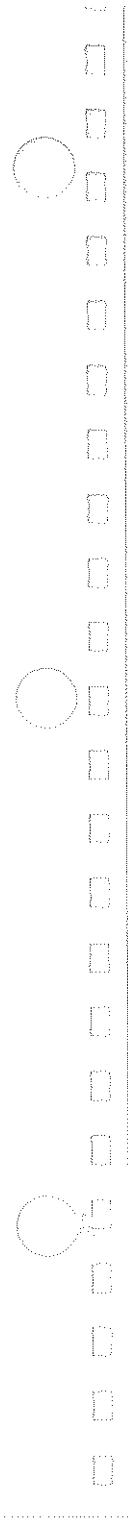

3

Becoming Familiar with the Front Panel

Introduction

The front panels of the HP 54111D and the HP 54112D are organized into four functional areas. These are: system control, display and selection, entry devices, and input. Each of these areas is discussed in detail in the *Front Panel Operation Reference*, however, a brief description here will give you enough information to complete the exercises in this book and get you off to a good start.

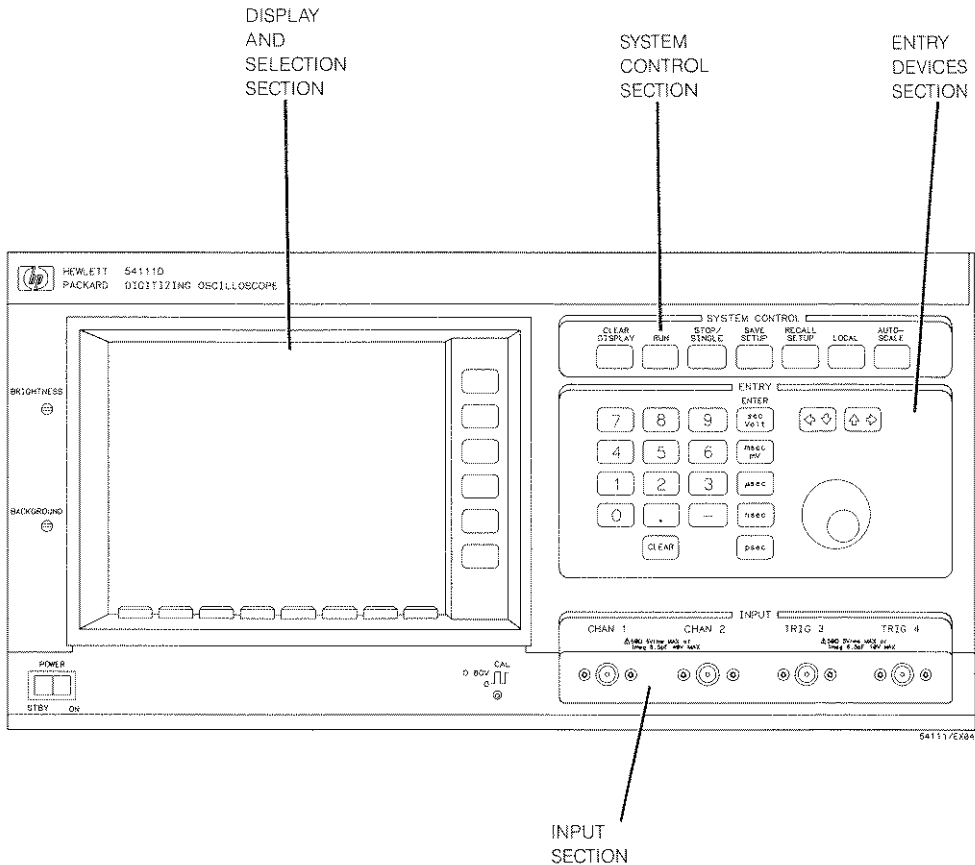

System Control

The System Control area, on the top right of the instrument, contains seven system keys. These keys override all other functions, and when pressed, are immediately executed. **AUTO—SCALE** (far right) is the key used most often (this is discussed in detail in chapter 5).

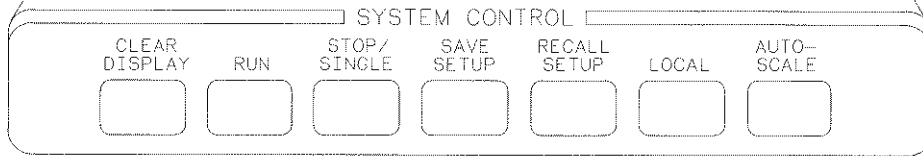
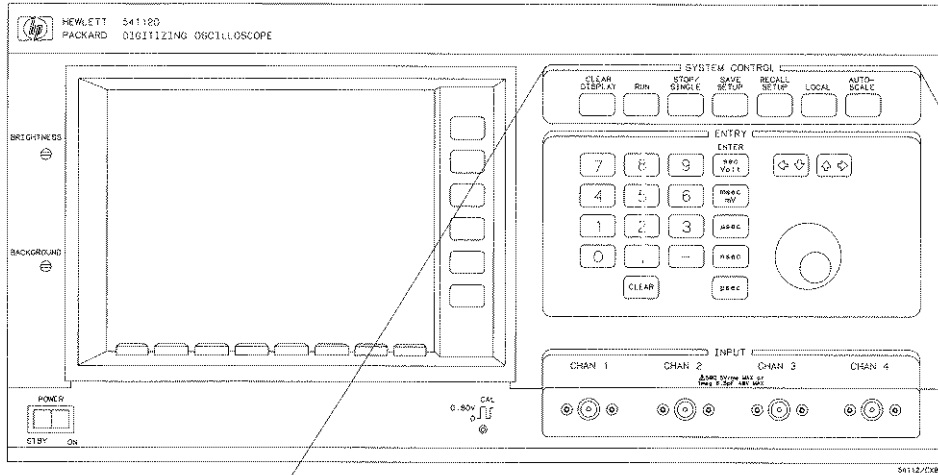

Becoming Familiar with the Front Panel

3-2

Display/Selection

The display and selection section contains the CRT, menu selection keys, function selection keys, and two manual adjustments. The menu selection keys are at the bottom of the CRT. These keys allow you to select different sets of function keys that are displayed to the right of the CRT. The keys at the right of the CRT are the function selection keys. They allow you to select a specific function from that menu. The labels for the menu selection keys and function selection keys are displayed on the CRT.

Two adjustments are to the left of the CRT. The brightness and background adjustments may be set for the most comfortable viewing levels.

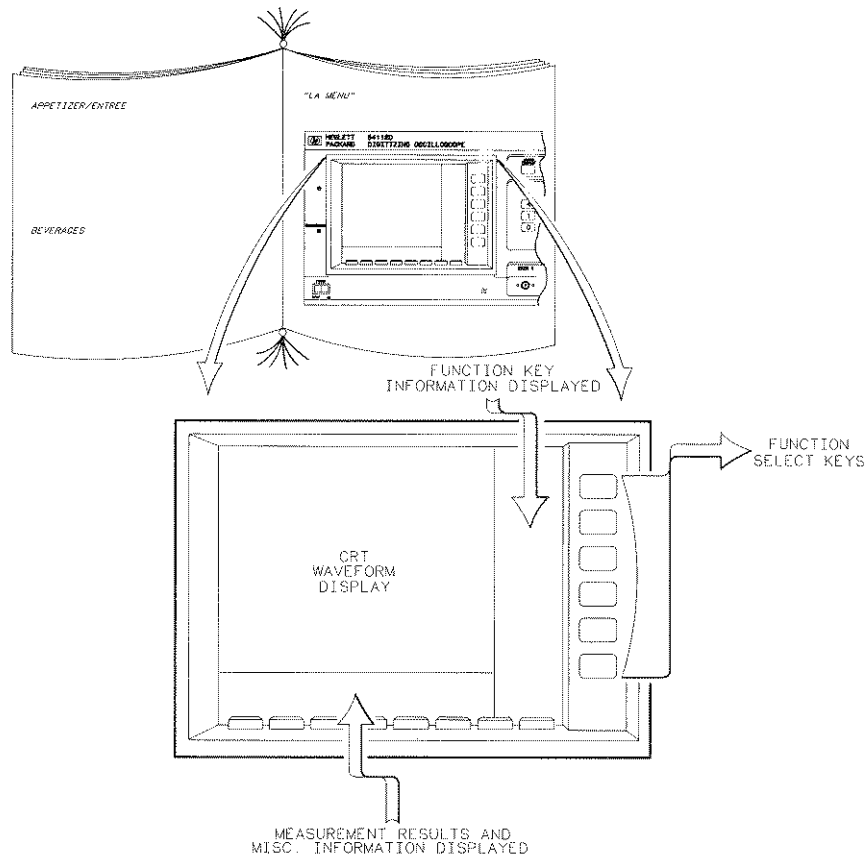

Becoming Familiar with the Front Panel

3-3

Entry Devices

There are three types of entry devices: a knob, increment/decrement (step) keys, and a numeric keypad. The function of the entry devices is defined by the function selected. The label of a function selection key is displayed in all capital letters and will assign the entry devices to a function. The knob and increment/decrement keys change values in programmed steps, while the numeric keypad allows any legal value for a function to be entered. If a value is entered with the numeric keypad, one of the five enter keys, located beneath the ENTER label, must also be pressed to input that value.

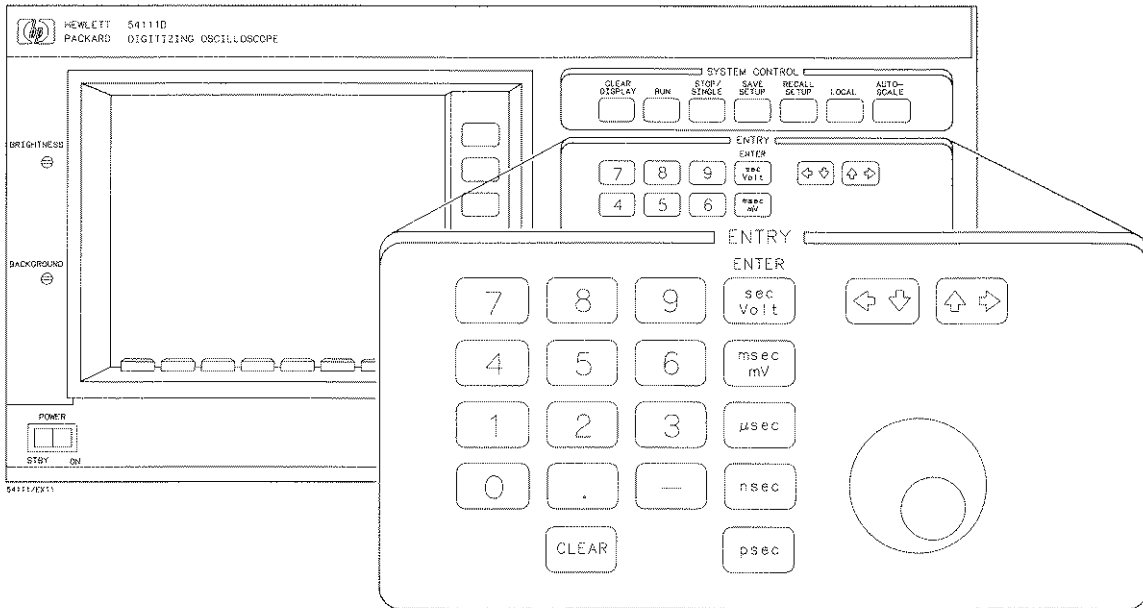

Becoming Familiar with the Front Panel

3-4

Inputs

One of the primary differences between the HP 54111D and the HP 54112D is the number of vertical inputs. The HP 54111D has two vertical inputs with two trigger inputs. The HP 54112D has four vertical inputs with one external trigger input on the rear panel. All vertical inputs have selectable input coupling and input impedance that can be set as follows:

HP 54111D

- ac at 1 M Ω
- dc at 1 M Ω
- dc at 50 Ω
- ground

HP 54112D

- ac at 1 M Ω
- dc at 1 M Ω
- dc at 50 Ω

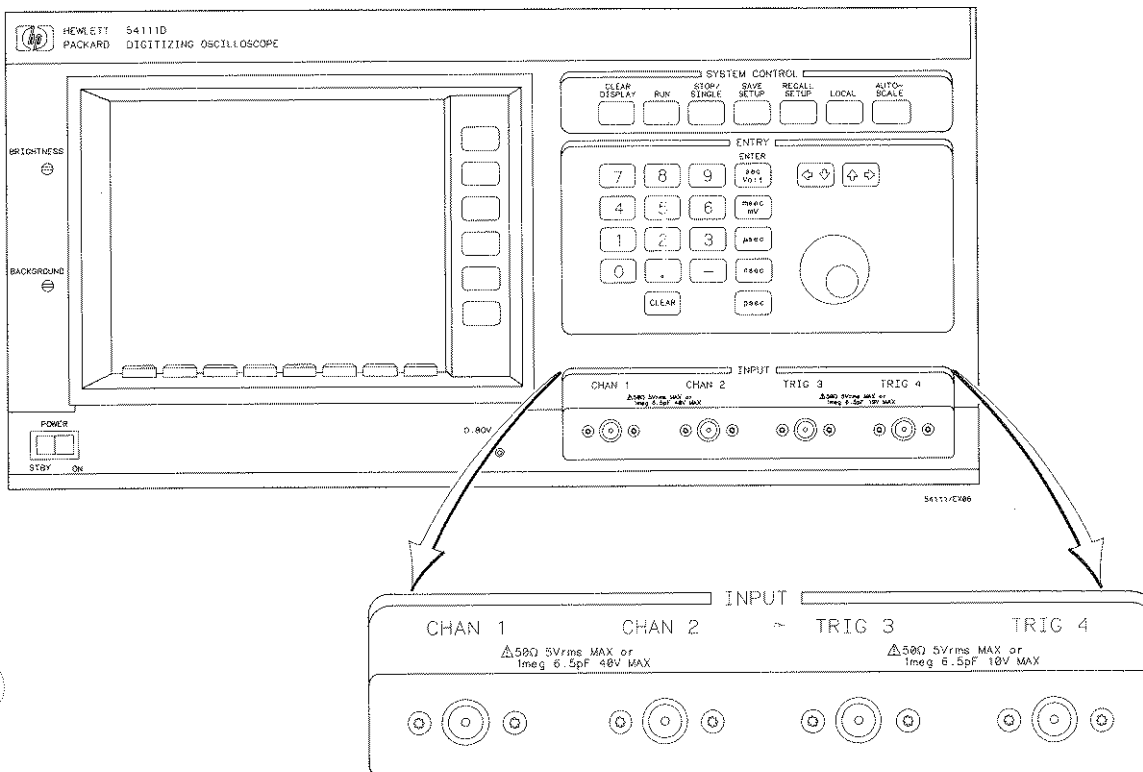

Becoming Familiar with the Front Panel

3-5

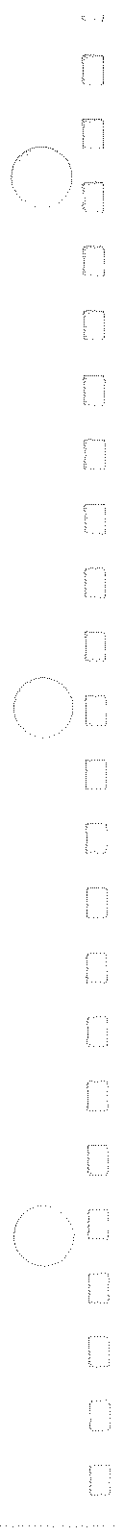

4

Connecting a Signal

Input

The HP 54111D has two vertical signal inputs and two trigger inputs, however, the HP 54112D has four vertical inputs.

Most illustrations in this book show the input connected to channel 1, however, any channel can be used. In exercises later in this book some of the alternate triggering inputs will be used. More information is available in chapter 6 of the *Front Panel Operation Reference*.

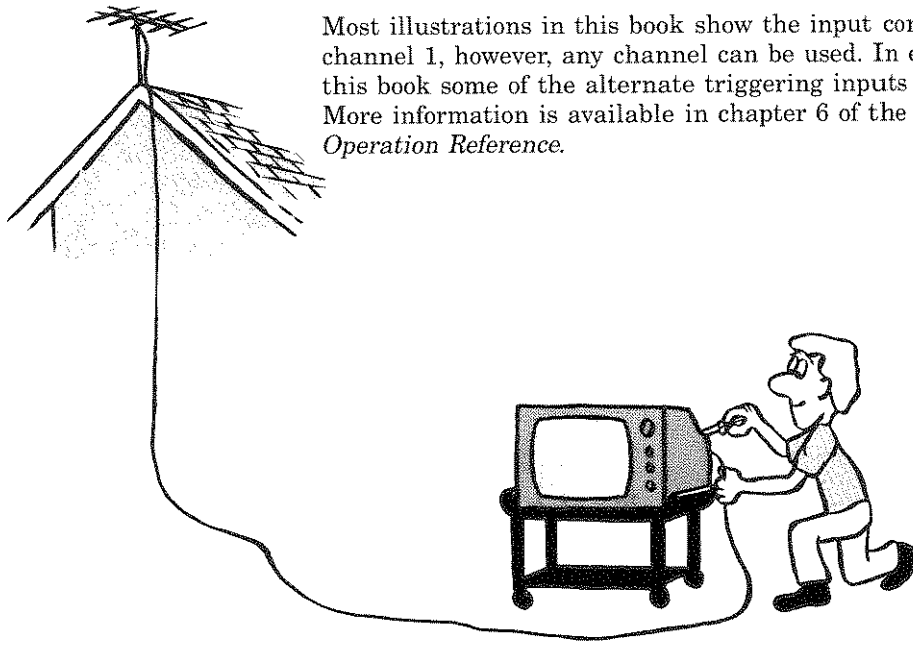

Signal Source

For most exercises in this manual the front-panel calibrator signal is used. The cal signal output is just below the CRT. Go ahead and connect the calibrator output (CAL) to the channel 1 input with one of the probes provided with the instrument.

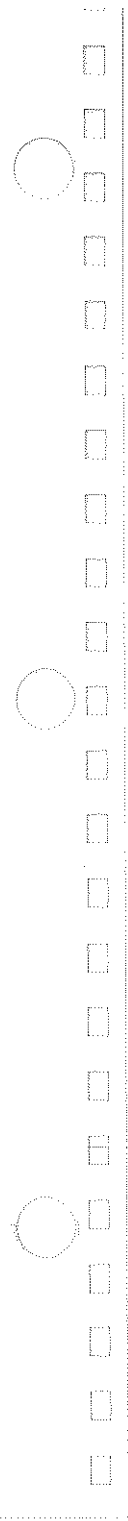

5

Setting Up the Instrument with Auto-Scale

What Is Auto-Scale?

Auto-scale is a function built into each instrument that automatically displays one or more waveforms. When the **AUTO-SCALE** key is pressed:

- the oscilloscope checks all channel inputs to determine whether a signal is present
- if a signal is found, the oscilloscope determines the amplitude and period of the input waveform
- it automatically sets the volts/division, sweep speed, offset, trigger level, and trigger slope
- it sets the trigger point to center screen and displays the incoming waveform in the repetitive mode

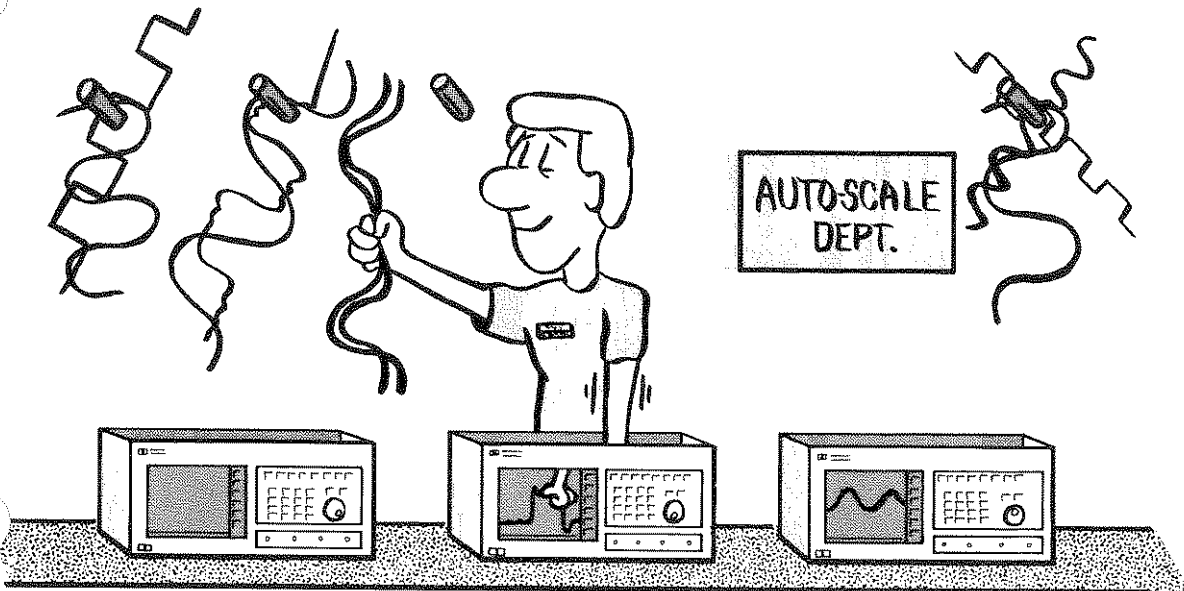

Getting a Signal to the Input

Use the front-panel CAL signal to demonstrate the **AUTO-SCALE** feature. The CAL signal is a square wave of approximately 800 mV, but it is accurate enough for the next few exercises and is certainly convenient.

To connect the calibrator to the input, simply connect a probe from the CAL output of the oscilloscope to the desired input and attach the ground clip to another input connector.

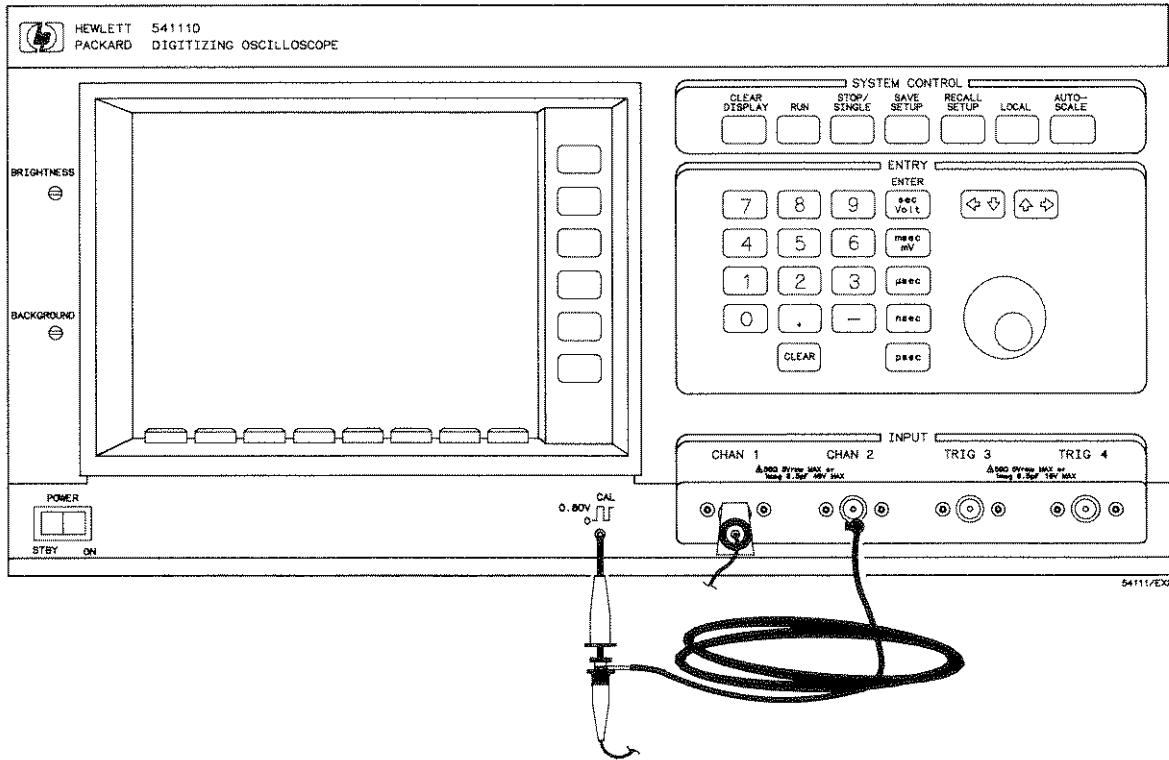

Setting Up the Instrument with Auto-Scale

5-2

When a Signal Is Found

If a signal is found on any of the vertical inputs, the instrument checks the amplitude, offset, and frequency of the signal and automatically scales the vertical attenuator, offset, and horizontal sweep time to display the waveform on the CRT. The number of cycles displayed is normally between one and four complete waveforms. However, if a waveform with a narrow pulse and long repetition rate is found, the oscilloscope may not display an entire cycle.

If there are signals present at channels 1 and 2 or channels 3 and 4, the oscilloscope will be set to dual screen and display the signals. If two or more signals are present in any other combination, the oscilloscope will be set to quad screen and be displayed from top to bottom.

Trigger Source

If a signal is present at two or more vertical inputs, the lowest numbered channel will be selected as the trigger source and will scale the horizontal sweep. If only one vertical input has a signal present, that signal is used as a trigger source, and the instrument is set to single screen mode.

Notice when the scaling is complete, the selected menu is **Timebase** and the selected function is **TIME/DIV**. This means that the entry devices are assigned to control the sweep speed of the oscilloscope. Try turning the knob and note how the sweep speed changes. As the sweep is changed, the signal expands and contracts in both directions from the center of the display. The center of the display is the trigger point, time zero on the display.

- Set the sweep speed to $100 \mu\text{s}$ by pressing the numeric keypad keys as follows: 1, 5, 0, μsec . The display should look like the illustration below.

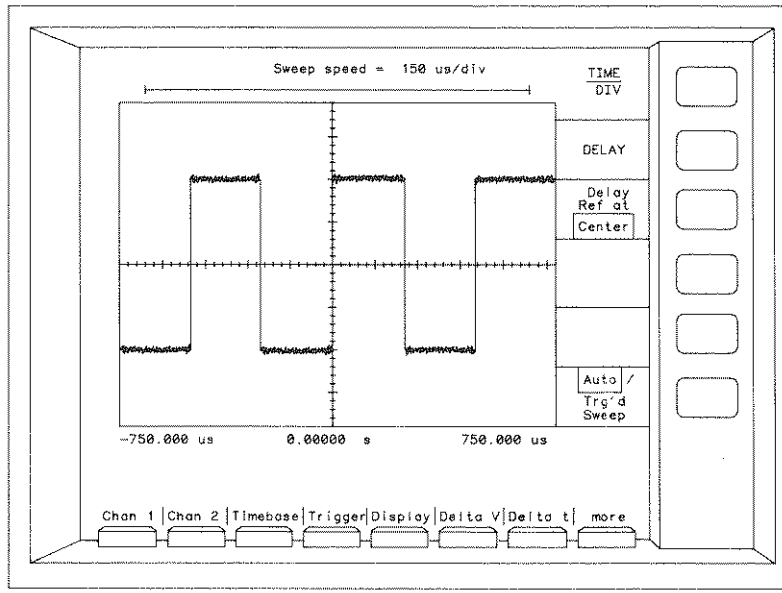

If no signal is present on any of the vertical inputs, the oscilloscope prints the advisory "No signal found" on the CRT and places the oscilloscope in an auto triggering mode. The auto triggering mode allows the instrument to sweep without a trigger signal being present, and the baseline is displayed.

Setting Up the Instrument with Auto-Scale

6

Using the Display

Color Display

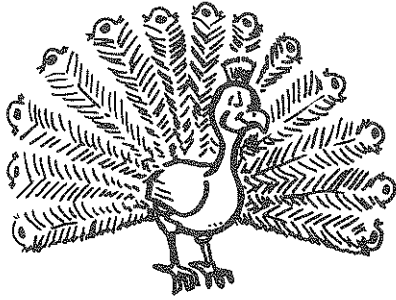

The full color display of the HP 54111D and the HP 54112D improves the usability and efficiency of the oscilloscopes. Sixteen separate colors are available for your use. Each channel is assigned a separate default color; channel 1 is yellow, channel 2 is green on both instruments. On the HP 54112D channel 3 is tangerine and channel 4 is pink. The factors associated with each color are displayed in that distinctive color. Some advantages of a full color display are:

- emphasizes or de-emphasizes waveforms
- reduces search time
- associates waveforms and labels with the same color
- distinguishes between separate waveforms
- reduces eye strain
- customizes colors to your preferences or needs

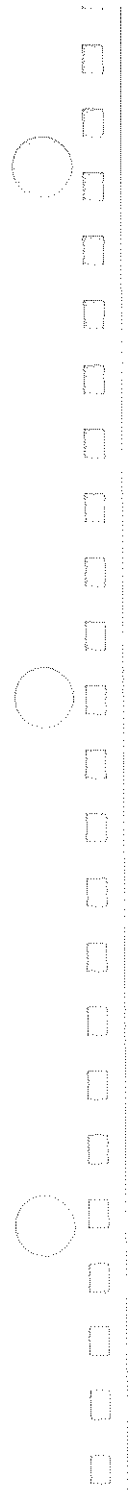

7

Making Automatic Parameter Measurements

Introduction

Automatic parameter measurements are functions built into the HP 54111D and HP 54112D that allow you to make parametric measurements on a displayed waveform. There are 12 automatic measurements you can make by pressing the appropriate key, or you can make all 12 of these measurements with the **All** key.

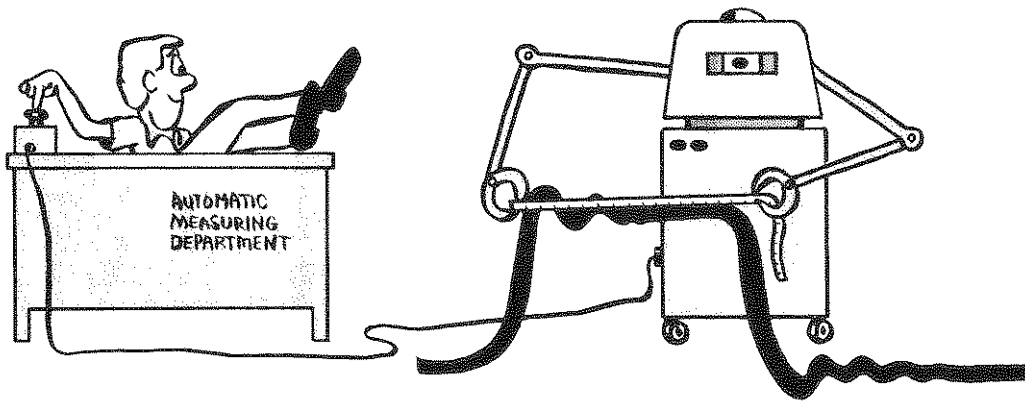

Setting Up the Measurement

To make automatic measurements, the signal must be displayed and triggered. The easiest way to accomplish this is to use the **AUTO-SCALE** key.

Once the signal is displayed and triggered, press the **more** menu select key at the bottom of the CRT. When this key is pressed, a new set of menu selections is displayed at the bottom of the CRT.

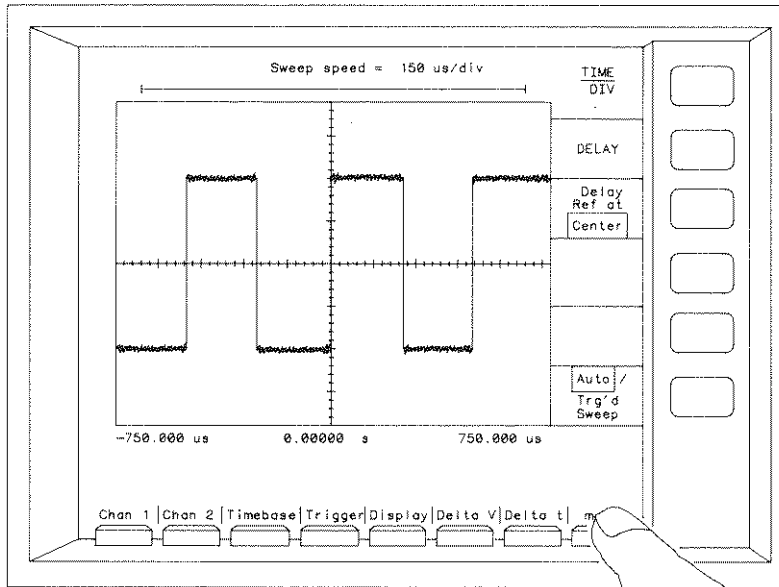

54111/EX14

Making Automatic Parameter Measurements

7-2

includes the **Measure** key. Press the **Measure** key, and notice the function menu at the right of the CRT changes to the **Measure** menu.

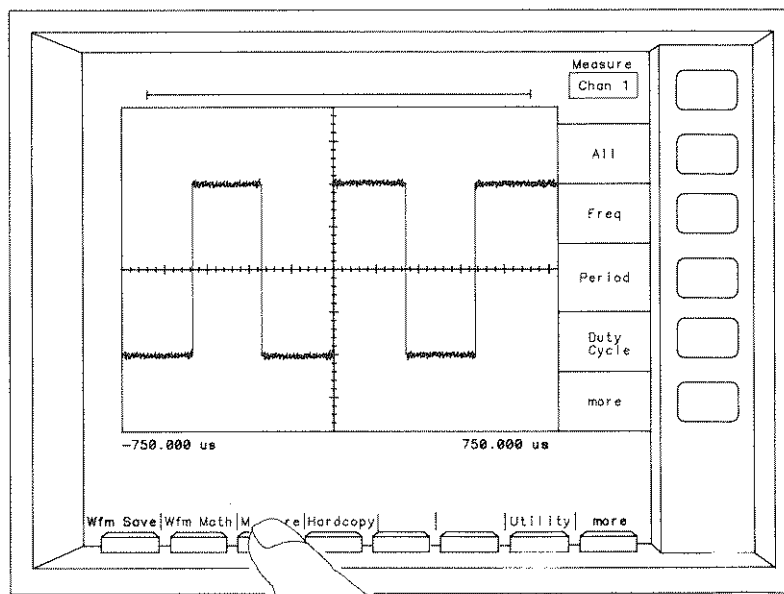

Using the Measure Menu

When you press the **Measure** key at the bottom of the CRT, one of three measure menus appears at the right of the CRT. Press the more function selection key in the vertical menu until **Measure** is at the top of the function selection. The top key allows you to select the source of the waveform to be measured.

The other keys in the Measure menu select the measurements to be made. Pressing **Freq** causes the oscilloscope to measure and display the frequency of the displayed waveform. Pressing **Period** causes the oscilloscope to measure and display the period of the waveform. The results of the selected measurements are displayed below the waveform display area.

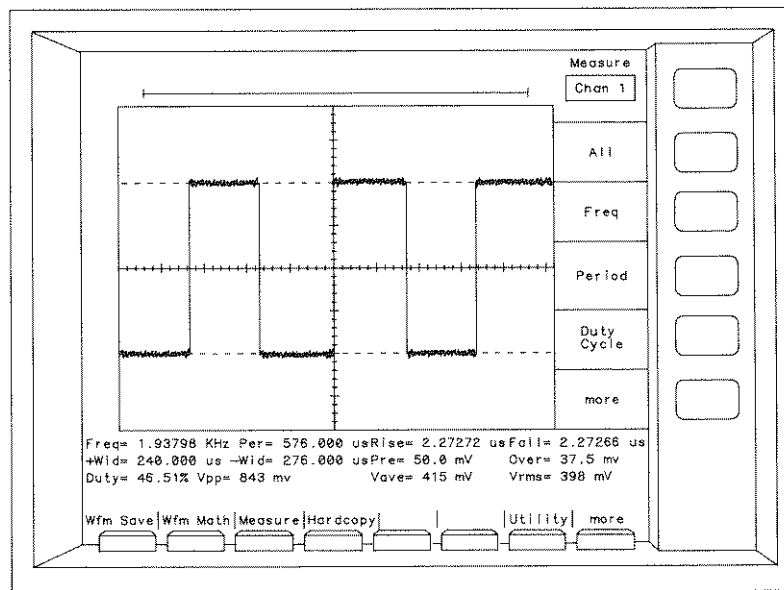

Making Automatic Parameter Measurements

Making a Rise Time Measurement

Press the **more** key on the vertical menu until the menu that includes the **Rise Time** key appears. Press the **Rise Time** key. Rise time is measured on the rising edge of the waveform and is the time it takes the waveform to transition between the 10% voltage point and the 90% voltage point.

The rise time value is printed on the CRT in the factors area below the waveform display area. For more information concerning accuracy of the measurements, see the *Front Panel Operation Reference*.

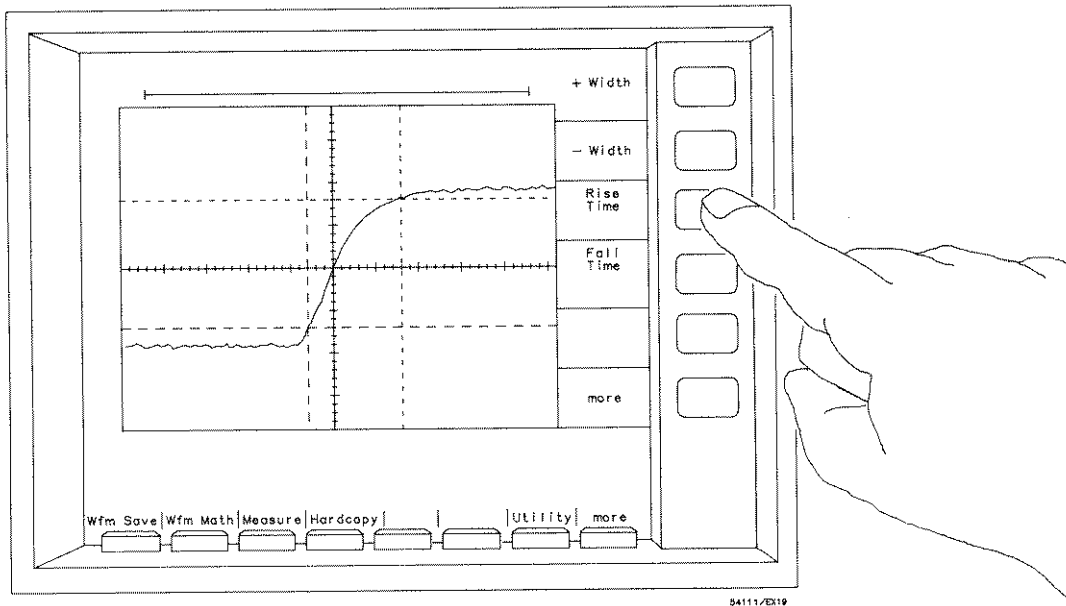

Making Other Auto Parameter Measurements

Make a few other measurements and note that the results for each measurement are added to the factors area as the measurement is made. Now, measure all 12 parameters with one key stroke, by pressing the All key.

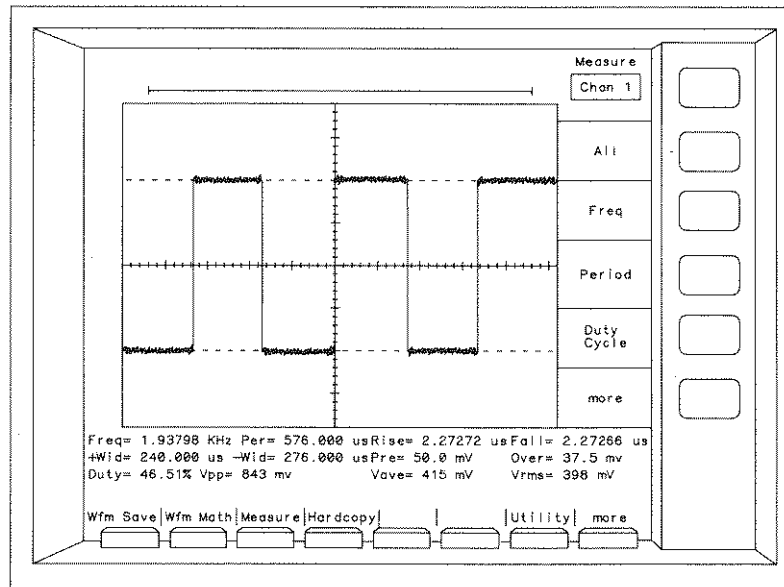

5411/EX28

Making Automatic Parameter Measurements

8

Making Voltage Measurements

Introduction

The Delta V menu provides two voltage markers for making voltage measurements either automatically or manually. Automatic functions available in this menu find the top and base of a waveform. You may set the voltage markers to a percentage of the top-base value, or any value you prefer, or you may set the manual markers at any point on the waveform you desire. This menu allows you to determine the actual voltage value at each of the markers and determine the ΔV (voltage) value between the markers.

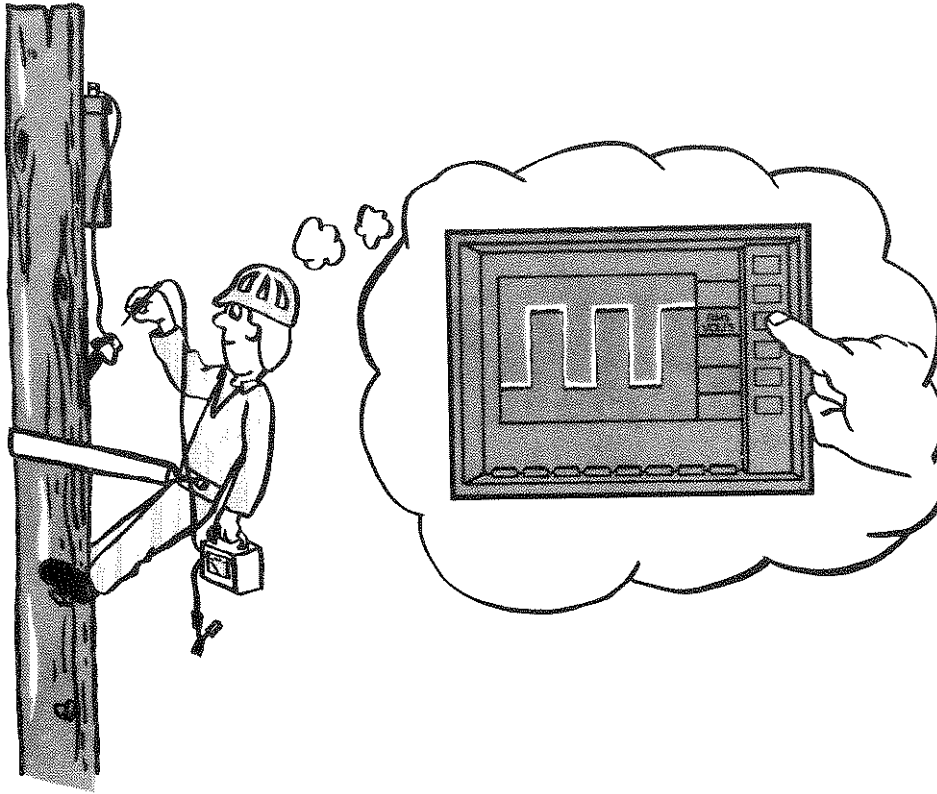

Automatic Voltage Measurements

This exercise teaches you how to use the voltage markers manually as well as how to use the automatic functions for finding several preset voltage levels. You will learn that making voltage measurements on a waveform is easy.

Please complete this exercise in the order described to ensure the illustrations presented are similar to your results. Remember, if you should get lost, simply press the **AUTO—SCALE** key and return to the start of the exercise.

1. Ensure the calibrator signal is connected to the channel 1 input, then press **AUTO—SCALE**.
2. Sweep speed (**TIME/DIV**) is the selected function when **AUTO—SCALE** is complete. Set the sweep speed to $150 \mu\text{s}$ by entering the value with the numeric keypad.
3. Select the **Delta V** menu. If you are using an HP 54112D, the Delta V menu is in the second level of menu selection keys.
4. Press the **V Markers** key to turn the markers on (i.e. V Markers On/Off).
5. Ensure that channel 1 is the selected source of **MARKER 1 POSITION** and **MARKER 2 POSITION**.
6. Press the **Preset Levels** function select key until 0-100% is selected.
7. Press the **Auto Level Set** key. This causes the instrument to locate the top and base of the input signal, then sets the V Markers to the selected percentage levels on the waveform. Marker 1 is at the lower level of the signal, and Marker 2 is at the upper level.

factors area. $V(1)$ is the voltage at V Marker 1 (long dash) on the base of the waveform. $V(2)$ is the voltage at V Marker 2 (short dash) at the top of the waveform. ΔV is the voltage difference between the top $V(2)$ and base $V(1)$ of the waveform.

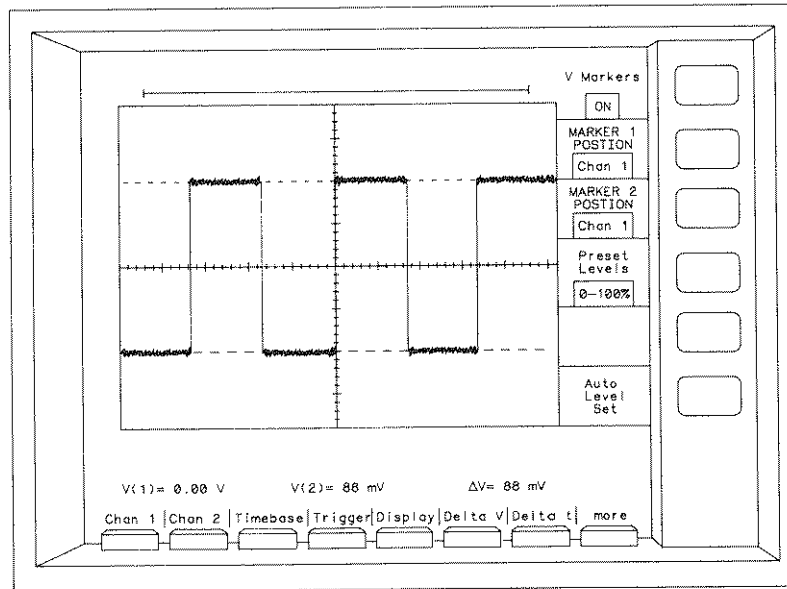

54111/EX15

The difference between top and base voltage values of a square wave is typically not the same as the peak-to-peak value. These instruments determine top and base voltages by finding the flattest portions of the top and bottom of the waveform. The top and base values do not typically include preshoot or overshoot. The peak-to-peak voltages are the minimum and maximum voltages in a waveform record. Keep this in mind when selecting either manual or automatic measuring techniques. Refer to the *Front Panel Operation Reference* for more information.

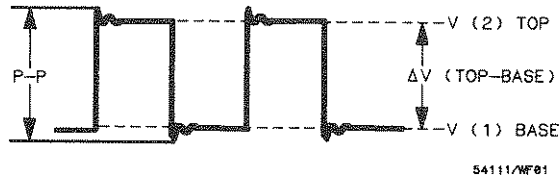

You can confirm this by selecting the **Measure** menu and measuring peak-to-peak voltage, preshoot, and overshoot. When you have finished, return to the **Delta V** menu (if you need a refresher, you can return to Chapter 7 and review the Measure menu).

9. Press the **Preset Levels** key several times until **Variable** is displayed. Notice that the V Markers move from the 0-100, 10-90, 20-80, 50-50, and variable percentage levels of the input signal. The fixed values set the markers to percentage levels shown with the top and base values as 0 and 100% references.
10. Press the **VARIABLE LEVELS** key to assign the knob to this function. Now, rotate the knob and notice that V Marker 1 moves, and the percentage value for V Marker 1 changes.
11. Press the **VARIABLE LEVELS** key and select the second value (V Marker 2). The range for the variable levels is -25% to 125%.

the waveform factors area change. They reflect the voltage levels of the V Markers on the waveform. ΔV represents the voltage difference between V Marker 1 and V Marker 2.

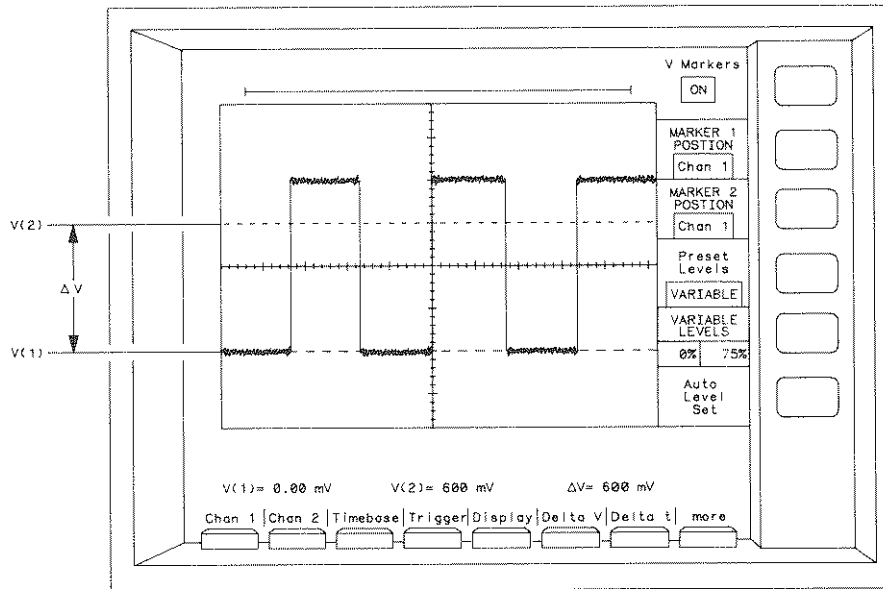

Manual Voltage Measurements

Voltage measurements can be made manually by moving the voltage markers to any desired location on the waveform and reading the values at V(1), V(2), and ΔV . Use the following procedure as a guide to setting the voltage markers.

1. Ensure that **MARKER 2 POSITION** is assigned to the channel of interest (channel 1). If more than one signal is displayed, the desired signal source can be selected by pressing the **MARKER 2 POSITION** key.
2. Now select V Marker 2, which you move by pressing the **MARKER 2 POSITION** (if it has not already been pressed). If this key is pressed more than once it changes the source selection, if more than one source is being used. When this key is pressed the first time, it assigns the entry devices to control the position of V Marker 2.
3. Press the decrement key and notice that each time it is pressed it steps down on the displayed signal. Determine the size of each step by pressing the increment/decrement keys and checking the V Marker 2 position (V2) value with each press.
4. Now, rotate the knob and note that the marker also moves in steps with the motion of the knob. Enter some values (i.e. 470 mV, 610 mV) with the numeric keypad and the **msec-mV** key. Note, you are able to set the V Marker to values between steps by entering the desired value.

9

Making Time Interval Measurements

Introduction

Time interval measurements are made with the start and stop markers. The time at these markers is measured from the trigger point, with the trigger point being time 0. The Delta time measurement is calculated by subtracting the time at the start marker from the time at the stop marker. If the stop marker is positioned in time before the start marker, the Delta time calculation will be a negative value. Time measurements can be made by manually setting the markers to desired points, or by allowing the oscilloscope to set the markers. To find waveform edges automatically on the HP 54111D or HP 54112D, you must position the voltage markers on the waveform so the waveform actually crosses the voltage markers.

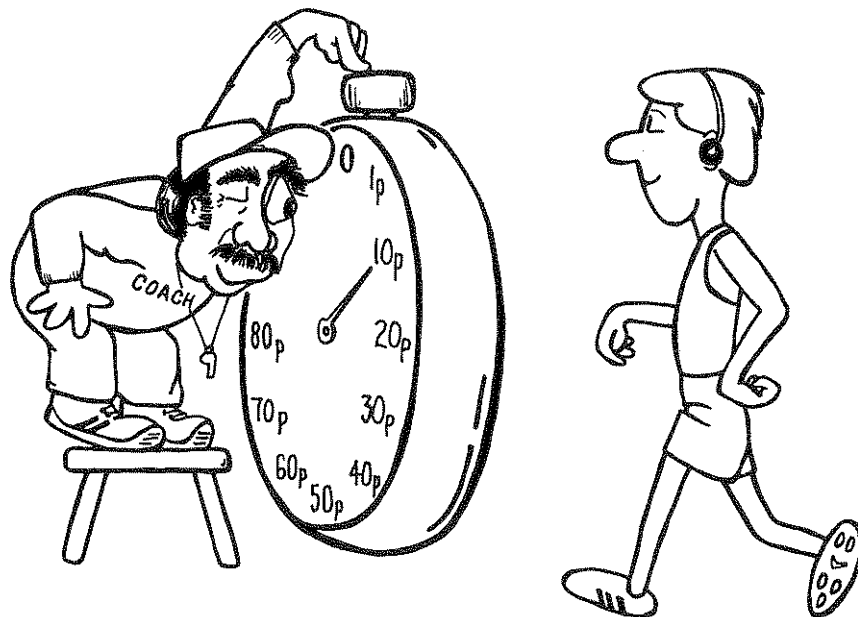

Automatic Time Measurements

1. Enter the **Delta V** menu.
2. Select the **Delta V** menu and press the **V Markers** key if they are not already on.
3. Set **Preset Levels** to 20-80%.
4. Press the **Auto Level Set** key. This sets the V Markers at the 20% and 80% levels of the waveform. The V Markers can be set at these levels because when the **Auto Level Set** key is pressed the instrument immediately checks the top and base levels and calculates the Preset Levels from those points.
5. Enter the **Delta t** menu and turn on the T Markers.
6. Press the **START ON POS EDGE** key.

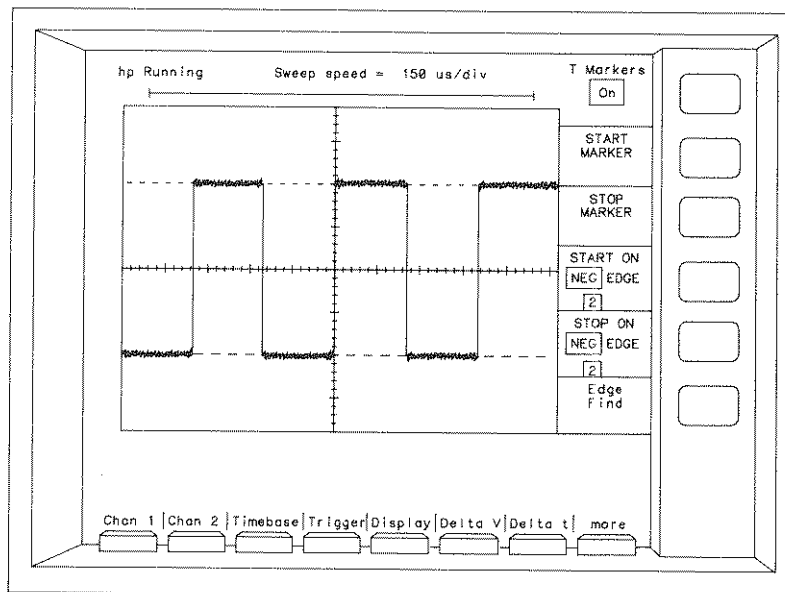

54111/EX08

Making Time Interval Measurements

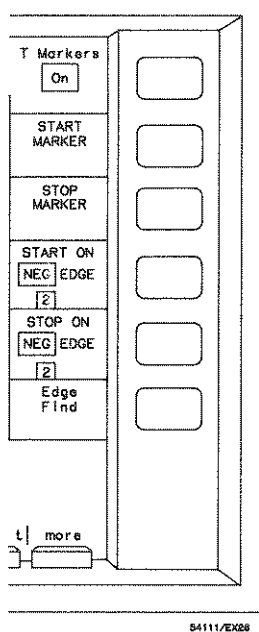

EDGE 1. The start marker (long dash) will move (jump) to the first positive-going edge. Read the time displayed for the start marker.

8. Press the **START ON POS EDGE 1** key again. Notice that the key label changes to **START ON NEG EDGE 1** and the start marker jumps to the negative edge.
9. With the entry devices (i.e., key pad, increment/decrement keys, or knob) set **START ON NEG EDGE** value to 2. If you use the key pad to enter this variable, make sure you press an **ENTER** key to complete the selection.
10. Place both the start and stop markers on Pos Edge 1 and notice the Δt reading is not 0, even though the markers appear to be together. The displayed ΔV value is not an error, it is just very difficult to see what is really happening. The oscilloscope places the start marker on the intersection of the waveform edge and V Marker 1, and the stop marker on the intersection of the waveform edge and V Marker 2. You have just made a 20-80% rise-time measurement. Refer to the figure to see what is really happening. For more information on risetime and measurement accuracy, see the *Front Panel Operation Reference*.

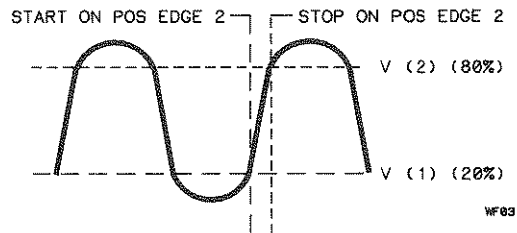

Manual Time Measurements

This portion of the exercise illustrates how to manually set the time markers to make measurements. If you get lost in this exercise, press **AUTO—SCALE** and start over.

1. Ensure the oscilloscope CAL signal is connected to channel 1 and press **AUTO—SCALE**. Set the sweep speed to $150 \mu\text{s}$.
2. Set Delta V Preset Levels to 50-50%.
3. Enter the **Delta t** menu and turn on the T Markers.
4. Select the **START MARKER** key and rotate the knob until the start marker (long dash) intersects the positive-going edge of the waveform that is displayed first. The time at the start marker should be approximately $-500 \mu\text{s}$. The time is negative because the trigger (time 0) is at center screen.

Note

*If you wish to confirm your reading, select the **Display** menu and press the **Graticule** key until **Grid** is highlighted, then return to the **Delta t** menu. Multiply the number of divisions from center screen (trigger point) to the start marker by the sweep speed (**TIME/DIV**) of the oscilloscope. The result of this multiplication should be approximately the same as the start reading. The sweep speed is displayed on the lower left of the CRT.*

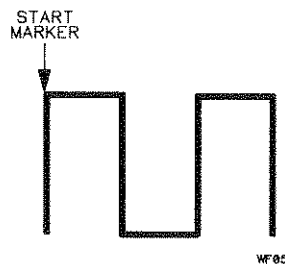

Making Time Interval Measurements

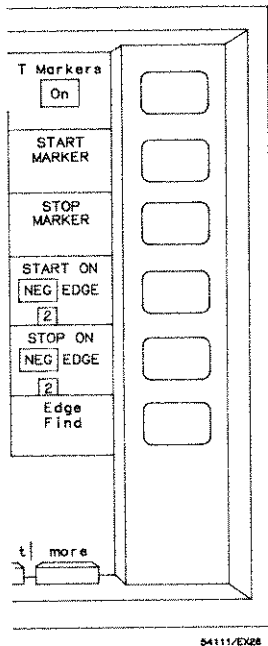

dash) to intersect the second rising edge by rotating the knob.

6. Read the period length of the waveform. In this measurement, Δt is the waveform period (stop-start). The instrument is triggering at the second positive-going edge, therefore, the waveform period is about $500 \mu\text{s}$.

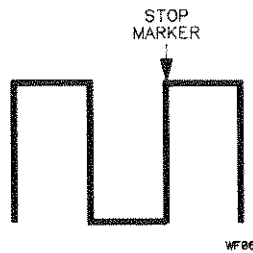

7. Move the stop marker to the first displayed falling edge. The positive pulse width of the waveform is the Δt value.

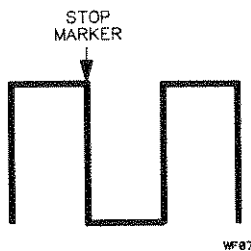

8. Move the stop marker to the first rising edge and the start marker to the first falling edge. The Δt should be approximately $-240 \mu\text{s}$. Pulse width CANNOT be negative! The minus sign simply means the stop marker is in front of the start marker.

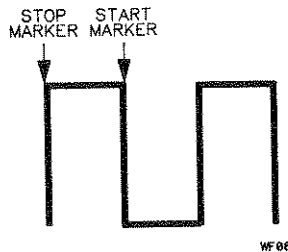

Measuring Complex Signals

For this part of the exercise use a 40 MHz square wave as the base frequency. This signal is gated (burst mode) to produce 20 pulses in each burst and set to start 1 μ s after the start of the preceding burst. An HP 8116A Pulse/Function Generator is recommended. If you are using some other waveform source, set the controls to produce the signal described above.

1. Select the square wave.
2. Set the function generator frequency to 40 MHz by selecting FRQ and pressing the Auto Vernier keys until 40.0 MHz is displayed.
3. Set the function generator amplitude to two volts by pressing the AMP key, then pressing the Auto Vernier keys until 2.00 V is displayed.
4. Ensure the offset voltage is set to 000 mV by pressing the OFS key. If some value other than 000 mV is displayed, use the Auto Vernier keys to set offset to 0 mV.
5. Select the internal burst mode by pressing the mode key with I.BUR in the column above it. When I.BUR is selected, two more keys become available, RPT and BUR.
6. Set the number of pulses in the burst to 20 by pressing BUR, then pressing the Auto Vernier keys until 20 is displayed. This causes 20 cycles of 40 MHz square waves to be produced within each burst.
7. Set the burst repeat rate to 1 μ s by pressing the RPT key, then press the Auto Vernier keys until 1.00 μ s is displayed.
8. Connect the Trig Output of the function generator to an external trigger input of the oscilloscope. On the HP 54111D that can be Trig 3 or Trig 4 on the front panel, or on the HP 54112D the EXT TRIG IN on the rear panel.
9. Connect the OUTPUT of the function generator to the channel 1 input of the oscilloscope.
10. Press the DISABLE key on the function generator, if necessary, to enable the waveform output. The disable light must be off.

Making Time Interval Measurements

Setting Up the Oscilloscope

Now that you have a signal to the oscilloscope, set the oscilloscope controls as follows:

1. Press **AUTO—SCALE**. When the **AUTO—SCALE** operation is complete, the instrument will be left in the **Timebase** menu with **TIME/DIV** selected.
2. Set the sweep speed to 200 ns/division. The sweep speed is displayed just above the waveform display area.
3. Press the **Delay Ref at** key until **Left** is displayed in the inverse video window. This sets the trigger point to the left side of the screen.
4. Enter the **Trigger** menu by pressing the **Trigger** key on the menu display area (below the CRT). Press **Trg Src** until the display corresponds with the external trigger you have selected. Press **TRIGGER LEVEL** and set the level to gain a triggered response. About 2.50 volts should be adequate. The display should resemble the figure below.
5. Press the **Chan 1** key and set **Input Coupling** to **ac**.

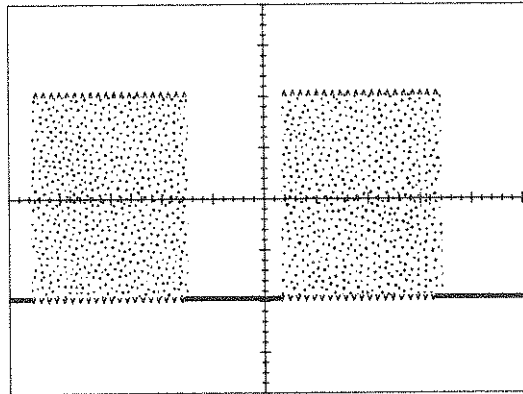

54111/EX28

Now that you have set up the function generator and oscilloscope, you are ready to continue with the exercise. If you would like to get a closer look at the waveforms in the burst, select the **Timebase** menu and increase the sweep speed until you can see the waveforms. Reset the sweep speed to 200 ns/division before you continue.

Measuring Time between Bursts

This part of the exercise shows you how to make a time interval measurement between two bursts of pulses with some automated features of the oscilloscope. Remember, you can press **AUTO—SCALE** to get back to a known starting point at any time. If you do press the **AUTO—SCALE** key, you will need to repeat the previous section “Setting Up the Oscilloscope.”

1. Enter the **Delta V** menu.
2. Set the V Markers to 50-50% and press **Auto Level Set**.
3. Press the **Delta t** menu selection key.
4. Press the **START ON EDGE** function select key and set it to read **START ON POS EDGE 1**. The polarity of the edge can be changed by pressing the **START ON EDGE** key again. The number of the edge can be changed with the entry devices. Set the edge to positive since the first waveform edge in the burst is positive.
5. Select the **STOP ON EDGE** function selection key. Set it to Pos and select edge 21. Positive edge 21 is the first edge in the second burst.

of the first burst and the stop marker (short dashed line) is at the first pulse of the second burst.

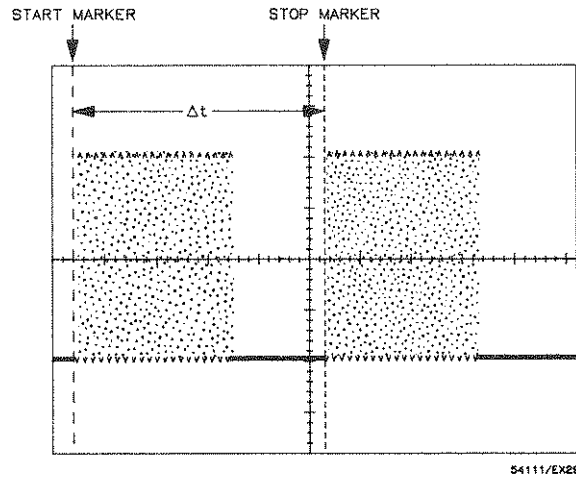

6. Read the burst repetition time in the factors area of the display. The burst repetition time is the time between the start and stop markers (Δt). This should be approximately the same time as the RPT value set on the function generator ($1 \mu s$).

10

Trigger Operation

Introduction

The HP 54111D and the HP 54112D have several trigger modes. This exercise will help you learn how to use the most basic trigger mode, edge trigger. The *Front Panel Operation Reference* has exercises on all trigger modes. In this exercise you will set up the function generator to produce a short duration pulse and observe the trigger in the mode.

Connecting the Equipment

Connect the HP 8116A Pulse/Function Generator to the oscilloscope as shown in the figure below. You will need one BNC tee and two 1-metre BNC cables.

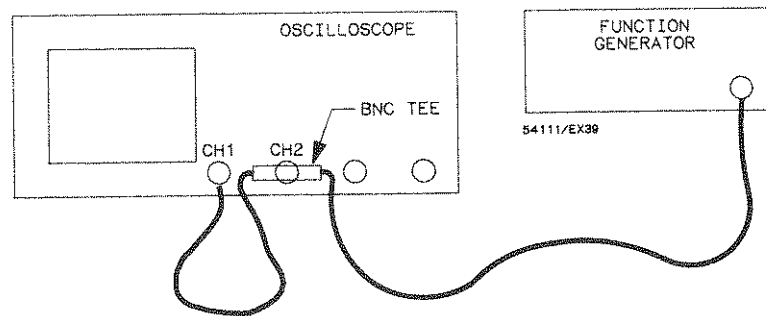

1. Connect one BNC cable from the output of the function generator to the BNC tee, then connect the BNC tee to the channel 2 input of the oscilloscope. Now connect the other BNC cable to the BNC tee and the channel 1 input of the oscilloscope.

Setting Up the Function Generator

Set the function generator to produce a 10 ns positive pulse at a 5 MHz rate as follows:

1. Select the pulse mode by pressing the pulse () key.
2. Set the pulse width to 10 ns by pressing the width (WID) key, then the Auto Vernier keys until 10.0 ns is displayed.
3. Set the frequency to 5 MHz by pressing the FRQ key, then the Auto Vernier keys until 5.00 MHz is displayed.
4. Set the pulse amplitude to two volts by pressing the amplitude (AMP) key, then the Auto Vernier keys until 2.00 V is displayed.
5. Press the DISABLE key on the function generator, if necessary, to enable the waveform output (disable light must be off).

Setting Up the Oscilloscope

So you can observe the triggering better, the channel 1 and channel 2 waveforms will be on one screen. The trigger level for channel 1 will be set toward the top of the channel 1 waveform and the trigger level for channel 2 will be set toward the bottom of the channel 2 waveform. Proceed with the oscilloscope setup as follows:

1. Press **AUTO-SCALE**.
2. Set the screen to single by pressing the **Display** menu selection key, then press the **Screen** function selection key until the inverse video label is **Single**.

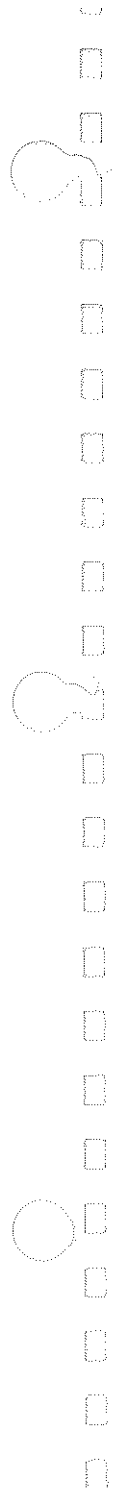

3. Set sweep speed to 5 ns/div by pressing the **Sweep** selection key, then rotate the knob until **Sweep Speed = 5.00 ns/div** is displayed above the waveform display area.

The displayed waveforms should now resemble the figure below.

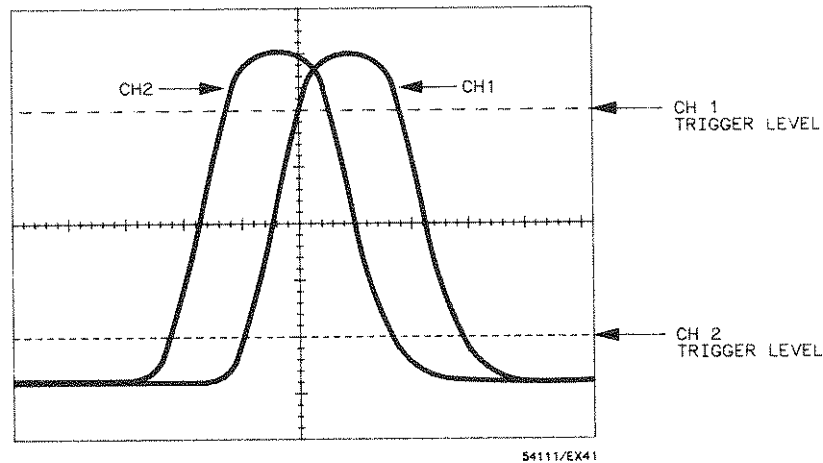

4. Set the channel 1 trigger level slightly below the crossing of the channel 1 and channel 2 waveforms by pressing the **Trigger** menu selection key, then the **TRIG LEVEL** function selection key. Rotate the knob until the channel 1 trigger level line is below the crossing of the waveforms. This trigger level value will be approximately 200 mV.
5. Set the channel 2 trigger level near the base of the waveforms by pressing the **Trig Src** function selection key, then rotate the knob until the value displayed is approximately 500 mV. The position of the trigger level lines is shown in the figure above.

Edge Trigger Mode

Now we can observe the oscilloscope triggering in the edge mode.

1. Select channel 1 as the trigger source by pressing the **Trg Src** function selection key until **Chan 1** is displayed.

Notice that the channel 1 signal crosses the trigger level line at the center line of the display. The center line of the display is time zero (trigger point) and you have set up the trigger on the positive-edge crossing of the channel 1 signal at the trigger level value.

2. Select **TRIG LEVEL** and rotate the knob. Observe that the waveform moves on the display in order to maintain the trigger point (where the positive-going waveform edge crosses the trigger level line) at center screen. If the trigger level is set above or below the waveform, the trigger is lost.

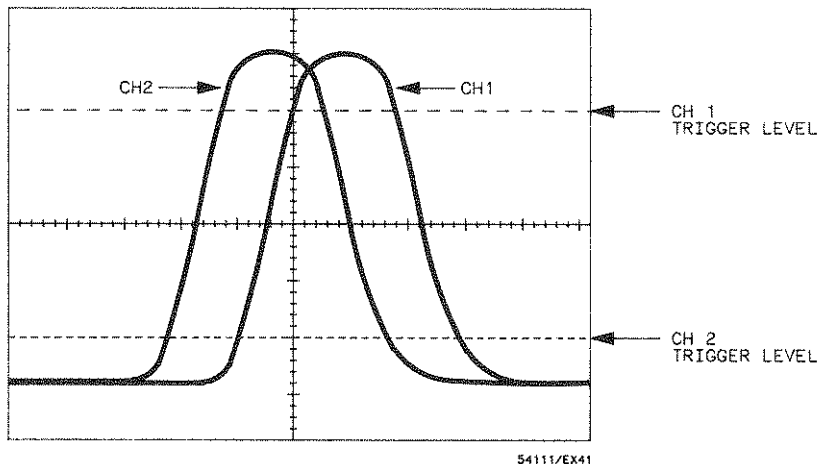

3. Return the trigger level to its original value (approximately 200 mV).
4. Change the trigger slope to negative by pressing the **Slope** function selection key.

The trigger is now produced when the negative-going edge of channel 1 crosses the trigger level line of channel 1.

5. Reset the trigger slope to positive.

6. Set the trigger source to channel 2 by pressing the **Trig Src** function selection key.

Now the trigger is produced when the channel 2 signal crosses the trigger level value of channel 2 in the positive direction.

7. Change the trigger slope to negative and notice where the oscilloscope triggers.

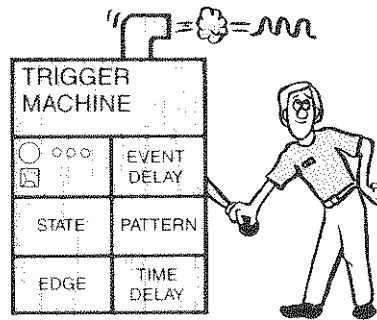

Introduction



Digitizing oscilloscopes with large memory capabilities enhance any single shot acquisition. Data that is captured can be manipulated and evaluated many times over, even if captured under destructive conditions. With the HP 54111D and two channel simultaneous acquisition you can capture over 16k points of data at one gigahertz. With the HP 54112D and four channel acquisition, you can capture 64k on each channel, or 256k points of data.

In this chapter you will capture a square wave signal with a single shot acquisition, learn to “pan” and “zoom” through the stored data and look at a single cycle. Then, you will look at the difference in memory capacities between the HP 54111D and the HP 54112D.

Setting Up the Signal Generator

Set the HP 8116A Pulse/Function Generator for a 5 MHz square wave signal of 2 volts. On this function generator the selections are active when the LED associated with that function is lighted.

1. Ensure the HP 8116A is set to NORM mode.
2. Set the pulse mode of the HP 8116A to the square wave function.
3. Set the HP 8116A to 5 MHz by pressing the FRQ key and pressing the Auto Vernier keys until 5 MHz is displayed.
4. Set the signal amplitude to 2 volts by pressing the AMP key, then Auto Vernier keys until 2.00 volts is displayed.
5. Ensure offset is still 0 by selecting the OFS key and verifying the setting is 0.
6. Press the DISABLE key on the function generator, if necessary, to enable the waveform output (disable light must be off).

2. Display a portion of captured memory by pressing the **DELAY** key, then rotating the knob. This time as the knob is rotated, notice that the memory bar marker waveform moves from center screen to show which portion of the total waveform is being displayed.

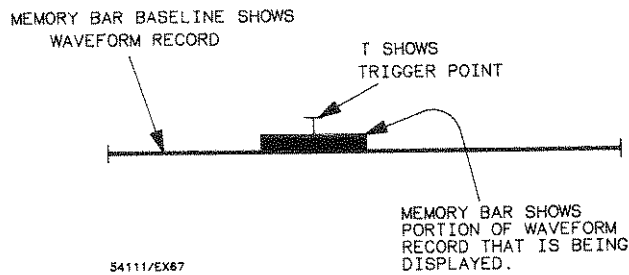

3. Display approximately two cycles of the waveform by using the pan (**DELAY**) and zoom (**TIME/DIV**) functions. Zoom (by turning the knob clockwise) until only two cycles are displayed.
4. Measure the frequency, period, positive pulse width, negative pulse width, rise time, and fall time of the displayed waveform by selecting the **Measure** menu and pressing the proper keys.

Display all the data that was captured by compressing the entire contents of memory. Use the following procedure:

5. Zoom (**TIME/DIV**) the display to $5 \mu\text{s}/\text{div}$. The oscilloscope is triggering on the first positive pulse on the left side of the display and has acquired 8k of data in the single-shot mode.
6. Measure the duration of the display using the **Delta t** technique discussed in chapter 9. The measurement should be approximately $20 \mu\text{s}$.
7. Press **RUN** to resume acquiring data.

Deep Memory

Deep, or extended memory, expands memory on the HP 54112D to 64k per channel simultaneously on all four channels. To illustrate this, use the function generator setup from the previous exercise.

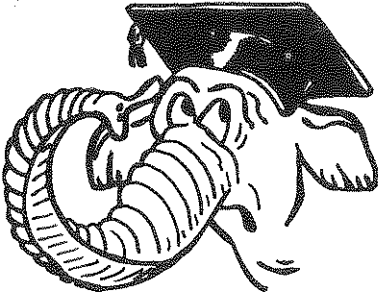

1. Select the 64k deep memory by pressing **Display** and then pressing the **Record Length** key. It should now display 64k in the inverse video window.
2. Press the **STOP/SINGLE** key to stop acquiring data.
3. Press the **CLEAR DISPLAY** key to erase all waveform data from the display.
4. Press the **STOP/SINGLE** key one time. The HP 54112D acquires all data single-shot.
5. Zoom (**TIME/DIV**) the display to 20 $\mu\text{s}/\text{div}$. The oscilloscope is triggering on the first positive pulse on the left side of the display and represents 64k of memory acquired in the single-shot mode.
6. Measure the duration of the display. The measurement should be approximately 160 μs .

If we compare the measurement made from the 8k acquisition to the measurement made on the HP 54112D at 64k, it is easy to recognize the deep memory capability.

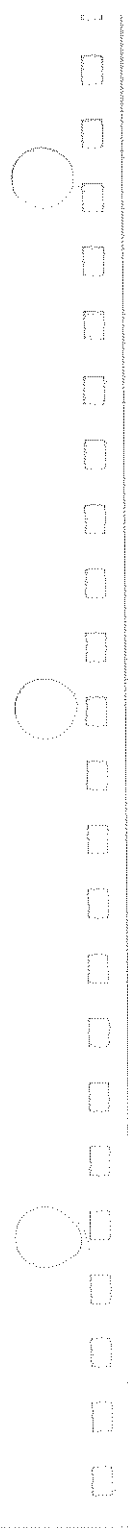

Setting Up the Oscilloscope

HP 54112D Digitizing Oscilloscope



Valuetronics International, Inc.
1-800-552-8258
MASTER COPY

© Copyright Hewlett-Packard Company 1987

Manual Part Number 54112D-90901
Microfiche Part Number 54112D-90801

Printed in U.S.A. September 1987



Introduction

The documentation for the HP 54112D Digitizing Oscilloscope has been separated into several manuals. The entire set of manuals is included when the instrument is shipped. Following is a brief description of each manual and its purpose:

This manual covers unpacking the oscilloscope, getting power to the oscilloscope, connecting the oscilloscope to a controller, and connecting the oscilloscope to other HP-IB instruments. Everyone should look this manual over to become familiar with the connections.

Next in the set of manuals is the *Getting Started Guide*. The *Getting Started Guide* will aid the user in learning the instrument. This manual discusses the basic operation and should be used after the installation is complete. The *Getting Started Guide* contains some tasks that can be performed in a short period of time that will get you familiar with the basic front-panel operation. Each of the tasks makes an actual setup or measurement. If you are a new oscilloscope user or are not familiar with this type of instrument, the tasks in this manual should be performed. If you are familiar with this type of instrument, you might want to skip this one.

The *Front-Panel Operation Reference* contains all the information required to operate the HP 54112D from the front panel. This manual contains information about each of the front-panel keys and menus. It also discusses the front- and rear-panel inputs and outputs. The *Front-Panel Operation Reference* contains some exercises and example measurements.

The *HP 54112D Programming Reference* contains the information to operate the HP 54112D over the Hewlett-Packard Interface Bus (HP-IB). This manual contains all bus commands, syntax diagrams, and programming examples. The *Programming Reference* is divided into operating subsystems. Most of the operating subsystems are related to one of the main front-panel menus.

The *HP 54112D Digitizing Oscilloscope Service Manual* contains the information required to test and repair the oscilloscope.

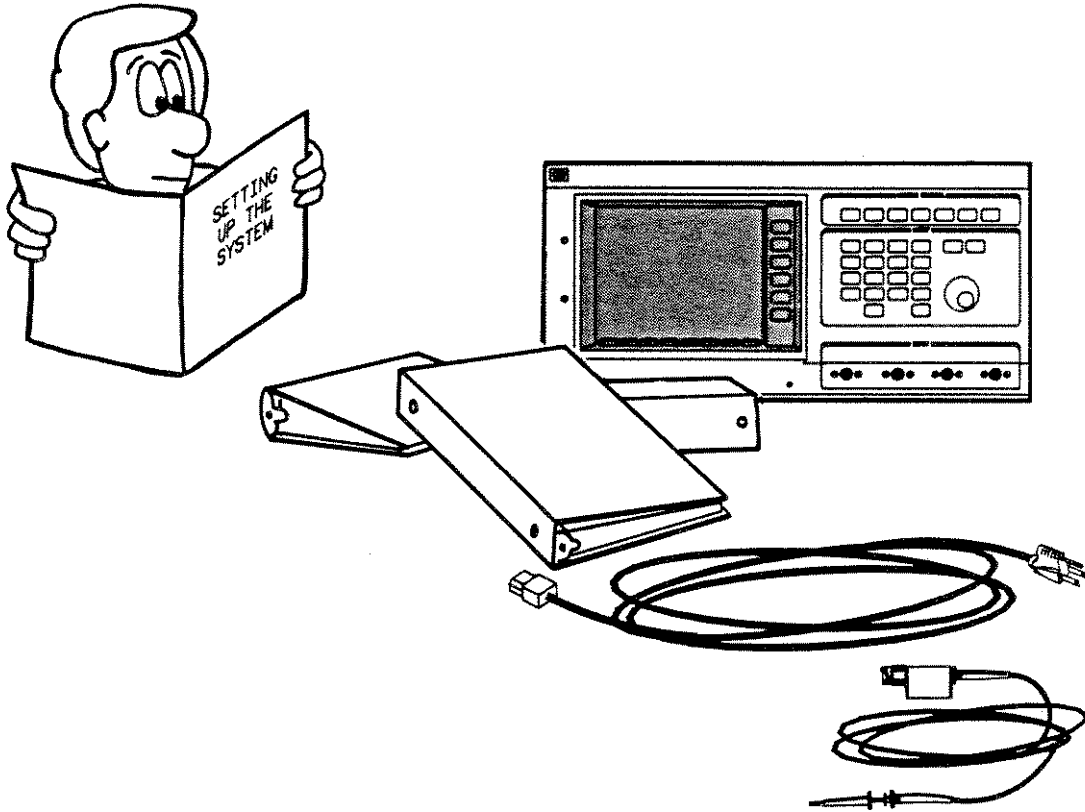

Table of Contents

Introduction

Chapter 1

Unpacking

- 1-1 Initial Inspection
 - 1-1 Contents of Shipment
-

Chapter 2

Operating Environment

Chapter 3

Applying Power

- 3-1 Selecting the Line Voltage
 - 3-2 Installing the Power Cord
 - 3-2 Safety Considerations
 - 3-3 Circuit Breaker and Line Switch
-

Chapter 4

Connecting to External Equipment

- 4-1 Connecting to a Controller
 - 4-2 Connecting to a Printer or Plotter
-

Chapter 5

What's Next?



1

Unpacking

Initial Inspection

Inspect the HP 54112D for damage that may have occurred during shipping. If any damage is apparent, do not apply power to the oscilloscope. If damage has occurred, refer to the *HP 54112D Service Manual* for instructions.

Contents of Shipment

The HP 54112D is supplied complete with the following:

- Four HP 10033A probes
- One power cable
- One *Setting Up the Oscilloscope* booklet
- One *Getting Started Guide*
- One *Front-Panel Operation Reference*
- One *Programming Reference*
- One *Service Manual*
- One *Feeling Comfortable with Digitizing Oscilloscopes*



2

Operating Environment

If the HP 54112D is being used in a normal office or laboratory environment, it must have proper ventilation. To ensure proper ventilation, allow at least two inches on the top, left side, and rear for air to move freely.

If the oscilloscope is being operated in other than a normal environment, refer to the instrument specifications in the *Front-Panel Operation Reference*.



3

Applying Power

Selecting the Line Voltage

Using a flat blade screwdriver, set the slide switch on the rear of the oscilloscope to the proper line voltage (115 V or 230 V displayed) for your area.

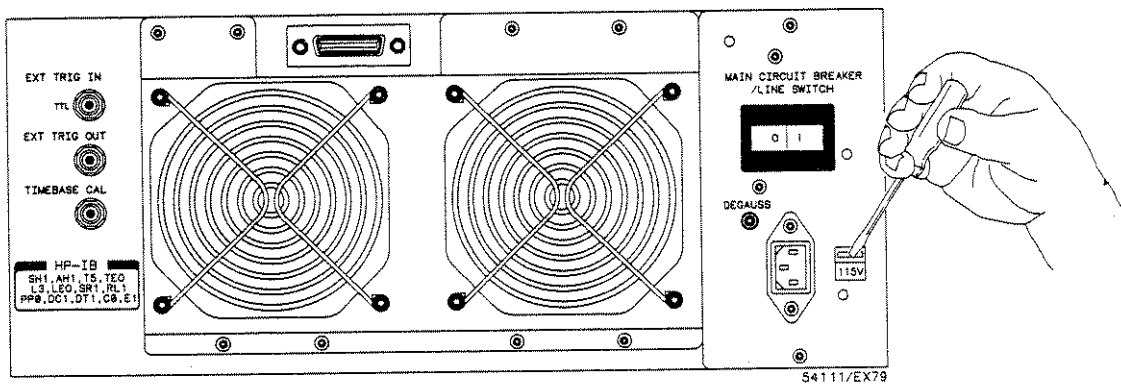

Installing the Power Cord

Ensure the slide switch on the rear panel is in the proper voltage setting (115 V or 230 V). Install the power cord to the oscilloscope, then plug into a three-prong grounded outlet to ensure proper instrument grounding.

Safety Considerations

The HP 54112D is a Safety Class 1 instrument (instrument with an exposed metal chassis that is directly connected to earth via the power supply cable).

WARNING

Before energizing this unit, you must ensure that the chassis of the instrument is properly grounded. This precaution is to avoid the possibility of electrical shock which may result if the protective ground is defeated.

The HP 54112D is provided with a 3-prong power cable. When this cable is connected to an appropriate AC power receptacle it provides a ground for the instrument chassis.

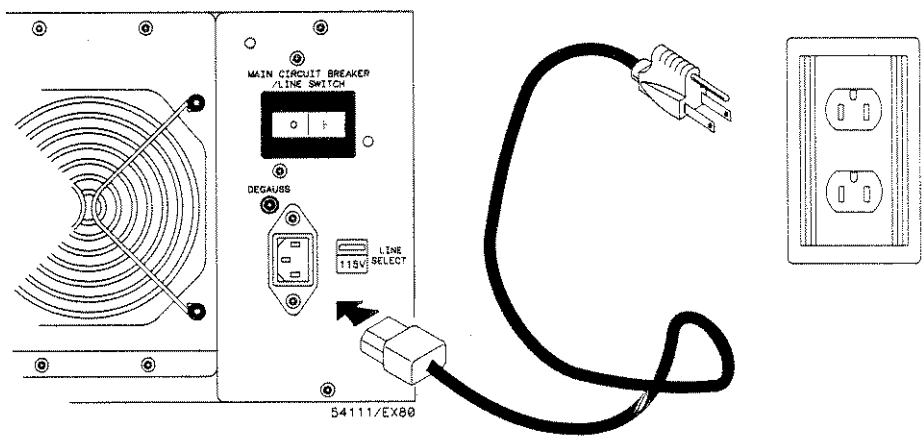

Circuit Breaker and Line Switch

The circuit breaker on the rear panel provides overload protection for the oscilloscope. If an overload condition does occur, the circuit breaker will open and remove power from the instrument. The circuit breaker must be in the on position (1 is pressed) in order for the instrument to operate. The power switch on the front of the instrument also must be ON for the instrument to operate.

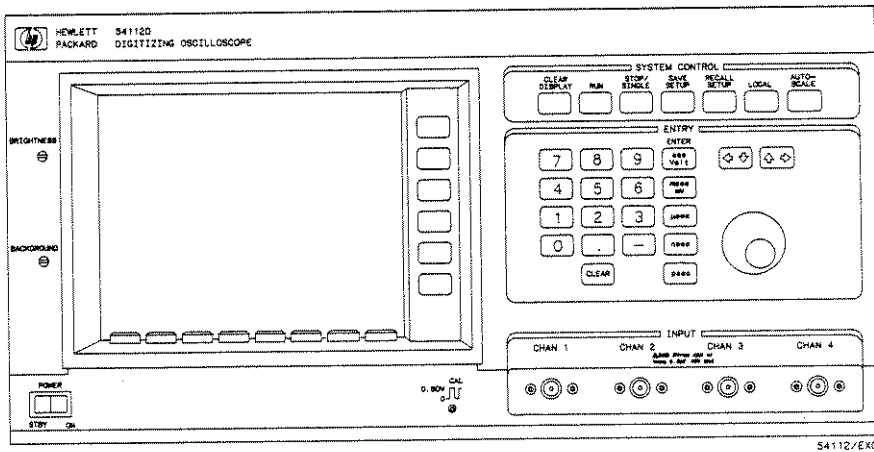
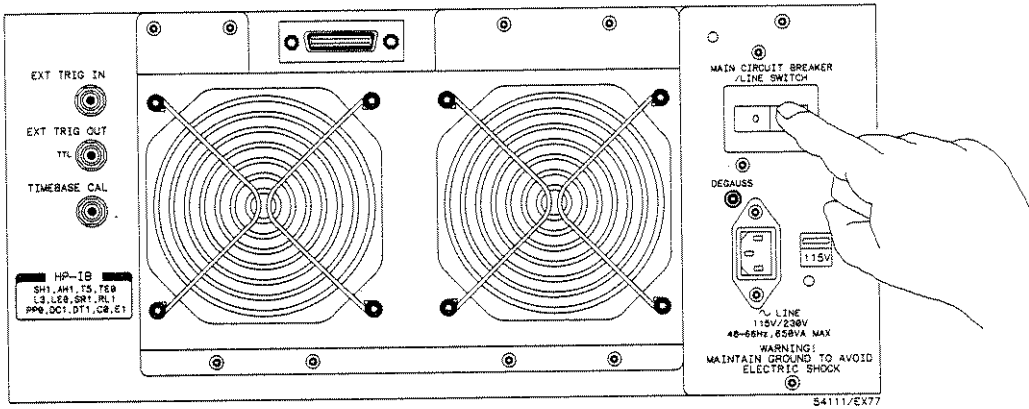



4

Connecting to External Equipment

Connecting to a Controller

The oscilloscope can be connected to a controller via the HP-IB by simply installing an HP-IB cable between the two units. The oscilloscope can be in any of three HP-IB operating modes:

- **Talk Only** - In this mode the oscilloscope can output data; it cannot receive commands or setups.
- **Listen Only** - In this mode the oscilloscope can receive commands and setups; it cannot output data or measurement results.
- **Talk/Listen** - In this mode bi-directional communication will result; the oscilloscope can receive commands and setups from the controller and output data and measurement results.

Refer to the *Front-Panel Operation Reference* for instructions on how to change the HP-IB operating mode.

Connecting to a Printer or Plotter

The HP 54112D can be connected to a printer or plotter either with or without a controller. If a controller is used, the printer or plotter is connected with an HP-IB cable. It may then be operated under program control by the controller. If the printer or plotter is used without a controller, the oscilloscope becomes the controller for the printer or plotter.

When operating a printer or plotter without a controller, the oscilloscope's HP-IB mode must be set to Talk Only. When operating in this mode the plotter or printer may be in Listen or Listen Always, and can be set to output a service request (SRQ). Refer to your printer or plotter manual for these settings.

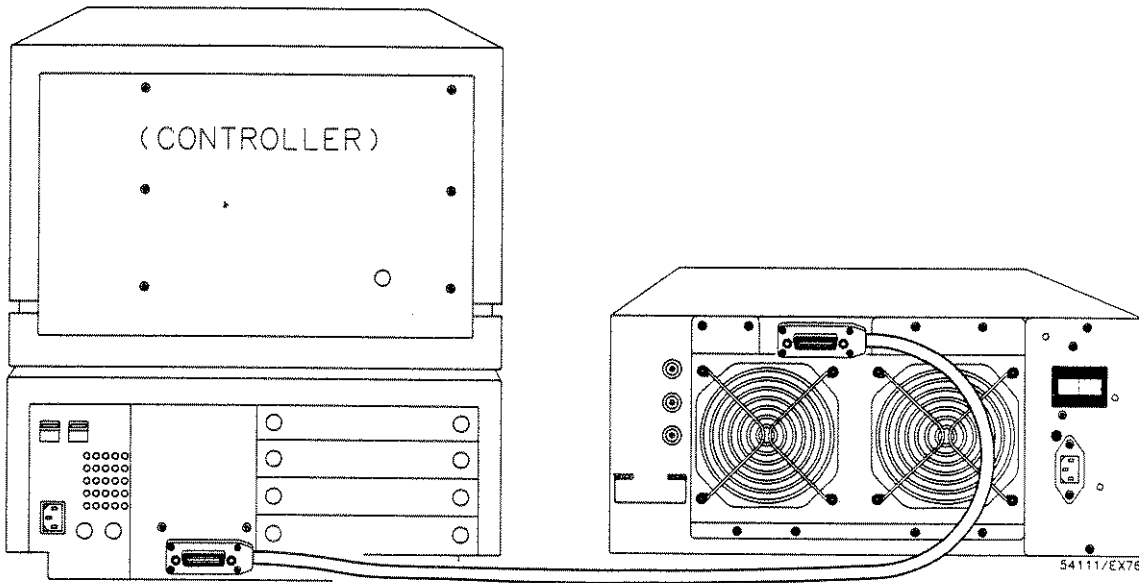

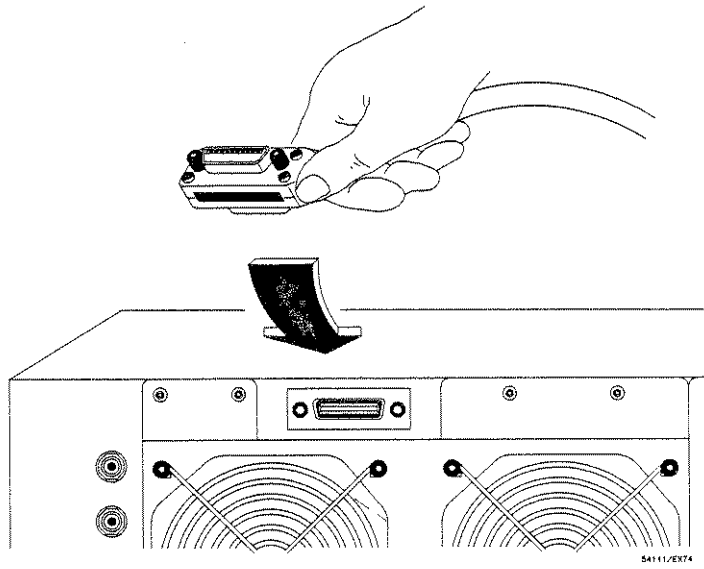
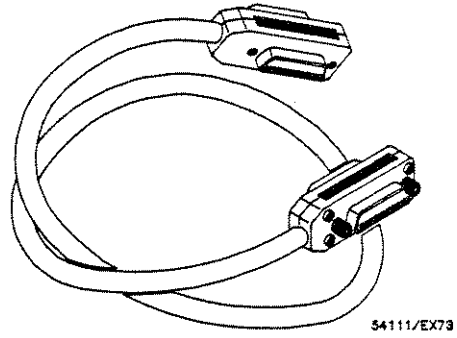
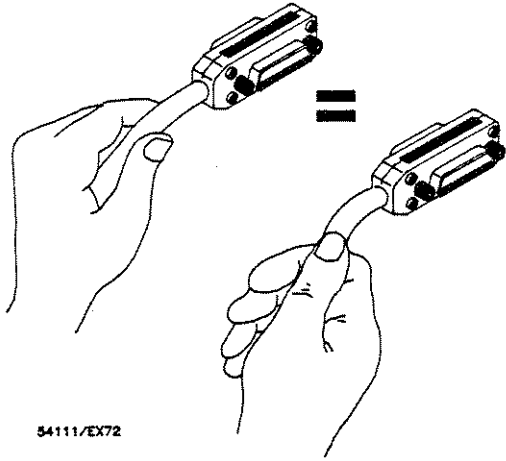



5

What's Next?

Now that you have the instrument unpacked, inspected and operating, your next step depends on your own needs. If you are a first time digitizing oscilloscope user you should now read the *Getting Started Guide*. If you are familiar with digitizing oscilloscopes, you will want to read either the *Getting Started Guide* or the *Front-Panel Operation Reference* depending on your knowledge of HP digitizing oscilloscopes.

The *Getting Started Guide* will introduce the operating features of the HP 54112D and teach you to use the menus, entry devices, and system control keys. Included in this manual are some actual measurements for you to make using the features of the HP 54112D.

The *Front-Panel Operation Reference* is your complete guide for front-panel operation. You will use this book for operating the HP 54112D to its full capabilities after you feel comfortable with the basic front-panel operation.

Feeling Comfortable with Digitizing Oscilloscopes is an introduction to the measurement techniques and capabilities provided by this new breed of oscilloscopes. This booklet compares digitizing scopes with their analog counterparts to help you understand the benefits and uses of your new instrument.

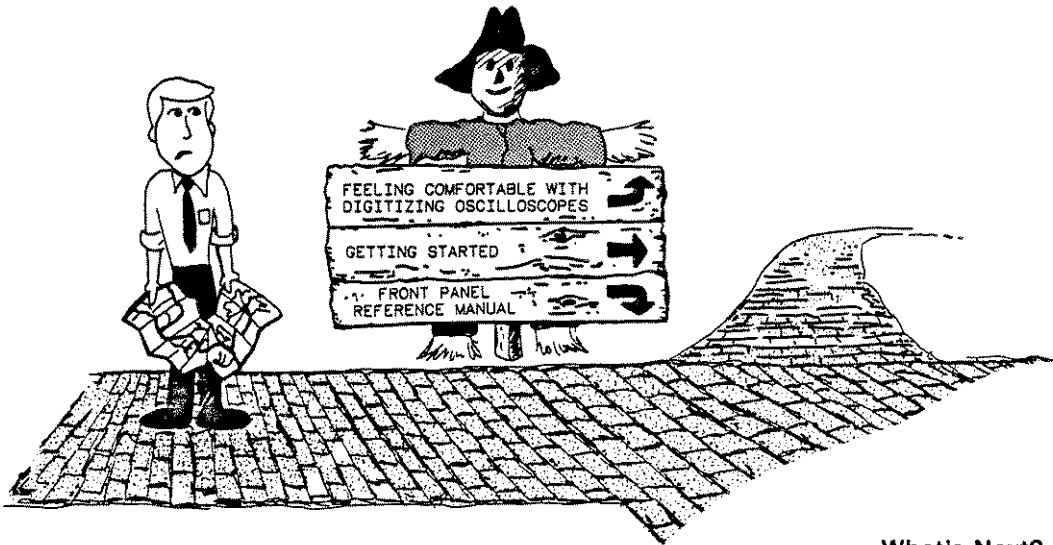

What's Next?

5-1



.....

.....

.....

.....

Front-Panel Operation Reference

HP 54112D Digitizing Oscilloscope



© Copyright Hewlett-Packard Company 1987

Manual Set Part Number 54112-90901
Microfiche Part Number 54112-90801

Printed in U.S.A. September 1987

Printing History

First Edition September 1987

Printed in U.S.A.



Table of Contents

Chapter 1: Introducing the HP 54112D Digitizing Oscilloscope

- 1-1 Introduction
 - 1-1 Special Features
-

Chapter 2: Basic Setup

- 2-1 Chapter Contents
 - 2-1 Operating Environment
 - 2-2 Power Requirements
 - 2-2 Applying Power
 - 2-4 Initial Color Display Setup
 - 2-4 List of Accessories
-

Chapter 3: Front-Panel Overview

- 3-1 Chapter Contents
 - 3-1 Front-Panel Organization
 - 3-1 System Control
 - 3-7 Entry Devices
 - 3-8 Display and Selection
 - 3-9 Input Selection
-

Chapter 4: Channel Menus

- 4-1 Chapter Contents
- 4-2 Display Key
- 4-2 Volts/Div Key
- 4-2 Offset Key
- 4-3 Preset Key
- 4-3 Input Coupling Key

Table of Contents (Continued)

Chapter 5:

Timebase Menu

- 5-1 Chapter Contents
 - 5-1 Time/Div Key
 - 5-3 Delay Key
 - 5-3 Delay Ref at Key
 - 5-4 Auto/Trg'd Sweep Key
-

Chapter 6:

Trigger Menu

- 6-1 Chapter Contents
 - 6-1 How The Trigger Modes Overlap
 - 6-2 Edge Trigger
 - 6-3 Pattern Trigger
 - 6-4 Pattern Trigger Exercise
 - 6-9 State Trigger
 - 6-10 State Trigger Exercise
 - 6-14 Time Trigger
 - 6-15 Time Delay Trigger Exercise
 - 6-18 Event Trigger
 - 6-19 Event Delay Trigger Exercise
-

Chapter 7:

Display Menu

- 7-1 Chapter Contents
- 7-2 Display Mode Key
- 7-4 Memory Bar Exercise
- 7-7 Screen Key
- 7-7 Graticule Key
- 7-8 Zoom and Pan Exercise

Table of Contents (Continued)

Chapter 8:

Delta V Menu

- 8-1 Chapter Contents
 - 8-1 V Markers
 - 8-3 Preset Levels Key
 - 8-3 Auto Level Set Key
 - 8-4 Source-to-Source Voltage Measurement Exercise
-

Chapter 9:

Delta t Menu

- 9-1 Chapter Contents
 - 9-2 Start and Stop Markers
 - 9-2 Start and Stop On Edge Keys
 - 9-3 Edge Find Key
 - 9-3 Time-Interval Measurement
-

Chapter 10:

Waveform Save Menu

- 10-1 Chapter Contents
 - 10-2 Waveform Memory Selection
 - 10-3 Real-Time Waveform Memories
 - 10-4 Repetitive Waveform Memories
 - 10-4 Pixel Memories
-

Chapter 11:

Waveform Math Menu

- 11-1 Chapter Contents
- 11-2 Function Menu
- 11-3 Waveform Math Exercise

Table of Contents (Continued)

Chapter 12:

Measure Menu

- 12-1 Chapter Contents
 - 12-1 Measure Key
 - 12-3 Repeat Key
 - 12-3 All Key
-

Chapter 13:

Hardcopy Menu

- 13-1 Chapter Contents
 - 13-2 Setting Up The System
 - 13-3 Printer Menu
 - 13-4 Plotter Menu
-

Chapter 14:

Utility Menu

- 14-1 Chapter Contents
 - 14-1 Probe Menu
 - 14-3 HP-IB Menu
 - 14-4 Cal Menu
 - 14-5 Vertical Cal
 - 14-6 Probe Tip Cal
 - 14-7 Offset Cal
 - 14-8 Trigger Cal
 - 14-9 Timebase Cal
 - 14-10 Color Menu
-

Chapter 15:

Specifications/Characteristics

- 15-1 Introduction
- 15-2 Vertical (Voltage)
- 15-3 Horizontal (Time)
- 15-4 Triggering

Table of Contents (Continued)

15-5	Trigger
15-5	Display
15-6	Environmental Conditions
15-6	Power Requirements
15-6	Weight

Appendix A

Automatic Parametric Measurements

A-1	Introduction
A-1	Measurement Setup
A-1	Making Measurements
A-1	Automatic Top-Base
A-2	Measurement Algorithms
A-2	Frequency
A-2	Period
A-2	Duty Cycle
A-3	Positive Pulse Width
A-3	Negative Pulse Width
A-3	Risetime
A-3	Falltime
A-3	Peak-to-Peak Voltage
A-4	RMS Voltage
A-4	Average Voltage
A-4	Preshoot
A-4	Overshoot



1 Introducing the HP 54112D Digitizing Oscilloscope

Introduction

The Hewlett-Packard 54112D digitizing oscilloscope provides a 400 megasample/second digitizing rate, full HP-IB programmability, four channels with 64k bytes per channel memory, and a powerful feature set for a wide range of applications.

Not only does the HP 54112D allow you to make four-channel simultaneous, high speed single-shot acquisition, but its extensive feature set makes it useful as a general-purpose oscilloscope.

For extensive waveform evaluation, the HP 54112D provides four 64k deep memories that can be viewed and measured. In addition, such easy-to-use features as zoom, pan and automated measurements are available at the press of a key.

Special Features

- 400 megasample/second digitizing rate
- 100 megahertz bandwidth in both repetitive and real-time modes
- 64k or 8k selectable memory per channel
- 8 waveform memories and 2 pixel memories
- Four-channel simultaneous capture at the full digitizing rate
- Pre- and post-trigger viewing capability
- Automatic triggering and display scaling
- Automatic waveform measurements with continuous update
- Waveform math functions
- 10 front-panel setup save and recall registers
- General-purpose input coupling
- Digital triggering capabilities
- Full color display
- Hardcopy output to printer or plotter
- Fully programmable over the HP-IB

2

Basic Setup

Chapter Contents

This chapter contains a review of the power requirements, operating environment, and initial color display setup, as well as a list of accessories provided with the instrument.

WARNING

It is important that you provide the correct power source and operating environment for this instrument. Failure to do this can cause serious damage to the instrument and be a health hazard to the user.

Operating Environment

CAUTION

Ensure that the instrument has adequate clearance on all surfaces to provide sufficient air flow for cooling. Do not block any of the vent holes on the fans' air inlet.

The operating environment must be maintained within the following parameters:

Temperature 0 degrees C to 45 degrees C
Humidity <95% up to 40 degrees C
Altitude <4600 metres (15 000 feet)

The instrument should be protected from temperature extremes that would cause condensation in the instrument.

Power Requirements

The HP 54112D requires a power source of 115 or 230 Vac +15/-25%; 48-66 Hz single phase. Power consumption is approximately 350 watts maximum or 700 VA maximum. A screwdriver may be used to change the position of this switch.

CAUTION

Before connecting this instrument to the ac power source, ensure that the line select switch on the rear panel of the instrument is set to the correct voltage. This will avoid damage to the instrument.

Applying Power

The HP 54112D can be turned on after you have selected the correct setting on the line select switch, installed the appropriate power cord, and connected it to the power outlet. The circuit breaker trip current is 7.5 amps. The HP 54112D has two switches that can interrupt the power to the instrument. The first is the (main) power breaker, the second is the STBY switch:

- the main breaker is located in the upper right-hand corner of the rear panel.
- the STBY switch is located in the lower left-hand corner of the front panel.

If the front-panel power switch is in the STBY position or if the main breaker is in the OFF or "0" position, the HP 54112D will not function.

WARNING

If the main breaker is in the ON or "1" position, electrical current is present inside the HP 54112D. This current could cause electrical shock and personal injury.

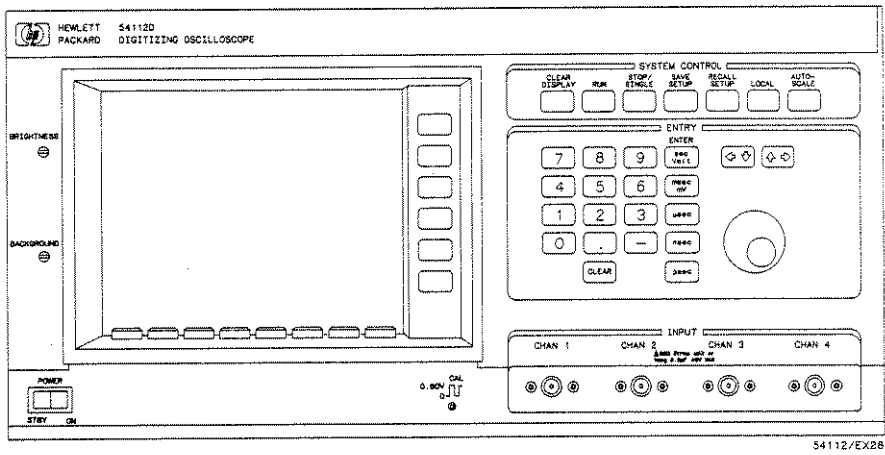

Figure 2-1. HP 54112D Front Panel

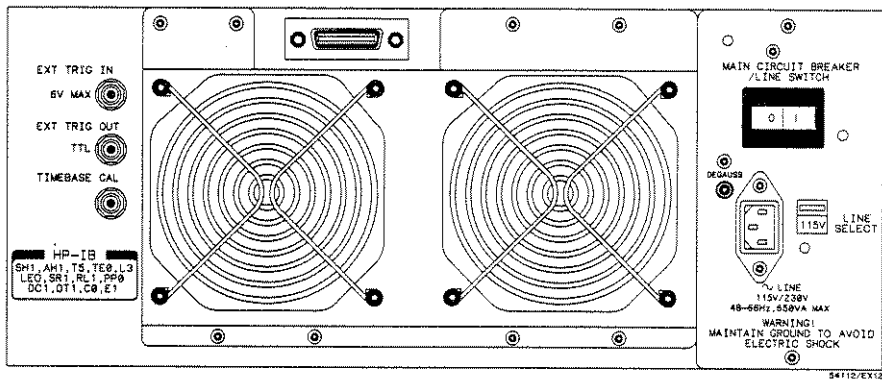

Figure 2-2. HP 54112D Rear Panel

Initial Color Display Setup

The HP 54112D's electromagnetic color display may require degaussing (i.e., demagnetizing) at installation, or later if necessary. To facilitate this, the display section contains a degaussing coil. The degaussing switch is located on the rear panel of the power panel. To degauss the CRT, press this switch several times.

Two screwdriver adjust controls for brightness and background are located on the front panel, to the left of the CRT. The background control sets the luminosity of the background of the CRT. The brightness control sets the gain of the Z axis (i.e., controls the intensity of the information displayed on the CRT). Adjust these controls to a comfortable setting.

List of Accessories

In addition to any optional accessories you may have ordered, the HP 54112D is shipped with the following:

- four HP 10033A 10:1 miniature probes
- one power cable
- one operating manual, consisting of the following books:
 - *Setting Up the Oscilloscope*
 - *Getting Started Guide*
 - *Front-Panel Operation Reference*
 - *Programming Reference Manual*
 - *Feeling Comfortable with Digitizing Oscilloscopes*
 - *Service Manual*

3

Front-Panel Overview

Chapter Contents

This chapter describes the functional areas of the front panel and the use of all the single function keys.

Front-Panel Organization

The HP 54112D has been designed to be very easy to use. To this end, its front panel is separated into four functional areas. These are:

- System Control
- Entry Devices
- Display and Selection
- Input

You have complete local control of the instrument with these four areas.

System Control

The SYSTEM CONTROL keys are located along the top right half of the front panel. These keys control acquisition, dynamic display, SAVE and RECALL SETUP registers, and automatic display scaling.

HP 54112D's fourteen menus. Each menu has its own section in which it is discussed in full.

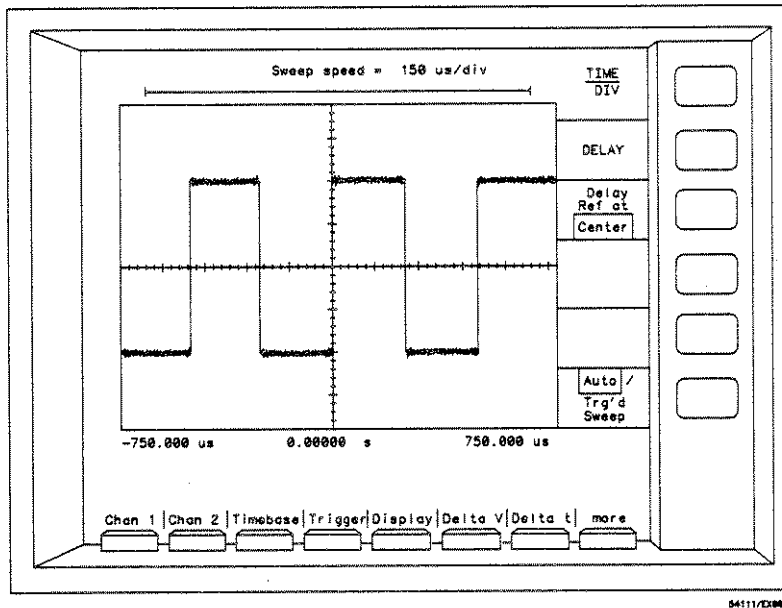

Figure 3-1. System Control Keys.

Clear Display Key Pressing the CLEAR DISPLAY key:

- causes the HP 54112D to momentarily stop acquiring data, erase the screen, and then resume acquiring data;
- erases the dynamic (active) display;
- does not erase a stored waveform that is being displayed;
- if the STOP/SINGLE key is pressed before the CLEAR DISPLAY key is pressed:
 - the screen remains clear and waveform acquisition does not resume until the RUN or single key is pressed.

- press the STOP/SINGLE key, then the CLEAR DISPLAY key, and then press the STOP/SINGLE key a second time.

If you have selected a high number of averages (repetitive display mode**) and you change the input signal:

- you can quickly set the average registers to the new signal levels by pressing the CLEAR DISPLAY key.

This saves the time that the display normally requires to settle to the new signal levels in the average mode.

Run Key Pressing the RUN key:

- causes the HP 54112D to resume acquiring data after acquisition has been stopped by the STOP/SINGLE key.

Stop/Single Key When the STOP/SINGLE key is pressed:

- the instrument stops acquiring data and displays the most recent data. Each subsequent STOP/SINGLE key press arms the instrument to make a single acquisition at the next trigger event. To return to the previous operating mode, press the RUN key.

In the repetitive display mode**, pressing the STOP/SINGLE key:

- erases the active display if you change the value of TIME/DIV, VOLTS/DIV, or any other front-panel control that rescales the displayed waveform (i.e., works as if the CLEAR DISPLAY key had been pressed).

In the real-time display mode**, pressing the STOP/SINGLE key:

- allows you to use the Timebase menu's TIME/DIV and DELAY functions to change the display.
 - TIME/DIV allows you to change the sweep speed (zoom).
 - DELAY allows you to pan the captured signal (scroll).

** The real-time and repetitive display are discussed in Chapter 7, "Display Menu."

Setup Keys front-panel setups in non-volatile memory. To save the current front-panel setup in one of the SAVE and RECALL SETUP registers:

- press SAVE SETUP, then press the number (0-9) of the register desired.

This saves all front-panel functions, modes, and color selections. This does not save menu selection and entry device assignments.

Table 3-1. Values That Can Be Saved and Recalled.

Channel 1/Channel 2/ Channel 3/Channel 4:	Display VOLTS/DIV OFFSET Input Coupling Input Impedance
Timebase:	TIME/DIV DELAY Delay Reference Auto/Triggered Sweep
Trigger:	Mode Edge Mode - All Parameters Pattern Mode - All Parameters State Mode - All Parameters Time Mode - All Parameters Events Mode - All Parameters
Display:	Mode Averaging (Repetitive Mode) Number of Averages (Repetitive Mode) DISPLAY TIME (Averaging) Record Length Filter Screen Graticule
Delta V:	V Markers MARKER POSITIONS Marker Sources Preset/Variable Levels
Delta t:	t Markers START/STOP MARKER positions Edge Slopes Edge Numbers

Wfm Save:	Display (for each MEMORY) Source for Store (WAVEFORM MEMORIES)
Wfm Math:	Functions On/Off Function Definitions
Measure:	Source
Hardcopy:	Device Print Display (Printer) Print Factors (Printer) Form Feed (Printer) Auto Pen (Plotter) Pen Speed (Plotter)
Utility:	Probe Attenuation Factor Color Settings

Note

The display does not change when you press SAVE SETUP. It does put the advisory, "Setup Saved," on the screen.

Pressing SAVE and RECALL SETUP does not cause execution of action keys.

To recall a previously saved front-panel setup:

- Press RECALL SETUP, then press the number (0-9) of the desired register.
The advisory "Setup recalled" will be displayed on screen.

To return to the condition that existed before the last Auto-Scale:

- press RECALL SETUP, then press AUTO-SCALE.

To cancel a SAVE and RECALL SETUP:

- press the CLEAR key before entering a 0-9 number.

- an RTL (return to local) message is sent to the HP-IB interface, and the instrument returns to local (front-panel) control if it was under remote control and if the HP-IB controller did not invoke a local lockout.

The LOCAL key is the only front-panel key that is active when the HP 54112D is under remote operation.

Auto-Scale Key When the AUTO-SCALE key is pressed:

- the HP 54112D automatically selects the vertical sensitivity, vertical offset, trigger level, and sweep speed needed to display input signals that are present.
- the HP 54112D sets itself to a known state by setting the delay reference to center screen, and delay to 0.

If input signals are present at all vertical inputs:

- the sweep is triggered on channel 1;
- the display goes to the quad-screen mode;
- the vertical sensitivity and vertical offset for each channel are scaled appropriately.

If only one of the vertical inputs has a signal on it:

- the display is in the single-screen mode.

When the AUTO-SCALE cycle is complete:

- the Timebase menu and TIME/DIV function are selected.

Entry Devices

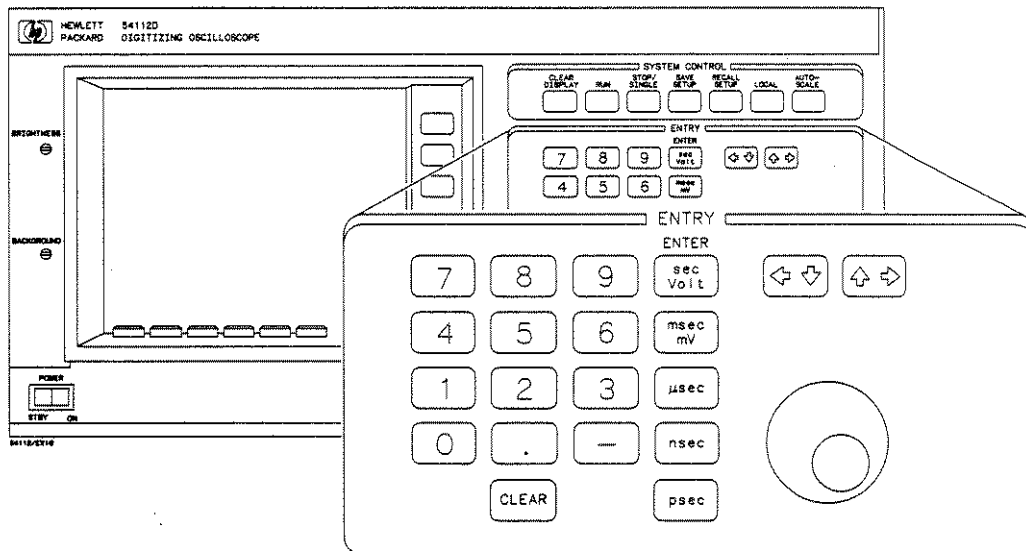

Figure 3-2. Entry Devices.

Under the SYSTEM CONTROL keys is an area labeled ENTRY. In this area of the front panel are the entry devices, which include:

- a number pad with a vertical column of five ENTER keys — after you enter a number, you must press one of the ENTER keys
- a knob
- an increment and a decrement key (step keys)

The entry devices are used to change the value of any of the items in the function menus that are displayed in capital letters (e.g., VOLTS/DIV and TIME/DIV).

Display and Selection

Wfm Save	Wfm Math	Measure	Delta V	Delta t	Hardcopy	Utility	more
Chan 1	Chan 2	Chan 3	Chan 4	Timebase	Trigger	Display	more

54112/BL13

Figure 3-3. Menu Selection.

The display and selection section contains the CRT, two manual adjustments, menu selection keys, and function selection keys.

The two manual adjustments are located to the left of the display. These are the brightness and background adjustments. Adjust them to a comfortable viewing level.

The HP 54112D provides two sets of softkeys that enable you to control the instrument's front panel. They are the menu and function selection keys.

The first set (menu selection) is located across the bottom of the CRT:

- menu selection keys are used to choose a desired function menu;
- pressing a menu selection key changes the function select keys;
- pressing the more key (the key furthest right) provides an additional set of menu selections;
- pressing the more key a second time returns you to the original menu.

The second set (function selection) is located on the right side of the CRT:

- some function keys are displayed in inverse video.
 - when they are pressed, the text in inverse video changesExample: pressing the top key when you're in the Trigger menu allows you to choose one of five trigger modes.

used to change the value of that function, and the value is displayed in the top center of the CRT.

Example: pressing the TIME/DIV key when you're in the Timebase menu allows you to enter the sweep speed at which you want the input signal displayed.

- some function keys are displayed with the first letter of each word capitalized and the other letters lowercase.
 - when pressed, the function executes immediately.

Example: pressing the All key in the Measure menu causes the oscilloscope to perform twelve parametric measurements on the designated waveform.

Note

If the function select key allows you to select a waveform source, the text of the selected source is the same color as the source's waveform. For example, if the default colors are used, text relating to channel 1 is yellow, text relating to channel 2 is green, text relating to channel 3 is tangerine, and text relating to channel 4 is pink.

Input Selection

This instrument has four vertical inputs and one trigger input. All inputs have selectable input coupling and impedance. Each input's coupling and impedance can be set to ac at 1 M Ω , dc at 1 M Ω , dc at 50 Ω .

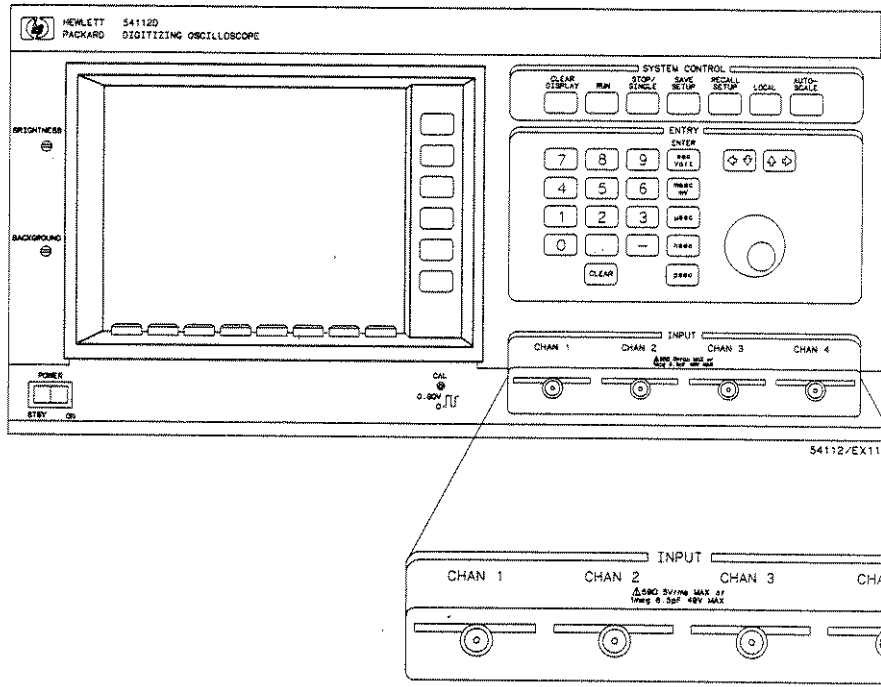

Figure 3-4. Input Selection.

4

Channel Menus

Chapter Contents

The Channel menus allow you to control the vertical operation of the display, as well as some of the HP 54112D's easy-to-use features. This chapter describes how these menus are used to control the vertical display, including vertical scaling and offset.

All four menus are identical except for references to the specific channels.

When you select a channel, either OFFSET or VOLST/DIV is highlighted, indicating that the function can be changed with any of the entry devices.

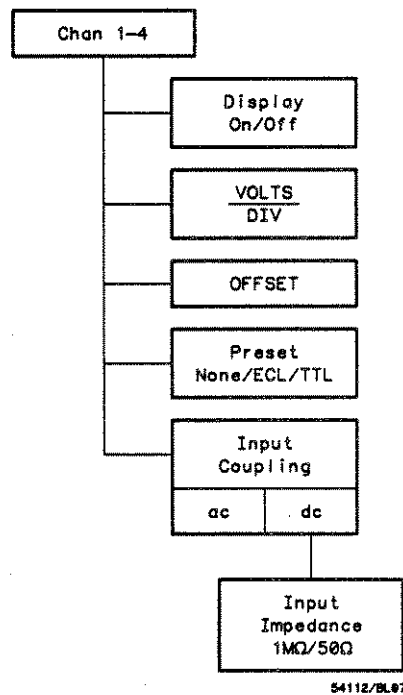

Figure 4-1. Channel Menu.

Display Key

Pressing the Display key causes the selected channel signal to be displayed or to not be displayed. The signal of each channel may be turned on or off, independent of any other channel. This allows you to use any number of channels at any one time.

In the real-time mode, although this key turns off the display for a particular channel, it does not stop that channel from acquiring data. In both real-time and repetitive modes, turning off the channel increases throughput slightly because there is no post-processing of data.

Volts/Div Key

When the VOLTS/DIV key is selected, the vertical sensitivity can be changed with one of the three entry devices as follows:

- The number pad and appropriate units keys set sensitivity to three-digit resolution.
- Turning the knob clockwise increases sensitivity in a 3-2-1 sequence and turning the knob counterclockwise decreases sensitivity in a 1-2-3 sequence.
- The increment/decrement (step) keys change sensitivity in a 1-2-5 sequence.

Offset Key

OFFSET allows you to move the displayed signal up or down. All of the entry devices control the offset.

This function works much the same as an analog oscilloscope's vertical position control. However, the HP 54112D has a true dc offset on the front end and provides a much wider offset range. The OFFSET voltage (referenced to the center of the waveform display area) is shown at the top of the waveform display area.

When the HP 54112D is not displaying current data, as in the stopped mode, any change in the offset will cause offset on the screen to be displayed in inverse video.

Preset Key

The Preset key allows for three choices:

- When ECL is selected, the HP 54112D automatically sets the offset to -1.3 V, the volts/div* to 200 mV, the trigger level to -1.3 V, and the input coupling to dc.
- When TTL is selected, the HP 54112D automatically sets the offset to 1.6 V, the volts/div* to 1 V, the trigger level to 1.6 V, and the input coupling to dc.
- When None is selected, the HP 54112D is automatically set to its previous settings.

To select the desired preset, press the Preset key until your desired setting is displayed in the inverse video window.

**These values are for a single-screen display; appropriate values are used for dual and quad screens.*

Input Coupling Key

Input coupling may be set to any of the following:

- When ac is selected, the default input impedance is $1\text{ M}\Omega$.
- When dc is selected, the bottom key on the function menu is activated, permitting the selection of $1\text{ M}\Omega$ or $50\ \Omega$.



5

Timebase Menu

Chapter Contents

This chapter describes how the Timebase menu works. The TIME/DIV, DELAY, and Delay Reference keys are available in this menu. The Timebase menu allows you to control the horizontal display. This menu also allows you to select a triggered function.

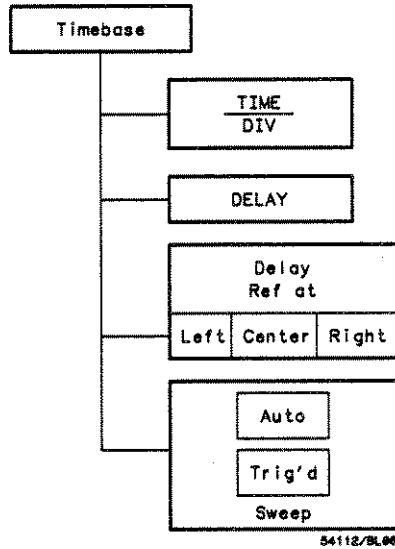

Figure 5-1. Timebase Menu.

Time/Div Key

The TIME/DIV key allows you to vary the time scale on the horizontal axis from 2 ns/div to 1 s/div. All of the entry devices control the Timebase menu and can be used in the following manner:

sensitivity with up to three digits of resolution.

- The knob changes the sweep speed in a 1-2-5 sequence.
- The increment/decrement keys change the sweep speed in a 1-2-5 sequence.

Changing the sweep speed in this menu will also change the sample rate. The sample rate is displayed to the right of the sweep speed, above the waveform display area. In the stopped mode, if any acquisition parameters are changed, the displayed rate will not change; however, the sampling rate will be displayed in inverse video.

The sweep speed corresponds to the sample rate in the following manner:

Sweep speed	Sample rate	64k Memory	8k Memory
2 ns/div — 249 ns/div	400 megasample/s	160 μ s	20 μ s
250 ns/div — 499 ns/div	200 megasample/s	320 μ s	40 μ s
500 ns/div — 999 ns/div	100 megasample/s	640 μ s	80 μ s
1 μ s/div — 1.99 μ s/div	50 megasample/s	1.28 ms	160 μ s
2 μ s/div — 4.99 μ s/div	25 megasample/s	2.56 ms	320 μ s
5 μ s/div — 9.99 μ s/div	10 megasample/s	6.4 ms	800 μ s
10 μ s/div — 19.9 μ s/div	5 megasample/s	12.8 ms	1.6 ms
20 μ s/div — 49.9 μ s/div	2.5 megasample/s	25.6 ms	3.2 ms
50 μ s/div — 99.9 μ s/div	1 megasample/s	64 ms	8 ms
100 μ s/div — 199 μ s/div	500 kilosample/s	128 ms	16 ms
200 μ s/div — 499 μ s/div	250 kilosample/s	256 ms	32 ms
500 μ s/div — 999 μ s/div	100 kilosample/s	640 ms	80 ms
1 ms/div — 1.99 ms/div	50 kilosample/s	1.28 s	160 ms
2 ms/div — 4.99 ms/div	25 kilosample/s	2.56 s	320 ms
5 ms/div — 9.99 ms/div	10 kilosample/s	6.4 s	800 ms
10 ms/div — 19.9 ms/div	5 kilosample/s	12.8 s	1.6 s
20 ms/div — 49.9 ms/div	2.5 kilosample/s	25.6 s	3.2 s
50 ms/div — 99.9 ms/div	1 kilosample/s	64 s	8 s
100 ms/div — 199 ms/div	500 samples/s	128 s	16 s
200 ms/div — 499 ms/div	250 samples/s	256 s	32 s
500 ms/div — 999 ms/div	100 samples/s	640 s	80 s
1 s/div —	50 samples/s	1280 s (21.3 min.)	160 s

In the real-time mode and with acquisition stopped, this key also controls the zoom feature. See Chapter 7, "Display Menu."

Delay Key

The DELAY key controls the pre- and post-trigger delays and can be changed with the entry devices. The maximum pre- and post-trigger delays change with sweep speed and the delay reference setting.

When the DELAY function is selected, the delay time is displayed at the top of the waveform display area.

- negative delay indicates time before the trigger event
- positive delay indicates time after the trigger event
- Delay = 0 indicates the trigger event occurs at the delay reference point (left, right, or center)

In the real-time mode when acquisition is stopped, DELAY controls the pan feature. See Chapter 7, "Display Menu."

Delay Ref at Key

The delay reference (Delay Ref at) key allows you to reference the delay at the right, left, or center of the graticule. When Delay is set to zero, then:

- Center** When center (default) is selected, the trigger event is at center screen; you are viewing pre-trigger data on the left half of the screen and post-trigger data on the right half.
- Left** When left is selected, the entire screen is post-trigger data because the trigger event is at the left side of the screen.
- Right** When right is selected, the entire screen is pre-trigger data.

**Auto/Trg'd Sweep
Key**

This key allows you to select one of the two sweep modes. Each mode has its own distinct advantages depending on the input signal or your specific use.

Auto-Sweep

Auto-sweep will generate a trigger if none is present. If no signal or trigger is present, the HP 54112D will trigger and display a baseline. The displayed signal initiated by auto-sweep is asynchronous with the signal on the sweep initiated by the trigger event. The oscilloscope will trigger normally if the trigger repetition rate is greater than 50 Hz.

Triggered Sweep

Triggered sweep prevents the HP 54112D from generating a sweep before the trigger event. If no signal or trigger is present, there will be no display. If a signal is present, but no trigger, the oscilloscope will not sweep and the display will be data acquired on the previous trigger.

6

Trigger Menu

Chapter Contents

This chapter describes the HP 54112D's five trigger modes, one trigger input, and four channel inputs that can be used as trigger inputs. Examples of pattern and state triggering and time and event-qualified triggering are included.

The Trigger menu allows you to select the trigger modes. In each of the trigger modes you can select source and slope. In this menu you can also access the HP 54112D's logic-pattern triggering.

The Trigger menu provides five trigger modes:

- edge
- pattern
- state
- time-delay
- event-delay

These are accessed by pressing the Trigger Mode key (the top function key) until the mode you want is displayed in inverse video.

How the Trigger Modes Overlap

TRIGGER LEVEL (i.e., threshold) is the only parameter that is passed unchanged from mode to mode once it has been specified in the edge mode for each trigger source.

If the trigger repetition rate is below 50 Hz, always use the triggered-sweep function. (See "Timebase Menu," Chapter 5 for more information.) This prevents the oscilloscope from prematurely producing a trigger when there is a large event-delay count or delay time.

Edge Trigger

The edge mode allows you to:

- select one of five trigger sources with the Trig Src key
- adjust the trigger level
- select the slope of the input signal with the Pos/Neg key

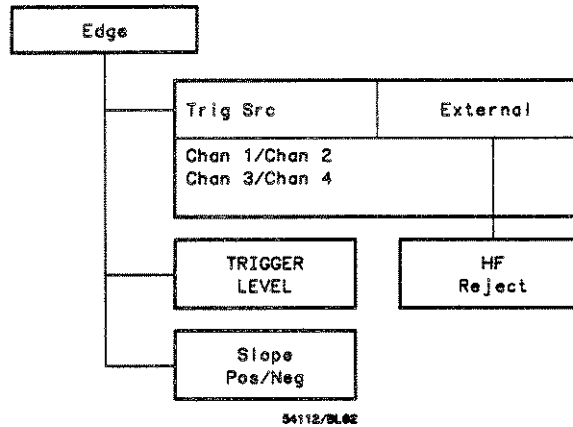

54112/BL02

Figure 6-1. Edge Menu

Trg Src Key The Trig Src key permits you to select one of five trigger sources:

- Chan 1
- Chan 2
- Chan 3
- Chan 4
- External

Trigger Level Key If you select a channel as a trigger source a horizontal line is displayed showing the trigger level for the displayed signal.

Slope Key Press Slope to define the trigger as either the positive or negative slope of the input signal you select.

Both the trigger slope and level can be set independently for each source and are retained even when another trigger source or mode is selected.

Pattern Trigger

The pattern mode allows you to set up the HP 54112D to recognize a five-bit pattern and trigger when entering or exiting the pattern.

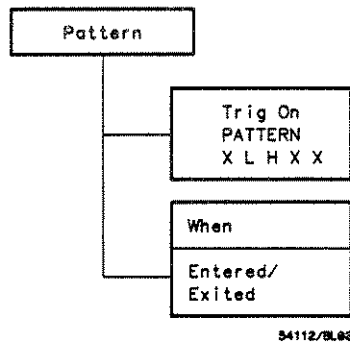

Figure 6-2. Pattern Menu

Trig On Pattern Key

Pressing the Trig On PATTERN key highlights one of five characters that are displayed in inverse video. The five characters are represented as channel 1, channel 2, channel 3, channel 4, and the external trigger input.

Use one of the entry devices to change this character to one of three letters:

- **L** requires an input less than the trigger level of that input.
- **H** requires an input greater than the trigger level of that input.
- **X** is a "don't care" condition (i.e., a bit with an X means that the associated input is not used as a trigger qualifier).

For example, if the pattern is "LHXXX," then the voltage on channel 1 must be less than the trigger level set for channel 1, and the voltage on channel 2 must be greater than the trigger level set for channel 2 to satisfy the pattern condition and make it true. The signals on channels 3, 4, and the external trigger input are ignored because they are set to "don't care" conditions.

displayed at the top of the waveform display area.

Note

Set the TRIGGER LEVEL for each trigger source while the HP 54112D is in the edge mode. These trigger levels must be set before you go to the pattern mode, or proper pattern triggering may not occur.

When Entered When Exited Key

When you press the When key, the inverse video window changes from:

- Entered
- to Exited

If Entered is selected:

- the HP 54112D triggers on the last transition that makes the pattern true.

If Exited is selected:

- the HP 54112D triggers on the first transition on any input that causes the PATTERN to be false after it has been true.

Pattern Trigger Exercise

This exercise demonstrates how the input signals can be used in combination to generate a trigger.

Pattern triggering is extremely valuable when you are testing digital circuitry and must qualify an acquisition with signals from more than one source.

The equipment required for this exercise includes:

- HP 54112D oscilloscope
- HP 8116A pulse/function generator
- BNC tee
- two one-metre coaxial cables

providing:

- variable width signal
- 10 MHz
- 2 volt output
- < 5 ns rise and fall time
- minimum pulse width of 10 ns

Initial Setup Set up the instruments by:

- connecting the BNC tee to channel 2
- connecting one cable from the output of the function generator to the BNC tee on channel 2
- connecting the other cable from channel 1 to the other side of the BNC tee

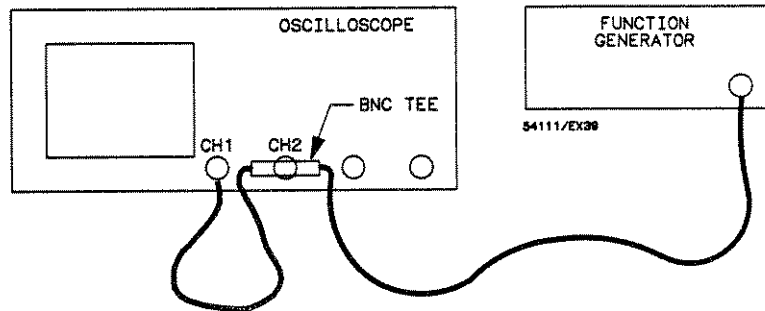

Figure 6-3. Equipment Connection

The extra cable length between channels 1 and 2 provides a time differential between the signals displayed on the oscilloscope. The propagation delay generated by a one-metre cable is approximately 6 to 7 ns. The delay between channels demonstrates the triggering capability of the HP 54112D.

Setup

- Function = Pulse
- Frequency = 10 MHz
- Width = 50 ns
- Amplitude = 2 V
- Offset = 0 V

If you are using an HP 8116A function generator, ensure that the DISABLE light is off.

Press AUTO-SCALE on the HP 54112D and set the controls as follows:

- Timebase menu
 - TIME/DIV = 5 ns/div
 - Sweep mode = 'Trg'd'
- Display menu
 - Display = Single Screen
 - Graticule = Axes
- Channel 1 and 2 menus
 - Channel 1 & 2 offset = 0
 - Channel 1 & 2 coupling = dc
 - Channel 1 input impedance = 50 Ω
 - Channel 2 input impedance = 1 M Ω
 - Channel 1 & 2 VOLTS/DIV = 400 mV/div
- Trigger menu
 - TRIGGER LEVEL for Chan 1 and Chan 2 = 0 (set TRIGGER LEVEL in the edge trigger mode)
 - Trig Src = Chan 1

the positive edge of channel 1.

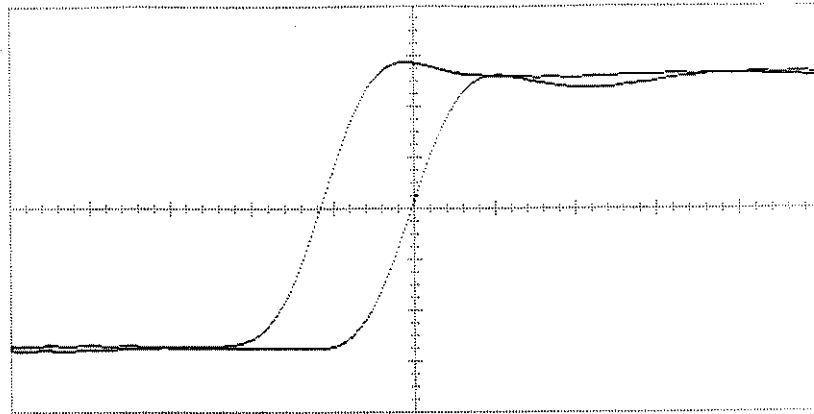
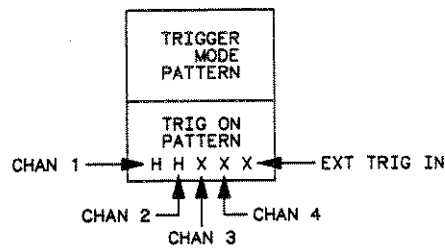

Figure 6-4. Pattern Trigger Waveform

Pattern When Entered

1. Select the Trigger menu.
2. Select the pattern trigger mode. You should only have to press the trigger mode key once to move the HP 54112D from edge mode to pattern mode.
3. Select "When Entered." This causes the HP 54112D to generate a trigger on the edge that makes the trigger pattern true.

The Trig On Pattern key allows you to define a pattern for triggering the oscilloscope. For this exercise use HHXX. H indicates high, and X indicates a "don't care" condition.



54111/EX56

Figure 6-5. Setting the Pattern

This pattern requires that the signals on channel 1 and 2 must be greater than the trigger level to generate a trigger.

for channels 1 and 2 was set to 0 V. This means that the last input on either channel 1 or 2 that goes above 0 V generates a trigger.

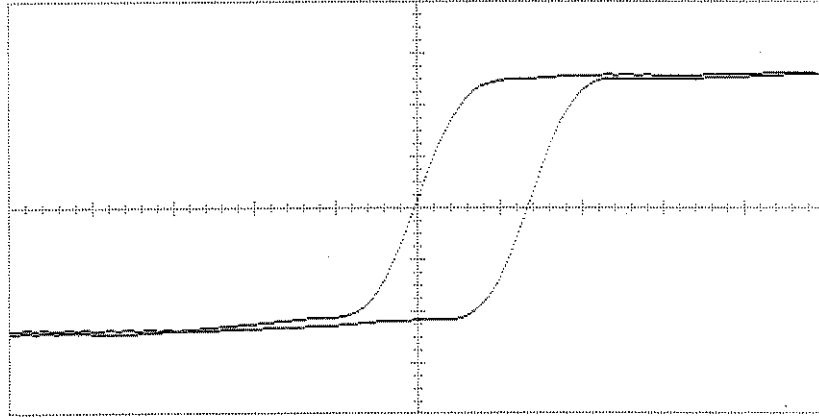

Figure 6-6. Pattern HHXXX Waveform

In this exercise, you referenced the trigger event to center screen. Notice that the signal from channel 2 crosses center screen at the 0 V level. This crossing completes the requirement for the trigger event.

**Pattern
When Exited**

You can also set up the HP 54112D to trigger on the first edge that makes the trigger pattern false by pressing the When key and selecting "Exited" as the variable. In this example, the first edge to make the pattern false is the negative edge from channel 2.

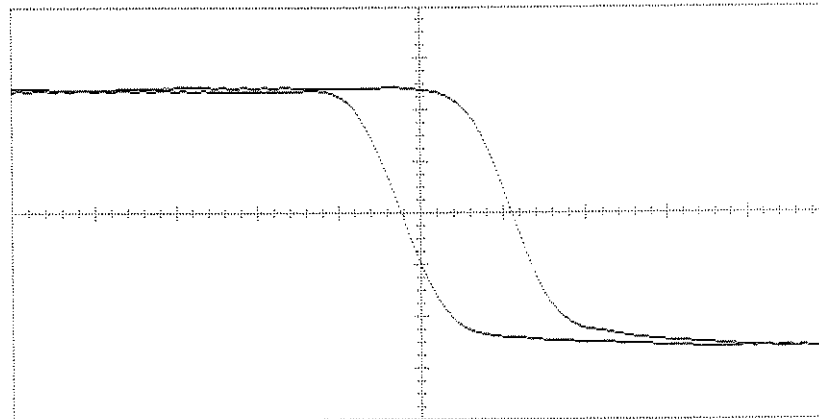

Figure 6-7. Waveform for Pattern HHXXX When "Exited"

State Trigger

The State mode allows you to select one of the inputs as a simple edge source (clock) and use the other four to define a pattern (X, L, or H as in the pattern mode).

Trig On Pos/Neg Edge Key

Pressing the Trig On Pos/Neg Edge key:

- selects the polarity of the edge of the clock source as the trigger.

Of Key

Pressing the Of key:

- selects the clock source (Chan 1, Chan 2, Chan 3, Chan 4 or external).
 - notice that as you press the Of key the PATTERN key variables change.
 - the “ - ” in the pattern shows which source is being used as the edge source or clock.

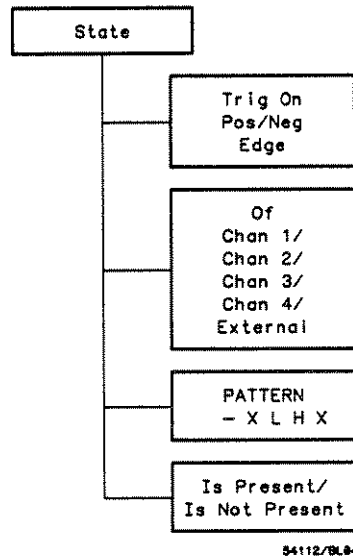

Figure 6-8. State Menu

- allows the four remaining inputs to be set to H (high), L (low), or X (don't care). This will define the logic pattern for qualifying the clock edge.

**Is Present/Is
Not Present Key**

Pressing the Is/Is Not Present key:

- determines if the pattern must be present or must not be present to qualify the clock edge as a trigger. The thresholds for each input of the pattern are those you set with TRIGGER LEVEL in the edge mode.
- in the state mode the clock can be no more than 80 MHz.

**State Trigger
Exercise**

This exercise demonstrates how an input pattern can be used to qualify a clock edge that is to be used as a trigger.

State triggering extends the logic triggering capability of the HP 54112D by letting you select one of the inputs as a clock and letting you use the other inputs as a qualifier.

This is useful when it is necessary to synchronize the display with a system clock to detect a system state. For example, consider a synchronous memory bus. The state trigger mode enables you to see only those events that occur when the HP 54112D is reading from a specific block of memory.

The equipment for this exercise includes:

- HP 54112D oscilloscope
- HP 8116A pulse/function generator
- BNC tee
- two one-metre coaxial cables

Setup

- connecting the BNC tee to channel 2 of the HP 54112D
- connecting one cable from the output of the function generator to the BNC tee on channel 2
- connecting the other cable from channel 1 to the other side of the BNC tee

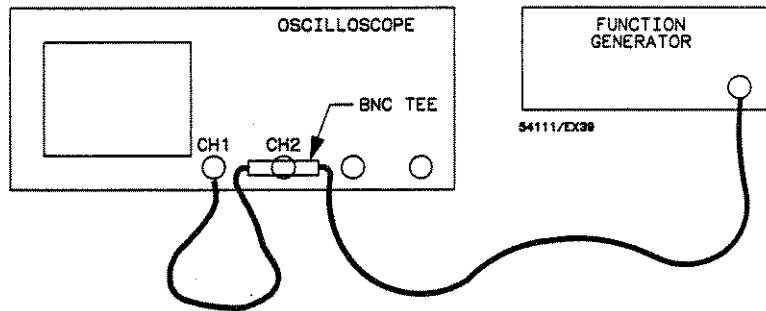

Figure 6-9. Equipment Connection

The extra cable length between channels 1 and 2 provides a time differential between the signals displayed on the oscilloscope. The propagation delay generated by a one-metre cable is approximately 6 to 7 ns. The delay between channels demonstrates the triggering capability of the HP 54112D.

Instrument Setup

Set the function generator controls as follows:

- Function = Pulse
- Frequency = 10 MHz
- Width = 50 ns
- Amplitude = 2 V
- Offset = 0 V
- If you are using an HP 8116A, ensure that DISABLE is off.

follows:

- Timebase menu
TIME/DIV = 5 ns/div
Sweep mode = Trg'd
- Display menu
Display = Single screen
Graticule = Axes
- Channel 1 and 2 menus
Channel 1 & 2 offset = 0
Channel 1 & 2 coupling = dc
Channel 1 input impedance = 50 Ω
Channel 2 input impedance = 1 M Ω
Channel 1 & 2 VOLTS/DIV = 400 mV/div
- Trigger menu
TRIGGER LEVEL for chan 1 and 2 = 0
(set TRIGGER LEVEL in the edge trigger mode)
Trig Src = Chan 1

After the setup is complete, the oscilloscope should be triggering on the rising edge of channel 1.

**Setting State
Trigger**

This exercise uses channel 2 as the edge source (clock) and channel 1 as the qualifier.

Select the Trigger menu:

1. Press the Trigger mode key until State is selected.
2. Set the Trig On Pos/Neg Edge key to Pos.
3. Set the Of key variable to Chan 2. This selects channel 2 as the clock source.
4. Set PATTERN = L-XXX. This indicates that channel 1 must be low (below the trigger level) before a signal edge on channel 2 can be used to generate a trigger.

In this configuration the **ALL** trigger triggers on the first positive edge on channel 2 that occurs during a low on channel 1.

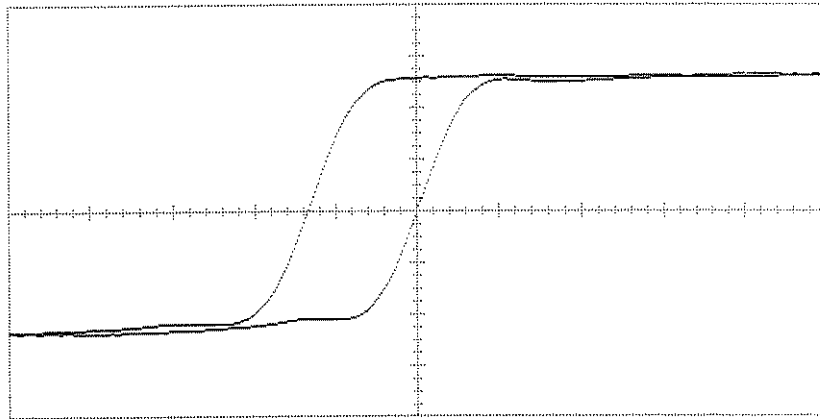

Figure 6-10. Pattern L-XXX Waveform

Notice that if you press the **Is Present/Is Not Present** key and change it to **Is Not Present**, the oscilloscope stops triggering. The signal on channel 1 is true when the positive-going edge on channel 2 occurs.

Time Trigger

The Time mode allows you to arm on a signal edge of any source, wait for a period of time, and then trigger on an edge from any of the five inputs.

Pos/Neg Edge Key

Pressing the Pos/Neg Edge key selects the polarity of the arming edge.

On Key

Pressing the top On key selects the source of the arming edge.

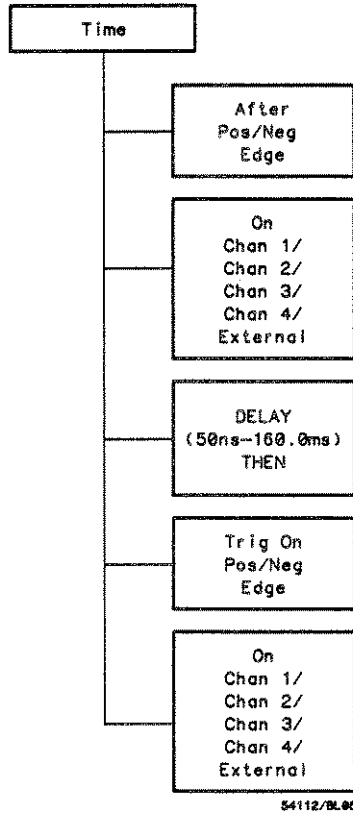

Figure 6-11. Time Menu

Delay...Then Key The DELAY...THEN key defines the period of time from when the edge arms to when the HP 54112D will accept a trigger. The range is from 50 ns to 160 ms.

Trig On Pos/Neg Edge Key Pressing the Trig On Pos/Neg Edge key selects the polarity of the trigger edge.

On Key Pressing the bottom On key selects the source for the trigger edge.

Time Delay Trigger Exercise

This exercise demonstrates how to use time to qualify a trigger event. Frequently in digital circuits there is a period of time when an output is invalid after a state change. This exercise shows how to set the HP 54112D so that it will ignore potential trigger events until after a defined period of time.

The equipment for this exercise includes:

- HP 54112D oscilloscope
- HP 8116A pulse/function generator
- two one-metre coaxial cables
- 1 BNC tee

- connecting the BNC tee to channel 2 of the HP 54112D
- connecting one cable from the output of the function generator to the BNC tee on channel 2
- connecting the other cable from channel 1 to the other side of the BNC tee

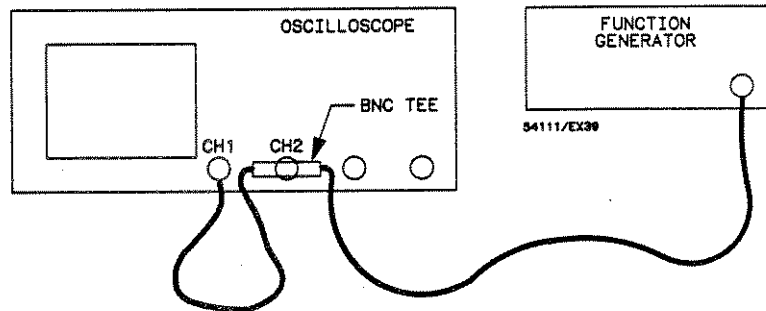

Figure 6-12. Equipment Connection

The extra cable length between channels 1 and 2 provides a time differential between the signals displayed on the oscilloscope. The propagation delay generated by a one-metre cable is approximately 6 to 7 ns. The delay between channels demonstrates the triggering capability of the HP 54112D.

Instrument Setup Set the function generator controls as follows:

- function = Pulse
- Frequency = 10 MHz
- Width = 50 ns
- Amplitude = 2 V
- Offset = 0 V
- If you are using an HP 8116A function generator, ensure the DISABLE light is off.

After pressing AUTO-SCALE, set the controls as follows:

- Timebase menu
 TIME/DIV = 5 ns/div
 Sweep mode = Trg'd

- Display menu
 - Display = Single screen
 - Graticule = Axes
- Channel 1 and 2 menus
 - Offset = 0
 - Coupling = dc
 - Channel 1 input impedance = 50 Ω
 - Channel 2 input impedance = 1 M Ω
 - VOLTS/DIV = 400 mV/div
- Trigger menu
 - TRIGGER LEVEL for chan 1 and 2 = 0
 - (set TRIGGER LEVEL in edge trigger mode)
 - Trg Src = Chan 1

The oscilloscope should now trigger on the positive edge of channel 1.

**Setting Time
Trigger**

Select the Trigger menu:

1. Press the Trigger menu key until Time is selected.
2. Set the After Pos/Neg key to Pos.
3. Set the top On key to Chan 1.
4. Set the DELAY...THEN key to DELAY 100.0 ms THEN.
5. Set the Trig On Neg/Pos Edge to Neg.
6. Set the bottom On key to Chan 2.

In this configuration, the HP 54112D generates a trigger on the last of three sequential events:

- on channel 1, a rising signal must cross the trigger threshold;
- one hundred milliseconds must elapse;
- on channel 2, a falling signal must cross the trigger threshold.

Press the CLEAR DISPLAY key and notice that the HP 54112D is triggering at 100 ms intervals.

Change the delay time and notice the time between trigger intervals changes proportionally with the delay time.

Change the polarity of the Trig On Edge key from Neg to Pos and notice the HP 54112D triggers on the positive edge of channel 2.

Event Trigger

The event trigger mode allows you to define an edge as a trigger qualifier. Once this edge is detected, the HP 54112D will accept a trigger after a definable number of edges on any input.

One application of this trigger mode is to isolate a specific line of video information by delaying the trigger a specific number of horizontal sync pulses after you have initially qualified the event delay with the vertical sync.

The delay-by-events mode is particularly useful in systems with a data rate that fluctuates or jitters, like in a disc drive. You can use the delay-by-events mode to arm on the index pulse in a disc drive, then trigger on a data pulse anywhere around the track. This stabilizes the display on a particular pulse.

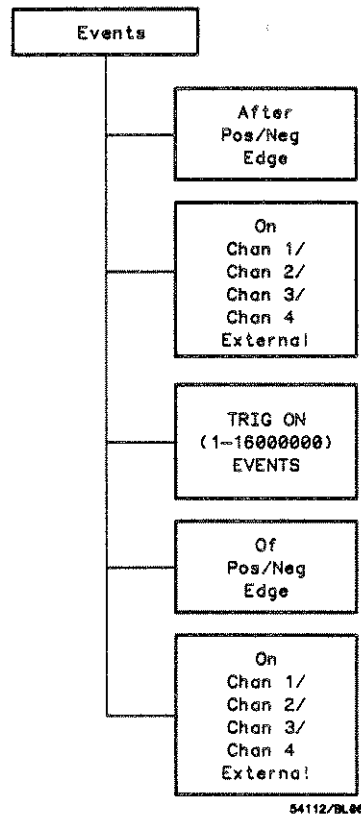

Figure 6-13. Events Menu

Key arming edge.

On Key Pressing the top On key selects the source of the arming edge.

Trig on N Events Key Pressing the TRIG ON N EVENTS key defines the number of trigger events that must occur before the HP 54112D will trigger (after the qualifier). The number of events is from 1 to 16000000.

Of Pos/Neg Edge Key Pressing the Of Pos/Neg Edge key selects the polarity of the trigger edge.

On Key Pressing the bottom On key selects the source of the trigger edge.

The polarity of the arming edge and the trigger edge are complementary if only a single channel is selected.

Event Delay Trigger Exercise

This exercise demonstrates the capability of the HP 54112D to delay the trigger by events.

The equipment for this exercise includes:

- HP 54112D oscilloscope
- HP 8116A pulse/function generator
- two one-metre coax cables
- BNC tee

Initial Setup Use the same oscilloscope setup as in the previous exercise.

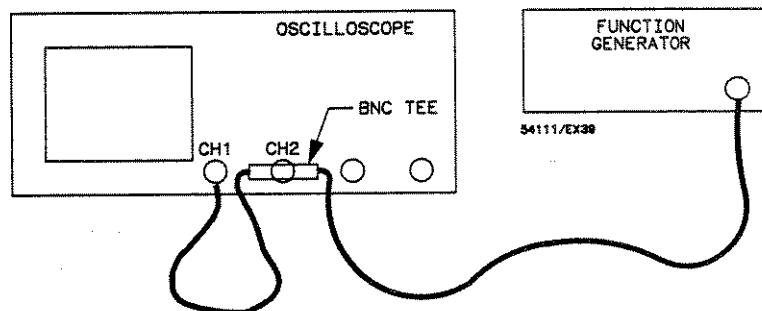

Figure 6-14. Equipment Connection

difference between the signals displayed on the oscilloscope. The propagation delay generated by a one-metre cable is approximately 6 to 7 ns. The delay between channels demonstrates the triggering capability of the HP 54112D.

Setting Event Trigger

This exercise uses a positive edge on channel 2 to cause the oscilloscope to start counting a given number of edges from a second source (channel 1). The oscilloscope generates a trigger after the specified number of edges on the second source have been connected.

Select the Trigger menu:

1. Press the Trigger mode key until Event is selected.
2. Set the After Neg/Pos Edge key to Neg.
3. Set the first On key to Chan 2 to select a qualifier source.
4. Set the TRIG ON...EVENTS key to TRIG ON 10000000 EVENTS. This defines the number of events used to delay the trigger.
5. Set the Of Pos/Neg Edge key to Pos to select the positive edge for the trigger source.
6. Set the second On key to On Chan 1 to select channel 1 as the source for the delay events and the trigger.

Press the CLEAR DISPLAY key and notice that the oscilloscope is triggering once a second. This is expected because the frequency of the function generator is set to 10 MHz.

Change the trigger-on-events number and notice the effect on the display. The trigger interval changes proportionally with the number of events.

7

Display Menu

Chapter Contents

This chapter describes the real-time (single-shot) and repetitive digitizing modes. The real-time mode has single-shot data capture capabilities and the repetitive mode has averaging and persistence capabilities. Also in this menu, you can choose from several different graticules for measuring ease and you can define the display for single or multiple waveforms.

The exercises in this chapter involve single-shot capture and techniques for manipulating the data.

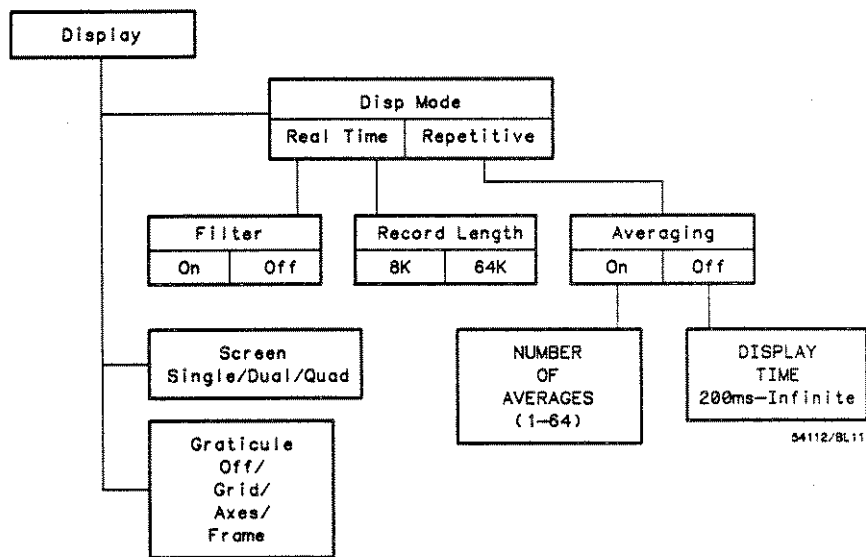

Figure 7-1. Display Menu.

Display Mode Key

In the Display menu, you may select either single-shot or repetitive acquisition.

After you have pressed the Display menu key, the Disp Mode key is highlighted allowing you to select:

- Real Time
- Repetitive

Repetitive Mode

In the repetitive mode the HP 54112D is repetitively acquiring data in a single-shot manner; however, the display reflects either an average of a selected number of waveforms or accumulated single-shot acquisitions over a selected period of time (persistence).

Averaging Key

The Averaging key is only available in the repetitive mode. It allows you to turn the Averaging mode on or off. The last acquired data points are averaged with previously acquired data before they are displayed.

Number of Averages

If Averaging is On:

- the NUMBER OF AVERAGES key is activated and controlled by the entry devices
- data from multiple acquisitions is averaged to generate the displayed waveform(s)

When you select the NUMBER OF AVERAGES key, the number of averages is displayed above the waveform display area. You can specify the number you want by changing the displayed number. This value is entered with the entry devices.

Non-correlated noise can be significantly reduced with the averaging mode. As the number of averages is increased from 1 to 64, the display becomes less responsive to changes to the input signal(s); however, using more averages reduces noise and improves resolution.

- the DISPLAY TIME key is activated and controlled by the entry devices
- data is maintained on the display for a defined period of time, from 200 ms to 10 seconds, or indefinitely (infinite)
- persistence time is displayed above the waveform display area on the CRT

In the infinite persistence mode data points remain on the display until the CLEAR DISPLAY key is pressed or any other major setup parameter is changed.

In the variable persistence mode (any persistence other than infinite):

- the display changes as the input signal changes
- the signal is stored indefinitely on the display if the trigger is lost and the HP 54112D is in Trg'd Sweep

A minimum persistence setting is useful when the input signal is changing and you need immediate feedback, such as when you are rapidly probing from point to point, or setting the amplitude or frequency of a signal source. More persistence is useful for observing long-term changes in the signal or low signal repetition rates. Infinite persistence is useful for worst-case characterizations of signal noise, jitter, drift, timing, etc.

- Real-Time Mode** If you select the real-time mode, the HP 54112D displays data collected during successive single-shot acquisitions from any or all input channels. Because the HP 54112D can make a single-shot capture simultaneously on all four channels, you can capture four simultaneous, non-recurring or very low repetition rate test events. Some or all of the 8k or 64k waveform buffer memories (each channel has its own buffers) can be displayed. The displayed signal is updated as each new acquisition is made.
- Filter Key** This key only appears in the real-time mode. It turns the digital filters on or off. This gives you the capability of viewing raw (uninterpolated) data at sweep speeds faster than 125 ns and with less than 500 data points on screen. The raw data viewed with the filters off appear as dots moving across the screen. These dots are data points and are separated in time by the sample interval.

can point for channel to accept the memory capacity. This key selection applies to all channels simultaneously.

In the real-time mode a memory bar is displayed above the waveform display area.

- The memory bar represents the displayed portion of the waveform record.
- The memory bar display line represents the entire waveform record (8k or 64k).
- "T" indicates the trigger point of the captured data.

Memory Bar Exercise

This exercise demonstrates the ability of the memory bar as well as the HP 54112D to display signals that occur before and after the trigger point. The memory bar is very helpful when it is important to know what portion of the waveform is being displayed.

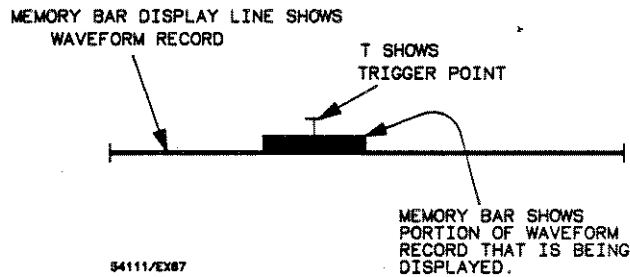

Figure 7-2. Memory Bar.

Equipment for this exercise:

- HP 8116A pulse/ function generator with a 5 MHz 2 V square wave connected to channel 1
- Set the sweep speed of the HP 54112D to 50 ns/div.
- Set the Display mode to Real Time and notice that the memory bar is displayed.

- select the Delay function of the Timebase menu and use the entry devices to vary the delay.

Note

When the HP 54112D is acquiring data (the STOP/SINGLE key is not pressed), varying DELAY will change the acquisition record with respect to the trigger point.

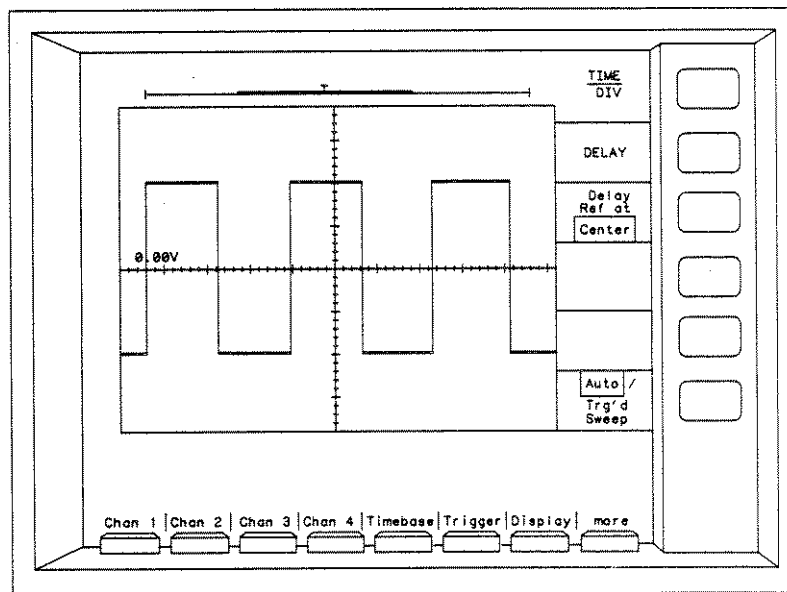

54112/EX15

Figure 7-3. Memory Bar When You Use Delay.

are selected with the Delay Ref at key (Timebase menu) and are as follows:

- left
- right
- center

While the HP 54112D is acquiring data, you can position the display window anywhere on the waveform record by changing the DELAY value.

Note

With Delay reference and the "T" to the right, all data acquired occurs before the trigger. In this situation, you cannot input any negative values.

Now, move the memory bar and "T" to the left or center screen. Delay time moves the acquisition window relative to the trigger point. As you change the delay, the "T" moves to the right or left of the memory bar depending on whether you use a negative or positive delay. Negative delay allows you to view pre-trigger events, while positive delay allows you to view post-trigger events.

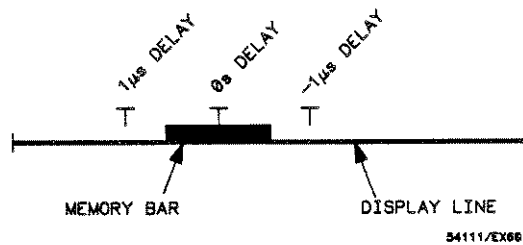

Figure 7-4. Memory Bar with 1 μ s Delay.

Set DELAY to 1 μ s:

- the "T" moves to the left of (before) the memory bar, indicating you are viewing the portion of the input signal that occurred 1 μ s after the trigger event.

- the “T” moves to the right of (after) the memory bar, indicating you are viewing the portion of the input signal that occurred 1 μ s before the trigger event.

Screen Key

The Screen key allows you to define the waveform display area as single, dual or quad screen.

- Single (full screen) displays all input signals, memories, and functions* superimposed in the waveform display area.
- Dual (2 separate areas) displays channel 1, channel 3 and function 1 in the top half and channel 2, channel 4, and function 2 in the bottom half. Any of the waveform memories may be independently displayed in either half of the display.
- Quad (4 separate areas) displays signals from channel 1, channel 2, channel 3 or function 1, and channel 4 or function 2 from top to bottom, respectively. Any of the waveform memories may be independently displayed in any of the four display areas.

Vertical scaling is changed automatically to provide an appropriate display as the screen function is changed.

* “Functions” refers to the functions you can set up in the Wfm (Waveform) Math menu. See Chapter 11.

Graticule Key

Pressing the Graticule key allows you to select from the following:

- Grid
- Axes
- Frame
- Off

Zoom and Pan Exercise

This exercise demonstrates how the TIME/DIV function can be used to zoom (horizontally expand or compress a captured single-shot waveform) in the real-time display mode. The DELAY function can be used to pan (horizontally move a single-shot waveform) in the real-time display mode.

Note

You can only use the zoom and pan features when the HP 54112D is in the real-time mode and acquisition is stopped.

Zooming either expands or compresses the waveform on the horizontal axis by adjusting TIME/DIV. Decreasing TIME/DIV expands the waveform, and increasing TIME/DIV compresses the waveform.

Panning moves the waveform on the horizontal axis and is changed by adjusting DELAY time. Increasing DELAY moves the waveform to the left, and decreasing DELAY moves the waveform to the right.

Applications that require precise evaluation of low repetition rate signals, such as radar or transponder pulse trains, are simplified by zooming and panning on single-shot data.

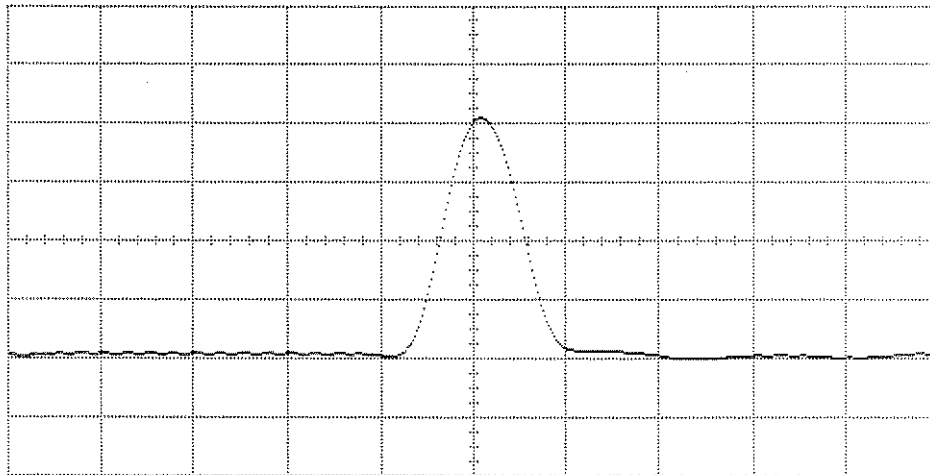

Figure 7-5. A Captured Waveform.

- HP 54112D oscilloscope
- HP 8116A pulse/function generator (or equivalent)
- one-metre coaxial cable

Initial Instrument Setup

Connect the output of the HP 8116A function generator to channel 1.

Set up the HP 8116A pulse/function generator as follows:

- Normal mode
- Frequency = 500 kHz
- Pulse width = 10 ns
- Amplitude = 2 V
- Offset = 0
- Function = pulse
- Ensure the disable light is off

Set the Disp mode of the HP 54112D to Repetitive.

After pressing AUTO-SCALE, set up the oscilloscope as follows:

- Chan 1 menu
 - VOLTS/DIV = 500 mV
 - Input Coupling = dc
 - Input Impedance = 50 Ω
- Timebase menu
 - TIME/DIV = 5 ns
 - Delay Ref at = center
- Display menu
 - Display mode = Real Time
 - Record Length = 64k

Zooming Acquire a single-shot waveform record.

- Press the STOP/SINGLE key to stop acquiring data.
- Press the CLEAR DISPLAY key to clear the display registers.
- Press the STOP/SINGLE key again to make a single acquisition.

After the 64k single-shot waveform record is acquired:

- enter the Timebase menu and select TIME/DIV

portion of the captured 64k waveform record. This allows you to display the whole waveform record by increasing TIME/DIV or to zoom in on a segment of the record by decreasing TIME/DIV. The memory bar expands or contracts as the portion of the record being displayed is increased or decreased.

- Set TIME/DIV = 20 μ s/div.

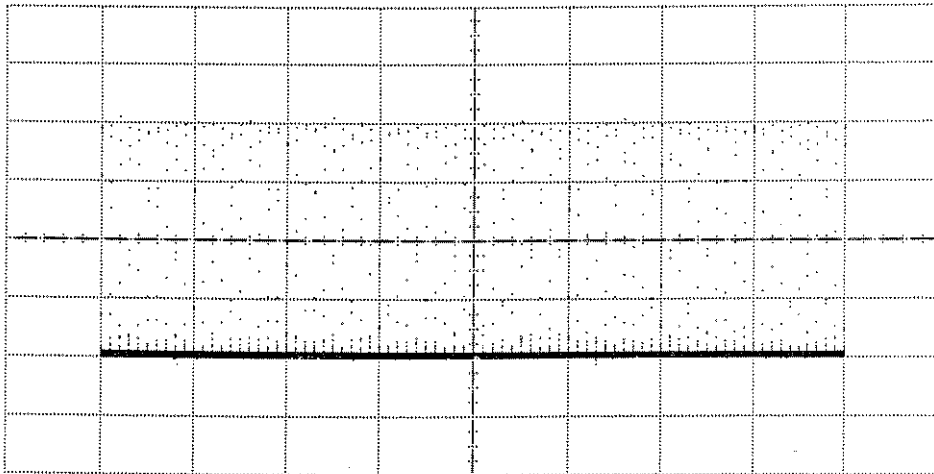

Figure 7-6. Zooming Out.

Changing the TIME/DIV to 20 μ s/div compresses the waveform to approximately eight horizontal divisions. The memory bar indicates that the entire waveform record is being displayed.

In this example, we acquired 64000 data points at a 400 megasample/second digitizing rate. Each data point is represented in the figure.

waveform memory is referred to as "zooming out." Conversely, decreasing TIME/DIV on these waveforms is referred to as "zooming in."

- Set TIME/DIV = 2 ns/div.

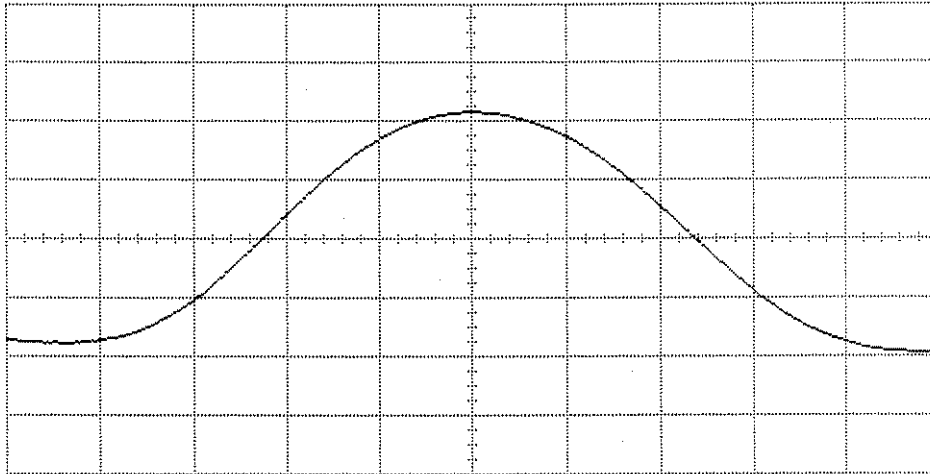

Figure 7-7. Zooming In.

As TIME/DIV is decreased, the amount of time represented on the display is reduced. This expands the signal. Now you can see one pulse of the previous display from the same single-shot capture.

Panning Varying DELAY time allows you to view various segments of the waveform record. To demonstrate panning:

- Set TIME/DIV = 5 ns.
- Set DELAY = 20 ns.

The screen now displays a detailed look at the waveform after the pulse. The delay time indicates that you are viewing the waveform 20 ns after the trigger point.

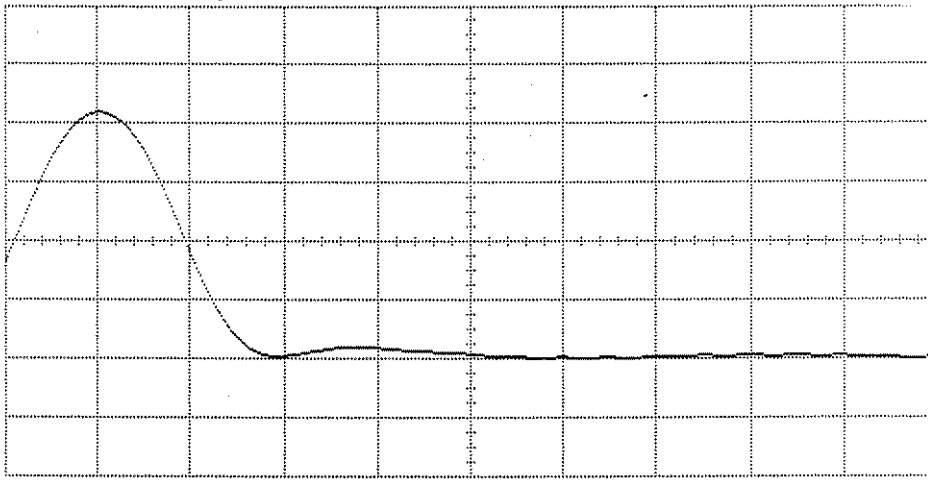

Figure 7-8. Panning Right.

If DELAY is increased in the negative time direction (i.e., decreased), the waveform moves to the right because you are viewing the signal before the trigger point.

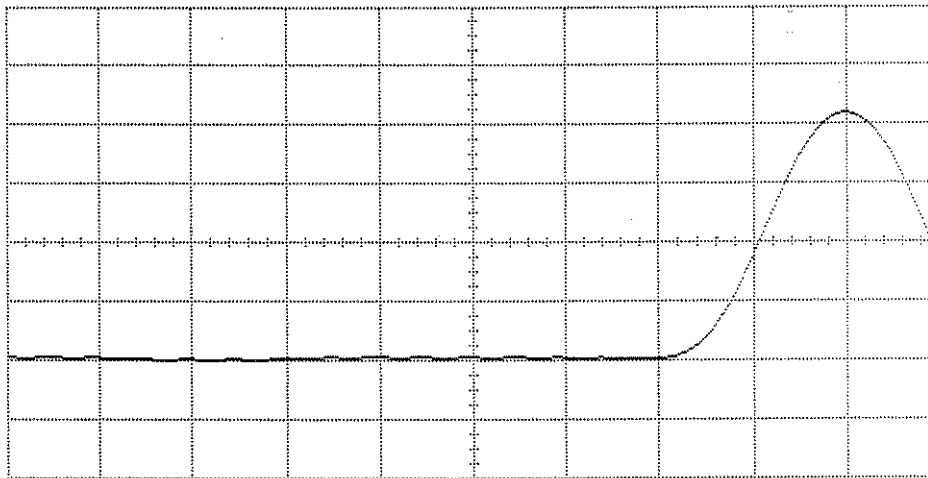

Figure 7-9. Panning Left.

This feature allows you to look at a large time window in detail. This is similar to using a magnifying glass to view a page of small print.

8

Delta V Menu

Chapter Contents

The Delta V menu allows you to control two horizontal markers for voltage measurements. You can set these markers to make absolute voltage measurements either automatically or manually on any displayed waveform. You can make relative voltage measurements on preset and variable conditions. The markers define voltage levels for Delta t measurements.

This chapter has an exercise that describes how to make a source-to-source voltage measurement.

V Markers

V Markers Off
MARKER 1 POSITION Chan 1
MARKER 2 POSITION Chan 1
Preset Levels 0 - 100%
Auto Level Set

After you have entered the Delta V menu and turned on the V Markers, you can select and position the source. The V Markers can be referenced to any source if the display for that source is turned on. The V Marker sources are:

- channels 1, 2, 3, 4
- functions 1 and 2, which are set up in the Wfm Math menu
- waveform memories 1, 2, 3, 4 in the real-time mode only
- waveform memories 5, 6, 7, 8 in the repetitive mode only

After you have assigned the markers to the desired source, the MARKER 1 POSITION and MARKER 2 POSITION function keys allow you to position the markers vertically with the entry devices.

If you are using the default colors, the V Marker you have selected and its label are orange. Marker 1 has long dashes and marker 2 short dashes. If one of the marker position keys is the selected function, the values for ΔV and the voltage level of the highlighted marker are also orange. The marker position key that is not highlighted and its associated marker are displayed in gray (halfbright). Values for ΔV (the difference between the markers) and the voltage level for each marker are displayed at the bottom of the waveform display area.

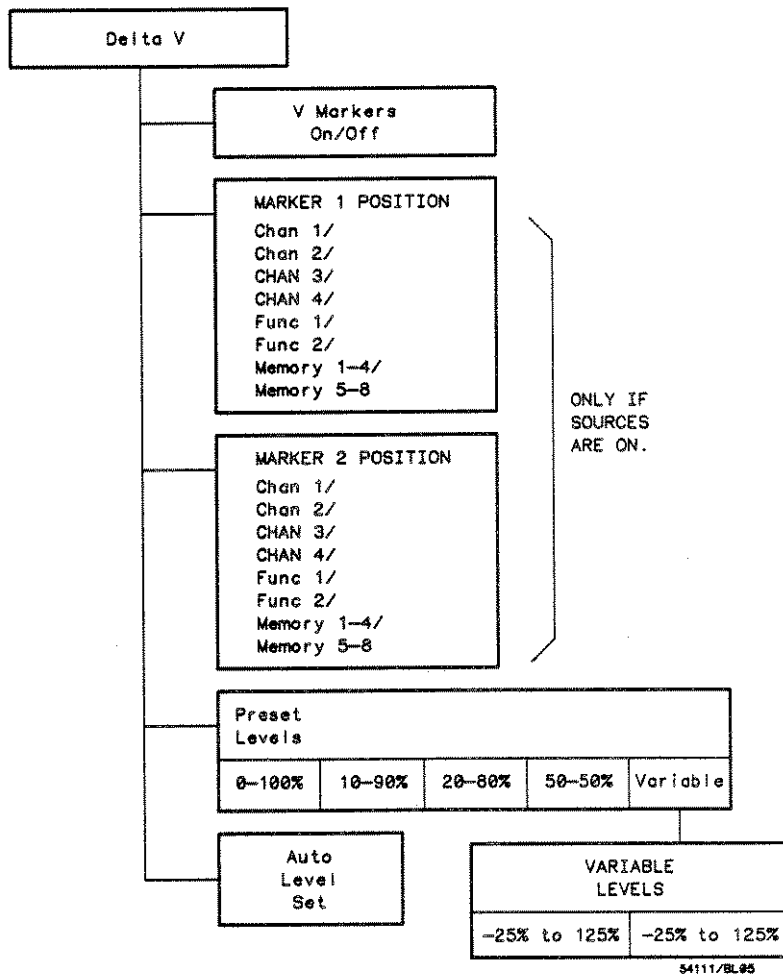

Figure 8-1. Delta V Menu.

Preset Levels Key

V Markers On
MARKER 1 POSITION Chan 1
MARKER 2 POSITION Chan 1
Preset Levels Variable
VARIABLE LEVELS 125% - 16%
Auto Level Set

When you press the Preset Levels key, the HP 54112D automatically positions the V Markers according to their current position. The preset conditions, displayed in inverse video, will change as the function selection key is pressed. The preset levels are listed below:

- 0-100%
- 10-90%
- 20-80%
- 50-50%
- Variable

Variable Selecting the Variable key activates the VARIABLE LEVELS key. This selection provides two variables for defining the levels of the V Markers the same way the fixed preset levels did.

Variable Levels Key The range of VARIABLE LEVELS is from -25% to 125%. These levels can be changed by any of the entry devices. The marker 1 variable is on the left side of the split window and marker 2 on the right. To change the variable that is under the control of the entry devices, press the VARIABLE LEVELS key again. The variable displayed with a beige background is the one subject to change.

Auto Level Set Key

The Auto Level Set key activates a top-base routine on the displayed data. The algorithm determines the 0% and 100% levels, then calculates the preset levels. When these levels have been determined, the HP 54112D sets the V Markers at the selected levels.

Source-to-Source Voltage Measurement Exercise

This exercise demonstrates how to use the Preset Levels key to position the V markers and make a source-to-source voltage measurement.

Set up the oscilloscope as follows:

1. Connect the HP 10033A probes to channels 1 and 2 and the input calibration signal.
2. Press AUTO-SCALE.
3. Enter the Delta V menu and turn on the markers.
4. Set Preset Levels = 0 – 100%.
5. Press Auto Level Set.

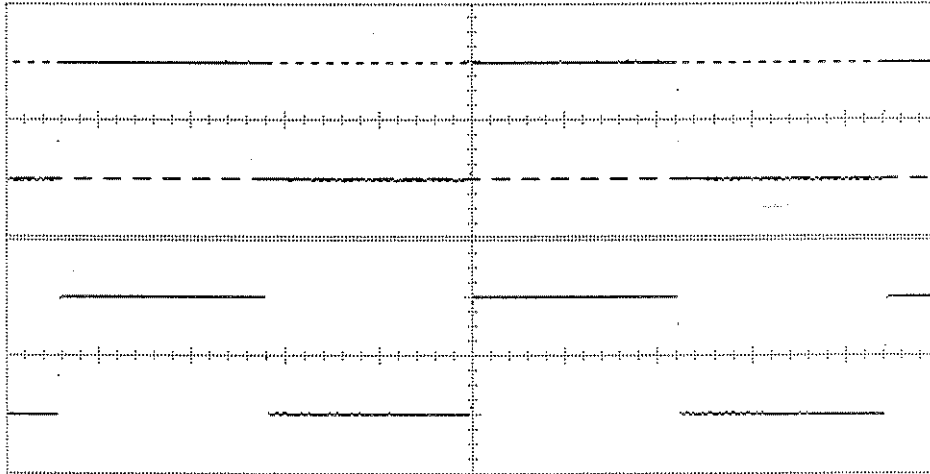

Figure 8-2. V Markers.

To see how the Preset Levels key works, press the key several times and notice how the markers move to the defined levels.

voltage measurements between those sources.

1. Ensure channel 2 display is turned on.
2. Set MARKER 2 POSITION = Chan 2.
3. Position marker 1 at the top of the channel 1 waveform with the entry devices.
4. Position marker 2 at the bottom of the channel 2 waveform.

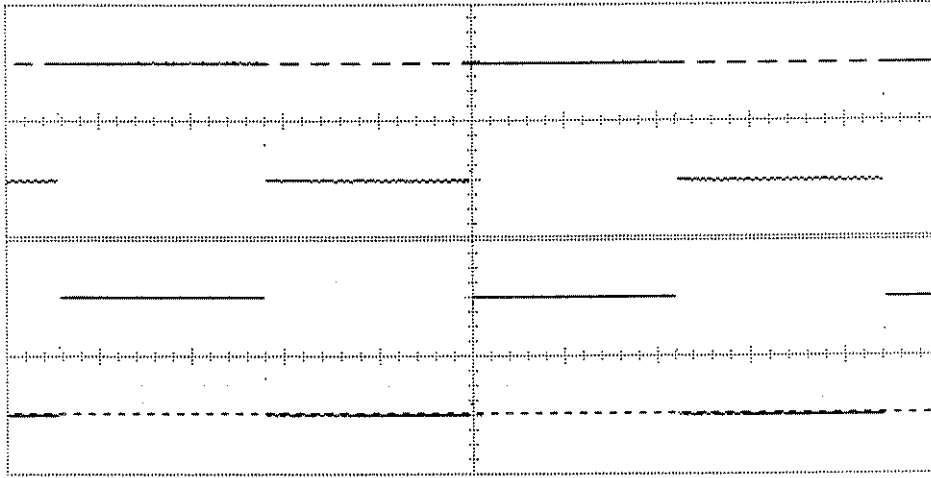

Figure 8-3. Source-to-Source V Markers.

Marker 1 is at the top of channel 1 (top display) and marker 2 at the bottom of channel 2 (bottom display).

The difference between the two voltage markers is listed at the bottom of the waveform display area labeled ΔV .

This technique can be used with any source to make source-to-source voltage measurements.



9

Delta t Menu

Chapter Contents

The Delta t function menu controls two calibrated time markers for making measurements in the time domain. These markers can be positioned with signal edges, time measurements, or time reference. This chapter describes how to use these t markers with an exercise on how to make a time interval measurement.

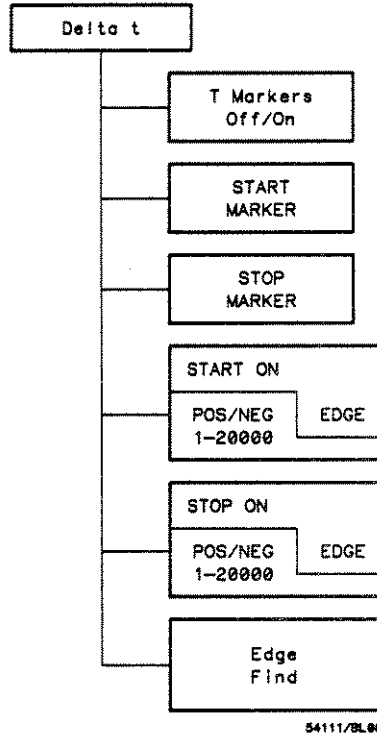

Figure 9-1. Delta t Menu.

Start and Stop Markers

The START and STOP markers are used to make manual time measurements on selected parameters. After you have selected the Delta t menu and turned on the time markers, you can move each marker manually. These markers are under the control of the entry devices.

- If default colors are used, the selected time marker is displayed in orange.
- The values of the two markers with respect to the trigger point and each other (Δt) are displayed at the bottom of the waveform display area.
- The start marker has long dashed lines and the stop marker has short dashed lines.

Start and Stop On Edge Keys

T Markers <input type="checkbox"/> Off
START MARKER
STOP MARKER
START ON <input type="checkbox"/> POS EDGE 1
STOP ON <input type="checkbox"/> POS EDGE 1
Edge Find

The START and STOP ON EDGE keys allow you to make automatic measurements on any on-screen signal edge based on the voltage marker values set in the Delta V menu.

- After you have selected one of the edge keys, you may select the number of the edge of interest with any of the entry devices.
- If an edge key has been selected and is pressed a second time, the polarity of the edge changes.

The V Marker levels define the intersections of the on-screen signal edges, as follows:

- the START ON EDGE marker is associated with V Marker 1 and the STOP ON EDGE marker is associated with V Marker 2;
- the associated V Marker must intersect the signal for the START and STOP ON EDGE markers in order to find the defined edges.

Note

If the advisory message, "Edges required for measurement not found," appears, return to the Delta V menu and adjust the V Markers to intersect the signal of interest.

Edge Find Key

The Edge Find key moves the t markers to the waveform edges defined by the START and STOP ON EDGE keys. If for any reason you have manually moved the markers from the defined edges, press the Edge Find key to automatically return to the defined edges.

Time Interval Measurement

This exercise demonstrates many functions available in the Delta t menu. Set up the HP 54112D oscilloscope as follows:

1. Connect the cal signal to channel 1 with an HP 10033A probe.
2. Press AUTO-SCALE.
3. Set TIME/DIV to 500 $\mu\text{s}/\text{div}$ to display approximately ten pulses.
4. Enter the Delta t menu and turn the t Markers on.
5. Move the START MARKER to the first negative edge of the cal signal with the entry devices.
6. Move the STOP MARKER to the second negative pulse.

At the bottom of the waveform display area the value of the start marker indicates that it is approximately 500 $\mu\text{s}/\text{div}$ before the stop marker, and 2.4 ms before (-2.4 ms) the trigger event. The time interval between the t markers (Δt) is approximately 500 μs .

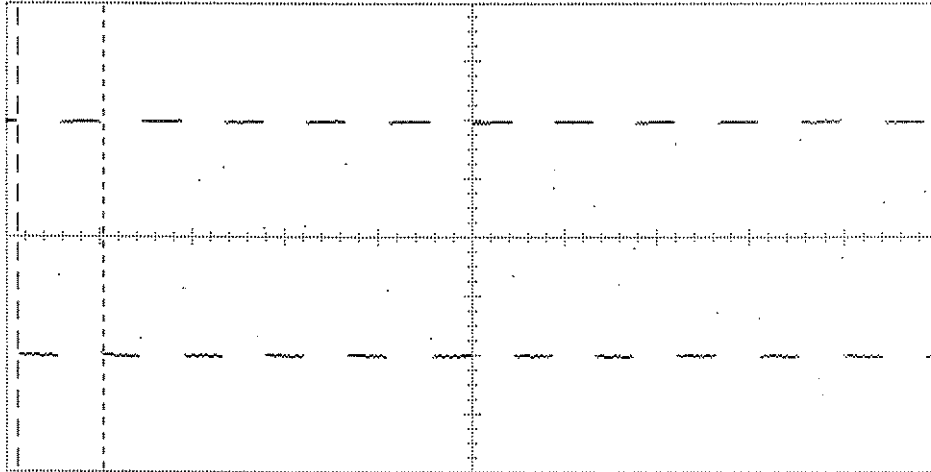

Figure 9-2. Time Interval Measurement.

7. Select the Delta V menu and turn on the V Markers.
8. Press the Preset Levels key until 50-50% is displayed.
9. Press Auto Level Set to move the V Markers to the preset levels.
10. Return to the Delta t menu and press the STOP ON POS/NEG EDGE key several times.

Notice that the POS/NEG indicator alternates and the stop marker jumps from the positive edge to the negative edge of the pulse. Try using each of the entry devices to move the start edge to another pulse. You can change the stop edge with the same technique.

Note

If you try to move one of the time markers to an edge that is not displayed, the error message, "Edges required for measurement not found," is displayed.

11. Set the start marker to the first positive edge and set the stop marker to the seventh positive edge.

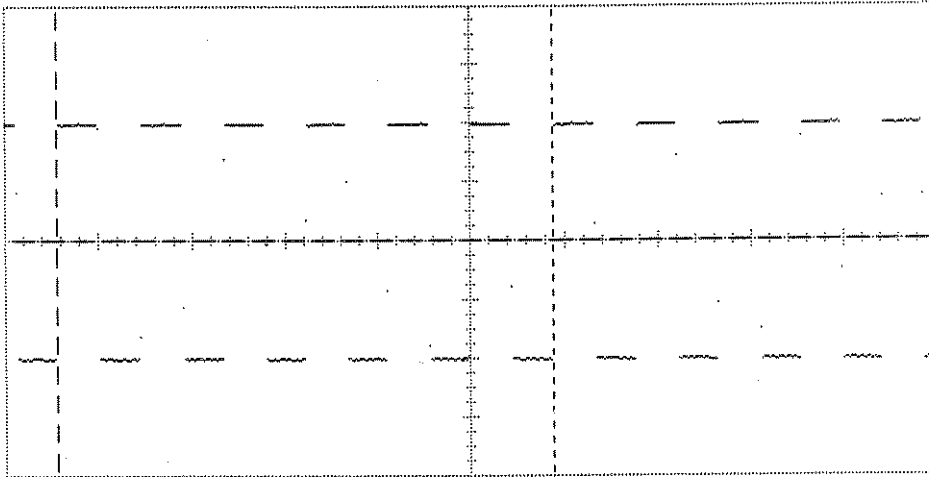

Figure 9-3. Start and Stop on Edges.

Chapter Contents

The Wfm Save Menu allows you to access the ten memories available from the front panel. Of the ten memories, eight are reserved as waveform and two as pixel memories.

This chapter describes how to store and view waveforms in the real-time and repetitive modes using waveform and pixel memories.

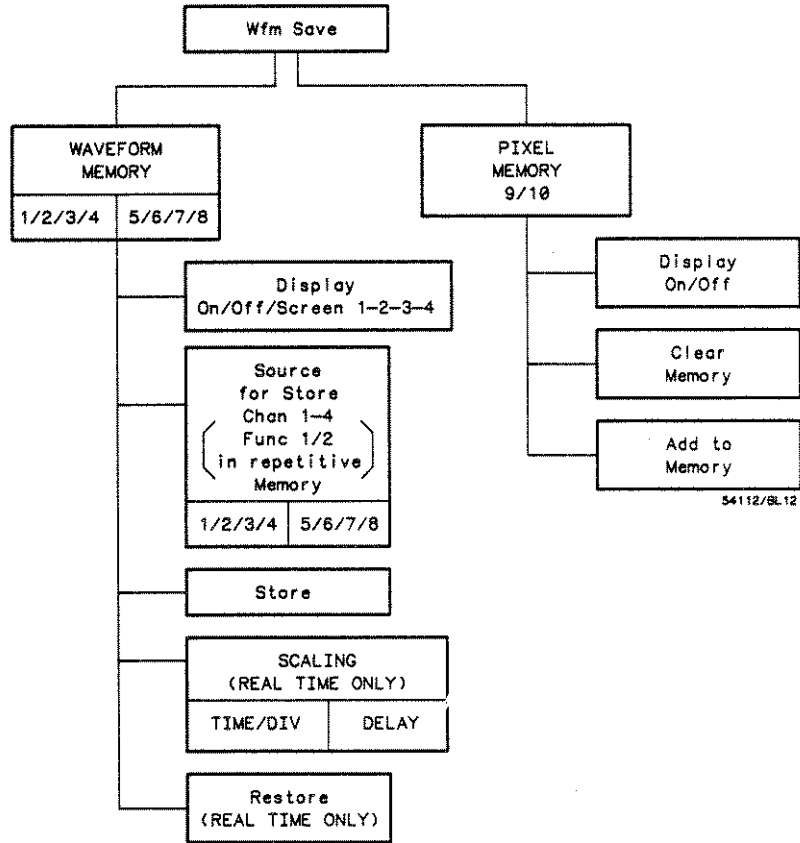

Figure 10-1. Waveform Save Menu.

Waveform Memory Selection

After you have entered the Wfm Save menu, the WAVEFORM/PIXEL MEMORY key is highlighted. This will allow you to use any one of the entry devices to select the desired memory.

The available memory selections are as follows:

- If the HP 54112D is in the real time mode, you can select Memory 1-4. These memories, selected in the Display menu, are 8k or 64k long.
- If the HP 54112D is in the repetitive mode, you can select Memory 5-8. These memories are 501 data points long.

Note

Waveform memories can store only one waveform at a time. If you store a waveform to a memory that already contains a waveform record, the first record is written over and lost.

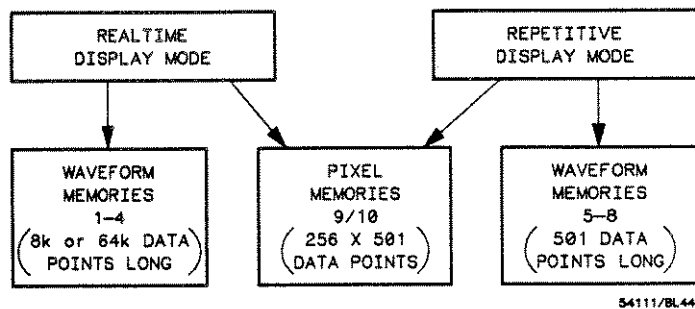

Figure 10-2. Memory Type vs. Display Mode.

the following waveform factors are stored as part of the record:

- vertical sensitivity
- vertical offset
- sweep speed
- time delay

This allows you to make automatic measurements on waveforms stored in these memories (all memories except pixel).

Real-Time Waveform Memories

When the HP 54112D is in the real-time mode, as selected from the Display menu, memories 1-4 are available.

Display Key This key allows you to turn the display for the selected memory on or off.

In the dual or quad screen mode you can select which screen displays the selected memory data. See Chapter 7, "Display Menu."

Source For Store Key This key allows you to select which source is to be stored in the selected WAVEFORM MEMORY. You can choose all four channels and memories 1-4 as sources.

A channel must be turned on to be used as a source. A memory must have a waveform record stored in it to be used as a source.

Store Key Pressing this key stores the specified waveform to the selected memory.

Note

Waveforms cannot be stored in the waveform memories in the 64k real time display mode while the instrument is "Running." To store 64k waveforms, use the pixel memories or stop the instrument, press the STOP/SINGLE key, wait until the status line indicates "Stopped" and then store the waveforms.

selected memory. It also allows zooming and panning (see Chapter 7).

Restore Key Pressing this key allows you to restore the selected memory to its original TIME/DIV and DELAY values. If you have been using the scaling functions, press Restore to return the waveform in the selected memory to its original memory values.

Repetitive Waveform Memories

When the HP 54112D is in the repetitive mode, as selected from the Display menu, memories 5-8 are available.

Display Key This key allows you to turn on (or off) the display for the selected memory.

In the dual or quad screen mode you can select which screen displays the selected memory data. See Chapter 7, "Display Menu."

Source For Store Key This key allows you to select which source is to be stored in the selected WAVEFORM MEMORY. You can choose all four channels, memories 5-8, or functions 1 and 2 as sources.

A channel or function must be turned on to be used as a source. A memory must have a waveform record stored in it to be used as a source.

Store Key Pressing this key stores the waveform to the selected memory.

Pixel Memories

Pixel memories are used when it is necessary to compare multiple signal acquisitions.

Pixel memories 9-10 are available in both display modes and are 256 X 501 bit memories. These are designed so that multiple waveforms can be stored in each. If more than one waveform is saved in pixel memory, the waveforms are superimposed.

Key

- Clear Memory Key** Pressing this key erases all data stored in the selected pixel memory.
- Add to Memory Key** This key allows you to store all displayed data from channels and functions in the selected pixel memory. This data joins whatever data is already stored.

Note

You cannot make automatic measurements from the Measure menu on waveforms stored in pixel memory because waveform factors are not maintained.



.....

.....

.....

Chapter Contents

The Waveform Math Menu allows you to define two functions. The functions can be used on data that is displayed on screen from any of the four channels or from the eight memory registers, but not from pixel memory.

A function is generated by adding or subtracting one operand to or from another, or by inverting an operand. The function can be:

- displayed
- evaluated with the HP 54112D automatic measurements
- stored in one of the waveform memories

This chapter describes how the built-in math functions operate and how you can use them to add, subtract, or invert waveforms. Also, in this chapter is an exercise demonstrating the functions.

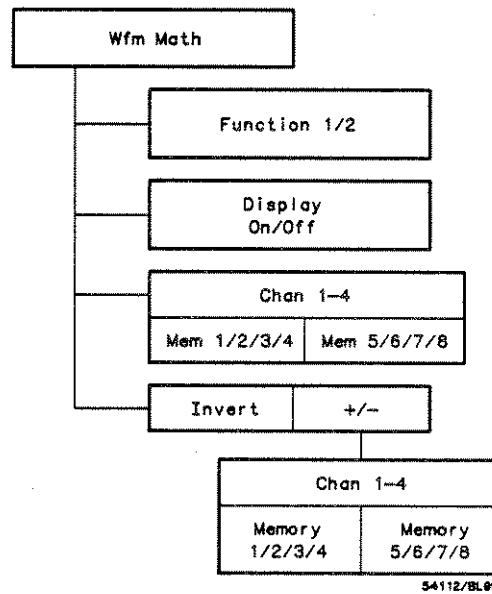

Figure 11-1. Waveform Math Menu.

Function Menu

After you have entered the Wfm Math menu, you can access the add and subtract functions and the waveform invert function. You can also select operands for the functions.

Function 1
Display Off
Chan 1
—
Chan 2

Function Key

This key allows you to define Function 1 or Function 2 using a mathematical computation between two waveforms.

Display Key

This key allows you to turn on (or off) the display for the desired function. If a function is turned on, the vertical deflection factor is displayed at the bottom of the waveform display area. If both functions are displayed, both sets of factors are displayed and offset appears on screen.

Note

Function 1 cannot be used with channel 3, and function 2 cannot be displayed with channel 4. If either function is turned on, the associated channel will automatically be turned off.

First Operand Key

You can select the operand with this key. This waveform is the first waveform to be manipulated. In the real-time mode you can choose from memories 1-4 or channels 1-4, or in the repetitive mode you can choose from memories 5-8 or channels 1-4. Memories can only be used in a function if a waveform is stored.

Key following:

- “+” adds the two operands.
- “-” subtracts the second operand from the first.
- “invert” the first operand and disable the second operand key.

Second Operand Key This key allows you to select the second operand for the math operations. The same selections are available as for the first operand key.

Waveform Math Exercise

In this exercise you will use the Wfm Math menu and subtract one waveform from another.

Instrument Setup Set up the HP 8116A as follows:

- Normal mode
- Frequency = 4 MHz
- Amplitude = 2 V
- Offset = 0
- Function = square wave

Set up the HP 54112D as follows:

1. Install the BNC tee to channel 1.
2. Connect one end of a coaxial cable to the output of the function generator and the other end to the BNC on channel 1.
3. Connect the other coaxial cable from channel 2 to the BNC tee on channel 1.

The extra length of cable between channels 1 and 2 provides a time delay that allows the signal to arrive at channel 2 after it arrives at channel 1.

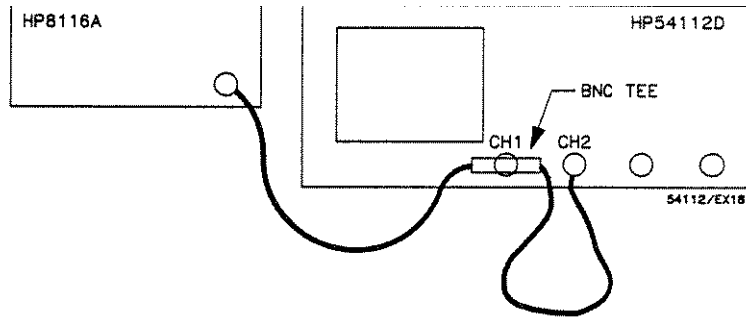

Figure 11-2. Equipment Connection.

4. Press AUTO-SCALE.
5. Enter the Display menu; select Repetitive mode and Quad screen.
6. Select Wfm Math menu and set Function 1 = Chan 1 – Chan 2.
7. Turn Function 1 display on.

Function 1 is the waveform displayed in the third screen. The spikes are the result of the delay from channel 1 to channel 2.

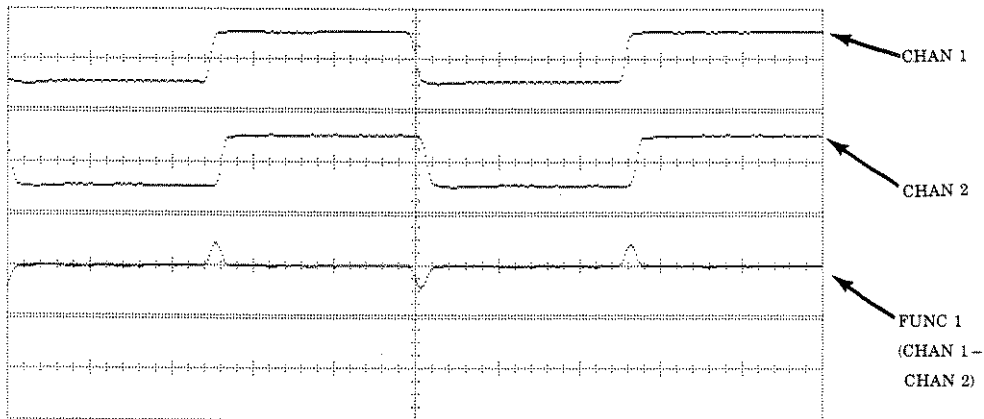

Figure 11-3. Waveform Math.

If you would like to keep this data for future reference, you can store Function 1 in one of the waveform memories. To characterize this function, select the Measure menu and use any of the automated measurements.

Chapter Contents

This chapter describes the automatic waveform measurements.

The Measure menu is your access to the HP 54112D's twelve automatic measurements. You can measure twelve waveform parameters simply by pressing the All key, you can select each measurement individually, and you can turn on the Repeat function and update your measurement or measurements approximately every half second. These automatic measurements conform to the IEEE standard 194-1977, "IEEE Standard Pulse Terms and Definitions." Refer to Appendix A of this manual for information on how the oscilloscope makes automatic measurements.

You can also document the results of the measurements with an HP-IB printer or plotter. See "Hardcopy Menu," chapter 13 for more details.

After you have selected the Measure menu, you can use three measure-function menus that you can cycle through by pressing the more key, the bottom key in the function menu.

Measure Key

The Measure key, the top key of the function menu, allows you to select the waveform source to be measured. To measure a source, ensure it is turned on (displayed).

You may select from the following:

- channels 1-4
- functions 1 and 2
- memories 1-4 when the HP 54112D is in the real-time mode
- memories 5-8 when the HP 54112D is in the repetitive mode

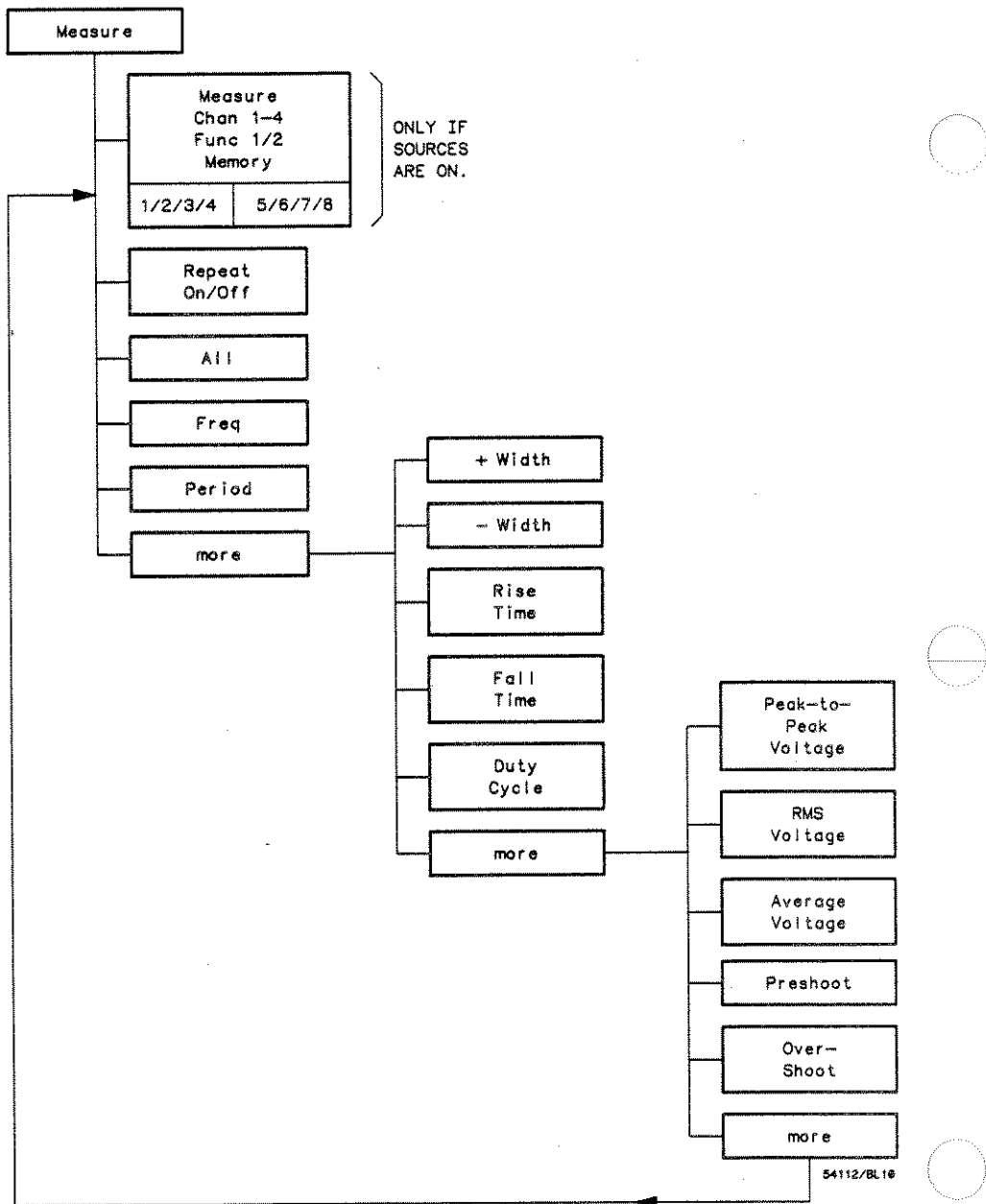

Figure 12-1. Measure Menu.

Repeat Key

Pressing the Repeat key causes the HP 54112D to update the last measurement selected every half-second or every acquisition, whichever is slower.

If you exit the Measure menu with the Repeat key on, you must reselect your desired measurement upon re-entering the menu.

To turn off the Repeat function, press the Repeat key again and the last update will remain on the display.

All Key

Pressing the All key causes the HP 54112D to automatically make the measurements listed below and displays the results at the bottom of the CRT.

Freq (frequency)	+ Width	Peak-to-Peak Voltage
Period	- Width	RMS Voltage
	Rise Time	Average Voltage
	Fall Time	Preshoot
	Duty Cycle	Overshoot

Any of these measurements can be made independently by pressing the appropriate key.

When a measurement is made, the voltage and time markers are automatically placed on the signal displayed.

If the All key is selected after the Repeat key has been turned on, all twelve measurements will be updated continuously.



Chapter Contents

The Hardcopy menu makes it possible to get a hardcopy, with either an HP-IB graphics printer or plotter without an external controller. The hardcopy will include the displayed waveform, measurement results, graticule, and time references.

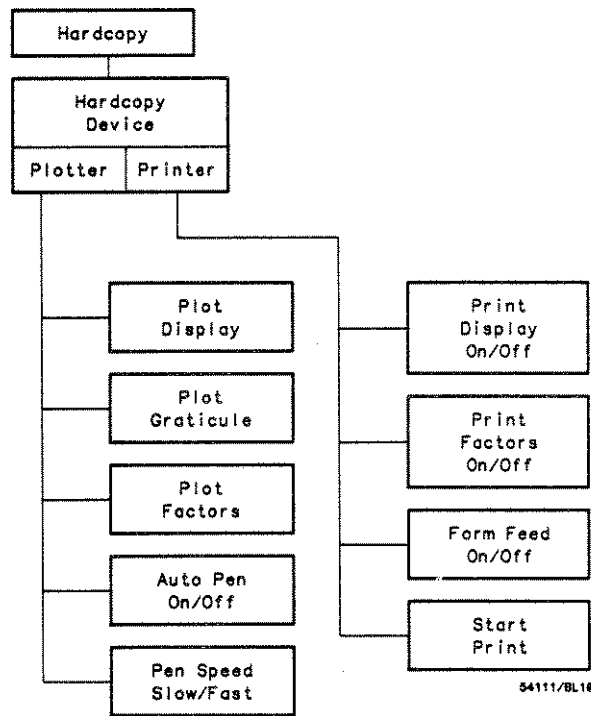

Figure 13-1. Hardcopy Menu.

Setting Up the System

To make a hardcopy without a controller the following settings are necessary:

- Set HP 54112D to "Talk Only," see Chapter 14, "Utility Menu."
- Set the printer or plotter to "Listen Only" or Listen Always."
- If there is no "Listen Only" switch, set the address of the peripheral device to 31 (all 1's on the address select switch). This is an invalid address and will automatically set the device to a "Listen Only" mode.
- Recycle the power of the printer or plotter after changing any switches or addresses.

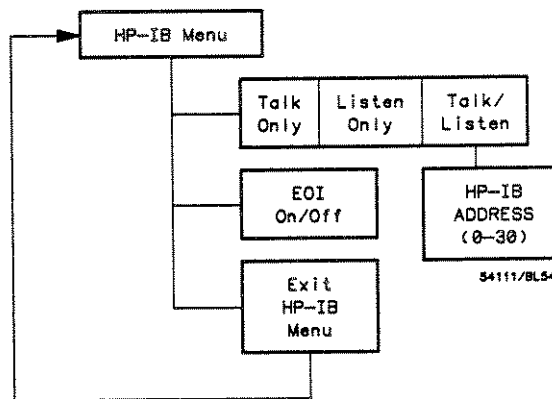

Figure 13-2. HP-IB Menu.

Hardcopy Device Key

This key allows you to select the peripheral device for a hardcopy. You can select between:

- Printer
- Plotter

After you have selected one of the two devices, the Hardcopy menu changes for further selections.

Printer Menu

The Printer menu lists print options for the data to be output over the HP-IB to a compatible printer. The HP 54112D supports all printers that use the Hewlett-Packard Raster Scan Standard.

You can modify the output by selecting one of three print options in the menu.

Hardcopy Device Printer
Print Display On
Print Factors On
Form Feed Off
Start Print

- Print Display** This key makes printing the waveform optional. If the Print Display is disabled, only the factors will be printed. The graticule will be printed, or not be printed, in conjunction with the waveform.
- Print Factors** This key can disable printing the measurement factors that are displayed under the waveform display area.
- Form Feed** If Form Feed is on, the paper will automatically form feed after all printing is complete.
- Start Print** After all options have been selected, press Start Print and printing will begin immediately.

Note

When printing begins, the HP 54112D stops acquiring data. The display is in the stopped mode.

While printing is in progress, the original menu is substituted with another containing the following interim commands.

Pause/Continue Key This key allows you to momentarily stop printing, then continue again.

Abort Key This key stops the printing process entirely.

Plotter Menu

If you select a plotter as the hardcopy device, the output of the HP 54112D is formatted to interface directly with plotters that use the Hewlett-Packard Graphics Language and HP-IB.

Hardcopy Device Plotter
Plot Display
Plot Graticule
Plot Factors
Auto Pen On
Pen Speed Fast

Plot Display

This key allows you to plot the display. Pressing this key plots only the display.

Plot Graticule

Pressing this key plots the graticule without the waveform.

Plot Factors

Pressing this key plots all measurements, display parameters, and data displayed under the waveform display area.

Note

When plotting begins, the HP 54112D stops acquiring data. The display is in the stopped mode.

Auto Pen

The HP 54112D supports multi-pen plotters. If the Auto Pen option is on, the plotter selects a new pen when a different item (display, factors, or graticule) is to be plotted.

Pen selection is as follows:

Pen #	Usage
1	Graticule, timebase factors, channel 3, function 1, and their associated factors
2	Channel 1 and associated factors
3	Waveform memories and associated factors, pixel memories 9 and 10
4	Channel 2 and associated factors
5	Markers and delta measurement results
6	Channel 4, function 2 and associated factors

new item is to be plotted.

Pen Speed Key The Pen Speed key allows you to select fast or slow speeds, if the plotter has that capability. Use a slow pen speed when making overhead transparencies and a faster pen speed when plotting on paper.

If the Display is in the persistence mode (repetitive display mode with averaging off) or if you are plotting pixel memories, the output from the HP 54112D causes the plotter to plot each dot of the display.

In the real-time mode, all points displayed on the CRT are plotted. In particular, if 8192 or 64000 points are displayed, they are sent to the plotter and plotted individually. In all other cases, waveforms are plotted in a continuous line.

While plotting is in progress, the original menu is substituted with another containing the following interim commands:

Pause/Continue Key This key allows you to discontinue plotting momentarily, then to begin again.

Abort This key allows you to stop plotting entirely and return to the menu.



.....

.....

.....

Chapter Contents

Probe Menu
HP-IB Menu
Cal Menu
Test Menu
Color Menu
CRT Setup Menu

The Utility menu key allows you to access six submenus that are displayed in the function menu area. These submenus are accessed by merely pressing the appropriate key.

The submenus are:

- Probe
- HP-IB
- Cal
- Test
- Color
- CRT Setup

The CRT Setup and Test menu used for performance verification and extended tests are described in detail in the *HP 54112D Service Manual* and are not covered here.

Probe Menu

After you have entered the Probe menu, you may select any of four channel inputs to change attenuation ratios. Any of the entry devices can be used to make the desired changes.

When a probe attenuation factor has been defined, the actual sensitivity at the BNC does not change; however, all voltage displays and markers are adjusted to reflect the attenuation factor.

The attenuation factors are stored with the rest of the front-panel setup in the Save and Recall registers.

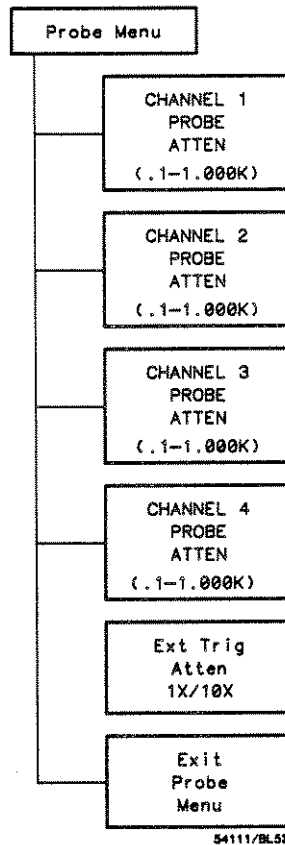

Figure 14-1. Probe Menu.

**Channel N
Probe Atten
Key**

- Each channel has a 100.0 m-1.000k attenuation range.
- When an HP 10033A (or any probe with a sense ring contact) is attached, the attenuation factor is multiplied by 10; when it is detached, the attenuation factor is divided by 10. For example, if the attenuation factor is 1.510 and the probe is attached, the attenuation factor becomes 15.10.
- At power up, the attenuation factor will be set to 1:1 if no probe is attached or 10:1 if an HP 10033A is attached. Factors are not saved when power is recycled.

**Ext Trig
Atten
Key**

- Attenuation factors of 1X or 10X may be selected.

HP-IB Menu

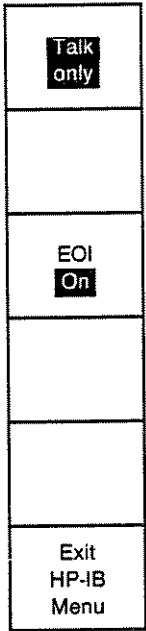

Talk/Listen Key

Select the HP-IB menu when you need to connect the HP 54112D to other HP-IB devices by way of the interface bus.

After you have selected the HP-IB menu, you may set the HP-IB mode to:

- Talk Only
- Listen Only
- Talk/Listen

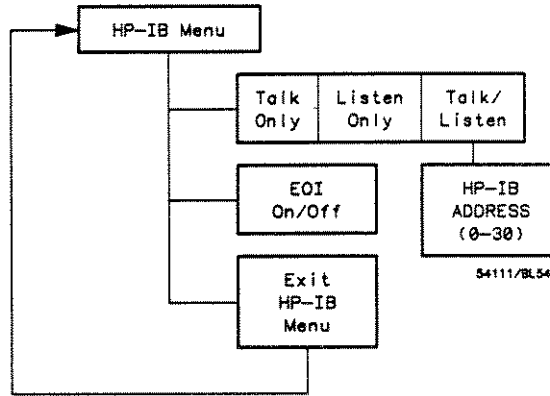

Figure 14-2. HP-IB Menu.

HP-IB Address Key

This key is only available when Talk/Listen is selected. You can set the output address of the HP 54112D (default address is 7).

EOI Key

The EOI (end or identify) key allows you to invoke this HP-IB function. When EOI is "On," the HP 54112D will set the EOI control line to true on the last byte of a data message from the instrument. The default condition for EOI is "On."

For more details about the HP 54112D's HP-IB capabilities, refer to the *HP 54112D Programming Reference Manual*.

Cal Menu

The Cal Menu allows you to calibrate:

- vertical sensitivity
- to the probe tip
- offset
- trigger levels and hysteresis
- channel-to-channel skew

The HP 54112D must be calibrated if the advisory "Powerup Self Test Failed ! Front Panel Calibration Needed" is displayed during power up. This advisory is displayed when:

- battery pack failure occurs
- microprocessor or I/O assemblies have been removed
- two-key down power up is performed

CAUTION

U.S. NBS instrument traceability will be lost if a two-key down power up is performed.

A one-key down power up sets the oscilloscope to the default conditions (see Table 1-1 in the *HP 54112D Programming Reference Manual* for a list of the reset conditions). A two-key down power up sets the oscilloscope to the default conditions, just as the one-key power up does. It also erases all software calibration factors and replaces them with defaults. After a two-key down power up, a complete software recalibration is required.

calibration routines can be performed by following this menu in the order listed.

- Vertical Cal
- Probe Tip Cal
- Offset Cal
- Trigger Cal
- Timebase Cal
- Exit Cal menu

Note

When the HP 54112D is turned on, a self-test is automatically performed and a message is displayed indicating whether the instrument passed or failed. If the instrument fails, recycle the power. If the instrument still fails the self-test, contact your nearest Hewlett-Packard Service Center.

Vertical Cal Vertical Cal allows you to software calibrate vertical sensitivity.

Vertical Cal Procedure: Enter the Cal menu by selecting Utility, then the Cal menu.

1. Press the Vertical Cal key and the advisory "Remove probes from all Channels Press Continue when ready" will be displayed.
2. Remove all probes from inputs and press Continue.

When the calibration has started, the advisory "Setting up hardware for Cal" will be displayed for about two seconds.

- The instrument will then calibrate vertical gain at 20.0 mV, 49.9 mV, 19.9 mV, 10.0 mV, 9.99 mV, and 5.00 mV, per division.
- A counter (moving arrow) will travel across the CRT during calibration to indicate that the instrument is working.

return to the Cal menu.

Note

If the Exit key is pressed before the calibration procedure is complete, the advisory "Vertical Calibration Aborted WARNING: Cal factors may be invalid" will appear and the instrument will return to the Cal menu. Any calibration routines not completed will be invalid.

Vertical cal failure is indicated by incorrect vertical gain or failure to complete the cal routine. If your instrument develops this condition or fails to calibrate, contact a Hewlett-Packard Service Center.

Probe Tip Cal Probe Tip Cal enables calibration from the probe tip through the A/D converter.

Instrument Setup: Connect the front-panel CAL signal through a 10:1 probe (HP 10033A) to the channel 1 input and connect the probe ground clip to the ground sleeve of another BNC input connector.

Note

If you change probes, perform a probe tip cal.

Probe Tip Cal Procedure: Enter the Cal menu by selecting the Utility menu, then the Cal menu.

1. Select the Probe Tip Cal key and display the Probe Tip Cal menu.
2. Select the key that will calibrate the channel you want to calibrate. All four channels are available in this menu.

The screen will clear, then display a set of instructions with a new function menu.

3. Connect the front-panel CAL signal through an HP 10033A probe to your desired channel and connect the probe ground clip to the ground sleeve of another BNC input connector.
4. Press the Continue key when you are ready to start calibration.

Channel N calibration to probe tip" will be displayed.

- The HP 54112D will calibrate the path from the probe tip to the A/D converter.
- A counter (moving arrow) will travel across the CRT during calibration to indicate the instrument is working.

When the calibration is complete, the HP 54112D will automatically return to the Probe Tip Cal menu.

Probe Tip Cal failure is indicated by incorrect vertical scaling. If problems or errors exist, or the instrument fails to calibrate, contact a Hewlett-Packard Service Center.

Offset Cal Offset Cal allows you to calibrate the offset to a known voltage level and accurately set the vertical scaling.

Instrument Setup: Use an HP 8116A pulse/function generator or a power supply as a dc signal source. If an HP 8116A is used, set it as follows:

1. Disable the four signal selection buttons (ensure the light is off).
2. Select OFS function selection key and set the voltage to 5.00 V.
3. Connect a BNC to probe tip adapter to the OUTPUT of the signal generator and insert the bare tip of an HP 10033A probe into the hole on the end of the adapter.
4. If a power supply is used, set the voltage to 10.0 volts and verify the voltage with a multimeter.
5. Enter the Cal menu and select Offset Cal.
6. Press the function selection key to calibrate channel 1.

The display is "Connect a 10 V (\pm 10mV) dc signal through a 10:1 probe to Channel 1 Press Continue when ready."

7. Press Continue when you're ready to begin calibrating channel 1 offset.
- The advisory "Performing vertical offset calibration" will appear.
 - A counter (moving arrow) will travel across the CRT during calibration to indicate the instrument is working.

remaining channels.

Note

If the Exit key is pressed before the calibration procedure is complete, the advisory "Offset Calibration Aborted...WARNING Cal factors may be invalid" will appear and the instrument will return to the Cal menu. Any calibration routines not completed will be invalid.

Trigger Cal Trigger Cal allows you to calibrate trigger levels and trigger sensitivity (hysteresis).

Instrument Setup: All inputs to all channels must be disconnected.

Trigger Cal Procedure: Enter the Cal menu by selecting the Utility menu, then the Cal menu.

1. Press the Trigger Cal key and the advisory "Remove probes from all Channels Press Continue when ready" will be displayed.

To start trigger calibration on all channels, remove probes from all inputs and press Continue.

- The advisory "Performing internal vertical trigger calibration of channels Setting sensitivity on Channel 1" will be displayed.
- The instrument will then calibrate the channel's trigger at the 20 mV, 10 mV, and 5 mV range.
- A counter (moving arrow) will travel across the CRT during calibration.

After each channel has been calibrated, the HP 54112D automatically repeats the same procedure for each channel until channel 4 has been calibrated. When all channels have been calibrated, the HP 54112D automatically returns to the Cal menu.

Note

If the Exit key is pressed before calibration is complete, the advisory appears "Trigger Calibration Aborted...WARNING Cal Factors may be invalid." Any calibration routines not completed will be invalid.

sensitivity. If problems or errors exist, or if the instrument fails to calibrate, contact a Hewlett-Packard Service Center.

Timebase Cal Timebase Cal is used to software calibrate channel-to-channel skew. Channel Skew aligns the timebase cal signal to the vertical channels.

Alignment occurs at the intersection of the cal signal's edge and the HP 54112D's center horizontal graticule. For each input, this point becomes time-aligned with the zero-delay point. This alignment includes time delays both internal and external to the instrument, including cable length.

Channel Skew Procedure: Enter the Cal menu by selecting the Utility menu, then the Cal menu.

1. Enter the Channel Skew menu by pressing the Timebase Cal key, then the Channel Skew key.
2. Read the displayed advisory and ensure all conditions are met.
3. Press Continue to start calibration.

If the Timebase Cal signal is connected, the instrument will preset the channels to single screen, to 200 mV/division sensitivity, 200 mV offset, 200 mV trigger level, and 50 Ω dc coupling.

The screen will display "Aligning Chan N to Chan N skew and Chan N Trigger Sweep Speed = XX ns." Skew will be calibrated at 20 ns, 2 ns, 250 ns, 500 ns, 1 μ s, and 5 μ s.

If the calibration fails, verify that the Timebase Cal signal is present. It is approximately a 0-500 mV, 33 khz square wave when terminated with 50 Ω .

Calibration of the following channels must be completed:

- Ch1 and Ch1 to Ch2
- Ch1 to Ch3
- Ch1 to Ch4
- Ch1 to Ext

Note

*If the Exit key is chosen before calibration is complete, the display is "Channel Skew Calibration aborted
WARNING Cal factors may be invalid."*

Color Menu

COLOR FIELD 0
HUE
SATUR- ATION
LUMIN- NOSITY
Default Setting
Exit Color Menu

The Color menu allows you to define the 16 (0-15) color fields available on the HP 54112D and can be individually modified to suit a specific need.

Color selections are maintained in non-volatile memory and are part of the Save and Recall memories.

After you have selected the Utility menu and the Color menu:

1. Use the Color Field key (top key) or one of the entry devices to select the color number you wish to change.
2. Then use the HUE, SATURATION, and LUMINOSITY functions to modify the color number.

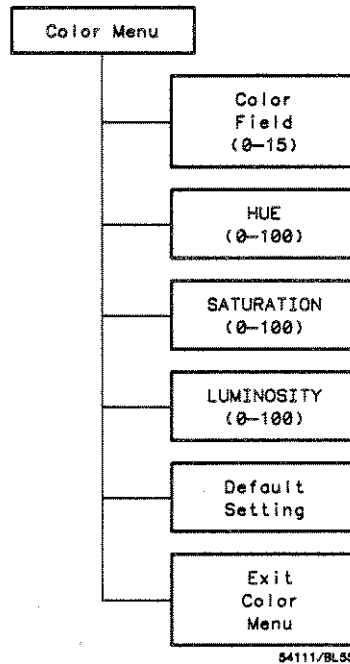

Figure 14-6. Color Menu.

Key

Hue Key The Hue key allows you to change the color.

- The range is from 0 to 100, with red located at 0/100, green at 33, and blue at 67.
- You can use any of the entry devices.

Saturation Key The SATURATION key allows you to define the percent of pure color to be mixed with white.

Luminosity Key The LUMINOSITY key allows you to define the relative brightness of the color.

- The range is from 0 to 100, with 0 being black and 100 maximum brightness.
- You can use any of the entry devices.

Default Setting Key The Default Setting key allows you to set all colors to their default states. Refer to Table 14-1.

COLOR #	COLOR	USE	HUE	SATURATION	LUMINOSITY
0	Black	Background	0	0	0
1	Beige	Highlighting	11	53	100
2	Gray	Text (Halfbright)	0	0	55
3	Red	Advisory	0	100	100
4	Yellow	Channel 1	17	100	100
5	Green	Channel 2	33	100	100
6	Orange	Markers	8	100	100
7	White	Stored traces (when selected)	50	85	90
8	Magenta	2 trace overlap	90	100	100
9	Tangerine	Function 1	11	100	100
10	Blue	Function 2	3	60	100
11	Magenta	Memory bar	90	100	100
12	Magenta	3 trace overlap	90	100	100
13	Magenta	2 trace + memory overlap	90	100	100
14	Magenta	3 trace + memory overlap	90	100	100
15	Magenta	4 trace + memory overlap	90	100	100

Table 14-1. Default Color Settings

Introduction

This section contains a list of specifications for reference and performance verification. This section also includes supplemental characteristics which are typical parameters that are included in this manual as additional information.

**VERTICAL
(VOLTAGE)**

Specifications****

Channels	4	
Bandwidth (-3dB)*	Real-time	Repetitive
dc-coupled	dc to 100 MHz	dc to 100 MHz
ac-coupled	10 Hz to 100 MHz	10 Hz to 100 MHz
Transition Time	See "Operating Characteristics"	
Deflection Factor (full scale=8 div)	5 mV/div to 5 V/div continuous	
Resolution (% of full scale)	6 bits (1.6%), 8 bits with averaging (0.4%)	
DC Gain Accuracy	±2% of full-scale**	
DC Offset Accuracy	±1.5% of setting ±0.2 div***	
DC Measurement Accuracy	±Gain Acc. ± Offset Acc. ± Resolution	
single data point	±Gain Acc. ± 2 x Resolution	
between data points on the same waveform		
DC Offset Range	±1 V (5 mV/div to 49mV/div) ±10 V (50 mV/div to 499 mV/div) ±40 V (500 mV/div to 5 V/div)	
Input Coupling	ac/dc/dc-50 Ω	
Maximum Safe Input Voltage	±40 Volts @ 1 MΩ (dc +peak ac), 5 Vrms @ 50 Ω	

Note

All voltages in table correspond to a 1:1 attenuation setting. If a 10:1 probe is attached, multiply all voltages by ten. The HP 10033A has a maximum voltage of ±200 V.

- * Bandwidth for settings 1 mV/div to 4 mV/div is reduced to 150 MHz.
- ** When calibrated to probe tip using the front panel calibration source. Applies to major ranges (5 mV/div, 10 mV/div, 20 mV/div, 50 mV/div, 100 mV/div, 200 mV/div, 500 mV/div, 1 V/div, and 2 V/div). All continuous settings between these ranges are ±3% of full-scale.
- *** Increases to ±0.4 divisions at 5 mV/div to 9 mV/div
- **** Applies for temperature ranges ±5° C from point of last software calibration.

**HORIZONTAL
(TIME)**

	Real-time	Repetitive
Digitizing Rate	400 megasample/s to 50 sample/s	
Deflection Factor	2 ns/div to 1 s/div	
Memory Depth Per Channel	64k or 8k	501
Pre-trigger Delay Range	-160 μ s at timebase settings 249 ns/div and faster, increasing to -1200 sec at 1 s/div.	
Post-trigger Delay Range	0.16 s at timebase settings .5 μ s/div and faster, increasing to 10,000 seconds at 1 s/div.	
Time Interval Measurement Accuracy single channel	± 500 ps ± 0.002 of reading*	
dual channel	± 1 ns $\pm 0.002\%$ of reading.**	

* Decreased to ($\pm 2\%$ of time range $\pm 0.002\%$ of reading) for time ranges 200 ns and slower. Time range is (time/div \times 10).

** Decreased to ($\pm 4\%$ of time range $\pm 0.002\%$ of reading) for time ranges 200 ns and slower. Time range is (time/div \times 10).

TRIGGERING

Sources	Internal Channels 1,4	External Trig.
Sensitivity	0.1 of full-scale, 100 MHz BW	20 mV (1:1) 50 MHz BW
Trigger Level Range	$\pm 3 \times$ full-scale	± 5 V (1:1)
Maximum Safe Voltage	NA	± 40 V (dc + peak ac),
Input Operating Range	NA	± 5 V (1:1) (dc + peak ac)

TRIGGER

Trigger Modes

Edge trigger: on any source.

Pattern trigger: a pattern can be specified for all sources. Each source can be specified as high, low, or don't care. Trigger can occur on the last edge to enter the specified pattern or the first edge to exit the specified pattern.

State trigger: a pattern can be specified for any of the sources. Trigger can be set to occur on an edge of either polarity on the source specified as the clock (not one of the pattern sources) when the pattern is present or not present. Setup time for the pattern to be present prior to the clock edge is < 4 ns; hold time is zero. Maximum clock repetition rate is 80 MHz.

Delay Trigger

Events-delayed mode: the trigger can be armed by an edge on any source, then triggered by the nth edge on any other source. The number of events, n, can be set from 1 to 16,000,000. Maximum event counting rate is 35 MHz.

Time-delayed mode: the trigger can be armed by an edge on any source, then triggered by the first edge on any other source after a specified time has elapsed.

Display

Data Display Resolution: 501 points horizontally by 256 points vertically.

Data Display Formats

Split screen: channel displays are two or four divisions high, corresponding to quad or dual display mode.

Full screen: channels are overlaid and are eight divisions high.

Display Modes

Variable persistence: the time that each data point is retained on the display can be varied from 200 ms to 10 seconds, or it can be displayed in the infinite persistence mode.

Averaging: the number of averages can be varied from 1 to 64. On each acquisition, 1/n times the new data is added to (n-1)/n of the previous value at each time coordinate. Averaging operates continuously; the average does not converge to a final value after n acquisitions, except over HP-IB.

General Characteristics

ENVIRONMENTAL CONDITIONS

Temperature

Operating: +0°C to + 45° C (+32° F to + 113° F)

Non-operating: -40° C to +75° C (-40° F to +167° F)

Humidity

Operating: up to 95% relative humidity (non-condensing) at
+40° C (+104° F)

Non-operating: up to 90% relative humidity at +65° C
(+149° F).

Altitude

Operating: up to 4600 metres (15,000 ft)

Non-operating: up to 15,300 metres (50,000 ft).

Vibration

Operating: random vibration 5-500 Hz, 10 minutes per axis,
~0.3 grams.

Non-operating: random vibration 5-500 Hz, 10 minutes per
axis, ~2.41 grms; resonant search 5-500 Hz swept sine,
1 octave/min sweep rate, 5 minute resonant dwell @ 4 resonances
per axis.

POWER REQUIREMENTS

Voltage: 115/230 V ac, -25% to + 15%, 48-66 Hz.

Power: 350 watts maximum, 700 VA maximum.

WEIGHT

Net: approximately 25 kg (55 lb).

Shipping: approximately 32 kg (70 lb).

A

Automatic Parametric Measurements

Introduction

One of the HP 54112D's primary features is its ability to make parametric measurements on displayed waveforms. This chapter provides details on how automatic measurements are performed and some tips on how to improve automatic measurement results.

Measurement Setup

Measurements typically should be made at the fastest possible sweep speed to obtain the most measurement accuracy possible. For any measurement to be made, the portion of the waveform required for that measurement must be displayed on the oscilloscope. That is:

- period or frequency measurement — at least one complete cycle must be displayed.
- pulse width measurement — the entire pulse must be displayed.
- risetime measurement — the leading (positive-going) edge of the waveform must be displayed.
- falltime measurement — the trailing (negative-going) edge of the waveform must be displayed.

Making Measurements

If more than one waveform, edge, or pulse is displayed, the measurements are made on the first (leftmost) portion of the displayed waveform that can be used.

When any of the defined measurements are requested, the oscilloscope first determines the top (100%) and base (0%) voltages of the waveform. From this information, it can determine the other important voltage values (10% voltage, 90% voltage, and 50% voltage) required to make the measurements. The 10% and 90% voltage values are used in the risetime and falltime measurements. The 50% voltage value is used for measuring frequency, period, pulse width, and duty cycle.

Automatic TOP-BASE

TOP-BASE is the heart of most automatic parametric measurements. It is used to find VTOP and VBASE, the 0% and 100% voltage levels at the top and the bottom of the waveform. From this information the instrument can determine the 10, 50, and 90 percent points, which are used in most automatic measurements. The TOP or BASE of the waveform is not necessarily the maximum or minimum voltage present on the waveform. Consider a pulse that has a slight amount of overshoot. It would be wrong to select the highest peak of

the waveform as the TOP since the waveform normally rests below the perturbation.

TOP-BASE performs a histogram on the waveform and finds the most prevalent point above and below the waveform midpoint. The most prevalent point is one that represents greater than approximately 5% of the total display points (501) and is considered to be either the TOP or BASE. If no point accounts for more than 5% of the total, then the TOP is chosen as the absolute maximum and the BASE is chosen as the absolute minimum.

Measurement Algorithms

Frequency The frequency of the first complete cycle on screen is measured using the 50% levels. The algorithm used is:

```
if the first edge on screen is rising
then
    frequency = 1/(time at second rising edge
                  - time at first rising edge)
else
    frequency = 1/(time at second falling edge
                  - time at first falling edge)
```

Period The period is measured at the 50% voltage level of the waveform. The algorithm for this measurement is:

```
if the first edge on screen is rising
then
    period = (time at second rising edge
              - time at first rising edge)
else
    period = (time at second falling edge
              - time at first falling edge)
```

Duty Cycle The positive pulse width and the period of the displayed signal are measured. Then the duty cycle is calculated using the following formula:

$$\text{duty cycle} = (+\text{pulse width}/\text{period}) \times 100$$

Positive Pulse width (+ Width) Pulse width is measured at the 50% voltage level. The algorithm for this measurement is:

if the first edge on screen is falling
then
width = (time at second falling edge
– time at first rising edge)
else
width = (time at first falling edge
– time at first rising edge)

Negative Pulse Width (- Width) Negative pulse width is the width of the first negative pulse on screen using the 50% levels. The algorithm used is:

if the first edge on screen is rising
then
width = (time at second rising edge
– time at first falling edge)
else
width = (time at first rising edge
– time at first falling edge)

Risetime The risetime of the first displayed rising (positive-going) edge is measured. To obtain the best possible measurement accuracy, set the sweep speed as fast as possible while leaving the leading edge of the waveform on the display. The risetime is determined by measuring the time at the 10% and 90% voltage points on the rising edge, and then the risetime is calculated using the formula:

$$\text{risetime} = (\text{time at 90\% point} - \text{time at 10\% point})$$

Falltime Falltime is measured between the 10% and 90% points of the falling (negative-going) edge. To obtain the best possible measurement accuracy, set the sweep speed as fast as possible while leaving the falling edge of the waveform on the display. The falltime is calculated using the following formula:

$$\text{falltime} = (\text{time at 10\% point} - \text{time at 90\% point})$$

Peak-to-Peak Voltage The maximum and minimum voltages for the selected source are measured. Then the peak-to-peak voltage is calculated using the formula:

$$\text{peak-to-peak voltage} = V_{\text{max}} - V_{\text{min}}$$

where V_{max} and V_{min} are the maximum and minimum voltages present on the selected source.

RMS Voltage The rms voltage is computed over one complete period with the following equation:

$$V_{rms} = \left[\frac{1}{n} \sum_{j=1}^{j=n} V_j^2 \right]^{1/2}$$

Average Voltage The average voltage of the first cycle of the displayed signal is measured. If a complete cycle is not present, the instrument will average the data points on screen.

Preshoot Preshoot measures the first edge on screen using the following algorithm:

```
if the first edge on screen is rising
then
    preshoot = Vbase - Vmin
else
    preshoot = Vmax - Vtop
```

Note that preshoot is measured on the top of a waveform if the first edge on screen is a falling edge. Also, V_{max} , V_{top} , V_{base} , and V_{min} are measured using all the data on screen.

Overshoot Overshoot measures the first edge on screen using the following algorithm:

```
if the first edge on screen is rising
then
    overshoot = Vmax - Vtop
else
    overshoot = Vbase - Vmin
```

Note that overshoot is measured on the base of a waveform if the first edge on screen is a falling edge. Also, V_{max} , V_{top} , V_{base} , and V_{min} are measured using all the data on screen.

Automatic Parametric Measurements

Index (Continued)

memory type versus display mode 10-2
menu selection 3-8
more key 3-8

N

negative pulse width measurement A-2
negative time 9-3
noise, reducing display 7-2
Number of Averages 7-2

O

Of Pos/Neg Edge key 6-9, 6-19
Offset Cal 14-7
Offset key 4-2
On key (Time trigger) 6-14
On key (Events trigger) 6-19
one-key down power-up 14-4
Operating Characteristics 15-6
operating environment 2-1
Operation key 11-3
overshoot measurement 12-3, A-4

P

pan 7-8, 7-11
PATTERN trigger 6-4
Pattern key (State trigger) 6-10
pattern trigger mode 6-4
pattern trigger exercise 6-4
Pattern When Entered 6-7
Pattern When Exited 6-8
Pause/Continue key 13-3, 13-5
peak-to-peak voltage measurement 12-3, A-4
Pen Speed key 13-5
period measurement 12-3, A-2
persistence 7-3
pixel memories 10-4
Plot Display key 13-4
Plot Factors key 13-4
Plot Graticule key 13-4
Plotter menu 13-4
Pos/Neg key (trigger, time) 6-14

positive pulse width measurement 12-3, A-4
power cable 2-4
power requirements 2-2, 15-6
Preset key 4-3
Preset levels key 8-2
preshoot measurement 12-3, A-4
pre-trigger delay 5-3
Print Display key 13-3
Print Factors key 13-3
Printer menu 13-3
probe 14-6
probe attenuation 14-1
Probe menu 14-1
Probe Tip Cal 14-6

quad area display 7-7

R

rack mount kit 2-4
real-time mode 7-1, 7-3
real-time waveform memories 10-3
RECALL SETUP 3-4
Record Length key 7-4
record length 7-10
Repeat key 12-3
repetitive mode 7-1
repetitive waveform memories 10-4
Restore key 10-3
return-to-local 3-6
rise time measurement 12-3, A-3
rms error A-1
rms voltage measurement 12-3, A-1
RUN key 3-3

S

sample rate 5-2
SATURATION key 14-11
SAVE SETUP 3-4
SCALING key 10-3
Screen key 7-7

second operand key 11-3
 single area display 7-7
 single-shot acquisition 7-1, 7-8
 single-shot exercise 7-8
 Slope key 6-3
 Source For Store key 10-3
 source-to-source voltage measurement 8-4
 Specifications 15-1
 STANDBY key (STBY) 2-2
 START marker 9-2
 Start Print key 13-3
 Start/Stop On Edge key 9-2
 state trigger mode 6-10
 state trigger exercise 6-11
 STOP marker 9-2
 STOP/SINGLE key 3-3
 Store key 10-3
 subtraction, waveform 11-1
 sweep speed 5-2
 system control section 3-1

T

Talk/Listen mode 13-2, 14-3
 Talk Only mode 13-2, 14-3
 temperature, operating 2-1
 temperature, drift 2-1
 Test Menu 14-1
 time delay trigger exercise 6-15
 TIME/DIV key 5-1, 7-8
 time-interval measurement exercise 9-3
 time markers (t Markers) 9-2
 Timebase Cal 14-9
 Timebase menu 3-4, 5-1
 Top-Base A-1
 top operand key 11-2
 traceability 14-4
 TRIG ON N EVENTS key 6-20
 Trig on PATTERN 6-4
 Trig on Pos/Neg Edge key (state) 6-10
 Trig On Pos/Neg Edge key (time) 6-16
 Trig Src key 6-3
 Trigger Cal 14-8
 trigger menu 3-4

TRIGGER LEVEL key 6-4
 Trigger menu 6-1, 6-2
 edge mode 6-2
 event mode 6-18
 pattern mode 6-3
 state mode 6-10
 time mode 6-14
 trigger mode overlap 6-1
 trigger slope 6-2
 trigger source 6-2
 triggered sweep 5-4
 TTL preset 4-3
 two-key down power-up 14-4

U

Utility menu 3-4, 14-1

V

variable 8-3
 VARIABLE LEVELS key 8-3
 Vertical Cal 14-5
 vertical operation 4-1
 vertical scaling 7-7
 voltage markers (V Markers) 8-1, 9-2
 Volts/Div key 4-2

W

waveform expansion/compression 7-8
 Waveform Math menu 3-4, 8-1, 11-1
 waveform math exercise 11-3
 waveform memories 10-2
 WAVEFORM/PIXEL MEMORY key 10-2
 waveform record 10-2
 Waveform Save menu 3-4, 10-1
 weight 15-6
 When entered key 6-5
 When exited key 6-5
 width measurement A-2

Z

zoom 7-8