

---

## Getting Started Guide

# HP 54500 Digitizing Oscilloscopes



©Copyright Hewlett-Packard Company 1992

Publication 5090-4364

Printed in the USA January 1992

# Table of Contents

---

**Chapter 1:** Introduction

---

**Chapter 2:** Layout and Setup

- 2-1 Front Panel Layout
- 2-2 Rear Panel Layout
- 2-3 Start Up
- 2-3 Connecting Power
- 2-3 Applying Power
- 2-4 Resetting the Instrument

---

**Chapter 3:** Instant Setup

- 3-2 Autoscale
- 3-3 Vertical Setup
- 3-5 Timebase Setup
- 3-7 Trigger Setup

---

**Chapter 4:** Making Automatic Measurements

- 4-2 Making the Measurements
- 4-5 Clearing the Measurements
- 4-5 Measuring Other Sources

---

<b>Chapter 5:</b>		<b>Making Manual Measurements</b>
	5-2	Making Voltage Measurements
	5-6	What are Time Interval Measurements?
	5-6	Measuring a Waveform Period

---

<b>Chapter 6:</b>		<b>Storing Setups and Waveforms</b>
	6-2	Storing Front-Panel Set Ups
	6-3	Storing a Waveform

---

<b>Chapter 7:</b>		<b>Making a Hardcopy Output</b>
	7-2	Setting Up the HP-IB
	7-3	Hardcopy Output

This Getting Started Guide is a hands-on introduction to the HP 54500 Digitizing Oscilloscopes.

Whether the oscilloscope user is a novice or just new to these particular models, this book gives a working knowledge of the operation of these oscilloscopes. This guide covers the following items:

- understanding the front- and rear-panel layouts,
- applying power to the instrument,
- setting up the oscilloscope,
- making some measurements,
- using and interpreting the display, and
- using some other basic features.

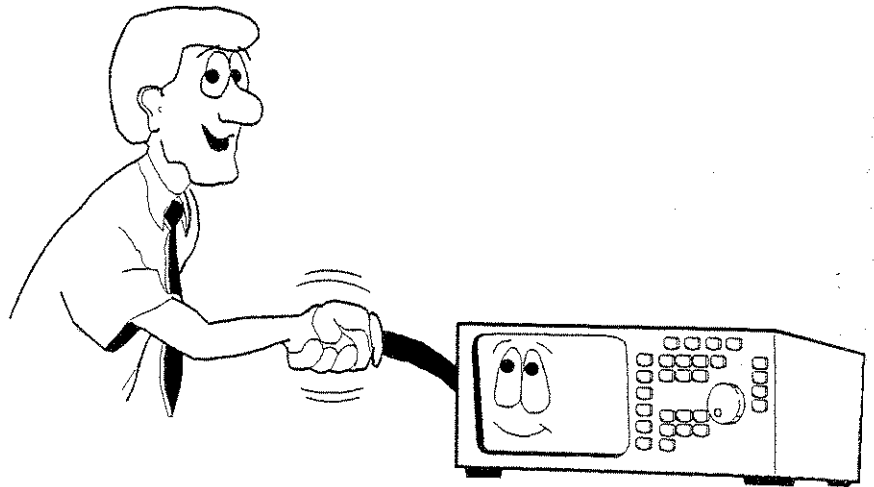

The names of front-panel keys (**AUTOSCALE**, **TIME/DIV**) are in bold type. The action text (rotate the knob, press the **AUTOSCALE** key) is offset by bullets. The text indented under the bullets explain the action.

The HP 54501A was used for most of the examples and figures in this guide. Although all of the oscilloscopes operate very similarly, there are differences in the features of each. The ac calibrator signal of the HP 54501A is approximately 1.5 kHz. On some other models the calibrator signal is approximately 500 Hz. Therefore, some of the values on the display and in the menus of the figures may be different than those displayed on the other oscilloscopes.

Every feature and function of the oscilloscopes is not covered in this guide. All menus and functions are described in the front-panel reference for each oscilloscope.

For an understanding of digitizing oscilloscopes read *Feeling Comfortable with Digitizing Oscilloscopes*, HP Part Number 9320-5776, supplied with each oscilloscope.

All HP 54500A Digitizing Oscilloscopes have the following features:

- Ability to view signal events prior to trigger
- Instant hardcopy output
- Autoscale for automatic setup
- Full HP-IB programmability
- Automatic measurements with user defined and statistics
- Measurement limit test
- Waveform math (+, -, X, vs, invert, only)
- Four nonvolatile setup memories
- Four nonvolatile waveform memories
- Two volatile pixel memories
- Dual timebase windowing, or pan and zoom
- Advanced logic triggering
- TV triggering

Complete specifications and characteristics are listed in appendix B of the Front-Panel Reference for each oscilloscope model.

## Front Panel Layout

The oscilloscope front panel is organized into six functional areas. Typical front panel operation consists of these three main steps:

- selecting a menu (Menu Select keys),
- selecting a function (Function keys),
- entering a numeric value and the unit value (Entry Devices).

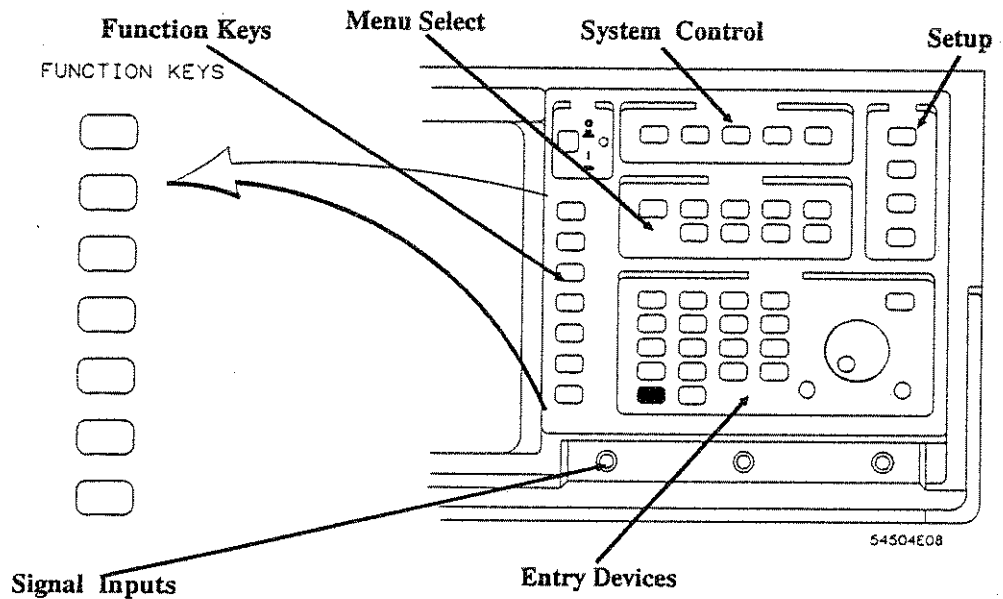

## Rear Panel Layout

The rear panel of the instrument contains the power input, voltage selector module, and power switch, HP-IB connector, probe compensation and ac calibrator output, and the dc calibrator output.

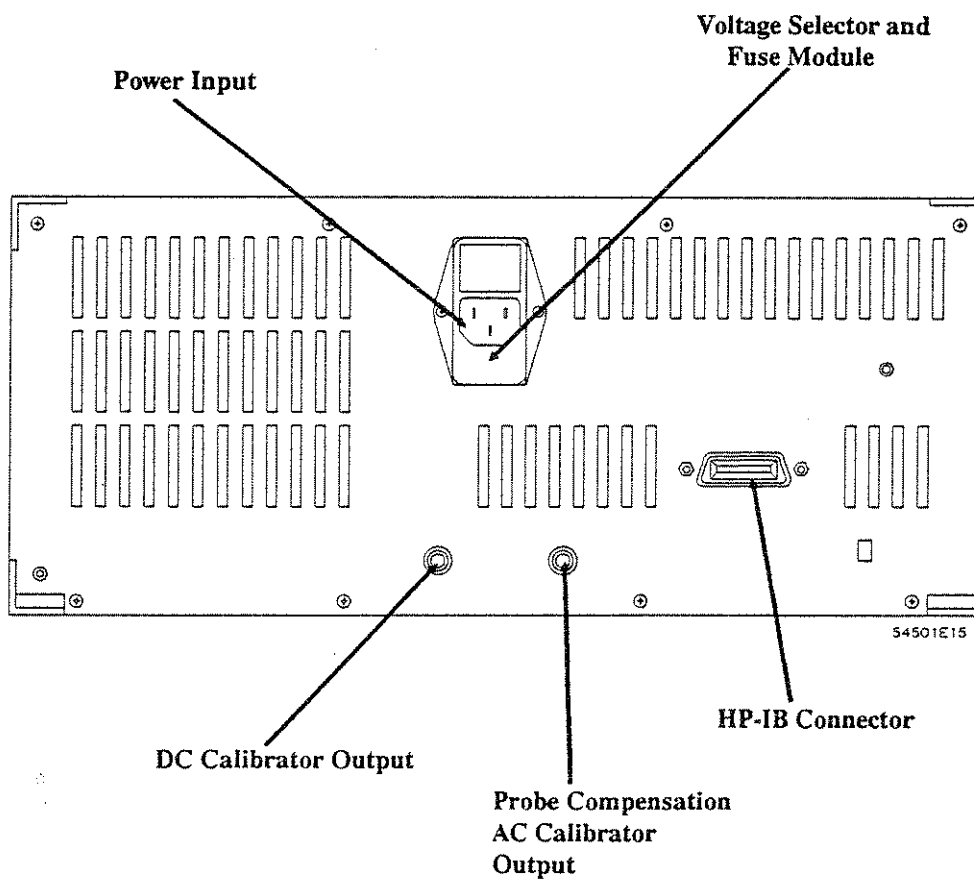

---

## Start Up

Refer to the Front-Panel Reference for complete installation instructions.

## Connecting Power

To ensure safe operation, the following items should be checked before power is applied to the instrument:

- Before connecting the instrument to an ac power source, ensure that the line voltage selector module is installed for the correct voltage. On the line voltage selector module, the correct voltage selection must be at the bottom.
- Make sure that the correct power cord is supplied with the oscilloscope. The correct power cord provides chassis ground for the instrument when it is plugged into the power receptacle.

## Applying Power

After the power cord has been connected to the instrument and power source, set the power switch ON to start instrument operation (0 indicates OFF and 1 indicates ON).



---

## Resetting the Instrument

All instrument settings are stored in nonvolatile memory when power is removed or turned off. These settings are remembered by the nonvolatile memory on power-up. In order to get all settings and keys to a known starting position:

- First press the front panel RECALL key,
- and then press the CLEAR key.

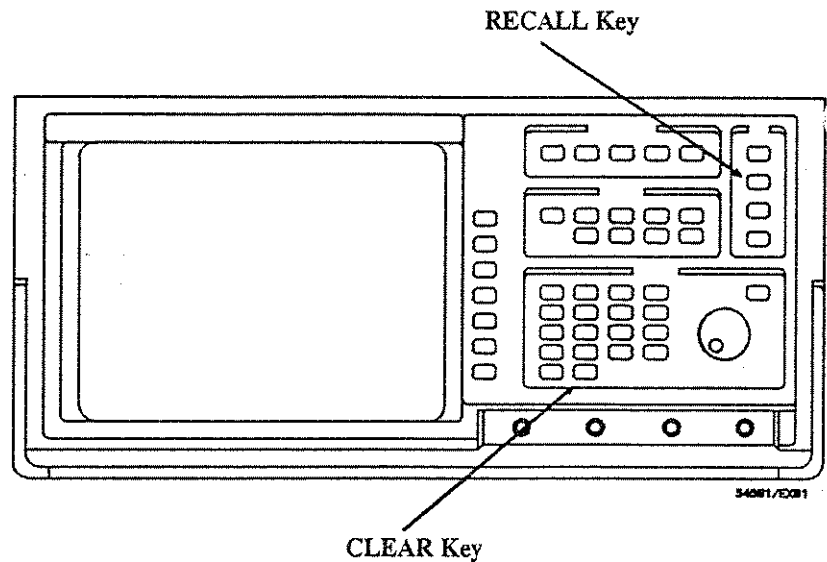

Basic oscilloscope setups are performed in this chapter. The setups are performed automatically and manually. Generally, the automatic setup is used on an unknown signal or signals, then the oscilloscope is adjusted manually for fine-tuning.

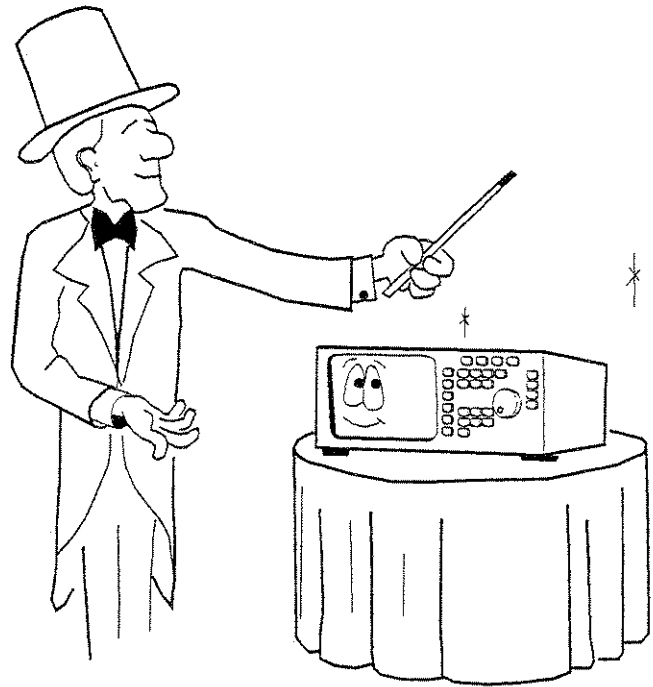

---

## Autoscaling the Oscilloscope

The autoscale feature automatically finds, scales, and displays the input waveform.

- Connect the ac calibrator output, on the rear panel of the oscilloscope to channel 1 input with the supplied probe and probe-to-BNC adapter.
- Press the AUTOSCALE key.

The channel settings and trigger information are displayed on the right of the display.

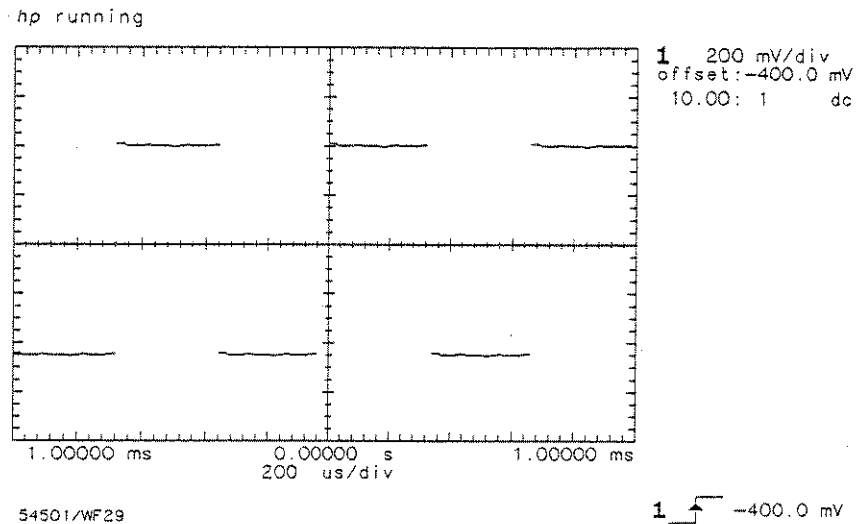

## Vertical Setup

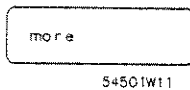
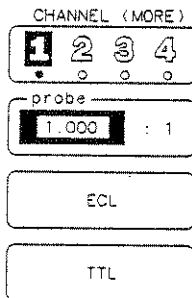
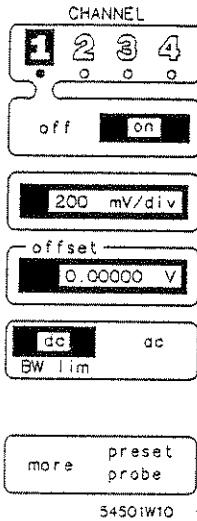

The vertical setup displays the signal at most amplitude levels.

- Press the CHAN Menu key.

The channel menu is displayed at the right edge of the display and volts/division is the active function (displayed in full-bright inverse video.)

- Press the more key.
- Change the probe attenuation to 10:1 (probe supplied with oscilloscope) with the keypad or the knob.

Notice the voltage information changes but the displayed waveform does not.

- Press the more key again to return to the first channel menu and then slowly rotate the knob.

The volts/division changes and the waveform amplitude on the display changes.

Notice the volts/division changes in small increments because of the change in probe attenuation.

- Enter 250 mvolts.

Press 2, 5, 0, mV keys in order. The unit key (mV) completes the entry.

- Press the channel on/off function key.

Turn the channel 1 display off.

The dot below the channel selection changes from inverse video to an outlined dot. This indicates that the channel is turned off.

- Press the channel on/off function key again.

The dot below the channel selection changes to from an outlined dot to inverse video. This indicates the channels is turned on.

## Timebase Setup

Setting the timebase displays the signal at different time/division settings. Remember the frequency of the rear-panel ac calibration signal is different on some models and different values are displayed.

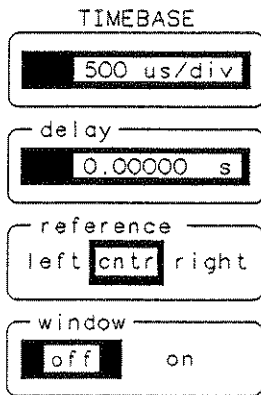

54501W08

- Press the TIMEBASE menu key.

The displayed menu changes to the timebase menu.

The active function is time/division (top key in menu, displayed in full bright).

- Rotate the knob.

The time/division changes in a 1, 2, 5 sequence as the knob is rotated.

hp running

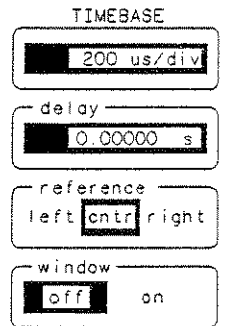
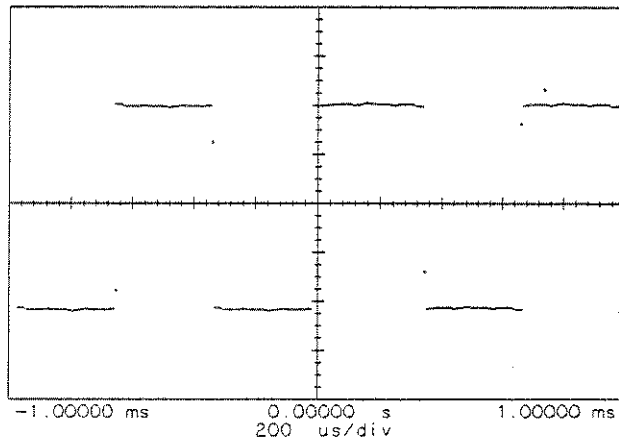

54501/WF 30

- Enter 500  $\mu$ seconds.

Press the 5, 0, 0, and  $\mu$ s keys in order.

Pressing the units key ( $\mu$ s)  
completes the entry.

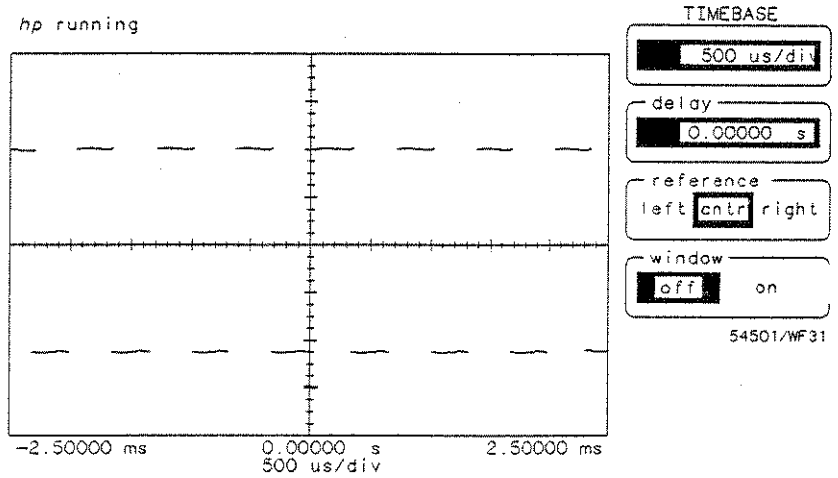

## Trigger Setup

The oscilloscope can be set to trigger at any threshold level with the trigger level function.

- Press the TRIG menu entry key.

The trigger menu is displayed on the right edge of the display.

The trigger level is the active function.

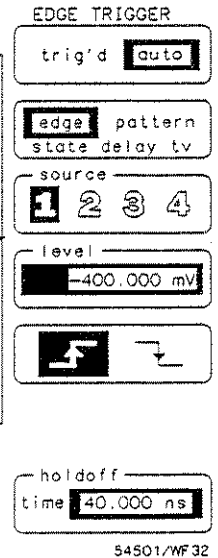
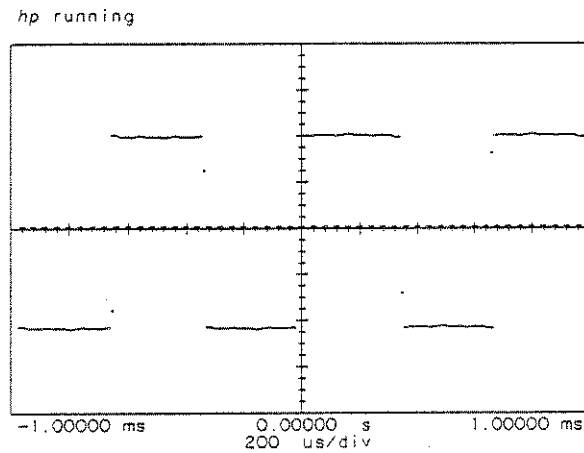
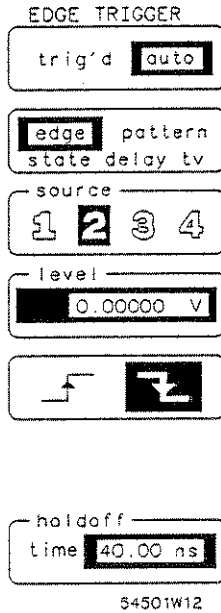



- Rotate the knob.

As the knob is turned the trigger level value is changed.

The trigger level is a horizontal dotted line that moves up and down on the display as the knob is turned.

- Set the trigger level to  $-650$  mvolts.

Enter this value with the keypad.

- Press SHOW key.

The SHOW key is located in the SETUP section of the oscilloscope front panel.

Channel and trigger setup information are displayed.

- Press SHOW key again.

The trigger menu is displayed.

## Making Automatic Measurements

---

4

There are 16 parametric measurements the oscilloscopes make automatically. These measurements are made with standard preset measurement definitions or with user-defined measurement thresholds. This chapter shows measurements using the standard measurement definitions. For more information on user-defined measurements, refer to the Define Measure Menu chapter of the Front-Panel Reference.

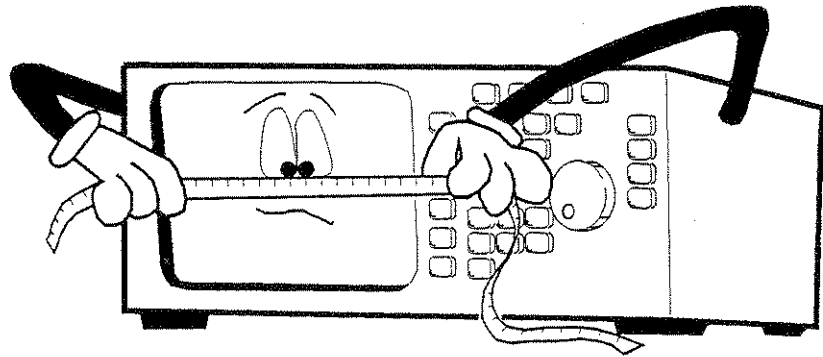

## Making the Measurements

This exercise measures frequency and peak-to-peak voltage of the displayed waveform.

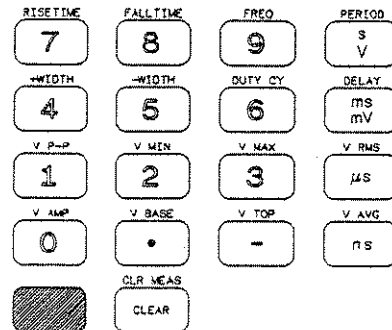

- Connect the ac calibrator signal from the rear panel to channel 1.
- Press the AUTOSCALE key.

The signal from channel 1 is displayed and triggered.

- Press the blue key.

This key is pressed first to select the alternate (blue letter) functions of the keypad.

- Press **FREQ (9)** entry key.

Select frequency as the measurement to be made.

At least one complete cycle of the signal must be displayed.

- Press the **1** entry key to select channel 1 as measurement source.

The result of the frequency measurement is displayed in the figure below. (Frequency of the rear-panel ac calibrator signal may be different than that of the HP 54501A in this figure. See "Introduction" of this guide.)

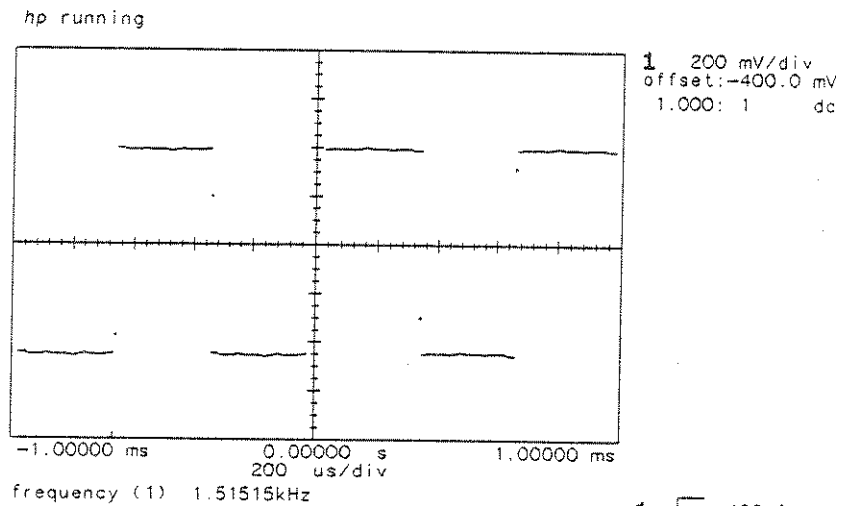

54501W34

- Press the blue key.

Selects the measurement functions.

- Press Vp-p [1] entry key.

Selects peak-to-peak voltage as the measurement.

- Press the 1 entry key to select channel 1 as the measurement source.

Measurement results are displayed below the waveforms. Up to eight measurements can be displayed at a time.

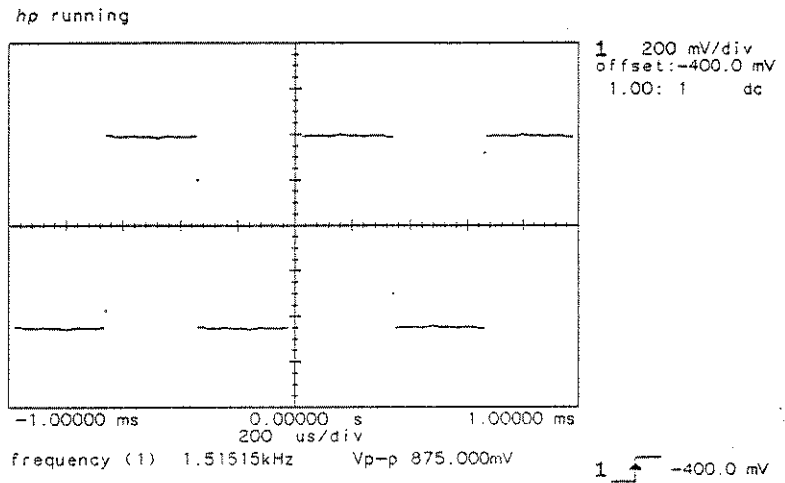

54501W35

If another measurement is made, after the screen is full, it is placed on the bottom display line and the top set of measurements are erased from the display.

---

## Clearing the Measurements

This portion of the exercise shows how to clear the automatic measurements from the display.

- Press the blue key then the CLEAR key.

All measurement results are erased from the display.

---

## Measuring Other Sources

Measurements can also be made on a waveform that is stored in a Waveform Memory or on the results of a mathematical calculation, a Waveform Function.

- Press the blue key then the V P-P [1] key.

The measurement source prompt **c#** (# for channel number) is displayed.

- Rotate the knob slowly.

The measurement source prompt cycles through **m#**, **f#**, and **c#**.

When **m#** is selected, a waveform memory number can be selected as the measurement source. When **f#** is selected, a waveform function number can be selected as the measurement source. When **c#** is selected, a channel number can be selected as the measurement source.

- Press the blue key.

The measurement is cancelled.

# Making Manual Measurements

Two sets of markers (or cursors) are available on the oscilloscopes to make manual time and voltage measurements. These procedures make voltage and time measurements with the voltage markers and time markers.

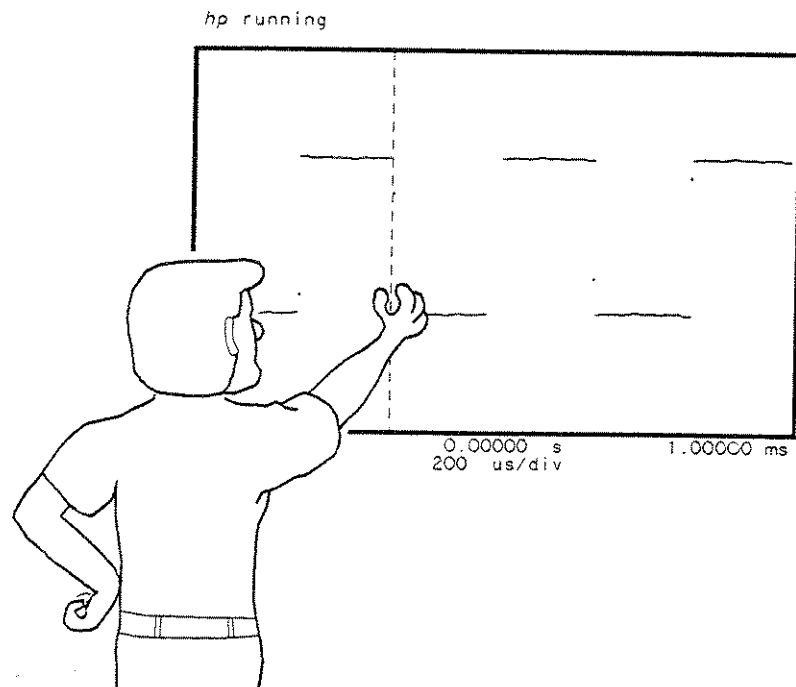



## Making Voltage Measurements

Voltage measurements are made with a pair of voltage markers to determine 1 or 2 specific voltage points on a waveform.

The oscilloscope automatically calculates the voltage difference between the two markers and displays that difference as the delta voltage value.

The following procedure makes a peak-to-peak voltage measurement, then a positive peak measurement with the voltage markers.

- Connect the ac calibrator output to the channel 1 input.
- Press the AUTOSCALE key (or set up the channel display manually).

AUTOSCALE triggers and displays the waveform.

hp running

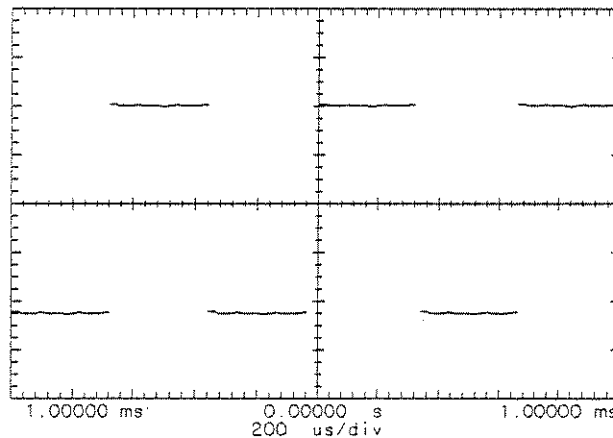

1 200 mV/div  
offset: -400.0 mV  
10.00: 1 dc

54501W29

1 -400.0 mV

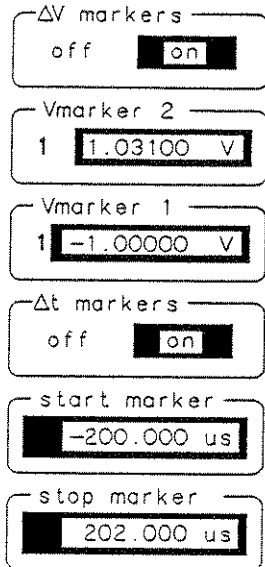

54501W05

- Press the  $\Delta t/\Delta V$  key.

This key selects the  $\Delta t$  and  $\Delta V$  function.

The  $\Delta t/\Delta V$  markers are off by default. Turn the  $\Delta t$  markers off if they are on.

- Press the  $\Delta V$  markers function key, then select on to enable the two markers.
- Press the Vmarker 2 function key a few times.

The selected function (intensified display) toggles between the Vmarker 2 source and the Vmarker 2 voltage.

- Select the Vmarker 2 source function for control and slowly rotate the knob clockwise.

As the knob is rotated all sources are displayed one at a time (channels, waveform memories, and waveform functions).

- Set the source selection to 1 (for channel 1) using the knob.
- Press the Vmarker 2 function key to select the Vmarker 2 voltage function.
- Rotate the knob.

Vmarker 2 is at the top of the waveform.

The actual voltage at Vmarker 2 with respect to the voltage reference is displayed as "Vmarker2(1) XXXX V."

The number in parentheses is the source for the measurement.

- Make sure the Vmarker 1 source is set to 1 (channel 1).

This key also toggles between a measurement source and a voltage level.

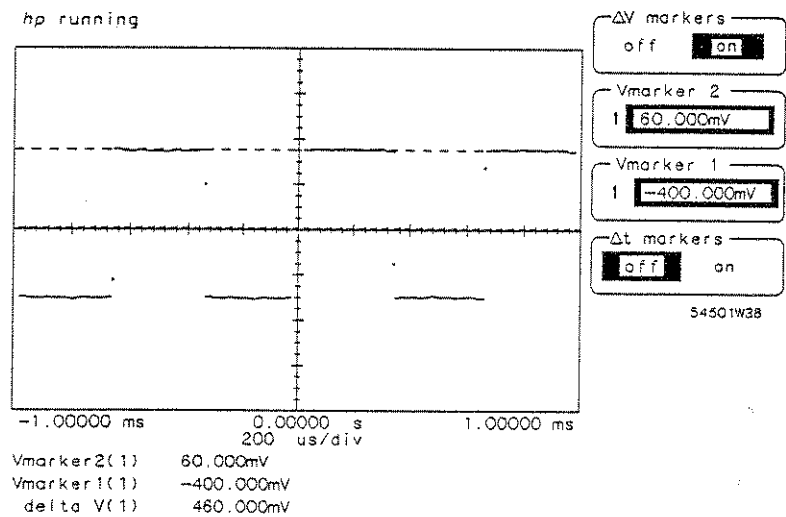

- Press the Vmarker 1 function key to select the Vmarker 1 voltage.
- Rotate the knob until Vmarker is at bottom of waveform.

Vmarker1 (1) XXXX V.

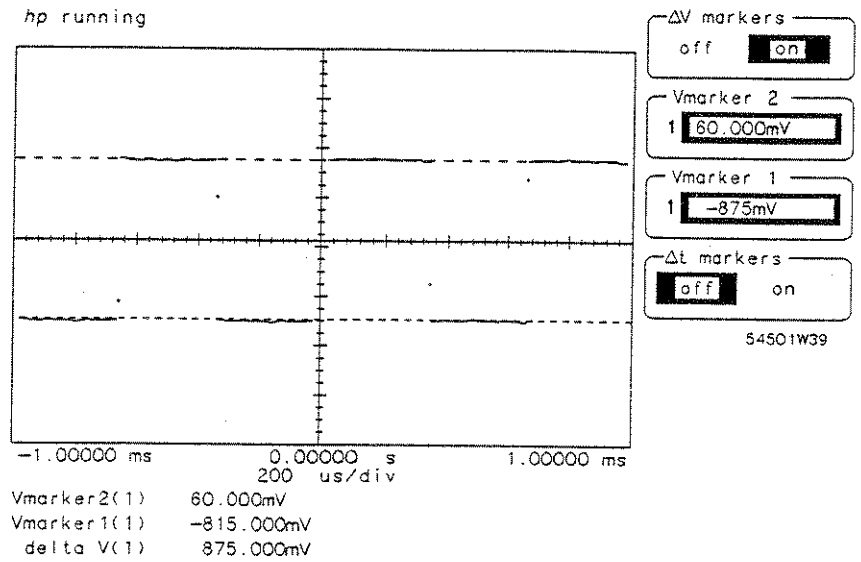

- The peak-to-peak voltage is displayed.

The peak-to-peak value is the delta V reading at the bottom of the display.

For more information about setting and using voltage markers, refer to the Δt/ΔV MENU section in the Front-Panel Reference of the oscilloscope.

---

## What are Time Interval Measurements?

Time interval measurements are made with one or both of the time markers to determine the relationship of a specific point on a waveform to the trigger point. The oscilloscope automatically calculates the time difference between the two markers. The "delta t" calculation is always made by subtracting the time at the "start marker" from the time at the "stop marker." Therefore it is possible to obtain negative time readings on "delta t" if the "stop marker" is placed on the display before the "start marker."

After pressing AUTOSCALE, the trigger point is displayed at the center of the display. When a time marker is placed on the left half of the display the time for that marker is negative, indicating it occurs before the trigger. Any marker to the right of the trigger point occurs after the trigger and its time reading is positive. The reference for the display (trigger point) can be changed to left, cntr (center), or right of the display in the TIMEBASE menu.

---

## Measuring a Waveform Period

The following procedure measures the period of a complete cycle of the calibrator signal.

- Connect the ac calibrator output to the channel 1 input.
- Press AUTOSCALE (or set up the oscilloscope display manually).
- Press the  $\Delta t/\Delta V$  key.
- Press the  $\Delta t$  markers function key to turn on the markers.

- Press start marker function key.

The start marker is now controlled by the ENTRY devices. Full-bright inverse video indicates a function is selected.

- Rotate the knob.

Set the start marker on the first displayed negative-going waveform edge.

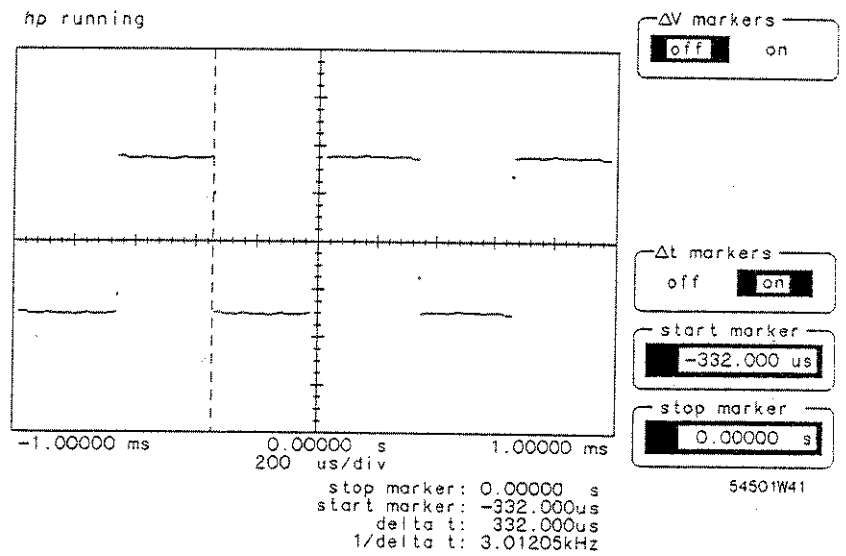

- Press stop marker key.

Select the stop marker as the active function.

- Rotate the knob.

Place the stop marker on the second displayed negative-going waveform edge.

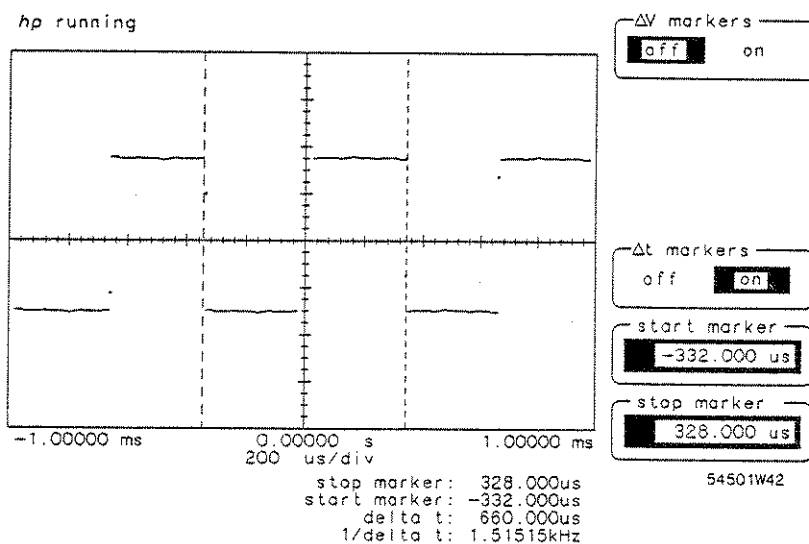

- The start marker time, stop marker time, and delta t time are all displayed.

The delta t value is the time at the stop marker minus the time at the start marker. The delta t value is the period of the waveform.

The 1/delta t reading displays the frequency of the selected period.

The oscilloscope stores and recalls up to four front-panel setups and up to four waveforms in nonvolatile memories. These procedures show how to save and recall front-panel setups and waveforms.

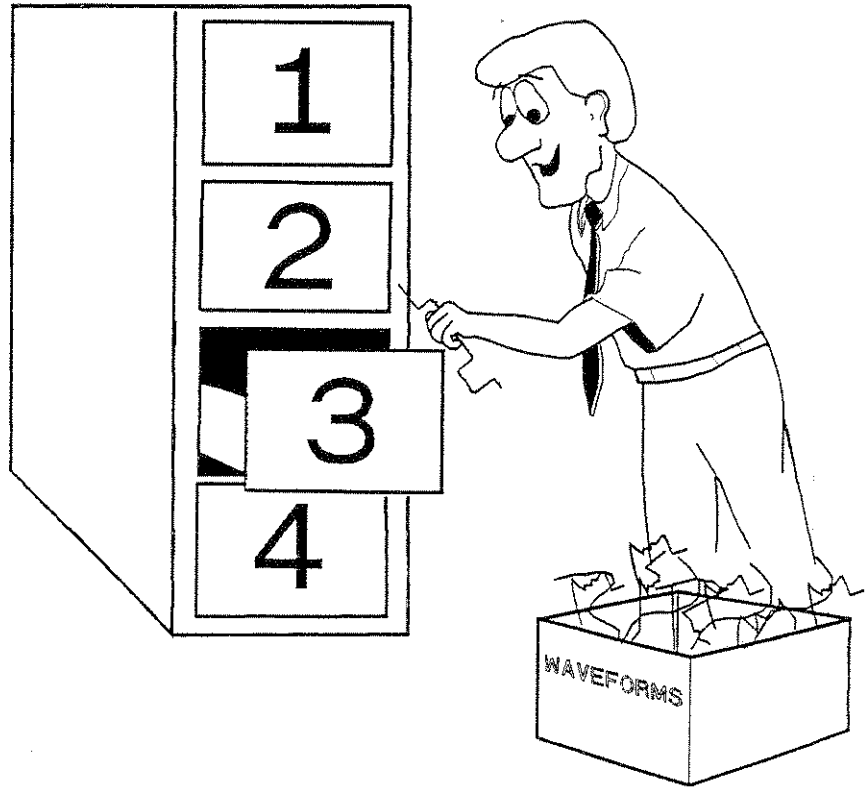



---

## Storing Front-Panel Set Ups

Connect a signal to the channel 1 input.

Use the ac calibrator or any other handy signal.

- Set the oscilloscope to display the waveform.

Press AUTOSCALE.

- Press the SAVE key and then the 4 key.

This saves the current front-panel setup in save/recall register number 4. There are four SAVE/RECALL memories numbered 1 through 4. Any one register can be selected.

- Change some front-panel settings for a different setup.

For example, change the time/division in the TIMEBASE menu and the volts/division in the CHAN menu.

- Press the RECALL key, then press the 4 key.

The instrument returns to the setup that was saved.

The save/recall registers save all front-panel selections and settings. Saving and recalling setups does not cause any actions to take place. For example when a front-panel setting is recalled, a measurement is not initiated.

## Storing a Waveform

This procedure stores a waveform, changes the offset setting, and then recalls the stored waveform to compare it to the currently displayed waveform.

WAVEFORM SAVE

waveform	pixel
----------	-------

nonvolatile

m1	m2	m3	m4
----	----	----	----

display

off	on
-----	----

source

chan	1	2	3	4
func	1	2		

store

54501W20

- Connect a signal to the channel 1 input.
- Set the oscilloscope to display a waveform.

Press **AUTOSCALE**.

- Press **WFORM SAVE** key.

Selects the waveform save menu.

- Select waveform with the waveform/pixel function key.
- Select memory 3 (m3) with the nonvolatile function key.

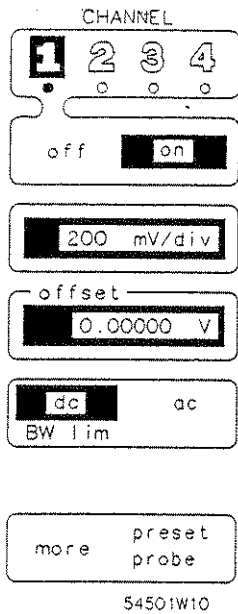

- Press source of store function key.

Select 1 (channel 1).

This selects channel 1 waveform to be stored. If waveform is displayed on channel 2, 3, or 4, select that source at this point.

- Press store function key.

The channel 1 (or selected channel) waveform is now stored in nonvolatile memory.

- Press the CHAN menu key.

- Press offset function key.

- Rotate knob to move the displayed waveform up or down.

This is to change the currently displayed waveform to make it easier to tell the difference from the stored waveform.

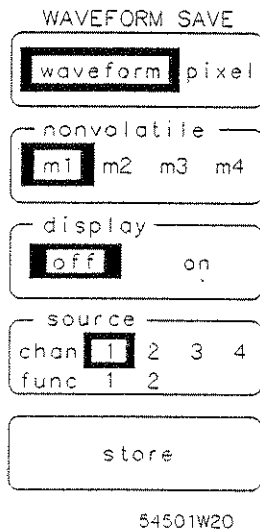

- Reselect the WFORM SAVE menu.

- If nonvolatile m3 is not selected, select it at this time.

- Press display function key in the waveform save menu.

Display the memory 3 (m3) waveform.

Two waveforms are displayed. The one that has the offset changed is the current waveform and is displayed in fullbright. The other is the stored waveform and is displayed in halfbright.

To see the stored waveform better, select the CHAN menu and turn the active display off.

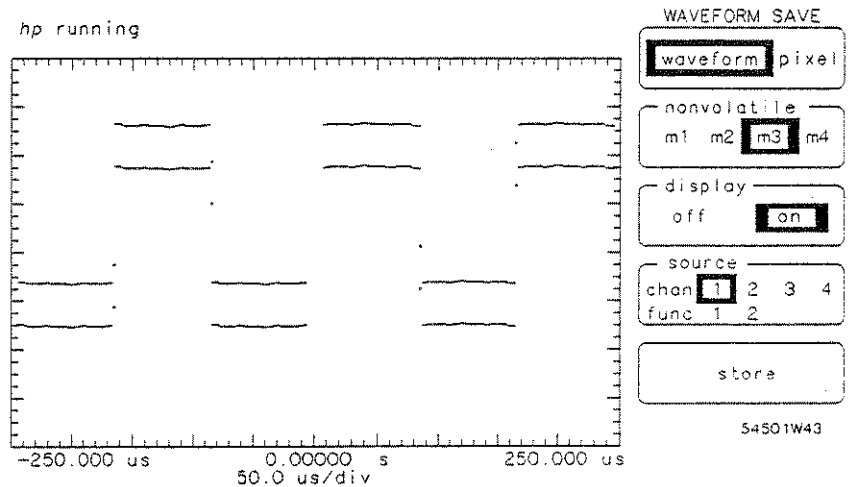



# Index

---

## A

- ac calibrator output, 2-2
- ac calibrator signal, 1-2
- action text, 1-2
- Applying Power, 2-3
- automatic frequency measurements, 4-2
- Automatic Measurements, 4-1
  - cancelling, 4-6
  - clearing, 4-5
  - Waveform Function (f#), 4-6
  - Waveform Memory (m#), 4-6
- automatic setup, 3-1
- Autoscale, 3-2, 5-2
- Autoscale Key, 3-2, 5-6
- Autoscaling the Oscilloscope, 3-2

## B

- blue key, 4-2
- bold type keys, 1-2
- bulleted text, 1-2

## C

- cancelling automatic measurements, 4-6
- Chan Menu key, 3-3
- channel number (c#)
  - as automatic measurement source, 4-6

- channel On/Off key, 3-4
- channel settings, 3-2
- channels
  - as manual measurement source, 5-3
- chassis ground, 2-3
- CLEAR key, 2-4, 4-5
- clearing automatic measurements, 4-5
- Connecting Power, 2-3
- cursors, 5-1

## D

- $\Delta/\Delta V$  MENU, 5-5
- dc calibrator output, 2-2
- delta t, 5-8
  - time interval measurements, 5-6
- delta t
  - waveform period, 5-8
- delta V, 5-5
- delta voltage value
  - manual measurement of, 5-2
- display key, 6-5
- displaying a stored waveform, 6-5
- $\Delta t$  markers, 5-6
- $\Delta t$  markers key, 5-6
- $\Delta t/\Delta V$  menu key, 5-3
- DUTY CY key, 4-4
- $\Delta V$  markers key, 5-3

## E

Entry Devices, 2-1

## F

features of the oscilloscopes, 1-2  
FREQ key, 4-3  
frequency  
    waveform period measurement, 5-8  
front-panel layout, 2-1  
front-panel setups  
    recalling from memory, 6-2  
    storing in memory, 6-2  
Function keys, 2-1

## H

HARDCOPY key, 7-3  
Hardcopy Output, 7-1  
horizontal dotted line, 3-8  
HP-IB  
    listen always, 7-2  
    setting up for output, 7-2  
    talk only, 7-2  
HP-IB  
    printers and plotters, 7-1  
HP-IB connector, 2-2

## I

installation instructions, 2-3  
Instant Setup, 3-1

Index-2

## K

key

AUTOSCALE, 3-2, 5-6  
CHAN menu, 3-3  
channel On/Off, 3-4  
Clear, 2-4, 4-5  
display, 6-5  
Dt/DV, 5-3  
DUTY CY, 4-4  
DV markers, 5-3  
FREQ, 4-3  
HARDCOPY, 7-3  
nonvolatile, 6-3  
Recall, 2-4, 6-2  
SAVE, 6-2  
SHOW, 3-8, 7-3  
source of store, 6-4  
start marker, 5-7  
store, 6-4  
talk only/addressed, 7-2  
TIME/DIV, 6-4  
TIMEBASE, 3-5, 6-4  
TRIG menu, 3-7  
trigger level, 3-7  
units, 3-6  
UTIL, 7-2  
V P-P, 4-6  
Vmarker, 5-3  
Vmarker 2, 5-4  
waveform/pixel, 6-3  
WFORM SAVE, 6-3  
blue, 4-2  
more, 3-3

keys

front-panel, 1-2

## Making a Hardcopy Output

---

7

The procedures in this chapter demonstrate how to get a hardcopy output of the oscilloscope display. An HP-IB compatible printer or plotter can be used with any HP 54500 Digitizing Oscilloscopes except for the HP 54501A. The HP 54501A is compatible with any HP-IB printer, but not plotters. This procedure uses an HP THINKJET printer as the output device. The first portion of the procedure sets up the HP-IB interface for proper operation between the printer and oscilloscope.

If the oscilloscope and plotter or printer are already operating together, skip to the second portion of this procedure, "Hardcopy Output".

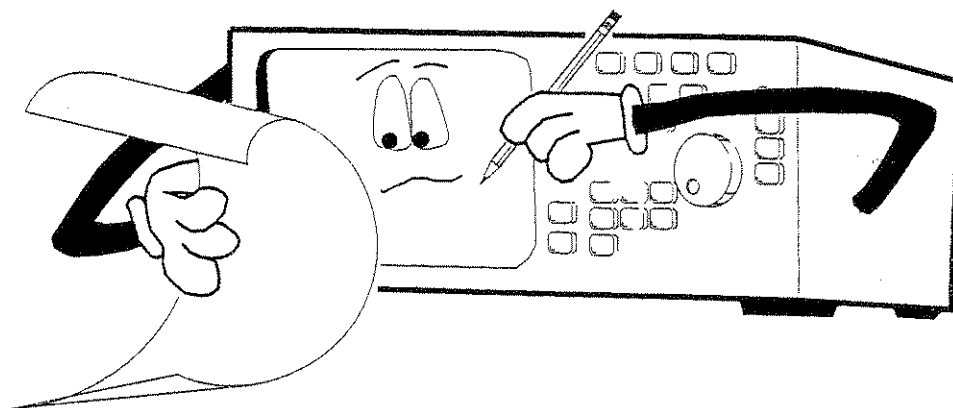



## Setting Up the HP-IB

Connect the printer to the oscilloscope with a standard HP-IB cable. The menus in this procedure are from the HP 54502A.

UTILITY

HP-IB menu

selftest menu

probe cal menu

self cal menu

service menu

clicker  
off  on

ac BNC probe comp  
trigger out

rev date 54502V08

- Set the printer to LISTEN ALWAYS.

Switch 2 on the printer must be set to the up position.

- Apply power to the printer.

If any printer switches have been changed, the printer power must be cycled so the new settings are read.

- Press UTIL key on the oscilloscope.

This selects the Utility menu functions of the oscilloscope.

- Press the top function key to select the HP-IB functions.

This shows a second level function to set the **talk only/addressed** mode.

HP-IB

talk only  
 addressed

- If talk only is not selected, press the talk only/addressed key.

EOI

off  on

This sets the oscilloscope to the **talk only** mode. In this mode, the oscilloscope becomes an HP-IB talker.

form feed

off  on

paper length

11in.  12in.

- If print is not selected in the device mode function, select it now.

device mode

print  plot

The oscilloscope and printer are now set to operate together.

exit menu

54503W01

---

## Hardcopy Output

Connect a signal to the oscilloscope input.

- Press **AUTOSCALE** or set up the oscilloscope to display the input signal manually.
- Make some automatic measurements, if desired.

This is only to demonstrate the output and not required to make a hardcopy.

- Press the **SHOW** key.

This key displays the setup information. This is not required to make the hardcopy.

- Press the **HARDCOPY** key.

The hardcopy device receives a copy of the oscilloscope display, including the measurements and setup information.

## R

rear-panel layout, 2-2  
RECALL key, 2-4, 6-2  
recalling front-panel setups, 6-2  
reference  
    trigger, time interval measurements, 5-6  
resetting the instrument, 2-4

## S

safe operation, 2-3  
SAVE key, 6-2  
save/recall registers, 6-2  
section  
    SETUP, 3-8  
selector  
    voltage module, 2-2  
setup  
    Timebase, 3-5  
    Trigger, 3-7  
    vertical, 3-3  
SHOW key, 3-8, 7-3  
source of store key, 6-4  
start marker  
    time interval measurements, 5-6  
Start Up, 2-3  
stop marker  
    time interval measurements, 5-6  
store key, 6-4  
stored waveform  
    displaying, 6-5  
storing a waveform, 6-3  
storing setups and waveforms, 6-1  
switch, power, 2-2

## T

talk only, 7-2  
talk only mode, 7-2  
talk only/addressed key, 7-2  
ThinkJet, 7-1  
threshold level, 3-7  
time interval measurements, 5-6  
    delta t calculations, 5-6  
    negative time readings, 5-6  
    start marker, 5-6  
    stop marker, 5-6  
    trigger point, 5-6  
time markers, 5-1  
TIME/DIV key, 6-4  
time/division, 3-5  
TIMEBASE key, 6-4  
TIMEBASE menu key, 3-5  
Timebase Setup, 3-5  
TRIG menu key, 3-7  
trigger information, 3-2  
trigger level, 3-7  
trigger level key, 3-7  
trigger menu, 3-7  
trigger point  
    time interval measurements, 5-6  
trigger reference  
    time interval measurements, 5-6  
Trigger Setup, 3-7

## U

units key, 3-6  
user-defined measurements, 4-1  
UTIL key, 7-2

## V

- V P-P key, 4-6
- vertical
  - waveform amplitude, 3-3
- vertical setup, 3-3
- Vmarker 2 key, 5-3 to 5-4
- voltage difference
  - manual measurements, 5-2
- voltage markers, 5-1 to 5-2
- Voltage Measurements
  - manual, 5-2
- voltage selector module, 2-2 to 2-3
- volts/division changes, 3-3

## W

- waveform
  - storing in memory, 6-3
- waveform amplitude, 3-3
- Waveform Function, 4-6
  - as manual measurement source, 5-3
- waveform function number (f#)
  - as measurement source, 4-6
- Waveform Memory, 4-6
  - as manual measurement source, 5-3
  - making automatic measurements on, 4-6
- waveform memory number (m#)
  - as automatic measurement source, 4-6
- waveform period
  - delta t, 5-8
- waveform period measurement
  - 1/delta t, 5-8
  - frequency, 5-8
- waveform/pixel key, 6-3
- WFORM SAVE key, 6-3

