

Front Panel Operation Reference HP 54501A Digitizing Oscilloscope

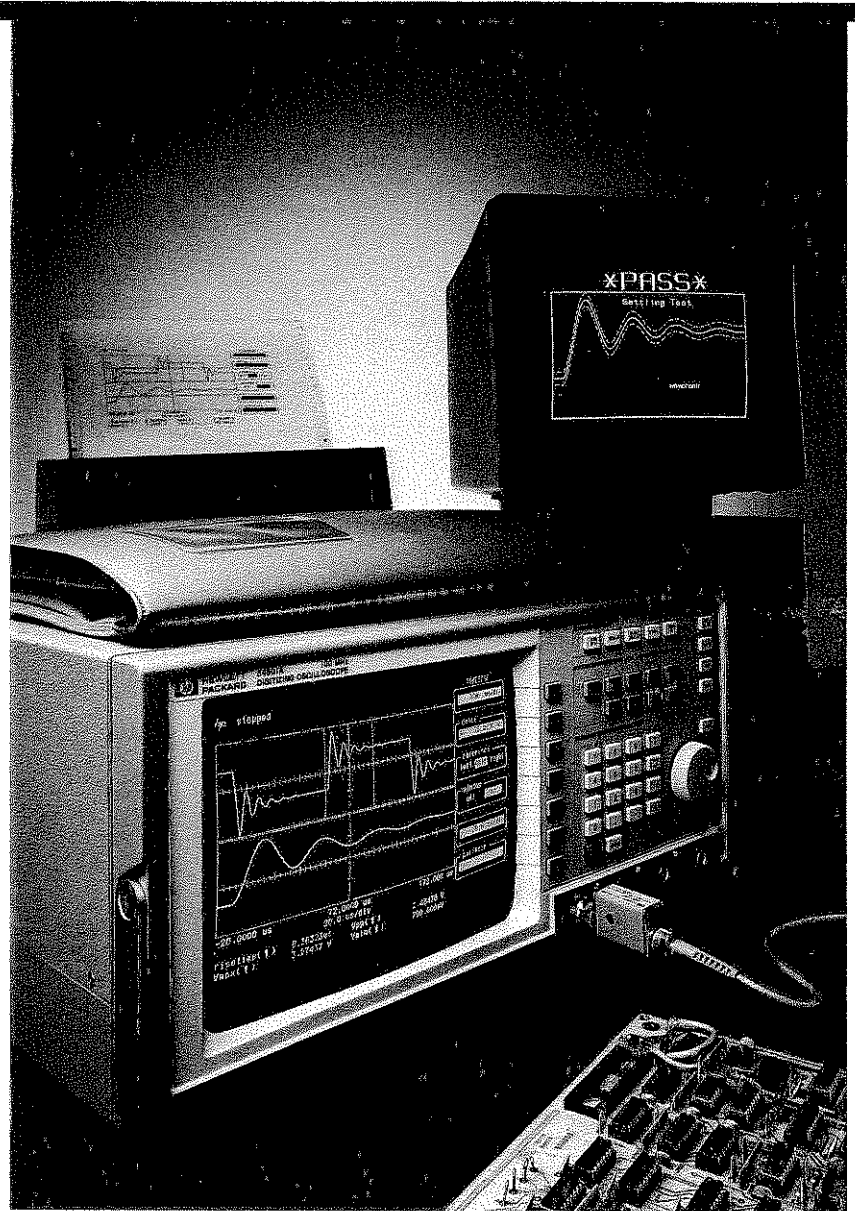

 HEWLETT
PACKARD

Quick Reference Guide

HP 54501A Digitizing Oscilloscope

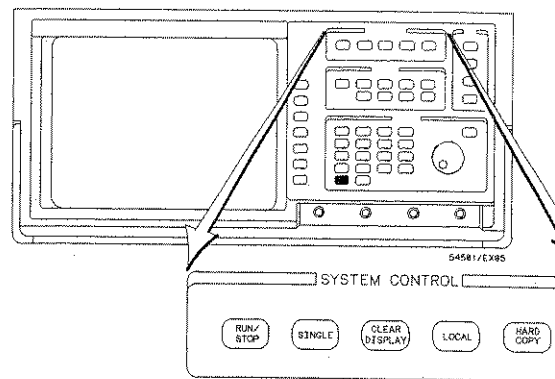
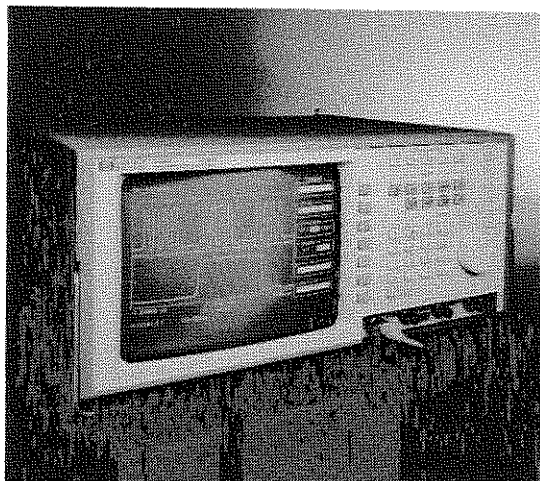

Keys in the System Control section:

- Cause immediate action when key is pushed
- Controls acquisition mode
- Returns the instrument from bus to local control
- Activates an immediate hardcopy output of the displayed waveforms and measurement factors

The HP 54501A Digitizing Oscilloscope has been designed for ease-of-use with easy-to-find control keys and a menu driven operating system. With a minimum of keystrokes virtually any function can be accessed, set up, and operated.

Use this *Quick Reference Guide* to locate the desired key and function until you are familiar with the instrument. If you need a little more experience with the HP 54501A, read the *Getting Started Guide* and do the exercises. For more in-depth information see the *Front Panel Operation Reference* manual.

The HP 54501A front panel has been designed with five functional sections.

- System Control
- Entry
- Setup
- Menus
- Function Selection

SELECTION KEYS

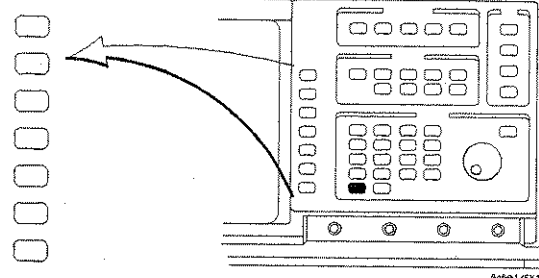

Each key in the Function Selection section:

- Corresponds to a displayed function
- Selects a function within the menu
- Functions that are displayed in fullbright are controlled by the knob, functions in halfbright can be controlled by corresponding selection keys

The **Entry Devices** consist of a numeric keypad and knob. Their purpose is:

- Keypad is used to enter numeric data when terminated with a units selection
- Shift (Blue) key changes to automatic measurement keys
- Knob changes highlighted fields
- Knob selects f# (function), c# (channel), or m# (memory) when making automatic measurements

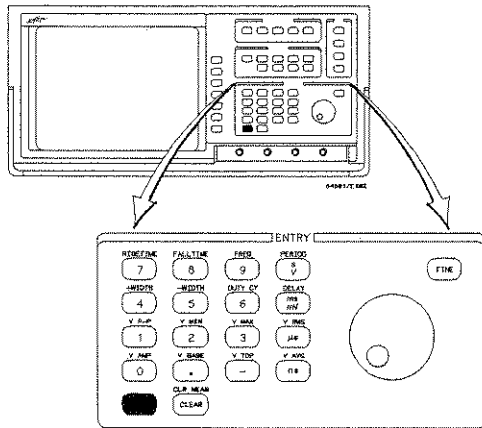

The **Setup** section consists of pushbutton control for automatic setup or previous setups:

- Autoscale automatically sets display parameters for vertical and horizontal scaling
- Saves and Recalls from memory setup registers
- Show key toggles to a screen with complete and detailed waveform setup information

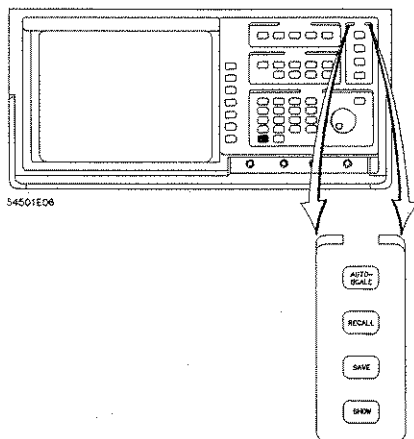

Menus allows quick access to any of nine separate subsystems. On the back page are menu maps that can guide you to any function and key location.

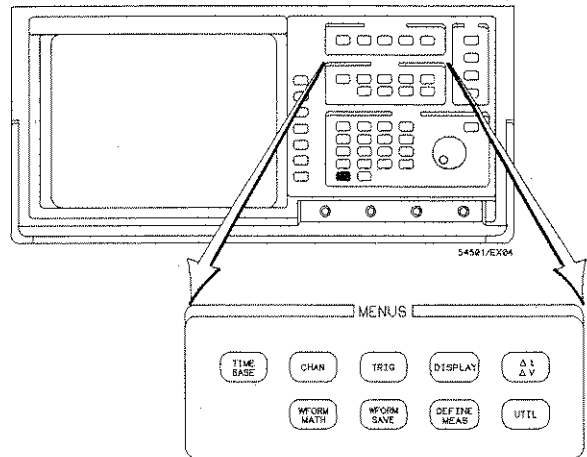

To make **automatic measurements** from the front panel you must first have a waveform displayed, then:

- Press the blue (shift) key on the keyboard, in the Entry Devices section.
- Press the key that corresponds to the desired measurement (labelled in blue above the key).
- Select the waveform source, m#, c#, or f#. You must turn the knob until the source of the displayed waveform is highlighted. Then press the specific source, 1-4 for channel number, 1 or 2 for function number, or 1-4 for memory number.



Copyright Hewlett-Packard Company 1988

5959-8793

Printed in the U.S.A. December 1988

The Timebase Menu controls the horizontal axis:

- variable settings for time/division
- delays the displayed trigger point
- accesses the dual timebase window

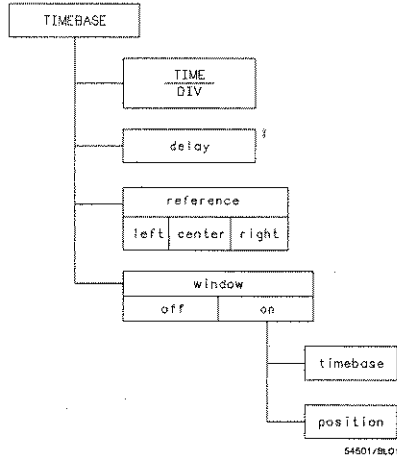

The Channel Menu controls the vertical axis:

- voltage/div
- input coupling
- attenuation
- TTL and ECL family presets

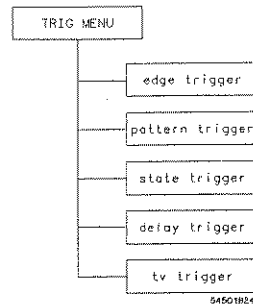
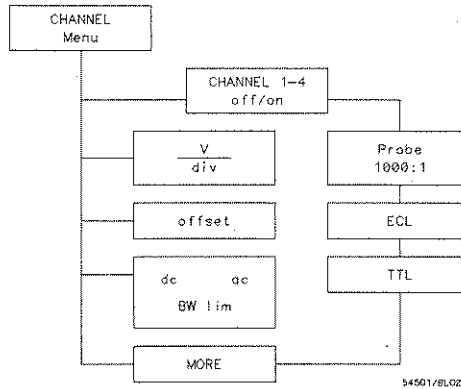

The Trigger Menu allows you to access the triggering modes

- edge trigger
- pattern trigger
- state trigger
- delay trigger
- tv trigger

The Display Menu allows you to control:

- the acquisition modes
- display modes
- display background
- number of viewing areas

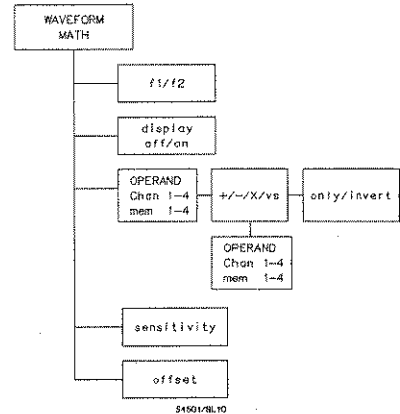
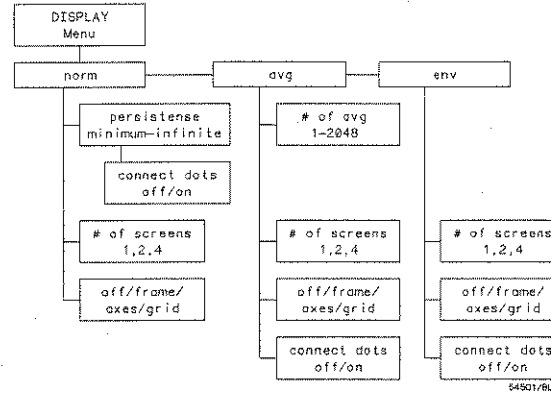

The Waveform Math Menu allows you to control:

- Six math functions
- Scaling and offset of the resultant waveform

The $\Delta t/\Delta V$ Menu allows you to access the manual measurement markers

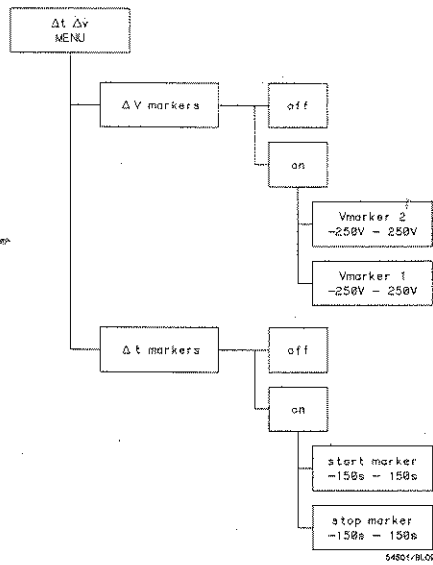

The **Define Measure Menu** allows you to:

- define the automatic measurement parameters
- limit test
- continuous measure and update

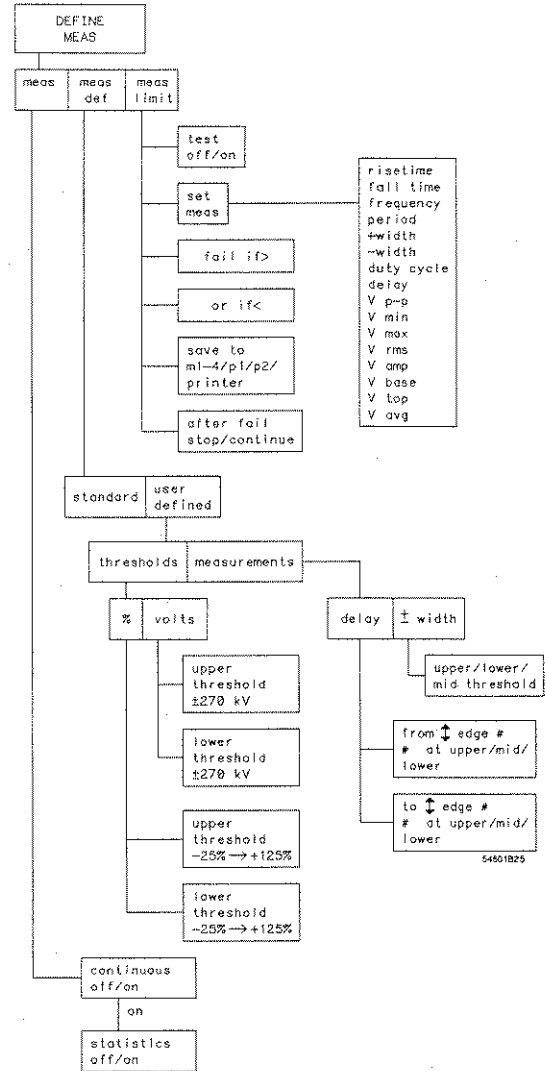

The **Waveform Save Menu** allows you to control:

- Four waveform memories
- Two pixel memories

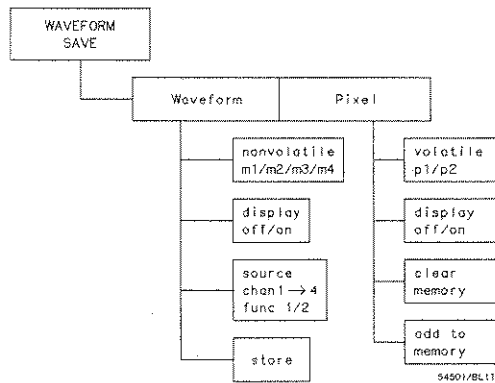

The **Utility Menu** is used for internal software calibration, selftests, and interface control

Herstellerbescheinigung

Hiermit wird bescheinigt, daß das Gerät/System

HP 54501A

in Übereinstimmung mit den Bestimmungen von Postverfügung 1046/84 funkentstört ist.

Der Deutschen Bundespost wurde das Inverkehrbringen dieses Gerätes/Systems angezeigt und die Berechtigung zur Überprüfung der Serie auf Einhaltung der Bestimmungen eingeräumt.

Zusatzinformation für MeB- und Testgeräte

Werden MeB- und Testgeräte mit ungeschirmten Kabeln und/oder in offenen MeBaufbauten verwendet, so ist vom Betreiber sicherzustellen, daß die Funk-Entstörbestimmungen unter Betriebsbedingungen an seiner Grundstücksgrenze eingehalten werden.

Manufacturer's declaration

This is to certify that this product HP 54501A meets the radio frequency interference requirements of directive 1046/84. The German Bundespost has been notified that this equipment was put into circulation and was granted the right to check the product type for compliance with these requirements.

Additional Information for Test- and Measurement Equipment

Note: If test and measurement equipment is operated with unshielded cables and/or used for measurements on open set-ups, the user must insure that under these operating conditions, the radio frequency interference limits are met at the border of his premises.

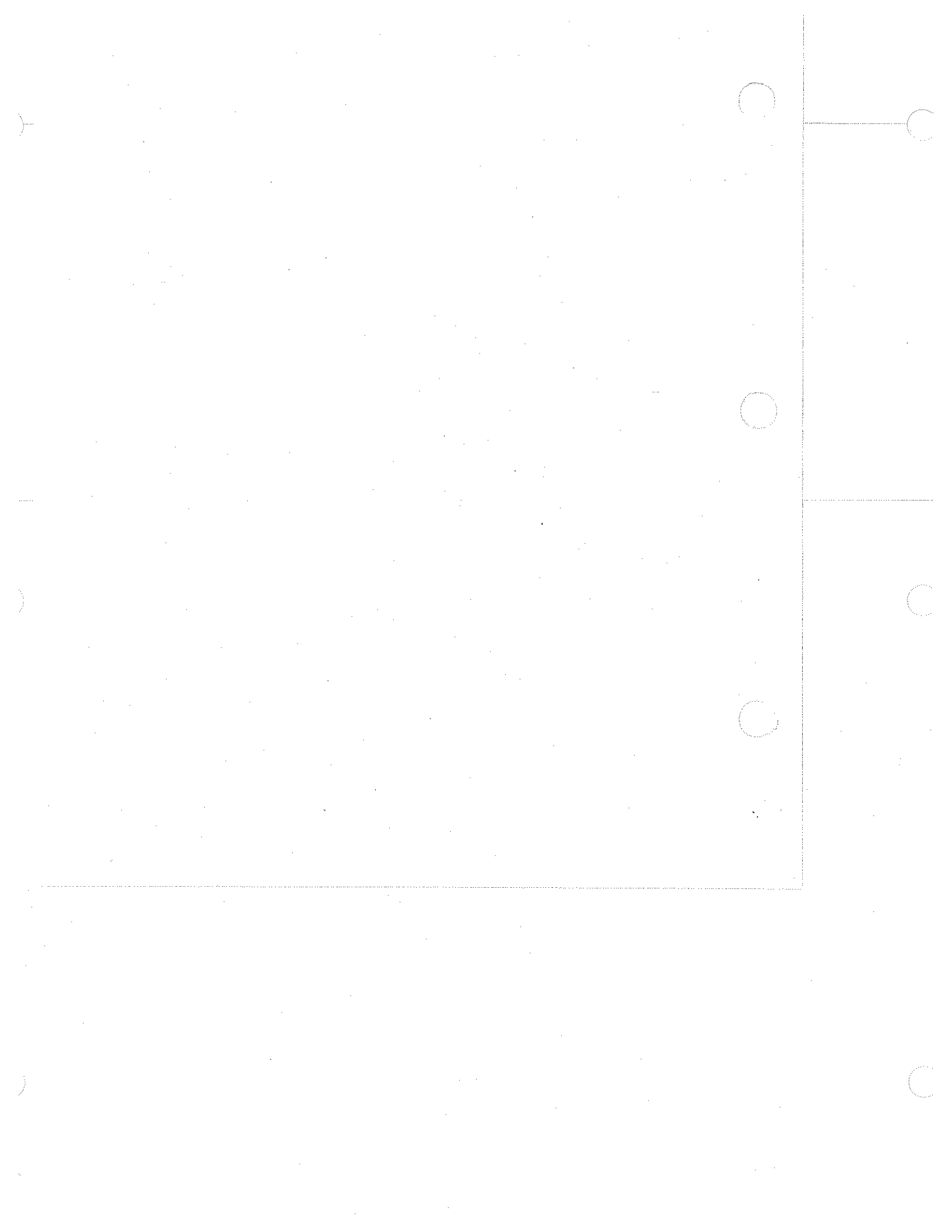

Front Panel Operation Reference

HP 54501A Digitizing Oscilloscope



Valuetronics International, Inc.
1-800-552-8258
MASTER COPY

Copyright Hewlett-Packard Company 1988

Publication 54501-90901

Printed in the U.S.A. August 1988



Product Warranty

This Hewlett-Packard product has a warranty against defects in material and workmanship for a period of three years from date of shipment. During warranty period, Hewlett-Packard Company will, at its option, either repair or replace products that prove to be defective.

For warranty service or repair, this product must be returned to a service facility designated by Hewlett-Packard. However, warranty service for products installed by Hewlett-Packard and certain other products designated by Hewlett-Packard will be performed at the Buyer's facility at no charge within the Hewlett-Packard service travel area. Outside Hewlett-Packard service travel areas, warranty service will be performed at the Buyer's facility only upon Hewlett-Packard's prior agreement and the Buyer shall pay Hewlett-Packard's round trip travel expenses.

For products returned to Hewlett-Packard for warranty service, the Buyer shall prepay shipping charges to Hewlett-Packard and Hewlett-Packard shall pay shipping charges to return the product to the Buyer. However, the Buyer shall pay all shipping charges, duties, and taxes for products returned to Hewlett-Packard from another country.

Hewlett-Packard warrants that its software and firmware designated by Hewlett-Packard for use with an instrument will execute its programming instructions when properly installed on that instrument. Hewlett-Packard does not warrant that the operation of the instrument software, or firmware will be uninterrupted or error free.

Limitation of Warranty

The foregoing warranty shall not apply to defects resulting from improper or inadequate maintenance by the Buyer, Buyer-supplied software or interfacing, unauthorized modification or misuse, operation outside of the environmental specifications for the product, or improper site preparation or maintenance.

**NO OTHER WARRANTY IS EXPRESSED OR IMPLIED.
HEWLETT-PACKARD SPECIFICALLY DISCLAIMS THE
IMPLIED WARRANTIES OR MERCHANTABILITY AND FITNESS
FOR A PARTICULAR PURPOSE.**

Exclusive Remedies THE REMEDIES PROVIDED HEREIN ARE THE BUYER'S SOLE AND EXCLUSIVE REMEDIES. HEWLETT-PACKARD SHALL NOT BE LIABLE FOR ANY DIRECT, INDIRECT, SPECIAL INCIDENTAL, OR CONSEQUENTIAL DAMAGES, WHETHER BASED ON CONTRACT, TORT, OR ANY OTHER LEGAL THEORY.

Assistance Product maintenance agreements and other customer assistance agreements are available for Hewlett-Packard products.

For any assistance, contact your nearest Hewlett-Packard Sales and Service Office.

Certification Hewlett-Packard Company certifies that this product met its published specifications at the time of shipment from the factory. Hewlett-Packard further certifies that its calibration measurements are traceable to the United States National Bureau of Standards, to the extent allowed by the Bureau's calibration facility, and to the calibration facilities of other International Standards Organization members.

Safety This product has been designed and tested according to International Safety Requirements. To ensure safe operation and to keep the product safe, the information, cautions, and warnings in this manual must be heeded.

Table of Contents

Chapter 1:		Introducing the HP 54501A
	1-1	Introduction

Chapter 2:		Instrument Setup
	2-1	Introduction
	2-1	Unpacking
	2-1	Contents of Shipment
	2-1	Initial Inspection
	2-2	List of Accessories
	2-2	Operating Environment
	2-2	Storage and Shipping
	2-3	Rear Panel Layout
	2-3	Power Requirements
	2-3	Applying Power
	2-5	Installing the Power Cord
	2-5	Selecting Line Voltage
	2-6	Checking for the Correct Fuse
	2-6	Line Switch
	2-7	Intensity Control
	2-7	Air Flow Requirements
	2-7	Storage and Shipment
	2-8	Connecting External Equipment

Chapter 3:

- Front Panel Overview**
- 3-1 Introduction to the Front Panel
- 3-2 System Control
 - 3-2 RUN/STOP Key
 - 3-3 SINGLE Key
 - 3-3 CLEAR DISPLAY Key
 - 3-3 LOCAL Key
 - 3-3 HARDCOPY Key
- 3-4 Setup
 - 3-5 AUTOSCALE Key
 - 3-5 RECALL Key
 - 3-6 SAVE Key
 - 3-6 SHOW Key
- 3-7 Menus
- 3-8 Entry
 - 3-8 Numeric Keypad
 - 3-9 Knob
 - 3-9 FINE Key
- 3-9 Input
- 3-10 Display
- 3-11 Instrument Reset

Chapter 4:

- Timebase Menu**
- 4-1 Introduction to the Timebase
- 4-1 Time/Div Key
- 4-2 delay Key
- 4-2 reference Key
- 4-3 window Key
 - 4-4 timebase Key
 - 4-4 position Key
- 4-4 Window Exercise
 - 4-4 Setting the Input Signal
 - 4-5 Setting the Oscilloscope
 - 4-5 Viewing the Window

Chapter 5:

Channel Menu

- 5-1 Introduction to Channels
 - 5-1 CHANNEL Key
 - 5-2 Vertical Sensitivity Key
 - 5-2 offset Key
 - 5-3 coupling Key
 - 5-3 more Key
 - 5-4 probe Key
 - 5-4 ECL Key
 - 5-5 TTL Key
-

Chapter 6:

Trigger Menu

- 6-1 Introduction to the Triggers
- 6-1 Trigger Mode Interaction
- 6-2 Edge Trigger Mode
 - 6-3 Trig'd/auto Key
 - 6-3 source Key
 - 6-3 level Key
 - 6-3 slope Key
 - 6-3 holdoff Key
- 6-4 Holdoff Exercise
 - 6-4 Instrument Setup
 - 6-4 Oscilloscope Setup
- 6-8 Pattern Trigger Mode
 - 6-9 pattern Key
 - 6-9 when Key
 - 6-10 holdoff Key
- 6-10 Pattern Trigger Exercise
 - 6-10 Instrument Setup
 - 6-11 Oscilloscope Setup
- 6-15 State Trigger Mode
 - 6-15 clock Key
 - 6-15 when Key
 - 6-16 present Key
 - 6-16 holdoff Key
- 6-16 State Trigger Exercise

6-16	Instrument Setup
6-17	Oscilloscope Setup
6-20	Delay Trigger Mode
6-20	qualify on Key
6-20	edge Qualify Option
6-21	pattern Qualify Option
6-21	state Qualify Option
6-22	delay Key
6-22	trigger on Key
6-23	Delay Trigger Exercise
6-23	Instrument Setup
6-23	Oscilloscope Setup
6-27	TV Trigger Mode
6-27	source Key
6-28	level/polarity Key
6-28	field Key
6-28	line Key
6-28	holdoff Key
6-29	TV Trigger Exercise
6-29	Instrument Setup
6-29	Oscilloscope Setup

Chapter 7:

	Display Menu
7-1	Introduction to the Display
7-2	Display Mode Key
7-2	norm
7-3	avg
7-3	env
7-4	# of screens Key
7-5	off/frame/ axes/grid Key
7-6	connect dots Key

Chapter 8:

	Delta t/Delta V Menu
8-1	Introduction to the Markers
8-2	DV markers
8-2	Vmarker 2
8-2	Vmarker 1
8-3	Dt markers
8-3	start marker
8-3	stop marker

Chapter 9:

	Waveform Math Menu
9-1	Introduction to the Functions
9-2	Defining a Function
9-2	Function Key
9-2	display Key
9-3	chan/mem Key
9-3	Operator Key
9-4	chan/mem Key
9-4	sensitivity Key
9-4	offset Key
9-4	Vertical Scaling Units
9-4	Displaying Functions
9-7	Waveform Math Exercise
9-7	Instrument Setup
9-7	Oscilloscope Setup

Chapter 10:

	Waveform Save Menu
10-1	Introduction to the Memories
10-1	waveform/pixel Key
10-2	waveform Menu
10-2	nonvolatile Key
10-2	display Key
10-2	source Key
10-2	store Key
10-3	pixel Menu
10-3	volatile Key
10-3	display Key
10-3	clear memory Key
10-3	add to memory Key
10-4	Waveform Save Exercise
10-4	Instrument Setup
10-4	Oscilloscope Setup

Chapter 11:

	Define Measure Menu
11-1	Introduction to Measurements
11-2	Measurement Selection
11-3	meas/meas def/meas limit Key
11-3	meas Sub-menu
11-3	continuous Key
11-3	statistics Key
11-4	Measure Define Sub-menu
11-4	standard/user defined Key
11-4	thresholds/measurements Key
11-7	Measure Limit Sub-menu
11-7	test Key
11-8	set Key
11-8	fail if Key
11-8	or if Key
11-8	save to Key
11-8	after save Key

Chapter 12:

	Utility Menu
12-1	Introduction to the Utilities
12-2	HP-IB menu
12-2	talk only mode
12-2	addressed mode
12-3	EOI Key
12-3	form feed Key
12-3	paper length Key
12-3	exit menu Key
12-4	selftest menu
12-5	ram Test
12-5	rom Test
12-6	acquisition Test
12-6	Miscellaneous Test
12-6	loop Test
12-6	start test Key
12-6	exit menu Key
12-7	probe cal menu
12-8	attenuation submenu
12-8	channel Key
12-8	start cal Key
12-8	continue Key
12-8	abort Key
12-8	exit menu Key
12-9	time null submenu
12-9	channel Key
12-9	time Key
12-9	exit menu Key
12-10	Self Cal menu
12-10	cal select Key
12-10	channel Key
12-10	start cal Key
12-11	continue Key
12-11	abort Key
12-11	exit menu Key
12-11	service menu
12-11	clicker Key
12-12	Calibration Procedure

Appendix A:

	Algorithms
A-1	Measurement Setup
A-1	Making Measurements
A-2	Automatic Top-Base
A-3	Edge Definition
A-3	Algorithm Definitions
A-3	delay
A-4	+ width
A-5	- width
A-5	Period
A-5	Frequency
A-5	Duty Cycle
A-5	Risetime
A-5	Falltime
A-5	V_{max}
A-5	V_{min}
A-5	V_{p-p}
A-6	V_{top}
A-6	V_{base}
A-6	V_{amp}
A-6	V_{avg}
A-6	V_{rms}

Appendix B:**Specifications and Characteristics**

Introducing the HP 54501A

1

Introduction

The HP 54501A is a general purpose, digitizing oscilloscope that is fully programmable and transportable. It is an excellent general purpose digitizing oscilloscope because of the friendly user interface, yet it has many sophisticated capabilities and multiple triggering functions.

Some of the key features of the HP 54501A are:

- Repetitive Bandwidth - 100 MHz
- Sample Rate - 10 Ms/second
- Four channel input and display *
- Maximum Vertical Sensitivity - 5 mV/division
- Minimum Vertical Sensitivity - 5 V/division
- Vertical Resolution (A/D) - 8 bits
- Auto-scale for automatic setup
- Automatic measurements, with User Defined and Statistics
- Hardcopy output
- Measurement Limit test
- Waveform Math (+, -, x, vs, invert, only)
- 4 nonvolatile set-up memories
- 4 nonvolatile waveform memories
- 2 volatile pixel memories
- Dual Timebase Windowing
- Advanced Logic Triggering
- TV Triggering
- Pre and Post trigger viewing capability
- ECL/TTL Presets

* 2 full attenuator channels and 2 reduced attenuator channels optimized for digital applications

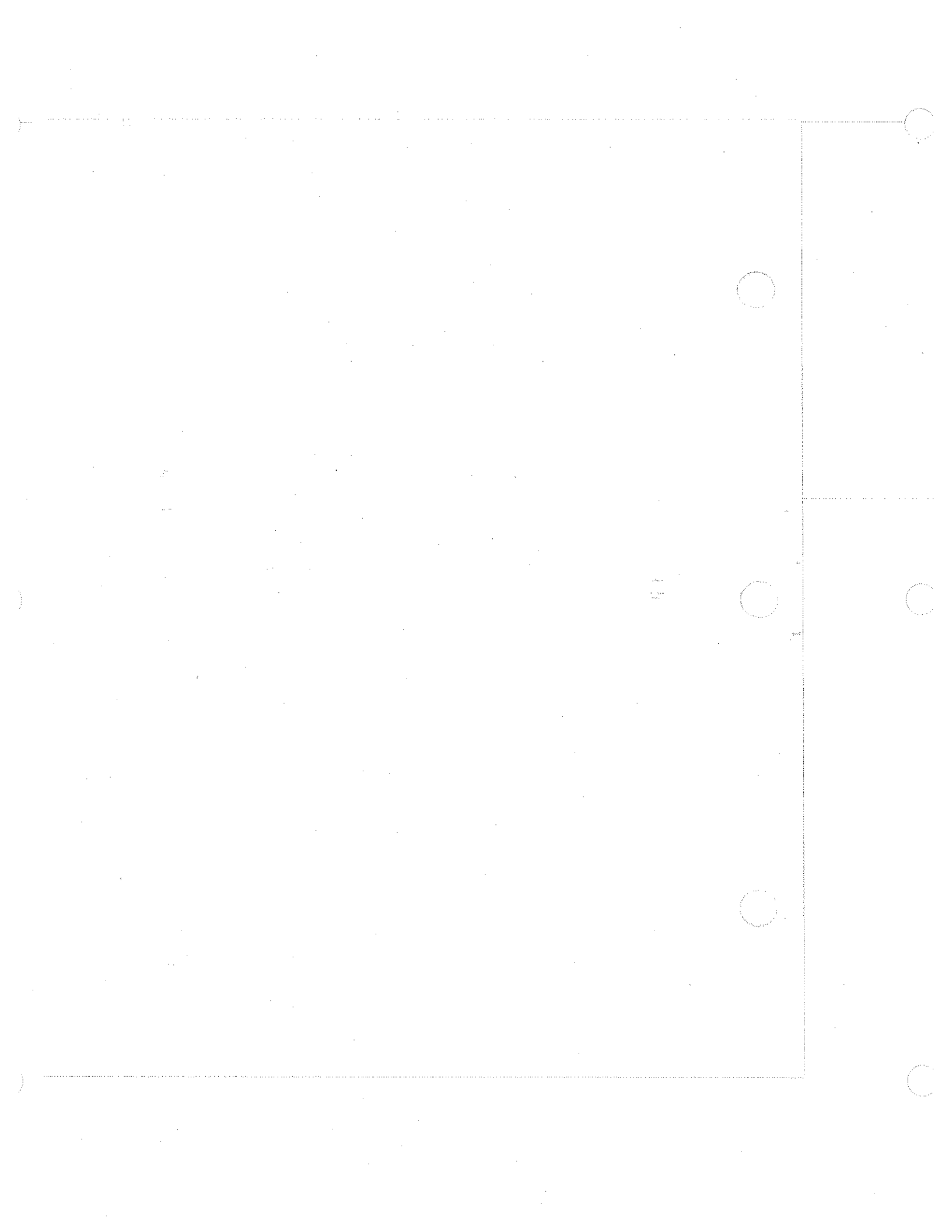

Introduction

This chapter contains information regarding instrument operation. By the time you finish reading this chapter you will have the HP 54501A unpacked, plugged in, hooked up and ready for operation.

It is important to follow the instructions carefully. A great deal of information is covered that will maximize the performance and effectiveness of the HP 54501A. For safe and trouble-free operation, you should follow these instructions and advisories.

Unpacking

Pay close attention when opening the shipping container. Make sure you have received a complete shipment. Check the enclosed list of accessories and the packing list against your order.

Contents of Shipment

Your HP 54501A digitizing oscilloscope comes complete with the following:

HP 54501A Digitizing Oscilloscope
Two HP 10432A Probes
Probe to BNC adapter, 1250-1454
Complete set of manuals including:

- *HP 54501A Getting Started Guide*
- *HP 54501A Front Panel Operation Reference manual*
- *HP 54501A Programming Reference manual*
- *HP 54501A Service manual*
- *Feeling Comfortable with Digitizing Oscilloscopes*

Initial Inspection

Inspect the shipping container for damage. If the shipping container or cushioning material is damaged, it should be kept until the contents of the shipment have been checked mechanically and electrically.

If the contents are not complete, if there is mechanical damage or defects, or if the instrument does not pass the Self Test Performance Verification, notify the nearest Hewlett-Packard service representative. Keep all shipping materials for the carrier's inspection. The Hewlett-Packard office will arrange for immediate repair or replacement without waiting for claim settlement.

List of Accessories Some of the accessories available for HP 54501A are as follows:

- Carrying case, HP part number 1540-1066
- Rack Mount kit, HP part number 5061-6175
- HP 10100C 50 Ω feedthrough terminator
- HP 1133A TV/Video Sync Pod
- HP 10024A Integrated Circuit 16 pin test clip
- HP 10211A Integrated Circuit 24 pin test clip
- PC Board Horizontal Mini Probe Socket, HP part number 1250-1737
- PC Board Vertical Mini Probe Socket, HP part number 1250-1918

Operating Environment

You may operate your HP 54501A oscilloscope in a normal lab or bench environment without any additional considerations. Pay special attention to the non-condensing humidity limitation. Condensation in the instrument cabinet can cause poor operation or malfunction. Protection should be provided against temperature extremes which cause condensation.

Storage and Shipping The HP 54501A may be stored or shipped in environments with the following limitations:

- Temperature: -40° C to $+75^{\circ}$ C
- Humidity: Up to 90% at 65° C
- Altitude: Up to 15,300 metres (50,000 feet)

Instrument Setup

Rear Panel Layout

The rear panel of the HP 54501A contains the power input, voltage selector module, power switch, external connectors, and calibrator protection switches.

Power Requirements The HP 54501A requires a power source of either 115 or 230 Vac, -22% to +10%; single phase, 48 to 66 Hz; 200 Watts maximum power.

Applying Power When power is applied to the HP 54501A, a power-up self test will be performed automatically. For more information concerning the test, see Chapter 12.

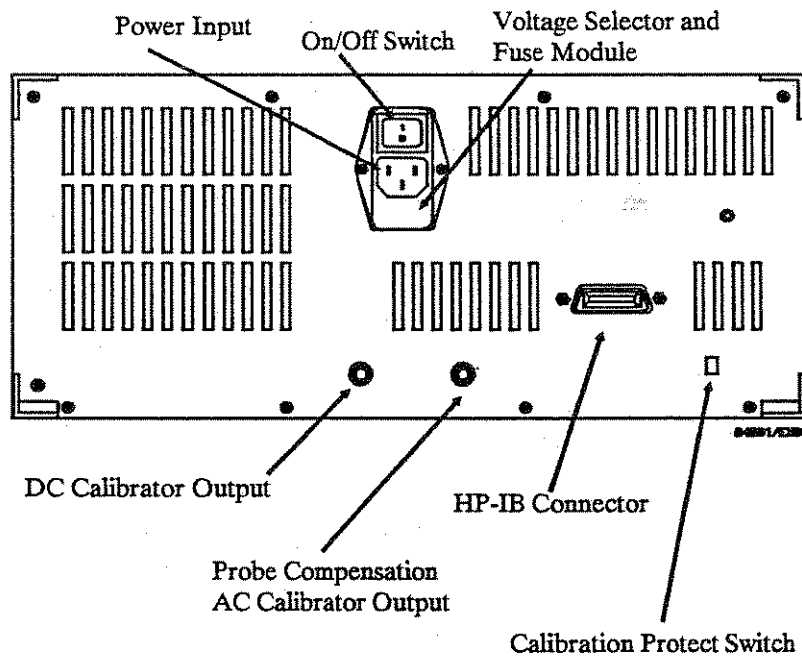



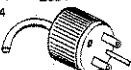

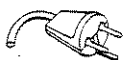



Figure 2-1. Rear Panel Layout

PLUG TYPE	CABLE PART NO.	PLUG DESCRIPTION	LENGTH IN/CM	COLOR	COUNTRY
OPT 250V 900 	8120-1351 8120-1703	Straight *BS1363A 90°	90/228 90/228	Gray Mint Gray	United Kingdom, Cyprus, Nigeria, Zimbabwe, Singapore
OPT 250V 901 	8120-1369 8120-0696	Straight *NZSS198/ASC 90°	79/200 87/221	Gray Mint Gray	Australia, New Zealand
OPT 250V 902 	8120-1689 8120-1692 8120-2857	Straight *CEE7-Y11 90° Straight (Shielded)	79/200 79/200 79/200	Mint Gray Mint Gray Coco Brown	East and West Europe, Saudi Arabia, So. Africa, India (Unpolarized in many nations)
OPT** 125V 903 	8120-1378 8120-1521 8120-1992	Straight *NEMA5-15P 90° Straight (Medical) UL544	90/226 90/226 96/244	Jade Gray Jade Gray Black	United States, Canada, Mexico, Philippines, Taiwan,
OPT** 250V 904 	8120-0696	Straight *NEMA6-15P	90/226	Black	United States, Canada
OPT 250V 905 	8120-1396 8120-1825	CEE22-V1 (System Cabinet Use) 250V	30/76 96/244	Jade Gray	For interconnecting system components and peripherals. United States and Canada only
OPT 250V 906 	8120-2104 8120-2296	Straight *SEV1011 1959-24507 Type 12 90°	79/200 79/200	Mint Gray Mint Gray	Switzerland
OPT 220V 912 	8120-2956 8120-2957	Straight *DHCK107 90°	79/200 79/200	Mint Gray Mint Gray	Denmark
OPT 250V 917 	8120-4211 8120-4600	Straight SABS164 90°	79/200 79/200	Jade Gray	Republic of South Africa India
OPT 100V 918 	8120-4753 8120-4754	Straight Miti 90°	90/230 90/230	Dark Gray	Japan

*Part number shown for plug is industry identifier for plug only. Number shown for cable is HP Part Number for complete cable including plug.

**These cords are included in the CSA certification approval of the equipment.

E = Earth Ground

L = Line

N = Neutral

Figure 2-2. Available Power Cords

Instrument Setup

2-4

Installing the Power Cord

The HP 54501A is a Safety Class 1 instrument (equipped with an exposed metal chassis that is directly connected to earth via the power supply cord) that meets IEC Standard 348.

Selecting Line Voltage

The line voltage selector has been factory set to the line voltage used in your country. It is a good idea to check the setting of the line voltage selector and become familiar with what it looks like. If the setting needs to be changed, do so by the following procedure.

CAUTION

Severe damage will occur if the line voltage is not properly set.

Change the line voltage by pulling the fuse module out and reinserting it with the appropriate arrows aligned.

- Carefully pry at the top center of the module (as shown) until you can grasp and pull it out by hand.

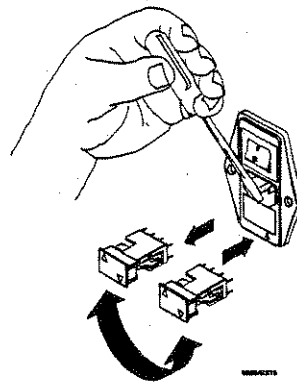

Figure 2-3. Selecting Line Voltage

Checking for the Correct Fuse

If you find it necessary to check or change fuses, remove the fuse module and look at each fuse for its amperage and voltage ratings.

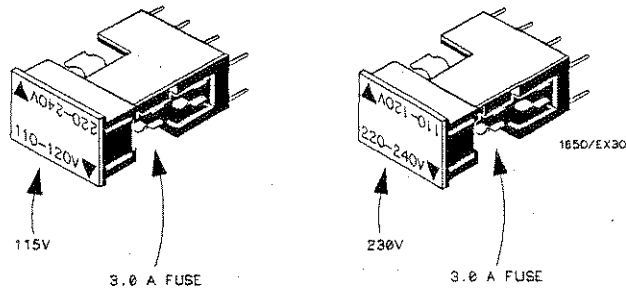

Figure 2-4. Checking for the Correct Fuse

Line Switch

The line switch is located on the rear panel. Turn on the oscilloscope by pressing the 1 on the rocker switch. The rocker switch is labelled 1 and 0, corresponding to on and off.

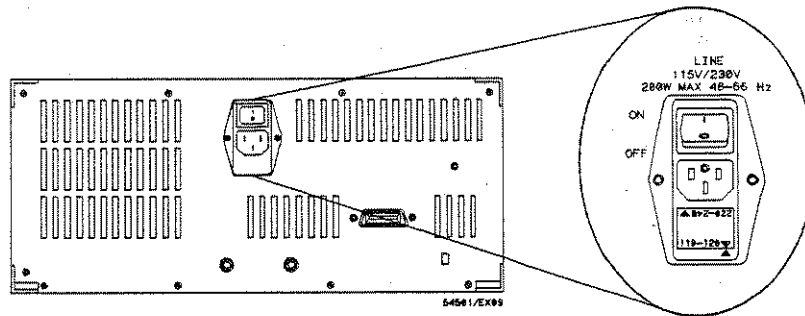

Figure 2-5. Line Switch

Intensity Control Once the oscilloscope has been turned on, you may want to set the display intensity to a more comfortable setting. Adjust the intensity by turning the DISPLAY INTENSITY control on the rear panel.

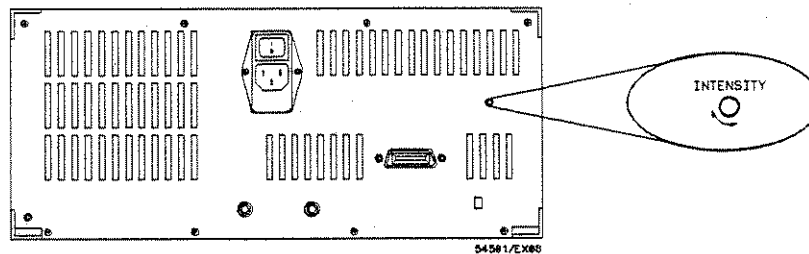

Figure 2-6. Intensity Control

Air Flow Requirements You must provide an unrestricted airflow for the fan and ventilation openings in the rear panel. You may stack the oscilloscope under, over, or between other instruments provided the other instruments are adequately cooled.

Storage and Shipment

If the instrument is to be shipped to a Hewlett-Packard service center for service or repair, attach a tag to the instrument identifying the owner, address of the owner, complete instrument model number and serial numbers and a description of the required service.

If the original packaging material is no longer available, identical packing material is available through local Hewlett-Packard offices. Mark the container FRAGILE to ensure careful handling. In any correspondence, refer to the instrument by the model and serial number.

Connecting External Equipment

The HP 54501A is equipped with an HP-IB connector on the rear panel. This allows a direct connection to a printer or an external controller.

Connect an HP-IB cable to the oscilloscope and a desired device (as shown). Tighten the HP-IB cable with the stackable screws to eliminate the potential of an inadvertent disconnection.

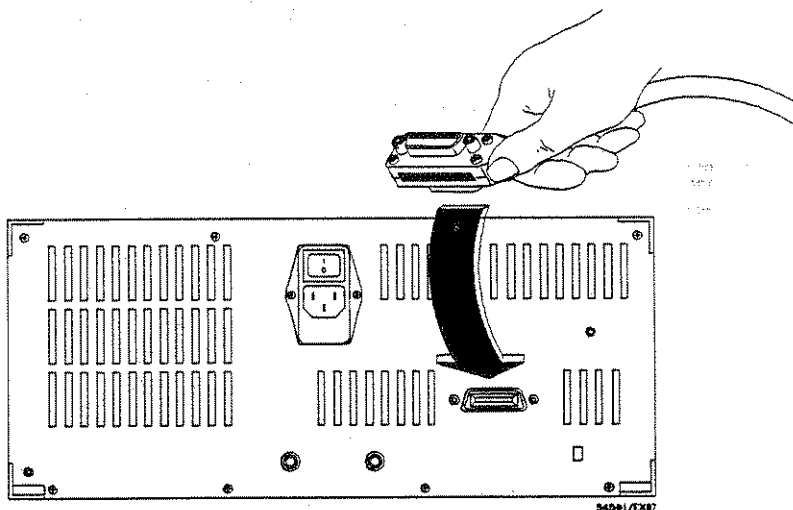

Figure 2-7. Connecting External Equipment

The HP 54501A must be properly addressed to communicate with the connected device. See Chapter 12, in the HP-IB submenu for more details.

Front Panel Overview

3

Introduction to the Front Panel

This chapter describes the functional sections of the HP 54501A front panel. The explanation of each area also contains their interaction with each other and provide a basis for applications and usages.

The HP 54501A has been designed for ease of use. The front panel is separated into six functional areas.

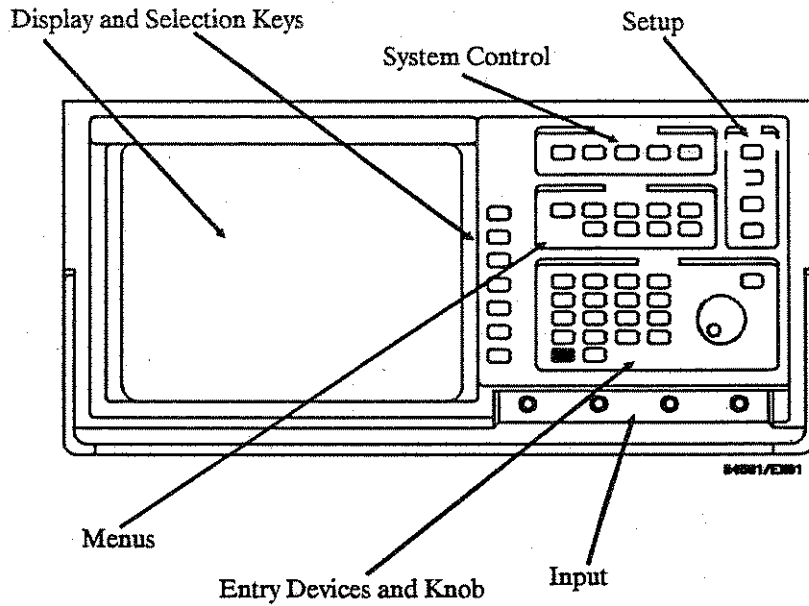

Figure 3-1. HP 54501A Front Panel

System Control

The System Control keys are located along the top of the oscilloscope to the right of the CRT. This section controls the following:

- dynamic display features
- selecting local control
- activating hardcopy

Selection of any key in the System Control section will cause the oscilloscope to execute that command immediately.

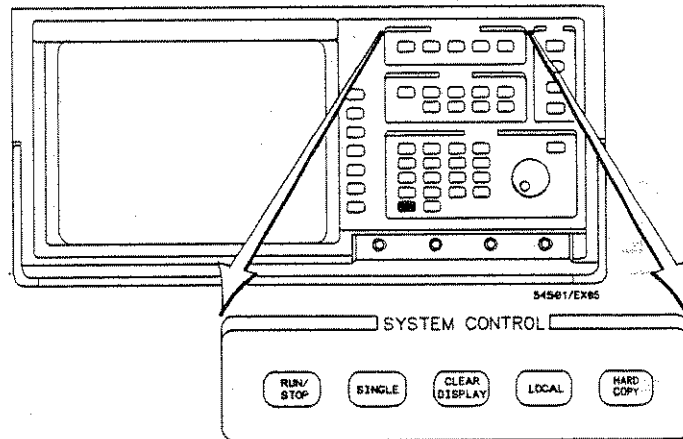

Figure 3-2. System Control Section

RUN/STOP Key The Run/Stop key is a toggle switch that changes the acquisition status of the HP 54501A. If the oscilloscope is currently running (current status is displayed in the top left corner of the CRT in the message field) the instrument will be placed in the *stopped* mode. In this mode, normal acquisition will be stopped and the last acquired data will be displayed. If the oscilloscope is stopped, it will immediately be changed to another mode (i.e. *running*, *awaiting trigger*, *auto-trigger*, etc).

SINGLE Key The Single key activates the acquisition system for one trigger event. One acquisition is made, displayed and then the data acquisition and display cycle is stopped. This single acquisition is superimposed on the current displayed data. If the display has been cleared before the Single key is pressed, only one acquisition is displayed.

CLEAR DISPLAY Key The Clear Display key will clear the display and reset all associated measurements. If the oscilloscope is in the stopped mode, all data that is currently displayed will be erased. If the oscilloscope is *running*, all data will be erased, however, new data will be displayed on the next acquisition. The RUN/STOP and SINGLE keys will not be affected.

The RUN/STOP, SINGLE, and CLEAR DISPLAY keys have a relationship that make it possible to manipulate data acquisitions and view one, two, or several acquisitions. It is possible to stop acquiring, clear the display and capture one acquisition for evaluation. You can clear the display while acquiring and capture new data. You can manipulate acquisitions with these three keys and not affect other keys and settings.

LOCAL Key The Local key will send a return to local control message to the HP-IB interface and return control to the front panel. This key can be locked out if a local lockout command is executed over the HP-IB.

This is the only active front panel key while the oscilloscope is in remote operation if it has not been locked out.

HARDCOPY Key The Hardcopy key executes an immediate hardcopy of the currently displayed data on a compatible graphics printer and stops all other oscilloscope functions while printing.

The oscilloscope must be in talk only, and the printer must be in listen always. Setup of the hardcopy options are accessed in the HP-IB submenu (see Chapter 12, "Utilities Menu.").

Selection of any key will abort the hardcopy action.

Setup

The Setup section of the front panel contains keys to control subsystems for proper display of input data. In this section you can control:

- AUTOSCALE for automatic scaling of the waveform display area
- Save and Recall setups
- Quick access to channel, function, and trigger information on the SHOW screen

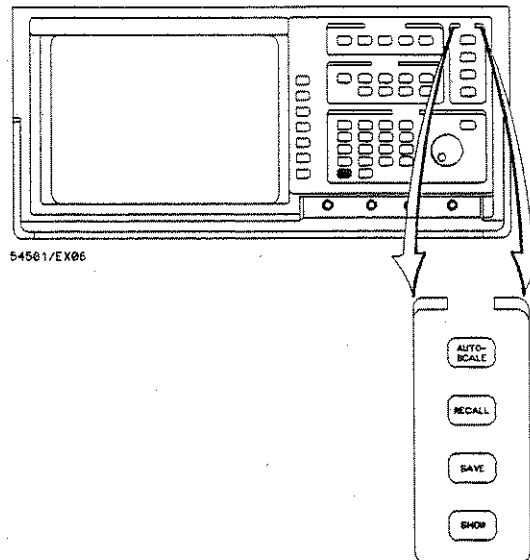

Figure 3-3. Setup Section

AUTOSCALE Key Pressing this key causes the oscilloscope to evaluate all input signals and set the correct conditions to display the signals. When Autoscale is pressed the following conditions are set:

- Vertical sensitivity on all channels
- Vertical offset on all channels
- Sets trigger to edge mode with minimum persistence, holdoff, positive slope, and proper trigger level for the trigger source
- Sweep speed of displayed channel

In addition, Autoscale includes a soft reset:

- Displays the correct number of screens
- Turns $\Delta t/\Delta V$ markers off
- Turns all measurements off
- Turns measurement limit test off
- Turns waveform math functions off
- Turns timebase window off
- Turns waveform/pixel memory display off
- Turns measurement limit test off
- Turns connect the dots off

The previous oscilloscope settings will be stored in volatile memory RECALL 0. To recall settings, press RECALL 0.

RECALL Key The RECALL key has three primary functions:

- By pressing the RECALL key and then selecting 1, 2, 3, or 4, the HP 54501A executes a recall of a previously saved setup configuration.
- The oscilloscope automatically saves the current configuration before executing an autoscale, recall, or setting up ECL/TTL presets. RECALL 0 is an undo of these actions. You cannot save to RECALL 0.
- RECALL CLEAR executes an instrument reset and returns the HP 54501A to default/power-up settings. The oscilloscope does not perform power-up self-tests (see Instrument Reset).

SAVE Key The SAVE key will immediately store the oscilloscope setup configuration in volatile memory. If you press SAVE, you must then select a save register: 1, 2, 3, or 4. An advisory will be displayed above the waveform display area indicating the setup configuration has been saved.

SHOW Key The SHOW key allows quick access to the following information:

1 2.00 V/div
offset: 50.00 mV

4 40.0 V/div
offset: -1.000 V

f2 1 + 1
4.00 V/div
offset: 100.0 mV

1 50.00 mV
54501/WF18

- Channel scaling
- Channel offset
- Channel coupling
- Probe attenuation
- Trigger source
- Trigger level
- Math function operation
- Math function scaling
- Math function offset
- Memories

Pressing the SHOW key allows you to toggle between the currently selected menu and the SHOW screen (as illustrated).

This screen affords the most complete and detailed instrument setup information. It is convenient to select this screen before making a hardcopy and include all SHOW screen information on your hardcopy.

Menus

The Menu section consists of nine keys to select from:

- Timebase
- Channel
- Trigger
- Display
- $\Delta t/\Delta V$
- Waveform Math
- Waveform Save
- Define Measure
- Utilities

One of these menus is discussed in each of the following chapters.

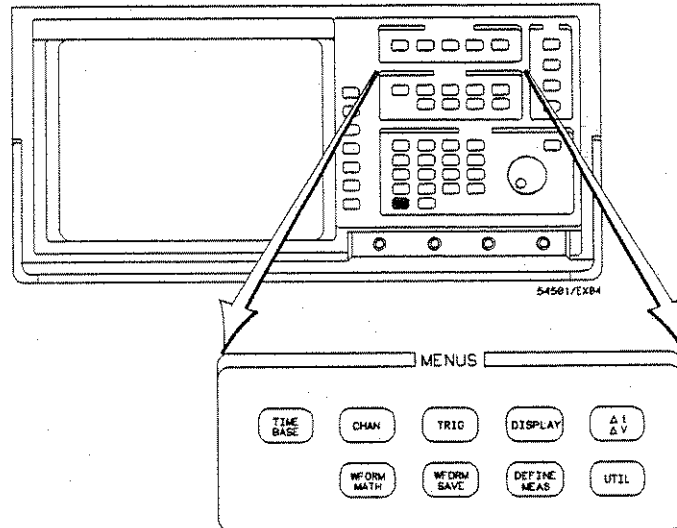

Figure 3-4. Menu Section

Entry

The Entry device section contains a multi-function numeric keypad, a selection knob, and a fine key.

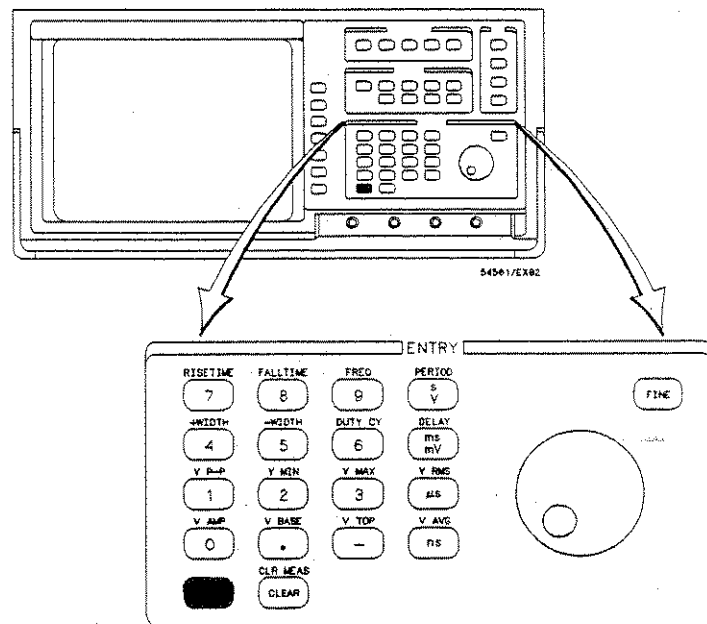

Figure 3-5. Entry Section

Numeric Keypad

The number keys on the numeric keypad are used for direct numeric input. When you wish to input known values directly, press the desired value and then press the desired units. For example, if you wish to set the vertical sensitivity to 500 mV:

- Ensure V/div in the Channel menu is the active field (displayed in fullbright)
- Press 5, 0, 0, mv in the proper sequence.

To the right of the number keys is a vertical column of keys with measurement units. The bottom row of keys contains a blue (Shift) key to select alternate keys that are labelled in blue and a CLEAR key to clear any selections made.

Knob The knob is used to change values within each function. It increments, decrements, or toggles the selection in the active field or function. The current selection is displayed in fullbright in the displayed menu area and can be changed with the knob.

FINE Key The FINE key changes the increment and decrement sequence. Instead of sequencing in the normal sequence, the values will change to increment/decrement in more precise values. This feature is useful when the normal sequence is too coarse for precision measurements or settings.

When the HP 54501A is operating in the fine mode, the word *fine* is displayed in the lower right corner of the CRT.

Input

The input section consists of connectors for signal input. All inputs have a nominal 1 M Ω input impedance shunted by approximately 16 pF at the input BNC. Each input has a maximum tolerance of 250 V.

Channels 1 and 4 are full range channels. Channels 2 and 3 have been optimized for digital uses with limited vertical ranges of 100 mV, 200 mV, and 500 mV/division.

Use channels 1 and 4 or 2 and 3 if you need continuous dual channel acquisition. Channels 1 and 2 share an acquisition A/D and channels 2 and 3 share.

Display

The Display section contains the screen and selection keys.

In a vertical column on the right side of the screen is the function display. The functions that are displayed at any one time will correspond to a key in the selection column. These keys can select any available function or field that is displayed in halfbright.

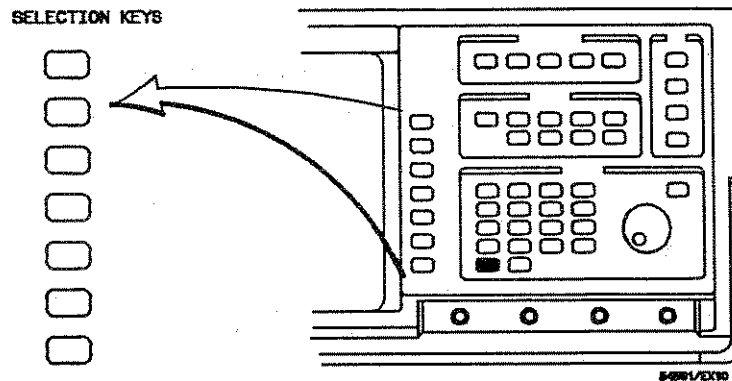

Figure 3-6. Selection Keys

- Numeric key fields that are displayed in fullbright can be changed by either of the entry devices. When these functions are not the active field they are displayed in halfbright; when they are displayed in fullbright they are active.
- Non-numeric fields that are displayed in halfbright will be changed to the next choice. These fields will always be displayed in halfbright, but they will also be active. By pressing the appropriate selection key the displayed entry will be changed to the next selection.

Instrument Reset

The HP 54501A has two methods used for instrument reset.

- Key-down power up is a hard reset of the oscilloscope. It is done by pressing and holding any front panel key while cycling power. If no input signals are present, the oscilloscope will power-up displaying a baseline (if no signal is present) and the SHOW screen and set with all default settings (see Table 3-1). A key-down power up must be performed before starting any calibration routines.
- RECALL CLEAR performs a soft reset of the oscilloscope. All default conditions are set (see Table 3-1 below). RECALL CLEAR is the same as a key-down power-up except that the the previous menu selections will be retained.

Table 3-1. Reset Default Conditions

Timebase Menu	
reference	cntr
Time/Div	100 μ s
delay	0.00 s
timebase window	off
Channel Menu	
Channel 1	on
Channel 2-4	off
Volts/Div	500 mV
offset	0.00
coupling	dc
probe attenuation	1.000:1

Table 3-1. Reset Default Conditions (continued)

Trigger Menu	
Mode	edge
source	Channel 1
level	0.0 V
slope	positive
holdoff	40 ns
Display Menu	
Mode	norm
persistence	minimum
# of screens	1
off/frame/axes/grid	axes
connect dots	off
$\Delta t/\Delta V$ Menu	
Δt markers	off
ΔV markers	off
Waveform Math Menu	
f1	off
f2	off
chan/mem	chan 1
operator	+
chan/mem	chan 1
function sensitivity	1.00 V/div
function offset	0.0 V
Waveform Save Menu	
waveform/pixel	waveform
nonvolatile	m1
display	off
source	chan 1
Define Meas Menu	
meas/def/limit	meas
continuous	on

Introduction to the Timebase

This chapter contains a complete description of how the Timebase menu works and controls the entire horizontal display and parameters. Each function key will be described in detail.

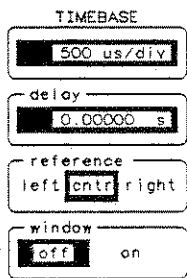

54501/WF08

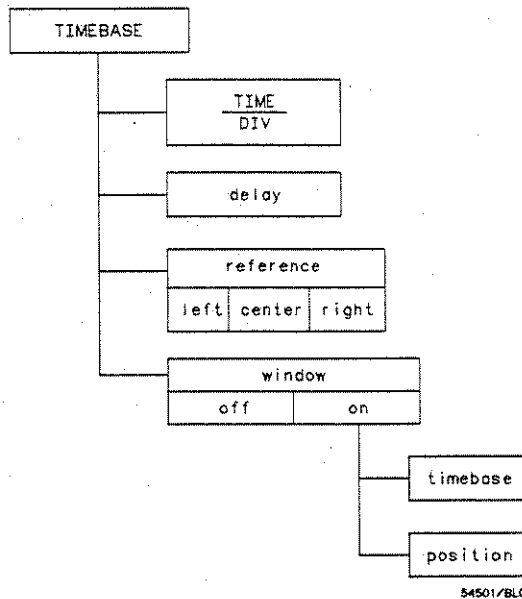

54501/BL01

Figure 4-1. Timebase Menu.

Time/Div Key

The time/division function allows you to control the sweep speed on the horizontal axis from 2 ns/div to 5 sec/div. The main Timebase is incremented and decremented in the 1-2-5 sequence. The FINE Key has no affect on the timebase settings.

When using slow sweep speeds (200 ms/div to 5 sec/div) the acquisition and write cycle changes. At these sweep speeds the oscilloscope needs up to 2.5 seconds to generate a trigger and acquisition, therefore, the displayed data is updated for each data sample. The HP 54501A must accommodate two trigger conditions for acquisition and display:

- *auto triggered scroll* is used when in auto trigger. The oscilloscope will acquire and display data in the auto triggered scroll mode and display each data sample as it is acquired. As it samples and displays a message is displayed at the top left corner of the CRT indicating this acquisition mode.
- *triggered scroll* is used when in the trig'd mode and scrolled acquisition is needed. Triggered scroll acquisitions are not displayed until all data is available (similar to normal acquisitions) to display. As data is being sampled the advisory *n s to initialize* is displayed while pre-trigger data is collected and *n s to complete* is displayed while post-trigger data is collected. This message indicates the time needed to complete acquisition where *n* is the remaining time (in seconds, *s*) and will continue to countdown until the time has elapsed. The advisory *running* is displayed as the write cycle to the screen is executed and displayed data is updated.

If the reference point is set to left the only advisory displayed is *n s to complete* because all data is post-trigger. When right reference is set all data is pre-trigger and the advisory is *n s to initialize*.

Both entry devices are available to change the sweep speed.

delay Key

Selection of the Delay function assigns delay as the active function. When delay is set to 0 the trigger event occurs at the delay reference point. Positive delay indicates time after the trigger and negative delay indicates time before the trigger. Therefore, a delay setting of -50 ns indicates that the trigger event occurs 50 ns after the delay reference point.

$$\text{reference} = \text{trigger event} + \text{delay}$$

Timebase

4-2

reference Key

The Reference key changes the delay reference point to one of the following:

- left
- cntr (center)
- right

If delay is set to 0, the reference point consists of pre-trigger data to the left and post-trigger data to the right.

window Key

With the window function turned on an expanded timebase is activated and the oscilloscope is placed in a multiple screen mode. The normal waveform, in the original timebase setting, is displayed in the top screen with markers, vertical dotted lines, that enclose a portion of the displayed waveform. Only the enclosed portion, between the markers, is displayed in the bottom screen.

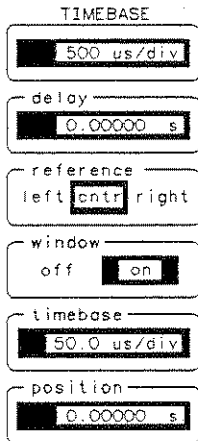

Note

The displayed timebase information under the waveform display area is windowed timebase information. When the window is on all measurement results and information are windowed information.

This feature is much the same as the delayed sweep on an analog oscilloscope, however, with the dual screen activated you can see what portion of the normal waveform you are viewing.

The timebase of the windowed waveform can be varied from equal to the normal timebase to 1/20 of the normal timebase. This equates to 1/2 of a major division.

54501/WF09

When the reference position is set to left, only the right window marker moves when the window timebase is changed. When reference is set to right, only the left marker moves, and when center is selected, both markers move. This maintains a specified time reference without changing any timebase settings and yet you have the ability to move the reference points for better viewing.

When the Window function is enabled, two selections are available for placing and sizing the window. They are:

- Window timebase
- Window position

timebase Key This key is activated only when the Window function is turned on and sets the timebase in the window.

As the window timebase is increased the time in the window displayed in the bottom screen is increased. The markers in the top screen move farther apart. When the window reaches full screen the main timebase and the window timebase become equal. As the window timebase is decreased the markers move closer together.

position Key This key is activated only when the Window function is turned on.

The window can be placed anywhere on the normal waveform. By adjusting the window position you can see any part of the waveform.

Note

When window timebase = time/division, there is only one possible setting for window position. Turning the knob will have no effect.

Window Exercise

To demonstrate how the window can be useful in making measurements and viewing the windowed waveform, perform the following exercise. This will give you a basic understanding of the window function.

Setting the Input Signal

For this exercise you will use a simulated ECL input signal, a 1 volt, 2 kHz squarewave with adequate offset to display the signal at midscreen.

Set up an HP 8116A Pulse/Function Generator or another signal generator that is capable of the same signal.

- Mode = NORM
- Set AMP = 1.00 V
- Set FRQ = 2 kHz
- Set DTY = 50%
- Set OFS = -1.20 V
- Set signal to squarewave

Setting the Oscilloscope

Input this signal to channel 1 on the HP 54501A and disconnect any inputs to any other channel.

- Press **AUTOSCALE** (see Figure 4-2).

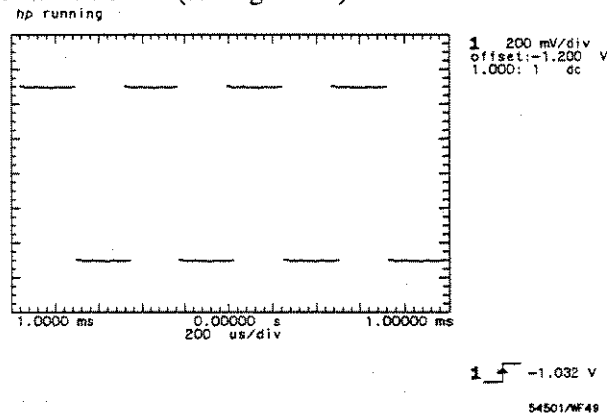

Figure 4-2. Input Signal for Window Viewing

- Press the Timebase menu key.
- Press the selection key to turn on the window function.
- Set the window timebase to 40 $\mu\text{s}/\text{div}$ (see Figure 4-3).

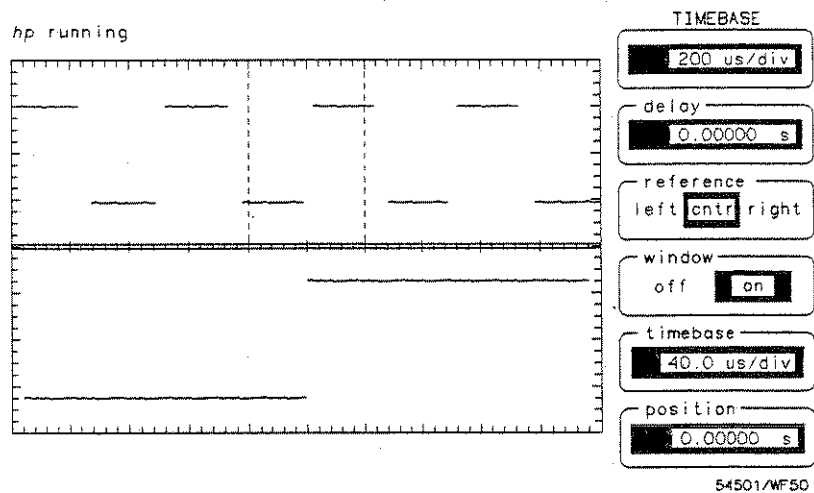

Figure 4-3. Input Signal with Window Turned On

Note

The timebase factors under the waveform display area have changed to reflect the window.

Viewing the Window The timebase width in the window is 40 μs (1/20 of 1 ms) with the trigger point at center reference and 0 time delay. If any of the following are the active fields:

- The **time/division field (top)**, as you turn the knob both timebases and displayed waveforms will change until window timebase equals the normal timebase.

- **delay**, as you turn the knob the window and waveform will move sideways and maintain the same size. This allows you to view the same section of the waveform at a different point in time. The two timebases will not change.
- **window timebase**, as you turn the knob only the window timebase will change. The range is from 1/20 of the normal timebase to equal the normal timebase.
- **window position**, as you turn the knob, the window changes position on the normal waveform allowing you to view different sections of the waveform.

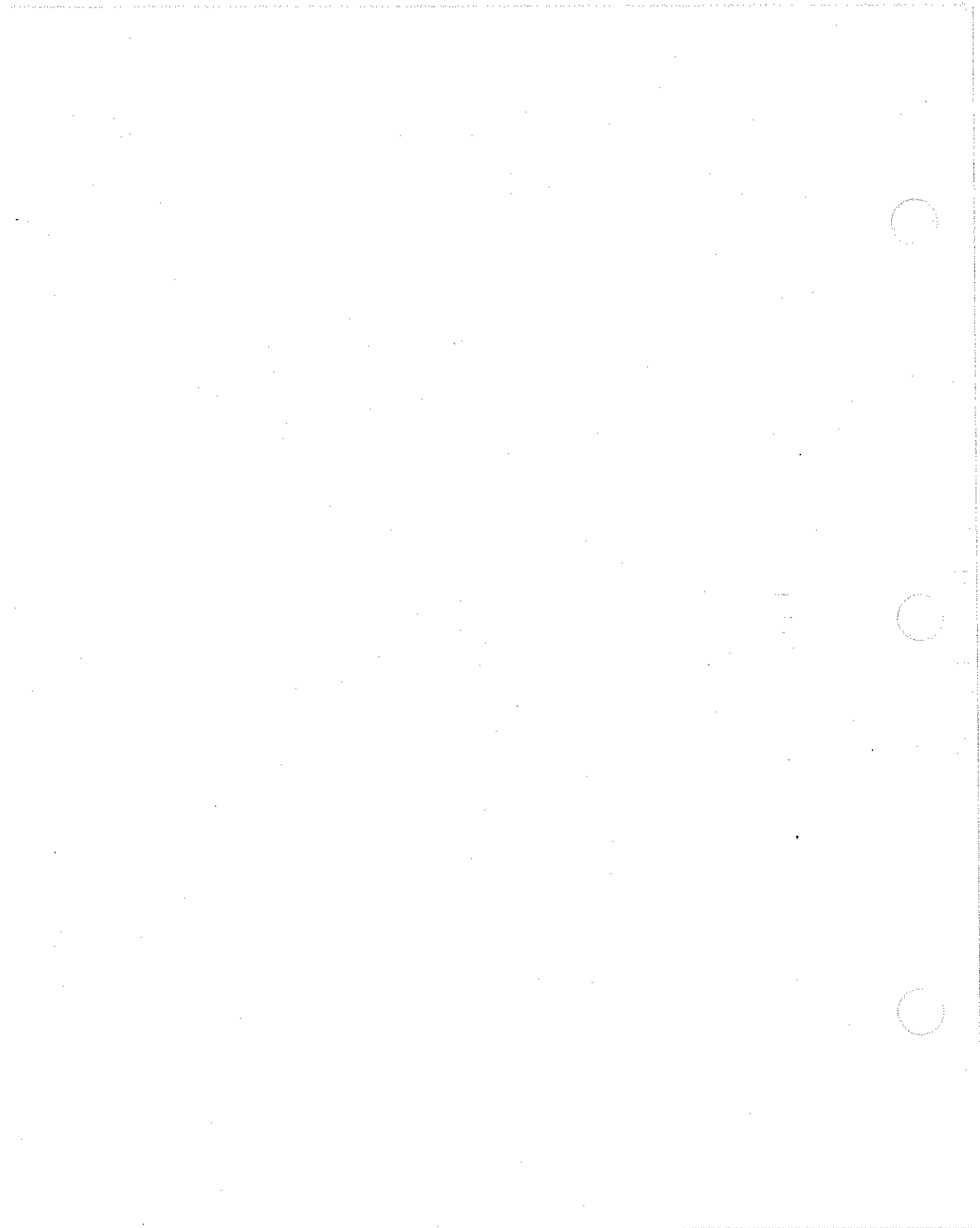

Introduction to Channels

The channel menu allows you to control the vertical operation of the HP 54501A. This chapter describes the use of the four channels, including vertical sensitivity, offset, coupling, attenuation and preset levels that are available.

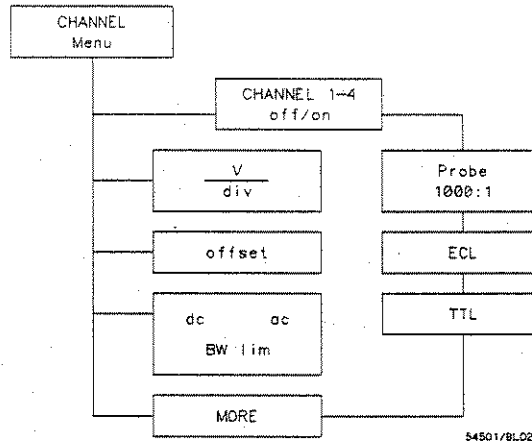
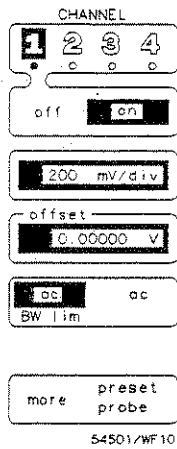

Figure 5-1 Channel Menu

CHANNEL Key

The top key in the channel menu is for channel selection. The selection toggles through channels one through four. When a channel is selected (highlighted in inverse video) you can turn it on by pressing the key second from the top in the same menu. When a channel is turned on the small circle immediately below the channel number is highlighted.

Note

It is possible to have a channel turned on and view while being in the vertical control menu of another channel. When making changes, ensure you have the proper channel and function selected and you are changing the channel you intend to change.

Vertical Sensitivity Key

The vertical sensitivity key is the third key from the top in the channel menu. The field itself is not labeled, however, the current volts/division is displayed with the units of the current selection. When this function is selected either of the entry devices can be used for data entry.

The range of the vertical sensitivity for the HP 54501A is from 5 mV/division to 5 V/division. Vertical sensitivity changes in a 1-2-5 sequence in the normal mode or can be changed in the fine mode. Channels 2 and 3 have a limited attenuation range and can only be set to 100 mV, 200 mV, and 500 mV/division.

offset Key

When offset is selected, 0 volts is on the vertical midpoint of the display. Offset is the voltage level at mid-screen.

Offset allows you to move the displayed signal up or down, similar to the vertical position adjustment on an analog oscilloscope. However, offset on the HP 54501A has a range of ± 16 divisions from center screen.

coupling Key

The coupling key has several selection variables. They are as follows:

- ac
- ac bandwidth limit
- dc
- dc bandwidth limit

Bandwidth limit reduces the effective bandwidth to ≈ 20 MHz. It reduces the noise in the display path as well as the trigger path.

more Key

Pressing the more key allows you to toggle between the two channel menus.

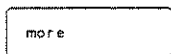
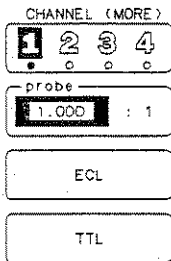

54501/WF11

probe Key

Using the probe key enables you to select probe attenuation with a range of 1000:1 down to 0.9000:1. To adjust the attenuation you can use either the knob or the entry keypad. When using the knob, and in the coarse mode, the adjustments will increment or decrement in the familiar 1-2-5 sequence. When in the fine mode the changes will be 0.1.

Probe attenuation does not affect sensitivity at the input, only scaling factors for the display.

Attenuation factors will be saved with the front panel setup.

ECL Key

The ECL key allows you to set the oscilloscope to levels optimized for ECL circuits. They are:

- V/Div: 200 mV/div
- offset: -1.3 V
- coupling: dc
- Trigger level: -1.3 V
- Trigger slope: no change

To return to the previous settings, press RECALL 0.

TTL Key

The TTL key allows you to set the oscilloscope with levels that are optimized for TTL circuits. They are:

- V/Div: 1 V/div
- offset: 2.5 V
- coupling: dc
- Trigger level: 1.4 V
- Trigger slope: no change

To return to the previous settings press RECALL 0.

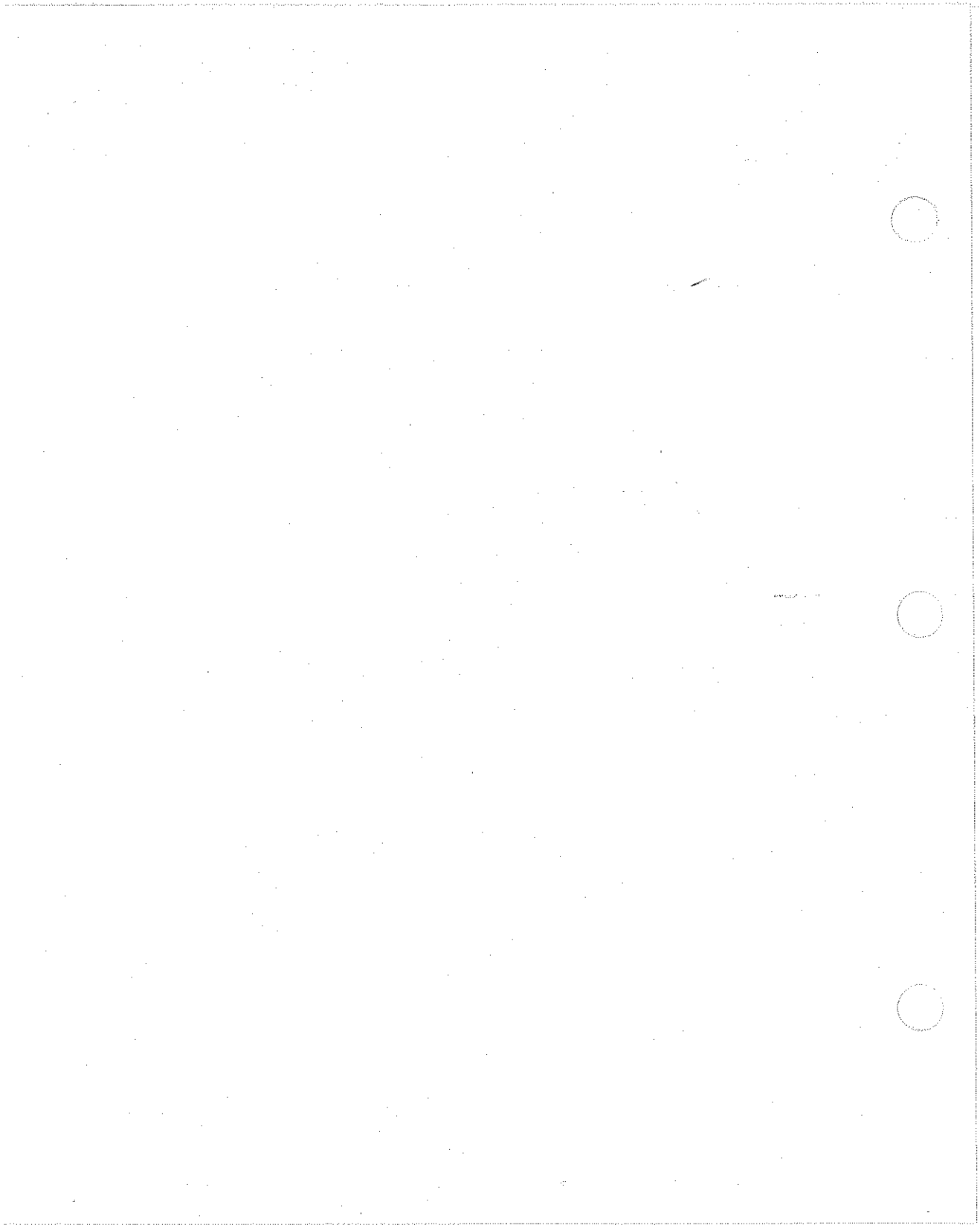

Introduction to the Triggers

The HP 54501A has five triggering modes available. These modes make available many distinctive techniques to trigger and capture data. Its capabilities range from simple edge triggering to logic triggering on multiple signals.

This chapter contains a complete description of the triggering modes, as well as explanations on how to use them, and exercises detailing some real life applications. The five modes are:

- edge
- pattern
- state
- delay
- tv

Trigger Mode Interaction

The trigger level (threshold) for each channel is set in the edge trigger mode and is set independently for each channel. It is carried over to all other modes, except the tv trigger mode. These levels are important settings because the high and low levels in the pattern, state, and delay modes are greater than or less than the trigger level.

The tv trigger is a special case and is set in the tv trigger menu.

Edge Trigger Mode

In the edge trigger mode you can make the following selections:

- trig'd/auto
- trigger source
- trigger level
- slope
- holdoff

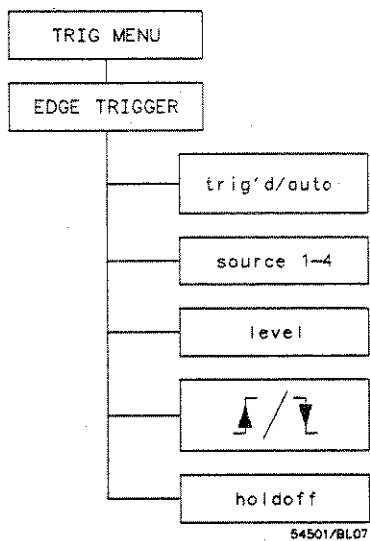
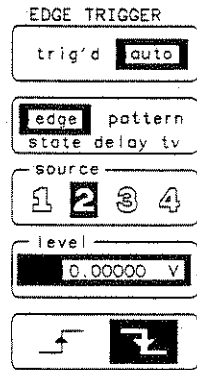

Figure 6-1. Edge Trigger Menu

Trig'd/auto Key

The trig'd/auto selection is a toggle selection and lets you select between the two. The current selection is displayed in inverse video. This field is available in all trigger modes.



When in the triggered mode the oscilloscope will not acquire data until all of the trigger requirements have been satisfied. In the auto mode the oscilloscope will generate a trigger if none is present. If no trigger is found it will generate a trigger and display acquired data. A status message will be displayed in the upper left corner of the screen.

If the oscilloscope is auto-triggered and the sweep speed is 200 ms/div, 500 ms/div, 1 s/div, 2 s/div, or 5 s/div, it will operate in the triggered scroll mode and display data points as they are acquired (see Chapter 4, "Timebase Menu").

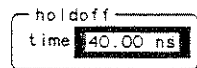

54501/WF12

source Key

Pressing this key allows you to select the trigger source. The options are channels 1-4. The current selection is highlighted in inverse video.

level Key

The level key allows you to set the trigger level. The range on this function is ± 6 divisions from center. It provides flexibility for setting exact triggering points and specifies levels used in the more sophisticated triggering modes.

slope Key

This field is not labeled, however, the available selections are graphic representations of the rising edge and falling edge. The current selection is highlighted in inverse video.

holdoff Key

Pressing the holdoff key assigns the entry devices to control holdoff. Holdoff disables the trigger circuit for a selectable time period after the trigger event. Holdoff is selected in time units, from 40 ns to 320 ms.

Holdoff Exercise

In this exercise you will set up the oscilloscope and a signal generator to view some of the features of the edge trigger. You will learn how to use holdoff to gain a stable trigger. This technique is not necessary for most applications and waveforms, however, for many non-recurring and irregular waveforms you may find it helpful to use.

Instrument Setup Follow the instructions for setting up the signal generator. The signal for this exercise is a burst pattern with two positive cycles that repeats every 5 μ s. Use an HP 8116A Pulse/Function Generator with the burst option or a signal generator capable of the same signal.

Make the following settings:

- MODE: I.BUR
- RPT: 5.00 μ s
- BUR: 2
- FRQ: 1 MHz
- DTY: 50%
- AMP: 1 V
- OFS: -200 mV
- Set the signal for a square wave.

Oscilloscope Setup Connect the the signal generator to the channel 1 input and disconnect all tother inputs..

- Press AUTOSCALE (see Figure 6-2).

hp running

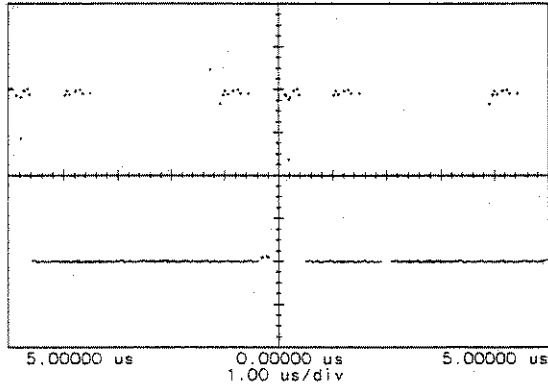

1 200 mV/div
offset:-225.0 mV
1.000: 1. dc

1 -225.0 mV
54501/WF59

Figure 6-2. Two-Burst Waveform after Autoscale

- Select the Timebase menu.
- Set the sweep speed to 500 ns/division.

hp running

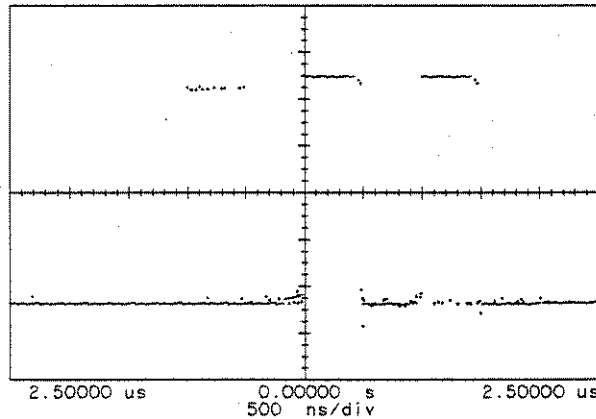

TIMEBASE

delay

reference
left cntr right

window
 off on

54501/WF58

Figure 6-3. Two-Burst Pulse

The HP 54501A sets up the display parameters. It is now attempting to trigger on the first rising edge of the two cycle burst.

- Enter the Trigger Menu and press the slope key.

The oscilloscope is now triggering on the first falling edge of the two cycle burst. Press the slope key again to trigger on the positive edge.

Note

The signal generator is set for two 500 ns pulses. The display on the oscilloscope appears to have three pulses. This is an unstable trigger condition. The following steps explain this condition and how to overcome it.

- Press the holdoff key.
- Set holdoff to 1.02000 μ s, using either of the entry devices.

Holdoff on the HP 54501A has a minimum setting of 40 ns. The input signal to the oscilloscope has two 500 ns pulses. On the first rising edge a trigger occurs and activates the 40 ns holdoff. When the holdoff time has elapsed the oscilloscope triggers on the next rising edge. The oscilloscope times a 40 ns holdoff and looks for another trigger. The oscilloscope will trigger on the first rising edge of the second burst. Each trigger event occurs on a different pulse, and consequently an unstable condition.

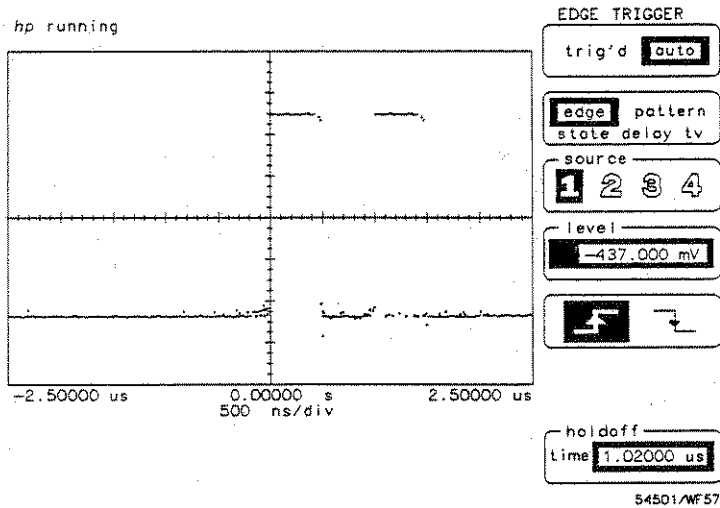

Figure 6-4. Two-Burst Pulse w/Stable Trigger

By adjusting the holdoff to wait until the rising edge of the second pulse passes, the oscilloscope triggers only on the first rising edge and the signal is stable. In this case the trigger becomes stable at approximately 1.02 μ s holdoff.

Pattern Trigger Mode

The pattern mode allows you to define a four character pattern that the oscilloscope will recognize and generate a trigger event. When the inputs satisfy the trigger pattern and conditions the HP 54501A will trigger and display the desired portion of the waveform.

The pattern mode is very useful for glitch detection because the HP 54501A will trigger on a glitch and display the resulting waveform.

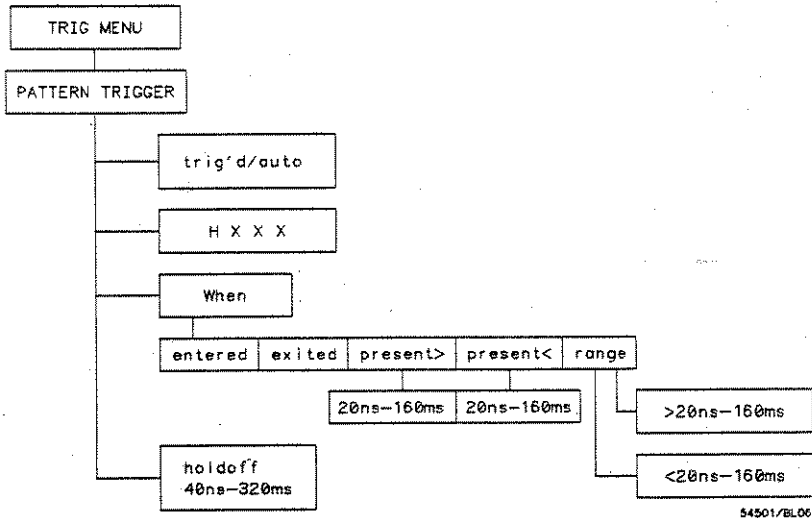
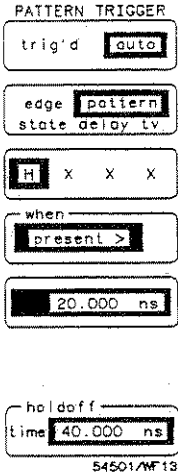

Figure 6-5. Pattern Trigger Menu

The top two selection keys remain the same as the Edge Trigger mode.

pattern Key This is an unlabelled field. The display depicts the four-bit pattern. The active field is displayed in fullbright and can be changed using the knob. The selection key changes the bit selection. The available selections are:

- H - high
- L - low
- X - don't care

The criteria for high is higher than the current trigger level, and low is lower than the current trigger level.

The four bit pattern is representative of the four-channel input.

For example, if the pattern is LXXH, the voltage on channel 1 must be lower than the trigger level set for channel 1, channels 2 and 3 are don't cares so the input levels are disregarded, and the channel 4 input must be higher than the trigger level set for channel four. If these conditions are satisfied by the inputs, then the oscilloscope will generate a trigger event.

Note

When any channel is not being used in the qualifier pattern, it should be set as don't care. The trigger level is still compared to the no input channel and a high or low is determined. The only true don't care is X.

If the pattern XXXX is selected, no trigger event will occur because no trigger event has been defined.

when Key This key controls five sets of conditions that must be satisfied to generate a trigger event. These conditions are as follows:

- **when entered:** a trigger is generated on the first transition that makes a pattern true. The pattern must be false and go true to generate the trigger.
- **when exited:** a trigger is generated on the first transition that makes the pattern false. The pattern must be true and go false to generate a trigger.

- **when present >** : a trigger is generated when a trigger pattern is true longer than a specified minimum time period. This time period is specified in the next selection key that is activated when present > is selected. The present > time ranges from 20 ns to 160 ms.
- **when present <** : a trigger is generated when a trigger pattern is true less than a specified maximum time period. This time period is specified in the next selection key that is activated when present < is selected. The present < time ranges from 20 ns to 160 ms.
- **range**: this trigger condition is a combination of present < and present >. A trigger is generated when a trigger pattern is true for longer than a specified minimum and shorter than a specified maximum time period. These time periods are specified in the next two selection keys that are activated when range is selected. The first range time setting must be less than the second range time setting.

holdoff Key Pressing the holdoff key assigns the entry devices to control holdoff. Holdoff disables the trigger circuit for a selectable time period after the trigger event. Holdoff is selected in time units, from 40 ns to 320 ms and is incremented in 20 ns intervals.

Pattern Trigger Exercise

This exercise demonstrates how to define the four bit pattern and how it affects the trigger, displays the signals, and reads the pattern.

Note

Set the trigger level for each trigger source while in the edge mode. These trigger levels must be set before you go to the pattern mode, or proper triggering may not occur.

Instrument Setup To perform the following exercise use the HP 8116A Pulse/Function Generator, or another function generator capable of producing the same 1 MHz, 1 volt, squarewave signal.

Set up the HP 8116A Pulse/Function Generator:

- Mode = NORM
- FRQ = 1.00 MHz
- DTY = 50%
- AMP = 1.00 V
- OFS = -2.00 V
- Pulse = squarewave

Connect the signal to a BNC tee on channel 1 using a 1 meter coaxial cable. Connect another 1 meter cable from the other side of the BNC tee to channel 4.

Oscilloscope Setup

The extra cable length between channels 1 and 4 provides a time delay between the signals displayed on the oscilloscope. The propagation of a 1 metre coaxial cable is approximately 6 to 7 ns. This time delay is used to demonstrate the HP 54501A triggering capability.

- Press AUTOSCALE.

Set up the HP 54501A as follows:

- Timebase = 10.00 ns/div
delay = 0.00 s
reference = cntr
window = off
- Channel 1
Vertical sensitivity = 500 mV/div
offset = -200.00 mV
dc coupling
- Channel 4
Vertical sensitivity = 500 mV/div
offset = --200.00 mV
dc coupling

- Display
 - zero persistence
 - 2 screens
 - axes
- Trigger
 - Channel 1 level = -200 mV
 - Channel 4 level = -200 mV
 - Set the trigger mode to pattern.

Set the pattern to HXXL as follows:

- Press the selection key until the first character is highlighted.
- Turn the knob until the highlighted area is H.
- Select the next character in the pattern and repeat the procedure.
- Continue until all characters are selected in the HXXL pattern.
- Press the when key until entered is selected.

The display should be similar to the following figure.

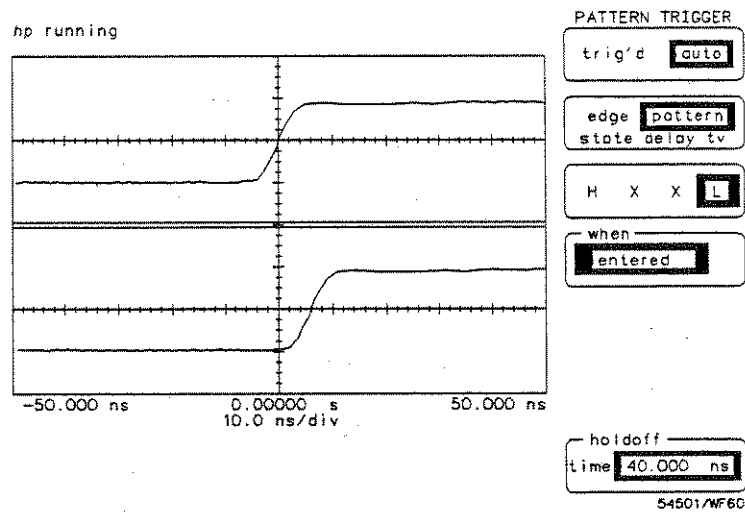

Figure 6-6. HXXL when entered Pattern

Channel 1 is displayed in the top screen. To satisfy the conditions of the bit pattern, channel 1 must be high (higher than the channel 1 trigger level) or greater than -200 mV. When the signal on channel 1 goes higher than -200 mV and channel 4 is still low (less than -200 mV) the pattern conditions have been satisfied as the signal is entering the trigger conditions and the HP 54501A triggers.

- Press the when key and change the condition to when exited.

The oscilloscope triggers on the first transition that makes the bit pattern false, in this case when channel 4 goes high.

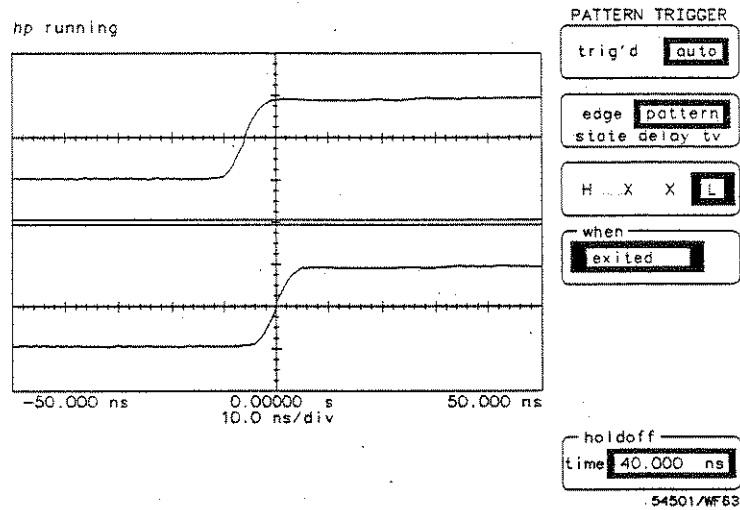

Figure 6-7. HXXL when exited Pattern

- Change the bit pattern to HXXH and select the entered condition.

To satisfy this bit condition both channels must be high. The oscilloscope will not trigger until channel 4 goes high while channel 1 is high.

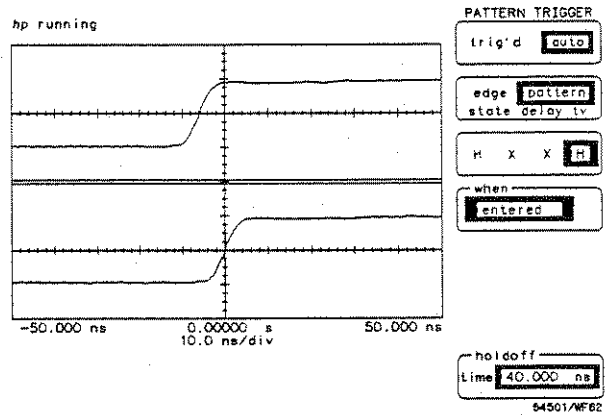

Figure 6-9. HXXH when entered Pattern

- Change the trigger condition to when exited.

While channel 4 is still high, when channel 1 goes low the bit pattern is no longer true and the HP 54501A triggers.

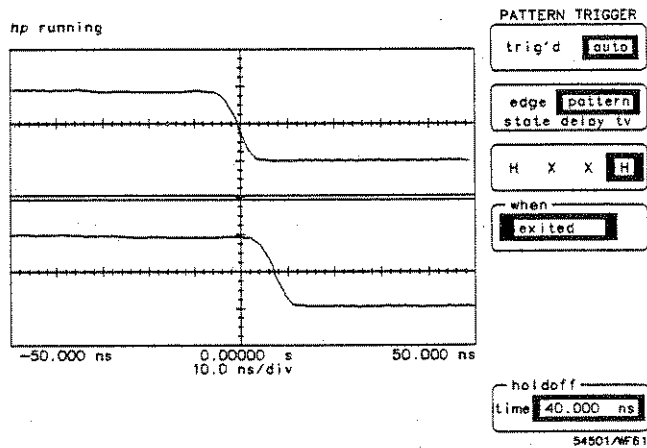

Figure 6-8. HXXH when exited Pattern

State Trigger Mode

The State trigger mode is similar to the pattern trigger mode except that one channel is selected as a clock edge and the other three channels define a pattern. When the pattern becomes true the HP 54501A triggers on the next clock edge if the pattern meets setup and hold criteria.

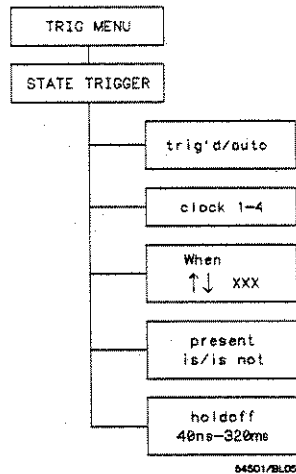
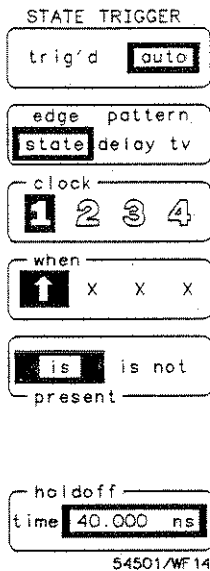

Figure 6-10. State Trigger Menu

The trig'd/auto and trigger mode selection keys remain displayed in all trigger modes.

- clock Key** You can select any channel to be used as the state clock. Select the channel by pressing the selection key until the desired channel is highlighted. The clock selection is reflected in the next field with an arrow, pointing either up for a positive slope or down for a negative slope.
- when Key** The when key depicts the desired pattern. The displayed pattern shows the arrow at the selected clock channel. The other three channels define the logic pattern that must be satisfied to generate a trigger event using the H, L, X convention described in the Pattern Trigger Mode.

To change the pattern:

- Press the selection key until the bit you want to change is highlighted.
- Rotate the knob until the desired setting is highlighted.
- Select the arrow if you need to change the trigger slope and turn the knob until the desired settings appear.

present Key A trigger event will be generated on the selected edge when the pattern is true and **is present** is selected, or a trigger will occur when the pattern is false and **not present** is selected.

holdoff Key Pressing the holdoff key assigns the entry devices to control holdoff. Holdoff disables the trigger circuit for a selectable time period after the trigger event. Holdoff is selected in time units, from 40 ns to 320 ms.

State Trigger Exercise

This exercise demonstrates how an input pattern can be used to qualify a clock edge that is to be used as a trigger.

State triggering extends the logic triggering capability of the HP 54501A by letting you select one of the inputs as a clock and using the other inputs as qualifiers.

This is useful when it is necessary to synchronize the display with a system clock to detect a system state. For example, consider a synchronous memory bus. The state trigger mode enables you to see only those events that occur when reading from a block of memory.

Instrument Setup To perform the following exercise use an HP 8116A Pulse/Signal generator or another signal generator capable of the same 1 MHz, 1 volt squarewave.

Set up the HP 8116A as follows:

- Mode = NORM
- FRQ = 1.00 MHz
- DTY = 50%
- AMP = 1.00 V
- OFS = -200 mV

Connect the signal to a BNC tee on channel 1 using a 1 meter coaxial cable. Connect another 1 meter cable from the other side of the BNC tee to channel 4.

Oscilloscope Setup

The extra cable length between channels 1 and 4 provides a time delay between the signals displayed on the oscilloscope. The propagation of a 1 meter coaxial cable is approximately 6 to 7 ns. This time delay is used to demonstrate the HP 54501A triggering capability.

- Press **AUTOSCALE**.

Set up the HP 54501A as follows:

- Timebase = 10.00 ns/div
delay = 0.00 s
reference = cntr
window = off
- Channel 1 turned on
Vertical sensitivity = 400 mV/div
offset = 1.25 V
dc coupling
- Channel 4 turned on
Vertical sensitivity = 400 mV/div
offset = -75 mV
dc coupling
- Display
zero persistence
2 screens

- **Trigger**
 - Channel 1 level = 125 mV
 - Channel 4 level = -100 mV
 - Set the trigger mode to state
- Set the pattern to \uparrow XXL as follows:
 1. Press the selection key until the first bit is highlighted.
 2. Turn the knob until the highlighted area is \uparrow .
 3. Select the next bit in the pattern and select H
 4. Continue until all bits are selected in the \uparrow XXL pattern
- Press the **when** key until **is present** is selected (see Figure 6-11).

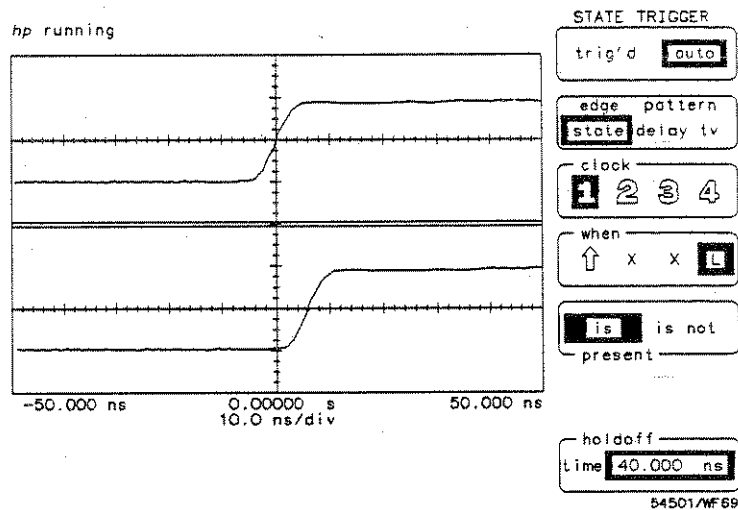

Figure 6-11. Channel 1 Clock XXL State

Channel 1 is displayed in the top screen. To satisfy the conditions of the bit pattern, channel 4 must be high (higher than the channel 4 trigger level) or greater than 125 mV. When the signal on channel 1 goes higher than 125 mV and channel 4 is still low (less than -100 mV) the pattern conditions have been satisfied, the HP 54501A triggers on the next positive pulse on channel 1.

- Press the **is/is not present** key and change the condition to **not present**.

The pattern becomes false when channel 4 turns high.

- Change the bit pattern to \uparrow XXH and select the **is not present** condition.

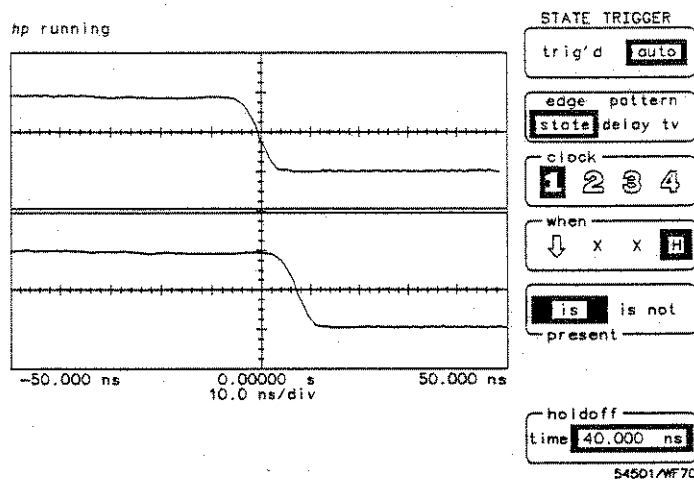
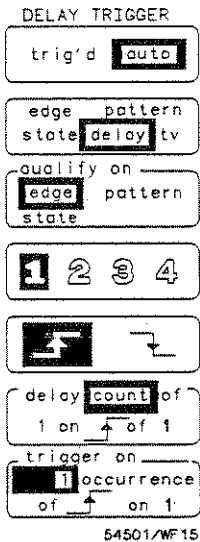

Figure 6-12. Channel 1 Clock XXH State

To satisfy this bit condition the clock channel must go low while channel 4 is high. The oscilloscope will not trigger until channel 1 goes low while channel 4 is high.

Delay Trigger Mode

The Delay Trigger mode allows you to qualify on a signal edge, pattern, or state, delay for a period of time (or occurrence of edges), and then trigger on a selected edge from any source.



This trigger mode is versatile and can accommodate most complex triggering situations. It allows you the flexibility to select different trigger sources, delay times, delay counts and then display various points of the waveform.

qualify on Key The qualify on key allows you to select which mode to qualify the trigger before a delay is defined.

The options are:

- edge
- pattern
- state

edge Qualify Option If the edge qualifier is selected the next two selection keys allow you to define the parameters. The next key is an unlabelled field that allows you to select the channel to be the source. The second key below the edge selection is the slope selection.

pattern Qualify Option When the pattern trigger option is selected, the next selection key allows you to define the qualifier pattern. Defining a pattern is the same as in the Pattern Trigger mode.

- Highlight the bit to be changed by pressing the selection key.
- Change the bit by rotating the knob.

After you have pressed the selection through all four bits the active field is changed to the condition field. This field allows you to set conditions as in the Pattern Trigger mode:

- when entered
- when exited
- when present >
- when present <
- range

These settings activate the next field, as appropriate, so you can set the specific time parameters.

state Qualify Option If the state trigger option is selected the next two selection keys allow you to define the state conditions.

As in the State Trigger mode, you select the channel to define the state clock. This selection is reflected in the pattern with an arrow and the slope is depicted with the arrowhead pointing up or down. Use the selection key to move the highlighted bit to change the pattern. When the pattern has been set the is/not present setting can be changed by moving the highlight to the is/not present field label and pressing the selection key again. When the label is highlighted you can toggle the setting between is/not present using the knob.

delay Key This field allows you to select between two delay options. To change between the **time** and **count** options rotate the knob until the desired option is displayed in the inverse video field.

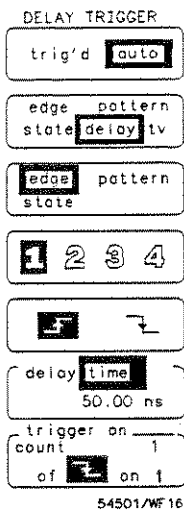

delay time disables the trigger circuit for a selected period of time, from 30 ns to 160 ms after the trigger has been qualified

Note

Time delay is not available in the time qualified pattern settings of when present >, when present <, or range

- Press the selection key until the highlight is on the first numeric field. This field allows you to select the amount of delay after qualification, ranging from 30 ns to 160 ms.

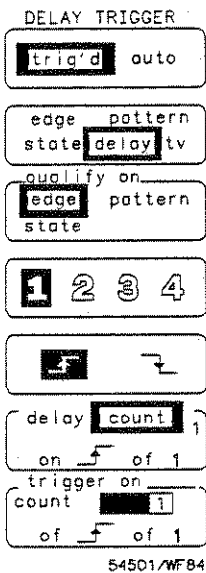

delay count (delay by edges) disables the trigger circuit for a selected count from 1 to 16,000,000 after the trigger has been qualified. After the selected count has been attained the HP 54501A will look for the user specified trigger edge.

- Press the selection key until the highlight is on the first numeric field. This field allows you to select the number of edges to delay after the trigger has been qualified (from 1 to 16,000,000).
- Press the selection key once more to activate the rising edge/falling edge option and select the desired edge using the knob.
- Press the selection key once more to highlight the third option field and select the channel to delay on.
- Press the selection key a fourth time to return to the first numeric field.

trigger on Key This key allows you to select a specific edge to trigger on after the qualification and delay conditions have been satisfied. All other keys in this menu have dealt with defining qualifying conditions, however, this field allows you to set the trigger point. This is another three position option switch.

- Press the selection key to highlight the numeric field and select which occurrence to trigger, using the knob to set the number (1 to 16,000,000).
- Press the selection key again and move the highlighted field to select the slope. The knob toggles the selection between rising and falling edge.
- Press the selection key again and highlight the channel selection. The knob is used to change the channel selection.

Delay Trigger Exercise

This exercise will demonstrate how to use the delay trigger and trigger on the exact point of a waveform. The exercise will lead you through setting up a complex signal, setting up the HP 54501A, and how to change settings and counts for viewing various points on the waveform.

Instrument Setup Set up an HP 8116A (or comparable signal/generator) for a burst pulse with ten bursts that repeats every 50 μ seconds.

Set up the HP 8116A Pulse/Function Generator:

- Mode = I.BUR
- RPT = 50 μ s
- BUR = 10
- FRQ = 5.0 MHz
- DTY = 50%
- AMP = 1.00 V
- OFS = -200 mV

Connect the signal to channel 1 of the HP 54501A.

Oscilloscope Setup The HP 54501A will Autoscale and display this signal, however, for our purposes it is necessary to make triggering changes.

- Press **AUTOSCALE**.

hp running

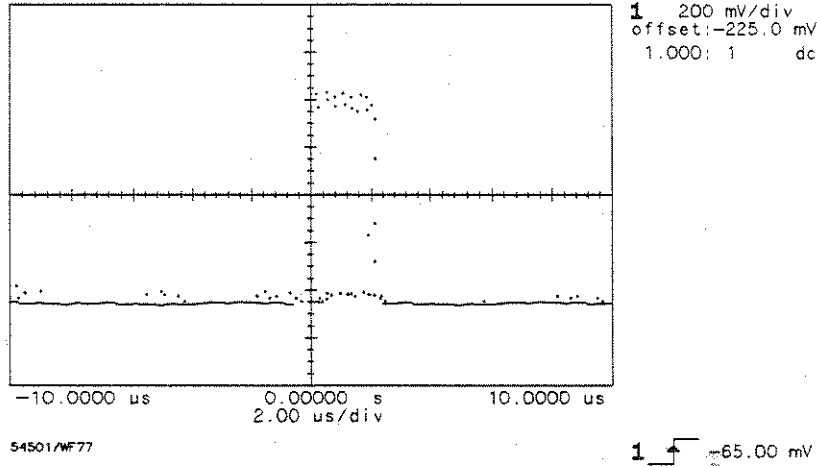

Figure 6-13. Ten Burst Pulse after AUTOSCALE

Set up the HP 54501A as follows:

- Press **TRIG** and select *trig'd* display.
- Select *delay* trigger mode.
- *Qualify on edge* and the rising edge of channel 1 as the source.
- Select a delay time of 2.5 μ s to gain a stable trigger.
- Set *trigger on* to trigger on rising edge 1 of channel 1.

This trigger setup will qualify on the first rising edge of the burst, delay through the remaining portion of the burst, then trigger on the specified edge of the next burst.

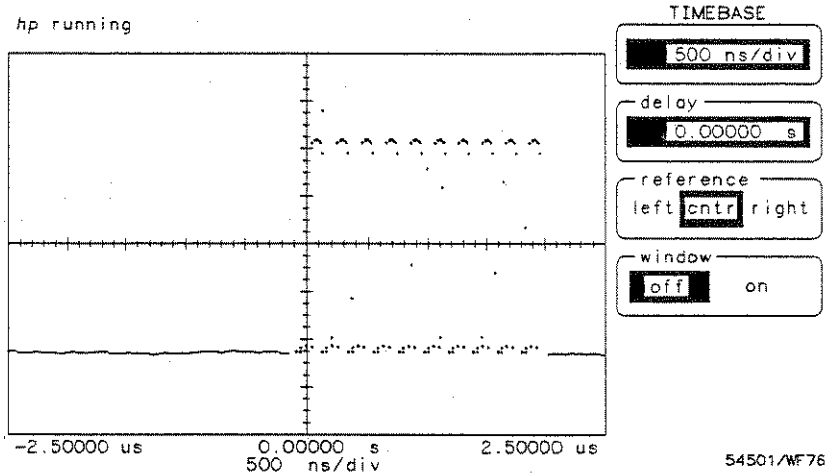

Figure 6-14. Ten Burst Pulse w/Stable Trigger

- Press TIMEBASE and set time/division to 500 ns.
- Return to the trigger menu and set *trigger on count* to 5. This tells the oscilloscope to trigger on the 5th rising edge of the burst (see Figure 6-15).

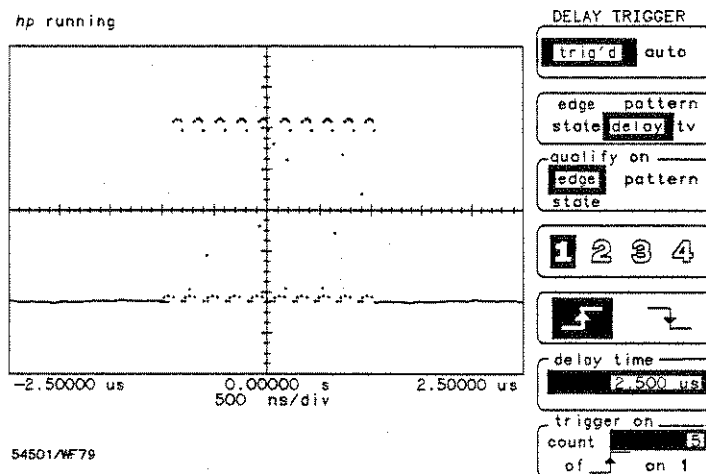

Figure 6-15. Ten Burst Pulse Triggered on Pulse 5

- Change the *trigger on count* key to 9 (see Figure 6-16).

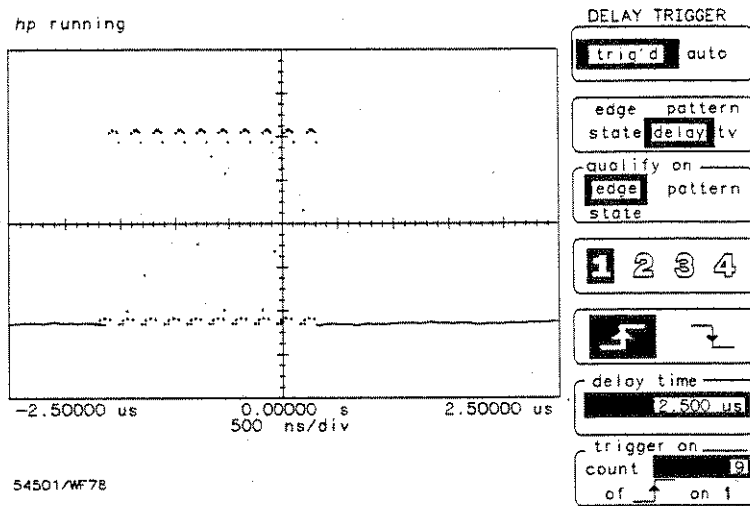

Figure 6-16. Ten Burst Pulse Triggered on Pulse 9

By setting the oscilloscope to the delay trigger mode you can set a specific time or count to delay between qualification and trigger.

In this exercise you delayed the trigger to get a stable display. When the time delay had elapsed the HP 54501A began counting rising edges until it found the edge you set.

TV Trigger Mode

TV TRIGGER

trig'd	auto
edge pattern	
state delay	tv
80 Hz/525 lines	
source	1
level	250.000 mV
polarity	
field	1 2
line	
holdoff	
time	40.000 ns

54501/WF 17

The tv Trigger menu enables the HP 54501A to trigger on clamped tv signals. The two most common tv standards; 60 Hz/525 lines or NTSC is the standard used in the United States, 50 Hz/625 lines is the standard used in most European countries. This trigger menu also allows for user defined tv signals that may be used in other parts of the world.

To move the highlighted inverse video window within a field you must press the selection key and to change the value displayed in the window you must rotate the knob.

Note

Pay close attention to the movement of the highlighted window; it moves to various options within the field.

Standard Select Key The source key allows you to choose between the NTSC standard tv signal used in the United States with a 60 Hz and 525 lines per frame, the standard of 50 Hz and 625 lines per frame used in most countries in Europe. The third option allows for user defined ranges of the tv signal.

To make the desired selection:

- Press the selection key and select the standard by rotating the knob. The active field is highlighted in inverse video.

Source Select Key To select the trigger channel to be used as a source,

- Press the selection key and move the highlighted field, rotate the knob until the desired channel is displayed.

level/polarity Key The level option allows you to set the trigger level that is applicable only to the tv trigger source.

- Press the selection key again and the highlighted window moves to the polarity option and allows you to select the rising edge or falling sync pulses to trigger on.

field Key The field key allows you to select field, 1 or 2.

line Key The line key allows you to select which line the trigger will be generated on. This selection is dependent upon which field has been selected previously.

If the previous selection is the 60 Hz, 525 lines standard, the options available depend upon which field, 1 or 2 is selected:

- If field 1 is selected, you can select from line 1 to 263 in field 1.
- If field 2 is selected, you can choose from line 1 to 262 in field 2.

This tv trigger mode is compatible with broadcast standard M.

If the 50 Hz, 625 lines standard is selected, the options are also dependent upon field settings:

- If field 1 is selected the range of lines is from 1 to 313,
- If field 2 is selected the range of lines if from 314 to 625.

This tv trigger mode is compatible with broadcast standards: B, C, D, G, H, I, K, K1, L, and N.

holdoff Key The holdoff key enables the oscilloscope to hold off the trigger event from 40 ns to 320 ms and is incremented in 20 ns time frames.

TV Trigger Exercise

Video signals are unique, and as such have unique requirements for proper triggering. This exercise demonstrates how to display and work with video signals on the HP 54501A.

Instrument Setup Use a standard NTSC signal generator with clamped video output for this exercise. Turn color bars on.

Oscilloscope Setup Connect the NTSC video signal to channel 1 of the HP 54501A.

- Press **AUTOSCALE**.
- Select the *tv* trigger mode.
- Set *60 Hz/525 lines* and channel 1 as the source.

You must determine the polarity of the sync pulse.

- Select the trigger level and rotate the knob until a stable display is attained. When you are able to see a sync pulse and can determine the polarity, select *polarity* (press the selection key) and set the sync pulse in accordance with the actual pulse.
- Set the trigger *level* at approximately the midpoint of the sync pulse.

This sets the trigger level just below the middle of the sync pulse and tells the oscilloscope to trigger on the leading edge.

- Set *trig'd/auto* to *trig'd*.

This eliminates the possibility of a premature trigger event occurring.

- Select *field 1* and *line 1*.
- Press **TIMEBASE** and set time/division to 100 μ s/div.

- Press DISPLAY and set persistence to ≈ 600.0 ms to accommodate video signals.

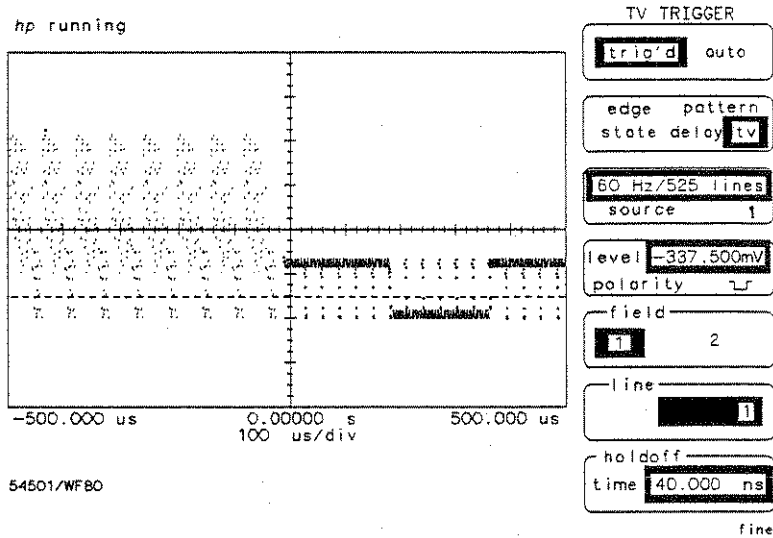

Figure 6-17. Trigger at Field 1, Line 1

The HP 54501A is triggering on the first equalizing pulse of field 1, the first pulse in the vertical interval. The pretrigger data that is being viewed (left half of the screen) is field 2, lines 256-262.

- Set time/division to $10 \mu\text{s}/\text{div}$ and set the trigger to *field 1, line 10*.

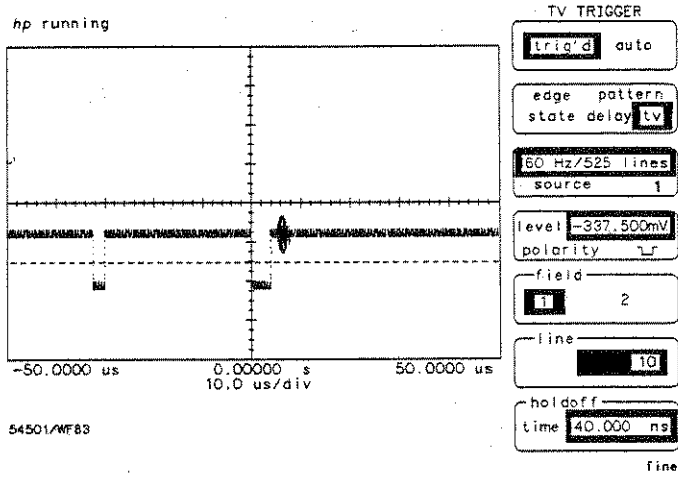

Figure 6-18. Trigger on Field 1, Line 10

The trigger is now on the first horizontal sync pulse in the vertical interval with color burst information.

- Change the trigger point to field 1, line 21.

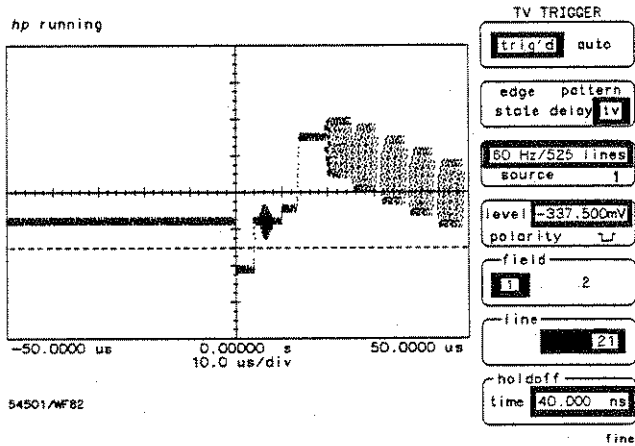

Figure 6-19. Trigger on Field 1, Line 21

The trigger point is now on the last sync pulse of the vertical interval. The next line contains color information, in this case color bars are present.

- Change the trigger to field 2, line 1.

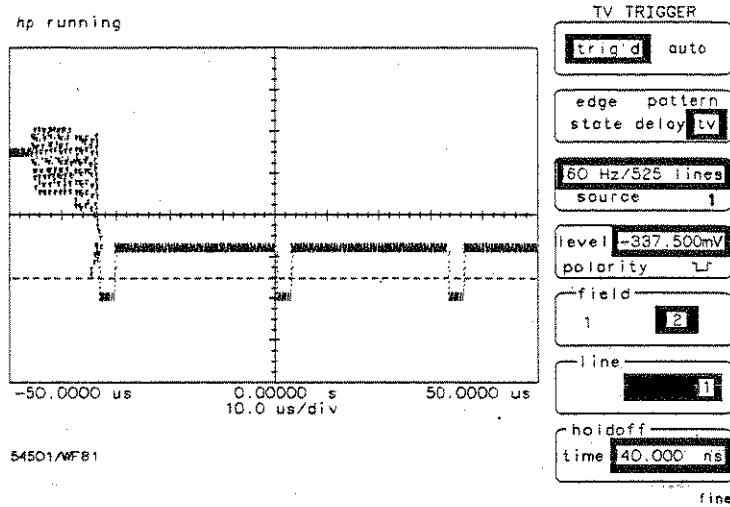

Figure 6-20. Trigger on Field 2, Line 1

The trigger point is on the second sync pulse of the vertical interval. This is the correct trigger point because fields 1 and 2 are interlaced.

Introduction to the Display

The Display menu controls most of the features that dictate how the acquired data is displayed. These features include ways to manipulate data for clarity, to eliminate noise, viewing best case/worst case situations, or the displayed background.

This chapter describes the Display menu, three submenus, how to control all the features, and how to display the most meaningful waveform for your measurements.

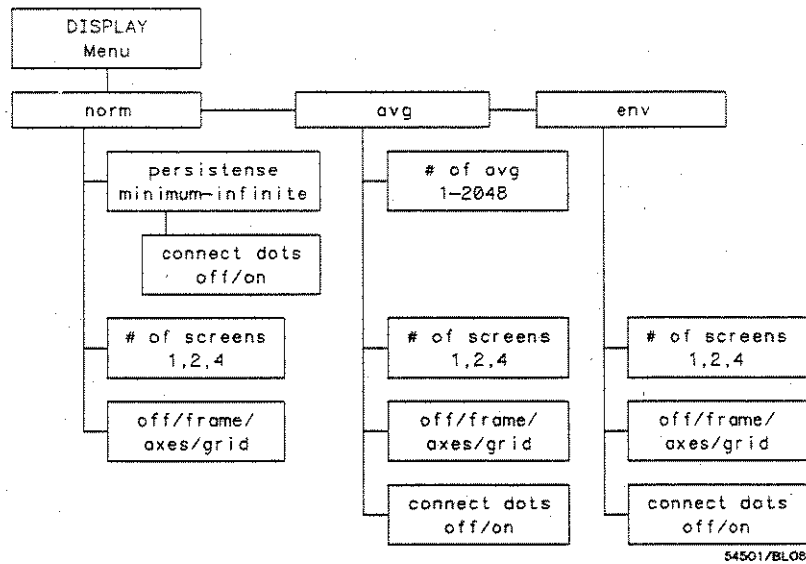

Figure 7-1. Display Menu

Display Mode Key

The Display mode key allows you to select from one of the three display modes. They are:

- normal
- averaged
- envelope

norm The *norm* mode allows you to set the time parameters for displaying data, or persistence. The range in the variable persistence mode is from minimum, very fast overwriting and updating the display, to infinite with variable settings in between, from 200 ms to 10 seconds. This means that you can preset your data display records to any of the persistence settings. Settings less than infinite will display data for the specified period of time and then overwrite old data.

DISPLAY

norm	avg	env
------	-----	-----

persistence

minimum

of screens

1	2	4
---	---	---

off axes

frame	grid
-------	------

connect dots

off	on
-----	----

54501/MF71

- Minimum persistence is very fast overwrite. As each new acquisition is displayed it overwrites the previous data. The current display is always the most recent acquisition.
- Fast persistence settings are useful when the input signal is changing and you need immediate feedback.
- More persistence is useful when observing long-term changes in the signal or low signal repetition rates.
- Infinite persistence can be used for worst-case characterizations of signal noise, jitter, drift, etc. In this mode the HP 54501A is used as a storage oscilloscope.

If you use the keypad to change persistence settings, any entry longer than 10 seconds will display the message *value out of range, set to limit* and set persistence to *infinite* and any entry less than 200 ms will display the same message and set persistence to *minimum*.

When **norm** has been selected, the selection key beneath the norm field is activated. This field displays the current persistence setting and can be set using either of the entry devices. Connect the dots is only available when in norm mode and minimum persistence.

avg The averaged mode allows you to select the number of waveform acquisitions that are averaged to generate the displayed waveform. The range for the averaging function is 1-2048 in powers of 2.

When averaged mode is selected the next selection key is activated and you can set the number of lverages, using either entry device.

Displayed signal noise is significantly reduced using the averaging mode. As the number of averages is increased from 1 to 2048, the display becomes less responsive to changes to the input signal(s), however, using more averages reduces the effects of displayed signal noise and improves resolution.

DISPLAY

norm **avg** env

at avg **32**

of screens **1** 2 4

off **frame**
axes grid

connect dots **off** on

54501/WF72

env The envelope mode needs no other parameters set. The display reflects the minimum and maximum voltages in each horizontal position. This is useful in viewing voltage or time jitter.

DISPLAY

norm avg **env**

of screens **1** 2 4

off **frame**
axes grid

connect dots **off** on

54501/WF73

of screens Key

The next selection key allows you to choose the number of screens you wish to view. The selections are:

- 1: the entire display area is one screen and any displayed waveforms are superimposed on top of each other.
- 2: the display area is divided into two screens. Channels 1 and 2 will be displayed in the top screen and channels 3 and 4 will be displayed in the bottom screen (See Figure 7-2).
- 4: the display is divided into four equal screens with one waveform displayed in each screen (See Figure 7-3).

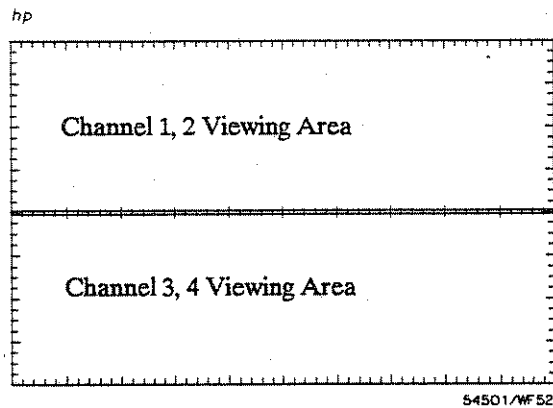

Figure 7-2. Dual Screen Display

When waveform math functions or the dual timebase window are turned on they will be displayed in the lower half of the screen and the channels will be displayed in the top half.

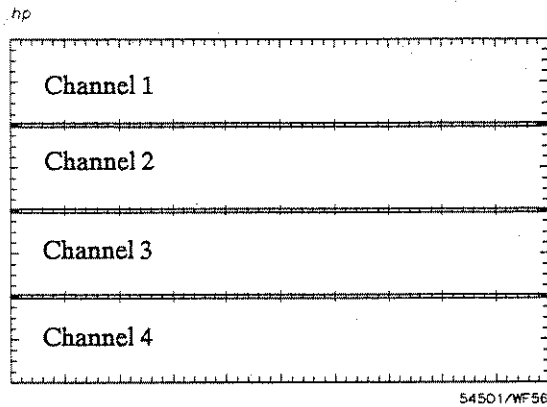

Figure 7-3. Quad Screen Display

off/frame/ axes/grid Key

This is an unlabelled field that is used to select the display background. Four options are available:

- **off:** The off option turns the background graticule off. The displayed waveform and waveform information is not turned off.
- **frame:** The frame option displays the outside border with a measurement scale. The measurement scale is incremented/decremented with major divisions and minor divisions based on the vertical and horizontal measurement settings.
- **axes:** The axes setting displays a background with the measurement scale crossing at mid-screen.
- **grid:** The grid background is a complete graticule with ten horizontal major divisions and eight vertical major divisions. Only the axis portion of the graticule has a minor division scale.

connect dots
Key

Connect the dots is a technique used to display waveform with all data points connected. This makes viewing the waveforms easier because the signal is complete and has no breaks.

Note

Connect the dots does not interpolate data and generate data points. The HP 54501A connects data points linearly.

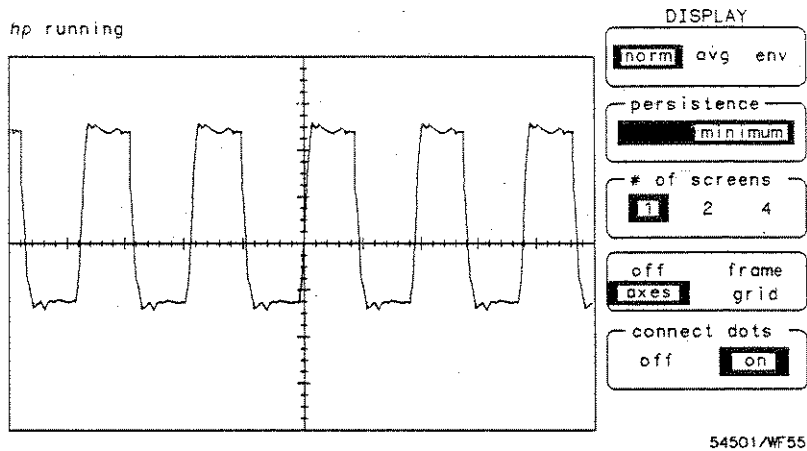

Figure 7-4. Connect the Dots

Introduction to the Markers

This chapter describes how to use the markers and make manual measurements on displayed waveforms.

In this menu you have control of two sets of markers. These markers give you manual control of the ΔV markers (horizontal voltage markers) and the Δt markers (vertical time markers). When the desired set of markers have been turned on the two marker fields are turned on. And this gives you individual control of each marker.

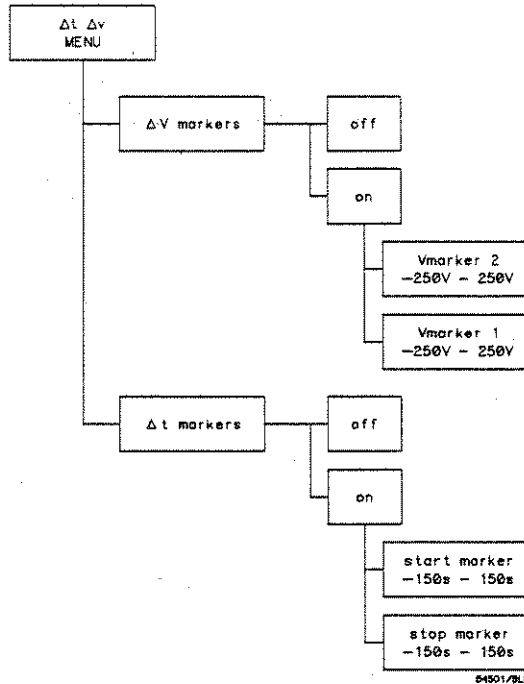
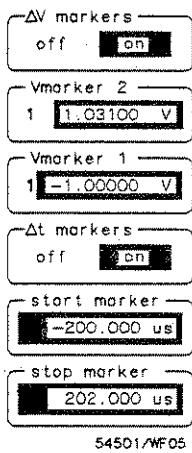
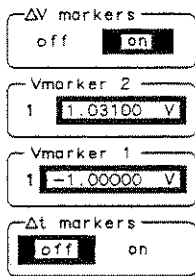

Figure 8-1. Delta t/Delta V Menu

ΔV markers



54501/WFO7

This selection key toggles the markers on and off. With the ΔV function turned on the next two fields are activated allowing you to control the two markers individually.

When the ΔV markers are turned on, *Vmarker2*, *Vmarker1*, and *delta V* appears in the factors display area. The delta V entry is calculated as the following:

$$\text{Vmarker 2} - \text{Vmarker 1} = \text{delta V}$$

If delta V is negative, Vmarker 1 is located at a more positive voltage level than Vmarker 2.

Vmarker 2 This selection key is a two function control field. The first selection allows you to select the desired channel, memory, or function to place Vmarker 2 for measurement. By pressing the selection key again, the highlighted field moves to the numeric display to select the voltage level. Typically, you will place Vmarker 2 at the desired level on the waveform display and read the level, both in the highlighted field, and in the factors area of the waveform display.

Vmarker 2 is the voltage marker with shorter dashes.

Vmarker 1 Vmarker 1 operation is identical to Vmarker 2, except it is represented by longer dashes.

Δt markers

This selection key toggles the time markers on and off. With the Δt function turned on the next two fields are activated allowing you to control the two markers individually

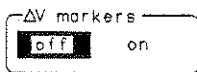

The markers are placed on the display respective of the trigger point. Positive time values are to the right of the trigger point and negative time values are to the left. Delta t values are determined by the following:

$$\text{stop marker} - \text{start marker} = \text{delta t}$$

Remember, there is no such thing as negative delta t, this only means that the start marker is placed later in time than the stop marker.

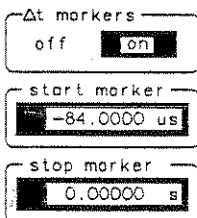

54501/WF64

$1/\text{delta t}$ is the inverse of delta t. Since the inverse of time is frequency, this ratio produces an answer in frequency, however, be alerted that if the markers are placed across parts of a waveform of differing time frames the answer may not be valid. This feature is useful if you are looking for the frequency in a burst that is different from the rest of the waveform. You can place the time markers across the burst (at similar points on the waveform) and determine the frequency of the burst.

start marker To set the start marker press the function selection key to highlight the field. This makes the start marker field active. Set the marker using the knob.

The start marker is represented with long dashes.

stop marker The stop marker is identical to the start marker, except that it is represented by short dashes.

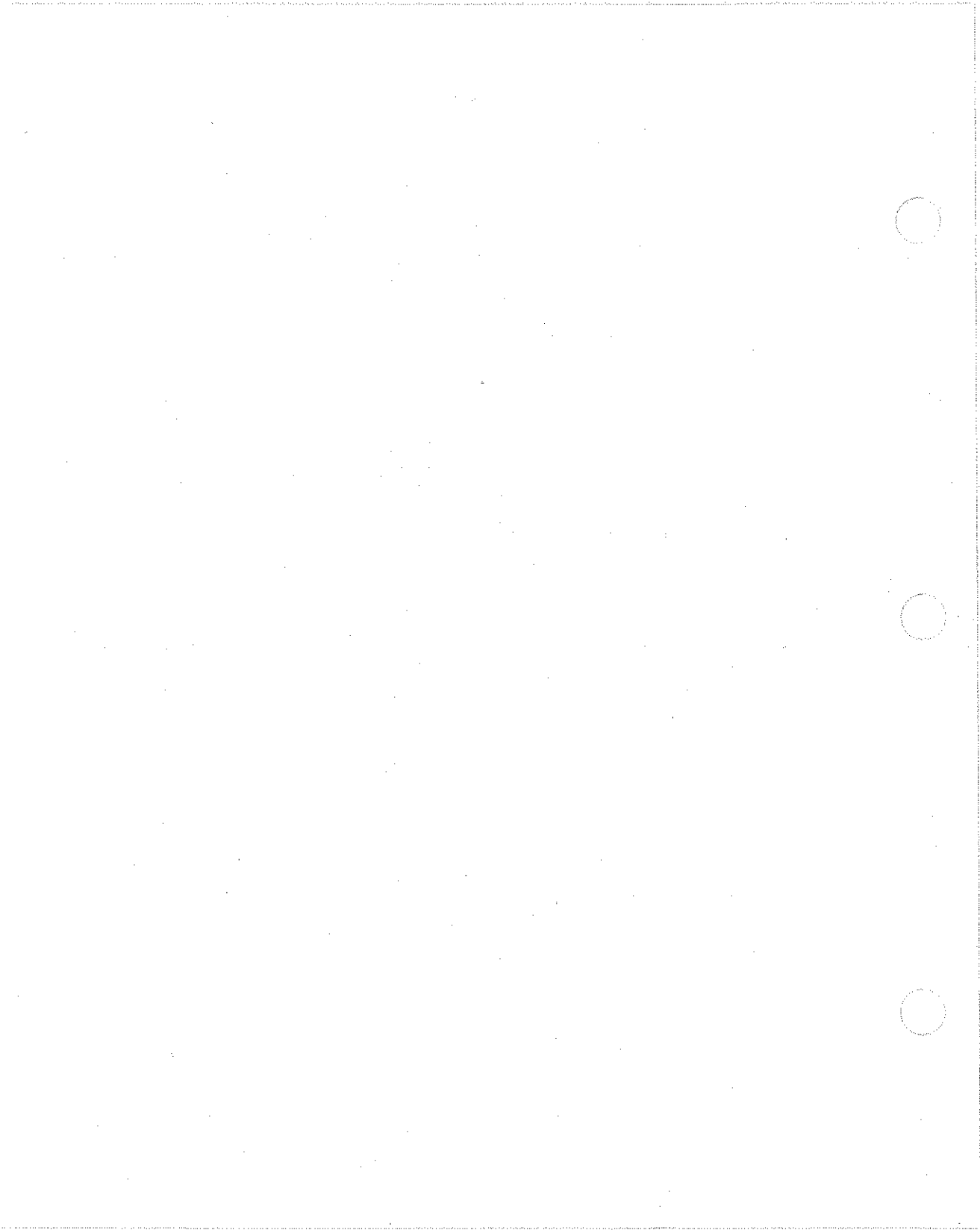

Introduction to the Functions

The Waveform Math function allows you to define one and/or two functions. The functions can be used on data that is displayed on screen from any of the four channels or from any of the four waveform memories.

A function is generated by mathematically manipulating one or two operands with known operations. The mathematical operations employed by the HP 54501A are:

- plus (+)
- minus (-)
- times (x)
- versus
- only
- invert

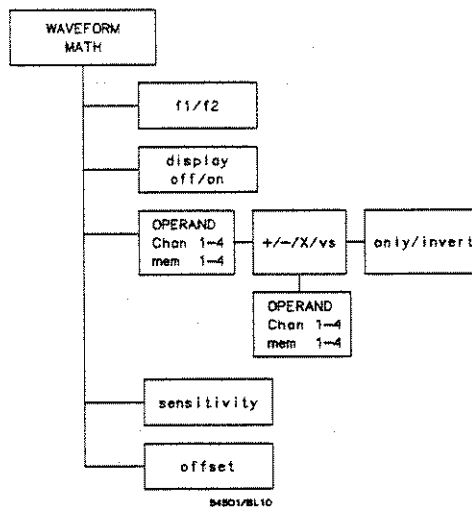

Figure 9-1. Waveform Math Menu

You can also adjust the vertical display and offset to place the function for best viewing.

When the function has been calculated, it can be used in the following manner:

- displayed
- evaluated with the measurement features
- stored in memory
- outputted over the HP-IB

Defining a Function

The Waveform Math menu allows you to select and preset any of various operations, sources, and displayed results.

WAVEFORM MATH

f1	f2
----	----

display

off	on
-----	----

chan 1 2 3 4

mem	1	2	3	4
-----	---	---	---	---

+ - x vs

only	invert
------	--------

chan 1 2 3 4

mem	1	2	3	4
-----	---	---	---	---

sensitivity

1.00	V/div
------	-------

offset

1.00	V
------	---

54501/WF65

Function Key This key allows you to select either function 1 or function 2.

display Key The display key allows you to turn the selected function on or off. The vertical sensitivity and offset are displayed in the function menu fields.

Waveform Math Menu

If the function display is turned on the screen will split with the original waveforms displayed in the top half screen while the functions are displayed in the bottom half screen. Both functions can be on at the same time and they will be displayed superimposed or in two screens in the bottom half of the CRT if multiple screens have been selected.

The timebase window will automatically be turned off when a function is turned on.

chan/mem Key Press this key to select the first operand of the mathematical operation, or the waveform to be manipulated. Your choice can be any displayed channel or any waveform memory that has a waveform stored. Ensure that the source is turned on.

You will notice that if the operator is only or invert, this is the only operand you may select.

Operator Key This key allows you to select any of the six functions. Continue pressing the selection key until the operation you desire is highlighted.

- **plus (+):** The two selected operands are added together in this function. Addition is calculated on a point-by-point basis.
- **minus (-):** The minus operation allows you to subtract the second operand from the first.
- **times (x):** The times operation multiplies the value of the first operand with the value of the second operand. Each data point is multiplied with a corresponding data point and the product is placed on the function display. The displayed waveform will usually be scaled to correspond to a different sized waveform.
- **vs (versus):** The versus function draws a volts versus volts display of the two selected operands. Versus cannot be stored in a waveform memory because measurements cannot be made on the resultant waveform, however, it can be stored in pixel memory.

- **only:** The only function allows you to display the first operand and scale it.
- **invert:** The invert function inverts the data of the first operand.

chan/mem Key With this selection key you select the second operand, or the waveform that is manipulated against the first operand. Your choices are any of the displayed channels or any of the memories.

This key is not available if the operator is **only** or **invert**.

sensitivity Key You may set the vertical sensitivity of the function with this key. This setting is for ease of viewing and making measurements with the newly developed waveform.

offset Key You may set the offset of the function with this key.

Vertical Scaling Units

The fundamental measuring units of an oscilloscope are volts/division in the vertical axis and time/division on the horizontal axis. This philosophy is used regardless of the mathematical function chosen. No provisions have been made to manage units for all combinations of operands and operations.

For example, apply a +2V signal to channel 1 and a -3V signal to channel 2. The HP 54501A displays the product as -6V, when in reality it is $-6V^2$.

Displaying Functions

The HP 54501A has several screen variations available to accommodate a 4 channel display, as well as two functions. The display may seem confusing until you understand how the separate screens are displayed.

- In the single screen mode with a function on, the mathematical results are displayed in the bottom half of the screen while the operands are superimposed in the top half of the screen.

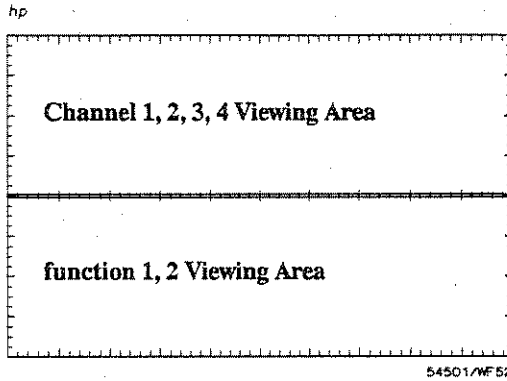

Figure 9-2. Single Screen w/Function On

- In the dual screen mode the functions are again displayed in the bottom half of the screen, however, the dual screens are displayed in the top half.

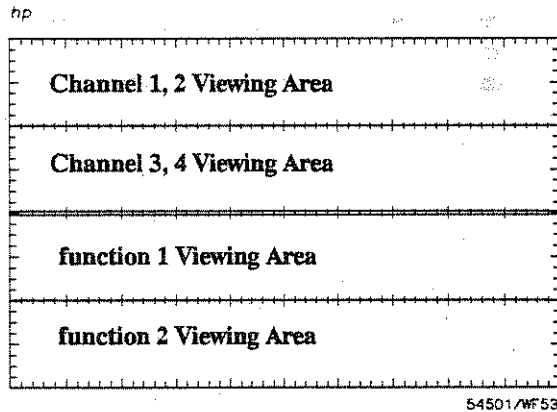

Figure 9-3. Dual Screen w/Function On

- In the quad screen mode, all four screens are displayed in the top half of the display while the functions are displayed in the bottom half.

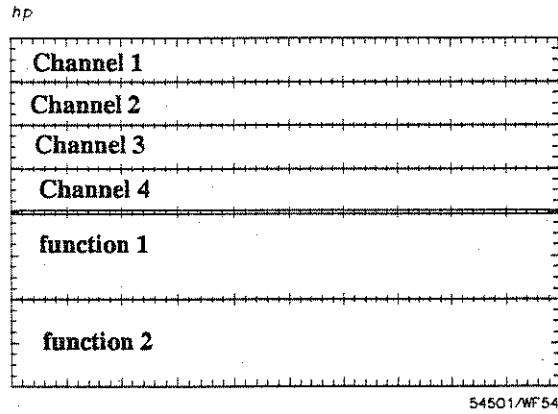

Figure 9-4. Quad Screen w/Function On

Waveform Math Exercise

In this exercise you will use the Waveform Math menu to subtract one waveform from another.

Instrument Setup Set up an HP 8116A, or a signal generator capable of a 1 MHz, 1 volt squarewave, as follows:

- MODE = NORM
- FRQ = 1 MHz
- DTY = 50%
- AMP = 1.00 V
- OFS = 0.00 V
- Pulse = squarewave

Connect the signal to a BNC tee on channel 1 using a 1 meter coaxial cable. Connect another 1 meter cable from the other side of the BNC tee and terminate in 50 Ω to channel 4.

Oscilloscope Setup The extra cable length between channels 1 and 4 provides a time delay between the signals on the oscilloscope. The propagation of a 1 meter coaxial cable is approximately 6 to 7 ns. This delay is used to demonstrate the math function.

The following procedure will assist you in setting up the HP 54501A for optimal viewing.

- Press **AUTOSCALE**.
- Press **DISPLAY** to set the best viewing conditions. Set display mode to *avg*, # of *avg* to 8, # of *screens* to 2.
- Press **WFORM MATH** to define the function. Select *f1* and turn the display on. Select *chan 1*, - (*minus*), *chan 4* and set the function sensitivity to 2.00 V/div.

Now you can see the function of subtracting channel 4 from channel 1. The propagation between channels has allowed a 6 to 7 ns spike. To better view the results:

- Press TIMEBASE and set the horizontal display to 50.0 ns/div (see Figure 9-5).

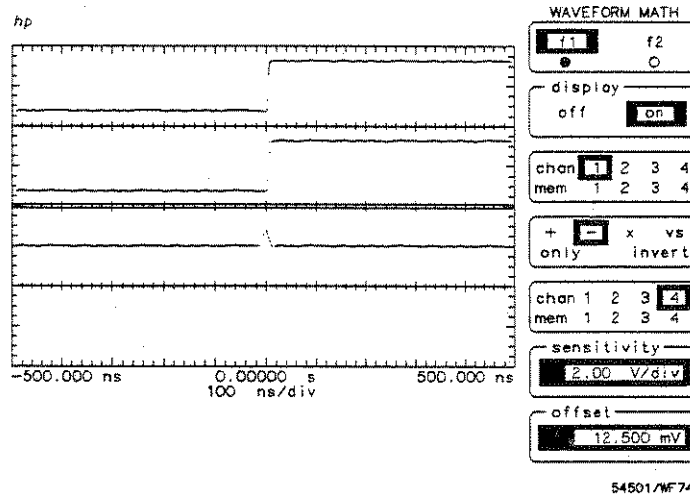

Figure 9-5. Channel 1 minus Channel 4

Waveform Save Menu

Introduction to the Memories

This chapter describes how to select the waveform and pixel memories on the HP 54501A. The menu consists of two submenus:

- waveform memories m1 - m4 used to store one waveform at a time.
- pixel memories p1 and p2 used as a screen store. In this manner the memories are used as a storage oscilloscope.

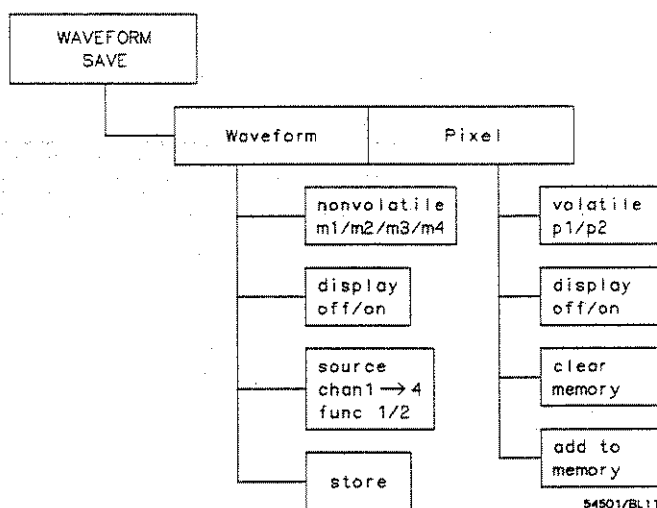

Figure 10-1 Waveform Save Menu

waveform/pixel Key

This is the selection key used to choose the desired type of memory. The active menu is highlighted. Each memory type, waveform or pixel, has a separate menu. When this key is pressed, the rest of the menu changes.

waveform Menu

WAVEFORM SAVE

waveform	pixel
----------	-------

nonvolatile

m1	m2	m3	m4
----	----	----	----

display

off	on
-----	----

source

chan	1	2	3	4
func	1	2		

store

54501/WF20

The waveform menu has four available memories, m1, m2, m3, and m4. These memories are nonvolatile and will not be cleared during AUTOSCALE, RECALL CLEAR, or recycling power. This permits you to disconnect power and transport the oscilloscope without losing the contents of waveform memories.

A waveform memory consists of a single waveform record, including the horizontal and vertical scaling parameters. This allows you to make measurements on stored waveform and function data. Voltage and time markers can be set on waveforms when they are displayed.

When the HP 54501A is in the envelope display mode and a waveform store is executed, the min value and max value are stored separately. The min value will be stored in m1 if m1 or m3 are the selected store locations, or m2 if m2 or m4 are the storage locations. The max values are stored in m3 or m4 respectively. A store message is displayed above the waveform display area informing you of the storage locations of both values.

nonvolatile Key

This key allows you to select which memory you wish to use. Your selections are nonvolatile memories m1, m2, m3 and m4. When each memory is turned on the small circle below the label is highlighted.

The waveform memories are record memories that store 2001 points of waveform information in each memory.

display Key

This is a toggle key that allows you to turn the selected memory display on or off.

source Key

The source key allows you to select the source waveform to be stored. The source alternatives are any channel or either function.

store Key

This is the active key in the menu. By pressing this key you store the specified waveform in the specified memory. When the key is pressed you execute an immediate erase of the selected memory and a write to the memory.

Waveform Save Menu

pixel Menu

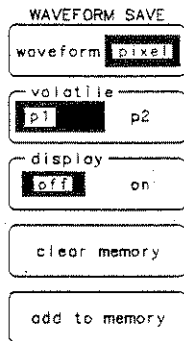

54501/WF 19

The pixel submenu allows you to select the pixel memories. These memories are very useful when you need additive memory capabilities. Waveforms can be stored and added to indefinitely.

volatile Key This is the memory select key. The alternatives are pixel memory 1 or 2. The pixel memories are complete pixel saves of the waveform area (excluding the graticule and markers) in volatile memory. The waveform display area is 256 X 451 pixels.

In pixel memory the entire screen is saved, therefore, data is mapped directly onto the display and displayed in halfbright. There are no measurement capabilities on pixel memories.

Pixel memories are additive. When all pixels are full, add to memory will merely overwrite existing data.

display Key This is a toggle key that allows you to turn the selected pixel memories on or off.

clear memory Key This key allows you purge all data from the selected pixel memory.

add to memory Key By pressing this key, you can add the currently displayed waveforms to the specified pixel memory.

Waveform Save Menu

10-3

Waveform Save Exercise

This exercise will demonstrate how to store a waveform, change the offset setting, and recall the stored waveform to be compared with the current display.

Instrument Setup Set up an HP 8116A or a signal generator capable of a 6 kHz, 1 volt squarewave:

- Mode = NORM
- FRQ = 6.00 kHz
- DTY = 50%
- AMP = 1.00 V
- OFS = 0.00 V
- Pulse = squarewave

Oscilloscope Setup This procedure will assist you in setting up the HP 54501A for optimal viewing.

- Connect this signal to the Channel 1 input.
- Press **AUTOSCALE**.
- Press **WFORM SAVE** and select the *waveform* submenu.
- Press the *nonvolatile* key until m3 is selected.
- Press the *source* key until chan 1 is selected.

- Press the *store* key.

You have saved the currently displayed waveform in nonvolatile memory m3. The remainder of this exercise demonstrates how to recall the stored waveform.

- Press the *display* key to turn on the m3 display.
- Press the CHAN menu key, change the *offset* of channel 1.

This will move the current display so you can view the stored waveform. The display should look like the following figure.

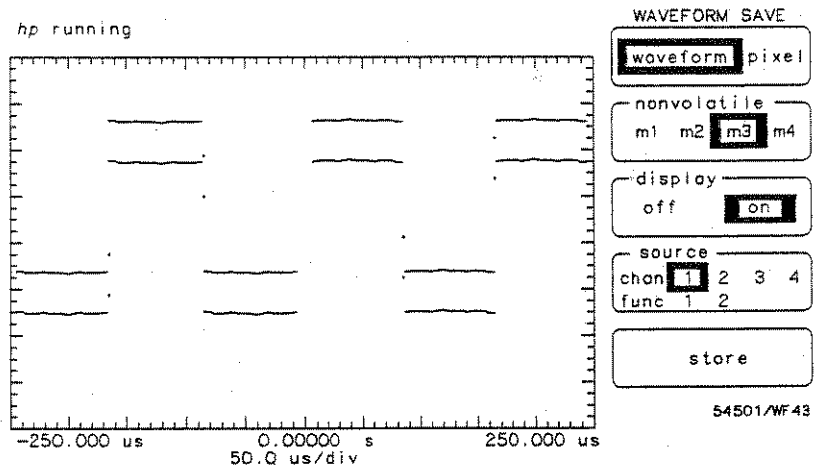
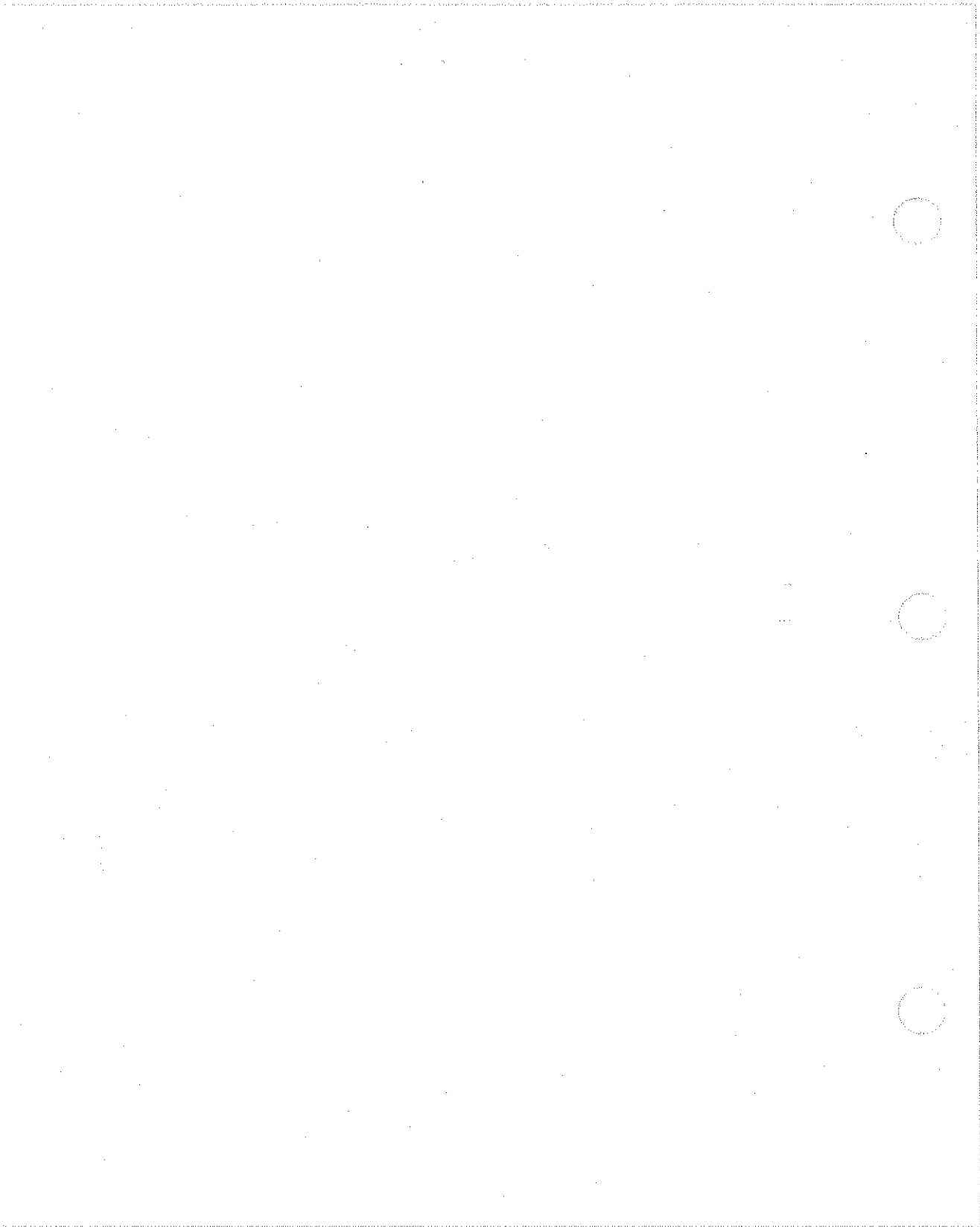

Figure 10-2. Displayed Memory



Introduction to Measurements

This chapter contains a description of how to use the measurement menu. This is a very powerful and encompassing feature. By pressing the front panel button **Define Meas** you can access the entire measurement function.

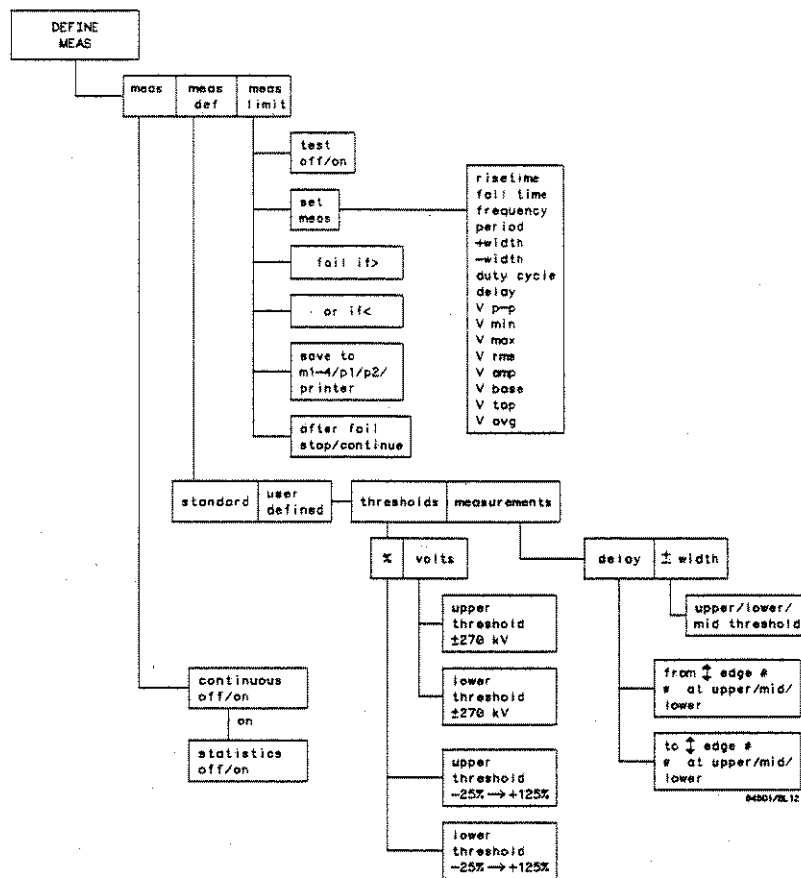

Figure 11-1. Define Measure Menu

The first menu allows you to set the dynamic controls for your measurement. The second allows you to set user-defined parameters for your measurements. And the third allows you to set up the measurement comparison test.

Measurement Selection

It is very simple to make measurements from the keyboard. Each key in the numeric keypad section has a secondary function. Above each key is a measurement selection printed in blue. To make an immediate measurement of the displayed waveform perform the following keystrokes:

- Press the blue (Shift) key on the numeric keypad to access the secondary keys.
- Press the key that corresponds to the measurement you wish to make.
- Rotate the knob to select the measurement source (channel number, c#; memory number, m#; or function number, f#). Your choice is displayed below the waveform display area.
- Press the appropriate number to select the source, channels 1-4, memories 1-4, or functions 1-2.

To make a selected measurement on a waveform source, it must be turned on. Upon selection of the measurement the time and voltage markers will be placed on the waveform to show you where the measurement was made if continuous measurements are off.

To clear measurements, press Shift CLR MEAS.

For complete details of the measurement definitions and algorithms, see Appendix A, "Algorithms."

**meas/meas
def/meas limit
Key**

This key is the primary sub-menu selection key. Press to select one of the available sub-menus. This field will always be the top selection so you can select other sub-menus at any time.

meas Sub-menu

The measure sub-menu is the default condition. You can access the continuous and statistics options.

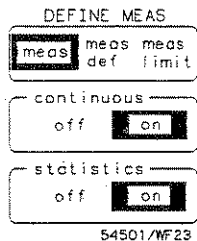

continuous Key

If this option is turned on when a measurement selection is made, the displayed measurement will be updated periodically. All subsequent measurements will be continuously updated as they are selected.

When **continuous** is off, the measurement will be made once and the $\Delta t/\Delta V$ markers will be placed on that measurement showing you where the measurement was made.

statistics Key

The continuous function must be on before the statistics key is available. When **continuous** is on, statistics will display the *min value*, *max value*, *average value*, and *current value* of up to three measurements.

Measure Define Sub-menu

The Measure Define sub-menu allows you to select measurement standards assigned by you, the user. This gives you the option of making measurements based on signal width or delay settings or threshold parameters.

standard/user defined Key

If **standard** is selected, no other choices are available and the HP 54501A will make measurements based on the IEEE standards for your particular measurement.

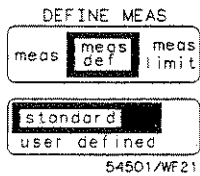

If, however, **user defined** is selected, two sets of test conditions are available to define your measurements.

thresholds/measurements Key

This key allows you to set the vertical test conditions, voltage or percentage ratios, independent of the horizontal test conditions, edge, slope, and count. Both sets of test conditions must be set to define your measurement.

The **thresholds** submenu allows you to set the vertical test conditions at:

- percentage ratio from -25% to 125%
- voltage levels from -250 kV to +250 kV

Note

The upper and lower thresholds must be set to levels that will fall on the displayed waveform. If either threshold is not on the waveform the measurement results will be the message 'not found.'

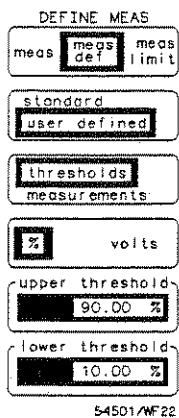

Threshold settings apply to all user defined front panel measurements.

This feature is useful when measuring for excessive overshoot or ringing. By defining your own measurements you can test for pass/fail criteria of your own choosing and test from the front panel, or set the HP 54501A in the limit test and allow the oscilloscope to report without your supervision.

Note

If the user defined upper and lower thresholds are placed too close together it is possible the HP 54501A will not be able to determine the mid-point. The message 'not found' will be displayed in the measurement factors area.

Measurements allows you to define more parameters, the horizontal test conditions, for three specific front panel keypad measurements:

- Delay
- + width
- - width

When any of the three measurements are selected the measurement is made on the selected edge count, slope, and transition point. The HP 54501A starts counting edges from the left edge of the screen, not at the reference point. The selected edge must be displayed. If the edge is not displayed, the message not found is displayed in the measurement results area below the screen.

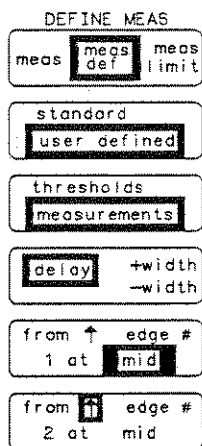

54501/WF67

Measurement delay, not to be confused with timebase delay (see Chapter 4, "Timebase Menu") is useful when measuring source-to-source delays or measuring time separation on the same source or a different source. The front panel delay measurement can be redefined by edge slope, edge count (from 1 to 100), and what part of the transition edge (upper, lower, mid) is used as a reference point.

- When setting edge count fields, it is handy to press the fine key. In the course mode the HP 54501A increments/decrements by tens (1, 11, 21,...100). In the fine mode the increment/decrement sequence is in 1's.

When you select the delay measurement from the front panel you must then select the sources (c#, f#, m#) and the source number.

+ width allows you to choose only the point on the waveform transition (upper, lower, mid) to measure when making the positive width of a displayed waveform.

- width allows you to choose only the point on the waveform transition (upper, lower, mid) to measure when making the negative width of a displayed waveform.

Measure Limit Sub-menu

DEFINE MEAS

meas	meas	meas
def	def	limit

test

off	on
-----	----

set

period

fail if >

50.0000 s

or if <

1.000 ns

save to

off	m1	m2	m3	m4
p1	p2	printer		

after save

stop	continue
------	----------

54501/WF24

The HP 54501A can run limit tests on up to three measurements. The menu allows you to preset certain conditions and store any failure data for evaluation at a later time. You set your limit test while in this menu and select your measurement from the front panel.

When a test is running, statistical data is displayed describing the test:

- current measurement
- minimum value
- maximum value
- average value

Failure data, as well as information regarding memory and save data is displayed.

Note

At least one measurement and up to three measurements must be selected from the keypad. The limit test will be run on front panel measurements.

test Key This is a toggle switch to turn the test routine on or off. When the test is turned on the oscilloscope will start running in the test mode on the most current measurements that have been selected.

set Key This allows you to select the measurement. You have sixteen measurements available; the same ones as are available on the numeric keypad.

- Press the selection key to highlight the field and rotate the knob to select the desired measurement.

fail if > Key This field allows you to set the upper failure threshold. The range on this field is dependent upon the units of the desired measurement.

or if < Key This key allows you to set the lower threshold of the failure parameters.

save to Key You may save the data associated with the failure to memories or to a hardcopy device. The channel that is saved is selected in the WAVEFORM SAVE menu.

- In the case of saving to nonvolatile memory, one memory may be selected. If multiple failures occur, only the last failure data will be saved because the most current data will overwrite the memory contents.
- If the data is saved to pixel memory, an accumulated save will occur. No measurements may be made on the pixel data.
- A save to a printer will immediately send the data to the peripheral device.
- The save to key can be turned off and no save will be effected.

after save Key You may elect to stop the test when a failure occurs, or you may continue the test.

Introduction to the Utilities

The Utility Menu is used to access the calibration and service functions, as well as set up the HP-IB interface. The submenus include self-test, calibration, printer hook-up and a listing for the current firmware revision date.

In this menu you can control all of the service functions that maintain the reliable performance of your oscilloscope.

The submenus are as follows:

- HP-IB menu
- selftest menu
- probe cal menu
- self cal menu
- service menu

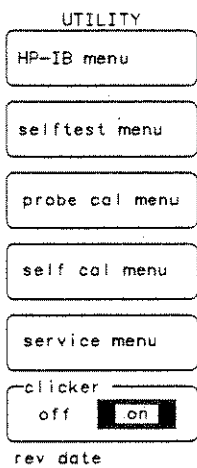

54501/WF28

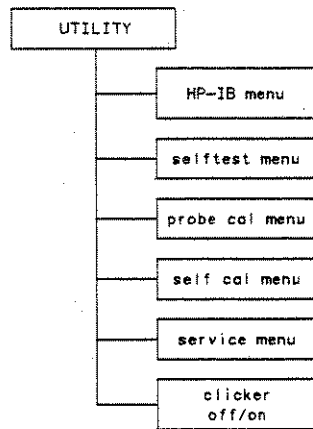

54501/BL13

Figure 12-1. Utility Menu

HP-IB menu

The HP-IB submenu allows you to make settings so the HP 54501A can talk to peripheral devices. This interface includes two primary settings:



- talk only mode
- addressed mode

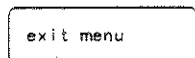
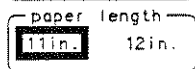
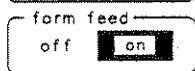

54501/WF25

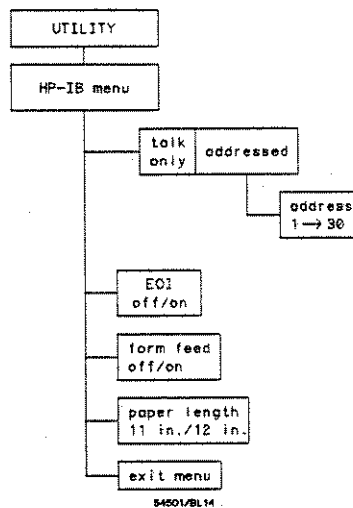

Figure 12-2. HP-IB Menu

talk only mode Set the oscilloscope to **talk only** when you wish to perform a hardcopy without intervention from an external controller. The attached printer must be set in the **listen only** or **listen always** mode.

addressed mode This mode allows a controlling device to selectively address the HP 54501A for talking or listening. The address of the HP 54501A can be selected while the instrument is in the addressed mode.

The range of available addresses is 0-30

EOI Key The EOI (End or Identify) key toggles this function on or off. EOI is a line on the HP-IB asserted with the last data byte of a message.

If this function is on, EOI will be asserted by the HP 54501A on the last byte of each message sent. If it is off, EOI will not be asserted.

This function only affects messages sent from the HP 54501A. The HP-IB will accept any of the legal IEEE 488.2 message terminators regardless of the setting of this function.

Note

IEEE 488.2 requires that EOI is asserted. Therefore, with EOI off, the HP 54501A will send messages that do not follow IEEE 488.2 rules concerning EOI. EOI should only be turned off if your controller does not deal with EOI appropriately.

form feed Key If the form feed option is on, the printer will perform a formfeed at the end of the hardcopy. If formfeed is off, the page will scroll up four lines when the hardcopy is complete.

paper length Key You can select between 11 inch or 12 inch pagelengths for auto form feed. This is used to set the 11 inch page, the U.S. standard, or the 12 inch page, U.K. and European standard.

exit menu Key Pressing this key will immediately return you to the Utility menu.

selftest menu

The HP 54501A has been designed to perform internal diagnostics. This selftest submenu allows you to test the oscilloscope to determine potential calibration errors.

If the HP 54501A fails any selftest perform the following:

- Recalibrate the oscilloscope.
- If that does not fix the problem, refer to the *HP 54501A Service manual*.

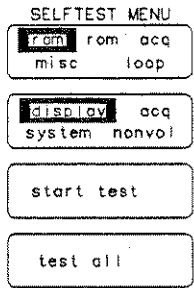

54501/WF68

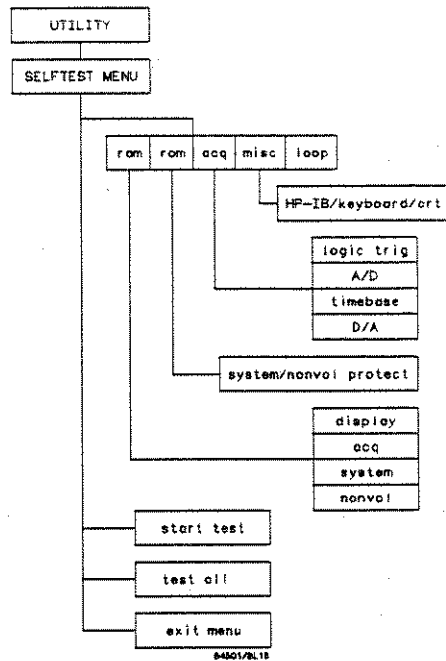

Figure 12-3. Self-Test Menu

The HP 54501A self-diagnostics and self-tests are designed to run operational tests on the following:

- ram
- rom
- acquisition
- miscellaneous

ram Test The ram test is a multiple selection field. The options are:

- display
- acquisition
- system
- unprotected nonvolatile memory

rom Test Two rom tests are available:

- system
- protected nonvolatile memory

The screenshot shows a terminal window with the following content:

```
SELFTEST MENU
ram  rom  acq
misc loop

8035

display  acq
system nonvol

start test

test all

exit menu

PASSED System RAM
PASSED Non-Volatile RAM
PASSED Display RAM
PASSED Protected Non-Volatile RAM
PASSED System ROM
PASSED Acquisition RAM
PASSED Logic Trigger
PASSED Timebase
PASSED D/A Converter
PASSED HP/IB
PASSED A/D Converter
to run selftest, disconnect all inputs

54501/WF75
```

Figure 12-4. Results of Selftest

acquisition Test Four acquisition tests are available:

- logic trigger
- A/D
- timebase
- D/A

Miscellaneous Test Three miscellaneous tests are available:

- HP-IB
- keyboard
- crt

loop Test The loop test is a function designed for use by qualified service personnel. It is unnecessary to use this function for normal oscilloscope operation. When a self-test loop has been initiated it will run until you stop the test by holding any key.

start test Key Pressing this key will begin the selected test.

exit menu Key Pressing this key will return you to the Utility menu.

probe cal menu

Two probe calibration procedures are available in the probe cal menu. They are:

- attenuation
- time null

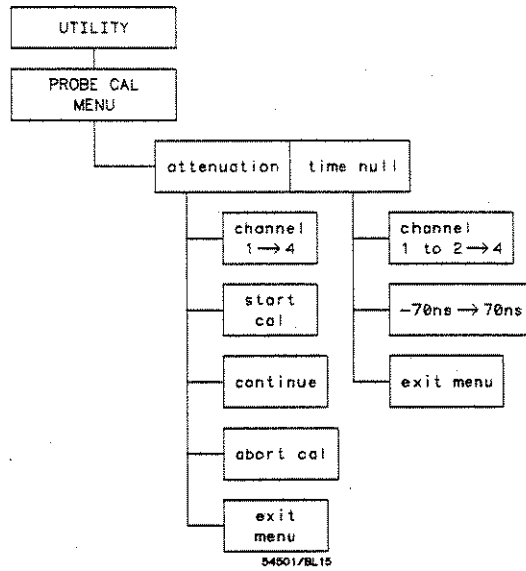

Figure 12-5. Probe Cal Menu

attenuation submenu

The attenuation submenu is used to calibrate channel gain at the probe tip. Channel gain can be corrected through probe attenuation down to 0.9 attenuation.

PROBE CAL MENU

attenuation
time null
channel
1 2 3 4
start cal
continue
abort
exit menu

- Below 0.9 the error message *Attenuation less than 1, see manual for action* is displayed. The corrective action is to recalibrate the HP54501A.

If the probe is not connected to the DC CALIBRATOR OUTPUT on the rear panel or the probe attenuation exceeds approximately 250, the error message *Attenuation too high or bad connection* is displayed. The corrective action is to check the connections and recalibrate. If recalibration is unsuccessful, refer to the *HP 54501A Service manual*.

- If the probe attenuation calibration is successful the displayed message is *Probe Attenuation = n.nnnnn This value has been entered into your channel probe setting.*

channel Key

Pressing this key allows you to select a channel to calibrate. By continually pressing the key you can increment through the fields, i.e. channels.

start cal Key

When the channel you wish to calibrate has been selected, press **start cal**. The advisory will appear at the bottom of the waveform display area *Connect the DC Cal rear panel bnc to the probe of channel n, then press continue*. Pressing this key prompts you for setup requirements.

continue Key

Press this key when all setup requirements have been satisfied. The actual calibration process will begin.

abort Key

This is the only active front panel key during the calibration process. If you press this key, the calibration process will be terminated with the previous calibration factors intact.

exit menu Key

Pressing this key will return you to the Utility menu.

time null submenu

Time null allows you to set the timing of all channels to correspond to each other. This eliminates any time discrepancies between channels and guarantees that channel to channel skew variations are non-existent. This is useful to manually adjust any differences in cable length.

PROBE CAL MENU
attenuation
time null
channel
1 to 2
0.00000 s

exit menu
54501/WF26

channel Key

This selection key allows you to select the channels to be set to each other. All channels are set to channel 1, therefore the selections are as follows:

- 1 to 2
- 1 to 3
- 1 to 4

This field is never displayed in fullbright designating it is an active field, however, it is always active. Pressing this key changes the selection. Each time the key is pressed, the selection is incremented.

time Key

This is an unlabelled field. You can set the time null between channels using either of the entry devices. The range is ± 70 ns.

exit menu Key

Pressing this key will return you to the Utility menu.

Self Cal menu

In the self cal menu you can calibrate two internal functions:

- vertical cal
- delay cal

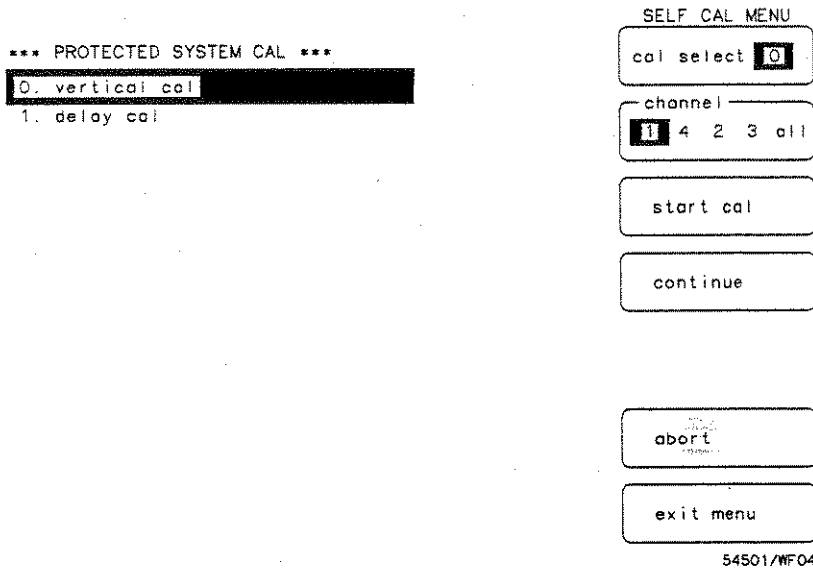

Figure 12-6. Self Cal Options

- cal select Key** This field allows you to select which of the calibration processes you wish to perform. As you press the cal select key the highlighted window will increment through 0-1 and the active field in the display will change to correspond with the selection.
- channel Key** You can select the channel you wish to calibrate.
- start cal Key** When the channel you wish to calibrate has been selected, and the specific cal routine has been selected, press the start cal key and follow the instructions displayed.

continue Key When all of the setup requirements have been satisfied, press the **continue** key and the actual calibration process will begin.

abort Key This is the only active front panel key during the calibration process. If you press this key the calibration process will terminate with the previous calibration factors intact.

exit menu Key This key returns you to the Utility menu.

service menu

The service menu is used primarily for software settings and hardware adjustments. These are to be used by qualified service personnel.

One calibration needed for the software calibration of the HP 54501A is in the service menu. You must set the default calibration before continuing with the selfcal menu. To set the default cal:

Note

If you run the default calibration, you must continue with the self calibration. This process returns all calibration factors to default.

- Press the service menu key and enter the menu.
- Press the cal select key until 3 is displayed in the window and default cal is highlighted.
- Press **start cal** and **continue** when the instructions are displayed.

See the *HP 54501A Service Manual*.

clicker Key

The clicker key allows you to turn on the function. When the clicker is turned on, an audible click is heard each time a key is pressed. The selections are either on or off.

Calibration Procedure

The process to calibrate the HP 54501A is very simple. When you have initiated the process the oscilloscope will display instructions for completion.

Note

Before the HP 54501A can be calibrated the CALIBRATION toggle switch on the rear panel must be set to UNPROTECTED.

The procedure for calibration is:

- Perform a key-down power up to set the HP 54501A to a known point. This allows the oscilloscope to begin the calibration routines from the same point each time.
- Set the default calibration factors in the Service menu.
- Exit the Service menu and enter the self cal menu.
- Select 0 in the cal select field and calibrate the vertical factors. This routine will calibrate the A/D, vertical gain, offset, and trigger.
- Select 1 in the cal select field and calibrate the delay.

When the software calibrations are complete reset the CALIBRATION toggle switch on the rear panel is set to PROTECTED.

Algorithms

A

One of the HP 54501A's primary features is its ability to make automatic measurements on displayed waveforms. This chapter provides details on how automatic measurements are calculated and some tips on how to improve results.

Measurement Setup

Measurements typically should be made at the fastest possible sweep speed for the most accurate measurement results. The entire portion of the waveform that is to be measured must be displayed on the oscilloscope. That is:

- at least one complete cycle must be displayed for period or frequency measurements
 - the entire pulse must be displayed for width measurements
 - the leading edge of the waveform must be displayed for risetime measurements
 - the trailing edge of the waveform must be displayed for falltime measurements
-

Making Measurements

If more than one waveform, edge, or pulse is displayed, the measurements are made on the first (leftmost) portion of the displayed waveform that can be used. If there are not enough data points the oscilloscope will display \leq with the measurement results. This is to remind you that the results may not be as accurate as possible. It is recommended that you re-scale the displayed waveform and make your measurement again.

Standard Measurements

When any of the standard measurements are requested, the HP 54501A first determines the top-base voltage levels at 100%-0%. From this information, it can determine thresholds (10%, 90%, and 50%) needed to make the measurements. The 10% and 90% thresholds are used in the risetime and falltime measurements. The 50% mid-point is used for measuring frequency, period, pulse width, and duty cycle.

The voltage thresholds are precise settings and sets specific locations on the waveform. If the thresholds are not placed on the waveform (above or below) the HP 54501A cannot make a measurement.

User defined Measurements

When any of the user defined measurements are requested, the HP 54501A still must determine the top-base voltage thresholds. From this information it can determine user defined upper and lower thresholds. The mid-point is then determined to be the 50% point between the upper and lower threshold.

Automatic Top-Base

Top-Base is the heart of most automatic measurements. It is used to determine V_{top} and V_{base} , the 0% and 100% voltage levels at the top and the bottom of the waveform. From this information the oscilloscope can determine the 10%, 50%, and 90% points, which are also used in most measurements. The top or base of the waveform is not necessarily the maximum or minimum voltage present on the waveform. Consider a pulse that has slight overshoot. It would be wrong to select the highest point of the waveform as the top since the waveform normally rests below the perturbation.

Top-Base performs a histogram on the waveform and finds the most prevalent point above and below the waveform midpoint. The most prevalent point is one that represents greater than approximately 5% of the total display points (501) and is considered to be either the top or base. If no point accounts for more than 5% of the total, then the top is chosen as the absolute maximum and the base is chosen as the absolute minimum.

Edge Definition

Both rising and falling edges are defined as transitional edges that must cross three thresholds.

A rising edge must cross the lower threshold in a positive direction (defining it as a rising edge), cross the mid threshold (any number of crossings, both positive and negative are permissible) and then cross the upper threshold without any crossing of the lower threshold.

A falling edge must cross the upper threshold in a negative direction, cross the mid threshold (any number of times), and then cross the lower threshold without crossing the upper threshold.

Note

Most time measurements are made based on the position of the first crossing of the middle threshold.

Algorithm Definitions

Following are the definitions that all measurements are based on:

delay There are three types of delay measurement:

- jitter
- standard
- user-defined

Jitter occurs only under the following circumstances:

- standard/user-defined key is set to standard
- two delay parameters are the same
- display mode is envelope

if
first edge on minimum waveform is rising
then
delay = mid-threshold of first rising edge of max waveform minus
mid-threshold of first rising edge on min waveform
else
delay = mid-threshold of first falling edge on min waveform
minus mid-threshold of first falling edge on max waveform

The standard delay measurement occurs when in the standard mode (not user-defined) and is not a jitter measurement.

standard delay = mid-threshold of the first edge of second parameter minus mid-threshold of the first edge of the first parameter

Note

Negative delay is possible

User defined delay = second channel edge minus first channel edge

+ width The + width algorithm has standard and user-defined considerations.

if
first edge is rising
then
+ width = mid-threshold crossing of first falling edge -
mid-threshold crossing of first rising edge
else
+ width = mid-threshold crossing of second falling edge -
mid-threshold crossing of first rising edge

User-defined is the same as Standard definition except user-defined threshold.

- width The - width algorithm has standard and user-defined considerations:

```
if
  first edge is rising
then
  -width = second rising edge - first falling edge
else
  -width = first rising edge - first falling edge
```

```
Period if
  first edge is rising
then
  period = second rising edge - first rising edge
```

Frequency frequency = 1/period

Duty Cycle duty cycle = (+ width/period) * 100

Note

+ width is always calculated using mid-threshold.

Risetime risetime = time at upper threshold - time at lower threshold

Falltime falltime = time at lower threshold - time at upper threshold

V_{max} V_{max} = voltage of the maximum point on screen

V_{min} V_{min} = voltage of the minimum point on screen

V_{p-p} V_{p-p} = V_{max} - V_{min}

V_{top} **V_{top} = most prevalent point above waveform midpoint**

V_{base} **V_{base} = most prevalent point below waveform midpoint**

V_{amp} **V_{amp} = V_{top} - V_{base}**

V_{avg} Average voltage of the first cycle of the displayed signal is measured. If a complete cycle is not present the oscilloscope will average all data points.

V_{rms} The rms voltage of the first cycle of the displayed signal is measured. If a complete cycle is not present, the measurement will compute rms on all data points.

$$V_{rms} (ac) = \left\{ \frac{1}{n} \sum_{j=1}^n V_j^2 - \left(\frac{1}{n} \sum_{j=1}^n V_j \right)^2 \right\}^{1/2}$$

Specifications

B

Bandwidth		
Repetitive	(dc coupled) dc to 100 MHz (-3 dB)	(ac coupled) 10 Hz to 100 MHz (-3 dB)
Single Shot	dc to 1 MHz (based on 10 points per period of input signal)	10 Hz to 1 MHz
Risetime		
3.5 ns		
Risetime = $0.35/\text{Bandwidth}$		
Number of Channels		
4 (2 + 2)		
Channels 2 and 3 are limited attenuator inputs, optimized for digital signals.		
Simultaneous Channels		
2 + 2		
Channels 1 and 2 simultaneous with 3 or 4. With more than two channels, the other channels are acquired alternately in pairs.		
Vertical Sensitivity		
Maximum 5 mV/div		
Minimum 5 V/div		
Vertical Gain Accuracy (dc)		
$\pm 1.5\%$		
Max Input voltage		
$\pm 250 \text{ V DC} + \text{peak AC } (< 10 \text{ kHz})$		
Offset Accuracy		
$\pm 2\%$ of offset + $0.2 \times (\text{V/div}) + 0.075 \text{ div}/^\circ\text{C}$ from the calibration temperature for 5 mV/div range, $\pm 2\%$ of offset + $0.4 \times (\text{V/div}) + 0.15 \text{ div}/^\circ\text{C}$ from the calibration temperature		
Voltage Measurement Accuracy		
Single Cursor	Gain Accuracy + offset accuracy + A/D resolution	
Dual Cursor	Gain Accuracy + $2 \times \text{A/D resolution}$	

Specifications and Characteristics

B-1

Timebase Range Minimum 2 ns/div
Maximum 5 s/div

Time Base Accuracy 0.005%

Delta t Accuracy $1 \text{ ns} \pm (5E-5) \times \text{Delta t} \pm 0.02 \times (t/\text{div})$
Delta t accuracy for dual-cursor, single-channel measurement, or for channel-to-channel measurement after visual time null calibration has been done.

Trigger Sensitivity

5 mV/div	dc-20 MHz	0.1 x full-scale
	20 MHz - 100 MHz	0.25 x full-scale
All Other	dc-20 MHz	0.05 x full-scale
	20 MHz - 100 MHz	0.125 x full-scale

Note

Specifications valid for temperature range $\pm 10^\circ \text{C}$ from calibration temperature with 8 averages selected and channel(s) in sensitivity range 1, 2, or 5

Characteristics

Vertical Resolution	$\pm 0.4\%$ - 8 bit A/D Since expansion is used for 5 mV/div range, A/D resolution is 7 bits (0.8%) in that range. $\pm 0.1\%$ - 10 bits via HP-IB (with averaging)								
Maximum Sample Rate	10 Msa/s								
Memory Depth	501 points (display) 1024 points (via HP-IB)								
Single Shot via HP-IB	500 points								
2 ns/div time base range	200 points								
5 ns/div time base range	up to 501 points								
Input RC (nominal)	1 M Ω , 16 pF								
Input Coupling	ac, dc								
Offset Range	<table><thead><tr><th>Sensitivity range</th><th>Available offset</th></tr></thead><tbody><tr><td>5-50 mV/div</td><td>$\pm 2V$</td></tr><tr><td>0.1-1 V/div</td><td>$\pm 20V$</td></tr><tr><td>1-5 V/div</td><td>$\pm 200V$</td></tr></tbody></table>	Sensitivity range	Available offset	5-50 mV/div	$\pm 2V$	0.1-1 V/div	$\pm 20V$	1-5 V/div	$\pm 200V$
Sensitivity range	Available offset								
5-50 mV/div	$\pm 2V$								
0.1-1 V/div	$\pm 20V$								
1-5 V/div	$\pm 200V$								
Dynamic Range	± 16 divisions from center Operating range for dc + peak AC input								
Channel-to-channel Isolation	40 dB @ dc to 20 MHz 30 dB @ 20 MHz to 100 MHz (with channels at equal sensitivity)								

Maximum Time Base Resolution

100 ps

Delay Range (post-trigger)

Time Base Setting

Available Delay

50 ms - 5 s
100 μ s - 20 ms
2 ns - 50 μ s

40 x (s/div)
1 s
-10,000 x (s/div)

Trigger Pulse Width (minimum)

7 ns

Trigger Level Range

\pm 6 divisions from center

Index

!

$\Delta t/\Delta V$ marker 3-5
n s to complete 4-2
+ width 1-3
- width 1-4

A

abort Key 12-6, 12-8, 12-11
acquisition test 12-5
add to memory Key 10-3
addressed 12-2
addressed menu 12-2
after save Key 11-6
Air Flow Requirements 2-7
Algorithms 1-1
alternate keys 3-9
Altitude 2-2
attenuation menu 12-7
auto triggered scroll 4-2
Automatic measurements 1-1
Automatic Top-Base 1-2
AUTOSCALE Key 3-5
axes 7-5

C

cal select Key 12-10
Calibration Procedure 12-12
calibrator protection 2-3
chan/mem Key 9-3
Channel 13-7
CHANNEL Key 5-1, 12-8 - 12-10
Channel Menu 5-1
CLEAR DISPLAY Key 3-3
CLEAR key 3-9
clear memory Key 10-3
clicker Key 12-11
clock Key 6-15
CLR MEAS key 11-2
connect dots Key 7-6
connect the dots 3-5
Contents of Shipment 2-1
continue Key 12-8, 12-11
continuous Key 11-3
coupling Key 5-3

D

Δ [delta]t markers 8-3
 Δ [delta]V markersDV markers8-2
data acquisition3-3
default cal12-11
default conditions3-11
Define Measure3-7

Define Measure Menu 11-1
delay Key 4-2, 6-22
Delay Trigger Exercise 6-23
Delay Trigger Mode 6-20
delayed sweep 4-3
Delta t/Delta V Menu 8-1
Display 3-7
display Key 9-2, 10-2 - 10-3
Display Menu 7-1
Display Mode Key 7-2
duty cycle 1-4

E

ECL Key 5-4
ECL/TTL presets 3-5
Edge Definition 1-2
Edge Trigger Exercise 6-4
edge Trigger Mode 6-2
Entry 3-8
EOI Key 12-3
Exercise
 Waveform Save 10-4
 Delay Trigger 6-23
 Holdoff 6-4
 Pattern Trigger 6-10
 State Trigger 6-16
 tv Trigger 6-29
 Waveform Math 9-7
 Waveform Save 10-4
exit menu Key 12-3, 12-6, 12-8, 12-11
External Equipment
 Connecting 2-8

F

fail if 11-6
falltime 1-4

falltime measurements 1-1
field Key 6-28
FINE key 3-8, 4-1
form feed Key 12-3
frame 7-5
frequency 1-4
Front Panel Overview 3-1
function display 3-10
Function Key 9-2
fuse module 2-5

G

Gain cal 12-10
grid 7-5

H

HARDCOPY Key 3-3
holdoff 3-5
Holdoff Exercise 6-4
holdoff Key 6-3, 6-10, 6-16, 6-28
HP-IB interface 3-3
HP-IB menu 12-2
Humidity 2-2

I

Initial Inspection 2-1
Input 3-9
Instrument Reset 3-11
Intensity Control 2-7

K

key

CLR MEAS 11-2
continuous 11-3
EOI 12-3
form feed 12-3
or if 11-6
Run/Stop 3-2
save after 11-6
save to 11-6
standard/user defined 11-4
abort 12-8, 12-11
add to memory 10-3
AUTOSCALE 3-5
cal select 12-10
chan/mem 9-3
Channel 5-1, 12-10
CLEAR 3-9
Clear Display 3-3
clear memory 10-3
clock 6-15
connect dots 7-6
continue 12-8, 12-11
coupling 5-3
Delay 4-2, 6-22
display 10-2 - 10-3
Display Mode 7-2
ECL 5-4
exit menu 12-3, 12-6, 12-8, 12-11
fail if 11-6
field 6-28
FINE 3-9
Function 9-2
Hardcopy 3-3
holdoff 6-3, 6-10, 6-16, 6-28
level 6-3
level/polarity 6-28
line 6-28

Local 3-3
meas/meas def/meas limit 11-3
more 5-3
nonvolatile 10-2
of screens 7-4
off/frame/axes/grid 7-5
offset 5-2, 9-4
operand 9-3
operator 9-3
paper length 12-3
pattern 6-9
position 4-4
present 6-16
probe 5-4
qualify on 6-20
RECALL 3-5
reference 4-2
SAVE 3-6
sensitivity 9-4
set 11-6
SHOW 3-6
single 3-3
slope 6-3
source 6-3, 6-27, 10-2
start cal 12-8, 12-10
start test 12-6
statistics 11-3
store 10-2
test 11-6
thresholds/measurements 11-4
Time/Div 4-1
timebase 4-4
trigger on 6-22
TTL 5-5
Vertical Sensitivity 5-2
volatile 10-3
waveform/pixel 10-1
when 6-9, 6-15
window 4-3
Key-down power up 3-11
knob 3-8 - 3-9

L

level Key 6-3
level/polarity Key 6-28
line Key 6-28
Line Switch 2-6
line voltage selector 2-5
List of Accessories 2-2
LOCAL Key 3-3
loop Test 12-6

M

Making Measurements 1-1
Maximum Vertical Sensitivity 1-1
meas Sub-menu 11-3
meas/meas def/meas limit Key 11-3
Measure Define 11-4
Measure Limit 11-5
measurement limit test 3-5
Measurement Selection 11-2
Measurement Setup 1-1
Memory 0 3-5
menu
 channel 5-1
Menus 3-7
Minimum Vertical Sensitivity 1-1
more Key 5-3

N

n s to initialize 4-2
noise reject Key 6-3
nonvolatile Key 10-2
nonvolatile memory 10-2

(number) of screens 7-4
numeric keypad 3-8

O

offset Key 5-2, 9-4
Offset, hysteresis, trigger cal 12-10
1/delta t 8-3
Operating Environment 2-2
Operator Key 9-3
or if Key 11-6

P

paper length Key 12-3
pattern Key 6-9
Pattern Trigger Exercise 6-10
pattern Trigger Mode 6-8
period 1-4
persistence 3-5
pixel Menu 10-3
position Key 4-4
power input 2-3
Power Requirements 2-3
power switch 2-3
present Key 6-16
probe attenuation 5-4
probe attenuation failure 12-8
probe cal menu 12-7
probe Key 5-4

Q

qualify on Key 6-20

R

ram Test 12-5
range 6-10
Rear Panel Layout 2-3
RECALL 0 3-5
RECALL CLEAR 3-5, 3-11
RECALL Key 3-5
reference Key 4-2
reference point 4-2
Repetitive Bandwidth 1-1
risetime 1-4
risetime measurements 1-1
rom Test 12-5
RUN/STOP Key 3-2 - 3-3

S

Sample Rate 1-1
SAVE Key 3-6
save to Key 11-6
Self Cal menu 12-10
selftest menu 12-4
sensitivity Key 9-4
service menu 12-11
set Key 11-6
Setup 3-4
Shift key 3-9
Shipment 2-7
Shipping 2-2
SHOW Key 3-6
SHOW screen 3-11
SINGLE Key 3-3
slope 3-5
slope Key 6-3
source Key 6-3, 6-27, 10-2
standard + width A-3

standard - width A-4
standard/user defined Key 11-4
start cal Key 12-8, 12-10
start marker 8-3
start test Key 12-6
State Trigger Exercise 6-16
state Trigger Mode 6-15
statistics Key 11-3
stop marker 8-3
Stopped mode 3-3
Storage 2-2, 2-7
store Key 10-2
submenu
 attenuation 12-8
 time null 12-9
Sweep speed 3-5, 4-1
System Control 3-2

T

talk only 12-2
talk only menu 12-2
Test
 loop 12-6
test Key 11-6
threshold 6-1
thresholds/measurements Key 11-4
time Key 12-9
time null submenu 12-9
Time/Div Key 4-1
Timebase 3-7
timebase Key 4-4
Timebase Menu 4-1
timebase window 3-5, 9-3
Trig'd/auto Key 6-3
Trigger 3-7
 delay 6-1, 6-20
 edge 6-1 - 6-2
 pattern 6-1, 6-8
 state 6-1, 6-15

tv 6-1, 6-27
Trigger level 3-5, 6-1
Trigger Menu 6-1
trigger on Key 6-22
triggered scroll 4-2
TTL Key 5-5
tv Trigger Exercise 6-29
tv Trigger Mode 6-27

U

Unpacking 2-1
user-defined + width A-3
Utilities 3-7
Utility Menu 12-1

V

Vamp A-5
Vavg A-5
Vbase A-4
Vertical offset 3-5
vertical position 5-2
Vertical Resolution 1-1
Vertical sensitivity 3-5
Vertical Sensitivity Key 5-2
Vmarker 1 8-2
Vmarker 2 8-2
Vmax A-4
Vmin A-4
volatile Key 10-3
voltage selector module 2-3
Vp-p A-4
Vrms A-5
Vtop A-4

W

waveform math 3-5, 3-7
Waveform Math Exercise 9-7
Waveform Math Menu 9-1
waveform Menu 10-2
Waveform Save 3-7
Waveform Save Exercise 10-4
Waveform Save Menu 10-1
waveform/pixel Key 10-1
when entered 6-9
when exited 6-9
when Key 6-9, 6-15
when present 6-10
window Key 4-3
Window position 4-4
Window timebase 4-4