

Errata

Title & Document Type: 54505B/06B/10B/12B Digitizing Oscilloscope Front Panel Reference

Manual Part Number: 54512-90904

Revision Date: May 1992

HP References in this Manual

This manual may contain references to HP or Hewlett-Packard. Please note that Hewlett-Packard's former test and measurement, semiconductor products and chemical analysis businesses are now part of Agilent Technologies. We have made no changes to this manual copy. The HP XXXX referred to in this document is now the Agilent XXXX. For example, model number HP8648A is now model number Agilent 8648A.

About this Manual

We've added this manual to the Agilent website in an effort to help you support your product. This manual provides the best information we could find. It may be incomplete or contain dated information, and the scan quality may not be ideal. If we find a better copy in the future, we will add it to the Agilent website.

Support for Your Product

Agilent no longer sells or supports this product. You will find any other available product information on the Agilent Test & Measurement website:

www.tm.agilent.com

Search for the model number of this product, and the resulting product page will guide you to any available information. Our service centers may be able to perform calibration if no repair parts are needed, but no other support from Agilent is available.

Front-Panel Reference

**HP 54505B and HP 54506B
500 MSa/s Digitizing Oscilloscopes
and
HP 54510B and HP 54512B
1 GSa/s Digitizing Oscilloscopes**



© Copyright Hewlett-Packard Company 1992

Publication 54512-90904

Printed in the U.S.A. May 1992

DECLARATION OF CONFORMITY

according to ISO/IEC Guide 22 and EN 45014

Manufacturer's Name: Hewlett-Packard Company

Manufacturer's Address: 1900 Garden of the Gods Road
Colorado Springs , CO 80901
U.S.A.

declares, that the product

Product Name: Digitizing Oscilloscope

Model Number(s): HP 54505B, 54506B, 54510B, 54512B

Product Options: All

conforms to the following product specifications:

Safety: IEC 348 / HD 401
UL 1244
CSA - C22.2 No. 231 (Series M-89)

EMC: CISPR 11:1990 /EN 55011 (1991): Group 1 Class A
IEC 801-2:1991 /EN 50082-1 (1992): 8 kV AD
IEC 801-3:1984 /EN 50082-1 (1992): 3 V/m
IEC 801-4:1988 /EN 50082-1 (1992): 1 kV

Supplementary Information:

Colorado Springs, May 1, 1992

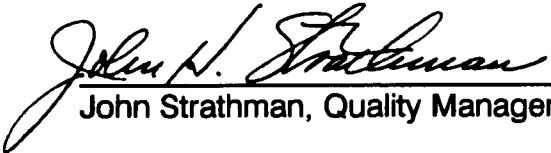
John Strathman, Quality Manager

European Contact: Your local Hewlett-Packard Sales and Service Office or Hewlett-Packard GmbH, Department ZQ /
Standards Europe, Herrenberger Straße 130, D-7030 Böblingen (FAX: +49-7031-144195)

**Product
Warranty**

This Hewlett-Packard product has a warranty against defects in material and workmanship for a period of three years from date of shipment. During warranty period, Hewlett-Packard Company will, at its option, either repair or replace products that prove to be defective.

For warranty service or repair, this product must be returned to a service facility designated by Hewlett-Packard. However, warranty service for products installed by Hewlett-Packard and certain other products designated by Hewlett-Packard will be performed at the Buyer's facility at no charge within the Hewlett-Packard service travel area. Outside Hewlett-Packard service travel areas, warranty service will be performed at the Buyer's facility only upon Hewlett-Packard's prior agreement and the Buyer shall pay Hewlett-Packard's round trip travel expenses.

For products returned to Hewlett-Packard for warranty service, the Buyer shall prepay shipping charges to Hewlett-Packard and Hewlett-Packard shall pay shipping charges to return the product to the Buyer. However, the Buyer shall pay all shipping charges, duties, and taxes for products returned to Hewlett-Packard from another country.

Hewlett-Packard warrants that its software and firmware designated by Hewlett-Packard for use with an instrument will execute its programming instructions when properly installed on that instrument. Hewlett-Packard does not warrant that the operation of the instrument software, or firmware will be uninterrupted or error free.

Limitation of Warranty

The foregoing warranty shall not apply to defects resulting from improper or inadequate maintenance by the Buyer, Buyer-supplied software or interfacing, unauthorized modification or misuse, operation outside of the environmental specifications for the product, or improper site preparation or maintenance.

**NO OTHER WARRANTY IS EXPRESSED OR IMPLIED.
HEWLETT-PACKARD SPECIFICALLY DISCLAIMS THE
IMPLIED WARRANTIES OR MERCHANTABILITY AND FITNESS
FOR A PARTICULAR PURPOSE.**

Exclusive Remedies THE REMEDIES PROVIDED HEREIN ARE THE BUYER'S SOLE AND EXCLUSIVE REMEDIES. HEWLETT-PACKARD SHALL NOT BE LIABLE FOR ANY DIRECT, INDIRECT, SPECIAL INCIDENTAL, OR CONSEQUENTIAL DAMAGES, WHETHER BASED ON CONTRACT, TORT, OR ANY OTHER LEGAL THEORY.

Assistance Product maintenance agreements and other customer assistance agreements are available for Hewlett-Packard products.

For any assistance, contact your nearest Hewlett-Packard Sales and Service Office.

Certification Hewlett-Packard Company certifies that this product met its published specifications at the time of shipment from the factory. Hewlett-Packard further certifies that its calibration measurements are traceable to the National Institute of Standards and Technology, to the extent allowed by the Bureau's calibration facility, and to the calibration facilities of other International Standards Organization members.

Safety This product has been designed and tested according to International Safety Requirements. To ensure safe operation and to keep the product safe, the information, cautions, and warnings in this manual must be heeded.

Safety Considerations

General Operation

This is a Safety Class I instrument (provided with terminal for protective earthing). BEFORE APPLYING POWER verify that the power transformer primary is matched to the available line voltage, the correct fuse is installed, and Safety Precautions are taken (see the following warnings).

In addition, note the instrument's external markings which are described under "Safety Symbols."

General Warnings and Cautions

- BEFORE SWITCHING ON THE INSTRUMENT, the protective earth terminal of the instrument must be connected to the protective conductor of the (mains) powercord. The mains plug shall only be inserted in a socket outlet provided with a protective earth contact. The protective action must not be negated by the use of an extension cord (power cable) without a protective conductor (grounding). Grounding one conductor of a two-conductor outlet is not sufficient protection.
- Servicing instructions are for use by service-trained personnel. To avoid dangerous electric shock, do not perform any servicing unless qualified to do so.
- If this instrument is to be energized via an auto-transformer (for voltage reduction) make sure the common terminal is connected to the earth terminal of the power source.
- Any interruption of the protective (grounding) conductor (inside or outside the instrument) or disconnecting the protective earth terminal will cause a potential shock hazard that could result in personal injury.
- Whenever it is likely that the protection has been impaired, the instrument must be made inoperative and be secured against any unintended operation.
- Only fuses with the required rated current, voltage, and specified type (normal blow, time delay, etc.) should be used. Do not use repaired fuses or short circuited fuseholders. To do so could cause a shock or fire hazard.
- Do not operate the instrument in the presence of flammable gasses or fumes. Operation of any electrical instrument in such an environment constitutes a definite safety hazard.
- Do not install substitute parts or perform any unauthorized modification to the instrument.
- Adjustments described in the manual are performed with power supplied to the instrument while protective covers are removed. Energy available at many points may, if contacted, result in personal injury.
- Any adjustment, maintenance, and repair of the opened instrument under voltage should be avoided as much as possible, and when inevitable, should be carried out only by a skilled person who is aware of the hazard involved.
- Capacitors inside the instrument may still be charged even if the instrument has been disconnected from its source of supply.

Safety Symbols



Instruction manual symbol. The product will be marked with this symbol when it is necessary for the user to refer to the instruction manual in order to protect against damage to the product.



Indicates Hazardous Voltages



Earth terminal (sometimes used in manual to indicate circuit common connected to grounded chassis).

Warning



The **WARNING** sign denotes a hazard. It calls attention to a procedure, practice, or the like, which, if not correctly performed or adhered to, could result in personal injury. Do not proceed beyond a **WARNING** sign until the indicated conditions are fully understood and met.

Caution



The **CAUTION** sign denotes a hazard. It calls attention to an operating procedure, practice, or the like, which, if not correctly performed or adhered to, could result in damage to or destruction of part or all of the product. Do not proceed beyond a **CAUTION** sign until the indicated conditions are fully understood or met.

Contents

Chapter 1	Introduction	
	Introduction	1-1

Chapter 2	Instrument Setup	
	Introduction	2-1
	Initial Inspection	2-1
	Contents of Shipment	2-1
	Available Accessories	2-2
	Operating Environment	2-2
	Storage and Shipping	2-2
	Rear Panel	2-3
	Power Requirements	2-3
	Selecting Line Voltage	2-4
	Verifying the Fuse	2-5
	Power Cord	2-5
	Intensity Control	2-7
	Air Flow Requirements	2-7
	Connecting External Equipment	2-8

Chapter 3	Front-Panel Overview	
	Introduction to the Front Panel	3-1
	System Control	3-2
	RUN/STOP Key	3-2
	SINGLE Key	3-3
	CLEAR DISPLAY Key	3-3
	LOCAL Key	3-3
	HARDCOPY Key	3-3
	Setup	3-4
	AUTOSCALE Key	3-5
	RECALL Key	3-5
	SAVE Key	3-6
	SHOW Key	3-6
	Menus	3-7

Entry Devices	3-8
Numeric Keypad	3-8
Knob	3-9
FINE Key	3-9
Probe Terminals	3-9
Input	3-9
Line Switch	3-10
Display	3-10
Instrument Reset	3-11

Chapter 4

Timebase Menu

Introduction to the Timebase	4-1
Time/Div Key	4-1
delay Key	4-3
reference Key	4-3
repetitive/ realtime Key	4-4
repetitive mode	4-4
realtime mode	4-4
Sequential Single-Shot	4-6
sequential Key	4-6
# of points Key	4-7
# of segments Key	4-7
Memory Bar Exercise	4-7
Single-Shot Exercise	4-9
Single-Shot in Repetitive Mode	4-9
Single-Shot in Real Time Mode	4-12
Sequential Single-Shot Exercise	4-13
Pan and Zoom	4-15
Pan and Zoom Exercise	4-15
Zooming	4-15
Panning	4-17

Chapter 5

Channel Menu

Introduction to Channels	5-1
CHANNEL Key	5-2
Vertical Sensitivity Key	5-2
offset Key	5-2
Coupling Key	5-3

Input Impedance	5-3
more preset/probe Key	5-4
probe key	5-4
ECL Key	5-5
TTL Key	5-5

Chapter 6

Trigger Menu

Introduction to the Triggers	6-1
Trigger Mode Interaction	6-1
trig'd/auto Key	6-1
Edge Trigger Mode	6-2
source Key	6-3
level Key	6-3
slope Key	6-3
noise reject Key	6-3
holdoff Key	6-3
Edge Trigger (with Holdoff) Exercise	6-4
Instrument Setup	6-4
Oscilloscope Setup	6-5
Pattern Trigger Mode	6-8
pattern Key	6-9
when Key	6-9
holdoff Key	6-10
Pattern Trigger Exercise	6-10
Instrument Setup	6-11
Oscilloscope Setup	6-11
State Trigger Mode	6-15
clock Key	6-15
when Key	6-15
present Key	6-16
holdoff Key	6-16
State Trigger Exercise	6-16
Instrument Setup	6-16
Oscilloscope Setup	6-17
Delay Trigger Mode	6-20
qualify on Key	6-20
qualify on edge	6-21
qualify on pattern	6-21
qualify on state	6-21

delay Key	6-22
trigger on Key	6-23
Delay Trigger Exercise	6-23
Instrument Setup	6-23
Oscilloscope Setup	6-24
TV Trigger	
Mode	6-27
Standard Select Key	6-28
Source Select Key	6-28
level/polarity Key	6-28
field Key	6-28
line Key	6-28
holdoff Key	6-29
TV Trigger Exercise	6-29
Instrument Setup	6-29
Oscilloscope Setup	6-29
Glitch Trigger	
Mode	6-33
source--state Key	6-33
level Key	6-33
when present Key	6-34
width Key	6-34
Holdoff Key	6-34
Glitch Trigger Exercise	6-34
Instrument Setup	6-34
Oscilloscope Setup	6-34

Chapter 7

Display Menu

Introduction to the Display	7-1
Repetitive Acquisition Display Menu	7-2
Display Mode Key	7-2
norm	7-3
avg	7-4
env	7-4
# of screens Key	7-4
off/frame/ axes/grid Key	7-6
connect dots Key	7-6
Realtime Acquisition Display Menu (seq off)	7-8
persistence Key	7-8
# of screens Key	7-8

off/frame/ axes/grid Key	7-9
connect dots Key	7-9
Realtime Acquisition Display Menu (seq on)	7-10
Display Mode Key	7-11
norm	7-11
avg	7-12
env	7-12
source Key	7-12
# of screens Key	7-12
off/frame/ axes/grid Key	7-12
connect dots Key	7-13
more exclude/include Key	7-13
exclude/include Key	7-13
from seg # Key	7-14
to seg # Key	7-14
enter changes Key	7-14
execute all changes Key	7-14
more Key	7-14
Sequential Single-Shot Display Exercise	7-15

Chapter 8

Marker Menu

Introduction to the Markers	8-1
off on Key	8-2
source x1,y1 Key	8-2
x1 position Key	8-2
y1 position Key	8-3
source x2,y2 Key	8-3
x2 position Key	8-3
y2 position Key	8-3

Chapter 9

Waveform Math Menu

Introduction to the Functions	9-1
Defining a Function	9-3
Function Key	9-3
display Key	9-3
operand (chan/mem) Key	9-4
Operator Key	9-4
chan/mem Key	9-5
sensitivity Key	9-5

offset Key	9-5
FFT Keys	9-6
peak search Key	9-6
search level Key	9-6
more Key	9-6
horiz magnify Key	9-7
freq span Key	9-7
center freq Key	9-7
# of points Key	9-8
sensitivity Key	9-9
offset Key	9-9
window Key	9-9
more Key	9-10
Vertical Scaling Units	9-10
Making FFT Measurements	9-10
Connect the Dots	9-10
Amplitude Measurements	9-10
Frequency Measurements	9-11
Computation of dBm	9-11
Computation of dBV	9-12
DC Value	9-12
Aliasing	9-12
Presetting FFT Parameters	9-13
Displaying Functions	9-14
Waveform Math Exercise	9-15
Instrument Setup	9-15
Oscilloscope Setup	9-16
Waveform Math FFT Exercise	9-17
Instrument Setup	9-17
Oscilloscope Setup	9-17
FFT Windows	9-19
Making Peak Measurements	9-20
Storing an FFT	9-22

Chapter 10

Waveform Save Menu

Introduction to the Memories	10-1
waveform/pixel/multiple/mask Key	10-2
waveform Menu	10-2
nonvolatile Key	10-2
display Key	10-2

source Key	10-3
store Key	10-3
protect Key	10-3
timebase/delay Key	10-3
pixel Menu	10-3
volatile Key	10-3
display Key	10-4
clear memory Key	10-4
add to memory Key	10-4
multiple Menu	10-4
nonvolatile Key	10-5
saved source Key	10-5
failure # Key	10-5
view failures Key	10-5
store failure Key	10-5
protect Key	10-5
mask Menu	10-6
main mask Menu	10-6
reference wfm Key	10-6
automask Key	10-7
mask editor Key	10-7
Automask Menu	10-7
automask Key	10-7
copy scaling Key	10-8
source-memory Key	10-8
tolerance units Key	10-8
horiz-vert Key	10-8
main mask menu Key	10-9
Mask Editor Menu	10-10
mark point Key	10-10
connect points Key	10-10
clear points Key	10-11
limit mask Key	10-11
horiz-vert Key	10-11
clear mask Key	10-11
main mask menu Key	10-11
Waveform Save Exercise	10-12
Mask Exercise	10-13

Chapter 11

Define Measure Menu

Introduction to Measurements	11-1
Measurement Selection	11-2
measure/define/limit/compare Key	11-3
meas Submenu	11-3
continuous Key	11-3
statistics Key	11-3
rms Key	11-3
Measure Define Sub-menu	11-4
standard/user defined Key	11-4
thresholds/ measurements Key	11-4
Measure Limit Submenu	11-7
test Key	11-7
set Key	11-8
fail if > Key	11-8
or if < Key	11-8
on fail, save Key	11-8
after fail Key	11-9
Compare Submenu	11-10
test key	11-10
compare Key	11-11
to Key	11-12
allowance Key	11-12
on fail, save Key	11-12
after fail Key	11-14

Chapter 12

Utility Menu

Introduction to the Utilities	12-1
HP-IB menu	12-2
talk only mode	12-2
addressed mode	12-2
form feed Key	12-3
paper length Key	12-3
device mode Key	12-3
exit menu Key	12-3
Selftest Menu	12-4
ram Test	12-6

rom Test	12-6
acquisition Test	12-6
Miscellaneous Test	12-6
loop Test	12-6
start test Key	12-6
test all Key	12-6
exit menu Key	12-6
Probe CAL Menu	12-7
attenuation submenu	12-8
channel Key	12-8
start cal Key	12-8
continue Key	12-8
channel impedance Key	12-8
abort Key	12-8
exit menu Key	12-8
max test voltage Key	12-9
time null submenu	12-9
channel Key	12-9
time Key	12-9
Self Cal menu	12-10
cal select Key	12-10
channel Key	12-11
start cal Key	12-11
continue Key	12-11
print cals Key	12-11
abort Key	12-11
exit menu Key	12-11
Service menu	12-12
System menu	12-13
date submenu	12-14
set date Key	12-14
year Key	12-14
month Key	12-14
day Key	12-14
exit menu Key	12-14
time submenu	12-15
set time Key	12-15
hour Key	12-15
minute Key	12-15
second Key	12-15
exit menu Key	12-15

clicker Key	12-16
AC BNC Key	12-16
registration form (print) Key	12-16
interpolation Key	12-16
exit menu Key	12-16
Calibration Procedure	12-16

Appendix A

Algorithms

Measurement Setup	A-1
Making Measurements	A-1
Standard Measurements	A-2
User defined Measurements	A-2
Automatic Top-Base	A-2
Edge Definition	A-3
Algorithm Definitions	A-3
delay	A-3
+ width	A-4
- width	A-5
Period	A-5
Frequency	A-5
Duty Cycle	A-5
Rise time	A-5
Falltime	A-5
Vmax	A-5
Vmin	A-5
Vp-p	A-5
Vtop	A-6
Vbase	A-6
Vamp	A-6
Vavg	A-6
Vrms	A-6
Integrate	A-6
Differentiate	A-6

Appendix B

General Information

Instrument Description	B-1
Accessories Supplied	B-1
Accessories Available	B-2
Options Available	B-2

Performance Specifications	B-3
Vertical	B-3
Horizontal	B-3
Trigger	B-3
Performance Characteristics	B-4
Vertical	B-4
Horizontal	B-6
Trigger	B-6
Operating Characteristics	B-6
Vertical	B-6
Horizontal	B-8
Trigger Modes	B-8
Delayed Trigger	B-9
TV Trigger	B-10
Glitch Trigger	B-11
Display	B-11
Display Modes	B-11
Markers	B-12
Waveform Math	B-12
Waveform Save	B-13
User-definable Measurement Thresholds	B-14
Setup Aids	B-15
Hardcopy	B-15
Full HP-IB Programmability	B-15
Product Support	B-17
General Characteristics	B-18
Environmental Conditions	B-18
Product Regulations	B-19
Power Requirements	B-20
Weight	B-20
Dimensions	B-20

Fast Fourier Transforms	B-21
Peak Search	B-21
Channels or Memories	B-21
Variable Sensitivity and Offset	B-21
Selectable Time Record Length	B-21
Horizontal Magnification and Center Frequency Control	B-21
Selectable Windows	B-22
FFT Operating Characteristics	B-22
Spectrum Displays	B-24
Log Display	B-24
Programmability	B-24

Introduction

The HP 54505B, HP 54506B, HP 54510B, and HP 54512B Digitizing Oscilloscopes are general-purpose repetitive and real-time oscilloscopes, fully programmable and transportable. The HP 54505B and HP 54510B have two input channels and an external trigger input, while the HP 54506B and HP 54512B have four input channels. Full HP-IB programmability is incorporated for use in a broad range of HP-IB applications, from high-speed ATE to device characterization in research and development environments. Both models also feature powerful triggering, easy waveform storage, automatic measurements, and instant hardcopy output.

Both the oscilloscopes feature an easy-to-use human interface, yet each has many sophisticated capabilities and multiple triggering functions. Waveforms are easily stored for future reference, waveform measurements are automatic, and instant hardcopy is available when the oscilloscope is used with an HP-IB compatible printer or plotter.

Some of the key features of the HP 54505B, HP 54506B, HP 54510B, and HP 54512B are listed here (features apply to all models unless otherwise specified). See Appendix B for a complete listing of specifications and characteristics.

- Bandwidth – dc to 125 MHz (realtime HP 54505B/54506B)
dc to 250 MHz (realtime HP 54510B/54512B)
dc to 300 MHz (repetitive all models)
- Maximum Sample Rate – 500 MSa/s (HP 54505B/54506B)
1 GSa/s (HP 54510B/54512B)
- Memory Depth per Channel – 8 K

- 8 bits Vertical Resolution
- Two-channel (HP 54505B/54510B) or four-channel (HP 54506B/54512B) Input and Display
- External Trigger Input (HP 54505B/54510B)

- Advanced Logic Triggering
- TV Trigger (including user-defined)
- Glitch Trigger
- Pre and Posttrigger Viewing

- Autoscale for Automatic Setup
- Automatic Measurements (User-defined and Statistical)
- Hardcopy Output

- Measurement Limit Test
- Waveform Comparison Test
- Waveform Math (+, -, x, vs, invert, magnify)
- Waveform Calculus (integrate, differentiate, and fast Fourier transform)
- Automatic Mask Generation
- Mask Editor

- Postacquisition Pan and Zoom
- Nine Nonvolatile Setup Memories
- Four Nonvolatile Waveform Memories

- 665 Volatile Multiple Test Failure Memories
- Two Volatile Pixel Memories
- Full HP-IB Programmability
- Segmentable Memory over Front Panel and HP-IB
- Up to 670 (500 point) waveforms per second
- Time/date Stamp on Hard Copy
- Time/date Stamp on Test Failure Multiple Memories

Introduction

This chapter contains information for unpacking, applying power, and connecting optional accessories to the oscilloscope. Inspection, power requirements, and instructions for running the oscilloscope's self-test for performance verification are also included in this chapter.

For safe and trouble-free operation, follow the instructions and advisories in this chapter. Read the Safety Summary included in this manual.

Initial Inspection

Inspect the shipping container for damage. If the shipping container or cushioning material is damaged, keep it until the contents of the shipment have been checked. Check the shipment for completeness and check the instrument electrically and mechanically.

If the contents are incomplete, there is mechanical damage or defect, or if the instrument does not pass the selftest performance verification, notify the nearest Hewlett-Packard Office. Keep the shipping materials for carrier's inspection. The Hewlett-Packard Office will arrange for repair or replacement at HP's option without waiting for claim settlement.

Contents of Shipment The following items are shipped with the Digitizing Oscilloscopes:

- Two (HP 54505B/54510B) or four (HP /54506B/54512B) HP 10441A Probes
- Probe to BNC Adapter, 1250-1454
- *HP 54500 Digitizing Oscilloscopes Getting Started Guide*
- *HP 54505B/54506B/54510B/54512B Front-Panel Reference*
- *HP 54505B/54506B/54510B/54512B Programming Reference*
- *HP 54505B/54506B/54510B/54512B Service Manual*
- *Feeling Comfortable with Digitizing Oscilloscopes*
- *Oscilloscope Probes and Accessories*

Available Accessories The following optional accessories are available for use with the Digitizing Oscilloscopes:

- Carrying Case, HP Part Number 1540-1066
- Rack Mount Kit, HP Part Number 5061-6175
- HP 1180A Testmobile
- HP 1133A TV/Video Sync Pod
- HP 1141A Differential Probe
- HP 1137A High-Voltage Probe
- HP 10024A Integrated Circuit 16-pin Test Clip
- HP 10211A Integrated Circuit 24-pin Test Clip
- PC Board Horizontal Mini-Probe Socket, HP Part Number 1250-1737
- PC Board Vertical Mini-Probe Socket, HP Part Number 1250-1918

Operating Environment

The oscilloscope is operated in a normal lab or bench environment without any additional considerations. Note the non-condensing humidity limitation in the list of characteristics supplied in this manual. Condensation in the instrument cabinet can cause poor operation or malfunction. Protection should be provided against temperature extremes which cause condensation.

Storage and Shipping The oscilloscope may be stored or shipped in environments with the following limitations:

- Temperature: -40° C to +75° C (-40° F to + 158° F)
- Humidity: Up to 90% at 65° C (149° F)
- Altitude: Up to 15,300 meters (50,000 feet)

If the oscilloscope is being shipped to a Hewlett-Packard Service Center for service or repair, attach a tag to the instrument identifying owner, address of owner, complete instrument model number and serial number and a description of required service.

If the original packaging material is no longer available, identical packing material is available through local Hewlett-Packard offices. Mark the container FRAGILE to ensure careful handling. In any correspondence, refer to the instrument by the model and serial number.

Rear Panel

The rear panel of the oscilloscope contains the power input, voltage selector module, external connectors, intensity adjustment, and calibrator protection switches as shown in figure 2-1.

Power Requirements The oscilloscope requires a power source of either 115 or 230 Volts ac, - 25% to + 15%; single phase, 48 to 66 Hz; 200 Watts maximum power.

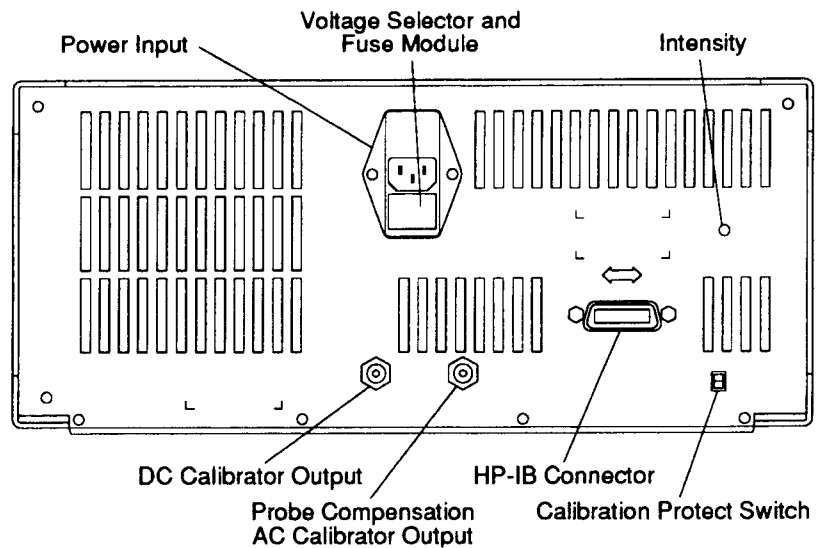

Figure 2-1. Oscilloscope Rear Panel

Selecting Line Voltage The fuse module is set at Hewlett-Packard to the line voltage used in the country of destination. Check the setting of the fuse module to verify it is in the correct position for the voltage to be used. If the setting needs to be changed, use the following procedure.

CAUTION

BEFORE APPLYING POWER TO THE INSTRUMENT, BE SURE THE FUSE MODULE IS SET TO THE CORRECT LINE VOLTAGE POSITION. Severe damage will occur if the line voltage is not properly set.

Change the fuse module position by pulling the fuse module out and reinserting it with the appropriate arrows aligned.

- Carefully pry at the top center of the module as shown in figure 2-2, until it can be grasped and pulled out.

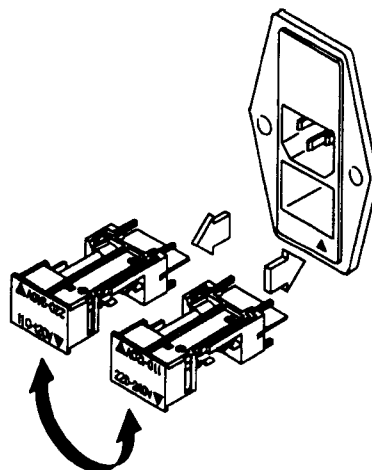

Figure 2-2. Selecting Line Voltage

Verifying the Fuse If it is necessary to check or change fuses, remove the fuse module and look at each fuse for its amperage and voltage ratings.

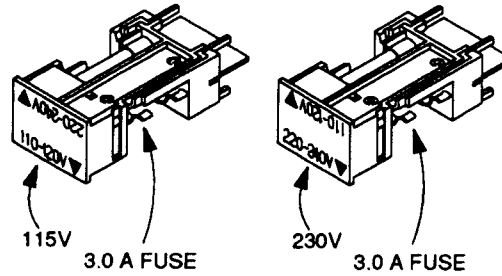







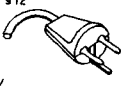

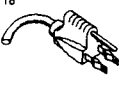

Figure 2-3. Checking for the Correct Fuse

WARNING

SHOCK HAZARD!
BEFORE CONNECTING THIS INSTRUMENT TO MAINS POWER OR LIVE MEASURING CIRCUITS, the protective earth terminal of the instrument must be connected to the protective conductor of the (Mains) power cord. The Mains plug must be inserted in a socket outlet provided with a protective earth contact. The protective action must not be negated by the use of an extension cord (power cable) without a protective conductor (grounding). Grounding one conductor of a two-conductor outlet does not provide an instrument ground.

Power Cord The HP 54505B, HP 54506B, HP 54510B, and HP 54512B are Safety Class 1 instruments with an exposed chassis that is directly connected to earth via the power supply cord to meet IEC Standard 348. These instruments are provided with a three-wire power cable. When connected to an appropriate ac power outlet, this cable grounds the instrument cabinet. The type of power cable plug shipped depends on the country of destination. See figure 2-4 for available power cords.

PLUG TYPE	CABLE PART NO.	PLUG DESCRIPTION	LENGTH IN/CM	COLOR	COUNTRY
OPT 900  250V	812D-1351 812D-1703	Straight +BS1363A 90°	90/228 90/228	Gray Mint Gray	United Kingdom, Cyprus, Nigeria, Zimbabwe, Singapore
OPT 901  250V	812D-1369 812D-0696	Straight +NZSS198/ABC 90°	79/200 87/221	Gray Mint Gray	Australia New Zealand
OPT 902  250V	812D-1689 812D-1692 812D-2857	Straight +CEE7-Y11 90° Straight (Shielded)	79/200 79/200 79/200	Mint Gray Mint Gray Coco Brown	East and West Europe, Saudi Arabia, So. Africa, India (Unpolarized in many nations)
OPT 903**  125V	812D-1378 812D-1521 812D-1992	Straight +NEMA5-15P 90° Straight (Medical) UL544	90/228 90/228 96/244	Jade Gray Jade Gray Black	United States, Canada, Mexico, Philippines, Taiwan
OPT 904**  250V	812D-0698	Straight +NEMA8-15P	90/228	Black	United States, Canada
OPT 905  250V	812D-1396 812D-1625	CEE22-V1 (System Cabinet Use) 250V	30/76 96/244	Jade Gray	For interconnecting system components and peripherals. United States and Canada only
OPT 906  250V	812D-2104 812D-2296	Straight +SEV1011 1959-24507 Type 12 90°	79/200 79/200	Mint Gray Mint Gray	Switzerland
OPT 912  220V	812D-2956 812D-2957	Straight +DHCK107 90°	79/200 79/200	Mint Gray Mint Gray	Denmark
OPT 917  250V	812D-4211 812D-4600	Straight SABS164 90°	79/200 79/200	Jade Gray	Republic of South Africa India
OPT 918  100V	812D-4753 812D-4754	Straight Miti 90°	90/230 90/230	Dark Gray	Japan

Rev. 1/NOV88

ART00018

*Part number shown for plug is industry identifier for plug only. Number shown for cable is HP part number for complete cable including plug.

**These cords are included in the CSA certification approval of the equipment.

E=Earth Ground

L=Line

N=Neutral

Figure 2-4. Available Power Cords

Intensity Control Once the oscilloscope has been turned on, the display intensity can be adjusted, if necessary. The intensity is adjusted with the Display Intensity control on the rear panel.

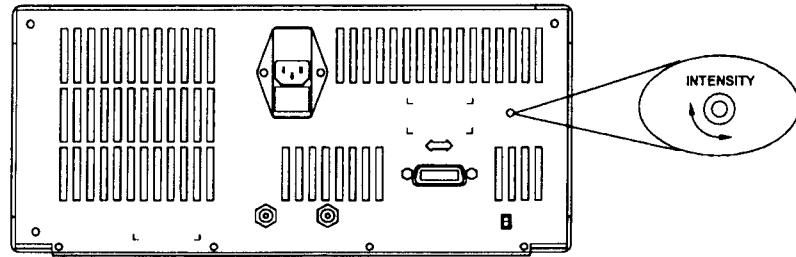

Figure 2-5. Intensity Control

Air Flow Requirements The oscilloscope must have unrestricted air flow for the fan and ventilation openings in the rear panel. The oscilloscope may be stacked under, over, or between other instruments provided the other instruments are adequately cooled.

Connecting External Equipment

The oscilloscope is equipped with an HP-IB connector on the rear panel. This allows a direct connection to an HP-IB compatible printer, plotter, or external controller.

Connect an HP-IB cable to the oscilloscope and any HP-IB compatible device. Tighten the HP-IB cable with the captive screws of the cable to avoid disconnecting the cable.

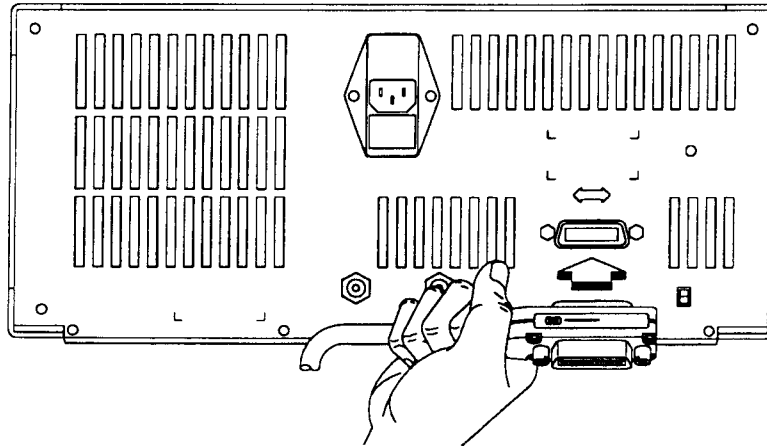

Figure 2-6. Connecting External Equipment

The oscilloscope must be properly addressed to communicate with the connected device. The oscilloscope's HP-IB address is set in the HP-IB submenu. See "HP-IB Menu" in Chapter 12 for detailed information.

Introduction to the Front Panel

This chapter describes the functional sections of the oscilloscope front panel. The explanation of each area also contains their interaction with each other and provide a basis for applications and usages.

The front panel is separated into nine functional areas.

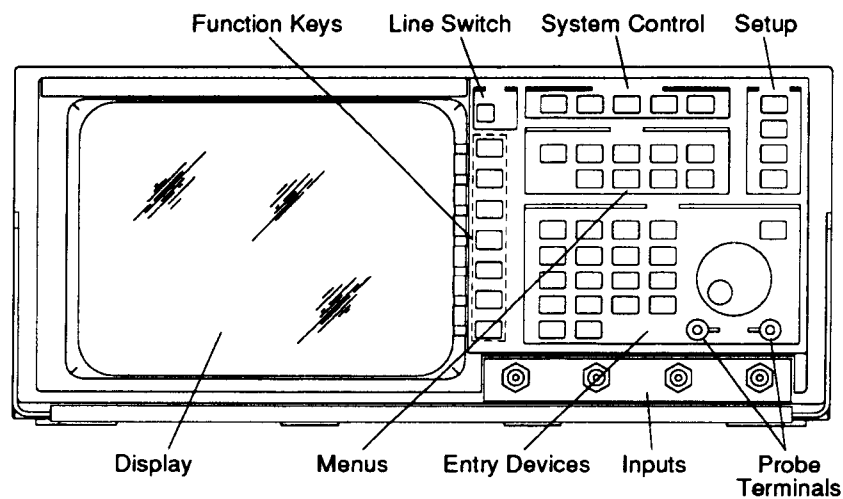

Figure 3-1. Oscilloscope Front Panel

System Control

The SYSTEM CONTROL keys are located along the top of the oscilloscope to the right of the display. This section controls the following functions:

- Controlling display and acquisition
- Selecting local control
- Activating hardcopy

Selection of any key in the SYSTEM CONTROL section causes the oscilloscope to execute that command immediately.

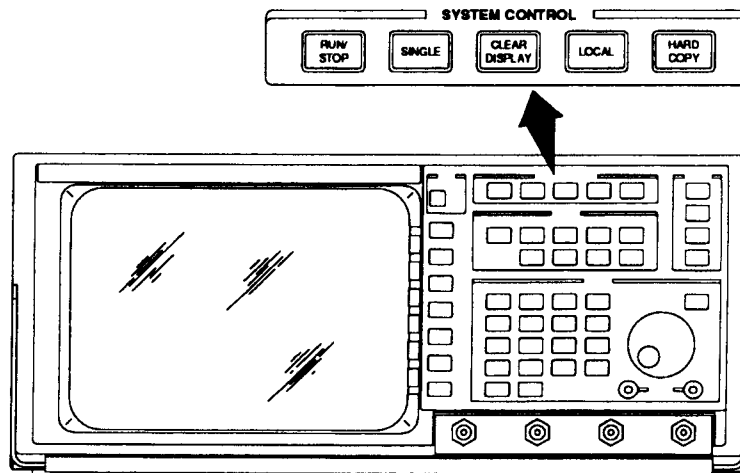

Figure 3-2. System Control Section

RUN/STOP Key The RUN/STOP key toggles the acquisition status of the oscilloscope. If the oscilloscope is currently running (the current status is displayed in the top left corner of the display in the message field), the instrument is placed in the *stopped* mode. In this mode, normal acquisition is stopped and the last acquired data is displayed. If the oscilloscope is stopped, it is immediately changed to another mode (for example, *running*, awaiting trigger, or auto-triggering).

SINGLE Key The SINGLE key activates the acquisition system for one trigger event. One acquisition is made and displayed; then the data acquisition and display cycle is stopped. In repetitive mode, this single acquisition is superimposed on the current displayed data. If the display has been cleared before the SINGLE key is pressed, only one acquisition is displayed.

CLEAR DISPLAY Key The CLEAR DISPLAY key clears the display and resets all associated measurements. If the oscilloscope is in the stopped mode, all data that is currently displayed is erased. If the oscilloscope is *running*, all data is erased; however, new data is displayed on the next acquisition. The RUN/STOP and SINGLE keys are not affected.

The RUN/STOP, SINGLE, and CLEAR DISPLAY keys have a relationship that make it possible to manipulate data acquisitions and view one, two, or several acquisitions. It is possible to stop acquiring data, to clear the display, and to capture one acquisition for evaluation.

LOCAL Key The LOCAL key sends a return to local control message to the HP-IB interface and returns control to the front panel. This key can be locked out if a local lockout command is executed over the HP-IB.

This is the only front-panel key that remains active while the oscilloscope is in remote operation, if it has not been locked out.

HARDCOPY Key The HARDCOPY key executes an immediate hardcopy of the currently displayed data on a compatible plotter or graphics printer and stops all other oscilloscope functions while printing.

The oscilloscope must be in the talk only mode, and the hardcopy device must be in the listen always mode. Setup of the hardcopy options is accessed in the HP-IB submenu (see Chapter 12, "Utilities Menu").

Selection of any key aborts the hardcopy action.

Setup

The SETUP section controls the following display information:

- AUTOSCALE for automatic scaling of the waveform display area
- SAVE and RECALL setups
- Quick access to channel, function, and trigger information on the SHOW screen

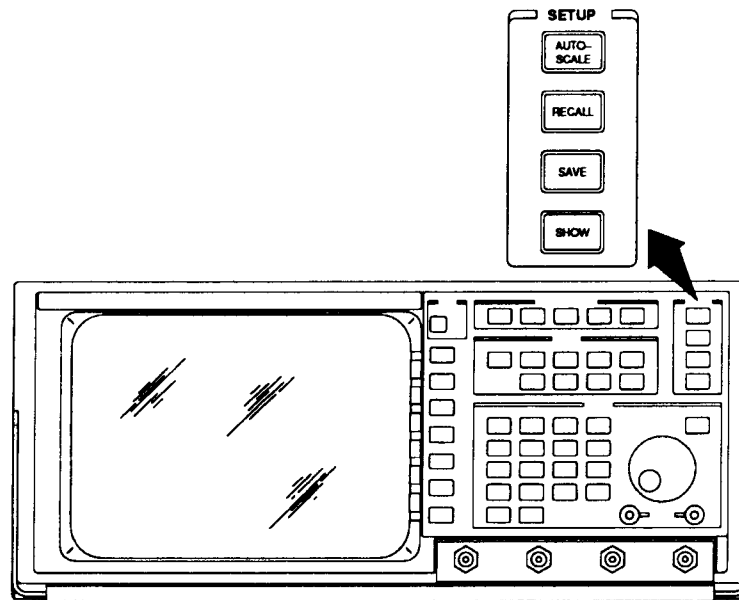

Figure 3-3. Setup Section

AUTOSCALE Key This key causes the oscilloscope to evaluate all input signals and set the correct conditions to display the signals. When AUTOSCALE is pressed the following conditions are set:

- Vertical sensitivity on all channels (if applicable)
- Vertical offset on all channels (if applicable)
- Trigger edge mode, positive slope, and proper trigger level for the trigger source
- Sets to minimum persistence when in normal display and repetitive acquisition modes (single persistence in real time acquisition mode)
- Time base delay to 0.0 seconds
- Time base reference to center
- Time per division

Autoscale also includes a soft reset which performs the following:

- Turns off $\Delta t/\Delta V$ (y/x) markers
- Turns off all measurements
- Turns off measurement limit test
- Turns off waveform compare test
- Turns off sequential single shot
- Turns off waveform math functions
- Turns off waveform/pixel/multiple memory display
- Turns off statistics
- Turns off connect-the-dots
- Sets holdoff to 40 ns (minimum value)

The previous oscilloscope settings are stored in volatile memory RECALL 0. To undo the autoscale function, press RECALL 0.

RECALL Key The RECALL key has three primary functions:

- Pressing the RECALL key and then selecting 1 through 9 causes a recall of a previously saved setup configuration.
- Pressing RECALL 0 will recall the configuration the oscilloscope was set at before an autoscale, recall, or setting up ECL/TTL preset. The current configuration is automatically saved in memory 0 before any of these actions.

- Pressing **RECALL CLEAR** resets the instrument and returns the oscilloscope to default/power-up settings shown in table 3-1.

SAVE Key The **SAVE** key immediately stores the oscilloscope setup configuration in nonvolatile memory. Press **SAVE**, and then select a save register: 1 through 9. An advisory is displayed above the waveform display area indicating the setup configuration has been saved. Note that register 0 is not available, as the oscilloscope uses this register to store the current configuration before executing an autoscale, recall, or **ECL/TTL** preset.

SHOW Key The **SHOW** key accesses the following information:

- Channel scaling
- Channel offset
- Channel coupling
- Channel impedance
- Probe attenuation
- Trigger mode
- Trigger source
- Trigger level
- Math function operation
- Math function scaling
- Math function offset
- Memories

Pressing the **SHOW** key toggles between the currently selected menu and the **SHOW** screen.

Menus

The MENU section consists of nine keys:

- TIME BASE
- CHAN
- TRIG
- DISPLAY
- $\Delta t/\Delta V$ (y/x)
- WFORM MATH
- WFORM SAVE
- DEFINE MEAS
- UTIL

Each of these menus is discussed in the following chapters.

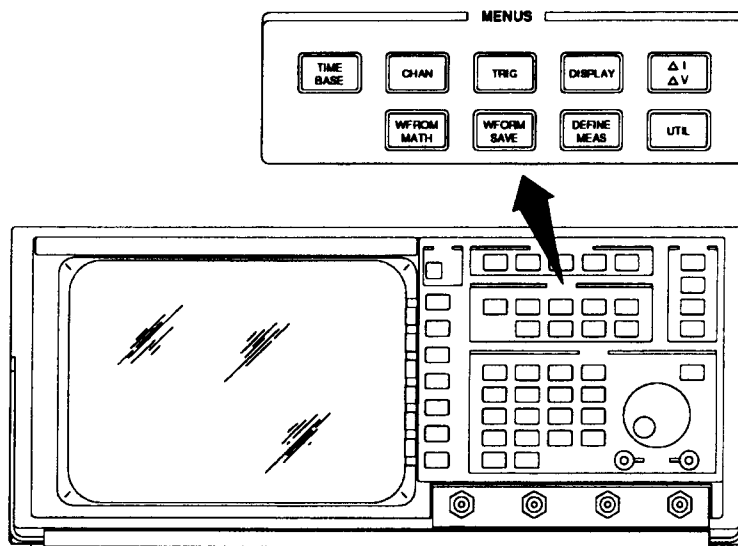

Figure 3-4. Menu Section

Entry Devices

The ENTRY device section contains a multifunction numeric keypad, a selection knob, and FINE key.

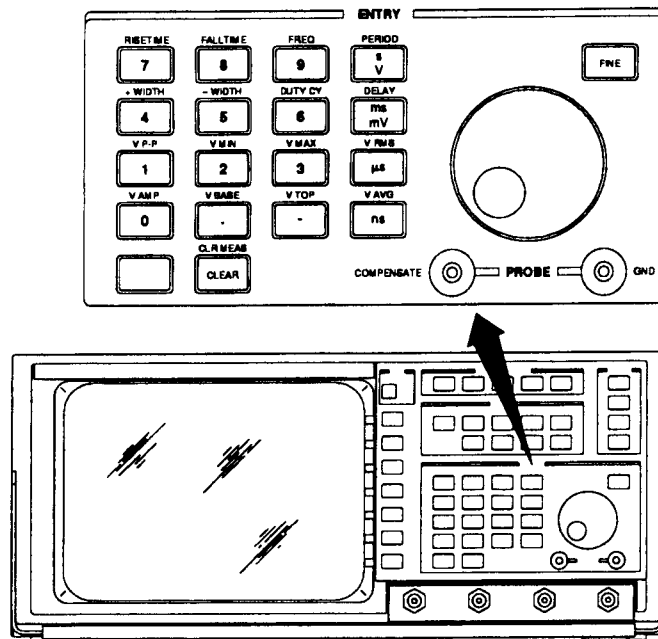

Figure 3-5. Entry Section

Numeric Keypad

The keypad is for direct numeric input. To input known values directly, press the associated softkey to activate the desired field on screen, and then select the units with the numeric keys. For example, do the following steps to set the vertical sensitivity to 500 mV:

- Select **V/div** in the Channel menu to ensure it is the active field (displayed in full-bright)
- Press 5, 0, 0, mV in sequence.

The blue key on the numeric keypad selects the alternate function when pressed before a numeric key on the front-panel keypad. The alternate function of the keys on the top (blue text) are automatic measurement functions. The CLEAR key clears any selections made for the active field.

Knob The knob changes values within each function. It increments, decrements, or toggles the selection in the active field or function. The current selection is displayed in full-bright in the displayed menu area.

FINE Key The FINE key changes the increment and decrement sequence. Instead of sequencing in the normal sequence, the values increment/decrement in more precise values. Use this feature when the normal sequence is too coarse for precision measurements or settings.

When the oscilloscope is operating in the fine mode, the word *fine* is displayed in the lower right corner of the CRT.

Probe Terminals

Two terminal studs provide a 500 Hz square wave used for probe compensation. Signal is present when *AC BNC probe comp* is selected in the Utility Menu. See Chapter 12, "Utility Menu," for more information.

Input

The input section consists of connectors for signal input. Channel inputs 1 and 2 (HP 54505B/54510B), or 1 through 4 (HP 54506B/54512B) select 1 M Ω or 50 Ω input impedances. Each is shunted by approximately 7 pF at the input BNC with a maximum input voltage of 250 V (> 50 mV/div range). See Appendix B, "General Information," for specifications on the input channels.

Line Switch

The line switch is located on the front panel. Turn on the oscilloscope by pressing the switch in. The green LED illuminates when the oscilloscope is set to on. The push switch position is labeled 1 and 0, corresponding to on and off, respectively.

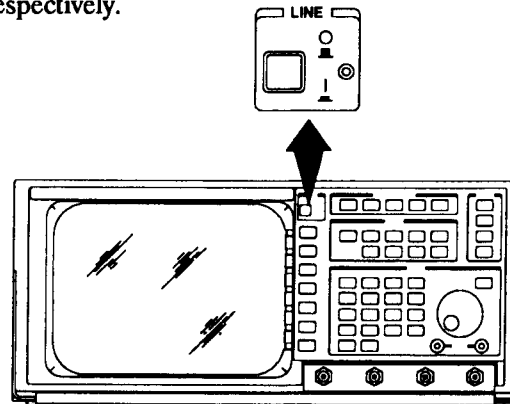

Figure 3-6. Line Switch

Display

The display section contains the screen and function keys.

The vertical column on the right side of the screen is the function display. The functions that are displayed at any one time correspond to a softkey.

- Numeric key fields displayed in full-bright video are changed by either numeric keys on the keypad or the knob. When these functions are not active, they are displayed in half-bright; when displayed in full-bright they are active.
- Non-numeric fields displayed in half-bright video toggle with the corresponding function key. These fields are displayed in half-bright, but are active for the function keys.

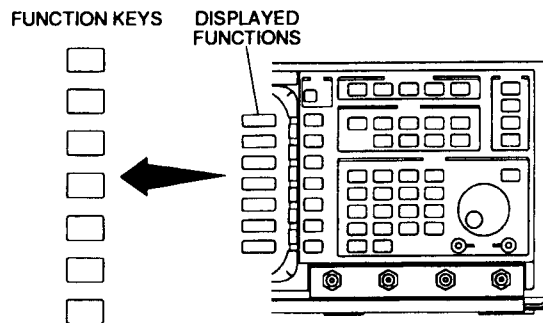

Figure 3-7. Function Keys

Instrument Reset

The oscilloscope has two methods of instrument reset.

- A key-down power up is a hard reset of the oscilloscope. It is done by pressing and holding any front panel key while cycling power. If input signals are not present, the oscilloscope will power-up displaying a baseline in the SHOW screen and set to all default settings (see table 3-1).
- **RECALL CLEAR** performs a soft reset of the oscilloscope. All default conditions are set (see table 3-1). **RECALL CLEAR** is the same as a key-down power-up except the previous menu selections are retained.

Table 3-1. Reset Default Conditions

Timebase Menu	
Time/Div	100 us/div
delay	0.00000 s
reference	cntr
repetitive/realtime	realtime
sequential	off
Channel Menu	
Channel 1	on
Channel 2	off
Channel 3 (HP 54506B and	off
Channel 4 HP 54512B only)	off
Volts/Div	500 mV
offset	0.00000 V
coupling	dc
impedance	1 M ohm
probe attenuation	1.000:1
Trigger Menu	
Trigger	auto
Mode	edge
source	Channel 1
slope	positive
noise reject	off
holdoff	40 ns
Display Menu	
Mode	realtime
persistence	minimum
# of screens	1
off/frame/axes/grid	axes
connect dots	off

Table 3-1. Reset Default Conditions (continued)

$\Delta t/\Delta V$ (y/x) Marker Menu	
markers	off
Waveform Math Menu	
f1	off
f2	off
f3	off
f4	off
chan/mem	chan 1
operator	+
chan/mem	chan 1
function sensitivity	1.00 V/div
function offset	0.0 V
Waveform Save Menu	
waveform/pixel/multiple/mask	waveform
nonvolatile	m1
display	off
source	chan 1
protect	off
Define Meas Menu	
measure/def/limit/compare	measure
continuous	on
statistics	off
rms	ac
Utility Menu (System submenu)	
clicker	on
AC BNC	probe comp
interpolation	on
Utility Menu (HP-IB submenu)	
address/talk*	address
address*	7
*at key-down power up, not changed during Recall Clear	

Introduction to the Timebase

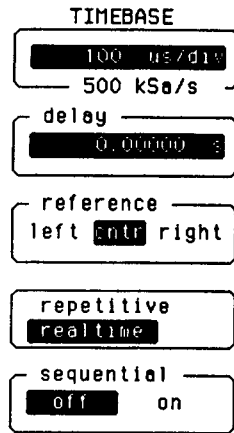

This chapter contains a description of the TIMEBASE menu and how the entire horizontal display and parameters are controlled with this menu.

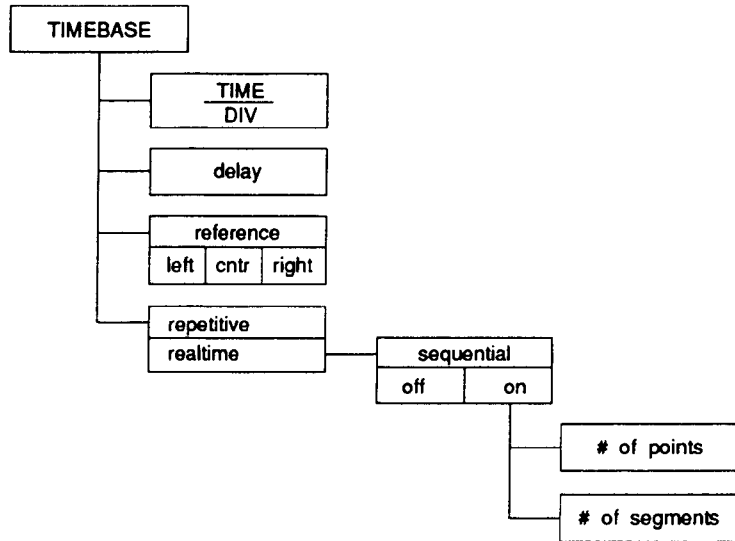

Figure 4-1. Timebase Menu

Time/Div Key

The time/division function controls the time scale on the horizontal axis from 1 ns/div (500MSa/s HP 54505B/54506B or 1 GSa/s HP 54510B/54512B to 5 sec/div (10 Sa/s). The main time base is incremented and decremented in a 1-2-5 sequence. The FINE key does not affect the time base settings while the acquisition is running.

This key affects the sample rate at which the scope acquires data. The sample rate for the selected time/div setting is displayed below the time/div field. In the realtime mode and with the acquisition stopped, this

Acquisitions are not displayed until all data is available (similar to normal acquisitions) to display. The advisory, **running**, is displayed as the write cycle to the screen is executed and displayed data is updated.

For sweep times greater than or equal to 20 ms/div, the advisory **n sec (prestore)** is displayed while pretrigger data is collected and **n sec (poststore)** is displayed while posttrigger data is collected. This message indicates the time needed to complete acquisition where **n** is the remaining time (in seconds, s) and continues to countdown until the time has elapsed. The advisory **running** is displayed after all data is collected and the write cycle to the screen is executed.

The total time acquired and the sample rate are dependent on the time base setting. Listed below are the total acquisition times and the sample rate for each timebase setting in realtime mode.

TIMEBASE	TOTAL TIME ACQUIRED (real time)	SAMPLE RATE
1 ns — 50 ns/div	8 us	500MSa/s (HP 54505B/54506B)
1 ns — 50 ns/div	8 us	1GSa/s (HP 54510B/54512B)
100 ns/div	16 us	500 MSa/s
200 ns/div	32 us	250 MSa/s
500 ns/div	80 us	100 MSa/s
1 us/div	160 us	50 MSa/s
2 us/div	320 us	25 MSa/s
5 us/div	800 us	10 MSa/s
10 us/div	1.6 ms	5 MSa/s
20 us/div	3.2 ms	2.5 MSa/s
50 us/div	8 ms	1 MSa/s
100 us/div	16 ms	500 kSa/s
200 us/div	32 ms	250 kSa/s
500 us/div	80 ms	100 kSa/s
1 ms/div	160 ms	50 kSa/s
2 ms/div	320 ms	25 kSa/s
5 ms/div	800 ms	10 kSa/s
10 ms/div	1.6 s	5 kSa/s
20 ms/div	3.2 s	2.5 kSa/s
50 ms/div	8 s	1 kSa/s
100 ms/div	16 s	500 Sa/s
200 ms/div	32 s	250 Sa/s
500 ms/div	80 s	100 Sa/s
1 s/div	160 s	50 Sa/s
2 s/div	320 s	25 Sa/s
5 s/div	800 s	10 Sa/s

delay Key

Selecting **delay** assigns delay as the active function. When delay is set to 0 the trigger event occurs at the delay reference point. Positive delay indicates time after trigger and negative delay indicates time before trigger. Therefore, a delay setting of -50 ns indicates that the trigger event occurs 50 ns after the delay reference point. In the real-time mode and with the acquisition stopped, delay controls the pan feature (see the pan and zoom exercise in this chapter.)

$$\text{reference} = \text{trigger event} + \text{delay}$$

reference Key

The **reference** key changes the delay reference point to one of three reference points:

- left
- cntr (center)
- right

If delay is set to 0 and reference to center, the reference point consists of pretrigger data to the left and posttrigger data to the right.

NOTE

The time from trigger changes with the delay setting and is displayed at the bottom of the waveform area at the left, center, and right of the display.

repetitive/ realtime Key

The **repetitive/realtime** key selects one of the two acquisition modes used by the oscilloscope:

- repetitive acquisition
- realtime acquisition

See Chapter 7, "Display Menu," for more on acquisition modes.

repetitive mode The repetitive mode sets the oscilloscope to acquire data in the repetitive acquisition mode (see *Feeling Comfortable With Digitizing Oscilloscopes*). In this mode, the oscilloscope samples and displays data continuously; this mode is useful when viewing a continuous waveform.

In the repetitive mode:

- The oscilloscope displays data collected from multiple acquisitions from either or both channel inputs.
- Data from defineable multiple acquisitions can be averaged to generate a display (when the **avg** key in the Display Menu is activated when in the *repetitive avg* mode).
- Data from each acquisition can be displayed for a definable period of time (persistence in the Display Menu in the *repetitive normal* mode).
- Waveform records are established at 501 data points on all time/division settings.

realtime mode When in realtime mode the oscilloscope displays data collected during successive single-shot acquisitions from any of the input channels. The oscilloscope can make a single-shot capture simultaneously on all channels. This allows simultaneous, nonrecurring, or very low repetition rate events to be captured at the same time.

Note

When realtime is selected, the *sequential* key is displayed in the off position. See *sequential single-shot* later in this chapter for more information.

In realtime mode when the oscilloscope is stopped, some or all of the 8K waveform buffer memories (each channel has its own 8K buffer) can be displayed. The displayed signal is completely updated as each acquisition is made.

The following graphics are shown at the top of the display area and in figure 4-2:

- memory bar - represents the displayed portion of the waveform record
- memory bar display line - represents the entire 8K waveform record
- "T" - indicates the trigger point's location within the 8K waveform record.

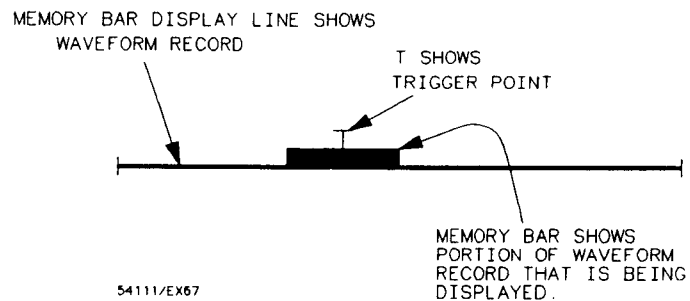

Figure 4-2. Display Memory Bar

Sequential Single-shot

Sequential Single-shot allows the user to define the acquisitions to be captured and stored for specific active channels. Once the # of points per acquisition and the # of segments to be captured are defined, the data is captured and processed. Measurements, waveform math functions, and pan and zoom features can all be performed on captured segments. Viewing acquisitions (segment by segment, averaged, or envelope) is performed using the display key. See Chapter 7, "Display Menu," for more information on displaying data.

Total sequential memory is 400k words allocated dynamically, so single channel acquisition can use all 400k words, while 2 channel acquisition is limited to 200k words per channel. Acquired data is not lost when the sequential single-shot mode is exited.

Note

Sequential data is retained unless:

- *another sequential single-shot capture is performed,*
- *failure data is saved to multiple memories,*
- *power is cycled.*

Sequential single-shot is only available when the oscilloscope is in realtime mode. Once realtime is selected, the sequential key is displayed. Note that this key is initially displayed in the off position (sequential single-shot disabled), allowing normal realtime mode operation. When sequential mode is set to on, the following additional keys are displayed:

- # of points
- # of segments

sequential Key Press this key to select the sequential single-shot mode. This mode is only available when the oscilloscope is in realtime mode. Once selected, the screen is cleared and the oscilloscope is placed in the stopped state to allow selection of acquisition parameters (points and segments).

Pressing the RUN key starts data acquisition. While the oscilloscope is acquiring data, the screen displays "running". If the oscilloscope is waiting

for a trigger, "ACQUIRING # XX" is displayed. Once the data has been acquired, messages stating that the data has been captured and processed are displayed. Press the STOP key to abort the acquisition process. See Chapter 7, "Display Menu," for information on displaying acquired data.

of points Key The # of points per acquisition (or segment) are specified (from 4 to 8000) by pressing the key and entering the desired value using the keypad or knob. Note that 501 points are acquired for a normal screen display.

of segments Key The # of segments are specified by pressing the key and entering the desired value using the keypad or knob. Note that the maximum number of available segments are displayed at the bottom of the key. This number is dependent on the # of points and active channels currently selected. Entry is not allowed if all channels are off.

Memory Bar Exercise

This exercise demonstrates the real time acquisition mode memory bar and the ability to display signals that occur before and after the trigger event of the displayed signal. The memory bar shows the portion of the waveform record that is being displayed.

- Connect the oscilloscope rear-panel AC CALIBRATOR signal to channel 1 with a coaxial cable.
- Disconnect any other signals that may be connected to other inputs.
- Press AUTOSCALE and then stop the acquisition with the RUN/STOP key.
- Select **delay** in the TIMEBASE menu.
- Use the entry devices to vary the delay. The memory bar at the top of the display moves with the delay reference changes. The memory bar is shown in figures 4-3, 4-4, and 4-5.

Three different portions of the waveform can be viewed while the acquisition is running as shown in figures 4-3, 4-4, and 4-5. Either left, center, or right can be selected with the delay reference key in the TIMEBASE menu.

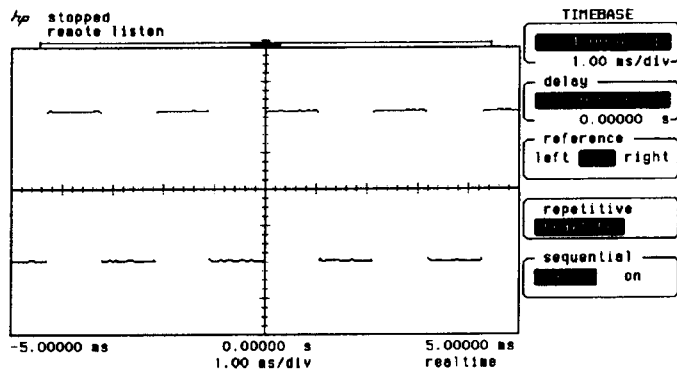

4-3. Memory Bar at Center of Acquisition

When the acquisition is stopped, the display can be placed at any portion of the waveform record by changing the delay value in the TIMEBASE menu.

The delay value moves the 8K acquisition display relative to the trigger point.

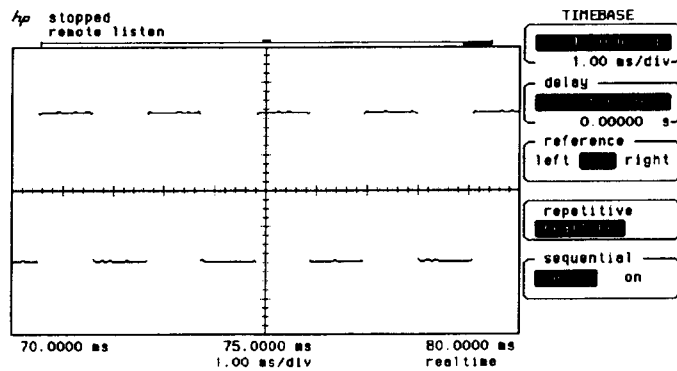

4-4. Memory Bar at Right of Acquisition

As the delay value is changed, the memory bar moves to the right or to the left depending on a positive or negative delay value. Negative delay values show pretrigger events and positive delay values show posttrigger events in the acquisition display.

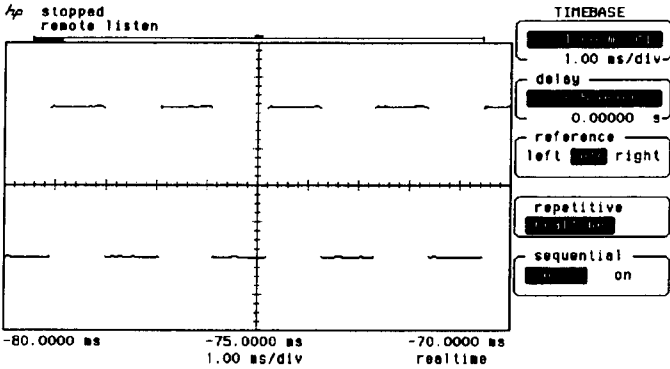

4-5. Memory Bar at Left of Acquisition

Single-shot Exercise

This exercise shows the single-shot capabilities of the oscilloscope. Single-shot, in repetitive display mode, is used to build a waveform while displaying the 500 megasample/second rate (HP 54505B/54506B) or the 1 gigasample/second rate (HP 54510B/54512B). Single-shot, in realtime mode, is used to compare interpolated with non-interpolated data.

The 500MSa/s or 1 GSa/s digitizing rate of the oscilloscope allows capture of very fast nonrecurring events, such as a microprocessor start-up sequence. Error causing glitches that disrupt system performance can be captured for analysis.

Single-shot in Repetitive Mode Single-shot is used to build a waveform while displaying the 500MSa/s or 1 GSa/s sample and digitize rate.

NOTE

The 1GSa/s (HP 54510B/54512B) rate is shown and described in the following example. The 500MSa/s rate (HP 54505B/54506B) will look identical, but requires more acquisitions to build the same waveform.

- Connect the oscilloscope rear-panel AC CALIBRATOR signal to channel 1 with a coaxial cable.
- Disconnect any other signals that may be connected to other inputs.
- Press AUTOSCALE.
- In the TIMEBASE menu, change time base to 10 ns.
- Set the acquisition mode to **repetitive**.
- Press the STOP/RUN key to stop acquisition.
- Press CLEAR DISPLAY key.
- Press the SINGLE and CLEAR DISPLAY keys alternately to display and erase single-shot data.

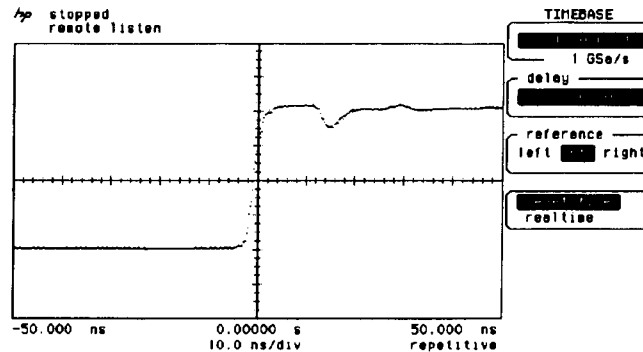

4-6. Single-shot Waveform Built-up in Repetitive Mode

- Press the SINGLE key repeatedly. The waveform fills in with each single-shot addition to the waveform, as in figure 4-6.

When averaging is off:

- Data points on the display are not changed by new data when the SINGLE key is pressed.
- Data stays on screen until the instrument setup is modified or CLEAR is pressed.

When averaging is on:

- Data on screen is averaged with new data each time SINGLE is pressed.
- Assume that enough data points have been acquired to satisfy the number of averages set in the DISPLAY menu.

To view the 500MSa/s or 1 GSa/s digitizing rate:

- Press CLEAR DISPLAY key.
- Press SINGLE key.

The display shows a series of points 1 ns apart as in figure 4-7. This 1 ns separation is defined by the 1 gigasample/second digitizing rate.

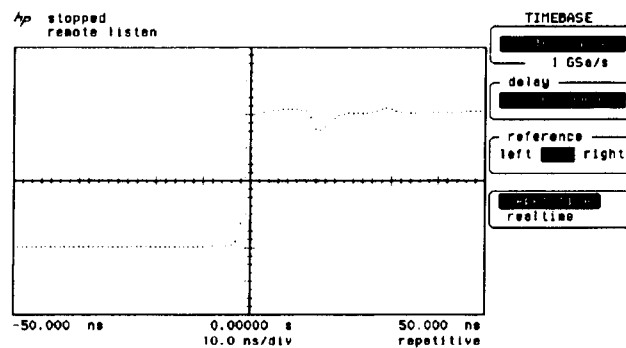

4-7. 1 Gigasample/second Digitizing Rate

NOTE

The HP 54505B/54506B will acquire at 500MSa/s and will show points 2 ns apart.

To observe the limitations of single-shot in the repetitive acquisition mode:

- Select the **TIMEBASE** menu and set time base to 1 ns.
- Press **CLEAR DISPLAY** and then **SINGLE**. Ten data points from the input signal are displayed as in figure 4-8.

NOTE

The HP 54505B/54506B will display 5 data points.

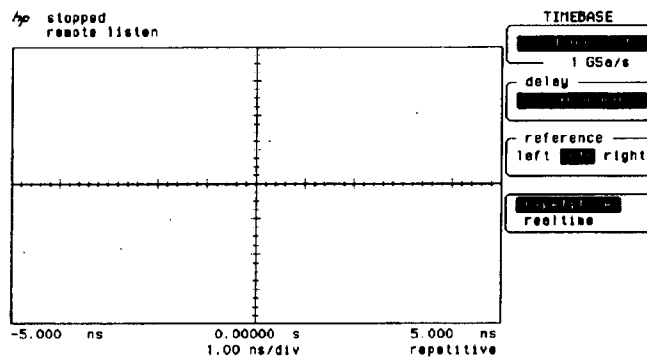

4-8. Ten-point Waveform in Repetitive Mode

Single-shot in Realtime Mode

In the realtime acquisition mode, the data is interpolated at faster time base settings for a more useful display. To observe the difference between non-interpolated and interpolated data:

- Select **realtime** in the **TIMEBASE** menu.
- Press the **CLEAR DISPLAY** key.
- Press the **SINGLE** key. The waveform is displayed as in figure 4-9.

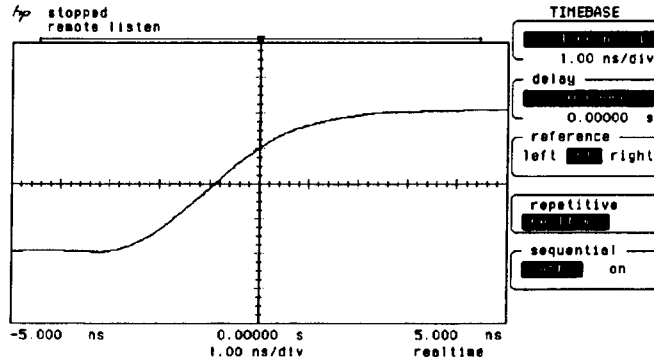

4-9. Ten-point Waveform in Realtime Mode

NOTE

The HP 54505B/54506B is five data points.

In the real time acquisition mode, the oscilloscope uses a digital oversampling filter to provide a more continuous waveform display. It automatically operates when there are less than 501 points on the display.

Sequential Single-Shot Exercise

This exercise shows the sequential single-shot capabilities of the oscilloscope. This mode is used to capture and display ten segments at 501 acquisition points of a signal connected to channel 1.

- Connect the oscilloscope rear-panel AC CALIBRATOR signal to channel 1 with a coaxial cable.
- Disconnect any other signals that may be connected to other inputs.
- Press AUTOSCALE key.
- Press TIME BASE key and select realtime mode.

- Set time base to 10 ns/div.
- Set sequential key to on, set # of points to 501, and # of segments to 10.
- Press RUN/STOP key to capture and process data.
- Press DISPLAY key, and set display to NORM.
- Press segment # key, and turn knob to display all ten segments. Turn knob past ten to view all segments simultaneously.

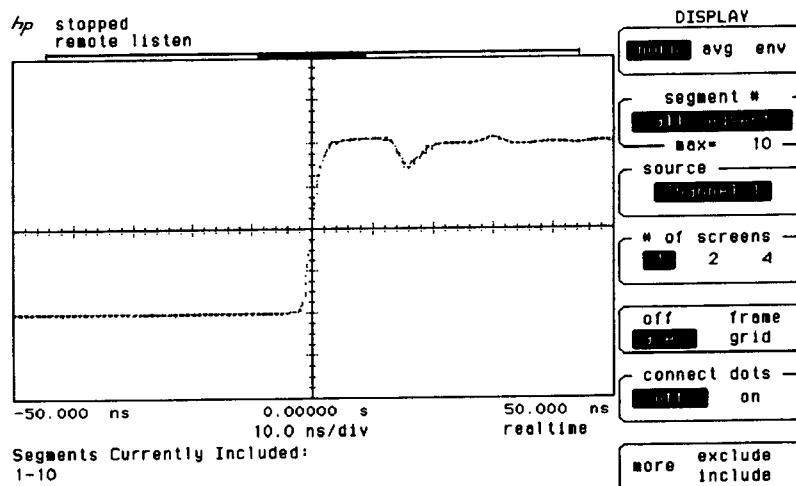

Figure 4-10. Sequential Single-Shot

Pan and Zoom

Pan and zoom features are available in the realtime acquisition mode and operable only when the acquisition is stopped. Applications that require precise evaluation of low repetition rate signals, such as radar and transponder pulse trains, are simplified by zooming and panning on single-shot data.

Zooming either expands or compresses the acquired waveform on the horizontal axis of the display. It is controlled by the time base **time/div** control for expansion, magnification, or compression of a single-shot waveform in the real time acquisition mode. Decreasing **time/div** expands the waveform and is referred to as "zooming in." Increasing **time/div** compresses the waveform and is referred to as "zooming out."

Panning is moving the acquired waveform horizontally on the display. It is controlled by the time base delay control. Increasing the delay moves the waveform to the left and increasing the delay moves the waveform to the right.

Pan and Zoom Exercise

This exercise shows how the time base is used to zoom in on and zoom out of a single-shot waveform. The delay time base is then used to pan the waveform horizontally on the display.

- Using a coaxial cable, connect the rear-panel AC CALIBRATOR signal of the oscilloscope to channel 1.
- Press AUTOSCALE. The rear-panel signal is displayed on screen as in figure 4-11.

Zooming In **TIMEBASE** menu, select **realtime** acquisition mode.

- Press RUN/STOP key to stop the acquisition.
- Press CLEAR DISPLAY key to clear the screen.

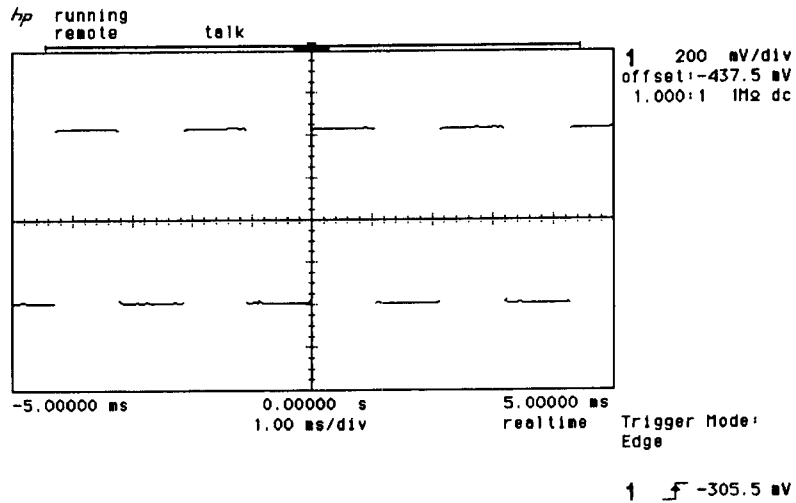

4-11. Rear-Panel Signal Autoscaled

- Press the SINGLE key to acquire one data acquisition.
- Select time/division in the TIMEBASE menu.
- Rotate the front-panel knob. Increasing **time/div** displays more of the acquired waveform on the screen. Decreasing **time/div** zooms in on the acquired waveform.
- Set time base to **20 ms/div**. The entire acquired waveform is displayed as in figure 4-12. The memory bar also shows that the entire memory is on the screen.
- Set time base to **20 us/div** to zoom in on the acquisition as in figure 4-13.

The oscilloscope uses a digital oversampling filter to fill in the waveform for a more usable display at this sampling rate. The memory bar indicates the portion of the acquisition that is displayed.

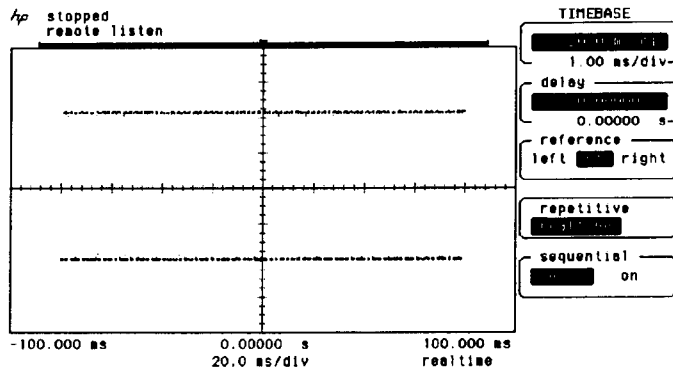

4-12. Zooming In on the Acquisition

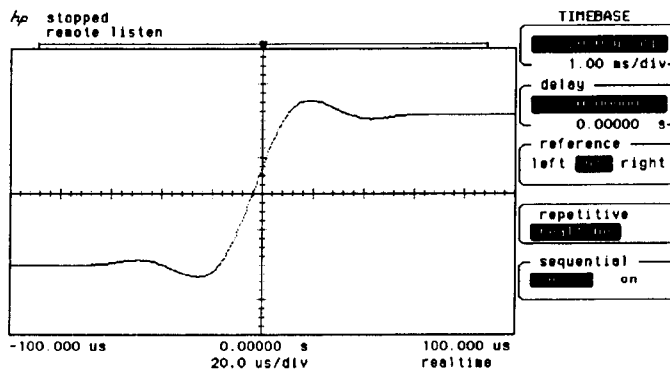

4-13. Zooming In on the Acquisition

Panning Panning moves the acquisition left and right for analyzation of waveforms.

- Select delay in the TIMEBASE menu.
- Use the front-panel knob to increase and decrease delay.

As delay is increased, the acquisition pans to the left because the window is past the trigger point, as in figure 4-14.

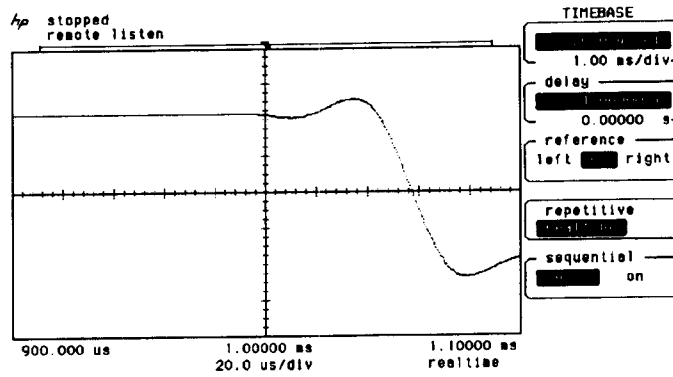

4-14. Panning to the Left

When the delay is decreased the waveform pans to the right as in figure 4-15. The data before the trigger point is being displayed.

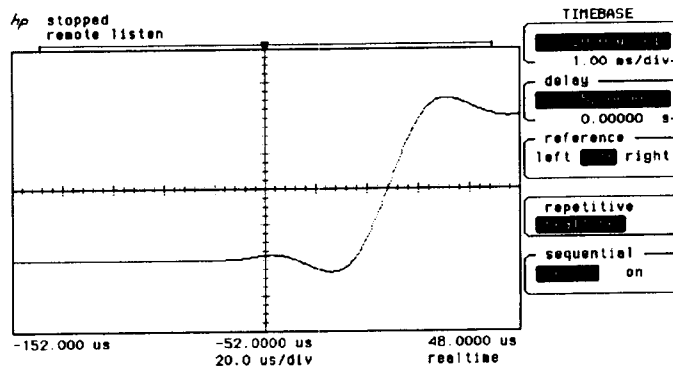

4-15. Panning to the Right

The memory bar moves to the left or right as the acquisition is panned. Panning and zooming can be used concurrently to examine the acquisition.

- Zoom out of the acquisition by increasing the time base.
- Select delay and use the knob to center the acquisition area of interest.
- Zoom back in on the waveform of interest.

Introduction to Channels

The channel menu is a two-level menu that controls the vertical operation of the oscilloscope. This chapter describes the use of the input channels, including vertical sensitivity, offset, coupling, impedance, attenuation, and preset levels.

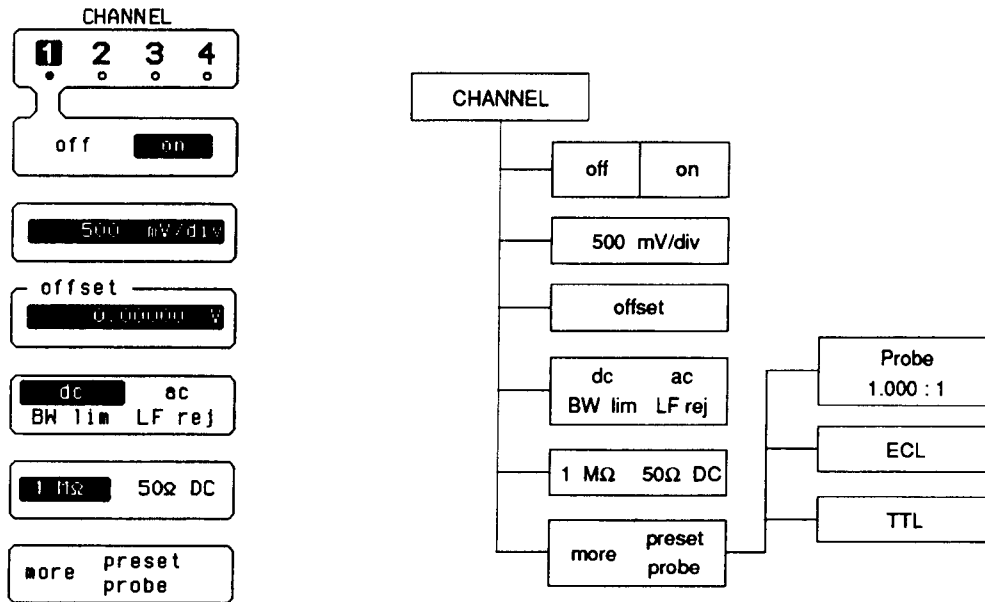

Figure 5-1. Channel Menu

CHANNEL Key

The top key in the channel menu is for channel selection. This key toggles between channels 1, 2, and external (HP 54505B/54510B) and channels 1-4 (HP 54506B/54512B). When a channel is selected (highlighted in inverse video), it can then be turned on. When a channel is turned on, the small circle immediately below the channel number is highlighted.

Note

It is possible to have one channel turned on displayed, while being in the vertical control menu of a different active channel. When making changes, ensure you have the proper channel and function selected, and that you are changing the channel you intend to change.

Vertical Sensitivity Key

The vertical sensitivity key is the third key from the top in the channel menu. However, the field itself is not labeled; the current volts/division is displayed with the units of the current selection. When this function is selected, either of the entry devices can be used for data entry.

The range of the vertical sensitivity for the oscilloscope is from 1 mV/division to 5 V/division. Vertical sensitivity changes in a 1-2-5 sequence with the knob. When the front-panel FINE key is selected, fully calibrated vernier adjustments can also be made using direct keypad entry or the knob. The current vertical sensitivity is shown at the right of the waveform display when the SHOW key is pressed.

offset Key

When **offset** is selected, the trace can be moved up or down with the knob or the keypad. Offset moves the voltage level at mid-screen.

Offset moves the displayed signal up or down, similar to the vertical position adjustment on an analog oscilloscope. However, because this

oscilloscope has a true dc offset at the front end, it provides a much wider offset range. The offset voltage (referenced to the vertical midpoint of the waveform display) is shown at the right of the waveform display when the SHOW key is pressed.

Coupling Key

The coupling key has several selection variables:

- dc
- dc BW lim
- ac
- ac BW lim
- ac LF reject

When dc is selected, 1 M Ω and 50 Ω dc input impedances are available as choices for input impedance. When ac is selected, only 1 M Ω is available for input impedance.

Bandwidth limit is switchable with the different combinations of the coupling function. Bandwidth limit reduces the effective dc bandwidth to about 30 MHz. Ac coupling provides a high-pass filter that rejects frequencies below about 10 Hz. The LF reject provides a high-pass filter rejecting frequencies below about 400 Hz. Bandwidth limits and LF reject filters reduce the noise in all vertical paths (channels), and also the HP 54505B/54510B trigger path.

Input Impedance

Input impedance is 1 M Ω for ac coupling and selectable 1 M Ω or 50 Ω dc when dc coupling is selected in the coupling function.

more preset probe Key

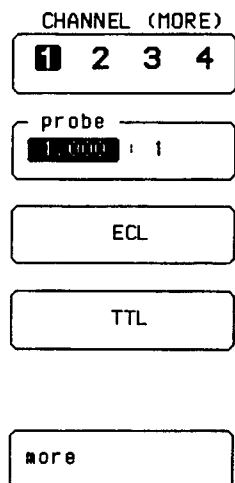

The more preset probe key toggles between the two levels of the channel menu.

probe key

The probe key selects probe attenuation with a range of 1000:1 to 0.9000:1. Attenuation is adjusted by either knob or entry keypad. When the knob is in coarse mode, adjustments are incremented or decremented in the 1-2-5 sequence. When in fine mode adjustments are in 0.1 increments.

Probe attenuation affects scaling factors for the display, not sensitivity at the input.

Probe attenuation is calibrated in the Utility menu. See Chapter 12, "Utility Menu," for information on probe calibration.

Attenuation factors are saved with the front panel setup.

ECL Key

The ECL key sets the oscilloscope to levels optimized for ECL circuits:

- V/Div: 200 mV/div (400 mV/div if # of screens is 2, and 800 mV/div if # of screens is 4)
- offset: -1.3 V
- coupling: dc
- impedance: 1M ohm
- Trigger level: -1.3 V
- Trigger slope: no change

RECALL 0 returns the menu to the previous settings.

TTL Key

The TTL key sets the oscilloscope to levels optimized for TTL circuits:

- V/Div: 1 V/div (2 V/div if # of screens is 2, and 4V/div if # screens is 4)
- offset: 2.5 V
- coupling: dc
- impedance: 1M ohm
- Trigger level: 1.4 V
- Trigger slope: no change

To return to the previous settings press RECALL 0.

Introduction to the Triggers

The trigger modes of the oscilloscope provide many distinctive techniques to trigger and capture data. The triggering capabilities range from simple edge triggering to logic triggering on multiple signals.

This chapter contains descriptions of the triggering modes, and explanations on how to use them, and exercises detailing some real life applications. The oscilloscope has six triggering modes:

- Edge
- Pattern
- State
- Delay
- TV
- Glitch

Trigger Mode Interaction

The trigger level (threshold) for each channel is set in the edge trigger menu and is independent for each channel. It is carried over to all other modes, except the TV and glitch trigger modes. These levels are important settings because the high and low levels in the pattern, state, and delay modes are defined as being greater than or less than the trigger level.

The levels for TV and Glitch trigger modes are special cases and are set in the appropriate trigger menu.

trig'd/auto Key The **trig'd/auto** selection toggles between the two trigger modes. The current selection is displayed in inverse video. This field is available in all trigger menus.

In the **trig'd** mode, the oscilloscope does not display data until all of the trigger requirements are satisfied. While waiting for the trigger requirements, the message *awaiting trigger* is displayed. In the auto

mode, if a trigger is not found, a trigger is generated and acquired data is displayed. A status message is displayed in the upper left corner of the screen.

Edge Trigger Mode

The edge trigger mode has the following selections:

- Trigger source
- Trigger level adjust
- Slope
- Noise reject
- Holdoff

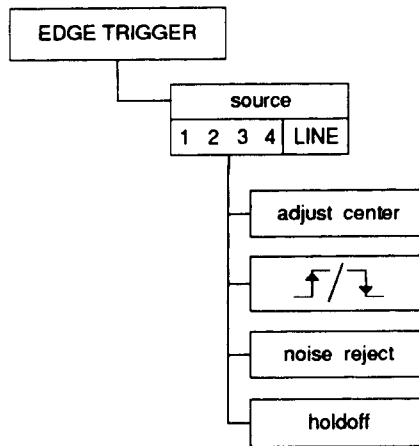
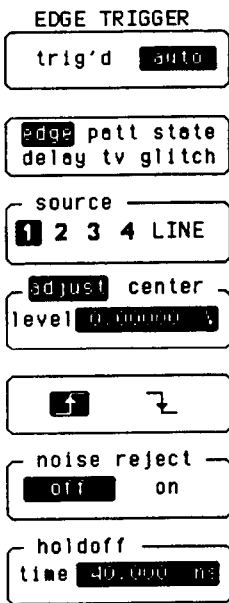

Figure 6-1. Edge Trigger Menu

- source Key** The **source** key selects the trigger source. The options are channels 1 or 2, external, or line trigger for the HP 54505B/54510B and channels 1 through 4, or line trigger for the HP 54506B/54512B. The current selection is highlighted in inverse video. When LINE is selected, the oscilloscope triggers using the line voltage and the remaining menu choices are removed.
- level Key** The **level** key sets the trigger level. The range on this function is ± 12 divisions from center. It provides flexibility for setting exact triggering points and specifies levels used in the more sophisticated triggering modes. The center can also be selected with **centered**.
- slope Key** This field is not labeled, however, the available selections are graphic representations of the rising edge and falling edge. The current selection is highlighted in inverse video.
- noise reject Key** Turn **noise reject on** for triggering on noisy signals without the problem of false triggering.
- holdoff Key** Pressing the **holdoff** key assigns the entry devices to control holdoff. Holdoff disables the trigger circuit for a selectable time period or number of events after the trigger event. Holdoff is selected in 20 ns time increments, from 40 ns to 320 ms or in number of events from 2 to 16 000 000. Time and event are toggled with the knob. Events are number of patterns (**patr**n), state (**state**), or edge and tv (**edge**).

Edge Trigger (with Holdoff) Exercise

This exercise sets up the oscilloscope and a signal generator to view some of the features of the edge trigger. Holdoff is used to gain a stable trigger. While this technique is not necessary for most applications and waveforms, it is useful for many non-recurring and irregular waveforms.

Instrument Setup Follow the instructions for setting up the signal generator. The signal for this exercise is a burst pattern with two positive cycles that repeats every $5\ \mu\text{s}$. Use an HP 8116A Pulse/Function Generator with the burst option or a signal generator capable of the same signal.

Make the following settings:

- MODE: I.BUR
- RPT: $5.00\ \mu\text{s}$
- BUR: 2
- FRQ: 1 MHz
- DTY: 50%
- AMP: 1 V
- OFS: -200 mV
- OUTPUT: square wave

Oscilloscope Setup Connect the the signal generator to the channel 1 input and disconnect all other inputs.

- Press AUTOSCALE (see Figure 6-2).
- Select the **DISPLAY MENU** and set **connect dots** to on.

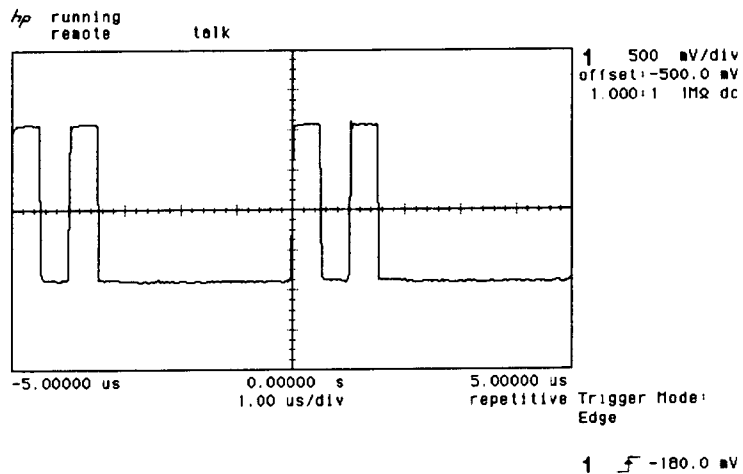

Figure 6-2. Two-Burst Waveform after Autoscale

- Select the **TIMEBASE MENU** and set the sweep speed to **500 ns/div**.
- Set acquisition mode to **repetitive**.

The oscilloscope sets up the display parameters. It is now attempting to trigger on the first rising edge of the two cycle burst.

- Enter the **TRIGGER MENU** and press the **slope** key.

The oscilloscope is now attempting to trigger on the first falling edge of the two-cycle burst. Press the **slope** key again to trigger on the positive edge.

Note

The signal generator is set for two 500 ns pulses. The display on the oscilloscope appears to have three pulses. This is an unstable trigger condition. The following steps explain this condition and how to overcome it.

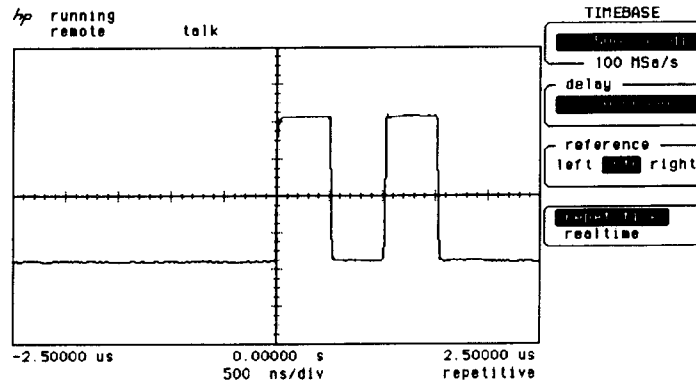

6-3. Two-burst Pulse

- **Determining holdoff time.** Change the time/div setting to 2 μ s/div. Press RUN/STOP (STOP), CLEAR DISPLAY, and SINGLE. This shows the period of the waveform. Since the oscilloscope is recognizing two valid trigger events (edges, in this case) of the burst, the holdoff time needs to be set such that it ignores the second pulse in the burst. Using Δt (x) markers, the second edge can be found to be about 1 μ s from the first edge. (See Chapter 8, "Marker Menu.")
- Press the **holdoff** key.
- Set **holdoff** to 1.04000 μ s, with keypad or knob.

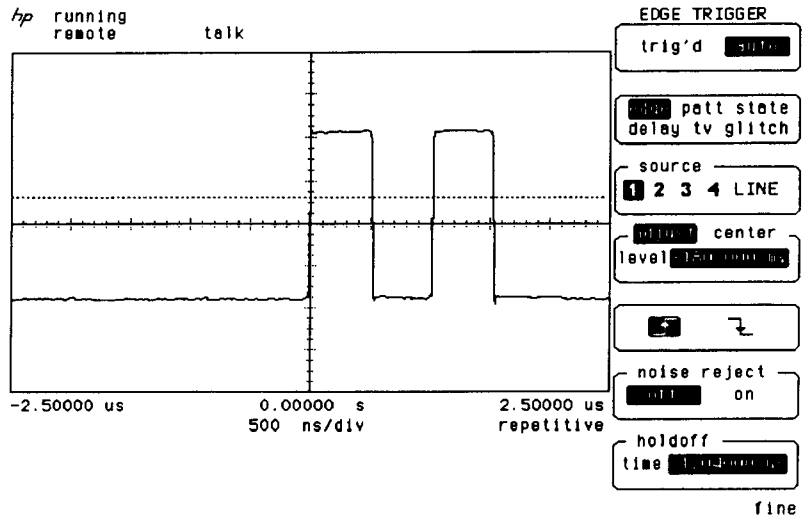

Figure 6-4. Two-Burst Pulse w/Stable Trigger

The input signal to the oscilloscope has two 500 ns pulses. On the first rising edge a trigger occurs and activates the holdoff timer. When the holdoff time (1.04000 μs) has elapsed, the oscilloscope looks for another trigger. The oscilloscope triggers on the first rising edge of the second burst. Each trigger event occurs on a different pulse, and is consequently an unstable condition.

By adjusting holdoff to wait until the rising edge of the second pulse passes, the oscilloscope triggers only on the first rising edge and the signal is stable. In this case the trigger is stable with approximately 1.04 μs holdoff.

Pattern Trigger Mode

The pattern mode defines a 3-bit (HP 54505B/54510B) or 4-bit (HP 54506B/54512B) pattern for the oscilloscope to recognize and generate a trigger event. When the inputs satisfy the trigger pattern and conditions, the oscilloscope triggers and displays the desired portion of the waveform.

The pattern mode is very useful for glitch detection (when greater than 20 ns) because the oscilloscope triggers on a glitch and displays the resulting waveform. See "Glitch Trigger Mode" later in this section for more information on glitch detection when occurrence is less than 20 ns.

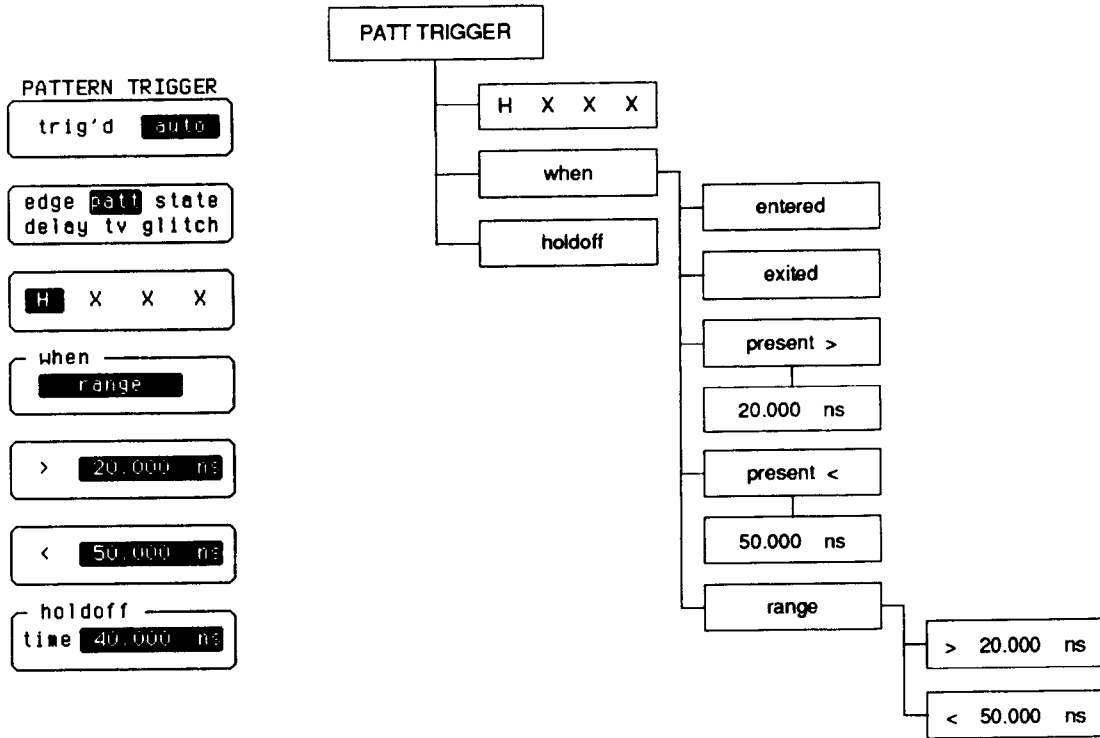

Figure 6-5. Pattern Trigger Menu

pattern Key This is an unlabelled field. The display depicts the bit pattern. The active field is displayed in full-bright and is changed with the knob. The function key changes the bit selection of three levels:

- **H** – high
- **L** – low
- **X** – don't care

The criteria for high is higher than the current trigger level, and low is lower than the current trigger level.

The bit pattern represents all the oscilloscope inputs. The left-most bit corresponds to channel 1 and the right-most bit corresponds to the external trigger channel on the HP 54505B/54510B or channel 4 on the HP 54506B/54512B.

For example on the HP 54505B/54510B, if the pattern is LXH, the voltage on channel 1 must be lower than the trigger level set for channel 1, channel 2 is don't care so the input level is disregarded, and the external trigger input must be higher than the trigger level set for external trigger. If these conditions are satisfied by the inputs, then the oscilloscope generates a trigger event.

Note

When any channel is not being used in the qualifier pattern, it should be set as don't care. The trigger level is still compared to the no input channel and a high or low is determined. The only true don't care is X.

If the pattern XXX (HP 54505B/54510B) or XXXX (HP 54506B/54512B) is selected, a trigger event does not occur because a trigger event is not defined.

when Key This key controls five sets of conditions that must be satisfied to generate a trigger event. These conditions are as follows:

- **when entered:** a trigger is generated on the first transition that makes a pattern true. The pattern must be false and go true to generate the trigger.

- **when exited:** a trigger is generated on the first transition that makes the pattern false. The pattern must be true and go false to generate a trigger.
- **when present > :** a trigger is generated when a trigger pattern is true longer than a specified minimum time period. This time period is specified in the next selection key that is activated when present > is selected. The present > time ranges from 20 ns to 160 ms.
- **when present < :** a trigger is generated when a trigger pattern is true less than a specified maximum time period. This time period is specified in the next selection key that is activated when present < is selected. The present < time ranges from 20 ns to 160 ms.
- **range:** this trigger condition is a combination of present < and present > . A trigger is generated when a trigger pattern is true for longer than a specified minimum and shorter than a specified maximum time period. These time periods are specified in the next two selection keys that are activated when range is selected. The first range time setting must be less than the second range time setting.

holdoff Key The holdoff key assigns the entry devices to control holdoff. Holdoff disables the trigger circuit for a selectable time period or number of events after the trigger event. Holdoff is selected in time units, from 40 ns to 320 ms and is incremented in 20 ns intervals or by number of patrn (patterns) from 2 to 16 000 000.

Pattern Trigger Exercise

This exercise demonstrates how to define the bit pattern and how it affects the trigger and the resulting display.

Note

Set the trigger level for each trigger source while in the edge mode. These trigger levels must be set before you go to the pattern mode, or proper triggering may not occur.

Instrument Setup To perform the following exercise use the HP 8116A Pulse/Function Generator, or another function generator capable of producing the same 1 MHz, 1 volt, square wave signal.

Set up the HP 8116A Pulse/Function Generator:

- Mode = NORM
- FRQ = 1.00 MHz
- DTY = 50%
- AMP = 1.00 V
- OFS = -200 mV
- Set the generator for a square wave signal

Connect the signal to a BNC tee on channel 1 using a 1-meter coaxial cable. Connect another 1-meter cable from the other side of the BNC tee and terminate in 50 Ω to channel 2 (HP 54505B/54510B) or channel 3 (HP 54506B/54512B).

Oscilloscope Setup The extra cable length between channels provides a time delay between the signals displayed on the oscilloscope. The propagation of a 1-meter coaxial cable is approximately 6 to 7 ns. This time delay is used to demonstrate the oscilloscope's triggering capability.

- Press AUTOSCALE.

Set up the oscilloscope as follows:

- Time base = 10.00 ns/div
delay = 0.00 s
reference = cntr
acquisition mode = repetitive
- Channel 1
Vertical sensitivity = 400 mV/div
offset = -200.00 mV
dc coupling
input impedance = 1 M Ω

- Channel 2 (HP 54505B/54510B) or Channel 3 (HP 54506B/54512B)
 - Vertical sensitivity = 400 mV/div
 - offset = - 200.00 mV
 - dc coupling
 - input impedance = 50 Ω
- Display
 - minimum persistence
 - 2 screens
 - axes
- Trigger
 - Channel 1 level = - 200 mV
 - Channel 2 (HP 54505B/54510B) or 3 (HP 54506B/54512B) level = - 200 mV
 - Set the trigger mode to pattern.

Set the pattern to HLX (HP 54505B/54510B) or HXLX (HP 54506B/54512B) as follows:

- Press the function key until the first character is highlighted.
- Turn the knob until the highlighted area is H.
- Select the next character in the pattern.
- Continue until all characters are selected in the pattern.
- Press the **when** key until **entered** is selected.

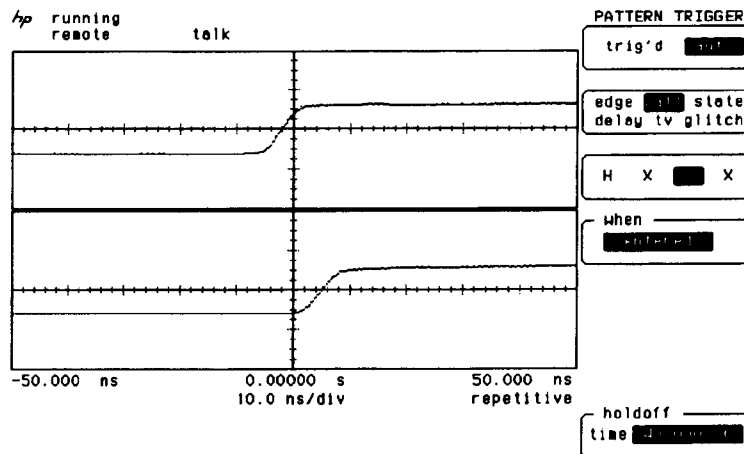

Figure 6-6. HXLX when entered Pattern

Channel 1 is displayed in the top screen. To satisfy the conditions of the bit pattern, channel 1 must be high (higher than the channel 1 trigger level) or greater than -200 mV. When the signal on channel 1 goes higher than -200 mV and channel 2 (or 3) is still low (less than -200 mV) the pattern conditions have been satisfied as the signal is entering the trigger conditions and the oscilloscope triggers.

- Press the **when** key and change the condition to **when exited**.

The oscilloscope triggers on the first transition that makes the bit pattern false, in this case when channel 2 (or 3) goes high.

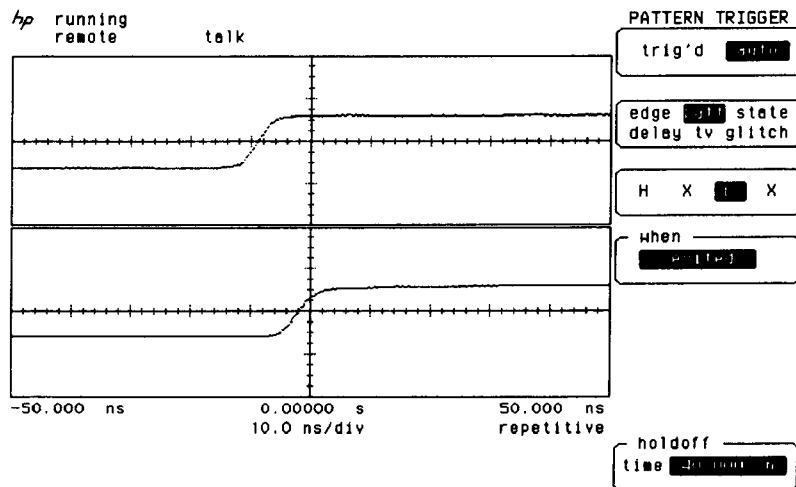

Figure 6-7. HXLX when exited Pattern

- Change the bit pattern to HHX (HP 54505B/54510B) or HXHX (HP 54506B/54512B) and select the **entered** condition.

To satisfy this bit condition both channels must be high. The oscilloscope does not trigger until channel 2 (or 3) goes high while channel 1 is high.

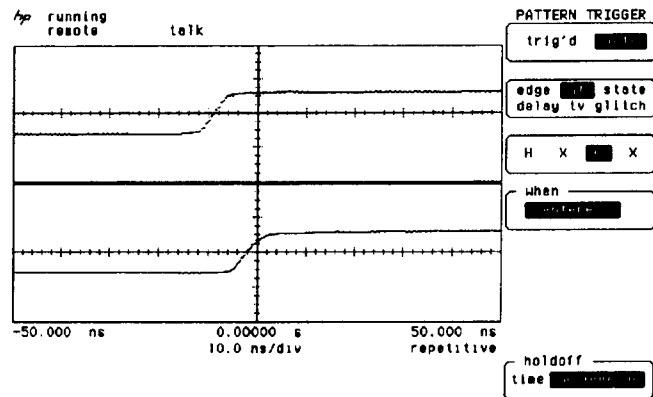

Figure 6-8. HXHX when entered Pattern

- Change the trigger condition to **when exited**.

While channel 2 (or 3) is still high, and when channel 1 goes low, the bit pattern is no longer true and the oscilloscope triggers.

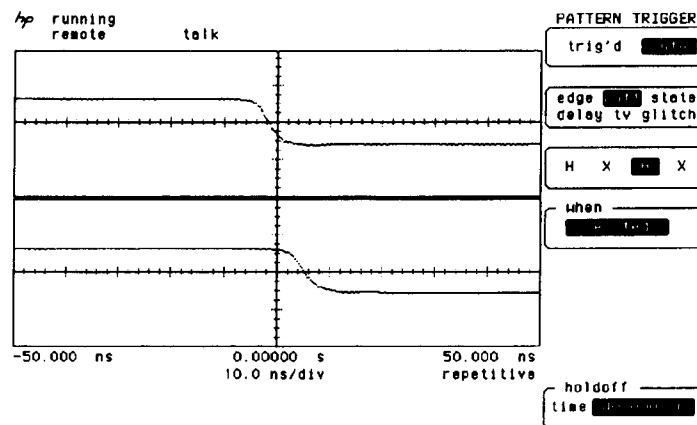

Figure 6-9. HXHX when exited Pattern

State Trigger Mode

The state trigger mode is similar to the pattern trigger mode except that one channel is selected as a clock edge and the other trigger sources define a pattern. When the pattern becomes true the oscilloscope triggers on the next clock edge if the pattern meets setup and hold criteria.

STATE TRIGGER

trig'd **auto**

edge patt **state**
delay tv glitch

clock **1** 2 3 4

when **↑** X X X

is is not
present

holdoff
time **40.000 ns**

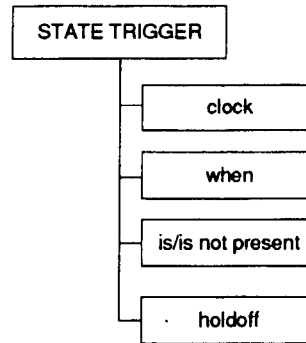

Figure 6-10. State Trigger Menu

- clock Key** Select any channel to be used as the state clock. Select the channel by pressing the function key until the desired channel is highlighted. The clock selection is reflected in the next field with an arrow, pointing either up for a positive slope or down for a negative slope.
- when Key** The **when** key depicts the desired pattern. The displayed pattern shows the arrow at the selected clock channel. The other trigger sources define the logic pattern that must be satisfied to generate a trigger event using the H, L, X convention described in the pattern trigger mode section of this chapter.

To change the pattern:

- Press the function key until the bit to be changed is highlighted.
- Rotate the knob until the desired setting is highlighted.
- Select the arrow to change the trigger slope, if necessary, and turn the knob until the desired settings appear.

present Key A trigger event is generated on the selected edge when the pattern is true and **is present** is selected, or a trigger occurs when the pattern is false and **not present** is selected.

holdoff Key The **holdoff** key assigns the entry devices to control holdoff. Holdoff disables the trigger circuit for a selectable time period after the trigger event. Holdoff is selected in 20 ns time increments, from 40 ns to 320 ms, or for events (count of states) 2 to 16 000 000. Time and event are toggled with the knob.

State Trigger Exercise

This exercise demonstrates how an input pattern is used to qualify a clock edge as a trigger.

State triggering extends the logic triggering capability of the oscilloscope by selecting one of the inputs as a clock and using the other inputs as qualifiers.

This is useful when it is necessary to synchronize the display with a system clock to detect a system state. For example, consider a synchronous memory bus. The state trigger mode enables only those events that occur when reading from a block of memory to be captured and displayed.

Instrument Setup To perform the following exercise use an HP 8116A Pulse/Signal generator or another signal generator capable of the same 1 MHz, 1 volt square wave.

Set up the HP 8116A as follows:

- Mode = NORM
- FRQ = 1.00 MHz
- DTY = 50%
- AMP = 1.00 V
- OFS = -200 mV
- Set the generator for a square wave signal

Connect the signal to a BNC tee on channel 1 using a 1-meter coaxial cable. Connect another 1-meter cable from the other side of the BNC tee to channel 2 (HP 54505B/54510B) or channel 3 (HP 54506B/54512B).

Oscilloscope Setup

The extra cable length between channels provides a time delay between the signals displayed on the oscilloscope. The propagation of a 1-meter coaxial cable is approximately 6 to 7 ns. This time delay demonstrates the oscilloscope's triggering capability.

- Press AUTOSCALE.

Set up the oscilloscope as follows:

- Time base = 10.00 ns/div
delay = 0.00 s
reference = cntr
acquisition mode = repetitive
- Channel 1 turned on
Vertical sensitivity = 400 mV/div
offset = -200 V
dc coupling
input impedance = 1 M Ω
- Channel 2 (HP 54505B/54510B) or 3 (HP 54506B/54512B) turned on
Vertical sensitivity = 400 mV/div
offset = -200 mV
dc coupling
input impedance = 50 Ω

- Display
 - minimum persistence
 - 2 screens
- Trigger
 - Channel 1 level = -200 mV
 - Channel 2 (HP 54505B/54510B) or 3 (HP 54506B/54512B) level = -200 mV
 - Set the trigger mode to state
- Set the pattern to ↑L X (HP 54505B/54510B) or ↑XL X (HP 54506B/54512B) as follows:
 1. Press the function key until the first bit is highlighted.
 2. Turn the knob until the highlighted area is ↑.
 3. Select the next bit in the pattern and select L or X.
 4. Continue until all bits are selected in the pattern.
- Press the when key until is present is selected (see Figure 6-11).

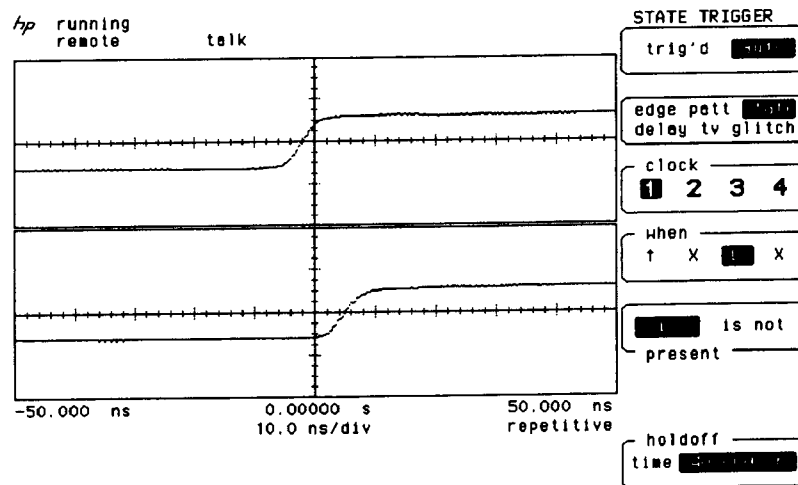

Figure 6-11. Channel 1 Clock XLX State

Channel 1 is displayed in the top screen. To satisfy the conditions of the bit pattern, channel 2 (or 3) must be low (lower than the channel's trigger level) or less than -200 mV. When the signal on channel 1 goes higher than -200 mV and channel 2 (or 3) is still low (less than -200 mV) the pattern conditions have been satisfied, the oscilloscopes triggers.

- Change the bit pattern to ↓LX (HP 54505B/54510B) or ↓XLX (HP 54506B/54512B) and select the **is not present** condition.

To satisfy this bit condition the clock channel must go low while channel 2 (or 3) is high. The oscilloscope triggers on the falling edge of channel 1 when the L on channel 2 (or 3) is not present, for example channel 2 (or 3) is high.

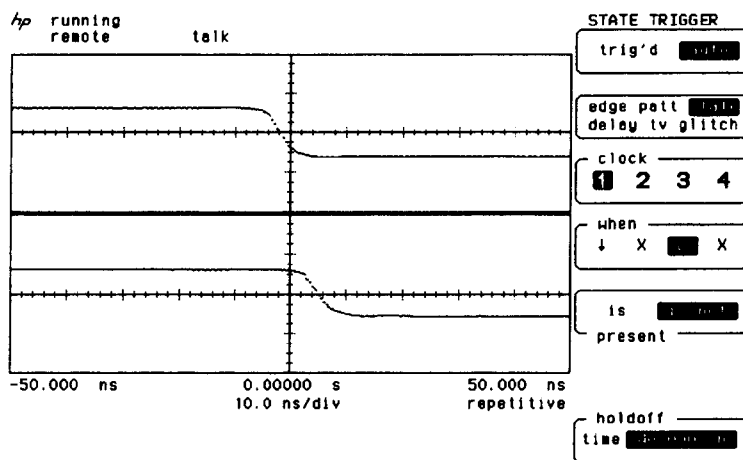

Figure 6-12. Channel 1 Clock XLX State

Delay Trigger Mode

The delay trigger mode qualifies on a signal edge, pattern, or state, delays for a period of time (or occurrence of edges), and then triggers on a selected edge from any source.

This trigger mode is versatile and accommodates most complex triggering situations. It has the flexibility to select different trigger sources, delay times, delay counts and then display various points of the waveform.

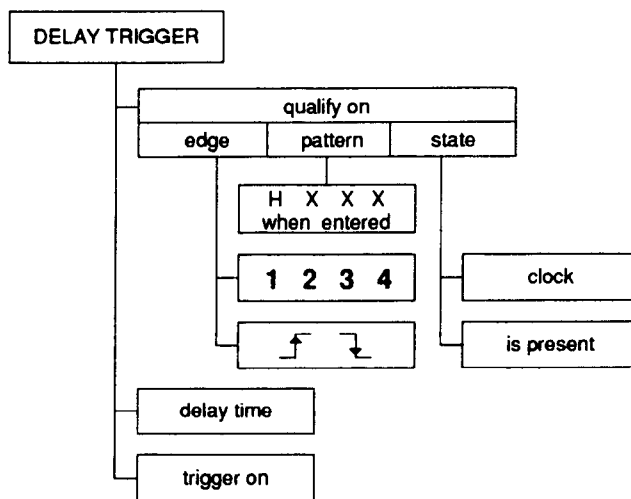
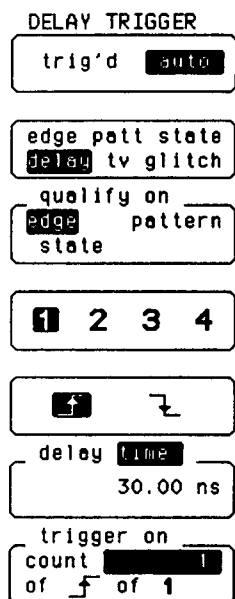

Figure 6-13. Delay Trigger Menu

qualify on Key The qualify on key selects which mode to qualify the trigger before a delay is defined. The qualify options are:

- edge
- pattern
- state

qualify on edge Select the edge qualifier and the next two function keys defines the parameters. The next key is an unlabelled field that selects the channel to be the source. The second key below the edge selection is the slope selection.

qualify on pattern When the pattern trigger option is selected, the next function key defines the qualifier pattern. Defining a pattern is the same as in the pattern trigger mode.

- Highlight the bit to be changed by pressing the function key.
- Change the bit by rotating the knob.

After all bits have been selected, the active field is changed to the condition field. This field sets conditions as in the Pattern Trigger mode:

- when entered
- when exited
- when present > [time]
- when present < [time]
- range > [time2] and < [time1]

These settings activate the next field, as appropriate, so the specific time parameters can be set.

qualify on state If the state trigger option is selected the next two function keys define the state conditions.

As in the state trigger mode, select the channel to define the state clock. This selection is reflected in the pattern with an arrow and the slope is depicted with the arrowhead pointing up or down. Use the function key to move the highlighted bit to change the pattern. When the pattern is set, the **is/not present** setting can be changed by moving the highlight to the **is/not present** field label and pressing the function key again. When the label is highlighted, toggle the setting between **is/not present** with the knob.

delay Key

This field selects between two delay options. To change between the **time** and **count** options rotate the knob until the desired option is displayed in the inverse video field.

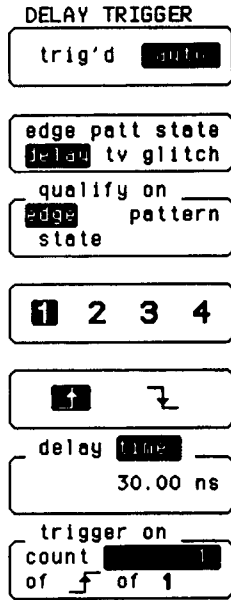

delay time disables the trigger circuit for a selected period of time, from 30 ns to 160 ms after the trigger has been qualified.

Note

Time delay is not available in the time qualified pattern settings of when present >, when present <, or range.

- Press the function key until the highlight is on the first numeric field. This field selects the amount of delay after qualification, ranging from 30 ns to 160 ms.

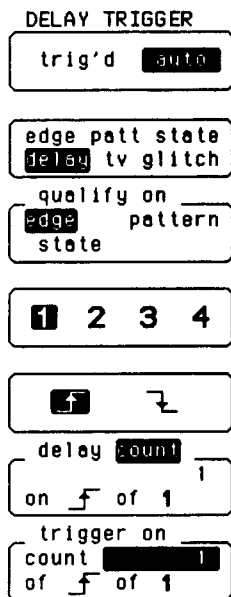

delay count (delay by edges) disables the trigger circuit for a selected count from 1 to 16 000 000 after the trigger has been qualified. After the selected count has been attained the oscilloscope looks for the user specified trigger edge.

- Press the function key until the highlight is on the first numeric field. This field to selects the number of edges to delay after the trigger has been qualified (from 1 to 16 000 000).
- Press the function key once more to activate the rising edge/falling edge option and select the desired edge with the knob.
- Press the function key once more to highlight the third option field and select the channel to delay on.
- Press the function key a fourth time to return to the first numeric field.

trigger on Key This key selects a specific edge to trigger on after the qualification and delay conditions have been satisfied. All other keys in this menu have dealt with defining qualifying conditions, however, this field sets the trigger point. This is another three position option switch.

- Press the function key to highlight the numeric field and select which occurrence to trigger, using the knob to set the number (1 to 16 000 000).
- Press the function key again and move the highlighted field to select the slope. The knob toggles the selection between rising and falling edge.
- Press the function key again and highlight the channel selection. The knob is used to change the channel selection.

Delay Trigger Exercise

This exercise demonstrates how to use the delay trigger to trigger on the exact point of a waveform. The exercise leads through setting up a complex signal, setting up the oscilloscope, and changing settings and counts for viewing various points on the waveform.

Instrument Setup Set up an HP 8116A (or comparable signal/generator) for a burst pulse with ten bursts that repeats every 50 μ seconds.

Set up the HP 8116A Pulse/Function Generator:

- Mode = I.BUR
- RPT = 50 μ s
- BUR = 10
- FRQ = 5.0 MHz
- DTY = 50%
- AMP = 1.00 V
- OFS = -200 mV
- Set generator for a pulse signal

Connect the signal to channel 1 of the oscilloscope.

Oscilloscope Setup The oscilloscope autoscales and displays this signal, however, for this example make the listed triggering changes after autoscaling.

- Press **AUTOSCALE**.

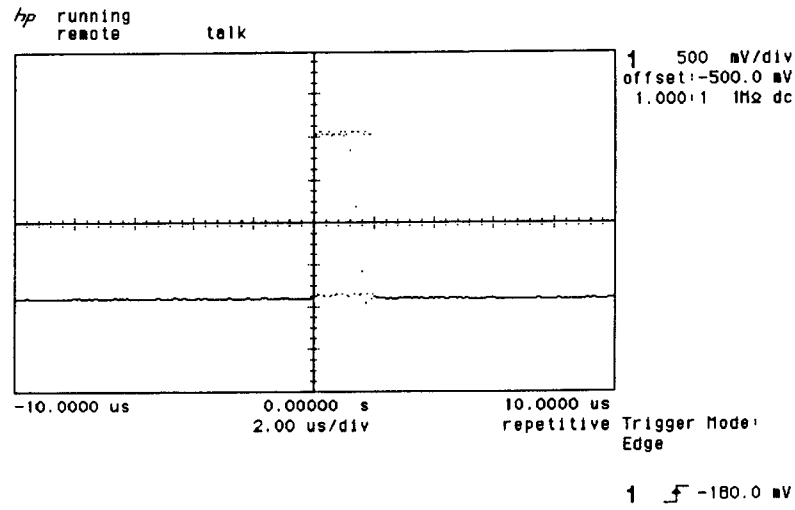

Figure 6-14. Ten Burst Pulse after AUTOSCALE

Set up the oscilloscope as follows:

- Press **TIME BASE** and select **repetitive**.
- Press **TRIG** and select **trig'd** display.
- Select **delay** trigger mode.
- **Qualify on edge** and the rising edge of channel 1 as the source.
- Select a delay time of **2.5 μ s** to gain a stable trigger.
- Set **trigger on** to trigger on rising edge 1 of channel 1.

This trigger setup qualifies on the first rising edge of the burst, delays through the remaining portion of the burst, then triggers on the first edge of the next burst.

- Press TIME BASE and set time/division to 500 ns.

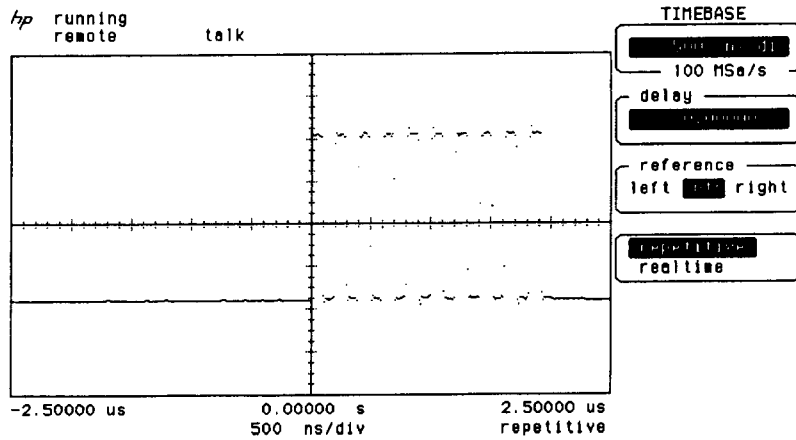

Figure 6-15. Ten Burst Pulse w/Stable Trigger

- Return to the trigger menu and set **trigger on count** to 5. This tells the oscilloscope to trigger on the 5th rising edge of the next burst (see Figure 6-16).

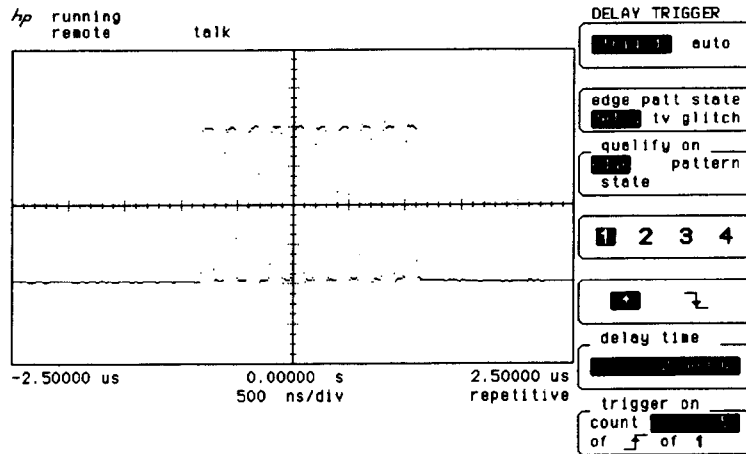

Figure 6-16. Ten Burst Pulse Triggered on Pulse 5

- Change the **trigger on count** key to 9 (see Figure 6-17).

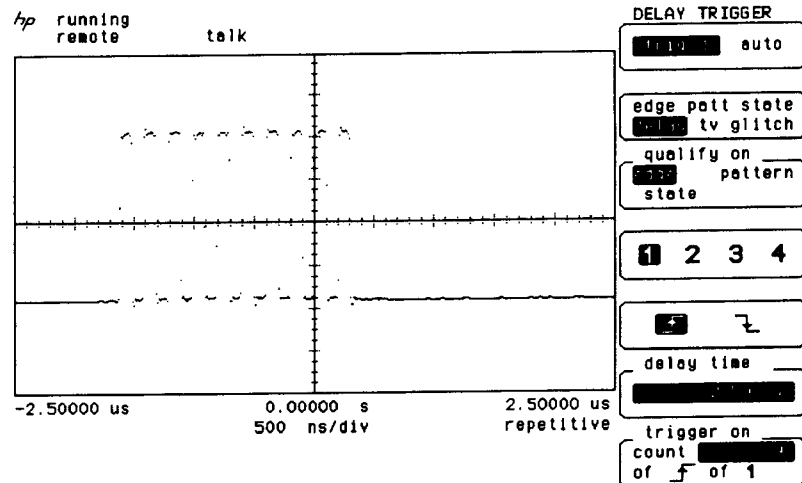

Figure 6-17. Ten Burst Pulse Triggered on Pulse 9

By setting the oscilloscope to the delay trigger mode, a specific time or count to delay between qualification and trigger can be added.

In this exercise, the trigger was delayed to get a stable display. When the time delay had elapsed the oscilloscope began counting rising edges until it found the ninth edge.

TV Trigger Mode

The TV TRIGGER menu enables the oscilloscope to trigger on clamped tv signals. The two most common tv standards; 60 Hz/525 lines or NTSC is the standard used in the United States, 50 Hz/625 lines is the standard used in most European countries. This trigger menu also allows for user defined tv signals that may be used in other parts of the world.

To move the highlighted inverse video window within a field you must press the selection key and to change the value displayed in the window you must rotate the knob.

Note

Pay close attention to the movement of the highlighted window; it moves to various options within the field.

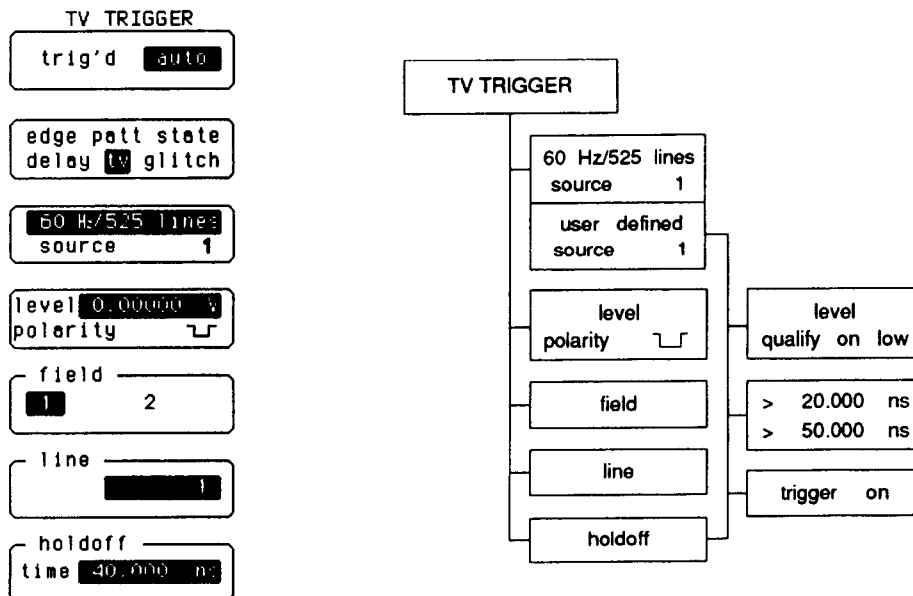

Figure 6-18. TV Trigger Menu

Standard Select Key The source key chooses between the NTSC standard tv signal used in the United States with a 60 Hz and 525 lines per frame, the standard of 50 Hz and 625 lines per frame used in most countries in Europe. The third option is for user defined ranges of the tv signal. User-defined ranges can be used to trigger on any of the proposed HDTV standards.

To make the desired selection:

- Press the selection key and select the standard by rotating the knob. The active field is highlighted in inverse video.

Source Select Key To select the trigger channel to be used as a source:

- Press the selection key and move the highlighted field, rotate the knob until the desired channel is displayed.

level/polarity Key The level option sets the trigger level (in volts) that is applicable only to the tv trigger source.

- Press the function key again and the highlighted window moves to the polarity option and selects the rising edge or falling sync pulses to trigger on.

field Key The field key selects field, 1 or 2.

line Key The line key selects which line the trigger will be generated on. This selection is dependent upon which field has been selected previously.

If the previous selection is the 60 Hz, 525 lines standard, the options available depend upon which field, 1 or 2 is selected:

- If field 1 is selected, select from line 1 to 263 in field 1.
- If field 2 is selected, choose from line 1 to 262 in field 2.

This tv trigger mode is compatible with broadcast standard M.

If the 50 Hz, 625 lines standard is selected, the options are also dependent upon field settings:

- If field 1 is selected the range of lines is from 1 to 313,
- If field 2 is selected the range of lines is from 314 to 625.

This tv trigger mode is compatible with broadcast standards: B, C, D, G, H, I, K, K1, L, and N.

holdoff Key The holdoff key enables the oscilloscope to hold off the trigger event from 40 ns to 320 ms and is incremented in 20 ns time frames.

TV Trigger Exercise

Video signals are unique, and as such have unique requirements for proper triggering. This exercise demonstrates how to display and work with video signals on the oscilloscope.

Instrument Setup Use a standard NTSC signal generator with clamped video output for this exercise. Turn color bars on.

Oscilloscope Setup Connect the NTSC video signal to channel 1 of the oscilloscope.

- Press AUTOSCALE.
- Select the tv trigger mode.
- Set **60 Hz/525 lines** and channel 1 as the source.

Determine the polarity of the sync pulse.

- Select the trigger level and rotate the knob until a stable display is attained. When a sync pulse is visible, determine the polarity, select **polarity** (press the function key) and set the sync pulse in accordance with the actual pulse.

- Set the trigger level at approximately the midpoint of the sync pulse.

This sets the trigger level just below the middle of the sync pulse and tells the oscilloscope to trigger on the leading edge.

- Set **trig'd/auto** to **trig'd**.

This eliminates the possibility of a premature trigger event occurring.

- Select **field 1** and **line 1**.
- Press **TIME BASE** and set time/division to **100 μ s/div**.
- Press **DISPLAY** and set persistence to \approx **600.0 ms** to accommodate video signals.

The oscilloscope is triggering on the first equalizing pulse of field 1, the first pulse in the vertical interval. The pretrigger data that is being viewed (left half of the screen) is field 2, lines 256-262.

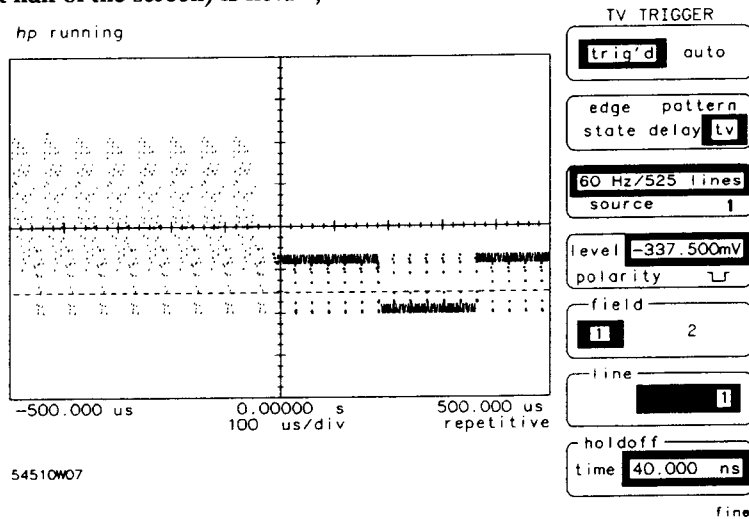

Figure 6-19. Trigger at Field 1, Line 1

- Set time/division to **10 μ s/div** and set the trigger to **field 1, line 10**.

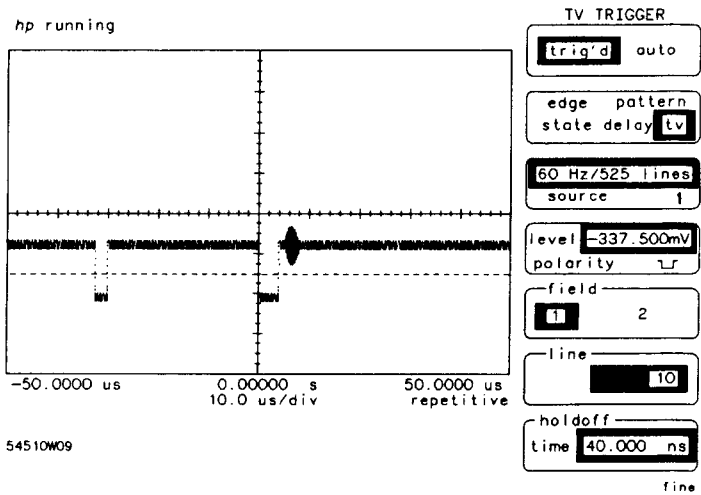

Figure 6-20. Trigger on Field 1, Line 10

The trigger is now on the first horizontal sync pulse in the vertical interval with color burst information.

- Change the trigger point to field 1, line 21.

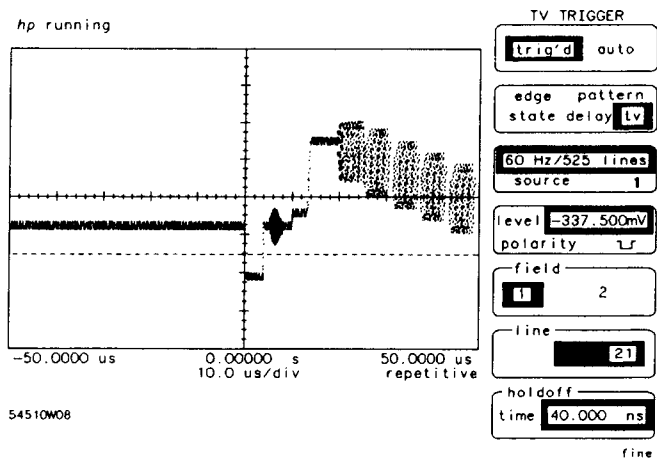

Figure 6-21. Trigger on Field 1, Line 21

The trigger point is now on the last sync pulse of the vertical interval. The next line contains color information, in this case color bars are present.

- Change the trigger to field 2, line 1.

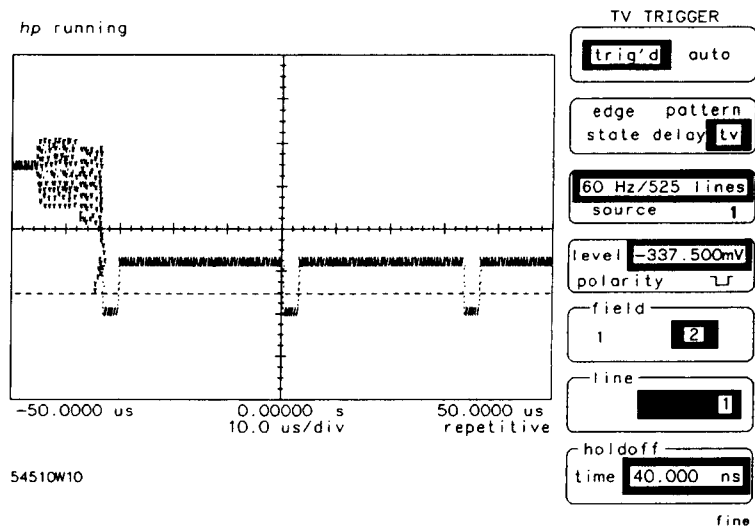

Figure 6-22. Trigger on Field 2, Line 1

The trigger point is on the second sync pulse of the vertical interval. This is the correct trigger point because fields 1 and 2 are interlaced.

Glitch Trigger Mode

The glitch mode is used to configure the oscilloscope to recognize a glitch on a single channel (down to 5 nsec), distinguish that glitch from glitches of other widths, and generate a trigger event. When the input satisfies the set trigger conditions, the oscilloscope triggers and displays the waveform present on all active channels.

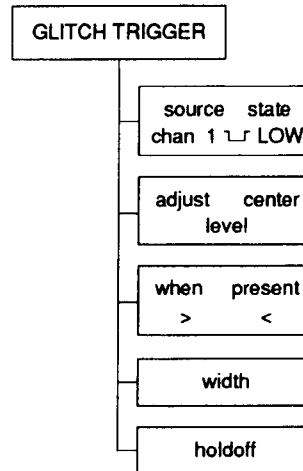
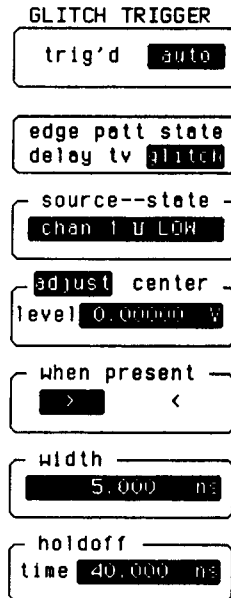

Figure 6-23. Glitch Trigger Menu

source -- state Key The **source -- state** key selects the source and pattern state used for triggering. The source options are channels 1 or 2, or external trigger (HP 54505B/54510B) or channels 1 through 4 (HP 54506B/54512B). The state for the source selected can be specified as either high or low, where high is higher than the current trigger level, and low is lower than the current trigger level. Only one source-state can be selected at one time. The current selection is highlighted in inverse video.

level Key The **level** key sets the trigger level used by the source-state key. The range on this function is ± 12 divisions. The current level is also displayed as a dotted line. The center can also be selected with **centered**.

when present The **when present** key sets the condition that must be satisfied to generate a trigger event. If **when present >** is selected, a trigger is generated when the trigger pattern is true longer than a specified width. If **when present <** is selected, a trigger is generated when the trigger pattern is true less than a specified width. The current selection is highlighted in inverse video.

width The width key sets the width of the pulse to generate the trigger on. Width ranges from 5 ns to 160 ms.

Holdoff Key the **holdoff** key assigns the entry devices to control holdoff. Holdoff disables the trigger circuit for a selectable time period after the trigger event. Holdoff is selected in 20 ns time increments, from 40 ns to 320 ms .

Glitch Trigger Exercise

This exercise demonstrates how to use the glitch trigger to capture a glitch that is 8 ns wide, and also how to distinguish it from glitches that are less than 5 ns wide or greater than 10 ns wide.

Instrument Setup Set up an HP 8116A (or comparable signal/generator) for a 1 MHz, 200 mV 8 ns wide pulse train.

Set up the HP 8116A Pulse/Function Generator:

- Mode = NORM
- FRQ = 1.0 MHz
- WID = 8 ns
- AMP = 200 mV
- OFS = 0 V
- Set generator for a pulse train

Connect the signal to channel 1 of the oscilloscope.

Oscilloscope Setup Connect the signal to channel 1 of the oscilloscope.

- Press **RECALL** then **CLEAR** keys.
- Press **TIME BASE** and select **5.00 ns/div**, and **repetitive mode**.

- Press **CHAN** and select **40 mv/div**, and **50 Ω DC**.
- Press **TRIG**, select **trig'd display**, then **glitch mode**.
- Set **source-state** to **chan 1 HIGH**.
- Set **when present** to **<**.
- Select a **width** and set to **20 ns**.

Because the trigger is set to capture positive pulses that are less than 20 ns wide, the oscilloscope displays the 8 ns wide pulse with the falling edge at center screen.

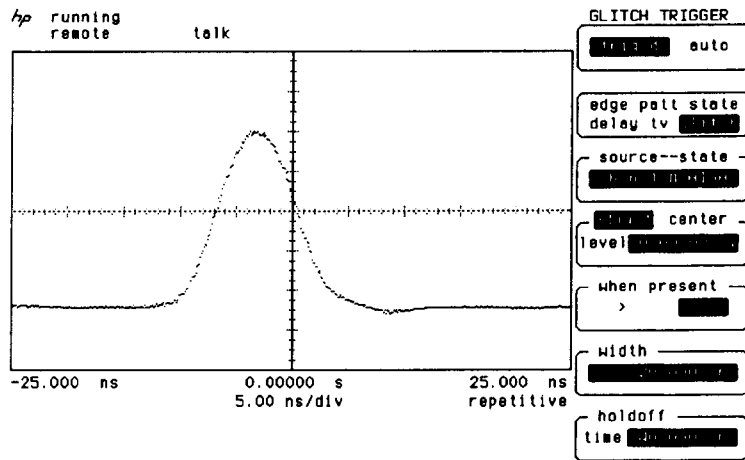

Figure 6-24. Glitch Trigger Exercise

- Select **width** and set to **10 ns** and verify the pulse remains displayed on the screen (8 ns still less than 10 ns).
- Select **width** and set to **5 ns** and verify the pulse is no longer displayed on the screen (8 ns is not less than 5 ns), and that "running - awaiting trigger" is displayed.

- Set **when present** to **>** and verify the pulse is again displayed on the screen (8 ns is greater than 5 ns).
- Select **width** and set to **10 ns** and verify the pulse is no longer displayed on the screen (8 ns is not greater than 10 ns), and that "running - awaiting trigger" is displayed.

Introduction to the Display

The **DISPLAY** menu controls most of the features that dictate how the acquired data is displayed. These features include ways to manipulate data for clarity, to eliminate noise, viewing selected memory segments, viewing best case/worst case situations, or the displayed background.

This chapter describes the **DISPLAY** menu, the submenus, how to control all the features, and how to display the most meaningful waveform for measurements.

There are three display menus, depending on which acquisition mode the oscilloscope is set to in the **TIMEBASE** menu.

- Repetitive acquisition display menu
- Realtime acquisition (sequential memory off) display menu
- Realtime acquisition (sequential memory on) display menu

Repetitive Acquisition Display Menu

The display menu selections available when the TIMEBASE acquisition mode is set to repetitive as shown in figure 7-1.

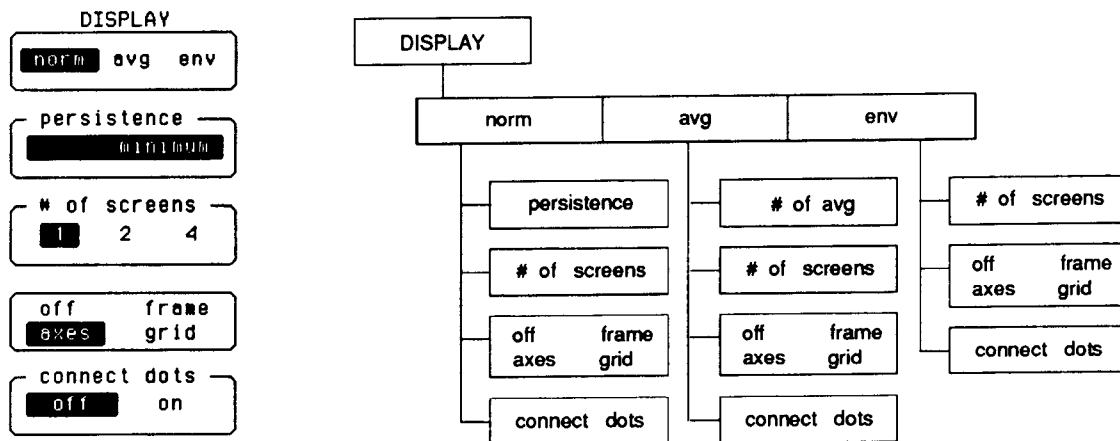

Figure 7-1. Repetitive Acquisition Mode Display Menu

Display Mode Key The DISPLAY mode key selects one of three display modes:

- normal
- averaged
- envelope

norm

The **norm** mode sets the time parameters for displaying data or selecting persistence. The range in the variable persistence mode is from minimum, very fast overwriting and updating the display, to infinite with variable settings in between, from 500 ms to 10 seconds. This means that data display records can be preset to any of the persistence settings. Settings less than infinite display data for the specified period of time and then overwrite old data.

When **norm** is selected, the function key beneath the norm field is activated. This field displays the current persistence setting that can be set using either of the entry devices.

NOTE

Connect-the-dots is available for waveform memories, but not for channels with persistence.

- Fast persistence settings are useful when the input signal is changing and immediate feedback is needed.
- More persistence is useful when observing long-term changes in the signal or low signal repetition rates.
- Infinite persistence can be used for worst-case characterizations of signal noise, jitter, drift, etc. In this mode the HP 54505B, HP 54506B, HP 54510B, and HP 54512B is used as a storage oscilloscope.
- At minimum persistence, a point is erased when a new point is acquired in the same time bucket on the display. Therefore, the waveform fills quickly and each point remains for a minimum amount of time.

Note

When the keypad is used to change persistence settings, any entry longer than 10 seconds causes the message value out of range, set

to limit to be displayed. Persistence then is automatically set to infinite. Any entry less than 500 ms causes the same message to be displayed and persistence is set to minimum.

avg

The averaged mode selects the number of waveform acquisitions that are averaged to generate the displayed waveform. The range for the averaging function is 1 to 2048 in powers of 2.

When averaged mode is selected, the next function key is activated and the number of averages is set using either entry keys or knob.

Displayed signal noise is significantly reduced by using the averaging mode. As the number of averages is increased from 1 to 2048, the display becomes less responsive to changes in the input signal(s), however, using more averages reduces the effects of displayed signal noise and improves resolution.

env

The envelope mode needs no other parameters set. The display reflects the minimum and maximum voltages in each horizontal position. This is useful in viewing voltage or time jitter.

of screens Key This key selects the number of screens to be displayed:

NOTE

References to "Channels" below also indicates where functions and memories (except pixel memories) are displayed.

- **1:** the entire display area is one screen and any displayed waveforms are superimposed on top of each other.

- 2: the display area is divided into two screens. Channel 1 (HP 54505B/54510B) or channels 1 and 2 (HP 54506B/54512B) are displayed in the top screen and channel 2 (HP 54505B/54510B) or channels 3 and 4 (HP 54506B/54512B) are displayed in the bottom screen (See figure 7-2).

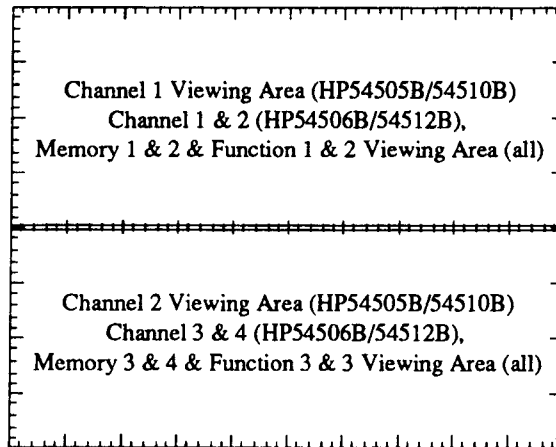

Figure 7-2. Dual Screen Display

- 4: the display area is divided into four screens. Each channel is displayed in the corresponding portion of the screen, starting with channel 1 at the top (See figure 7-3).

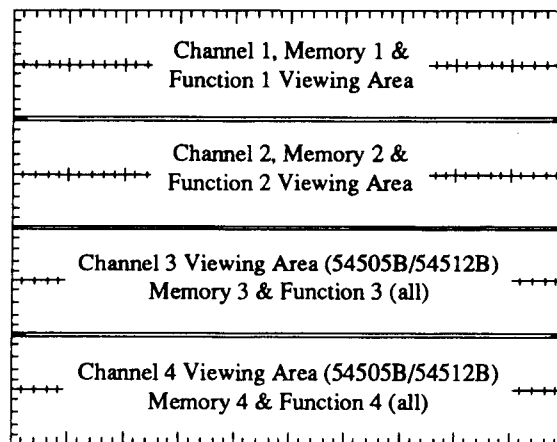

Figure 7-3. Four Screen Display

**off/frame/ axes/grid
Key**

This unlabeled field selects one of four display backgrounds:

- **off:** turns the background graticule off. The displayed waveform and waveform information is not turned off.
- **frame:** displays the outside border with a measurement scale. The measurement scale is incremented/decremented with major divisions and minor divisions based on the vertical and horizontal measurement settings.
- **axes:** displays a background with the measurement scale crossing at mid-screen.
- **grid:** background is a complete graticule with ten horizontal major divisions and eight vertical major divisions. Only the axes portion of the graticule has a minor division scale.

connect dots Key

Connect-the-dots is a technique used to display waveforms with all data points connected. This makes viewing the waveforms easier because the signal is complete and has no breaks. The waveform in figure 7-4 is the same as in figure 6-16 after the connect-the-dots key is on.

Note

Connect-the-dots does not generate data points. The oscilloscope connects data points linearly.

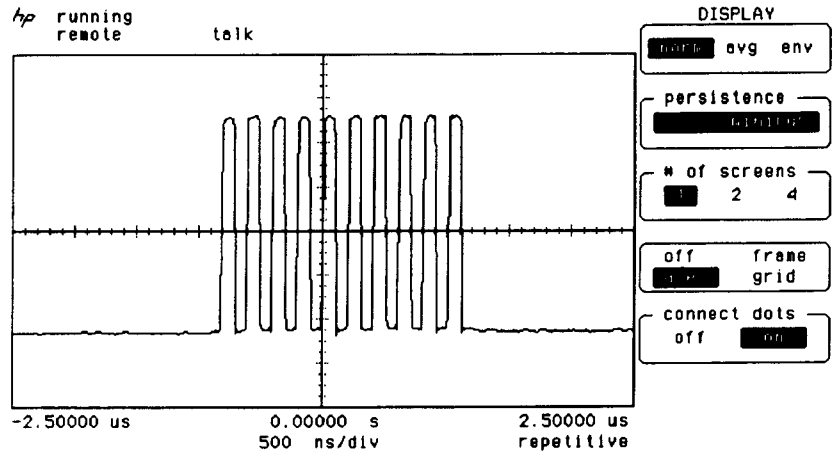
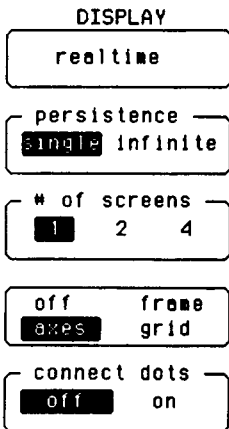
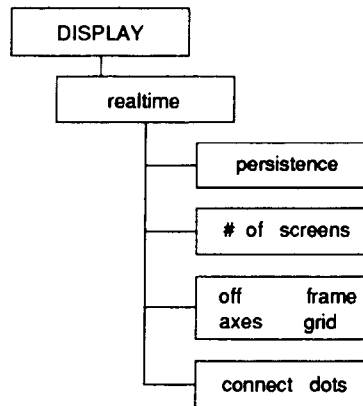

Figure 7-4. Connect the Dots

Realtime Acquisition Display Menu (seq off)



The display menu selections available when the TIMEBASE acquisition mode is set to realtime and sequential is set to off as shown in figure 7-5.



7-5. Realtime Acq Mode (Seq off) Display Menu

persistence Key This key is used to select persistence during realtime acquisition.

- Single persistence is very fast overwrite. As each new acquisition is displayed it overwrites the previous data. The current display is always the most recent acquisition.
- Infinite persistence can be used for worst-case characterizations of signal noise, jitter, drift, etc. In this mode the oscilloscope is used as a storage oscilloscope.

of screens Key This key selects the number of screens to be displayed. Refer to Repetitive Display Menu for more information.

off/frame/ axes/grid Key This unlabeled field selects one of four display backgrounds. Refer to Repetitive Display Menu for more information.

connect dots Key This key is used to display waveforms with all data points connected. Refer to Repetitive Display Menu for more information.

Realtime Acquisition Display Menu (seq on)

The display menu selections available when the TIMEBASE acquisition mode is set to realtime and sequential is set to on as shown in figure 7-6. Items in this menu are used to display previously defined (using the TIMEBASE menu) and captured (using the RUN key) segments. Refer to Chapter 4 for additional information.

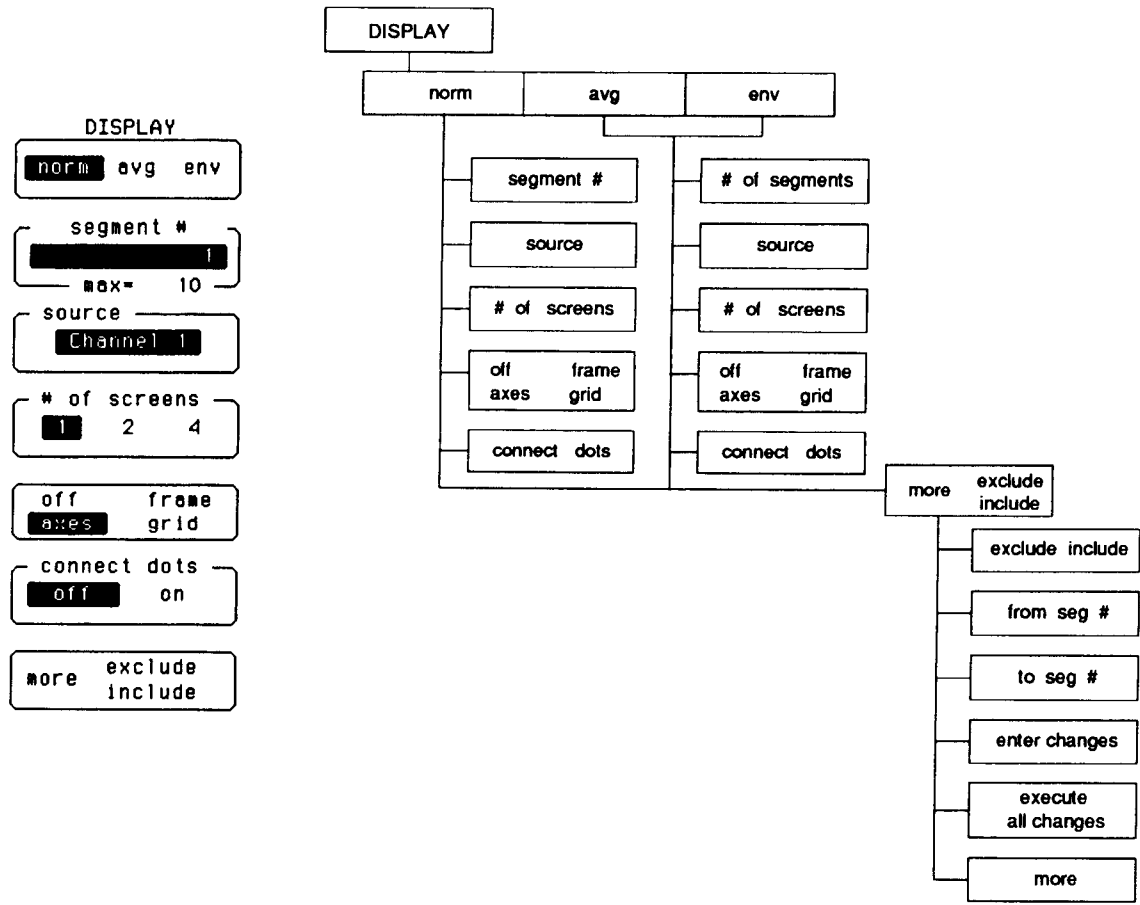

Figure 7-6. Realtime Acq Mode (seq on) Display Menu

All measurements, waveform math functions, and pan and zoom features are available when displaying the previously captured segments. Refer to the appropriate chapters in this manual for more information. Note that data interpolation does not occur in sequential single-shot mode.

NOTE

This specific oscilloscope setup is referred to as "Sequential Single-shot" throughout the remainder of this manual.

Display Mode Key The **DISPLAY** mode key selects one of three display modes:

- normal
- averaged
- envelope

norm

The **norm** mode allows each captured segment to be viewed individually. The segments that can be viewed are determined by the **include exclude** key.

When **norm** is selected, the function key beneath the **norm** field is activated. This field displays the current segment number being viewed, and can be set using the knob or keypad. Selecting a segment# larger than the maximum captured will cause the display to enter infinite persistence mode (displays all segments), where all the "included" segments from the selected source are displayed at one time. Selecting an excluded segment causes "segment X is excluded" to be displayed.

NOTE

Measurements performed in infinite persistence mode are made on a last hit bases.

avg

The **average** mode averages each captured segment into a composite waveform. Only segments selected as *include* using the **exclude include** key are averaged. When **avg** is selected, the segment number currently being averaged is displayed in the lower left corner of the screen, and the **# of segments** key is activated. The **# of segments** key displays the total number of segments that were averaged.

env

The **envelope** mode displays the minimum and maximum voltages in each captured segment. Only segments selected as *include* using the **exclude include** key are used. When **env** is selected, the segment number currently being evaluated is displayed in the lower left corner of the screen, and the **# of segments** key displays the total number of segments that were used.

For all the display modes, the **#of segments** key displays the following messages:

- **no segments:** displayed when there are no previously captured segments for the selected source.
- **channel off:** displayed when the source currently selected is set to off.

source Key This key specifies the source used during all display operations. Press key to highlight field, then use the knob to enter the desired value. Any active channel can be selected as the source. If no previously captured segments exist for the channel specified, a status message is displayed and the **# of segments** key displays *no segments*.

of screens Key This key selects the number of screens to be displayed. Refer to Repetitive Display Menu for more information.

off/frame/ axes/grid Key This unlabeled field selects one of four display backgrounds. Refer to Repetitive Display Menu for more information.

connect dots Key This key is used to display waveforms with all data points connected. Refer to Repetitive Display Menu for more information.

more exclude include Key Press to display the segment exclude include menu choices.

DISPLAY (MORE)

exclude include

from seg #

Channel 1

to seg #

max= 10

enter changes

execute
all changes

more

exclude include Key This key is used to select which of the previously captured segments can be used for display operations. Press key to highlight desired choice as follows:

- **exclude:** segments specified using the **from seg #** and **to seg #** keys cannot be viewed in normal mode, and are not used during average and envelope modes.
- **include:** previously excluded segments specified using the **from seg #** and **to seg #** keys can now be viewed, and are now used during average and envelope modes.

Note

*All segments are initially acquired as "included". A list of currently included segments are shown on the bottom left of the screen, along with a counter showing the current segment being used in average, envelope, or normal (when **all segments** is selected) mode.*

- from seg # Key** This key is used to specify the beginning segment number when entering the range of segments to be excluded or included from display operations. Press key to highlight field, then use the keypad or knob to enter desired value. Any positive value within the number of segments currently acquired can be entered; however, the **from seg #** entry cannot exceed the **to seg #** entry. Bottom of the key displays the source currently selected.
- to seg # Key** This key is used to specify the ending segment number when entering the range of segments to be excluded or included from display operations. Press key to highlight field, then use the keypad or knob to enter desired value. Any positive value within the number of segments currently acquired can be entered; however, the **to seg #** entry cannot precede the **from seg #** entry. Bottom of the key displays the maximum number of segments acquired.
- enter changes Key** Pressing this key enters the currently selected **exclude include**, **from seg #**, and **to seg #** values. These entries will not be implemented until the **execute all changes** key is pressed. Once the **enter changes** key is pressed, a status message is displayed at the top of the screen. To abort the process without executing the changes, press the **more** key.
- execute all changes Key** Pressing this key immediately processes all changes that have been entered, and displays the new included segments list at the lower left portion of the screen. If average or envelope modes are selected, the new composite waveform is generated using the updated segment list.
- more Key** Press to toggle the other display menu choices.

Note

*The preferred method of making changes is to enter all desired changes, then press the **execute all changes** key.*

Sequential Single-Shot Display Exercise

This exercise is a continuation of the Sequential Single-Shot Mode Exercise provided in Chapter 4, "Timebase." During the previous exercise, an acquisition of 10 segments of 501 points each was performed, and each segment was displayed. During this exercise, a waveform that is the average of segments 5 through 10 will be constructed and displayed.

- Toggle the **DISPLAY** mode key until **avg** is selected.
- Press the **more exclude include** key.
- Toggle the **exclude include** key until **exclude** is highlighted.
- Press the **from seg #** key and use the knob to select 1.
- Press the **to seg #** key and use the knob to select 4.
- Press the **enter changes** key, then the **execute all changes** key.
- The waveform will be reconstructed and displayed using the average of segments 5 through 10.

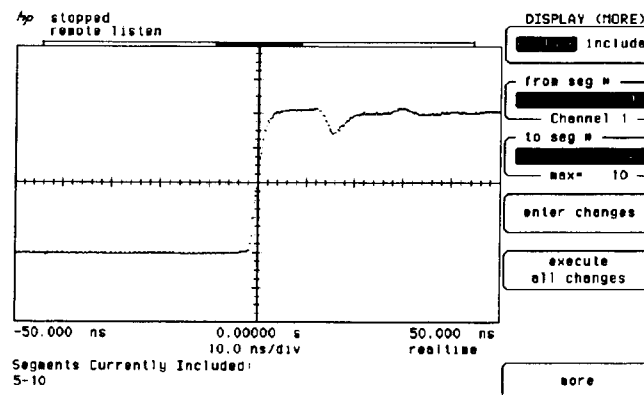

Figure 7-7. Sequential Single-Shot Display Example

Introduction to the Markers

This chapter describes how to use the markers and make manual measurements on displayed waveforms.

In this menu, two sets of x- and y-axis markers are provided, each with a separately selectable source. The **x markers** (vertical) measure voltage (or power in FFT mode), and the **y markers** (horizontal) measure time (or frequency in FFT mode) for the currently selected source. Each marker is individually controlled and labeled.

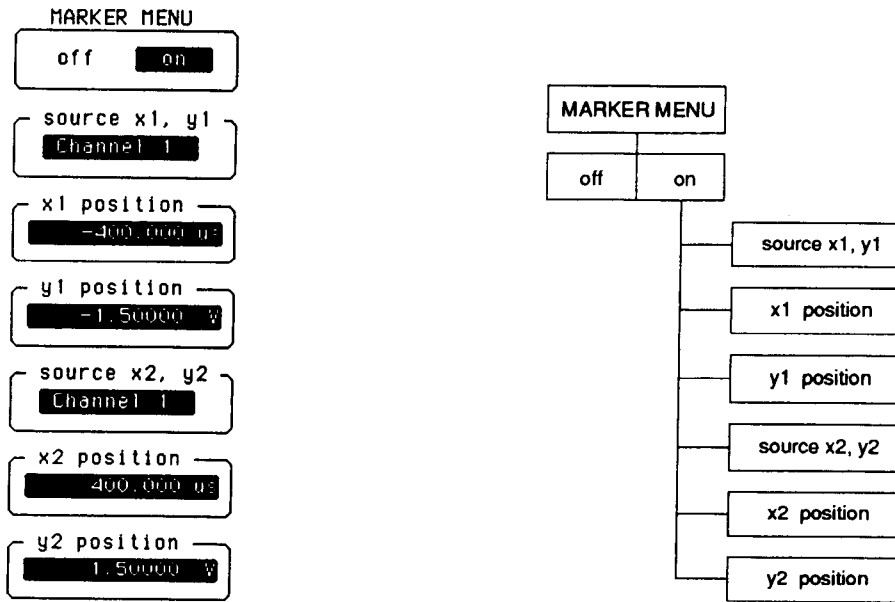

Figure 8-1. Marker Menu

off on Key This function key toggles both sets of markers on and off. When set to on, all markers are displayed on the waveform. The current x/y marker position and source, delta x/y information, and 1/delta x information also appears in the factors display area.

The delta entries are calculated as follows:

$$\text{marker2} - \text{marker 1} = \text{delta}$$

If delta is negative, marker 1 is located at a more positive level or previous time than marker 2. If all delta information is full of dashes (- - - -), then one of the sources currently selected is not on.

source x1,y1 Key This key selects the source for the x1 and y1 markers. Available sources for marker measurements include all channels, functions, and nonvolatile waveform memories. Pressing the key and use the knob to select the desired source. If the currently selected source is not on, "Source Off" is displayed in the factors display area, and all delta x/y information is filled with dashes.

x1 position Key This key selects the x1 marker as the marker being positioned. When selected, the field is highlighted and the x1marker is moved using the knob. The x1marker is placed on the display respective of the trigger point. Positive time values are to the right of the trigger point and negative time values are to the left. Measurement information is displayed in the highlighted field and in the factors area of the waveform display. Displays seconds in all modes except FFT, where the display units are in Hz.

x1marker is the vertical marker with longer dashes, and is marked on the top of the display as "x1".

y1 position Key This key selects the y1 marker as the marker being positioned. When selected, the field is highlighted and the y1marker is moved using the knob. Typically, place the y1marker at the desired level on the waveform display and read the level in the highlighted field, and in the factors area of the waveform display. Displays volts in all mode except FFT, where the display units are in dBm.

y1marker is the horizontal marker with longer dashes, and is marked on the left side of the display as "y1".

Note

The x/y markers can be moved on a selected source even though that source is not displayed. Make sure that the markers are assigned to the proper source to be measured, or the numeric field may be incorrect.

source x2, y2 Key Operation is identical to **source x1, y1** key, except source is specified for the x2 and y2 markers.

x2 position Key Operation is identical to **x1 position** key, except x2 marker is the vertical marker with shorter dashes, and is marked on the bottom of the display as "x2".

y2 position Key Operation is identical to **y1 position** key, except y2 marker is the horizontal marker with shorter dashes, and is marked on the right side of the display as "y2".

Waveform Math Menu

Introduction to the Functions

The **WAVEFORM MATH** menu defines one of four math functions. The operands for the functions can be any channel or one of four waveform memories.

A function is generated by mathematically manipulating one or two operands with one of the following nine operations:

- plus (+)
- minus (-)
- times (X)
- versus
- magnify
- invert
- integrate
- differentiate
- fft

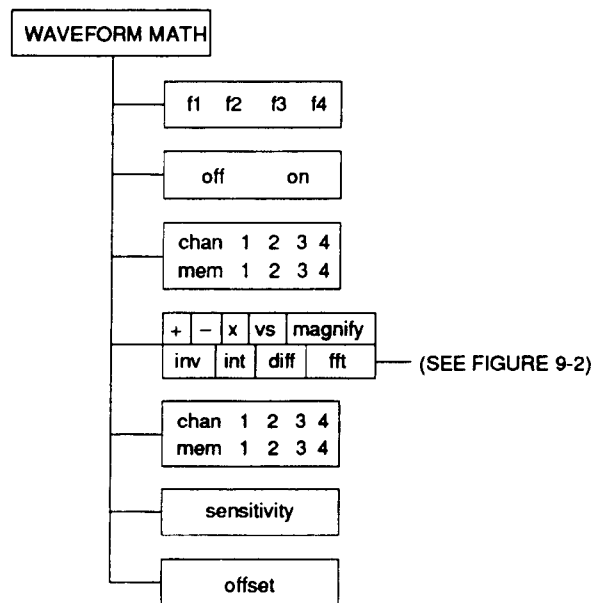

Figure 9-1. Waveform Math Menu

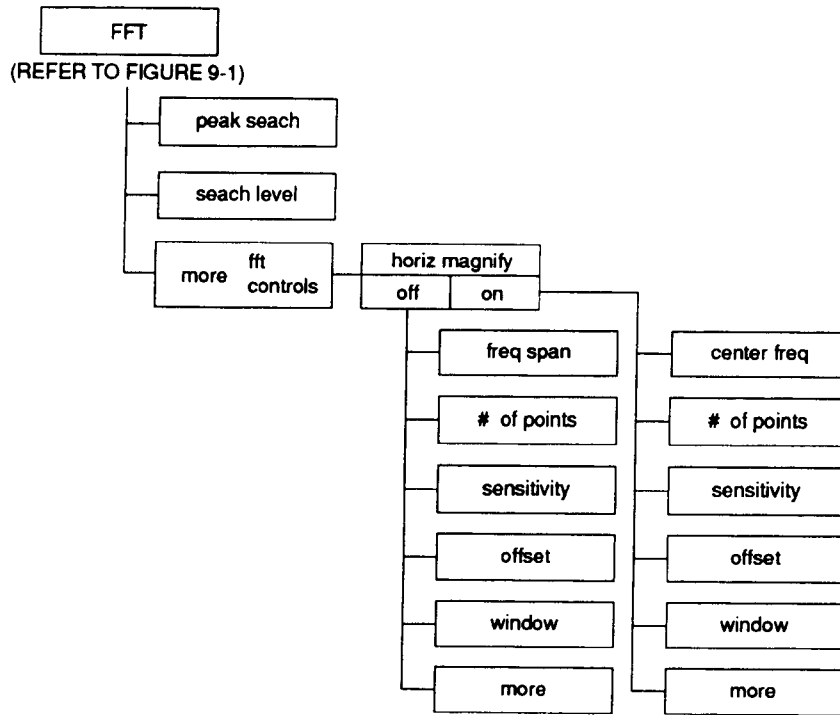

Figure 9-2. FFT Waveform Math Menu

The vertical display and offset can be adjusted to place the function for best viewing.

When the function has been calculated, it can be used in the following manners:

- displayed
- evaluated with the measurement features
- stored in memory
- transferred over the HP-IB

Functions are transferred over the HP-IB by first storing the function to a memory and then transferring the memory over the HP-IB.

Defining a Function

WAVEFORM MATH

f1	f2	f3	f4
o	o	o	o

display	off	on
---------	-----	----

Chan	1	2	3	4
mem	1	2	3	4

- x vs magnify
inv int diff fft

chan	1	2	3	4
mem	1	2	3	4

sensitivity	1.00	V/div
-------------	------	-------

offset	0.0000	V
--------	--------	---

The Waveform Math menu selects and presets any of various operations, sources, and displayed results.

Function Key

This key selects either function 1, 2, 3, or 4. When a function is turned on, the small circle immediately below the function number is highlighted.

display Key

The display key turns the selected function on or off.

The display of the functions depends on the display mode in the DISPLAY MENU. In single display the functions are displayed in one screen. In dual mode display, functions 1 and 2 are displayed in the top screen and functions 3 and 4 are displayed in the bottom screen. In four mode display, each functions is displayed in its appropriate area, starting with 1 on the top.

operand (chan/mem) Key

Press this key to select the first operand of the mathematical operation, or the waveform to be manipulated. The choice can be any channel or any waveform memory that has a waveform stored.

If the operator is **magnify**, **invs**, **int**, **diff**, or **fft** this is the only operand that may be selected.

Operator Key

This key selects any of the nine functions. Continue pressing the selection key until the operation desired is highlighted.

- **plus (+)**: the two selected operands are added together. Addition is calculated on a point-by-point basis.
- **minus (-)**: the minus operation subtracts the second operand from the first.
- **times (x)**: the times operation multiplies the value of the first operand by the value of the second operand. Each data point is multiplied with a corresponding data point and the product is placed on the function display.
- **vs (versus)**: the versus function draws a volts versus volts display of the two selected operands. Versus cannot be stored in a waveform memory because measurements cannot be made on the resultant waveform, however, it can be stored in pixel memory. In source x versus source y, the vertical range of source y determines the horizontal range of the vs function.
- **magnify**: The magnify function displays and scales the first operand.
- **inv (inverse)**: The inverse function inverts the data of the first operand.

- **int** (integrate): The integrate function calculates the integral (with respect to time) of the vertical value of the designated operand. Integration proceeds on a point-by-point basis. If a data point is not encountered in the operand, integration uses the next valid data point. Any non-existing data points encountered are not summed, only the available data is integrated. Default scaling is determined by the original operand.
- **diff** (differentiate): The differentiate function calculates the derivative of the designated operand with respect to time. Differentiation proceeds on a point-by-point basis. If a data point is not encountered in the operand, then differentiation uses the next valid data point. Default scaling is determined by the original operand. The differentiation function, by nature, amplifies noise effects. Therefore, differentiation should be applied to signals with high signal-to-noise ratios.
- **fft** (fast Fourier transform): When **fft** is selected, the fast Fourier transform function of the specified channel or memory is plotted. Selecting this key adds the **fft** functions to the WAVEFORM MATH menu. In the WAVEFORM MATH menu, when the **fft** function is selected, the readout for the horizontal axis changes from time to Hertz and the vertical readout changes from volts to dBm.

chan/mem Key

This key selects the second operand that is manipulated against the first operand. The choices are any of the displayed channels or any of the memories. This key is not available if the operator is **magnify**, **inv**, **int**, **diff**, or **fft**.

sensitivity Key

The vertical sensitivity of the function is set with this key. This setting is for ease of viewing and making measurements on the function.

offset Key

The offset of the function is set with this key.

FFT Keys

The following keys are available when the **fft** operator is selected.

peak search Key

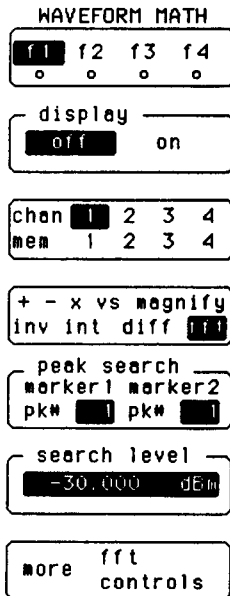

The peak search measures the amplitude and frequency of peaks on the display when the **fft** function of the oscilloscope is turned on. To qualify as a peak, the amplitude of the peak must be at least one display division, or half a division in split-screen mode. The peaks must also be greater than the search level specified. The peak search key causes the markers to turn on.

The markers are set to the specified peaks in the peak search field. Markers x1 and y1 are set on the first peak specified. Markers x2 and y2 are set on the second peak specified. Peak numbers, from 1 to 99, may be specified in the peak search field. Pressing the blue key and CLR MEAS key removes the markers from the display.

A peak search for both peaks is performed every time the peak search key is pressed.

If a peak is not found, a message is displayed and the vertical marker is set to the right side of the screen and the horizontal marker is set to the bottom of the screen.

For maximum frequency accuracy when using peak search, the FFT horizontal magnify function should be turned on.

search level Key

The search level key sets the minimum search level for the peak search.

more Key

The more key selects the second level of the WAVEFORM MATH menu when the **fft** function is selected.

horiz magnify Key

WAVEFORM MATH

horiz magnify
 off on

freq span
500 MHz

of points
512

res 1.95 MHz
sensitivity
10.0 dB/div

offset
-30.000 dBm

window
rectangular
"transients"

more

54510W45

The horizontal magnify key allows expansion of the frequency record when **on** is selected. The magnify **off** mode is useful for viewing the entire FFT spectrum. The magnify **on** mode is useful for looking at two frequencies that are close together and for making maximum accuracy measurements. When **on** is selected, the center freq key is available in the menu for centering on the desired frequency.

The number of points displayed on the screen for FFT functions is always 500. When magnify is off a compression algorithm is used to compress all of the fft points into 500 points. The algorithm accurately displays peaks and most noise. However, low points in the noise are occasionally missed. When magnify is on, the actual fft points are displayed, 500 points at a time.

freq span Key

The frequency span controls the span of the FFT record. Changing the span of the FFT record with a channel source causes the timebase to change. The span is the sample frequency divided by two (except for timebase rates < 100 nsec/div (HP 54505B/54506B) or < 50 nsec/div (HP 54510B/54512B) in the repetitive mode). Since the sample frequency for memories is fixed, once a record is stored, the span is also fixed and cannot be changed. The front panel keypad does not have keys for entering MHz or kHz. The frequency span is entered from the keypad by entering the number in MHz or kHz followed by 6 or 3 zeroes and then pressing the enter key (s V key).

center freq Key

The center frequency key allows centering of the frequency record to the desired frequency when horizontal magnify is **on**.

of points Key

The number of points key assigns the number of data points to be used for the FFT computation. The number of points affects the computation speed, frequency resolution, and the noise floor. The frequency resolution of an FFT is $\frac{F_s}{N}$, where: F_s is the sampling frequency and N is the number of points. The maximum signal-to-noise ratio of an FFT is related to both the A/D converter bits of resolution and the number of points.

An FFT performed on a small number of points can be computed faster. An FFT performed on a large number of points has better frequency resolution and a lower noise floor. The resolution affects how accurately frequencies can be measured and how well two frequencies that are close together can be resolved.

If the oscilloscope is in repetitive mode, or the operand is a memory that was stored from the repetitive mode, the number of points defaults to 512 and cannot be changed.

When the operand is a repetitive source, on-screen data is used for the FFT. When the operand is realtime, the FFT is performed on data in the 8K record, but not necessarily the data that is displayed on the screen. The points used from the record are selected based on the TIME BASE reference setting of **left**, **center**, or **right**. When the TIME BASE reference is set to **left**, data at the beginning of the record is used. When **center** is selected, data in the middle of the record is used. When **right** is selected, data at the end of the record is used.

The memory bar above the graticule indicates what portion of the acquisition record is used for the FFT time record. The memory bar shows the FFT record whenever the FFT menu with the # of points key is selected.

An FFT with an input record of N points is transformed into a frequency record of N points. Because half of the points are above the Nyquist frequency and provide redundant information, they are not used, so the frequency points are half that of the input. The FFTs are computed on records that are powers of two.

If the number of FFT points is 512, 256 additional frequency points are created by interpolating between the actual points to give 512 frequency points. The number of FFT points and the resultant

frequency points is listed below. The display time is with connect-the-dots off.

INPUT POINTS	FREQUENCY POINTS
512 (repetitive)	512
512 (real time)	512
1024	512
2048	1024
4096	2048
8192	4096

sensitivity Key

The vertical sensitivity of the function is set with this key. The setting is for ease of viewing and making measurements on the function.

offset Key

The offset of the function is set with this key.

window Key

Three windows can be selected with the window key: rectangular, hanning, and flattop. The FFT operation assumes that the time record repeats. Unless there is an integral number of cycles of the sampled waveform in the record, a discontinuity is created at the end of the record. This is referred to as leakage. In order to minimize spectral leakage, windows that approach zero smoothly at the beginning and end of the signal are employed as filters to the FFT.

Windows work by weighting points in the middle of the waveform record higher than those at the ends of the record. For example, a hanning window looks like the first half of a sine wave. The hanning window multiplies the points in the center of the record by 1 and the points at the start and the end of the record by zero.

The **rectangular** window is essentially no window. All points in the record are multiplied by 1. The **rectangular** window is useful for transients signals and signals where there are an integral number of cycles in the time record. The **hanning** window is useful for frequency resolution and general purpose use. It is good for resolving two frequencies that are close together or for making frequency measurements. The **flattop** window is the best window for making accurate amplitude measurements of frequency peaks.

more Key

The **more** Key returns the first WAVEFORM MATH menu to the display.

Vertical Scaling Units

The fundamental measuring units of an oscilloscope are volts/division in the vertical axis and time/division on the horizontal axis. This philosophy is used for all the function operations except for FFT's. No provisions have been made to manage units for all combinations of operands and operations.

For example, apply a +2V signal to channel 1 and a -3V signal to channel 2. The oscilloscope display the product as -6V, when in reality it is $-6V^2$.

Making FFT Measurements

The following information will help to make optimum measurements in the frequency spectrum.

Connect the Dots

It is easiest to view FFT's with connect the dots on. Connect the dots is set in the DISPLAY MENU.

Amplitude Measurements

For best vertical accuracy on peak measurements:

1) Make sure the source impedance and probe attenuation is set correctly. The impedance and probe attenuation are set from the CHANNEL MENU if the operand is a channel.

2) Set the source sensitivity so that the input signal is near full screen, but not clipped.

3) Use the flattop window.

4) Set the FFT sensitivity to a sensitive range, such as 2 dBm/division in the single screen mode (or 4 dBm/division in the dual screen mode).

Frequency Measurements

For best frequency accuracy on peaks:

- 1) Turn magnify on
- 2) Use the Hanning window
- 3) Set the frequency span so that the signal of interest is in the upper part of the screen (not down at DC)
- 4) Set the number of points to 8192, or as high as possible if computation time is a consideration

The frequency accuracy is the sum of two terms. The first term is because there are a limited number of frequency bins. The measurement is accurate to plus or minus half a bin. The second term is related to the accuracy of the internal oscillator which generates the sample clock.

$$\begin{aligned} \text{accuracy} &= \pm \left(\frac{\text{frequency resolution}}{2} + \frac{\text{signal frequency}}{20000} \right) \\ &= \pm \left(\frac{\text{sample frequency}}{2 \times \text{number of points}} + \frac{\text{signal frequency}}{20000} \right) \\ &= \pm \left(\frac{\text{frequency span}}{\text{number of points}} + \frac{\text{signal frequency}}{20000} \right) \end{aligned}$$

Computation of dBm

The vertical units of the FFT functions are dBm. 0 dBm is defined to be 1 milliwatt signal. The formula for converting a signal of power P into dBm is:

$$\text{dBm} = 10 \log \left(\frac{P}{1\text{mw}} \right)$$

A handier formula, and the one which is used in the instrument is one for calculating dBm from the peak voltage.

$$\text{dBm} = 20 \log \left(\frac{V_p}{0.316228\text{Volts}} \right)$$

The bottom term, 0.316228 Volts, is the peak voltage of a 1 milliwatt signal into a 50 ohm resistor. The calculation is shown below.

$$\begin{aligned} V_P &= \frac{V_{rms}}{0.707107} = \frac{\sqrt{P \times R}}{0.707107} \\ &= \frac{\sqrt{1\text{ mW} \times 50\text{ ohms}}}{0.707107} \\ &= 0.316228\text{Volts} \end{aligned}$$

If the power of a signal is being measured, then the source should be terminated into 50 ohms in order to get the correct dBm reading. However, if voltage is being measured the source impedance does not have to be 50 ohms. The equation above for dBm as a function of peak voltage still applies.

Computation of dBV

Another common unit of amplitude is dBV. A 0 dBV signal is defined to be a 1 Volt RMS signal. A dBm reading can be converted to a dBV reading by subtracting 13.01 dB.

$$\begin{aligned} dBV &= 20\log\left(\frac{0.707107 \times V_p}{1\text{Volt}}\right) \\ &= 20\log\left(\frac{V_p}{0.316228\text{Volts}}\right) + 20\log\left(\frac{0.707107 \times 0.316228\text{Volts}}{1\text{Volt}}\right) \\ &= dBm\text{ value} - 13.01dB \end{aligned}$$

DC Value

The FFT computation produces a DC value that is incorrect. It does not take the offset at center screen into account and is 1.41421 times greater than its actual value. The DC value is not corrected in order to accurately represent frequency components near DC.

Aliasing

When using FFT's, it is important to be aware of aliasing. Aliasing happens when there are insufficient samples on each cycle of the input signal to recognize the signal. It occurs whenever the frequency of the input signal is greater than the Nyquist frequency (sample frequency divided by 2).

When a signal is aliased, it shows up in the FFT spectrum as a signal of a lower frequency. Since the frequency span goes from 0 to the

Nyquist frequency, the best way to prevent aliasing is to make sure that the frequency span is greater than the frequencies present in the input signal. Keep in mind that most periodic signals that are not sine waves have frequency components that are much higher than the frequency of the signal.

Presetting FFT Parameters

The FFT vertical parameters, magnify and center frequency are preset whenever the operand or operator is changed. They are preset over the bus whenever the FFT command is sent.

Displaying Functions

The HP 54505B, HP 54506B, HP 54510B, and HP 54512B oscilloscopes have three screen choices available to accommodate a 2-channel display (HP 54505B/54506B) or 4-channel display (HP 54510B/54512B), as well as four functions.

- In the single screen mode with a function on, the mathematical results and the operands are displayed using the full display area.

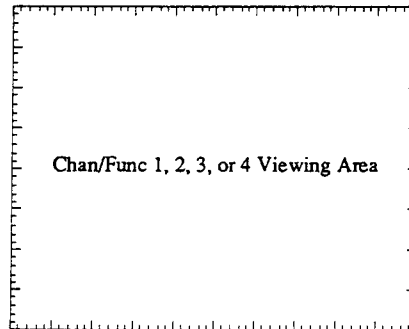

9-3. Single Screen with Function On

- In the dual screen mode on the HP 54505B/54510B, channel/function 1 is displayed in the top half of the screen, and channel/function 2 is displayed in the bottom half. On the HP 54506B/54512B, channels/functions 1 and 2 are displayed in the top half of the screen, and channels/functions 3 and 4 are displayed in the bottom half.

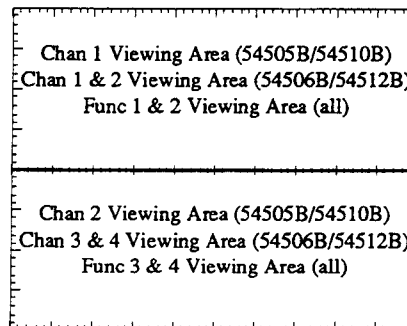

Figure 9-4. Dual Screen w/Function On

- In the four screen mode, each channel/function is displayed in the corresponding portion of the display as shown in figure 9-5.

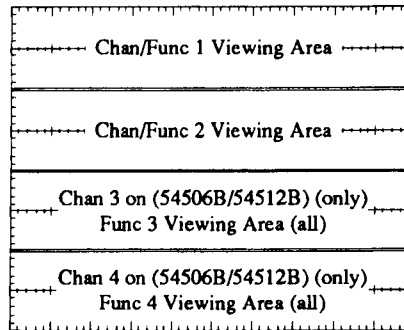

Figure 9-5. Four Screen w/Function On

Waveform Math Exercise

In this exercise the **WAVEFORM MATH** menu is used to subtract one waveform from another.

Instrument Setup

Set up an HP 8116A, or a signal generator capable of a 1 MHz, 1 volt squarewave, as follows:

- **MODE = NORM**
- **FRQ = 1 MHz**
- **DTY = 50%**
- **AMP = 1.00 V**
- **OFS = 0.00 V**
- Set the generator for a square wave signal

Connect the signal to a BNC tee on channel 1 using a 1-meter coaxial cable. Connect another 1-meter cable from the other side of the BNC tee and terminate in $50\ \Omega$ to channel 2 (HP 54505B/54510B) or channel 3 (HP 54506B/54512B).

Oscilloscope Setup

The extra cable length between channels provides a time delay between the signals on the oscilloscope. The propagation of a 1-meter coaxial cable is approximately 6 to 7 ns. This delay is used to demonstrate the math function.

The following procedure assists in setting up the oscilloscope for optimal viewing.

- Press **AUTOSCALE**.
- Set the mode to repetitive in the **TIMEBASE MENU**.
- Press **DISPLAY** to set the best viewing conditions. Set display mode to *avg*, # of avg to 8, # of screens to 2.
- Press **WFORM MATH** to define the function. Select *f1* and turn the display on. Select *chan 1, - (minus), chan 2* (HP 54505B/54510B) or *chan 3* (HP 54506B/54512B) and set the function sensitivity to 2.00 V/div.

The function subtracts channel 2 (or 3) from channel 1. The propagation between channels has allowed a 6 to 7 ns spike. To better view the results:

- Press **TIME BASE** and set the horizontal display to 50.0 ns/div (see Figure 9-6) . This display is best viewed when the oscilloscope is in **repetitive acquisition mode**.

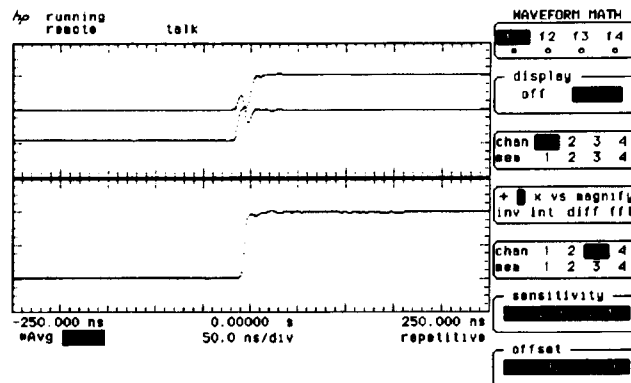

Figure 9-6. Channel 1 Minus Channel 2 (or 3)

Waveform Math FFT Exercise

In this exercise the **WAVEFORM MATH** *fft* function is used to demonstrate the effect of the three different windows and to measure peaks.

Instrument Setup

Set up an HP 8116A, or signal generator capable of a 25 MHz, 1-volt square wave, as follows:

- **MODE** = NORM
- **FRQ** = 25 MHz
- **DTY** = 50%
- **AMP** = 1.00 V
- **OFS** = 0.0 V
- Select a square-wave signal

Connect the signal to channel 1 of the oscilloscope with a one-meter coaxial cable.

Oscilloscope Setup

The following procedure assists in setting up the signal on the oscilloscope for optimal viewing.

- Press **AUTOSCALE**.
- Set the mode to real time in the **TIMEBASE MENU**.
- Press **DISPLAY** and turn connect-the-dots *on*.
- Select the **CHANNEL MENU** and set volts per division for a full-scale, but not clipped, display. Use the vernier of the pulse generator, if necessary, to set the signal to full scale as in figure 9-7.



Note

The oscilloscope cannot compute a correct FFT from a clipped signal, and if the signal is too small, there may be errors due to noise.

- Turn **CHANNEL 1** *off*. The screen will be blank with channel 1 turned off.

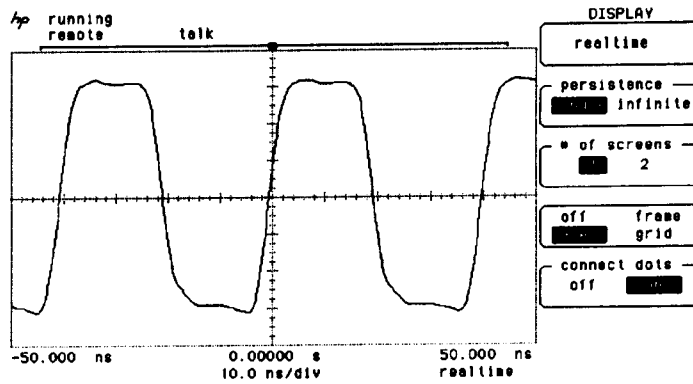

Figure 9-7. Maximum Vertical Signal Setup

- Press WFORM MATH to define the function. Select *f2* and turn the display *on*. Select the *fft* operator and *chan 1* operand. The FFT is plotted on the display as in figure 9-8.

Note 

Range shown in the following figures (0 Hz to 500 MHz) is for the HP 54510B/54512B. The HP 54505B/54506B range is 0Hz to 250MHz, with a slower sample rate.

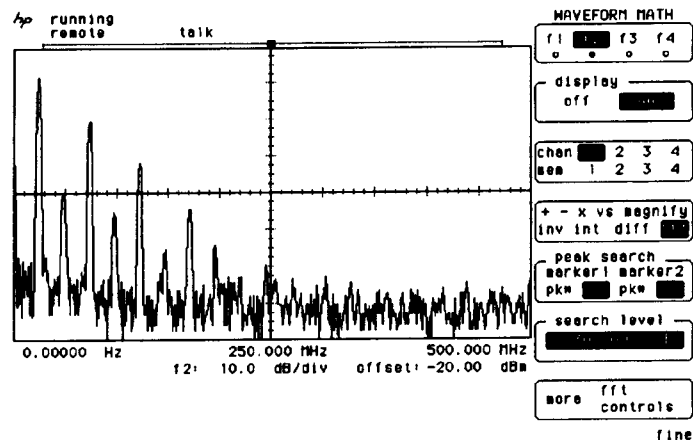

Figure 9-8. FFT Plot of Channel 1 Signal

FFT Windows

Set the # of points to 1024 and the window to rectangular. The same signal is shown in figures 9-9 through 9-11 filtered by the different windows by selecting **rectangular**, **hanning**, and then **flattop**.

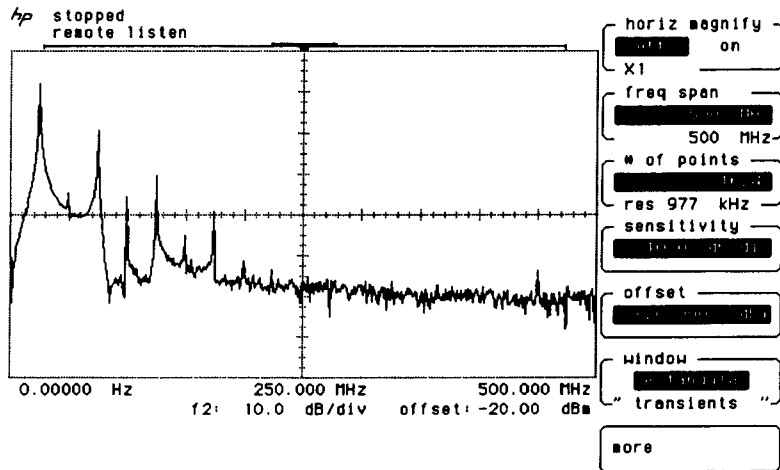

Figure 9-9. Rectangular Window for Transients

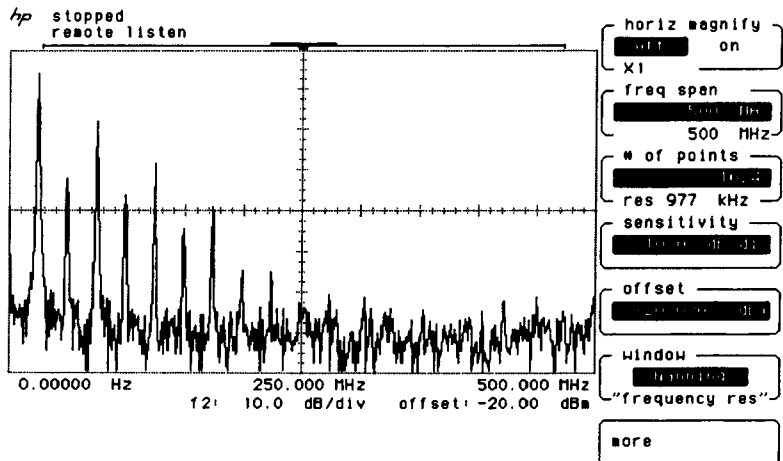

Figure 9-10. Hanning Window for Frequency Resolution

Making Peak Measurements

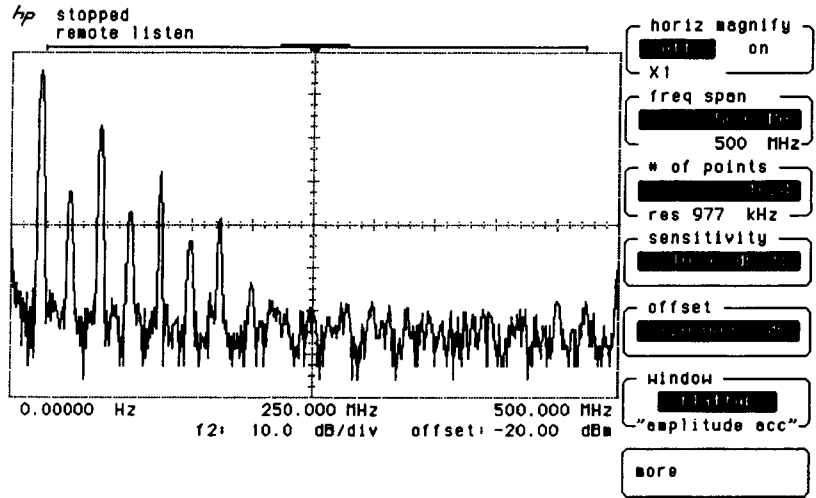
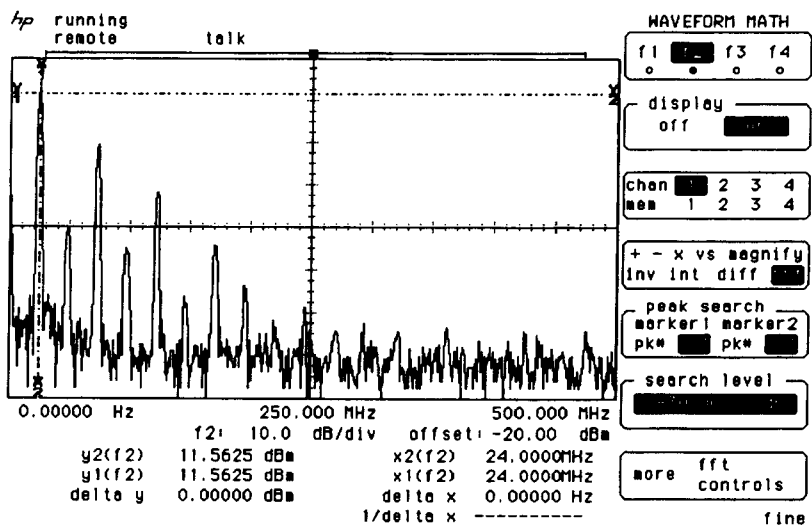

Figure 9-11. Flattop Window for Amplitude Measurements

The oscilloscope makes automatic peak measurements from the WAVEFORM MATH fft menu. Set both search fields to the first peak. The markers are then set on the first peak as in figure 9-12.



9-12. Automatic FFT Peak Measurement

Turn fft magnify on for maximum measurement accuracy. Any two peaks, from 1 to 99 and above the specified search level, can be selected and measured as in figure 9-13. In this example peaks 3 and 5 are marked.

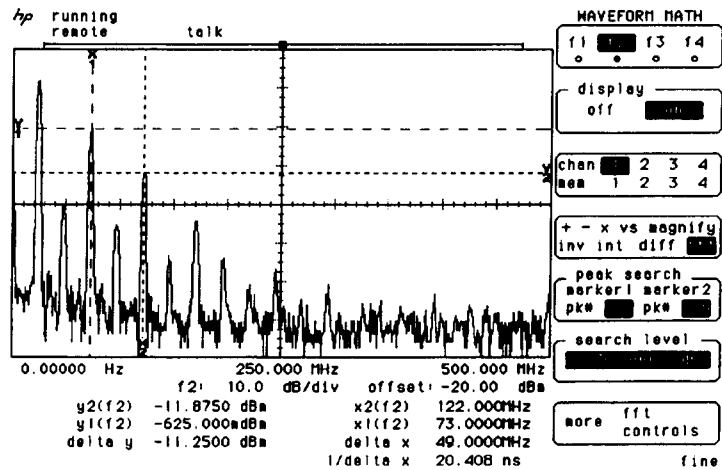

9-13. Measuring FFT Peaks

Display both channel and function with the display menu. Select the marker menu and change both sources to channel 1. The x1 and x2 markers change from Hz to time as in figure 9-14.

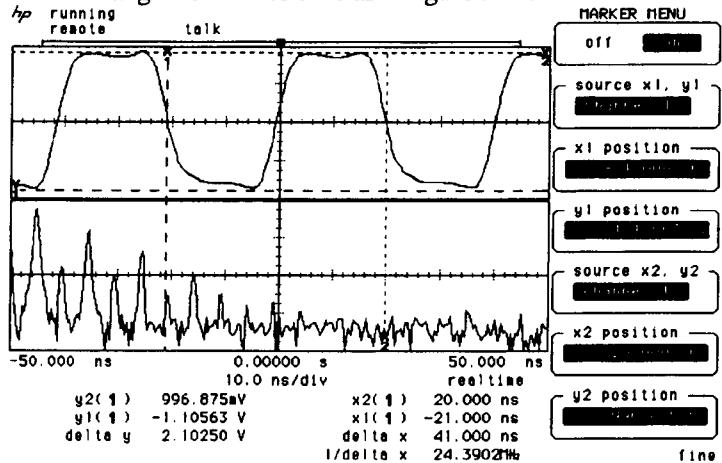

9-14. Using Markers on FFT Source

Storing an FFT

To store the FFT. Press the WFORM SAVE key and select *waveform*, *nonvolatile m1*, and *func 2* as in figure 9-15. Press *store* function key.

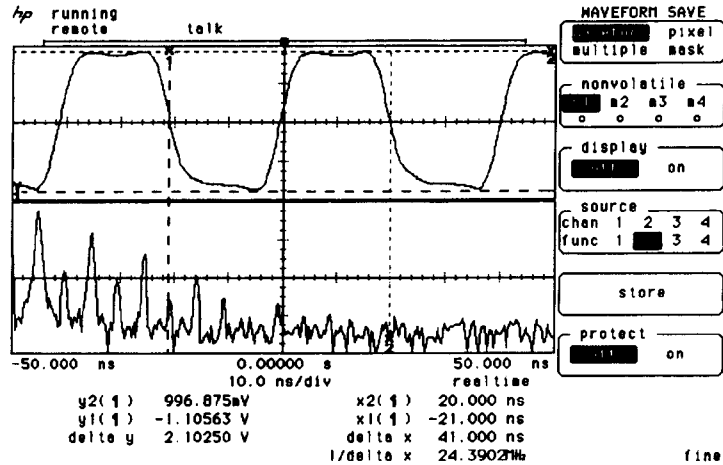

9-15. Storing an FFT

Press CLEAR DISPLAY and the blue key and CLEAR to clear the screen. Turn *display on* to view the stored FFT. Notice the memory readouts are in time rather than frequency.

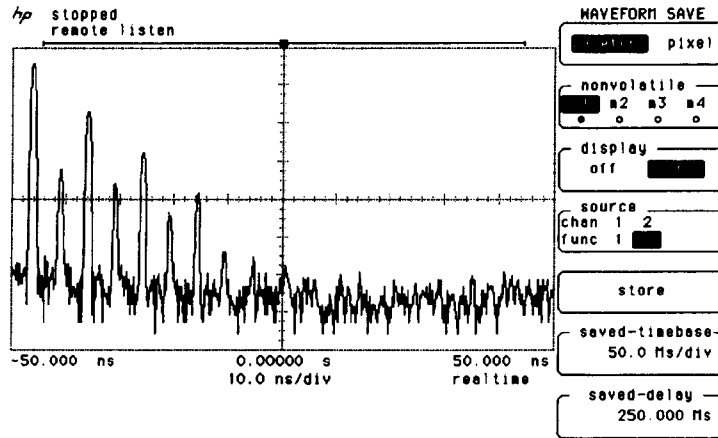

9-16. Displaying Memory 1 FFT

Introduction to the Memories

This chapter describes how to select the waveform, pixel, multiple, and mask memories on the oscilloscope. The menu consists of four submenus:

- waveform memories m1 - m4 used to store one waveform at a time.
- pixel memories p1 and p2 used as a screen store. In this manner the memories are used as a storage oscilloscope.
- multiple memories 1 to 665 used to store failure data on limit and compare tests.
- mask memory pairs m1-m2 and m3-m4 used to generate and store upper and lower waveform masks for compare testing.

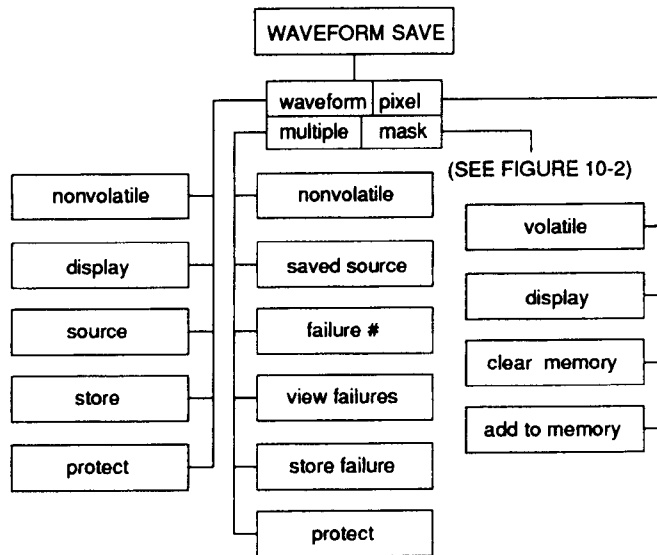
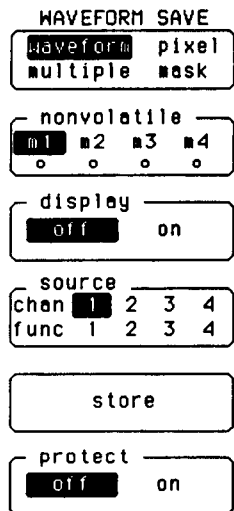

Figure 10-1. Waveform Save Menu

waveform/pixel/ multiple/mask Key

This is the function key used to choose the desired type of memory. The active menu is highlighted. Each memory type (waveform, pixel, or mask) has a separate menu. When this key is pressed, the appropriate menu is displayed.

waveform Menu



The waveform menu has four available memories, m1, m2, m3, and m4. These memories are nonvolatile and will not be cleared during AUTOSCALE, RECALL CLEAR, or recycling power. This permits disconnection of power and transportation of the oscilloscope without losing the contents of waveform memories.

A waveform memory consists of a single waveform record, including the horizontal and vertical scaling parameters. This allows measurements on previously stored waveform and function data. x and y markers can be set on waveforms when they are displayed.

When the oscilloscope is in the envelope display mode and a waveform store is executed, the minimum value and maximum value are stored separately. The maximum value will be stored in m1 if m1 or m2 are the selected store locations, or m3 if m3 or m4 are the storage locations. The minimum values are stored in m2 or m4 respectively. A store message is displayed above the waveform display area to show the storage locations of both values.

nonvolatile Key

This key selects which memory to use. The selections are nonvolatile memories m1, m2, m3 and m4. When a memory is turned on the small circle below the label is highlighted. When the memory is protected (see protect Key), the small circle has an "x" through it. The waveform memories are record memories that store 8000 points (realtime) or 500 points (repetitive) of waveform information in each memory.

display Key

This key toggles the selected waveform memory display on or off. When on is selected, an additional key is displayed that shows the TIMEBASE and DELAY settings when the waveform was stored.

- source Key** The source key selects the source waveform to be stored. The source alternatives are any channel or function.
- store Key** This is the active key in the menu. By pressing this key the specified waveform is stored in the specified memory (if the memories protect is off). When the key is pressed an immediate erase of the selected memory and a write to the memory is executed. If the destination memory is protected, a message indicating that the store was not successful is displayed.
- protect Key** This key toggles the selected waveform memory write protect to on or off. When on is selected, any attempt to store data is not allowed, and a message indicating that the store was not successful is displayed.
- timebase/delay Key** Only displayed when the memory selected is set to on. Initially displays the timebase and delay settings when the waveform was stored. Pressing the key cycles between the timebase and delay values. Use the knob to change values for pan and/or zoom of displayed waveform.

pixel Menu

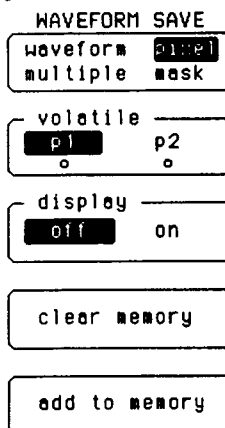

The pixel submenu selects the pixel memories. These memories are useful when additive memory capabilities are needed. Waveforms can be stored to and added to indefinitely.

- volatile Key** This is the memory select key. The alternatives are pixel memory 1 or 2. The pixel memories are complete pixel saves of the waveform area (excluding the graticule and markers) in volatile memory. The waveform display area is 256 by 451 pixels.

In pixel memory the entire screen is saved. Therefore, data is mapped directly onto the display and displayed in half-bright. There are no measurement capabilities on pixel memories.

Pixel memories are additive. When all pixels are full, adding to memory will overwrite the existing data.

display Key This key toggles the selected pixel memories on or off.

clear memory Key This key purges all data from the selected pixel memory.

add to memory Key Pressing this key adds the currently displayed waveforms to the specified pixel memory.

multiple Menu

The multiple submenu selects one of the 665 possible volatile failure memories. These are the memories where failure data from both the limit and waveform comparison tests can be saved. Failure data stored in volatile multiple memories can be viewed, and/or transferred to nonvolatile memories m1-m4. The multiple memories store 501 points of waveform information (no raw data) in each memory. Measurements cannot be performed unless the data is first transferred into one of the nonvolatile memories.

```
HAVEFORM SAVE
waveform pixel
multiple mask

nonvolatile
m1 m2 m3 m4
o o o o

saved source
None
max saved= 0

failure #
NO FAILURES

view failures
off on

store failure

protect
off on
```

- nonvolatile Key** This key selects which of the four nonvolatile memories to use when transferring multiple memory failure data. The selections are nonvolatile memories m1, m2, m3 and m4. When a memory is turned on (using the waveform submenu), the small circle below the label is highlighted. When the memory is protected (see protect key), the small circle has an "x" through it. Refer to the **Waveform Submenu** earlier in this Chapter for more information.
- saved source Key** The saved source key selects the multiple memory source to be viewed or transferred. Press key to highlight the field and use the knob to select the desired source. Source alternatives are any channel or function that has failure data saved, as selected when configuring the limit or compare test using the define measurement menu. See *define measurement* in Chapter 11 for more information. Displays "None" when no failure data is available (max saved = 0). The maximum number of data records saved is also displayed on the bottom portion of the key display.
- failure# Key** This key selects a specific multiple memory to view or transfer. Press the key to highlight the failure, then use the knob to select the desired data record. Also displays the time and date the selected record was saved. The source is specified using the saved source key. Maximum records available are displayed at the bottom of the saved source key. Displays "NO FAILURES" when failure data is not available.
- view failures Key** This key toggles the multiple memory display on or off. If failure data has not been saved, the key remains off and a message stating multiple memory is empty is displayed.
- store failure Key** By pressing this key, the specified multiple memory (using saved source and failure# keys) is stored in the currently selected nonvolatile memory location. When the key is pressed an immediate erase of the selected memory occurs, then a write to the memory is executed. If the destination memory is protected, a message indicating that the store was not successful. If no failure data has been saved, a status message is displayed.
- protect Key** This key toggles the selected waveform memory write protect to on or off. When on is selected, any attempt to store data is not allowed, and a message indicating that the store was not successful is displayed.

mask Menu

The mask menu allows the user to create upper and lower limit masks (or templates) used during the compare test. These templates can be created automatically using a sample signal and entering specific tolerance levels, or generating manually on the screen using the cursor.

The mask menu is comprised of the following three submenus:

- main mask menu
- automask menu
- mask editor menu

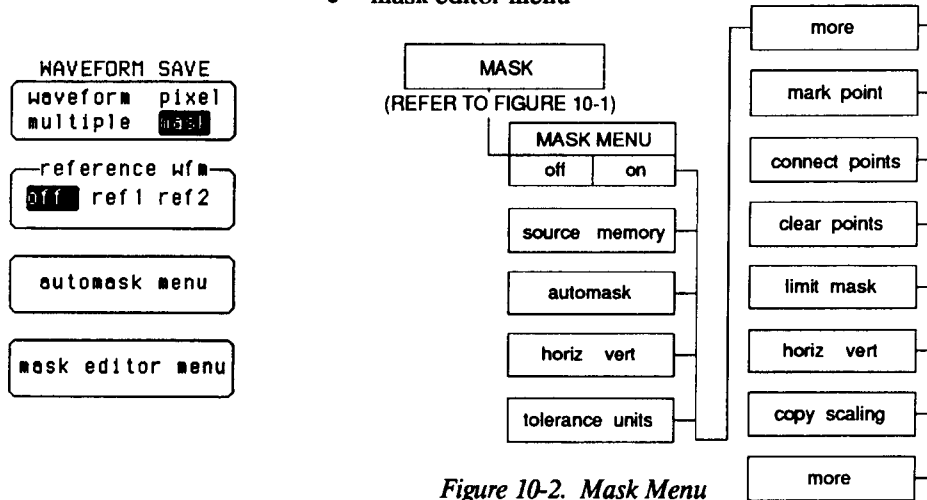

Figure 10-2. Mask Menu

main mask Menu

This menu is displayed when mask is selected from the waveform save menu. The mask main menu allows viewing of the reference waveforms, or selection of the automask and mask editor submenus.

reference wfm Key The reference wfm key is used to view the waveform that was used to automatically generate the upper and lower limit masks during automask. ref1 displays the waveform used to generate the masks in memory pair m1 and m2, and ref2 displays the waveform used to generate the masks in memory pair m3 and m4. Off clears the display of reference waveforms.

automask Key Press to display the automask submenu.

mask editor Key Press to display the mask editor submenu.

Automask Menu

The Automask submenu contains the selections used to generate upper and lower limit masks at defined tolerances using data from a selected source. Masks are generated and stored in waveform memory pairs m1/m2 or m3/m4.

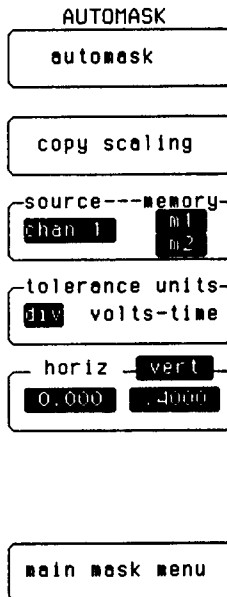

automask Key Pressing this key causes an upper and lower limit mask to be generated for the selected source waveform at the tolerance specified. Each mask is stored in the nonvolatile memory pair specified.

CAUTION

Once a successful automask has been performed, the current contents of the selected memory pair are overwritten. Any data previously stored will be lost.

NOTE

Prior to performing an automask, verify that the data for the selected source is valid, that the source selected is set to ON, that the destination memories are not protected, and that the horizontal and vertical tolerance has been specified.

Information for selecting parameters is provided in the following paragraphs. Failure to set these parameters can result in unsuccessful or incorrect mask generation.

copy scaling Key Pressing this key copies the scaling information from the selected source to the specified nonvolatile memory pair. Both the source and the memory pair are selected using the **source---memory** key.

source—memory Key This key is used to select both the source of the waveform used during an automask function, and the destination memory pair for the resulting upper and lower limit masks. All channels, functions, and reference waveforms are available as source selections. Memory pairs are either m1/m2 or m3/m4, where the upper limit mask is stored in m1 or m3 and the lower limit mask is stored in m2 or m4. Press key to highlight parameter and use the knob to select desired choice.

tolerance units Key This key is used to select the vertical and horizontal tolerance units used during an automask function to generate the upper and lower limit masks. Tolerance can be specified as divisions or in volts and time (seconds). Pressing key toggles between units and also changes the **horiz-vert** key display accordingly. Once desired units are selected, use the **horiz-vert** Key to enter the tolerance.

horiz-vert Key This key is used to select and enter the horizontal and vertical tolerance parameters. The horizontal parameter defines the maximum signal excursion right and left of the selected source. The vertical parameter defines the maximum signal excursion above and below the selected source.

Maximum signal excursion is equal in both directions from the selected source, except when the source is channel, the sampling mode is repetitive, and the display mode is envelope. In this case, upper and lower limit masks are generated as follows:

- If vertical and horizontal tolerances are set to zero, then the lower limit mask will be the minimum envelope waveform and the upper limit mask will be the maximum envelope waveform.
- If vertical and horizontal tolerances are set to any value other than zero, then the lower limit mask will be the minimum envelope waveform with the specified tolerance applied, and the upper limit mask will be the maximum envelope waveform with the specified tolerance applied.

Tolerance can be entered in either divisions or volts and seconds, depending on the current selection of the **tolerance units Key**. Pressing the key toggles between parameters, and the highlighted parameter can be changed using the knob or keypad.

When units are divisions:

- Horizontal entries of from 0.000 to 1.000 are allowed.
- Vertical entries of from 0.000 to 8.000 are allowed.

When units are volts-time:

- Horizontal entries are limited to the current time base setting. Entries of from 0.00000 to 200.0000 seconds are allowed; however, if the entered value exceeds the current time base value (time/division), it is automatically adjusted to the maximum value allowed.
- Vertical entries are limited to the currently selected source's vertical setting. Entries of from 0.00000 to 40.0000 volts are allowed, however, if entered value exceeds eight times the vertical volts/division value for the source selected, it is automatically adjusted to the maximum value allowed.

main mask menu Key Press key to return to the Main Mask Menu.

Mask Editor Menu

The Mask Editor submenu contains the selections used to edit previously generated and stored masks using the Automask Menu. Using the mask editor menu, it is also possible to clear existing masks and create a new one using the mark and connect point method.

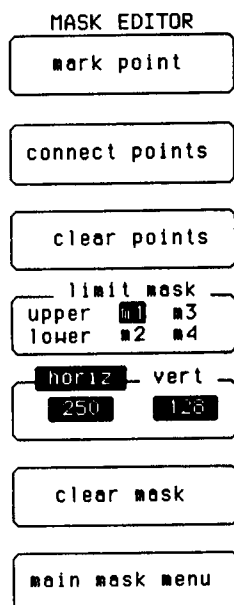

NOTE

If the active limit mask (defined by the limit mask key) is not displayed, pressing any key in the Mask Editor Menu (except clear mask or main mask menu) will cause it to be displayed immediately.

mark point Key

Used to record the current horizontal and vertical field values. This point is used as the anchor point when connecting or clearing points from the screen. These values are displayed in the **horiz vert** Key, and represented on the screen at the junction of the $x2/y2$ markers. When the key is pressed, the current values are saved, and the $x1/y1$ markers are moved to that point on the screen (imposed over the $x2/y2$ markers). See **horiz vert** Key for information on moving markers.

connect points Key

Pressing this key replaces the portion of the existing active limit mask from the mark point (junction of $x1/y1$ markers) to the connect point (junction of $x2/y2$ markers) with a straight line. See **horiz vert** Key for information on moving markers.

clear points Key Pressing this key replaces the portion of the existing active limit mask from the mark point (junction of x1/y1 markers) to the connect point (junction of x2/y2 markers) with a hole. See **horiz vert Key** for information on moving markers.

limit mask Key This key is used to select the active limit mask for the mask editor menu functions. Limit masks are stored in pairs, where m1 (or m3) contains the upper limit mask and m2 (or m4) contains the lower limit mask.

horiz vert Key These keys are used to change the horizontal and vertical field values, and the position of the x2/y2 markers on the screen during mask edits. Acceptable vertical settings are from 0 (y2 @ bottom of screen) to 255 (y2 @ top of screen). Acceptable horizontal settings are from 0 (x2 @ left of screen) to 500 (x2 @ right of screen). Press key until desired parameter is highlighted, then use knob or keypad to enter new value and move the marker.

When **horiz** is selected, the vertical y2marker (and field) is slaved to the horizontal x2marker (and field). As the x2marker is changed, the y2marker follows the displayed active limit mask, and updates the data values at each location. If the mask has a hole present, the y2marker (and field) will not be changed.

NOTE

x1/y1 markers can only be moved when the mark point key is pressed.

clear mask Key Pressing this key replaces the entire active limit mask with holes (blanks the screen).

main mask menu Key Press key to return to the Main Mask Menu.

Waveform Save Exercise

This exercise demonstrates how a waveform is stored, the offset setting changed, and the stored waveform recalled to be compared with the current display.

- Connect this oscilloscope's rear-panel AC CALIBRATOR signal to the Channel 1 input with a coaxial cable.
- Disconnect any other signals that may be connected to other inputs.
- Press AUTOSCALE.
- Press WFORM SAVE and select the **waveform** submenu.
- Press the **nonvolatile** key until **m3** is selected.
- Press the **source** key until **chan 1** is selected.
- Press the **store** key.

The currently displayed waveform is saved in nonvolatile memory **m3**. The remainder of this exercise demonstrates how to recall the stored waveform.

- Press the **display** key to turn on the **m3** display.
- Press the CHAN menu key, change the **offset** of channel 1.

This moves the current display so the stored waveform can be viewed. The display should look like figure 10-3.

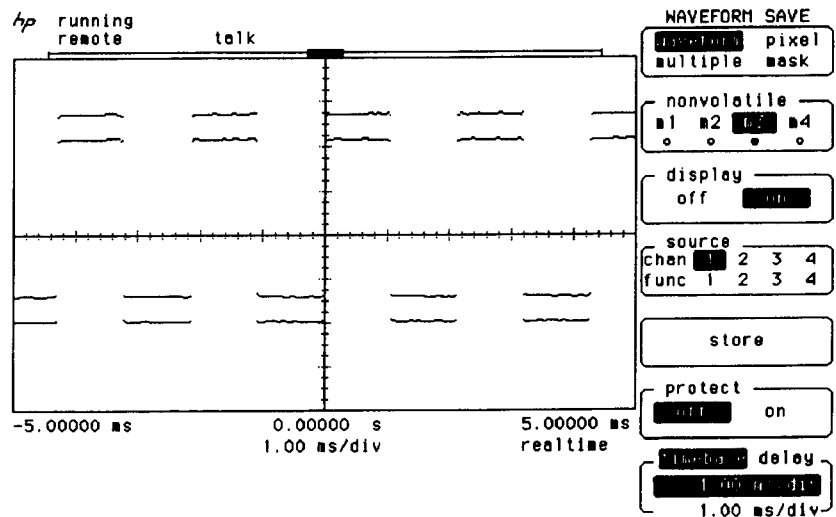

Figure 10-3. Displayed Memory

Mask Exercise

This exercise demonstrates how to generate upper and lower masks using a reference waveform at a tolerance of +/- one-half a horizontal and vertical division.

- Connect this oscilloscope's rear-panel AC CALIBRATOR signal to the Channel 1 input with a coaxial cable.
- Disconnect any other signals that may be connected to other inputs.
- Press AUTOSCALE.
- Press DISPLAY and select **connect dots** to on.
- Press WFORM SAVE and select the **mask** submenu.
- Press the **automask** menu key to select the **automask** submenu.

- Press **source** key until **source** is highlighted, then turn the knob until **chan 1** is selected.
- Press **source** key until **memory** is highlighted, then turn the knob until **m1/m2** is selected.
- Press **tolerance units** key until **div** is highlighted.
- Press **horiz vert** key until **horiz** is highlighted, then use the keypad to enter **.5000** and press **S/V** key.
- Press **horiz vert** key until **vert** is highlighted, then use the keypad to enter **.5000** and press **S/V** key.
- Press **automask** key. Verify "upper stored in mem 1, lower stored in mem 2" is displayed. The upper limit mask, lower limit mask, and reference waveform are all displayed as in figure 10-4.

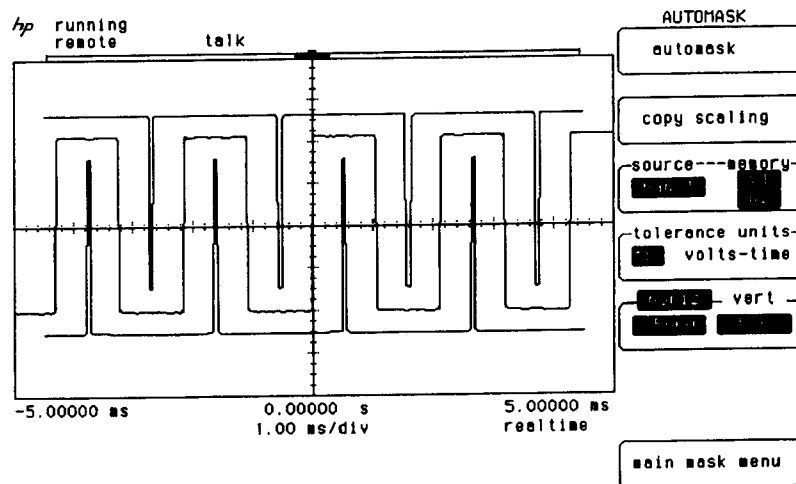

Figure 10-4. Automask Example

Introduction to Measurements

This chapter contains a description of the measurement menu. The entire measurement function, with all possible options, is accessed with the **DEFINE MEAS** menu.

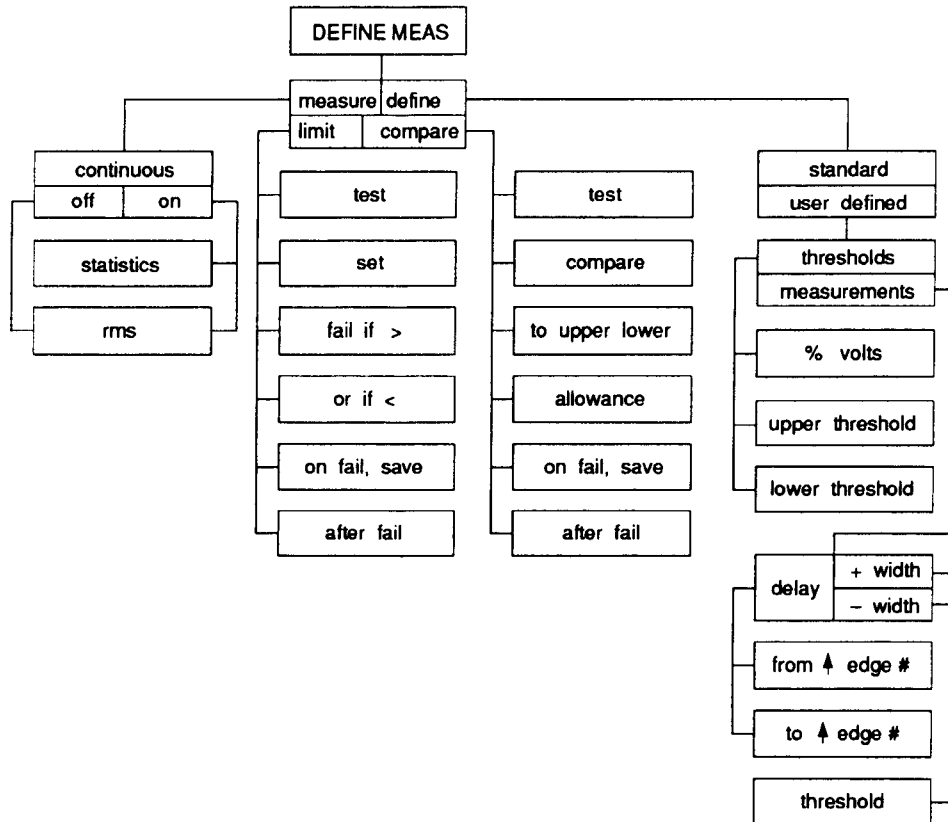

Figure 11-1. Define Measure Menu

The first menu sets the dynamic controls for measurements. The second menu sets user-defined parameters for the measurements. The third menu sets up and initiates the limit test. The fourth menu sets up and initiates the measurement comparison test.

Measurement Selection

Each key in the numeric keypad section has a secondary function. Above each key is a measurement selection printed in blue. To make an immediate measurement of the displayed waveform, perform the following keystrokes:

- Press the blue (Shift) key on the numeric keypad to access the secondary keys.
- Press the key that corresponds to the measurement about to be made.
- Rotate the knob to select the measurement source (channel number, c#; memory number, m#; or function number, f#). The choice made is displayed below the waveform display area.
- Press the appropriate number to select the source, channels 1 or 2 (HP 54505B/54510B) or channels 1 through 4 (HP 54506B/54512B), memories 1 through 4, or functions 1 through 4.
- Make sure the measurement source is on.

Upon selection of the measurement, the time and voltage markers are placed on the waveform. The markers show where the measurement was made if continuous measurements are off.

To clear measurements, press Shift CLR MEAS.

For complete details of the measurement definitions and algorithms, see Appendix A, "Algorithms."

measure/define limit/compare Key

This key is the primary submenu selection key. Press to select one of the available submenus. This field is always the top selection so other submenus may be selected at any time.

meas Submenu

The measure submenu is the default condition. Continuous and statistics options are accessed from this submenu.

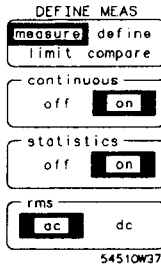

continuous Key

If this option is turned on when a measurement selection is made, the displayed measurement is updated periodically. All subsequent measurements are continuously updated when selected.

When **continuous** is off, the measurement is made once, and the $\Delta t/\Delta V$ (x/y) markers are placed on that measurement showing where the measurement was made.

statistics Key

The continuous function must be on before the statistics key is available. When **continuous** is on, statistics display the *minimum*, *maximum*, *average*, and *current values on up to three measurements*.

rms Key

Select either ac or dc rms voltage with the rms key. The ac rms voltage of the first cycle of the displayed signal is measured when **ac** is selected. The true rms voltage of the first cycle of the displayed signal is measured when **dc** is selected. See "Appendix A, Algorithms" for the formulas used to calculate these values.

Measure Define Sub-menu

The Measure Define submenu selects measurement standards assigned by the user. This gives the option of making measurements based on signal width or delay settings or threshold parameters.

standard/user defined Key

If **standard** is selected, no other choices are available and the oscilloscope makes measurements based on IEEE standards.

If, however, **user defined** is selected, two sets of test conditions are available to define the measurements.

thresholds/measurements Key

This key sets vertical test conditions, voltage or percentage ratios, independent of the horizontal test conditions, edge, slope, and count. Both sets of test conditions must be set to define the measurement.

The **thresholds** submenu sets the following vertical test conditions:

- percentage ratio from – 25% to 125%
- voltage levels from – 250 kV to + 250 kV

Note

The upper and lower thresholds must be set to levels that will fall on the displayed waveform. The message 'not found' is displayed if either threshold is not found on the waveform.

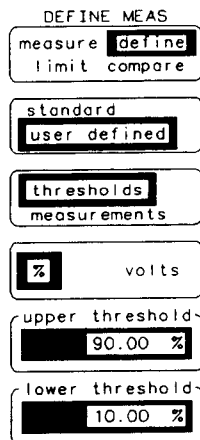

54502W57

Threshold settings apply to all user-defined front panel measurements.

This feature is useful when measuring for excessive overshoot or ringing. By defining the measurements, pass/fail criteria of any choice can be tested. Test from the front panel, or set the oscilloscope in the limit test over HP-IB, and allow the oscilloscope to report without supervision.

Note

If time measurements are performed and the signal does not exceed 8 A-to-D levels or 8 vertical pixel levels, the message 'not found' will be displayed in the measurement factors area.

Measurements define more parameters, the horizontal test conditions, for three specific front panel keypad measurements:

- Delay
- + width
- - width

When any of the three measurements are selected, the measurement is made on the selected edge count, slope, and transition point. The oscilloscope starts counting edges from the left edge of the screen, not at the reference point. The selected edge must be displayed. If the edge is not displayed, the message *not found* is displayed in the measurement results area below the screen.

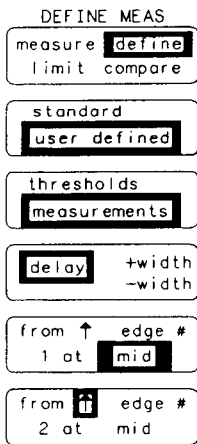

54502W58

Measurement delay, not to be confused with time base delay, is useful when measuring source-to-source delays or measuring time separation on the same source or a different source (see chapter 4, "Timebase Menu"). The front panel delay measurement can be redefined by edge slope, edge count (from 1 to 4000), and the part of the transition edge (upper, lower, mid) used as a reference point.

- When setting edge count fields, it is handy to press the fine key. In the coarse mode the oscilloscope increments/decrements by tens (1, 11, 21,...,4000). In the fine mode the increment/decrement sequence is in 1's.
- When the delay measurement is selected from the front panel, the source (c#, f#, m#) and the source number must also be selected.
- + width allows choice of only the point on the waveform transition (upper, lower, mid) to measure when making the positive width of a displayed waveform.
- – width allows the choice of only the point on the waveform transition (upper, lower, mid) to measure when making the negative width of a displayed waveform.

Measure Limit Submenu

```
DEFINE MEAS
measure define
limit compare
test
off on
set
risetime
fail if >
50.0000
or if <
1.000 ns
on fail, save
chan 1 % off
after fail
stop continue
```

The oscilloscope can run limit tests on up to three measurements. The menu presets certain conditions and stores any failure data for evaluation at a later time. Set the limit test while in this menu and select the measurement from the front panel.

When a test is running, statistical data is displayed describing the test:

- current measurement
- minimum value
- maximum value
- average value

Failure data, as well as information regarding memory and save data is displayed.

Note

At least one measurement (and up to three measurements) must be selected from the keypad. The limit test runs on front-panel measurements.

test Key This key toggles the test routine on or off. When the test is turned on, the oscilloscope starts running in the test mode on the most current measurements that have been selected.

set Key This key selects the measurement. There are sixteen measurements available; these are same ones as are available on the numeric keypad.

- Press the function key to highlight the field and rotate the knob to select the desired measurement.

Note

This key does not select the measurements on which the limit test operates, that selection is made from the keypad with the blue (Shift) key.

fail if > Key This field sets the upper failure threshold. The range on this field is dependent upon the units of the desired measurement.

or if < Key This key sets the lower threshold of the failure parameters.

on fail, save Key This key saves the data associated with the failure (from selected channel, function, or screen) to memories or to a hardcopy device. The source and destination of the save are selected by pressing the key until the desired parameter is highlighted, then turning the knob. Source choices include any channel, function, or the screen. Destination choices include off (not saved), waveform memories, multiple memories, pixel memories, and hardcopy. Destination choices available depend on the source currently selected, as follows:

- *Channel* - off, nonvolatile memories, or multiple
- *Function* - off, nonvolatile memories, or multiple
- *Screen* - off, pixel memories, or hardcopy.

The type or amount of failure data saved depends on the destination selected.

Note

If a destination is selected and the channel or function is off, a message is displayed indicating that the data is invalid and failure data is not stored.

- In the case of saving to nonvolatile memory, one memory may be selected. If multiple failures occur, only the last failure data is saved because the most current data will overwrite the memory contents. More than one source can specify the same nonvolatile memory. An attempted write to protected nonvolatile memory will result in a memory write error.
- When saving to multiple memory, up to 665 records can be saved (data includes time/date). If multiple failures occur and *stop after fail* mode is selected, then the test will terminate after all available memory space is filled. If the *continue after fail* mode is selected, the data records will wrap around. If more than one source is specified with a multiple destination, then the data records will be partitioned between the specified sources.
- If the data is saved to pixel memory, an accumulated save occurs. No measurements may be made on the pixel data.
- A save to **hardcopy** sends the failure data to the peripheral device. Hardcopy will be aborted if a device is not properly connected.
- A save to **off** turns off the save function and no save is affected.

after fail Key The test can be stopped when a failure occurs, or it can be continued. Refer to saving multiple and nonvolatile memory for additional information.

Compare Submenu

```

DEFINE MEAS
measure define
limit compare

test
off on

compare
chan 1 2 3 4
func 1 2 3 4

to
upper m1 m3
lower m2 m4

allowance
0.000 div

on fail, save
chan 1 0 off

after fail
stop continue
  
```

The compare mode allows a point-by-point comparison of an input channel to a memory pair (m1 and m2, or m3 and m4). The result is a displayed PASS or FAIL message. The menu allows the choice of input channel and memory pair to be compared. A failure allowance value can be entered to give the effect of trace separation, where needed. On failure, the menu allows for storage of the data with a stop/continue option.

When the compare test is on, each point of the of the input channel is compared against the memory pair. The channel and the memories must have valid data stored in them and must be on. Holes are ignored during the test. If the input channel waveform point falls within the mask memory pair, the test will PASS. If the channel waveform falls outside the memory pair, the point is tested against the allowance value with a resulting PASS or FAIL. If the test fails, a failbar will be displayed above the graticule showing the point or points that failed the test. The compare test will run only on 500- or 501-point records.

In the compare mode, the 16-bit words in the memory and channel buffers are directly compared to the pulse mask memories. Since the compare is performed on the 16-bit unscaled data, this test is faster than the limit test.

It is important that the test be set up so the upper mask is in memory m1 for memory pair m1 & m2 or memory 3 for memory pair m3 & m4. The lower mask must be in memory m2 for memory pair m1 & m2 or m3 for memory pair m3 & m4. If the masks are stored to the reverse of the memory pairs, the test will fail.

test Key The test key toggles the compare test routine on or off. When the test is turned on, the oscilloscope compares the input channel waveform against the selected memory pair. PASS or FAIL is displayed when the test is complete. If the test fails, the failed points are displayed above the graticule at the point of failure.

Error Messages

PASS: channel waveform is contained in the memory pair.

FAIL: channel waveform is not contained in the memory pair and the allowance value. Test has failed or the memory pair contents could be reversed (upper waveform in memory 2 or 4 and lower waveforms in memory 1 or 3).

Er 0: invalid data in channel; CLEAR DISPLAY has been pressed or a setting (such as s/div, V/div, etc.) has been changed to invalidate data. The test is not performed.

Er 1: either the channel or the compare waveform memory is off; test is not performed.

Er 2: Versus mode is not a valid compare mode.

Notes

*Only one measurement test routine may be on at one time. If the measurement limit test is on, the message **limit test on: cannot turn on** is displayed. If the compare test is on, the measurement limit test key causes the message **comp test on: cannot turn on** to be displayed.*

If an attempt is made to turn on a second test over the HP-IB, a message is displayed stating the command is ok but settings conflict.

compare Key The **compare** key selects the channel or function for comparison to the memory pair.

to Key This key selects the memory pair, **m1 & m2** or **m3 & m4**, for comparison to the chosen input channel. It is required that **m1** be greater than **m2** for all values across the screen when memory pair **m1 & m2** is selected. When memory pair **m3 & m4** is selected, **m3** must be greater than **m4** for all values across the screen. Refer to *Chapter 10 Waveform Save (Mask)* for more information on creating waveform masks.

Note

If m1 is less than m2 or m3 is less than m4, the compare test fails. The display is misleading in this case because the waveform appears to be in the bounds of the memory pair. The upper and lower boundaries are stored in the inverse memories.

allowance Key When a point on the waveform fails the compare test, the point is tested again against the allowance set in this field. Allowance refers to the distance a point may be above the upper mask or below the lower mask and still pass the compare test. The distance is measured in divisions. The allowance range can be set from 0 to 8 divisions in 1/40 division increments. Figure 11-2 is a flow chart of the waveform comparison test.

on fail, save Key This key saves the data associated with the failure (from selected channel, function, or screen) to memories or to a hardcopy device. The source and destination of the save are selected by pressing the key until the desired parameter is highlighted, then turning the knob. Source choices include any channel, function, or the screen. Destination choices include off (not saved), waveform memories, multiple memories, pixel memories, and hardcopy. Destination choices available depend on the source currently selected, as follows:

- *Channel* - off, nonvolatile memories, or multiple
- *Function* - off, nonvolatile memories, or multiple
- *Screen* - off, pixel memories, or hardcopy.

The type or amount of failure data saved depends on the destination selected.

Note

If a destination is selected and the channel or function is off, a message is displayed indicating that the data is invalid and failure data is not stored.

- In the case of saving to nonvolatile memory, one memory may be selected. Selection of the memory pair containing the comparison waveform is not allowed. If multiple failures occur, only the last failure data is saved because the most current data will overwrite the memory contents. More than one source can specify the same nonvolatile memory. An attempted write to protected nonvolatile memory will result in a message.
- When saving to multiple memory, up to 665 records can be saved (data includes time/date). If multiple failures occur and *stop after fail* mode is selected, then the test will terminate after all available memory space is filled. If the *continue after fail* mode is selected, the data records will wrap around. If more than one source is specified with a multiple destination, then the data records will be partitioned between the specified sources.
- If the data is saved to pixel memory, an accumulated save occurs. No measurements may be made on the pixel data.
- A save to *hardcopy* immediately sends the data to the peripheral device. If any source is designated as *multiple*, then the hard copy is performed after all 665 multiple memories are filled. Hardcopy will be aborted if a device is not properly connected.
- A save to *off* turns off the save function and no save is affected.

Note

If the compare test is on, with save to hardcopy, and after fail set to continue and a FAIL condition occurs, the hardcopy continues as long as the FAIL condition persists.

after fail Key The test can be stopped when a failure occurs, or it can be continued. Refer to saving multiple and nonvolatile memory for additional information.

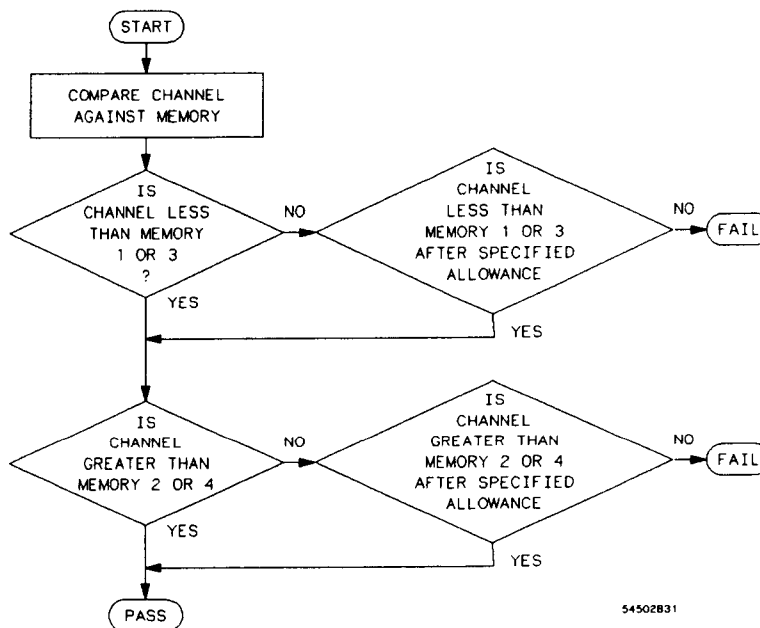

Figure 11-2. Waveform Comparison Test

Introduction to the Utilities

The **UTILITY** menu accesses the calibration and service functions, as well as sets up the HP-IB interface. The submenus include self-test, calibration, service, real time clock, and a listing for the current firmware revision date.

This menu controls all of the service functions that maintain the reliable performance of the oscilloscope.

These submenus are part of the **UTILITY** menu:

- HP-IB menu
- selftest menu
- probe cal menu
- self cal menu
- service menu
- system menu

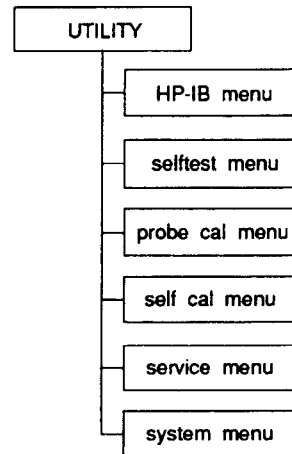
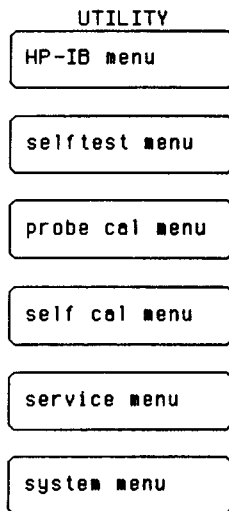

Figure 12-1. Utility Menu

HP-IB menu

The HP-IB submenu makes settings so the oscilloscope can talk to peripheral devices. This interface includes two primary settings:

- Talk-only mode
- Addressed mode

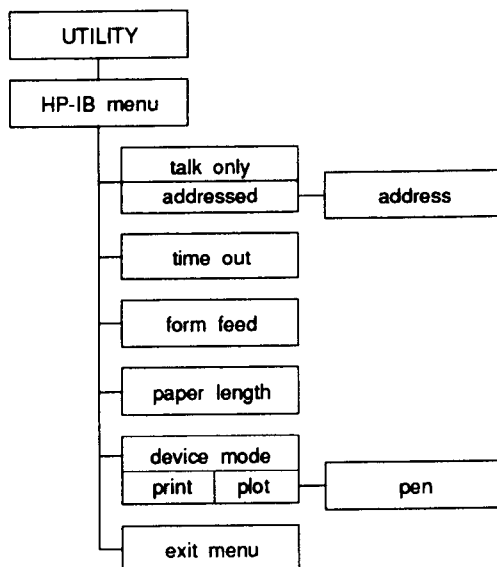
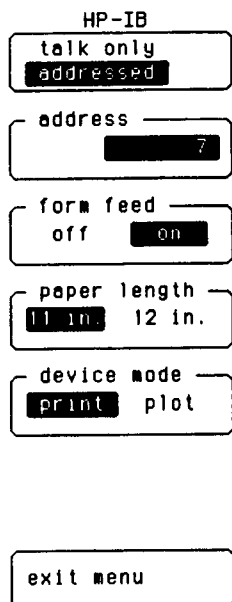

Figure 12-2. HP-IB Menu

talk only mode Set the oscilloscope to **talk only** to perform a hardcopy without intervention from an external controller. The attached printer, or plotter, must be set in the **listen only** or **listen always** mode. The amount of time that the oscilloscope will attempt to talk to the external device (time out) can be selected while the instrument is in the talk mode. The range of available time out is 0 through 16,000,000 seconds.

addressed mode This mode selectively addresses the oscilloscope for talking or listening. The address of the oscilloscope can be selected while the instrument is in the addressed mode. The range of available addresses is 0 through 30.

form feed Key If the form feed option is on, the printer performs a form feed at the end of the hardcopy. If form feed is off, the page is scrolled up four lines when the hardcopy is complete.

paper length Key This key selects between 11-inch or 12-inch pagelengths for auto form feed. The 11-inch page is a U.S. standard and the 12-inch page a U.K. and European standard.

device mode Key This key selects whether the hardcopy goes to a printer or plotter. The oscilloscope sends hardcopy to HP printers and plotters with HP-IB options.

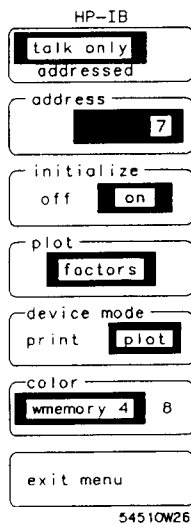

The following printers have been tested with the oscilloscope:
 HP 2225A HP-IB ThinkJet, HP 2227B QuietJet, and
 HP 3630A Option 002 PaintJet.

The following plotters have been tested with the oscilloscope:
 HP 7440A Option 002 Color Pro, HP 7470A Option 002, HP 7475A
 Option 002, HP 7550A and HP 9872C.

When **plot** is selected in **device mode**, three options appear on the menu. Initialize before plot can be turned **on** or **off** and **Graticule**, **Display**, **Factors**, **Labeled**, or **All**, can be chosen for the plot.

In the **pen** field, nineteen of the display parameters can be selected. Any pen, 1 through 8, can be assigned to the parameter for assorted plotter pen colors or weights. The following parameters can be selected (* indicates HP 54506B/54512B only):

channel1	wmemory2	function3	y2marker	timebase
channel2	wmemory3	function4	x1marker	measures
channel3*	wmemory4	pmemory1	x2marker	titles
channel4*	function1	pmemory2	graticule	
wmemory1	function2	y1marker	trigger	

exit menu Key Pressing exit returns the UTILITY menu to the screen.

SELFTEST MENU

The oscilloscope is designed to perform internal diagnostics. This selftest submenu tests the oscilloscope to give a high confidence level of instrument functionality.

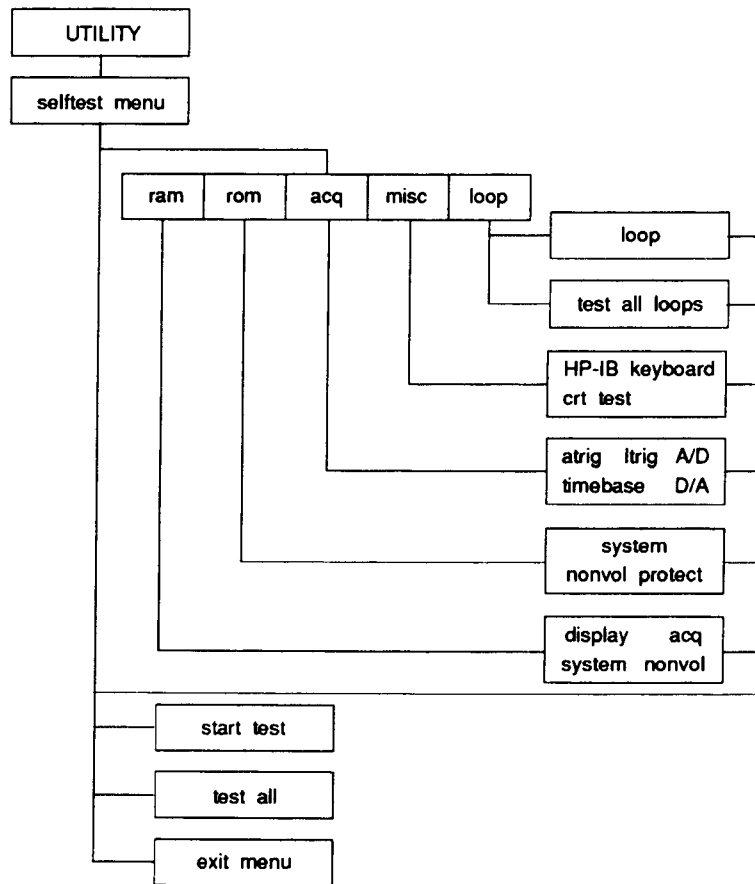
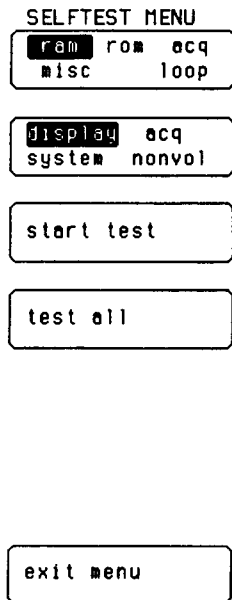

Figure 12-3. Self-Test Menu

If the instrument fails any self-test, perform the following:

- Recalibrate the oscilloscope.
- If that does not fix the problem, refer to the *HP 54505B/54506B and HP 54510B/54512B Service Manual*.

The oscilloscope self-diagnostics and self-tests, are designed to run operational tests on the following:

- RAM
- ROM
- Acquisition
- Miscellaneous
- Loop for service testing

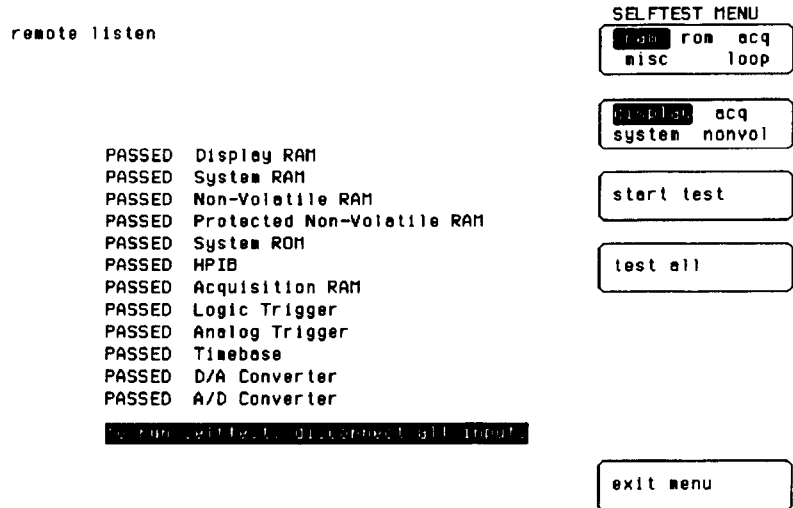

Figure 12-4. Results of Selftest

ram Test The RAM test is a multiple selection field. The options are:

- display
- acquisition
- system
- unprotected nonvolatile memory

rom Test Two ROM tests are available:

- system
- protected nonvolatile memory

acquisition Test Five acquisition tests are available:

- atrig
- ltrig
- A/D
- time base
- D/A

Miscellaneous Test Three miscellaneous tests are available:

- HP-IB
- keyboard
- crt test

loop Test The loop test is a function designed for use by qualified service personnel. It is unnecessary to use this function for normal oscilloscope operation. When a self-test loop has been initiated it runs until stopped by pressing and holding any key.

start test Key Pressing this key begins the selected test.

test all Key This key runs all tests in sequence.

exit menu Key Pressing this key returns the Utility menu to the screen.

PROBE CAL MENU

Two probe calibration procedures are available in the probe cal menu:

- attenuation
- time null

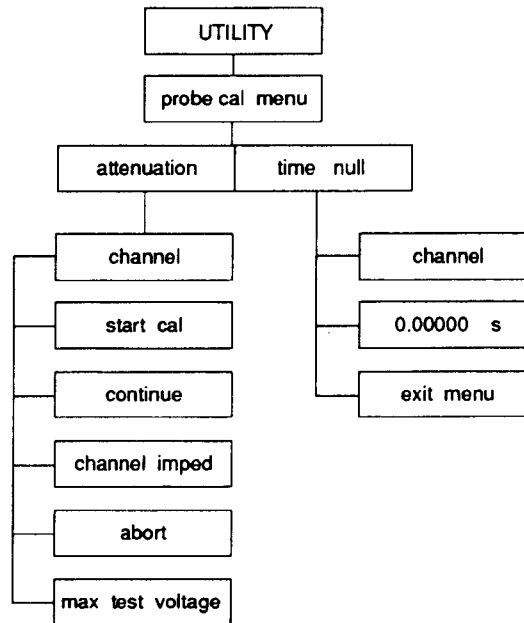
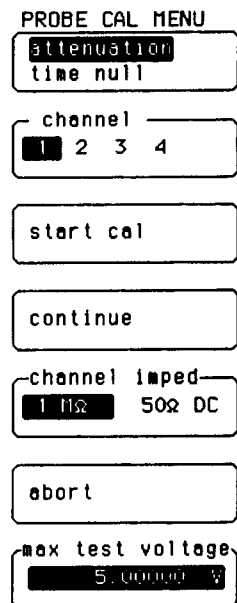

Figure 12-5. Probe Cal Menu

attenuation submenu



The attenuation submenu calibrates channel gain at the probe tip. Channel gain can be corrected through probe attenuation down to 0.9 attenuation.

- Below 0.9 the error message *Attenuation less than 1, see manual for action* is displayed. The corrective action is to recalibrate the oscilloscope.

If the probe is not connected to the DC CALIBRATOR OUTPUT on the rear panel or the probe attenuation exceeds approximately 250, the error message *Attenuation too high or bad connection* is displayed. The corrective action is to check the connections and recalibrate. If recalibration is unsuccessful, refer to the *HP 54505B/54506B and HP 54510B/54512B Service Manual*.

- If the probe attenuation calibration is successful the displayed message is *Probe Attenuation = n.nnnnn*. This value has been entered into your channel probe setting.

channel Key Pressing this key selects a channel to calibrate.

start cal Key When the channel to be calibrated has been selected, press **start cal**. The advisory appears at the bottom of the waveform display area *Connect the rear-panel DC CALIBRATOR OUTPUT to the probe of channel n, then press continue*. Pressing this key prompts for setup requirements.

continue Key Press this key when all setup requirements have been satisfied. The actual calibration process begins.

channel impedance Key This key is used to select the impedance of the probe connected to the channel input.

abort Key This is the only active front panel key during the calibration process. The calibration process is terminated with the previous calibration factors intact when this key is pressed.

max test voltage Key Pressing this key allows you to set a maximum voltage for the calibration signal. The maximum voltage is the DC voltage output by the DC CALIBRATOR OUTPUT. To prevent damage to the probe connected to the channel input, select a maximum voltage for the probe in use. Normally, a maximum voltage of 5 volts is acceptable for most probes. However, some probes, such as the HP 1141A, require a lower maximum voltage.

time null submenu Time null sets the timing of all channels to correspond to each other at the probe tip. This eliminates time discrepancies between channels and channel-to-channel skew variations. This is useful to manually adjust any differences in cable length.

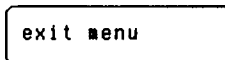
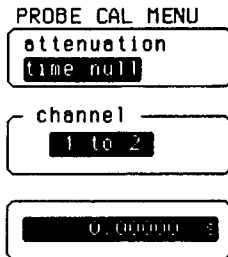

channel Key *HP 54506B/54512B only.* Pressing this key selects the channel being calibrated. Press to select channel 1 to 2, 1 to 3, or 1 to 4.

time Key This is an unlabelled field. The time null between the selected channels can be set using either of the entry devices. The range is ± 70 ns.

exit menu Key Pressing this key returns to the Utility menu.

Self Cal menu

The self cal menu calibrates two internal functions:

- vertical cal
- delay cal
- time null cal
- logic trigger cal

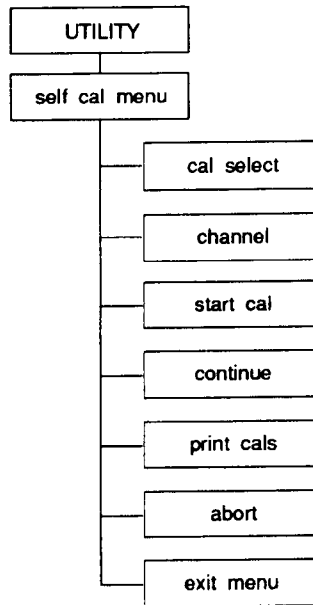
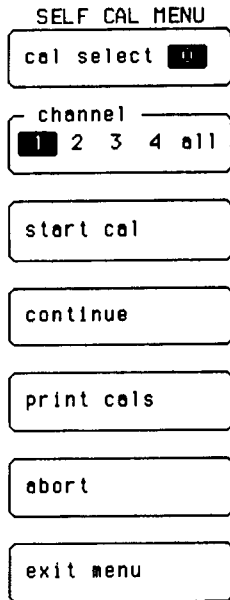

Figure 12-6. Self Cal Menu

cal select Key This field selects which of the calibration processes to perform. The cal select key and the highlighted window increments through 0-3 and the active field in the display changes to correspond with the selection. See Calibration procedure in this chapter.

Note

All calibrations must be performed in the order given (e.g., Cal 0 must pass before CAL1 can be performed successfully, etc).

- channel Key** The channel key selects the channel(s) to calibrate. Available choices are dependent on the current **cal select key**.
- start cal Key** When the channel to calibrate is selected, and the specific cal routine is selected, press the **start cal key** and follow the instructions displayed. If the cal ram is write protected when start cal is selected, an error message is displayed.
- continue Key** When all of the setup requirements are satisfied, press the **continue key** and the actual calibration process begins.
- print cals Key** The print cals key sends a complete listing of the most recent self calibration factors to a printer, if connected to the oscilloscope. Refer to the service manual for more information on self calibration and calibration factors.
- abort Key** This is the only active front panel key during the calibration process. Pressing this key terminates the calibration process leaving the previous calibration factors intact.
- exit menu Key** This key returns to the Utility menu.

```

remote listen
*** PROTECTED SYSTEM CAL ***
1.delay 2.time null 3.logic trigger

```

```

P = passed, F = failed, D = defaulted, C = corrupted
prefixed '*' if new rom revision without re-cal
function  chan1    chan2    chan3    chan4
A/D       *P          *P          *P          *P
Gain      *P          *P          *P          *P
Offset    *P          *P          *P          *P
Hysteresis *P          *P          *P          *P
Trigger    *P          *P          *P          *P
Delay      *P          *P          *P          *P
Time Null  *P          *P          *P          *P
Logic Trigger P

```

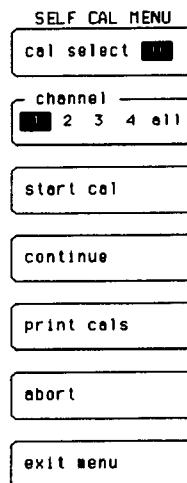

Figure 12-7. Self Cal Options

service menu

The service menu is used for firmware calibrations, hardware adjustments, and calibrations that need not be performed often. These are explained in the service manual and are to be used only by qualified service personnel.

Note

When certain calibrations have been performed, other calibrations must be continued. Only qualified service personnel, with access to the service manual, are to perform calibrations in the service menu.

See the *HP 54505B/54506B and HP 54510B/54512B Service Manual* for complete information on the service menu and calibration cycles.

SYSTEM MENU

The System submenu is used to set the realtime clock, rear panel AC BNC output, clicker, de-select interpolation, and print registration forms.

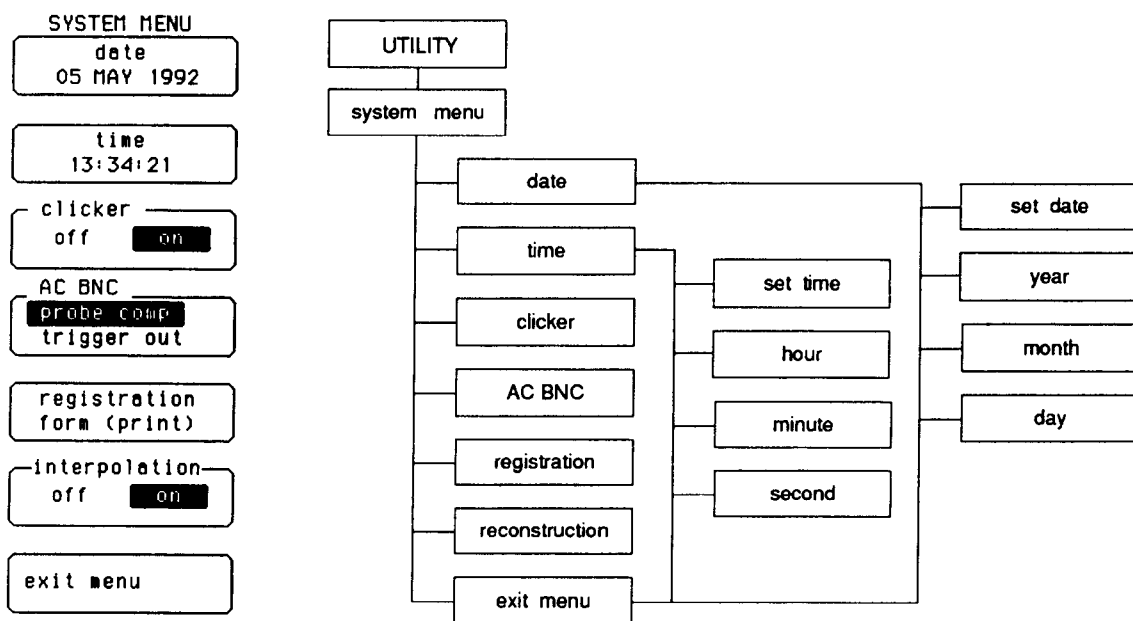
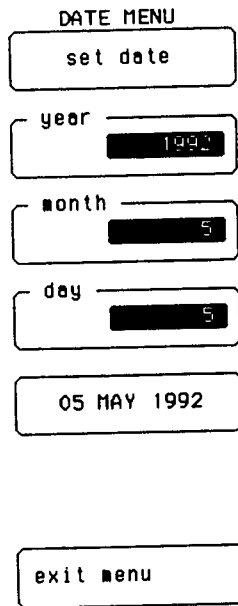

Figure 12-8. System Menu

date submenu The date submenu is used to change the current realtime date. Current date is displayed on the screen.



set date Key Press to enter the currently selected year, month, and day. Current date is displayed by the fifth key.

year Key Press to highlight current year, then use keypad or knob to enter the new value.

month Key Press to highlight current month, then use keypad or knob to enter the new value.

day Key Press to highlight current day, then use keypad or knob to enter the new value.

exit menu Key This key returns to the System menu.

time submenu The time submenu is used to change the current real time. Current time is displayed on the screen.

TIME MENU

set time

hour 13

minute 34

second 39

13:35:00

exit menu

set time Key Press to enter the currently selected hour, minute, and second. Current time is displayed by the fifth key.

hour Key Press to highlight current hour, then use keypad or knob to enter the new value in 24-hour format.

minute Key Press to highlight current minute, then use keypad or knob to enter the new value.

second Key Press to highlight current day, then use keypad or knob to enter the new value.

exit menu Key This key returns to the System menu.

- clicker Key** The clicker key turns on the clicker function. When the clicker is turned on, an audible click is heard each time a key is pressed. The selections are either on or off.
- AC BNC Key** The AC BNC key selects the output for the rear panel BNC and front panel probe compensation terminals. The probe compensation signal is a square wave of approximately 500 Hz, available on both the front and rear. When trigger out is selected, the rear panel BNC is a trigger output, and nothing is present at the front panel.
- registration form (print) Key** Pressing this key causes a registration form to be printed on an externally connected hardcopy device. Please fill out and send in form.
- interpolation Key** When in realtime sampling with time ranges of < 50ns/div, data is normally routed through an interpolation filter to create additional points. These points fill in data buckets between the real acquired points. Select **interpolation Key** to off to bypass the interpolation filter and view the actual non-filtered data (dots) for all active channels (running or stopped). Active memories with realtime data displayed at < 50ns will also be displayed as dots. Note that the dot displays are not available over HP-IB. Turning interpolation to off will also turn off any active measurements, and any attempt to perform operations (such as measurements, data input, etc) will not be allowed.
- Select on or exit the system menu to restore the filter to the 'on' state.
- exit menu Key** This key returns to the Utility menu.

Calibration Procedure

There are two levels of calibration for the oscilloscope. The first level is in the self cal menu and suggested by HP to be performed under the following conditions:

- at six month intervals or every 1000 hours of use
- if the ambient temperature changes more than 10° C from the temperature at full calibration
- the user would like to optimize measurement accuracy

Self calcs do not require any equipment other than cables. It is necessary to UNPROTECT the calibration which may not be allowed in some circumstances. Follow the Self Cal Menu calibration procedures to perform this first level of self cal.

The second level of self calibrations are to be performed only by qualified service personnel with access to the service manual.

Note

Before the oscilloscope can be calibrated the CALIBRATION switch on the rear panel must be set to UNPROTECTED.

The procedure for calibration is:

- Set the rear panel CALIBRATION switch to UNPROTECTED.
- Select 0 in the cal select field and calibrate the vertical factors for all the channels (separately or all at once). This routine calibrates the A/D, vertical gain, offset, hysteresis, and trigger with the rear panel dc calibrator signal.
- Select 1 in the cal select field and calibrate the delay and the repetitive factors for each channel. This procedure uses the rear panel ac calibrator signal.
- Select 2 in the cal select field and calibrate the time null from channel 1 to 2 (and 1 to 3 / 1 to 4 for the HP 54506B/54512B). This procedure uses the rear panel ac calibrator signal.
- Select 3 in the cal select field and calibrate the logic trigger for channel 1. This procedure uses the rear panel ac calibrator signal.

When the software calibrations are complete reset the CALIBRATION switch on the rear panel to PROTECTED.

One of the primary features of the oscilloscope is the ability to make automatic measurements on displayed waveforms. This chapter provides details on how automatic measurements are calculated and some tips on how to improve results.

Measurement Setup

Measurements typically should be made at the fastest possible sweep speed for the most accurate measurement results. The entire portion of the waveform that is to be measured must be displayed on the oscilloscope. For the most accurate measurements, consider the following conditions:

- at least one complete cycle must be displayed for period or frequency measurements
 - the entire pulse must be displayed for width measurements
 - the leading edge of the waveform must be displayed for rise time measurements
 - the trailing edge of the waveform must be displayed for falltime measurements
-

Making Measurements

If more than one waveform, edge, or pulse is displayed, the measurements are made on the first (leftmost) portion of the displayed waveform that can be used. If there are not enough data points the oscilloscope will display \leq with the measurement results. This is to remind you that the results may not be as accurate as possible. It is recommended that you re-scale the displayed waveform and make your measurement again.

Standard Measurements When any of the standard measurements are requested, the oscilloscope first determines the top-base voltage levels at 100%-0%. From this information, it can determine thresholds (10%, 90%, and 50%) needed to make the measurements. The 10% and 90% thresholds are used in the rise time and falltime measurements. The 50% midpoint is used for measuring frequency, period, pulse width, and duty cycle.

The voltage thresholds are precise settings and sets specific locations on the waveform. If the thresholds are not placed on the waveform (above or below) the oscilloscope cannot make a measurement.

User defined Measurements When any of the user defined measurements are requested, the oscilloscope still must determine the top-base voltage thresholds. From this information it can determine user defined upper and lower thresholds. The mid-point is then determined to be the 50% point between the upper and lower threshold.

Automatic Top-Base

Top-Base is the heart of most automatic measurements. It is used to determine V_{top} and V_{base} , the 0% and 100% voltage levels at the top and the bottom of the waveform. From this information the oscilloscope can determine the 10%, 50%, and 90% points, which are also used in most measurements. The top or base of the waveform is not necessarily the maximum or minimum voltage present on the waveform. Consider a pulse that has slight overshoot. It would be wrong to select the highest point of the waveform as the top since the waveform normally rests below the perturbation.

Top-Base performs a histogram on the waveform and finds the most prevalent point above and below the waveform midpoint. The most prevalent point is one that represents greater than approximately 5% of the total display points (501) and is considered to be either the top or base. If no point accounts for more than 5% of the total, then the top is chosen as the absolute maximum and the base is chosen as the absolute minimum.

Edge Definition

Both rising and falling edges are defined as transitional edges that must cross three thresholds.

A rising edge must cross the lower threshold in a positive direction (defining it as a rising edge), cross the mid threshold (any number of crossings, both positive and negative are permissible) and then cross the upper threshold without any crossing of the lower threshold.

A falling edge must cross the upper threshold in a negative direction, cross the mid threshold (any number of times), and then cross the lower threshold without crossing the upper threshold.

Note

Most time measurements are made based on the position of the first crossing of the middle threshold.

Algorithm Definitions

Following are the definitions that all measurements are based on:

delay There are three types of delay measurement:

- jitter
- standard
- user-defined

Jitter occurs only under the following circumstances:

- standard/user-defined key is set to standard
- two delay parameters are the same
- display mode is envelope

if
first edge on minimum waveform is rising

then
delay = mid-threshold of first rising edge of max waveform minus
mid-threshold of first rising edge on min waveform

else
delay = mid-threshold of first falling edge on min waveform
minus mid-threshold of first falling edge on max waveform

The standard delay measurement occurs when in the standard mode (not user-defined) and is not a jitter measurement.

standard delay = mid-threshold of the first edge of second
parameter minus mid-threshold of the first edge of the first
parameter

Note

Negative delay is possible.

User defined delay = second channel edge minus first channel
edge

+ width The + width algorithm has standard and user-defined considerations.

if
first edge is rising

then
+ width = mid-threshold crossing of first falling edge -
mid-threshold crossing of first rising edge

else
+ width = mid-threshold crossing of second falling edge -
mid-threshold crossing of first rising edge

User-defined is the same as Standard definition except user-defined threshold.

- **width** The - width algorithm has standard and user-defined considerations:

if
 first edge is rising

then
 - width = second rising edge - first falling edge

else
 - width = first rising edge - first falling edge

Period **if**
 first edge is rising

then
 period = second rising edge - first rising edge

Frequency frequency = 1/period

Duty Cycle duty cycle = (+ width/period) * 100

Note

+ width is always calculated using mid-threshold.

Rise time rise time = time at upper threshold - time at lower threshold

Falltime falltime = time at lower threshold - time at upper threshold

V_{max} V_{max} = voltage of the maximum point on screen

V_{min} V_{min} = voltage of the minimum point on screen

V_{p-p} V_{p-p} = V_{max} - V_{min}

V_{top} **V_{top} = most prevalent point above waveform midpoint**

V_{base} **V_{base} = most prevalent point below waveform midpoint**

V_{amp} **V_{amp} = V_{top} - V_{base}**

V_{avg} Average voltage of the first cycle of the displayed signal is measured. If a complete cycle is not present the oscilloscope averages all data points.

V_{rms} The rms voltage of the first cycle of the displayed signal is measured. If a complete cycle is not present, the measurement computes rms on all data points. Either ac or dc rms value can be selected in the measure submenu of the Define Measure menu. The ac rms calculation removes the dc component.

$$V_{rms}(ac) = \left[\frac{1}{n} \sum_{j=0}^{n-1} V_j^2 - \left(\frac{1}{n} \sum_{j=0}^{n-1} V_j \right)^2 \right]^{\frac{1}{2}}$$

$$V_{rms}(dc) = \left[\frac{1}{n} \sum_{j=0}^{n-1} (V_j)^2 \right]^{\frac{1}{2}}$$

Integrate
$$I_n = \sum_{i=0}^{n-1} C_i \Delta t$$

The equation is the integral of the channel, where I represents the integral and C represents the channel. The integral is calculated by adding voltage points multiplied by the time bucket width, Δt.

Differentiate $d_1 = 0$

$$d_n = \frac{c_n - c(n-1)}{\Delta t}$$

The equation is the differential waveform of the channel, where d represents the differential and c represents the channel. The differential is the voltage differences between consecutive points in time divided by the time bucket width, Δt .

Instrument Description

The HP 54505B, HP 54506B, HP 54510B, and HP 54512B Digitizing Oscilloscopes are general-purpose oscilloscopes with 300-MHz bandwidth. The HP 54505B/54510B have two input channels and an external trigger input, while the HP 54506B/54512B have four input channels. The HP 54505B/54506B can digitize at a maximum rate of 500 Msa/s, while the HP 54510B/54512B can digitize at a maximum rate of 1 Gsa/s. Each oscilloscope can simultaneously digitize any input channel, each with 8000 samples of memory. All channels have 1 mV to 5 V/div sensitivity. Channel/trigger input impedance is 1 M Ω or 50 Ω , switchable.

The time base provides sweep speeds from 1 ns to 5 s/div in a 1-2-5 sequence. Pan and zoom can be used to expand a displayed waveform for a detailed view.

All channels (and the external trigger) can be combined triggers for complex triggering functions.

The oscilloscope has an Autoscale feature, 17 automatic pulse parameter measurements, and easy waveform storage. It has full programmability over the HP-IB, and when set up with a printer or plotter, the oscilloscope provides instant hardcopy output.

Accessories Supplied

The following accessories are supplied with the oscilloscope.

- Two (HP 54505B/54510B) or four (HP 54506B/54512B) HP 10441A miniature passive probes
- One miniature probe to BNC male adapter (HP 1250-1454)
- One 2.3 meter (7.5 feet) power cord (See section 2 for available power cords)
- One Front-Panel Reference and Programming Reference Set
- One Service Manual

Accessories Available

The following accessories are available for use with the oscilloscope.

- HP 10430A 10:1 1M Ω probe (1m)
- HP 10437A 1:1 50 Ω probe (2m)
- HP 10438A 1:1 probe (1m)
- HP 10439A 1:1 probe (2m)
- HP 10441A 10:1 1 M Ω probe (2m)
- HP 10002A 50:1 1 M Ω (1000 V peak) probe
- HP 10020A Resistive Divider Probe Kit
- HP 1141A/HP 1142A Differential Probe system
- HP 1143A Probe Power for Active Probe
- HP 54701 2.5 GHz/0.6 pF Active Probe
- HP 1137A 1000:1 High voltage divider probe
- HP 1133A TV/Video Sync Pod
- HP 10211A 24-pin IC Clip
- HP 10224A 16-pin IC Clip
- HP 1250-1454 BNC to Miniature Probe Adapter
- HP 1250-1737 PC Board Mini-Probe Socket (horiz)
- HP 1250-1918 PC Board Mini-Probe Socket (vert)
- HP 10240B BNC Blocking Capacitor
- HP 11094B 75 Ω Feedthrough Termination
- HP 5061-6175 Rack Mount Kit
- HP 1494-0015 Rack Mount Slide Kit
- HP 1540-1066 Soft Carrying Case
- HP 9211-2645 Transit Case
- HP 5061-6183 Front Panel Cover
- HP 1180A Tilt-tray Testmobile
- HP 92199B Power Strip

Options Available

The following options are available for the oscilloscope.

- Option 908 - Rack Mount Kit (HP 5061-6175)
- Option 910 - Additional Manual set
- Option 090 - Deletion of probes
- Option 105 - Scopelink Software (HP 54653A)

Performance Specifications

The following are performance specifications for the Digitizing Oscilloscope.

Vertical Bandwidth (-3dB, dc coupled):¹ dc to 300 MHz (repetitive mode)
dc to 125 MHz (realtime mode HP 54505B/54506B)
dc to 250 MHz (realtime mode HP 54510B/54512B)

Rise Time:² 1.2 ns repetitive (2.8 ns realtime HP 54505B/54506B)
(1.4 ns realtime HP 54510B/54512B)

Input R (selectable): 1 M Ω \pm 1% or 50 Ω \pm 1%

Maximum Input Voltage

1 M Ω : \pm 100 V [dc + peak ac(< 10 kHz)] 1 mV to 50 mV/div
1 M Ω : \pm 250 V [dc + peak ac(< 10 kHz)] > 50 mV to 5 V/div
50 Ω : 5 V_{rms}

Offset Accuracy:³ \pm (1% of channel offset + 2% of full scale)

Voltage Measurement Accuracy (dc)^{3,4}

Dual Cursor: \pm (1.25% of full scale + 0.032 \times V/div)

Single Cursor: \pm (1.25% of full scale + offset accuracy + 0.016 \times V/div)

Horizontal Delta-t Accuracy⁵

Repetitive (\geq 8 averages): \pm (0.005% \times delta-t + 2E-6 \times delay setting + 100 ps)

Real Time (single acquisition):

\pm (0.005% \times delta-t + 2E-6 \times delay setting + 300 ps HP 54505B/54506B)

\pm (0.005% \times delta-t + 2E-6 \times delay setting + 150 ps HP 54510B/54512B)

Trigger Trigger Sensitivity³

Internal (dc to 100 MHz): 0.5 division

Internal (100 MHz to 300 MHz): 1.0 division

External (dc to 300 MHz): 100 mV_{p-p} into 50 Ω

Glitch Trigger Timing Accuracy (5 ns to 10 ns): \pm 1.5 ns

Notes:

1. Upper bandwidth reduces by 2.5 MHz for each °C above 35°C. Bandwidth in Realtime mode is typically greater than 250 MHz (tested at a 6 division reference).
2. Rise time figures are calculated from: $t_r = 0.35/\text{Bandwidth}$.
3. Magnification is used below 7 mV/div range so vertical resolution and accuracies are correspondingly reduced. Below 7 mV/div, full scale is defined as 56 mV.
4. Voltage measurement accuracy decreases 0.08% of full scale per °C from firmware calibration temperature. This specification is valid for a temperature range $\pm 10^\circ\text{C}$ from firmware calibration temperature. Specification applies to both modes; repetitive and real time (single acquisition).
5. Specification applies at the maximum sampling rate for bandwidth limited signals ($t_r = 1.4 \times \text{sample interval}$). At lower sampling rates the specification is $\pm (0.005\% \times \text{delta-t} + (2 \times 10^{-9}) \times \text{delay setting} + 0.15 \times \text{sample interval})$ for bandwidth limited signals ($t_r = 1.4 \times \text{sample interval}$). Sample interval is defined as $1/(\text{sample rate})$. Specification also applies to those automatic measurements computing time intervals on pulses with identical slope edges (i.e. pos-pos, neg-neg).

Performance Characteristics

The following are performance characteristics of the Digitizing Oscilloscopes.

Vertical Switchable Bandwidth Limits
ac-coupled (lower -3 dB frequency): 10 Hz
LF reject (lower -3 dB frequency): 400 Hz
Bandwidth Limit (upper -3 dB frequency): 30 MHz

Number of Channels: 2 (HP 54505B/54510B) or 4 (HP 54506B/54512B)
(simultaneous acquisition)

Vertical Sensitivity Range: 1 mV/div to 5 V/div

Vertical Gain Accuracy (dc):^{1,2} $\pm 1.25\%$ of full scale

Vertical Resolution:² 8 bits over 8 divisions ($\pm 0.4\%$), 10 bits via HP-IB with averaging ($\pm 0.1\%$)

Maximum Sample Rate: 500 MSa/s (HP 54505B/54506B)
1 GSa/s (HP 54510B/54512B)

Waveform Record Length:³ 8001 points real time, 501 points repetitive

Input C: 7 pF nominal

Input Coupling: ac, dc

Offset Range: Vertical Sensitivity Available Offset

1 mV - 50 mV/div	± 2 V
> 50 mV - 250 mV/div	± 10 V
> 250 mV - 1.25 V/div	± 50 V
> 1.25 V - 5 V/div	± 250 V

Dynamic Range: $\pm 1.5 \times$ full scale from center of screen

Channel-to-channel Isolation (with channels at equal sensitivity):

dc to 50 MHz: 40 dB

50 to 250 MHz: 30 dB

Notes:

1. Gain accuracy decreases 0.08% of full scale per °C from firmware calibration temperature. This characteristic is valid for a temperature range $\pm 10^\circ\text{C}$ from firmware calibration temperature. Characteristic applies to both modes; repetitive and real time (single acquisition).
2. Expansion is used below 7 mV/div range so vertical resolution and accuracies are correspondingly reduced. Below 7 mV/div full scale is defined as 56 mV.
3. Available over HP-IB, waveform record length is:

Real Time-	8000 points
Repetitive-	500 points

Horizontal Time Base Range: 1 ns/div to 5 s/div

Time Base Resolution: 20 ps

Delay Range (posttrigger): $10,000 \times (s/div)$

Delay Range:	Time/div Setting	Available Delay
(pretrigger)	100 ns - 5 s/div	- $160 \times (s/div)$
	1 ns - 50 ns/div	- $16 \mu s$ (HP 54505B/54506B)
		- $8 \mu s$ (HP 54510B/54512B)

Trigger Trigger Pulse Width (minimum)

Internal: 1.75 ns

External: 2.8 ns

Trigger Level Range

Internal: $\pm 1.5 \times$ full scale from center of screen

External: $\pm 2 V$

Operating Characteristics

The following are operating characteristics of the Digitizing Oscilloscope.

Vertical Deflection Factors: All input channels: With single screen selected, deflection factors are adjustable from 1 mV/div to 5 V/div in a 1-2-5 sequence with the knob. Fully calibrated vernier adjustments can be made using direct keypad entry or the knob with the FINE key selected.

Probe Attenuation Factors: Values from 0.9 to 1000 may be entered to scale the oscilloscope for external probes or attenuators attached to the channel inputs. When probe tip calibration is done, this value is calculated automatically.

Input Impedance: 1 M Ω or 50 Ω , selectable for any channel and the HP 54505B/54510B EXT TRIG.

Bandwidth Limit (HF Reject): Provides low pass filter with a – 3 dB point at approximately 30 MHz for both triggering and signal display. Can be selected for each vertical input individually, but is not available for the external trigger inputs on the HP 54505B/54510B.

LF Reject: Provides high pass filter with a – 3 dB point at approximately 400 Hz for triggering and vertical signal. Can be selected for each vertical input individually, but is not available for the external trigger inputs on the HP 54505B/54510B.

ac Coupling: Provides high-pass filter with a – 3 dB point at approximately 7 Hz for both triggering and signal display. Can be selected for each vertical input individually, but is not available for the external trigger inputs on the HP 54505B/54510B.

ECL/TTL Presets: Vertical deflection factor, coupling, offset, and trigger level can be preset independently on any vertical input channels for ECL and TTL levels, but is not available for the external trigger inputs on the HP 54505B/54510B.

Effective Resolution: The maximum sample rate and the number of bits in an oscilloscope's digitizer are too often used for comparing oscilloscopes. These specifications, however, do not describe performance under dynamic signal conditions. Effective Resolution is a figure of merit that describes the oscilloscope's performance under dynamic conditions, and is measured using the sinewave curve fit test. This method considers:

- Quantization error
- Non-linearities (including preamp and A/D)
- System noise
- Frequency of input signal

All of these affect the effective resolution of the instrument. Some manufacturers specify effective bits using half-scale sinewaves. While the effective bits performance using half-scale testing is overstated when compared to full-scale testing, Hewlett-Packard publishes both sets of numbers for the oscilloscope so that, when comparing effective bits

performance between digitizing oscilloscopes, a fair comparison can be made.

The oscilloscopes's typical performance for a single acquisition is shown below:

Frequency	50 kHz	1 MHz	20 MHz	50 MHz	100 MHz	250 MHz*
Full scale	7.2	6.7	6.3	5.6	5.0	4.9
Half scale	7.4	7.1	7.0	6.4	6.0	5.2

* HP 54510B and 54512B only

For more information about effective resolution, please contact your Hewlett-Packard sales office, and ask for Product Note 5180A-2, *Dynamic Performance Testing of A to D Converters*, (pub # 02-5952-7629).

Horizontal Pan and Zoom: Changing the Time/div and/or Delay values once acquisition has been stopped allows access to all 8k points of data that are captured on each acquisition (Real-time mode only.)

Delay Between Channels: Difference in delay between channels can be nulled out to compensate for differences in input cables or probe length. Use "time null cal," found in the Probe Cal menu (see UTIL key).

Reference Location: The reference point can be located at the left edge, center, or right edge of the display. The reference point is defined as the trigger point plus the delay time.

Trigger Modes Edge Trigger: Positive or negative edge can be selected for trigger on any channel, or on the HP 54505B/54510B external trigger input.

Pattern Trigger: A pattern can be specified using any channel/external trigger input. Each of the inputs can be specified as a *high*, *low*, or *don't care* with respect to the level setting in the edge trigger menu. The trigger

can be selected to occur on the last edge to enter the specified pattern or the first edge to exit the specified pattern.

Time Qualified Pattern Trigger: A trigger will occur on the first edge to exit a pattern only if it meets the specified time criteria. The available time qualified modes are (user-specified time is in brackets):

- pattern present < [time]
- pattern present > [time]
- range: pattern present > [time1] and < [time2]

The time settings are adjustable from 20 ns to 160 ms ($\pm 3\% \pm 2$ ns). The time filter recovery time is ≤ 12 ns. In the "pattern present < [time]" mode, the pattern must be present for more than 1.75 ns, (2.8 ns for the external trigger) before the trigger will respond.

Glitch Trigger: Use "pattern present < [time]" with [time] selected such that it is just less than the nominal pulse width of the signal you are analyzing. The minimum glitch width is 1.75 ns, (2.8 ns for the external trigger). Use Glitch Trigger Mode for glitch widths from 5 ns to 20 ns.

State Trigger: A pattern is specified on any two of the three inputs with the third input used as clock. The user may specify that a trigger will occur on the rising or falling edge of the input specified as the clock, when the pattern is present or not present. Setup time for the pattern with respect to the clock is 10 ns or less and hold time is zero.

Delayed Trigger

Event-Delayed Mode: The trigger can be qualified by an edge, pattern, time qualified pattern, or state. The delay can be specified as a number of occurrences of a rising or falling edge of any of the three inputs. After the delay, an occurrence of a rising or falling edge of any of the three inputs will generate the trigger. The trigger occurrence value is selectable from 1 to 16,000,000. The maximum edge counting rate is 70 MHz.

Time-Delayed Mode: The trigger can be qualified by an edge, pattern, or state. The delay is selectable from 30 ns to 160 ms. After the delay, an occurrence of a rising or falling edge of any of the three inputs will generate the trigger. The trigger occurrence value is selectable from 1 to 16,000,000. The maximum edge counting rate is 70 MHz.

TV Trigger 60 Hz / 525 Lines: Trigger source is selected to be any one of the three inputs. Trigger level is adjustable for the selected trigger source. Polarity is selected for positive or negative synchronizing pulses. A trigger occurs on the selected line and field of a 2/1 interlaced composite video signal. Line numbering is 1 to 263 for field 1 and 1 to 262 for field 2. This TV trigger mode is compatible with broadcast standard M.

50 Hz / 625 Lines: Same as 60 Hz / 525 lines except that line numbering is 1 to 313 for field 1 and 314 to 625 for field 2. This TV trigger mode is compatible with broadcast standards B, C, D, G, H, I, K, K1, L, and N.

User-Defined Mode: Source is selected to be any one of the three inputs. Trigger level is adjustable for the selected source. The trigger is qualified with a high or low pulse that meets a selectable time range. The trigger is an occurrence of a rising or falling edge of the source after the qualifying pulse. The time settings for the qualifier are selectable from 20 ns to 160 ms. The trigger occurrence value is selectable from 1 to 16,000,000.

NOTE: *All TV trigger modes require a clamped video signal for stable triggering. Use the HP 1133A TV/Video Sync Pod to provide clamped video output that can be used in conjunction with the oscilloscope's TV triggering capabilities.*

Trigger Holdoff: Trigger can be held off either by time or events over the ranges:

- time: 40 ns - 320 ms
- events: 2 - 16,000,000

An event is defined as the specified trigger condition. A separate holdoff setting (time or events) is available for each trigger mode except delayed trigger, which is set to 40 ns.

Noise Reject Trigger: Provides improved triggering on noisy signals by increasing trigger hysteresis (internal trigger only).

Glitch Trigger Used to capture qualified glitches as narrow as 5 ns, and up to 160 ms.

Display **Data Display Resolution:** 451 points horizontally by 256 points vertically.

Number of Screens: 1, 2, or 4 screens can be selected. This can provide overlapping channels or memories for comparison, or separate displays on a split viewing area.

Display Modes **Graticules:** The user may choose full grid, axes, frame, or no graticule.

Connect-the-Dots: Provides a continuous display, connecting the sample points with straight lines. *Connect-the-dots* is operative for modes in which a single-valued waveform can be connected, including average, envelope, single, and minimum-persistence modes. *Connect-the-dots* is not available in the variable or infinite persistence mode.

Time Base In Repetitive Mode

Averaging: The number of averages can be specified in powers of 2, up to 2,048. On each acquisition, $1/n$ times the new data is added to $(n-1)/n$ of the previous value at each time coordinate. Averaging operates continuously, except for the HP-IB *digitize* command, for which averaging terminates at the specified number of averages.

Envelope: Provides a display of the running maximum and minimum voltage levels at each horizontal time position.

Minimum Persistence: One waveform data value is displayed in each horizontal time position of the display. The waveform is updated as new data is acquired for a particular horizontal time position.

Variable Persistence: The time that each data point is retained on the display can be varied from 500 ms to 10 seconds, or the points can be displayed indefinitely.

Time Base in Realtime Mode

Single Persistence: One waveform data value is displayed in each horizontal time position. The entire waveform is replaced with each new acquisition.

Infinite Persistence: Waveform data is allowed to continuously accumulate on the screen, and remains until display is cleared.

Oversampling Filter: On time/division settings when less than 500 points are acquired across the screen (< 100 ns/div for HP 54505B/54506B or < 50 ns/div for HP 54510B/54512B) a built-in digital filter automatically reconstructs the data. This filter is a combination between a (Sin X)/X and a Gaussian filter.

Time Base in Sequential Single-Shot

Used to view previously captured segments as defined in the TIMEBASE menu. Individual segment numbers from any channel can be excluded, selected, and viewed. Viewing options include:

Normal: Selection and viewing of any or all previously captured segments.

Average: Averages and displays previously captured segments into a composite waveform.

Envelope: Displays the minimum and maximum voltages of all previously captured segments.

Markers Dual voltage and time markers are available. Each set of markers can be independently assigned to channels, memories, or functions.

Waveform Math Four independent functions are provided for waveform math. The operators are +, -, ×, *vs*, *inverts*, *magnify*, *integrate*, *differentiate*, and *FFT*. The vertical channels or any of the waveform memories can be used as operands for waveform math. Sensitivity and offset for these functions

can be adjusted independently. FFT characteristics are provided at the end of this Appendix.

Waveform Save The oscilloscope contains four non-volatile waveform memories, two volatile pixel memories, 665 multiple failure memories. Waveform memories store single-valued waveforms, such as an averaged waveform. If an envelope waveform is stored to a waveform memory, it will automatically be stored with the upper waveform in one waveform memory and the lower waveform in another.

Waveform memory pairs m1/m2 and m3/m4 also store the upper and lower limit masks used during compare testing. These masks can be created and edited using sample signals, or created manually.

Pixel memories store an entire screen of waveform data. They are useful for storing multiple overlapping waveforms and infinite persistence waveforms. Automatic measurements may be performed on the four non-volatile waveform memories but not on the volatile pixel memories.

Multiple memories store failure data from limit and compare tests. This data can be viewed or transferred to the waveform memory for nonvolatile storage and/or measurement.

Automatic Pulse Parameter Measurements: The oscilloscope offers 17 automatic pulse parameter measurements from the front panel (shown below) and additional measurements via HP-IB including *All*, *Overshoot*, and *Preshoot*. The standard measurements are performed with 10%, 50%, and 90% voltage thresholds, as defined by IEEE standard 194-1977, "IEEE Standard Pulse Terms and Definitions."

Automatic measurements available on the Digitizing Oscilloscopes:

Rise time	Pulse Width +	Volts amp	Volts avg	Preshoot (HP-IB only)
Fall time	Pulse width -	Volts base	Volts max	Overshoot (HP-IB only)
Frequency	Duty Cycle	Volts top (HP-IB only)	Volts min	Volts time (HP-IB only)
Period	Delay	Volts p-p	Volts RMS dc Volts RMS ac	

**User-definable
Measurement
Thresholds**

The oscilloscope allows you to set your own thresholds for automatic measurements. Both the upper and lower thresholds can be set from - 25% to 125%, as long as the upper threshold value is always greater than or equal to the lower threshold. The middle threshold is always equal to the mid-value between the upper and lower threshold.

Continuous Measurements: Can be turned on or off. With continuous measurements off, the voltage (y) and time (x) markers are placed on the waveform to indicate where the last measurement was taken.

Measurement Statistics: The maximum, minimum, average, and most recent of continuously updated measurements are calculated and displayed. Any three measurements can be selected for simultaneous display.

Measurement Limit Test: Maximum and minimum limits can be set for any three of the front-panel automatic measurements. These continuously updated measurements are compared to the maximum and minimum limits. If the measurements are found to be outside the defined limits, the waveform can be stored in a memory or the screen can be sent to a hardcopy device. In addition, the HP-IB Service Request line can be set to flag the controller. Measurement limit test can be set to stop after test limits have been exceeded, or to continue testing.

Setup Aids **Autoscale:** Pressing the Autoscale button automatically adjusts the vertical and horizontal deflection factors, and the trigger level for a display appropriate to the signals applied to the inputs. The Autoscale feature requires a signal with a duty cycle greater than 0.5% and a frequency greater than 50 Hz. Autoscale is operative only for relatively stable input signals.

Save/Recall: Nine front panel setups (1-9) may be saved in non-volatile memory.

Recall Clear: Pressing the RECALL key followed by the CLEAR key resets the oscilloscope to its factory default settings.

Recall 0: If Autoscale, ECL or TTL preset, or recall setup are inadvertently selected, recall 0 restores the instrument to its last state prior to erroneous selection.

Show: Displays instrument status, including volts/div, offset, and trigger condition.

Hardcopy The CRT display, including menus and measurement answers, can be transferred directly to an HP-IB raster graphics printer, including the HP 2225A ThinkJet, HP 2227B QuietJet, or other compatible printers. Hardcopy from HP graphics plotters including the HP 7440A, HP 7470A, HP 7475A, and HP 7550A is also available.

Full HP-IB Programmability The oscilloscope is fully programmable. Instrument settings and operating modes, including automatic measurements, may be remotely programmed via HP-IB (IEEE-488). HP-IB programming complies with IEEE 488.2-1988 "Standard Codes, Formats, Protocols, and Common Commands."

Sequential Single-shot Data Acquisition and Transfer Rate: Using the front panel TIMEBASE menu or HP-IB command "Raw Data," the oscilloscope can automatically capture, store, and label a waveform; and re-arm the trigger; and then repeat this process until the oscilloscope's entire 400K word RAM (volatile) is filled. Once the specified number of waveforms have been captured and stored, the oscilloscope can transfer the entire block of waveforms to the external computer. HP-IB bus users can specify the number of points to be stored and the number of waveforms to be captured. Repetition rates vary depending on record length and time base setting (slower sampling rates). See figures below.

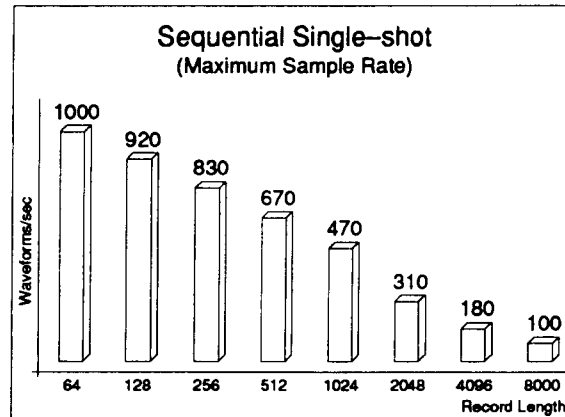

Data Transfer Rate: Approximately 120 KBytes per second.

Probe Compensation, ac Calibrator Output: A 500 Hz (approx.) square wave is provided for probe compensation. A probe-to-BNC adapter is used to connect the probe to the rear panel Probe Compensation BNC output. During instrument self-calibration, this output is used to provide other calibration signals, as described in the Service Manual.

This same BNC connector is used for trigger output. The utility menu allows the user to switch the BNC from probe compensation and calibration signals to a trigger output pulse. The rising edge, with amplitude from approximately -400 mV to 0 V (when terminated into 50

Ω), is synchronous with system trigger. The falling edge of this pulse occurs approximately at the end of holdoff. The rising edge should be used as the edge synchronous with trigger.

dc Calibrator Output: This output is used for vertical calibration of the oscilloscope, as described in the Service Manual.

Product Support **Built in Self-Test and Calibration Routines:** Internal self-test capabilities provide a 90% confidence the instrument is operating properly. External test procedures in the service manual provide a 100% confidence. Self-calibration routines, also selected through the front panel "utility" menu, ensure that the instrument is operating with its greatest accuracy and require no external test equipment.

Low Cost of Ownership: The oscilloscope includes a standard three year, return to HP warranty.

To minimize the mean time to repair and calibration time, the oscilloscope was designed with only one main assembly adjustment per channel. In addition, Hewlett-Packard's board exchange program assures economical and timely repair of units, reducing the cost of ownership.

Reliability: Estimated mean time between failures (MTBF) for the HP oscilloscope is 30,000 hours. MTBF is computed using an instrument usage of 2,000 hours per year.

Solutions: Hewlett-Packard's System Engineering Organization can help you configure an HP-IB system and provide software support for your application, developing solutions to meet your measurement needs. Contact your HP Sales and Service office for more information.

General Characteristics

Environmental Conditions

Temperature

Operating: 0°C to +55°C (32°F to +131°F)

Non-operating: -40°C to +70°C (-40°F to +158°F)

Humidity

Operating: up to 95% relative humidity (non-condensing) at +40°C (+104°F)

Non-operating: up to 90% relative humidity at +65°C (+149°F)

Altitude

Operating: up to 4,600 meters (15,000 ft)

Non-operating: up to 15,300 meters (50,000 ft)

Vibration

Operating: Random vibration 5-500 Hz, 10 minutes per axis, 0.3 grms.

Non-operating: Random vibration 5-500 Hz, 10 minutes per axis, 2.41 grms. Resonant search 5 to 500 Hz swept sine, 1 Octave/minute sweep rate, (0.75g), 5 minute resonant dwell at 4 resonances per axis.

Product Regulations Safety

IEC 348
UL 1244
CSA-C22.2 No 231 (Series M-89)

EMC

This product meets the requirements of the European Communities (EC) EMC Directive 89/336/EEC.

Emissions EN55011/CISPR 11 (ISM)
(Group 1, Class A equipment)

SABS RAA Act No. 24 (1990)

Immunity EN50082-1

Code (1)Notes

IEC 801-2 (ESD) 8kV AD	1
IEC 801-3 (Rad.) 3 V/m	1
IEC 801-4 (EFT) 1 kV	1

(1) Performance Codes:

- | |
|---|
| 1 PASS - Normal operation, no effect. |
| 2 PASS - Temporary degradation, self recoverable. |
| 3 PASS - Temporary degradation, operator intervention reqd. |
| 4 FAIL - Not recoverable, component damage. |

Sound Pressure Level
Less than 60 dBA

HP 54505B/54506B/54510B/54512B
Front-Panel Reference

General Information
B-19

Power Requirements Voltage: 115/230 V ac, - 25% to + 15%, 48-66 Hz.
Power: 350 VA maximum.

Weight Net: approximately 10 kg (22 lb).
Shipping: approximately 20 kg (44 lb).

Dimensions Refer to the outline drawings below.

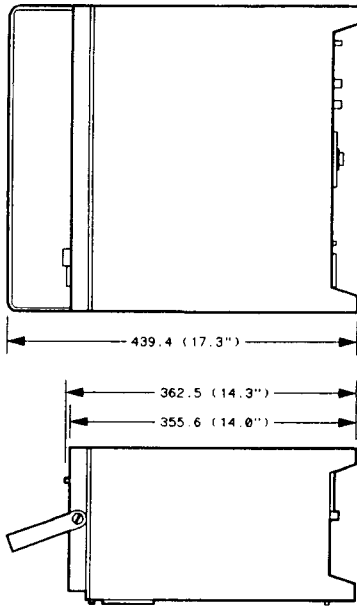

54501E12

NOTES

1. Dimensions are for general information only. If dimensions are required for building special enclosures, contact your HP field engineer.
2. Dimension are in millimetres and (inches).

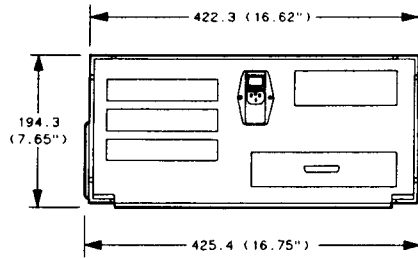

General Information
B-20

HP 54505B/54506B/54510B/54512B
Front-Panel Reference

Fast Fourier Transforms

The following features pertain to the FFT function of the oscilloscope.

- 2-channel (HP 54505B/54510B) or 4-channel (HP 54506B/54512B) simultaneous acquisition at up to 500 MSa/s (HP 54505B/54506B) or 1 GSa/s (HP 54510B/54512B).
- FFTs on both repetitive and single-shot transient signals.
- Selectable 512 to 8192 point time record FFTs.
- Frequency resolution from 1.22 mHz (milliHz) to 975 kHz (HP 54505B/54506B) or 1.22 mHz to 1.95 MHz (HP 54510B/54512B) in the real-time acquisition mode.
- Automatic peak search cursors read amplitude and frequency.
- Selectable FFT window functions including the flattop window for very accurate amplitude measurements.

Peak Search Peak search automatically snaps cursors to any two selected peaks located anywhere in the displayed frequency span. You can select peaks from peak number 1 up to peak number 99. Frequency and dBm are automatically displayed at the bottom of the screen together with the difference in frequency between the two selected peaks. Peak search saves time by eliminating the need to manually set cursors.

Channels or Memories FFTs can be executed on any of the oscilloscope input channels, or on waveforms stored in any of four nonvolatile memories.

Variable Sensitivity and Offset Sensitivity and vertical offset (position) are controlled from the front panel to display an optimum view of the spectrum. Sensitivity is calibrated in dB per division; vertical offset is calibrated in dBm.

Selectable Time Record Length Time record length can be set from 512 points to 8192 points in powers of 2. Increasing time record length improves frequency resolution at the expense of update speed.

Horizontal Magnification and Center Frequency Control The horizontal magnification feature allows you to set the center of the display to a frequency of interest. The display is magnified about that point so that you get a closer view.

Selectable Windows Three windows are selectable: hanning, for best frequency resolution and general purpose use; flattop, for best amplitude accuracy; and rectangular, for single-shot signals such as transients and signals where there are an integral number of cycles in the time record.

FFT Operating Characteristics **Vertical Analog System**

Number of Channels: 2 (simultaneous acquisition) plus external trigger for the HP 54505B/54510B, or 4 (simultaneous acquisition) for the HP 54510B/54512B.

Channel Connectors: BNC female

Bandwidth (-3 dB): dc to 250 MHz

Vertical Sensitivity Range: 1 mV/div to 5 V/div (10 mV/div to 50 V/div with 10:1 divider probes)

Vertical Resolution (A/D Converter): 8 bits

Maximum Sample Rate: 1 GSa/s

Input R: 1 Mohm +/- 1% or (selectable) 50 ohm +/- 1%

Input C: 7 pF nominal

Maximum Input Voltage: 1 Mohm +/- 250 V [dc + peak ac]
50 ohm: 5 V RMS

Frequency

FFT Frequency Range: dc to 250 MHz (HP 54505B/54506B) or dc to 500 MHz (HP 54510B/54512B) (real-time acquisition.) On the HP 54510B/54512B, signals above 250 MHz can be viewed with reduced amplitude accuracy (amplitude is down typically 8 dB @ 500 MHz).

-3 dB Frequency Range: dc to 250 MHz (analog bandwidth)

Frequency Resolution: 1.22 mHz (milliHz) to 975 kHz (HP 54505B/54506B), or 1.22 mHz to 1.95 MHz (HP 54510B/54512B) (real-time acquisition).

Maximum Displayed Frequency: 5 Hz to 250 MHz (HP 54505B/54506B), or 5 Hz to 500 MHz (HP 54510B/54512B), selectable (real-time acquisition). Display is from dc to a selectable upper frequency, in steps from 5 Hz to 250/500 MHz. Maximum frequency displayed is 1/2 the sample rate.

Horizontal Magnify Mode: This mode allows you to specify the frequency that is displayed at center screen, and magnify the frequency-domain display about that point. Magnification increases as the number of time-record samples increases. At the maximum time-record length of 8192 points, magnification reduces the displayed frequency span to about 12% of that in the unmagnified display. Horizontal magnification allows you to zero in on and expand desired portions of the frequency-domain display.

$$\text{Frequency Accuracy: } \pm \left[\frac{\text{sample freq}}{2 \times 8192} + \frac{\text{signal freq}}{20000} \right]$$

Window Characteristics:

Window	Highest Side Lobe (dB)	3dB Bandwidth (bins)	6dB Bandwidth (bins)	Scallop Loss (dB)
Rectangular	-13	0.89	1.21	3.92
Hanning	-32	1.44	2.00	1.42
Flattop	-70	3.38	4.17	0.005

Split display operation: A time-domain waveform and its FFT spectrum can be displayed simultaneously on the top and bottom halves of the screen. Four FFT spectra can be displayed simultaneously in the same way. Four sets of time-domain waveforms and their spectra may also be displayed simultaneously.

Spectrum Displays **Amplitude:** Power in dBm

Signal-to-noise Ratio: 55 to 65 dB (typical) Noise floor can be reduced by increasing the number of points in the FFT.

Log Display Both sensitivity and offset (position) can be set by the user:

Sensitivity Range: 1 dBm/div to 100 dBm/div

Offset Range : -200 dBm to + 200 dBm

Programmability All front-panel controls are fully programmable over HP-IB.

Index

!

of points Key, 4-7, 9-8
of screens Key, 7-4, 7-8, 7-12
of segments Key, 4-7
+ width, A-4
- width, A-5

A

A/D acquisition test, 12-6
abort Key, 12-8, 12-11
accessories, 2-2
Accessories Available, B-2
Accessories Supplied, B-1
acquisition
 relationship to timebase and sample rate, 4-2
acquisition status, 3-2
acquisition Test, 12-6
acquisition, realtime, 4-4, 7-8, 7-10
acquisition, repetitive, 4-4, 7-2
acquisitions, 4-2
add to memory Key, 10-4
addressed, 12-2
addressed menu, 12-2
after fail Key, 11-9, 11-14
Air Flow Requirements, 2-7
Algorithms, A-1
Aliasing, 9-12
allowance Key, 11-12

alternate function key, 3-9
Altitude, 2-2
Amplitude Measurements, 9-10
atrig acquisition test, 12-6
attenuation submenu, 12-8
auto-trigger, 3-2, 6-1
automask Key, 10-7
Automask Menu, 10-7
Automatic measurements, 1-2, A-1
Automatic Top-Base, A-2
AUTOSCALE Key, 3-5
Available Accessories, 2-2, B-2
available options, B-2
awaiting trigger, 3-2, 6-1
axes, 7-6

B

blue key, 3-9

C

cable, HP-IB connection, 2-7
cal select Key, 12-10
Calibration Procedure, 12-16
calibrator protection, 2-3
center freq Key, 9-7
chan/mem Key, 9-4
Channel coupling, SHOW, 3-6
CHANNEL Key, 5-1, 12-9, 12-11
channel impedance Key, 12-8

Channel Menu, 5-1
channel offset, 5-2
Channel offset, SHOW, 3-6
Channel scaling, SHOW, 3-6
channel select, 5-2
channel sensitivity, 5-2
characteristics, general, B-18
characteristics, operating, B-6
characteristics, performance, B-4
CLEAR DISPLAY Key, 3-3
CLEAR key, 3-9
clear mask Key, 10-11
clear memory Key, 10-4
clear points Key, 10-11
clicker Key, 12-16
clock (state trigger) Key, 6-15
CLR MEAS key, 11-2
compare key, 11-11
Compare menu, 11-10
connect dots Key, 7-6, 7-9, 7-13
connect points Key, 10-10
connect the dots, 9-10
connect the dots after autoscale, 3-5
Contents of Shipment, 2-1
continue Key, 12-8, 12-11
continuous Key, 11-3
copy scaling Key, 10-8
coupling Key, 5-3
CRT test, 12-6

D

Δ

Δt markers, 8-1
ΔV markers, 8-1
D/A acquisition test, 12-6
data acquisition, 3-3
Date menu, 12-14
day Key, 12-14
dBm computation, 9-11

dBV computation, 9-12
DC value, 9-12
default conditions, 3-11
Define Measure Menu, 11-1
delay (timebase) Key, 4-3
delay (trigger) Key, 6-22
Delay Trigger Exercise, 6-23
Delay Trigger Mode, 6-20
Delayed Trigger (operating characteristics), B-9
delta t markers key, 8-1
delta V markers, 8-1
description of instrument, B-1
description of product, 1-1
diagnostics, self-tests, 12-5
display (function) Key, 9-3
Display (operating characteristics), B-11
display (pixel memory) Key, 10-4
display (waveform memory) Key, 10-2
display line for memory bar, 4-5
Display Menu, 7-1
Display Mode Key, 7-2, 7-11
Display Modes (operating characteristics), B-11
display section, 3-10
duty cycle, A-5

E

ECL Key, 5-5
ECL/TTL presets, 3-5
Edge Definition, A-3
Edge Trigger Exercise, 6-4
edge Trigger Mode, 6-2
enter changes Key, 7-14
ENTRY device section, 3-8
Environmental Conditions, B-18
exclude/include Key, 7-13
execute all changes Key, 7-14
Exercise
 Delay Trigger, 6-23
 Edge Trigger, 6-4

- Glitch Trigger, 6-34
- Holdoff, 6-4
- Mask, 10-13
- Pattern Trigger, 6-10
- Sequential Single-shot, 4-13, 7-15
- State Trigger, 6-16
- tv Trigger, 6-29
- Waveform Save, 10-4, 10-12
- Exercise, Waveform Math, 9-15, 9-17
- exit menu Key, 12-3, 12-6, 12-11, 12-14 - 12-16
- External Equipment
 - Connecting, 2-7

F

- fail if , 11-8
- failure # Key, 10-5
- falltime, A-5
- falltime measurements, A-2
- features, 1-1
- FFT
 - Keys, 9-6
 - measurement, 9-10
 - operating characteristics, B-21
 - parameters, 9-13
 - windows, 9-19
- field Key, 6-28
- FINE key, 3-8
- FINE key, effect on timebase, 4-1
- firmware revision, 12-1
- form feed Key, 12-3
- frame, 7-6
- freq span Key, 9-7
- frequency, A-5
- Frequency Measurements, 9-11
- from seg # Key, 7-14
- Front Panel Overview, 3-1
- front-panel knob, 3-9
- function display, 3-10
- Function Key, 9-3

HP 54505B/54506B/54510B/54512B
Front-Panel Reference

- functional sections of front panel, 3-1
- fuse module, 2-4

G

- Gain cal, 12-11
- General Characteristics, B-17
- General Information, B-1
- Glitch Trigger
 - exercise, 6-34
 - mode, 6-33
 - operating characteristics, B-11
- grid, 7-6

H

- hard reset, 3-11
- Hardcopy (operating characteristics), B-15
- HARDCOPY Key, 3-3
- holdoff after autoscale, 3-5
- holdoff
 - exercise, 6-4
 - Key, 6-3, 6-10, 6-16, 6-29, 6-34
- horiz magnify Key, 9-7
- horiz-vert Key, 10-8, 10-11
- horizontal characteristics, B-6
- horizontal operating characteristics, B-8
- horizontal specifications, B-3
- hour Key, 12-15
- HP-IB (operating characteristics), B-15
- HP-IB interface, 3-3
- HP-IB menu, 12-2
- HP-IB test, 12-6
- HP-IB, connecting the interface, 2-7
- Humidity, 2-2

Index-3

I

include Key, 7-13
Input, 3-9
inspecting the instrument, 2-1
Instrument Description, B-1
Instrument Reset, 3-11
Intensity Control, 2-7
interpolation Key, 12-16

K

key

of points, 4-7, 9-8
of segments, 4-7
of screens, 7-4, 7-8, 7-12
abort, 12-8, 12-11
add to memory, 10-4
after fail, 11-9, 11-14
allowance, 11-12
automask, 10-7
AUTOSCALE, 3-5
cal select, 12-10
center freq, 9-7
chan/mem, 9-4
channel, 12-9, 12-11
channel impedance, 12-8
channel select, 5-2
Clear Display, 3-3
clear memory, 10-4
clear mask, 10-11
clear points, 10-11
clock, 6-15
CLR MEAS, 11-2
compare, 11-11
connect dots, 7-6, 7-9, 7-13
connect points, 10-10

key (continued)

continue, 12-8, 12-11
continuous, 11-3
copy scaling, 10-8
coupling, 5-3
day, 12-14
Delay, 4-3, 6-22
delay (timebase), 4-3
delta t (x) markers, 8-1
delta V (y) markers, 8-1
display (function), 9-3
display (pixel memory), 10-4
display (waveform memory), 10-2
Display Mode, 7-2
ECL, 5-5
enter changes, 7-14
exclude/include, 7-13
execute all changes, 7-14
exit menu, 12-3, 12-6, 12-9, 12-11, 12-14 - 12-16
fail if, 11-8
failure #, 10-5
FFT, 9-6
field, 6-28
FINE, 3-9
form feed, 12-3
freq span, 9-7
from seg #, 7-14
Function, 9-3
Hardcopy, 3-3
holdoff, 6-3, 6-10, 6-16, 6-29, 6-34
horiz magnify, 9-7
horiz-vert, 10-8, 10-11
hour, 12-15
interpolation, 12-16
level (adjust/centered), 6-3, 6-33
level/polarity, 6-28
limit mask, 10-11
line, 6-28
Local, 3-3
main mask menu, 10-9, 10-11
mark point, 10-10

key (continued)

- mask editor, 10-7
- max test voltage, 12-9
- measure/define/limit/compare, 11-3
- minute, 12-15
- month, 12-14
- more, 7-14, 9-6, 9-10
- more exclude/include, 7-13
- more preset/probe, 5-4
- nonvolatile, 10-2, 10-5
- off/on, 8-2
- off/frame/axes/grid, 7-6, 7-9, 7-12
- offset, 9-5, 9-9
- offset, channel, 5-2
- on fail, save, 11-8, 11-12
- operand, 9-4
- operator, 9-4
- or if, 11-8
- paper length, 12-3
- pattern, 6-8
- peak search, 9-6
- persistence, 7-8
- present, 6-16
- probe, 5-4
- protect, 10-3, 10-5
- qualify on, 6-20
- RECALL, 3-5
- reference, 4-3
- reference wfm, 10-6
- registration form, 12-16
- repetitive/realtime, 4-4
- rms (ac,dc), 11-3
- RUN/STOP, 3-2
- SAVE, 3-6
- save to, 11-9
- saved source, 10-5
- search level, 9-6
- second, 12-15
- sensitivity, 9-5, 9-9
- sensitivity, channel, 5-2
- sequential, 4-6

key (continued)

- set, 11-8
- set date, 12-14
- set time, 12-15
- SHOW, 3-6
- single, 3-3
- slope, 6-3
- source, 6-3, 6-28, 7-12
- source-memory, 10-8
- source-state, 6-33
- source (waveform save), 10-3
- source x1,y1, 8-2
- source x2,y2, 8-3
- Standard Select (tv), 6-28
- standard/user defined, 11-4
- start cal, 12-8, 12-11
- start test, 12-6
- statistics, 11-3
- store (waveform), 10-3
- store failure, 10-5
- test, 11-7, 11-10
- thresholds/measurements, 11-4
- Time/Div, 4-1
- timebase/delay, 10-3
- to, 11-12
- to seg #, 7-14
- tolerance units, 10-8
- trigger on, 6-23
- TTL, 5-5
- Vertical Sensitivity, 5-2
- view failures, 10-5
- volatile, 10-3
- waveform/pixel, 10-1
- when, 6-9, 6-15
- vertical sensitivity, 5-2
- x1 position, 8-2
- x2 position, 8-3
- y1 position, 8-2
- y2 position, 8-3
- when present, 6-34
- width, 6-34

key (continued)
 window, 9-9
 year, 12-14
key features, 1-1
Key-down power up, 3-11
keyboard test, 12-6
knob, 3-8 - 3-9

L

level adjust Key, 6-3, 6-33
level/polarity Key, 6-28
 limit mask Key, 10-11
line Key, 6-28
Line Switch, 3-10
line voltage, selecting, 2-4
LOCAL Key, 3-3
loop Test, 12-6
ltrig acquisition test, 12-6

M

main mask menu Key, 10-9, 10-11
Making Measurements, A-1
mark point Key, 10-10
markers, 8-1
markers after autoscale, 3-5
Marker (operating characteristics), B-12
markers, x/y, 8-1
mask editor Key, 10-7
mask editor menu, 10-10
mask exercise, 10-13
mask menu, 10-2, 10-6
Math function offset, SHOW, 3-6
Math function operation, SHOW, 3-6
Math function scaling, SHOW, 3-6
max test voltage Key, 12-9
meas Sub-menu, 11-3

Index-6

measure/define/limit/compare Key, 11-3
Measure Define, 11-4
Measure Limit, 11-7
measurement limit test after autoscale, 3-5
Measurement Selection, 11-2
Measurement Setup, A-1
measurements after autoscale, 3-5
Memories, SHOW, 3-6
memory bar, 4-5
menu
 channel, 5-1
Menus, 3-7
Menus section, 3-7
minute Key, 12-15
Miscellaneous Test, 12-6
month Key, 12-14
more Key, 7-14, 9-6, 9-10
more exclude/include Key, 7-13
more preset/probe Key, 5-4
multiple menu, 10-2, 10-4

N

negative delay, 4-3
noise reject Key, 6-3
nonvolatile Key, 10-2, 10-5
nonvolatile memory, 10-2
numeric keypad, 3-8

O

off/frame/axes/grid Key, 7-6, 7-9, 7-12
off/on Key, 8-2
offset Key, 5-2, 9-5, 9-9
offset level for ECL, 5-5
offset level for TTL, 5-5
Offset, hysteresis, trigger cal, 12-10
on fail, save, 11-8, 11-12

**HP 54505B/54506B/54510B/54512B
Front-Panel Reference**

Operating Characteristics, B-6
Operating Environment, 2-2, B-18
Operator Key, 9-4
Options Available, B-2
or if Key, 11-8

P

pan and zoom, 4-15
panning, 4-17
panning example, 4-18
paper length Key, 12-3
pattern Key, 6-8
Pattern Trigger Exercise, 6-10
Peak Measurements, 9-20
peak search Key, 9-6
Performance Characteristics, B-4
Performance Specifications, B-3
period, A-5
persistence, 7-8
persistence after autoscale, 3-5
pixel Menu, 10-3
positive delay, 4-3
power input, 2-3
Power Requirements, 2-3
power switch, 3-10
present Key, 6-16
probe attenuation, 5-4
probe attenuation failure, 12-8
Probe attenuation, SHOW, 3-6
probe cal menu, 12-7
probe key, 5-4
Probe Terminal section, 3-9
product description, 1-1
product regulations, B-19
protect Key, 10-3, 10-5

Q

qualify on
edge, 6-21
pattern, 6-21
state, 6-21
qualify on Key, 6-20

R

ram test, 12-6
range, 6-10
realtime acquisition, 4-4
Realtime Mode (operating characteristics), B-12
Rear Panel Layout, 2-3
RECALL 0, 3-5
RECALL CLEAR, 3-6, 3-11
RECALL Key, 3-6
registration form Key, 12-16
reference Key, 4-3
reference wfm Key, 10-6
repetitive acquisition, 4-4
Repetitive Bandwidth, 1-1
Repetitive Mode (operating characteristics), B-11
repetitive mode, single-shot exercise, 4-9
repetitive/realtime Key, 4-4
reset, 3-11
rise time, A-5
rise time measurements, A-1
rms (ac, dc) Key, 11-3
rom Test, 12-6
RUN/STOP Key, 3-2
running, 3-2

S

- sample rate
 - relationship to acquisition and timebase, 4-2
- SAVE Key, 3-6
- saved source Key, 10-5
- search level Key, 9-6
- second Key, 12-15
- selecting line voltage, 2-4
- Self Cal menu, 12-10
- selftest menu, 12-4
- sensitivity (CHANNEL menu), 5-2
- sensitivity Key, 9-5, 9-9
- sequential Key, 4-6
- Sequential single-shot, 4-6, 4-13, 7-15
- service menu, 12-12
- set Key, 11-8
- settings after autoscale, 3-5
- Setup, 3-4
- Setup Aids (operating characteristics), B-15
- SETUP section, 3-4
- shift key, 3-8
- Shipping an instrument, 2-2
- SHOW display, 3-10
- SHOW Key, 3-6
- SINGLE Key, 3-3
- single shot
 - Real Time Mode, 4-12
- single shot
 - Repetitive Mode, 4-9
- single-shot
 - exercise, 4-9
- single-shot in repetitive mode, 4-9
- slope after autoscale, 3-5
- slope Key, 6-3
- soft reset, 3-5, 3-11
- softkeys, 3-10
- source (display) Key, 7-12
- source (trigger) Key, 6-3, 6-28

- source (waveform save) Key, 10-2
- source-memory Key, 10-8
- source-state Key, 6-33
- source x1,y1 Key, 8-2
- source x2,y2 Key, 8-3
- specifications, performance, B-3
- standard + width, A-4
- standard - width, A-5
- Standard Select Key (tv), 6-28
- standard/user defined Key, 11-4
- start cal Key, 12-8, 12-11
- start test Key, 12-6
- State Trigger Exercise, 6-16
- state Trigger Mode, 6-15
- statistics after autoscale, 3-5
- statistics Key, 11-3
- status message, 3-2
- status of acquisition, 3-2
- stopped mode, 3-3
- store (waveform) Key, 10-3
- store failure Key, 10-5
- storing an instrument, 2-2
- storing FFT, 9-22
- supplied accessories, B-1
- sweep speed, time/division function, 4-1
- SYSTEM CONTROL keys, 3-2
- System menu, 12-13

T

- T, trigger point
 - position above memory bar, 4-5
- talk only, 12-2
- talk only menu, 12-2
- Test
 - acquisition, 12-6
 - loop, 12-6
 - ram, 12-6
 - rom, 12-6
- test Key, 11-7, 11-10

- threshold, 6-1
- thresholds/measurements Key, 11-4
- time Key, 12-9
- time markers, 8-1
- Time menu, 12-15
- time null submenu, 12-9
- timebase/delay Key, 10-3
- Time/Div Key, 4-1
- timebase acquisition test, 12-6
- Timebase Menu, 4-1
- timebase setting
 - relationship to sample rate and acquisition , 4-2
- to Key, 11-12
- to seg # Key, 7-14
- tolerance units Key, 10-8
- Trig'd/auto Key, 6-1
- trigger
 - delay, 6-1, 6-20
 - edge, 6-1 - 6-2
 - glitch, 6-33, 6-34
 - pattern, 6-1, 6-8
 - state, 6-1, 6-15
 - tv, 6-1, 6-27
- trigger characteristics, B-6
- trigger edge mode after autoscale, 3-5
- trigger level, 6-1
- trigger level after autoscale, 3-5
- trigger level for ECL, 5-5
- trigger level for TTL, 5-5
- Trigger level, SHOW, 3-6
- Trigger Menu, 6-2
- Trigger Modes (operating characteristics), B-8
- trigger on Key, 6-23
- trigger point in memory bar, 4-5
- Trigger source, SHOW, 3-6
- trigger specifications, B-3
- TTL Key, 5-5
- TV Trigger (operating characteristics), B-10
- tv Trigger Exercise, 6-29
- tv Trigger Mode, 6-27

U

- Unpacking the instrument, 2-1
- User-definable Measurement Thresholds , B-14
- user-defined + width, A-4
- Utility Menu, 12-1

V

- V/div for ECL, 5-5
- V/div for TTL, 5-5
- Vamp, A-6
- Vavg, A-6
- Vbase, A-6
- vertical characteristics, B-4
- vertical operating characteristics, B-6
- vertical position, 5-2
- Vertical Resolution, 1-1
- vertical sensitivity after autoscale, 3-5
- Vertical Sensitivity Key, 5-2
- vertical specifications, B-3
- vertical offset after autoscale, 3-5
- view failures Key, 10-5
- Vmarker , 8-1
- Vmax, A-5
- Vmin, A-5
- volatile Key, 10-3
- voltage selector module, 2-3
- Vp-p, A-5
- Vrms, A-6
- Vrms (ac), A-6
- Vrms (dc), A-6
- Vtop, A-6

W

Waveform Math (Operating Characteristics), B-12
Waveform Math Exercise, 9-15, 9-17
waveform math functions, autoscaled, 3-5
Waveform Math Menu, 9-1
waveform Menu, 10-2
Waveform Save (operating characteristics), B-13
Waveform Save Exercise, 10-12
Waveform Save Menu, 10-1
waveform/pixel/multiple/mask Key, 10-2
waveform/pixel memory display after autoscale, 3-5
Weight, B-20
when entered, 6-9
when exited, 6-10
when Key (pattern trigger mode), 6-9
when Key (state trigger mode), 6-15
when present, 6-10
when present Key, 6-34
width Key, 6-34
window Key, 9-9

Z

zooming, 4-15
zooming example, 4-15

X

x1 position Key, 8-2
x2 position Key, 8-3

Y

year Key, 12-14
y1 position Key, 8-2
y2 position Key, 8-3