

About this Manual

We've added this manual to the Agilent website in an effort to help you support your product. This manual is the best copy we could find; it may be incomplete or contain dated information. If we find a more recent copy in the future, we will add it to the Agilent website.

Support for Your Product

Agilent no longer sells or supports this product. Our service centers may be able to perform calibration if no repair parts are needed, but no other support from Agilent is available. You will find any other available product information on the Agilent Test & Measurement website, www.tm.agilent.com.

HP References in this Manual

This manual may contain references to HP or Hewlett-Packard. Please note that Hewlett-Packard's former test and measurement, semiconductor products and chemical analysis businesses are now part of Agilent Technologies. We have made no changes to this manual copy. In other documentation, to reduce potential confusion, the only change to product numbers and names has been in the company name prefix: where a product number/name was HP XXXX the current name/number is now Agilent XXXX. For example, model number HP8648A is now model number Agilent 8648A.

User's Reference

Publication number 54542-97048
First edition, March 1996

This book applies directly to firmware revision code 2.XX.

For Safety information, Warranties, and Regulatory
information, see the pages behind the index

© Copyright Hewlett-Packard Company 1993-1996
All Rights Reserved

HP 54520C and HP 54540C Series Oscilloscopes

HP 54520C and HP 54540C Series Oscilloscopes

The HP 54520C and HP 54540C series are high-performance, portable oscilloscopes. Each channel provides 8 bits, 32K maximum acquisition memory, and 500-MHz bandwidth. Firmware modularity is provided by a 3-1/2 inch disk drive and flash ROMs, which allows for upgrades of the system firmware features in the oscilloscopes. Each of the oscilloscopes has an auxiliary trigger input on the rear panel. The sample rate and channel count depends on the model number.

- HP 54542C has 4 channels with 2-GSa/s maximum sample rate on each channel.
- HP 54522C has 2 channels with 2-GSa/s maximum sample rate on each channel, and there is an external trigger input on the front panel.
- HP 54540C has four channels with 2-GSa/s maximum sample rate when one channel is turned on, 1-GSa/s maximum sample rate when two channels are turned on, and 500 MSa/s when four channels are turned on.
- HP 54520C has two channels with 1-GSa/s maximum sample rate when one channel is turned on, and 500 MSa/s when two channels are turned on, and there is an external trigger input on the front panel.

This oscilloscope has many powerful features, and each of them is described in this book. Your key to unlocking power of the oscilloscope depends how you combine its features for your application, and your knowledge of how each feature effects the operation of the oscilloscope.

All calibration and repair information is contained in the Service Guide, and all programming information is contained in the Programmer's Reference.

Accessories Supplied

The following accessories are supplied with the oscilloscope.

- 2 HP 10441A 10:1, 1M Ω , passive probes on the 2-channel models, and 4 passive probes on the 4-channel models.
- This User's Reference
- One Quick Start Guide
- One Programmer's Reference
- One Service Guide
- One 2.3 meter (7.5 feet) power cord

See Also

The Service Guide for available power cords.

Accessories Available

The following accessories are available for use with the oscilloscope.

- HP 10430A 10:1, 1M Ω , 1 meter, passive probe
- HP 10437A 1:1, 50 Ω , 2 meter, passive probe
- HP 10438A 1:1, 1 meter, passive probe
- HP 10439A 1:1, 2 meter, passive probe
- HP 10441A 10:1, 1M Ω , 2 meter, passive probe
- HP 10442A 10:1, 500 Ω , 2 meter, passive probe
- HP 10443A 20:1, 1000 Ω , 2 meter, passive probe
- HP 10450A SMT probe accessory kit
- HP 10072A SMT probe accessory kit
- HP 10002A 50:1, 9M Ω , 1000 V peak, passive probe
- HP 10020A resistive divider probe kit
- HP 1137A 1000:1, high voltage divider probe
- HP 1141A 200-MHz, differential probe
- HP 1142A probe power for HP 1141 probe
- HP 1143A probe power for HP 54701A probe
- HP 1144A 800 MHz, 2 pF, 1M Ω , active probe
- HP 54701A 2.5 GHz, 0.6 pF active probe
- HP 10211A 24-pin IC clip
- HP 10024A 16-pin IC clip
- HP 1250-1454 BNC to miniature probe adapter
- HP 1250-2427 horizontal, PC board, mini-probe socket

- HP 1250-2428 vertical, PC board, mini-probe socket
- HP 01144-61604 1:2 probe power fanout
- HP 10240B BNC blocking capacitor
- HP 11094B 75 Ω feedthrough termination
- HP 5062-7379 rackmount kit
- HP 1494-0015 rackmount slide kit
- HP 1540-1066 Soft carrying case
- HP 1180A tilt-tray testmobile
- HP 92199B power strip for test mobile
- HP 540 Centronics printer
- HP 560C Centronics printer
- Color Pro HPIB, plotter
- HP 7470A HPIB, plotter
- HP 7475A option 002 HPIB, plotter
- HP 7550A option 005 HPIB, plotter















Options

- 090 Delete probes
- 908 Rackmount kit
- 910 Additional manuals
- 001 Telecom Mask Test Software (Downloaded)
- 002 HP 1145A 2-ch 750 MHz, SMT Active Probe
- 003 HP 1144A 800 MHz Active Probe

In this book

This book consists of 14 chapters, a glossary, and an index. Most of the chapters describe the various menus in the oscilloscope. These chapters contain the word "Menu" as part of their title. For example, "Display Menu" discusses the various softkey menus that come up on the display when you press the Display key on the front panel. Other chapters, like Vertical, discuss the softkey menu and knobs associated with the control of the vertical portion of the front panel. The remaining chapters contain additional information about the oscilloscope. For example, "Measurements" discusses how the oscilloscope calculates the measurement results when you select an automatic measurement.

You will find it easier to use this reference book if you are at least a little familiar with how to use the front panel. The best way to learn how to use the front panel is by reading the User's Quick Start Guide that is supplied with the oscilloscope.

1	Setting Up the Oscilloscope	
2	Front-Panel Overview	
3	Vertical	
4	Horizontal	
5	Trigger	
6	Display Menu	
7	Marker Menu	
8	Define Measure Menu	
9	Waveform Save Menu	
10	Math/FFT Menu	
11	Utility Menu	
12	Disk Menu	
13	Measurements	
14	Specifications and Characteristics	



Glossary



Index

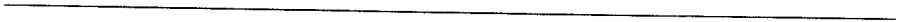



1 Setting Up the Oscilloscope

- Initial Inspection 1-3
- Operating Environment 1-3
- Rear Panel 1-4
- Connecting External Equipment 1-8

2 Front-Panel Overview

- Control 2-4
- Menus 2-14
- Entry/Measure 2-15
- Probe Terminal 2-17
- Line Switch 2-17
- Display 2-17
- Instrument Reset 2-20
- Disk Drive 2-20

3 Vertical



- Channel Softkey 3-4
- Vertical Sensitivity Softkey 3-4
- Position Softkey 3-5
- Coupling Softkey 3-6
- Input Impedance Softkey 3-7
- More Preset Probe Softkey 3-7
- Probe Softkey 3-8
- ECL Softkey 3-9
- TTL Softkey 3-9
- More Softkey 3-9

4 Horizontal

- Time/Div Softkey 4-4
- Delay Softkey 4-5
- Pan and Zoom 4-6
- Reference Softkey 4-11
- Repetitive/Real Time Softkey 4-12
- Memory Bar 4-20
- Sequential softkey 4-22
- Sample Clock Softkey 4-28
- Record Length Softkey 4-29

5 Trigger

- Trigger Basics 5-3
- Common Trigger Softkeys 5-4
- Edge Trigger Mode 5-5
- Pattern Trigger Mode 5-9
- State Trigger Mode 5-13
- Delay Trigger Mode 5-15
- TV Trigger Mode 5-19
- Glitch Trigger Mode 5-21

6 Display Menu

- Repetitive Acquisition Display Menu 6-3
- Real-Time Acquisition Display Menu (seq off) 6-7
- Real-Time Acquisition Display Menu (sequential on) 6-9

7 Marker Menu

- Off On Softkey 7-4
- Source x1, y1 Softkey 7-4
- x1 Position Softkey 7-4
- y1 Position Softkey 7-5
- Source x2, y2 Softkey 7-5
- x2 position Softkey 7-5
- y2 position Softkey 7-5
- Markers and Measurements 7-6
- Off On Softkey 7-8
- + Source and X Source 7-8
- + Position and x Position 7-8

8 Define Measure Menu

- Measurement Selection 8-3
- Measure Menu 8-4
- Define Measurement Menu 8-7
- Limit Test Menu 8-10
- Waveform Compare Menu 8-14

9 Waveform Save Menu

- Waveform Save Menu 9-3
- Pixel Menu 9-7
- Multiple Menu 9-9
- Mask Menu 9-12
- Main Mask Menu 9-13
- Automask Menu 9-14
- Mask Edit Menu 9-17

10 Math/FFT Menu

- Defining a Function 10-4
- FFT Softkeys 10-9
- Vertical Scaling Units 10-15
- Making FFT Measurements 10-15
- Displaying Functions 10-19

11 Utility Menu

- HP-IB/RS-232/CENT Menu 11-3
- Self-Test Menu 11-10
- Probe Cal Menu 11-10
- Attenuation Menu 11-11
- Time Null Menu 11-13
- Self-Cal Menu 11-14
- Service Menu 11-14
- System Menu 11-15
- Software Revisions 11-20

12 Disk Menu

- Disk Menu 12-2
- Load Scope 12-4
- Store Scope 12-9
- File Formats 12-12
- Store Image 12-28
- Delete 12-31
- Format 12-32
- Directory 12-33

13 Measurements



- Automatic Parametric Measurements 13-3
- Data Collection 13-4
- Building a Histogram 13-5
- Calculating Minimum and Maximum from the Data Record 13-6
- Calculating Top and Base 13-6
- Calculating Thresholds 13-8
- Determining Rising and Falling Edges 13-9
- Voltage Measurements 13-12
- Timing Definitions 13-14
- Measurement Considerations 13-16
- Making Automatic Measurements from the Front Panel 13-17

14 Specifications and Characteristics

Specifications 14-3
Performance Characteristics 14-5
Operating Characteristics 14-8
General Characteristics 14-23



Setting Up the Oscilloscope

Setting Up the Oscilloscope

This chapter contains information for unpacking, applying power, and connecting optional accessories to the oscilloscope. For safe and troublefree operation, follow the instructions and advisories in this chapter. You may also want to read the safety summary at the end of the book.



Initial Inspection

Inspect the shipping container for damage. If the shipping container or cushioning material is damaged, keep it until the contents of the shipment are checked. Check the shipment for completeness and check the instrument electrically and mechanically.

If the contents are incomplete, if there is mechanical damage, or if the oscilloscope does not power up correctly, notify the Hewlett-Packard Sales Office. Keep the shipping materials for the carrier's inspection. The Hewlett-Packard Sales Office will arrange for repair or replacement at HP's option without waiting for a claim settlement.

Operating Environment

The environmental conditions that you need to be aware of when operating, storing, or shipping the oscilloscope are listed in chapter 16 under "General Characteristics." Because condensation in the instrument cabinet can cause poor operation or malfunction, make sure you avoid temperature extremes which can cause condensation.

If you are shipping the oscilloscope to a Hewlett-Packard Service Center for service or repair, attach a tag to the oscilloscope that identifies the owner, address of the owner, model number, serial number, and a description of the service work that is required.

If the original packaging material is no longer available, identical packing material is available through your local Hewlett-Packard Sales office. Mark the container FRAGILE to ensure careful handling. In any correspondence, refer to the oscilloscope by the model and serial number.

THE 54540A WITH CENTRONICS PORT AND
660 DRIVER WILL INTERFACE PROPERLY WITH
THE DESKJET 670 C PRINTER

Rear Panel

The rear panel of the oscilloscope contains the power input, voltage selector module, external connectors, intensity adjustment, and calibrator protection switches

Figure 1-1

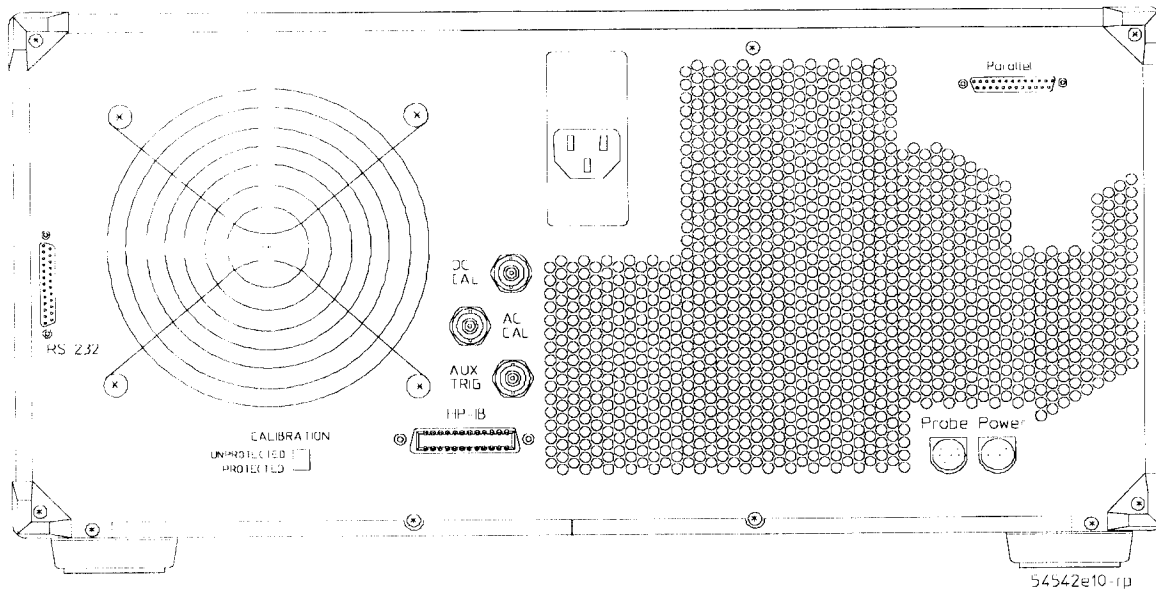

Rear-panel of the oscilloscope



Power Requirements

The oscilloscope requires a power source of either 115 or 230 volts ac, -25% to +15%; single phase, 48 to 440 Hz; 170 W maximum .

Power Cord

This oscilloscope is a Safety Class 1 instrument with an exposed chassis that is directly connected to earth through the power cord that meets IEC Standard 1010. The oscilloscope is provided with a three-wire power cord. When connected to an appropriate ac power outlet, the cord grounds the instrument cabinet. The type of power-cord plug shipped depends on the country of destination.

See also

The Service Guide for a listing of the power cords that are available for the oscilloscope.

WARNING

SHOCK HAZARD! Before connecting the oscilloscope to the power line or connecting to circuits that are connected to the power line, make sure the protective earth terminal of the oscilloscope is connected to the protective conductor of the power cord. Failure to do so could result in electrical shock.

Also, make sure you insert the power plug into an outlet that contains a protective earth contact. Do not use an extension cord without a protective earth conductor (grounding). The grounding of one conductor on a two-conductor outlet is not sufficient for grounding purposes to prevent the possibility of electrical shock.

Line Voltage Selection

The fuse module is set at Hewlett-Packard to the line voltage used in the country of destination. Check the setting of the fuse module to verify it is in the correct position for the voltage you are using.

CAUTION



INSTRUMENT DAMAGE! Before applying power to the oscilloscope, make sure that the fuse module is set to the correct line voltage position. Damage to the oscilloscope can occur if the line voltage is not set correctly.

To change the line voltage selection.

- 1 Unplug the oscilloscope.
- 2 Carefully pry at the top center of the fuse module until you can pull it out.
- 3 Insert the fuse module with the arrow for the line voltage you want aligned with the arrow below the fuse module.
- 4 Plug-in the oscilloscope.

Figure 1-2

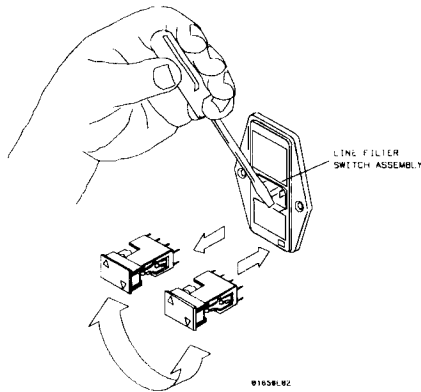

Removing and installing the fuse module.



Verifying the Fuse

If it is necessary to check or change fuses, remove the fuse module and check each fuse for its amperage and voltage ratings.

Figure 1-3

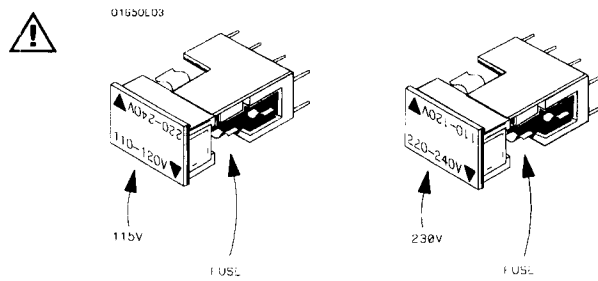

Fuse location on fuse module

Air Flow Requirements

Make sure the oscilloscope has unrestricted air flow for the fan and ventilation openings in the rear panel. You can stack the oscilloscope under, over, or between other instruments provided the other instruments are adequately cooled.

Connecting External Equipment

The oscilloscope is equipped with an HP-IB connector on the rear panel. This allows direct connection to an HP-IB compatible printer, plotter, or external controller. Make sure you tighten the captive screws of the HP-IB cable to ensure a good electrical connection. If you do not have an HP-IB printer, you can use the Centronics port.

You have to set the HP-IB address of the oscilloscope in order to communicate with the connected device. The oscilloscope's HP-IB address is set in the Utility menu.

See also

"HP-IB/RS-232/CENT Menu" in Chapter 11 for information on the HP-IB menu selections.



Front-Panel Overview

Front-Panel Overview

This chapter describes the various areas of the front panel and an explanation of each areas function.

The front panel is separated into nine functional areas: display, control, disk drive, menu, entry/measure, vertical, horizontal, trigger, and probe compensation terminals. All of these areas, except for the last three, are discussed in this chapter. The vertical, horizontal, and trigger sections are discussed in other chapters in this book.

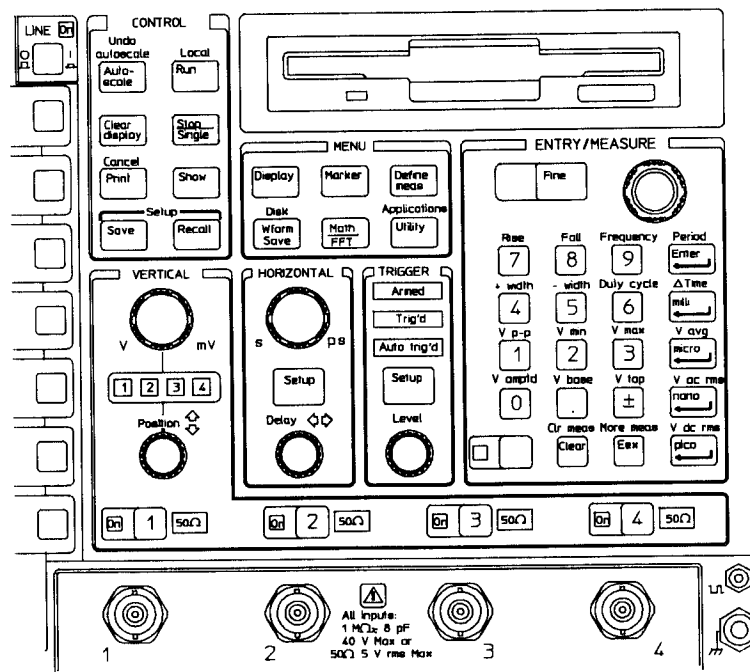

There are two types of keys: front-panel keys and softkeys. A front-panel key has text or numbers printed on it, or it is blue in color. Softkeys are to the right side of the display, and the labels for the softkeys are displayed on the screen next to each softkey. These labels are referred to as menus, and which menu is displayed depends on the front-panel key you press. Not all front-panel keys cause softkey menus to display on the screen.

In this book, *key* is used when referring to front-panel keys, and *softkey* is used when referring to softkeys.

Control

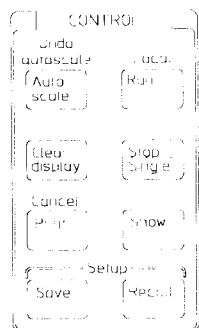

174.142e05

The area of the front-panel marked Control is located at the top of the oscilloscope and to the right of the display.

Autoscale Key

Pressing the Autoscale key causes the oscilloscope to quickly analyze the signal. Then, it sets up the vertical, horizontal, and trigger to best display that signal. The autoscale function can find repetitive signals with a frequency greater than or equal to 50 Hz, a duty cycle greater than one percent, and an amplitude of 50 mV p-p or greater.

The Autoscale function looks for signals on all channels, even if they are turned off. On two-channel models, the scope looks for a trigger signal on the external trigger input; then, it consecutively looks at the channel inputs starting with channel 1. The scope consecutively looks for a trigger signal at the channel inputs starting with channel 1.

When the Autoscale key is pressed, the following conditions are set:

- Vertical sensitivity — To best display signals on active channels
- Vertical offset — To best display signals on active channels
- Trigger — Edge mode, positive slope, and trigger level on the found source
- Display — To minimum persistence when in normal display and repetitive acquisition modes (single persistence in real-time acquisition mode)
- Time base delay — 0.0 seconds
- Time base reference — Center
- Time per division — To best display the signal

Autoscale also includes a partial reset which performs the following:

- Turns off markers
- Turns off all measurements
- Sets measurements to screen instead of markers
- Turns off measurement limit test
- Turns off waveform compare test
- Turns off sequential single shot
- Turns off waveform math functions
- Turns off waveform/pixel/multiple memory display
- Turns off connect-the-dots
- Turns off peak detect
- Sets holdoff to 40 ns (minimum value)

The previous oscilloscope settings are stored in setup memory 0. You can either press Recall 0 or undo autoscale to restore the previous settings.

Undo Autoscale Key

You can access the undo autoscale key by pressing the blue shift key on the keypad, followed by pressing the Autoscale key again.

You may find situations where you have pressed the Autoscale key unintentionally. When this happens, you can use the Undo Autoscale key to return the oscilloscope to the settings prior to pressing the Autoscale key.

Run Key

The Run key causes the oscilloscope to resume acquiring data. If the oscilloscope is stopped, it starts acquiring data on the next trigger event. If the oscilloscope is already in the run mode, it continues to acquire data on successive trigger events.

If pressing the Run key does not cause waveform data to display on the screen, try the following hints:

- Press the Autoscale key (unless the signal is single-shot).
- Make sure that a signal is connected to one of the channels and that the display for that channel is turned on.
- Make sure that the offset does not have the trace clipped off the display.
- Check the trigger setup conditions to make sure that the trigger conditions are valid for the signal.
- Set the trigger sweep mode to auto. Auto sweep forces the oscilloscope to trigger, which may allow you to see enough of the signal, so that you can set up the front panel controls.

Local Key

You can access the Local key by pressing the blue shift key on the keypad, followed by pressing the Run key. The Local key sets the oscilloscope to return control to the front panel. This is the only active key when the oscilloscope is under remote control. The exception occurs when the controller sends a local lockout command. The local lockout command prevents the local key from returning control of the oscilloscope to the front panel.

Clear Display Key

The Clear Display key erases all waveform data from the graticule area, clears waveform math functions, and it resets all associated measurements and measurement statistics. Pressing the Clear Display key does not affect the waveform memories.

When the oscilloscope is stopped If the oscilloscope is stopped, the display remains cleared of waveform data until the trigger circuit is rearmed and the oscilloscope is triggered. Then, the new data is displayed and measurements are recalculated.

When the oscilloscope is running If the oscilloscope is running, new waveform data is displayed on the next acquisition and all measurements are recalculated.

Stop/Single Key

Pressing the Stop/Single key causes the oscilloscope to stop acquiring data. The status area of the screen displays the message "Stopped." In the auto-trigger mode, the next press of the Stop/Single key arms the trigger circuit. If no trigger occurs, the scope triggers itself. In the triggered mode, the next press of the Stop/Single key arms the trigger circuit. If a trigger event is not immediately present, the Armed light on the front-panel lights and the message "running-awaiting trigger" is displayed. If the trigger event is immediately present, you may not see the arm light turn on or the message "running-awaiting trigger." The next trigger event causes the oscilloscope to make a single acquisition, the trig'd (triggered) light briefly lights, the message "stopped" is displayed, and any measurements are recalculated. Each subsequent press of the Stop/Single key rearms the trigger circuit. If all of the channels are turned off or if a trigger event can not be found, the oscilloscope will not acquire any data.

Capturing single-shot events

Single-shot events are waveforms that occur only once or infrequently. Some examples of single-shot events are a switch closure, a power supply turning on, the impact of an object on the floor, or an errant pulse that causes your system to fail.

In order to capture a single-shot event, you need to have some knowledge of the waveform you are trying to capture. Before you can set up the trigger, vertical, and horizontal controls to capture and display the event, you must know the approximate amplitude, duration, and dc offset of the signal. For example, if you are using a logic family, the two common trigger levels you can use to capture an intermittent glitch are VIH minimum and VIL maximum.

To capture a single-shot event

- 1** Connect the signal to the oscilloscope.
- 2** Set the Display softkey to on for that channel. Then, select the appropriate vertical scale and position settings to display the signal.
- 3** Select the appropriate horizontal scale and delay settings to display the signal.
- 4** Press the trigger setup key. Then, set up the trigger menu to best capture the signal. Set the triggering mode to trig'ed (triggered).
- 5** Press the horizontal setup key. Then, set the Sampling mode to real time and select the desired record length.
- 6** Press the Stop/Single key.

This stops the oscilloscope from acquiring any additional data.

- 7** Press the Clear display key.

This erases any previously acquired data from the display and resets any measurement results.

- 8** Press the Stop/Single key again.

This rearms the trigger circuit. The next event that meets the trigger criteria specified in step 4 is captured by the oscilloscope. If the channel and horizontal controls are set correctly, the signal will be displayed on the screen and any measurement results will be recalculated.

To capture another set of data, press the Stop/Single key again. Depending on your application, you can press the Clear display key between acquisitions, or you can allow the display to build a waveform.

To allow the waveform to build on the display, set the display persistence to infinite and do not press the Clear display key between acquisitions.

Control

Print

Pressing the Print key causes the oscilloscope to immediately print the currently displayed data on a compatible plotter or graphics printer, and it stops all other oscilloscope functions while printing. Also, the message "hardcopy active" is displayed.

The oscilloscope must be in the talk only mode, and the printer or plotter must be in the listen always mode. Setup of the printer or plotter options is accessed in the HP-IB/RS-232/CENT menu. If a printer or plotter is not connected to the oscilloscope or if the oscilloscope cannot communicate with them, the oscilloscope stops the printing process after an amount of time set by the time out softkey in the Utility menu.

See also

"HP-IB/RS-232/CENT Softkey" in chapter 11 for information on setting up the oscilloscope to print to a printer or plotter.

Cancel

You can access the cancel print function by pressing the blue shift key on the keypad, followed by pressing the Print key again. Pressing Cancel print stops the printing process to the printer or plotter.

**Show Key**

The Show key gives you quick access to channel, function, and trigger information with the show screen. Pressing the Show key toggles between the currently selected menu and the show screen. The show screen displays the following information about channels, memories, or functions that are on:

- Channel scaling
- Channel offset
- Channel coupling
- Channel impedance
- Probe attenuation
- Trigger mode
- Trigger source
- Trigger level
- Math function operation
- Math function scaling
- Math function offset
- Memories
- Waveform memory scaling

Control**Save Key**

The Save key allows you to save the current front-panel setup to one of the nine non-volatile setup memories. When you press the Save key, the message "select digit 1-9 for setup save" is displayed. Simply use the keypad to select one of the nine waveform memories. After you select a setup memory, the message "setup #*n* saved" is displayed. The oscilloscope uses memory 0 to store the current configuration before executing an autoscale, recall, or ECL/TTL preset.

Recall Key

The Recall key has three functions.

First, you can use the Recall key to retrieve a front-panel setup from one of the nine setup memories (providing that you previously saved a setup to that memory). If a setup was previously saved to that memory, the scope is immediately configured to match that setup, and the message "setup #*n* recalled" is displayed. If a setup is not stored in that memory, the configuration of scope is left alone, and the message "bad data no recall done" is displayed.

Second, you can use the Recall key to retrieve the previous configuration by pressing Recall 0.

Third, you can use the Recall key to set the oscilloscope to a default operating condition by pressing Recall clr (clear key on the keypad). The default settings are shown in table 2-1.

Table 2-1

Default Settings

Horizontal Menu

Time/Div	100 μ s/div
Delay	0.00000 s
Reference	Cntr (center)
Repetitive/real time	Real time
Sequential	Off
Record length	512
Sample clock	Auto

Vertical Menu

Channel 1	On
Channel 2	Off
Channel 3 *	Off
Channel 4 *	Off
Volts/Div	500 mV
Offset	0.00000 V
Coupling	dc
Impedance	1 M Ω
Probe attenuation	1.000:1

Trigger Menu

Trigger	Auto
Mode	Edge
Source	Channel 1
Slope	Positive
Noise reject	Off
Holdoff	40 ns
Level	0.00 V

Define Meas Menu

Meas/def/limit/compare	Measure
Continuous	On
Measure window	Screen
Statistics	Off
Extended analysis	Off

Marker menu

Markers	Off
---------	-----

Display Menu

Mode	Normal
Persistence	Single
# of screens	1
Off/frame/axes/grid	Axes
Connect dots	Off

Math/FFT Menu

f1	Off
f2	Off
f3	Off
f4	Off
Chan/mem	Chan 1
Operator	+
Chan/mem	Chan 1
Function sensitivity	1.00 V/div
Function offset	0.0 V

Waveform Save Menu

Waveform/pixel	Waveform
Nonvolatile	m1
Display	Off
Source	Chan 1
Protect	Off

Utility Menu, System Submenu

AC BNC	Probe comp
Interpolation	On
Probe comp freq	496.484 Hz

Utility Menu System Util Submenu

Clicker	On
Gnd markers	On
Chan labels	Off
Chan factors	On
Power up	Run
FP ontime hrs	6

*On 4-channel models only

Menus

The menu section of the front panel has six keys, two of which have shifted functions: disk and applications. Each of these menu keys, except applications, has its own chapter in this book. When you purchase an application from Hewlett-Packard, the documentation you need comes with that application.

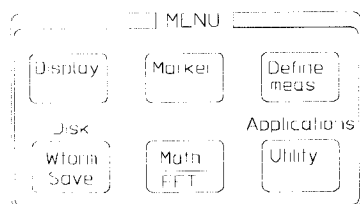

54542e06

- Display Menu — Chapter 6
- Marker Menu — Chapter 7
- Define meas Menu — Chapter 8
- Wform save Menu — Chapter 9
- Math/FFT Menu — Chapter 10
- Utility Menu — Chapter 11
- Disk Menu (a shifted function) — Chapter 12

The channel, time base, and trigger menus are found in the following chapters:

- Vertical menu — Chapter 3
- Horizontal menu — Chapter 4
- Trigger Menu — Chapter 5

Entry/Measure

The entry/measure portion of the front-panel has a multifunctional numeric keypad, a selection knob, and fine key.

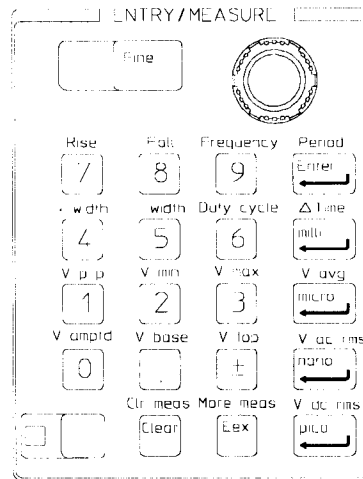

54542e07

Numeric Keypad

The keypad is for direct numeric input. To input known values directly, press the associated softkey to activate the desired field on screen, and then select the units with the numeric keys. For example, to set the vertical sensitivity to 500 mV, select V/div in the vertical menu to ensure it is the active field (displayed in full-bright). Then, press 5, 0, 0, milli in sequence.

When pressed, the blue key on the numeric keypad allows you to select the alternate (shifted) functions. The shifted function above the keys (blue text) are automatic measurement functions. The clear key erases any selections made for the active field. The shift clr meas key erases all measurements and markers.

Entry Knob

The entry knob changes values within each function. It increments, decrements, or toggles the selection in the active field or function. The current selection is displayed yellow in the softkey menu area.

Fine Key

The Fine key changes the increment and decrement sequence. Instead of sequencing in the normal sequence, the values increment or decrement in more precise values. You can use this feature when the normal sequence is too coarse for precision measurements or settings. When the oscilloscope is operating in the fine mode, the word "fine" is displayed in the lower right corner of the display, and the LED next to the fine key is illuminated.

Blue Shift Key

The blue shift key allows you to access the functions that are written in blue above the other keys on the front panel. When you press the blue shift key, the message "select shift function" is displayed, and the LED next to the blue shift key is illuminated.

Probe Terminal

The probe terminal provides a square wave used for probe compensation. You can vary the frequency of the probe compensation signal from about 250 mHz to 32 kHz. The default setting is about 500 Hz. The signal is present when the AC BNC softkey is set to probe compensation in the System Submenu of the Utility Menu.

See also

"System Menu" in Chapter 11 for more information on the probe compensation softkey and the probe compensation signal.

Line Switch

The line switch is located on the front panel. You turn on the oscilloscope by pressing the switch in. The green LED illuminates when the oscilloscope is turned on. The switch position is labeled 1 and 0, corresponding to on and off, respectively.

Display

The display section contains the screen and the labels for the softkeys. The vertical column on the right side of the display show the labels for the softkeys. Each label corresponds to a softkey.

Numeric fields, when highlighted yellow, are changed by either numeric keys on the keypad or by one of the knobs. The numeric fields are displayed in highlighted white when inactive and in yellow when active.

Nonnumeric fields are displayed in highlighted white and are changed by toggling the corresponding softkey.

When the acquisition mode in the horizontal menu is set to the real-time mode, a memory bar is displayed above the graticule area. The graticule area, also referred to as the waveform viewing area, is where all the waveform data and markers are displayed. Below the graticule area are the measurement results, marker settings, and statistical results.

There is a ground marker on the left side of the display for each channel that is turned on. The ground markers give you a visual indication of where the

ground reference point is for each channel that is turned on. When a channel is turned on, the ground marker is displayed. When channel markers is selected, the channel # is displayed. If the ground reference for a channel is positioned vertically off the screen, the ground marker turns into an arrow that points in the direction of the ground reference. Ground markers are printed with hardcopy prints. You can turn the ground markers on or off with the **GND MARKERS** softkey in the Utility/system menu/system util menu.

When selected, there is a channel marker on the right side of the display for each channel that is turned on. The channel markers help you keep track of the source channel for each displayed waveform. The channel labels are printed with hardcopy prints. You can turn the channel lables on and off with the **CHAN LABELS** softkey in the Utility/system menu/system util menu.

The volts/div and offset (channel factors) settings for each channel that is turned on are displayed on the screen. If measurements are turned off, the channel factors are displayed below the graticule area. If measurements are turned on, the channel factors are displayed near the bottom of the graticule area. You can turn on or off the display of the channel factors with the **CHAN FACTORS** softkey in the Utility/system menu/system util menu. You can also press the Show front-panel key to see the complete setup of any channels that are turned on. The channel factors are printed with hardcopy prints.

Figure 2-1

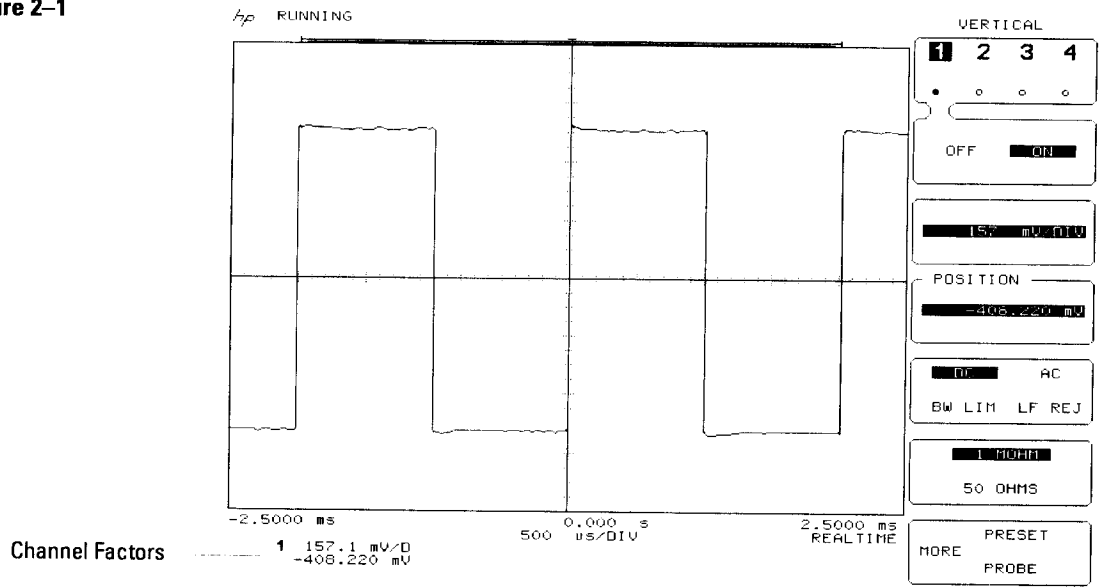
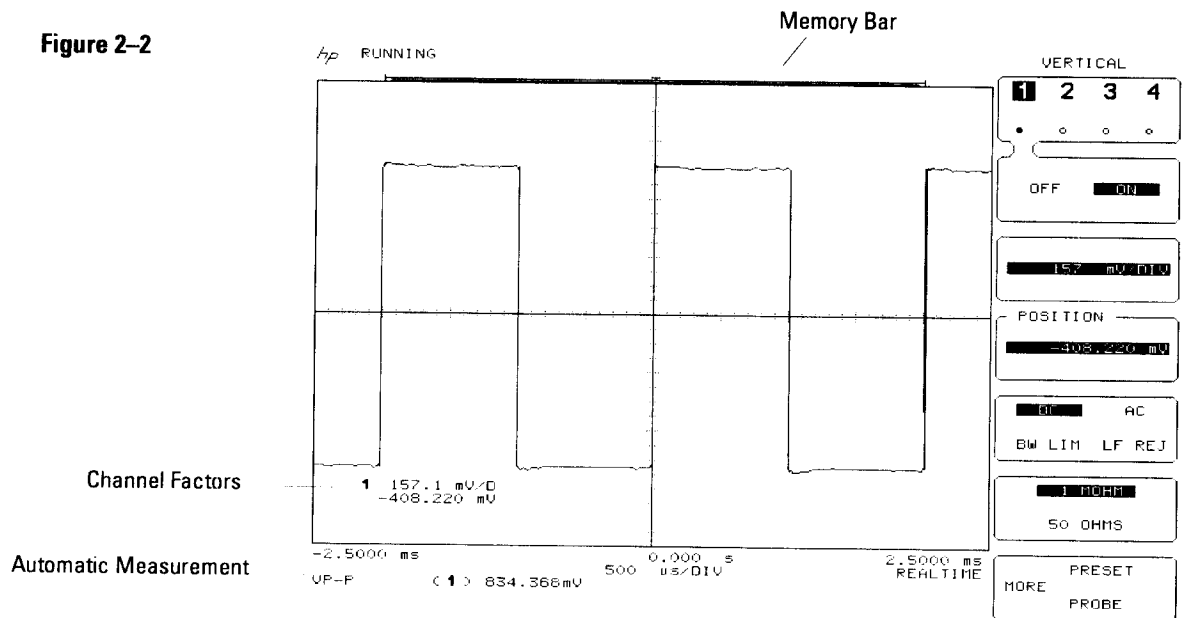

Figure 2-2



Instrument Reset

The oscilloscope has two methods of instrument reset: key-down power up or Recall clr.

Key-Down Powerup A key-down power up is a hard reset of the oscilloscope. It is done by pressing and holding any front-panel key while cycling power.

The oscilloscope powers up displaying a baseline, the show screen, and the front-panel configuration is set to the default settings. Except for the following additions, the default settings are the same as those in table 2-1.

Utility Menu (HP-IB menu)

Address/talk	Address
Address	7

Recall Clr (Clear) Recall clr (clear) is a soft reset that sets the scope to the default conditions in table 2-1. Performing a recall clear is similar to a key-down power-up except the previous menu selections are retained.

Disk Drive

The oscilloscope has a high-density, 3-1/2 inch, MS-DOS[®] compatible disk drive. In the disk menu you can save and recall waveforms, save and recall front-panel setups, delete files from a disk, format a disk, or obtain a directory listing of a disk. You can also use the disk drive to load new system firmware into the flash ROMs or you can load applications.

See also

Chapter 12, "Disk Menu" for information about the disk menu and its features.

MS-DOS[®] is a US registered trademark of Microsoft Corporation.



Vertical

Vertical

This chapter describes the portion of the oscilloscope that controls the vertical display of waveforms and the acquisition parameters. On the portion of the front panel marked VERTICAL are the volts/division knob, position knob, and the numbered front-panel keys for the channel menu for each channel.

The volts/div knob changes the vertical scaling for the selected channel. The channel indicator tells you which channel's parameters you are changing with the vertical menu or the knobs. The position knob moves displayed waveforms vertically on the display. The numbered channel keys bring up the vertical menu on the display and turns the channel on or off. The On indicator is lit when a channel is turned on, and the 50 Ω indicator is lit when the channel input impedance is set to 50 Ω .

The 2-channel models have two input channels and an external trigger input. The 4-channel models have four input channels and no external trigger input. Each channel is shunted by about 7 pF at the input BNC with a maximum input voltage of 250 V.

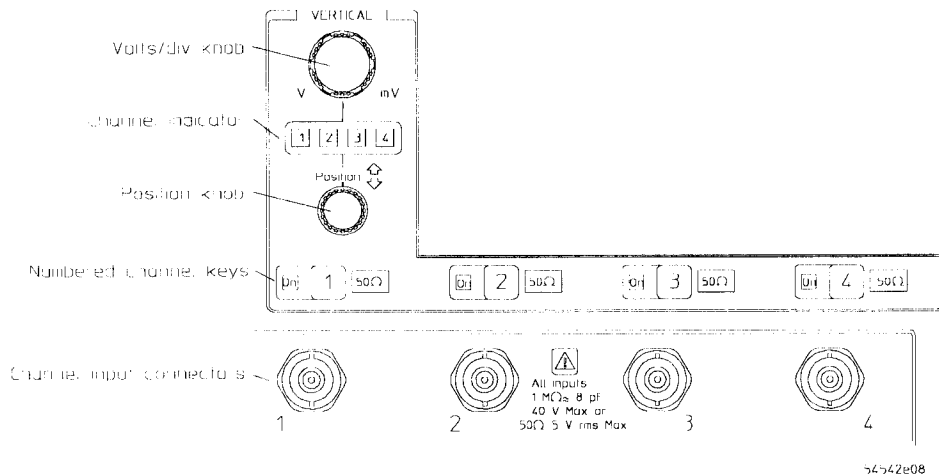

When you press a numbered channel key on the front panel, the vertical menu that corresponds to the key you pressed is displayed on the right hand portion of the screen. The vertical menu and menu map are shown below.

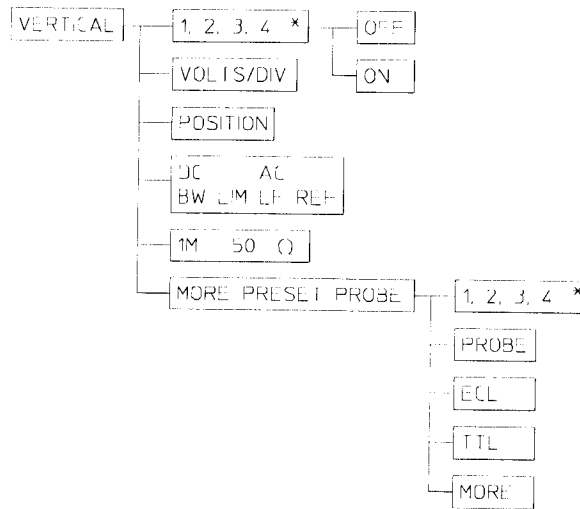
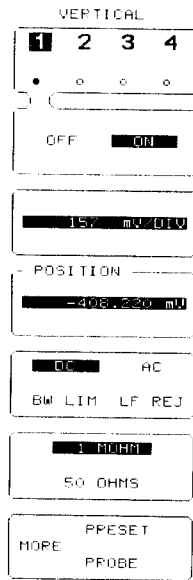

* CHANNELS 3 AND 4 ARE ONLY AVAILABLE ON THE 4 CHANNEL MODELS

54542m35

Channel Softkey

The top key in the vertical menu is for channel selection. This key toggles between channels. You can use the channel softkey to select a channel or you can use the numbered channel keys on the front panel to select a channel. When a channel is selected (highlighted), you can turn that channel on or off. When a channel is turned on, the small circle immediately below the channel number is highlighted, and the LED is turned on. When you turn a channel off, the channel menu automatically switches to the lowest numbered active channel.

Because you may have a channel turned on while being in the vertical control menu of a different active channel, make sure you that you are changing the functions for the channel you intend to change. You can tell which channel you are affecting by checking which number is lit directly below the volts/div knob, or by noting which channel is in inverse video in the vertical menu.

Vertical Sensitivity Softkey

The **VERTICAL SENSITIVITY** softkey is the third softkey from the top in the channel menu. The current volts/division is displayed with the units of the currently selected channel. You can use the volts/div knob to change the vertical scaling at any time, even if you are in a different menu or even when the **VOLTS/DIV** softkey is not the active function. However, when the **VOLTS/DIV** softkey is the active function, you can use the volts/div knob, the entry knob, or the keypad to change the vertical scaling of the selected channel.

When the probe attenuation is set to 1:1, the vertical sensitivity range is from 1 mV/division to 5 V/division, and it changes in a 1-2-5 sequence. You can use the keypad to enter values not in the normal 1-2-5 sequence. When the Fine key is selected, you can make fully calibrated vernier adjustments using the entry knob. When the Show key is pressed, the current vertical sensitivity is shown at the right of the waveform display for channels that are turned on.

Position Softkey

The **POSITION** softkey is the fourth softkey. Selecting position assigns position as the active function. You can use the position knob to change the position setting at any time, even if you are in a different menu or when position is not the active function. When position is the active function, you can use either the position knob or the entry knob to change the position setting of the selected channel.

position moves the trace vertically up or down similar to the vertical position adjustment on an analog oscilloscope. However, because digital oscilloscopes have a true dc offset at the front end, they provide a much wider offset range. When the Show key is pressed, the position voltage is shown at the right of the waveform display. The position value is the voltage level at the vertical center of the screen.

Coupling Softkey

The **COUPLING** softkey has several selections: dc, dc BW lim (dc bandwidth limited), ac, ac BW lim (ac bandwidth limited), and ac LF reject (ac low-frequency reject).

CAUTION



Because the 50 Ω selection sinks more current than the 1M Ω setting, make sure you do not exceed the maximum rated input of the channel when switching from 1M Ω to 50 Ω .

When dc is selected, 1 M Ω and 50 Ω dc input impedances are available as choices for input impedance. When ac is selected, only 1 M Ω is available for input impedance. Bandwidth limit is switchable for both ac and dc coupling. Bandwidth limit, LF reject, and ac coupling filter both the vertical and trigger paths.

- dc — The dc bandwidth of the scope, which is 500 MHz.
- dc bandwidth limit — Adds a 30 MHz low-pass filter.
- ac — Adds a 10 Hz high-pass filter.
- ac bandwidth limit — Band-pass filter that consists of a 10 Hz high-pass filter and a 30 MHz low-pass filter.
- LF reject — Adds a 400 Hz, high-pass filter.

See Also

"Edge Trigger Mode" in chapter 5 for information about ac coupling or adding LF reject to the trigger path separately from the vertical path.

Input Impedance Softkey

The **INPUT IMPEDANCE** softkey allows you to select the input coupling impedance. The choices are 1 M Ω for ac coupling and selectable 1 M Ω or 50 Ω dc when dc coupling is selected in the coupling function. When 50 Ω is selected, the 50 Ω indicator LED on the front panel is lit for that channel.

More Preset Probe Softkey

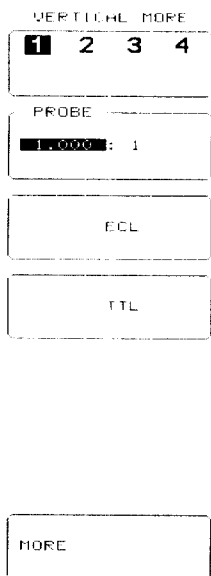

The **MORE PRESET PROBE** softkey gives you access to a second-level channel menu.

Probe Softkey

The **PROBE** softkey allows you to select a probe attenuation from 0.9000:1 to 1000:1. Attenuation is adjusted by either the entry knob or keypad. When the entry knob is in coarse mode, adjustments are incremented or decremented in the 1-2-5 sequence. When in the fine mode, adjustments are in 0.1 increments.

Probe attenuation affects scaling factors for the display, not the sensitivity at the input connector. Also, the attenuation factors are saved with the front panel setups. You can let the oscilloscope calibrate (calculate) the probe or cable attenuation for you in the utility menu.

See Also

"Probe Cal Menu" in Chapter 11 for information on probe calibration.

ECL Softkey

The **ECL** softkey sets the oscilloscope to levels optimized for ECL circuits:

- V/Div 200 mV/div (400 mV/div if the number of screens is 2, and 800 mV/div if the number of screens is 4)
- Offset -1.3 V
- Coupling dc
- Trigger level -1.3 V
- Trigger slope No change

Recall 0 returns the menu to the previous settings.

TTL Softkey

The **TTL** softkey sets the oscilloscope to levels optimized for TTL circuits:

- V/Div 1 V/div (2 V/div if number of screens is 2, and 4 V/div if number screens is 4)
- Offset 2.5 V
- Coupling dc
- Trigger level 1.4 V
- Trigger slope No change

Recall 0 returns the menu to the previous settings.

More Softkey

The **MORE** softkey returns you to the vertical menu.



Horizontal

Horizontal

This chapter contains a description of the portion of the oscilloscope that controls the horizontal display of waveforms and the acquisition parameters. You may notice that the front panel is divided into several areas. On the area of the front panel marked HORIZONTAL are the time/division knob, delay knob, and the setup key for the horizontal menu.

The time/div knob changes the horizontal scaling for displayed waveforms. The setup key brings up the horizontal menu on the display. The delay knob moves displayed waveforms horizontally across the display.

Time/div knob

Setup key

Delay knob

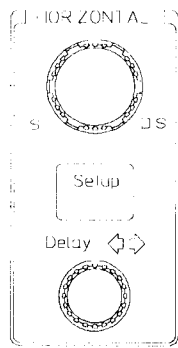

54542L23

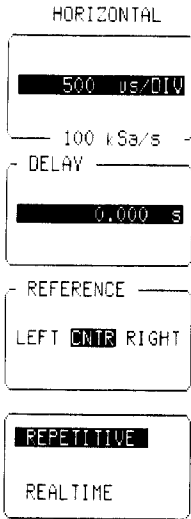

When you press the horizontal Setup key on the front panel, the horizontal menu is displayed on the right hand portion of the screen. The horizontal softkey menu and menu map are shown below. When the real-time mode is selected, three additional softkeys are added to the softkey menu.

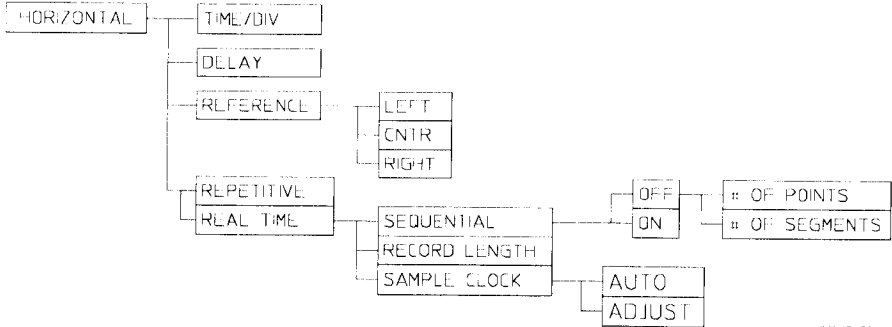

54542m06

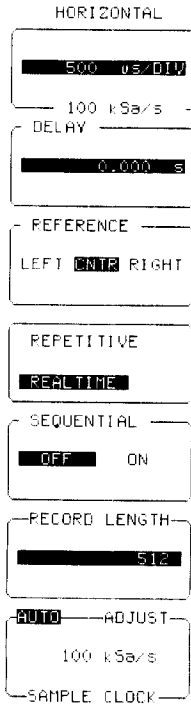

When real time is selected, these three keys are available.

Time/Div Softkey

The top softkey in the horizontal menu is the **TIME/DIV** softkey, which displays the horizontal scaling factor. When the scope is running, this softkey also displays the current sample rate. You can use the horizontal knob to change the time base scaling at any time, even if you are in a different menu or when the time/div softkey is not the active function. However, when the time/div softkey is the active function, you can use either the horizontal knob, keypad, or the entry knob to change the horizontal scaling.

Horizontal scaling changes in a 1-2-5 sequence from 500 ps/div to 5 s/div. When the HP 54540C is sampling at 1 GSa/s in the real-time mode, the 500 ps setting is not available. When the HP 54540C and HP 54520C are sampling at 500 MSa/s in the real-time mode, the 500 ps and 1 ns setting are not available. The fine key does not affect the time base sequence while the acquisition is running, unless the auto adjust softkey is set to adjust.

The horizontal scale setting affects the sample rate at which the oscilloscope acquires data, except when the sample clock softkey is set to adjust in the real-time mode. When the scope is running, the current sample rate is displayed below the time/div setting in the time base menu.

In the real-time mode and with the acquisition stopped, the time/div knob also controls the zoom feature. By observing the memory bar, you can tell what portion of the memory is being displayed.

An acquisition is not displayed on the screen until all data is available. The data is available when the waveform record is full. The advisory "running" is displayed after the scope triggers.

When the sample clock and record length are set such that it takes two seconds or longer to collect the data, the advisory "*n* sec (prestore)" is displayed while pretrigger data is collected, and "*n* sec (poststore)" is displayed while posttrigger data is collected. These messages indicate the time needed to complete an acquisition, where *n* is the remaining time in seconds, and continues to count down until the time has elapsed.

The total time acquired and the sample rate are dependent on the sample clock setting and the selected record length of the acquisition (as per table 4-1).

See Also

"Repetitive/Real-Time Softkey" in this chapter for information on sampling modes.

Delay Softkey

Selecting delay assigns delay as the active function. You can use the delay knob to change the delay setting at any time, even if you are in a different menu or when delay is not the active function. However, when delay is the active function, you can use either the delay knob, keypad, or the entry knob to change the delay setting.

The trigger event always occurs at time zero. When delay is set to 0, the trigger point occurs at the delay reference point. Positive delay indicates time after trigger (posttrigger) and negative delay indicates time before trigger (pretrigger). For example, a delay setting of -50 ns indicates that the trigger event occurs 50 ns after the delay reference point. Viewing pretrigger information is a useful feature because you can see the events that led up to the trigger event.

In the real-time mode and with the acquisition stopped, delay also controls the pan feature. If you watch the memory bar just above the waveform area, you can see what portion of the memory you are panning across.

Pan and Zoom

The normal running mode displays 500 points on the screen. But when the scope is stopped, you can observe any portion or all of the waveform record by using pan and zoom. The pan and zoom feature performs the same function as the time base windowing feature used in many digitizing oscilloscopes. The pan and zoom feature is available in the real-time acquisition mode and is operable only when the acquisition is stopped. Applications that require precise evaluation of low-repetition-rate signals, such as radar and transponder pulse trains, are simplified by zooming and panning on single-shot data.

Zooming either expands or compresses the acquired waveform on the horizontal axis of the display. It is controlled by the time/div controls, and it is used for expansion or compression of a single-shot waveform in the real-time mode. Increasing time/div compresses the waveform and is referred to as "zooming out." Because you can acquire record lengths up to 32,768 and the display is limited to 500 points when the scope is running, you may find situations when zooming out that up to 65 sample points can be mapped to one pixel column. Decreasing time/div expands the waveform and is referred to as "zooming in."

Panning is moving the acquired waveform horizontally on the display. It is controlled by the time base delay controls. Increasing delay moves the waveform to the left and decreasing delay moves the waveform to the right. By observing the memory bar, you can tell what portion of the memory is being displayed.

**Pan and Zoom
Exercise**

This exercise shows how to use the time base to zoom in and to zoom out on a single-shot waveform. Then, you use delay to pan the waveform horizontally on the display.

- 1 Press the Recall key. Then, press the Clr key.
- 2 Connect a coaxial cable between the rear-panel AC connector and channel 1.
- 3 Press the Autoscale key.
- 4 Use the time/div knob to change the time base to 500 $\mu\text{s}/\text{div}$.
- 5 Press the Horizontal Setup key. Then, select the **REAL-TIME** mode.
- 6 Press the **RECORD LENGTH** softkey. Then, use the entry knob to set the record length to 8192 points.

Figure 4-1

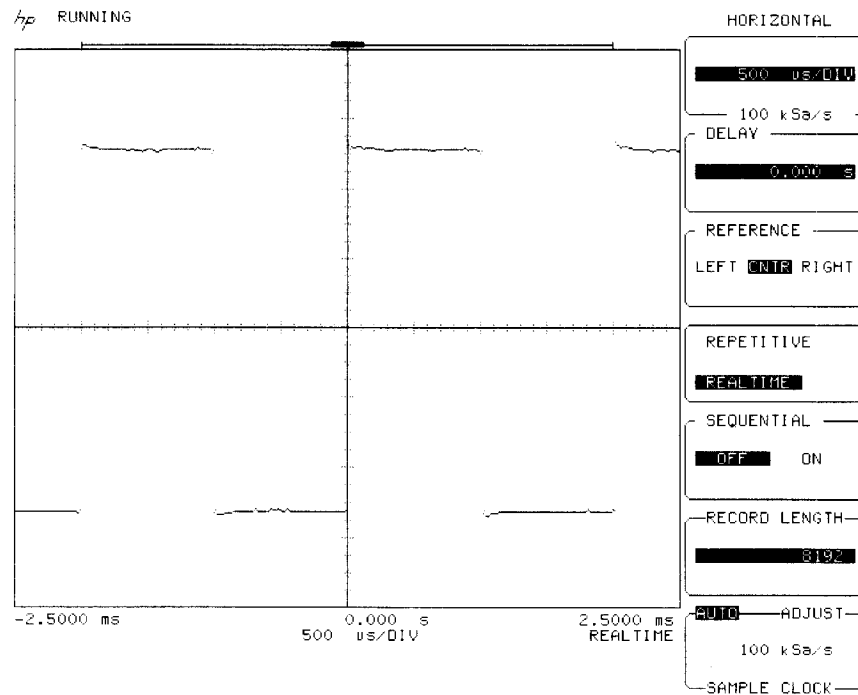

- 7** Press the Stop/Single key. Then, press the Clear display key.
- 8** Press the Stop/Single key to perform a single-shot acquisition.
- 9** While watching the display, rotate the time/div knob. Then, rotate the delay knob.

Selecting slower time/div settings zooms out (displays more of the acquired waveform on the screen), while selecting faster time/div settings zooms in on the acquired waveform. You may notice that when zooming in or out on a waveform, the memory bar indicates what portion of the waveform record is currently displayed on the screen.

Changing the delay setting pans across the data in the waveform memory. You may notice that the memory bar moves to the left or right as the acquisition is panned. You can use both panning and zooming to examine an acquisition.

- 10 Use the time/div knob to change the time base to 10 ms/div. Then, use the delay knob to set the delay to 0.00 s.

All of the data in the waveform record is displayed on the screen. Because the sample rate is 100 kSa/s and the record length is 8192, you can use the following formula to calculate the amount of captured data.

$$\frac{1}{\text{Sample Rate}} (\text{Record Length}) = \text{Time Duration of the Record}$$

$$\frac{1}{100 \text{ kSa/s}} (8192) = 81.92 \text{ ms}$$

There are 81.92 ms of data in the waveform record, and indeed, figure 4-2 shows 81.92 ms of data. That is why the waveform does not fill the screen. The memory bar also indicates that the entire waveform memory is on the screen.

Figure 4-2

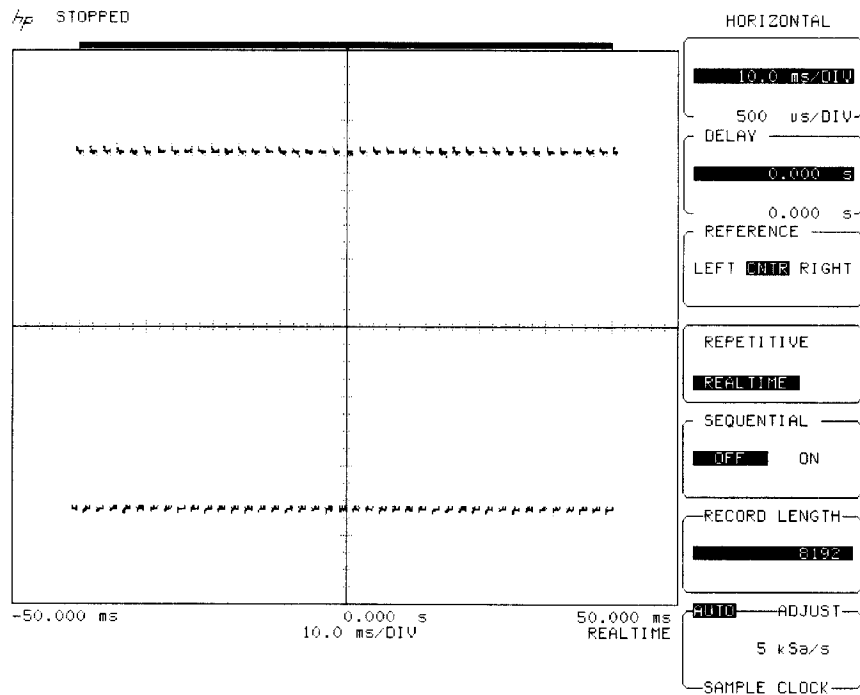

- 11 Set the time base back to 500 $\mu\text{s}/\text{div}$, and set the waveform record to 512 points.
- 12 Press the Clear display key. Then, press the Stop/Single key.
- 13 Use the time/div knob to change the time base to 1 ms/div.

Because of the shorter record length, there is now only 5.12 ms of data in the waveform record.

$$\frac{1}{100 \text{ kSa/s}} (512) = 5.12 \text{ ms}$$

Because there is less data in the waveform record, you only need to zoom out to 1 ms/div to have the entire waveform record on the display.

Figure 4-3

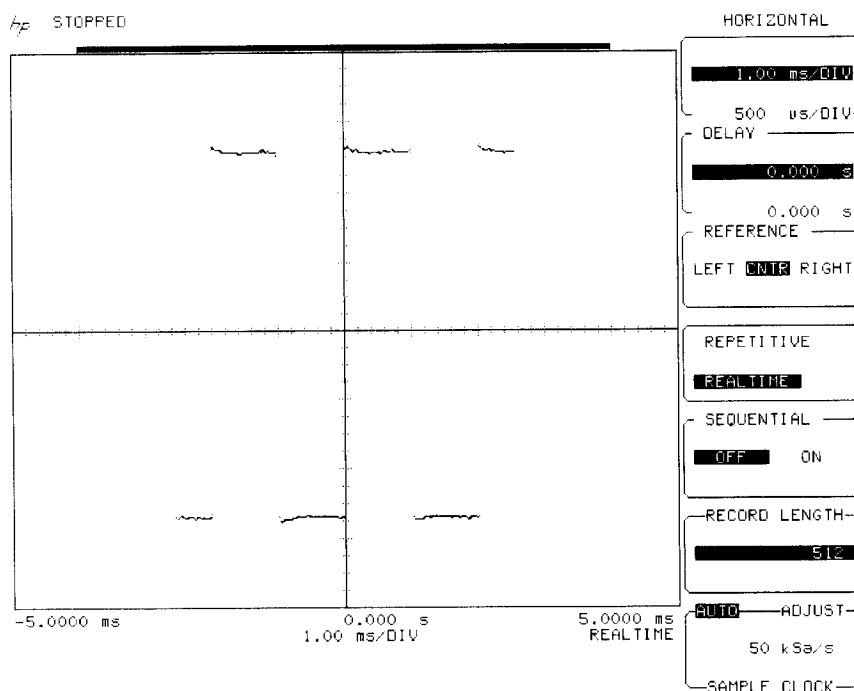

Reference Softkey

The **REFERENCE** softkey changes the delay reference point to one of three reference points: left, cntr (center), or right. The time from the trigger changes with the delay setting, and is displayed below the waveform area at the left, center, and right of the display. If delay is set to 0 and reference is set to center, pretrigger data is to the left of the reference point and posttrigger data is to the right of the reference point.

Center

The data is acquired evenly on both sides of the reference point. The data in the waveform record is centered around the reference point, and changing the scale expands or contracts the signal about the reference point.

Left

The data is acquired starting at the reference point, and the data in the waveform record is all posttrigger data.

Right

The data is acquired before the reference point, and the data in the waveform record is all pretrigger data.

Repetitive/Real Time Softkey

The **REPETITIVE/REAL TIME** softkey selects one of the two acquisition modes used by the oscilloscope: repetitive and real time.

Repetitive

The repetitive mode (also known as equivalent time) sets the oscilloscope to acquire data in the repetitive acquisition mode. In this mode, the data from many acquisitions may be interleaved, which can result in a greater effective sample rate. At 50 ns/div and slower, enough data is acquired on each acquisition that interleaving acquisitions is not required. In the repetitive mode, the sample rate is dependent on the time/div setting. The sample rate from 500 ps/div to 50 ns/div is 1 GSa/s. At settings slower than 50 ns/div, the sample rate is reduced, depending on the selected time/div setting. For example, at 50 ns/div the sample rate is 1 GSa/s, and at 50 μ s/div the sample rate is 1 MSa/s. You can calculate the number of points captured on one trigger and plotted to the screen in both the real-time and repetitive modes with the following formula.

Number of points = sample rate \times time/div setting \times 10

The repetitive mode is typically used on repetitive signals. You can still use the repetitive mode for single-shot applications. However, because the interpolation filter is turned off in the repetitive mode, the maximum single-shot frequency you can reasonably view and also avoid aliasing is about one-tenth the current sample rate. Also, the record length is the size of the screen.

Because the oscilloscope is in the repetitive mode, the sample rate is dependent on the time base setting. To ensure a full screen display of 500 points on the slower time base ranges, as the time base is slowed down the sample rate is also slowed down.

You can view the data using the normal, averaged, and envelope display modes. You can average data from multiple acquisitions by selecting averaging in the display menu, or you can choose to display data for a definable period of time (persistence) by using normal in the display menu.

See also

Chapter 7, "Display Menu," for information on acquisition modes.

**Repetitive
Single-Shot
Exercise**

This exercise shows the single-shot capabilities of the oscilloscope in the repetitive mode. The exercise uses single-shot acquisitions in the repetitive mode to build a waveform while displaying the 1-GSa/s sample rate.

- 1 Press the Recall key. Then, press the Clr key.
- 2 Connect a coaxial cable between the rear-panel AC connector and channel 1.
- 3 Press the Autoscale key.
- 4 Use the time/div knob to change the time base to 2 ns/div. Then, use Delay knob to horizontally move the signal so it is slightly to the right of center screen.
- 5 Press the Horizontal Setup key. Then select the **REPETITIVE** mode.

Figure 4-4

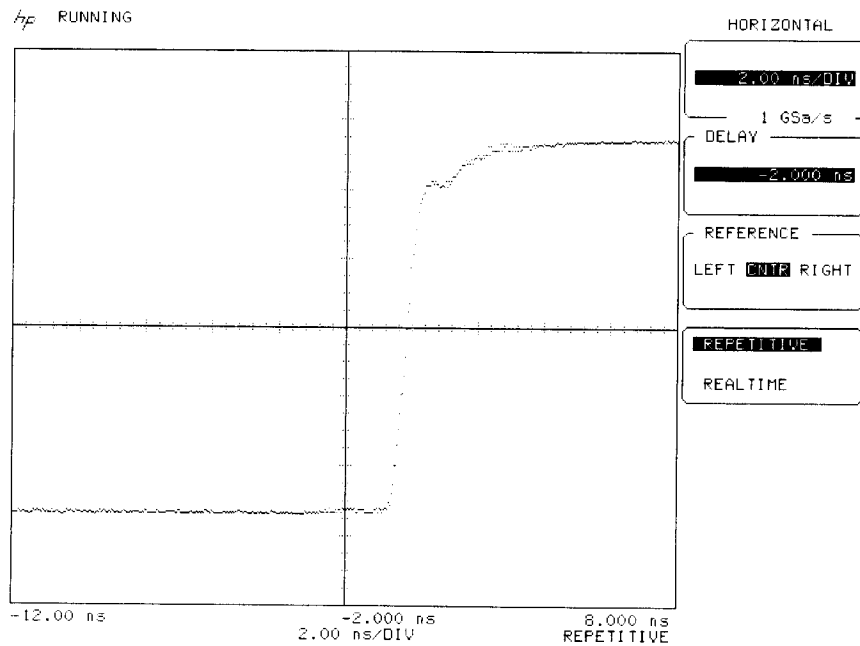

- 6 Press the Stop/Single key to stop the acquisition. Then, press the Clear display key.
- 7 Alternately press the Stop/Single and Clear display keys to alternately display and erase the single-shot data.

At 2 ns/div, 20 points are captured. Because interpolation is turned off in the repetitive mode, only 20 points are displayed on the screen with each new acquisition. Because the sample rate is 1 GSa/s, the data points are 1 ns apart. The 20 data points are referred to as raw data because they are the actual data points that are captured.

At 20 ns/div and faster, it may take several acquisitions to fill the screen (all 500 pixel columns). At 50 ns/div and slower, each acquisition contains enough data to fill the screen and the screen is completely refreshed with each acquisition in the minimum persistence mode.

Figure 4-5

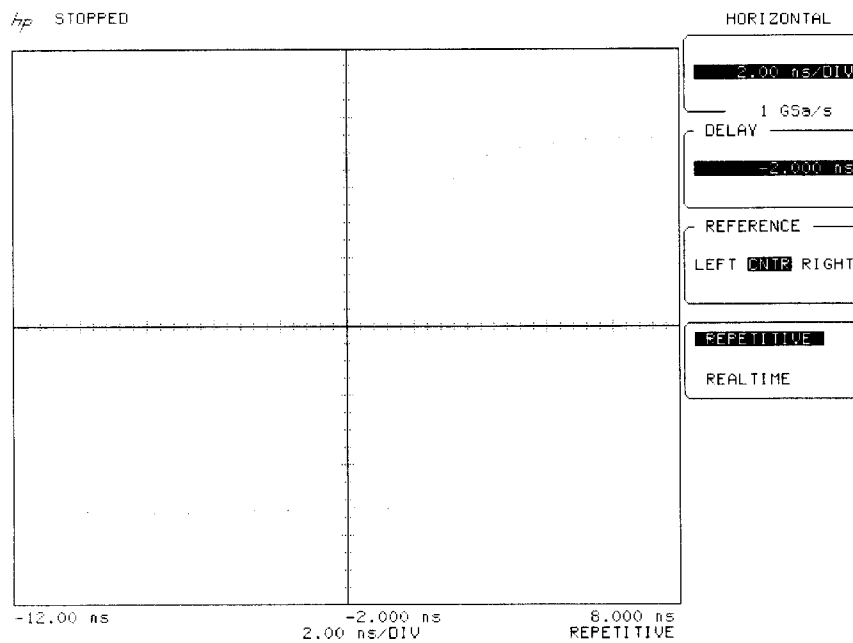

8 Press the Stop/Single key repeatedly without pressing the Clear display key.

By not pressing the clear display key, the waveform fills in with each single-shot addition to the waveform. Interpolation is still turned off and 40 points are captured with each acquisition. The waveform fills in because the data from previous acquisitions is retained on the screen and each new acquisition is interleaved with the previous data.

When averaging is off and persistence is set to minimum If newly acquired data points fall into time buckets that are empty, the data points are stored in the time buckets and the display is updated. If a time bucket already contains a data point, the old data is replaced by the new data point. Data stays on screen until you modify the instrument setup or you press the Clear display key.

When averaging is on If newly acquired data points fall into time buckets that are empty, the data points are added to the time buckets and added to the display. If a time bucket already contains a data point, the new data is averaged with the old data point. Depending on how many data points are acquired with each acquisition, it can take multiple acquisitions to meet the number of averages selected. At 50 ns/div and slower, enough data is acquired so that each acquisition corresponds to one average.

Real-Time

The real-time mode sets the oscilloscope to acquire data in the real-time acquisition mode. In this mode, all the data points that make up a waveform come from one trigger event.

The real-time mode is typically used to capture signals that happen either once or infrequently. The oscilloscope can simultaneously capture a single-shot acquisition on all channels at sampling rates up to 2 GSa/s. This allows the capturing of simultaneous, nonrecurring, or low-repetition-rate events at the same time.

In the real-time mode, you can set the sample rate to auto or adjust, and you can vary the record length. When real time is selected, three additional softkeys are displayed: sequential key, record length, sample clock. Each of these keys are discussed later in this chapter. You can calculate the amount of time captured in memory in the realtime mode using the following formula.

Time = record length ÷ sample rate

See also

Feeling Comfortable with Digitizing Oscilloscopes, that is supplied with the oscilloscope, for additional information on repetitive and real-time sampling.

**Real-Time
Single-Shot
Exercise**

In the real-time mode, data is interpolated (reconstructed) at the faster time base settings for an improved display of the waveform. The 2-GSa/s sampling rate of the oscilloscope allows the capture of very fast nonrecurring events, like a microprocessor start-up sequence, or error-causing glitches that disrupt system performance. This exercise shows you the difference between noninterpolated and interpolated data:

- 1 Press the Recall key. Then, press the Clr key.
- 2 Connect a coaxial cable between the rear-panel AC connector and channel 1.
- 3 Press the Autoscale key.
- 4 Use the time/div knob to change the time base to 2 ns/div. Then, use the delay knob to horizontally move the signal so it is slightly to the right of center screen.
- 5 Press the Horizontal Setup key. Then select the **REAL-TIME** mode.

Figure 4-6

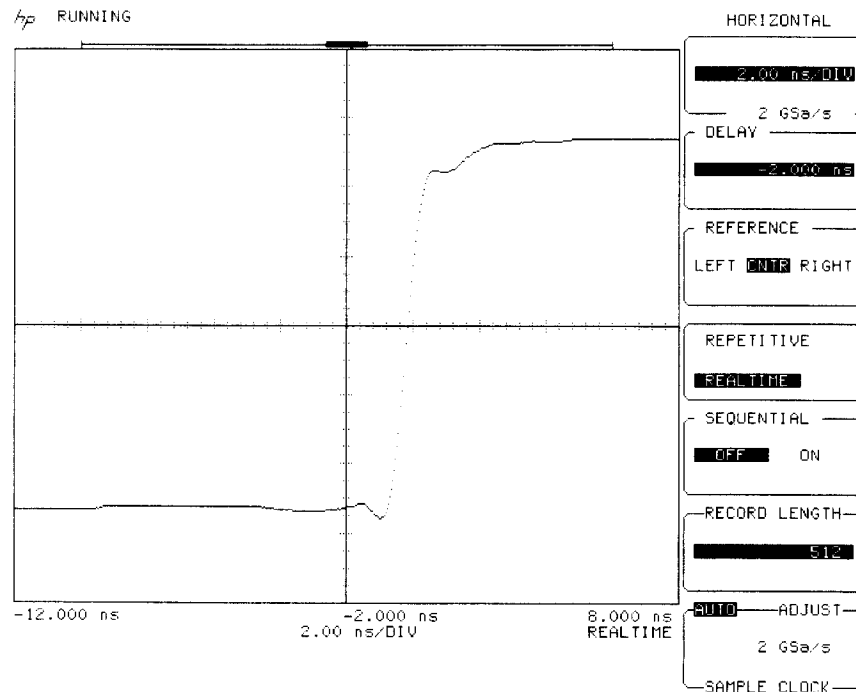

- 6 Press the Stop/Single key to stop the acquisition. Then, press the Clear display key.
- 7 Press the Stop/Single key to acquire a single-shot acquisition.

In the Repetitive Single-Shot Exercise, only the 20 raw data points that were captured are displayed at the 2 ns/div sweep speed. Even though 40 points are captured in the real-time mode, the interpolator fills in the remaining 461 points so that 501 points are displayed on the screen.

Figure 4-7

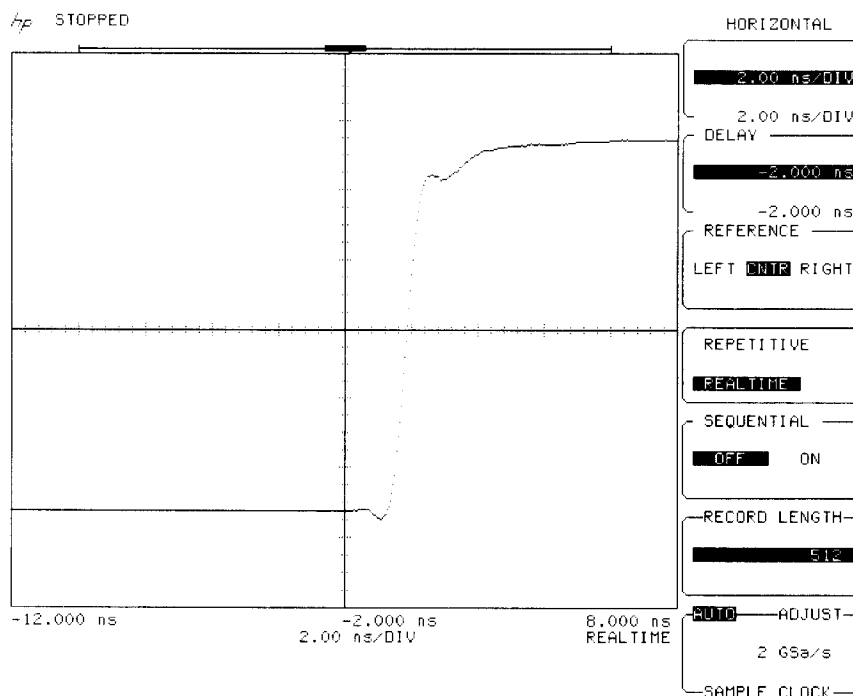

To see the raw data points, turn off the interpolator in the real-time mode.

To turn the interpolator off in the real-time mode:

- 1 Press the **Utility** key.
- 2 Press the **SYSTEM MENU** softkey.
- 3 Set the **INTERPOLATION** softkey to **OFF**.
When you exit the utility menu, the interpolator is automatically turned on.

Single-shot acquisition using the real-time sampling mode and with the interpolator turned off.

Figure 4-8

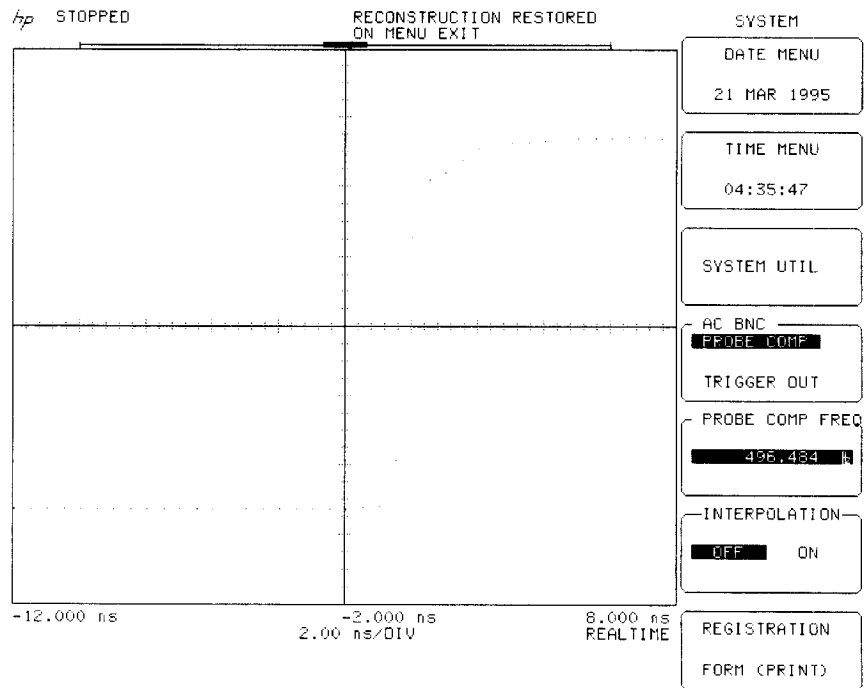

Memory Bar

When the real-time mode is selected, the memory bar is displayed above the graticule area, except when the compare mode is active. When the compare mode is active, the memory bar is replaced by the fail bar. Figure 4-9 shows the components of the memory bar.

The memory bar display line represents the entire waveform record. The memory bar represents the displayed portion of the waveform record. The memory bar at the top of the display moves as the delay changes. The "T" indicates the location of the trigger point within the waveform record.

You can view the waveform from three different positions with respect to the trigger point by selecting left, center, or right with the reference softkey.

When the acquisition is stopped, you can place the display at any portion of the waveform record by changing the delay setting. The delay knob moves the acquisition display relative to the trigger point.

Figure 4-9

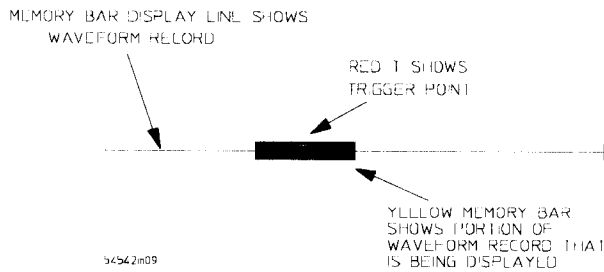

**Memory Bar
Exercise**

This exercise demonstrates how to use the memory bar to display those captured portions of the waveform that occur before and after the trigger event. The memory bar shows the portion of the waveform record that is being displayed.

- 1 Press the Recall key. Then, press the Clr key.
- 2 Connect a coaxial cable between the rear-panel AC connector and channel 1.
- 3 Press the Autoscale key. Then, press the Stop/Single key to stop the acquisition.
- 4 While watching the memory bar, use the delay knob to move the waveform horizontally on the screen.

As the delay value is changed, the memory bar moves to the right or to the left, depending on whether the delay value is positive or negative. Negative delay values show pretrigger events and positive delay values show posttrigger events.

Sequential softkey

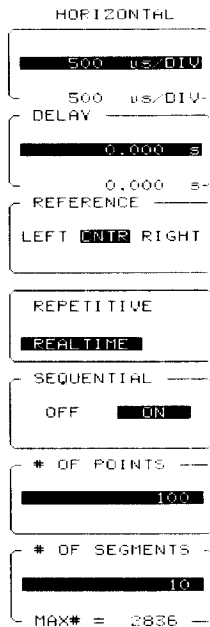

Sequential single-shot is a real-time feature that is used to maximize the oscilloscope's data capture rate while improving memory efficiency. You define the number of points the oscilloscope captures on each acquisition and the number of segments (events) that are captured. You can make measurements, calculate waveform math functions, or use pan and zoom on captured segments. Also, a time tag is placed on each captured event. The time tag allows you to determine when a captured segment occurred with respect to the first captured segment.

Normal oscilloscope operation is a 5-step process:

- Acquire new data into high-speed memory.
- Transfer the data to slower, conventional memory.
- Process the data.
- Make measurements on the data.
- Display the data.

The last three steps — processing, measuring, and displaying the data — takes up most of the oscilloscope's time. This time span is also referred to as oscilloscope dead time because the oscilloscope is not acquiring new data at that time. The sequential single-shot mode delays performing the last three steps until after all of the selected events are acquired.

Use the sequential single-shot mode when you need to rapidly capture events by minimizing oscilloscope dead time, or when there is a significant dead time between events and you are interested in the events rather than the time between events. For example, if you have a series of 100-ns pulses that are 10 ms apart, the time between pulses is 100,000 times greater than the width of each pulse. If you are only interested in specific events, you can adjust the triggering and you can set the number of points so only the events you are interested in are captured (pulses, rising edges, or falling edges). Then, you can set the number of segments to capture the number of events you want to analyze. The time tag feature allows you to piece together the captured events in time with respect to the first event.

The total sequential memory is 400k words, and it is allocated depending on how many points and segments are selected. A single-channel acquisition can use up to 400k words, while a dual-channel acquisition can use up to 200k words per channel. Acquired data is not lost when the sequential single-shot mode is exited. Sequential data is retained unless one of the following events happen:

- Another sequential single-shot capture is performed.
- Failure data is saved to multiple memories using the limit or compare tests.
- Power is cycled.

To allow the scope to power up in the running mode, sequential signal-shot is turned off when the power is cycled.

Sequential single-shot is only available when the oscilloscope is in the real-time mode. You may notice that this key is initially displayed in the off position (sequential single-shot disabled), allowing for normal real-time mode operation. When the sequential mode is set to on, the # of points (number of points) and # of segments (number of segments) softkeys are displayed

Figure 4-10

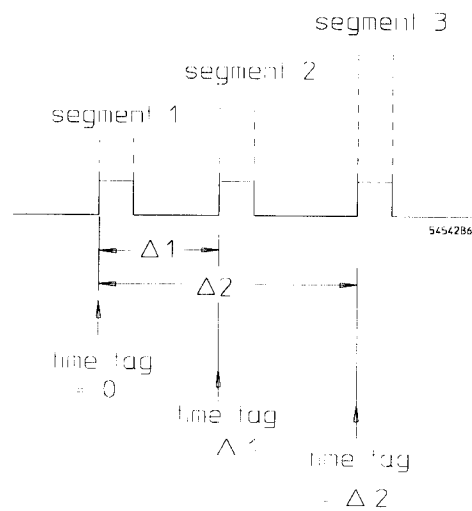

When the sequential softkey is set to on, the screen is cleared and the oscilloscope is placed in the stopped state to allow selection of the acquisition parameters (number of points and segments). The sample rate is set by the time/div knob.

Pressing the run key starts data acquisition. While the oscilloscope is acquiring data, the message "ACQUIRING" is displayed. If the oscilloscope is waiting for a trigger, "ACQUIRING # *n*" is displayed (where *n* is the segment number the oscilloscope is waiting to acquire). After all of the segments are captured, the message "sequential data captured, processing..." is displayed. After the data is processed, the message "sequential data processed, select DISPLAY menu" is displayed. You can press the Stop/Single key at any time to stop the acquisition process.

See also

Chapter 7, "Display Menu," for information on displaying acquired sequential single-shot data.

of points softkey

The number of points softkey defines how large a segment is, and you can think of a segment as an event. An event can be a piece of a pulse or it can be several pulses. You can specify any number of points from 4 to 32,768. Because 500 points are displayed for a normal screen display, you can use the pan and zoom feature to view segments that are larger than 500 points.

of segments softkey

The number of segments softkey defines how many segments the oscilloscope is to acquire. The maximum number of available segments is displayed at the bottom of the softkey. This number is dependent on the number of points, record length, and the number of active channels. If all of the channels are off, the softkey is disabled.

**Sequential
Single-Shot
Exercise**

This exercise uses a 500-Hz square wave to demonstrate the sequential single-shot feature. You set up the oscilloscope to capture one pulse on each acquisition, and to capture a total of 10 pulses.

- 1 Press the Recall key. Then, press the Clr key.
- 2 Connect the oscilloscope's rear-panel AC CALIBRATOR signal to channel 1 with a coaxial cable.
- 3 Press the Autoscale key.
- 4 Use the time/div knob to change the time base to 1 ms/div.
You may notice that there are five pulses on the screen. Because there are 500 points across the screen, each pulse takes up about 100 points.
- 5 Press the Horizontal Setup key. Then, select the **REAL-TIME** mode.

Figure 4-11

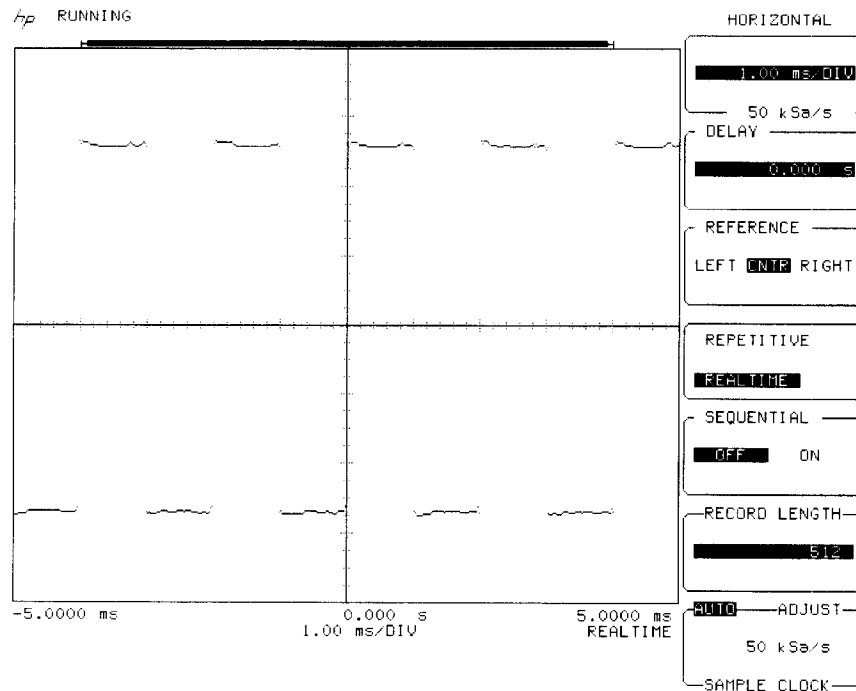

Horizontal
Sequential softkey

- 6 Set the **SEQUENTIAL** softkey to **ON**.
- 7 Press the **# OF POINTS** softkey, Then, use the keypad or entry knob to set the **# OF POINTS** to 100.

Set the number of points to capture the event of interest. For this exercise, 100 points are used because each pulse takes up about 100 points on the screen, and because this exercise is using a pulse as an event. You could also have used 200 points to capture two pulses, or 25 points to capture part of a pulse. You can also increase the sample rate to use more points to capture the pulse.

- 8 Press the **# OF SEGMENTS** softkey. Then, use the keypad or entry knob to set the **# OF SEGMENTS** to 10.

Set the number of segments to capture the number of events you are interested in. Below the selected number of segments is the maximum number of segments allowed. You may notice that as you increase the selected number of points, the maximum number of segments the scope can capture decreases. For this exercise, 10 segments were chosen, so that 10 pulses are captured.

Figure 4-12

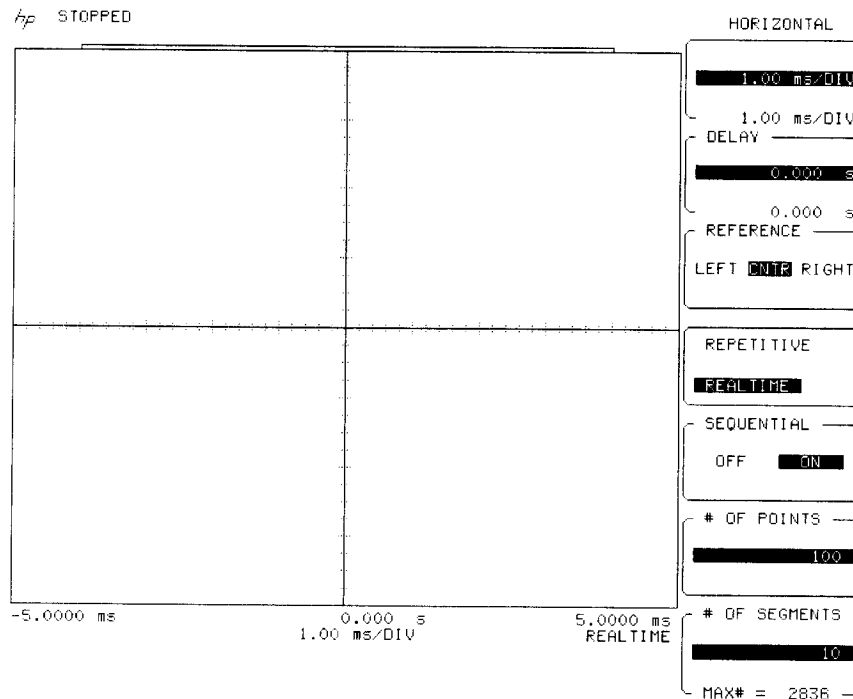

9 Press the Run key to capture and process data.

You may notice that the oscilloscope captures all of the data before the data is processed.

10 Press the Display key. Then, set the DISPLAY softkey to NORM (normal).

The captured segments are viewed in the display menu.

11 Press the SEGMENT # softkey. Then, use the entry knob to display each of the ten segments.

You may notice that below the graticule area a time tag is displayed for each segment. The scope captures only the number of points you specify for each segment. The time tag allows you to determine when the trigger for each subsequent segment occurred in relation to the trigger event for the first segment. You may notice that each of the time tags is about 6 ms apart

The entry knob allows you to scroll through the 10 captured pulses (events). Turning the knob past ten allows you to view all of the segments simultaneously. Because viewing all the segments at once overlays the segments, you can notice if one of the events is radically different than the others. You can also set the display to average (average all the segments) or envelope, and you can use the more key to exclude or include segments.

Figure 4-13

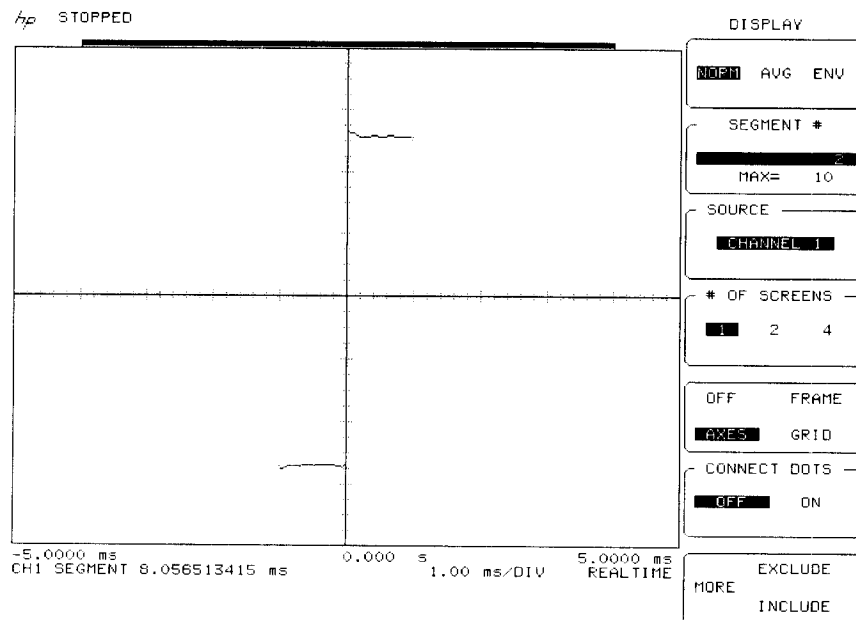

Sample Clock Softkey

The sample clock softkey is available in the real-time mode only. Sample clock (sampling rate) and waveform record length (waveform memory) are closely tied together. Sampling rate determines how often the oscilloscope samples the signal you are measuring. Record length is the amount of memory the oscilloscope fills up before it updates the display and measurement results.

Usually, you use a high sample rate, so there are plenty of data points to better reconstruct the original waveform. For fastest throughput, use a short waveform record because the oscilloscope must fill up the waveform record before it updates the display and measurement results. The higher the sample rate, the faster the waveform record fills up. Therefore, a long waveform record slows down the throughput of the oscilloscope. As a result, you must often make a trade-off between sample rate and record length to achieve a desired throughput, both of which affect the measurement speed and accurate reconstruction of the waveform.

You may prefer to sacrifice measurement throughput by selecting a high sample rate and a long record length, or you may want to have a high sample rate and a short record length to maximize the measurement throughput.

Auto

Auto lets the oscilloscope select the sampling rate for you. The advantage is that the oscilloscope selects a sample rate that optimizes the way the waveform is displayed and the display update rate.

Adjust

Adjust lets you specify a sample rate. The maximum sample rate is always available to you regardless of the time/div setting. However, do not overlook the interaction among sample rate, record length, and measurement throughput. Also, when in the adjust mode, you can use the fine mode to adjust the time base range to values not in the normal 1-2-5 sequence.

Record Length Softkey

The record length softkey is available in the real-time mode only. The record length softkey allows you to set the memory depth for the waveform record.

The time between the sample points equals 1 divided by the sample rate, and the amount of data in memory equals the time between the points times the number of points. For example, if the sample rate is 2 GSa/s and the record length is 512 points, the time between the sample points is 500 ps; and, 500 ps times 512 points is 256 ns of waveform data stored in the waveform record. Because there are ten horizontal divisions, set the time base to 20 ns/div to display the most of the waveform record. To display the entire waveform record, set the time base to 25 ns/div. To set the time base to 25 ns/div while the scope is running, set the sample rate to the adjust mode and press the Fine key.

$$\frac{1}{\text{Sample Rate}} (\text{Record Length}) = \text{Time Duration of the Record}$$

Each channel has its own 32K waveform memory. The default setting is 512. If you specify a 2K record, then each channel uses 2K of its available 32K record. You cannot specify a different record length for each channel. For single-shot applications, you may want to capture as much data as possible by using a 32K record. You can pan and zoom through the data at a later time. If you are not using pan and zoom, use a 512-point record, or use enough memory so all of the data that is acquired on each acquisition is displayed on the screen.

You can specify a record length from 512 points to 32,768 points with the entry knob. Remember that sample rate and record length work together. If you combine a short record length with a high sample rate, you will have a very fast throughput, but very little data in the record.

Because the shortest record length is 512 points and the screen displays 500 of these points, there are 12 data points in the waveform record that are not displayed at sweep speeds of 50 ns/div and faster. You can use pan and zoom to view any data points that are not displayed.



Trigger

Trigger

The trigger modes of the oscilloscope provide many distinctive techniques for triggering and capturing data. The triggering capabilities range from simple edge triggering to logic triggering on multiple signals.

This chapter contains descriptions of the triggering modes, and explanations on how to use them. The oscilloscope has six triggering modes: edge, pattern, state, delay, TV, and glitch.

The three lights indicate the present status of the trigger circuitry in the oscilloscope.

- Armed — The oscilloscope is waiting for a trigger event to occur.
- Triggered — The oscilloscope triggered on a valid trigger event.
- Auto Triggered — Valid trigger events are not occurring, and the oscilloscope is automatically triggering because it is in the auto sweep trigger mode.

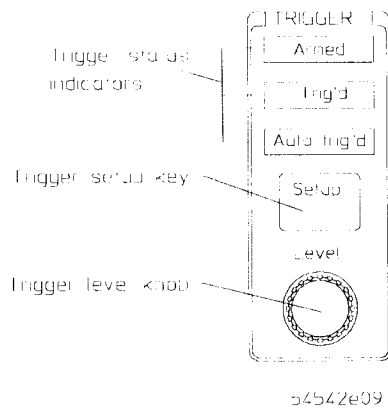

Trigger Basics

A trigger event is defined as an edge of a selected slope (either positive or negative) that transitions through a selected voltage (trigger level). This is referred to as the edge trigger mode. Events leading up to the trigger event are referred to as occurring in negative time, and events that occur after the trigger event are referred to as occurring in positive time. No matter what mode the trigger circuit is in, a valid trigger is always caused by an edge.

Additional trigger features are added, like logic triggering and holdoff, that allow you to further qualify the trigger event. The logic trigger modes are pattern, state, delay by time, and delay by events. Basically you can think of the logic trigger features as adding a 3- or 4-bit logic analyzer to your oscilloscope. The edge trigger mode looks at only one channel, while logic triggering allows you to qualify the trigger across all of the available trigger sources. Rather than clutter up the waveform record with useless data that you have to sift through, you can use logic triggering to pick out the area of the signal you are most interested in viewing. Then, you can use time base delay to view what happened before and after the trigger event.

The trigger circuit and sampler circuit operate in parallel. The sampler samples the input signal at a specific rate. The trigger circuit operates independently of the sampler circuit, and a trigger event does not have to occur at the same time as a sample point. Because the oscilloscope knows when the trigger event happened in relation to the sampled data, the oscilloscope knows where to place the sampled data on the display.

Figure 5-1

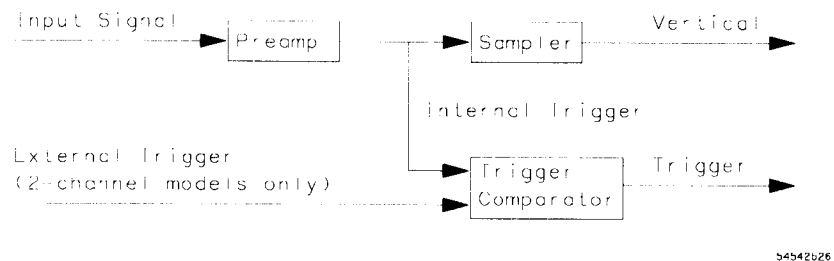

Common Trigger Softkeys

The top two softkeys are common to all of the trigger modes. The remaining trigger keys are discussed in the topic for each of the trigger modes.

You set the trigger level for the TV and Glitch trigger modes in the TV and glitch trigger menus.

Trig'd/Auto Softkey

The **TRIG'D** (triggered)/**AUTO** softkey toggles between the two trigger modes. The current selection is displayed in inverse video.

Triggered The oscilloscope displays data only after all of the trigger conditions are met. The triggered mode keeps the oscilloscope from displaying data on the screen before a specific trigger event occurs. After each trigger event, the trigger circuit is rearmed for the next trigger event.

Auto After the trigger circuit is armed, the oscilloscope waits for a trigger to occur. If a trigger does not occur, the oscilloscope triggers itself, and the data that is acquired with the trigger is displayed on the screen. The rate at which auto trigger occurs is dependent upon the sweep speed setting.

Use the Auto mode when you are unsure how to setup the trigger menu to trigger the oscilloscope. This mode forces the oscilloscope to trigger if a trigger event is not found, giving you glimpses of the signal, which then allows you to set up the oscilloscope to display the signal.

Mode Softkey

The second softkey selects the various trigger modes. The oscilloscope has six triggering modes: edge, pattern, state, delay, TV, and glitch. Each of these modes are discussed later in this chapter.

Edge Trigger Mode

Edge is the basic trigger mode, all the other trigger modes are a variation of the edge mode.

The edge trigger mode identifies a trigger point by looking for a specified slope and voltage level on a waveform on one source only. This process is accomplished by arming the trigger on a voltage either slightly higher or slightly lower than the trigger level. The difference between the arming voltage and the trigger level is hysteresis. The arming voltage is set slightly lower than the trigger level for a positive slope and slightly higher than the trigger level for a negative slope. Then, a signal with the correct slope and voltage level triggers the oscilloscope. You can use the edge trigger mode to easily detect logic level transitions.

The trigger level (threshold) for each channel is set in the edge trigger menu and is independent for each channel. It is carried over to all other modes, except for the TV and glitch trigger modes. These levels are important settings because the high and low levels in the pattern, state, and delay modes are defined as being greater than or less than the trigger level.

Figure 5-2

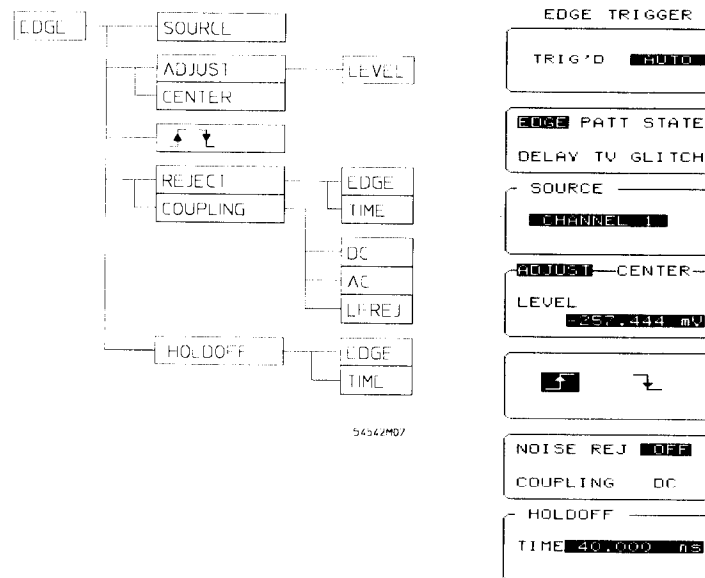

Source Softkey

The **SOURCE** softkey selects the trigger source. The options are any channel input, auxiliary input (on the rear panel), external trigger input (on the 2-channel models only), or line trigger. The current selection is highlighted in inverse video. When line is selected as the source, the oscilloscope uses the power line as the trigger source, and the remaining menu choices are removed. Also, holdoff is not available with line trigger or auxiliary trigger.

Level Softkey

The **LEVEL** softkey has two modes, adjust and center.

Adjust Adjust allows the flexibility of setting exact triggering points and specifies levels used in the other triggering modes. The trigger level range depends on the source.

- Channel inputs — ± 12 divisions from the center of the screen.
- Auxiliary input — ± 5 V.
- External trigger — There are three ranges: ± 1 V, ± 5 V, and ± 25 V.

Center For the channel inputs, center sets the trigger level to the same value as the channel offset for the selected source, which places the trigger level at the center of the screen. For the auxiliary and external inputs, center sets the trigger level to 0 V.

Slope Softkey

The **SLOPE** softkey is not labeled. However, the available selections are graphic representations of the rising edge and falling edge. The current selection is highlighted in inverse video. You can set the slope for each trigger source except line trigger. Slope applies only to the edge mode.

Reject-Coupling Softkey

The **REJECT-COUPLING** softkey allows you to turn noise reject on or off, and allows you to select the trigger coupling.

Reject When on, reject increases the trigger hysteresis band, so that it takes a larger trigger signal to trigger the oscilloscope. When noise reject is on, it makes the trigger circuitry less sensitive to noise. You can use noise reject when triggering on noisy signals without the problem of false triggering. You can set noise reject independently for each trigger source, the selection also applies to the logic trigger modes.

Coupling Coupling allows you to further condition the trigger signal independent of the channel conditioning circuitry. Figure 5-3 shows that the input signal goes through the input signal conditioning before the trigger coupling path. For example, you can set the channel path to dc coupling and the trigger path to ac coupling. Coupling applies only to the edge mode.

- dc allows dc and ac signals into the trigger path.
- ac blocks out any dc portion of the trigger signal and allows ac signals greater than 7 Hz into the trigger path.
- lfrej (low frequency reject) adds a 50-kHz, low-pass filter to the trigger path.

Figure 5-3

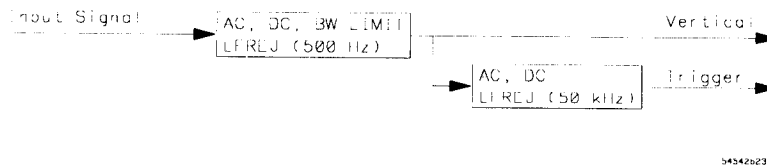

Holdoff Softkey

The **HOLDOFF** softkey disables the trigger circuit for a selectable time period or for a number of events after the trigger event. Holdoff is selected in 20-ns time increments from 40 ns to 320 ms, or by number of events from 2 to 16,000,000. Time and event are toggled with the knob. An event is a pattern, state, or edge. The maximum event counting rate is 70 MHz.

You use holdoff to synchronize a waveform to a trigger signal. Holdoff is used to stabilize the display of complex waveforms, or to trigger on a burst of pulses that are separated by time. Figure 5-4 shows a pulse burst with the holdoff time represented as T_1 . You may notice that holdoff keeps the trigger circuit from rearming until after the pulse burst is over. That way, the first pulse in the next burst is the trigger event.

The advantage of digital holdoff is that it is a fixed number. As a result, changing the time base settings does not affect holdoff and the oscilloscope remains triggered. In contrast, the holdoff in analog oscilloscopes is a function of the time base setting, making it necessary to readjust the holdoff each time you change the time base setting. Also, there is no holdoff when edge triggering using auxiliary or line trigger as the source.

Figure 5-4

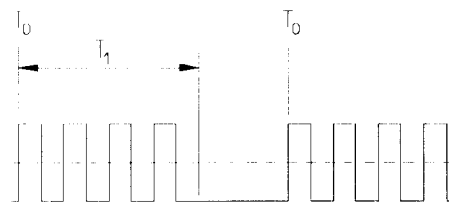

54542in01

Pattern Trigger Mode

Pattern allows you to have the oscilloscope search for a pattern that you define. You can define a pattern using any channel and external trigger (on the 2-channel models), up to a 4-bit pattern on 4-channel models and up to a 3-bit pattern on 2-channel models. The oscilloscope triggers on the last edge to make the condition true, or the first edge that makes the condition false as set by the when softkey. You define a pattern by assigning each trigger source either as an L, X, or H (L = low, X = don't care, and H = high). A high is a voltage above the trigger level, and a low is a voltage below the trigger level. The thresholds for the channel trigger levels (or H/L levels) are set in the edge trigger menu.

You can use the pattern mode to detect glitches greater than 20 ns wide, however, use the glitch trigger mode to detect glitches less than 20 ns wide.

See also

"Glitch Trigger Mode" later in this chapter for information on capturing and differentiating glitch widths less than 20-ns.

Figure 5-5

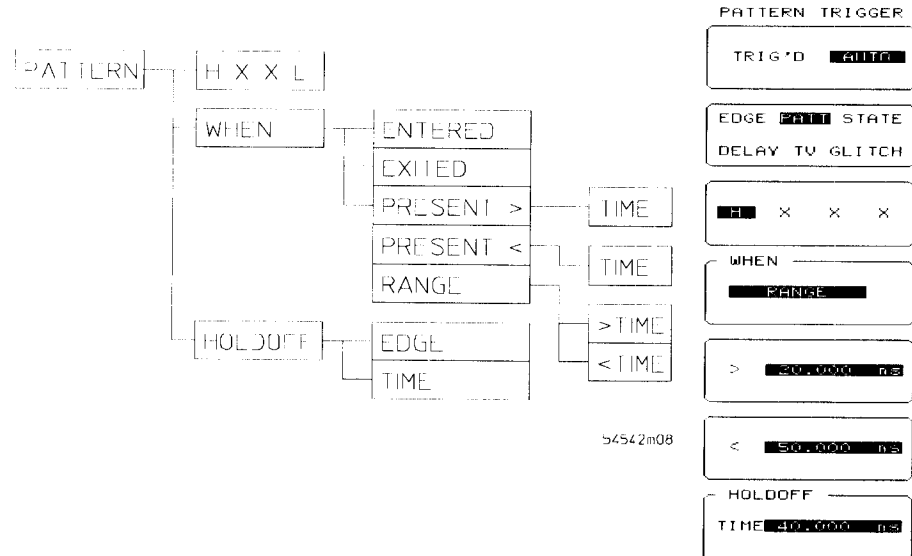

Pattern Softkey

The **PATTERN** softkey is not labeled, but it is the third softkey from the top. The pattern softkey defines a 4-bit pattern for which the oscilloscope searches. The positions correspond to the channel or trigger inputs, as shown in figure 5-6. For example, on 4-channel models, the left-most bit corresponds to channel 1 and the right-most bit corresponds to channel 4. On 2-channel models, the left-most bit corresponds to channel 1 and the right-most bit corresponds to the external trigger input.

If the pattern is set to all X's (don't care), a trigger event will not occur because a trigger event is not defined. Any trigger source that you are not using as part of the qualifier pattern should be set to a don't care to make sure that the source does not cause false triggering.

You can set the trigger level and noise reject independently on each source in the edge menu. For example, you can set the trigger level on channel 1 to a TTL high and the trigger level on channel 2 to an ECL low. However, all of the channels are set to dc coupling for all of the trigger modes except for the edge mode.

Figure 5-6



54542629

When Softkey

The **WHEN** softkey selects when the trigger is to occur. The choices are listed below:

- Entering a pattern — The trigger occurs on the edge of the source that is the last edge to make the pattern true.
- Exiting a pattern — The trigger occurs on the edge of the source that is the first edge to make the pattern false.
- A pattern is present greater than a defined time — A timer starts when the pattern is entered. If the pattern is present greater than the specified time, a trigger occurs on the first edge to exit the pattern.
- A pattern is present less than a defined time — A timer starts when the pattern is entered. If the pattern is present less than the specified time, the trigger occurs when the pattern is exited.
- A time range — When a pattern is present greater than a defined time and less than another defined time. A timer starts when the pattern is entered. If the pattern is present greater than one specified time and less than another specified time, the trigger occurs when the pattern is exited.

Holdoff Softkey

The **HOLDOFF** softkey allows you to select the amount of holdoff. Holdoff disables the trigger circuit for a selectable time period or number of patterns after the pattern is found. Holdoff is selected in time units, from 40 ns to 320 ms and is incremented in 20-ns intervals or by the number of patterns from 2 to 16,000,000. The maximum pattern counting rate is 70 MHz.

Trigger
Pattern Trigger Mode

Figure 5-7 shows pattern triggering on two channels. The trigger location is indicated on a few examples with an arrow. Also shown is the Boolean equivalent of each pattern.

Figure 5-7

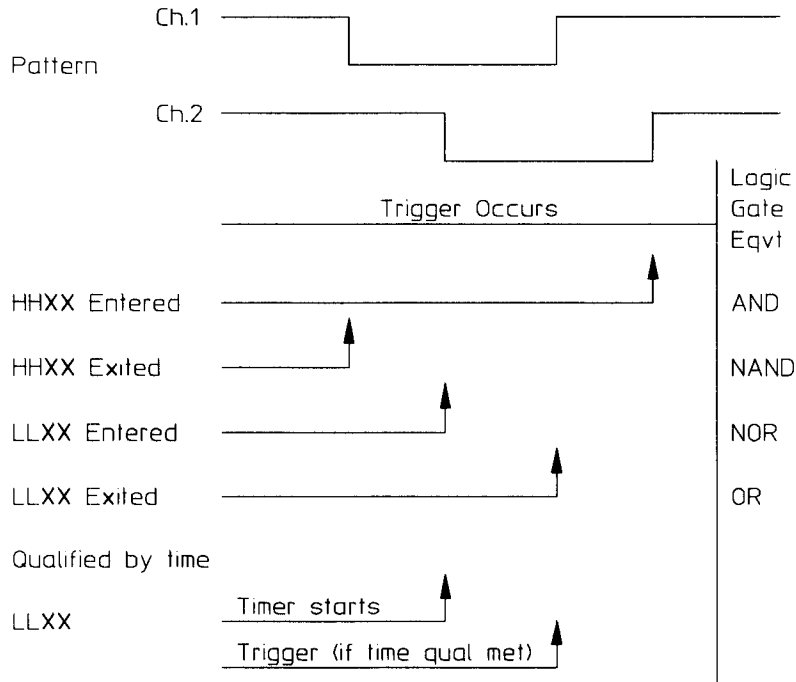

54720M11

State Trigger Mode

State triggering is similar to pattern triggering, except that you select one channel as a clock edge, and you set the remaining channels to define a pattern. Basically state is a selective pattern trigger. The pattern can occur often, but it is checked for validity only on the selected clock edge. The thresholds for the channel trigger levels (or H/L levels) are set in the edge trigger menu.

Clock Softkey

The **CLOCK** softkey allows you to select any trigger source as the clock. The trigger source you select as the clock is indicated with an arrow under the when softkey.

When Softkey

The **WHEN** softkey sets the other channels to form a trigger pattern. An arrow indicates which trigger source is the clock, and the direction of the arrow indicates the selected slope. You can select the polarity of the clock edge as either rising or falling, and you can select the pattern on the remaining sources.

Figure 5-8

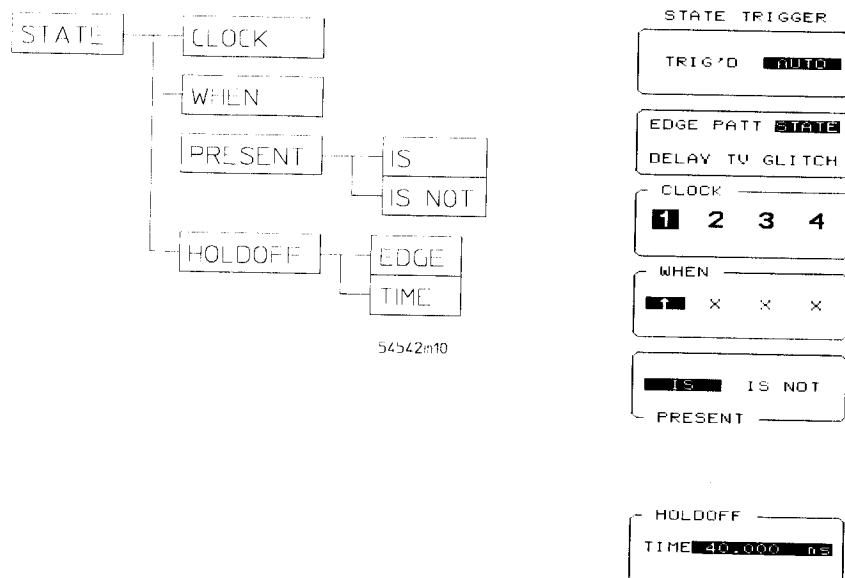

Present Softkey

The **PRESENT** softkey sets the oscilloscope to trigger when the pattern is either present or not present. The pattern is checked for only on the designated clock edge.

Holdoff Softkey

The **HOLDOFF** softkey allows you to select the amount of holdoff. Holdoff disables the trigger circuit for a selectable time period after the state event has occurred. Holdoff is selected in 20 ns time increments, from 40 ns to 320 ms, or for events (count of states) 2 to 16,000,000. The maximum state counting rate is 70 MHz.

Figure 5-9 shows a three-channel timing diagram. For this example, the clock is a rising edge on channel 3. The oscilloscope was also set to look for when a pattern is present, and the oscilloscope is looking for a high on channels 1 and 2. You may notice that channels 1 and 2 are both high during clock pulses A, B, and C. In the state mode, the pattern is checked for validity only on the selected clock edge. On the rising edge of clock pulses A and B, channel 2 is a low level. Therefore, the pattern is valid only on the rising edge of clock pulse C.

Figure 5-9

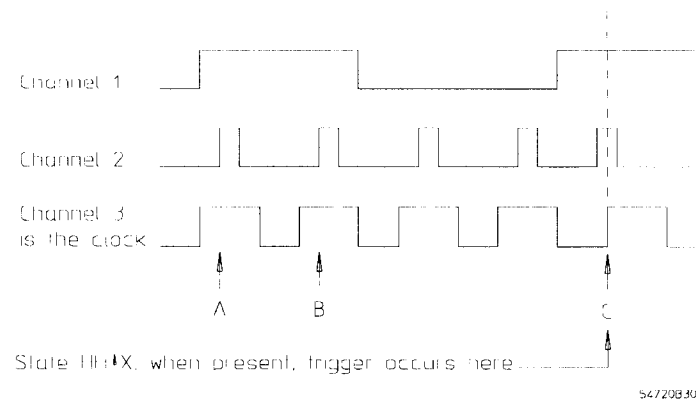

Delay Trigger Mode

The delay trigger mode qualifies on an edge, pattern, or state from one trigger source, waits for a selected period of time or events, then triggers on the *n*th edge from any of the other trigger sources. Basically you can think of delay as two edge triggers that are separated by a selectable time or event counter.

The traditional method to view events that happen after the trigger event is to use time base position to pan through the data. The problem with this is that the further the point of interest is from the trigger event, the greater the possibility that signal jitter makes it difficult to analyze the point of interest.

Delay by time or events eliminates this problem because it moves the trigger event closer to the point of interest, which reduces any jitter on long delay measurements.

For example, a disk drive motor does not spin at a constant speed all the time. If you use time base delay to look at a pulse separated from the trigger event by a long time period, the jitter on the pulse caused by variations in the motor's speed can make it almost impossible to see the desired pulse. Delay by time allows you to delay out to the pulse of interest, then trigger on that pulse. Because you are triggering on the pulse of interest, signal jitter is not a factor in viewing the pulse.

Figure 5-10

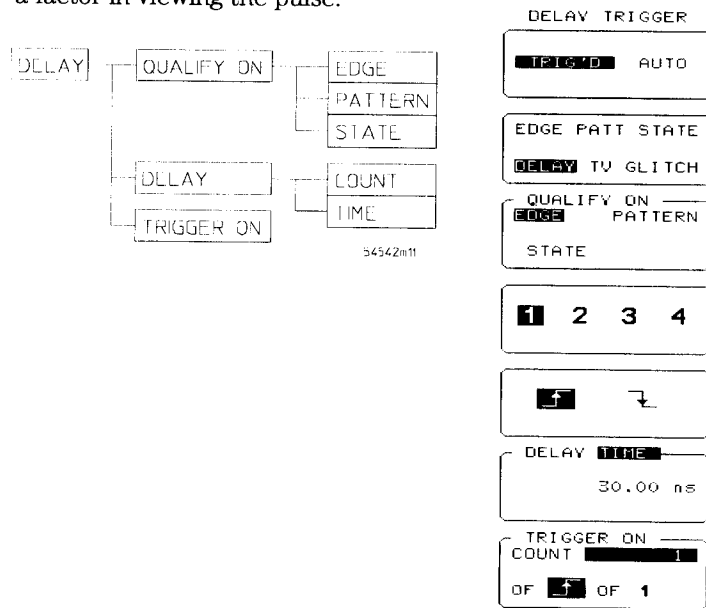

Qualify On Softkey

The **QUALIFY ON** softkey selects which mode to qualify the trigger before a delay is defined. The qualify options are edge, pattern, and state.

Qualify On Edge When you select edge qualify, the next two softkeys allow you to select which trigger source and slope to use for the edge qualification.

Qualify On Pattern When you select pattern qualify, the next softkey allows you to select a pattern to use for qualification, and allows you to select when the qualification occurs: entered, exited, when present greater than a time, when present less than a time, or when present for a range of times. You set the range of times with the next softkey.

Qualify On State When you select state qualify, the next two softkeys allow you to select a clock edge and a pattern to use for qualification. It also allows you to select when the qualification occurs: when entered or when exited.

Delay Softkey

The **DELAY** softkey selects between delay by time and delay by count. Delay time disables the trigger circuit for a selected period of time, from 30 ns to 160 ms after the trigger is qualified.

Time delay is not available in the time qualified pattern settings of when present greater than, when present less than, and when present for a range of times. Delay count (delay by edges) disables the trigger circuit for a selected count from 1 to 16,000,000 after the trigger is qualified. After the selected count is met, the oscilloscope looks for the selected trigger edge.

Trigger On Softkey

The **TRIGGER ON** softkey selects a specific edge to trigger on after the qualification and delay conditions are met. All the other softkeys in this menu dealt with defining qualifying conditions. The **TRIGGER ON** softkey sets the trigger point. You can select the number of counts, slope, and source for the trigger event.

Trigger Delay Trigger Mode

Figure 5-11 shows a delay-by-time timing diagram. You may notice that the qualifying event is channel 1, and the trigger event is channel 2. By changing the amount of delay, you can look at various events in a pulse train without the effects of jitter. After the delay timer times out, the scope triggers on the edge number you select.

Figure 5-11

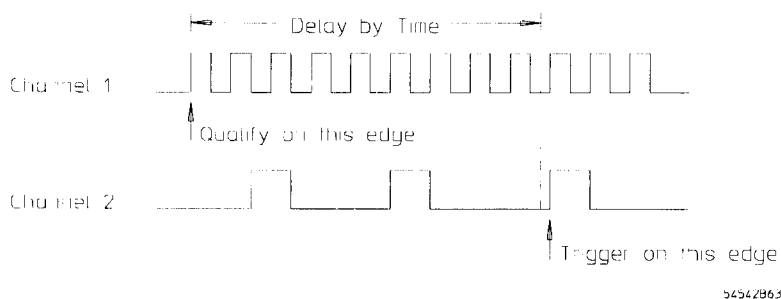
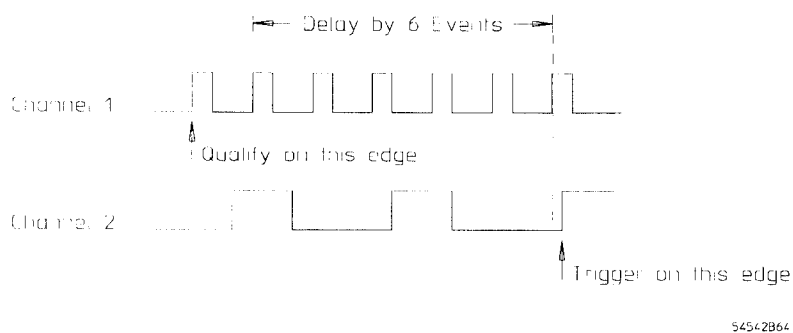

Figure 5-12 shows a delay-by-events timing diagram. You may notice that the qualifying event is channel 1, and the trigger event is channel 2. By changing the number of events, you can consecutively look at pulses in a pulse burst without the effects of jitter. After the number of events are counted, the scope triggers on the edge number you select.

Figure 5-12



TV Trigger Mode

The TV trigger mode enables the oscilloscope to trigger on clamped TV signals. The two most common TV standards are NTSC and PAL. NTSC (60 Hz/525 lines) is the standard used in the United States, and PAL (50 Hz/625 lines) is the standard used in most European countries. This trigger menu also allows for user defined triggering on TV signals that are used in other parts of the world.

Press the softkey to move the highlighted inverse video window, and use the entry knob to change the value displayed in the window.

Standard/Source Softkey

The **STANDARD/SOURCE** softkey is not labeled, but it is the third softkey from the top. The upper portion of the softkey allows you to choose between the NTSC standard TV signal used in the United States (60 Hz/525 lines), or the PAL standard used in most European countries (50 Hz/625 lines). The third option is for user-defined ranges of the TV signal. User-defined ranges are used to trigger on any of the proposed HDTV standards. The lower portion of the softkey allows you to select the trigger source.

Figure 5-13

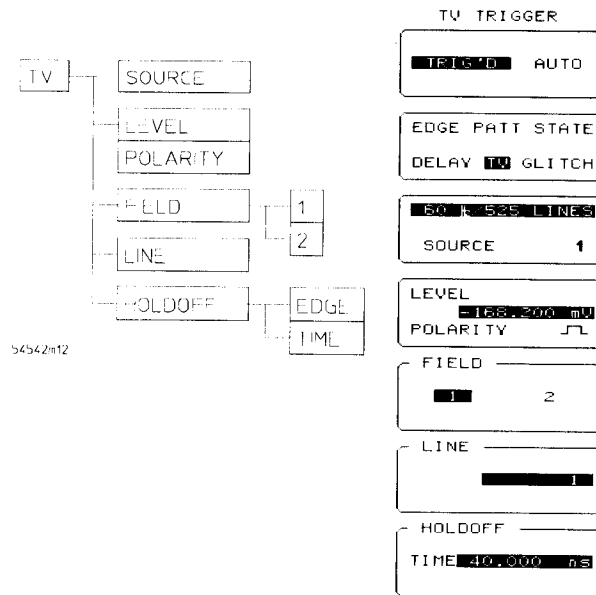

Level/Polarity Softkey

The **LEVEL** softkey sets the trigger level (in volts) that is applicable only to the TV trigger source.

Field Softkey

The **FIELD** softkey selects field 1 or 2 of the TV video signal.

Line Softkey

The **LINE** softkey selects which line the trigger is generated on. This selection depends upon which field was selected.

If the previous selection is the 60 Hz, 525 line standard (which is compatible with broadcast standard M), the options available depend upon which field is selected. If field 1 is selected, the range of lines is from 1 to 263. If field 2 is selected, the range of lines is from 1 to 262.

If the 50 Hz, 625 line standard is selected (which is compatible with broadcast standards B, C, D, G, H, I, K, K1, L, and N), the options are also dependent upon the field selection. If field 1 is selected, the range of lines is from 1 to 313. If field 2 is selected, the range of lines is from 314 to 625.

Holdoff Softkey

The **HOLDOFF** softkey enables the oscilloscope to hold off the trigger event from 40 ns to 320 ms, and is incremented in 20-ns time frames.

Glitch Trigger Mode

The glitch mode is like the pattern duration triggering, except a single channel defines the pattern, with the additional time selections of 2.5 ns, 5 ns, and 10 ns.

Source--State Softkey

The **SOURCE--STATE** softkey selects the source and glitch polarity used for triggering. The sources available are any channel input and (on the two channel models) external trigger input. You can specify the state for the source selected as either a high or a low, where high is higher than the current trigger level, and low is lower than the current trigger level. You can select only one source or state at a time. The current selection is highlighted in inverse video.

Level Softkey

The **LEVEL** softkey sets the trigger level used by the **SOURCE--STATE** softkey. The choices are adjust or center.

Adjust Adjust allows the flexibility for setting exact triggering points

and specifies levels used in the other triggering modes. The trigger level range is ± 12 divisions from the center of the screen.

Center Center has the oscilloscope automatically set the trigger level to the same value as the channel offset for the selected source.

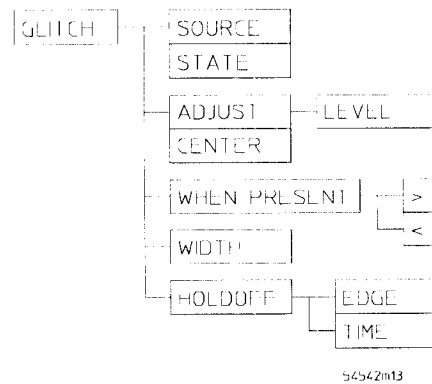
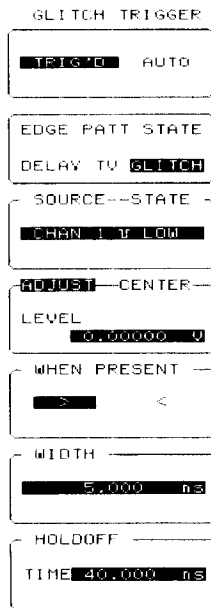

Figure 5-14

Trigger Glitch Trigger Mode

When Present Softkey

The **WHEN PRESENT** softkey sets the condition that must be satisfied to generate a trigger event. If **WHEN PRESENT >** is selected, a trigger is generated when the glitch is true longer than a specified width. If **WHEN PRESENT <** is selected, a trigger is generated when the glitch is true less than a specified width. The current selection is highlighted in inverse video.

Width Softkey

The **WIDTH** softkey sets the width of the pulse to generate the trigger on. The oscilloscope can trigger glitches as narrow as 1 ns, even though the width selections are from 2.5 ns to 160 ms.

Holdoff Softkey

The **HOLDOFF** softkey sets the holdoff value. Holdoff disables the trigger circuit for a selectable time period after the trigger event. Holdoff is selected in 20-ns time increments, from 40 ns to 320 ms.

Glitch timing requirements

For the oscilloscope to trigger on a glitch, the opposite polarity of the glitch must be present for at least 5 ns. The polarity of the glitch is determined by the trigger level. Voltages above the trigger level are of positive polarity, and voltages below the trigger level are of negative polarity. For example, Figure 5-15 shows a positive polarity glitch. The signal must be below the trigger level for at least 5 ns for the oscilloscope to detect the glitch. If a negative polarity glitch is selected, then the signal must be above the trigger level for at least 5 ns for the oscilloscope to detect the glitch.

Figure 5-15

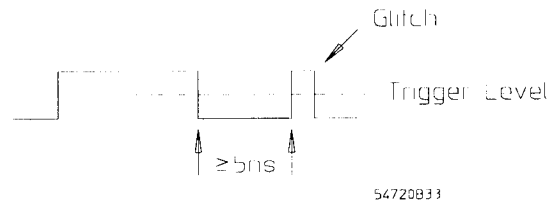

If the selected glitch width is from 2.5 ns to 20 ns, the time between similar edges must be greater than the selected glitch width. Figure 5-16 illustrates the timing between like edges. For example, if the selected width is 10 ns, then the time from point A to point B must be greater than 10 ns.

Figure 5-16

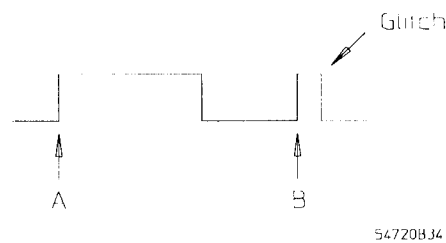



Display Menu

Display Menu

The display menu controls most of the features that dictate how the acquired data is displayed on the screen. These features include manipulating data for clarity, eliminating noise, and viewing selected memory segments.

This chapter describes the display menu, how to control all the features, and how to display the most meaningful waveform for measurements.

There are three display menus, depending on which acquisition mode the oscilloscope is set to in the time base menu.

- Repetitive acquisition
- Real-time acquisition with sequential memory turned off
- Real-time acquisition with sequential memory turned on

The menu map for each of the three display menus is included with the topic that covers that menu.

Repetitive Acquisition Display Menu

The display menu selections available when the time base is set to the repetitive mode is shown below.

Figure 6-1

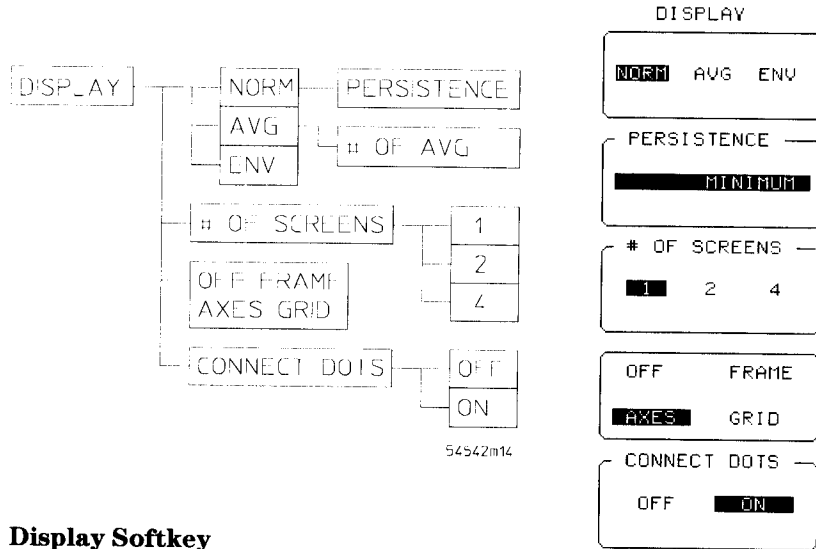

Display Softkey

The **DISPLAY** softkey selects one of three display modes: normal, averaged, and envelope.

Norm (Normal) The normal mode sets the time parameters for displaying data or selecting persistence. The range in the variable persistence mode is from minimum, very fast overwriting and updating of the display, to infinite with variable settings from 500 ms to 10 seconds. Persistence allows you to display data records to any of the persistence settings. For settings of less than infinite, the data is displayed for the specified period of time. When norm is selected, the function key below the normal field is activated. This field displays the current persistence setting. The following are some hints in using the normal display mode:

- Connect-the-dots is available in the minimum persistence, average, and envelope display modes.
- Use fast persistence settings when the input signal is changing and when immediate display feedback is needed.
- Use more persistence when observing long-term changes in the signal or in low-repetition-rate signals.
- Use infinite persistence for worst-case characterizations of signal noise, jitter, and drift. The persistence mode is similar to a storage oscilloscope.

At minimum persistence, a point is erased when a new point is acquired in the same time bucket on the display. Therefore, the waveform fills in quickly and each point remains for a minimum amount of time. Measurements are performed using the newest data in each pixel column.

When the keypad is used to change persistence settings, any entry longer than 10 seconds displays the message "value out of range... set to limit", and persistence is automatically set to infinite. Any entry less than 500 ms causes the same message to be displayed, and persistence is set to minimum.

Avg (Average) The averaged mode selects the number of waveform acquisitions that are averaged to generate the displayed waveform. The range for the averaging is from 1 to 2048 in powers of 2.

When the averaged mode is selected, the # of avg (number of averages) softkey is displayed.

Averaging significantly reduces displayed signal noise. As the number of averages increases from 1 to 2048, the display becomes less responsive to changes in the input signal. Using more averages reduces the effects of displayed signal noise and improves resolution.

Env (Envelope) The envelope mode needs no other parameters set. The display reflects the minimum and maximum voltages in each horizontal position. Use the envelope mode when viewing voltage or time jitter.

of Screens Softkey

The **NUMBER OF SCREENS** softkey allows you to choose how many graphs the waveform viewing area is divided into.

1 screen The entire waveform viewing area is one screen and any displayed waveforms are superimposed on top of each other.

2 screens The waveform viewing area is divided into two screens. On the 4-channel models, channels 1 and 2, memories 1 and 2, and functions 1 and 2 are displayed in the top screen, and channels 3 and 4, memories 3 and 4, and functions 3 and 4 are displayed in the bottom screen. On the 2-channel models, channel 1, memory 1 and 2, and function 1 and 2 are in the top screen, and channel 2, memory 3 and 4, and function 3 and 4 are in the bottom screen.

4 screens The waveform viewing area is divided into four screens. Each channel, memory, and function is displayed in the corresponding portion of the screen, starting with channel 1, memory 1, and function 1 at the top screen.

Off/Frame/Axes/Grid Softkey

This softkey selects one of the four display backgrounds.

Off Off turns the background graticule off. Displayed waveforms are not turned off.

Frame Frame displays the outside border with a measurement scale. The measurement scale is marked with major and minor divisions based on the vertical and horizontal measurement settings.

Axes Axes displays a background with the measurement scale crossing at midscreen.

Grid Grid displays a background that is a complete graticule with ten horizontal major divisions and eight vertical major divisions. Only the axes portion of the graticule has a minor division scale.

Connect Dots Softkey

Connect-the-dots is a technique used to display waveforms with all the data points connected. This makes viewing waveforms easier because the signal is complete and has no breaks. Connect-the-dots connects data points linearly rather than generating new data points. Connect-the-dots is available in the minimum persistence, average, and envelope display modes.

Real-Time Acquisition Display Menu (seq off)

The display menu selections available when the time base acquisition mode is set to real time and sequential is set to off is shown below.

Only the softkeys that are added to the display menu in the real-time mode are discussed.

Figure 6-2

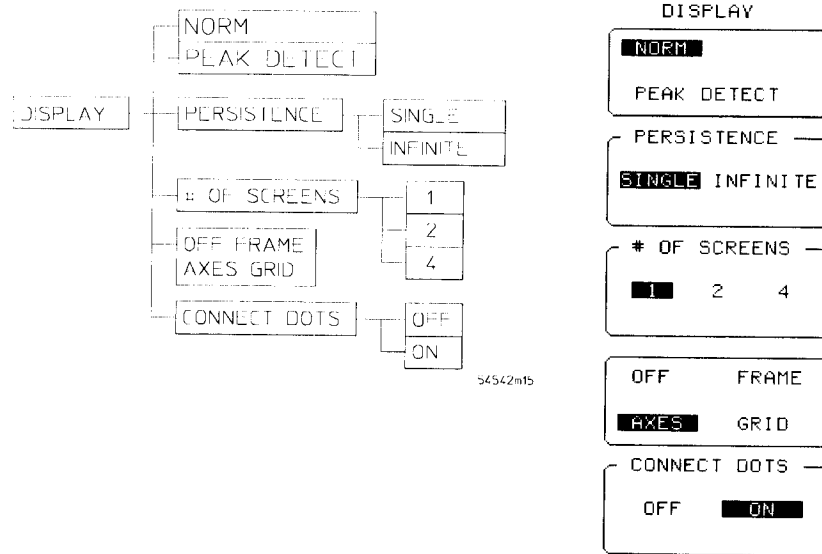

Normal Mode

This key is used to select persistence during the real-time mode. Persistence has two choices: single and infinite.

Single Single persistence is a very fast overwrite. As each new acquisition is displayed, it overwrites the previous data. The current display is always the most recent acquisition.

Infinite Infinite persistence is used for worst-case characterizations of signal noise, jitter, and drift. In this mode the oscilloscope is used as a storage oscilloscope because waveforms are not erased. Measurements are performed using the newest data in each pixel column.

Peak Detect Mode

Peak detect is only available in the real-time mode when the sampling rate is less than or equal to 250 MSa/s and with sequential single-shot turned off. When the sample rate is greater than 250 MSa/s, the peak detect mode is not displayed on the softkey. Peak detect is an acquisition mode rather than a display mode. An acquisition mode affects how the oscilloscope acquires data. A display mode does not affect how the data is acquired; rather, it is a postprocessing feature that affects how the data is displayed on the screen, like connect the dots and persistence.

Peak detect stores the minimum and maximum values (pairs) for each time bucket. Peak detect can detect excursions as narrow as 1 ns. When peak detect is on, the sample rate that appears in the time base menu is the sample rate at which the minimum and maximum pairs are stored. You may notice that peak detect functions at sample rates up to 250 MSa/s. Because peak detect stores two data points per sample clock, the memory size divides in half. For example, if the record length is set to 32,768 and you turn on peak detect, the record length changes to 16,384.

See Also

"# of Screens Softkey" and "Off/Frame/Axes/Grid Softkey" earlier in this chapter for information on these keys.

Real-Time Acquisition Display Menu (sequential on)

The real-time mode menu map, with sequential single-shot turned on, is shown below.

All measurements, waveform math functions, and pan and zoom features are available when displaying the previously captured segments. In the sequential single-shot mode, data interpolation does not occur and peak detect is not available.

Only the softkeys that are added to the display menu when the real-time mode is selected are discussed.

Figure 6-3

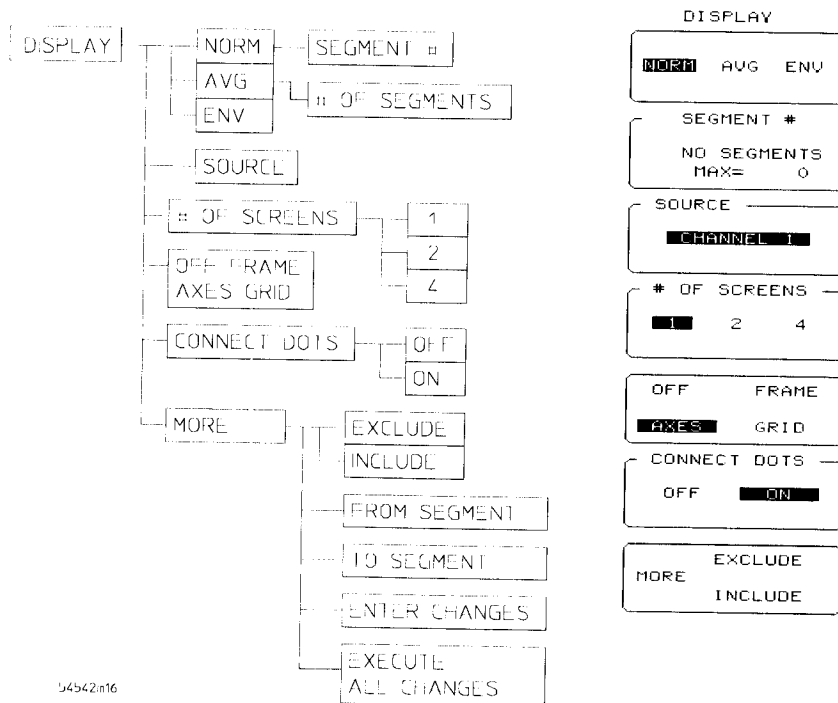

Display Softkey

The Display softkey selects one of three display modes: normal, averaged, and envelope.

Norm (Normal) The normal mode allows you to view each captured segment individually. The viewable segments are determined by the include exclude softkey.

When norm is selected, the function key below the display softkey is activated. This field displays the current segment number being viewed, and is set using either the knob or keypad. Selecting a segment number larger than the maximum captured causes all segments to be displayed (overlaid), where all the included segments from the selected source are displayed at one time. Selecting an excluded segment causes "segment X is excluded" to be displayed.

Measurements are performed using the newest data in each pixel column.

Avg (Average) The average mode averages each captured segment into a composite waveform. Only segments selected as included using the include exclude softkey are averaged. When average is selected, the segment number currently being averaged is displayed in the lower left corner of the screen, and the number of segments softkey is activated. The number of segments key displays the total number of segments that were averaged.

Env (Envelope) The envelope mode displays the minimum and maximum voltages in each captured segment. Only segments selected as include using the include exclude softkey are used. When envelope is selected, the segment number currently being evaluated is displayed in the lower left corner of the screen, and the number of segments softkey displays the total number of segments that were used.

Segment # Softkey

You can use the segment number softkey to select which captured segment to display. The range is 1 to n , where n is the number of segments selected in the time base menu. After n , the next selection is all segments. All segments overlays all of the captured segments allowing you to compare the segments for abnormalities.

Because sequential single-shot captures a series of segments, a time tag is displayed below the graticule area as each segment is displayed. The time tag tells you when each segment was captured relative to the trigger for first captured segment. When all segments is selected, the time tag is not displayed.

You may see the segment number softkey display one of the following messages:

- no segments: displayed when there are no captured segments for the selected source.
- channel off: displayed when the selected source is turned off.

Source Softkey

This key specifies the source used during all display operations. Press it to highlight the field, then use the knob to enter the desired value. You can select any active channel as the source. If no previously captured segments exist for the selected channel, the status message "no segmentable data on channel n " is displayed and the number of segments key displays "no segments."

See Also

"# of Screens Softkey," "Off/Frame/Axes/Grid Softkey," and "Connect Dots Softkey" earlier in this chapter for information on these keys. "Sequential Softkey," in Chapter 4 for information on the sequential softkey selections.

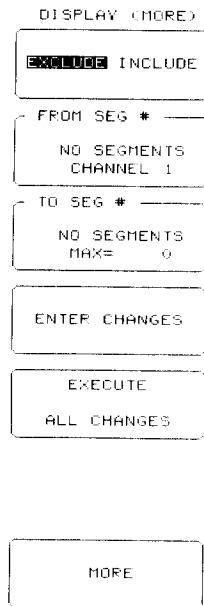

More Exclude Include Softkey

Pressing this softkey brings up the **SEGMENT EXCLUDE INCLUDE** softkey menu.

Exclude Include softkey

This softkey is used to select which of the previously captured segments is used for display operations. Press the softkey to highlight the desired choice.

Exclude Segments specified using the **FROM SEG #** and **TO SEG #** softkeys cannot be viewed in the normal mode, and are not used during the average and envelope modes.

Include Previously excluded segments specified using the **FROM SEG #** and **TO SEG #** softkeys are now viewed, and are now used during the average and envelope modes.

All segments are initially acquired as included. A list of currently included segments are shown on the bottom left of the screen, along with a counter showing the current segment used in the average, envelope, or normal (when all segments is selected) mode.

From seg # softkey

This softkey is used to specify the beginning segment number when entering the range of segments to be excluded or included from display operations. Press the softkey to highlight the field, then use the keypad or knob to enter desired value. Any positive value within the number of segments currently acquired can be entered; however, the **FROM SEG #** softkey entry cannot exceed the **TO SEG #** softkey entry. The bottom of the softkey displays the currently selected source.

To seg # softkey

This key is used to specify the ending segment number when entering the range of segments to be excluded or included from display operations. Press the softkey to highlight the field, then use the keypad or knob to enter desired value. Any positive value within the number of segments currently acquired can be entered; however, the **TO SEG #** softkey entry cannot precede the **FROM SEG #** softkey entry. The bottom of the softkey displays the maximum number of segments acquired.

Enter changes softkey

Pressing this softkey enters the currently selected exclude include, **FROM SEG #**, and **TO SEG #** values. These entries are not implemented until the execute all changes softkey is pressed. Once the enter changes softkey is pressed, a status message is displayed at the top of the screen. To cancel the process without executing the changes, press the more softkey.

Execute all changes softkey

Pressing this softkey immediately processes all changes that were entered, and displays the new included segments list at the lower left portion of the screen. If the average or envelope modes are selected, the new composite waveform is generated using the updated segment list.

More softkey

Press this softkey to toggle to the other display menu choices. The best method of making changes is to enter all the desired changes. Then, press the execute all changes softkey.

**Sequential
Single-Shot Display
Exercise**

This exercise is a continuation of the "Sequential Single-Shot Exercise" in Chapter 4, "Horizontal." During that exercise, an acquisition of 10 segments of 100 points each was performed, and each segment was displayed. During the following exercise, a waveform that is the average of segments 5 through 10 is constructed and is displayed.

- 1 Use the **DISPLAY** softkey to select **AVG** (average).
- 2 Press the **MORE EXCLUDE INCLUDE** softkey.
- 3 Use the **EXCLUDE INCLUDE** softkey to select **EXCLUDE**.
- 4 Press the **FROM SEG #** softkey. Then, use the entry knob to select **1**.
- 5 Press the **TO SEG #** softkey. Then, use the entry knob to select **4**.
- 6 Press the **ENTER CHANGES** softkey.
- 7 Press the **EXECUTE ALL CHANGES** softkey.

The averaged waveform is recalculated and displayed using the average of segments 5 through 10.



Marker Menu

Marker Menu

This chapter describes how to use the markers and make manual measurements on displayed waveforms. There are two marker modes available: manual and waveform.

When you press the Marker key on the front panel, the marker menu is displayed on the right hand portion of the screen. The marker menu is shown below.

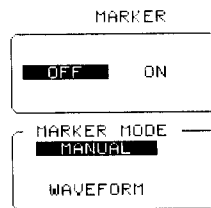

When in the manual marker mode, there are two sets of x and y axis markers, each with a separately selectable source. The x markers (horizontal) measure voltage (or power in FFT mode), and the y markers (vertical) measure time (or frequency in FFT mode) for the currently selected source. Each marker is individually controlled and labeled. The menu map for manual markers is shown below.

Figure 7-1

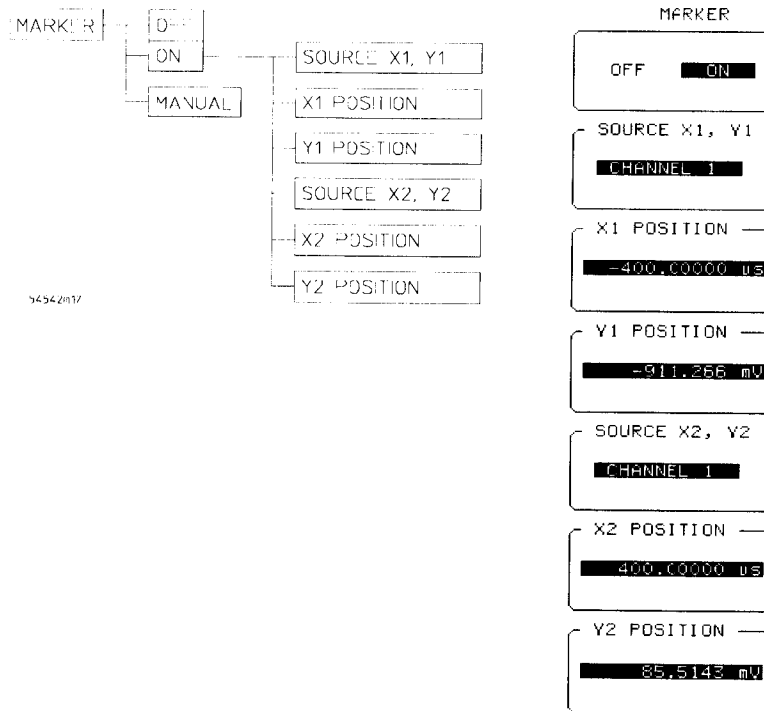

Off On Softkey

This softkey toggles both sets of manual markers on and off when the marker mode is set to manual. When on, all markers are displayed on the waveform, and the current x/y marker position and source, delta x/y information, and 1/delta x information are displayed below the waveform viewing area.

The delta entries are calculated as follows:

marker 2 – marker 1 = delta

If the delta is negative, marker 1 is located at a more positive level or later time than marker 2.

If all delta information is full of dashes (-----), then one of the sources currently selected is not turned on.

Source x1, y1 Softkey

This softkey selects the source for the x1 and y1 markers. Available sources for marker measurements include all channels, functions, and nonvolatile waveform memories that are currently turned on. Press the softkey. Then use the entry knob to select source that is turned on. If all sources are turned off, then all delta x/y information is filled with dashes and the Source x1, y1 softkey shows NONE.

x1 Position Softkey

This softkey selects the x1 marker for positioning on a waveform. When selected, the field is highlighted, and you use the entry knob to move the x1 marker across the display. The x1 marker is the vertical marker with longer dashes, and is marked on the top of the waveform viewing area as "x1."

The x1 marker is placed on the display respective to the trigger point. Positive time values are to the right of the trigger point and negative time values are to the left. Measurement information is displayed in the highlighted field and below the graticule area. The display units are seconds in all modes except FFT, where the display units are in Hz.

y1 Position Softkey

This softkey selects the y1 marker for positioning on a waveform. When selected, the field is highlighted, and you use the entry knob to move the y1 marker vertically. The y1 marker is the horizontal marker with longer dashes, and is marked on the left side of the display as "y1."

You can place the y1 marker at the desired level on the waveform. Measurement information is displayed in the highlighted field and below the graticule area. The display units are volts in all mode except FFT, where the display units are in dBm.

You can position the x/y markers on a selected source even though that source is not displayed. You may want to check which source the markers are assigned to before you move the markers or make measurements with the markers.

Source x2, y2 Softkey

The operation is identical to source x1, y1 softkey, except that the source is specified for the x2 and y2 markers.

x2 position Softkey

Operation is identical to x1 position softkey, except that the x2 marker is the vertical marker with shorter dashes, and is marked on the bottom of the display as "x2."

y2 position Softkey

Operation is identical to y1 position softkey, except y2 marker is the horizontal marker with shorter dashes, and is marked on the right side of the display as "y2."

Markers and Measurements

Automatic measurements are usually made on waveforms displayed on the screen. One way you can make custom measurements with the markers is by placing them on the portion of the displayed waveform you are interested in. Then, reading the values directly from the x and y marker positions, or reading the differential values using the delta x and delay y values.

Another way to make custom measurements is by setting the meas window softkey to markers in the define measure menu. Then, you can use the markers to window on the displayed waveform, and you can use the automatic measurements to make the measurement.

If the continuous softkey in the define measure is turned off, the markers are automatically turned on and they are placed on the displayed waveform showing you where the measurement was made.

Waveform Marker Mode

There are two waveform markers: + and x. The waveform markers track the waveform data in memory rather than on the displayed waveform. Because the waveform data in memory has a much greater resolution than the display, the measurements you make with the waveform markers are much more precise than measurements made with the manual markers.

The waveform markers track the timebase changes of the source signal. This allows you to make accurate delay measurements without having both markers on the display. Vertical amplitude is not available unless the waveform markers are on the display. The waveform marker menu map is shown below.

Figure 7-2

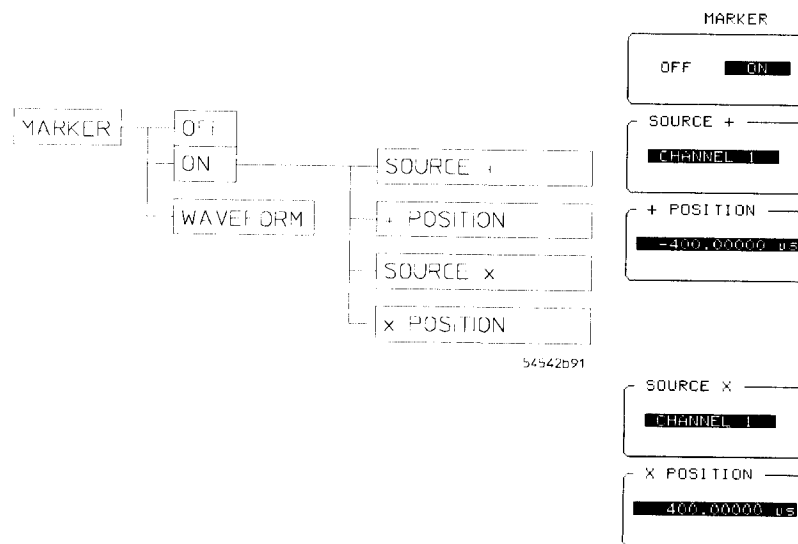

Off On Softkey

This softkey toggles both waveform markers on and off when the marker mode is set to waveform. When on, both markers are displayed on the waveform.

+ Source and X Source

You can set the marker sources as channels, functions, or memories which are currently turned on. For example, you can set the + Source function to a waveform memory and the X Source function to a channel. The scale used to position each marker on the display is based on the scale of the waveform source that the marker is tied to. If all sources are turned off, then all delta x/y information is filled with dashes and the + Source and X Source softkeys show "NONE." Also, when you are placing markers on a waveform, make sure that the source is set to that waveform.

+ Position and x Position

The + marker is controlled by the + Position function and the X marker is controlled by the X Position function. Use the knob, arrow keys, or keypad to position the markers on the signal.

The + marker is controlled by the + Position function and the x marker is controlled by the x Position function. Use the knob, arrow keys, or keypad to position the markers on the signal.

The marker position readouts are displayed near the bottom of the display. Each waveform marker has an X and a Y value. The Y value is determined by the waveform, and ΔY is the difference between the Y values of the + and x waveform markers. Timing measurements are made using the X values of the + and x markers, and ΔX is the difference between the X values. If you are using the markers to measure the period of a signal, then $1/\Delta X$ is the frequency of that signal.



Define Measure Menu

Define Measure Menu

This chapter contains a description of the measurement menu. The measurement functions are accessed with the define measure menu.

The Define measure gives you access to four other softkey menus. Which menu is displayed depends on the selection of the top softkey in the define measure menu.

- **Measure Menu** Sets the dynamic controls for the measurement.
- **Define Measurement Menu** Allows the choice of standard or user defined thresholds.
- **Limit Test Menu** Configures and initiates the measurement limit test.
- **Waveform Compare Menu** Configures and initiates the waveform compare test.

The menu map for each of the four menus is included with the topic that covers that menu.

Measurement Selection

Each key on the keypad has a secondary function. Above each key is a measurement selection printed in blue.

Make sure the measurement source is on. For example, if the measurement source is channel 3, make sure that channel 3 is turned on by checking the vertical menu or by looking at the LED by the channel 3 front-panel key.

To make a measurement:

- 1 Press the blue shift key.
- 2 Press the key that corresponds to the measurement you are making.
- 3 Use the Entry knob to select the measurement source.

The current measurement source is shown, in inverse video, next to the selected measurement on the display: channel number, c#; memory number, m#; or function number, f#.

- 4 Use the keypad to select the correct channel, function, or waveform memory.

To clear measurements from the display:

Press the blue shift key. Then, press the Clr meas key.

See also

Chapter 13, "Measurements," for complete details on measurement definitions and algorithms.

Measure Menu

When you set the top softkey to measure, the softkey menu at the left is displayed. The measure menu is the default selection for the define measure menu.

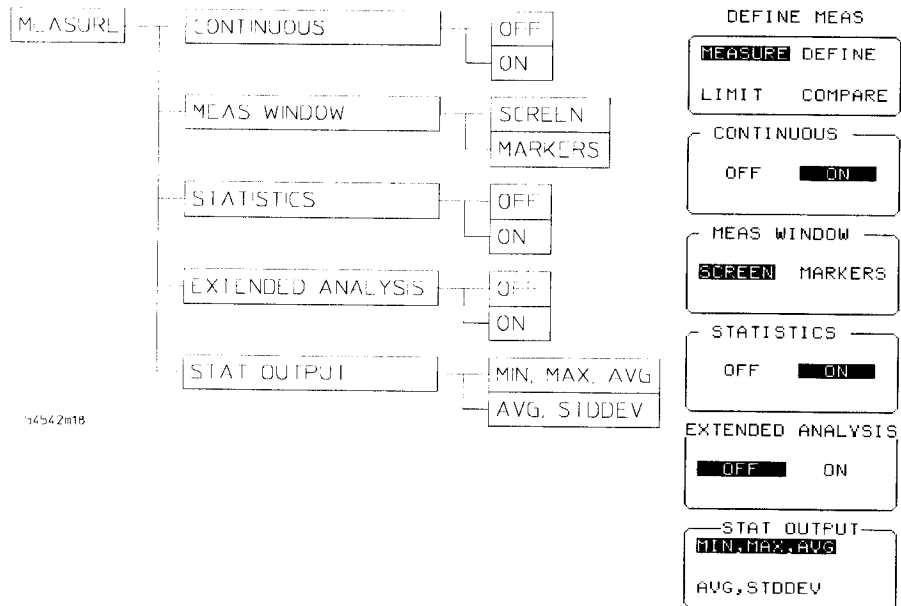

14542m18

Continuous Softkey

When the **CONTINUOUS** softkey is set to off, the time and voltage markers are placed on the waveform showing where the measurement was made. The measurement is performed once, and you must repeat the measurement to get another measurement result.

When the **CONTINUOUS** softkey is set to on, the measurement is performed continuously and the results are updated each time the measurement is made. The time and voltage markers are not placed on the waveform. Also, the statistics softkey is displayed. If statistics is turned off, you can have up to eight measurements on the display at one time.

Statistics Softkey

The **CONTINUOUS** softkey must be on before the **STATISTICS** softkey is available. When the **STATISTICS** softkey is set to on, either the minimum, maximum, and average values are displayed or the average and standard deviation values are displayed. Which statistics are displayed depends on the selection of the statistics output softkey. Statistics operates on up to three measurements.

When the oscilloscope is in the Sequential Single Shot mode, statistics are only calculated for the currently displayed segment. If all segments are displayed, statistics are only calculated for the last segment in the list of displayed segments.

Measure Window Softkey

The **CONTINUOUS** softkey must be on before the measure window softkey is available. The **MEASUREMENT WINDOW** softkey allows you to customize where measurements are made. The choices are screen and markers.

Screen When screen is selected, the measurement is made on the waveform data that is displayed on the screen.

Measure Menu

Markers When markers is selected, you can use the x1 and x2 markers to window the data on the display. Then, measurements are made on the data displayed within the window set by the markers. You turn on and position the markers from the marker menu.

By using the markers to set the measurement window, you can make a measurement on a particular portion of the data rather than on all of the data displayed on the screen.

See Also

Chapter 7, "Marker Menu," for information on positioning the markers.

Extended Analysis

The **CONTINUOUS** softkey must be on before the **EXTENDED ANALYSIS** softkey is available. When extended analysis is turned off, certain measurements (like period, frequency, +width, and -width) are made on the first pulse or period that is displayed on the screen. When extended analysis is turned on, measurements are made on all pulses or periods that are displayed on the screen, and the results are averaged together.

Statistic Output Softkey

The **CONTINUOUS** softkey must be on before the statistics output softkey is available. The **STATISTICS OUTPUT** softkey determines which set of statistics are displayed on the screen. The choice is either the minimum, maximum, and average values or the average and standard deviation values.

Define Measurement Menu

The define measurement menu sets the measurement points (thresholds) where the measurements are made. The menu influences the measurement algorithm by allowing you to use the standard IEEE measurement points, or by allowing you to customize the measurements with the user-defined settings.

Figure 8-2

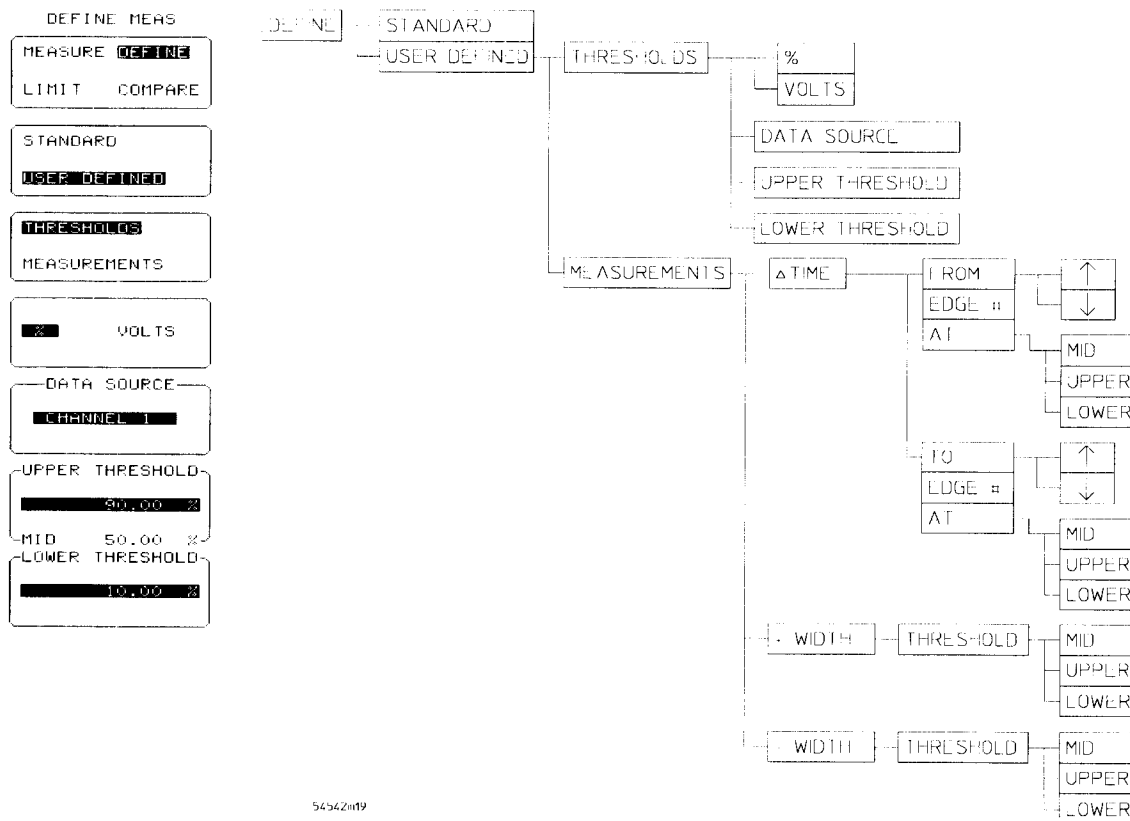

54542m19

Standard/User Defined Softkey

Standard uses the IEEE measurement points for all measurements. Figure 13-1 shows some of the standard measurement thresholds. User defined allows you to customize the measurements for your specific applications.

Thresholds/Measurements Softkey

Threshold settings apply to all user-defined front panel measurements. Thresholds sets the measurement points for all timing measurements.

Thresholds You can use the **PERCENT/VOLTS** softkey to set the thresholds as a percentage of the calculated top and base, or as a specific voltage.

- The percentage range is from -25% to +125%
- Voltage levels from -250 kV to +250 kV

The **DATA SOURCE** softkey allows you to select a source that the upper and lower thresholds track. You can select any channel, function, or memory was a source, and you can set the thresholds individually for any source. For example, you can set the thresholds for channel 1 as 10%/90%, and you can set the thresholds for channel 2 as 20%/80%.

The upper threshold softkey and lower threshold softkey allows you to set the upper and lower measurement thresholds. The upper and lower thresholds must be set to levels that fall on the displayed waveform. The message "not found" is displayed if either threshold is not on the waveform.

This feature is used when measuring excessive overshoot or ringing. By defining the measurements, you can test for pass/fail criteria of any choice. You can test from the front panel, or you can set the oscilloscope in the limit test over HP-IB allowing the oscilloscope to collect measurement data without supervision.

If time measurements are performed and the signal does not exceed 8 A/D levels or 8 vertical pixel levels, the message "not found" is displayed in the measurement area. Expand the signal vertically so the oscilloscope can make the measurement.

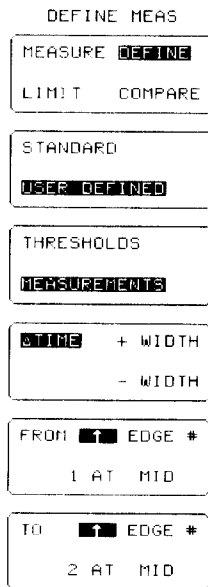

Measurements The measurements selection allows you to further customize the +width, -width, and Δ time (delay) measurements. Width measurements allow you to select the threshold (upper, middle, or lower). Where these thresholds occur is defined by the thresholds softkey.

The Δ time choice allows you to select positive or negative slope, edge number, and threshold (upper, middle, or lower). The oscilloscope starts counting edges from the left edge of the screen, not at the reference point. The selected edge must be displayed. If the edge is not displayed, the message "not found" is displayed in the measurement results area below the screen.

You can use Δ time when measuring source-to-source delays or measuring time separation on the same source or a different source. The Δ time measurement is defined by edge slope, edge count (from 1 to 4000), and the part of the transition edge (upper, lower, mid) used as a reference point.

When setting edge count fields, use the fine key. In the coarse mode the oscilloscope increments/decrements by ten (1, 11, 21,...,4000). In the fine mode the increment/decrement sequence is by 1.

Because Δ time measurements are made between two sources, the display prompts you to select the source (c#, f#, m#) and the source number for each source.

Limit Test Menu

The oscilloscope can run limit tests on up to three measurements simultaneously. Using this menu, you can preset the test parameters and store any failure data for evaluation at a later time. You start the limit test in this menu, and you select the measurement from the front panel.

When a test is running, statistical data describing the test is displayed. You must have at least one measurement selected before limit test can run.

Figure 8-3

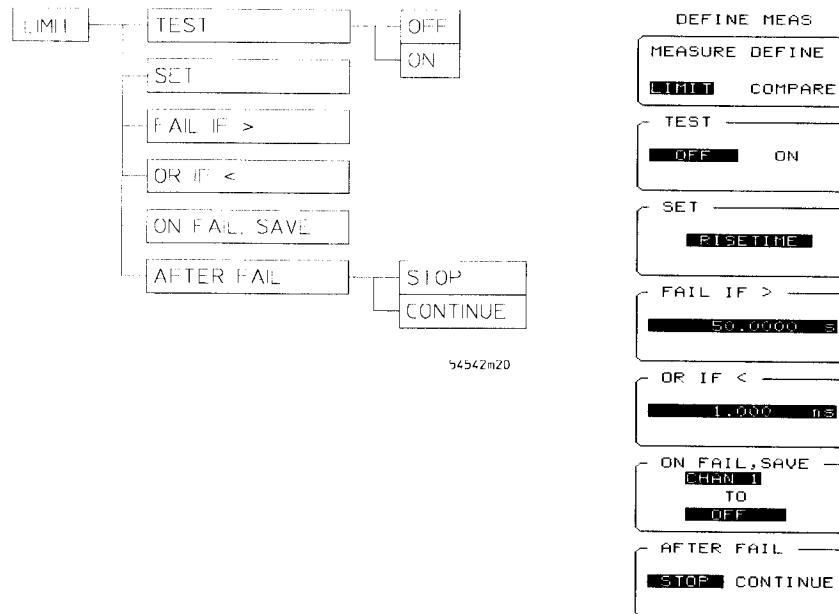

Test Softkey

The **TEST** softkey toggles the limit test on or off. When limit test is turned on, the oscilloscope starts running in the test mode on the most current measurements that are running.

Set Softkey

The **SET** softkey allows you to select a measurement so that you can set up the fail criteria for that test. The set softkey allows you to scroll through all of the measurements; these are the same measurements as are available on the keypad. The set softkey does not select the measurements on which the limit test operates, that selection is made from the keypad.

Fail if Softkey

The **FAIL IF** softkey sets the upper failure threshold. The upper range is dependent upon the units of the selected measurement.

or if Softkey

The **OR IF** softkey sets the lower failure threshold. The lower range is dependent upon the units of the selected measurement.



on Fail, Save Softkey

The **ON FAIL, SAVE** softkey allows you to determine what happens to the data from each source on a failure. You select the source and destination of the save function by pressing the softkey until the desired parameter is highlighted, then by turning the entry knob to scroll through the available choices. The source choices are any channel, function, or the screen. The destination choices are off (not saved), waveform memories, multiple memories, pixel memories, and hardcopy. The available destination choices depend on the source selected.

- Channel — off, nonvolatile memories, or multiple
- Function — off, nonvolatile memories, or multiple
- Screen — off, pixel memories, or hardcopy.

The type or amount of failure data saved depends on the destination selected. If the channel or function being sent to a destination is turned off, the message "data invalid nothing stored" is displayed.

When saving to a waveform memory, you can select one memory. Only the waveform viewing area is saved to the memory. If multiple failures occur, only the last failure data is saved because the most current data overwrites the memory contents. More than one source can use the same waveform memory. However, as each source is saved to that memory, the previous contents are overwritten. If a waveform memory is set to protected, the message "protect on: cannot store to memory" is displayed.

When saving to multiple memories, you can save up to 665 records (data includes a time/date stamp). Only the waveform viewing area is saved to the memory. If multiple failures occur and stop after fail mode is selected, then the test terminates after all available memory space is filled. If the continue after fail mode is selected, after the 665 memories are filled, the data records wrap around and new data overwrites previous data. If more than one source is specified with a multiple destination, then the data records are partitioned between the specified sources. Because the multiple memories are are volatile, cycling power results in a loss of data stored to them.

When saving to a pixel memory, the entire screen area is save to the pixel memory. New data is added to the pixel memory without overwriting the previously stored data. Because pixel memories do not contain any parametric data, you cannot make measurements on pixel data.

When saving to a hardcopy device, the entire screen area is sent to the peripheral device. Hardcopy stops if a device is not connected to the oscilloscope.

If the destination is set to off, data from that source is not saved.

You can set a different destination for each source. For example, you could save channel 1 data to waveform memory 3 and the entire screen to pixel memory 1.

After Fail Softkey

The **AFTER FAIL** softkey determines what action the oscilloscope takes after a failure: stop or continue.

Stop If the **ON FAIL, SAVE** softkey is set to a waveform memory, the test stops after a failure occurs. If the **ON FAIL, SAVE** softkey is set to multiple, the test continues to run until all of the 665 records are filled.

Continue If the **ON FAIL, SAVE** softkey is set to a waveform memory, the new fail data is written to the memory after each failure. The previous data is overwritten, unless the protect softkey is set to on in the waveform save menu. If the waveform protect softkey is set to on, the message "PROTECT ON: CANNOT STORE TO MEMORY #," and the data is not saved. If the **ON FAIL, SAVE** softkey is set to multiple, the test continues to run until all of the 665 memories are filled. Then, the test continues to run and starts overwriting the data that was previously stored in the memories. The test continues to run until you turn off the test with the test softkey or after fail softkey.

See also

Chapter 9 "Waveform Save Menu," for information on displaying data that was saved to multiple memories or saved to waveform memories.

Waveform Compare Menu

The waveform compare test allows a point-by-point comparison of an input channel to a waveform memory pair (m1 and m2, or m3 and m4). The result is a displayed PASS or FAIL message. The menu allows you to compare your choice of input channel or function with a memory pair. You can enter a failure allowance value to give the effect of trace separation, where needed. On failure, the menu allows for storage of the data with a stop/continue option.

If limit test is on, you cannot turn on the compare test.

Figure 8-4

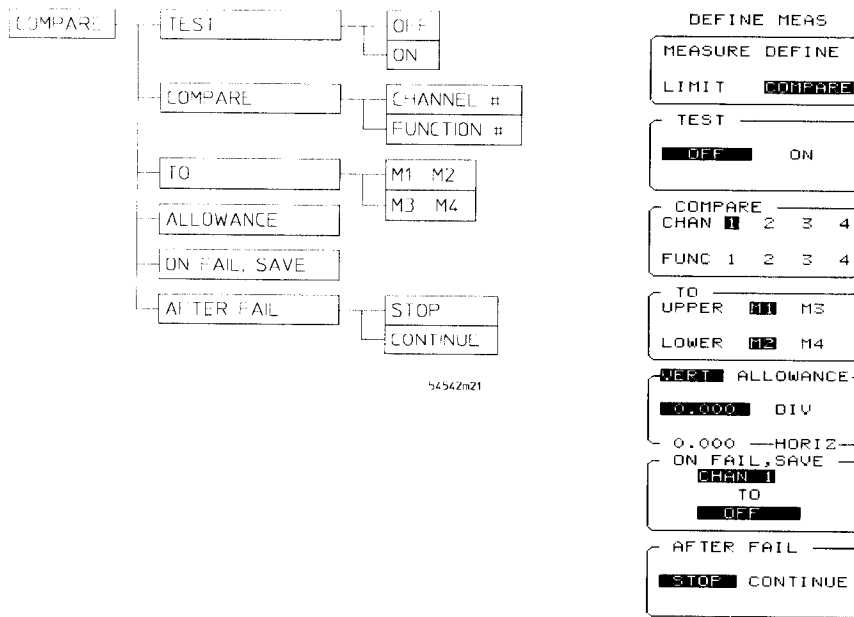

When the compare test is on, each point of the input channel or function is compared against the memory pair. The channel or function and the memory pair must have valid data stored in them and must be set to on. Holes are ignored during the test. If the input channel waveform point falls within the mask memory pair, the test passes. If the waveform falls outside the memory pair, the point is tested against the allowance value with a resulting PASS or FAIL message. If the test fails, a failbar is displayed above the graticule showing the point or points that failed the test. The compare test runs only on 500-point records.

In the compare mode, the 16-bit words in the memory and channel buffers are directly compared to the pulse mask memories. Because the compare is performed on the 16-bit unscaled data, this test is faster than the limit test.

If you are generating a mask without having the oscilloscope generate the mask for you, make sure the test is set up so that the upper mask is in memory m1 for memory pair m1 & m2 or memory 3 for memory pair m3 & m4. Likewise, the lower mask must be in memory m2 for memory pair m1 & m2 or m4 for memory pair m3 & m4. If the masks are stored to the reverse of the memory pairs, the test will fail.

Test Softkey

The **TEST** softkey toggles the compare test routine on or off. When the test is turned on, the oscilloscope compares the input channel waveform against the selected memory pair. PASS or FAIL is displayed when the test is complete. The memory bar is removed during test on and is replaced by the fail bar. If the test fails, the failed points are displayed above the graticule at the point of failure as a four-pixel high red line.

See also

"Mask Editor Menu" in Chapter 9 for more information on creating waveform masks.

Messages

PASS A channel or function waveform is contained in the memory pair.

FAIL Channel or function waveform is not contained in the memory pair and within the allowance value. The test has failed or the memory pair contents are reversed (upper waveform in memory 2 or 4 and lower waveforms in memory 1 or 3).

ER 0 Invalid data in the channel; Either the Clear display was pressed or a setting (like *s/div* or *V/div*) was changed to invalidate the data. The test is not performed.

ER 1 Either the channel or function or the compare waveform memory is off. The test is not performed.

ER 2 Versus mode is not a valid compare mode.

Only one measurement test routine may be turned on at one time. If the measurement limit test is on, the message "limit test on: cannot turn on" is displayed. If the compare test is on, the measurement limit test selection causes the message "comp test on: cannot turn on" to be displayed.

If an attempt is made to turn on a second test over the HP-IB, a message is displayed stating the command is ok but that the settings conflict.

Compare Softkey

The **COMPARE** softkey selects the channel or function for comparison to the memory pair.

To Softkey

The **TO** softkey selects the memory pair, m1 and m2 or m3 and m4, for comparison to the chosen input channel or function. Make sure that m1 is greater than m2 for all values across the screen when memory pair m1 & m2 is selected. When memory pair m3 & m4 is selected, make sure that m3 is greater than m4 for all values across the screen. If m1 is less than m2 or if m3 is less than m4, the compare test fails. The display is misleading in this case because the waveform appears to be in the bounds of the memory pair.

Allowance Softkey

When a point on the waveform fails the compare test, the point is tested again against the allowance set with the **ALLOWANCE** softkey. Allowance refers to the distance a point may be above the upper mask or below the lower mask and still pass the compare test. The distance is measured in divisions. The allowance range is from 0 to 8 divisions in 1/40 division increments.



On Fail, Save Softkey

The **ON FAIL, SAVE** softkey saves the data associated with the failure (from selected channel, function, or screen) to memories or to a hardcopy device. You can select the source and destination of the save by pressing the softkey until the desired parameter is highlighted, then by turning the entry knob to change selections. The source choices include any channel, function, or the screen. The destination choices include off (not saved), waveform memories, multiple memories, pixel memories, and hardcopy. The destination choices available depend on the source currently selected:

- Channel — off, nonvolatile memories, or multiple
- Function — off, nonvolatile memories, or multiple
- Screen — off, pixel memories, or hardcopy.

The type or amount of failure data saved depends on the destination selected.

If a destination is selected and the channel or function is off, a message is displayed indicating that the data is invalid and failure data is not stored.

When saving to a waveform memory, you can select one memory. Selection of the memory pair containing the comparison waveform is not allowed. If multiple failures occur, only the last failure data is saved because the most current data overwrites the memory contents. However, as each source is saved to that memory, the previous contents are overwritten. If a waveform memory is set to protected, the message "protect on: cannot store to memory" is displayed and the data is not saved.

When saving to multiple memories, you can save up to 665 records (data includes a time/date stamp). If multiple failures occur and the stop after fail mode is selected, then the test terminates after all available memory space is filled. If the continue after fail mode is selected, after the 665 memories are filled, the data records wrap around and new data overwrites previous data. If more than one source is specified with a multiple destination, then the data records are partitioned between the specified sources.

When saving to a pixel memory, the entire screen area is save to the pixel memory. New data is added to the pixel memory without overwriting the previously stored data. Because pixel memories do not contain any parametric data, you cannot make measurements on pixel data.

A save to hardcopy immediately sends the data to the peripheral device. If any source is designated as multiple, then the hard copy is performed after all 665 multiple memories are filled. Hardcopy is canceled if a device is not connected.

If the destination is set to off, data from that source is not saved.

If the compare test is on, with save to hardcopy, and after fail set to continue and a FAIL condition occurs, the hardcopy continues as long as the FAIL condition exists.

After Fail Softkey

The after fail softkey determines what action the oscilloscope takes after a failure.

Stop If the **ON FAIL, SAVE** softkey is set to a waveform memory, the test stops after a failure occurs. If the **ON FAIL, SAVE** softkey is set to multiple, the test continues to run until all of the 665 records are filled.

Continue If the **ON FAIL, SAVE** softkey is set to a waveform memory, the new fail data is written to the memory after each failure. The previous data is overwritten, unless protected in the waveform save menu. If the **ON FAIL, SAVE** softkey is set to multiple, the test continues to run until all of the 665 memories are filled. Then, the test continues to run and starts overwriting the data that was previously stored in the memories.

See also

Chapter 9 for information on displaying data saved to multiple memories and data saved to waveform memories.



Waveform Save Menu

Waveform Save Menu

This chapter describes how to select the waveform, pixel, multiple, and mask memories on the oscilloscope. The chapter is divided into four menus:

- **Waveform** Menu used to store and display the four nonvolatile waveform memories.
- **Pixel** Menu used to store and display the two volatile pixel memories.
- **Multiple** Menu used to store and view failure data from the limit and waveform compare tests that were saved to the multiple memories.
- **Mask** Menu used to generate masks in memory pairs m1 and m2 or m3 and m4.

When you press the Waveform Save key on the front panel, one of four softkey menus is displayed on the right hand portion of the screen. The menu that is displayed depends on the selection of the top softkey in the waveform save menu. The menu map for each of the four menus is included with the topic that covers that menu.

Waveform Save Menu

The waveform save menu has four memories: m1, m2, m3, and m4. These memories are nonvolatile and are not cleared by pressing the Autoscale key, by pressing the Recall key, or by recycling the power. Because the memories are nonvolatile, you can disconnect the power and transport the oscilloscope without losing the contents of the waveform memories.

Figure 9-1

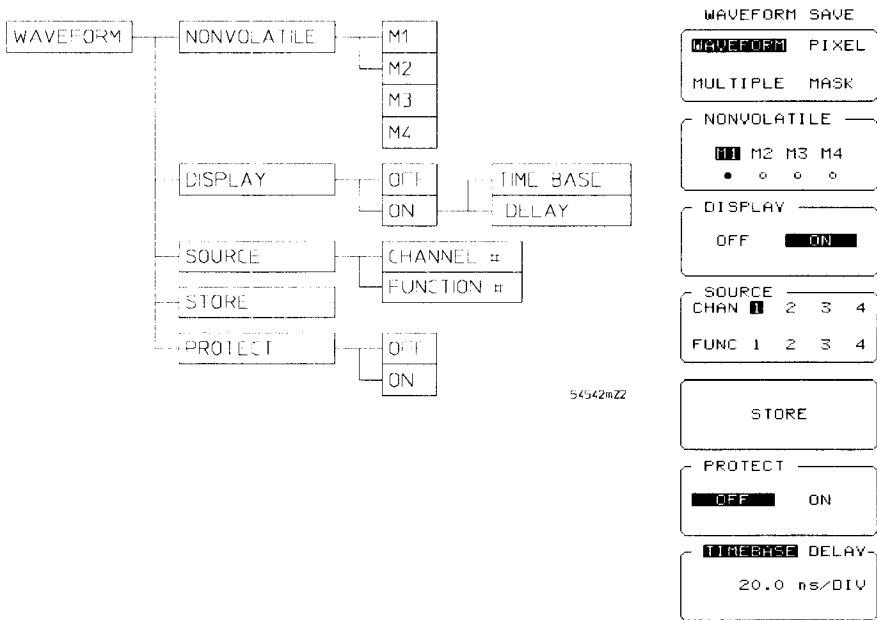

Waveform Save Menu

Waveform Save Menu

A waveform memory consists of a single waveform record, including the horizontal and vertical scaling parameters. The scaling parameters allow measurements on previously stored waveform and function data. Also, you can set the x and y markers on stored waveforms when they are displayed on the screen.

When the oscilloscope is in the envelope display mode and a waveform store is executed, the minimum value and maximum value are stored separately. The maximum value is stored in m1 if m1 or m2 are the selected store locations, or in m3 if m3 or m4 are the storage locations. The minimum values are stored in m2 or m4 respectively. A message is displayed above the waveform display area indicating the storage locations of both values.

Nonvolatile Softkey

The **NONVOLATILE** softkey lets you select which memory to use. The selections are nonvolatile memories m1, m2, m3 and m4. When a memory is turned on, the small circle below the label is highlighted. When the memory is protected, the small circle has an "x" through it. The waveform memories are record memories that store up to 32K points in the real-time mode or 500 points in the repetitive mode.

Display Softkey

The **DISPLAY** softkey toggles the selected waveform memory display on or off. When on is selected, the **TIME BASE DELAY** softkey is displayed that shows the time base and delay settings when the waveform was stored. You can use the show menu to see the vertical and trigger settings.

Source Softkey

The **SOURCE** softkey selects the source waveform to store in the selected memory. You can select any channel or function as a source.

Store Softkey

The **STORE** softkey is the active softkey in the menu. When pressed, the memory is erased and new data is stored to the memory. If the destination memory is protected, the message "protect on: cannot store waveform" is displayed, indicating that the store was not successful.

Protect Softkey

The **PROTECT** softkey toggles the selected waveform memory write-protect to on or off. When on is selected, any attempt to store data is not allowed, and the message "protect on: cannot store waveform" is displayed, indicating that the store was not successful.

Timebase/Delay Softkey

The **TIME BASE DELAY** softkey is displayed when the selected memory is turned on. It initially displays the time base and delay settings when the waveform was stored. Pressing the softkey cycles between the time base and delay values. If the data was saved in the real-time mode, you can use the knob to change the values to pan and zoom displayed waveforms.



**Waveform Save
Exercise**

This exercise demonstrates how to store and recall a waveform.

- 1 Press the Recall key. Then, press the Clr key.
 - 2 Connect a coaxial cable between the rear-panel AC connector and channel 1.
 - 3 Disconnect any other signals connected to other inputs.
 - 4 Press the Autoscale key.
 - 5 Press the Wform save key. Then, select **WAVEFORM**.
 - 6 Use the **NONVOLATILE** softkey to select **M3** as the waveform memory.
 - 7 Use the **SOURCE** softkey **CHAN 1** as the source.
 - 8 Press the **STORE** softkey.
The currently displayed waveform is saved in nonvolatile waveform memory, m3.
 - 9 Set the **DISPLAY** softkey to **ON** to display the contents of memory m3.
 - 10 Use the vertical position knob to move the channel signal vertically so that you can see the stored waveform.
The waveform from channel 1 overlaps the display of the waveform memory. You can either turn off the display of channel 1 or move the display of channel 1, so that you can see the stored waveform in m3.
-

Pixel Menu

The pixel menu selects the pixel memories. These memories are useful when additive memory capabilities are needed or for storing infinite persistence data.

Figure 9-2

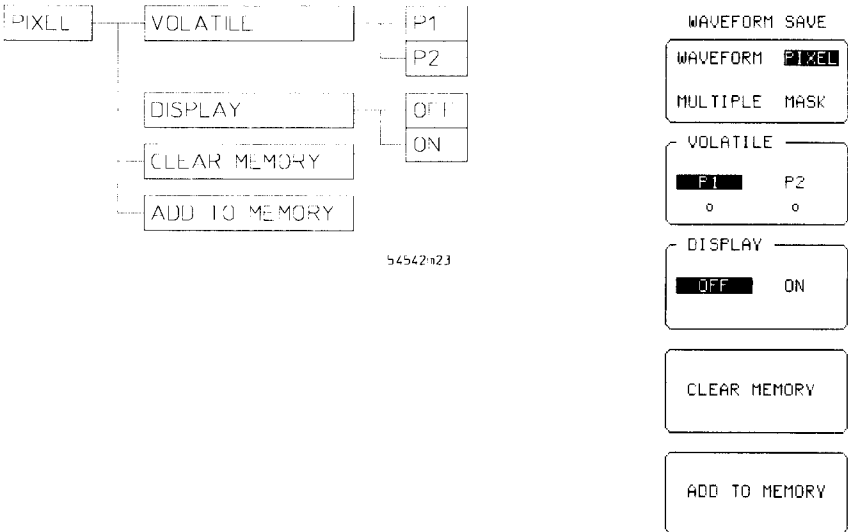

Pixel Menu

Volatile Softkey

The **VOLATILE** softkey selects between pixel memories 1 or 2. The pixel memories are complete pixel saves of the waveform area (excluding the graticule and markers) in volatile memory. Data stored to a volatile memory is lost when the power is cycled.

The entire 256 by 500 point display area is saved in pixel memory.

Therefore, data is mapped directly onto the display and displayed in half-bright. Because the pixel memories do not contain any scaling parameters, there are no measurement capabilities on pixel memories.

Pixel memories are additive. If new data occurs in the same pixel as old data, the new data overwrites the old data.

Display Softkey

The **DISPLAY** softkey toggles the selected pixel memories on or off.

Clear Memory Softkey

The **CLEAR MEMORY** softkey purges all data from the selected pixel memory.

Add to Memory Softkey

The **ADD TO MEMORY** softkey adds the currently displayed screen to the specified pixel memory.

Multiple Menu

You can use the multiple menu to display one of the 665 possible volatile failure memories. These are the memories where failure data from both the limit and waveform comparison tests are saved. Failure data stored in volatile multiple memories can be viewed, or transferred to nonvolatile memories m1 through m4. The multiple memories store 500 points of waveform information (no raw data) in each memory. Measurements are not performed unless the data is first transferred into one of the nonvolatile memories.

Figure 9-3

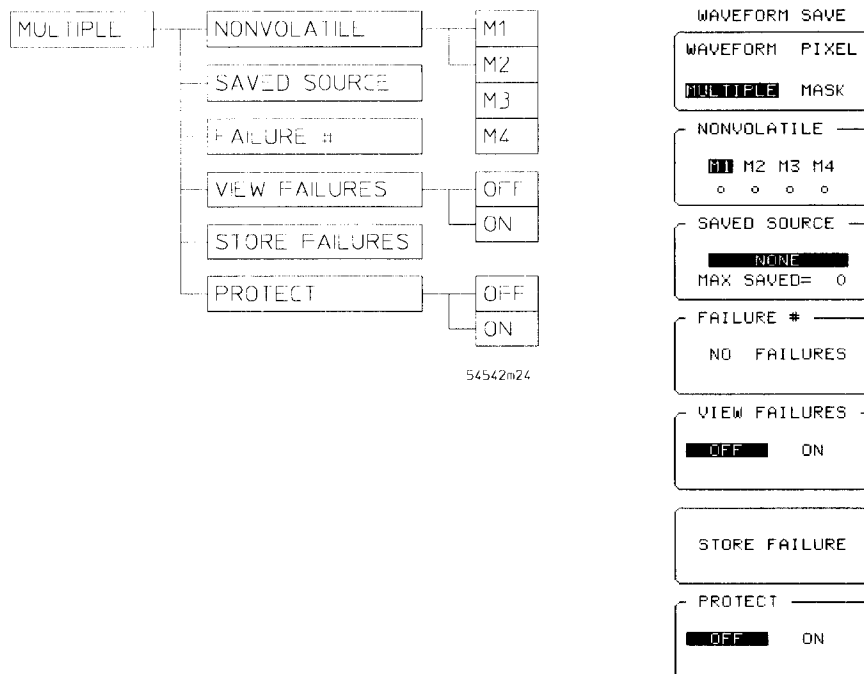

Nonvolatile Softkey

The **NONVOLATILE** softkey selects which of the four nonvolatile memories to use when transferring multiple memory failure data. The selections are nonvolatile memories m1, m2, m3 and m4. When a memory is turned on (using the waveform menu), the small circle below the label is highlighted. When the memory is protected, the small circle has an "x" through it.

Saved Source Softkey

The **SAVED SOURCE** softkey selects the multiple memory source to view or to transfer. The source alternatives are any channel or function that has failure data saved, as selected when configuring the limit or compare tests in the define measurement menu. When the **SAVED SOURCE** softkey displays "None", no failure data is available (max saved=0). The maximum number of data records saved is also displayed on the bottom portion of the softkey display.

Failure # Softkey

The **FAILURE #** (number) softkey selects a specific multiple memory to view or to transfer. Also, it displays the time and date the selected record was saved. The source is specified using the saved source softkey. The maximum number records available are displayed at the bottom of the saved source softkey. When "NO FAILURES" is displayed, no failure data is available.

View Failures Softkey

The **VIEW FAILURES** softkey toggles the multiple memory display on or off. If failure data was not saved, the softkey remains off and a message stating that the multiple memory is empty is displayed.

Store Failure Softkey

The **STORE FAILURE** softkey saves the specified multiple memory to the currently selected nonvolatile memory location. When pressed, the memory is erased and new data is stored to the memory. If the destination memory is protected, the message "protect on: cannot store waveform" indicating that the store was not successful is displayed. If failure data was not saved, the status message "no valid data... nothing stored" is displayed.

Protect Softkey

The **PROTECT** softkey toggles the selected waveform memory write protect to on or off. When on is selected, any attempt to store data is not allowed, and the message "protect on: cannot store to memory" is displayed. Any data stored to the multiple memories is lost when the power is cycled.



Mask Menu

The mask menu allows you to create upper and lower limit masks (or templates) for the waveform compare test. You can create these templates automatically using a sample signal and entering specific tolerance levels, or generating the template manually on the screen using the cursor.

The mask menu is comprised of the following three menus: main mask menu, automask menu, and mask editor menu.

Figure 9-4

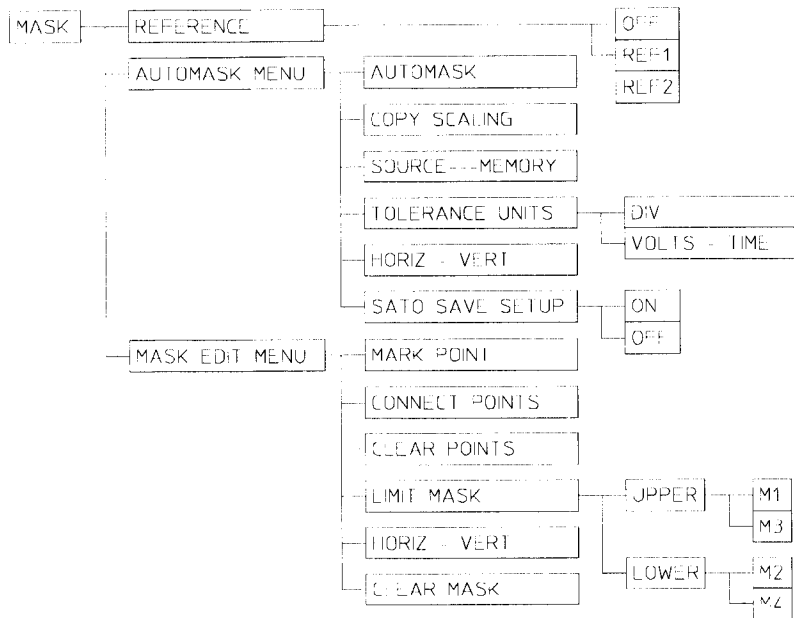

54942m34

Main Mask Menu



This menu is displayed when mask is selected from the waveform save menu. The mask main menu allows you to view the reference waveforms, or to select the automask or mask editor menus.

Reference Wfm Softkey

The **REFERENCE WFM** (waveform) softkey allows you to view the waveform that was used to automatically generate the upper and lower limit masks during generation of the automask. Ref1 displays the waveform used to generate the masks in memory pair m1 and m2, and ref2 displays the waveform used to generate the masks in memory pair m3 and m4. Off clears the display of the reference waveforms.

Automask Softkey

The **AUTOMASK** softkey brings up the automask menu on the display.

Mask Editor Softkey

The **MASK EDITOR** softkey brings up the mask editor menu on the display.

Automask Menu

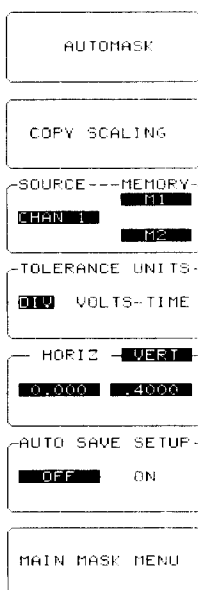

The Automask menu contains the selections used to generate the upper and lower limit masks at defined tolerances using the data from a selected source. Masks are generated and stored in waveform memory pairs m1 and m2 or m3 and m4.

Automask Softkey

The **AUTOMASK** softkey generates the upper and lower limit mask for the selected source waveform at the specified tolerance. Each mask is stored in the selected nonvolatile memory pair.

Once an automask is generated, the previous contents of the selected memory pair are overwritten. Any data previously stored is lost.

Prior to performing an automask, verify that the data for the selected source is valid, the source selected is set to on, the destination memories are not protected, and the horizontal and vertical tolerance are specified.

Make sure you set the **SOURCE---MEMORY**, **TOLERANCE UNITS**, and **HORIZ-VERT** softkeys correctly. Otherwise, the mask may not generate, or it may generate incorrectly.

Copy Scaling Softkey

The **COPY SCALING** softkey copies the scaling information from the selected source to the specified nonvolatile memory pair. Both the source and the memory pair are selected using the **SOURCE---MEMORY** softkey. You can use the **COPY SCALING** feature when you plan to make measurements on the mask or make comparisons to the mask.

Source---Memory Softkey

The **SOURCE---MEMORY** softkey is used to select both the source of the waveform used during an automask function, and the destination memory pair for the resulting upper and lower limit masks. All channels, functions, and reference waveforms are available as source selections. Memory pairs are either m1 and m2 or m3 and m4. The upper limit mask is stored in m1 or m3, and the lower limit mask is stored in m2 or m4.

Tolerance Units Softkey

The **TOLERANCE UNITS** softkey allows you to select the vertical and horizontal tolerance units used during an automask function to generate the upper and lower limit masks. You can specify tolerance as divisions or in volts and time (seconds). Once desired units are selected, use the **HORIZ-VERT** softkey to enter the tolerance.



Horiz-Vert Softkey

The **HORIZ-VERT** softkey is used to select and enter the horizontal and vertical tolerance parameters. The horizontal parameter defines the maximum signal excursion right and left of the selected source. The vertical parameter defines the maximum signal excursion above and below the selected source.

The maximum signal excursion is equal in both directions from the selected source, except when the source is channel and the display mode is envelope. In that case, the upper and lower limit masks are generated as follows:

- If the vertical and horizontal tolerances are set to zero, then the lower limit mask is the minimum envelope waveform and the upper limit mask is the maximum envelope waveform.
- If vertical and horizontal tolerances are set to any value other than zero, then the lower limit mask is the minimum envelope waveform with the specified tolerance applied, and the upper limit mask is the maximum envelope waveform with the specified tolerance applied.

You can enter the tolerance either in divisions or in volts and seconds, depending on the current selection of the tolerance units softkey.

When units are divisions, horizontal entries of from 0.000 to 1.000 are allowed, and vertical entries of from 0.000 to 8.000 are allowed.

When units are volts-time, horizontal entries are limited to the current time base setting. Entries from 0.00000 to 200.0000 seconds are allowed.

However, if the entered value exceeds the current time base value (time/division), it is automatically adjusted to the maximum value allowed.

Vertical entries are limited to the currently selected source's vertical setting.

Entries from 0.00000 to 40.0000 volts are allowed. However, if entered value exceeds eight times the vertical volts/division value for the source selected, it is automatically adjusted to the maximum value allowed.

Main Mask Menu Softkey

The **MAIN MASK** softkey returns you to the main mask menu.

Mask Edit Menu

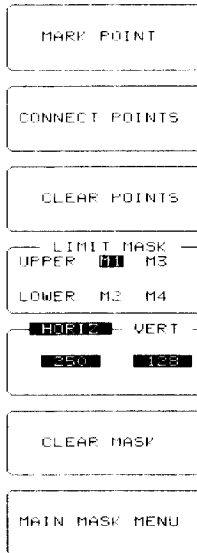

The Mask Edit menu contains the selections used to edit previously generated or stored masks using the automask menu. By using the mask editor menu, it is also possible to clear any existing masks and create a new one using the mark and connect-point method.

If the active limit mask (defined by the limit mask softkey) is not displayed, pressing any softkey in the mask editor menu (except clear mask or main mask menu) causes the active limit mask to display.

Mark Point Softkey

The **MARK POINT** softkey records the current horizontal and vertical field values. This point is used as the anchor point when connecting or clearing points from the screen. These values are displayed in the horiz-vert softkey, and represented on the screen at the junction of the $x2/y2$ markers. When the softkey is pressed, the current values are saved, and the $x1/y1$ markers are moved to that point on the screen (imposed over the $x2/y2$ markers).

Connect Points Softkey

The **CONNECT POINTS** softkey replaces the portion of the existing active limit mask from the mark point (junction of $x1/y1$ markers) to the connect point (junction of $x2/y2$ markers) with a straight line.

Clear Points Softkey

The **CLEAR POINTS** softkey replaces the portion of the existing active limit mask from the mark point (junction of $x1/y1$ markers) to the connecting point (junction of $x2/y2$ markers) with a hole.

Limit Mask Softkey

The **LIMIT MASK** softkey selects the active limit mask for the mask editor menu functions. Limit masks are stored in pairs, where m1 or m3 contains the upper limit mask and m2 or m4 contains the lower limit mask.

Horiz-Vert Softkey

The **HORIZ-VERT** softkey changes the horizontal and vertical field values, and the position of the x2/y2 markers on the screen during mask edits. The acceptable vertical settings are from 0 (y2 at the bottom of the screen) to 255 (y2 the at top of the screen). The acceptable horizontal settings are from 0 (x2 at the left of the screen) to 500 (x2 at the right of the screen).

When horizontal is selected, the vertical y2 marker is slaved to the horizontal x2 marker. As the x2 marker is changed, the y2 marker follows the displayed active limit mask and updates the data values at each location. If the mask has a hole present, the y2 marker are not changed.

You can move the x1/y1 only when the mark point softkey is pressed.

Clear Mask Softkey

The **CLEAR MASK** softkey replaces the entire active limit mask with holes (blanks the screen).

Main Mask Menu Softkey

The **MAIN MASK** softkey returns you to the main mask menu.

Mask Exercise

This exercise demonstrates how to generate upper and lower masks using a reference waveform at a tolerance of \pm one-half a horizontal and vertical division.

- 1 Press the Recall key. Then, press the Clr key.
- 2 Connect a coaxial cable between the rear-panel AC connector and channel 1.
- 3 Disconnect any other signals connected to other inputs.
- 4 Press the Autoscale key.
- 5 Press the Display key. Then, set **CONNECT DOTS** to on.
- 6 Press the Wform save key. Then, select **MASK**.
- 7 Press the **AUTOMASK MENU** softkey.
- 8 Use the **SOURCE --- MEMORY** softkey to set the source to chan 1 and memory to m1/m2.
- 9 Use the **TOLERANCE UNITS** softkey to select div.
- 10 Use the **HORIZ - VERT** softkey to select **HORIZ**. Then, use the entry knob or keypad to set the horizontal tolerance to 0.500.
- 11 Use the **HORIZ - VERT** softkey to select **VERT**. Then, use the entry knob or keypad to set the vertical tolerance to 0.500.
- 12 Press the **AUTOMASK** softkey.

You may notice that the message "upper stored in mem 1, lower stored in mem 2" is displayed.



Math/FFT Menu

Math/FFT Menu

The Math/FFT menu allows you to perform waveform math functions and FFT functions. You can define one of four math functions, and the operands for the functions can be any channel or one of four waveform memories.

A function is generated by mathematically manipulating one or two operands into a new waveform called a function. You can generate a new waveform with one of the following nine operations:

- + (add)
- – (subtract)
- × (multiply)
- vs (versus)
- magnify
- inv (invert)
- int (integrate)
- diff (differentiate)
- FFT

The vertical display and offset are adjusted to place the function for best viewing.

When the function is calculated, it can be used in the following ways:

- Displayed on the screen
- Evaluated with the measurement features
- Stored in memory
- Transferred over HP-IB

Functions are transferred over the HP-IB by storing the function to a memory. Then, the contents of the memory are transferred over HP-IB.

When you press the Math/FFT key on the front panel, the waveform math menu is displayed on the right-hand portion of the screen. The Math and FFT softkey menu and menu map are shown below. When you select FFT as the math operator, additional keys are available which allow you to define the FFT function. The FFT menu and menu map are described later in this chapter.

See also

"FFT Softkeys" later in this chapter for information on the FFT functions.

Figure 10-1

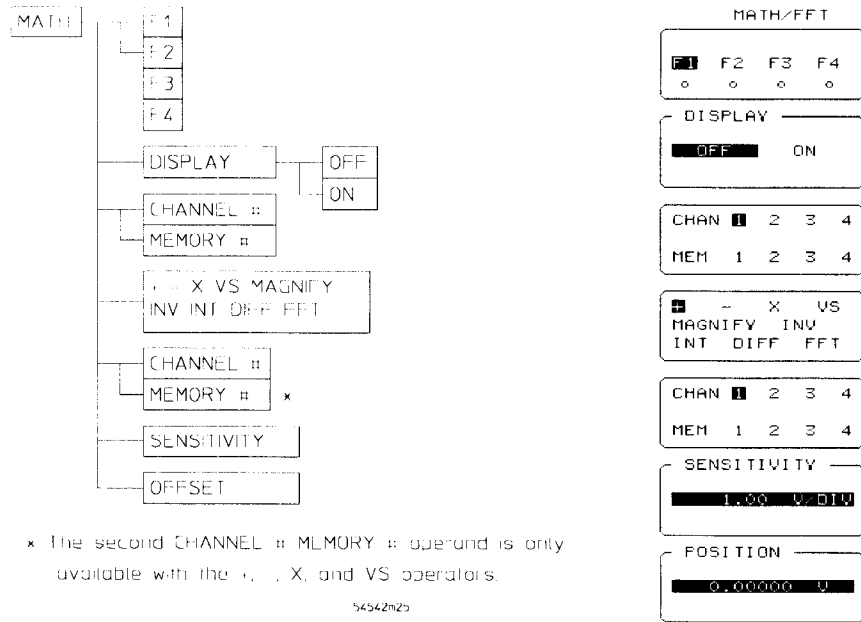

Defining a Function

The Waveform Math/FFT menu selects and presets any of various operations, sources, and displayed results.

Function Softkey

The **FUNCTION** softkey selects one of the four functions.

Display Softkey

The **DISPLAY** softkey turns the selected function on or off. The display of the functions depends on the display mode in the display menu. When the number of screens is set to 1, the functions are displayed in one screen. When the number of screens is set to 2, functions 1 and 2 are displayed in the top screen and functions 3 and 4 are displayed in the lower screen. When the number of screens is set to 4, each function is displayed in its own area, starting with function 1 on the top.

Chan/Mem Softkey

A math operand is defined by the **CHAN/MEM** softkey. The math operators +, -, ×, and ÷ use two operands, while the math operators magnify, inv, int, diff, and FFT, use one operand. The **CHAN/MEM** softkey defines the first operand of the mathematical operation, or the waveform to be manipulated. If two operands are required, a second **CHAN/MEM** softkey is displayed that allows you to define the second operand. You can define the operand to be any channel or waveform memory (if there is a waveform stored in that memory).

Operator Softkey

The **OPERATOR** softkey selects any of the nine functions. Continue pressing the selection softkey until the operation desired is highlighted.

Because math operators are post-processing techniques, functions are calculated after the data is acquired.

+ **(add)** The voltages of the two selected operands are added together in a point-by-point manner.

– **(subtract)** The voltage of the second operand is subtracted from the first operand in a point-by-point manner.

× **(multiply)** The voltages of the two selected operands are multiplied together in a point-by-point manner.

Vs (versus) The voltage of the first operand is used to determine the displayed point's vertical position, and the voltage of the second operand is used to determine the displayed point's horizontal position.

Because the versus functions does not create a single valued waveform, you cannot store a versus function in a waveform memory or make measurements on the resultant waveform. However, you can store it in a pixel memory, and you can place markers on the versus function. The voltage range of the first operand is used to determine the horizontal range.

Magnify The voltage of the operand is scaled and positioned in a point-by-point manner.

Inv (inverse) The voltage of the operand is inverted in a point-by-point manner.

Int (integrate) The voltage of the operand is intergrated in a point-by-point manner. If a data point is not encountered in the operand, integration uses the next valid data point. Only the available data is integrated. Default scaling is determined by the original operand.



Diff (differentiate) The voltage of the operand is differentiated in a point-by-point manner. If a data point is not encountered in the operand, differentiation uses the next valid data point. Only the available data is differentiated

Default scaling is determined by the original operand. The differentiation function, by nature, amplifies noise effects. Therefore, use differentiation on signals with high signal-to-noise ratios.

FFT (fast Fourier transform) When FFT is selected, a fast Fourier transform of the specified channel or memory is displayed. Selecting this mode adds FFT specific controls to the math menu. When the FFT function is selected, the readout for the horizontal axis changes from time to Hertz and the vertical readout changes from volts to dBm.

Chan/Mem Softkey

The **CHAN/MEM** softkey selects the second operand for use by the selected operator. You can choose any displayed channel or waveform memory. This softkey is not available for the magnify, inv, int, diff, or FFT operators.

Sensitivity Softkey

The **SENSITIVITY** softkey scales the function on the screen. Sensitivity does not affect the hardware settings in the scope. Sensitivity is adjusted with the knob or keypad.

Offset Softkey

The **OFFSET** softkey moves the function vertically on the screen. Offset is adjusted with the knob or keypad. Also, offset is the value at the center of the graticule area.

**Subtracting
 Waveforms Exercise**

In this exercise you subtract two waveforms in the Math menu.

- 1 Press the Recall key. Then, press the Clr key.
 - 2 Connect a power splitter or BNC Tee to channel 1. Connect a coaxial cable between the rear-panel AC cal connector and one side of the BNC Tee. Then, connect a one-meter coaxial cable between the other side of the BNC Tee and channel 2.
- A power splitter provides better signal fidelity than a BNC Tee. The extra cable length between channels provides a time delay between the signals on the oscilloscope. The propagation of a 1-meter coaxial cable is about 6 to 7 ns. This delay is used to demonstrate the math function.
- 3 Press the Vertical 1 key. Then, set the channel 1 and channel 2 input coupling to 50 Ω dc.
 - 4 Press the Autoscale key.
 - 5 Use the time/div knob to change the time base to 5 ns/div. Then, use the delay knob to position the waveforms on the screen.
 - 6 Press the Horizontal Setup key. Then, select the **REPETITIVE** mode.

Figure 10-2

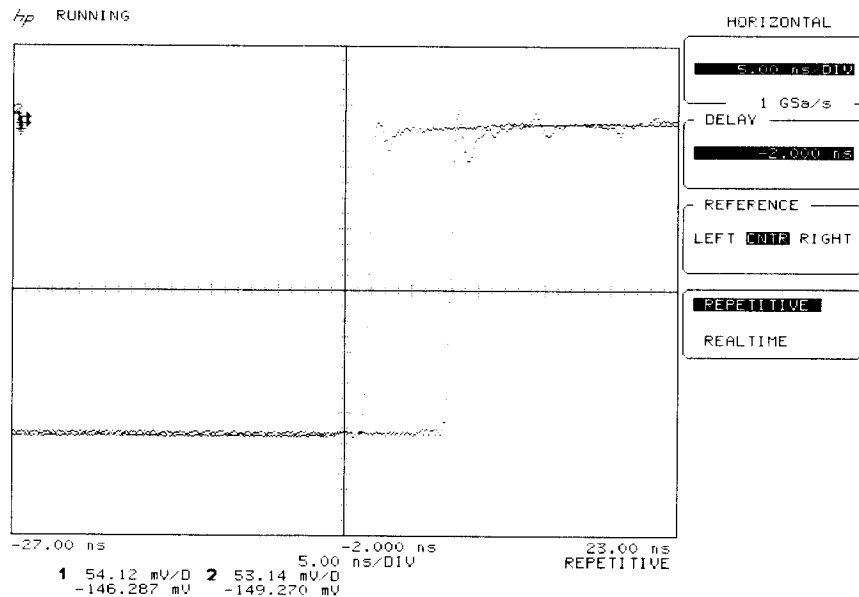

Math/FFT Menu
Defining a Function

- 7 Press the Display key. Select the **AVG** (average) mode. Then, set the **# OF AVG** to 8.
- 8 Press the Vertical 1 key. Then, turn off channel 1 and channel 2.
- 9 Press the Math/FFT key. Then, select function f1, display on, channel 1 subtract channel 2.

The function subtracts channel 2 from channel 1. The propagation delay between channels results in a 6- to 7-ns spike.

Figure 10-3

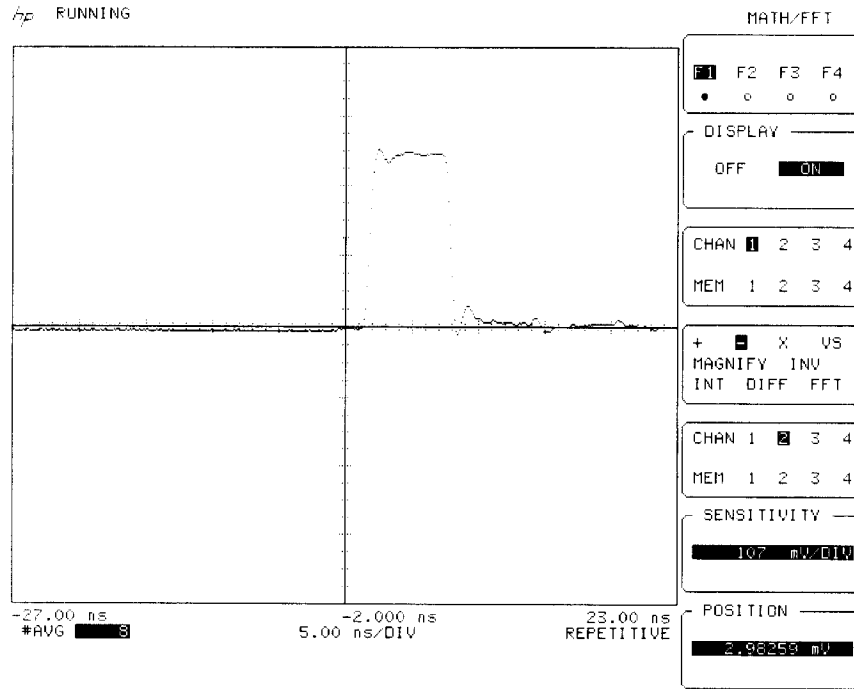

FFT Softkeys

When you select FFT as the math operator, additional control keys are available to define the FFT function. The FFT menu and menu map are shown below.

Figure 10-4

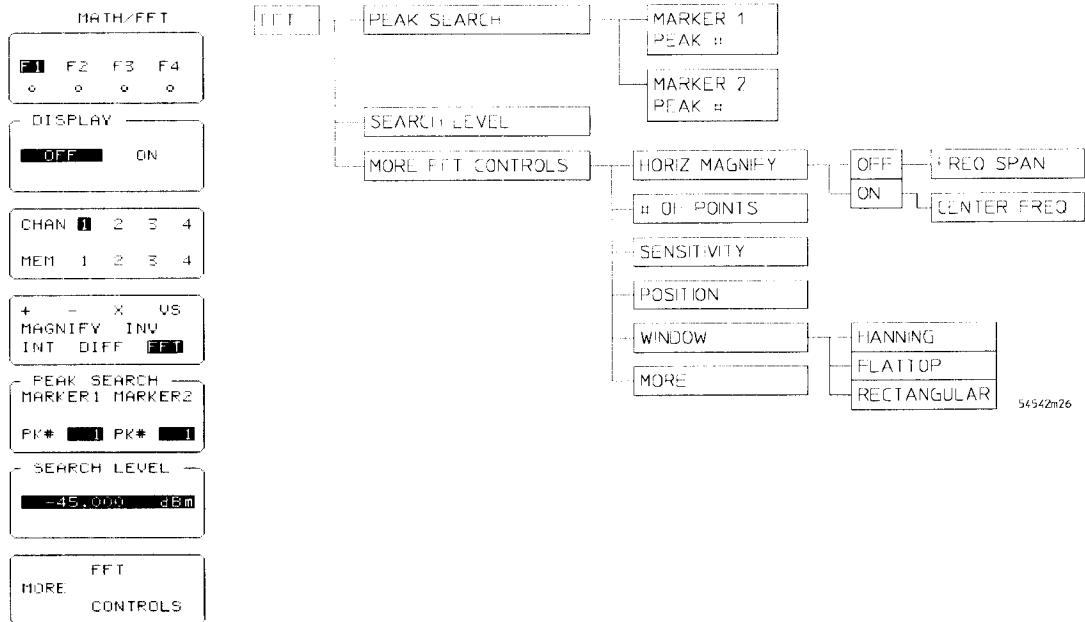

54942m26

Peak Search Softkey

You can use the **PEAK SEARCH** softkey to measure the amplitude and frequency of peaks on the display generated by the FFT function. To qualify as a peak, the amplitude of the peak must be at least one display division, (half a division in the splitscreen mode), and the peak must also be greater than the search level specified.

The peak search softkey also turns on the markers. The markers are set to the selected peaks in the peak search field. Markers x1 and y1 are set on the first peak specified, and markers x2 and y2 are set on the second peak specified. You can select peak numbers from 1 to 99.

To remove the markers from the display.

Press the **Shift** key. Then, press the **Clr meas** key.

A peak search for both peaks is performed every time the peak search softkey is pressed. If a peak is not found, a message is displayed, the vertical marker is set to the right side of the waveform area, and the horizontal marker is set to the bottom of the waveform area.

For maximum frequency accuracy when using peak search, turn on the FFT horizontal magnify function, and use both the **CENTER FREQ** and **# OF POINTS** softkeys to isolate the peak of interest.

Search Level Softkey

The **SEARCH LEVEL** softkey sets the minimum search level for the peak search.

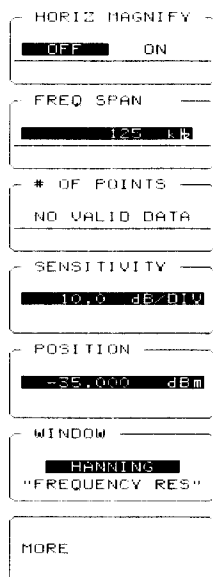

More Softkey

The **MORE** softkey selects the second level of the math menu when the FFT function is selected.

Horiz Magnify Softkey

The **HORIZONTAL MAGNIFY** softkey allows expansion of the frequency record. Use the **MAGNIFY OFF** mode for viewing the entire FFT spectrum. Use the **MAGNIFY ON** mode for looking at two frequencies that are close together and for making maximum accuracy measurements. When on is selected, the **CENTER FREQ** softkey is available for centering on the desired frequency. The **CENTER FREQ** softkey uses software expansion to center the frequency record to the desired frequency.

The number of points displayed on the screen for FFT functions is always 500. When magnify is off, a compression algorithm is used to compress all of the FFT points into 500 points. The algorithm accurately displays peaks and most noise. However, low points in the noise are occasionally missed. When magnify is on, the actual FFT points are displayed, 500 points at a time.

Freq Span Softkey

The **FREQUENCY SPAN** softkey controls the span, the maximum frequency, of the FFT record when the **HORIZONTAL MAGNIFY** softkey is set to off. Changing the span of the FFT record with a channel source causes the time base setting to change. The span is the sample frequency divided by two. Because the sample frequency for memories is fixed, once a record is stored, the span is also fixed and cannot be changed.

The keypad does not have keys for entering MHz or kHz. But, the keypad does have a key for enter exponents, Eex. For example, to set the span frequency to 125 kHz, press the following keys: 1, 2, 5, Eex, 3, Enter.

Center Freq Softkey

The **CENTER FREQUENCY** softkey allows centering of the frequency record to the desired frequency when horizontal magnify is set to on.

of Points Softkey

The **# OF POINTS** softkey assigns the number of data points to be used for the FFT computation. The number of points affects the computation speed, frequency resolution, and the noise floor. The frequency resolution of an FFT is F_s/N , where F_s is the sampling frequency and N is the number of points. The maximum signal-to-noise ratio of an FFT is related to both the A/D converter bits of resolution and the number of points.

An FFT performed on a small number of points is computed faster. But, an FFT performed on a large number of points has better frequency resolution and a lower noise floor. The resolution affects how accurately frequencies are measured and how well two frequencies that are close together are resolved.

If the oscilloscope is in the repetitive mode, or the operand is a memory that was stored from the repetitive mode, the number of points defaults to 512 and cannot be changed.

When the operand is a repetitive source, onscreen data is used for the FFT. When the operand is a real-time source, the FFT is performed on data in the selected record length, but not necessarily on the data that is displayed on the screen. The points used from the record are selected based on the time base reference setting of left, center, or right. When the reference is set to left, data at the beginning of the record is used. When center is selected, data in the middle of the record is used. When right is selected, data at the end of the record is used.

The memory bar above the graticule indicates what portion of the acquisition record is used for the FFT time record. The memory bar shows the FFT record whenever a FFT menu is selected. An exception is that the compare mode fail bar replaces the memory bar when compare mode is on.

In the Math/FFT and Math/FFT More menus with functions on and FFT selected, the memory bar references the FFT mode. In all other menus either the channel or the waveform memories control the memory bar.

An FFT with an input record of N points is transformed into a frequency record of N points. Because half of the points are above the Nyquist frequency and provide redundant information, they are not used, so the frequency points are half that of the input. The FFTs are computed on records that are in powers of two.

If the number of FFT points is 512, 256 additional frequency points are created by interpolating between the actual points to give 512 frequency points. The number of FFT points and the resultant frequency points is listed below.

Input points	Frequency points
512 (repetitive)	512
512 (real time)	512
1024	512
2048	1024
4096	2048
8192	4096
16384	8192
32768	16384

Sensitivity Softkey

The **SENSITIVITY** softkey scales the function vertically by using software expansion. It does not affect the hardware settings. The scaling units are in dB per division. For example, if the scale is set to 10 dB/div, and a peak is two divisions high, you know that the amplitude of the frequency peak is 20 dB. This setting is for ease of viewing and making measurements on the function.

Position Softkey

The **POSITION** softkey positions the function vertically on the screen. Position is the offset value at the center of the graticule area. If you adjust the offset so that a peak is at the vertical center of the graticule area, then you know that the peak magnitude is the offset value. For example, if the peak of the spike is at the vertical center of the graticule area, and the position reading is -16.2 dBm, then you know that the peak magnitude is -16.2 dBm.

Window Softkey

The **WINDOW** softkey allows you to select from three windows: rectangular, Hanning, and flattop. The FFT operation assumes that the time record repeats indefinitely. Unless there is an integral number of cycles of the sampled waveform in the record, a discontinuity is created at the end of the record. This is referred to as leakage. In order to minimize spectral leakage, windows that approach zero smoothly at the beginning and end of the signal are employed as filters to the acquired data record.

Windows work by weighting points in the middle of the waveform record higher than those at the ends of the record. For example, a Hanning window looks like the first half of a sine wave. The Hanning window multiplies the points in the center of the record by 1 and multiplies the points at the start and the end of the record by zero.

The rectangular window multiplies all the points in the record by 1. The rectangular window is used for transients signals and signals where there are an integral number of cycles in the time record. The Hanning window is used for frequency resolution and general purpose use. It is good for resolving two frequencies that are close together or for making frequency measurements. The flattop window is the best window for making accurate amplitude measurements of frequency peaks.

More Softkey

The **MORE** softkey returns to the previous Math/FFT softkey menu.

Vertical Scaling Units

The fundamental measuring units of an oscilloscope are volts/division on the vertical axis and time/division on the horizontal axis. This philosophy is used for all the function operations except for FFTs. No provisions were made to manage units for all combinations of operands and operations.

For example, if you applied a +2 V level to channel 1 and a -3 V level to channel 2. The oscilloscope displays the product as -6 V, when in reality it is $-6 V^2$.

Making FFT Measurements

The following information will help you to make optimum measurements in the frequency spectrum.

Connect the Dots

It is easier to view FFTs with connect the dots turned on. You can turn connect the dots on in the Display menu.

Amplitude Measurements

For best vertical accuracy on peak measurements:

- Make sure the source impedance and probe attenuation is set correctly. If the operand is a channel, the impedance and probe attenuation are set in the channel menu.
- Set the source sensitivity so that the input signal is near full screen, but not clipped.
- Use the flattop window.
- Set the FFT sensitivity to a sensitive range, like 2 dB/division, in the single-screen mode or 4 dB/division in the dual-screen mode.



Frequency Measurements

For best frequency accuracy on peaks:

- Turn on magnify.
- Use the Hanning window.
- Set the frequency span so that the signal of interest is in the upper part of the screen (not down at dc).
- Set both the record length and the number of points to 32,768, or as high as possible if computation time is a consideration. (The greater the record length, the longer the computation time.)

The frequency accuracy is the sum of two terms. The first term is supplied because there are a limited number of frequency bins. The measurement is accurate to plus or minus half a bin. The second term is related to the accuracy of the internal oscillator which generates the sample clock.

$$\begin{aligned} \text{accuracy} &= \pm \left(\frac{\text{frequency resolution}}{2} \right) + (\text{signal frequency} \times 0.005\%) \\ &= \pm \left(\frac{\text{sample frequency}}{2 \times \text{number of points}} \right) + (\text{signal frequency} \times 0.005\%) \\ &= \pm \left(\frac{\text{frequency span}}{\text{number of points}} \right) + (\text{signal frequency} \times 0.005\%) \end{aligned}$$

Computation of dBm

The vertical units of the FFT functions are dBm. 0 dBm is defined as a 1 milliwatt signal. The formula for converting a signal of power P into dBm is:

$$dBm = 10 \log \left(\frac{P \text{ in } mW}{1mW} \right)$$

A handier formula, and the one that is used in the instrument is for calculating dBm from the peak voltage.

$$dBm = 20 \log \left(\frac{V_p \text{ in volts}}{0.316228V} \right)$$

The bottom term, 0.316228 Volts, is the peak voltage of a 1 milliwatt signal into a 50 Ω resistor.

$$\begin{aligned} V_P &= \frac{V_{rms}}{0.707107} = \frac{\sqrt{P \times R}}{0.707107} \\ &= \frac{\sqrt{1 \text{ mW} \times 50 \Omega}}{0.707107} \\ &= 0.316228 \text{ Volts} \end{aligned}$$

If you are measuring the power of a signal, then terminate the source into 50 Ω in order to get the correct dBm reading. However, if you are measuring a voltage, the 50- Ω source impedance is not a requirement. The above equation for dBm as a function of peak voltage still applies.



Computation of dBV

Another common unit of amplitude is dBV. A 0 dBV signal is defined as a 1 Volt rms signal. A dBm reading is converted to a dBV reading by subtracting 13.01 dB.

$$\begin{aligned} dBV &= 20\log(0.707107 \times V_p \text{ in volts}) \\ &= 20\log\left(\frac{V_p}{0.316228}\right) + 20\log(0.707107 \times 0.316228) \\ &= dBm \text{ value} - 13.01 \text{ dB} \end{aligned}$$

dc Value

The FFT computation produces a dc value that is incorrect. It does not take the offset at center screen into account and is 1.41421 times greater than its actual value. The dc value is not corrected in order to accurately represent frequency components near dc.

Aliasing

When using FFTs, make sure you avoid signal aliasing. Aliasing occurs when there are insufficient samples on each cycle of the input signal to recognize the signal. It occurs whenever the frequency of the input signal is greater than the Nyquist frequency (sample frequency divided by 2).

When a signal is aliased, it shows up in the FFT spectrum as a signal of a lower frequency. Because the frequency span goes from 0 to the Nyquist frequency, the best way to prevent aliasing is to make sure that the frequency span is greater than the frequencies present in the input signal. Keep in mind that most periodic signals that are not sine waves have frequency components that are much higher than the frequency of the signal.

Presetting FFT Parameters

The FFT vertical parameters, magnify and center frequency are preset whenever the operand or operator is changed.

Displaying Functions

In the single screen mode and with a function tuned on, the mathematical results and the operands are displayed using the full display area.

In the 2-screen mode, functions 1 and 2 are displayed in the top half of the screen, and functions 3 and 4 are displayed in the bottom half. In the 4-screen mode, each function is in its own area starting with function 1 at the top of the waveform viewing area.

FFT Exercise

In this exercise you have the oscilloscope calculate the FFT function on a square wave connected to channel 1. Then, you demonstrate the effect of the three different FFT windows, and you measure the magnitude of several FFT peaks.

- 1 Press the Recall key. Then, press the Clr key.
- 2 Connect a coaxial cable between the rear-panel AC cal connector and channel 1.
- 3 Press the Autoscale key.
- 4 Use the time/div knob to change the time base to 1 ms/div.
- 5 Press the Horizontal Setup key. Select the **REAL-TIME** mode. Then, set the record length to 1024

Figure 10-5

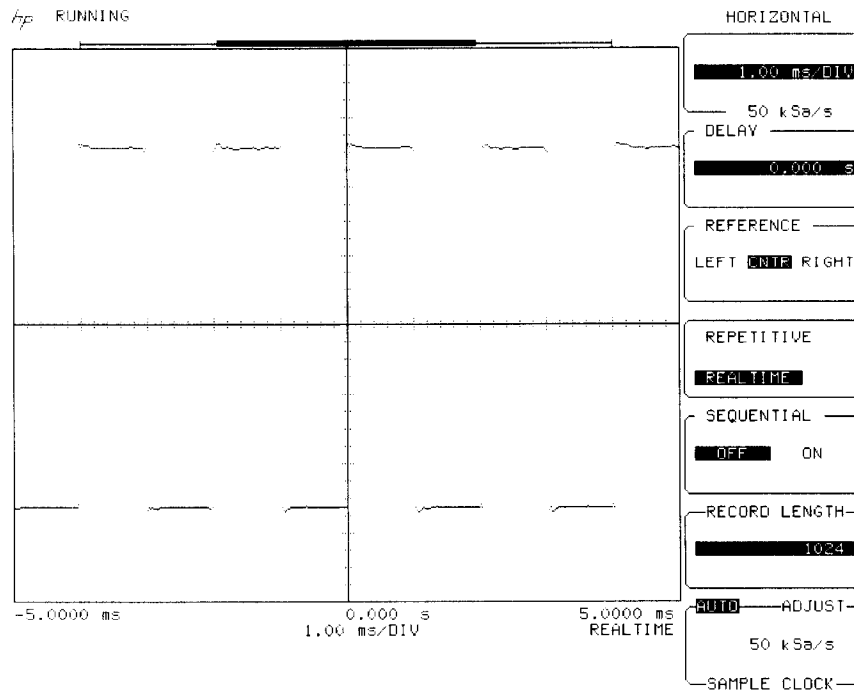

- 6 Press the Display key. Then, select the **FRAME** display mode and turn on connect the dots.
- 7 Press the Fine key. Then, adjust the volts/div knob and the position knob so that the signal almost fills the screen vertically without clipping the signal.

The oscilloscope cannot compute a correct FFT from a clipped signal, and errors from noise can occur if the signal is too small.

Figure 10-6

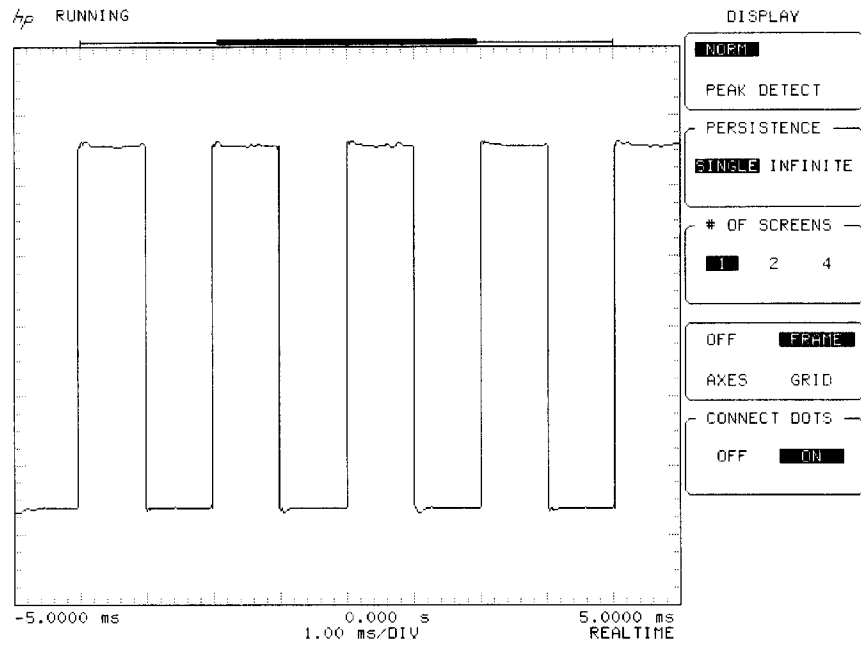

- 8 Press the Vertical 1 key. Then, turn off channel 1.
- 9 Press the Math/FFT key. Then, select function f1, set the display to on, select channel 1, and set the operator to FFT.
- 10 Press the MORE FFT CONTROLS softkey. Set the # OF POINTS to 1024. Then, set the window to RECTANGULAR.
- 11 Press the MORE softkey.

You can use the oscilloscope to make automatic peak measurements in the Math/FFT menu.

- 12 Using the PEAK SEARCH softkey and the entry devices, set marker 1 and marker 2 to the first peak.

When FFT is the selected operator, the time base settings beneath the waveform viewing area change from time values to frequency values, like Hz or kHz. Also, when the PEAK SEARCH softkey is pressed, the marker source is slaved to the FFT function. This feature saves you time because you do not have to access the marker menu to set the markers to the FFT function. Because both markers are on the same peak, they have the same marker reading.

Figure 10-7

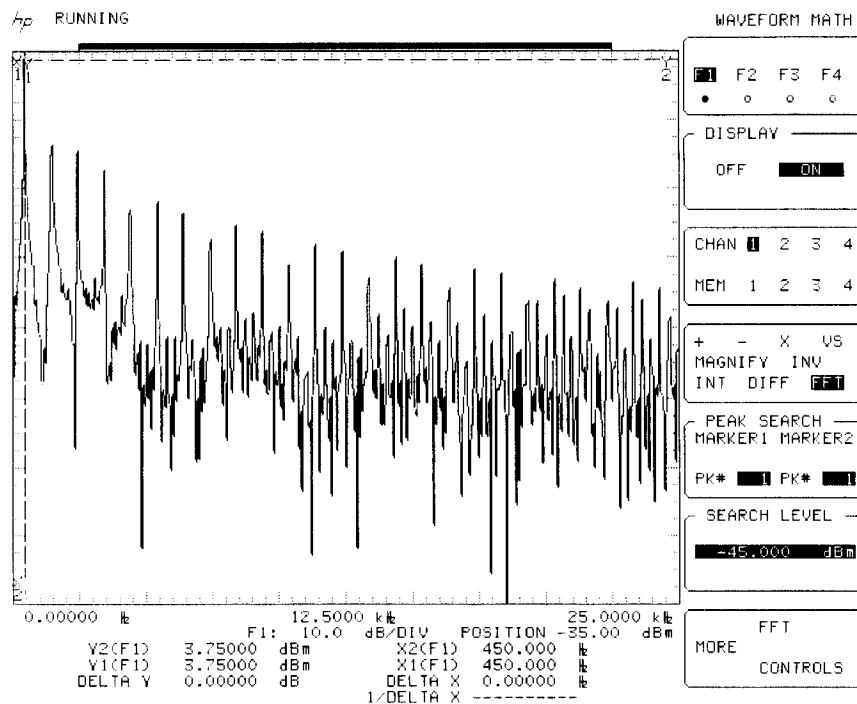

12 Set the search level to -15 dBm.

The search level sets a threshold for peak detection. All peaks below the search level are ignored during peak search. The first peak from the left side of the display that is above the search level is considered by the oscilloscope as peak number one.

13 Select the PEAK SEARCH softkey. Then, use the entry knob to slowly move marker 2 to peak number 6.

You may notice that as you select each peak, marker 2 snaps to the next peak above the search level. Depending on the setup of your oscilloscope and the signal you are using, somewhere around peak number 4 the search level will be above the peak. When the oscilloscope cannot find any additional peaks, the message "marker 2 peak not found" is displayed, and marker 2 snaps to the right edge of the display.

Figure 10-8

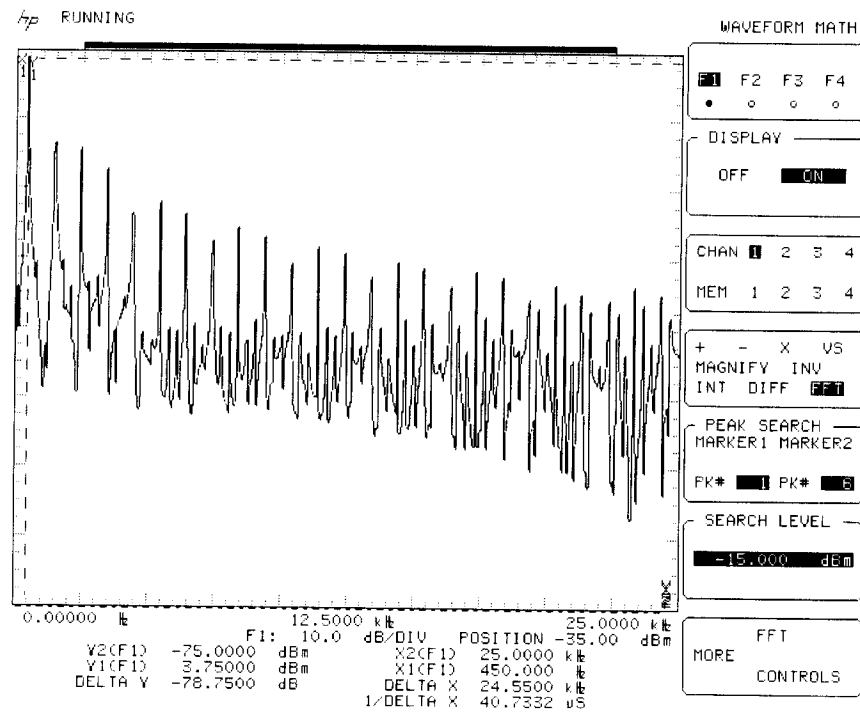

To display both channel 1 and the function.

Select 2 screens in the display menu. Then, set the FFT to function 3 or function 4.

See also

"Displaying Functions" in this chapter for information on where the oscilloscope places channels, functions, and memories on the display.



Utility Menu

Utility Menu

The utility menu accesses the calibration and service functions, as well as sets up the HP-IB interface. The menus include self-test, calibration, service, system, a listing of the current firmware revision date, and access to the product-update registration form.

Also, this menu controls all of the service functions that maintain the reliable performance of the oscilloscope.

The utility menu actually consists of several other menus that you access through the utility menu.

- HP-IB menu
- Self-test menu
- Probe cal menu
- Self-cal menu
- Service menu
- System menu
- Software Revisions

The menu map for each of these menus is included with the topic that covers that menu.

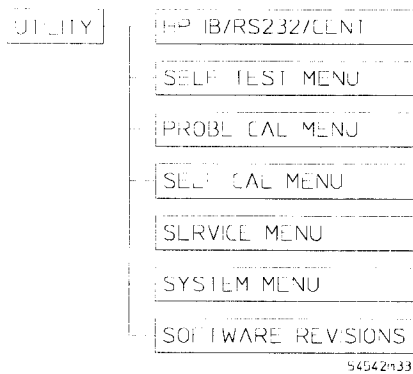

HP-IB/RS-232/CENT Menu

The HP-IB menu makes settings so the oscilloscope can talk to peripheral devices. This interface includes three primary settings: HP-IB talk, HP-IB addressed, RS232 talk, RS-232 addressed, and Centronics.

Figure 11-1

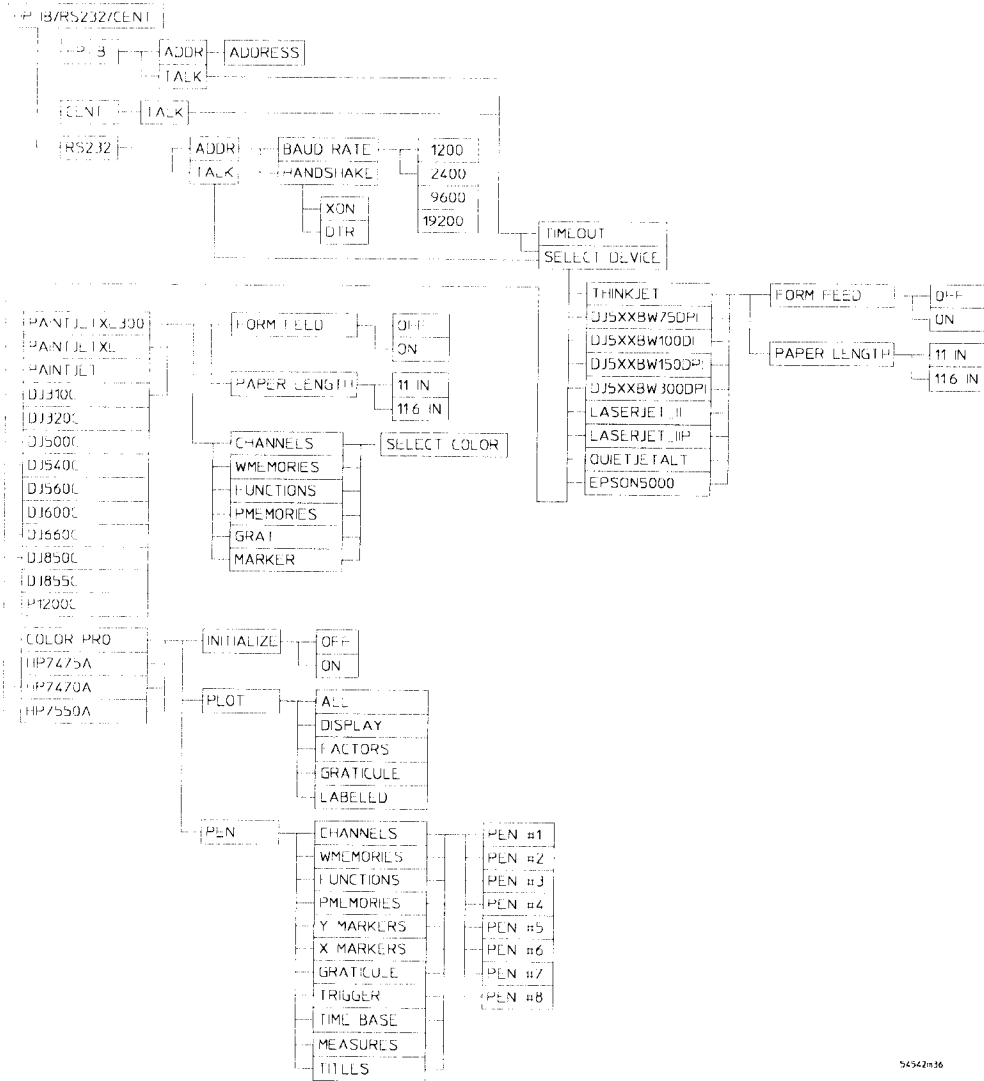

54342n36

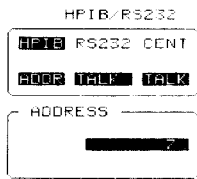

HP-IB

The Hewlett-Packard Interface Bus (HP-IB) is Hewlett-Packard's implementation of IEEE Standard 488-1978, "Standard Digital Interface for Programmable Instrumentation." The HP-IB is a carefully defined interface that simplifies the integration of various instruments and computers into systems.

The HP-IB interface uses an addressing technique to ensure that each device on the bus (interconnected by HP-IB cables) receives only the data that is intended for it. To accomplish this, each device is set to a different address and this address is used to communicate with other devices on the bus. You can use the **HP-IB ADDR** mode to set the address of the scope from 0 to 30.

The **HP-IB TALK** mode sets the oscilloscope to print hardcopies without intervention from an external controller. Make sure the attached printer or plotter is in the listen only or listen always mode. You can set the amount of time that the oscilloscope attempts to talk to the printer or plotter (time out) while the scope is in the talk only mode.



RS-232

The RS-232C interface is Hewlett-Packard's implementation of EIA Recommended Standard RS-232C, "Interface between Data Terminal Equipment and Data Communications Equipment Employing Serial Binary Data Interchange." The RS-232 interface sends data one bit at a time and characters are not synchronized with preceding or subsequent data characters. Each character is sent as a complete entity without relationship to other events.

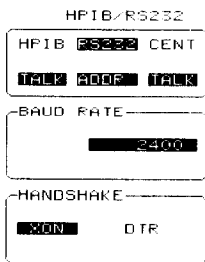

Talk/Addr Mode

The HP-IB and RS232 interfaces can be in talk or address mode. Use the entry knob to toggle between talk and address.

In address mode, the RS232 interface provides a selection mode for baud rate and handshake. The HP-IB address mode provides an address selection. In talk mode, all three interfaces provide various output configurations.

Baud rate The baud rate is the rate at which bits are transferred between the interface and the peripheral device. The baud rate must be set to transmit and receive at the same rate as the peripheral device.



Handshake You can use handshake to select either a hardware or software handshake. Data Terminal Ready (DTR) is a hardware handshake. A three-wire interface using DTR does not allow the sending or receiving device to control data flow. No control over the data flow increases the possibility of missing data or transferring incomplete data. With an extended hardware interface, selecting DTR allows a hardware handshake to occur that uses hardware signals to control data flow.

XON is a software handshake that uses Transmit On (XON) and Transmit Off (XOFF). A software handshake allows the receiving device to control the data flow by requesting that the transmitting device temporarily stop sending data until the receiving device is ready to receive additional data. XOFF stops data transfer while XON resumes data transfer.

RS232 Connector Pin Out

Pin Number	Signal
1	Data Terminal Ready
2	Transmit
3	Receive
4	Request to Send
5	Clear to Send
6	Data Set Ready
7	Ground
8	Data Carrier Detected
9	Ring
Shell	Protective Ground

Figure 11-2

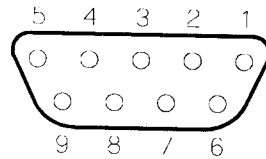

54600B07

Pin out of RS-232 port looking into the connector

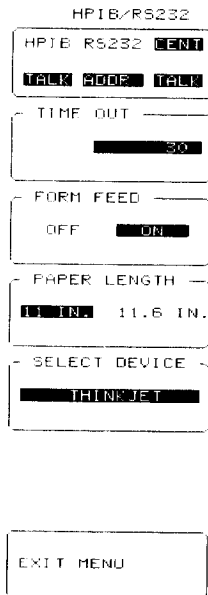

Centronics

The **CENT TALK** selection is for printing to Centronics compatible printers that use the Hewlett-Packard Printer Control Language (HP PCL). When **CENT TALK** is selected, the Print key will output through the Centronics port on the back of the oscilloscope. If no device is connected to the Centronics port, the message NO LISTENERS HARDCOPY ABORTED will eventually appear on the screen.

Time Out Softkey

The **TIME OUT** softkey is available when talk only mode is selected. The **TIME OUT** softkey sets the amount of time that the oscilloscope attempts to talk to an external device. If the oscilloscope does not hear back from the external device within the time frame set by the **TIME OUT** softkey, the scope assumes there is a problem with the external device and stops trying to communicate with the external device. The time out range is from 0 to 3600 seconds.

If you set the time out to 0, the oscilloscope will time out before it even starts the plot. A normal setting for time out is 5 to 10 seconds. However, on some plotters, it may be necessary to increase the time out value in order for the plotter to have enough time to communicate back to the scope.

Address Softkey

The **ADDRESS** softkey is available when the HP-IB address mode is selected. The address softkey sets the address of the oscilloscope, so that the oscilloscope can selectively talk or listen to external devices. The address of the oscilloscope is set while the oscilloscope is in the addressed mode. The address range is from 0 to 30.

Form Feed Softkey

The **FORM FEED** softkey allows you to select on or off. If **FORM FEED** is set to on, the printer performs a form feed at the end of the hardcopy. If **FORM FEED** is off, the page is scrolled up four lines when the hardcopy is complete.

Paper Length Softkey

The **PAPER LENGTH** softkey selects between 11-inch or 11.6-inch page lengths for auto form feed. The 11-inch page is a U.S. standard and the 11.6-inch page is a U.K. and European standard.

Device Mode Softkey

The **DEVICE MODE** softkey selects whether the hardcopy goes to a printer or plotter. Plotters must speak the Hewlett-Packard Graphics Language (HP GL), and printers must speak Hewlett-Packard Printer Control Language (HP PCL). The supported printers and plotters are: ThinkJet, Deskjet at 75, 100, 150, and 300 dpi, LaserJetII, LaserJetII_P, QuietJetAlt, PaintJetXL, Color Pro, HP 7470A, HP 7475A, HP 7550A, DeskJet 310C, DeskJet 320C, DeskJet 500C, DeskJet 540C, DeskJet 560C, DeskJet 600C, DeskJet 660C, DeskJet 850C, DeskJet 855C, DeskJet 1200C, QuietJetAlt, and Epson 5000.

When PaintJet and DeskJet printers are selected, an additional softkey is provided; this softkey provides a choice of colors for channels, wmemories, functions, pmemories, graticule, and markers. When a plotter is selected, three additional softkeys are available: initialize, plot, and pen.

Initialize When off, the plotter is not initialized. Off allows you to setup the plotter so that the hardcopy from the oscilloscope is plotted to a specific area of the paper installed in the plotter. When on, the plotter is initialized. On is like sending the **IN** command over the bus to the plotter.

See also

The manual for your plotter for information on setting up the plotter, and for information on what the **IN** command initializes on the plotter.

Plot The **PLOT** softkey allows you to choose what information the oscilloscope sends to the plotter. There are five plot options: graticule, display, factors, labeled, and all.

- Graticule plots only the graticules without waveforms or setup information.
- Display plots only the waveform data without the graticule or setup information.
- Factors plots only the setup of the oscilloscope without graticules or waveform data.
- Labeled plots the graticules, waveform data, and setup factors. Also, the plotted image is reduced and a label is placed on the right side of the paper for each channel that is turned on. Then, a line is drawn from each label to its corresponding waveform.
- All plots the graticules, waveform data, and factors without labels.

Pen The **PEN** softkey allows you to assign a pen color to nineteen of the display parameters. You can assign any pen number from 1 to 8 to each parameter for assorted plotter pen colors. You can select the following parameters:

channels 1 to 4*	x1 marker	graticule
waveform memories 1 to 4	x2 marker	trigger
pixel memories 1 and 2	y1 marker	time base
functions 1 to 4	y2 marker	measurements
		titles

* Channels 3 and 4 are available on 4-channel models only.

Exit Menu Softkey

The **EXIT MENU** softkey returns you to the utility menu.



Self-Test Menu

The self-test menu is for performing service work on the oscilloscope. Refer to the Service Guide supplied with the oscilloscope for details on the features in this menu.

Probe Cal Menu

The probe cal menu allows you to calibrate the attenuation factor for high-impedance probes, and to compensate for variations in probe lengths. You can select from two probe calibration procedures: attenuation and time null.

Attenuation Menu

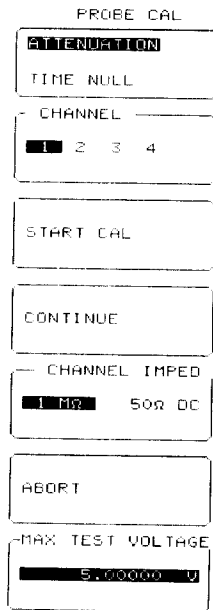

The attenuation menu calibrates the channel gain to the tip of the probe on high impedance probes. The oscilloscope calibrates to correct for channel gain through probe attenuation down to a 0.9 attenuation factor.

Below 0.9 the message "attenuation less than 1, see manual for action" is displayed. The corrective action is to perform a self-calibration on the oscilloscope.

If the probe is not connected to the DC cal output connector on the rear panel, the probe compensation connector on the front panel, or the probe attenuation exceeds 250, the error message "attenuation too high or bad connection" is displayed. The corrective action is to check the connections and redo the probe calibration. If recalibration is unsuccessful, refer to the Service Guide.

If the probe attenuation calibration is successful, the displayed message "probe attenuation = n.nnnnn this value has been entered into your channel probe setting" is displayed.

Probe Attenuation Calibration Error

Impedance Approximate error

100 k Ω 0.5%

1 M Ω 0.05%

10 M Ω 0.005%

Channel Softkey

The **CHANNEL** softkey selects which channel to calibrate.

Start Cal Softkey

The **START CAL** softkey displays the instructions for the probe calibration.

Continue Softkey

The **CONTINUE** softkey actually begins the calibration process.

Channel Impedance Softkey

The **CHANNEL IMPEDANCE** softkey key allows you to select the impedance of the probe connected to the channel input. Use the 50- Ω selection for active probes that have a high input impedance, and use the 1M Ω selection for BNC cables.

Abort Softkey

The **ABORT** softkey is the only active key during the calibration process. The calibration process is terminated and the previous calibration factors are left intact when the abort softkey is pressed.

Max Test Voltage Softkey

CAUTION

The **MAX TEST VOLTAGE** softkey allows you to set a maximum voltage for the calibration signal. The maximum voltage is the dc voltage output of the rear panel DC cal output connector, or front-panel probe compensation connector. To prevent damage to the probe connected to the channel input, select a maximum voltage for the probe you are using. Normally, a maximum voltage of 5 volts is acceptable for most probes. However, some probes, like the HP 1141A, require a lower maximum voltage.

Time Null Menu

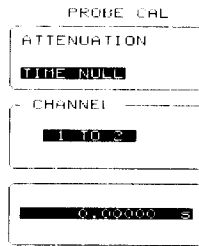

The time null menu sets the timing of all channels to correspond to channel 1 at the probe tip. This eliminates time discrepancies between channels caused by variations in cable lengths. Also, you can use time null to manually adjust for any differences in cable length by horizontally overlaying displayed waveforms that are time-skewed.

Channel Softkey

The **CHANNEL** softkey selects which channel to skew as referenced to channel 1.

Time Softkey

This is an unlabelled softkey. The **TIME** softkey shows the time null setting between the selected channels. You can use the entry knob or keypad to change the time null setting. The range of time null is ± 70 ns.



Exit Menu Softkey

The **EXIT MENU** softkey returns you to the utility menu.

Self-Cal Menu

The self-cal menu is typically used for performing service work on the oscilloscope. Refer to the Service Guide supplied with the oscilloscope for details on the features in this menu.

Service Menu

The service menu is for performing service work on the oscilloscope. Refer to the Service Guide supplied with the oscilloscope for details on the features in this menu.

System Menu

The System menu is used to set the real-time clock, rear panel AC BNC output, clicker, disable interpolation, and print registration forms.

Figure 11-6

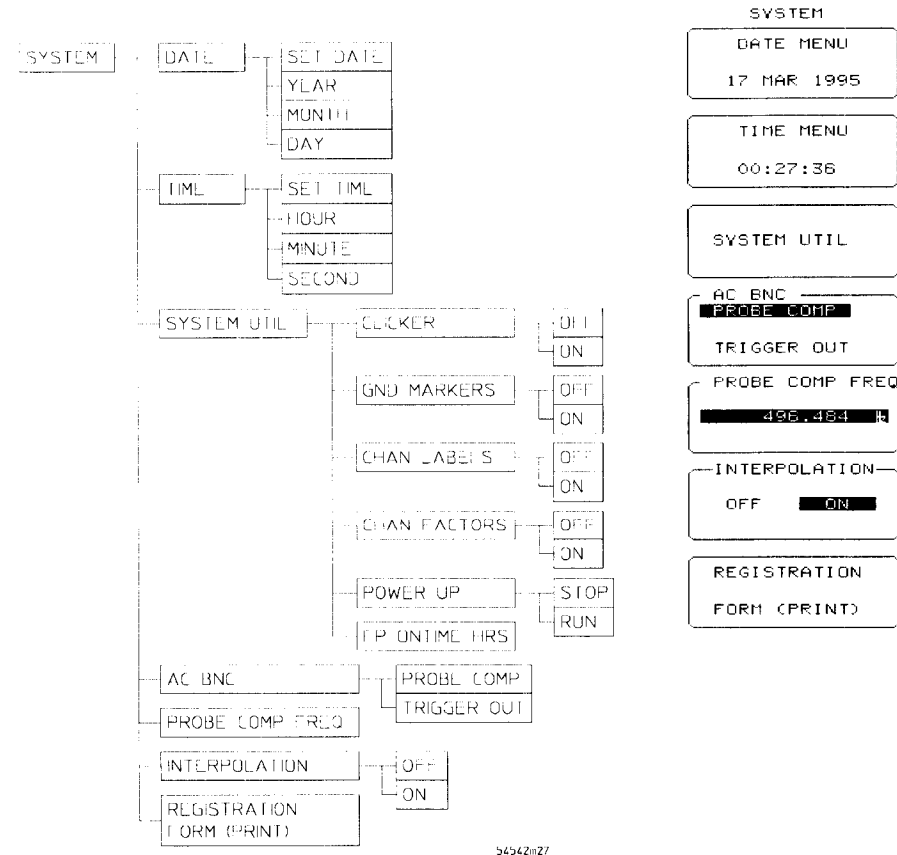

Date Softkey

The **DATE MENU** softkey allows you to change the date. The date is used to time- and date-stamp hardcopy files and files stored to the disk. Also, the date-time stamp is used on files stored to multiple memory on failures in the measure limit and waveform compare tests. When you press the **DATE MENU** softkey, additional softkeys are displayed that allow you to set the year, month, and day.

Time Softkey

The **TIME MENU** softkey allows you to change the time. The time is used to time- and date-stamp hardcopy files and files stored to the disk. Also, the date-time stamp is used on files stored to multiple memory on failures in the measure limit and waveform compare tests. When you press the **TIME MENU** softkey, additional softkeys are brought up on the display that allow you to set the hour, minute, and second.

System Util Softkey

The **SYSTEM UTIL** softkey brings up another menu that has six additional softkeys.

Clicker Softkey The **CLICKER** softkey turns on and off the clicker. When the clicker is turned on, an audible click is heard each time a key is pressed.

Ground Markers Softkey The **GND MARKERS** softkey turns on and off the ground markers that are displayed on the screen. When turned on, there is a ground marker on the left side of the display for each channel that is turned on. The ground markers give you a visual indication of where the ground reference point is for each channel that is turned on. If the ground reference for a channel is positioned vertically off the screen, the ground marker turns into an arrow that points in the direction of the ground reference. Ground markers are printed with hardcopy prints.

Channel Labels Softkey The **CHAN LABELS** softkey turns on and off the channel labels that are displayed on the screen. When turned on, there is a channel label on the right side of the display for each channel that is turned on.

Channel Factors Softkey The **CHAN FACTORS** softkey turns on and off the display of the channel factors. When on, the volts/div and offset for each channel that is turned on is displayed on the screen. If measurements and markers are both turned off, the channel factors are displayed below the graticule area. If either measurements or markers are turned on, the channel factors are displayed near the bottom of the graticule area. With the **CHAN FACTORS** softkey turned on or off, you can also press the Show front-panel key to see the complete setup of any channels that are turned on.

Power Up Softkey The Power Up key allows the oscilloscope to be powered on with the oscilloscope in a stopped state and the compare/limiters tests turned off. This protects any data in memories WMem1-4. The selections are run and stop. The default is run.

Front Panel Ontime Softkey The **FP ONTIME HRS** key allows you to set the number of hours that the front panel display will be on with no activity before the timeout takes effect. The timeout turns the display off, which increases the life of the backlight. The choices are 1 to 12 hours or infinite (timeout inactivated). When the display is off due to reaching the specified number of hours with no activity, three events will turn it back on and restart the timeout period: a trigger, a front panel key depression, or an HP-IB command. The default is six hours.

AC BNC Softkey

The **AC BNC** softkey selects between a probe compensation signal and the system trigger. When probe comp is selected, the probe comp signal is an output at the rear-panel BNC connector and at the front-panel probe compensation terminals. When trigger out is selected, the trigger signal is an output at the rear-panel BNC connector and at the front-panel probe compensation terminals. The default signal is the probe compensation signal which is a square wave of about 500 Hz.

Both the probe comp signal and the trigger out signal are about 0 V to -800 mV into a high impedance, and about 0 V to -400 mV into 50 Ω . You can vary the frequency of the probe comp signal from 250 mHz to about 32 kHz. The signal at the rear-panel AC BNC connector has a rise time of about 400 ps, while the signal at the front-panel probe compensation connector has a rise time of about 1 μ s.

Interpolation Softkey

When in the real-time sampling mode with the sample clock set to auto and on time ranges faster than 20 ns/div, data is normally routed through an interpolation filter that calculates and adds additional data points. These additional data points fill in the time buckets between the acquired data points. You can set the **INTERPOLATION** softkey to off to bypass the interpolation filter and to view the actual nonfiltered (raw) data points for all active channels (running or stopped). Active memories with real-time data displayed at faster than 20 ns are also displayed as dots. Turning interpolation to off also turns off any active measurements, and any attempt to perform measurements is not allowed. Either select on or exit the system menu to turn on the filter again.

You can also use the sequential capture mode in the time base menu to view the raw data points. You can measure, store, and transfer over the bus the raw data points acquired in the sequential capture mode.

Registration form (Print) Softkey

The **REGISTRATION FORM (PRINT)** softkey allows you to print out a registration form to an externally connected printer.

You can complete the form and fax or mail it to Hewlett-Packard to ensure that Hewlett-Packard can contact you when either software updates or new product information becomes available. Anyone responsible for the maintenance of the oscilloscope and anyone who is using the oscilloscope can register. You can fill out the form even if you are not the original purchaser. You can also use this form to notify Hewlett-Packard of an address change.

You can print out a copy of the registration by simply connecting a printer to the oscilloscope, then pressing the registration form softkey. If a printer is not available, make a copy of the form that is at the end of this chapter.



Software Revisions

The **SOFTWARE REVISIONS** softkey lists the installed date code and revision number of the Boot ROM firmware, Boot ROM software, System software, and Keyboard firmware.



Disk Menu

Disk Menu

The oscilloscope has a high-density, 3-1/2 inch, 1.44 MByte, MS-DOS[®] compatible disk drive. You can perform several operations with the disk menu.

- Save waveforms and front-panel setups to a disk
- Recall waveforms and front-panel setups from a disk
- Save screen images to a disk in TIFF, PCX or EPS formats
- Delete files from a disk
- Format a disk
- Make directories and subdirectories on a disk
- Load new system firmware

To load new system firmware

- 1** Place the disk containing the system firmware into the disk drive.
- 2** Press and hold any front-panel key while cycling the power.
This is referred to as performing a one-key-down powerup.
- 3** Press the blue shift key on the keypad to install new system firmware.
Otherwise, press any other front-panel key to continue with a normal power up.

If a disk is not in the disk drive or if the wrong disk is in the disk drive, the screen prompts you that it cannot find the system files. Simply install the system firmware disk, then press the shift key again to continue. If you do not want to continue loading new system firmware, simply cycle the scope's power again.

To access the disk menu.

- Press the blue shift key on the keypad, then press the **WFORM SAVE** key.

The disk menu is a shifted function above the Wform (waveform) save key.

When you access the disk menu, you can choose from six disk operations: load scope, store scope, store image, delete, format, and directory. If there is a disk in the drive, you will also see the present working directory (PWD: \) plus a listing displayed on the screen of all the files and subdirectories in that directory. The directory listing includes the file name, date, time, and size of each file on the disk, as well as immediate subdirectories. If there is no disk in the drive, only the disk menu is displayed.

If the type of file is not recognized by the oscilloscope, the type field is not highlighted. Also, the oscilloscope lists only those files that are in the present working directory of the disk. All other directories on the disk are listed like files, except that a file extension is not appended to the filename and the file size is listed as 0 bytes. Any files that are not in the root directory are not included in the directory listing. You can view any additional files by changing to the directory that contains those files.



Load Scope

The load scope menu allows you to bring waveform, setup, or pixel files from a disk into the oscilloscope. You can only load files from the present working directory. To change to another directory, press the **directory** softkey. You can use the entry knob to scroll through the directory listing of the disk, or you can press the **from file** softkey to enter a file name. Pressing the **from file** softkey displays another menu that allows you to enter a file name. The **to** softkey allows you to pick where the data from the file is placed in the oscilloscope.

Figure 12-1

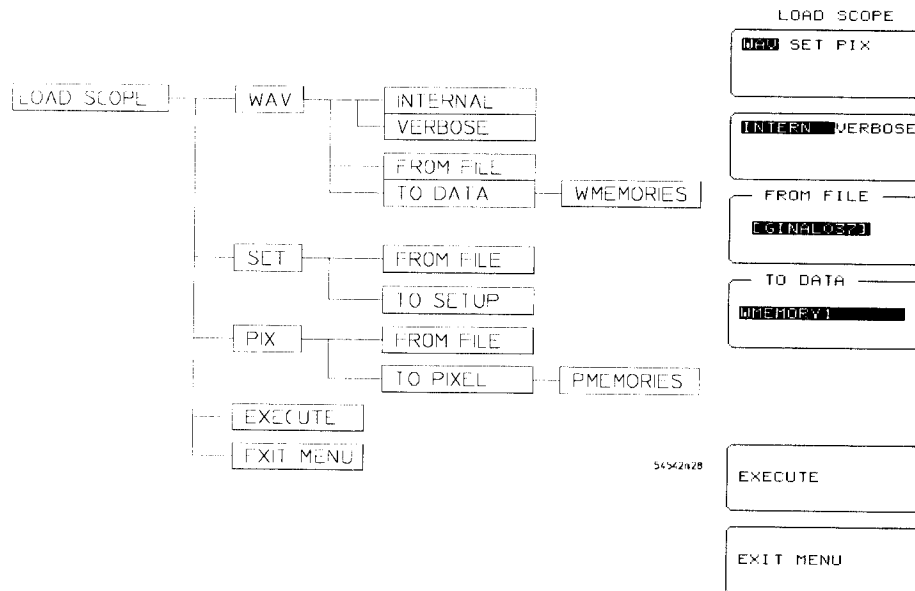

Type Softkey

The top softkey determines the type of file to load from the disk. The oscilloscope uses the file extension to determine the file type.

- .WAV for internal waveforms
- .TXT for text waveforms
- .PIX for pixel memories
- .SET for front-panel setups

Waveform The waveform file type is for loading waveforms from a disk into one of the four nonvolatile memories. The two waveform formats are internal and text verbose. The file extensions are .WAV for internal waveforms and .TXT for text waveforms.

When waveform is selected, the file format softkey is available that allows you to select internal or verbose formats. Waveform and text files are loaded into a waveform memory by overwriting any data previously stored in that memory, as long as the memory is not protected.

Setup A setup file is a copy of the front-panel setups, and it has a .SET file extension. Saving setups to a disk allows you to save more front-panel setups than the nine available in the oscilloscope. You can load the setup file as the current front-panel setup or as one of the nine front-panel setup memories. If you load the setup into a setup memory, the previous data is overwritten. Then, you must recall that setup to have it be the active configuration.

Pixel A pixel memory file has a .PIX file extension, and it is a copy of the pixel memory. It is a bitmapped file, so it does not contain any vertical or horizontal scaling information. You can use pixel files to store infinite persistence data on the screen, or to make timing diagrams for signal analysis. When you load a pixel file into the oscilloscope, it is loaded into one of the two selectable pixel memories by overwriting any data that was previously stored in that pixel memory.



File Format Softkey

The second softkey from the top is the **FILE FORMAT** softkey. The file format softkey is displayed only when waveform is selected as the file type. The two file formats are internal and text verbose.

Internal The internal format is a binary file format, which if you try to read it in a word processing program, you will see meaningless information. However, this is the preferred waveform-storage method because the files take up one-third as much disk space as text files. You can always convert them to text files at a later date. Internal format files have a .WAV file extension. The internal format is also compatible with the HP-IB preamble and data query commands.

Waveform files stored using the internal format contain the vertical and horizontal scaling parameters of the original waveform. Therefore, you can go into the waveform save menu and turn on the display for the waveform memory that the file was loaded into. Then, you can perform measurements on the waveform, compare it to other waveforms, rescale it horizontally, or use it as an operand in a math function.

Text Verbose The text verbose format is an ASCII file format that uses alphanumeric characters to represent the waveform. You can load text files into a word processing program.

Text verbose waveforms have the file extension .TXT. You may notice that text files use about three times more disk space than files stored to a disk using the internal format. Figure 12-3 through Figure 12-7 show examples of the text verbose format.

Waveforms loaded from disk

When waveforms are loaded from disk in internal or verbose mode, they are always referenced to the left of the screen in memory.

When a text waveform is read back into the oscilloscope, the header information can be in any order. Because the oscilloscope converts all characters to uppercase, the header information can be a mix of uppercase and lowercase characters. Also, there must be at least one space between a header and its corresponding data. For example, there must be at least one space between "Type" and "raw."

If you have modified the header information and a header field is omitted, the oscilloscope sets that field to the default value. The default values with a description of the header fields are listed in the **File Formats** section. If the header information is incorrect, you will get one of the following error messages.

"Waveform data is not valid" An error was detected in the waveform data. This error occurs if one of the data points is not a valid floating point number.

"Header information is not valid" An error was detected in the header information. This error occurs if one of the header fields or the header data is incorrect.

If the results are not what you expected after reading an ASCII waveform back into the oscilloscope, then the oscilloscope is interpreting your data differently than you expected. Try restoring the ASCII waveform from the waveform memory back to the disk. By comparing the restored data to what you had entered into the oscilloscope, you may find the error.

From File Softkey

The **FROM FILE** softkey selects a file for a disk operation. You may notice that the file name in the **FROM FILE** softkey matches the highlighted file name in the directory listing. You can use the entry knob to scroll through the list of files, or you can press the **FROM FILE** softkey to enter a file name. You can also use the **DIRECTORY** softkey to change to another directory.

Pressing the **FROM FILE** softkey displays another menu that allows you to spell out the name of the file you want. The entry knob positions the cursor over a letter or number in the character list. Press the top softkey to enter that character into the file name field. The **BACKSPACE** softkey backspaces over characters in the file name. The **DELETE** softkey deletes characters from the file name.

Disk Menu
Load Scope

You do not add a file extension because the oscilloscope automatically assigns a file extension depending the type of file you selected.

- .WAV for internal waveforms
- .TXT for text waveforms
- .PIX for pixel memories
- .SET for front-panel setups

To Softkey

The **TO** softkey selects where the data from the file on the disk is placed. Waveforms are placed into one of the four waveform memories. Setups are loaded as the current setup or one of the nine setup memories. Pixel files are loaded into one of the two pixel memories.

Store Scope

The store scope menu allows you to store waveforms, pixel memories, or front-panel setups to a disk. Files are stored to the present working directory. Storing data to a disk allows you to transport the data to another oscilloscope, computer, or to keep a backup copy of your data. The oscilloscope contains four waveform memories, nine setup memories, and two pixel memories for your data. By using the disk drive, you can store additional data to a disk. You are limited only by the amount of data each disk can hold and the number of disks you are using.

Figure 12-2

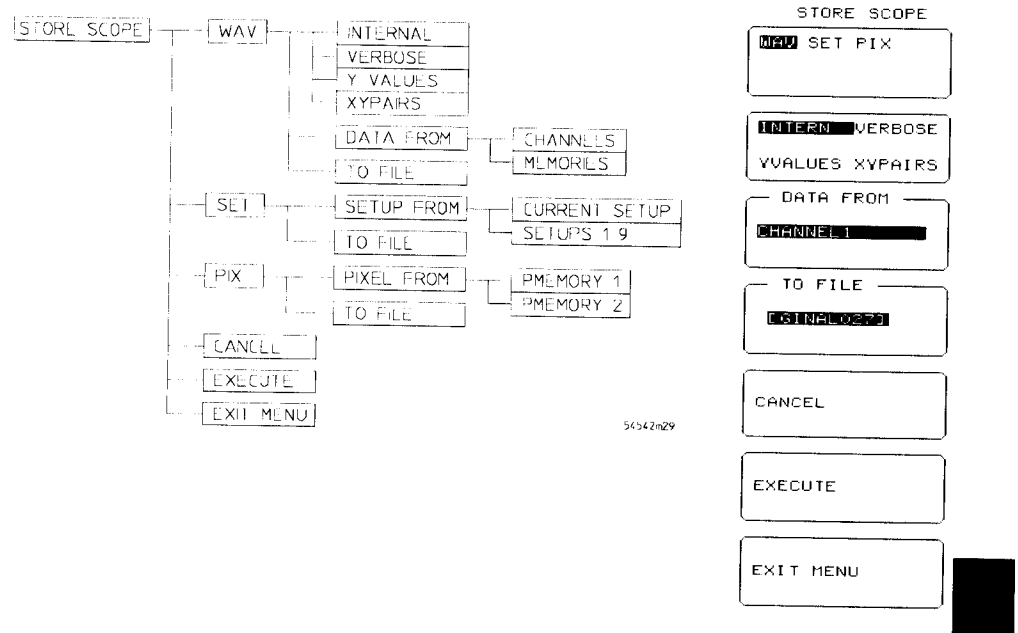

Type Softkey

The top softkey determines the type of file to store to the disk. The oscilloscope automatically appends the correct file extension to the file depending on the type of file you select. The four file types are waveform, setup, pixel, and mask.

- .WAV for internal waveforms
- .TXT for text waveforms
- .PIX for pixel memories
- .SET for front-panel setups

Waveform Waveform is for storing waveforms to the disk. Waveform saves a copy of a waveform from any of the channels or any of the four waveform memories. When waveform is selected, the file format softkey is available that allows you to select among the four formats: internal, verbose, Y values, and XY pairs.

The verbose, Y value, and XY pairs formats make it easy to transfer files to personal computer applications. The internal format maximizes the use of disk space, and allows for a higher waveform transfer rate to and from the disk.

See also

"File Format Softkey" in this chapter for information on the three file types.

Setup Setup saves a copy of the current front-panel setup or a copy of any of the nine setup memories. Setup files have a .SET file extension.

Pixel A pixel memory file has a .PIX file extension, and it is a copy of the pixel memory. It is a bitmapped file, so it does not contain any vertical or horizontal scaling information. You can use pixel files to store infinite persistence data on the screen, or to make timing diagrams for signal analysis.

From Softkey

The **FROM** softkey selects the data source for the file being stored to the disk. Waveforms are stored from any channel or waveform memory. Setups are stored from the current front-panel setup or any of the nine setup memories. Pixel data is stored from either of the two pixel memories.

To File Softkey

The **TO FILE** softkey selects a file name for a disk operation. You may notice that the file name in the **TO FILE** softkey matches the highlighted file name in the directory listing. You can use the entry knob to scroll through the list of file, or you can press the **TO FILE** softkey to enter a file name.

You can also use the **DIRECTORY** softkey to change to another directory.

Pressing the **TO FILE** softkey displays another menu that allows you to spell out the name of the file you want. The entry knob positions the cursor over a letter or number in the character list. Press the top softkey to enter that character into the filename field. The filename can contain up to eight characters. The **BACKSPACE** softkey backspaces over characters in the file name, while the **DELETE** softkey deletes characters from the file name.

You do not need to add a file extension because the oscilloscope automatically assigns a file extension depending the type of file you selected.

- .WAV for internal waveforms
- .TXT for text waveforms.
- .PIX for pixel memories
- .SET for front-panel setups

Cancel Softkey The **CANCEL** softkey is activated if you try to store to an existing file. The message FILE EXISTS: OVERWRITE? Y = EXECUTE N = CANCEL appears on the screen. To cancel the store operation, press the **CANCEL** softkey. To overwrite, press the **EXECUTE** softkey.

Execute Softkey

When you press the **EXECUTE** softkey, the data from the selected source is stored to the selected destination file. If the file already exists on the disk, a warning appears on the screen. To cancel, press the **CANCEL** softkey. To overwrite, press the **EXECUTE** softkey.

If the disk is full when the store function is executed, the message "The disk is full" is displayed on the status line, which is near the upper-left corner of the display.

File Formats

The following is a description of the verbose header format.

Type Type describes how the waveform was acquired: normal, raw, interpolate, average, or versus. When this field is read back into the oscilloscopes, all the modes, except versus, are converted to raw. The default value is normal.

Points Points indicates the number of data points contained in the waveform record. The number of points is set by the Record length softkey in the Acquisition menu. The default value is 500.

The number of points stored when the oscilloscope is in the envelope display mode is twice the number of points shown in the verbose header. In this mode, two waveforms are stored: the minimum value points waveform and the maximum value points waveform.

Count Count represents the minimum number of hits at each time bucket in the waveform record when the waveform was created using an ensemble acquisition mode, like averaging. For example, when averaging, a count of four would mean every waveform data point in the waveform record has been averaged at least four times. Count is ignored when it is read back into the oscilloscope. The default value is 0.

XInc X increment is the time duration between data points on the X-axis. X increment is equal to the YData range value for versus waveforms. The default value is 2 E^{-6} .

XOrg X origin is the x-value of the first data point in the data record. X origin is equal to the YData center value for versus waveforms. The default value is -1.3107 E^{-6} .

XRef X reference is always set to zero when it is read back into the oscilloscope. The default value is 3.125 E^{-2} .

YData range Y data range is the full voltage range covered by the A/D converter. If this field is omitted, it is calculated when read back into the oscilloscope. The default value is 0.

YData center YData center is voltage level at the center of the YData range. If this field is omitted, it is calculated when read back into the oscilloscope. The default value is 0.

Coupling Coupling is ignored when it is read back into the oscilloscope. The default value is dc 50 Ω .

XRange XRange is the time duration across 10 horizontal divisions of the display. The default value is 100 E⁻⁶.

XOffset XOffset is the time at the left edge of the display. The default value is 0.

YRange YRange is the voltage across eight vertical divisions of the display. The default value is 4.0 E⁻⁰.

YOffset YOffset is the voltage at the center of the display. The default value is 0.

Date Date is the date when the waveform was acquired. The default value is 10 AUG 1992.

Time Time is the time when the waveform was acquired. The default value is 01:00:00.

Frame Frame is the model and serial number of the oscilloscope that acquired the waveform. The default value is 54542A:00000A00000.

Acq mode Acquisition mode is the sampling mode used to acquire the waveform, either real time or equivalent time. The default value is real time.

Completion Completion represents the percent of the time buckets in the waveform record that contain data. The number of time buckets is equal to the number of points in the waveform record. Completion is ignored when it is read back into the oscilloscope. The default value is 100.

X Units X units is the horizontal scaling units set in the channel menu: unknown, volt, second, constant, or ampere. The default value is unknown.

Y Units Y units is the vertical scaling units set in the channel menu: unknown, Volt, second, constant, or Ampere. The default value is unknown.

Max bandwidth Maximum bandwidth is an estimation of the maximum bandwidth limit of the source signal. The default value is 500 MHz.

Min bandwidth Minimum bandwidth is an estimation of the minimum bandwidth limit of the source signal. The default value is 0.

Data The data is in exponential format with a value of 9.9999E+37 representing a data record which has no valid data.

The following figures show all of the different file formats that can be stored on disk for text waveforms.

Figure 12-3

```
Type: Normal
Points: 500
Count: 1
XInc: 9.99999971718E-10
XOrg: 0.000000000000E+00
XRef: 0
YData range: 1.60000E-01
YData center: 0.000000E+00
Coupling: DC
XRange: 5.00000E-07
XOffset: -2.500000000000E-07
YRange: 1.60000E-01
YOffset: 0.00000E+00
Date: 1 NOV 1995
Time: 1:06:21
Frame: 54542A:3207A00101
Acq mode: equivalent time
Completion: 100
X Units: second
Y Units: Volt
Max bandwidth: 500000000
Min bandwidth: 0
Data:
-3.14173E-02
-3.14173E-02
.
.
.
4.04331E-02
4.02756E-02
```

Equivalent time acquisition mode type normal verbose format for a text waveform



Figure 12-4

Type:	Average
Points:	500
Count:	1
XInc:	9.9999971718E-10
XOrg:	0.000000000000E+00
XRef:	0
YData range:	1.60000E-01
YData center:	0.000000E+00
Coupling:	DC
XRange:	5.00000E-07
XOffset:	-2.500000000000E-07
YRange:	1.60000E-01
YOffset:	0.00000E+00
Date:	1 NOV 1995
Time:	1:06:21
Frame:	54542A:3207A00101
Acq mode:	equivalent time
Completion:	100
X Units:	second
Y Units:	Volt
Max bandwidth:	500000000
Min bandwidth:	0
Data:	
	-3.14173E-02
	-3.14173E-02
	.
	.
	.
	4.04331E-02
	4.02756E-02

Equivalent time acquisition mode type average verbose format for a text waveform

Figure 12-5

Type:	Envelope	
Points:	500	
Count:	1	
XInc:	9.99999971718E-10	
XOrg:	0.0000000000000E+00	
XRef:	0	
YData range:	1.60000E-01	
YData center:	0.000000E+00	
Coupling:	DC	
XRange:	5.00000E-07	
XOffset:	-2.5000000000000E-07	
YRange:	1.60000E-01	
YOffset:	0.00000E+00	
Date:	1 NOV 1995	
Time:	1:06:21	
Frame:	54542A:3207A00101	
Acq mode:	equivalent time	
Completion:	100	
X Units:	second	
Y Units:	Volt	
Max bandwidth:	500000000	
Min bandwidth:	0	
Data:		
-3.14173E-02		Start of lower waveform
-3.14173E-02		
.		
.		
4.04331E-02		
4.02756E-02		
-3.14753E-02		Start of upper waveform
-3.14753E-02		
.		
.		
4.0E-02		
4.02756E-02		

Equivalent time acquisition mode type envelope verbose format for a text waveform

Figure 12-6

```
Type: Normal
Points: 512
Count: 1
XInc: 9.9999971718E-10
XOrg: 0.000000000000E+00
XRef: 0
YData range: 1.60000E-01
YData center: 0.00000E+00
Coupling: DC
XRange: 5.00000E-07
XOffset: -2.500000000000E-07
YRange: 1.60000E-01
YOffset: 0.00000E+00
Date: 1 NOV 1995
Time: 1:06:21
Frame: 54542A:3207A00101
Acq mode: real time
Completion: 100
X Units: second
Y Units: Volt
Max bandwidth: 500000000
Min bandwidth: 0
Data:
-3.14173E-02
-3.14173E-02
.
.
.
4.04331E-02
4.02756E-02
```

Real time acquisition mode (greater than 500 points) type normal verbose format for a text waveform

Figure 12-7

```

Type: Sequential Normal
Acquisitions: 10 of 10 stored to disk
Points: 512
Count: 1
XInc: 9.99999971718E-10
XOrg: 0.0000000000000E+00
XRef: 0
YData range: 1.60000E-01
YData center: 0.00000E+00
Coupling: DC
XRange: 5.00000E-07
XOffset: -2.5000000000000E-07
YRange: 1.60000E-01
YOffset: 0.00000E+00
Date: 1 NOV 1995
Time: 1:06:21
Frame: 54542A:3207A00101
Acq mode: real time
Completion: 100
X Units: second
Y Units: Volt
Max bandwidth: 500000000
Min bandwidth: 0
Data:
Timetag: #1, 0.0000000000000E+00
-3.14173E-02
.
.
.
4.04331E-02
.
.
.
Timetag: #10, 1.11721189047721E-03
-3.14173E-02
.
.
.
4.04331E-02

```

Timetag 2 through 9

Real time acquisition mode type sequential normal verbose format for a text waveform

This file format cannot be loaded into the oscilloscope waveform memories.

Figure 12-8

Type:	Sequential Average
Acquisitions:	10 averaged
Points:	500
Count:	1
XInc:	9.9999971718E-10
XOrg:	0.000000000000E+00
XRef:	0
YData range:	1.60000E-01
YData center:	0.00000E+00
Coupling:	DC
XRange:	5.00000E-07
XOffset:	-2.500000000000E-07
YRange:	1.60000E-01
YOffset:	0.00000E+00
Date:	1 NOV 1995
Time:	1:06:21
Frame:	54542A:3207A00101
Acq mode:	real time
Completion:	100
X Units:	second
Y Units:	Volt
Max bandwidth:	500000000
Min bandwidth:	0
Data:	
	-3.14173E-02
	-3.14173E-02
	.
	.
	.
	4.04331E-02
	4.02756E-02

Real time acquisition mode type sequential average verbose format for a text waveform

Figure 12-9

Type:	Sequential Envelope	
Acquisitions:	10 enveloped	
Points:	500	
Count:	1	
XInc:	9.99999971718E-10	
XOrg:	0.0000000000000E+00	
XRef:	0	
YData range:	1.60000E-01	
YData center:	0.000000E+00	
Coupling:	DC	
XRange:	5.00000E-07	
XOffset:	-2.5000000000000E-07	
YRange:	1.60000E-01	
YOffset:	0.00000E+00	
Date:	1 NOV 1995	
Time:	1:06:21	
Frame:	54542A:3207A00101	
Acq mode:	real time	
Completion:	100	
X Units:	second	
Y Units:	Volt	
Max bandwidth:	500000000	
Min bandwidth:	0	
Data:		Start of lower waveform
-3.14173E-02		
-3.14173E-02		
.		
.		
4.04331E-02		
4.02756E-02		Start of upper waveform
-3.14753E-02		
-3.14753E-02		
.		
.		
4.0E-02		
4.02756E-02		

Real time acquisition mode type sequential envelope verbose format for a text waveform

Text Y values Text Y value files are identical to the text verbose files, except the header information is deleted from the front of the file. Figure 12-10 shows an example of the text Y value format for all modes except for the sequential normal type which is shown in figure 12-11. Text Y value files also have a .TXT file extension.

Text Y value files are intended for importing into other applications. They do not contain any header information. If they are loaded into the oscilloscope, the current horizontal setup of the oscilloscope is used but the vertical setup is adjusted to fit the waveform on screen.

Figure 12-10

```
5.657E-001
6.433E-001
5.974E-001
1.864E-001
8.05E-002
-3.147E-001
-3.057E-001
-4.77E-002
5.280E-001
6.296E-001
6.296E-001
2.297E-001
1.259E-001
-3.147E-001
-3.147E-001
-9.40E-002
```

Text Y value format

If the file is of type envelope which contains two waveforms then the loaded waveform will be the top waveform appended by the bottom waveform. The reason for this is there is no way to tell from the file that it is an envelope type without the header information.

Figure 12-11

```
Timetag:      #1, 0.0000000000000E+00  
6.433E-001  
.  
.  
5.974E-001  
.  
.  
Timetag:      #10, 9.59958496525758E-03  
5.280E-001  
.  
.  
6.296E-001
```

Timetag 2 through 9

Text Yvalues for sequential normal type format

This file format cannot be loaded into the oscilloscope waveform memories.



XY pairs XY pairs files are identical to the text Y value files, except they also contain the relative time of the measurement. Like text Y value files, header information is deleted from the front of the file. XY pairs files also have a .TXT file extension.

Figure 12-12 through figure 12-18 show examples of the different XY pairs formats. The first column is the time, the second column is the voltage. Negative time indicates events before the trigger.

XY pairs files are intended for importing into other applications and cannot be loaded into the oscilloscope.

Figure 12-12

```
XYPairs: Normal
Acquisitions: 1
Points: 500
-2.5763e-03,-1.04E+00
-2.5663e-03,-1.04E+00
.
.
.
+2.3737e-03,-2.47E-02
+2.3837e-03,-2.47E-02
```

Equivalent time acquisition mode type normal format for XYpairs text waveform

Figure 12-13

```
XYPairs: Average
Acquisitions: 1
Points: 500
-2.5763e-03,-1.04E+00
-2.5663e-03,-1.04E+00
.
.
.
+2.3737e-03,-2.47E-02
+2.3837e-03,-2.47E-02
```

Equivalent time acquisition mode type average format for XYpairs text waveform

Figure 12-14

```
XYPairs: Envelope
Acquisitions: 1
Points: 500
-2.5763e-03,-1.04E+00
-2.5663e-03,-1.04E+00
.
.
+2.3737e-03,-2.47E-02
+2.3837e-03,-2.47E-02
-3.1475e-02,-2.00E-02
-3.1475e-02,-2.00E-02
.
.
4.0315e-02,-3.14E-02
4.0275e-02,-3.15E-02
```

Start of lower waveform

Start of upper waveform

Equivalent time acquisition mode type envelope format for XYpairs text waveform

Figure 12-15

```
XYPairs: Normal
Acquisitions: 1
Points: 512
-2.5763e-03,-1.04E+00
-2.5663e-03,-1.04E+00
.
.
+2.3737e-03,-2.47E-02
+2.3837e-03,-2.47E-02
```

Real time acquisition mode (greater than 500 points) type normal format for XYpairs text waveform

Figure 12-16

```
XYPairs: Sequential Normal
Acquisitions: 10 of 10 stored to disk
Points/Acquisition: 512
Timetag: #1, 0.00000000000000E+00
-2.5535e-07,-3.11719E-02
.
.
.
+2.5564e-07,3.96094E-02
.
.
.
Timetag: #10, 9.5495896525758E-03
-2.5535e-07,-3.11719E-02
.
.
.
+2.5564e-07,3.96094E-02
```

Timetag 2 through 9

Real time acquisition mode type sequential normal format for XYpairs text waveform

Figure 12-17

```
XYPairs: Sequential Average
Acquisitions: 10
Points/Acquisition: 500
-2.5535e-07,-3.11719E-02
+2.5564e-07,-3.96094E-02
.
.
.
-2.4234e-07,4.04395E-02
+2.4334e-07,4.02783E-02
```

Real time acquisition mode type sequential average format for XYpairs text waveform

Figure 12-18

XYPairs: Sequential Envelope	
Acquisitions: 10 enveloped	
Points/Acquisition: 500	
-2.5535e-07,-3.11719E-02	Start of lower waveform
+2.5564e-07,-3.96094E-02	
.	
.	
.	
-2.4234e-07,4.04395E-02	
+2.4334e-07,4.02783E-02	Start of upper waveform
-3.1475e-02,-2.00E-02	
-3.1475e-02,-2.00E-02	
.	
.	
.	
4.0315e-02,-3.14E-02	
4.0275e-02,-3.15E-02	

Real time acquisition mode type sequential envelope format for XYpairs text waveform



Store Image

The store image menu allows you to store oscilloscope screen images to a disk in TIFF, PCX, or EPS formats. You can import files in these formats to a variety of computer programs. The size of the file stored to the disk depends on the settings of the **FORMAT**, **COMPRESSION**, and **RENDERING** softkeys.

Disabled and Enabled Softkey

You store a screen image to the disk in a TIFF, PCX, or EPS format by setting this softkey to enabled and pressing the Print front-panel key when the screen of interest is displayed. The disabled setting allows you to set up the store image menu without altering the normal function of the Print front-panel key.

Format Softkey

The **FORMAT** softkey allows you to select TIFF, PCX, or EPS as the file format. TIFF stands for Tagged Image File Format, PCX is the PC Paintbrush format, and EPS stands for encapsulated PostScript format. TIFF files comply with the TIFF 6.0 specification, PCX files comply with revision 4 of the PCX technical reference manual, and EPS files comply with EPS version 3.0. All EPS images, except those with B/W rendering and compression off, use level 2 PostScript features.

Figure 12-19

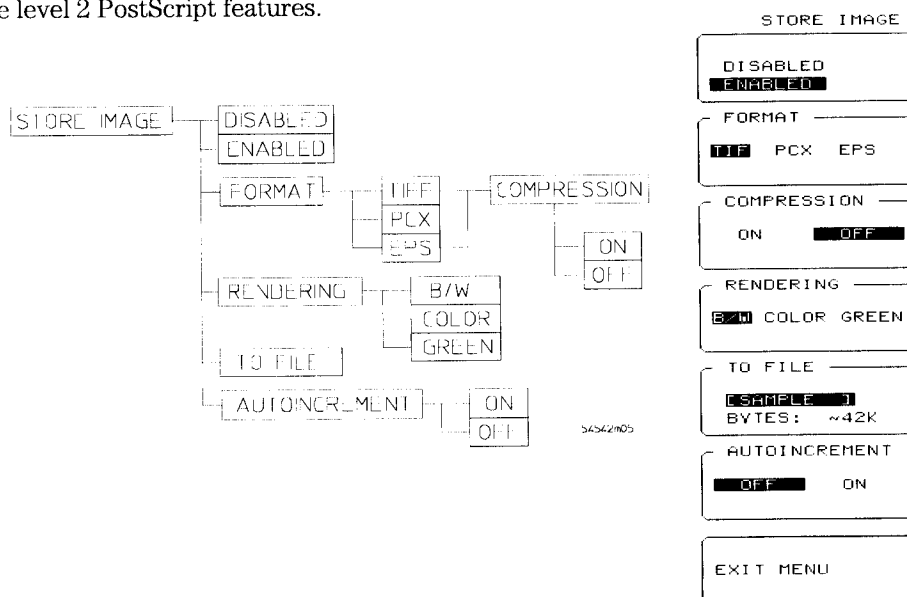

Compression Softkey

This is lossless data compression using run length encoding as specified by the selected file format. Because compressed files take up less disk space, the default selection is on. You would turn compression off if you need to see the raw data, or if the importing application cannot properly interpret the compressed data.

Rendering Softkey

The B/W selection is black text on a white page, just like a hardcopy printout. Most applications use the black text on a white background. Color reproduces the yellow, just like the scope screen. Green is shades of green on a black background just like the scope screen.

To File Softkey

The **TO FILE** softkey selects a file name for a disk operation. You may notice that the file name in the **TO FILE** softkey matches the highlighted file name in the directory listing. You can use the entry knob to scroll through the list of files, or you can press the **TO FILE** softkey to enter a file name. You can also use the **DIRECTORY** softkey to change to another directory.

Pressing the **TO FILE** softkey displays another menu that allows you to spell out the name of the file you want. The entry knob positions the cursor over a letter or number in the character list. Press the the top softkey to enter that character into the filename field. The filename can contain up to eight characters. The **BACKSPACE** softkey backspaces over characters in the file name, while the **DELETE** softkey deletes characters from the file name.

You do not need to add a file extension because the oscilloscope automatically assigns a file extension depending on the type of file selected. LIF files do not have a file extension, but they have descriptions which appear in the directory listing.

- .TIF for TIFF files
- .PCX for PC Paintbrush files
- .EPS for encapsulated PostScript files

Autoincrement Softkey

Autoincrement allows you to store up to 100 files to a disk without having to return to the store image menu and rename the file. If the filename takes up six or less characters, *nn* is appended to the file name. If the filename takes up seven or eight characters, the filename is truncated to six characters and *nn* is appended to the filename.

For example, if the filename is TEST.TIF, the filename changes to TESTnn.TIF. If the filename is TESTING.TIF, the filename changes to TESTINnn.TIF. As files are stored to the disk, nn increments from 00 to 99. Once 99 is reached, the value no longer increments and subsequent stores overwrite the file that has 99 appended to the filename. Because autoincrement always starts from 00, you cannot set it to start from any other number.

When you return to the store image menu, the autoincrement automatically defaults to off. When autoincrement is turned on again, the numbering restarts from 00.

Delete

Delete allows you to delete a selected file or directory from the disk. Directories can only be deleted if there are no files in the directory. Simply use the entry knob to scroll through the directory listing of the disk, or press the File name softkey to enter a file name or directory name. Pressing the File name softkey displays another softkey menu that allows you to enter a file name. You can also use the **DIRECTORY** softkey to change to another directory.

Figure 12-20

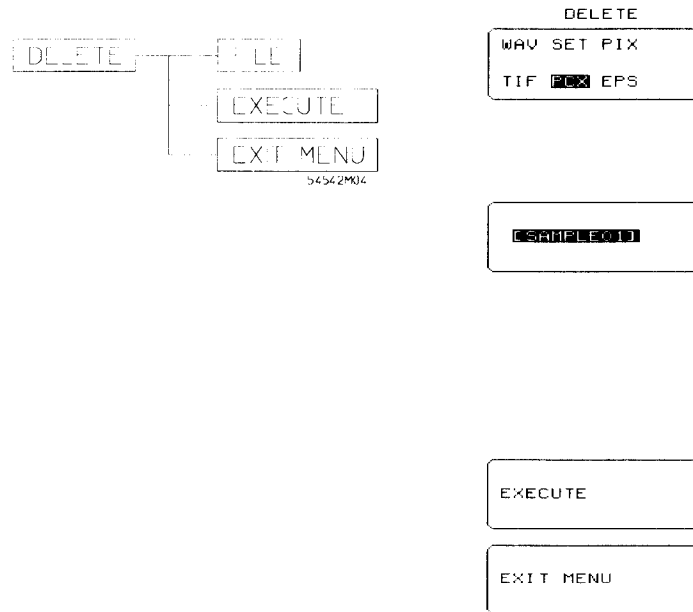

Format

Format allows you to format 3-1/2 inch, high-density disks in the oscilloscope. You can choose to format disk as MS-DOS or LIF. You can use the MS-DOS disk in other drives that are also MS-DOS compatible, however, you may notice that there is a faster disk access time when you use disks in the oscilloscope that were formatted by the oscilloscope. This is because some computers and disk drives format disks with a different disk interleave factor than that used by the oscilloscope. The interleave factor used when the oscilloscope formats a disk maximizes the data transfer rate to and from the internal disk drive.

Figure 12-21

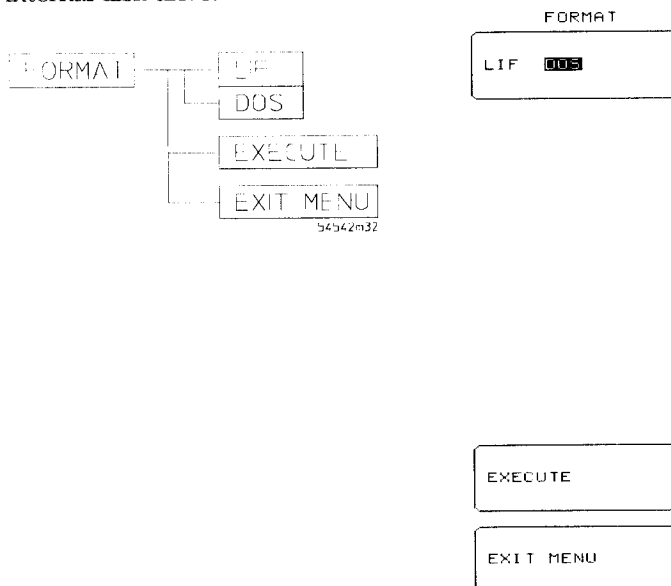

Directory

The directory menu allows you to change the present working directory or make new directories on the disk. The present working directory is displayed next to PWD:\ on the screen, above the directory listing.

Change Directory Softkey

Pressing the **CHANGE DIRECTORY** softkey changes the present working directory to the directory shown in the **DIRECTORY** listing. You may notice that the directory name in the **DIRECTORY** softkey matches the highlighted directory name in the directory listing. You can use the entry knob to scroll through the list of directories.

Make Directory Softkey

The **MAKE DIRECTORY** softkey allows you to create a directory or subdirectory in the present working directory. Before making a directory, you have to enter the directory name using the **DIRECTORY** softkey. If you try to make a directory when an existing file name is shown in the **DIRECTORY** softkey, a subdirectory with that file name is created. If you try to make a directory when an existing directory name is shown in the **DIRECTORY** softkey, an error message appears.

Figure 12-22

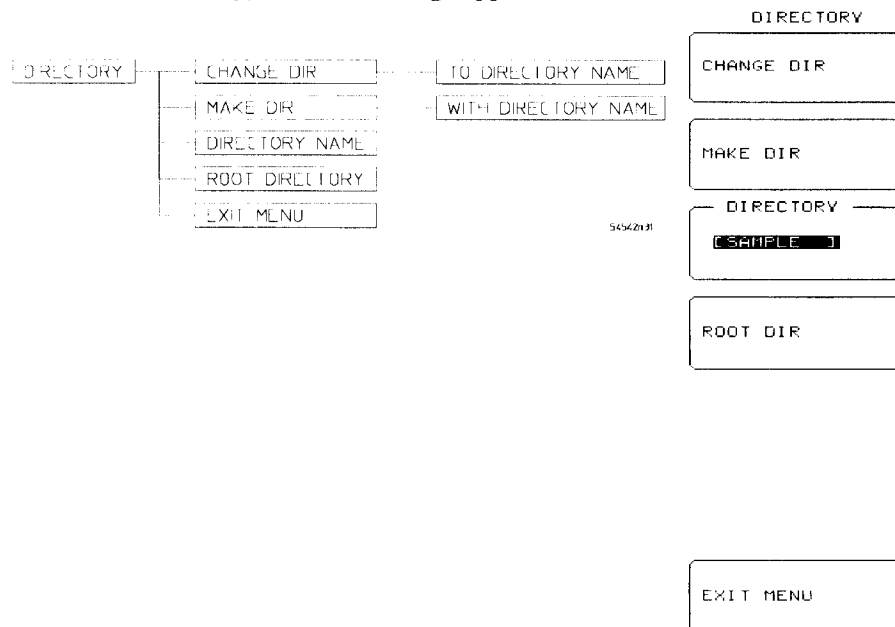

Directory

Directory softkey

The **DIRECTORY** display selects a directory name for a disk operation. You may notice that the name in the **DIRECTORY** softkey matches the highlighted name in the directory listing. You can use the entry knob to scroll through the list, or you can press the **DIRECTORY** softkey to enter a name.

Pressing the **DIRECTORY** softkey displays another menu that allows you to spell out the name of the directory you want. The entry knob positions the cursor over a letter or number in the character list. Press the the top softkey to enter that character into the filename field. The filename can contain up to eight characters. The **BACKSPACE** softkey backspaces over characters in the file name, while the **DELETE** softkey deletes characters from the file name.

Root Directory Softkey

Pressing the **ROOT DIRECTORY** softkey returns you to the root directory of the disk.



Measurements

Measurements

This chapter describes the process the oscilloscope uses to make waveform measurements. It also describes the parameters that are measured and how to set up measurements for the best solution. Like any tool, it is important to understand how to use the tool, its limitations, and methods that may overcome some of the shortcomings.

The waveform in figure 13-1 shows the pulse parameters that the oscilloscope measures. Hewlett-Packard has been using these parameters in its measurements for the past 10 years. This chapter defines these parameters and discusses how they are measured.

Figure 13-1

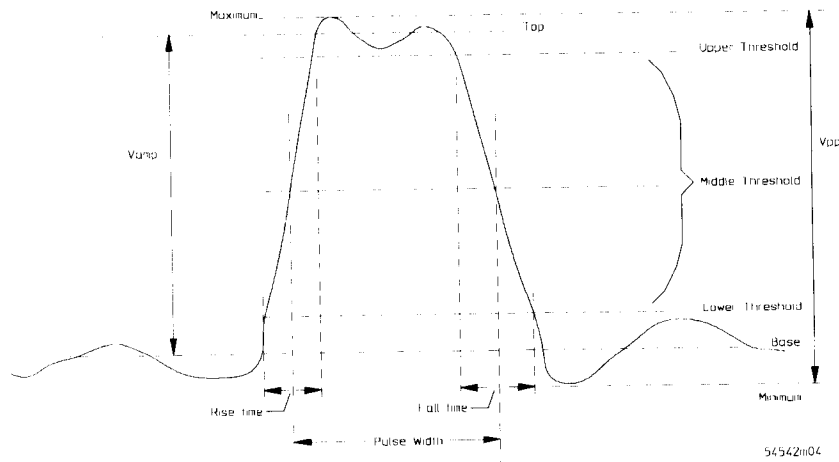

Pulse parameters the oscilloscope measures

Automatic Parametric Measurements

The illustration below shows the basic process used by the oscilloscope when making automatic parametric measurements, like rise time, V_{p-p} , or frequency. These measurements can be made on input signals, stored waveforms, or functions.

In order to start the measurement process, the oscilloscope captures a data record. From this data record, the oscilloscope builds a histogram, recording how many times each q level (a q level is an internal voltage representation) is present in the data record. From the histogram, and from the data record, the absolute maximum and minimum voltage levels, as well as relative maximum (top) and minimum (base) voltage levels, are determined. Using the top and base levels, threshold levels are calculated. The data record is again analyzed using the thresholds to determine signal edges. Finally, with all this information, the requested parametric measurements are calculated as shown in figure 13-2.

Figure 13-2

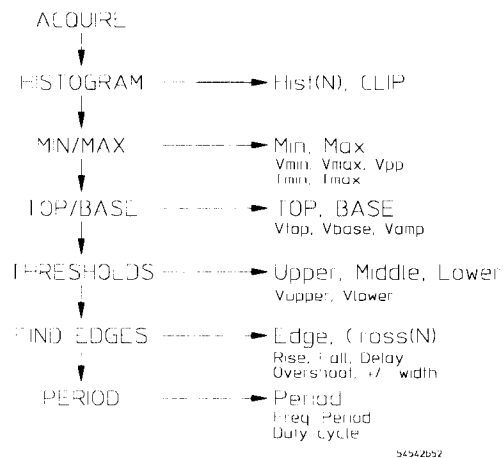

The oscilloscope uses this process for waveform measurement

Data Collection

In order to make measurements on a signal, the instrument must first collect data. The data collected for input signals is used to make measurements on channels. The data record used for making measurements on waveform memories is the stored data. Finally, measurements being made on functions require that the function be calculated before the measurement process is started.

Building a Histogram

Once a data record is available, the measurement process builds a histogram of the distribution of the internal voltage levels as shown in figure 13-3. The histogram is built on eight bits of data, and, if in the average mode, does not represent the full resolution of the data as this would result in a very large histogram array. The oscilloscope uses the histogram to determine the statistical maximum (top) and minimum (base) of the data record.

Figure 13-3

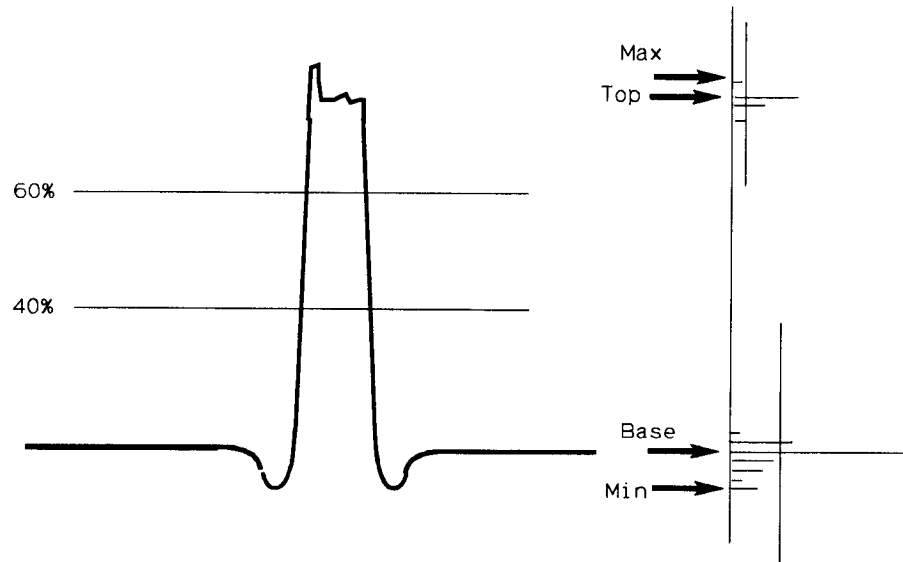

Some measurements are made from the histogram

Calculating Minimum and Maximum from the Data Record

The maximum and minimum voltage levels are determined from the histogram. If the waveform is clipped, this information is also recorded. After the minimum and maximum measurements are complete, the V_{min} , V_{max} , V_{p-p} , T_{min} , T_{max} , and T_{volt} measurements can be made. The remaining primitives of the measurement process (calculate thresholds, find edge, and period) are executed only if other measurements, such as fall time, frequency, or delta time, are requested.

Calculating Top and Base

The next measurements made are the top and base of the waveform. These measurements come directly from the histogram. The top 40 percent is scanned for the top, and the bottom 40 percent of the histogram is scanned for the base. The center portion of the histogram is not searched to prevent a baseline value from being chosen as the top or base as shown in figure 13-4.

Figure 13-4

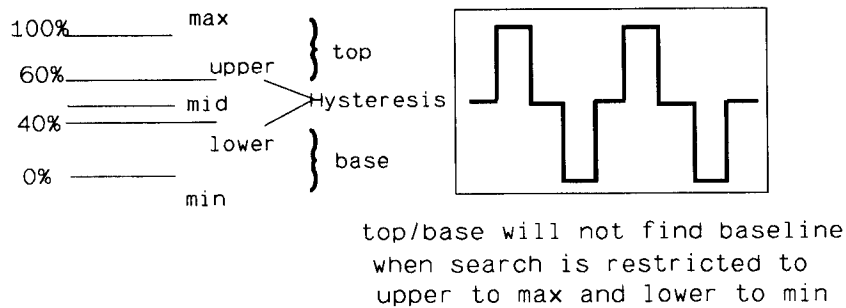

The middle 20 percent of the waveform is ignored

The greatest number of data occurrences in the top half of the histogram corresponds to the top. If the occurrence count is less than five percent of the total, the top defaults to the value of the absolute maximum. Likewise, the base represents the level with the greatest number of occurrences in the bottom portion of the histogram. If the occurrence count is less than five percent of the total, the base defaults to the value of the absolute minimum. This may be the case for very irregular waveforms or those in which the voltage rises or falls slowly over time.

This selection technique prevents the top and base from jumping around on waves with even histogram distributions such as triangle waves. It also allows the detection of the top and base for low duty cycle signals.

Once the top and base measurements are complete, V_{top} , V_{base} , and V_{amp} measurements can be made.



Calculating Thresholds

Top and base are used to calculate the threshold levels used for timing measurements. These thresholds may be the IEEE values of 10, 50, and 90 percent, or values in percentages or volts that you set. These thresholds are called upper, middle, and lower thresholds in the measurement menu.

These thresholds are used by all timing measurements as they are needed to determine the presence of a rising or falling edge. In addition, the thresholds are used by various measurements. For example, rise time is measured from the lower threshold to the upper threshold of a rising edge. Period and frequency measurements use the middle threshold as shown in figure 13-5.

See also Chapter 8, "Define Measure Menu," for information on manually setting the thresholds.

Figure 13-5

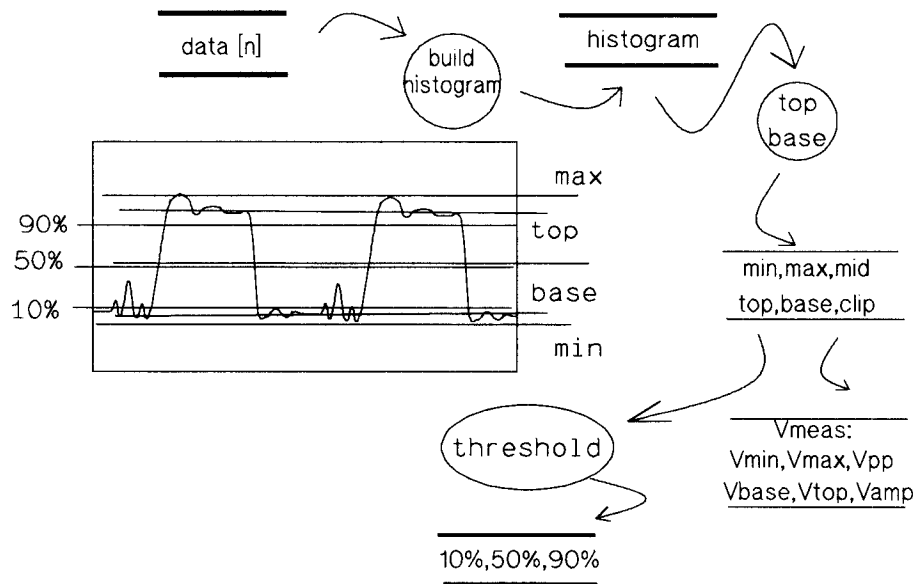

The oscilloscope calculates the 10, 50, and 90 percent thresholds

Determining Rising and Falling Edges

The final analysis needed to make timing measurements is to define the transition points of the waveform through the threshold levels and to define the rising and falling edges. A rising edge is defined as a transition that passes through the lower, middle, and upper threshold levels. A falling edge is defined as a transition that passes through the upper, middle, and lower threshold levels. For an edge to be present and defined, it must complete the transition through all three threshold levels.

Once the transition points and edges are identified, the instrument next calculates timing measurements (rise time, fall time, and frequency). Finally, it calculates voltage measurements that need timing information (V_{rms} cycle and V_{avg} cycle) as shown in figure 13-6.

Figure 13-6

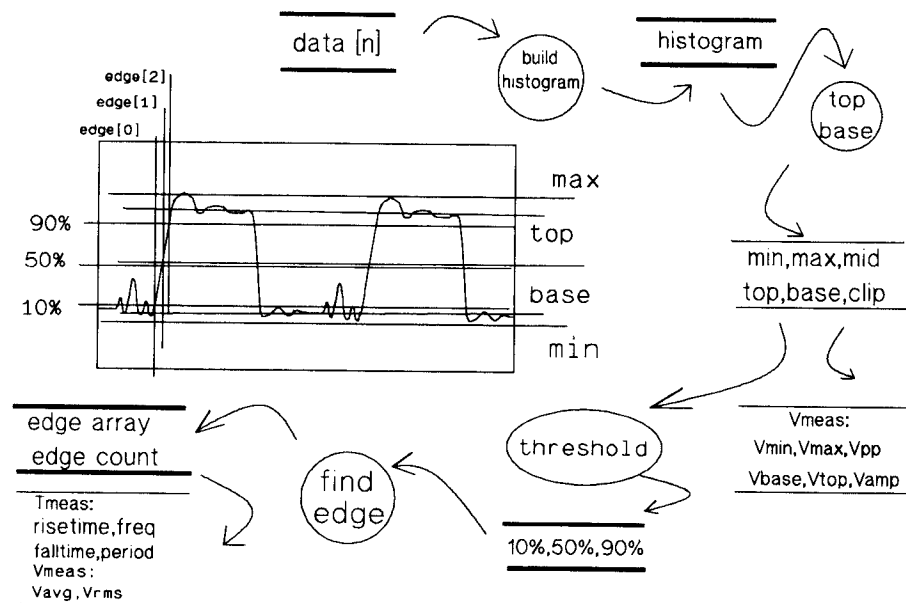

Thresholds are used to determine edges

Measurements
Determining Rising and Falling Edges

If there are not enough points on an edge, the rise time measurement, for example, is either not made or is flagged as questionable.

The oscilloscope scans the waveform data and records the transitions through the three thresholds. If a waveform data point does not exactly correspond to the threshold level value, the system interpolates between the two points about the threshold. Then the location of the transition point is recorded in an edge array. The system ignores incomplete transitions and glitches as shown in as shown in figure 13-7.

Figure 13-7

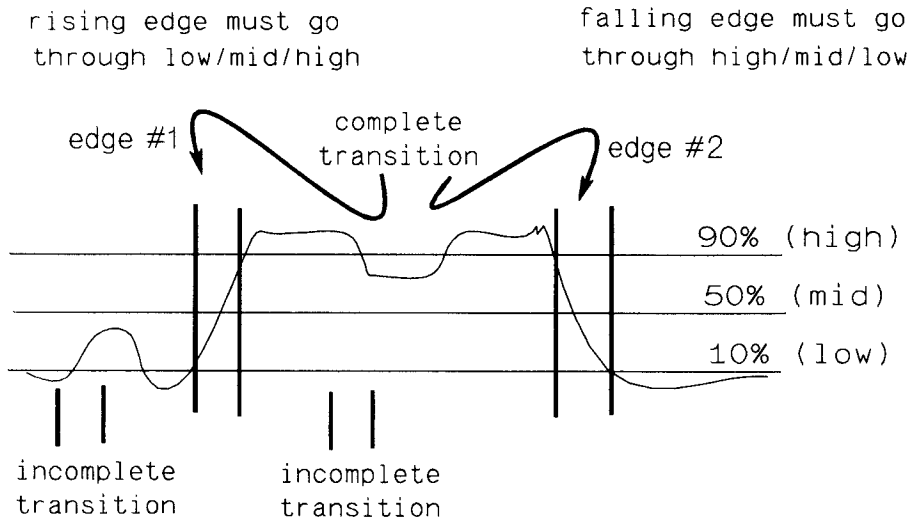

The system ignores incomplete transitions when defining edges

The oscilloscope defines the points on a rising edge as the last point before crossing the lower threshold to the first point crossing the upper threshold. The points on a falling edge include the last point before crossing the upper threshold to the first point crossing the lower threshold. This will measure the fastest rise and fall times.

As shown in figure 13-8, it is clear that measuring the rise time from the first point crossing the lower threshold to the last point through the upper threshold gives a different answer than the shaded line that uses the edge definition given in the previous paragraph.

Figure 13-8

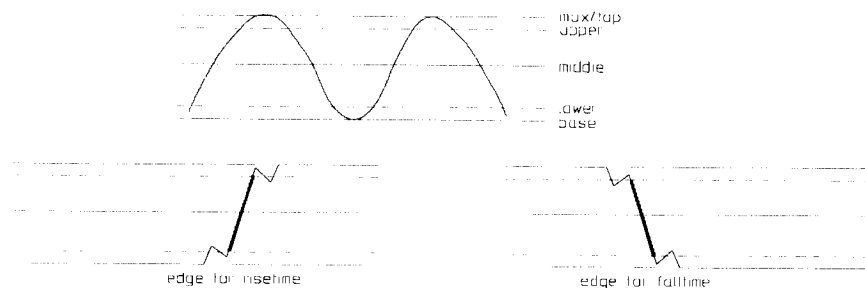

54542n03

Waveform period is measured at the middle threshold

Voltage Measurements

Once the top and base calculations are completed, most of the voltage measurements can be made.

- V_{min} = voltage of the absolute minimum level
- V_{max} = voltage of the absolute maximum level
- $V_{p-p} = V_{max} - V_{min}$
- V_{base} = voltage of the statistical minimum level
- V_{top} = voltage of the statistical maximum level
- $V_{amp} = V_{top} - V_{base}$

V_{base} may be equal to V_{min} for many waveforms, such as triangle waveforms. Likewise, V_{top} may be equal to V_{max} . Figure 13-9 shows where these waveform definitions occur.

Figure 13-9

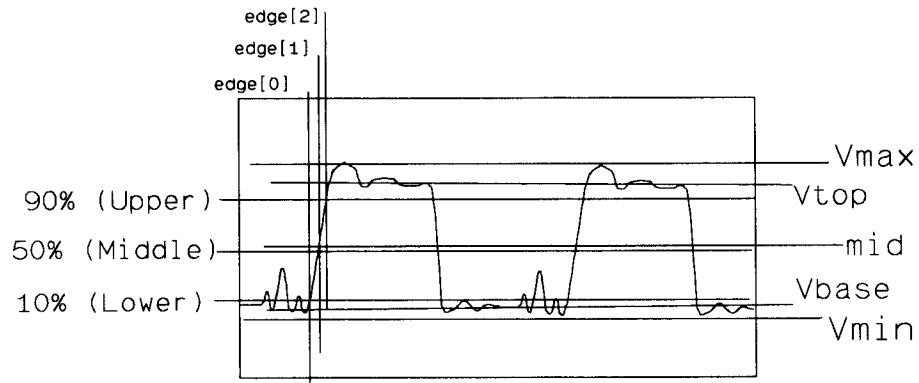

Waveform definitions used to make voltage measurements

Several of the voltage measurements require threshold and edge information before they can be made.

- V_{avg} = average voltage of the first cycle of the signal
- Overshoot = a distortion which follows a major transition
 - If first edge is rising
 - then overshoot = local max – top
 - else overshoot = base – local min
- Preshoot = a distortion which precedes a major transition
 - If first edge is falling
 - then preshoot = base – local min
 - else preshoot = local max – top



Timing Definitions

Once the edges and transition points have been defined, timing measurements are made. Timing measurements are made on the first rising or falling edge on the display.

- Rise time = time at the upper threshold – time at the lower threshold on the first rising edge
- Fall time = time at the lower threshold – time at the upper threshold on the first falling edge
- Period = If the first edge is rising
then period = mid-threshold crossing of second rising edge – mid-threshold crossing of first rising edge
else period = mid-threshold crossing of second falling edge – mid-threshold crossing of first falling edge
- Frequency = $1/\text{period}$
- +Width = if first edge is rising
then +width = mid-threshold crossing of first falling edge – mid-threshold crossing of first rising edge
else +width = mid-threshold crossing of second falling edge – mid-threshold crossing of first rising edge
- –Width = if first edge is rising
then –width = mid-threshold crossing of second rising edge – mid-threshold crossing of first falling edge
else –width = mid-threshold crossing of first rising edge – mid-threshold crossing of first falling edge
- Duty Cycle = $(+\text{width}/\text{period})(100)$

User Defined Δ Time

On the oscilloscope, you may select the threshold level (lower/middle/upper), polarity of edge (either rise or fall), and the edge number. The measurement is then calculated as the time from the first source's edge to the second source's edge.

This gives flexibility in defining Δ time measurements between channels or on a single channel between edges. To avoid confusing the delay measurement with time base delay and trigger delay, the delay measurement has been called Δ time as shown in figure 13-10.

See also

Chapter 7, "Define Measure Menu," for information on delay measurements.

Figure 13-10

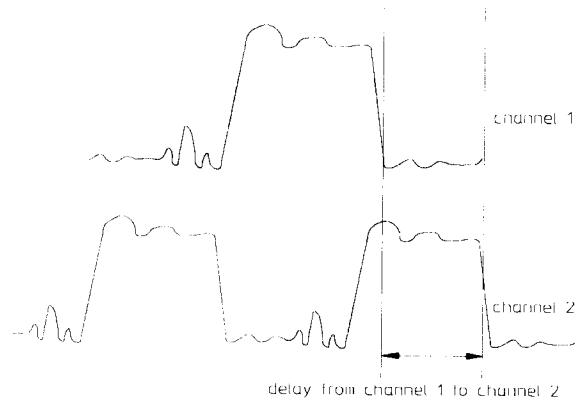

User defined Δ time
from rising/falling edge an at low/mid/upper of 1st source
to rising/falling edge an at low/mid/upper of 2nd source

54542m02

You may define Δ time

Measurement Considerations

In the repetitive and real-time modes, measurements are made two or three times per second when continuous is on and statistics is off. When statistics is on, measurements are made every time the oscilloscope triggers.

When continuous is turned off, the markers are placed on the display showing where the measurement was made. This helps you verify that the oscilloscope is measuring the correct phenomena and to aid you in windowing the signal for measurement.

Statistics are available on the oscilloscope, so you may display the mean, standard deviation, min, and max for each measurement result.

In the user defined mode, you may also define some of the measurement you want to make. Specify your own thresholds rather than using the standard 10, 50, and 90 percent levels. Specify the IEEE standard definitions of thresholds and measurements. Or set thresholds in either voltage or percent. You may rely on the oscilloscope to set top and base, or define those levels yourself in voltage. The Δ time, +width, -width measurement is also under your control.

Making Automatic Measurements from the Front Panel

The oscilloscope makes its measurements using the data showing on the display (except for Δt measurements in the real-time mode). Therefore, it is important that you correctly window the display to get accurate measurements. Windowing allows you to pick one pulse out of a series of pulses to make measurements on.

If more than one waveform, edge, or pulse is displayed, automatic time measurements are made on the first (leftmost) portion of the displayed waveform that can be used. Voltage measurements, like V_{p-p} , use the whole waveform.

When making measurements on non symmetrical waveforms, expand the signal as necessary and move the baseline out of the window. This will avoid having the baseline selected as the top of the signal.

If the signal is clipped, the oscilloscope cannot make some automatic measurements. You will get a warning or error message if this occurs.

If the measurement window is set to markers, the measurement is made on the data between the X1 and X2 markers.

Period and Frequency Measurements

At least one full cycle of the waveform, with at least two like edges, must be displayed for period and frequency measurements.

Additionally, you can increase the accuracy of frequency measurements by windowing on multiple pulses. Automatic waveform measurements use a single pulse and may have significant errors introduced by interpolation. By placing marker 1 on edge 1 and marker 2 on edge 20, for example, you can get an average that negates errors that may be introduced in automatic measurements. This becomes even more important when using the deep memory feature of the oscilloscope.

Set the markers to accomplish average frequency measurements from the front panel by using the Δt measurement in the define measure menu.

Pulse Width Measurements

A complete positive pulse must be displayed to make a +Width measurement.

A complete negative pulse must be displayed to make a –Width measurement.

Remember that an edge must pass through all three thresholds to be recognized as an edge. Therefore, it is important that the pulse be positioned so that all three thresholds are displayed on the screen.

Rise Time, Fall Time, Preshoot, and Overshoot Measurement

The leading (rising) edge of the waveform must be displayed for rise time and rising edge preshoot and overshoot measurements.

The trailing (falling) edge of the waveform must be displayed for fall time and falling edge preshoot and overshoot measurements.

Remember that an edge must pass through all three thresholds to be recognized as an edge. Therefore, it is important that the pulse be positioned so that all three thresholds are displayed on the screen.

Rise time, fall time, preshoot, and overshoot measurements will be more accurate if you expand the edge of the waveform by selecting a faster sweep speed. Expanding the waveform will provide more data points on the edge and thus a more accurate measurement.

Specifications and
Characteristics



Specifications and Characteristics

This chapter contains the specifications and characteristics for the HP 54542C, HP 54540C, HP 54522C, and HP 54520C Oscilloscopes.

Specifications

Specifications are valid after a 30 minute warm-up period.

Vertical

Bandwidth (-3dB, dc coupled)

Repetitive (all models) dc to ≥ 500 MHz (equivalent time)

Real Time

HP 54520C dc to ≥ 125 MHz (2 channels on),
dc to ≥ 250 MHz (1 channel on)

HP 54522C dc to ≥ 500 MHz

HP 54540C dc to ≥ 125 MHz (3 or 4 channels on),
dc to ≥ 250 MHz (2 channels on)
dc to ≥ 500 MHz (1 channel on)

HP 54542C dc to ≥ 500 MHz

Rise Time ¹

Repetitive (all models) ≤ 700 ps

Real Time

HP 54520C ≤ 2.8 ns (2 channels on),
 ≤ 1.4 ns (2 channels on)

HP 54522C ≤ 700 ps

HP 54540C ≤ 2.8 ns (3 or 4 channels on),
 ≤ 1.4 ns (2 channels on)
 ≤ 700 ps (1 channel on)

HP 54542C ≤ 700 ps

Input R (selectable) $1\text{ M}\Omega \pm 1\%$ or $50\ \Omega \pm 1\%$



Maximum Input Voltage

$1\text{ M}\Omega$ ± 250 V [dc + peak ac (<10 kHz)]

$50\ \Omega$ $5\ V_{\text{rms}}$

Offset Accuracy ² $\pm(1.25\%$ of channel offset + 2% of full scale)

Voltage Measurement Accuracy (dc) 2,3

Dual Cursor $\pm[1.25\%$ of full scale + $(0.032)(\text{V/div})]$

Single Cursor $\pm[1.25\%$ of full scale + offset accuracy + $(0.016)(\text{V/div})]$

Specifications**Time Base****Delta-t Accuracy**

Repetitive (≥ 8 averages) $\pm[(0.005\%)(\text{delta-t}) + (0.1\%)(\text{full scale}) + 100 \text{ ps}]$

Real Time ⁴ $\pm[(0.005\%)(\text{delta-t}) + (0.2)(\text{sample period})]$

Peak Detect $\pm[(0.005\%)(\text{delta-t}) + 1 \text{ sample period}]$

Trigger**Sensitivity** ²

	dc to 100 MHz	100 MHz to 500 MHz
Internal	0.5 division	1.0 division
External	0.0225 \times signal range	0.045 \times signal range
<small>(HP 54520C/54540C)</small>		
Auxiliary	dc to 50 MHz, 250 mVp-p	

**Maximum Input Voltage**

External Trigger (HP 54520C and 54522C)

1M Ω $\pm 250 \text{ V}$ [dc + peak ac (<10 kHz)]

50 Ω 5 V_{rms}

Auxiliary Trigger $\pm 15 \text{ V}$

Notes:

- 1) Rise time figures are calculated from: $t_r = 0.35/\text{Bandwidth}$.
- 2) Magnification is used below 7 mV/div range so the vertical resolution and accuracies are correspondingly reduced. Below 7 mV/div, full scale is defined as 56 mV.
- 3) The voltage measurement accuracy decreases 0.08% of full scale per $^{\circ}\text{C}$ from the firmware calibration temperature. This specification is valid for a temperature range $\pm 10^{\circ}\text{C}$ from the firmware calibration temperature. The specification applies to both the repetitive and real time modes.
- 4) The specification applies for bandwidth limited signals ($t_r = 1.4 \times \text{sample interval}$). The sample interval is defined as $1/(\text{sample rate})$. The specification also applies to those automatic measurements computing time intervals on pulses with identical slope edges (i.e. pos-pos, neg-neg).

Performance Characteristics

Vertical

Switchable Bandwidth Limits

ac-coupled (lower -3 dB frequency) 10 Hz
LF reject (lower -3 dB frequency) 400 Hz
Bandwidth Limit (upper -3 dB frequency) 30 MHz

Number of Channels (Simultaneous Acquisition)

HP 54520C/54522C 2
HP 54540C/54542C 4

Vertical Sensitivity Range

 1 mV/div to 5 V/div

Vertical Gain Accuracy (dc)^{1,2}

 ±1.25% of full scale

Vertical Resolution² 8 bits over 8 divisions (±0.4%), 10 bits over HP-IB with averaging (±0.1%)

Maximum Sample Rate (Realtime Mode)

HP 54520C 500 MSa/s (2 CH on), 1 GSa/s (1 CH on)
HP 54522C 2 GSa/s
HP 54540C 500 MSa/s (3 or 4 CH on), 1 GSa/s (2 CH on),
2 GSa/s (1 CH on)
HP 54542C 2 GSa/s

Waveform Record Length³

Real Time 32,768 pts (Selectable in powers of 2: 512, 1024, 2048 . . .)
When peak detect is on, 16,384 (Selectable in power of 2)
Repetitive 501 points

Input C 7 pF nominal

Input Coupling ac, dc

Specifications and Characteristics
Performance Characteristics

Offset Range

1 mV - 50 mV/div ± 2 V
>50 mV - 250 mV/div ± 10 V
>250 mV - 1.25 V/div ± 50 V
>1.25 V - 5 V/div ± 250 V

Dynamic Range $\pm(1.5 \times \text{full scale})$ from the center of the screen

Channel-to-channel Isolation (with channels at equal sensitivity)

dc to 50 MHz 50 dB
50 to 500 MHz 40 dB

Horizontal

Time Base Range 500 ps/div to 5 s/div
(The 500 ps and 1 ns time base settings are not available with the 500 MSa/s models.)

Time Base Resolution 10 ps

Time Tag Accuracy $\pm(0.005\%$ of reading + 100 ps)

Time Tag Resolution 100 ps

Delay Range

Posttrigger $10^7 \times \text{sample period}$
Pretrigger $32k \times \text{sample period}$

Trigger

Trigger Pulse Width (minimum)

Internal and External 1 ns
Auxiliary 15 ns

Trigger Level Range

Internal $\pm(1.5 \times \text{full scale})$ from the center of the screen
External (HP 54520C and 54540C) Selectable: ± 1 V, ± 5 V, ± 25 V
Auxiliary ± 5 V

Auxiliary Input R $4k \Omega$

FFTs

Freq Range ³ dc to:	54520C 250 MHz	54522C 1GHz	54540C 250 MHz (3-4 CH) 500 MHz (1-2 CH)	54542C 1GHz
Freq Resolution				
Minimum (max sample rate/512 pts)	977 kHz	3.9 MHz	997 kHz (3-4 CH) 1.95 MHz (1-2 CH)	3.9 MHz
Maximum (minimum sample rate)(32768 points):	0.305 mHz (all models)			
-3 dB Frequency Range	dc to 500 MHz (analog bandwidth)			

Frequency Accuracy

$$\pm \left[\frac{\text{sample freq}}{2 \times \text{number of points}} \right] + (\text{signal frequency} \times 0.005\%)$$

Spectrum Displays

Amplitude Power in dBm

Signal-to-noise Ratio 55 to 65 dB (typical). Noise floor can be reduced by increasing the number of points in the FFT.

Sensitivity Range 1 dBm/div to 100 dBm/div

Dynamic Range 55 to 65 dB (typical)

Offset Range -200 dBm to +200 dBm

Notes:

- 1) The gain accuracy decreases 0.08% of full scale per °C from the firmware calibration temperature. This characteristic is valid for a temperature range ±10°C from the firmware calibration temperature. The characteristic applies to both modes; repetitive and real time (single acquisition).
- 2) Expansion is used below 7 mV/div range so vertical resolution and accuracies are correspondingly reduced. Below 7 mV/div full scale is defined as 56 mV.
- 3) The available waveform record length over HP-IB is 32,768 points in the real-time mode and 500 points in the repetitive mode.



Operating Characteristics

Vertical

Deflection Factors All input channels: With a single screen selected, you can adjust deflection factors from 1 mV/div to 5 V/div in a 1-2-5 sequence with the knob. You can make fully calibrated vernier adjustments using direct keypad entry or the using the knob with Fine selected.

Probe Attenuation Factors You can enter values from 0.9 to 1000 to scale the oscilloscope for external probes or attenuators attached to the channel inputs. When probe tip calibration is performed, this value is calculated automatically. The front-panel, probe compensation output source impedance is 500 Ω , so with low probe impedances, automatic calibration accuracy is dependent on the impedance of the probe.

Input Impedance 1 M Ω or 50 Ω , selectable for channels and the external trigger.

Bandwidth Limit (HF Reject) A low-pass filter with a -3 dB point at about 30 MHz for both triggering and signal display. You can select HF reject for each front-panel input individually, whether vertical or external trigger.

LF Reject A high-pass filter with a -3 dB point at about 400 Hz for the triggering and vertical signal. You can selected LF reject for each front-panel input individually, whether vertical or external trigger.

ac Coupling A high-pass filter with a -3 dB point at about 10 Hz for both triggering and signal display. You can selected ac coupling for each front-panel input individually, whether vertical or external trigger.

ECL/TTL Presets For ECL and TTL levels, you can preset the vertical deflection factor, coupling, offset, and trigger level independently on any vertical input channel. It is not available for the external trigger input.

Effective Resolution The maximum sample rate and the number of bits in an oscilloscope's digitizer are too often used for comparing oscilloscopes. These specifications, however, do not describe performance under dynamic signal conditions. Effective Resolution is a figure of merit that describes the digitizing oscilloscope's performance under dynamic conditions, and is measured using the sinewave curve fit test. This method considers:

- Quantization error
- Non-linearities (including preamp and ADC)
- System noise
- Frequency of input signal

All of these affect the effective resolution of the instrument. Some manufacturers specify effective bits using half-scale sinewaves. While the effective bits performance using half-scale testing is overstated when compared to full-scale testing, Hewlett-Packard publishes both sets of numbers for the oscilloscope so that, when comparing effective bits performance between digitizing oscilloscopes, a fair comparison can be made. The oscilloscope's typical performance for a single acquisition is shown below:

Frequency	50 kHz	1 MHz	20 MHz	50 MHz	100 MHz	250 MHz	500 MHz
Full scale	7.5	7.4	6.6	5.8	5.8	5.2	5.2
Half scale	7.6	7.4	7.0	6.5	6.5	5.8	5.5



Horizontal

Pan and Zoom Changing the Time/div and/or Delay values once acquisition is stopped allows access to all captured data on each acquisition in the real-time sampling mode only.

The record length control sets the number of points (512 to 32,768) acquired with each acquisition. The auto adjust softkey allows setting the sample rate independent of the time base. The entire record length may be displayed when the oscilloscope is in the run mode.

Delay Between Channels You can null out differences in delay between channels to compensate for differences in input cables or probe length using the probe null feature.

Reference Location You can set the reference point at the left edge, center, or right edge of the display. The reference point is the trigger point plus the delay time.

Trigger

Auto Trigger Auto trigger provides an acquisition when no trigger is present. When set to auto, if the instrument does not see a trigger within about 20 ms, it will automatically start an acquisition. When set to trg'd, it will wait for the next qualified trigger.

Trigger Holdoff Trigger can be held off either by time or events over the ranges:

- time: 40 ns - 320 ms
- events: 2 - 16,000,000

An event is defined as the specified trigger condition. A separate holdoff setting (time or events) is available for each trigger mode except delayed trigger, which is set to 40 ns. Holdoff is not available for the auxiliary or line trigger. The maximum event counting rate is 70 MHz.

Noise Reject Trigger Reject provides improved triggering on noisy signals by increasing trigger hysteresis (internal trigger only). When set on, noise reject is active for all trigger modes.

Trigger Modes

Edge Trigger

You can select a positive or negative edge for trigger on any channel, the external trigger input (HP 54520C/54540C), or the auxiliary input. For the channel and external trigger sources, you can set coupling to dc, ac (10 Hz), or lfrej (low frequency reject, 50 kHz). Trigger coupling is independent of the vertical signal coupling and noise reject. This coupling only applies in the edge mode. In all other trigger modes, the channel and external trigger coupling is set to dc. You can also select line trigger in the edge trigger menu. Trigger coupling is automatically set to dc for all sources in all trigger modes, except in the edge trigger mode.

Pattern Trigger

You can specify a pattern using any front panel channel or external trigger input. Each input can be specified as a high, low, or don't care with respect to the level setting in the edge trigger menu. The trigger can be selected to occur on the last edge to enter the specified pattern or the first edge to exit the specified pattern. This pattern must be present for at least 1.75 ns before the trigger will respond.

Time Qualified Pattern Trigger A trigger occurs on the first edge to exit a pattern only if it meets the specified time criteria. The available time qualified modes are (user-specified time is in brackets):

- pattern present < [time]
- pattern present > [time]
- range: pattern present > [time1] and < [time2]

The time settings are adjustable from 20 ns to 160 ms ($\pm 3\%$ ± 2 ns). The time filter recovery time is ≤ 12 ns. In the "pattern present < [time]" mode, the pattern must be present for at least 1.75 ns before the trigger will respond.

Glitch Pattern Trigger Pattern triggering can be used to glitch trigger in conjunction with a pattern. Using any front panel channel or external trigger input. Use "pattern present < [time]" with [time] selected such that it is just less than the nominal pulse width of the signal you are analyzing. The minimum glitch width is 1 ns.

You can use the Glitch Trigger mode for glitch triggering on single sources with glitch widths from 1 ns to 160 ms.

State Trigger

After selecting any front panel channel or external trigger input as a clock, a pattern is specified using any of the remaining front panel inputs. The user may specify that a trigger will occur on the rising or falling edge of the input specified as the clock, when the pattern is present or not present. Setup time for the pattern with respect to the clock is 10 ns or less and hold time is zero.

Delayed Trigger

Event-Delayed Mode The trigger can be qualified by an edge, pattern, time qualified pattern, or state. The delay can be specified as a number of occurrences of a rising or falling edge of any one of the selected channels. After the delay, an occurrence of a rising or falling edge of any channel or external trigger inputs generates the trigger. The trigger occurrence value is selectable from 1 to 16,000,000. The maximum edge counting rate is 70 MHz.

Time-Delayed Mode The trigger can be qualified by an edge, pattern, or state. The delay is selectable from 30 ns to 160 ms. After the delay, an occurrence of a rising or falling edge of any one of the selected channels or external trigger generates the trigger. The trigger occurrence value is selectable from 1 to 16,000,000. The maximum edge counting rate is 70 MHz.

TV Trigger

60 Hz / 525 Lines Trigger source is selected to be any one of the four inputs (three inputs in two channel models). Trigger level is adjustable for the selected trigger source. Polarity is selected for positive or negative synchronizing pulses. A trigger occurs on the selected line and field of a 2/1 interlaced composite video signal. Line numbering is 1 to 263 for field 1 and 1 to 262 for field 2. This TV trigger mode is compatible with broadcast standard M.

50 Hz / 625 Lines Same as 60 Hz / 525 lines except that line numbering is 1 to 313 for field 1 and 314 to 625 for field 2. This TV trigger mode is compatible with broadcast standards B, C, D, G, H, I, K, K1, L, and N.

User-Defined Mode Source is selected to be any one of the three inputs. Trigger level is adjustable for the selected source. The trigger is qualified with a high or low pulse that meets a selectable time range. The trigger is an occurrence of a rising or falling edge of the source after the qualifying pulse. The time settings for the qualifier are selectable from 20 ns to 160 ms. The trigger occurrence value is selectable from 1 to 16,000,000.

Glitch Trigger

Used to trigger the oscilloscope on a positive or negative glitch that is less than or greater than a selectable setting. Settings are 2.5 ns, 5 ns, 10 ns, 20 ns, 40 ns, 60 ns . . . The oscilloscope will trigger on glitches from 1 ns to 160 ms. Glitch accuracy from 2.5 to 10 ns is ± 1.5 ns and from 20 ns to 160 ms is $\pm(3\% + 2$ ns).

Display

Data Display Resolution 501 points horizontally by 384 points vertically.

Number of Screens You can select 1, 2, or 4 screens. This can provide overlapping channels or memories for comparison, or separate displays on a split viewing area.

Screen Update Rate (typical at 500 ns/div, no measurements, and trigger frequency ≥ 50 kHz)

Real Time	Record Length	512	8K	16K	32K
	Updates/s	150	100	72	47
Repetitive	Mode	normal	8 averages	128 averages	
	Updates/s	150	91	91	



Display Modes

Graticules You can choose full grid, axes, frame, or no graticule.

Number of Screens You can select 1, 2, or 4 screens.

Connect-the-Dots Provides a continuous display, connecting the sample points with straight lines. Connect-the-dots is operative for modes in which a single-valued waveform can be connected, including average, envelope, single, and minimum-persistence modes. Connect-the-dots is not available in the variable or infinite persistence mode.

Time Base in the Repetitive Mode

Averaging You can specify the number of averages in powers of 2, up to 2,048. On each acquisition, $1/n$ times the new data is added to $(n-1)/n$ of the previous value at each time coordinate. Averaging operates continuously, except for the HP-IB digitize command, for which averaging terminates at the specified number of averages.

Envelope Provides a display of the running maximum and minimum voltage levels at each horizontal time position.

Minimum Persistence One waveform data value is displayed in each horizontal time position of the display. The waveform is updated as new data is acquired for a particular horizontal time position.

Variable Persistence You can vary from 500 ms to 10 seconds, the time that each data point is retained on the display, or display the points indefinitely by using the infinite persistence mode.

Time Base in the Real Time Mode

Single Persistence One waveform data value is displayed in each horizontal time position. The entire waveform is replaced with each new acquisition.

Peak Detect Displays the amplitude of pulses that have a pulse width of 1 ns or wider regardless of the time base setting. Peak detect works in real-time mode only at sample rates ≤ 250 MSa/s.

Infinite Persistence Waveform data is allowed to continuously accumulate on the screen, and remains until display is cleared.

Oversampling Filter On time/division settings when less than 500 points are acquired across the screen, a built-in digital filter automatically reconstructs the data. This filter is a combination between a $(\sin X)/X$ and a Gaussian filter (also known as interpolation).

Time Base in Sequential Single-Shot

Used to view previously captured segments as defined in the time base menu. You can exclude, select, or view individual segment numbers from any channel. Viewing options include:

Normal Selection and viewing of any or all previously captured segments.

Average Averages and displays previously captured segments into a composite waveform.

Envelope Displays the minimum and maximum voltages of all previously captured segments.

Markers

Dual voltage and time markers are available. You can independently assign voltage markers to channels, memories, or functions.

Waveform Math

Four independent functions are provided for waveform math. The operators are +, -, ×, ÷, vs, magnify, inv (invert), int (integrate), and diff (differentiate), and FFT. You can use the vertical channels or any of the waveform memories for waveform math. Sensitivity and offset for these functions are adjusted independently.

**Fast Fourier
Transforms (FFT)**

Peak Search Peak search automatically snaps cursors to any two selected peaks located anywhere in the displayed frequency span. You can select peaks from peak number 1 up to peak number 99. Frequency and dBm are automatically displayed at the bottom of the screen together with the difference in frequency between the two selected peaks. Peak search saves time by eliminating the need to manually set cursors.

Channels or Memories FFTs can be executed on any of the oscilloscope input channels, or on waveforms stored in any of four nonvolatile memories.

Variable Sensitivity and Offset Sensitivity and offset (vertical position) can be controlled to display an optimum view of the spectrum. Sensitivity is calibrated in dB per division; offset is calibrated in dBm.

Selectable Number of Points You can set the number of points the oscilloscope uses to calculate the FFT, from 512 to 32,768 (in powers of 2). Increasing the number of points improves frequency resolution at the expense of update speed. The point choices available are dependent on the data being operated upon.

Horizontal Magnify Mode This mode allows you to specify the frequency that is displayed at center screen, and magnify the frequency-domain display about that point. Magnification increases as the number of time-record samples increases. At the maximum of 32,768 points, magnification reduces the displayed frequency span to about 12% of that in the unmagnified display. Horizontal magnification allows you to zero in on and expand desired portions of the frequency-domain display.

Center Frequency Control Enabling horizontal magnification allows you to set the center of the display to a frequency of interest. The display is magnified about that point so that you get a closer view.

Selectable Windows Three windows are selectable: Hanning, for best frequency resolution and general purpose use; flattop, for best amplitude accuracy; and rectangular, for single-shot signals such as transients and signals where there are an integral number of cycles in the time record.

Maximum Displayed Frequency 5 Hz to 500 MHz selectable (real-time acquisition). Display is from dc to a selectable upper frequency, in steps from 5 Hz to 500 MHz. Maximum frequency displayed is 1/2 the sample rate.

Window Characteristics The window characteristics are shown below.

Window	Highest Side Lobe (dB)	3 dB Bandwidth (bins)	6 dB Bandwidth (bins)	Scallop Loss (dB)
Rectangular	-13	0.89	1.21	3.92
Hanning	-32	1.44	2.00	1.42
Flattop	-70	3.38	4.17	0.005

Highest Side Lobe The minimum attenuation in the stop band. It indicates the level of leakage present in the filter; that is, how high the skirts are in relation to the main peak.

3 dB bandwidth The width of the peak at a level 3 dB down. A narrow 3 dB bandwidth helps in separating frequency peaks that are close together.

6 dB Bandwidth The width of the peak at a level 6 dB down.

Bins The distance between frequency points. One bin equals the resolution.

Scallop Loss The attenuation of the peak half way between bins. The scallop loss determines the amplitude accuracy of a window. It measures the attenuation of a signal that falls between frequency bins versus one that is exactly on a frequency bin.

Split display operation A time-domain waveform and its FFT spectrum can be displayed simultaneously on the top and bottom halves of the screen. Four FFT spectra can be displayed simultaneously in the same way. Four sets of time-domain waveforms and their spectra may also be displayed simultaneously.

Log Display Sensitivity and offset can be set by the user.

Waveform Save

The oscilloscope contains four, nonvolatile waveform memories, two volatile pixel memories, and 665 multiple failure memories. The four nonvolatile memories can store four waveforms up to 32K each. The 665 multiple failure memories store 500 point records. Waveform memories store single-valued waveforms, such as an averaged waveform. If an envelope waveform is stored to a waveform memory, it is automatically stored with the upper waveform in one waveform memory and the lower waveform in another. You can perform automatic measurements on the four nonvolatile waveform memories but not the volatile pixel memories.

Waveform memory pairs m1/m2 and m3/m4 also store the upper and lower limit masks used during compare testing. You can create and edit these masks using sample signals, or you can create them manually.

Pixel memories store an entire screen of waveform data. Use them for storing multiple overlapping waveforms and infinite persistence waveforms.

Multiple memories store failure data from limit and compare tests. You can view or transfer this data to the waveform memory for nonvolatile storage or measurement.

Waveform and pixel memories can be saved to the disk drive (Disk menu).

**Automatic Pulse
 Parameter
 Measurements**

The oscilloscope offers 23 automatic pulse parameter measurements from the front panel (shown below) and over HP-IB. The standard measurements are performed with 10%, 50%, and 90% voltage thresholds, as defined by IEEE standard 194-1977, "*IEEE Standard Pulse Terms and Definitions.*"

Automatic measurements available on the oscilloscopes

Rise	Fall	Frequency	Period	preshoot	time at max voltage
+width	-width	Duty cycle	Δ Time	overshoot	time at min voltage
V p-p	V min	V max	V avg	voltage at time	time at voltage
V amptd	V base	V top	V ac rms		
			V dc rms		

User-definable Measurement Thresholds The oscilloscope allows you to set your own thresholds for automatic measurements. You can set both the upper and lower thresholds from -25% to 125%, as long as the upper threshold value is always greater than or equal to the lower threshold. The middle threshold is always equal to the midvalue between the upper and lower threshold.

Continuous Measurements You can turn continuous measurements on or off. With continuous measurements off, the voltage (y) and time (x) markers are placed on the waveform to indicate where the last measurement was taken.

Measurement Statistics The maximum, minimum, average, standard deviation, and most recent of continuously updated measurements are calculated and displayed. You can select any three measurements for simultaneous display.

Measurement Limit Test You can set the maximum and minimum limits for any three of the front-panel automatic measurements. These continuously updated measurements are compared to the maximum and minimum limits. If the measurements are outside the defined limits, you can store the waveform in a memory or print the screen on a hardcopy device. In addition, the HP-IB Service Request line can be set to flag the controller. You can set the measurement limit test to stop after test limits are exceeded, or to continue testing.



Operating Characteristics

Setup Aids

Autoscale Pressing the Autoscale button automatically adjusts the vertical, horizontal, and trigger to best display the input signals. Autoscale requires a signal with a duty cycle greater than 0.5% and a frequency greater than 50 Hz. Autoscale is effective only for relatively stable input signals.

Undo autoscale Undo autoscale returns the instrument to the setup previous to the autoscale. (See Recall 0.)

Save/Recall You can save nine front panel setups (1-9) in nonvolatile memory.

Recall Clear Pressing the Recall key followed by the Clr key resets the oscilloscope to its default settings.

Recall 0 If Autoscale, ECL or TTL preset, or recall setup are inadvertently selected, recall 0 restores the instrument to the previous setup.

Show Displays instrument status, including volts/div, offset, and trigger condition.

Disk Drive

There is a high density, 3.5-inch, MS-DOS[®] compatible disk drive on the front panel.

Hardcopy

You can transfer the display, including menus and measurement answers, directly to a wide variety of HP graphics printers and plotters.

**Full HP-IBand
RS-232
Programmability**

The oscilloscope is fully programmable. Instrument settings and operating modes, including automatic measurements, are remotely programmed over RS-232 or HP-IB (IEEE-488). HP-IB programming complies with IEEE 488.2-1988 "Standard Codes, Formats, Protocols, and Common Commands."

Sequential Single-shot Data Acquisition and Transfer Rate Using the front-panel time base menu or HP-IB command "Raw Data," the oscilloscope can automatically capture, store, and label a waveform; and rearm the trigger; and then repeat this process until the oscilloscope's entire 400K word RAM (volatile) is filled. Once the specified number of waveforms are captured and stored, the oscilloscope can transfer the entire block of waveforms to the external computer. HP-IB bus users can specify the number of points to store and the number of waveforms to capture. Repetition rates vary depending on record length and time base setting (slower sampling rates).

Data Transfer Rate Approximately 120 Kbytes per second.

CAL Signals

Probe Compensation, ac Calibrator Output A square wave signal is provided on the front panel and rear panel for probe compensation and other uses. The default frequency is approximately 500 Hz, but it is adjustable from approximately 250 mHz to about 32 kHz. During instrument self-calibration, this output is used to provide other calibration signals, as described in the Service Guide.

The rear panel BNC connector is also used for trigger output. The utility menu allows the user to switch the BNC from probe compensation and calibration signals to a trigger output pulse. The rising edge, with amplitude from about -400 mV to 0 V (when terminated into 50 Ω), is synchronous with system trigger. The falling edge of this pulse is approximately at the start of the acquisition. The rising edge should be used as the edge synchronous with trigger.

dc Calibrator Output This output is used for vertical calibration of the oscilloscope, as described in the Service Guide.

Product Support

Built in Self-Test and Calibration Routines Internal self-test capabilities provide a 90% confidence the oscilloscope is operating properly. External test procedures in the Service Guide provide a 100% confidence. Self-calibration routines, also selected through the front-panel "utility" menu, ensure that the instrument is operating with its greatest accuracy and require no external test equipment.

Low Cost of Ownership The oscilloscope includes a standard three year, return to HP warranty.

To minimize the repair and calibration times, the oscilloscope was designed with only one main assembly adjustment per channel. In addition, Hewlett-Packard's board exchange program assures economical and timely repair of units, reducing the cost of ownership.

Reliability Estimated mean time between failures (MTBF) for this oscilloscope is 30,000 hours. MTBF is computed using an instrument usage of 2,000 hours per year.

Solutions Hewlett-Packard's System Engineering Organization can help you configure an HP-IB system and provide software support for your application, developing solutions to meet your measurement needs. Contact your HP Sales and Service office for more information.

General Characteristics

These general characteristics apply to the HP 54520/42C oscilloscope.

Environmental Conditions

The instruments meet Hewlett-Packard's environmental specifications (section 750) for class B-1 products with exceptions as described for temperature and condensation. Contact your local HP field engineer for complete details.

Temperature

Operating 0 °C to +55 °C (32 °F to +131 °F)

Non-operating -40 °C to +70 °C (-40 °F to +158 °F)

Humidity

Operating up to 95% relative humidity (non-condensing) at +40 °C (+104 °F)

Non-operating up to 90% relative humidity at +65 °C (+149 °F)

Altitude

Operating up to 4,600 meters (15,000 ft)

Non-operating up to 15,300 meters (50,000 ft).

Vibration

Operating Random vibration 5-500 Hz, 10 minutes per axis, 0.3 grms

Non-operating Random vibration 5-500 Hz, 10 minute per axis, 2.41 grms; Resonant search, 5 to 500 Hz swept sine, 1 Octave/minute sweep rate, 0.75g, 5 minute resonant dwell at 4 resonances per axis.

Specifications and Characteristics

General Characteristics

Power

Requirements



Voltage 115/230 Vac, -25% to +15%, 48-440 Hz.

Power 170 W maximum

Weight

Net Approximately 10 kg (22.02 lb.)

Shipping Approximately 20 kg (44.03 lb.)

Dimensions

Refer to the outline drawings

Notes

1. Dimensions are for general information only. If dimensions are required for building special enclosures, contact your HP field engineer.
2. Dimensions are in millimeters and (inches).

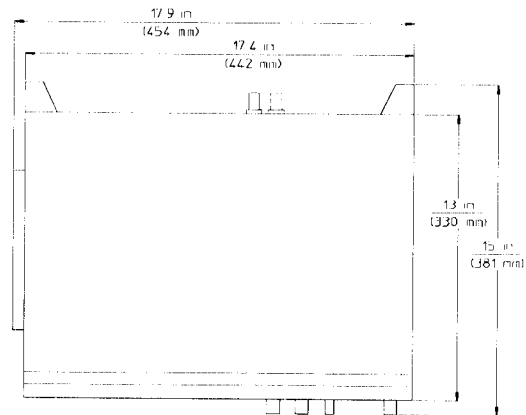
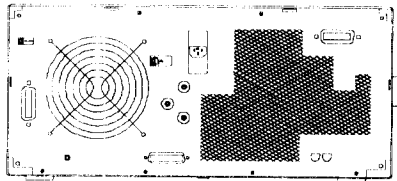
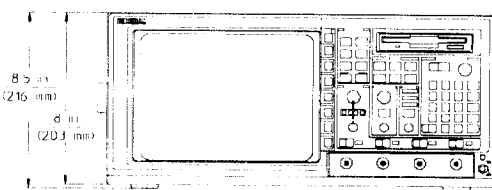

54542L22

Product Regulations

Safety IEC 1010
UL 3111
CSA Standard C22.2 No. 1010.1-92

EMC This product meets the requirement of the European Communities (EC)
EMC Directive 89/336/EEC.

Emissions EN55011/CISPR 11 (ISM, Group 1, Class A equipment)

Immunity	EN50082-1	Code ¹	Notes ²
	IEC 801-2 (ESD) 4kV CD, 8kV AD	2	
	IEC 801-3 (Rad.) 3 V/m	2	
	IEC 801-4 (EFT) 1kV	2	

- 1 Performance Codes:
1 PASS - Normal operation, no effect.
2 PASS - Temporary degradation, self recoverable.
3 PASS - Temporary degradation, operator intervention required.
4 FAIL - Not recoverable, component damage.

2 Notes:
(None)



Acquisition The process of sampling and digitizing instantaneous values of a continuous analog waveform and storing the values in memory.

Acquisition system A combination of hardware and firmware that performs the acquisition process and assembles individual waveform samples into coherent waveform records.

Averaging Before updating the display or measurements, the oscilloscope averages newly acquired data with existing data. The higher the number of averages, the less impact each new waveform has on the composite averaged waveform. Averaging is typically used to eliminate random noise from a repetitive waveform.

Bit map A two-dimensional array in which each element stores the state of a corresponding pixel (dot) on a video display. Typically, there is one bit in the array for each pixel on the display. The bit indicates whether the pixel is illuminated (1) or off (0).

Connect dots A straight line is drawn between two-adjacent data points on the display. Connect dots is a display feature; it has no affect on the waveform record stored in memory or on measurements.

Delay Delay moves the waveform horizontally on the display. Digitizing oscilloscopes allow you to view events that happened before the trigger event. A negative delay value is time before the trigger event, and a delay position value is time after the trigger event. Some oscilloscopes refer to delay as position.

Delay-by-events triggering The trigger circuitry arms on an edge from one of the channel or trigger inputs, waits for a number of events, then triggers on an edge from any of the channel or trigger inputs. Basically, it is two edge triggers separated by a selectable number of events.

Delay-by-time triggering The trigger circuitry arms on an edge from one of the channel or trigger inputs, waits for a time period, then triggers on an edge from any of the channel or trigger inputs. Basically, it is two edge triggers separated by a selectable time period.

Edge triggering The traditional triggering mode. A trigger event is defined as a transitioning edge of a specified polarity crossing a specified voltage threshold.

Equivalent-time sampling
A term that is used on other oscilloscopes to refer to repetitive

sampling. The terms are interchangeable. See "Repetitive sampling" in this glossary.

Flash ROM A type of electronically erasable and programmable read only memory (EEPROM) used to store the instrument's firmware. The use of this variety of memory makes it possible to upgrade the instrument's firmware using only a floppy disk without having to touch or change any of the internal components.

Glitch triggering Glitch triggering allows the oscilloscope to trigger on pulses less than or greater than a selected width.

Internal waveform file format A binary file format that the oscilloscope uses to store waveforms to a disk. The binary file format uses less disk space than the text file formats. Also, the binary file format is a convenient method for transporting waveforms from oscilloscope to oscilloscope, or from a disk back into the oscilloscope.

Interpolate A finite impulse response digital filter that makes the best possible reconstruction of the waveform. The reconstruction is done by using digital signal processing to add data points between the acquired data points. Then, linear interpolation is performed with the higher sample density.

Linear interpolation Another term for *connected dots*. A straight line is drawn between two adjacent data points.

Logic triggering Logic triggering allows you to qualify the trigger event further than the standard edge trigger mode. Basically, logic triggering is like adding a 4-bit logic analyzer trigger to your oscilloscope.

Memory depth Another term for *record length*. See "Record length" in this glossary.

Offset Another term for Position. Refer to "*Position*" in this glossary.



Panning Panning is used when the acquisition is in the stopped mode. Panning is moving the acquired waveform horizontally on the display. It is controlled by the time base delay controls in the real-time mode. Increasing delay moves the waveform to the left and decreasing delay moves the waveform to the right.

Pattern triggering Pattern triggering qualifies the trigger event by having the oscilloscope search for a pattern across the oscilloscope inputs. You can define the pattern as a combination of highs, lows, or don't care levels. Voltages above the trigger level are a high, and voltages below the trigger level are a low.

Peak detect Peak detect stores the minimum and maximum values (pairs) for each time bucket. Peak detect can detect excursions as narrow as 1 ns, and it functions on sample rates up to 250 MSa/s.

Pixel memory A pixel memory is a volatile, screen image, storage area. It is essentially a snap shot of the display and has no vertical or horizontal scaling factors associated with it.

Position Position (offset) moves the waveform vertically on the display. It is similar to the vertical position control on analog oscilloscopes except that it is precisely calibrated. The position voltage is the voltage at the center of the graticule area.

Real-time sampling All the data points that make up a waveform come from a single trigger event. The real-time sampling mode is typically used on events that occur either once or infrequently.

Reconstruction Also known as *interpolation*. Sampling theory indicates that if a signal is bandwidth-limited to less than half of the sampling frequency (the Nyquist frequency), the continuous signal can be determined exactly from the sequence of samples. Two problems exist in the real world to prevent exact determination of the continuous input. First, many signals are not bandwidth-limited, and second, the ideal determination requires an infinite number of samples. Reconstruction uses the assumption that the signal has minimal frequency components above the Nyquist frequency in order to accurately (but not exactly) rebuild the continuous signal from the finite set of discrete samples.

Record length The number of waveform samples stored in the waveform record. The greater the memory depth, the greater the amount of sampled data that is available for analysis or measurements.

Repetitive sampling A waveform is reconstructed from data points that are acquired from several trigger events. The repetitive sampling mode is typically used on repetitive signals.

Sample rate The rate at which the acquisition system samples a waveform. In the real-time mode, all samples in a given waveform record are taken from one trigger event and are evenly spaced in time at a distance of $1/\text{sample rate}$. In the repetitive mode and when less than 500 points are captured on each acquisition, a waveform record is built up by interleaving samples taken from multiple trigger events. This process allows samples in the waveform record to be spaced more closely together for repetitive waveforms. As a result, the waveforms appear to have been sampled at a much higher rate, sometimes referred to as an *effective sample rate*. The effective sample rate is record length/time length of the record. This is the same as $1/(\text{time}$

between the sample points) or $1/(\text{time base resolution})$.

Scale (channel) Channel scale controls the vertical scaling of displayed waveforms.

Scale (time base) Time base scale controls the horizontal scaling of displayed waveforms. Time base scale is often referred to as *sweep speed* in other oscilloscopes.

Skew Skew changes the horizontal position of a waveform on the display independent of any other waveforms on the display. The time base position control moves all of the waveforms on the display at the same time, whereas skew moves individual waveforms. Skew is typically used for overlaying waveforms, or eliminating timing difference caused by diverse cable and probe lengths.

State triggering State triggering is an edge qualified, pattern trigger. A trigger event occurs if a 3-bit pattern is present when an edge occurs on the designated clock waveform.



Text verbose An ASCII text file format that uses alphanumeric characters to represent a waveform. This format includes header information about the waveform and when it was acquired. The text file formats are a convenient method for transferring waveforms to desktop publishing programs.

Text Y values Similar to the text verbose file format, except that the header information is deleted from the beginning of the file.

Throughput Throughput is the rate at which the oscilloscope can acquire, display, and make measurements on a waveform. The faster the throughput of an oscilloscope, the more waveforms per second that it can process.

Time base reference A reference point along the time axis (X axis) of the waveform. This point can be either the left side of the display, the center, or the right side. The time of this point, relative to the trigger event, is set using the time base position control. When the time base scale is changed, the time location at the time base reference remains fixed and the waveform display either expands or contracts about the reference point.

Time bucket A storage location within a waveform record which is used to hold a waveform data sample. A waveform record is made up of a series of waveform data samples stored in ascending time order. Each waveform sample is stored in a specific time bucket within the waveform record based upon its time relationship to the other samples. The waveform record length (number of points) determines the number of time buckets in a record. A time bucket is considered "full" if it contains a waveform data sample.

Time tag Time tag is used in the sequential mode. The time tag number associated with the n th trigger or acquisition is the time from the first trigger to the n th trigger.

Trigger event A change of some type in the trigger source waveform which causes the acquisition system to begin storing waveform samples into the waveform records. The time at which the trigger event occurs is the time reference for the waveform and is, by definition, 0 seconds.

Waveform memory A waveform memory is a convenient, nonvolatile, waveform storage area. A waveform memory contains a single waveform record along with the vertical and horizontal scaling factors for that waveform.

Zooming Zooming is used when the acquisition is in the stopped mode. Zooming either expands or compresses the acquired waveform on the horizontal axis of the display. It is controlled by the time base time/div controls for expansion or compression of a single-shot waveform in the real-time mode. Decreasing time/div expands the waveform and is referred to as "zooming in." Increasing time/div compresses the waveform and is referred to as "zooming out."

- !
- # (number) of points softkey, 4-24, 10-12
- # (number) of screens softkey, 6-5
- # (number) of segments softkey, 4-24
- (+) Plus function, 10-5
- (-) Minus function, 10-5
- (x) Times function, 10-5
- + width, 13-18
- width, 13-18
- 4-bit pattern, 5-10

- A**
- Abort softkey, 11-12
- AC BNC softkey, 11-18
- Address softkey, 11-7
- adjust mode, 5-6
- Adjust softkey, 4-28, 5-21
- After fail softkey, 8-13, 8-19
- air flow, 1-7
- aliasing, 10-18
- altitude characteristics, 14-23
- Attenuation menu, 11-11
- attenuation too high or bad connection
 - error message, 11-11
- auto mode, 5-4
- Auto softkey, 4-28
- auto triggered, 5-2
- Autoincrement softkey, 12-30
- autoscale, 2-4
 - undo, 2-5
- average mode, 6-5
- averaging, 4-15

- B**
- bandwidth limit characteristics, 14-8
- bandwidth specifications, 14-3
- baud rate, 11-4
- binary file format, 12-6
- bitmapped file, 12-10
- blue shift key, 2-15 to 2-16

- C**
- Cal (calibration) signal characteristics, 14-21
- Cancel key, 2-10
- Center freq (frequency) softkey, 10-11 to 10-12
- center mode, 5-6
- Center softkey, 5-21
- Chan/Mem (channel/memory) softkey, 10-4, 10-6
- channel
 - indicator, 3-2
 - models, 3-2
 - selection, 3-4
 - timing adjustments, 11-13
- Channel factors softkey, 2-18
- Channel impedance softkey, 11-12
- Channel labels softkey, 2-18, 11-17
- Channel softkey, 3-4, 11-11, 11-13
- characteristics
 - automatic pulse parameter measurements, 14-19
 - bandwidth limit, 14-8
 - Cal (calibration) signal, 14-21
 - disk drive, 14-20
 - display, 14-13
 - display modes, 14-14
 - environmental conditions, 14-23
 - FFT (fast Fourier transform), 14-7, 14-16
 - general, 14-23 to 14-25
 - hardcopy, 14-20
 - horizontal, 14-6, 14-10
 - HP-IB Programmability, 14-20
 - marker, 14-15
 - operating, 14-8 to 14-22
 - performance, 14-5 to 14-7
 - setup aids, 14-20
 - trigger, 14-6, 14-10
 - vertical, 14-5, 14-8 to 14-9
 - waveform math, 14-15
 - waveform save, 14-18
 - window, 14-17
- Clear display key, 2-7
- Clear key, 2-15
- Clicker softkey, 11-17
- clipped signal, 13-17
- Clock softkey, 5-13
- Compare softkey, 8-17
- Compression softkey, 12-29
- Connect dots softkey, 6-6
- connect the dots, 10-15, 14-14
- Continue softkey, 8-19, 11-11
- Continuous softkey, 8-5 to 8-6
- control area, 2-4
- coupling, 5-7
- Coupling softkey, 3-6
- cursor setting, 14-16

- D**
- D time, 8-9, 13-15
- data
 - calculating, 2-7
 - collection, 13-4
 - destination, 8-12
 - display, 2-7
 - failure, 8-12
 - in memory, 4-29
 - record calculating, 13-6
 - saving failure, 8-18
 - storage, 8-10
 - transfer rate, 14-21
- Data source softkey, 8-8
- Date softkey, 11-16
- dBm computation, 10-17
- dBV computation, 10-18
- dc value, 10-18
- default resetting, 2-12
- Define measure softkey menu, 8-2
- Define measurement menu, 8-7
- delay
 - reference point, 4-11
 - trigger mode, 5-15
- Delay softkey, 4-5, 5-17
- Delete key, 12-31
- delta entry calculations, 7-4
- delta-t accuracy specifications, 14-4
- demensions characteristics, 14-24
- device communications, 11-4
- Diff (differentiate) function, 10-6
- dimensions instrument, 14-24
- Disabled/Enabled softkey, 12-28
- disk
 - formatting, 12-32
 - operation, 12-7, 12-11, 12-29
 - storing, 12-9, 12-28
- disk drive
 - characteristics, 14-20
 - overview, 2-20
- Disk menu, 12-2 to 12-3
- display
 - characteristics, 14-13

-
- mode characteristics, 14-14
 - section, 2-17
 - Display softkey, 6-3, 6-10, 10-4
 - drift, 6-8
 - E**
 - ECL (Emitter Couple Logic) softkey, 3-9
 - edge
 - count field, 8-9
 - measurements, 13-18
 - trigger mode, 5-3, 5-5
 - Enter changes softkey, 6-13
 - entry knob, 2-16
 - entry/measure area, 2-15
 - envelope mode, 6-5
 - environmental conditions, 14-23
 - EPS files, 12-28
 - equipment connecting, 1-8
 - equivalent time, 4-12
 - er 0 (screen message), 8-16
 - er 1 (screen message), 8-16
 - er 2 (screen message), 8-16
 - erasing selection, 2-15
 - error message, 11-11, 12-7
 - event, 4-24
 - Exclude all changes softkey, 6-13
 - Exclude include softkey, 6-12
 - Exclude softkey, 6-12
 - Execute softkey, 12-11
 - Exit menu softkey, 11-13
 - Extended analysis softkey, 8-6
 - F**
 - fail (screen message), 8-16
 - Fail if softkey, 8-11
 - fall time measurement, 13-18
 - falling edge, 13-11
 - calculations, 13-9 to 13-11
 - FFT (fast Fourier transform)
 - characteristics, 14-7, 14-16
 - function, 10-6
 - measurements, 10-15 to 10-18
 - menu map, 10-9
 - presetting parameters, 10-19
 - Field softkey, 5-20
 - fields
 - nonnumeric, 2-17
 - numeric, 2-17
 - file
 - data placement, 12-7, 12-11
 - data storage, 12-11
 - deleting, 12-31
 - entering name, 12-11, 12-29
 - extensions, 12-5
 - format, 12-6, 12-12 to 12-13, 12-22, 12-24
 - loading, 12-4 to 12-5
 - overwriting, 12-11
 - selection, 12-7, 12-11
 - storing, 12-9 to 12-10
 - File format softkey, 12-6
 - file formats
 - EPS, 12-28
 - PCX, 12-28
 - TIFF, 12-28
 - Fine key, 2-16
 - firmware loading, 12-2
 - flattop window, 10-14
 - Form feed softkey, 11-8
 - Format key, 12-32
 - Format softkey, 12-28
 - four (4) bit pattern, 5-10
 - four-channel models, 3-2
 - Freq (frequency) span softkey, 10-11
 - frequency
 - accuracy, 10-16
 - displaying, 14-16
 - setting, 14-17
 - From file softkey, 12-4, 12-7, 12-11
 - From seg (segment) # (number) softkey, 6-12
 - From softkey, 12-10
 - front panel
 - control, 2-6
 - entry/measure, 2-15
 - keys, 2-3
 - menus, 2-14
 - overview, 2-2
 - recalling, 2-12
 - saving, 2-12
 - setup, 2-12
 - vertical, 3-2
 - Front panel ontime softkey, 11-18
 - function displaying, 10-19
 - Function softkey, 10-4
 - fuse, 1-7
 - G**
 - general characteristics, 14-23 to 14-25
 - glitch, 5-2
 - detection, 5-9
 - timing, 5-23
 - trigger mode, 5-21
 - graticule
 - area, 2-17
 - selection, 6-6
 - Ground markers softkey, 2-18, 11-17
 - H**
 - Hanning window, 10-14
 - hardcopy
 - characteristics, 14-20
 - saving, 8-13, 8-19
 - Header information is not valid
 - error message, 12-7
 - histogram
 - building, 13-5
 - calculations, 13-6 to 13-7
 - Holdoff softkey, 5-8, 5-11, 5-14, 5-20, 5-22
 - horizontal
 - characteristics, 14-6, 14-10
 - markers, 7-3
 - scaling, 4-4
 - Horizontal setup key, 4-3
 - Horz (horizontal magnify) softkey, 10-11
 - HP-IB
 - device communication, 11-4
 - menu, 11-3
 - programmability characteristics, 14-20
 - HP-IB/RS-232 softkey, 11-4
 - humidity characteristics, 14-23
 - hysteresis, 5-5
 - I**
 - IEEE values, 13-8
 - image
 - storing, 12-28
 - Include softkey, 6-12
 - infinite persistence, 6-8
-

-
- Initialize softkey, 11-8
input impedance, 3-6
Input impedance softkey, 3-7
input R specifications, 14-3
instrument
 dimensions, 14-24
 reset, 2-20
 weight, 14-24
Int (integrate) function, 10-5
interleave factor, 12-32
internal file format, 12-6
Interpolation softkey, 11-19
Inv (inverse) function, 10-5
- J**
jitter, 5-15, 6-8
- K**
key
 blue, 2-15
 blue shift, 2-16
 Cancel, 2-10
 Clear, 2-15
 Clear display, 2-7
 Delete, 12-31
 explanation, 2-3
 Fine, 2-16
 Format, 12-32
 Horizontal setup, 4-3
 Local, 2-6
 Marker, 7-2
 Math/FFT (fast Fourier transform), 10-3
 Print, 2-10
 Recall, 2-12
 Run, 2-6, 4-24
 Save, 2-12
 Show, 2-11
 See also softkey
 Stop/Single, 2-7
key-down power up, 2-20
keypad, 2-15
- L**
leakage, 10-14
Level softkey, 5-6, 5-20 to 5-21
Limit test menu, 8-10
Limit test softkey menu, 8-2
- line
 switch, 2-17
 voltage, 1-6
Line softkey, 5-20
Load menu, 12-4
Local key, 2-6
lockout command, 2-6
logic trigger modes, 5-3
Lower threshold softkey, 8-9
- M**
Magnify function, 10-5
marker characteristics, 14-15
Marker key, 7-2
Marker menu, 7-2
Markers
 + and X, 7-8
 Waveform, 7-7
Markers softkey, 8-6
mask, generating, 8-15
math
 menu, 10-11
 operator, 10-3
 operators, 10-4
Math/FFT (fast Fourier transform) key, 10-3
Math/FFT (fast Fourier transform) menu, 10-2
Max (maximum) test voltage softkey, 11-12
maximum input voltage specifications, 14-3
Measure menu, 8-4
Measure softkey menu, 8-2
Measure window softkey, 8-5
measurements
 active, 11-19
 amplitude, 10-15
 automatic, 7-6, 13-17
 automatic parametric, 13-3
 automatic pulse parameter characteristics, 14-19
 averaging, 8-6
 considerations, 13-16
 continuous, 8-5
 custom, 7-6, 8-5, 8-7, 8-9
 errors, 13-17
 frequency, 13-17
- making, 8-3
multiple, 13-17
period, 13-17
pulse width, 13-18
timing, 8-8
voltage, 13-12 to 13-13
waveform, 13-2, 13-18
waveform peak, 10-10
windows, 8-6, 13-17
Measurements softkey, 8-9
measuring units, 10-15
memory bar, 4-20, 10-13
memory pair, 8-17
menus, 2-14
Mode softkey, 5-4
mode, user defined, 13-16
More exclude include softkey, 6-12
More preset probe softkey, 3-7
More softkey, 3-9, 6-13, 10-11, 10-14
- N**
n sec (screen displays), 4-4
negative
 delay, 4-5
 time, 5-3
noise
 clicking, 11-17
 reject, 5-7
noisy signal, 6-5, 6-8
nonnumeric fields, 2-17
normal mode, 6-4, 6-8, 6-10
not found (screen message), 8-9
Number (#) of points softkey, 4-24, 10-12
Number (#) of screens softkey, 6-5
Number (#) of segments softkey, 4-24
numbered channel keys, 3-2
numbered key, 3-3
numeric fields, 2-17
- O**
Off on softkey, 7-4
Off/Frame/Axes/Grid softkey, 6-6
offset accuracy specifications, 14-3
Offset softkey, 3-5, 10-6, 10-14
offset voltage, 3-5
On fail, save softkey, 8-12 to 8-13, 8-18
operand
 calculations, 10-5 to 10-6
-

-
- function, 10-4
 - operating characteristics, 14-8 to 14-22
 - operating conditions
 - See general characteristics
 - Operator softkey, 10-4
 - Or if softkey, 8-11
 - oscilloscope operation, 4-22
 - overshoot
 - defined, 13-13
 - measurement, 13-18
 - overwriting, 6-8
- P**
- panning, 4-6
 - Paper length softkey, 11-8
 - pass (screen message), 8-16
 - Pattern softkey, 5-10
 - pattern trigger mode, 5-9, 5-13
 - PCX files, 12-28
 - peak
 - detect mode, 6-8
 - frequency accuracy, 10-16
 - measurement accuracy, 10-15
 - Peak search softkey, 10-10
 - Pen softkey, 11-9
 - Percent/Volts softkey, 8-8
 - performance characteristics, 14-5 to 14-7
 - persistence mode, 6-4
 - pixel
 - file, 12-10
 - memory, 8-13, 8-19
 - memory file, 12-5
 - Plot softkey, 11-9
 - plotting, 11-9
 - See also printing
 - points setting, 14-16
 - position knob, 3-2
 - positive delay, 4-5
 - positive time, 5-3
 - power
 - cord, 1-5
 - requirements, 1-5, 14-24
 - Power Up softkey, 11-17
 - Present softkey, 5-14
 - preshoot
 - defined, 13-13
 - measurement, 13-18
 - Print key, 2-10
 - printing, 2-10, 11-19
 - to printer, 11-8
 - probe
 - attenuation, 3-8
 - calibration, 11-11 to 11-12
 - compensation, 2-17, 14-21
 - compensation signal, 11-18
 - impedance, 11-12
 - terminals, 2-17
 - probe attenuation (screen message), 11-11
 - Probe cal (calibration) menu, 11-10
 - Probe softkey, 3-8
 - product
 - regulations, 14-25
 - support, 14-22
 - Protect on: cannot store to memory (screen message), 8-18
 - pulse width measurements, 13-18
- Q**
- Qualify on softkey, 5-16
- R**
- Real time acquisition display menu, 6-7, 6-9 to 6-14
 - real time mode, 4-16, 13-16
 - Real-time clock, 11-15
 - rear panel, 1-4 to 1-7
 - Recall Clr (clear), 2-20
 - Recall key, 2-12
 - record length, 4-28 to 4-29
 - Record length softkey, 4-29
 - rectangular window, 10-14
 - Reference softkey, 4-11
 - Registration form (print) softkey, 11-19
 - regulations for product, 14-25
 - Reject softkey, 5-7
 - Reject-Coupling softkey, 5-7
 - Rendering softkey, 12-29
 - Repetitive acquisition display menu, 6-3
 - repetitive mode, 4-12, 13-16
 - Repetitive/Real time softkey, 4-12
 - reset instrument, 2-20
 - rise time
 - measurement, 13-18
 - specifications, 14-3
 - rising edge
 - calculations, 13-9 to 13-11
 - defined, 13-11
 - Run key, 2-6, 4-24
 - running (screen display), 4-4
- S**
- Sample clock softkey, 4-28
 - sampler circuit, 5-3
 - sampling rate, 4-28
 - Save key, 2-12
 - saving
 - data failure, 8-18
 - hardcopy, 8-13, 8-19
 - pixel memory, 8-19
 - screen display
 - n sec, 4-4
 - running, 4-4
 - Screen softkey, 8-5
 - Search level softkey, 10-10
 - segment, 4-24
 - Segment # (number) softkey, 6-11
 - Self-Cal (calibration) menu, 11-14
 - Self-test menu, 11-10
 - Sensitivity softkey, 10-6, 10-13
 - sequencing, 2-16
 - sequential
 - memory, 4-23
 - single shot, 4-22
 - Sequential softkey, 4-22 to 4-27
 - Service menu, 11-14
 - Set softkey, 8-11
 - setup
 - aids, 14-20
 - file, 12-5, 12-10
 - shipping, 1-3
 - Show key, 2-11
 - signal
 - analyzing, 2-4
 - clipped, 13-17
 - locating, 2-4
 - noise, 6-5
 - optimizing, 2-4
 - repetitive, 2-4
 - single persistence, 6-8
 - single shot
 - acquisition, 4-16, 14-21
 - events, 2-8
 - sequential, 4-22 to 4-27
-

-
- Slope softkey, 5-7
 - softkey
 - # (number) of points, 4-24, 10-12
 - # (number) of screens, 6-5
 - # (number) of segments, 4-24
 - Abort, 11-12
 - AC BNC, 11-18
 - Address, 11-7
 - Adjust, 4-28, 5-21
 - After fail, 8-13, 8-19
 - Auto, 4-28
 - Autoincrement, 12-30
 - Center, 5-21
 - Center freq (frequency), 10-11 to 10-12
 - Chan/Mem (channel/memory), 10-4, 10-6
 - Channel, 3-4, 11-11, 11-13
 - Channel factors, 2-18
 - Channel impedance, 11-12
 - Channel labels, 2-18, 11-17
 - Clicker, 11-17
 - Clock, 5-13
 - Compare, 8-17
 - Compression, 12-29
 - Connect Dots, 6-6
 - Continue, 8-19, 11-11
 - Continuous, 8-5 to 8-6
 - Coupling, 3-6
 - Data source, 8-8
 - Date, 11-16
 - Delay, 4-5, 5-17
 - Display, 6-3, 6-10, 10-4
 - ECL (Emitter Couple Logic), 3-9
 - Enabled/Disabled, 12-28
 - Enter changes, 6-13
 - Exclude, 6-12
 - Exclude all changes, 6-13
 - Exclude include, 6-12
 - Execute, 12-11
 - Exit menu, 11-13
 - Extended analysis, 8-6
 - Fail if, 8-11
 - Field, 5-20
 - File format, 12-6
 - Form feed, 11-8
 - Format, 12-28
 - Freq (frequency) span, 10-11
 - From, 12-10
 - From file, 12-7, 12-11
 - From seg (segment) # (number), 6-12
 - Front panel ontime hours, 11-18
 - Function, 10-4
 - Ground markers, 2-18, 11-17
 - Holdoff, 5-8, 5-11, 5-14, 5-20, 5-22
 - Horiz (horizontal) magnify, 10-11
 - HP-IB/RS-232, 11-4
 - Include, 6-12
 - Initialize, 11-8
 - Input impedance, 3-7
 - Interpolation, 11-19
 - Level, 5-6, 5-20 to 5-21
 - Line, 5-20
 - Lower threshold, 8-9
 - Markers, 8-6
 - Max (maximum) test voltage, 11-12
 - Measure window, 8-5
 - Measurements, 8-9
 - Mode, 5-4
 - More, 3-9, 6-13, 10-11, 10-14
 - More exclude include, 6-12
 - More preset probe, 3-7
 - Number (#) of points, 4-24
 - Number (#) of screens, 6-5
 - Number (#) of segments, 4-24
 - Off on, 7-4
 - Off/Frame/Axes/Grid, 6-6
 - Offset, 3-5, 10-6, 10-14
 - On fail save, 8-12 to 8-13
 - On fail, save, 8-18
 - Operator, 10-4
 - Or if, 8-11
 - Paper length, 11-8
 - Pattern, 5-10
 - Peak search, 10-10
 - Pcn, 11-9
 - Percent/Volts, 8-8
 - Plot, 11-9
 - Power Up, 11-17
 - Present, 5-14
 - Probe, 3-8
 - Qualify on, 5-16
 - Record length, 4-29
 - Reference, 4-11
 - Registration form (print), 11-19
 - Reject, 5-7
 - Reject-Coupling, 5-7
 - Rendering, 12-29
 - Repetitive/Real time, 4-12
 - reset, 2-20
 - Sample clock, 4-28
 - Screen, 8-5
 - Search level, 10-10
 - Sensitivity, 10-6, 10-13
 - Sequential, 4-22 to 4-27
 - Set, 8-11
 - Slope, 5-7
 - Source, 5-6, 6-11
 - Source x2, y2, 7-5
 - Standard/User defined, 8-8
 - Standard/Source, 5-19
 - Start cal (calibration), 11-11
 - Statistic output, 8-6
 - Statistics, 8-5
 - Stop, 8-19
 - System util, 11-17
 - Test, 8-11, 8-15
 - Thresholds/Measurements, 8-8
 - Time, 11-13, 11-16
 - Time base menu, 4-3
 - Time out, 11-7
 - Time/Div (division), 4-4
 - To, 8-17
 - To file, 12-11, 12-29
 - To seg (segment) # (number), 6-13
 - Trig'd (triggered) auto, 5-4
 - Trigger on, 5-17
 - Trigger, common ones, 5-4
 - TTL (Transistor Transistor Logic), 3-9
 - Type, 12-5, 12-10
 - unlabeled, 5-10, 5-19
 - Upper threshold, 8-9
 - Vertical sensitivity, 3-4
 - When, 5-11, 5-13
 - When present, 5-22
 - Width, 5-22
 - Window, 10-14
 - x1 Position, 7-4
 - x2 Position, 7-5
 - y1 Position, 7-5
 - y2 Position, 7-5
 - Source softkey, 5-6, 6-11
 - Source x2, y2 softkey, 7-5
 - specifications, 14-3 to 14-4
 - input R, 14-3
-

-
- rise time, 14-3
 - time base, 14-4
 - trigger, 14-4
 - vertical, 14-3
 - voltage measurement accuracy, 14-3
 - spectral leakage, 10-14
 - Standard/Source softkey, 5-19
 - Standard/User defined softkey, 8-8
 - Start cal (calibration) softkey, 11-11
 - state trigger mode, 5-13
 - Statistic output softkey, 8-6
 - Statistics softkey, 8-5
 - Stop softkey, 8-19
 - Stop/Single key, 2-7
 - Store image menu, 12-28
 - Store menu, 12-9
 - storing
 - EPS files, 12-28
 - PCX files, 12-28
 - TIFF files, 12-28
 - System menu, 11-15
 - System util softkey, 11-17
- T**
- temperature characteristics, 14-23
 - test parameters preset, 8-10
 - Test softkey, 8-11, 8-15
 - text verbose format, 12-6
 - threshold calculations, 13-8
 - thresholds, 8-8
 - Thresholds/Measurements softkey, 8-8
 - throughput, 4-28
 - TIFF files, 12-28
 - time
 - negative, 5-3
 - positive, 5-3
 - sample points, 4-29
 - tag feature, 4-22
 - time base, 14-15
 - characteristics, 14-14
 - delay, 5-3
 - scaling, 4-4
 - specifications, 14-4
 - windowing, 4-6
 - Time base softkey menu, 4-3
 - time bucket, 4-15, 6-8, 11-19, 12-12
 - Time null menu, 11-13
 - Time out softkey, 11-7
 - time parameters, 6-4
 - Time softkey, 11-13, 11-16
 - time tag, 6-11
 - Time/Div (division) softkey, 4-4
 - timing
 - definitions, 13-14 to 13-15
 - measurements, 13-9
 - To file softkey, 12-11, 12-29
 - To seg (segment) # (number) softkey, 6-13
 - To softkey, 8-17
 - trace movement, 3-5
 - Trig'd (triggered)/auto softkey, 5-4
 - trigger
 - basics, 5-3
 - characteristics, 14-6, 14-10
 - circuit, 5-11
 - delay mode, 5-15
 - delayed, 14-12
 - disabling, 5-14
 - disabling circuit, 5-8
 - edge, 14-11
 - glitch, 14-11
 - level, 5-5, 5-20
 - mode, 5-5, 14-11 to 14-13
 - on burst of pulses, 5-8
 - output, 14-21
 - pattern, 5-13, 14-11
 - pattern mode, 5-9, 5-13
 - point, 4-20
 - rearming, 2-7
 - sensitivity, 5-7
 - source, 5-13
 - specifications, 14-4
 - state, 14-12
 - status, 5-2
 - system, 11-18
 - TV, 14-12
 - TV signals, 5-19 to 5-20
 - Trigger on softkey, 5-17
 - Trigger softkeys, common, 5-4
 - triggered mode, 5-4
 - triggering
 - auto, 5-2
 - delay, 5-15, 5-17
 - edge, 5-11, 5-15, 5-17
 - glitch, 5-23
 - glitch polarity, 5-21
 - level, 5-21
 - modes, 5-2
 - patterns, 5-10, 5-13 to 5-14
 - points, 5-6, 5-21
 - source, 5-21
 - time, 4-5
 - TTL (Transistor Transistor Logic) softkey, 3-9
 - turning on, 2-17
 - TV trigger mode, 5-19
 - two-channel models, 3-2
 - Type softkey, 12-5, 12-10
- U**
- undo autoscale, 2-5
 - Upper threshold softkey, 8-9
 - user defined mode, 13-16
 - Utility menu, 11-2
- V**
- valid trigger, 5-3
 - value changing, 2-16
 - vertical, 3-2
 - adjustment, 3-5
 - characteristics, 14-5, 14-8 to 14-9
 - markers, 7-3
 - movement, 10-6
 - peak accuracy, 10-15
 - scaling, 3-4
 - scaling units, 10-15
 - sensitivity, 10-13
 - specifications, 14-3
 - Vertical sensitivity softkey, 3-4
 - vibration characteristics, 14-23
 - voltage measurement
 - accuracy specifications, 14-3
 - voltage measurements, 13-12 to 13-13
 - volts/div (division) knob, 3-2
 - Vs (versus) function, 10-5
- W**
- waveform
 - calculating, 13-6
 - compare mode, 8-15
 - compare test, 8-14 to 8-19
 - connect the dots, 6-6
 - data display, 2-7
 - data recalculating, 2-7
-

-
- crasing data, 2-7
 - FFT (fast Fourier transform) functions, 10-2
 - file, 12-5 to 12-6, 12-10
 - infrequent, 2-8
 - marker mode, 7-7
 - marker positioning, 7-5
 - math, 10-2 to 10-3, 10-5, 14-15
 - measurement errors, 13-17
 - measurements, 13-18
 - memory, 4-29, 8-12
 - non symmetrical, 13-17
 - See also peak
 - peak measurements, 10-10
 - problems, 6-8
 - record, 4-20
 - save characteristics, 14-18
 - saving, 8-12 to 8-13
 - slope choice, 8-9
 - status messages, 8-16
 - storing, 12-9
 - synchronizing, 5-8
 - thresholds, 8-9, 13-8
 - viewing area see also graticule, 2-17
 - Waveform compare menu, 8-14
 - Waveform compare softkey menu, 8-2
 - Waveform data is not valid
 - error message, 12-7
 - weight
 - instrument, 14-24
 - When present softkey, 5-22
 - When softkey, 5-11, 5-13
 - width measurements, 13-18
 - Width softkey, 5-22
 - window
 - characteristics, 14-17
 - selecting, 14-17
 - Window softkey, 10-14
 - windowing, 13-17
- X**
- x markers, 7-3
 - x1 Position softkey, 7-4
 - x2 Position softkey, 7-5
 - XY Pairs, 12-24
- Y**
- y markers, 7-3
 - y1 Position softkey, 7-5
 - y2 Position softkey, 7-5
- Z**
- zooming, 4-6

DECLARATION OF CONFORMITY

according to ISO/IEC Guide 22 and EN 45014

Manufacturer's Name: Hewlett-Packard Company

Manufacturer's Address: 1900 Garden of the Gods Road
Colorado Springs , CO 80907
U.S.A.

Declares, That the product

Product Name: Digitizing Oscilloscope

Model Number(s): HP 54542C, 54540C, 54522C, 54520C

Product Options: All

Conforms to the following Product Specifications:

Safety: IEC 1010-1: 1990+A1/EN 61010-1: 1993
UL 3111
CSA - C22.2 No. 1010.1: 1993

EMC: CISPR 11:1990 /EN 55011: 1991 Group 1 Class A
IEC 801-2:1991 /EN 50082-1: 1992 4 kV CD, 8 kV AD
IEC 801-3:1984 /EN 50082-1: 1992 3 V/m, {1 kHz 80% AM, 27-1000 MHz}
IEC 801-4:1988 /EN 50082-1: 1992 0.5 kV Sig. Lines, 1 kV Power Lines

Supplementary Information:

The product herewith complies with the requirements of the Low Voltage Directive 73/23/EEC and the EMC Directive 89/336/EEC and carries the CE marking accordingly.

This product was tested in a typical configuration with Hewlett-Packard test systems.

Colorado Springs, March 15, 1995

John Strathman, Quality Manager

European Contact: Your local Hewlett-Packard Sales and Service Office or Hewlett-Packard GmbH,
Department ZQ / Standards Europe, Herrenberger Strasse 130, 71034 Böblingen Germany (FAX: +49-7031-143143)

© Copyright Hewlett-Packard Company 1995-1996
All Rights Reserved.

Reproduction, adaptation, or translation without prior written permission is prohibited, except as allowed under the copyright laws.

Document Warranty

The information contained in this document is subject to change without notice.

Hewlett-Packard makes no warranty of any kind with regard to this material, including, but not limited to, the implied warranties of merchantability or fitness for a particular purpose.

Hewlett-Packard shall not be liable for errors contained herein or for damages in connection with the furnishing, performance, or use of this material.

Safety

This apparatus has been designed and tested in accordance with IEC Publication 1010, Safety Requirements for Measuring Apparatus, and has been supplied in a safe condition. This is a Safety Class I instrument (provided with terminal for protective earthing). Before applying power, verify that the correct safety precautions are taken (see the following warnings). In addition, note the external markings on the instrument that are described under "Safety Symbols."

Warning

- Before turning on the instrument, you must connect the protective earth terminal of the instrument to the protective conductor of the (mains) power cord. The mains plug shall only be inserted in a socket outlet provided with a protective earth contact. You must not negate the protective action by using an extension cord (power cable) without a protective conductor (grounding). Grounding one conductor of a two-conductor outlet is not sufficient protection.
- Only fuses with the required rated current, voltage, and specified type (normal blow, time delay, etc.) should be used. Do not use repaired fuses or short-circuited fuseholders. To do so could cause a shock or fire hazard.

- Service instructions are for trained service personnel. To avoid dangerous electric shock, do not perform any service unless qualified to do so. Do not attempt internal service or adjustment unless another person, capable of rendering first aid and resuscitation, is present.

- If you energize this instrument by an auto transformer (for voltage reduction), make sure the common terminal is connected to the earth terminal of the power source.

- Whenever it is likely that the ground protection is impaired, you must make the instrument inoperative and secure it against any unintended operation.

- Do not operate the instrument in the presence of flammable gasses or fumes. Operation of any electrical instrument in such an environment constitutes a definite safety hazard.

- Do not install substitute parts or perform any unauthorized modification to the instrument.

- Capacitors inside the instrument may retain a charge even if the instrument is disconnected from its source of supply.

- Use caution when exposing or handling the Flat Panel Display (FPD). Handling or replacing the FPD shall be done only by qualified maintenance personnel.

Safety Symbols



Instruction manual symbol: the product is marked with this symbol when it is necessary for you to refer to the instruction manual in order to protect against damage to the product.



Hazardous voltage symbol.



Earth terminal symbol: Used to indicate a circuit common connected to grounded chassis.

WARNING

The Warning sign denotes a hazard. It calls attention to a procedure, practice, or the like, which, if not correctly performed or adhered to, could result in personal injury. Do not proceed beyond a Warning sign until the indicated conditions are fully understood and met.

CAUTION

The Caution sign denotes a hazard. It calls attention to an operating procedure, practice, or the like, which, if not correctly performed or adhered to, could result in damage to or destruction of part or all of the product. Do not proceed beyond a Caution symbol until the indicated conditions are fully understood or met.

Hewlett-Packard
P.O. Box 2197
1900 Garden of the Gods Road
Colorado Springs, CO 80901

Product Warranty

This Hewlett-Packard product has a warranty against defects in material and workmanship for a period of three years from date of shipment. During the warranty period, Hewlett-Packard Company will, at its option, either repair or replace products that prove to be defective.

For warranty service or repair, this product must be returned to a service facility designated by Hewlett-Packard.

For products returned to Hewlett-Packard for warranty service, the Buyer shall prepay shipping charges to Hewlett-Packard and Hewlett-Packard shall pay shipping charges to return the product to the Buyer. However, the Buyer shall pay all shipping charges, duties, and taxes for products returned to Hewlett-Packard from another country.

Hewlett-Packard warrants that its software and firmware designated by Hewlett-Packard for use with an instrument will execute its programming instructions when properly installed on that instrument.

Hewlett-Packard does not warrant that the operation of the instrument software, or firmware will be uninterrupted or error free.

Limitation of Warranty

The foregoing warranty shall not apply to defects resulting from improper or inadequate maintenance by the Buyer, Buyer-supplied software or interfacing, unauthorized modification or misuse, operation outside of the environmental specifications for the product, or improper site preparation or maintenance.

No other warranty is expressed or implied. Hewlett-Packard specifically disclaims the implied warranties of merchantability or fitness for a particular purpose.

Exclusive Remedies

The remedies provided herein are the buyer's sole and exclusive remedies.

Hewlett-Packard shall not be liable for any direct, indirect, special, incidental, or consequential damages, whether based on contract, tort, or any other legal theory.

Assistance

Product maintenance agreements and other customer assistance agreements are available for Hewlett-Packard products.

For any assistance, contact your nearest Hewlett-Packard Sales Office.

Certification

Hewlett-Packard Company certifies that this product met its published specifications at the time of shipment from the factory. Hewlett-Packard further certifies that its calibration measurements are traceable to the United States National Institute of Standards and Technology, to the extent allowed by the Institute's calibration facility, and to the calibration facilities of other International Standards Organization members.

About this edition

This is the first edition of the *HP 54520C and HP 54540C Series Oscilloscope User's Reference*.

Publication number
54542-97048

Printed in USA.

Edition dates are as follows:
First edition, March 1996

New editions are complete revisions of the manual. Update packages, which are issued between editions, contain additional and replacement pages to be merged into the manual by you. The dates on the title page change only when a new edition is published.

A software or firmware code may be printed before the date. This code indicates the version level of the software or firmware of this product at the time the manual or update was issued. Many product updates do not require manual changes; and, conversely, manual corrections may be done without accompanying product changes. Therefore, do not expect a one-to-one correspondence between product updates and manual updates.

The following list of pages gives the date of the current edition and of any changed pages to that edition.

All pages original edition

HP 54500C Series Oscilloscope Registration Form

Please complete this form and FAX or MAIL it to Hewlett-Packard to ensure that HP can contact you when software updates or new product information becomes available. Anyone responsible for the maintenance of this product as well as the end user should register. Please register even if you are not the original purchaser. This form can also be used to inform us if your address changes.

Provide as much information as possible so Hewlett-Packard can contact you.

Your Name _____ Job Title _____
Company Name _____ Division _____
Telephone Area/Country Code _____ Phone Number _____
Street Address _____ Fax Number _____
Mail Stop _____ Department _____
City _____ Prov/State _____
Postal/Zip _____ Code Country _____
Model Number _____ **Options** _____
Serial Number _____ **Software Revision** _____
Date _____

How would you prefer to be contacted? _____ Mail _____ FAX _____ Phone

By Mail:

Hewlett-Packard Company
Electronic Measurement Division
Software Upgrade Service/EMD
P.O. Box 2197, Colorado Springs, Colorado, 80901-2197 USA

By Fax: (719) 590-2193

Optional Information

What are you making measurements on?

- | | |
|----------------------------------------------------|------------------------------------------------------|
| <input type="checkbox"/> Computers | <input type="checkbox"/> Disk Drives |
| <input type="checkbox"/> Tape Drives | <input type="checkbox"/> ICs |
| <input type="checkbox"/> Lasers | <input type="checkbox"/> Fiber Optics |
| <input type="checkbox"/> Instrumentation | <input type="checkbox"/> Video |
| <input type="checkbox"/> Datacomm | <input type="checkbox"/> Telecomm |
| <input type="checkbox"/> Microprocessors (# _____) | <input type="checkbox"/> RF/Microwave Communications |
| <input type="checkbox"/> High-Energy Research | <input type="checkbox"/> TV |
| <input type="checkbox"/> Other (Please describe) | |
-
-

What is the primary application for this product?

- | | |
|-------------------------------------------------------|-------------------------------------------------------------|
| <input type="checkbox"/> General Troubleshooting | <input type="checkbox"/> Computer Aided Test (CAT) |
| <input type="checkbox"/> Digital Design and Debug | <input type="checkbox"/> Data Acquisition |
| <input type="checkbox"/> Analog Design Verification | <input type="checkbox"/> Go/No Go Measurement Limit Testing |
| <input type="checkbox"/> Device Characterization/Test | <input type="checkbox"/> Go/No Go Waveform Compare Testing |
| <input type="checkbox"/> Transient Waveform Capture | <input type="checkbox"/> Other (Please describe) |
-
-

Any additional comments about this product?
