I/O Function Guide

Publication Number 54652-97001
First edition, February 1996

© Copyright Hewlett-Packard Company 1991-1996
All rights reserved

Interface Modules for HP 54600-Series Instruments

Introduction

These modules provide the means for remote communication with HP 54600-series instruments. For programming specifics, refer to the Programmer's Guide or Programmer's Reference shipped with your oscilloscope or logic analyzer. The hardcopy process does not interrupt front-panel operation of the instrument. While any of the interfaces are connected to the rear panel of the instrument, the instruments trace memories become nonvolatile and are saved when the power is removed from the instrument.

HP 54650A HP-IB Interface Module

- Full programmability
- Hardcopy output

HP 54651A RS-232-C Interface Module

- Full programmability
- Hardcopy output

HP 54652A Parallel Interface Module

- Hardcopy output

HP 54652B Parallel/RS-232-C Interface Module

- Full programmability
- Hardcopy output
- Connection to both an RS-232-C controller and a parallel printer at the same time.

HP 54655A Test Automation Module (HP-IB) and HP 54656A Test Automation Module (RS-232-C)

- Full programmability.
- Hardcopy output.
- 100 nonvolatile sequence steps.
- 40 nonvolatile mask templates.

- 2 nonvolatile trace memories.
- Built-in automatic mask generation and mask editing capabilities.
- Protection of test sequence and mask template setup through software.

The HP 54656A has the following additional features:

- External input lines for Next, Previous and Reset control.
- 5 user-definable output lines.
- Recessed protection switch.

**HP 54657A Measurement/Storage Module (HP-IB),
HP 54658A Measurement/Storage Module (RS-232-C), and
HP 54659B Measurement/Storage Module (RS-232-C/Parallel)**

- Full programmability.
- Hardcopy output.
- Three additional automatic voltage measurements (amplitude, preshoot, and overshoot).
- Two additional automatic time measurements (delay and phase angle).
- User defined measurement thresholds of 10%/90%, 20%/80%, or selected voltage values.
- Two additional cursor measurements (voltage in percent and time in degrees).
- Two additional cursor measurement sources (math function 1 and 2).
- Waveform math functions (addition, subtraction, multiplication, differentiation, integration, and FFT).
- Time and date tagging of hardcopy and nonvolatile memories.
- Three nonvolatile trace memories.
- Additional 64K of nonvolatile trace memory (with data compression).

The HP 54659B has an additional parallel output connector which allows the module to be connected to both an RS-232-C controller and a parallel printer at the same time.

I/O Function Guide

Interface I/O functions

Interface module	Interface connection	I/O Function
HP 54650A	HP-IB	HP-IB controller <u>or</u> HP-IB output to printer/plotter
HP 54651A	RS-232-C	RS-232-C controller <u>or</u> RS-232-C output to printer/plotter
HP 54652A	Parallel	Parallel output to printer
HP 54652B ²	RS-232-C and parallel	RS-232-C controller <u>and</u> parallel output to printer, or RS-232-C output to printer/plotter
HP 54655A ^{1,3}	HP-IB	HP-IB controller <u>or</u> HP-IB output to printer/plotter
HP 54656A ^{1,3}	RS-232C	RS-232-C controller <u>or</u> RS-232-C output to printer/plotter
HP 54657A ¹	HP-IB	HP-IB controller <u>or</u> HP-IB output to printer/plotter
HP 54658A ¹	RS-232-C	RS-232-C controller <u>or</u> RS-232-C output to printer/plotter
HP 54659B ^{1,2}	RS-232-C and parallel	RS-232-C controller <u>and</u> parallel output to printer, or RS-232-C output to printer/plotter

¹ The enhanced features of the HP 54655A/56A/57A/58A/59B are not available to the HP 54620A/C Logic Analyzer. These modules supply enhanced oscilloscope programming functions. The I/O functions of these modules will function when used with the HP 54620A/C Logic Analyzer.

² The 54652B and HP 54659B are not compatible with the HP 54600A, HP 54601A, HP 54602A, and HP 54610A.

³ The 54655A and HP 54656A are not compatible with the HP 54615B and HP 54616B.

To install the interface module

- 1 Turn off the instrument.
- 2 Install the module as shown below.

The instrument is reset after installation. The installed interface module is shown in the message displayed when you turn on the instrument. The I/O functions (controller and hardcopy) are available by pressing the instrument front-panel **Print/Utility** key.

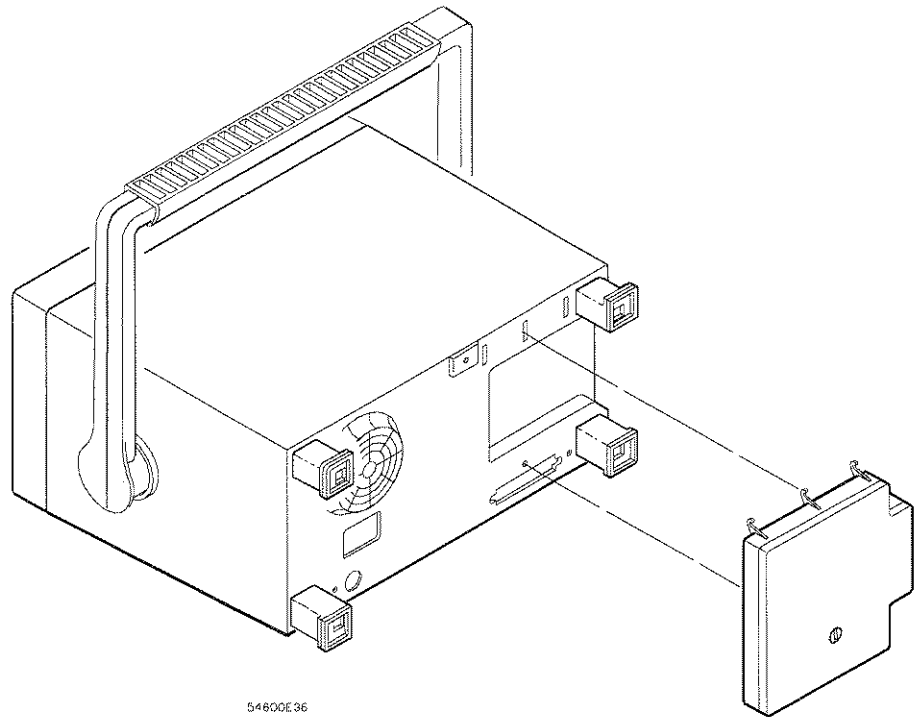

Installation of interface to HP 54600-Series instrument

I/O Function Guide
To install the interface module

Interface Cables

Interface module	Cable function (Instrument to ..)	Module connector	Printer/plotter/ controller connector	HP part number	Cable Length
HP 54650A, HP 54655A ^{1,3} , HP 54657A ¹ (HP-IB)	Printer/plotter/ controller	HP-IB	HP-IB	HP 10833A	1 m (3.3 ft)
				HP 10833B	2 m (6.6 ft)
				HP 10833C	4 m (13.2 ft)
				HP 10833D	0.5 m (1.6 ft)
HP 54651A, HP 54656A ^{1,3} , HP 54658A ¹ (RS-232-C)	Printer/plotter/ controller	25-pin F	25-pin F	HP 13242G	5 m (16.7 ft)
				HP 17255M	1.5 m (4.9 ft)
				Controller	25-pin F
	Controller	25-pin F	9-pin M	HP 17255D	1.5 m (4.9 ft)
	Controller	25-pin F	9-pin M	HP 24542G	3 m (9.9 ft)
HP 54652A (parallel output only)	Parallel printer	parallel	parallel	C2950A	2 m (6.6 ft)
				C2951A	3 m (9.9 ft)
HP 54652B ² , HP 54659B ^{1,2} (RS-232-C and parallel output)	RS-232 controller	9-pin M	25-pin M	HP 34398A	2.5 m (8.2 ft)
	RS-232 controller	9-pin M	9-pin M	HP 34398A	2.5 m (8.2 ft)
	RS-232 printer/ plotter/controller	9-pin M	25-pin F	HP 34398A + HP 34399A adapter kit	2.5 m (8.2 ft)
	Parallel printer	parallel	parallel	C2950A	2 m (6.6 ft)
				C2951A	3 m (9.9 ft)

¹ The enhanced features of the HP 54655A/56A/57A/58A/59B are not available to the HP 54620A/C Logic Analyzer. These modules supply enhanced oscilloscope programming functions. The I/O functions of these modules will function when used with the HP 54620A/C Logic Analyzer.

² The 54652B and HP 54659B are not compatible with the HP 54600A, HP 54601A, HP 54602A, and HP 54610A.

³ The 54655A and HP 54656A are not compatible with the HP 54615B and HP 54616B.

Print/Utility Menu

The Print/Utility menu of the instrument is different for each of the interfaces after installation. The following figures show how to select I/O functions in the Print/Utility menu.

HP 54650A (HP-IB)

- Press **Print/Utility** , then press the **HP-IB Menu** softkey.

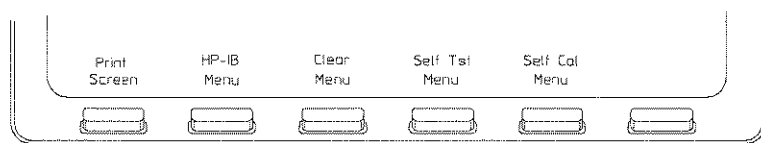

- Press the **Connect to HP Plot, HP Print, or Computer** softkey and assign the **HP-IB Address**.
- This menu also allows you to set **Factors** (see page 16) and print **Resolution** (see page 14).

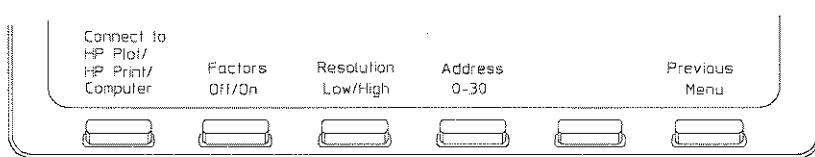

- Press the **Previous Menu** softkey. If HP Plot or HP Print was selected, pressing the **Print Screen** softkey sends the screen image to the printer/plotter.
- For controller operation, refer to the instrument Programmer's Guide.

I/O Function Guide
HP 54651A (RS-232-C)

HP 54651A (RS-232-C)

- Press **Print/Utility** , then press the **RS-232 Menu** softkey.



54652E05

- Press the **Connect to HP Plot, HP Print, Computer , or Epson** softkey and assign the **Baud Rate** and **Handshake** protocol.
- This menu also allows you to set **Factors** (see page 16) and print **Resolution** (see page 14).

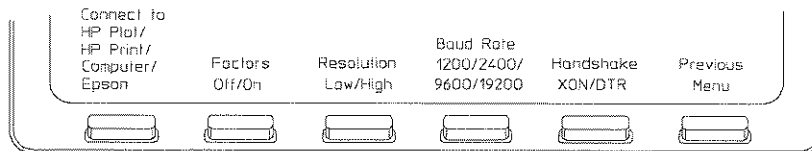

54652E01

- Press the **Previous Menu** softkey. If HP Plot, HP Print, or Epson was selected, pressing the **Print Screen** softkey sends the screen image to the printer/plotter.
- For controller operation, refer to the instrument Programmer's Guide.

HP 54652A (parallel output)

- Press **Print/Utility** , then press the **Printer Menu** softkey.

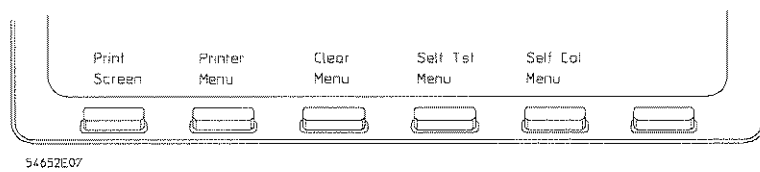

- Press the **Connect to HP Print or Epson** printer softkey.
- This menu also allows you to set **Factors** (see page 16) and print **Resolution** (see page 14).

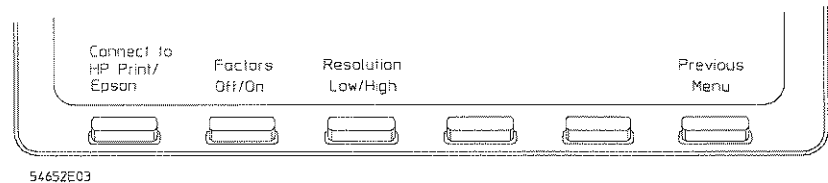

- Press the **Previous Menu** softkey. Pressing the **Print Screen** softkey sends the screen image to the hardcopy device.

I/O Function Guide
HP 54652B and HP 54659B (RS-232-C and parallel output)

HP 54652B and HP 54659B
(RS-232-C and parallel output)

- Press **Print/Utility** , then press the **Hardcopy Menu** softkey.

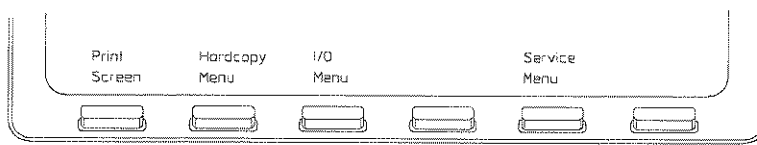
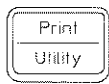

54652E04

- Press the **Destination Parallel** or **RS232** softkey. Parallel or RS232 can be used for hardcopy output.
- Press the **Format HP Print, Epson printer, or Plotter (RS-232 only)** softkey.

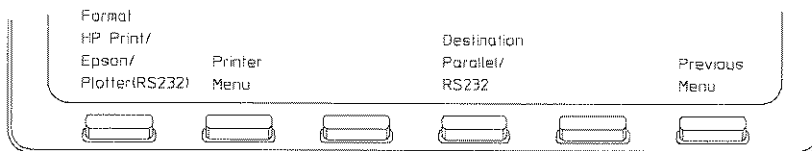

54652E08

- Press the **Printer Menu** softkey. This menu allows you to set **Factors** (see page 16) and **Grey Scale** (see page 15).

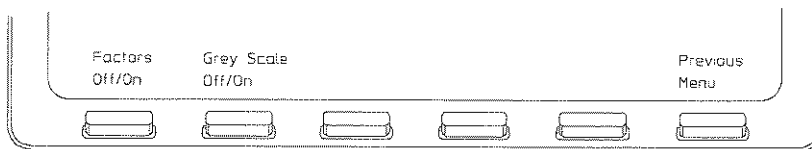

54652E09

- Press the **Previous Menu** softkey, then press the **I/O Menu** softkey to assign the **Baud Rate** and **Handshake** protocol.

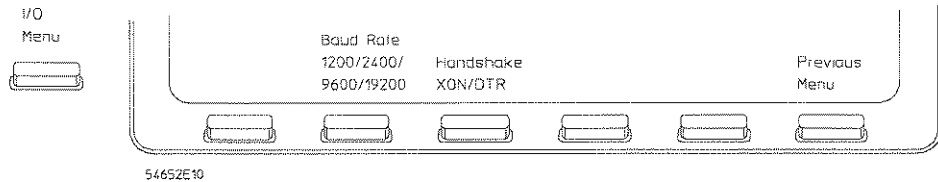

- Press the **Previous Menu** softkey. If HP Plot, HP Print, or Epson was selected, pressing the **Print Screen** softkey sends the screen image to the printer/plotter.

- The **Service Menu** is discussed in the instrument **User and Service Guide**.

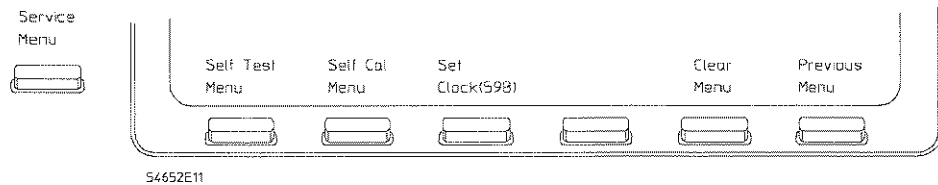

- For controller operation, refer to the instrument **Programmer's Guide** and module **User's Guide** if using the HP 54659B.

I/O Function Guide
HP 54655A and HP 54657A (HP-IB)

HP 54655A and HP 54657A (HP-IB)

- Press **Print/Utility** , then press the **HP-IB Menu** softkey.

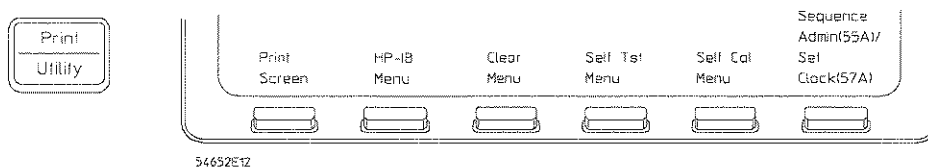

- Press the **Connect to HP Plot, HP Print, or Computer** softkey and assign the **HP-IB Address**.
- This menu also allows you to set **Factors** (see page 16) and print **Resolution** (see page 14).

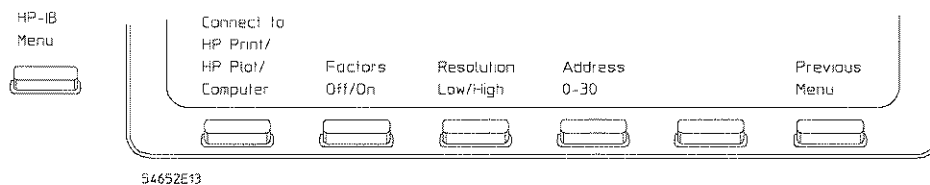

- Press the **Previous Menu** softkey. If HP Plot or HP Print was selected, pressing the **Print Screen** softkey sends the screen image to the printer/plotter.
- For controller operation, refer to the instrument Programmer's Guide and module User's Guide.

HP 54656A and 54658A (RS-232-C)

- Press **Print/Utility** , then press the **RS-232 Menu** softkey.

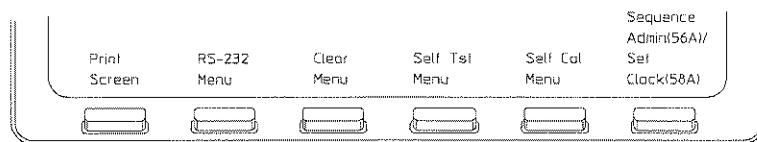

- Press the **Connect to HP Plot, HP Print, Computer, or Epson** softkey and assign the **Baud Rate** and **Handshake** protocol.
- This menu also allows you to set **Factors** (see page 16) and print **Resolution** (see page 14).

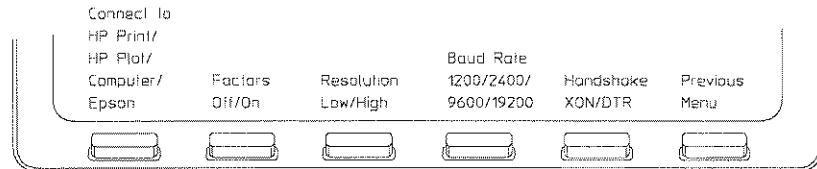

- Press the **Previous Menu** softkey. If HP Plot, HP Print, or Epson was selected, pressing the **Print Screen** softkey sends the screen image to the printer/plotter.
- For controller operation, refer to the instrument Programmer's Guide and module User's Guide.

Print Resolution (HP 54650A/51A/52A/55A/56A/57A/58A only)

High or low hardcopy resolution can be selected in the print menu.

High resolution printing requires an HP-PCL printer capable of 300 dpi (dots-per-inch), such as an HP LaserJet II Series printer.

When high resolution is selected, the full-bright and half-bright traces on the instrument screen are printed or plotted on the hardcopy.

High resolution plot uses two pens for the hardcopy. Half-bright traces are plotted with plotter pen 1 and full-bright traces are plotted with plotter pen 2.

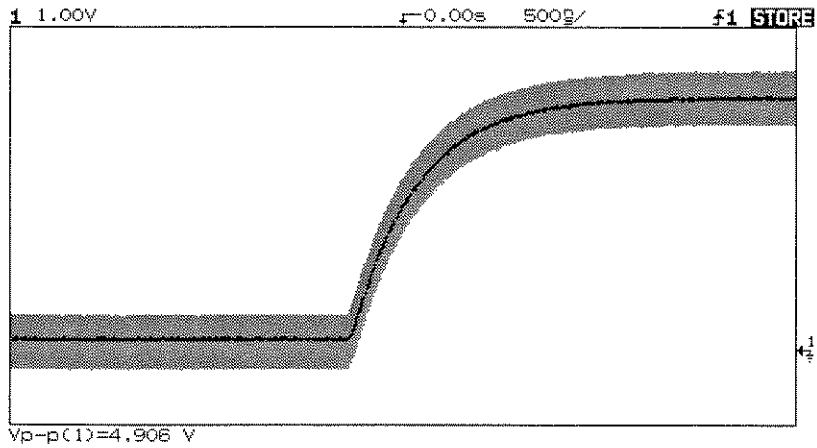

High Resolution Print

Grey scale (HP 54652B and HP 54659B)

Grey Scale On or Off can be selected in the print menu.

Grey scale printing requires an HP-PCL printer capable of 300 dpi (dots-per-inch), such as an HP LaserJet II Series printer.

When Grey Scale is selected, the full-bright and half-bright traces on the instrument screen are printed or plotted on the hardcopy.

Grey scale plot uses two pens for the hardcopy. Half-bright traces are plotted with plotter pen 1 and full-bright traces are plotted with plotter pen 2.

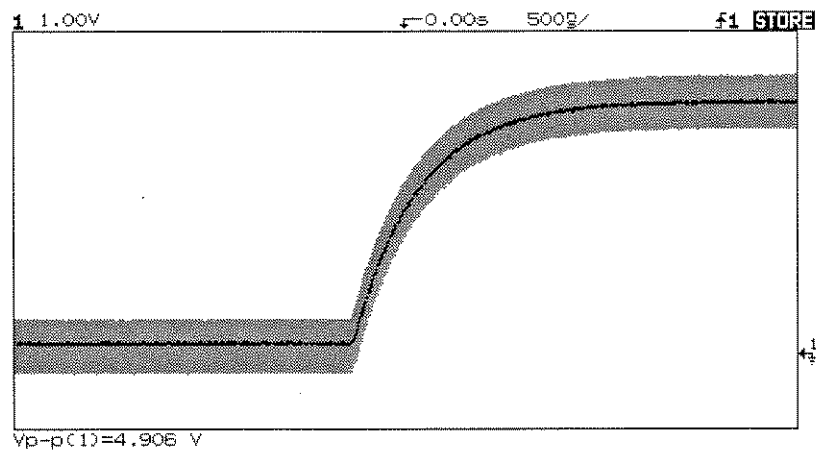

Grey Scale Print

I/O Function Guide
Print Factors

Print Factors

Instrument factors may be turned on or off for hardcopy prints and plots. All factors are printed on the hardcopy when on is selected. When factors is selected for a hardcopy plot, the plot is in portrait mode. When factors is not selected for hardcopy plot, the plot is in landscape mode.

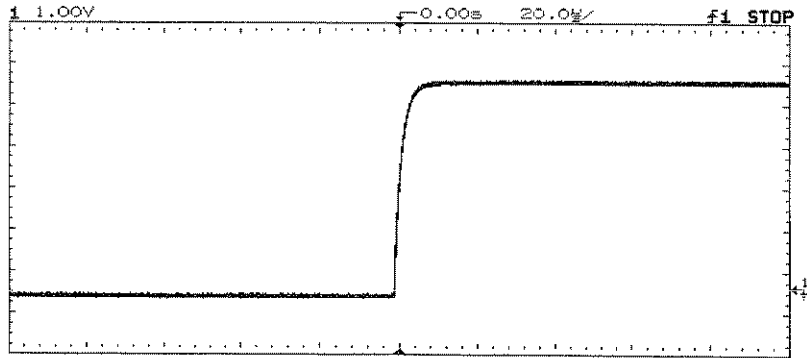

Chan	State	Volts/Div	Position	Couplg	BW Lim	Invert	Probe
Chan 1	On	1.000 V	-2.366 V	DC	Off	Off	1:1
Chan 2	Off	100.0mV	0.000 V	DC	Off	Off	1:1
Chan 3	Off	100.0mV	0.000 V	DC	---	---	1:1
Chan 4	Off	100.0mV	0.000 V	DC	---	---	1:1

Horizontal	Mode	Main Time/Div	Main Delay	Time Ref	Delayed Time/Div	Delayed Delay
Horizontal	Normal	20.00us/	0.000 s	Cntr	-----	-----

Trigger Mode	Source	Level	Holdoff	Slope	Couplg	Reject	NoiseRej
AutoLvl	Ch 1	2.366 V	200.0ns	Pos	DC	Off	Off

Display Mode: Normal

Print or Plot with Factors On

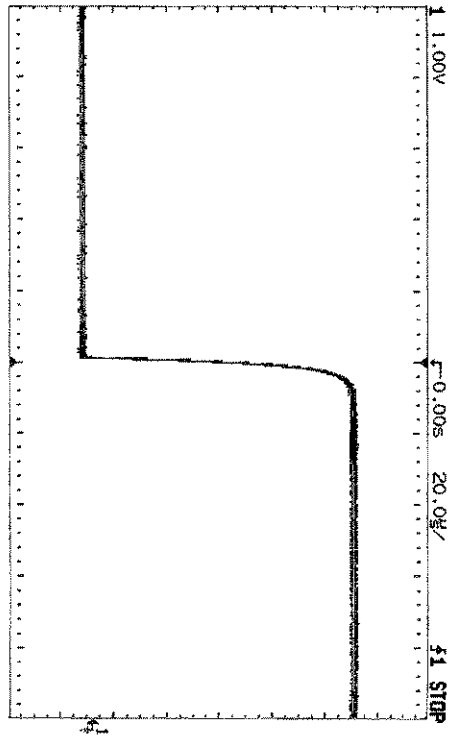

Plot with Factors Off (landscape mode)

© Copyright Hewlett-Packard Company 1991-1996
All Rights Reserved.

Reproduction, adaptation, or translation without prior written permission is prohibited, except as allowed under the copyright laws.

Publication number
54652-97001

Printed in USA.

Edition dates are as follows:
First edition, February 1996
Printed in USA.

Warranty

The information contained in this document is subject to change without notice.

Hewlett-Packard makes no warranty of any kind with regard to this material, including, but not limited to, the implied warranties or merchantability and fitness for a particular purpose.

Hewlett-Packard shall not be liable for errors contained herein or for incidental or consequential damages in connection with the furnishing, performance, or use of this material.

This Hewlett-Packard product has a warranty against defects in material and workmanship for a period of three years from date of shipment. During the warranty period, Hewlett-Packard Company will, at its option, either repair or replace products that prove to be defective.

For warranty service or repair, this product must be returned to a service facility designated by Hewlett-Packard.

For products returned to Hewlett-Packard for warranty service, the Buyer shall prepay shipping charges to Hewlett-Packard and Hewlett-Packard shall pay shipping charges to return the product to the Buyer. However, the Buyer shall pay all shipping charges, duties, and taxes for products returned to Hewlett-Packard from another country.

Hewlett-Packard warrants that its software and firmware designated by Hewlett-Packard for use with an instrument will execute its programming instructions when properly installed on that instrument. Hewlett-Packard does not warrant that the operation of the instrument software, or firmware will be uninterrupted or error free.

Limitation of Warranty

The foregoing warranty shall not apply to defects resulting from improper or inadequate maintenance by the Buyer, Buyer-supplied software or interfacing, unauthorized modification or misuse, operation outside of the environmental specifications for the product, or improper site preparation or maintenance.

No other warranty is expressed or implied. Hewlett-Packard specifically disclaims the implied warranties or merchantability and fitness for a particular purpose.

Exclusive Remedies

The remedies provided herein are the buyer's sole and exclusive remedies. Hewlett-Packard shall not be liable for any direct, indirect, special, incidental, or consequential damages, whether based on contract, tort, or any other legal theory.

Assistance

Product maintenance agreements and other customer assistance agreements are available for Hewlett-Packard products. For any assistance, contact your nearest Hewlett-Packard Sales Office.

Certification

Hewlett-Packard Company certifies that this product met its published specifications at the time of shipment from the factory. Hewlett-Packard further certifies that its calibration measurements are traceable to the United States National Institute of Standards and Technology, to the extent allowed by the Institute's calibration facility, and to the calibration facilities of other International Standards Organization members.

Hewlett-Packard
P.O. Box 2197
1900 Garden of the Gods Road
Colorado Springs, CO 80901