

User and Service Guide

Publication number 54701-97003
September 2002

For Safety and Regulatory information, see the pages behind the index.

© Copyright Agilent Technologies 1992-2002
All Rights Reserved

Agilent Technologies 54701A 2.5-GHz Active Probe

Agilent Technologies 54701A 2.5-GHz Active Probe

The Agilent Technologies 54701A 2.5-GHz Active Probe is a probe solution for high-frequency applications. This probe is designed to be powered from a connector at the front of the oscilloscope, or with the 1143A Probe Offset Control and Power Module. It can be used with any measuring instrument with a 50- Ω input. Following are the main features. See Chapter 3 for full specifications and characteristics.

- A bandwidth of 2.5 GHz
- Input resistance of 100 k Ω
- Input capacitance of approximately 0.6 pF
- Dynamic range of ± 5 V peak ac and ± 50 Vdc
- Variable dc offset of ± 50 V
- Excellent immunity to ESD and over-voltages

Accessories Supplied

The following accessories are supplied. See “Using probe accessories” in chapter 1 for a complete list.

- Type N(f) to BNC(m) adapter
- “Walking-stick” ground
- Box of small accessories
- Carrying case
- User and Service Guide

Accessories Available

The following accessories can be ordered.

- Type N(m) to probe tip adapter and 50- Ω termination, 11880A
- BNC(m) to probe tip adapter, 10218A
- Type N(f) to APC 3.5(f) bulkhead adapter, 5081-7722 (For use with the 54120 family. Order with the probe as Option 001.)

Options Available

The following options are available.

- Option 001, Type N(f) to APC 3.5(f) bulkhead adapter (To use the probe with 54120 family)
- Option 0B1, Additional User and Service Guide

Service Strategy

Except for the probe tip, there are no field replaceable parts in the Active Probe. Depending on the warranty status of your probe, if it fails it will be replaced or exchanged. See chapter 3, “Service,” for further information and how to return your probe to Agilent Technologies for service.

Option 001

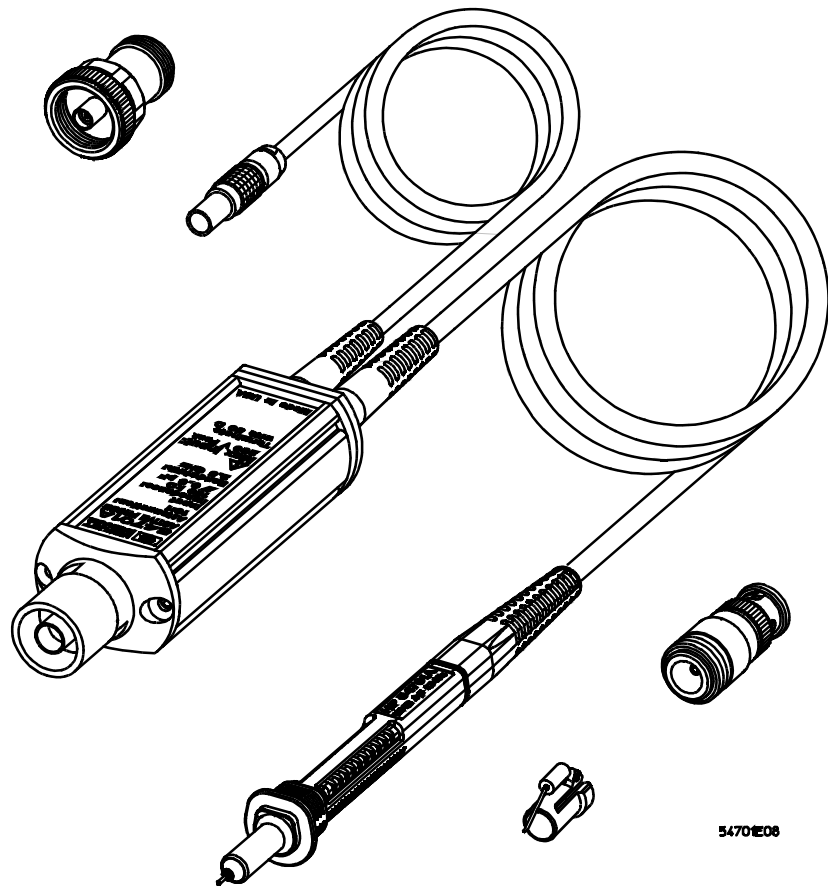

In This Book

This book provides use and service documentation for the 54701A 2.5-GHz Active Probe. It is divided into three chapters.

Chapter 1 shows you how to set up and operate the probe using the power connector on the oscilloscope or the separately available 1143A Probe Offset Control and Power Module.

Chapter 2 gives you information about some important aspects of probing and how to get the best results with your probe.

Chapter 3 provides service information. Included is how to test the probes performance, how and when to make the one adjustment, and how to determine if your probe needs repair.

Contents

In This Book 4

1 Operating the Probe

To inspect the probe 9
To connect the probe 12
Connecting the probe to the 54120 family oscilloscopes 13
Using the probe with oscilloscope power 14
Using the probe with the 1143A power module 15
Using probe accessories 16
Additional Accessories 20

2 Probing Considerations

Capacitive Loading Effects 25
Ground Inductance Effects 27
Probe Bandwidth 31
Conclusion 32

3 Service

Specifications	35
Characteristics	36
General Characteristics	37
Recommended Test Equipment	38
Service Strategy	39
To clean the instrument	40
To return the probe to for service	40
To test input resistance	42
To test dc gain accuracy	43
To test bandwidth	45
To adjust offset zero	49
Failure Symptoms	51
To prepare the probe for exchange	53
Replaceable Parts	54
Theory of Operation	56

Operating the Probe

Figure 1

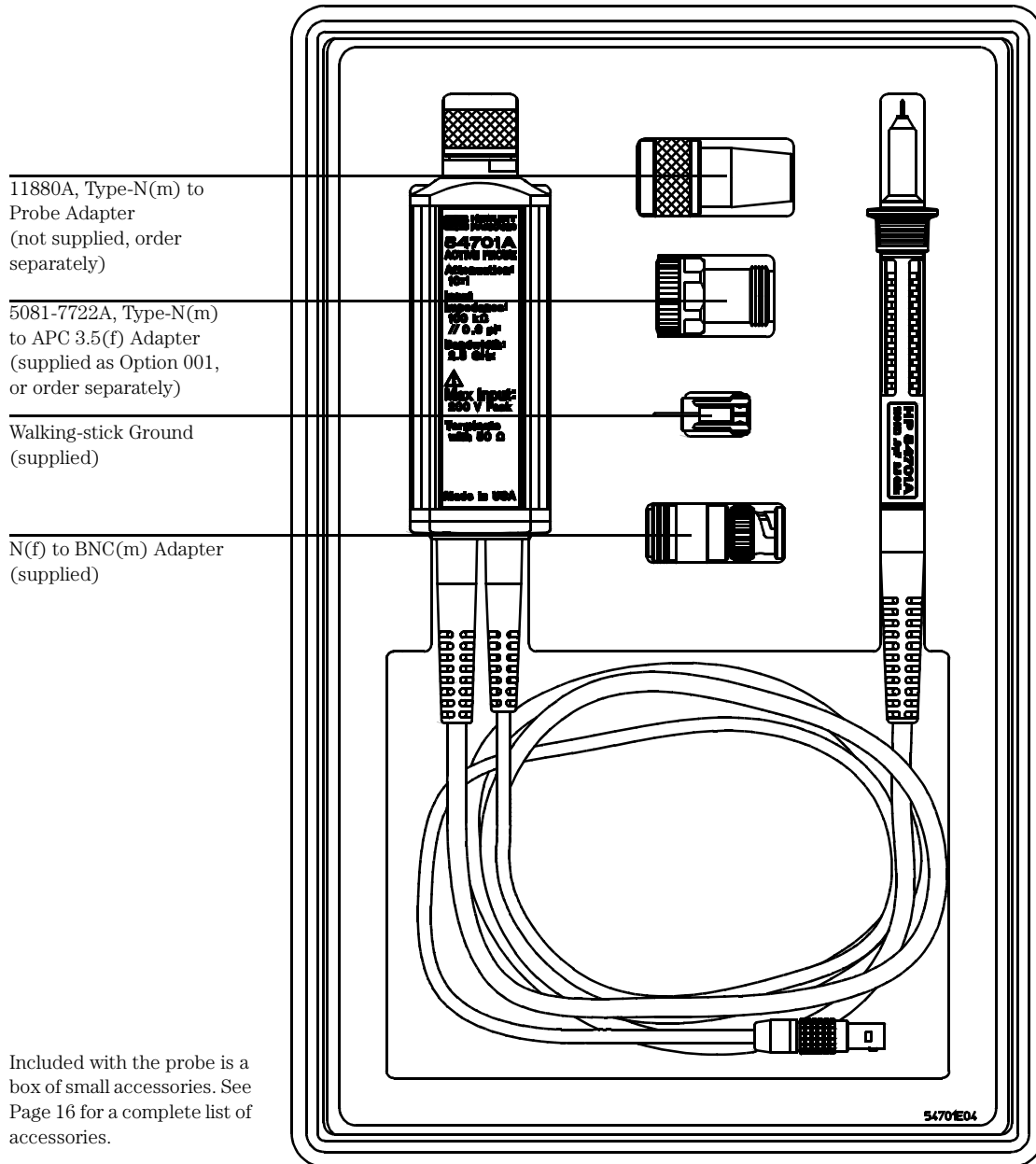

54710A Active Probe

Introduction

This chapter shows you how to connect and operate the 54701A Active Probe. The following information is covered in this chapter:

- Inspection
- Probe operating range
- Connecting the probe
- Operating the probe with oscilloscope power
- Operating the probe with a power module
- Using accessories

To inspect the probe

- ❑ Inspect the shipping container for damage.

Keep a damaged shipping container or cushioning material until the contents of the shipment have been checked for completeness and the instrument has been checked mechanically and electrically.

- ❑ Check the accessories.

Accessories supplied with the instrument are listed in "Accessories Supplied" in table 1, page 16 in this manual.

- If the contents are incomplete or damaged notify your Agilent Technologies sales office.

- ❑ Inspect the instrument.

- If there is mechanical damage or defect, or if the instrument does not operate properly or pass calibration tests, notify your Agilent Technologies sales office.
- If the shipping container is damaged, or the cushioning materials show signs of stress, notify the carrier as well as your Agilent Technologies sales office. Keep the shipping materials for the carrier's inspection. The Agilent office will arrange for repair or replacement at Agilent Technologies' option without waiting for claim settlement.

Probe Operating Range

Figure 2 shows the maximum input voltage for the active probe as a function of frequency. This is the maximum input voltage that can be applied without risking damage to the probe.

Figure 2

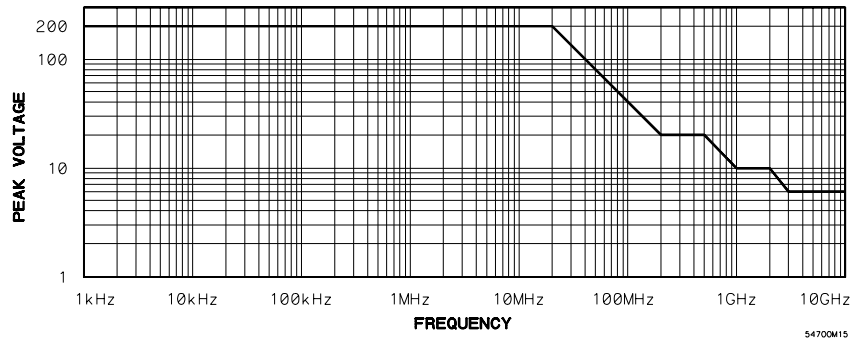

Maximum Input Voltage vs Frequency

Figure 3 shows the operating range of the probe. For the most accurate measurements and safety for the probe, signals should be within the indicated operating region.

Figure 3

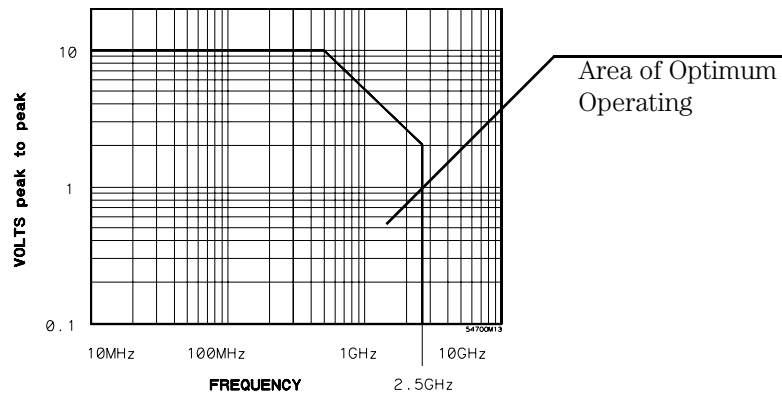

Probe Operating Range

The curves in figures 4 and 5 represent the typical input signal limits for several levels of second and third harmonic distortion in the output signal. For input signals below a given curve, the level of harmonic distortion in the output is equal to or below that represented by the curve. The dashed straight line in each figure represents the operating range limit as shown in figure 3 on the previous page.

Figure 4

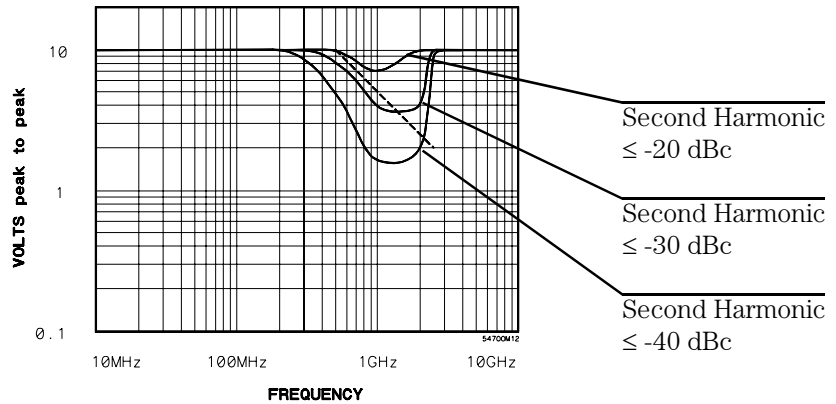

Second Harmonic Distortion, Input Voltage vs Frequency

Figure 5

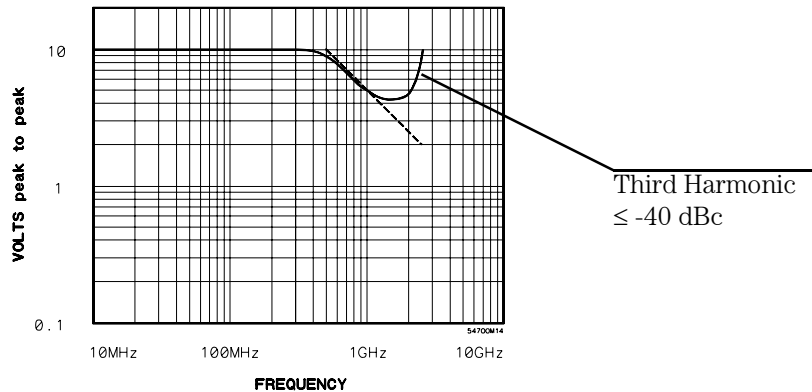

Third Harmonic Distortion, Input Voltage vs Frequency

To connect the probe

1 Connect the probe output to the instrument input.

The probe output is through a Type-N connector and the probe is designed to be terminated with $50\ \Omega$ 1%.

- If your instrument has a fixed $50\text{-}\Omega$ input, connect the probe output.
- If your instrument has selectable input resistance, connect the probe output and set the instrument input resistance to $50\ \Omega$. If your oscilloscope has probe power for this probe, it may automatically set the input resistance to $50\ \Omega$ for you.
- If your instrument does not provide a $50\text{-}\Omega$ input, connect a Type-N(f) to BNC(m) adapter and a $50\text{-}\Omega$ feedthrough (such as an 10100C) to the output of the probe. Then, connect the probe to the input of your instrument.

2 Connect the probe power cable to a Power connector.

Red dots on the cable connector housing align with the connector keys. Align the keys when inserting the cable connector into the power connector.

CAUTION:

The probe power cable connector automatically locks in the mating power connector. To separate the connectors, you must pull on the knurled part of the cable connector housing. This releases the lock. If you pull on the cable the connectors won't release and you may damage the connector or cable.

- If your oscilloscope has the appropriate probe power connector, connect the probe power cable.

Some oscilloscopes have more than one channel, or signal channels with separate trigger inputs. In these instruments, a probe power connector may be associated with a specific input. Be sure to connect the probe power cable to the correct connector so the instrument will respond correctly to the presence of the probe.

- If your instrument does not have the appropriate probe power connector, connect the probe power cable to one of the connectors on the 1143A Probe Offset Control and Power Module. The 1143A provides probe power and offset control for two probes.

3 Calibrate the oscilloscope and probe combination with the instrument calibration routines.

Some oscilloscopes allow you to calibrate the probe as part of the input signal path. Consult the oscilloscope User Guide for further information.

- If calibrating the probe with the 54700 family oscilloscope, you must calibrate the plug-in with the mainframe before calibrating the probe with the system. Use the following procedure:
 - a. Calibrate the oscilloscope using the best accuracy procedure.
 - b. Calibrate the probe with the oscilloscope using the probe calibration procedure.

When the probe has been calibrated with the 54700 system, the dc gain, offset zero, and offset gain will be calibrated. The degree of accuracy specified at the probe tip is dependent on the 54700 system specifications.

- If using an 1143A power module for probe power, set the Offset controls to Local and Zero while performing the calibration. Follow the calibration procedures for your oscilloscope.

CAUTION:

An effort has been made to design this probe to take more than the average amount of physical and electrical stress. However, with an active probe, the technologies necessary to achieve high performance do not allow the probe to be unbreakable. Treat the probe with a moderate amount of care. It can be damaged if it is dropped from excessive heights onto a hard surface.

Connecting the probe to the 54120 family oscilloscopes

There are a few things to consider when connecting the 54701A Active Probe to one of the 54120 family of high performance oscilloscopes.

- Use the special Type N(f) to APC 3.5(f) bulkhead adapter to connect the probe output to the input of the test set. The adapter provides the full bandwidth and pulse fidelity of the probe as well as full mechanical support. The use of other adapters can compromise signal fidelity and may be vulnerable to mechanical damage.

Probe Operating Range

The Type-N(f) to APC 3.5(f) adapter can be ordered with the probe as Option 001 or ordered separately, part number 5081-7722.

- The dynamic range of the system will be 3.2 V (6.4 V_{p-p}) which, with probe offset, covers most digital technologies.

Using the probe with oscilloscope power

Probe power and offset control are provided by the oscilloscope. There are several factors to consider about the oscilloscope and probe combination.

- The oscilloscope recognizes the presence and type of probe and adapts the vertical scale factors to reflect the probe characteristics.
- The offset function is transferred to the probe but this is transparent to the user. The offset will be limited to a range acceptable to the probe. With 54700 family of oscilloscope plug-ins, the offset range is 50 V. See the sidebar below.
- Since the 54701A is an active probe, the bandwidth of the oscilloscope and probe combination is a mathematical combination of their individual specifications.

Equation 1

$$\text{System Bandwidth} = \frac{0.35}{\sqrt{(tr1)^2 + (tr2)^2}}$$

where

tr1 is the risetime of the oscilloscope.

tr2 is the risetime of the probe

If you are using a 54700 family oscilloscope, the resultant bandwidth with a specific mainframe, plug-in, and probe combination is noted on a sticker on the side panel of the plug-in

The probe has limiting designed to avoid excessive power dissipation. The input operating range of the probe is 5 V. If the input and offset exceeds +14V relative to the probe tip, the output of the probe will limit at +1.4 V. As the input plus offset reaches -14 V, the output will limit at -1.4 V; then, it will fold back to approximately -0.8V as the input plus offset exceeds -14 V. The output of the probe will remain at the limit voltage until the input plus offset falls below approximately -8 Vdc.

Using the probe with the 1143A power module

Probe power and offset control is provided by the 1143A Probe Offset Control and Power Module.

- 1 Set up the power module by following the instructions in the User and Service Guide.
- 2 Connect the probe using “To connect the probe” on page 12" of this guide.
- 3 Turn on the power for the power module.
- 4 Set the appropriate Remote/Local switch.
 - To control offset voltage with the power module, set the switch to Local.
 - To control the offset voltage remotely, set the switch to Remote.
- 5 With Local control, set the appropriate Zero/Variable switch.
 - To enable the local offset control, set the switch to Variable.
 - To disable the local offset control, set the switch to Zero.
- 6 Connect the probe to the signal to be measured.

If the oscilloscope has an offset feature, be sure that it is set to zero so that the probe offset does not have to compensate for the oscilloscope offset.
- 7 If necessary, adjust the Coarse and Fine offset controls so the desired part of the signal is displayed on the oscilloscope. See sidebar below. The offset range is greater than 50 V relative to the probe tip.

Bandwidth issues are the same as covered on the previous page

The probe has limiting designed to avoid excessive power dissipation. The input operating range of the probe is 5 V. If the input and offset exceeds +14V relative to the probe tip, the output of the probe will limit at +1.4 V. As the input plus offset reaches -14 V the output will limit at -1.4 V; then, it will fold back to approximately -0.8V as the input plus offset exceeds -14 V. The output of the probe will remain at the limit voltage until the input plus offset falls below approximately -8 Vdc.

See Also

The *User and Service Guide* for the 1143A Probe Offset Control and Power Module about remote probe operation.

Using probe accessories

The following figure and table illustrate the accessories supplied with the 54701A Active Probe.

Figure 6

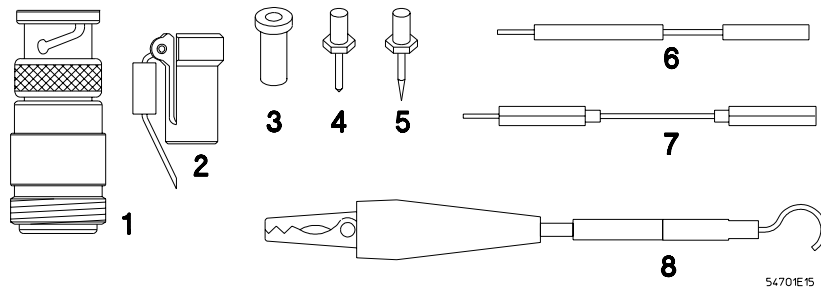

Table 1

Accessories Supplied

Item	Description	Qty	Part Number
1	Type-N(f) to BNC(m) adapter	1	1250-0077
2	Walking-stick ground	1	5960-2491
3	Single contact socket	5	1251-5185
4	Standard probe pin	5	54701-26101
5	Sharp probe pin	2	5081-7734
	Nut Driver 3/32-in (not shown)	1	8710-1806
6	200-Ω signal lead	1	54701-81301
7	Ground extension lead	1	0650-82103
8	Alligator ground lead	1	01123-61302
*	Flexible Probe Adapter	1	54701-63201
*	Probe Socket	1	5041-9466
*	Coaxial Socket	3	1250-2428
	Operating and Service Guide	1	see title page

* These parts are illustrated on pages 18 and 19.

Type-N to BNC Adapter

The Type-N(f) to BNC(m) adapter connects the output of the probe to instruments with a BNC input. If the instrument input does not have a 50- Ω termination, use an adapter with an integral 50- Ω load or add a 50- Ω feedthrough (10100C) between the adapter and instrument input.

Walking-stick Ground

The walking-stick ground is the best ground for general probing. It is short, and the ground wire includes a bead for damping probe resonance. This provides a well maintained probe response for frequencies to 2.5 GHz.

Single Contact Socket

The single contact sockets can be soldered into a circuit to provide a probe point to hold the probe tip or ground. The socket accepts 0.018-inch to 0.040-inch pins. The sockets accept the probe tips, the walking-stick ground, the 200- Ω signal lead, and the ground extension lead.

Probe Pins

There are two types of replaceable probe pins furnished with the probe. The 0.030-inch round standard probe pin is for general applications. It is made of a material that will generally bend before breaking. The 0.025-inch round sharp probe pin has a narrower point and is a harder material. It can be used to probe constricted areas or penetrate hard coatings.

CAUTION:

Do not solder the probe tip into circuitry. Excessive heat may damage the tip or circuitry inside the probe. If you need to solder something into your circuitry, use the single contact sockets, ground extension lead, or 200- Ω signal lead. They are less easily damaged and less expensive to replace.

- To remove and replace probe pins, use the nut driver to unscrew the tip from the end of the probe.
- Be sure to screw the replacement tip all the way in or the probe may be intermittent or appear ac coupled.

Nut Driver

The 3/32-in nut driver is provided for easier replacement of the probe tips.

Chapter 1: Operating the Probe

Probe Operating Range

200- Ω Signal Lead

This 2-inch orange extension lead includes a molded-in resistor to dampen resonance caused by the lead inductance. Use this lead and the ground extension lead to provide a flexible connection to the circuit under test.

There is a tradeoff when using the extension leads. To maintain a clean pulse response, the probing system bandwidth is limited to 1.5 GHz. Probe resonance is damped by the walking-stick bead and the resistor in the signal lead.

Ground Extension Lead

This 2.25-inch black ground lead can be used to extend ground from the walking-stick to the circuit under test. When used with the walking-stick ground the probe resonance is damped by the bead on the walking-stick.

Alligator Ground Lead

The alligator ground lead can be used in general applications when the bandwidth of the signal is 350 MHz or lower. With no signal lead extension the probe resonant frequency is about 650 MHz.

Flexible Probe Adapter

The flexible probe adapter provides a high-quality connection between a coaxial socket and the 54701A probe. The right-angle connection allows the probe to remain parallel to a PC board and the flexibility prevents the leverage of the probe and cable from damaging PC board circuitry.

As with any cable-type interconnection, always apply insertion and removal forces to the connectors directly, and not through the cable itself (see the illustration).

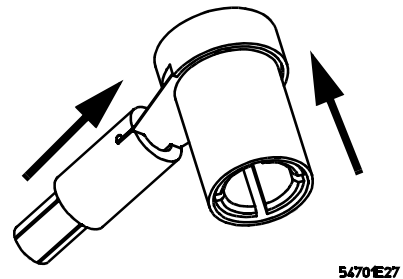

Probe Socket

The probe socket is a direct fit to the shield surface of the 54701A probe. Use this socket and the single contact socket to design the highest quality probing of a PC board. The illustration shows the socket and the PC board layout needed to mount the parts.

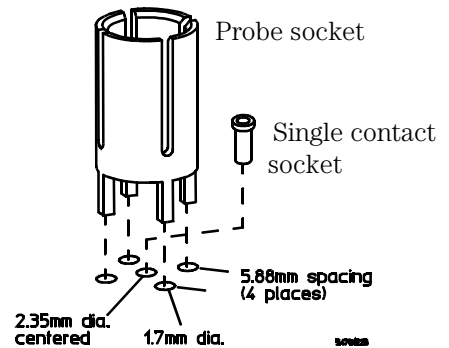

Coaxial Socket

The coaxial socket is designed to fit the standard mini-probe. When used with the flexible probe adapter, it can be installed in a circuit so you can probe with the 54701A. The illustration shows the socket and the PC board layout needed to mount the socket to the board.

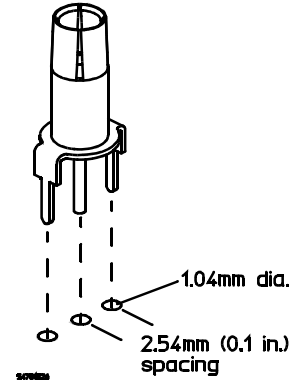

See Also

Chapter 2, "Probing Considerations," for a more complete discussion about the effects of probe connection techniques on signal fidelity.

See Also

"Replaceable Parts" chapter 3 for replacement parts that are available but not listed here.

Additional Accessories

The following accessories enhance use of the active probe. For ordering information, see "Replaceable Parts" in chapter 3.

Type-N to APC 3.5 Adapter

The Type-N(f) to APC 3.5(f) bulkhead adapter is an optional adapter (Option 001, part no. 5081-7722) specifically designed to connect the active probe to the input of the 54120 family of high-performance oscilloscopes. The adapter provides the full bandwidth and pulse fidelity of the probe as well as full mechanical support. The use of other adapters can compromise signal fidelity and may be vulnerable to mechanical damage. This adapter can be ordered with the probe as Option 001.

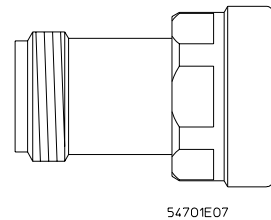

Type-N to Probe Tip Adapter

The 11880A Type-N(m) to probe tip adapter is available to connect the input of the active probe to Type-N connectors. It has an internal 50-Ω load. It can be used for general testing and is specifically recommended for testing the probe bandwidth. This adapter must be ordered separately.

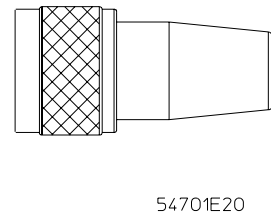

BNC to Probe Tip Adapter

The 10218A BNC(m) to probe tip adapter is available to connect the input of the active probe to BNC type connectors. It does not have an internal load so it is not recommended for testing where the full bandwidth of the probe is needed. This adapter must be ordered separately.

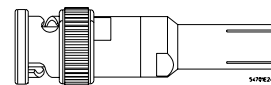

Probing Considerations

Introduction

This chapter gives you some guidance about the effects of probing and how to get the best measurement results. The effect of the following parameters are covered in this chapter:

- Resistive Loading
- Capacitive Loading
- Ground Inductance
- Bandwidth

Two important issues while measuring signals with probes are how the probe/oscilloscope combination represents the signal at the probe tip and how the probe affects the circuit during the measurement.

When a probe is connected to a circuit to measure a signal it becomes part of the circuit. Probing a signal can be easy and successful if some forethought is given to the nature of the circuit under test and what type of probe best solves the measurement problem. Because of the wide variety of signals that may be encountered, ranging from high bandwidth (fast rise times) to high impedance, in a given situation one probe may do a better job than another. Therefore, it is helpful to understand the different effects caused by the interaction between the probed circuit and the probe.

Resistive Loading Effects

The two major effects caused by resistive loading are amplitude distortion and changes in dc bias conditions in the circuit under test.

Amplitude Distortion

Amplitude distortion is depicted in figure 7, where waveform 1 is the signal before probing and waveform 2 is the signal while probing. (The baselines of these signals have been overlaid to show the amplitude change. If the baseline of a signal is not at zero volts it will shift when the signal is probed.)

Figure 7

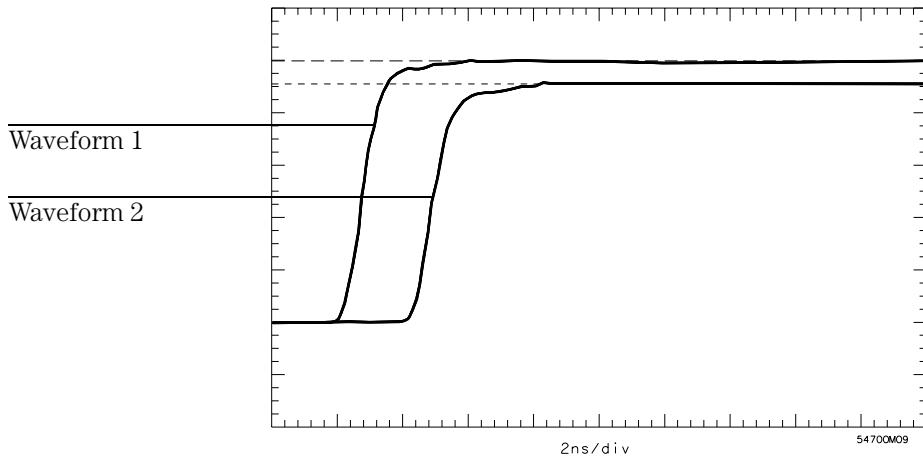

Oscilloscope Display Showing Amplitude Distortion

The cause of the error is the voltage divider developed between the source resistance of the device under test and the input resistance of the probe being used. Equation 2 calculates the error caused by the voltage divider.

Equation 2

$$\text{Error(\%)} = \frac{R_{\text{source}}}{R_{\text{source}} + R_{\text{probe}}} \times 100$$

A probe with an input resistance ten times that of the source resistance of the device under test causes a 9.09% error in the measurement. It is best to use a probe with an input resistance at least ten times that of the source resistance.

Resistive Loading Effects**Bias Changes**

Probes with low input resistance can cause bias changes in the device under test. A good example of this effect can be seen when probing ECL circuits. Figure 8 represents a typical ECL node with a 60- Ω bias resistor to -2 V. I_P represents current that flows from ground into the circuit when the probe is connected. The table shows the current that flows in each device at both the high (-0.8 V) and low (-1.75 V) states, with and without a 500- Ω probe connected.

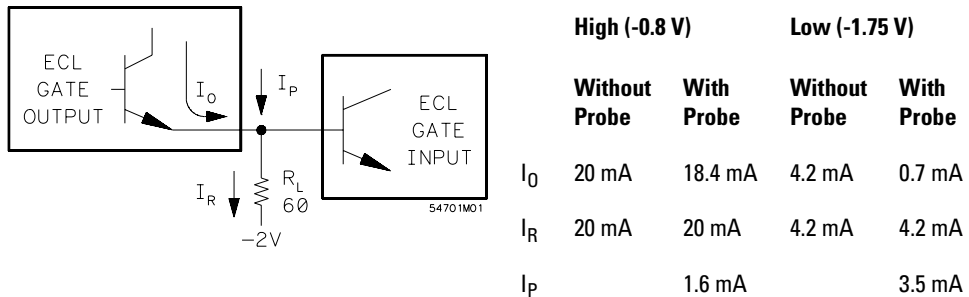
Figure 8**Probing ECL Circuits**

Note that in the high state there is little difference in current flow with or without the probe connected. However, in the low state the output stage is closer to cutoff. Connecting the probe sources current into the output node, which reduces the current sourced from the gate output. The output current drops from 4.2 mA to 0.7 mA. The low output current can cause problems with switching noise margins. The output gate will have difficulty reaching the low threshold, so ac performance will suffer because the falling edge degrades. If a larger bias resistor had been used to keep the current levels lower, when a 500- Ω probe is attached the output gate could go into cutoff before it reaches the low threshold.

Recommendation

Be careful not to use a probe just because it has the highest input resistance available. High-resistance probes usually come with trade-offs in other important parameters, such as higher capacitance, which also affect measurement accuracy.

Capacitive Loading Effects

The input capacitance of a probe causes the overall input impedance to decrease as a function of frequency. For this reason, input capacitance becomes one of the most important parameters that affect high frequency measurements. Figure 9 plots the probe impedance vs frequency for two probes: a 1-M Ω , 6-pF probe and the 54701A probe (100 k Ω , 0.6 pF). It shows that because of the lower input capacitance, the 54701A probe actually has a higher input impedance for frequencies above 240 kHz. At frequencies above 2.65 MHz, it has as much as 10 times the impedance of the 1-M Ω probe.

Figure 9

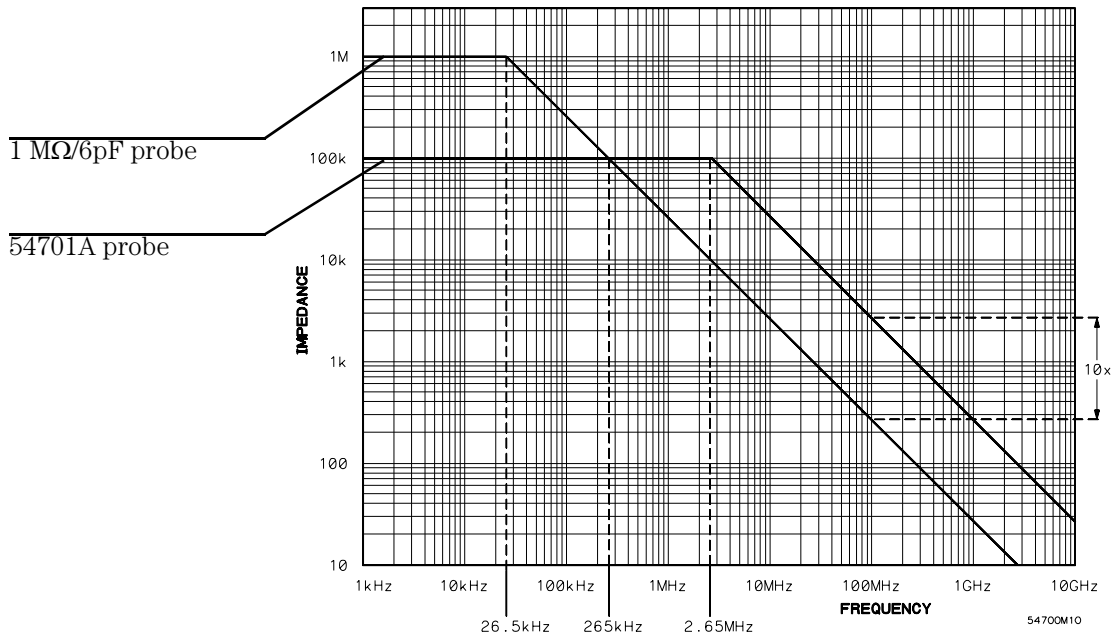

Probe Impedance vs Frequency

The input capacitance of a probe forms an RC time constant with the parallel combination of source impedance and probe input resistance. This can cause an increase in the circuit rise time and a time delay in a pulse edge.

Resistive Loading Effects

Figure 10 represents plots from three spice simulations showing this loading effect. Plot 1 shows the signal edge before probing. Plot 2 shows the edge after probing with a 6-pF probe and plot 3 after probing with a 15-pF probe.

Figure 10

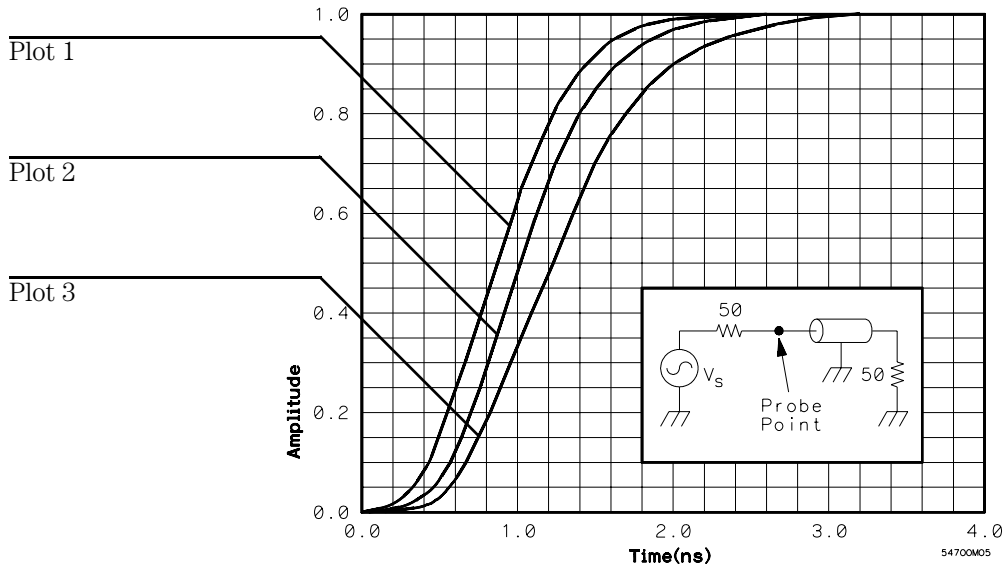

Spice Simulation Of Probe Capacitance Loading Effects

Table 2 summarizes the data. It shows that the 6-pF probe didn't significantly increase the rise time of the signal, but delayed it (referenced at the 50% point) approximately 150 ps. The 15-pF probe not only slowed the rise time approximately 33% but also delayed the edge 340 ps.

Table 2

Probe Capacitance Loading Effect		
Plot	Risetime	Delay
1	1 ns	0.0 ps
2	1.067 ns	150 ps
3	1.33 ns	340 ps

Ground Inductance Effects

Probe grounding techniques are an important factor in making accurate high frequency measurements. The main limitation, probe resonance, is a function of the input capacitance of the probe and the inductance of the ground return. These two parameters in series form an LC resonant circuit that, when connected to the circuit under test, becomes part of the circuit's response.

The probe resonance can cause overshoot and ringing on pulse edges that contain energy in the same frequency band as the resonance. The true response is masked, the false response gets transferred to the oscilloscope, and the oscilloscope display shows an incorrect result. If overshoot and ringing added by a probe during troubleshooting changes how the circuit functions, it can produce an incorrect judgment about circuit operation.

To minimize the problem of ground ringing, use the shortest possible ground with a probe that has the lowest possible input capacitance. Equation 3 can be used to calculate the frequency where a certain probe and grounding technique resonates.

Equation 3

$$f_r = \frac{1}{2\pi\sqrt{LC}}$$

where

C is the probe input capacitance. (It is usually found in the probe data sheet.)

L is the inductance of the ground return. (It can be approximated using the constant of 25 nH per inch.)

Figure 11 plots the probe impedance vs frequency for two probes: a 1-M Ω , 6-pF probe and the 54701A probe (100 k Ω , 0.6 pF). It also plots the inductive reactance vs frequency for three different values of ground inductance. The 5-nH inductance represents a PC board socket, the 20-nH inductance a spanner ground, and the 100-nH inductance a 4-inch ground wire. Where the probe plots cross the inductance plots gives the resonant frequency of the probe and ground combination. You can see from the graphs that in all three cases the 6-pF probe resonates at approximately one-third the frequency of the 54701A (0.6 pF). The lower resonance means that the effect of the resonance is more likely to influence the representation of the signal.

Chapter 2: Probing Considerations
Resistive Loading Effects

Figure 11

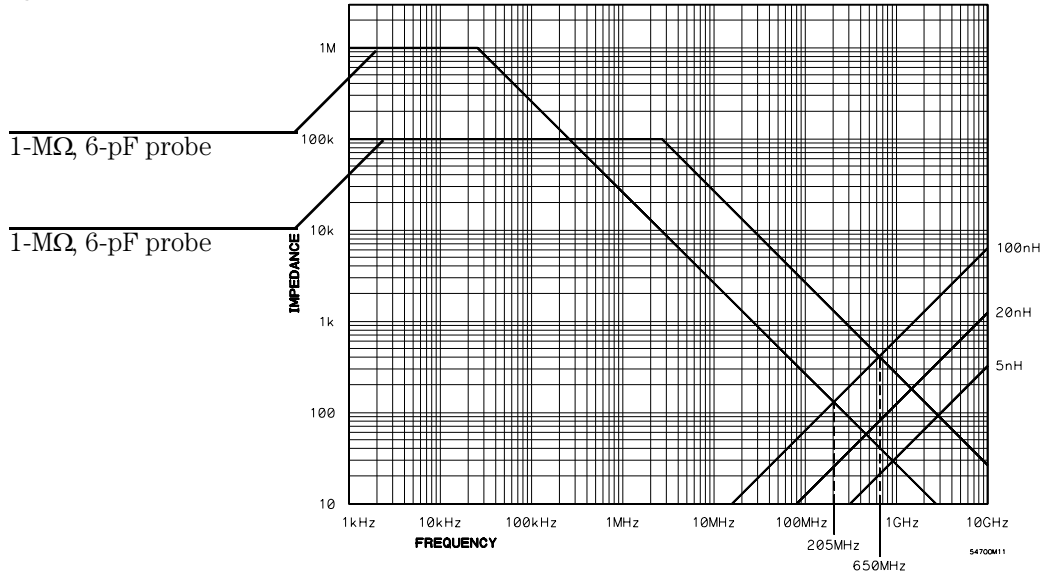

Probe Impedance and Resonance

Figure 12 shows waveforms measured by the 54701A (100 k Ω , 0.6 pF) and the 1-M Ω , 6-pF probe; both probes are connected to a 1-GHz oscilloscope.

Figure 12

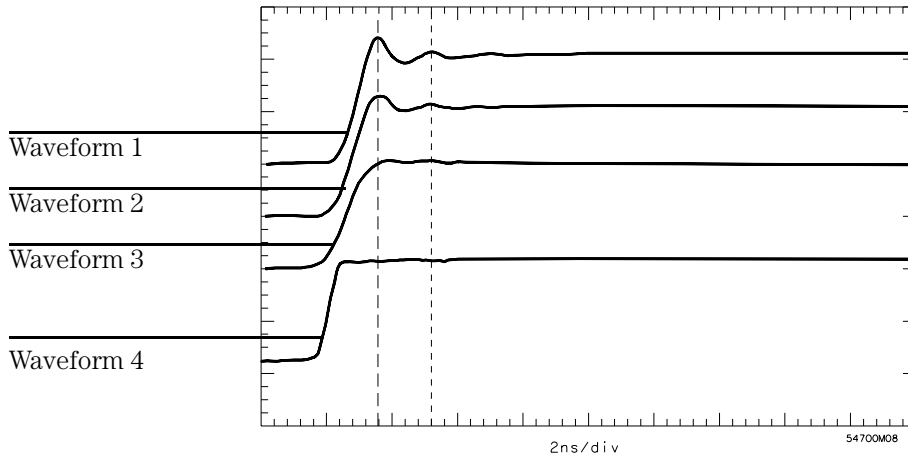

Probe Resonance Effects

Waveform 1 shows the pulse response of a 6-pF probe measuring a 400-ps step. The ringing on the pulse is caused by the input capacitance of the probe and by the inductance of the ground return. The period of the ringing measures 1.72 ns, representing a frequency of 581 MHz. The circuit had a ground return of 1/2 inch. Using equation 3 to calculate the resonant frequency (12.5 nH and 6 pF) results in 580 MHz. The measurement and the calculation yield the same result, showing how probe resonance causes problems when probing high speed signals.

Waveform 2 shows the pulse response when the same 6-pF probe measures an 800-ps edge. Notice that the overshoot and ringing are still present, but are significantly reduced. This is because the slower signal edge has less energy at the resonant frequency of the probe.

Waveform 3 shows the pulse response when the 6-pF probe measures a 1.25-ns edge. The ringing is nearly subdued and doesn't play a significant role in the measurement.

Waveform 4 shows the 54701A 0.6-pF probe, with a one-inch ground lead, measuring the 400-ps edge. Because of its much lower capacitance, and even with a longer ground lead, its resonant frequency is much higher and it shows no ringing in the response.

Chapter 2: Probing Considerations

Resistive Loading Effects

The measurements from the first three waveforms lead to a rule of thumb:

To minimize signal distortion due to probe resonance, provide a two-to-one, or greater, difference between the resonant frequency of the probe and the bandwidth of the signal being measured.

For pulsed data applications, the rise time of a signal can be related to the bandwidth by using a constant of 0.35 as shown in equation 4. This equation is derived from a first order RC response.

Equation 4

$$\text{Bandwidth} = \frac{0.35}{t_r}$$

Example The 1.25-ns edge (waveform 3 in figure 12) equates to a 280-MHz bandwidth.

$$\text{Bandwidth} = \frac{0.35}{t_r} = \frac{0.35}{1.25 \times 10^{-9}} = 280 \text{ MHz}$$

This is approximately half the resonant frequency calculated for the 6-pF probe with 1/2-inch ground, 580 MHz. Therefore the subdued ringing on waveform 3 validates the rule of thumb.

As noted before, waveform 4 shows the effect when a low-capacitance probe measures a high-frequency signal. Because of the low capacitance the resonant frequency is high. Therefore, there is less chance of the probing system affecting the measurement of the signal.

Probe Bandwidth

The bandwidth of the probe is often given much consideration during purchase, then forgotten while making measurements. Error in measurements occur when the frequency content (at the -3 dB point) of the signal being measured approaches or exceeds the bandwidth of the probe. The probe can be modeled as a low-pass filter for the signal.

Example

If a 700-MHz probe is used to measure a 1-ns signal, the rise time error can be calculated using equations 4 and 5. For this exercise assume that the oscilloscope bandwidth is great enough not to contribute any errors.

Equation 5

$$t_r = \sqrt{(t_{r,1})^2 + (t_{r,2})^2},$$

where

$t_{r,1}$ is the rise time of the probe,

$t_{r,2}$ is the rise time of the signal.

1. Calculate the rise time of the 700-MHz probe (equation 4).

$$t_r = \frac{0.35}{\text{Bandwidth}} = \frac{0.35}{700\text{MHz}} = 0.5\text{ns}$$

2. Calculate the rise time of the 1-ns signal as measured by the 700-MHz probe (equation 5).

$$t_r = \sqrt{(0.5)^2 + (1.0)^2} = \sqrt{1.25} = 1.12\text{ns}$$

The measurement error between the actual signal and what was measured is 12%. To keep measurement errors less than 6%, use a probe with a bandwidth three or more times that of the signal.

3. Calculate the bandwidth of the 1-ns signal (equation 4).

$$\text{Bandwidth} = \frac{0.35}{1\text{ns}} = 350\text{MHz}$$

Use a probe with a bandwidth of 1.05 GHz (the rise time is 0.333 ns, equation 4).

4. Calculate the rise time of the 1-ns signal measured by the 1.05-GHz probe (equation 5).

$$t_r = \sqrt{(0.333)^2 + (1.0)^2} = \sqrt{1.11} = 1.054\text{ns}$$

Now, the measurement error is less than 6%.

Conclusion

In conclusion we can review the issues by using the effect the 54701A Active Probe (100 k Ω , 0.6 pF) has while measuring a fast CMOS gate.

Resistive Loading

Resistive loading is caused by the input resistance of the probe. When the CMOS output is high (5 V) the 100 k Ω input resistance of the probe draws 50 mA. A CMOS gate can drive many times this current, so the load is insignificant. In addition, the output impedance of a CMOS gate is the on resistance of the output FET. Whether high or low, this is typically less than 100 Ω . The voltage divider of 100 Ω and 100 k Ω is also insignificant and will not change the value of either state of the gate.

Capacitive Loading

CMOS gates typically have an input capacitance between 5 and 10 pF. The traces between gates will contribute another 5 to 10 pF, which gives a total of 10 to 20 pF. The 0.6-pF input capacitance of the 54701A probe is about 3% to 6% that of the circuit capacitance. It will not significantly change the time constant in the node being probed.

Ground Inductance

The CMOS gate has a risetime approaching 1 ns. This equates to a bandwidth of 350 MHz (equation 4). If we use the walking-stick ground (about 20 nH) provided with the 54701A probe, the probe resonance will be about 1.45 GHz (equation 3). We can see that the CMOS equivalent bandwidth (350 MHz) is at less than half the resonant frequency of the probe. This fits within the rule of thumb given previously, that to avoid ringing in the response, the resonance of the probe should be at least twice the frequency of the energy in the signal.

Bandwidth

Although it was specifically not covered in this chapter, the bandwidth of the probe and oscilloscope combination is also very important. As previously noted, with CMOS signals of 1 ns risetimes the signal bandwidth is 350 MHz. This means for an accurate representation the probe and oscilloscope combination should have at least a 3-to-1 margin in bandwidth, at least 1.05GHz.



Service

Introduction

This chapter provides service information for the 54701A Active Probe. The following sections are included in this chapter:

- Specifications and Characteristics
- Returning for Service
- Calibration Testing Procedures
- Making Adjustments
- Troubleshooting and Repair

General Information

The following general information applies to the 54701A 2.5 GHz Active Probe.

Specifications

Table 3 gives specifications used to test the active probe.

Table 3

Specifications	
Attenuation Factor	10:1
Bandwidth (-3dB)	>2.5 GHz
dc Gain Accuracy	±0.5%
Input Resistance	100 k Ω 1%

Characteristics

Table 4 gives characteristics that are typical for the active probe.

Table 4

Characteristics	
Rise time*	<140 ps
Input Capacitance	0.6 pF (typical)
Maximum Input Voltage	±200 V[dc + peak ac(<20 MHz)]
ESD Tolerance (150 Ω/150 pF)	±12 kV
Flatness	
<3 ns from rising edge	±6%
3 ns from rising edge (for input edge 170 ps)	±1%
Dynamic Range (<1.5% gain compression)	±5 V peak ac and 50 Vdc
Offset Adjustment Range (referenced to the probe tip)	±50 V
Offset Accuracy	±1% of offset 1 mV
Offset Gain (referenced to the probe tip)	11.5 V/mA
RMS Output Noise (dc to 2.5 GHz, input loaded by 50 Ω)	<300 mV
Propagation Delay	7.5 ns (approximately)

* Risetime figure calculated from $tr = 0.35/\text{Bandwidth}$

General Characteristics

The following general characteristics apply to the active probe.

Table 5

General Characteristics		
Environmental Conditions		
	Operating	Non-operating
Temperature	0°C to +55 C° (32°F to +131°F)	-40°C to +70°C (-40°F to +158°F)
Humidity	up to 95% relative humidity (non-condensing) at +40°C (+104°F)	up to 90% relative humidity at +65°C (+149°F)
Altitude	up to 4,600 meters (15,000 ft)	up to 15,300 meters (50,000 ft)
Vibration	Random vibration 5 to 500 Hz, 10 minutes per axis, 0.3grms.	Random vibration 5 to 500 Hz, 10 min. per axis, 2.41 grms. Resonant search 5 to 500 Hz swept sine, 1octave/min. sweep rate, (0.75g), 5 min. resonant dwell at 4 resonances per axis.
Power Requirements	±17 Vdc and -17 Vdc at 110 mA each (+16.5 Vdc and -16.5 Vdc minimum respectively)	
Weight	Net: approximately 0.6 kg (1.3 lb) Shipping: approximately 1.0 kg (2.3 lb)	
Dimensions	Refer to the outline drawings below.	

Figure 13

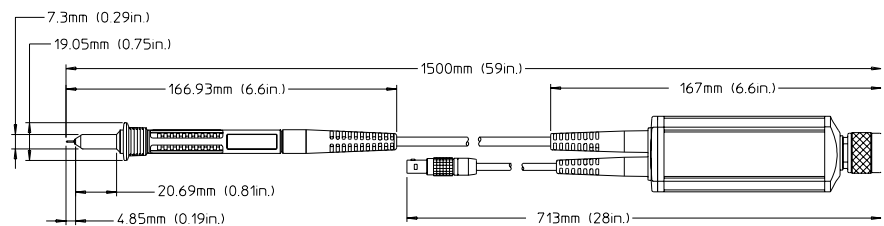

5470E17

Mechanical Dimensions

Product Regulations

Safety IEC 348

UL 1244

CSA-C22.2 No.231 (Series M-89)

EMC This product meets the requirement of the European Communities (EC)
EMC Directive 89/336/EEC.

Emissions EN55011/CISPR 11 (ISM, Group 1, Class A equipment)
SABS RAA Act No. 24 (1990)

Immunity	EN50082-1	Code ¹	Notes ²
	IEC 801-2 (ESD) 4 kV CD,8kV AD	1	
	IEC 801-3 (Rad.) 3 V/m	1	
	IEC 801-4 (EFT) 1kV	1	

¹Performance Codes:

1PASS - Normal operation, no effect.

2PASS - Temporary degradation, self recoverable.

3PASS - Temp. degradation, operator intervention required.

4FAIL - Not recoverable, component damage.

² Notes:

(None)

Recommended Test Equipment

The table on the next page is a list of the test equipment required to service this instrument. The table indicates the critical specification of the test equipment and for which procedure the equipment is necessary. Equipment other than the recommended model may be used if it satisfies the critical specification listed in the table.

Table 6

Recommended Test Equipment			
Equipment Required	Critical Specifications	Recommended Model/Part	Use
Signal Generator	50 MHz to 2.5 GHz	8663A	C
Power Meters (2) or one Dual- Channel	50 MHz to 2.5 GHz, ±3% accuracy	436A (2), 437A (2), or 438A (1)	C
Power Sensor (2)	50 MHz to 2.5 GHz, 300 mW	8482A	C
Power Splitter	dc to 2.5 GHz, ≤0.2 dB output tracking, Type-N	11667A	C
Power Supply	Power and control for probe under test	1143A	C,A,T
DVM	Resistance ±0.1,% Volts and ohms ±0.01%	3458A	C,A,T
Power Supply	5 Vdc	6114A	C
Adapter/termination	N(f)-to-probe, 50 Ω	11880A	C
Adapter	N(f-f), 50 Ω	1250-1472	C
Adapter	N(f)-to-BNC(m), 50 Ω	1250-0077	C,A,T
Termination	50 Ω, BNC feed-through	10100C	C,A,T
Adapter	BNC (f) to banana (m)	1251-2277	C

C = Calibration Tests, A = Adjustments, T = Troubleshooting

Service Strategy

The 54701A Active Probe is a high-frequency instrument with many critical relationships between parts. For example, the frequency response of the amplifier on the hybrid is trimmed to match the output coaxial cable. As a result, to return the probe to optimum performance requires factory repair. If the probe is under warranty, normal warranty services apply. If the probe is not under warranty, a failed probe can be exchanged for a reconditioned one at a nominal cost.

See Also

"Troubleshooting and Repair" for further information.

To clean the instrument

Use mild soap and water to clean the instrument. Harsh soaps will damage the water-based paint finish of the instrument.

To return the probe to for service

Before shipping the instrument to Agilent Technologies, contact your nearest Agilent sales office for additional details.

1 Write the following information on a tag and attach it to the instrument.

- Name and address of owner
- Instrument model number
- Instrument serial number
- Description of the service required or failure indications

2 Remove all accessories from the instrument.

Accessories include all cables. Do not include accessories unless they are associated with the failure symptoms.

3 Protect the instrument by wrapping it in plastic or heavy paper.

4 Pack the instrument in foam or other shock absorbing material and place it in a strong shipping container.

You can use the original shipping materials or order materials from an Agilent Technologies Sales Office. If neither are available, place 3 to 4 inches of shock-absorbing material around the instrument and place it in a box that does not allow movement during shipping.

5 Seal the shipping container securely.

6 Mark the shipping container as FRAGILE.

In any correspondence, refer to instrument by model number and full serial number.

Calibration Testing Procedures

The calibration procedures in this section are used to determine if the 54701A meets the designated warranted specifications.

Testing Interval

The calibration test procedures may be performed for incoming inspection of the instrument and should be performed periodically thereafter to ensure and maintain peak performance. The recommended test interval is yearly or every 2,000 hours of operation. Amount of use, environmental conditions, and the user's experience concerning need for testing will contribute to verification requirements.

The calibration cycle is covered in the "Making Adjustments" section in this chapter.

Equipment Required

A complete list of equipment required for the calibration tests is in the Recommended Test Equipment table on page 41. Equipment required for individual tests is listed in the test. Any equipment satisfying the critical specifications listed may be substituted for the recommended model.

Test Record

The results of the calibration tests may be tabulated on the Test Record provided at the end of this section on page 50. The Test Record lists the calibration tests and provides an area to mark test results. The results recorded in the table at incoming inspection may be used for later comparisons of the tests during periodic maintenance, troubleshooting, and after repairs or adjustments.

To test input resistance

This test checks the input resistance of the active probe.

Specification: 100 k Ω 1%

Equipment Required

Equipment	Critical Specification	Recommended Model/Part
Digital Multimeter	Resistance 0.1%	3458A

- 1 Connect the DMM between the probe tip and the ground shell at the front of the probe.
- 2 Set up the DMM to measure resistance.
The resistance should read 100 k Ω 1K Ω .
- 3 Record the reading in the "Calibration Test Record" on page 47.

If the test fails

Go to the "Troubleshooting and Repair" section in this chapter.

To test dc gain accuracy

This test checks the dc gain accuracy of the probe.

Specification: 0.1 0.5%

Equipment Required

Equipment	Critical Specification	Recommended Model/Part
Power Supply	5 Vdc	6114A
Digital Multimeter	Better than 0.1% accuracy	3458A
Power Supply	Power and control for probe under test	1143A
Adapter	N(f)-to-BNC(m)	1250-0077
Termination	50 Ω , BNC feed-through	10100C
Adapter	BNC (f) to banana (m)	1251-2277

- 1 Set the power supply for 5.0 V 0.05% (2.50 mV)

Use the DVM to measure the voltage if necessary.

- 2 Connect the power connector of the active probe to the 1143A Probe Offset Control and Power Module or an oscilloscope with an appropriate probe power output.

- 3 Connect the output of the probe to the input of the DVM using the N-to-BNC adapter, 50- Ω feedthrough, and BNC-to-banana adapter.

- 4 Set the probe offset to zero.

If using the 1143A power module, set the Offset controls to Local and Zero.

If using an oscilloscope for probe power, use the channel menu to set the offset to 0.0 V.

- 5 Short the input pin of the probe to the shield at the probe tip.

You can use the 11880A (see “To test bandwidth” on page 45.) which is an Type N-to-probe tip adapter with an internal 50- Ω termination. The objective is to effectively short the probe input without inducing any signal. Another method can be used if it meets that requirement.

Chapter 3: Service
Calibration Testing Procedures

- 6 Read and record the offset voltage on the DVM. _____mV
If the offset voltage is greater than 1.0 mV, continue with the test but see the second sidebar at the end of this test.
- 7 Connect the probe to the 5.0 V supply.
- 8 Read and record the voltage reading on the DVM. _____mV
- 9 Subtract the reading in step 6 from the reading in step 8.
_____mV
The result should be 500 mV 2.5 mV.
- 10 Calculate the dc gain.
$$\frac{\text{result in step 9}}{5.00 \text{ V (supply voltage)}}$$

The dc gain should be between 0.09950 and 0.10050 (0.10 0.5%).
- 11 Record the results of step 10 in the Calibration Test Record on page 50..

If the test fails

Go to the troubleshooting section in this chapter.

If the offset voltage is greater than 1.0 mV

If the offset voltage is close to the specification, it should not affect this test. Use the "Troubleshooting and Repair" section to determine why the offset voltage is not at zero.

To test bandwidth

This test checks the bandwidth of the probe. A high-frequency signal generator and two power meters are used to set the input and measure the output of the probe.

Specification: down less than 3 dB, dc to 2.5 GHz

Equipment Required

Equipment	Critical Specifications	Recommended Model/Part
Signal Generator	50 MHz to 2.5 GHz	8663A
Power Meters (2) or one Dual-Channel	50 MHz to 2.5 GHz, ±3% accuracy	436A (2), 437A (2), or 438A (1)
Power Sensor (2)	50 MHz to 2.5 GHz, 300 mW	8482A
Power Splitter	dc to 2.5 GHz, ≤0.2 dB output tracking, Type-N	11667A
Power Supply	Power and control for probe under test	1143A
Adapter/termination	N(f)-to-probe, 50 Ω	11880A
Adapter	N(f-f), 50 Ω	1250-0772
Adapter	N(m-m), 50 Ω	1250-0078

- 1 Zero and calibrate the power meters with the power sensors.
- 2 Connect the equipment as in the figure on the next page.
- 3 Connect the probe power input connector to the 1143A or oscilloscope probe power.
- 4 Set the probe offset to zero.

If using an 1143A power module, set Offset controls to Local and Zero.
If using an oscilloscope for probe power, use the channel menu to set the offset to 0.0 V.

- 5 Set the signal generator for 50 MHz at 0.0 dBm.
- 6 Set the power meter calibration factors to the 50 MHz value on the power sensors.

Chapter 3: Service
Calibration Testing Procedures

Figure 14

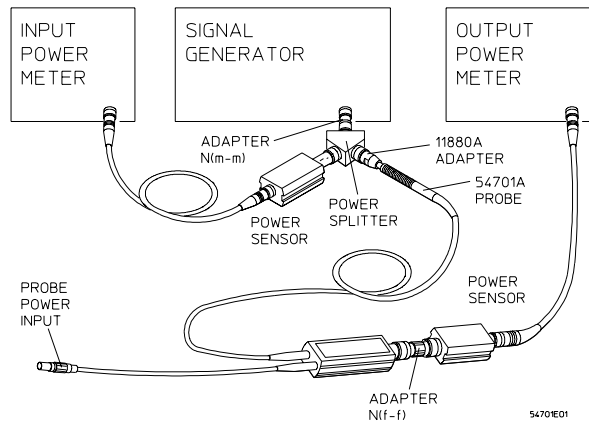

Bandwidth Test Setup

- 7 Adjust the signal generator power output for exactly -6.0 dBm as read on the input power meter.
- 8 Note the power level reading on the output power meter. 50 MHz power level _____ dBm.

The output power level will be approximately -26 dBm. This corresponds to the 10:1 division ratio of the probe.

- 9 Change the signal generator frequency to 2.5 GHz.
- 10 Set the power meter calibration factors to the 2.5 GHz value on the power sensors.
- 11 Re-level the signal generator output power for a -6.0 dBm reading on the input power meter.
- 12 Note the power level reading on the output power meter. 2.5 GHz power level _____ dBm
- 13 Subtract the reading in step 8 from the reading in step 12 and record the result in the “Calibration Test Record” on page 47.

The difference should be 3.0 dB .

If the test fails

Go to the troubleshooting section in this chapter.

Table 7

Calibration Test Record		
54701A Active Probe		
Serial No. _____	Tested by _____	
Recommended Test Interval - 1 Year/2000 hours	Work Order No. _____	
Recommended next testing _____	Date _____	
	Temperature _____	

Test	Limits	Results
Input Resistance	100 kΩ ±1%, 99.0 kΩ to 101.0 kΩ	_____
dc Gain Accuracy	0.10 ± 0.5%, 0.09950 to 0.10050	_____
Bandwidth	down less than 3 dB at 2.5 GHz	_____

Making Adjustments

This section provides an adjustment procedure for the 54701A Active Probe.

Equipment Required

Equipment required for adjustments is listed in the Recommended Test Equipment table on page 39 of this chapter. Any equipment that satisfies the critical specification listed in the table may be substituted for the recommended model. Equipment for individual procedures is listed at the procedure.

Adjustment Interval

There is no defined adjustment interval for the active probe. The adjustment is considered a factory adjustment and does not require periodic maintenance. Make adjustments only when directed by other service procedures. Defining an adjustment interval will depend on your experience.

To adjust offset zero

This procedure adjusts the offset zero of the probe. Some offset in the probe can be caused by a residual offset signal from the probe's control input. Therefore, the procedure compensates for any external offset signal.

Equipment Required

Equipment	Critical Specifications	Recommended Model/Part
Power Supply	1 Vdc	6114A
Digital Multimeter	Better than 0.1% accuracy	3458A
Power Supply Adapter	Power and control for probe under test	1143A
Termination	N(f)-to-BNC(m) 50 Ω , BNC feed-through	10100C

- 1 With a #10 Torx screwdriver, remove the two screws at the "N" connector end of the probe power housing.
- 2 Slide the end plate aside, then slide the cover off the power housing.
- 3 To avoid damage to the cabling, temporarily refasten the end plate to the power housing.
- 4 Short the input pin of the probe to the shield at the probe tip.

You can use the 11880A which is the Type N-to-probe tip adapter used in the bandwidth test. It has an internal 50- Ω termination. The objective is to effectively short the probe input without inducing any signal. Another method can be used if it provides the same result.

- 5 Terminate the output of the probe with the N-to-BNC adapter and BNC 50- Ω feedthrough.
- 6 Connect the probe power connector to the 1143A power module or an oscilloscope with the appropriate probe power connection.
- 7 Apply power and allow at least a 3-minute warm-up.
- 8 Set the Zero/Variable switch on the power module to Zero or set the oscilloscope vertical offset to 0.0 V.

Chapter 3: Service
Making Adjustments

Use the figure below to locate the appropriate measurement points in the probe power housing.

Figure 15

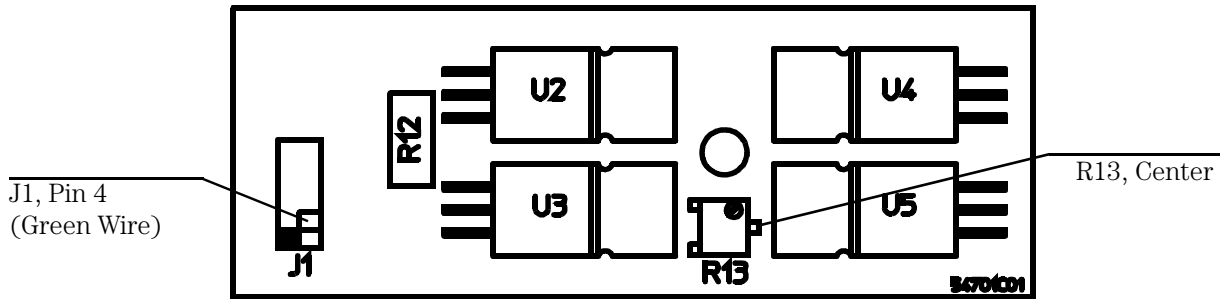

Probe Power Box Adjustment Locator

- 9 Connect the DVM to measure the voltage between ground (the "N" connector) and the center of the adjustment pot R13.
- 10 Adjust R13 for a DVM reading of 0.0 V ± 25 mV.
- 11 Connect the DVM to measure the voltage between ground and J1 pin 4 (green wire of the cable connector) and record the voltage reading.
_____ mV
This voltage is typically less than 5 mV. Measure it with 10 mV resolution.
- 12 Multiply the reading in the previous step by -2.3. Observe the signs.
_____ mV
- 13 Connect the DVM to measure the voltage between ground and the output of the probe at the 50-Ω feedthrough.
- 14 Adjust R13 for a reading the same as the result obtained in step 12, within 100 mV.
- 15 Disconnect the equipment and reassemble the probe. .

If the adjustment cannot be made, see the "Troubleshooting and Repair" section in this chapter.

Troubleshooting and Repair

This section provides information to determine if your probe needs adjustment or repair.

- If your probe is under warranty and requires repair, returned it to. Contact your nearest Service Center.
 - If the failed probe is not under warranty, you may exchange it for a reconditioned probe. See "To Prepare the Probe for Exchange" in this chapter.
-

Failure Symptoms

The following symptoms may indicate a problem with the probe or the way it is used. Possible remedies and repair strategies are included.

The most important troubleshooting technique is to try different combinations of equipment so you can isolate the problem to a specific instrument.

Probe Calibration Fails

Probe calibration failure with an oscilloscope is usually caused by improper setup. If the calibration will not pass, check the following:

- Be sure the instrument passes calibration without the probe.
- Check that the probe passes a signal with the correct amplitude.
- If the probe is powered by the oscilloscope, check that the offset is approximately correct. The probe calibration cannot correct major failures.
- If the probe is powered by an 1143A power module, be sure the offset is set to Local and Zero during calibration.

Incorrect Frequency Response

Incorrect frequency response may be caused by a defective probe, plug-in or oscilloscope mainframe, or an improper application such as poor connections or grounding etc. Read chapter 2, "Probing Considerations," in this guide. If the application is correct, try the probe with another oscilloscope.

If the probe appears ac coupled at a high frequency, check for a loose probe tip.

Chapter 3: Service

Troubleshooting and Repair

The frequency response of the probe is determined by the amplifier hybrid in the probe and the probe cable. If the probe fails the bandwidth test, factory repair is necessary. Also read "Incorrect Pulse Response" below.

Incorrect Pulse Response (flatness)

If the probe's pulse response shows a top that is not flat (incorrect ac gain), it is most likely caused by an inaccurate 50- Ω load on the probe. The probe is designed to work into a 50- Ω load that is accurate within 1.0% ($\pm 0.5 \Omega$). Check the value of the load you are using before you suspect the probe. If the load is accurate, the gain problem with the probe will have to be repaired by the factory.

If the probe appears ac coupled at a high frequency, check for a loose probe tip.

Incorrect dc Gain

The dc gain is a function of the values of internal parts. It is independent of the load on the probe. Any failure of the accuracy of the dc gain requires factory repair.

Incorrect Input Resistance

First, check that the probe tip is not loose. The input resistance is determined in the amplifier hybrid in the probe and cannot be repaired in the field. The probe must be returned to the factory for repair.

Incorrect Offset

Incorrect offset can be caused by a misadjusted offset zero (see "Offset Will Not Zero" on the next page), lack of probe calibration with the oscilloscope, or faulty offset drive current from the 1143A power module.

- If the probe is connected to an oscilloscope for probe power, the probe should be calibrated with the plug-in and mainframe. See "Connecting the Probe" in chapter 1 of this manual or the calibration information in your oscilloscope manual. When the probe is calibrated with an 54700 series oscilloscope, dc gain, offset zero, and offset errors should be calibrated to specifications as long as the probe is working.
- If the probe is connected to an 1143A power module for probe power, check the offset drive range of the power module (See, "To Troubleshoot the Offset Circuitry" in chapter 2 of the 1143A User and Service Guide).

Offset Will Not Zero

With no signal input and no offset setting, the dc output of the probe should be within 1 mV. An error can be caused by several factors.

- If the probe is connected to an 54700 family oscilloscope for probe power, the oscilloscope will calibrate out an offset zero error during a probe calibration. If the offset error can not be calibrated out, the probe calibration will fail. Check the offset zero before continuing (see "To Adjust Offset Zero" in this chapter). If the probe cannot be adjusted, return it to Agilent for repair.
- If the probe is connected to an 1143A power module for probe power, lack of zero can be caused by misadjustment of the probe or a residual offset current from the power module (see "To adjust offset zero" in this chapter and "To adjust offset zero" in chapter 2 of the 1143A User and Service Guide).

To prepare the probe for exchange

If your probe is out of warranty and you want to exchange your failed probe for a reconditioned probe, you need to keep the cover plate that holds the probe serial number. The reconditioned probe will not have a serial number. When you receive the reconditioned probe, put your cover plate with serial number on the reconditioned probe.

Use the following procedure to remove or replace the cover plate.

- 1 With a #10 Torx screwdriver, remove the two screws at the "N" connector end of the probe power housing.
- 2 Slide the end plate aside and slide the cover off the power housing.
- 3 To protect the cabling, use the two screws to re-fasten the end plate to the housing.
- 4 Reverse the procedure to fit your serial plate to the probe power housing of the reconditioned probe.
- 5 For return instructions, see "To return the probe to for service" on page 40.

The exchange part number is listed in table 8, "Replaceable Parts" on page 54.

Replaceable Parts

Except for the accessories, which includes probe tips, there are few field replaceable parts for the 54701A Active Probe. The replaceable parts are listed in table 8 below. Accessory part numbers are listed in table 1, page 16.

Ordering Information

To order a part, quote the part number, indicate the quantity desired, and address the order to the nearest Agilent sales office.

Direct Mail Order System

Within the USA, Agilent can supply parts through a direct mail order system. There are several advantages to this system:

- Direct ordering and shipment from the parts center in California, USA.
- No maximum or minimum on any mail order (there is a minimum amount for parts ordered through a local Agilent sales office when the orders require billing and invoicing).
- Prepaid transportation (there is a small handling charge for each order).
- No invoices.

In order for Agilent Technologies to provide these advantages, please send a check or money order with each order.

Mail order forms and specific ordering information are available through your local Agilent sales office. Addresses and telephone numbers are located in a separate document shipped with the manuals.

Table 8

Replaceable Parts			
Ref. Des.	Description	Qty	Part Number
A1	Exchange assembly, active probe		54701-69101
MP1	Label, active probe	1	54701-94301
MP2	Label, probe power box	1	54701-94303
MP3	Probe system caring case (without MP4 and MP5)		

Replaceable Parts

Ref. Des.	Description	Qty	Part Number
MP4	Foam set	1	5041-9442
MP5	Label, carrying case	1	5090-4488
MP6	Plastic parts box	1	1540-0022

Theory of Operation

The following is a brief discussion of the basic operating principles of the 54701A active probe. Use the simplified circuit diagram shown below.

Figure 16

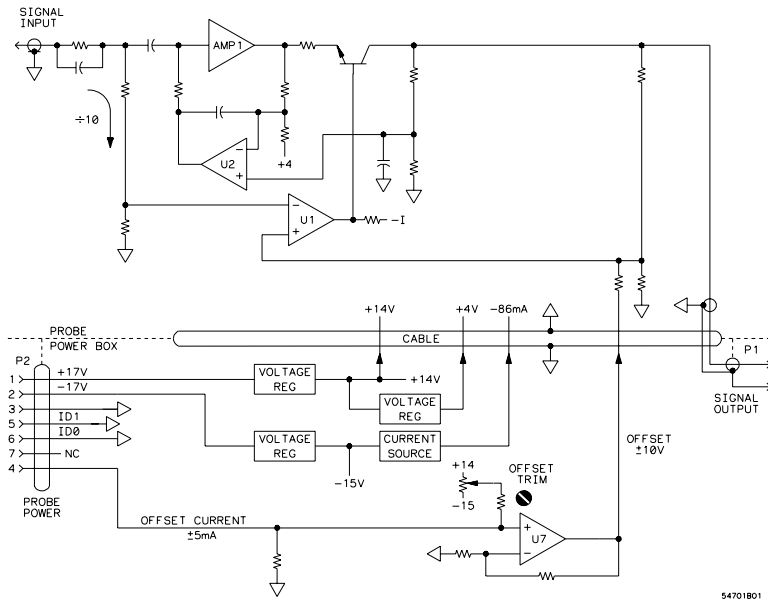

Active Probe Simplified Circuit Diagram

Probe Circuitry

All of the probe circuitry is constructed on a ceramic substrate with discrete parts and two operational amplifier chips. The circuit is a two-path amplifier, one path for the high-frequency component of the signal and one for the low-frequency component.

Input Divider

The signal is divided twice in the input impedance network. It is divided by ten and fed to the high-frequency amplifier. Another pickoff, 0.4% above ground, goes to the low-frequency amplifier.

High-Frequency Path The 10 signal is ac coupled to a series of discrete emitter followers, Amp 1. Operational amplifier U2 sets the bias at the input of the emitter follower amplifier. The high-frequency signal drives the emitter of a common base amplifier. The common base amplifier drives the output cable.

Low-Frequency Path U1 provides the low-frequency path. One input to U1 is 4% of the signal to the high-frequency amplifier. The other input to U1 is 4% of the probe output voltage, summed with the offset voltage from the probe power box. The gain/bandwidth product of U1 limits the frequency response of the low-frequency amplifier to 400kHz. U1 drives the base of the common base stage.

Power Box Circuitry

Power Box Circuitry The probe signal is fed via the coaxial cable directly through the power box to the Type-N connector.

The power box takes five inputs from the probe power connector and conditions them for the probe. The probe power inputs are:

- Two probe ID lines
- Two supplies, +17 Vdc and -17 Vdc
- Offset current of 5 mA

The probe ID lines are pulled to ground and identify the probe when it is used with oscilloscope probe power.

- The probe power box provides to the probe:
- Two voltage supplies, +14 Vdc and +4 Vdc
- A current source of -86 mA
- An offset voltage of 10 V

An adjustment in the offset circuitry trims any offset error when there is no offset input.

Chapter 3: Service
Troubleshooting and Repair

Index

A

accessories, 16
 200-ohm signal lead, 18
 alligator ground Lead, 18
 BNC to probe tip adapter, 20
 coaxial socket, 19
 flexible probe adapter, 18
 ground extension lead, 18
 nut driver, 17
 probe pins, 17
 probe socket, 19
 single contact socket, 17
 Type-N to APC 3.5 adapter, 20
 Type-N to probe tip adapter, 20
 walking-stick ground, 17
accessories available, 2
accessories supplied, 2
accessories,using, 16-19
adjusting, active probe, 48
adjustment, interval, 48

B

bandwidth, 31
 of oscilloscope with probe, 32
 of probe, 31
 of signals, 31-32
 testing active probe, 45
 with 54700 family, 14
 with oscilloscope, 14

C

calibration
 failure, 51
 probe with oscilloscopes, 13
capacitive loading, 32
characteristics, 36
cleaning, 40
cleaning the instrument, 63
connecting power, 12
connecting to 54120 family, 13
connecting to oscilloscope, 12

D

dimensions, 37
direct mail ordering, 54

E

errors
 amplitude distortion, 23
 bias changes, 24
 capacitive loading, 25-26
 probe resonance, 27-30
 resistive loading, 23-24
exchanging, 53

F

failure symptoms, 51

G

gain accuracy, testing active probe,
 43
ground inductance, 27, 32

H

harmonic distortion, 11

I

input capacitance, 27
input resistance, oscilloscope, 12
input resistance, testing active
 probe, 42
inspecting, 9
instrument, cleaning the, 63

L

limiting, probe offset, 14-15
lock, probe power cable, 12

M

maximum input voltage, 10

O

offset
 with 1143A power, 15
 with oscilloscope power, 14
offset errors, 52
offset limiting, 14-15
offset zero
 adjusting, 49
 errors, 53
operating environment, 37
operating probe
 with 1143A power, 15
 with oscilloscope power, 14
operating range, 10-11
options, 3
ordering parts, 54

P

packing for return, 40
parts list, 54
performance test record, 47
power requirements, 37
preparing for exchange, 53
probe ID, 57
probe power cable lock, 12
probes
 capacitive loading, 25-26
 capacitive loading effects, 26
 ground inductance, 27-30
 grounding, 27
 high resistance, 24
 input impedance, 25
 resistive loading, 23-24
 resonance, 27

R

remote operation, 15
repair, 51-53
replacing parts, 54
resistive loading, 32
resonance
 of probe, 27-30

rule of thumb, 30
resonant frequency, 27
returning probe, 40

S

service strategy, 3, 39
specifications, 35
storage environment, 37

T

terminating probe, 12
test equipment required, 39
test interval, 41
test record, 41
testing active probe
 bandwidth, 45
 dc gain accuracy, 43
 input resistance, 42
testing performance, 41
theory, 56
troubleshooting, 51-55

W

weight, 37

DECLARATION OF CONFORMITY

According to ISO/IEC Guide 22 and CEN/CENELEC EN 45014

Manufacturer's Name: Agilent Technologies, Inc.
Manufacturer's Address: 1900 Garden of the Gods Road
Colorado Springs, CO
80907 USA

Declares, that the product

Product Name: Oscilloscope Active Probe / Power Supply
Model Number: 54701A / 1143A
Product Option: This declaration covers all options of the above product(s).

Conforms to the following product standards:

EMC	Standard	Limit
	IEC 61326-1:1997+A1:1998 / EN 61326-1:1997+A1:1998	
	CISPR 11:1990 / EN 55011:1991	Group 1 Class A ^[1]
	IEC 61000-4-2:1995+A1:1998 / EN 61000-4-2:1995	4 kV CD, 8 kV AD
	IEC 61000-4-3:1995 / EN 61000-4-3:1995	3 V/m, 80-1000 MHz
	IEC 61000-4-4:1995 / EN 61000-4-4:1995	0.5 kV signal lines, 1 kV power lines
	IEC 61000-4-5:1005 / EN 61000-4-5:1995	0.5 kV line-line, 1 kV line-ground
	IEC 61000-4-6:1996 / EN 61000-4-6:1996	3 V, 0.15-80 MHz
	IEC 61000-4-11:1994 / EN 61000-4-11:1994	1 cycle, 100%
	Canada: ICES-001:1998	
	Australia/New Zealand: AS/NZS 2064.1	

Safety: IEC 61010-1:1990+A1:1992+A2:1995 / EN 61010-1:1993+A2:1995

Conformity/Supplementary Information:

The product herewith complies with the requirements of the Low Voltage Directive 73/23/EEC and the EMC Directive 89/336/EEC (including 93/68/EEC) and carries the CE Marking accordingly (European Union).

^[1] The product was tested in a typical configuration with Agilent Technologies test systems.

Date: 06/30/2000

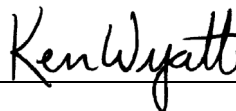

Ken Wyatt, Product Regulations Manager

For further information, please contact your local Agilent Technologies sales office, agent, or distributor

Product Regulations

Safety IEC 61010-1:1990+A1:1992+A2:1995 / EN 61010-1:1993+A2:1995

EMC This Product meets the requirement of the European Communities (EC) EMC Directive 89/336/EEC.

Emissions EN55011/CISPR 11 (ISM, Group 1, Class A equipment)

Immunity EN50082-1

Performance Criteria

IEC 61326-1:1997+A1:1998 / EN 61326-1:1997+A1:1998

CISPR 11:1990 / EN 55011:1991

IEC 61000-4-2:1995+A1:1998 / EN 61000-4-2:1995

A

IEC 61000-4-3:1995 / EN 61000-4-3:1995

B

IEC 61000-4-4:1995 / EN 61000-4-4:1995

A

IEC 61000-4-5:1995 / EN 61000-4-5:1995

A

IEC 61000-4-6:1996 / EN 61000-4-6:1996

A

IEC 61000-4-11:1994 / EN 61000-4-11:1994

A

Canada: ICES-001:1998

Australia/New Zealand: AS/NZS 2064.1

¹Performance Criteria:

A PASS - Normal operation, no effect.

B PASS - Temporary degradation, self recoverable.

C PASS - Temporary degradation, operator intervention required.

D FAIL - Not recoverable, component damage.

Notes: (none)

Sound Pressure Level N/A

Regulatory Information for Canada

ICES/NMB-001

This ISM device complies with Canadian ICES-001.
Cet appareil ISM est conforme à la norme NMB-001 du Canada.

Regulatory Information for Australia/New Zealand

This ISM device complies with Australian/New Zealand AS/NZS 2064.1

Safety Notices

This apparatus has been designed and tested in accordance with IEC Publication 1010, Safety Requirements for Measuring Apparatus, and has been supplied in a safe condition. This is a Safety Class I instrument (provided with terminal for protective earthing). Before applying power, verify that the correct safety precautions are taken (see the following warnings). In addition, note the external markings on the instrument that are described under "Safety Symbols."

Warnings

- Before turning on the instrument, you must connect the protective earth terminal of the instrument to the protective conductor of the (mains) power cord. The mains plug shall only be inserted in a socket outlet provided with a protective earth contact. You must not negate the protective action by using an extension cord (power cable) without a protective conductor (grounding). Grounding one conductor of a two-conductor outlet is not sufficient protection.
- Only fuses with the required rated current, voltage, and specified type (normal blow, time delay, etc.) should be used. Do not use repaired fuses or short-circuited fuseholders. To do so could cause a shock or fire hazard.
- If you energize this instrument by an auto transformer (for voltage reduction or mains isolation), the common terminal must be connected to the earth terminal of the power source.

- Whenever it is likely that the ground protection is impaired, you must make the instrument inoperative and secure it against any unintended operation.

- Service instructions are for trained service personnel. To avoid dangerous electric shock, do not perform any service unless qualified to do so. Do not attempt internal service or adjustment unless another person, capable of rendering first aid and resuscitation, is present.

- Do not install substitute parts or perform any unauthorized modification to the instrument.

- Capacitors inside the instrument may retain a charge even if the instrument is disconnected from its source of supply.

- Do not operate the instrument in the presence of flammable gasses or fumes. Operation of any electrical instrument in such an environment constitutes a definite safety hazard.

- Do not use the instrument in a manner not specified by the manufacturer.

To clean the instrument

If the instrument requires cleaning: (1) Remove power from the instrument. (2) Clean the external surfaces of the instrument with a soft cloth dampened with a mixture of mild detergent and water. (3) Make sure that the instrument is completely dry before reconnecting it to a power source.

Safety Symbols



Instruction manual symbol: the product is marked with this symbol when it is necessary for you to refer to the instruction manual in order to protect against damage to the product.



Hazardous voltage symbol.



Earth terminal symbol: Used to indicate a circuit common connected to grounded chassis.

Notices

© Agilent Technologies, Inc. 2002

No part of this manual may be reproduced in any form or by any means (including electronic storage and retrieval or translation into a foreign language) without prior agreement and written consent from Agilent Technologies, Inc. as governed by United States and international copyright laws.

Manual Part Number

54701-97003, September 2002

Print History

54701-97000 December 1993

54701-97002, March 2002

Agilent Technologies, Inc.
1601 California Street
Palo Alto, CA 94304 USA

Restricted Rights Legend

If software is for use in the performance of a U.S. Government prime contract or subcontract, Software is delivered and licensed as "Commercial computer software" as defined in DFAR 252.227-7014 (June 1995), or as a "commercial item" as defined in FAR 2.101(a) or as "Restricted computer software" as defined in FAR 52.227-19 (June 1987) or any equivalent agency regulation or contract clause. Use, duplication or disclosure of Software is subject to Agilent Technologies' standard commercial license terms, and non-DOD Departments and Agencies of the U.S. Government will receive no greater than Restricted Rights as defined in FAR 52.227-19(c)(1-2) (June 1987). U.S. Government users will receive no greater than Limited Rights as defined in FAR 52.227-14 (June 1987) or DFAR 252.227-7015 (b)(2) (November 1995), as applicable in any technical data.

Document Warranty

The material contained in this document is provided "as is," and is subject to being changed, without notice, in future editions. Further, to the maximum extent permitted by applicable law, Agilent disclaims all warranties, either express or implied, with regard to this manual and any information contained herein, including but not limited to the implied warranties of merchantability and fitness for a particular purpose. Agilent shall not be liable for errors or for incidental or consequential damages in connection with the furnishing, use, or performance of this document or of any information contained herein. Should Agilent and the user have a separate written agreement with warranty terms covering the material in this document that conflict with these terms, the warranty terms in the separate agreement shall control.

Technology Licenses

The hardware and/or software described in this document are furnished under a license and may be used or copied only in accordance with the terms of such license.

WARNING

A WARNING notice denotes a hazard. It calls attention to an operating procedure, practice, or the like that, if not correctly performed or adhered to, could result in personal injury or death. Do not proceed beyond a WARNING notice until the indicated conditions are fully understood and met.

CAUTION

A CAUTION notice denotes a hazard. It calls attention to an operating procedure, practice, or the like that, if not correctly performed or adhered to, could result in damage to the product or loss of important data. Do not proceed beyond a CAUTION notice until the indicated conditions are fully understood and met.