



HEWLETT
PACKARD

HP 8360 Series
Synthesized Sweepers
Quick Reference Guide

Introduction This document is a Quick Reference Guide (QRG) for the HP 8360 Series Synthesized Sweepers. It is presented in two sections a "Front Panel Menu Guide," and a "SCPI Programming Reference" (Standard Commands for Programmable Instruments is Hewlett-Packard's implementation of IEEE 488.2). The QRG is intended to provide quick reference material for an experienced user/programmer.

Front Panel Menu Guide The "Front Panel Menu Guide," includes softkey menu maps, functional descriptions, and the corresponding SCPI commands to automate a measurement made from the front panel.

SCPI Programming Reference The "SCPI Programming Reference," includes a complete SCPI command and syntax reference, a general SCPI syntax flow graph, and status register structure and specifications. This programming reference is presented to aid the experienced system programmer needing syntax information without functional explanations.

Contents

Front Panel Menu Guide Table of Contents	2
How to Use the Front Panel Menu Guide	3
Introduction to SCPI	41
SCPI Programming Reference	42
Status Register Structure and Specifications	50
Common Warning and Error Messages	53
Rear Panel Connections	54
Index	56

Front Panel Menu Guide Contents

Numeric Entry
 Arrow Keys
 Rotary Knob
 Unless otherwise
 stated, all synthesizer
 parameter values
 are set using these.

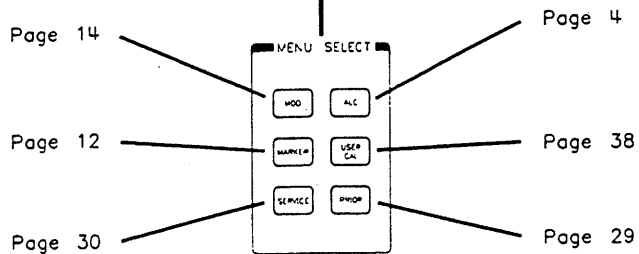
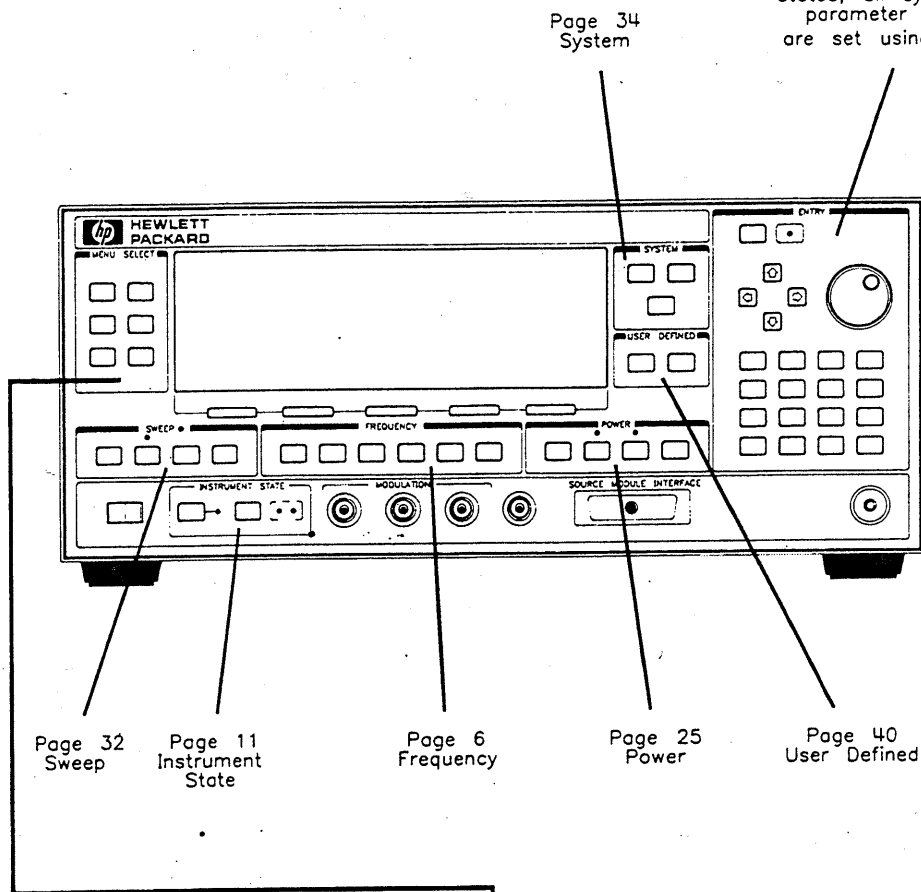

How to Use the Front Panel Menu Guide

This section of the QRG describes the hard and softkeys, where they are located, and gives enough information to set the synthesizer to a desired output. A typical page of this guide, as shown below, is arranged alphabetically by synthesizer function.

Softkeys labeled *[more m/n]* lead to menu, M+1/N, and softkeys labeled *[more n/n]* lead back to menu 1/N.

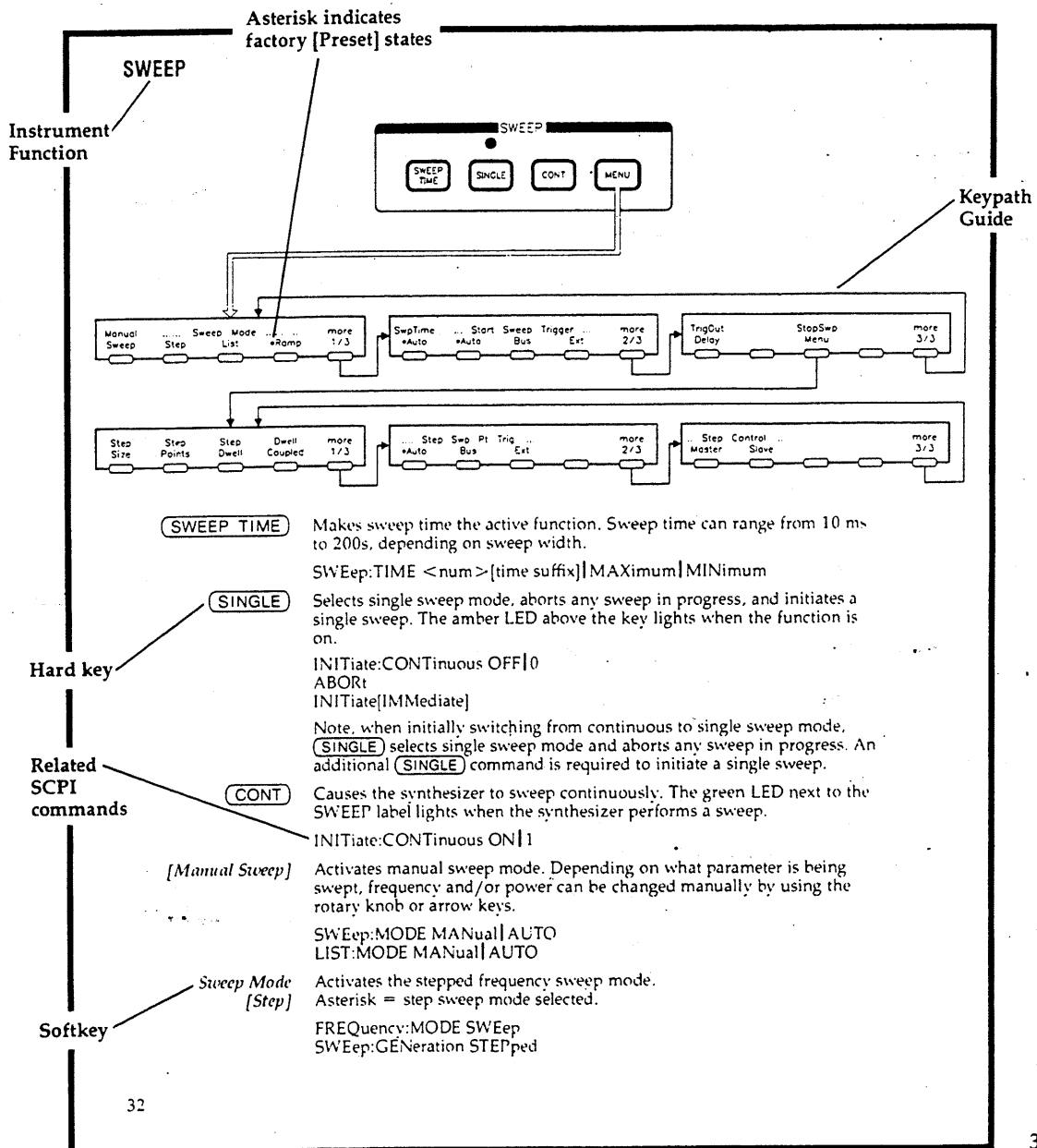

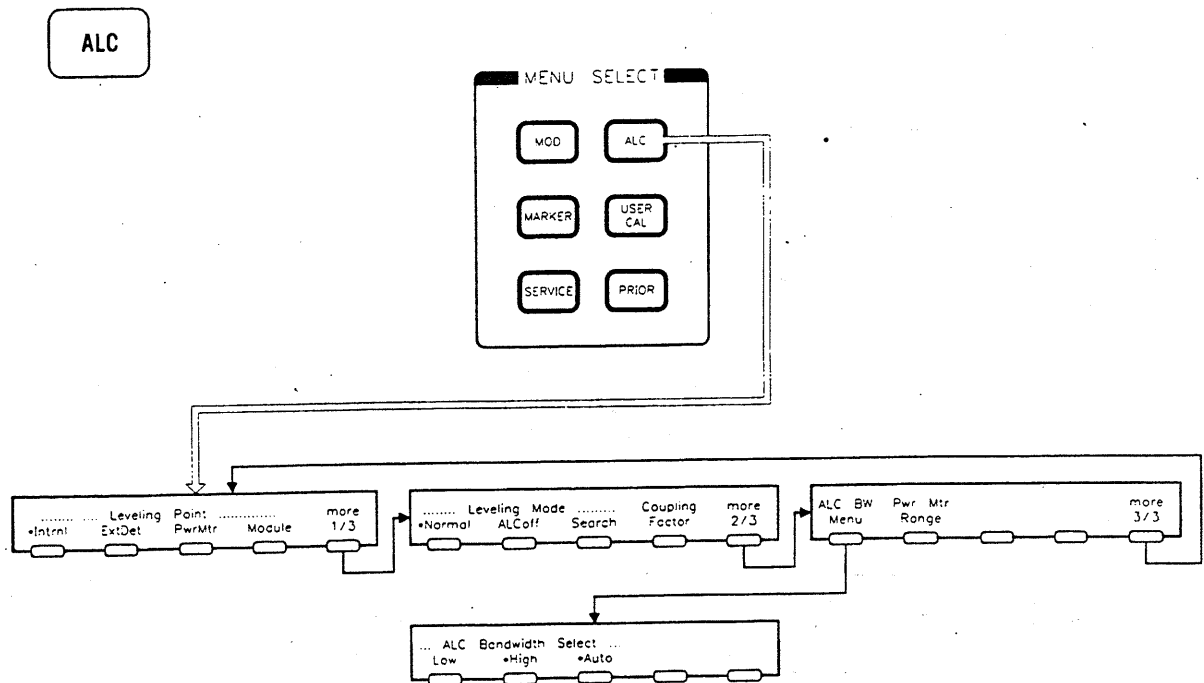

- Leveling Point [Intrnl]** Sets the synthesizer to level power internally. This is the factory preset leveling point. Asterisk = internal leveling point selected.
POWER:ALC:SOURce INTERNAL
- Leveling Point [ExtDet]** Sets the synthesizer to level power at an external diode detector. This mode of operation requires an external feedback connection from a negative-output crystal detector, at the leveling point, to the synthesizer's EXT ALC BNC connector. To obtain calibrated leveled output power, input a coupling factor and perform a detector calibration, [Ext Det Cal], after selecting this function. Asterisk = external leveling point selected.
POWER:ALC:SOURce DIODE
- Leveling Point [PwrMtr]** Sets the synthesizer to level power at the power sensor of an external power meter. This mode of operation requires a feedback connection from the recorder output of a power meter to the synthesizer's EXT ALC BNC connector. Asterisk = power meter leveling point selected.
POWER:ALC:SOURce PMETER
- Leveling Point [Module]** Sets the synthesizer to level power at the output of an HP 8355X series millimeter-wave source module. All necessary leveling loop feedback connections are contained in the source module interface cable. Asterisk = mm module leveling point selected.
POWER:ALC:SOURce MMHead
- Leveling Mode [Normal]** Sets the synthesizer to its factory preset mode of continuous leveling, at the user-selected leveling point. Asterisk = on, active.
POWER:ALC[:STATe] ON|1

- Leveling Mode**
[ALCOff] Disables ALC leveling circuitry. Provides uncalibrated level control by allowing direct control of the internal linear modulator and step attenuator. The modulator is set using the rotary knob or the arrow keys. With a 1 dB change in modulator setting corresponding to approximately 1 dB of change in output power. The step attenuator is set using the [Set Atten] softkey in the POWER menu. Asterisk = ALC disabled selected.
POWER:ALC[:STATe] OFF|0
- Leveling Mode**
[Search] Activates power search leveling mode. This mode levels the synthesizer to a user-specified output power level then disables the ALC circuitry and holds the modulator drive constant. For a complete description of search leveling mode refer to, "Operating and Programming Reference," in the *User's Handbook*. Asterisk = search leveling mode selected.
POWER:SEARCh ON|OFF|1|0|ONCE
- [Coupling Factor] Specifies the coupling factor of the external coupler/detector used to externally level source output power. The coupling factor range is from 0 to 90 dB.
POWER:ALC:CFACTOR <num>[power suffix]|MAXimum|MINimum
- [Pwr Mtr Range] Specifies the range of operation of an external power meter used to level source output power. This range can be adjusted in 10 dB increments between +30 and -90 dBm. Factory preset is 0 dBm.
POWER:RANGe <num>[power suffix]|MAXimum|MINimum
- [ALC BW Menu] Accesses the ALC bandwidth selection menu.
- ALC Bandwidth**
Select [Low] Sets the ALC bandwidth to the low bandwidth position (10 kHz). When in this mode the ALC operates using a narrow bandwidth for all sweep and modulation conditions. Sending the synthesizer an ALC bandwidth frequency value <10 kHz will cause it to select the low ALC bandwidth mode. Asterisk = low ALC bandwidth selected.
POWER:ALC:BANDwidth:AUTO OFF
POWER:ALC:BANDwidth <freq>[freq suffix]|MAXimum|MINimum
- ALC Bandwidth**
Select [High] Sets the ALC bandwidth to the high bandwidth position (100 kHz). When in this mode the ALC operates using a wide bandwidth for all sweep and modulation conditions. Sending the synthesizer an ALC bandwidth frequency value >10 kHz will cause it to select the high ALC bandwidth mode. Asterisk = high ALC bandwidth selected.
POWER:ALC:BANDwidth:AUTO OFF
POWER:ALC:BANDwidth <freq>[freq suffix]|MAXimum|MINimum
- ALC Bandwidth**
Select [Auto] Specifies that the ALC bandwidth will automatically be chosen by the synthesizer depending on the current sweep and modulation conditions.
POWER:ALC:BANDwidth:AUTO ON|1

FREQUENCY

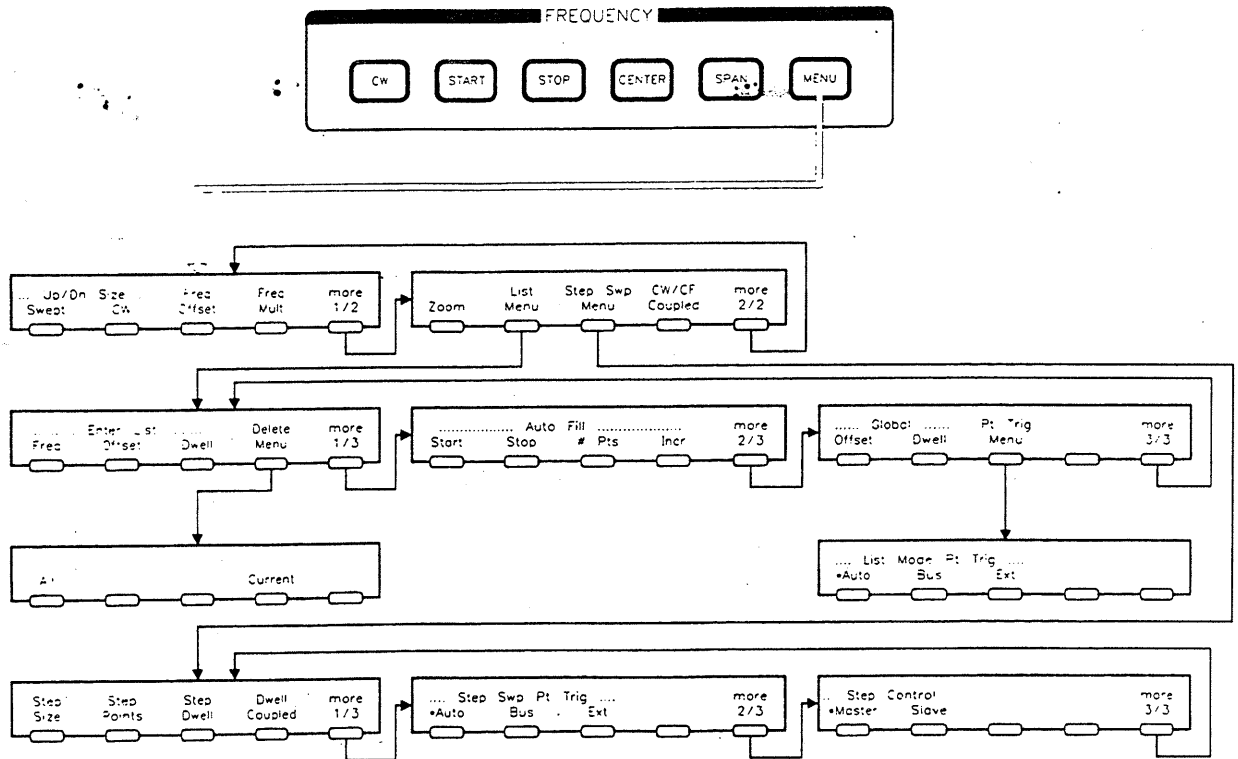

- CW** Activates CW frequency mode and makes CW frequency the active function.
 FREQUENCY[:CW] <num>[freq suffix]|MAXimum|MINimum|UP|DOWN
 FREQUENCY:MODE CW
- START** Activates swept frequency mode and makes start frequency the active function.
 FREQUENCY:START <num>[freq suffix]|MAXimum|MINimum|UP|DOWN
 FREQUENCY:MODE SWEep
- STOP** Activates swept frequency mode and makes stop frequency the active function.
 FREQUENCY:STOP <num>[freq suffix]|MAXimum|MINimum|UP|DOWN
 FREQUENCY:MODE SWEep
- CENTER** Activates swept frequency mode and makes center frequency the active function.
 FREQUENCY:CENTER <num>[freq suffix]|MAXimum|MINimum|UP|DOWN
 FREQUENCY:MODE SWEep
- SPAN** Activates swept frequency mode and makes frequency span the active function.
 FREQUENCY:SPAN <num>[freq suffix]|MAXimum|MINimum|UP|DOWN
 FREQUENCY:MODE SWEep

FREQUENCY

- Up/Dn Size [Swept]** Sets the frequency step size in swept frequency step mode. The step size can be set between 1 Hz and 10 GHz. The factory preset step size is 100 MHz. Asterisk = swept step size selected.
FREQUENCY:STEP[:INCR] <num>[freq suffix]|MAXimum|MINimum
- Up/Dn Size [CW]** Sets the frequency step size in CW frequency mode. The step size can be set between 1 Hz and 10 GHz. The factory preset step size is 100 MHz. CW frequency is incremented/decremented by pressing the up and down arrow keys. Asterisk = CW step size selected.
FREQUENCY:STEP[:INCR] <num>[freq suffix]|MAXimum|MINimum
- [Freq Offset]** Sets the frequency offset value, and applies it to all pertinent frequency parameters. The frequency offset can range ± 110 GHz. The factory preset value is 0. Asterisks appear next to all frequency values offset and next to the key label when this function is on.
FREQUENCY:OFFSet <num> |MAXimum|MINimum
FREQUENCY:OFFSet:STATe ON|OFF|1|0
- [Freq Mult]** Sets the frequency multiplier value, and applies it to all frequency parameters. The integer value of the frequency multiplier can range from +36 to -36. The factory preset value is 1. Asterisks appear next to all frequency values multiplied and next to the key label when this function is on.
FREQUENCY:MULTiplier <num> |MAXimum|MINimum
FREQUENCY:MULTiplier:STATe ON|OFF|1|0
- [Zoom]** Assigns the rotary knob and the numerical keypad to control the center frequency function, and assigns the up and down arrow keys to control the span function. The left and right arrow keys control the resolution with which the center frequency can be changed. This is a front panel only feature, and is inaccessible over HP-IB.
- [CW/CF Coupled]** Couples CW and center frequency. Any change initiated in one of these parameters results in a change in the other. Asterisk = CW/CF Coupled.
FREQUENCY:CW:AUTO ON|OFF|1|0
- [List Menu]** Accesses the frequency list menus. The softkeys in these menus help front panel users enter and edit frequency list parameters. These editing softkeys are not accessible over HP-IB. To load a frequency list over HP-IB the list must first be generated in entirety by the controlling program then downloaded to the synthesizer. The corresponding SCPI commands are given below. For more information about frequency list mode refer to "Operating and Programming Reference" in the *User's Handbook*.
LIST:FREQUENCY { <num>[freq suffix]|MINimum|MAXimum}
LIST:CORRection { <num>[DB]|MINimum|MAXimum}
LIST:DWELL { <num>[time suffix]|MINimum|MAXimum}
- In the above 3 commands the entries contained in {} can be repeated from 1 to 201 times.

FREQUENCY

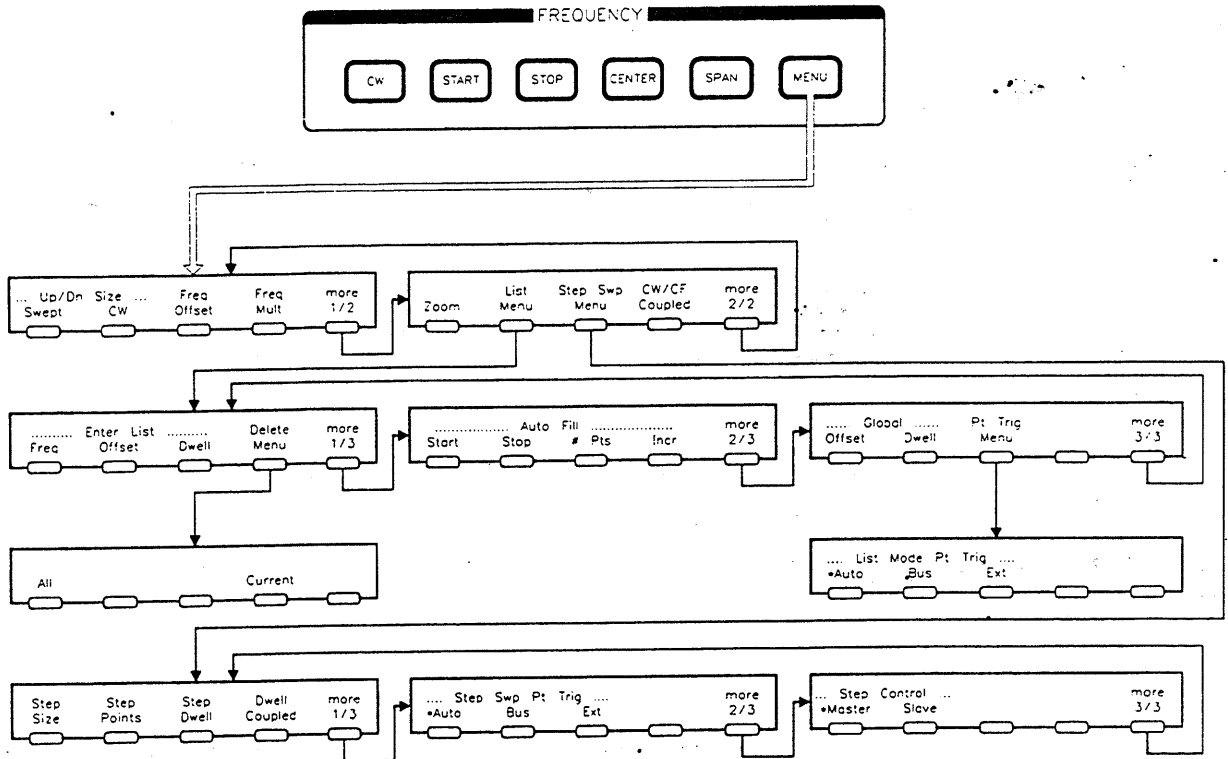

- Enter List [Freq]** Enables the entry of a frequency value into the frequency list. The number of frequency points in the frequency list can range from 1 to 201 points. Asterisk = list frequency selected.
- Enter List [Offset]** Enables the entry of a power correction value for a frequency in the frequency list. Asterisk = list offset selected.
- Enter List [Dwell]** Enables the entry of a dwell time for a frequency in the frequency list. Asterisk = list dwell selected.
- Auto Fill [Start]** Enables the entry of the auto fill start frequency. This value does not affect the synthesizer start frequency.
- Auto Fill [Stop]** Enables the entry of the auto fill stop frequency. This value does not affect the synthesizer stop frequency.
- Auto Fill [#Pts]** Automatically creates a frequency list containing a user-specified number of points. This list includes the auto fill start and stop frequencies, with the remainder of points equally spaced between them.
- Auto Fill [Incr]** Automatically creates a frequency list beginning at the auto fill start frequency and ending at a frequency less than or equal to the auto fill stop frequency, with all points separated by the frequency increment value.

FREQUENCY

- Global [Offset]** Automatically sets the ALC output power correction value for all points in the frequency list to a user-specified value.
- Global [Dwell]** Automatically sets the dwell time for all points in the frequency list to a user-specified value.
- [Delete Menu]** Accesses the frequency list delete menu.
- Delete [All]** Deletes *all* points in the frequency list.
- Delete [Current]** Deletes the frequency point and associated offset and dwell in the active line of the frequency list.
- [Pt Trig Menu]** Accesses the point trigger menu of the frequency list.
- List Mode Pt Trig [Auto]** Automatically steps the synthesizer to the next point in the frequency list. The time between points is equal to the sum of the dwell and phase lock times. Asterisk = auto point trigger selected.
LIST:TRIGger:SOURce IMMEDIATE
- List Pt Mode Trig [Bus]** Steps the synthesizer to the next point in the frequency list when an HP-IB trigger (*TRG, <GET>) is received. Asterisk = bus point trigger selected.
LIST:TRIGger:SOURce BUS
- List Mode Pt Trig [Ext]** Steps the synthesizer to the next point in the frequency list when an external hardware trigger is received at the trigger input BNC. Asterisk = external point trigger selected.
LIST:TRIGger:SOURce EXTERNAL
- [Step Swp Menu]** Accesses the stepped frequency sweep entry menus.
- [Step Size]** Sets the step size in the stepped frequency sweep mode.
 $[Step Size] = \frac{SPAN}{[Step Points]}$
SWEep:STEP <num>[freq suffix]|MAXimum|MINimum
- [Step Points]** Sets the number of points in the stepped frequency sweep mode. The number of points in the stepped frequency sweep can range from 2 to 801.
SWEep:POINts <num>|MAXimum|MINimum
- [Step Dwell]** Sets the dwell time for points in the stepped frequency sweep mode. The dwell time for points in a stepped frequency sweep can range from 100 us to 3.2s. The actual time between points in stepped frequency sweep mode is the sum of dwell and phase lock times.
SWEep:DWELl <num>[time suffix]|MAXimum|MINimum
- [Dwell Coupled]** Couples the dwell time for points in the stepped frequency sweep mode to the ramp sweep mode sweep time. Asterisk = on, active.
 $[Step Dwell] = \frac{SWEEP TIME}{[Step Points]} = 5 \text{ ms.}$
SWEep:DWELl:AUTO ON|OFF|1|0
- Step Swp Pt Trig [Auto]** Automatically steps the synthesizer to the next point in the stepped frequency sweep. The time between points is equal to the sum of the dwell and phase lock times. Asterisk = auto point trigger selected.
SWEep:TRIGger:SOURce IMMEDIATE

FREQUENCY

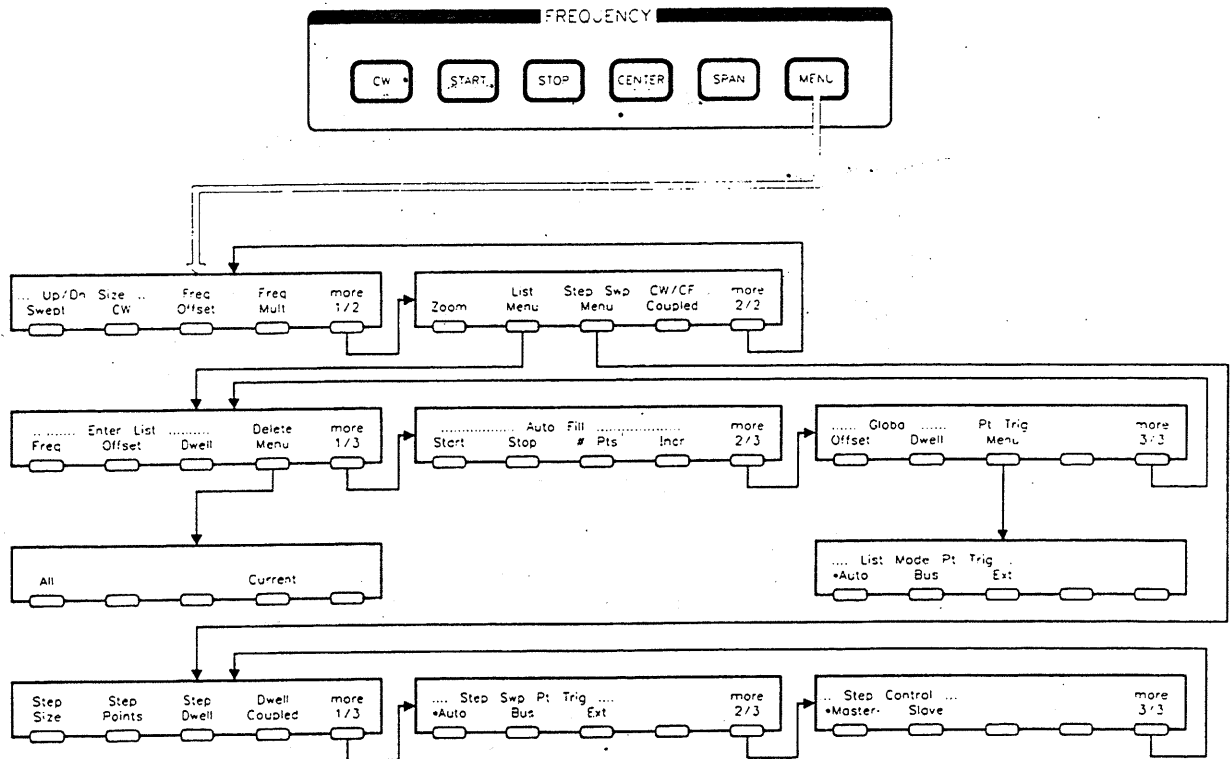

Step Swp Pt Trig [Bus] Steps the synthesizer to the next point in the stepped frequency sweep when an HP-IB trigger (*TRG, <GET>) is received. Asterisk = bus point trigger selected.

SWEep:TRIGger:SOURce BUS

Step Swp Pt Trig [Ext] Steps the synthesizer to the next point in the stepped frequency sweep when an external hardware trigger is received at the trigger input BNC. Asterisk = external point trigger selected.

SWEep:TRIGger:SOURce EXT

Step Control [Master] Causes the synthesizer to act as the master control in a dual synthesizer measurement setup. Asterisk = master control selected.

SWEep:CONTRol:STATe ON|OFF|1|0
SWEep:CONTRol:TYPE MASTer

Step Control [Slave] Causes the synthesizer to act as the slave in a dual synthesizer measurement setup. Asterisk = slave mode selected.

SWEep:CONTRol:STATe: ON|OFF|1|0
SWEep:CONTRol:TYPE SLAVe

INSTRUMENT STATE

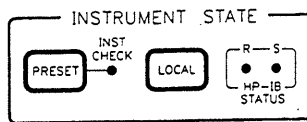

- PRESET** Returns the synthesizer to the preset state. This state is defined using the preset mode softkeys in the SYSTEM menu.
SYSTem:PRESet[:EXECute]
- LOCAL** Returns the synthesizer to local front panel operation.
LOCAL

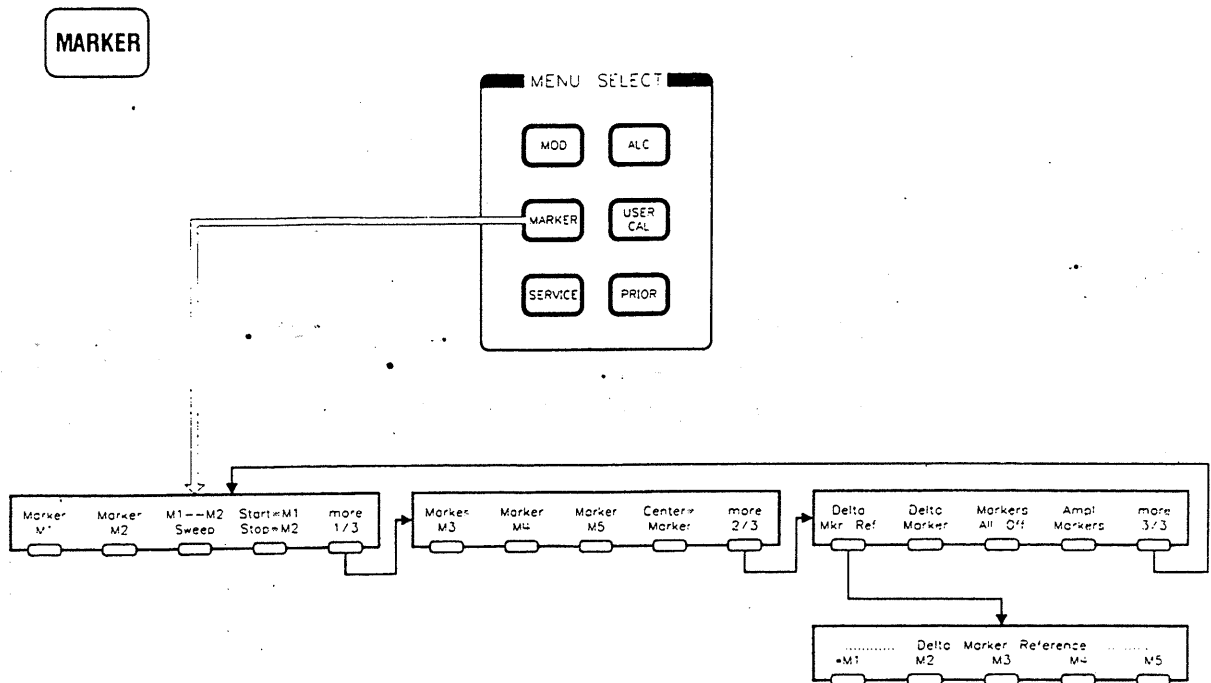

[Marker M1] Turns on/off marker 1, and makes its frequency the active function.
Asterisk = marker 1 on.

MARKer[1]:FREQuency <num>[freq suffix]| MAXimum| MINimum
MARKer[1]:STATe] ON|OFF|1|0

[Marker M2] Turns on/off marker 2, and makes its frequency the active function.
Asterisk = marker 2 on.

MARKer2:FREQuency <num>[freq suffix]| MAXimum| MINimum
MARKer2:STATe] ON|OFF|1|0

[M1—M2 Sweep] Causes the synthesizer to sweep between the frequency values of marker 1 and marker 2. Activating this function *temporarily* changes the start and stop frequencies of the synthesizer. Deactivating this function returns the start and stops frequencies to their previous values.
Asterisk = marker sweep on.

SWEep:MARKer:STATe ON|OFF|1|0

**[Start = M1
Stop = M2]** Changes the synthesizer start frequency to the frequency value of marker 1, and the synthesizer stop frequency to the frequency value of marker 2.

SWEep:MARKer:XFER

[Marker M3] Turns on/off marker 3, and makes its frequency the active function.
Asterisk = marker 3 on.

MARKer3:FREQuency <num>[freq suffix]| MAXimum| MINimum
MARKer3:STATe] ON|OFF|1|0

MARKER

- [Marker M4]* Turns on/off marker 4, and makes its frequency the active function.
Asterisk = marker 4 on.
MARKer4:FREQUency <num>[freq suffix]|MAXimum|MINimum
MARKer4[:STATe] ON|OFF|1|0
- [Marker M5]* Turns on/off marker 5, and makes its frequency the active function.
Asterisk = marker 5 on.
MARKer5:FREQUency <num>[freq suffix]|MAXimum|MINimum
MARKer5[:STATe] ON|OFF|1|0
- [Center = Marker]* Changes the synthesizer center frequency to the value of the most recently activated marker, and centers the span about that value.
MARKer[n]:FREQUency ?
FREQUency:CENTer <freq from above>[freq suffix]
- [Delta Mkr Ref]* Accesses the delta marker reference menu. In this menu the user can select a reference marker from markers 1 through 5.
MARKer:REFerence <n>
- [Delta Marker]* Displays (in the entry display) the frequency difference between delta marker reference and the active marker designated as DELTA.
Asterisk = delta marker mode selected.
MARKer[n]:MODE DELTa|FREQUency
To query the difference between two markers over HP-IB use:
MARKer[n]:DELTA? <num>, <num>
- [Markers All Off]* Turns off all markers.
MARKer:AOFF
- [Ampl Markers]* Turns on the amplitude marker function and makes its amplitude size the active function. This feature causes an RF amplitude pulse to occur at the marker frequency. Asterisk = amplitude markers selected.
MARKer:AMPLitude[:STATe] ON|OFF|1|0
The height of this pulse can be set from -10 dB to 10 dB relative to the current RF output power.
MARKer:AMPLitude:VALue <number>[DB]

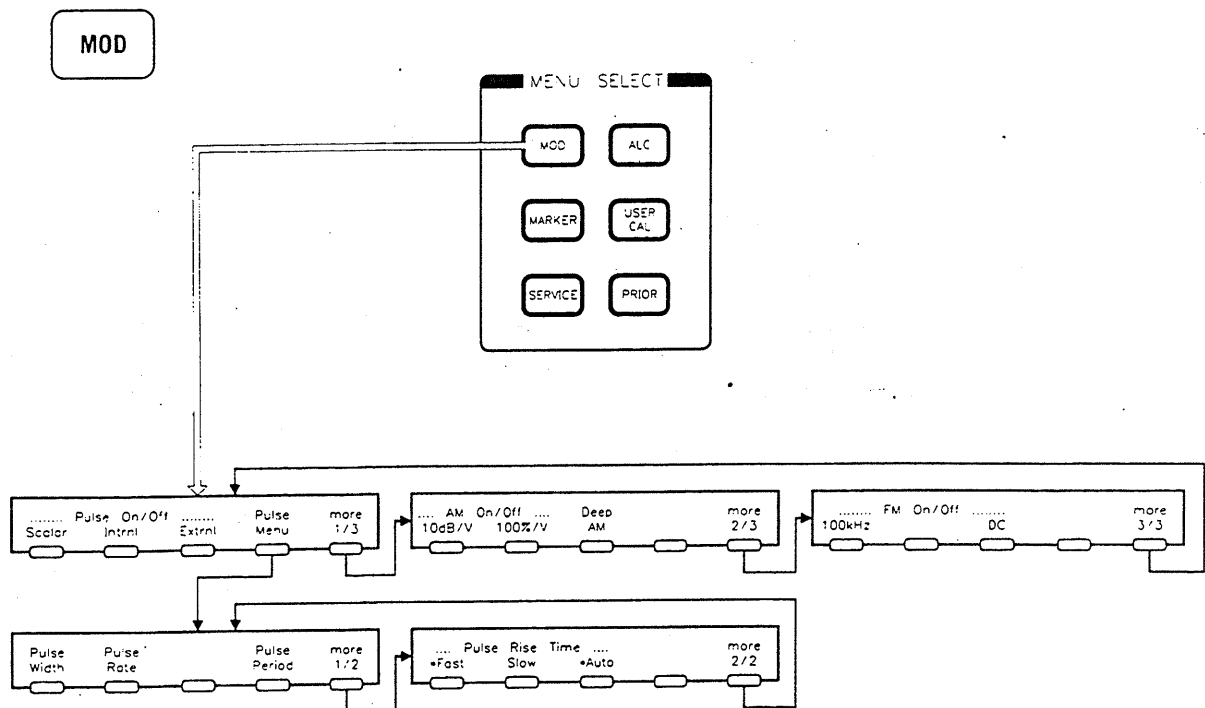

Note: There are two modulation menus. This modulation menu is for synthesizers *without* Option 002.

- Pulse On/Off**
[Scalar] Activates pulse modulation and causes the synthesizer's internal pulse modulator to produce 27.8 kHz square wave pulses (18 us pulse width and 36 us period). The rise and fall times of the RF envelope are approximately 2 us. These pulses are used in operation with scalar network analyzers. Asterisk = scalar pulse selected.

PULM:SOURce SCALAR
PULM:STATe ON|OFF|1|0
- Pulse On/Off**
[Intrnl] Activates pulse modulation and selects the synthesizer's internal pulse modulator as the modulation source. Asterisk = internal pulse selected.

PULM:SOURce INTRnal
PULM:STATe ON|OFF|1|0
- Pulse On/Off**
[Extrnl] Activates pulse modulation and accepts input from an external pulse modulator, at the PULSE BNC, as the modulation source. TTL - low level inputs turn off the RF output. TTL - high level inputs turn on the RF output. Asterisk = external pulse selected.

PULM:SOURce EXTRnal
PULM:STATe ON|OFF|1|0
- [Pulse Menu] Accesses the pulse control menu.
- [Pulse Width] Makes the internal pulse generator's pulse width the active function. The pulse width can range from 1 us to 65.5 ms. The factory preset value is 1 ms.

PULSe:WIDTh <num>[time suffix]|MAXimum|MINimum

- [Pulse Rate]** Makes the internal pulse generator's pulse repetition rate the active function. The repetition rate can range from 15.26 Hz to 500 kHz. The factory preset value is 500 Hz.
PULSe:FREQUency <num>[freq suffix]|MAXimum|MINimum
- [Pulse Period]** Makes the internal pulse generator's pulse period the active function. The pulse period can range from 2 us to 65.5 ms. The factory preset value is 2 ms.
PULSe:PERiod <num>[time suffix]|MAXimum|MINimum
- Pulse Rise Time [Fast]** Sets the synthesizers pulse rise time to a minimum value, ≤ 50 ns or ≤ 10 ns with Option 006.
PULM:SLEW <num>[time suffix]|MINimum
- Pulse Rise Time [Slow]** Applies a slow rise pulse filter to both internal and external pulse waveforms. This results in pulses having approximately 2 us rise/fall times. Asterisk = slow rise pulse selected.
PULM:SLEW <num>[time suffix]|MAXimum
- Pulse Rise Time [Auto]** Sets the synthesizer's pulse rise time based on the state of the scalar pulse function. When *Pulse On/Off [Scalar]* is selected or the synthesizer is connected to an HP 8757C/E Scalar Network Analyzer, *Pulse Rise Time [Slow]* is activated. If *Pulse On/Off [Scalar]* has not been selected *Pulse Rise Time [Fast]* is activated.
PULM:SLEW:AUTO ON|OFF|1|0
- AM On/Off [10 dB/V]** Turns on/off exponentially scaled amplitude modulation (AM). Asterisk = exponential AM selected.
AM:TYPE EXPOnential
AM:MODE NORMAl
AM:STATe ON|OFF|1|0
- AM On/Off [100%/V]** Turns on/off linearly scaled amplitude modulation (AM). Asterisk = linear AM selected.
AM:TYPE LINear
AM:MODE NORMAl
AM:STATe ON|OFF|1|0
- [Deep AM]** Puts the synthesizer into deep AM mode. This mode provides 99% (40 dB), AM modulation depth for modulation rates > 10 Hz. Asterisk = deep AM mode selected.
AM:MODE DEEP
AM:STATe ON|OFF|1|0

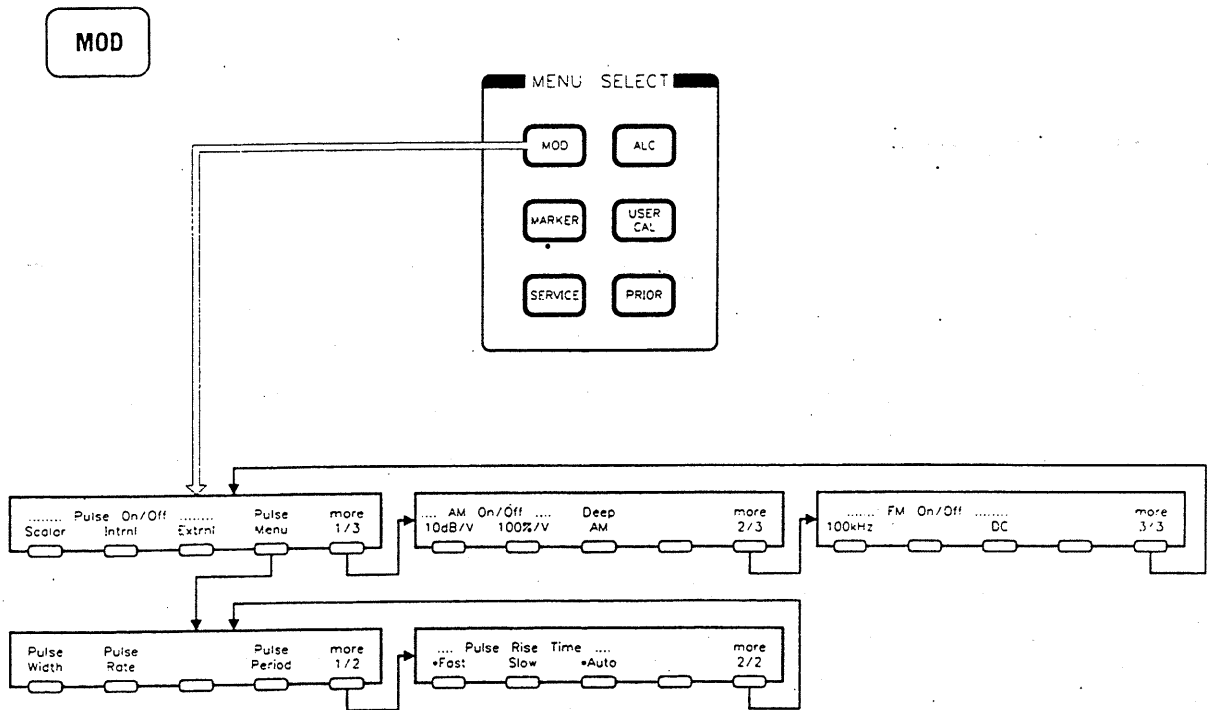

FM On/Off [AC] Turns on/off AC-coupled frequency modulation (FM) and makes FM input sensitivity the active function. The input sensitivity can be set to 100 kHz/V, 1 MHz/V or 10 MHz/V. The maximum FM deviation is 8 MHz. Asterisk = AC-coupled FM selected.

FM:SENSitivity <num>[freq/V suffix]|MAXimum|MINimum
 FM:COUpling AC
 FM:STATe ON|OFF|1|0

FM On/Off [DC] Turns on/off DC-coupled frequency modulation (FM) and makes FM input sensitivity the active function. The input sensitivity can be set to 100 kHz/V, 1 MHz/V or 10 MHz/V. The maximum FM deviation is 8 MHz. Asterisk = DC-coupled FM selected.

FM:SENSitivity <num>[freq/V suffix]|MAXimum|MINimum
 FM:COUpling DC
 FM:STATe ON|OFF|1|0

MOD
OPT. 002

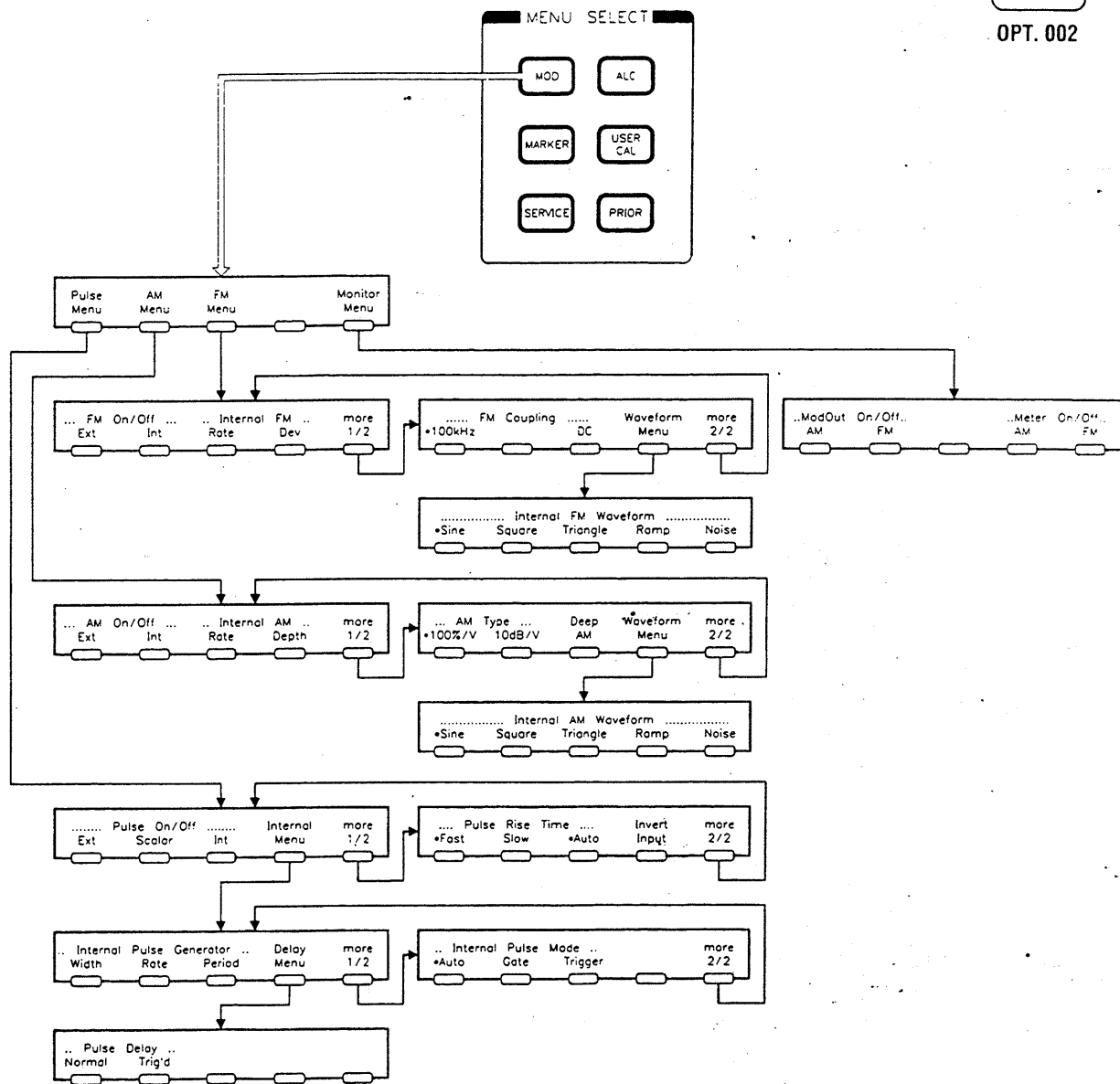

Note: There are two modulation menus. This modulation menu is for synthesizers *with* Option 002.

[Pulse Menu] This softkey accesses the pulse modulation softkeys. These softkeys engage external, internal, and scalar pulse modulation. They allow you to define the rise time, and give access to the internal menu for defining the parameters of the internally-generated pulse modulation.

MOD

OPT. 002

- [Pulse On/Off Extrnl]* This softkey activates the pulse modulation mode for an external pulse source. The pulse source is connected to the PULSE INPUT BNC connector and fed to the pulse modulator through a buffer circuit.
- When pulse modulation is in effect, the RF output is turned on (programmed power is produced) and off (80 dB attenuation) at a rate determined by the pulse modulation input. Pulse and amplitude modulation can be in effect simultaneously. Asterisk = external pulse active.
- PULSe:SOURce EXTernal
PULSe[:STATe] ON|OFF|1|0
- [Pulse On/Off Scalar]* This softkey activates pulse modulation mode, and sets the internal pulse generator to produce 27.778 kHz square wave pulses (18 μ s pulse width, 36 μ s pulse period). The rise and fall times of the RF envelope are approximately 2 μ s. These pulses allow proper operation with HP scalar network analyzers in ac detection mode. Asterisk = scalar pulse selected.
- PULSe:SOURce SCALAr
PULSe[:STATe] ON|OFF|1|0
- [Pulse On/Off Intrnl]* This softkey activates pulse modulation mode using the internal pulse generator. No external connection is needed. When internal pulse modulation is selected the PULSE INPUT BNC becomes an output for the internally generated signal. The pulse parameters (width, period, rate, rise time, etc.) are controlled by other softkeys. Asterisk = internal pulse active.
- PULSe:SOURce INTernal
PULSe[:STATe] ON|OFF|1|0
- [Pulse Rise Time Fast]* This softkey lets you set the pulse rise time to ≤ 50 ns regardless of any other conditions. Asterisk = fast pulse rise time selected.
- PULM:SLEW <num>[time suffix]|MINimum
- [Pulse Rise Time Slow]* This softkey lets you set the synthesizer to apply a slow rise pulse filter to both internal and external pulse waveforms. This results in pulses having approximately 2 μ s rise/fall times. Asterisk = slow pulse rise time selected.
- PULM:SLEW <num>[time suffix]|MAXimum
- [Pulse Rise Time Auto]* This softkey lets you set the pulse rise time to depend on the state of the synthesizer pulse scalar function. If pulse scalar is on, rise time is set to slow. Conversely if pulse scalar is off, then the rise time is set to fast. The factory default is pulse rise time set to auto. Asterisk = auto pulse rise time selected.
- PULM:SLEW:AUTO ON|OFF|1|0
- [Invert Input]* This softkey inverts the logic of the external pulse input. With this function active, +5 V turns off RF power.
- PULM:EXTernal:POLarity INVerted
- [Internal Menu]* This softkey lets you define the parameters of the internal pulse modulation.

**[Internal Pulse
Generator Width]**

This softkey lets you set a value for the internal pulse generator's pulse width. The pulse is adjustable from 25 ns to 400 ms with 25 ns resolution. The factory preset default is 1 ms pulse width. If you set a value for the pulse width that is greater than the pulse period, the pulse period is recalculated to a value equal to the pulse width plus 25 ns. When this feature is active, its current value is displayed in the active entry area.

PULM:INTernal:WIDTh <num>[time suffix]|MAXimum|MINimum

**[Internal Pulse
Generator Rate]**

This softkey lets you set a value for the internal pulse generator's pulse rate. The range of acceptable values is from 2.5 Hz to 3.33 MHz. (These values are obtained by taking the inverse of the period.) The factory preset default is 500 Hz. When this feature is active, its current value is displayed in the active entry area.

Since rate and period are inversely related, if both are given values, only the last one will be applied which will cause the first one to be recalculated. Use the one that is convenient for your application. For example, if you set the pulse rate, do not change the pulse period (the synthesizer automatically adjusts the period to match the rate.)

PULM:INTernal:FREQuency <num>[freq suffix]|MAXimum|MINimum

**[Internal Pulse
Generator Period]**

This softkey lets you set a value for the internal pulse generator's pulse period. The pulse is adjustable from 300 ns to 400 ms with 25 ns resolution. The factory preset default is 2 ms pulse period. When this feature is active, its current value is displayed in the active entry area.

Since period and rate are inversely related, if both are given values, only the last one will be applied which will cause the first one to be recalculated. Use the one that is convenient for your application. For example, if you set the pulse period, do not change the pulse rate (the synthesizer automatically adjusts the rate to match the period.)

PULS:INTernal:PERiod <num>[time suffix]|MAXimum|MINimum

**[Internal Pulse
Mode Auto]**

This softkey is the default mode of generating internal pulses. It is not synchronized to any trigger signal. Asterisk = auto internal pulse mode active.

PULM:INTernal:TRIGger:SOURce INTernal

**[Internal Pulse
Mode Gate]**

This softkey logically "ANDs" the internal pulse generator with a gating signal supplied from an external source.

PULM:INTernal:GATE ON|OFF|1|0
PULM:INTernal:TRIGger:SOURce INTernal

**[Internal Pulse
Mode Trigger]**

This softkey lets you set the internal pulse generator to trigger on the leading edge of the externally generated pulse.

PULM:INTernal:TRIGger:SOURce EXTernal

[Delay Menu]

This softkey accesses the pulse delay softkeys. These softkeys let you delay the internally generated pulsed output from either the PULSE SYNC OUT signal or from the external pulse signal at the PULSE input.

MOD

OPT. 002

[Pulse Delay Normal] This softkey lets you set a value for the internal pulse generator's pulse delay. The output pulse is delayed from the leading edge of the PULSE SYNC OUT signal. The range of acceptable values is from 0 to a maximum of 25 ns *less than* the period. The factory preset default is 0 ns. Use the numeric entry keys, arrow keys, or rotary knob to change the value. When this feature is active, its current value is displayed in the active entry area.

PULM:INTernal:DELay <num>[time suffix]|MAXimum|MINimum

[Pulse Delay Trig'd] This softkey lets you set a value for the internal pulse generator's pulse delay. The output pulse is delayed from the leading edge of the PULSE input signal. The range of acceptable values is from 225 ns to 419 ms. The factory preset default is 225 ns. Use the numeric entry keys, arrow keys, or rotary knob to change the value. When this feature is active, its current value is displayed in the active entry area.

PULM:EXTernal:DELay <num>[time suffix]|MAXimum|MINimum

[AM Menu] This softkey accesses the amplitude modulation softkeys. These softkeys engage external and internal amplitude modulation. They allow you to define the scaling, waveform, rate, and depth of the internal AM.

[AM On/Off Ext] This softkey activates the amplitude modulation mode for an external source. The AM source is connected to the AM modulation connector.

When external AM is in effect, the RF output is amplitude modulated with a rate and depth set by the external source. Amplitude scaling is controlled by the following softkeys: **[AM Type 100%/V]** **[AM Type 10dB/V]**.
Asterisk = external AM active.

AM:SOURce EXTernal
AM:STATe ON/OFF

[AM On/Off Int] This softkey activates the internal amplitude modulation mode. No external source is needed.

When internal AM is in effect, the parameters are controlled by the following softkeys: **[Internal AM Rate]** **[Internal AM Depth]** **[AM Type 100%/V]** **[AM Type 10dB/V]** **[Deep AM]** **[Waveform Menu]**.
Asterisk = internal AM active.

AM:SOURce INTernal
AM:STATe ON/OFF

[Internal AM Rate] This softkey lets you set the AM rate for internally-generated AM. Use the numeric entry keys, arrow keys, or rotary knob to change the rate. The synthesizer accepts values from 1 Hz to 1 MHz, however it is specified to 1 MHz only for a sine waveform. Refer to the specifications. The factory preset rate is 100 kHz.

AM:INTernal:FREQuency <num>[<freq suffix>]|MAXimum|MINimum

MOD

OPT. 002

- [Internal AM Depth]** This softkey lets you set the AM depth for internally-generated AM. Use the numeric entry keys, arrow keys, or rotary knob to change the value of the depth. The synthesizer accepts values from 0 to 99.9 percent (0 percent is equivalent to no modulation) and has a resolution of 0.1 percent. The factory preset depth is 30 percent.
- AM[:DEPTH] <num>[PCT]|MAXimum|MINimum| <num>DB
UNIT:AM DB|PCT
- [AM Type 100%/V]** This softkey scales the amplitude modulation function linearly. The amplitude of the RF output changes linearly as a function of AM input changes (or at a rate set by softkey for internal AM). See "Specifications" for the AM characteristics, input range, and damage level. Asterisk = AM scaled to 100%/V.
- AM:TYPE LINear
- [AM Type 10 dB/V]** This softkey scales the amplitude modulation exponentially. Amplitude modulation lets the RF output of the synthesizer be continuously and exponentially varied at a rate determined by the AM input or at a rate set by softkey for internal AM. See "Specifications" for the AM characteristics, input range, and damage level. Asterisk = AM scaled to 10 dB/V.
- AM:TYPE EXPponential
- [Deep AM]** Puts the synthesizer into deep AM mode. This mode provides 99% (40 dB) AM modulation depth for modulation rates >10 Hz. Asterisk = deep AM mode active.
- AM:MODE DEEP
AM:STATe ON|OFF|1|0
- [Waveform Menu]** The waveform menu allows you to choose sine, square, triangle, ramp, and noise waveforms for internal AM and FM. The default is sine wave. There are two waveform menus. The waveform menu in the AM menu sets the waveform for amplitude modulation only. The waveform menu in the FM menu sets the waveform for frequency modulation only.
- [Internal FM Waveform Sine]** This softkey lets you set the FM waveform to sine wave for internally-generated FM. Sine wave is the factory preset waveform. Asterisk = sine waveform selected.
- FM:INternal:FUNCTION SINusoid
- [Internal FM Waveform Square]** This softkey lets you set the FM waveform to square wave for internally-generated FM. Sine wave is the factory preset waveform. Asterisk = square waveform selected.
- FM:INternal:FUNCTION SQUare
- [Internal FM Waveform Triangle]** This softkey lets you set the FM waveform to triangle wave for internally-generated FM. Sine wave is the factory preset waveform. Asterisk = triangle waveform selected.
- FM:INternal:FUNCTION TRIangle

MOD

OPT. 002

- [Internal FM Waveform Ramp]** This softkey lets you set the FM waveform to ramp for internally-generated FM. Sine wave is the factory preset waveform. Asterisk = ramp waveform selected.
FM:INTERNAL:FUNCTION RAMP
- [Internal FM Waveform Noise]** This softkey lets you set the FM waveform to noise (white noise FM rate; gaussian distribution centered around FM deviation) for internally-generated FM. Sine wave is the factory preset waveform. Asterisk = ramp waveform selected.
FM:INTERNAL:FUNCTION NOISE
- [FM Menu]** This softkey accesses the frequency modulation softkeys. These softkeys engage external and internal frequency modulation. They allow you to define the coupling, waveform, rate, and deviation of the internal FM.
- [FM On/Off Ext]** This softkey activates the frequency modulation mode for an external source. The FM source is connected to the FM modulation connector. The FM sensitivity function is active. It is factory preset to 10 MHz/V. Use the numeric entry keys, arrow keys, or rotary knob to change the sensitivity to 100 kHz/V or 1 MHz/V.
When external FM is in effect, the RF output is frequency modulated with a rate and depth set by the external source. The FM coupling is controlled by the following softkeys: **[FM Coupling 100kHz]** **[FM Coupling DC]**. The FM coupling defaults to 100 kHz. This is AC coupling for FM rates of 100 kHz or greater. For modulation rates below 100 kHz, choose DC-coupled FM. Asterisk = external FM active.
FM:SOURCE EXTERNAL
FM:SENSITIVITY <num>[freq suffix/V]|MAXIMUM|MINIMUM
FM:STATE ON|OFF
- [FM On/Off Int]** This softkey activates the internal frequency modulation mode. No external source is needed.
When internal FM is in effect, the parameters are controlled by the following softkeys: **[Internal FM Rate]** **[Internal FM Deviation]** **[FM Coupling 100kHz]** **[FM Coupling DC]** **[Waveform Menu]**. The synthesizer is factory preset to a 1 MHz rate, 1 MHz deviation, and sine wave parameters. Asterisk = internal FM active.
FM:SOURCE INTERNAL
FM:STATE ON|OFF
- [Internal FM Rate]** This softkey lets you set the FM rate for internally-generated FM. Use the numeric entry keys, arrow keys, or rotary knob to change the value of the rate. The synthesizer accepts values from 1 Hz to 1 MHz, however it is specified to 1 MHz only for a sine waveform. Refer to the specifications. The factory preset rate is 1 MHz (note that the synthesizer also presets to a sine waveform).
FM:INTERNAL:FREQUENCY <num>[freq suffix]|MAXIMUM|MINIMUM

MOD

OPT. 002

- [Internal FM Deviation]** This softkey lets you set the FM deviation for internally-generated FM. Use the numeric entry keys, arrow keys, or rotary knob to change the value of the deviation. The synthesizer accepts values from 1 Hz to 10 MHz. The factory preset deviation is 1 MHz.
FM[:DEVIation] <num>[freq suffix]|MAXimum|MINimum
- [FM Coupling 100kHz]** This softkey lets you set the FM input to be AC-coupled. If you choose AC-coupled FM, you will be modulating a phase locked carrier. This is the specified synthesized operation. You *must* modulate at a 100 kHz rate or greater. If not, the frequency changes caused by the modulation are inside the phase locked loop bandwidth and the output will not be linear FM. For modulation frequencies below 100 kHz, choose DC-coupled FM. Asterisk = AC FM coupling selected.
FM:FILTer:HPASs <num>[freq suffix]|MAXimum|MINimum
- [FM Coupling DC]** This softkey lets you set the FM input to be DC-coupled. Use DC coupling for modulation rates below 100 kHz. In this mode, the phase-locked loop is de-activated. This means that the synthesizer is operating as an open loop sweeper. The synthesizer will not be phase locked, and therefore, be aware that the phase noise and CW frequency accuracy specifications do not apply. Asterisk = DC FM coupling selected.
FM:FILTer:HPASs <num>[freq suffix]|MAXimum|MINimum
- [Waveform Menu]** The waveform menu allows you to choose sine, square, triangle, ramp, and noise waveforms for internal AM and FM. The default is sine wave. There are two waveform menus. The waveform menu in the AM menu sets the waveform for amplitude modulation only. The waveform menu in the FM menu sets the waveform for frequency modulation only.
- [Internal AM Waveform Sine]** This softkey lets you set the AM waveform to sine wave for internally-generated AM. Sine wave is the factory preset waveform. Asterisk = sine waveform selected.
AM:INTernal:FUNCTion SINusoid
- [Internal AM Waveform Square]** This softkey lets you set the AM waveform to square wave for internally-generated AM. Sine wave is the factory preset waveform. Asterisk = square waveform selected.
AM:INTernal:FUNCTion SQUARE
- [Internal AM Waveform Triangle]** This softkey lets you set the AM waveform to triangle wave for internally-generated AM. Sine wave is the factory preset waveform. Asterisk = triangle waveform selected.
AM:INTernal:FUNCTion TRIangle
- [Internal AM Waveform Ramp]** This softkey lets you set the AM waveform to ramp for internally-generated AM. Sine wave is the factory preset waveform. Asterisk = ramp waveform selected.
AM:INTernal:FUNCTion RAMP

MOD

OPT. 002

- [Internal AM Waveform Noise]* This softkey lets you set the AM waveform to noise (white noise AM rate; gaussian distribution centered around AM depth) for internally-generated AM. Sine wave is the factory preset waveform. Asterisk = noise waveform selected.
AM:INTernal:FUNCTion NOISe
- [Monitor Menu]* This softkey accesses the menu which allows you to output internally-generated AM and FM waveforms to the rear panel AM/FM OUTPUT connector. It also accesses the softkeys which allow you to display the AM depth and FM deviation of the modulation waveforms.
- [ModOut On/Off AM]* This softkey lets you output the internally-generated amplitude modulation waveforms to the rear panel AM/FM OUTPUT connector. When scaled linearly at 100%/V, the maximum output voltage is +1 V and the minimum output voltage is -1 V. Asterisk = AM modulation output.
MODulation:OUTput:SOURce AM
MODulation:OUTput:STATe ON|OFF|1|0
- [ModOut On/Off FM]* This softkey lets you output the internally-generated frequency modulation waveforms to the rear panel AM/FM OUTPUT connector. When scaled exponentially at 10 dB/V, the maximum output voltage is offset to 0 V and the minimum voltage level is -4 V. Asterisk = FM modulation output.
MODulation:OUTput:SOURce FM
MODulation:OUTput:STATe ON|OFF|1|0
- [Meter On/Off AM]* This softkey lets you display the value of the depth of the externally-generated amplitude modulation. Asterisk = AM depth displayed.
• MEASure:AM?
- [Meter On/Off FM]* This softkey lets you display the frequency deviation produced by the externally-generated frequency modulation. Asterisk = FM deviation displayed.
MEASure:FM?

POWER

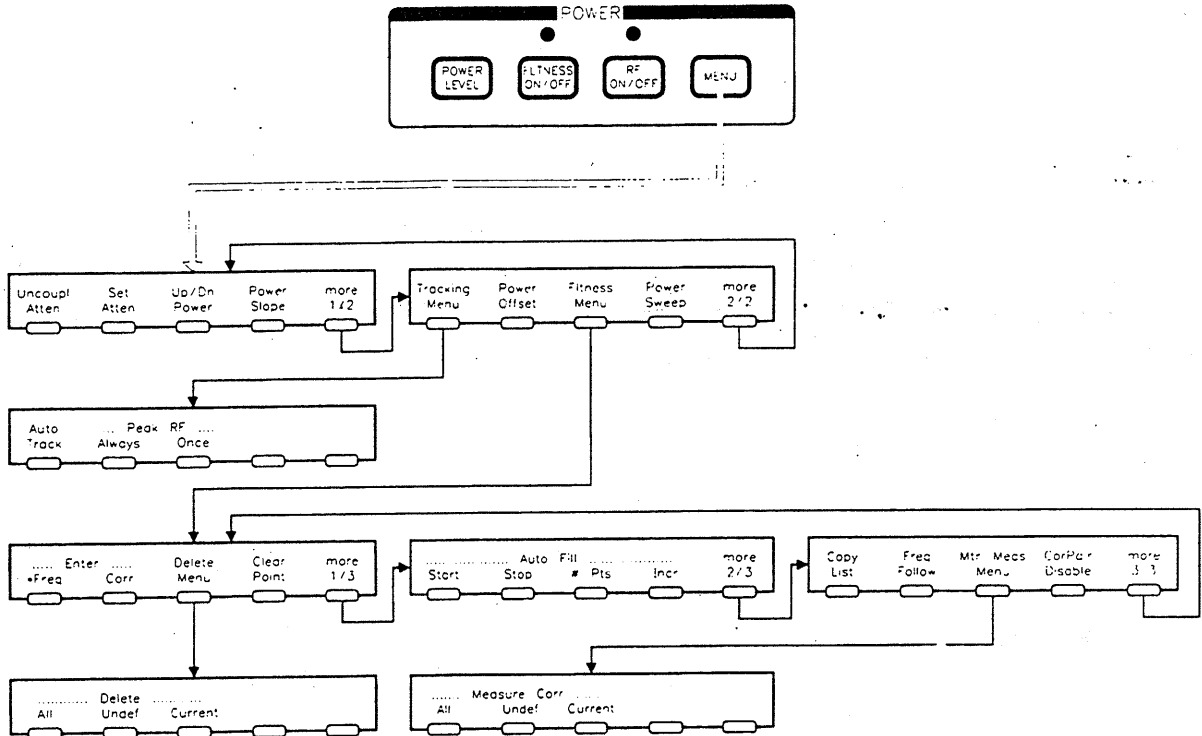

POWER LEVEL Makes power level the active function. Factory preset is 0 dBm.
 POWER[:LEVEL] <num>[DBM]|MAXimum|MINimum|UP|DOWN

FLTNESS ON/OFF Turns on/off user flatness correction. Amber LED above the key lights when this function is on.
 CORREction[:STATe] ON|OFF|1|0

RF ON/OFF Turns on/off the RF output power. Amber LED above the key lights when this function is on. Factory preset is RF on.
 POWER:STATe ON|OFF|1|0

[Uncoupl Atten] Uncouples the internal attenuator and the ALC. Asterisk = attenuator uncoupled.
 POWER:ATTenuation:AUTO ON|OFF|1|0

[Set Atten] Makes the attenuator value the active function. The attenuator has 10 possible settings, 0 through 90 dB. This function sets the attenuator value and decouples the attenuator.
 POWER:ATTenuation <num>[DB]|MAXimum|MINimum|UP|DOWN

[Up/Dn Power] Makes power step size the active function. It can be set from 0.01 to 20 dB. The factory preset step size is 10 dB. In this mode, power is stepped by pressing the up and down arrow keys. Asterisk = power step selected.
 POWER:STEP[:INCR] <num>[DB]|MAXimum|MINimum
 POWER:STEP:AUTO ON|OFF

POWER

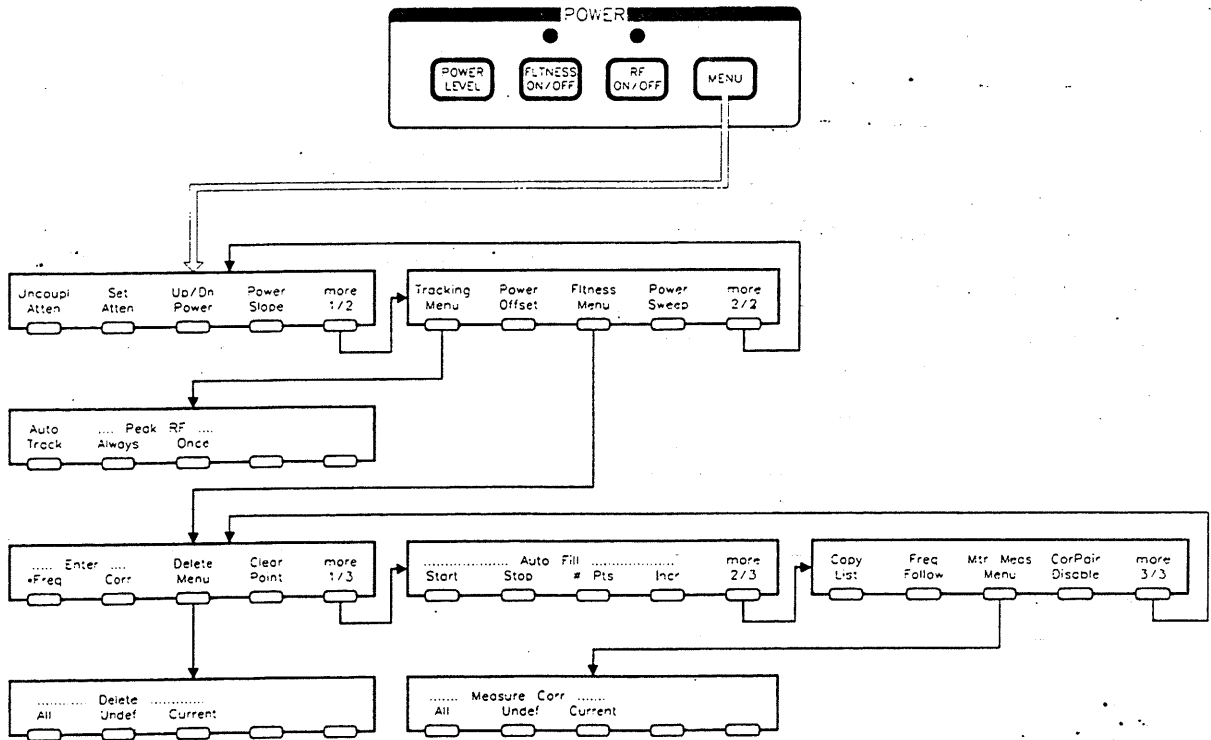

[Power Slope] Applies a linear change to the synthesizer's output power relative to frequency. Slope can range from -2.5 dB/GHz to 2.5 dB/GHz. The power level at the beginning of the sweep equals the current power level. Asterisk = power slope selected.

POWER:SLOPe:STATe ON|OFF|1|0
 POWER:SLOPe <num>[DB]|MAXimum|MINimum|UP|DOWN

[Power Offset] Changes the displayed power to include an offset, but does not change the output power of the synthesizer. Asterisk = power offset selected.

POWER:OFFset:STATe ON|OFF|1|0
 POWER: OFFset <num>[DB]|MAXimum|MINimum|UP|DOWN

[Power Sweep] Activates power sweep mode and makes power sweep (dB/swp) the active function. Asterisk = power sweep selected.

POWER:MODE SWEep|FIXed
 POWER:START <num>[vl suffix]|MAXimum|MINimum
 POWER:SPAN <num>[vl suffix]|MAXimum|MINimum

[Tracking Menu] Accesses the tracking calibration menu.

[Auto Track] Aligns the synthesizer's output filter to maximize output power for the swept frequency mode.

CALibration:TRACk

POWER

- Peak RF [Always]** Periodically aligns the synthesizer's output filter to maximize output power for the CW frequency mode. This peaking will occur each time the frequency is changed or every 7 minutes. Asterisk = peak RF always selected.
CALibration:PEAKing:AUTO ON|OFF|1|0
- Peak RF [Once]** Aligns the synthesizer's output filter to maximize output power for the CW frequency mode.
CALibration:PEAKing[:EXECute]
- [Fitness Menu]** Accesses the flatness correction menus that control user-defined flatness correction. The softkeys in these menus help front panel users enter and edit flatness correction parameters. These editing softkeys are not accessible over HP-IB. To load correction arrays over HP-IB, the correction arrays must first be created by the controlling program and then downloaded to the synthesizer. The corresponding SCPI commands are given below. For more information about user flatness correction mode refer to, "Operating and Programming Reference," in the *User's Handbook*.
CORRection:FLATness {<num>[freq suffix],<num>[DB]}
The portion of the above command contained in {} can be entered from 1 to 801 times.
CORRection:ARRay {<num>[DB]}
The portion of the above command contained in {} must be entered 1601 times. This array must contain 1601 evenly spaced correction values.
- Enter [Freq]** Enables the entry of a single frequency point into the flatness correction array. Asterisk = frequency enter active.
- Enter [Corr]** Enables the entry of a power correction value for a point in the flatness correction array. Asterisk = correction value active.
- [Clear Point]** Removes the correction value from one point in the flatness correction array. Once this operation is complete the correction for the point in question is displayed as, "undefined".
- Auto Fill [Start]** Enables the entry of the auto fill start frequency. This value does not affect the synthesizer start frequency.
- Auto Fill [Stop]** Enables the entry of the auto fill stop frequency. This value does not affect the synthesizer stop frequency.
- Auto Fill [#Pts]** Automatically loads a user-specified number of points into the frequency parameter of the flatness correction array. These points includes the auto fill start and stop frequencies, with the remainder of points equally spaced between them.
- Auto Fill [Incr]** Automatically loads a frequency list into the frequency parameter of the flatness correction array. This list begins at the auto fill start frequency and ends at a frequency less than or equal to the auto fill stop frequency, with all points separated by the frequency increment value.
- [Copy List]** Copies the present list frequency array into the frequency parameter of the flatness correction array.

POWER

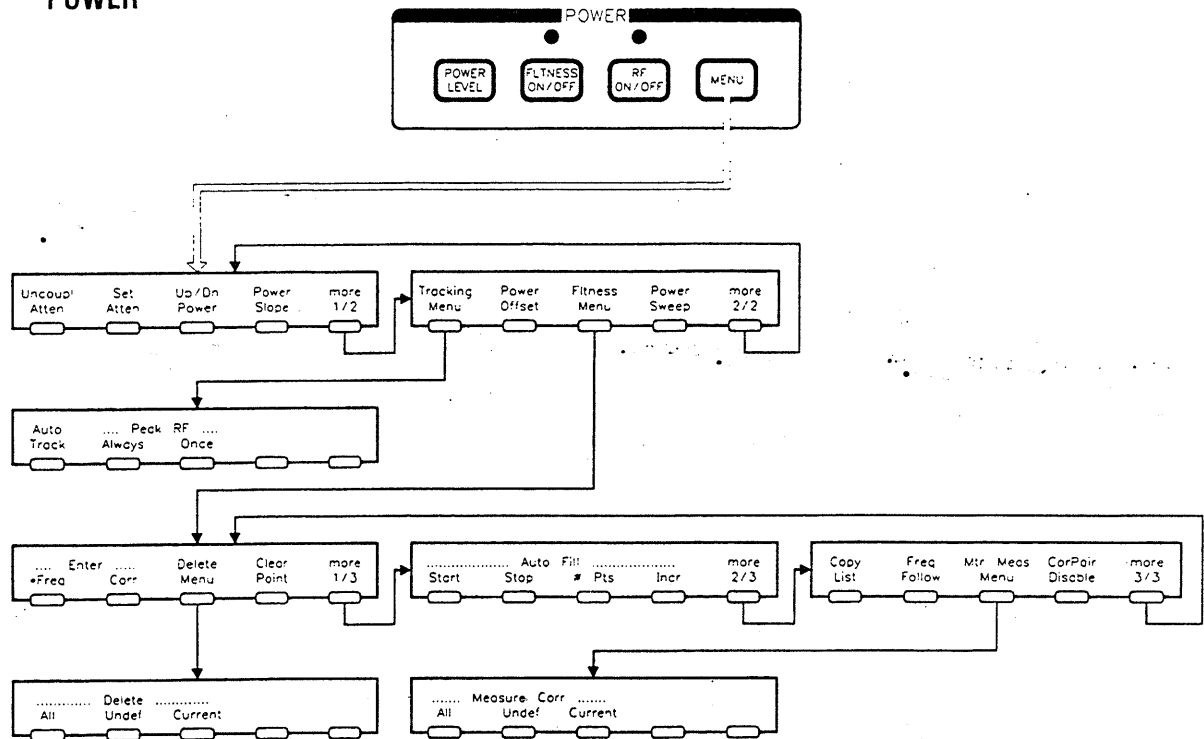

[Freq Follow] Lets the user step through the frequencies in the flatness correction array and adjust correction at each step. For more information about user flatness correction mode, refer to "Operating and Programming Reference," in the *User's Handbook*. Asterisk = frequency follow selected.

[CorPair Disable] Disables the flatness correction array. Asterisk = array disabled.

[Delete Menu] Accesses the delete menu.

Delete [All] Deletes *all* points in the flatness correction array.

Delete [Undef] Deletes all *undefined* points in the flatness correction array.

Delete [Current] Deletes the frequency point and associated correction value *in the active line* of the flatness correction array.

[Mtr Meas Menu] Accesses the meter measure menu. The meter measure function uses an external HP 437B power meter to automatically measure power correction values relative to frequency and store them into the flatness correction array.

CALibration:PMETER:FLATness:INITiate? USER
CALibration:PMETER:FLATness:NEXT? <num>[lv] suffix]

Measure Corr [All] Measures ALC correction values for all points in the flatness correction array.

Measure Corr [Undef] Measures ALC correction values for all undefined points in the flatness correction array.

Measure Corr [Current] Measures an ALC correction value for the point in the active line of the flatness correction array.

PRIOR

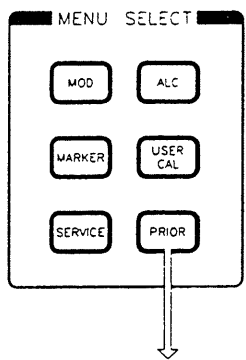

PRIOR Returns to the previously selected menu.

SERVICE

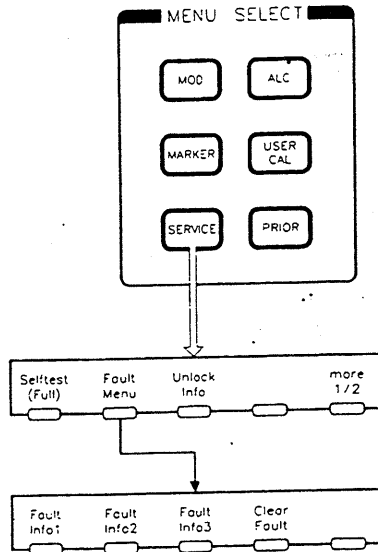

- [Self Test (Full)]** Performs a complete synthesizer self test.
*TST?
- [Unlock Info]** Provides locked/unlocked status of all phase lock loops.
Asterisk = unlocked information selected.
DIAGnostics:OUTPut:UNLocks?
- [Fault Menu]** Accesses the fault information menu. The following SCPI command outputs and clears all faults.
DIAGnostics:OUTPut:FAULts
- [Fault Info 1]** Indicates the latched status of the following:
PEAK
TRACK
RAMP
SPAN
V/GHZ
ADC
- [Fault Info 2]** Indicates the latched status of the following:
EEROM
PWRON
CALCO
PLLZERO
PLLWAIT
FNXFER

SERVICE

[Fault Info 3] Indicates the latched status of the following:

CALYO
CALMAN
TMR CNFLCT
SEARCH

[Clear Fault] Clears all latched fault status indicators.

SWEEP

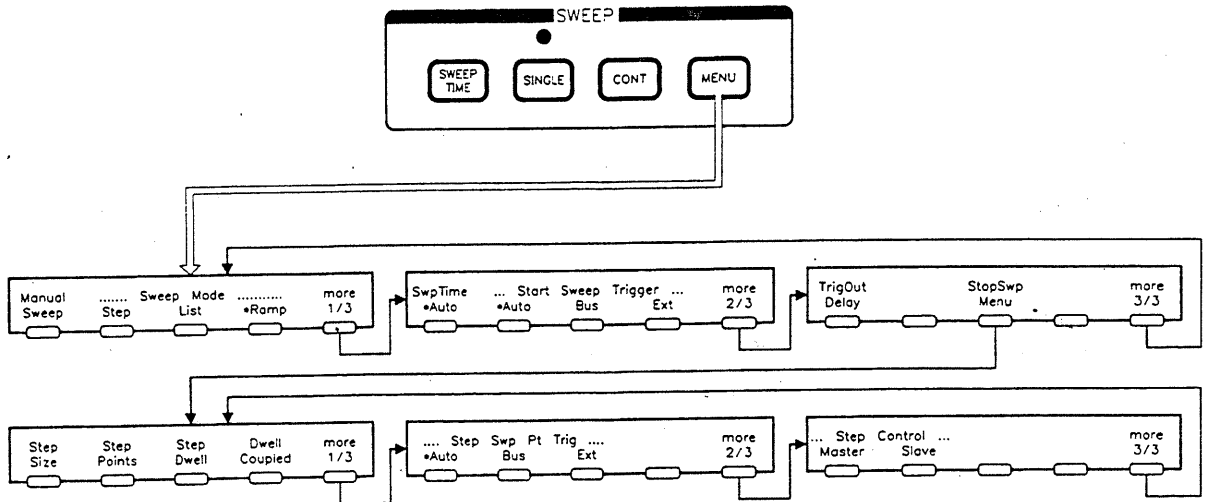

SWEEP TIME

Makes sweep time the active function. Sweep time can range from 10 ms to 200s, depending on sweep width.

SWEEP:TIME <num>[time suffix]|MAXimum|MINimum

SINGLE

Selects single sweep mode, aborts any sweep in progress, and initiates a single sweep. The amber LED above the key lights when the function is on.

INITiate:CONTinuous OFF|0

ABORT

INITiate[IMMediate]

Note, when initially switching from continuous to single sweep mode, (SINGLE) selects single sweep mode and aborts any sweep in progress. An additional (SINGLE) command is required to initiate a single sweep.

CONT

Causes the synthesizer to sweep continuously. The green LED next to the SWEEP label lights when the synthesizer performs a sweep.

INITiate:CONTinuous ON|1

[Manual Sweep]

Activates manual sweep mode. Depending on what parameter is being swept, frequency and/or power can be changed manually by using the rotary knob or arrow keys.

SWEEP:MODE MANUAL|AUTO

LIST:MODE MANUAL|AUTO

Sweep Mode [Step]

Activates the stepped frequency sweep mode. Asterisk = step sweep mode selected.

FREQUENCY:MODE SWEEP

SWEEP:GENERATION STEPPed

SWEEP

- Sweep Mode [List]* Activates the list frequency sweep mode.
Asterisk = list sweep mode selected. ,
FREQUency:MODE LIST
- Sweep Mode [Ramp]* Activates analog frequency sweep mode.
Asterisk = ramp sweep mode selected.
FREQUency:MODE SWEep
SWEep:GENeration ANALog
- [Sweep Time Auto]* Sets the synthesizer's sweep time to a minimum value for a chosen span.
Sweep time is limited by a 300 MHz/ms sweep rate.
SWEep:TIME:AUTO ON|OFF|1|0
- Start Sweep Trigger [Auto]* Sets the synthesizer to automatically trigger a sweep when initiated via (SINGLE) or (CONT). Asterisk = auto sweep trigger selected.
TRIGger:SOURce IMMEDIATE
- Start Sweep Trigger [Bus]* Sets the synthesizer to wait for an HP-IB trigger before triggering a sweep when initiated via (SINGLE) or (CONT). Asterisk = bus sweep trigger selected.
TRIGger:SOURce BUS
- Start Sweep Trigger [Ext]* Sets the synthesizer to wait for a positive edge of a TTL signal connected to the EXT TRIG INPUT before triggering a sweep when initiated via (SINGLE) or (CONT). Asterisk = external sweep trigger selected.
TRIGger:SOURce EXT
- [TrigOut Delay]* Specifies the amount of time after phase-lock before a trigger pulse is sent out of the TRIGGER OUTPUT BNC. This delay can be set from 0 to 3.2s.
TRIGger:ODELay <num>[time suffix].

SYSTEM

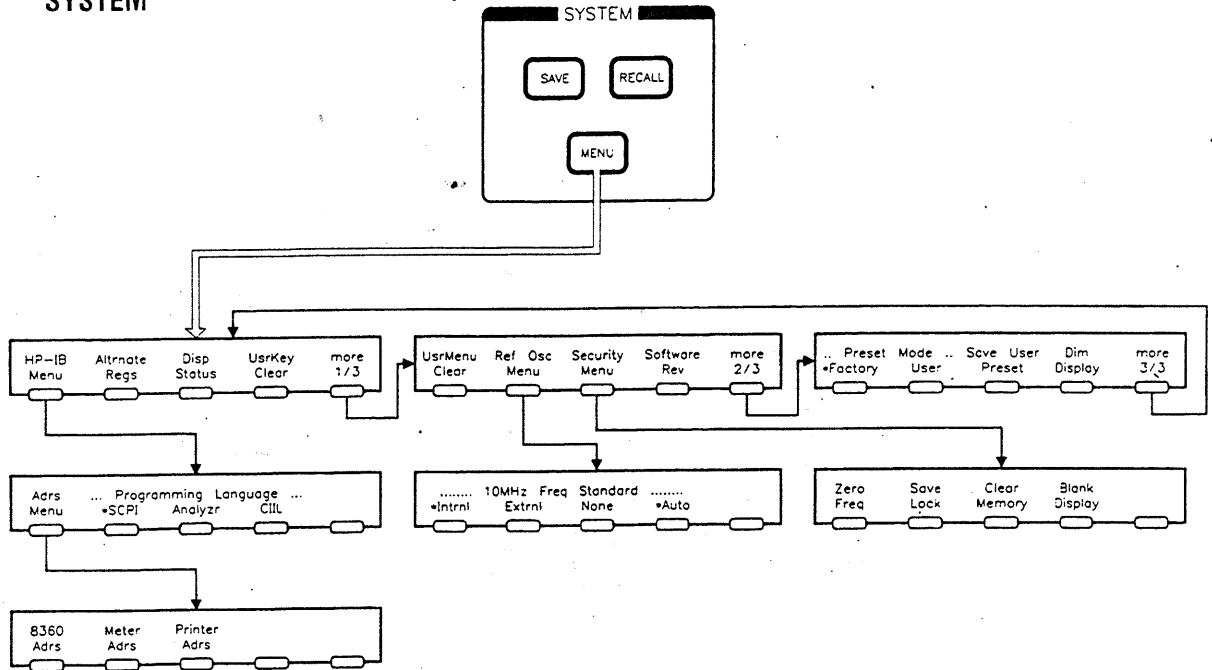

SAVE Saves the present instrument state in one of the eight (1-8) internal storage registers.

*SAV <num>

RECALL Recalls one of the nine (0-8), internally stored, user-defined instrument states. State 0 is a recall only state and contains the last state of the synthesizer prior to preset.

*RCL <num>

[Alternate Regs] Causes the synthesizer to alternate state on successive sweeps between the present instrument state and a second instrument state stored in an internal register (1-8). Asterisk = alternate register mode selected.

SYSTEM:ALternate:STATe ON|OFF|1|0
SYSTEM:ALternate <num> |MAXimum|MINimum

[Disp Status] Displays the present synthesizer status.
Asterisk = present synthesizer status displayed.

[UsrKey Clear] Activates the user-defined menu, and allows the user to remove a *single* key from the user-defined menu.

SYSTEM:KEY:CLEAr <n>n = a number 1-12

[UsrMenu Clear] Activates the user-defined menu and clears *all* softkeys in it.

SYSTEM:KEY:CLEAr ALL

[Software Rev] Displays the synthesizer's firmware revision in the active entry area.

*IDN?

SYSTEM

- Preset Mode*
[Factory] Selects the factory preset state of operation as the state to be recalled by the **PRESET** key. Asterisk = factory preset mode selected.
SYSTem:PRESet:TYPE FACTory
- Preset Mode*
[User] Selects the user-defined preset state as the state to be recalled by the **PRESET** key. Asterisk = user preset mode selected.
SYSTem:PRESet:TYPE USER
- [Save User Preset]* Stores the present instrument state in the user-defined preset storage register.
SYSTem:PRESet:SAVE
- [Dim Display]* Dims the synthesizer's front panel display.
- [HP-IB Menu]* Accesses the HP-IB control menu.
- Programming Language*
[SCPI] Selects SCPI as the synthesizer's external interface language. Any commands occurring within 1s of a change of language may be ignored or lost. Asterisk = SCPI.
- Programming Language*
[Analyzer] Selects Analyzer Language as the synthesizer's external interface language. This language accepts HP 8340/8341 mnemonics and provides network analyzer compatibility. Any command occurring within 1s of a change of language may be ignored or lost. Asterisk = Analyzer.
SYSTem:LANGUage COMPAtible
- Programming Language*
[CIIL] Selects CIIL as the synthesizer's external interface language. Any commands occurring within 1s of a change of language may be ignored or lost. Asterisk = CIIL.
SYSTem:LANGUage CIIL
- [Adrs Menu]* Accesses the HP-IB address menu.
- [8360 Adrs]* Controls the synthesizer's HP-IB address. The address value can be set from 0 to 30, and stored in non-volatile memory. The factory preset address is 19.
SYSTem:COMMunicate:GPIB:ADDRess <num>
- [Meter Adrs]* Controls the system power meter address. The address value can be set from 0 to 30, and stored in non-volatile memory.
DIAGNostics:INStrument:PMETer:ADDRess <num>
- [Printer Adrs]* Controls the system printer address. The address value can be set from 0 to 30, and stored in non-volatile memory.
DIAGNostics:INStrument:PRINter:ADDRess <num>
- [Ref Osc Menu]* Accesses the reference oscillator menu.
- 10 MHz Freq Stand*
[Intrnl] Selects the internal 10 MHz oscillator as the synthesizer's frequency reference. Asterisk = internal 10 MHz standard selected.
ROSCillator:SOURce INTernal

SYSTEM

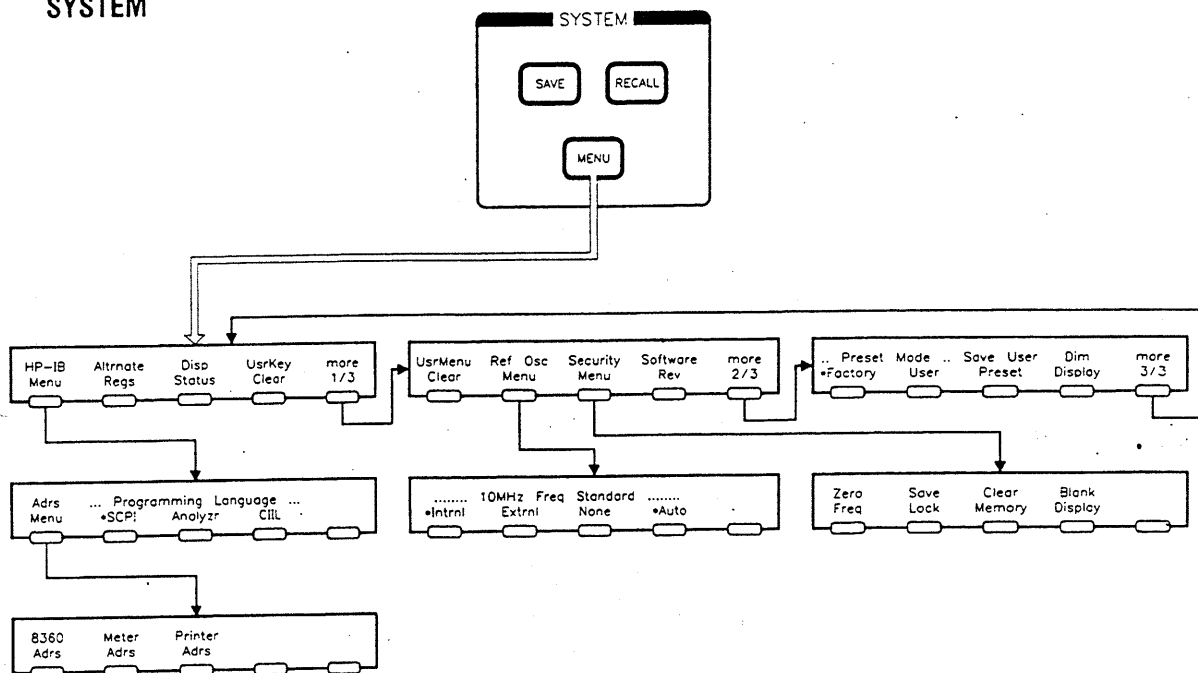

10 MHz Freq Standard [Extrnl] Accepts an external 10 MHz signal as the synthesizer's frequency reference. This external signal must be applied to the 10 MHz REF INPUT BNC connector on the rear panel of the synthesizer. Asterisk = external 10 MHz standard selected.

ROSCillator:SOURce EXTERNAL

10 MHz Freq Standard [None] Selects a free-run mode of operation where the synthesizer uses no frequency reference. Asterisk = operation without 10 MHz standard.

ROSCillator:SOURce NONE

10 MHz Freq Standard [Auto] Automatically selects the frequency reference to be used by the synthesizer. If an external standard is connected it is chosen as the reference. If no external reference is connected the internal standard is chosen. Asterisk = auto selection from available 10 MHz standards.

ROSCillator:SOURce:AUTO ON|OFF|1|0

[Security Menu] Accesses the system security menu.

[Zero Freq] This security feature writes zeros over all accessible frequency information. Once this security feature has been activated it can only be turned off by presetting the synthesizer. Asterisk = zero frequency mode selected.

SYSTEM:SECURITY:STATe] ON

[Save Lock] Prohibits the saving of the present instrument state into a save/recall register. Asterisk = lock save mode selected.

SYSTEM:KEY:DISable SAVE
SYSTEM:KEY:ENable SAVE

SYSTEM

[Clear Memory] Writes alternating ones and zeroes over all instrument state information, save/recall registers, and frequency lists a selectable number of times then returns the synthesizer to the factory preset state of operation.

```
SYSTem:SECurity:COUNT <n>  
SYSTem:SECurity[:STATe] ON|1  
SYSTEM:SECurity[:STATe] OFF|0
```

[Blank Display] Turns off the synthesizer's display. Once this security feature has been activated it can only be turned off by presetting the synthesizer. Asterisk = blank display mode selected.

```
DISPlay[:STATe] ON|OFF|1|0
```

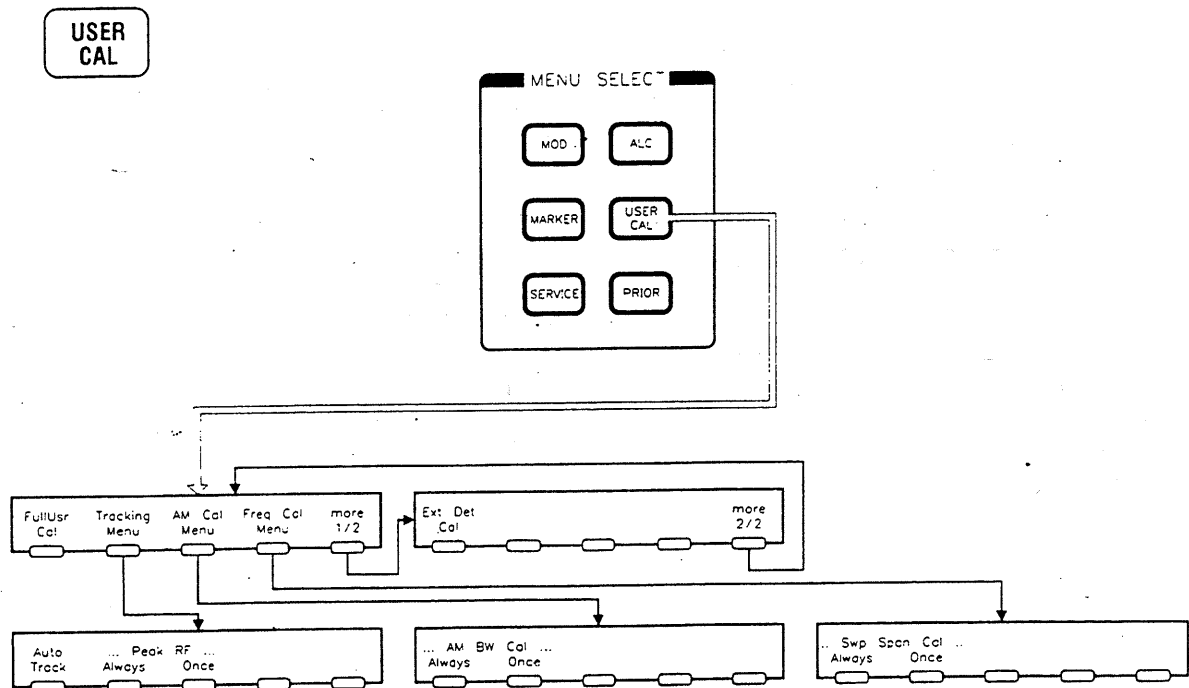

[FullUsr Cal] Performs a full synthesizer user calibration. This calibration is instrument state dependent. For example, selecting this key while in ramp sweep mode causes a sweep span calibration and an auto-track to be performed. Selecting this key while amplitude modulating a CW signal causes RF peaking and an AM BW calibration to be performed.

*CAL?

[Tracking Menu] Accesses the tracking calibration menu.

[Auto Track] Aligns the synthesizer's output filter to maximize output power for the swept frequency mode.

CALibration:TRACk

Peak RF [Always] Periodically aligns the synthesizer's output filter to maximize output power for the CW frequency mode. This peaking will occur each time the frequency is changed or every 7 minutes. Asterisk = peak RF always selected.

CALibration:PEAKing:AUTO ON|OFF|1|0

Peak RF [Once] Aligns the synthesizer's output filter to maximize output power for the CW frequency mode.

CALibration:PEAKing[:EXECute]

- [AM Cal Menu]* Accesses the AM calibration menu.
- AM BW Cal* Causes an AM bandwidth calibration to be performed every time a
[Always] frequency or power parameter is changed.
CALibration:AM:AUTO ON
- AM BW Cal* Performs an AM bandwidth calibration.
[Once] CALibration:AM[:EXECute]
- [Freq Cal Menu]* Accesses the sweep span calibration menu.
- Swp Span Cal* Causes a sweep span calibration to be performed each time the frequency
[Always] span is changed.
CALibration:SPAN:AUTO ON|OFF|1|0
- Swp Span Cal* Immediately performs a sweep span calibration.
[Once] CALibration:SPAN[:EXECute]
- [Ext Det Cal]* Uses an external power meter to calibrate an external detector's output
voltage relative to power for use with *Leveling Point [ExtDet]*.
CALibration:PMETer:DETector:INITiate? DIODE
CALibration:PMETer:DETector:NEXT? <num> [lvl suffix]

USER DEFINED

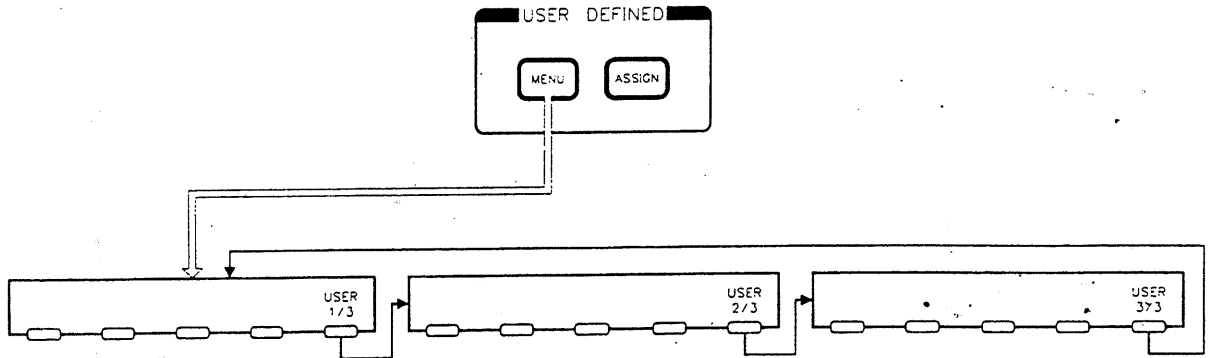

ASSIGN Allows the user to select any softkey and assign its function to 1 of 12 keys in the user-defined menu.

SYSTEM:KEY:ASSign <n>,<n>

The first <n> in the command above corresponds to the key number to be assigned, the second <n> corresponds to the user menu key number where it is to be placed in the user menu. For a complete list of synthesizer key numbers refer to "Operating and Programming Reference," in the *User's Handbook*.

MENU Accesses the user-defined menu, which provides 12 softkeys that can be specified by using the **ASSIGN** key.

Introduction to SCPI

Standard Commands for Programmable Instruments (SCPI) is the instrument control programming language adopted by Hewlett-Packard. SCPI provides commands that are common from one Hewlett-Packard product to another, thereby eliminating "device specific" commands.

SCPI uses easy to learn, self explanatory syntax that provide flexibility for both novice and expert programmers.

SCPI was developed to conform to the IEEE 488.2 standard (replacing IEEE 728-1982). The IEEE 488.2 standard provides codes, formats, protocols and common commands that were unavailable in the previous standard. For more information, refer to the IEEE standard itself.

SCPI commands are organized in a tree structure. In the command tree shown in figure 1, the command at the top is the **root command**, or simply the **root**. Notice that you must follow a particular **keyword path**, or simply the **path**, to reach lower level subcommands. Each keyword represents an optional path that can be used in writing a command statement.

For more information about SCPI syntax and programming commands see the "SCPI Programming Reference," portion of this guide.

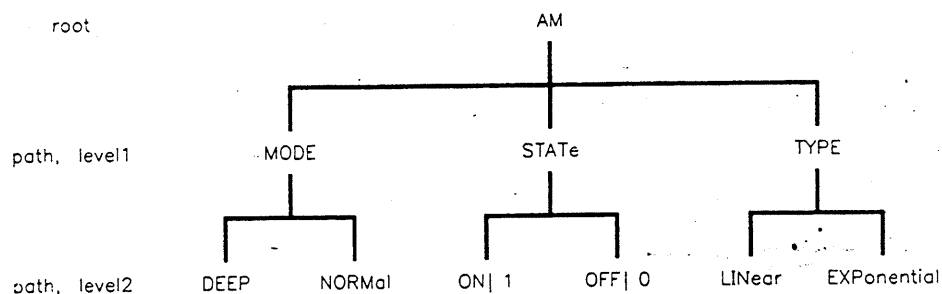
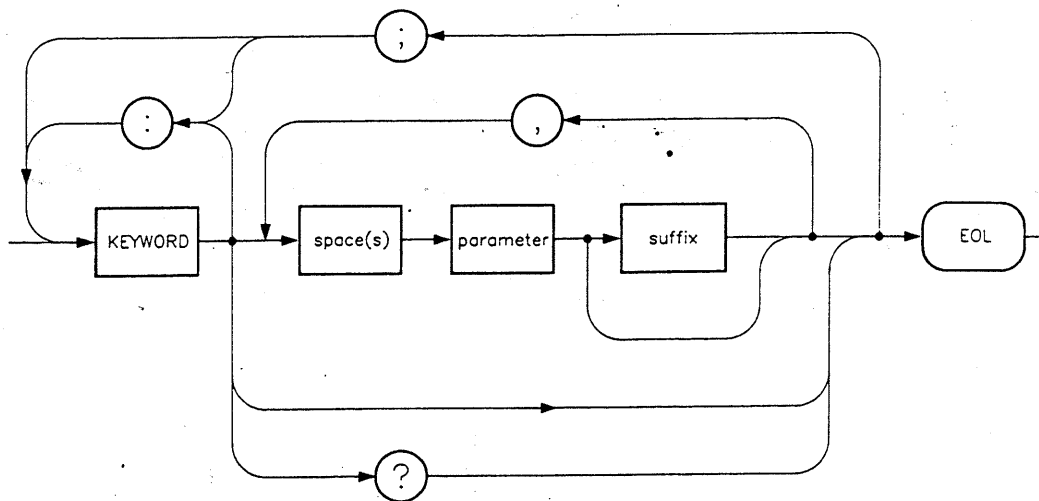

Figure 1. `AM:TYPE LINear`

SCPI Programming Reference

This section of the QRG provides a SCPI programming reference for the HP 8360 Series Synthesized Sweeper. A general SCPI syntax flow graph and example are shown below. Included at the end of this section is a status register structure and specifications reference.



In SCPI, a colon is used to separate the root command from a keyword path, or to separate two consecutive paths. For example,
 root:keyword:keyword
 SYSTem:PRESet:SAVE

Keyword path statements followed by a command parameter must be separated by a space. For example,
 FREQuency:STARt 10GHZ or POWer 0DBM.

One of n (1/n), choices are separated by vertical lines. For example, ON|OFF|0|1.

Optional syntax commands appear in square brackets. For example, [freq suffix].

To query the synthesizer for information about its present instrument state, place a question mark after the appropriate path statement.

For more detailed information about SCPI programming, see "Getting Started Programming" in the *User's Handbook*.

IEEE 488.2 COMMON COMMANDS

- *IDN? Outputs an identifying string over HP-IB. The identifying string of the synthesizer will be "Hewlett-Packard, model number, serial number, firmware revision."
- *LRN? This returns a string of device specific characters that, when sent back to the synthesizer will restore the instrument state active when *LRN? was sent.
- *OPC Operation complete command. The synthesizer will generate the OPC message in the Standard Event Status Register when all pending operations have been completed (e.g. a frequency step, or a self test).
- *OPC? Operation Complete query. The synthesizer will return an ASCII '1' when all pending operations have been completed.
- *RCL <num> Recalls the specified instrument state from internal memory. <num> ranges between 0 and 8.
- *RST Returns the instrument to its preset state. This command is different from the front panel **PRESET** function.
- *SAV <num> Saves the specified instrument state in internal memory. <num> ranges between 1 and 8.
- *TST? Performs and returns the result of a complete self test. An ASCII '0' indicates no failures found. Any other character indicates a specific module failure. For more specific information see "Getting Started Programming" in the *User's Handbook*.
- *WAI Prohibits the instrument from executing any new commands until all pending commands have been completed.
- *CLS Clears the instrument Status Byte. This also clears the Data Questionable Event Register, the Standard Event Status Register, the Device Operation Status Register, and all other register that are summarized in the Status Byte. Also clears the error queue accessed by SYST:ERR?
- *CAL? Performs a full instrument calibration, and generates a response that indicates whether or not the device completed calibration without error (returns a 1 for pass, 0 for fail).
- *ESE <num> Sets the value of the Standard Event Status Enable Register.
- *ESE? Queries the value of the Standard Event Status Enable Register.
- *ESR? Queries the Standard Event Status Register. This is a destructive read.
- *SRE <num> Sets the value of the Service Request Enable Register.
- *SRE? Queries the value of the Service Request Enable Register.
- *STB? Non-destructively queries the instrument Status Byte.
- *TRG Performs a group execute trigger, as defined by IEEE 488.1.

HP 8360 SCPI COMMAND SUMMARY

ABORt

.AM

```

:DEPTH          <num>[PCT]|MAXimum|MINimum|<num>DB
:INTERNAL
:FREQUENCY      <num>[<freq suffix>]|MAXimum|MINimum
:FUNCTion       SINusoid|SQUare|TRIangle|RAMP|NOISE
:MODE           DEEP|NORMal
:SOURce         INTernal|EXTernal
:STATE         ON|OFF|1|0
:TYPE          LINear|EXPonential

```

CALibration

```

:AM
:AUTO           ON|OFF|1|0
[:EXECute]
:PEAKing
:AUTO           ON|OFF|1|0
[:EXECute]
:PMETer
:DETEctor      IDETector|DIODE
:INITiate?     <num> [lvl suffix]
:NEXT?
:FLATness      INTernal|USER|DIODE|PMETer|MMHead
:INITiate?     <num> [lvl suffix]
:NEXT?
:SPAN
:AUTO           ON|OFF|1|0
[:EXECute]
:TRACK

```

CORRection

```

:ARRay[0|1]    {<num>[DB]}1601*1601
:FLATness      {<num>[freq suffix],<num>[lvl suffix]}2*801
:POINTS?      [MAXimum|MINimum]
:SOURce[0|1]  ARRay|FLATness
[:STATE]      ON|OFF|1|0

```

DIAGnostics

```

:ABUS
:AVERage       <num>
:STATus?
:FREQUENCY
:COUNter       [:EXECute]
               :ERRor?
               :FREQUency?
               :PERCent? <num>
               :POINts?

```

	:INSTRument		
	:PMETer		
		:ADDRess	<num>
	:PRINter		<num>
		:ADDRess	<num>, <num>
	:IORW		
	:LED		
	:ACTive		ON OFF 1 0
	:ERRor		ON OFF 1 0
	IOCheck		ON OFF 1 0
	:OSC		
	:FNCW		<num> [freq suffix]
	:FNDN		
	:FNUP		
	:HARM		<num> [freq suffix]
	:IF		<num> [freq suffix]
	:SAMP		<num> [freq suffix]
	:YO		<num> [freq suffix]
	:OUTPut		
	:BANDcross?		
	:FAULts?		
	:FREQs?		
	:UNLocks?		
	:YODacs?		
	:YTMdacs?		
	:RESult?		
	:TEST		
		:CONTInue	
		:DATA	
		:DESC?	
		:MAXimum?	
		:MINimum?	
		:VALue?	
	:DISable		<num>, <num> * ALL
	:ENABle		<num>, <num> * ALL
	[:EXECute]		<num>
	:LOG		
		:SOURce	ALL FAIL
		[:STATe]	ON OFF 1 0
	:LOOP		ON OFF 1 0
	:NAME?		[<num>]
	:PATCh		
		:DATA	{<num>}5*5
		:DELete	ALL <num>
		:POINts?	
	:RESult?		[<num>]
			<num>
DISPlay			
	[:STATe]		ON OFF 1 0
FM			
	:COUPling		AC DC
	:FILTer		
	:HPASs		<num> [<freq suffix>] MAXimum MINimum

	:INTERNAL	:FREQUENCY	<num>[<freq suffix>] MAXimum MINimum
		:FUNCTION	SINusoid SQUARE TRIangle RAMP NOISE
	:SENSitivity		<num>[freq suffix/V] MAXimum MINimum
	:STATE		ON OFF 1 0
	:SOURCE		INTERNAL EXTERNAL
FREQUENCY	:CENTER		<num>[freq suffix] MAXimum MINimum UP DOWN
	[:CW]		<num>[freq suffix] MAXimum MINimum UP DOWN
	:CW		
		:AUTO	ON OFF 1 0
	:MANual		<num>[freq suffix] MAXimum MINimum UP DOWN
	:MODE		CW SWEEp LIST
	:MULTiplier		<num> MAXimum MINimum
		:STATE	ON OFF 1 0
	:OFFSet		<num> MAXimum MINimum
		:STATE	ON OFF 1 0
	:SPAN		<num>[freq suffix] MAXimum MINimum UP DOWN
	:START		<num>[freq suffix] MAXimum MINimum UP DOWN
	:STEP		
		:AUTO	ON OFF 1 0
		[:INCRement]	<num>[freq suffix] MAXimum MINimum
	:STOP		<num>[freq suffix] MAXimum MINimum UP DOWN
INITiate	:CONTinuous		ON OFF 1 0
	[:IMMediate]		
LIST	:CORREction		{ <num>[DB] MAXimum MINimum} 1*201
	:DWELl		{ <num>[time suffix] MAXimum MINimum} 1*201
		:POINTs?	{ MAXimum MINimum}
	:FREQUency		{ <num>[freq suffix] MAXimum MINimum} 1*201
		:POINTs	{ MAXimum MINimum}
	:MANual		<num>
	:MODE		AUTO MANual
	:TRIGger		
		:SOURCE	IMMediate BUS EXTERNAL

#n is 1-5, 1 is the default

MARKer[n]	:AMPLitude		ON OFF 1 0
		[:STATE]	< num>[dB] MAXimum MINimum
		:VALue	
	:AOff		<num>,<num>
	:DELTA?		<num>[freq suffix] MAXimum MINimum
	:FREQUency		FREQUency DELTA
	:MODE		<n>
	:REFerence		ON OFF 1 0
	[:STATE]		
MEASure	:AM?		
	:FM?		

MODulation	:OUTPut			
	:SOURce		AM FM	
	:STATe		ON OFF 0 1	
	:STATe?			
POWer	:ALC			
	:BANDwidth		<num>[freq suffix] MAXimum MINimum	
	:AUTO		ON OFF 1 0	
	:CFACtor		<num>[dB] MAXimum MINimum UP DOWN	
	:SOURce		INtErnal DIODe PMETer MMHead	
	[:STATe]		ON OFF 1 0	
	:ATTenuation		<num>[DB] MAXimum MINimum UP DOWN	
	:AUTO		ON OFF 1 0	
	:CENTer		<num>[lvl suffix] MAXimum MINimum UP DOWN	
	[:LEVel]		<num>[lvl suffix] MAXimum MINimum UP DOWN	
	:MODE		FIXed SWEEp	
	:OFFSet		<num>[level suffix] MAXimum MINimum UP DOWN	
	:STATe		ON OFF 1 0	
	:RANGE		<num>[lvl suffix] MAXimum MINimum UP DOWN	
	:SEARCh		ON OFF 1 0 ONCE	
	:SLOPe		<num>[DB] MAXimum MINimum UP DOWN	
	:STATe		ON OFF 1 0	
	:SPAN		<num>[DB] MAXimum MINimum UP DOWN	
	:START		<num>[lvl suffix] MAXimum MINimum UP DOWN	
	:STATe		ON OFF 1 0	
	:STEP			
	:AUTO		ON OFF 1 0	
	[:iNCRement]		<num>[lvl suffix] MAXimum MINimum	
	:STOP		<num>[lvl suffix] MAXimum MINimum UP DOWN	
PULSe	:FREQuency		<num>[freq suffix] MAXimum MINimum	
	:PERiod		<num>[time suffix] MAXimum MINimum	
	:WIDTh		<num>[time suffix] MAXimum MINimum	
PULM	:EXTernal			
	:DELay		<num>[<time suffix>] MAXimum MINimum	
	:POLarity		NORMal iNVERTed	
	:INTernal			
	:DELay		<num>[<time suffix>] MAXimum MINimum	
	:FREQuency		<num>[<freq suffix>] MAXimum MINimum	
	:GATE		ON OFF 0 1	
	:PERiod		<num>[<time suffix>] MAXimum MINimum	
	:TRIGger			
	:SOURce		INtErnal EXTernal	
	:WIDTh		<num>[<time suffix>] MAXimum MINimum	
	:SLEW		<num>[time suffix] MAXimum MINimum	
	:AUTO		ON OFF 1 0	
	:SOURce		INtErnal EXTernal SCALar	
	[:STATe]		ON OFF 1 0	

```

ROSCillator
:SOURCE
:AUTO
INTERNAL|EXTERNAL|NONE
ON|OFF|1|0

STATus
:OPERation
:CONDition?
:ENABle
:[EVENT]?
:NTRansition
:PTRansition
<num>
<num>
<num>

:PRESet
:QUEStionable
:CONDition?
:ENABle
:[EVENT]?
:NTRansition
:PTRansition
<num>
<num>
<num>

SWEep
:CONTRol
:STATe
:TYPE
ON|OFF|1|0
MASTer|SLAVe
:DWELI
<num>[time suffix]|MAXimum|MINimum
:GENeration
:AUTO
ON|OFF|1|0
:MANual
STEPped|ANALog
:POINT
<num>
[:RELative]
<num>

:MARKer
:STATe
ON|OFF|1|0
:XFER

:MODE
:POINTs
:STEP
:TIME
AUTO|MANual
<num>|MAXimum|MINimum
<num>[freq suffix]|MAXimum|MINimum
<num>[time suffix]|MAXimum|MINimum
:LLIMit
ON|OFF|1|0
<num>[time suffix]|MAXimum|MINimum

:TRIGger
:SOURce
IMMediate|BUS|EXTernal

SYSTEM
:ALTErnate
<num>|MAXimum|MINimum
:STATe
ON|OFF|1|0
:COMMunicate
:GPIB
:ADDRESS <num>

:DUMP
:PRINter?
<num>

:ERRor?

```

:KEY	:ASSign :CLEAr [:CODE] :DISAbLe :ENABLe	<num> , <num> <num> ALL <num> 1*? SAVE SAVE SCPI CIIL COMPAtible
:LANGUage :PRESet	[:EXEC] :SAVE :TYPE	FACTory USER
:SECurity	:COUnT [:STATe]	<num> MAXimum MINimum ON OFF 1 0
:VERsion		
TRIGger	[:IMMEdiate] :ODELay :SOURce	<num> [time suffix] IMMEdiate BUS EXTernal
TSWEEP		
UNIT	:AM :POWer	DB PCT <lvl suffix>

SUFFIX DEFINITIONS :

[freq suffix] = GHZ | MHZ | KHZ | HZ
 [lvl suffix] = DBM | W | MW | V | DBV | UV
 [time suffix] = S | MS | US | NS | PS

SCPI Status Register Structure

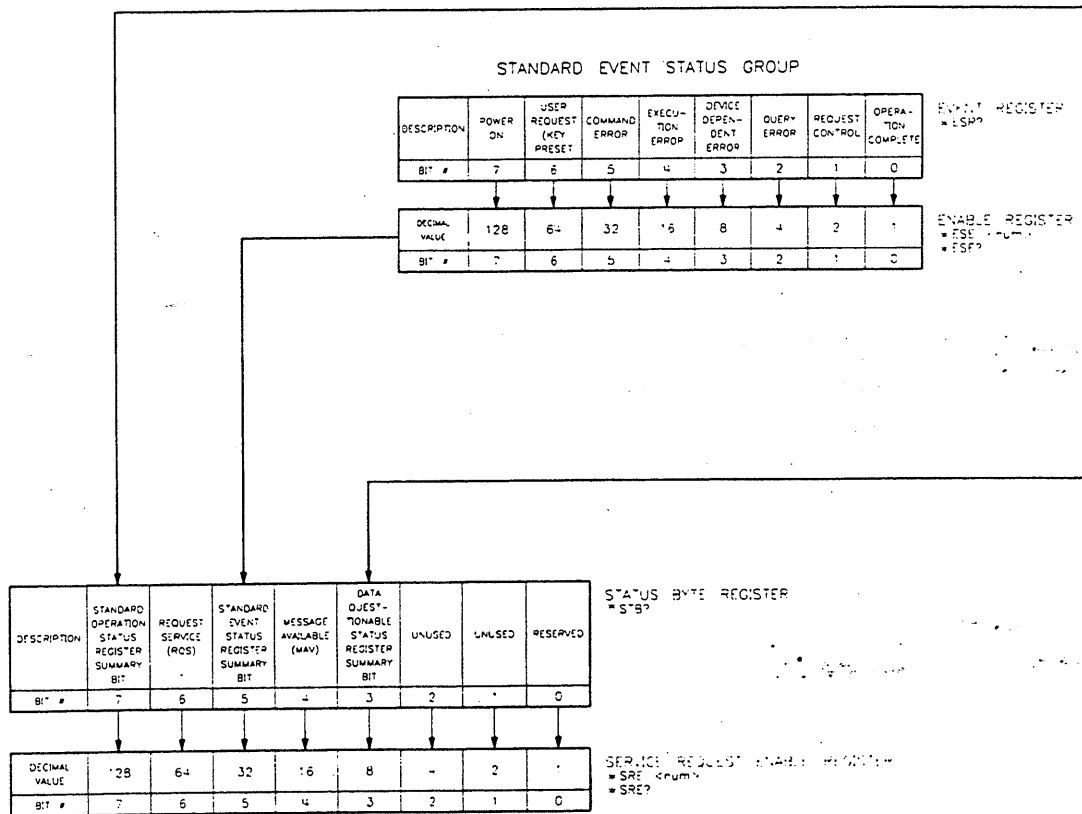

STANDARD OPERATION STATUS GROUP

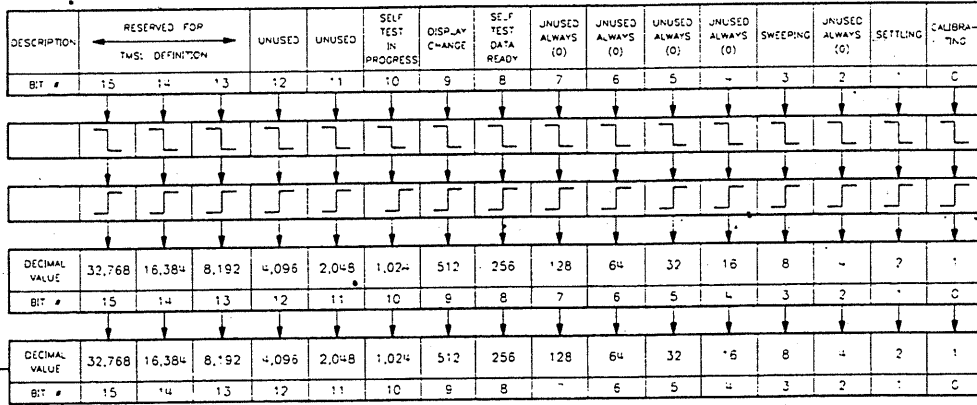

DATA QUESTIONABLE STATUS GROUP

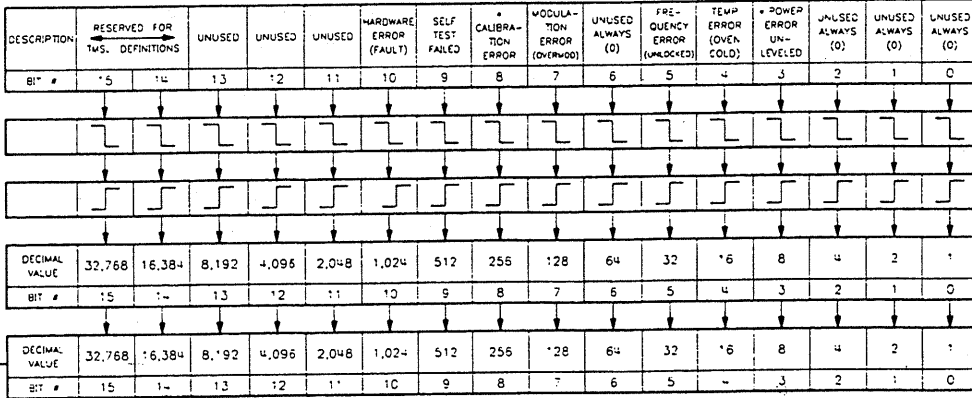

NOTE:
STAT_PRES
THIS COMMAND PRESETS THE FOLLOWING
ENAB, AND TRANSITION REGISTERS:
OPER, AND QUES.

Rear Panel Connections

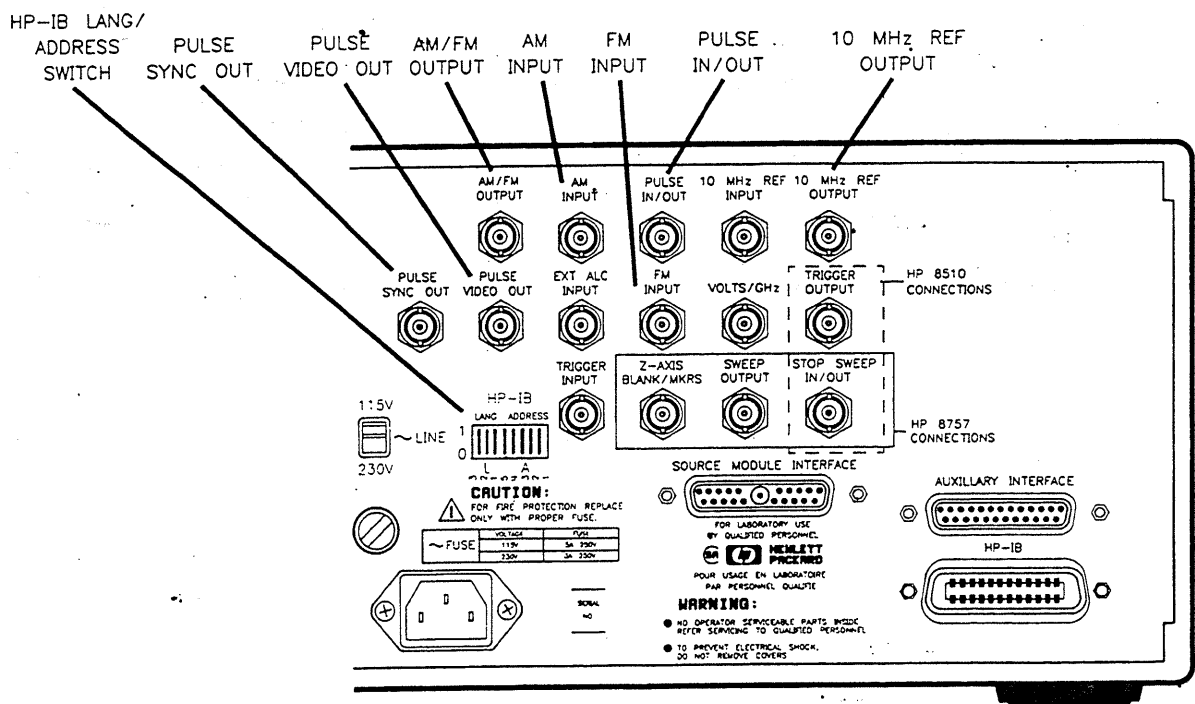

HP 8510 Connections are TRIGGER OUTPUT, STOP SWEEP IN/OUT and HP-IB Interface.

HP 8510B Rev 5.9 and earlier should use SWEEP OUTPUT, STOP SWEEP IN/OUT, and HP-IB Interface connections.

HP 8757 connections are Z-AXIS BLANK/MKRS, SWEEP OUTPUT, STOP SWEEP IN/OUT and HP-IB Interface.

PULSE SYNC OUT: (Option 002 only) Outputs a 50 ns wide TTL pulse synchronized to the leading edge of the internally-generated pulse.

PULSE VIDEO OUT: (Option 002 only). Outputs the pulse modulation waveform that is supplied to the modulator. This can be either the internally- or externally-generated pulse modulation.

AM/FM OUTPUT: (Option 002 only) Outputs the internally-generated AM or FM waveform. This output can drive 50Ω or greater. The AM output is scaled the same as it is generated, either 100%/V or 10 dB/V. The FM scaling depends on the FM deviation chosen.

AM INPUT: Sensitivity in the linear mode, 100%/volt; in the exponential mode 10 dB/volt.

FM INPUT: Sensitivity 100 kHz, 1 MHz, or 10 MHz/volt, selectable.

PULSE IN/OUT: A TTL-low signal turns the RF off. When using the internal pulse generator, a TTL level pulse-sync signal preceeding the RF pulse is produced.

10 MHz REF OUTPUT: The output of the internal frequency standard that can be used as the master clock reference for a network of instruments.

HP-IB LANG/ADDRESS switch: Preset at the factory for SCPI and address 19. Language selections are SCPI = 000, Analyzer = 001, and CIIL = 010.

Index

AC coupled FM	16	Cal, AM	39
Address, menu	35	Cal, detector	39
ALC Bandwidth Select Auto	5	Cal, swp span	39
ALC Bandwidth Select High	5	Cal, user	38
ALC Bandwidth Select Low	5	Center frequency	6
ALC BW menu	5	Center, = marker	13
ALC menu	4	CIIL, power up language	35
ALCoff	5	Clear Fault	31
All, delete, flatness correction	28	Clear, flatness values	27
All, delete, frequency list	9	Clear Memory	37
All, measure corr, flatness	28	Clear Point	27
All off, markers	13	Clear userkey	34
Alternate registers	34	Clear usermenu	34
Alternate state	34	Continuous sweep	32
Always peak RF	27,38	Copy List	27
AM, 10 dB/V	15	Correction, flatness value	27
AM, 100%/V	15	Correction, pair disable	28
AM BW Calibration, Always	39	Coupled dwell times	9
AM Calibration menu	39	Coupling factor	5
AM BW Calibration, Once	39	Current, delete, flatness correction	28
AM, deep	15,20	Current, measure, flatness correction	28
AM depth	20	CW/CF Coupled	7
AM external	20	CW frequency	6
AM/FM output connector	24	CW up/dn size	7
AM internal	20		
AM menu	20	DC coupled FM	16
AM rate	20	Deep AM	15,20
AM type 10 dB/V	20	Delay menu	19
AM type 100%/V	20	Delete all, flatness correction	28
Amplitude markers	13	Delete all, frequency list	9
Analyzer, power up language	35	Delete current, flatness	28
Assign menu	40	Delete current, frequency list	9
Attenuator, set	25	Delete menu, flatness	28
Attenuator, uncouple	25	Delete menu, frequency list	9
Auto 10 MHz frequency standard	36	Delete undefined, flatness correction	28
Auto Fill Increment	8,27	Delta marker	13
Auto Fill # of Points	8,27	Delta Mkr Ref	13
Auto Fill Start	8,27	Detector cal, external	39
Auto Fill Stop	8,27	Detector, external leveling	4
Auto list point trigger	9	Display, blank	37
Auto step point trigger	9	Display, dim	35
Auto sweep trigger	33	Display status	34
Auto pulse mode	19	Dwell coupled	9
Autotrack	26,38	Dwell, list	8
		Dwell, step	9
Blank display	37		
Bus list point trigger	9	Enter Correction	27
Bus step point trigger	10	Enter Frequency	27
Bus sweep trigger	33	Enter List Dwell	8

Enter List Frequency	8	Gating, pulse mode	19
Enter List Offset	8	Global Dwell	9
Exponential AM	20	Global Offset	9
External 10 MHz frequency standard	36		
External AM	20	HP-IB address	35
External detector calibration	39	HP-IB menu	35
External detector leveling point	4		
External pulse	18	Instrument State-	11
External pulse modulation	14	Internal 10 MHz frequency standard	27
		Internal AM	20
Factor, coupling	5	Internal leveling point	4
Factory preset mode	35	Internal menu	18
Fault information	30	Internal pulse	14,18
Flatness, clear	27	Internal pulse generator period	19
Flatness correction menu	27	Internal pulse generator rate	19
Flatness On/Off	17	Internal pulse generator width	19
Flatness	25,27	Internal pulse mode gate	19
FM, AC coupled	16	Internal pulse mode trigger	19
FM coupling	23	Internal pulse modulation	18
FM, DC coupled	16	Invert input	18
FM deviation	23		
FM menu	22	Language, power up, analyzer	35
FM on/off	22	Language, power up, CIIL	35
FM rate	22	Language, power up, SCPI	35
Frequency Calibration menu	39	Leveling mode, ALCoff	5
Frequency, center	6	Leveling mode, normal	4
Frequency, CW	6	Leveling mode, search	5
Frequency, flatness correction	27	Leveling point, external detector	4
Frequency follow	28	Leveling point, internal	4
Frequency list dwell time	8	Leveling point, module	4
Frequency list offset value	8	Leveling point, power meter	4
Frequency list	7-8	Linear AM	20
Frequency list value	8	List, copy	27
Frequency menu	6	List frequency dwell time	8
Frequency multiplier	7	List frequency menu	7
Frequency offset	7	List frequency offset value	8
Frequency span	6	List frequency value	8
Frequency standard, auto	36	List menu	7
Frequency standard, external	36	List point trigger, auto	9
Frequency standard, internal	35	List point trigger, bus	9
Frequency standard, none	36	List point trigger, ext	9
Frequency, start	6	List sweep mode	9
Frequency, step dwell time	9	Local	11
Frequency, step #of points	9	Lock save	36
Frequency, step size	9		
Frequency, step sweep	6	Manual sweep	24
Frequency, stop	6	Marker, delta	13
Frequency, zero	36	Marker = center	13
Frequency, zoom function	7		
Full User Calibration	38		

Marker menu	12	Noise waveform	20,24
Markers,1-5	12,13	Normal leveling mode	4
Markers all off	13	Number of points, flatness menu	27
Markers, amplitude	13	Number of points, list menu	8
Markers off	13	Number of points, step frequency	9
Marker sweep	12		
Master, step control	10	Off, markers	13
Measure correction all	28	Offset, frequency	7
Measure correction current	28	Offset, power	26
Measure correction undefined	28	Oscillator, reference, auto	36
Menu, ALC	4	Oscillator, reference, external	36
Menu, delete, flatness	28	Oscillator, reference, internal	35
Menu, delete, list	9	Oscillator, reference, none	36
Menu, flatness	27		
Menu, frequency	6	Peak RF always	27,38
Menu, frequency calibration	39	Peak RF once	27,38
Menu, HP-IB	35	Points, number of, flatness	19
Menu, list	7	Points, number of, list	8
Menu, marker	12	Points, step	9
Menu, meter measure	28	Point trigger, list, auto	9
Menu, modulation	14,17	Point trigger, list, bus	9
Menu, power	25	Point trigger, list, ext	9
Menu, pulse control	14	Point trigger, list, menu	9
Menu, security	36	Point trigger, step, auto	9
Menu, step sweep	9	Point trigger, step, bus	10
Menu, sweep	32	Power level	25
Menu, system	34	Power menu	25
Menu, tracking	26,38	Power meter leveling point	4
Menu, user cal	38	Power meter range	5
Meter address	35	Power offset	26
mm module leveling point	4	Power slope	26
Mode, leveling, ALCoff	5	Power step	25
Mode, leveling, normal	4	Power sweep	26
Mode, leveling, search	5	Power up language, analyzer	35
Mode, sweep, list	33	Power up language, CIIL	35
Mode, sweep, ramp	33	Power up language, SGPI	35
Mode, sweep, step	32	Preset mode, factory	35
Modout on/off	24	Preset mode, user	35
Modulation, AM	15	Preset	11
Modulation, FM	16	Preset, store user	35
Modulation menu	14,17	Printer address	35
Modulation meter	24	Prior	29
Monitor menu	24	Pulse, auto rise	15
Modulation, pulse	14	Pulse delay	20
Module leveling point	4	Pulse, external	14,18
More	3	Pulse, fast rise	15
Multiplier, frequency	7		

Pulse, internal	14	Step point trigger, auto	9
Pulse menu	14,17	Step point trigger, bus	10
Pulse mode, auto	19	Step point trigger, ext	10
Pulse, period	15	Step size	9
Pulse period, internal	19	Step sweep menu	9
Pulse rate	15	Step sweep mode	9
Pulse rate, internal	19	Stop frequency	6
Pulse rise time	18	Store user preset	35
Pulse, slow rise	15	Sweep, continuous	32
Pulse, scalar	14,18	Sweep list	33
Pulse, width	14	Sweep, manual	32
Pulse width, internal	19	Sweep, marker	12
Purge all memory	37	Sweep menu	32
		Sweep mode, list	33
Ramp sweep mode	33	Sweep mode, ramp	33
Ramp waveform	20,23	Sweep mode, step	32
Recall	34	Sweep, single	32
Reference, 10 MHz oscillator	35	Sweep span calibration, always	39
Reference Oscillator menu	35-36	Sweep span calibration, once	39
Registers, alternate	34	Sweep time auto	33
Revision, software	34	Sweep time	32
RF On/Off	25	Sweep trigger, auto	33
RF peak always	27,38	Sweep trigger, bus	33
RF peak once	27,38	Sweep trigger, ext	33
Rise time, pulse	18	Swept up/dn size	7
		Syntax	42
Save lock	36	System language	35
Save	34	System menu	34
Save User Preset	35		
Scalar, pulse	18	10 dB/V AM	15
Scalar pulse on/off	14	10 MHz frequency standard Auto	36
SCPI, power up language	35	10 MHz frequency standard External	36
Search leveling mode	5	10 MHz frequency standard Internal	35
Security menu	36	10 MHz frequency standard None	36
Self Test (Full)	30	100%/V AM	15
Service menu	30	Tracking menu	26,38
Set attenuator	32	Triangle waveform	20,23
Sine waveform	20,23	Trigger, list point	9
Single	24	Trigger, out delay	32
Slave, step control	10	Trigger, step point	10
Slow rise pulse	15	Trigger, sweep	32
Software revision	34		
Span, frequency	6	Uncouple attenuator	25
Square waveform	20,23	Undefined, delete, flatness menu	28
Start frequency	6	Unlock information	30
Start = M1, Stop = M2	12	Up/dn size, CW	7
State, alternate	34	Up/dn size, power	25
Status, display	34	Up/dn size, swept	7
Step control master	10	User calibration menu	38
Step control slave	10	User defined, Assign	40
Step dwell	9	User defined menu	40
Step points	9	User defined preset	35

Userkey clear	34
Usermenu clear	34
Waveform menu	20,23
Zero frequency	36
Zoom	7