

---

**HP 8360 B-Series Swept Signal Generator/  
HP 8360 L-Series Swept CW Generator**

# **Troubleshooting Guide**

## **SERIAL NUMBERS**

This manual applies to any instrument with the following model number and serial number prefix combinations. You may have to modify this manual so that it applies *directly* to your instrument version. Refer to the "Instrument History" chapter.

**HP 83620B/22B/23B/24B/30B/40B/50B**  
3614A

**HP 83623L/30L/40L/50L**  
3614A



**HP Part No. 08360-90124**  
**Printed in USA April 1996**

---

## **Notice**

The information contained in this document is subject to change without notice.

Hewlett-Packard makes no warranty of any kind with regard to this material, including but not limited to, the implied warranties of merchantability and fitness for a particular purpose. Hewlett-Packard shall not be liable for errors contained herein or for incidental or consequential damages in connection with the furnishing, performance, or use of this material.

## **Restricted Rights Legend**

Use, duplication, or disclosure by the U.S. Government is subject to restrictions as set forth in subparagraph (c) (1) (ii) of the Rights of Technical Data and Computer Software clause at DFARS 252.227-7013 for DOD agencies, and subparagraphs (c) (1) and (c) (2) of the Commercial Computer Software Restricted Rights clause at FAR 52.227-19 for other agencies.

**Certification**

Hewlett-Packard Company certifies that this product met its published specifications at the time of shipment from the factory. Hewlett-Packard further certifies that its calibration measurements are traceable to the United States National Institute of Standards and Technology, to the extent allowed by the Institute's calibration facility, and to the calibration facilities of other International Standards Organization members.

**Warranty**

This Hewlett-Packard instrument product is warranted against defects in material and workmanship for a period of one year from date of shipment. During the warranty period, Hewlett-Packard Company will, at its option, either repair or replace products which prove to be defective.

For warranty service or repair, this product must be returned to a service facility designated by Hewlett-Packard. Buyer shall prepay shipping charges to Hewlett-Packard and Hewlett-Packard shall pay shipping charges to return the product to Buyer. However, Buyer shall pay all shipping charges, duties, and taxes for products returned to Hewlett-Packard from another country.

Hewlett-Packard warrants that its software and firmware designated by Hewlett-Packard for use with an instrument will execute its programming instructions when properly installed on that instrument. Hewlett-Packard does not warrant that the operation of the instrument, or software, or firmware will be uninterrupted or error-free.

#### LIMITATION OF WARRANTY

The foregoing warranty shall not apply to defects resulting from improper or inadequate maintenance by Buyer, Buyer-supplied software or interfacing, unauthorized modification or misuse, operation outside of the environmental specifications for the product, or improper site preparation or maintenance.

NO OTHER WARRANTY IS EXPRESSED OR IMPLIED. HEWLETT-PACKARD SPECIFICALLY DISCLAIMS THE IMPLIED WARRANTIES OF MERCHANTABILITY AND FITNESS FOR A PARTICULAR PURPOSE.

#### EXCLUSIVE REMEDIES

THE REMEDIES PROVIDED HEREIN ARE BUYER'S SOLE AND EXCLUSIVE REMEDIES. HEWLETT-PACKARD SHALL NOT BE LIABLE FOR ANY DIRECT, INDIRECT, SPECIAL, INCIDENTAL, OR CONSEQUENTIAL DAMAGES, WHETHER BASED ON CONTRACT, TORT, OR ANY OTHER LEGAL THEORY.

#### **Assistance**

*Product maintenance agreements and other customer assistance agreements are available for Hewlett-Packard products. For any assistance, contact your nearest Hewlett-Packard Sales and Service Office.*

© Copyright Hewlett-Packard Company 1996  
All Rights Reserved. Reproduction, adaptation, or translation without prior written permission is prohibited, except as allowed under the copyright laws.  
1400 Fountaingrove Parkway, Santa Rosa CA, 95403-1799,  
USA



---

## Safety Notes

The following safety notes are used throughout this manual. Familiarize yourself with each of the notes and its meaning before operating this instrument.

---

### WARNING

**Warning denotes a hazard. It calls attention to a procedure which, if not correctly performed or adhered to, could result in injury or loss of life. Do *not* proceed beyond a warning note until the indicated conditions are fully understood and met.**

---

### CAUTION

Caution denotes a hazard. It calls attention to a procedure that, if not correctly performed or adhered to, would result in damage to or destruction of the instrument. Do *not* proceed beyond a caution sign until the indicated conditions are fully understood and met.

---

## General Safety Considerations

### **WARNING**



- 
- **These servicing instructions are for use by qualified personnel only. To avoid electrical shock, do not perform any servicing unless you are qualified to do so.**
  - **The opening of covers or removal of parts is likely to expose dangerous voltages. Disconnect the instrument from all voltage sources while it is being opened.**
  - **The detachable power cord is the instrument disconnecting device. It disconnects the mains circuits from the mains supply before other parts of the instrument. The front panel switch is only a standby switch and is not a LINE switch.**
  - **The power cord is connected to internal capacitors that may remain live for 5 seconds after disconnecting the plug from its power supply.**
  - **This is a Safety Class I product (provided with a protective earthing ground incorporated in the power cord). The mains plug shall only be inserted in a socket outlet provided with a protective earth contact. Any interruption of the protective conductor, inside or outside the instrument, is likely to make the instrument dangerous. Intentional interruption is prohibited.**
  - **For continued protection against fire hazard replace line fuse only with same type and rating (F 5A/250V). The use of other fuses or material is prohibited.**
-

## CAUTION

- 
- Always use the three-prong ac power cord supplied with this instrument. Failure to ensure adequate earth grounding by not using this cord may cause instrument damage.
  - Before switching on this product, make sure that the line voltage selector switch is set to the voltage of the power supply and the correct fuse is installed. Assure the supply voltage is in the specified range.
- 

---

## Manual Conventions

	This represents a key physically located on the instrument.
	This indicates a “softkey,” a key whose label is determined by the firmware of the instrument.
Screen Text	This indicates text displayed on the instrument’s screen.

---

## Instruments Covered By This Manual

This manual applies to instruments having a serial number prefix listed on the title page (behind the “Documentation Map” tab). Some changes may have to be made to this manual so that it applies directly to each instrument; refer to Chapter 2, “Instrument History”, to see what changes may apply to your instrument.

A serial number label (see the figure) is attached to the instrument’s rear panel. A prefix (four digits followed by a letter), and a suffix (five digits unique to each instrument), comprise the instrument serial number.

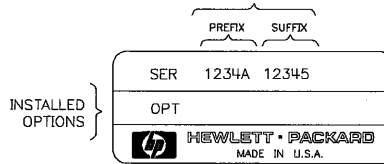

**Typical Serial Number Label**

This manual applies to HP 8360 B-Series swept signal generator and HP 8360 L-Series swept CW generator having a model number and serial number prefix listed on the title page (behind the “Documentation Map” tab). Some changes may have to be made to this manual so that it applies directly to each instrument; refer to Chapter 2, “Instrument History” in this manual to see what changes may apply to your instrument.

# Troubleshooting

---

## How to Use This Chapter

**Menus** If you are not familiar with the menus in this instrument, the *HP 8360 B-Series Swept Signal Generator/HP 8360 L-Series Swept CW Generator Service Guide* contains fold-out menu maps which are located behind the “Menu Maps” tab. Use the map for reference as you troubleshoot.

Some menus have more than one page of softkeys. Select the **More** softkey to see the next page of softkeys. **More** is *not* included in the keystrokes given in this chapter.

## Where to Begin Troubleshooting

### Caution

---

Follow all troubleshooting procedures in the order given. Done out of order, these procedures can miss critical checks. You can waste time, and possibly replace the wrong assembly.

---

Begin with “Instrument-Level Troubleshooting”. This section directs you to the appropriate troubleshooting module.

## Troubleshooting Modules

These modules pictorially guide you through the required measurement steps (see the following example). Each module covers one or more assemblies, and isolates a problem to the assembly level.

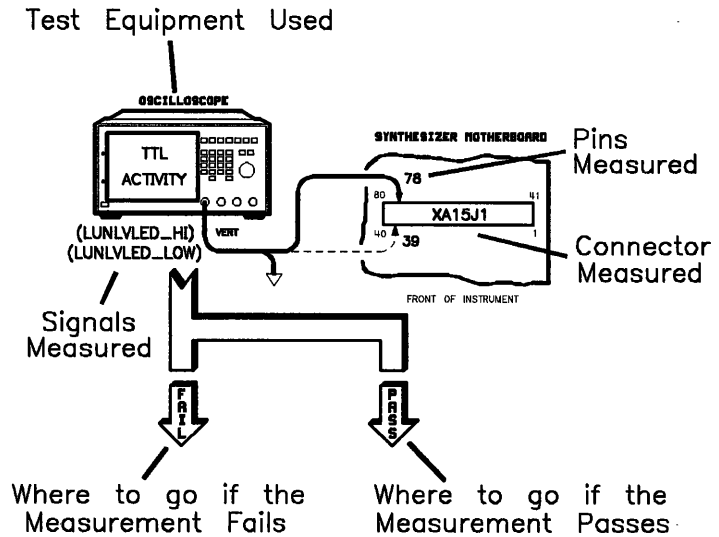

## Special Cases

This section covers problems not isolated in the troubleshooting modules. “Special Cases” also contains an instrument block diagram.

## Troubleshooting Foldout

The troubleshooting foldout, referenced in the troubleshooting modules, is located just prior to the “Special Cases” tab.

## **Equipment Required**

Table 1-1 lists recommended troubleshooting equipment. You may use any equipment that meets the critical specifications listed.

## **Instruments Without a Front Panel Keyboard**

If your instrument does not have a keyboard, there are two ways you can troubleshoot it:

1. Use the front panel emulation software, as instructed in instrument-level troubleshooting. The software itself is documented in the “Automated Tests” chapter of the *HP 8360 B-Series Swept Signal Generator/HP 8360 L-Series Swept CW Generator Service Guide*.
2. Use a substitute front panel (to order, see “Replaceable Parts”, in the *HP 8360 B-Series Swept Signal Generator/HP 8360 L-Series Swept CW Generator Service Guide*.

## **Lifting the RF Deck Up Into the Service Position**

In some of the troubleshooting procedures you will be required to lift the RF deck up into the service position. Instructions for this procedure are documented in the “Disassembly & Replacement Procedures” chapter of the *HP 8360 B-Series Swept Signal Generator/HP 8360 L-Series Swept CW Generator Service Guide* as part of the “RF Deck Disassembly & Reassembly” procedure.

**Table 1-1. Recommended Troubleshooting Equipment**

Instrument	Critical Specifications	Recommended HP Model or PN
Digital Voltmeter	Range: -50 to +50 Vdc Accuracy: $\pm 0.01\%$ Input Impedance: $\geq 10\text{ M}\Omega$	3456A 3457A
Frequency Counter <sup>1</sup>	Range: 0.01 to 26.5 GHz Accuracy: Time base: $\pm 1$ count Aging Range: $5 \times 10^{-10}$	5343A
Function Generator	Sine Wave Amp: $\geq 1$ Vrms Sine Wave Freq: dc to 100 kHz	3325A
Oscilloscope	Dual Channel Bandwidth: dc to 300 MHz Vert Sensitivity: $\leq 5$ mV/Div Horiz Sensitivity: 50 ns/Div 10 Magnifier Trigger: Event Triggerable	54111D 54110D
Oscilloscope Probes		10033A
Power Meter <sup>1</sup>	Power Range: $1\ \mu\text{W}$ to 100 mW Accuracy: $\pm 0.01\%$	436A 437B 438A
Power Sensor	0.01 to 0.05 GHz 0.05 to 20 GHz 0.05 to 40 GHz	8481A 8485A 8487A
Service Accessory Kit <sup>2</sup>		08360-60060

1 May be replaced by a spectrum analyzer.

2 For ordering information, see "Replaceable Parts".



## Instrument Level Troubleshooting

---

### **ILT.000 Begin Troubleshooting**

Follow the instructions in this section in the order given. The equipment required to troubleshoot the synthesizer is listed in Table 1-1 in Chapter 1. You may use any equipment that meets the critical specifications listed.

Go to paragraph ILT.100

---

## ILT.100

Can you safely connect the instrument to line power?

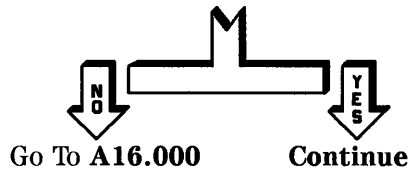

## ILT.101

Turn on line power and make the following observations *during* power up:

- The amber standby light goes off.
- The green power-on light comes on.
- The fan operates. Because the fan is very quiet, you may need to feel for airflow.

Is line power on and does the unit appear safe to operate?

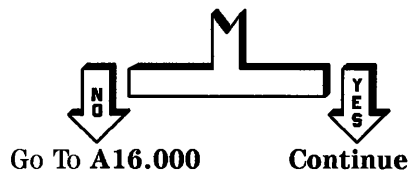

Does the amber standby light go off, the green power-on light come on, and the fan operate?

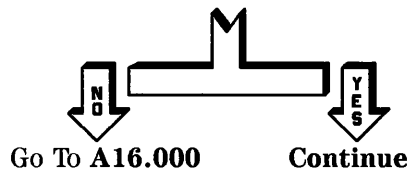

**ILT.102** Does the synthesizer have a front panel with a display and keyboard?

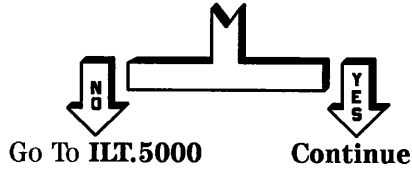

**ILT.103** Enable factory preset:

1. Press SYSTEM **MENU**.
2. Select **Preset Mode Factory**.
3. Press **PRESET**.

Could you complete the factory preset?

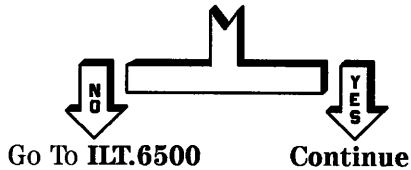

**ILT.104** Press **PRESET**.

Start(MHz)	Stop(MHz)	Power(dBm)
10.000000	20000.000000	INT: 0.00
-----		

Compare the synthesizer display to the figure shown. Stop and start frequencies may vary depending on the synthesizer model number. Also, flashing messages may appear on the front panel. These messages include (but are not limited to) OVEN, UNLOCK, LOW UNLVLED, and OVRMOD. Do not consider these messages failures at this time.

Is the display correct?

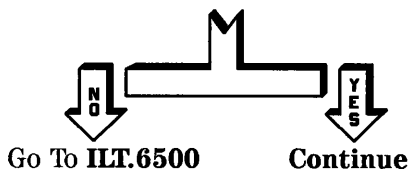

**ILT.105** Has a PC board or assembly recently been repaired or replaced? (If the instrument has passed self-tests since the assembly was replaced, answer this question “No”).

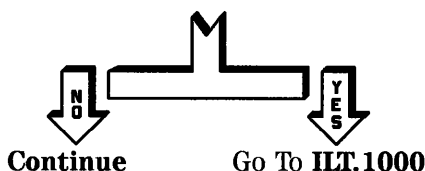

**ILT.106** Ensure that all external cables are removed from the synthesizer and then perform a full self-test:

1. Press **SERVICE**.
2. Select **Selftest (Full)**.
3. Wait about 1 minute for self-tests to run.

Continue with paragraph ILT.107.

## ILT.107

```
**** ALL SELF-TESTS HAVE PASSED ! ****  
No failures were found in any of the  
tests on the self-test list.
```

```
Abort          ....Options....  
                Loop   Log   Cont
```

At the end of self-test, if the display shows ALL SELF-TESTS HAVE PASSED ! continue with ILT.108. Otherwise, follow the directions displayed on the synthesizer.

## ILT.108

Were the self-tests run to confirm correct operation of the synthesizer? For example, were self-tests run after a repair, as a periodic check, or as part of a calibration?

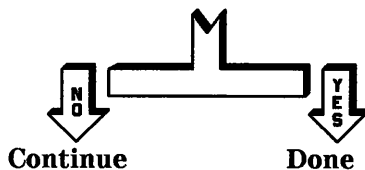

**ILT.109**

Does the synthesizer have a front panel with a display and keyboard, and do you want to test the display and keyboard?



Go To **ILT.111**

**Continue**

Test the display by running self-test #257:

1. Press **PRESET** **SERVICE**.
2. Select **Selftest Menu**.
3. Press **257** **ENTER**.
4. Select **Do Test #257**. To exit the test, press **PRESET**.

Do marching characters and a fast-moving cursor (-) appear on the display?



Go To **A21.9000**

**Continue**

**ILT.110** Test the keyboard by running self-test #21:

1. Press **SERVICE**.
2. Select **Selftest Menu**.
3. Press **21** **ENTER**.
4. Select **Do Test #21**.
5. Turn the rotary knob on the front panel clockwise and counter clockwise.

Do an X and a dash (-) flash in the upper right corner of the display?



Go To **ILT.6000**

**Continue**

Press all keys on the front panel *except* **PRESET**.

Do all dashes (-) change to Xs?



Go To **A1.9000**

**Continue**

**ILT.111** If a password is set, you must know it to do this step.

View calibration constant #463 (hardware configuration):

1. Press **PRESET** **SERVICE**.
2. Select **Adjust Menu**.
3. If **ENTER PASSWORD: 0** appears on the top line of the display:
  - a. Enter the password.
  - b. Press **ENTER**.
  - c. Select **Adjust Menu**.
4. Select **Calib Menu** **Select Cal**.
5. Press **463** **ENTER**.
6. Note the value of calibration constants #463 and #464.
7. Note the options listed on the rear panel of the instrument.
8. Note the model number of the instrument.
9. Using the options listed on the rear panel, the model number, and the table below, calculate the hardware configuration calibration constants (see the following examples).



**Table 1a-1.  
Hardware Configuration Cal Constants #463 and #464**

Synthesizer Model Number	#463 Hardware Config 1						#464 Hardware Config 2	
	Starting Cal Constant	Option 001	Option 002	Option 004	Option 006	Option H10 <sup>1</sup>	Starting Value	Option 006
HP 83620B	+ 19,600	-128	+ 4	+ 4096	+ 2	-	+ 1	+ 2
HP 83622B	+ 19,584	-128	+ 4	+ 4096	+ 2	-	+ 1	+ 2
HP 83623B	+ 19,608	-128	+ 4	+ 4096	+ 2	-127	+ 1	+ 2
HP 83624B	+ 19,592	-128	+ 4	+ 4096	+ 2	-	+ 1	+ 2
HP 83630B	+ 19,600	-128	+ 4	+ 4096	+ 2	-	+ 1	+ 2
HP 83640B	+ 19,632	-128	+ 4	+ 4096	+ 2	-127	+ 1	+ 2
HP 83650B	+ 19,888	-128	+ 4	+ 4096	+ 2	-	+ 1	+ 2
HP 83621B	+ 30,864	-	-	-	-	-	-	-
HP 83631B	+ 30,864	-	-	-	-	-	-	-
HP 83651B	+ 32,176	-	-	-	-	-	-	-
HP 83623L	+ 27,792	-128	-	+ 4096	-	-	+ 1	-
HP 83630L	+ 27,792	-128	-	+ 4096	-	-	+ 1	-
HP 83640L	+ 27,824	-128	-	+ 4096	-	-	+ 1	-
HP 83650L	+ 28,080	-128	-	+ 4096	-	-	+ 1	-

1 Option H10 and all other options are mutually exclusive.

**Example:** Calibration constant #463

$$\begin{aligned} \text{HP 83620B} &+ 001 + 004 = ? \\ 19,600 &- 128 + 4096 = 23,568 \end{aligned}$$

**Example:** Calibration constant #464

$$\begin{aligned} \text{HP 83620B} &+ 006 = ? \\ 1 &+ 2 = 3 \end{aligned}$$

Is the synthesizer hardware configuration number correct?

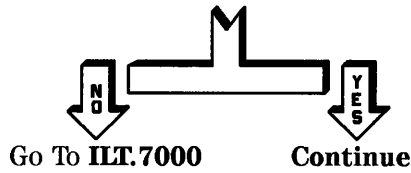

**ILT.112** Does the synthesizer have a user preset implemented?

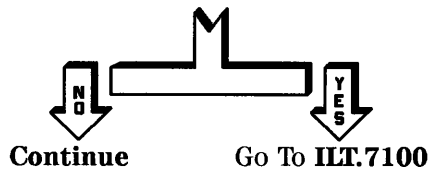

**ILT.113** Were self-tests run because an adjustment failed?

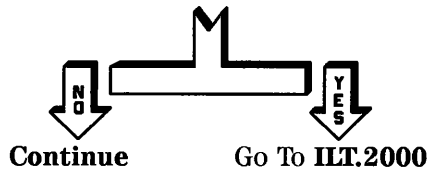

**ILT.114** If a FAULT message is displayed, check the Fault Menu. Does a RAMP fault exist?

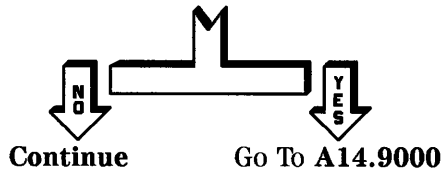

**ILT.115** Perform the following calibration:

1. Press **PRESET** **USER CAL**.
2. Select **FullUsr Cal**.
3. Wait for the calibration to complete ( $\leq 1$  minute).

If the calibration runs without errors, continue with ILT.115. Otherwise, go to performance tests and adjustments.

**ILT.116** Were self-tests run because of a faulty signal at one or more of the I/O ports listed below?

* Display Out	* Keyboard In
* HP-IB In/Out	* 10 MHz Ref In
* 10 MHz Ref Out	* Trigger In
* Sweep Out	* Stop Sweep In/Out
* AM In	* Volts/GHz Out
* FM In	* Z-Axis Blanking/Markers Out
* Pulse In/Out	* Rear Panel SMI
* External ALC In	* Front Panel SMI
* RF Out	* Trigger Out
* Auxiliary Int	* HP-IB Switches
* Pulse Video Out	* AM/FM Out
* Pulse Sync Out	* AUX OUTPUT

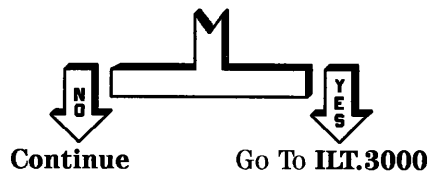

**ILT.117** Do *all* of the following work properly?

- Power level functions:
  - RF on/off.
  - Power sweep.
  - Power slope.
  - Attenuator uncoupling.
  - Up/down power size.
- Setting frequencies (start, stop, CW, etc.):
  - Up/down size.
  - Frequency offset.
  - Frequency multiplier.
- Marker functions.
- Sweep functions:
  - List.
  - Step:
    - Step size.
    - Step points.
    - Step dwell.
    - Step sweep trigger.
  - Sweep ramp.
- Frequency list.
- Fast sweep time ( $\leq 100$  ms sweep time).
- Slow sweep time ( $\geq 5$  s sweep time).
- Single sweep or manual sweep.
- Trigger sweep.
- Trigger out delay.
- Save/recall registers.

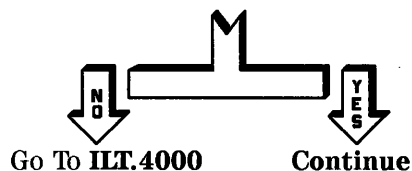

**ILT.118** Did one or more of the following performance tests fails (or do you believe they would have)?

* Internal Timebase Aging Rate	* Spurious Signals (Harmonics)
* Frequency Switching Time	* Power Accuracy
* Power Flatness	* Maximum Leveled Power
* External Leveling	* Swept Frequency Accuracy
* Step Attenuator Flatness and Accuracy	* Spurious Signals (Line Related)
* Single Sideband Phase Noise	* Spurious Signals (Non-Harmonics)
* FM Maximum Frequency Deviation	* Pulse Modulation Video Feedthrough
* AM Accuracy	* Pulse Performance
* AM Dynamic Range	* FM Accuracy
* AM Flatness	* FM Flatness
* Pulse On/Off Ratio	* Internal Pulse Accuracy
* Modulation Meter	

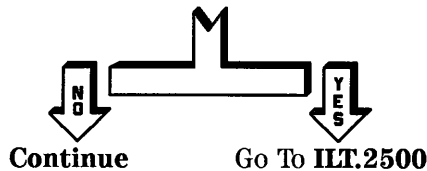

**ILT.119** Were self-tests run because of a failure associated with a source module?

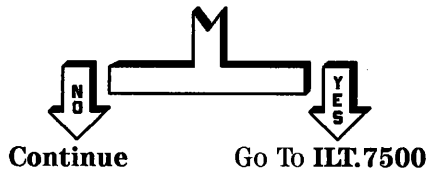

**ILT.120** Were self-tests run because of a network or scalar analyzer system failure?

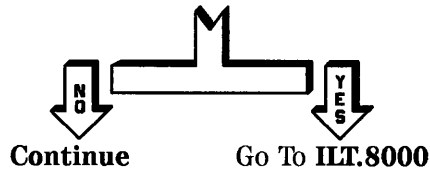

**ILT.121** Are all failures gone?

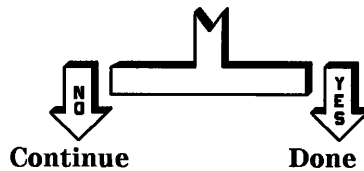

**ILT.122** You have encountered a problem not dealt with by these procedures. Consult the "Special Cases" section to troubleshoot this problem.

---

## ILT.1000

Calibration constants are used to identify which assembly revisions are installed in the instrument. General instrument operation, as well as self-test operation, are dependent on these calibration constants being correct.

If a password is set, you must know it to do this step.

To view calibration constant #xxx:

1. Press **PRESET** **SERVICE**.
2. Select **Adjust Menu**.
3. If **ENTER PASSWORD: 0** appears on the top line of the display:
  - a. Enter the password.
  - b. Press **ENTER**.
  - c. Select **Adjust Menu**.
4. Select **Calib Menu** **Select Cal**.
5. Press xxx **ENTER**.
6. Note the value of calibration constant xxx.
7. Compare it with the calibration constant value listed in the following table for the assembly installed in the instrument.
8. If necessary, update and save the calibration constant:
  - a. Select **Modify Cal**.
  - b. Enter the correct value and press **ENTER**.
  - c. Select **Cal Util Menu**.
  - d. Select **Save** and answer **Yes**.

Go To ILT.106

**Table 1a-2.  
Assemblies and Corresponding Cal Constant ID  
Numbers and Revisions**

Assembly	ID Number	Revision	Part Number	Description
A1	None	#493 0	08360-60001	Keyboard
A2	None	#493 0	08360-60002	Source Module Interface
A3	None	#495 0	08360-60003	Front Panel Processor
A4	None	#496 0	08360-60010	Fractional-N
A5	None	#497 1	08360-60209	YO Phase Detector
A6	None	#498 1	08360-60214	Sampler (No VCO Adj.)
A7	None	#499 0 1	08360-60008	Reference Future Use
A8	None	#500 0	08360-60166	Modulation Generator
A9	#671 1	#501 0	08360-60232	Pulse (Self Bias SRD)
A10	#678 1 0	#502 0 0	08360-60206 08360-60222	ALC (HP 83640B/L and HP 83650B/L) ALC (HP 83620B/22B/24B, HP 83623B/L, and HP 83630B/L)
A11	None	#503 0	08360-60011	FM Driver
A12	#672 1	#504 0	08360-60212	Multiplier/Filter Driver
A13	None	#505 3 4	08360-60213 08360-60207	YO Driver (HP 83621B/31B/51B) YO Driver (Quick Step)



**Table 1a-2.  
Assemblies and Corresponding Cal Constant ID  
Numbers and Revisions (continued)**

<b>Assembly</b>	<b>ID Number</b>	<b>Revision</b>	<b>Part Number</b>	<b>Description</b>
A14	None	#506 0	08360-60014	Sweep Generator
A15	None	#507 1	08360-60264	CPU (Battery) 2 ROM Chip Set
A16	None	#508 0	08360-60016	Post Regulator
A17	None	#509 0	08360-60017	Rectifier/Filter
A18	None	#510 0	08360-60198	Switching Regulator
A19	None	#511 0	08360-60019	Rear Panel Interface
A20	#670 0	#512 2	08360-60266	RF Interface
A21	None	#513 0	1990-1295	Alphanumeric Display
A22	None	#514 0	08360-60196	Motherboard
A23	None	#515 0	HP 10811E	10 MHz Reference Standard
A24	None	#641 0	5086-7463	Low Band
A25	None	#642 1		Directional Coupler
A26	None	#643 0	5086-7515	YO
A27	None	#644 0		

**Table 1a-2.  
Assemblies and Corresponding Cal Constant ID  
Numbers and Revisions (continued)**

<b>Assembly</b>	<b>ID Number</b>	<b>Revision</b>	<b>Part Number</b>	<b>Description</b>	
A28	#673	#645			
		1	0	5086-7596	Switched Amp/Mult (HP 83621B/31B)
		2	1	5086-7622	Amp/Mult (HP 83630B/L and HP 83650B/L)
		2	2	5086-7622	Amp/Mult with Aux Out (HP 83620B, HP 83622B, HP 83623B/L, HP 83624B, HP 83640B/L, and HP 83651B)
A29	#674	#646			
		1	1	5086-7623	Amp/Filter (HP 83630B/L, HP 83640B/L, HP 83650B/L, and HP 83651B)
		2	1	5086-7636	Amp/Filter (HP 83630B/40B/50B Option 006)
		3	0	5086-7616	Amp/Filter (HP 83620B/22B/23B/24B)
	4	1	5086-7637	Amp/Filter (HP 83623L)	
A30	None	#647			
		0	0955-0148	Directional Coupler (HP 83623B/L and HP 83624B)	
		0	5086-7645	Bridge Detector (HP 83620B/22B and HP 83630B/L)	
		0	0955-0125	Directional Coupler (HP 83631B)	
		0	5086-7656	Bridge Detector (HP 83640B/L and HP 83650B/L)	
		0	0955-0523	Directional Coupler (HP 83651B)	
A31	None	#648			
		0	33326-60003	Step Attenuator (HP 83620B/22B/24B, HP 83623B/L, and HP 83630B/L)	
		0	33326-60002	Step Attenuator (HP 83640B/L)	
	0	33326-60005	Step Attenuator (HP 83650B/L)		

**Table 1a-2.  
Assemblies and Corresponding Cal Constant ID  
Numbers and Revisions (continued)**

<b>Assembly</b>	<b>ID Number</b>	<b>Revision</b>	<b>Part Number</b>	<b>Description</b>
A32	#677	#649		
	0	1	5086-7607	Frequency Doubler (HP 83640B/L)
	1	1	5086-7604	Frequency Doubler (HP 83650B/L)
	1	1	5086-7513	Frequency Doubler (HP 83651B)
A33	None	#650		
		0	5086-7465	Amplifier (High Power) (HP 83623B)
		0	5086-7510	Amplifier (High Power) (HP 83624B)
A34	None	#651		
		0	08360-60061	RP Floating BNC (Option 004)
		0	08360-60186	RP Floating BNC (Option 002 and 004)
A35	None	#652		
		0		Not Used
A36	#676	#653		
		0		Not Used
A37				
A38	#675	#655		
	1	0	5086-7602	Dual Modulator (HP 83620B, HP 83622B, HP 83623B/L, HP 83624B, HP 83630B/L, HP 83640B/L, and HP 83650B/L)
	2	0	5086-7634	AM Modulator (Option 006 and HP 83621B/31B/51B)

**Table 1a-2.  
Assemblies and Corresponding Cal Constant ID  
Numbers and Revisions (continued)**

<b>Assembly</b>	<b>ID Number</b>	<b>Revision</b>	<b>Part Number</b>	<b>Description</b>
A42	#676	#653		
	0	0		(HP 83620B/22B/24B and HP 83623B/L)
	1	1		(HP 83630B/L, HP 83640B/L, and HP 83650B/L)
	0	1	5086-7628	Pulse Mod Switched Filter (HP 83620B/22B Option 006)
	0	1	5086-7629	Pulse Mod Switched Filter (HP 83623B/24B Option 006)
	1	1	5086-7630	Pulse Mod Switched Filter (HP 83630B Option 006)
	1	1	5086-7631	Pulse Mod Switched Filter (HP 83640B/50B Option 006)

## ILT.2000

Select the failing adjustment and go to the indicated paragraph.

<b>Failed Adjustment</b>	<b>Go to Paragraph</b>
ADC Calibration	A15.9000
10 MHz Standard	A23.9000
Fractional-N VCO	A4.9000
Fractional-N Reference and API Spurs	A4.9000
Sweep Ramp	A14.9000
YO Driver +10V Reference	A13.9000
Modulation Generator	A8.9000
Sampler Assembly	ILT.2010
YO Loop Gain	A5.9000
YO Driver Gain and Linearity	ILT.2030
YO Delay	ILT.2030
FM Gain	ILT.2100
FM Gain, Opt. 002 installed	ILT.2140
Modulator Offset and Gain	ILT.2110
AM Delay	ILT.2130
AM Delay, Opt. 002 installed	ILT.2150
AM Accuracy	ILT.2130
AM Accuracy, Opt. 002 installed	ILT.2150
Power Flatness	ILT.2240
ALC Power Level Accuracy	ILT.2240
SYTM Tracking and Delay Compensation	RF.2890
Low Power SRD Bias	RF.2890
Square Wave Symmetry	A9.9000
Step Attenuator Flatness	ILT.2300

## ILT.2010 Set up for power measurement:

1. Set the power switch to standby.
2. Remove the top and bottom covers.
3. Turn the synthesizer power on.
4. Press **PRESET** **CW** **SERVICE**.
5. Select **Tools Menu** **CntlPLL Menu** **NoPhaseLock** (asterisk on).
6. Select **LoopCntl Menu** **Y0 Loop Freq.**
7. Press **2** **GHz**.
8. Using the rotary knob, sweep the frequency from 2.0 to 7.4 GHz and verify that power is greater than -25 dBm.

## Set up for frequency measurement:

1. Press **2** **GHz**.
2. Using **▲**, increment the frequency.
3. The measured frequency equals the front panel indication  $\pm 40$  MHz (2.0 to 7.4 GHz).

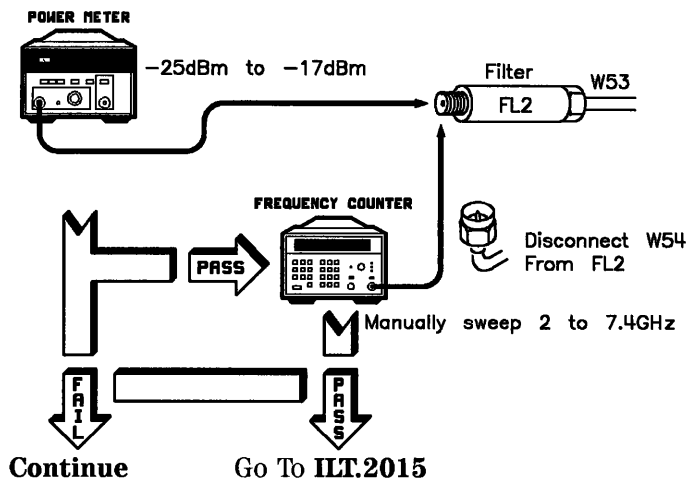

## ILT.2011

Set up for power measurement:

1. Reconnect any disconnected cables.
2. Put the RF deck in the service position.
3. Remove the 15 dB attenuator (AT3) from the directional coupler (A39).
4. Press **PRESET** **CW** **SERVICE**.
5. Select **Tools Menu** **Cnt1PLL Menu** **NoPhaseLock** (asterisk on).
6. Select **LoopCnt1 Menu** **Y0 Loop Freq.**
7. Press **2** **GHz**.
8. Using the rotary knob, sweep the frequency from 2 to 7.4 GHz and verify that power is  $\geq -7$  dBm.

Set up for frequency measurement:

1. Press **2** **GHz**.
2. Using **▲**, increment the frequency.
3. The measured frequency equals the front panel Indication  $\pm 40$  MHz (2 to 7.4 GHz).

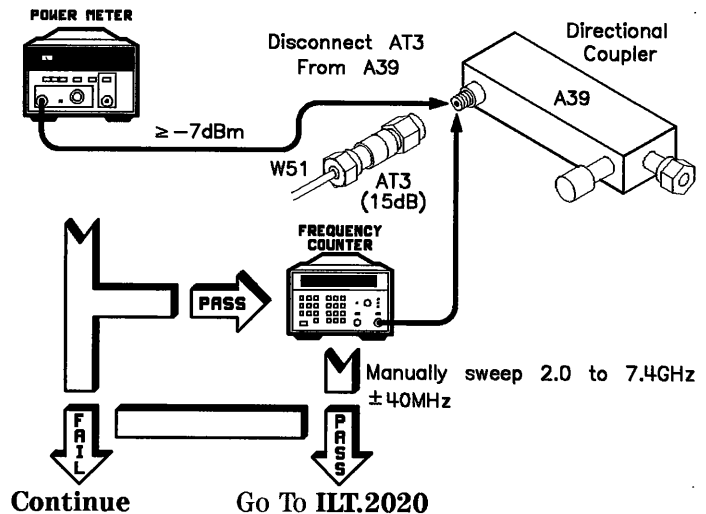

**ILT.2012** Set up for power measurement:

1. Reconnect any disconnected cables.
2. Put the RF deck in the service position.
3. Remove W52 (connects the YIG oscillator, A26, to the directional coupler (A39)).
4. Press **PRESET** **CW** **SERVICE**.
5. Select **Tools Menu** **CntlPLL Menu** **NoPhaseLock** (asterisk on).
6. Select **LoopCntl Menu** **YD Loop Freq**.
7. Press **2** **GHz**.
8. Using the rotary knob, sweep the frequency from 2.0 to 7.4 GHz and verify that power is  $\geq 8$  dBm.

Set up for frequency measurement:

1. Press **2** **GHz**.
2. Using **▲**, increment the frequency.
3. The measured frequency equals the front panel indication  $\pm 40$  MHz (2.0 to 7.4 GHz).

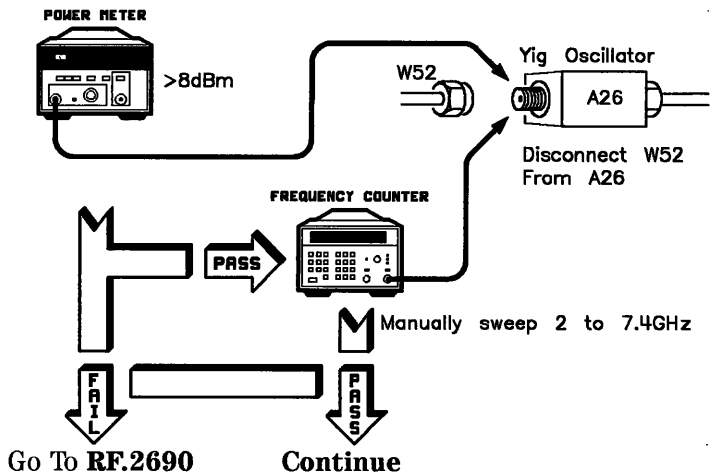



**ILT.2013** Check W52 for damage, deformation, or excessive RF path loss.

Is W52 defective?



Go To **RF.3990**      **Continue**

Replace W52 and go to the Troubleshooting Foldout, block 1 (located just prior to the "Special Cases" tab).

**ILT.2015** Remove A6 from the synthesizer and disconnect W54 from A6. Inspect and test W54 for defects.

Is W54 defective?



Go To **A6.9000**      **Continue**

Replace W54 and go to the Troubleshooting Foldout, block 1 (located just prior to the "Special Cases" tab).

**ILT.2020** There is a high-loss path between the directional coupler (A39) and the sampler (A6). This path includes two hard lines (W54, W51), a low pass filter (FL2), and an attenuator (AT3). The most likely failure is a poor connection. Correct the faulty connection or replace the faulty part (W54, FL2, W51, AT3). Isolate and replace the faulty component and go to the Troubleshooting Foldout, block 1 (located just prior to the “Special Cases” tab).

To check for excessive loss in a cable or filter, connect the component input to a known-good signal for the frequency bands in question (see the block diagram located behind the “Troubleshooting Block Diagrams” tab) and test the output. Over the frequency range of 2.0 to 8.0 GHz, the loss for a coaxial cable should be  $\leq 2.0$  dB; the loss for a filter should be  $\leq 4.0$  dB.

**ILT.2030** The most likely cause of this failure is A26, the YIG oscillator (go to RF.2690.) If replacing A26 does not resolve the problem, it is possible (but less likely) that A13, the YO driver assembly could be the cause. Go to A13.9000 to replace A13.

- ILT.2100** Check the continuity from the front or rear panel FM input to the end of W8 (which connects to A11J1).

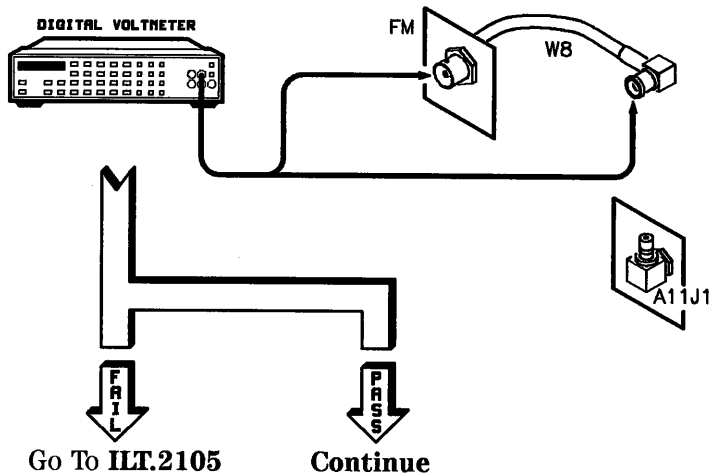

- ILT.2101** Perform the following setup:

1. Reconnect all cables.
2. Set the power switch to standby.
3. Put the RF deck in the service position.
4. Disconnect W26 from A26J3.
5. Connect an oscilloscope to the disconnected end of W26.
6. Connect a function generator to the FM input on the front (or rear) panel.
7. Turn synthesizer power on.
8. Set the function generator for a 0.25 V rms sine wave at 1.0 MHz.
9. Press **PRESET** **CW** **5.0** **GHz** **MOD**.
10. Select **FM On/Off AC**.
11. Set the FM sensitivity to 10 MHz/V.
12. Adjust A11R55 to adjust the amplitude of the waveform.

The oscilloscope should display an undistorted waveform approximately 3.2 V rms (9 Vp-p). Try adjusting A11R55. There should be some range of adjustment above and below this level.

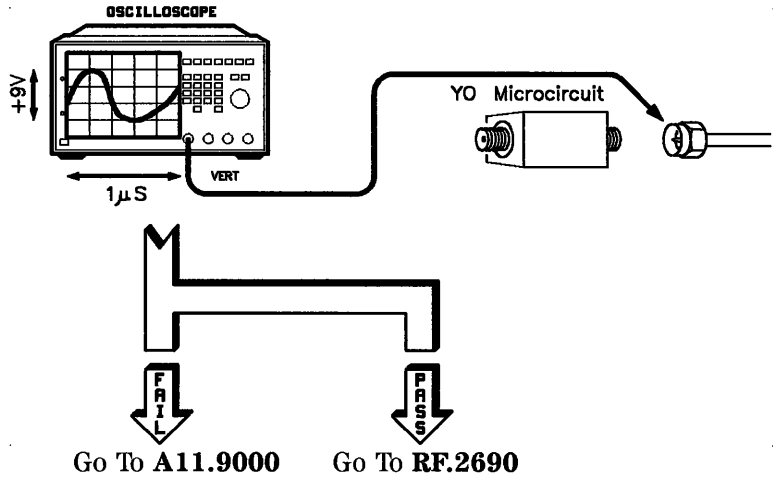

**ILT.2105** Replace W8 (front or rear panel FM input to A11J1) and go to the Troubleshooting Foldout, block 1 (located just prior to the “Special Cases” tab).

**ILT.2110** Does the adjustment (modulator offset and gain) fail above 2 GHz?

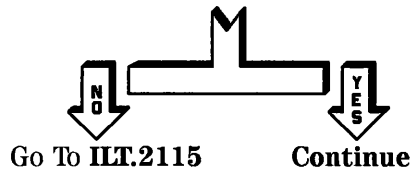

**ILT.2111** Does the adjustment (modulator offset and gain) fail *below* 2 GHz?

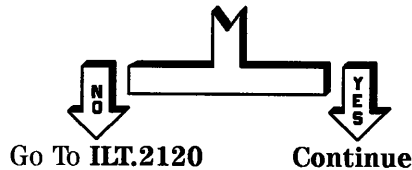

**ILT.2112** The problem is most likely the A10 assembly (it is possible, however, that A24 and A38 are both faulty).  
First go to paragraph A10.9000. If this does not fix the problem, consider RF.2490, and/or RF.3890.

**ILT.2115** The problem is most likely either the A24 or the RF cables connected to A24. It is possible, however, that the A10 assembly may be the problem.  
If A24 has *not* been replaced, go to RF.2490, otherwise go to A10.9000.

**ILT.2120** The problem is most likely either A38 or the RF cables connected to A38. It is possible, however, that the A10 assembly may be the problem.  
If A38 has *not* been replaced, go to RF.3890, otherwise go to A10.9000.

**ILT.2130** The most likely cause of this problem is the A10 assembly. If this assembly has not been replaced, go to A10.9000. If this assembly has been replaced, consider changing the dual modulator (RF.3890) or, for instruments with Option 006, change the AM modulator (RF.3890). However, if the problem exists only in low band, try changing the low band assembly (RF.2490).

**ILT.2140** Check the continuity from the front (or rear) panel FM input to the end of W8 (which connects to A8J10).

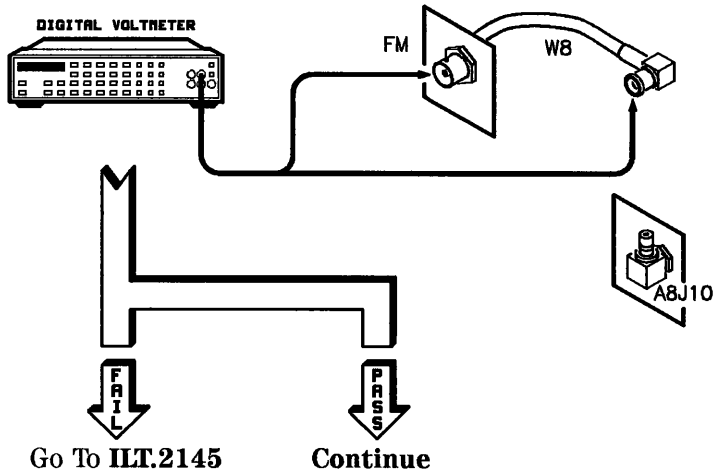

**ILT.2141** Perform the following setup.

1. Reconnect all cables.
2. Set the power switch to standby.
3. Disconnect W68 from A11J1.
4. Connect an oscilloscope to the disconnected end of W68.
5. Connect a function generator to the FM input on the front (or rear) panel.
6. Turn synthesizer power on.
7. Set the function generator for a 0.25 V rms sine wave at 1.0 MHz.
8. Press **PRESET**.

The oscilloscope should display the same signal as the function generator, a sine wave approximately 0.25 V rms (.707 V p-p) at 1.0 MHz.

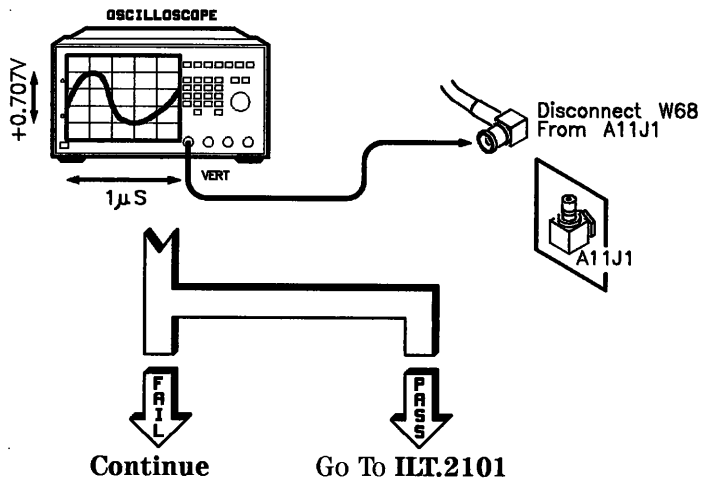

**ILT.2142** Perform the following setup:

1. Reconnect all cables.
2. Set the power switch to standby.
3. Disconnect W68 from A8J9.
4. Connect an oscilloscope to the A8J9 connector.
5. Connect a function generator to the FM input on the front (or rear) panel.
6. Turn on synthesizer power.
7. Set the function generator for a 0.25 V rms sine wave at 1.0 MHz.
8. Press **PRESET**.

The oscilloscope should display the same signal as the function generator, a sine wave approximately 0.25 V rms (.707 V p-p) at 1.0 MHz.

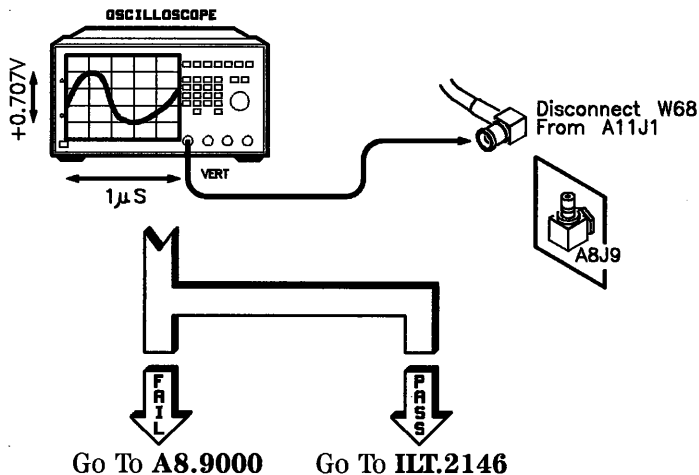

**ILT.2145** Replace W8 (front or rear panel FM input to A8J10) and go to the Troubleshooting Foldout, block 1 (located just prior to the “Special Cases” tab).

**ILT.2146** Replace W68 (cable between A8J9 and A11J1) and go to the Troubleshooting Foldout, block 1 (located just prior to the “Special Cases” tab).



**ILT.2150** Check the continuity from the front (or rear) panel AM input to the end of W7 (which connects to A8J7).

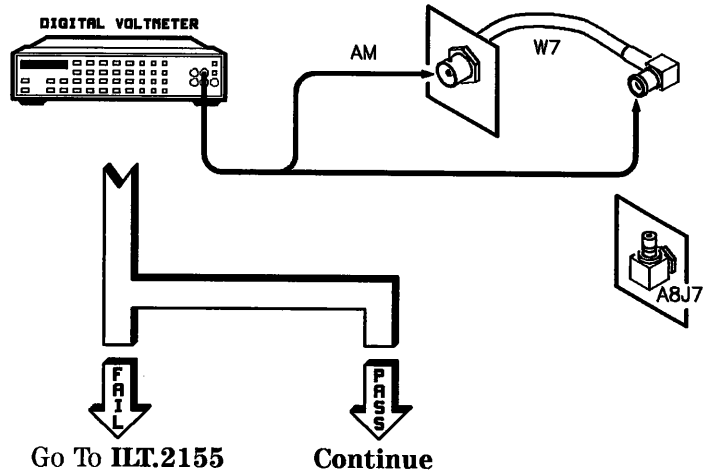

**ILT.2151** Perform the following setup:

1. Reconnect all cables.
2. Set the power switch to standby.
3. Disconnect W67 from A10J1.
4. Connect an oscilloscope to the disconnected end of W67.
5. Connect a function generator to the AM input on the front (or rear) panel.
6. Turn on synthesizer power.
7. Set the function generator for a 0.25 V rms sine wave at 1.0 MHz.
8. Press **PRESET**.

The oscilloscope should display the same signal as the function generator, a sine wave approximately 0.25 V rms (.707 V p-p) at 1.0 MHz.

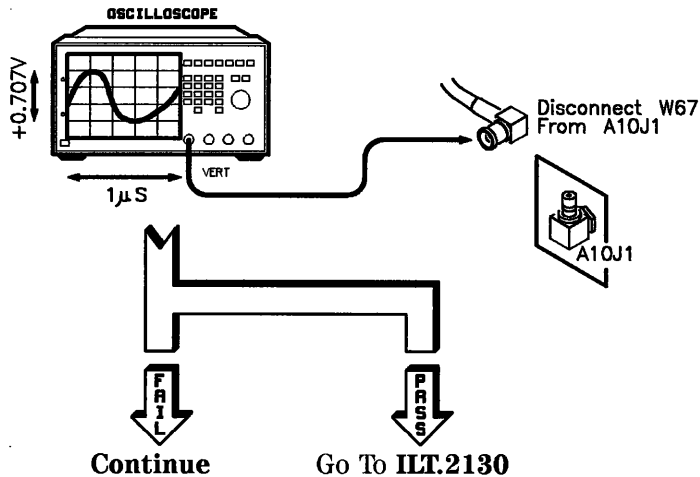

**ILT.2152** Perform the following setup:

1. Reconnect all cables.
2. Set the power switch to standby.
3. Disconnect W67 from A8J8.
4. Connect an oscilloscope to the A8J8 connector.
5. Connect a function generator to the AM input on the front (or rear) panel.
6. Turn on synthesizer power.
7. Set the function generator for a 0.25 V rms sine wave at 1.0 MHz.
8. Press **PRESET**.

The oscilloscope should display the same signal as the function generator, a sine wave approximately 0.25 V rms (.707 V p-p) at 1.0 MHz.

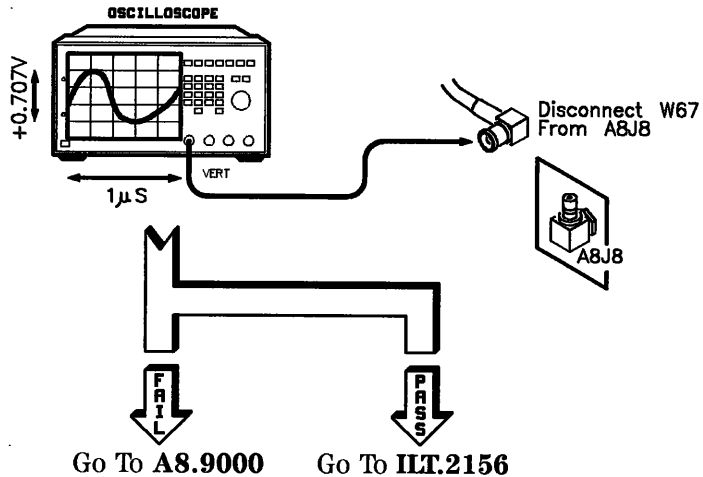

**ILT.2155** Replace W7 (front or rear panel AM input to A8J7) and go to the Troubleshooting Foldout, block 1 (located just prior to the "Special Cases" tab).

**ILT.2156** Replace W67 (cable between A8J8 to A10J1) and go to the Troubleshooting Foldout, block 1 (located just prior to the “Special Cases” tab).

**ILT.2240** The most common problem with RF power is loose or damaged connectors and coax cables (especially hard lines on the RF deck). If the instrument has sudden drops in power above 10 GHz, check for faulty connections. Check all hard lines, making sure that none of the cables are cross-threaded, canted, or damaged. Check all connections from the YO (A26) to the RF OUTPUT connector (J1).

Are all connections and cables good?

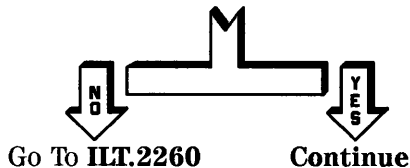

**ILT.2241** Does the instrument have low band ( $\leq 2$  GHz), and does the RF power problem exist only in low band?

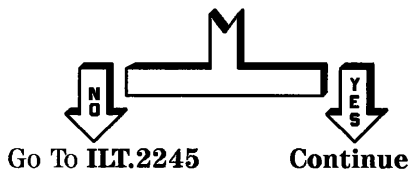

**ILT.2242**

The problem is most likely the low band microcircuit (A24). A less likely possibility is the microcircuit that selects the A24 low band output. Depending on the instrument block diagram, this switching is done in the following microcircuits:

All models with Option 006:

A42 Pulse Modulation Switched Filter

HP 83620B, HP 83630B/L, and HP 83623L:

A29 Amplifier Filter

HP 83640B/L and HP 83650B/L:

A32 Frequency Doubler

HP 83623B:

A33 Amplifier Switch

Before continuing, check again for loose or poorly seated connectors.

Has A24 been previously replaced?



Go To **RF.2490**

Go To **ILT.2257**

**ILT.2245**

Does the RF power problem exist *only* at frequencies  $\geq 2$  GHz?



Go To **ILT.2256**

**Continue**

**ILT.2246** Is the synthesizer upper frequency limit  $\geq$  40 GHz?

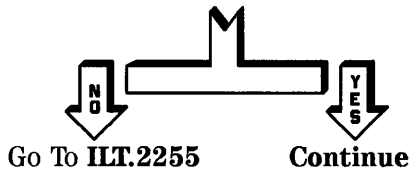

**ILT.2247** Does the RF power problem exist *only* above 26.5 GHz?

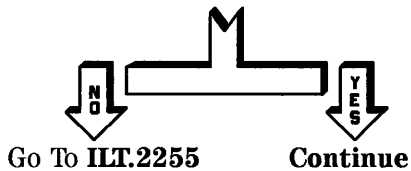

**ILT.2248** Loose connections or bad RF cabling can easily cause problems at these frequencies. Check all cabling from the amp/mult (A28) to the RF OUTPUT (J1). If all RF cabling appears intact, the most probable cause is the amp/doubler (A32).

Are the cabling and J1 intact?

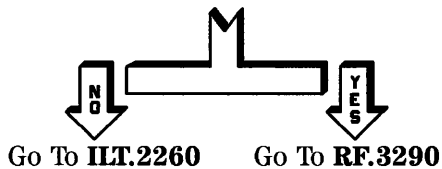

## **ILT.2255**

The most probable fault is a loose cable between A30 and the RF OUTPUT connector. Use the block diagram to guide you in checking power levels between A30 and the RF OUTPUT connector. Then use the block diagram to check the following items.

1. The RF OUTPUT connector.
2. If the instrument has option 001, the attenuator (RF.3190).
3. The bridge detector in all models except the HP 83623B/24B and HP 83623L or the coupler/detector in the HP 83623B/24B and HP 83623L (RF.3090).
4. The low power adjustment.
5. For *abrupt power drop out only*, amplifier/multiplier and amplifier/filter adjustments.
6. The amp/multiplier (RF.2890).
7. The amp/filter (RF.2990).
8. If present, the amp/switch (RF.3390).
9. If present, the pulse modulation switched filter (RF.4290).

If these alternatives do not fix the problem, use the instrument block diagram (located behind the "Troubleshooting Block Diagrams" tab) to troubleshoot this problem.

## **ILT.2256**

A general power level problem exists. The assemblies that affect a broad band of frequencies start with the coupler/detector, and end with J1. If a power level accuracy problem exists, it is possible that the A10 assembly (ALC) is faulty. There is no easy and effective way to continue testing without additional equipment. The following is a prioritized list of the most probable causes:

1. For power measurement level accuracy only, the A10 assembly (A10.9000).
2. The RF OUTPUT connector.
3. Hard lines between the A30 assembly and the RF OUTPUT connector.
4. If the instrument has option 001, the attenuator (RF.3190).

5. The bridge detector in all models except the HP 83623B/24B and HP 83623L or the coupler/detector in the HP 83623B/24B and HP 83623L (RF.3090).

If these alternatives do not fix the problem, use the instrument block diagram (located behind the “Troubleshooting Block Diagrams” tab) to troubleshoot this problem.

**ILT.2257** The most probable fault is a loose cable between A24 and the RF OUTPUT connector. Use the block diagram to guide you in checking power levels between A30 and the RF OUTPUT connector. Then use the block diagram to check the following items.

1. The RF OUTPUT connector.
2. The appropriate assembly for your model and option configuration from the following table:

**Table 1a-3.**

	<b>Instruments Without Option 006</b>	<b>Instruments With Option 006</b>
<b>HP 83620B/22B</b>	Amp/Filter (RF.2990)	Pulse Mod Switched Filter (RF.4290)
<b>HP 83630B</b>	Amp/Filter (RF.2990)	Pulse Mod Switched Filter (RF.4290)
<b>HP 83623B/24B</b>	Amp/Switch (RF.3390)	Pulse Mod Switched Filter (RF.4290)
<b>HP 83640B/50B</b>	Amp Doubler (RF.3290)	Amp Doubler (RF.3290)
<b>HP 83623L/30L</b>	Amp/Filter (RF.2990)	N/A
<b>HP 83640L/50L</b>	Amp Doubler (RF.3290)	N/A

3. If present, the attenuator (RF.3190).
4. The bridge detector in all models except the HP 83623B/24B and HP 83623L or the coupler/detector in the HP 83623B/24B and HP 83623L (RF.3090).



**ILT.2260** Repair, reseal, or reconnect the cables as required and continue with the performance tests or adjustments as required.

**ILT.2300** The step attenuator is the most likely failure, but loose or damaged connectors are always a possibility. Go to RF.3190.

If these alternatives do not fix the problem, use the instrument block diagram (located behind the “Troubleshooting Block Diagrams” tab) to troubleshoot this problem.

**ILT.2500** At this point in the procedure, all adjustments related to the failing performance test should have been successfully completed.

Select the first failing performance test and go to the indicated paragraph.

<b>Failing Performance Test</b>	<b>Go to Paragraph</b>
Internal Timebase Aging Rate	A23.000
Frequency Switching Time	ILT.2670
Swept Frequency Accuracy	ILT.2660
FM Accuracy	ILT.2690
FM Maximum Frequency Deviation	ILT.2690
FM Bandwidth	ILT.2690
Power Flatness	ILT.2695
Power Accuracy	ILT.2695
Maximum Leveled Power	ILT.2695
Step Attenuator Flatness and Accuracy	RF.3190
External Leveling	A10.9000
AM Dynamic Range	ILT.2620
AM Accuracy	ILT.2620
AM Frequency Response and Bandwidth	ILT.2620
Spurious Signals (Harmonics)	ILT.2650
Spurious Signals (Line Related)	ILT.2610
Spurious Signals (Non-Harmonics)	ILT.2630
Single Sideband Phase Noise	ILT.2640
Pulse Performance	ILT.2680
Pulse On Off Ratio	ILT.2680
Pulse Modulation Video Feedthrough	ILT.2600
Internal Pulse Accuracy	A8.9000
Modulation Meter	A8.9000

**ILT.2600** Does the pulse modulation feedthrough occur *only* below 2 GHz?

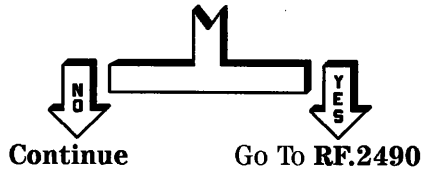

**ILT.2601** Is Option 006 installed?

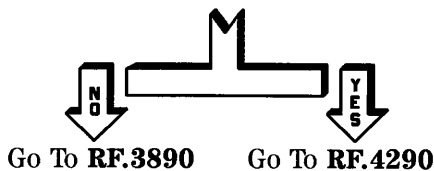

**ILT.2610** Line related spurs are spurious signals offset from the carrier by multiples of the line frequency. If, for example, the line frequency is 60 Hz, line related spurs can occur at 60, 120, 180, 240 Hz, and so on. The most prevalent spur is the second harmonic.

The most likely cause of line related spurs is EMI (electromagnetic interference) from other sources or from poor grounding. EMI can occur as a result of shielding degradation in the synthesizer due to damage or faulty reinstallation of the top or bottom covers, or the braided shielding. A faulty line filter (FL1) can also cause spurs. Recheck the measurement and set up for faulty grounds. Check the synthesizer shielding. Check the environment for unusually strong line currents close to the measurement.

If there is no likely external source, replace FL1. After taking action, go to the Troubleshooting Foldout, block 1 (located just prior to the "Special Cases" tab).

**ILT.2620** The problem can be caused by the A10 assembly (ALC), the A8 assembly (mod/gen), or by a microcircuit. Using the table below, go to the indicated paragraphs.

Failing Frequency Range or Failure Mode	Go to Paragraph
$\leq$ 2 GHz only	A10.9000 (ALC) or RF.2490 (low band)
$\geq$ 2 GHz only	A10.9000 (ALC) or RF.3890 (dual modulator or AM modulator in Opt. 006)
Above <i>and</i> below 2 GHz	A10.9000 (ALC) or A8.9000 (mod/gen)
Fails AM Accuracy or Dynamic Range for internal modulation	A8.9000 (mod/gen)

**ILT.2630** There are two types of non-harmonic, non-line related spurious signals (spurs):

- Crossing spurs. These are usually caused by poor shielding, or by interaction between the YO loop phase detector assembly (A5) and the sampler assembly (A6). Another cause is 10 MHz or a harmonic of 10 MHz getting into the sampler assembly. Check shielding, grounds, filtering on the A6 assembly, and cable routing.
- Fixed offset spurs. These are the most common spurs. They appear at a fixed offset from the carrier.

The following table lists the most common offset spurs, the their possible causes.

**Note**

---

If the fault is only in low band, the low band microcircuit (A24) is also a possible cause.

---

Offset from Carrier	Most Likely Fault
60 kHz	Grounds, connections and shielding, A16, A17, A18
120 kHz	A16, A17, A18
20 or 40 kHz	A3, A6 shielding/filtering
125 kHz	A4 API adjustment, shielding, filtering; possibly reference shielding, filtering.
Random Low Frequency	Fan (B1)
10 or 20 MHz	Routing of cables to and from A7.

These problems are very difficult to isolate, and require patience. Often, the quickest and most economical way to isolate a problem is to substitute modules.

After taking action, go to the Troubleshooting Foldout, block 1 (located just prior to the “Special Cases” tab).

### **ILT.2640**

Poor grounds or shielding problems in either the environment or the measurement system can produce what looks like a failure in phase noise measurements. Another common source of phase noise is physical vibration. When you are sure that the measurements accurately reflect a failure, refer to the following graph. Locate the failed frequency on the graph and go to the paragraph shown for that frequency. Note, if your failure is between 100 Hz and 1 kHz, check frequencies above and below the failure. If the frequencies below 100 Hz are failing or are close to failing, go to A7.9000. If the frequencies above 1 kHz are failing or are close to failing, go to A6.9000. In the synthesizer, phase noise is usually concentrated at one of three carrier offsets. Failures of phase noise at these offsets have fairly predictable causes. Before you change a module, check the phase noise measurement system.

## Note

If the fault is only in low band, the low band microcircuit (A24) is also a possible cause (RF.2490).

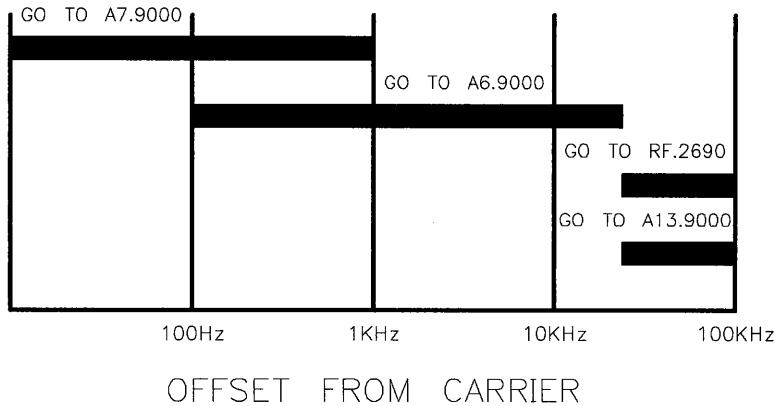

These problems are very difficult to isolate, and require patience. Often, the quickest and most economical way to isolate a problem is to substitute modules.

After taking action go to the Troubleshooting Foldout, block 1 (located just prior to the "Special Cases" tab).

## ILT.2650

Perform a full user calibration:

1. Press **USER CAL**.
2. Select **FullUsr Cal**.

If the problem still exists, continue. In general, troubleshoot harmonics using the block diagram. Go from the RF OUTPUT (J1) to each of the active RF devices (A24, A26, A28, A29, A33, A38, A42, for models with Option 006, and A32, for models capable of >26.5 GHz). Use the ALC menus to help control the level during a measurement. Pay attention to the bands in which the

problem appears. Use the table below to help isolate the problem.

Failing Data Points	Most Likely Causes
$\leq$ 2 GHz only	Low band microcircuit (A24)
> 26.5 GHz (HP 83640B/50B and HP 83640L/50L)	Amp/Doubler (A32)
All Other Cases	YO (A26); amp/multiplier (A28); amp/filter (A29); amp/switch (A33); dual modulator (A38); and pulse mod switched filter (A42)

After taking action, go to the Troubleshooting Foldout, block 1 (located just prior to the “Special Cases” tab).

### ILT.2660

The most likely cause is the YO driver assembly (go to A13.9000), the next possibility is YO assembly (go to RF.2690).

After taking action, go to the troubleshooting foldout, block 1 (located just prior to the “Special Cases” tab).

### ILT.2670

The most likely faults are listed below:

1. The most likely fault is the measurement setup. Check the setup.
2. Check the calibration constants listed in the *HP 8360 B-Series Swept Signal Generator/ HP 8360 L-Series Swept CW Generator Service Guide*. Pay special attention to the following calibration constants:
  - a. Lock dwell time.
  - b. Max phase lock wait.
3. If an unlock message appears, press **PRESET** **SERVICE** **Unlock Info**. The following is a prioritized list. Find the first one that applies.
  - a. REF UNLOCK: go to A7.9000.
  - b. SAMPLER UNLOCK: go to A6.9000.

- c. FRACN UNLOCK: go to A4.9000.
  - d. YO UNLOCK: consider the following, in the order listed.
    - i. A6: go to A6.9000.
    - ii. A5: go to A5.9000.
    - iii. A13: go to A13.9000.
    - iv. A26: go to RF.2690.
  - e. HET UNLOCK: go to RF.2490.
4. The microprocessor may cause the fault, go to A15.9000.

If these alternatives do not fix the problem, use the instrument block diagram (located behind the “Troubleshooting Block Diagrams” tab) to troubleshoot this problem.

**ILT.2680**

If the problem occurs only at < 2 GHz, it is most likely the low band (A24). Go to RF. 2490. Otherwise, the following table shows the three basic types of pulse problems and their most likely causes:

Failure Mode	Most Likely Fault
Rise and Fall Time	Amp/Filter (RF.2990) or, for Opt. 006, pulse mod switched filter (RF.4290)
Leveling	Pulse (A9.9000); or ALC (A10.9000)
On/Off Ratio	Dual/modulator (RF.3890) or, for Opt. 006, pulse mod switched filter (RF.4290); Amp/multiplier (RF.2890); YO (RF.2690); or poor connections

If these alternatives do not fix the problem, use the instrument block diagram (located behind the “Troubleshooting Block Diagrams” tab) to troubleshoot this problem.



**ILT.2690**

The most likely fault is the YO (A26). However, first check the following items before going to RF.2690 to replace the A26 assembly:

1. If the performance test fails at modulation rates of about 100 kHz in AC FM, do the "YO Loop Gain" adjustment.
2. If the performance test fails only in DC FM, the YO driver (A13) may be at fault.
3. Go to ILT.2101 to check the FM driver (A11). If this test fails then replace A11.
4. Go to ILT.2141 to check the modulation generator (A8) if Option 002 is installed. If this test fails then replace A8.

**ILT.2695**

The diagnostics already performed are probably more accurate than the remaining procedures. These procedures may not be able to identify the failed assembly. This is particularly true when a specification has only marginally failed. Before continuing, verify all RF cable connections on the RF deck. If no problems are found, go to ILT.2240.

## ILT.3000

Select the first faulty I/O port listed below.

<b>Failing Input or Output</b>	<b>Go to Paragraph</b>
Display Output	ILT.3010
Keyboard Input	ILT.3020
RF Output	ILT.2240
AM Input	ILT.3030
AM Input, Opt. 002 installed	ILT.3230
FM Input	ILT.3040
FM Input, Opt. 002 installed	ILT.3240
Pulse Input,Output	ILT.3050
Pulse Input,Output, Opt. 002 installed	ILT.3250
External ALC Input	ILT.3062
Rear Panel Source Module Interface	ILT.3070
Front Panel Source Module Interface	ILT.3080
HP-IB Input,Output	ILT.3090
10 MHz Ref Input	ILT.3100
10 MHz Ref Output	ILT.3110
Trigger Input	ILT.3120
Sweep Output	ILT.3200
V/GHz Output	ILT.3300
Stop Sweep Input, Output	ILT.3400
Z-Axis Blanking, Markers Output	ILT.3500
Trigger Output	ILT.3600
Auxiliary Interface	ILT.3700
Rear Panel HP-IB Address Switches	ILT.3800
Pulse Video Output	ILT.3900
Pulse Sync Output	ILT. 3910
AM/FM Output	ILT.3920
AUX OUTPUT	ILT.3930

**ILT.3010**

If the display is dim and flickering, check the dim display option: Press SYSTEM (MENU), and select Dim Display. Repeatedly select Dim Display to toggle this attribute.

Does the problem remain when you toggle Dim Display?

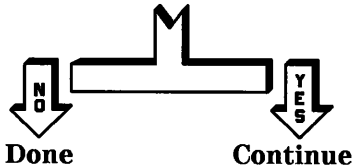
**ILT.3011**

The remaining display problems are most likely one of the following:

- Cosmetic fault. The display appearance is fuzzy, varies in brightness from segment to segment, or another superficial characteristic is questionable. Replace the display (go to A21.9000).
- The display takes a long time to update, and UNLOCK flashes in the display.

Press (PRESET) (SERVICE) and select Unlock Info. The following is a prioritized list. Find the first one that applies.

1. REF UNLOCK: go to A7.9000.
  2. SAMPLER UNLOCK: go to A6.9000.
  3. FRACN UNLOCK: go to A4.9000.
  4. YO UNLOCK: consider the following, in the order listed:
    - a. A6: go to A6.9000.
    - b. A5: go to A5.9000.
    - c. A13: go to A13.9000.
    - d. A26: go to RF.2690.
  5. HET UNLOCK: go to RF.2490.
- If the display updates slowly, examine (and modify, if required) calibration constant #554 using the following procedure:

Press (PRESET) (SERVICE).

Select **Adjust Menu** **Calib Menu** **Select Cal**.  
Press **554** **ENTER**.

Calibration constant #554 should be set to 245. If it is not, continue with the following:

Select **Modify Cal**.

Press **245** **ENTER**.

Select **Cal Util Menu** **Save Cal** **yes**.

- The display has an intermittent fault such as going blank, or unintelligible characters displayed. Possible failures include the following:
  1. Display (A21).
  2. Front panel processor (A3).
  3. Cables (W1, W3, W4).

If these alternatives do not fix the problem, use the instrument block diagram (located behind the “Troubleshooting Block Diagrams” tab) to troubleshoot this problem.

## ILT.3020

Keyboard problems are most likely one of the following:

- The display takes a long time to update, and UNLOCK flashes in the display Press **PRESET** **SERVICE** and select **Unlock Info**. The following is a prioritized list. Find the first one that applies.
    1. REF UNLOCK: go to A7.9000.
    2. SAMPLER UNLOCK: go to A6.9000.
    3. FRACN UNLOCK: go to A4.9000.
    4. YO UNLOCK: consider the following, in this order:
      - a. A6: go to A6.9000.
      - b. A5: go to A5.9000.
      - c. A13: go to A13.9000.
      - d. A26: go to RF.2690.
    5. HET UNLOCK: go to RF.2490.
  - Cosmetic fault. The appearance, or another superficial characteristic, is questionable. Replace the keyboard (go to A1.9000).
  - The keyboard has an intermittent fault. Possible failures include the following:
    1. Keyboard (A1).
    2. Front panel processor (A3).
    3. Cables (W3, W5).
  - If the display updates slowly, examine (and modify, if required) calibration constant #554 using the following procedure:

Press **PRESET** **SERVICE**.

Select **Adjust Menu** **Calib Menu** **Select Cal**.

Press **554** **ENTER**.

Calibration constant #554 should be set to 245. If it is not, continue with the following:

Select **Modify Cal**.

Press **245** **ENTER**.

Select **Cal Util Menu** **Save Cal** **yes**.
- If these alternatives do not fix the problem, use the instrument block diagram (behind the “Troubleshooting Block Diagrams” tab) to troubleshoot this problem.

- ILT.3030** Check the continuity between front/rear panel AM input and the end of W7 (connects to A10J1).

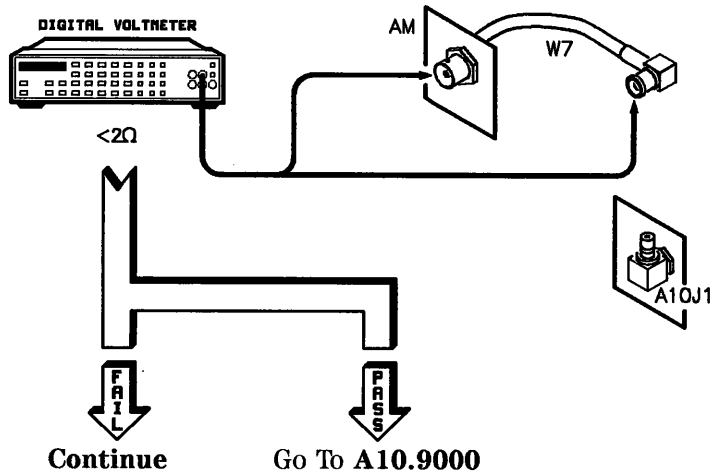

- ILT.3031** Replace the cable (W7) connecting the front/rear panel AM input to A10J1, and go to the Troubleshooting Foldout, block 1 (located just prior to the "Special Cases" tab).

- ILT.3040** Check the continuity from the front/rear panel to the end of W8 (connects to A11J1).

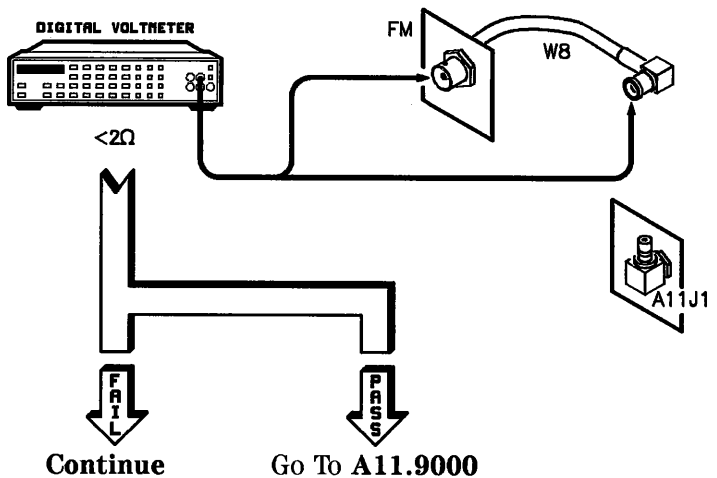

**ILT.3041** Replace the cable (W8) that connects the front/rear panel FM input to A11J1, and go to the Troubleshooting Foldout, block 1 (located just prior to the “Special Cases” tab).

**ILT.3050** Check the continuity from the front/rear panel pulse input and the end of W6 (connects to A9J4).

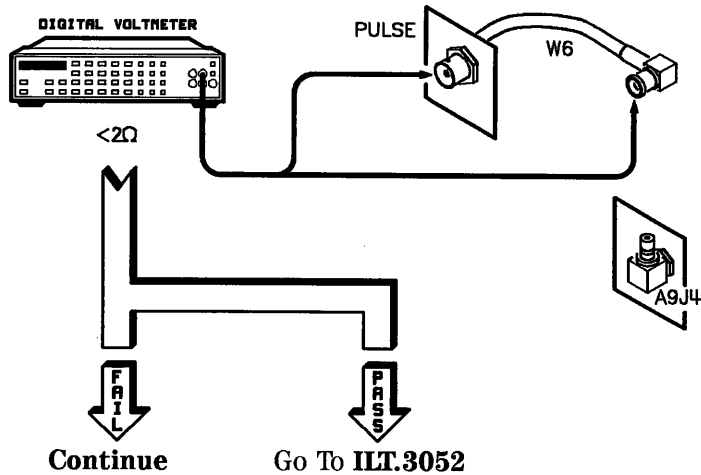

**ILT.3051** Replace the cable (W6) that connects the front/rear panel pulse input to A9J4 and go to the Troubleshooting Foldout, block 1 (located just prior to the “Special Cases” tab).

**ILT.3052** Does the pulse problem exist *only* below 2 GHz?

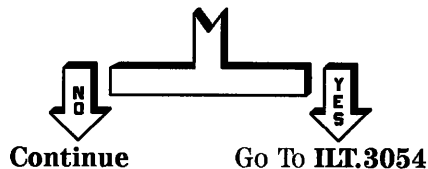

**ILT.3053** Does the pulse problem exist *only* above 2 GHz?



Go To **A9.9000**      Go To **ILT.3057**

**ILT.3054** Perform the following key sequence:

1. Press **PRESET** **SERVICE**.
2. Select **Selftest Menu**.
3. Press **108** **ENTER**.
4. Select **Log** (asterisk on).
5. Select **Output Menu** **When to Log Always**.
6. Press **PRIOR**.
7. Select **Do Test #108**.
8. Select **Cont** **Cont**.

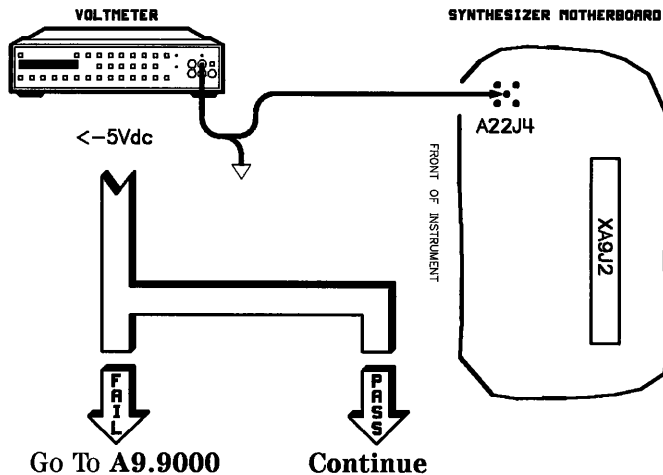



## ILT.3055

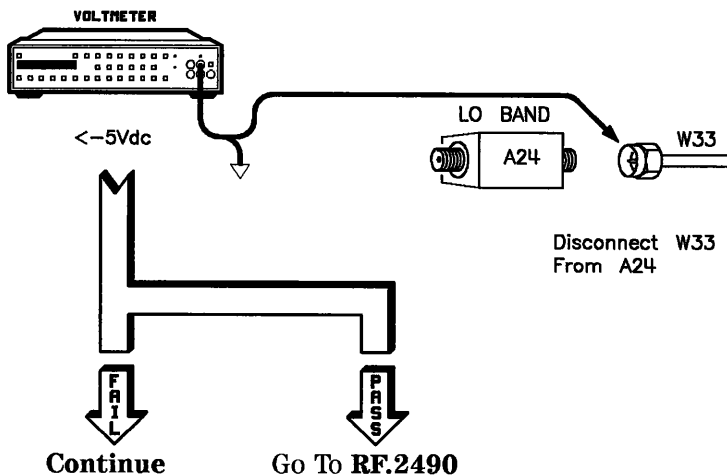

**ILT.3056** Replace W33 and then go to the Troubleshooting Foldout, block 1 (located just prior to the "Special Cases" tab).

**ILT.3057** Perform the following key sequence:

1. Press **PRESET** **SERVICE**.
2. Select **Selftest Menu**.
3. Press **108** **ENTER**.
4. Select **Log** (asterisk on).
5. Select **Output Menu** **When to Log Always**.
6. Press **PRIOR**.
7. Select **Do Test #108**.
8. Select **Cont** until HB Mod OFF [mV] is displayed.

Make the following measurements.

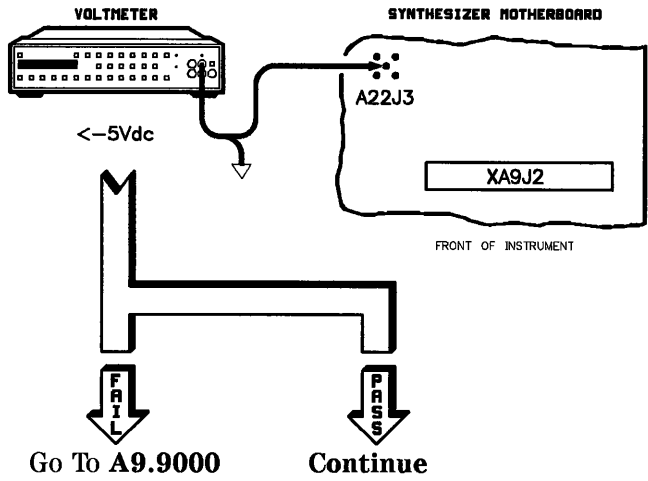

**ILT.3058** Is Option 006 installed?

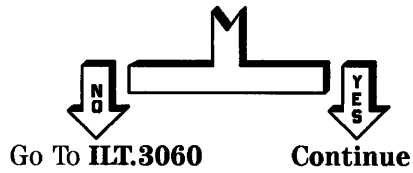

### ILT.3059

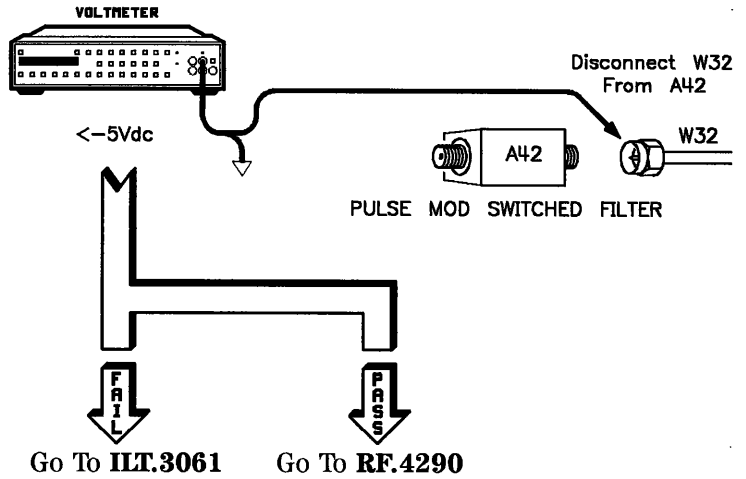

### ILT.3060

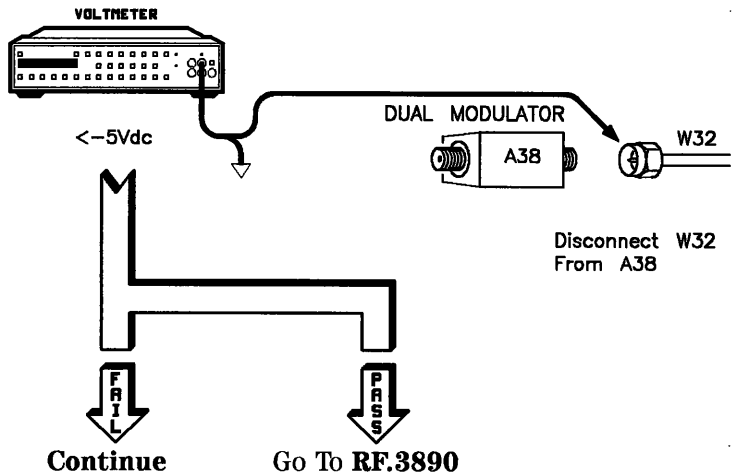

**ILT.3061** Replace W32 and then go to the Troubleshooting Foldout, block 1 (located just prior to the “Special Cases” tab).

**ILT.3062** Check the continuity from the front panel external ALC input (rear panel for option 004) to the end of W9 (connects to A10J4).

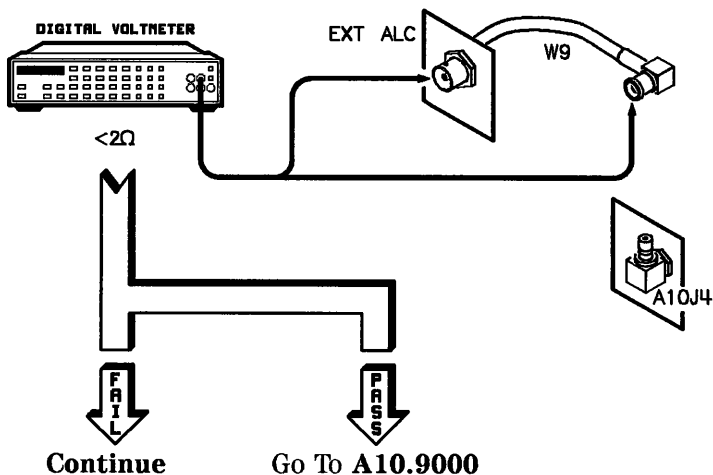

**ILT.3063** Replace the cable (W9) that connects the front panel external ALC input to A10J4, and go to the Troubleshooting Foldout, block 1 (located just prior to the “Special Cases” tab).

**ILT.3070** Using either an oscilloscope or a voltmeter, check the following voltages at the front panel SMI connector.

Location	Measurement
Pin 7	+ 5.2 Vdc
Pin 5	+ 15.0 Vdc
Pin 10, 18, 19, 20	TTL High

Did all voltages pass?

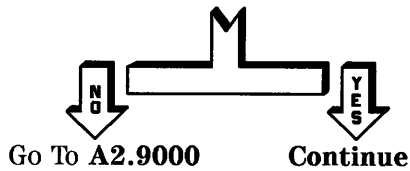

### ILT.3071

Perform the following setup:

1. Press **PRESET**.
2. Press **SWEEP TIME** **10.0** **SEC**.

Using either an oscilloscope or a voltmeter, check the following voltages on the front panel SMI connector. Note that pin 12 is a sweep ramp. To adjust the sweep ramp, change the instrument sweep time (if you use an oscilloscope, try a sweep time of approximately 100 ms).

Location	Measurement
Pin 15	-15 Vdc
Pin 6	+8.0 Vdc
Pin 12	Sweep Ramp (0 to 10.0 V)

Did all voltages pass?

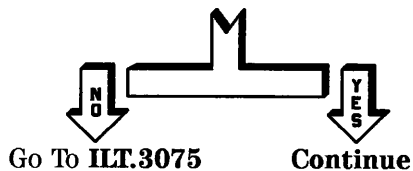

**ILT.3072** Measure on the center pin at each end of the cable.

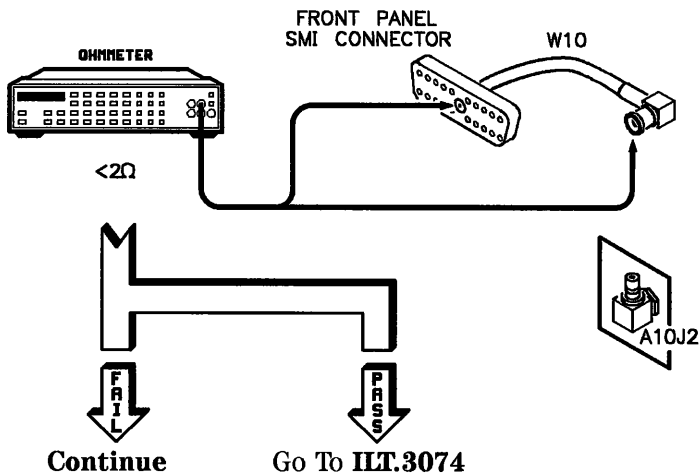

**ILT.3073** Replace the cable (W10) that connects the front panel SMI input to the A10 assembly, and go to the Troubleshooting Foldout, block 1 (located just prior to the “Special Cases” tab).

**ILT.3074** Although the problem has not been isolated, the following are possible:

- The front panel SMI (A2) is faulty.
- W2 is faulty (connects A2 to the motherboard).
- The ALC assembly (A10) is faulty. This is true if leveling is the problem.
- The source module used with the synthesizer is faulty. To confirm this, either use the rear panel SMI, or substitute a new source module or synthesizer.
- A remote possibility exists that the motherboard (A22) is faulty.

If these alternatives do not fix the problem, use the instrument block diagram (located behind the “Troubleshooting Block Diagrams” tab) to troubleshoot this problem.

**ILT.3075** Either the front panel SMI (A2) or the ribbon cable (W10) is faulty. Inspect the ribbon cable. Replace the A2 assembly or W10, as required, and go to the Troubleshooting Foldout, block 1 (located just prior to the “Special Cases” tab).

**ILT.3080** Using either an oscilloscope or a voltmeter, check the following voltages at the rear panel SMI connector.

Location	Measurement
Pin 7	+ 5.2 Vdc
Pin 5	+ 15.0 Vdc
Pin 10, 18, 19, 20	TTL High

Did all voltages pass?



Go To **A19.9000**

**Continue**

**ILT.3081** Perform the following setup:

1. Press **PRESET**.
2. Press **SWEEP TIME** **10** **SEC**.

Using an oscilloscope or a voltmeter, check the following voltages on the rear panel SMI connector. Note that pin 12 is a sweep ramp. To change the sweep ramp, change the sweep time (using an oscilloscope, try a sweep time of approximately 100 ms).

Location	Measurement
Pin 15	-15 Vdc
Pin 6	+8.0 Vdc
Pin 12	Sweep Ramp (0 to 10 V)

Did all voltages pass?

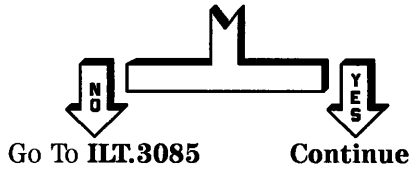

**ILT.3082** Measure at the center pin at each end of the cable.

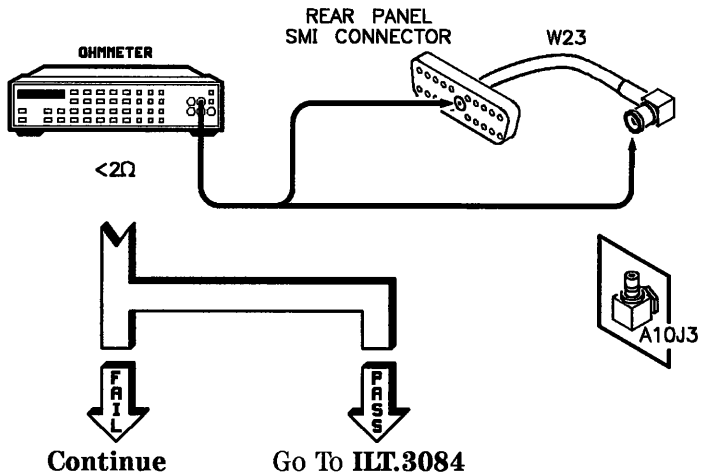

**ILT.3083** Replace the cable (W23) that connects the rear panel SMI input to the A10 assembly, and go to the Troubleshooting Foldout, block 1 (located just prior to the "Special Cases" tab).



**ILT.3084** The problem is not isolated, but the following are possible failures:

- The rear panel SMI (A19) is faulty.
- W31 is faulty (connects A19 to the motherboard).
- The ALC assembly (A10) is faulty. This is true if leveling is the problem.
- The source module used with the synthesizer is faulty. To confirm this, try to use the front panel SMI, or substitute either a new source module or synthesizer.
- A remote possibility exists that the motherboard (A22) is faulty.

If these alternatives do not fix the problem, use the instrument block diagram (located behind the “Troubleshooting Block Diagrams” tab) to troubleshoot this problem.

**ILT.3085** Either the rear panel SMI (A19) or the ribbon cable (W23) is faulty. Inspect the ribbon cable. Replace the A19 assembly or W23, and go to the Troubleshooting Foldout, block 1 (located just prior to the “Special Cases” tab).

**ILT.3090** HP-IB problems involve a ribbon cable and one of three assemblies. The assemblies are listed below from most to least likely to fail. First, run the HP-IB port self-test that follows. If this self-test fails, the CPU assembly (A15) is the most likely failure. If this test passes, change the assemblies in the order listed.

1. Ensure that nothing is connected to the HP-IB connector.
2. Press **PRESET** **SERVICE**.
3. Select **SelfTest Menu**.
4. Press **236** **ENTER**.
5. Select **Do Test #236**.

Most likely failures:

1. An excessive length of HP-IB cable. (The specification for length of HP-IB cable is no more than 2 meters per

instrument and a maximum of 20 meters. Exceeding this length may lock up the data bus.)

2. The rear panel SMI (A19).
3. The CPU assembly (A15).
4. The ribbon cable W23 (connects A19 to motherboard).
5. There is a remote possibility of a motherboard (A22) fault.

If these alternatives do not fix the problem, consult "Special Cases" to troubleshoot this problem.

**ILT.3100** Check the continuity from the rear panel 10 MHz input to the end of W16 (connects to A7J1).

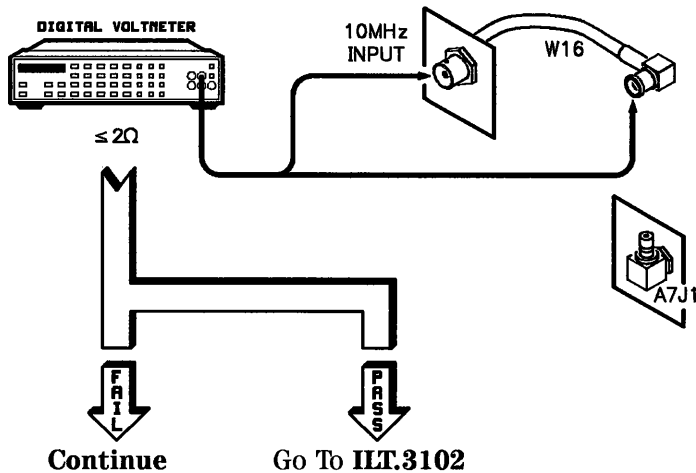

**ILT.3101** Replace W16 and go to the Troubleshooting Foldout, block 1 (located just prior to the "Special Cases" tab).

### ILT.3102

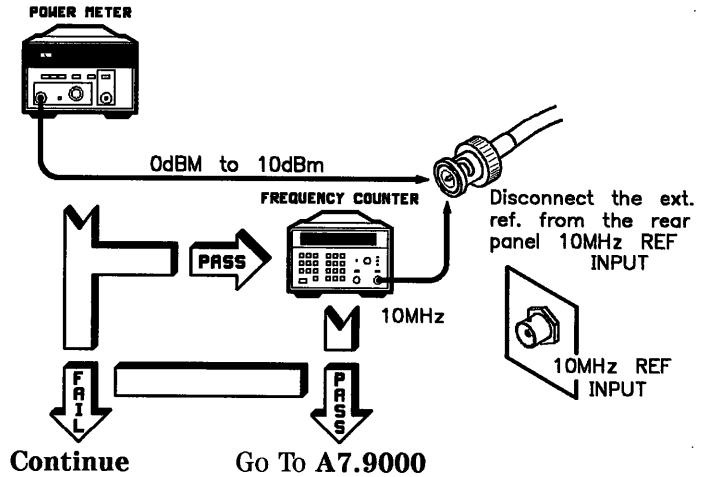

### ILT.3103

Correct the reference into the rear panel. If a problem still exists, refer to the instrument block diagram (located behind the "Troubleshooting Block Diagrams" tab) to troubleshoot this problem.

### ILT.3110

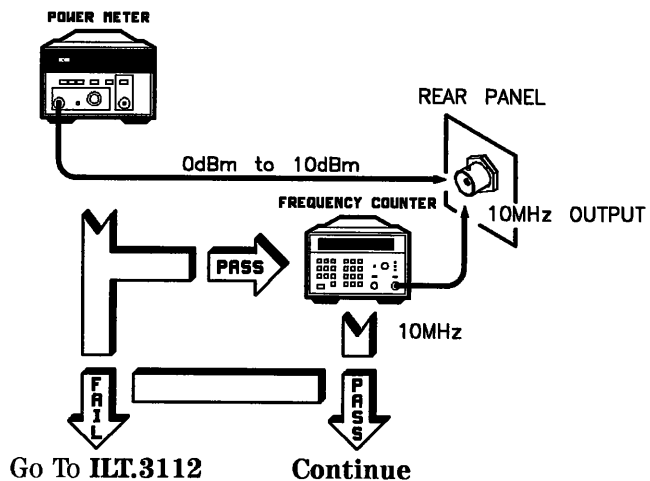

**ILT.3111** There does not seem to be a failure. The rear panel output should be 10 MHz at approximately 0 dBm. If a problem still exists, refer to the instrument block diagram (located behind the “Troubleshooting Block Diagrams” tab) to troubleshoot this problem.

**ILT.3112**

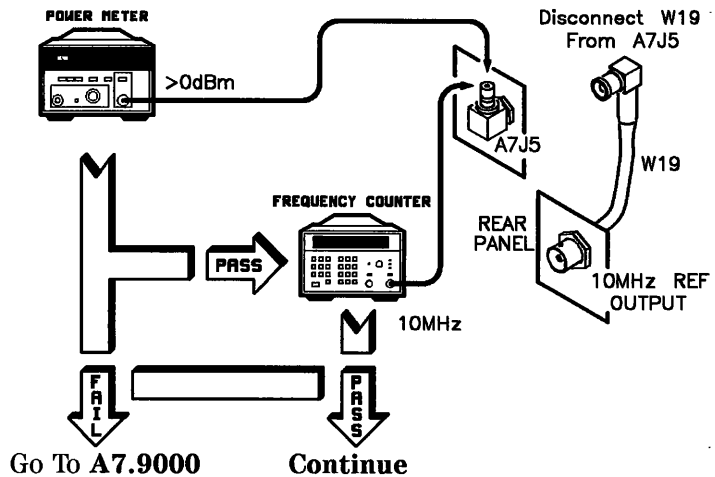

**ILT.3113** Replace W19, the coaxial cable that connects A7J5 to the rear panel, and go to the Troubleshooting Foldout, block 1 (located just prior to the “Special Cases” tab).

**ILT.3120**

Before continuing, be sure that auto sweep operates correctly. If it does not, restart troubleshooting at ILT.000.

Measure the resistance between the TRIGGER INPUT and XA15J1-61.

Is the resistance  $\geq 90$  and  $\leq 110 \Omega$ ?

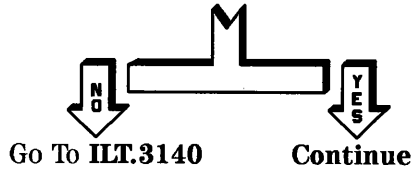
**ILT.3121**

Perform the following setup:

1. Press **PRESET** SWEEP **MENU**.
2. Select **Start Sweep Trigger Ext.**
3. Press **SWEEP TIME** **5** **SEC**.

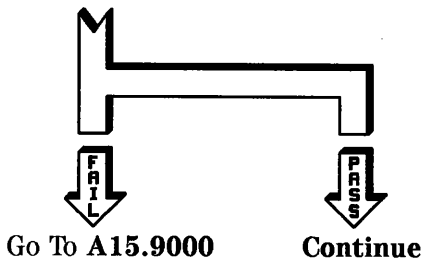
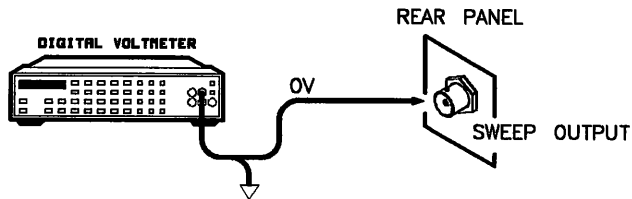

**ILT.3122** Is the front panel SWEEP indicator flashing and do you have a front panel?

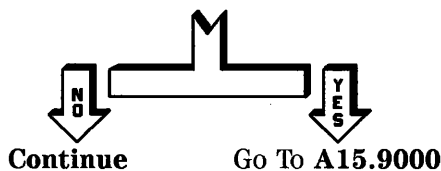

**ILT.3123** Perform the following setup:

- Connect a function generator to the rear panel trigger input.
- Set the function generator for a 10 Hz, TTL square wave.
- Observe the SWEEP OUTPUT on the rear panel.

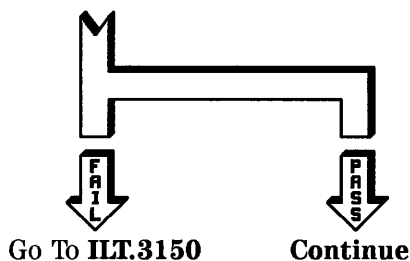
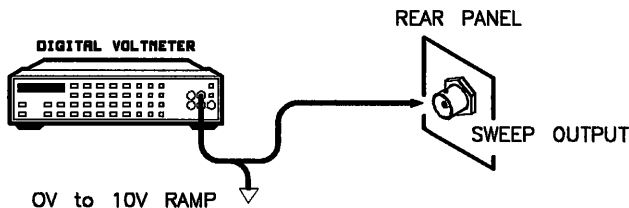

**ILT.3124** Does your instrument have a front panel with a display and is the front panel SWEEP indicator flashing?

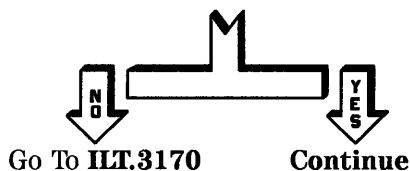

**ILT.3125** The trigger and sweep outputs seem to be working. If an undetected failure exists, look at the instrument block diagram (located behind the “Troubleshooting Block Diagrams” tab). The assemblies most intimately tied to the trigger input and sweep output are the sweep generator assembly (A14) and the CPU assembly (A15).

**ILT.3140** Measure the resistance between A22J8-41 and XA15J1-61.

Is the resistance  $> 2 \Omega$ ?

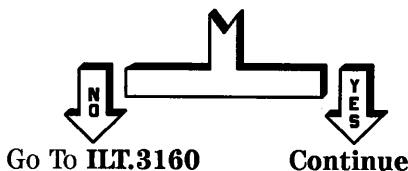

**ILT.3141** There is an open on the motherboard between A22J8-41 and XA15J1-61. Verify this with an ohmmeter. Is jumpering an acceptable repair?

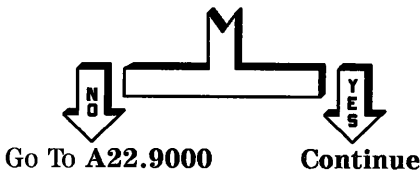

**ILT.3142** Install a jumper and go to the Troubleshooting Foldout, block 1 (located just prior to the “Special Cases” tab).

**ILT.3150** Measure the resistance between SWEEP OUTPUT and XA14J2-4.

Is the resistance 90 to 110  $\Omega$ ?

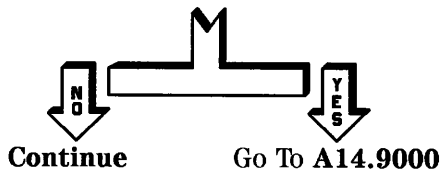

- ILT.3151** Measure the resistance between A22J8-31 and XA14J2-4.  
Is the resistance  $> 2 \Omega$ ?

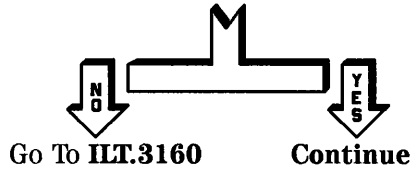

- ILT.3152** There is an open on the motherboard between A22J8-31 and XA14J2-4. Verify this with an ohmmeter. Is jumpering an acceptable repair?

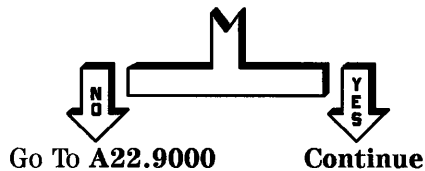

- ILT.3153** Install a jumper and go to the Troubleshooting Foldout, block 1 (located just prior to the "Special Cases" tab).

- ILT.3160** A fault exists in either the rear panel SMI (A19) or the ribbon cable W31. Inspect W31. Replace the rear panel SMI (A19) or W31, and go to the Troubleshooting Foldout, block 1 (located just prior to the "Special Cases" tab).



### ILT.3170

Perform the following setup:

1. Press **PRESET** **START** **5** **GHz**.
2. Press **STOP** **7** **GHz**.
3. Press **SWEEP TIME** **5** **SEC**.
4. Press **SINGLE**.
5. To make the measurement repeatedly, press **SINGLE**.  
A TTL should be present that goes low for about 5 seconds, then high, each time you press **SINGLE**.

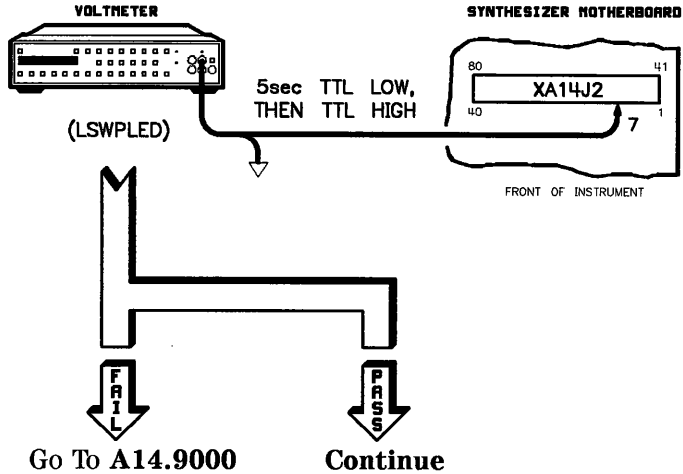

**ILT.3171** Repeatedly press **(SINGLE)**. You should see a 5 second TTL low.

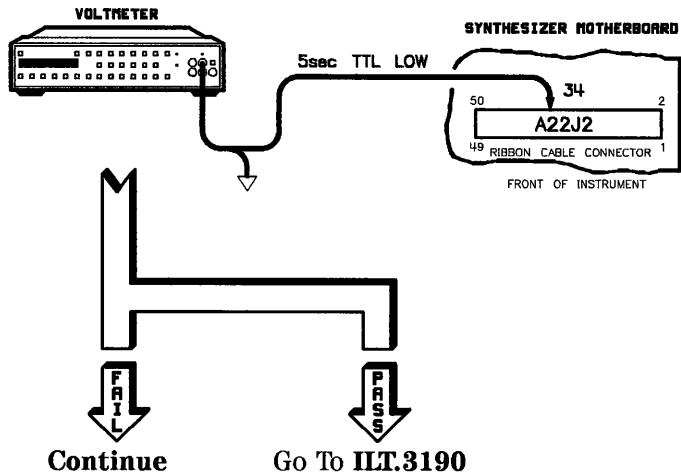

**ILT.3180** There is an open on the motherboard between XA14J2-7 and A22J2-34. Verify this with an ohmmeter. Is jumpering an acceptable repair?

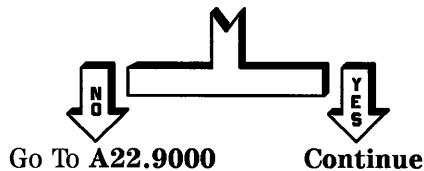

**ILT.3181** Install a jumper and go to the Troubleshooting Foldout, block 1 (located just prior to the "Special Cases" tab).

**ILT.3190** There is a fault associated with the front panel processor assembly (A3), keyboard (A1), or the interconnecting cables W3 (motherboard to A3) or W5 (A3 to A1). Either check the ribbon cables, replace the appropriate assemblies, or both. If these alternatives do not fix the problem, use the instrument block diagram (located at the end of "Special Cases") to troubleshoot this problem.

**ILT.3200** Perform the following setup:

1. Press **PRESET** **START** **5** **GHz**.
2. Press **STOP** **7** **GHz**.
3. Press **SWEEP TIME** **100** **msec**.

You should see a 100 ms, 0.0 to 10.0 V ramp.

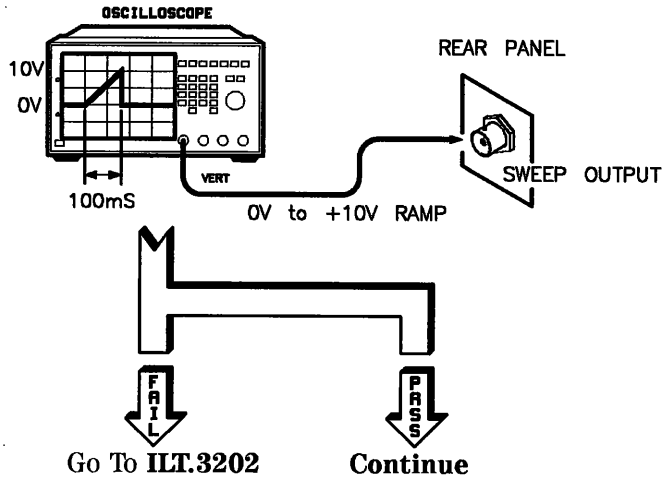

**ILT.3201**

Nothing seems to fail. If an intermittent or non-linear sweep output failure exists, the most likely failure is the sweep generator assembly (A14). Less likely failures are the rear panel SMI (A19), and the ribbon cable (W31). If these alternatives do not fix the problem, use the instrument block diagram (located at the end of "Special Cases") to troubleshoot this problem.

### ILT.3202

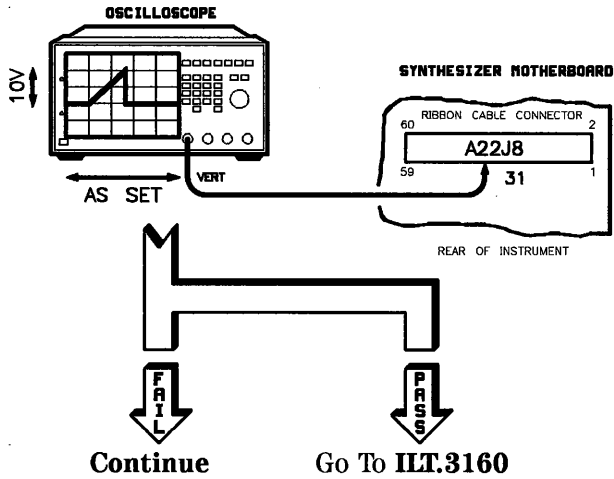

### ILT.3203

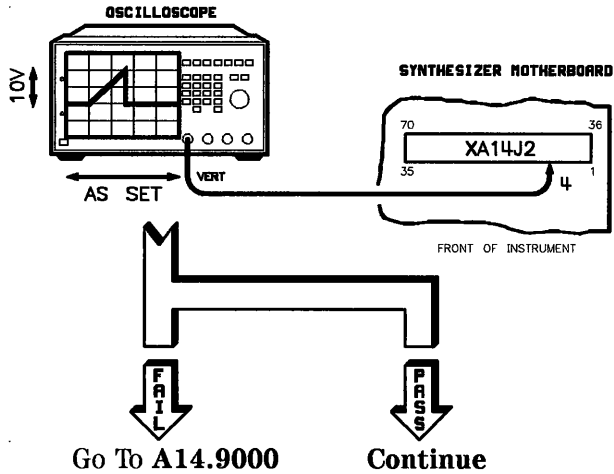

- ILT.3204** There is an open on the motherboard between XA14J2-4 and A22J8-31. Verify this with an ohmmeter. Is jumpering an acceptable repair?

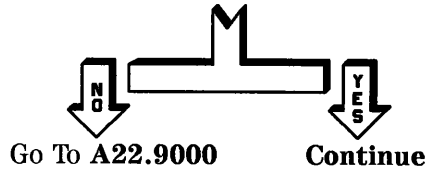

- ILT.3205** Install a jumper and go to the Troubleshooting Foldout, block 1 (located just prior to the "Special Cases" tab).

- ILT.3230** Check the continuity from the front (or rear) panel AM input to the end of W7 (which connects to A8J7).

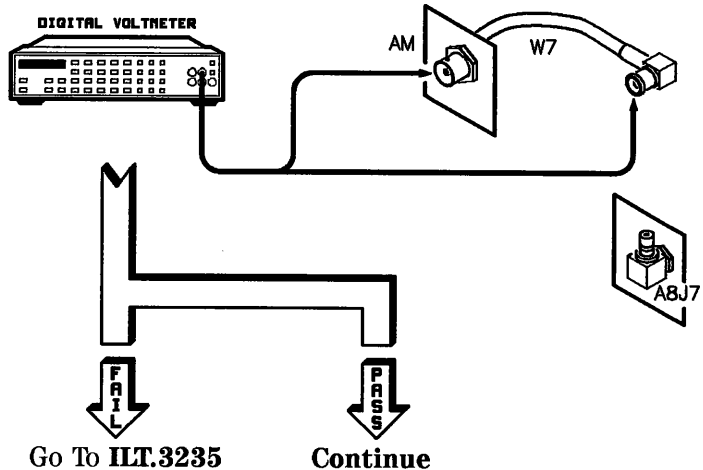

**ILT.3231** Perform the following setup:

1. Reconnect all cables.
2. Set the power switch to standby.
3. Disconnect W67 from A10J1.
4. Connect an oscilloscope to the disconnected end of W67.
5. Connect a function generator to the AM input on the front (or rear) panel.
6. Turn on synthesizer power.
7. Set the function generator for a 0.25 V rms sine wave at 1.0 MHz.
8. Press **PRESET**.
9. Press **MOD** **AM Menu** **AM On/Off Ext** (asterisk on).

The oscilloscope should display the same signal as the function generator, a sine wave approximately 0.25 V rms (.707 V p-p) at 1.0 MHz.

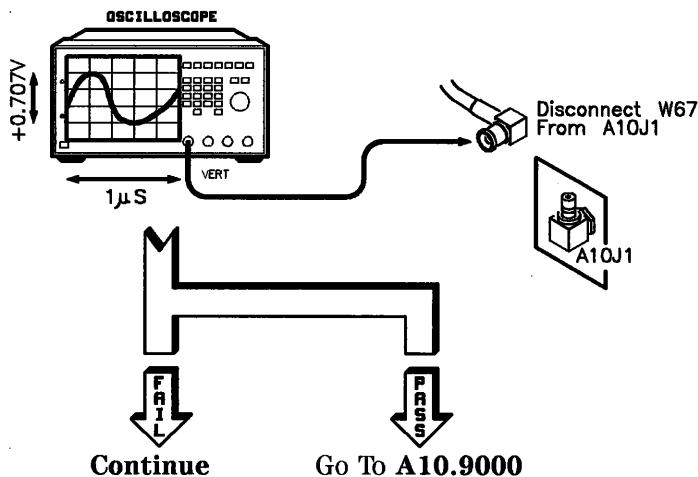

**ILT.3232** Perform the following setup:

1. Reconnect all cables.
2. Set the power switch to standby.
3. Disconnect W67 from A8J8.
4. Connect an oscilloscope to the A8J8 connector.
5. Connect a function generator to the AM input on the front (or rear) panel.
6. Turn on synthesizer power.
7. Set the function generator for a 0.25 V rms sine wave at 1.0 MHz.
8. Press **PRESET**.
9. Press **MOD** **AM Menu** **AM On/Off Ext** (asterisk on).

The oscilloscope should display the same signal as the function generator, a sine wave approximately 0.25 V rms (.707 V p-p) at 1.0 MHz.

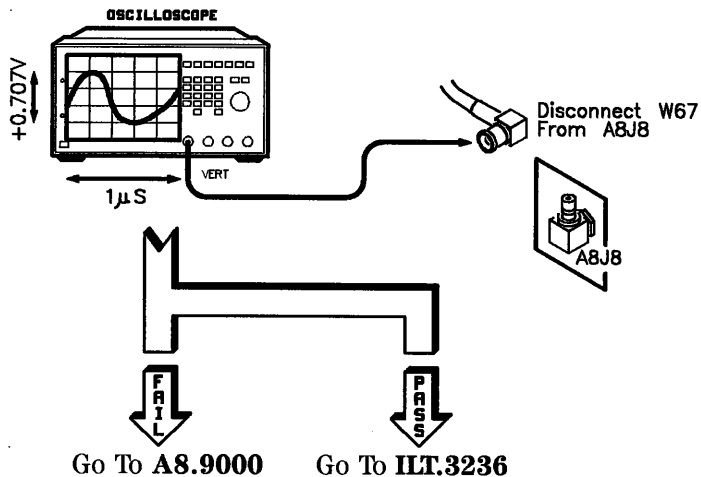

**ILT.3235** Replace W7 (front or rear panel AM input to A8J7) and go to the Troubleshooting Foldout, block 1 (located just prior to the “Special Cases” tab).

**ILT.3236** Replace W67 (cable between A8J8 and A10J1) and go to the Troubleshooting Foldout, block 1 (located just prior to the “Special Cases” tab).

**ILT.3240** Check the continuity from the front (or rear) panel FM input to the end of W8 (which connects to A8J10).

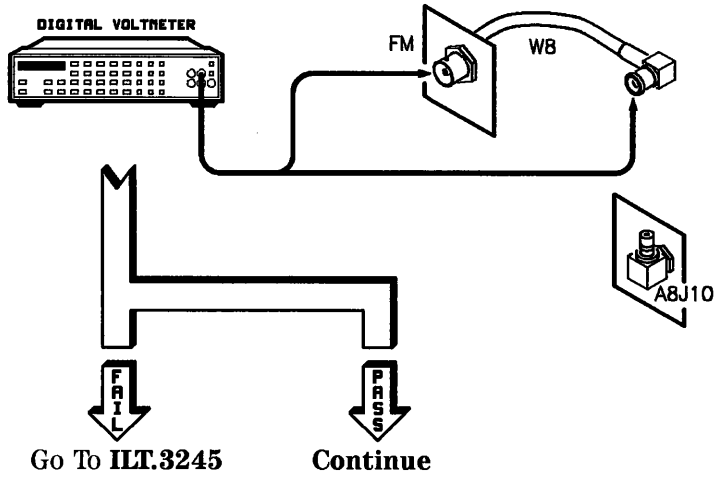



**ILT.3241** Perform the following setup:

1. Reconnect all cables.
2. Set the power switch to standby.
3. Disconnect W68 from A11J1.
4. Connect an oscilloscope to the disconnected end of W68.
5. Connect a function generator to the FM input on the front (or rear) panel.
6. Turn synthesizer power on.
7. Set the function generator for a 0.25 V rms sine wave at 1.0 MHz.
8. Press **PRESET**.
9. Press **MOD** **FM Menu** **FM On/Off Ext** (asterisk on).

The oscilloscope should display the same signal as the function generator, a sine wave approximately 0.25 V rms (.707 V p-p) at 1.0 MHz.

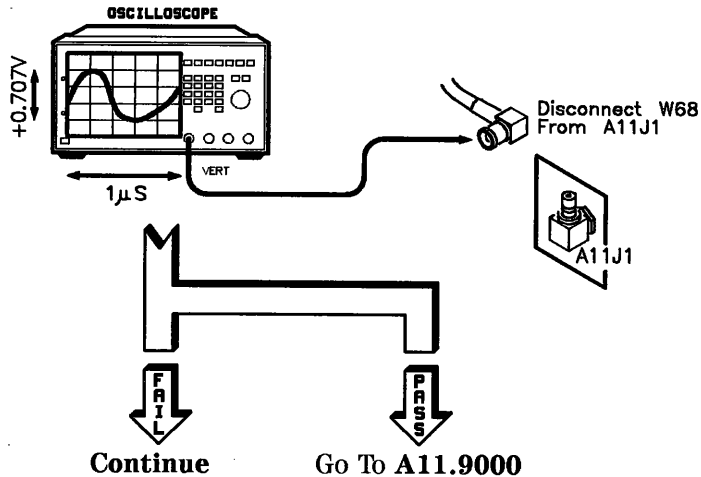

**ILT.3242** Perform the following setup:

1. Reconnect all cables.
2. Set the power switch to standby.
3. Disconnect W68 from A8J9.
4. Connect an oscilloscope to the A8J9 connector.
5. Connect a function generator to the FM input on the front (or rear) panel.
6. Turn on synthesizer power.
7. Set the function generator for a 0.25 V rms sine wave at 1.0 MHz.
8. Press **PRESET**.
9. Press **MOD** **FM Menu** **FM On/Off Ext** (asterisk on).

The oscilloscope should display the same signal as the function generator, a sine wave approximately 0.25 V rms (.707 V p-p) at 1.0 MHz.

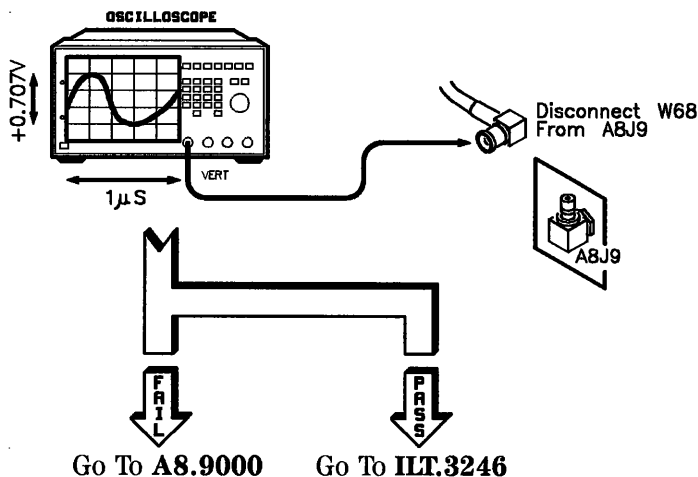

**ILT.3245** Replace W8, front (or rear) panel FM input to A8J10, and go to the Troubleshooting Foldout, block 1 (located just prior to the "Special Cases" tab).

**ILT.3246** Replace W68 (cable between A8J9 to A11J1) and go to the Troubleshooting Foldout, block 1 (located just prior to the "Special Cases" tab).

**ILT.3250** Check the continuity from the front or rear panel PULSE INPUT to the end of W6 (which connects to A8J3).

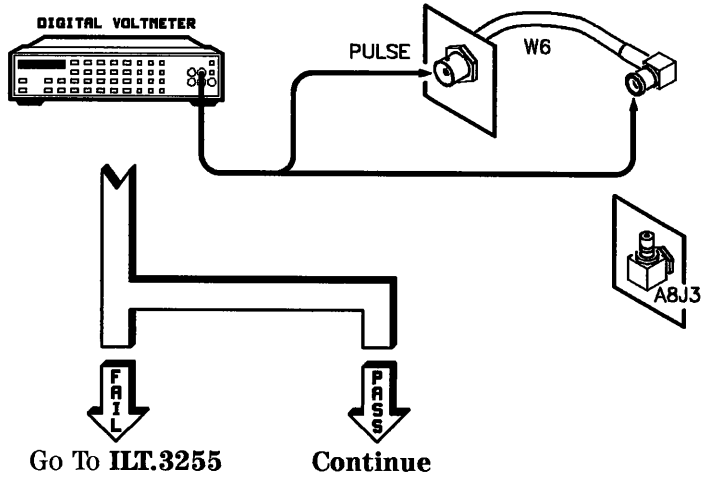

**ILT.3251** Perform the following setup:

1. Reconnect all cables.
2. Set the power switch to standby.
3. Disconnect W66 from A9J3.
4. Connect an oscilloscope to the disconnected end of W66.
5. Connect a function generator to the PULSE INPUT on the front (or rear) panel.
6. Turn on synthesizer power.
7. Set the function generator for a 1.6 V rms square wave at 1.0 MHz.
8. Press **PRESET**.
9. Press **MOD** **Pulse Menu** **Pulse On/Off Ext** (asterisk on).

The oscilloscope should display a TTL signal at 1.0 MHz.

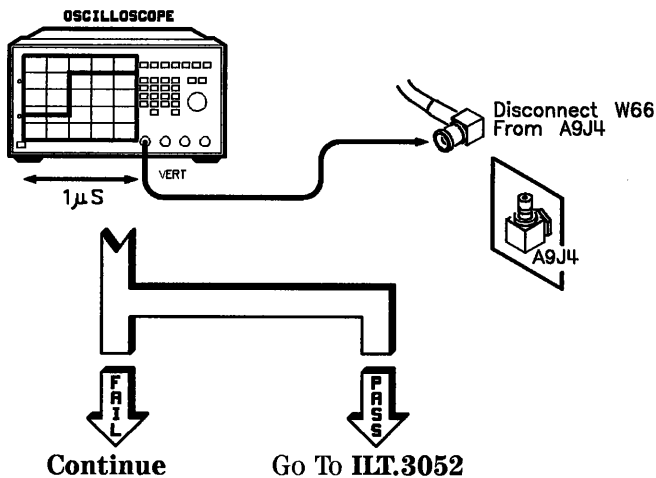

**ILT.3252** Perform the following setup:

1. Reconnect all cables.
2. Set the power switch to standby.
3. Disconnect W66 from A8J5.
4. Connect an oscilloscope to the A8J5 connector.
5. Connect a function generator to the PULSE INPUT on the front (or rear) panel.
6. Turn on synthesizer power.
7. Set the function generator for a 1.6 V rms square wave at 1.0 MHz.
8. Press **PRESET**.
9. Press **MOD** **Pulse Menu** **Pulse On/Off Ext** (asterisk on).

The oscilloscope should display a TTL signal at 1.0 MHz.

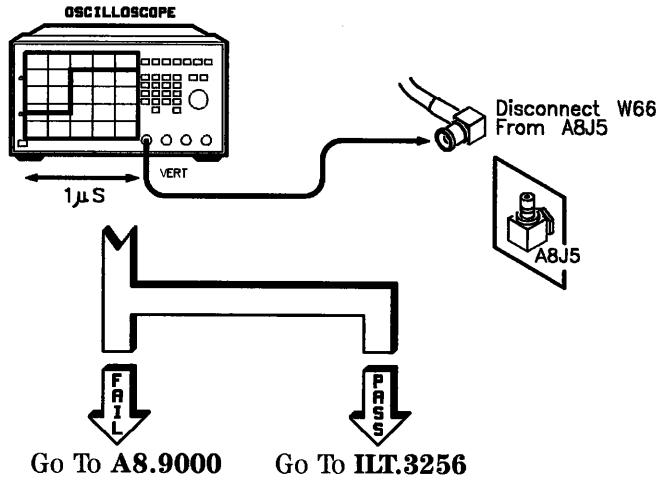

**ILT.3255** Replace W6 (front or rear panel PULSE INPUT to A8J3) and go to the Troubleshooting Foldout, block 1 (located just prior to the “Special Cases” tab).

**ILT.3256** Replace W66 (cable between A8J5 and A9J3) and go to the Troubleshooting Foldout, block 1 (located just prior to the “Special Cases” tab).

**ILT.3300** Turn the power switch to standby and remove the SYTM driver assembly (A12). Inspect the DIP switch on the A12 assembly. The switch should be set as indicated in the table below.

Upper Freq Limit	Switch 1	Switch 2	Switch 3	Switch 4	Switch 5
≤ 15.0 GHz	Closed	Closed	Closed	Closed	Open
15.0 to 30.0 GHz	Open	Open	Closed	Closed	Open
≥ 30.0 GHz	Open	Open	Open	Open	Open

Are any of the switches set incorrectly?

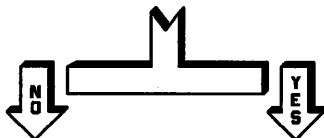

Go To **ILT.3301**

**Continue**

Correct the switch settings, reinstall A12, and go to the Troubleshooting Foldout, block 1 (located just prior to the “Special Cases” tab).

**ILT.3301** Perform the following setup:

1. Press **PRESET** **SWEEP TIME**.
2. Press **5** **SEC**.
3. Observe the Volts/GHz out the rear panel.
4. The scaling of the ramp can be 1, 0.5, or 0.25 V/GHz.  
See the following table.

Upper Frequency Limit (GHz)	Scaling Volts/GHz
$\leq 15$	1.0
15 to 30	0.5
$\geq 30$	0.25

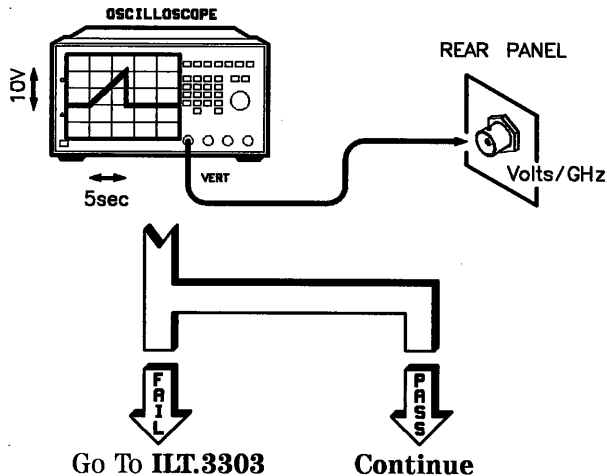

**ILT.3302** Nothing seems to be wrong with the VOLTS/GHz output. If there is an undetected fault, the most likely source is the SYTM driver assembly (A12). If the problem still exists, go to "Special Cases" to troubleshoot this problem.

## ILT.3303

Upper Frequency Limit (GHz)	Scaling Volts/GHz
$\leq 15$	1.0
15 to 30	0.5
$\geq 30$	0.25

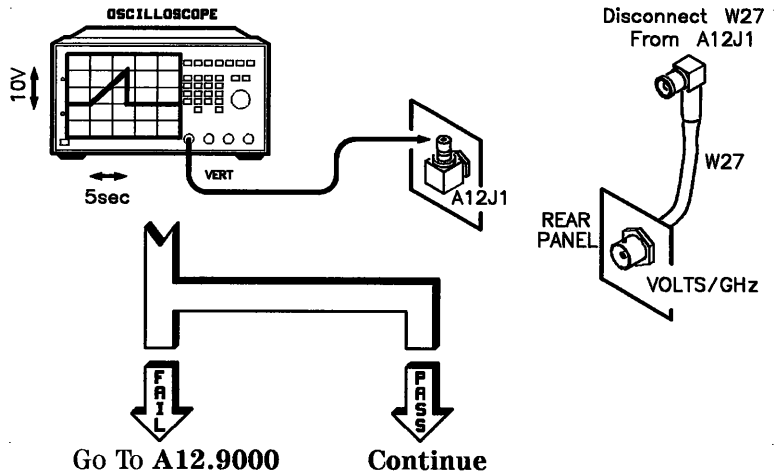

Replace W27 (connects A12 to the rear panel Volts/GHz), and go to the Troubleshooting Foldout, block 1 (located just prior to the "Special Cases" tab).

## ILT.3400

Perform the following setup:

1. Press **PRESET** **SWEEP TIME**.
2. Press **30** **SEC**.

Alternately short to ground and open the rear panel STOP SWEEP IN/OUT center conductor. Observe the SWEEP OUTPUT at the rear panel with a voltmeter; if the instrument has a front panel with a display and keyboard, observe the SWEEP indicator on the front panel. When the center conductor is shorted to ground, the SWEEP OUTPUT should stop sweeping and the front panel SWEEP indicator should be off; when the center



conductor is not shorted to ground, the output should sweep, and the indicator should be on (or blinking).

Does the STOP SWEEP IN/OUT properly control the rear panel SWEEP OUTPUT and the front panel SWEEP indicator?

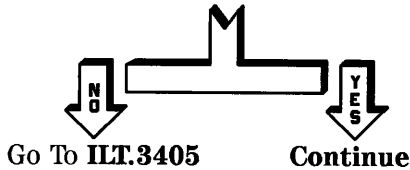

### ILT.3401

Press **SWEEP TIME** **2** **SEC**. You should see a TTL high with a short TTL low every 2 to 3 seconds.

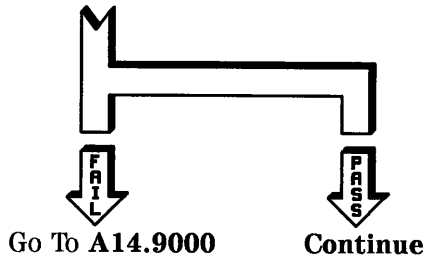
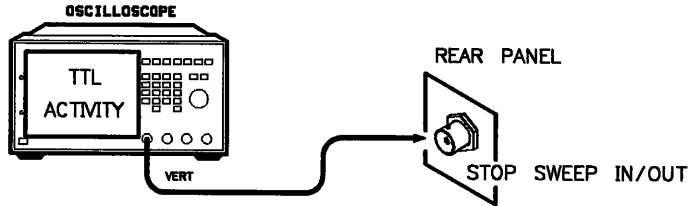

### ILT.3402

The rear panel STOP SWEEP IN/OUT seems to be working properly. If an undetected problem exists, consider replacing the sweep generator assembly (A14.9000). Otherwise, use the instrument block diagram (located at the end of "Special Cases") to troubleshoot this problem.

**ILT.3405**

Identify XA14J2-36. Alternately short to ground and open the XA14J2-36. Observe the SWEEP OUTPUT at the rear panel with a voltmeter; if the instrument has a front panel with a display and keyboard, observe the SWEEP indicator on the front panel. When the pin is shorted to ground, the SWEEP OUTPUT should stop sweeping and the front panel SWEEP indicator should be off; when the pin is not shorted to ground, the output should sweep, and the indicator should be on (or blinking).

Does XA14J2-36 properly control the front panel SWEEP indicator?

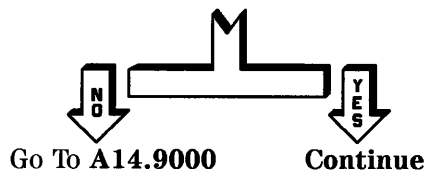
**ILT.3406**

Identify A22J8-35. Alternately short to ground and open A22J8-35. Observe the SWEEP OUTPUT at the rear panel with a voltmeter; if the instrument has a front panel with a display and keyboard, observe the SWEEP indicator on the front panel. When the pin is shorted to ground, the SWEEP OUTPUT should stop sweeping and the front panel SWEEP indicator should be off; when the pin is not shorted to ground, the output should sweep, and the indicator should be on (or blinking).

Does A22J8-35 properly control the front panel SWEEP indicator?

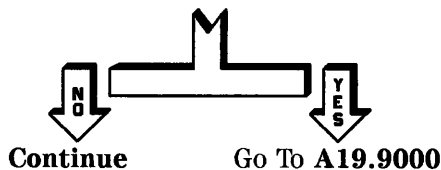

**ILT.3407**

There is an open on the motherboard between XA14J2-36 and A22J8-35. Verify this with an ohmmeter. Is jumpering an acceptable repair?



Go To **A22.9000**

**Continue**

Install a jumper and go to the Troubleshooting Foldout, block 1 (located just prior to the "Special Cases" tab).

**ILT.3500**

Perform the following setup:

1. Press **PRESET**.
2. Press **SWEEP TIME** **5** **SEC** **SINGLE**.
3. Press **START** **5** **GHz**.
4. Press **STOP** **7** **GHz**.
5. Checking the Z-AXIS BLANK/MKRS on the rear panel, repeatedly press **SINGLE**.
  - a. While not sweeping = TTL high.
  - b. During sweep = TTL low.

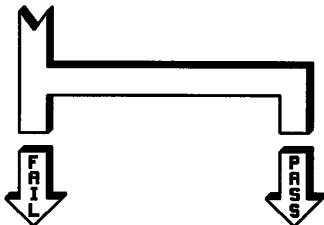
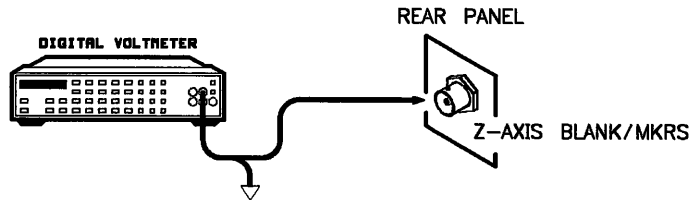

Go To **ILT.3505**

**Continue**

**ILT.3501** The rear panel Z-AXIS BLANK/MKRS seems to be working properly. If an undetected problem exists, consider replacing the sweep generator assembly (A14.9000).

**ILT.3505** Checking XA14J1-78, repeatedly press **(SINGLE)**.

- Not sweeping = TTL high.
- During sweep = TTL low.

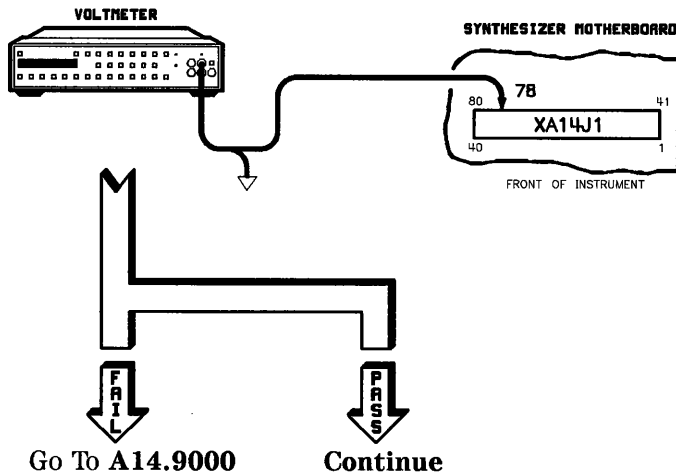

**ILT.3506** Checking A22J8-37, repeatedly press **(SINGLE)**.

- Not sweeping = TTL high.
- During sweep = TTL low.

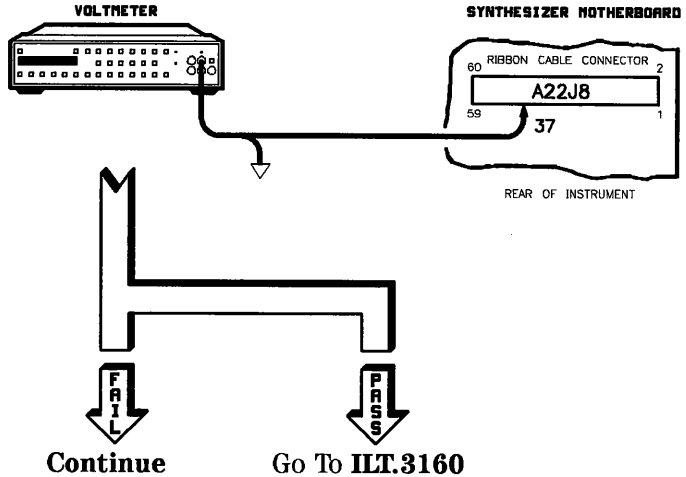

**ILT.3507** There is an open on the motherboard between XA14J1-78 and A22J8-37. Verify this with an ohmmeter. Is jumpering an acceptable repair?

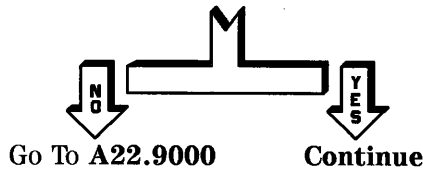

**ILT.3508** Install a jumper and go to the Troubleshooting Foldout, block 1 (located just prior to the "Special Cases" tab).

**ILT.3600** Press **PRESET**. Check for a negative going TTL pulse at the TRIGGER OUTPUT connector on the rear panel.

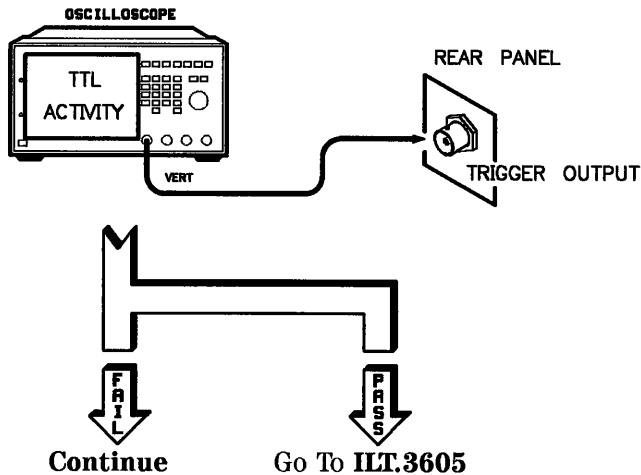

**ILT.3601** Press **PRESET**. Check for a negative going TTL pulse at A14J2.

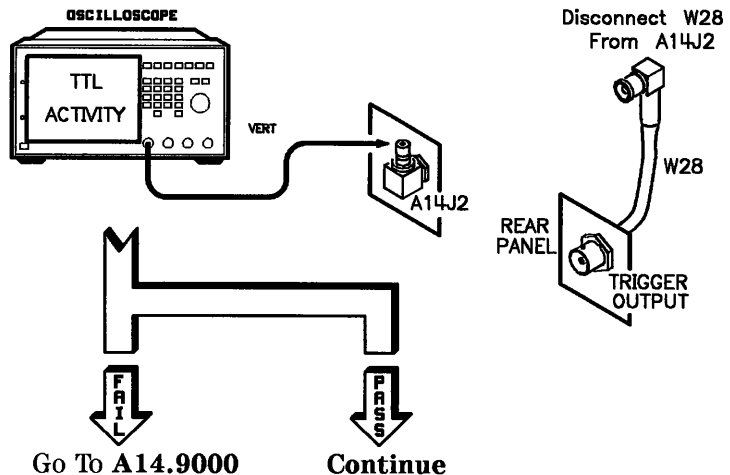

Replace W28 and go to the Troubleshooting Foldout, block 1 (located just prior to the "Special Cases" tab).

**ILT.3605** The rear panel TRIGGER OUTPUT seems to be working properly. If an undetected problem exists, consider replacing the sweep generator assembly (A14.9000).

**ILT.3700** Press **PRESET**. Using an oscilloscope, check for TTL levels at the following points on the rear panel AUXILIARY INTERFACE connector. If a failure occurs (there is no TTL activity on one or more of the lines), go to the indicated paragraph.

**Note:** Some of these signals move very slowly.

Pin Number	Go to Paragraph
2	ILT.3710
5	ILT.3720
12	ILT.3730
15	ILT.3740
24	A19.9000

If no failure occurs, continue with ILT.3701.

**ILT.3701** Perform the following setup:

1. Press **START SWEEP** **3** **GHz**.
2. Press **STOP SWEEP** **7** **GHz**.

Check for a 0 to 10 V ramp at pin 18 of the AUXILIARY connector.

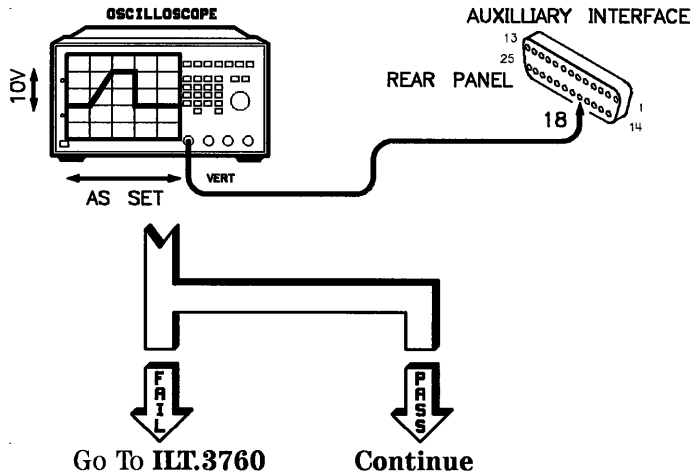

**ILT.3702** Locate pin 5 on the auxiliary interface. Alternately short to ground and open pin 5. Observe pin 18 with a voltmeter; if the instrument has a front panel with a display and keyboard, observe the SWEEP indicator on the front panel. When pin 5 is shorted to ground, the output at pin 18 should stop sweeping and the front panel SWEEP indicator should be off; when the pin is not shorted to ground, the output at pin 18 should sweep, and the indicator should be on (or blinking). This is the stop sweep line that connects to the rear panel BNC of the same name.

Did the sweep stop and start as described?

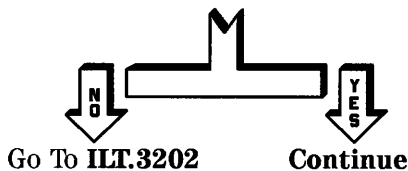



**ILT.3703**

Locate pin 15 on the auxiliary interface. Alternately short to ground and open pin 15. Observe pin 18 with a voltmeter; if the instrument has a front panel with a display and keyboard, observe the SWEEP indicator on the front panel. When the pin is shorted to ground, the output at pin 18 should stop sweeping and the front panel SWEEP indicator should be off; when the pin is not shorted to ground, the output at pin 18 should sweep, and the indicator should be on (or blinking). This is the LQSS signal, used to synchronize the A4 assemblies in systems that have more than one HP 8360 L-Series synthesizer.

Did the sweep stop and start as described?

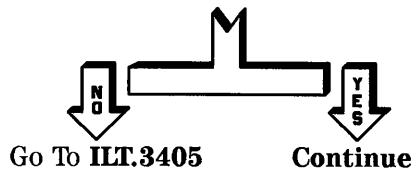
**ILT.3704**

Most (but not all) auxiliary inputs and outputs have been checked. The remaining faults will appear to be synchronization problems related to having multiple HP 8360 L-Series synthesizers in a system, or problems with markers.

Are you sure the instrument has an auxiliary interface problem?

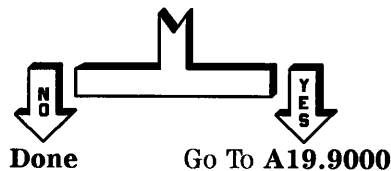

**ILT.3710** Press **PRESET** and check for TTL activity.

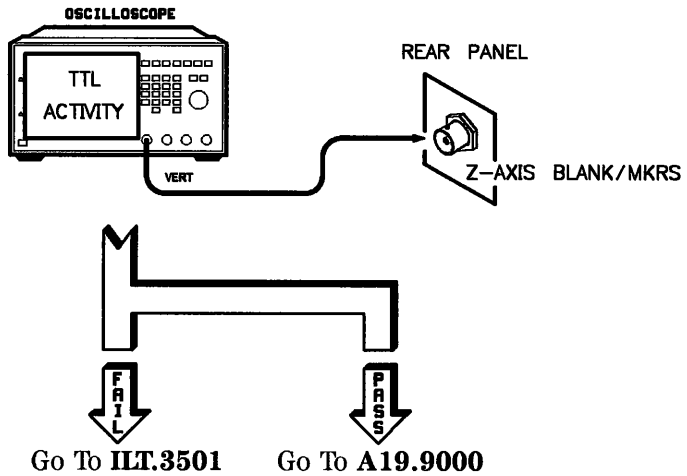

**ILT.3720** Press **PRESET** and check for TTL activity.

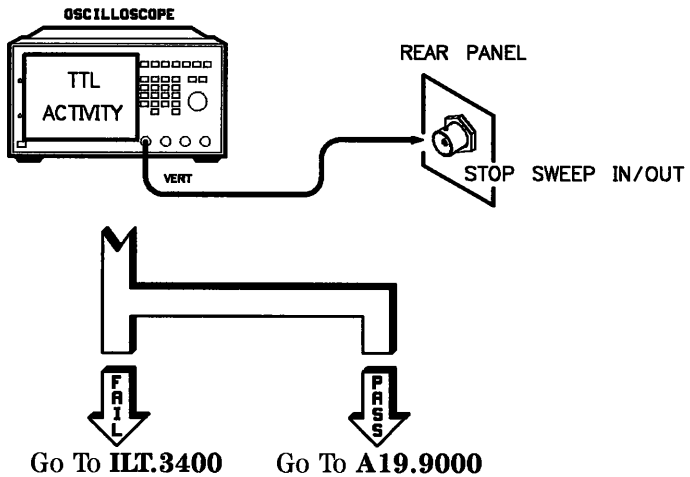

**ILT.3730** Check for TTL activity at J8-36 on the motherboard.

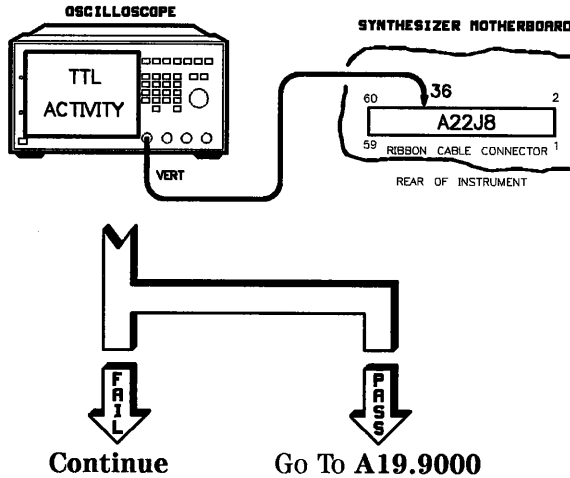

**ILT.3731** Check for TTL activity at XA14P2-37 on the motherboard.

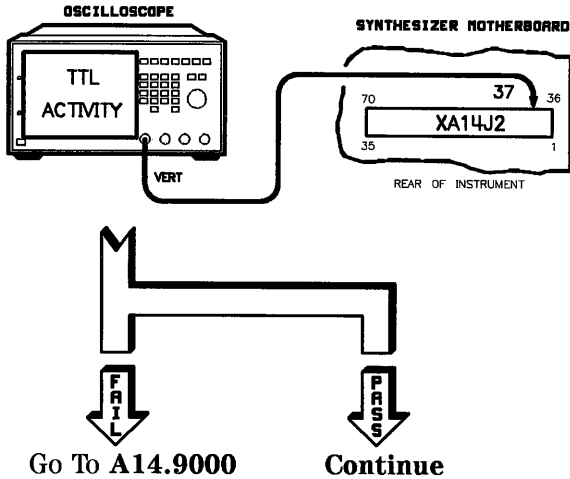

**ILT.3735** There is an open on the motherboard between A22J8 and XA14J2-37. Verify this with an ohmmeter. Is jumpering an acceptable repair?

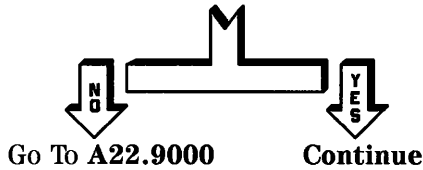

**ILT.3736** Repair the open between J8-36 and XA14P2-37, and go to the Troubleshooting Foldout, block 1 (located just prior to the "Special Cases" tab).

**ILT.3740** Check for TTL activity at J8-39 on the motherboard.

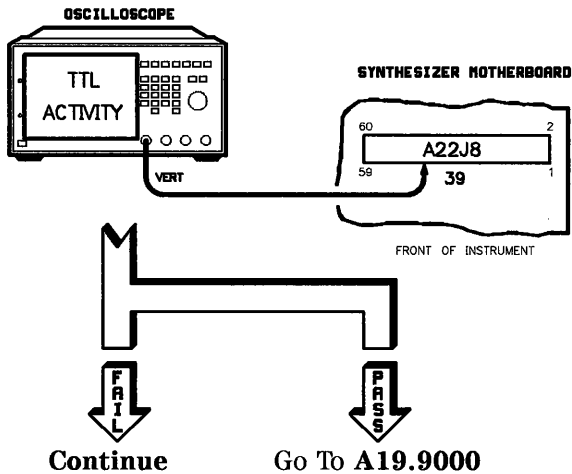

**ILT.3741** Check for TTL activity at XA14P1-68 on the motherboard.

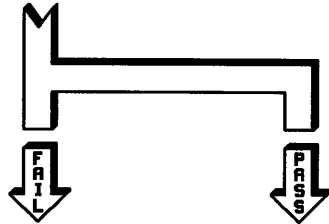
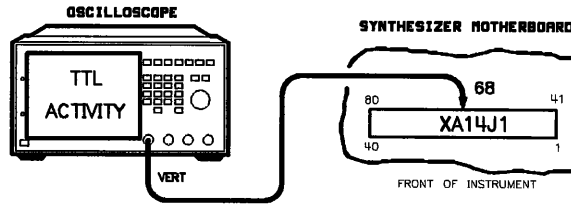

Go To **A14.9000**

**Continue**

**ILT.3745** There is an open on the motherboard. Is jumpering an acceptable repair?



Go To **A22.9000**

**Continue**

**ILT.3746** Repair the open between J8-39 and XA14P1-68, and go to the Troubleshooting Foldout, block 1 (located just prior to the "Special Cases" tab).

**ILT.3760** You should see a 0.0 to 10.0 V ramp.

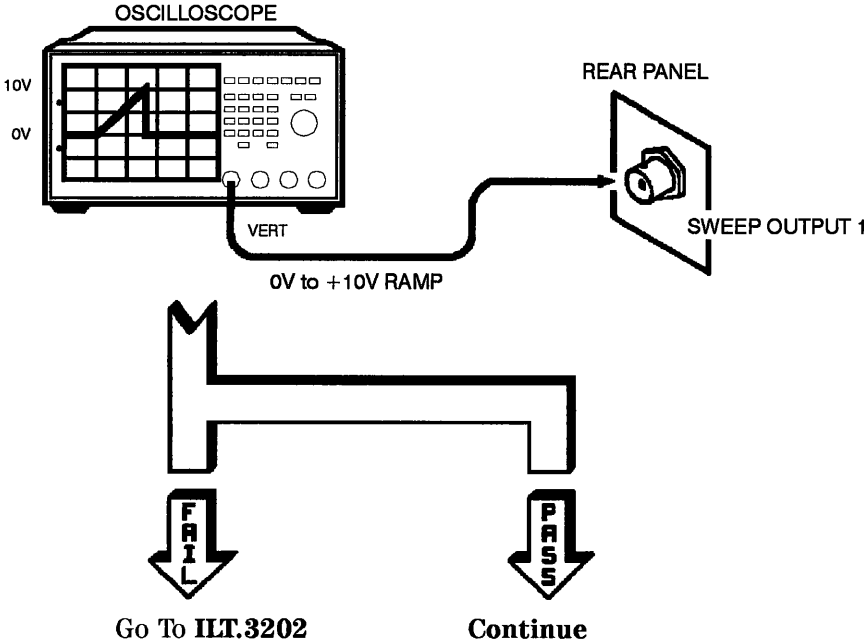

## ILT.3800

The rear panel HP-IB switch controls the instrument language and address. Check the following list for possible solutions to the problem:

- To control the language from the front panel, the language portion of the HP-IB switch must be set to 7 (binary 111).
- For instruments using SCPI, set the language part of the switch to 0 (binary 000).
- For instruments using Analyzer language, set the switch to 1 (binary 001). If the instrument is used with HP 8510 systems, either set the language part of the switch to 1 or set the language to Analyzer language at the front panel. This also applies to systems that depend on HP 8340/8341 compatibility.
- For instruments using CIIL, either set the switch to 2 (binary 010), or set it to 7 (binary 111) and set the language to CIIL at the front panel. This language is an option.
- For MSIB instruments (including option H10), set the switch to 3 (binary 011). This cannot be set from the front panel.
- Concerning the address switches, the HP 8510 (and other systems) assume that the HP-IB address is 19 (binary 10011).

Did any of these suggestions fix the problem?

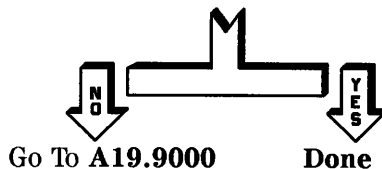

**ILT.3900** Perform the following setup:

1. Press **PRESET** **MOD**.
2. Select **Pulse Menu** **Pulse On/Off Int** (asterisk on).

You should see a TTL level, 500 kHz pulse with 50% duty cycle.

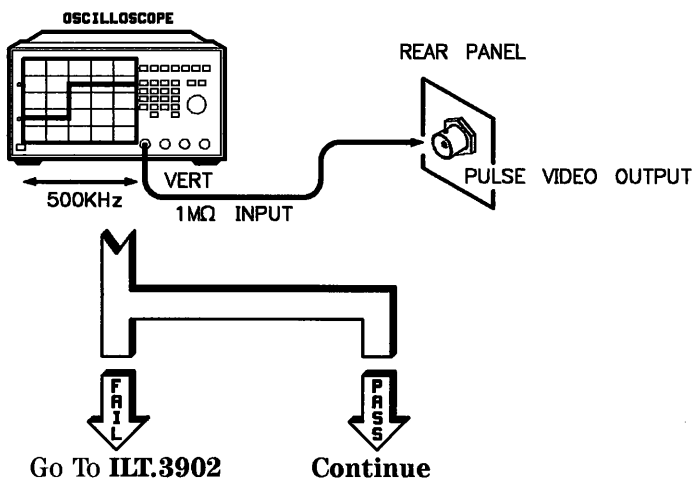

**ILT.3901** Nothing seems to fail. If an intermittent or non-linear video output failure exists, the most likely failure is the modulation generator assembly (A8). If replacing A8 does not fix the problem, use the instrument block diagram (located at the end of “Special Cases”) to troubleshoot this problem.



- ILT.3902** Check the continuity from the rear panel to the end of W62 (connects to A8J4).

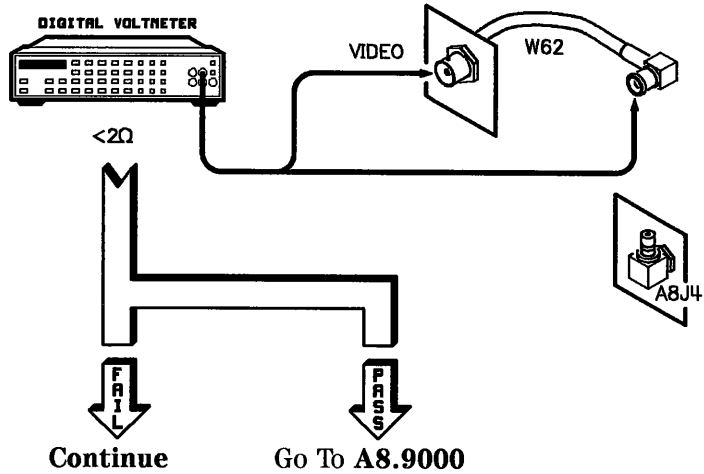

- ILT.3903** Replace the cable (W62) that connects the rear panel PULSE VIDEO OUTPUT to A8J4 and go to the Troubleshooting Foldout, block 1 (located just prior to the "Special Cases" tab).

**ILT.3910** Perform the following setup:

1. Press **PRESET** **MOD**.
2. Select **Pulse Menu** **Pulse On/Off Int** (asterisk on).

You should see a TTL high, 50 ns  $\pm$  10 ns wide pulse.

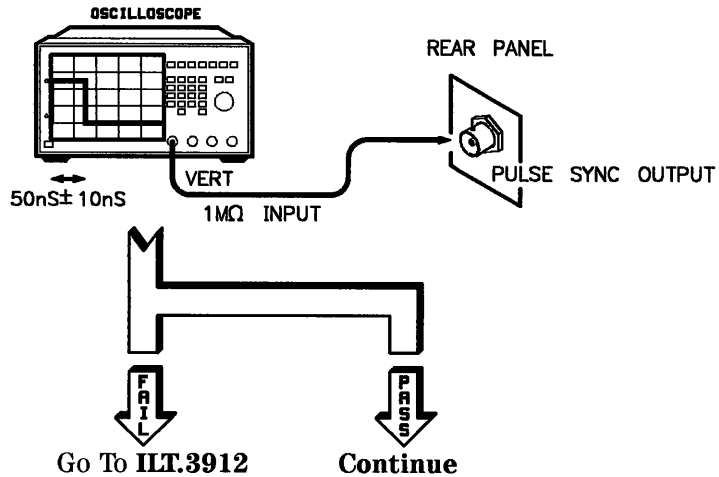

**ILT.3911** Nothing seems to fail. If an intermittent or non-linear sync output failure exists, the most likely failure is the modulation generator assembly (A8). If replacing A8 does not fix the problem, use the instrument block diagram (located at the end of “Special Cases”) to troubleshoot the problem.

- ILT.3912** Check the continuity from the rear panel to the end of W63 (connects to A8J6).

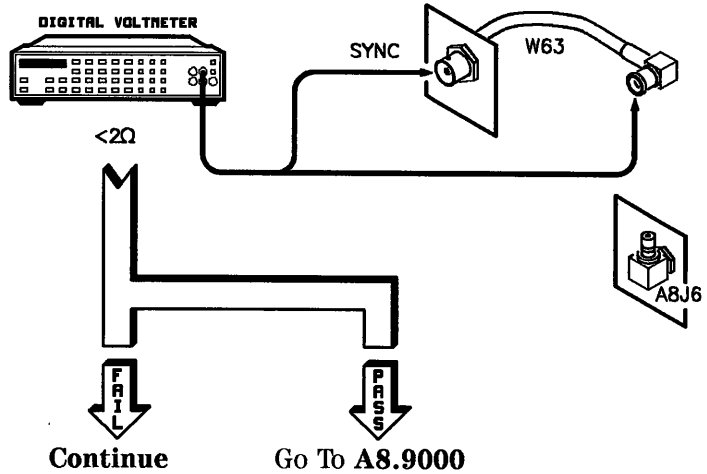

- ILT.3913** Replace the cable (W63) that connects the rear panel PULSE SYNC OUTPUT to A8J6 and go to the Troubleshooting Foldout, block 1 (located just prior to the "Special Cases" tab).

**ILT.3920** Perform the following setup:

1. Press **PRESET** **MOD**.
2. Select **AM Menu** **AM On/Off Int** (asterisk on).
3. Press **PRIOR**.
4. Select **Monitor Menu** **ModOut On/Off AM** (asterisk on).

You should see a 100 kHz, 600 mV p-p  $\pm 100$  mV sine wave.

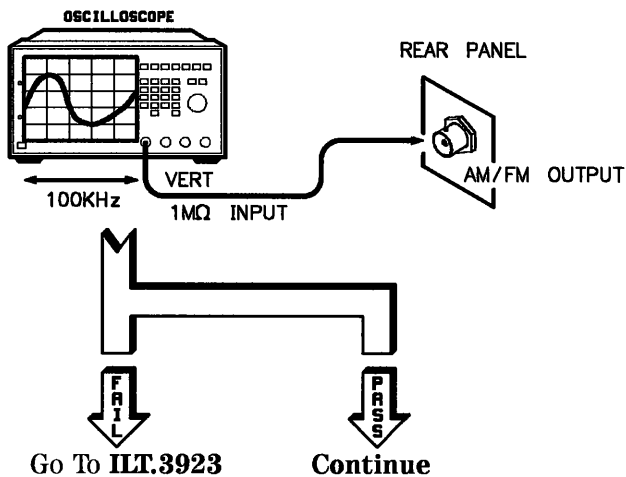

### ILT.3921

Perform the following setup:

1. Press **PRESET** **CW** **MOD**.
2. Select **FM Menu** **FM On/Off Int** (asterisk on).
3. Press **PRIOR**.
4. Select **Monitor Menu** **ModOut On/Off FM** (asterisk on).

You should see a 1 MHz, 2 V  $\pm$ 200 mV sine wave.

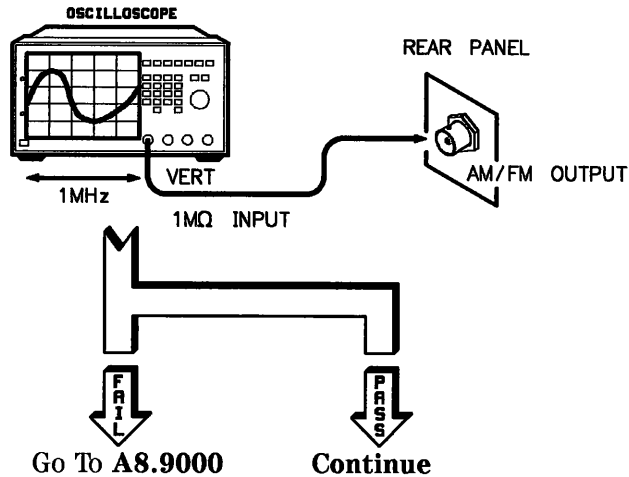

### ILT.3922

Nothing seems to fail. If an intermittent or non-linear AM/FM OUTPUT failure exists, the most likely failure is the modulation generator assembly (A8). If replacing A8 does not fix the problem, use the instrument block diagram (located at the end of "Special Cases") to troubleshoot this problem.

**ILT.3923** Check the continuity from the rear panel to the end of W64 (connects to A8J11).

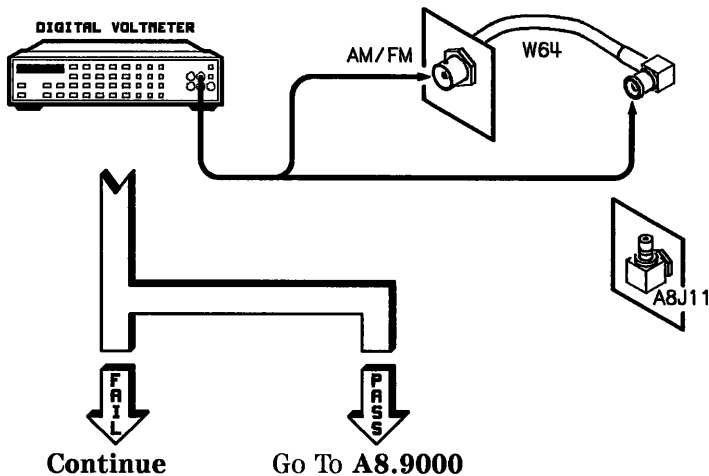

**ILT.3924** Replace the cable (W64) that connects the rear panel AM/FM OUTPUT to A8J11 and go to the Troubleshooting Foldout, block 1 (located just prior to the "Special Cases" tab).

**ILT.3930**

Disconnect the 50 ohm load from the rear panel AUX OUTPUT connector. Set the synthesizer to CW. Tune the frequency from 2 to 26.5 GHz (or 2 to 20 GHz for synthesizers with a maximum frequency of 20 GHz).

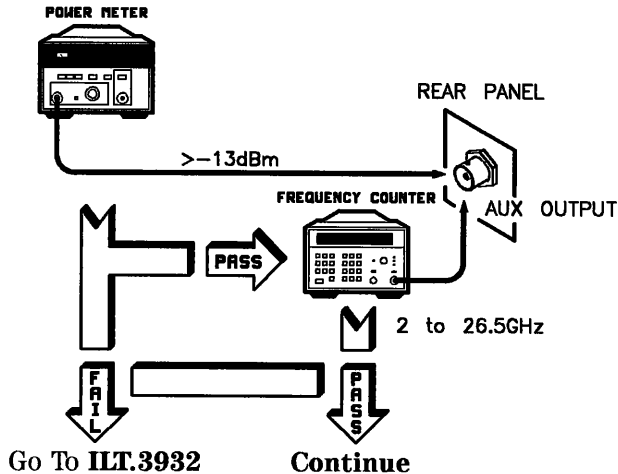
**ILT.3931**

There does not seem to be a failure. The rear panel output should tune from 2 GHz to 26.5 GHz with greater than  $-13\text{ dBm}$  power. If a problem still exists, refer to the instrument block diagram (located behind the "Troubleshooting Block Diagrams" tab) to troubleshoot this problem.

**ILT.3932**

Lift up the RF deck into the service position (refer to the “Disassembly and Replacement Procedures” in the *HP 8360 B-Series Swept Signal Generator/HP 8360 L-Series Swept CW Generator Service Guide* for instructions). Set the synthesizer to CW. Tune the frequency from 2 to 26.5 GHz (or 2 to 20 GHz for synthesizers with a maximum frequency of 20 GHz).

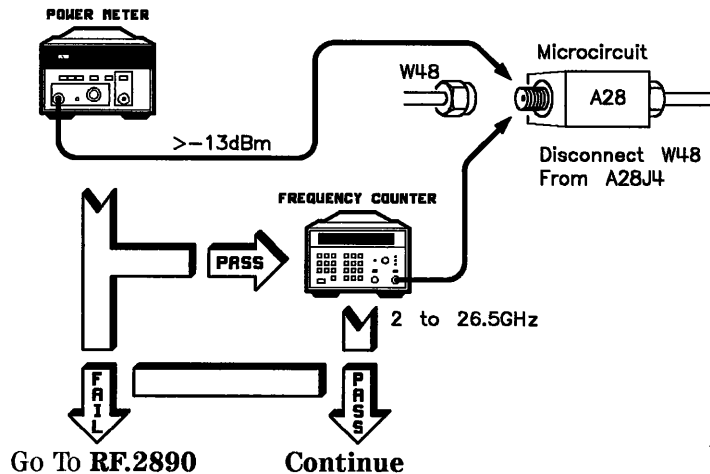
**ILT.3933**

Replace W48, the coaxial cable that connects A28J4 to the rear panel, and go to the Troubleshooting Foldout, block 1 (located just prior to the “Special Cases” tab).



---

## ILT.4000

Each function has a most likely assembly or group of assemblies responsible for an undefined fault. Most of these faults are microprocessor control type faults, and often point to the CPU assembly (A15). The circuitry has been previously exercised by the self-tests. The functions listed below are primarily microprocessor manipulations of the previously tested hardware. Also use the block diagram (located at the end of "Special Cases") for further assistance.

- Power level functions:
  - RF on/off does not function properly: go to ILT.3052.
  - Power sweep does not function: go to A15.9000, possibly A14.9000.
  - Unable to set power slope: go to A15.9000.
  - Unable to uncouple the attenuator: go to A15.9000 or A20.9000.
  - Unable to set up/down power size: go to A15.9000.
- Setting frequencies (start, stop, CW, etc.):
  - Unable to set up/down size: go to A15.9000.
  - Unable to set frequency offset: go to A15.9000.
  - Unable to set frequency multiplier: go to A15.9000.
- Unable to control marker functions: go to A15.9000, possibly A14.9000.
- Sweep function control:
  - List function does not work properly: go to A15.9000.
  - Unable to control one of the following:
    - Step size: go to A15.9000.
    - Step points: go to A15.9000.
    - Step dwell: go to A15.9000.
    - Step sweep trigger: go to A15.9000.
  - Sweep ramp functions improperly: go to A14.9000.
- Frequency list does not work properly:
  - For frequency changes greater than 500 MHz, if unleveled or unlock indicators appear, try the Amplifier/Multiplier or Amplifier/Filter adjustments.
  - For all other cases, A15 is the most likely cause of failure. Go to A15.9000 to replace A15.
- Fast sweep time problems ( $\leq 100$  ms sweep time): Do the YO Delay, Amplifier/Multiplier, or Amplifier/Filter

adjustments (see the *HP 8360 B-Series Swept Signal Generator/HP 8360 L-Series Swept CW Generator Service Guide*).

- Slow sweep time problems ( $\geq 5$  s sweep time): Do the YO Delay, Amplifier/Multiplier, or Amplifier/Filter adjustments (see the *HP 8360 B-Series Swept Signal Generator/HP 8360 L-Series Swept CW Generator Service Guide*).
- Unable to properly control single sweep or manual sweep:
  - Single sweep: If you cannot control single sweep, go to A15.9000. If you *can* control single sweep but the RF signal deteriorates badly, you may need to adjust the amp/multiplier, amp/filter, or the YO. Go to the *HP 8360 B-Series Swept Signal Generator/HP 8360 L-Series Swept CW Generator Service Guide*.
  - Manual Sweep: go to A15.9000. If the rotary knob is not functioning, replace only the RPG (rotary pulse generator).
- Unable to use trigger sweep:
  - If the problem is that the sweep is triggered on the wrong edge of the trigger pulse, verify the “External Trigger Edge Selection” adjustment before going to A15.9000.
  - If the “External Trigger Edge Selection” adjustment just does not work, go to A15.9000.
- Trigger out delay does not work: First replace the A15 assembly (go to A15.9000). If the problem remains, replace the A14 assembly (go to A14.9000).
- Save/recall registers do not function properly:
  - If you are unable to save or recall registers: go to A15.9000.
  - If the save/recall registers are lost when AC line power is disconnected for  $< 5$  days, replace the CPU (go to A15.9000).

If these alternatives do not fix the problem, use the instrument block diagram (located at the end of “Special Cases”) to troubleshoot this problem.

---

## **ILT.5000**

To continue, you will need either the front panel emulation software for the HP 8360 L-Series synthesizers, or a substitute front panel. Refer to “Automated Tests” in the *HP 8360 B-Series Swept Signal Generator/HP 8360 L-Series Swept CW Generator Service Guide* for the software and instructions. Refer to “Replaceable Parts” in this volume for substitute front panel ordering information. Start the front panel emulation software, or install a substitute front panel.

If the front panel emulation software or substitute front panel is operational, go to ILT.103. If not, use the following information to determine the next step:

- If you used a substitute front panel but it didn’t work, restart troubleshooting with that substitute front panel installed (go to ILT.000).
- If you used the front panel emulator program (part of the “Service Support Software”) but it didn’t work, go to ILT.6810.

---

## **ILT.6000**

Replace RPG1 and go to the Troubleshooting Foldout, block 1 (located just prior to the “Special Cases” tab).

## ILT.6500

Does your instrument have a front panel display and keyboard?

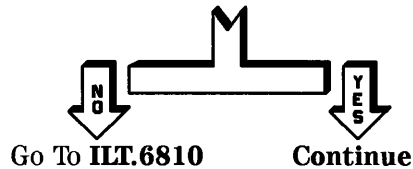

## ILT.6501

Does the instrument display  
\*\*\* POWER SUPPLY FAILURE \*\*\*?

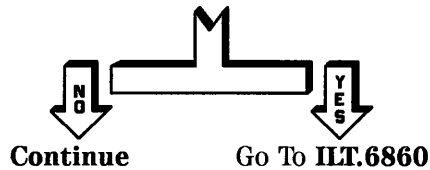

## ILT.6502

Does the instrument display  
\*\*\* CHECK INSTRUMENT \*\*\*?

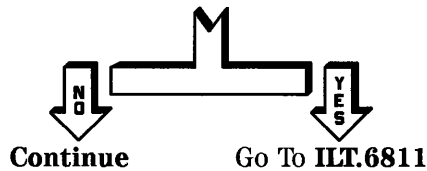

## ILT.6504

Is the display blank, nearly blank, or unintelligible?

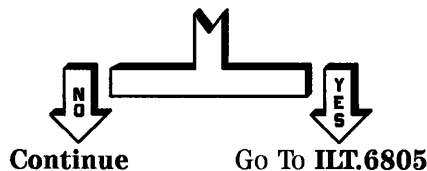

**ILT.6505** Is the keyboard unresponsive?

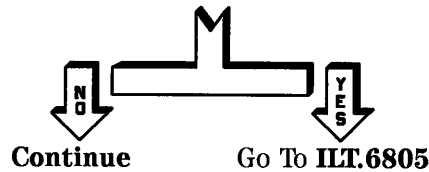

**ILT.6506** Is the front panel red INSTR CHECK light not blinking or flashing?

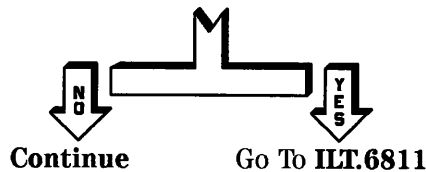

**ILT.6507** Does the display appear correct except for missing segments?

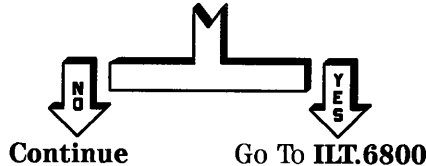

**ILT.6508** Since these tests could not isolate the problem, go to “Special Cases” and continue troubleshooting.

**ILT.6800** The most likely cause for this failure is the display (A21.9000), but the front panel microprocessor assembly (A3.9000) could also be at fault.

If these alternatives do not fix the problem, use the instrument block diagram (located at the end of “Special Cases”) to troubleshoot this problem.

**ILT.6805** Perform the following:

1. Set the line power switch to STANDBY.
2. Remove the front panel (refer to the disassembly procedures as needed).
3. Reseat all ribbon cables on the front panel.
4. Reseat all ribbon cables connecting the front panel to the motherboard.
5. Replace the front panel on the instrument.
6. Set the line power switch to ON.

Is the keyboard or display problem still present?

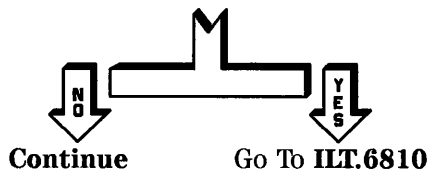

**ILT.6806** The problem has apparently been solved by reseating the cables and reassembling the front panel. Restart troubleshooting at ILT.000.

**ILT.6810** Do the following:

1. Turn the line power switch to ON.
2. Check the indicators on the top edge of A16 for the following:
  - a. Check that all eight green indicators are on.
  - b. Check that all red indicators are off.

Are all A16 indicators correct?

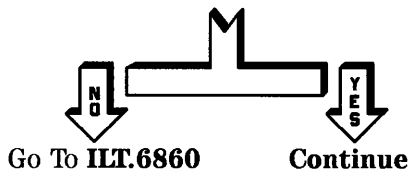

**ILT.6811**

Observe the 12 small red indicators on the top edge of A15 during the following power-up sequence:

1. Set the line power switch to STANDBY. All indicators should be off.
2. Set the line power switch to ON. All indicators should be on 1 to 3 seconds after power-up and then turn off and remain off 2 to 5 seconds after power-up.

No other indicator state should occur.

Was the sequence of indicators correct?



Go To **ILT.6850**

**Continue**

**ILT.6812**

The power supply and microprocessor (A15, A6, A7, A18) appear to be operating correctly. If you still have a problem, replace the following assemblies in the order given:

1. A3 (go to A3.9000).
2. A21, if you have a display problem (go to A21.9000).
3. A1, if you have a keyboard problem (go to A1.9000).
4. A15 (go to A15.9000).

If replacing these assemblies does not solve the problem, go to "Special Cases".

**ILT.6850**

Did all indicators turn on momentarily (1 to 3 seconds after power-on)?



Go To **A15.9000**

**Continue**

**ILT.6851**

If you need to, repeat the sequence given in ILT.6811 to gather the following information. After power-on, the four, left-most, A15 indicators will indicate a single digital state or a sequence of digital states. Record each state observed. The zero state (0000) is the most difficult state to recognize: Observe all 12 indicators. If there is activity in the other 8 indicators and the four, left-most indicators are off, this is the zero state. However, if *all 12 indicators* are on 1 to 3 seconds after power-up, and then *all 12 indicators* are off 2 to 5 seconds after power-up, then this is *not* a zero state, it is correct performance.

After recording each state observed, compare them to the following table. The state of the indicators is given in priority. If you observed the first state (0010), regardless of where it occurred in the sequence, go to the paragraph shown (A15.1200). If not, did you observe the next state (0011)? If so, go to the paragraph shown. If not, continue to use the table to identify, and then go to, the next paragraph.

State of Indicators	Go To Paragraph
0010	A15.1200
0011	A15.1300
0100	A15.1400
0000	A15.1100
All Else	A15.9000



## ILT.6860

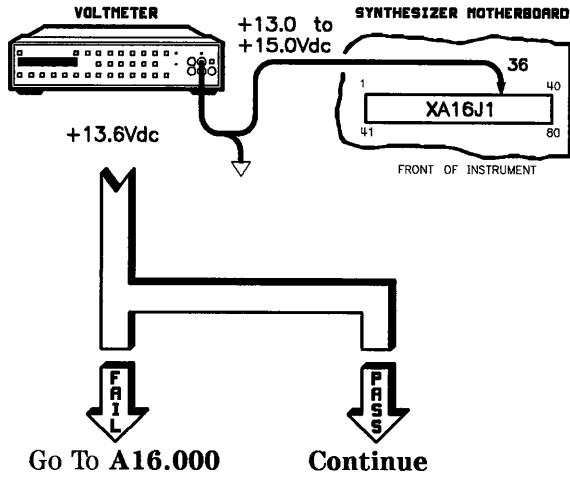

## ILT.6861

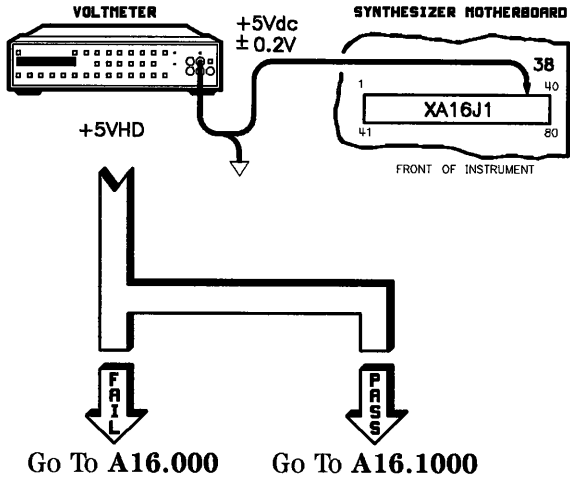

**ILT.6900** The most likely cause for this failure is the keyboard assembly (A1.9000), but the front panel microprocessor assembly (A3.9000) could also be at fault.

If these alternatives do not fix the problem, use the instrument block diagram (located at the end of "Special Cases") to troubleshoot this problem.

---

## ILT.7000

Recall the calibration constants from EEPROM.

1. Press **PRESET** **SERVICE**.
2. Select **Adjust Menu** **Calib Menu** **Cal Util Menu** **Recall Cal** **yes**.

View calibration constant #463 (hardware configuration) again:

If a password is set, you must know it to do this step.

1. Press **PRESET** **SERVICE**.
2. Select **Adjust Menu**.
3. If **ENTER PASSWORD: 0** appears on the top line of the display:
  - a. Enter the password.
  - b. Press **ENTER**.
  - c. Select **Adjust Menu**.
4. Select **Calib Menu** **Select Cal**.
5. Press **463** **ENTER**.
6. Note the value of calibration constant #463.
7. Note the options listed on the rear panel of the instrument.
8. Note the model number of the instrument.
9. Using the options listed on the rear panel, the model number, and the table below, calculate the hardware configuration calibration constant (see the following examples).

**Table 1a-4.  
Hardware Configuration Cal Constants #463 and #464**

Synthesizer Model Number	#463 Hardware Config 1						#464 Hardware Config 2	
	Starting Cal Constant	Option 001	Option 002	Option 004	Option 006	Option H10 <sup>1</sup>	Starting Value	Option 006
HP 83620B	+19,600	-128	+4	+4096	+2	-	+1	+2
HP 83622B	+19,584	-128	+4	+4096	+2	-	+1	+2
HP 83623B	+19,608	-128	+4	+4096	+2	-127	+1	+2
HP 83624B	+19,592	-128	+4	+4096	+2	-	+1	+2
HP 83630B	+19,600	-128	+4	+4096	+2	-	+1	+2
HP 83640B	+19,632	-128	+4	+4096	+2	-127	+1	+2
HP 83650B	+19,888	-128	+4	+4096	+2	-	+1	+2
HP 83621B	+30,864	-	-	-	-	-	-	-
HP 83631B	+30,864	-	-	-	-	-	-	-
HP 83651B	+32,176	-	-	-	-	-	-	-
HP 83623L	+27,792	-128	-	+4096	-	-	+1	-
HP 83630L	+27,792	-128	-	+4096	-	-	+1	-
HP 83640L	+27,824	-128	-	+4096	-	-	+1	-
HP 83650L	+28,080	-128	-	+4096	-	-	+1	-

<sup>1</sup> Option H10 and all other options are mutually exclusive.

**Example:** Calibration constant #463

$$\begin{aligned} \text{HP 83620B} + 001 + 004 &= ? \\ 19,600 - 128 + 4096 &= 23,568 \end{aligned}$$

**Example:** Calibration constant #464

$$\begin{aligned} \text{HP 83620B} + 006 &= ? \\ 1 + 2 &= 3 \end{aligned}$$

Is the synthesizer hardware configuration number correct?

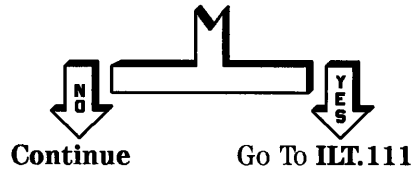

**ILT.7001** Since the hardware configuration number was incorrect in both the working memory and EEPROM, it is likely that this is not the only fault.

If you are *sure* the synthesizer hardware configuration number is *wrong*, continue with the following key sequence, otherwise go to paragraph ILT.113.

1. Select **Modify Cal.**.
2. Input the correct calibration constant and press **ENTER**.
3. Select **Cal Util Menu Save Cal yes.**
4. Press **PRESET**.

Go to paragraph ILT.111.

**ILT.7100**

A custom or user preset can look like a failure especially if the user preset is mistakenly implemented instead of the factory preset. The following is a list of failures you might encounter and some possible causes to look for in a user preset:

Failures	Possible Causes
UNLOCK	External reference is selected, and: *External reference is not 10 MHz at 0 dBm. *External reference is not connected. *Reference is connected incorrectly.
UNLVLED LOW UNLVLED	External leveling is selected, and: *There is no external ALC input. *An improper external leveling point is selected. *The external ALC input is connected, but the RF source is turned off. *Leveling mode <b>ALCoff</b> is selected. *There is an improper combination of external ALC and ALC bandwidths.
Inaccurate RF Power	External leveling or AM selected, and: *ALC leveling search mode is selected. *AM is selected with dc levels at the AM input. *An instrument without a front panel has the RF output turned off.
Inaccurate Frequency	DC FM, frequency offset or multiplier is selected, and: *DC FM is selected with a dc voltage applied. *A frequency offset is selected. *A frequency multiplier is selected.
Sweep Does Not Function	Single or external sweep is selected, and: *External sweep trigger is selected. *An improper external trigger is selected. *Single sweep is selected.

Discontinue use of the user preset for the remainder of your troubleshooting.

Go to ILT.112.

**ILT.7500** The source module makes three connections with the HP 8360 L-Series synthesizer:

- The source module interface.
- The RF output.
- The external ALC connection. This is the shielded connection that is part of the SMI connector.

If you are using a rear panel source module interface, go to ILT.7700.

If you are using a front panel source module interface, continue with ILT.7600.

**ILT.7600** Using either an oscilloscope or a voltmeter, check the following voltages at the front panel SMI connector.

Location	Measurement
Pin 7	+ 5.2 Vdc
Pin 5	+ 15.0 Vdc
Pin 10, 18, 19, 20	TTL High

Did all voltages pass?

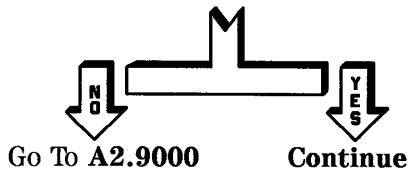

**ILT.7601** Perform the following setup:

- Press **PRESET**.
- Press **SWEEP TIME** **10** **SEC**.

Using an oscilloscope or a voltmeter, check the following voltages on front panel SMI connector. Note that pin 12 is a sweep ramp. To adjust the sweep time, use the front panel controls (if you use an oscilloscope, try a sweep time of approximately 100 ms).

Location	Measurement
Pin 15	-15 Vdc
Pin 6	+8.0 Vdc
Pin 12	0 to 10 V Sweep Ramp

Did all voltages pass?

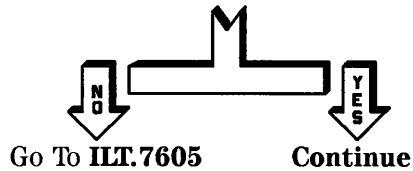



**ILT.7602** Measure at the center pin at each end of the cable.

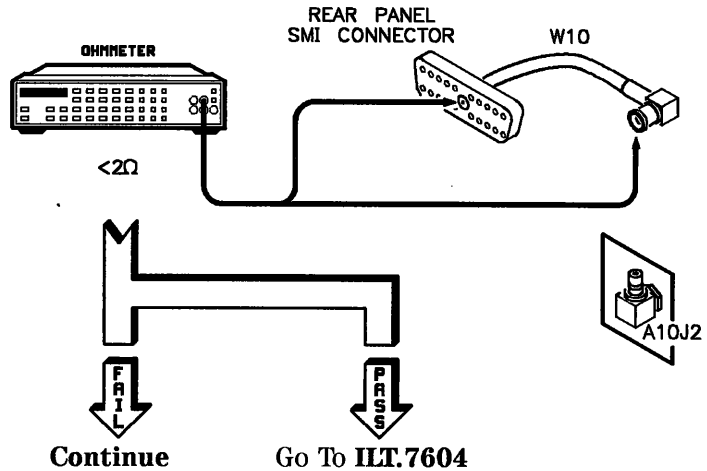

**ILT.7603** Replace the cable (W10) that connects the front panel SMI input to the A10 assembly, and go to the Troubleshooting Foldout, block 1 (located just prior to the “Special Cases” tab).

**ILT.7604** An SMI or ALC connection does not seem to be a problem. Go to paragraph ILT.7800.

**ILT.7605** Either the front panel SMI (A2) or the ribbon cable (W10) is faulty. Inspect the ribbon cable. Replace the A2 assembly (go to A2.9000) or replace W10, as required, and go to the Troubleshooting Foldout, block 1 (located just prior to the “Special Cases” tab).

**ILT.7700** Using either an oscilloscope or a voltmeter, check the following voltages at the rear panel SMI connector.

Location	Measurement
Pin 7	+ 5.2 Vdc
Pin 5	+ 15.0 Vdc
Pin 10, 18, 19, 20	TTL High

Did all voltages pass?

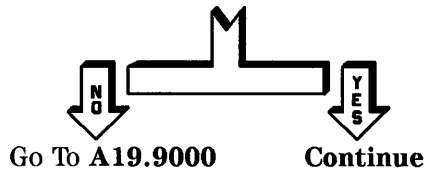

**ILT.7701** Perform the following setup:

- Press **PRESET**.
- Press **SWEEP TIME** **10** **SEC**.

Using an oscilloscope or a voltmeter, check the following voltages on the rear panel SMI connector. Note that pin 12 is a sweep ramp. To adjust the sweep time, use the front panel controls (if you use an oscilloscope, try a sweep time of approximately 100 ms).

Location	Measurement
Pin 15	-15 Vdc
Pin 6	+ 8.0 Vdc
Pin 12	0 to 10 V Sweep Ramp

Did all voltages pass?

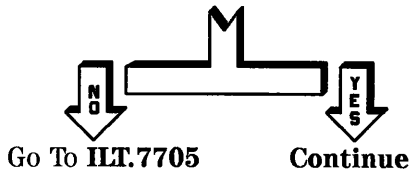

**ILT.7702** Measure at the center pin at each end of the cable.

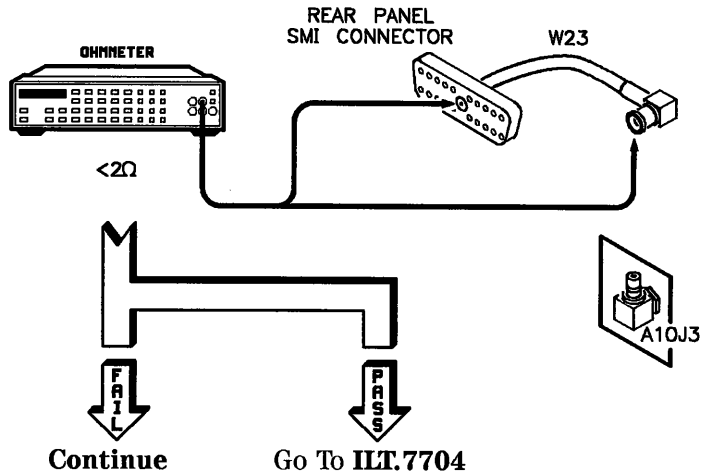

**ILT.7703** Replace the cable (W23) that connects the rear panel SMI input to the A10 assembly, and go to the Troubleshooting Foldout, block 1 (located just prior to the "Special Cases" tab).

**ILT.7704** An SMI or ALC connection does not seem to be a problem. Go to paragraph ILT.7800.

**ILT.7705** Either the rear panel SMI (A19) or the ribbon cable (W23) is faulty. Inspect the ribbon cable. Replace the A19 assembly (go to A19.9000) or replace W23, as required, and go to the Troubleshooting Foldout, block 1 (located just prior to the “Special Cases” tab).

**ILT.7800** Before performing this check, press **PRESET** **USER CAL** and select **FullUsr Cal.**. Wait until the instrument has completed the tracking process. Using the source module *User’s Handbook*, determine the range of frequencies and power levels provided by the synthesizer. Set the synthesizer for a manual sweep over the specified frequency range, at the specified power.

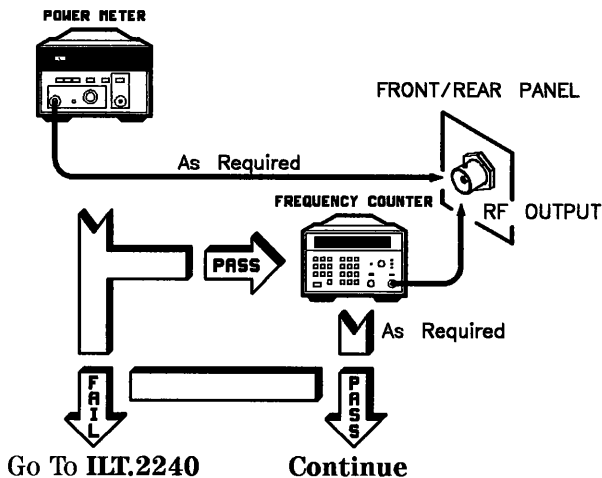

**ILT.7801**

Since the previous tests didn't clearly isolate the problem, the following is a prioritized list of the most likely causes of failure:

1. Using the source module *User's Handbook*, verify that the connections between the source module and the synthesizer are correct.
2. Front/Rear Panel SMI (A2, A19) is faulty.
3. W2 is faulty (connects the A2 assembly to the motherboard).
4. W31 is faulty (connects the A19 assembly to the motherboard).
5. The ALC assembly (A10) is faulty. This may be true only if leveling is the problem.
6. The source module is faulty. To confirm this, try to use the unused SMI connector, or substitute a new source module or synthesizer.
7. A remote possibility exists that the motherboard (A22) has a fault.

If these alternatives do not fix the problem, use the instrument block diagram (located at the end of "Special Cases") to troubleshoot this problem.

---

## ILT.8000

The best way to find network analyzer problems is by testing the input and output ports. To do this, refer to paragraph ILT.3000. Each port is listed and can be tested separately. The ports of interest in a network analyzer will most likely be the following:

- For instruments using Analyzer language, set the switch to 1 (binary 001). If the instrument is used with HP 8510 systems, either set the language part of the switch to 1 or set the language to Analyzer language at the front panel. This also applies to systems that depend on HP 8340/8341 compatibility.
- Concerning the address switches, the HP 8510 (and other systems) assume that the HP-IB address is 19 (binary 10011).
- Using the network analyzer's *On-Site Service Handbook* verify that all connections between the HP 8510 and the other instruments are correct.
- RF output.
- Stop sweep in/out.
- Sweep output.
- Trigger output.
- HP-IB.
- Front or rear panel source module interface.
- Auxiliary Interface.

If these alternatives do not fix the problem, use the instrument block diagram (located at the end of "Special Cases") to troubleshoot this problem.

# **Troubleshooting Modules A1.000 through AX.xxx**

---

The following lists of each troubleshooting section in this chapter and the page number which the section begins.

A1 Front Panel Keyboard .....	1b-2
A2 Source Module Interface .....	1b-4
A3 Front Panel Processor .....	1b-19
A4 Fractional-N .....	1b-22
A5 YO Loop .....	1b-43
A6 Sampler .....	1b-60
A7 Reference .....	1b-77
A8 Modulation Generator .....	1b-102
A9 Pulse .....	1b-105
A10 ALC .....	1b-122
A11 FM Driver .....	1b-142
A12 Multiplier/Filter Driver .....	1b-153
A13 YO Driver .....	1b-173
A14 Sweep Generator .....	1b-191
A15 CPU .....	1b-202
A16, A17, A18 Power Supply .....	1b-265
A17 Rectifier/Filter Replacement .....	1b-379
A18 Preregulator Replacement .....	1b-380
A19 Rear Panel Interface .....	1b-381
A20 RF Interface .....	1b-399
A21 Display .....	1b-412
A22 Motherboard Replacement .....	1b-414
A23 10 MHz Reference Replacement ....	1b-415

---

## A1 Front Panel Keyboard Troubleshooting

**A1.000** When the full self-tests are run (from the service menu) the keyboard test is not run. Only the keyboard to A3 interface is tested. To test the keyboard, run the following test.

Perform the following key sequence:

1. Press **PRESET** **SERVICE**.
2. Select **Selftest Menu**.
3. Press **21** **ENTER**.
4. Select **Do Test #21**.

On the display you will see a dash (—) corresponding to each front panel softkey and hardkey (except for **PRESET**). Pressing a key causes the corresponding dash to toggle to an 'X'. Each successive key press toggles the 'X' to the dash and back. In addition, the rotary knob (RPG) toggles the two dashes in the upper right hand corner of the display. The one that toggles depends on the direction the RPG is turned.

To exit the test, press **PRESET**.

If this test fails (the key press does not cause a toggle to occur), you may still have a good keyboard. The front panel processor provides the interface between the keyboard and the rest of the instrument. A bad interface could cause this test to fail. Go to A3.000 to check the A3 to A1 interface.



**A1.9000** Replace the A1 assembly.

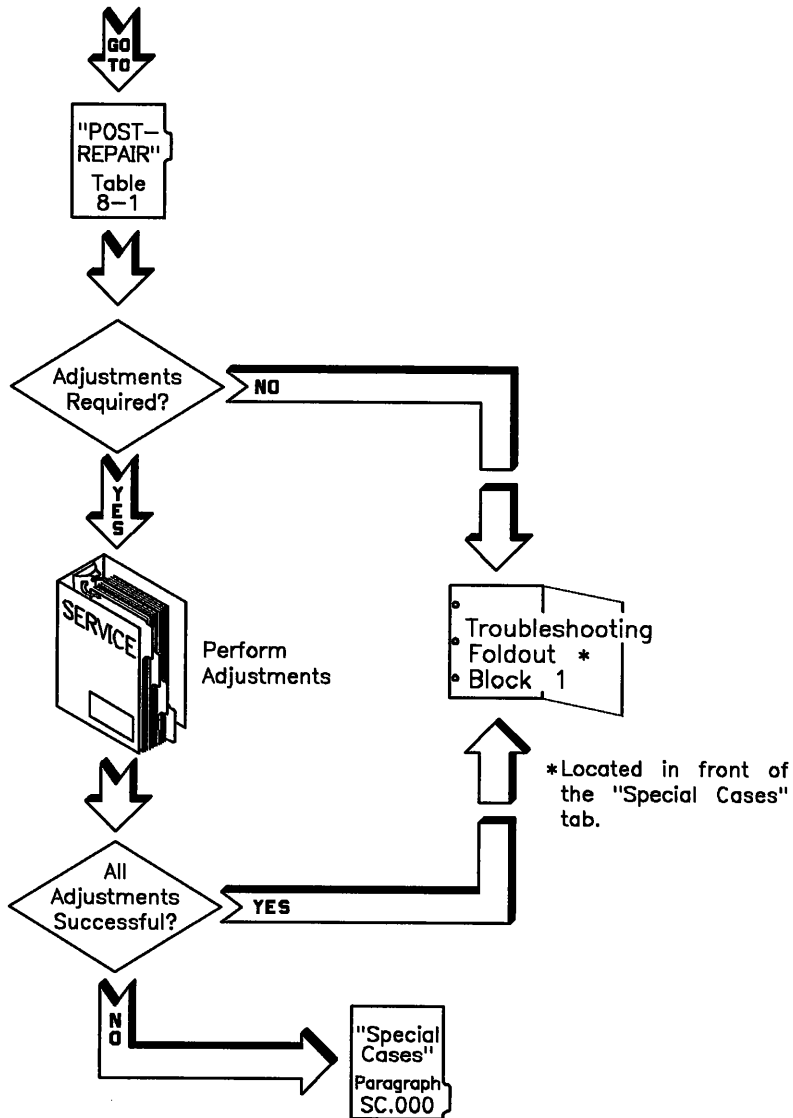

---

## A2 Source Module Interface Troubleshooting

<b>A2.000</b>	<b>Message Displayed on Synthesizer</b>	<b>Go to Paragraph</b>
	A2 : LED Control Latch	A2.100
	A2 : SMI Control Latch	A2.200
	A2 : SMI Sensing Circuit	A2.8000

**A2.100** A22J1 is located at the very front of the instrument on the motherboard. Early versions of the A22J1 (motherboard) pins *may* be mislabeled. The square pad correctly indicates pin 1.

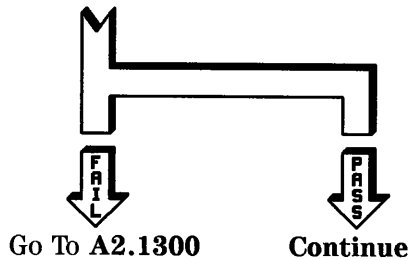
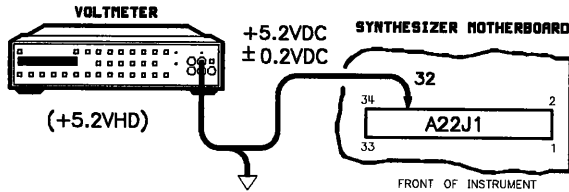

## A2.101

Loop self-test #232:

1. Press **PRESET** **SERVICE**.
2. Select **Selftest Menu**.
3. Press **232** **ENTER**.
4. Select **Loop Do Test #232**.

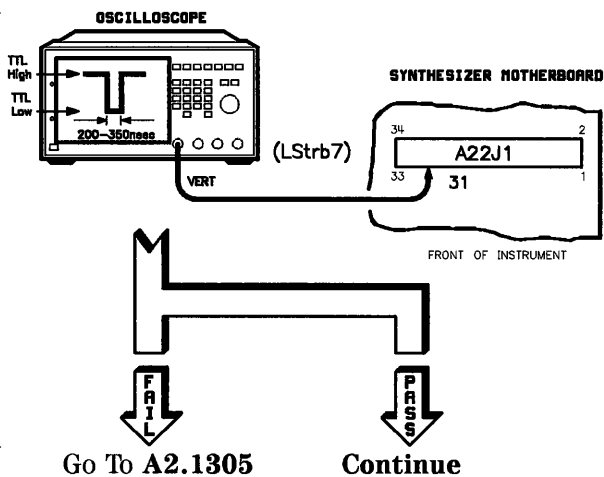

## A2.103

Loop self-test #233:

1. Press **PRESET** **SERVICE**.
2. Select **Selftest Menu**.
3. Press **233** **ENTER**.
4. Select **Loop Do Test #233**.

Check *all* signals listed below for *TTL pulses* at A22J1. A22J1 is located at the very front of the instrument on the motherboard. Early versions of the A22J1 (motherboard) pins *may* be mislabeled. The square pad correctly indicates pin 1.

Signal	Location
DB0	A22J1-22
DB1	A22J1-21
DB2	A22J1-20
DB3	A22J1-19
DB4	A22J1-18
DB5	A22J1-17
DB6	A22J1-16
DB7	A22J1-15

If one or more signals do *not* have *TTL pulses*, the test has failed. If *all* signals have *TTL pulses*, the test has passed.

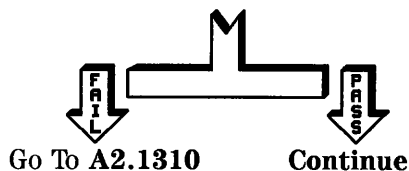

## A2.104

Loop self-test #231:

1. Press **PRESET** **SERVICE**.
2. Select **Selftest Menu**.
3. Press **231** **ENTER**.
4. Select **Loop Do Test #231**.

Signal	Location
AB2	A22J1-28
AB3	A22J1-27
AB4	A22J1-26
AB5	A22J1-25
AB6	A22J1-23

If one or more signals do *not* have *TTL pulses*, the test has failed. If *all* signals have *TTL pulses*, the test has passed.

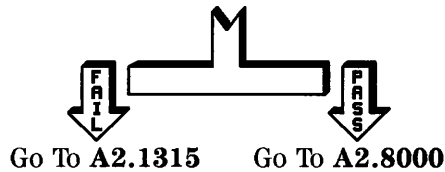

## A2.200

A22J1 is located at the very front of the instrument on the motherboard. Early versions of the A22J1 (motherboard) pins *may* be mislabeled. The square pad correctly indicates pin 1.

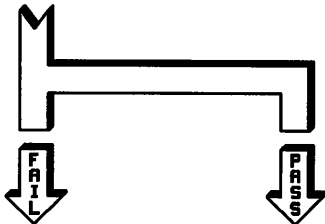
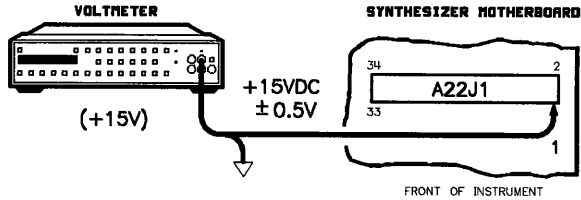

Go To A2.1320

Continue

## A2.201

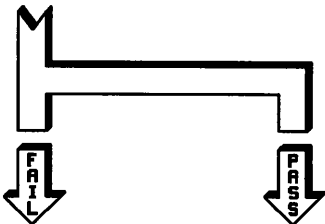
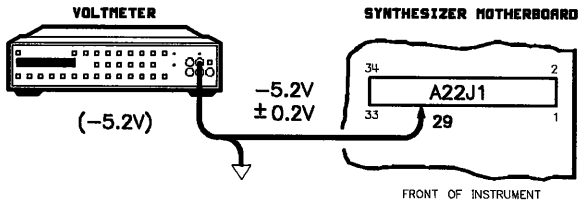

Go To A2.1325

Go To A2.8000

### A2.1300

There is an open on the motherboard between A22J1-32 and XA17J1-4, 5, 6, 34, 35, or 36. Verify this with an ohmmeter. Is jumpering an acceptable repair?

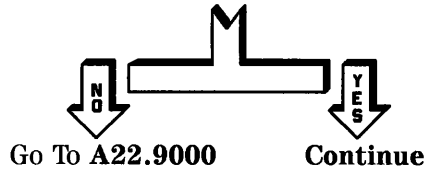

### A2.1301

Install a jumper. Then go to the Troubleshooting Foldout, block 1 (located just prior to the "Special Cases" tab).

### A2.1305

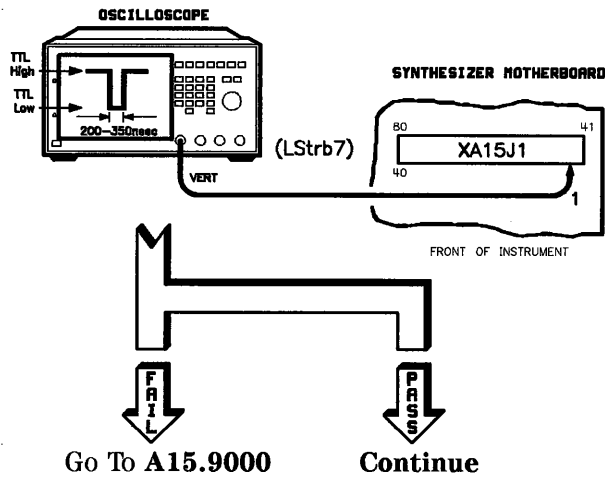



### A2.1306

There is an open on the motherboard between A22J1-31 and XA15J1-1. Verify this with an ohmmeter. Is jumpering an acceptable repair?



Go To **A22.9000**

**Continue**

### A2.1307

Install a jumper. Then go to the Troubleshooting Foldout, block 1 (located just prior to the “Special Cases” tab).

### A2.1310

Check *all* signals listed below for *TTL pulses* at XA15J1.

Signal	Location
DB0	XA15J1-12
DB1	XA15J1-52
DB2	XA15J1-13
DB3	XA15J1-53
DB4	XA15J1-14
DB5	XA15J1-54
DB6	XA15J1-15
DB7	XA15J1-55

If one or more signals do *not* have *TTL pulses*, the test has failed. If *all* signals have *TTL pulses*, the test has passed.



Go To **A15.9000**

**Continue**

### A2.1311

There is an open on the motherboard data bus between A22J1 and XA15J1. Verify this with an ohmmeter. Is jumpering an acceptable repair?

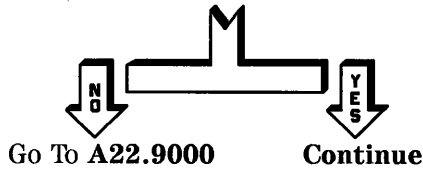

### A2.1312

Select the failing signals and install jumpers as required.

Signal	A2 Location	A15 Location
DB0	A22J1-22	XA15J1-12
DB1	A22J1-21	XA15J1-52
DB2	A22J1-20	XA15J1-13
DB3	A22J1-19	XA15J1-53
DB4	A22J1-18	XA15J1-14
DB5	A22J1-17	XA15J1-54
DB6	A22J1-16	XA15J1-15
DB7	A22J1-15	XA15J1-55

When the repair is complete, go to the Troubleshooting Foldout, block 1 (located just prior to the “Special Cases” tab).

## A2.1315

Check *all* signals listed below for *TTL pulses* at XA15J1.

Signal	Location
AB2	XA15J1-8
AB3	XA15J1-48
AB4	XA15J1-9
AB5	XA15J1-49
AB6	XA15J1-10

If one or more signals do *not* have *TTL pulses*, the test has failed. If *all* signals have TTL pulses, the test has passed.



Go To **A15.9000**

Continue

## A2.1316

There is an open on the motherboard data bus between A22J1 and XA15J1. Verify this with an ohmmeter. Is jumpering an acceptable repair?



Go To **A22.9000**

Continue

## A2.1317

Select the failing signals and install jumpers as required.

Signal	A2 Location	A15 Location
AB2	A22J1-28	XA15J1-8
AB3	A22J1-27	XA15J1-48
AB4	A22J1-26	XA15J1-9
AB5	A22J1-25	XA15J1-49
AB6	A22J1-23	XA15J1-10

When the repair is complete, go to the Troubleshooting Foldout, block 1 (located just prior to the "Special Cases" tab).

## A2.1320

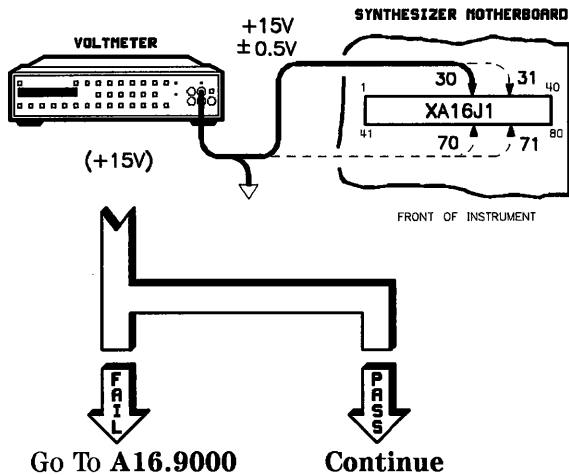

### A2.1321

There is an open on the motherboard between A22J1-1 and XA16J1-30, 31, 70, or 71. Verify this with an ohmmeter. Is jumpering an acceptable repair?

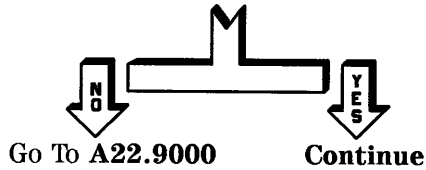

### A2.1322

Install a jumper. Then go to the Troubleshooting Foldout, block 1 (located just prior to the "Special Cases" tab).

### A2.1325

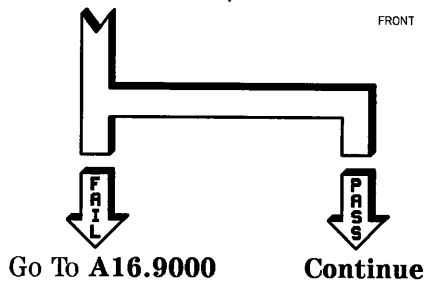
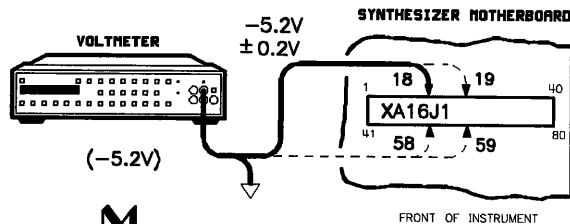

### **A2.1326**

There is an open on the motherboard between A22J1-29 and XA16J1-18, 19, 58, or 59. Verify this with an ohmmeter. Is jumpering an acceptable repair?



Go To **A22.9000**

**Continue**

### **A2.1327**

Install a jumper. Then go to the Troubleshooting Foldout, block 1 (located just prior to the “Special Cases” tab).

**A2.8000** Perform the following tasks:

1. Remove front panel.
2. Completely remove W2 (W2 connects A2 to the motherboard).
3. Using an ohmmeter, check W2.

Is W2 Faulty?



Go To **A2.9000**

**Continue**

**A2.8500**

Replace W2. You may want to consider replacing the A2 assembly. Then go to Troubleshooting Foldout, block 1 (located just prior to the “Special Cases” tab).

**A2.9000** Replace the A2 assembly.

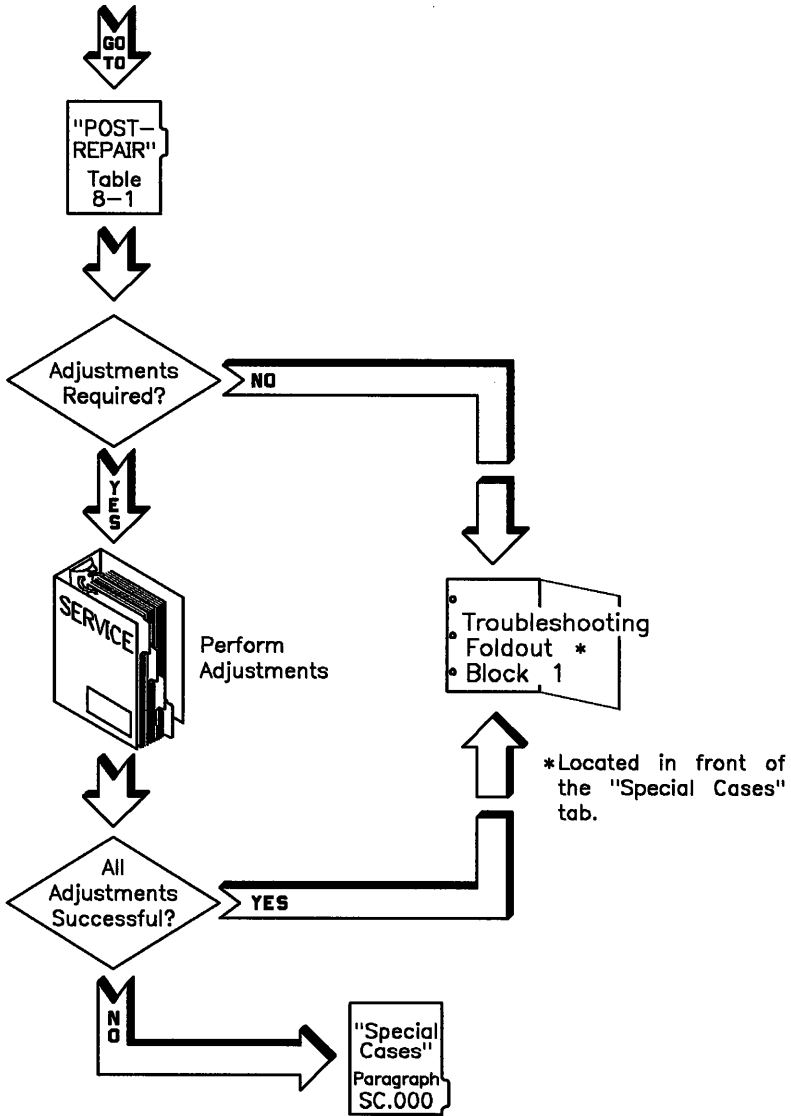



---

## A3 Front Panel Processor Troubleshooting

**A3.000** The front panel processor (A3) serves as an interface between the rest of the instrument and the display (A21) and keyboard (A1). Go to A21.000 for display testing. Keyboard testing is given in A1.000, however, the following is an additional test that checks whether the keyboard can communicate with the front panel processor.

Perform the following key sequence:

1. Turn the line power switch to on.
2. Press **PRESET** and any other key together.
3. Release **PRESET** and then release the other key.
4. Look at the top edge of the front panel processor just to the left of the rotary knob (RPG). A series of six indicators should be visible. To observe the data interchange between the keyboard and the front panel processor, press a key and you should see the key code change. The indicators should change each time you press a different key.

The following selected key sequences do a good job of checking the interface between A3 and A1. If these (or others) are faulty the problem will be A3, A1, or the connecting ribbon cable (W5).

Key	Indicators <sup>1</sup>
<b>9</b>	101 101
<b>CENTER</b>	010 010
First (left-most) Softkey	100 000
Second Softkey	010 000
Third Softkey	110 000
Fourth Softkey	001 000
Fifth Softkey	101 000
<b>ENTRY ON/OFF</b>	000 001
<b>CW</b>	000 010
USER DEFINED <b>MENU</b>	000 100
<b>PRIOR</b>	111 110
SYSTEM <b>RECALL</b>	011 011

1 1 = ON, 0 = OFF

**A3.9000** Replace the A3 assembly.

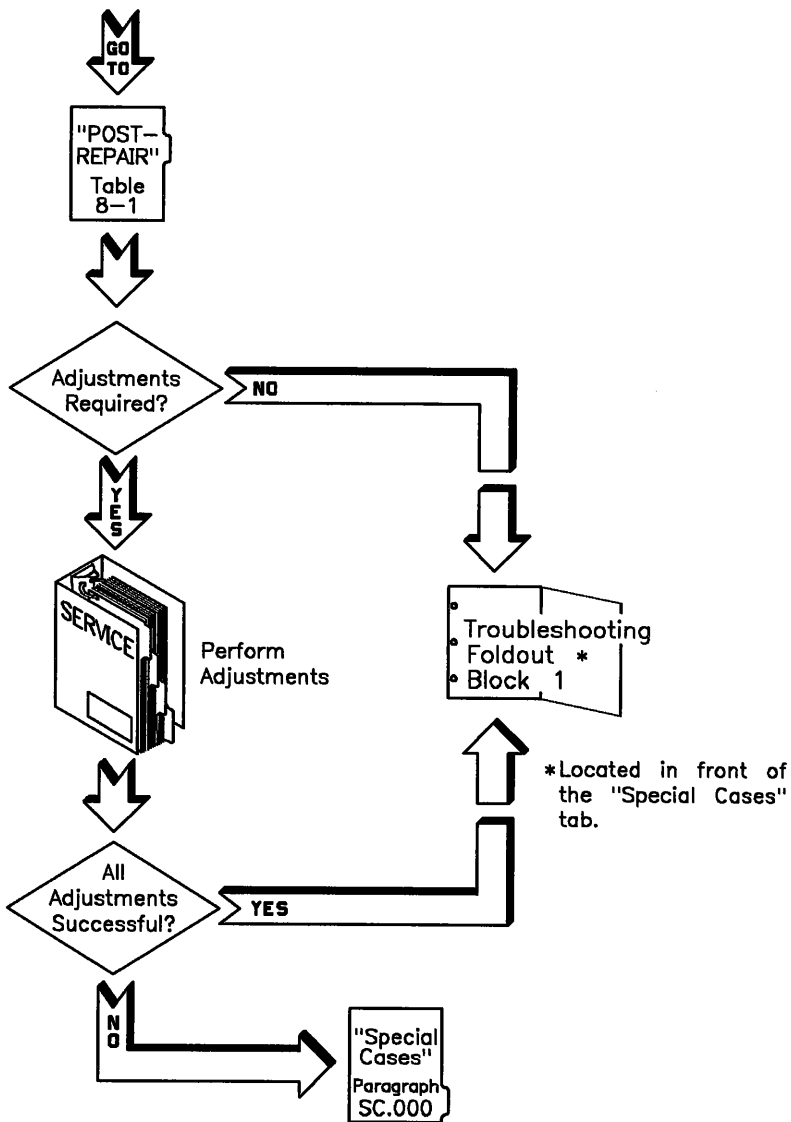

---

## **A4 Fractional-N Troubleshooting**

<b>A4.000</b>	<b>Message Displayed on Synthesizer</b>	<b>Go to Paragraph</b>
	A4 : Read Buffers	A4.100
	A4 : -3.25V Supply	A4.200
	A4 : Tuning Range	A4.300
	A4 : FNGO Control	A4.400
	A4 : D-REF Supply	A4.9000
	A4 : FN Chip Registers	A4.9000
	A4 : +2.2V Supply	A4.9000
	A4 : Sweep Test	A4.9000
	A4 : Switching Speed	A4.9000
	A4 : Monotonicity	A4.9000

## A4.100

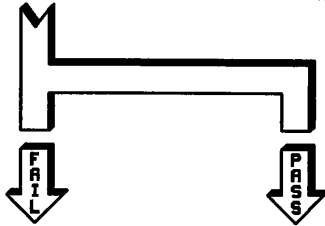
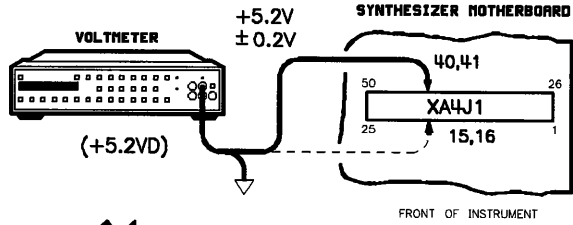

Go To A4.1300

Continue

## A4.101

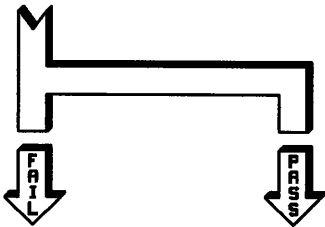
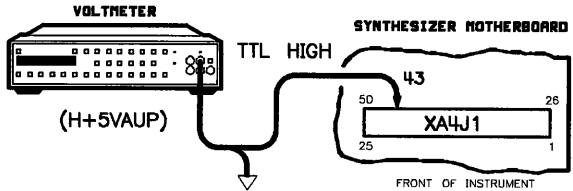

Go To A4.1305

Continue

## A4.102

Loop self-test #232:

1. Press **PRESET** **SERVICE**.
2. Select **Selftest Menu**.
3. Press **232** **ENTER**.
4. Select **Loop Do Test #232**.

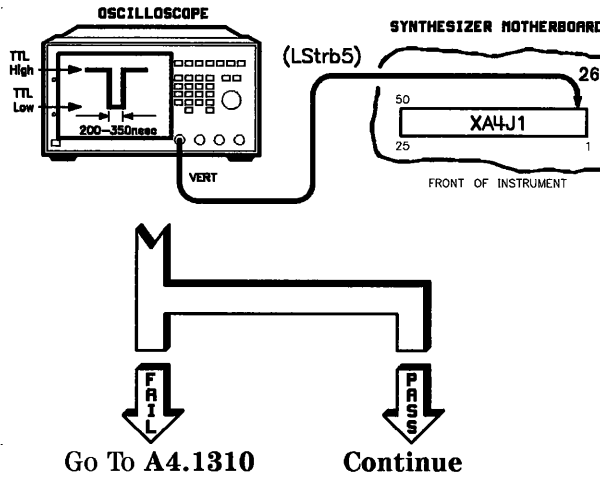

## A4.103

Loop self-test #231:

1. Press **PRESET** **SERVICE**.
2. Select **Selftest Menu**.
3. Press **231** **ENTER**.
4. Select **Loop Do Test #231**.

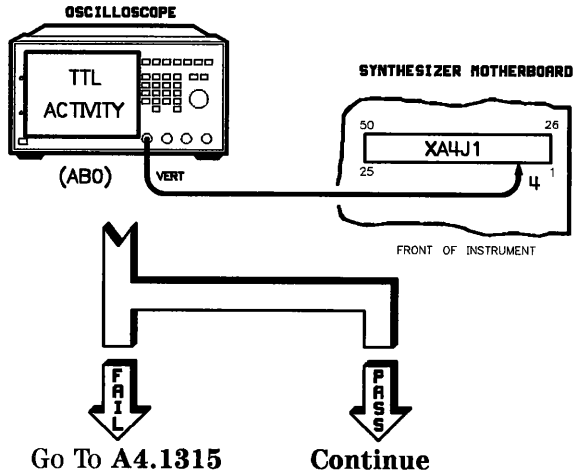

### A4.104

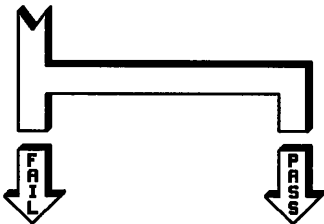
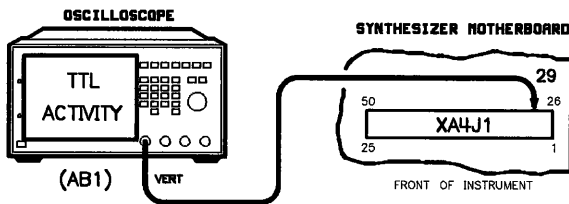

Go To A4.1320

Continue

### A4.105

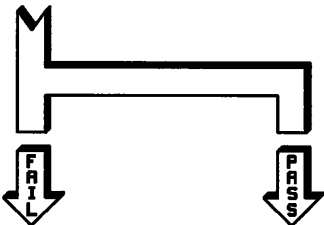
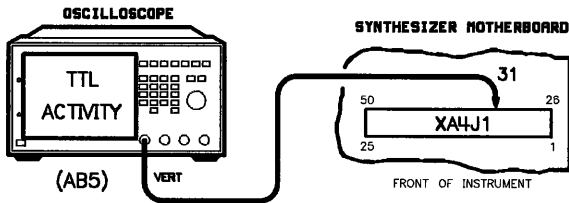

Go To A4.1325

Go To A4.9000



## A4.200

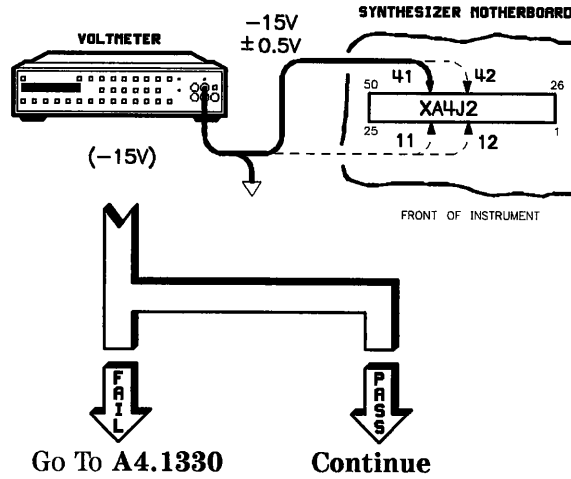

## A4.201

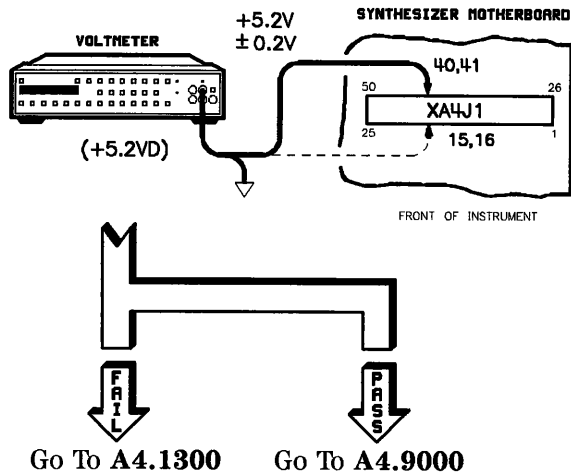

**A4.300** The pulse width is 10 to 20 ns. The frequency is 125 kHz. The oscilloscope must present a 50Ω load. Do not use a high impedance probe. The combination of low frequency and narrow pulse width makes this a very difficult pulse to see. Do not use a frequency counter to check frequency, because of the tendency to count the second harmonic.

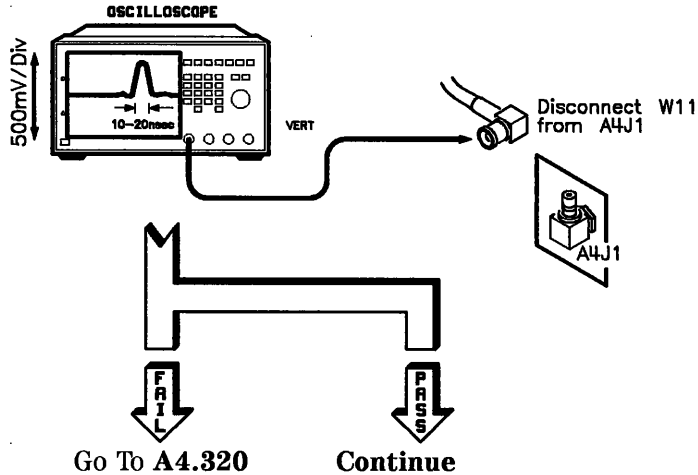

### A4.301

Perform the following setup:

1. Turn the synthesizer off.
2. Remove the A4 assembly.
3. Turn the synthesizer on.
4. Press **PRESET** **CW** **SERVICE**.
5. Select **Unlock Info**.

Does FRACN indicate OK?

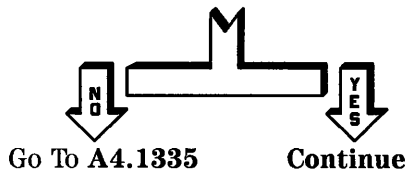

### A4.302

Perform the following setup:

1. Carefully short XA4J1-50 to ground (A4 should still be removed).
2. Select **Unlock Info** **Unlock Info** (press **Unlock Info** twice to reacquire data).

Does FRACN indicate UNLOCK?



Go To **A4.1335**

**Continue**

### A4.303

Perform the following setup:

1. Turn the synthesizer off.
2. Re-install the A4 assembly and reconnect the cables.
3. Turn the synthesizer on.

Loop self-test #35:

1. Press **PRESET** **SERVICE**.
2. Select **Selftest Menu**.
3. Press **35** **ENTER**.
4. Select **Loop Do Test #35**.

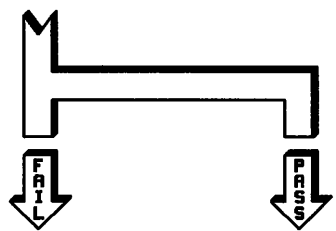
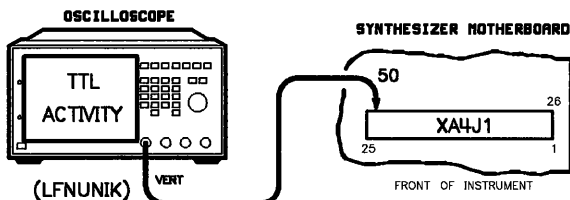

Go To A4.9000

Continue

### A4.304

Perform the following setup:

1. Press **PRESET** **SERVICE**.
2. Select **Adjust Menu** **AssyAdj Menu**.
3. Select **A4 VCO Tune**.

Is the adjustment needle in the middle third of the synthesizer display?



Continue

Go To A4.9000

### A4.305

Try to execute the A4 VCO tune adjustment (refer to the *HP 8360 B-Series Swept Signal Generator/HP 8360 L-Series Swept CW Generator Service Guide*) and then continue.

Was the adjustment successful?



Go To **A4.9000**

**Continue**

### A4.306

Do self-test #29:

1. Press **PRESET** **SERVICE**.
2. Select **Selftest Menu**.
3. Press **29** **ENTER**.
4. Select **Do Test #29**.

Did self-test #29 pass?



Go To **A4.9000**

**Continue**

### A4.307

The adjustment may have repaired the A4 assembly. Go to "Instrument Level Troubleshooting."

### A4.320

The pulse width is 10 to 20 ns. The frequency is 125 kHz. The oscilloscope must present a 50  $\Omega$  load. Do not use a high impedance probe. The combination of low frequency and narrow pulse width makes this a very difficult pulse to see. Do not use a frequency counter to check frequency, because of the tendency to count the second harmonic.

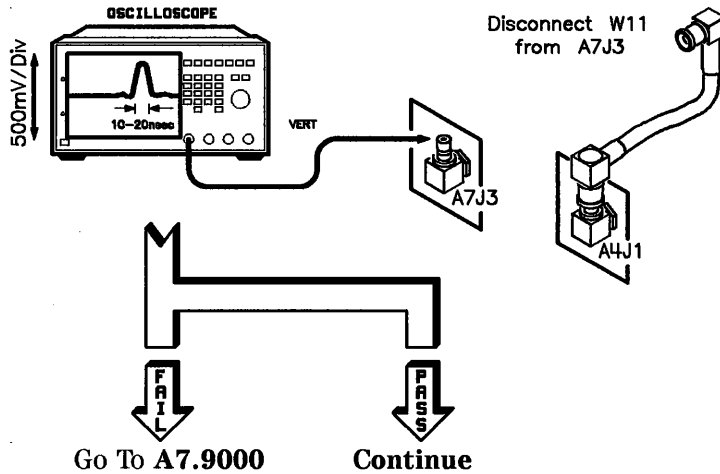

### A4.321

Replace W11 (A7J3 to A4J1) and go to the Troubleshooting Foldout, block 1 (located just prior to the "Special Cases" tab).

**A4.400** Loop self-test #37:

1. Press **PRESET** **SERVICE**.
2. Select **Selftest Menu**.
3. Press **37** **ENTER**.
4. Select **Loop Do Test #37**.

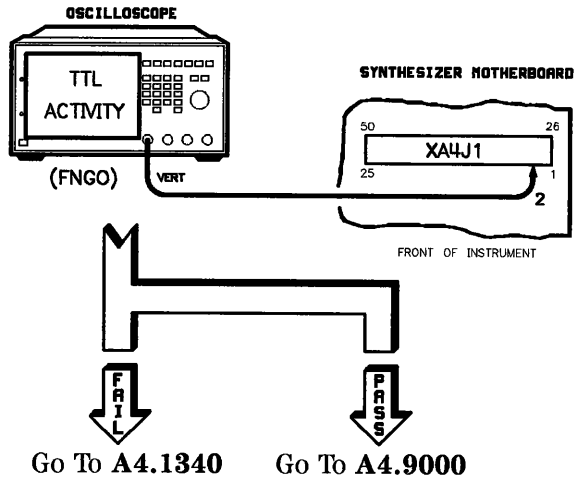

#### **A4.1300**

There is an open on the motherboard between XA4J1-15, 16, 40, or 41 and XA7J1-15, 16, 40, or 41. Verify this with an ohmmeter. Is jumpering an acceptable repair?



Go To **A22.9000**

**Continue**

#### **A4.1301**

Install a jumper and go to the Troubleshooting Foldout, block 1 (located just prior to the "Special Cases" tab).

#### **A4.1305**

There is an open on the motherboard between XA4J1-43 and XA7J1-43. Verify this with an ohmmeter. Is jumpering an acceptable repair?



Go To **A22.9000**

**Continue**

#### **A4.1306**

Install a jumper and go to the Troubleshooting Foldout, block 1 (located just prior to the "Special Cases" tab).



### A4.1310

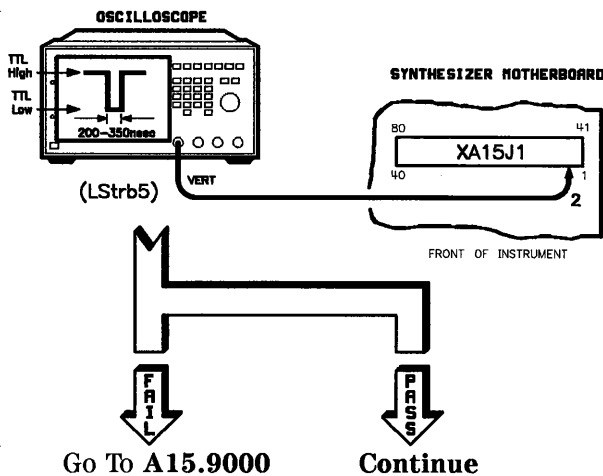

### A4.1311

There is an open on the motherboard between XA4J1-26 and XA15J1-2. Verify this with an ohmmeter. Is jumpering an acceptable repair?

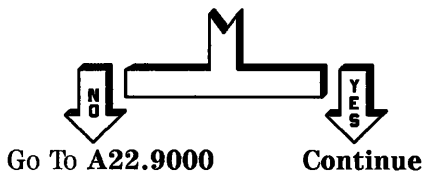

### A4.1312

Install a jumper and go to the Troubleshooting Foldout, block 1 (located just prior to the "Special Cases" tab).

### A4.1315

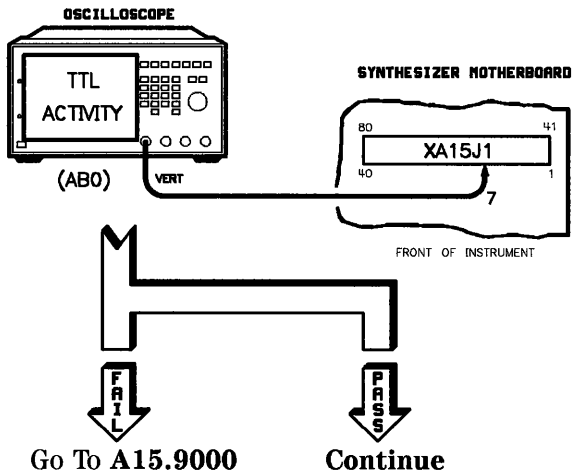

### A4.1316

There is an open on the motherboard between XA4J1-4 and XA15J1-7. Verify this with an ohmmeter. Is jumpering an acceptable repair?

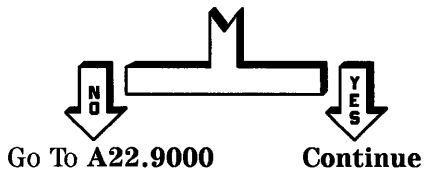

### A4.1317

Install a jumper and go to the Troubleshooting Foldout, block 1 (located just prior to the "Special Cases" tab).

### A4.1320

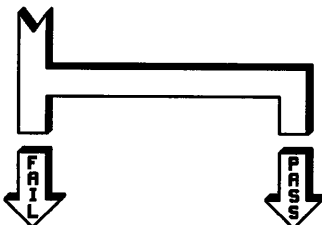
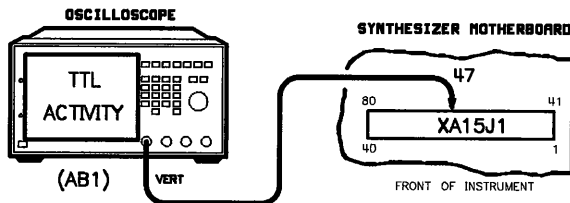

Go To **A15.9000**

**Continue**

### A4.1321

There is an open on the motherboard between XA4J1-29 and XA15J1-52. Verify this with an ohmmeter. Is jumpering an acceptable repair?



Go To **A22.9000**

**Continue**

### A4.1322

Install a jumper and go to the Troubleshooting Foldout, block 1 (located just prior to the "Special Cases" tab).

### A4.1325

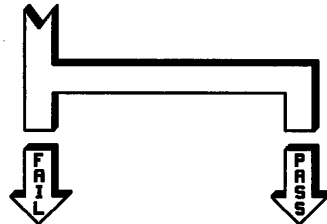
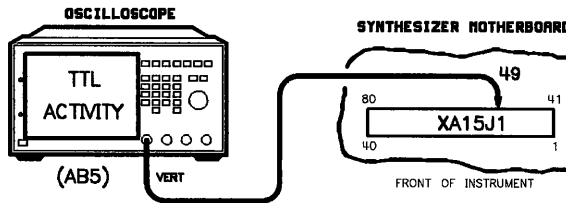

Go To A15.9000

Continue

### A4.1326

There is an open on the motherboard between XA4J1-31 and XA15J1-49. Verify this with an ohmmeter. Is jumpering an acceptable repair?



Go To A22.9000

Continue

### A4.1327

Install a jumper and go to the Troubleshooting Foldout, block 1 (located just prior to the "Special Cases" tab).

#### **A4.1330**

There is an open on the motherboard between XA4J2-11, 12, 41, or 42 and XA7J2-11, 12, 41, or 42. Verify this with an ohmmeter. Is jumpering an acceptable repair?



Go To **A22.9000**

**Continue**

#### **A4.1331**

Install a jumper and go to the Troubleshooting Foldout, block 1 (located just prior to the "Special Cases" tab).

#### **A4.1335**

Using an ohmmeter, measure the resistance from XA4J1-50 to XA15J1-77.

Is the resistance less than or equal to 2  $\Omega$ ?

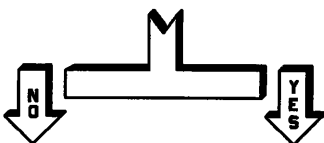

**Continue**

Go To **A15.9000**

### A4.1336

There is an open on the motherboard between XA4J1-50 and XA15J1-77. Verify this with an ohmmeter. Is jumpering an acceptable repair?

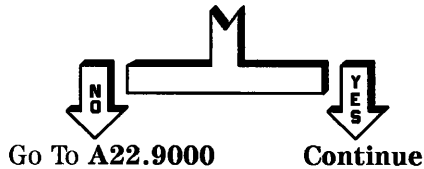

### A4.1337

Install a jumper and go to the Troubleshooting Foldout, block 1 (located just prior to the "Special Cases" tab).

### A4.1340

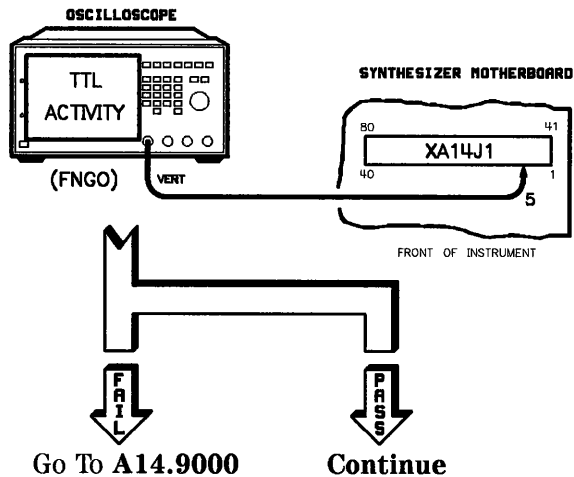

#### **A4.1341**

There is an open on the motherboard between XA4J1-2 and XA14J1-5. Verify this with an ohmmeter. Is jumpering an acceptable repair?



Go To **A22.9000**

**Continue**

#### **A4.1342**

Install a jumper and go to the Troubleshooting Foldout, block 1 (located just prior to the "Special Cases" tab).

**A4.9000** Replace the A4 assembly.

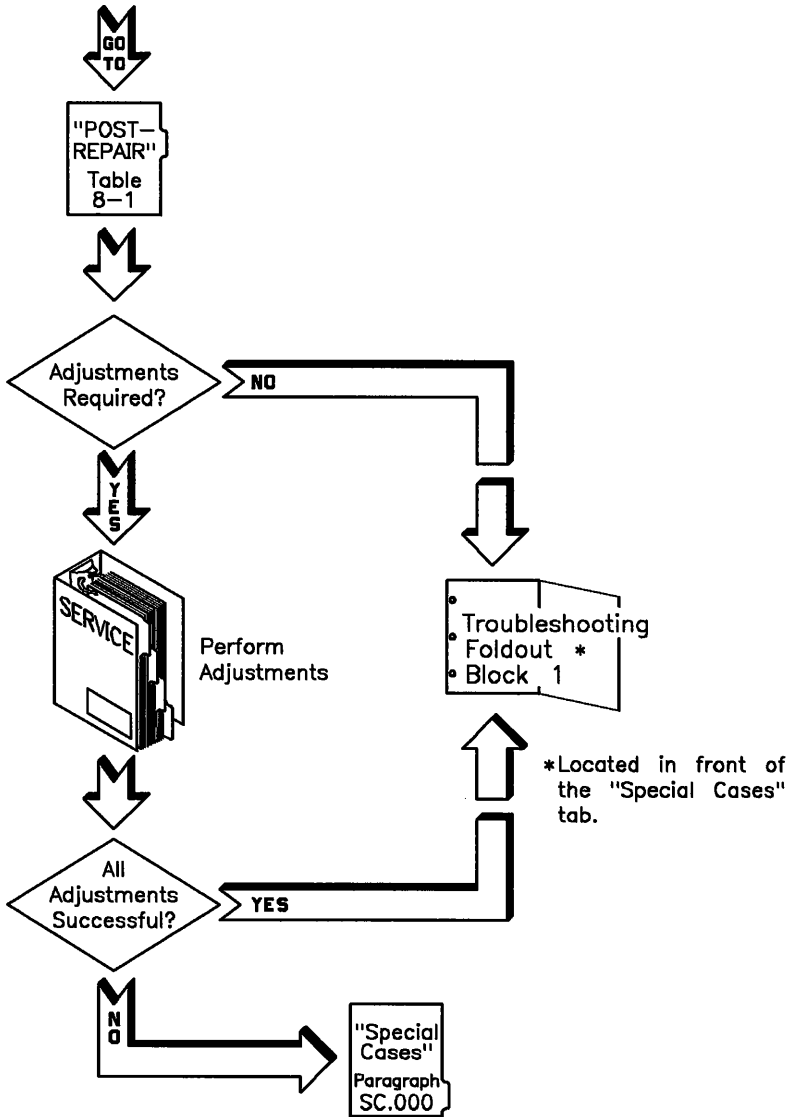



---

## A5 YO Loop Troubleshooting

<b>A5.000</b>	<b>Message Displayed on Synthesizer</b>	<b>Go to Paragraph</b>
	A5 : Digital Interface	A5.100
	A5 : ABUS Ground	A5.200
	A5 : Switched Amplifier	A5.300
	A5 : IF Frequency Counter	A5.400
	A5 : Integrator	A5.500
	A5 : Overmod Detector	A5.600
	A5 : Phase Detector	A5.8500
	A5 : Output to YO Driver	A5.8500
	A5 : Output to FM Coil	A5.8500
	A5 : Track and Hold	A5.8500

**A5.100** Perform the following key sequence:

1. Press **PRESET** **SERVICE**.
2. Select **Selftest Menu**.
3. Press **231** **ENTER**.
4. Select **Loop** (asterisk on).
5. Select **Do Test #231**.

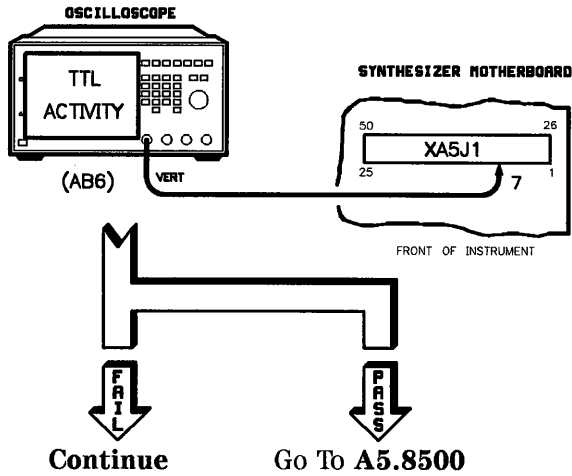

**A5.110**

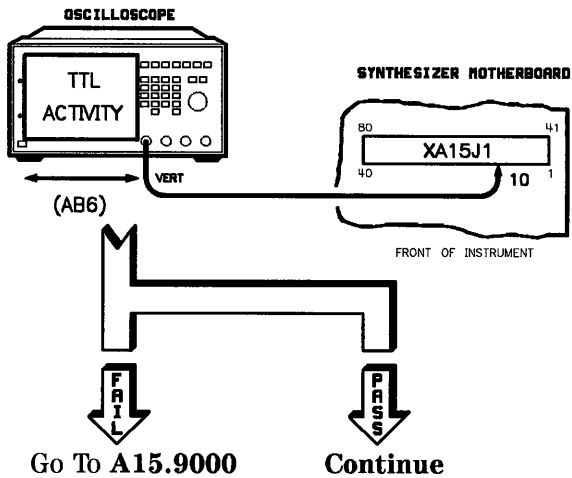

### **A5.111**

There is an open on the motherboard between XA5J1-7 and XA15J1-10. Verify this with an ohmmeter. Is jumpering the open an acceptable repair?



Go To **A22.9000**

**Continue**

### **A5.112**

Install a jumper and go to the Troubleshooting Foldout, block 1 (located just prior to the “Special Cases” tab).

**A5.200** Perform the following key sequence:

1. Press **PRESET** **SERVICE** **CW**.
2. Select **Selftest Menu**.
3. Press **49** **ENTER**.
4. Select **Loop** (asterisk on).
5. Select **Do Test #49**.

Verify that portions of the signal are  $\leq 700$  mV. However, expect other portions of the signal to rise to levels of up to 15 Vdc. This is not a failure as long as portions of the signal are  $\leq 700$  mV.

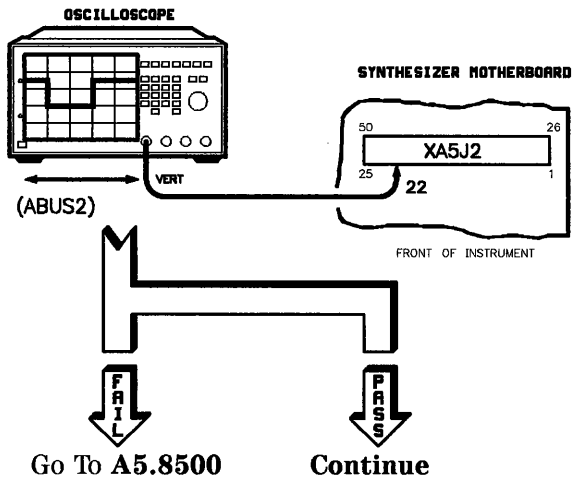

### A5.220

Verify that portions of the signal are  $\leq 700$  mV. However, expect some portions of the signal to rise to levels of up to 15 Vdc. This is not a failure as long as portions of the signal are  $\leq 700$  mV.

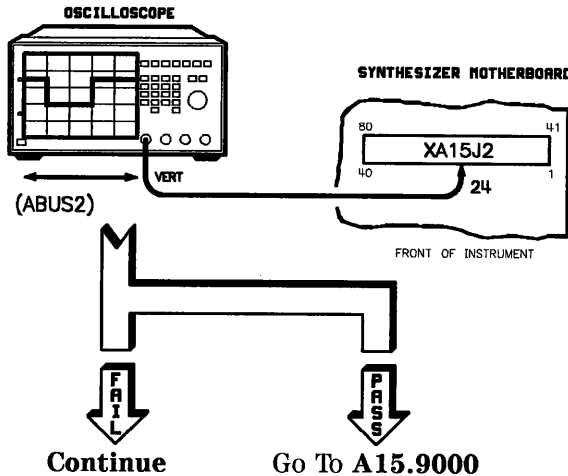

### A5.221

There is an open on the motherboard between XA5J2-22 and XA15J2-24. Verify this with an ohmmeter. Is jumpering the open an acceptable repair?

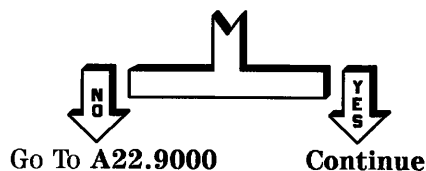

### A5.222

Install a jumper and go to the Troubleshooting Foldout, block 1 (located just prior to the "Special Cases" tab).

### A5.300

The instrument may be showing an UNLOCK message. If so, the keyboard response will be very sluggish. This is normal. Also, the frequency may be somewhat unstable.

Perform the following key sequence:

1. Press **PRESET** **SERVICE**.
2. Select **Tools Menu** **CntlPLL Menu** **Sampler Menu** **Sampler Freq.**
3. Press **200** **MHz**.

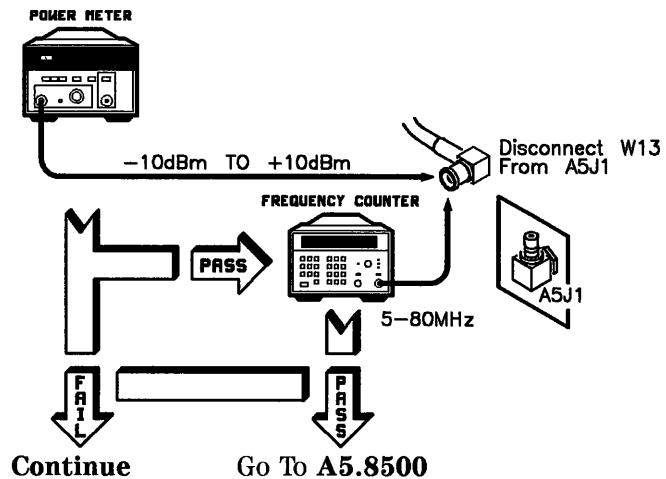

### A5.301

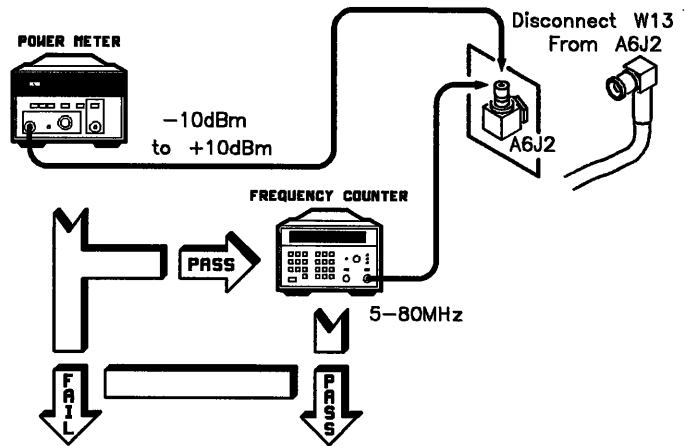

Go To **A6.9000**      Go To **A5.302**

### A5.302

Replace W13 and go to the Troubleshooting Foldout, block 1 (located just prior to the "Special Cases" tab).

**A5.400** Perform the following key sequence:

1. Press **PRESET** **CW** **SERVICE**.
2. Select **Selftest Menu**.
3. Press **51** **ENTER**.
4. Select **Loop** (asterisk on)
5. Select **Do Test #51**.

Note that this TTL signal cycles about every one to three seconds. It is a low duty cycle, low frequency signal that is difficult to see.

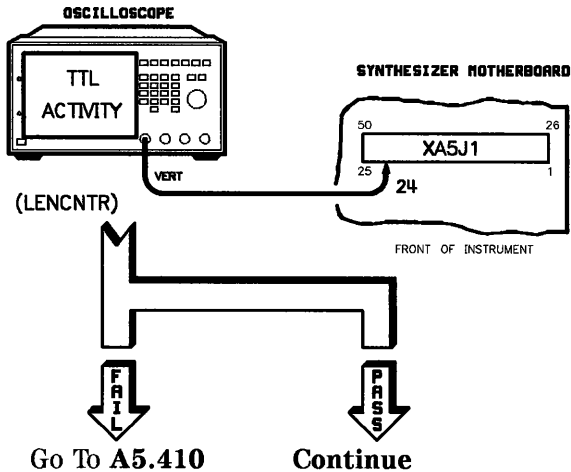



### A5.401

Set up the following measurement and look for a very slow-moving TTL signal.

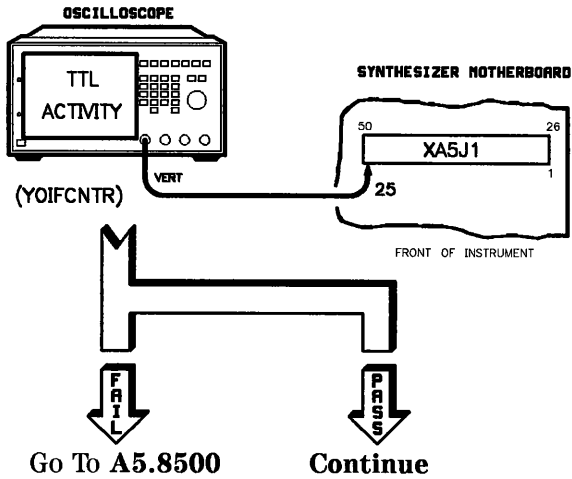

### A5.402

Set up the following measurement and look for a very slow-moving TTL signal.

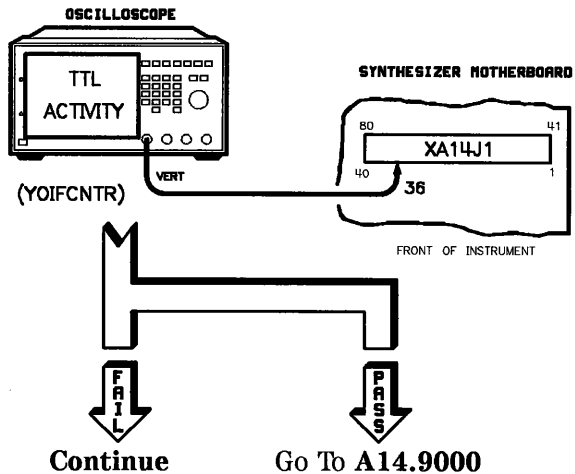

### A5.403

There is an open on the motherboard between XA5J1-25 and XA14J1-36. Verify this with an ohmmeter. Is jumpering the open an acceptable repair?

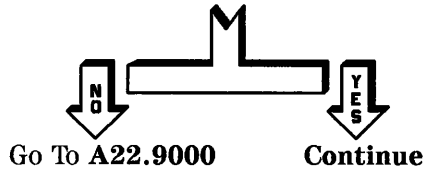

### A5.404

Install a jumper and go to the Troubleshooting Foldout, block 1 (located just prior to the "Special Cases" tab).

### A5.410

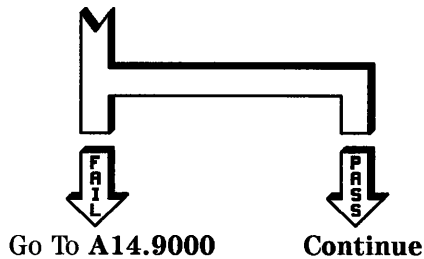
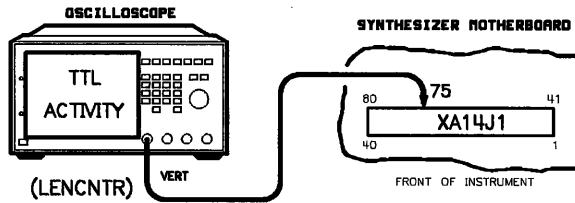

### **A5.411**

There is an open on the motherboard between XA5J1-24 and XA14J1-75. Verify this with an ohmmeter. Is jumpering the open an acceptable repair?



Go To **A22.9000**

**Continue**

### **A5.412**

Install a jumper and go to the Troubleshooting Foldout, block 1 (located just prior to the "Special Cases" tab).

**A5.500** Perform the following key sequence:

1. Press **PRESET** **CW** **SERVICE**.
2. Select **Tools Menu** **CntlPLL** **Frac N Menu** **CW**.
3. To enter a frequency Press **XXXX** **ENTER**.

Where XXX is the frequency of the fractional-N loop.  
The frequency of the fractional-N loop is valid from 30 MHz to 60 MHz.

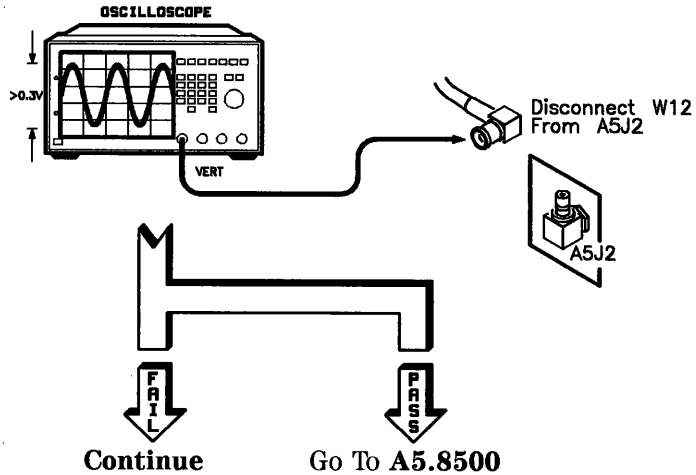

**A5.501**

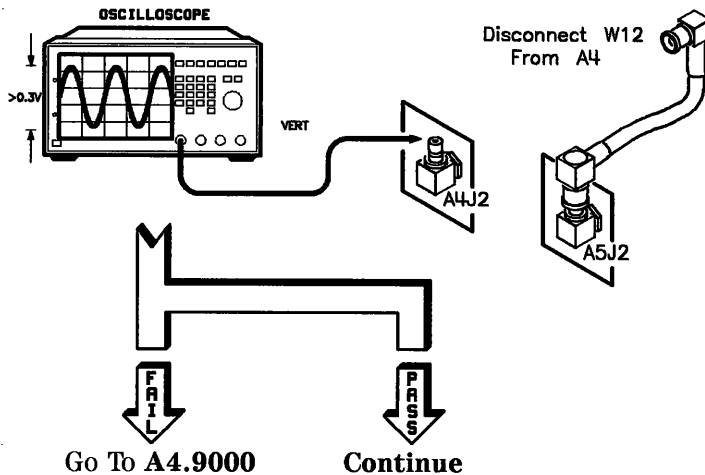

## **A5.502**

Replace W12 and go to the Troubleshooting Foldout, block 1 (located just prior to the “Special Cases” tab).

**A5.600** On the synthesizer, press **PRESET**.

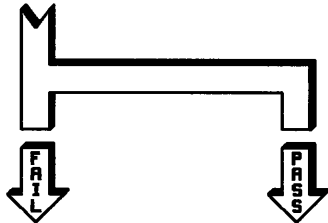
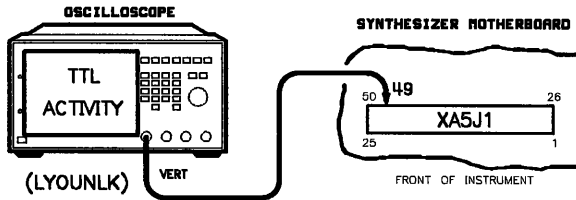

Go To A5.8500

Continue

**A5.601**

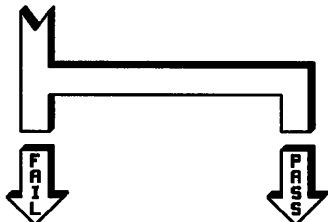
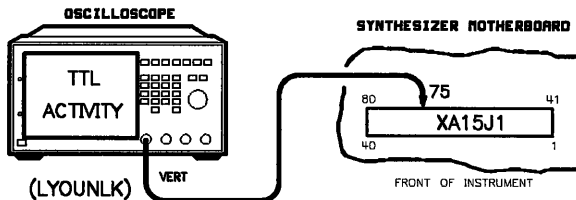

Continue

Go To A15.9000

### **A5.602**

There is an open on the motherboard between XA5J1-49 and XA15J1-75. Verify this with an ohmmeter. Is jumpering the open an acceptable repair?

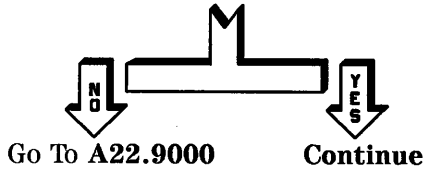

### **A5.603**

Install a jumper. Then go to Troubleshooting Foldout, block 1 (located just prior to the “Special Cases” tab).

**A5.8500** Are all five switch positions on A5S1 open?

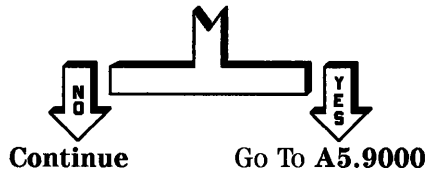

**A5.8501**

Open all five switch positions on A5S1 and rerun self-tests. If the same failure occurs as the original failure, go to A5.9000 and replace A5. If the same failure does not occur, go to the Troubleshooting Foldout, block 1 (located just prior to the “Special Cases” tab.)



**A5.9000** Replace the A5 assembly.

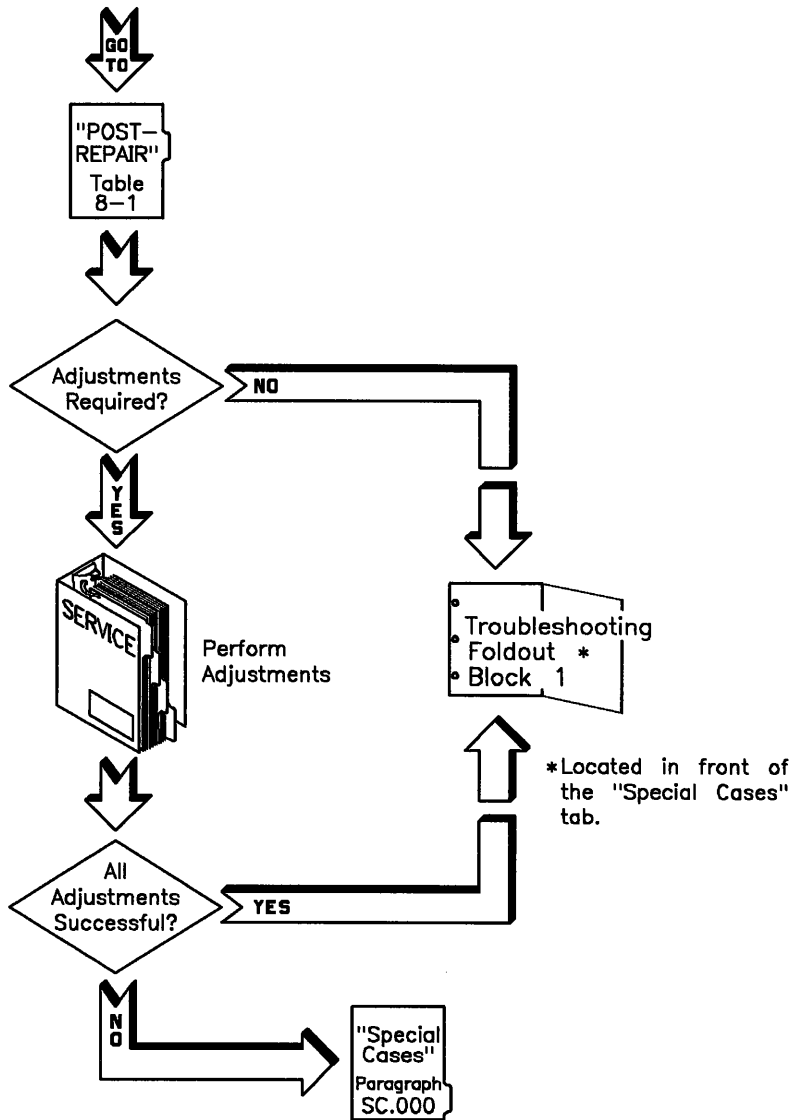

---

## A6 Sampler Troubleshooting

<b>A6.000</b>	<b>Message Displayed on Synthesizer</b>	<b>Go to Paragraph</b>
	A6 : ABUS Ground	A6.100
	A6 : UNLOCK Detector	A6.200
	A6 : Phase Amplifier	A6.300
	A6 : IF Output Level	A6.400
	A6 : VTUNE Endpoints	A6.500
	A6 : Loop Integrator	A6.9000
	A6 : Loop Gain DAC	A6.9000
	A6 : PAL Check	A6.9000
	A6 : IF Amplifier Bias	A6.9000
	A6 : Speed-up Circuit	A6.9000
	A6 : VTUNE Monotonicity	A6.9000
	A6 : Switching Speed	A6.9000

**A6.100** Perform the following key sequence:

1. Press **PRESET** **SERVICE**.
2. Select **Selftest Menu**.
3. Press **232** **ENTER**.
4. Select **Loop** (asterisk on).
5. Select **Do Test #232**.

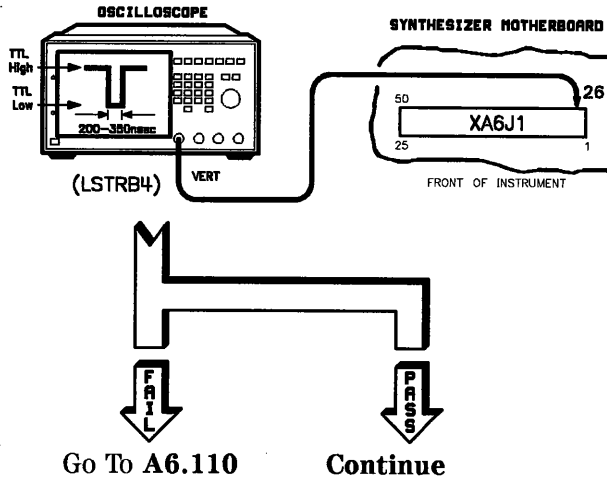

### A6.101

Perform the following key sequence:

1. Press **PRESET** **SERVICE**.
2. Select **Selftest Menu**.
3. Press **66** **ENTER**.
4. Select **Loop** (asterisk on).
5. Select **Do Test #66**.

Verify a signal of  $\leq 700$  mV. However, expect some portions of the signal to rise to levels of up to 15 Vdc. This is not a failure as long as the signal is primarily  $\leq 700$  mV.

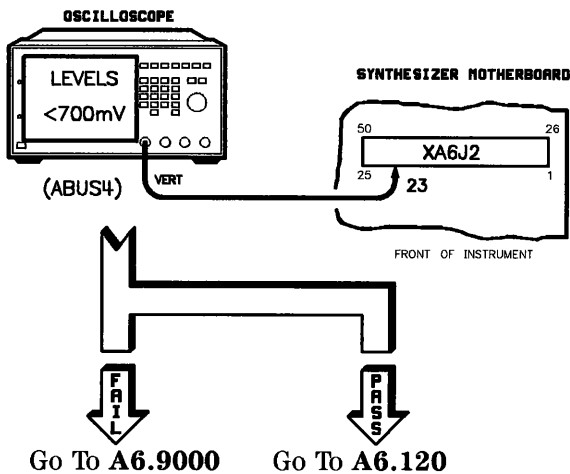

### A6.110

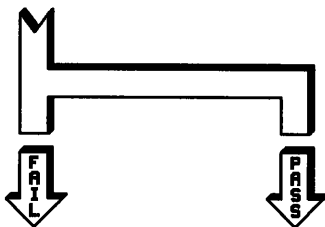
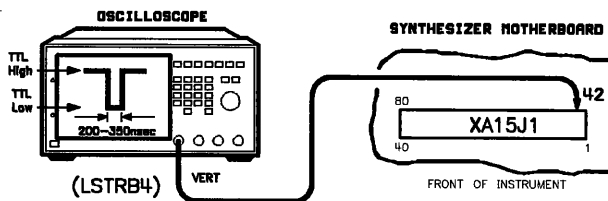

Go To **A15.9000**

**Continue**

### A6.111

There is an open on the motherboard between XA6J1-26 and XA15J1-42. Verify this with an ohmmeter. Is jumpering the open an acceptable repair?

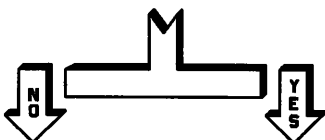

Go To **A22.9000**

**Continue**

### A6.112

Install a jumper and go to the Troubleshooting Foldout, block 1 (located just prior to the "Special Cases" tab).

### A6.120

Verify a signal of  $\leq 700$  mV. However, expect some portions of the signal to rise to levels of up to 15 Vdc. This is not a failure as long as the signal is primarily  $\leq 700$  mV.

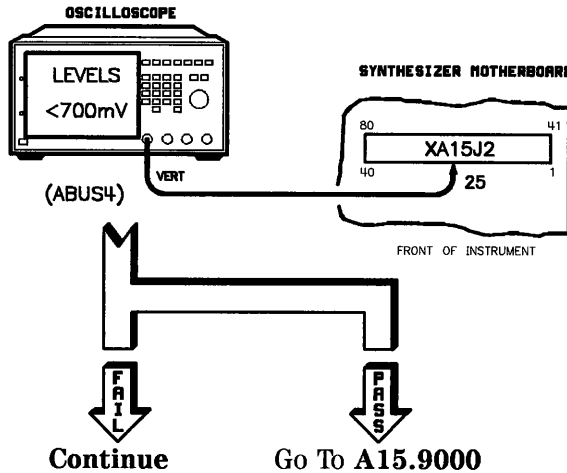

### A6.121

There is an open on the motherboard between XA6J1-23 and XA15J1-25. Verify this with an ohmmeter. Is jumpering the open an acceptable repair?

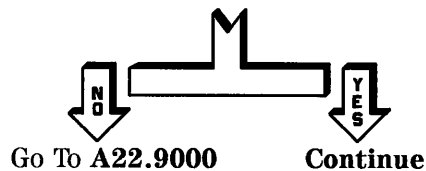

### A6.122

Install a jumper and go to the Troubleshooting Foldout, block 1 (located just prior to the "Special Cases" tab).

**A6.200** Perform the following key sequence:

1. Press **PRESET** **SERVICE**.
2. Select **Selftest Menu**.
3. Press **67** **ENTER**.
4. Select **Loop** (asterisk on).
5. Select **Do Test #67**.

The signal should be dominated by a TTL low. Some TTL highs may be present. A failure is defined as a signal with no TTL lows.

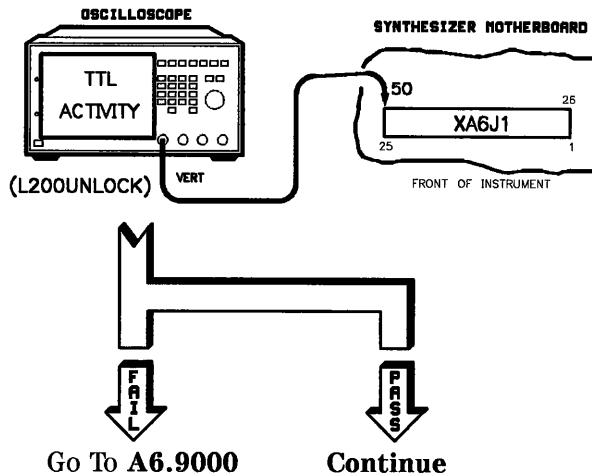

### A6.201

The signal should be dominated by a TTL low. Some TTL highs may be present. A failure is defined as a signal with no TTL lows.

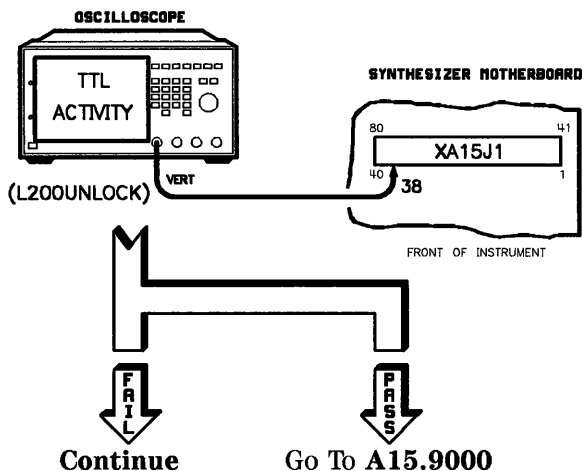

### A6.202

There is an open on the motherboard between XA6J1-50 and XA15J1-38. Verify this with an ohmmeter. Is jumpering the open an acceptable repair?

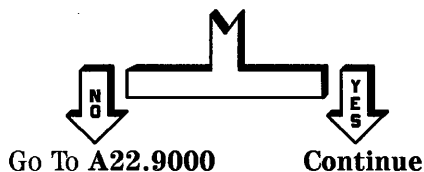

### A6.203

Install a jumper and go to the Troubleshooting Foldout, block 1 (located just prior to the "Special Cases" tab).



**A6.300** Is Option 002 installed?

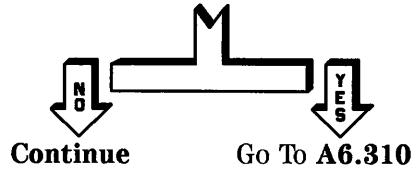

**A6.301**

Set up the oscilloscope for 50 Ω input impedance.

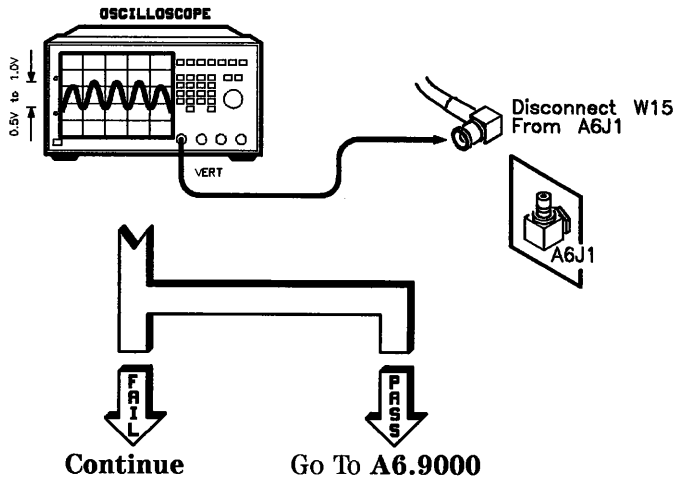

### A6.302

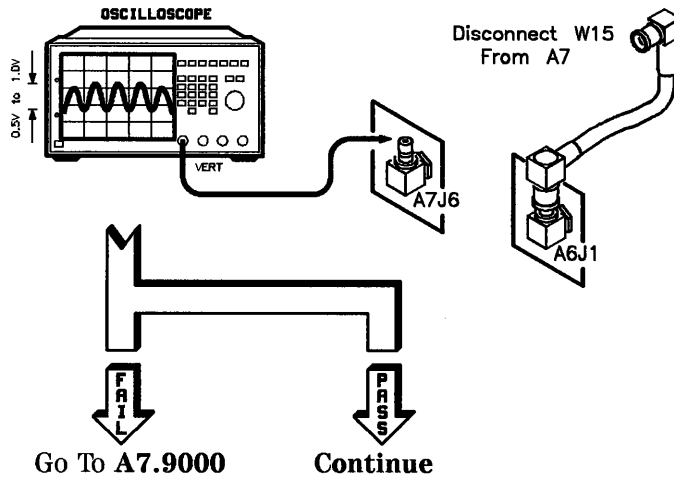

### A6.303

Replace W15 and go to the Troubleshooting Foldout, block 1 (located just prior to the "Special Cases" tab).

### A6.310

Set up the oscilloscope for 50  $\Omega$  input impedance.

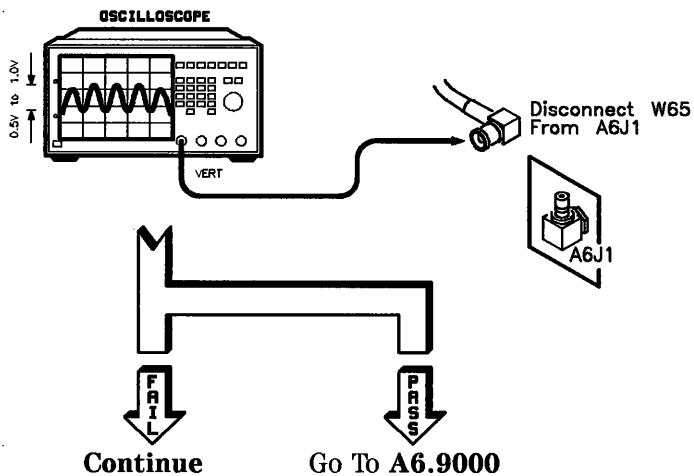

### **A6.311**

The most likely cause of the failure is W65. Replace W65 (from A8J2 to A6J1) and go to the Troubleshooting Foldout, block 1 (located just prior to the “Special Cases” tab). If this does not solve the problem, replace A8.

## A6.400 Set up for power measurement:

1. Set the power switch to standby.
2. Remove the top and bottom covers.
3. Turn the synthesizer power on.
4. Press **PRESET** **CW** **SERVICE**.
5. Select **Tools Menu** **CntlPLL Menu** **NoPhaseLock** (asterisk on).
6. Select **LoopCntl Menu** **YD Loop Freq.**
7. Press **2** **GHz**.
8. Using the rotary knob, sweep the frequency from 2.0 to 7.4 GHz and verify that power is greater than -25 dBm.

## Set up for frequency measurement:

1. Press **2** **GHz**.
2. Using **▲**, increment the frequency.
3. The measured frequency equals the front panel indication  $\pm 40$  MHz (2.0 to 7.4 GHz).

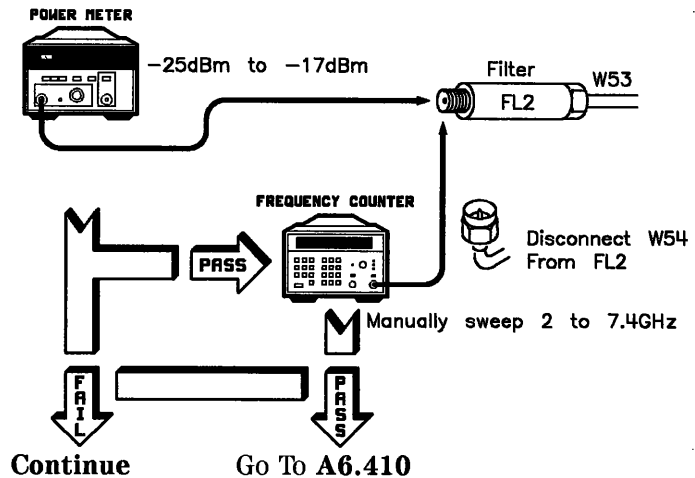

## A6.401

Set up for power measurement:

1. Reconnect any disconnected cables.
2. Put the RF deck in the service position.
3. Remove the 15 dB attenuator (AT3) from the directional coupler (A39).
4. Press **PRESET** **CW** **SERVICE**.
5. Select **Tools Menu** **CntlPLL Menu** **NoPhaseLock** (asterisk on).
6. Select **LoopCntl Menu** **Y0 Loop Freq.**
7. Press **2** **GHz**.
8. Using the rotary knob, sweep the frequency from 2 to 7.4 GHz and verify that power is  $\geq -7$  dBm.

Set up for frequency measurement:

1. Press **2** **GHz**.
2. Using **▲**, increment the frequency.
3. The measured frequency equals the front panel Indication  $\pm 40$  MHz (2 to 7.4 GHz).

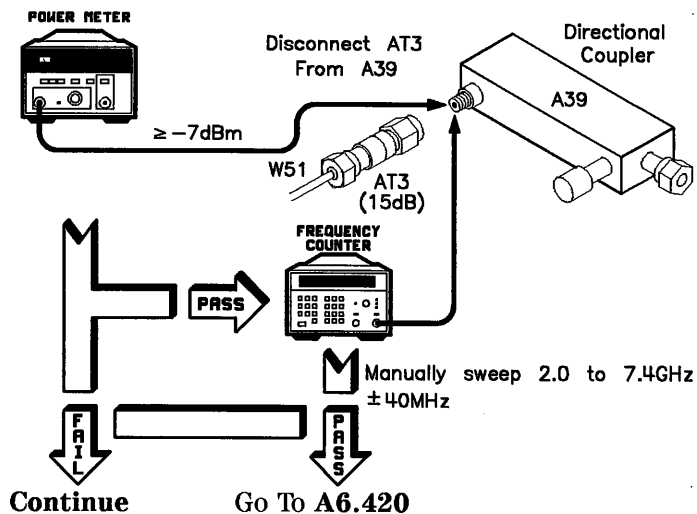

## A6.402

Set up for power measurement:

1. Reconnect any disconnected cables.
2. Put the RF deck in the service position.
3. Remove W52 (connects the YIG oscillator, A26, to the directional coupler (A39)).
4. Press **PRESET** **CW** **SERVICE**.
5. Select **Tools Menu** **CntlPLL Menu** **NoPhaseLock** (asterisk on).
6. Select **LoopCntl Menu** **Y0 Loop Freq**.
7. Press **2** **GHz**.
8. Using the rotary knob, sweep the frequency from 2.0 to 7.4 GHz and verify that power is  $\geq 8$  dBm.

Set up for frequency measurement:

1. Press **2** **GHz**.
2. Using **▲**, increment the frequency.
3. The measured frequency equals the front panel indication  $\pm 40$  MHz (2.0 to 7.4 GHz).

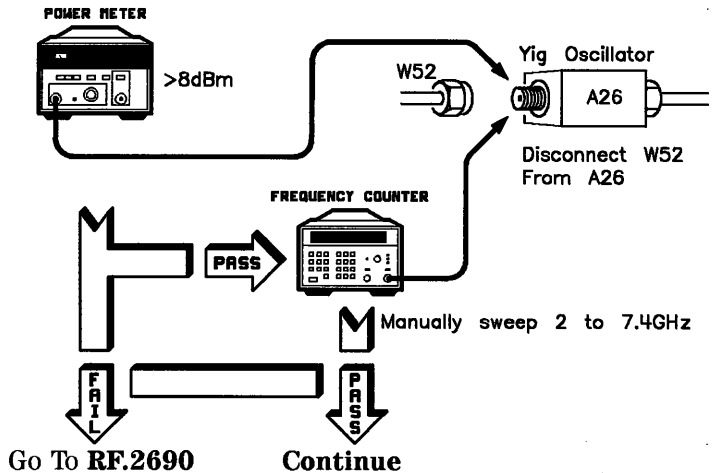

### **A6.403**

Check W52 for damage, deformation, or excessive RF path loss.

Is W52 defective?



Go To **RF.3990**

**Continue**

Replace W52 and go to the Troubleshooting Foldout, block 1 (located just prior to the “Special Cases” tab).

### **A6.410**

Remove A6 from the synthesizer and disconnect W54 from A6. Inspect and test W54 for defects.

Is W54 defective?



Go To **A6.9000**

**Continue**

Replace W54 and go to the Troubleshooting Foldout, block 1 (located just prior to the “Special Cases” tab).

## **A6.420**

There is a high-loss path between the directional coupler (A39) and the sampler (A6). This path includes two hard lines (W54, W51), a low pass filter (FL2), and an attenuator (AT3). The most likely failure is a poor connection. Correct the faulty connection or replace the faulty part (W54, FL2, W51, AT3). Isolate and replace the faulty component and go to the Troubleshooting Foldout, block 1 (located just prior to the “Special Cases” tab).

To check for excessive loss in a cable or filter, connect the component input to a known-good signal for the frequency bands in question (see the block diagram located behind the “Troubleshooting Block Diagrams” tab) and test the output. Over the frequency range of 2.0 to 8.0 GHz, the loss for a coaxial cable should be  $\leq 2.0$  dB; the loss for a filter should be  $\leq 4.0$  dB.



**A6.500** Refer to the calibration manual. Perform the following adjustments and return.

- A6 VCO Tune.
- A6 Sampler Match.
- A6 Loop Gain.
- A6 IF Gain.

Were you able to perform the adjustments?

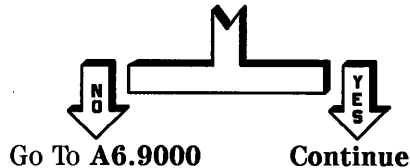

### **A6.501**

Perform the following key sequence:

1. Press **PRESET** **SERVICE**.
2. Select **Selftest Menu**.
3. Press **65** **ENTER**.
4. Select **Loop** (asterisk on).
5. Select **Do Test #65**.

Use the rotary knob to review the results of the A6 self-tests. If any A6 self-tests fail, go to A6.9000. Otherwise, go to the Troubleshooting Foldout, block 1 (located just prior to the "Special Cases" tab).

**A6.9000** Replace the A6 assembly.

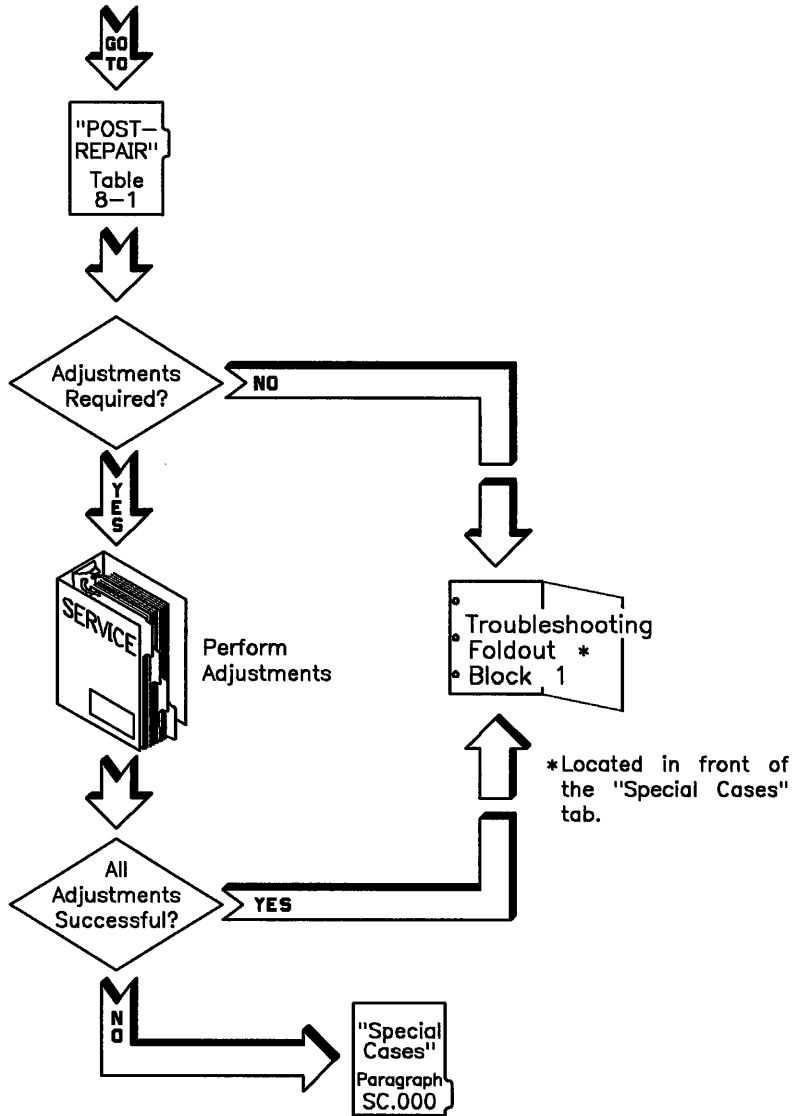

---

## A7 Reference Troubleshooting

<b>A7.000</b>	<b>Message Displayed on Synthesizer</b>	<b>Go to Paragraph</b>
	A7 : ABUS Ground	A7.100
	A7 : -12V Supply	A7.200
	A7 : 10 MHz Standard Input	A7.300
	A7 : UNLOCK Detector	A7.400
	A7 : EXT Reference Switch	A7.500
	A7 : +5V Supply	A7.9000
	A7 : -5V Supply	A7.9000
	A7 : Open Loop VTUNE	A7.9000
	A7 : 40 MHz Output	A7.9000
	A7 : 125 kHz Output	A7.9000
	A7 : INT Reference Switch	A7.9000

## A7.100

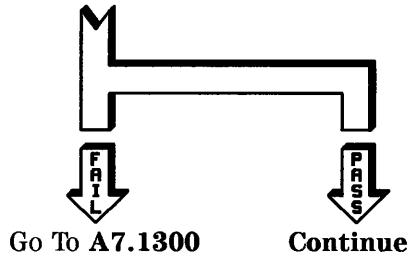
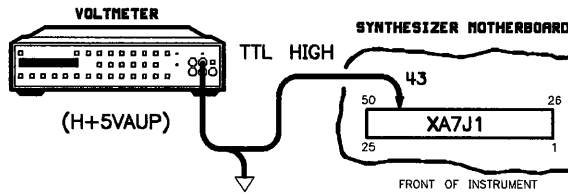

## A7.101

Loop self-test #231:

1. Press **PRESET** **SERVICE**.
2. Select **Selftest Menu**.
3. Press **231** **ENTER**.
4. Select **Loop Do Test #231**.

### A7.102

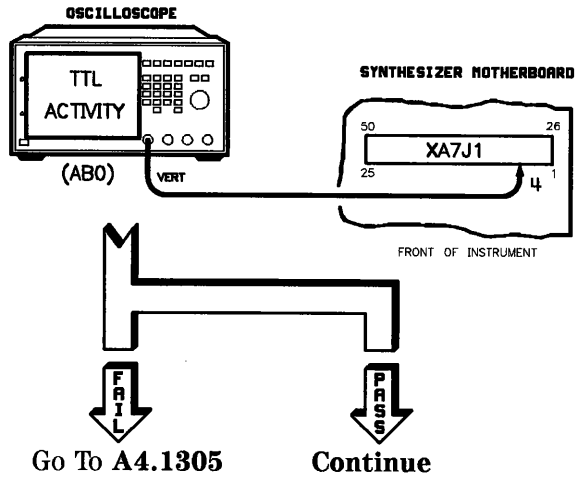

### A7.103

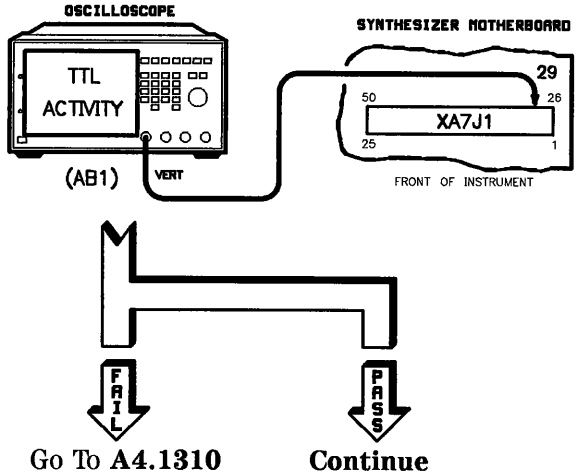

### A7.104

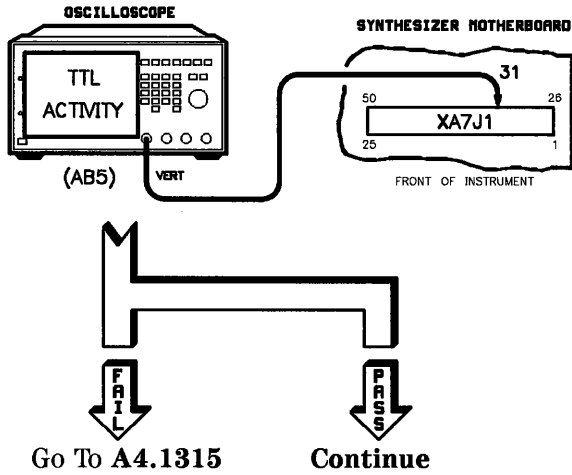

### A7.105

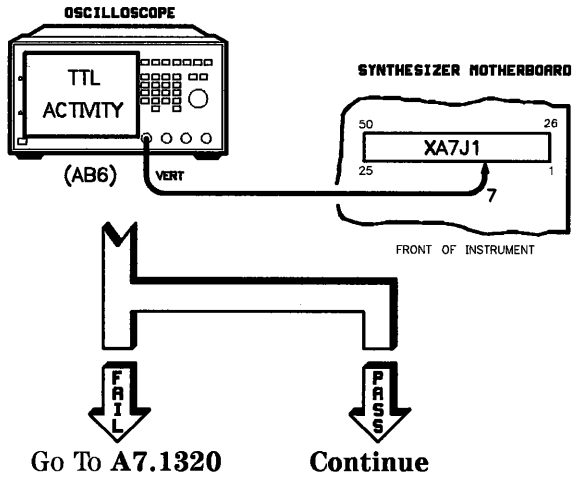

## A7.106

Loop self-test #232:

1. Press **PRESET** **SERVICE**.
2. Select **Selftest Menu**.
3. Press **232** **ENTER**.
4. Select **Loop Do Test #232**.

## A7.107

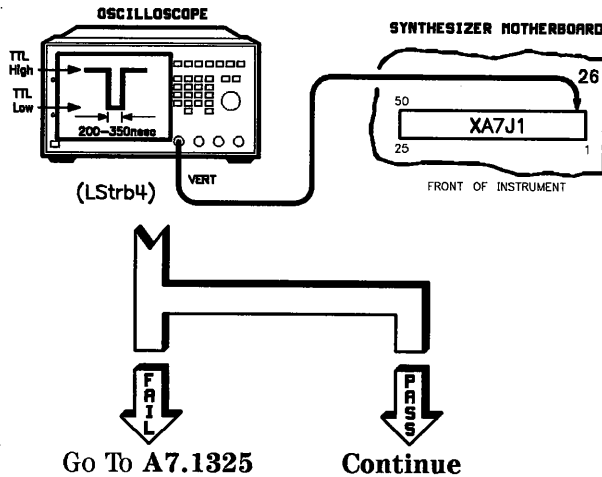

## A7.108

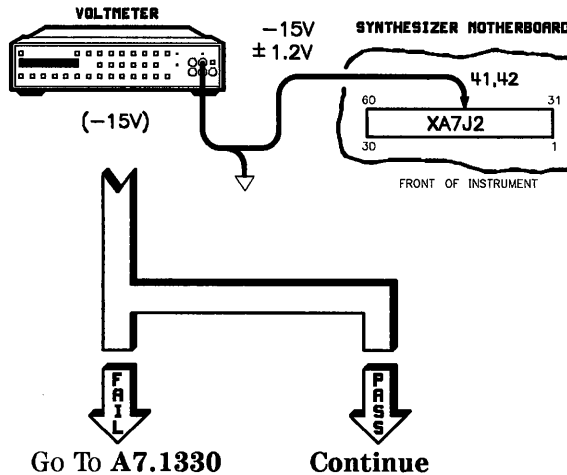

## A7.109

Log self-test #86 to display always:

1. Press **PRESET** **SERVICE**.
2. Select **Selftest Menu**.
3. Press **86** **ENTER**.
4. Select **Log** (asterisk on)
5. Select **Output Menu** **When to Log Always** (asterisk on).
6. Press **PRIOR**.
7. Select **Do Test #86**.



### A7.110

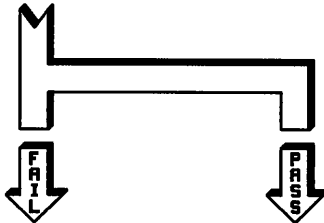
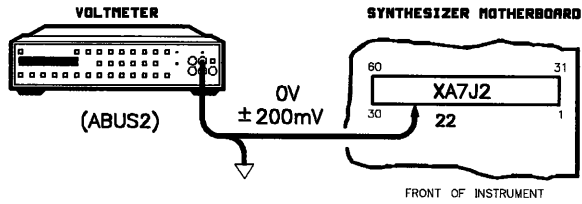

Go To A7.9000

Continue

### A7.111

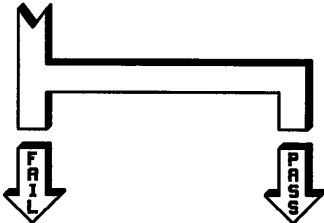
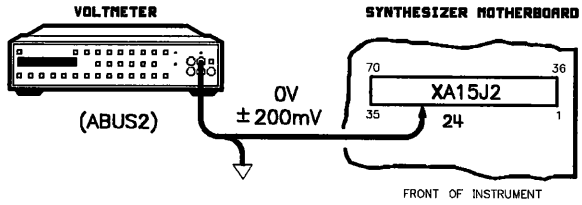

Go To A7.1335

Go To A15.8500

## A7.200

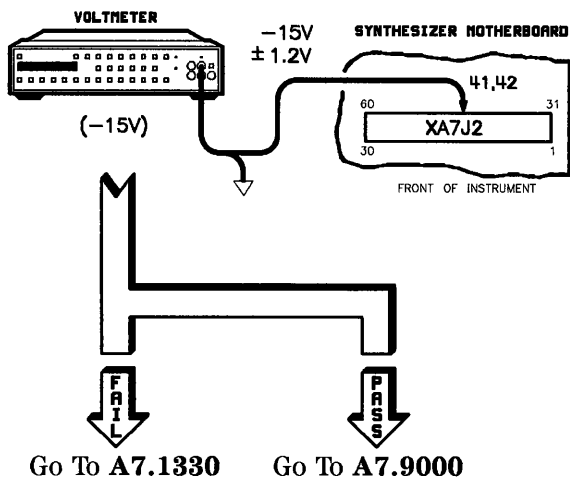

## A7.300

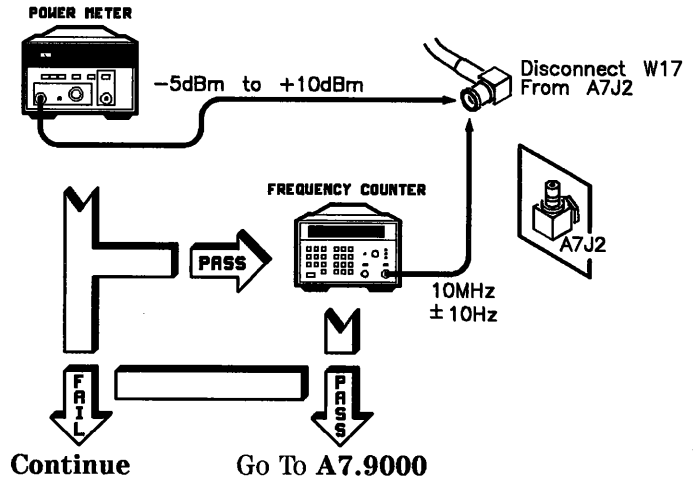

### A7.301

Perform the following setup:

1. Set the synthesizer to standby.
2. Unplug the synthesizer.
3. Remove the 8 screws holding the rear panel, and tilt the rear panel back to access A23 (the reference oscillator).
4. Temporarily replace W17 (connects A23J1 to A7J2) with W15 (connects A6J2 to A5J1).
5. Replace the rear panel with W15 in place of W17.
6. Plug in the synthesizer.
7. Turn the synthesizer on.

### A7.302

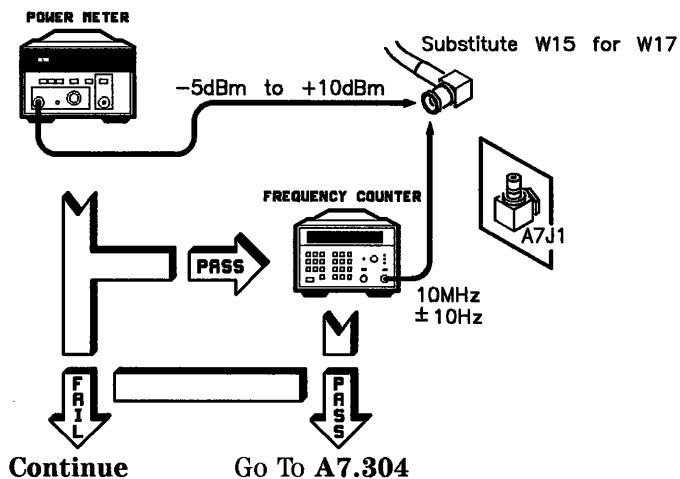

### A7.303

Go to A23.000 (troubleshoot the 10 MHz reference).

### A7.304

Replace W17 and go to the Troubleshooting Foldout, block 1 (located just prior to the "Special Cases" tab).

### A7.400 Loop self-test #94:

1. Press **PRESET** **SERVICE**.
2. Select **Selftest Menu**.
3. Press **94** **ENTER**.
4. Select **Loop Do Test #94**.

### A7.401

Check for a TTL signal with a period of *1.5 to 3.0 seconds*.

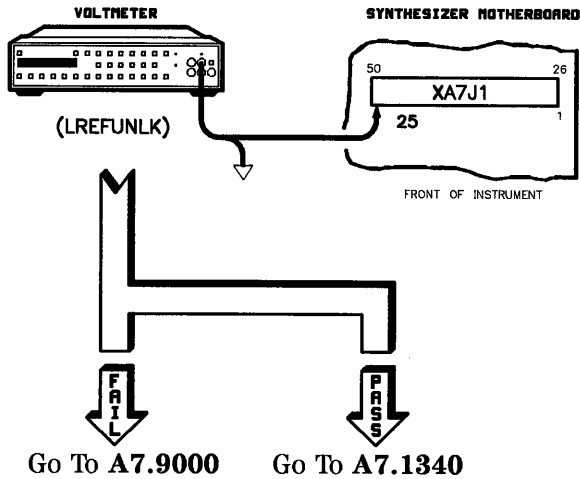

**A7.500** Are you using an external standard?

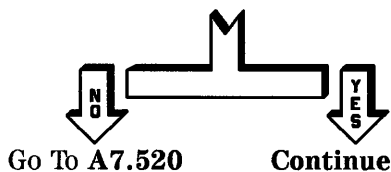

**A7.501**

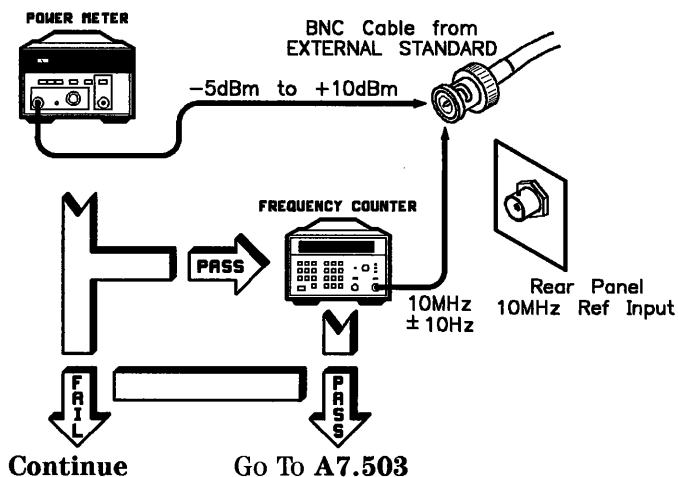

**A7.502**

The external standard is faulty. Correct the external reference (see instrument specifications) and go to the Troubleshooting Foldout, block 1 (located just prior to the "Special Cases" tab).

### A7.503

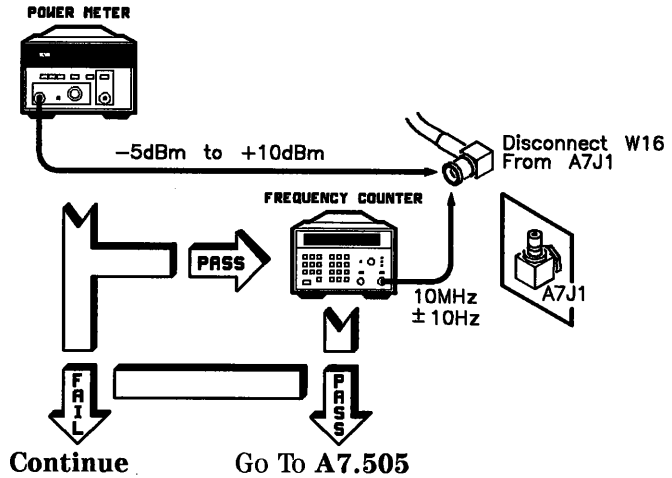

### A7.504

Replace W16 and go to the Troubleshooting Foldout, block 1 (located just prior to the "Special Cases" tab).

### A7.505

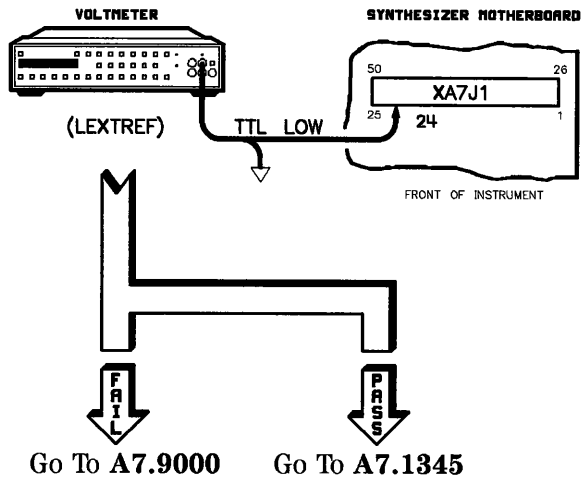

# A7.520

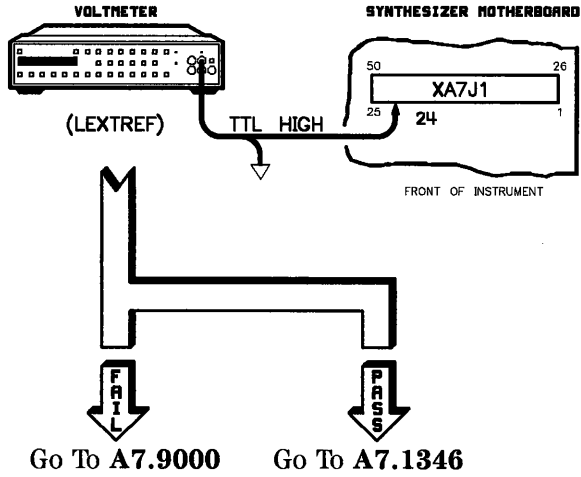



## A7.1300

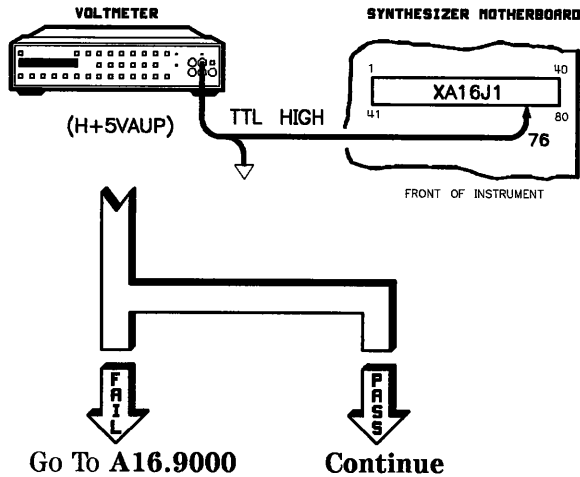

## A7.1301

There is an open on the motherboard between XA7J1-43 and XA16J1-76. Verify this with an ohmmeter. Is jumpering an acceptable repair?

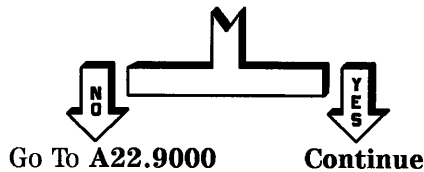

## A7.1302

Install a jumper and go to the Troubleshooting Foldout, block 1 (located just prior to the "Special Cases" tab).

### A7.1305

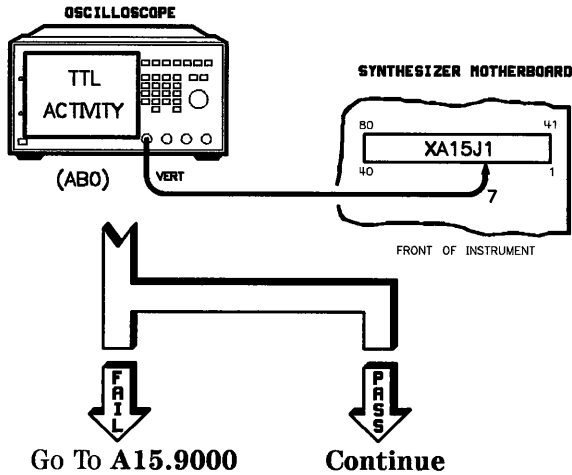

### A7.1306

There is an open on the motherboard between XA7J1-4 and XA15J1-7. Verify this with an ohmmeter. Is jumpering an acceptable repair?

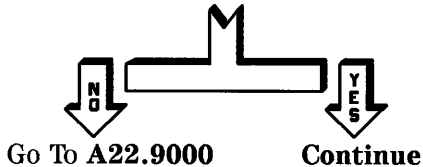

### A7.1307

Install a jumper and go to the Troubleshooting Foldout, block 1 (located just prior to the "Special Cases" tab).

### A7.1310

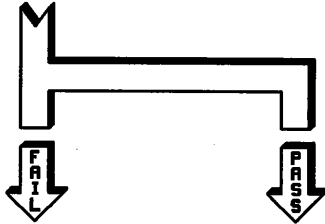
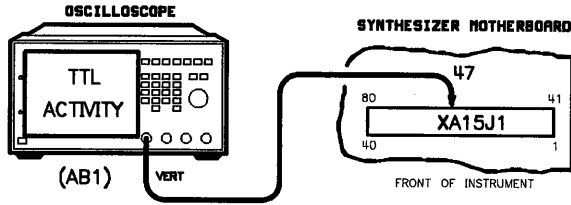

Go To **A15.9000**

**Continue**

### A7.1311

There is an open on the motherboard between XA7J1-29 and XA15J1-47. Verify this with an ohmmeter. Is jumpering an acceptable repair?



Go To **A22.9000**

**Continue**

### A7.1312

Install a jumper and go to the Troubleshooting Foldout, block 1 (located just prior to the "Special Cases" tab).

### A7.1315

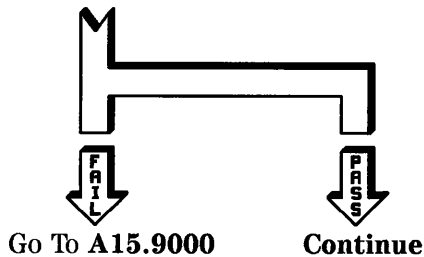
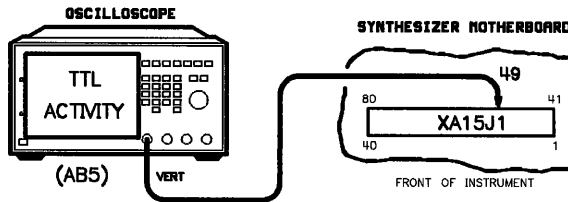

### A7.1316

There is an open on the motherboard between XA7J1-31 and XA15J1-49. Verify this with an ohmmeter. Is jumpering an acceptable repair?

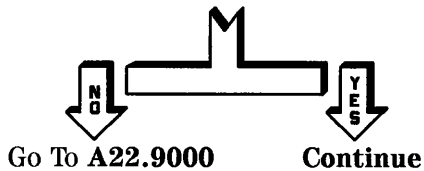

### A7.1317

Install a jumper and go to the Troubleshooting Foldout, block 1 (located just prior to the "Special Cases" tab).

### A7.1320

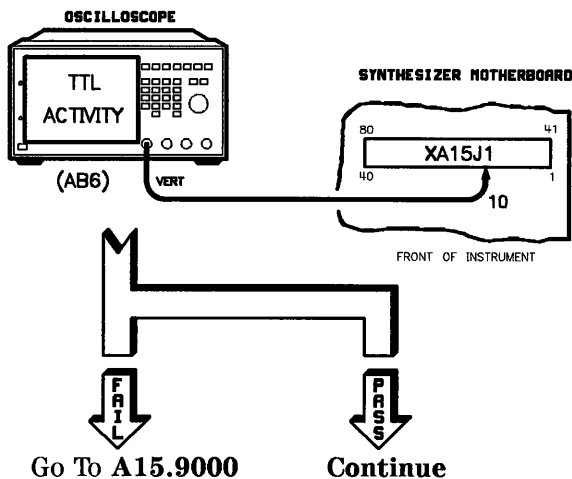

### A7.1321

There is an open on the motherboard between XA7J1-7 and XA15J1-10. Verify this with an ohmmeter. Is jumpering an acceptable repair?

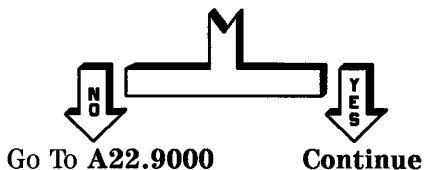

### A7.1323

Install a jumper and go to the Troubleshooting Foldout, block 1 (located just prior to the "Special Cases" tab).

### A7.1325

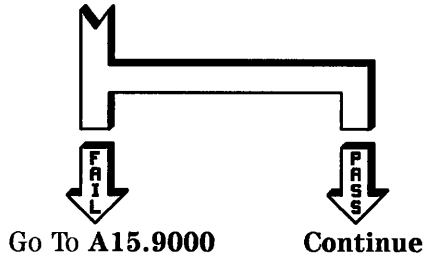
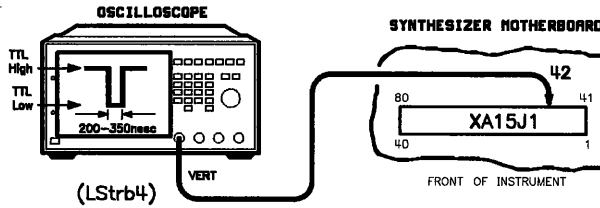

### A7.1326

There is an open on the motherboard between XA7J1-26 and XA15J1-42. Verify this with an ohmmeter. Is jumpering an acceptable repair?

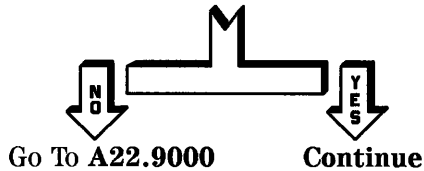

### A7.1327

Install a jumper and go to the Troubleshooting Foldout, block 1 (located just prior to the "Special Cases" tab).

### A7.1330

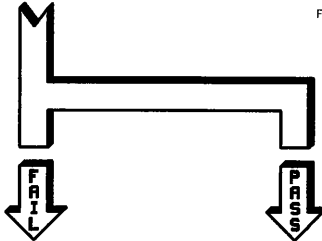
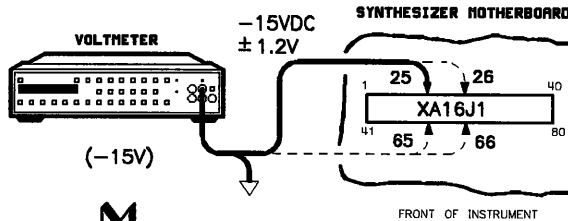

Go To **A16.9000**

**Continue**

### A7.1331

There is an open on the motherboard between XA7J2-41 or 42 and XA16J1-25, 26, 65, or 66. Verify this with an ohmmeter. Is jumpering an acceptable repair?



Go To **A22.9000**

**Continue**

### A7.1332

Install a jumper and go to the Troubleshooting Foldout, block 1 (located just prior to the "Special Cases" tab).

### A7.1335

There is an open on the motherboard between XA7J2-22 and XA15J2-24. Verify this with an ohmmeter. Is jumpering an acceptable repair?

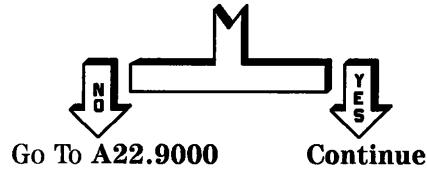

### A7.1336

Install a jumper and go to the Troubleshooting Foldout, block 1 (located just prior to the "Special Cases" tab).

### A7.1340

Check for a TTL signal with a period of *1.5 to 3.0 seconds*.

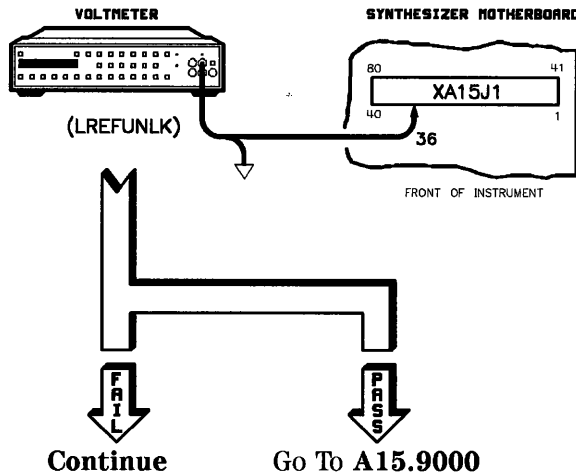



### A7.1341

There is an open on the motherboard between XA7J1-25 and XA15J1-36. Verify this with an ohmmeter. Is jumpering an acceptable repair?

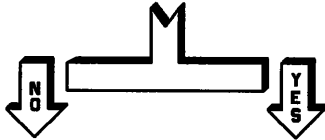

Go To **A22.9000**

**Continue**

### A7.1342

Install a jumper and go to the Troubleshooting Foldout, block 1 (located just prior to the "Special Cases" tab).

### A7.1345

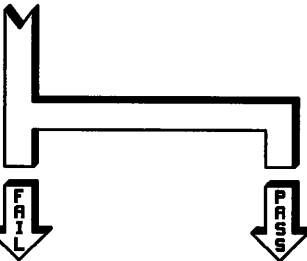
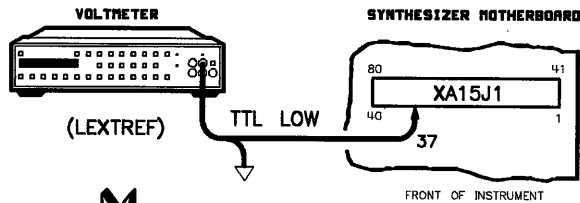

Go To **A7.1347**

Go To **A15.9000**

### A7.1346

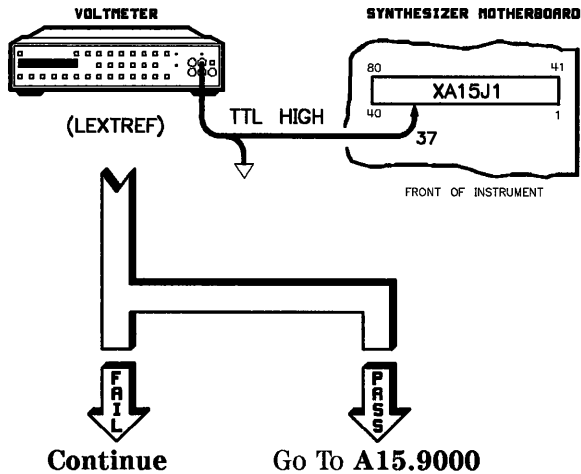

### A7.1347

There is an open on the motherboard between XA7J1-24 and XA15J1-37. Verify this with an ohmmeter. Is jumpering an acceptable repair?

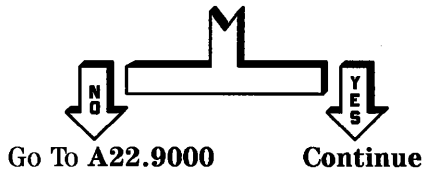

### A7.1348

Install a jumper and go to the Troubleshooting Foldout, block 1 (located just prior to the "Special Cases" tab).

**A7.9000** Replace the A7 assembly.

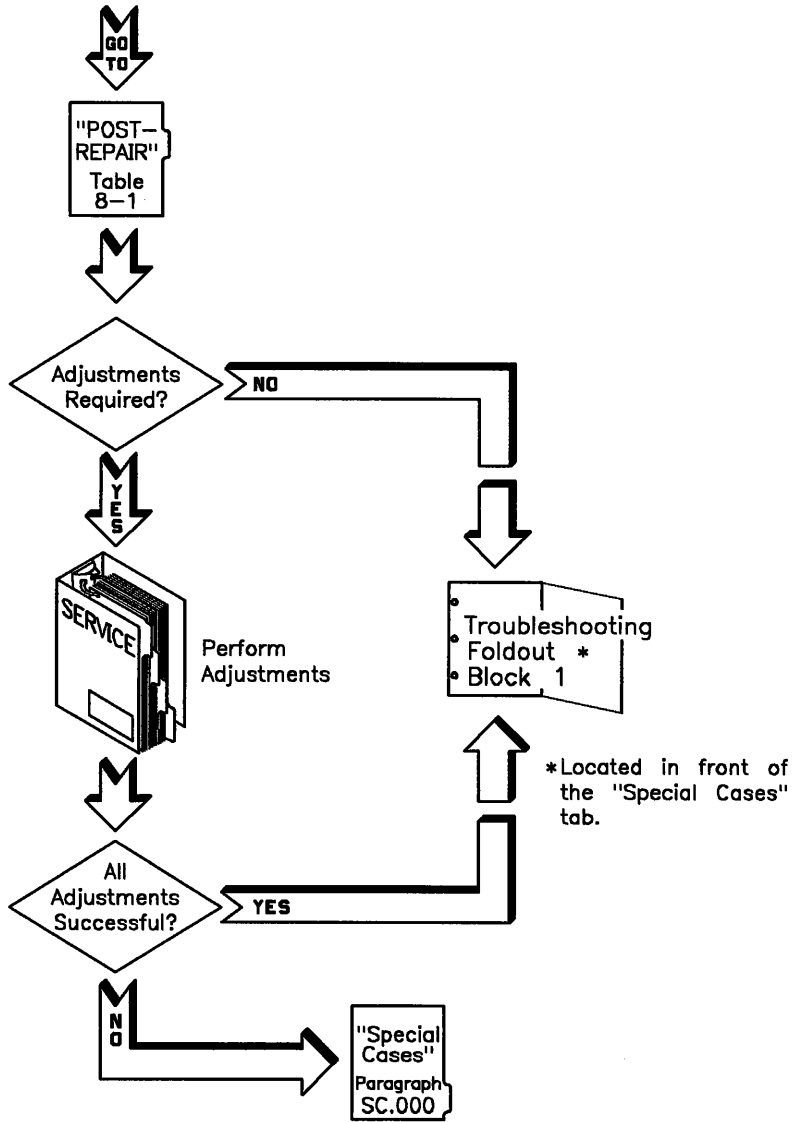

---

## A8 Modulation Generator Troubleshooting

<b>A8.000</b>	<b>Message Displayed on Synthesizer</b>	<b>Go to Paragraph</b>
	A8 : VCXO Locking	A8.100
	A8 : Pulse Generator	A8.9000
	A8 : AM Generator	A8.9000
	A8 : FM Generator	A8.9000
	A8 : Monitor Output	A8.9000
	A8 : Peak Detector	A8.9000

**A8.100** Set up the oscilloscope for a 50 Ω input impedance.

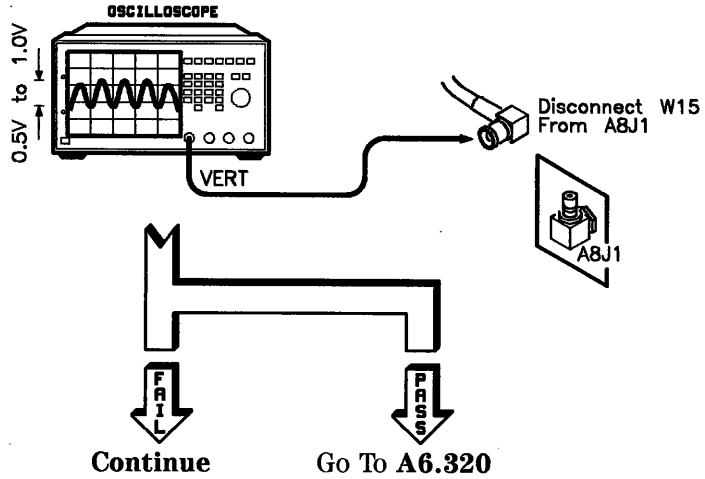

**A8.101**

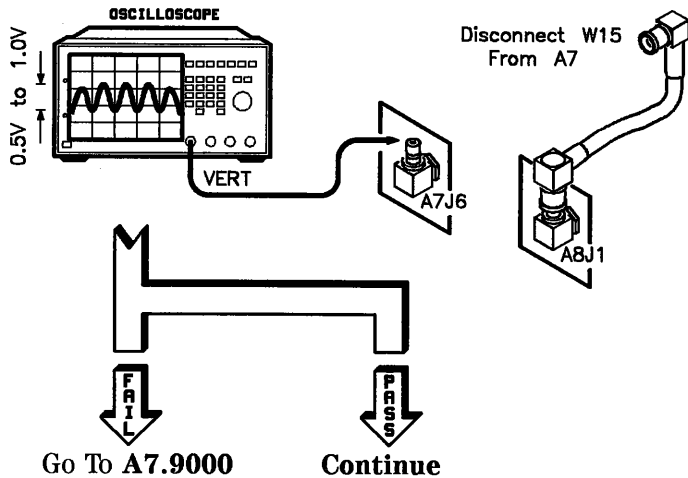

**A8.102**

Replace W15 (from A7J6 to A8J1) and go to the Troubleshooting Foldout, block 1 (located just prior to the "Special Cases" tab).

**A8.9000** Replace the A8 assembly.

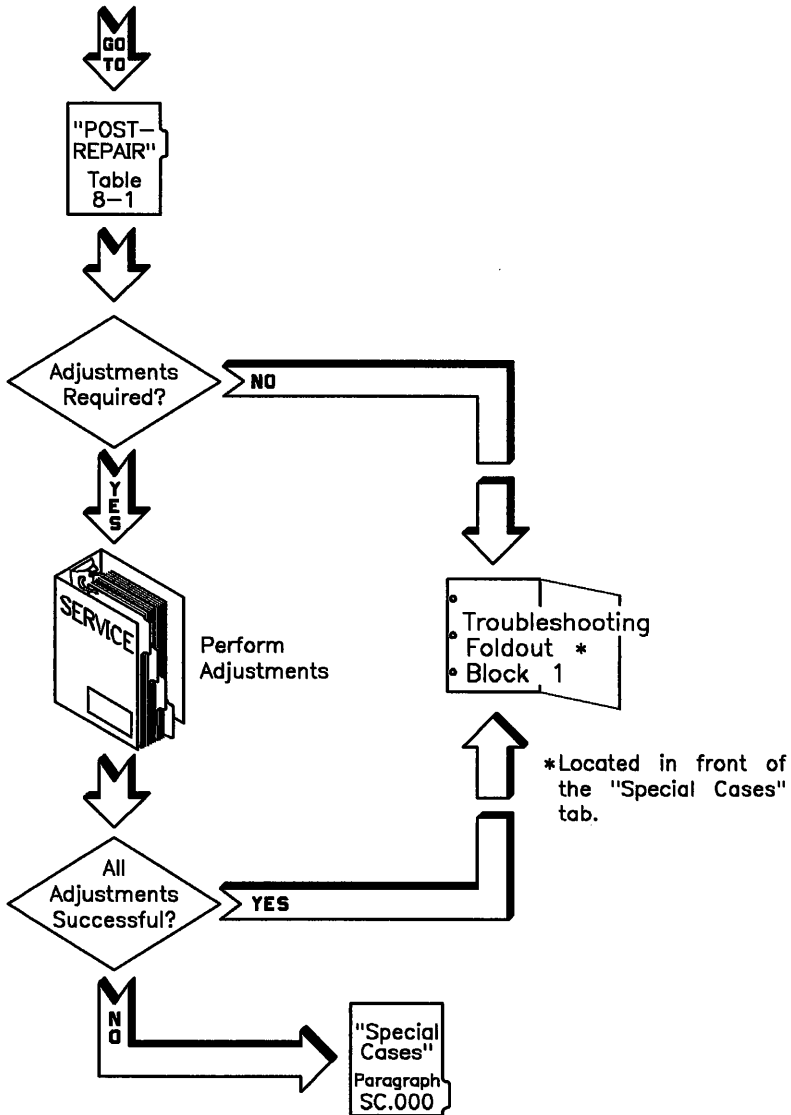

---

## **A9 Pulse Troubleshooting**

<b>A9.000</b>	<b>Message Displayed on Synthesizer</b>	<b>Go to Paragraph</b>
	A9 : Squegging Clamp	A9.200
	A9 : Modulator Selection	A9.300
	A9 : Integrate/Hold Switch	A9.400
	A9 : SRD Bias Generator	A9.500
	A9 : Detector Track/Hold	A9.600
	A9 : Control Gating	A9.600
	A9 : Ramp Bias	A9.600
	A9 : Slow Pulse Drive	A9.9000

**A9.200** Press **PRESET**.

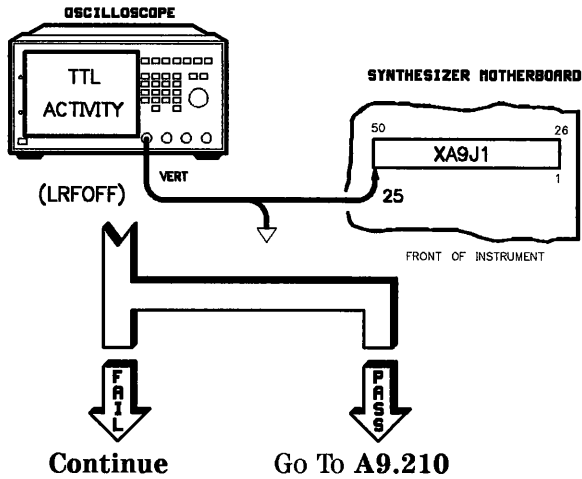

**A9.201**

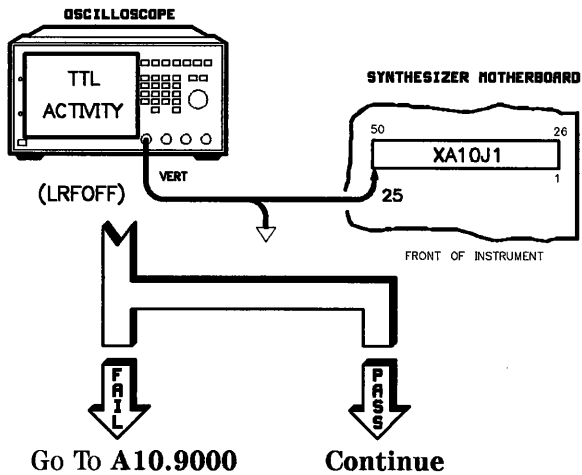



### A9.202

There is an open on the motherboard between XA9J1-25 and XA10J1-25. Verify this with an ohmmeter. Is jumpering the open an acceptable repair?



Go To **A22.9000**

Continue

### A9.203

Install a jumper and go to the Troubleshooting Foldout, block 1 (located just prior to the "Special Cases" tab).

### A9.210

Perform the following setup and key sequence:

1. Remove the A10 ALC assembly from the card cage.
2. Press **PRESET** **SERVICE**.
3. Select **SelfTest Menu**.
4. Press **110** **ENTER**.
5. Select **Loop** (asterisk on).
6. Select **Output Menu Always** (asterisk on).
7. Press **PRIOR**.
8. Select **Do Test #110**.

Does test #110 pass with the A10 ALC assembly removed?



Go To **A9.9000**

Go To **RF.3890**

**A9.300** Perform the following key sequence:

1. Press **PRESET** **SERVICE**.
2. Select **Selftest Menu**.
3. Press **108** **ENTER**.
4. Select **Loop** (asterisk on).
5. Select **Do Test #108**.

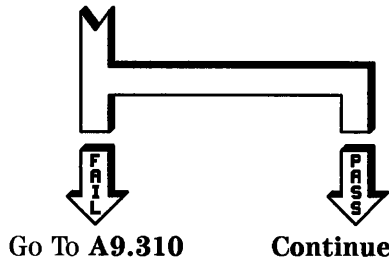
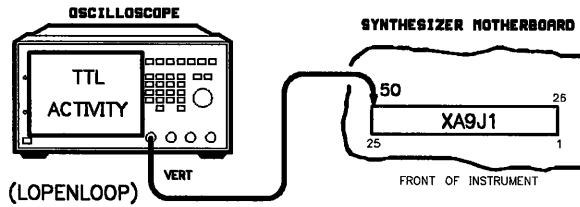

**A9.301**

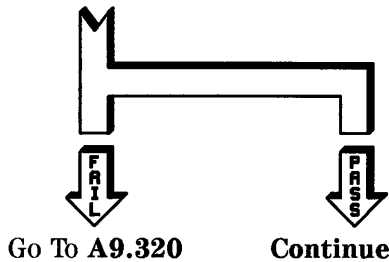
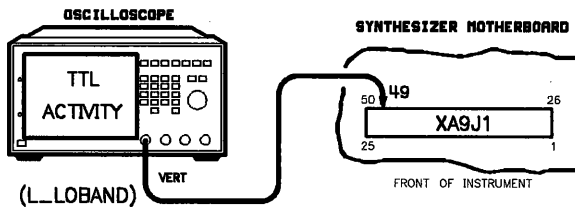

### A9.302

Do the following:

1. Select **Loop** (asterisk off).
2. Disconnect W32 from A22J3 and disconnect W33 from A22J4. (These cables are located between the RF deck and the card cage.)
3. Select **Do Test #108**.

Did self-test #108 pass?

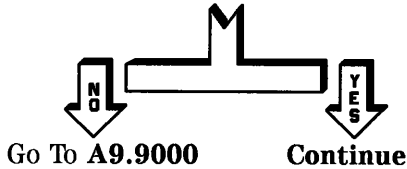

### A9.303

Do the following:

1. Reconnect W32 to A22J3.
2. Select **Do Test #108**.

Did self-test #108 pass?

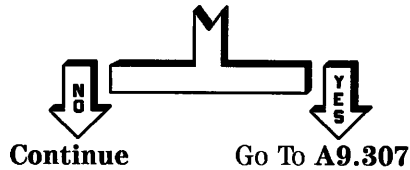

### A9.304

Is Option 006 installed?

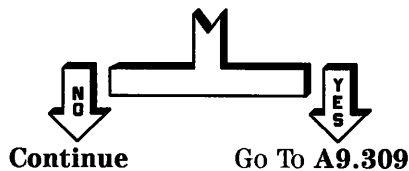

### A9.305

Do the following:

1. Disconnect W32 from A38J3.
2. Select **Do Test #108**.

Did self-test #108 pass?

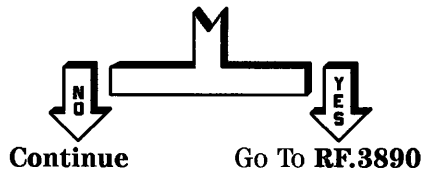

### A9.306

Replace W32 and go to the Troubleshooting Foldout, block 1 (located just prior to the "Special Cases" tab).

### A9.307

Do the following:

1. Reconnect W33 to A22J4.
2. Disconnect W33 from A24J6.
3. Select **Do Test #108**.

Did self-test #108 pass?

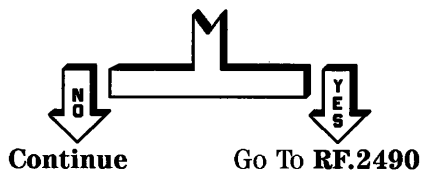

### A9.308

Replace W33 and go to the Troubleshooting Foldout, block 1 (located just prior to the "Special Cases" tab).

### A9.309

Do the following:

1. Disconnect W32 from A42J3.
2. Select Do Test #108.

Did self-test #108 pass?

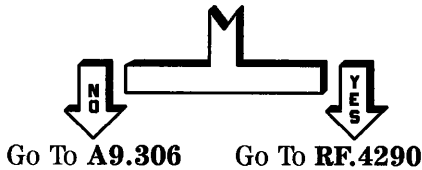

### A9.310

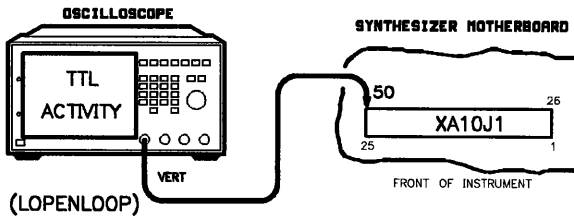

(LOPENLOOP)

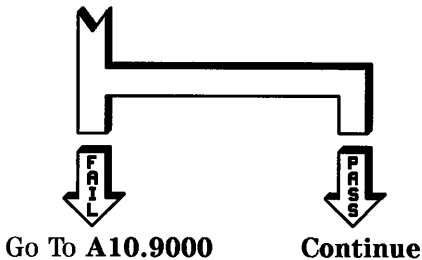

### A9.311

There is an open on the motherboard between XA9J1-50 and XA10J1-50. Verify this with an ohmmeter. Is jumpering the open an acceptable repair?

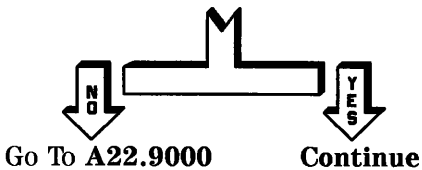

### A9.312

Install a jumper and go to the Troubleshooting Foldout, block 1 (located just prior to the “Special Cases” tab).

### A9.320

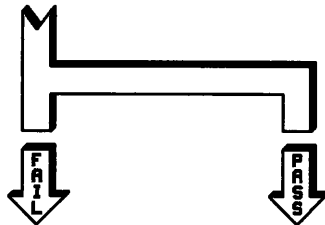
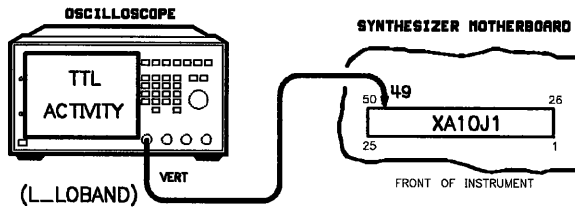

Go To A10.9000

Continue

### A9.321

There is an open on the motherboard between XA9J1-49 and XA10J1-49. Verify this with an ohmmeter. Is jumpering the open an acceptable repair?



Go To A22.9000

Continue

### A9.322

Install a jumper and go to the Troubleshooting Foldout, block 1 (located just prior to the “Special Cases” tab).

### A9.400 Is Option 002 installed?

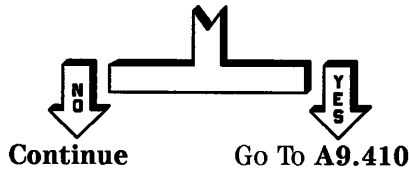

### A9.401

Perform the following key sequence:

1. Press **PRESET** **SERVICE**.
2. Select **Selftest Menu**.
3. Press **105** **ENTER**.
4. Select **Loop** (asterisk on).
5. Press **PRIOR**.
6. Select **Do Test #105**.

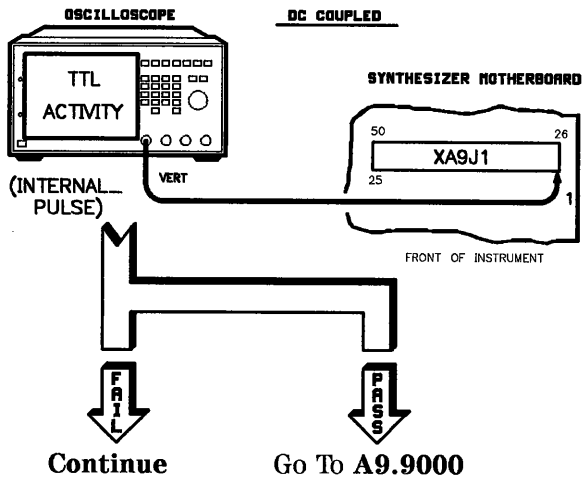

### A9.402

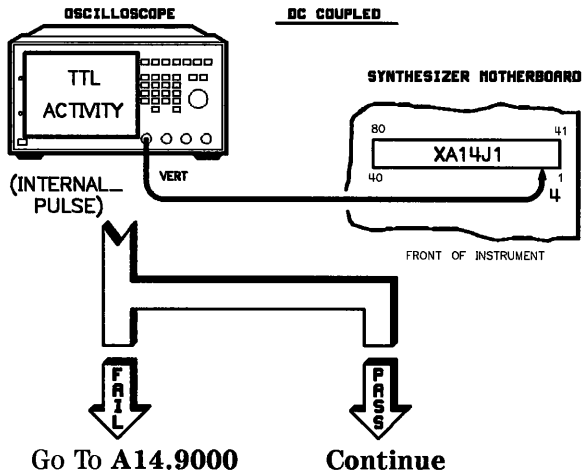

### A9.403

There is an open on the motherboard between XA9J1-1 and XA14J1-4. Verify this with an ohmmeter. Is jumpering the open an acceptable repair?

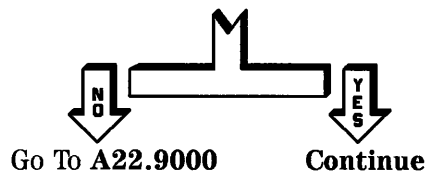

### A9.404

Install a jumper and go to the Troubleshooting Foldout, block 1 (located just prior to the "Special Cases" tab).



## A9.410

Perform the following key sequence:

1. Press **PRESET** **SERVICE**.
2. Select **Selftest Menu**.
3. Press **105** **ENTER**.
4. Select **Loop** (asterisk on).
5. Press **PRIOR**.
6. Select **Do Test #105**.

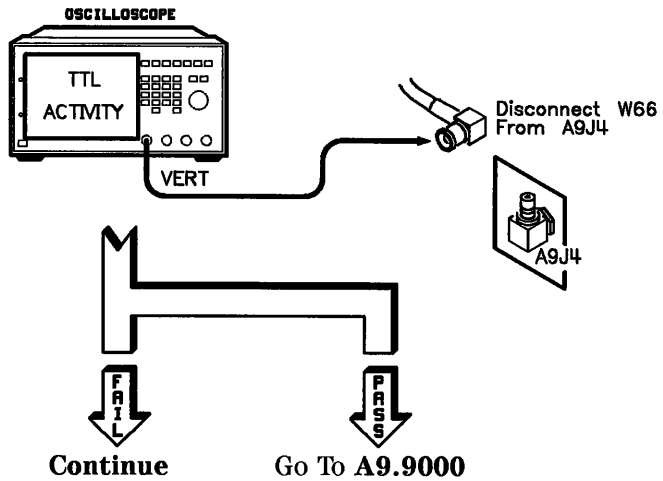

### A9.411

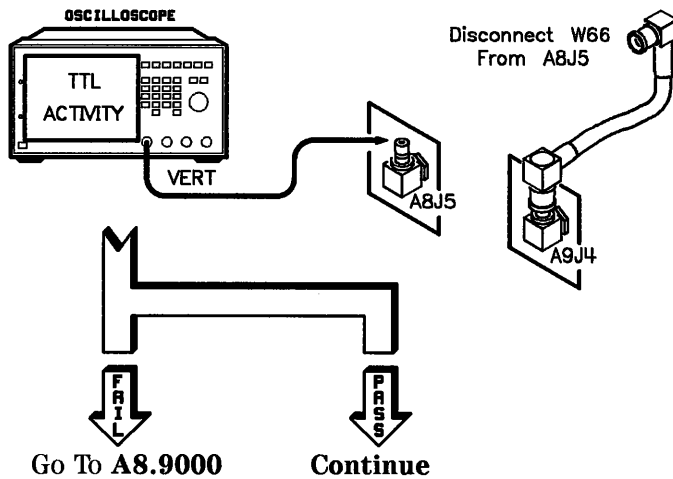

### A9.412

Replace W66 and go to the Troubleshooting Foldout, block 1 (located just prior to the "Special Cases" tab).

**A9.500** Perform the following key sequence:

1. Press **PRESET**.
2. **START** **2.3** **GHz**.
3. **STOP** **7.0** **GHz**.

Ensure when viewing the waveform that the input to the oscilloscope is DC coupled. An AC coupled input may distort the waveform.

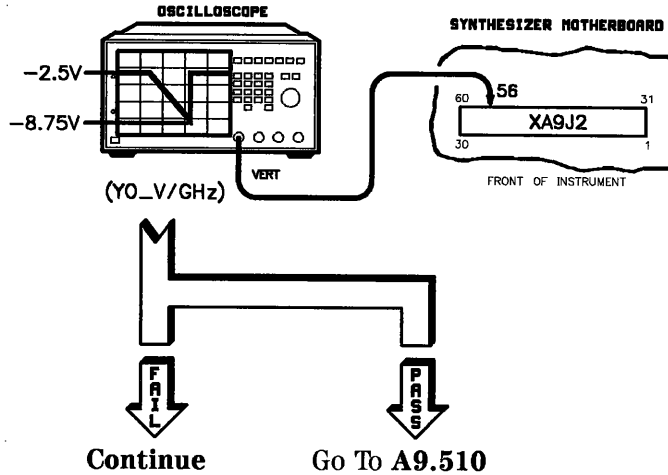

**A9.501**

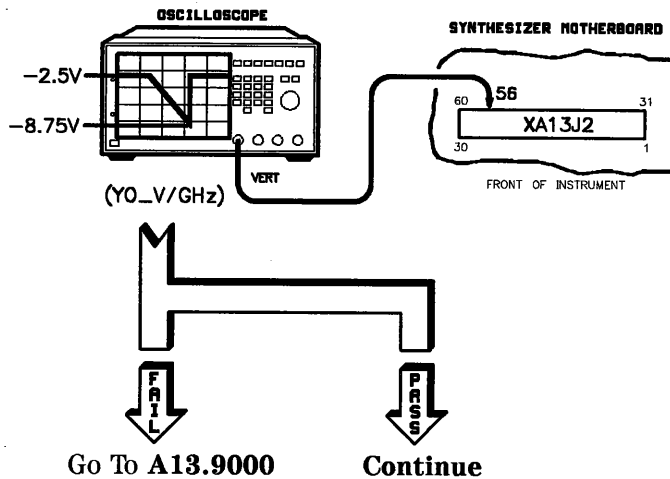

### A9.502

There is an open on the motherboard between XA9J2-56 and XA13J2-56. Verify this with an ohmmeter. Is jumpering the open an acceptable repair?

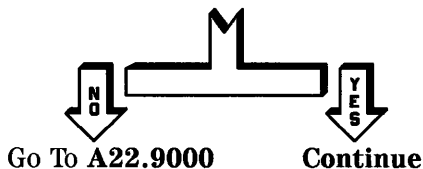

### A9.503

Install a jumper and go to the Troubleshooting Foldout, block 1 (located just prior to the "Special Cases" tab).

### A9.510

Using the disassembly and replacement procedures, lift the RF deck into the service position. Check the ribbon cable that connects the amp/multiplier (A28) to the RF interface board (A20) for any damage. Disconnect the ribbon cable from the amp/multiplier.

Perform the following test:

1. Press **PRESET** **SERVICE**.
2. Select **Selftest Menu**.
3. Press **112** **ENTER**.
4. Select **Do Test #112**.

Did self-test #112 pass?

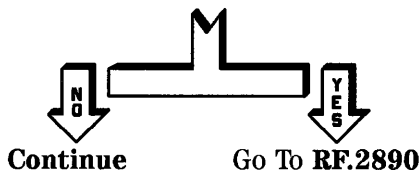

### **A9.511**

The problem is most likely the A9 pulse board. However, the ribbon cable between the RF interface board, A20, and the amp/multiplier, A28, could be damaged. Carefully inspect the ribbon cable before replacing A9.

**A9.600** These self-tests apply to instruments of an earlier vintage than documented in this manual. Refer to the *Assembly-Level Repair* manual (HP part number 08360-90060) for troubleshooting.

**A9.9000** Replace the A9 assembly.

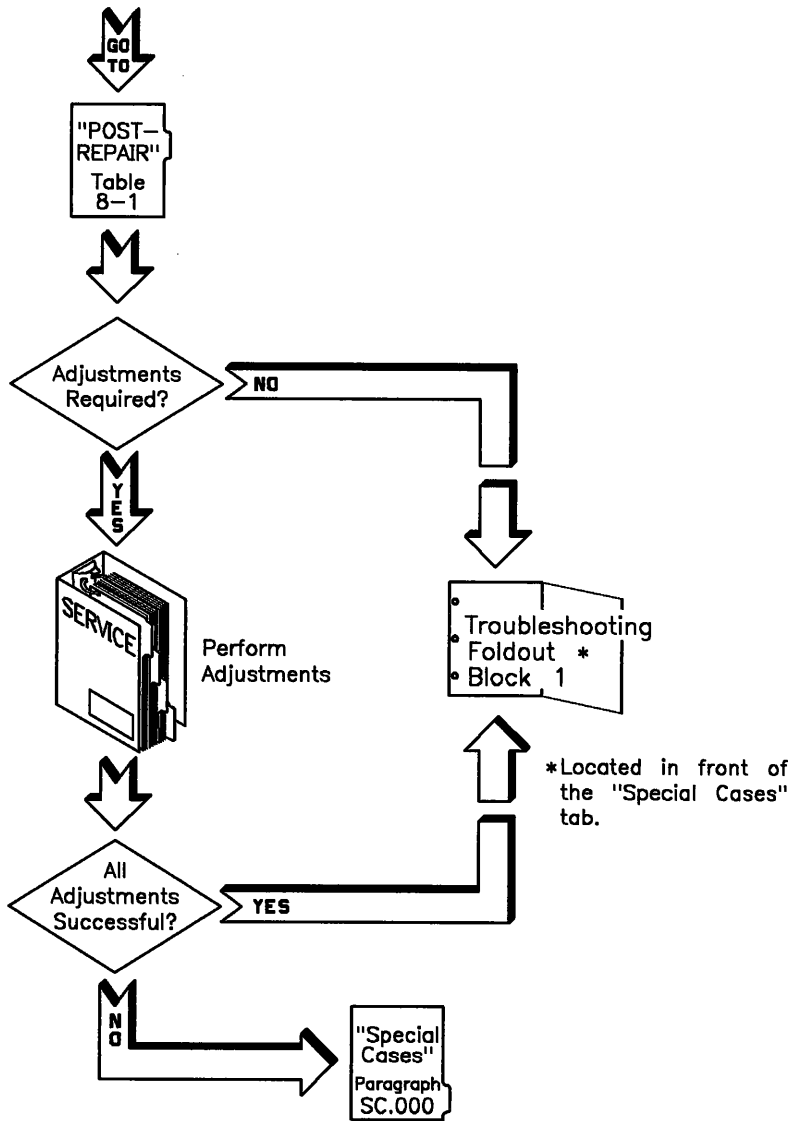

---

## A10 ALC Troubleshooting

<b>A10.000</b>	<b>Message Displayed on Synthesizer</b>	<b>Go to Paragraph</b>
	A10 : -10VF Supply	A10.100
	A10 : Meter Log Amplifier	A10.200
	A10 : ALC Reference	A10.300
	A10 : Detector Log Amplifier	A10.400
	A10 : Source Module Intfc	A10.500
	A10 : Unleveled Detectors	A10.600
	A10 : Modulator Drive Lo Bnd	A10.700
	A10 : Modulator Drive Hi Bnd	A10.700
	A10 : Loop Integrator	A10.800
	A10 : T.C. Ref Supply	A10.9000
	A10 : Detector Offset DAC	A10.9000
	A10 : Detector x10 Amplifier	A10.9000
	A10 : AM Logger Offset	A10.9000



## A10.100

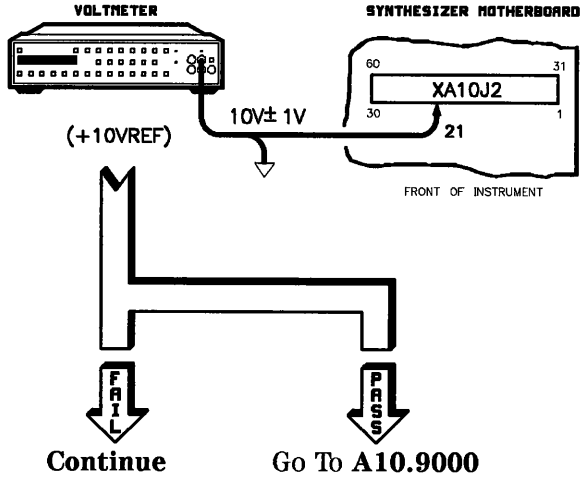

## A10.101

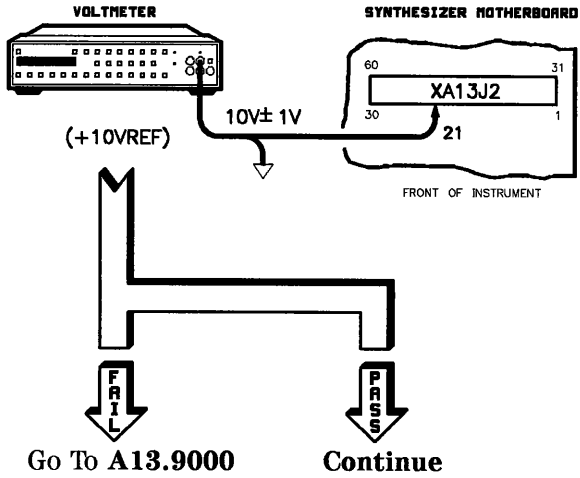

### **A10.102**

There is an open on the motherboard between XA10J2-21 and XA13J2-21. Verify this with an ohmmeter. Is jumpering the open an acceptable repair?



Go To **A22.9000**

**Continue**

### **A10.103**

Install a jumper. Then go to the Troubleshooting Foldout, block 1 (located just prior to the “Special Cases” tab).

**A10.200** Are there any cables connected to the rear/front panel ALC input?



Go To **A10.202**

**Continue**

**A10.201**

Perform the following setup:

1. Remove all connections to the external ALC input.
2. Press **PRESET** **SERVICE**.
3. Select **Selftest Menu**.
4. Press **124** **ENTER**.
5. Select **Do Test #124**.

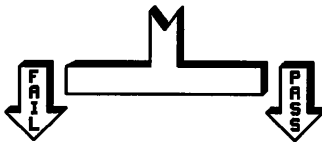

**Continue**

Go To **ILT.000**

### A10.202

Press **PRESET** **CW**.

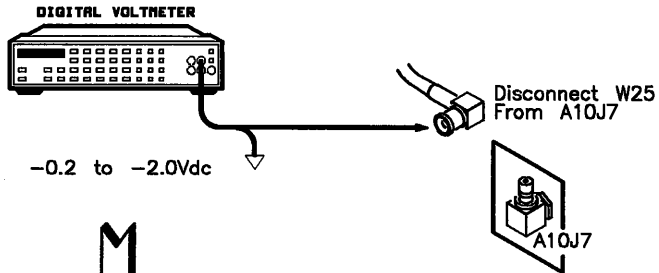

**FAIL**  
Continue

**PASS**  
Go To A10.9000

### A10.203

Perform the following setup:

1. Press **PRESET** **CW** **5** **GHz**.
2. Press **POWER LEVEL** **10** **dBm**.

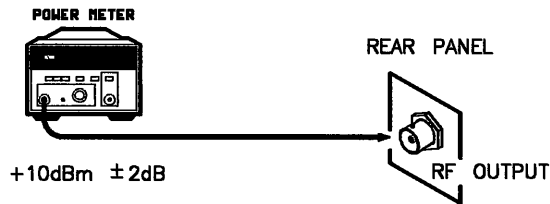

**FAIL**  
Continue

**PASS**  
Go To RF.3090

### **A10.204**

There is an RF output problem. This failure made the A10 diagnostics fail. Before we can go further this RF problem must be isolated.

Go to ILT.2240.

**A10.300** Perform the following setup:

1. Press **PRESET** **SERVICE**.
2. Select **Selftest Menu**.
3. Press **128** **ENTER**.
4. Select **Log** (asterisk on).
5. Select **Output Menu** **When to Log Always** (asterisk on).
6. Press **PRIOR**.
7. Select **Do Test #128**.
8. The voltage at XA10J2-4 should be  $-4.5\text{ V} \pm 1.5\text{ V}$ .
9. Select **Cont.**.
10. The voltage at XA10J2-4 should be  $-0.0\text{ V} \pm 1.5\text{ V}$ .
11. Select **Cont.**.
12. The voltage at XA10J2-4 should be  $-9.0\text{ V} \pm 1.5\text{ V}$ .
13. Select **Cont.**.

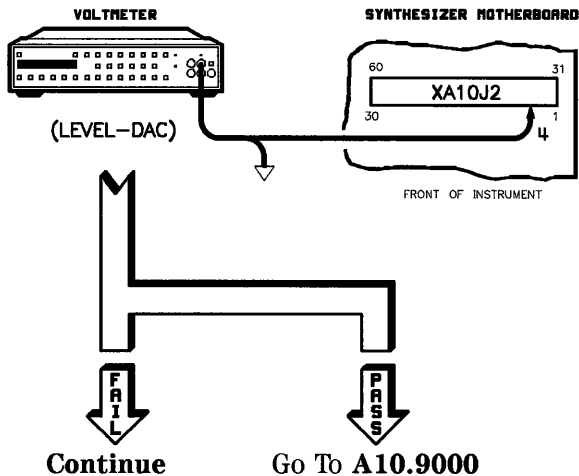

## A10.301

Perform the following setup:

1. Press **PRESET** **SERVICE**.
2. Select **Selftest Menu**.
3. Press **128** **ENTER**.
4. Select **Log** (asterisk on).
5. Select **Output Menu** **When to Log Always** (asterisk on).
6. Press **PRIOR**.
7. Select **Do Test #128**.
8. The voltage at XA14J2-1 should be  $-4.5\text{ V} \pm 1.5\text{ V}$ .
9. Select **Cont**.
10. The voltage at XA14J2-1 should be  $-0.0\text{ V} \pm 1.5\text{ V}$ .
11. Select **Cont**.
12. The voltage at XA14J2-1 should be  $-9.0\text{ V} \pm 1.5\text{ V}$ .
13. Select **Cont**.

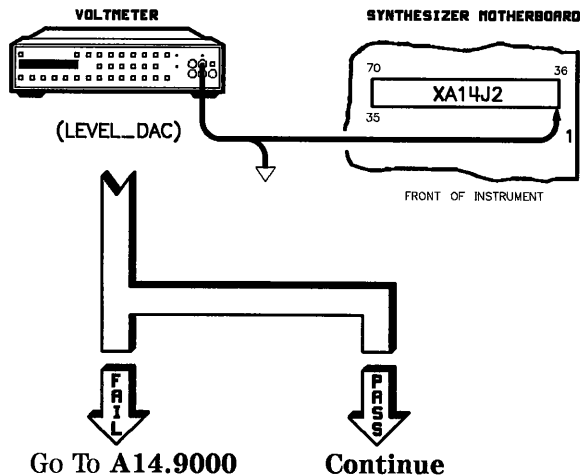

### **A10.302**

There is an open on the motherboard between XA10J2-4 and XA14J2-1. Verify this with an ohmmeter. Is jumpering the open an acceptable repair?

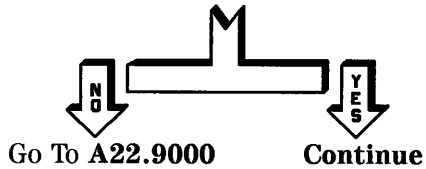

### **A10.303**

Install a jumper. Then go to the Troubleshooting Foldout, block 1 (located just prior to the “Special Cases” tab).



**A10.400** Perform the following setup:

1. Press **PRESET** **SERVICE**.
2. Select **Selftest Menu**.
3. Press **126** **ENTER**.
4. Select **Loop Do Test #126**.

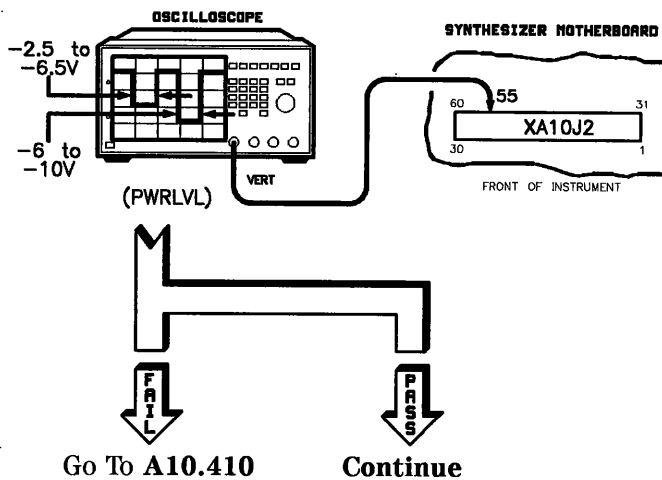

### A10.401

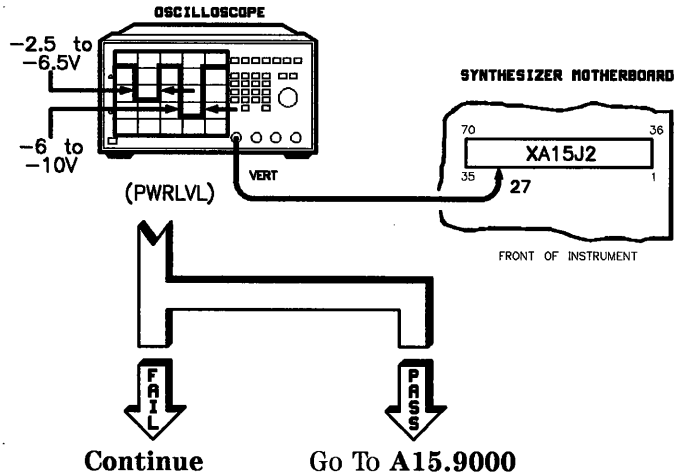

### A10.402

There is an open on the motherboard between XA10J2-55 and XA15J2-27. Verify this with an ohmmeter. Is jumpering the open an acceptable repair?

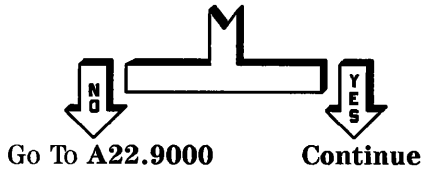

### A10.403

Install a jumper. Then go to the Troubleshooting Foldout, block 1 (located just prior to the "Special Cases" tab).

## A10.410

For instrument models with A24 installed, remove ribbon cable W39 (A20J4 to A24J1) from A20J4 and perform the following setup. If A24 is not installed, continue with A10.411.

1. Press **PRESET** **SERVICE**.
2. Select **Selftest Menu**.
3. Press **126** **ENTER**.
4. Select **Loop Do Test #126**

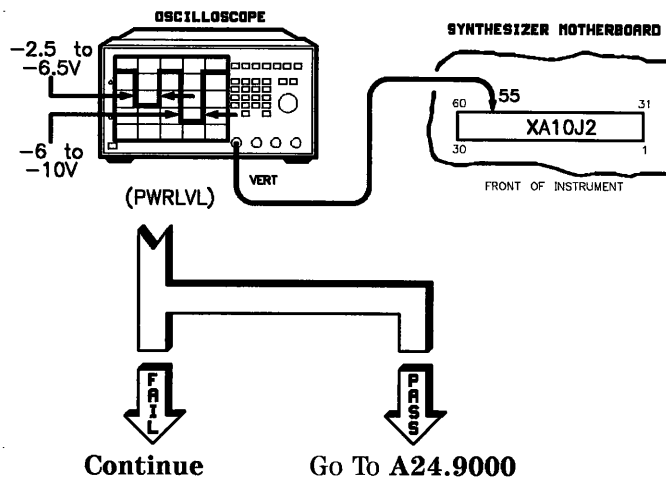

### A10.411

Re-connect W39. Disconnect the wiring harness to A30 (W73) from A20. Perform the following setup:

1. Press **PRESET** **SERVICE**.
2. Select **Selftest Menu**.
3. Press **126** **ENTER**.
4. Select **Loop Do Test #126**

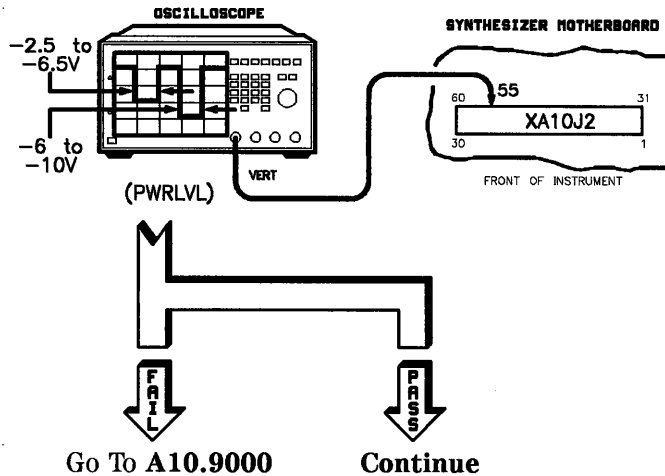

### A10.412

For all models except the HP 83623B/24B and HP 83623L, replace the bridge detector A30. For the HP 83623B/24B and HP 83623L, replace CR1. Go to the Troubleshooting Foldout, block 1 (located just prior to the "Special Cases" tab).

**A10.500** Are there any cables connected to the rear/front panel SMI (source module interface) connectors?



Go To **A10.9000**

**Continue**

### **A10.501**

Perform the following setup:

1. Remove all connections to the SMI inputs.
2. Press **PRESET** **SERVICE**.
3. Select **Selftest Menu**.
4. Press **127** **ENTER**.
5. Select **Do Test #127**.

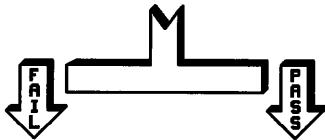

Go To **A10.9000**

**Continue**

### **A10.502**

The problem appears to be partially solved. Remove any remaining connections and go to the Troubleshooting Foldout, block 1 (located just prior to the "Special Cases" tab).

**A10.600** Perform the following setup:

1. Press **PRESET** **SERVICE**.
2. Select **Selftest Menu**.
3. Press **131** **ENTER**.
4. Select **Loop** (asterisk on).
5. Select **Do Test #131**.

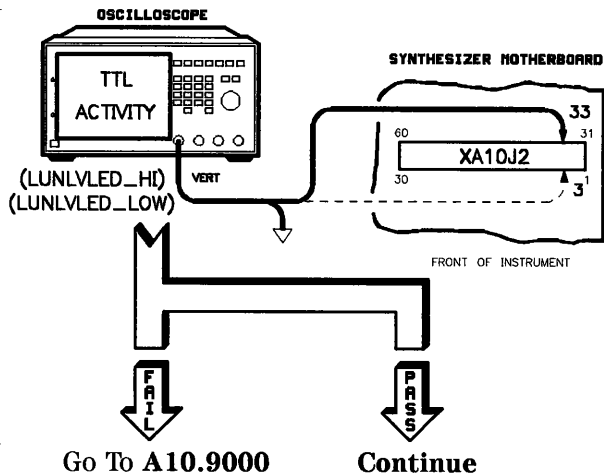

**A10.601**

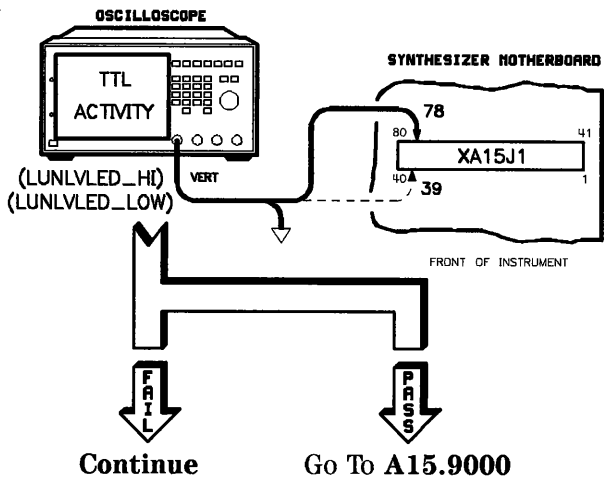

### **A10.602**

There is an open on the motherboard between XA10J2-3 and XA15J1-39, or there is an open between XA10J2-33 and XA15J1-78 (note that these lines are two separate signals). Verify this with an ohmmeter.

Is jumpering the open an acceptable repair?



Go To **A22.9000**

**Continue**

### **A10.603**

Install a jumper. Then go to the Troubleshooting Foldout, block 1 (located just prior to the “Special Cases” tab).

**A10.700** Perform the following setup:

1. Press **PRESET** **SERVICE**.
2. Select **Selftest Menu**.
3. Press **132** **ENTER**.
4. Note the pass/fail condition of test 132.
5. Press **133** **ENTER**.
6. Note the pass/fail condition of test 133.

Did both test #132 and test #133 fail?

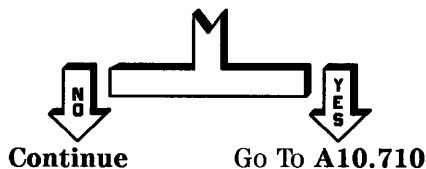

**A10.701**

Did only test #132 fail?

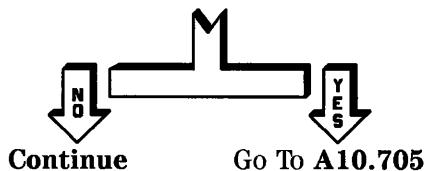

**A10.702**

The most likely cause of this failure is either W34 (A22J6 to A25J2) or A10. However, before replacing A10, check all cables (especially W34) and wiring harnesses around A10 and the RF deck. If you find any problems, correct them and then go to the Troubleshooting Foldout, block 1 (located just prior to the "Special Cases" tab).

If you do not find any problems, replace A10 (go to A10.9000) if it has not already been replaced. Otherwise, go to RF.3890 and replace the A38 dual modulator (if you have Option 006, replace the A38 AM modulator.)



### **A10.705**

The most likely cause of this failure is either W35 (A22J5 to A24J7) or A10. However, before replacing A10, check all cables (especially W35) and wiring harnesses around A10 and the RF deck. Note that W35 does not slip on to A24J7, it screws on. If you find any problems, correct them and then go to the Troubleshooting Foldout, block 1 (located just prior to the “Special Cases” tab).

If you do not find any problems, replace A10 (go to A10.9000) if it has not already been replaced. Otherwise, replace the A24 (go to RF.2490.)

### **A10.710**

The problem is almost certainly A10. However, before replacing A10, check all cabling and wiring harnesses around A10 and the RF deck. If you find any problems, correct them and then go to the Troubleshooting Foldout, block 1 (located just prior to the “Special Cases” tab).

If you do not find any problems, replace A10 (go to A10.9000) if it has not already be replaced. If A10 has been replaced, go to A10.702, A10.705, and “Special Cases” for additional information.

**A10.800** Are *all* cables removed from the synthesizer including any connections to EXT ALC?

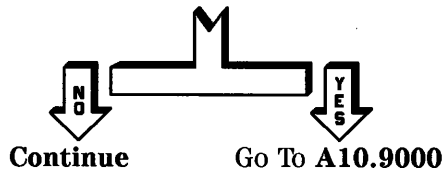

**A10.801**

Remove *all* cables and go to ILT.105.

**A10.9000** Replace the A10 assembly.

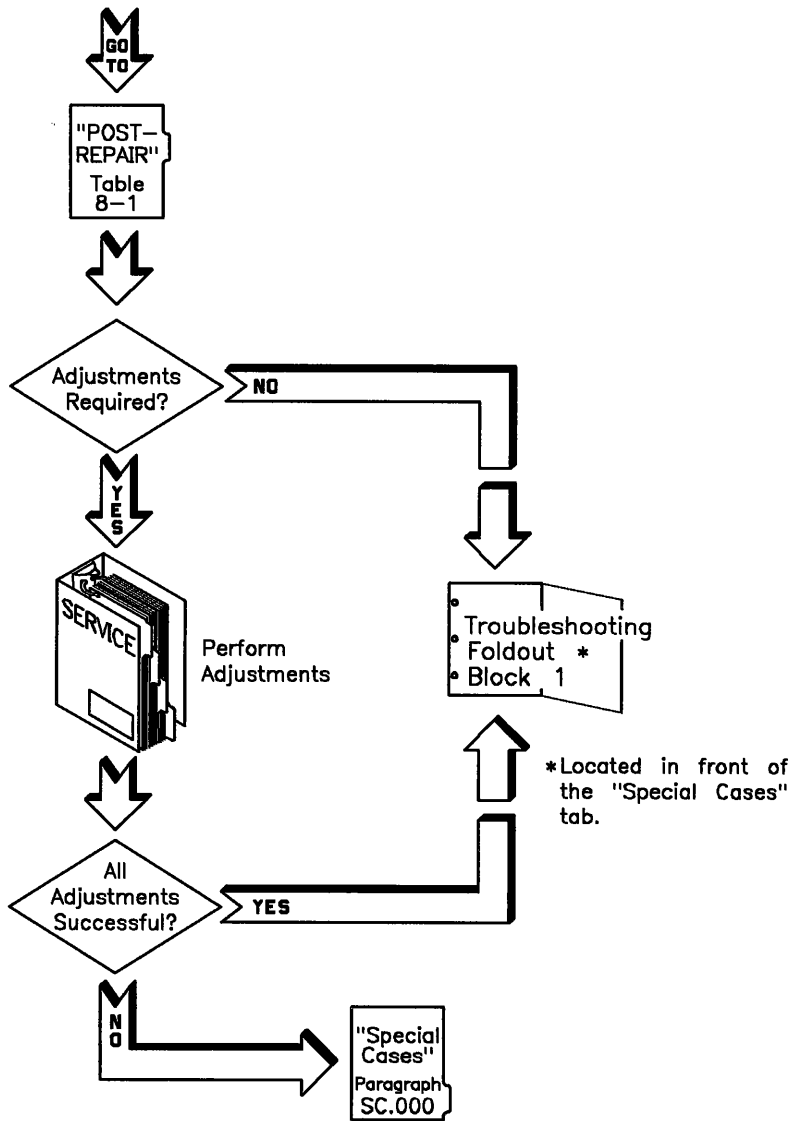

---

## A11 FM Driver Troubleshooting

<b>A11.000</b>	<b>Message Displayed on Synthesizer</b>	<b>Go to Paragraph</b>
	A11 : ABUS Ground	A11.100
	A11 : AC Overmod Detector	A11.200
	A11 : -20V Supply	A11.300
	A11 : Range Attenuator	A11.400
	A11 : MM Band Attenuator	A11.9000
	A11 : YTM Attenuator	A11.9000
	A11 : Driver Amplifier	A11.9000
	A11 : DC Overmod Detector	A11.9000

**A11.100** Perform the following key sequence:

1. Press **PRESET** **SERVICE**.
2. Select **Selftest Menu**.
3. Press **232** **ENTER**.
4. Select **Loop** (asterisk on).
5. Select **Do Test #232**.

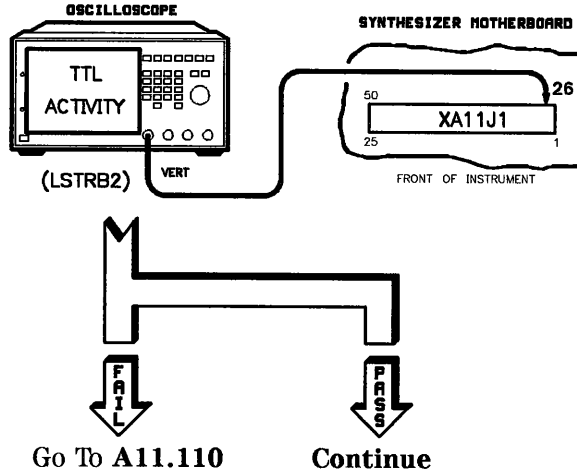

## A11.101

Perform the following key sequence:

1. Press **PRESET** **SERVICE**.
2. Select **Selftest Menu**.
3. Press **142** **ENTER**.
4. Select **Loop** (asterisk on).
5. Select **Do Test #142**.

Verify a signal of  $\leq 700$  mV. However, expect some portions of the signal to rise to levels of up to 15 Vdc. This is not a failure as long as the signal is primarily  $\leq 700$  mV.

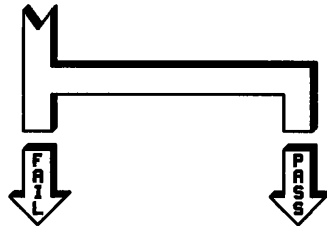
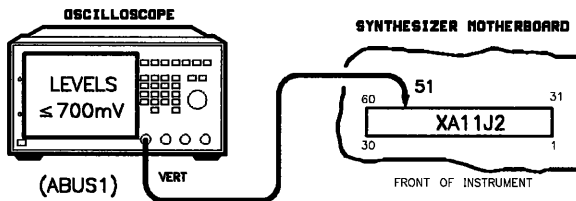

Go To A11.9000

Go To A11.120

### A11.110

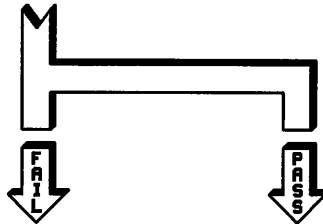
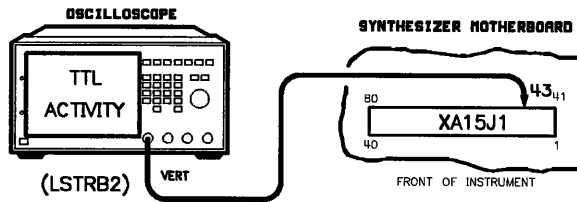

Go To A15.9000

Continue

### A11.111

There is an open on the motherboard between XA11J1-26 and XA15J1-43. Verify this with an ohmmeter. Is jumpering the open an acceptable repair?



Go To A22.9000

Continue

### A11.112

Install a jumper and go to the Troubleshooting Foldout, block 1 (located just prior to the "Special Cases" tab).

### A11.120

Verify a signal of  $\leq 700$  mV. However, expect some portions of the signal to rise to levels of up to 15 Vdc. This is not a failure as long as the signal is primarily  $\leq 700$  mV.

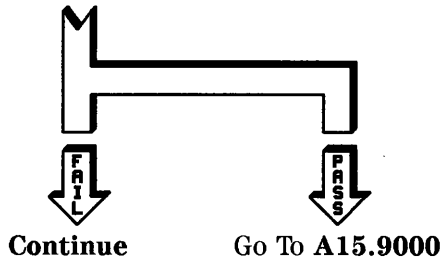
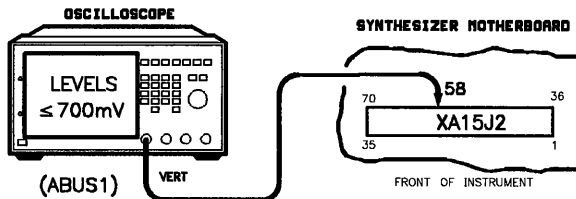

### A11.121

There is an open on the motherboard between XA11J1-51 and XA15J1-58. Verify this with an ohmmeter. Is jumpering the open an acceptable repair?

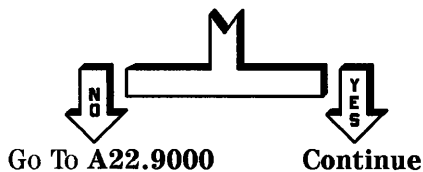

### A11.112

Install a jumper and go to the Troubleshooting Foldout, block 1 (located just prior to the "Special Cases" tab).



**A11.200** Perform the following key sequence:

1. Press **PRESET** **SERVICE**.
2. Select **Selftest Menu**.
3. Press **148** **ENTER**.
4. Select **Loop** (asterisk on).
5. Select **Do Test #148**.

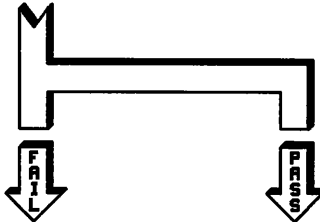
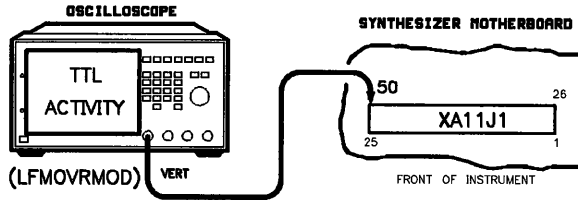

Go To A11.9000

Continue

**A11.201**

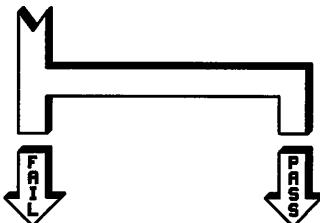
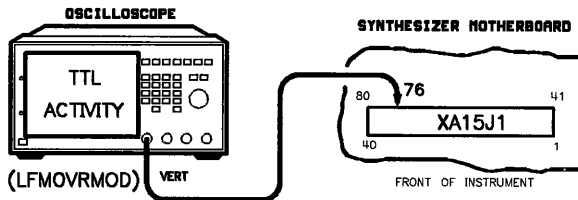

Continue

Go To A15.9000

### **A11.202**

There is an open on the motherboard between XA11J1-50 and XA15J1-76. Verify this with an ohmmeter. Is jumpering the open an acceptable repair?



Go To **A22.9000**

**Continue**

### **A11.203**

Install a jumper and go to the Troubleshooting Foldout, block 1 (located just prior to the “Special Cases” tab).

### A11.300

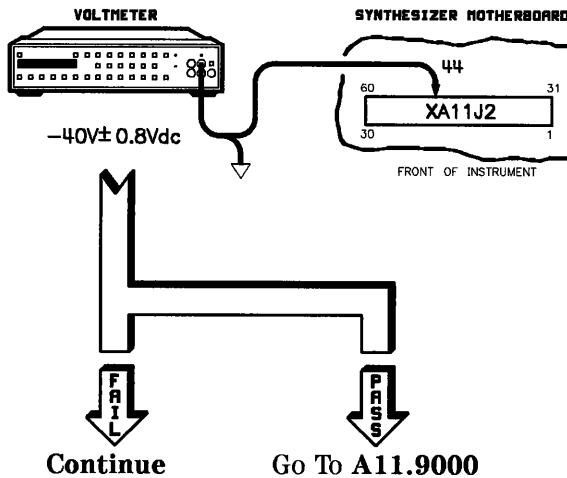

### A11.301

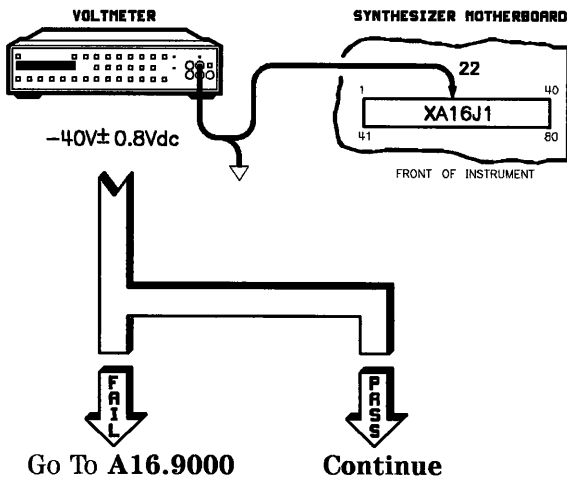

### **A11.302**

An open exists between XA11J2-44 and XA16J1-22.  
Verify this with an ohmmeter. Is jumpering the open an acceptable repair?



Go To **A22.9000**

**Continue**

### **A11.303**

Install a jumper and go to the Troubleshooting Foldout, block 1 (located just prior to the “Special Cases” tab).

**A11.400** Are *all* cables removed from the synthesizer including connections to the FM input?

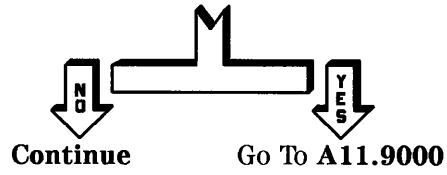

**A11.401**

Remove *all* cables and go to ILT.105.

**A11.9000** Replace the A11 assembly.

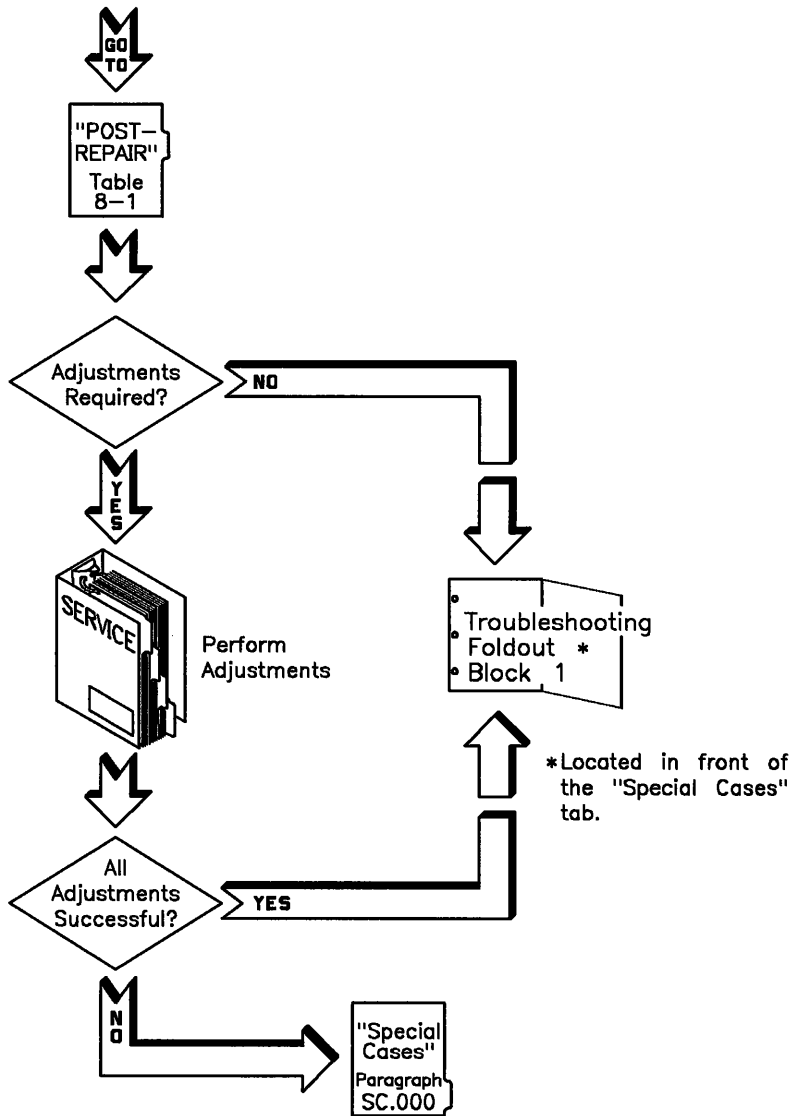

---

## A12 Multiplier/Filter Driver Troubleshooting

<b>A12.000</b>	<b>Message Displayed on Synthesizer</b>	<b>Go to Paragraph</b>
	A12 : -10 V Supply	A12.100
	A12 : YTM Kick Circuit	A12.200
	A12 : Rise-time Comp Circuit	A12.300
	A12 : Output Driver	A12.400
	A12 : YO Error Attenuator	A12.500
	A12 : YTF Output Driver	A12.600
	A12 : Delay Offset DAC	A12.9000
	A12 : Delay Gain DAC	A12.9000
	A12 : Droop Circuit	A12.9000
	A12 : V/GHZ Buffer	A12.9000
	A12 : Rear Panel V/GHZ	A12.9000
	A12 : Offset DAC	A12.9000
	A12 : Slope DAC	A12.9000
	A12 : VCOMP Summer	A12.9000
	A12 : V/GHZ Attenuator	A12.9000
	A12 : Track/Hold Circuit	A12.9000
	A12 : YTM Tune in LO Band	A12.9000
	A12 : YTF Kick	A12.9000
	A12 : YTF Delay Offset DAC	A12.9000
	A12 : YTF Delay Gain DAC	A12.9000
	A12 : YTF Offset DAC	A12.9000
	A12 : YTF Slope DAC	A12.9000
	A12 : YTF VCOMP Summer	A12.9000

## A12.100

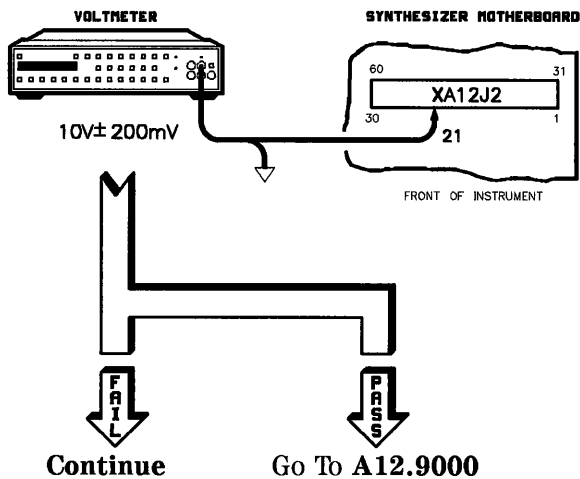

## A12.101

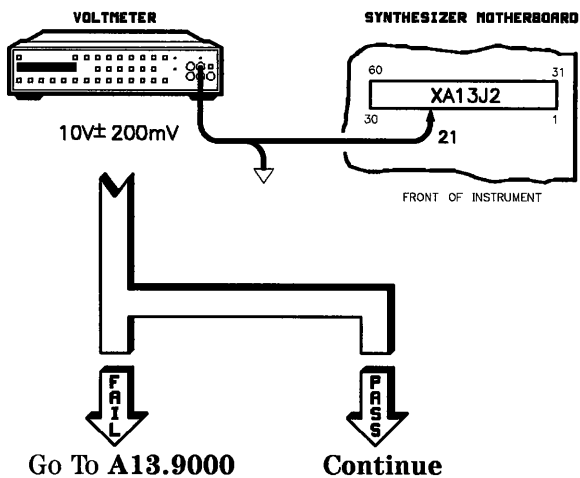



### **A12.110**

There is an open on the motherboard between XA13J2-2 and XA12J2-21. Verify this with an ohmmeter. Is jumpering the open an acceptable repair?



Go To **A22.9000**

**Continue**

### **A12.111**

Install a jumper and go to the Troubleshooting Foldout, block 1 (located just prior to the "Special Cases" tab).

### A12.200 Perform the following key sequence:

1. Press **PRESET** **SERVICE**.
2. Select **Selftest Menu**.
3. Press **159** **ENTER**.
4. Select **Loop** (asterisk on).
5. Select **Do Test #159**.

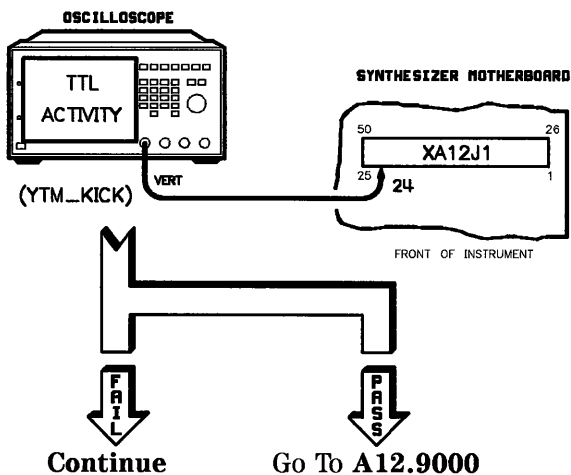

### A12.201

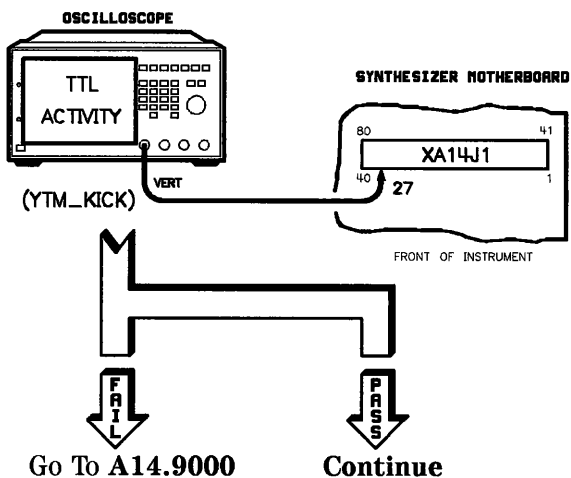

### **A12.210**

There is an open on the motherboard between XA12J1-24 and XA14J1-27. Verify this with an ohmmeter. Is jumpering the open an acceptable repair?

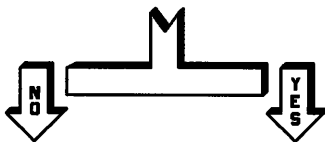

Go To **A22.9000**

**Continue**

### **A12.211**

Install a jumper and go to the Troubleshooting Foldout, block 1 (located just prior to the “Special Cases” tab).

### A12.300 Perform the following key sequence:

1. Press **PRESET** **SERVICE**.
2. Select **Selftest Menu**.
3. Press **160** **ENTER**.
4. Select **Loop** (asterisk on).
5. Select **Do Test #160**.

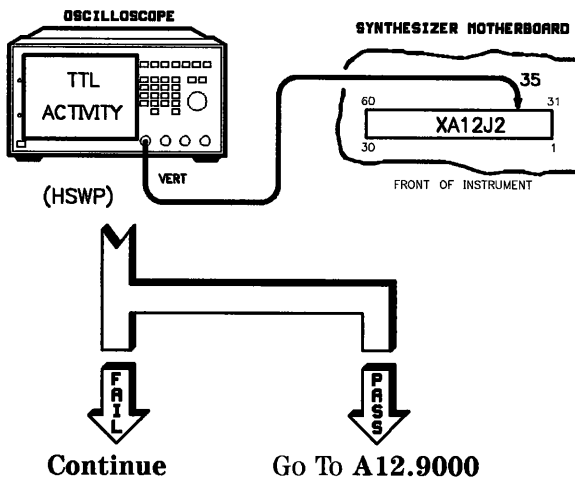

### A12.301

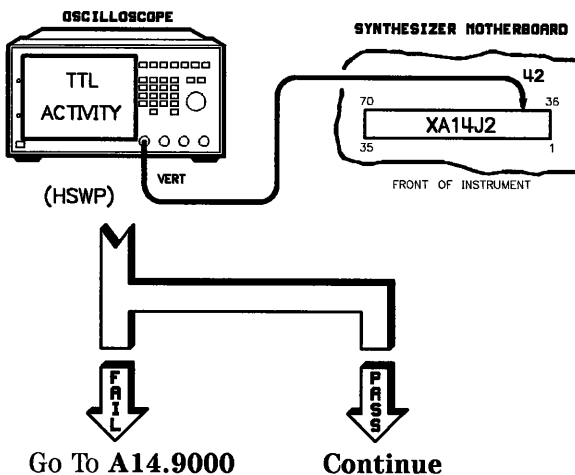

### **A12.310**

There is an open on the motherboard between XA12J2-35 and XA14J2-42. Verify this with an ohmmeter. Is jumpering the open an acceptable repair?



Go To **A22.9000**

**Continue**

### **A12.311**

Install a jumper and go to the Troubleshooting Foldout, block 1 (located just prior to the "Special Cases" tab).

**A12.400** Do the following:

1. Set power switch to STANDBY.
2. Disconnect the power cord.
3. Measure the resistance of the YTM tuning coil from XA12J2-14 to XA12J2-60.

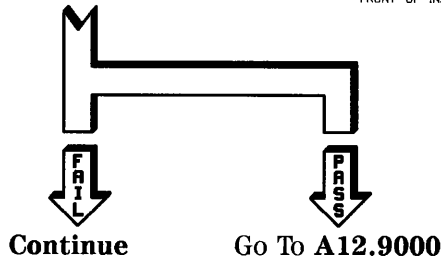
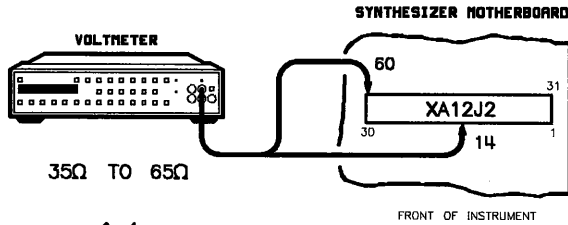

**A12.401**

Was the resistance  $\leq 35 \Omega$ ?

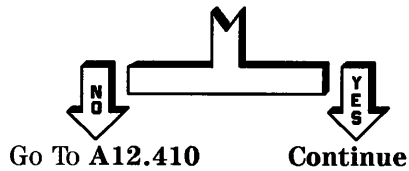

## A12.402

Do the following:

1. Remove A12.
2. Measure the resistance of the SYTM tuning coil from XA12J2-14 to XA12J2-60.

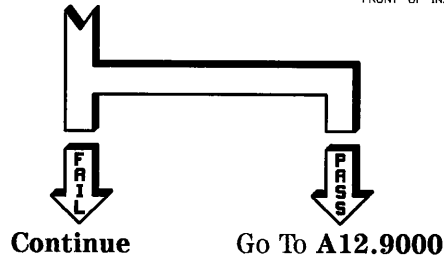
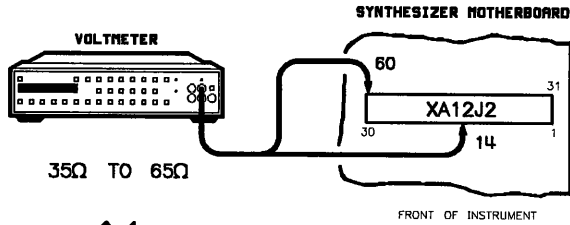

### A12.403

Do the following:

- Disconnect W37 from A28J1 (ribbon cable connecting RF interface to amp/multiplier).
- Check for an open circuit between XA12J2-14 and XA12J2-60 ( $\geq 100\text{ k}\Omega$ ).

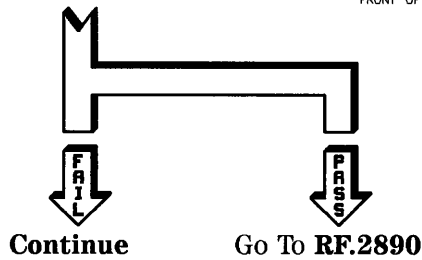
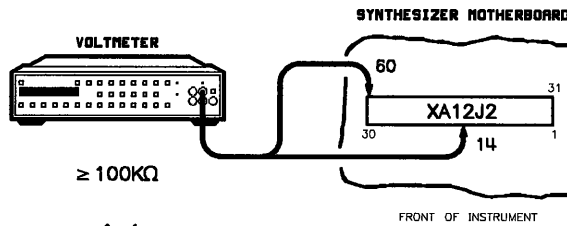



## A12.404

Do the following:

- Using the disassembly instructions in the manual remove the RF Deck.
- Check for an open circuit between XA12J2-14 and XA12J2-60 ( $\geq 100\text{ k}\Omega$ ).

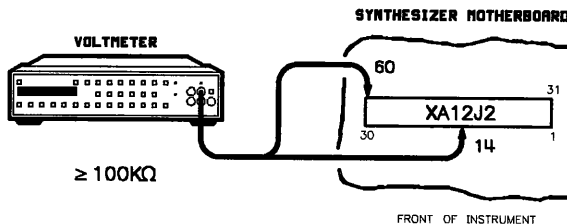

$\geq 100\text{K}\Omega$

FRONT OF INSTRUMENT

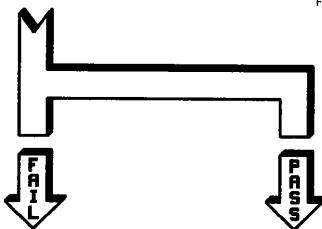

Go To **A22.9000**

Go To **A20.9000**

### A12.410

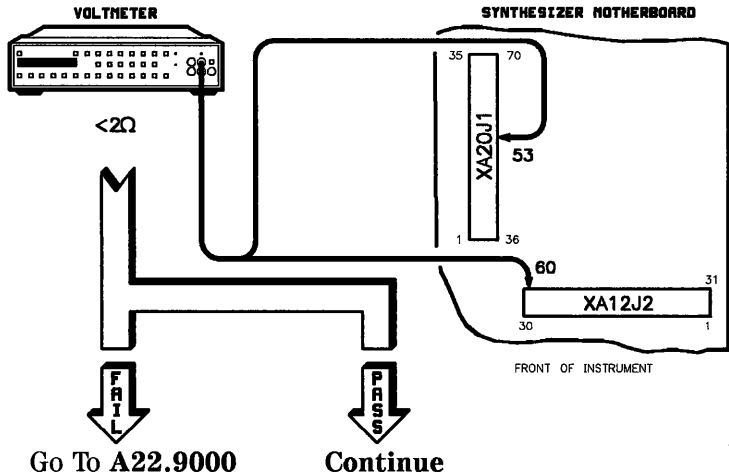

### A12.411

Do the following:

- Using the disassembly instructions in the manual remove the RF deck.
- Disconnect W37 from A28 (amp/multiplier).
- Measure the resistance of the YTM coil at the amp/multiplier. The resistance should be  $\geq 35$  and  $\leq 65 \Omega$  between A28J7-4 and A28J7-12.

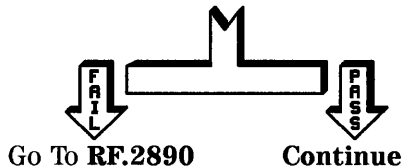

### A12.412

A high resistance exists on either W37 (the ribbon cable that connects the RF deck to A28) or on A20 itself (the RF interface assembly). Replace W37 or A20 and then go to the Troubleshooting Foldout, block 1 (located just prior to the "Special Cases" tab).

**A12.500** Perform the following key sequence:

1. Press **PRESET** **SERVICE**.
2. Select **Selftest Menu**.
3. Press **170** **ENTER**.
4. Select **Log Output Menu** **When to Log Always** (asterisk on).
5. Press **PRIOR**.
6. Select **Do Test #170** **Cont** **Cont**.

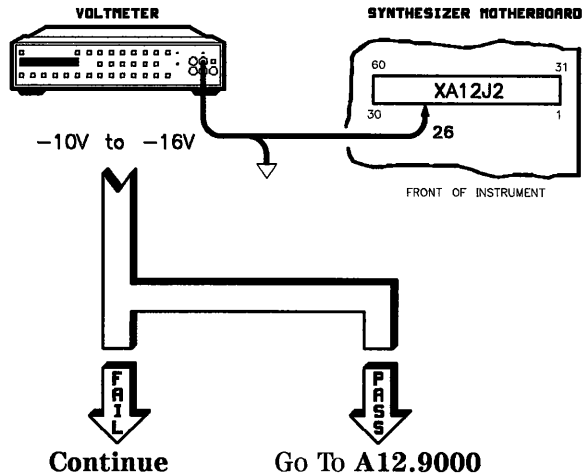

### A12.501

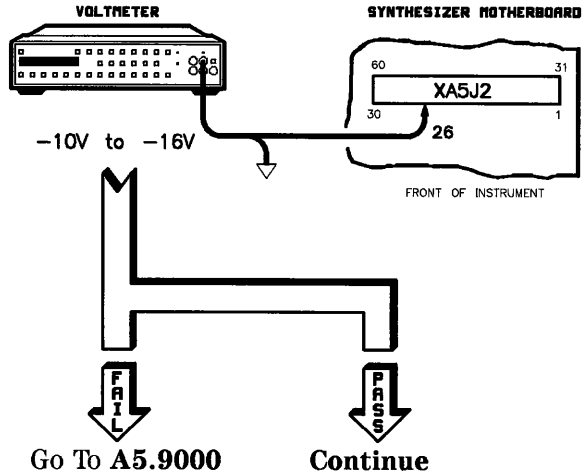

### A12.502

There is an open on the motherboard between XA12J2-26 and XA5J2-26. Verify this with an ohmmeter. Is jumpering the open an acceptable repair?

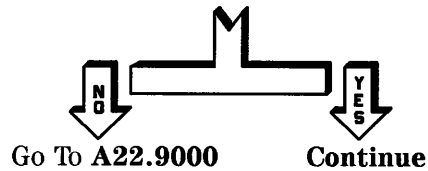

### A12.503

Install a jumper and go to the Troubleshooting Foldout, block 1 (located just prior to the "Special Cases" tab).

### A12.600

Do the following:

1. Set power switch to standby.
2. Disconnect the power cord.
3. Measure the resistance of the YTF tuning coil from XA12J2-44 to XA12J2-30.

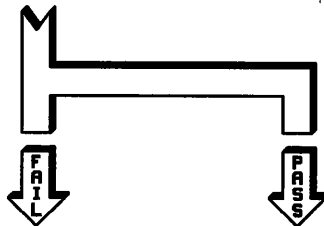
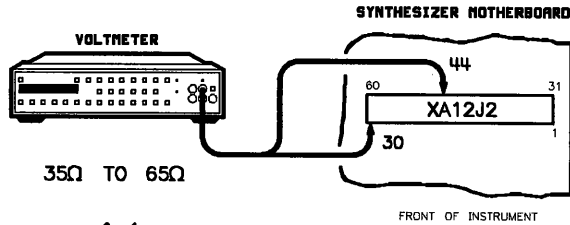

Continue

Go To A12.9000

### A12.601

Was the resistance  $\leq 35 \Omega$ ?



Go To A12.610

Continue

## A12.602

Do the following:

1. Remove A12.
2. Measure the resistance of the YTF tuning coil from XA12J2-44 to XA12J2-30.

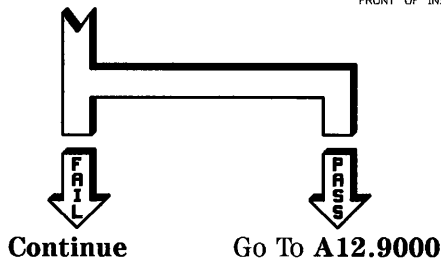
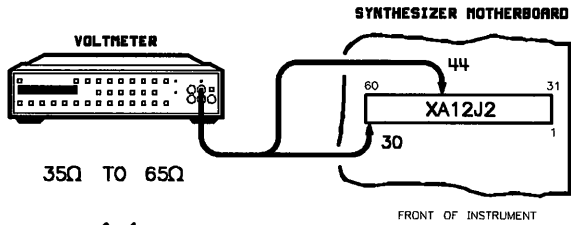

## A12.603

Do the following:

- Disconnect W41 from A29J1 (ribbon cable connecting RF interface to amp/filter).
- Check for an open circuit between XA12J2-44 and XA12J2-30 ( $\geq 100\text{ k}\Omega$ ).

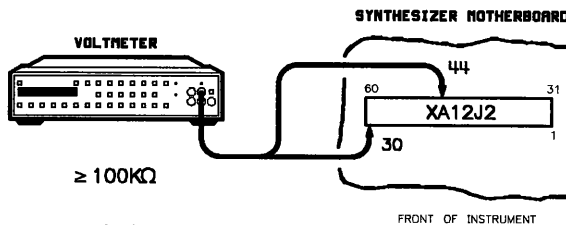

$\geq 100\text{K}\Omega$

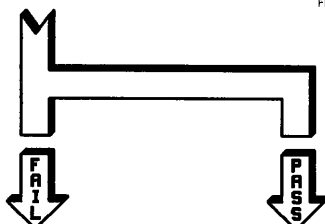

Continue

Go To **RF.2990**

### A12.604

Do the following:

- Using the disassembly instructions in the manual remove the RF Deck.
- Check for an open circuit between XA12J2-44 and XA12J2-30 ( $\geq 100\text{ k}\Omega$ ).

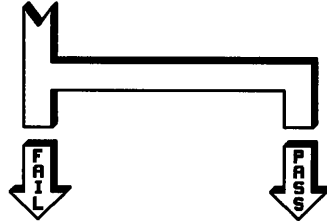
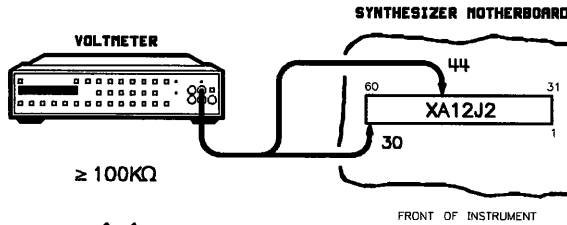

Go To **A22.9000**

Go To **A20.9000**

### A12.610

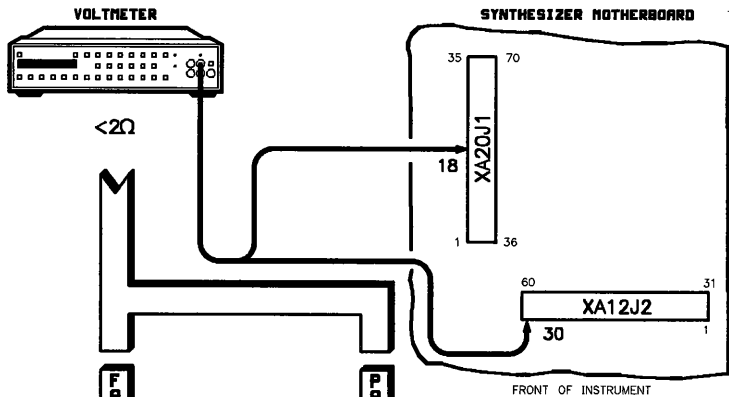

Go To **A22.9000**

**Continue**



## A12.611

Do the following:

- Using the disassembly instructions in the manual remove the RF deck.
- Disconnect W41 from A29 (amp/filter).
- Measure the resistance of the YTF coil at the amp/filter. The resistance should be  $\geq 35 \Omega$  and  $\leq 65 \Omega$  between A29J7-4 and A29J7-12.



Go To **RF.2990**

**Continue**

## A12.612

A high resistance exists on either W41 (the ribbon cable that connects the RF interface to A29) or on A20 itself (the RF interface assembly). Replace W41 or A20 and then go to the Troubleshooting Foldout, block 1 (located just prior to the "Special Cases" tab).

**A12.9000** Replace the A12 assembly.

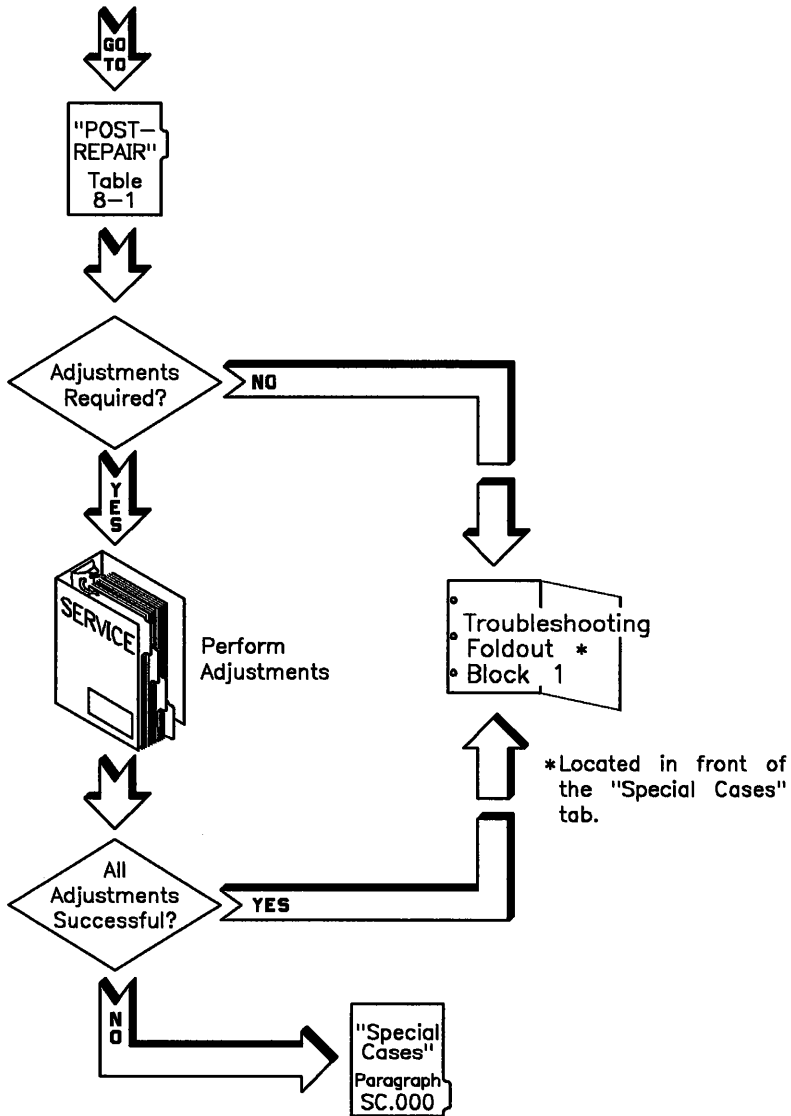

---

## A13 YO Driver Troubleshooting

<b>A13.000</b>	<b>Message Displayed on Synthesizer</b>	<b>Go to Paragraph</b>
	A13 : +10V Reference	A13.100
	A13 : YO Kick Circuit	A13.200
	A13 : Width DAC [U3B]	A13.300
	A13 : Delay OFFSET DAC [U10A]	A13.400
	A13 : YO Loop Error	A13.500
	A13 : Driver Amplifier	A13.600
	A13 : YO V/GHz Buffer	A13.9000
	A13 : CW DAC [U3B]	A13.9000
	A13 : Sweep Attenuator	A13.9000
	A13 : SWP Vern DAC [U16A]	A13.9000
	A13 : OFF Vern DAC [U16B]	A13.9000
	A13 : Delay GAIN DAC [U10B]	A13.9000
	A13 : Narrow/Wide Switch	A13.9000

### A13.100 Perform self-test #182:

1. Remove the A10, A12, and A14 assemblies.
2. Press **PRESET** **SERVICE**.
3. Select **Selftest Menu**.
4. Press **182** **ENTER**.
5. Select **Loop** (asterisk on).
6. Select **Do Test #182**.

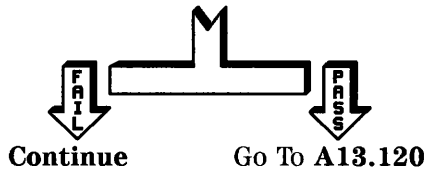

### A13.101

Perform the following key sequence:

1. Press **PRESET** **SERVICE**.
2. Select **Selftest Menu**.
3. Press **232** **ENTER**.
4. Select **Loop** (asterisk on).
5. Select **Do Test #232**.

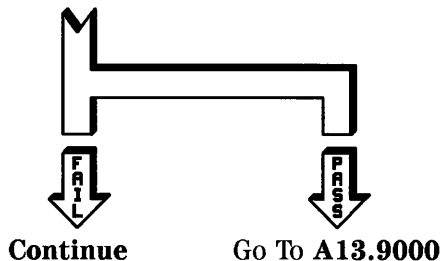
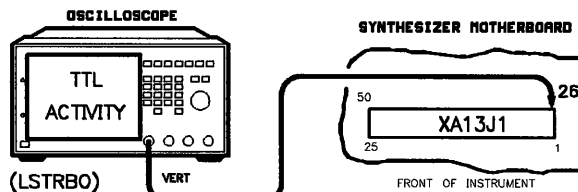

### A13.102

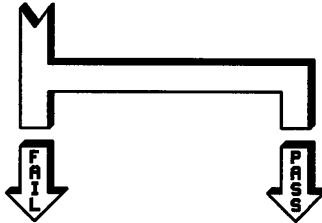
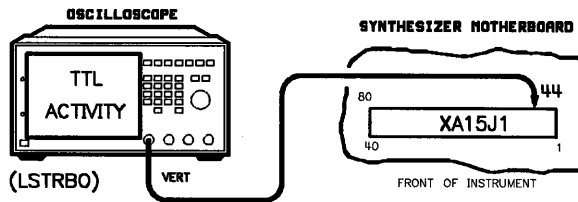

Go To **A15.9000**

**Continue**

### A13.103

There is an open on the motherboard between XA13J1-26 and XA15J1-44. Verify this with an ohmmeter. Is jumpering the open an acceptable repair?



Go To **A22.9000**

**Continue**

### A13.104

Install a jumper and go to the Troubleshooting Foldout, block 1 (located just prior to the "Special Cases" tab).

### **A13.120**

One of the following assemblies is defective:

A10 ALC.

A12 multiplier/filter Driver.

A14 sweep generator.

Replace any one of the assemblies and perform the following test:

1. Press **PRESET** **SERVICE**.
2. Select **Selftest Menu**.
3. Press **182** **ENTER**.
4. Select **Do Test #182**.

If the test fails, the assembly just replaced is defective. If the test does not fail, replace another assembly and repeat test number 182. When the defective assembly is identified, go to the 9000 paragraph for that assembly for replacement instructions. For example, for A10 go to A10.9000, for A12, go to A12.9000, and so on.

**A13.200** Perform the following key sequence:

1. Press **PRESET** **SERVICE**.
2. Select **Selftest Menu**.
3. Press **183** **ENTER**.
4. Select **Loop** (asterisk on).
5. Select **Do Test #183**.

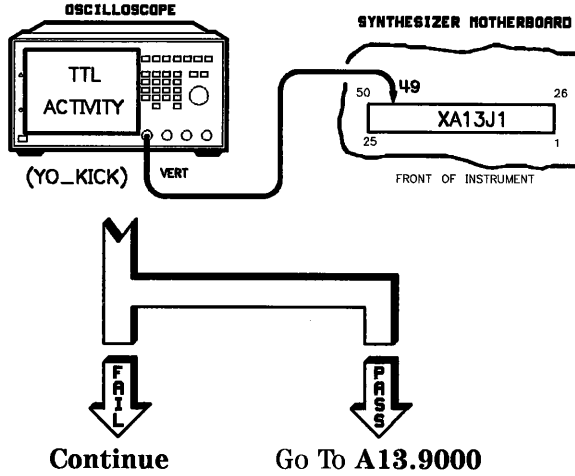

**A13.201**

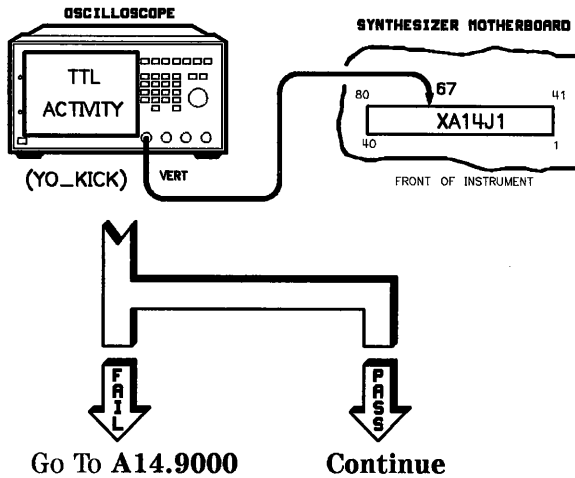

### **A13.202**

There is an open on the motherboard between XA13J1-49 and XA14J1-67. Verify this with an ohmmeter. Is jumpering the open an acceptable repair?

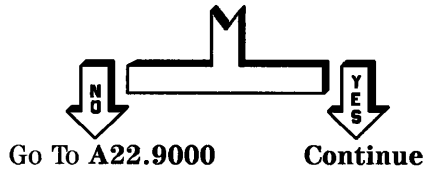

### **A13.203**

Install a jumper and go to the Troubleshooting Foldout, block 1 (located just prior to the "Special Cases" tab).



**A13.300** Perform the following key sequence:

1. Press **PRESET** **SERVICE**.
2. Select **Selftest Menu**.
3. Press **185** **ENTER**.
4. Select **Loop** (asterisk on).
5. Select **Do Test #185**.

When comparing the oscilloscope waveform to the one shown, the amplitude of the pulses is important; the timing is not.

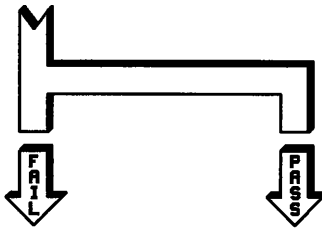
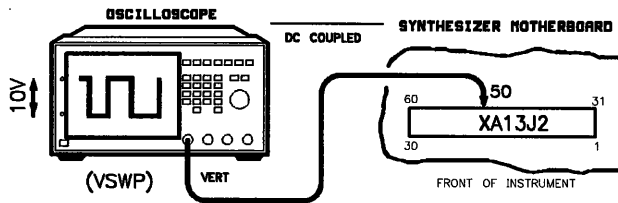

**Continue**

**Go To A13.9000**

### A13.301

When comparing the oscilloscope waveform to the one shown, the amplitude of the pulses is important; the timing is not.

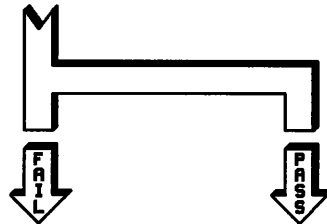
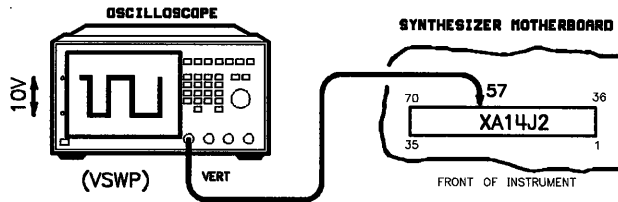

Go To **A14.9000**

**Continue**

### A13.302

There is an open on the motherboard between XA13J2-50 and XA14J2-57. Verify this with an ohmmeter. Is jumpering the open an acceptable repair?



Go To **A22.9000**

**Continue**

### A13.303

Install a jumper and go to the Troubleshooting Foldout, block 1 (located just prior to the "Special Cases" tab).

**A13.400** Perform the following key sequence:

1. Press **PRESET** **SERVICE**.
2. Select **Selftest Menu**.
3. Press **208** **ENTER**.
4. Select **Loop** (asterisk on).
5. Select **Do Test #208**.

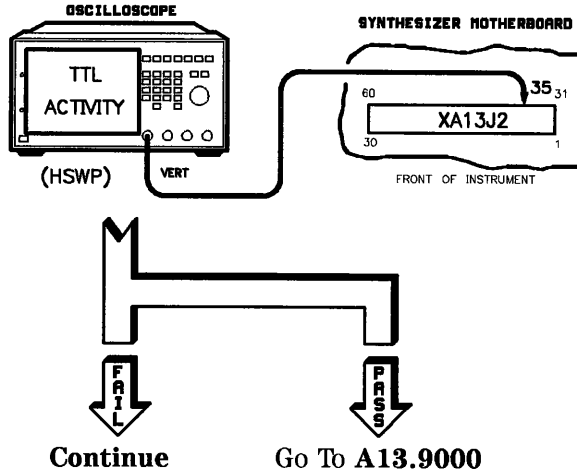

**A13.401**

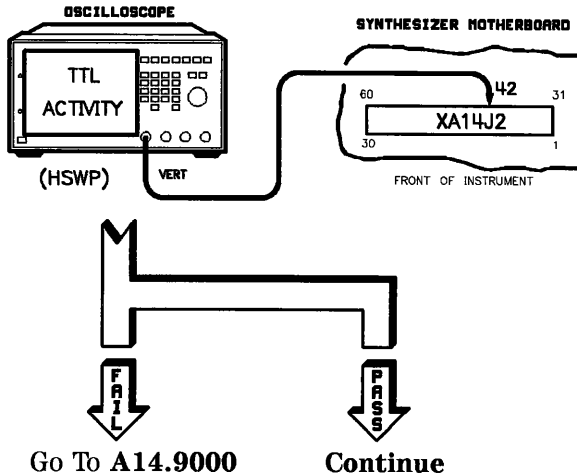

### **A13.402**

There is an open on the motherboard between XA13J2-35 and XA14J2-42. Verify this with an ohmmeter. Is jumpering the open an acceptable repair?



Go To **A22.9000**

**Continue**

### **A13.403**

Install a jumper and go to the Troubleshooting Foldout, block 1 (located just prior to the “Special Cases” tab).

**A13.500** Perform the following key sequence:

1. Press **PRESET** **SERVICE**.
2. Select **Selftest Menu**.
3. Press **194** **ENTER**.
4. Select **Loop** (asterisk on).
5. Select **Do Test #194**.

When comparing the oscilloscope waveform to the one shown, the amplitude of the pulses is important; the timing is not.

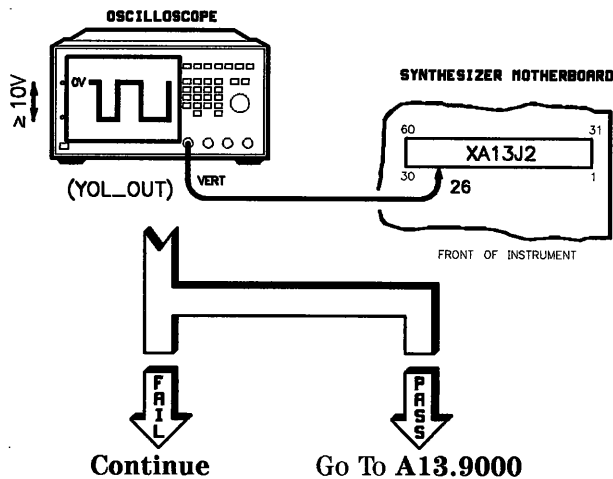

### A13.501

When comparing the oscilloscope waveform to the one shown, the amplitude of the pulses is important; the timing is not.

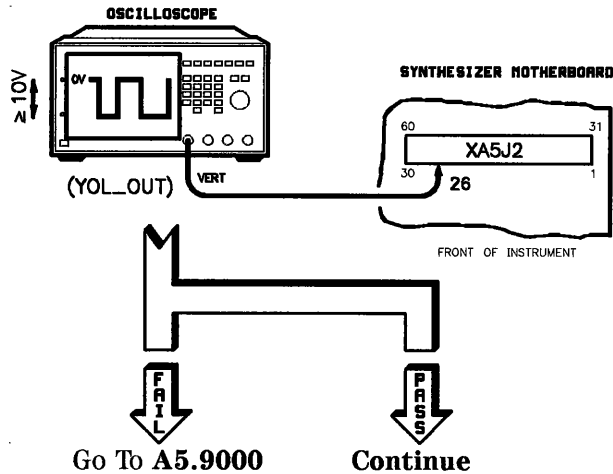

### A13.502

There is an open on the motherboard between XA13J2-26 and XA5J2-26. Verify this with an ohmmeter. Is jumpering the open an acceptable repair?

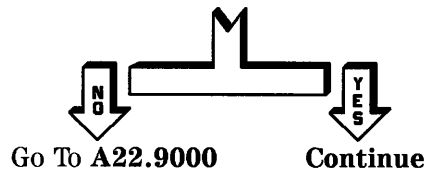

### A13.503

Install a jumper and go to the Troubleshooting Foldout, block 1 (located just prior to the "Special Cases" tab).

### A13.600

Do the following:

1. Set the line power switch to standby.
2. Disconnect the power cord.
3. Measure the resistance of the YO tuning coil.  
XA13J2-14 to XA13J2-60 should be  $\geq 35 \Omega$  and  $\leq 65 \Omega$ .

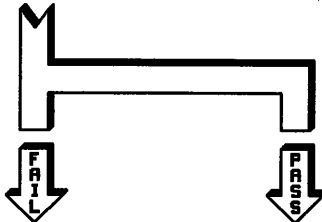
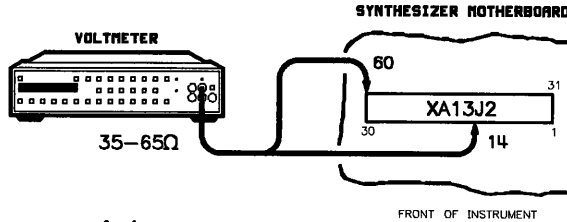

Continue

Go To A13.9000

### A13.601

Was the resistance  $\leq 35 \Omega$ ?



Go To A13.610

Continue

## A13.602

Do the following:

1. Remove A13.
2. Measure the resistance of the YO tuning coil (XA13J2-14 to XA13J2-60).

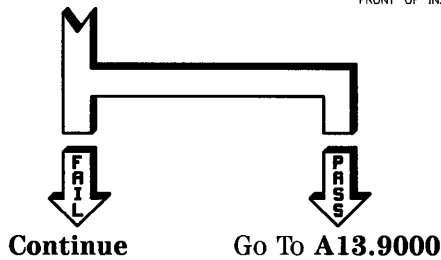
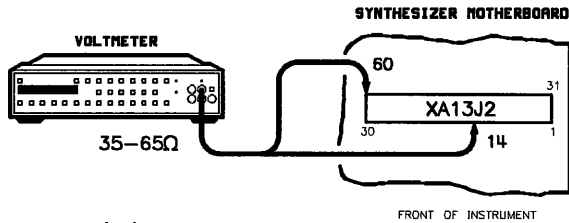



### A13.603

Do the following:

1. Disconnect W42 from A26J1 (ribbon cable connecting RF interface to YO).
2. Check for an open circuit between XA13J2-14 and XA13J2-60 ( $\geq 100 \text{ k}\Omega$ ).

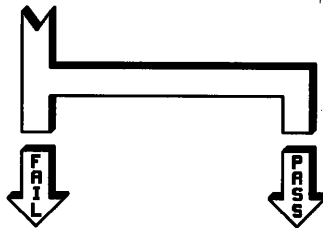
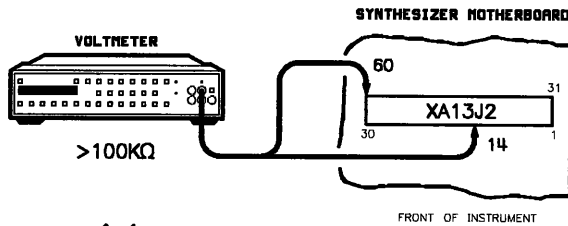

Continue

Go To **RF.2690**

## A13.604

Do the following:

1. Using the instructions in the “Disassembly and Replacement Procedures” chapter of the *HP 8360 B-Series Swept Signal Generator/ HP 8360 L-Series Swept CW Generator Service Guide*, remove the RF deck.
2. Check for an open circuit between XA13J2-14 and XA13J2-60 ( $\geq 100\text{ k}\Omega$ ).

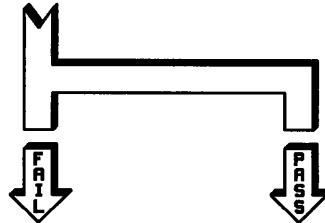
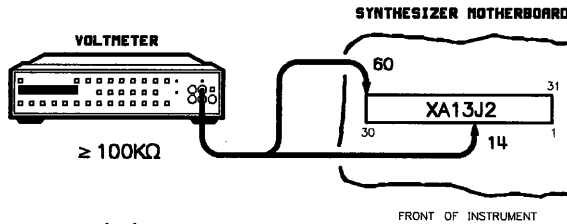

Go To **A22.9000**

Go To **A20.9000**

## A13.610

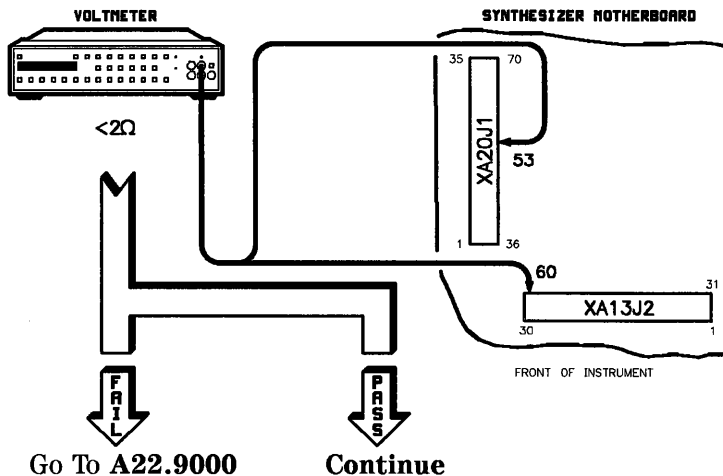

### A13.611

Perform the following:

1. Using the disassembly instructions in the *HP 8360 B-Series Swept Signal Generator/ HP 8360 L-Series Swept CW Generator Service Guide*, remove the RF deck.
2. Disconnect W42 from A26 (YO).
3. Measure the resistance of the YO coil at the YO. The resistance should be  $\geq 35 \Omega$  and  $\leq 65 \Omega$  between A26J1-4 and A26J1-12.

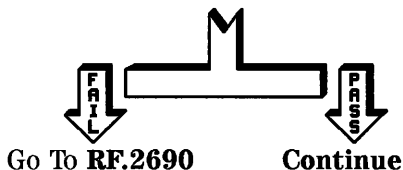

### A13.612

A high resistance exists on either W42 (ribbon cable that connects the RF deck to A26) or on A20 itself. Replace W42 or A20 and then go to the troubleshooting foldout, block 1 (located just prior to the "Special Cases" tab).

**A13.9000** Replace the A13 assembly.

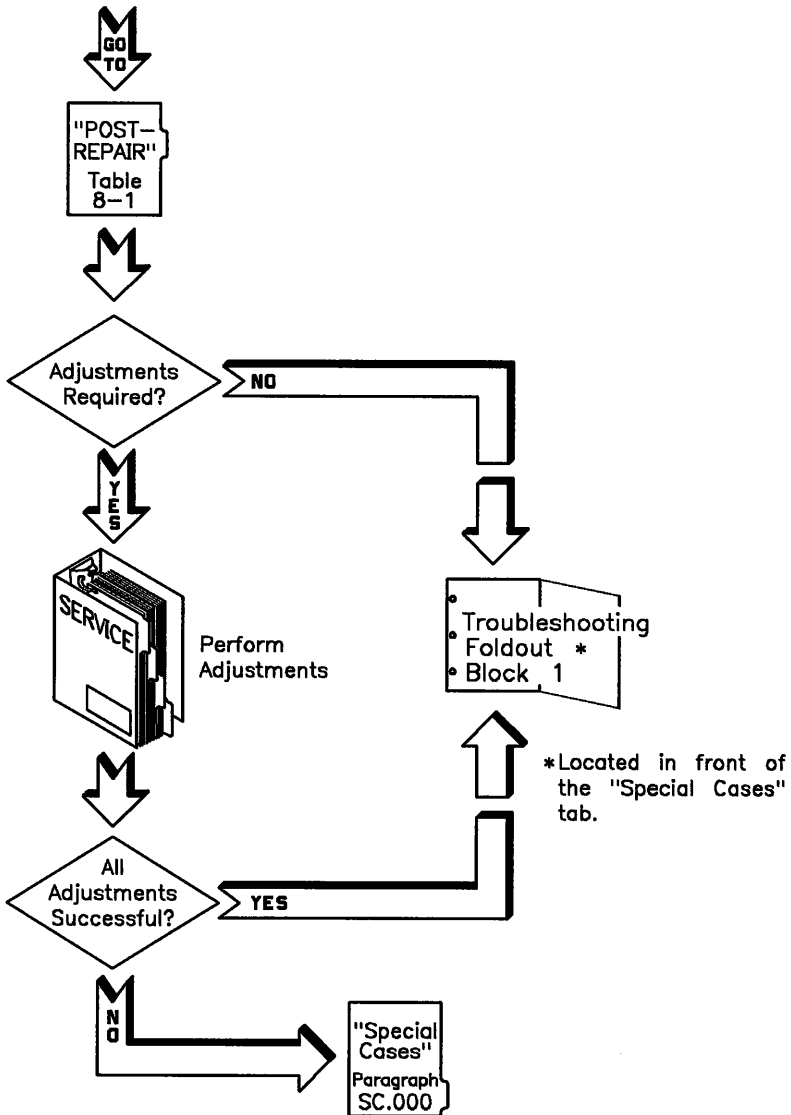

---

## A14 Sweep Generator Troubleshooting

<b>A14.000</b>	<b>Message Displayed on Synthesizer</b>	<b>Go to Paragraph</b>
	A14 : -10VREF Supply	A14.100
	A14 : 1 MHz Clock	A14.200
	A14 : Sweep Status Line	A14.300
	A14 : Z-Axis Blanking	A14.400
	A14 : Rear Panel VSWP	A14.500
	A14 : Triple Timer U12	A14.9000
	A14 : Triple Timer U13	A14.9000
	A14 : Bucket Counter	A14.9000
	A14 : Event Latch/Buffer	A14.9000
	A14 : Event RAM	A14.9000
	A14 : Marker Control	A14.9000
	A14 : Stop Sweep Control	A14.9000
	A14 : Bucket Generator	A14.9000
	A14 : ABUS Ground	A14.9000
	A14 : Level Correction DAC	A14.9000
	A14 : Sweep Time DAC	A14.9000
	A14 : VSWP Output	A14.9000
	A14 : Ramp Generator	A14.9000
	A14 : Reset Loop	A14.9000

## A14.100

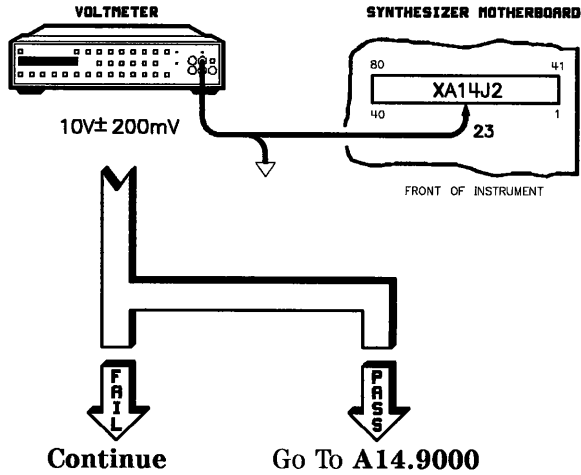

## A14.101

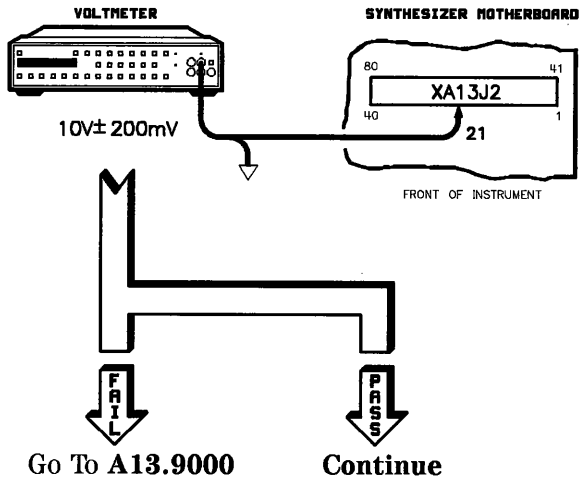

### **A14.110**

There is an open on the motherboard between XA14J2-23 and XA13J2-21. Verify this with an ohmmeter. Is jumpering the open an acceptable repair?



Go To **A22.9000**

**Continue**

### **A14.111**

Install a jumper and go to the Troubleshooting Foldout, block 1 (located just prior to the "Special Cases" tab).

## A14.200

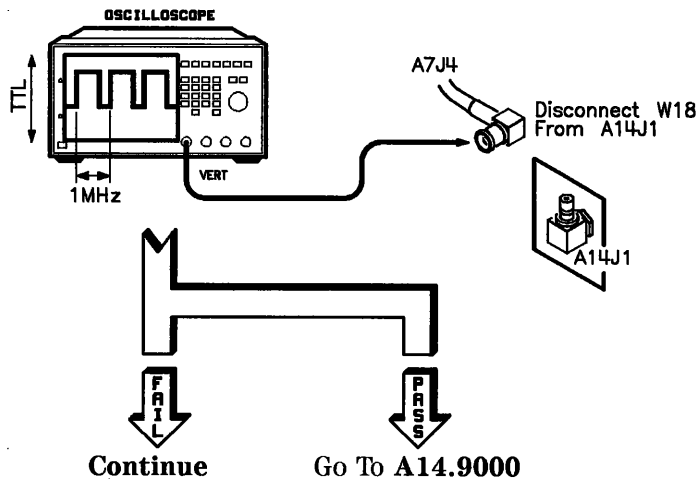

## A14.201

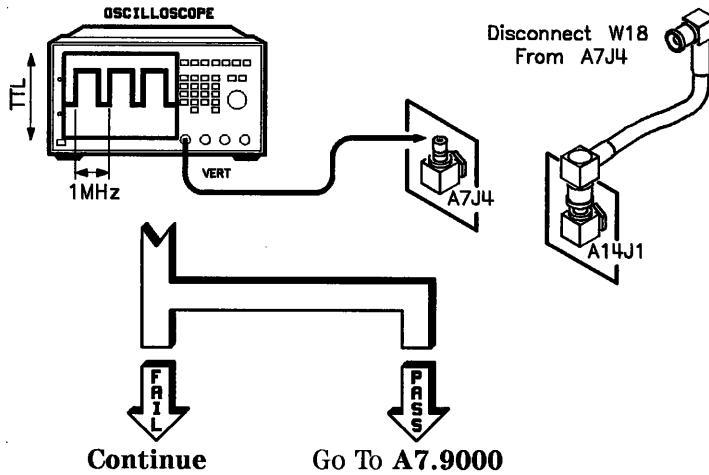

## A14.210

W18 is open or damaged. Replace W18 and then go to the Troubleshooting Foldout, block 1 (located just prior to the "Special Cases" tab).



**A14.300** Perform the following key sequence:

1. Press **PRESET** **SERVICE**.
2. Select **Selftest Menu**.
3. Press **209** **ENTER**.
4. Select **Loop** (asterisk on).
5. Select **Do Test #209**.

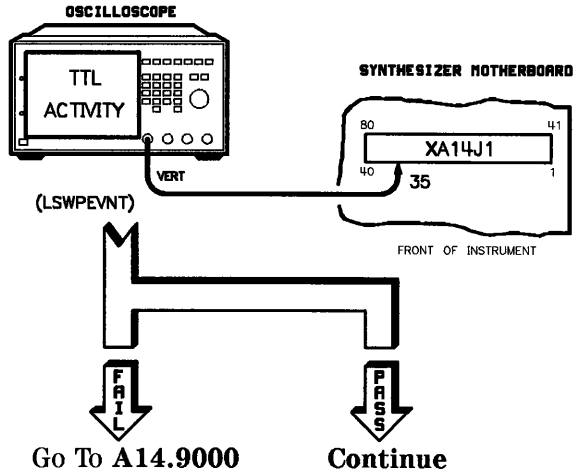

**A14.301**

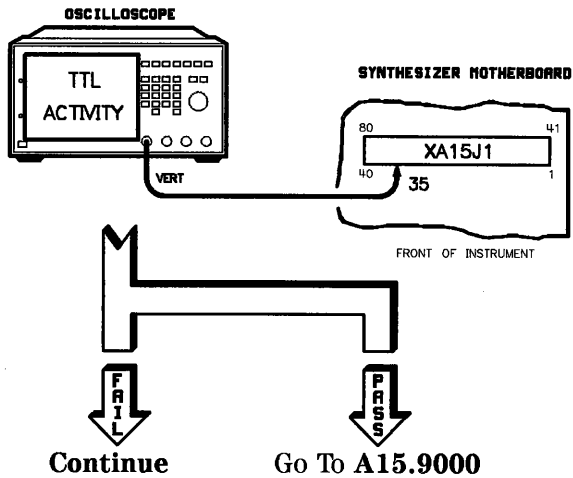

### **A14.310**

There is an open on the motherboard between XA14J1-35 and XA15J1-35. Verify this with an ohmmeter. Is jumpering the open an acceptable repair?

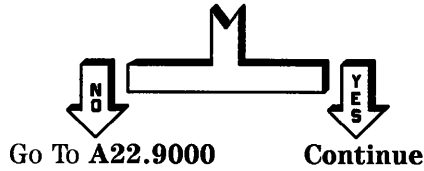

### **A14.311**

Install a jumper and go to the Troubleshooting Foldout, block 1 (located just prior to the “Special Cases” tab).

**A14.400** Do the following:

1. Set the line power switch to standby.
2. Unplug the line power cord.
3. Measure the resistance between XA14J1-78 and ground ( $\geq 10\text{ k}\Omega$ ).

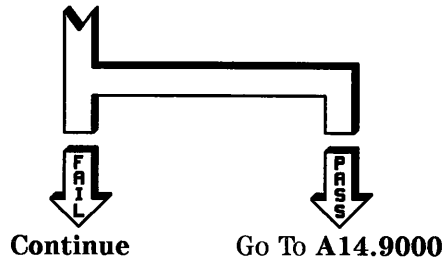
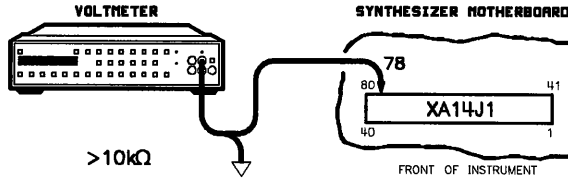

## A14.401

Do the following:

1. Ensure the instrument is still disconnected from line power.
2. Remove A14.
3. Measure the resistance between XA14J1-78 and ground ( $\geq 10\text{ k}\Omega$ ).

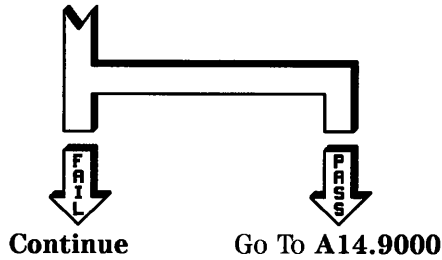
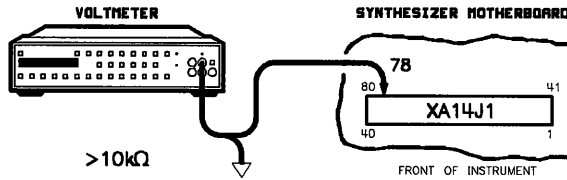

## A14.402

Do the following:

1. Ensure the instrument is still disconnected from line power.
2. Remove the rear panel.
3. Disconnect the ribbon cable connecting A19 to the motherboard (W31).
4. Measure the resistance between XA14J1-78 and ground ( $\geq 10\text{ k}\Omega$ ).

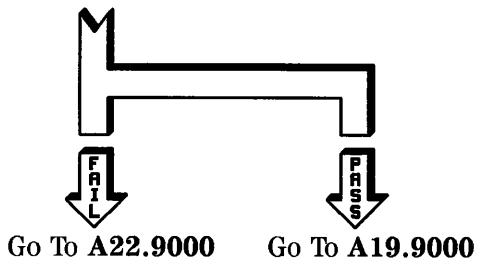
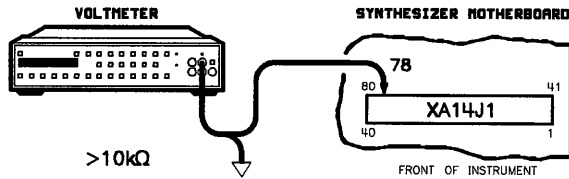

**A14.500** Are *all* cables removed from the synthesizer including the VSWP connection?

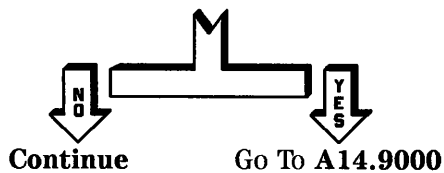

**A14.501**

Remove *all* cables and go to ILT.105.

**A14.9000** Perform the "Sweep Ramp" adjustment. If this does not cure the fault, replace the A14 assembly.

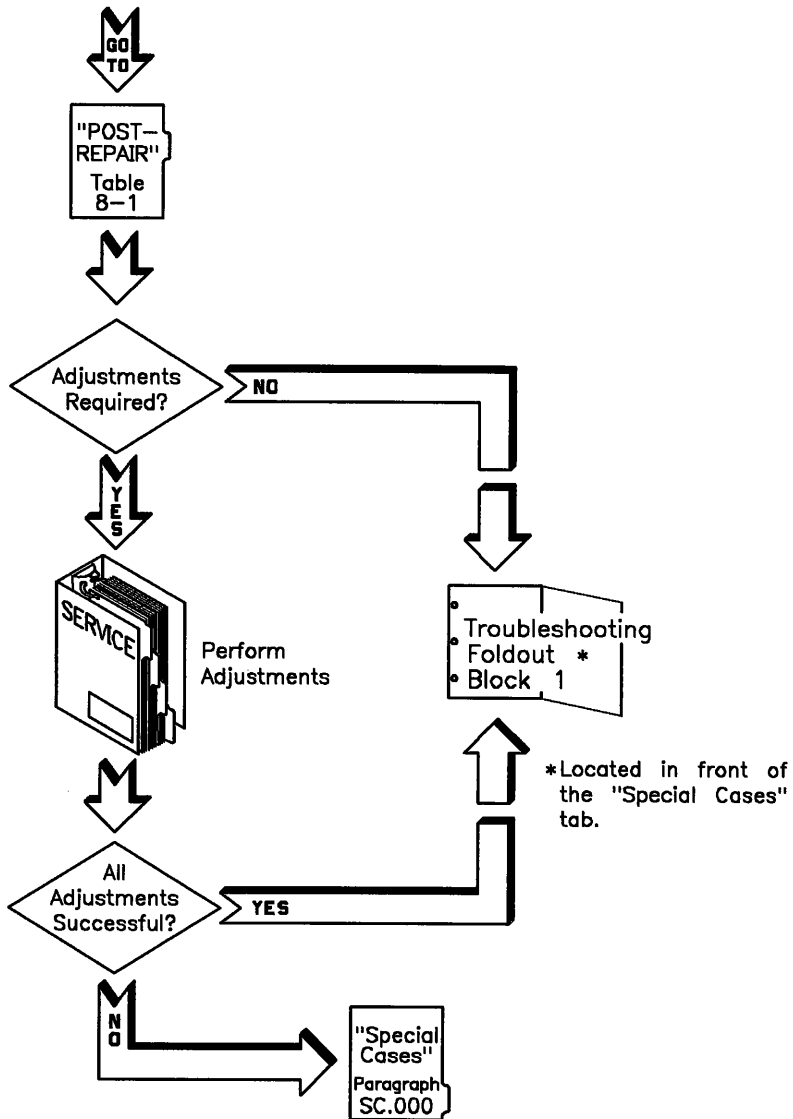

---

## A15 CPU Troubleshooting

<b>A15.000</b>	<b>Message Displayed on Synthesizer</b>	<b>Go to Paragraph</b>
	A15 : I/O Address	A15.100
	A15 : I/O Strobe	A15.200
	A15 : I/O Data	A15.300
	A15 : ROM Tests	A15.400
	A15 : HPIB Interface Chips	A15.500
	A15 : ADC Circuitry	A15.9000
	A15 : uProcessor Test	A15.9000
	A15 : Peripheral/Timers	A15.9000
	A15 : RAM Tests	A15.9000



**A15.100** Perform the following setup:

1. Set the line power switch to standby.
2. Completely remove the following assemblies:
  - A4 fractional-N.
  - A5 YO loop.
  - A7 reference.
  - A8 modulation generator (Opt. 002).
  - A9 pulse.
  - A10 ALC.
  - A11 FM driver.
  - A12 multiplier/filter driver.
  - A13 YO driver.
  - A14 sweep generator.
3. Set the line power switch to on.
4. Press **PRESET** **SERVICE**.
5. Select **Selftest Menu**.
6. Press **231** **ENTER**.
7. Select **Do Test #231**.

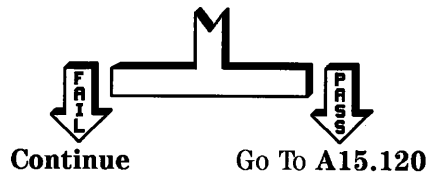

## A15.101

Perform the following setup:

1. Set the line power switch to standby.
2. Replace all of the assemblies removed in the previous step and reconnect all cables.
3. Carefully remove the A6 assembly. Be sure to disconnect all flexible and semi-rigid coax cables before removing A6.
4. Set the line power switch to on.
5. Press **PRESET** **SERVICE**.
6. Select **Selftest Menu**.
7. Press **231** **ENTER**.
8. Select **Do Test #231**.

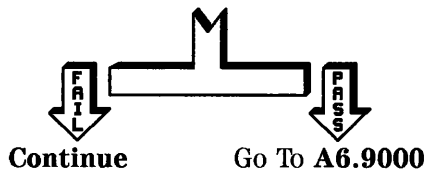

## A15.102

Perform the following setup:

1. Set the line power switch to standby.
2. Disconnect the line power cord.
3. Wait for all the indicators in the power supply section to go out.
4. Replace the A6 assembly (removed in the previous step) and reconnect all cables.
5. Using the disassembly instructions in the *HP 8360 B-Series Swept Signal Generator/HP 8360 L-Series Swept CW Generator Service Guide*, remove the front panel and disconnect W2 (the ribbon cable that connects the motherboard to A2.)
6. Temporarily replace the front panel leaving W2 loose.
7. Reconnect line power (the power-on control is on A2 so the synthesizer will power up automatically, even in standby).
8. Press **PRESET** **SERVICE**.
9. Select **Selftest Menu**.
10. Press **231** **ENTER**.
11. Select **Do Test #231**.

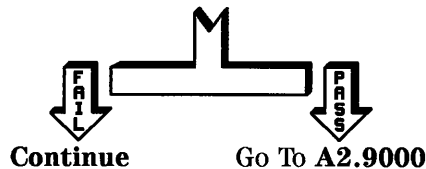

### A15.103

Perform the following setup:

1. Disconnect the line power cord.
2. Wait for all the indicators in the power supply section to go out.
3. Remove the front panel.
4. Reconnect W2 to A2.
5. Disconnect W3 (the ribbon cable that connects A3 to the motherboard.)
6. Temporarily replace the front panel leaving the ribbon cable loose.
7. Reconnect the line power cord.
8. Set the line power switch to on.
9. Observe the red indicators on A15.

Are all A15 indicators off?

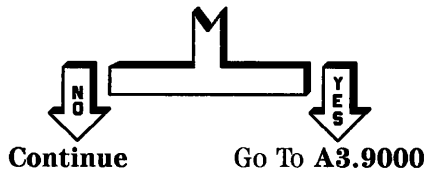

### WARNING

---

**When the instrument is connected to AC line power or the A18 high voltage neon indicator is on, there are voltages present that can cause personal injury or death. Only trained, qualified personnel, who are aware of the hazards involved, should perform service on this instrument with its protective covers removed.**

---

## A15.104

Perform the following setup:

1. Set the line power switch to standby.
2. Disconnect the line power cord.
3. Wait for all the indicators in the power supply section to go out.
4. Remove the front panel and reconnect W3 (the ribbon cable that connects A3 to the motherboard.)
5. Reinstall the front panel.
6. Remove the rear panel and disconnect W31 (the ribbon cable that connects the motherboard to A19.) Refer to the disassembly procedures in the *HP 8360 B-Series Swept Signal Generator/HP 8360 L-Series Swept CW Generator Service Guide* as needed.
7. Temporarily replace the rear panel leaving the ribbon cable (W31) loose. Take great care to ensure that the ribbon cable is not in contact with any line power wires or connections.
8. Reconnect the line power cord.
9. Set the line power switch to on.
10. Press **PRESET** **SERVICE**.
11. Select **Selftest Menu**.
12. Press **231** **ENTER**.
13. Select **Do Test #231**.

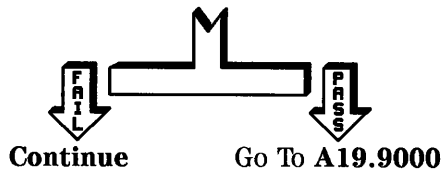

## A15.105

Perform the following setup:

1. Set the line power switch to standby.
2. Disconnect the line power cord.
3. Wait for all the indicators in the power supply section to go out.
4. Reconnect W31 (the ribbon cable that connects A19 to the motherboard.)
5. Remove the RF deck. Refer to the disassembly procedures in the *HP 8360 B-Series Swept Signal Generator/HP 8360 L-Series Swept CW Generator Service Guide* as needed.
6. Reconnect the line power cord.
7. Set the line power switch to on.
8. Press **PRESET** **SERVICE**. Ignore all unlevelled indications.
9. Select **Selftest Menu**.
10. Press **231** **ENTER**.
11. Select **Do Test #231**.

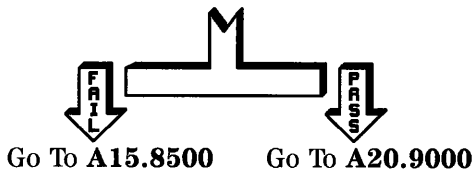

## A15.120

One of the following assemblies is defective:

- A4 fractional-n.
- A5 YO loop.
- A7 reference.
- A8 modulation generator (Opt. 002).
- A9 pulse.
- A10 ALC.
- A11 FM driver.
- A12 multiplier/filter driver.
- A13 YO driver.
- A14 sweep generator.

Replace any one of the assemblies and perform the following test:

1. Press **PRESET** **SERVICE**.
2. Select **Selftest Menu**.
3. Press **231** **ENTER**.
4. Select **Do Test #231**.

If the test fails, the assembly just replaced is defective. If the test does not fail, replace another assembly and repeat test number 231. When the defective assembly is identified, go to the 9000 paragraph for that assembly for replacement instructions. For example, for A4, go to A4.9000, for A5, go to A5.9000, and so on.

**A15.200** Perform the following setup:

1. Set the line power switch to on.
2. Press **PRESET** **SERVICE**.
3. Select **Selftest Menu**.
4. Press **232** **ENTER**.
5. Select **Log Output Menu** **When to Log Always** (asterisk on).
6. Press **PRIOR**.
7. Select **Do Test #232**.
8. Press **Continue**. Note the fail or pass status of each strobe.
9. Use the following table to determine your next step.

<b>Strobes</b>	<b>Go To Paragraph</b>
Only strobe #0 fails	A15.210
Only strobe #1 fails	A15.220
Only strobe #2 fails	A15.230
Only strobe #3 fails	A15.240
Only strobe #4 fails	A15.250
Only strobe #5 fails	A15.260
Only strobe #6 fails	A15.270
Only strobe #7 fails	A15.280
All other strobe failures	A15.8500

**WARNING**

---

**When the instrument is connected to AC line power or the A18 high voltage neon indicator is on, there are voltages present that can cause personal injury or death. Only trained, qualified personnel, who are aware of the hazards involved, should perform service on this instrument with its protective covers removed.**

---



## A15.210

Perform the following setup:

1. Set the line power switch to standby.
2. Disconnect the line power cord.
3. Wait for all the indicators in the power supply section to go out.
4. Remove the rear panel and disconnect W31 (the ribbon cable that connects the motherboard to A19.) (Refer to the disassembly procedures in the *HP 8360 B-Series Swept Signal Generator/HP 8360 L-Series Swept CW Generator Service Guide* as needed.)
5. Temporarily replace the rear panel, leaving the ribbon cable loose. Take great care to ensure that the ribbon cable is not in contact with any line power wires or connections.
6. Reconnect the line power cord.
7. Set the line power switch to on.
8. Press **PRESET** **SERVICE**.
9. Select **Selftest Menu**.
10. Press **231** **ENTER**.
11. Select **Do Test #232**.

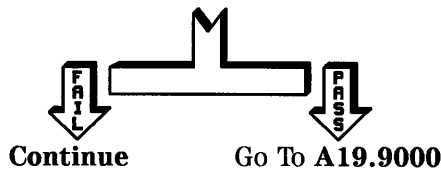

## A15.211

Perform the following setup:

1. Set the line power switch to standby.
2. Disconnect the line power cord.
3. Wait for all the indicators in the power supply section to go out.
4. Reconnect W31 (the ribbon cable that connects A19 to the motherboard.)

Go to A15.8500.

### A15.220

Perform the following:

1. Set the line power switch to standby.
2. Remove the A14 assembly.
3. Set the line power switch to on.
4. Press **PRESET** **SERVICE**.
5. Select **Selftest Menu**.
6. Press **232** **ENTER**.
7. Select **Do Test #232**.

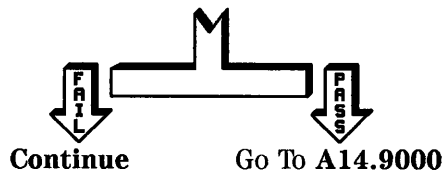

### A15.221

Perform the following:

1. Set the line power switch to standby.
  2. Replace the A14 assembly.
- Go to A15.8500.

### A15.230

Perform the following:

1. Set the line power switch to standby.
2. Remove the A11 and A12 assemblies.
3. Set line power switch to on.
4. Press **PRESET** **SERVICE**.
5. Select **Selftest Menu**.
6. Press **232** **ENTER**.
7. Select **Do Test #232**.

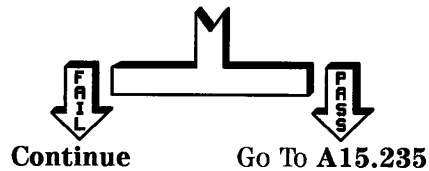

### A15.231

Perform the following:

1. Set the line power switch to standby.
2. Replace the A11 and A12 assemblies.

Go to A15.8500.

## A15.235

Perform the following:

1. Set the line power switch to standby.
2. Replace the A11 assembly.
3. Set the line power switch to on.
4. Press **PRESET** **SERVICE**.
5. Select **Selftest Menu**.
6. Press **232** **ENTER**.
7. Select **Do Test #232**.

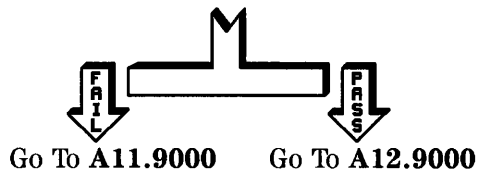

## A15.240

Perform the following:

1. Set the line power switch to standby.
2. Remove the A9 and A10 assemblies.
3. Set the line power switch to on.
4. Press **PRESET** **SERVICE**.
5. Select **Selftest Menu**.
6. Press **232** **ENTER**.
7. Select **Do Test #232**.



Continue

Go To A15.245

## A15.241

Perform the following:

1. Set the line power switch to standby.
2. Replace the A9 and A10 assemblies.

Go to A15.8500.

### A15.245

Perform the following:

1. Set the line power switch to standby.
2. Replace the A9 assembly.
3. Set the line power switch to on.
4. Press **PRESET** **SERVICE**.
5. Select **Selftest Menu**.
6. Press **232** **ENTER**.
7. Select **Do Test #232**.



Go To **A9.9000**

Go To **A10.9000**

### A15.250

Perform the following:

1. Set the line power switch to standby.
2. Remove the A7 assembly (and the A8 assembly – Opt. 002).
3. Carefully remove the A6 assembly. Be sure to disconnect all cables.
4. Set the line power switch to on.
5. Press **PRESET** **SERVICE**.
6. Select **Selftest Menu**.
7. Press **232** **ENTER**.
8. Select **Do Test #232**.

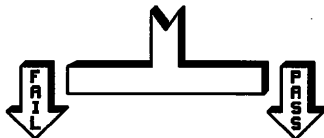

Continue

Go To **A15.255**

### **A15.251**

Perform the following:

1. Set the line power switch to standby.
2. Replace the A6 and A7 assemblies (and the A8 assembly - Opt. 002).

Go To A15.8500.

### **A15.255**

Perform the following for Option 002.

1. Set the line power switch to standby.
2. Replace the A8 assembly.
3. Set the line power switch to on.
4. Press **PRESET** **SERVICE**.
5. Select **Selftest Menu**.
6. Press **232** **ENTER**.
7. Select **Do Test #232**.



Go To **A8.9000**

**Continue**

### A15.256

Perform the following:

1. Set the line power switch to standby.
2. Replace the A7 assembly.
3. Set the line power switch to on.
4. Press **PRESET** **SERVICE**.
5. Select **Selftest Menu**.
6. Press **232** **ENTER**.
7. Select **Do Test #232**.



Go To **A7.9000**      Go To **A6.9000**

### A15.260

Perform the following:

1. Set the line power switch to standby.
2. Remove the A4 and A5 assemblies.
3. Set the line power switch to on.
4. Press **PRESET** **SERVICE**.
5. Select **Selftest Menu**.
6. Press **232** **ENTER**.
7. Select **Do Test #232**.



**Continue**      Go To **A15.265**



### **A15.261**

Perform the following:

1. Set the line power switch to standby.
2. Replace the A4 and A5 assemblies.

Go To A15.8500.

### **A15.265**

Perform the following:

1. Set the line power switch to standby.
2. Replace the A4 assembly.
3. Set the line power switch to on.
4. Press **PRESET** **SERVICE**.
5. Select **Selftest Menu**.
6. Press **232** **ENTER**.
7. Select **Do Test #232**.



Go To **A4.9000**

Go To **A5.9000**

## A15.270

Perform the following:

1. Set the line power switch to standby.
2. Using the disassembly instructions in the *HP 8360 B-Series Swept Signal Generator/HP 8360 L-Series Swept CW Generator Service Guide*, carefully remove the RF deck.
3. Set the line power switch to on.
4. Press **PRESET** **SERVICE**.
5. Select **Selftest Menu**.
6. Press **232** **ENTER**.
7. Select **Do Test #232**.

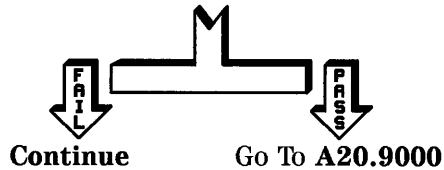

## A15.271

Perform the following:

1. Set the line power switch to standby.
  2. Replace the A20 assembly.
- Go To A15.8500.

## A15.280

Perform the following setup:

1. Set the line power switch to standby.
2. Disconnect the line power cord.
3. Wait for all the indicators in the power supply section to go out.
4. Remove the front panel and disconnect W2 and W3 (the ribbon cables connecting A2 and A3 to the motherboard.) Refer to the disassembly procedures in the *HP 8360 B-Series Swept Signal Generator/HP 8360 L-Series Swept CW Generator Service Guide* as needed.
5. Temporarily replace the front panel leaving the ribbon cables loose.
6. Reconnect line power (the power-on control is on A2 so the synthesizer will power up automatically, even in standby).
7. Observe the red indicators on A15.

Are all A15 indicators off?

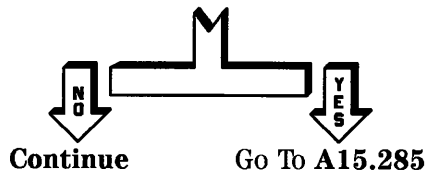

## A15.281

Perform the following:

1. Set the line power switch to standby.
2. Reconnect the ribbon cables for A2 and A3.

Go To A15.8500.

## A15.285

Perform the following:

1. Set the line power switch to standby.
2. Disconnect the line power cord.
3. Wait for all the indicators in the power supply section to go out.
4. Reconnect W3, the ribbon cable that connects the motherboard to A3.
5. Temporarily replace the front panel.
6. Reconnect the line power cord.
7. Press **PRESET** **SERVICE**.
8. Select **Selftest Menu**.
9. Press **232** **ENTER**.
10. Select **Do Test #232**.

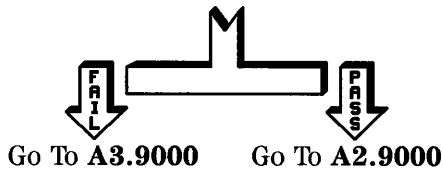

**A15.300** Perform the following setup:

1. Set the line power switch to standby.
2. Remove the following assemblies:
  - A4 fractional-n.
  - A5 YO loop.
  - A7 reference.
  - A8 modulation generator (Opt. 002).
  - A9 pulse.
  - A10 ALC.
  - A11 FM driver.
  - A12 multiplier/filter driver.
  - A13 YO driver.
  - A14 sweep generator.
3. Set the line power switch to on.
4. Press **PRESET** **SERVICE**.
5. Select **Selftest Menu**.
6. Press **233** **ENTER**.
7. Select **Do Test #233**.

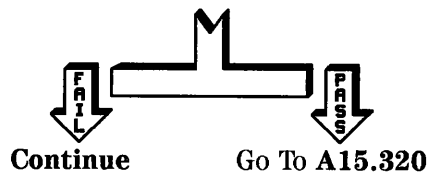

### A15.301

Perform the following:

1. Set the line power switch to standby.
2. Replace all of the assemblies removed in the previous step.
3. Carefully remove the A6 assembly. Be sure to disconnect all flexible and semi-rigid coax cables before removing A6.
4. Set the line power switch to on.
5. Press **PRESET** **SERVICE**.
6. Select **Selftest Menu**.
7. Press **233** **ENTER**.
8. Select **Do Test #233**.

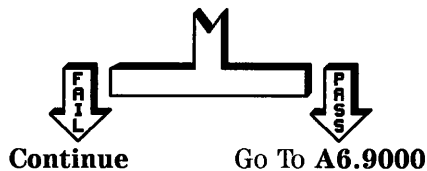

## A15.302

Perform the following setup:

1. Set the line power switch to standby.
2. Disconnect the line power cord.
3. Wait for all the indicators in the power supply section to go out.
4. Replace the A6 assembly removed in the previous step.
5. Remove the front panel and disconnect W2 (the ribbon cable that connects the motherboard to A2.) Refer to the disassembly procedures in the *HP 8360 B-Series Swept Signal Generator/HP 8360 L-Series Swept CW Generator Service Guide* as needed.
6. Temporarily replace the front panel leaving W2 loose.
7. Reconnect line power (the power-on control is on A2 so the synthesizer will power up automatically, even in standby).
8. Press **PRESET** **SERVICE**.
9. Select **Selftest Menu**.
10. Press **233** **ENTER**.
11. Select **Do Test #233**.

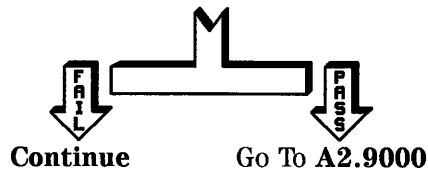

### A15.303

Perform the following setup:

1. Disconnect the line power cord.
2. Wait for all the indicators in the power supply section to go out.
3. Remove the front panel.
4. Reconnect W2 to A2. Disconnect W3 (the ribbon cable that connects A3 to the motherboard.)
5. Temporarily replace the front panel, leaving W3 loose.
6. Reconnect line power.
7. Set the line power switch to on.
8. Observe the red indicators on A15.

Are all A15 indicators off?

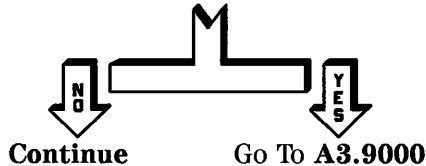

### WARNING

---

When the instrument is connected to AC line power or the A18 high voltage neon indicator is on, there are voltages present that can cause personal injury or death. Only trained, qualified personnel, who are aware of the hazards involved, should perform service on this instrument with its protective covers removed.

---



## A15.304

Perform the following setup:

1. Set the line power switch to standby.
2. Disconnect the line power cord.
3. Wait for all the indicators in the power supply section to go out.
4. Remove the front panel and reconnect W3 (the ribbon cable that connects A3 to the motherboard.)
5. Replace the front panel.
6. Remove the rear panel and disconnect W31 (the ribbon cable that connects the motherboard to A19.) Refer to the disassembly procedures in the *HP 8360 B-Series Swept Signal Generator/HP 8360 L-Series Swept CW Generator Service Guide* as needed.
7. Temporarily replace the rear panel leaving W31 loose. Take great care to ensure the ribbon cable is not in contact with any line power wires or connections.
8. Reconnect line power.
9. Set the line power switch to on.
10. Press **PRESET** **SERVICE**.
11. Select **Selftest Menu**.
12. Press **233** **ENTER**.
13. Select **Do Test #233**.

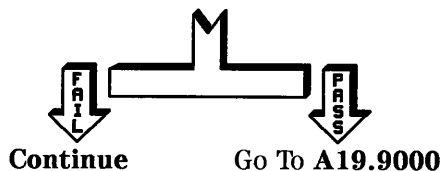

## A15.305

Perform the following:

1. Set the line power switch to standby.
2. Disconnect the line power cord.
3. Wait for all the indicators in the power supply section to go out.
4. Reconnect the A19 assembly removed in the previous step.
5. Remove the RF deck. Refer to the disassembly procedures in the *HP 8360 B-Series Swept Signal Generator/HP 8360 L-Series Swept CW Generator Service Guide* as needed.
6. Reconnect line power.
7. Set the line power switch to on.
8. Press **PRESET** **SERVICE**.
9. Select **Selftest Menu**.
10. Press **233** **ENTER**.
11. Select **Do Test #233**.

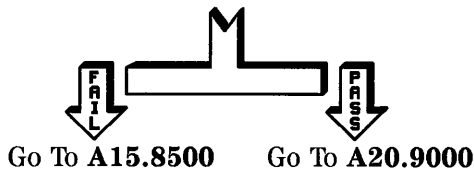

## **A15.320**

One of the following assemblies is defective:

- A4 fractional-n.
- A5 YO loop.
- A7 reference.
- A8 modulation generator (Opt. 002).
- A9 pulse.
- A10 ALC.
- A11 FM driver.
- A12 multiplier/filter driver.
- A13 YO driver.
- A14 sweep generator.

Replace any one of the assemblies and perform the following test:

1. Press **PRESET** **SERVICE**.
2. Select **Selftest Menu**.
3. Press **233** **ENTER**.
4. Select **Do Test #233**.

If the test fails, the assembly just replaced is defective. If the test does not fail, replace another assembly and repeat test number 233. When the defective assembly is identified, go to the 9000 paragraph for that assembly for replacement instructions. For example, for A4, go to A4.9000, for A5, go to A5.9000, and so on.

**A15.400** Perform the following:

1. Set the line power switch to on.
2. Press **PRESET** **SERVICE**.
3. Select **Selftest Menu**.
4. Press **234** **ENTER**.
5. Select **Log Output Menu** **When to Log Always** (asterisk on).
6. Press **PRIOR**.
7. Select **Do Test #234**.
8. Press **Continue**. Note the fail or pass status of the EEROM tests (ignore all other pass/fails).

Did all EEROM tests pass?

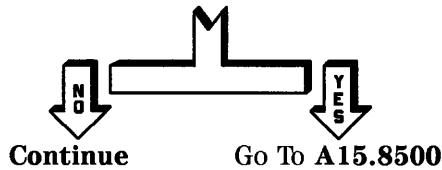

**A15.401**

Perform the following:

1. Set the line power switch to on.
2. Press **PRESET** **SERVICE**.
3. Select **Selftest Menu**.
4. Press **235** **ENTER**.
5. Select **Do Test #235**.

Did all RAM tests pass?

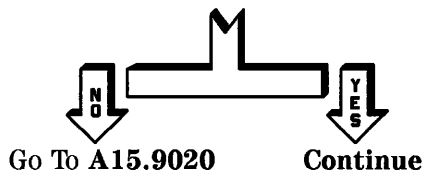

## A15.405

Perform the following:

### Note

---

Take great care during these procedures not to short out the one farad capacitor used as the back-up power supply for the RAM.

---

1. Set the line power switch to standby.
2. Disconnect the line power cord.
3. Very carefully remove the A15 assembly and place it on an ESD mat.
4. Using plastic tools and taking great care not to short out the battery backed-up RAM, remove and replace the EEROMs (U14 and U62) on A15 with new EEROMs.
5. Reinstall A15.
6. Reconnect line power.
7. Set the line power switch to on.
8. Press **PRESET** **SERVICE**.
9. Select **Adjust Menu** **Calib Menu** **Cal Util Menu**.
10. Select **Save Cal** **yes**.

Were you able to save calibration constants from RAM to EEROM successfully?

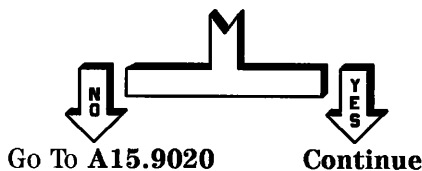

## A15.406

Perform the following:

1. Press **PRESET** **SERVICE**.
2. Select **Selftest (Full)**.

Do all tests pass?

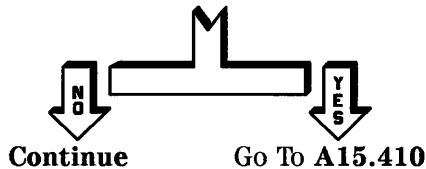

## A15.407

The synthesizer indicates one or more self-test failures. Go to the paragraph shown on the synthesizer for the failure *unless* the message is A15 : ROM tests. In that case, rather than the paragraph shown on the synthesizer, go to A15.9020.

## A15.410

When EEROM was lost, most of the calibration data was saved by copying from backed-up RAM. However, two types of data were not saved. These data were test patches for the diagnostics and attenuator correction data. Both sets of data will have to be recreated.

To recreate the attenuator correction data, refer to the performance tests and adjustments. For the test patches on the diagnostics, refer to the appropriate service or installation notes.

**A15.500** When the HP-IB diagnostic was performed, was the synthesizer disconnected from all HP-IB busses?

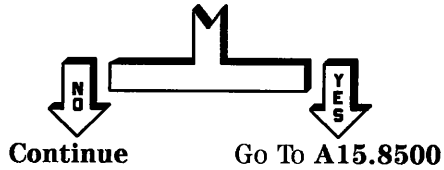

**A15.501**

Remove all HP-IB connections and restart the troubleshooting process.

**A15.1100** Perform the following setup:

1. Set the line power switch to standby.
2. Completely remove the following assemblies:
  - A4 fractional-n.
  - A5 YO loop.
  - A7 reference.
  - A8 modulation generator (Opt. 002).
  - A9 pulse.
  - A10 ALC.
  - A11 FM driver.
  - A12 multiplier/filter driver.
  - A13 YO driver.
  - A14 sweep generator.
3. Repeat the power-on sequence and observe the indicators on A15.

Did all the indicators turn on temporarily and then turn off?

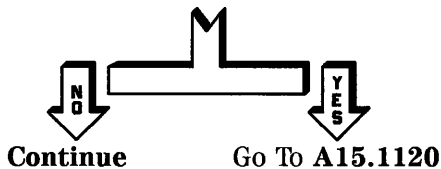



## **A15.1101**

Perform the following setup:

1. Set the line power switch to standby.
2. Replace all of the assemblies removed in the previous step and reconnect all cables.
3. Carefully remove the A6 assembly. Be sure to disconnect all flexible and semi-rigid coax cables before removing A6.
4. Repeat the power-on sequence and observe the indicators on A15.

Did all the indicators turn on temporarily and then turn off?

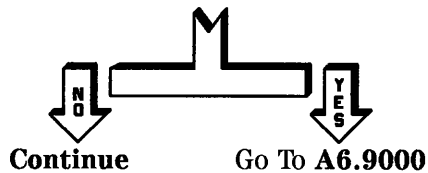

## A15.1102

Perform the following setup:

1. Set the line power switch to standby.
2. Disconnect the line power cord.
3. Wait for all the indicators in the power supply section to go out.
4. Replace the A6 assembly (removed in the previous step) and reconnect all cables.
5. Using the disassembly instructions in the *HP 8360 B-Series Swept Signal Generator/ HP 8360 L-Series Swept CW Generator Service Guide*, remove the front panel and disconnect W2 (the ribbon cable that connects the motherboard to A2.)
6. Temporarily replace the front panel leaving W2 loose.
7. Reconnect line power (the power-on control is on A2 so the synthesizer will power up automatically, even in standby) and observe the indicators on A15.

Did all the indicators turn on temporarily and then turn off?

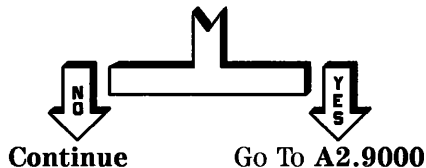

### A15.1103

Perform the following setup:

1. Disconnect the line power cord.
2. Wait for all the indicators in the power supply section to go out.
3. Remove the front panel.
4. Reconnect W2 to A2.
5. Disconnect W3 (the ribbon cable that connects A3 to the motherboard.)
6. Temporarily replace the front panel leaving the ribbon cable loose.
7. Reconnect the line power cord.
8. Repeat the power-on sequence and observe the indicators on A15.

Did all the indicators turn on temporarily and then turn off?

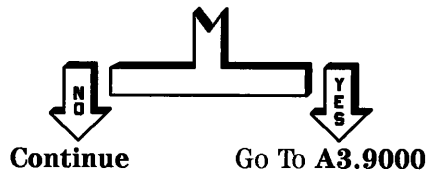

### WARNING

**When the instrument is connected to AC line power or the A18 high voltage neon indicator is on, there are voltages present that can cause personal injury or death. Only trained, qualified personnel, who are aware of the hazards involved, should perform service on this instrument with its protective covers removed.**

## A15.1104

Perform the following setup:

1. Set the line power switch to standby.
2. Disconnect the line power cord.
3. Wait for all the indicators in the power supply section to go out.
4. Remove the front panel and reconnect W3 (the ribbon cable that connects A3 to the motherboard.)
5. Replace the front panel.
6. Remove the rear panel and disconnect W31 (the ribbon cable that connects the motherboard to A19.) Refer to the disassembly procedures in the *HP 8360 B-Series Swept Signal Generator/HP 8360 L-Series Swept CW Generator Service Guide* as needed.
7. Temporarily replace the rear panel leaving the ribbon cable loose. Take great care to ensure the ribbon cable is not in contact with any line power wires or connections.
8. Reconnect the line power cord.
9. Repeat the power-on sequence and observe the indicators on A15.

Did all the indicators turn on temporarily and then turn off?

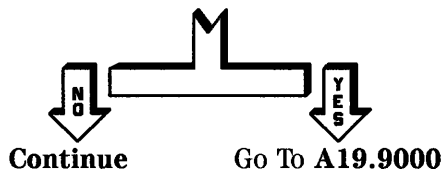



## **A15.1120**

One of the following assemblies is defective:

- A4 fractional-n.
- A5 YO loop.
- A7 reference.
- A8 modulation generator (Opt. 002).
- A9 pulse.
- A10 ALC.
- A11 FM driver.
- A12 multiplier/filter driver.
- A13 YO driver.
- A14 sweep generator.

1. Set the line power switch to standby.
2. Replace an assembly.
3. Set the line power switch to on.
4. Check the display's operation. If the display or the indicators on A15 begin to operate incorrectly, the assembly just replaced is defective. If the display does not fail, replace another assembly and repeat the process. When the defective assembly is identified, go to the 9000 paragraph for that assembly for replacement instructions. For example, for A4, go to A4.9000, for A5, go to A5.9000, and so on.

**A15.1200**

Perform the following setup:

1. Set the line power switch to on and observe the 12 LEDs on the top edge of A15.
2. When the 4 left-most LEDs (DS1) display 0010, observe and record the state of the right 8 LEDs (DS2 and DS3).
3. Find the state of the right 8 LEDs in the following table and go to the indicated paragraph.

<b>LEDs</b>	<b>Go To Paragraph</b>
X1XX XXXX	A15.1201
1XXX XXXX	A15.1201
11XX XXXX	A15.1201
All Else	A15.8500
<b>X = don't care</b>	

## A15.1201

An EEROM failure has occurred. There is some chance that the EEROM data can be partially recovered from RAM. This test determines if any data might be recovered.

1. Set the line power switch to standby and then set it to on and observe the 12 LEDs on the top edge of A15.
2. When the 4 left-most LEDs (DS1) display 0010, observe and record the state of the right 8 LEDs (DS2 and DS3).
3. Find the state of the right 8 LEDs in the following table and go to the indicated paragraph.

LEDs	Go To Paragraph
X1XX XXXX	A15.1201
1XXX XXXX	A15.1201
11XX XXXX	A15.1201
All Else	A15.8500
<b>X = don't care</b>	



## A15.1205

Perform the following:

### Note

---

Take great care during these procedures not to short out the one farad capacitor used as the back-up power supply for the RAM.

---

1. Set the line power switch to standby.
2. Disconnect the line power cord.
3. Very carefully remove the A15 assembly and place it on an ESD mat.
4. Using plastic tools and taking great care not to short out the backed-up RAM, remove the EEROMs (U14 and U62) on A15 and install new EEROMs.
5. Reinstall A15.
6. Reconnect line power.
7. Set the line power switch to on.
8. Press **PRESET** **SERVICE**.
9. Select **Adjust Menu** **Calib Menu** **Cal Util Menu**.
10. Select **Save Cal** **yes**.

Were you able to save calibration constants from RAM to EEROM successfully?

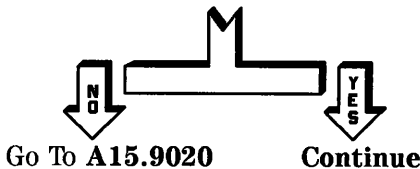

## A15.1206

Perform the following:

1. Press **PRESET** **SERVICE**.
2. Select **Selftest (Full)**.

Do all tests pass?

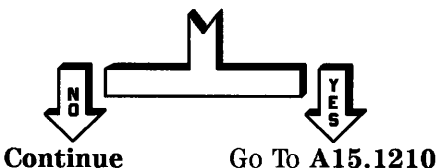

## A15.1207

The synthesizer indicates one or more self-test failures. Go to the paragraph shown on the synthesizer for the failure *unless* the message is A15 : ROM tests. In that case, rather than the paragraph shown on the synthesizer, go to A15.9020.

## A15.1210

When EEROM was lost, most of the calibration data was saved by copying from backed-up RAM. However, two types of data were not saved. These data were test patches for the diagnostics and attenuator correction data. Both sets of data will have to be recreated.

To recreate the attenuator correction data, refer to the performance tests and adjustments. For the test patches on the diagnostics, refer to the appropriate service or installation notes.

## A15.1300

Perform the following setup:

1. Set the line power switch to on and observe the 12 LEDs on the top edge of A15.
2. When the 4 left-most LEDs (DS1) display 0011, observe and record the state of the right 8 LEDs (DS2 and DS3).
3. Find the state of the right 8 LEDs in the following table and go to the indicated paragraph.

LEDs	Go To Paragraph
0000 0001	A15.1310
0000 0010	A15.1320
0000 0100	A15.1330
0000 1000	A15.1340
0001 0000	A15.1350
0010 0000	A15.1360
0100 0000	A15.1370
1000 0000	A15.1380
All Else	A15.8500

## WARNING

---

**When the instrument is connected to AC line power or the A18 high voltage neon indicator is on, there are voltages present that can cause personal injury or death. Only trained, qualified personnel, who are aware of the hazards involved, should perform service on this instrument with its protective covers removed.**

---

### A15.1310

Perform the following setup:

1. Set the line power switch to standby.
2. Disconnect the line power cord.
3. Wait for all the indicators in the power supply section to go out.
4. Remove the rear panel and disconnect W31 (the ribbon cable that connects the motherboard to A19.) Refer to the disassembly procedures in the *HP 8360 B-Series Swept Signal Generator/HP 8360 L-Series Swept CW Generator Service Guide* as needed.
5. Temporarily replace the rear panel leaving the ribbon cable loose. Take great care to ensure the ribbon cable is not in contact with any line power wires or connections.
6. Reconnect the line power cord.
7. Repeat the power-on sequence and observe the indicators on A15.

Did all the indicators turn on temporarily and then turn off?

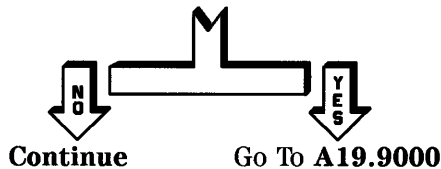

### A15.1311

Perform the following setup:

1. Set the line power switch to standby.
2. Disconnect the line power cord.
3. Wait for all the indicators in the power supply section to go out.
4. Reconnect W31 (the ribbon cable that connects A19 to the motherboard.)

Go to A15.8500.

### **A15.1320**

Perform the following setup:

1. Set the line power switch to standby.
2. Remove the A14 assembly.
3. Repeat the power-on sequence and observe the indicators on A15.

Did all the indicators turn on temporarily and then turn off?

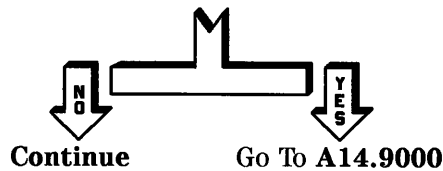

### **A15.1321**

Perform the following:

1. Set the line power switch to standby.
2. Replace the A14 assembly.

Go to A15.8500.

### **A15.1330**

Perform the following setup:

1. Set the line power switch to standby.
2. Remove the A11 and A12 assemblies.
3. Repeat the power-on sequence and observe the indicators on A15.

Did all the indicators turn on temporarily and then turn off?

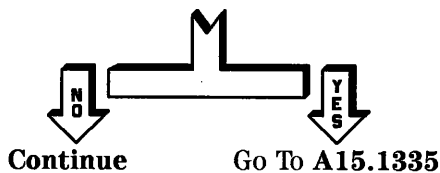

### **A15.1331**

Perform the following:

1. Set the line power switch to standby.
2. Replace the A11 and A12 assemblies.

Go to A15.8500.

### **A15.1335**

Perform the following setup:

1. Set the line power switch to standby.
2. Replace the A11 assembly.
3. Repeat the power-on sequence and observe the indicators on A15.

Did all the indicators turn on temporarily and then turn off?



Go To **A11.9000**

Go To **A12.9000**

### **A15.1340**

Perform the following setup:

1. Set the line power switch to standby.
2. Remove the A9 and A10 assemblies.
3. Repeat the power-on sequence and observe the indicators on A15.

Did all the indicators turn on temporarily and then turn off?



**Continue**

Go To **A15.1345**

### **A15.1341**

Perform the following:

1. Set the line power switch to standby.
2. Replace the A9 and A10 assemblies.

Go to A15.8500.

### **A15.1345**

Perform the following setup:

1. Set the line power switch to standby.
2. Replace the A9 assembly.
3. Repeat the power-on sequence and observe the indicators on A15.

Did all the indicators turn on temporarily and then turn off?



Go To **A9.9000**

Go To **A10.9000**

### **A15.1350**

Perform the following setup:

1. Set the line power switch to standby.
2. Remove the A7 assembly.
3. Carefully remove the A6 assembly. Be sure to disconnect all cables.
4. Repeat the power-on sequence and observe the indicators on A15.

Did all the indicators turn on temporarily and then turn off?



**Continue**

Go To **A15.1355**

### **A15.1351**

Perform the following:

1. Set the line power switch to standby.
2. Replace the A6 and A7 assemblies.

Go To A15.8500.

### **A15.1355**

Perform the following setup:

1. Set the line power switch to standby.
2. Replace the A7 assembly.
3. Repeat the power-on sequence and observe the indicators on A15.

Did all the indicators turn on temporarily and then turn off?



Go To **A7.9000**

Go To **A6.9000**

### **A15.1360**

Perform the following setup:

1. Set the line power switch to standby.
2. Remove the A4 and A5 assemblies.
3. Repeat the power-on sequence and observe the indicators on A15.

Did all the indicators turn on temporarily and then turn off?



**Continue**

Go To **A15.1365**



### **A15.1361**

Perform the following:

1. Set the line power switch to standby.
2. Replace the A4 and A5 assemblies.

Go To A15.8500

### **A15.1365**

Perform the following setup:

1. Set the line power switch to standby.
2. Replace the A4 assembly.
3. Repeat the power-on sequence and observe the indicators on A15.

Did all the indicators turn on temporarily and then turn off?

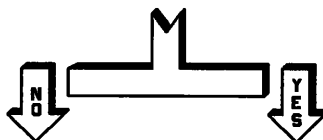

Go To **A4.9000**

Go To **A5.9000**

### **A15.1370**

Perform the following setup:

1. Set the line power switch to standby.
2. Using the disassembly instructions in the *HP 8360 B-Series Swept Signal Generator/HP 8360 L-Series Swept CW Generator Service Guide*, carefully remove the RF deck (A20).
3. Repeat the power-on sequence and observe the indicators on A15.

Did all the indicators turn on temporarily and then turn off?



**Continue**

Go To **A20.9000**

### **A15.1371**

Perform the following:

1. Set the line power switch to standby.
2. Replace the A20 assembly.

Go To A15.8500.

### **A15.1380**

Perform the following setup:

1. Set the line power switch to standby.
2. Disconnect the line power cord.
3. Wait for all the indicators in the power supply section to go out.
4. Remove the front panel and disconnect W2 and W3 (the ribbon cables connecting A2 and A3 to the motherboard.) Refer to the disassembly procedures in the *HP 8360 B-Series Swept Signal Generator/HP 8360 L-Series Swept CW Generator Service Guide* as needed.
5. Temporarily replace the front panel leaving the ribbon cables loose.
6. Reconnect line power (the power-on control is on A2 so the synthesizer will power up automatically, even in standby) and observe the indicators on A15.

Did all the indicators turn on temporarily and then turn off?

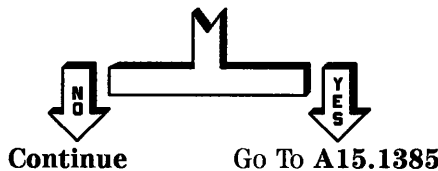

### **A15.1381**

Perform the following:

1. Set the line power switch to standby.
2. Reconnect the ribbon cables for A2 and A3.

Go To A15.8500.

## **A15.1385**

Perform the following setup:

1. Set the line power switch to standby.
2. Disconnect the line power cord.
3. Wait for all the indicators in the power supply section to go out.
4. Reconnect W3, the ribbon cable that connects the motherboard to A3.
5. Temporarily replace the front panel.
6. Reconnect the line power cord.
7. Repeat the power-on sequence and observe the indicators on A15.

Did all the indicators turn on temporarily and then turn off?

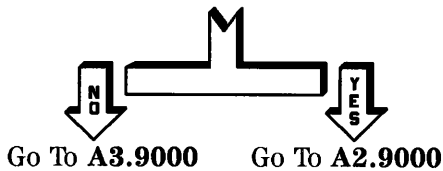

**A15.1400** Perform the following setup:

1. Set the line power switch to standby.
2. Completely remove the following assemblies:
  - A4 fractional-n.
  - A5 YO loop.
  - A7 reference.
  - A8 modulation generator (Opt. 002).
  - A9 pulse.
  - A10 ALC.
  - A11 FM driver.
  - A12 multiplier/filter driver.
  - A13 YO driver.
  - A14 sweep generator.
3. Repeat the power-on sequence and observe the indicators on A15.

Did all the indicators turn on temporarily and then turn off?

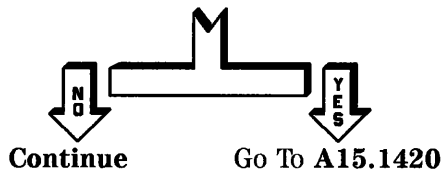

## **A15.1401**

Perform the following setup:

1. Set the line power switch to standby.
2. Replace all of the assemblies removed in the previous step and reconnect all cables.
3. Carefully remove the A6 assembly. Be sure to disconnect all flexible and semi-rigid coax cables before removing A6.
4. Repeat the power-on sequence and observe the indicators on A15.

Did all the indicators turn on temporarily and then turn off?

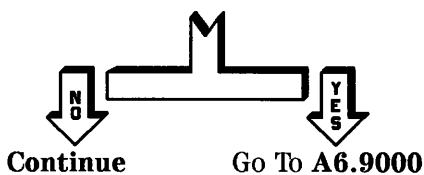

## A15.1402

Perform the following setup:

1. Set the line power switch to standby.
2. Disconnect the line power cord.
3. Wait for all the indicators in the power supply section to go out.
4. Replace the A6 assembly (removed in the previous step) and reconnect all cables.
5. Using the disassembly instructions in the *HP 8360 B-Series Swept Signal Generator/HP 8360 L-Series Swept CW Generator Service Guide*, remove the front panel and disconnect W2 (the ribbon cable that connects the motherboard to A2.)
6. Temporarily replace the front panel leaving the ribbon cable loose.
7. Reconnect line power (the power-on control is on A2 so the synthesizer will power up automatically, even in standby) and observe the indicators on A15.

Did all the indicators turn on temporarily and then turn off?

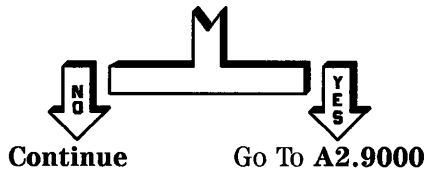

### **A15.1403**

Perform the following setup:

1. Disconnect the line power cord.
2. Wait for all the indicators in the power supply section to go out.
3. Remove the front panel.
4. Reconnect W2 to A2.
5. Disconnect W3 (the ribbon cable that connects A3 to the motherboard.)
6. Temporarily replace the front panel leaving the ribbon cable loose.
7. Reconnect the line power cord.
8. Repeat the power-on sequence and observe the indicators on A15.

Did all the indicators turn on temporarily and then turn off?



**Continue**

**Go To A3.9000**

### **WARNING**

**When the instrument is connected to AC line power or the A18 high voltage neon indicator is on, there are voltages present that can cause personal injury or death. Only trained, qualified personnel, who are aware of the hazards involved, should perform service on this instrument with its protective covers removed.**

## A15.1404

Perform the following setup:

1. Set the line power switch to standby.
2. Disconnect the line power cord.
3. Wait for all the indicators in the power supply section to go out.
4. Remove the front panel and reconnect W3 (the ribbon cable that connects A3 to the motherboard.)
5. Replace the front panel.
6. Remove the rear panel and disconnect W31 (the ribbon cable that connects the motherboard to A19.) Refer to the disassembly procedures in the *HP 8360 B-Series Swept Signal Generator/HP 8360 L-Series Swept CW Generator Service Guide* as needed.
7. Temporarily replace the rear panel leaving the ribbon cable loose. Take great care to ensure the ribbon cable is not in contact with any line power wires or connections.
8. Reconnect the line power cord.
9. Repeat the power-on sequence and observe the indicators on A15.

Did all the indicators turn on temporarily and then turn off?

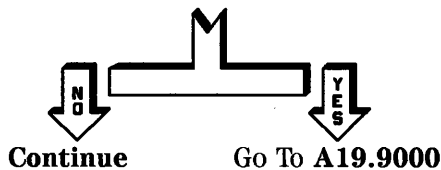



## A15.1405

Perform the following setup:

1. Set the line power switch to standby.
2. Disconnect the line power cord.
3. Wait for all the indicators in the power supply section to go out.
4. Reconnect W31 (the ribbon cable that connects A19 to the motherboard.)
5. Remove the RF deck. Refer to the disassembly procedures in the *HP 8360 B-Series Swept Signal Generator/HP 8360 L-Series Swept CW Generator Service Guide* as needed.
6. Reconnect the line power cord.
7. Repeat the power-on sequence and observe the indicators on A15.

Did all the indicators turn on temporarily and then turn off?

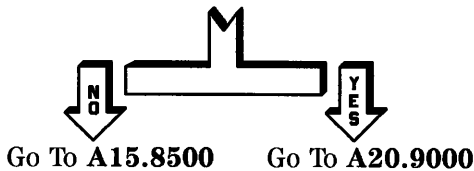

## **A15.1420**

One of the following assemblies is defective:

- A4 fractional-n.
- A5 YO loop.
- A7 reference.
- A8 modulation generator (Opt. 002).
- A9 pulse.
- A10 ALC.
- A11 FM driver.
- A12 multiplier/filter driver.
- A13 YO driver.
- A14 sweep generator.

Replace the assemblies one at a time. Then check the display's operation. If the display begins to operate incorrectly, the assembly just replaced is defective. If the test does not fail, replace another assembly and repeat the process. When the defective assembly is identified, go to the 9000 paragraph for that assembly for replacement instructions. For example, for A4, go to A4.9000, for A5, go to A5.9000, and so on.

## A15.8500

Perform the following:

1. Set the line power switch to standby.
2. Replace any remaining assemblies that had been removed.
3. Remove and replace A15 (this resets the edge connector).
4. Set the line power switch to on.
5. Press **PRESET** **SERVICE**.
6. Select **Selftest Menu**.
7. Press **228** **ENTER**.
8. Press **Do Test #228**.



Go To **A15.9000**

**Continue**

## A15.8501

Removing and replacing A15 has apparently fixed the problem. Most likely, it was an intermittent problem associated with the edge connector or IC sockets on A15. Record this situation for future reference. If the problem recurs, or if this is a recurrence, then replace A15 (go to A15.9000). Otherwise you are done.

## A15.9000 Perform the following:

1. Set the line power switch to standby.
2. Remove the A15 assembly.
3. Install a new A15 assembly.
4. Set the line power switch to on.
5. Press **PRESET** **SERVICE**.
6. Select **Selftest Menu**.
7. Press **228** **ENTER**.
8. Press **Do Test #228**.

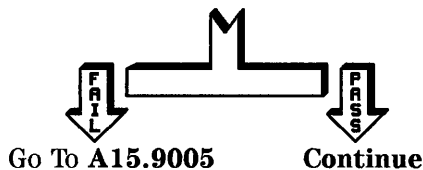

## A15.9001

The calibration data stored in RAM and EEROM on the failed A15 assembly appears intact. The following procedure retains the calibration data by transferring the EEROMs to the new A15 assembly. However, the replacement of the EEROMs on A15 is somewhat complex. Do not rush through this procedure. A single error could cause you to lose all the calibration data. This data requires several days to recreate. Carefully follow these steps:

1. Set the line power switch to standby.
2. Remove the line power cord.
3. Very carefully remove the defective A15 assembly and place it on an ESD mat.
4. Using appropriate tools, and taking great care not to damage the EEROMs (U14 and U62), remove the EEROMs from the defective A15 assembly and install the EEROMs on the new A15 assembly. If the defective A15 assembly had only one EEROM (U14) and the new A15 assembly has two EEROMs (U14 and U62), install U14 in the U14 socket on the replacement A15 assembly.

5. Install the new A15 assembly in the instrument.
6. Reconnect line power.
7. Set the line power switch to on.
8. Press **PRESET** **SERVICE**.
9. Select **Adjust Menu** **Calib Menu** **Cal Util Menu**  
**Recall Cal** **yes**.
10. Select **Selftest Menu**.
11. Press **228** **ENTER**.
12. Press **Do Test #228**.



Go To **A15.9020**

**Continue**

### **A15.9002**

To retain traceability, perform the ADC Adjustment using the automated tests software supplied with the synthesizer. An HP 9000 series 200/300 desktop computer and HP BASIC are required in addition to the software. Follow the procedure given in “Automated Tests” in the *HP 8360 B-Series Swept Signal Generator/HP 8360 L-Series Swept CW Generator Service Guide*. After completing the adjustment, go to the Troubleshooting Foldout, block 1 (located just prior to the “Special Cases” tab).

### **A15.9005**

This new A15 assembly is defective also. Remove this A15 assembly and reinstall the original (defective) A15 assembly. You must have the original A15 assembly because it contains all the calibration data for the instrument.

Go to A15.9000 and replace A15 again. If the new A15 is not defective, you will be instructed to transfer the calibration data to that assembly.

## **A15.9020**

You have lost both EEROM and backed-up RAM. This means that all hardware configuration data and all firmware correction are lost. Before the instrument will perform properly you must complete the following steps in the order given.

1. Replace the A15 assembly.
2. Install any firmware diagnostic patches as required (the installation instructions for A15 should indicate which patches are required and how to install them).
3. Using the instrument level troubleshooting (ILT.000), run the diagnostics to isolate any additional problems.
4. Recreate the hardware configuration data (you will need to contact Hewlett-Packard for instructions or assistance).
5. Run the diagnostics and solve any additional problems as required.
6. Recreate all the calibration data (use the performance tests and adjustments).

---

## **A16, A17, A18 Power Supply Troubleshooting**

### **WARNING**

---

**When the instrument is connected to AC line power or the A18 high voltage neon indicator is on, there are voltages present that can cause personal injury or death. Only trained, qualified personnel, who are aware of the hazards involved, should perform service on this instrument with its protective covers removed. An isolation transformer must be used during all these procedures.**

**Observe all safety practices. Remove all jewelry/metal that can short to ground.**

---

**A16.000** Troubleshooting power supplies is dangerous. Be extra cautious. Perform a complete visual inspection of the instrument and resolve any safety issues as required.

Continue to A16.100.

### **A16.100**

Do the following:

1. Set the line power switch to standby.
2. Disconnect the AC line power cord.
3. Remove the instrument's top cover.
4. Wait for all the indicators in the power supply section to go out.
5. Completely remove the following assemblies:
  - A16 post regulator.
  - A17 rectifier and filter.
  - A18 switching regulator.
6. Inspect the line fuse on the rear of the instrument. Replace it, if necessary.
7. Connect the instrument to AC line power using an isolation transformer. Do not turn the instrument on.
8. Listen and watch. The instrument should remain inactive.
9. Disconnect the AC line power cord.
10. Inspect the line fuse (it should be undamaged).

Does the instrument remain inactive and is the line fuse undamaged?

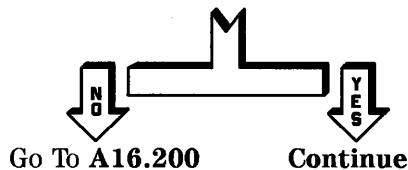



## A16.101

Inspect A17 and A18 for signs of physical damage. On the A18 assembly, look closely at the large resistors underneath and adjacent to the large heat sinks on A18. Check the fuses on A17 and A18 (one each). If they are open replace them. Then, using the following table, go to the indicated paragraph.

Either Fuse Open?	Either A17 or A18 Damaged?	Go To Paragraph
Yes	Yes	A16.321
Yes	No	A16.321
No	Yes	A16.206
No	No	A16.102

## A16.102

Continue with the following setup:

1. With AC line power *disconnected*, install A17 and A18.
2. Connect the instrument to AC line power using an isolation transformer. Do not turn the instrument on.
3. Observe the indicators on A18 and the amber standby light on the front panel of the instrument. Compare their status to the following list:
  - Amber standby light (front panel) – ON.
  - A18 neon high voltage indicator (DS2) – ON.
  - A18 green +13.6 V LED (DS1) – ON.
  - A18 amber preregulator shutdown LED (DS7) – ON.
  - All other A18 LEDs – OFF.

Were all indicators correct and does the instrument still appear safe to operate?

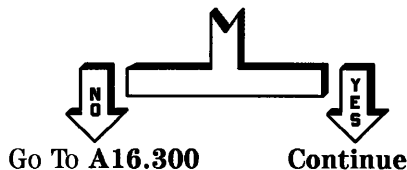

### A16.103

1. Turn the instrument on and make the following observations *during* power up.
  - Amber standby light (front panel) – OFF.
  - Green power-on light (front panel) – ON.
  - A18 neon high voltage indicator (DS2) – ON.
  - A18 green +13.6 V LED (DS1) – ON.
  - A18 amber preregulator shutdown LED (DS7) – OFF.
  - All other A18 LEDs – OFF.
2. Turn the instrument to standby.

Were all indicators correct and does the instrument still appear safe to operate?

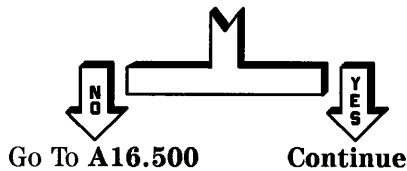

## A16.104

1. Verify that the line switch is in standby.
2. Disconnect the AC line power cord.
3. Wait for all the indicators in the power supply section to go out.
4. Install A16.
5. Reconnect AC line power through an isolation transformer.
6. Observe the amber standby light and the green power-on light on the front panel of the instrument. Also check the indicators on A16 and A18. Compare their status to the following list:
  - Amber standby light – ON.
  - Green power-on light – OFF.
  - A18 neon high voltage indicator (DS2) – ON.
  - A18 green +13.6 V LED (DS1) – ON.
  - A18 amber preregulator shutdown LED (DS7) – ON.
  - Other A18 LEDs – OFF.
  - A16 green +22 V standby LED – ON.
  - Other A16 LEDs – OFF.

Were all indicators correct and does the instrument still appear safe to operate?

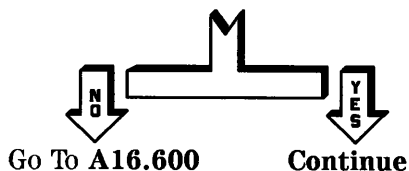

## A16.105

1. Turn the line power switch to on and make the following observations *during* power up:
  - Amber standby light – OFF (front panel).
  - Green power-on light – ON (front panel).
  - A18 neon high voltage indicator (DS2) – ON.
  - A18 green +13.6 V LED (DS1) – ON.
  - A18 amber preregulator shutdown LED (DS7) – OFF.
  - All other A18 LEDs – OFF.
  - A16 green LEDs (from left to right, component side or from right to left when facing the front of the instrument):
    - +22 V STBY – ON.
    - +5 V – ON.
    - +8 V – ON.
    - +15 V – ON.
    - +5 VHD – ON.
    - 5 V – ON.
    - 15 V – ON.
    - 40 V – ON.
  - A16 red LEDs – OFF.
  - The fan is operating.
2. Ignore any activity on the front panel display.
3. Turn the line power switch OFF.

Were all the indicators correct and does the instrument appear safe to operate?

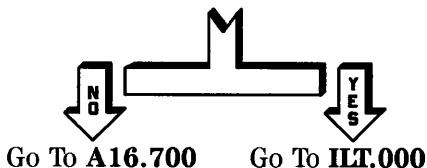

## A16.200

Do the following:

1. Disconnect the AC line power cord.
2. Wait for all the indicators in the power supply section to go out.
3. Remove the rear panel completely (refer to the disassembly and replacement procedures in the *HP 8360 B-Series Swept Signal Generator/HP 8360 L-Series Swept CW Generator Service Guide* as required).
4. Disconnect and inspect the 8-pin line switch connector, AC voltage selection switch, line module, fuse holder and other attached hardware for damage or discoloration.
5. Inspect the motherboard.

Do the parts appear damaged?

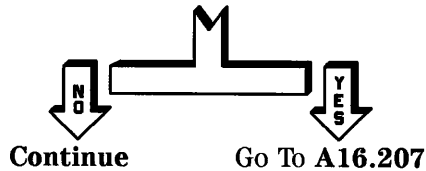

### A16.201

Measure the resistance of the three line power connections (high, low and ground) with reference to the instrument chassis. High line and low line resistance to ground should be  $\geq 1\text{ M}\Omega$ . The ground connection resistance to instrument chassis should be  $\leq 0.1\ \Omega$ .

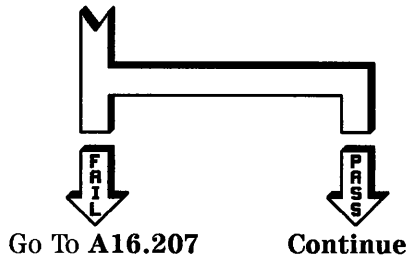
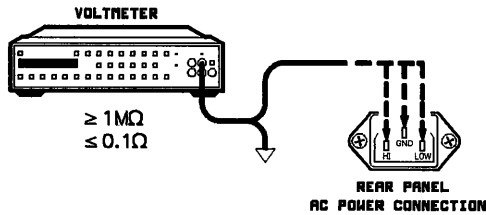

### A16.202

Measure the resistance between high line and low line.

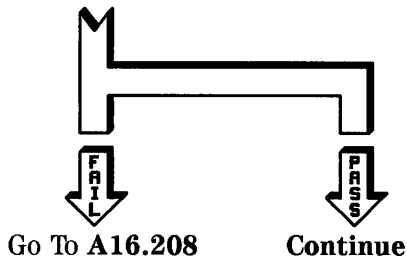
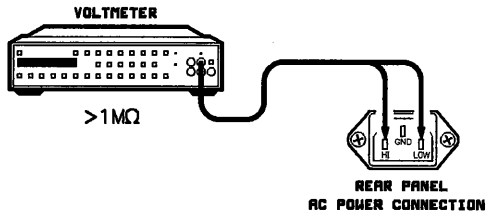

### A16.203

Reconnect the rear panel, 8-pin line switch connector to the motherboard (A22J9). Measure the resistance between high line and low line.

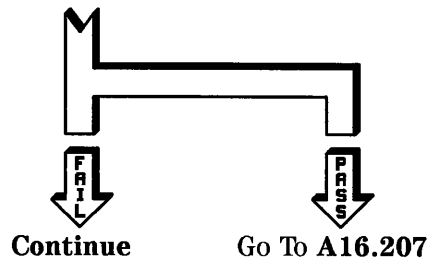
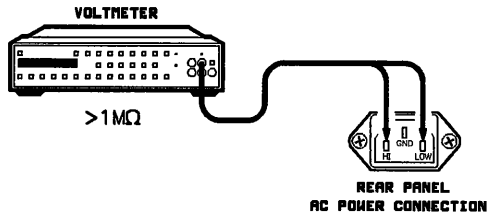

## A16.204

### WARNING

**Direct connections to line voltages will be exposed during this and subsequent steps. Ensure that line power is completely removed.**

Ensure that all power is disconnected and all capacitors are discharged. Remove the small red cover (high voltage cover) at the bottom rear of the instrument. The cover is held in place with three screws. Two screws are located on either side of XA18J1 (A18 motherboard connector) and are accessed from the top of the motherboard. The third screw is located at the rear edge of the motherboard. You may have to remove the rear panel to access this third screw. Inspect the line power traces on the motherboard. Look for signs of shorting, discoloration, or other signs of damage.

Are any of the line power traces on the motherboard damaged?

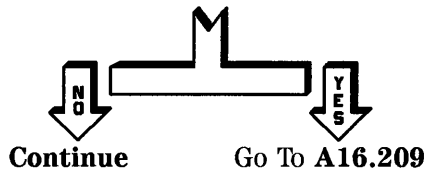

## A16.205

Inspect A17 and A18. Check for signs of physical damage. On the A18 assembly, look closely at the large resistors underneath and adjacent to the large heat sinks on A18. Check the fuses on A17 and A18 (one each). If they are open replace them.

Do A17 and A18 appear damaged?

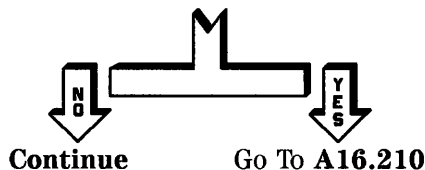



## **A16.206**

If the problem was open fuses on either A17 or A18, it is unlikely that replacing the fuses will solve the problem completely. Typically, open fuses are an indication of other failures. However, you may want to replace the fuses and restart troubleshooting at A16.000. Otherwise, do the following:

Replace the following:

1. AC voltage selection switch/wiring harness.
2. FL1 line module-filtered.
3. Fuse and fuse holder.
4. Other line-related hardware that shows any amount of damage.

Inspect and replace, if damaged, the following:

1. A17 rectifier/filter.
2. A18 switching regulator.
3. A16 post regulator.
4. A22 motherboard (inspect A22 closely before replacing).

Refer to the disassembly instructions and replaceable parts information in the *HP 8360 B-Series Swept Signal Generator/HP 8360 L-Series Swept CW Generator Service Guide* as necessary. Restart troubleshooting at A16.0000.

## **A16.207**

Replace the following:

- FL1, line module - filtered.
- AC voltage selection switch/wiring harness.
- Fuse and fuse holder.
- Any other damaged or discolored parts or assemblies.
- Replace the motherboard if damaged.

Restart troubleshooting at A16.000.

### **A16.208**

Replace FL1, line module - filtered and AC voltage selection switch/wiring harness and then restart troubleshooting at A16.000.

### **A16.209**

The A22 motherboard has a defect in the traces carrying line power. Do *not* attempt to repair A22. Replace A22 (go to A22.9000). Inspect A17 and A18. Check for signs of physical damage. On the A18 assembly, look closely at the large resistors underneath and adjacent to the large heat sinks on A18. Check the fuses on A17 and A18 (one each). If they are open, replace them. Restart troubleshooting with A16.000.

### **A16.210**

Do not attempt to repair either assembly. Replace A17 and A18 as required. Reassemble the instrument and restart troubleshooting from the beginning of instrument level troubleshooting. If you have already taken this action, refer to A16.206 for additional information.

### A16.300

Are any A18 indicators on?



Go To **A16.302**

**Continue**

### A16.301

Select the first correct condition and go to the indicated paragraph.

Neon HIGH VLT	Green + 13.6 V	Amber PRERGSHTDWN	Go To Paragraph
OFF	-	-	A18.9000
ON	OFF	-	A16.320
ON	ON	OFF	A16.360
ON	ON	ON	A16.380

A dash ( - ) indicates a don't care condition.

### A16.302

Set the line power switch to standby. Disconnect the AC line cord and check the line fuse.

Is the line fuse good?



Go To **A16.400**

Go To **A16.204**

### A16.320

Do the following:

1. Disconnect the instrument from line power.
2. Wait for all the indicators in the power supply section to go out.
3. Carefully remove A18 and discharge all the large capacitors.
4. Check the fuse on A18 (A18F1).

Is A18F1 good?

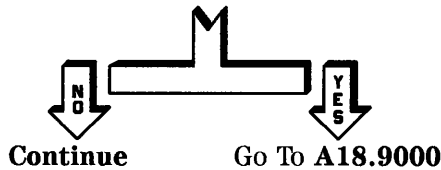

### A16.321

Reinstall A16. Then measure the resistance of XA16J1-36 to ground.

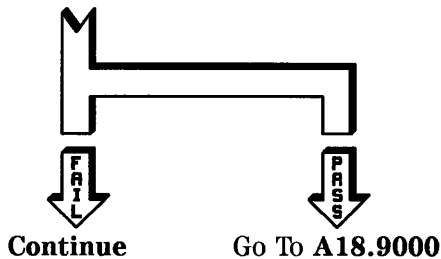
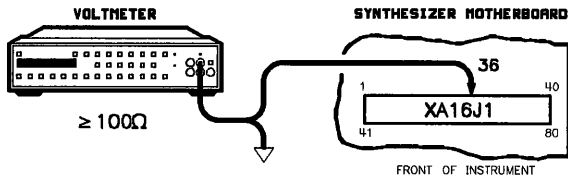

### A16.322

Remove A16. Then measure the resistance of XA16J1-36 to ground.

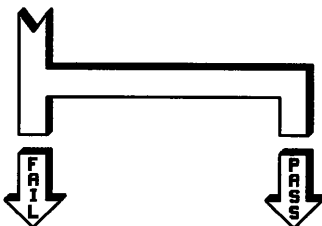
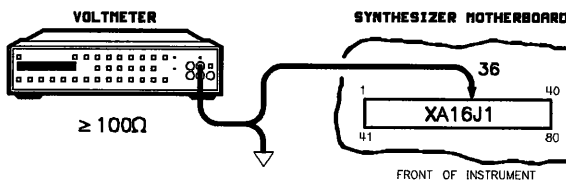

Continue

Go To A16.9000

### A16.323

Remove the front panel completely. Refer to the disassembly procedures in the *HP 8360 B-Series Swept Signal Generator/HP 8360 L-Series Swept CW Generator Service Guide*. Measure the resistance of XA16J1-36 to ground.

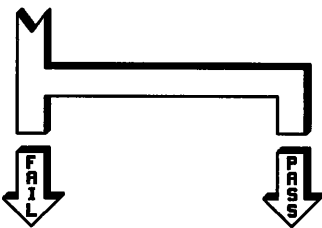
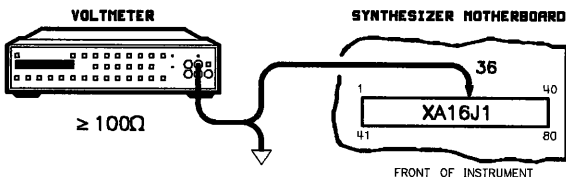

Go To A16.329

Continue

### A16.324

Connect W2 from the source module interface assembly (A2) to the motherboard (A22). Then measure the resistance of XA16J1-36 to ground.

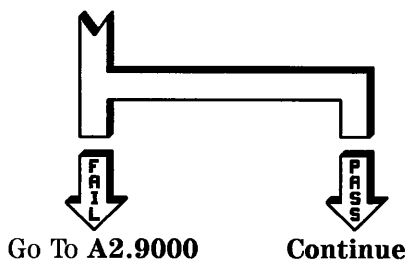
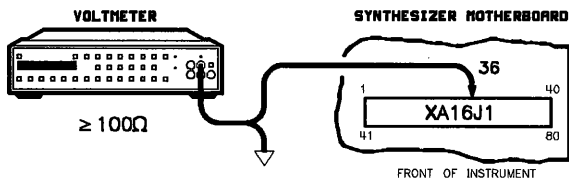

### A16.325

Do the following:

1. Connect W3 from the front panel processor (A3) to the motherboard (A22).
2. Disconnect the two ribbon cables (W1, W4) that connect the A3 front panel processor to the A21 display.
3. Measure the resistance of XA16J1-36 to ground.

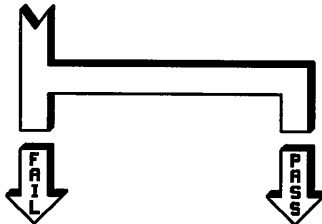
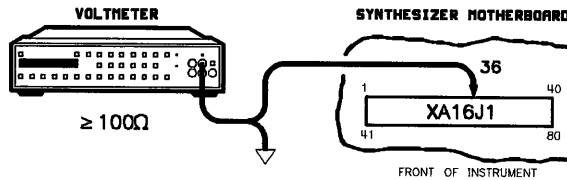

Go To **A3.9000**

Go To **A21.9000**

### A16.329

Since all of the connections to the +13.6 V power supply have been removed and the resistance measurement is still less than  $100\Omega$ , there is a short on the motherboard. Go to A22.9000 (replace the motherboard).

## A16.360

Do the following:

1. Set the line power switch to standby.
2. Disconnect the instrument from line power and wait until all A18 indicators are off.
3. Remove A18.
4. With the line switch in the standby position, measure the resistance of XA18J1-25 to ground. Pin 25 is accessible from the component side (top) of the motherboard. It is the pin at the left rear corner of connector XA18J1 as viewed with the instrument front panel facing towards you.

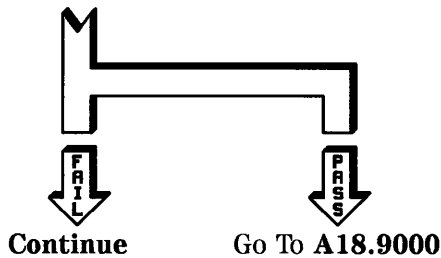
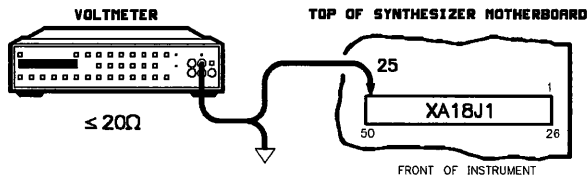



### A16.361

Measure the resistance of A22J1-33 to ground with the power switch in standby. Note that the numbering on the A22J1 connector may be incorrect. Pin 33 is the left-rear corner of A22J1.

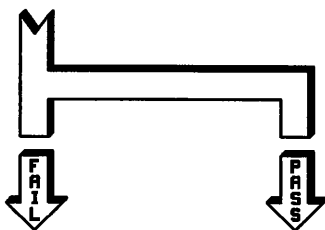
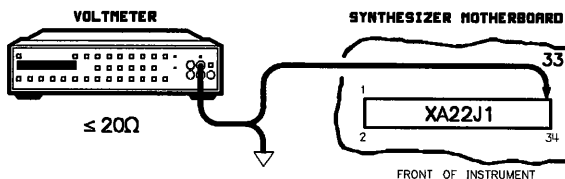

Continue

Go To A16.365

### A16.362

Remove the front panel and check the seating of the ribbon cables connecting the front panel to the motherboard. If no seating problem is found, check the ribbon cable and replace it if damaged. Otherwise, go to A2.9000.

### A16.365

An open exists between XA18J1-25 and A22J1-33. Do not attempt to repair this open. Go to A22.9000, and replace the motherboard.

### A16.380

Select the first correct condition and go to the indicated paragraph.

Red (DS6) CURR LIMIT	Red (DS5) OVERVOLT	Red (DS4) OVERCURR	Red (DS3) OVERTEMP	Go To Paragraph
OFF	-	-	ON	A16.381
ON	-	-	ON	A16.383
ON	-	-	OFF	A16.384
OFF	ON	OFF	OFF	A16.384
OFF	ON	ON	OFF	A16.384
OFF	OFF	ON	OFF	A16.390

A dash ( - ) indicates a don't care condition.

### A16.381

Has the instrument overheated (is the instrument very warm to the touch)?

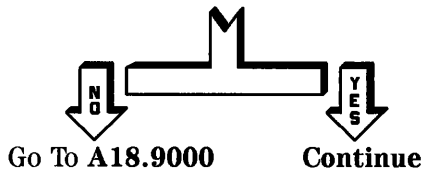

### **A16.382**

There are several things that could cause overheating. Two things to check are: the air flow and environment. For instance, is the fan blocked? Is the airflow on the sides of the instrument blocked? If the instrument is in a racked system, is the direction of airflow the same as other instruments in the system? If these conditions do not exist, take the following action:

1. Check all fuses on A16. There are six small plug-in fuses and two solder-in fuses. All the fuses are close to the bottom of the board.
2. Check the fan connection to the motherboard (remove the rear panel and possibly the RF deck to gain access). See the disassembly instructions in the *HP 8360 B-Series Swept Signal Generator/HP 8360 L-Series Swept CW Generator Service Guide* for more information.
3. If these don't fix the problem then consider one or more of the following:
  - a. Replace the fan (refer to the *HP 8360 B-Series Swept Signal Generator/HP 8360 L-Series Swept CW Generator Service Guide* for replacement instructions).
  - b. Replace A16 (go to A16.9000).
  - c. Replace A17 (go to A17.9000).

### **A16.383**

Refer to A16.382. In addition, consider A18 for replacement (go to A18.9000). Finally, return to the Troubleshooting Foldout, block 1 (located just prior to the "Special Cases" tab).

### **A16.384**

Perform the following:

1. Set the line power switch to standby.
2. Disconnect power and wait for all indicators in the power supply to go out.
3. Remove A17 and A18.

Go to A16.205.

### **A16.385**

In this case, change both A18 and A17. Go to A17.9000 then A18.9000. Then restart troubleshooting at A16.000. When you are confident that the power supply is good, begin troubleshooting at ILT.000.

### **A16.390**

Do the following:

1. Set the line power switch to standby.
2. Disconnect the instrument from AC line power.
3. Remove A15.
4. Connect the instrument to AC line power using an isolation transformer and set the line power switch to on.

Is the A18 +5 VHD OVER CURRENT indicator on?

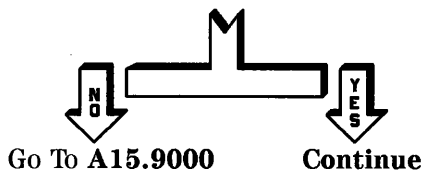

### **A16.391**

Do the following:

1. Set the line power switch to standby.
2. Disconnect the instrument from AC line power.
3. Wait for all the indicators in the power supply section to go out.
4. Install A15.
5. Install A16.
6. Remove the front panel and disconnect the ribbon cables W2 and W3 that connect the front panel to the motherboard.
7. Connect the instrument to AC line power using an isolation transformer and set the line power switch to on.

Is the A18 +5 VHD OVER CURRENT indicator on?

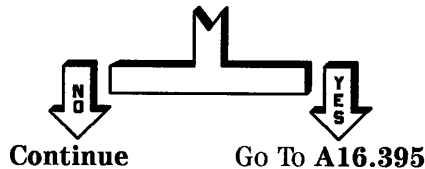

### **A16.392**

Do the following:

1. Set the line power switch to standby.
2. Disconnect the instrument from AC line power.
3. Wait for all the indicators in the power supply section to go out.
4. Reconnect W2.
5. Connect the instrument to AC line power through an isolation transformer and set the line power switch to on.

Is the A18 +5 VHD OVER CURRENT indicator on?

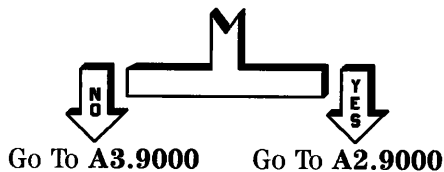

## **A16.395**

Do the following:

1. Set the line power switch to standby.
2. Disconnect the instrument from AC line power.
3. Wait for all the indicators in the power supply section to go out.
4. Install A15.
5. Remove A14.
6. Connect the instrument to AC line power using an isolation transformer and set the line power switch to on.

Is the A18 +5 VHD OVER CURRENT indicator on?

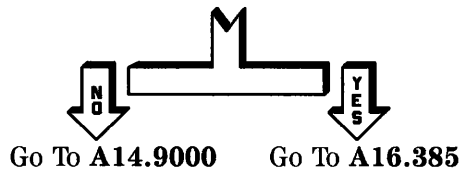

### **A16.400**

Do the following:

1. Replace the line fuse.
2. Remove the rear panel.
3. Disconnect A22J10 wiring harness from the motherboard. This wiring harness connects the 22 V toroidal transformer to the motherboard.
4. Ensure that the 22 V wiring harness is out of the way and then replace the rear panel.
5. Connect the instrument to AC line power using an isolation transformer. Do *not* turn on the instrument.

Are any A18 indicators on?



Go To **A16.205**

**Continue**

### **A16.401**

Replace the 22 volt transformer and then go to the Troubleshooting Foldout, block 1 (located just prior to the “Special Cases” tab).

### A16.500

Select the first correct condition and go to the indicated paragraph.

Neon HIGH VLT	Green + 13.6 V	Amber PREREGSHTDWN	Go To Paragraph
OFF	-	-	A16.205
ON	OFF	-	A16.560
ON	ON	-	A16.380

A dash ( - ) indicates a don't care condition.

### A16.560

Do the following:

1. Set the line power switch to standby.
2. Disconnect the instrument from AC line power.
3. Wait for all the indicators in the power supply section to go out.
4. Install A16.
5. Remove the front panel and disconnect the ribbon cables W2 and W3 that connect the front panel to the motherboard.
6. Connect the instrument to AC line power using an isolation transformer and set the line power switch to on.

Is the + 13.6 V LED (green, DS1) on?

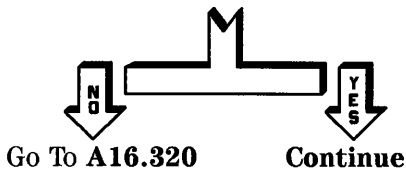



## A16.561

Do the following:

1. Set the line power switch to standby.
2. Disconnect the instrument from AC line power.
3. Wait for all the indicators in the power supply section to go out.
4. Reconnect W2.
5. Connect the instrument to AC line power using an isolation transformer and set the line power switch to on.

Is the +13.6 V LED (green, DS1) on?

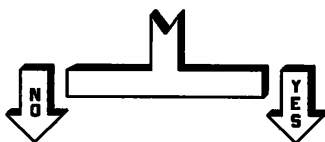

Go To **A2.9000**

**Continue**

## A16.562

Perform the following setup:

1. Set the line power switch to standby.
2. Disconnect the instrument from AC line power.
3. Wait for all the indicators in the power supply section to go out.
4. Reconnect W3.
5. Disconnect the two ribbon cables (W1, W4) that connect the A3 front panel processor to the A21 display.
6. Connect the instrument to AC line power using an isolation transformer and set the line power switch to on.

Is the +13.6 V LED (green, DS1) on?

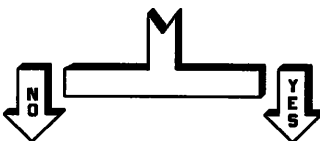

Go To **A3.9000**

Go To **A16.1000**

### A16.600

Were the A18 indicators correct in the previous step?

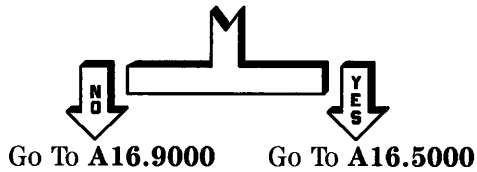

### A16.700

Were *all* A18 indicators correct?

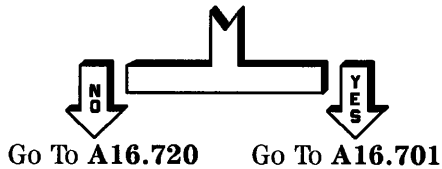

### A16.701

Did the fan turn properly when power was turned on?

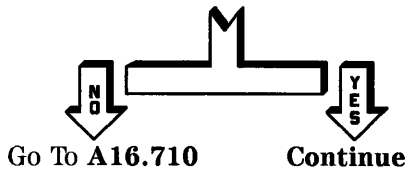

### A16.702

Are any red A16 LEDs on?

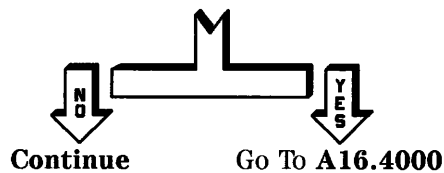

### A16.703

Measure the voltage of the +13.6 Vdc supply at XA16J1-36 to ground.

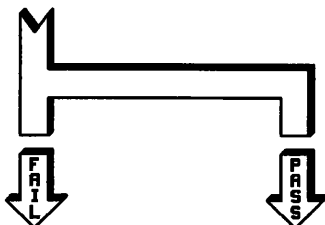
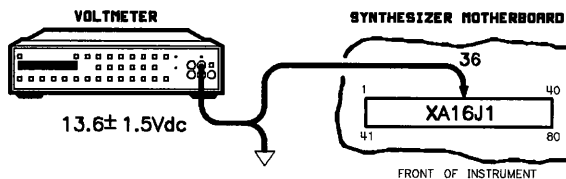

Continue

Go To A16.9000

### A16.704

Either an open exists on the motherboard between XA16J1-36 and XA18P1-49 or A18 is faulty. Verify the open with an ohmmeter. If an open does exist, do not attempt to repair it but go to A22.9000. If no open exists, go to A18.9000.

## A16.710

Do the following:

1. Set the line power switch to standby.
2. Disconnect the instrument from AC line power.
3. Wait for all the indicators in the power supply section to go out.
4. Remove A16.
5. Remove the rear panel and disconnect the fan.
6. Check all fuses on A16. There are six small plug-in fuses and two solder-in fuses. All the fuses are close to the bottom of the board.
7. Replace any fuses that are open.
8. Reinstall A16.
9. Connect the instrument to AC line power using an isolation transformer and set line power to ON (the fan should still be disconnected).

Continue with A16.711.

## A16.711

Measure the voltage at XA16J1-1.

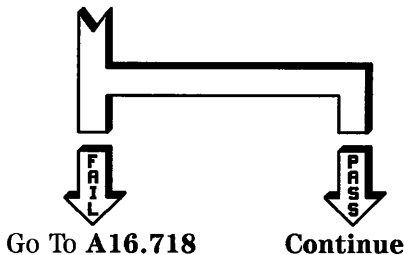
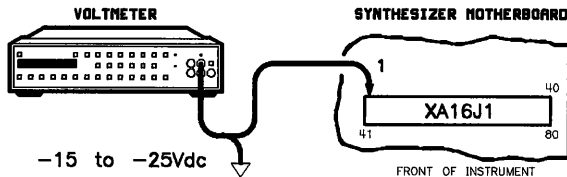

### A16.712

Wait 2 to 3 minutes. Measure the voltage at XA16J1-41 for a positive voltage greater than 2.0 Vdc. This voltage may increase in value while the measurement is taken.

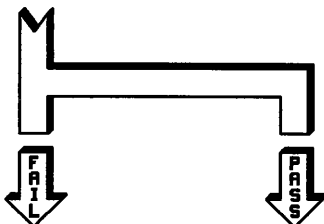
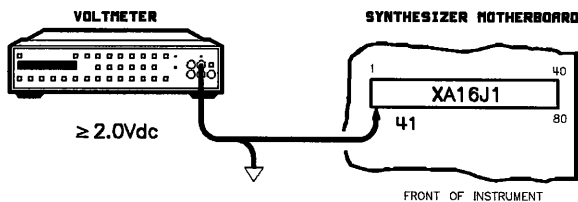

Go To **A16.718**

**Continue**

### A16.713

Measure the voltage at A22J11-3. This connector is located at the right-rear of the instrument (by the fan).

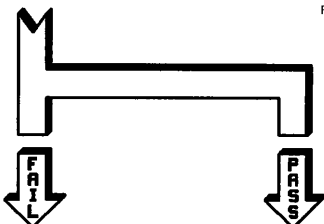
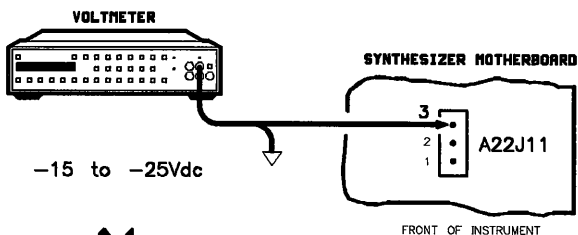

Go To **A16.716**

**Continue**

### A16.714

Wait 2 to 3 minutes. Measure the voltage at A22J11-1 for a positive voltage greater than 2.0 Vdc. This voltage may increase in value while the measurement is taken. This connector is located at the right-rear of the instrument (by the fan).

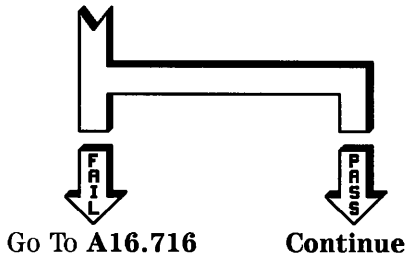
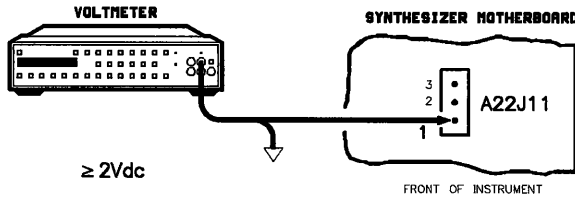

### A16.715

The fan is either defective or the instrument has an intermittent connection. Replace the fan and then go to the Troubleshooting Foldout, block 1 (located just prior to the "Special Cases" tab).

### **A16.716**

Reconnect the fan.

There is an open in the motherboard between one of the following two points.

- XA16J1-1 and A22J11-3.
- XA16J1-41 and A22J11-1.

Is a jumper wire on the motherboard an acceptable repair?



Go To **A22.9000**

**Continue**

### **A16.717**

Repair the motherboard and go to the Troubleshooting Foldout, block 1 (located just prior to the “Special Cases” tab).

### **A16.718**

Do the following:

1. Set the line power switch to standby.
2. Disconnect the instrument from AC line power.
3. Wait for all the indicators in the power supply section to go out.
4. Reconnect the fan.

Go to A16.9000.

## **A16.720**

Do the following:

1. Set the line power switch to standby.
2. Disconnect the instrument from AC line power.
3. Wait for all the indicators in the power supply section to go out.
4. Reconnect the fan.
5. Remove A18.
6. Check fuse A18F1.

Is the fuse damaged?

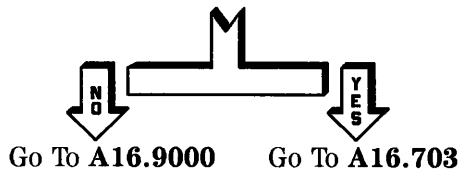



**A16.1000** With the line power switch set to on and the top cover removed, check the A16 power supply LEDs in the order shown. Choose the first LED that is *off* and go to the indicated paragraph. If all LEDs are on, go to A16.1001.

LED Name	Go To Paragraph
-40V	A16.4200
+5VHD	A16.9000
+22V STBY	A16.4300
-15V	A16.4400
-5V	A16.4500
+5V	A16.4600
+8V	A16.4700
+15V	A16.4800

### A16.1001

Is the red A16 PRS LED (post regulator shutdown) on?

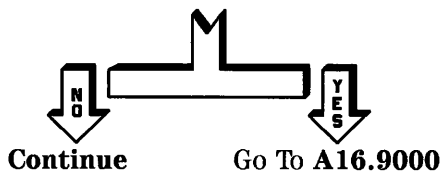

### A16.1002

Is the red A16 PRA LED (post regulator alert) on?

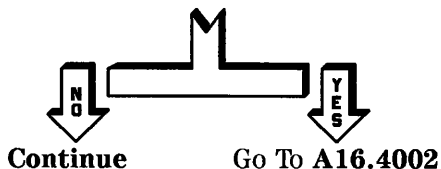

**A16.2000** Measure the power supply voltages in the order given. Measure all of the voltages at the test points on the top edge of A16. If a voltage is out of specification, go to the paragraph indicated.

**Note** These power supply voltages and tolerances rely on a DC voltmeter accuracy of better than  $\pm 0.5\%$ . If your voltmeter is less accurate, compensate accordingly.

Power Supply Name	Nominal Voltage	Tolerance	Go To Paragraph
-40V	-40 Vdc	$\pm 0.8$ Vdc	A16.9000
+22V STBY	+22 Vdc	$\pm 0.4$ Vdc	A16.9000
-15V	-15.07 Vdc	$\pm 0.3$ Vdc	A16.9000
-5V	-5.2 Vdc	$\pm 0.1$ Vdc	A16.9000
+5V	+5.2 Vdc	$\pm 0.1$ Vdc	A16.9000
+8V	+8 Vdc	$\pm 0.2$ Vdc	A16.9000
+15V	+15.12 Vdc	$\pm 0.3$ Vdc	A16.9000
+5VHD	TTL Hi	TTL Hi	A17.9000
H+5VAUp	TTL Hi	TTL Hi	A16.9000

If no errors occur, go to "Special Cases" or restart troubleshooting with ILT.000.

**A16.4000** Is the red A16 PRS LED (post regulator shutdown) off?

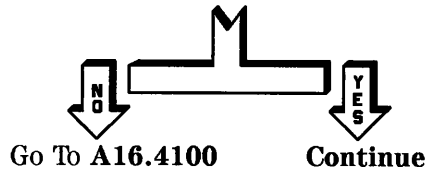

**A16.4001**

Are all green LEDs on the A16 assembly on?

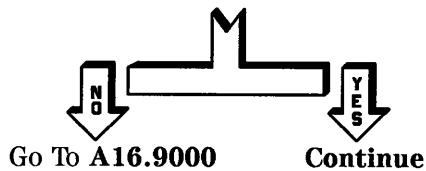

**A16.4002**

Do the following:

1. Set line power switch to standby.
2. Disconnect the instrument from line power.
3. Wait for all the indicators in the power supply section to go out.
4. Remove A15.
5. Reconnect the instrument to line power using an isolation transformer.
6. Set the line power switch to on.

Is the red A16 PRA LED (post regulator alert) on?

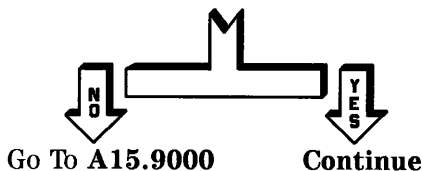

### **A16.4003**

Do the following:

1. Set line power switch to standby.
2. Disconnect the instrument from line power.
3. Wait for all the indicators in the power supply section to go out.
4. Install A15.
5. Remove the front panel and disconnect ribbon cable W3 from the motherboard.
6. Reconnect the instrument to line power using an isolation transformer.
7. Set the line power switch to on.

Is the red A16 PRA LED still on?

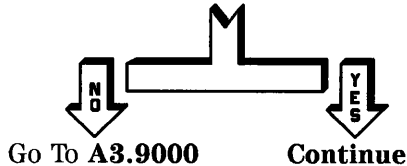

## A16.4004

Do the following:

1. Set line power switch to standby.
2. Disconnect the instrument from line power.
3. Wait for all the indicators in the power supply section to go out.
4. Remove A16.

Measure the resistance from XA16J1-78 to ground.

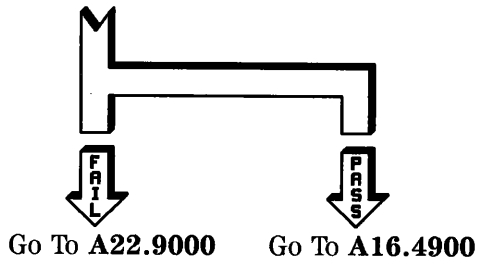
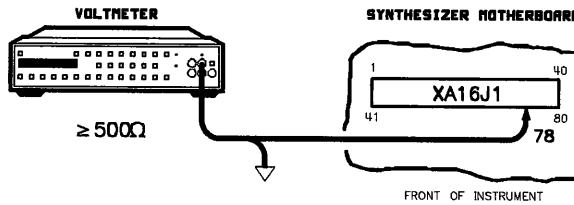

### A16.4100

With the line power switch set to on and the top cover removed, check the A16 power supply LEDs in the order given. Choose the first LED that is *off* and go to the indicated paragraph. If all LEDs are on, go to A16.9000.

LED Name	Go To Paragraph
-40V	A16.4200
+5VHD	A16.9000
+22V STBY	A16.4300
-15V	A16.4400
-5V	A16.4500
+5V	A16.4600
+8V	A16.4700
+15V	A16.4800

### A16.4200

Measure the -40 Vdc unregulated supply at XA16J1-23 and 63.

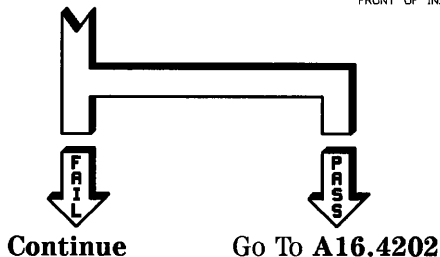
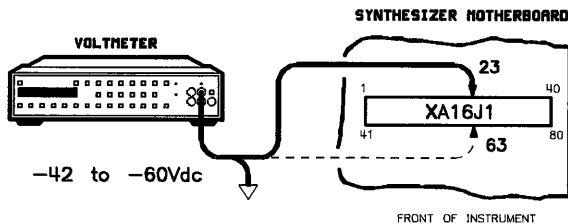

## A16.4201

Do the following:

1. Set line power switch to standby.
2. Disconnect the instrument from line power.
3. Wait for all the indicators in the power supply section to go out.
4. Remove A16.

Measure the  $-40$  Vdc unregulated supply from A17 to A16 at XA16J1-23 and 63.

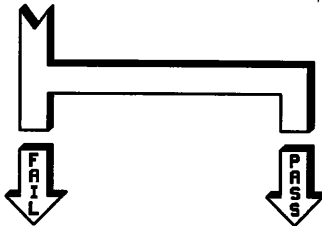
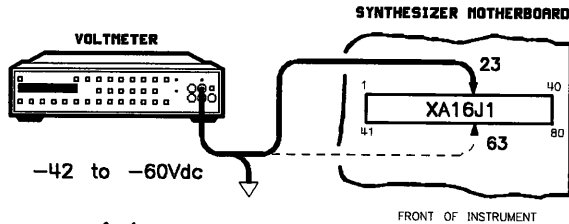

Go To A17.9000

Continue

## A16.4202

Do the following if not already performed:

1. Set line power switch to standby.
2. Disconnect the instrument from line power.
3. Wait for all the indicators in the power supply section to go out.
4. Remove A16.

Measure the resistance of the  $-40$  Vdc supply to ground (XA16J1-62 to ground).

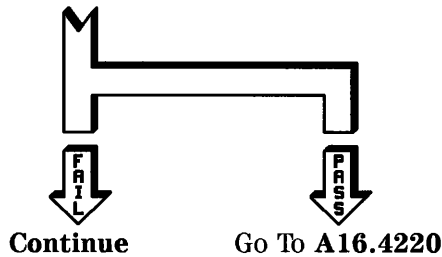
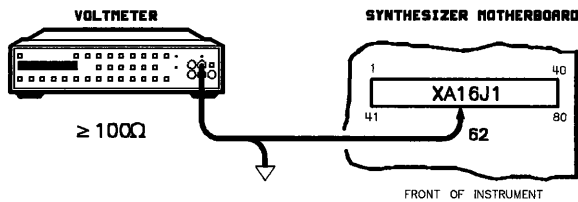



## A16.4203

Remove the following assemblies:

- A11 FM driver.
- A12 multiplier/filter driver.
- A13 YO driver.
- A14 sweep generator.

Measure the resistance of the -40 Vdc supply to ground (XA16J1-62 to ground).

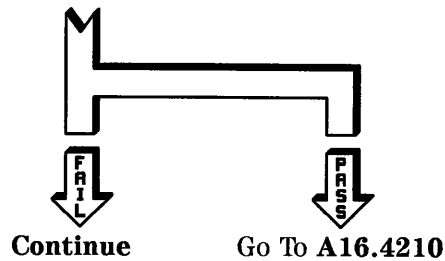
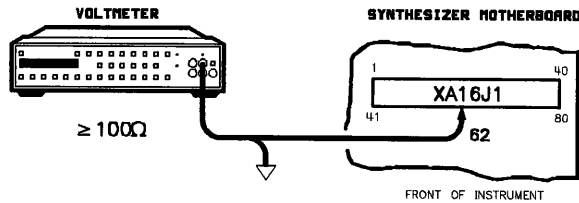

## A16.4204

Refer to the disassembly procedures in the *HP 8360 B-Series Swept Signal Generator/ HP 8360 L-Series Swept CW Generator Service Guide* to remove the RF deck. Measure the resistance of the -40 Vdc supply to ground (XA16J1-62 to ground).

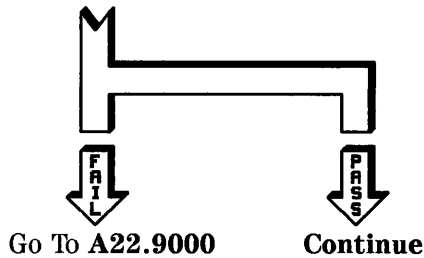
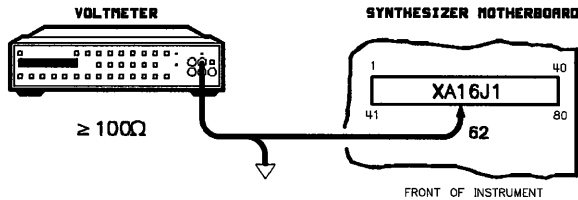

## A16.4205

Reinstall the RF deck in the *service position*. Refer to the disassembly procedures in the *HP 8360 B-Series Swept Signal Generator/HP 8360 L-Series Swept CW Generator Service Guide*. Remove the ribbon cables that connect the microcircuits to the RF deck:

Measure the resistance of the  $-40$  Vdc supply to ground (XA16J1-62 to ground).

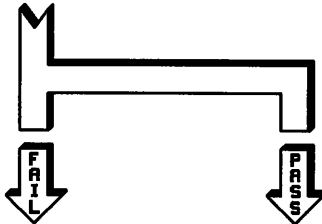
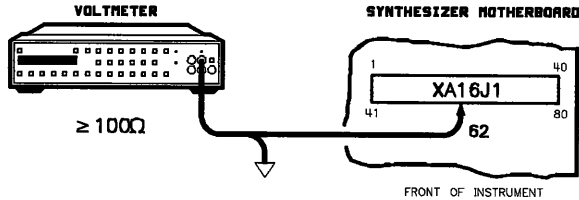

Go To **A20.9000**

**Continue**

## A16.4206

Reconnect the microcircuit ribbon cables one at a time while measuring the resistance of the  $-40$  Vdc to ground (XA16J1-62 to ground). Replace the microcircuit that causes a resistance measurement of  $< 100 \Omega$ . Also, check the  $-40$  V fuse on A16 and replace it if open. If no microcircuit causes a low resistance measurement, you may have removed the defect in the disassembly process or the problem may be intermittent. Go to the Troubleshooting Foldout, block 1 (located just prior to the "Special Cases" tab).

### **A16.4210**

Reinstall the previously removed assemblies one at a time while measuring the resistance of the  $-40$  Vdc supply to ground (XA16J1-62 to ground). Replace the assembly that causes a resistance measurement of  $< 100 \Omega$ . Also check the  $-40$  V fuse on A16 and replace it if defective. If no assembly causes a low resistance measurement, you may have removed the defect in the disassembly process or the problem may be intermittent. Go to the Troubleshooting Foldout, block 1 (located just prior to the "Special Cases" tab).

### **A16.4220**

Check the  $-40$  V fuse on A16.

Is the fuse defective?

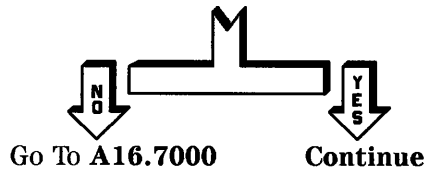

### **A16.4221**

Do the following:

1. Replace the defective fuse.
2. Install A16.
3. Connect the instrument to line power using an isolation transformer.
4. Set the line power switch to on.

Is the green A16  $-40$  V LED on?

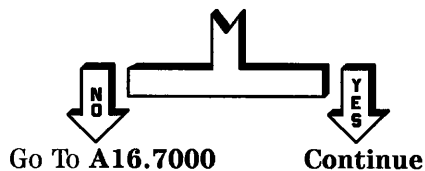

Replacing the fuse seems to have fixed the problem, but this simple solution is suspect. You may want to monitor

the instrument for several minutes with the covers on to insure that an intermittent problem does not exist. Go to the Troubleshooting Foldout, block 1 (located just prior to the "Special Cases" tab).

### A16.4300

Do the following if not already performed:

1. Set line power switch to standby.
2. Disconnect the instrument from line power.
3. Wait for all the indicators in the power supply section to go out.
4. Remove A16.

Measure the resistance of the +22 Vdc supply to ground (XA16J1-2, 42 to ground).

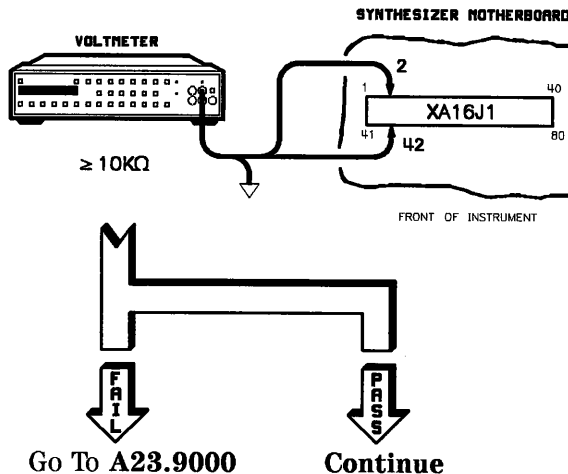

## A16.4301

Do the following if not already performed:

1. Set line power switch to standby.
2. Disconnect the instrument from line power.
3. Wait for all the indicators in the power supply section to go out.

Measure the resistance of the +22 Vdc supply to ground (XA16J1-43 to ground).

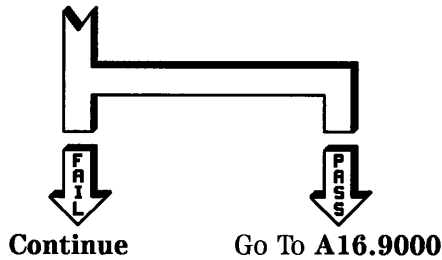
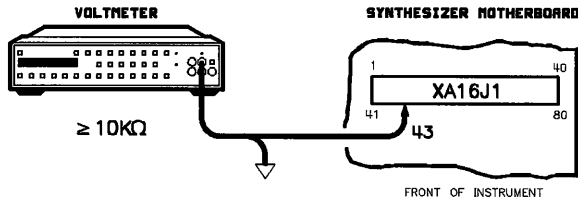

## A16.4302

Remove A12. Measure the resistance of +22 Vdc to ground (XA16J1-43 to ground).

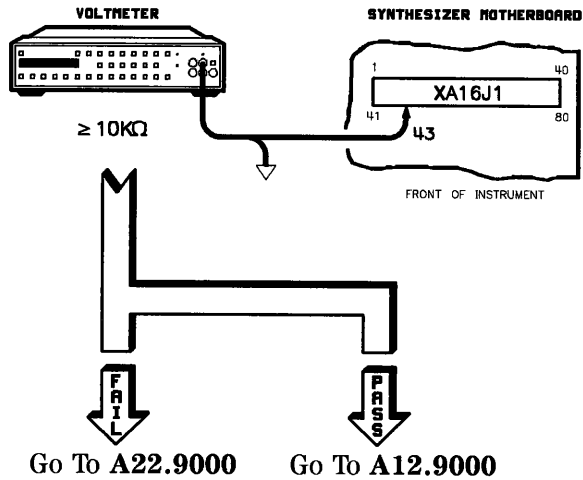

## A16.4400

Measure the voltage of the  $-15\text{ Vdc}$  unregulated supply from A17 to A16 at XA16J1-27, 28, 67, and 68.

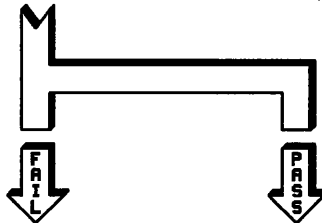
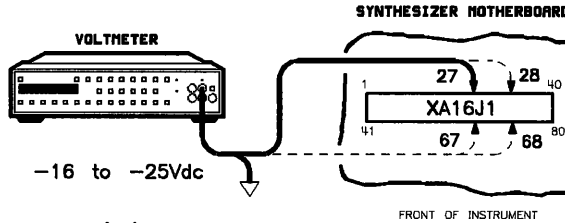

Continue

Go To A16.4402

## WARNING

When the instrument is connected to AC line power or the A18 high voltage neon indicator is on, there are voltages present that can cause personal injury or death. Only trained, qualified personnel, who are aware of the hazards involved, should perform service on this instrument with its protective covers removed. An isolation transformer must be used during all these procedures.

Observe all safety practices. Remove all jewelry/metal that can short to ground.



## A16.4401

Do the following:

1. Set line power switch to standby.
2. Disconnect the instrument from line power.
3. Wait for all the indicators in the power supply section to go out.
4. Remove A16.
5. Connect the instrument to line power using an isolation transformer.
6. Set the line power switch to on.

Measure the  $-15$  Vdc unregulated supply from A17 to A16 at XA16J1-27, 28, 67, and 68.

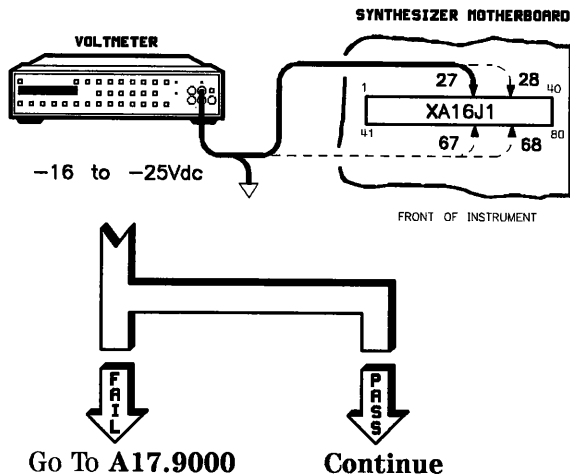

## A16.4402

Do the following if not already performed:

1. Set line power switch to standby.
2. Disconnect the instrument from line power.
3. Wait for all the indicators in the power supply section to go out.
4. Remove A16.

Measure the resistance of the -15 Vdc supply to ground (XA16J1-25, 26, 65, and 66 to ground).

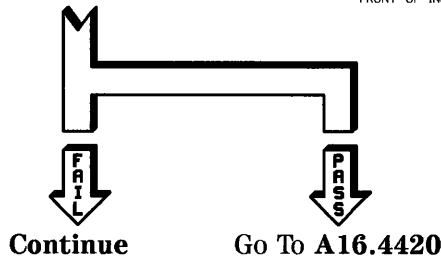
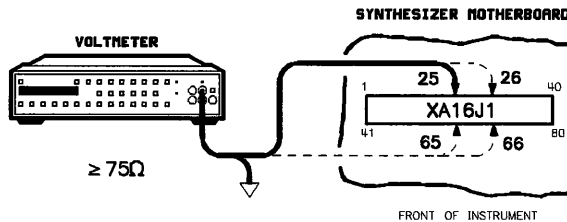

## A16.4403

Remove the following assemblies:

- A4 fractional-N.
- A5 YO phase detector.
- A7 reference.
- A8 modulation generator (Opt. 002).
- A9 pulse.
- A11 FM driver.
- A12 multiplier/filter driver.
- A13 YO driver.
- A14 sweep generator.
- A15 microprocessor.
- A6 sampler.

### Note

Be sure to disconnect the rigid cable connected to the input of A6 before removing A6. Otherwise damage to the cable, A6, and possibly the filter (FL2) can occur.

Measure the resistance of the  $-15$  Vdc supply to ground (XA16J1-25, 26, 65, and 66 to ground).

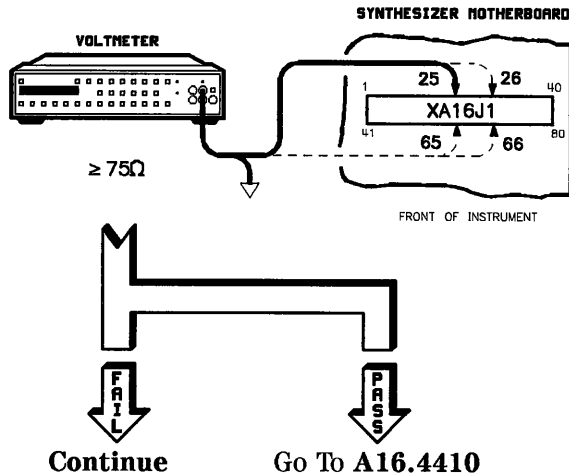

### A16.4404

Follow the disassembly procedures in the *HP 8360 B-Series Swept Signal Generator/ HP 8360 L-Series Swept CW Generator Service Guide* to remove the RF deck.

Measure the resistance of the -15 Vdc supply to ground (XA16J1-25, 26, 65, and 66 to ground).

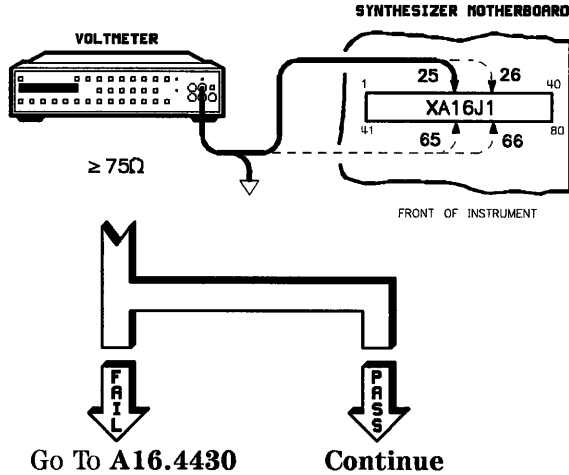

### A16.4405

Reinstall the RF deck in the *service position*. Refer to the disassembly procedures in the *HP 8360 B-Series Swept Signal Generator/HP 8360 L-Series Swept CW Generator Service Guide* as needed. Remove the ribbon cables that connect the microcircuits to the RF deck: Measure the resistance of the  $-15$  Vdc supply to ground (XA16J1-25, 26, 65, and 66 to ground).

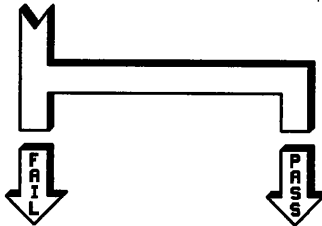
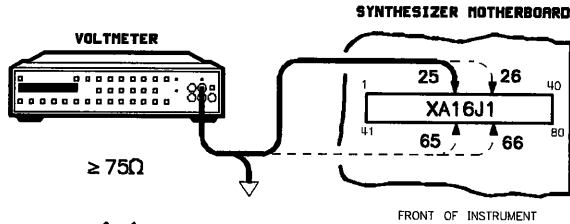

Go To A20.9000

Continue

### A16.4406

Reconnect the microcircuit ribbon cables one at a time while measuring the resistance of the  $-15$  Vdc supply to ground (XA16J1-25, 26, 65, and 66 to ground). Replace the microcircuit that causes a  $< 75 \Omega$  resistance measurement. Also, check the  $-15$  V fuse on A16 and replace it if open.

Did a microcircuit cause a low resistance measurement?



Go To A16.4408

Continue

### **A16.4407**

Go to the paragraph indicated below to replace the faulty microcircuit.

<b>Microcircuit</b>	<b>Go To Paragraph</b>
A29 amp/filter	RF.2990
A28 amp/multiplier	RF.2890
A26 YO	RF.2690
A24 low band	RF.2490
A31 attenuator	RF.3190
A32 amp/doubler	RF.3290
A33 amp switch	RF.3390
A38 dual modulator	RF.3890
A38 AM modulator (Opt. 006)	RF.3890
A42 pulse mod switched filter	RF.4290

### **A16.4408**

You may have removed the defect in the disassembly process or the problem may be intermittent. Also check the -15 V fuse on A16 and replace it if open. Go to the Troubleshooting Foldout, block 1 (located just prior to the "Special Cases" tab).

### **A16.4410**

Reinstall the previously removed assemblies one at a time while measuring the resistance of the -15 Vdc to ground (XA16J1-25, 26, 65, and 66 to ground). If the assembly does not fail (a failure is a resistance measurement of  $< 75 \Omega$ ), reinstall another assembly and repeat the measurement. When the defective assembly is identified, go to the 9000 paragraph for that assembly for replacement instructions. For example, for A4, go to A4.9000; for A5, go to A5.9000, and so on.

If no assembly causes a low resistance measurement, you may have removed the defect in the disassembly

process or the problem may be intermittent. Also check the  $-15$  V fuse on A16 and replace it if open. Go to the Troubleshooting Foldout, block 1 (located just prior to the “Special Cases” tab).

#### **A16.4420**

Check the  $-15$  V fuse on A16.

Is the fuse open?

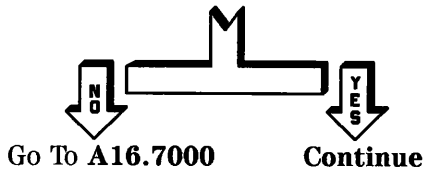

#### **A16.4421**

Do the following:

1. Replace the defective fuse.
2. Install A16.
3. Connect the instrument to line power using an isolation transformer.
4. Set the line power switch to on.

Is the green  $-15$  V LED on?

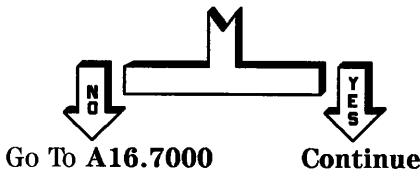

Replacing the fuse seems to have fixed the problem, but this simple solution is suspect. You may want to monitor the instrument for several minutes with the covers on to insure that an intermittent problem does not exist. Go to the Troubleshooting Foldout, block 1 (located just prior to the “Special Cases” tab).

### A16.4430

Follow the disassembly procedures in the *HP 8360 B-Series Swept Signal Generator/ HP 8360 L-Series Swept CW Generator Service Guide* to remove the rear panel and disconnect ribbon cable, W31 from the motherboard. Measure the resistance of the -15 Vdc supply to ground (XA16J1-25, 26, 65, and 66 to ground).

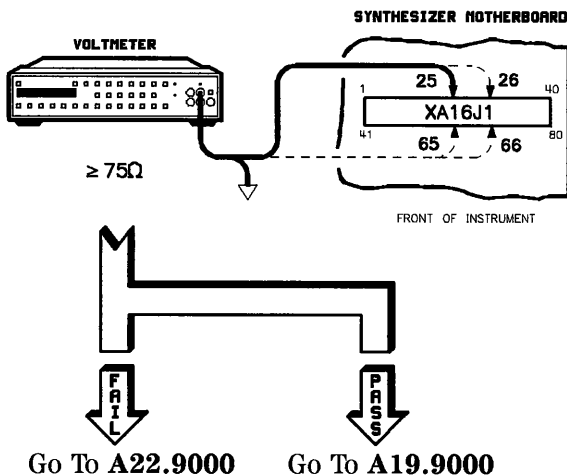



## A16.4500

Measure the voltage of the  $-5$  Vdc unregulated supply from A17 to A16 at XA16J1-20, 21, 60, and 61.

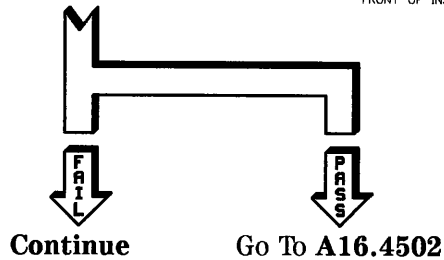
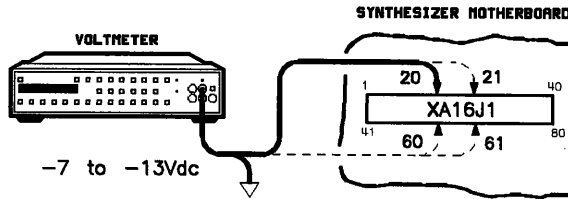

## A16.4501

Do the following:

1. Set line power switch to standby.
2. Disconnect the instrument from line power.
3. Wait for all the indicators in the power supply section to go out.
4. Remove A16.
5. Connect the instrument to line power using an isolation transformer.
6. Set the line power switch to on.

Measure the voltage of the  $-5$  Vdc unregulated supply from A17 to A16 at XA16J1-20, 21, 60, and 61.

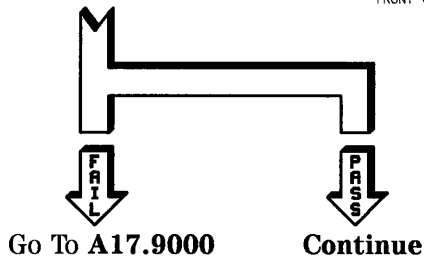
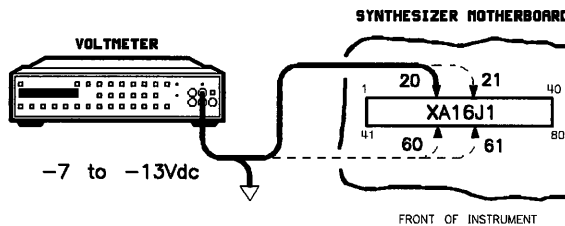

## A16.4502

Do the following if not already performed:

1. Set line power switch to standby.
2. Disconnect the instrument from line power.
3. Wait for all the indicators in the power supply section to go out.
4. Remove A16.

Measure the resistance of the  $-5$  Vdc supply to ground (XA16J1-18, 19, 58, and 59 to ground).

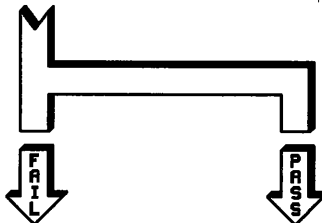
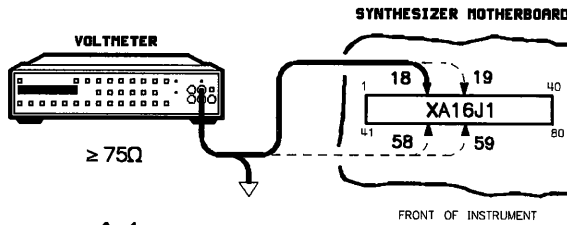

Continue

Go To A16.4520

## A16.4503

Remove the following assemblies:

- A4 fractional-N.
- A5 YO phase detector.
- A7 reference.
- A8 modulation generator (Opt. 002).
- A9 pulse.
- A11 FM driver.
- A12 multiplier/filter driver.
- A13 YO driver.
- A14 sweep generator.
- A15 microprocessor.
- A6 sampler.

### Note

Be sure to disconnect the rigid cable connected to the input of A6 before removing A6. Otherwise damage to the cable, A6, and possibly the filter (FL2) can occur.

Measure the resistance of the  $-5$  Vdc supply to ground (XA16J1-18, 19, 58, and 59 to ground).

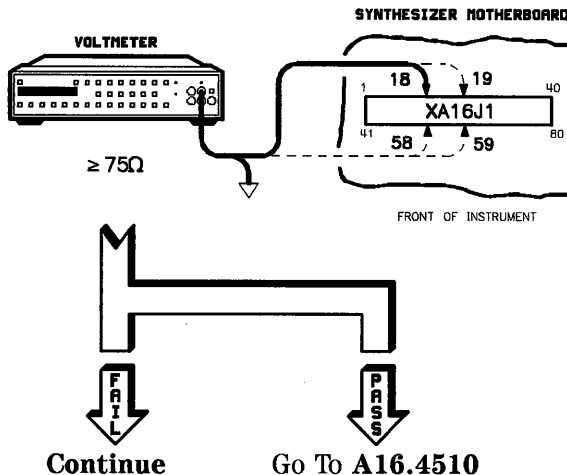

## A16.4504

Refer to the disassembly procedures in the *HP 8360 B-Series Swept Signal Generator/ HP 8360 L-Series Swept CW Generator Service Guide* to remove the RF deck.

Measure the resistance of the  $-5$  Vdc supply to ground (XA16J1-18, 19, 58, and 59 to ground).

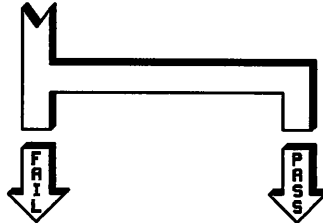
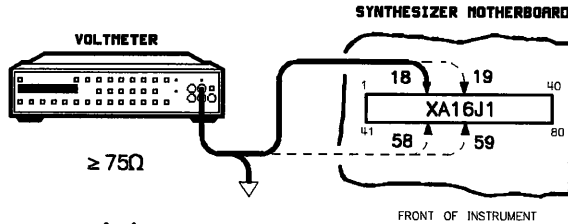

Go To **A16.4530**

**Continue**

### A16.4505

Refer to the disassembly procedures in the *HP 8360 B-Series Swept Signal Generator/ HP 8360 L-Series Swept CW Generator Service Guide* and reinstall the RF deck in the *service position*. Remove the ribbon cables that connect the microcircuits to the RF deck.

Measure the resistance of the  $-5$  Vdc supply to ground (XA16J1-18, 19, 58, and 59 to ground).

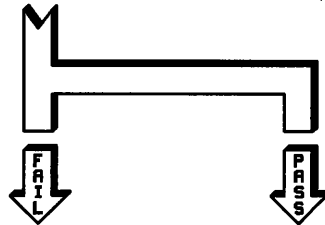
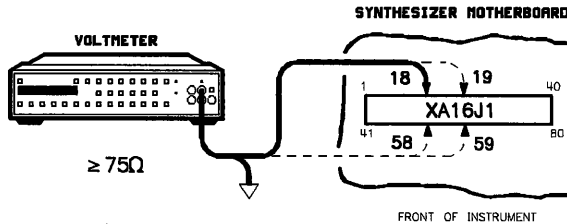

Go To **A20.9000**

**Continue**

### A16.4506

Reconnect the microcircuit ribbon cables one at a time while measuring the resistance of the  $-5$  Vdc supply to ground (XA16J1-18, 19, 58, and 59 to ground). Also check the  $-5$  V fuse on A16 and replace it if open.

Does a microcircuit cause a resistance measurement of  $< 75 \Omega$ ?



Go To **A16.4508**

**Continue**

### **A16.4507**

Go to the paragraph indicated to replace the faulty microcircuit.

<b>Microcircuit</b>	<b>Go To Paragraph</b>
A29 amp/filter	RF.2990
A28 amp/multiplier	RF.2890
A26 YO	RF.2690
A24 low band	RF.2490
A31 attenuator	RF.3190
A32 amp/doubler	RF.3290
A33 amp switch	RF.3390
A38 dual modulator	RF.3890
A38 AM modulator (Opt. 006)	RF.3890
A42 pulse mod switched filter	RF.4290

### **A16.4508**

You may have removed the defect in the disassembly process or the problem may be intermittent. Also check the -5 V fuse on A16 and replace it if open. Go to Troubleshooting Foldout, block 1 (located just prior to the "Special Cases" tab).

### **A16.4510**

Reinstall the previously removed assemblies one at a time while measuring the resistance of the  $-5$  Vdc supply to ground (XA16J1-18, 19, 58, 59 to ground). If the assembly does not fail (a failure is a resistance measurement of  $< 75 \Omega$ ), reinstall another assembly and repeat the measurement. When the defective assembly is identified, go to the 9000 paragraph for that assembly for replacement instructions. For example, for A4, go to A4.9000; for A5, go to A5.9000, and so on.

If no assembly causes a low resistance measurement, you may have removed the defect in the disassembly process or the problem may be intermittent. Also check the  $-5$  V fuse on A16 and replace it if open. Go to Troubleshooting Foldout, block 1 (located just prior to the "Special Cases" tab).

### **A16.4520**

Check the  $-5$  V fuse on A16.

Is the fuse open?

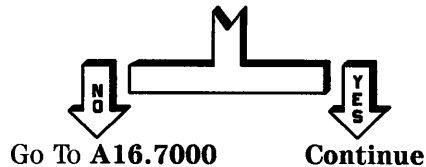



## **A16.4521**

Do the following:

1. Replace the defective fuse.
2. Install A16.
3. Connect the instrument to line power using an isolation transformer.
4. Set the line power switch to on.

Is the green  $-5$  V LED on?



Go To **A16.7000**

**Continue**

Replacing the fuse seems to have fixed the problem, but this simple solution is suspect. You may want to monitor the instrument for several minutes with the covers on to insure that an intermittent problem does not exist. Go to the Troubleshooting Foldout, block 1 (located just prior to the "Special Cases" tab).

### A16.4530

Refer to the disassembly procedures in the *HP 8360 B-Series Swept Signal Generator/ HP 8360 L-Series Swept CW Generator Service Guide* to remove the rear panel and disconnect ribbon cable, W31, from the motherboard. Measure the resistance of the -5 Vdc supply to ground (XA16J1-18, 19, 58, and 58 to ground).

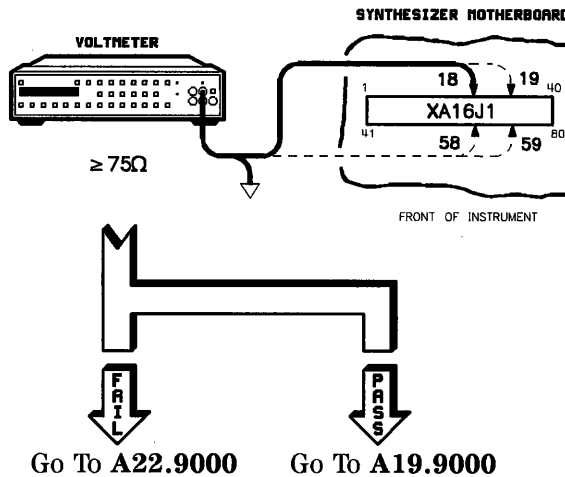

## A16.4600

Measure the voltage of the +5 Vdc unregulated supply from A17 to at XA16J1-15, 16, 55, and 56.

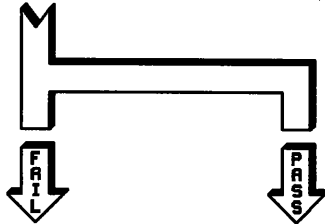
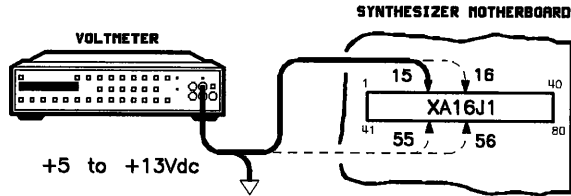

Continue

Go To A16.4602

## A16.4601

Do the following:

1. Set line power switch to standby.
2. Disconnect the instrument from line power.
3. Wait for all the indicators in the power supply section to go out.
4. Remove A16.
5. Connect the instrument to line power using an isolation transformer.
6. Set the line power switch to on.

Measure the voltage of the +5 Vdc unregulated supply from A17 to A16 at XA16J1-15, 16, 55, and 56.

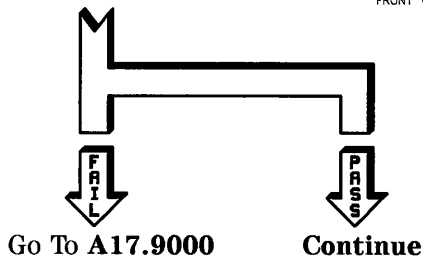
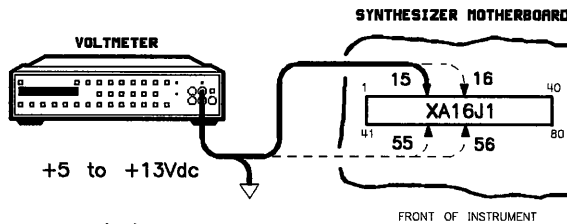

## A16.4602

Do the following if not already performed:

1. Set line power switch to standby.
2. Disconnect the instrument from line power.
3. Wait for all the indicators in the power supply section to go out.
4. Remove A16.

Measure the resistance of the +5 Vdc supply to ground (XA16J1-13, 14, 39, 40, 53, 54, 79, and 80 to ground).

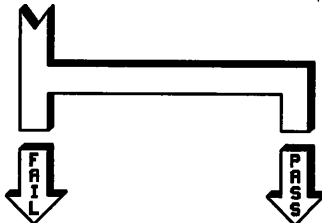
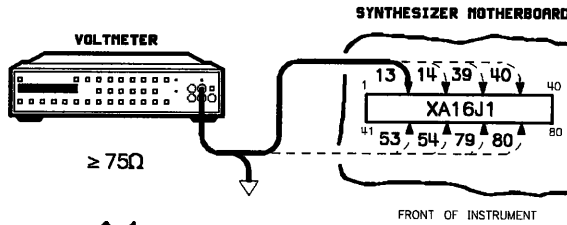

## A16.4603

Remove the following assemblies:

- A4 fractional-N.
- A5 YO phase detector.
- A7 reference.
- A8 modulation generator (Opt. 002).
- A9 pulse.
- A11 FM driver.
- A12 multiplier/filter driver.
- A13 YO driver.
- A14 sweep generator.
- A15 microprocessor.
- A6 sampler.

### Note

Be sure to disconnect the rigid cable connected to the input of A6 before removing A6. Otherwise damage to the cable, A6, and possibly the filter (FL2) can occur.

Measure the resistance of the +5 Vdc supply to ground (XA16J1-13, 14, 39, 40, 53, 54, 79, and 80 to ground).

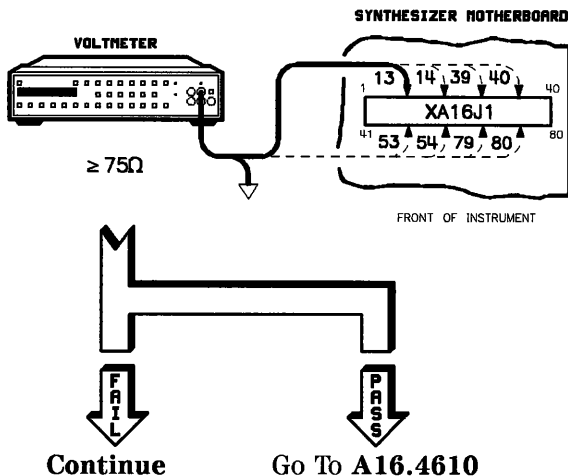

## A16.4604

Refer to the disassembly procedures in the *HP 8360 B-Series Swept Signal Generator/ HP 8360 L-Series Swept CW Generator Service Guide* and remove the RF deck.

Measure the resistance of the +5 Vdc supply to ground (XA16J1-13, 14, 39, 40, 53, 54, 79, and 80 to ground).

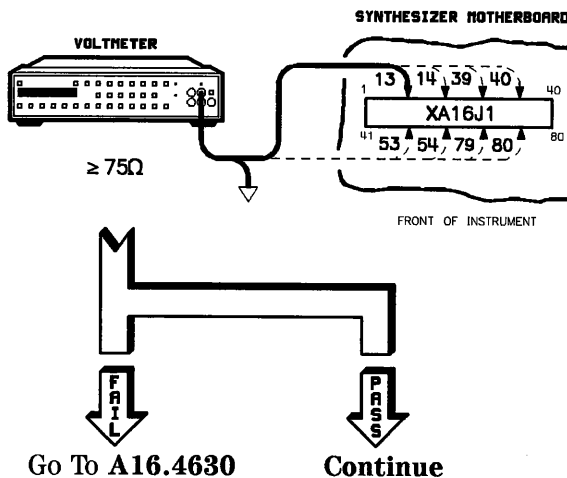

### A16.4605

Reinstall the RF deck in the *service position*. Refer to the disassembly procedures in the *HP 8360 B-Series Swept Signal Generator/HP 8360 L-Series Swept CW Generator Service Guide*. Remove the ribbon cables that connect the microcircuits to the RF deck:

Measure the resistance of the +5 Vdc supply to ground (XA16J1-13, 14, 39, 40, 53, 54, 79, and 80 to ground).

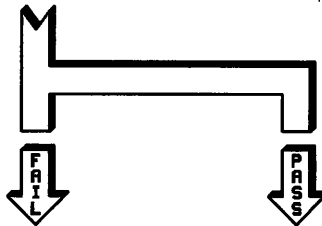
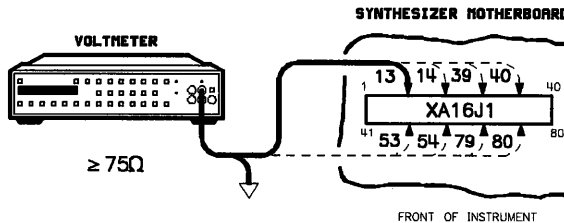

Go To **A20.9000**

**Continue**

### A16.4606

Reconnect the microcircuit ribbon cables one at a time while measuring the resistance of the +5 Vdc supply to ground (XA16J1-13, 14, 39, 40, 53, 54, 79, and 80 to ground). Finally, check the +5 V fuse on A16 and replace it if open.

Did a microcircuit cause a resistance measurement of  $< 75 \Omega$ ?



Go To **A16.4608**

**Continue**



### **A16.4607**

Go to the paragraph indicated to replace the faulty microcircuit.

<b>Microcircuit</b>	<b>Go To Paragraph</b>
A29 amp/filter	RF.2990
A28 amp/multiplier	RF.2890
A26 YO	RF.2690
A24 low band	RF.2490
A31 attenuator	RF.3190
A32 amp/doubler	RF.3290
A33 amp switch	RF.3390
A38 dual modulator	RF.3890
A38 AM modulator (Opt. 006)	RF.3890
A42 pulse mod switched filter	RF.4290

### **A16.4608**

You may have removed the defect in the disassembly process or the problem may be intermittent. Also check the +5 V fuse on A16. Replace it if defective. Go to Troubleshooting Foldout, block 1 (located just prior to the "Special Cases" tab).

### **A16.4610**

Reinstall the previously removed assemblies one at a time while measuring the resistance of the +5 Vdc supply to ground (XA16J1-13, 14, 39, 40, 53, 54, 79, and 80 to ground). If the assembly does not fail (a failure is a resistance measurement of  $< 75 \Omega$ ), reinstall another assembly and repeat the measurement. When the defective assembly is identified, go to the 9000 paragraph for that assembly for replacement instructions. For example, for A4, go to A4.9000; for A5, go to A5.9000, and so on.

If no assembly causes a low resistance measurement, you may have removed the defect in the disassembly process or the problem may be intermittent. Also check the -5 V fuse on A16 and replace it if open. Go to Troubleshooting Foldout, block 1 (located just prior to the "Special Cases" tab).

### **A16.4620**

Check the +5 V fuse on A16.

Is the fuse defective?

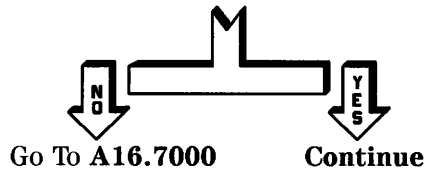

## **A16.4621**

Do the following:

1. Replace the defective fuse.
2. Install A16.
3. Connect the instrument to line power using an isolation transformer.
4. Set the line power switch to on.

Is the green +5V LED on?



Go To **A16.7000**

**Continue**

Replacing the fuse seems to have fixed the problem, but this simple solution is suspect. You may want to monitor the instrument for several minutes with the covers on to insure that an intermittent problem does not exist. Go to the Troubleshooting Foldout, block 1 (located just prior to the "Special Cases" tab).

## A16.4630

Refer to the disassembly procedures in the *HP 8360 B-Series Swept Signal Generator/ HP 8360 L-Series Swept CW Generator Service Guide* to remove the rear panel and disconnect ribbon cable, W31 from the motherboard. Measure the resistance of the +5 Vdc supply to ground (XA16J1-13, 14, 39, 40, 53, 54, 79, and 80 to ground).

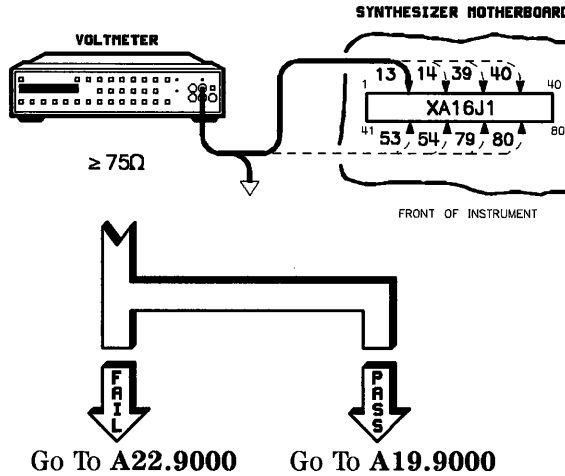

## A16.4700

Measure the voltage of the +8 Vdc unregulated supply from A17 to A16 at XA16J1-9, 10, 49, and 50.

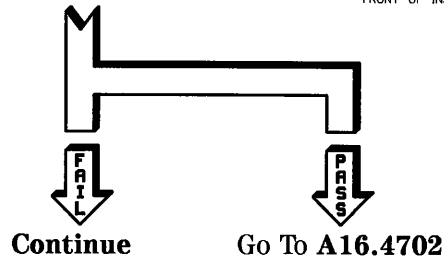
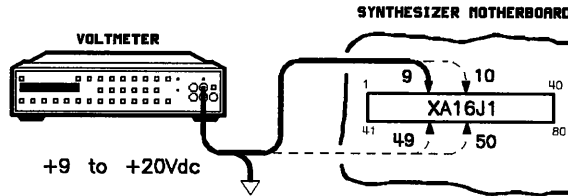

## A16.4701

Do the following:

1. Set line power switch to standby.
2. Disconnect the instrument from line power.
3. Wait for all the indicators in the power supply section to go out.
4. Remove A16.
5. Connect the instrument to line power using an isolation transformer.
6. Set the line power switch to on.

Measure the voltage of the +8 Vdc unregulated supply from A17 to A16 at XA16J1-9, 10, 49, and 50.

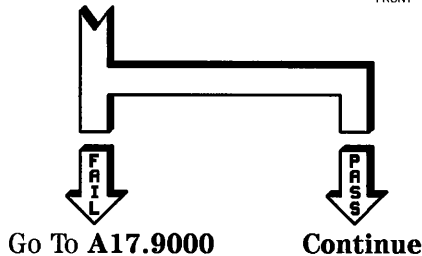
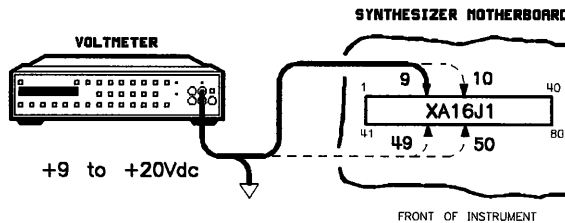

## A16.4702

Do the following if not already performed:

1. Set line power switch to standby.
2. Disconnect the instrument from line power.
3. Wait for all the indicators in the power supply section to go out.
4. Remove A16.

Measure the resistance of the +8 Vdc supply to ground (XA16J1-7, 8, 47, and 48 to ground).

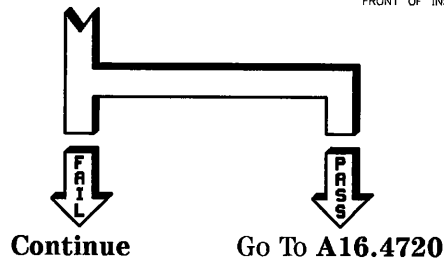
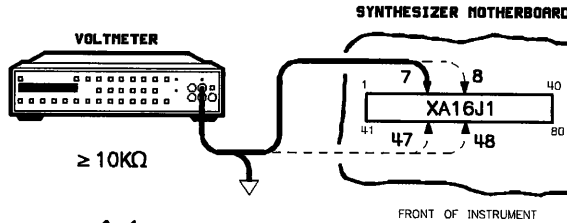

### A16.4703

Remove the following assemblies:

- A4 fractional-N.
- A5 YO phase detector.
- A7 reference.
- A8 modulation generator (Opt. 002).
- A9 pulse.
- A11 FM driver.
- A12 multiplier/filter driver.
- A13 YO driver.
- A14 sweep generator.
- A15 microprocessor.
- A6 sampler.

#### Note

Be sure to disconnect the rigid cable line connected to the input of A6 before removing A6. Otherwise damage to the cable, A6, and possibly the filter (FL2) can occur.

Measure the resistance of the +8 Vdc supply to ground (XA16J1-7, 8, 47, and 48 to ground).

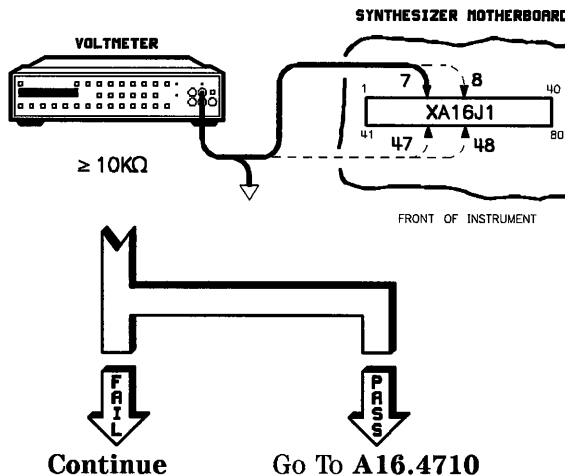



## A16.4704

Refer to the disassembly procedures in the *HP 8360 B-Series Swept Signal Generator/ HP 8360 L-Series Swept CW Generator Service Guide* to remove the RF deck.

Measure the resistance of the +8 Vdc supply to ground (XA16J1-7, 8, 47, and 48 to ground).

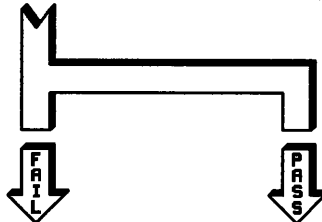
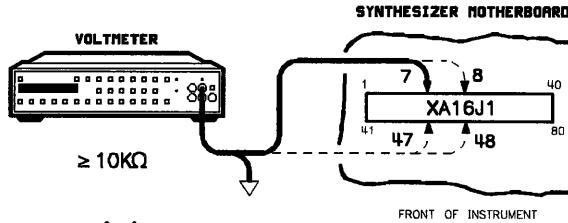

Go To **A16.4730**

**Continue**

### A16.4705

Refer to the disassembly procedures in the *HP 8360 B-Series Swept Signal Generator/ HP 8360 L-Series Swept CW Generator Service Guide* and reinstall the RF deck in the *service position*. Remove the ribbon cables that connect the microcircuits to the RF deck:

Measure the resistance of the +8 Vdc supply to ground (XA16J1-7, 8, 47, and 48 to ground).

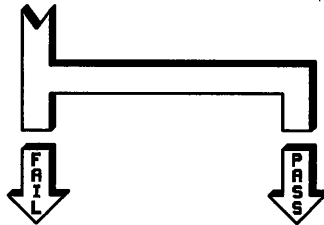
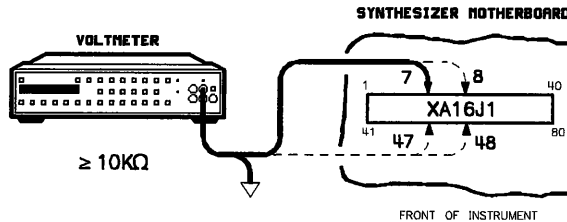

Go To **A20.9000**

**Continue**

### A16.4706

Reconnect the microcircuit ribbon cables one at a time while measuring the resistance of the +8 Vdc supply to ground (XA16J1-7, 8, 47, and 48 to ground). Also check the +8 V fuse on A16. If defective, replace it.

Did a microcircuit cause a resistance measurement < 10 k $\Omega$ ?

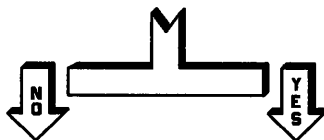

Go To **A16.4708**

**Continue**

### **A16.4707**

Go to the paragraph indicated to replace the faulty microcircuit.

<b>Microcircuit</b>	<b>Go To Paragraph</b>
A29 amp/filter	RF.2990
A28 amp/multiplier	RF.2890
A26 YO	RF.2690
A24 low band	RF.2490
A31 attenuator	RF.3190
A32 amp/doubler	RF.3290
A33 amp switch	RF.3390
A38 dual modulator	RF.3890
A38 AM modulator (Opt. 006)	RF.3890
A42 pulse mod switched filter	RF.4290

### **A16.4708**

You may have removed the defect in the disassembly process or the problem may be intermittent. Also check the +8 V fuse on A16. Replace it if defective. Go to the Troubleshooting Foldout, block 1.

### **A16.4710**

Reinstall the previously removed assemblies one at a time while measuring the resistance of the +8 Vdc supply to ground (XA16J1-7, 8, 47, and 48 to ground). If the assembly does not fail (a failure is a resistance measurement of  $< 10\text{ k}\Omega$ ), reinstall another assembly and repeat the measurement. When the defective assembly is identified, go to the 9000 paragraph for that assembly for replacement instructions. For example, for A4, go to A4.9000; for A5, go to A5.9000, and so on.

If no assembly causes a low resistance measurement, you may have removed the defect in the disassembly process or the problem may be intermittent. Also check the +8 V fuse on A16. If defective, replace it. Go to Troubleshooting Foldout, block 1 (located just prior to the "Special Cases" tab).

### **A16.4720**

Check the +8 V fuse on A16.

Is the fuse defective?

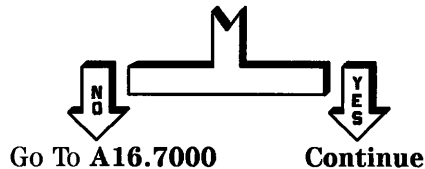

## **A16.4721**

Do the following:

1. Replace the defective fuse.
2. Install A16.
3. Connect the instrument to line power using an isolation transformer.
4. Set the line power switch to on.

Is the green +8 V LED on?



Go To **A16.7000**

**Continue**

Replacing the fuse seems to have fixed the problem, but this simple solution is suspect. You may want to monitor the instrument for several minutes with the covers on to insure that an intermittent problem does not exist. Go to the Troubleshooting Foldout, block 1.

## A16.4730

Refer to the disassembly procedures in the *HP 8360 B-Series Swept Signal Generator/ HP 8360 L-Series Swept CW Generator Service Guide* to remove the rear panel and disconnect ribbon cable W31 from the motherboard. Measure the resistance of the +8 Vdc supply to ground (XA16J1-7, 8, 47, and 48 to ground).

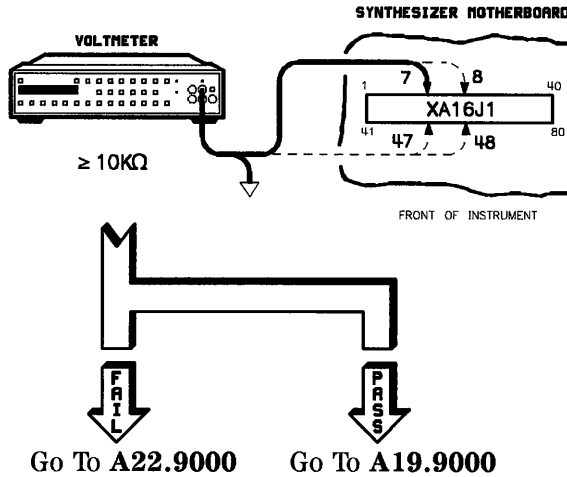

## A16.4800

Measure the voltage of the +15 Vdc unregulated supply from A17 to A16 at XA16J1-32, 33, 72, and 73.

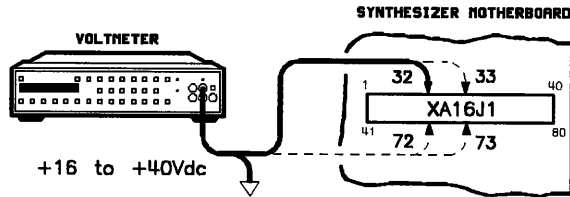

FRONT OF INSTRUMENT

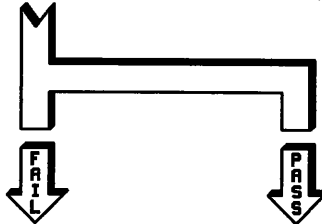

Continue

Go To A16.4802

## A16.4801

Do the following:

1. Set line power switch to standby.
2. Disconnect the instrument from line power.
3. Wait for all the indicators in the power supply section to go out.
4. Remove A16.
5. Connect the instrument to line power using an isolation transformer.
6. Set the line power switch to on.

Measure the voltage of the +15 Vdc unregulated supply from A17 to A16 at XA16J1-32, 33, 72, and 73.

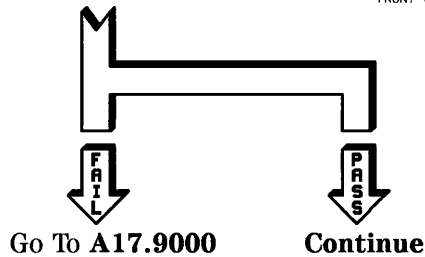
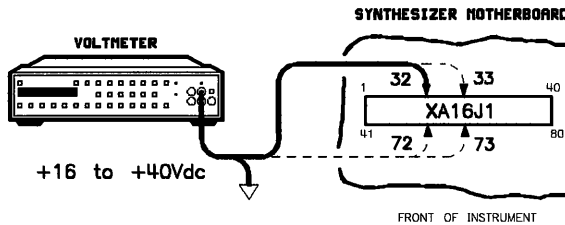



## A16.4802

Do the following if not already performed:

1. Set line power switch to standby.
2. Disconnect the instrument from line power.
3. Wait for all the indicators in the power supply section to go out.
4. Remove A16.

Measure the resistance of the +15 Vdc supply to ground (XA16J1-30, 31, 70, and 71 to ground).

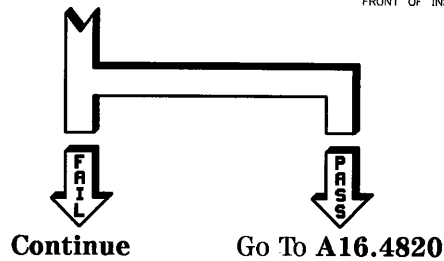
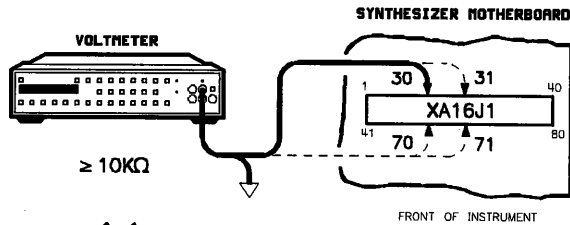

## A16.4803

Remove the following assemblies:

- A4 fractional-N.
- A5 YO phase detector.
- A7 reference.
- A8 modulation generator (Opt. 002).
- A9 pulse.
- A11 FM driver.
- A12 multiplier/filter driver.
- A13 YO driver.
- A14 sweep generator.
- A15 microprocessor.
- A6 sampler.

### Note

Be sure to disconnect the rigid cable connected to the input of A6 before removing A6. Otherwise damage to the cable, A6 and possibly the filter (FL2) can occur.

Measure the resistance of the +15 Vdc supply to ground (XA16J1-30, 31, 70, and 71 to ground).

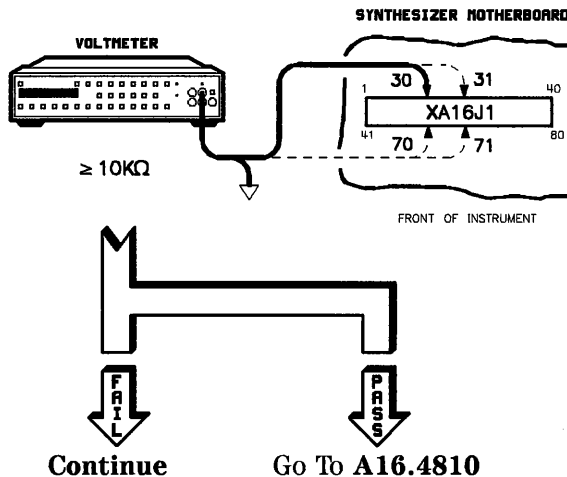

## A16.4804

Refer to the disassembly procedures in the *HP 8360 B-Series Swept Signal Generator/ HP 8360 L-Series Swept CW Generator Service Guide* to remove the RF deck.

Measure the resistance of the +15 Vdc supply to ground (XA16J1-30, 31, 70, and 71 to ground).

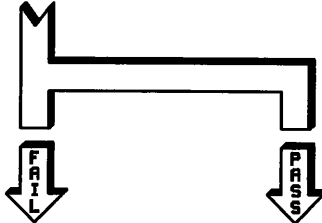
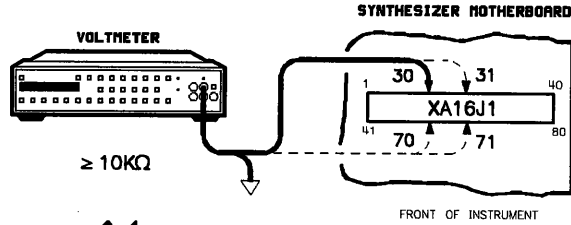

Go To **A16.4830**

**Continue**

## A16.4805

Refer to the disassembly procedures in the *HP 8360 B-Series Swept Signal Generator/ HP 8360 L-Series Swept CW Generator Service Guide* and reinstall the RF deck in the *service position*. Remove the ribbon cables that connect the microcircuits to the RF deck:

Measure the resistance of the +15 Vdc supply to ground (XA16J1-30, 31, 70, and 71 to ground).

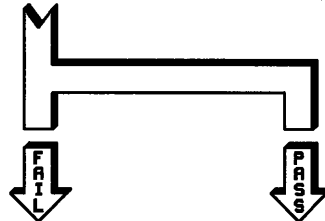
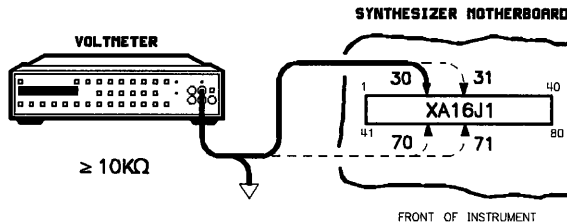

Go To **A20.9000**

**Continue**

## A16.4806

Reconnect the microcircuit ribbon cables one at a time while measuring the resistance of the +15 Vdc supply to ground (XA16J1-30, 31, 70, and 71 to ground). Also check the +15 V fuse on A16. If defective, replace it.

Did a microcircuit cause a resistance measurement of  $< 10\text{ k}\Omega$ ?

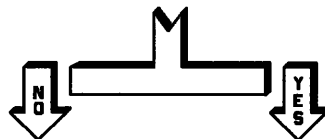

Go To **A16.4808**

**Continue**

### **A16.4807**

Go to the paragraph indicated to replace the faulty microcircuit.

<b>Microcircuit</b>	<b>Go To Paragraph</b>
A29 amp/filter	RF.2990
A28 amp/multiplier	RF.2890
A26 YO	RF.2690
A24 low band	RF.2490
A31 attenuator	RF.3190
A32 amp/doubler	RF.3290
A33 amp switch	RF.3390
A38 dual modulator	RF.3890
A38 AM modulator (Opt. 006)	RF.3890
A42 pulse mod switched filter	RF.4290

### **A16.4808**

You may have removed the defect in the disassembly process or the problem may be intermittent. Also check the +15 V fuse on A16. If defective, replace it.

Go to Troubleshooting Foldout, block 1.

### **A16.4810**

Reinstall the previously removed assemblies one at a time while measuring the resistance of the +15 Vdc supply to ground (XA16J1-30, 31, 70, and 71 to ground). If the assembly does not fail (a failure is a resistance measurement of  $< 10\text{ k}\Omega$ ), reinstall another assembly and repeat the measurement. When the defective assembly is identified, go to the 9000 paragraph for that assembly for replacement instructions. For example, for A4, go to A4.9000; for A5, go to A5.9000, and so on.

If no assembly causes a low resistance measurement, you may have removed the defect in the disassembly process or the problem may be intermittent. Also check the +15 V fuse on A16. If defective, replace it. Go to Troubleshooting Foldout, block 1 (located just prior to the "Special Cases" tab).

### **A16.4820**

Check the +15 V fuse on A16.

Is the fuse defective?

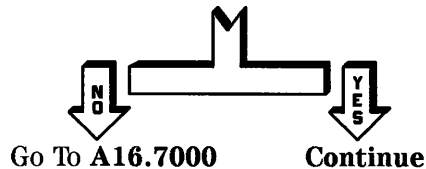

## **A16.4821**

Do the following:

1. Replace the defective fuse.
2. Install A16.
3. Connect the instrument to line power using an isolation transformer.
4. Set the line power switch to on.

Is the green +15 V LED on?



Go To **A16.7000**

**Continue**

Replacing the fuse seems to have fixed the problem, but this simple solution is suspect. You may want to monitor the instrument for several minutes with the covers on to insure that an intermittent problem does not exist. Go to the Troubleshooting Foldout, block 1.

## A16.4830

Refer to the disassembly procedures in the *HP 8360 B-Series Swept Signal Generator/ HP 8360 L-Series Swept CW Generator Service Guide* to remove the rear panel and disconnect ribbon cable W31 from the motherboard. Measure the resistance of the +15 Vdc supply to ground (XA16J1-30, 31, 70, and 71 to ground).

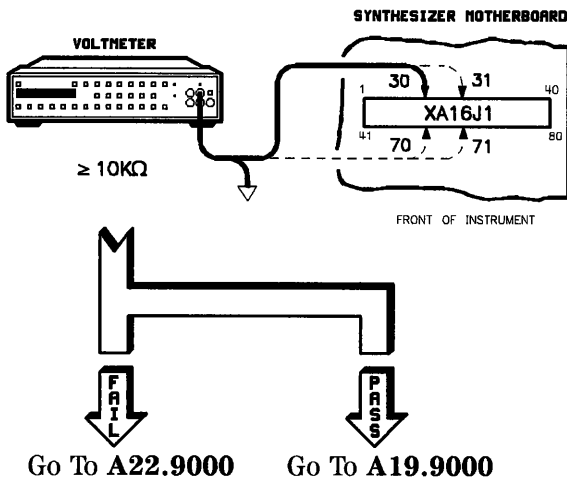



## A16.4900

Do the following:

1. Set line power switch to standby.
2. Disconnect the AC line power cord.
3. Wait for all the indicators in the power supply section to go out.
4. Remove A16.
5. Measure the resistance of the +5 VAUp to ground (XA16J1-76 to ground).

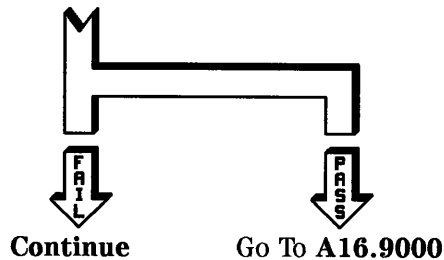
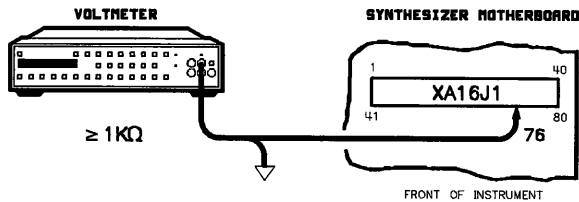

## A16.4901

Remove the following assemblies:

- A4 fractional-N.
- A5 YO phase detector.
- A7 reference.
- A8 modulation generator (Opt. 002).
- A9 pulse.
- A11 FM driver.
- A12 multiplier/filter driver.
- A13 YO driver.
- A14 sweep generator.
- A15 microprocessor.

Measure the resistance of the +5 VAUp to ground (XA16J1-76 to ground).

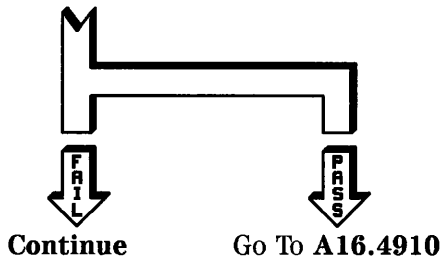
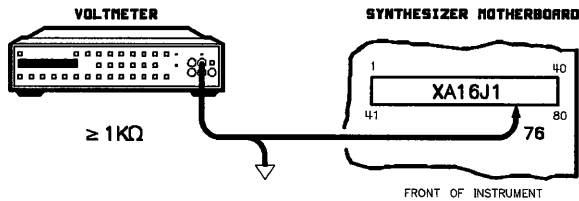

## A16.4902

Refer to the disassembly procedures in the *HP 8360 B-Series Swept Signal Generator/ HP 8360 L-Series Swept CW Generator Service Guide* to remove the RF deck. Also remove A6.

### Note

Be sure to disconnect the rigid cable connected to the input of A6 before removing A6. Otherwise damage to the cable, A6 and possibly the filter (FL2) can occur.

Measure the resistance of the +5 VAUp to ground (XA16J1-76 to ground).

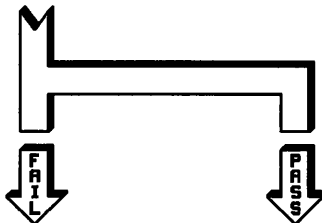
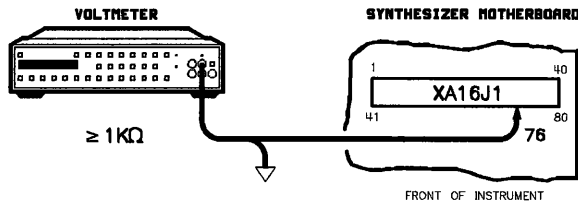

Go To **A16.4930**

**Continue**

### A16.4905

Refer to the disassembly procedures in the *HP 8360 B-Series Swept Signal Generator/ HP 8360 L-Series Swept CW Generator Service Guide* and reinstall the RF deck in the *service position*. Remove the ribbon cables that connect the microcircuits to the RF deck:

Measure the resistance of the +5 VAUp to ground (XA16J1-76 to ground).

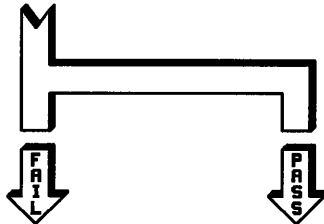
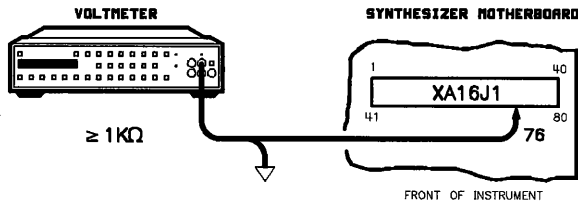

Go To **A20.9000**

**Continue**

### A16.4906

Reconnect the microcircuit ribbon cables one at a time while measuring the resistance of the +5 VAUp to ground (XA16J1-76 to ground).

Did a microcircuit cause a resistance measurement of < 1 kΩ?



Go To **A16.4908**

**Continue**

### **A16.4907**

Go to the paragraph indicated to replace the faulty microcircuit.

<b>Microcircuit</b>	<b>Go To Paragraph</b>
A29 amp/filter	RF.2990
A28 amp/multiplier	RF.2890
A26 YO	RF.2690
A24 low band	RF.2490
A31 attenuator	RF.3190
A32 amp/doubler	RF.3290
A33 amp switch	RF.3390
A38 dual modulator	RF.3890
A38 AM modulator (Opt. 006)	RF.3890
A42 pulse mod switched filter	RF.4290

### **A16.4908**

Reinstall A6. Measure the resistance of the +5 VAUp to ground (XA16J1-76 to ground). If A6 causes a resistance measurement of  $< 1 \text{ k}\Omega$ , go to A6.9000. If not, you may have removed the defect in the disassembly process or the problem may be intermittent. Go to Troubleshooting Foldout, block 1.

### **A16.4910**

Reinstall the previously removed assemblies one at a time while measuring the resistance of the +5 VAUp to ground (XA16J1-76 to ground). If the assembly does not fail (a failure is a resistance measurement of  $< 1\text{ k}\Omega$ ), reinstall another assembly and repeat the measurement. When the defective assembly is identified, go to the 9000 paragraph for that assembly for replacement instructions. For example, for A4, go to A4.9000; for A5, go to A5.9000, and so on.

If no assembly causes a low resistance measurement, you may have removed the defect in the disassembly process or the problem may be intermittent. Go to Troubleshooting Foldout, block 1 (located just prior to the "Special Cases" tab).

### **A16.4930**

Refer to the disassembly procedures in the *HP 8360 B-Series Swept Signal Generator/ HP 8360 L-Series Swept CW Generator Service Guide* to remove the rear panel and disconnect ribbon cable W31 from the motherboard. Measure the resistance of the +5 VAUp to ground (XA16J1-76 to ground).

Is the resistance  $> 1\text{ k}\Omega$ ?

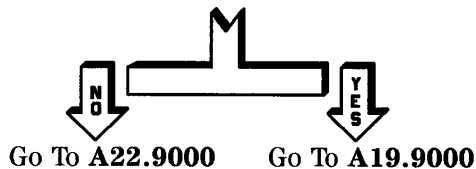

### **A16.5000**

1. Remove A16.
2. Check the +22 V plug-in style fuse. Replace the fuse if required.
3. Reinstall A16.

Continue to the next step.

### **A16.5001**

Is the A16 +22V STBY LED on?

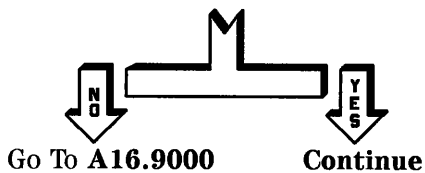

## A16.5002

Do the following:

1. Set the line power switch to standby.
2. Remove A16.
3. Connect the instrument to line power using an isolation transformer.
4. Set the line power switch to on.
5. Measure the voltage of the +22 Vdc supply at XA16J1-4 and 44.

Is the measured voltage between +23 and +55 Vdc with less than 2 Vdc ripple?

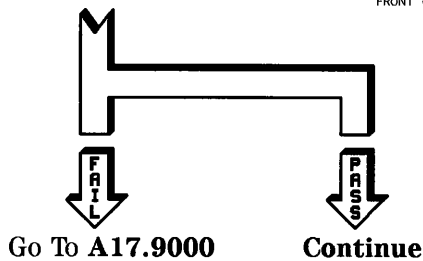
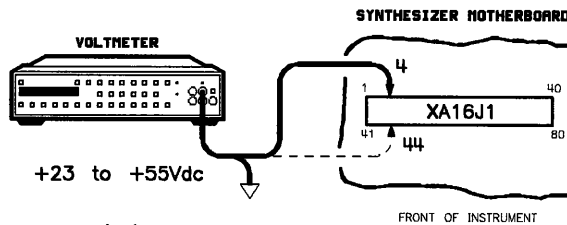



### A16.5003

Reinstall A16. Measure the voltage of the +22 Vdc supply at XA16J1-4 and 44.

Is the measured voltage between +23 and +55 Vdc with less than 2 Vdc ripple?

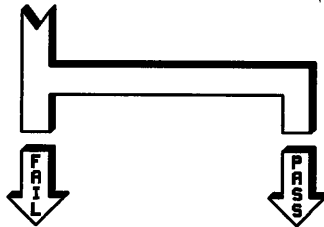
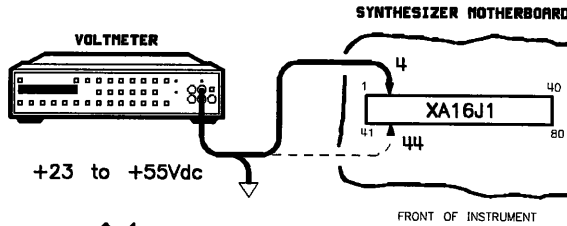

Continue

Go To A16.9000

### A16.5004

The problem is most likely A16 (go to A16.9000). However, some chance exists that A17 is unable to supply sufficient current. If replacing A16 does not solve the problem, then replace A17 (go to A17.9000). Then go to Troubleshooting Foldout, block 1.

### **A16.7000**

The most probable fault is A16. However, some chance exists that the supply in question could be loaded by an assembly only when power is applied. If you suspect this type of loading, continue with A16.7001; otherwise, go to A16.9000.

### **A16.7001**

The following is a general procedure. You will have to adapt this procedure to your own situation. If you are unsure how to proceed, or you have questions about safety, do *not* continue with this procedure. Instead, refer the instrument to qualified service personnel.

### **WARNING**

---

**When the instrument is connected to AC line power or the A18 high voltage neon indicator is on, there are voltages present that can cause personal injury or death. Only trained, qualified personnel, who are aware of the hazards involved, should perform service on this instrument with its protective covers removed. An isolation transformer must be used during all these procedures.**

**Observe all safety practices. Remove all jewelry/metal that can short to ground.**

---

The power supply interconnect tables, located in "Special Cases" are useful in determining where to make your measurements.

Continue with A16.7002.

## **A16.7002**

1. Set the line power switch to standby.
2. Remove the following assemblies:
  - A4 fractional-N.
  - A5 YO phase detector.
  - A7 reference.
  - A8 modulation generator (Opt. 002).
  - A9 pulse.
  - A11 FM driver.
  - A12 multiplier/filter driver.
  - A13 YO driver.
  - A14 sweep generator.
  - A15 microprocessor.
3. Set the line power switch to on.
4. Measure the previously-failed voltage.

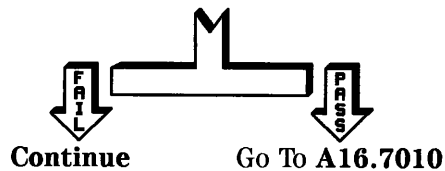

### A16.7003

1. Set the line power switch to standby.
2. Replace all previously removed assemblies.
3. Remove A6.

#### Note

---

Be sure to disconnect the rigid cable connected to the input of A6 before removing A6. Otherwise damage to the cable, A6, and possibly the filter (FL2) can occur.

---

4. Set the line power switch to on.
5. Measure the previously-failed voltage.

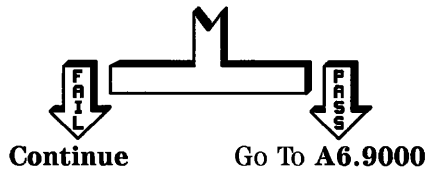

### A16.7004

1. Set the line power switch to standby.
2. Replace A6.
3. Remove the RF deck. Refer to the disassembly and replacement procedures in the *HP 8360 B-Series Swept Signal Generator/HP 8360 L-Series Swept CW Generator Service Guide* as required.
4. Set the line power switch to on.
5. Measure the previously-failed voltage.

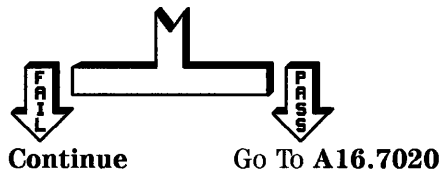

## A16.7005

1. Set the line power switch to standby.
2. Disconnect the instrument from AC line power.
3. Replace the RF deck.
4. Remove the front panel assembly. Refer to the disassembly and replacement procedures in the *HP 8360 B-Series Swept Signal Generator/HP 8360 L-Series Swept CW Generator Service Guide* as required.
5. Disconnect all ribbon cables between the motherboard and the front panel.
6. Reconnect the line power cord.
7. Set the line power switch to on.
8. Measure the previously-failed voltage.

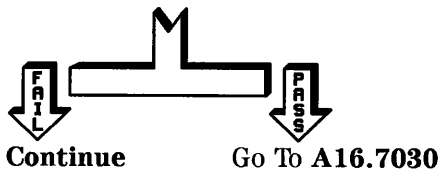

## A16.7006

1. Set the line power switch to standby.
2. Disconnect the instrument from AC line power.
3. Wait for all the indicators in the power supply section to go out.
4. Reinstall the front panel.

### WARNING

**When the instrument is connected to AC line power or the A18 high voltage neon indicator is on, there are voltages present that can cause personal injury or death. Only trained, qualified personnel, who are aware of the hazards involved, should perform service on this instrument with its protective covers removed. An isolation transformer must be used during all these procedures.**

**Observe all safety practices. Remove all jewelry/metal that can short to ground.**

5. Remove the rear panel. Refer to the disassembly and replacement procedures in the *HP 8360 B-Series Swept Signal Generator/HP 8360 L-Series Swept CW Generator Service Guide* as required.
6. Disconnect W31 (the ribbon cable connecting the rear panel interface, A19, to the motherboard, A22).
7. Reinstall the rear panel with the ribbon cable still disconnected.
8. Reconnect the instrument to AC line power.
9. Set the line power switch to on.
10. Measure the previously-failed voltage.

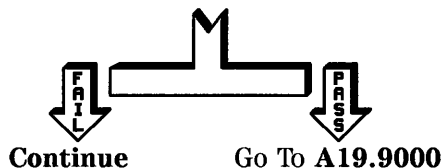

### **A16.7007**

1. Set the line power switch to standby.
2. Disconnect the instrument from AC line power.
3. Wait for all the indicators in the power supply section to go out.
4. Remove the rear panel. Refer to the disassembly and replacement procedures in the *HP 8360 B-Series Swept Signal Generator/HP 8360 L-Series Swept CW Generator Service Guide* as required.
5. Reconnect the ribbon cable, W31, between the rear panel interface, A19 and the motherboard, A22.
6. Reinstall the rear panel.

Go To A16.9000

### **A16.7010**

1. Set the line power switch to standby.
2. Reinstall one of the previously removed assemblies.
3. Set the line power switch to on.
4. Remeasure the voltage. If the voltage now fails, the assembly just installed is faulty. When the defective assembly is identified, go to the 9000 paragraph for that assembly for replacement instructions. For example, for A4, go to A4.9000; for A5, go to A5.9000, and so on.
5. Repeat this procedure until the problem has been isolated or until no more assemblies exist.

If no more assemblies exist, go to "Special Cases".

### A16.7020

1. Lift the RF deck up into the service position. Refer to the disassembly and replacement procedures in the *HP 8360 B-Series Swept Signal Generator/HP 8360 L-Series Swept CW Generator Service Guide* as required.
2. Set the line power switch to standby.
3. Remove all ribbon cables connecting the microcircuits to the RF interface board (A20).
4. Set the line power switch to on.
5. Measure the previously-failed voltage.

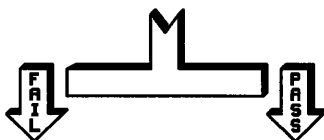

Go To A20.9000

Continue

### A16.7021

1. Lift the RF deck up into the service position. Refer to the disassembly and replacement procedures in the *HP 8360 B-Series Swept Signal Generator/HP 8360 L-Series Swept CW Generator Service Guide* as required.
2. Set the line power switch to standby.
3. Select a microcircuit, attenuator, or other assembly on the RF deck and reconnect the ribbon cable for that assembly.
4. Set the line power switch to on.
5. Remeasure the voltage. If the voltage now fails, this assembly is faulty.
6. Go to RF.xx90 where xx is the assembly number. For example, if the assembly is A29, then go to RF.2990.
7. Repeat this procedure until the problem has been isolated or until no more microcircuits exist.

If no more microcircuits exist, go to "Special Cases".



### **A16.7030**

1. Set the line power switch to standby.
2. Disconnect the instrument from AC line power.
3. Reconnect only W2 (the ribbon cable connecting the source module interface assembly, A2, to the motherboard, A22).
4. Reconnect the instrument to AC line power.
5. Set the line power switch to on.
6. Measure the previously-failed voltage.



Go To **A2.9000**

**Continue**

### **A16.7031**

1. Set the line power switch to standby.
2. Disconnect the instrument from AC line power.
3. Reconnect W3 (the ribbon cable connecting the front panel processor, A3, to the motherboard, A22).
4. Disconnect the ribbon cables connecting the front panel processor (A3) to the display (A21) and the keyboard (A1).
5. Reconnect the instrument to AC line power.
6. Set the line power switch to on.
7. Measure the previously-failed voltage.



Go To **A3.9000**

**Continue**

### **A16.7032**

1. Set the line power switch to standby.
2. Disconnect the instrument from AC line power.
3. Reconnect W1 and W4 (the cables connecting the front panel processor, A3, to the display, A21).
4. Reconnect the instrument to AC line power.
5. Set the line power switch to on.
6. Measure the previously-failed voltage.

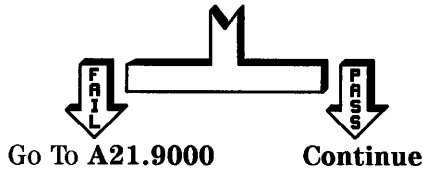

### **A16.7033**

1. Set the line power switch to standby.
2. Disconnect the instrument from AC line power.
3. Reconnect W5 (the ribbon cable connecting the front panel processor, A3, to the keyboard, A1).
4. Reconnect the instrument to AC line power.
5. Set the line power switch to on.
6. Measure the previously-failed voltage.

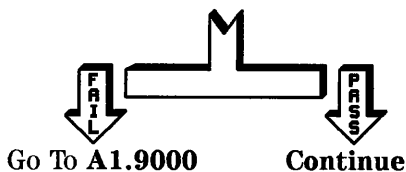

### **A16.7034**

The problem may be intermittent. Go to “Special Cases” if you need additional assistance.

**A16.9000** Replace the A16 assembly.

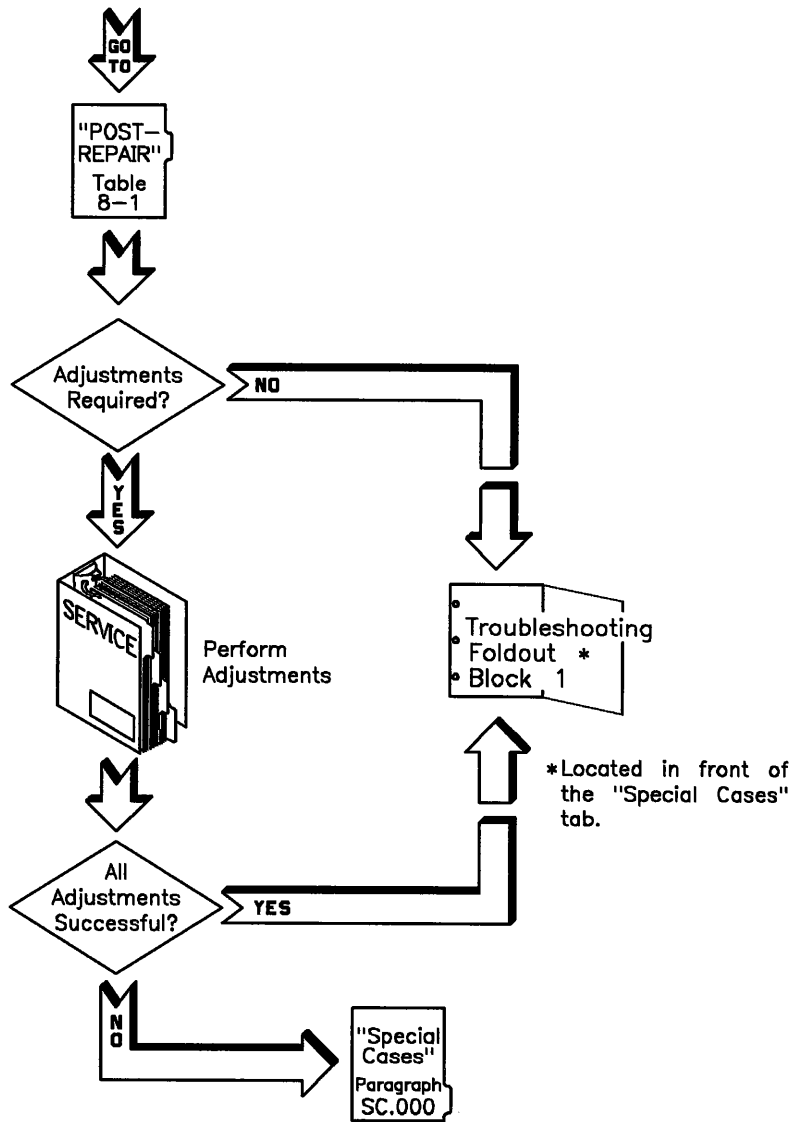

---

## **A17 Rectifier/Filter Replacement**

**A17.000** If you think the problem with your instrument may originate on the A17 assembly, go to “Instrument-Level Troubleshooting.”

**A17.9000** Replace the A17 assembly and go to the Troubleshooting Foldout, block 1 (located just prior to the “Special Cases” tab). A17 and A18 are never completely isolated. If replacing A17 does not resolve your problem, try replacing A18.

---

## **A18 Preregulator Replacement**

**A18.000** If you think the problem with your instrument may originate on the A18 assembly, go to “Instrument-Level Troubleshooting.”

**A18.9000** Replace the A18 assembly and go to the Troubleshooting Foldout, block 1 (located just prior to the “Special Cases” tab). A17 and A18 are never completely isolated. If replacing A18 does not resolve your problem, try replacing A17.

---

## **A19 Rear Panel Interface Troubleshooting**

<b>A19.000</b>	<b>Message Displayed on Synthesizer</b>	<b>Go to Paragraph</b>
	A19 : Control Latch	A19.100
	A19 : SMI Control Latch	A19.200
	A19 : SMI Sensing Circuit	A19.300
	A19 : Switched STD Supply	A19.9000

**A19.100** The A22J8 connector is located at the back of the motherboard.

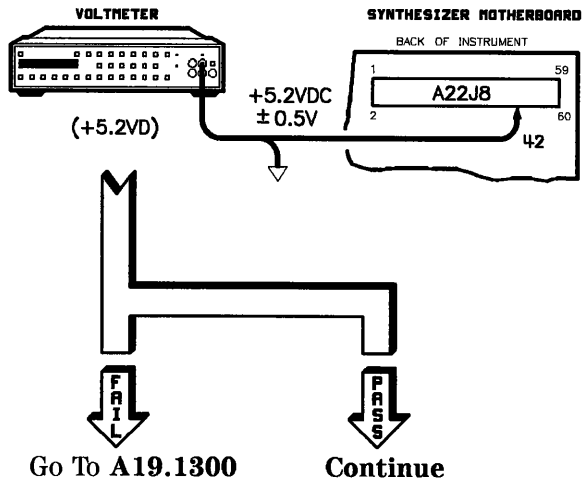

## A19.101

Loop self-test #232:

1. Press **PRESET** **SERVICE**.
2. Select **Selftest Menu**.
3. Press **232** **ENTER**.
4. Select **Loop Do Test #232**.

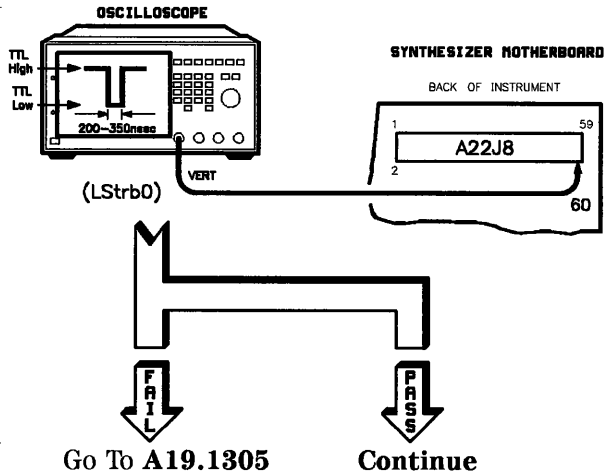



## A19.102

Loop self-test #233:

1. Press **PRESET** **SERVICE**.
2. Select **Selftest Menu**.
3. Press **233** **ENTER**.
4. Select **Loop Do Test #233**.

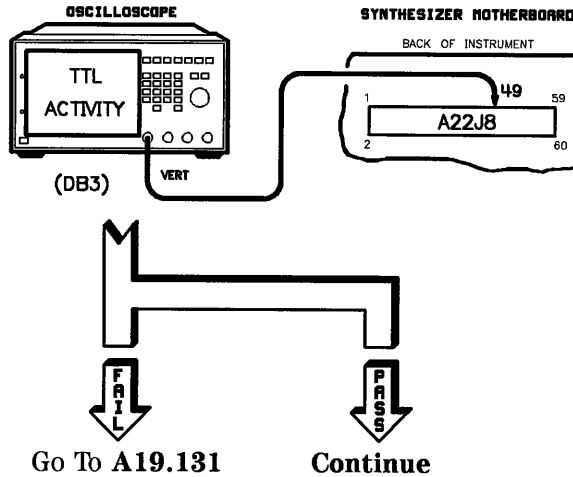

### A19.103

Loop self-test #231:

1. Press **PRESET** **SERVICE**.
2. Select **Selftest Menu**.
3. Press **231** **ENTER**.
4. Select **Loop Do Test #231**.

Signal	Location
AB0	A22J8-57
AB1	A22J8-58
AB4	A22J8-55
AB5	A22J8-56
AB6	A22J8-54

If *one or more* signals do *not* have *TTL pulses*, the test has *failed*. If *all* signals have *TTL pulses*, the test has passed.

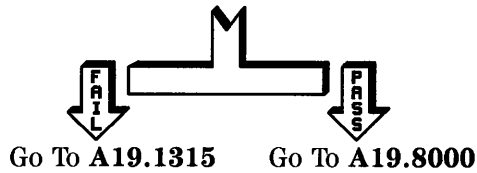

**A19.200** Loop self-test #233:

1. Press **PRESET** **SERVICE**.
2. Select **Selftest Menu**.
3. Press **233** **ENTER**.
4. Select **Loop Do Test #233**.

Signal	Location
DB0	A22J8-52
DB1	A22J8-51
DB2	A22J8-50
DB3	A22J8-49
DB4	A22J8-48
DB5	A22J8-47
DB6	A22J8-46
DB7	A22J8-45

If one or more signals do *not* have *TTL pulses*, the test has failed. If *all* signals have *TTL pulses*, the test has passed.

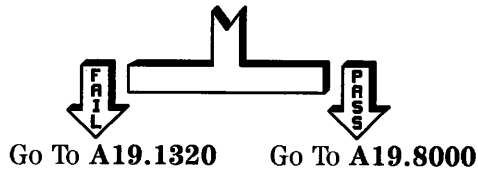

## A19.300

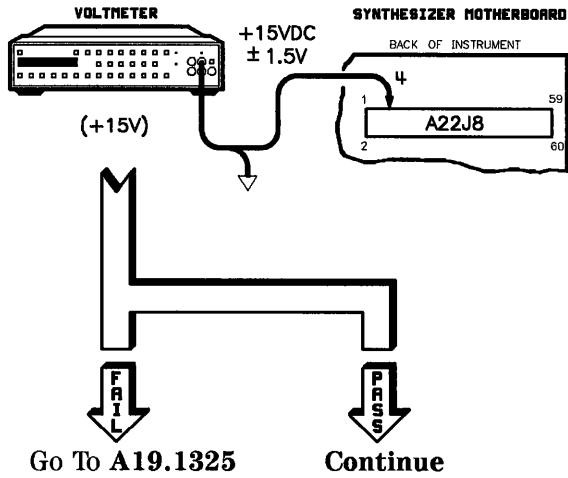

## A19.301

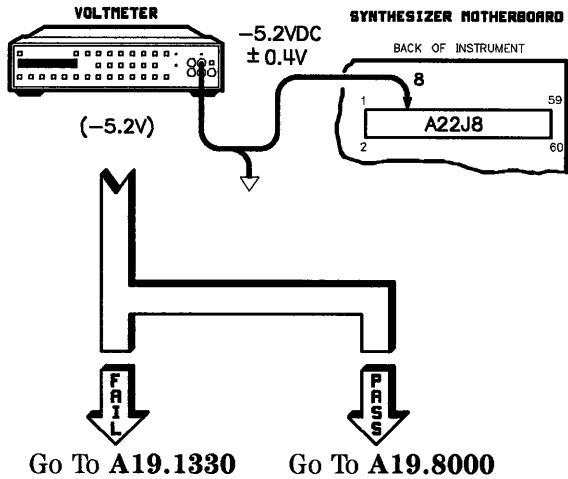

## A19.1300

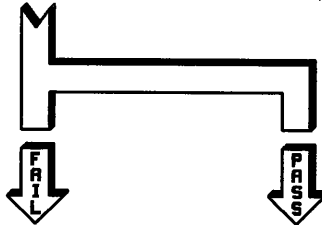
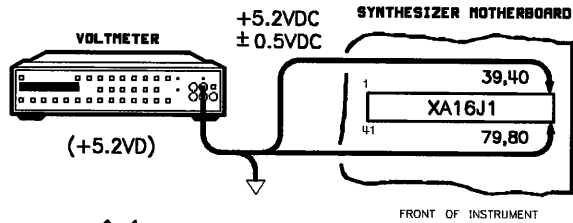

Go To **A16.9000**

**Continue**

## A19.1301

There is an open on the motherboard between A22J8-42 and A16J-39, 40, 79, or 80. Verify this with an ohmmeter. Is jumpering an acceptable repair?



Go To **A22.9000**

**Continue**

## A19.1302

Install a jumper and go to the Troubleshooting Foldout, block 1 (located just prior to the "Special Cases" tab).

### A19.1305

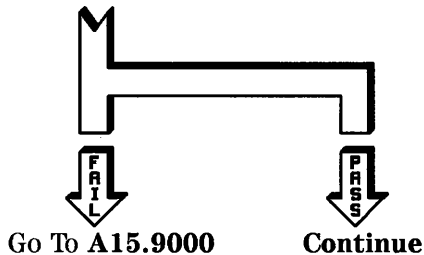
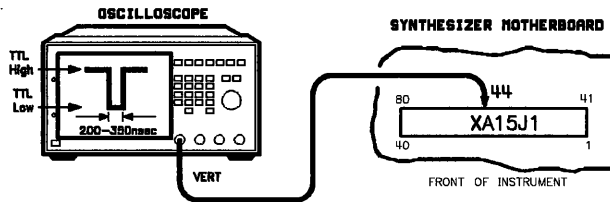

Go To A15.9000

Continue

### A19.1306

There is an open on the motherboard between A22J8-60 and XA15J1-44. Verify this with an ohmmeter. Is jumpering an acceptable repair?

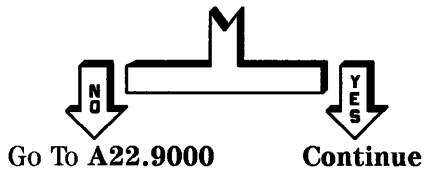

Go To A22.9000

Continue

### A19.1307

Install a jumper and go to the Troubleshooting Foldout, block 1 (located just prior to the "Special Cases" tab).

### A19.1310

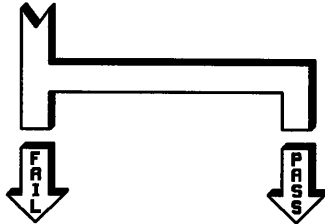
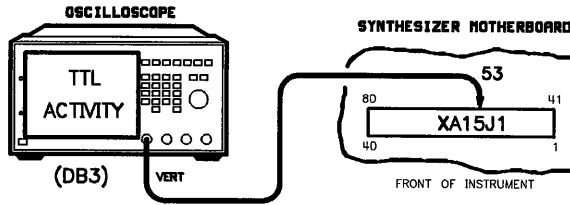

Go To A15.9000

Continue

### A19.1311

There is an open on the motherboard between A22J8-49 and XA15J1-53. Verify this with an ohmmeter. Is jumpering an acceptable repair?



Go To A22.9000

Continue

### A19.1312

Install a jumper and go to the Troubleshooting Foldout, block 1 (located just prior to the "Special Cases" tab).

### A19.1315

Check the following locations for TTL activity.

Signal	Location
AB0	XA15J1-7
AB1	XA15J1-47
AB4	XA15J1-9
AB5	XA15J1-49
AB6	XA15J1-10

If one or more signals do *not* have *TTL pulses*, the test has failed. If *all* signals have *TTL pulses*, the test has passed.

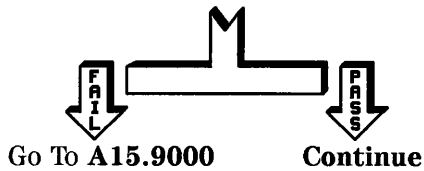

### A19.1316

There is an open on the motherboard between XA15J1 and A22J8. Verify this with an ohmmeter. Is jumpering an acceptable repair?

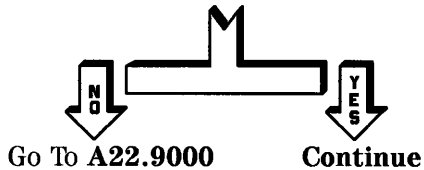



### **A19.1317**

Select the failing signals and install jumpers as required.

<b>Signal</b>	<b>A19 Location</b>	<b>A15 Location</b>
AB0	A22J8-57	XA15J1-7
AB1	A22J8-58	XA15J1-47
AB4	A22J8-55	XA15J1-9
AB5	A22J8-56	XA15J1-49
AB6	A22J8-54	XA15J1-10

After you repair the opens, go to the Troubleshooting Foldout, block 1 (located just prior to the "Special Cases" tab).

### A19.1320

Check *all* signals listed below for *TTL pulses* at XA15J1.

Signal	Location
DB0	XA15J1-12
DB1	XA15J1-52
DB2	XA15J1-13
DB3	XA15J1-53
DB4	XA15J1-14
DB5	XA15J1-54
DB6	XA15J1-15
DB7	XA15J1-55

If one or more signals do *not* have *TTL pulses*, the test has failed. If *all* signals have *TTL pulses*, the test has passed.

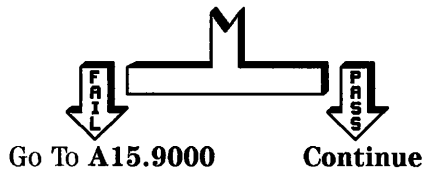

### A19.1321

There is an open on the motherboard data bus between A22J8 and XA15J1. Verify this with an ohmmeter. Is jumpering an acceptable repair?

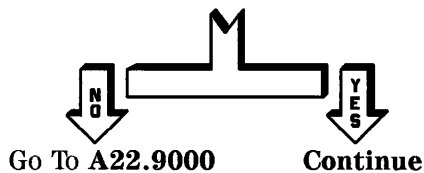

### A19.1322

Select the failing signals and install jumpers as required.

Signal	A19 Location	A15 Location
DB0	A22J8-52	XA15J1-12
DB1	A22J8-51	XA15J1-52
DB2	A22J8-50	XA15J1-13
DB3	A22J8-49	XA15J1-53
DB4	A22J8-48	XA15J1-14
DB5	A22J8-47	XA15J1-54
DB6	A22J8-46	XA15J1-15
DB7	A22J8-45	XA15J1-55

After you repair the opens, go to the Troubleshooting Foldout, block 1 (located just prior to the "Special Cases" tab).

### A19.1325

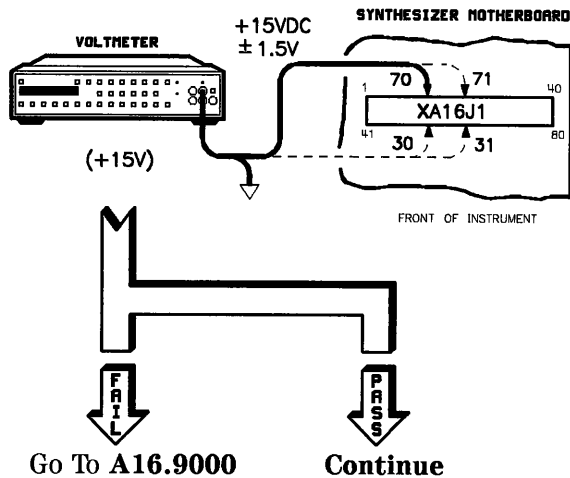

### A19.1326

There is an open on the motherboard between A22J8-4 and A16J1-30, 31, 70, or 71. Verify this with an ohmmeter. Is jumpering an acceptable repair?

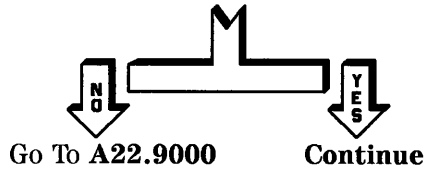

### A19.1327

Install a jumper and go to the Troubleshooting Foldout, block 1 (located just prior to the "Special Cases" tab).

### A19.1330

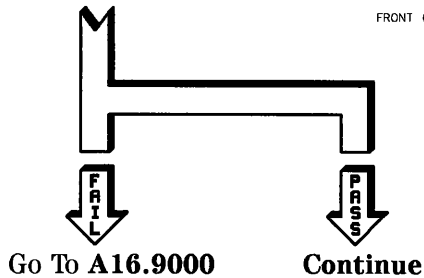
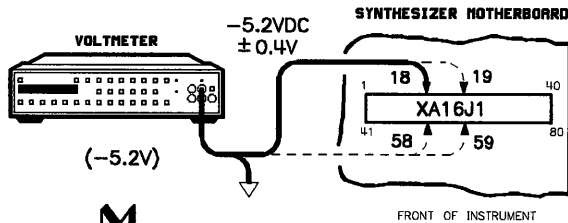

### **A19.1331**

There is an open on the motherboard between A22J8-8 and A16J1-18, 19, 58, or 59. Verify this with an ohmmeter. Is jumpering an acceptable repair?



Go To **A22.9000**

**Continue**

### **A19.1332**

Install a jumper and go to the Troubleshooting Foldout, block 1 (located just prior to the “Special Cases” tab).

**A19.8000** Perform the following:

1. Turn the synthesizer off.
2. Unplug the line power cord.
3. Remove the 8 screws that hold the rear panel.
4. Lower the rear panel (there is no need to disconnect it completely).
5. Completely remove W31 (W31 connects A19 to the motherboard).
6. Using an ohmmeter, check W31.

Is W31 Faulty?



Go To **A19.9000**

**Continue**

**A19.8100**

Replace W31. You may also want to replace A19. Then go to the Troubleshooting Foldout, block 1 (located just prior to the "Special Cases" tab).

**A19.9000**    Replace the A19 assembly.

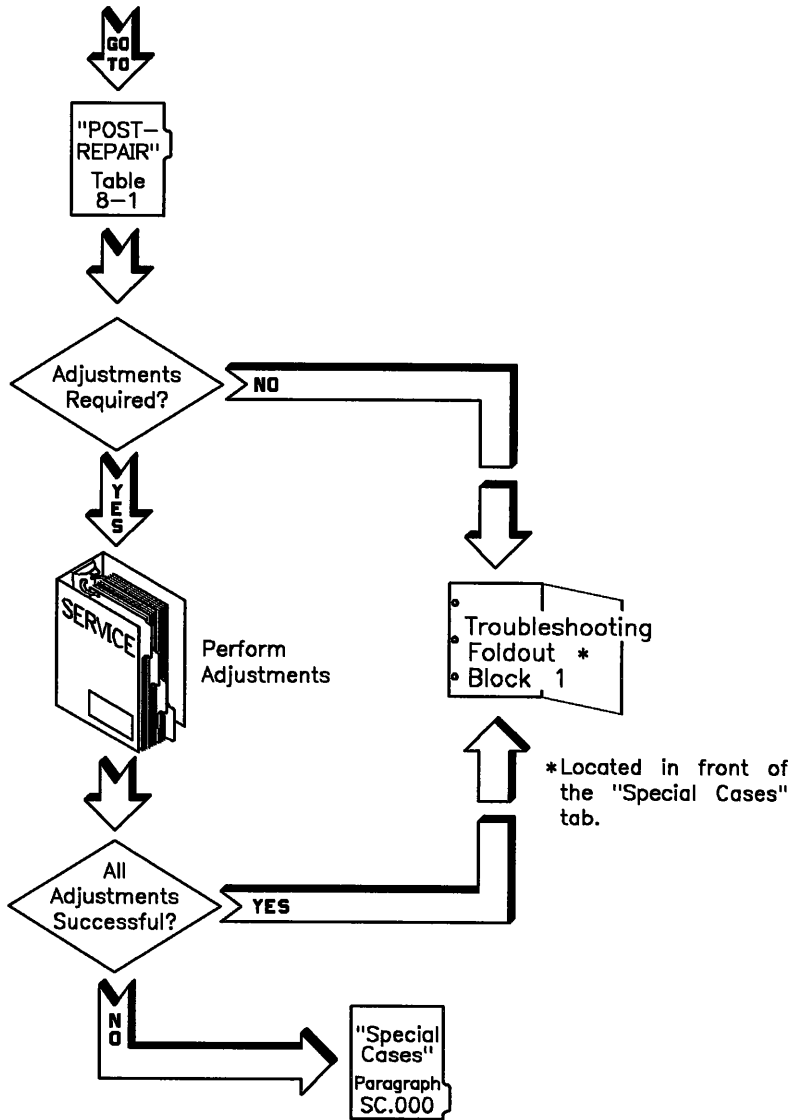

---

## **A20 RF Interface Troubleshooting**

**A20.000**    **Message Displayed on Synthesizer**

**Go to  
Paragraph**

A20 : RF Interface +8V

A20.100



**A20.100** Perform the following voltage checks. If any measurement fails, the test has failed. If *all* measurements pass, the test has passed.

Name	Limits	Location
+15VDC	+14.7 to +15.5	XA20J1-24, 25, 59, 60
-15VDC	-14.5 to -15.6	XA20J1-26, 61
-40VDC	-39.4 to -40.6	XA20J1-27, 62
+5VA	+5.0 to +5.3	XA20J1-31, 32, 66, 67
+5VD	+5.0 to +5.3	XA20J1-13, 48
+5VAUp	TTL High	XA20J1-68
+8VDC	+7.75 to +8.25	XA20J1-14, 15, 49, 50

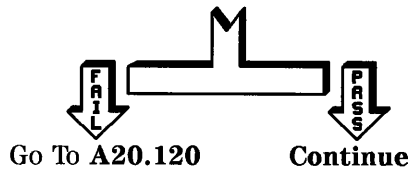

## A20.101

Perform the following setup:

1. Press **PRESET** **SERVICE**.
2. Select **Selftest Menu**.
3. Press **231** **ENTER**.
4. Select **Loop** (asterisk on).
5. Select **Do Test #231**.
6. Check for TTL activity at the points listed in the following table.
7. If any measurement fails, the test has failed. If *all* measurements pass, the test has passed.
8. To exit the test, select **Loop** (asterisk off).

Signal	Location
AB2	XA20J1-44
AB3	XA20J1-8
AB4	XA20J1-43
AB5	XA20J1-7
AB6	XA20J1-42

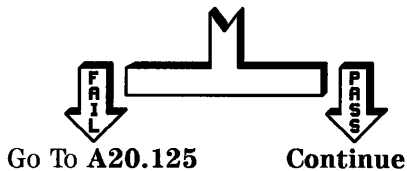

## A20.102

Perform the following:

1. Press **PRESET** **SERVICE**.
2. Select **Selftest Menu**.
3. Press **233** **ENTER**.
4. Select **Loop** (asterisk on).
5. Select **Do Test #233**.
6. Check for TTL activity at the points listed in the following table.
7. If any measurement fails, consider the test failed. If *all* measurements pass, consider the test passed.
8. To exit the test, select **Loop** (asterisk off).

Signal	Location
DB0	XA20J1-5
DB1	XA20J1-39
DB2	XA20J1-4
DB3	XA20J1-38
DB4	XA20J1-3
DB5	XA20J1-37

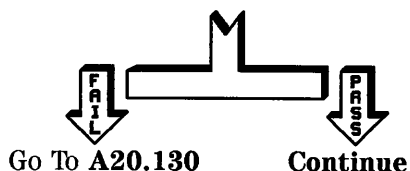

### A20.103

Perform the following setup:

1. Press **PRESET** **SERVICE**.
2. Select **Selftest Menu**.
3. Press **232** **ENTER**.
4. Select **Loop** (asterisk on)
5. Select **Do Test #232**.
6. After making the following measurement, to exit the test, select **Loop** (asterisk off).

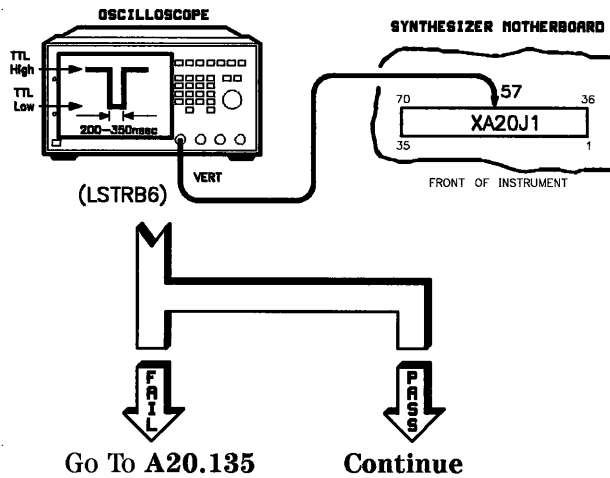

## A20.104

Perform the following setup:

1. Press **PRESET** **SERVICE**.
2. Select **Selftest Menu**.
3. Press **255** **ENTER**.
4. Select **Log** (asterisk on).
5. Select **Output Menu** **When to Log Always** (asterisk on).
6. Press **PRIOR**.
7. Select **Do Test #255**.
8. After making the following measurement, to exit the test, select **Loop** (asterisk off).

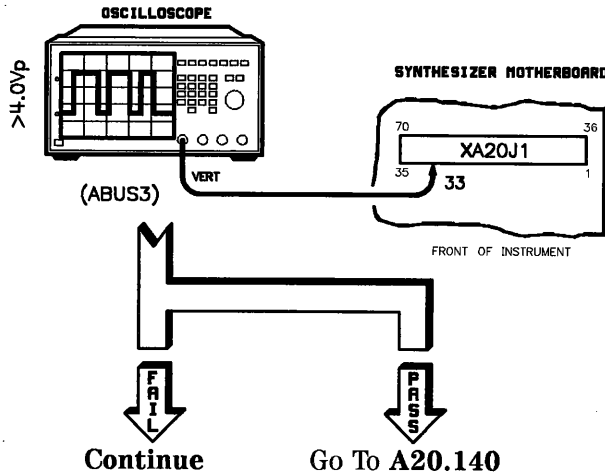

## **A20.105**

Following the disassembly and replacement procedures in the *HP 8360 B-Series Swept Signal Generator/HP 8360 L-Series Swept CW Generator Service Guide*, lift the RF deck up into the service position. Check the ribbon cable that connects the YO (A26) to the RF interface board (A20). If it is loose, then reseal the cable. Correct any other obvious faults.

Perform the following test:

1. Press **PRESET** **SERVICE**.
2. Select **Selftest Menu**.
3. Press **266** **ENTER**.
4. Select **Do Test #266**.

If the test fails, go to RF.2690. Otherwise, go to the Troubleshooting Foldout, block 1, (located just prior to the "Special Cases" tab).

## A20.120

There is an open on the motherboard between the RF interface board (A20) and the post-regulator (A16). Consult the following table to determine the exact location of the open. Verify this with an ohmmeter.

Name	A16 Post Regulator	A20 RF Interface Board
+15VDC	XA16J1-30, 31, 70, 71	XA20J1-24, 25, 59, 60
-15VDC	XA16J1-25, 26, 65, 66	XA20J1-26, 61
-40VDC	XA16J1-22, 62	XA20J1-27, 62
+5VA	XA16J1-13, 14, 53, 54	XA20J1-31, 32, 66, 67
+5VD	XA16J1-39, 40, 79, 80	XA20J1-13, 48
+5VAUp	XA16J1-76	XA20J1-68
+8VDC	XA16J1-6, 7, 8, 46, 47, 48	XA20J1-14, 15, 49, 50

Is jumpering the open an acceptable repair?



Go To **A22.9000**

**Continue**

## A20.121

Install a jumper. Then go to the Troubleshooting Foldout, block 1, (located just prior to the "Special Cases" tab).

## A20.125

There is an open on the motherboard between the RF interface board (A20) and the processor (A15). Consult the following table to determine the exact location of the open. Verify this with an ohmmeter.

Name	A15 Processor	A20 RF Interface Board
AB2	XA15J1-8	XA20J1-44
AB3	XA15J1-48	XA20J1-8
AB4	XA15J1-9	XA20J1-43
AB5	XA15J1-49	XA20J1-7
AB6	XA15J1-10	XA20J1-42

Is jumpering the open an acceptable repair?

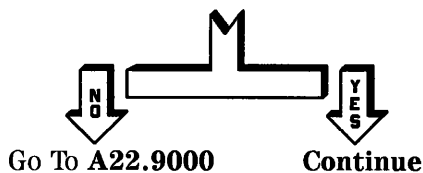

## A20.126

Install a jumper. Then go to the Troubleshooting Foldout, block 1, (located just prior to the “Special Cases” tab).



### A20.130

There is an open on the motherboard between the RF interface board (A20) and the processor (A15). Consult the following table to determine the exact location of the open.

Name	A15 Processor	A20 RF Interface Board
DB0	XA15J1-12	XA20J1-5
DB1	XA15J1-52	XA20J1-39
DB2	XA15J1-13	XA20J1-4
DB3	XA15J1-53	XA20J1-38
DB4	XA15J1-14	XA20J1-3
DB5	XA15J1-54	XA20J1-37

Is jumpering the open an acceptable repair?

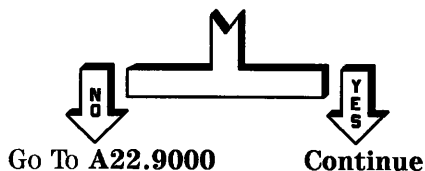

### A20.131

Install a jumper. Then go to the Troubleshooting Foldout, block 1, (located just prior to the “Special Cases” tab).

### A20.135

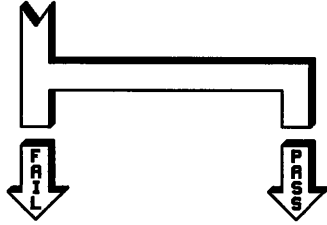
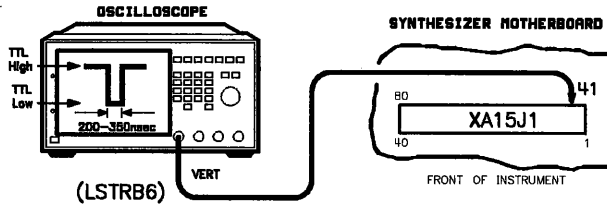

Continue

Go To A15.9000

### A20.136

There is an open on the motherboard between XA20J1-57 and XA15J1-41. Verify this with an ohmmeter. Is jumpering the open an acceptable repair?



Go To A22.9000

Continue

### A20.137

Install a jumper. Then go to the Troubleshooting Foldout, block 1, (located just prior to the "Special Cases" tab).

### A20.140

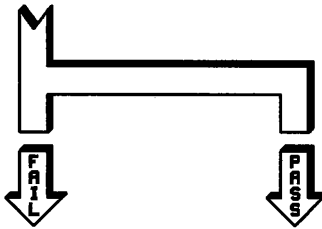
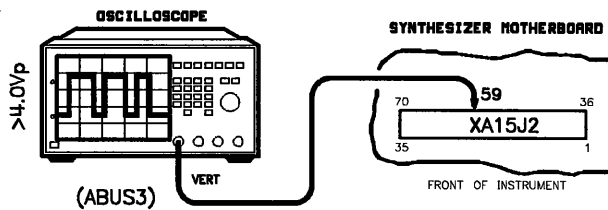

Continue

Go To A15.9000

### A20.141

There is an open on the motherboard between XA20J1-33 and XA15J2-59. Verify this with an ohmmeter. Is jumpering the open an acceptable repair?



Go To A22.9000

Continue

### A20.142

Install a jumper. Then go to the Troubleshooting Foldout, block 1, (located just prior to the "Special Cases" tab).

**A20.9000** Replace the A20 assembly.

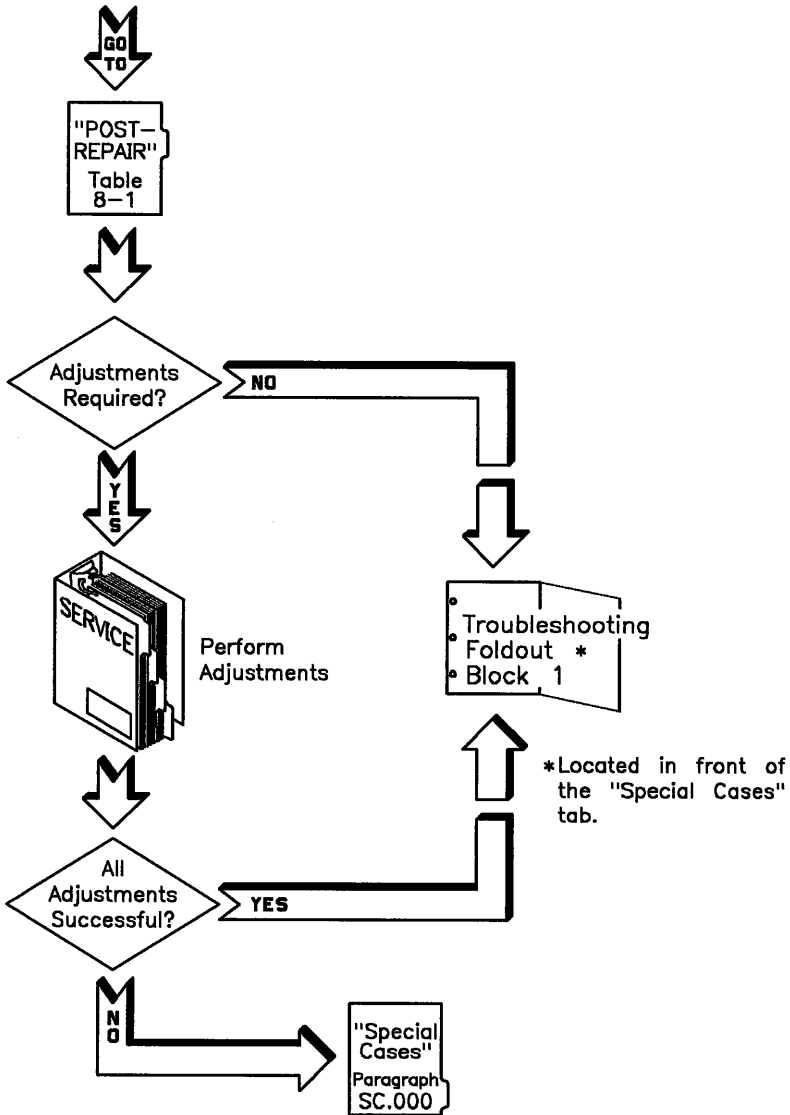

---

## A21 Display Troubleshooting

**A21.000** When the full self-tests are run (from the service menu) the display test is not run. Only the display to A3 interface is tested. To test the display, run the following test.

Perform the following key sequence:

1. Press **PRESET** **SERVICE**.
2. Select **Selftest Menu**.
3. Press **257** **ENTER**.
4. Select **Do Test #257**.

You will see a fast-moving cursor moving from side to side and line to line and a walking character set on each line. In this way you can check each segment and the display's logic in presenting the characters.

To exit the test, press **PRESET**.

### Note

---

If the message **POWER SUPPLY FAILURE** or **CHECK INSTRUMENT** appears on the display, this is a sign that the front panel processor (A3) was not able to communicate with the main processor (A15). In this case, the display is not at fault. Go to **ILT.000**.

---

**A21.9000** Replace the A21 assembly.

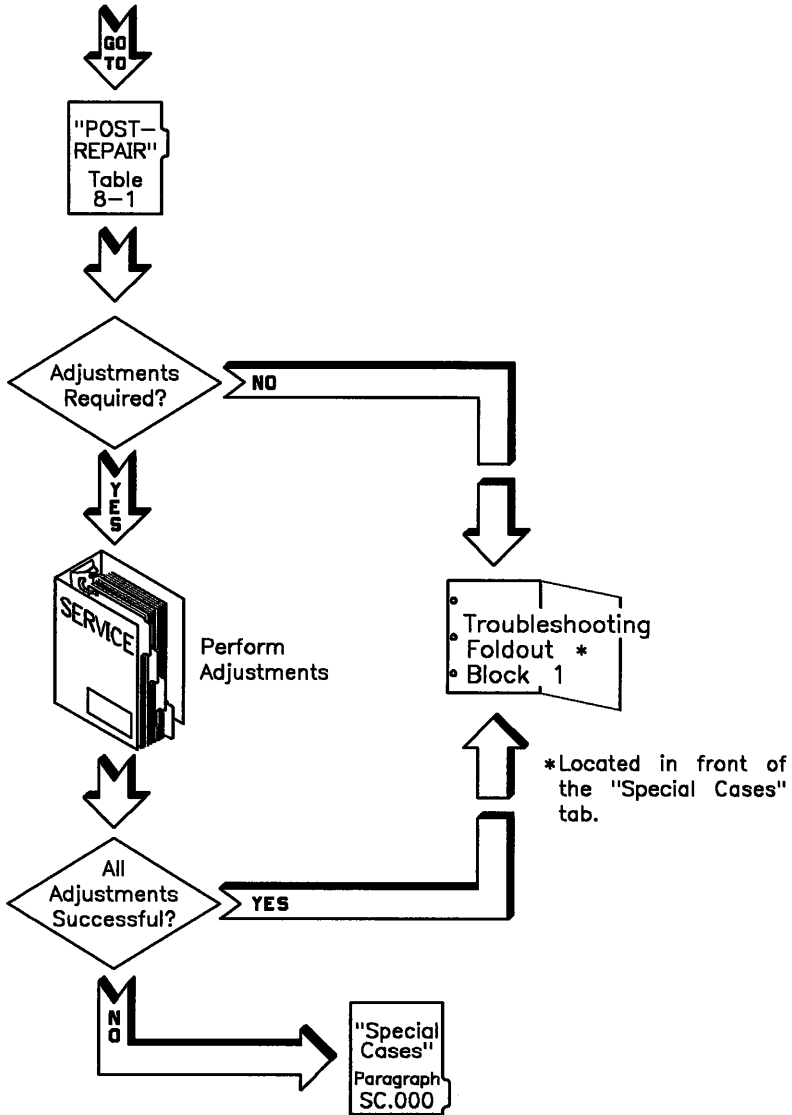

---

## A22 Motherboard Replacement

**A22.000** There are no motherboard-specific self-tests. If you think the problem with your instrument may originate on the A22 assembly, go to “Instrument-Level Troubleshooting.”

**A22.9000** If you suspect an open trace, verify it with an ohmmeter before replacing A22.

To replace the motherboard assembly, see “Disassembly and Replacement Procedures” in the *HP 8360 B-Series Swept Signal Generator/HP 8360 L-Series Swept CW Generator Service Guide*. Then go to the Troubleshooting Foldout, block 1 (located just prior to the “Special Cases” tab).

---

## **A23 10 MHz Reference Replacement**

**A23.000** The 10 MHz reference standard is shipped with a cable (W30). When replacing the reference standard, verify that this cable is correct. If necessary, remove this cable and solder cable W30 from your old reference standard in its place. The disassembly and replacement procedures show this cable.

Go to A23.9000 for A23 replacement.



**A23.9000** Replace the A23 assembly.

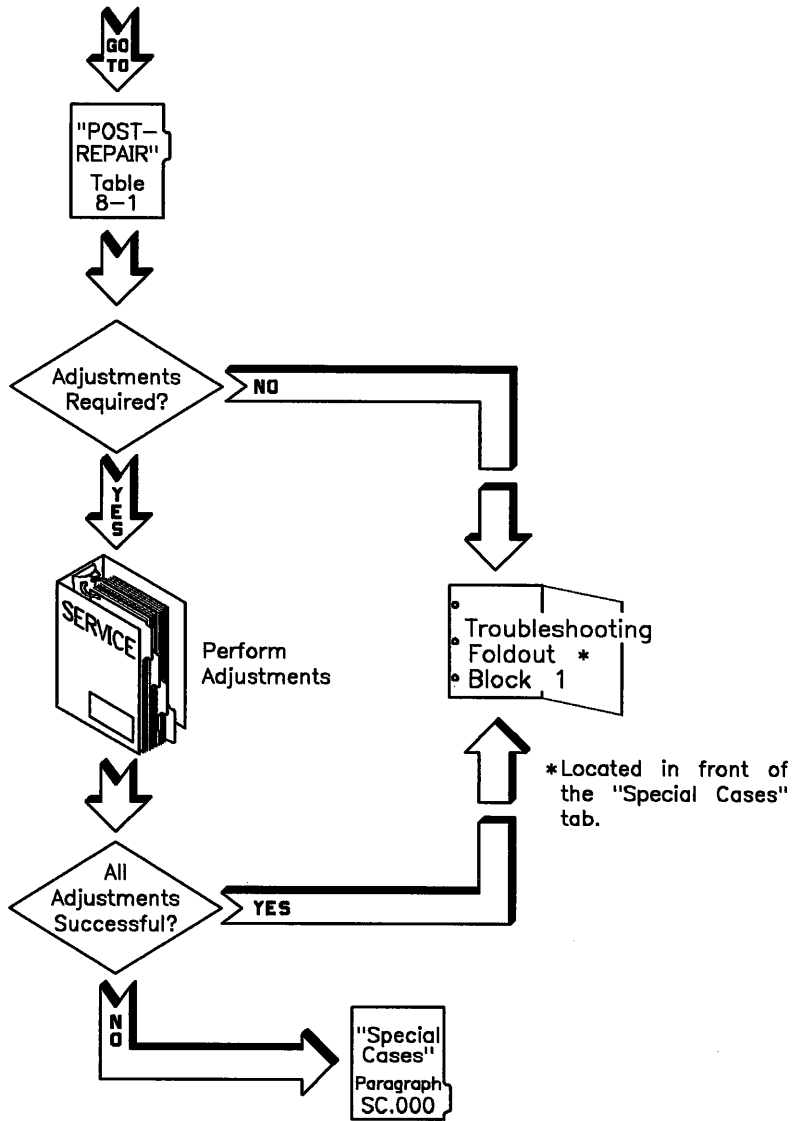

## RF and System Troubleshooting

---

This chapter contains the following two sections. The page number of each section is also listed.

RF Troubleshooting .....	1c-2
System Troubleshooting .....	1c-24

---

## **RF Troubleshooting**

---

### **RF.000**

#### **Message Displayed on Synthesizer**

#### **Go to Paragraph**

RF : YO Amplifier Bias	RF.100
RF : LOBAND Tuning Voltage	RF.200
RF : LOBAND Locked Check	RF.300
RF : Dual Modulator	RF.400
RF : Amp/Multiplier	RF.500
RF : Amp/Filter	RF.600
RF : Amplifier/Switch	RF.700
RF : LOBAND Output Level	RF.800
RF : Mod-Split Prelevel Det	RF.900
RF : Amplifier/Detector	RF.900
RF : Doubler	RF.900
RF : Option 006 Pulse	RF.900

---

## RF.100

Following the disassembly and replacement procedures in the *Service* manual, lift the RF deck into the service position. Check the ribbon cable that connects the YO (A26) to the RF interface board (A20). If it is loose, then reseat the cable. Correct any other obvious faults.

Perform the following test:

1. Press **PRESET** **SERVICE**.
2. Select **Selftest Menu**.
3. Press **266** **ENTER**.
4. Select **Do Test #266**.

If the test fails, go to RF.2690. Otherwise, go to the Troubleshooting Foldout, block 1 (located just prior to the “Special Cases” tab).

## RF.200

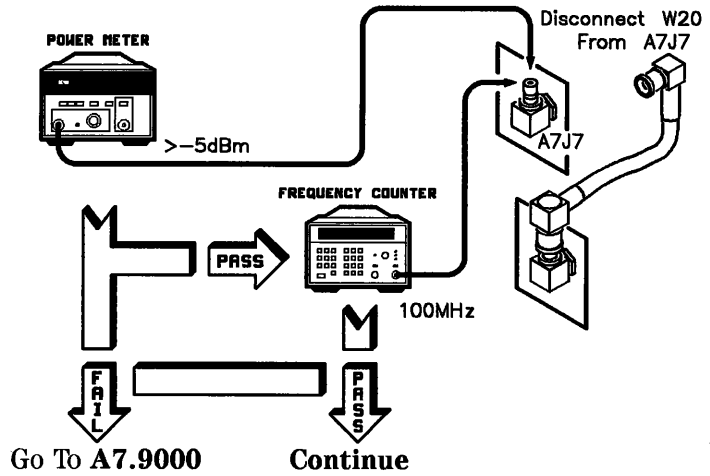

## RF.201

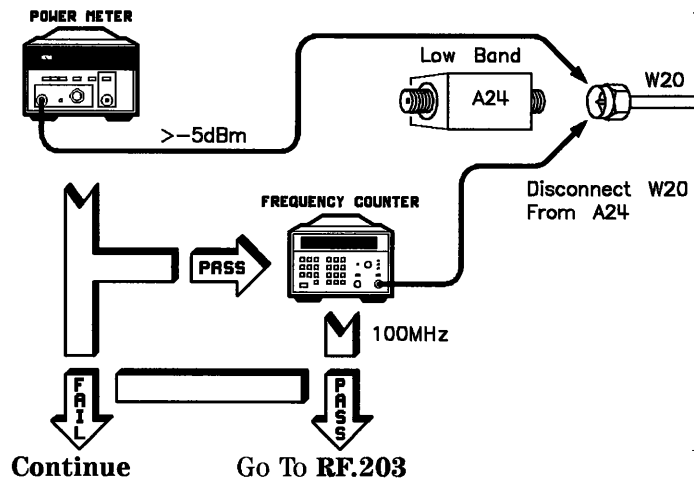

**RF.202** Replace W20 and go to the Troubleshooting Foldout, block 1 (located just prior to the “Special Cases” tab).

**RF.203** Using the disassembly and replacement procedures in the *Service* manual, lift the RF deck into the service position. Check the ribbon cable that connects the low band assembly (A24) to the RF interface board (A20). If it is loose, reseal the cable. Correct any other obvious physical faults. Reassemble the RF deck into the instrument.

Perform the following test:

1. Press **PRESET** **SERVICE**.
2. Select **Selftest Menu**.
3. Press **268** **ENTER**.
4. Select **Do Test #268**.



Go To **RF.2490**

**Continue**

**RF.204** The failure appears to be corrected. Go to the Troubleshooting Foldout, block 1 (located just prior to the “Special Cases” tab).

## RF.300

Perform the following test:

1. Press **PRESET** **SERVICE**.
2. Select **Selftest Menu**.
3. Press **269** **ENTER**.
4. Select **Loop** (asterisk on).
5. Select **Do Test #269**.
6. After making the following measurement, to exit the test, select **Loop** (asterisk off).

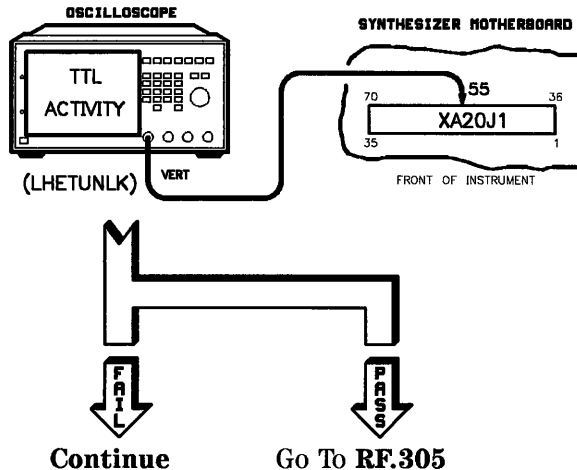

## RF.301

A20 is the most-likely failure. However, some chance exists that the low band microcircuit was unable to drive the out-of-lock circuitry to its limits. Replace A20 (go to A20.9000) then retest. If you get the same failure again, replace the low band microcircuit (go to RF.2490).

### RF.305

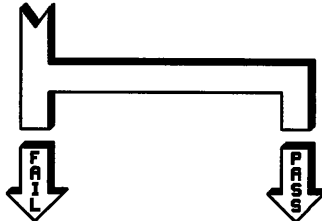
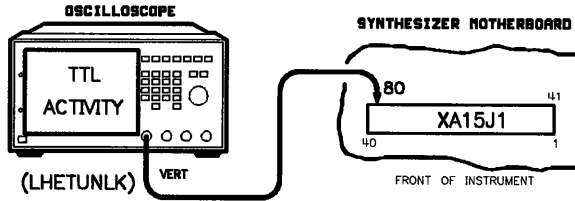

Continue

Go To A15.9000

### RF.306

There is an open on the motherboard between XA20J1-55 and XA15J1-80. Verify this with an ohmmeter. Is jumpering the open an acceptable repair?



Go To A22.9000

Continue

### RF.307

Install a jumper. Then go to the Troubleshooting Foldout, block 1 (located just prior to the "Special Cases" tab).



---

## RF.400

Using the disassembly and replacement procedures, lift the RF deck into the service position.

For instruments *with* Option 006 installed:

- Check the ribbon cable that connects the AM modulator (A38) to the RF interface board (A20).
- Check the flexible coaxial cable that connects the AM modulator to the motherboard (A22).

If any cables are loose, reseal them. Correct any obvious faults.

If all cable connections are good, replace the A38 AM modulator (RF.3890).

For instruments *without* Option 006 installed:

- Check the ribbon cable that connects the dual modulator (A38) to the RF interface board (A20).
- Check the flexible coaxial cables that connect the dual modulator to the ALC (A10) and to the motherboard (A22).

If any cables are loose, reseal them. Correct any obvious faults.

Perform the following test and log the results to the display:

1. Press **PRESET** **SERVICE**.
2. Select **Selftest Menu**.
3. Press **277** **ENTER**.
4. Select **Output Menu** **When to Log Always** (asterisk on).
5. Press **PRIOR**, then select **Log** (asterisk on).
6. Select **Do Test #277**.
7. Note the result of each measurement in the test. Select **Cont** to go on to the next measurement until the test is complete

If all the measurements are within specifications, the test passes. Go to the Troubleshooting Foldout, block 1 (located just prior to the “Special Cases” tab).

If only the “Detector Output” test fails, go to RF.401. If any other measurement fails, go to RF.3890.

### RF.401

1. Press **PRESET**.
2. Press **CW** **5** **GHz** **POWER LEVEL** **25** **dBm**.

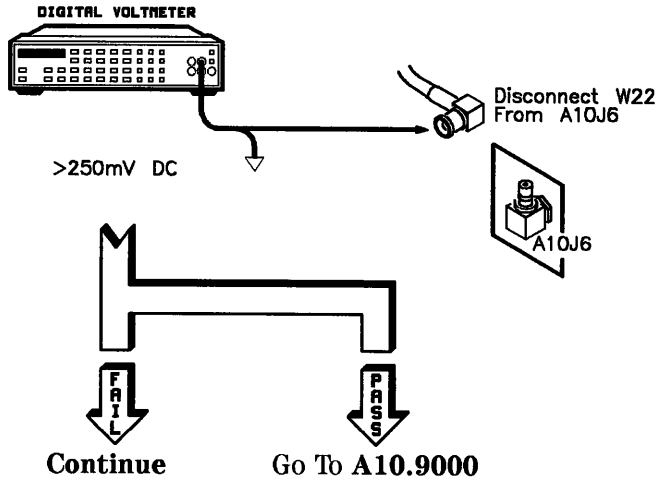

## RF.402

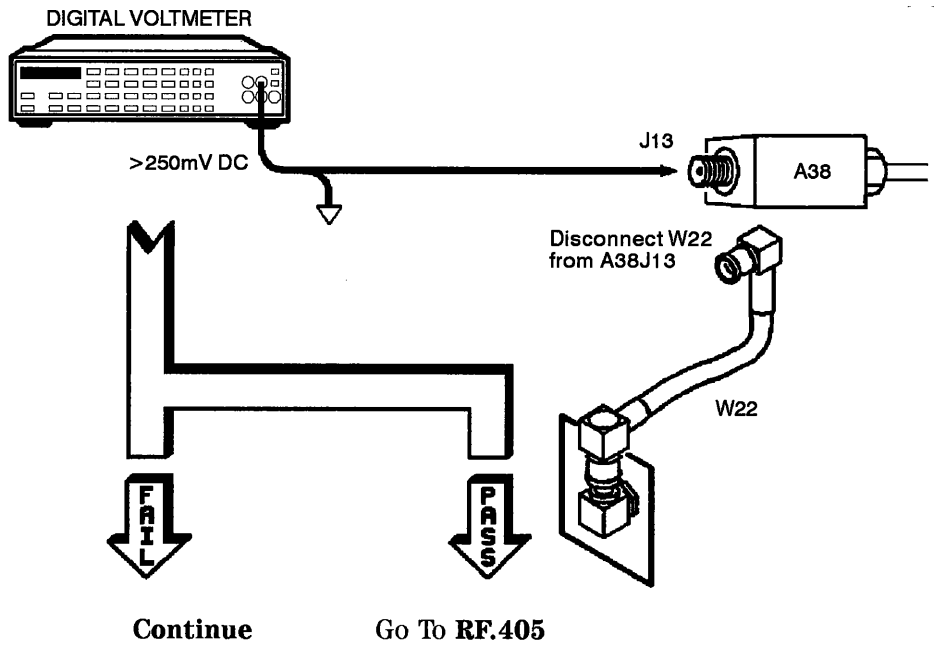

**RF.403** Set up for power measurement:

1. Set the line power switch to standby.
2. Remove W56 (the cable that connects the amp/multiplier, A28, to the dual modulator, A38).
3. Set the line power switch to on.
4. Press **PRESET** **CW** **5** **GHz**.

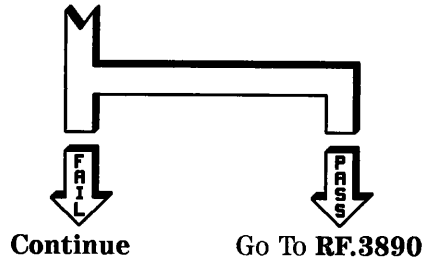
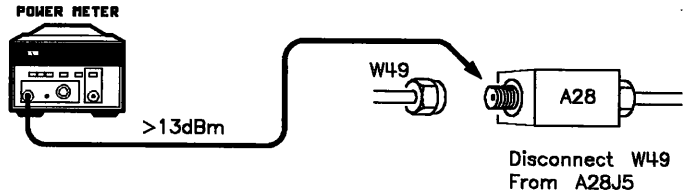

**RF.404** Set up for power measurement:

1. Set the line power switch to standby.
2. Remove W49 (the cable that connects the diode switch, A41, to the amp/multiplier, A28).
3. Set the line power switch to on.
4. Press **PRESET** **CW** **5** **GHz**.
5. Make sure power is  $> 6$  dBm.

Set up for frequency measurement:

1. Press **5** **GHz**.
2. The measured frequency should be 5 GHz plus and minus the frequency counter accuracy.

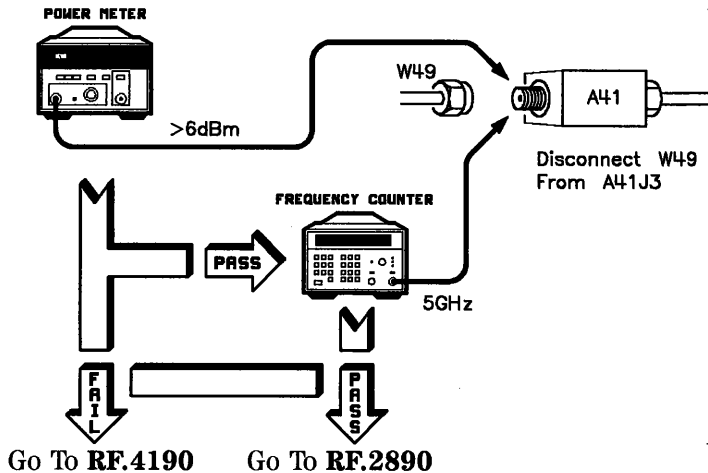

**RF.405** Replace W22 (the cable that connects the dual modulator detector output to the A10 assembly) and go to the Troubleshooting Foldout, block 1 (located just prior to the “Special Cases” tab).

---

## RF.500

Using the disassembly and replacement procedures, lift the RF deck into the service position. Check the ribbon cable that connects the amp/multiplier (A28) to the RF interface board (A20). If it is loose, reseal the cable. Correct any other obvious physical faults.

Perform the following test:

1. Press **PRESET** **SERVICE**.
2. Select **Selftest Menu**.
3. Press **275** **ENTER**.
4. Select **Do Test #275**.

If the test fails, go to RF.2890. Otherwise, go to the Troubleshooting Foldout, block 1 (located just prior to the "Special Cases" tab).

---

## RF.600

Using the disassembly and replacement procedures, lift the RF deck into the service position. Check the ribbon cable that connects the amp/filter (A29) to the RF interface board (A20). If it is loose, reseal the cable. Correct any other obvious physical faults.

Perform the following test:

1. Press **PRESET** **SERVICE**.
2. Select **Selftest Menu**.
3. Press **276** **ENTER**.
4. Select **Do Test #276**.

If the test fails, go to RF.2990. Otherwise, go to the Troubleshooting Foldout, block 1 (located just prior to the "Special Cases" tab).

---

## RF.700

Using the disassembly and replacement procedures, lift the RF deck into the service position. Check the ribbon cable that connects the amp/switch (A33) to the RF interface board (A20). If it is loose, reseal the cable. Correct any other obvious physical faults.

Perform the following test:

1. Press **PRESET** **SERVICE**.
2. Select **Selftest Menu**.
3. Press **271** **ENTER**.
4. Select **Do Test #271**.

If the test fails, go to RF.3390. Otherwise, go to the Troubleshooting Foldout, block 1 (located just prior to the "Special Cases" tab).



## RF.800

Using the disassembly and replacement procedures, lift the RF deck into the service position. Check the ribbon cable that connects the low band assembly, A24, to the RF interface board, A20. If it is loose, reseal the cable. Correct any other obvious physical faults.

1. Press **PRESET** **SERVICE**.
2. Select **Selftest Menu**.
3. Press **270** **ENTER**.
4. Select **Do Test #270**.

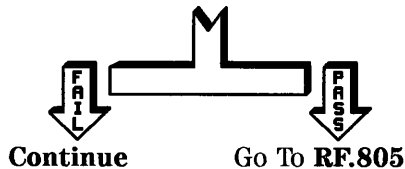

## RF.801 Do the following:

1. Set the line power switch to standby.
2. Disconnect W50 from A41.
3. Set the line power switch to on.
4. Press **PRESET** **SERVICE**.
5. Select **Tools Menu** **ViewHdwr Menu** **Y0 Freq/Harm**.
6. Press **CW** **10** **MHz**.

Use the RPG knob to vary the CW frequency over a range of 10 MHz to 1.99 GHz.

Measure the power and frequency over this range as shown in the following figure.

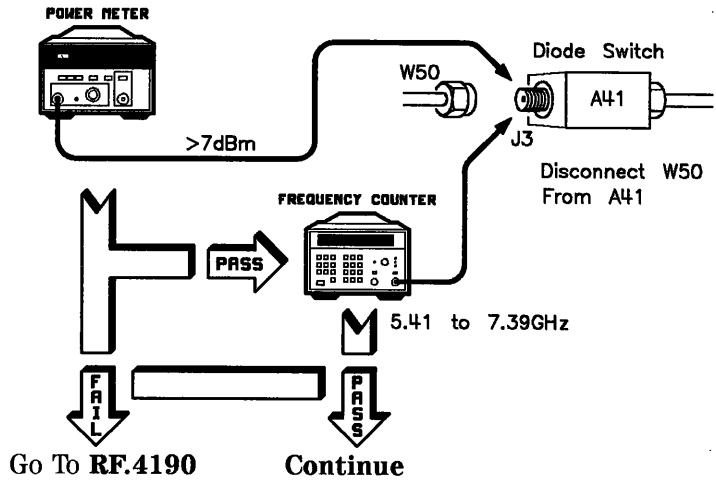

**RF.802** Press **PRESET** **CW**.

Measure the DC voltage at 100 MHz, 500 MHz, 1 GHz, and 2 GHz.

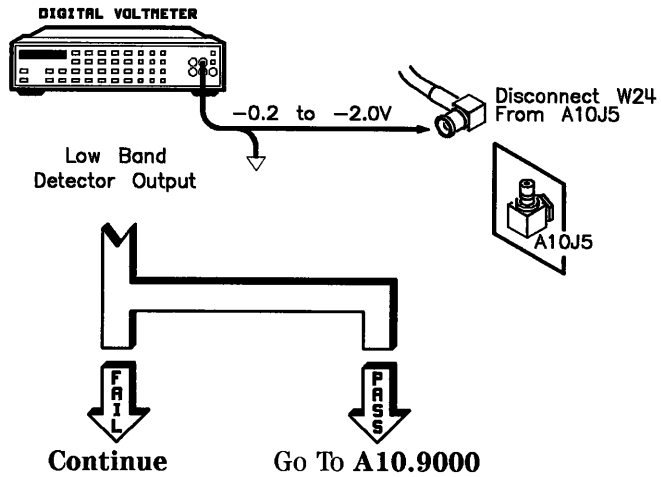

**RF.803** Measure the DC voltage at 100 MHz, 500 MHz, 1 GHz, and 2 GHz.

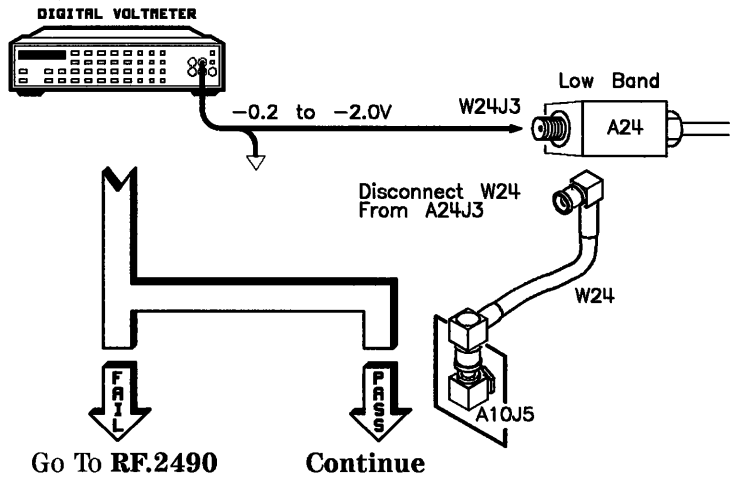

**RF.804** Replace W24 and go to the Troubleshooting Foldout, block 1 (located just prior to the “Special Cases” tab).

---

## **RF.900**

These self-tests apply to instruments of an earlier vintage than documented in this manual. Refer to the *Assembly-Level Repair* manual (HP part number 08360-90060) for troubleshooting.

---

## Microcircuit Assembly Replacement

**RF.2490** The low band assembly (A24) is the most-likely failure. There is a small chance that A20 has failed.

Has the low band assembly (A24) been replaced?

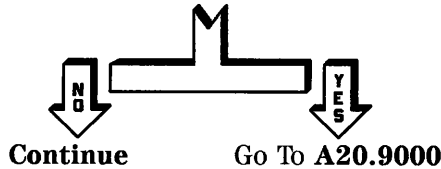

**RF.2491** Following the disassembly and replacement procedures in the *Service* manual, replace the low band assembly (A24). Then perform the appropriate adjustments and performance tests and restart troubleshooting.

**RF.2690** The YO (A26) is the most-likely failure. However, there is a small chance that the failure is A20.

Has the YO (A26) been replaced?

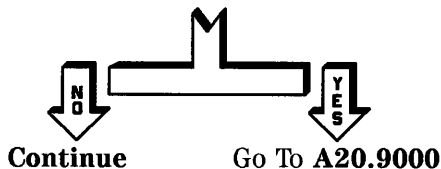

**RF.2691** Following the disassembly and replacement procedures in the *Service* manual, replace the YO (A26). Then perform the appropriate adjustments and performance tests and restart troubleshooting.

**RF.2890** The amp/multiplier (A28) is the most-likely failure. However, there is a small chance that the failure is A20. Has the amp/multiplier (A28) been replaced?

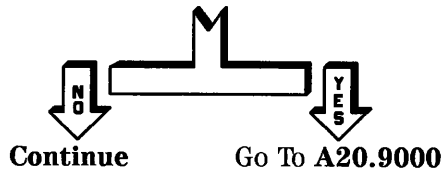

**RF.2891** Following the disassembly and replacement procedures in the *Service* manual, replace the amp/multiplier (A28). Then perform the appropriate adjustments and performance tests and restart troubleshooting.

**RF.2990** The amp/filter (A29) is the most-likely failure. However, there is a small chance that the failure is A20 (the RF interface assembly) or W57 (the cable that connects A29, the amp/filter, to A38, the dual modulator). Has the amp/filter (A29) been replaced?

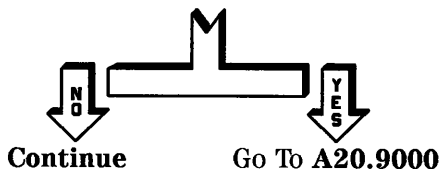

**RF.2991** Following the disassembly and replacement procedures in the *Service* manual, replace the amp/filter (A29). Then perform the appropriate adjustments and performance tests and restart troubleshooting.

**RF.3090** If you have an HP 83620B/22B/30B/40B/50B or an HP 83630L/40L/50L, the A30 bridge detector has failed. Replace it and perform the appropriate adjustments and performance tests. If you have an HP 83623B/24B and HP 83623L, the detector, (CR1, part of A30) has failed. Replace it and its bias board together. The directional

coupler rarely fails, however replace it at this time also *only* if it has failed.

- RF.3190** The most likely failure is the step attenuator, A31. However, it is possible that the RF interface assembly, A20, or the ribbon cable connecting A31 to A20, W40, has failed. Replace the step attenuator using the disassembly and replacement procedures in the *Service* manual. Perform the appropriate adjustments and restart troubleshooting.
- RF.3290** Replace the amp/doubler, A32, using the disassembly and replacement procedures in the *Service* manual. Perform the appropriate adjustments and restart troubleshooting.
- RF.3390** Replace the amp/switch, A33, using the disassembly and replacement procedures in the *Service* manual. Perform the appropriate adjustments and restart troubleshooting.
- RF.3890** Replace the dual modulator (or the AM modulator for instruments with Option 006), A38, using the disassembly and replacement procedures in the *Service* manual. Perform the appropriate adjustments and restart troubleshooting.
- RF.3990** Replace the directional coupler, A39, using the disassembly and replacement procedures in the *Service* manual. Perform the appropriate adjustments and restart troubleshooting.
- RF.4090** Replace the DC block, A40, using the disassembly and replacement procedures in the *Service* manual. Perform the appropriate adjustments and restart troubleshooting.

- RF.4190** Replace the diode switch, A41, using the disassembly and replacement procedures in the *Service* manual. Perform the appropriate adjustments and restart troubleshooting.
- RF.4290** Replace the pulse modulation switched filter, A42, using the disassembly and replacement procedures in the *Service* manual. Perform the appropriate adjustments and restart troubleshooting.



---

## System Troubleshooting

---

<b>SYS.000</b>	<b>Message Displayed on Synthesizer</b>	<b>Go to Paragraph</b>
	SYS : YO Loop Locking	SYS.100
	SYS : LBAND Modulators	SYS.200
	SYS : LBAND Leveling	SYS.300
	SYS : HBAND Modulators	SYS.400
	SYS : HBAND Leveling	SYS.500
	SYS : YTM Tracking	SYS.600
	SYS : YTM Biasing	SYS.700

---

## SYS.100

Perform the following setup:

1. Press **PRESET** SYSTEM **MENU**.
2. Select **Security Menu** **Clear Memory**.
3. Press **1** **ENTER**.
4. Press **SERVICE**.
5. Select **Selftest Menu**.
6. Press **282** **ENTER**.
7. Select **Do Test #282**.

If the test fails, go to SYS.101. Otherwise, go to the Troubleshooting Foldout, block 1 (located just prior to the “Special Cases” tab).

**SYS.101** Perform the following:

1. Set the line power switch to standby.
2. Disconnect W14 from A5J3.
3. Set the line power switch to on.
4. Press **PRESET** **START** **3** **GHz** **STOP** **7** **GHz**.
5. Press **SWEEP TIME** **15** **msec**. (Ignore the UNLOCK message).
6. Set the oscilloscope as follows:
  - Trigger on negative edge.
  - Sweep time 15 ms.
7. Compare the waveform on the oscilloscope to the one shown. Ignore the amplitude of the pulses. Look for A5 sweeping to lock.
8. Reconnect W14 to A5J3.

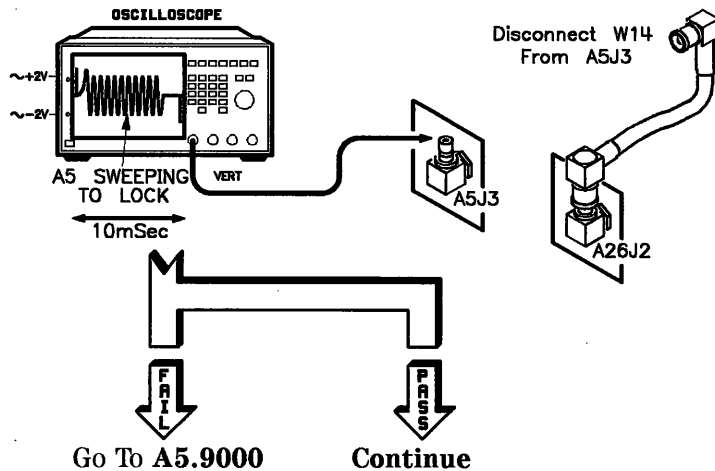

**SYS.102** Perform the following setup:

1. Set the line power switch to standby.
2. Disconnect W14 from the YO (A26J2). Ensure that the cable does not short out anything else.
3. Set the line power switch to on.
4. Press **PRESET** **START** **3** **GHz** **STOP** **7** **GHz**.
5. Press **SWEEP TIME** **15** **msec**. (Ignore the UNLOCK message.)
6. Set the oscilloscope as follows:
  - Trigger on negative edge.
  - Sweep time 10 ms.
7. Compare the waveform on the oscilloscope to the one shown. Ignore the amplitude of the pulses. Look for A5 sweeping to lock.
8. Reconnect W14 to A26J2.

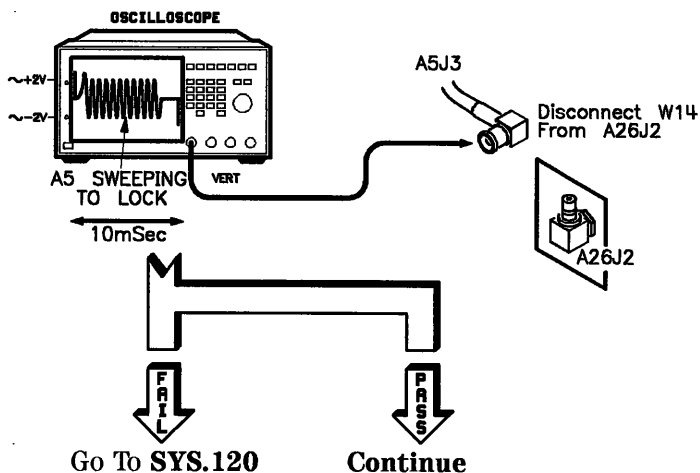

**SYS.104** Perform the following setup:

1. Press **PRESET** **SERVICE**.
2. Select **Selftest Menu**.
3. Press **282** **ENTER**.
4. Select **Log** (asterisk on).
5. Select **Output Menu** **When to Log Always** (asterisk on).
6. Press **PRIOR**.
7. Select **Do Test #282**.
8. Note the data points that fail and select **CONT** until the test is complete.

The “YO Driver Gain and Linearity” adjustment is the most-likely cause of failure of the previous test. Other YO-related adjustments can also be contributing to the failures.

If the adjustments don’t resolve the failure, or if you have good reason to suspect another assembly rather than the adjustments, use the following table. The table, used with the pass/fail data obtained from the previous test, indicates which assembly is the most-likely cause of failure. Each paragraph indicates several possible causes of failure in order of most probable cause listed first.

<b>Data Point Failures</b>	<b>Go To Paragraph</b>
2.303 GHz only	SYS.105
5.7499 GHz only	SYS.106
6.8009 GHz only	SYS.106
7.4 GHz only	SYS.107
Switching Test only	SYS.108
2.303 GHz and 6.8009 GHz only	SYS.109
All Other Combinations	SYS.110

- SYS.105**
1. YO adjustments.
  2. Sampler adjustments.
  3. Sampler (A6).
  4. YO (A26).
- SYS.106**
1. Sampler adjustments.
  2. Sampler (A6).
  3. YO (A26).
- SYS.107**
1. YO adjustments.
  2. RF path from the directional coupler (A39) to the sampler (A6). This path includes FL2, W51, and AT3.
  3. YO (A26).
  4. YO driver (A13).
- SYS.108**
1. YO phase detector (A5).
  2. YO driver (A13).
  3. YO (A26).
- SYS.109**
1. Sampler (A6).
  2. Sampler adjustments.
- SYS.110**
- Using the troubleshooting block diagram located at the end of “Special Cases”, examine the YO loop for the cause of failure:
1. RF path from the directional coupler (A39), FL2, W51, and AT3 to the sampler (A6).
  2. YO, sampler, and YO phase detector adjustments.
  3. Sampler or YO (A26).
  4. YO phase detector (A5) or YO driver (A13).
- SYS.120**
- Replace W14. Then go to the Troubleshooting Foldout, block 1 (located just prior to the “Special Cases” tab).

---

## **SYS.200**

1. Check W33 (A22J4 to A24J6) for poor connection or damage.
2. Reseat the pulse assembly (A9).
3. Replace the pulse assembly (A9) or the low band microcircuit (A24).

---

## **SYS.300**

1. Check all cabling and connections associated with the ALC (A10) and low band (A24) assemblies.
2. Perform the low band (A24) and ALC (A10) adjustments.



---

## **SYS.400**

1. Check W32 for poor connection or for damage. (W32 connects A22J3 to A38J3 or it connects A22J3 to A42J3 in instruments with Option 006.)
2. Reseat the pulse board (A9).
3. Replace either the pulse board (A9) or the dual modulator microcircuit (A38). In instruments with Option 006, replace either the pulse board (A9) or the pulse modulation switched filter (A42).

---

## **SYS.500**

1. Check all cabling and connections associated with A10 (the ALC assembly) and A38 (the dual modulator or, in instruments with Option 006, the AM modulator).
2. Perform the “Modulator Offset and Gain” and ALC adjustments.
3. Replace the dual modulator if it has not already been replaced. For instruments with Option 006, replace the AM modulator if it has not already been replaced.
4. Replace the RF interface (A20).
5. Replace the ALC assembly (A10).

## SYS.600

Perform the following setup:

1. Set the line power switch to on.
2. Press **CW** **4** **GHz** **ALC** **Leveling Mode** **ALCoff**.
3. Press **USER CAL** **Tracking Menu** **Peak RF** **Once**.
4. Press **POWER LEVEL** and adjust the synthesizer rotary knob for a +5 dBm RF output as measured by the power meter.

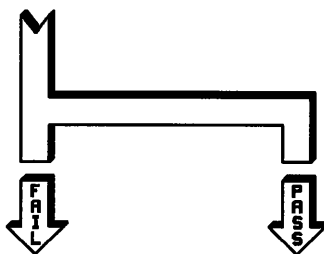

Continue

Go To **SYS.640**

## SYS.601

Instrument Description	Go To Paragraph
HP 83640B/L or HP 83650B/L (Frequency doubler)	SYS.602
HP 8360 B-Series Option 006 (Fast pulse, no frequency doubler)	SYS.610
HP 83623B or HP 83624B (High power not Option 006)	SYS.620
HP 83623L (High power)	RF.2990
HP 83620B or HP 83622B (Not Option 006)	SYS.690
HP 83630B/L (Not Option 006)	SYS.690

### SYS.602

Perform the following:

1. Connect the power meter to the doubler's output A32J4.
2. Press **CW** **4** **GHz** **ALC** **Leveling Mode** **ALCoff**.
3. Press **POWER LEVEL** and adjust the synthesizer rotary knob for a +5 dBm RF output as measured by the power meter.

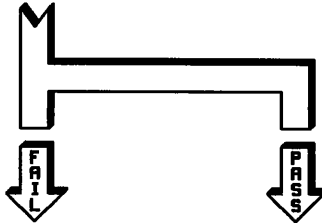
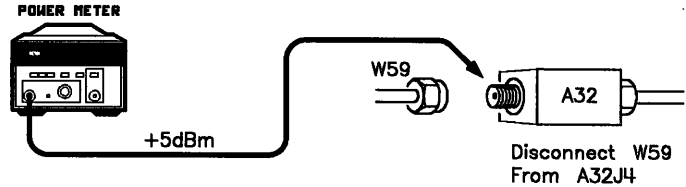

Continue

Go To **SYS.636**

### SYS.603

Is Option 006 installed?



Go To **SYS.690**

Continue

**SYS.610** Perform the following:

1. Connect the power meter to the output of the pulse modulation switched filter, A42J6.
2. Press **CW** **4** **GHz** **ALC** **Leveling Mode** **ALCoff**.
3. Press **POWER LEVEL** and adjust the synthesizer rotary knob for a +5 dBm RF output as measured by the power meter.

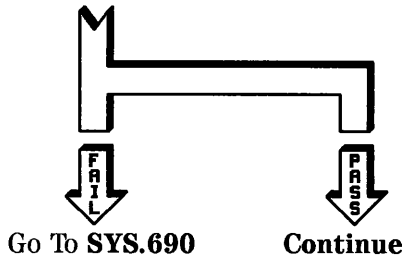
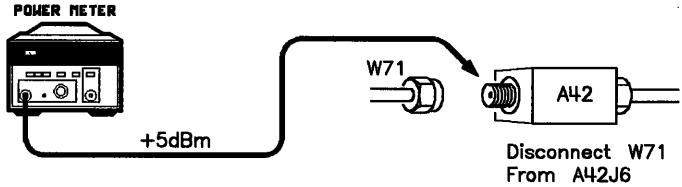

**SYS.611** Is the instrument an HP 83640B/L or HP 83650B/L?

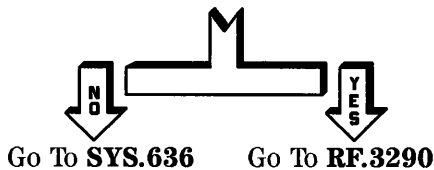

## SYS.620

Perform the following:

1. Connect the power meter to the amplifier's output A33J4.
2. Press **CW** **4** **GHz** **ALC** **Leveling Mode** **ALCoff**.
3. Press **POWER LEVEL** and adjust the synthesizer rotary knob for a +5 dBm RF output as measured by the power meter.

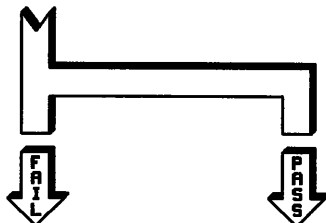
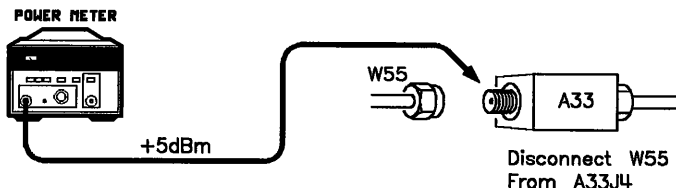

Go To **SYS.690**

Go To **SYS.635**

## SYS.635

The problem is either the input cable to the coupler (W45) or the coupler (A30). Visually inspect the cable and the coupler. Especially check for damaged connectors. Replace the damaged component (if in doubt, replace the cable first).

## SYS.636

The problem is either the input cable to the bridge detector (W45) or the bridge detector (A30). Visually inspect the cable and the bridge detector. Especially check for damaged connectors. Replace the damaged component (if in doubt, replace the cable first).

**SYS.640** Disconnect W25 from A10J7. Measure the detector voltage at the output of the cable and adjust the synthesizer power level for  $-50$  mV.

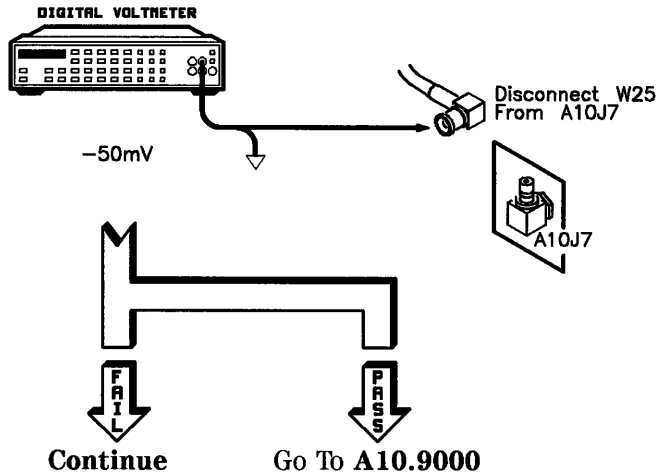

**SYS.641** On all models except the HP 83623B/24B and HP 83623L, disconnect W25 from the bridge detector. On the HP 83623B/24B and HP 83623L, disconnect W25 from CR1. Measure the detector voltage at the output of the detector and adjust the synthesizer power level for  $-50$  mV.

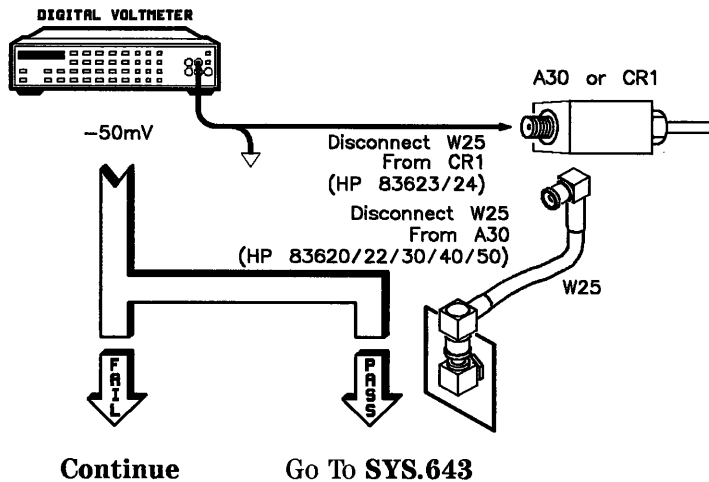

**SYS.642** For all models except the HP 83623B/24B and HP 83623L, the problem is most likely the bridge detector A30. Replace A30.

For the HP 83623B/24B and HP 83623L, the problem is most likely the detector (CR1). Replace CR1. If that does not fix the problem, replace the coupler (A30).

**SYS.643** Replace W25.

**SYS.690** Perform the following:

1. Connect the power meter to the amp/filter output A29J3.
2. Press **CW** **4** **GHz** **ALC** **Leveling Mode ALCoff**.
3. Press **POWER LEVEL** and adjust the synthesizer rotary knob for a +4 dBm RF output as measured by the power meter.

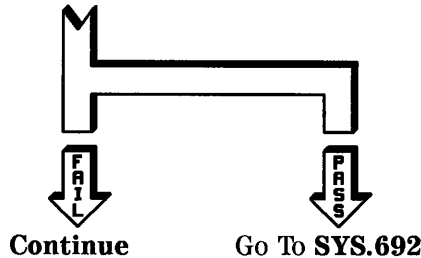
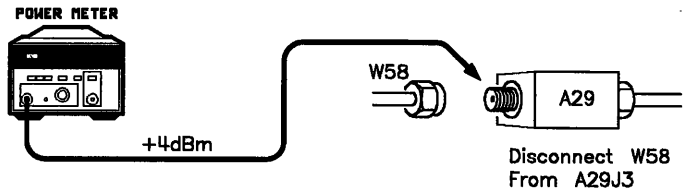



**SYS.691** Perform the following:

1. Connect the power meter to the dual modulator output A38J16. In instruments with Option 006, connect the power meter to the output of the AM modulator, A38J9.
2. Press **CW** **4** **GHz** **ALC** **Leveling Mode** **ALCoff**.
3. Press **POWER LEVEL** and adjust the synthesizer rotary knob for a +3 dBm RF output as measured by the power meter.

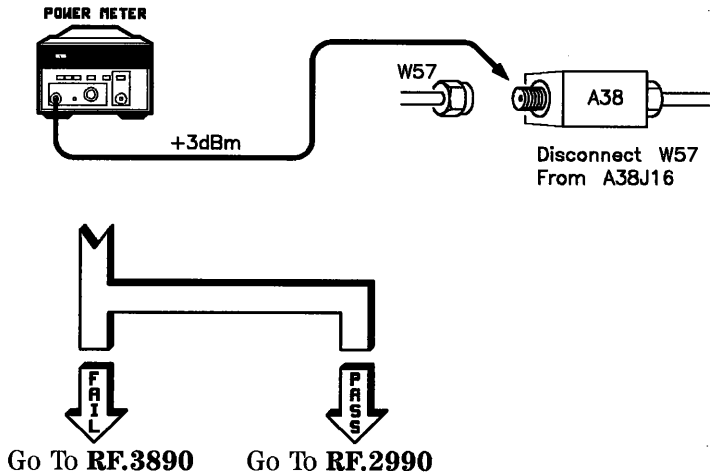

**SYS.692**

Instrument Description	Go To Paragraph
HP 83640B/L or HP 83650B/L (Frequency Doubler not Option 006)	RF.3290
HP 8360 B-Series Option 006 (Fast Pulse)	RF.4290
HP 83623B or HP 83624B (High Power not Option 006)	RF.3390
HP 83620B or HP 83622B (Not Option 006)	RF.3090
HP 83630B/L (Not Option 006)	RF.3090

---

## SYS.700

1. If firmware has been replaced recently, delete all self-test patches. Press **SERVICE** **Adjust Menu** **TestPatch Menu**. Press **Delete Patch** until the patch list is empty.
2. Check the cabling associated with the amp/multiplier (A28).
3. Replace the amp/multiplier (go to RF.2890).



## 1. After Replacement or Repair

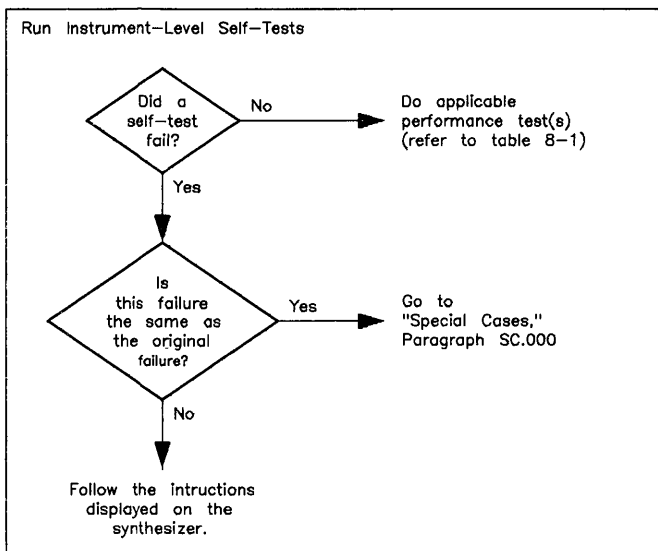

## 2. After Adjustment Only

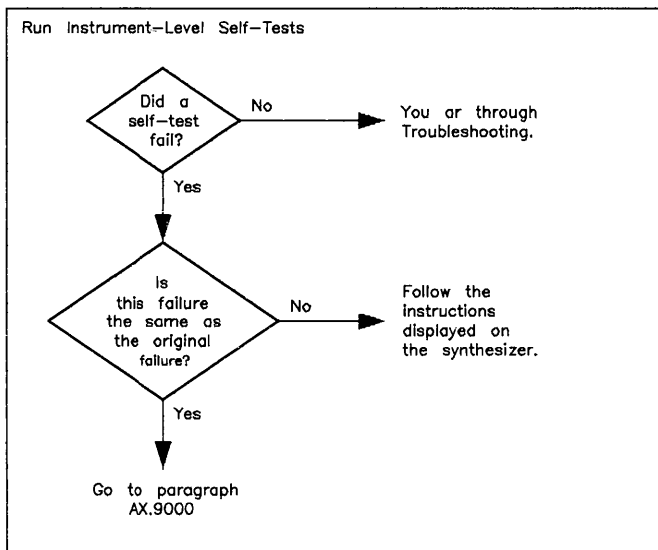

**Special Cases**

---

## **SC.000 Introduction**

If you have not used the “Instrument Level Troubleshooting” section yet, go to ILT.000 before continuing with “Special Cases”. The “Instrument Level Troubleshooting” section contains help with hard failures, performance test and adjustment failures, as well as some system failures.

“Special Cases” is not a step-by-step process. It is a collection of routines, techniques, and information describing the block diagram. It deals with failures and situations not covered in the previous troubleshooting sections. This information is intended to be used with the overall block diagram at the end of this section. In using this section you will be required to select and develop your own testing processes and make your own judgments in analyzing the results of your tests.

---

## SC.100 Safety Considerations

### Warning

---

**When the instrument is connected to ac line power or the A18 high voltage neon indicator is on, there are voltages present that can cause personal injury or death. Only trained, qualified personnel, who are aware of the hazards involved, should perform service on this instrument with its protective covers removed. An isolation transformer must be used during all power supply troubleshooting procedures.**

**Observe all safety practices. Remove all jewelry/metal that can short to ground.**

---

Line power is located at the rear of the instrument under the red plastic protective cover. However, dangerous voltages exist outside this area especially in the covered power supply section and the cable harnesses located at the rear of the instrument. Before removing the power supply cover, servicing any of the cables or harnesses, or working in the proximity of these parts, completely disconnect line power and wait for all power supply indicators to go off. Follow this procedure anytime you install or remove assemblies or parts or otherwise physically service the instrument.

If your instrument does not have a red, plastic WARNING cover at the bottom rear of the motherboard, install one before continuing. Completely disconnect line power before doing any servicing with the warning cover removed or damaged. Also, completely disconnect line power before installing or removing the warning cover.

---

## SC.200 Classify Your Failure

Classify your failure using the following definitions:

<b>Failure</b>	<b>Definition</b>
System	The failure has only been demonstrated as a part of a system (a collection of instruments). In general, the failure cannot be repeated or characterized without a system present.
Repeatable	The failure occurs each and every time a particular circumstance or sequence of events occurs. (The opposite of repeatable is intermittent.)
Detected	The failure is reported by the firmware diagnostics. If a failure is reported after running the full self-tests, then the failure is <i>detected</i> regardless of whether or not the failure has been <i>isolated</i> . (Don't use "Special Cases" unless "Instrument Level Troubleshooting" did not isolate the failure.)



After you have classified your failure, use this table to determine which techniques to use to isolate your failure.

System	FAILURE		PARAGRAPHS
	Repeatable	Detected	
No	No	No	SC.210 SC.250 SC.230 SC.220
No	No	Yes	SC.210 SC.250 SC.230
No	Yes	No	SC.220 SC.230 SC.250
No	Yes	Yes	SC.220 SC.250 SC.230
Yes	Yes or No	Yes or No	SC.240

As an example, if an instrument has an intermittent loss of RF power out the front panel (maybe it fails once a day) that hasn't been detected by the diagnostics, you would use the techniques explained in paragraphs SC.210, SC.250, SC.230 and SC.220. This is because it is a nonsystem failure, nonrepeatable (intermittent) failure, and undetected by the diagnostics.

## SC.210 Looping and Logging

The service looping and logging techniques can be used to localize an intermittent failure. Looping repeatedly cycles the instrument through a series of states or tests. Logging reports any detected failures. These techniques work well with temperature cycling. Other techniques that may be useful are frequency list mode and alternate registers. The list mode and alternate registers lack a logging feature but they can be used to exercise the instrument in a customized fashion without the use of an external controller or computer.

### How to Loop and Log a Diagnostic Test

You may loop on the full self-tests (test #0), a group of tests (for example test #47 tests the A5 assembly), or on a single test. The following example loops on a single diagnostic test:

1. Press **PRESET** **SERVICE**.
2. Select **Selftest Menu**.
3. Press **51** **ENTER**. This is the "IF Frequency Counter" test.
4. Select **Loop** (asterisk on).
5. Select **Do Test #51**.

The instrument will continuously repeat test #51. Each time the test is completed the Number of PASSES or Number of FAILS is updated on the display. The selftest menu will be updated with the results of the last test. (This can be useful in determining how often a failure occurs.)

Continue with the following:

6. Select **Loop** (asterisk off). The looping should stop.
7. Select **Do Test #51**.

Notice that the test is run once and the pass/fail status in the selftest menu is updated. Continue with the following to log the results of test #51 to the display.

8. Select **Output Menu** **When to Log Always** (asterisk on).
9. Press **PRIOR**.
10. Select **Log** (asterisk on).
11. Select **Do test #51**.
12. Select **Cont** until the test is complete (the selftest menu will return when the test is complete).

Selecting **When to Log Always** causes the results of each measurement or group of measurements to be reported. In many cases, this might be too much data. To reduce the amount of data, and how often you have to select **Cont**, you can select **When to Log OnFail**. In this case, only failures are logged to the display. To continually run test #51 and report only failures to the display, loop and log to the display as shown in the following sequence:

13. Select **Output Menu** **When to Log OnFail** (asterisk on).
14. Press **PRIOR**.
15. Select **Loop** (asterisk on). **Log** also has an asterisk on.
16. Select **Do test #51**.
17. To stop the looping, select **Loop** (asterisk off).
18. To restart the looping, select **Loop** (asterisk on) and **Do Test #51**.
19. Remove the instrument top cover and carefully remove the coax cable from A5J1 (the left-most coax cable connected to A5). Notice that the instrument immediately begins to log the failures to the display.
20. Reconnect the cable and press **Cont** (you may have to press **Cont** more than once). When the test is complete, the instrument will begin logging to the display until it encounters another failure.
21. To stop looping and logging, again press **Loop** and **Log** (asterisks off).

In the following example, you will run a test and log all of the test results to a printer. As in logging to the display, you can choose to log all of the data or fail-only data. Logging data to a printer can be useful in situations that require testing over a long period of time or during temperature cycling.

22. Connect the printer to the synthesizer's HP-IB port.
23. Set the printer to listen only and address 0.
24. Cycle the printer power.
25. Select **Output Menu** **Log Data to Printer** (asterisk on).
26. Select **When to Log Always** (asterisk on).
27. Press **(PRIOR)**.
28. Press **Loop** (asterisk off). **Log** also has an asterisk on.
29. Select **Do Test #51**.

The printer should print the results of test #51. To stop the printing, select **Loop** (asterisk off).

The following demonstrates logging only failures to the printer.

30. Select **Output Menu**.
31. Select **When to Log OnFail** (asterisk on).  
**Log Data to Printer** also has an asterisk on.
32. Press **(PRIOR)**.
33. Select **Loop** (asterisk on). **Log** also has an asterisk on.
34. Select **Do Test #51**.

The printer will not print unless the synthesizer fails this test.

35. Remove the instrument top cover and carefully remove the coax cable from A5J1 (the left-most coax cable connected to A5). Notice that the printer immediately begins to log the failures.
36. Reconnect the cable. The printer should stop logging.
37. To stop looping the test, select **Loop** (asterisk off).

## Frequency List and Alternate Registers

These features may be used to replicate a problem. Frequency list allows you to set up an arbitrary list of frequencies, power levels, and dwell times. Alternate registers causes the synthesizer to alternate on successive sweeps between the present instrument state and a second instrument state stored in an internal register. See the "Operating and Programming Reference" for additional information. Once you have created a frequency list or have set up for alternating registers, then exercise the instrument and check for unlock failures.

The following example creates a frequency list that steps from 200 to 500 MHz in 10 steps. The instrument will dwell at each frequency for 500 ms. The list is saved to register 1. The instrument's fault and unlock indicators are monitored. Finally, a ramp sweep is alternated with a list sweep.

1. Press **PRESET** **FREQUENCY** **MENU**.
2. Select **List Menu**.
3. Select **Delete Menu All** (This clears any current list.)
4. Select **Auto Fill Start**.
5. Press **200** **MHz**.
6. Select **Auto Fill Stop**.
7. Press **500** **MHz**.
8. Select **Auto Fill #Pts**.
9. Press **10** **ENTER**.
10. Select **Global Dwell**.
11. Press **500** **msec**.
12. Press **SWEEP** **MENU**.
13. Select **Sweep Mode List** (asterisk on). (This starts the list sweep mode.)
14. Press **SAVE** **1** **ENTER** (Saves the list to register 1.)

Now, to view the instrument's state:

15. Press **SERVICE**.

16. Select **Fault Menu**.
17. Select any one of the three fault menus.
18. Press **(PRIOR)**.
19. Select **Unlock Info** (asterisk on). You can now see the state of any of the major loops (see SC.220 for more information)

The following is an example of a setup for alternating registers. One will be the frequency list saved to register 1 in the previous example, the other will be the preset state of the instrument (an analog sweep).

20. Press **(PRESET) SYSTEM (MENU)** (the instrument should be sweeping normally).
21. Select **Alternate Regs** (asterisk on).
22. You should now see the sweep indicator flashing as it switches between the two setups.

## SC.220 Direct Control and Monitoring

Direct control and monitoring allow you to test or monitor hardware in a particular state. Since you have some control over the individual modules and loops, you can verify whether a specific instrument state causes a failure and you can check the apparent state (what the processor thinks) of the hardware.

The following example sets up the fractional-N (A4) loop at 50 MHz, looks at the fractional-N OOL line (Out Of Lock), and views the YO and other frequencies.

### Note

---

When the display indicates a loop value, this is the frequency that the microprocessor has set up. The frequency was not measured and reported. Therefore, if the frequency displayed is different from real frequency you have an indication of a problem.

---

1. Press **PRESET** **CW** (CW keeps the fractional-N at one frequency).
2. Press **SERVICE**.
3. Select **Tools Menu**.
4. Select **CntlPLL Menu** (Control Phase Locked Loop).
5. Select **Frac N Menu** **CW**.
6. Press **50** **MHz** (Sets the fractional-N to 50 MHz).
7. Press **PRIOR** **PRIOR**.
8. Select **ViewHdwr Menu** (View Hardware).
9. Select **PLLs Freqs** (asterisk on). You can see the fractional-N is set to 50 MHz.

Interpret the **ViewHdwr** display as follows:

<b>Label</b>	<b>Interpretation</b>
FRAC-N(MHz)	The frequency of the fractional-N (A4).
SAMPLER(MHz)	The frequency of the sampler (A6).
/	The fractional-N frequency divisor in the YO phase detector (A5). This number should be 3 or 4.
HARM	The harmonic of the sampler frequency.
BAND	The frequency band we are using (0 through 4). This indicates the harmonic of the YO to which the amp/mult (A28) is tuned. [Except in the case of band 0 where the frequency of the YO is mixed down using the low band (A24) assembly.]

Now select **YO Freq/Harm** (asterisk on). Interpret the display as follows:

<b>Label</b>	<b>Interpretation</b>
CW(MHz)	The frequency of the YO.
BAND	The frequency band we are using (0 through 4). This indicates band 2 because the frequency is set to slightly more than 10 GHz.

Just as you set the fractional-N frequency, you can control the sampler (A6) frequency using **(SERVICE)** **Tools Menu** **CntlPLL Menu** **Sampler Menu**.

In the sampler menu you can set the frequency of the sampler.



Other useful softkeys in the **CntlPLL Menu** are

**Loop Cntl Menu** and **NoPhase Lock**. **Loop Cntl Menu** allows you to control the phase lock loop frequency.

**NoPhase Lock** lets you open the YO loop which allows you to tune the YO independent of the rest of the loop.

1. Select **PLLs Freqs** (asterisk off).
2. Press **(SERVICE)**.
3. Select **Unlock Info** (asterisk on).

The modules shown are checked for unlock failures. If no unlock is found, OK is displayed.

Sometimes it is useful to open up the ALC loop to keep it from railing. (Press **(ALC)** and select **Leveling Mode ALCoff**.) An UNLVLED indicator comes on because leveling (ALC action) is not functioning. In normal operation this indicator means that the power requested is not available.

## SC.230 Exchanging Assemblies

Exchanging assemblies might be the only way to isolate some problems. The following is a list of assemblies and the adjustments that may be required to make the synthesizer operational if the assembly is replaced. If the adjustments are not performed, failures may occur such as severe power loss or drop out, failure to lock or sweep properly, squegging, and unlevelled indications. Perform the adjustments indicated in the following table in order to verify that you have eliminated the problem assembly. Then, to ensure that the synthesizer meets specifications, go to "Post Repair Procedures" and perform the required adjustments and performance tests.

Assembly	Adjustments Required for Operation	Difficulty	Equipment Required
A15	ADC	Low	Minimal
	Move Memory (A15.9001)	Medium	None
A5	YO Loop Gain	Low	None
A6	Sampler Assembly	Low	None
A9	Amplifier Detector Offset	Low	None
	Pulse Delay	Low	Minimal
A12	Amplifier/Multiplier Adjustments	High	Extensive
	Low Power SRD Bias	Low	Minimal
A13	YO Driver + 10V Reference	Low	None
	YO Gain & Linearity	Low	None
	YO Delay	Low	None
A28	Amplifier/Multiplier Adjustments	High	Extensive
A33	Power Flatness	Low	Minimal
	Amplifier Detector Gain	Medium	None

Calibration data specific to your instrument is stored in the microprocessor (A15). If you are exchanging assemblies, be sure you know which ones are the originals. The original calibration data will *not* apply to new assemblies. To avoid having to reacquire calibration data through adjustments that can be lengthy, once you have located the failed assembly ensure that you return all of the other *original* assemblies to the instrument.

The calibration data for the instrument resides in RAM and EEROM on A15. If A15 has failed, this data must be transferred to the new A15 assembly. Be *certain* that A15 has failed before attempting to move the calibration data. An error in the procedure could cause all of this information to be lost and recreating the information is a very lengthy procedure. A15.9001 gives the procedure for transferring the calibration data.

## SC.240 System Failures

System failures are failures that have only been demonstrated as a part of a system (a collection of instruments). In general, the failure cannot be repeated or characterized without a system present. When troubleshooting system failures, use the following suggestions in the order given:

1. Ensure that you have the proper equipment for troubleshooting. A spectrum analyzer and an oscilloscope are usually required.
2. Run the diagnostic routines of all instruments in the system. Eliminate any errors that are identified by the diagnostics before continuing.
3. Determine the minimum system required to replicate the problem. When eliminating portions of the system, eliminate software first, if possible.
4. Check the system for excessive cable lengths, poor grounds and improper installation (overheating, air blockage).
5. Verify that all instruments contain compatible versions of firmware and software.
6. If the failure is also intermittent, check the environment and timing of the failures. Note any relationship to time of day, local maintenance schedules, day of the month, weekends, season, or local holidays. Also check any severe line power problems or limitations (these may be related to local production efforts.)

## SC.250 Block Diagram Notes

This section describes the YO loop RF path and the two ALC loops and gives help interpreting the block diagram. Also, tables showing the interconnection of data, addresses, and busses are given.

The YO loop phase lock is obtained using a feedback path. The entire path (forward and feedback) is as follows. Beginning with the YO (A26), the signal is passed to the directional coupler (A39). The coupled output of

the directional coupler is fed back through AT3, W51, FL2, and W54 to the sampler (A6). Harmonic mixing takes place in the sampler (A6) and then the heterodyned output from the sampler (A6) is fed to the YO phase detector. This signal is mixed with the divided output of the fractional-N (A4) to obtain phase error information. This phase error signal is amplified by the YO driver and used to control the frequency of the YO (A26). Note that the YO is driven by a low frequency path (via A13) and a high frequency path out of the YO phase detector (A5). If either path is broken, the YO will not lock.

Two ALC loops exist. One loop exists for band 0; the other loop is for all other bands. The band 0 path includes the sampled and detected output from the low band (A24) via W24 to the ALC (A10). This voltage is compared to a reference (from A14). The difference between these signals is an error signal that is amplified and sent back to the low band (A24) modulator.

The second ALC loop begins with the bridge detector (A30) or the coupler/detector in the HP 83623B/24B and HP 83623L. Like band 0, this signal goes to the ALC (A10) where it is compared to a reference. The difference between the reference and the detector output voltage is used as an error signal. This error signal is sent back to the dual modulator (A38) where it is used to control the loop gain. And finally the level-corrected signal out of the dual modulator (A38) is frequency multiplied and filtered (A28).

Notice that the reference signal for level control in both ALC loops is created by the sweep generator (A14). This is specifically the "LEVEL REF TO A10" exiting the sweep generator. While it is not shown on the block diagram, it does connect directly to the ALC (A10). If this level reference is lost, the ALC loop will not be controllable.

The block diagram is intended to relate both physical and electrical information. The following items will help you interpret the block diagram:

- PC assemblies shown with tabs are located in the open card cage or in the in the covered power supply cage (A17, A18) located at the left, rear corner of the instrument.
- The 22 V transformer shown next to the switching regulator (A18) is located between the covered power supply section and the rear panel. Dangerous voltages exist in this area.
- All components located on the RF deck are located inside the heavy border labeled RF DECK.
- Semi-rigid coax cables are shown with a double line and are labeled with a reference designator (for example, W46 from A38 to A28 on the RF deck).
- Flexible coax cables are shown with a single line and are labeled with a reference designator (for example, W20 from A7J7 to A24).
- All other lines are part of the motherboard.
- All fuses are shown.
  - The rear panel line fuse is next to the switching regulator (A18).
  - Eight fuses are located on the post regulator (A16). Some of these fuses are soldered-in.
  - One fuse is located on the rectifier/filter (A17).
  - One fuse is located on the switching regulator (A18). This fuse has an LED located close by. If the LED is on, the fuse is good.
  - One fuse is located on the RF Interface (A20, on the RF deck).
- Assemblies shown in the front or rear panels are located in those panels including A2. However, part of A2 is shown in the lower left-hand corner of the block diagram. This portion of A2 contains the front panel power switch and was positioned at this point on the block diagram for convenience.
- Signals are labeled with power and frequency limits if appropriate. Signals not labeled are either TTL (digital) signals or they are too complex or unique to characterize for the purposes of the block diagram.

- Cables are labeled with reference designators.
- Signals going from the RF interface (A20) to the RF deck are actually ribbon cables. These ribbon cables carry power supply voltages and signals required for controlling the microcircuits.

### Data and Address Bus Connections

	Data Bus								Address Bus						
	0	1	2	3	4	5	6	7	0	1	2	3	4	5	6
XA4J1 XA5J1 XA6J1 XA7J1 XA8J1 XA9J1 XA10J1 XA11J1 XA12J1 XA13J1	9	34	10	35	11	36	12	37	4	29	5	30	6	31	7
XA14J1 XA15J1	12	52	13	53	14	54	15	55	7	47	8	48	9	49	10
XA20J1	5	39	4	38	3	37	2	36	10	9	44	8	43	7	42
A22J1	22	21	20	19	18	17	16	15	-	-	28	27	26	25	23
A22J2	23	24	25	26	27	28	29	30	14	15	16	17	18	19	20
A22J8	52	51	50	49	48	47	46	46	57	58	-	-	55	56	54

## Strobes

	Source	Sinks
<b>Strobe0</b>	XA15J1-44	XA13J1-26 A22J8-60
<b>Strobe1</b>	XA15J1-4	XA14J1-44
<b>Strobe2</b>	XA15J1-43	XA11J1-26 XA12J1-26 XA14J1-43
<b>Strobe3</b>	XA15J1-3	XA9J1-26 XA10J1-26 XA14J1-3
<b>Strobe4</b>	XA15J1-42	XA6J1-26 XA7J1-26 XA8J1-26 XA14J1-42
<b>Strobe5</b>	XA15J1-2	XA4J1-26 XA5J1-26 XA14J1-2
<b>Strobe6</b>	XA15J1-41	XA14J1-41 XA20J1-57
<b>Strobe7</b>	XA15J1-1	A2J1-31 A3J2-12 XA14J1-1



### Power Supply Connections (1 of 3)

	-5.2V	-8V	+8V	-15V	-40V	+5.2VA	+5.2VD	+15V
<b>XA4J1-</b>	-	-	-	-	-	-	15 16 40 41	-
<b>XA4J2-</b>	16 17 46 47	-	-	11 12 41 42	14 44	19 49	-	8 9 38 39
<b>XA5J1-</b>	-	-	-	-	-	-	15 16 40 41	-
<b>XA5J2-</b>	16 17 46 47	-	-	11 12 41 42	14 44	19 49	-	8 9 38 39
<b>XA6J1-</b>	-	-	-	-	-	-	15 16 40 41	-
<b>XA6J2-</b>	16 17 46 47	-	-	11 12 41 42	14 44	19 49	-	8 9 38 39
<b>XA7J1-</b>	-	-	-	-	-	-	15 16 40 41	-
<b>XA7J2-</b>	16 17 46 47	-	-	11 12 41 42	14 44	19 49	-	8 9 38 39
<b>XA8J1-</b>	-	-	-	-	-	-	15 16 40 41	-
<b>XA8J2-</b>	16 17 46 47	-	-	11 12 41 42	14 44	19 49	-	8 9 38 39

### Power Supply Connections (2 of 3)

	-5.2V	-8V	+8V	-15V	-40V	+5.2VA	+5.2VD	+15V
<b>XA9J1-</b>	-	-	-	-	-	-	15 16 40 41	-
<b>XA9J2-</b>	16 17 46 47	-	-	11 12 41 42	14 44	19 49	-	8 9 38 39
<b>XA10J1-</b>	-	-	-	-	-	-	15 16 40 41	-
<b>XA10J2-</b>	16 17 46 47	-	-	11 12 41 42	14 44	19 49	-	8 9 38 39
<b>XA11J1-</b>	-	-	-	-	-	-	15 16 40 41	-
<b>XA11J2-</b>	16 17 46 47	-	-	11 12 41 42	14 44	19 49	-	8 9 38 39
<b>XA12J1-</b>	-	-	-	-	-	-	15 16 40 41	-
<b>XA12J2-</b>	16 17 46 47	-	-	11 12 41 42	14 44	19 49	-	8 9 38 39
<b>XA13J1-</b>	-	-	-	-	-	-	15 16 40 41	-
<b>XA13J2-</b>	16 17 46 47	-	-	11 12 41 42	14 44	19 49	-	8 9 38 39

### Power Supply Connections (3 of 3)

	-5.2V	-8V	+8V	-15V	-40V	+5.2VA	+5.2VD	+15V
<b>XA14J1-</b>	-	-	-	-	-	-	18 19 58 59	-
<b>XA14J2-</b>	18 19 53 54	-	-	13 14 48 49	16 51	21 56	-	10 11 45 46
<b>XA15J1-</b>	-	-	-	-	-	-	18 19 58 59	-
<b>XA15J2-</b>	18 19 53 54	-	-	13 14 48 49	16 51	21 56	-	10 11 45 46
<b>XA16J1-</b>	18 19 58 59	-	6 7 8 46 47 48	25 26 65 66	22 62	13 14 53 54	39 40 79 80	30 31 70 71
<b>XA17J1-</b>	-	30 60	-	-	-	-	-	17 18 47 48
<b>XA20J1-</b>	29 64	34 35 69 70	14 15 49 50	26 61	27 62	31 32 66 67	13 48	-
<b>J1-</b>	29	-	9 10 11 12	2	-	-	-	-
<b>J8-</b>	8	-	1 2 3 5	6	-	-	42	4

# **Troubleshooting Block Diagrams**

---



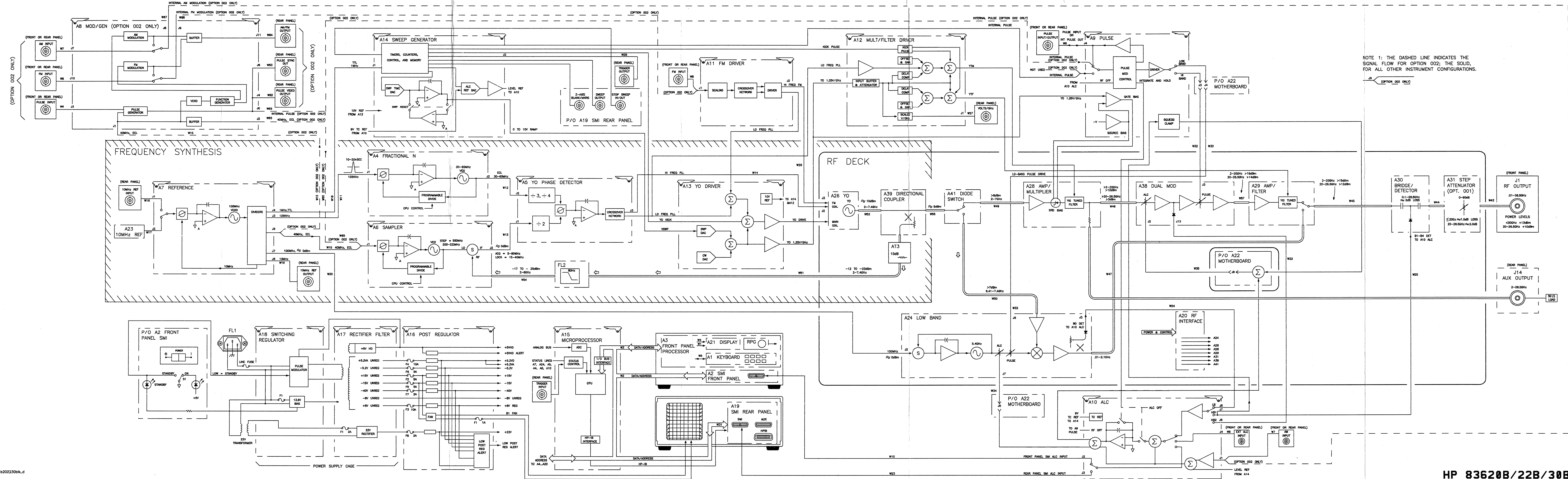

NOTE 1: THE DASHED LINE INDICATES THE SIGNAL FLOW FOR OPTION 002; THE SOLID, FOR ALL OTHER INSTRUMENT CONFIGURATIONS.

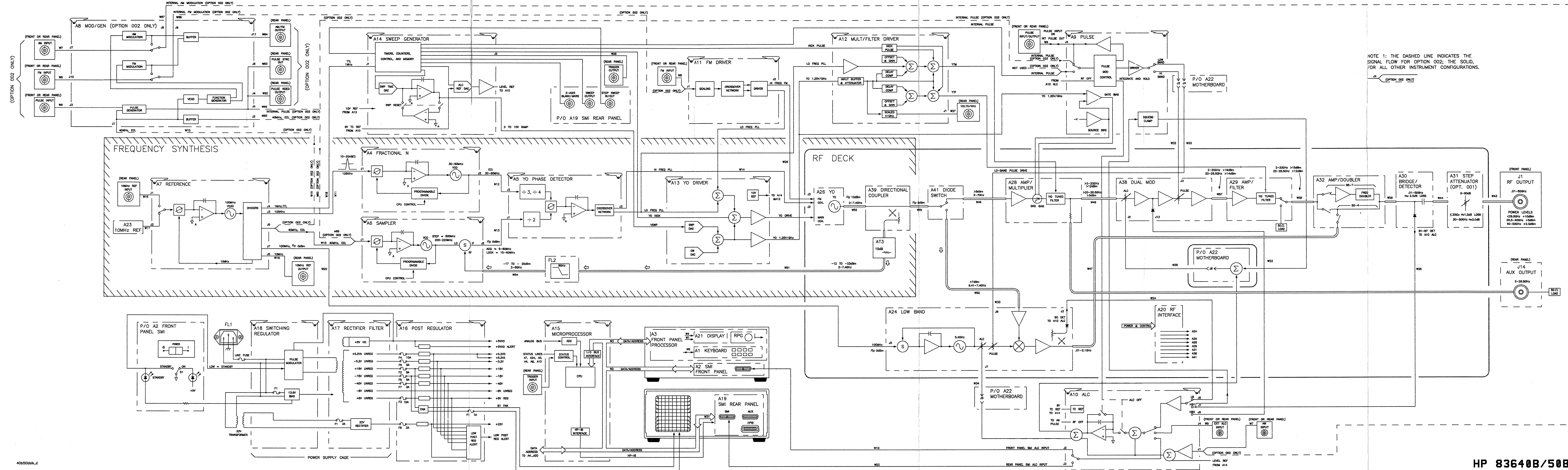

NOTE 1: THE DASHED LINE INDICATES THE SIGNAL FLOW FOR OPTION 002; THE SOLID, FOR ALL OTHER INSTRUMENT CONFIGURATIONS.

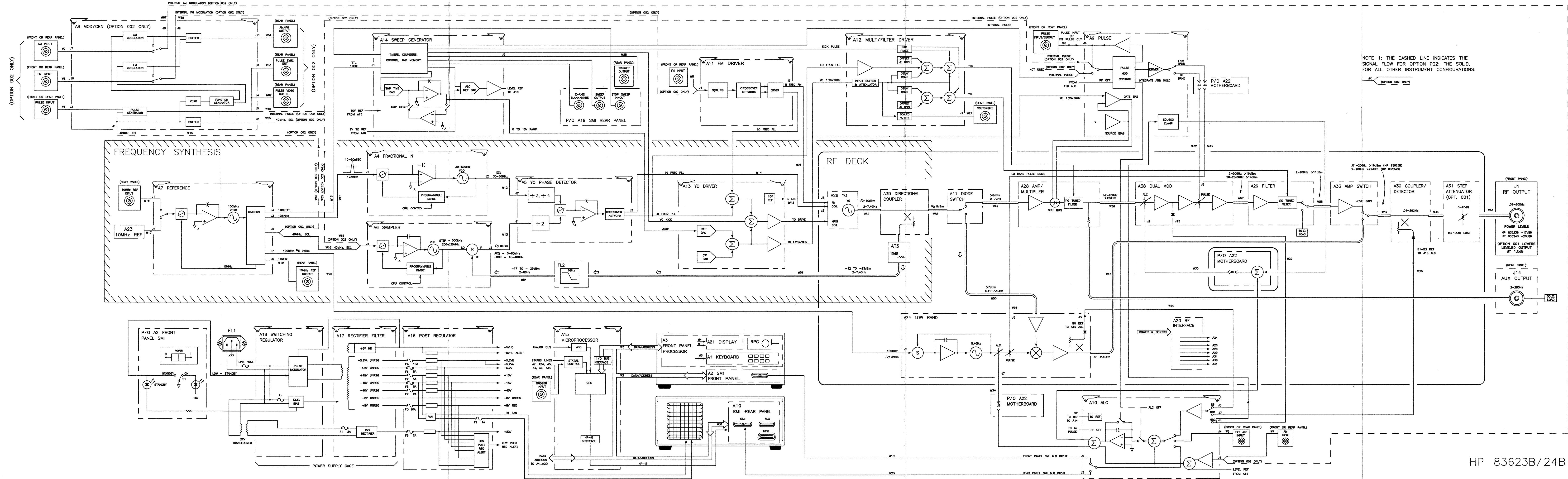

NOTE 1: THE DASHED LINE INDICATES THE SIGNAL FLOW FOR OPTION 002; THE SOLID, FOR ALL OTHER INSTRUMENT CONFIGURATIONS.



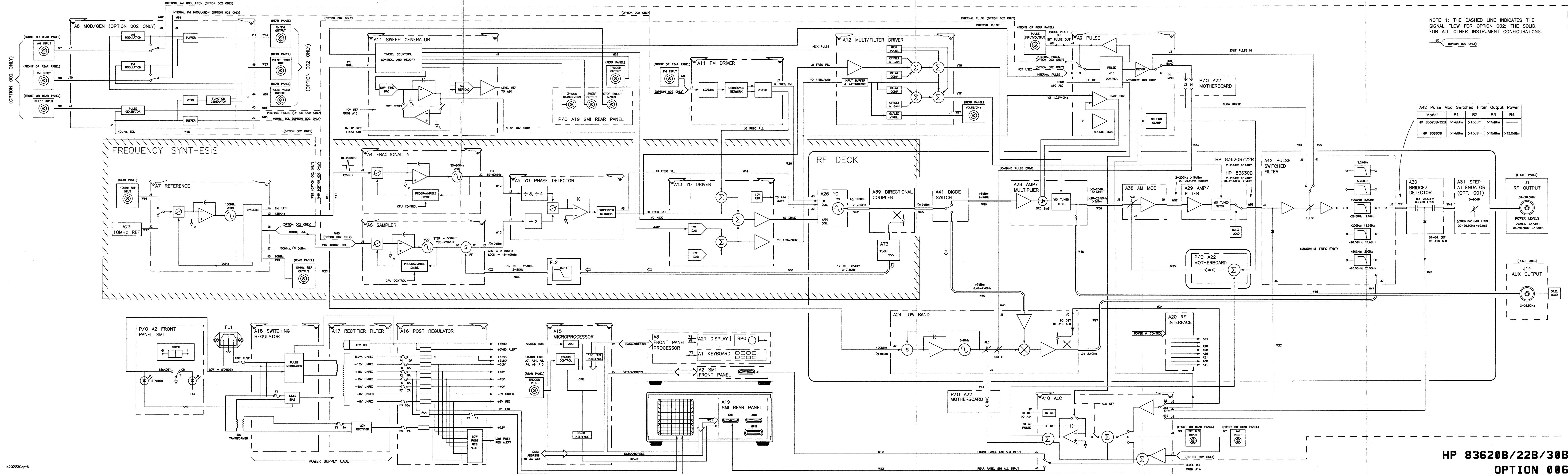

NOTE 1: THE DASHED LINE INDICATES THE SIGNAL FLOW FOR OPTION 002; THE SOLID, FOR ALL OTHER INSTRUMENT CONFIGURATIONS.

Model	B1	B2	B3	B4
HP 83620B/22B	>14dBm	>15dBm	>15dBm	
HP 83630B	>14dBm	>15dBm	>15dBm	>13.5dBm

**HP 83620B/22B/30B**  
**OPTION 006**



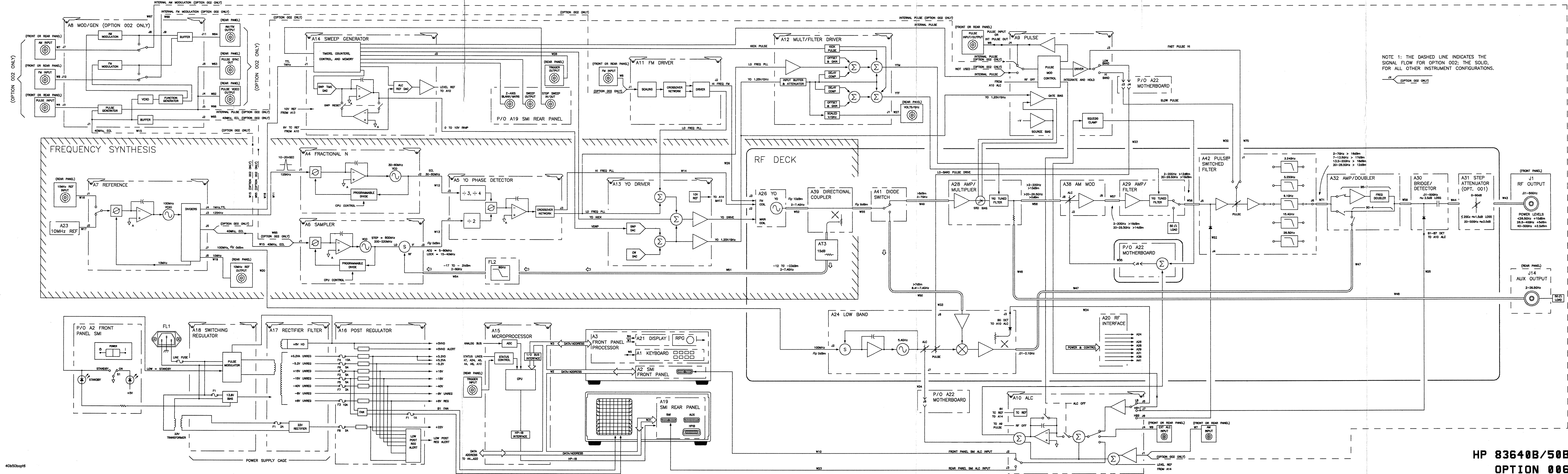

NOTE 1: THE DASHED LINE INDICATES THE SIGNAL FLOW FOR OPTION 002; THE SOLID, FOR ALL OTHER INSTRUMENT CONFIGURATIONS.



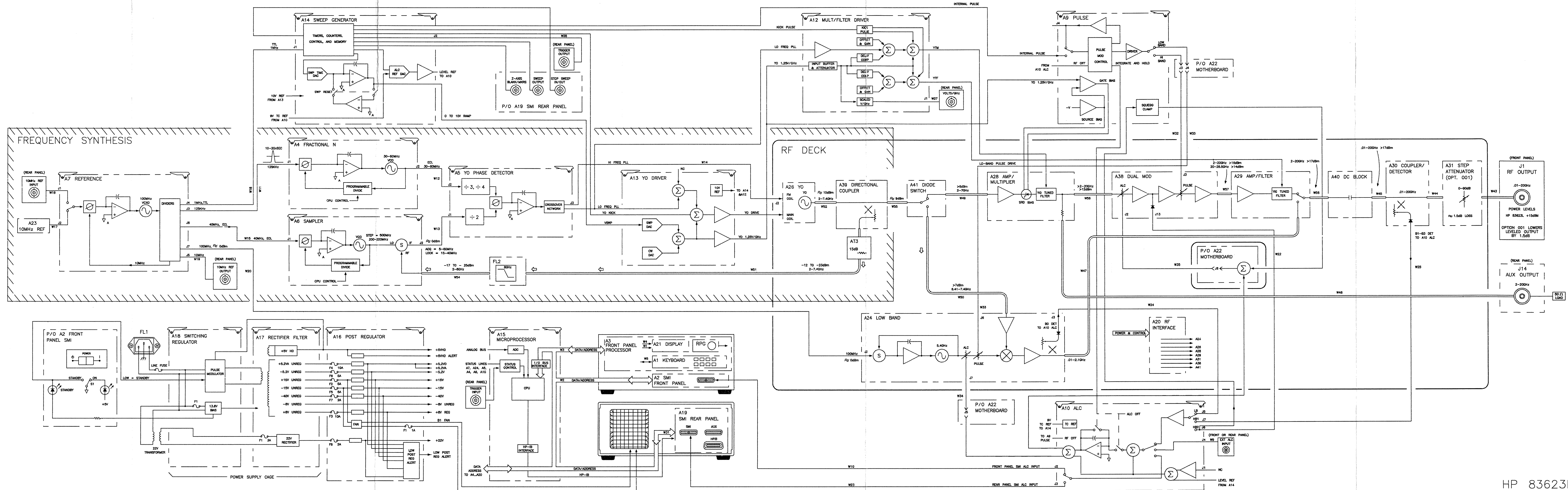

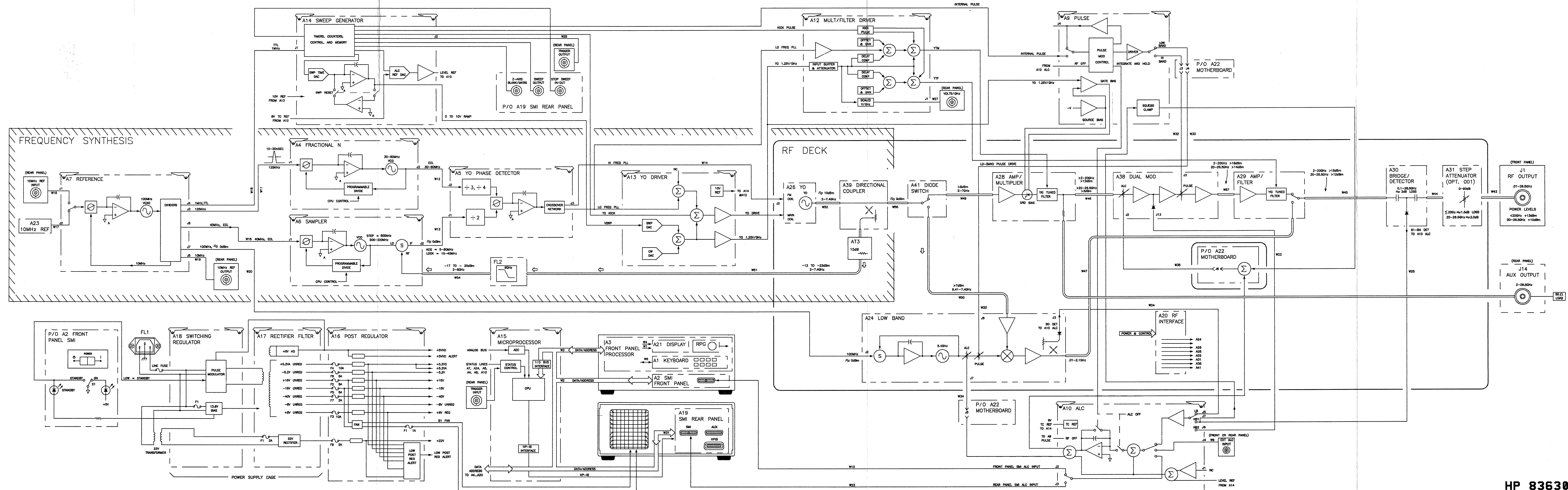

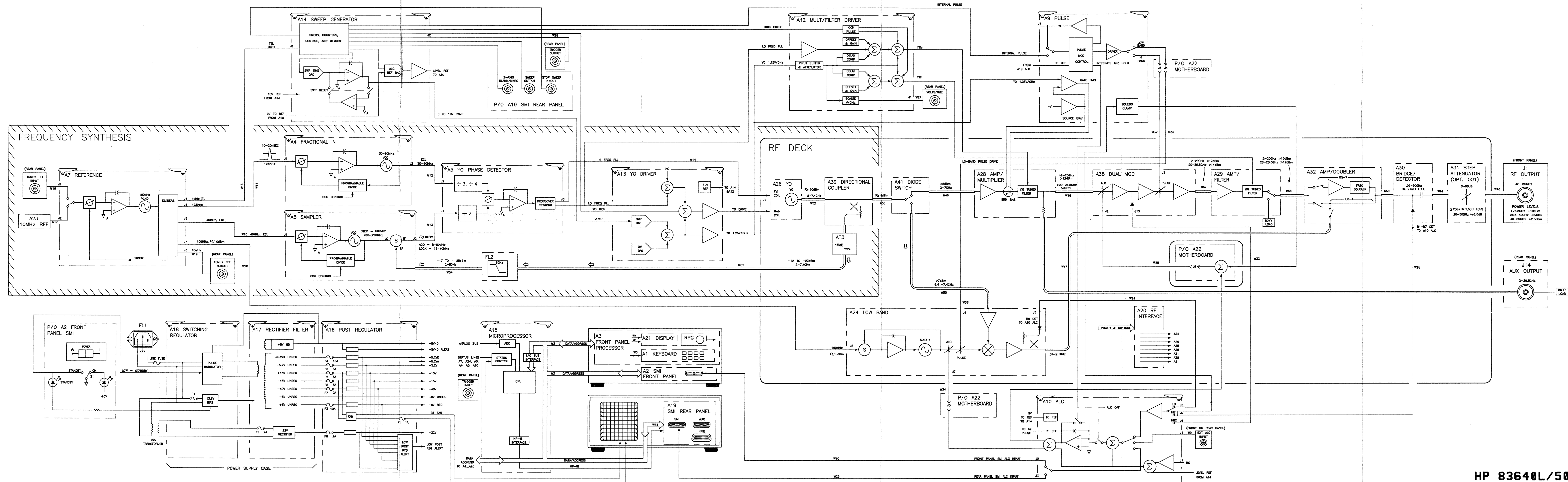

## Instrument History

---

This chapter is left blank until this manual requires changes.