

## Errata

**Title & Document Type:** 8731A/8732A Synthesized Signal Generator User's Guide

**Manual Part Number:** 83731-90001

**Revision Date:** November 1992

---

### HP References in this Manual

This manual may contain references to HP or Hewlett-Packard. Please note that Hewlett-Packard's former test and measurement, semiconductor products and chemical analysis businesses are now part of Agilent Technologies. We have made no changes to this manual copy. The HP XXXX referred to in this document is now the Agilent XXXX. For example, model number HP8648A is now model number Agilent 8648A.

### About this Manual

We've added this manual to the Agilent website in an effort to help you support your product. This manual provides the best information we could find. It may be incomplete or contain dated information, and the scan quality may not be ideal. If we find a better copy in the future, we will add it to the Agilent website.

### Support for Your Product

Agilent no longer sells or supports this product. You will find any other available product information on the Agilent Test & Measurement website:

[www.tm.agilent.com](http://www.tm.agilent.com)

Search for the model number of this product, and the resulting product page will guide you to any available information. Our service centers may be able to perform calibration if no repair parts are needed, but no other support from Agilent is available.

---

HP 83731A/2A  
Synthesized Signal  
Generator

---

# The HP 83731A/2A Synthesized Signal-Generator

The HP 83731A and HP 83732A Synthesized Signal Generators (referred to as "Synthesizers" throughout this manual) provide FM, Logarithmic AM, and Pulse modulation capability. The HP 83731A has a carrier frequency range of 1 GHz to 20 GHz and the HP 83732A has a carrier frequency range of 10 MHz to 20 GHz. Specification information can be found in Chapter 4, "Specifications and Options".

The HP 83731A/2A User's Guide is written to accommodate the novice and the expert user. If you are unfamiliar with the Synthesizer, Chapter 2, "Performing Fundamental Synthesizer Operations", is useful. If you are familiar with the Synthesizer, Chapter 3, "Generating Signals with the Synthesizer" section is helpful. If you are looking for specific, detailed information about the Synthesizer, the section of this manual entitled "REFERENCE" contains the answers that you need. Also, see the learning products map at the end of this book for other documentation references.

# The Synthesizer at a Glance

The following figure and accompanying text explains some features of the HP 83731A. The HP 83732A is nearly identical.

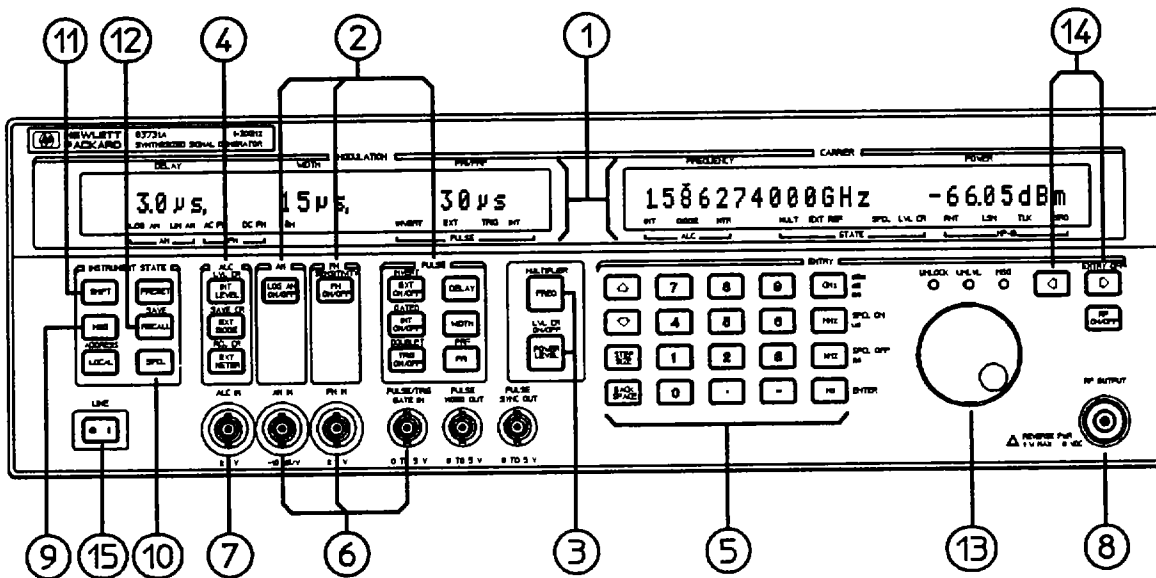

HP 83731A Synthesized Signal Generator

1. The displays show the current values of Synthesizer parameters as well as the status of many of the Synthesizer functions. The rightmost display shows the current carrier frequency and output power level. The leftmost display shows current modulation parameters when they are selected. The leftmost display also displays parameters as they are being entered or modified. The annunciators that appear below the parameters are only visible when their associated function is active. For example, the **LOG AM** annunciator will only be visible when logarithmic AM is active.
2. The modulation keys are used to select the various modulation types that are available and enter or modify their associated parameters.
3. These keys set the carrier frequency and RF output power level of the Synthesizer.
4. The Automatic Level Control keys select the method used to regulate the Synthesizer output power level. Either internal leveling, external power meter leveling, or external diode detector leveling can be selected. Additional external equipment is required when either external power meter leveling or external diode detector leveling is used.
5. The data entry keys are used to enter and modify various Synthesizer parameters. The **BACKSPACE** key cancels all or part of an erroneous parameter entry before it has been terminated. The terminator keys (the rightmost column of keys) are used to choose the units for the entered parameter as well as to terminate the parameter entry. The **↑**, **↓**, and **STEP SIZE** keys are used to increase or decrease a parameter in predetermined steps.
6. The modulation inputs provide the connections for external modulating signals. The RF output can be modulated with any combination of logarithmic AM, FM or pulse modulation. The **PULSE/TRIG, GATE IN** connector is also used as a trigger/gate input for certain internal pulse modulation modes. These connectors mate with male BNC type connectors.
7. The Automatic Level Control voltage input (ALC IN) connector is used as the feedback path to the Synthesizer when its RF output power level is being leveled externally.
8. The **RF OUTPUT** connector mates with a female APC-3.5mm precision connector on instruments with option 1E9 installed. The connector mates with a type-N male connector on non-option 1E9 instruments.
9. The **MSG** key allows you to display any error messages on the front panel display. Error messages are generated when you perform a keystroke sequence that is not valid, try to operate the Synthesizer in a mode that is not allowed, etc.
10. The **SPCL** key is used to initiate the activation of several special functions available in the Synthesizer. Special functions are additional functions that are not activated by pressing a front panel key or shifted key.
11. The **SHIFT** key changes the function of some of the keys. When you press the **SHIFT** key and then press another key, the Synthesizer performs the function printed in blue above the key.
12. The save/recall keys are used to save most of the Synthesizer operating parameters in one of nine nonvolatile register locations so that they can be recalled and used at a later time.
13. The knob is used to increase or decrease the digit under the cursor | ▼ | in the display in steps of one.
14. The **←** and **→** keys move the cursor that is over one of the digits in the display either to the right or left when pressed. The digit that is under the cursor will be modified when the knob is rotated. If no cursor appears in the display, parameter entry or modification has been inhibited.
15. The **LINE** switch turns the Synthesizer either on or off.

Synthesizer rear panel features are depicted and described in detail in Chapter 5, "Front/Rear Panel" in this book.

---

## In This Book

This book is divided into two sections: "OPERATION" and "REFERENCE". The sections are further subdivided into chapters.

The "OPERATION" section provides step-by-step instructions for many of the tasks that you perform with the HP 83731A/2A Synthesizers. The chapters in the OPERATION section are as follows:

- Chapter 1, "Installing and Verifying the Synthesizer" contains procedures for installing the Synthesizer and verifying its operation.
- Chapter 2, "Performing Fundamental Synthesizer Operations" familiarizes you with the fundamental operation of the Synthesizer.
- Chapter 3, "Generating Signals with the Synthesizer" explains how to generate signals using various combinations of AM, FM, pulse modulation, and signal leveling.

The "REFERENCE" section, provides information about each instrument feature and function. Information is divided into chapters as follows:

- Chapter 4, "Specifications and Options" contains a list of the Synthesizer performance specifications as well as the various mechanical, electrical, warranty, and documentation options that are available.
- Chapter 5, "Front/Rear Panel" contains entries that explain different aspects of the Synthesizer front and rear panel. (For example, you turn to this chapter for information on the RF connectors).
- Chapter 6, "Keys/Shifted Functions" contains entries on the function of each key on the Synthesizer front panel as well as the shifted or alternate function of certain keys.
- Chapter 7, "Special Functions" contains entries on the special functions available in the Synthesizer. Special functions are hidden during normal instrument operation and can only be invoked by typing a specific key sequence on the Synthesizer front panel.
- Chapter 8, "Error Messages" contains a table that lists all of the error messages that might be generated during use of the instrument. Each table entry contains a sequence that can be followed to recover from the error condition.

- Chapter 9, “Legal and Regulatory Information” contains information related to safety and SCPI conformance information. The product warranty is also contained in this chapter.

This Page Intentionally Left Blank







---

# Contents

<b>1. Installing and Verifying the Synthesizer</b>	
Installing the Synthesizer . . . . .	1-3
To Unpack the Synthesizer . . . . .	1-3
To Install the Synthesizer . . . . .	1-3
Verifying Synthesizer Functionality . . . . .	1-5
If You Encounter a Problem . . . . .	1-6
Mechanical or Electrical Damage . . . . .	1-6
Power-up Problems . . . . .	1-6
Self Test Failures . . . . .	1-8
<b>2. Performing Fundamental Synthesizer Operations</b>	
To Enter Data with the Numeric Keypad . . . . .	2-3
To Modify Data with the Knob . . . . .	2-4
To Modify Data with the Arrow Keys . . . . .	2-6
To Save and Recall Synthesizer States . . . . .	2-8
To Read the Contents of the Error Queue . . . . .	2-10
To Set the HP-IB Address . . . . .	2-12
If You Encounter a Problem . . . . .	2-13
Data Entry Problems . . . . .	2-13
Programming Problems . . . . .	2-14
<b>3. Generating Signals with the Synthesizer</b>	
To Generate a CW Signal . . . . .	3-3
To Generate an AC FM Signal . . . . .	3-5
To Generate a Power Sweep . . . . .	3-8
To Generate Repetitive, Internal Pulse Modulation . . . . .	3-12
To Generate Externally Triggered Pulse Modulation . . . . .	3-16
To Generate Repetitive, External Pulse Modulation . . . . .	3-21
To Generate a Doublet Pulse . . . . .	3-25
To Generate Gated Pulse Modulation . . . . .	3-30
To Generate Simultaneous Log AM and Pulse Modulation . . . . .	3-35
To Generate Millimeter Signals . . . . .	3-40
To Use External Diode Detector Leveling . . . . .	3-43
To Use External Power Meter Leveling . . . . .	3-47
To Use the Level Correct Routine . . . . .	3-50
To Use Previously Stored Level Correct Data . . . . .	3-58

If You Encounter a Problem . . . . .	3-60
Annunciators Turned On . . . . .	3-60
RF Output Problems . . . . .	3-61
<b>4. Specifications and Options</b>	
Specifications . . . . .	4-3
Frequency . . . . .	4-3
RF Output . . . . .	4-4
Spectral Purity . . . . .	4-7
Modulation . . . . .	4-10
General . . . . .	4-14
Rear Panel Connectors . . . . .	4-15
Options . . . . .	4-16
Electrical Options . . . . .	4-16
Option 1E1 - Add Output Step Attenuator . . . . .	4-16
Option 1E5 - Add High Stability Timebase . . . . .	4-16
Option 1E8 - 1 Hz Frequency Resolution . . . . .	4-16
Option 1E9 - 3.5 mm RF Output Connector . . . . .	4-17
Mechanical Options . . . . .	4-17
Option 1CM - Rack Mount Kit . . . . .	4-17
Option 1CP - Front Handle Kit . . . . .	4-17
Option 1CR - Rack Mount and Handle Kit . . . . .	4-17
Warranty Options . . . . .	4-17
Option W30 - Two Additional Years Return-to-HP Service . . . . .	4-18
Option W32 - Three Year Return to HP Calibration Service . . . . .	4-18
Option W34 - Three Year Mil-std Calibration Service . . . . .	4-18
Documentation Options . . . . .	4-18
Option OB2 - Extra Operating Documentation . . . . .	4-18
Option OB3 - Service Documentation . . . . .	4-18
<b>5. Front/Rear Panel</b>	
Annunciators . . . . .	5-3
Connectors . . . . .	5-6
Coaxial Connectors . . . . .	5-7
HP-IB Connector . . . . .	5-9
Display . . . . .	5-12
Knob . . . . .	5-15
LINE Switch . . . . .	5-17
Power Cables . . . . .	5-18

<b>6. Keys/Shifted Functions</b>	
⇒	6-3
⇐	6-5
↑	6-7
↓	6-9
ADDRESS	6-11
BACK SPACE	6-12
DELAY	6-13
Positive/Negative Delay	6-13
DOUBLET	6-15
Doublet Pulse Mode	6-15
ENTER (Hz)	6-17
ENTRY OFF	6-19
EXT DIODE	6-20
External Diode Detector Leveling	6-20
Applications	6-21
Advantages of Diode Detector Leveling	6-22
Disadvantages of Diode Detector Leveling	6-22
EXT METER	6-24
External Power Meter Leveling	6-24
Applications	6-25
External Equipment Limitations	6-26
Advantages of Power Meter Leveling	6-26
Disadvantages of Power Meter Leveling	6-26
EXT ON/OFF	6-29
FM ON/OFF	6-30
FREQ	6-31
GATED	6-33
Internal Gated Pulse Mode	6-33
INT LEVEL	6-36
Advantages of Internal Leveling	6-37
Disadvantages of Internal Leveling	6-37
INT ON/OFF	6-39
INVERT	6-40
LOCAL	6-42
LOG AM ON/OFF	6-43
LVL CR	6-44
LVL CR ON/OFF	6-48
MSG	6-50
MULTIPLIER	6-51
Numeric Keypad	6-53

POWER LEVEL . . . . .	6-54
PRESET . . . . .	6-56
PRF . . . . .	6-58
PRI . . . . .	6-61
RCL CR . . . . .	6-63
RECALL . . . . .	6-65
RF ON/OFF . . . . .	6-66
SAVE . . . . .	6-67
SAVE CR . . . . .	6-68
SENSITIVITY . . . . .	6-70
SHIFT . . . . .	6-72
SPCL . . . . .	6-73
SPCL OFF (kHz) . . . . .	6-74
SPCL ON (MHz) . . . . .	6-76
STEP SIZE . . . . .	6-78
TRIG ON/OFF . . . . .	6-80
WIDTH . . . . .	6-82

**7. Special Functions**

ATTEN HOLD ON/OFF . . . . .	7-3
Applications . . . . .	7-3
Advantages . . . . .	7-4
Disadvantages . . . . .	7-4
AVG PWR INHIBIT ON/OFF . . . . .	7-6
Application . . . . .	7-7
Pulsed Power Pre-Calibration Program . . . . .	7-7
CLEAR DISPLAY . . . . .	7-12
DC FM ON/OFF . . . . .	7-14
Advantage . . . . .	7-14
Disadvantage . . . . .	7-15
ERASE MEMORY . . . . .	7-16
Application . . . . .	7-16
PWR MTR ADDRS . . . . .	7-18
PWR MTR SELECT . . . . .	7-20
SELECT RISETIME . . . . .	7-22
Applications . . . . .	7-23
SELF TEST . . . . .	7-25
Service-Related Special Functions . . . . .	7-27
SHOW INFO . . . . .	7-28

<b>8. Error Messages</b>	
Error Messages List . . . . .	8-3
Messages . . . . .	8-5
<b>9. Legal and Regulatory Information</b>	
Safety Considerations . . . . .	9-3
Before Applying Power . . . . .	9-3
Safety Earth Ground . . . . .	9-3
Safety Symbols . . . . .	9-4
SCPI Conformance . . . . .	9-6
Warranty . . . . .	9-12
Certification . . . . .	9-12
Warranty . . . . .	9-12
Limitation of Warranty . . . . .	9-13
Exclusive Remedies . . . . .	9-13
Assistance . . . . .	9-13
Declaration of Conformity . . . . .	9-14

---

## Figures

1-1. Line Fuse Removal and Replacement . . . . .	1-7
3-1. AC FM Equipment Setup . . . . .	3-5
3-2. Log AM Equipment Setup . . . . .	3-8
3-3. Example Sawtooth Waveform . . . . .	3-10
3-4. Externally Triggered Pulse Modulation Equipment Setup . . .	3-16
3-5. Triggered Pulse Mode Timing Example . . . . .	3-18
3-6. External Pulse Modulation Equipment Setup . . . . .	3-21
3-7. Doublet Pulse Equipment Setup . . . . .	3-25
3-8. Doublet Pulse Mode Timing Example . . . . .	3-27
3-9. Gated Pulse Modulation Equipment Setup . . . . .	3-30
3-10. Gated Pulse Mode Timing Example . . . . .	3-32
3-11. Antenna Scan Equipment Setup . . . . .	3-36
3-12. Example Antenna Scan Input . . . . .	3-37
3-13. Example Modulated Antenna Scan Pattern . . . . .	3-37
3-14. Millimeter-Wave Equipment Setup . . . . .	3-40
3-15. External Diode Detector Leveling Setup . . . . .	3-44
3-16. External Power Meter Leveling Setup . . . . .	3-47
3-17. Level Correct Routine Equipment Setup . . . . .	3-51
5-1. Synthesizer Display Annunciators . . . . .	5-3
5-2. Synthesizer Connectors - Front Panel . . . . .	5-6
5-3. Synthesizer Connectors - Rear Panel . . . . .	5-6
5-4. HP-IB Connector and Cable . . . . .	5-9
5-5. Synthesizer Display . . . . .	5-12
5-6. Power Cable and Line (Mains) Plug Part Numbers . . . . .	5-19
6-1. Doublet Pulse Mode Timing . . . . .	6-15
6-2. External Diode Detector Leveling Setup . . . . .	6-21
6-3. External Power Meter Leveling Setup . . . . .	6-25
6-4. Internal Gated Pulse Mode Timing . . . . .	6-34
6-5. Internal Triggered Pulse Mode Timing . . . . .	6-80

---

Tables

9-1. SCPI Conformance . . . . . 9-7



## Contents



---

---

**OPERATION**

The "Operation" section of the *HP 83731A/2A User's Guide* provides complete step-by-step instructions for many tasks that you perform with the HP 83731A or HP 83732A Synthesizers. This section is divided into three chapters which identify three general types of users. Each task within a chapter is written independent of the others so that you can access the tasks separately and in any given order. Wherever there is a programming procedure that parallels the front panel procedure, a specific programming example is given.

Chapter 1, "Installing and Verifying the Synthesizer" contains tasks for users who perform an incoming inspection or functional check of the Synthesizer, or those who want to install it.

Chapter 2, "Performing Fundamental Synthesizer Operations" is written for the user who is unfamiliar with the Synthesizer.

Chapter 3, "Generating Signals with the Synthesizer" provides procedures for common Synthesizer applications. Tasks are listed in order of increasing complexity. Procedures range from generating a CW signal to generating an antenna scan pattern with simultaneous AM and pulse modulation. Programming examples are included with each procedure.

An important part of each chapter is the section entitled, "If You Encounter a Problem". Each of these sections lists the more common problem symptoms that relate to the tasks within the chapter. Procedures and checkpoints are listed under each symptom so that you can quickly solve the problem and get back to work.

For additional programming information, refer to the *Beginner's Guide to SCPI*, HP part number H2325-90001 or the *HP 83731A/2A Programmer's Reference*. Also, see the learning products map at the end of this book for other relevant documentation references.

---

This Page Intentionally Left Blank





— Installing and Verifying the  
Synthesizer

---

## Installing and Verifying the Synthesizer

This chapter contains procedures for properly installing your HP 83731A or HP 83732A Synthesizer and procedures for functional verification of the instrument.

---

## Installing the Synthesizer

This procedure explains how to inspect, install, and power-up the Synthesizer.

---

### To Unpack the Synthesizer

1. Inspect the shipping container for damage.

Look for signs of damage such as a dented or torn shipping container or cushioning material that shows signs of unusual stress or compacting.

2. Carefully remove the contents from the shipping container and inspect each item for damage.

If the instrument or any accessories appear to be damaged, refer to "Mechanical or Electrical Damage" at the end of this chapter.

3. Keep the shipping materials for future use.

If undamaged, shipping materials are useful for shipment or storage of the instrument. If damaged, shipping materials should be kept for the carrier's inspection.

---

### To Install the Synthesizer

The following provides a general procedure for installation and initial power up of the HP 83731A or HP 83732A Synthesizer.

1. Check to make sure that the power cable is undamaged.

Do not use the power cable if the plug contacts are bent or broken or if the wire insulation is damaged or if wire is exposed. Never use a power cable if the grounding contact has been removed.



**Installing the Synthesizer**

2. Set the LINE switch on the Synthesizer to standby (ϕ).
3. Set the line voltage selector switch to match the mains voltage.

The line voltage selector switch is located on the rear panel of the Synthesizer to the right of the power module. Use a small flat blade screwdriver to set the switch up for mains voltages in the range of 90V to 132V; 50, 60, or 400 Hz or down for mains voltages in the range of 198V to 264V; 50 or 60 Hz.

---

**WARNING**

This is a Safety Class I system (that is, it is provided with a protective earth terminal). An uninterruptable safety earth ground must be provided from the main power source to the product input wiring terminals through the power cable or supplied power cable set. Whenever it is likely that the protection has been impaired, the product must be made inoperative and be secured against any unintended operation

Any interruption of the protective (grounding) conductor (inside or outside the system) or disconnecting the protective earth terminal will cause a potential shock hazard that could result in personal injury. (Grounding one conductor of a two conductor outlet is not sufficient protection.) In addition, verify that a common ground exists between the unit under test and the system prior to energizing either unit.

If this system is to be energized via an autotransformer (for voltage reduction) make sure the common terminal is connected to neutral (that is, the grounded side of the mains supply.)

- 
4. Push the module end of the power cable into the power module on the rear panel of the Synthesizer until it is firmly seated.
  5. Connect the plug end of the power cable to a suitable mains power receptacle.
  6. Set the LINE switch to on ( I ).

When you turn the Synthesizer on, the displays and annunciators light momentarily and the ventilation fan starts. In addition, it is normal for the LED annunciators (including the MSG LED) to turn on and then off during a power-up test. (The MSG LED should be off when the power-up test is complete.)

Once the power-up test is complete, frequency and power level will be displayed in the rightmost display and pulse parameters will be displayed in the leftmost display if pulse modulation is enabled.

---

## Verifying Synthesizer Functionality

The verification procedure is suitable for incoming inspection; however, you can refer to the *HP 83731A/2A Service Guide* or the *Calibration Guide* for procedures that test all warranted specifications.

1. **Activate the SELF TEST special function.**

To activate the SELF TEST special function, perform the following procedure.

- a. Press the **SPCL** key.
- b. Press **5** on the Synthesizer numeric keypad.
- c. Terminate the special function entry by pressing the **ENTER (Hz)** key.

The leftmost display will read "SELF TEST?, PRESS ENTER"

2. **Press the ENTER key again to initiate the Synthesizer self test routine.**

When the self test routine is running, the leftmost display will read "SELF TESTING". After the test completes, the leftmost display momentarily reads "Test Result=XX" and then "SELF TEST DONE!".

3. **If the self test indicates an error condition, refer to the section entitled "If You Encounter a Problem" at the end of this chapter.**

An error condition exists when "XX" in the statement "Test Result=XX" is a non-zero value.

---

## If You Encounter a Problem

If you have a problem while installing or verifying the Synthesizer, check the following list of commonly encountered problems and troubleshooting procedures. If the problem that you encounter is not in the following list, contact the nearest Hewlett-Packard office for assistance.

---

### Mechanical or Electrical Damage

If the instrument is mechanically or electrically damaged:

- Contact the nearest Hewlett-Packard office.

If the shipping materials are damaged and the instrument is mechanically or electrically damaged:

- Contact the carrier as well as the nearest Hewlett-Packard office.
- Keep the shipping materials for the carrier's inspection.

---

### Power-up Problems

If the Synthesizer appears dead:

- Check that the power cord is fully seated in both the mains power receptacle and the Synthesizer power module.
- Check that the Synthesizer line fuse is not open.

---

**WARNING**

For continued protection against fire hazard, replace fuse with same type and rating.

Refer to Figure 1-1 to remove the fuse from the power module. You can use a continuity light or an ohmmeter to check the fuse. An ohmmeter should

read very close to zero ohms if the fuse is good. The 6.3A, 250V fuse is HP part number 2110-0703.

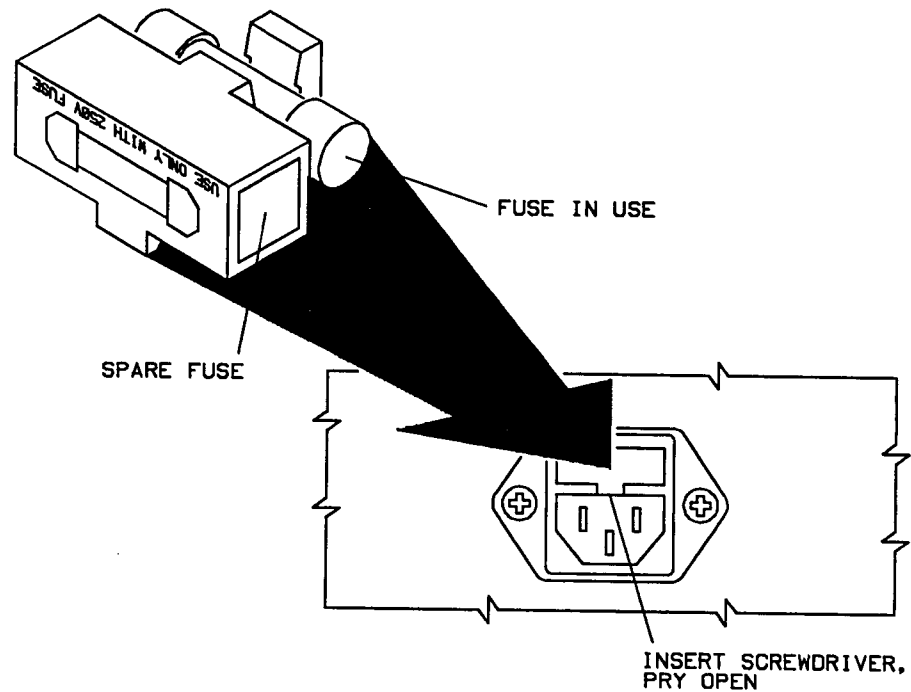

**Figure 1-1. Line Fuse Removal and Replacement**

- Contact the nearest Hewlett-Packard office for service, if necessary.

If the displays light, but the ventilation fan does not start:

- Check that the fan is not stuck. To check the fan, follow these steps:

1. Set the LINE switch to standby (⏻).
2. Check that the fan blades are not jammed.

- Contact the nearest Hewlett-Packard office for service, if necessary.

If the Synthesizer MSG LED annunciator remains on after the power-up test is complete:

**If You Encounter a Problem**

If the Synthesizer MSG annunciator is on, there is a problem with the Synthesizer. To determine the error and turn off the MSG annunciator, refer to “To Read the Contents of the Error Queue” in Chapter 2 and the listing of error messages in Chapter 8.

---

## Self Test Failures

**If the Self Test Fails:**

- Check the contents of the error queue for error messages.

To determine errors and clear them, refer to “To Read the Contents of the Error Queue” in Chapter 2 and the listing of error messages in Chapter 8.





## Performing Fundamental Synthesizer Operations

---

## Performing Fundamental Synthesizer Operations

This chapter describes fundamental Synthesizer operations. The purpose of this chapter is to familiarize you with the fundamental operation of the Synthesizer. Procedures cover how to enter or modify data, how to set the HP-IB address, how to save and recall instrument states, etc.



---

## To Enter Data with the Numeric Keypad

The Synthesizer numeric keypad and units terminator keys provide one way to enter function parameters.

1. Select the desired function key or shifted function key.

The function must have a numeric value (parameter) associated with it in order to enter a new value with the numeric keypad. **FREQ** and **PRF** (**SHIFT**, **PRI**) are examples of functions with parameters.

For example, to select power level so that its parameter is active, press the **POWER LEVEL** key.

Notice that a cursor (  $\blacktriangledown$  ) appears over one of the digits in the power level display. The cursor will always appear over one of the digits of the active parameter.

2. Enter the desired value of the parameter by pressing the numeric keys and, if necessary, the negative and decimal keys.

Notice that, as you press the keys, the display shows the numbers that are entered.

3. Press the appropriate units terminator key to enter the value.

The units terminator keys appear to the right side of the numeric keypad.

The following steps show how to enter a value of  $-9.5$  dBm for power level:

- a. Press the **POWER LEVEL** key.
- b. Press **-**, **9**, **.**, **5** on the numeric keypad.
- c. Press the **dBm** (**GHz**) key to terminate the entry.

Once you terminate the entry, the Synthesizer updates the power level value to  $-9.5$  dBm.

---

## To Modify Data with the Knob

The Knob on the Synthesizer front panel is used to modify data. You turn the Knob in order to increase or decrease the parameter value of the currently active function. Additionally, you can modify the position of the cursor (▼) that is over the active parameter in order to increase or decrease the rate at which the function parameter changes.

1. Select the function key of the parameter to be modified.

When the function key is selected, the cursor appears over one of the digits of the selected parameter.

For example, to select the frequency function, press the **FREQ** key. The frequency parameter is selected when the cursor appears over one of the digits of the frequency display.

2. Turn the Knob clockwise to increase the parameter or counterclockwise to decrease the parameter.

When you turn the Knob, the digit under the cursor increases or decreases in steps of one.

For example, when frequency is in its preset state and is the active parameter, the frequency display shows the following:

3.000000000 GHz

Where the cursor appears over the third "0" to the right of the decimal. When you turn the Knob in this case, the output frequency changes in 1 MHz steps.

3. If you wish to move the position of the cursor one position to the right, press the **⇒** key.

Pressing **⇒** once moves the position of the cursor to the right one digit in order to decrease the Knob resolution by a factor of ten.

4. If you wish to move the position of the cursor one position to the left, press the **⇐** key.

**⇐** moves the position of the cursor to the left one digit in order to increase the Knob resolution by a factor of ten.

5. Continue to press the **⇒** or **⇐** key until the cursor is positioned over the desired digit.

For example, suppose that frequency is the current active parameter, and you wish to change the cursor position from 1 MHz to 1 GHz. The steps that follow illustrate how to accomplish this:

- a. Press the **PRESET** key.

When the instrument has been set to the preset state, the frequency display indicates the following:

3.000000000 GHz

Where the cursor appears over the third "0" to the right of the decimal.

- b. Press the **←** key three times. This moves the cursor from the position corresponding to MHz to the position corresponding to GHz. (The cursor is now over the "3".)
- c. Rotate the Knob slowly so that you can see the frequency change in 1 GHz steps.

**NOTE**

The Knob and **↑**, **↓** keys operate independently of each other. The **↑**, **↓** keys increase or decrease parameters in defined steps.

---

## To Modify Data with the Arrow Keys

The Synthesizer  $\uparrow$  and  $\downarrow$  (Arrow) keys increase or decrease the value of the currently active parameter by an amount set with the **STEP SIZE** key. The amount set with the **STEP SIZE** key is referred to as the increment value.

1. Select the function key of the parameter to be modified.

When the function key is selected, a cursor (  $\blacktriangledown$  ) appears over one of the digits of the selected parameter.

For example, to select the frequency function, press the **FREQ** key. The frequency parameter is selected when the cursor appears over one of the digits of the frequency display.

2. Press the  $\uparrow$  key to increase the parameter by the current increment value or press the  $\downarrow$  key to decrease the parameter by the current increment value.

For example, when frequency is in its preset state, the frequency display shows the following:

3.000000000 GHz



Where the cursor appears over the third "0" to the right of the decimal. The preset frequency increment value is 100 MHz. When you press the  $\uparrow$  key, the value of frequency increases to 3.100000000 GHz.

3. If you wish to change the increment value, you can do so using the **STEP SIZE** key.



The **STEP SIZE** key allows you to change the increment value of the currently active function. For example, suppose that frequency is the current active parameter, and you wish to change the increment value from its preset value of 100 MHz to 250 MHz. The steps that follow illustrate how to accomplish this:

- a. Press the **STEP SIZE** key.
- b. Type **2**, **5**, **0** on the Synthesizer numeric keypad.
- c. Terminate the frequency increment value entry by pressing the **MHz** key.

Performing Fundamental Synthesizer Operations  
**To Modify Data with the Arrow Keys**

When either the  or  key is pressed, the frequency will be either increased or decreased by 250 MHz instead of 100 MHz.

**NOTE**

The knob and ,  keys operate independently of each other. The knob increases or decreases the digit in the display that is under the cursor.

---

## To Save and Recall Synthesizer States

When you use the Synthesizer for a specific application, you can save and then recall the instrument state for future use. You can save up to ten different instrument states.

1. Press the **(SHIFT)** key and then the **(RECALL)** (SAVE) key.

When **(SHIFT)**, **(RECALL)** is pressed, the text "SAVE STATE IN REG XXX" is shown on the Synthesizer display where "XXX" is the last register number entered.

2. Use the numeric keypad to enter the desired register number.

Valid register numbers are 0 through 9.

3. Press the ENTER **(Hz)** key to terminate the entry.

4. To recall the instrument state from memory, press the **(RECALL)** key.

When **(RECALL)** is pressed, the text "RECALL STATE FROM REG 0" is shown on the Synthesizer display.

5. Use the numeric keypad to enter the desired register number.

6. Press the ENTER **(Hz)** key to terminate the entry.

### Notes

1. When an instrument state is saved to an instrument state register, it will write over any instrument state previously stored to that register.
2. If an instrument state has not been previously stored to an instrument state register, the Synthesizer will be set to the preset state if you attempt to recall the instrument state from that register.

---

## Programming Example

Use the following commands to store the instrument state to register 9 and then recall it from register 9:

```
OUTPUT 719; "*SAV 9" Saves the current instrument state to register #9.
OUTPUT 719; "*RCL 9" Recalls the previously stored instrument state
from register #9.
```

---

## To Read the Contents of the Error Queue

When one or more error messages are stored in the Synthesizer error queue, the front panel MSG LED annunciator will light. Once all error messages have been read and all error conditions have been corrected, the MSG annunciator will turn off.

1. Press the **MSG** key.

When the **MSG** key is pressed, the most recent uncleared manual error number and the front panel error message will appear on the leftmost display.

2. Look up the manual error number in Chapter 8.

Chapter 8 is organized in ascending manual error number order.

3. Perform the instructions following the error message in the list to correct or clear the error condition.

After you have completed the procedure in the list, return to this procedure to continue.

4. If the MSG LED annunciator is still lit, perform steps 1 through 3 again until the MSG annunciator turns off. If the MSG annunciator is turned off, continue with the next step.

5. Press the **MSG** key one more time.

Pressing the **MSG** key again returns the leftmost display to normal operation.

---

## Programming Example

To read the entire contents of the error queue, run the following program:

```
10 DIM B$(160)           Dimensions array B$ to accept 160 characters.
20  OUTPUT 719; "SYST:ERR?" Queries the oldest uncleared error number and
                               message in the HP-IB error queue.
```



Performing Fundamental Synthesizer Operations  
**To Read the Contents of the Error Queue**

```
30 ENTER 719; A,B$  
40 PRINT A,B$  
50 IF A<>0 THEN 20  
60 END
```

*Enters the error number into variable A and the HP-IB error message into variable B\$.*  
*Prints the error number and HP-IB error message to the controller screen.*  
*Returns to line 20 if there are more errors in the queue.*

---

## To Set the HP-IB Address

The Synthesizer default HP-IB address is preset to 19. You can, however, change the HP-IB address of the Synthesizer from the front panel.

1. Press the **(SHIFT)** key on the Synthesizer front panel.
2. Press the ADDRESS **(LOCAL)** key.

The leftmost display indicates "HP-IB ADDRESS XX" when the **(LOCAL)** key is pressed where "XX" is the current HP-IB address..

3. Enter the desired HP-IB address using the numeric keypad.

For example, if you want to set the Synthesizer HP-IB address to 12, type **(1)**, **(2)** on the numeric keypad.

The display indicates "HP-IB ADDRESS 12".

4. Terminate the HP-IB address entry by pressing the ENTER **(Hz)** key.

Note that when ENTER **(Hz)** is pressed, the cursor appears over the address parameter in the display. The Synthesizer HP-IB address is now set to the new value (12 in the example), but you can still change it with the numeric keypad, Knob, or arrow keys at this point. Pressing ENTER **(Hz)** again returns the display to normal operation.

---

## Programming Example

To set the Synthesizer HP-IB address to 12, send the following command:

OUTPUT 719; "SYST:COMM:GPIB:ADDR 12" *Sets the Synthesizer HP-IB address to 12.*





---

## If You Encounter a Problem



If you have a problem operating the Synthesizer, check the following list of commonly encountered problems and troubleshooting procedures. If the problem that you encounter is not in the following list, contact the nearest Hewlett-Packard office for assistance.

---



### Data Entry Problems

If the data entry controls (Keypad, Knob, , , ,  keys) do not respond:

- Check that the ENTRY OFF function is not enabled.

The ENTRY OFF function is enabled when the cursor (  ) doesn't appear over any of the parameters in the display. To return to normal entry mode, press the desired function key which has a numeric parameter associated with it (for example, press  if you want to enter frequency).

- Check that the function key which is selected accepts data.



For instance,  accepts data, but,  does not.

- Check that the Synthesizer is in the local (not remote) operating mode.

If the Synthesizer is in the remote operating mode, the RMT annunciator will be lit. Press the  key on the front panel to return the Synthesizer to local operating mode.

If no cursor (  ) appears over a parameter in the display:

- Check that the ENTRY OFF function is not enabled.

The ENTRY OFF function is enabled when the cursor (  ) doesn't appear over any of the parameters in the display. To return to normal entry mode, press the desired function key which has a numeric parameter associated with it (for example, press  if you want to enter frequency).

If the parameter you are trying to enter is not accepted by the Synthesizer:

**If You Encounter a Problem**

- Ensure that you are not trying to set the parameter greater than or less than its limit. Refer to the specification table in this manual for the parameter limits.

- Check that the MSG LED annunciator is off.

If the Synthesizer MSG annunciator is on, there is a problem with the Synthesizer. To determine the error and turn off the MSG annunciator, refer to "To Read the Contents of the Error Queue" in this chapter and the listing of error messages in chapter 8.

If the Synthesizer does not display/output the carrier frequency entered.

- Check that the frequency multiplier value entered is the expected value.

When a multiplier value other than one is entered, the frequency resolution of the signal before multiplication must be obeyed. For example, for a desired frequency of 40 GHz using a multiplier value of three, the Synthesizer would have to output a frequency of 13.33333333 GHz. Since frequency resolution at that frequency is 1 kHz, the closest the Synthesizer can set the frequency is 13.333333000 GHz. This yields 39.999999000 GHz after multiplication, not 40 GHz.

---

## Programming Problems

If the Synthesizer does not respond to programming commands:

- Refer to the procedure, "To Set the HP-IB Address", in this chapter to check and, if necessary, change the HP-IB address.

### 3 Generating Signals with the Synthesizer



— Generating Signals with  
the Synthesizer

---

## Generating Signals with the Synthesizer

This section provides procedures for generating signals with the HP 83731A/2A. The steps in the procedures assume that you are familiar with the fundamental Synthesizer operations. Refer to Chapter 2, "Performing Fundamental Synthesizer Operations", if you are not familiar with these.

Procedures in this chapter include how to generate signals with various modulations, how to use external automatic level control, how to generate antenna scan patterns, etc.

The procedures in this chapter are, in general, listed in order of increasing complexity.

---

## To Generate a CW Signal

You can generate a CW (continuous wave) signal with no modulation characteristics.

1. Press the **INT LEVEL** key to enable internal leveling.

2. Set the desired CW frequency.

For example, perform the following procedure to set the output frequency to 2.000203 GHz.

a. Press the **FREQ** key.

b. Type **2**, **.**, **0**, **0**, **0**, **2**, **0**, **3** on the Synthesizer numeric keypad.

c. Terminate frequency entry by pressing the **GHz** key.

3. Set the desired RF output power level.

For example, perform the following procedure to set the output power level to -15.1 dBm.

a. Press the **POWER LEVEL** key.

b. Type **-**, **1**, **5**, **.**, **1** on the Synthesizer numeric keypad.

c. Terminate the power level entry by pressing the **GHz (dBm)** key.

4. If any of the modulations are turned on, press the appropriate key to turn them off.

If any of the modulations are turned on, the annunciator shown in the second column of the following table will be lit.



Generating Signals with the Synthesizer  
**To Generate a CW Signal**

Modulation Type	Annunciator	Press This Key
logarithmic AM	LOG AM	LOG AM ON/OFF
AC coupled FM	AC FM	FM ON/OFF
DC coupled FM	DC FM	FM ON/OFF
internal pulse	INT (PULSE)	INT ON/OFF
external pulse	EXT (PULSE)	EXT ON/OFF
external inverted pulse	INVERT EXT	EXT ON/OFF
internal triggered pulse	TRIG INT	TRIG ON/OFF

5. If the RF output is currently turned off, press the **RF ON/OFF** key to turn it on.

If the RF output is off, the word OFF appears in the power level portion of the rightmost display.

---

## Programming Example

In the following example, an internally leveled, CW signal will be generated at a frequency of 2.000203 GHz with a power level of -15.1 dBm.

```

10 OUTPUT 719; "*RST"           Presets the Synthesizer.
20 OUTPUT 719; "POW:ALC:SOOR INT" Enables internal leveling.
30 OUTPUT 719; "FREQ 2.000203GHZ" Sets the output frequency to 2.000203 GHz.
40 OUTPUT 719; "POW:LEV -15.1DBM" Sets the output power level to -15.1 dBm.
50 OUTPUT 719; "OUTP:STAT ON"   Turns the RF output on.
60 END

```

---

## To Generate an AC FM Signal

You can generate an AC coupled frequency modulated (AC FM) signal at any carrier frequency within the Synthesizer output frequency range. When the modulating signal has a minimum rate greater than 1 kHz, AC FM is used as the frequency accuracy and stability is not degraded as it is when using DC FM.

Generating an AC FM signal requires the following external equipment.

Equipment	Requirements
Modulating Signal Source	Modulating signal level must be in the range of +2V to -2V for specified FM performance. The input impedance of the FM IN connector is 600Ω.

---

### CAUTION

The modulating signal must never exceed  $\pm 10V$  or damage to the input can occur.

1. Connect the equipment as shown in Figure 3-1:

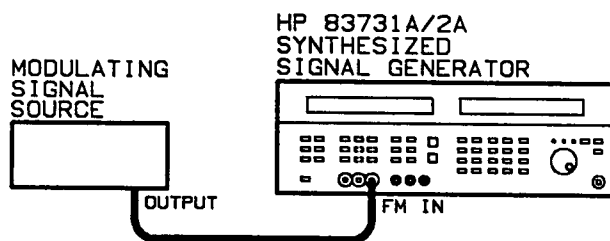

Figure 3-1. AC FM Equipment Setup

2. Set FM coupling to AC  
Perform the following procedure to set FM coupling to AC.
  - a. Press the **SPCL** key.
  - b. Type **3**, **0** on the Synthesizer numeric keypad.

Generating Signals with the Synthesizer  
**To Generate an AC FM Signal**

- c. Activate the DC FM on/off function by pressing the **[Hz]** (ENTER) key.
- d. Press the **[kHz]** (SPCL OFF) key to set FM coupling to AC (the leftmost display will indicate "DC FM OFF").

3. Press the **[FM ON/OFF]** key to turn frequency modulation on.

When frequency modulation is turned on, the AC FM annunciator will be lit.

4. If any of the other modulations are turned on, press the appropriate key to turn them off.

If any of the other modulations are turned on, the annunciator shown in the second column of the following table will be lit.

Modulation Type	Annunciator	Press This Key
logarithmic AM	LOG AM	<b>[LOG AM ON/OFF]</b>
internal pulse	INT (PULSE)	<b>[INT ON/OFF]</b>
external pulse	EXT (PULSE)	<b>[EXT ON/OFF]</b>
external inverted pulse	INVERT EXT	<b>[EXT ON/OFF]</b>
internal triggered pulse	TRIG INT	<b>[TRIG ON/OFF]</b>

5. Press the **[INT LEVEL]** key to enable internal leveling.

6. Set the desired RF output power level.

For example, perform the following procedure to set the output power level to -5 dBm.

- a. Press the **[POWER LEVEL]** key.
- b. Type **[−]**, **[5]** on the Synthesizer numeric keypad.
- c. Terminate the power level entry by pressing the **[GHz]** (dBm) key.

7. Set the desired carrier frequency.

For example, perform the following procedure to set the carrier frequency to 12.5 GHz.

- a. Press the **[FREQ]** key.
- b. Type **[1]**, **[2]**, **[.]**, **[5]** on the Synthesizer numeric keypad.
- c. Terminate the carrier frequency entry by pressing the **[GHz]** key.

8. Set the controls of the modulating signal source to generate the desired frequency modulated signal.
9. If the RF output is currently turned off, press the **RF ON/OFF** key to turn it on.

If the RF output is off, the word OFF appears in the power level portion of the rightmost display.

---

## Programming Example

In the following example, an internally leveled, AC coupled FM signal will be generated at a carrier frequency of 12.5 GHz with a power level of  $-5$  dBm. In order to accomplish this, connect the equipment as shown in Figure 3-1, set the modulating signal source for the desired FM characteristics, and then run the following program.

10 OUTPUT 719; "*RST"	<i>Presets the Synthesizer.</i>
20 OUTPUT 719; "FM:COUP AC"	<i>Sets FM coupling to AC.</i>
30 OUTPUT 719; "FM:STAT ON"	<i>Turns frequency modulation on.</i>
40 OUTPUT 719; "POW:ALC:SOUR INT"	<i>Enables internal leveling.</i>
50 OUTPUT 719; "FREQ 12.5GHZ"	<i>Sets the carrier frequency to 12.5 GHz.</i>
60 OUTPUT 719; "POW:LEV -5DBM"	<i>Sets the output power level to <math>-5</math> dBm.</i>
70 OUTPUT 719; "OUTP:STAT ON"	<i>Turns the RF output on.</i>
80 END	

---

## To Generate a Power Sweep

You can generate a power sweep by connecting the output of a function generator to the AM IN connector and modulating the RF output with a sawtooth wave. This will have the effect of linearly sweeping the power level of the RF output from a lower power level value to a higher power level value (or vice versa) at a regular interval.

Generating a power sweep requires the following external equipment.

Equipment	Requirements
Function Generator	Must be capable of producing a sawtooth signal from a minimum of 0 volts to a maximum up to +6 volts, depending on the amount of attenuation required in the power sweep. The input impedance of the <b>AM IN</b> connector is 5 k $\Omega$ .

---

### CAUTION

The sawtooth signal must never exceed the range of +15.5V to -15.5V or damage to the AM IN input can occur.

1. Connect the equipment as shown in Figure 3-2:

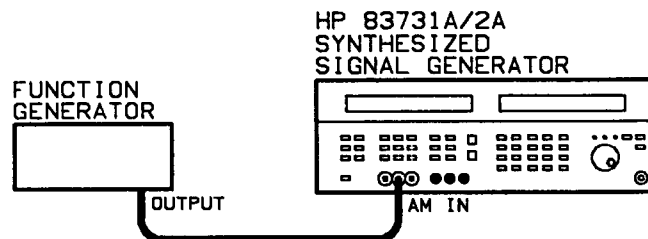

Figure 3-2. Log AM Equipment Setup

2. Press the **LOG AM ON/OFF** key to turn logarithmic amplitude modulation on.

When logarithmic amplitude modulation is turned on, the LOG AM annunciator will be lit.

3. If any of the other modulations are turned on, press the appropriate key to turn them off.

If any of the other modulations are turned on, the annunciator shown in the second column of the following table will be lit.

Modulation Type	Annunciator	Press This Key
DC coupled FM	DC FM	<b>FM ON/OFF</b>
AC coupled FM	AC FM	<b>FM ON/OFF</b>
internal pulse	INT (PULSE)	<b>INT ON/OFF</b>
external pulse	EXT (PULSE)	<b>EXT ON/OFF</b>
external inverted pulse	INVERT EXT	<b>EXT ON/OFF</b>
internal triggered pulse	TRIG INT	<b>TRIG ON/OFF</b>

4. Press the **INT LEVEL** key to enable internal leveling.

5. Set the desired carrier frequency.

For example, if you are performing an amplifier 1 dB gain compression test at 2.3 GHz, perform the following procedure to set the carrier frequency..

- a. Press the **FREQ** key.
- b. Type **2**, **.**, **3** on the Synthesizer numeric keypad.
- c. Terminate the carrier frequency entry by pressing the **GHz** key.

6. Set the RF output power level to the highest value needed in the power sweep.

For example, if the power is to sweep from -30 dBm to -5 dBm, perform the following procedure to set the output power level to -5 dBm.

- a. Press the **POWER LEVEL** key.
- b. Type **-**, **5** on the Synthesizer numeric keypad.
- c. Terminate the power level entry by pressing the **GHz** (dBm) key.

7. Set the controls of the function generator for a sawtooth waveform that will produce the desired power sweep.

**To Generate a Power Sweep**

For every +1 volt at the AM IN connector, The RF output will be attenuated by 10 dB. For example, the waveform in Figure 3-3 applied to the AM IN connector will cause the RF output to sweep linearly from -5 dBm to -30 dBm every 100 ms.

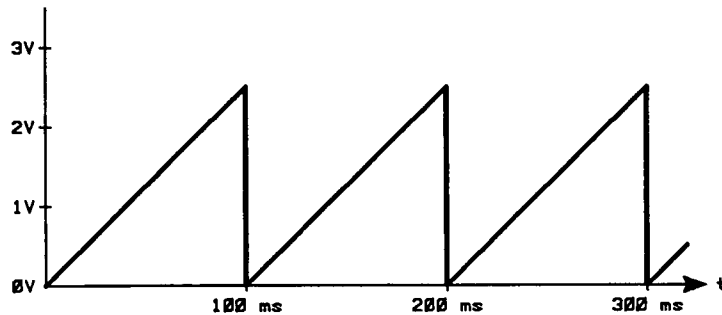

**Figure 3-3. Example Sawtooth Waveform**

The power sweep can vary from a lower to a higher power value or vice versa, depending on the slope of the sawtooth waveform. Note that maximum frequency of the sawtooth waveform that will produce a linear power sweep depends on the voltage excursion of the waveform. Refer to Slow Time in the specification table in this manual for the actual limitation.

8. If the RF output is currently turned off, press the **RF ON/OFF** key to turn it on.

If the RF output is off, the word OFF appears in the power level portion of the rightmost display.

---

## Programming Example

In the following example, a power sweep will be generated at a carrier frequency of 2.3 GHz. The power will sweep from a minimum level of -30 dBm to a maximum level of -5 dBm.

To program the Synthesizer to generate the power sweep explained above, connect the equipment as shown in Figure 3-2. Set the function generator to generate the sawtooth waveform shown in Figure 3-3, and then run the following program.

10 OUTPUT 719; "*RST"	<i>Presets the Synthesizer.</i>
20 OUTPUT 719; "AM:STAT ON"	<i>Turns logarithmic amplitude modulation on.</i>
30 OUTPUT 719; "POW:ALC:SOOR INT"	<i>Enables internal leveling.</i>
40 OUTPUT 719; "FREQ 2.3GHZ"	<i>Sets the carrier frequency to 2.3 GHz.</i>
50 OUTPUT 719; "POW:LEV -5DBM"	<i>Sets the output power level to -5 dBm (the maximum level needed in the power sweep).</i>
60 OUTPUT 719; "OUTP:STAT ON"	<i>Turns the RF output on.</i>
70 END	



---

## To Generate Repetitive, Internal Pulse Modulation

You can generate a repetitive, pulse modulated signal at any carrier frequency within the Synthesizer output frequency range. When internal pulse modulation is used, the pulsed RF output signal will have pulse width, delay, and pulse repetition frequency parameters set via the Synthesizer front panel.

1. Press the **INT ON/OFF** key to turn internal pulse modulation on.

When internal pulse modulation is turned on, the INT (PULSE) annunciator will be lit.

2. If any of the other modulations are turned on, press the appropriate key to turn them off.

If any of the other modulations are turned on, the annunciator shown in the second column of the following table will be lit.

Modulation Type	Annunciator	Press This Key
logarithmic AM	LOG AM	<b>LOG AM ON/OFF</b>
DC coupled FM	DC FM	<b>FM ON/OFF</b>
AC coupled FM	AC FM	<b>FM ON/OFF</b>

3. Press the **INT LEVEL** key to enable internal leveling.

4. Set the desired carrier frequency.

For example, perform the following procedure to set the carrier frequency to 3.085 GHz.

- a. Press the **FREQ** key.
- b. Type **3,0,8,5** on the Synthesizer numeric keypad.
- c. Terminate the carrier frequency entry by pressing the **GHz** key.

5. Set the desired RF output power level.

For example, perform the following procedure to set the output power level to -26 dBm.

- a. Press the **POWER LEVEL** key.

- b. Type **[−]**, **[2]**, **[6]** on the Synthesizer numeric keypad.
  - c. Terminate the power level entry by pressing the **[GHz]** (dBm) key.
6. Set the desired pulse repetition interval (PRI).
- For example, perform the following procedure to set the pulse repetition interval to 100 ms.
- a. Press the **[PRI]** key.
  - b. Type **[1]**, **[0]**, **[0]** on the Synthesizer numeric keypad.
  - c. Terminate the pulse repetition frequency entry by pressing the **[GHz]** (ms) key.
7. Set the desired pulse width.
- For example, perform the following procedure to set the pulse width to 25 ms.
- a. Press the **[WIDTH]** key.
  - b. Type **[2]**, **[5]** on the Synthesizer numeric keypad.
  - c. Terminate the pulse width entry by pressing the **[GHz]** (ms) key.
8. Set the desired pulse delay.
- For example, perform the following procedure to set the pulse delay to 200  $\mu$ s.
- a. Press the **[DELAY]** key.
  - b. Type **[2]**, **[0]**, **[0]** on the Synthesizer numeric keypad.
  - c. Terminate the pulse delay entry by pressing the **[MHz]** (us) key.
9. If the RF output is currently turned off, press the **[RF ON/OFF]** key to turn it on.
- If the RF output is off, the word OFF appears in the power level portion of the rightmost display.

The Synthesizer will produce a pulsed RF output signal with pulse width, delay, and pulse repetition frequency parameters set via the front panel.

**NOTE**

If the Synthesizer pulsed RF output is to be connected to average power sensitive circuitry, refer to AVG PWR INHIBIT ON/OFF in chapter 7 of this manual.

---

## Programming Example

In the following example, an internally leveled, internally pulse modulated signal will be generated at a carrier frequency of 3.085 GHz with a power level of -26 dBm. The pulses will have pulse repetition interval of 100 ms with a 25 ms pulse width and a 200  $\mu$ s delay.

10 OUTPUT 719; "*RST"	<i>Presets the Synthesizer.</i>
20 OUTPUT 719; "PULM:SOUR INT"	<i>Sets pulse source to internal.</i>
30 OUTPUT 719; "TRIG:SOUR IMM"	<i>Sets pulse trigger source to immediate (non-triggered).</i>
40 OUTPUT 719; "PULM:STAT ON"	<i>Turns pulse modulation on.</i>
50 OUTPUT 719; "POW:ALC:SOUR INT"	<i>Enables internal leveling.</i>
60 OUTPUT 719; "FREQ 3.085GHZ"	<i>Sets the carrier frequency to 3.085 GHz.</i>
70 OUTPUT 719; "POW:LEV -26DBM"	<i>Sets the output power level to -26 dBm.</i>
80 OUTPUT 719; "POW:PROT:STAT ON OFF"	<i>Turns average power inhibit on or off.</i>
90 OUTPUT 719; "PULS:PER 100MS"	<i>Sets the pulse repetition interval to 100 ms.</i>
100 OUTPUT 719; "PULS:WIDT 25MS"	<i>Sets the pulse width to 25 ms.</i>
110 OUTPUT 719; "PULS:DEL 200US"	<i>Sets the pulse delay to 200 <math>\mu</math>s.</i>
120 OUTPUT 719; "OUTP:STAT ON"	<i>Turns the RF output on.</i>
130 END	

## Related Tasks

- AVG PWR INHIBIT ON/OFF
- To Generate Externally Triggered Pulse Modulation
- To Generate Repetitive, External Pulse Modulation
- To Generate a Doublet Pulse
- To Generate Gated Pulse Modulation
- To Generate Simultaneous Log AM and Pulse Modulation

## To Generate Externally Triggered Pulse Modulation

You can generate an externally triggered, pulse modulated signal at any carrier frequency within the Synthesizer output frequency range. When externally triggered pulse modulation is used, a valid TTL level trigger signal at the PULSE/TRIG, GATE IN connector will cause pulsed RF to appear at the RF OUTPUT connector with pulse width and delay set with the **WIDTH** and **DELAY** keys.

Generating externally triggered, pulse modulated signals requires the following external equipment.

Equipment	Requirements
Trigger Signal Source	Must be capable of sourcing a TTL level signal into a 50Ω load.

### CAUTION

The trigger signal must never exceed the range of +5.5V to -0.5V or damage to the PULSE/TRIG, GATE IN input can occur.

1. Connect the equipment as shown in Figure 3-4:

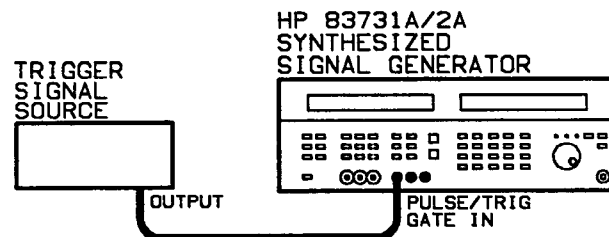

Figure 3-4. Externally Triggered Pulse Modulation Equipment Setup

2. Press the **TRIG ON/OFF** key to turn externally triggered internal pulse modulation on.

When externally triggered internal pulse modulation is turned on, the TRIG INT annunciator will be lit.

3. If any of the other modulations are turned on, press the appropriate key to turn them off.

If any of the other modulations are turned on, the annunciator shown in the second column of the following table will be lit.

Modulation Type	Annunciator	Press This Key
logarithmic AM	LOG AM	LOG AM ON/OFF
DC coupled FM	DC FM	FM ON/OFF
AC coupled FM	AC FM	FM ON/OFF

4. Press the **INT LEVEL** key to enable internal leveling.  
 5. Set the desired carrier frequency.

For example, perform the following procedure to set the carrier frequency to 5 GHz.

- a. Press the **FREQ** key.
  - b. Type **5** on the Synthesizer numeric keypad.
  - c. Terminate the carrier frequency entry by pressing the **GHz** key.
6. Set the desired RF output power level.

For example, perform the following procedure to set the output power level to -5 dBm.

- a. Press the **POWER LEVEL** key.
  - b. Type **-**, **5** on the Synthesizer numeric keypad.
  - c. Terminate the power level entry by pressing the **GHz (dBm)** key.
7. Set the desired pulse width.

For example, perform the following procedure to set the pulse width to 23 ms.

- a. Press the **WIDTH** key.
  - b. Type **2**, **3** on the Synthesizer numeric keypad.
  - c. Terminate the pulse width entry by pressing the **GHz (ms)** key.
8. Set the desired pulse delay.

**To Generate Externally Triggered Pulse Modulation**

For example, perform the following procedure to set the pulse delay to 100  $\mu$ s.

- a. Press the **DELAY** key.
  - b. Type **1**, **0**, **0** on the Synthesizer numeric keypad.
  - c. Terminate the pulse delay entry by pressing the **MHz** ( $\mu$ s) key.
9. Set the controls of the trigger signal source to generate the desired external pulse trigger signal.
  10. If the RF output is currently turned off, press the **RF ON/OFF** key to turn it on.

If the RF output is off, the word OFF appears in the power level portion of the rightmost display.

When the Synthesizer receives a valid trigger signal from the trigger signal source, an RF pulse will appear at the Synthesizer RF OUTPUT connector with width and delay parameters set with the **WIDTH** and **DELAY** keys. For example, if the width has been set to 23 ms and delay has been set to 100  $\mu$ s, the pulse shown in Figure 3-5 will result upon a valid trigger signal.

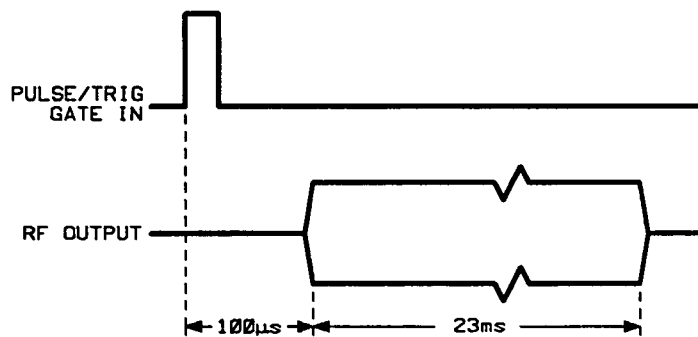

**Figure 3-5. Triggered Pulse Mode Timing Example**

**NOTE**

If the Synthesizer pulsed RF output is to be connected to average power sensitive circuitry, refer to AVG PWR INHIBIT ON/OFF in chapter 7 of this manual.

---

## Programming Example

In the following example, an internally leveled, externally triggered pulse modulated signal will be generated at a carrier frequency of 5 GHz with a power level of  $-5$  dBm. The pulses will have a 23 ms pulse width and a 100  $\mu$ s delay.

To program the Synthesizer to generate the signal explained above, connect the equipment as shown in Figure 3-4, set the trigger signal source for the desired triggering characteristics, and then run the following program.

10 OUTPUT 719; "*RST"	<i>Presets the Synthesizer.</i>
20 OUTPUT 719; "PULM:SOUR INT"	<i>Sets pulse source to internal.</i>
30 OUTPUT 719; "TRIG:SOUR EXT"	<i>Enables triggered pulse mode.</i>
40 OUTPUT 719; "PULM:STAT ON"	<i>Turns pulse modulation on.</i>
50 OUTPUT 719; "POW:ALC:SOUR INT"	<i>Enables internal leveling.</i>
60 OUTPUT 719; "FREQ 5GHZ"	<i>Sets the carrier frequency to 5 GHz.</i>
70 OUTPUT 719; "POW:LEV -5DBM"	<i>Sets the output power level to <math>-5</math> dBm.</i>
80 OUTPUT 719; "POW:PROT:STAT ON OFF"	<i>Turns average power inhibit on or off.</i>
90 OUTPUT 719; "PULS:WIDT 23MS"	<i>Sets the pulse width to 23 ms.</i>
100 OUTPUT 719; "PULS:DEL 100US"	<i>Sets the pulse delay to 100 <math>\mu</math>s.</i>
110 OUTPUT 719; "OUTP:STAT ON"	<i>Turns the RF output on.</i>
120 END	



---

## Related Tasks

- AVG PWR INHIBIT ON/OFF
- To Generate Repetitive, Internal Pulse Modulation
- To Generate Repetitive, External Pulse Modulation
- To Generate a Doublet Pulse
- To Generate Gated Pulse Modulation
- To Generate Simultaneous Log AM and Pulse Modulation

---

## To Generate Repetitive, External Pulse Modulation

You can generate a repetitive, pulse modulated signal at any carrier frequency within the Synthesizer output frequency range. When external pulse modulation is used, the pulsed RF output signal will have pulse width, delay, and pulse repetition frequency parameters set via an external pulse source.

Generating external pulse modulation requires the following external equipment.

Equipment	Requirements
Pulse Source	Must be capable of sourcing a TTL level signal into a 50Ω load.

---

### CAUTION

The pulse modulating signal must never exceed the range of +5.5V to -0.5V or damage to the PULSE/TRIG, GATE IN input can occur.

1. Connect the equipment as shown in Figure 3-6:

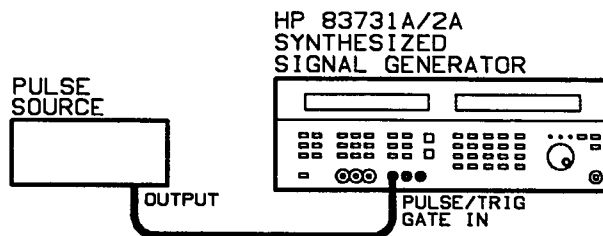

Figure 3-6. External Pulse Modulation Equipment Setup

2. Press the **EXT ON/OFF** key to turn external pulse modulation on or press the **SHIFT** key and then the **EXT ON/OFF** (INVERT) key to turn inverted external pulse modulation on.

When external pulse modulation is turned on, the EXT annunciator will be lit. When inverted external pulse modulation is turned on, the INVERT EXT annunciator will be lit.

**To Generate Repetitive, External Pulse Modulation**

If inverted external pulse modulation is used, the external pulse modulating signal sense will be inverted before affecting the envelope of the pulse modulated RF output signal.

3. If any of the other modulations are turned on, press the appropriate key to turn them off.

If any of the other modulations are turned on, the annunciator shown in the second column of the following table will be lit.

Modulation Type	Annunciator	Press This Key
logarithmic AM	LOG AM	LOG AM ON/OFF
DC coupled FM	DC FM	FM ON/OFF
AC coupled FM	AC FM	FM ON/OFF

4. Press the **INT LEVEL** key to enable internal leveling.
5. Set the desired carrier frequency.

For example, perform the following procedure to set the carrier frequency to 12.02 GHz.

- a. Press the **FREQ** key.
  - b. Type **1, 2, ., 0, 2** on the Synthesizer numeric keypad.
  - c. Terminate the carrier frequency entry by pressing the **GHz** key.
6. Set the desired RF output power level.

For example, perform the following procedure to set the output power level to -25 dBm.

- a. Press the **POWER LEVEL** key.
  - b. Type **=, 2, 5** on the Synthesizer numeric keypad.
  - c. Terminate the power level entry by pressing the **GHz (dBm)** key.
7. Set the controls of the pulse source for the desired pulse PRF, width, and delay.

8. If the RF output is currently turned off, press the **RF ON/OFF** key to turn it on.

If the RF output is off, the word OFF appears in the power level portion of the rightmost display.

The Synthesizer will produce a pulsed RF output signal with pulse width, delay, and pulse repetition frequency parameters set with an external pulse source.

**NOTE**

If the Synthesizer pulsed RF output is to be connected to average power sensitive circuitry, refer to AVG PWR INHIBIT ON/OFF in chapter 7 of this manual.

---

## Programming Example

In the following example, an internally leveled, externally pulse modulated signal will be generated at a carrier frequency of 12.02 GHz with a power level of  $-25$  dBm. The pulse characteristics (PRI, width, and delay) will be set with an external pulse source.

To program the Synthesizer to generate the signal explained above, connect the equipment as shown in Figure 3-6, set the pulse source for the desired PRI, width, and delay, and then run the following program.

10 OUTPUT 719; "*RST"	<i>Presets the Synthesizer.</i>
20 OUTPUT 719; "PULM:SOUR EXT"	<i>Sets pulse source to external.</i>
30 OUTPUT 719; "PULM:EXT:POL <u>NORM INV</u> "	<i>Sets external pulse polarity. Choose "NORM" for non-inverted external pulse modulation or "INV" for inverted external pulse modulation.</i>
40 OUTPUT 719; "PULM:STAT ON"	<i>Turns pulse modulation on.</i>
50 OUTPUT 719; "POW:ALC:SOUR INT"	<i>Enables internal leveling.</i>
60 OUTPUT 719; "FREQ 12.02GHZ"	<i>Sets the carrier frequency to 12.02 GHz.</i>
70 OUTPUT 719; "POW:LEV -25DBM"	<i>Sets the output power level to <math>-25</math> dBm.</i>
80 OUTPUT 719; "POW:PROT:STAT <u>ON OFF</u> "	<i>Turns average power inhibit on or off.</i>
90 OUTPUT 719; "OUTP:STAT ON"	<i>Turns the RF output on.</i>
100 END	

---

## Related Tasks

- AVG PWR INHIBIT ON/OFF
- To Generate Repetitive, Internal Pulse Modulation
- To Generate Externally Triggered Pulse Modulation
- To Generate a Doublet Pulse
- To Generate Gated Pulse Modulation
- To Generate Simultaneous Log AM and Pulse Modulation

## To Generate a Doublet Pulse

You can generate a doublet pulse at any carrier frequency within the Synthesizer output frequency range. When a doublet pulse is generated, the Synthesizer will generate two RF pulses. The envelope of the first RF pulse will follow a valid (TTL high) pulse provided at the PULSE/TRIG, GATE IN connector. The second RF pulse is generated internally and will have a pulse width and pulse delay as set with the **WIDTH** and **DELAY** keys.

Generating doublet pulses requires the following external equipment.

Equipment	Requirements
Pulse Source	Must be capable of sourcing a TTL level signal into a 50Ω load.

### CAUTION

The pulse modulating signal must never exceed the range of +5.5V to -0.5V or damage to the PULSE/TRIG, GATE IN input can occur.

1. Connect the equipment as shown in Figure 3-7:

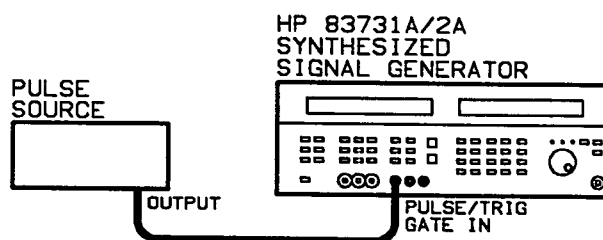

Figure 3-7. Doublet Pulse Equipment Setup

2. Press the **SHIFT** key and then the **DOUBLET (TRIG ON/OFF)** key to turn doublet pulse mode on.

When doublet pulse mode is turned on, the text "DOUBLET" will appear in the PRF/PRI portion of the leftmost display.

**To Generate a Doublet Pulse**

3. If any of the other modulations are turned on, press the appropriate key to turn them off.

If any of the other modulations are turned on, the annunciator shown in the second column of the following table will be lit.

Modulation Type	Annunciator	Press This Key
logarithmic AM	LOG AM	LOG AM ON/OFF
DC coupled FM	DC FM	FM ON/OFF
AC coupled FM	AC FM	FM ON/OFF

4. Press the **INT LEVEL** key to enable internal leveling.

5. Set the desired carrier frequency.

For example, perform the following procedure to set the carrier frequency to 10 GHz.

- a. Press the **FREQ** key.
- b. Type **1**, **0** on the Synthesizer numeric keypad.
- c. Terminate the carrier frequency entry by pressing the **GHz** key.

6. Set the desired RF output power level.

For example, perform the following procedure to set the output power level to -25 dBm.

- a. Press the **POWER LEVEL** key.
- b. Type **-**, **2**, **5** on the Synthesizer numeric keypad.
- c. Terminate the power level entry by pressing the dBm **GHz** key.

7. Set the desired pulse width.

For example, perform the following procedure to set the pulse width to 1  $\mu$ s.

- a. Press the **WIDTH** key.
- b. Type **1** on the Synthesizer numeric keypad.
- c. Terminate the pulse width entry by pressing the  $\mu$ s **MHz** key.

8. Set the desired pulse delay.

For example, perform the following procedure to set the pulse delay to 2  $\mu\text{s}$ .

- a. Press the **DELAY** key.
  - b. Type **2** on the Synthesizer numeric keypad.
  - c. Terminate the pulse delay entry by pressing the  $\mu\text{s}$  (**MHz**) key.
9. Set the controls of the pulse source to generate the desired pulse.
10. If the RF output is currently turned off, press the **RF ON/OFF** key to turn it on.

If the RF output is off, the word OFF appears in the power level portion of the rightmost display.

Delay is measured from the rising edge of the input pulse. By varying the Synthesizer delay time, you can vary the off time between the two pulses. This is useful when testing receiver recovery time (shadow time). For example, if the width has been set to 1  $\mu\text{s}$  and delay has been set to 2  $\mu\text{s}$ , the pulses shown in Figure 3-8 will result upon a 500 ns gate signal.

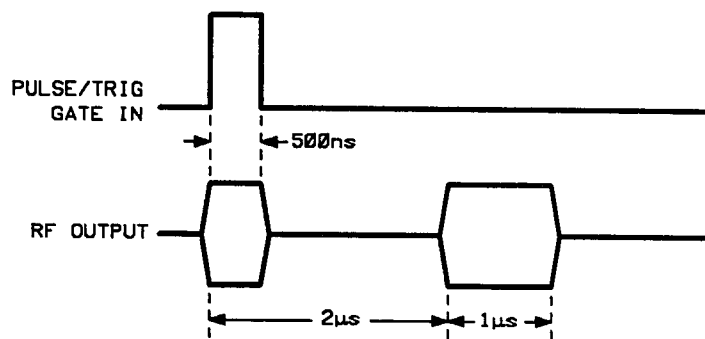

Figure 3-8. Doublet Pulse Mode Timing Example



**To Generate a Doublet Pulse**

**NOTE**

If the Synthesizer pulsed RF output is to be connected to average power sensitive circuitry, refer to AVG PWR INHIBIT ON/OFF in chapter 7 of this manual.

---

## Programming Example

In the following example, doublet pulses will be generated at a carrier frequency of 10 GHz with a power level of  $-25$  dBm. The pulses will have a  $1 \mu\text{s}$  pulse width and a pulse delay of  $2 \mu\text{s}$ .

To program the Synthesizer to generate the pulses explained above, connect the equipment as shown in Figure 3-7, set the gate signal source for the desired gate pulse characteristics, and then run the following program.

10 OUTPUT 719; "*RST"	<i>Presets the Synthesizer.</i>
20 OUTPUT 719; "PULM:SOUR INT"	<i>Sets pulse source to internal.</i>
30 OUTPUT 719; "PULS:DOUB ON"	<i>Enables doublet pulse mode.</i>
40 OUTPUT 719; "PULM:STAT ON"	<i>Turns pulse modulation on.</i>
50 OUTPUT 719; "POW:ALC:SOUR INT"	<i>Enables internal leveling.</i>
60 OUTPUT 719; "FREQ 10GHZ"	<i>Sets the carrier frequency to 10 GHz.</i>
70 OUTPUT 719; "POW:LEV -25DBM"	<i>Sets the output power level to <math>-25</math> dBm.</i>
80 OUTPUT 719; "POW:PROT:STAT <u>ON OFF</u> "	<i>Turns average power inhibit on or off.</i>
90 OUTPUT 719; "PULS:WIDT 1US"	<i>Sets the pulse width to <math>1 \mu\text{s}</math>.</i>
100 OUTPUT 719; "PULS:DEL 2US"	<i>Sets the pulse delay to <math>2 \mu\text{s}</math>.</i>
110 OUTPUT 719; "OUTP:STAT ON"	<i>Turns the RF output on.</i>
120 END	

---

## Related Tasks

- AVG PWR INHIBIT ON/OFF
- To Generate Repetitive, Internal Pulse Modulation
- To Generate Externally Triggered Pulse Modulation
- To Generate Repetitive, External Pulse Modulation
- To Generate Gated Pulse Modulation
- To Generate Simultaneous Log AM and Pulse Modulation

---

## To Generate Gated Pulse Modulation

You can generate a gated, pulse modulated signal at any carrier frequency within the Synthesizer output frequency range. When gated pulse modulation is used, a valid TTL level gate signal at the PULSE/TRIG, GATE IN connector will cause pulsed RF to appear at the RF OUTPUT connector as long as the gate signal remains at a TTL high level. The pulsed RF output will have a pulse width and pulse repetition frequency as set with the **WIDTH** and PRF **(PRI)** keys.

Generating gated, pulse modulated signals requires the following external equipment.

Equipment	Requirements
Gate Signal Source	Must be capable of sourcing a TTL level signal into a 50Ω load.

---

### CAUTION

The gate signal must never exceed the range of +5.5V to -0.5V or damage to the PULSE/TRIG, GATE IN input can occur.

1. Connect the equipment as shown in Figure 3-9:

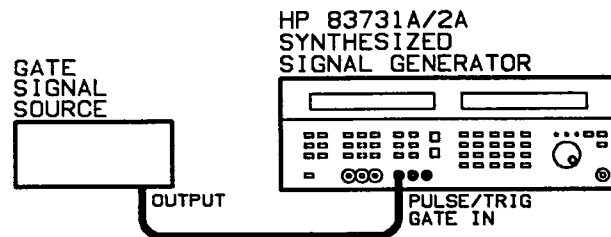

Figure 3-9. Gated Pulse Modulation Equipment Setup

2. Press the **(SHIFT)** key and then the GATED **(INT ON/OFF)** key to turn gated pulse modulation on.

When gated pulse modulation is turned on, the text "GATED" will appear in the delay portion of the leftmost display.

3. If any of the other modulations are turned on, press the appropriate key to turn them off.

If any of the other modulations are turned on, the annunciator shown in the second column of the following table will be lit.

Modulation Type	Annunciator	Press This Key
logarithmic AM	LOG AM	LOG AM ON/OFF
DC coupled FM	DC FM	FM ON/OFF
AC coupled FM	AC FM	FM ON/OFF

4. Press the INT LEVEL key to enable internal leveling.

5. Set the desired carrier frequency.

For example, perform the following procedure to set the carrier frequency to 6.67 GHz.

- a. Press the FREQ key.
- b. Type 6, ., 6, 7 on the Synthesizer numeric keypad.
- c. Terminate the carrier frequency entry by pressing the GHz key.

6. Set the desired RF output power level.

For example, perform the following procedure to set the output power level to -45 dBm.

- a. Press the POWER LEVEL key.
- b. Type -, 4, 5 on the Synthesizer numeric keypad.
- c. Terminate the power level entry by pressing the dBm (GHz) key.

7. Set the desired pulse width.

For example, perform the following procedure to set the pulse width to 100  $\mu$ s.

- a. Press the WIDTH key.
- b. Type 1, 0, 0 on the Synthesizer numeric keypad.
- c. Terminate the pulse width entry by pressing the  $\mu$ s (MHz) key.

Generating Signals with the Synthesizer  
**To Generate Gated Pulse Modulation**

8. Set the desired pulse repetition frequency (PRF).

For example, perform the following procedure to set the pulse repetition frequency to 1 kHz.

- a. Press the **SHIFT** key and then the PRF (**PRI**) key.
- b. Type **1** on the Synthesizer numeric keypad.
- c. Terminate the pulse repetition frequency entry by pressing the **kHz** key.

9. Set the controls of the gate signal source to generate the desired gate signal.

10. If the RF output is currently turned off, press the **RF ON/OFF** key to turn it on.

If the RF output is off, the word **OFF** appears in the power level portion of the rightmost display.

When the gate signal from the gate signal source is at a TTL high level, RF pulses will appear at the Synthesizer RF OUTPUT connector for as long as the gate signal remains high. If the gate signal switches to a TTL low level during when a pulse is present at the RF OUTPUT, the last pulse will complete before the pulse train ceases. For example, if the width has been set to 100  $\mu$ s and PRF has been set to 1 kHz (PRI set to 1 ms), the pulses shown in Figure 3-10 will result upon a valid gate signal.

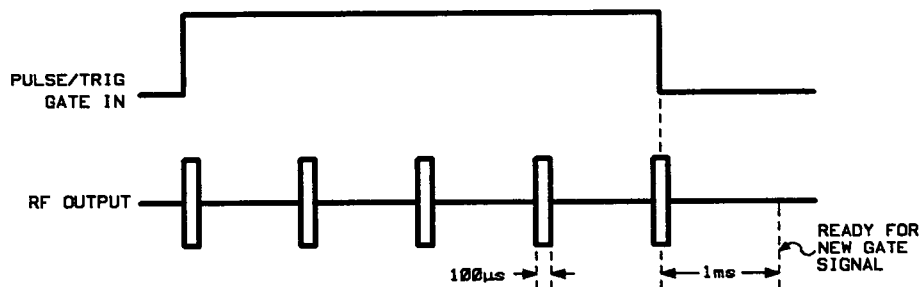

**Figure 3-10. Gated Pulse Mode Timing Example**

**NOTE**

If the Synthesizer pulsed RF output is to be connected to average power sensitive circuitry, refer to AVG PWR INHIBIT ON/OFF in chapter 7 of this manual.

---

## Programming Example

In the following example, a gated, pulse modulated signal will be generated at a carrier frequency of 6.67 GHz with a power level of  $-45$  dBm. The pulses will have a  $100\ \mu\text{s}$  pulse width and a pulse repetition frequency of 1 kHz..

To program the Synthesizer to generate the signal explained above, connect the equipment as shown in Figure 3-9, set the gate signal source for the desired gate signal characteristics, and then run the following program.

10 OUTPUT 719; "*RST"	<i>Presets the Synthesizer.</i>
20 OUTPUT 719; "PULM:SOUR INT"	<i>Sets pulse source to internal.</i>
30 OUTPUT 719; "TRIG:SOUR EXT"	<i>Enables triggered pulse mode.</i>
40 OUTPUT 719; "TRIG:STOP:SOUR EXT"	<i>Sets the pulse trigger stop source to external.</i>
50 OUTPUT 719; "PULM:STAT ON"	<i>Turns pulse modulation on.</i>
60 OUTPUT 719; "POW:ALC:SOUR INT"	<i>Enables internal leveling.</i>
70 OUTPUT 719; "FREQ 6.67GHZ"	<i>Sets the carrier frequency to 6.67 GHz.</i>
80 OUTPUT 719; "POW:LEV -45DBM"	<i>Sets the output power level to <math>-45</math> dBm.</i>
90 OUTPUT 719; "POW:PROT:STAT <u>ON OFF</u> "	<i>Turns average power inhibit on or off.</i>
100 OUTPUT 719; "PULS:WIDT 100US"	<i>Sets the pulse width to <math>100\ \mu\text{s}</math>.</i>
110 OUTPUT 719; "PULS:FREQ 1KHZ"	<i>Sets the pulse repetition frequency to 1 kHz.</i>
120 OUTPUT 719; "OUTP:STAT ON"	<i>Turns the RF output on.</i>
130 END	

## Related Tasks

- AVG PWR INHIBIT ON/OFF
- To Generate Repetitive, Internal Pulse Modulation
- To Generate Externally Triggered Pulse Modulation
- To Generate Repetitive, External Pulse Modulation
- To Generate a Doublet Pulse
- To Generate Simultaneous Log AM and Pulse Modulation

---

## To Generate Simultaneous Log AM and Pulse Modulation

You can generate simultaneous logarithmic AM and pulse modulation by applying a voltage waveform to the Synthesizer AM IN connector while simultaneously applying either internal, external, or gated pulse modulation. The resulting signal at the Synthesizer RF OUTPUT connector is useful for antenna scan patterns that can be used in radar receiver test applications.

Generating simultaneous logarithmic AM and pulse modulation requires the following external equipment.

Equipment	Requirements
Arbitrary Waveform Generator	Must be capable of producing the desired antenna scan waveform with an amplitude varying from a minimum of 0 volts to a maximum up to +6 volts, depending on the amount of dynamic range required in the antenna scan pattern. The input impedance of the <b>AM IN</b> connector is 5 k $\Omega$ .
Pulse Generator <i>(optional)</i>	Must be capable of sourcing a TTL level signal into a 50 $\Omega$ load.

---

### CAUTION

1. The antenna scan waveform must never exceed the range of +15.5V to -15.5V or damage to the AM IN input can occur.
2. The pulse modulating signal must never exceed the range of +5.5V to -0.5V or damage to the PULSE/TRIG, GATE IN input can occur.

1. Connect the equipment as shown in Figure 3-11:



**To Generate Simultaneous Log AM and Pulse Modulation**

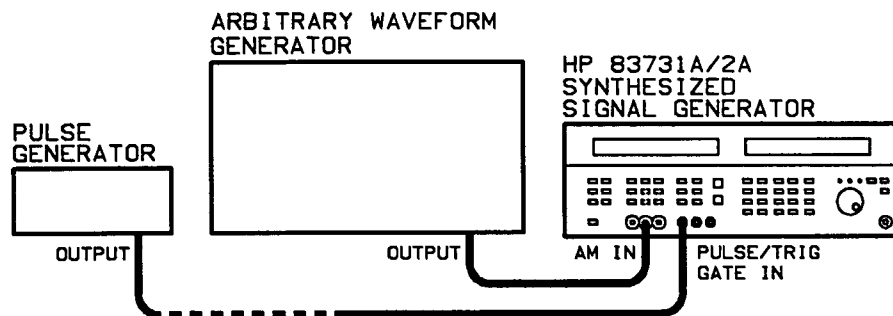

Figure 3-11. Antenna Scan Equipment Setup

2. Press the **INT LEVEL** key to enable internal leveling.

3. Choose the type of pulse modulation and set the pulse characteristics as required for your particular application.

Set the Synthesizer frequency to the required carrier frequency for the pulsed RF. Set the power level to the power level required at the peak of the main lobe of the scan. You can use one of six pulse modulation modes, depending on your application. The six pulse modes are internal, external, external inverted, gated, doublet, and internal triggered pulse modulation.

4. Press the **LOG AM ON/OFF** key to turn logarithmic amplitude modulation on.

When logarithmic amplitude modulation is turned on, the LOG AM annunciator will be lit.

5. If frequency modulation is turned on, press the **FM ON/OFF** key to turn it off.

If frequency modulation is turned on, either the DC FM or AC FM annunciator will be lit.

6. If the RF output is currently turned off, press the **RF ON/OFF** key to turn it on.

If the RF output is off, the word OFF appears in the power level portion of the rightmost display.

7. Set the arbitrary waveform generator to produce a scan waveform with amplitude characteristics that will produce the desired antenna scan with the desired dynamic range.

Generating Signals with the Synthesizer  
To Generate Simultaneous Log AM and Pulse Modulation

The antenna scan waveform should vary from a positive voltage to zero volts. For every +1 volt at the AM IN connector, the RF output will be attenuated by 10 dB. For example, the waveform shown in Figure 3-12 applied to the AM IN connector will cause the antenna scan pattern shown in Figure 3-13 to appear at the Synthesizer RF OUTPUT connector (provided the output level of the Synthesizer has been set to -20 dBm).

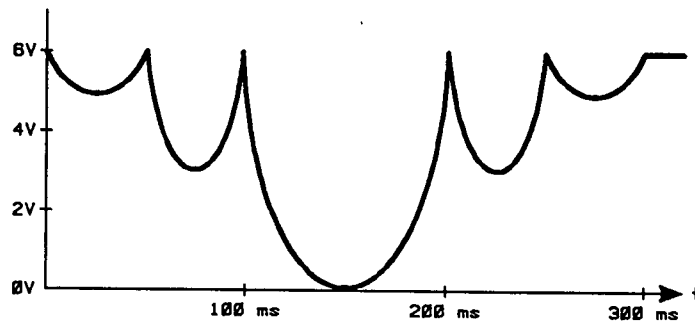

Figure 3-12. Example Antenna Scan Input

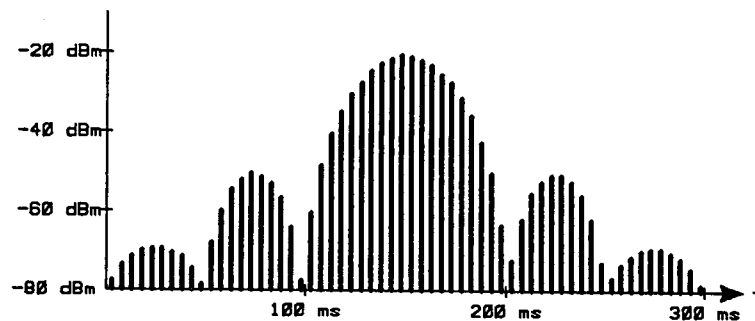

Figure 3-13. Example Modulated Antenna Scan Pattern

When the Synthesizer is used to generate antenna scan patterns, the pulsed signal does not have any duty cycle limitations.

**To Generate Simultaneous Log AM and Pulse Modulation**

**NOTE**

If the Synthesizer pulsed RF output is to be connected to average power sensitive circuitry, refer to AVG PWR INHIBIT ON/OFF in chapter 7 of this manual.

---

## Programming Example

In the following example, an antenna scan pattern will be generated using simultaneous logarithmic AM and internal pulse modulation (external or gated pulse modulation can also be used). A carrier frequency of 2.3 GHz at a peak main lobe power level of  $-20$  dBm will be used. The pulse repetition frequency will be 10 kHz with a pulse width of 1  $\mu$ s.

To program the Synthesizer to generate the antenna scan pattern explained above, connect the equipment as shown in Figure 3-11, omitting the pulse generator. Set the scan generator to produce the scan waveform shown in Figure 3-12, and then run the following program.

10 OUTPUT 719; "*RST"	<i>Presets the Synthesizer.</i>
20 OUTPUT 719; "PULM:SOUR INT"	<i>Sets pulse source to internal.</i>
30 OUTPUT 719; "TRIG:SOUR IMM"	<i>Sets pulse trigger source to immediate (non-triggered).</i>
40 OUTPUT 719; "PULM:STAT ON"	<i>Turns pulse modulation on.</i>
50 OUTPUT 719; "POW:ALC:SOUR INT"	<i>Enables internal leveling.</i>
60 OUTPUT 719; "FREQ 2.3GHZ"	<i>Sets the carrier frequency to 2.3 GHz.</i>
70 OUTPUT 719; "POW:LEV -20DBM"	<i>Sets the output power level to <math>-20</math> dBm (this is the peak main lobe power level).</i>
80 OUTPUT 719; "PULS:FREQ 10KHZ"	<i>Sets the pulse repetition frequency to 10 kHz.</i>
90 OUTPUT 719; "PULS:WIDT 1US"	<i>Sets the pulse width to 1 <math>\mu</math>s.</i>
100 OUTPUT 719; "PULS:DEL 0S"	<i>Sets the pulse delay to zero (no delay).</i>
110 OUTPUT 719; "AM:STAT ON"	<i>Turns logarithmic amplitude modulation on.</i>
120 OUTPUT 719; "OUTP:STAT ON"	<i>Turns the RF output on.</i>
130 END	

## Related Tasks

- AVG PWR INHIBIT ON/OFF
- To Generate Repetitive, Internal Pulse Modulation
- To Generate Repetitive, External Pulse Modulation
- To Generate Gated Pulse Modulation

## To Generate Millimeter Signals

By using external equipment with the Synthesizer, you can generate millimeter-wave signals.

Generating millimeter-wave signals uses the following external equipment.

Equipment	Requirements
Microwave Amplifier	Must be compatible with the HP 8355X Source Module used.
HP 8355X Source Module	Must be capable of generating the desired frequency.

In addition, you must supply any cables and adapters necessary to connect the equipment.

1. Connect the equipment as shown in Figure 3-14:

### CAUTION

Turn off the AC power to the microwave amplifier prior to connecting or disconnecting the source module interface cable.

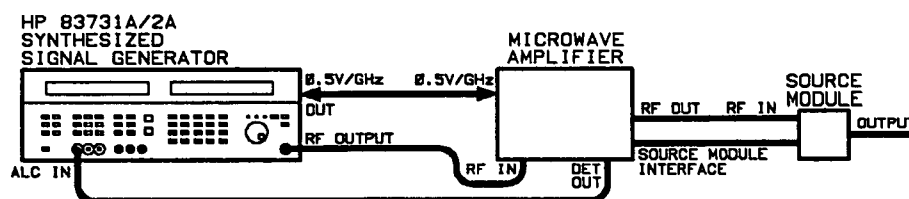

Figure 3-14. Millimeter-Wave Equipment Setup

2. Enter the proper multiplier value for the HP 8355X-series source module that you are using into the Synthesizer.

Perform the following procedure to select and enter the proper multiplier value.

- a. Press the **SHIFT** key.

- b. Press the **(FREQ)** key.
- c. Press the numeric key on the Synthesizer numeric keypad that corresponds to the proper multiplier value from the following table:

Source Module Model Number	Frequency Band	Multiplier Value
HP 83554A	26.5 - 40 GHz	2
HP 83555A	33 - 50 GHz	3
HP 83556A	40 - 60 GHz	3
HP 83557A	50 - 75 GHz	4
HP 83558A	75 - 110 GHz	6

- d. Terminate the multiplier value entry by pressing the **(Hz)** (**ENTER**) key.
3. Set the frequency for the desired output signal.

The Synthesizer frequency display will show the frequency at the output of the millimeter source module, not the Synthesizer RF OUTPUT connector.

For example, if you want to generate a 30 GHz CW only signal, perform the following steps:

- a. Press the **(FREQ)** key.
  - b. Type **(3)**, **(0)** on the numeric keypad.
  - c. Press the **(GHz)** key to terminate the entry.
4. If the RF output is currently turned off, press the **(RF ON/OFF)** key to turn it on.

If the RF output is off, the word OFF appears in the power level portion of the rightmost display.

5. Press the **(INT LEVEL)** key to enable internal leveling.
6. Set the approximate desired RF output power at the output of the millimeter source module using the display on the microwave amplifier.

For example, to set the level to 0 dBm, press **(POWER LEVEL)** and rotate the Synthesizer knob until "0 dBm" is shown on the microwave amplifier display.

7. Press the **(EXT DIODE)** key.

**To Generate Millimeter Signals**

8. Set the RF output power level desired at the output of the millimeter source module using the display on the microwave amplifier.

The display on the microwave amplifier shows the power level at the output of the source module to within  $\pm 2$  dB. You should use the display on the microwave amplifier, not the Synthesizer, when adjusting the RF output power. For example, to set the output power level to 0 dBm, press the **POWER LEVEL** key and rotate the knob until "0 dBm" is shown on the microwave amplifier display.

**NOTE**

The knob resolution can be changed using the **⇒** and **⇐** keys. However, the multiplied signal frequency resolution is further limited due to the multiplier value used. For example, if the multiplier value is set to 3 and the Synthesizer baseband resolution is 1 kHz, the resulting resolution is 3 kHz.

---

## Programming Commands

The following commands are related to the generation of millimeter signals.

<b>FREQ:MULT</b> <u>mult</u>	<i>Sets the multiplier value to the value defined by the "mult" parameter.</i>
<b>POW:ALC:SOUR</b> MMH	<i>Enables external diode detector leveling. Diode detector leveling is used during generation of millimeter signals.</i>

---

## To Use External Diode Detector Leveling

External diode detector leveling is useful when you desire leveled RF output power from the Synthesizer at a point other than the RF OUTPUT connector.

External diode detector leveling uses the following external equipment.

Equipment	Requirements
Diode Detector	Must be specified for use at the desired Synthesizer output frequency. Must produce greater than 1 mv of ALC voltage for the power levels present at the sampling point.
Power Splitter <i>or</i> Directional Coupler	Must be specified for use at the desired Synthesizer output frequency.
Power Meter <i>(optional)</i>	None.
Power Sensor <i>(optional)</i>	Must be capable of measuring power at the frequency and level present at the sampling point in the leveling loop.

### NOTE

The power meter and power sensor are not required, but are helpful when adjusting the Synthesizer output power for the desired power level at the sampling point.

In addition, you must supply the cables and adapters necessary to connect the equipment.

1. Connect the equipment as shown in Figure 3-15:



Generating Signals with the Synthesizer  
**To Use External Diode Detector Leveling**

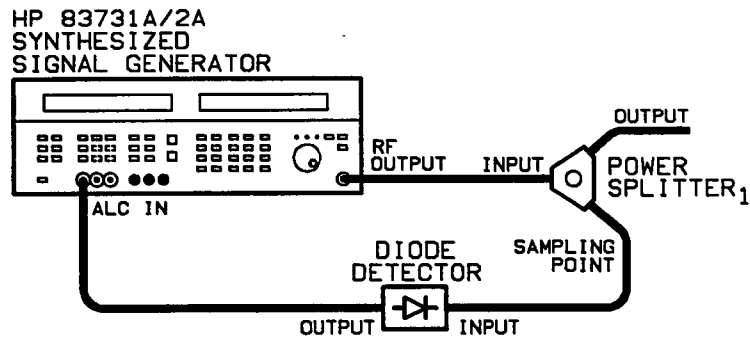

**Figure 3-15. External Diode Detector Leveling Setup**

2. Press the **(INT LEVEL)** key to enable internal leveling.
3. Set the desired output signal frequency using the **(FREQ)** key and any modulation.
4. Set the desired output power level using the **(POWER LEVEL)** key.
5. If the RF output is currently turned off, press the **(RF ON/OFF)** key to turn it on.

If the RF output is off, the word OFF appears in the power level portion of the rightmost display.

6. Adjust the Synthesizer output power so that the desired power at the sampling point is attained.

For example, assume that you are using a power splitter and you want  $-5$  dBm at the output of the splitter. In this case, you must set the power at the sampling point to  $-5$  dBm. Perform the following procedure to set the power at the sampling point to  $-5$  dBm.

- a. Disconnect the diode detector from the power splitter and temporarily connect the power meter and sensor at the sampling point.
- b. Press the **(POWER LEVEL)** key.
- c. Rotate the knob until the power meter reads  $-5$  dBm (disregard the Synthesizer power level reading).

- d. Disconnect the power meter and sensor from the sampling point and reconnect the diode detector.
7. Press the **EXT DIODE** key on the Synthesizer.

When the **EXT DIODE** key is pressed, the Synthesizer enters the external diode detector leveling mode. Power is then held at a constant level at the sampling point, regardless of gain changes in the signal path between the Synthesizer RF OUTPUT connector and the sampling point.

**Notes**

1. When the **EXT DIODE** key is pressed, the Synthesizer output power might change. Therefore, you might want to check the sampled power and readjust if necessary.
2. External diode detector leveling does not provide temperature compensation, thus, output level recalibration might be required in environments that are not temperature stabilized.

---

## Programming Command

The following command is related to external diode detector leveling.

**POW:ALC:SOUR DIOD** *Enables external diode detector leveling.*

---

## Related Tasks

- To Use External Power Meter Leveling

## To Use External Power Meter Leveling

External power meter leveling is useful when you desire leveled RF output power from the Synthesizer at a point other than the RF OUTPUT connector.

External power meter leveling requires the following external equipment.

Equipment	Requirements
Power Meter	Must have a recorder output and range hold capability.
Power Sensor	Must be capable of measuring power at the frequency and level present at the sampling point in the leveling loop.
Power Splitter or Directional Coupler	Must be specified for use at the desired Synthesizer output frequency.

In addition, you must supply the cables and adapters necessary to connect the equipment.

1. Connect the equipment as shown in Figure 3-16:

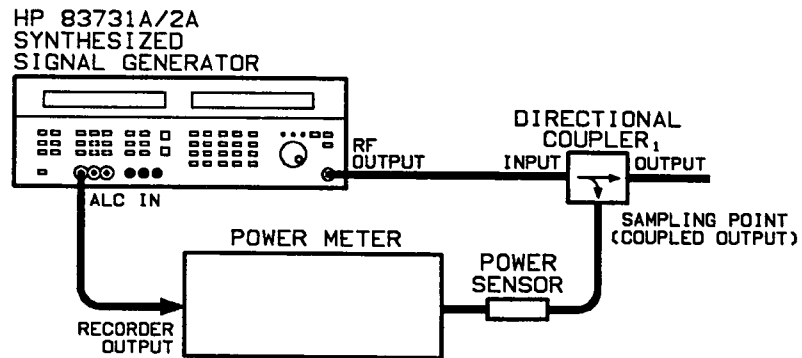

<sup>1</sup>A POWER SPLITTER CAN BE USED IN PLACE OF THE DIRECTIONAL COUPLER.

Figure 3-16. External Power Meter Leveling Setup

2. Press the **INT LEVEL** key to enable internal leveling.

**To Use External Power Meter Leveling**

3. Set the desired output signal frequency using the **(FREQ)** key and any modulation.
4. Set the desired output power level using the **(POWER LEVEL)** key.
5. If the RF output is currently turned off, press the **(RF ON/OFF)** key to turn it on.

If the RF output is off, the word OFF appears in the power level portion of the rightmost display.

6. Select auto range on the power meter.
7. Modify the Synthesizer output power so that the power meter display indicates the power desired at the sampling point.

For example, assume that you are using a directional coupler that has a coupling factor of 22 dB and you want +5 dBm at the output of the coupler. In this case, you must set the power at the sampling point (the coupled output) to -17 dBm. Perform the following procedure to set the power at the sampling point to -17 dBm.

- a. Press the **(POWER LEVEL)** key.
  - b. Rotate the knob on the Synthesizer until the power level displayed on the power meter is -17 dBm. Disregard the power level shown on the Synthesizer display.
8. Select range hold on the power meter.
  9. Press the **(EXT METER)** key on the Synthesizer.

When the **(EXT METER)** key is pressed, the text "RNG-HOLD, POWER XXXdBm" appears in the leftmost display, where "XXX" is the last range hold meter value that was entered.

10. Enter the power shown on the power meter display into the Synthesizer using the numeric keypad.

The value entered into the Synthesizer is called the range hold meter value. For example, if the power meter currently reads -17 dBm, perform the following procedure to enter -17 dBm into the Synthesizer:

- a. Type **(-)**, **(1)**, **(7)** on the Synthesizer numeric keypad.
- b. Terminate the range hold meter value entry by pressing the dBm **(GHz)** key.

When the range hold meter value is terminated, the Synthesizer enters the external power meter leveling mode. Power is then held at a constant level at the sampling point, regardless of gain changes in the signal path between the Synthesizer RF OUTPUT connector and the sampling point.

---

## Programming Commands

The following commands are related to external power meter leveling.

<code>POW:ALC:PMET <u>reading</u></code>	<i>Reads the initial power meter reading into the Synthesizer. The initial power meter reading is defined by the "reading" parameter.</i>
<code>POW:ALC:SOUR PMET</code>	<i>Enables external power meter leveling.</i>

---

## Related Tasks

- To Use External Diode Detector Leveling

---

## To Use the Level Correct Routine

When activated, the level correct function adjusts the Synthesizer output power (to compensate for losses or gains) to provide constant, leveled power at output of the external signal path.

When the level correct routine is used, the Synthesizer performs a calibration process that corrects for external losses or power variations in an external signal path. When the level correct routine is run, a power meter that is under control of the Synthesizer will measure power variations at the output of the external signal path over a user-defined frequency range. The Synthesizer then reads back the power level data from the power meter and creates a table of correction values for each frequency point (the level correction table). The level correction table resides in non-volatile memory and up to four level correction tables can be stored for later use. If the power meter is in a favorable range, the level correct routine takes approximately two minutes to run.

### NOTE

When using the level correct routine, the external path to the Synthesizer must be linear (must have a 1 dB per 1 dB transfer function).

Using the level correct routine requires the following external equipment.

Equipment	Requirements
HP 437B, 438A, 70100A, or SCPI compatible power meter	No substitute.
Power Sensor	Must be compatible with the power meter used. Must be capable of measuring power at the frequencies and levels present at the output of the signal path being leveled.

In addition, you must supply the cables and adapters necessary to connect the equipment.

1. Connect the equipment as shown in Figure 3-17:

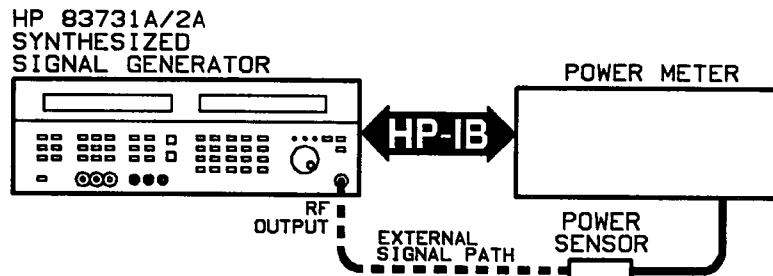

Figure 3-17. Level Correct Routine Equipment Setup

2. Set the address that the Synthesizer will use to address the power meter during the level correct routine.  
For example, use the following procedure to set the power meter address to 23.
  - a. Press the **SPCL** key.
  - b. Type **2**, **0** on the Synthesizer numeric keypad.
  - c. Press the **ENTER (Hz)** key. You will be prompted to enter the power meter address.
  - d. Type **2**, **3** on the Synthesizer numeric keypad.
  - e. Terminate the power meter address by pressing the **Hz (ENTER)** key.
3. Choose the programming language that the Synthesizer will use to communicate with the power meter over the HP-IB.  
For example, use the following procedure to choose HP 437B compatible programming language.
  - a. Press the **SPCL** key.
  - b. Type **2**, **1** on the Synthesizer numeric keypad.
  - c. Press the **ENTER (Hz)** key.
  - d. Press the **↑** or **↓** key until the display reads "POWER METER IS HP437B".
4. Press the **POWER LEVEL** key.



**To Use the Level Correct Routine**

5. Adjust the power level to a level near the center of the power sensor range.
6. Press the **(SHIFT)** key and then the LVL CR **(INT LEVEL)** key.

When **(SHIFT)**, LVL CR **(INT LEVEL)** is pressed, the words "COR START XXX" appear in the leftmost display where "XXX" is the current level correct start frequency.

7. Enter the desired level correct start frequency. If the start frequency shown in the display is the desired start frequency, continue with step 8.

For example, use the following procedure to set the level correct start frequency to 3.5 GHz.

- a. Type **(3)**, **(.)**, **(5)** on the Synthesizer numeric keypad.
- b. Terminate the level correct start frequency by pressing the **(GHz)** key.

Note that the level correct start frequency remains on the display after it is terminated so that it can be modified using the knob or **(↑)**, **(↓)** keys if desired.

8. Press the ENTER **(Hz)** key to begin level correct stop frequency entry.

When the ENTER **(Hz)** key is pressed, the words "COR STOP XXX" appear in the leftmost display where "XXX" is the current level correct stop frequency.

9. Enter the desired level correct stop frequency. If the stop frequency shown in the display is the desired stop frequency, continue with step 10.

For example, use the following procedure to set the level correct stop frequency to 9.75 GHz.

- a. Type **(9)**, **(.)**, **(7)**, **(5)** on the Synthesizer numeric keypad.
- b. Terminate the level correct stop frequency by pressing the **(GHz)** key.

Note that the level correct stop frequency remains on the display after it is terminated so that it can be modified using the knob or **(↑)**, **(↓)** keys if desired.

10. Press the ENTER **(Hz)** key to begin the number of points entry.

When the ENTER (Hz) key is pressed, the words "SET NUMBER OF POINTS XXX" appear in the leftmost display where "XXX" is the current number of points.

11. Enter the desired number of points. If the number of points shown in the display is the desired number of points, continue with step 12.

Note that the start frequency and stop frequency are included in the number of points. Use the following procedure to set the number of points to 100, for example.

- a. Type 1, 0, 0 on the Synthesizer numeric keypad.
- b. Terminate the number of points entry by pressing the ENTER (Hz) key.

Note that the number of points entry remains on the display after it is terminated so that it can be modified using the knob or (↑), (↓) keys if desired.

12. Press the ENTER (Hz) key.

When the ENTER (Hz) key is pressed, the words "RUN CORRECTION?, HIT ENTER" appear in the leftmost display

13. Press ENTER (Hz) to run the level correct routine.

The level correct routine can be aborted before it begins running by pressing the LOCAL key. It can also be aborted any time while it is running by pressing the LOCAL key.

As the level correct routine is running, the rightmost display will be blanked and the leftmost display will show each frequency point and measured power level as each measurement occurs. When the level correct routine has finished running, the leftmost display will blank and the frequency and output power level will return to the rightmost display.

**To Use the Level Correct Routine**

**NOTE**

As the routine is running, the Synthesizer sends the power meter each frequency point so that the correct calibration factor at each frequency can be used. For best accuracy, the correct calibration factors for the power sensor being used should be entered into the power meter prior to running the level correct routine.

14. When the level correct routine has finished running, press the **(SHIFT)** key and then the LVL CR ON/OFF (**(POWER LEVEL)**) key to enable the Synthesizer to use the level correct data when determining the output power level.

When the use the level correct data has been enabled, the LVL CR annunciator will be lit.

15. Disconnect the power meter and power sensor from the level correct setup.

The output of the external signal path can now be connected to the device under test.

The data stored in non-volatile memory will only be valid for the current external signal path. If the external signal path is changed, the level correct routine will have to be rerun.

The table of level correct values can be stored in one of four level correction register locations for later use. To store the table of level correct values in a level correction register location, perform the following procedure.

1. Press the **(SHIFT)** key and then the SAVE CR (**(EXT DIODE)**) key.

The display will show "SAVE IN TABLE XXX" where "XXX" is the current level correction register number.

2. Enter the desired level correction register number.

For example, use the following procedure to choose level correction register number 2.

- a. Type **2** on the Synthesizer numeric keypad.
- b. Terminate the level correction register number entry by pressing the ENTER (**Hz**) key.

**NOTE**

Once the level correction register number entry has been terminated, the current table of level correct values will write over any old level correct data stored at that register location.

---

## Programming Example

During the level correct routine, the Synthesizer must act as a controller. Therefore, it is not possible for another system controller to initiate a level correct routine. The following program can be used to gather level correct data externally, then load the collected data into one of the Synthesizer level correct tables.

```
10 DIM Frequencies(1:401)
   Dimensions frequency array.
20 DIM Losses(1:401)
   Dimensions correction factor array.
30 Synthesizer=719
   Sets Synthesizer address variable to 719.
40 Power_meter=713
   Sets power meter address variable to 719.
50 PRINT "CHOOSE THE START FREQUENCY IN GHZ (1.654321 FOR
   EXAMPLE)"
60 ENTER KBD;Start_freq
   Enters start frequency into variable Start_freq.
70 PRINT "CHOOSE THE START FREQUENCY IN GHZ (15.123456 FOR
   EXAMPLE)"
80 ENTER KBD;Stop_freq
```

## Generating Signals with the Synthesizer

### To Use the Level Correct Routine

*Enters stop frequency into variable Stop\_freq.*  
90 PRINT "CHOOSE THE NUMBER OF POINTS (2 TO 401)"  
100 ENTER KBD;Points  
*Enters number of points into variable Points.*  
110 PRINT "CHOOSE THE LEVEL CORRECTION TABLE TO STORE DATA  
INTO (1 TO 4)"  
120 ENTER KBD;Table\_num  
*Enters correction table number into variable Table\_num.*  
130 PRINT "CHOOSE THE SYNTHESIZER POWER LEVEL TO USE  
DURING ";  
140 PRINT "THE LEVEL CORRECTION"  
150 PRINT "(-3.32 FOR EXAMPLE)"  
160 ENTER KBD;Power\_level  
*Enters power level into variable Power\_lev.*  
170 OUTPUT Synthesizer; "\*RST"  
*Presets the Synthesizer.*  
180 OUTPUT Synthesizer; "POW ";Power\_level  
*Sets Synthesizer power level to the entered value.*  
190 OUTPUT Power\_meter; "\*RST"  
*Presets the power meter.*  
200 OUTPUT Power\_meter; "FM 32 EN"  
*Sets number of averages.*  
210 OUTPUT Power\_meter; "TR0"  
*Sets power meter to trigger hold mode.*  
220 Step\_freq=(Stop\_freq-Start\_freq)/(Points-1)  
*Calculates the frequency step.*  
230 Current\_freq=Start\_freq  
*Sets first frequency in array to start frequency.*  
240 FOR I=1 TO Points  
250     Frequencies(I)=Current\_freq  
*Stores current frequency in array.*  
260     OUTPUT Synthesizer; "FREQ ";Current\_freq;" GHZ"  
*Sets Synthesizer frequency to the current frequency in array.*  
270     OUTPUT Power\_meter; "FR ";Current\_freq;" GZ"  
*Sets power meter frequency to the current frequency in array.*  
280     OUTPUT Power\_meter; "TR2"  
*Sets power meter to trigger with delay.*  
290     WAIT 5  
*Waits five seconds for power meter to settle.*  
300     ENTER Power\_meter;Meter\_reading  
*Enters current power meter reading into variable Meter\_reading.*  
310     Losses(I)=Power\_level-Meter\_reading  
*Stores the correction factor in array.*  
320     Current\_freq=Current\_freq+Step\_freq  
*Increments current frequency to the next frequency in the table.*

```
330 NEXT I
340 OUTPUT Synthesizer; "MEM:TABL:SEL
      FDAT";TRIM$(VAL$(Table_num))
Selects a table to store data to.
350 !
360 ! Store frequencies
370 !
380 OUTPUT Synthesizer; "MEM:TABL:FREQ ";
Commands Synthesizer to load following frequency points into table.
390 FOR I=1 TO Points
400   OUTPUT Synthesizer;Frequencies(I);"GHZ";
Adds a frequency point into the table.
410   IF I<Points THEN OUTPUT Synthesizer;",";
Adds a data separator (comma).
420 NEXT I
430 OUTPUT Synthesizer USING "/"
Adds a line feed.
440 !
450 ! Store losses
460 !
470 OUTPUT Synthesizer; "MEM:TABL:LOSS ";
Commands Synthesizer to load following correction factors into table.
480 FOR I=1 TO Points
490   OUTPUT Synthesizer;Losses(I);
Adds a correction factor into the table.
500   IF I<Points THEN OUTPUT Synthesizer;",";
Adds a data separator (comma).
510 NEXT I
520 OUTPUT Synthesizer USING "/"
Adds a line feed.
530 PRINT "END OF PROGRAM"
540 END
```

---

## Related Tasks

- To Use Previously Stored Level Correct Data

---

## To Use Previously Stored Level Correct Data

When the level correct routine is run, the Synthesizer creates a table of correction values for each frequency point in the table). Up to four level correction tables can be stored in the Synthesizer memory. If the current signal path at the Synthesizer output (the external signal path) is identical to the external signal path on which a level correct routine had been previously run, the level correction table can be recalled from memory and be used at a later time.

1. Verify that the current external signal path is correct for the level correct table you want to recall from memory and use.

The current external signal path must be identical to the external signal path that was calibrated and stored in the level correct table that you wish to recall. If the current external signal path is different, the data can cause inaccurate output power levels at the output of the external signal path.

2. Press the **(SHIFT)** key and then the RCL CR **(EXT METER)** key.

The display will show "RECALL FRM TABLE XXX" where "XXX" is the last level correction register number recalled.

3. Enter the level correction register number of the register that contains the level correct data you want to use.

For example, use the following procedure to choose level correction register number 2.

- a. Type **(2)** on the Synthesizer numeric keypad.
- b. Terminate the level correction register number entry by pressing the ENTER **(Hz)** key.

4. Press the **(SHIFT)** key and then the LVL CR ON/OFF **(POWER LEVEL)** key to enable the Synthesizer to use the level correct data when determining the output power level.

When the use the level correct data has been enabled, the LVL CR annunciator will be lit.

## Programming Example

In the following example, level correct data will be recalled from level correction register number four and used to level the Synthesizer output power level.

To program the Synthesizer to level the output power level using the level correct data in register number four, ensure that the current external signal path is correct for the level correct data stored in register number four, and then run the following program.

```
10 OUTPUT 719; "CORR:CSET FDATA4" Selects the level correction table in register number four.
20 OUTPUT 719; "CORR:STAT ON" Enables all corrections.
30 OUTPUT 719; "CORR:CSET:STAT ON" Turns flatness correction on.
40 END
```

---

## Related Tasks

- To Use the Level Correct Routine



---

## If You Encounter a Problem

If you have a problem generating signals with the Synthesizer, check the following list of commonly encountered problems and troubleshooting procedures. If the problem involves data entry, check the chapter 2 section entitled "If You Encounter a Problem". If the problem that you encounter is not in the following list or in chapter 2, contact the nearest Hewlett-Packard office for assistance.

---

### Annunciators Turned On

If the UNLVL LED annunciator is on:

- Check the leveled power specification to make sure that you have not exceeded the specification.

The maximum power specification is frequency dependent. Typically less maximum power is available as the Synthesizer output frequency is increased.

- If external diode detector leveling or external power meter leveling is being used, ensure that the leveling loop is not opened.
- If external diode detector leveling or external power meter leveling is being used, ensure that the Synthesizer output is not being forced into an unlevelled condition by the leveling circuitry.

If the circuit path before the sampling point has a lot of attenuation, the Synthesizer will have to source high power even though the required power at the sampling point seems low. For example, if the circuit before the sampling point has 23 dB of attenuation and the power required at the sampling point is 5 dBm, the Synthesizer will need to source 28 dBm, which is more than its maximum specified power level.

If the MSG LED annunciator is on:

If the Synthesizer MSG annunciator is on, there is a problem with the Synthesizer. To determine the error and turn off the MSG annunciator, refer

to “To Read the Contents of the Error Queue” in Chapter 2 and the listing of error messages in Chapter 8.

---

## RF Output Problems

If there is no signal at the RF Output connector:

- Check that the signal at the RF OUTPUT connector is turned on.

If the RF OUTPUT connector is turned off, the text “OFF” will be displayed in place of “dBm” in the rightmost display.

If the signal at the RF OUTPUT connector is turned off, press the **RF ON/OFF** key once to turn it on.

- If external modulation (Logarithmic AM, FM, or pulse modes) is being used, check the external modulating signal or external gate/trigger signals for problems.

If modulation is on and the signal is distorted:

- Check that the external modulating signal is within the Synthesizer specifications. Refer to the Specification table in this manual for the individual modulating signal input specifications.

If the signal at the RF OUTPUT connector does not appear to be phase locked to the external reference:

- Check that the external reference is within Synthesizer specifications. Refer to the Specification table in Chapter 4 for the external reference input specifications.
- If FM is being used, check if FM coupling is set to DC.

In order for the Synthesizer to generate DC coupled FM, the internal circuitry is not phase locked. This is a characteristic of DC coupled FM.

Generating Signals with the Synthesizer  
**If You Encounter a Problem**



## REFERENCE

The "Reference" section of this *User's Guide* provides detailed information about various features of the Synthesizer hardware and firmware. The information is divided into several categories as chapters.

Chapters 4 through 7 provide detailed information on specifications and options, front and rear panel features, front panel keys, shifted functions and special functions.

Chapter 8, "Error Messages" lists all front panel and programming-related error messages in error number order with a recovery sequence for each error.

Chapter 9, "Legal and Regulatory Information" contains warranty information as well as safety information and SCPI conformance information.

---

This Page Intentionally Left Blank



**4 Specifications  
and Options**



---

Specifications and Options



---

## Specifications and Options

This chapter contains listings of the Synthesizer performance specifications and the mechanical, electrical, warranty, and documentation options that are available.

---

## Specifications

Specifications describe the instruments warranted performance over the 0° to 55° temperature range unless otherwise noted. Supplemental characteristics (indicated by italics) are intended to provide information useful in estimating instrument capability in your application by describing typical, but not warranted, performance.

---

## Frequency

Range: HP 83731A, 1.0 to 20.0 GHz;

HP 83732A, 0.01 to 20 GHz

Resolution: 1 kHz (1 Hz with Option 1E8)

Stability (with high stability timebase, Option 1E5):

*Aging Rate:  $<1.5 \times 10^{-9}$ /day after 24-hour warm up.*

*Temperature Effects:  $<1 \times 10^{-7}$  over 0 to 55° C, nominally  $<1.4 \times 10^{-9}/^{\circ}\text{C}$*

*Line Voltage Effects:  $<5 \times 10^{-10}$  for 10% change in line voltage*

Stability (without high stability timebase):

*Aging Rate:  $<1.0 \times 10^{-8}$ /day after 72-hours at 25° C  $\pm 10^{\circ}$  C*

*Temperature Effects:  $<5 \times 10^{-6}$  over 0 to 55° C referenced to 25° C*

Stability (with external 10 MHz reference):

Same as external reference.

*Frequency Switching Time:  $<50$  ms to within 1 kHz*

---

## RF Output

Maximum Leveled Output Power:

Frequency	Standard	with Option 1E1
0.01–1 GHz	+13 dBm	+13 dBm
1–18 GHz	+11 dBm	+10 dBm
18–20 GHz	+10 dBm	+8 dBm

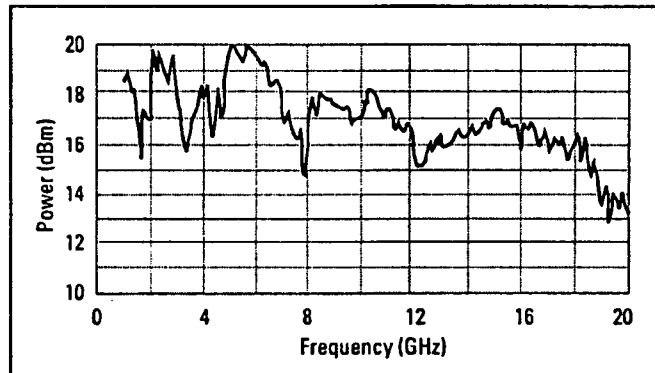

Typical maximum available output power from 1 to 20 GHz, at 25°C with output step attenuator (Option 1E1) installed.

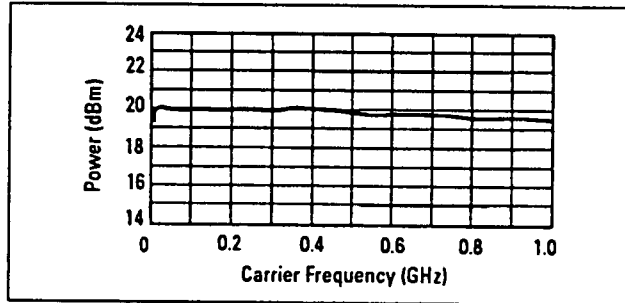

**Typical maximum available output power from 0.01 to 1 GHz at 25°C.**

Minimum Leveled Output Power: -4 dBm, -90 dBm with Option 1E1

Display Resolution: 0.01 dB

Accuracy:  $\pm 1.0$  dB, 50 MHz-20 GHz,  $\pm 1.3$  dB, 10-50 MHz (-4 dBm to specified maximum leveled output power).

$\pm 2.0$  dB, 50 MHz-20 GHz,  $\pm 2.3$  dB, 10-50MHz (over all specified temperatures, frequencies and power levels).

The use of Type-N RF connectors above 18.0 GHz degrades specification typically by 0.2 dB.

**Specifications**

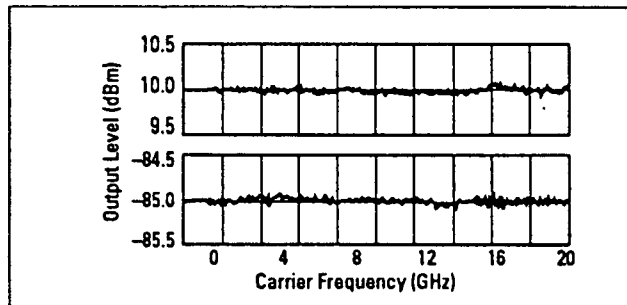

**Typical output level accuracy and flatness at +10 and -85 dBm**

**Flatness:**  $\pm 0.5$  dB. The use of Type-N RF connectors above 18.0 GHz degrades specification typically by 0.2 dB.

**Level Switching Time:**  $< 15$  ms (without step attenuator range change. Attenuator range changes occur at -4 dBm, -14 dBm, -24 dBm, etc.)

**Output SWR:**  $< 2.0 : 1$  nominal

## Spectral Purity

SSB Phase Noise (dBc/Hz):

Carrier Freq.	Offsets			
	100 Hz	1 kHz	10 kHz	100 kHz
500 MHz	-70	-86	-103	-119
2 GHz	-66	-74	-91	-107
10 GHz	-69	-75	-79	-101
18 GHz	-63	-70	-73	-89

Phase noise decreases 6 dB/octave below 500 MHz and reaches a floor of  $< -140$  dBc/Hz.

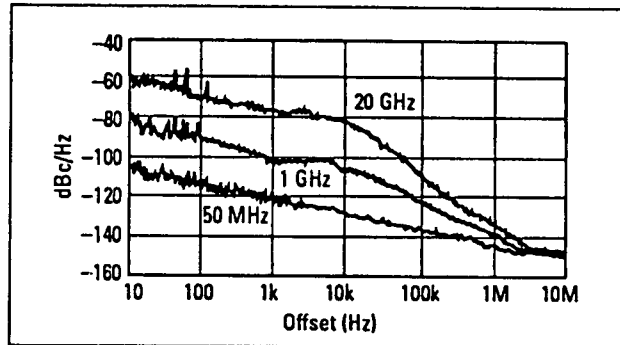

**Typical single-sideband phase noise at 50 MHz, 1 GHz and 20 GHz, 25° C, CW mode. Offsets less than 100 Hz require the high stability timebase, Option 1E5**

Harmonics:  $< -55$  dBc at output levels  $< +6$  dBm, 0.01 to 20 GHz

Specifications and Options

**Specifications**

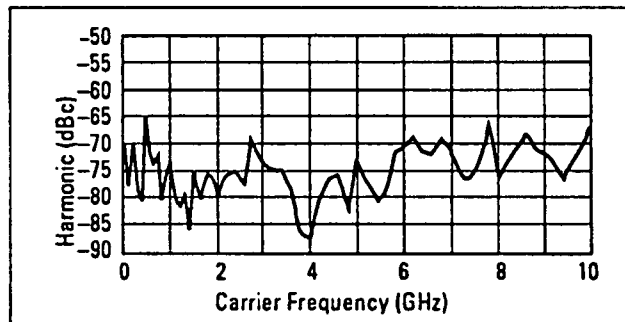

**Typical 2nd harmonic levels measured at output power of +6 dBm**

**Non-Harmonic Spurious ( $\geq 3$  kHz):  $< -60$  dBc (includes power supply and frequency synthesis spurious).**

*Non-Harmonic Spurious ( $< 3$  kHz):  $< -50$  dBc*

*Sub-Harmonics: None*

*Residual FM:*

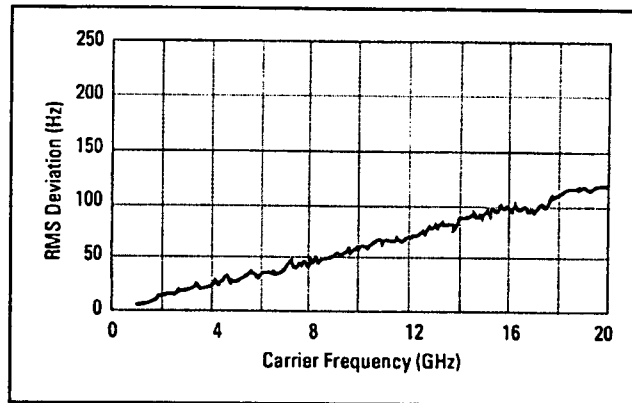

**Typical residual FM measured in 50 Hz - 15 kHz bandwidth, CW mode, with high stability timebase (Option 1E5)**

*At 1 GHz, <15 Hz in 50 Hz-15 kHz bandwidth. Residual FM decreases 6 dB per octave below 1 GHz.*

*AM Noise Floor: (at 0 dBm and offsets greater than 5 MHz from carrier)  
<-150 dBm/Hz, 1-20 GHz.  
<-140 dBm/Hz, 0.01-1 GHz.*



Specifications and Options  
**Specifications**

---

## Modulation

CARRIER FREQUENCY	<25 MHz	25 · <64 MHz	64 · <128 MHz	128 · <500 MHz	500 · <1000 MHz	1 · 20 GHz
Minimum Pulse Width	<1 $\mu$ s		<100 ns		<25 ns <i>Typically &lt;10 ns</i>	
Rise/Fall Time	<500 ns	<350 ns	<50 ns	<35 ns	<20 ns	<10 ns
Video Feedthrough	<2 mV peak-to-peak at 0 dBm					<20 mV peak-to-peak at 0 dBm
Pulse Width Compression	$\pm 150$ ns		$\pm 15$ ns		$\pm 5$ ns	
Pulse Delay (Video out to RF out)	<1 $\mu$ s		<200 ns		<125 ns	<100 ns

### Pulse Modulation

On/Off Ratio: > 80 dB

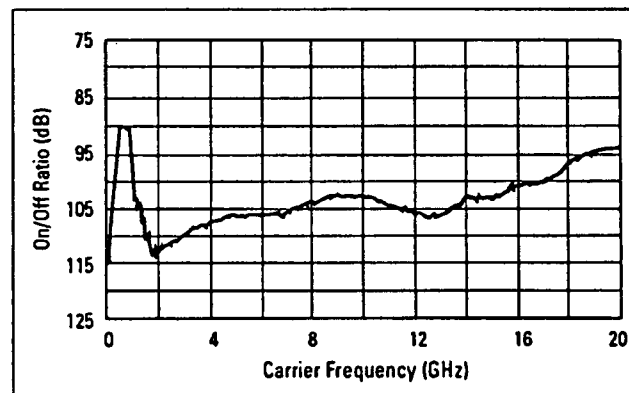

Typical pulse modulation on/off ratio at +8 dBm

*Maximum Pulse Repetition Frequency: > 3 MHz*  
*Minimum Pulse Duty Cycle: No restrictions on duty cycle.*  
*Pulse Level Accuracy:  $\pm 1.0$  dB (relative to CW)*  
*Pulse Overshoot: < 10%*  
*Input Impedance: 50 $\Omega$  nominal; TTL drive levels*

*Maximum Leveled Output Power in Pulse Mode: -0.5 dB relative to CW*

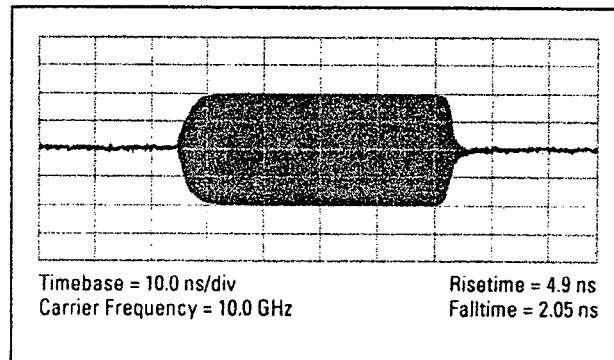

**Typical pulse modulation envelope illustrates the fast rise and fall times, excellent flatness and pulse fidelity of the HP 83731A/83732A**

#### Internal Pulse Source

Pulse Source Modes: Free-run, triggered with delay, doublet and gated.  
Triggered with delay, doublet and gated require external trigger source.

Pulse Repetition Frequency: 3 Hz to >3 MHz

Pulse Repetition Interval (PRI): 300 ns to 419 ms

Pulse Width ( $T_w$ ): 25 ns to 419 ms

Variable Pulse Delay (free-run mode,  $T_d$ ):  $\pm 419$  ms from sync pulse to video modulation

Variable Pulse Delay (triggered with delay & doublet modes,  $T_d$ ): 225 ns to 419 ms with  $\pm 25$  ns jitter

Pulse Width/Delay/PRI Resolution: 25 ns

*Pulse Delay (Video to RF,  $T_m$ ): Nominally, <20 ns, 1 to 20 GHz*

All pulse modulation specifications and supplemental characteristics apply during use of internal pulse source.

Specifications and Options  
**Specifications**

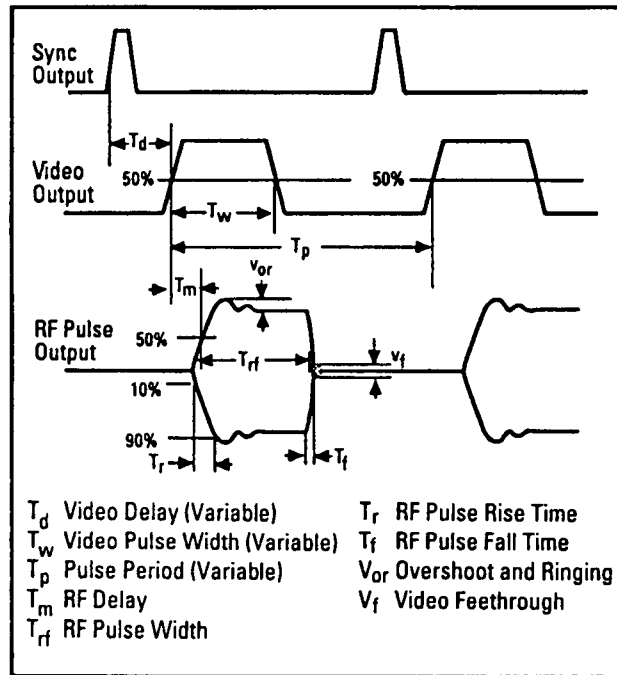

**Frequency Modulation**

Rates: 1 kHz to 1 MHz

Flatness:  $\pm 2$  dB

Maximum Deviation: 10 MHz peak, 2 - 20 GHz. 5 MHz peak, 1 - 2 GHz. 2.5 MHz peak, 500 MHz - 1 GHz. 1.25 MHz peak, 256 - 500 MHz.

Maximum deviation decreases by a factor of 2 for each octave below 256 MHz.

Modulation Index:  $> 300$ , 2 - 20 GHz.  $> 150$ , 1 - 2 GHz.  $> 75$ , 500 MHz - 1 GHz.  $> 37$ , 256 - 500 MHz. Modulation index decreases by a factor of 2 for each octave below 256 MHz.

FM Sensitivity: 5 MHz/V, 1 - 20 GHz. 1.25 MHz/V, 256 MHz - 1 GHz. 320 kHz/V, 64 - 256 MHz. 80 kHz/V, 16 - 64 MHz. 40 kHz/V, 10 - 16 MHz.

FM Sensitivity Accuracy:  $\pm 25\%$  at 100 kHz

Incidental AM:  $< 5\%$

FM Input Impedance: 600 $\Omega$  nominal

*Harmonic Distortion: < 1% (1 MHz peak deviation @ 100 kHz rate)*

**Logarithmic Amplitude Modulation (Scan Modulation)**

*Maximum Depth: > 60 dB*

*Sensitivity: -10 dB/V; (0 to +6V for 0 to -60 dBc)*

*Step Response (50 dB change in level): rise and fall < 5μs, 1 - 20 GHz.*

*Rise < 10 μs, < 1 GHz. Fall < 20 μs, < 1 GHz*

*Input Impedance: 5000Ω nominal*

*Maximum Leveled Output Power in Log AM Mode (relative to CW):*

< 1 GHz	1 - 4 GHz	> 4 GHz
0 dB	-4.5 dB	-1.0 dB

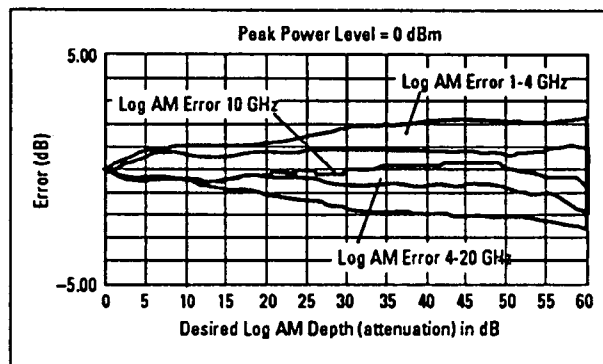

**Typical log AM error (deviation from desired depth) at 25°C for carrier frequencies between 1.0 and 20 GHz**

**Simultaneous Modulations**

Full AM bandwidth and depth is available at any pulse rate or width. FM is completely independent of AM and pulse modulation.

**Specifications**

---

## General

### Programming

The HP 83731A and HP 83732A are fully compatible with the Standard Commands for Programmable Instruments (SCPI). SCPI programming complies with IEEE 488.2-1987. Optional CIL programming compatibility is available. Please consult your HP sales representative for details.

### Environmental

Operating Temperature Range: 0° to 55°C

EMC: Meets or exceeds EN55011/CISPR 11/1990, Class A and Mil-Std-461C Part 2 RE02, CE03, CS02, RS03.

### Acoustic Noise Emission (Geraeuschemission)

LpA <70 dB(A) per ISO 3744 (LpA <70 dB(A) nach DIN 45635 pt. 1)

*LpA Operator position: 44.6 dB, based upon type test per ISO 6081. (LpA*

*am Arbeitsplatz: 44.6 dB, typpruefungsergebnis nach DIN 45635 pt. 19)*

*LpA Bystander position: 38.4 dB, based upon type test per ISO 6081. (LpA*

*fiktiver Arbeitsplatz: 38.4 dB, typpruefungsergebnis nach DIN 45635 pt. 19)*

### Power Requirements

Power: 90-132V, 48-440 Hz. 198-264V, 48-66 Hz.

400 VA maximum.

### Physical Dimensions

Net Weight: < 16 kg (35 lb)

Shipping: < 23 kg (49 lb)

Size: 498 mm D × 426 mm W × 133 mm H (19.6"×16.8"×5.2")

Transit case available by ordering HP Part Number 9211-2655.

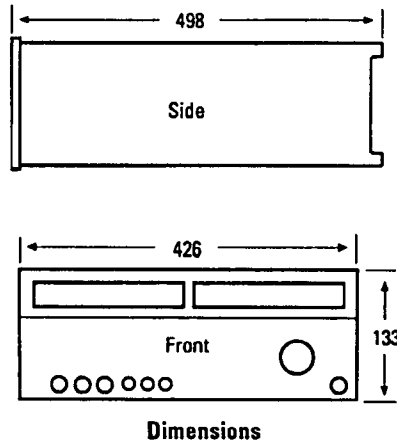

---

## Rear Panel Connectors

### 10 MHz Input

Accepts a 10 MHz  $\pm$  100 Hz, 0 to +10 dBm, external reference signal for operation from an external high stability timebase. Nominal input impedance is 50 $\Omega$ .

### 10 MHz Output

Outputs the 10 MHz reference signal, nominally +3 dBm, for use as an external reference signal. Nominal source impedance is 50 $\Omega$ .

### 0.5V/GHz Output

Supplies a voltage proportional to output frequency for use with mm-wave frequency multipliers, including the HP 83550 Series Millimeter Wave Source Modules.

---

## Options

There are several electrical, mechanical, warranty, and documentation options available for the Synthesizer.

---

The following paragraphs explain the different options that are available.

---

### Electrical Options

There are three electrical options available for the Synthesizer. These options are as follows:

**Option 1E1 - Add Output  
Step Attenuator**

If option 1E1 is ordered, an internal step attenuator is included before the RF OUTPUT connector. The step attenuator has a range of 0 to 90 dB in 10 dB steps. The correct amount of attenuation is selected automatically by the Synthesizer dependent on the output power level selected. If this option is installed, you can select whether or not the step attenuator will automatically switch. This function is useful during certain applications, such as when external automatic level control is used.

**Option 1E5 - Add High  
Stability Timebase**

If option 1E5 is ordered, the Synthesizer is shipped with a 10 MHz temperature controlled crystal reference oscillator for increased frequency accuracy and stability. If option 1E5 is installed, the Synthesizer must be connected to AC mains power to keep the reference oscillator at operating temperature. If the reference oscillator has not been connected to mains power (the oven is cold), the Synthesizer requires 30 minutes to warm up.

**Option 1E8 - 1 Hz Frequency  
Resolution**

Consult your HP sales representative for details on availability and retrofit information.

Option 1E9 - 3.5 mm RF  
Output Connector

If option 1E9 is ordered, the RF OUTPUT connector is a male APC-3.5 precision connector in place of the standard female type-N connector.

---

## Mechanical Options

There are three mechanical options available for the Synthesizer. If these options were not ordered with the original shipment and are now desired, they can be ordered from the nearest Hewlett-Packard office using the part numbers included in each of the following paragraphs. These options are as follows:

Option 1CM - Rack Mount Kit The Synthesizer can be mounted to an instrument rack using the rack mount kit. The Rack Mount Kit part number is 5062-3977.

Option 1CP - Rack Mount and Handle Kit The Synthesizer can be mounted to an instrument rack using the rack flange kit. In addition, ease of handling is increased when the Synthesizer is not rack mounted by using the front panel handles. The Rack Mount Kit part number is 5062-4071 and the Front Handle Kit part number is 5062-3989.

Option 1CR - Rack Slide Kit This kit is useful when the Synthesizer is rack mounted. Access to internal circuits and components or the rear panel is possible without removing the Synthesizer from the rack. The Rack Slide Kit part number is 1494-0059. If a non-HP rack enclosure is used, rack adapters can be ordered to allow the slide kit to be used with the non-HP rack. The part number for metric rack adapters is 1494-0023 and the part number for standard inch rack adapters is 1494-0061.

---

## Warranty Options

There are three warranty options available for the Synthesizer. These options are as follows:



## Specifications and Options

### Options

- Option W30 - Two Additional Years Return-to-HP Service This option extends the benefits of factory warranty to provide a total of 3 years of customer return repair service.
- Option W32 - Three Year Return to HP Calibration Service This option provides 3 years of HP calibration service at HP customer service centers.
- Option W34 - Three Year Mil-std Calibration Service This option provides 3 years of standards compliant calibration at HP customer service centers.

---

## Documentation Options

There are two documentation options available for the Synthesizer. If the documentation was not ordered with the original shipment and is now desired, it can be ordered from the nearest Hewlett-Packard office using the part numbers included in each of the following paragraphs. These options are as follows:

- Option OB2 - Extra Operating Documentation If option OB2 is ordered, the shipment includes *extra* copies of the *HP 83731A/2A Synthesized Signal Generator User's Guide* (HP part number 5960-7094), *HP 83731A/2A Synthesized Signal Generator Programmer's Reference* (HP part number 83731-90005), *HP 83731A/2A Synthesized Signal Generator Quick Start Guide* (HP part number 83731-90002), and the *Signal Generator Calibration Guide* (HP part number 5960-7082).
- Option OB3 - Service Documentation If option OB3 is ordered, the shipment includes a copy of the *HP 83731A/2A Synthesized Signal Generator Service Guide* (HP part number 83731-90004), the *Signal Generator Calibration Guide* (HP part number 5960-7082), and *HP 83731A/2A Synthesized Signal Generator Component Level Information* (HP part number 83731-90003). Note that these two documents are not shipped with the Synthesizer if option OB3 is not ordered.





Front/Rear Panel



---

## Front/Rear Panel

This chapter contains detailed information on various aspects of the Synthesizer front and rear panel. Information on the Synthesizer display, front panel connectors, power cable, etc., can be found in this chapter.

# Annunciators

The HP 83731A/2A front panel display contains annunciators that show the status of several of the Synthesizer functions and settings.

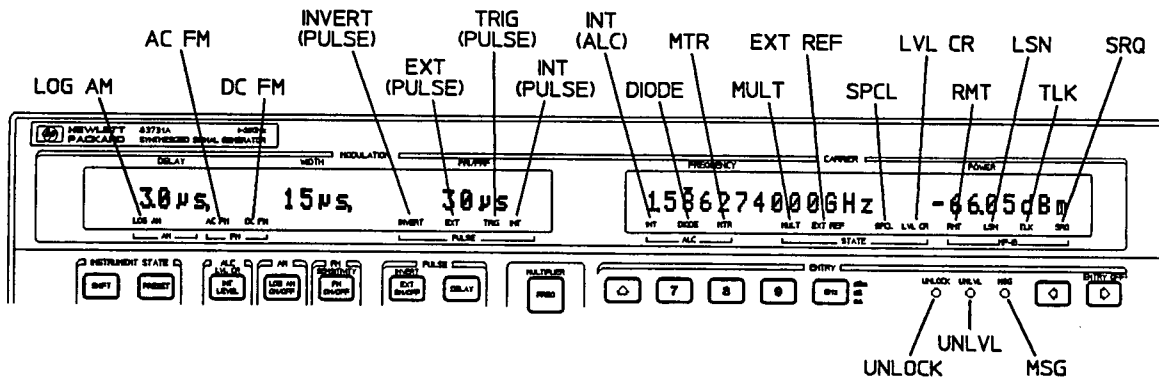

Figure 5-1. Synthesizer Display Annunciators

All annunciators except the UNLOCK, UNLVL, and MSG annunciators are contained on the two fluorescent displays. A description of each of the annunciators follows.

- LOG AM This annunciator indicates that logarithmic amplitude modulation is enabled.
- AC FM This annunciator indicates that AC coupled frequency modulation is enabled.
- DC FM This annunciator indicates that DC coupled frequency modulation is enabled.
- INVERT (PULSE) This annunciator indicates that inverted external pulse modulation is enabled. When inverted external pulse modulation is enabled, signals at the PULSE/TRIG, GATE IN connector will be inverted. When inverted external pulse

Front/Rear Panel  
**Annunciators**

	modulation is enabled, the INVERT EXT annunciator will be lit.
EXT (PULSE)	This annunciator indicates that the pulse modulating source is external and non-inverted.
TRIG (PULSE)	This annunciator indicates that pulse modulation using the internal pulse modulation source will occur when an external trigger occurs at the PULSE/TRIG, GATE IN connector. When triggered external pulse modulation is enabled, TRIG INT annunciator will be lit.
INT (PULSE)	This annunciator indicates that the internal pulse modulating source is active.
INT (ALC)	This annunciator indicates that internal power leveling is selected.
DIODE (ALC)	This annunciator indicates that external diode power leveling is selected.
MTR (ALC)	This annunciator indicates that external power meter leveling is selected.
MULT	This annunciator indicates that the frequency multiplier function is active.
EXT REF	This annunciator indicates that an external time base is currently being used.
SPCL	This annunciator indicates that one or more special functions are enabled.
LVL CR	This annunciator indicates that the Synthesizer output is currently being leveled using stored level correction data.
RMT	This annunciator indicates that the instrument is in the HP-IB remote state, that is, the instrument is under control of an external HP-IB controller.
LSN	This annunciator indicates that the instrument is addressed to listen (accept data or commands).
TLK	This annunciator indicates that the instrument is addressed to talk (output data).
SRQ	This annunciator indicates that the instrument is generating a service request to the external controller.

UNLOCK	This LED annunciator indicates that one or more of the Synthesizer frequency control circuits is not phase locked.
UNLVL	This LED annunciator indicates that the Synthesizer output power is unlevelled. When the UNLVL annunciator is lit, the power level shown in the rightmost display might be incorrect.
MSG	This LED annunciator indicates that uncleared error messages are in the Synthesizer front panel error queue.

---

### See Also

Connectors  
DC FM ON/OFF  
Display  
**EXT DIODE**  
**EXT METER**  
**EXT ON/OFF**  
**FM ON/OFF**  
**INT LEVEL**  
**INT ON/OFF**  
INVERT  
**LOG AM ON/OFF**  
**MSG**  
MULTIPLIER  
**SPCL**  
**TRIG ON/OFF**

# Connectors

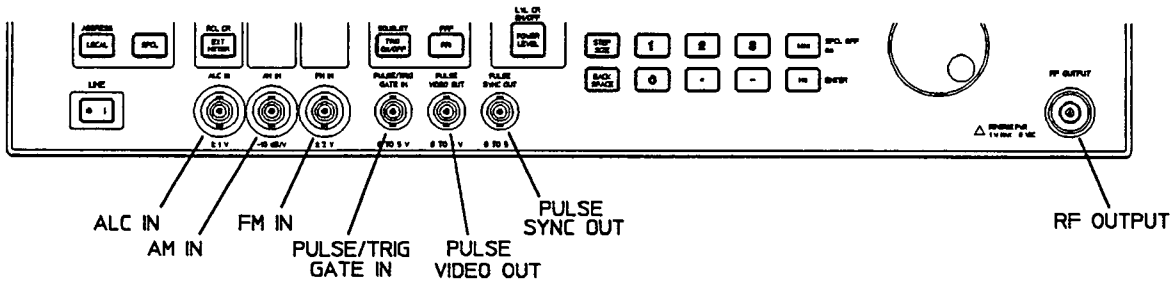

Figure 5-2. Synthesizer Connectors - Front Panel

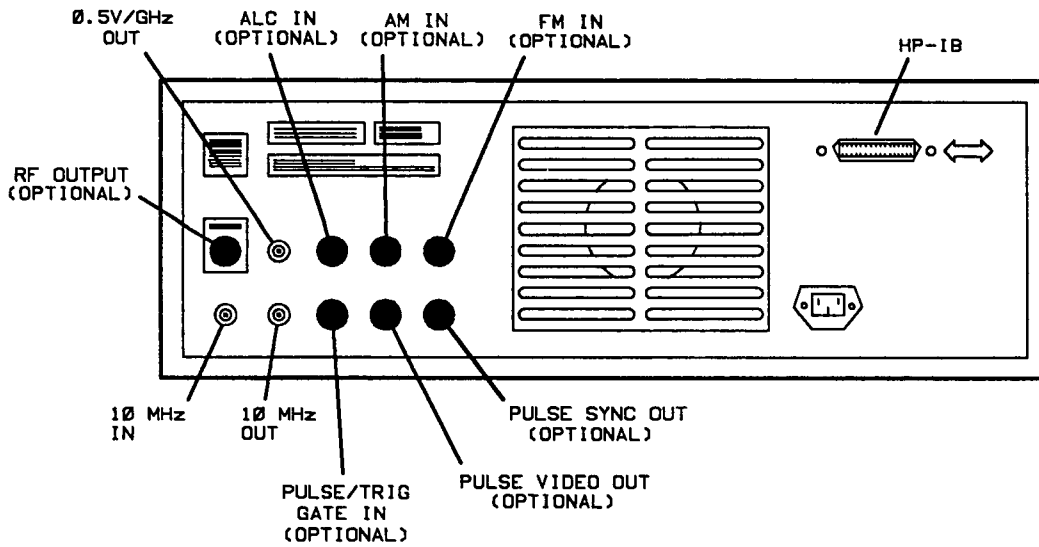

Figure 5-3. Synthesizer Connectors - Rear Panel



---

## Coaxial Connectors

- 0.5 V/GHz OUT This rear panel BNC connector can be used as one of the inputs to a recorder. It produces a DC voltage output that varies linearly with the frequency currently at the RF OUTPUT connector. For example, if the current frequency setting is 5.5 GHz, the voltage at this connector would be 2.75V. The nominal source impedance is  $\leq 250\Omega$ .
- 10 MHz IN This rear panel BNC connector accepts a 10 MHz, 0 to +10 dBm reference signal for operation referenced to an external time base. The nominal input impedance of this input is  $50\Omega$ . This connector detects when a valid reference signal is connected to it and automatically switches from internal to external reference operation.
- 10 MHz OUT This rear panel BNC connector provides a  $3\text{ dBm} \pm 3\text{ dB}$ , 10 MHz signal derived from the internal frequency standard of the Synthesizer. The nominal source impedance is  $50\Omega$ .
- ALC IN This front panel BNC connector allows the Synthesizer to be externally leveled. It is used with external power meter leveling or external diode leveling. The leveling signal at this input must be in the  $\pm 1\text{V}$  range. The nominal input impedance is  $150\text{ k}\Omega$ . The damage level is  $\geq +12\text{V}$  or  $\leq -12\text{V}$ .
- AM IN This front panel BNC connector provides the amplitude modulating signal input when Log AM is enabled. The amplitude modulation changes logarithmically at  $-10\text{ dB/V}$ . The input range is 0 to +6V. Signals less than 0V have no affect on RF output power. When the level at the AM IN connector is 0V, RF OUTPUT power is unchanged. The nominal input impedance is  $5\text{ k}\Omega$ . The damage level is  $\geq +15.5\text{V}$  or  $\leq -15.5\text{V}$ .
- FM IN This front panel BNC connector provides the frequency modulating signal input when DC or AC FM is enabled. This input accepts a modulating signal between +2V and -2V. The FM deviation is proportional to the voltage at the FM IN connector. The nominal input impedance of this connector is  $600\Omega$ . The damage level is  $\geq +10\text{V}$  or  $\leq -10\text{V}$ .

Front/Rear Panel  
**Connectors**

**PULSE/TRIG,  
GATE IN** This front panel BNC connector can be used as either an external pulse input or an external trigger pulse input for internal pulse modulation. In either case, it is TTL level compatible and has a nominal input impedance of  $50\Omega$ . The damage level is  $\geq +5.5V$  or  $\leq -0.5V$ .

A TTL high level ( $> +2V$ ) enables the selected power level to be at the RF OUTPUT connector, while a TTL low level turns the pulse off. When inverted external pulse modulation is active, these states are inverted.

In externally triggered pulse mode, a valid TTL level trigger signal causes pulsed RF to appear at the RF OUTPUT connector with pulse width and delay set by the **WIDTH** and **DELAY** keys.

**PULSE SYNC  
OUT** This front panel BNC connector provides a synchronizing signal during internal and triggered pulse modulation. The rising edge of this 50 ns pulse defines the time zero reference for the internal pulse mode delay. In triggered pulse mode, a pulse will occur at this connector nominally 225 ns after the leading edge of the external pulse trigger signal. The nominal source impedance is  $50\Omega$ . The pulse amplitude is greater than 2.4 volts into a  $50\Omega$  load.

**PULSE VIDEO  
OUT** This front panel BNC connector provides a synchronizing signal that follows the RF output in all pulse modes. In internal pulse mode, delay is measured from the rising edge of the pulse at the PULSE SYNC OUT connector to the rising edge of the pulse at the PULSE VIDEO OUT connector. In triggered pulse mode, delay is measured from the rising edge of the pulse at the PULSE/TRIG, GATE IN connector to the rising edge of the pulse at the PULSE VIDEO OUT connector. The nominal source impedance is  $50\Omega$ . The pulse amplitude is greater than 2.4 volts into a  $50\Omega$  load.

**RF OUTPUT** The standard front panel RF OUTPUT connector is a Type-N precision connector. When option 1E9 is installed, this front panel connector is a 3.5 mm precision connector. The nominal source impedance is  $50\Omega$ .

When making connections to this connector, carefully align the center conductor elements, then rotate the knurled

barrel while mating components remain still. Tighten the barrel until firm contact is made.

Take care when working with this connector. If the connector is mechanically degraded in any way, high frequency losses can occur. Refer to application note 326, *Coaxial Systems - Principles of microwave connector care* (HP part number 5954-1566) for more information.

---

## HP-IB Connector

This connector allows the Synthesizer to be connected to other instruments or devices on the interface bus. Details of this cable are shown in Figure 5-4. HP part numbers for various HP-IB cables that are available are shown in the table following the figure.

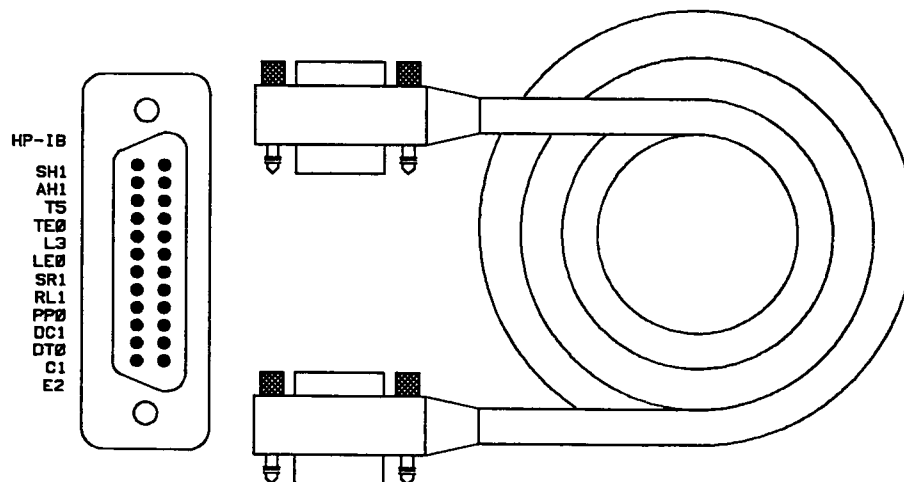

Figure 5-4. HP-IB Connector and Cable

**Connectors****HP-IB Interface Cables Available**

HP-IB Cable Part Number	Length
HP 10833A	1m (3.3 ft)
HP 10833B	2m (6.6 ft)
HP 10833C	4m (13.2 ft)
HP 10833D	0.5m (1.6 ft)

As many as 14 HP-IB instruments can be connected to the Synthesizer (15 total instruments in the system). The cables can be interconnected in a star pattern (one central instrument with the HP-IB cables emanating from that instrument like spokes on a wheel), or in a linear pattern (like boxcars on a train), or a combination of the two. There are certain restrictions that must be followed when interconnecting instruments. These restrictions are as follows:

- Each instrument must have a unique HP-IB address, ranging from 0 to 30 (decimal). Refer to "To Set the HP-IB Address" in chapter 2 for information on setting the Synthesizer HP-IB address.
- In a two-instrument system that uses just one HP-IB cable, the cable length must not exceed 4 meters (13.2 ft).
- When more than two instruments are connected on the bus, the cable length to each instrument must not exceed two meters (6.6 ft).
- The total cable length between all instruments must not exceed 20 meters (65 ft).

Hewlett-Packard manufactures HP-IB extender instruments (Models HP 37201A and HP 37204A/B) that overcome the range limitations imposed by the cabling rules. These extenders allow twin pair cable operation up to 1 km (3,280 ft), and telephone modem operation over any distance. HP sales and service offices can provide additional information on the HP-IB extenders.

The codes in the following list describe the HP-IB interface capabilities of the Synthesizer using IEEE Std. 488.1 compatibility codes (HP-IB, GP-IB, IEEE-488, and IEC-625 are all electrically equivalent). Briefly, the mnemonics translate as follows:

SH1                    Source Handshake, complete capability.  
AH1                    Acceptor Handshake, complete capability.

T5	Talker; capable of basic talker, serial poll, and unaddress if MLA.
TE0	Talker, Extended address; no capability.
L3	Listener; capable of basic listener and unaddress if MTA.
LE0	Listener, Extended address; no capability.
SR1	Service Request, complete capability.
RL1	Remote Local, complete capability.
PP0	Parallel Poll, no capability.
DC1	Device Clear, complete capability.
DT0	Device Trigger, no capability.
C1	Controller capability, system controller.
E2	Electrical specification indicating tri-state outputs.

These codes are described completely in the IEEE Standard 488 (1978), *IEEE Standard Digital Interface for Programmable Instrumentation* or the identical ANSI Standard MC1.1.

---

## Display

The HP 83731A/2A front panel display contains two areas for displaying the current operating parameters of the Synthesizer. Front panel annunciators show the status of several of the Synthesizer functions and settings.

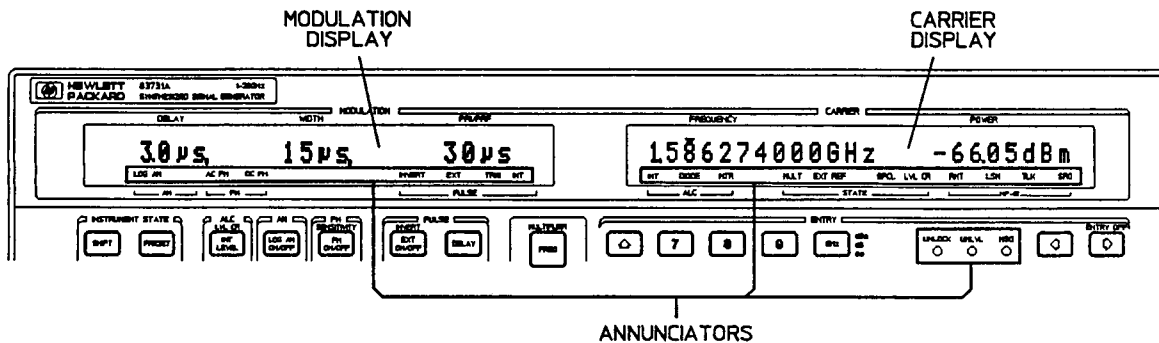

**Figure 5-5. Synthesizer Display**

A description of the display follows:

**Annunciators** The front panel annunciators show the status of several of the Synthesizer functions and settings. *An annunciator that is in one of the fluorescent displays is not visible if its associated function is not active or selected.* For example, if external pulse modulation is currently selected, the EXT annunciator will be lit, otherwise, it will not be visible. The fluorescent display annunciators are LOG AM, AC FM, DC FM, INVERT, EXT (PULSE), TRIG (PULSE), INT (PULSE), INT (ALC), DIODE (ALC), MTR (ALC), MULT, EXT REF, SPCL, LVL CR, RMT, LSN, TLK, and SRQ.

The three front panel LED annunciators (UNLOCK, UNLVL, and MSG) will be lit to warn you that an associated condition exists. (For example, if error messages are in

the error queue, the MSG annunciator will be lit.) An explanation of each annunciator can be found in the "Annunciators" entry in this section of the manual.

**Carrier Display** The carrier display is the fluorescent display that is on the right side of the front panel. The primary purpose of this display is to indicate the current setting of the Synthesizer output frequency and power level. The display is 24 characters wide. Output frequency always occupies character positions 1 through 14 (starting from the left) and power level occupies character positions 16 through 24. Character position 15 is always blank. If a cursor (▼) appears over one of the digits in the display, this digit will be increased or decreased as the knob is rotated. Note that the cursor indicates that that particular parameter is active. The cursor can be moved left or right by pressing the (←) or (→) keys. In this manual, the carrier display is referred to as the "rightmost" display.

**Modulation Display** The modulation display is the fluorescent display that is on the left side of the front panel. The primary purpose of this display is to indicate the current settings of the pulse modulation parameters ("Delay", "Width", and "PRI/PRF") if pulse modulation is active. When parameter entry is initiated, the pulse information in this display will be temporarily replaced with a parameter entry display. Pressing ENTER (Hz) returns the pulse information to the display. As an example, if the (RECALL) key is pressed, the text "RECALL STATE FROM REG 0" appears in the modulation display.

If a cursor (▼) appears over one of the digits in the display, this digit will be increased or decreased as the knob is rotated. Note that the cursor indicates that that particular parameter is active. The cursor can be moved left or right by pressing the (←) or (→) keys. In this manual, the modulation display is referred to as the "leftmost" display.

**Display**

**NOTE**

When operating the Synthesizer in a secure environment, the display can be blanked so that the Synthesizer parameters and status cannot be viewed. For more information, refer to the "Clear Display" entry in chapter 7 of this manual.

---

**See Also**



Annunciators

CLEAR DISPLAY

DISPlay[:WINDow][:STATe]

Knob



---

## Knob

The knob is used to increase or decrease parameter values. A cursor (▼) over a digit in the display indicates that that digit will be increased or decreased in steps of one as the knob is rotated.

---

Clockwise rotation of the knob increases the display digit under the cursor and counterclockwise rotation decreases it. Pressing the (⇐) key moves the display cursor to the left and pressing the (⇒) key moves the cursor to the right. As the knob is rotated, the display will carry over to the adjacent digit. For example, if the display reads 9.00000000 GHz with the cursor over the “9” digit, clockwise rotation of the knob will cause the displayed frequency to change to 10.00000000 GHz. The cursor will remain over the first digit before the decimal point (the “0” in “10”).

If ENTRY OFF (SHIFT, ⇐) has been enabled, the cursor will disappear from the display and rotating the knob will have no effect on the Synthesizer parameters.

---

## Equivalent SCPI Command

There is no equivalent SCPI command for knob rotation, however, the “SYST:KEY 61” command simulates clockwise knob rotation and the “SYST:KEY 62” command simulates counterclockwise knob rotation.

Front/Rear Panel  
Knob

---

## See Also



ENTRY OFF  
SYSTEM:KEY

---

## LINE Switch

The LINE Switch turns power to the Synthesizer to either on ( I ) or standby ( Ⓟ ).

---

The HP 83731A/2A LINE switch is located at the bottom left corner of the front panel and is a rocker-type switch. Pressing the I symbol turns the Synthesizer on and pressing the Ⓟ symbol turns it to standby. When set to standby, most of the Synthesizer circuitry is powered off, however, power to the internal timebase is not disconnected.

---

### WARNING

Before turning the Synthesizer on, make sure that it is grounded through the protective conductor of the power cable to a mains power receptacle provided with protective earth contact. Any interruption of the protective grounding conductor inside or outside of the Synthesizer or disconnection of the protective earth terminal can result in personal injury.

---

### CAUTION

Before turning the Synthesizer on, set the LINE Voltage Selector to the voltage of the power source. Failure to do this can cause instrument damage when the power cable is plugged in. For information on setting the Line Voltage Selector, refer to "To Install the Synthesizer" in Chapter 1 of this manual.

---

## See Also

To Install the Synthesizer  
Power Cables

---

## Power Cables

The line power cable is supplied in one of several configurations, depending on the destination of the original shipment.

---

Each instrument is equipped with a three-wire power cable. When connected to an appropriate AC power receptacle, this cable grounds the instrument chassis. The type of power cable shipped with each instrument depends on the country of destination. See Figure 5-6, "Power Cable and Line (Mains) Plug Part Numbers", for the part numbers of these power cables. Cables are available in different lengths and some with right-angle plugs to the instrument. Check with your nearest Hewlett-Packard service center for descriptions and part numbers for these cables.

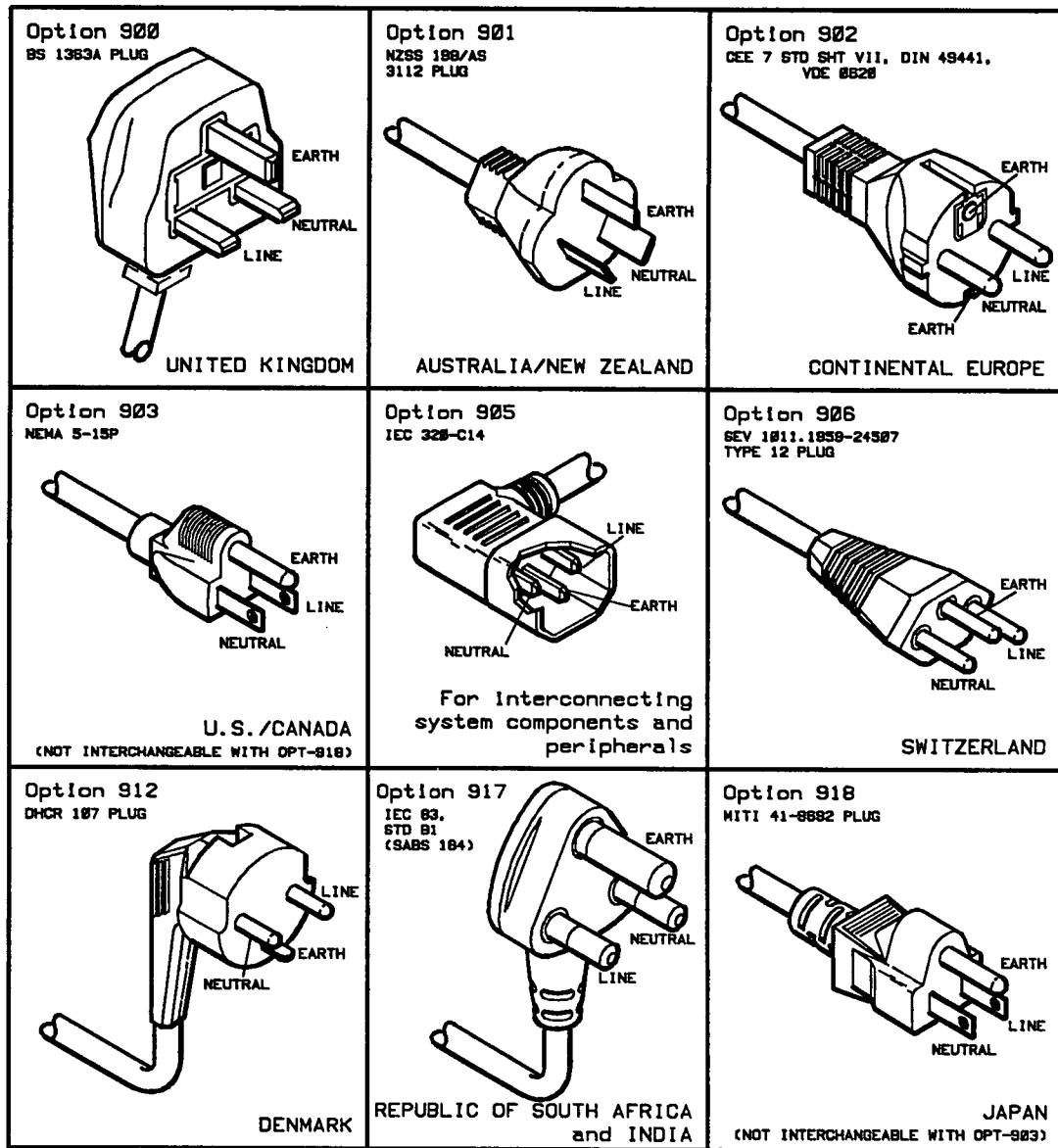

Figure 5-6. Power Cable and Line (Mains) Plug Part Numbers

Front/Rear Panel  
**Power Cables**





**6 Keys/Shifted  
Functions**





Keys/Shifted Functions





---

## Keys/Shifted Functions

This chapter contains detailed information on the various keys and shifted functions found on the Synthesizer front panel. Key names are printed on the keycap and represent the primary function of the key. The shifted function names appear above certain keys on the Synthesizer front panel. Shifted functions are always accessed by pressing the **SHIFT** key and then the key below the shifted function name. If no text appears above a given key, that key has no shifted function associated with it.



The key moves the cursor (▼) that appears over one of the digits in the display to the right one digit each time it is pressed.

The digit that is currently under the cursor will be increased or decreased in steps of one as the knob is rotated. Clockwise rotation of the knob increases the digit under the cursor and counterclockwise rotation decreases it. If pressing the key moves the cursor too far to the right, pressing the key will move the cursor back to the left.

**NOTE**

The digit under the cursor is affected only by the knob, not the and keys.

If ENTRY OFF (, ) has been enabled, the cursor will disappear from the display and rotating the knob will have no effect on the parameter. Note that the cursor indicates that that particular parameter is active. For example, if the cursor appears over any digit in the frequency display, the frequency parameter is the active parameter.



If an arrow key is pressed so as to move the cursor to a position that is off the display, another cursor will appear next to the original cursor to indicate that the actual cursor position is off the display. For example, if a frequency multiplier of six is entered into the Synthesizer, the maximum frequency entry that can be made is 120 GHz (20 GHz×6). The display, however, only has room to display two digits to the left of the decimal point. If you were to attempt to position the cursor three digits to the left of the decimal point, the double cursor would appear, indicating that the actual cursor position is off the display.

Keys/Shifted Functions

⇒

---

## Equivalent SCPI Command

There is no equivalent SCPI command for the  key, however, sending the "SYST:KEY 45" command is effectively the same as pressing the  key.

---

## See Also



ENTRY OFF  
Knob  
SYSTem:KEY



The key moves the cursor ( ) that appears over one of the digits in the display to the left one digit each time it is pressed.

The digit that is currently under the cursor will be increased or decreased in steps of one as the knob is rotated. Clockwise rotation of the knob increases the digit under the cursor and counterclockwise rotation decreases it. If pressing the key moves the cursor too far to the left, pressing the key will move the cursor back to the right.

**NOTE**

The digit under the cursor is affected only by the knob, not the and keys.

If ENTRY OFF (, ) has been enabled, the cursor will disappear from the display and rotating the knob will have no effect on the parameter. Note that the cursor indicates that that particular parameter is active. For example, if the cursor appears over any digit in the frequency display, the frequency parameter is the active parameter.



If an arrow key is pressed so as to move the cursor to a position that is off the display, another cursor will appear next to the original cursor to indicate that the actual cursor position is off the display. For example, if a frequency multiplier of six is entered into the Synthesizer, the maximum frequency entry that can be made is 120 GHz (20 GHz×6). The display, however, only has room to display two digits to the left of the decimal point. If you were to attempt to position the cursor three digits to the left of the decimal point, the double cursor would appear, indicating that the actual cursor position is off the display.

Keys/Shifted Functions

←

---

## Equivalent SCPI Command

There is no equivalent SCPI command for the  key, however, sending the "SYST:KEY 37" command is effectively the same as pressing the  key.

---

## See Also



ENTRY OFF  
Knob  
SYSTem:KEY



The key allows you to incrementally add to the current value of a parameter.

---

Pressing the key will increase the currently active parameter by the increment value set with the **STEP SIZE** key. A parameter can be made active by pressing its associated function key. For example, pressing the **FREQ** key will make frequency the active parameter, pressing the **POWER LEVEL** key will make output power level the active parameter, etc. If no parameter is currently active, or the ENTRY OFF (**SHIFT**, ) function has been enabled, pressing the key will have no effect.

If the key is pressed and held down, the key will auto-repeat, that is, the active parameter will automatically increase rapidly in increment value steps.

---

## Equivalent SCPI Commands

There is no equivalent SCPI command for the key, however, the various SCPI commands that send numeric parameter data include an "UP" parameter option. Sending the "UP" parameter in place of the numeric parameter is effectively the same as pressing the key. For example, if you want to increase the output frequency by its current increment value, send the following command:

```
OUTPUT 719; "FREQ UP"
```

Keys/Shifted Functions

↑

---

## See Also









ENTRY OFF

STEP SIZE



The  key allows you to incrementally subtract from the current value of a parameter.



---

Pressing the  key will decrease the currently active parameter by the increment value set with the  key. A parameter can be made active by pressing its associated function key. For example, pressing the  key will make frequency the active parameter, pressing the  key will make output power level the active parameter, etc. If no parameter is currently active, or the ENTRY OFF (, ) function has been enabled, pressing the  key will have no effect.

If the  key is pressed and held down, the key will auto-repeat, that is, the active parameter will automatically decrease rapidly in increment value steps.

---

## Equivalent SCPI Commands

There is no equivalent SCPI command for the  key, however, the various SCPI commands that send numeric parameter data include a "DOWN" parameter option. Sending the "DOWN" parameter in place of the numeric parameter is effectively the same as pressing the  key. For example, if you want to decrease the output frequency by its current increment value, send the following command:

```
OUTPUT 719; "FREQ DOWN"
```



Keys/Shifted Functions



---

## See Also



ENTRY OFF

STEP SIZE

---

## ADDRESS

Invoking the ADDRESS function (pressing the **SHIFT** key and then the **LOCAL** key) displays and allows you to change the Synthesizer HP-IB address.

---

When **SHIFT**, **LOCAL** is pressed, the current HP-IB address will be displayed across the leftmost display in the following format:

HP-IB ADDRESS XX

Where "XX" is the current HP-IB address. The range for valid addresses is 00 to 30. The HP-IB address is preset at the factory to 19. Pressing the **PRESET** key has no effect on the HP-IB address. The preset up/down arrow increment value is 1.

---

## Equivalent SCPI Command

`SYST:COMM:GPIB:ADDR address` *sets the Synthesizer HP-IB address as defined by the "address" parameter.*

---

## See Also

SYSTem:COMMunicate:GPIB:ADDress

---

## BACK SPACE

The **BACK SPACE** key allows you to cancel part or all of a parameter during entry.

---

The **BACK SPACE** key has an effect on the display only after a function key (**FREQ**, **POWER LEVEL**, etc.) is pressed and before the entry is terminated. If **BACK SPACE** is pressed repeatedly so that the whole parameter is canceled, the display reverts back to what it was before the function key was pressed.

---

## Equivalent SCPI Command

There is no equivalent SCPI command for the **BACK SPACE** key, however, sending the "SYST:KEY 54" command is effectively the same as pressing the **BACK SPACE** key.

---

## See Also

SYSTem:KEY

---

## DELAY

The **DELAY** key enables you to modify the pulse delay parameter. Pulse delay is used in internal, internal triggered, or doublet pulse modes.

---

The delay parameter is displayed under the "DELAY" portion of the leftmost display. When the delay is entered, the text "DELAY XXX" will appear across the leftmost display where "XXX" is the entered value and the appropriate units suffix.

The allowable range for entries is as shown in the following table.

**Allowable Delay Range**

<b>Internal Pulse Mode</b>	<b>Triggered or Doublet Pulse Mode</b>
$\pm 419$ ms	+225 ns minimum +419 ms maximum <sup>1</sup>

<sup>1</sup> In triggered pulse mode, the sum of pulse width and pulse delay can not exceed 419 ms.

All entries have a resolution of 25 ns; entries with resolution finer than 25 ns will be rounded to the nearest 25 ns. If a delay entry is made that is not within the allowable range, the delay will be set to the upper or lower limit. The preset value for delay is 1  $\mu$ s.

The allowable range for up/down arrow increments is 25 ns to 419 ms with 25 ns resolution. The preset up/down arrow increment value is 25 ns.

---

## Positive/Negative Delay

When in internal pulse modulation mode, the delay parameter can be positive or negative. Delay is the time between the rising edge of the synchronizing pulse at the PULSE SYNC OUT connector and the rising edge of the RF pulse at the RF OUTPUT connector. When the delay is positive, the synchronizing pulse precedes the RF pulse by the value of the delay. When the delay is

Keys/Shifted Functions

## **DELAY**

negative, the RF pulse precedes the synchronizing pulse by the value of the negative delay.

---

### Equivalent SCPI Command

`PULS:DEL delay` *sets the pulse delay as defined by the "delay" parameter.*

---

### See Also

`EXT ON/OFF`

`INT ON/OFF`

`INVERT`

`PRF`

`PRI`

`[SOURce[1]:]PULSe:DELay`

`TRIG ON/OFF`

`WIDTH`

---

## DOUBLET

Invoking the DOUBLET function (pressing the **SHIFT** key and then the **TRIG ON/OFF** key) toggles doublet pulse modulation on and off.

---

When doublet pulse modulation is turned on, the word "DOUBLET" will appear in the leftmost display along with the current value of pulse width and pulse delay.

When the Synthesizer is set to the preset state, doublet pulse modulation is turned off.

---

### Doublet Pulse Mode

When doublet pulse modulation is used, each trigger event will produce two pulses at the RF OUTPUT connector. The first pulse will follow the external trigger signal that is applied to the PULSE/TRIG IN, GATE IN connector. The second pulse will have delay and width parameters as set via the front panel or with programming commands. Pulse delay is measured from the leading edge of the external trigger signal. Figure 6-1 summarizes the timing characteristics of doublet pulse mode.

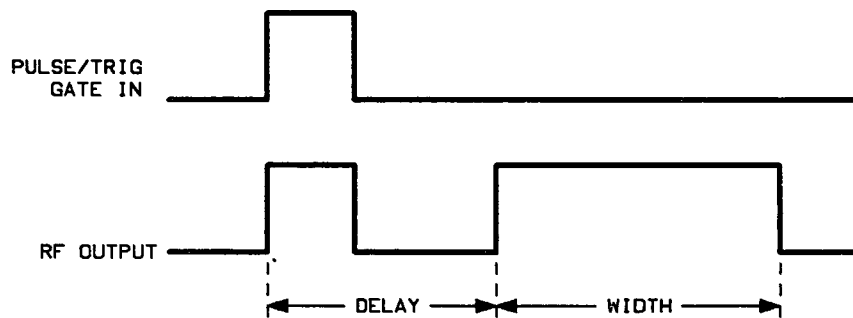

Figure 6-1. Doublet Pulse Mode Timing

**DOUBLET**

---

### Equivalent SCPI Commands

PULM:SOUR INT      *sets pulse source to internal.*  
PULS:DOUB ON      *turns doublet pulse mode on.*  
PULM:STAT ON|OFF      *turns pulse modulation on or off.*

---

### See Also

**DELAY**  
[SOURce[1]:]PULM:SOURce  
[SOURce[1]:]PULM:STATe  
[SOURce[1]:]PULSe:DOUBle[:STATe]  
**WIDTH**

---

## ENTER (Hz)

The ENTER key (actually the secondary function of the **(Hz)** key) is used to terminate unitless parameter entries. It can also be used to return the display to its default state.

---

The ENTER (**(Hz)**) key is used to terminate unitless parameter entries. The unitless parameters are multiplier values, special function numbers, instrument state register numbers, level correction register numbers, and the Synthesizer and power meter HP-IB addresses.

The ENTER key can also be used to return the display to its default state. When the display is in the default state, the leftmost display is blanked and the rightmost display shows frequency and power level. In the display default state, no parameters are active. To use the ENTER key to return the display to the default state, press the ENTER key without first pressing a numeric key (that is, the keys numbered 0 through 9). For example, if a multiplier value of 5 is entered, the leftmost display will continue to show "FREQUENCY MULTIPLIER 5" after the entry is terminated with the cursor (▼) over the 5. Pressing ENTER again will return the display to the default state mentioned above.

---

## Equivalent SCPI Command

There is no equivalent SCPI command for the ENTER key, however, sending the "SYST:KEY 58" command is effectively the same as pressing the ENTER key.



Keys/Shifted Functions  
**ENTER (Hz)**

---

## See Also

ADDRESS  
MULTIPLIER  
PWR MTR ADDRS  
RCL CR  
**RECALL**  
SAVE  
SAVE CR  
**SPCL**  
SYSTEM:KEY

---

## ENTRY OFF

Invoking the ENTRY OFF function (pressing the **SHIFT** key and then the **⇒** key) disables the parameter entry/modification keys. The parameter entry/modification keys include the numeric keypad as well as the **↑**, **↓**, **STEP SIZE**, **←**, and **⇒** keys and the knob.

---

Once the entry off function has been enabled, it will be canceled as soon as one of the function keys (**FREQ**, **POWER LEVEL**, **WIDTH**, etc.) are pressed.

---

## Equivalent SCPI Command

There is no equivalent SCPI command for the ENTRY OFF function, however, sending the "SYST:KEY 0;KEY 45" command is effectively the same as pressing **SHIFT**, **⇒**.

---

## See Also

SYSTem:KEY

---

## EXT DIODE

The **EXT DIODE** key enables external diode leveling. External diode leveling is a method of automatic level control (ALC) of the output signal using an external diode detector.

---

When the **EXT DIODE** key is pressed, the DIODE annunciator will be lit. If the procedure, "To Use External Diode Detector Leveling" has been followed correctly, the Synthesizer RF output will be externally leveled via the diode detector feedback loop.

---

## External Diode Detector Leveling

The purpose of a leveling circuit is to provide constant power, independent of the load, and minimize power variations versus frequency.

External diode detector leveling is used in applications where it is desired to level the power at some point outside the Synthesizer with an external diode detector. When frequency dependent losses are involved, the RF output power at the end of the signal path will not have a constant amplitude over the Synthesizer frequency range. For example, if a cable is used at the output of the Synthesizer that has a constant 0.5 dB/GHz loss, 5 dB of attenuation at the output of the cable occurs after a 10 GHz frequency increase, even though the power at the input to the cable is constant. By externally leveling power at the output of the cable, the Synthesizer would increase power at the input of the cable to produce a constant power level at the output of the cable.

External diode detector leveling requires that external equipment be connected to the Synthesizer, as shown in Figure 6-2.

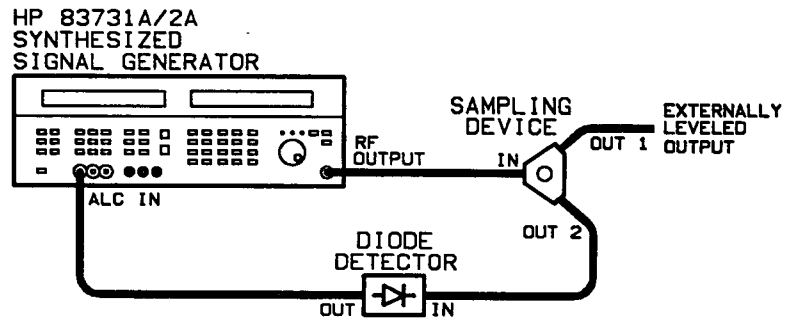

**Figure 6-2. External Diode Detector Leveling Setup**

When external diode detector leveling is chosen, power is sampled at the external sampling device (either a directional coupler or power splitter) by an external diode detector that is typically operating in the square law region. When the diode detector is operating in the square law region, it will provide a DC voltage that is proportional to the power sampled at the input to the detector. This DC voltage is fed back to the Synthesizer via the ALC IN connector. The Synthesizer then adjusts its output power level to maintain a constant power level at the input to the external diode detector.

---

## Applications

External leveling can be used when your application requires long cables that will cause frequency-dependent losses. It also enables devices, such as amplifiers, mixers, etc. to be inserted into the RF signal path so that the output of the inserted device is controlled by the Synthesizer.

---

## Advantages of Diode Detector Leveling

When diode detector leveling is used, power level correction is continuous.

External diode detector leveling has the advantage of faster settling time than power meter leveling. The settling time is variable and is dependent on the devices in the external leveling loop.

---

## Disadvantages of Diode Detector Leveling

The diode detector must be capable of producing between 1 mV and 1V of ALC voltage for the power level at the sampling point. This typically restricts the lower limit at which external diode detector leveling will function.

Diode detector leveling might not provide an accurate power display on the Synthesizer if the diode detector is operating outside of the square law region. Diode detector leveling also does not provide temperature compensation. Power level recalibration might be required in environments that are not temperature stabilized.

External diode detector leveling requires that external equipment be connected to the Synthesizer.

### **NOTE**

Before selecting **EXT DIODE**, you should adjust the Synthesizer power level using internal leveling so that the step attenuator is set to the correct setting.

---

## Equivalent SCPI Command

`POW:ALC:SOUR DIOD` *enables external diode detector leveling.*

---

## See Also

`EXT METER`

`INT LEVEL`

`[SOURce[1]:]POWer:ALC:SOURce`

To Use External Diode Detector Leveling

To Use the Level Correct Routine

---

## EXT METER

The **EXT METER** key enables external power meter leveling. External power meter leveling is a method of automatic level control (ALC) of the output signal using an external power meter and power sensor.

---

When the **EXT METER** key is pressed, you are prompted to put the power meter in the range hold mode and then enter the power meter reading into the Synthesizer. After the range hold power meter value is entered, the MTR annunciator will be lit. If the procedure, "To Use External Power Meter Leveling" has been followed correctly, the RF output will be externally leveled via the power meter feedback loop.

### **NOTE**

The range hold power meter reading is the power level that is used by the Synthesizer to calibrate the recorder output voltage of the power meter versus the Synthesizer output power.

---

## External Power Meter Leveling

The purpose of a leveling circuit is to provide constant power, independent of the load, and minimize power variations versus frequency.

External power meter leveling is used in applications where it is desired to level the power at some point outside the Synthesizer with an external power meter. When frequency dependent losses are involved, the RF output power at the end of the signal path will not have a constant amplitude over the Synthesizer frequency range. For example, if a cable is used at the output of the Synthesizer that has a constant 0.5 dB/GHz loss, 5 dB of attenuation at

the output of the cable occurs after a 10 GHz frequency increase, even though the power at the input to the cable is constant. By externally leveling power at the output of the cable, the Synthesizer would increase power at the input of the cable to produce a constant power level at the output of the cable.

External power meter leveling requires that external equipment be connected to the Synthesizer, as shown in Figure 6-3.

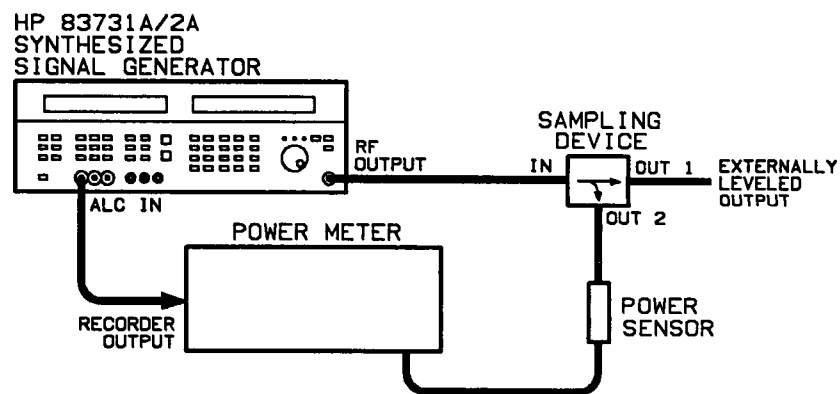

**Figure 6-3. External Power Meter Leveling Setup**

When external power meter leveling is chosen, power is sampled at the external sampling device (either a directional coupler or power splitter) by the external power sensor. An automatic level control voltage is then generated by the external power meter and fed back to the Synthesizer via the ALC IN connector. The Synthesizer then adjusts its output power level to maintain a constant power level at the input of the external power sensor.

---

## Applications

External leveling can be used when your application requires long cables that will cause frequency-dependent losses. It also enables devices, such as amplifiers, mixers, etc. to be inserted into the RF signal path so that the output of the inserted device is controlled by the Synthesizer.



---

## External Equipment Limitations

**Power Meter**

The power meter must be capable of producing a 0V to 1V output voltage linearly proportional to power over each decade of range. The recorder output of most power meters provides this voltage.

**Power Sensor**

The power sensor must have a frequency range that is appropriate for the range of frequencies being leveled. The sensor must also have enough dynamic range to measure the level at the output of the directional coupler or power splitter. As an example, to level signals in the  $-7$  dBm to 0 dBm range using a 10 dB coupler, the power sensor must be capable of measuring power in the  $-17$  to  $-10$  dBm range.

---

## Advantages of Power Meter Leveling

When power meter leveling is used, power level correction is continuous.

External power meter leveling has the advantages of better accuracy and temperature stability, and improved vernier linearity than external diode detector leveling. Using a sensitive power sensor allows ALC at levels as low as the power meter and sensor can measure.

---

## Disadvantages of Power Meter Leveling

One disadvantage of power meter leveling is a longer settling time than diode detector or internal leveling. The settling time is dependent on the power range and sensor used. The Synthesizer assumes a settling time of two seconds to allow the sensor to reach the correct power level.

Depending on the power sensor and range being used, the power meter might or might not have finished settling. Power is typically settled within two seconds for the two highest ranges of the power meter.

Another disadvantage of external power meter leveling is that it can not be used when the output is being pulse modulated.

External power meter leveling requires that external equipment be connected to the Synthesizer.

**NOTE**

Before selecting **EXT METER**, you should adjust the power level using internal leveling so that the step attenuator is set to the correct setting.

---

## Equivalent SCPI Commands

**NOTE**

The following is only the command that selects external power meter leveling. External power meter leveling, however, is a multi-step process that involves issuing several commands.

**POW:ALC:PMET pmeter** *sets the power meter range hold value as defined by the "pmeter" parameter.*  
**POW:ALC:SOUR PMET** *sets the alc source to power meter.*

Keys/Shifted Functions  
**EXT METER**

---

## See Also

**EXT DIODE**

**INT LEVEL**

[SOURce[1]:]POWer:ALC:PMETer

[SOURce[1]:]POWer:ALC:SOURce

To Use External Power Meter Leveling

---

## EXT ON/OFF

The **EXT ON/OFF** key toggles external pulse modulation on and off.

---

The type of external pulse modulation that is toggled on and off with the **EXT ON/OFF** key is non-inverted. **SHIFT**, **EXT ON/OFF** toggles external inverted pulse modulation on and off.

When external pulse modulation is turned on, the EXT (PULSE) annunciator will be lit.

When the Synthesizer is set to the preset state, external pulse modulation is turned off.

---

## Equivalent SCPI Commands

PULM:SOUR EXT	<i>sets pulse source to external.</i>
PULM:EXT:POL NORM	<i>sets external pulse polarity to non-inverted.</i>
PULM:STAT <u>ON OFF</u>	<i>turns pulse modulation on or off.</i>

---

## See Also

Connectors  
INVERT  
[SOURCE[1]:]PULM:EXTernal:POLarity  
[SOURCE[1]:]PULM:SOURce  
[SOURCE[1]:]PULM:STATe

---

## FM ON/OFF

The **FM ON/OFF** key toggles frequency modulation on and off.

---

When frequency modulation is turned on, either the AC FM or DC FM annunciator will be lit, depending on the status of the DC FM ON/OFF special function.

When the Synthesizer is set to the preset state, frequency modulation is turned off.

---

## Equivalent SCPI Command

**FM:STAT ON|OFF** *turns frequency modulation on or off.*

---

## See Also

Connectors  
DC FM ON/OFF  
SENSITIVITY  
[SOURce[1]:]FM:COUPling  
[SOURce[1]:]FM:STATe

---

## FREQ

The **FREQ** (frequency) key allows you to set the output frequency of the Synthesizer.

---

Frequency is displayed in the left-hand position of the rightmost display. The frequency entered is the CW frequency if no modulation is chosen, or the carrier frequency of any modulation type that is chosen. The preset value is 3 GHz.

The valid output frequency range differs depending on the Synthesizer model:

- HP 83731A - 1.0 GHz to 20.0 GHz
- HP 83732A - 0.01 GHz to 20.0 GHz

If a frequency entry is made that is outside the allowable range, an error message will be generated and the actual frequency will be set to either its upper or lower limit (whichever is closest to the input frequency). Standard frequency resolution is 1 kHz over the range of 1 GHz to 20 GHz and 250 Hz from 0.01 GHz to 1.0 GHz.



### NOTE

When option 1E8 is installed in either the HP 83731A or HP 83732A, frequency resolution is 1 Hz over the entire frequency range.

The preset up/down arrow increment value is 100 MHz. The increment value will be rounded to the nearest 1 kHz if the output frequency is between 1 GHz and 20 GHz. The increment value will be rounded to the nearest 250 Hz in the HP 83732A if the output frequency is between 0.01 GHz and 1 GHz.

**FREQ**

**Notes**

1. The HP 83732A Synthesizer will accept increment values with 250 Hz resolution when the output frequency is between 1 GHz and 20 GHz. However, when the  or  keys are pressed, the increment value will be rounded to the nearest 1 kHz. When option 1E8 is installed in either the HP 83731A or HP 83732A, increment values with 1 Hz resolution are accepted over the entire frequency range.
2. If the Multiplier function is being used, the frequency displayed is the frequency at the output of the multiplier, not the output of the Synthesizer.

---

**Equivalent SCPI Command**

**FREQ freq** *sets the Synthesizer output frequency as defined by the "freq" parameter.*

---

**See Also**

**MULTIPLIER**  
[SOURce[1]:]FREQuency[:CW]:FIXed]

---

## GATED

Invoking the GATED function (pressing the **SHIFT** key and then the **INT ON/OFF** key) toggles internal gated pulse modulation on and off.

---

When internal gated pulse modulation is turned on, the word "GATED" will appear in the leftmost display along with the current value of pulse width and pulse repetition frequency (PRF).

When the Synthesizer is set to the preset state, internal gated pulse modulation is turned off.

---

## Internal Gated Pulse Mode

When the rising edge of a valid gate signal is applied to the PULSE/TRIG/GATE IN connector, a pulse train will appear at the Synthesizer RF OUTPUT connector with pulse width and pulse repetition frequency (PRF) parameters as set via the front panel or with programming commands. When the falling edge of the gate signal is sensed at the PULSE/TRIG/GATE IN connector, the pulse train will cease. If the falling edge of the gate signal occurs in the middle of a pulse at the RF OUTPUT connector, the last pulse will complete before the pulse train ceases. Once the falling edge of the gate signal is sensed, a time interval equal to the pulse repetition interval ( $\frac{1}{PRF}$ ) must elapse before another rising edge at the PULSE/TRIG/GATE IN connector will be valid. Figure 6-4 summarizes the critical timing characteristics of internal gated pulse mode.



Keys/Shifted Functions  
**GATED**

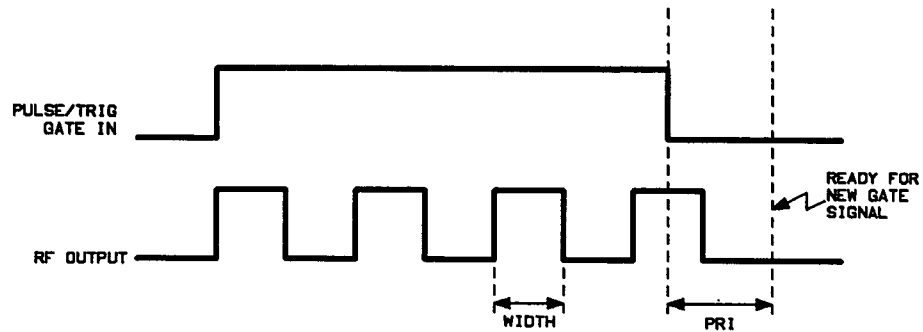

Figure 6-4. Internal Gated Pulse Mode Timing

---

### Equivalent SCPI Commands

<code>PULM:SOUR INT</code>	<i>sets pulse source to internal.</i>
<code>TRIG:SOUR EXT</code>	<i>sets pulse trigger source to external (triggered).</i>
<code>TRIG:STOP:SOUR EXT</code>	<i>sets pulse trigger stop source to external.</i>
<code>PULS:DOUB OFF</code>	<i>turns doublet pulse mode off.</i>
<code>PULM:STAT <u>ON OFF</u></code>	<i>turns pulse modulation on or off.</i>

---

## See Also

PRF

**PRI**

[SOURCE[1]:]PULM:SOURce

[SOURCE[1]:]PULM:STATe

[SOURCE[1]:]PULSe:DOUBle[:STATe]

TRIGger[SEQUence[1]:]START[:SOURce]

TRIGger:SEQUence2[:STOP:SOURce]

**WIDTH**

---

## INT LEVEL

The **INT LEVEL** key enables internal leveling. Internal leveling uses an internal ALC (automatic level control) detector to provide automatic level control of the output power at the RF OUTPUT connector.

---

When the **INT LEVEL** key is pressed, the INT (ALC) annunciator will be lit.

Internal leveling is used to control the internal RF signal over a specified range (the vernier range) of  $-4$  to  $+10$  dBm. Additional dynamic range is provided by an optional 90 dB step attenuator (Option 1E1) to give an effective dynamic range of  $-90$  to  $+8$  dBm.

An ALC unlevelled condition occurs when the internal ALC circuitry cannot maintain leveling. This can occur due to an instrument fault or because the instrument is set to level for an RF output level that is beyond its capability. Calibrated output level is only guaranteed when the UNLVL annunciator is not lit.

When the Synthesizer UNLVL annunciator lights, the knob, arrow keys, or the numeric keypad can still be used to change displayed power up to the maximum value. However, the actual output power will *not* increase. Only the displayed value changes.

The internal ALC circuit maintains a constant RF power level over frequency at the RF OUTPUT connector. The ALC circuit is a feedback control system where output power is measured and compared to the desired power level. When output power does not equal the desired power level, the ALC changes the output until the actual and desired levels are equal.

The actual maximum leveled power available is dependent upon the frequency and varies across the range of the Synthesizer.

The allowable range for power level entries (using the **POWER LEVEL** key) is  $-15$  dBm to  $+30$  dBm for standard configuration instruments and  $-100$  dBm to  $+30$  dBm if option 1E1 is installed.

**NOTE**

The actual maximum internally leveled output power for your instrument at a given frequency can be found by increasing the Synthesizer output power until the **UNLVL** annunciator lights.

When the Synthesizer is set to the preset state, internal leveling is selected over external diode leveling or external power meter leveling.

---

### Advantages of Internal Leveling

Internal leveling is self-contained; it does not require any external equipment as does external diode leveling or external power meter leveling. Leveled power is specified at the RF OUTPUT connector.

---

### Disadvantages of Internal Leveling

Internal leveling does not compensate for losses or gains in the output signal path.

---

### Equivalent SCPI Commands

`POW:ALC:SOUR INT` *enables internal leveling.*

Keys/Shifted Functions  
**INT LEVEL**

---

**See Also**

**EXT DIODE**

**EXT METER**

**POWER LEVEL**

[SOURce[1]:]POWER:ALC

To Use the Level Correct Routine

---

## INT ON/OFF

The **INT ON/OFF** key toggles internal pulse modulation on and off.

---

When internal pulse modulation is turned on, the INT (PULSE) annunciator will be lit.

When the Synthesizer is set to the preset state, internal pulse modulation is turned off.

---

## Equivalent SCPI Commands

PULM:SOUR INT	<i>sets pulse source to internal.</i>
TRIG:SOUR IMM	<i>sets pulse trigger source to immediate (non-triggered).</i>
PULS:DOUB OFF	<i>turns doublet pulse mode off.</i>
PULM:STAT <u>ON OFF</u>	<i>turns pulse modulation on or off.</i>

---

## See Also

**DELAY**  
PRF  
**PRI**  
[SOURCE[1]:]PULM:SOURce  
[SOURCE[1]:]PULM:STATe  
TRIGger[SEQUence[1]:]START]:SOURce  
**TRIG ON/OFF**  
**WIDTH**

---

## INVERT

Invoking the INVERT function (pressing the **SHIFT** key and then the **EXT ON/OFF** key) toggles inverted external pulse modulation on and off.

---

When inverted external pulse modulation is turned on, the INVERT EXT annunciator will be lit. Pulses at the PULSE/TRIG, GATE IN connector will then be inverted before affecting the pulse envelope of the output signal. This means that when the input signal is high, there is no power at the RF OUTPUT connector. When the input signal is low, there is power at the RF OUTPUT connector. Non-inverted external pulse modulation is the opposite of inverted external pulse modulation.

When **SHIFT**, INVERT (**EXT ON/OFF**) is pressed so that the invert function is turned off, non-inverted external pulse modulation remains on.

When the Synthesizer is set to the preset state, inverted external pulse modulation is turned off.

---

## Equivalent SCPI Commands

PULM:SOUR EXT	<i>sets pulse source to external.</i>
PULM:EXT:POL INV	<i>sets external pulse polarity to inverted.</i>
PULM:STAT <u>ON OFF</u>	<i>turns pulse modulation on or off.</i>

---

## See Also

### Connectors

**EXT ON/OFF**

[SOURCE[1]:]PULM:EXTeRnal:POLarity

[SOURCE[1]:]PULM:SOURce

[SOURCE[1]:]PULM:STATe



---

## LOCAL

The **LOCAL** key removes the Synthesizer from the remote state.

---

When the Synthesizer is no longer in the remote state, the RMT annunciator in the right-hand display will no longer be lit.

If the instrument is in the local lockout (LLO) state, pressing the **LOCAL** key will not remove the instrument from the remote state. In this case, the only way to return the Synthesizer to local operation is either by setting the REN bus control line false or sending the instrument the go-to-local (GTL) bus command.

---

## Equivalent SCPI Command

There is no equivalent SCPI command for the **LOCAL** key, however, sending the "SYST:KEY 8" command is effectively the same as pressing the **LOCAL** key.

---

## See Also

Connectors  
SYSTem:KEY

---

## LOG AM ON/OFF

The **LOG AM ON/OFF** key toggles logarithmic amplitude modulation on and off.

---

When logarithmic AM is turned on, the LOG AM annunciator will be lit.

Logarithmic amplitude modulation allows you to continuously and exponentially vary the RF OUTPUT of the Synthesizer at a rate determined by AM IN input.

When the Synthesizer is in Log AM mode, the AM IN input accepts 0 to 6V. For every 1V input, the RF OUTPUT level decreases by 10 dB. For example, +3V causes a 30 dB attenuation in the RF output signal. The full range of attenuation varies from 0 dB to 60 dB. Negative voltage inputs have no effect on the RF Output signal (ie. 0 dB attenuation). For complete Log AM specifications, see Chapter 4, "Specifications and Options".

When the Synthesizer is set to the preset state, logarithmic AM is turned off.

---

## Equivalent SCPI Command

`AM:STAT ON|OFF` *turns logarithmic amplitude modulation on or off.*

---

## See Also

Connectors  
[SOURce[1]:]AM:STATe

---

## LVL CR

The LVL CR (level correct) function allows you to calibrate external path losses in the signal path. The level correct function creates a table in Synthesizer memory of external path loss values versus frequency.

Invoking the LVL CR (level correct) function (pressing the **SHIFT** key and then the **INT LEVEL** key) causes the Synthesizer to prompt you for the start frequency, stop frequency, and number of points in the level correction table. Once the start frequency, stop frequency, and number of points are entered, you are given the option of running the level correct routine.

---

When **SHIFT**, **INT LEVEL** (LVL CR) is pressed, the Synthesizer initially prompts you for the level correct start frequency.

- When **SHIFT**, **INT LEVEL** (LVL CR) is pressed, the text "COR START = XXXGHZ" will be displayed where "XXX" is the current start frequency. At this point, a new start frequency can be entered or the existing start frequency can be modified using the knob or arrow keys. The start frequency is used to determine the beginning frequency for the level correction table. The start frequency is the first frequency point in the table.

### NOTE

You do not have to choose a new start frequency (or stop frequency or number of points). To keep the same parameter value, press ENTER (**Hz**) without entering a new parameter and the next parameter in the sequence will be displayed.

Once you have chosen the proper start frequency, pressing any terminator key while a numeric parameter entry is not in progress will cause the Synthesizer to go to stop frequency entry mode.

- When in stop frequency entry mode, the Synthesizer will display COR STOP = XXXGHZ. Stop frequency entry is identical to start frequency entry. The

stop frequency is used to determine the ending frequency for the level correction table. The stop frequency is the last frequency point in the table.

Once you have chosen the proper stop frequency, pressing any terminator key while a numeric parameter entry is not in progress will cause the Synthesizer to go to number of points entry mode.

- When in number of points entry mode, the Synthesizer will display SET NUMBER OF POINTS = XXX. The number of points value determines how many frequency points will be in the level correct table. The number of points includes the start and stop frequency points. The Synthesizer uses the start and stop frequency values and number of points and places evenly spaced frequency points in the level correction table. Note that if the calculated frequency points are not within the Synthesizer frequency resolution, they will be rounded.

Once you have chosen the proper number of points, pressing any terminator key while a numeric parameter entry is not in progress will cause the Synthesizer to ask if you want to run the level correction routine.

- When the Synthesizer is asking if you want to run the level correction routine, the display indicates RUN CORRECTION?, HIT ENTER. If you press the ENTER (HZ) key, the Synthesizer begins collecting new level correction data.

For each frequency point in the table, the Synthesizer sends the power meter the frequency, waits for the meter to settle, and then reads the power value from the power meter. As the correction runs, the Synthesizer calculates the loss data by subtracting the power meter reading from the current power level. (The Synthesizer power level is constant during the level correct routine.)

**LVL CR**

**Notes**

1. If the level correction routine is aborted (by pressing the **LOCAL** key), the existing level correction data will be unaffected.
2. After the level correction routine has successfully completed, it will automatically be saved to the level correction table chosen by the "SAVE CR" function. If the routine fails, the entered start and stop frequencies, and number of points will remain at what they were set at. Be aware, however, that the data in the level correct table will still reflect the last successful level correction that was run.

Once the Synthesizer has completed the level correct routine and the new level correction table has been generated, it remains resident in Synthesizer memory even if power is turned off. Pressing **PRESET** has no effect on the table. The table can also be stored in one of four level correction table registers.

The start frequency lower limit is equal to the Synthesizer lower frequency limit. The start frequency upper limit is equal to the stop frequency minus the minimum frequency resolution at that frequency. The preset value for start frequency increment value is 100 MHz.

The stop frequency lower limit is equal to the start frequency plus the minimum frequency resolution at that frequency. The stop frequency upper limit is 20 GHz. The preset value for stop frequency increment value is 100 MHz.

The allowable range for number of points is 2 to 401. The preset increment value is 1.

---

## Equivalent SCPI Command

There is no equivalent SCPI command for the LVL CR function, however, the commands under the “Level Correction Commands” tab in Chapter 1 of the *HP 83731A/2A Programmer's Reference* explain how to load data into level correct tables, select tables, turn level correction on, etc.

---

## See Also

LVL CR ON/OFF  
PWR MTR ADDRS  
RCL CR  
SAVE CR  
To Use the Level Correct Routine

---

## LVL CR ON/OFF

The LVL CR ON/OFF (level correct on/off) function (**SHIFT**, **POWER LEVEL**) toggles the level correct function on and off.

---

When the level correct function is on, the LVL COR annunciator is lit and the data in the current level correction table is used to change the power level of the Synthesizer. The current level correction table is either the last level correction that was run or the last table recalled from one of the four level correction register locations.

The level correct function compensates for path loss measured during the level correct routine and changes power levels accordingly. Thus, power is flat and leveled over the range of frequency points where data was measured during the routine. For example, assume that the level correction factor at 10 GHz is  $-4$  dB (because there is 4 dB of path loss between the RF OUTPUT connector and the test point). Then, if  $-10$  dBm is desired at 10 GHz (and the level correct function is turned on), the Synthesizer actually generates  $-6$  dBm so that the power level at the test point is  $-10$  dBm. Notice that path loss correction is independent of power level.

The preset condition for this function is off.

### Notes

1. When level correction is activated and more power is required at the RF OUTPUT than the Synthesizer can deliver, an error message is generated and the **UNLVL** annunciator lights. This can occur when the external signal path has loss and the power level is set close to maximum leveled power.
2. If the level correct function is on and an output frequency is requested from the Synthesizer that is either greater than the stop frequency or less than the start frequency, *an error message will be generated and the level correction factor for the requested frequency will be zero (no correction).*

---

## Equivalent SCPI Commands

`CORR:CSET:SEL FDAT`tableno *selects the level correct table as defined by the "tableno" parameter.*  
`CORR:STATe` ON|OFF *turns user corrections on or off.*  
`CORR:CSET:STAT` ON|OFF *turns level corrections on or off.*

---

## See Also

LVL CR  
PWR MTR ADDRS  
RCL CR  
SAVE CR  
[SOURce[1]:]CORRection:CSET[:SElect]  
[SOURce[1]:]CORRection:CSET[:STATe]  
[SOURce[1]:]CORRection[:STATe]  
To Use the Level Correct Routine



---

## MSG

The **MSG** key causes the instrument to display the most recent uncleared error number and a short description of the error to the front panel display.

---

When uncleared error messages are in the error queue, the front panel MSG annunciator will be lit. The MSG annunciator will remain lit until all error messages in the queue have been cleared. When an error is read using the **MSG** key, it is cleared as long as the error condition no longer exists.

When the **MSG** key is pressed, the most recent error in the error queue will be displayed. Successive presses of the **MSG** key will display any other errors in the queue. Pressing any function key will remove the error from the display.

When the Synthesizer is set to the preset state, the error queue is cleared.

---

## Equivalent SCPI Command

`SYST:ERR?` *returns the oldest uncleared error number and message that is in the error queue.*

---

## See Also

Error Messages  
SYSTem:ERRor?

---

## MULTIPLIER

Invoking the MULTIPLIER function (pressing the **SHIFT** key and then the **FREQ** key) allows you to enter a multiplier value so that the frequency display will indicate the frequency at the output of a frequency multiplier.

### NOTE

External equipment is required for frequency multiplication.

---

When **SHIFT**, **FREQ** is pressed, the multiplier value will be displayed across the leftmost display in the following format:

FREQUENCY MULTIPLIER XXX

Where "XXX" is the multiplier value. The allowable range for multiplier values is 1 to 100. The preset value is 1 and the preset up/down arrow increment value is 1.

Entering a frequency multiplier value is useful when generating millimeter-wave signals with external multiplier equipment. *The display shows the frequency at the output of the external frequency multiplier, not at the Synthesizer RF OUTPUT connector.*

For example, assume a frequency of 30 GHz is required. The Synthesizer cannot generate a 30 GHz signal directly, but a frequency doubler can be connected at the RF OUTPUT connector to multiply a 15 GHz signal by two. Setting the multiplier value to two allows you to display the frequency at the output of the multiplier on the Synthesizer. Setting the multiplier value to two will display 30 GHz, while the Synthesizer is actually generating 15 GHz. Entering a new frequency of 32 GHz will set the Synthesizer to 16 GHz.

The minimum resolution at the output of the frequency multiplier is the Synthesizer minimum resolution multiplied by the frequency multiplier value. As an example, assume a multiplier value of two has been entered and

## **MULTIPLIER**

you attempt to enter a frequency of 30,000,001,000 Hz from the numeric keypad. The Synthesizer will try to generate 15,000,000,500 Hz. However, the resolution of this signal (assuming Option 1E8 is not installed) is 500 Hz which is finer than the minimum specified resolution of 1,000 Hz. The actual output frequency would be rounded to 15,000,001,000 Hz and the display would show 30,000,002,000 Hz.

---

### Equivalent SCPI Command

`FREQ:MULT multiplier` *sets the multiplier value as defined by the "multiplier" parameter.*

---

### See Also

**FREQ**  
[SOURce[1]:]FREQuency:MULTiplier  
To Generate Millimeter Signals

---

## Numeric Keypad

The numeric keypad is used to enter a value for the current active function. The number is entered (recognized by the Synthesizer) when you press the appropriate units terminator key or the ENTER ( $\text{Hz}$ ) key.

---

The numeric keypad consists of the numeric keys 0 through 9, 0,  $\text{MHz}$ , and the units terminator keys  $\text{GHz}$ ,  $\text{MHz}$ ,  $\text{kHz}$ , and  $\text{Hz}$ . When making an entry, the parameter change will not take effect until a units terminator key is pressed. The  $\text{GHz}$  key also functions as the units terminator key for dBm, dB, and ms entries. The  $\text{MHz}$  key also functions as the units terminator key for  $\mu\text{s}$  entries. The  $\text{kHz}$  key also functions as the units terminator key for ns. The  $\text{Hz}$  key functions as the terminator key for entries that are unitless (for example, multiplier value entries).

When the numeric keypad is used, data is entered for the active parameter. A cursor ( $\blacktriangledown$ ) will always appear over one of the digits in the active parameter display. If the cursor is absent from the display, the entry hold function is active and the desired function key must be pressed to re-enable the numeric keypad.

The knob or and  $\uparrow$ ,  $\downarrow$  keys can also be used to change the currently active parameter.

---

## See Also



ENTER

ENTRY OFF

Knob

To Enter Data with the Numeric Keypad

---

## POWER LEVEL

The **POWER LEVEL** key allows you to set the output power level of the Synthesizer.

---

Power level is displayed in the right-hand position of the rightmost display.

The allowable range for power level entries is  $-15$  dBm to  $+30$  dBm for standard configuration instruments and  $-100$  dBm to  $+30$  dBm when option 1E1 is installed.

### NOTE

The actual maximum internally leveled output power for your instrument at a given frequency can be found by increasing the Synthesizer output power until the **UNLVL** annunciator lights.

Power level resolution is 0.01 dB. The preset power level value is 0 dBm for standard configuration instruments. For instruments with option 1E1 installed, the preset power level value is  $-90.00$  dBm. The preset up/down arrow increment value is 1.00 dBm. The minimum increment value is 0.01 dBm.

### NOTE

Changing frequency or power level while pulse modulating the output triggers an internal power level calibration. This calibration includes a CW burst for approximately 30 ms. Refer to "AVG PWR INHIBIT ON/OFF" for information on how to protect devices sensitive to CW power.

Three options are available for leveling of the output power. These are internal leveling (**INT LEVEL**), external diode detector leveling (**EXT DIODE**), and external power meter leveling (**EXT METER**). Refer to the respective reference entries in this chapter for information on the different leveling options.

---

### Equivalent SCPI Command

**POW level** sets the Synthesizer output power level as defined by the "level" parameter.

---

### See Also

**EXT DIODE**

**EXT METER**

**INT LEVEL**

AVG PWR INHIBIT ON/OFF

[SOURCE[1]:]POWER[:LEVEL]

[SOURCE[1]:]POWER:UNIT

# PRESET

The **PRESET** key sets the Synthesizer to a known state.

The preset conditions are shown in the following table:

**PRESET Conditions**

Parameter	Condition	Parameter	Condition
Average Power Inhibit	Not Inhibited	Level Correction State	Off
Display	On	Level Correction Number of Points Increment	1
Doublet Pulse Modulation	Off	Level Correction Start Frequency Increment	100 MHz
Error Queue (HP-IB)	Not Cleared	Level Correction Stop Frequency Increment	100 MHz
External Diode Leveling	Off	Lock Step Attenuator	Off
Ext. Power Meter Leveling	Off	Log AM	Off
External Pulse Modulation	Off	Macros (HP-IB)	Not Enabled
FM	Off	Power Level	0 dBm <sup>1</sup>
FM Coupling	AC	Power Level Increment	1 dB
FM Sensitivity	5 MHz/V	PRF	10 kHz
Frequency	3 GHz	PRF Increment	100 Hz
Frequency Increment	100 MHz	PRI	100 $\mu$ s
Frequency Multiplier	1	PRI Increment	1 $\mu$ s
Frequency Multiplier Increment	1	Pulse Delay	1 $\mu$ s
Front Panel Error Queue	Cleared	Pulse Delay Increment	25 ns
Gated Pulse Modulation	Off	Pulse Invert	Off
HP-IB Address Increment	1	Pulse Risetime	AUTO <sup>2</sup>
Initial Power Meter Level	0 dBm	Pulse Width	10 $\mu$ s
Initial Power Meter Level Increment	1 dB	Pulse Width Increment	100 ns
Internal Leveling	On	RF On/Off	On
Internal Pulse Modulation	Off	Special Functions	Off
Last Special Function Active	1	Triggered Pulse Mode	Off

<sup>1</sup> When option 1E1 is installed, the preset value for power level is -90 dBm.

<sup>2</sup> HP 83732A only.

---

## Equivalent SCPI Commands

**\*RST**            *sets the Synthesizer to a known state.*

*or*

**SYST:PRES**

---

## See Also

**\*RST**

**SYSTem:PRESet**



---

## PRF

Invoking the PRF function (pressing the **SHIFT** key and then the **PRI** key) enables you to modify the pulse repetition frequency. PRF is used during internal pulse modulation and gated pulse modulation.

---

The pulse repetition frequency parameter is displayed under the "PRI/PRF" portion of the leftmost display. When the pulse repetition frequency is entered, the text "PRF XXX" will appear across the leftmost display where "XXX" is the entered value and the appropriate units suffix.

The accepted range for entries is from a minimum of 2.5 Hz to a maximum that is limited according to the carrier frequency set with the **FREQ** key. The limits are as follows:

**Maximum Specified PRF**

Carrier Frequency	Maximum Specified PRF
10 MHz to 128 MHz	0.1 MHz
128 MHz to 500 MHz	1 MHz
500 MHz and up	3.3 MHz

### Notes

1. The maximum PRF limits in the above table apply to the HP 83732A only. The maximum PRF limit for the HP 83731A is 3.3 MHz over the entire carrier frequency range.
2. The value for pulse width can not be greater than the value for  $\frac{1}{PRF}$ .

If a PRF entry is made that is not within the allowable range, the pulse characteristics will be out of specification and an error message will be generated.

The resolution for PRF can be found by rounding the reciprocal of PRF (1/PRF or PRI) to the nearest 25 ns and then taking the reciprocal of that value. For example, assume a PRF of 432 kHz is needed. The reciprocal of 432 kHz is 1/432 kHz or 2315 ns. This value rounded to the nearest 25 ns is 2325 ns. Taking the reciprocal of 2325 ns is 1/2325 ns or 430.107526 kHz. Therefore, if you enter a PRF of 432 kHz, the display will show 432 kHz but the actual PRF generated by the instrument will be 430.107526 kHz. The preset value for PRF is 10 kHz. The preset up/down arrow increment value is 100 Hz.

**NOTE**

Changing the PRF parameter automatically causes the PRI (pulse repetition interval) parameter to change since these two parameters are reciprocals of each other.

---

### Equivalent SCPI Command

`PULS:FREQ prf` sets the pulse repetition frequency as defined by the "prf" parameter.

Keys/Shifted Functions  
**PRF**

---

## See Also

**DELAY**  
**EXT ON/OFF**  
**INT ON/OFF**  
INVERT  
**PRI**  
[SOURce[1]:]PULSe:FREQuency  
**TRIG ON/OFF**  
**WIDTH**

---

## PRI

The **(PRI)** key enables you to modify the pulse repetition interval. PRI is used during internal pulse modulation and gated pulse modulation.

---

The pulse repetition interval parameter is displayed under the "PRI/PRF" portion of the leftmost display. When the pulse repetition interval is entered, the text "PRI XXX" will appear across the leftmost display where "XXX" is the entered value and the appropriate units suffix.

The accepted range for entries is from a maximum of 419 ms to a minimum that is limited according to the carrier frequency set with the **(FREQ)** key. The limits are as follows:

**Minimum Specified PRI**

Carrier Frequency	Minimum Specified PRI
10 MHz to 128 MHz	10 $\mu$ s
128 MHz to 500 MHz	1 $\mu$ s
500 MHz and up	0.3 $\mu$ s

### Notes

1. The minimum PRI limits in the above table apply to the HP 83732A only. The minimum PRI limit for the HP 83731A is 0.3  $\mu$ s over the entire carrier frequency range.
2. The value for pulse width can not be greater than the value for PRI.

**PRI**

The resolution for PRI entries is 25 ns; entries with resolution finer than 25 ns will be rounded to the nearest 25 ns. If a PRI entry is made that is not within the allowable range, the pulse characteristics will be out of specification and an error message will be generated. The preset value for PRI is 100  $\mu$ s. The preset up/down arrow increment value is 1  $\mu$ s.

**NOTE**

Changing the PRI parameter automatically causes the PRF (pulse repetition frequency) parameter to change since these two parameters are reciprocals of each other.

---

## Equivalent SCPI Command

PULS:PER pri *sets the pulse repetition interval as defined by the "pri" parameter.*

---

## See Also

**DELAY**

**EXT ON/OFF**

**INT ON/OFF**

**INVERT**

**PRF**

**[SOURce[1]:]PULSe:PERiod**

**TRIG ON/OFF**

**WIDTH**

---

## RCL CR

Invoking the RCL CR (recall level correction table) function (pressing the **SHIFT** key and then the **EXT METER** key) allows you to recall a previously stored table of level correction data from one of four level correction register locations.

---

The allowable range for register locations is 1 through 4. When **SHIFT**, **EXT METER** is pressed, the text "RECALL FRM TABLE XXX" will be shown on the Synthesizer display where "XXX" is the last level correction register number entered. Once you press a valid numeric key (1 through 4) and terminate the entry by pressing **Hz** (**ENTER**), the table of level correction data will be recalled from the location indicated by the numeric key pressed. If level correction data has not been previously stored to a level correction register, an error message is generated and no change to the current data takes place if you attempt to recall a level correction table from that register.

### **NOTE**

The four level correction registers are separate from the instrument state registers. Level correction data is not cleared from memory when the Synthesizer is set to the preset state and is unaffected if an instrument state is recalled from one of the instrument state registers.

---

## Equivalent SCPI Command

There is no equivalent SCPI command for the RCL CR function, however, the "SOUR1:CORR:CSET:SEL" command is used to select which level correct table is used to correct power at the Synthesizer RF OUTPUT connector.

Keys/Shifted Functions  
**RCL CR**

---

## See Also

LVL CR  
LVL CR ON/OFF  
SAVE CR  
To Use the Level Correct Routine

---

## RECALL

The **RECALL** key allows you to recall a previously stored instrument state from one of ten register locations.

---

The allowable range for register locations is 0 through 9. When **RECALL** is pressed, the text "RECALL STATE FROM REG XXX" will be shown on the instrument display where "XXX" is the last register number entered. Once you press a valid numeric key (0 through 9) and terminate the entry, the instrument state will be recalled from the location indicated by the numeric key pressed.

If the instrument state has not been previously stored to an instrument state register, the Synthesizer will be set to the preset state if you attempt to recall the instrument state from that register.

---

### Equivalent SCPI Command

\*RCL register *recalls a previously stored instrument state from the register defined by the "register" parameter.*

---

### See Also

**PRESET**  
\*RCL  
\*SAV  
SAVE



---

## RF ON/OFF

The **RF ON/OFF** key toggles the signal at the RF OUTPUT connector on and off.

---

When the RF OUTPUT is turned off, the text "OFF" will be indicated in the level display in place of "dBm".

When the RF Output is turned off, the internal oscillators are turned off and the internal RF power shutdown circuit is turned on.

When the Synthesizer is set to the preset state, the signal at the RF OUTPUT connector is turned on.

---

## Equivalent SCPI Command

`OUTP:STAT ON|OFF` *turns the signal at the RF Output connector on or off.*

---

## See Also

`OUTPut[:STATe]`

---

## SAVE

Invoking the SAVE function (pressing the **SHIFT** key and then the **RECALL** key) allows you to save the instrument state in one of ten register locations.

---

The allowable range for register locations is 0 through 9. When **SHIFT**, **RECALL** is pressed, the text "SAVE STATE IN REG XXX" will be shown on the instrument display where "XXX" is the last register number entered. Once you press a valid numeric key (0 through 9) and terminate the entry, the instrument state will be saved to the location indicated by the numeric key pressed. Saving the instrument state to a given register location will write over any instrument state previously stored at that location.

All user settings that are affected when the **PRESET** key is pressed will be saved. Level correction tables, however, will not be saved. For information on saving level correction tables, refer to "SAVE CR" in this chapter.

---

### Equivalent SCPI Command

*\*SAV register saves the instrument state to the register defined by the "register" parameter.*

---

### See Also

**RECALL**  
\*SAV  
SAVE CR

---

## SAVE CR

Invoking the SAVE CR (save level correction table) function (pressing the **SHIFT** key and then the **EXT DIODE** key) allows you to save the current table of level correction data in one of four level correction register locations.

The allowable range for register locations is 1 through 4. When **SHIFT**, **EXT DIODE** is pressed, the text "SAVE IN TABLE XXX" will be shown on the Synthesizer display where "XXX" is the last level correction register number entered. Once you press a valid numeric key (1 through 4) and terminate the entry by pressing **Hz** (ENTER), the table of level correction data will be saved to the location indicated by the numeric key pressed. Saving the table of level correction data to a given level correction register location will write over any level correction data previously stored at that location.

### **NOTE**

The four level correction registers are separate from the instrument state registers. Level correction data is not cleared from memory when the Synthesizer is set to the preset state and is unaffected if an instrument state is recalled from one of the instrument state registers.

---

## Equivalent SCPI Command

There is no equivalent SCPI command for the SAVE CR function, however, the "MEM:TABL:FREQ" and "MEM:TABL:LOSS:MAGN" commands can be used to load frequency and correction factor points into a selected level correct table.

---

## See Also

LVL CR  
LVL CR ON/OFF  
RCL CR  
To Use the Level Correct Routine

---

## SENSITIVITY

Invoking the SENSITIVITY function (pressing the **SHIFT** key and then the **FM ON/OFF** key) enables you to view the current FM sensitivity.

---

When **SHIFT**, **FM ON/OFF** (SENSITIVITY) is pressed, the FM sensitivity will be displayed across the leftmost display in the following format:

FM SENS = XXX

Where "XXX" is the FM sensitivity with its appropriate units terminator (either kHz or MHz).

When the Synthesizer is set to the preset state, sensitivity is 5 MHz/V.

FM sensitivity is defined as the ratio of the peak frequency deviation from the carrier per volt change of modulating signal amplitude.

FM sensitivity is dependent on the range of the carrier frequency currently set with the **FREQ** key (see the following table).

**FM Sensitivity**

Carrier Frequency	Sensitivity <sup>1</sup>
greater than 1 GHz	5.00 MHz/V
256 to 1000 MHz	1.28 MHz/V
64 to 256 MHz	320 kHz/V
16 to 64 MHz	80.0 kHz/V
less than 16 MHz	20.0 kHz/V

<sup>1</sup> FM Sensitivity for the HP 83731A is a constant 5 MHz/V over the entire carrier frequency range since the carrier frequency of this instrument does not extend below 1 GHz.

For example, if the carrier frequency were set to 1 GHz and a sine wave signal of 1 volt peak were connected to the FM IN connector, the carrier would deviate between 995 MHz and 1.005 GHz. If the carrier were set to 19

GHz in the above example, the carrier would deviate between 18.995 GHz and 19.005 GHz. Note that the sensitivity shown in the table is constant over the carrier frequency range shown in the table.

**Notes**

1. FM sensitivity cannot be changed; it can only be viewed. It is displayed due to the fact that FM sensitivity is a function of carrier frequency.
2. When a frequency multiplier is used at the Synthesizer output, the sensitivity displayed will be multiplied by the multiplier value. As an example, if the multiplier value is set to 2 and the carrier is set to 30 GHz ( $2 \times 15$  GHz), the sensitivity that would be displayed would be 10.0 MHz/V ( $2 \times 5$  MHz/V).

---

## Equivalent SCPI Command

**FM:SENS?** *returns the current FM sensitivity.*

---

## See Also

Connectors

**FM ON/OFF**

**FREQ**

**MULTIPLIER**

[SOURce[1]:]FM:SENSitivity?

---

## SHIFT

The **SHIFT** key causes the alternate function of any key pressed directly after it to be executed.

---

When the **SHIFT** key is pressed, the word "SHIFT" will be displayed in the leftmost display. The next key that is pressed after the **SHIFT** key will execute the function that is indicated by the text that is above the key. As an example, note that PRF appears directly above the **PRI** key. PRF (pulse repetition frequency) is the alternate function of the **PRI** key. Pressing **SHIFT**, **PRI** will enable PRF entry mode.

If the **SHIFT** key is pressed prior to pressing a key that has no alternate function, "SHIFT" will be canceled from the display and no action will be taken by the instrument.

If you press the **SHIFT** key accidentally, pressing it again will cancel it without altering Synthesizer operation.

---

## Equivalent SCPI Command

There is no equivalent SCPI command for the **SHIFT** key, however, sending the "SYST:KEY 0" command is effectively the same as pressing the **SHIFT** key.

---

## See Also

SYSTem:KEY

---

## SPCL

The **SPCL** key initiates activation of special functions. Once a special function has been activated, it can be turned on or off, or its parameter value can be changed.

---

When the **SPCL** key is pressed, the current special function that is active is shown on the display followed by a short description. For example, if special function #2 is the currently active special function, the display would indicate the following after **SPCL** is pressed:

```
SPCL 2 ATTEN HOLD ON
```

Once a special function has been activated (by pressing the **SPCL**, *special number*, ENTER key sequence), the function can be turned on or off by pressing the SPCL ON (**MHz**) or SPCL OFF (**kHz**) keys.

If a special function has an associated parameter, the parameter can be modified by using the **↑** or **↓** keys, knob, or numeric keypad (after the **SPCL**, *special number*, ENTER key sequence has been pressed). The parameter entry is terminated the same way as any parameter entry.

When the Synthesizer is set to the preset state, the currently active special function is set to 1 (SHOW INFO).

---

## Equivalent SCPI Command

There is no equivalent SCPI command for the **SPCL** key, however, sending the "SYST:KEY 9" command is effectively the same as pressing the **SPCL** key.



---

## SPCL OFF (kHz)

The SPCL OFF key (actually the secondary function of the **(kHz)** key) is used to turn on/off-type special functions off.

---

The SPCL OFF (**(kHz)**) key is used to turn on/off-type special functions off when they are displayed in the leftmost display. The on/off-type special functions are ATTN HOLD ON/OFF, AVG PWR INHIBIT ON/OFF, CLEAR DISPLAY, and DC FM ON/OFF.

The SPCL OFF key will turn the special function off whether it has been selected via the numeric keypad or by using the knob or **(↑)**, **(↓)** keys. When the special function has been turned off, the word "OFF" will be shown in the right side of the leftmost display and the SPCL annunciator will turn off if no other special functions are selected.

---

## Equivalent SCPI Command

There is no equivalent SCPI command for the SPCL OFF key, however, sending the "SYST:KEY 50" command is effectively the same as pressing the SPCL OFF key.

---

## See Also

ATTEN HOLD ON/OFF  
AVG PWR INHIBIT ON/OFF.  
CLEAR DISPLAY  
DC FM ON/OFF  
**SPCL**  
SPCL ON  
SYSTEM:KEY

---

## SPCL ON (MHz)

The SPCL ON key (actually the secondary function of the **(MHz)** key) is used to turn on/off-type special functions on.

---

The SPCL ON **(MHz)** key is used to turn on/off-type special functions on when they are displayed in the leftmost display. The on/off-type special functions are ATTEN HOLD ON/OFF, AVG PWR INHIBIT ON/OFF, CLEAR DISPLAY, and DC FM ON/OFF.

The SPCL ON key will turn the special function on whether it has been selected via the numeric keypad or by using the knob or **(↑)**, **(↓)** keys. When the special function has been turned on, the word "ON" will be shown in the right side of the leftmost display and the SPCL annunciator will be lit.

---

## Equivalent SCPI Command

There is no equivalent SCPI command for the SPCL ON key, however, sending the "SYST:KEY 42" command is effectively the same as pressing the SPCL ON key.

---

**See Also**

ATTEN HOLD ON/OFF  
AVG PWR INHIBIT ON/OFF.  
CLEAR DISPLAY  
DC FM ON/OFF  
**SPCL**  
SPCL OFF  
SYSTEM:KEY

---

## STEP SIZE

The **STEP SIZE** key enables you to change the increment value for the current active parameter. The increment value is the value that the current parameter will be increased or decreased by when the **↑** or **↓** keys are pressed.

---

The preset increment value for each parameter can be found under the pertinent key/function entries in this section.

If the ENTRY OFF (**SHIFT**, **⇒**) function has been enabled, you will not be able to change any increment values using the **STEP SIZE** key and pressing the **↑** or **↓** keys will have no effect on the active parameter.

---

## Equivalent SCPI Commands

<code>FREQ:STEP <u>increment</u></code>	<i>sets frequency increment value as defined by the "increment" parameter.</i>
<code>FREQ:MULT:STEP <u>increment</u></code>	<i>sets multiplier increment value as defined by the "increment" parameter.</i>
<code>POW:STEP <u>increment</u></code>	<i>sets power level increment value as defined by the "increment" parameter.</i>
<code>POW:ALC:PMET:STEP <u>increment</u></code>	<i>sets external power meter leveling increment value as defined by the "increment" parameter.</i>
<code>PULS:DEL:STEP <u>increment</u></code>	<i>sets pulse delay increment value as defined by the "increment" parameter.</i>
<code>PULS:FREQ:STEP <u>increment</u></code>	<i>sets pulse repetition frequency increment value as defined by the "increment" parameter.</i>
<code>PULS:PER:STEP <u>increment</u></code>	<i>sets pulse period increment value as defined by the "increment" parameter.</i>

PULS:WIDTH:STEP increment

*sets pulse width increment value as defined by the "increment" parameter.*

---

See Also



ENTRY OFF

---

## TRIG ON/OFF

The **TRIG ON/OFF** key toggles internal triggered pulse modulation on and off.

---

When internal triggered pulse modulation is turned on, the TRIG INT annunciator will be lit.

When internal triggered pulse modulation is enabled, an RF pulse will occur at the RF OUTPUT connector whenever a valid trigger signal occurs at the PULSE/TRIG IN, GATE IN connector. The RF pulse will have pulse width and delay as set with the **WIDTH** and **DELAY** keys. Figure 6-5 summarizes the timing characteristics of internal triggered pulse mode.

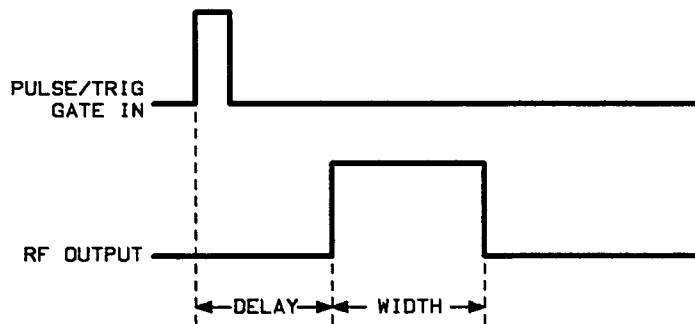

**Figure 6-5. Internal Triggered Pulse Mode Timing**

When the Synthesizer is set to the preset state, internal triggered pulse modulation is turned off.

---

## Equivalent SCPI Commands

<code>PULM:SOUR INT</code>	<i>sets pulse source to internal.</i>
<code>TRIG:SOUR EXT</code>	<i>enables triggered pulse mode.</i>

TRIG:STOP:SOUR IMM *sets the trigger stop source to immediate.*  
PULS:DOUB OFF *turns doublet pulse mode off.*  
PULM:STAT ON|OFF *turns pulse modulation on or off.*

---

## See Also

Connectors

**DELAY**

[SOURCE[1]:]PULM:SOURce

[SOURCE[1]:]PULM:STATe

TRIGger[:SEQuence[1]:]START[:SOURce

**WIDTH**



---

## WIDTH

The **WIDTH** key enables you to modify the pulse width parameter. Pulse width is used in internal, triggered internal, gated, and doublet pulse modes.

---

The pulse width parameter is displayed under the "WIDTH" portion of the leftmost display. When the width is entered, the text "WIDTH XXX" will appear across the leftmost display where "XXX" is the entered value and the appropriate units suffix.

The allowable range for entries is 0 ns to 419 ms with a resolution of 25 ns; entries with resolution finer than 25 ns will be rounded to the nearest 25 ns. If a width entry is made that is greater than the upper limit, the value will be set to the upper limit. The preset value for width is 10  $\mu$ s.

### Notes

1. In triggered pulse mode, the sum of pulse width and pulse delay can not exceed 419 ms.
2. The value for pulse width can not be greater than the value for PRI.

The allowable range for up/down arrow increments is 25 ns to 419 ms with 25 ns resolution. The preset up/down arrow increment value is 100 ns.

---

## Equivalent SCPI Command

**PULS:WIDT** width *sets the pulse width as defined by the "width" parameter.*

---

See Also

**DELAY**  
**EXT ON/OFF**  
**INT ON/OFF**  
INVERT  
PRF  
**PRI**  
[SOURce[1]:]PULSe:WIDTh  
**TRIG ON/OFF**

Keys/Shifted Functions  
**WIDTH**







## Special Functions



---

## Special Functions

This chapter contains detailed information on the various special functions available for the Synthesizer. Special functions are hidden during normal Synthesizer operation and can only be invoked by pressing the **(SPCL)** key and then entering the special function number. Note that special functions are organized in this chapter alphabetically by special function name, not by special function number.

---

## ATTEN HOLD ON/OFF

Invoking the ATTEN HOLD ON/OFF function (pressing **SPCL**, **2**, **ENTER (Hz)**) selects the attenuator hold function. This function toggles between locking and unlocking the 10 dB step attenuator in its current setting.

### NOTE

The attenuator hold function is only available if option 1E1 is installed.

---

When **SPCL**, **2**, **ENTER (Hz)** is pressed, the leftmost display shows the following:

ATTEN HOLD XXX

Where "XXX" is the current state of the step attenuator (ON=Locked and OFF=Unlocked).

Once the attenuator hold function is enabled, pressing **SPCL ON (MHz)** locks the Synthesizer step attenuator at its current setting. Pressing **SPCL OFF (kHz)** unlocks the step attenuator.

When the Synthesizer is set to the preset state, the attenuator hold function is turned off.

---

## Applications

The attenuator hold function can be used to extend the vernier range to prevent the step attenuator from switching between two attenuator settings. Locking the step attenuator keeps the attenuator from switching between the

## **ATTEN HOLD ON/OFF**

two levels as leveled power is varied above and below the threshold level, thus saving wear on the attenuator. Refer to the specification table in this manual for the level at which the attenuator switches.

---

### **Advantages**

Locking the step attenuator prevents switching between two levels when the leveled output power is set near an attenuator switching threshold.

---

### **Disadvantages**

When the step attenuator is locked, the output power dynamic range is limited to the vernier range at the current output frequency. Locking the step attenuator typically extends the lower limit of the vernier range by 5 dB. The upper limit of the vernier range is the Synthesizer maximum output power which changes with frequency. The minimum dynamic range when the attenuator hold function is on is typically 19 dB.

#### **NOTE**

The ATTEN HOLD ON/OFF function will not activate when the Synthesizer is in the external diode detector leveling or external power meter leveling mode.



---

## Equivalent SCPI Command

`POW:ATT:AUTO ON|OFF` *turns the attenuator hold function on or off. When the parameter is set to "on", the attenuator hold function is off and when the parameter is set to "off", the attenuator hold function is on.*

---

## See Also

`POWER LEVEL`  
`[SOURce[1]:]POWer:ATTenuation:AUTO`

---

## AVG PWR INHIBIT ON/OFF

Invoking the AVG PWR INHIBIT ON/OFF function (pressing **SPCL**, **3**, **1**, **ENTER** (**Hz**)) selects the average power inhibit function. Once this function is selected, you can set average power inhibit on or off.

The AVG PWR INHIBIT ON/OFF function is used to protect average power sensitive devices during pulse modulation.

### NOTE

This function is not available if option 1E1 (step attenuator) is not installed.

---

When **SPCL**, **3**, **1**, **ENTER** (**Hz**) is pressed, the leftmost display shows the following:

AVG PWR INHIBIT XXX

Where "XXX" is the current state of the average power inhibit function (either "ON" or "OFF").

Once the average power inhibit function is enabled, it can be turned on by pressing **SPCL ON** (**MHz**). Pressing **SPCL OFF** (**kHz**) turns the average power inhibit function off.

When the Synthesizer is set to the preset state, the average power inhibit function is turned off.

---

## Application

The average power inhibit function can be used during pulse modulation to protect devices sensitive to high average power. When the output power level or frequency of the Synthesizer is changed during pulse modulation, the internal leveling algorithm causes the RF output to be momentarily switched to CW to enable the Synthesizer circuitry to sample the signal level and make a correction. If the output of the Synthesizer is connected to circuitry that is average power-sensitive, damage to the circuitry could result during this CW calibration. When in internal leveling mode, the CW calibration is approximately 30 ms.

When the average power inhibit function is off (the preset condition), the CW calibration will follow output power level and frequency changes. The CW calibration will also occur the first time pulse or logarithmic amplitude modulation is enabled. When average power inhibit is on, the internal step attenuator will switch in 90 dB of attenuation during the CW calibration. This will protect power-sensitive circuitry connected to the RF OUTPUT connector, but will cause extra wear on the step attenuator. Turning the function on will also cause a momentary drop in signal power (approximately 200 ms) and will lengthen frequency and power level switching times by 70 ms.

---

## Pulsed Power Pre-Calibration Program

As stated in the previous paragraph, the average power inhibit function causes the internal step attenuator to switch in 90 dB of attenuation whenever frequency or power level is changed. This causes extra wear on the step attenuator.

When you know the various frequencies and power levels that you will be using in a test routine, the following program can be used to gather the CW calibration values for frequency/power level pairs. After activating the special pulse modulation mode, calibration values can be sent for each frequency/power level pair and the CW calibration will be eliminated. This

**AVG PWR INHIBIT ON/OFF**

program provides an alternative to turning the average power inhibit function on and, therefore, minimizes wear on the step attenuator.

When the calibration portion of the program is run, you should disconnect average power sensitive circuitry from the RF OUTPUT to avoid damaging it. During the calibration, using a substitute load with the exact characteristics as the circuit load will preserve the specified CW-to-pulse level accuracy. The calibration should not be performed until the instrument has had sufficient time to warm up (usually 30 minutes). The calibration data remains valid as long as the ambient temperature remains stable. CW-to-pulse level accuracy degrades nominally by 0.07 dB/°C. For best accuracy, the calibration should be repeated whenever the ambient temperature changes.

The time the calibration routine takes to obtain the CW calibration values is equivalent to the normal frequency and power level switching times. In special pulse modulation mode, frequency and power level changes (without an attenuator range change) occur faster than during normal pulsed operation.

When running the following program, once the calibration is complete *and special pulse modulation mode is entered*, the following events will happen during pulsed frequency switching:

- The frequency ("FREQ ";Freqs(I); "MHZ") command is sent: This causes the Synthesizer to change frequency and the power level will drop to the minimum vernier level. The output power remains pulsed.
- The power level ("POW ";Powers(I); "DBM") command is sent: This causes the Synthesizer to adjust *only* the attenuator range. The vernier remains at its minimum level.
- The ("DIAG:IBUS 23, ";Verniers(I)) command is sent: This adjusts the vernier level to its correct level. The Synthesizer is now pulsing at the correct frequency and power level.

**NOTE**

The preceding commands must always be executed in the order presented for proper instrument operation. However, there are two cases when use of the frequency and/or power level commands can be minimized.

**Case 1** - If the Synthesizer will only be operating at one frequency, the frequency command only needs to be sent once.

**Case 2** - If the Synthesizer will only be operating at one attenuator range, the power level command only needs to be sent once.

10 OPTION BASE 1

*Sets the lowest element of all arrays to 1.*

20 DIM Freqs(100),Powers(100),Verniers(100)

*Dimensions arrays.*

30 Num\_points=4

*Sets variable "Num\_points" to 4 for this example. "Num\_points" must be equal to the number of frequency/power level pairs in the DATA statement.*

40 DATA 1000,0,1330,-4,1750,-25,2000,12

*The frequency/power level pairs to be used by this program. The first number and every other number is a frequency; the second number and every other number is a corresponding power level.*

50 OUTPUT 719;"\*RST"

*Presets the Synthesizer.*

60 OUTPUT 719;"PULM:SOUR EXT"

*Selects external pulse mode for this example. Modify this statement for your desired pulse mode.*

70 OUTPUT 719;"PULM:EXT:POL NORM"

*Selects normal pulse polarity for this example. Modify this statement for your desired pulse polarity.*

80 OUTPUT 719;"PULM:STAT ON"

*Turns pulse modulation on.*

90 INPUT "DISCONNECT AVERAGE POWER SENSITIVE DEVICES FROM THE RF OUTPUT,  
THEN PRESS ENTER",A.

100 !

110 FOR I=1 TO Num\_points

120 READ Freqs(I),Powers(I)

*Reads frequency into the "I" position of array "Freqs" and power level into the "I" position of array "Powers".*

## Special Functions

### AVG PWR INHIBIT ON/OFF

```
130  OUTPUT 719;"FREQ ";Freqs(I);"MHZ;POW ";Powers(I);"DBM"  
Sets Synthesizer frequency and power level to the values in the arrays specified by "I".  
140  OUTPUT 719;"DIAG:IBUS? 23"  
Queries the vernier DAC setting at the current frequency/power level.  
150  ENTER 719;Verniers(I)  
Reads vernier DAC setting into the "I" position of array "Verniers".  
160  NEXT I  
170  !  
180  OUTPUT 719;"DIAG:IBUS 73,16"  
Activates special pulse modulation mode.  
190  INPUT "CONNECT DUT TO RF OUTPUT AND PRESS ENTER.",A  
200  PRINT  
210  !  
220  FOR I=1 TO Num_points  
230  OUTPUT 719;"FREQ ";Freqs(I);"MHZ;POW ";Powers(I);"DBM"  
Sets Synthesizer frequency and power level to the values in the arrays specified by "I".  
240  OUTPUT 719;"DIAG:IBUS 23,";Verniers(I)  
Sets vernier DAC to the value in the "I" position of array "Verniers".  
250  PRINT "SYNTHESIZER FREQUENCY IS CURRENTLY ";Freqs(I);" MHz, AND  
      POWER LEVEL IS CURRENTLY ";Powers(I);" dBm."  
260  IF I=Num_points THEN GOTO 300  
270  INPUT "PRESS ENTER WHEN YOU ARE READY TO GO TO THE NEXT  
      FREQUENCY/POWER LEVEL PAIR.",A  
280  NEXT I  
290  !  
300  INPUT "PRESS ENTER TO EXIT SPECIAL PULSE MODULATION MODE.",A  
310  !  
320  OUTPUT 719;"*RST"  
Presets the Synthesizer.  
330  PRINT  
340  PRINT "NOTE: CYCLE SYNTHESIZER POWER OFF AND ON TO  
      TERMINATE SPECIAL PULSE MODULATION MODE."  
350  PRINT  
360  PRINT "END OF PROGRAM"  
370  END
```

---

## Equivalent SCPI Command

POW:PROT:STAT ON|OFF *turns the average power inhibit function on or off.*

---

See Also

**POWER LEVEL**  
[SOURCE[1]:]POWER:PROTECTION:STATE

---

## CLEAR DISPLAY

Invoking the clear display function (pressing **SPCL**, **3**, **ENTER (Hz)**) enables you to turn off the Synthesizer fluorescent displays and LED annunciators or turn them on if they are currently turned off.

---

When **SPCL**, **3**, **ENTER (Hz)** is pressed, the leftmost display will display the following:

CLEAR DISPLAY XXX

Where "XXX" is "ON" if the clear display function is currently on and "OFF" if the clear display function is currently off.

Once the clear display function has been enabled, pressing **SPCL ON** blanks the displays and LED annunciators and "DISPLAY BLANKED" is displayed across the leftmost display.

The display state is stored in the instrument state registers along with other instrument state data, so if sensitive instrument settings are stored to a register, the settings are not revealed when the register is recalled.

When the Synthesizer is set to the preset state, the display is restored if it had been previously cleared.

### **NOTE**

Cycling the LINE switch off and then on will not restore the display.



---

## Equivalent SCPI Command

DISP:STAT ON|OFF *turns the display on or off.*

---

## See Also

Display  
DISPlay[:WINDow][:STATE]

---

## DC FM ON/OFF

Invoking the DC FM on/off function (pressing **SPCL**, **3**, **0**, **ENTER (Hz)**) enables you to set frequency modulation to either AC or DC coupling.

---

When **SPCL**, **3**, **0**, **ENTER (Hz)** is pressed, the DC FM on/off function is activated. The display will be as follows:

DC FM XXX

Where "XXX" is "OFF" if FM is currently set to AC and "ON" if FM is currently set to DC.

Once the function has been activated, the status of the DC FM function can be changed by pressing either the **SPCL ON (MHz)**, or **SPCL OFF (kHz)** keys. Pressing **SPCL ON (MHz)** sets DC FM on and pressing **SPCL OFF (kHz)** sets DC FM off. The display will change to indicate either "DC FM ON" or "DC FM OFF". In addition, the pertinent annunciator (AC FM or DC FM) will be lit to indicate the current status of the DC FM function when **FM ON/OFF** is set to on.

When the Synthesizer is set to the preset state, the DC FM On/Off function is set to off.

When DC FM is off, the Synthesizer circuitry is configured so that the FM IN connector will accept a modulating signal with a minimum rate of 1 kHz. When DC FM is on, the FM IN connector will accept a modulating signal with a minimum rate of 0 Hz (DC). Maximum FM deviation does not change.

---

## Advantage

When DC FM is selected, the modulation index is unlimited:

$$\text{modulation index} = \text{peak deviation} / \text{modulation rate}$$

Where modulation rate can range down to 0 Hz (DC).

---

## Disadvantage

When DC FM is enabled, the internal phase locked loop circuit is disabled, causing the output frequency accuracy and stability to be degraded.

---

## Equivalent SCPI Command

**FM:COUP** AC|DC *sets frequency modulation to either AC or DC.*

---

## See Also

Annunciators

Connectors

**FM ON/OFF**

[SOURce[1]:]FM:COUPling

---

## ERASE MEMORY

Invoking the erase memory function (pressing **SPCL**, **4**, **ENTER (Hz)**) clears all application-specific information from Synthesizer memory.

---

When **SPCL**, **4**, **ENTER (Hz)** is pressed, all user settings are set to the preset state, save/recall registers are erased, and level correction tables are cleared. The erase memory function does not clear factory calibration data stored in the EEPROM.

When the erase memory function is invoked, the display will momentarily display the following:

INITIALIZING MEMORY

---

## Application

The erase memory function is useful when removing the Synthesizer from a secure area as the setup history of the Synthesizer will be erased.

---

## Equivalent SCPI Command

`MEM:RAM:INIT` *clears Synthesizer memory.*

---

**See Also**

**PRESET**  
RCL CR  
**RECALL**  
SAVE  
SAVE CR  
MEMory:RAM:INTTialize[:ALL]

---

## PWR MTR ADDRS

Invoking the PWR MTR ADDRS (power meter address) function (pressing **(SPCL)**, **(2)**, **(0)**, **ENTER (Hz)**) changes the HP-IB address that the Synthesizer uses when communicating with an external power meter during the level correct routine.

---

When **(SPCL)**, **(2)**, **(0)**, **(Hz)** is pressed, you will be prompted to enter the address that the Synthesizer will use when communicating with the external power meter or when receiving data from the external power meter during the level correct routine. The valid power meter address range is 00 to 30 (decimal).

The external power meter HP-IB address set at the factory is 13. Setting the Synthesizer to the preset state will not modify the address.

### NOTE

This function *does not* set the address at the power meter. You should refer to the power meter manual for information on how to change the power meter address.

---

## Equivalent SCPI Command

`SYST:COMM:PMET:ADDR address` *changes the HP-IB address that the Synthesizer uses when communicating with an external power meter as defined by the "address" parameter.*

---

## See Also

LVL CR  
LVL CR ON/OFF  
PWR MTR SELECT  
RCL CR  
SAVE CR  
SYSTem:COMMunicate:PMETer:ADDRess  
To Use the Level Correct Routine

---

## PWR MTR SELECT

Invoking the power meter select function (pressing **SPCL**, **2**, **1**, **ENTER** (**Hz**)) allows you to set the programming language that the Synthesizer will use when communicating with the power meter during the level correct routine.

---

When **SPCL**, **2**, **1**, **ENTER** (**Hz**) is pressed, the leftmost display shows the following:

POWER METER IS XXX

Where "XXX" is the currently selected power meter language (HP70100A, HP437B, HP438A, or SCPI).

Once the power meter select function is enabled, you can use the **↑** or **↓** keys to choose one of the four power meter language options. When "SCPI" is chosen, the Synthesizer will communicate with any SCPI-compatible power meter.

When the Synthesizer is set to the preset state, the power meter language chosen with this command is not changed.

---

## Equivalent SCPI Command

There is no equivalent SCPI command for the power meter select function.



---

## See Also

LVL CR  
LVL CR ON/OFF  
PWR MTR ADDRS  
RCL CR  
SAVE CR  
To Use the Level Correct Routine

---

## SELECT RISE TIME

Invoking the select risetime function (pressing **SPCL**, **4**, **0**, **ENTER (Hz)**) allows you to manually choose either a slow, medium, or fast pulse risetime or enable the instrument to automatically select optimum pulse risetime for the selected carrier frequency.

### Notes

1. This special function can be selected at any carrier frequency, however, at carrier frequencies above 1 GHz, pulse risetime is fixed at 10 ns.
2. This special function is only available in the HP 83732A.

---

When **SPCL**, **4**, **0**, **ENTER (Hz)** is pressed, the leftmost display shows the following:

RISE TIME: XXX SLOPE

Where "XXX" is the currently selected pulse risetime (SLOW, MEDIUM, or FAST; AUTO indicates the instrument automatically selects optimum pulse risetime).

### NOTE

Risetime is not continuously variable, but may be set to one of three different values.

Once the select risetime function is enabled, you can use the  $\uparrow$  or  $\downarrow$  keys to change the pulse risetime between the three values or select automatic pulse risetime selection. Note that you cannot use the numeric keypad to enter a risetime value; the arrow keys must be used to change the risetime.

When the Synthesizer is set to the preset state, pulse risetime is set to AUTO.

**NOTE**

When you manually set the risetime with this function, the falltime (pulse trailing edge) will be automatically set to the same value. There is no method of changing the falltime independently of the risetime.

---

## Applications

A series of low pass filters are used to reduce output harmonics when the Synthesizer output frequency is less than 1 GHz. The filter passbands can be narrow enough to induce pulse ringing if the pulse risetime is too fast.

The Synthesizer automatically selects a slower pulse risetime (when AUTO is selected) as the carrier frequency is decreased to minimize ringing and video feedthrough caused by the low pass filtering. The appropriate pulse risetime is automatically selected as follows:

Output Frequency	Pulse Risetime
10 MHz to 64 MHz	300 ns
64 MHz to 500 MHz	30 ns
Greater than 500 MHz	10 ns

Special Functions  
**SELECT RISETIME**

In applications where a faster pulse risetime than that shown in the table is needed at output frequencies less than 1 GHz, you can manually choose a pulse risetime. The disadvantage of choosing a faster pulse risetime is degraded pulse performance.

---

### Equivalent SCPI Command

<code>PULS:TRAN:STAT <u>ON OFF</u></code>	<i>selects either manual (ON) or automatic (OFF) risetime selection.</i>
<code>PULS:TRAN:LEAD <u>SLOW MED FAST</u></code>	<i>selects either a slow, medium, or fast pulse risetime.</i>

---

### See Also

`[SOURce[1]:]PULSe:TRANsition[:LEADing]`  
`[SOURce[1]:]PULSe:TRANsition:STATe`

---

## SELF TEST

Invoking the self-test function (pressing **SPCL**, **5**, **ENTER** (**Hz**)) enables you to cause the Synthesizer to run a functional verification (self-test) on itself.

---

When **SPCL**, **5**, **Hz** is pressed, the text "SELF TEST?, PRESS ENTER" will be shown on the Synthesizer display. Pressing **ENTER** (**Hz**) will then cause all self-test segments to be run. Pressing any key other than **Hz** will cause the self-test not to run.

If any of the self-test segments fail, error messages will be placed in the error queue to explain the failures. The error messages can then be read either via the front panel or using programming commands. If a particular self-test segment failure makes running subsequent self-test segments impossible, the self-tests will abort.

### Notes

1. It is recommended that you clear the error queue before running the self-test.
2. For more information on reading the contents of the error queue, refer to "To Read the Contents of the Error Queue" in Chapter 2 of this manual.
3. Refer to the *HP 83731A/2A Calibration and Repair Guide* for a listing of the test segments that are run during the self-test.

Special Functions  
**SELF TEST**

---

## Equivalent SCPI Command

\*TST? *causes the Synthesizer to run a functional verification (self-test) on itself.*

---

## See Also

**MSG**  
SYSTEM:ERROR?  
To Read the Contents of the Error Queue  
\*TST?

---

## Service-Related Special Functions

The Synthesizer firmware contains several service related routines that can be used when diagnosing faults in its circuitry. Use of these special functions is detailed in the *HP 83731A/2A Calibration and Repair Guide* (option 0B3; HP part number 83731-60004).

---

The service-related special functions are listed in the following table. They can be accessed by pressing (SPCL), *f-number*, ENTER (Hz) where *f-number* is a number from the first column of the table. Details on how to use each special function can be found in the service manual.

**Service-Related Special Functions**

Special Function Number	Special Function Name	Description
60	DIRECT CONTROL	Allows direct manipulation of certain data bits within the Synthesizer circuitry.
61	METER NODE	Allows entry of a measurement node where the internal volt/ammeter will take a measurement.
62	LO FREQ	Displays the Synthesizer internal LO phase locked loop frequency.
63	OFFSET FREQ	Displays the Synthesizer internal Offset phase locked loop frequency.
70	HOLD POWER ON/OFF	Holds the power loop at its current setting.
71	CAL YIG OSC	Recalibrates the YIG oscillator and stores the new tuning curve in EEPROM.

---

### See Also

HP 83731A/2A Calibration and Repair Guide

---

## SHOW INFO

Invoking the SHOW INFO (show information) function (pressing **SPCL**, **1**, **ENTER** (**Hz**)) displays the software version number and instrument serial number on the Synthesizer display.

---

When **SPCL**, **1**, **Hz** is pressed, the following text will be shown on the Synthesizer display.

SW: X.X SERIAL: YYYYYYYYYY

Where "X.X" is the version number of the software currently installed in the Synthesizer and "YYYYYYYYYY" is the Synthesizer serial number.

---

## Equivalent SCPI Command

There is no equivalent SCPI command for the SHOW INFO function, however, the "\*IDN?" query returns the Synthesizer model number, serial number, and firmware revision number.

---

## See Also

\*IDN?







Error Messages



---

## Error Messages

If an error condition occurs in the Synthesizer, it will always be reported to both the front panel and HP-IB error queues. These two queues are viewed and managed separately. The **(MSG)** key is used to view the contents of the front panel error queue. The HP-IB query "SYSTem:ERRor?" is used to view the contents of the HP-IB error queue.

If there are any error messages in the front panel error queue, the front panel MSG annunciator will be lit. Pressing the **(MSG)** key repeatedly until the MSG annunciator turns off will empty the front panel error queue. The **(MSG)** key has no affect on the HP-IB error queue. Emptying the HP-IB error queue has no affect on the front panel queue, therefore, it will not affect the MSG annunciator.

There are some special error types that are called permanent errors. Permanent errors remain in the error queues until the error condition is cleared. Pressing the **(MSG)** key will empty the front panel error queue, but the permanent errors will be re-reported if the error conditions still exist. In the HP-IB error queue, the permanent errors are re-reported after the message, 0, "No error" is read using the "SYSTem:ERRor?" query or after the "\*CLS" command is executed.

---

## Error Messages List

The list of error messages in this chapter lists all of the error messages associated with Synthesizer operation. An example of the error format found in the list of error messages is as follows:

---

2003 -222, "Data out of range;CW FREQ(2003)"

Select a CW frequency that is within range of the installed options. If other modules or options are installed that extend the CW frequency range of the Signal Generator, this frequency range will be extended also.

---

The following explains each element of an error message listing.

- **Manual Error Number** – The number 2003 to the left and in the parenthesis is called the Manual Error Number. The error message list is organized in ascending order off the manual error number. The manual error number will always be found in the parenthesis contained in the message.
- **Error Message** – The bold text -222, "Data out of range;CW FREQ(2003)" is the error message. When the **MSG** key is pressed, the error message is displayed in the leftmost display. The entire message is returned by the HP-IB query "SYSTem:ERRor?". The error message contains the following parts:
  - **SCPI Error Number** – The standard SCPI error number (-222 in the example) usually differs from the manual error number because the manual error number is unique for every possible message. Standard SCPI error numbers are always negative (except for 0, "No error"). If there is no standard SCPI error number for a message, the manual error number replaces it in the error message.
  - **SCPI Error Message** – The SCPI error message is Data out of range in the example.
  - **Detailed Description** – All information after the semicolon (;) is a detailed description of what exactly caused the error. In the example, CW FREQ tells you that CW frequency was out of range. If no detailed description exists, it will be omitted from the message.

## Error Messages

### Error Messages List

- **Action Required** – The text that appears below each error message listing contains corrective actions that should be followed in order to correct the error condition. Note that the action required is never shown in the Synthesizer display.

#### Notes

1. For more information related to error messages, refer to "To Read the Contents of the Error Queue" in Chapter 2, the "MSG" reference entry in Chapter 6, and the "SYSTEM:ERROR?" reference entry in Chapter 1 of the *HP 83731A/2A Programmer's Reference*.
2. Error messages related to hardware failures are listed in the *HP 83731A/2A Service Guide* (HP part number 83731-90004).

---

## Messages

The following pages list all error messages in ascending manual error number order

–440 –440, "Query UNTERMINATED after indefinite response;(-440)"

Correct the HP-IB controller program so that the query that returns indefinite length block data is the last item on the program line.

–430 –430, "Query DEADLOCKED;(-430)"

Correct the HP-IB controller program so that no more than eight queries are executed within the same line of the program.

–420 –420, "Query UNTERMINATED;(-420)"

Correct the HP-IB controller program so that the controller terminates commands with the newline character (NL) before the controller attempts to read query response data.

–410 –410, "Query INTERRUPTED;(-410)"

Check the HP-IB controller program to see if the controller is programmed to read the entire query response data before issuing a subsequent command.

–400 –400, "Query error;(-400)"

Some problem occurred while parsing an HP-IB query. Insure that your programming is correct and try the query again. Look at –440 through –400 for types of problems to look for.

–350 –350, "Queue overflow"

The error queue overflowed at this point and this message replaced the 16th error message. No action is required. Note: To clear the HP-IB error queue, use \*CLS.

–330 –330, "Self-test failed;(-330)"

See the explanation for error number 4000.

–315 –315, "Configuration memory lost;(-315)"

See error 1803.

–314 –314, "Save/recall memory lost;(-314)"

## Error Messages

### Messages

See error 1803.

–311 –311,"Memory error;(-311)"

See error 1803.

–310 –310,"System error;(-310)"

Some problem occurred while parsing an HP-IB command or query. Insure that your programming is correct and try the command again.

–300 –300,"Device specific error;(-300)"

A remote command or query could not be executed because an error occurred in the Signal Generator.

–278 –278,"Macro header not found;(-278)"

A \*GMC? or \*RMC macro label could not be found in the list of defined macro labels. Use \*LMC? to get a list of all the currently defined macro labels.

–277 –277,"Macro redefinition not allowed;(-277)"

Indicates that a macro label in the \*DMC command could no be defined because the macro label was already defined.

–276 –276,"Macro recursion error;(-276)"

The nesting/recursion of macros got deeper than 4 levels. Don't use more than 4 levels when defining macros of macros.

–275 –275,"Macro definition too long;(-275)"

The macro definition must be 255 characters or less.

–274 –274,"Macro parameter error;(-274)"

A macro parameter placeholder was improperly used.

–273 –273,"Illegal macro label;(-273)"

Indicates that a macro label defined in the \*DMC command has a legal string syntax; but, it is too long, it is the same as a common command header, or contain invalid header syntax.

–272 –272,"Macro execution error;(-272)"

Indicates that a syntactically legal macro program data sequence could not be executed due to some error in the macro definition.

- 271 –271, "Macro syntax error;(–271)"  
Indicates that a syntax error exists in the macro definition.
- 270 –270, "Macro error;(–270)"  
An error occurred while attempting to define, query or use a macro. Check that the macros are correct using \*LMC? and \*GMC?.
- 261 –261, "Math error in expression;(–261)"  
An expression could not be evaluated due to a math error; for example, a divide-by-zero was attempted.
- 260 –260, "Expression error;(–260)"  
An expression could not be evaluated because it contains an error.
- 241 –241, "Hardware missing;(–241)"  
The requested hardware does not exist in the Signal Generator. Use \*OPT? to check which options are installed.
- 240 –240, "Hardware error;(–240)"  
The remote command or query could not be executed because of a hardware error.
- 226 –226, "Tables not same length;(–226)"  
See error 731.
- 225 –225, "Out of memory;(–225)"  
The Signal Generator has run out of memory. The memory requested has not been allocated.
- 224 –224, "Illegal parameter value;(–224)"  
Correct the HP-IB controller program so that the data included with the HP-IB command is an acceptable parameter for the command.
- 223 –223, "Too much data;(–223)"  
Correct the HP-IB controller program so that there is less data on a single command line. The Signal Generator does not have enough memory to buffer it all.
- 222 –222, "Data out of range;(–222)"



Error Messages

**Messages**

- The parameter data was out of range. Unlike other –222 errors, details are not known about the command or query which caused this error.
- 221 –221, "Settings conflict;(–221)"  
The current Signal Generator state does not allow the remote command or query to be executed.
- 220 –220, "Parameter error;(–220)"  
The parameter included with the remote command or query is incorrect.
- 213 –213, "Init ignored;(–213)"  
Indicates that an initiate was ignored because a trigger was already in progress.
- 212 –212, "Arm ignored;(–212)"  
An arming signal was received and recognized but was ignored.
- 211 –211, "Trigger ignored;(–211)"  
A GET, \*TRG or triggering signal was received and recognized but was ignored. Currently, there is no bus trigger capability in the Signal Generator.
- 210 –210, "Trigger error;(–210)"  
A trigger error occurred in the Signal Generator.
- 201 –201, "Invalid while in local;(–201)"  
The remote command or query cannot be executed when the Signal Generator is in local mode.
- 200 –200, "Execution error;(–200)"  
Some problem occurred while executing an HP-IB command or query. Insure that your programming is correct and try the command again.
- 184 –184, "Macro parameter error;(–184)"  
Indicates that a command inside the macro definition had the wrong number or type of parameters.
- 183 –183, "Invalid inside macro definition;(–183)"  
Indicates that the program message sequence sent with \*DMC or \*DDT command, is syntactically invalid.

- 181 –181, "Invalid outside macro definition;(-181)"  
Indicates that a macro parameter placeholder was encountered outside of the macro definition.
- 180 –180, "Macro error;(-180)"  
An error occurred while attempting to define, query or use a macro. Check that the macros are correct using \*LMC? and \*GMC?.
- 178 –178, "Expression data not allowed;(-178)"  
Correct the HP-IB controller program so that the data included with the HP-IB command does not contain parentheses.
- 171 –171, "Invalid expression;(-171)"  
The expression contained a syntax error like unmatched parenthesis or an illegal character.
- 170 –170, "Expression error;(-170)"  
The expression contains a syntax error.
- 168 –168, "Block data not allowed;(-168)"  
Correct the HP-IB controller program so that the data included with the HP-IB command does not contain block data (no # character).
- 161 –161, "Invalid block data;(-161)"  
Correct the HP-IB controller program so that it contains a correct block data type. A block data type should begin with "#" followed by a number.
- 160 –160, "Block data error;(-160)"  
The block data contains a syntax error.
- 158 –158, "String data not allowed;(-158)"  
Correct the HP-IB controller program so that the data included with the HP-IB command does not contain string data (no single or double quote characters).
- 151 –151, "Invalid string data;(-151)"  
Correct the HP-IB controller program so that the string data included with the HP-IB command is terminated with a single or double quote. The terminating quote must be the same as the leading quote of the

Error Messages

**Messages**

string. A string can also be valid if invalid characters are contained in it.

-150 -150,"String data error;(-150)"

The string data was too long to be buffered in the Signal Generator string data area.

-148 -148,"Character data not allowed;(-148)"

Correct the HP-IB controller program so that the data included with the HP-IB command is not character data.

-144 -144,"Character data too long;(-144)"

The character data element contains more than 12 characters.

-141 -141,"Invalid character data;(-141)"

Either the character data element contains an invalid character or the particular element is not valid for the command or query.

-140 -140,"Character data error;(-140)"

The character data contains a syntax error.

-138 -138,"Suffix not allowed;(-138)"

Correct the HP-IB controller program so that the decimal data included with the HP-IB command does not use a suffix. Use exponential notation instead.

-134 -134,"Suffix too long;(-134)"

The suffix contained more than 12 characters.

-131 -131,"Invalid suffix;(-131)"

Correct the HP-IB controller program so that the decimal data included with the HP-IB command contains a valid suffix for that command or query.

-130 -130,"Suffix error;(-130)"

The suffix contains a syntax error.

-128 -128,"Numeric data not allowed;(-128)"

Correct the HP-IB controller program so that the data included with the HP-IB command is not numeric data.

- 124 –124, "Too many digits;(–124)"  
The matissa of a decimal numeric data element contained more than 255 digits excluding leading zeros.
- 123 –123, "Exponent too large;(–123)"  
The magnitude of the exponent was larger than 32000.
- 121 –121, "Invalid character in number;(–121)"  
Correct the HP-IB controller program so that the decimal data or non-decimal numeric included with the HP-IB command contains the correct numeric characters.
- 120 –120, "Numeric data error;(–120)"  
An invalid numeric or non-decimal numeric was parsed but it was syntactically invalid.
- 114 –114, "Header suffix out of range;(–114)"  
Indicates that a header suffix was too large.
- 113 –113, "Undefined header;(–113)"  
The header is syntactically correct, but it is undefined for the Signal Generator.
- 112 –112, "Program mnemonic too long;(–112)"  
The header contains more than 12 characters.
- 111 –111, "Header separator error;(–111)"  
An illegal header separator was encountered while parsing the header.
- 110 –110, "Command header error;(–110)"  
An error was detected in the header.
- 109 –109, "Missing parameter;(–109)"  
This error indicates that an HP-IB command or query has too few parameters. Correct the HP-IB controller program so that the HP-IB command or query contains the correct number of parameters.
- 108 –108, "Parameter not allowed;(–108)"

Error Messages

**Messages**

This error indicates that an HP-IB command or query has too many parameters. Correct the HP-IB controller program so that the HP-IB command or query contains the correct number of parameters.

-105 -105, "GET not allowed;(-105)"

Correct the HP-IB controller program so that the group execute trigger does not occur within a line of HP-IB program code.

-104 -104, "Data type error;(-104)"

The parser recognized a data element different than one allowed. For example, numeric or string data was expected but block data was encountered.

-103 -103, "Invalid separator;(-103)"

A separator was expected but an illegal character was encountered. For example, the space is missing from the following, `FREQ.01GHz`.

-102 -102, "Syntax error;(-102)"

An unrecognized command or data type was encountered.

-101 -101, "Invalid character;(-101)"

A syntactic element contains a character which is invalid for that type. For example, a header containing an ampersand would give this error.

-100 -100, "Command error;(-100)"

Some problem occurred while parsing an HP-IB command or query. Insure that your programming is correct and try the command again.

0 0, "No error"

The error queue contains no errors.

110 110, "EEPROM unprotected;(110)"

The PG switch is set to 0 which leaves the EEPROM unprotected. Open up the Signal Generator and switch the PG switch to 1. This error message is only a warning.

511 511, "YTO cal data init error;(511)"

The YIG oscillator factory calibration data checksum was incorrect. A new YIG calibration should be performed or else the instrument may be unable to attain lock at some frequencies.

- 600 600,"ALC loop went unlevel;(600)"  
Power is set to a level that is higher than the instrument can supply. This is usually due to attenuator hold and the power is set to a value that requires the vernier to be operating out of its specified range. Change the power level or turn off attenuator hold. This is a "permanent" error.
- 601 601,"Hardware driver Power limit;(601)"  
Due to instrument specials such as attenuator hold, the circuits cannot supply the specified power. Change the power level or turn off attenuator hold. This is a "permanent" error.
- 602 602,"Vernier has been set to the limit;(602)"  
Due to instrument options such as attenuator hold, the circuits cannot supply the specified power. The vernier has been limited to a valid value. Change the power level or turn off attenuator hold. This is a "permanent" error.
- 603 603,"RF on/off command not valid;(603)"  
An invalid request to turn off RF power was ignored by the instrument.
- 604 604,"Atten driver error while setting level;(604)"  
The attenuators could not be set to the range requested. Change output power to a valid setting.
- 605 605,"Vernier driver error while setting level;(605)"  
The vernier value requested was not possible. Change output power to a valid setting.
- 606 606,"Level is not in guaranteed range.;(606)"  
The power level requested is beyond specifications and may be invalid. This could be due to a very low vernier setting required when attenuator hold is active. This is a "permanent" error.
- 608 608,"Attenuator not set before Ext Meter mode;(608)"  
The attenuator range must match that of the meter range desired for External meter ALC mode. Turn off attenuator hold mode and make sure the power meter is in range hold before entering external power meter mode.

Error Messages

**Messages**

- 610 610, "Track and hold failed, level is invalid;(610)"  
Power level was too high to do a power level setting in pulse or scan AM mode. Try setting power to a lower value.
- 611 611, "Track and hold failed, level is invalid;(611)"  
Power level was too high to do a power level setting in pulse or scan AM mode. Try setting power to a lower value.
- 650 650, "PG switch not set to 0;(650)"  
ALC calibration data was not saved in EEPROM because the PG switch was protecting the EEPROM from "writes". Open up the Signal Generator and switch the PG switch to 0.
- 651 651, "Invalid vernier cal data for 1-20GHz;(651)"  
Valid vernier calibration data is not available for the 1-20GHz band. If you need to use this frequency range, see the explanation for error number 4000.
- 652 652, "ALC term verification after EEPROM write;(652)"  
ALC vernier calibration data was not written into EEPROM correctly. Try writing the data into the Signal Generator again.
- 653 653, "Invalid vernier cal data for 0.01-1GHz;(653)"  
Valid vernier calibration data is not available for the 0.01-1GHz band. If you need to use this frequency range, see the explanation for error number 4000.
- 655 655, "PG switch not set to 0;(655)"  
Factory frequency correction data was not saved in EEPROM because the PG switch was protecting the EEPROM from "writes". Open up the Signal Generator and switch the PG switch to 0.
- 656 656, "Factory flatness cal data verification;(656)"  
Factory frequency level calibration data was not written into EEPROM correctly. Try writing the data into the Signal Generator again.
- 657 657, "Factory flatness cal data is invalid;(657)"  
A valid factory frequency level calibration is not available for one or more of the frequency bands and/or attenuator settings. See the explanation for error number 4000.

- 670 670, "Meter power input is out of range;(670)"  
The ALC input is not a valid level. The power meter range may be wrong. This is a "permanent" error.
- 700 700, "Hardware driver Frequency limit;(700)"  
The frequency entered cannot be generated by the Signal Generator with the set of options available.
- 701 701, "Lo synthesizer set error;(701)"  
The LO synthesizer cannot be set to the level requested. Enter a new frequency.
- 702 702, "Offset synthesizer set error;(702)"  
The Offset synthesizer cannot be set to the level requested. Enter a new frequency.
- 704 704, "YTO driver set error;(704)"  
The YIG oscillator cannot be set to the level requested. Enter a new frequency.
- 706 706, "Low pass filter set error;(706)"  
The Low pass filter cannot be set to the requested setting. Enter a new frequency.
- 710 710, "LO synthesizer went out of lock;(710)"  
The LO synthesizer went out of lock. This may be due to hookup or disconnection of an external time base. Enter a different RF frequency and then set the frequency back to the desired value to re-lock. This is a "permanent" error.
- 711 711, "Offset synthesizer went out of lock;(711)"  
The offset synthesizer board was unable to attain lock. Enter a different RF frequency and then set the frequency back to the desired value to re-lock. This is a "permanent" error.
- 712 712, "Frequency loop went out of lock;(712)"  
Enter a different RF frequency and then set the frequency back to the desired value to re-lock. This is a "permanent" error.
- 713 713, "Possible FM overmodulation;(713)"



Error Messages

**Messages**

Reduce the level of the modulating signal into the FM IN connector.

730 730, "Invalid data in level correct table;(730)"

The active level correction table has no data in it. Select a level correction table with valid data, perform an automatic level correction to get valid data into the active table, or use HP-IB to load the active table. This is a "permanent" error.

731 -226, "Tables not same length;Level correct(731)"

The active level correction table has a mismatch between the number of frequencies stored and the number of losses stored. Select a level correction table with valid data, perform an automatic level correction to get valid data into the active table, or use HP-IB to load tables with the same length. This is a "permanent" error.

732 732, "Same frequencies with different losses;(732)"

The active level correction table has duplicate frequencies with different losses. Select a level correction table with valid data, perform an automatic level correction to get valid data into the active table, or use HP-IB to load tables with non-duplicate frequencies. This is a "permanent" error.

733 733, "Frequency table not in ascending order;(733)"

The MEM:TABL:FREQ command did not contain frequencies in ascending order. The whole MEM:TABL:FREQ command was rejected, leaving the old selected table unaltered.

734 734, "Frequency table not in ascending order;(734)"

The active level correction table does not contain frequencies in ascending order. Select a level correction table with valid data, perform an automatic level correction to get valid data into the active table, or use HP-IB to load a table with ascending ordered frequencies. This is a "permanent" error.

735 735, "Level correct points less than 2;(735)"

The number of points in a level correction table must be from 2 to 401. Either too few points were entered or duplicate frequencies caused the number of "real" points to shrink below 2.

736 736, "Factory level corr 1-20GHz, 1-9 table;(736)"

Factory frequency level correction data for 1-20GHz band, non-thru paths are not valid. If you need to use this frequency range and you are using a step attenuator, see the explanation for error number 4000.

737 737,"Factory level corr 0.01-1GHz, 1-9 table;(737)"

Factory frequency level correction data for 0.01-1GHz band, non-thru paths are not valid. If you need to use this frequency range and you are using a step attenuator, see the explanation for error number 4000.

738 738,"Factory level corr 0.01-1GHz, 0dB table;(738)"

Factory frequency level correction data for 0.01-1GHz band, thru path is not valid. If you need to use this frequency range and you work with output levels that don't use the step attenuator, see the explanation for error number 4000.

739 739,"Invalid data in table, not recalled;(739)"

This error indicates that a level correction table recall failed. Try selecting the same level correction table again. If this error message persists you will have to recreated the saved table.

740 740,"Another controller is on the HP-IB bus;(740)"

An automatic level correction was attempted but failed because there is a controller on the HP-IB bus. Remove all controllers from the HP-IB bus and try again.

741 741,"No HP-IB devices found;(741)"

An automatic level correction was attempted but failed to find any other devices on the HP-IB bus. Connect the desired power meter to the HP-IB bus and try again. Check the HP-IB cable(s) for loose connections.

742 742,"Errors in cleanup of HP-IB;(742)"

When exiting the automatic level correction, the Signal Generator failed to finish resetting the HP-IB bus and presetting the power meter. Make sure the power meter address matches the power meter address setting on the Signal Generator. Check the HP-IB cable(s) for loose connections.

743 743,"No HP-IB devices found;(743)"

An automatic level correction was attempted but failed to find any other devices on the HP-IB bus. Connect the desired power meter to

Error Messages

**Messages**

the HP-IB bus and try again. Make sure the power meter address matches the power meter address setting on the Signal Generator. Check the HP-IB cable(s) for loose connections.

744 744, "Cannot find power meter on HP-IB bus;(744)"

An automatic level correction was attempted but failed to find a power meter on the HP-IB bus. Connect the desired power meter to the HP-IB bus and try again. Make sure the power meter address matches the power meter address setting on the Signal Generator. Check the HP-IB cable(s) for loose connections.

745 745, "Meter returns error msg +9.0000E+40;(745)"

While running the automatic level correction, the power meter returned +9.0000E+40 as the power reading. This number indicates an error within the power meter.

746 746, "Data measured is invalid or out of range;(746)"

While running the automatic level correction, the power meter returned an out of range power reading or the power meter returned a non-number as its power reading. Check that the power meter is reading an appropriate value by looking at it.

747 747, "Unable to receive msg from meter;(747)"

An automatic level correction was attempted but failed to power readings back from the power meter. Make sure the power meter address matches the power meter address setting on the Signal Generator. Check the HP-IB cable(s) for loose connections.

748 748, "Erasing corrupted level correct table;(748)"

A level correction table was corrupt and was erased to fix it.

749 749, "Frequency not within level correct data;(749)"

This message is a warning that the current CW frequency is not contained within the frequencies in the active level correction table. Therefore, the correction applied to the output will be 0 dB. This is a "permanent" error.

751 751, "Parameters cause points to be too large;(751)"

The level correction parameters cannot define a new table because they create too many level correction points.

- 752 -222, "Data out of range;Data set to minimum(752)"  
Loss data must be in the range of -40 to +40 dB.
- 753 -222, "Data out of range;Data set to maximum(753)"  
Loss data must be in the range of -40 to +40 dB.
- 754 754, "Total points reduced from that requested;(754)"  
The number of points requested for an automatic level correction has been reduced to avoid duplicate frequencies.
- 755 755, "Invalid data in active table, not saved;(755)"  
This error indicates that a level correction table save failed. Try selecting the same level correction table again. If this error message persists you will have to recreated the table.
- 756 756, "Factory level corr 1-20GHz, 0dB table;(756)"  
Factory frequency level correction data for 1-20GHz band, thru path is not valid. If you need to use this frequency range and you work with output levels that don't use the step attenuator, see the explanation for error number 4000.
- 757 757, "Bad attenuator setting parameter;(757)"  
The attenuator range for looking up factory frequency level correction data, is 0 through 120 (resolution is 10).
- 758 -222, "Data out of range;Data set to minimum(758)"  
Loss data for factory frequency level correction was less than minimum.
- 759 -222, "Data out of range;Data set to maximum(759)"  
Loss data for factory frequency level correction was more than maximum.
- 760 760, "Bad index into data table;(760)"  
A data lookup from a calibration table found that the index data is out of range. Try setting the same Signal Generator function again. If this error message persists, run the instrument self-test.
- 761 761, "Bad index into offset table;(761)"

Error Messages

**Messages**

A data lookup from the factory level correction offset table found that the index data is out of range. Try setting the same Signal Generator function again. If this error message persists, run the instrument self-test.

763 763, "Unable to write to EEPROM;(763)"

Calibration table was not loaded into EEPROM because the EEPROM was protected or the EEPROM load did not verify. Open up the Signal Generator and switch the PG switch to 0.

764 764, "Unable to write to RAM;(764)"

A write to RAM failed to verify. Run the self-test routine to check RAM for problems.

765 765, "Attempt to write to ROM;(765)"

There was attempt to write calibration data to ROM. This should not occur, but if it does, try setting the same Signal Generator function again. If this error message persists, run the instrument self-test.

766 766, "Number of writes to EEPROM exceeds max;(766)"

The number of EEPROM writes has exceeded the maximum allowed. However, the data was written to the EEPROM anyway. This is only a warning; but, you should check to make sure your data was correctly stored in EEPROM.

770 770, "YTO cal data invalid;(770)"

The YIG oscillator factory calibration data checksum was incorrect. Select the CAL YIG OSC feature to perform a YIG oscillator calibration. If you do not re-calibrate, the Signal Generator may be unable to attain lock at some frequencies.

771 771, "Invalid YIG DAC value in cal table.:(771)"

The YIG oscillator factory calibration data checksum was incorrect. Select the CAL YIG OSC feature to perform a YIG oscillator calibration. If you do not re-calibrate, the Signal Generator may be unable to attain lock at some frequencies.

772 772, "YTO cal values for Up/Down search vary;(772)"

The YIG oscillator factory calibration data checksum was incorrect. Select the CAL YIG OSC feature to perform a YIG oscillator calibration.

If you do not re-calibrate, the Signal Generator may be unable to attain lock at some frequencies.

774 774,"EEPROM protected, YTO cal aborted;(774)"

An automatic YIG oscillator calibration was not performed because the PG switch was protecting the EEPROM from "writes". Open up the Signal Generator and switch the PG switch to 0.

775 775,"Low band yto cal failed;(775)"

The low band calibration failed and the data for the calibration was not saved. Re-try the YIG calibration and watch for the default cal points indicated when the DAC value shown for a given point says 'dflt = ' instead of 'DAC = '.

776 776,"High band yto cal failed;(776)"

The low band calibration failed and the data for the calibration was not saved. Re-try the YIG calibration and watch for the default cal points indicated when the DAC value shown for a given point says 'dflt = ' instead of 'DAC = '.

777 777,"Low band yto cal could not write EEPROM;(777)"

The data for the low band YIG calibration could not be written to EEPROM. Make sure the PG switch on the processor board was closed during the cal and re-try the YIG calibration.

778 778,"High band yto cal could not write EEPROM;(778)"

The data for the low band YIG calibration could not be written to EEPROM. Make sure the PG switch on the processor board was closed during the cal and re-try the calibration.

779 779,"Only 2GHz or 10GHz allowed for YTO Cal;(779)"

The start frequency specified for the CAL:YIG:FREQ:START command was not valid. Re-enter the start frequency and start the YIG calibration again.

785 785,"Cal Data not saved, PG switch is not 0;(785)"

The calibration data could not be saved because the PG switch on the microprocessor board was not closed. Close the PG switch and do the calibration again.

786 786,"Cal Data verification after EEPROM write;(786)"

Error Messages

**Messages**

- The calibration data was not written correctly after the calibration. Close the PG switch and do the calibration again.
- 787 787, "FM cal and Pinchoff cal not initialized;(787)"
- The YIG calibration has not been done for both YIG bands or else the pinchoff cal values have not been entered yet.
- 790 790, "Scan-mod 0.01-1 GHz gain tables bad;(790)"
- Checksum was invalid for the AM gain tables. If you need to use this frequency range and scan AM modulation, see the explanation for error number 4000.
- 793 793, "Scan AM cal not valid, defaults used;(793)"
- Scan AM level may be in error due to invalid calibration data. If you need to use scan AM modulation, see the explanation for error number 4000.
- 794 794, "Scan-mod 1-20 GHz gain tables bad;(794)"
- Checksum was invalid for the AM scan gain tables. If you need to use this frequency range and scan AM modulation, see the explanation for error number 4000.
- 795 795, "Scan-mod 1-20 GHz linear 1 tables bad;(795)"
- Checksum was invalid for the AM scan linear 1 tables. If you need to use this frequency range and scan AM modulation, see the explanation for error number 4000.
- 796 796, "Scan-mod 1-20 GHz linear 2 tables bad;(796)"
- Checksum was invalid for the AM scan linear 2 tables. If you need to use this frequency range and scan AM modulation, see the explanation for error number 4000.
- 800 800, "Options not saved, PG switch is not 0;(800)"
- The instrument option bit-fields were not saved to EEPROM. Open up the Signal Generator, switch the PG switch to 0, and try setting the option bit-fields again.
- 801 801, "Serial num not saved, PG switch is not 0;(801)"
- The instrument serial number was not saved to EEPROM. Open up the Signal Generator, switch the PG switch to 0, and try setting the serial number again.

- 900 900,"PRI increased to fit pulse width;(900)"  
The current pulse width is too large for the current PRI. The PRI is increased to allow for the pulse width. This is a "permanent" error.
- 901 901,"Delay and width decreased to fit max PRI;(901)"  
The current pulse width plus the current pulse delay is too large because they are greater than the maximum PRI. The delay and/or the width were reduced to fit. This is a "permanent" error.
- 940 940,"Oven is cold;(940)"  
The high stability time base oven is cold. The oven must be allowed to warm up before proper instrument operation will occur. This is a "permanent" error.
- 944 944,"Reference synthesizer went out of lock;(944)"  
The reference synthesizer went out of lock. The out of lock condition may have been due to an external time base being connected or disconnected. Enter a different RF frequency and then set the frequency back to the desired value to re-lock. This is a "permanent" error.
- 1101 1101,"Loop number is invalid.:(1101)"  
If you are using the direct hardware control service feature, you have entered an out of range value. If this error occurs while not using the direct hardware control service feature, low level hardware drivers could not set the requested Signal Generator setting. Try setting the Signal Generator again. If this error message persists, run the instrument self-test.
- 1102 1102,"Start bit is negative.:(1102)"  
See the explanation for error number 1101.
- 1103 1103,"Length less than 0 or more than 32;(1103)"  
See the explanation for error number 1101.
- 1104 1104,"Start bit is invalid for given loop.:(1104)"  
See the explanation for error number 1101.
- 1105 1105,"Length is invalid for given loop;(1105)"  
See the explanation for error number 1101.



Error Messages

**Messages**

- 1106 1106, "Data is too large for given length;(1106)"  
See the explanation for error number 1101.
- 1107 -222, "Data out of range;Bit field number(1107)"  
See the explanation for error number 1101.
- 1108 -222, "Data out of range;Query port field(1108)"  
If you are using the direct hardware control service feature, you have entered an out of range query address. If this error occurs while not using the direct hardware control service feature, low level hardware drivers could not complete a query. Try setting the Signal Generator again. If this error message persists, run the instrument self-test.
- 1109 1109, "Query Port mode;(1109)"  
See the explanation for error number 1108.
- 1462 1462, "Keybd processor reports status error;(1462)"  
A key press was not successful. Try pressing the same key again. If the error message persists, see the explanation for error number 4000.
- 1463 1463, "Keybd processor data lines incorrect;(1463)"  
A key press was not successful. Try pressing the same key again. If the error message persists, see the explanation for error number 4000.
- 1801 1801, "Slave Module Not Present;(1801)"  
The slave module accessed by SYST:PTHR:ADDR is not present in the MMS main frame(s). Check that the slave shows up in the "address map" on the display.
- 1802 1802, "Low Battery Voltage;(1802)"  
The Signal Generator battery voltage is low. This could cause loss of RAM data if Signal Generator power is turned off. Note: Calibration data will never be lost.
- 1803 1803, "RAM data lost at power on;(1803)"  
All RAM data was lost. This includes all front panel settings, save/recall registers, level corrections, and other user settable values. This error message can occur when the battery voltage is low, or options change in the Signal Generator. Note: Calibration data will never be lost.

- 1804 1804,"Self-test failure, run the self-test;(1804)"  
The power-on self-test detected an error or warning. See the explanation for error number 4000.
- 1805 1805,"Processor Board or IBUS test Failure;(1805)"  
The power-on self-test detected an error or warning for the microprocessor board circuits or power supply monitors. See the explanation for error number 4000.
- 1806 1806,"ROM checksum test failure;(1806)"  
The Signal Generator ROM check sum does not match the data in ROM. See the explanation for error number 4000.
- 2003 -222,"Data out of range;CW FREQ(2003)"  
Select a CW frequency that is within range of the installed options. If other modules or options are installed that extend the CW frequency range of the Signal Generator, this frequency range will be extended also.
- 2006 -222,"Data out of range;POWER LEVEL(2006)"  
Select a power level within the following ranges:  
No attenuator options, -15 dBm to +30 dBm. Option 1E1, -100 dBm to +30 dBm.
- 2012 -224,"Illegal parameter value;ALC SOURCE(2012)"  
The requested ALC source is not available in the Signal Generator. Use \*OPT? to check which options are installed.
- 2015 -222,"Data out of range;SPECIAL(2015)"  
Select a special function number that is available in the Signal Generator.
- 2018 -222,"Data out of range;FREQ MULTIPLIER INCR(2018)"  
Select a frequency multiplier increment from 1 to 99.
- 2024 -222,"Data out of range;CW FREQ INCR(2024)"  
Select a CW frequency increment from 1kHz to 19.99GHz. If other modules or options are installed that extend the CW frequency range of the Signal Generator, this frequency range will be extended also. If

Error Messages

**Messages**

the 1E8 option is installed the limits will also change to allow for 1 hertz resolution.

2030 –222, "Data out of range;DIRECT HW CONTROL(2030)"

Select Signal Generator direct hardware control values within range. See the Service Manual for more details on this feature.

2033 –222, "Data out of range;POWER LEVEL INCR(2033)"

Select a power level within the following ranges:  
No attenuator options, 0.01 dBm to +45 dBm. Option 1E1, 0.01 dBm to +130 dBm.

2036 –222, "Data out of range;EXT METER LEVEL(2036)"

Select an external power meter reading within the following ranges:  
No attenuator options, -15 dBm to +30 dBm. Option 1E1, -100 dBm to +30 dBm.

2042 –222, "Data out of range;DIAG:IBUS:DIR(2042)"

Correct the HP-IB command DIAG:IBUS:DIR or DIAG:IBUS:DIR? so that its parameters are within their appropriate ranges. See the Service Manual for more details on this HP-IB only feature.

2048 –222, "Data out of range;SYST:KEY(2048)"

Select a key code available on the Signal Generator's front panel.

2051 –161, "Invalid block data;SYST:SET bad size(2051)"

The "learn string" sent to the Signal Generator is corrupt (incorrect number of bytes). Check that the HP-IB controller is sending the string correctly. In addition, insure that the controller loaded the learn string correctly in the first place. Note: The \*LRN? query always returns the same length string regardless of the state of the Signal Generator; but, the \*LRN? response can change if the firmware version changes.

2054 –222, "Data out of range;CAL:ALC:CURV(2054)"

Correct the HP-IB command CAL:ALC:CURV so that its parameters are within the following ranges:

1st parameter: 0.0 to 4.0  
2nd parameter: -2.0 to 2.0  
3rd-6th parameter: -1.0 to 1.0  
7th parameter: 0.0 to 25.0

- 2057 –222, "Data out of range;HPIB ADDRESS(2057)"  
Select an HP-IB address for the Signal Generator from 0 to 30.
- 2060 –222, "Data out of range;SAVE(2060)"  
Select a save state register number from 0 to 9.
- 2066 –222, "Data out of range;RECALL(2066)"  
Select a recall state register number from 0 to 9.
- 2069 –224, "Illegal parameter value;SYST:PTHR(2069)"  
Correct the HP-IB command SYST:PTHR or SYST:PTHR? so that its string parameter is 255 characters or less.
- 2072 –224, "Illegal parameter value;SYST:PTHR:ADDR(2072)"  
Correct the HP-IB command SYST:PTHR:ADDR so that its string parameter is 25 characters or less.
- 2075 –222, "Data out of range;LO FREQ(2075)"  
Select an LO frequency from 300 MHz to 359.5 MHz.
- 2078 –222, "Data out of range;OFFSET FREQ(2078)"  
Select an offset frequency from 5 MHz to 40 MHz.
- 2081 –222, "Data out of range;DIAG:FREQ:CYCL(2081)"  
Correct the HP-IB command DIAG:FREQ:CYCL so that its parameters are within range. See the Service Manual for more details on this feature.
- 2087 –222, "Data out of range;YIG OSC CAL FREQ(2087)"  
Correct the HP-IB command CAL:YIG:FREQ:START so that its parameter is 2 GHz or 10 GHz.
- 2090 –222, "Data out of range;CAL:YIG(2090)"  
Correct the HP-IB command CAL:YIG[:DATA] so that all of its parameters are from 0 to 65535.
- 2096 –224, "Illegal parameter value;PULSE TRIG SOUR(2096)"  
The requested pulse trigger source is not available in the Signal Generator. Use \*OPT? to check which options are installed.
- 2099 –222, "Data out of range;FREQ MULTIPLIER(2099)"

Error Messages

**Messages**

Select a frequency multiplier from 1 to 100.

2102 –222, "Data out of range;EXT METER INCR(2102)"

Select an external power meter reading increment within the following ranges:

No attenuator options, 0.01 dBm to +45 dBm. Option 1E1, 0.01 dBm to +130 dBm.

2105 –222, "Data out of range;CAL:ALC:CURV:FREQ(2105)"

Correct the HP-IB command CAL:ALC:CURVe:FREQuency:STARt so that its parameter is from 10 MHz to 40 GHz. See the Service Manual for more details on this feature.

2114 –224, "Illegal parameter value;ATTEN LOCK(2114)"

The HP-IB command "POWeR:ATTenuation:AUTO OFF" can only be used if the 1E1 option is installed.

2123 –222, "Data out of range;PULSE WIDTH(2123)"

Select a pulse width from 0 to 419ms.

2126 –222, "Data out of range;PULSE PRI/PRF(2126)"

Select a pulse repetition interval from 419ms to a minimum depending on the current carrier frequency or select a pulse repetition frequency from 2.5Hz to a maximum depending on the current carrier frequency.

2135 –224, "Illegal parameter value;EXT PULSE INV(2135)"

The requested external pulse polarity is not available in the Signal Generator. Use \*OPT? to check which options are installed.

2138 –224, "Illegal parameter value;PULSE SOURCE(2138)"

If the internal pulse source is not installed in the Signal Generator, the HP-IB command PULM:SOURce only allows EXTeRnal as a parameter.

2144 –222, "Data out of range;PULSE DELAY(2144)"

Select a pulse delay from -419ms to 419ms. The minimum delay is 0 if external trigger pulse mode is being used.

2159 –224, "Illegal parameter value;AM TYPE(2159)"

If the linear internal AM source is not installed in the Signal Generator, the HP-IB command AM:TYPE only allows EXPonential as a parameter.

- 2162 –222, "Data out of range;LIST:FREQ(2162)"  
Select a CW frequency that is within range of the installed options. If other modules or options are installed that extend the CW frequency range of the Signal Generator, this frequency range will be extended also.
- 2165 –224, "Illegal parameter value;REMOTE LANGUAGE(2165)"  
Select an HP-IB remote language which is available in the Signal Generator. "SCPI" is the default but others are available as options.
- 2168 –222, "Data out of range;PULSE DELAY INCR(2168)"  
Select a pulse delay increment from 25ns to 838ms.
- 2171 –222, "Data out of range;PULSE WIDTH INCR(2171)"  
Select a pulse width increment from 25ns to 419ms.
- 2174 –222, "Data out of range;PULSE PRI/PRF INCR(2174)"  
Select a pulse repetition interval increment from 25ns to 419ms or select a pulse repetition frequency increment from 1mHz to 3.3MHz.
- 2177 –222, "Data out of range;CAL:FLAT(2177)"  
Loss data for factory frequency level correction was out of range.
- 2180 –224, "Illegal parameter value;FM AC DC(2180)"  
The requested FM coupling is not available in the Signal Generator. Use \*OPT? to check which options are installed.
- 2189 –224, "Illegal parameter value;DISPLAY STATE(2189)"  
The display state could not be set to the state requested.
- 2198 –224, "Illegal parameter value;EXT REF(2198)"  
The reference oscillator could not be set to INTernal because an internal oscillator does not exist or the reference oscillator could not be set to EXTernal because an external oscillator does not exist.
- 2216 –222, "Data out of range;NODE MEASURE(2216)"  
Select a meter node number within range. See the Service Manual for more details on this feature.
- 2219 –222, "Data out of range;OPTION WRITE(2219)"

Error Messages

**Messages**

Select an option bit-field number within range. See the Service Manual for more details on this feature.

2225 –222, "Data out of range;FM SENSITIVITY(2225)"

Select an FM sensitivity withing its range for the current CW frequency and multiplier.

2231 –224, "Illegal parameter value;PULSE RISE TIME(2231)"

The requested pulse rise time is not available in the Signal Generator. Use \*OPT? to check which options are installed.

2237 –222, "Data out of range;OFFSET FREQ INCR(2237)"

Select an offset frequency increment from 1 kHz to 35 MHz. If the 1E8 option is installed the lower limit will change to 1Hz to allow for 1 hertz resolution.

2240 –222, "Data out of range;LO FREQ INCR(2240)"

Select an LO frequency increment from 1 kHz to 359.5 MHz.

2243 –222, "Data out of range;DIRECT HW CONTROL INC(2243)"

Select Signal Generator direct hardware control increment values within range. See the Service Manual for more details on this feature.

2246 –224, "Illegal parameter value;INIT:CONT(2246)"

Currently, the remote command INIT:CONTinuous only allows ON as a parameter.

2249 –222, "Data out of range;DIAG:ABUS?(2249)"

Correct the HP-IB query DIAG:ABUS? so that its parameter is within their appropriate range. See the Service Manual for more details on this HP-IB only feature.

2252 –222, "Data out of range;CAL:AM:LIN(2252)"

Correct the HP-IB command CAL:AM:LINear[:DATA] so that all of its parameters are from 0 to 255.

2255 –222, "Data out of range;CAL:AM:LIN:TABL(2255)"

Correct the HP-IB command CAL:AM:LINear:TABLE so that its parameter is 1 or 2.

2264 –222, "Data out of range;CAL:YIG:FM:SENS(2264)"

- Correct the HP-IB command CAL:YIG:FM:SENSitivity so that all of its parameters are from -80 to 80.
- 2276 –222, "Data out of range;CORR:FLAT(2276)"
- Correct the HP-IB command CORRection:FLATness[:DATA] so that all of its frequency parameters are from 1 GHz to 20 GHz and all of its loss parameters are from -40 dB to +40 dB. If other modules or options are installed that extend the frequency range of the Signal Generator, this frequency range will be extended also.
- 2277 2277, "CORR:FLAT cannot query empty table;(2277)"
- The selected level correction table data cannot be queried because it is invalid or it does not exist. Check that MEMory:TABLE:SElect is set to a level correction table that has data.
- 2291 –224, "Illegal parameter value;SERIAL NUM(2291)"
- Correct the HP-IB command SYSTem:SNUMber so that its string parameter is 10 characters or less.
- 2292 –151, "Invalid string data;SERIAL NUM bad char(2292)"
- A serial number can only contain characters from ASCII 32 (space) through ASCII 126 (~). However, ASCII 44 (,) and ASCII 59 (;) cannot be used.
- 2294 –222, "Data out of range;POW METER ADDRESS(2294)"
- Select a power meter address for automatic level correction from 0 to 30. Secondary addresses may be allowed in future firmware revisions.
- 2300 –222, "Data out of range;CAL:FLAT:FREQ:START(2300)"
- Correct the HP-IB command CAL:FLATness:FREQuency:STARt so that its parameter is from 10 MHz to 40 GHz. See the Service Manual for more details on this feature.
- 2303 –222, "Data out of range;CAL:FLAT:ATT(2303)"
- Correct the HP-IB command CAL:FLATness:ATTenuation so that its parameter is from 0 dB to 120 dB with a resolution of 10 dB. See the Service Manual for more details on this feature.
- 2306 –222, "Data out of range;CAL:AM(2306)"
- Correct the HP-IB command CAL:AM[:DATA] so that all of its parameters are from 0 to 255.



Error Messages

**Messages**

- 2309 –222, "Data out of range;CAL:AM:FREQ:START(2309)"  
Correct the HP-IB command CAL:AM:FREQuency:STARt so that its parameter is from 10 MHz to 40 GHz. See the Service Manual for more details on this feature.
- 2444 –222, "Data out of range;LEVEL CORR START FREQ(2444)"  
Select an automatic level correction start frequency from 1GHz to 20GHz. If other modules or options are installed that extend the CW frequency range of the Signal Generator, this frequency range will be extended also.
- 2447 –222, "Data out of range;LEVEL CORR STOP FREQ(2447)"  
Select an automatic level correction start frequency from 1GHz to 20GHz. If other modules or options are installed that extend the CW frequency range of the Signal Generator, this frequency range will be extended also.
- 2457 2457, "RF on before running level correct;(2457)"  
The RF must be turned on before running an automatic level correction. Turn RF on and try running the automatic level correction again.
- 2462 –222, "Data out of range;LEVEL CORR START INC(2462)"  
Select an automatic level correction start frequency increment from 1kHz to 19.99GHz. If other modules or options are installed that extend the CW frequency range of the Signal Generator, this frequency range will be extended also. If the 1E8 option is installed the limits will also change to allow for 1 hertz resolution.
- 2465 –222, "Data out of range;LEVEL CORR STOP INC(2465)"  
Select an automatic level correction stop frequency increment from 1kHz to 19.99GHz. If other modules or options are installed that extend the CW frequency range of the Signal Generator, this frequency range will be extended also. If the 1E8 option is installed the limits will also change to allow for 1 hertz resolution.
- 2471 –222, "Data out of range;HPIB ADDRESS INCR(2471)"  
Select an HP-IB address increment from 1 to 29.
- 2474 –222, "Data out of range;YIG OSC CAL FREQ INC(2474)"

- Correct the HP-IB command CAL:YIG:FREQUENCY:START:STEP so that its parameter is from 1 GHz to 10 GHz.
- 2477 –222, "Data out of range;CAL:PULSe:PINCh(2477)"  
Correct the HP-IB command CAL:PULSe:PINCh[:DATA] so that all of its parameters are from 0 to 255.
- 2480 –222, "Data out of range;CAL:PULS:FREQ:START(2480)"  
Correct the HP-IB command CAL:PULSe:FREQUENCY:START so that its parameter is 10 MHz.
- 2522 –222, "Data out of range;POW METER ADDRESS INC(2522)"  
Select a power meter address increment from 1 to 29.
- 2525 –222, "Data out of range;NODE MEASURE INC(2525)"  
Select a meter node increment within range.
- 2528 –222, "Data out of range;OPTION WRITE INC(2528)"  
Select an option bit-field increment within range.
- 2531 –222, "Data out of range;LEVEL CORR POINTS(2531)"  
Select automatic level correction number of points from 2 to 401.
- 2534 –222, "Data out of range;LEVEL CORR POINTS INC(2534)"  
Select automatic level correction number of points increment from 1 to 401.
- 2537 –222, "Data out of range;LEVEL CORRECT SAVE(2537)"  
Select an automatic level correction register from 1 to 4.
- 2540 –222, "Data out of range;LEVEL CORR SELECT(2540)"  
Select an automatic level correction register from 1 to 4.
- 2567 –224, "Illegal parameter value;PULSE RISE TIME(2567)"  
The requested pulse rise time is not available in the Signal Generator. Use \*OPT? to check which options are installed.
- 2570 –224, "Illegal parameter value;POWERMETER TYPE(2570)"  
The selected power type is not supported by the Signal Generator.
- 2576 –224, "Illegal parameter value;PULSE STOP SOUR(2576)"

Error Messages

**Messages**

- The requested pulse trigger stop source is not available in the Signal Generator. Use \*OPT? to check which options are installed.
- 2579 –224, "Illegal parameter value;TRIG:STOP:SLOP(2579)"
- The requested pulse trigger stop slope is not available in the Signal Generator. Use \*OPT? to check which options are installed.
- 2588 –224, "Illegal parameter value;MEM:TABL:SEL(2588)"
- Select an automatic level correction register from 1 to 4.
- 2591 –222, "Data out of range;MEM:TABL:FREQ(2591)"
- Correct the HP-IB command MEMory:TABLE:FREQuency so that all of its parameters are from 1 GHz to 20 GHz. If other modules or options are installed that extend the frequency range of the Signal Generator, this frequency range will be extended also.
- 2592 2592, "MEM:TABL:FREQ cannot query empty table;(2592)"
- The selected level correction table data cannot be queried because it is invalid or it does not exist. Check that MEMory:TABLE:SElect is set to a level correction table that has data.
- 2597 –222, "Data out of range;MEM:TABL:LOSS(2597)"
- Correct the HP-IB command MEMory:TABLE:LOSS[:MAGnitude] so that all of its parameters are from -40 dB to +40 dB.
- 2598 2598, "MEM:TABL:LOSS cannot query empty table;(2598)"
- The selected level correction table data cannot be queried because it is invalid or it does not exist. Check that MEMory:TABLE:SElect is set to a level correction table that has data.
- 2612 –224, "Illegal parameter value;FM SOURCE(2612)"
- If the internal FM source is not installed in the Signal Generator, the HP-IB command FM:SOURce only allows EXTernal as a parameter.
- 2615 –222, "Data out of range;INT FM FREQ(2615)"
- Select an internal FM frequency ( rate ) from 0.5Hz to 1MHz.
- 2618 –222, "Data out of range;INT FM FREQ INC(2618)"
- Select an internal FM frequency ( rate ) increment from 0.5Hz to 999.9995kHz.

- 2621 –222, "Data out of range;INT FM DEV(2621)"  
Select an internal FM deviation from 0Hz to 10MHz.
- 2624 –222, "Data out of range;INT FM DEV INC(2624)"  
Select an internal FM deviation increment from 0.01Hz to 10MHz.
- 2627 –224, "Illegal parameter value;FM:FEED(2657)"  
Change the FM:FEED input parameter to a source that is available in the Signal Generator.
- 2642 –224, "Illegal parameter value;AM SOURCE(2642)"  
If the internal AM source is not installed in the Signal Generator, the HP-IB command AM:SOURce only allows EXTERNAL as a parameter.
- 2645 –222, "Data out of range;INT AM FREQ(2645)"  
Select an internal AM frequency ( rate ) from 0.5Hz to 20kHz.
- 2648 –222, "Data out of range;INT AM FREQ INC(2648)"  
Select an internal AM frequency ( rate ) increment from 0.5Hz to 20kHz.
- 2651 –222, "Data out of range;INT AM DEPTH(2651)"  
Select an internal AM depth from 0dB to 60dB.
- 2654 –222, "Data out of range;INT AM DEPTH INC(2654)"  
Select an internal AM depth increment from 0.0075dB to 60dB.
- 2657 –224, "Illegal parameter value;AM:FEED(2657)"  
Change the AM:FEED input parameter to a source that is available in the Signal Generator.
- 2672 –222, "Data out of range;CAL:MODS:AM(2672)"  
Correct the HP-IB command CAL:MODS:AM[:DATA] so that all of its parameters are from 0 to 255.
- 2678 –222, "Data out of range;CAL:MODS:FM(2678)"  
Correct the HP-IB command CAL:MODS:FM[:DATA] so that all of its parameters are from 0 to 255.
- 2702 –222, "Data out of range;ADD OPTION(2702)"

Error Messages

**Messages**

Select an option bit number within range. See the Service Manual for more details on this feature.

2705 –222, "Data out of range;DELETE OPTION(2705)"

Select an option bit number within range. See the Service Manual for more details on this feature.

3500 –221, "Settings conflict;PULSE DELAY(3500)"

The current pulse delay value was changed because the pulse delay limits changed for the current pulse mode. For example, if pulse delay is -100ms and the Signal Generator is placed into external trigger mode, this error will be reported and the pulse delay will be set to 0ms.

4000 –330, "Self-test failed;(4000)"

Run the instrument self-test a couple times, checking the error queue each time the self-test is run. If the error message persists, use the ERASE MEMORY feature, press the preset key and cycle the power; try the self-test again. If the error message persists, an instrument failure may have occurred and servicing may be required. If the Signal Generator is functioning to your satisfaction, you may wish to ignore the error message.

4001 –330, "Self-test failed;(4001)"

See the explanation for error number 4000.

4002 –330, "Self-test failed;(4002)"

See the explanation for error number 4000.

4003 –330, "Self-test failed;(4003)"

See the explanation for error number 4000.

4004 –330, "Self-test failed;(4004)"

See the explanation for error number 4000.

4005 –330, "Self-test failed;(4005)"

See the explanation for error number 4000.

4006 –330, "Self-test failed;(4006)"

See the explanation for error number 4000.

- 4007 -330,"Self-test failed;(4007)"  
See the explanation for error number 4000.
- 4008 -330,"Self-test failed;(4008)"  
See the explanation for error number 4000.
- 4009 -330,"Self-test failed;(4009)"  
See the explanation for error number 4000.
- 4010 -330,"Self-test failed;(4010)"  
See the explanation for error number 4000.
- 4011 -330,"Self-test failed;(4011)"  
See the explanation for error number 4000.
- 4012 -330,"Self-test failed;(4012)"  
See the explanation for error number 4000.
- 4013 -330,"Self-test failed;(4013)"  
See the explanation for error number 4000.
- 4014 -330,"Self-test failed;(4014)"  
See the explanation for error number 4000.
- 4015 -330,"Self-test failed;(4015)"  
See the explanation for error number 4000.
- 4016 -330,"Self-test failed;(4016)"  
See the explanation for error number 4000.
- 4017 -330,"Self-test failed;(4017)"  
See the explanation for error number 4000.
- 4018 -330,"Self-test failed;(4018)"  
See the explanation for error number 4000.
- 4019 -330,"Self-test failed;(4019)"  
See the explanation for error number 4000.
- 4020 -330,"Self-test failed;(4020)"

Error Messages  
**Messages**

- See the explanation for error number 4000.
- 4021 –330,"Self-test failed;(4021)"  
See the explanation for error number 4000.
- 4022 –330,"Self-test failed;(4022)"  
See the explanation for error number 4000.
- 4023 –330,"Self-test failed;(4023)"  
See the explanation for error number 4000.
- 4024 –330,"Self-test failed;(4024)"  
See the explanation for error number 4000.
- 4025 –330,"Self-test failed;(4025)"  
See the explanation for error number 4000.
- 4026 –330,"Self-test failed;(4026)"  
See the explanation for error number 4000.
- 4027 –330,"Self-test failed;(4027)"  
See the explanation for error number 4000.
- 4028 –330,"Self-test failed;(4028)"  
See the explanation for error number 4000.
- 4029 –330,"Self-test failed;(4029)"  
See the explanation for error number 4000.
- 4030 –330,"Self-test failed;(4030)"  
See the explanation for error number 4000.
- 4031 –330,"Self-test failed;(4031)"  
See the explanation for error number 4000.
- 4032 –330,"Self-test failed;(4032)"  
See the explanation for error number 4000.
- 4033 –330,"Self-test failed;(4033)"  
See the explanation for error number 4000.

- 4034 –330,"Self-test failed;(4034)"  
See the explanation for error number 4000.
- 4035 –330,"Self-test failed;(4035)"  
See the explanation for error number 4000.
- 4036 –330,"Self-test failed;(4036)"  
See the explanation for error number 4000.
- 4037 –330,"Self-test failed;(4037)"  
See the explanation for error number 4000.
- 4038 –330,"Self-test failed;(4038)"  
See the explanation for error number 4000.
- 4039 –330,"Self-test failed;(4039)"  
See the explanation for error number 4000.
- 4040 –330,"Self-test failed;(4040)"  
See the explanation for error number 4000.
- 4041 –330,"Self-test failed;(4041)"  
See the explanation for error number 4000.
- 4042 –330,"Self-test failed;(4042)"  
See the explanation for error number 4000.
- 4043 –330,"Self-test failed;(4043)"  
See the explanation for error number 4000.
- 4044 –330,"Self-test failed;(4044)"  
See the explanation for error number 4000.
- 4045 –330,"Self-test failed;(4045)"  
See the explanation for error number 4000.
- 9000 –330,"Self-test failed;(9000)"  
See the explanation for error number 4000.
- 9500-  
9999 Many different error messages can occur here.



Error Messages  
**Messages**

Errors with a number from 9500 to 9999 are MMS MSIB errors. These errors occur when the Signal Generator has some problem with communication over the MSIB bus. See the explanation for error number 4000.



---

Legal and Regulatory  
Information

---

## Legal and Regulatory Information

This chapter contains information pertaining to safety, SCPI conformance, and the warranty. The Declaration of Conformity is also at the end of this chapter.

---

## Safety Considerations

This product and related documentation must be reviewed for familiarization with safety markings and instructions before operation.

This product is a Safety Class I system (provided with a protective earth terminal).

---

## Before Applying Power

Verify that the product is set to match the available line voltage and the correct fuses are installed.

---

## Safety Earth Ground

An uninterruptable safety earth ground must be provided from the main power source to the product input wiring terminals through the power cable or supplied power cable set.

**Safety Considerations**

---

**WARNING**

Any interruption of the protective (grounding) conductor (inside or outside the system) or disconnecting the protective earth terminal will cause a potential shock hazard that could result in personal injury. (Grounding one conductor of a two conductor outlet is not sufficient protection.) In addition, verify that a common ground exists between the unit under test and the system prior to energizing either unit.

Whenever it is likely that the protection has been impaired, the system must be made inoperative and be secured against any unintended operation.

If this system is to be energized via an autotransformer (for voltage reduction) make sure the common terminal is connected to neutral (that is, the grounded side of the mains supply.)

Servicing instructions are for use by service-trained personnel only. To avoid dangerous electric shock, do not perform any servicing unless qualified to do so.

Adjustments described in the manual are performed with power supplied to the system's instruments while protective covers are removed. Energy available at many points may, if contacted, result in personal injury.

Capacitors inside the system's instruments might still be charged even if the system has been disconnected from its source of supply.

For continued protection against fire hazard, replace the line fuses only with 250V fuses of the same current rating and type (for example, normal blow, time delay, etc.). Do not use repaired fuses or short circuited fuse holders.

---

---

## Safety Symbols



Instruction manual symbol: The product will be marked with this symbol when it is necessary for the user to refer to the instruction manual (see Table of Contents for page references).



Indicates hazardous voltages.



Indicates earth (ground) terminal.

---

**WARNING**

---

The **WARNING** sign denotes a hazard. It calls attention to a procedure, practice, or the like which, if not correctly performed or adhered to, could result in personal injury. Do not proceed beyond a **WARNING** sign until the indicated conditions are fully understood and met.

---

**CAUTION**

---

The **CAUTION** sign denotes a hazard. It calls attention to a procedure, practice, or the like which, if not correctly performed or adhered to, could result in damage to or destruction of part or all of the product. Do not proceed beyond a **CAUTION** sign until the indicated conditions are fully understood and met.

---

## SCPI Conformance

The Synthesizer uses the SCPI (Standard Commands for Programmable Instruments) language for HP-IB communication. The SCPI commands and queries that the Synthesizer understands are listed and described individually in Chapter 1 of the *HP 83731A/2A Programmer's Reference*.

Table 9-1 lists all of the commands and queries that the Synthesizer understands and whether they are SCPI approved, SCPI confirmed, or non-SCPI. The commands and queries that are labeled "IEEE 488.2 Required" and "IEEE 488.2 Optional" are also non-SCPI.

**NOTE**

In the table, if a command is terminated with a question mark enclosed in parentheses [(?)], that particular syntax is both a command and a query.

The SCPI version number that the Synthesizer supports at the writing of this manual is 1991.0

If you need more information about SCPI, refer to the *Beginner's Guide to SCPI* (HP part number H2325-90001).



**Table 9-1. SCPI Conformance**

<b>Programming Command</b>	<b>Status</b>
ABORt	SCPI Confirmed
*CLS	IEEE 488.2 Required
DISPlay[:WINDow][:STATe][?]	SCPI Confirmed
*DMC	IEEE 488.2 Optional
*EMC[?]	IEEE 488.2 Optional
*ESE[?]	IEEE 488.2 Required
*ESR?	IEEE 488.2 Required
*GMC?	IEEE 488.2 Optional
*IDN?	IEEE 488.2 Required
INITiate:CONTinuous[?]	SCPI Confirmed
*LMC?	IEEE 488.2 Optional
*LRN?	IEEE 488.2 Optional
MEMory:RAM:INITialize	Non-SCPI
MEMory:TABLE:SElect[?]	SCPI-Confirmed
MEMory:TABLE:FREQuency[?]	SCPI-Confirmed
MEMory:TABLE:FREQuency:POINts?	SCPI-Confirmed
MEMory:TABLE:LOSS[:MAGNitude][?]	SCPI-Confirmed
MEMory:TABLE:LOSS[:MAGNitude]:POINts?	SCPI-Confirmed
*OPC[?]	IEEE 488.2 Required
*OPT?	IEEE 488.2 Optional
OUTPut:IMPedance?	SCPI Confirmed
OUTPut:PROTection[:STATe][?]	SCPI Confirmed

Legal and Regulatory Information  
**SCPI Conformance**

**Table 9-1. SCPI Conformance (continued)**

<b>Programming Command</b>	<b>Status</b>
OUTPut[:STATe]{?}	SCPI Confirmed
*PMC	IEEE 488.2 Optional
*PSC{?}	IEEE 488.2 Optional
*RCL	IEEE 488.2 Optional
*RMC	IEEE 488.2 Optional
*RST	IEEE 488.2 Required
*SAV	IEEE 488.2 Optional
[SOURce{1}]:JAM:STATe{?}	SCPI Confirmed
[SOURce{1}]:JAM:TYPE{?}	SCPI Confirmed
[SOURce{1}]:CORRection:STATe{?}	SCPI Confirmed
[SOURce{1}]:CORRection:CSET[:SElect]{?}	SCPI Confirmed
[SOURce{1}]:CORRection:CSET:STATe{?}	SCPI Confirmed
[SOURce{1}]:FM:COUPling{?}	SCPI Confirmed
[SOURce{1}]:FM:SENSitivity?	SCPI Confirmed
[SOURce{1}]:FM:STATe{?}	SCPI Confirmed
[SOURce{1}]:FREQuency[:CW[:FIXed]]{?}	SCPI Confirmed
[SOURce{1}]:FREQuency[:CW[:FIXed]:STEP]{?}	SCPI Confirmed
[SOURce{1}]:FREQuency:MULTiplier{?}	SCPI Confirmed
[SOURce{1}]:FREQuency:MULTiplier:STEP{?}	SCPI Confirmed
[SOURce{1}]:MODulation:AOFF	Non-SCPI
[SOURce{1}]:MODulation:STATe{?}	Non-SCPI
[SOURce{1}]:POWer:ALC:PMETer{?}	Non-SCPI

**Table 9-1. SCPI Conformance (continued)**

<b>Programming Command</b>	<b>Status</b>
{SOURCE[1]:]POWER:ALC:PMEter:STEP[?]	Non-SCPI
{SOURCE[1]:]POWER:ALC:SOURCE[?]	SCPI Confirmed
{SOURCE[1]:]POWER:ATTenuation:AUTO[?]	SCPI Confirmed
{SOURCE[1]:]POWER[:LEVel][?]	SCPI Confirmed
{SOURCE[1]:]POWER[:LEVel]:STEP[?]	SCPI Confirmed
{SOURCE[1]:]POWER:PROtection:STATe[?]	SCPI Confirmed
{SOURCE[1]:]PULM:EXternal:POLarity[?]	SCPI Confirmed
{SOURCE[1]:]PULM:SOURCE[?]	SCPI Confirmed
{SOURCE[1]:]PULM:STATe[?]	SCPI Confirmed
{SOURCE[1]:]PULSe:DElay[?]	SCPI Confirmed
{SOURCE[1]:]PULSe:DElay:STEP[?]	SCPI Confirmed
{SOURCE[1]:]PULSe:DOUBle:STATe[?]	SCPI Confirmed
{SOURCE[1]:]PULSe:FREQuency[?]	SCPI Confirmed
{SOURCE[1]:]PULSe:FREQuency:STEP[?]	SCPI Confirmed
{SOURCE[1]:]PULSe:PERiod[?]	SCPI Confirmed
{SOURCE[1]:]PULSe:PERiod:STEP[?]	SCPI Confirmed
{SOURCE[1]:]PULSe:TRANSition[:LEADing][?]	SCPI Confirmed
{SOURCE[1]:]PULSe:TRANSition:STATe[?]	SCPI Confirmed
{SOURCE[1]:]PULSe:WIDTh[?]	SCPI Confirmed
{SOURCE[1]:]PULSe:WIDTh:STEP[?]	SCPI Confirmed
{SOURCE[1]:]ROSCillator:SOURCE?	SCPI Confirmed
*SRE[?]	IEEE 488.2 Required
STATus:OPERation:CONDition?	SCPI Confirmed

Legal and Regulatory Information  
**SCPI Conformance**

**Table 9-1. SCPI Conformance (continued)**

<b>Programming Command</b>	<b>Status</b>
STATus:OPERation:ENABle(?)	SCPI Confirmed
STATus:OPERation[:EVENT]?	SCPI Confirmed
STATus:OPERation:NTRansition(?)	SCPI Confirmed
STATus:OPERation:PTRansition(?)	SCPI Confirmed
STATus:PRESet	SCPI Confirmed
STATus:QUEStionable:CONDition?	SCPI Confirmed
STATus:QUEStionable:ENABle(?)	SCPI Confirmed
STATus:QUEStionable[:EVENT]?	SCPI Confirmed
STATus:QUEStionable:NTRansition(?)	SCPI Confirmed
STATus:QUEStionable:PTRansition(?)	SCPI Confirmed
*STB?	IEEE 488.2 Required
SYSTem:COMMunicate:GPIB:ADDRess(?)	SCPI Confirmed
SYSTem:COMMunicate:GPIB:ADDRess:STEP(?)	SCPI Confirmed
SYSTem:COMMunicate:PMETer:ADDRess(?)	Non-SCPI
SYSTem:ERRor?	SCPI Confirmed
SYSTem:KEY(?)	SCPI Confirmed
SYSTem:LANGuage(?)	SCPI Confirmed
SYSTem:PRESet	SCPI Confirmed
SYSTem:VERSion?	SCPI Confirmed
TRIGger[:SEQuence[1]]:STARt:SOURce(?)	SCPI Confirmed
TRIGger:SEQuence2[:SDP]:SOURce(?)	SCPI Confirmed

**Table 9-1. SCPI Conformance (continued)**

<b>Programming Command</b>	<b>Status</b>
*TST?	IEEE 488.2 Required
UNIT:FREQuency(?)	SCPI Confirmed
UNIT:POWer[:VOLTagel?]	SCPI Confirmed
UNIT:TIME(?)	SCPI Confirmed
*WAI	IEEE 488.2 Required

---

## Warranty

---

## Certification

*Hewlett-Packard Company certifies that this product met its published specifications at the time of shipment from the factory. Hewlett-Packard further certifies that its calibration measurements are traceable to the United States National Institute of Standards and Technology, (NIST), to the extent allowed by the Institute's calibration facility, and to the calibration facilities of other International Standards Organization members.*

---

## Warranty

This Hewlett-Packard instrument product is warranted against defects in material and workmanship for a period of one year from date of shipment. During the warranty period, Hewlett-Packard Company will, at its option, either repair or replace products which prove to be defective.

For warranty service or repair, this product must be returned to a service facility designated by HP. Buyer shall prepay shipping charges to HP and HP shall pay shipping charges to return the product to Buyer. However, Buyer shall pay all shipping charges, duties, and taxes for products returned to HP from another country.

HP warrants that its software and firmware designated by HP for use with an instrument will execute its programming instructions when properly installed on that instrument. HP does not warrant that the operation of the instrument, or software, or firmware will be uninterrupted or error free.

---

## Limitation of Warranty

The foregoing warranty shall not apply to defects resulting from improper or inadequate maintenance by Buyer, Buyer-supplied software or interfacing, unauthorized modification or misuse, operation outside of the environmental specifications for the product, or improper site preparation or maintenance.

**NO OTHER WARRANTY IS EXPRESSED OR IMPLIED. HP SPECIFICALLY DISCLAIMS THE IMPLIED WARRANTIES OF MERCHANTABILITY AND FITNESS FOR A PARTICULAR PURPOSE.**

---

## Exclusive Remedies

**THE REMEDIES PROVIDED HEREIN ARE BUYER'S SOLE AND EXCLUSIVE REMEDIES. HP SHALL NOT BE LIABLE FOR ANY DIRECT, INDIRECT, SPECIAL, INCIDENTAL, OR CONSEQUENTIAL DAMAGES, WHETHER BASED ON CONTRACT, TORT, OR ANY OTHER LEGAL THEORY.**

---

## Assistance

*Product maintenance agreements and other customer assistance agreements are available for Hewlett-Packard products.*

*For any assistance, contact your nearest Hewlett-Packard Sales and Service Office. Addresses are provided at the back of this manual.*

## DECLARATION OF CONFORMITY

according to ISO/IEC Guide 22 and EN 45014

**Manufacturer's Name:** Hewlett-Packard Company

**Manufacturer's Address:** Stanford Park Division  
1501 Page Mill Road  
Palo Alto, CA 94304 USA

declares, that the product:

**Product Name:** SYNTHESIZED SIGNAL GENERATOR

**Model Number(s):** 83731A & 83732A

**Product Options:** 1E1, 1E5, 1E8 & 1E9

conforms to the following Product Specifications:

**Safety:** IEC 348

**EMC:** EN 55011/1991, Class A CISPR 11/1990, Class A

EN50082-1/1991 12

IEC 801-2/1991, 2nd EDITION (4 kV CD, 8 kV AD)

IEC 801-3/1984, 1st EDITION (3 V/m, 27-500MHz)

IEC 801-4/1988, 1st EDITION (Level 2)

Supplementary Information:

**Palo Alto**

**25 feb 92**

Location

Date

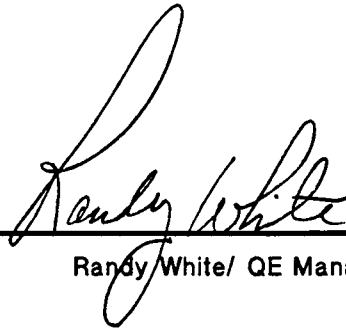

Randy White/ QE Manager





---



Index



- 0 0.5 V/GHz OUT connector, 5-7
- 1 10 MHz IN connector, 5-7
  - 10 MHz OUT connector, 5-7
  - 1 Hz frequency resolution - option 1E8, 4-16
- 3 3.5 mm RF output connector - option 1E9, 4-16
- 4 488.1 compatability codes, 5-10
- A AC coupled FM, 7-14
  - AC FM annunciator, 5-3
  - AC FM signal
    - generating, 3-5
  - active parameter, 6-53
  - add high stability timebase - option 1E5, 4-16
  - add output step attenuator - option 1E1, 4-16
  - address
    - setting the HP-IB, 2-12
  - ADDRESS, 6-11
  - advantages
    - attenuator hold function, 7-4
    - DC FM, 7-14
  - ALC IN connector, 5-7
  - ALC unlevelled condition, 6-36
  - AM IN connector, 5-7
  - annunciators, 5-12
    - fluorescent display, 5-12
    - LED, 5-12
  - Annunciators, 5-3
  - ANSI Standard MC1.1, 5-11
  - antenna scan patterns, 3-35
  - application
    - attenuator hold function, 7-3
    - average power inhibit function, 7-6
    - erase memory function, 7-16
    - select risetime, 7-23
  - arrow keys
    - modifying data with, 2-6
  - ↓ (down arrow), 6-9
  - ⇐ (left arrow), 6-5
  - ⇒ (right arrow), 6-3
  - ↑ (up arrow), 6-7
  - ATTEN HOLD ON/OFF, 7-3
  - attenuator hold function, 7-3
  - average power inhibit function, 7-6

AVG PWR INHIBIT ON/OFF, 7-6

- B** BACK SPACE, 6-12
  - book introduction, vi
  
- C** carrier display. *See* rightmost display
  - CLEAR DISPLAY, 7-12
  - coaxial connectors, 5-6-9
  - connector care, 5-9
  - connectors
    - coaxial, 5-6-9
    - damage levels, 5-6-9
    - front panel, 5-6
    - HP-IB, 5-9-11
    - impedances, 5-6-9
    - rear panel, 5-6
  - Connectors, 5-6
  - cursor
    - double, 6-3, 6-5
  - CW signal
    - generating, 3-3
  
- D** damage
  - electrical, 1-6
  - mechanical, 1-3, 1-6
- data
  - entering with numeric keypad, 2-3
  - modifying with arrow keys, 2-6
  - modifying with knob, 2-4
- Data Entry Problems, 2-13-14
- DC coupled FM, 7-14
- DC FM annunciator, 5-3
- DC FM ON/OFF, 7-14
- default state
  - display, 6-17
- delay
  - negative, 6-13
  - positive, 6-13
- DELAY, 6-13
- DIODE (ALC) annunciator, 5-4
- diode detector leveling
  - advantages, 6-22
  - applications, 6-21
  - disadvantages, 6-22
  - using, 3-43
- diode detector square law region, 6-21, 6-22
- disadvantages

- attenuator hold function, 7-4
- DC FM, 7-14
- display
  - default state, 6-17
  - leftmost, 5-13
  - rightmost, 5-13
- Display, 5-12
- documentation options, 4-18
- double cursor, 6-3, 6-5
- DOUBLET, 6-15
- doublet pulse, 3-25
- doublet pulse modulation timing, 6-15

**E** electrical options, 4-16

- ENTER, 6-17
- ENTRY OFF, 2-13, 6-19
- ENTRY OFF key, 2-13
- ERASE MEMORY, 7-16
- erase memory function, 7-16
- error message
  - action required, 8-3
  - detailed description, 8-3
  - hardware failures, 8-4
  - manual error number, 8-3
  - SCPI error message, 8-3
  - SCPI error number, 8-3
- error message format, 8-3
- error messages list, 8-5-40
- error queue
  - reading, 2-10
- errors
  - permanent, 8-2
- EXT DIODE, 6-20
- externally triggered pulse modulation, 3-16
- external pulse modulation, 3-21
- EXT METER, 6-24
- EXT ON/OFF, 6-29
- EXT (PULSE) annunciator, 5-4
- extra operating documentation - option OB2, 4-18
- EXT REF annunciator, 5-4

- F factory calibration data, 7-16
- failures
  - self test, 1-8
- fan
  - checking, 1-7
- FM
  - AC, 7-14
  - DC, 7-14
- FM IN connector, 5-7
- FM ON/OFF, 6-30
- FM sensitivity. *See* sensitivity
- FM signal
  - generating, 3-5
- FREQ, 6-31
- frequency multiplier value. *See* multiplier value
- functional verification. *See* self-test
- fuse
  - checking, 1-6
  
- G GATED, 6-33
  - gated pulse modulation, 3-30
  
- H HP-IB address
  - setting, 2-12
- HP-IB connector, 5-9-11
- HP-IB extender instruments, 5-10
- HP-IB interface capabilities, 5-10
- HP-IB restrictions, 5-10
  
- I IEEE Standard 488 (1978), 5-11
- increment value, 2-6, 6-78
- Installing the Synthesizer, 1-3
- instrument state recall, 6-65
- instrument state save, 6-67
- INT (ALC) annunciator, 5-4
- interface capabilities
  - HP-IB, 5-10
- internal leveling
  - advantages, 6-37
  - disadvantages, 6-37
- internal pulse modulation, 3-12
- In This Book, vi
- INT LEVEL, 6-36
- INT ON/OFF, 6-39
- INT (PULSE) annunciator, 5-4
- introduction
  - book, vi

INVERT, 6-40  
INVERT (PULSE) annunciator, 5-3

- K** keypad  
    numeric, 6-53  
knob  
    modifying data with, 2-4  
Knob, 5-15  
knob resolution  
    decreasing, 2-4  
    increasing, 2-4
- L** leftmost display, 5-13  
level correct data  
    using previously stored, 3-58  
level correction register, 6-63, 6-68  
level correct routine, 6-44  
    using, 3-50  
leveling  
    using diode detector, 3-43  
    using power meter, 3-47  
LINE Switch, 5-17  
line voltage selector, 1-4  
LLO, 6-42  
LOCAL, 6-42  
LOCAL key, 2-13  
local lockout, 6-42  
log AM and pulse modulation  
    generating simultaneous, 3-35  
LOG AM annunciator, 5-3  
LOG AM ON/OFF, 6-43  
LSN annunciator, 5-4  
LVL CR, 6-44  
LVL CR annunciator, 5-4  
LVL CR ON/OFF, 6-48
- M** mechanical damage, 1-3  
mechanical options, 4-17  
millimeter signals  
    generating, 3-40  
modulation display. *See* leftmost display  
modulation index, 7-14  
MSG, 6-50  
MSG annunciator, 1-7, 3-60, 5-5  
MTR (ALC) annunciator, 5-4  
MULT annunciator, 5-4  
MULTIPLIER, 6-51

multiplier value, 6-51  
multiplier values for HP source modules, 3-41

- N** negative delay, 6-13  
number of points, 6-44  
numeric keypad, 6-53  
entering data with, 2-3
- O** option 1CM - rack mount kit, 4-17  
option 1CP - rack mount and handle kit, 4-17  
option 1CR - rack slide kit, 4-17  
option 1E1 - add output step attenuator, 4-16  
option 1E5 - add high stability timebase, 4-16  
option 1E8 - 1 Hz frequency resolution, 4-16  
option 1E9 - 3.5 mm RF output connector, 4-16, 5-8  
option OB2 - extra operating documentation, 4-18  
option OB3 - service documentation, 4-18  
options, 4-2  
documentation, 4-18  
electrical, 4-16  
mechanical, 4-17  
warranty, 4-17  
option W30 - two years return-to-HP service, 4-17  
option W32 - three year return-to-HP calibration service, 4-18  
option W34 - three year Mil-std calibration service, 4-18
- P** parameter  
active, 6-53  
unitless, 6-17  
permanent errors, 8-2  
points  
number of, 6-44  
positive delay, 6-13  
power cable configurations, 5-18  
power cables, 5-18  
POWER LEVEL, 6-54  
power meter address function, 7-18  
power meter leveling  
advantages, 6-26  
applications, 6-25  
disadvantages, 6-26  
equipment limitations, 6-26  
using, 3-47  
power meter select function, 7-20  
power sweep  
generating, 3-8  
use for, 3-8



- Power-up Problems, 1-6-8
- PRESET, 6-56
- preset conditions
  - instrument, 6-56
- PRF, 6-58
- PRI, 6-61
- problems
  - data entry, 2-13-14
  - power-up, 1-6-8
  - programming, 2-14
  - RF output, 3-61
- Programming Problems, 2-14
- pulsed power pre-calibration program, 7-7
- pulse modulation
  - doublet, 6-15
  - gated, 6-33
  - generating doublet, 3-25
  - generating externally triggered, 3-16
  - generating gated, 3-30
  - generating repetitive, external, 3-21
  - generating repetitive, internal, 3-12
  - internal triggered, 6-80
  - inverted external, 6-40
- pulse modulation and log AM
  - generating simultaneous, 3-35
- pulse repetition frequency. *See* PRF
- pulse repetition interval. *See* PRI
- pulse risetime selection. *See* select risetime
- PULSE SYNC OUT connector, 5-8
- PULSE/TRIG, GATE IN connector, 5-7
- PULSE VIDEO OUT connector, 5-8
- PWR MTR ADDRS, 7-18
- PWR MTR SELECT, 7-20

**R** rack mount and handle kit - option 1CP, 4-17  
rack mount kit - option 1CM, 4-17  
rack slide kit - option 1CR, 4-17  
RCL CR, 6-63  
reading the error queue, 2-10  
RECALL, 6-65  
recalling synthesizer states, 2-8  
restrictions

- HP-IB, 5-10

RF ON/OFF, 6-66  
RF OUTPUT connector, 5-8  
RF Output Problems, 3-61  
rightmost display, 5-13  
RMT annunciator, 2-13, 5-4

**S** SAVE, 6-67  
 SAVE CR, 6-68  
 saving synthesizer states, 2-8  
 scan patterns  
     antenna, 3-35  
 SCPI conformance information, 9-6  
 SCPI conformance table, 9-6-11  
 SELECT RISETIME, 7-22  
 select risetime function, 7-22  
 self test  
     running, 1-5  
 SELF TEST, 7-25  
 Self Test Failures, 1-8  
 self-test function, 7-25  
 SENSITIVITY, 6-70  
 serial number, 7-28  
 service documentation - option OB3, 4-18  
 service-related special functions, 7-27  
 SHIFT, 6-72  
 SHOW INFO, 7-28  
 show information function, 7-28  
 software version number, 7-28  
 source modules  
     multiplier values for, 3-41  
 SPCL, 6-73  
 SPCL annunciator, 5-4  
 SPCL OFF, 6-74  
 SPCL ON, 6-76  
 special functions, 6-73, 7-2  
     service-related, 7-27  
 specifications, 4-2, 4-3  
 square law region  
     diode detector, 6-21, 6-22  
 SRQ annunciator, 5-4  
 Standard Commands for Programmable Instruments. *See* SCPI  
 standby, 5-17  
 start frequency, 6-44  
 STEP SIZE, 6-78  
**STEP SIZE**, 2-6  
 stop frequency, 6-44  
 supplemental characteristics, 4-3  
 synthesizer  
     installing, 1-3  
 Synthesizer at a Glance, iv  
 synthesizer states  
     saving and recalling, 2-8

- T** terminator keys, 2-3
  - three year Mil-std calibration service - option W34, 4-18
  - three year return-to-HP calibration service - option W32, 4-18
  - timing
    - doublet pulse modulation, 6-15
    - gated pulse modulation, 6-33
    - triggered pulse modulation, 6-80
  - TLK annunciator, 5-4
  - To Generate a CW Signal, 3-3
  - To Generate a Doublet Pulse, 3-25
  - To Generate an AC FM Signal, 3-5
  - To Generate a Power Sweep, 3-8
  - To Generate Externally Triggered Pulse Modulation, 3-16
  - To Generate Gated Pulse Modulation, 3-30
  - To Generate Millimeter Signals, 3-40
  - To Generate Repetitive, External Pulse Modulation, 3-21
  - To Generate Repetitive, Internal Pulse Modulation, 3-12
  - To Generate Simultaneous Log AM and Pulse Modulation, 3-35
  - To Use External Diode Detector Leveling, 3-43
  - To Use External Power Meter Leveling, 3-47
  - To Use Previously Stored Level Correct Data, 3-58
  - To Use the Level Correct Routine, 3-50
  - triggered pulse modulation timing, 6-80
  - TRIG ON/OFF, 6-80
  - TRIG (PULSE) annunciator, 5-4
  - turn-on sequence, 1-4
  - two years return-to-HP service - option W30, 4-17
  
- U** unitless parameters, 6-17
  - units terminator keys, 2-3
  - unleveled condition
    - ALC, 6-36
  - UNLOCK annunciator, 5-4
  - UNLVL annunciator, 5-5
  
- V** verification procedure, 1-5
  
- W** warranty options, 4-17
  - WIDTH, 6-82