

# Notice

---

## **Hewlett-Packard to Agilent Technologies Transition**

This documentation supports a product that previously shipped under the Hewlett-Packard company brand name. The brand name has now been changed to Agilent Technologies. The two products are functionally identical, only our name has changed. The document still includes references to Hewlett-Packard products, some of which have been transitioned to Agilent Technologies.

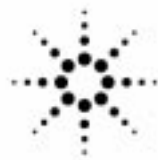

**Agilent Technologies**

# **Installation and Quick Start Guide**

**Agilent Technologies**

**83751A/B and 83752A/B Synthesized Sweeper**



**Manufacturing Part Number: 83750-90006**

**Printed in USA**

**August 2000**

© Copyright 1998 - 2001 Agilent Technologies

---

## Notice

The information contained in this document is subject to change without notice.

Agilent Technologies makes no warranty of any kind with regard to this material, including but not limited to, the implied warranties of merchantability and fitness for a particular purpose. Agilent Technologies shall not be liable for errors contained herein or for incidental or consequential damages in connection with the furnishing, performance, or use of this material.

---

## Safety Information

The following safety symbols are used throughout this manual. Familiarize yourself with the symbols and their meaning before operating this instrument.

---

### WARNING

***Warning* denotes a hazard. It calls attention to a procedure which, if not correctly performed or adhered to, could result in injury or loss of life. Do not proceed beyond a warning note until the indicated conditions are fully understood and met.**

---

### CAUTION

*Caution* denotes a hazard. It calls attention to a procedure that, if not correctly performed or adhered to, could result in damage to or destruction of the instrument. Do not proceed beyond a caution sign until the indicated conditions are fully understood and met.

---

### NOTE

*Note* calls out special information for the user's attention. It provides operational information or additional instructions of which the user should be aware.



The instruction documentation symbol. The product is marked with this symbol when it is necessary for the user to refer to the instructions in the documentation.



This symbol is used to mark the on position of the power line switch.



This symbol is used to mark the standby position of the power line switch.



This symbol indicates that the input power required is AC.

---

**WARNING**      **This is a Safety Class 1 Product (provided with a protective earth ground incorporated in the power cord). The mains plug shall be inserted only in a socket outlet provided with a protected earth contact. Any interruption of the protective conductor inside or outside of the product is likely to make the product dangerous. Intentional interruption is prohibited.**

---

**WARNING**      **No operator serviceable parts inside. Refer servicing to qualified personnel. To prevent electrical shock do not remove covers.**

---

**WARNING**      **If this product is not used as specified, the protection provided by the equipment could be impaired. This product must be used in a normal condition (in which all means for protection are intact) only.**

---

**CAUTION**      Always use the three-prong AC power cord supplied with this product. Failure to ensure adequate grounding may cause product damage.

---

---

## **Warranty**

This Agilent Technologies instrument product is warranted against defects in material and workmanship for a period of three years from date of shipment. During the warranty period, Agilent Technologies will, at its option, either repair or replace products which prove to be defective.

For warranty service or repair, this product must be returned to a service facility designated by Agilent Technologies. Buyer shall prepay shipping charges to Agilent Technologies and Agilent Technologies shall pay shipping charges to return the product to Buyer. However, Buyer shall pay all shipping charges, duties, and taxes for products returned to Agilent Technologies from another country.

Agilent Technologies warrants that its software and firmware designated by Agilent Technologies for use with an instrument will execute its programming instructions when properly installed on that instrument. Agilent Technologies does not warrant that the operation of the instrument, or software, or firmware will be uninterrupted or error-free.

---

## **LIMITATION OF WARRANTY**

The foregoing warranty shall not apply to defects resulting from improper or inadequate maintenance by Buyer, Buyer-supplied software or interfacing, unauthorized modification or misuse, operation outside of the environmental specifications for the product, or improper site preparation or maintenance.

NO OTHER WARRANTY IS EXPRESSED OR IMPLIED. AGILENT TECHNOLOGIES SPECIFICALLY DISCLAIMS THE IMPLIED WARRANTIES OF MERCHANTABILITY AND FITNESS FOR A PARTICULAR PURPOSE.

---

## **EXCLUSIVE REMEDIES**

THE REMEDIES PROVIDED HEREIN ARE BUYER'S SOLE AND EXCLUSIVE REMEDIES. AGILENT TECHNOLOGIES SHALL NOT BE LIABLE FOR ANY DIRECT, INDIRECT, SPECIAL, INCIDENTAL, OR CONSEQUENTIAL DAMAGES, WHETHER BASED ON CONTRACT, TORT, OR ANY OTHER LEGAL THEORY.

By internet, phone, or fax, get assistance with all your test and measurement needs.

**Table 1-1 Contacting Agilent**

**Online assistance:** [www.agilent.com/find/assist](http://www.agilent.com/find/assist)

**United States**  
(tel) 1 800 452 4844

**Latin America**  
(tel) (305) 269 7500  
(fax) (305) 269 7599

**Canada**  
(tel) 1 877 894 4414  
(fax) (905) 282-6495

**Europe**  
(tel) (+31) 20 547 2323  
(fax) (+31) 20 547 2390

**New Zealand**  
(tel) 0 800 738 378  
(fax) (+64) 4 495 8950

**Japan**  
(tel) (+81) 426 56 7832  
(fax) (+81) 426 56 7840

**Australia**  
(tel) 1 800 629 485  
(fax) (+61) 3 9210 5947

**Asia Call Center Numbers**

Country	Phone Number	Fax Number
Singapore	1-800-375-8100	(65) 836-0252
Malaysia	1-800-828-848	1-800-801664
Philippines	(632) 8426802 1-800-16510170 (PLDT Subscriber Only)	(632) 8426809 1-800-16510288 (PLDT Subscriber Only)
Thailand	(088) 226-008 (outside Bangkok) (662) 661-3999 (within Bangkok)	(66) 1-661-3714
Hong Kong	800-930-871	(852) 2506 9233
Taiwan	0800-047-866	(886) 2 25456723
People's Republic of China	800-810-0189 (preferred) 10800-650-0021	10800-650-0121
India	1-600-11-2929	000-800-650-1101

---

# Contents

<b>1. Installing Your Sweeper</b>	
To Check the Shipment . . . . .	1-4
To Meet Electrical and Environmental Requirements . . . . .	1-6
To Select the Sweeper GPIB Address and Language Mode	1-7
Setting the Sweeper Address Default . . . . .	1-7
Setting the sweeper to default to the address you selected on the rear panel . . . . .	1-8
Setting the sweeper to default to the address you selected from the front panel . . . . .	1-9
Setting the Language Mode Default . . . . .	1-9
Setting the sweeper to default to the language mode you selected on . . . . .	1-10
Setting the sweeper to default to the language mode you selected . . . . .	1-11
Setting the Sweeper Storage Register Default . . . . .	1-13
To Configure the Sweeper in a Scalar System . . . . .	1-14
To Configure the Sweeper in a Millimeter System . . . . .	1-15
To Configure the Sweeper in a Noise Figure Meter System	1-16
To Install the Sweeper Front Handles and Rack Flange Kits	1-17
To Attach Rack Flanges to a Sweeper (Option 1CM) . . . . .	1-18
To Attach Rack Flanges and Front Handles to a Sweeper (Option 1CP) . . . . .	1-19
To Attach Handles to the Sweeper . . . . .	1-21
Checking the Sweeper Operation . . . . .	1-22
To Invoke the Full Self-Tests . . . . .	1-22
To Invoke Peak Power-Tracking . . . . .	1-23
To Check the Maximum-Leveled Power . . . . .	1-23
For 83752B Instruments Only . . . . .	1-24
To Verify Output Power . . . . .	1-25

**To save and recall instrument states**

**2. Quick Start**

To Set a CW (Continuous Wave) Signal . . . . .	2-4
To Set a CF (Center Frequency) and Span . . . . .	2-5
To Set a Frequency Sweep . . . . .	2-6
Setting the Frequency Range . . . . .	2-6
To Set the Sweep Trigger . . . . .	2-8
To Set the Sweep Time . . . . .	2-10
To Set the Output Power Level . . . . .	2-11
To Set a Power Sweep . . . . .	2-12
To Set a Power Slope . . . . .	2-14
To Set Up Markers . . . . .	2-16
Defining the Sweep Range with Markers . . . . .	2-17
Scrolling the Marker Settings . . . . .	2-17
To Save and Recall Instrument States . . . . .	2-19



---

## Figures

1-1. Installation Overview . . . . .	1-3
1-2. Items Included with Your Shipment . . . . .	1-4
1-3. Location of Language Mode and GPIB Address Switch . . . . .	1-7
1-4. Switch Position for Sweeper to Default to Address Selected from Rear Panel . . . . .	1-8
1-5. Switch Position for Sweeper to Default to Address Selected from Front Panel . . . . .	1-9
1-6. Switch Position for Sweeper to Default to Language Mode Selected from Rear Panel . . . . .	1-11
1-7. Switch Position for Sweeper to Default to Language Mode Selected from Front Panel . . . . .	1-12
1-8. Switch Positions for Setting the Storage Register Default . . . . .	1-13
1-9. Scalar System Connections . . . . .	1-14
1-10. Millimeter System Connections . . . . .	1-15
1-11. Noise Figure Meter System Connections . . . . .	1-16
1-12. Installation of Rack Flanges . . . . .	1-18
1-13. Installation of Rack Flanges and Front Handles . . . . .	1-20
1-14. Installation of Front Handles . . . . .	1-21
1-15. Connections for Verifying Output Power . . . . .	1-25
2-1. 83750 Series Quick Start Overview Locations of Keys for Setting a CW Signal . . . . .	2-3
2-2. Locations of Keys for Setting a CW Signal . . . . .	2-4
2-3. Location of Keys for Setting a CF and Span . . . . .	2-5
2-4. Locations of Keys for Setting a Frequency Sweep . . . . .	2-6
2-5. Locations of Keys for Setting the Sweep Trigger . . . . .	2-8
2-6. Locations of Keys for Setting the Sweep Time . . . . .	2-10
2-7. Location of Keys for Setting the Output Power Level . . . . .	2-11
2-8. Location of Keys for Setting the Power Sweep . . . . .	2-12
2-9. Representation of Example Power Sweep . . . . .	2-13
2-10. Location of Keys for Setting a Power Slope . . . . .	2-14
2-11. Representation of Example Power Slope . . . . .	2-15
2-12. Location of Keys for Setting Markers . . . . .	2-16
2-13. Location of Keys for Saving and Recalling Instrument States . . . . .	2-19

## Contents

| \_

---

| \_

---

## Installing Your Sweeper

---

# Installing Your Sweeper

This chapter contains procedures that show you how to install your sweeper into various system configurations. Procedures for ensuring the correct operation of your instrument are also included in this chapter:

- checking the shipment
- meeting electrical and environmental requirements
- selecting the sweeper GPIB address and language mode
- configuring the sweeper in a system
  - scalar system
  - millimeter system
  - noise figure meter system
- checking the sweeper operation
  - full self-test
  - peak power-tracking
  - maximum leveled power
  - output power verification

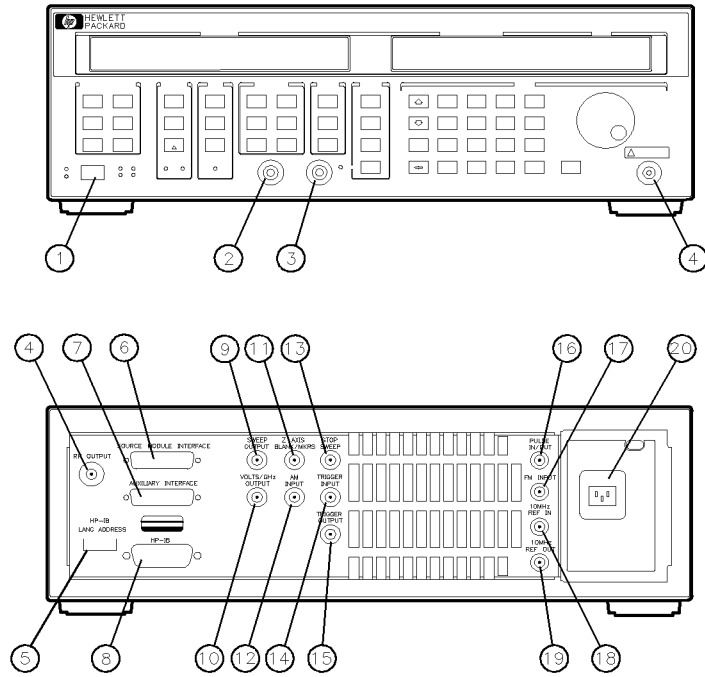

qq414 ab

Figure 1-1. Installation Overview

- |                                      |                      |
|--------------------------------------|----------------------|
| 1 line power switch                  | 11 Z-AXIS BLANK/MKRS |
| 2 SWEEP OUT                          | 12 AM INPUT          |
| 3 ALC IN                             | 13 STOP SWEEP        |
| 4 RF OUTPUT                          | 14 TRIGGER INPUT     |
| 5 GPIB/LANG ADDRESS switch           | 15 TRIGGER OUTPUT    |
| 6 SOURCE MODULE INTERFACE (opt. 1EE) | 16 PULSE IN/OUT      |
| 7 AUXILIARY INTERFACE                | 17 FM INPUT          |
| 8 GPIB interface                     | 18 10 MHZ REF IN     |
| 9 SWEEP OUTPUT                       | 19 10 MHZ REF OUT    |
| 10 VOLTS/GHZ OUTPUT                  | 20 AC power input    |

---

## To check the shipment

1. Unpack the contents of all the shipping containers.
2. Verify that all the accessories have been included with the sweeper (refer to the figure and table below).
3. Carefully inspect the sweeper to ensure that it was not damaged during shipment.

If your sweeper was damaged during shipment, contact your nearest Agilent Technologies office or sales representative.

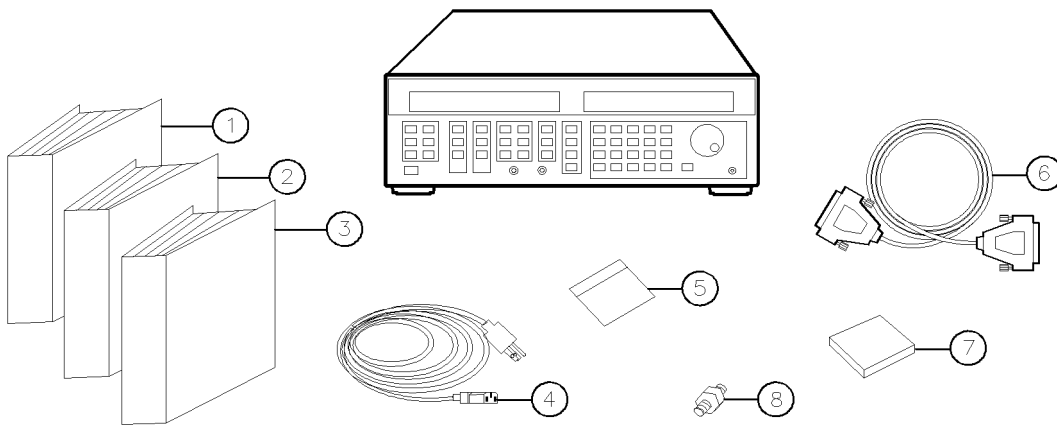

qg415ab

**Figure 1-2. Items Included with Your Shipment**

**Shipment Verification Checklist**

<b>Received</b>	<b>Part Number</b>	<b>Item Number</b>	<b>Description</b>
	83750-90004	<b>1.</b>	User's Guide
	83570-90003	<b>2.</b>	Service Guide
	83570-90005	<b>3.</b>	Programming Guide
	unique to country	<b>4.</b>	AC power cable
	83570-10001	<b>5.</b>	Calibration Software
	5062-7202	<b>6.</b>	mm Extention Cable [Option 1EE]
	5062-3977	<b>7.</b>	<sup>1</sup> Rack Flange Kit without Handles [Option 1CM]
	5062-3983		Rack Flange Kit with Handles [Option 1CP]
	5062-3989		Front Handle Kit [Standard]
	1250-1158	<b>8.</b>	Adapter, SMA, F-F [not included with opt. 1ED]

<sup>1</sup> One kit is included in your shipment.

---

## To meet electrical and environmental requirements

1. Ensure the available AC power source meets the following requirements:

- 90 - 132 VAC
- 50 - 60 Hz / 400 Hz (single phase)

OR

- 198 - 264 VAC
- 50 - 60 Hz (single phase)

OR

- 90 - 132 VAC (47 - 66 Hz)
- 103.5 - 126.5 VAC (380 - 420 Hz)
- 198 - 250 VAC (47 - 66 Hz)

The instrument automatically switches between 110 and 220 volt ranges to match the available power source.

### **NOTE**

The sweeper power consumption is 400 VA max or 100 VA standby.

2. Verify that the power cable is not damaged, and that the power-source socket outlet provides a protective earth contact.

---

### **WARNING**

Any interruption of the protective (grounding) conductor or disconnection of the protective earth terminal, can result in personal injury.



**To meet electrical and environmental requirements**

3. Ensure the operating environment meets the following requirements:

- 0 to 50°C
- < 90% relative humidity
- < 15000 feet (4600 meters) altitude

Refer to the “User’s Guide” for information on the environmental compatibility of warranted performance.

---

## To select the sweeper GPIB address and language mode

The rear panel switch allows you to select the following sweeper defaults:

- GPIB address
- language mode
- storage register mode

You can position the rear panel switch so the sweeper defaults to a selected language mode and GPIB address when you apply AC power. The switch also allows you to select whether or not the sweeper clears the storage registers at power up.

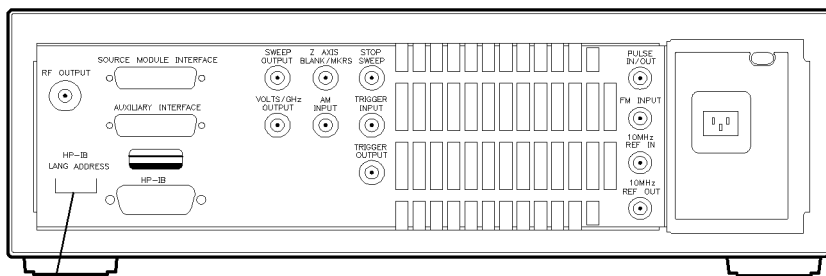

LANGUAGE MODE AND  
HP-IB ADDRESS SWITCH

qq416ab

**Figure 1.3. Location of Language Mode and GPIB Address Switch**

---

## Setting the sweeper address default

The switch allows you to select the default address in two ways:

- front panel selection
- rear panel selection

With rear panel selection, you can still modify the GPIB address through the front panel. However, when you cycle the line power, the sweeper defaults to the selection you set on the rear panel switch.

With front panel selection, you position the rear panel switch so the sweeper defaults to the address you last set from the front panel.

## Installing Your Sweeper

### To select the sweeper GPIB address and language mode

Setting the sweeper to default to the address you selected on the rear panel

1. Position the ADDRESS portion of the rear panel switch to the desired default address. Figure 1-4 shows the factory set address of 31.

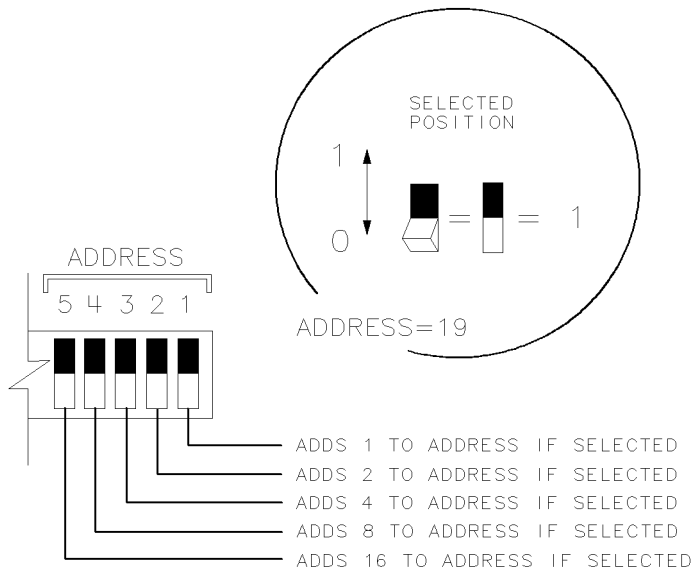

qg425ab

**Figure 1-4. Switch Position for Sweeper to Default to Address Selected from Rear Panel**

2. Cycle the instrument AC power by turning the power off and on. This allows the sweeper to read the switch position on the rear panel.
3. Press **PRESET** **SHIFT** **ADDRESS**.

The GPIB address is shown in the **MARKER/SWEEP/STATUS** portion of the display. The display shows:

```
HPIB Address=19
```

When the rear panel switch is in the current position, the sweeper allows you to change the instrument address from the front panel. However, when you cycle the line power, the sweeper defaults to the address that corresponds to the rear panel switch position.

**To select the sweeper GPIB address and language mode**

Setting the sweeper to default to the address you selected from the front panel

1. Position the ADDRESS portion of the rear panel switch as shown in Figure 1-5.

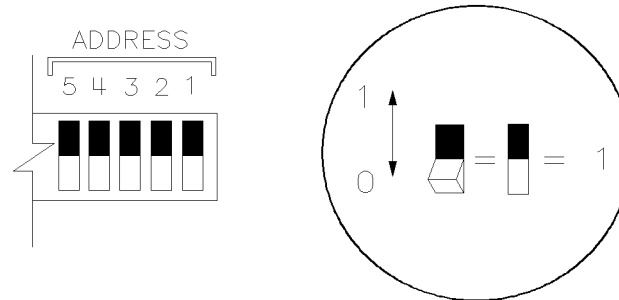

qg424ab

**Figure 1-5. Switch Position for Sweeper to Default to Address Selected from Front Panel**

2. To select the sweeper's address, press **SHIFT ADDRESS** and either press the **↑** **↓** keys, turn the front panel knob, or enter the address from the keypad.

With the rear panel switch in the current position, a line power cycle will cause the sweeper to default to the address you last set from the front panel.

---

## Setting the language mode default

The rear panel switch allows you to select a default for the sweeper language mode:

- Standard Commands for Programmable Instruments (SCPI)
- 8350 instrument language (8350)

The switch also allows you to select the default language mode in two ways:

- front panel selection
- rear panel selection

With rear panel selection, you can still modify the language mode through the front panel. However, when you cycle the line power, the sweeper defaults to the selection you set on the rear panel switch.

With front panel selection, you position the rear panel switch so the sweeper defaults to the language mode you last set from the front panel.

### **NOTE**

The sweeper can use most all of the 8350 instrument commands, but there are a few 8350 commands it cannot use. Refer to the *Programming Guide* for information on the compatibility of SCPI and 8350 language commands.

**To select the sweeper GPIB address and language mode**

Setting the sweeper to default to the language mode you selected on the rear panel

1. Set the **LANG** portion of the rear panel switch to the position that corresponds to your choice of instrument language, as shown in Figure 1-6.

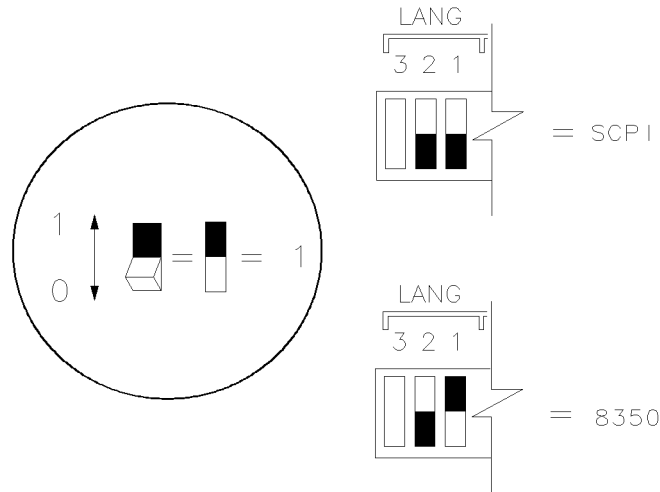

qq426ab

**Figure 1-6. Switch Position for Sweeper to Default to Language Mode Selected from Rear Panel**

2. Cycle the instrument AC power by turning the power off and on. This allows the sweeper to read the switch position on the rear panel.
3. Press **(SHIFT) SPECIAL (15) (Hz/s/ENTER)**.

Your instrument language selection is shown in the **MARKER/SWEEP/STATUS** portion of the display.

When the rear panel switch is in the current position, the sweeper allows you to change the language mode from the front panel. However, when you cycle the line power, the sweeper defaults to the language that corresponds to the rear panel switch position.

## Installing Your Sweeper

### To select the sweeper GPIB address and language mode

Setting the sweeper to default to the language mode you selected from the front panel

1. Set the **LANG** portion of the rear panel switch to the position as shown in Figure 1-7.

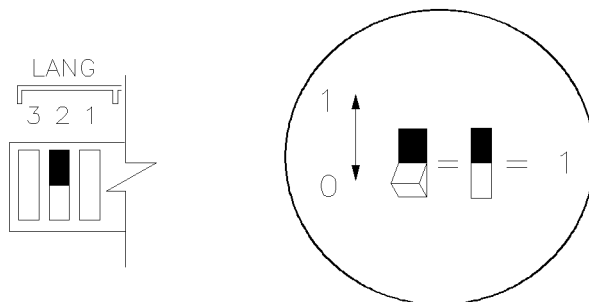

qq427ab

**Figure 1-7. Switch Position for Sweeper to Default to Language Mode Selected from Front Panel**

2. Press **(SHIFT) SPECIAL (15) (Hz/s/ENTER)** and **(↑)** repeatedly.

With the rear panel switch in the current position, a power cycle will cause the sweeper to default to the language mode you last set from the front panel.

Refer to the *Programming Guide* for information on the compatibility of the two instrument language commands.



## Setting the sweeper storage register default

The rear panel switch allows you to select how the sweeper manages the storage register contents when you cycle the AC power:

- saves storage register contents
- clears storage register contents

1. Set the rear panel switch to the position that corresponds to your selection. Refer to Figure 1-8.

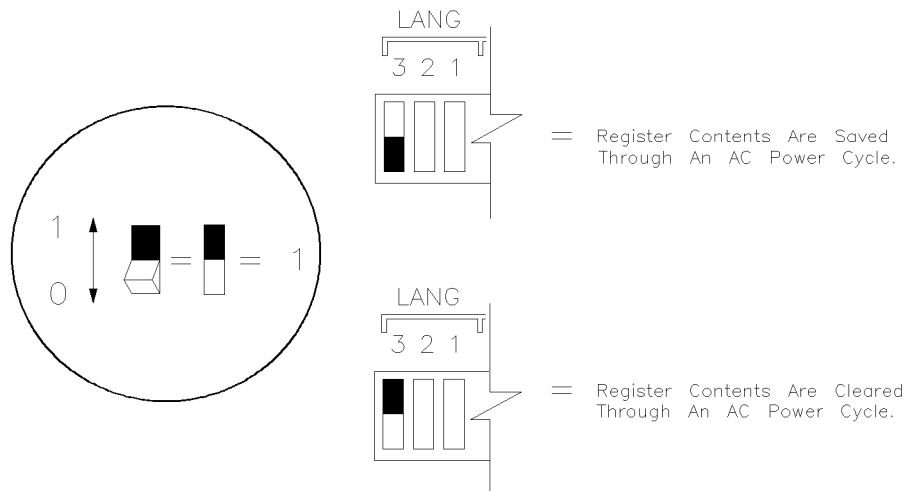

qq423ab

**Figure 1-8. Switch Positions for Setting the Storage Register Default**

---

## To configure the sweeper in a scalar system

Connect the cables and test accessories as shown in Figure 1-9.

**NOTE**

The scalar network analyzer must have firmware revision 6.0 or above for all the available features to function.

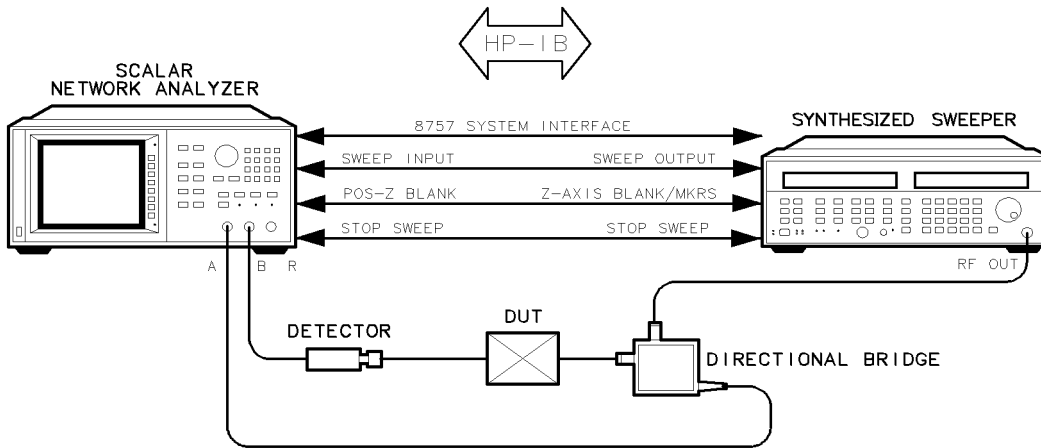

qq419ab

**Figure 1-9. Scalar System Connections**

---

## To configure the sweeper in a millimeter system

Connect the cables and test accessories as shown in Figure 1-10.

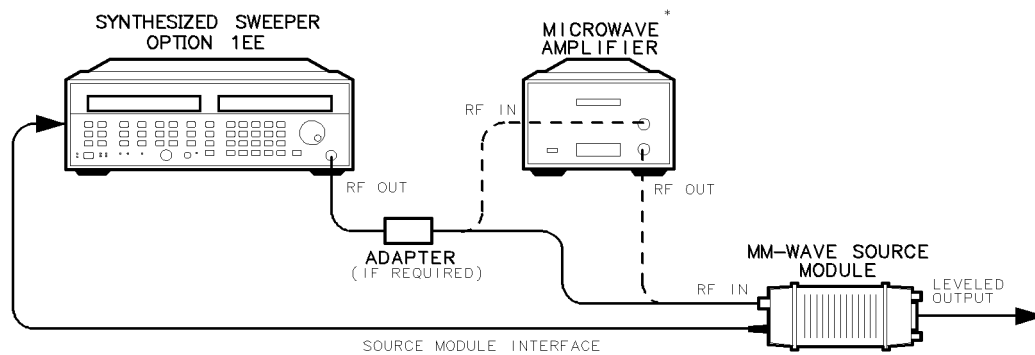

\* MICROWAVE AMPLIFIER IS ONLY NECESSARY FOR HP 83751A AND HP 83752A.

qq418ab

**Figure 1-10. Millimeter System Connections**

### **NOTE**

After you have made all the connections, press **(PRESET)** so the sweeper automatically configures for millimeter operation.

---

## To configure the sweeper in a noise figure meter system

Connect the cables and test accessories as shown in Figure 1-11.

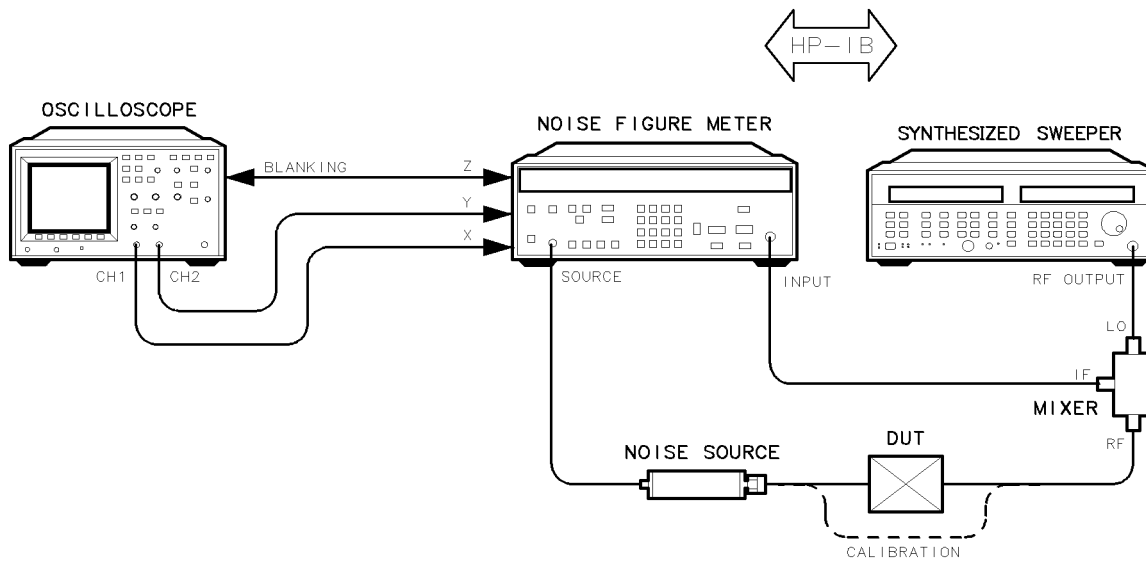

qq417ab

**Figure 1-11. Noise Figure Meter System Connections**

---

## To install the sweeper front handles and rack flange kits

There are three kits available for the sweeper:

- rack flange kit for instruments without handles (option 1CM)
- rack flange kit for instruments with handles (option 1CP)
- instrument front handles kit

**To install the sweeper front handles and rack flange kits**

---

## To Attach rack flanges to a sweeper (option 1CM)

### Contents of Rack Flange Kit

Quantity	Contents
2	rack mount flanges
6	screws

1. Remove the front panel trim strips from each side.
2. Attach the rack flanges to the sides of the front panel using three screws for each flange.
3. Remove the bottom and back feet and the tilt stands before rack mounting the instrument.

Installing Your Sweeper  
**To install the sweeper front handles and rack flange kits**

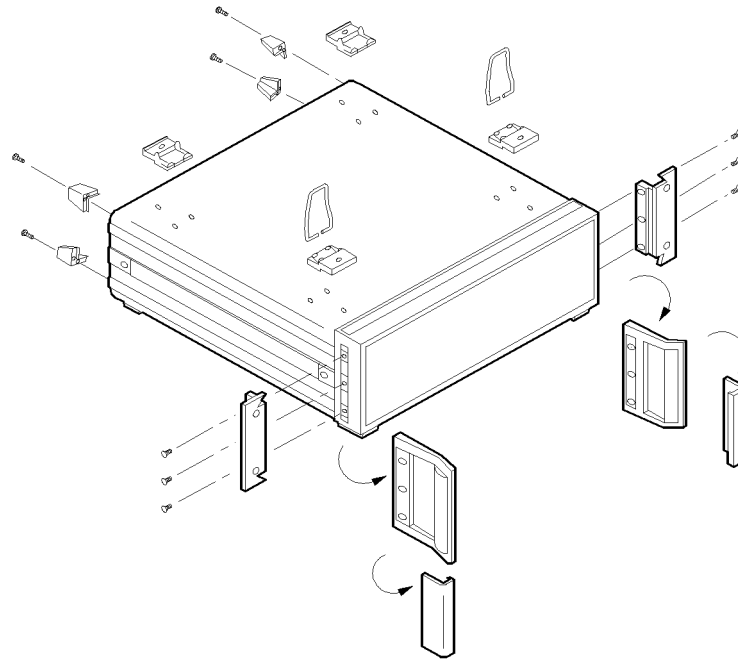

qg422ab

**Figure 1-12. Installation of Rack Flanges**

**To install the sweeper front handles and rack flange kits**

---

**To attach rack flanges and front handles to a sweeper (option 1CP)**

**Contents of Rack Flange Kit  
With Handles**

<b>Quantity</b>	<b>Contents</b>
2	rack mount flanges
2	front handles
6	screws

1. Remove the handle trim strips.
2. Attach the rack mount flanges and the handles to the sides of the front panel, using the six screws. (Attach the flanges to the outside of the handles.)
3. Remove the bottom and back feet and the tilt stands before rack mounting the instrument.



To install the sweeper front handles and rack flange kits

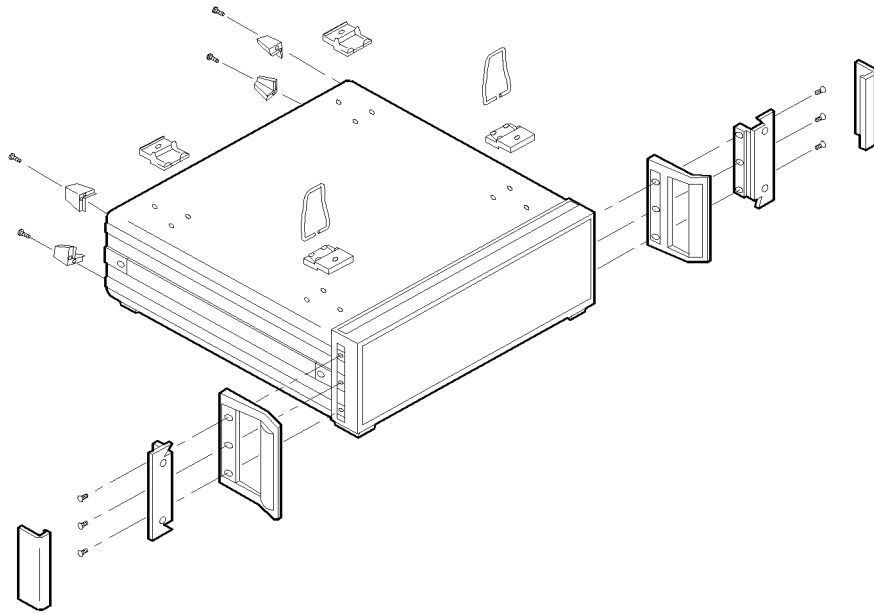

qq421ab

Figure 1-13. Installation of Rack Flanges and Front Handles

**WARNING**

If an instrument handle is damaged, you should replace it immediately. Damaged handles can break while you are moving or lifting the instrument. This may cause damage to the instrument or personal injury.

**To install the sweeper front handles and rack flange kits**

---

**To attach handles to the sweeper**

**Contents of Front Handles Kit**

Quantity	Contents
2	front handles
6	screws
2	trim strips

1. Remove the handle trim strips.
2. Attach the handles to the sides of the front panel, using three screws for each handle.
3. Place the new trim strip over the screws on the handles.

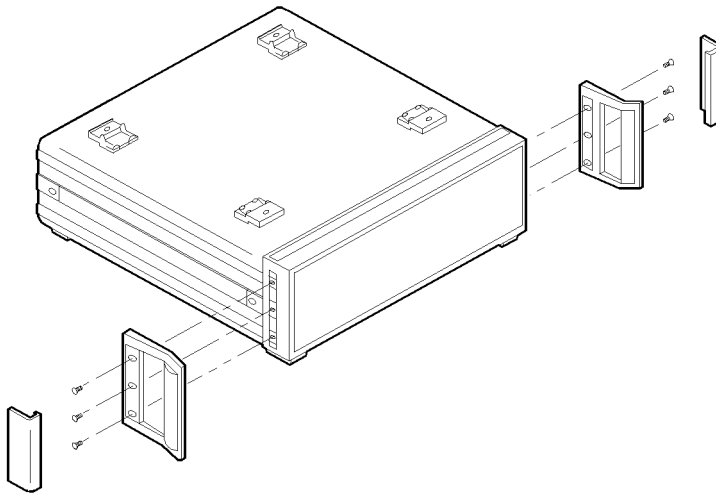

qg420ab

**Figure 1-14. Installation of Front Handles**

**To install the sweeper front handles and rack flange kits**

---

**WARNING**

---

If an instrument handle is damaged, you should replace it immediately. Damaged handles can break while you are moving or lifting the instrument. This may cause damage to the instrument or personal injury.

---

## Checking the Sweeper Operation

This series of procedures allows you to check that your instrument is operating correctly.

- invoking full self-test
- invoking peak power-tracking
- checking maximum level power
- verifying output power

---

### To invoke the full self-tests

**NOTE**

Disconnect any cables that may be attached to the sweeper.

1. Press the following keys:

**PRESET**

**SHIFT** **SPECIAL**

**21** **(Hz/s/ENTER)**

The right portion of the display shows:

Full Test NOTRUN

2. To run the self-tests, press **Hz/s/ENTER** again.

The display shows flashing asterisks as each test is run. When the instrument passes all the tests, the display shows:

```
Full Test PASSED
```

If the instrument fails a test, the display shows the title of the failed test. If the instrument fails more than one test, the test title shown is the most significant failure. Send the instrument to an Agilent Technologies service center for repair, including a description of the failed test and any other error messages.

3. Either press **PRESET** or cycle the AC power after the full self-test is complete.

---

## To invoke peak power-tracking

When you invoke the peak power-tracking, the instrument optimizes its output power over the sweeper's full frequency range by tracking the output filter with the RF source output.

1. Connect a load (attenuator or power sensor) to the RF OUTPUT connector.
2. Press **PRESET** **SHIFT** **PEAK**.

The display shows the progression of the sweep as the instrument adjusts the power-tracking.

---

## To check the maximum-leveled power

1. Press **PRESET**.
2. Press **POWER LEVEL** and enter the specified maximum leveled power for your instrument. (For an 83752B, set the power to the specification for < 2 GHz.)

**Checking the Sweeper Operation**

Instrument	Maximum Leveled Power Specification
83751A/83752A <sup>1</sup>	+ 10 dBm
83751B <sup>1</sup>	17 dBm
83752B <sup>1</sup>	
<2 GHz	+ 16 dBm
≥2 GHz	+ 17 dBm

<sup>1</sup> Option 1E1 (step attenuator), reduce by 1 dB.

3. Press **TIME** **2** **Hz/s/ENTER** to change the sweep time to 2 seconds.
4. Press **TRIG MODE** repeatedly until the display shows:  
Sweep Trig=Single
5. Press **SINGLE TRIG** and watch for the **UNLEV** annunciator in the “Power” window to flash during the sweep.
  - If the annunciator does NOT flash, your instrument’s maximum leveled power is satisfactory.
  - If the annunciator does flash, this indicates the instrument sweep is unlevelled. Contact the nearest Agilent Technologies office or your sales representative.

For 83752B instruments only

The 83752B sweepers have a power specification that is split at 2 GHz.

6. Press the following keys to set a sweep range of 2 GHz to 20 GHz and a power level of 17 dBm:  
**START** **2** **GHz/dB(m)**  
**POWER LEVEL** **17** **GHz/dB(m)**
7. Press **SINGLE TRIG** and watch for the **UNLEV** annunciator to flash during the sweep.
  - If the annunciator does NOT flash, your instrument’s maximum leveled power is satisfactory.
  - If the annunciator does flash, this indicates the instrument sweep is unlevelled. Contact the nearest Agilent Technologies office or your sales representative.

## To verify output power

1. Connect the equipment as shown.

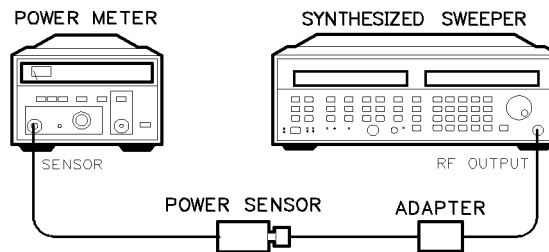

sg418ab

**Figure 1-15. Connections for Verifying Output Power**

2. Press **PRESET**.
3. Press **CW** **20** **(18)** for option 1E1) **GHz/dB(m)**.
4. Press **POWER LEVEL** and enter the specified maximum leveled power for the CW frequency you set. Terminate the power level entry by pressing **GHz/dB(m)**. Refer to the table below for maximum leveled power specifications.

Instrument	Maximum Leveled Power Specification
83751A/83752A <sup>1</sup>	+ 10 dBm
83751B <sup>1</sup>	17 dBm
83752B <sup>1</sup>	
<2 GHz	+ 16 dBm
≥2 GHz	+ 17 dBm

<sup>1</sup> Option 1E1 (step attenuator), reduce by 1 dB.

**Checking the Sweeper Operation**

5. Set the power meter calibration factor to the value listed on the power sensor that corresponds to the frequency you set.
6. Verify that the measured output power meets the instrument specification.
  - If the measured value is less than the specified power, turn the front panel knob until the value measured is at least the specified power level.
  - Watch that the **UNLEV** annunciator doesn't light. (If the annunciator does light, this indicates an unlevelled condition.)
7. Repeat steps 3 through 6 for the following setting(s):
  - 2.5 GHz
  - 1.5 GHz - for 83752A/B instruments only
  - 50 MHz - for 83752A/B instruments only



**Quick Start**

---

## Quick Start

This chapter contains procedures that show you how to utilize basic sweeper functions.

- Continuous Wave (CW) Signal
- Sweep Type
  - Center Frequency (CF)/Span
  - Start/Stop
  - Manual
- Sweep Trigger
  - Continuous
  - Single
  - External
- Sweep Time
- RF Power Level
- Power Sweep
- Power Slope
- Markers
- Save and Recall Instrument States

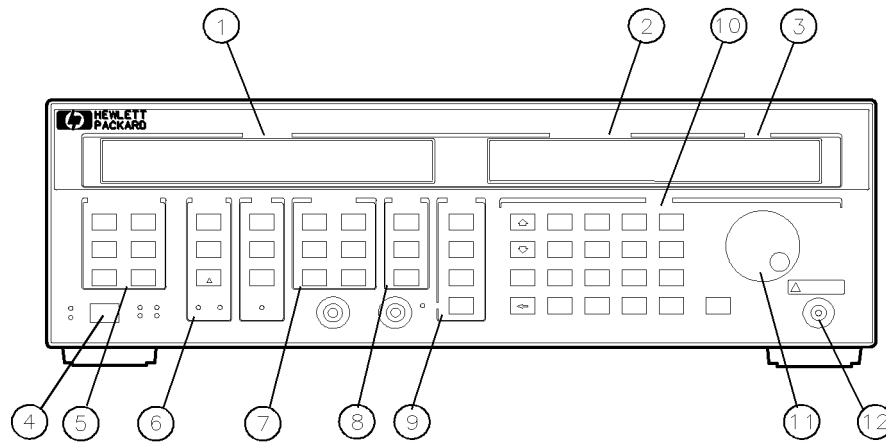

qq410b

**Figure 2-1. 83750 Series Quick Start Overview Locations of Keys for Setting a CW Signal**

- |                               |                     |
|-------------------------------|---------------------|
| 1 FREQUENCY display           | 7 FREQUENCY keys    |
| 2 MARKER/SWEEP/STATUS display | 8 SWEEP keys        |
| 3 POWER display               | 9 POWER keys        |
| 4 line power switch           | 10 ENTRY keys       |
| 5 INSTRUMENT STATE keys       | 11 front panel knob |
| 6 MARKER keys                 | 12 RF OUTPUT        |

---

## To set a CW (continuous wave) signal

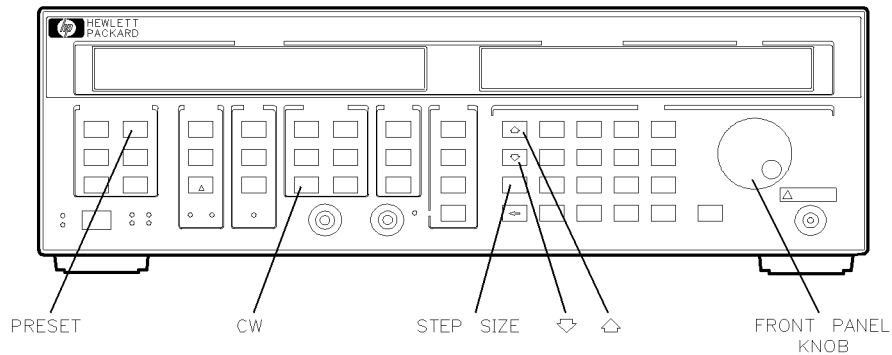

qq42ab

**Figure 2-2. Locations of Keys for Setting a CW Signal**

1. Press **PRESET** **CW** **10** **GHz/dB(m)**.  
The frequency portion of the display shows:  
10.000000000GHz.
2. Press **STEP SIZE** **10** **MHz/μs**.  
The **Marker/Sweep/Status** display shows:  
STEP=10.000000 MHz.
3. Press the **↑** and **↓** keys to change the CW frequency up and down in 10 MHz steps.
4. Turn the front panel knob to change the CW frequency.

---

## To set a CF (center frequency) and span

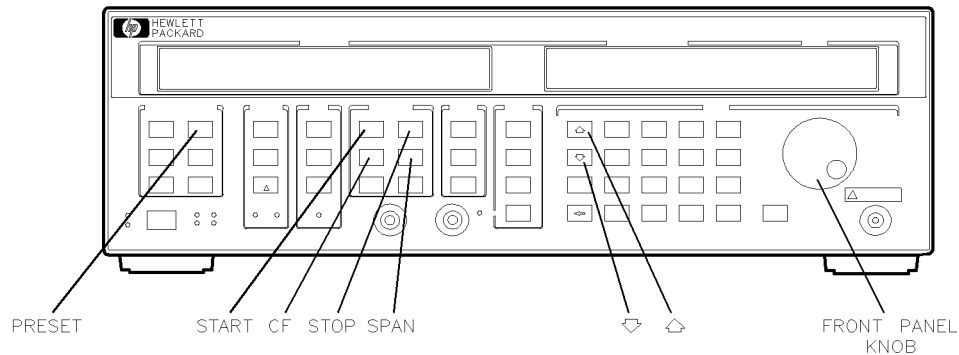

qg43ab

**Figure 2-3. Locations of Keys for Setting a CF and Span**

1. Press **PRESET** **CF** **10** **GHz/dB(m)** to set a center frequency of 10 GHz.
2. Press **SPAN** **2** **GHz/dB(m)**.

The instrument sweeps from 9 GHz to 11 GHz. You can see the frequency values displayed by pressing **START** or **STOP**.

3. Change the frequency span by pressing **SPAN** and either entering a value from the front panel, pressing the **↑** and **↓** keys, or turning the front panel knob.
4. Press **CF** and either turn the front panel knob, press **↑** **↓**, or enter a frequency value to change the center frequency.
5. Press either **START** or **STOP** to see the frequencies that the instrument is now sweeping.

---

## To set a frequency sweep

You can set the instrument to sweep a span of frequencies as wide as the instrument's frequency range (0.01 or 2 GHz to 20 GHz) or as narrow as 0 Hz (swept CW).

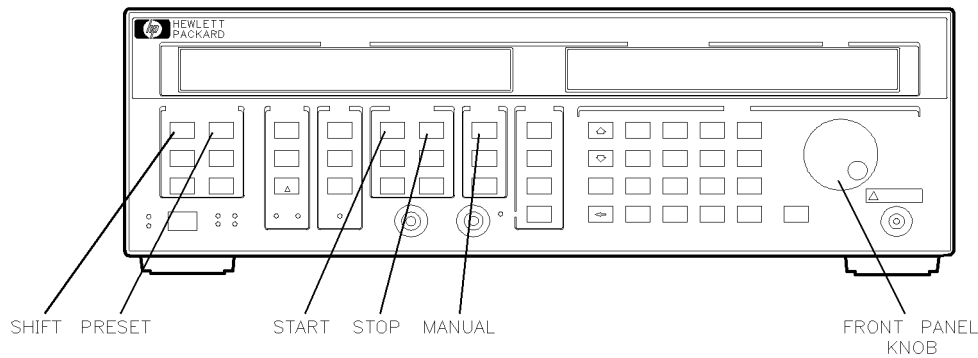

qq44 ab

**Figure 2-4. Locations of Keys for Setting a Frequency Sweep**

Setting the Frequency Range

1. Press **PRESET**.

The **FREQUENCY** portion of the display shows the preset frequency sweep:

For 83751A/B

10.000000MHz    20.000000GHz

For 83572A/B

2.000000GHz    20.000000GHz

2. To set a frequency sweep from 5 to 15 GHz, press:

**START** **5** **GHz/dB(m)**  
**STOP** **15** **GHz/dB(m)**

You could also change the start and stop frequencies by pressing each key (**START** and **STOP**) and turning the front panel knob.

3. You can manually sweep the frequency range that you selected by pressing **SHIFT** **MANUAL** and either turning the front panel knob or pressing the **↑** **↓**.

The **MARKER/SWEEP/STATUS** portion of the display shows the center frequency of the current sweep:

MAN=8.5000000GHz

As you turn the knob, you can view the frequency that corresponds to the sweeper output.

---

## To set the sweep trigger

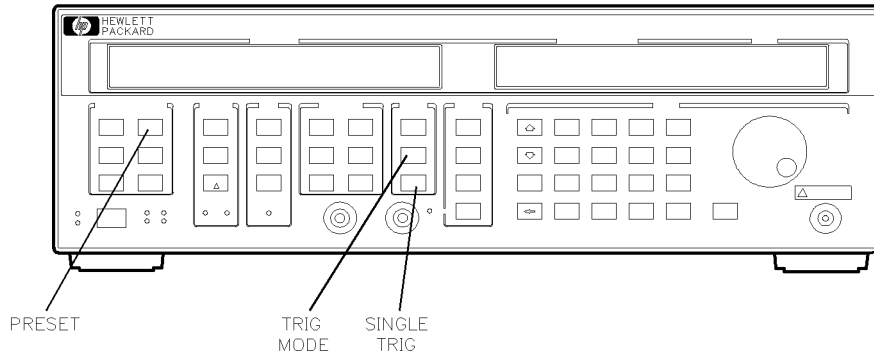

qq45ab

**Figure 2-5. Locations of Keys for Setting the Sweep Trigger**

1. Press **PRESET** **TRIG MODE**.

The **MARKER/SWEEP/STATUS** portion of the display shows:

```
Swp Trig=Cont
```

2. Press **TRIG MODE** or the **↑** **↓** keys repeatedly to scroll through the three choices of sweep trigger (continuous, single, external). You can select the type of trigger by showing it in the display.
  - Select **Swp Trig=Cont** if you want the frequency sweep continuously triggered. That is, a continuous cycle of sweeping and retracing.
  - Select **Swp Trig=Extern** if you want to input a sweep trigger that is generated external to the sweeper. The sweeper external trigger is a TTL input on the rear panel **TRIGGER INPUT** and is active on the rising edge of the signal.
  - Select **Swp Trig=Single** if you want to manually trigger a single sweep by pressing the **SINGLE TRIG** key.



**To set the sweep trigger**

3. Select the single trigger mode by pressing the **(TRIG MODE)** key until the display shows:

Swp Trig=Single

4. Press **(SINGLE TRIG)** to trigger a sweep.

For the instrument to make a new sweep, you must press **(SINGLE TRIG)** again.

During the single trigger mode, the **SWEEP** annunciator in the **FREQUENCY** display is activated through the sweep.

---

## To set the sweep time

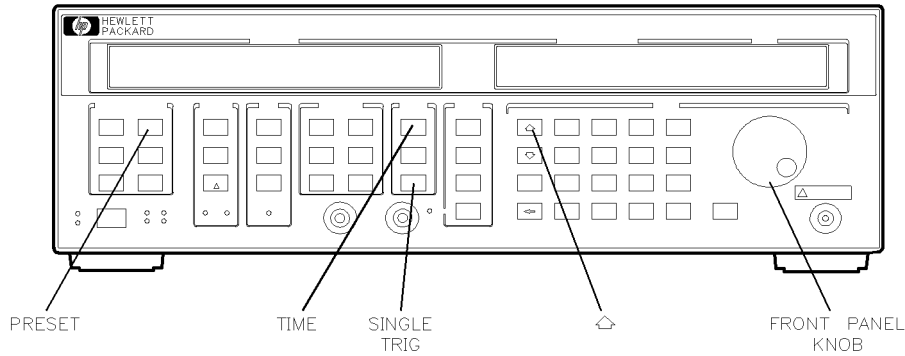

qq46ab

**Figure 2-6. Locations of Keys for Setting the Sweep Time**

1. Press **PRESET** **TIME**.

The **MARKER/SWEEP/STATUS** portion of the display shows the preset sweep time value:

```
SweepTime=50 ms
```

2. Press the **↑** key or turn the front panel knob to change the sweep time.
3. Enter a 2 second sweep time by pressing **2** **Hz/s/ENTER**.
4. Press **SINGLE TRIG** **SINGLE TRIG** to trigger a 2 second sweep.

The **SWEEP** annunciator stays illuminated throughout the 2 second sweep.

---

## To set the output power level

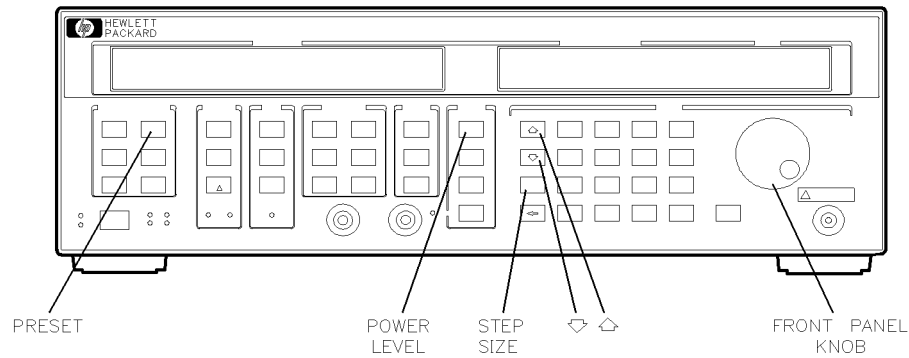

qg47ab

**Figure 2-7. Locations of Keys for Setting the Output Power Level**

1. Press **PRESET**.  
The **POWER** portion of the display shows the preset default power level:  
0.0 dBm.
2. To change the power level to 6 dBm, press **POWER LEVEL** **6** **GHz/dB(m)**.
3. Press **STEP SIZE** **0.5** **GHz/dB(m)**.
4. To change the power level by 0.5 dB, press the **↑** or **↓** key.  
You can also change the power level by turning the front panel knob or entering a power value on the keyboard.

---

## To set a power sweep

The instrument allows you to set a sweep of the output power (positive or negative) in either a frequency sweep or swept CW mode. You can use this feature to input a power sweep to a test device (for example an amplifier or mixer), and watch the device output power for roll-off, indicating compression.

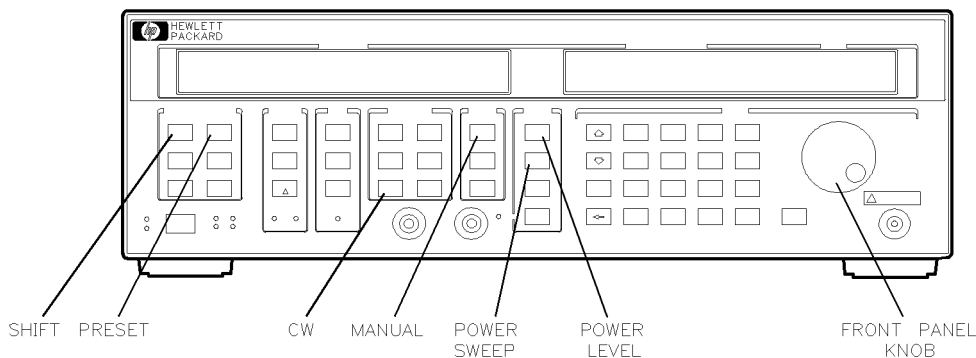

qq48ab

**Figure 2-8. Locations of Keys for Setting the Power Sweep**

1. Press **PRESET** **SHIFT** **SWEPT CW** **POWER SWEEP**.

The righthand display shows:

Pwr. Sweep=0.0 dB 0.0dBm

- The Pwr. Sweep=0.0 dB message indicates how much the power will change through the power sweep.
  - The 0.0 dBm message indicates the sweeper output power level at the start of the power sweep.
2. Turn the front panel knob or press **10** **GHz/dB(m)** to set a 10 dB total power change through the power sweep.

The instrument is sweeping power from 0.0 dBm to 10 dBm.

3. Press **POWER LEVEL** and either turn the front panel knob or press **-2** **(GHz/dB(m))** to set the start of the power sweep to  $-2$  dBm.  
The power sweep is set to start at  $-2$  dBm and sweep up to  $8$  dBm.
4. Press **SHIFT** **MANUAL** and turn the front panel knob to manually sweep the power. Refer to Figure 2-9.

The **MARKER/SWEEP/STATUS** portion of the display shows the output power level progression as you sweep the power.

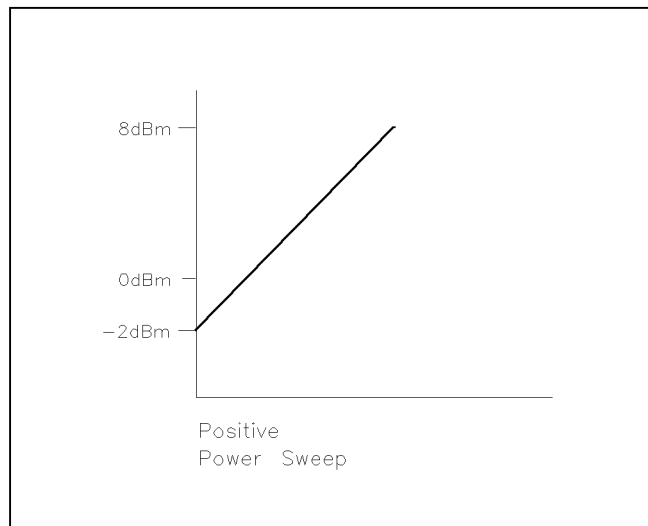

qq49ob

**Figure 2-9. Representation of Example Power Sweep**

---

## To set a power slope

You can set the instrument to compensate for cable losses in a measurement system by using the sweeper's power slope function. This function linearly increases the sweeper output power as the frequency increases.

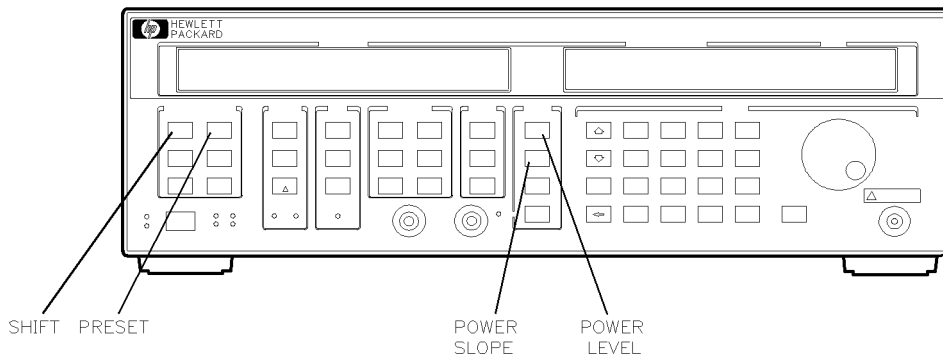

ag410ab

**Figure 2-10. Locations of Keys for Setting a Power Slope**

1. Press **PRESET**.
2. Press **START** **10** **GHz/dB(m)** to set up a frequency sweep from 10 GHz to 20 GHz.
3. Press **SHIFT** **SLOPE** to activate a power slope.

The righthand display shows:

```
Slope=0.00 dB/GHz   0.00 dBm.
```

The Slope=0.0 dB/GHz message indicates the slope is set to change 0 dB per each GHz of RF frequency. The current setting engages a flat slope.

4. Set a slope that changes 0.5 dB for each GHz of RF frequency by pressing **0.5** **GHz/dB(m)**.
5. Set the reference power level to start at -5 dBm by pressing **POWER LEVEL** **-5** **GHz/dB(m)**.

At the beginning of the power slope the power level is at  $-5$  dBm. At the end of the slope, the power level is at  $+5$  dBm. The power slope is always referenced to  $0$  Hz, not the start of the instrument's frequency sweep. Therefore, at the beginning of the  $10$  GHz to  $20$  GHz frequency sweep, the power slope level is  $0$  dBm. Refer to Figure 2-11.

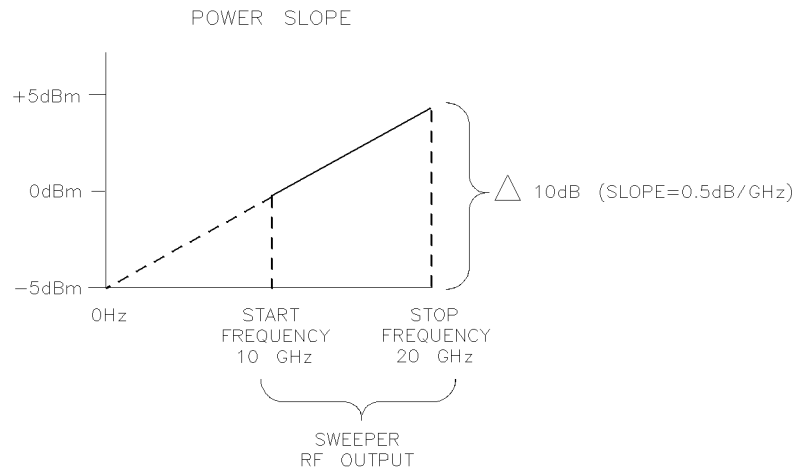

qq411ab

**Figure 2-11. Representation of Example Power Slope**

---

## To set up markers

You can assign up to ten markers (M0 - M9) to various frequencies within the instrument's current sweep range. You can view the markers on an oscilloscope or analyzer screen display.

### NOTE

To display the markers on an oscilloscope, you must connect the sweeper's Z-AXIS BLANK/MKRS to the oscilloscope's POS-Z BLANK. To display the markers on a scalar analyzer, you must connect the system interface between the sweeper and the analyzer.

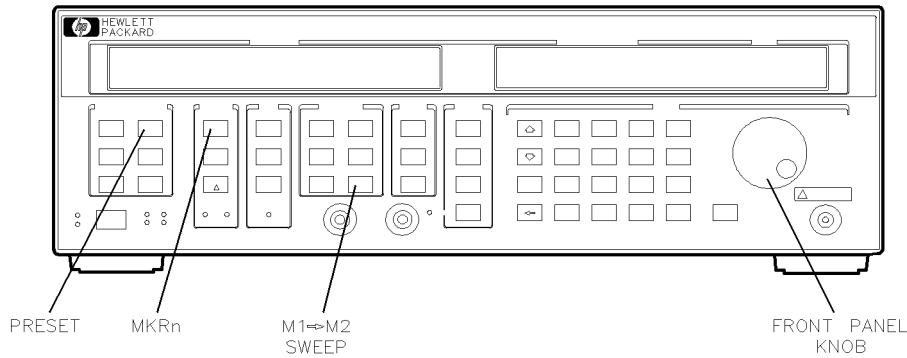

qq412ab

**Figure 2-12. Locations of Keys for Setting Markers**

1. Press **PRESET** **MKR n** **1** to select marker 1.

The **MARKER/SWEEP/STATUS** portion of the display shows:

For 83751A/B

M1= 10.005000GHz



For 83752A/B

M1= 11.0000000GHz

2. Assign marker 1 (M1) to 5 GHz by turning the front panel knob or pressing **5** **GHz/dB(m)**.
3. Press **MKR n** **2** to bring up marker 2.
4. Assign marker 2 (M2) to 15 GHz by turning the front panel knob or pressing **15** **GHz/dB(m)**.

The instrument allows you to assign markers 0 through 9 to various frequencies within the current sweep range.

Defining the Sweep Range  
with Markers

5. Press **M1→M2 SWEEP**.

The instrument is sweeping between the assigned frequencies for marker 1 and marker 2. Therefore the sweep starts at 5 GHz and stops at 15 GHz, as shown in the **FREQUENCY** portion of the display.

6. Press **M1→M2 SWEEP** again.

The instrument toggles between the previous frequency sweep and the sweep designated by markers 1 and 2 each time you press **M1→M2 SWEEP**.

7. Press **MKR n** **3** to bring up marker 3.
8. Press **10** **GHz/dB(m)** to assign marker 3 (M3) to 10 GHz.

Scrolling the Marker  
Settings

9. To change the frequency of the 5 GHz marker to 6 GHz, press **←** and then **↑** repeatedly to scroll through the activated markers and locate the 5 GHz value.
10. Press **Hz/s/ENTER** **6** **GHz/dB(m)** to change marker 1 to 6 GHz.
11. To turn off marker 1, press **OFF**.
12. To turn off the remaining markers, press **SHIFT** **ALL OFF**.

Quick Start

**To set up markers**

13. To reactivate the markers, press:

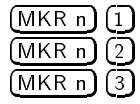

When you reactivate the markers, they appear at the frequencies you previously assigned to them.

---

## To save and recall instrument states

You can save instrument states in storage registers for recalling later and using in other applications.

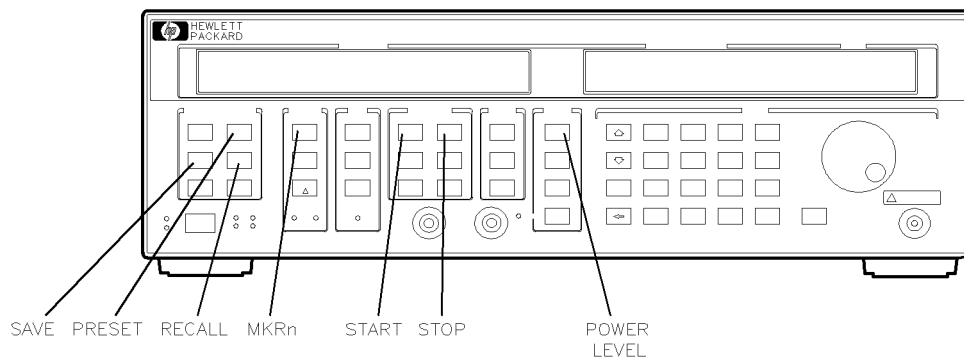

ag413ab

**Figure 2-13. Locations of Keys for Saving and Recalling Instrument States**

1. To set up an example instrument state, press:

PRESET  
START 3 GHz/dB(m)  
STOP 15 GHz/dB(m)  
POWER LEVEL -10 GHz/dB(m)  
MKR n 1  
4.5 GHz/dB(m)  
MKR n 2  
11.2 GHz/dB(m)

2. Save the instrument state to register 1 by pressing (SAVE) (1).

**To save and recall instrument states**

3. Verify that the instrument state was saved to register 1 by pressing **PRESET** **RECALL** **1**.

The display shows:

```
3.0000000 GHz  15.000000 GHz  RECALL Reg=1  -10.0dBm
```

The markers annunciator indicates that at least one marker is active.

4. Press **MKRn** **1** to view the frequency assigned to marker 1.
5. Press **MKRn** **2** to view the frequency assigned to marker 2.

You can save instrument states in registers 1 through 9.