

HP 85025C DETECTOR ADAPTER

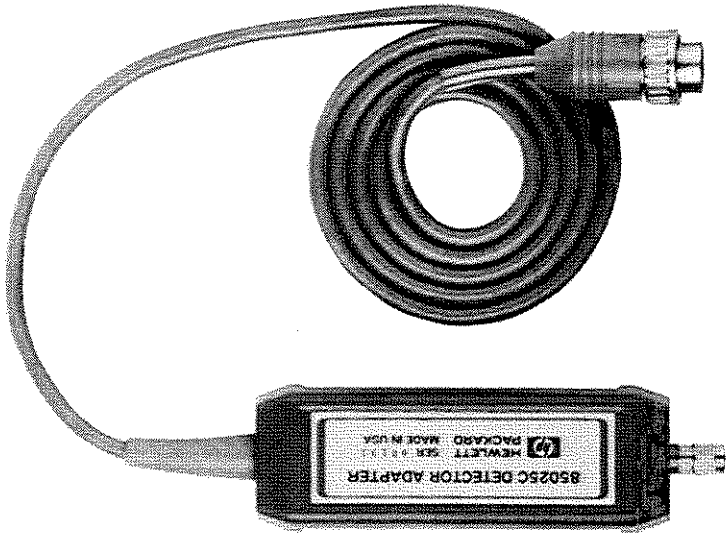

WARRANTY

This Hewlett-Packard instrument product is warranted against defects in material and workmanship for a period of one year from date of shipment. During the warranty period, Hewlett-Packard Company will, at its option, either repair or replace products which prove to be defective.

For warranty service or repair, this product must be returned to a service facility designated by HP. Buyer shall prepay shipping charges to HP and HP shall pay shipping charges to return the product to Buyer. However, Buyer shall pay all shipping charges, duties, and taxes for products returned to HP from another country.

HP warrants that its software and firmware designated by HP for use with an instrument will execute its programming instructions when properly installed on that instrument. HP does not warrant that the operation of the instrument, or software, or firmware will be uninterrupted or error free.

LIMITATION OF WARRANTY

The foregoing warranty shall not apply to defects resulting from improper handling by Buyer, Buyer-supplied software or interfacing, unauthorized modification or misuse, or operation outside of the environmental specifications for the product.

NO OTHER WARRANTY IS EXPRESSED OR IMPLIED, HP SPECIFICALLY DISCLAIMS THE IMPLIED WARRANTIES OR MERCHANTABILITY AND FITNESS FOR A PARTICULAR PURPOSE.

EXCLUSIVE REMEDIES

THE REMEDIES PROVIDED HEREIN ARE BUYER'S SOLE AND EXCLUSIVE REMEDIES, HP SHALL NOT BE LIABLE FOR ANY DIRECT, INDIRECT, INCIDENTAL, SPECIAL, INCIDENTAL, OR CONSEQUENTIAL DAMAGES, WHETHER BASED ON CONTRACT, TORT, OR ANY OTHER LEGAL THEORY.

ASSISTANCE

Product maintenance agreements and other customer assistance agreements are available for Hewlett-Packard Products.

For any assistance, contact your nearest Hewlett-Packard Sales and Service Office. Addresses are provided at the back of this manual.



MANUAL PART NUMBER 85025-90003
Microfiche Part Number 85025-90004

Printed: NOVEMBER 1985

© Copyright
HEWLETT-PACKARD COMPANY
1400 FOUNTAIN GROVE PARKWAY, SANTA ROSA, CA 95401 U.S.A.
1985

This manual applies directly to HP 85025C detector
adapters with serial number 00100 and above.
For additional information concerning serial numbers,
refer to INSTRUMENTS COVERED BY THIS
MANUAL, in General Information.

SERIAL NUMBERS

**HP 85025C
DETECTOR ADAPTER**

TABLE OF CONTENTS

PAGE

GENERAL INFORMATION

Introduction 1

Safety Considerations 1

General 1

Safety Symbols 1

Description 1

Typical Operating Characteristics 1

Performance 1

Instruments Covered by This Manual 2

Accessories 2

Equipment Required but Not Supplied 2

Recommended Test Equipment 2

Initial Inspection 3

Preparation for Use 4

Power Requirements 4

Detector Lead Identification 4

Mating Connector 4

Connecting the HP 85025C 5

Operating Environment 5

Storage and Shipment 6

Packaging 6

Returning Instrument for Service 6

Ordering Manual/Microfiche 7

OPERATION

Introduction 1

Features 1

Operating Precautions 1

Operator's Check 2

Operating Theory 3

Detector Adapter 3

Diode Detector 3

Detection Modes 5

AC Detection Mode 5

DC Detection Mode 5

Pre-Measurement Steps 6

External Detector Measurement Calibration 6

AC vs DC Measurement Calibration 8

Changing a Stored Measurement Calibration 8

Uncalibrated Operation 8

DC Detection 10

Zeroing 10

Coarse Zero 10

Autozero 11

OPERATOR'S CHECK

Introduction 1

Noise Floor Measurement 2

Dynamic Accuracy Procedure 4

ADJUSTMENTS

Introduction 1

Cover Removal Procedure 2

Adjustment Procedure 3

SERVICE

Introduction 1

Theory of Operation 1

Connector Inspection 3

Troubleshooting 5

To Access the Circuit Board 5

Cable Continuity Check 5

Supply Check 6

Buffer Amplifier Check 7

Mode Line Check 7

Preamplifier/Clock Check 8

Power Cable Replacement 8

Replaceable Parts 13

Introduction : 13

Ordering Instructions 13

Figure 1. HP 85025C and Accessories Supplied

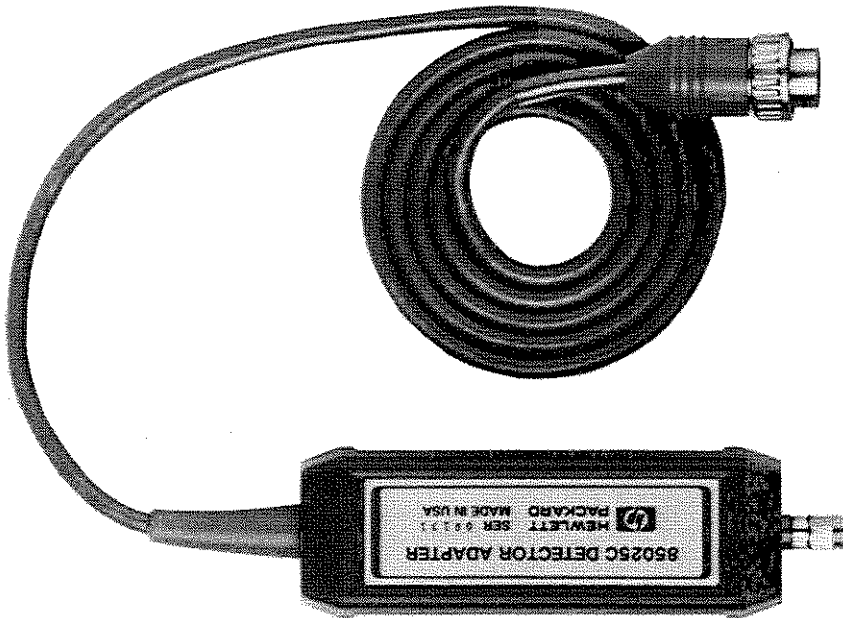

**HP 85025C
DETECTOR ADAPTER**

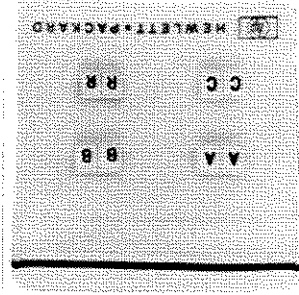

CABLE MARKER KIT
(HP Part No. 5061-1044)

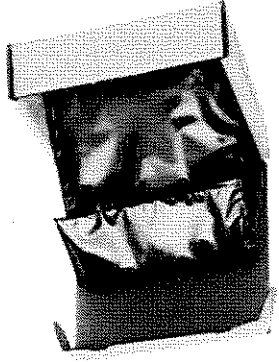

**PACKAGING POUCH
AND CARTON**
(HP Part No. 9211-4917)

ALIGNMENT TOOL
(HP Part No. 8710-1300)



GENERAL INFORMATION

INTRODUCTION

This manual contains information required to operate, test and service the Hewlett-Packard 85025C detector adapter. Figure 1 shows the instrument and the accessories that are supplied with it.

Operating information is provided under the major heading OPERATION. OPERATOR'S VERIFICATION contains instructions for verifying that your detector adapter is operating correctly. HP 85025C adjustments are under the heading ADJUSTMENTS, and repair information is under the heading SERVICE.

SAFETY CONSIDERATIONS

General

Read this manual to become familiar with all safety instructions before you use the HP 85025C detector adapter. This product was designed and tested in accordance with international standards.

Safety Symbols

WARNING This indicates a personal hazard. **WARNING** calls attention to a procedure, practice, etc., that, if not performed correctly, can cause personal injury. Do not continue past a **WARNING** until you fully understand and meet the stated conditions.

CAUTION This indicates a mechanical hazard. **CAUTION** calls attention to an operating procedure, practice, etc., that, if not correctly performed or adhered to, can cause damage to (or destruction of) part or all of the instrument. Do not continue past a **CAUTION** until you fully understand and meet the stated conditions.

DESCRIPTION

The HP 85025C detector adapter is used to adapt any standard diode detector output for display on the HP 8757A scalar network analyzer (it is NOT compatible with the HP 8755C or 8756A scalar network analyzers). The detector adapter enables the analyzer to measure either modulated (AC) or unmodulated (DC) test signals. The ability to use a standard diode detector extends the frequency range of the HP 8757A to that of the detector used.

TYPICAL OPERATING CHARACTERISTICS

Table 1 lists the HP 85025C typical operating characteristics.

PERFORMANCE

Figure 2 shows an example of HP 85025C performance with an HP U422A detector.

INSTRUMENTS COVERED BY THIS MANUAL

Each HP 85025C detector adapters has a unique serial number. This manual applies to instruments with serial number 100 and above.

A detector adapter manufactured after the printing of this manual may require a manual changes supplement to document instrument change information. When applicable, the supplement is included with the instrument manual. In addition to change information, the supplement contains information that applies to all instruments, regardless of their serial number.

To keep this manual as current as possible, you should periodically request the latest manual changes supplement. The supplement for this manual is keyed to its print date and part number, which appear on the title page. Complementary copies of the supplement are available from your local Hewlett-Packard office.

ACCESSORIES

The following accessories are available for the HP 85025C:
HP 11679A, 7.6 metre (25 foot) extension cable.
HP 11679B, 61 metre (200 foot) extension cable.

To order these accessories, refer to ORDERING PARTS under the major heading SERVICE.

EQUIPMENT REQUIRED BUT NOT SUPPLIED

To make reflection and transmission measurements you will need:

1. One or more separate (zero biased, crystal, silicon or gallium arsenide) detectors (e.g. HP 422 series).
2. One HP 85025C for each detector.
3. One connector adapter (if required) for each detector (see Table 2).
4. An HP 8757A scalar network analyzer (firmware revision 2.0, or later. A firmware update kit is available; order HP P/N 08757-60051).
5. A source covering the frequency range of the detector(s) used.
6. For AC mode only: Either the source must be capable of 27.778 KHz squarewave amplitude modulation or, if the RF source cannot provide the modulated signal directly, you must use an external modulator (e.g. HP 11655B) that squarewave modulates the RF signal.
7. A dual directional coupler (or two single directional couplers) or a directional bridge.

RECOMMENDED TEST EQUIPMENT

The equipment required for testing the HP 85025C is listed in Table 3. Other equipment may be substituted if it meets or exceeds the critical specifications indicated in the table.

Dynamic Range:	Function of the external detector.
Maximum Input Voltage:	DC: $\pm 10V$; AC: 10V peak-to-peak.
Dimensions:	Cable length is 1.22 m (48 in).
Weight:	Net 0.24 kg (0.5 lb); Shipping 1.0 kg (2.2 lb).
Maximum Measurable Input Voltage:	DC: $\pm 3V$; AC: 3V peak-to-peak.

Table 1. Typical Operating Characteristics

Also, notify the carrier if the shipping container is damaged or if the cushioning material shows signs of stress. Keep all shipping materials for the carrier's inspection. Hewlett-Packard will arrange for repair or replacement without waiting for a claim settlement.

- * There is mechanical damage or defect.
- * The shipping contents are incomplete.
- * The instrument does not pass the operator's verification and the procedures under SERVICE do not correct the problem.

Notify your nearest Hewlett-Packard office if any of the following conditions exist:

3. Test the detector adapter electrically. Refer to OPERATOR'S VERIFICATION in this manual.
2. Check connector, cable and body for mechanical damage.

1. Check the package for completeness. Figure 1 shows the items you should receive.

If the shipping container or cushioning material is damaged, keep it until the contents of the shipment are checked for completeness, and the instrument is checked both mechanically and electrically.

INITIAL INSPECTION

* Be sure that all connectors are clean and undamaged. A mechanically defective connector makes low power level readings unstable; the analyzer trace jumps around when the connector is touched or moved.

The HP 85025C input connector is an SMA male type. This connector should mate directly with most detector output connectors; for best performance, the detector adapter should be connected directly to the detector. If, however, the detector you are using does not mate directly with the HP 85025C, an adapter can be used (see Table 2), but you must be aware that several factors can effect the performance of your instrument:

Mating Connector

Use the furnished coded cable clips (cable marker kit) to identify leads when you use two or more detector adapters. Place matching clips on both ends of the same detector cable.

Detector Lead Identification

Power for the detector adapter is supplied by the HP 8757A scalar network analyzer. Each detector requires approximately 0.5 watt.

Power Requirements

The detector adapter is susceptible to damage from static discharge.

CAUTION

PREPARATION FOR USE

Figure 2. Example of HP 85025C Performance with an HP U422A Detector

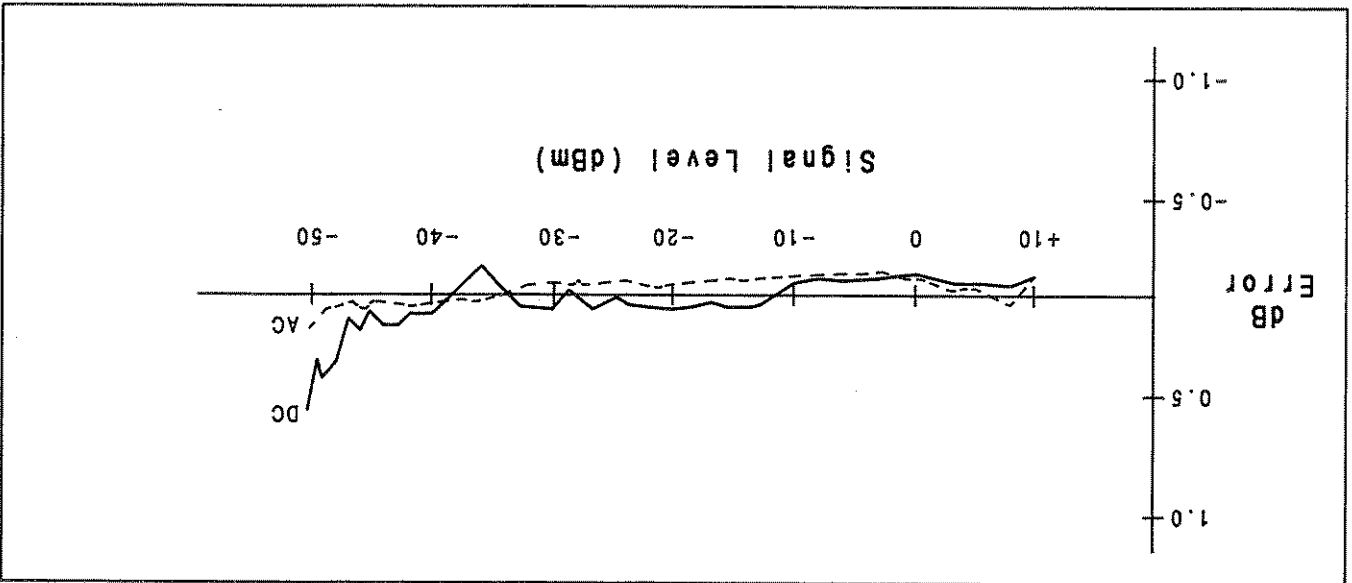

Provide protection from temperature extremes. Condensation may occur within the instrument if it is exposed to temperature extremes or to higher humidity levels.

Altitude: Up to 7,620m (25,000 ft).
 Humidity: Up to 95%.
 Temperature: 0° to +55°C

The HP 85025C detector adapter operates within the following environmental limits:

OPERATING ENVIRONMENT

1. Connect the detector adapter to the detector by turning the male connector OUTER shell clockwise.
2. Insert the multi-pin connector into the HP 8757A mating connector. The HP 85025C connector is keyed; insert the plug with the key downward.
3. Secure the multi-pin connector in the analyzer by turning the OUTER shell clockwise.
3. Connect the RF input by turning the male connector OUTER shell clockwise.

Connect the detector adapter to the HP 8757A as follows:

Connecting the HP 85025C

CONNECTOR TYPE	CONNECTOR MFR.	PART NUMBER
SMA female	None Required	
BNC male	Sealctro Omni Spectra	050-674-6800-89 3282-2240-00
SMC male	Omni Spectra	5082-2240-00

Table 2. Adapters

- a. Cause errors in DC mode at low power levels, due to loss through the cable.
- b. Slow the AC response of the diode detector, due to capacitance in the cable.

* Putting a length of coaxial cable between the detector and the HP 85025C can:

STORAGE AND SHIPMENT

The instrument may be stored or shipped in environments within the following limits:

Temperature: -25° to +75°C

Humidity: Up to 95%.

Altitude: Up to 7,620m (25,000 ft).

Provide protection from temperature extremes, which can cause condensation within the instrument.

Packaging

Containers and materials identical to those used in factory packaging are available through your Hewlett-Packard office. If, however, you choose to package the instrument with commercially available materials, follow these instructions:

1. Wrap the instrument in heavy paper.

2. Use a strong shipping container. A double-wall carton made of 159-kg (350-lb) test material is adequate.

3. Use shock-absorbing material, a 76 to 102 mm (3 to 4 in) layer, around all sides of the instrument to provide a firm cushion and to prevent movement inside the container.

4. Seal the shipping container securely.

5. Mark the shipping container **FRAGILE**.

Returning Instrument for Service

If you ship the instrument to a Hewlett-Packard office or service center, please include the following information:

1. Your company name and address.

2. The technical contact person within your company, and their complete phone number.

3. The complete model and serial number of the instrument.

4. The type of service required.

5. Any other information that may expedite service.

When making inquiries, either by correspondence or by telephone, please refer to the instrument by model number and full serial number.

ORDERING MANUAL/MICROFICHE

On the title page of this manual is a manual part number and a microfiche part number. Both can be used to order extra copies of this manual. Microfiche are 10 X 15 cm (4 X 6 in) microfilm transparencies. Each microfiche contains reduced photocopies of the manual pages. Also included in the microfiche package are the latest manual changes supplement and pertinent service notes. The manual part number also appears on the back cover, in the lower left hand corner.

Table 3. Recommended Test Equipment

INSTRUMENT	CRITICAL SPECIFICATIONS	RECOMMENDED MODEL	USE*
Network Analyzer	85025C AC/DC compatible	HP 8757A with rev. 2.0 firmware	0,A,S
RF Source	8757A compatible	HP 8350B with RF plug-in	0,A
Oscilloscope	Bandwidth: DC to 28 KHz	HP 1740A	S
Digital Voltmeter	Accuracy: $\pm 0.01\%$ Input Impedance $\geq 10M$ ohms	HP 3456A	A,S
DC Power Supply	Accuracy: $\pm 0.3\%$	HP 6212B	A,S
Step Attenuator	0 to 70 dB in 10 dB steps	HP 8495A	0
Detector	Low Barrier (Zero Bias)	HP 8470B	0
Phillips Screwdriver	Size 0 Point	HP 8710-0978	S
Wrench	1/2 X 7/16 inch hex nut	HP 8720-0009	S
Adjustment Tool	Fits adjustment potentiometers	HP 8710-1300	A
Short		HP 0960-0054	A

*0=Operator's Check A=Adjustments S=Service

OPERATION

CAUTION

The HP 85025C detector adapter is susceptible to electrostatic discharge (ESD) as low as 5,000 volts. ESD can reach 20,000 volts or more before you even notice it.

Materials conducive to static build-up include carpeting, nylon, dry air, paper adhesive tape, styrofoam and vinyl.

The best method of preventing ESD is to wear a grounding strap connected to a conductive bench mat that provides a path to ground of between 1 and 2.5M ohms. Alternatively, you can ground yourself by touching any grounded instrument before touching the detector connector.

Whenever possible, turn the source and the HP 8757A off when connecting or disconnecting a cable to the detector, the detector to the detector adapter, or the HP 85025C to the scalar network analyzer.

As an extra precaution, discharge both the cable and the detector adapter by grounding the center conductor of each to its outer conductor before connecting either one to the detector.

NEVER touch the detector or the HP 85025C center contacts.

INTRODUCTION

This section contains information concerning the operation of the HP 85025C detector adapter.

FEATURES

Figure 1 details the features of the HP 85025C.

OPERATING PRECAUTIONS

Ensure that your HP 8757A firmware is revision 2.0 or greater.

Read and observe all CAUTIONS.

Tighten the HP 85025C connectors with fingers only.

DO NOT use a wrench unless it is a torque wrench set at 9.2 cm/kg (8 in/lb).

A procedure for verifying the operation of the detector adapter is included in this manual under the heading OPERATOR'S CHECK. The operator's check provides reasonable assurance that the scalar network analyzer, detector, and the HP 85025C detector adapter are functioning properly. This procedure should meet the needs of an incoming inspection.

OPERATOR'S CHECK

Before you connect a cable to the diode detector, always short the cable's center conductor to instrument ground. Do NOT apply more than ± 10 volts DC or 10 volts peak-to-peak to the HP 85025C, or electrical damage can occur.

Do NOT apply more than 9.2 cm/kg (8 in/lb) of torque when tightening the connectors. Greater surface torque may deform the mating surface.

CAUTION

Figure 1. HP 85025C Features

1. **RF INPUT CONNECTOR.** This connector (SMA male) accepts the RF signal from the diode detector.
2. **COARSE DC ZERO.** This adjustment compensates for any large offset voltage.
3. **MULTI-PIN CONNECTOR.** This connector supplies the necessary DC voltage for the operation of the HP 85025C, and feeds the detector adapter output signal to the network analyzer.

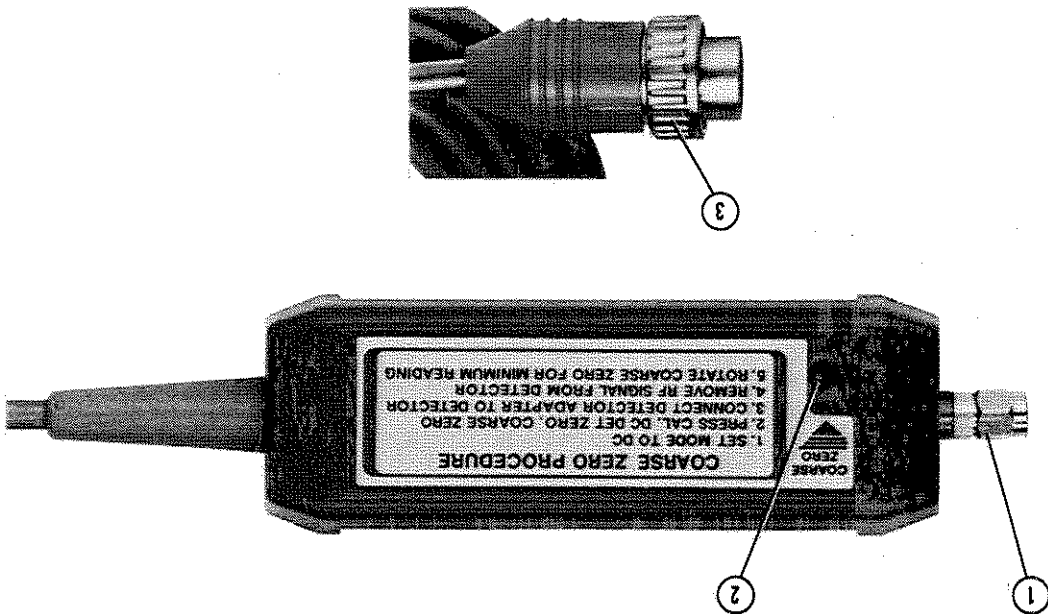

OPERATING THEORY

Detector Adapter

The HP 85025C adapts the output of a diode detector whose input is either an unmodulated RF signal (DC mode) or a squarewave amplitude modulated RF signal (AC mode) so that it can be displayed on the HP 8757A scalar network analyzer. In either AC or DC detection mode, the detector adapter provides a 27.778 KHz squarewave signal for the analyzer to interpret and display.

In AC detection, an RF or microwave signal is amplitude modulated with a 27.778 KHz squarewave. The detector used with the HP 85025C demodulates (envelope detects) the signal to produce a 27.778 KHz squarewave whose peak-to-peak voltage corresponds to the magnitude of the RF signal at the detector input. This signal passes to the analyzer, amplified by the detector adapter.

In the DC mode, no modulation is required. The detector diode converts the RF signal to an equivalent DC voltage that the HP 85025C detector adapter chops at a 27.778 KHz rate. This chopped signal is amplified, and passed to the analyzer.

Diode Detector

Diode detectors have three separate types (regions) of response to an input signal (see Figure 2). Using Figure 2, when an input signal is below A dbm, the diode is operating in the Square Law region. In this region, the output voltage is proportional to the square of the input voltage. When an input signal is between A and B dbm, the diode is operating in the Transition region. As the name implies, this region provides a smooth transition between the other two regions.

When an input signal is above B dbm, the diode is operating in the Linear region. In this region, the output voltage is proportional to the input voltage.

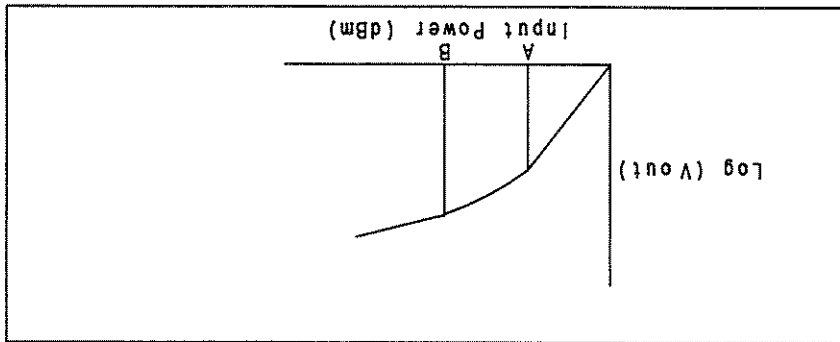

Figure 2. Response of a Typical Diode Detector

This is a general description of diode detector response. The exact values of A and B are determined by the diode detector you use.

MEASUREMENT SYSTEM CONFIGURATION

Figure 3. HP 85025C/8757A Typical Coaxial Measurement Setup

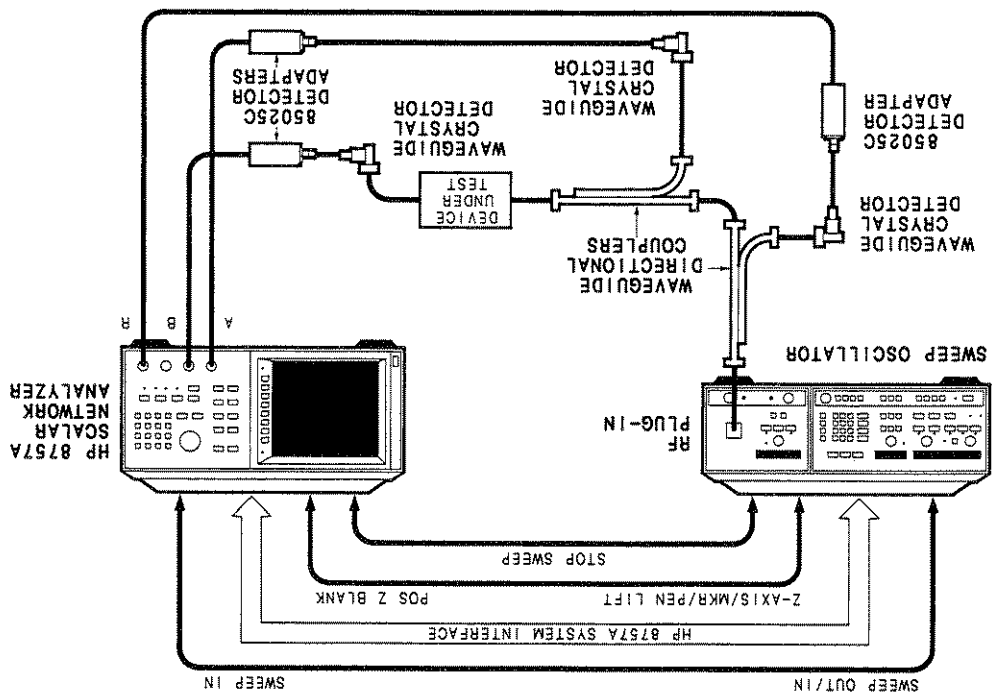
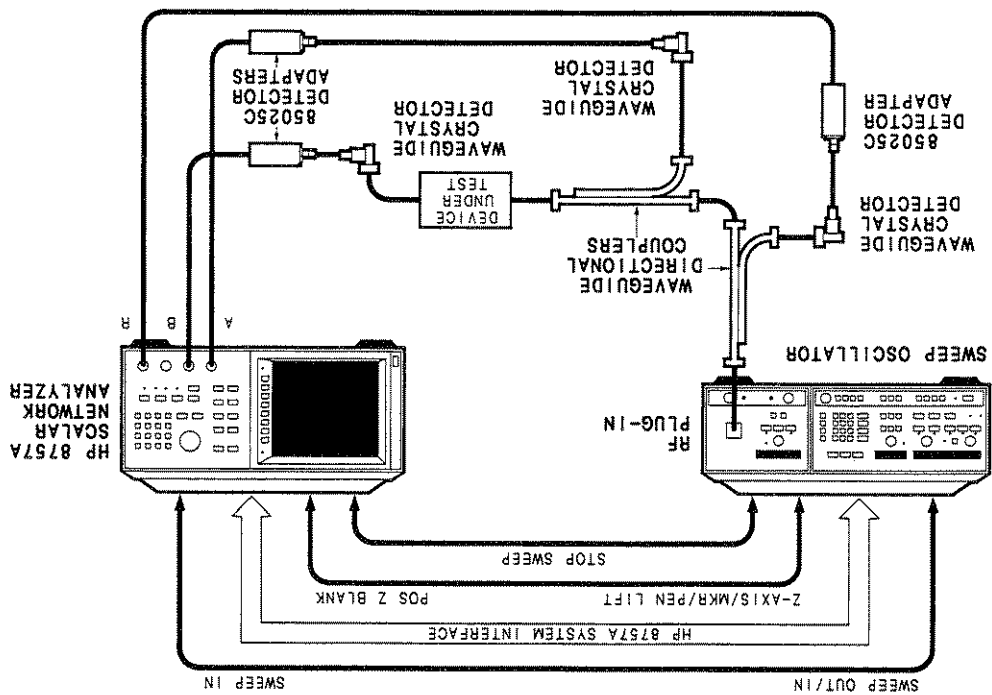

Figure 4. HP 85025C/8757A Typical Waveguide Measurement Setup



DETECTION MODES

With the HP 8757A and 85025C, you must pay special attention to system configuration. The PRESET state of the analyzer is AC mode; you do not need to do anything special to make an AC measurement. To enable DC mode operation, however, you must perform the proper analyzer keystroke sequence.

Note: To make DC mode measurements with the measurement set up shown in Figure 3, you must use a directional bridge capable of both AC and DC detection (HP 85027A/B/C).

Because the HP 85025C is used with an external (separate) detector, whether you select AC or DC detection, you should perform a firmware based measurement calibration procedure. This procedure (External Detector Measurement Calibration) adapts the analyzer's dynamic range to each detector/detector adapter. You should perform this procedure whenever you connect a detector/detector adapter to a different input than the one on which it was calibrated, or if you change either the detector or the detector adapter.

AC Detection Mode

You do not have to set AC detection on the analyzer unless DC mode was used in the previous measurement (even if the HP 8757A is turned off, it remembers the measurement mode). If the last measurement was in DC mode, press [SYSTEM] and select [MODE AC/DC] to turn AC mode on (AC lights). You can also press [PRESET] to set the AC detection mode; AC detection is automatically set when the analyzer presets.

For the majority of measurements, AC detection is the preferred method. It offers greater sensitivity and immunity to noise and drift with time and temperature. AC detection amplitude measurements using the HP 85025C detector adapter and the HP 8757A scalar network analyzer require a modulation envelope. This envelope is provided through a 27.778 KHz squarewave amplitude modulation of the RF test signal. Test set connections depend on the source; Figures 2 and 3 illustrate typical measurement setups.

DC Detection Mode

DC detection offers greater power measurement accuracy and ability to characterize oscillators and modulation sensitive devices. To use DC detection, you must first set the DC measurement mode on the HP 8757A. There is also a zeroing operation in DC mode that compensates for the effects of DC drift and temperature fluctuations.

PRE-MEASUREMENT STEPS

Before you make measurements with the HP 85025C detector adapter, there are several steps to perform, depending on the measurement mode that you use. In either AC or DC mode, you should perform an external detector measurement calibration the first time that you use a detector/detector adapter on a given analyzer input. There are no further pre-measurement steps for subsequent measurements in AC mode. In DC mode, however, you should periodically perform the zeroing function.

External Detector Measurement Calibration

Because you use an external (separate) detector with the HP 85025C, you must perform the firmware based measurement calibration procedure to accurately characterize the diode detector's dynamic response.

The response of output voltage versus input power (see Diode Detector under OPERATING THEORY) is described by a general equation within the HP 8757A. To adapt this equation to describe your particular detector, the analyzer uses data measured at two points on the detector's response.

The External Detector Measurement Calibration requires that you measure two different power levels (HI and LO) and that you enter the exact values of the power levels via the analyzer keypad. For best results, the HI power level should be in the diode detector's linear region of operation, and the LO power level should be in its square law region.

The power levels +6 and -24 dbm used in the following procedure are simply examples. The power levels you choose depend on the response of your diode detector, and the output power of your source.

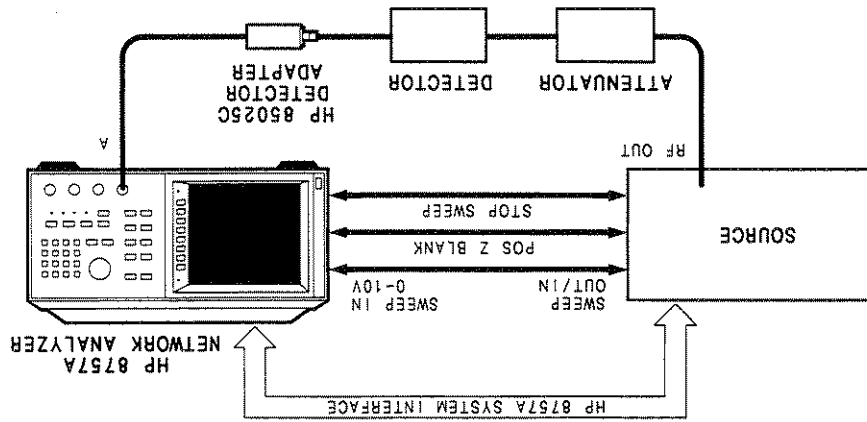

Figure 5. External Detector Measurement Calibration Set Up

1. Connect the equipment as shown in Figure 5. Allow 30 minutes warm up.
On the HP 8757A:
2. Press [PRESET].
3. If you will be using DC detection, press [SYSTEM] and select [MODE AC/DC]. If you will be using AC detection, continue with Step 4.
- NOTE:** A measurement calibration in one mode is not valid for the other (see AC vs DC Measurement Calibration below).
4. Press [CAL]. Select [MORE] then [EXT DET CAL].
5. Select [DET PMR CAL].
6. Select [DET A], or the appropriate input.
If you are using AC detection, the analyzer displays ENTER POWER (HI). Go to Step 9.
If you are using DC detection, the analyzer displays Adjust COARSE ZERO for minimum response.
- On the HP 85025C:
7. Adjust COARSE ZERO (AIR23) for a minimum signal on the analyzer.
On the HP 8757A:
8. Select [CONT].
The analyzer displays ENTER POWER (HI).
On the source:
9. Select a CW frequency within the detector's range.
10. Set the power to a level in the detector's square law region greater than -10 dbm (e.g. +6 dbm). For best accuracy, use a power meter to set the power level.
- On the HP 8757A:
11. Enter the power level incident on the detector (e.g. 6 dbm).
The analyzer displays ENTER POWER (LO).
12. Set the attenuator so that the power to the detector is in the square law region, and less than -20 dbm (e.g. 30 db of attenuation).
13. Enter the power level incident on the detector (e.g. -24 dbm).
The analyzer performs the external detector measurement calibration and displays the DET X CAL VAL when it is finished. Record this value for future reference (on the detector/detector adapter, if possible).

If you change the detector or the detector adapter, you must perform a new measurement calibration.

The displayed value is retained by the analyzer as long as an HP 85025C is connected to that input. If another detector/detector adapter is connected to the same input, the analyzer uses the first measurement calibration value until you perform a new measurement calibration.

You can bypass the measurement calibration procedure if you select the softkey [CAL VALUE] rather than [DET PWR CAL] in the measurement calibration sequence, and enter the known value for your detector/detector adapter.

AC vs DC Measurement Calibration. A measurement calibration performed in one measurement mode may not be valid in the other mode. For the best measurement accuracy, perform a measurement calibration in the mode you will be using.

The difference between an AC and a DC mode measurement calibration depends on the detector you use. All detectors do not respond the same to a given input signal: some respond very quickly, while others respond more slowly.

A detector that responds very quickly produces an output signal that has the same amplitude in either AC or DC mode.

A detector that responds more slowly, however, produces an output signal that is smaller in amplitude in AC mode than in DC. Because the signal amplitude is not the same in both measurement modes, a power calibration done in one is not valid in the other.

Changing a Stored Measurement Calibration. When you perform the measurement calibration procedure, the analyzer stores the calibration value. The analyzer keeps that value until you change it. You can change a calibration value in any of three ways:

* Perform an external detector measurement calibration with a new detector/detector adapter. The new calibration value replaces the original.

* Enter a known calibration value manually: press [CAL], [MORE], [EXT DET CAL], [CAL VALUE], [DET A] (or the appropriate input). The analyzer displays DET A CAL VAL and the value stored for that input.

Enter the value you wish stored for that input and press [ENT]. The analyzer displays DET A CAL VAL and the new value.

* Use the default calibration value that is stored in the analyzer (see Uncalibrated Operation below).

Only one measurement calibration value is stored at one time for each input; the analyzer does not keep separate AC and DC calibration values.

Uncalibrated Operation. When you are making relative measurements at low power levels (in the diode detector's square law region), you don't have to perform a measurement calibration. The analyzer has a default calibration value that describes the response of a typical detector/detector adapter (see Figure 6).

As you increase the attenuation, the analyzer continues to accurately indicate the amount of attenuation. The accuracy will degrade as the input signal level approaches the diode detector's noise floor. For higher power levels, the accuracy of the displayed signal level depends on the diode detector used.

4. Add 10 dB of attenuation to the input signal. The analyzer displays -10 dB.
3. Press [DISPLAY], [MEAS->MEM], [MEAS-MEM]. The HP 8757A displays 0 dB (not dbm).

On the HP 8757A:

2. Connect the detector/detector adapter to a signal below -15 dbm.
1. Connect the detector/detector adapter to the HP 8757A and set the analyzer default calibration value.

Example for a diode detector with a square law region below -15 dbm:

Press [CAL], [MORE], [EXT DET CAL], [CAL VALUE], [DET A] (or the appropriate input) [RESET CAL VAL]. The analyzer displays DET A CAL VAL and the stored default value.

To set the default value:

Figure 6. Default Response Curve

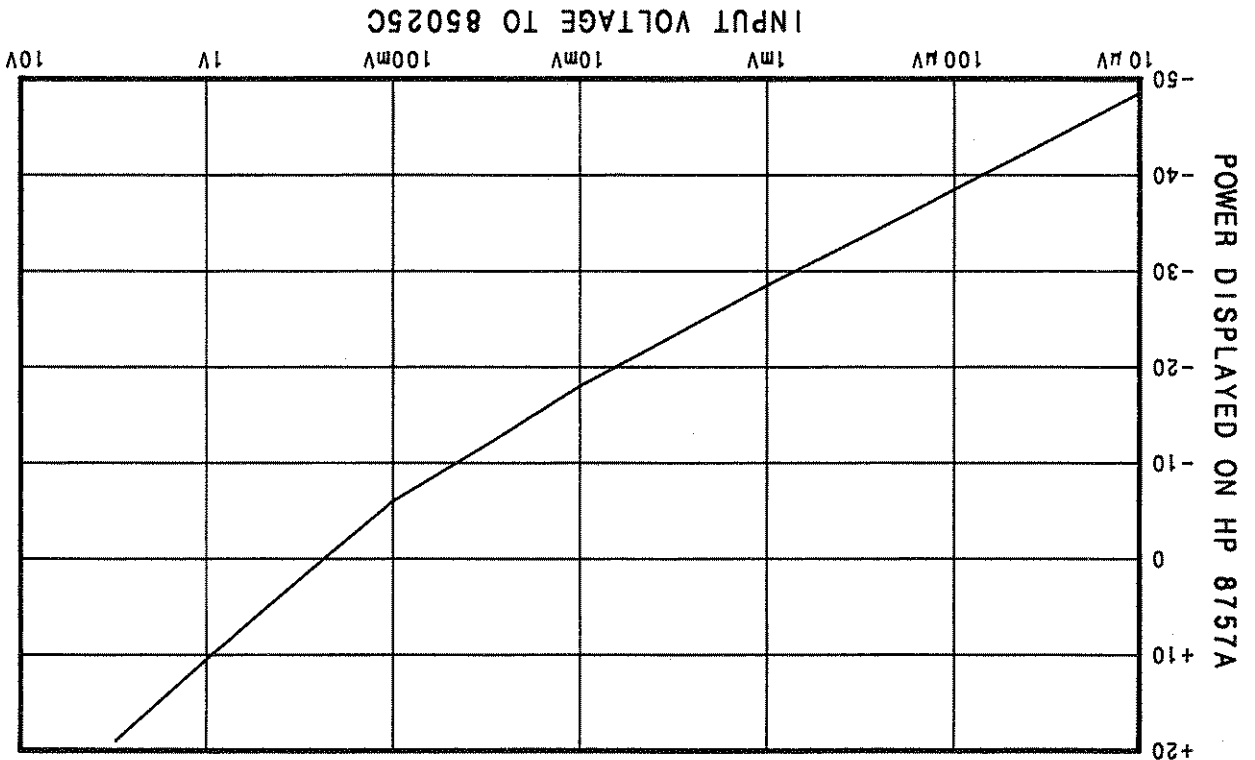

DC Detection

The ability to make DC measurements and the softkeys specific to DC mode are not automatically accessible. The HP 8575A must acknowledge the presence of an AC/DC detector adapter.

1. Connect the detector/detector adapter to the HP 8757A.

On the HP 8757A:

2. Press [PRESET].

During preset:

* The analyzer reads each input port and identifies the detector or detector adapter connected to it (AC/DC or AC only).

* The HP 8757A DC mode softkeys are enabled. You can access [DC DET ZERO] (in the CAL menu) and [MODE AC/DC] (in the SYSTEM menu).

3. To turn on DC mode, press [SYSTEM] and select the softkey [MODE AC/DC]. AC dims and DC lights up.

Selecting DC mode with the softkey [MODE AC/DC] turns off the squarewave modulation on the source (HP 8350B, 8340A or 8341A).

You can have the analyzer read the inputs without using [PRESET]: Press [CAL] and select the softkey [CONFIG SYSTEM].

If you remove and/or exchange a detector adapter, you must reconfigure the system, using either [PRESET] or the softkey [CONFIG SYSTEM], so that the correction factors match the port and the device.

Zeroing

When you make DC mode measurements, it is important that you perform a zeroing operation to compensate for the effects of DC drift and temperature fluctuations (this is not required for AC detection). The zeroing operation eliminates small DC voltages from the diode detector that would otherwise cause amplitude measurement errors at low (-40 dBm and below) power levels. Zeroing also establishes the displayed noise level (noise floor of the system) with no RF signal applied.

Zeroing the HP 85025C consists of two parts: Coarse Zero, which compensates for any large offset voltage; and Autozero, which compensates for any small drift in the offset voltage:

Coarse Zero:

1. Connect the detector/detector adapter to the analyzer.

On the HP 8757A:

2. Turn the analyzer on and press [PRESET]. Allow the instruments to warm up for 30 minutes.

3. Press [SYSTEM] and select the softkey [MODE AC/DC] to turn DC mode on.

4. Press [CAL] and select the softkey [DC DET ZERO].

5. Select [COARSE ZERO].

6. Select the softkey that corresponds to the detector adapter that you wish to zero (e.g. [DET A]). The analyzer displays Adjust COARSE ZERO for minimum response.

On the HP 85025C:

7. Adjust Coarse DC Zero (AIR23) for a minimum signal on the analyzer.

Autozero:

On the HP 8757A:

8. After adjusting Coarse Zero, press the softkey [CONT]. The analyzer performs an Autozero.

If the error voltage is too large for Autozero to compensate for, the analyzer displays the message WARNING: DC DET ZERO failed on X. If this happens, you must adjust Coarse Zero to bring the error voltage within Autozero range.

Repeat Autozero, [REPT AZ ON/OFF], periodically repeats the Autozero.

Manual Zero, [MANUAL], is similar to zeroing a power meter. First, remove the RF signal from the detector. Then press [MANUAL] to perform the zeroing.

NOTE: If a device under test generates RF signals or noise, Autozero is not valid. Devices that can generate RF energy are microwave amplifiers and mixers with the local oscillator signal applied. If you are testing such devices, use Manual Zero.

NOTE: For optimum performance, the outer conductor of the source RF output connector must be electrically connected to the outer conductor of the detector adapter input.

NOTE: If the operating environment changes significantly, you should repeat the zeroing operation.

Refer to the HP 8757A Operating Manual for detailed information on softkeys.



HP 8757A	Network Analyzer	Source	HP 8350B with RF plug-in
HP 8495/96	Step Attenuator	Detector	HP 8470B
HP 8710-1300	Adapter (BNC to SMA)	Adjustment Tool	Omni Spectra P/N 3282-2240-00

EQUIPMENT

Figure 1. Equipment Set Up.

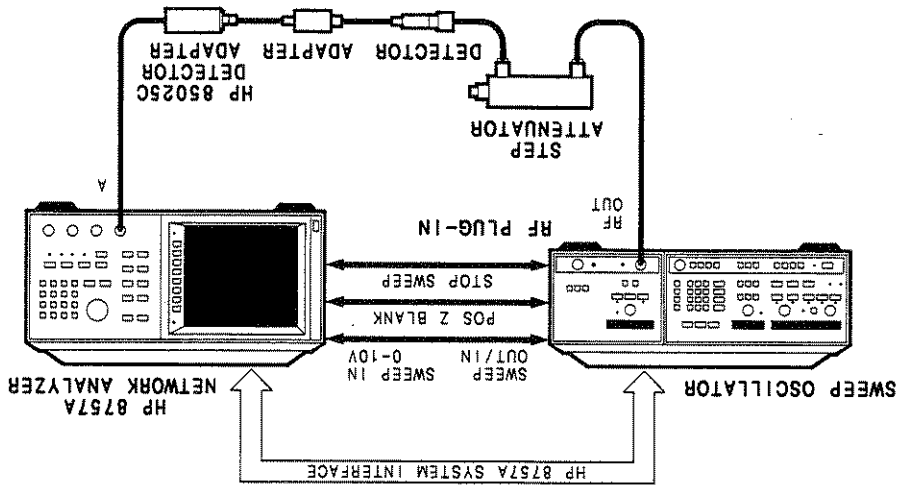

The two procedures in this section test the noise floor and dynamic accuracy of the HP 85025C detector adapter in both AC and DC modes. The required equipment and test set up are identical for both tests. Each test may be performed without access to the interior of the detector adapter.

INTRODUCTION

OPERATOR'S CHECK

HP 85025C Operator's Check

NOISE FLOOR MEASUREMENT

Description

Noise floor is the power level indicated on the HP 8757A with no signal present at the detector input. Because this value is dependent on the detector used in the test set up, this test is recommended as a general check of adapter operation. The detector used in this procedure should be the same as the one used in actual day to day operation.

This test can be performed in both AC and DC modes.

Procedure

1. Connect the equipment as shown in Figure 1. Allow the equipment to warm up for 30 minutes.

On the HP 8757A:

2. Press [INSTR PRESET].

3. Press [SYSTEM].

4. For DC operation, select the softkey [AC/DC] in the system menu. DC will light up.

5. Press [CAL].

Select [MORE], [EXT DET CAL], [DET PWR CAL]

6. Select the [DET A] softkey.

In AC mode, go to step 11.

On the source:

7. Turn RF power off.

8. Set the step attenuator to its highest attenuation.

On the HP 85025C:

9. Adjust COURSE DC ZERO so that the minimum power level (noise floor) is displayed on the HP 8757A.

On the HP 8757A:

10. Press [CONT]

On the source:

11. Select a CW frequency within the detector's range.

12. Set the source output power level to +6 dBm. On sources which do not have +6dBm capability, use the highest power level available.

13. Set the step attenuator to 0 dB.
On the HP 8757A:
14. At the ENTER POWER (HI) prompt, press [6] [dbm] or enter the highest power level that was attained.
15. Set the step attenuator to 30 dB.
On the HP 8757A:
16. At the ENTER POWER (LO) prompt, press [-] [2] [4] [dbm] or enter the original power level less 30 dB attenuation.
17. Turn RF power off.
18. Set the step attenuator to its highest attenuation.
19. The power level displayed on the analyzer is the noise floor of the system. This value should always be less than -45 dbm in AC mode, -40 dbm in DC mode. If your results are not within this range, refer to TROUBLESHOOTING in the service section of this manual.
The noise floor measurement is now complete.

DYNAMIC ACCURACY PROCEDURE

Description

Dynamic accuracy is the deviation of the power measured at the output of the detector adapter from the power at the output of the attenuator. Because this value is dependent on the detector used in the test set up, this test is recommended as a general check of adapter operation. It is recommended that the detector used in this procedure should be one of those mentioned in the equipment list at the front of this section. If one is unavailable, the detector used in this procedure should be the same as that used in actual day to day operation.

This test can be performed in both AC and DC modes.

Procedure

1. Perform the NOISE FLOOR MEASUREMENT if you have not done so.

On the source:

2. Select a CW frequency within the detector's range at +10 dBm output power. On sources which do not have +10 dBm output power capability, use the highest power level available.

On the HP 8757A:

3. Press:

```
[DISPLAY]
[MEAS --> MEM]
[MEAS - MEM]
[CURSOR]
```

This should result in a 0 dB reading.

4. Using the step attenuator, attenuate the signal 10 dB. Note the deviation of the analyzer reading from the setting on the step attenuator.

5. Repeat step 4 until the signal is attenuated 50 dB or when the detector input power reaches -40 dBm, whichever comes first. At each step, the deviation should never be greater than 2 dB. If your results are not within this range, refer to TROUBLESHOOTING in the service section of this manual.

The dynamic accuracy procedure is now complete.

ADJUSTMENTS

INTRODUCTION

There are two adjustments in the HP 85025C:

1. The gain adjustment
2. The 55 kHz null adjustment.

Perform both adjustments only after you have performed the connector's inspection in the service section, and if the values found in the operator's check are not within an acceptable range.

You must remove the detector adapter's plastic outer shell to perform both adjustments; the adjustment potentiometers are then accessible without removing the inner metal sleeve. If these adjustments are unsuccessful in correcting a problem, refer to TROUBLESHOOTING in the service section of this manual.

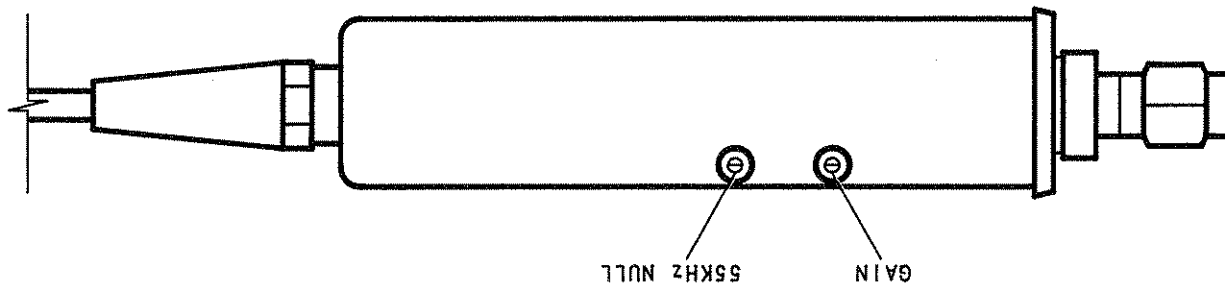

Figure 1. Detector Adapter Adjustment Access Points

EQUIPMENT

- Network Analyzer HP 8757A
- DC Power Supply HP 6212B
- Digital Voltmeter (DVM) HP 3456A
- Sweep Oscillator HP 8350B with RF plug-in
- Adjustment Tool HP 8710-1300
- Short HP 0960-0054

1. Place the detector adapter so its narrow side is on a flat surface. Position it so that the RF connector is facing away from you. Refer to Figure 2.
2. Hold the sides of the detector adapter near the cable end.
3. At an angle, carefully insert the tip of a flat-head screwdriver into the seam of the cover assembly until it slips under the seam. Be sure your hand is not in the path of the screwdriver.
4. Turn the screwdriver to snap apart the cover assembly.
5. Turn the detector adapter over and repeat steps 3 and 4.
6. The cover assembly may be pulled apart to expose the metal housing.

While removing the covers DO NOT hold the detector adapter in the palm of your hand. Personal injury may result. READ the entire procedure before attempting to remove the cover assembly.

WARNING

Figure 2. Cover Removal.



COVER REMOVAL PROCEDURE

ADJUSTMENT PROCEDURE

Description

The first adjustment in this procedure ensures that the 55 kHz signal generated internal to the HP 85025C does not appear at the detector adapter's output. With the input of the HP 85025C shorted, the 55 kHz null potentiometer is adjusted until the noise floor is at its highest point.

In the adjustment, the gain of the internal amplifier is adjusted to ensure a consistent relationship between detected voltage and power displayed. With 1.00V at the input of the detector adapter, the gain potentiometer is adjusted until the HP 8757A displays a 10.50 dbm power level.

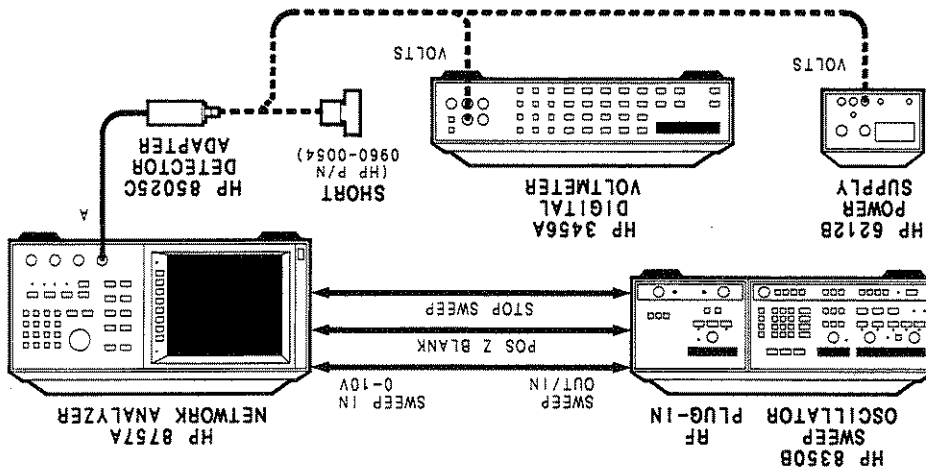

Figure 3. Adjustment Procedure Set Up.

Procedure

1. Remove the plastic cover from the detector adapter using the COVER REMOVAL PROCEDURE that precedes this adjustment.
2. Connect the equipment as shown in Figure 3, with the DC power supply connected to the digital voltmeter (DVM). Allow the equipment to warm up for 30 minutes.
3. Set the DC power supply to $1.000 \pm .003V$.
- On the HP 8757A:
 4. Press [INSTR PRESET].
 5. Press [SYSTEM].
 6. Select the softkey [AC/DC] in the system menu. DC lights up.

7. Press [CAL] and select [MORE].

8. Select:

[EXT DET CAL]

[CAL VALUE]

[DET A]

[RESET CAL VAL].

9. Connect a short to the input of the HP 85025C.

On the HP 8757A:

10. Press [CAL].

11. Select the softkeys [DC DET ZERO], [COARSE ZERO], and then [DET A] in the cal menu.

On the HP 85025C:

12. Adjust COARSE DC ZERO so that the minimum power level (noise floor) is displayed on the HP 8757A.

On the HP 8757A:

13. Select [CONT].

55 KHZ Null Adjustment

14. Select [AUTOZERO] in the cal menu.

On the HP 85025C:

15. Adjust the 55 KHZ null potentiometer (shown in Figure 1) until the signal level (noise floor) reaches its highest point.

Repeat steps 14 and 15 until there is no noticeable change in signal level after step 15.

Gain Adjustment

17. Remove the short from the input of the detector adapter.

18. Connect the DC power supply to the input of the HP 85025C.

On the HP 8757A:

19. Press [CURSOR].

On the HP 85025C:

20. Adjust the gain potentiometer (shown in Figure 1) until a $10.50 \pm .05$ dBm power level is displayed on the HP 8757A.

The detector adapter is now adjusted.

SERVICE

INTRODUCTION

This section provides information concerning the troubleshooting and repair of the HP 85025C detector adapter.

Begin troubleshooting the detector adapter by performing the OPERATOR'S CHECK provided in this manual. If the results of this check are not within the specified range, refer to ADJUSTMENTS. If the problem persists, consult TROUBLESHOOTING PROCEDURES in this section.

WARNING

Any servicing, maintenance, or repair of this product must be performed by qualified personnel only.

THEORY OF OPERATION

The 85025C detector adapter accepts detected RF or microwave signals that are either 27.8 kHz modulated (AC mode) or unmodulated (DC mode). In either detection mode, the detector adapter provides a 27.8 kHz square wave signal for the analyzer to interpret and display.

In DC mode, the detector's output is a constant voltage proportional to the power of the input signal. The 85025C chops and amplifies this voltage level, creating a 27.8 kHz square wave for input to the analyzer.

In AC mode, the signal is modulated at 27.8 kHz at the source. The detector's output, therefore, is the modulated square wave required by the analyzer. In this case, the adapter acts as a buffer between the detector and the analyzer.

- HP 8757A Network Analyzer
- HP 3456A Digital Voltmeter
- HP 6212B DC Power Supply
- HP 8710-0978 Phillips Screwdriver
- HP 8720-0009 7/16 Inch Hex Nut Wrench
- HP 1740A Oscilloscope

EQUIPMENT

Figure 1. Overall Block Diagram

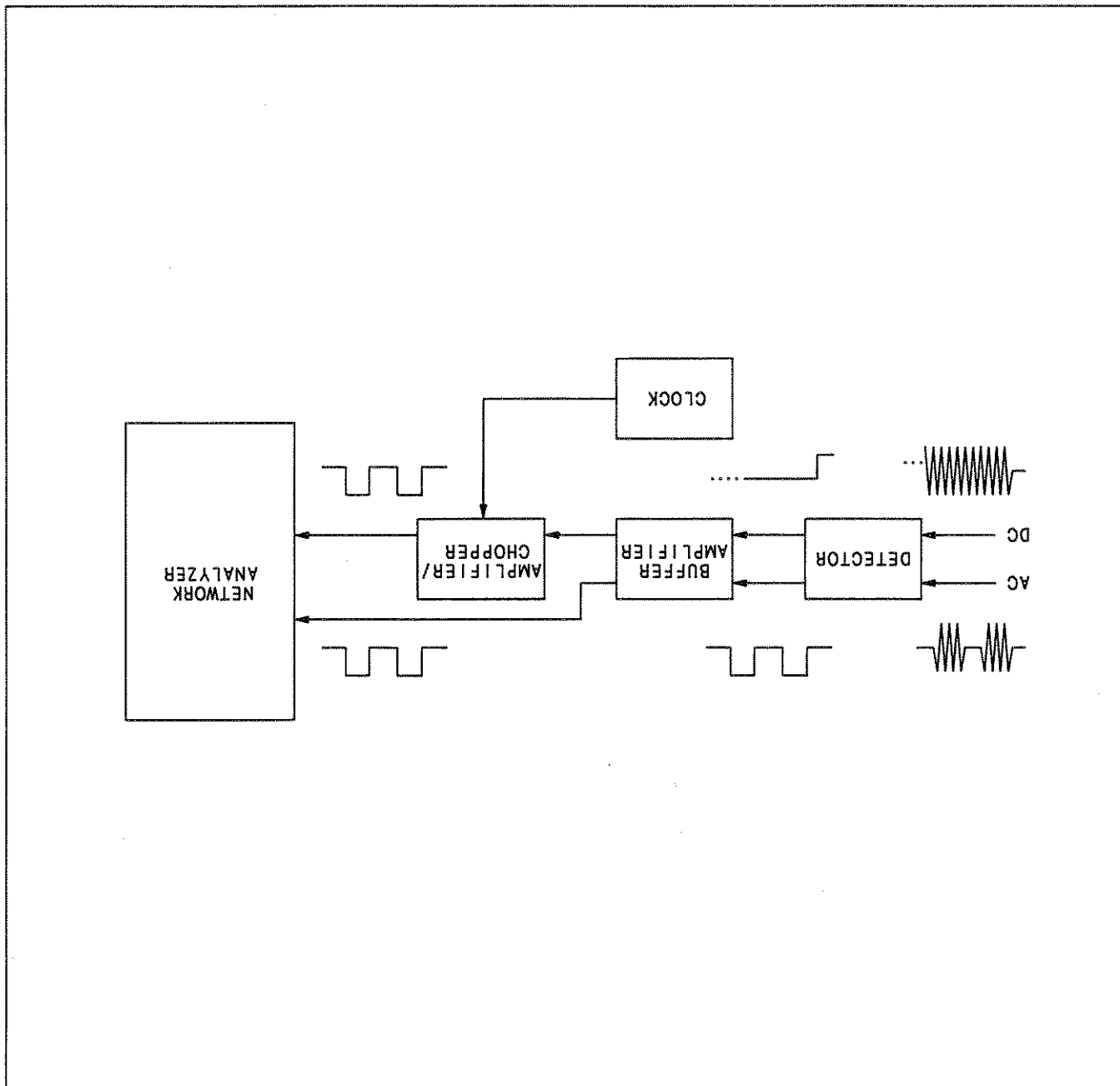

CONNECTOR INSPECTION

Periodically inspect all connectors; a bad connector can damage a good one on the first connection. If a connector fails the inspection, replace it.

When you inspect connectors, use an illuminated, 4-power magnifying glass. The exact power is not critical, but the lighting is very important. Normal room lighting, especially indirect desk lamp lighting, casts shadows that can mask the small defects you are trying to expose. A magnifying glass with integral lighting provides shadowless illumination; this type of magnifying glass is readily available from general equipment suppliers.

Examine connectors for obvious problems such as deformed or clogged threads, contamination, or corrosion. On the contact surfaces, look for burrs, scratches, rounded shoulders, or other signs of wear or damage. Defects that you can see with the magnifying glass can degrade performance. Replace defective connectors.

If a connector is dirty, refer to Figure 2 for cleaning suggestions. First, try blowing the dirt off with compressed air. Carefully, brush or wipe any remaining dirt from the surface. Use trichlorotrifluoroethane (liquid Freon) sparingly as a cleaning solvent, if required. Do not use abrasives or other solvents that could damage the thin metal plating or the plastic dielectric supporting element.

Figure 2. Cleaning Connectors.

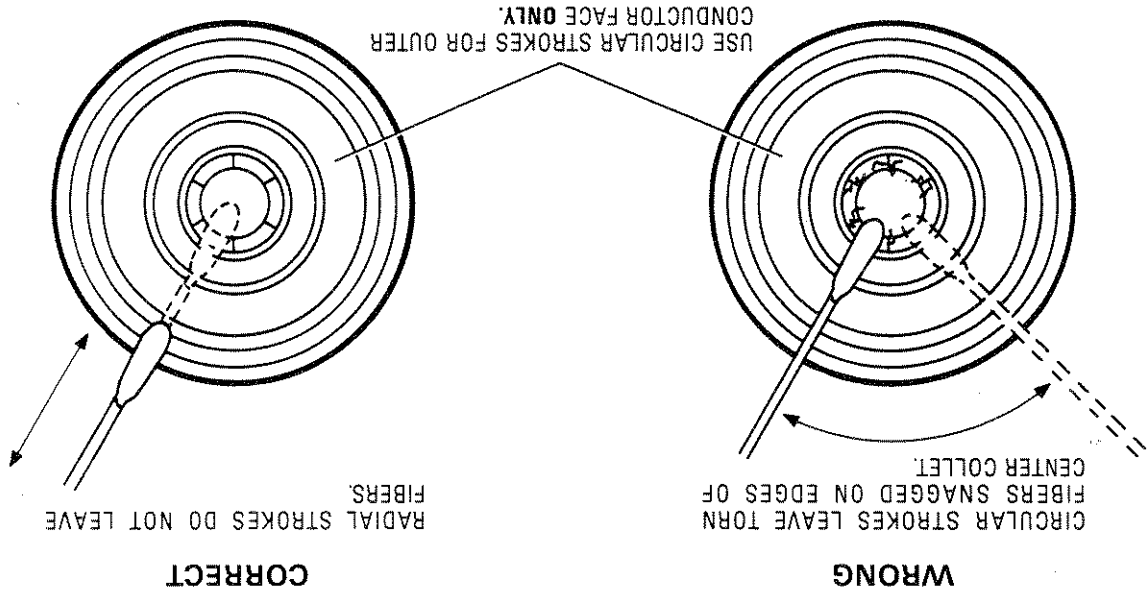

WRAP THIN FOAM OR A LINT-FREE CLOTH AROUND A SLENDER WOODEN ROD (SUCH AS A TOOTHPICK) FOR CLEANING AREAS THAT ARE TOO SMALL FOR THE SWABS.

TRY TO CLEAN THE CONNECTOR WITH COMPRESSED AIR BEFORE RESORTING TO SWABS.

NOTE

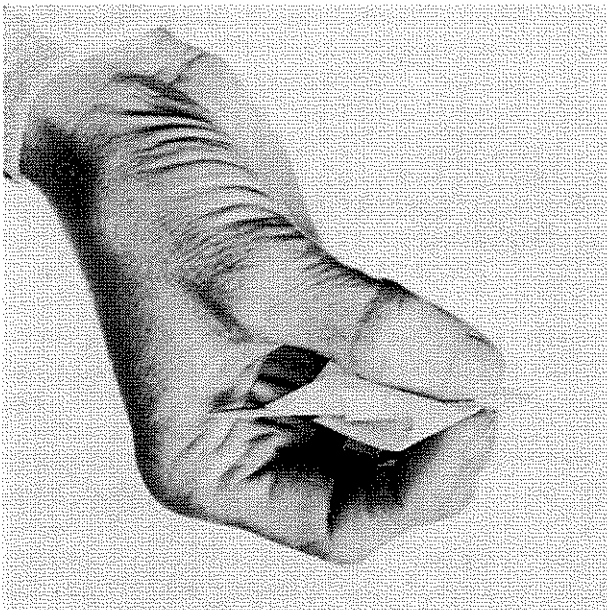

TROUBLESHOOTING

This section provides a sequential procedure for troubleshooting the HP 85025C. To avoid troubleshooting errors and unnecessary repair costs, perform this procedure in the order given.

1. To Access the Circuit Board

- a. Disconnect the HP 85025C detector adapter from the network analyzer and remove the detector.

- b. Remove the plastic outer cover (refer to the COVER REMOVAL PROCEDURE under the heading ADJUSTMENTS).

- c. To remove the inner metal sleeve, remove the two screws located on the base plate next to the cable. Slide the sleeve away from the housing and over the cable to expose the circuit board.

- d. Perform a visual inspection of the detector adapter circuit board.

2. Cable Continuity Check

- a. Use a digital voltmeter (DVM) to check the continuity of the power cable conductors from the connector pins to the wire connections inside the detector adapter housing. Table 1 lists the cable connector pins and the corresponding wires.

Table 1. Power Cable Conductors.

Signal	Conductor (Label)	Connector Pin	
	Output Return Control -12.6v +15v	White (W) Green (G) Yellow (Y) Blue (B) Red (R)	

- b. Use the DVM to check for possible shorts between the connector pins and ground (frame).
- c. If there are any discontinuities, replace the cable by following the instructions in Power Cable Replacement.

- c. If any of these voltages are not within specification, remove the detector adapter from the analyzer and check the +15V and -12.6V supplies from the HP 85025C or the HP 8757A. This step isolates the malfunction to either the HP 85025C or the HP 8757A.

Figure 3. Circuit Board Power Supply Check Points.

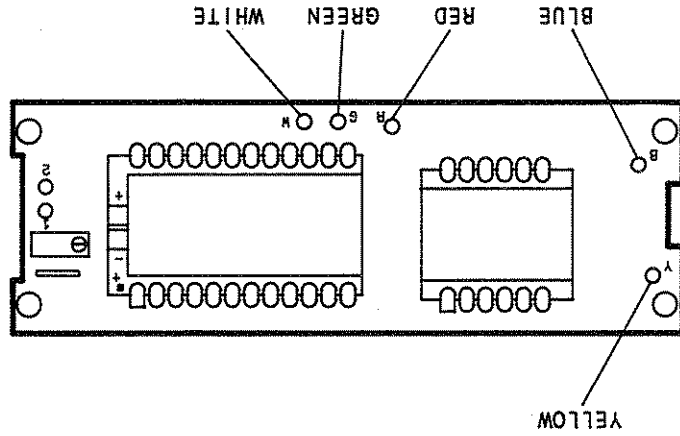

- b. Check the power supply voltages shown in Figure 3. Because +15V and -12.6V are supplied by the analyzer, these voltages are specified in the analyzer manual. The +8V should be $+8.3 \pm 0.5V$; the -5V should be $-5 \pm 0.5V$.

- a. Attach the HP 85025C to the HP 8757A network analyzer and turn the analyzer on.

3. Supply Check

NOTE: For troubleshooting procedures 4, 5, and 6, refer to Figure 4, Component Location Diagram.

4. Buffer Amplifier Check

- a. Attach the HP 85025C to the network analyzer and turn the analyzer on.
- b. Set the analyzer to DC mode.
- c. Connect 1.0V to the input of the detector adapter.
- d. Measure the voltage opposite the connector just inside the main housing. This should also be 1.0V. If it is not 1.0V, replace the connector.
- e. Check the voltage at U6, pin 6. This should also be 1.0V. If it is not 1.0V, replace the buffer amplifier, U6.

5. Mode Line Check

- a. Connect the HP 85025C detector adapter to the network analyzer.
- b. On the HP 8757A, set the mode to AC.
- c. Using a DVM, measure the voltage at the pad connected to the yellow (control) wire. This voltage should be less than -5.5V. If it is not, troubleshoot the network analyzer.
- d. Check the voltage at U3, pin 7. This voltage should be $-1V \pm 0.5V$. If it is not within this range, go to step 5h.
- e. On the network analyzer, set the mode to DC.
- f. Using a DVM, measure the voltage at the pad connected to the yellow (control) wire. This voltage should be between -3.0V and +3.0V. If it is not within this range, troubleshoot the network analyzer.
- g. Check the voltage at U3, pin 7. This voltage should be $-5V \pm 0.5V$. If it is not within this range, perform steps 5h through 1. If the voltage measured is within this range, go to the Preamplifier/Clock Check procedure.
- h. Remove the HP 85025C from the network analyzer.
- i. Using an ohmmeter, measure the resistance between U3, pin 7 and U2, pin 10.
- j. If the resistance measured in step 5i is $30k \pm 3k$ ohms, replace the comparator, U3.
- k. If the resistance measured in step 5i is less than 27k ohms, replace the clock, U2.
- l. If the resistance measured in step 5i is greater than 33k ohms, check the connection between U3, pin 7 and U2, pin 8. If this connection is good, replace the clock, U2.

- a. Open the detector adapter using the instructions in Accessing the Circuit Board.
- b. Unsolder the wires connected to the power cable/circuit board assembly. Note that the pads to which the wires are soldered are labeled as indicated in Table 1.
- c. Remove the 1/2 inch hex nut that fastens the cable to the end plate.
- d. Remove the old cable.
- e. Replace the cable, and install the new one by performing steps a through d of this procedure in reverse order.

Power Cable Replacement

- a. Using an oscilloscope measure the signal at U2, pin 1. The waveform should be a 13 Vpp, 27.8 kHz square wave.
- b. The signal present at U2, pin 2 should be the same as the signal in step 6a, but 180 degrees out of phase with that signal.
- c. The signal measured at U2, pin 4 should be a 13 Vpp, 55 kHz pulse wave with a duty cycle of approximately 15%.
- d. If each of the signals measured in steps 6a, b, and c are correct, replace the preamplifier.
- e. If any of the signals is incorrect, replace the clock. If the three signals coming from the clock now match those given in 6a, b, and c, the clock was defective. If not, replace the preamplifier, U1.

6. Preamplifier/Clock Check



Figure 4b. Component Location Diagram (bottom)

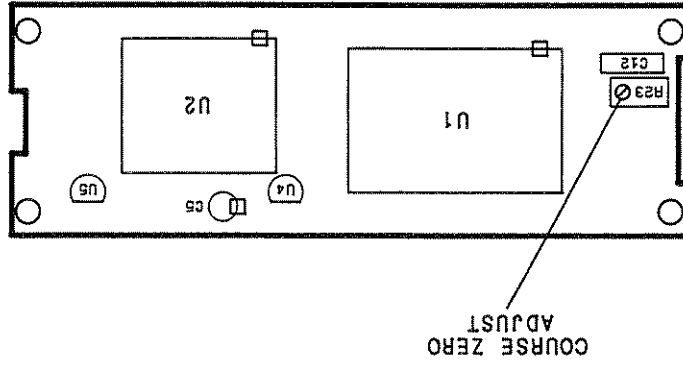
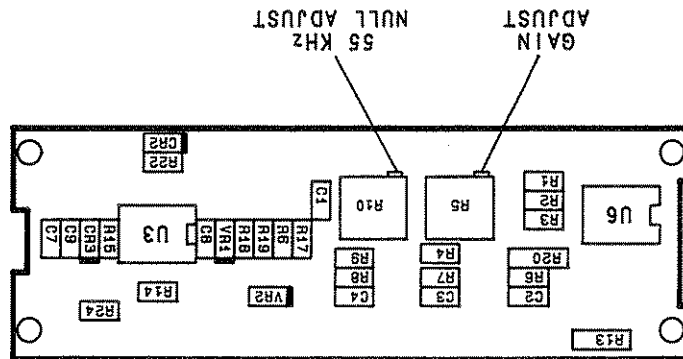
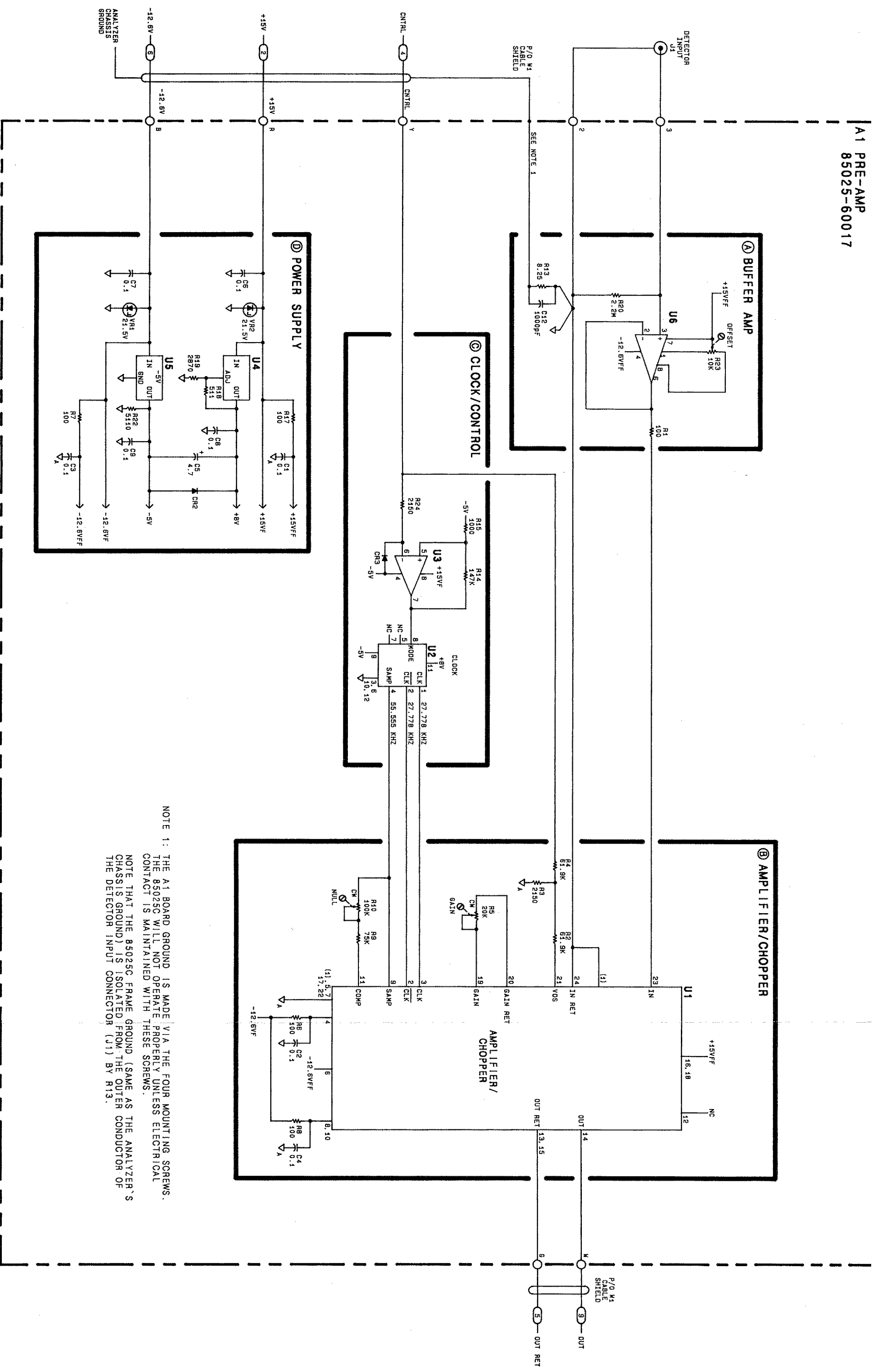

Figure 4a. Component Location Diagram (top)





NOTE 1: THE A1 BOARD GROUND IS MADE VIA THE FOUR MOUNTING SCREWS. THE 85025C WILL NOT OPERATE PROPERLY UNLESS ELECTRICAL CONTACT IS MAINTAINED WITH THESE SCREWS.

NOTE THAT THE 85025C FRAME GROUND (SAME AS THE ANALYZER'S CHASSIS GROUND) IS ISOLATED FROM THE OUTER CONDUCTOR OF THE DETECTOR INPUT CONNECTOR (J1) BY R13.

Figure 8-2. A1 Circuit Board Schematic

REPLACEABLE PARTS

INTRODUCTION

This section contains replaceable parts ordering information. Table 1 lists abbreviations used in the parts list, and throughout this manual. Table 2 lists the manufacturers' code numbers that are used in the parts list. Table 3 lists all replaceable parts.

REPLACEABLE PARTS

Table 3 lists replaceable parts. The following information is given for each part:

- * The Hewlett-Packard part number.
- * The part number check digit (CD).
- * The total quantity (Qty) in the instrument.
- * A description of the part.
- * The five digit code of a typical manufacturer (from Table 2).
- * The manufacturer's number for the part.

ORDERING INSTRUCTIONS

To order a part in Table 3:

- a. Indicate the Hewlett-Packard part number (with check digit).
- b. Indicate the quantity required.
- c. Address your order to the nearest Hewlett-Packard office.

The check digit will ensure that your order is processed accurately and quickly.

To request information on a part that is not listed in Table 3:

- a. Indicate the instrument model number.
- b. Indicate the instrument serial number.
- c. Include a description and function of the part.
- d. Address your inquiry to the nearest Hewlett-Packard office.

Table 1. Abbreviations

A	Assembly	MM	Millimetre
AC	Alternating Current	MP	Miscellaneous Part
ADJ	Adjust	NS	Nanoseconds
AMP	Amplifier	PF	Picofarad
C	Capacitor	PRCN	Precision
CER	Ceramic	PKG	Package
CR	Diode	PP	Peak-to-Peak
CM	Centimetre	R	Resistor
DBM	Decibels	RF	Radio Frequency
DIP	Dual In-Line Package	RGLTR	Regulator
DO	Package Type Designation	SIG	Signal
ESD	Electrostatic Discharge	SM	Small
F	Fahrenheit; Female;	TA	Tantalum
FXD	Fixed	TC	Temperature Coefficient
GHZ	Gigahertz	TO	Package Type Designation
IC	Integrated Circuit	TRMR	Trimmer
J	Jack	TRN	Turn
IN	Inch	U	Integrated Circuit
K	Kilo (1000)	UF	Microfarad
KG	Kilogram	V	Variable; Volt; Voltage
L	Inductor (coil)	VR	Zener Diode
M	Male; Metre	VDC	Volts, Direct Current
MFR	Manufacturer	W	Cable; Watt
MISC	Miscellaneous	ZNR	Zener (diode)

Table 2. Manufacturers Code List

CODE	MANUFACTURER	ADDRESS	ZIP CODE
04713	Motorola Semiconductor Products	Phoenix AZ Tinley Park IL Santa Clara Ca	85008 60477 95050
06383	Panduit Corp	Tinley Park IL	60477
06665	Precision Monoliths Inc	Santa Clara Ca	95050
24546	Corning Glass Works (Bradford)	Bradford Pa	16701
25088	Siemens Corp	Isetlin NJ	08830
27014	National Semiconductor Corp	Santa Clara Ca	95051
28480	Hewlett-Packard Co Corp	Palo Alto Ca	94304
32997	Bourns Inc Trimpot Prod Div	Riverside Ca	92507

See Introduction to this section for ordering information. Indicates factory selected value.

Reference	HP Part Number	D	C	Qty	Description	Mfr Code	Mfr Part Number
1	1250-1389	2	1	1	INPUT CONNECTOR SMA(M) (1)	29480	1250-1389
2	85025-20021	2	2	1	LOCK NUT	29480	85025-20021
3	85025-40005	2	2	1	INSULATOR	29480	85025-40005
4	85025-40001	2	2	1	SOLID PLASTIC HALF-BODY	29480	85025-40001
5	85025-20020	1	1	1	BODY INTERFACE	29480	85025-20020
6	8160-0030	3	3	2	WIRE 22 GAGE 300V 2 INCH-LG (Not visible)	29480	8160-0030
7	0890-0034	2	7	1	FLEXIBLE TUBING, YELLOW, 0.11 FT	29480	0890-0034
8	0515-0976	2	4	4	SCREW-MACHINE, M2.0X.4;6MM-LG	29480	0515-0976
9	2190-0654	5	5	1	LOCK WASHER, 2.0MM	29480	2190-0654
10	85025-60003	2	2	1	CABLE (W1)	29480	85025-60003
11	85025-20007	2	2	1	SCREW-MACHINE, M2.5X0.45; 4MM-LG	29480	85025-20007
12	0515-0061	6	6	2	CAN	29480	0515-0061
13	2190-0583	9	9	2	LOCK WASHER, 2.5MM	29480	2190-0583
14	85025-20006	1	1	1	FRAME CASTING	29480	85025-20006
15	0890-0035	1	1	1	FLEXIBLE TUBING, BLUE, 0.11 FT	29480	0890-0035
16	85025-20022	1	1	1	PLASTIC HALF-BODY WITH ADJUSTMENT HOLE	29480	85025-20022
17	5061-1044	9	1	1	CABLE MARKER KIT	29480	5061-1044
18	8710-1300	1	1	1	ALIGNMENT TOOL	29480	8710-1300
19	85025-80006	4	4	1	PACKAGING POUCH AND CARTON	29480	85025-80006
	9211-4917	1	1	1	LABEL: ID 85025C (Not Shown)	29480	9211-4917
	85025-80007	7	1	1	LABEL: WARNING MAX INPUT (Not Shown)	29480	85025-80007
	85025-80008	9	1	1	LABEL: COARSE ZERO (Not Shown)	29480	85025-80008

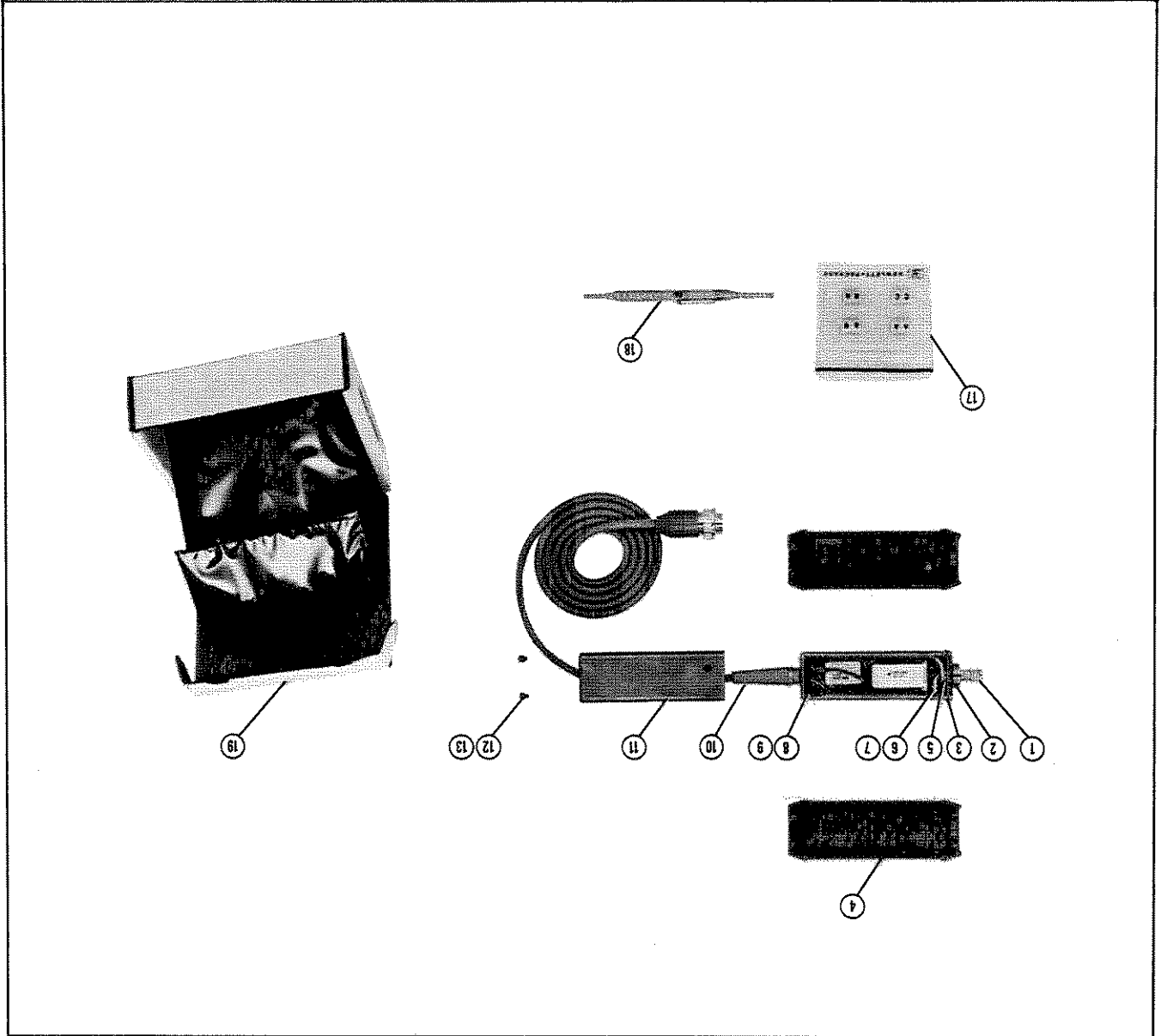

Table 3. Replaceable Parts

HP 85025C Service

Table 3. Replaceable Parts cont'd

Reference Designation	HP Part Number	C	D	Qty	Description	Mfr Code	Mfr Part Number
A1	85025-60017	2	1	2	CIRCUIT BOARD ASSEMBLY	28480	85025-60017
A1C1	0160-5375	2	2	8	CAPACITOR-FXD .1UF +-10% 50VDC CER	28480	0160-5375
A1C2	0160-5375	2	2	2	CAPACITOR-FXD .1UF +-10% 50VDC CER	28480	0160-5375
A1C3	0160-5375	2	2	2	CAPACITOR-FXD .1UF +-10% 50VDC CER	28480	0160-5375
A1C4	0160-5375	2	2	2	CAPACITOR-FXD .1UF +-10% 50VDC CER	28480	0160-5375
A1C5	0180-2883	1	1	1	CAPACITOR-FXD 4.7UF+-20% 35VDC TA	28480	0180-2883
A1C6	0160-5375	2	2	2	CAPACITOR-FXD .1UF +-10% 50VDC CER	28480	0160-5375
A1C7	0160-5375	2	2	2	CAPACITOR-FXD .1UF +-10% 50VDC CER	28480	0160-5375
A1C8	0160-5375	2	2	2	CAPACITOR-FXD .1UF +-10% 50VDC CER	28480	0160-5375
A1C9	0160-5375	2	2	2	CAPACITOR-FXD .1UF +-10% 50VDC CER	28480	0160-5375
A1C12	0160-3456	6	1	1	CAPACITOR-FXD 1000PF +-20% 100VDC CER	28480	0160-3456
A1C33	1901-0539	3	1	3	DIODE-SM SWITCHING 80V 200MA 2NS DO-35	28480	1901-0539
A1C33	1901-0539	3	1	3	DIODE-SM SWITCHING 80V 200MA 2NS DO-35	28480	1901-0539
A1R1	0698-7212	9	5	9	RESISTOR 100 1% .05W F TC=0+-100	24546	0698-7212
A1R2	0698-7279	8	2	8	RESISTOR 2.15K 1% .05W F TC=0+-100	24546	0698-7279
A1R3	0698-7244	7	2	7	RESISTOR 2.15K 1% .05W F TC=0+-100	24546	0698-7244
A1R4	0698-7249	9	9	9	RESISTOR 61.9 1% .05W F TC=0+-100	24546	0698-7249
A1R5	2100-3091	1	2	1	RESISTOR-TMR 20K 10% C TOP-ADJ 17-TRN	32997	2100-3091
A1R6	0698-7212	9	9	9	RESISTOR 100 1% .05W F TC=0+-100	24546	0698-7212
A1R7	0698-7212	9	9	9	RESISTOR 100 1% .05W F TC=0+-100	24546	0698-7212
A1R8	0698-7212	9	9	9	RESISTOR 100 1% .05W F TC=0+-100	24546	0698-7212
A1R9	0698-8615	8	8	8	RESISTOR 75K 1% .05W F TC=0+-100	28480	0698-8615
A1R10	2100-4098	0	1	1	RESISTOR-TMR 100K 10% C TOP-ADJ 17-TRN	32997	2100-4098
A1R13	0698-8823	0	1	0	RESISTOR 8.25 1% .12W F TC=0+-100	28480	0698-8823
A1R14	0698-7288	9	1	9	RESISTOR 147K 1% .05W F TC=0+-100	24546	0698-7288
A1R15	0698-7236	7	1	7	RESISTOR 1K 1% .05W F TC=0+-100	24546	0698-7236
A1R17	0698-7212	9	9	9	RESISTOR 100 1% .05W F TC=0+-100	24546	0698-7212
A1R18	0698-7229	8	1	8	RESISTOR 511 1% .05W F TC=0+-100	24546	0698-7229
A1R19	0698-7247	0	1	0	RESISTOR 2.87K 1% .05W F TC=0+-100	24546	0698-7247
A1R20	0698-2255	9	1	9	RESISTOR 5.11K 5% .25W F TC=0+-100	28480	0698-2255
A1R22	0698-7253	8	8	8	RESISTOR 10K 1% .05W F TC=0+-100	24546	0698-7253
A1R23	0698-7251	8	8	8	RESISTOR 10K 1% .05W F TC=0+-100	24546	0698-7251
A1R24	0698-7251	6	6	6	RESISTOR 1.25K 1% .05W F TC=0+-100	24546	0698-7251
A1U1	1NB7-8045	6	1	6	PREAMP HYBRID ASSEMBLY	28480	1NB7-8045
A1U2	1NB7-8039	8	1	8	CLOCK HYBRID ASSEMBLY	28480	1NB7-8039
A1U3	1828-0412	1	1	1	IC COMPARATOR PRON DUAL 8-DIP-P PKG	27014	1828-0412
A1U4	1828-0772	6	1	6	IC V RGLTR ADJ POS 1.2/32V TO-.92 PKG	1828-0772	1828-0772
A1U5	1828-0285	6	1	6	IC V RGLTR TO-.92	04713	1828-0285
A1U6	1828-0932	0	1	0	IC OP AMP PRON 8-DIP-C PKG	06665	1828-0932
A1VR1	1902-3245	6	2	6	DIODE-ZNR 21.5V 5% DO-35 PD=.4W	28480	1902-3245
A1VR2	1902-3245	6	2	6	DIODE-ZNR 21.5V 5% DO-35 PD=.4W	28480	1902-3245
J1	1250-1389	2	1	2	INPUT CONNECTOR	28480	1250-1389
W1	85025-90003	5	1	5	CABLE ASSY	28480	85025-90003
					OPERATING AND SERVICE MANUAL	28480	85025-90003
					MISCELLANEOUS PARTS	28480	1250-1389
						28480	85025-60003

See Introduction to this section for ordering information. Indicators in every selected value.

Hewlett-Packard Sales and Service Offices

US FIELD OPERATIONS	
<p>Headquarters California, Northern Hewlett-Packard Co. 301 E. Evelyn Mountain View, CA 94041 (415) 694-2000</p>	<p>California, Southern Hewlett-Packard Co. 1421 South Manhattan Ave. Fullerton, CA 92631 (714) 999-6700</p>
<p>Colorado Hewlett-Packard Co. 24 Inverness Place, East Englewood, CO 80112 (303) 649-5512</p>	<p>Georgia Hewlett-Packard Co. 2000 South Park Place Atlanta, GA 30339 (404) 955-1500</p>
<p>New Jersey Hewlett-Packard Co. 150 Green Pond Rd. Rockaway, NJ 07866 (201) 586-5400</p>	<p>Texas Hewlett-Packard Co. 930 E. Campbell Rd. Richardson, TX 75081 (214) 231-6101</p>
EUROPEAN FIELD OPERATIONS	
<p>France Hewlett-Packard S.A. 150, Route du Nant-d'Avril 1217 Meyrin 2/Geneva (41 22) 780.8111</p>	<p>Germany Hewlett-Packard GmbH Hewlett-Packard Strasse 61352 Bad Homburg v.d.H Zone D'Activite De Courtaboeuf F-91947 Les Ulis Cedex France (33 1) 69 82 60 60</p>
<p>Great Britain Hewlett-Packard Ltd. Eskdale Road, Wimmersh Triangle Wokingham, Berkshire RG41 5DZ England (44 734) 696622</p>	<p>Switzerland F-91947 Les Ulis Cedex Germany (49 6172) 16-0</p>
INTERCON FIELD OPERATIONS	
<p>Headquarters Australia Hewlett-Packard Australia Ltd. 31-41 Joseph Street Blackburn, Victoria 3130 (61 3) 895-2895</p>	<p>Canada Hewlett-Packard (Canada) Ltd. 17500 South Service Road Trans-Canada Highway Kirkland, Quebec H9J 2X8 Canada (514) 697-4232</p>
<p>China China Hewlett-Packard Company 38 Bei San Huan XI Road Shuang Yu Shu Hai Dian District Beijing, China (86 1) 256-6888</p>	<p>Japan Hewlett-Packard Japan, Ltd. 1-27-15 Yabe, Sagamihara Kanagawa 229, Japan (81 427) 59-1311</p>
<p>Headquarters Hewlett-Packard Company 3495 Deer Creek Road Palo Alto, California, USA 94304-1316 (415) 857-5027</p>	<p>Taiwan Hewlett-Packard Taiwan 8th Floor, H-P Building 337 Fu Hsing North Road Taipei, Taiwan (886 2) 712-0404</p>

MANUAL CHANGES SUPPLEMENT

HP 85025C Detector Adapter

MANUAL IDENTIFICATION

Manual Part Number: 85025-90003
Date Printed: November 1985

Manual Change Supplements are revised as often as necessary to keep manuals as current and accurate as possible. Hewlett-Packard recommends that you periodically order the latest edition of this supplement. Copies are available through any HP office. When ordering copies, quote the supplement part number from the bottom of this page, or the model number and print date from the title page of the manual.

This supplement contains important information for correcting manual errors and for adapting the manual to instruments containing improvements made after the printing of the manual.

TO USE THIS SUPPLEMENT: Make all changes applicable to the serial prefix or number of your instrument as indicated in the following reference table.

Note that there may be more than one Title Page and/or Parts Cross-Reference Table included in this supplement. The last changes applicable to your instrument will contain the most current information for these specific pages.

■ = NEW ITEM, CHANGED ITEM



HP Part Number 85025-91057 (For HP Internal Use Only)
Part of HP Part Number 85025-90057

13 MARCH 1989

Printed in U.S.A.

Serial Prefix or Number	1	0300 and above	2	All Serials
Make Manual Changes				

REFERENCE TABLE

■ = NEW ITEM

■ = NEW ITEM

NUMBERED CHANGES INDEX

Serial Prefix Number	Change Number	Assemblies Affected	New Assembly Part Number	Manual Sections Affected
00300 and above	1	A1	85025-60035	Schematic Diagram Replaceable Parts
■ All Serials	2	A1	N/A	Schematic Diagram Replaceable Parts

MANUAL IDENTIFICATION

HP Model Number: HP 85025C
Manual Part Number: 85025-90003
Date Printed: November 1985

CHANGE 1

Change 1 documents units with serial numbers of 0300 and above.

This change changes A1U6 with a new operational amplifier. The new part eliminates undesired voltage spikes at the output of the detector adapter that occur when the HP 8757 network analyzer is shut off. The new part has different Vcc pin-out.

INSTRUCTIONS

Replace — Replace the existing manual pages with the pages provided in this change. These pages supersede the existing pages in the manual, provided that the serial number prefix of your instrument is the same or higher than the one indicated on this page. To keep your documentation applicable to all versions of instruments, place the superseded pages in the back of your manual for future reference. Note: the old manual title page may be discarded.

ADD — Add the pages to your manual as indicated. Do not remove any pages.

Replace the following pages:

Title Page
Page 11/12

Add the following page:

16a/16b behind page 16

©Copyright HEWLETT-PACKARD COMPANY 1985
1400 FOUNTAIN GROVE PARKWAY, SANTA ROSA, CA 95401 U.S.A.

This manual applies directly to HP 85025C detector adapters
with serial number 00100 and above.
For additional information about serial numbers, refer to
INSTRUMENTS COVERED BY THIS MANUAL, in
General Information.
Manual Changes Supplement Print Date: 14 MAY 1987
■ Change 1 documents serial numbers 00300 and above.

SERIAL NUMBERS

HP 85025C DETECTOR ADAPTER

WARRANTY

This Hewlett-Packard instrument product is warranted against defects in material and workmanship for a period of one year from date of shipment. During the warranty period, Hewlett-Packard Company will, at its option, either repair or replace products which prove to be defective.

For warranty service or repair, this product must be returned to a service facility designated by HP. Buyer shall prepay shipping charges to HP and HP shall pay shipping charges to return the product to Buyer. However, Buyer shall pay all shipping charges, duties, and taxes for products returned to HP from another country.

HP warrants that its software and firmware designated by HP for use with an instrument will execute its programming instructions when properly installed on that instrument. HP does not warrant that the operation of the instrument, or software, or firmware will be uninterrupted or error free.

LIMITATION OF WARRANTY

The foregoing warranty shall not apply to defects resulting from improper handling by Buyer, Buyer-supplied software or interfacing, unauthorized modification or misuse, or operation outside of the environmental specifications for the product.

NO OTHER WARRANTY IS EXPRESSED OR IMPLIED, HP SPECIFICALLY DISCLAIMS THE IMPLIED WARRANTIES OR MERCHANTABILITY AND FITNESS FOR A PARTICULAR PURPOSE.

EXCLUSIVE REMEDIES

THE REMEDIES PROVIDED HEREIN ARE BUYER'S SOLE AND EXCLUSIVE REMEDIES, HP SHALL NOT BE LIABLE FOR ANY DIRECT, INDIRECT, INCIDENTAL, SPECIAL, INCIDENTAL, OR CONSEQUENTIAL DAMAGES, WHETHER BASED ON CONTRACT, TORT, OR ANY OTHER LEGAL THEORY.

ASSISTANCE

Product maintenance agreements and other customer assistance agreements are available for Hewlett-Packard Products.

For any assistance, contact your nearest Hewlett-Packard Sales and Service Office. Addresses are provided at the back of this manual.

When replacing a part, cross-reference it to the following table. If the part does not appear in this table, use the original part number in Table 3.

Parts Cross-Reference Table

Ref. Desig.	HP Part Number	Replace With HP Part Number	New Description	Serial Numbers Affected
AI	85025-60017	85025-60035*	Same description	00300 and above
AIU6	1826-0932	1826-1702	Same description	00300 and above

*Recommended replacement for all units, regardless of serial number.

MANUAL IDENTIFICATION

HP Model Number: HP 85025C
Manual Part Number: 85025-90003
Date Printed: November 1985

CHANGE 2

Change 2 documents units with all serial numbers.

This change changes the values of ATR9 and ATR10. The new values allow adjustment of the 55 kHz feedthru despite the variations of the sampler FET.

INSTRUCTIONS

Replace — Replace the existing manual pages with the pages provided in this change. These pages supersede the existing pages in the manual. To keep your documentation applicable to all versions of instruments, place the superseded pages in the back of your manual for future reference. Note: the old manual title page may be discarded.

ADD — Add the pages to your manual as indicated. Do not remove any pages.

Replace the following pages:

Title Page
Change sheet page 16a/16b

Perform the following changes:

Page 11/12, figure 8-2:
Change R9 to 51.1K and change R10 to 200 K.

HP 85025C DETECTOR ADAPTER

SERIAL NUMBERS

This manual applies directly to HP 85025C detector adapters with serial number 00100 and above.

For additional information about serial numbers, refer to INSTRUMENTS COVERED BY THIS MANUAL, in General Information.

Manual Changes Supplement Print Date: 13 MARCH 1989
Change 1 documents serial numbers 00300 and above.
■ Change 2 documents all serials.

©Copyright
HEWLETT-PACKARD COMPANY
1400 FOUNTAIN GROVE PARKWAY, SANTA ROSA, CA 95403 U.S.A.
1985

MANUAL PART NO. 85025-90003

Microfiche Part Number 85025-90004

Printed: NOVEMBER 1985



WARRANTY

This Hewlett-Packard instrument product is warranted against defects in material and workmanship for a period of one year from date of shipment. During the warranty period, Hewlett-Packard Company will, at its option, either repair or replace products which prove to be defective.

For warranty service or repair, this product must be returned to a service facility designated by HP. Buyer shall prepay shipping charges to HP and HP shall pay shipping charges to return the product to Buyer. However, Buyer shall pay all shipping charges, duties, and taxes for products returned to HP from another country.

HP warrants that its software and firmware designated by HP for use with an instrument will execute its programming instructions when properly installed on that instrument. HP does not warrant that the operation of the instrument, or software, or firmware will be uninterrupted or error free.

LIMITATION OF WARRANTY

The foregoing warranty shall not apply to defects resulting from improper handling by Buyer, Buyer-supplied software or interfacing, unauthorized modification or misuse, or operation outside of the environmental specifications for the product.

NO OTHER WARRANTY IS EXPRESSED OR IMPLIED, HP SPECIFICALLY DISCLAIMS THE IMPLIED WARRANTIES OR MERCHANTABILITY AND FITNESS FOR A PARTICULAR PURPOSE.

EXCLUSIVE REMEDIES

THE REMEDIES PROVIDED HEREIN ARE BUYER'S SOLE AND EXCLUSIVE REMEDIES, HP SHALL NOT BE LIABLE FOR ANY DIRECT, INDIRECT, SPECIAL, INCIDENTAL, OR CONSEQUENTIAL DAMAGES, WHETHER BASED ON CONTRACT, TORT, OR ANY OTHER LEGAL THEORY.

ASSISTANCE

Product maintenance agreements and other customer assistance agreements are available for Hewlett-Packard Products.

For any assistance, contact your nearest Hewlett-Packard Sales and Service Office. Addresses are provided at the back of this manual.

When replacing a part, cross-reference it to the following table. If the part does not appear in this table, use the original part number in Table 3.

Parts Cross-Reference Table

Ref. Design.	HP Part Number	Replace With HP Part Number	New Description	Serial Numbers Affected
A1	85025-60017	85025-60035*	Same description	00300 and above
A1U6	1826-0932	1826-1702	Same description	00300 and above
A1R9	0698-8615	0698-7277*	Resistor 51.1K 1% .05W	All serials
A1R10	2100-4098	2100-4229*	R-VT 200K 10% 17T	All serials

*Recommended replacement for all units, regardless of serial number.

