

OPERATING AND SERVICE MANUAL

HP 85052B/D 3.5 mm CALIBRATION KIT

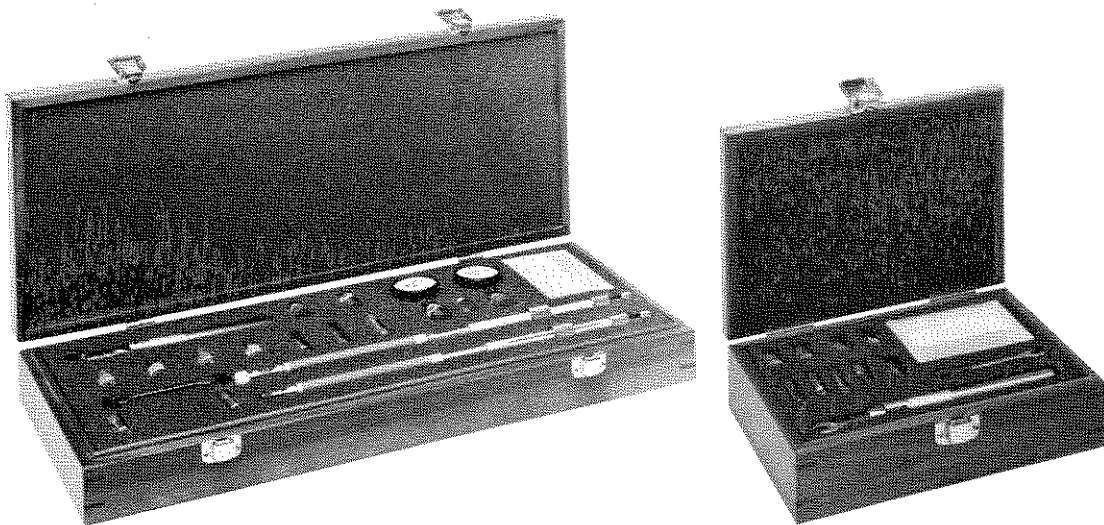

 **HEWLETT
PACKARD**

CERTIFICATION

Hewlett-Packard Company certifies that this product met its published specifications at the time of shipment from the factory. Hewlett-Packard further certifies that its calibration measurements are traceable to the United States National Bureau of Standards, to the extent allowed by the Bureau's calibration facility, and to the calibration facilities of other International Standards Organization members.

WARRANTY

This Hewlett-Packard instrument product is warranted against defects in material and workmanship for a period of one year from date of delivery. During the warranty period, Hewlett-Packard Company will, at its option, either repair or replace products which prove to be defective.

For warranty service or repair, this product must be returned to a service facility designated by HP. Buyer shall prepay shipping charges to HP and HP shall pay shipping charges to return the product to Buyer. However, Buyer shall pay all shipping charges, duties, and taxes for products returned to HP from another country.

HP warrants that its software and firmware designated by HP for use with an instrument will execute its programming instructions when properly installed on that instrument. HP does not warrant that the operation of the instrument, or software, or firmware will be uninterrupted or error free.

LIMITATION OF WARRANTY

The foregoing warranty shall not apply to defects resulting from improper or inadequate maintenance by Buyer, Buyer-supplied software or interfacing, unauthorized modification or misuse, operation outside of the environmental specifications for the product, or improper site preparation or maintenance.

NO OTHER WARRANTY IS EXPRESSED OR IMPLIED. HP SPECIFICALLY DISCLAIMS THE IMPLIED WARRANTIES OF MERCHANTABILITY AND FITNESS FOR A PARTICULAR PURPOSE.

EXCLUSIVE REMEDIES

THE REMEDIES PROVIDED HEREIN ARE BUYER'S SOLE AND EXCLUSIVE REMEDIES. HP SHALL NOT BE LIABLE FOR ANY DIRECT, INDIRECT, SPECIAL, INCIDENTAL, OR CONSEQUENTIAL DAMAGES, WHETHER BASED ON CONTRACT, TORT, OR ANY OTHER LEGAL THEORY.

ASSISTANCE

Product maintenance agreements and other customer assistance agreements are available for Hewlett-Packard products.

For any assistance, contact your nearest Hewlett-Packard Sales and Service Office. Addresses are provided at the back of this manual.

HP 85052B/D 3.5 mm CALIBRATION KIT

© Copyright HEWLETT-PACKARD COMPANY 1988
1400 FOUNTAINGROVE PARKWAY, SANTA ROSA, CA 95401 U.S.A.

MANUAL PART NO. 85052-90038
Microfiche Part Number 85052-90039

Printed: MARCH 1988



**HEWLETT
PACKARD**

**HP 85052B/D
HP 85050B/D
HP 85054B
CALIBRATION KITS**

Printed: MARCH 1988

HP Part Number 08720-90052

© Copyright HEWLETT-PACKARD COMPANY 1988

1400 FOUNTAINGROVE PARKWAY, SANTA ROSA, CA 95403, U.S.A.



**HEWLETT
PACKARD**

THIS SUPPLEMENT APPLIES ONLY TO THE HP 8720A NETWORK ANALYZER

The devices in this calibration kit are compatible with the HP 8720A network analyzer. Although the kit contains a data tape and disc, they do not apply to the HP 8720A. The data supplied on the tape is for the HP 8510 network analyzer only. The data for the HP 8720A is stored in the instrument firmware.

For complete system calibration procedures, refer to Chapter 5, *Measurement Calibration*, in the *HP 8720A System Operating and Programming Manual*. This chapter describes the different measurement calibration procedures available in the HP 8720A, which errors they correct, and the measurements for which each should be used. An appendix at the end of the chapter provides further information on characterizing systematic errors and using error models to analyze overall measurement performance.





1400 Fountaingrove Parkway, Santa Rosa, CA 95403, Telephone (707) 577-1400

Dear Customer,

A revised program disc (HP part number 08510-10031) and data disc (HP part number 08510-10032) from the HP 8510 Specifications and Performance Verification software have been included with this product to allow you to calculate the specifications of your system with your new model instrument/accessory. Previous revisions of the discs do not include the file for this model. Refer to the specifications section of the HP 8510B system manual for instructions on the use of these discs.

Upon receiving your instrument/accessory, check the revision of each disc you just received and compare it with the revision of the disc you are currently using. Use the disc with the latest revision and discard the other disc(s). The revisions are sequentially numbered. For example, Rev.A.01.01 is more current than Rev.A.01.00. Follow the same procedure if you receive more than one instrument/accessory (and updated disc) at a time. Also, it is good practice to make a backup copy of the most current discs you are using.

Example Disc Label

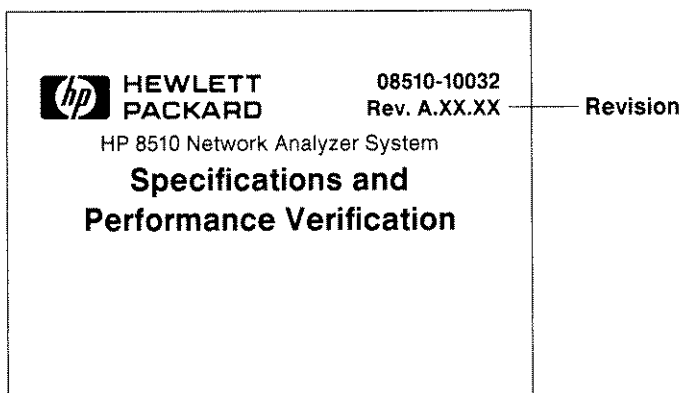



TABLE OF CONTENTS

HP 85052B/D

3.5 mm Calibration Kit

SECTION 1. GENERAL INFORMATION

Introduction	1-1
Equipment Required But Not Supplied	1-1
Using the Adapters	1-1
Using SMA Connectors	1-1
Serial Numbers	1-3
Incoming Inspection	1-3
Replaceable Parts	1-3

SECTION 2. SPECIFICATIONS

Environment	2-1
Temperature	2-1
Barometric Pressure and Relative Humidity	2-2
Torque	2-2
Mechanical Specifications	2-2
Electrical Specifications	2-5
Verifying Specifications	2-5

SECTION 3. PREPARATION FOR USE

Operating Precautions	3-1
Handling and Storage	3-1
Electrostatic Discharge	3-2
Connection Techniques	3-2
Using the Torque Wrench	3-2
Wear	3-3
Visual Inspection	3-3
Mechanical Inspection	3-3
3.5 mm Calibration Coefficients Tape	3-4

SECTION 4. CONNECTING THE CALIBRATION DEVICES

Connecting the Sliding Load	4-1
Zero the connector gage	4-1
Gaging the sliding load	4-2
Connect the sliding load to a cable/test port connector	4-2
Adjusting the Set Back Mechanism	4-4
Calibration Check Using Offset Terminations	4-5/4-6

SECTION 5. REFERENCE/TROUBLESHOOTING

Compatible Network Analyzers	5-1
Loading the Calibration Coefficients Tape	5-1
Electrical Characteristics	5-2
Standard Definition	5-2
Class Assignment	5-2
Examining the Calibration Coefficients	5-2
Modifying the Electrical Delay	5-3
Troubleshooting	5-3
Further Information	5-3

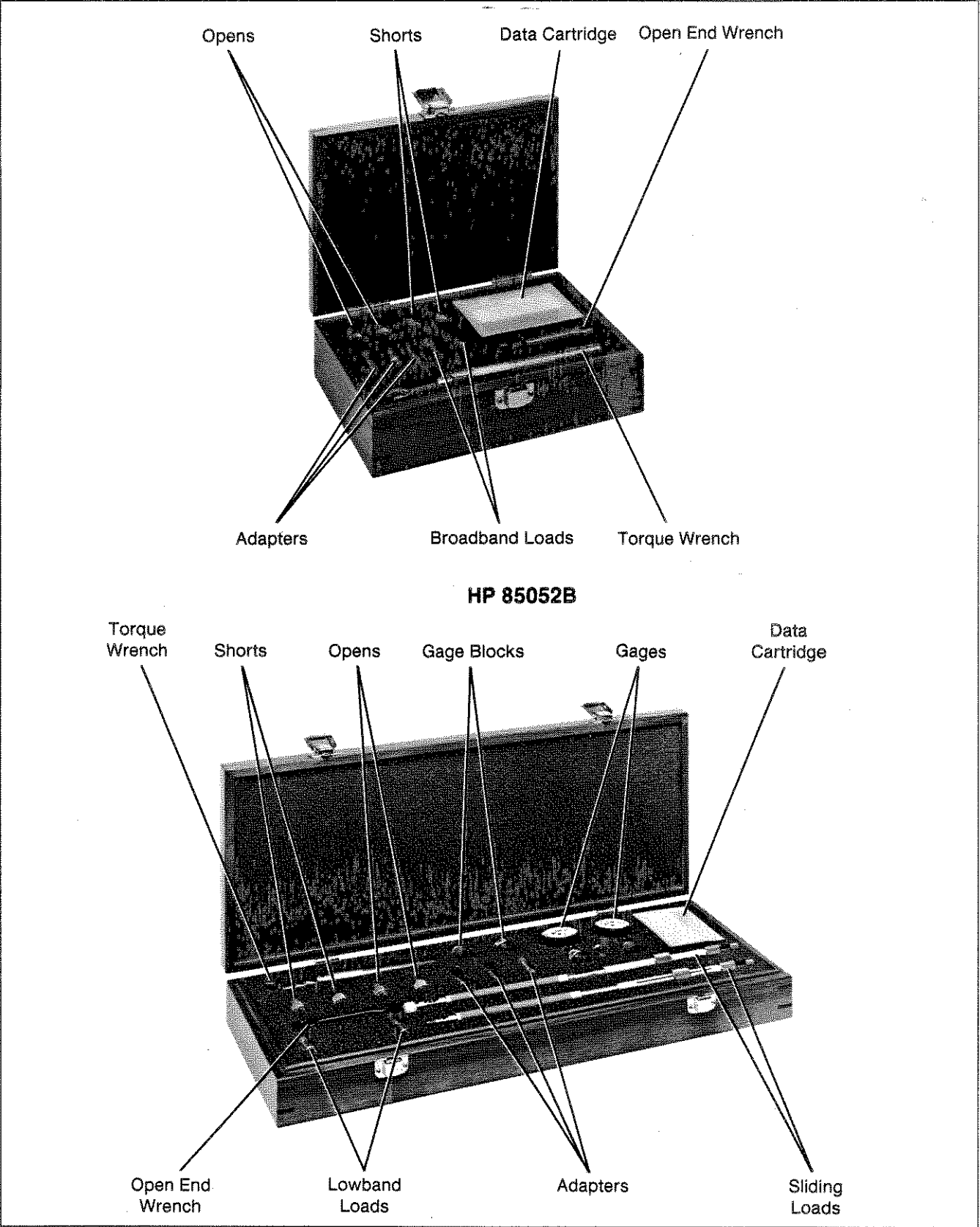

Figure 1-1. HP 85052B/D 3.5 mm Calibration Kits

Section 1. General Information

INTRODUCTION

The Hewlett-Packard 85052B/D 3.5 mm calibration kit (Figure 1-1) is designed to be used with network analyzer systems such as the HP 8510. The HP 85052D 3.5 mm economy calibration kit consists of open, short and fixed broadband load terminations, several adapters, and a data cartridge containing the calibration coefficients of the termination devices in the kit. Also included is a 5/16 inch torque wrench for use on the 3.5 mm connections and an open end wrench for the 7 mm flats on the adapters. The HP 85052B 3.5 mm calibration kit replaces the broadband loads with two sliding loads and two lowband loads (male and female) and includes a 3.5 mm connector gage kit.

The female connectors in this calibration kit are metrology grade PSC-2.4 (precision slotless connectors). These connectors insure the highest performance available.

This manual describes the devices in the HP 85052B/D 3.5 mm calibration kit, gives their mechanical and electrical specifications and the electrical characteristics of each device. It also shows how to make connections with the sliding load termination.

NOTE: It is assumed that proper cleaning, gaging and connection skills are known by the operator. There are two Hewlett-Packard publications available to help you learn these skills:

Microwave Connector Care (see Table 1-1 for part number) explains in detail how to care for, inspect, clean, gage and make connections with coaxial microwave connectors. It is designed to be helpful regardless of the application or the kind of measurement being made.

HP Application Note 326, *Principles of microwave connector care*, summarizes the key points in *Microwave Connector Care* and is available free from the nearest HP office.

EQUIPMENT REQUIRED BUT NOT SUPPLIED

The following items are required but not supplied with this kit. Refer to Table 1-1 for part numbers.

- 5/16 inch open end wrench – used on the wrench flats of opens, shorts and load
- 5/16 inch torque wrench – 56 N-cm, 5 in-lb if SMA connectors are used
- Microwave connector cleaning kit or equivalent

Using the Adapters

The 3.5 mm to 3.5 mm adapters supplied with this kit are of similar electrical performance to each other and are intended to facilitate non-insertable component measurements.

Using SMA Connectors

The 3.5 mm connector gages can be used to measure SMA connectors if the dielectric in the SMA connector does not protrude beyond the shoulder of the outer conductor. Protrusion of the dielectric can give false gage readings of pin depth and may also damage the 3.5 mm connector.

CAUTION

SMA CONNECTORS

SMA connectors will mate with precision 3.5 mm connectors if extreme caution is used. Damaged or worn SMA connectors or SMA connectors out of mechanical tolerance can destroy 3.5 mm connectors the first time they are mated. Hewlett Packard recommends that you keep two points clearly in mind when you mate SMA and precision 3.5 mm connectors.

1. SMA connectors are not precision mechanical devices. They are not designed for repeated connections and disconnections and they are susceptible to mechanical wear.

Before mating SMA and 3.5 mm connectors inspect the SMA connector carefully (visually and mechanically).

2. Important structural and dimensional differences exist between these two types of connectors (Figure 1-2). Precision 3.5 mm connectors are air dielectric devices. At the connector interface, only air exists between the center and outer conductors. The male and female center conductor is supported by a plastic "bead" deep within the connector body. In SMA connectors a plastic dielectric supports the entire length of the center conductor. The diameters of both the center and the outer conductors differ between SMA and precision 3.5 mm connectors. Because of these structural and dimensional differences the connection will exhibit some discontinuity (SWR).

PRECISION 3.5mm CONNECTOR

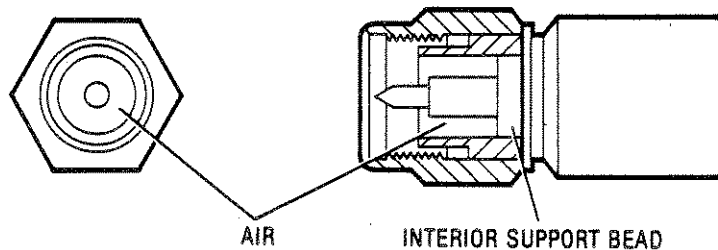

SMA CONNECTOR

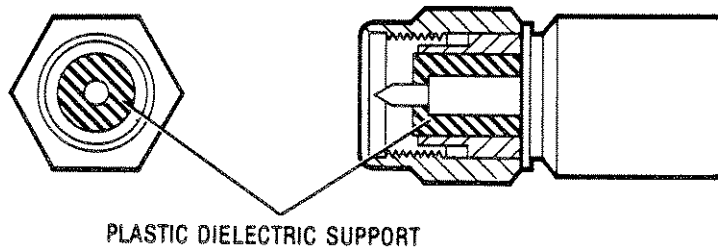

Figure 1-2. Precision 3.5 mm and SMA Connectors

SERIAL NUMBERS

A serial number label is attached to this calibration kit. A typical serial number label is shown in Figure 1-3. The first four digits followed by a letter comprise the serial number prefix, the last five digits are the sequential suffix unique to each calibration kit.

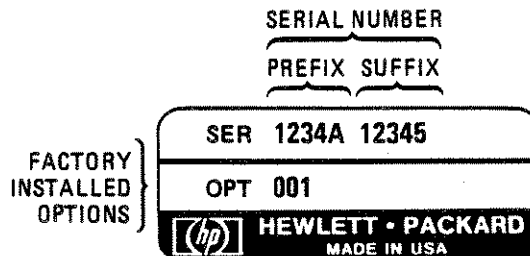

Figure 1-3. Typical Serial Number Label

INCOMING INSPECTION

Use Table 1-1 or 1-2 and Figure 1-4 to verify that your shipment is complete. Some of the devices in this kit do not have HP part numbers on them. In these instances, use Figure 1-4 to verify that the correct items were received.

The foam-lined storage case provides protection for the calibration kit devices during shipping. If the case or devices appear to be damaged, set aside the calibration kit and all packaging materials and contact the nearest Hewlett-Packard office listed inside the back cover of this manual.

Hewlett-Packard will arrange for repair or replacement of incomplete or damaged shipments without waiting for a settlement from the transportation company.

REPLACEABLE PARTS

Tables 1-1 and 1-2 give the individual Hewlett-Packard part numbers for all of the components of the HP 85052B/D 3.5 mm calibration kit.

To order an HP part, list the description, HP part number, check digit and quantity desired. Telephone or send your order to the nearest Hewlett-Packard office listed inside the back cover of this manual.

Table 1-1. HP 85052B 3.5 mm Calibration Kit Replaceable Parts

Description	Quantity Per Kit	Replacement HP Part Number	Check Digit
Terminations			
Offset Short Circuit (m)	1	85052-60006	8
Offset Short Circuit (f)	1	85052-60007	9
Offset Open Circuit (m)	1	85052-60008	0
Offset Open Circuit (f)	1	85052-60009	1
Load, Lowband (m)	1	85052-60010	4
Load, Lowband (f)	1	85052-60011	5
Sliding Load (m)	1	85052-60017	1
Sliding Load (f)	1	85052-60018	2
Adapters			
3.5 mm (m) to 3.5 mm (m)	1	85052-60014	8
3.5 mm (m) to 3.5 mm (f)	1	85052-60013	7
3.5 mm (f) to 3.5 mm (f)	1	85052-60012	6
Miscellaneous Items			
Calibration Coefficients Tape	1	85052-10002	9
Operating and Service Manual	1	85052-90021	0
Calibration Kit Storage Case with Foam	1	85052-60020	6
3.5 mm Protective End Cap (m)	9	1401-0208	3
3.5 mm Protective End Cap (f)	9	1401-0202	7
3.5 mm Connector Gage Kit	1	85052-80010	6
5/16 inch Torque Wrench, 8 in-lb	1	8710-1765	1
7mm Open End Wrench	1	8710-1761	7
Items Not Included in Kit			
Connector Cleaning Kit		92193Z	3
Foam Swabs		9300-1270	5
Grounding Wrist Strap		9300-0970	0
Conductive Bench Mat		9300-0797	9
5/16 inch Torque Wrench, 5 in-lb		8710-1582	0
5/16 inch Open End Wrench		8720-0015	3
Microwave Connector Care Manual		08510-90064	4
Anti-rotation Clamps		08515-60003	3
See <i>Replaceable Parts</i> in this manual for ordering information.			

Table 1-2. HP 85052D 3.5 mm Economy Calibration Kit Replaceable Parts

Description	Quantity Per Kit	Replacement HP Part Number	Check Digit
Terminations			
Offset Short Circuit (m)	1	85052-60006	8
Offset Short Circuit (f)	1	85052-60007	9
Offset Open Circuit (m)	1	85052-60008	0
Offset Open Circuit (f)	1	85052-60009	1
Load, Broadband (m)	1	85052-60027	3
Load, Broadband (f)	1	85052-60028	4
Adapters			
3.5 mm (m) to 3.5 mm (m)	1	85052-60014	8
3.5 mm (m) to 3.5 mm (f)	1	85052-60013	7
3.5 mm (f) to 3.5 mm (f)	1	85052-60012	6
Miscellaneous Items			
Calibration Coefficients Tape	1	85052-10004	1
Data Base Disc ¹	1	08510-10032	8
Operating and Service Manual	1	85052-90021	0
Calibration Kit Storage Case with Foam	1	85052-60029	5
3.5 mm Protective End Cap (m)	6	1401-0208	3
3.5 mm Protective End Cap (f)	6	1401-0202	7
5/16 inch Torque Wrench, 8 in-lb	1	8710-1765	1
7mm Open End Wrench	1	8710-1761	7
¹ Refer to the Specifications Section of the HP 8510B System Manual for instructions on using the data base disc.			

TERMINATIONS - MALE

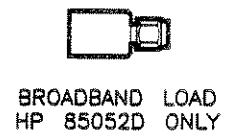
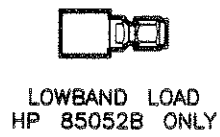

TERMINATIONS - FEMALE

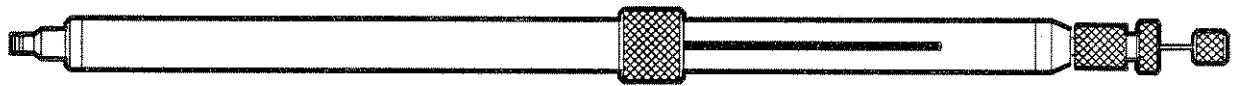
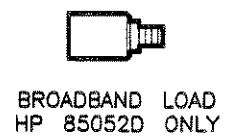
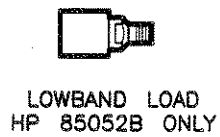

SLIDING LOAD (f)
HP 85052B ONLY



SLIDING LOAD (m)
HP 85052B ONLY

3.5mm TO 3.5mm ADAPTER SET

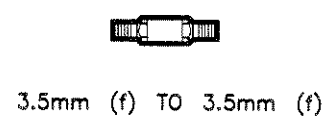
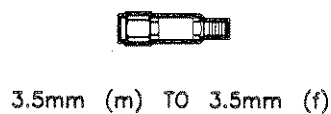
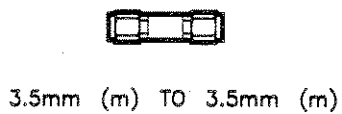
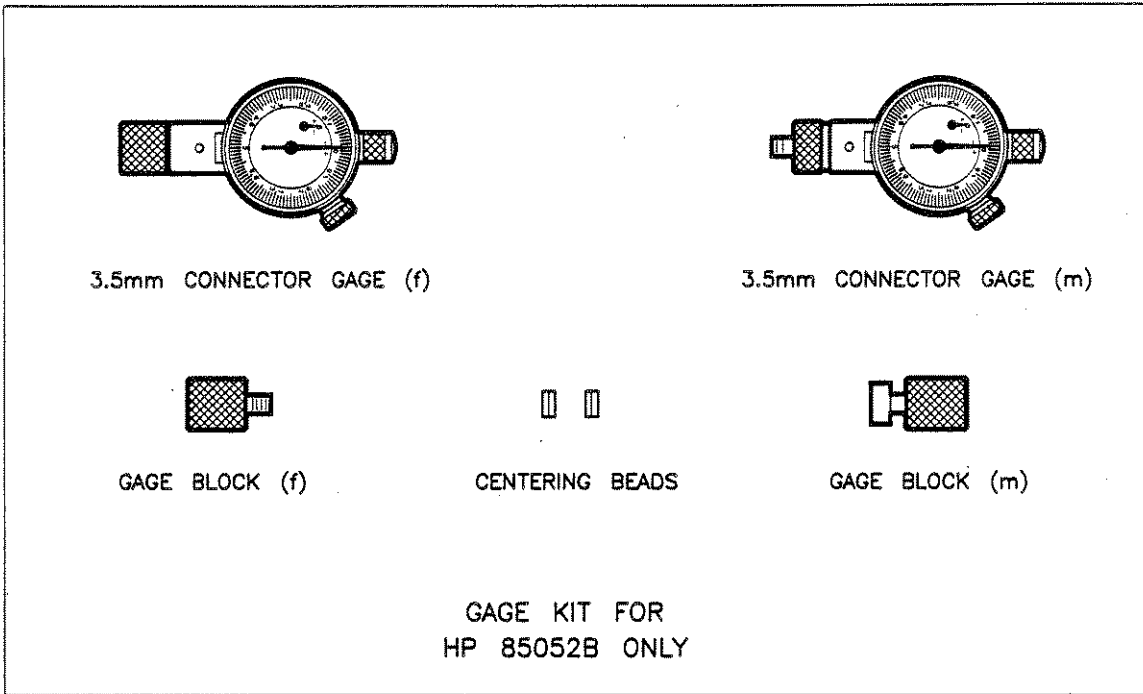

Figure 1-4. HP 85052B/D Calibration Kit (1 of 2)



3.5mm CONNECTOR TORQUE WRENCH



7mm OPEN END WRENCH

Not Shown

- Storage Case
- Operating and Service Manual
- Calibration Coefficients Tape
- Data Base Disc (HP 85052D only)

Figure 1-4. HP 85052B/D Calibration Kit (2 of 2)

Section 2. Specifications

This section gives the environmental, mechanical and electrical specifications for the devices in the HP 85052B/D 3.5 mm calibration kit.

ENVIRONMENT

Table 2-1 lists the environmental specifications for the devices in the HP 85052B/D 3.5 mm calibration kit.

Table 2-1. Environmental Specifications

Calibration Temperature	+20° to +26°C (+68° to +79°F)
Accuracy Enhanced Operating Temperature	Calibration Temperature $\pm 1^\circ\text{C}$ ($\pm 1.8^\circ\text{F}$)
Storage Temperature	-40° to +75°C (-40° to +167°F)
Barometric Pressure	
Operation	<4,500 metres (15,000 feet)
Storage	<15,000 metres (50,000 feet)
Relative Humidity	Non-Condensing at All Times
Operation	0 to 80% (26°C maximum dry bulb temperature)
Storage	0 to 95%

Temperature

Temperature of the calibration devices is critical because device dimensions (and therefore electrical characteristics) change with temperature. The temperature of the calibration devices and all connectors must be stable before use and within the operating limits shown above.

After measurement calibration, performance verification and actual device measurements must be made within the accuracy enhanced operating temperature specification. This is true even if the accuracy enhanced operating temperature falls outside of the calibration temperature window.

Example. If measurement calibration is performed at +20°C (+68°F), verification and measurements must be made between +19°C (+66.2°F) and +21°C (+69.8°F). Also, if the accuracy enhanced operating temperature deviates from the allowable range a new measurement calibration must be performed to assure optimum accuracy.

Remember that your fingers are a heat source, so avoid unnecessary handling of the devices during calibration. Always hold the sliding loads and verification airlines by their plastic insulating jackets.

Barometric Pressure and Relative Humidity

Barometric pressure and relative humidity also affect device performance. Air exists between the inner and outer conductors of these devices and the dielectric constant of air varies as pressure and humidity change.

TORQUE

The torque specification for 3.5 mm connectors is 96 N-cm, (8 in-lb). When mating 3.5 mm and SMA connectors, torque the connection to 56 N-cm, (5 in-lb) to avoid damaging the SMA connector.

MECHANICAL SPECIFICATIONS

Table 2-2 and Figure 2-1 show the pin depth specifications for the devices in the HP 85052B/D 3.5 mm calibration kit.

Table 2-2. Pin Depth Specifications

3.5 mm Connectors	Pin Depth Specification
Short Circuit Open Circuit	0.0000 to 0.0004 in 0.000 to 0.010 mm
Lowband Load	0.000 to 0.002 in 0.000 to 0.050 mm
Adapters	0.0001 to 0.0005 in 0.0025 to 0.013 mm
Sliding Load	0.0000 to -0.0002 in 0.000 to -0.005 mm
Broadband Load (85052D)	0.0001 to 0.0010 in 0.0025 to 0.025 mm

NOTE: The factory uncertainty of the numbers given in Tables 2-2 and 2-3 is less than ± 0.0001 inch. Gage accuracy is ± 0.0001 inch.

Fixed Load Terminations

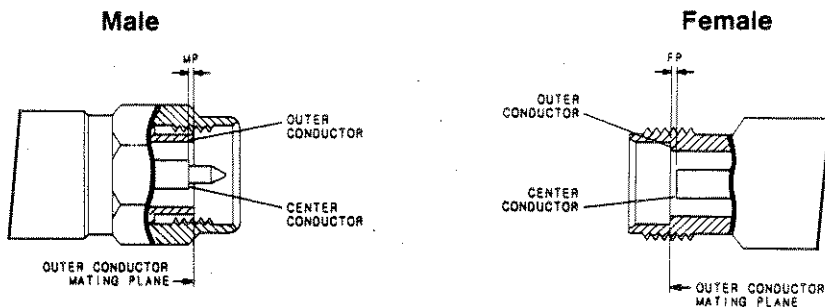

Short Circuits

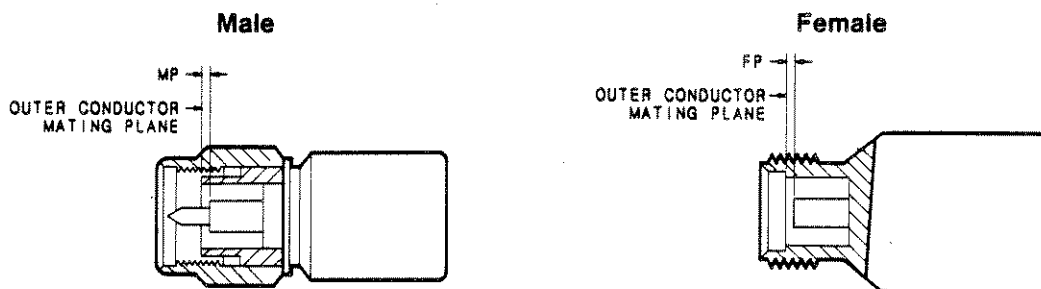

Figure 2-1. 3.5 mm Terminations

MP = recession of male contact pin shoulder behind outer conductor mating plane.

FP = recession of end of female center pin behind outer conductor mating plane.

Table 2-3 shows the mechanical dimensions of the sliding load terminations that are included in the HP 85052B 3.5 mm calibration kit.

The expected electrical performance of the sliding load terminations can be calculated using the mechanical dimensions in Table 2-3 and the equations in these two publications:

Nelson, Robert E., and Marlene R. Coryell, "Electrical Parameters of Precision, Coaxial, Air-Dielectric Transmission Lines", U.S. National Bureau of Standards Monograph No. 96.

Somlo, P.I., "The Computation of Coaxial Line Step Capacitances", IEEE Transactions on Microwave Theory and Techniques, Volume MTT-15, No. 1, January, 1967.

This measurement method may be used for a general idea of the expected device characteristic impedance. Variations in connector interfaces and beads within the connectors can have a large effect on your actual electrical measurements.

Table 2-3. Sliding Load Dimensions

Sliding Load		
Diameters		
D (outer conductor)	0.1378 ± 0.0003 in 3.500 ± 0.0076 mm	
d (center conductor)	0.05984 ± 0.0002 in 1.520 ± 0.005 mm	
Straightness		
D (outer conductor)	0.0002 in/in	0.002 mm/cm
d (center conductor)	0.0003 in/in	0.003 mm/cm
Uniformity		
D (outer conductor)	0.0003 in	0.0076 mm
d (center conductor)	0.0002 in	0.005 mm
Uniformity is the difference between the largest and smallest measured diameters.		

ELECTRICAL SPECIFICATIONS

The electrical specifications of the devices in the HP 85052B/D 3.5 mm calibration kit are listed in Table 2-4. Note that the specifications for the sliding load termination include the airline portions *only*.

Table 2-4. Electrical Specifications

Device	Specification
Lowband Loads (return loss)	≥ 46 dB, DC to 2 GHz ≥ 44 dB, 2 to 3 GHz ≥ 20 dB, 3 to 26.5 GHz
Broadband Loads (return loss)	≥ 42 dB, DC to 3 GHz ≥ 38 dB, 3 to 8 GHz ≥ 36 dB, 8 to 20 GHz ≥ 30 dB, 20 to 26.5 GHz
Sliding Load	> 44 dB Return Loss, 3 to 26.5 GHz ¹
Short Circuit	$\alpha \pm 1.5^\circ$ from nominal $\pm 1^\circ$ average deviation (at 26.5 GHz) ^{2,3}
Open Circuit	$\alpha \pm 2.0^\circ$ from nominal $\pm 1^\circ$ average deviation (at 26.5 GHz) ^{3,4}

1. Airline portion with sliding element pulled back.
 2. This specification applies to the location of the effective shorting plane.
 3. Nominal, in this case, is the center of the distribution of all parts manufactured over time.
 4. The phase shift of any HP 85052B/D open relative to any HP 85052B/D short is $180^\circ \pm 5.2^\circ$.

VERIFYING SPECIFICATIONS

Hewlett-Packard uses two methods to verify the specifications of these devices:

1. Precisely measure the physical dimensions of several standards and theoretically determine their expected performance according to fundamental microwave theory. Hewlett-Packard measures the physical dimensions of a group of devices and selects the best devices from this group for use as standards. These standards provide a link from Hewlett-Packard to the United States National Bureau of Standards (NBS).
2. Electrically compare the HP 85052B/D 3.5 mm standards with standards of *significantly* higher quality. Each device in the calibration kit is tested electrically and compared to the standards that were chosen above.

These two methods combined establish a traceable link to NBS for Hewlett-Packard to the extent allowed by the Bureau's calibration facility. The devices in this kit are traceable to NBS through Hewlett-Packard.

Calibrating your network analyzer with the devices in this kit and performing a successful verification of your network analyzer with the appropriate verification kit indicates that the devices in this calibration kit are suitable for use. Keep a record of your verification data and compare it with the data from later performance verifications. If there are significant changes in the total uncertainty, compare the performance of known good calibration and verification kits with the performance of this calibration kit and a known good verification kit. If the network analyzer system which has been calibrated with the suspected defective calibration kit fails performance verification at least one device in the calibration kit is defective and should be replaced.

Section 3. Preparation For Use

This section provides some precautionary information necessary to care for the calibration devices and to prepare them for use.

OPERATING PRECAUTIONS

There are several precautions that must be observed to protect the devices in this kit and the instruments with which they are being used.

Handling and Storage

Handle and store these calibration devices with great care; their continued performance and accuracy depend on maintaining very precise mechanical tolerances.

When the calibration devices are not in use, replace their protective end caps and store them in the foam lined storage case. As shown in Figure 3-1, the storage case lid is detachable so that the case can be stored in a shallow drawer.

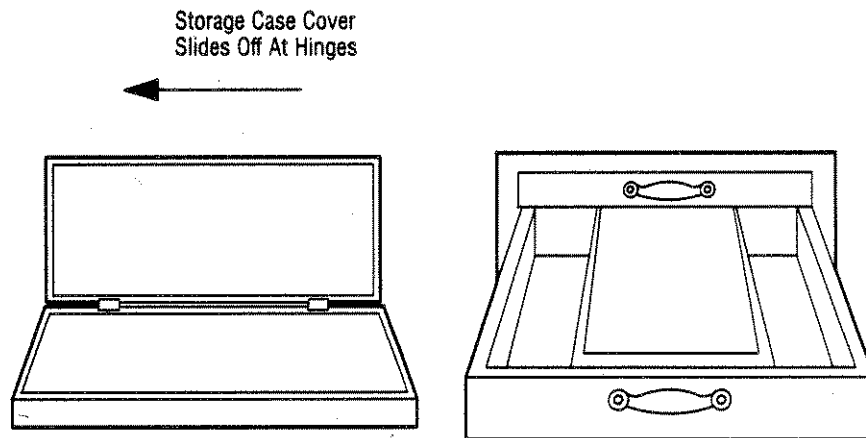

Figure 3-1. Removing Storage Case Cover

Electrostatic Discharge

When you clean or inspect connectors attached to any static sensitive circuits, either directly through the test port connector or indirectly through a cable that is connected to the test port connector, protect against electrostatic discharge (ESD).



The human body almost always has some static charge. You are usually not aware of this charge because the human threshold for the perception of a static discharge shock is approximately 3,000 volts. ESD as low as 60 volts can destroy sensitive microcircuits. Always wear a grounding wrist strap connected to a conductive bench mat when working near sensitive equipment.

Connection Techniques

The mechanical tolerances of the connectors in this calibration kit, and their electrical performance, are better than most other 3.5 mm connectors. Because of this, slight errors in technique that would not be noticeable with other connectors can appear when these precision connectors are used. Extreme care should be taken when making connections or disconnections with these precision devices.

Using the Torque Wrench



When making connections with the calibration devices, turn the nut on the device, never turn the device itself. Doing so may cause damage to the device or to the attaching connector.

1. Hand tighten the connection to be torqued.
2. Hold the torque wrench with your thumb and index finger near the groove in the handle.
3. Tighten the connection until the ball in the handle crests on the cam (as the handle begins to break). It is not recommended or necessary to "fully break" the handle of the torque wrench to reach the specified torque (Figure 3-2).

Reverse the above procedure to disconnect the connection.

NOTE: When making connections with these devices, it may be necessary to use a 5/16 inch open end wrench or a 7 mm open end wrench (supplied with kit) to hold one device stationary while torquing the nut on the other device/cable connector.

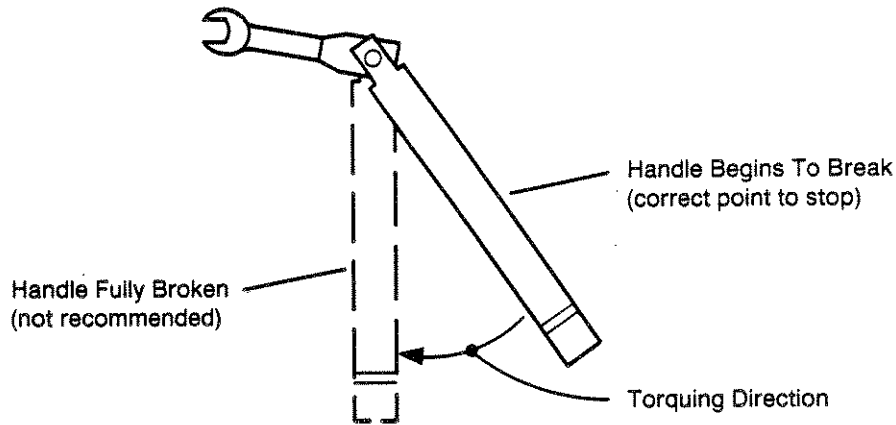

Figure 3-2. Using the Torque Wrench

Wear

Connector wear eventually degrades performance. The calibration devices, which may be used only a few times a week, should have a long life. The connectors to the network analyzer test set may have many connections each day, and are therefore more subject to wear. Replace damaged or worn connectors when necessary.

VISUAL INSPECTION

Visually inspect and, if necessary, clean all connectors each time a connection is made. Metal particles from the connector threads may find their way onto the mating plane surfaces when a connection is disconnected. Do not use damaged connectors.

MECHANICAL INSPECTION

Inspect the end of the connector gage and the gage calibration block visually before any mechanical measurements of the connectors are made.

The threaded gages that are included with this kit are used in the same manner as the gages referred to in the Microwave Connector Care Manual. The only difference is that they are torqued on to the device being measured instead of pushing on to the device.

3.5 mm CALIBRATION COEFFICIENTS TAPE

The calibration coefficients tape included in this kit contains the calibration coefficients for the devices in the HP 85052B/D 3.5 mm calibration kit. Hewlett-Packard recommends that the coefficients on this tape are loaded into the network analyzer's memory whenever a calibration is performed. The coefficients are listed in section 5 of this manual.

Section 4. Connecting the Calibration Devices

This section provides a step-by-step procedure for setting the pin depth of the sliding load terminations and connecting them to a test port or cable connector.

Before making any connections to the test set, be sure that bias power to the test set is OFF. Avoid electrostatic discharge by wearing a grounded wrist strap. Also, it is good practice to grasp the outer shell of the test port just before you make any connection to the test set. This discharges any static electricity on your body by providing a conductive path to an earth ground.

CONNECTING THE SLIDING LOAD (85052B only)

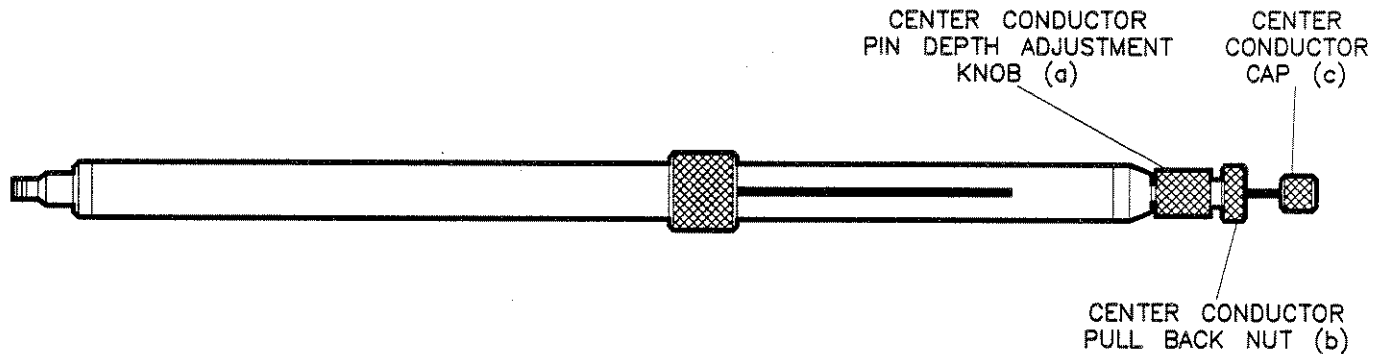

Figure 4-1. Sliding Load Termination

The sliding load should be gaged before each use. If the pin depth of the sliding load is out of specification, refer to *Adjusting the Set Back Mechanism* later in this section to readjust the set back mechanism of the sliding load.

Zero the connector gage:

1. Attach the appropriate gage block to the gage. Torque the connection.
2. Loosen the dial lock screw on the gage and adjust the dial on the face of the gage so the pointer reads zero. Tighten the dial lock screw and remove the gage block.
3. Attach the gage block again to verify that the zeroed setting is repeatable. Remove the gage block.

Gage the sliding load:

1. Remove the protective end cap from the sliding load. Loosen the center conductor pull back nut (b) completely, press the center conductor cap (c) to extend the center conductor. Continue to press the center conductor cap (c) and mate the center conductor of the sliding load with the gage's center conductor.

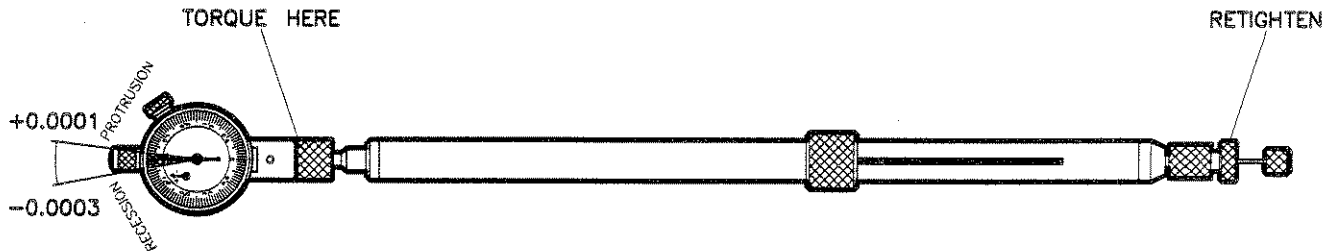

Figure 4-2. Gaging the Sliding Load Termination

2. Mate the outer conductor of the sliding load with the gage's outer conductor. Torque the connection with a 5/16 inch torque wrench to 8 in-lb (Figure 4-2). Retighten the center conductor pull back nut (b) — it will 'click' when it is tight.
3. The pin depth specification of the sliding load is 0.0000 to -0.0002 inch.* If the sliding load's pin depth is out of the allowable range, follow the procedure *Adjusting the Set Back Mechanism* later in this section to readjust the set back mechanism of the sliding load.
4. Loosen the connection between the gage and the sliding load and remove the sliding load from the gage.

Connect the sliding load to a cable/test port connector:

1. Loosen the center conductor pull back nut (b) completely. Press the center conductor cap (c) to extend the center conductor of the sliding load (Figure 4-1).

* Due to the gage accuracy of ± 0.0001 inch, it is permissible to read $+0.0001$ to -0.0003 inch on the connector gage.

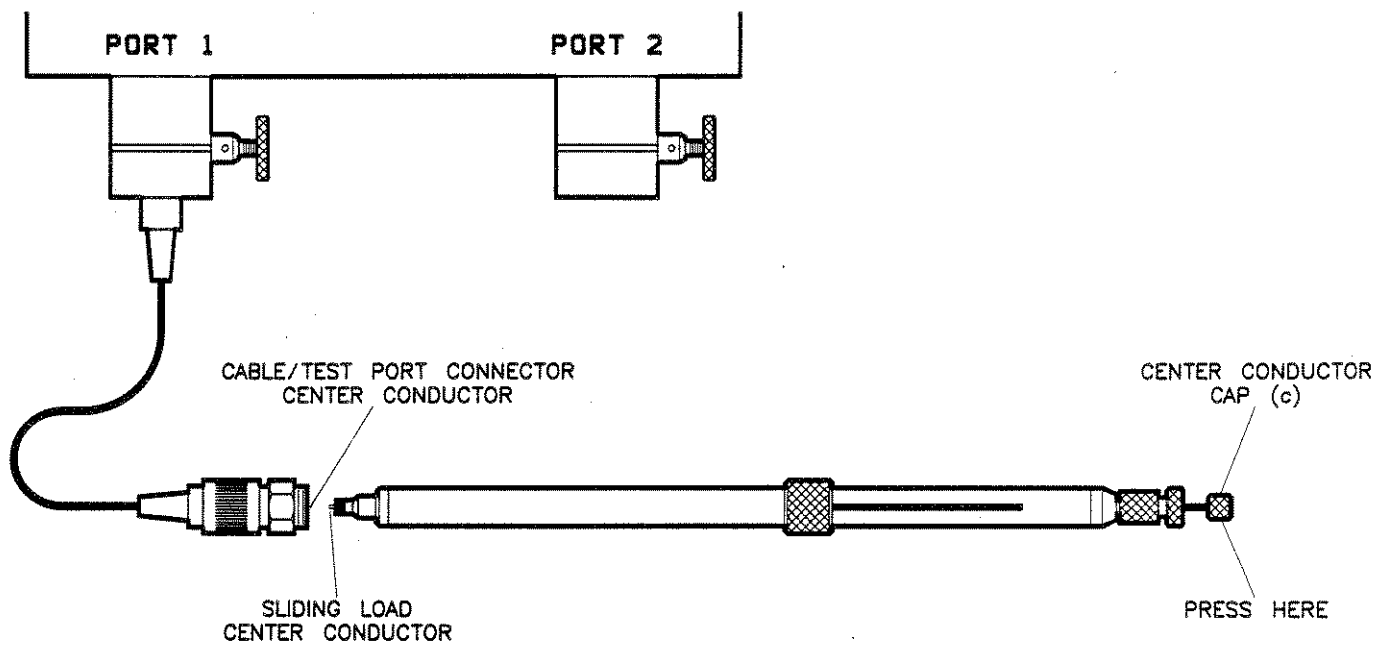

Figure 4-3. Aligning the Center Conductors

2. Continue to press the center conductor cap (c) and mate the center conductor of the sliding load with the cable/test port connector's center conductor (Figure 4-3).

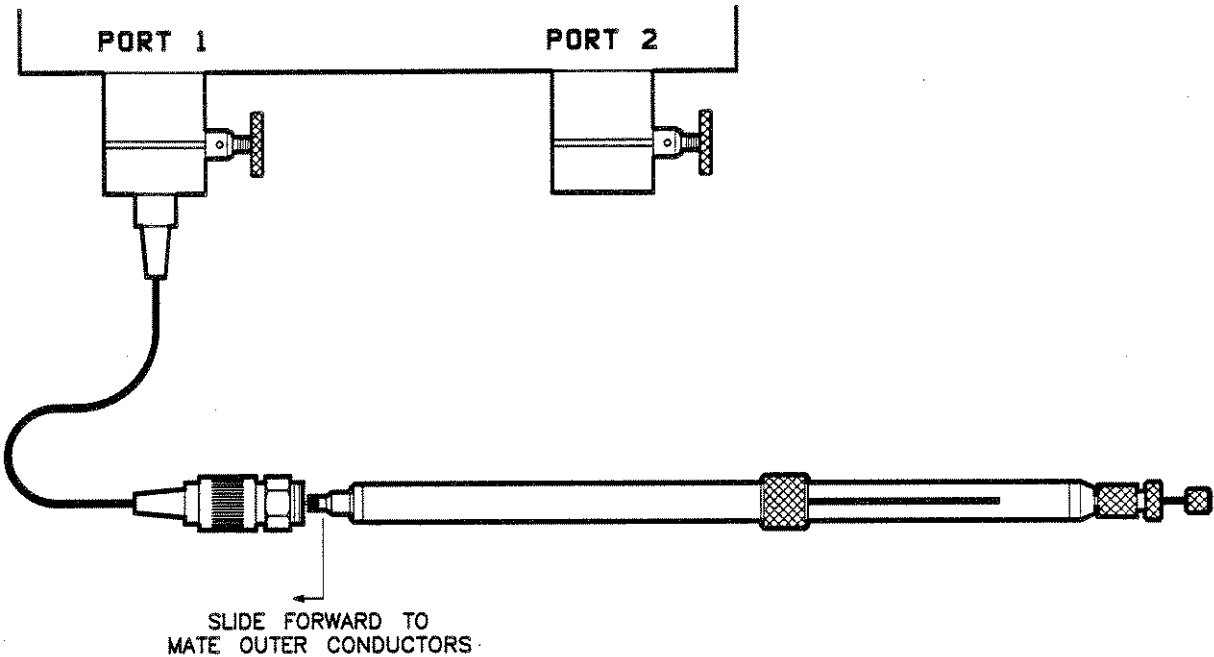

Figure 4-4. Mating the Outer Conductors

3. Mate the outer conductor of the sliding load with the cable/test port connector's outer conductor (Figure 4-4). Torque the connection to 8 in-lb.
4. Retighten the center conductor pull back nut (b).

To remove the sliding load from the cable/test port connector, loosen the connecting nut. Replace the protective end caps on the sliding load and the gage when they are not in use.

ADJUSTING THE SET BACK MECHANISM

The sliding load included in this calibration kit has a set back mechanism that allows the pin depth of the sliding load to be set to 0.000 inch (or any desired value). This sliding load's pin depth is preset to a range of 0.0000 to -0.0002 inch at the factory and should not have to be reset each time it is used. Check the pin depth of the sliding load before each use. If the sliding load's pin depth is out of the allowable range ($+0.0001$ to -0.0003 inch), follow the procedure below to reset it to -0.0001 inch.

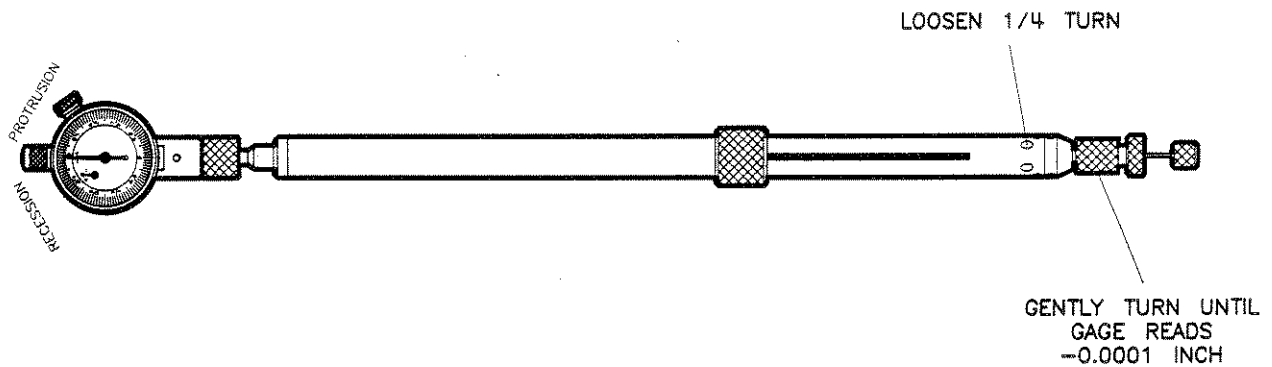

Figure 4-5. Setting the Pin Depth

1. Zero the gage then attach the gage to the sliding load using the above procedures. The back side of the sliding load and the face of the gage should be facing up (Figure 4-5).

CAUTION

Do not loosen any hex screws other than the two largest hex screws pointed out in Figure 4-5. Doing so may render the set back mechanism in the sliding load inoperable.

2. With a 0.050 inch hex key, loosen the 2 largest hex screws 1/4 turn (Figure 4-5).
3. Gently turn the center conductor pin depth adjustment knob (a) on the sliding load until the pointer on the gage reads -0.0001 inch (Figure 4-5).
4. Tighten the 2 hex screws until they are finger tight.
5. Set the assembly down for 5 minutes to let the temperature stabilize. Repeat from step 2 if the reading on the gage drifts out of the allowable range.
6. Loosen the connecting nut and remove the gage from the sliding load.

The sliding load's pin depth is now set to a range of 0.0000 to -0.0002 inch and is ready for use. Replace the protective caps on the sliding load and the gage when they are not in use.

CALIBRATION CHECK USING OFFSET TERMINATIONS

The open and short circuit devices in this kit are offset devices, therefore, the Smith chart representation will show some rotation from a perfect open or short after a calibration is performed. A quick check of your calibration can be done by connecting the offset devices and examining their Smith chart representation. Entering an electrical delay of twice the offset delay (taken from Table 5-1) should make the Smith chart representation of the opens and shorts perfect dots. The quality of the calibration is determined by the closeness of the trace to a dot. If the trace isn't close to a dot after the electrical delay is entered, the calibration is likely to be bad and should be redone. Reset the electrical delay to zero before any measurements are made. Refer to *Modifying the Electrical Delay* in section 5 of this manual for a procedure to modify the electrical delay of your network analyzer.

Section 5. Reference/Troubleshooting

This section provides a list of network analyzers that are compatible with these calibration devices, some instrument specific procedures, and a troubleshooting flowchart.

COMPATIBLE NETWORK ANALYZERS

The devices in this kit are compatible with the HP 8510 network analyzer system.

For the HP 8510 network analyzer system calibration procedures, refer to the HP 8510 Operating and Programming Manual.

LOADING THE CALIBRATION COEFFICIENTS TAPE

Hewlett-Packard recommends that you load the coefficients on this tape into the HP 8510 memory prior to calibration because they may be more refined than those already in the HP 8510. Use the following procedure to load the calibration coefficients tape.

1. Insert the calibration coefficients tape from the HP 85052B/D calibration kit into the HP 85101 tape drive.
2. Press the following keys:

[TAPE]

[LOAD]

The prompt "SELECT DATA TYPE TO LOAD" is displayed on the CRT.

Press:

[CAL KIT 1 - 2]

[CAL KIT *2]

The prompt "SELECT CAL KIT FILE TO LOAD" is displayed on the CRT.

Press:

[* FILE 1] if this is the ONLY file # that has an asterisk (*) next to it,

OR press

[* FILE 2] if there is more than one file # that has an asterisk (*) next to it.

This loads the 3.5 mm calibration kit coefficients from the tape into HP 8510 memory. Remove the tape from the HP 85101 tape drive and store it in the plastic case provided.

ELECTRICAL CHARACTERISTICS

Standard Definition

Standard Definition is the process of mathematically modeling the electrical characteristics (delay, attenuation and impedance) of each calibration standard. These electrical characteristics can be mathematically derived from the physical dimensions and material of each calibration standard or from its actual measured response. Table 5-1 lists the parameters that are used by the HP 8510 to specify the mathematical model.

Class Assignment

Class Assignment is the process of organizing calibration standards into a format which is compatible with the error models used in measurement calibration. A class or group of classes correspond to the systematic errors which are to be removed from the measured network analyzer response. Table 5-2 lists the classes that are used by the HP 8510.

The values given in Tables 5-1 and 5-2 are valid only in the specified temperature range. Alternate characteristics may be generated by the customer for temperatures outside of this specified range. Blank copies of Tables 5-1 and 5-2 are included for this purpose. Refer to Product Note 8510-5, *Specifying calibration standards for the HP 8510 network analyzer*, for information on modifying calibration coefficients and the parameters and classes listed in Tables 5-1 and 5-2.

EXAMINING THE CALIBRATION COEFFICIENTS

Follow the procedure below to examine the calibration coefficients residing in the HP 8510 memory.

Press the following keys:

[CAL]
[MORE]
[MODIFY 2] (If calibration coefficients were loaded into CALKIT 2)
[DEFINE STANDARD]
[1], [x1] (This is the number of the calibration standard)
The softkey 'SHORT' should be underlined.

Press:

[SHORT]
[SPECIFY OFFSET]
[OFFSET DELAY], screen displays the value.
[OFFSET LOSS], screen displays the value.
[OFFSET Z₀], screen displays the value.
[MINIMUM FREQUENCY], screen displays the value
[MAXIMUM FREQUENCY], screen displays the value
The softkey 'COAX' should be underlined.

Press:

[PRIOR MENU]

[LABEL STANDARD]

The word 'SHORT' should be displayed in upper left corner of the CRT.

[PRIOR MENU] three times, 'DEFINE STANDARD' should be the top softkey.

[ENTRY OFF]

This completes the procedure to examine the calibration coefficients of one standard type. To examine the other standard types, substitute the standard number above (1 for the short) with the standard number of the device you wish to examine. This is the step following "DEFINE STANDARD". For example: Press [2], [X1] to examine the calibration coefficients for an open. The standard number comes from the first column of the Standard Definitions (Table 5-1).

MODIFYING THE ELECTRICAL DELAY

Use the following procedure to change the electrical delay in your HP 8510 when checking your calibration with the offset open and short.

To adjust the electrical delay:

Under the 'RESPONSE' menu press [MENU] [ELECTRICAL DELAY]

Connect the offset open or offset short to port one (port 2 for S_{22}) of the test set. Select S_{11} . Press [SMITH CHART] under the 'FORMAT' menu. Enter twice the value of the open or short's offset delay from Table 5-1.

Example [.] [0] [6] [3] [5] [6] [6] [G/n] for the HP 85052B offset short circuit.

Repeat this procedure for port 2 (S_{22}) if a two-port calibration was performed.

NOTE: Always reset the electrical delay to zero after checking your calibration.

TROUBLESHOOTING

Follow the steps in the troubleshooting flowchart (Figure 5-1) if you suspect a bad calibration or if your instrument did not pass performance verification.

FURTHER INFORMATION

This manual contains limited information about operating network analyzer systems. For complete information, refer to the Operating and Service Manual of the instrument being used. If you need additional information, contact your local HP representative or the nearest HP office listed inside the back cover of this manual.

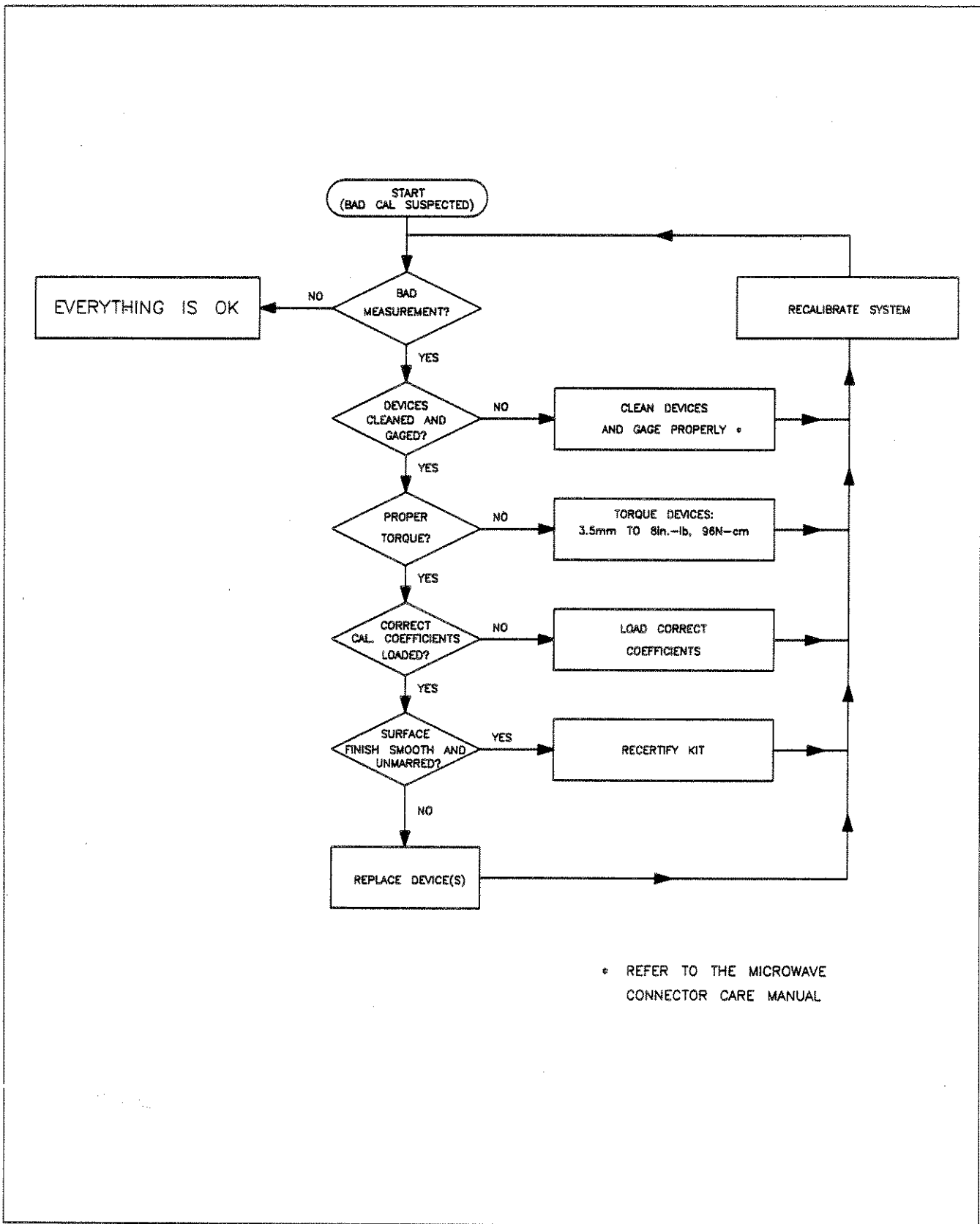

Figure 5-1. Troubleshooting Flowchart

CALIBRATION KIT 3.5mm B.1

TAPE FILE NUMBER 1

STANDARD DEFINITIONS

STANDARD NO.	TYPE	C0 x10 ⁻¹⁵ F L0 x10 ⁻¹² H	C1 x10 ⁻²⁷ F/Hz L1 x10 ⁻²⁴ H/Hz	C2 x10 ⁻³⁹ F/Hz ² L2 x10 ⁻³² H/Hz ²	C3 x10 ⁻⁴⁵ F/Hz ³ L3 x10 ⁻⁴² H/Hz ³	FIXED OR ² SLIDING	OFFSET			FREQUENCY (GHz) ³		COAX or WAVEGUIDE	STANDARD LABEL
							DELAY ps	Z ₀ Ω	LOSS dB/s	MINIMUM	MAXIMUM		
1	SHORT	0	0	0	0		31.783	50	1.3	0	999	COAX	SHORT
2	OPEN	43.45	818.7	-48.93	1.247		29.24	50	1.3	0	999	COAX	OPEN
3													
4													
5													
6													
7													
8													
9	LOAD					FIXED	0	50	0	0	999	COAX	BROADBAND
10	LOAD					SLIDING	0	50	0	2.999	999	COAX	SLIDING
11	DELAY/ THRU						0	50	0	0	999	COAX	THRU
12	LOAD					FIXED	0	50	0	0	3.001	COAX	LOWBAND
13	DELAY/ THRU						94.75	50	2.510	0	999	COAX	ADAPTER
14													
15													
16													
17													
18													
19													
20													
21													

- NOTES**
1. Open, Short, Load, Delay/Thru, or Arbitrary Impedance.
 2. Load or Arbitrary Impedance Only.
 3. For Waveguide, minimum frequency is same as F_{co}.
 4. For OFFSET load types, LOAD NO OFFSET and LOAD OFFSET are the same device. Offset Delay is not used when LOAD NO OFFSET is selected.

Table 5-1. Standard Definitions (HP 85052B) (1 of 2)

STANDARD DEFINITIONS

STANDARD ¹	NO.	TYPE	C0 x10 ⁻¹⁵ F L0 x10 ⁻¹² H	C1 x10 ⁻²¹ F/Hz L1 x10 ⁻²⁴ H/Hz	C2 x10 ⁻³⁶ /Hz ² L2 x10 ⁻³³ /Hz ²	C3 x10 ⁻⁴⁶ F/Hz ³ L3 x10 ⁻⁴² H/Hz ³	FIXED OR ² SLIDING	OFFSET			FREQUENCY (GHz) ³		COAX or WAVEGUIDE	STANDARD LABEL
								DELAY ps	Z ₀ Ω	LOSS dB/s	MINIMUM	MAXIMUM		
	1	SHORT	0	0	0	0		31.763	50	1.3	0	999	COAX	SHORT
	2	OPEN	43.45	818.7	-48.93	1.247		29.24	50	1.3	0	999	COAX	OPEN
	3													
	4													
	5													
	6													
	7													
	8													
	9	LOAD					FIXED	0	50	0	0	999	COAX	BROADBAND
	10													
	11	DELAY/ THRU						0	50	0	0	999	COAX	THRU
	12													
	13	DELAY/ THRU						94.75	50	2.510	0	999	COAX	ADAPTER
	14													
	15													
	16													
	17													
	18													
	19													
	20													
	21													

- NOTES**
1. Open, Short, Load, Delay/Thru, or Arbitrary Impedance.
 2. Load or Arbitrary Impedance Only.
 3. For Waveguide, minimum frequency is same as F_{co}.
 4. For OFFSET load types, LOAD NO OFFSET and LOAD OFFSET are the same device. Offset Delay is not used when LOAD NO OFFSET is selected.

Table 5-1. Standard Definitions (HP 85052D) (2 of 2)

**CALIBRATION KIT
TAPE FILE NUMBER**

STANDARD DEFINITIONS

NO.	STANDARD ¹ TYPE	C0 x10 ⁻¹⁵ F L0 x10 ⁻¹⁴ H		C1 x10 ⁻²⁷ F/Hz L1 x10 ⁻²⁴ H/Hz		C2 x10 ⁻³⁹ F/Hz ² L2 x10 ⁻³³ H/Hz ²		C3 x10 ⁻⁴⁹ F/Hz ³ L3 x10 ⁻⁴² H/Hz ³		FIXED OR? SLIDING	TERMINAL IMPEDANCE Ω^3	OFFSET			FREQUENCY (GHz) ⁴		COAX or WAVEGUIDE	STND LABEL
								DELAY μ s	Z ₀ Ω			LOSS dB/s	MIN	MAX				
1																		
2																		
3																		
4																		
5																		
6																		
7																		
8																		
9																		
10																		
11																		
12																		
13																		
14																		
15																		
16																		
17																		
18																		
19																		
20																		
21																		

- NOTES**
1. Open, Short, Load, Delay/Thru, or Arbitrary Impedance.
 2. Load or Arbitrary Impedance Only.
 3. Arbitrary Impedance Only, Device Terminating Impedance. (Defaults: Short = 0 Ω , Open = $\infty\Omega$, Load = 50 Ω .)
 4. For Waveguide, minimum frequency is same as F_{co}.

Table 5-1a. Standard Definitions (blank)

Table 5-2. Standard Class Assignments (HP 85052B) (1 of 2)

STANDARD CLASS ASSIGNMENTS

CALIBRATION KIT 3.5 mm B.1

TAPE FILE NUMBER 1

	A	B	C	D	E	F	G	STANDARD CLASS LABEL
S ₁₁ A	2							OPEN
S ₁₁ B	1							SHORT
S ₁₁ C	9	10	12					LOADS
S ₂₂ A	2							OPEN
S ₂₂ B	1							SHORT
S ₂₂ C	9	10	12					LOADS
Forward Transmission	11							THRU
Reverse Transmission	11							THRU
Forward Match	11							THRU
Reverse Match	11							THRU
Forward Isolation ¹	9							ISOL'N STD
Reverse Isolation	9							ISOL'N STD
Frequency Response	1	2	11					RESPONSE
TRL Thru	—							undefined
TRL Reflect	—							undefined
TRL Line	—							undefined
Adapter	13							ADAPTER

1. Forward Isolation Standard is also used for Isolation part of Response and Isolation calibration.

Table 5-2. Standard Class Assignments (HP 85052D) (2 of 2)

STANDARD CLASS ASSIGNMENTS

CALIBRATION KIT 3.5 mm D.1

TAPE FILE NUMBER 1

	A	B	C	D	E	F	G	STANDARD CLASS LABEL
S ₁₁ A	2							OPEN
S ₁₁ B	1							SHORT
S ₁₁ C								LOADS
S ₂₂ A	2							OPEN
S ₂₂ B	1							SHORT
S ₂₂ C								LOADS
Forward Transmission	11							THRU
Reverse Transmission	11							THRU
Forward Match	11							THRU
Reverse Match	11							THRU
Forward Isolation ¹	9							ISOL'N STD
Reverse Isolation	9							ISOL'N STD
Frequency Response	1	2	11					RESPONSE
TRL Thru	—							undefined
TRL Reflect	—							undefined
TRL Line	—							undefined
Adapter	13							ADAPTER

1. Forward Isolation Standard is also used for Isolation part of Response and Isolation calibration.

Table 5-2a. Standard Class Assignments (blank)

STANDARD CLASS ASSIGNMENTS

CALIBRATION KIT _____

TAPE FILE NUMBER _____

	A	B	C	D	E	F	G	STANDARD CLASS LABEL
S ₁₁ A								
S ₁₁ B								
S ₁₁ C								
S ₂₂ A								
S ₂₂ B								
S ₂₂ C								
Forward Transmission								
Reverse Transmission								
Forward Match								
Reverse Match								
Forward Isolation ¹								
Reverse Isolation								
Frequency Response								
TRL Thru								
TRL Reflect								
TRL Line								
Adapter								

1. Forward Isolation Standard is also used for Isolation part of Response and Isolation calibration.

REGIONAL SALES AND SUPPORT OFFICES

For information relating to Sales or Support of Hewlett-Packard products first contact your local Hewlett-Packard office listed in the white pages of your telephone directory. If none is listed locally, contact one of the addresses listed below to obtain the address or phone number of the Hewlett-Packard Sales or Support office nearest you.

ASIA

Hewlett-Packard Asia Ltd.
47/F, 26 Harbour Road,
Wanchai, **HONG KONG**
G.P.O. Box 863, Hong Kong
Tel: (852) 5-8330833
Telex: 76793 HPA HX
Cable: HPASIAL TD

AUSTRALASIA

Hewlett-Packard Australia Ltd.
31-41 Joseph Street
BLACKBURN, Victoria 3130
Australia
Tel: (61) 895-2895
Telex: 31-024
Cable: HEWPARD Melbourne

CANADA

Hewlett-Packard (Canada) Ltd.
6877 Goreway Drive
MISSISSAUGA, Ontario L4V 1M8
Tel: (416) 678-9430
Telex: 069-8644

JAPAN

Yokogawa-Hewlett-Packard Ltd.
29-21 Takaido-Higashi, 3 Chome
Suginami-ku **TOKYO** 168
Tel: 03 (331) 6111
Telex: 232-2024 YHPTOK

MEDITERRANEAN AND MIDDLE EAST

Hewlett-Packard S.A.
Mediterranean and Middle East
Operations
Atrina Centre
32 Kifissias Avenue
Paradissos-Amarousion, **ATHENS**
Greece
Tel: (30) 682 88 11
Telex: 21-6588 HPAT GR
Cable: HEWPACKSA Athens

BENELUX & SCANDINAVIA

Hewlett-Packard S.A.
Uilenstede 475
P.O. Box 999
NL-1183 AG **AMSTELVEEN**
The Netherlands
Tel: (31) 20/43 77 71
Telex: 18 919 hpner nl

SOUTH & EAST EUROPE, AFRICA

Hewlett-Packard S.A.
7, rue du Bois-du-Lan
CH-1217 **MEYRIN 2**, Geneva
Switzerland
Tel: (41) 22/83 12 12
Telex: 27835 hmea
Cable: HEWPACKSA Geneve

FRANCE

Hewlett-Packard France
Parc d'activités du Bois Briard
2, avenue du Lac
91040 **EVRY** Cedex
Tel: 1 6/077 83 83
Telex: 6923 15F

GERMAN FEDERAL REPUBLIC

Hewlett-Packard GmbH
Hewlett-Packard-Strasse
Postfach 1641
D-6380 **BAD HOMBURG**
West Germany
Tel: 06172/400-0
Telex: 410 844 hpbhg

ITALY

Hewlett-Packard Italiana S.p.A.
Via G. Di Vittorio 9
1-20063 **CERNUSCO SUL
NAVIGLIO**
(Milano)
Tel: 02/92 36 91
Telex: 334632

UNITED KINGDOM

Hewlett-Packard Ltd.
King Street Lane
Winnersh, **WOKINGHAM**
Berkshire RG11 5AR
Tel: 734/78 47 74
Telex: 847178

EASTERN USA

Hewlett-Packard Co.
4 Choke Cherry Road
ROCKVILLE, MD 20850
Tel: (301) 670-4300

MIDWESTERN USA

Hewlett-Packard Co.
5201 Tollview Drive
ROLLING MEADOWS, IL 60008
Tel: (312) 255-9800

SOUTHERN USA

Hewlett-Packard Co.
2000 South Park Place
P.O. Box 105005
ATLANTA, GA 30348
Tel: (404) 955-1500

WESTERN USA

Hewlett-Packard Co.
5161 Lankershim Blvd.
P.O. Box 3919
NO. HOLLYWOOD, CA 91609
Tel: (818) 506-3700

OTHER INTERNATIONAL AREAS

Hewlett-Packard Co.
Intercontinental Headquarters
3495 Deer Creek Road
PALO ALTO, CA 94304
Tel: (415) 857-1501
Telex: 034-8300
Cable: HEWPACK

February, 1986

